

Tube 1961

STATUS OF COLOR TV SERVICING

A NEW DIMENSION CONTROL FOR STEREO TAPE RECORDING IN INDUSTRIAL INSTRUMENTATION

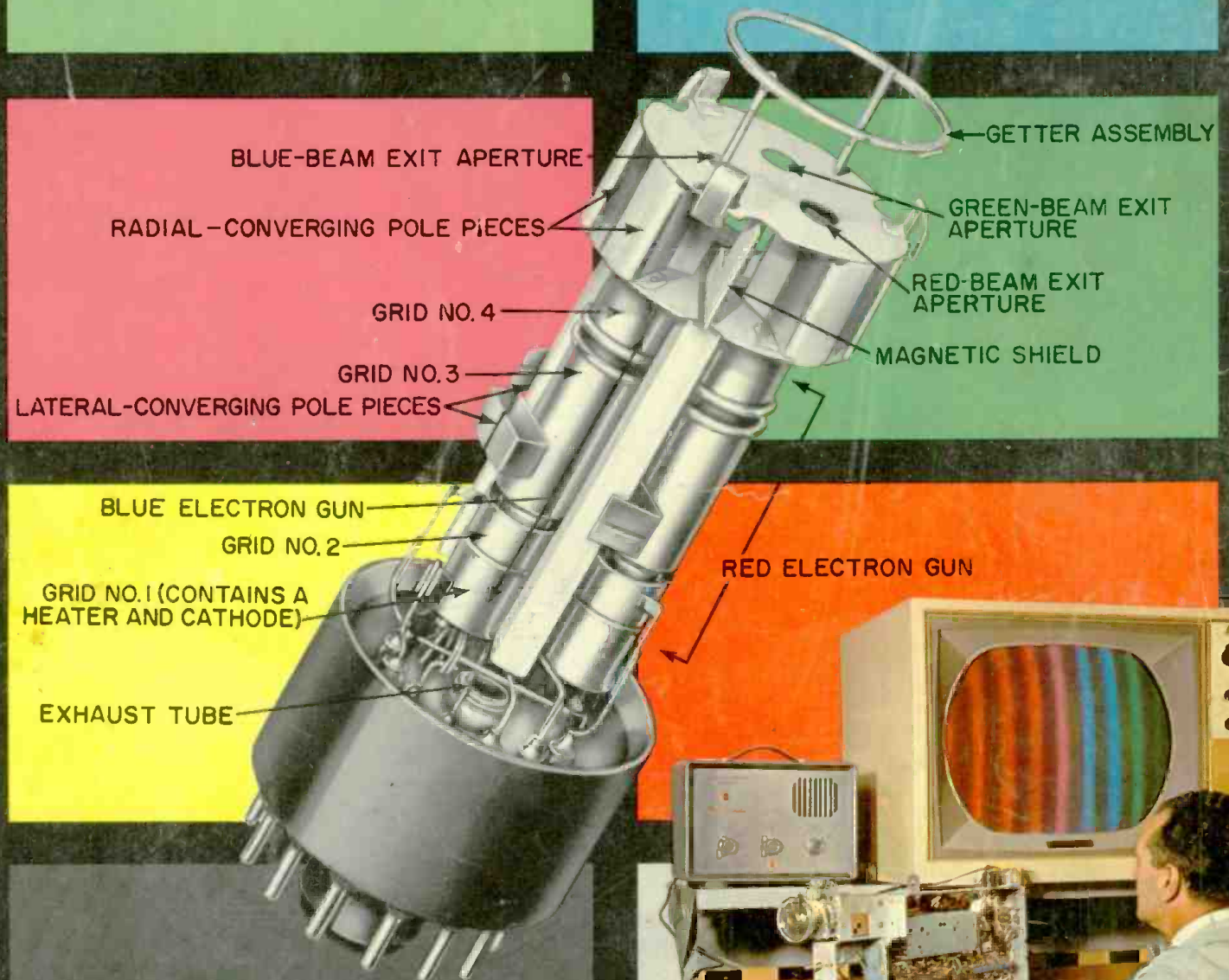

COVER STORY

(See Page 43)



WAD180101
S SACHS
2244 N 10TH ST
PHILADELPHIA PA



Make your profit picture
“BRIGHT AND WIDE”



with Sylvania 6DQ6A and 6BQ6GTA

New improvements provide long life, high output, excellent high voltage cutoff.

Tube performance and life can mean the difference between a bright and dismal profit picture. Let's look at some of the proved-in-the-set Sylvania features:

Plate current capabilities have been increased. Plate to screen current ratio has been improved. A special screen-grid coating provides excellent heat dissipation eliminating interelement shorts without causing cathode "poisoning"—a major cause of short tube life. Tests for voltage breakdown, heater and tube life add up to extra quality assurance. The famous Sylvania "Automount" construction is used for the 6DQ6A.

Result: Sylvania 6BQ6GTA and 6DQ6A

- Deliver the horizontal output essential to full picture width.
- Increase picture tube light output.
- Offer extra-long life in TV set.

Here's a servicing plus: tapered pins provide easy insertion in hard-to-get-at sockets.

Make your servicing profits brighter . . . right now. Specify Sylvania 6BQ6GTA and 6DQ6A on your next tube order.

Electronic Tubes Division, Sylvania Electric Products Inc., Dept. 234, 1740 Broadway, New York 19, N. Y.



SYLVANIA

Subsidiary of **GENERAL TELEPHONE & ELECTRONICS** 

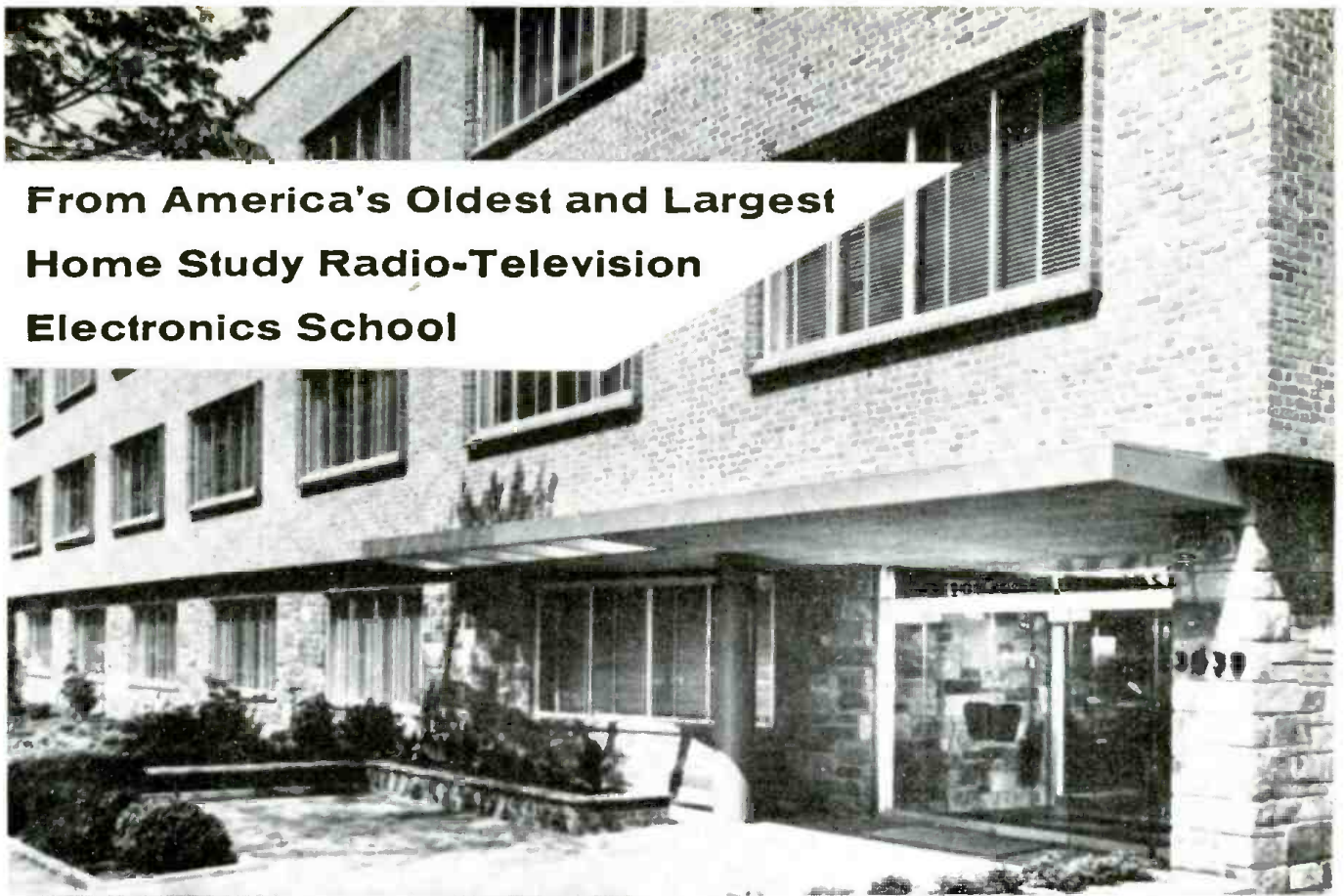

**From America's Oldest and Largest
Home Study Radio-Television
Electronics School**

**A NEW NRI HOME-STUDY COURSE IN
ELECTRONICS: Principles-Practices-Maintenance**

**SPECIAL
TRAINING
EQUIPMENT
INCLUDED**



At no extra cost NRI sends special equipment that gives actual experience, makes theory you learn come to life in an interesting, easy-to-understand manner. Perform dozens of experiments working with basic circuits and components. You keep all equipment.

Some Experiments You Perform:

Build a Vacuum Tube Voltmeter—test filter circuits—use tubes, rectifiers, transistors. Study detector circuits, modulation, demodulation. Determine motor torque, use magnetic amplifiers. Learn effects of feedbacks and experiment with multivibrators. Practice with telemetry circuits used in satellites. Perform other interesting experiments—teaching *basic principles* utilized in Electronic equipment. MAIL COUPON TODAY for 64-page catalog.

Expanding uses for Electronics in industry, business, the military are increasing the demand for trained Technicians. 4 to 7 Electronic Technicians are needed for every engineer. To meet this demand, NRI now offers a new, comprehensive course in ELECTRONICS—Principles, Practices, Maintenance. Train at home in spare time for a new career.

Job Counselors Recommend

Electronics is a key industry now and in the future. But you *must be properly trained* to qualify for higher earnings and advancement. Prepare now. NRI training is for beginners or men with some experience who need more knowledge to move up to better jobs.

For over 45 years NRI has meant the best in training. From the early days NRI has expanded from Radio to Television, from servicing and communications, to industrial and military Electronics. More NRI graduates are filling more good jobs because NRI is the oldest and largest school of its kind.

Learn More to Earn More

NRI supplies the best training at the most reasonable cost. Mail coupon for 64-page catalog. It's FREE. Read what NRI graduates do and earn. Read about the Electronics, Radio-TV training that fits you best. National Radio Institute, Washington 16, D.C.

**FREE
CATALOG**

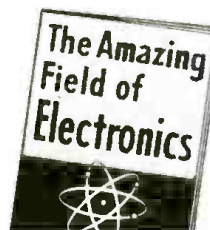

MAIL THIS COUPON NOW

NRI NATIONAL RADIO INSTITUTE
WASHINGTON 16, D.C. IDE

Please send me full information without cost or obligation.
(No representative will call. Please PRINT.)

Name _____ Age _____

Address _____

City _____ Zone _____ State _____

ACCREDITED MEMBER NATIONAL HOME STUDY COUNCIL

Publisher
PHILLIP T. HEFFERNAN

Editor
WM. A. STOCKLIN, B. S.

Technical Editor
MILTON S. SNITZER, W2QY1

Service Editor
SIDNEY C. SILVER

Associate Editor
P. B. HOEFER

Editorial Consultant
OLIVER READ, D. Sc., W1ET1

Industrial Consultant
WALTER H. BUCHSBAUM

Art Editor
MILTON BERWIN

Art and Drafting Dept.
J. A. GOLANEK

Advertising Director
JOHN A. RONAN, JR.

Advertising Manager
GEORGE E. MORRISSEY

Midwest Adv. Manager
GILBERT J. JORGENSON

Western Adv. Manager
ADRIAN WHITED



ZIFF-DAVIS PUBLISHING COMPANY
William B. Ziff, President; W. Bradford Briggs, Executive Vice-President; Herschel B. Sarbin, Vice-President and General Manager; Michael Michaelson, Vice-President and Circulation Director; M. T. Birmingham, Jr., Vice-President and Business Manager; Richard Kislik, Treasurer; Charles Housman, Financial Vice-President.

Editorial and Executive Offices
One Park Avenue
New York 16, N. Y. OR. 9-7200



Member
Audit Bureau of
Circulations



BRANCH OFFICES: Midwestern Office, 434 S. Wabash Ave., Chicago 5, Ill.; Western Office, 9025 Wilshire Blvd., Beverly Hills, Calif.; James R. Pierce, manager.

FOREIGN ADVERTISING REPRESENTATIVES: D. A. Goodall Ltd., London; Albert Milhado & Co., Antwerp and Dusseldorf.

First in radio-television-audio-electronics

CONTENTS

INDUSTRIAL AND GENERAL ELECTRONICS

Electronics for the Jet Age (Editorial)	W. A. Stocklin	6
Third-Quarter Component Output Declines		8
Spot News	Washington Correspondent	24
Tape Recording in Industrial Instrumentation	Ray A. Shiver & William Stillwell	61
Recent Developments in Electronics		76
Calendar of Events		86
Electronic Crosswords	Bruce Balk	117

HIGH FIDELITY AND AUDIO

High-Quality T.R.F. AM Tuner	John Potter Shields	36
A Dimension Control for Stereo	Ralph Glasgal	56
Four-Track Tape System (Part 2—Playback Preamps)	Kenneth F. Buegel	58
Hi-Fi—Audio Product Review		66
Sound on Tape	Bert Whyte	82
Product Test Report (Harman-Kardon "Citation IV"; Channel Master CM-10 Speaker System; Pickering Model 381A Stereo Cartridge) EW Lab Tested		92
Hum Elimination	Charles E. Diehl	106

SERVICING — TV, RADIO, ETC.

Color TV Service Today	Charles Tepfer	29
Home-Call TV Diagnosis	Walter H. Buchsbaum	33
Interference Tough Dogs	George P. Oberio	40
Making Colors Electronically (Cover Story)		43
Tube Inventory for Service Shops	Robert A. Larsen	46
Diodes are Different	J. H. Hazlehurst	50
Understanding the Balance Sheet	John E. Flippin	52
New Products for the Radio and TV Service Technician		54
Mac's Service Shop	John T. Frye	60
Service Industry News		88
Voltage Regulator Diode-Tube Combinations	Dave Stone	104
Service Notes		122

TEST EQUIPMENT

Simple Electronic Engine Analyzer	R. A. Lebowitz & R. M. Sonkin	38
Simple Crystal Mixer	Jennings David	85

COMMUNICATIONS AND AMATEUR

Speech Clipper For CB Transceiver	Irving Krause & Gerald Wilner	32
Adjusting Communications Transmitters (Part 2)	Edward M. Noll	44
Changes in WWV Standard Broadcasts		51
Product Test Report (Eico Model 723 Amateur Transmitter Kit) EW Lab Tested		96
New Products for CB-Amateur and Communications		124

ELECTRONIC CONSTRUCTION

TV Commercial Silencer	Robert J. Mack	48
------------------------	----------------	----

(For information on Next Month's Features, see page 8)

DEPARTMENTS

Letters from Our Readers	12	Technical Books	102
Within the Industry	20	Manufacturers' Literature	108

Net Paid Circulation 251,895

Radio & TV News • Radio News • Television News Trademarks Reg. U. S. Pat. Off.

Copyright © 1961 by Ziff-Davis Publishing Company. All rights reserved.

SUBSCRIPTION SERVICE: Forms 3579 and all subscription correspondence should be addressed to Electronics World, Circulation Department, 434 South Wabash Avenue, Chicago 5, Illinois. Please allow at least four weeks for change of address. Include your old address as well as new—enclosing if possible an address label from a recent issue.

CONTRIBUTIONS: Contributors are advised to retain a copy of their manuscripts and illustrations. Contributions should be mailed to the New York Editorial Office and must be accompanied by return postage. Contributions will be handled with reasonable care, but this magazine assumes no responsibility for their safety. Any copy accepted is subject to whatever adaptations and revisions are necessary to meet the requirements of this publication. Payment covers all author's, contributor's, and contestant's rights, title, and interest in and to the material accepted and will be made at our current rates upon acceptance. All photos and drawings will be considered as part of the material purchased.

Do you WISH you were EMPLOYED in ELECTRONICS?

F.C.C. LICENSE—THE KEY TO BETTER JOBS

An F.C.C. *commercial* (not amateur) license is your ticket to higher pay and more interesting employment. This license is Federal Government evidence of your qualifications in electronics. Employers are eager to hire *licensed* technicians.

WHICH LICENSE FOR WHICH JOB?

The **THIRD CLASS** radiotelephone license is of value primarily in that it qualifies you to take the second class examination. The scope of authority covered by a third class license is extremely limited.

The **SECOND CLASS** radiotelephone license qualifies you to install, maintain and operate most all radiotelephone equipment except commercial broadcast station equipment.

The **FIRST CLASS** radio telephone license qualifies you to install, maintain and operate every type of radiotelephone equipment (except amateur) including all radio and television stations in the United States, its territories and possessions. This is the highest class of radiotelephone license available.

GRANTHAM TRAINING PREPARES YOU

The Grantham course covers the required subject matter completely. Even though it is planned primarily to lead directly to a first class FCC license, it does this by **TEACHING** you electronics. Some of the subjects covered in detail are: Basic Electricity for Beginners, Basic Mathematics, Ohm's and Kirchhoff's Laws, Alternating Current, Frequency and Wavelength, Inductance, Capacitance, Impedance, Resonance, Vacuum Tubes, Transistors, Basic Principles of Amplification, Classes of Amplifiers, Oscillators, Power Supplies, AM Transmitters and Receivers, FM Transmitters and Receivers, Antennas and Transmission Lines, Measuring Instruments, FCC Rules and Regulations, and extensive theory and mathematical calculations associated with all the above subjects explained simply and in detail.

OUR GUARANTEE

If you should fail the F. C. C. exam after finishing our course, we guarantee to give additional training at **NO ADDITIONAL COST**. Read details in our free booklet.

Get Your First Class Commercial F.C.C. LICENSE QUICKLY!

Learn by Correspondence or in Resident Classes

Grantham training is offered by correspondence or in resident classes. Either way, we train you quickly and thoroughly---teach you a great deal of electronics and prepare you to pass the F.C.C. examination for a first class license. Get details now. Mail coupon below.

This booklet FREE!

This free booklet gives details of our training and explains what an F.C.C. license can do for your future. Send for your copy today.

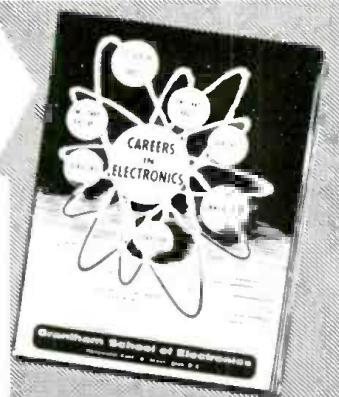

To get ahead in electronics—first, you need the proper training; then, you need “proof” of your knowledge. Your first class commercial F. C. C. license is a “diploma” in communications electronics, awarded by the U. S. Government when you pass certain examinations. This diploma is recognized by employers. Grantham School of Electronics specializes in preparing you to earn this diploma.

Grantham training is offered in resident classes or by correspondence. Our free booklet gives complete details. If you are interested in preparing for your F. C. C. license, mail the coupon below to the School's **home office** at 1505 N. Western Ave., Hollywood 27, California—the address given in the coupon—and our free booklet will be mailed to you promptly. No charge—no obligation.

Grantham School of Electronics

HOLLYWOOD
CALIF.

SEATTLE
WASH.

KANSAS CITY
MO.

WASHINGTON
D. C.

RESIDENT CLASSES HELD IN FOUR CITIES

If you are interested in attending day or evening classes mail the coupon for free information to our home office in Hollywood, Calif.



(Mail in envelope or paste on postal card)

To: **GRANTHAM SCHOOL OF ELECTRONICS**
1505 N. Western Ave., Hollywood, Calif.

Gentlemen:

Please send me your free booklet telling how I can get my commercial F.C.C. license quickly. I understand there is no obligation and no salesman will call.

Name _____ Age _____

Address _____

City _____ State _____

I am interested in: Home Study; Seattle classes
 Hollywood classes, Kansas City classes, Washington classes

16D

MAIL COUPON NOW—NO SALESMAN WILL CALL →

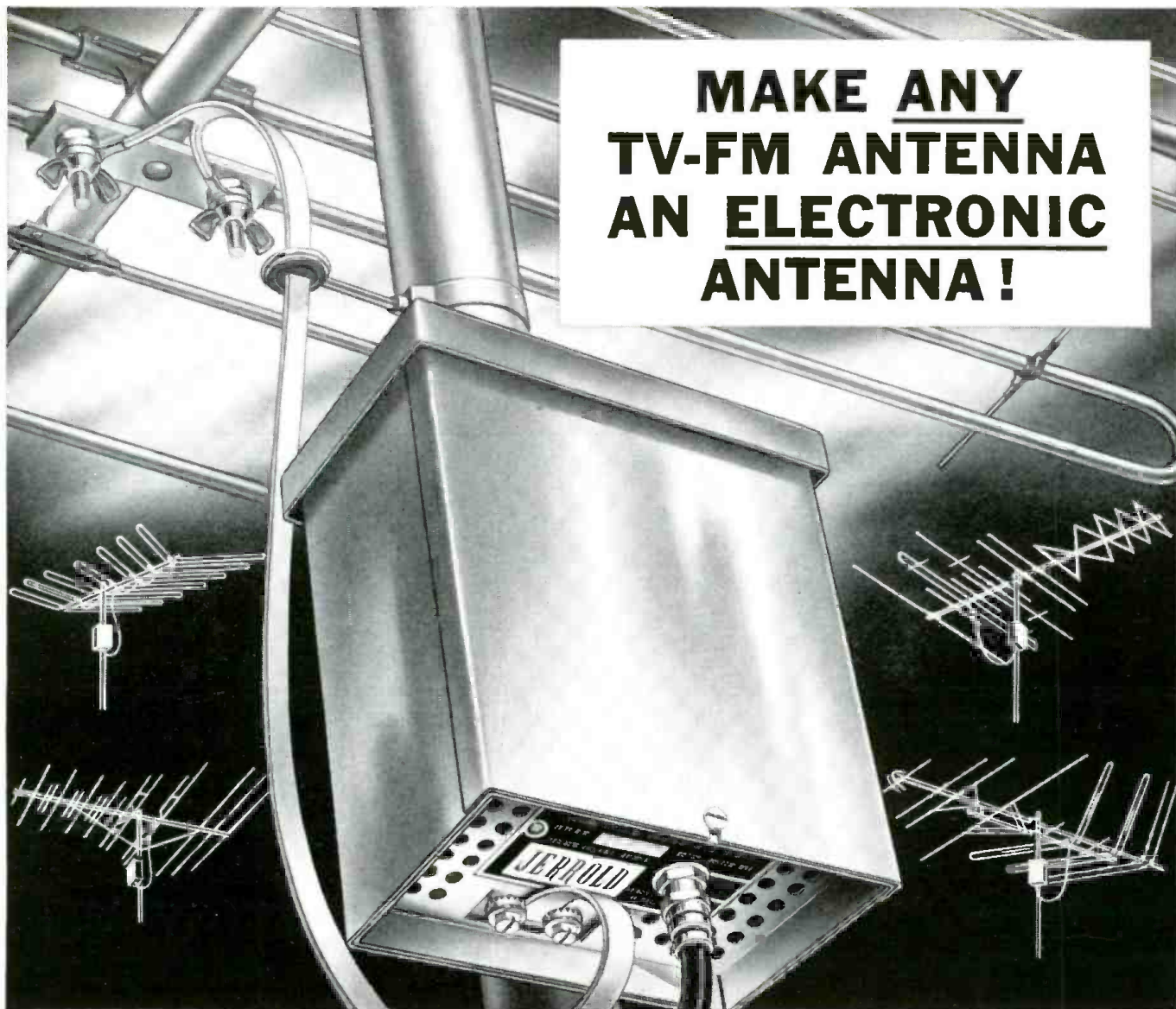

**MAKE ANY
TV-FM ANTENNA
AN ELECTRONIC
ANTENNA!**

New Jerrald DE-SNOWER[®] Model 202 Increases Gain of Any Antenna **10 TIMES!**

Out of the Jerrald laboratories, where the famous DSA-132 was born, comes the ultimate in signal preamplifiers for all channel TV (VHF) and FM reception. By combining *two* frame grid 6DJ8 dual triodes in a special low noise circuit, Jerrald's new DSA-202 develops *minimum* 20 db gain (10 times) on all TV channels and 8db (min.) on FM . . . *triple* the gain developed when using one 6DJ8. Also featured is a new lightweight iridite-aluminum weather-proof housing; no-strip twin lead terminals; and sliding access panel. All new high output remote power supply reduces a 117v AC to a safe 22 volts which goes up same cable that amplified signal comes down.

Only Jerrald assures you of proven reliability and unequalled performance based on more than a decade of designing and producing mast mounted preamplifiers . . . more Jerrald De-Snowers are in use today than all other makes combined.

See your Jerrald distributor or write for eight page booklet No. 435-286



ELECTRONICS CORPORATION • Distributor Sales Division
Dept. IDS-132, Philadelphia 32, Pa.

Jerrald Electronics (Canada) Ltd., Toronto
Export Representative: CBS International, New York 22, N.Y.



Includes new power supply model 407-P. Has "on-off" switch and handy cable compensating control.

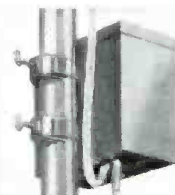

Output uses shielded coax. to eliminate antenna feed-back and interference pick-up on down-lead.

Two 6DJ8 tubes develop 20 db gain (minimum) on all TV (VHF) and FM channels.

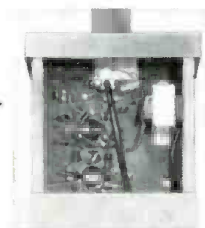

how to get a Commercial FCC LICENSE

An FCC License, Or Your Money Back!

Completion of the Master Course (both Sections) will prepare you for a First Class Commercial Radio Telephone License with a Radar Endorsement. Should you fail to pass the FCC examination for this license after successfully completing the Master Course, you will receive a full refund of all tuition payments. This guarantee is valid for the entire period of your enrollment agreement.

Get This Handy Pocket Electronics Data Guide

Free

Puts all the commonly used conversion factors, formulas, tables, and color codes at your fingertips. Yours absolutely free if you mail the coupon today. No further obligation.

FREE



find out how . . .

1. You can handle the new electronic devices.
2. You can solve the problems that stump your fellow technicians.
3. Training is Job Insurance when employment is tough to find . . . and more money for you when times are good.

CLEVELAND INSTITUTE OF ELECTRONICS

1776 E. 17th St. Desk RN52 Cleveland 14, Ohio
RN52



good training
doesn't cost . . .
it pays!

get all three **FREE!**

Increase Your Technical Knowledge

Get a government license plus an understanding of such electronic applications as computers . . . industrial electronics . . . radar . . . communications . . . and many more.

Not For Beginners

Please inquire only if you really want to get ahead and to add to what you have already learned in school, in the service, or on the job. Some previous schooling or experience in electronics, electricity, or related fields is necessary for success in Cleveland Institute programs.

Accredited by the National Home Study Council

Cleveland Institute of Electronics

Desk RN52 1776 E. 17th St. Cleveland 14, Ohio

Please send Free Career Information prepared to help me get ahead in Electronics. I have had training or experience in Electronics as indicated below.



- | | |
|---|---|
| <input type="checkbox"/> Military | <input type="checkbox"/> Broadcasting |
| <input type="checkbox"/> Radio-TV Servicing | <input type="checkbox"/> Home Experimenting |
| <input type="checkbox"/> Manufacturing | <input type="checkbox"/> Telephone Company |
| <input type="checkbox"/> Amateur Radio | <input type="checkbox"/> Other _____ |

In what kind of work are you now engaged?

In what branch of Electronics are you interested?

Name _____ Age _____

Address _____

City _____ Zone _____ State _____

RN52

**ONE
QUICK
STEP
TO STEREO**

**FISHER
500-S**

**STEREO FM-AM
RECEIVER**



■ Now you can update monophonic installations to stereo in a matter of minutes. The FISHER 500-S is an ideal replacement for older high fidelity equipment—for its stereo tuners, stereo preamps and dual-channel amplifiers are all on *one compact chassis*. Simply connect a turntable and two speakers—and you have a complete stereo system. What's more, your customer knows that the FISHER name is a name he can trust.

OUTSTANDING FEATURES: Wide-Band Tuners, flexibility, ease of operation, 45-watt output, handsome solid architectural brass front panel. **\$349.50**

*Write Today
For Complete Specifications!*

FISHER RADIO CORPORATION
21-38 44th Drive • Long Island City 1, N.Y.



...for the Record

By **W. A. STOCKLIN**
Editor

Electronics for the Jet Age

ALTHOUGH the precise cause of the mid-air collision over New York City last December has not yet been determined, and may never be, it is the first air tragedy in which an electronic device proved to be the mute witness. Today Federal regulations require that all aircraft capable of flying at altitudes above 25,000 feet carry a flight recorder.

In size, the flight recorder is comparatively small in relation to other electronic equipment aboard an aircraft. Its outside dimensions are approximately 20" x 8" x 6". Basically, it is an airborne oscillographic-type scribe (manufactured by *Waste King Corporation*) which provides a record of four in-flight parameters: altitude, air speed, heading, and vertical acceleration. This information is etched by a diamond stylus on a nickel-alloy tape. The unit is designed to survive heat of 2000 degrees F, a shock more than 100 times the force of gravity, and immersion in sea water for more than 36 hours.

Only one of the two planes involved in the New York City collision carried such a recorder—the jet which landed in a Brooklyn street. Despite the impact of the crash and the tremendous temperatures of the burning aircraft, the recorder was obviously recovered intact since investigators were able to study the flight path and the last minutes of the staggering, twirling aircraft as it hurtled from the sky. The recorded information is expected to play a vital role in determining just why the two aircraft collided while under the control and direction of the FAA air-traffic controllers.

Of importance not only in the case of collision, the flight recorders are being used by airlines to determine operation of aircraft at given altitudes and the response of their instruments to the ground navigational systems.

The flight recorder is, without question, a significant electronic contribution to aviation safety and all of us in the electronics industry have a right to be proud not only of this new development but of communications and landing systems that have been developed by our industry for the aviation field.

Obviously our industry cannot rest on its laurels since there is a dire need, in view of the coming jet age, for much improved electronic equipment—to reduce to an absolute minimum the possibility of human error.

We don't pretend, in this brief discussion, to offer a "solution" to our complex air-traffic-control problem—that we leave to the air-traffic-control experts.

But we would like to raise a few

questions. Air-traffic controllers at the New York Air Traffic Control Center work an eight-hour tour of duty, without a specified time for lunch. Aviation experts observing this unusual personnel practice concede that the controllers are doing an excellent job but question whether the average annual salary of \$6000 is commensurate with their responsibilities. They point out that higher salaries would attract men with a stronger electronic background which is certainly requisite in the jet age.

This recommendation appears to be in line with the philosophy of the new FAA administrator, Najeeb Halaby, who said "we should have more electronic controls so that everyone can fly safer." Mr. Halaby, a pilot-lawyer, is credited with making the first non-stop continental flight by jet in 1945 while serving as a Navy test pilot.

All of which puts the problem right back in our "electronic lap." Mr. Halaby, it appears, has pointed up our sins of omission.

The FAA's air-traffic-control system is using the same electronic equipment today as they used twenty years ago to guide and direct two-engined propeller craft whose top speed was not in excess of 200 mph. At this writing that same system, with slight modifications, is guiding and directing high-speed jet aircraft at more than 500 mph! It is almost like trying to meld horse-drawn vehicles into the traffic pattern of a high-speed turnpike.

In short, the present control system is incompatible with jet speed and inadequate for the supersonic aircraft which is expected by 1970.

While no one can fail to be impressed by the achievements of the electronics industry in the field of missiles and space, its failure to provide the tools for the vital and immediate needs of air-traffic control cannot be overlooked. Such equipment is as important to the air traveller as the block-signal system is to the railroad passenger. We are told that three-dimensional radar is vital in high-density traffic areas such as New York, Chicago, and Los Angeles. Despite this urgency, such 3D radar is still in the "development" stage and the various types of computers to assist the air-traffic controller in handling the traffic load are "under test and experimentation."

The computers are scheduled for trial installation in the Boston Air Route Traffic Control Center later this year. Three-dimensional radar now undergoing test, even if proved successful, could not become operational before 1964 at the earliest.

ALLIED value-packed 1961

444-PAGE ELECTRONICS CATALOG

including special products available only from Allied

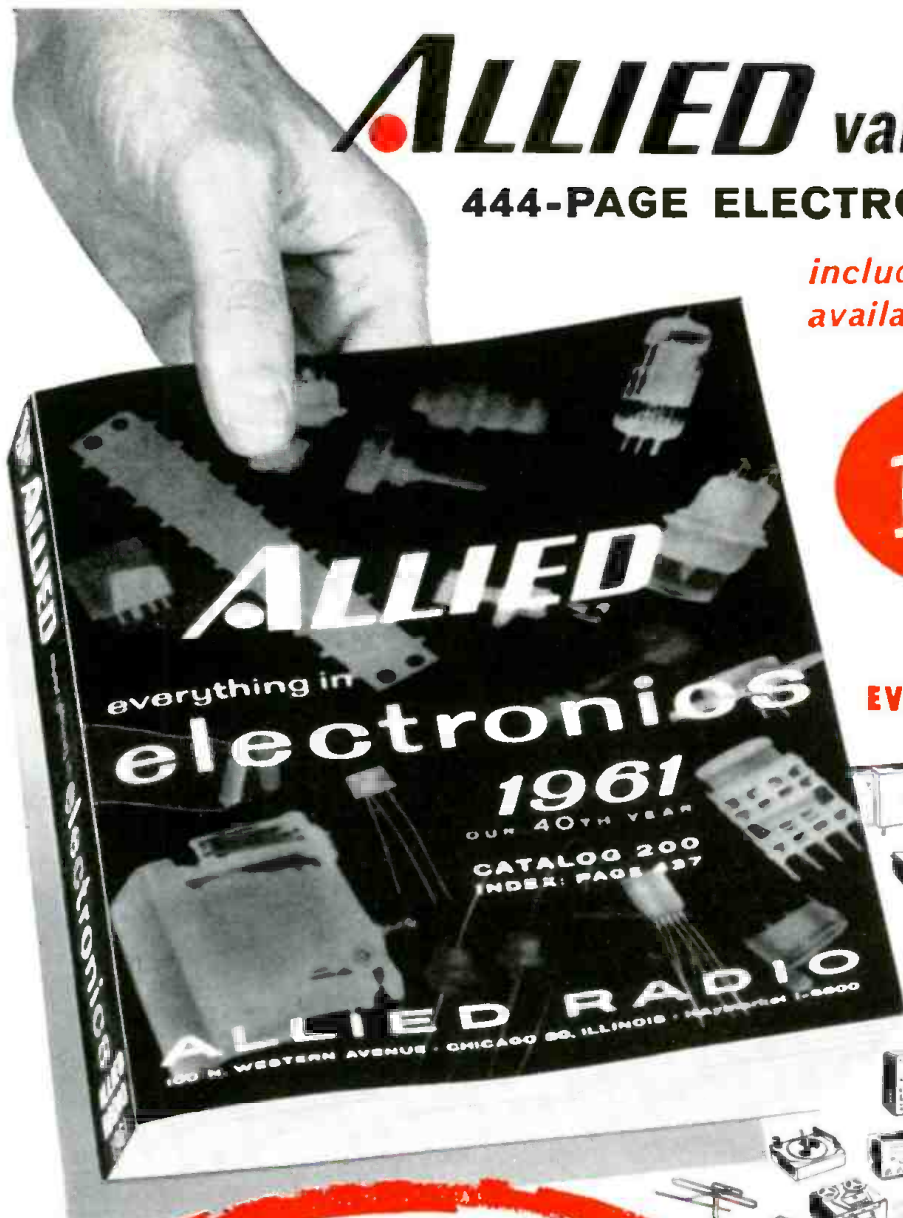

free

SAVE MOST ON
EVERYTHING IN ELECTRONICS

- New Stereo Hi-Fi Systems— Everything in Hi-Fi Components
- Money-Saving, Build-Your-Own KNIGHT-KITS® for Every Need
- Best Buys in Recorders & Supplies
- Newest Public Address Systems, Paging and Intercom Equipment
- Amateur Receivers, Transmitters and Station Gear
- Citizen's Band 2-Way Radio
- Test and Laboratory Instruments
- TV Tubes, Antennas, Accessories
- Huge Listings of Parts, Tubes, Transistors, Tools, Books

BUY ON EASIEST TERMS
only \$2 down on orders up to \$50;
only \$5 down on orders up to \$200;
only \$10 down over \$200.
Up to 24 months to pay.

ALLIED exclusives:

MONEY-SAVING KNIGHT-KITS®—truly the very best in build-your-own electronic equipment—lowest in cost, easiest to assemble, best for performance. Select from a complete line of Stereo hi-fi kits, Hobbyist kits, Test Instrument and Amateur kits. KNIGHT-KITS are an exclusive ALLIED product.

KNIGHT® STEREO HI-FI—Comparable to the best in quality, styling and performance, yet priced far lower. Select super-value KNIGHT components or complete systems and save most. Also see the largest selections of famous-name hi-fi components and money-saving ALLIED-recommended complete high-fidelity music systems.

Exclusive Allied products save you more

You get every buying advantage at ALLIED: Lowest, money-saving prices, fastest shipment, expert personal help, easiest-pay terms, satisfaction guaranteed or your money back.

send coupon today
for 444-page catalog

free

ALLIED RADIO

Satisfaction Guaranteed or Your Money Back

World's Largest Electronic Supply House



our 40th year

ALLIED RADIO, Dept. 1-D1
100 N. Western Ave., Chicago 80, Ill.

Send FREE 1961 Allied Catalog No. 200

Name _____
PLEASE PRINT

Address _____

City _____ Zone _____ State _____

THE REMARKABLE SONY RADIO WIRELESS MICROPHONE

The convenience and variety of uses for this remarkable instrument are almost beyond the imagination. The Sony CR-4 mike and radio transmitter can be slipped into a coat pocket for completely wireless on-the-street interviewing, studio audience interviewing or on-the-spot broadcasting from awkward places. It gives complete freedom to active singers, dancers, comedians, performers with electric instruments and actors, eliminating the need for cumbersome mike booms and entangling wires.

Microphone, transmitter, receiver and carrying case, \$250. For information or literature, write: Superscope, Inc., Dept. 6, Sun Valley, California.

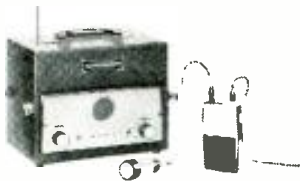

SONY
SUPERSCOPE The Tapeway to Stereo

No one will deny that the aeronautic sciences have provided this nation and the world with the best aircraft ever produced. Has the electronics industry done its part in providing comparable

tools for air-traffic control? Have we in the electronics industry failed to live up to our potential in this area or has the government failed to provide the necessary guidance and incentive? —30—

THIRD-QUARTER COMPONENT OUTPUT DECLINES

According to the U.S. Department of Commerce, shipments of electronic components declined approximately 5% during the third quarter of 1960. Most of the decline can be charged to components shipped for military

end-use although the report pointed out that non-military component output failed to show the normal upward movement during the latter half of the year. Following are details on unit and dollar value production. —30—

COMPONENT	UNITS	VALUE
Power and Special Purpose Tubes	2,661,000	\$ 58,728,000
Receiving Tubes	103,221,000	\$ 87,244,000
Semiconductor Devices	81,925,000	\$126,583,000
Capacitors	338,408,000	\$ 61,368,000
Complex Components (including PC's, etc.)	10,686,000	\$ 10,319,000
Connectors	21,607,000	\$ 40,099,000
Quartz Crystals	1,550,000	\$ 5,729,000
Relays	7,678,000	\$ 41,593,000
Resistors	570,102,000	\$ 61,058,000
Transformers and Reactors	7,161,000	\$ 42,617,000



COMING NEXT MONTH



4-TRACK STEREO ADDS DEPTH TO TAPES

Two-dimensional stereo can be achieved with 4-channel, 4-track tapes. Here is how such a system can be set up, including details on the requisite transistorized playback and record amplifiers.

1961 AUTO RADIOS: GM CARS

Practical and often hard-to-get information for the service technician on sets used in 1961 Chevrolets, Pontiacs, and Oldsmobiles.

RUMBLE FILTERS FOR STEREO

Improve the quality of record reproduction by designing and building a rumble filter for stereo setups. All the necessary information, as well as practical examples, is included.

SPEED-CHECKING I.F. SYSTEMS

Although i.f. systems are seldom the culprit, when they need to be checked, use this system to save trouble and time.

SALVAGING "DO-IT-YOURSELF" JBBS

Nothing can be more time-consuming than a service job which the owner has "started"—often producing misleading

symptoms. Here's a practical system for coping with these "home-butchered" receivers.

COMPUTER ARITHMETIC CIRCUITS

A basic discussion of the various types of adders used in binary systems.

WIDE-RANGE INDUCTANCE METER

A simple, single-tube tester which will measure inductance values from 2.5 μ h. to 6300 h. It is designed to be used in conjunction with external generator and output meter to keep cost down.

LIGHTNING PROTECTION FOR HAM STATIONS

Since lightning annually takes a larger toll of lives than either hurricanes or tornadoes, lightning protection for the ham station is a "must." The author provides practical tips and procedures.

All these and many more interesting and informative articles will be yours in the May issue of *ELECTRONICS WORLD* . . . on sale

April 18th

ELECTRONICS WORLD

Here's The Offer No Other Radio-TV School DARES MAKE!

LEARN AT HOME in Spare Time!

YOU DO MANY PRACTICAL JOBS with the kits we send you. That's right, you PRACTICE what we TEACH! You build a Signal Generator, AC-DC Power Pack, and AC-DC Superheterodyne Radio Receiver and top quality 21 inch TV Set. EARN AS YOU LEARN with the famous RTS 30 Day Income Plan. Full instructions provided. NO HIGH SCHOOL DIPLOMA NECESSARY. This is a COMPLETE course which starts with basic subjects and gradually advances to Radio-TV. . . . ALL FOR A PRICE YOU CAN AFFORD!

*THE ONLY VERTICAL MULTI-CHASSIS 21" TV KIT OFFERED BY ANY RADIO-TV SCHOOL



YOU BUILD THESE AND OTHER UNITS!

COMPLETE COLOR TV INSTRUCTION INCLUDED!

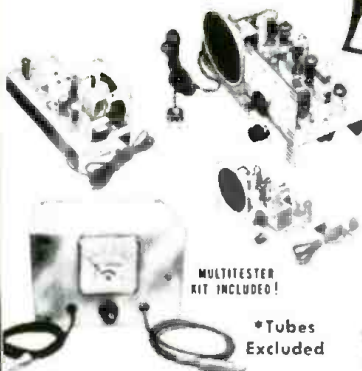

MULTITESTER KIT INCLUDED!

*Tubes Excluded

Each student is entitled to unlimited consultation service. All questions are answered promptly and completely by highly specialized instructors.

RTS' Membership in The Association of Home Study Schools is your assurance of Reliability, Integrity and Quality of Training.



RADIO-TELEVISION TRAINING SCHOOL

815 E. ROSECRANS AVENUE
LOS ANGELES 59, CALIFORNIA

L 1010

Est. 1922



Rush Coupon for FREE FACTS!

RTS Will Train You at a Price You Can Afford and When You Are a Qualified Graduate Will Help You Open a Service Shop of Your Own and Supply You With Every Bit of Equipment You Need to Get Started - Plus an Inventory of Parts and Necessary Supplies.

ALL FINANCED WITHOUT INTEREST OR CARRYING CHARGES!!
You Also Receive . . . Advertising Help and Material, Shop Plans, Business Systems, Letterheads, Calling Cards and Much More!

Here's What Two of Many Business Plan Shop Owners Have to Say!

This business takes in between \$1500 and \$2000 a month. I've had to hire help to keep up with it.

CULLEN W. IRBY
Corpus Christi, Texas

The school lives up to its promises 100%. RTS does not lose interest in its students once they graduate.

HAROLD R. STANLAKE
Perry, Michigan

DON'T LOSE OUT — FIND OUT!

RADIO TELEVISION TRAINING SCHOOL, Dept. EW-41

815 E. ROSECRANS AVE. LOS ANGELES 59, CALIF.

Rush me full information by return mail. (Please Print)

NAME _____ AGE _____
STREET _____
CITY _____ ZONE _____ STATE _____

NO SALESMAN WILL CALL ON YOU!

IT COULD HAPPEN TO YOU...



Somewhere it said: "Build this kit in an amazing 10 hours!" Looks like you're running into overtime because you spent the first 7½ hours sorting out the jumbled mess of small parts and hardware. Well, it's good training for looking for needles in haystacks.



If drug manufacturers made the mistakes in labeling you find in some kits, the world would be a quieter, lonelier place. You know a selenium rectifier when you see one, and if this is a selenium rectifier, you're Thomas Alva Edison.



Let's see. On Page 5 it says; "See diagram Page 12." On Page 12 it says; "See instructions Page 5." Well, if you hold Page 5 open with your tongue, and Page 12 open with your left ear, that still leaves you three fingers on your left hand free for soldering and also...

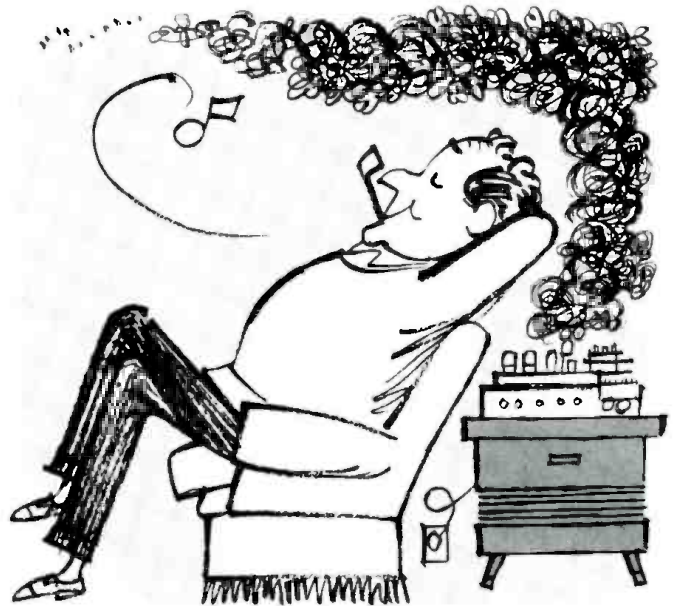

Don't look now, but while Heifetz fiddles, your amplifier burns. When the smoke clears, you'll probably find that the 100 microfarad electrolytic was shorted because it had not been pre-tested. All work and no play, makes Jack a very mad boy!

UNLESS THE KIT YOU BUILD IS A PACO

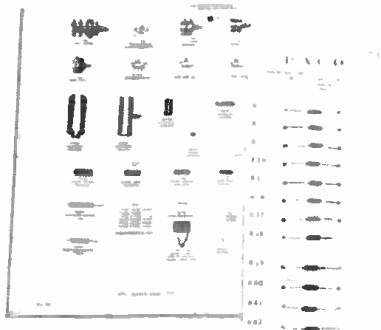

No mistaken identity or endless searching. Parts are clearly pictured and labeled; resistors are neatly mounted and identified!



Step-by-step instruction book makes assembling a Paco Kit foolproof! Paco gives you giant, fold-out diagrams on corresponding instruction pages so you can see both at the same time.



PACO Model C-25 IN-CIRCUIT CAPACITOR TESTER KIT

Reveals dried out, shorted, or open electrolytics—in the circuit—with Paco's exclusive Capacity Dial. Instantly finds open or direct shorted capacitors without removing from circuit. Great time saver!

Specifications:

SIMPLE SEQUENTIAL TEST: reveals open or shorted capacitors, including electrolytic types.

ELECTROLYTIC DIAL: indicates actual electrolytic values while capacitor is in-circuit; any electrolytic which yields a capacity reading on Electrolytic Dial is automatically revealed as not open or shorted.

ELECTROLYTIC TEST: indicates in-circuit electrolytic capacity from 2 mfd to 400 mfd in two ranges; condenser is automatically proved non-short and not open if Capacity Reading can be obtained.

Model C-25: Kit, complete with PACO-detailed assembly-operating manual. Kit Net Price: \$19.95

Model C-25W: Factory-wired, ready to operate. Net Price: 29.95



PACO Model DF-90 TRANSISTORIZED DEPTH FINDER KIT

Protect your boat against shoals and underwater hazards with this compact, easy-to-read depth finder. Transistors prolong battery life, provide utmost accuracy and portability. A boon to fishermen—locates hard-to-find schools of fish. A low cost safety device for every boat owner.

Specifications:

FULLY TRANSISTORIZED: 5 transistors, with a low battery drain for extremely long battery life.

HIGH INTENSITY INDICATOR: for sensitive, accurate response under all conditions.

FAST, EASY READINGS: made possible by means of over-sized scale calibrated at one-foot intervals from 0 to 120 feet.

Model DF-90: Kit, complete with PACO-detailed assembly-operating manual. Kit Net Price: \$84.50

Model DF-90W: Factory-wired, ready to operate. Net Price: \$135.50

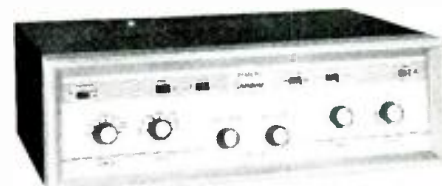

PACO Model SA-40 STEREO PREAMP-AMPLIFIER KIT

Assemble a superb home music system with this true 40 watt stereo preamp-amplifier. Unmatched flexibility, less than 0.5% distortion, and handsome design make this the ideal component for music lover and audiophile alike!

Specifications:

MUSIC WAVEFORM POWER OUTPUT: 25 watts per channel (50 watts total).

RESPONSE: 30 cps to 90Kc, $\pm 1.0\%$ db

HARMONIC DISTORTION: less than 0.5% at 20 watts per channel output.

Model SA-40: Kit, complete with black and gold case and PACO-detailed assembly-operating manual. Kit Net Price: \$79.95

Model SA-40W: Factory-wired, with black and gold case, ready to operate. Net Price: \$129.95

FREE! COMPLETE ILLUSTRATED CATALOG

Mail this coupon for the complete Paco catalog of electronic equipment kits, including test instruments, measuring instruments, and high fidelity components.

PACO KITS BY PACOTRONICS, INC.

Paco Electronics Company, Inc., DEPT. EW-4
70-31 84th Street, Glendale 27, L. I., N. Y.
Please send me your complete illustrated catalog.

Name

Address

City Zone State

© PACOTRONICS, INC. 1961



**REK-O-KUT N-34H STEREO TABLE
COMBINES INTEGRITY OF
DESIGN WITH CLASSIC
BEAUTY OF APPEARANCE**

Once in a decade, a manufacturing firm designs a machine which offers matchless specifications at a price which seems impossibly low. Word-of-mouth spreads the story to dealer and customer alike and suddenly, the new machine becomes the runaway best-seller in its class. This is now happening to the new REK-O-KUT N-34H Stereotable. Here are the reasons why—

THE N-34H IS SUPERBLY QUIET...

The marriage of the precision-built hysteresis synchronous motor and new revolutionary Rekothane Belt is an engineering break-through which results in the unprecedented low rumble level of -59 db.—beyond a doubt the best ever achieved in a two-speed machine.

THE N-34H MAKES RECORDS COME ALIVE...

The hysteresis synchronous motor provides locked-in accuracy of rotational speed at all times, regardless of power line fluctuation and load. Wow and flutter become insignificant at 0.15%. Stereo and mono records, old and new, sound like the original live performance!

N-34H QUALITY IS HERE TO STAY...

The N-34H is so carefully made it will measure up to the same high specifications, year in, year out. Examine the parts—the turntable shaft machined to aircraft tolerances, permanently lubricated motor bearings, the heavy steel deck-plate which can never warp, the deceptively soft Rekothane Belt which absorbs shock like a cushion and is especially compounded for a lifetime of use.

- N-34H—does not include base and arm **\$79.95** net
- S-320 Stereo Tonearm with Omni-Balance
Designed for 1-hole mounting on N-34H **\$32.95** net
- Model BN Tapered Base in Oiled Walnut
Designed for N-34H **\$14.95** net
- Acousti-Mounts Recommended for all
cabinet installations **\$3.50** net



**REK-O-KUT
STEREOTABLES**

REK-O-KUT Co., Inc., Dept. EW-41, 38-19 108 St., Corona 68, N.Y. Export: Morhan Exporting Corp., 458 Broadway, New York. Canada: Atlas Radio, 50 Wingold Avenue, Toronto 19

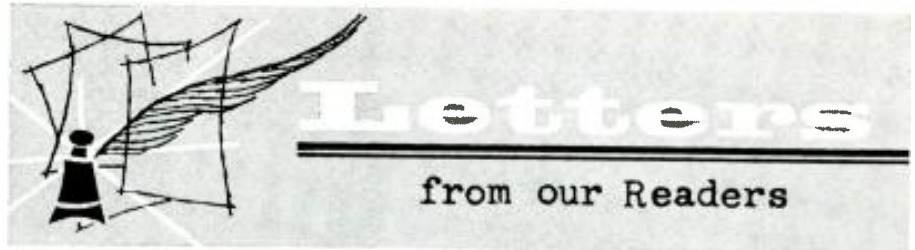

AUDIO-ULTRASONIC PICKUP

To the Editors:

In the October, 1960 issue of *ELECTRONICS WORLD* is published an article titled "Audio-Ultrasonic Pickup Circuit" by Mr. Harold Reed.

This article covers construction of a transistorized voice-operated relay. The printed material and the wiring diagram shown in the article call for a 22.5-volt battery.

We are in process of building this unit. Having secured the specified G-E 2N107 transistors we note that the manufacturer specified a *maximum* voltage of -10 volts. Your article calls for -22.5 volts input.

Will you please check these contradictory specifications and give us the correct answer?

PHILIP A. BOERNER
Tydings Electronics, Inc.
Pittsburgh, Penna.

Here are Author Reed's comments on the above question.—Editors.

Dear Mr. Boerner:

You are right about the d.c. voltage being above the rating for the 2N107. Two circuits were set up here, one with CK722 transistors using a 22½-volt battery and the other with the 2N107 using a 9-volt battery. The 2N107 circuit was given in the article since it seemed to be more stable. The battery used with the CK722 was erroneously listed on the 2N107 diagram.

After receiving your letter I was naturally concerned about other constructors who may not notice this as you did so I made tests on the circuit as given in the article, using the 22½-volt battery. The maximum collector-base voltage listed by G-E for the 2N107 is 12 volts. In this circuit it measured 20 volts. Several transistors were tried for prolonged periods with no ill effects. This agrees with past experience in that I never lost a transistor due to exceeding, within reason, the maximum collector rating (usually accidentally) as long as the dissipation rating was not exceeded.

The constructor who uses the circuit as is, will probably experience no difficulty. Since you are in the process of building the unit, use a 22½-volt battery with transistors like the CK722 and a 9-volt battery with the 2N107.

HAROLD REED
Hyattsville, Maryland

THE TRANSISTOR "ALPHA BOX"

To the Editors:

In Fig. 1 of my article "The Transistor 'Alpha Box'" which appeared in the November issue, transistor V. (2N293)

should be drawn as an *n-p-n* type rather than a *p-n-p*, as shown.

DON STONER
Alta Loma, California

We are sorry we couldn't catch this correction before we went to press. The circuit still operates just as indicated by the article, however.—Editors.

* * *

HI-FI RECORD CHANGERS

To the Editors:

In your article "Hi-Fi Record Changers" (*ELECTRONICS WORLD*, December 1960) relative to intermixing records, it is stated, "Of course, in all instances, the stack must be made up of records of the same speed."

I believe you will find that on *Webcor* models incorporating the "Magic Mind" (Models 141A, 1631A, 1641A, and others) seven-inch 45-rpm records and ten- or twelve-inch 33½-rpm records can be intermixed, and the changer will shift to the appropriate speed as each record is dropped.

JOHN E. HANNAN
Plumb Electronics
Houston, Texas

In addition to the Webcor models indicated above, Glaser-Steers and Heath also have changers available with this same speed-changing function.—Editors.

* * *

SENSITIVE ELECTRONIC RELAY

To the Editors:

I have just finished building the electronic relay described in the January edition of *ELECTRONICS WORLD* and find it extremely sensitive. Sensitivity may be adjusted to maximum by adding a 3000-ohm, 4-watt potentiometer in series with R₁ and ground.

Your readers may be interested to know the relay makes an excellent "wet-the-bed" alarm for very young children.

L. PARKER
Pickering, Ontario

To the Editors:

The electronic relay described on page 62 of your January, 1961 issue could easily be a lethal gadget since not only the chassis but also one of the control elements is connected directly to one side of the a.c. line. In one position of the a.c. plug this would mean that anyone touching one of the control elements and a ground such as a radiator, water pipe, furnace register, etc. would be subjected to full line voltage. The same device can be built at practically the same cost complete with a transformer supply, fuses, switch, enclosed cabinet, and a sensitivity control

NEW

TESTS All TV and Radio Tubes
—both old and new

TESTS the Nuvistors

TESTS the new 10-pin tubes

TESTS the new 12-pin Compactrons

TESTS voltage regulators, thyratrons,
auto radio hybrid tubes,
European hi-fi tubes, and
most industrial types.



Model **600**
DYNA-QUIK

only **\$69⁹⁵**
NET

8½" x 11" x 4½"
Handsome, sturdy
leatherette-covered
carrying case

NEW TUBE
INFORMATION
SERVICE

available every 3
months for all B&K
Dyna-Quik Tube Testers



for the first time, a
B & K QUALITY
TUBE TESTER
at this
amazing low cost!

Checks for all shorts, grid
emission, leakage, and gas

Checks each section of multi-
section tubes separately

Checks tube capability under
simulated load conditions

Rejects bad tubes
—not good tubes

For the man who wants the performance and reliability of a B&K professional-quality tester at minimum cost . . . there's nothing like the new "600". No other tube tester in this price range is so complete and up-to-date. Tests the newest tube types, as well as the old. It's fast . . . it's accurate . . . it's easy to use. Quickly reveals tube condition. Saves customers. Sells more tube replacements. Stops call-backs. Steps up servicing profit . . . day after day. Pays for itself over and over again.

Exclusive adjustable grid emission test. Sensitivity to over 100 megohms. Phosphor bronze socket contacts. Complete tube listing in handy reference index. Extremely compact.

B & K MANUFACTURING CO.

1801 W. BELLE PLAINE AVE • CHICAGO 13, ILL.

Canada: Atlas Radio Corp., 50 Wingold, Toronto 19, Ont.

Export: Empire Exporters, 277 Broadway, New York 7, U.S.A.

RESIDENT SCHOOL COURSES IN
LOS ANGELES AND NEW YORK CITY

START YOUR CAREER IN ELECTRONICS NOW AT RCA INSTITUTES...

Choose from this list

	Course	Qualifications	Length of Course
A	Advanced Electronic Technology (T-3)	High School grad, with Algebra, Physics or Science	Day 2¼ yrs. Eve. 6¾ yrs.
B	TV and General Electronics (V-7)	2 yrs. High School, with Algebra, Physics or Science	Day 1½ yrs. Eve. 4½ yrs.
C	Radio & TV Servicing (V-3)	2 yrs. High School, with Algebra, Physics or Science	Day 9 mos. Eve. 2¼ yrs.
D	Transistors	V-3 or equivalent	Eve. 3 mos.
E	Electronic Drafting (V-11 V-12)	2 yrs. High School, with Algebra, Physics or Science	Eve. Basic: 1 yr. Advanced: 2 yrs.
F	Color TV	V-3 or equivalent	Day 3 mos. Eve. 3 mos.
G	Audio-Hi Fidelity	V-3 or equivalent	Eve. 3 mos.
H	Video Tape	V-3 or equivalent	Eve. 3 mos.
I	Technical Writing (V-10)	V-3 or equivalent	Eve. 3-18 mos.
J	Computer Programming	High School grad	Day 6 weeks Eve. 24 weeks Sat. 30 weeks
K	Radio Code (V-4)	8th Grade	Eve. as desired
L	Preparatory Math & Physics (P-0)	1 yr. High School	Day 3 mos.
M	Preparatory Mathematics (P-0A)	1 yr. High School	Eve. 3 mos.

RCA Institutes is one of the largest technical institutes in the United States devoted exclusively to electronics. Coeducational Day and Evening classes. Free placement service. Applications now being accepted.



The Most Trusted Name
in Electronics
RADIO CORPORATION OF AMERICA



Send to the school nearest you

RCA Institutes, Inc. Dept. EWR-41
350 West Fourth Street Pacific Electric Building
New York 14, New York 610 S. Main St., L.A. 14, Calif.

Please send me your FREE catalog. I am interested in the courses circled below.

A B C D E F G H I J K L M

Name _____ (please print)

Address _____

City _____ Zone _____ State _____

For Home Study Courses See Ad On Opposite Page

which would make it relatively safe, even for children. Most of your articles cover well-designed equipment which is reasonably safe to operate, but occasionally one is shown which is definitely unsafe. Too many people do not realize the danger present in those nice little bare wires and terminals under the chassis and poke around with soldering irons and screwdrivers among a maze of 200, 300, or more d.c. volts little realizing that 200 volts d.c. can be more deadly than a rattlesnake. Perhaps an article on electrical safety in some future issue would be in order.

I hope you will forgive the somber tone of this letter. In general, ELECTRONICS WORLD is a high-quality publication and has added to my education and enjoyment for many years. but, as an industrial engineer, I sometimes become concerned with the pictures and descriptions of seemingly innocent, but potentially deadly, a.c.-d.c. circuits, open chassis, etc.

K. C. McCARTT
Senior Research Engineer
Universal-Rundle Corporation
Mahoningtown, Pa.

We had hoped that by this time our readers should be pretty well aware of the dangers of working with electricity and in working with devices that do not use isolating transformers. We have run so many articles on the subject of safety, power-line hazards, the use of isolating transformers, and the use of polarized plugs, that we have lost count of them.

We do agree with you, however, that we should always be aware of the novice in the field who reads our articles, and that we should keep a strong emphasis on these warnings in any articles where they apply.

We would like to point out, however, that the article in question indicates at the very beginning of the circuit description that a polarized line plug should be used to reduce or eliminate danger of shock or short circuits. Perhaps we should have emphasized this very important matter even more.—Editors.

LINE-VOLTAGE ISOLATOR

To the Editors:

With reference to your article "A Variable Line-Voltage Isolator" in your January issue, the output-outlet hookup isn't going to help the transformer as it is shown. In addition to this, there will be no output voltage as you have drawn the circuit.

W. GREEN
Long Island City, New York

Thanks to Reader Green for pointing out our oversight in the circuit. We were so concerned that the switch was hooked in right, that all of us who proofread the article neglected the very obvious short circuit across the outlet. If this lead is deleted, the circuit should then work properly as shown.—Editors.

FIVE-MINUTE CB TIMER

To the Editors:

While I did not attempt to construct the "Five-Minute CB Timer" by Leo Morgan in your January issue, I did read the article with interest. That there is a five-minute time limit is news to me even though I am supposed to receive transmittal sheets from the FCC to keep me up to date.

I believe that you would do your readers a great service by printing an interpretation of the rules as they stand at this time.

FRANK W. KNOTTINGHAM
Port Orford, Oregon

The so-called five-minute rule on the Citizens Band has been covered by us in a brief one-column story that ran quite a few months ago. Briefly, the rule is that no contact should exceed five consecutive minutes and that this should be followed by a two-minute silent period. However, this rule does not apply to contacts between units of the same station, nor does it apply to emergency communications.

We refer you to paragraph 19.61 of the "FCC Rules and Regulations on Citizens Band" as amended March 15, 1960.—Editors.



LET RCA TRAIN YOU IN ELECTRONICS

RCA Institutes, one of the world's leading electronic technical schools, offers Home Study Courses in . . .

RADIO, TV, TRANSISTORS, AUTOMATION

. . . Now you have five comprehensive courses for your electronic training. Practical work with the very first lesson. With the new Voluntary Tuition Plan, you pay for each study group only when you order it. If you interrupt the course at any time, for any reason, you don't pay until you resume the course.

Even if you have not completed high school, you can begin your electronic career training at RCA Institutes. Choose from any of these courses.

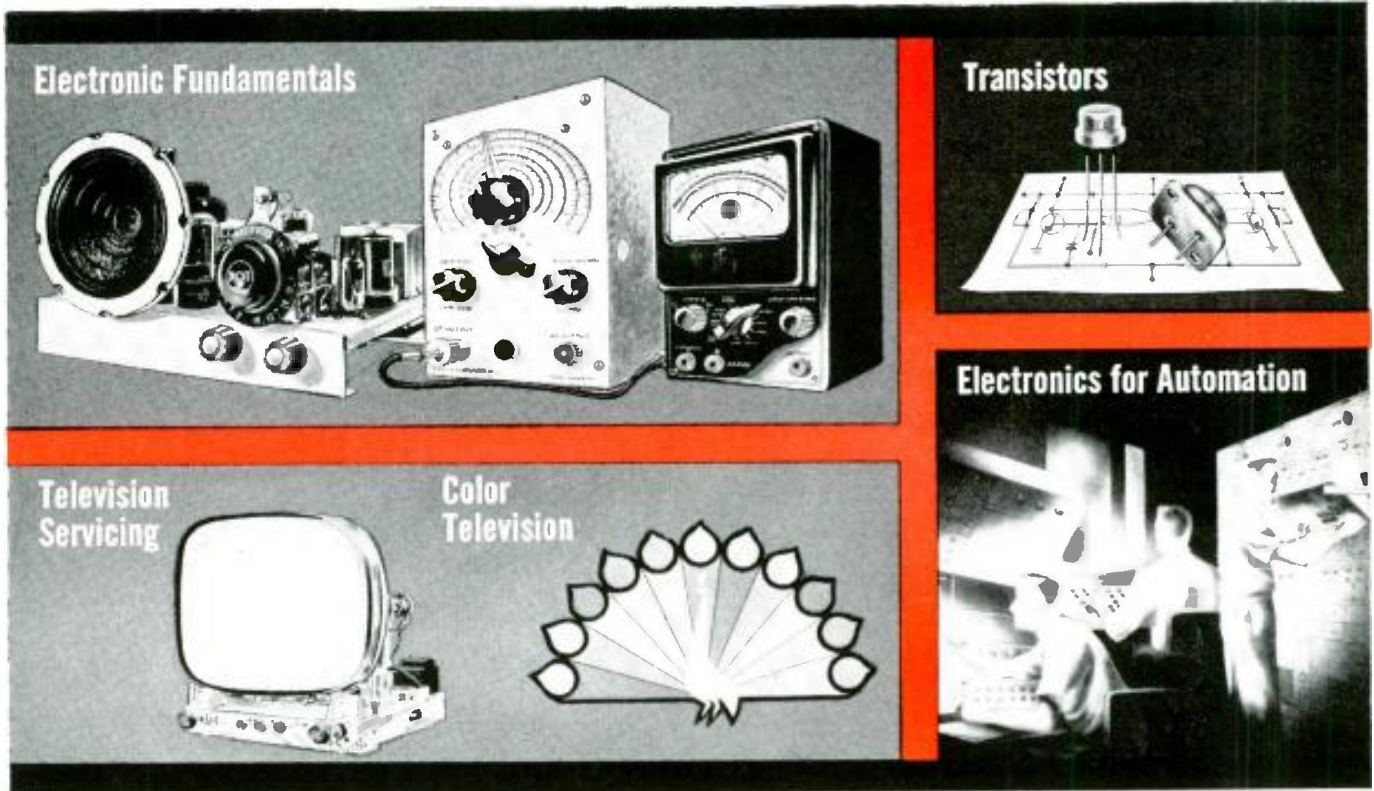

Send for our
64 page Home
Study Catalog

FREE!

RESIDENT SCHOOLS in New York City and Los Angeles offer Technical Institute and Vocational School Courses in Electronics. Day and Evening classes start 4 times each year. Resident School Catalog sent free on request.



RCA INSTITUTES, Inc. Home Study School, Dept. EW-41

A Service of Radio Corporation of America

350 West Fourth Street, New York 14, N. Y.

Please rush me your FREE illustrated 64-page book "Your Career in Electronics," describing your home training programs. No obligation. No salesman will call.

Name Age

Address

City Zone State

Veterans: Enter discharge date

CANADIANS — Take advantage of these same RCA courses at no additional cost. No postage, no customs, no delay. Send coupon to:
RCA Victor Company, Ltd., 5581 Royalmount Ave., Montreal 9, Quebec
To save time, paste coupon on postcard.



**NO ADVANCED
EDUCATION NEEDED!**

**NO PREVIOUS
TECHNICAL EXPERIENCE
REQUIRED!**

MEN 17-55

Prepare now to enter one of the many profitable branches of

ELECTRONICS

SEND FOR FREE FACTS!

The day the first Satellite spiraled into outer space will be known to thousands of men throughout the United States and Canada as "Opportunity Day" — because it brought to light the tremendous possibilities that the field of Electronics holds for the man who seeks a better job or a business of his own.

One of the great things about the giant field of Electronics is the fact that even a man who does not have an advanced education or previous technical experience can prepare for many profitable opportunities in his spare time at home . . . or, if he desires, he may attend our well-equipped CHICAGO or TORONTO laboratories.

If you seek a better job or a business of your own, why don't you fill in the coupon below for FREE facts?

Make "Satellite Day" your "Opportunity Day," too!

DRAFT AGE?

We have valuable information for every man of draft age; so if you are subject to military service be sure to check the coupon.

LIVE-WIRE EMPLOYMENT SERVICE

Through long-established contacts with well-known employers, DeVry Tech's Placement Department has helped many men toward better jobs in Communications, Guided Missile Control, Radar, Automation, Television, Instrumentation, etc. The service is free to graduates.

SEND for 2 FREE BOOKLETS

We'll give you a free copy of 2 interesting booklets, "Electronics in Space Travel" and "Pocket Guide to Real Earnings." See for yourself how you may take advantage of the opportunities in this fast-growing field.



DeVRY TECH OF CANADA, LTD.
TORONTO 19, ONTARIO

**WILL NOT
INTERFERE
WITH
PRESENT
JOB!**

**EARN
WHILE
YOU
LEARN!**

**Get into One of
Today's Fastest
Growing Fields!**

**IN YOUR SPARE
TIME AT HOME OR
IN OUR CHICAGO
OR TORONTO
LABORATORIES.**

*Look at these
Job Opportunities!*

- Radar • Guided Missile Control
- Television • Microwaves
- Communications • Radio
- Industrial Electronics • Computers
- Automation Electronics • Broadcasting

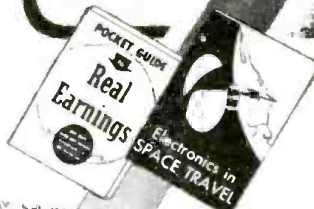

**MAIL POSTAL CARD
INSERTED ABOVE FOR
2 FREE BOOKLETS
TODAY!**

MEN 17 to 55



DeVry Tech's Electronic Training

has helped Men like these Get Better Jobs or Shops of their own...

How about YOU?



**No Advanced
Education
Required**

NO PREVIOUS TECHNICAL EXPERIENCE NEEDED!

Men from practically every walk of life have won better jobs or businesses of their own through DeVry Tech's program. Many of these men, like thousands of others, had no previous technical experience. They prepared either in our well-equipped Toronto or Chicago laboratories, or at home in their spare time without interfering with their regular jobs.

The "Electronic Age" is here! Opportunities for men 17 to 55 are great! Fill in coupon below for FREE details! Act now!

LIVE-WIRE EMPLOYMENT SERVICE

DeVry Tech's Placement Department is in contact with some of the best-known employers in the Electronics field. The service is free to all graduates — and DeVry Tech's record in helping to place men has been outstanding.

Accredited Member
of National
Home Study Council

DRAFT AGE?

We have valuable information for every man of draft age; so if you are subject to military service be sure to check the coupon.



Mail Postal Card inserted above for free copies of interesting booklets, "Pocket Guide to Real Earnings" and "Electronics in Space Travel." See for yourself how you may take advantage of the opportunities in this growing field.

"One of North America's Foremost Electronics Training Centers"

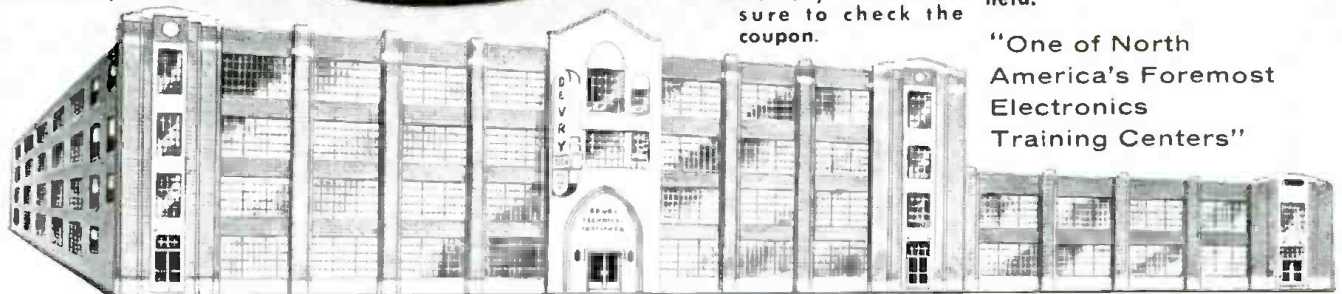

DeVRY TECHNICAL INSTITUTE CHICAGO 41, ILLINOIS



FIX ANY TV OR RADIO ever made!

COMPLETE TRAINING FOR BETTER RADIO-TV SERVICE JOBS

These two giant Ghirardi home training manuals make it easy for you to be an expert on ALL types of TV-AM-FM service . . . at only a fraction of the price you might expect to pay for such complete training. Almost 1500 pages, over 800 clear illustrations and dozens of procedure charts explain each detail of every service job as clearly as A-B-C. Each book contains up to the minute data. Each is based on approved professional methods. You learn time-saving shortcuts. You learn to work better, more profitably. Ideal as complete training for beginners or as a handy reference library for experienced servicemen who want to look up puzzling jobs or develop new and faster methods.

A complete guide to TROUBLESHOOTING & REPAIR

① This 820-page **Radio & TV TROUBLESHOOTING AND REPAIR MANUAL** guides you through each service procedure . . . from locating troubles to making repairs fast and right. Step-by-step charts cover practically every type of troubleshooting from Television problems to AM and FM re-tuning to IF and Detector Sections, car radios, record players, communications receivers, etc. 417 illustrations. Price \$10 separately.

The complete "know how" of SET CIRCUITS & OPERATION

② Learn all about circuits and their peculiarities and watch your service "headaches" disappear! This 649-page **Radio & TV Receiver CIRCUITRY AND OPERATION** manual covers all basic circuits and circuit variations used in modern home equipment; explains their likely trouble spots; teaches you to go right to the seat of trouble without useless testing; helps you develop fast, true professional service techniques. Price \$9 separately.

SAVE \$2.00 under this offer:

If sold as a course and sent to you in lesson form, you'd regard these two famous manuals as a bargain at \$100 or more. Instead you buy them complete in handy book form for only \$17 for the two (regular price \$19.00). You save \$2.00 . . . No lessons to wait for! Everything is at your finger tips. You learn fast . . . and you learn right! OUR MONEY-BACK GUARANTEE PROTECTS YOU FULLY!

STUDY 10 DAYS FREE!

Dept. RN-41 Technical Division,
HOLT, RINEHART and WINSTON, Inc.,
383 Madison Ave., New York 17, N. Y.

Send books below for 10-day FREE EXAMINATION. In 10 days I will either remit price indicated (plus postage) or return books postpaid and owe you nothing:

Radio & TV TROUBLESHOOTING & REPAIR (\$10 separately)

Radio & TV CIRCUITRY & OPERATION (\$9 separately)

MONEY-SAVING COMBINATION OFFER . . . Save \$2.00! Send both big books at special price of only \$17 for the two (regular price \$19 . . . you save \$2.00!)

Save! Send cash with order and we pay postage. Same 10-day return privilege with money refunded.

Name

Address

City, Zone, State

Outside U.S.—TROUBLESHOOTING & REPAIR \$10.50; CIRCUITRY & OPERATION \$9.50; both books \$18. Cash with order, but 10-day return privilege with money refunded.

Within the Industry

WILL RAYMENT, president of *Sargent Rayment Co.*, has resigned his post to join the *Fisher Berkeley Corporation* as executive vice-president.



He joined *Sargent Rayment* in 1947 and served as chief engineer and general sales manager from 1950.

In his new job with the Emeryville, California manufacturer of intercoms and commercial sound systems, Mr. Rayment will concentrate on sales and the development of new products for industrial and commercial sound applications.

WESCON, the Western Electronic Show and Convention which will convene at the Cow Palace in San Francisco on August 22, 23, 24, 25, 1961, has named its principal executives for the 1961 show.

Albert J. Morris, of *Radiation at Stanford*, is chairman of the board while O. H. Brown, of *Eitel-McCullough*, will serve as chairman of the executive committee. Convention director is Dr. John V. N. Granger of *Granger Associates* and Calvin K. Townsend, of *Jennings Radio Corporation*, has been appointed show director.

Board members who will participate in the general policy of WESCON 1961 are Bruce S. Angwin of *General Electric*; Donald C. Duncan of *Duncan Electronics*; S. H. Bellue of *Osborne Electronic Corporation*; and Edward C. Bertolet of *Behlman Engineering*.

BERNARD REICH is now president of *Molecular Electronics Inc.*, a wholly owned subsidiary of *Precision Circuits, Inc.* . . . ROBERT E. MILLER has been elected to the new position of vice-president for advanced development by the board of directors of *Melpar, Inc.* . . . DR. GEORGE CARYOTAKIS is manager of the newly

formed high-power laboratory of *Eitel-McCullough*. . . CHARLES K. TITUS has joined the staff of the Communication and Data Processing Division of the *Collins Radio Company* as manager of the scientific analysis and programming department. . . PHILLIPS N. BUFORD has joined *Page Communications Engineers, Inc.*, a subsidiary of the *Northrop Corporation*, as senior staff engineer in the research and development directorate. . . JAMES K. DRAPER is now manager of engineering at *International Electric Industries, Inc.*, Nashville, Tenn. . . *Hollywood Radio and Electronics, Inc.* announces the election of DONALD AARONS as vice-president and member of the board. . . J. A. BRUSTMAN has been appointed manager, electronic system engineering of the Advanced Systems Development Engineering Activity, *RCA's Electronic Data Processing Division*. . . DR. WILLIAM O. BAKER, vice-president-research of *Bell Telephone Laboratories*, has been elected to the Board of Trustees of the Rockefeller Institute. . . *Essex Wire Corporation* announces three major executive appointments within its *Chicago Standard Transformer Division*: WILLIAM E. WILSON will be vice-president and general manager; JACK D. HALL will assume the duties of vice-president, sales and marketing; and KARL F. CREASE will be vice-president in charge of manufacturing. . . DR. TREVOR LAW, a former member of the technical staff at *Bell Labs*, has been named senior engineer of the materials department at *Motorola Semiconductor Products Division*. . . FRANK M. HICKEY is the new manager of industrial products sales for *CBS Electronics*. He was formerly merchandising manager of industrial products.

AUSTIN C. LESCARBOURA, who for the past 35 years has headed his own advertising agency, was recently tendered a dinner on the occasion of his 50th anniversary in the radio-electronic industry.

One of the wireless pioneers, he began his career as a ham in 1907. He served as assistant engineer for *Telefunken Wireless Telegraph Co.* and participated in some of the early wireless telephone demonstrations. He worked for *Electro Importing Co.*, a firm specializing in supplying the needs of the radio amateur. He was the editor of "Modern Electrics" and "The World's Advance" (now "Popular Science Monthly"), as well as managing editor of "Scientific American" from 1915-24.

He is the author of six books and innumerable articles in magazines, newspapers, and trade journals. He is a fellow of the Radio Club of America, a Senior Member of the IRE, as well as the recipient of an impressive number of honors.

His many friends in the industry and ham fraternity join in wishing "A.C." a long and happy "retirement."

Motorola Semiconductor Products Division. . . FRANK M. HICKEY is the new manager of industrial products sales for *CBS Electronics*. He was formerly merchandising manager of industrial products.

MOTOROLA INC. will move its corporate headquarters to its new administration building in Franklin Park, Illinois. The new \$7.5-million structure, at 9401 West Grand Ave., encompasses a total area

BREAK THROUGH TO HIGHER PAY

in ELECTRONICS

TV-RADIO

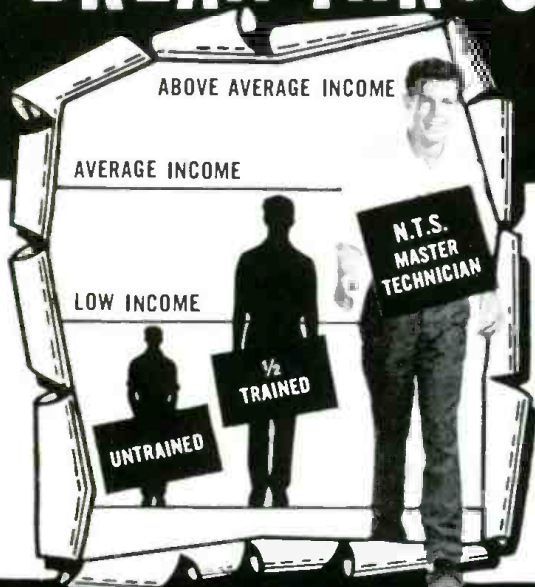

START NOW! Break through the Earning Barrier that stops half-trained men. N.T.S. "All-Phase" training prepares you — at home in spare time — for a high-paying CAREER in Electronics — TV — Radio as a MASTER TECHNICIAN. One Master Course at One Low Tuition trains you for unlimited opportunities in All Phases: Servicing, Communications, Preparation F.C.C. License, Broadcasting, Manufacturing, Automation, Radar and Micro-Waves, Missile and Rocket Projects.

A more rewarding job... a secure future... a richer, fuller life can be yours! As an N.T.S. MASTER TECHNICIAN you can go straight to the top in industry... or in your own profitable business.

You work on actual job projects

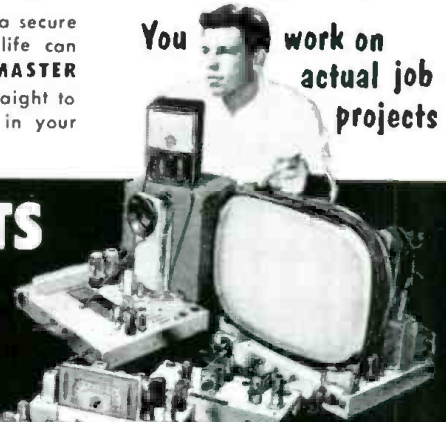

SUCCEED IN MANY HIGH-PAYING JOBS LIKE THESE...

- TV-Radio Sales, Service and Repair
- Profitable Business of Your Own
- Communications Technician — F.C.C. License
- Hi-Fi, Stereo & Sound Recording Specialist
- TV-Radio Broadcasting Operator
- Technician in Computers & Missiles
- Electronics Field Engineer
- Specialist in Microwaves & Servomechanisms
- Expert Trouble Shooter
- All-Phase Master Technician

19 BIG KITS YOURS TO KEEP

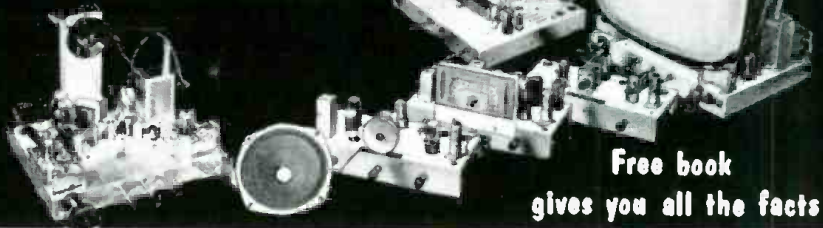

Free book gives you all the facts

NATIONAL TECHNICAL SCHOOLS

WORLD-WIDE TRAINING SINCE 1905
4000 S. FIGUEROA ST., LOS ANGELES 37, CALIF., U.S.A.
Write Dept. RH-41



RESIDENT TRAINING AT LOS ANGELES

If you wish to take your training in our Resident School at Los Angeles, the world's TV capital, start NOW in our big, modern Shops, Labs, and Radio-TV Studios. Here you work with latest Electronic equipment — professionally installed — finest, most complete facilities offered by any school. Expert friendly instructors. Personal attention. Graduate Employment Service Help in finding home near school — and part time job while you learn.

WRITE FOR SPECIAL RESIDENT SCHOOL CATALOG AND INFORMATION



ACCREDITED MEMBER... the only nationally recognized accrediting agency for private "home study" schools.

N.T.S. Shop-Tested HOME TRAINING is Better, More Complete, Lower Cost... and it is your key to the most fascinating, opportunity-filled industry today!

YOU LEARN QUICKLY AND EASILY THE N.T.S. SHOP-TESTED WAY

You get lessons, manuals, job projects, unlimited consultation, graduate advisory service.

You build a Short Wave-Long Wave Superhet Receiver, plus a large-screen TV set from the ground up, with parts we send you at no addi-

tional cost. You also get a Professional Multimeter for your practical job projects.

EARN AS YOU LEARN... WE SHOW YOU HOW!

Many students pay for entire tuition — and earn much more — with spare time work they perform while training. You can do the same... we show you how.

SEND FOR INFORMATION NOW... TODAY! IT COSTS YOU NOTHING TO INVESTIGATE.

N.T.S. HOME TRAINING is

- Classroom Developed
- Lab-Studio Planned
- Shop-Tested
- Industry-Approved
- Specifically Designed for Home Study

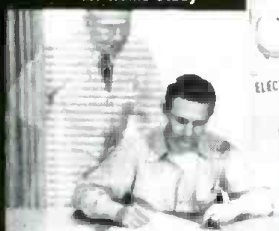

MAIL COUPON NOW for FREE BOOK and ACTUAL LESSON

NO OBLIGATION! NO SALESMAN WILL CALL

NATIONAL TECHNICAL SCHOOLS

WORLD-WIDE TRAINING SINCE 1905

Mail Now To National Technical Schools, Dept. RH-41 4000 S. Figueroa St., Los Angeles 37, Calif.

Please rush FREE Electronics-TV-Radio "Opportunity" Book and Actual Lesson. No Salesman will call.

Name _____ Age _____

Address _____

City _____ Zone _____ State _____

Check here if interested ONLY in Resident Training at Los Angeles.

VETERANS: Give date of discharge _____

**Assemble your kit
faster and better
with the tool that
makes soldering
a cinch**



**Weller®
DUAL HEAT SOLDERING GUN KIT**

Strong, noise-free soldered connections are the most important and time consuming operation in kit building. That's why a Weller Dual Heat Gun is a *must*. Instant heat saves time. Spotlight illuminates your work. 2 trigger positions give 2 soldering temperatures — low 90-watt heat for soldering near heat-sensitive components — high 125-watt heat for making chassis connections. Long life iron-plated copper tip provides superior heat transfer. Weller is the original Soldering Gun—used by virtually all electronic servicemen. On sale at your Electronic Parts Distributor.



Send for this booklet today—only 15¢

Fully illustrated, it tells how to make soldered connections simply and securely. Send your request to Weller Electric Corp., 601 Stone's Crossing Rd., Easton, Pa.

WELLER ELECTRIC CORP. EASTON, PA.

of 327,148 square feet and has provision for the addition of a lightweight sixth floor to increase the usable area by as much as 52,000 square feet . . . **ROBERTS ELECTRONICS, INC.** of Los Angeles is erecting a new \$1-million, 50,000-square-foot plant at 5918 Bowercraft Ave. The building will house the company's administrative offices as well as engineering and warehousing facilities . . . **PEERLESS RADIO DISTRIBUTORS** has acquired a new building in Lynbrook, Long Island to house its industrial electronic sales division. The new building contains 25,000 square feet of office and warehouse space. . . **GENERAL INSTRUMENT CORPORATION** has opened its new \$3-million, 50,000-square-foot plant, devoted exclusively to the development and mass production of semiconductors, at Hicksville, N.Y. . . . **GENERAL ELECTRIC COMPANY** plans to spend more than \$1-million this year to enlarge its present communications products department headquarters at Lynchburg, Va. . . . **REMINGTON RAND's Univac** military department has selected Roseville, Minn. as the site of its new 130,000-square-foot building. Occupancy is slated for late this Spring . . . **HARMAN-KARDON, INC.** has moved from Westbury, Long Island to its new 52,000-square-foot high-fidelity equipment plant at Plainview, Long Island.

ALBERT J. MORRIS has been elected president of *Radiation at Stanford* which is a newly formed subsidiary of *Radiation Incorporated*. Previously, he was senior vice-president-engineering for the *Levinthal Electronic Products Corporation*.



Mr. Morris was named a director of WESCON in 1958 and became convention chairman the following year. This year he is chairman of the board for the 1961 WESCON show and convention. He is a past chairman of the San Francisco section of the IRE, and is currently a director and member of the IRE's Executive and Operating committees.

Prior to joining *Levinthal*, he was Research Associate (Electronics) for the U. S. Navy Office of Scientific Research in San Francisco.

UTAH RADIO's stock has been acquired by **SERRICK CORPORATION** of Defiance, Ohio. The purchase will facilitate the expansion of the company's facilities and products in both the industrial and distributor electronic markets. The corporate structure of the company will remain unchanged. . . . The name of the **MARION INSTRUMENT DIVISION** has been changed to **PRECISION METER DIVISION**. The name change was made to more clearly identify the division's product line . . . **LIONEL CORPORATION** has acquired **TELERAD MANUFACTURING COMPANY** of New York by purchasing the firm's authorized, but unissued, common stock. The new subsidiary will be (Continued on page 74)

a college-level home study program in electronics ...for serious-minded men desiring higher income and status



CREI's Extension Division offers you a college-level home study program in electronics comparable in technological content to advanced residence courses.

CREI has developed a program of home study that is comparable in technological content to advanced residence courses in electronics. The program was developed hand-in-hand with leading companies and Government agencies contributing to the Nation's efforts in electronics, communications, missiles, and space exploration.

This CREI program in Electronics Engineering Technology may be completed in 2 to 4 years, depending on how much of your spare time you can devote to study. The courses are presented in easy-to-understand form. Our instructors will give you personal attention and assist you when you need help.

To qualify CREI graduates for advancement to key technical positions, CREI offers a complete program in electronics, including—

Automation • Instrumentation • Industrial Electronics
Aeronautical Electronics • Guided Missiles • Radar
Servo-mechanisms • Computers • Astronautics • Telemetering • Communications • Electronics Manufacturing
Field Engineering • Nuclear Engineering Technology

There is a drastic need in the electronics industry for well-educated engineers and technical personnel. Although the great majority of students find ample opportunity for advancement with their present companies, CREI maintains a Placement Bureau to assist graduates and advanced students in finding more desirable positions. For many years, the demand for CREI graduates and advanced students has far exceeded the supply.

• • • • •

Regularly across my desk, comes evidence that CREI's advanced Home Study Program in Electronics has provided an answer both for industry and for far-sighted men, who want to rise to higher levels of achievement. This evidence takes the form of letters from industry leaders and CREI graduates, who express their appreciation for the program and its value in their industry. These letters also state that advancements for CREI men are frequent and extensive. The CREI graduate may enjoy the benefits of new recognition, superior status and higher earnings as a result of his college-level electronics education.

*E. H. Rietzke, President
Capitol Radio Engineering Institute*

A few of the private companies and government agencies whose officials approve CREI for their own personnel:

U. S. Navy (5,240 enrolled in extension program)	Florida Power & Light
Army, Air Force, Marine Corps, Coast Guard	Pan American Airways
Columbia Broadcasting System	United Airlines
National Broadcasting Company	The Martin Company
Federal Electric Corporation	All America Cable & Radio
	Voice of America
	... and many others

***QUALIFICATIONS FOR CREI.** You qualify if you have a high school diploma or equivalent, and if you have had basic electronic training and practical experience in electronics. Available to Veterans.

Write for our detailed 56-page catalog giving you complete facts, CREI also offers a Residence School program that qualifies graduates for an AAS degree. Day and evening classes.



Mail this coupon ... today!

CAPITOL RADIO ENGINEERING INSTITUTE

ECPD Accredited Technical Institute Curricula • Founded 1927
Dept. 1104-H-3224 Sixteenth St., N. W., Washington 10, D. C.

England: CREI London, Granville House, 132-135 Sloane Street, London S.W. 1, England

Please send me your course outline and FREE 56-Page Book "Your Future in Electronics and Nuclear Engineering Technology"... describing opportunities and CREI home study courses in Advanced Engineering Technology.

Check field of greatest interest Radar, Servo and Computer Engineering Technology
 Electronic Engineering Technology
 Communications Engineering Technology
 Television Engineering Technology
 Aeronautical Electronic Engineering Technology
 Automation and Industrial Electronic Engineering Technology
 Nuclear Engineering Technology

Name _____ Age _____

Street _____

City _____ Zone _____ State _____

Check: Home Study Residence School Korean Veteran

To obtain fast, immediate service and to avoid delay, it is necessary that the following information be filled in:

Employed by _____

Type of present work _____

Education: Years high school _____ Other _____

Electronics experience _____



Latest Information

on the Electronic Industry

Spot News

By ELECTRONICS WORLD'S
WASHINGTON CORRESPONDENT

BRIGHT OUTLOOK SEEN FOR '61 INSTRUMENT SALES—Sales of scientific and industrial instruments are expected to increase substantially in 1961, Washington reported recently. The sales surge is projected because of government outlays and spending by industry. About \$500-million has been budgeted for Federal research and facilities, with many of these dollars allocated for the purchase of meteorological, geophysical, and similar instruments for these laboratories. Industry is expected to up their purchases to about \$800-million, an increase of \$120-million over 1960.

NAVY TO INSTALL 560,000-WATT SPACE SURVEILLANCE TRANSMITTER—The gap in the Navy's silent satellite detection system, stretching across the southern part of the country, will be plugged by one of the world's most powerful transmitters—a 560,000-watt installation 35 miles southwest of Wichita Falls, Texas, near Archer City. Five times as effective as the largest television transmitter, signals will be fed into a nine-section antenna, each section measuring 576 feet long and 24 feet wide, so arranged that one can be operative without affecting the other.

SATELLITE COMMUNICATIONS SHIP TO BE BUILT BY NAVY—The Bureau of Ships is now designing and developing equipment for a shipboard satellite communications terminal capable of communicating with two Army shore stations through the "Advent" satellite. Aimed at creating a military capability for high-capacity, secure, world-wide instantaneous communications using high-altitude hovering satellites, "Advent" will receive and amplify signals received from the earth and re-transmit them to other earth-bound stations. Orbiting at an altitude of 22,000 statute miles over the equator, "Advent's" period will be 24 hours, just sufficient to keep it hovering over a fixed point on the earth. At this height, the single satellite will be in direct line-of-sight of all points on earth enclosed in a circle 11,300 miles in diameter, centered just beneath the satellite. Thus there will be no reason to store messages received on tape for later repetition as is done by the satellite "Courier." Messages received by "Advent" will be transmitted immediately and with extensive channel capacity.

AIR FORCE TO ESTABLISH NEW COMMUNICATIONS SERVICE—The Air Force will set up a new command on July 1st to be known as the Air Force Communications Service. Headquartered at Scott Air Force Base, Illinois, the new command will be responsible for the operation and maintenance of all Air Force telecommunications point-to-point and air-to-ground on a global basis, including operation of Air Force terminal and en-route navigation aids.

FCC ISSUES EXPERIMENTAL GRANT TO BOUNCE SIGNALS OFF MOON—The Commission recently authorized ITT to build an experimental station to bounce signals off the moon and passive (non-radio-equipped) earth satellites for basic research and study of space communications theory. The grant, for but one year, specifies operation on 2120 mc. or 2299.5 mc. until July 1, after which only 2299.5 mc. may be used. The station, which will be in Nutley, N.J., will use input power of 10 kw. to a 40-foot steerable antenna for directing narrow-band transmission space-ward. The reflected signals will be received by the same station. See page 77 for photo.

ARMY MOBILE DIGITAL COMPUTER NOW IN EUROPE—The Army's first operational mobile digital computer (MOBIDIC), a large-scale unit designed for field combat use, has been moved in three 30-foot trailers from the Brooklyn Army Terminal to the Seventh Army in Europe. After arrival at the French port of St. Nazaire, the vans were driven across France to NATO quarters at Zweibrucken, West Germany, the Army's stock-control center. Here, the computer will serve to control thousands of supply requisitions for urgently needed items such as replacement parts for rockets, guided missiles, electronic warfare, air defense, combat surveillance, and atomic artillery.

\$38-MILLION TO BE SPENT FOR VOICE-OF-AMERICA RELAYS—Two major "Voice-of-America" relays, costing almost \$38-million, will be installed in Greenville, North Carolina and Monrovia, Liberia. The U.S. station, which will cost over \$25-million, will have a total available power output in excess of 4.8-million watts.

-30-

Proof! From the pages of the leading news magazines

of 1960...

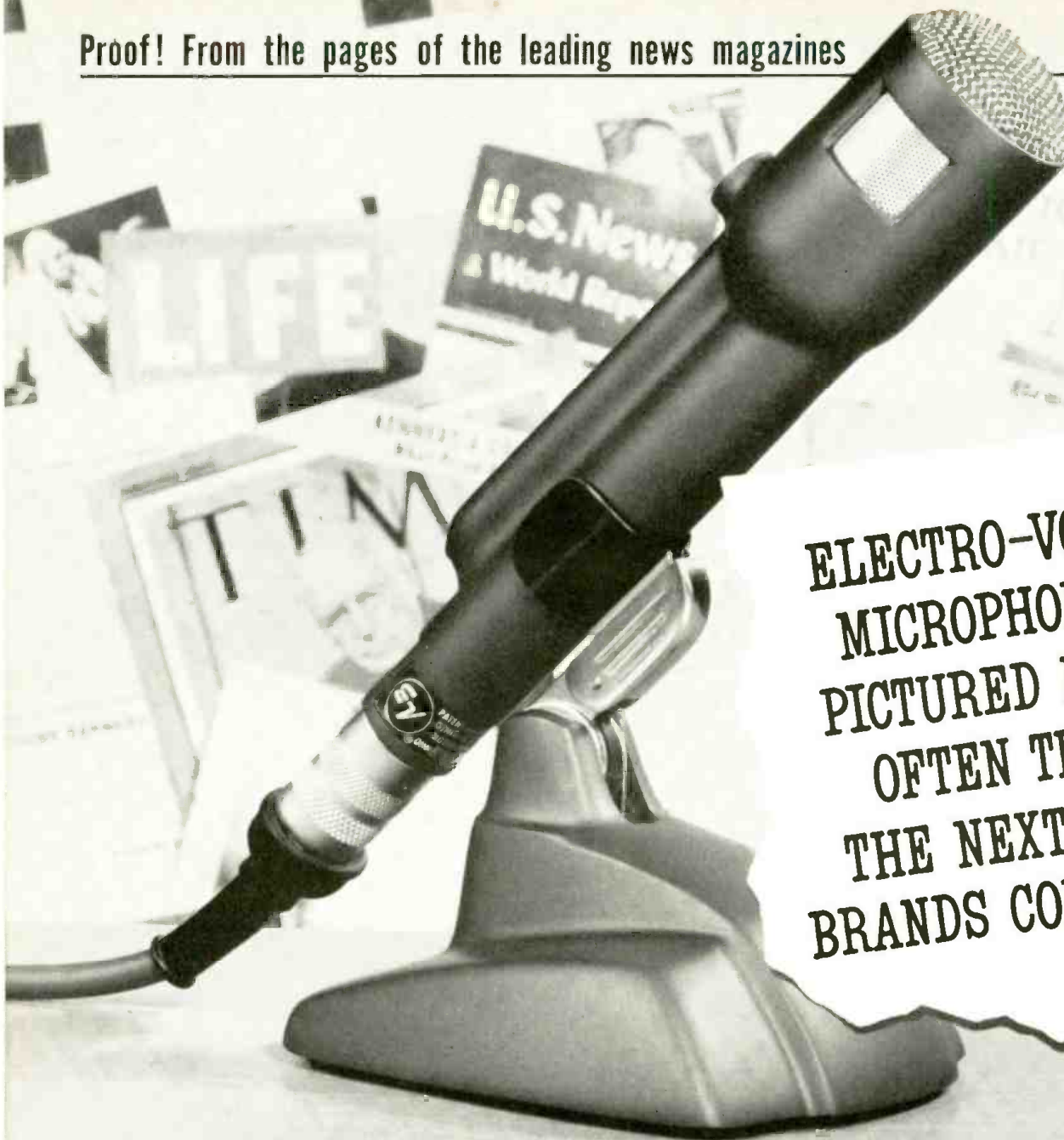

**ELECTRO-VOICE
MICROPHONES
PICTURED MORE
OFTEN THAN
THE NEXT FOUR
BRANDS COMBINED!**

In a thorough page-by-page, picture-by-picture analysis of the 1960 issues of Life, Time, Newsweek and U.S. News & World Report, Electro-Voice microphones were photographed at major news events more often than the next four brands combined. 87.3 per cent more often than any other single brand!

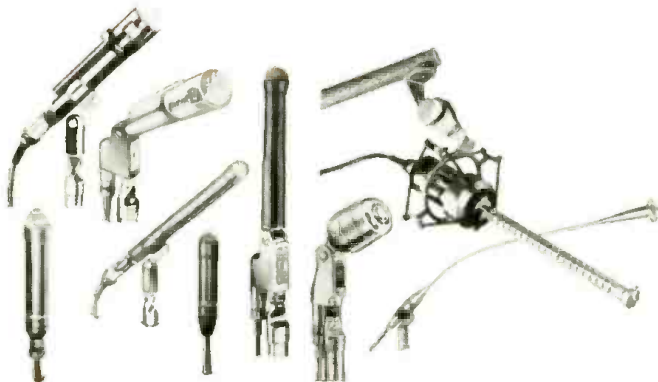

This survey is dramatic proof that throughout the world, TV, radio, newsreel and professional sound engineers depend on E-V quality and reliability. This clear-cut superiority will be yours when you choose your next microphone from the world's most complete line — Electro-Voice.

For full information on how E-V microphones can help you solve your most difficult sound pickup problems, write for our free, fact-filled catalog and the name of your nearby Electro-Voice microphone headquarters.

ELECTRO-VOICE, INC., Commercial Products Division, Dept. 411N, Buchanan, Michigan

Electro-Voice®

For window-size blowups of this message, send 10¢ to Sprague to cover handling and mailing costs.

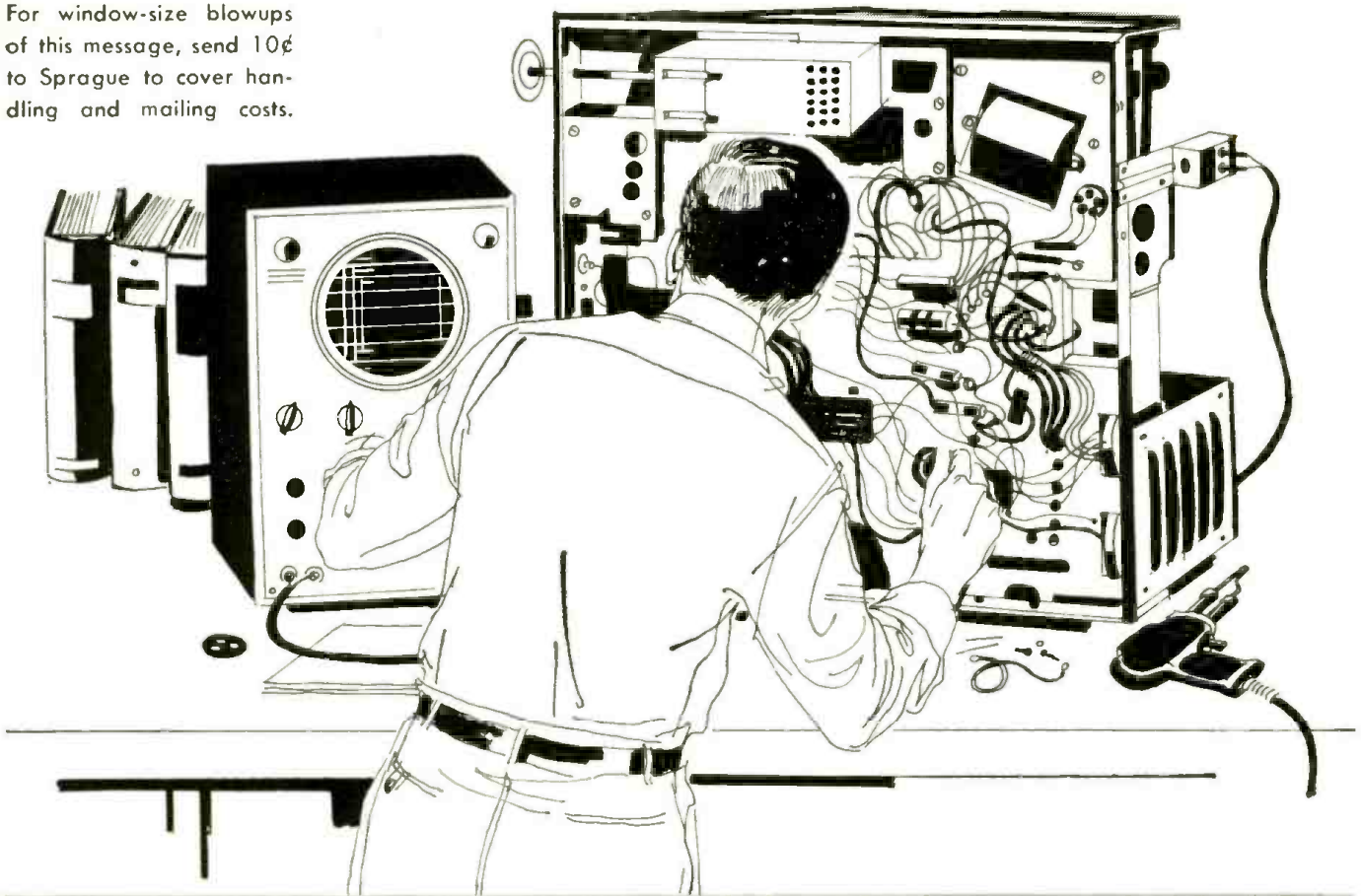

**More than 5600 ft. of circuitry ... 590 parts ...
and he has to know how to fix 'em all!**

YOUR TV SET is the most complicated piece of equipment you've ever owned. It represents a considerable investment of money. It provides your family with a wealth of entertainment pleasure. You value it highly.

Nobody is more aware of these facts than your neighborhood TV-Radio technician. And because he stakes his reputation on your satisfaction, *he strives to be worthy of your trust in him.* He achieves this by years of training and practice in electronic theory and application. He equips himself with expensive but essential test equipment, tools, and service

manuals. He spends countless hours keeping up-to-date on new developments, new circuits, new trouble-shooting techniques.

His training and experience qualify him as a modern, professional expert. As such, he asks a fair, professional price for his services. Since he will not use cut-rate methods or cut-rate parts in your TV set, he cannot offer cut-rate prices. *Remember, you get only your money's worth in TV-Radio service. When you are taken in by a "bargain-type" offer, you can expect to get "bargain-type" service. BEWARE THE SERVICE BARGAIN!*

**THIS MESSAGE WAS PREPARED BY SPRAGUE PRODUCTS COMPANY,
DISTRIBUTORS' SUPPLY SUBSIDIARY OF SPRAGUE ELECTRIC CO., NORTH ADAMS, MASS., FOR**

YOUR NEIGHBORHOOD TV-RADIO TECHNICIAN

DESIGNED

AS YOU WOULD DESIGN IF YOU WERE AN ELECTRONICS ENGINEER...

Praised by the experts as Best Buys... **EICO**



A
PEAK-TO-PEAK
VTVM #232 & UNI-PROBE #250
KIT \$29.95 WIRED \$49.95
U. S. Pat. No. 2,790,051



B
COLOR & MONOCHROME
DC TO 5 MC LAB & TV
5 OSCILLOSCOPE #460
KIT \$79.95 WIRED \$129.50

Also available:
5" Push-Pull
Oscilloscope #425
Kit \$44.95 Wired \$79.95



C
RF SIGNAL
GENERATOR #324
KIT \$26.95 WIRED \$39.95
Turn Page For More EICO Values

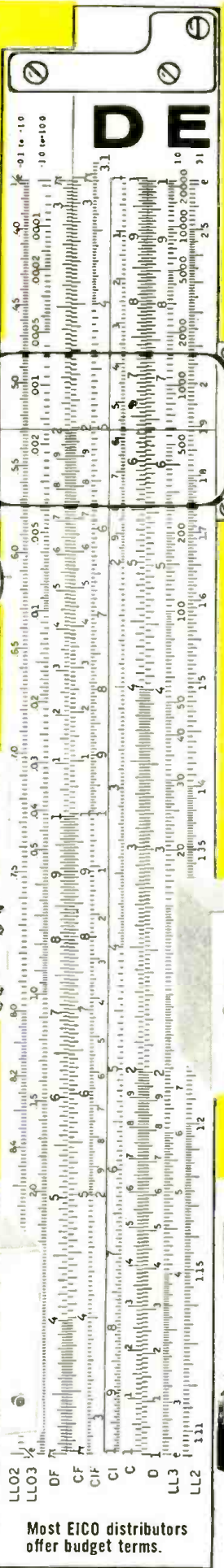

A By far the best professional VTVM value in electronics, nobody but EICO brings you such outstanding instrument performance for so low a price! Calibration without removing from cabinet. Measure directly p-p voltage of complex & sine waves: 0-4, 14, 42, 140, 420, 1400, 4200. DC/RMS sine volts: 0-1.5, 5, 15, 50, 150, 500, 1500 (up to 30,000 volts with HVP probe, & 250 mc with PRF probe). Ohms: 0.2 ohms to 1000 megs. 4 1/2" meter, can't-burn-out circuit. 7 non-skip ranges on every function. Zero center. Features EICO's exclusive UNI-PROBE: your terrific time-saver, performs all functions: a half turn of probe-tip selects DC or AC-Ohms!

B An engineering achievement unmatched in the industry! EICO-designed for laboratory precision and EICO-priced for lowest cost. Features DC amplifiers. Flat from DC to 4.5 mc, usable to 10 mc. Vert. Sens.: 25 mv/in.; input 2 3 megs; direct-coupled & push-pull throughout. 4-step frequency-compensated attenuator up to 1000:1. Sweep: perfectly linear 10 cps - 100 kc (ext. cap. for range to 1 cps). Pre-set TV V & H positions. Auto sync limiter & amplifier Direct or C coupling; balanced or unbalanced inputs; edge-lit engraved lucite screen with dimmer control.

C More features and versatility, more range and accuracy than in generators costing three to four times as much. 150 kc to 435 mc with ONE generator in 6 fundamental bands and 1 harmonic band! $\pm 1.5\%$ frequency accuracy. Colpitts RF oscillator directly plate-modulated by K-follower for improved modulation. Variable

depth of internal modulation 0-50% by 400 cps Colpitts oscillator. Variable gain external modulation amplifier; only 3 volts needed for 30% mod. Turret-mounted, slug-tuned coils for max. accuracy. Fine & Coarse (3-step) RF attenuators. RF output 100,000-uv, AF output to 10 v.

D Provides more ranges, greater ease and accuracy, and better performance than any competitive unit. Entirely electronic sweep circuit with accurately-biased inductor for excellent linearity. Extremely flat RF output. Exceptional tuning accuracy, Hum & leakage eliminated. 5 fundamental sweep ranges: 3-216 mc. Variable marker range: 2-75 mc in 3 fund. bands, 60-225 mc on harmonic band. 4.5 mc crystal marker osc., crystal supplied. Ext. marker provision. Attenuators: Marker Size, RF Fine, RF Coarse (4-step decade). Narrow range phasing control for accurate alignment.

E Speedy, simple operation, unexcelled sensitivity and accuracy; superb electrical and mechanical design. Tests all receiving tubes (picture tubes with adapter), n-p-n and p-n-p transistors. Composite indication of Gm, Gp & peak emission. Simultaneous selection of any one of 4 combinations of 3 plate voltages, 3 screen voltages, 3 ranges of continuously variable grid voltage (with 5% accurate pot.). Sensitive 200 ua meter. 10 six-position lever switches; freepoint connection of each tube pin. 10 push-buttons; rapid insert of any tube element in leakage test circuit. Direct reading of inter-element leakage in ohms. New gear-driven rollchart. CRA Adapter \$4.50.



D
TV-FM SWEEP GENERATOR
& MARKER #368
KIT \$69.95 WIRED \$119.95

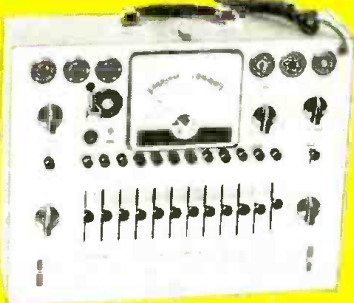

E
DYNAMIC CONDUCTANCE
TUBE & TRANSISTOR
TESTER #666
KIT \$69.95 WIRED \$109.95
Complete with steel cover and handle



All Transistor
Portable RA-6
Kit \$29.95
Wired \$49.95
less battery



Power & Bias
Supply for
Transistorized
Eqt. #1020
Kit \$19.95
Wired \$27.95



DeLuxe
Multi-Signal
Tracer #147
Kit \$24.95
Wired \$39.95



Tube Tester #625
Kit \$34.95
Wired \$49.95
Pix Tube Test
Adapter \$4.50



6 & 12V Battery
Eliminator
& Charger #1050
Kit \$29.95
Wired \$38.95
#1060 Kit \$38.95
Wired \$47.95



V-O-M #565
Kit \$24.95
Wired \$29.95
V-O-M #536
Kit \$12.90
Wired \$14.90



R-C Bridge & R-C-L
Comparator #950B
Kit \$19.95
Wired \$29.95

EICO 33-00 Northern Blvd., L. I. C. 1, N. Y. EW-4
Show me HOW TO SAVE 50% on Test Instruments
 Hi-Fi Ham Gear. Send me FREE Catalog, name
of neighborhood dealer. Send free Short Course
for Novice License.

Name

Address

City..... Zone..... State.....

Most EICO distributors offer budget terms.

EXPORT: Roburn Agencies, Inc., 431 Greenwich St., New York 13, N.Y.

SEE OUR OTHER ADVERTISEMENT ON PAGE 117

1961-EICO-33-00 N. Blvd., L. I. C. 1, N. Y. Add 5% in the West

*dedicated
to
perfection*



4-TRACK STEREO TAPE DECK

MODEL RP-100W

Completely assembled, wired and tested. **\$395.00**

MODEL RP-100K

Semi-kit includes a completely assembled and tested transport, electronics in kit form. **\$289.95**

Perfected 4-track stereo/mono recording, 4 & 2 track playback. True high fidelity transistor electronics, individual for record & playback, plus separate record & playback heads permitting off-the-tape monitor. 2 recording level meters, mixing, mic & level controls, switched sound-on-sound recording. Electrodynamically braked supply & take-up reel motors; hysteresis synchronous capstan motor; individual solenoids for pinch-roller & tape lifters. All-electric, interlocked push-button transport control & interlocked safety "record" pushbutton. Precision tape guidance & sweep loading — no pressure pads. No slurring or tape bounce problems. Digital turns counter. Vertical or horizontal mounting. Modular plug-in construction. An original, exclusive EICO product designed & manufactured in U. S. A. (patents pending).

NEW MEDALIST LINE

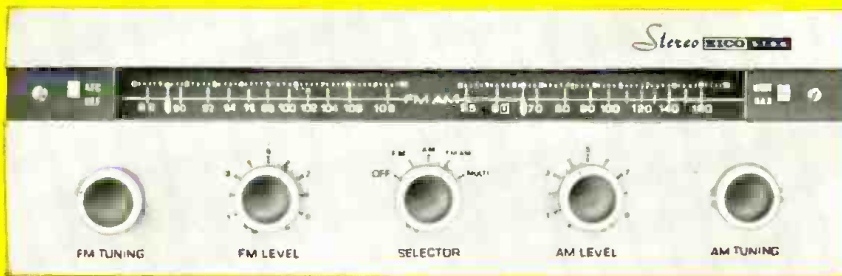

FM-AM STEREO TUNER ST96

Kit \$89.95 Includes Metal Cover and FET Wired \$129.95

FM and AM stereo tuners on one compact chassis. Easy-to-assemble: prewired, prealigned RF and IF stages for AM and FM. Exclusive precision prewired EYE-TRONIC® tuning on both AM and FM.

FM TUNER

Switched AFC (Automatic Frequency Control). Sensitivity: 1.5uv for 20db quieting. Frequency Response: 20-15,000 cps ± 1db.

AM TUNER

Switched "wide" and "narrow" bandpass. High Q filter eliminates 10 kc whistle. Sensitivity: 3uv for 1.0V output at 20db S/N ratio. Frequency Response: 20-9,000 cps ("wide"); 20-4,500 cps ("narrow").

OF EICO STEREO



70-WATT INTEGRATED STEREO AMPLIFIER ST70

Kit \$94.95 Includes Metal Cover Wired \$144.95

40-WATT INTEGRATED STEREO AMPLIFIER ST40

Kit \$79.95 Includes Metal Cover Wired \$124.95

BOTH AMPLIFIERS: Complete stereo centers plus two excellent power amplifiers. Accept, control, and amplify signals from any stereo or mono source.

ST70: Cathode-coupled phase inverter circuitry preceded by a direct-coupled voltage amplifier. Harmonic Distortion: less than 1% from 25-20,000 cps within 1db of 70 watts. Frequency Response: ± 1/2 db 10-50,000 cps.

ST40: Highly stable Williamson-type power amplifiers. Harmonic Distortion: less than 1% from 40-20,000 cps within 1 db of 40 watts. Frequency Response: ± 1/2 db 12-25,000 cps.

Over 2 MILLION EICO instruments in use. Most EICO Dealers offer budget terms.

There's an EICO for your every stereo/mono need. Send for FREE catalog.

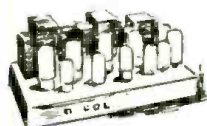

EICO, 3300 N. Blvd., L.I.C. 1, N. Y. Ew-4
 Send free 32-page catalog & dealer's name
 Send new 36-page Guidebook to HI-FI for which I enclose 25¢ for postage & handling.
 Name
 Address
 City Zone State

Add 5% in West. Turn Page For More EICO Values.

Listen to the EICO Hour, WABC-FM, N. Y. 95.5 MC, Mon.-Fri., 7:15-8 P.M. © 1961 by EICO, 33-00 N. Blvd., L. I. C. 1, N. Y.

COLOR

TV SERVICE TODAY

By CHARLES TEPFER

Are there enough color sets to bother about? Can independents get the work? Can they handle it?

MANY YEARS have passed since the independent service technician was first told that he had to get ready to handle color receivers, and that he couldn't waste much time about it either. Many things were implicit in this statement, which he heard from the manufacturers, from the magazines he read, and in lectures at service-association meetings. It meant that there would soon be many color sets in use all over the country. It also meant that the independent was the man who would be called on to install, adjust, and repair this equipment.

What actually happened was something very different from this. The public was slow to buy. Today, in fact, only about one TV-viewing household in a hundred owns a color receiver. The overwhelming number of these sets were made by *RCA*, and most of these were sold with service contracts to be fulfilled by the *RCA Service Co.* Some independents, who in their eagerness to get an early jump, actively read up on the subject and even picked up color-bar generators and other accessories, have since had occasion to look ruefully at the layer of dust gathering on such paraphernalia. And writers stopped pushing the "get-ready-for-color-now" theme.

How has the situation changed, if at all? Does it even pay to read further in this article? Let's look at the signs.

The leading manufacturer, *RCA*, reports that the percentage increase in

color sales is spiraling upward. An optimistic statement, by itself, may be nothing more than whistling in the dark. However, it is a fact that this manufacturer is expanding its facilities significantly for producing both the three-gun picture tubes and the sets.

At the beginning of the color "boom" that never took place, at least half a dozen other set makers came out with color models. No significant quantity of these sets was sold. As a result, most manufacturers eventually withdrew, many of them saying that they would not get back into color until they could do so profitably. Today they are definitely coming back. *Admiral*, *Packard-Bell*, and *Magnavox* are some of those now selling color sets. *Emerson* has announced its definite intention of doing so. Others are being heard from as this is being written. These people are entering the field with the intention of staying and making a profit.

This still does not make a boom, but it does suggest a marked upward trend, and it is supported by other signs. The earliest color sets went to well-to-do buyers or to owners of such public places as bars and restaurants. Ownership of color TV was a mark of status, much as is ownership of a *Cadillac*. Today's statistics show that a very large percentage of such receivers are being bought on the installment plan. Members of the so-called lower-middle class are prominently represented in this group. Check a suburban area like that



Fig. 1. A degaussing coil is being used to demagnetize a color picture tube.

in Levittown, N. Y. and you get a surprise when you talk to service dealers. You say, "Not doing much on color, are you?" and they answer, "Well, you'd be surprised..." They then go on to tell you how many of their customers own or are now buying color TV.

Well, then, color really is on the way in. But does the independent shop get a chance to work on the sets? To answer this, let's start out with a familiar, full-page ad frequently run by RCA. "21-inch living color with only 8 more tubes than a black and white set," reads one. A large photo shows the top of a color-TV chassis. It is neat and looks relatively uncomplicated. "Servicing is so easy," the ad continues, "that most adjustments can be made without removing the back of the set. Components

give him a try? What can you lose?

Very well, you can get the work—but can you handle it? You probably can, and without much trouble. It is true that the latest color sets are simpler to adjust and service and less critical in operation. This is the result of continuing refinement in recent years, rather than radical change. It is true that most defects are identical with or similar to the ones you will run into on black-and-white sets. It is true that the faults peculiar to color circuits only still involve basic circuits that are familiar and should yield to conventional troubleshooting.

We will not attempt to prove the point with an exhaustive treatment of the theory and practice of color servicing. This has been done many times, al-

pens with black-and-white sets. Also, in many cases, it is not even necessary to demagnetize the color picture tube.

You remember that the picture tube and associated components often would pick up a residual magnetism in shipment because the tube, in the packing case, was moved through various magnetic fields (the earth's and others) during shipment. This would affect color purity and the tube had to be demagnetized with a large degaussing coil (Fig. 1) when the set was installed. Not only that, but this step was often necessary even when the set was moved within the same room in a home. Well, in many cases this is out. The picture tubes have closer tolerance in manufacture. Even more important, they are now all glass and do not have the mag-



Fig. 2. Compare new CRT shield (left) with old shield (right).

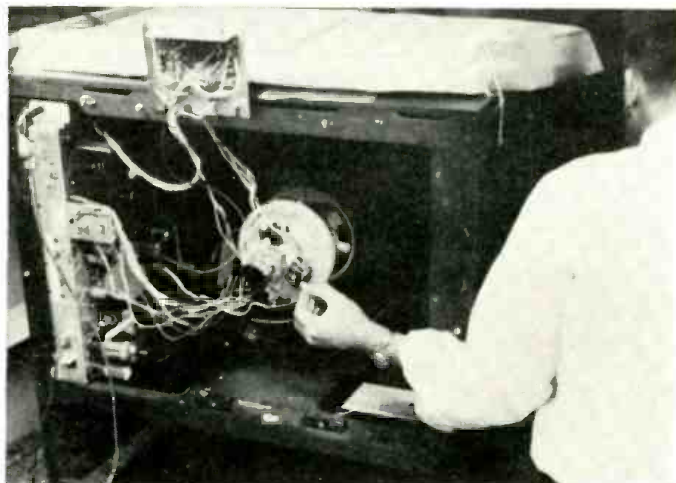

Fig. 3. Adjusting the convergence magnets in the yoke assembly.

used in color receivers provide superior performance and dependability as proved by actual life and performance tests."

How much truth there is in this claim involves another question, which we will get to later. The important thing is that, true or not, the public appears to be accepting it. Buyers know that the charge for installation and a 1-year service contract, which cost \$100 in 1959, is down to \$70 today. They also know that, whereas they started with service contracts on their monochrome sets many years ago, they soon found it cheaper to drop them and rely on individual service calls. In addition, the new buyers—who must watch dollars more carefully—can make a considerable saving at the time they decide to buy color by eliminating the contract. Add to this the fact that earlier buyers have actually found that they get little opportunity to use the service contracts they have paid for. Many of them do not renew.

Initially these color-TV owners without contracts doubtless feel that they can call the service company on a single-call basis when trouble occurs. However, when the defect develops, they tend to do the same thing they did with their black-and-white sets: The local independent is faster and probably less expensive. If he has proved dependable on monochrome TV and lets it be known that he can handle color too, why not

be it not recently. However, it will be useful to compare some of the "special" techniques still required today with these same procedures as they were performed just a few years ago.

The Improvements

Among the greatest headaches in color purity and convergence adjustments are the back-and-forth controls. You know the kind—first you adjust one control and then you go to another and then back to the first to touch it up, and then to the second again, and so on. This is not entirely eliminated in the new sets, but it is dramatically reduced. Adjustments are more positive and fool-proof.

Second, during initial installation, it is no longer necessary to go through an elaborate set-up procedure. The sets work as soon as they are plugged in. Sure, some will not, but this also hap-

netically sensitive metallic shells.

Third, the author actually timed a complete "kine" replacement. From start to finish it took 13 minutes! This included all necessary color purity and convergence adjustments and a general touch-up of the set. Admittedly this was done by an expert, but he did not depart in any radical way from the step-by-step instructions contained in the service manual for the set. One of the reasons this is possible in the new sets is that it is no longer required to take the complete chassis out of the cabinet to change the CRT. Now, the cabinet is so arranged that the kine is in a harness right up at the safety glass and is simply locked into place. There is adequate clearance for the tube to be removed without jabbing into the high-voltage cage or other part of the chassis. Also, the CRT no longer wears the cumbersome corset shield of metal and plastic it once did. Now, it is protected by a much smaller shield which slips on as easily as a two-way stretch on a slender girl. The old and new shields are shown in Fig. 2.

Forget all about rim magnets for equalizing the magnetic field, forget about retaining rings and yoke shields. forget about turning the set down on its face on the floor. Replacing the kine in the new color sets is just about the same as for black-and-white tubes, mechanically that is. Now we come to the

Fig. 4. Most electrical adjustments for the CRT are located at rear of chassis.

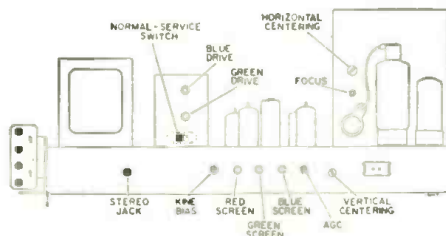

kicker: what about the color adjustments?

Color Adjustments

We said that the new color sets are more stable than their predecessors. What do we mean by stability? When you can set all rear-apron and interior chassis controls so that the set will operate satisfactorily with only minor and infrequent adjustment of the viewer controls, you have stability. The viewer controls on new color sets are: "on-off," volume, channel selector, fine tuning, color, tint, brightness, contrast, horizontal-hold, vertical-hold, and sometimes, sound tone. All other controls are interior ones, and not meant for the viewer to adjust. If the color set has been operating satisfactorily up until

First, turn the set on and adjust it for a good black-and-white picture. This of course involves the focus, linearity, hold, picture-size, and contrast adjustments. Next, connect a dot generator to the receiver, either at the antenna-input terminals (if the generator has a modulated r.f. output) or to some other points in the receiver according to the instructions for your instrument. Now adjust the red, green, and blue magnets in the deflection-yoke assembly (Fig. 3) to produce white dots in the center of the screen. The yoke assembly now contains these small plastic encased bar magnets. The convergence magnets are no longer on a separate ring as was the case in former sets.

The next step, demagnetizing the CRT, may or may not be necessary.

Now you are ready for the heart of the operation, the purity and convergence adjustments. Hold on to your hats, we'll race through them.

To obtain purity, we want a field of one color only—red. So we temporarily cut off output from the blue and green guns by manipulating the two appropriate controls available at the rear of the set (Fig. 4). Slide the entire yoke assembly back on the tube's neck and rotate the purity magnet (on the neck behind the yoke). At the same time, adjust the tabs on the magnet until you get a uniform red at the center of the CRT face. Now move the yoke forward against the bell of the tube, and adjust to obtain a completely uniform red screen.

At the rear of the set (Fig. 4), there



Fig. 5. Guns are balanced with vertical deflection killed.

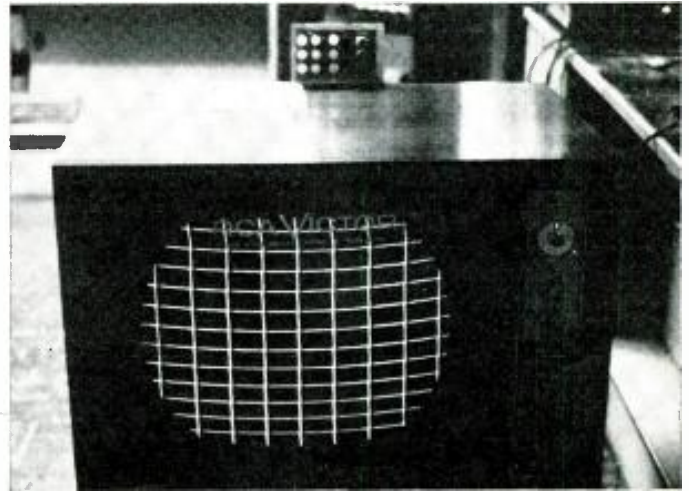

Fig. 6. Rear-mounted convergence-control board is swung up.

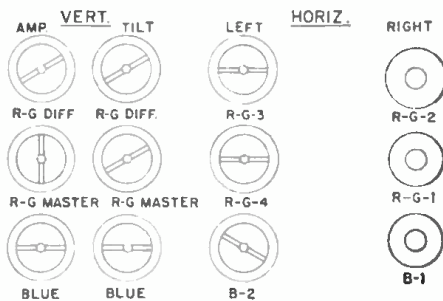

Fig. 7. Detail shows twelve adjustments mounted on the convergence-control board.

the time when the kine has to be replaced, because of age or some other reason confined to the picture tube, then chances are that the amount of color-control adjustment necessary will be minor. What happens though if this isn't the case, if the color set does need the complete "soup to nuts" color-adjustment job?

It is not our intention to go through a complete procedure. If you are faced with the necessity of doing this, better use the service-data manual for the specific set as a guide, although you will probably not need to after you have done it two or three times. However, a quick run-down on the new technique will allow you to compare it with the previous time-consuming, back-and-forth fiddling of the many controls.

However, it is a good precautionary measure in order to assure maximum color purity. To do this, use a degaussing coil 12 inches in diameter and made of 425 turns of number 20 enamel-covered copper wire (Fig. 1). Tape up the coil and connect the ends to a conventional line cord and plug so that it may be plugged into the a.c. line. Plug in the degaussing coil and slowly move it around in front of the kine face; then slowly withdraw to a distance of at least five feet before you remove the plug.

is a two-position "Normal-Service" switch. Flip it into the "Service" position, in which video and vertical-deflection circuits are cut out. The result, on the tube's face, is a horizontal trace (Fig. 5). Advance each of the color screen controls on the chassis so that the horizontal lines produced by each color are of equal brightness. You may have to touch up the bias control on the rear apron to bring up the brightness if you have trouble seeing a particular

(Continued on page 118)

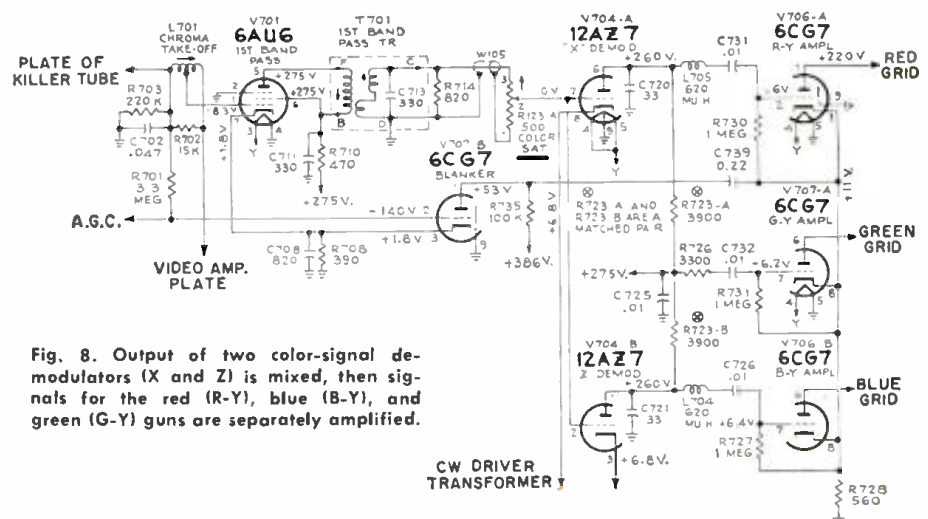

Fig. 8. Output of two color-signal demodulators (X and Z) is mixed, then signals for the red (R-Y), blue (B-Y), and green (G-Y) guns are separately amplified.

Speech Clipper For CB Transceiver

By IRVING KRAUSE & GERALD WILNER

Increase the talk-power of your CB rig by building this simple transistorized speech-clipper circuit.

IF YOU HAVE constructed your own CB transceiver (see March 1959 issue of *ELECTRONICS WORLD*), then you know what a job it is to try and squeeze the last bit of power out of your transmitter and still stay within the legal FCC power input limit. Here's a suggestion for increasing the apparent output power of your transmitter without touching the transceiver itself. The method is well-known to hams and is commonly known as "speech clipping."

An analysis of ordinary speech will show a number of sharp peaks, as indicated in Fig. 1. This shows that the peaks, being so much larger in amplitude, tend to bring the average level, or

it would give rise to "splatter," creating unwanted additional sidebands. This, of course, would invite a citation from the FCC. In order to avoid this situation, a low-pass filter with a cut-off of about 3200 cycles is inserted after the clipper, which attenuates any higher order harmonics that may have been generated by clipping.

Speech clipping as high as 20 db may be accomplished before it affects intelligibility. It will be observed, however, that the "naturalness" of the voice decreases but the normal amount of clipping will actually increase intelligibility at a distant receiver because of the increase in sideband power.

Construction of the unit is neither difficult nor critical. The speech clipper was built in a small chassis box measuring 1 3/4" x 2" x 4". This particular unit was designed for a carbon microphone (Fig. 2) but if you are using a crystal, dynamic, or ceramic unit use the circuit suggested in Fig. 3. In this case, an additional mike preamp (V₃) is used and the circuit of V₁ is modified. *Note:* In order to use a carbon microphone in conjunction with the original circuit, the grid of the 12AX7 was grounded and the microphone connected to its cathode. Thus the 12AX7 is supplied operating bias.

The microphone is fed into the emitter of V₁, which supplies the operating bias for the carbon microphone. A greatly amplified signal appears across the clipping level pot, R₂, which is then clipped by the zener diode, CR₁. Because the capacitor C₂ is large, the leakage increases the efficiency of the diode and the zener diode can be connected either way.

The resultant signal is fed through the low-pass filter consisting of C₄, C₅, and RFC₁, whose cut-off is about 3200 cycles. An emitter-follower, V₂, drives the succeeding circuitry (cathode of tube for carbon microphone and grid for crystal mike). Capacitor C₇ must be inserted if the speech clipper is to be used ahead of a crystal microphone input.

Just a word of warning. It is entirely possible that overmodulation of the transmitter could occur with this unit. Therefore, it is mandatory that the unit be adjusted by a person holding a commercial radiotelephone license. He will adjust the audio gain control and lock it so that overmodulation cannot occur. The clip level control may then be operated by the owner at his own discretion.

This clipping unit will operate with any type CB transceiver as long as it has an accessible mike jack. -30-

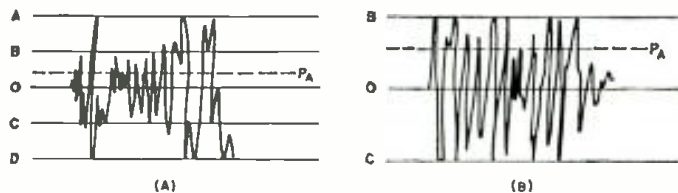
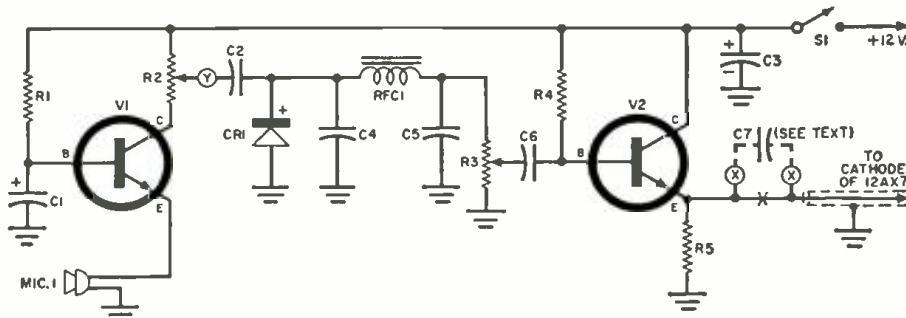

Fig. 1. Ordinary speech waveforms are shown at (A) before clipping. Note the low average power. After clipping (B), power is higher.



- | | |
|---|---|
| R ₁ —82,000 ohm, 1/2 w. res. | C ₁ , C ₂ —.05 μf., 150 v. capacitor |
| R ₂ —1000 ohm pot ("Clipping Level") | RFC ₁ —75 mhy. r.f. choke |
| R ₃ —5000 ohm pot (locking type, "Gain") | Mic.—Carbon microphone (see text) |
| R ₄ —100,000 ohm, 1/2 w. res. | S ₁ —S.p.s.t. switch |
| R ₅ —620 ohm, 1/2 w. res. | CR ₁ —4.7-volt zener diode (Texas Instruments 1N750) |
| C ₃ —50 μf., 12 v. elec. capacitor | V ₁ , V ₂ —"n-p-n" transistor (Texas Instruments 2N364 or equiv.) |
| C ₄ , C ₅ —.1 μf., 150 v. capacitor | |
| C ₇ —50 μf., 150 v. elec. capacitor | |

Fig. 2. Diagram of the speech clipper designed for use with a carbon microphone.

average power contained therein, down to a level indicated as P₁. In fact, even if a transmitter were capable of 100% modulation (which many are not), the speech power would still be a small part.

Speech clipping consists of cutting off the peaks, leaving that portion between "B" and "C". The resultant wave will no longer contain many sharp peaks.

Due to this clipping, the remaining waveform will have a distinctly higher ratio of average power to peak amplitude (compare P₁ in Fig. 1A as against P₁ in Fig. 1B). Consequently, more sideband power will result when the clipped portion is used to modulate a transmitter at maximum level.

However, mere clipping does not give us any real advantage by itself because

Fig. 3. Preamp to be used with a crystal, ceramic, or dynamic microphone. Note that V₁ is the same stage as in Fig. 2, except for emitter-bias network that is employed.

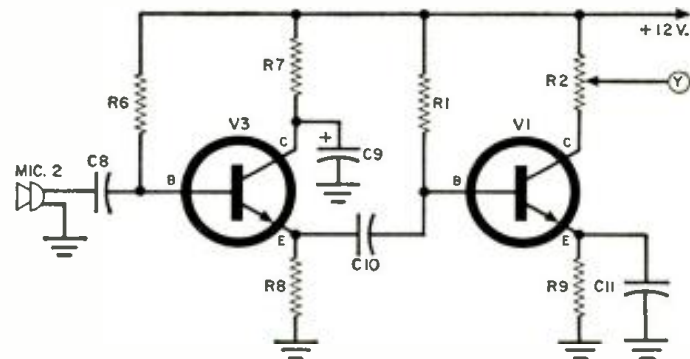

- | | |
|--|---|
| R ₁ , R ₂ —82,000 ohm, 1/2 w. res. | C ₉ , C ₁₀ , C ₁₁ —.1 μf., 150 v. capacitor |
| R ₃ —1000 ohm pot | C ₇ —50 μf., 12 v. elec. capacitor |
| R ₄ —470 ohm, 1/2 w. res. | Mic.—Crystal microphone (see text) |
| R ₅ —2200 ohm, 1/2 w. res. | V ₁ , V ₃ —"n-p-n" transistor (Texas Instruments 2N364 or equiv.) |
| R ₆ —200 ohm, 1/2 w. res. | |

HOME- CALL TV DIAGNOSIS

TV REPAIR

Can the set be fixed on the spot?
Must it be pulled? What will it
cost? Owners want quick answers.

By **WALTER H. BUCHSBAUM**
Industrial Consultant



LIKE ANY professional man, the TV technician will find that his major assets are his knowledge and his time. Time is literally worth money to him because the more sets he can repair in a working day, the more profit he will make. Customers often think that the TV technician likes to build up a service job so as to be able to charge more; but the truth is that there is much more profit in many, quick repair jobs than in fewer, drawn-out ones. Many, quick jobs mean a faster turnover of the tube and parts inventory and a greater number of active customers, not to mention a reputation of being both honest and very capable.

Next to being able to repair every set at once, it would be nice if we could at least diagnose the trouble immediately so that we can tell the customer what the bill will be and how long the job will take. Many technicians have adopted the policy of taking a good guess whenever they are not sure what the trouble really is. Sometimes they are right, but often an optimistic guess leads to disappointment of both the customer and the technician. For this reason, many are reluctant to give estimates even though this makes the customer unhappy.

We know that perfection is not possible, but improvements can always be made, and the method which we offer in this article should help our readers to diagnose TV trouble more quickly. It is not the only possible approach, but it will be useful to those who do not have a better system or who have none at all. Although it is not fool-proof, it should work more than 75 per cent of the time. It requires a basic understanding of how a TV receiver works and what functions the different sections fulfill.

The main purpose of this method is to troubleshoot relatively simple defects rapidly and determine if a job will require considerable bench work. Before describing our method, certain ground rules concerning the home call have to

be established. These rules should be followed religiously, no matter how strong the temptation to "go just a little bit further":

1. Explain to the set owner that you are going to attempt quick diagnosis, but if you cannot find the trouble it means the defect is more complex and the set will have to go to the shop for a more thorough investigation.
2. Total time spent on every set is to be no more than 30 minutes. (Don't count time to get at the tubes and inner controls.)
3. Use nothing more sophisticated than a v.o.m. or v.t.v.m.
4. A schematic diagram is desirable, but a tube layout is the minimum from which we can work.
5. Exclude all home-built sets or those where repairs or alterations have already been attempted by an amateur.

Such sets usually are "tough dogs" and the owner should be cautioned that costs will therefore be higher.

6. Go through the four following steps without skipping a point. (Once we allow the customer or some other influence to disturb our procedure, the whole value of using a methodical approach is lost and we might as well use the shotgun technique of the screw-driver mechanic.) And now to work:

A. *Symptoms.* Before we can repair a set, we must know what is wrong. The symptoms are established by first questioning the set owner and then verifying the complaint. Once the symptoms are verified, we will try to relate them to a likely area in the set. We can then replace tubes in that area and proceed with some basic tests. If the nature of the defect is now essentially known, we can estimate the repair or else estimate

Fig. 1. A common TV receiver circuit is shown in this functional block diagram. Variations are possible in many blocks.

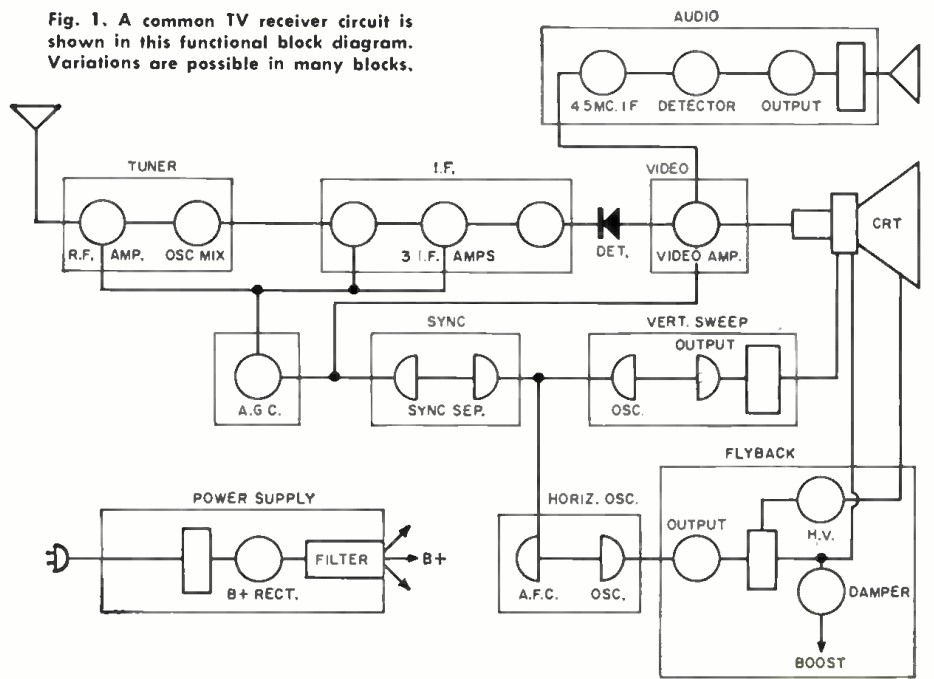

Symptom	Probable Defect Location	What to Check	Remarks
1. No raster, no sound	Filaments, "B+" or a.c. line	Filaments on? Ohmmeter on a.c. line; voltage on "B+" line.	Is plug in outlet? Are series filaments used? Fuses or circuit breaker checked?
2. Sound, but no raster	High voltage, flyback, "B+", or video and brightness control, CRT	Filament of CRT on? Measure H.V. on CRT, measure d.c. on CRT.	Wait for slow-heating CRT or H.V. rectifier.
3. Raster, but no sound or picture (no "snow")	Antenna, lead-in, tuner, i.f. and detector sections	Filaments on in these sections? Measure "B+" on tuner, i.f. and measure a.g.c. bias on all stages.	+135 volts sometimes goes through audio output tube.
4. Raster and sound, but no picture	If separate audio i.f. is used, check video i.f., video amp., contrast control, a.g.c.	Measure bias on video amp., detector output, a.g.c. bus; measure "B+" on video and sync stages.	Check CRT socket and contrast control.
5. Weak, snowy picture; sound may be OK	Antenna, lead-in, tuner, i.f., detector, video and a.g.c. section	Check connections at antenna, lead-in, tuner contacts, and tube sockets. Measure a.g.c. bias.	Use portable antenna as test substitution.
6. Picture OK, sound weak or distorted	4.5-mc. sound i.f., or 21.25-mc. in separate (split) sound i.f. systems; FM detector, audio-output stages	Check limiter bias, FM det. d.c. output as fine tuning is varied. Check "B+" on plate and screen grid of output tube.	Defective parts replacement and alignment make this a bench job.
7. Picture fuzzy, raster lines don't show	Focusing circuit, brightness control or focus "B+"	Location and setting of FM focus ring or ion trap. "B+" on electrostatic CRT.	Dirty faceplate often aggravates this type of trouble.
8. Top or bottom of picture compressed or stretched	Vertical-sweep section; "B+" boost circuit	Adjust height and linearity. Measure d.c. voltages on vertical-output stage.	Defective resistors in vertical sweep often due to other trouble.
9. "Glittering" vert. lines, vert. streaks	Flyback section, damper, or deflection yoke	Tap horizontal output tube and damper. Check connections to yoke damping capacitor.	Barkhausen oscillation can be fixed by taping small magnet to output tube.
10. Bent or twisted pictures; edge tearing	Horiz. asc. or output, sync separator or video amp.	Try horiz. drive and width. Adjust a.g.c. control, check for intermittents.	Locating defective part may require scope signal tracing.
11. Picture rolls up or down	Vert. asc. or sync separator; video amp.	Adjust vert. hold and other vert. controls and a.g.c. Open or shorted vert. integrator network.	Loss of vert. sync usually requires scope signal tracing.
12. Picture appears "sliced" or weaves back and forth	Horiz. asc., sync separator, or a.g.c. (if keyed)	Try all horiz. adjustments. Look for overheated resistors.	Aging components can be compensated by slight adjustments.
13. Dark horiz. bar in picture on all channels (60 cps in video)	Tuner, i.f. or "B+"	Ohmmeter check "B+" filters; check for cathode-filament shorts.	Jump electrolytic across various "B+" points as check.
14. Picture OK but 60-cps audio hum on all channels	Video amp., detector, or 4.5-mc. traps	Try slight touch-up of each trap and FM detector. Check a.g.c. action.	Grid clipping on video amp. can also cause this.
15. All black lines smeared to right	Tuner, video i.f., video amp.	Check low-freq. compensating capacitor in video amp.	Loss of low frequencies usually means alignment.
16. Picture fades rapidly on all channels	Antenna, lead-in, tuner, a.g.c.	Ohmmeter on antenna and lead-in; check all wiring up to tuner input.	Intermittent a.g.c. filter is a possibility.
17. Intermittent picture and sound when set is hit or vibrated	Tuner, i.f., or video amp.	Check contacts on tuner, tube sockets and grounds. Tap tubes.	Tuner contact cleaner may clear up trouble at once.
18. Picture too narrow	Horiz. output, horiz. asc.; damper circuit	Adjust width and horiz. drive. Check grid bias of output tube, check "B+" on screen, "B+" boost.	When this occurs during warm-up, defective part will need scope signal tracing.
19. Picture too short top and bottom	Vert. asc., output, or "B+" boost-voltage section	Adjust height and linearity; measure tube voltages and "B+" boost.	Intermittent or warm-up type defect needs scope signal tracing.
20. Picture changes size when contrast or brightness is changed	Flyback and H.V. section; picture tube gassy	Measure H.V. under all conditions, including low power-line voltage.	Gassy CRT is least likely.

Table 1. Reference chart of common symptoms with causes, checkpoints, and cures.

the cost of further troubleshooting. But first the symptoms must be determined.

In this connection, a customer may simply say that the set "doesn't work right" and expect the technician to guess that the trouble only occurs on Wednesdays at 6 p.m. and only on one channel. It would then take a long time to determine that the "intermittent" is simply interference from a local source. Even when the set is completely dead, and nothing lights up inside, it helps to know if this happened after hours of playing, accompanied by smoke and arcing, or if the set has been dead ever since it was transported back from the summer vacation home. For this reason we should always question the set owner on the following points:

"What is wrong? Since when? How did it happen? On all channels? At all times or only occasionally? Has anyone tried to fix it? Who and how?"

Verifying the Complaint: Remember that the set owner, as a rule, is technically ignorant and will confuse such troubles as horizontal and vertical sync defects, brightness and contrast, audio distortion and mistuning, to cite just a few examples.

Each complaint must therefore be verified before troubleshooting can start. Defects due to heat, unauthorized tampering, certain intermittents and, of course, antenna troubles (if the set is brought to the shop) will usually take longer than 30 minutes and will require more elaborate test equipment. In such instances, the customer should be told the facts and our rapid TV troubleshooting technique can be abandoned. These few instances are likely to be involved, difficult, and expensive service jobs.

B. Logical Analysis. The amateur's approach to a defective TV set will be to first check and/or replace all tubes and, if this does not help, to look for broken wires and burnt resistors. In the average 16-tube set, the first step alone will usually take up the entire 30-minute period and yet may yield no results. What also happens occasionally is that a tube replacement works for a few hours, and then the trouble occurs again. This is due to a part failure which, in turn, burns out tubes. A professional technician cannot afford such a waste of time and must therefore proceed logically, using his knowledge of TV receiver circuitry to associate the symptoms with the defect.

To facilitate a rapid preliminary diagnosis, we include the troubleshooting check list of Table 1. A total of 20 frequent symptoms is listed here, together with probable locations of the defect and suggestions on how to check it quickly. Under the column "Probable Defect Location," are suggestions as to which tube replacements should be attempted.

As a reminder of the functions of the various tubes of a TV receiver, we also offer the block diagram of Fig. 1, which is based on a roughly typical receiver. Remember that many variations are possible. Older sets still use a separate sound i.f. section (21.25 mc.). In many

sets, more tubes are used for the vertical sweep, horizontal sync, sync separator, video amplifier, and other circuits. A tube layout diagram of the receiver should be available to save time in locating suspected tubes.

Once the symptoms have been verified, relate them to the particular receiver section and, if possible, to a particular stage. For example, if the picture is too short (Item 19 in the check list), we know that the defect is most likely in the vertical-sweep section. It could also be the vertical oscillator, output stage, or even the "B+" boost voltage. If the oscillator and output stage are housed in a single tube envelope, replacement of that tube will be the first step. Under "What to Check," we find a suggestion to adjust height and linearity controls. This will be part of the trouble verification and, if tube replacement does not remedy the defect, measurement of the voltages in the output section will be next. Voltage checks at the tube socket will show such defects as open controls or resistors. If voltages seem correct, it is apparent that more sophisticated troubleshooting will be required.

C. *Troubleshooting.* Once we have de-

- | |
|--|
| <p>1 Set Hand Tools (diagonal pliers, needle-nose pliers, socket wrenches, screwdrivers, gas pliers, soldering gun, solder, etc.)</p> <p>1 Octal Tube Socket Adapter</p> <p>9-Pin Tube Socket Adapter</p> <p>7-Pin Tube Socket Adapter</p> <p>1 Set Alignment Tools</p> <p>1 Interlock A.C. Cord (cheater)</p> <p>1 Flashlight</p> <p>1 Set of Clip Leads</p> <p>1 V.O.M. or V.T.V.M.</p> <p>1 High-Voltage Probe for V.O.M. or V.T.V.M.</p> <p>1 Adjustable Indoor Antenna</p> <p>Tube Assortment</p> <p>1 Isolating Transformer</p> <p>1 80-μf., 450-volt Electrolytic Capacitor</p> <p>Assorted Fuses</p> <p>Contact Cleaner (for tuners and potentiometers)</p> <p>Anti-Corona Dope</p> |
|--|

Table 2. Listed equipment will facilitate recommended house-call techniques.

vided where the defect is likely to be found and how we will attack it, we are ready to swing into action—but not before. Instead of blindly changing tubes, we can now proceed methodically. Where a clear-cut symptom points directly to a particular tube, we will replace it; but after the new tube is plugged in, the d.c. voltages should be checked. The diagram of Fig. 2 gives approximate voltages for each tube in a typical set. This serves to check that the defective tube was not damaged by wrong voltages due to some other defect. On some of the recent models which use printed wiring, the tube socket connections are readily accessible. On most older sets, a tube-socket adapter comes in very handy for checking voltages. (We have included a set of adapters in our list of tools, Table 2.) Watch for transformerless "hot" sets and use an isolating transformer or other precautions in such cases.

Also remember that, with the many

Fig. 2. Normal voltage readings for type of TV circuit shown in Fig. 1. User can draw up alternate blocks for circuit variations, including readings.

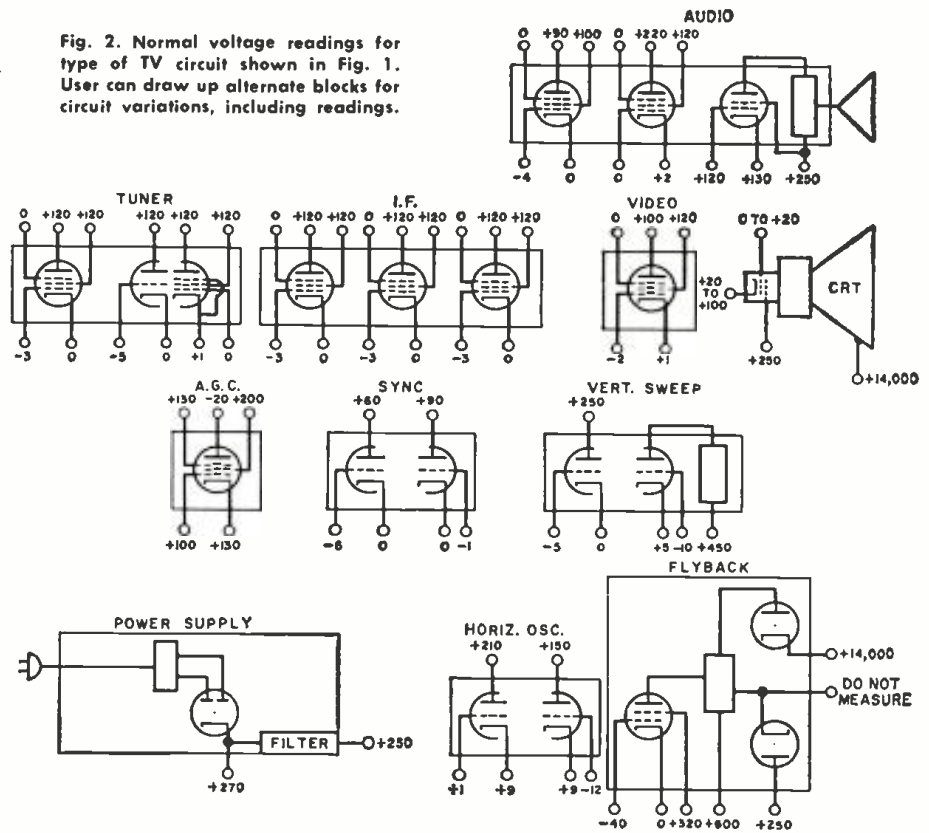

possible variations in individual circuits, corresponding variations would occur in the voltage readings. For example, normal voltages for a tuner using a pentode r.f. amplifier are shown. If a cascode r.f. amplifier is used, high "B+" voltage (about 250 volts) would appear at the plate of one triode but approximately half that value at the plate of the other triode. If a stacked "B+" supply is *not* used, plate voltage of the audio-output tube may or may not be lower than that shown, but grid and cathode voltages will be much closer to ground than those shown. Some sets will not use keyed a.g.c. Fig. 2 should therefore be considered to be not a definitive guide, but a skeleton aid to which common variations may be added.

Where the symptoms do not point clearly to a particular tube or where replacement does not help, certain additional checking is reasonable. Rapid visual and mechanical inspections are in order, plus some electrical tests.

In the visual inspection, clear away dirt and dust and apply some light to the specific chassis area in which the suspected section is located. Watch for such signs as leakage from capacitors, charred wires, resistors with the color coding burned off, and the like. Observe tubes for such internal clues as plates that get cherry red or the purplish glow around elements that indicates gas.

During the mechanical inspection, use an insulated alignment tool or small, rubber-tipped hammer for gently tapping tubes, connections, wires, and components in the suspected area. This often flushes out breaks or defective parts that escape visual observation. Rock each suspected tube gently in its socket to make sure that trouble is not

due to something like bad contacts.

As for electrical tests, our limited time permits only such major checks as voltage and resistance measurements. When nothing lights up, resistance checks of the primary power and the filament string are the first approach. When tubes light but neither sound nor video appears, we will check the various "B+" voltages and, if there is no "B+," resistance checks across the "B+" will determine the presence of a short circuit. The electrolytic capacitors in the "B+" filter will, of course, at first indicate a short on the ohmmeter, but the resistance will increase as the capacitors are charged up.

Voltage measurements should be made at the plate, screen, cathode, and grid of each tube in the suspected trouble area and the values should be noted down to permit the technician a few moments of orderly analysis of these test results.

While it is not possible to make a thorough voltage or resistance analysis in the allotted 30 minutes, certain defects can be determined quickly. By measuring the voltage at the plate of a tube and comparing it with the "B+," we can see at once how much current passes through the load resistor and the tube. If the load resistance is correct and if "B+" and plate voltage are practically the same, very little current flows. This means that the tube is cut off and this, in turn, may be due to an open circuit in the cathode or some defect in the grid circuit. The audio limiter, sync clipper, and the a.g.c. amplifier are intended to work at or near cut-off.

Grid bias should not be measured

(Continued on page 87)

Here are complete construction details on a broadcast-band tuner that features very low distortion, that may be added to your present high fidelity sound setup.

By JOHN POTTER SHIELDS

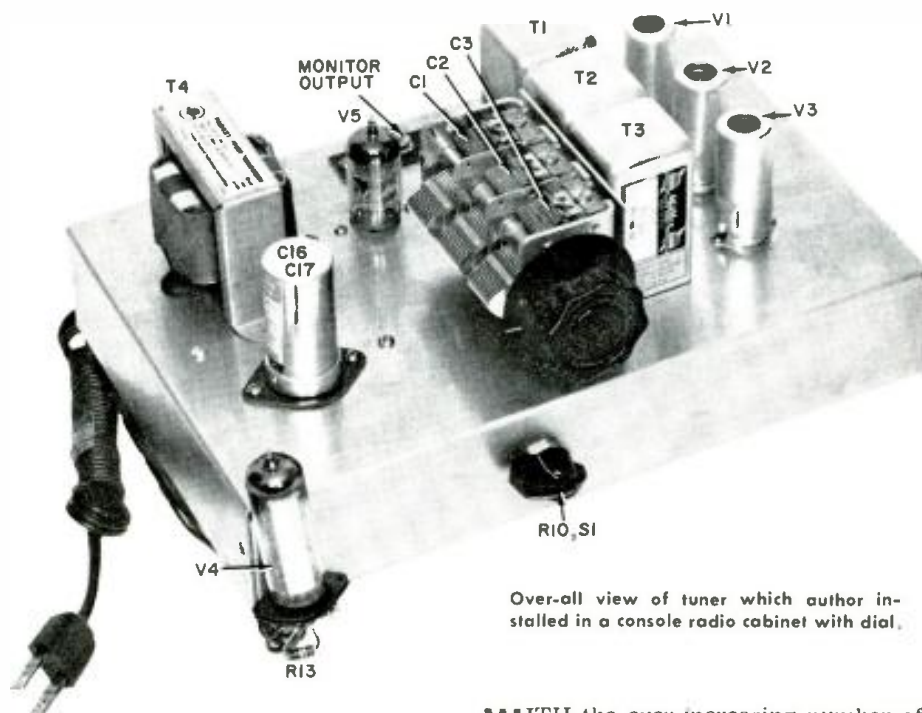

HIGH-QUALITY T.R.F. AM TUNER

Fig. 1. Circuit diagram shows use of 2 r.f. stages, infinite-impedance detector, along with an optional tuning indicator. If power requirements can be obtained from another piece of gear, no rectifier or filter are required for the tuner.

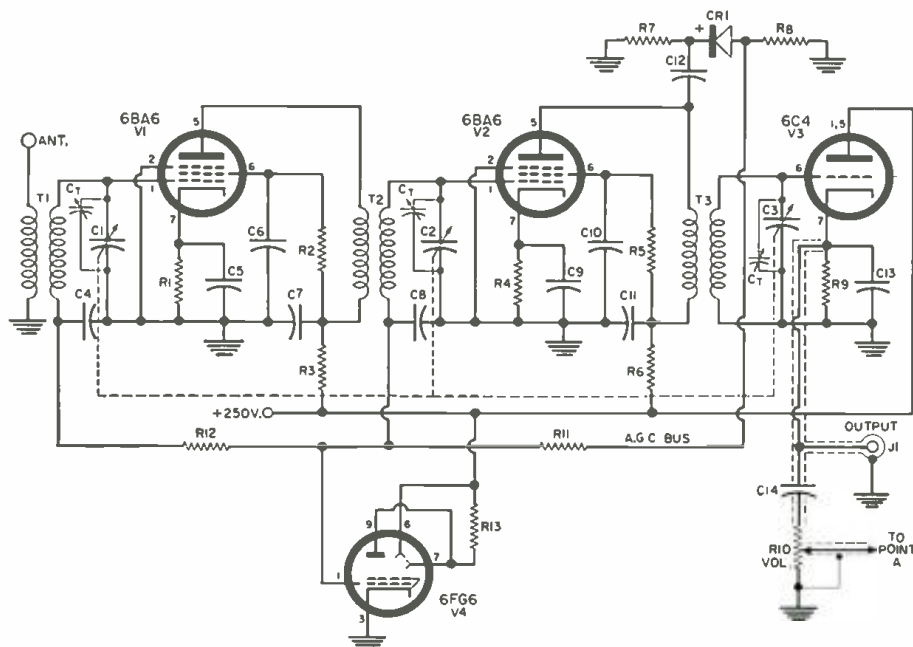

R_1, R_2 —68 ohm, $\frac{1}{2}$ w. res.
 R_3, R_4 —22,000 ohm, $\frac{1}{2}$ w. res.
 R_5, R_6 —10,000 ohm, $\frac{1}{2}$ w. res.
 R_7, R_8, R_{11}, R_{12} —2.2 meg., $\frac{1}{2}$ w. res.
 R_9 —100,000 ohm, $\frac{1}{2}$ w. res.
 R_{10} —500,000 ohm audio taper pot
 R_{13} —470,000 ohm, $\frac{1}{2}$ w. res.
 C_1, C_2, C_3 —3-section variable cap., 365 $\mu\text{f.}$ /sect. with trimmers
 C_4 to C_{11} —.01 $\mu\text{f.}$, 600 v. disc cap.
 C_{12} —.05 $\mu\text{f.}$, 600 v. disc cap.

C_{13} —.0005 $\mu\text{f.}$, 600 v. disc cap.
 C_{14} —.1 $\mu\text{f.}$, 600 v. paper cap.
 T_1 —Shielded antenna coil (Miller 44-A, or equiv.)
 T_2, T_3 —Shielded r.f. coil (Miller 44-RF, or equiv.)
 CR_1 —1N34-A, or equiv. germanium diode
 J_1 —Phono or mic. jack
 V_1, V_2 —6B.16 tube
 V_3 —6C4 tube
 V_4 —6FG6 E.M.84 tube

WITH the ever-increasing number of AM-FM stereo programs available and the generally improved quality of AM transmission, a good-quality AM tuner is almost a must for the serious audiophile. Such a tuner should have adequate r.f. bandpass characteristics so as to avoid carrier sideband attenuation, sufficient sensitivity, a low-distortion output at all carrier levels, and sufficient flexibility to tie in readily with existing audio gear. The tuner to be described was developed by the author with the above requirements in mind and is capable of excellent performance coupled with ease of construction and alignment.

Figures 1 and 2 show schematics of the complete tuner. It was decided to use a two-stage t.r.f. amplifier driving a low-distortion detector rather than the more conventional superhet arrangement, in order to easily obtain the wide bandpass characteristics. While it is quite possible to design a broadband superhet, it is not quite so simple for the experimenter to obtain and adjust i.f. transformers with the necessary broadband characteristics. Although "swamping resistors" may be shunted across the i.f. transformer windings to reduce their effective "Q", the stage gain is then reduced. This often requires an additional stage of amplification. Also, the t.r.f. circuitry is more economical of parts; requiring no converter stage, and the alignment is extremely simple.

Circuit Description

Signals arriving at the antenna terminal are coupled by the antenna transformer, T_1 , to the control grid of the first r.f. amplifier, V_1 . The first section of the tuning capacitor, C_1 , in conjunction with the secondary of T_1 , select the desired frequency. The signal is amplified by V_1 and applied across the primary of the r.f. transformer T_2 . The secondary of T_2 is tuned to the operating frequency by the second section of

the tuning capacitor, C_2 , and the signal is applied to the control grid of the second r.f. amplifier stage, V_2 . The signal is further amplified by V_2 and applied to the primary of the next r.f. transformer, T_2 . The r.f. signal developed across the secondary of this transformer, tuned by the third section of the tuning capacitor, C_3 , is applied to the detector stage.

Considerable thought was given as to the proper type of detector to use with this tuner and it was finally decided to use the infinite-impedance detector for several reasons. First, unlike the diode detector which requires eight to ten

This gives a much better indication than the older indicator types, such as the 6E5, 6U5, etc.

The tuner is provided with two outputs: one directly from the infinite-impedance detector and a "monitor" output, which provides sufficient signal to drive a speaker at modest volume. This "monitor" output is supplied by a two-stage RC-coupled amplifier consisting of both sections of V_3 , which receives its signal from the output of the detector *via* the volume control, R_{10} . The volume control is so connected that it does not affect the detector output. No output transformer was provided due to chassis space limitations, but any inexpensive universal output transformer with a primary impedance of around 6000 ohms can be used. Note that the leads from the tuner to the monitor speaker's transformer are "hot," so be careful.

The power supply is conventional, consisting of the isolation/power transformer, T_1 , feeding a voltage-doubler rectifier setup using a pair of selenium rectifiers, SR_1 and SR_2 . A π -section RC filter smooths the output from the rectifiers.

If the constructor has another power supply available, or can get the voltages needed from other equipment, then it will not be necessary to build the rectifier circuit shown in Fig. 2. Just be sure the external supply can deliver at least 1½ amps. at 6.3 volts for the heaters and about 50 ma. at 250 volts for the plates. Also, if a monitor speaker is not needed, then the circuit with V_3 will not be necessary. The output at J_1 is then fed directly to the hi-fi preamp or amplifier. Output may also be taken at point A if control of volume is needed.

Construction

The author built the tuner on a standard 7" x 9" x 2" aluminum chassis. No front panel or calibrated dial is shown in the photos as the tuner was installed in an old console cabinet which had an existing dial. The 6FG6 tuning

indicator socket was mounted on a small aluminum angle bracket which was screwed to the inside of the cabinet's front panel. Standard shaft extensions were used on the tuning capacitor and volume control shafts to lengthen them sufficiently to fit through the rather thick panel. (The two knobs shown in the photos were used only to "doll up" the tuner when its picture was being taken.)

Alignment

As mentioned earlier, this tuner is a breeze to align. If you wish, you can align the tuner by means of a standard broadcast station signal although of course the use of a signal generator is to be preferred. If alignment by means of a broadcast station signal is to be used, select a station around 1400 to 1600 kc. and peak all three tuning capacitor trimmers for maximum signal output by ear or as indicated on the tuning indicator or a v.t.v.m. connected between the a.g.c. bus and ground. It is best to rock the tuning capacitor slightly as the trimmers are being peaked for maximum output. Now, select a station around 500 to 600 kc. and repeat this process. You may find that the trimmer settings are slightly different at the low frequency end of the band and it is therefore best to average out the high- and low-frequency trimmer settings.

If a signal generator is used in alignment, the low, middle, and high frequency settings of the band should be checked and the trimmers adjusted for nearly constant output over the entire band.

Well, that's the story on the little tuner. I'm sure you will be more than pleased with its performance. By the way, I think you will be more than a little surprised at how clean those few tenths of a watt from the monitor output will sound when fed into a decent transformer and speaker, or how fine the unit sounds when played through your hi-fi system.

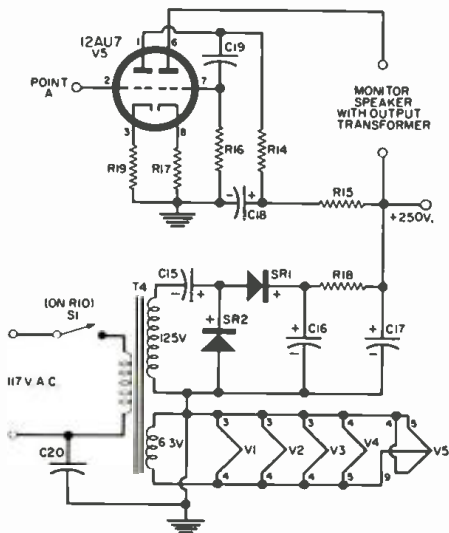

- R_{11} —220,000 ohm, ½ w. res.
- R_{12} —22,000 ohm, ½ w. res.
- R_{13} —470,000 ohm, ½ w. res.
- R_{14} —470 ohm, 1 w. res.
- R_{15} —680 ohm, 2 w. res.
- R_{16} —2200 ohm, ½ w. res.
- C_{15} , C_{17} —20 μ f., 150 v. elec. cap.
- C_{16} , C_{17} —40 μ f./40 μ f., 250 v. elec. cap.
- C_{18} —1 μ f., 600 v. paper cap.
- C_{19} —0.01 μ f., 600 v. disc cap.
- T_1 —Power/Isolation transformer, 125 v. @ 50 ma., 6.3 v. @ 2 amp. (Stancor P.1-8421, or equiv.)
- S_1 —S.p.s.t. switch on R_{10}
- SR_1 , SR_2 —65 ma. selenium rectifier
- V_5 —12AU7 tube

Fig. 2. Optional power supply and output stage required to drive monitor speaker.

volts of r.f. input for an output of reasonably low distortion, the infinite-impedance detector provides an extremely low-distortion output for any given r.f. input voltage. This is due to the large amount of negative feedback provided by its large cathode resistor. Second, the effective output impedance of the infinite-impedance detector is considerably lower than that of a conventional diode detector. This allows a reasonable length of shielded cable to be run from the detector output to the amplifier input without appreciable attenuation of the higher frequencies.

The infinite-impedance detector has one distinct disadvantage however: it does not provide a convenient d.c. output voltage proportional to the carrier level which can be used for a.g.c. control purposes. To solve this problem, a separate diode a.g.c. rectifier is used, consisting of CR_1 , plus its associated filter network, R_8 , R_{11} , R_{12} , C_1 , and C_2 . A 6FG6 tuning indicator is tied into the a.g.c. bus to indicate proper station tuning.

Under side of the chassis. Wiring need not be crowded as there is adequate space.

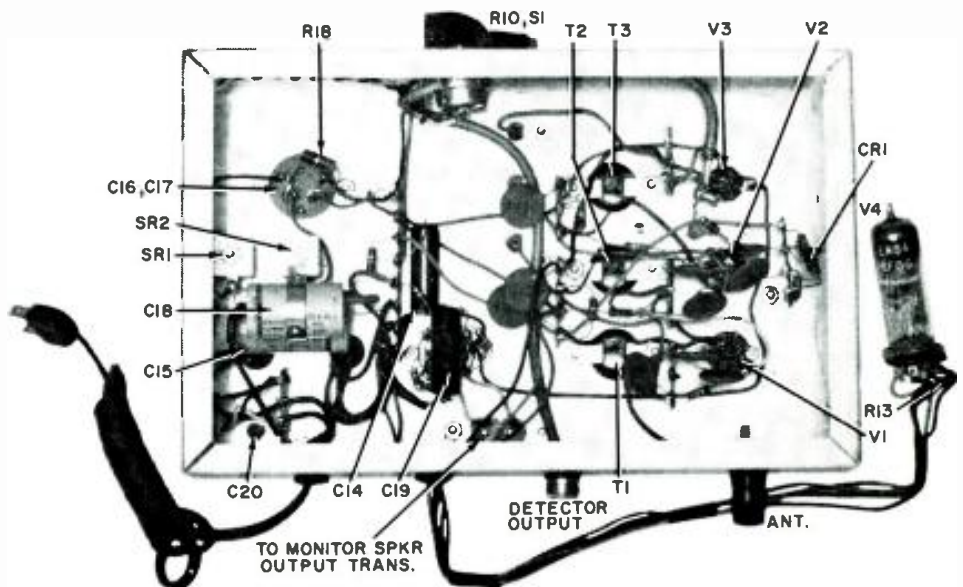

Simple Electronic Engine Analyzer



By R. A. LEBOWITZ and R. M. SONKIN

Construction of a one-transistor instrument that will measure engine speed, point dwell, and battery voltage.

THIS article describes a simple, one-transistor instrument that is capable of measuring engine speed, distributor contact-point dwell, and battery voltage. It needs no external power source and will operate on either 6- or 12-volt systems. It can be included in a permanent dashboard installation or used as a portable service instrument.

This small device can provide the user valuable information on the condition of the automobile electrical system. It can, for example, detect: 1. malfunctioning or worn spark plugs; 2. worn or incorrectly set distributor points; 3. maladjustment of the voltage regulator; 4. defective generator; and 5. shorted, weak, or overcharged battery.

The three functions (rpm, dwell, battery voltage) are individually selected by a rotary switch. The tachometer or rpm function needs little description. It measures engine speed in revolutions per minute (rpm). The maximum rpm reading can be adjusted by means of a calibrating control. This maximum value can be set for 5000 rpm for installation in American cars and for 8000 rpm for use in foreign cars or for service work.

The dwell function measures the time that the points are closed relative to the entire ignition cycle. Fig. 1 will be used to illustrate the dwell angle in further detail. Fig. 1A is the schematic of the ignition system of an automobile while Fig. 1B is the waveform appearing at the points. The ratio T_1/T_2 , expressed as a percentage, is indicated directly on the dwell meter. To express this percentage

in terms of angle, the following constants of proportionality apply: 4-cylinder engine—% dwell $\times 90 =$ degrees dwell; 6-cylinder engine—% dwell $\times 60 =$ degrees dwell; and 8-cylinder engine—% dwell $\times 45 =$ degrees dwell.

As shown in Fig. 2, there are two scales for percentage dwell. The top

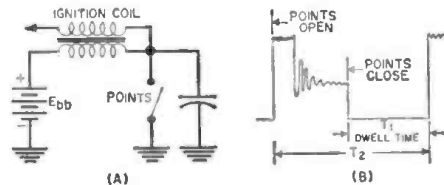

Fig. 1. The basic ignition system of a car, and the waveform at the car's points.

Fig. 2. The new meter scales used by the authors. The top scale indicates engine speed, the next two scales indicate dwell per-cent for cars with either a negative or a positive ground system, and the bottom scale indicates the voltage of the battery.



scale is for an automobile with its negative battery terminal grounded; the bottom for a positive terminal ground. The importance of proper dwell setting cannot be overemphasized; factory service manuals specify dwell to within ± 2 degrees.

The final function is that of a battery voltmeter. This serves to indicate the condition of the battery and of its charging apparatus.

Principles of Operation

Fig. 3 will help to illustrate the operation of the tachometer circuit. When the points are open, transistor V_1 will be conducting on an automobile with a positive ground (negative voltage applied to the transistor base) and cut off on one with a negative ground (positive voltage applied to the transistor base). When the points are in the condition to produce conduction in V_1 , the applied battery voltage causes sufficient base current to flow to make V_1 fully conducting. The rise and fall of current between conducting and cut-off states is almost instantaneous, hence V_1 acts as if it were a switch that turns the current in R_1 and R_2 on and off. This produces a square wave of voltage across both portions of the potentiometer.

When the transistor is cut off, capacitor C charges through R_1 , CR_1 , and the indicating meter, M_1 . The time constant of this charging circuit is small so that only a sharp pulse of current flows. The diode, CR_2 , is connected in the circuit in such a manner as to prevent the current from flowing in it when C is charging.

When the transistor conducts, the voltage at the junction of R_1 and R_2 drops (becomes less negative) and C discharges through V_1 , R_3 , R_6 , and CR_2 . The diodes in the input base circuit of the transistor (CR_1 and CR_2 in Fig. 5) pass a negative-voltage pulse to the base but block a positive-voltage pulse. The diodes are used to protect the transistor from high-voltage input spikes. If a higher-back-voltage diode is available, it can be installed in place of the 1N34 for CR_2 . Under these conditions, CR_1 would not be needed.

The number of pulses flowing through the meter per unit of time is proportional to the speed of the engine. The panel meter reading is proportional to the average direct current flowing through it which is, in turn, proportional to the number of pulses flowing in it per unit of time and thus to engine speed.

Fig. 4 will help to illustrate the operation of the dwell-angle circuit. The base-to-emitter voltage tends to remain constant when a transistor is conducting. It is approximately 0.3 volt for germanium. Thus the current through the meter in Fig. 4 remains constant when the transistor conducts and is zero when it is cut off. The meter reads the average current flowing over both states.

On an ignition system with a positive ground, the current flows when the points are open and thus the average meter current is inversely proportional to dwell angle. The longer the points are open, the greater proportion of the time that the current flows and thus the higher the meter reading. Under these conditions, the dwell time (during which the points are closed) is low.

On a negatively grounded system the current flows when the points are closed and the current is directly proportional to the dwell angle.

The battery voltmeter consists of a resistance in series with the milliammeter connected across the battery terminals.

Construction

The layout and construction of the unit are not critical. Fig. 5 is the complete schematic of the unit. Transistor V_1 can be practically any audio or general-purpose $p-n-p$ germanium transistor. A *Motorola* 2N653 and a *Texas Instruments* 2N367 were used in the units constructed by the authors. The components may be laid out on a phenolic

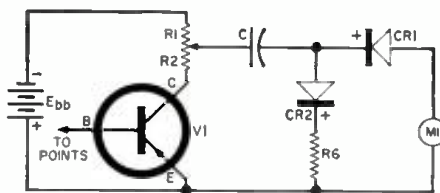

Fig. 3. Partial schematic of the analyzer, whose complete circuit is shown in Fig. 5, illustrating the engine-speed function.

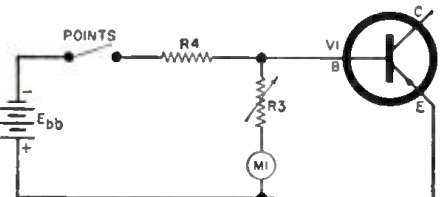

Fig. 4. This partial schematic shows the operation of the dwell-angle function.

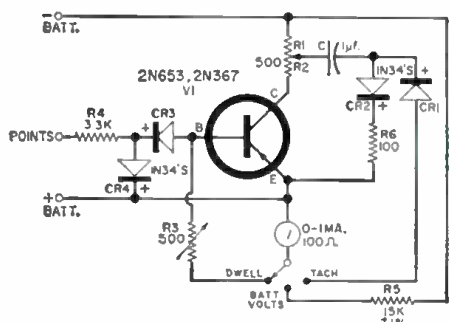

Fig. 5. Complete circuit diagram and parts values for the engine analyzer.

board and then mounted onto the meter case, as shown in the photographs. Another idea would be to buy a four-pole, triple-throw rotary switch and mount all components, except the potentiometers, on the unused terminals. Three wires are brought out to the rear of the unit. These wires are connected to the plus and minus battery terminals and to the primary terminal of the distributor. The 1-ma. meter should be of the low-resistance type, approximately 100 ohms.

To make the instrument useful with engines of various numbers of cylinders, the meter is calibrated in per-cent dwell instead of angle of dwell. Per-cent dwell can be corrected to angle by use of the formulas given earlier. If the unit is made for dashboard use, it can be calibrated directly in dwell angle for the specific engine.

The rpm circuit is the only one that requires auxiliary equipment for calibration. Obtain one of the following pieces of test equipment and connect it as required: 1. a calibrated mechanical or electrical tachometer, connected as specified in the instruction manual; 2. an oscilloscope with a calibrated sweep speed, connected between the distributor primary terminal and ground (obtain the sync signal from the same point); or 3. a Strobotac with its beam flashed upon the fan-belt pulley of the engine.

Connect the proper wires from the engine analyzer to the plus and minus battery terminals and to the distributor primary terminal. Rev up the engine to full speed, measure the speed by means of the auxiliary speed indicator (tach, scope, or strobe) and adjust potentiometer R_1 - R_2 until the engine analyzer reads correctly.

The Strobotac and auxiliary tachometer are direct-reading in rpm, but the oscilloscope reads period or time directly rather than rpm and its dial indication must be converted to rpm. Adjust the oscilloscope dials to obtain one or two full ignition cycles on the scope screen and measure the cycle period. The following equation gives the relation between period and rpm for various engines:

$$rpm = \frac{120}{\text{period (in sec.)} \times \text{no. of cylinders}}$$

If no auxiliary tachometer or oscilloscope is available, it is possible to calculate the rpm portion of the engine analyzer if a manual shift automobile is used. The engine speed can be calculated back from the automobile speed through the various gear ratios between the rear wheels and the engine crankshaft.

The voltmeter circuit requires no calibration since a 1 per-cent resistor is used for R_5 .

The dwell-circuit calibration is quite simple. The switch is thrown to "dwell" position and the engine is cranked in short bursts until the meter reads upscale with the engine stopped. R_2 is then adjusted for full-scale reading on the meter.

A pair of these units have been in use in the authors' automobiles for over 10,000 miles and have operated perfectly during this period. During a cross-country trip improperly operating points were discovered and replaced before a breakdown occurred.

The entire circuit is built within a housing that fits the meter. New scales have been drawn for the face of the meter.

In this model, all the components have been mounted on small metal brackets that are secured to the meter's binding posts.

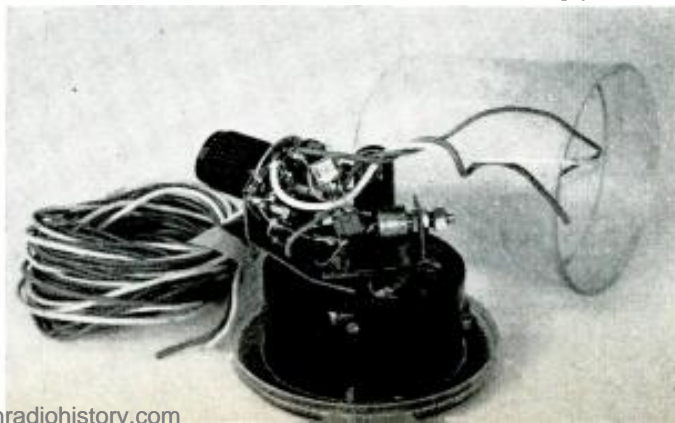

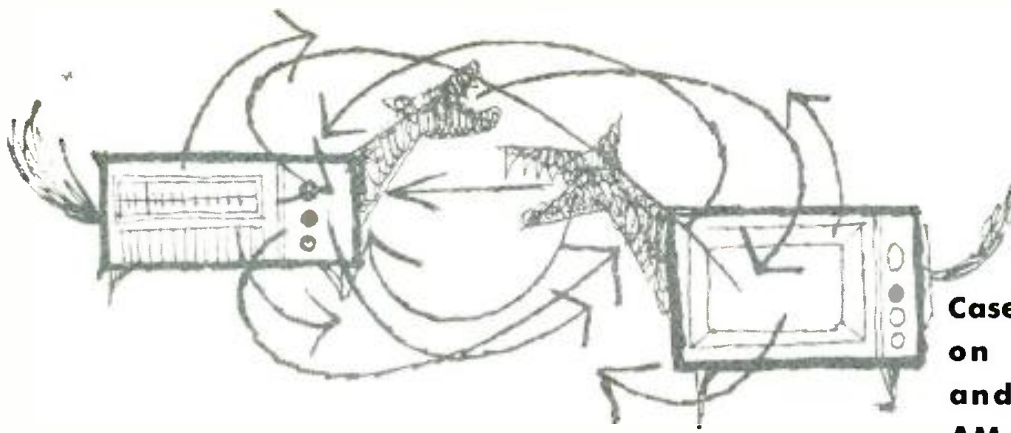

Case histories shed light on the strange causes and cures involved with AM, FM, and TV reception.

Interference Tough Dogs By GEORGE P. OBERTO

WITH THE increasing number and variety of AM broadcast, short-wave, FM, TV, and other services in simultaneous operation today, difficulties due to interference have correspondingly increased. Although these many signals are carefully separated from each other so that they will not interact during transmission, there are numerous outside factors and conditions that will bring them into conflict, and these factors are seldom obvious. As a result, cases of interference tend to be tough dogs—the bane of the technician's existence.

No matter how difficult it may seem to meet these troubles, a cure is usually found if logic, past experience, theory, and careful observation are used to full effectiveness. However, there is such great diversity in causes and the ways of tracking them down that it is difficult to formulate a single troubleshooting technique. Perhaps more can be learned from evaluating individual case histories and noting how they were resolved.

AM Broadcast

Some of the most commonly encountered interference problems involve broadcast radios. One that at first appears somewhat puzzling has been observed more than once on all types of radios, whether they use power transformers or are of the a.c.-d.c. type: automobile-ignition noise occurs on home AM reception. This can happen every time traffic passes through the street on which the receiver is located. Although ignition interference occurs over a broad range of frequencies, it is generally heavy enough to give trouble in the v.h.f. range—FM and TV—but not to broadcast receivers that are at a reasonable distance from the interference source.

When it does appear with AM signals, the likelihood is that spurious, high-frequency signals are being developed in the receiver's oscillator-converter stage. Parasitic oscillation generated here may be in the v.h.f. range, and ignition interference may react with this oscillation. This spurious signal then beats with the other signals present in the converter, and the interference is thus transferred to the desired signal.

The solution involves suppression of the parasitics. Low-ohmage resistors in

the grids of the converter stage will do the job. As shown in Fig. 1, a 47-ohm carbon resistor in series with the signal grid and another in series with the oscillator grid will do the job. Make connections close to the tube socket using short leads.

An unusual problem was encountered on an old (1939 vintage) set, which was otherwise operating well. A loud hum was riding through on all stations, but it was tunable. The hum disappeared whenever the radio was not set to receive a transmission. This radio did not have a built-in antenna, relying on an outside installation. A similar trouble could develop on any set, regardless of age, that uses an outdoor antenna. That the latter was involved became evident when the radio was checked in the shop; it had to be returned to its original location and original antenna for the symptom to appear.

An inspection revealed that the antenna system was in poor shape, with most connections badly corroded, including those to the ground rod. The lightning arrestor was almost shorted out. The arrestor was replaced and all connections were cleaned up. This eliminated the symptom.

What was happening was that the external ground, to which the chassis was connected, was making poor contact. The small 60-cycle current passing through the bypass capacitors across the a.c. line (Fig. 2) was therefore going to external ground through another path; the antenna system and the faulty

lightning arrestor. The latter, acting like a rectifier, mixed the 60-cycle signal with the incoming broadcast signal, resulting in hum. The hum path is shown in heavy lines.

It is not unusual to get an interfering short-wave transmission on local broadcast-band reception. A common headache of this kind occurs when a specific out-of-band station booms in on a specific, regular AM station. Reception on the latter becomes impossible whenever the interfering transmission is active.

Tracing signal in a set afflicted with this difficulty may show that the condition exists as far back as the converter stage. The strong, local, interfering signal will force its way in through the signal grid, although the latter is tuned only to the desired station. Since the oscillator, in addition to its fundamental frequency, is generating many higher harmonics, the interfering signal evidently beats with one of these harmonics to produce a beat at or near the intermediate frequency. This signal is then passed on through the i.f. section along with the desired one.

The cure is to block the interfering signal before it can get far enough to do the damage. A high-C, parallel trap is installed, as shown in heavy lines in Fig. 3, in series with the signal grid. This trap is tuned to the frequency of the interfering signal.

To find the proper frequency, a separate short-wave receiver can be used to identify the interfering signal. Most problems of this sort involve signals in the range from 1.8 to 6 mc., with the 75-meter voice and 80-meter code bands possible troublemakers.

A fixed mica capacitor, 140 $\mu\text{f.}$, is used in conjunction with an adjustable inductance. The latter can be made up from a small, slug-tuned coil form, like the *National XR-50*. About 50 or 60 turns of #22 enamel wire will permit the coil to be tuned to trap out frequencies in the range from 3.5 to 4 mc. Peel off turns for higher frequencies and add turns for lower frequencies.

Entry through Audio Stages

When sets suffer from interference that is evident no matter where the tuning dial is set, the unwanted signal may be entering through the i.f. system but is most likely getting into one of the audio stages directly. The interfer-

Fig. 1. Suppressor resistors (47 ohms) stop symptoms due to local parasitics.

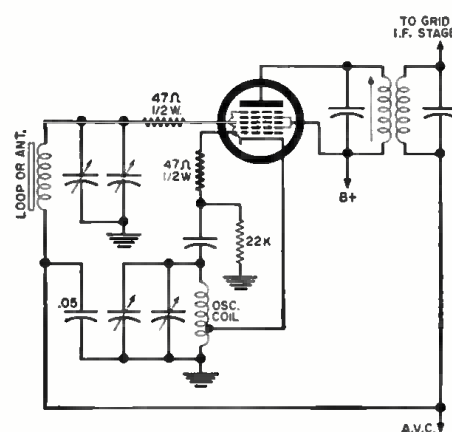

ing signal may be of any frequency. The r.f. signal is usually picked up in the grid circuit of an audio stage, detected by some non-linearity in that stage, and amplified. This symptom obviously is not confined to receiving equipment; it could occur in a hi-fi amplifier or any other device that uses audio amplification.

The cure is to bypass or filter out the interfering signal at the point of entry. It is possible to use signal-tracing techniques to determine this point, but it is usually safe to apply the remedy to the first stage of audio amplification. If interference is reduced but still persists, other low-level, high-gain audio stages may be given the same treatment. Several ways of doing this are shown in Fig. 4.

For simple broadcast radios, the filter shown in heavy lines in Fig. 4A should be satisfactory. This will provide some roll-off of the higher audio frequencies, but not enough to make a difference on AM. In hi-fi systems, an r.f. choke in series with the tube's grid (2.5 millihenrys, Fig. 4B) should do the job without deteriorating the higher audio frequencies. Sometimes there is not sufficient room to accommodate the installation of this addition. In that case, a 47,000-ohm resistor (Fig. 4C), which is smaller, may do the trick.

Short-Wave Reception

Interference to reception on short-wave sets, most often from lower-frequency signals like AM broadcasts, is not at all unusual. What's more, this may occur on anything from a simple set of the type used by a layman to an expensive communications receiver. Often it is not the receiver itself that is at fault.

In one case, a high-priced communications receiver suffered from heavy, broadcast-band interference in the range from 1.8 to 6 mc. It was first thought that the AM broadcaster was at fault; however, no interference showed up at all on the troubled set when it was checked in the shop, located just a few blocks up the street from the customer's home. The owner's antenna system was checked for deterioration or evidence of other defects, but none were found. A substitute antenna was tried anyhow, but without success. Next wave traps were tried, but again to no avail.

Finally a portable short-wave receiver was used as an interference probe. It was tuned to the points in the range from 1.8 to 6 mc. where the unwanted signals were noted to be coming in and moved about throughout the vicinity of the customer's home. A spot was finally found where the interference seemed to be worst. This also happened to be the point at which telephone lines led into the house.

The telephone service box, mounted on the outside of the house, was checked.

All connections looked dirty, with fraying evident on the wires. When the lightning-arrestor section was disconnected, by removing the two carbon elements, the interference disappeared

altogether. Actually, handling this property is outside the province of the service technician, so the results of the check were passed along to the local telephone company. A telephone repairman promptly went over the whole installation, putting things back in good shape. This resulted in a permanent cure.

Evidently the lightning arrestor, particularly the two carbon blocks, was acting as a rectifier or non-linear device. Incoming, strong signals from nearby broadcast stations that were reaching this device were converted to spurious secondary signals, probably higher harmonics that fell in the short-wave band. These signals were being radiated well enough to be effective for a radius of a hundred feet or more.

The telephone problem calls to mind another unusual one involving a customer who was an enthusiastic experimenter. He brought a small, all-wave receiver into the shop with the complaint that there were severe whistles on the broadcast band as well as interference by AM broadcasts on short-wave reception.

After a complete check, which did not locate the fault, the set was returned to its owner. At this time, quite by coincidence, it was learned that he was working on a new crystal receiver with a transistorized audio amplifier. When the outside antenna that was being used with this experimental unit was disconnected, the trouble cleared up completely. The customer was simply instructed to switch out the crystal set's antenna when listening to his all-wave receiver. He was also strongly advised to check with his close neighbors to make certain that he wasn't bothering any of them.

When lower-frequency signals interfere with short-wave reception, it is not always because some outside agency is altering the frequency of the original,

Fig. 2. Sneak earth-ground path (heavy lines), set up by corrosion of outside antenna, caused tunable hum modulation.

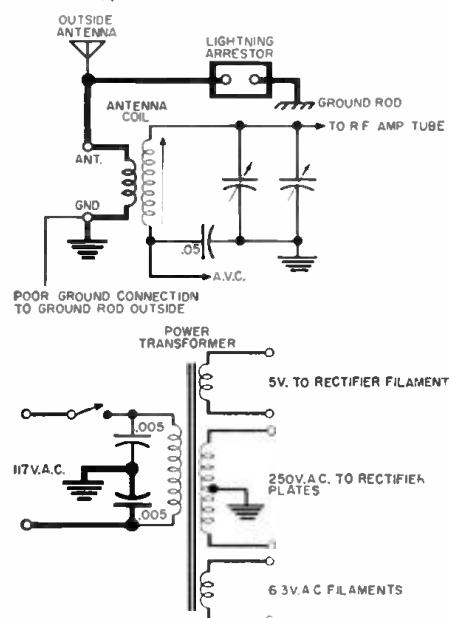

interfering signal. Often the original signal enters through the antenna and causes havoc in some other way. Traps for various conditions and circuit configurations are shown in Fig. 5.

In some cases, the interfering signal is the same as the i.f. of the short-wave receiver. Many sets of the latter type use more than one i.f., and the higher one may fall in the broadcast band. In such cases, a series wave trap connected as shown by heavy lines in Fig. 5A and tuned to the intermediate frequency should be a satisfactory cure.

Often the strong, local AM broadcast signal enters through the antenna, but overloads the front end so that spurious signals of other frequencies are generated. The cure may still be obtained by trapping out directly the fundamental of the interfering signal. It may be necessary to use a combination of series and parallel wave traps for effective rejection, as shown in Fig. 5B. The combination to the left is used in conjunction with single-wire or unbalanced antenna-input systems. The configuration to the right, in which the elements of each trap are split up, is used with balanced antenna inputs.

Since all elements in each trap are adjustable, values for capacitance and

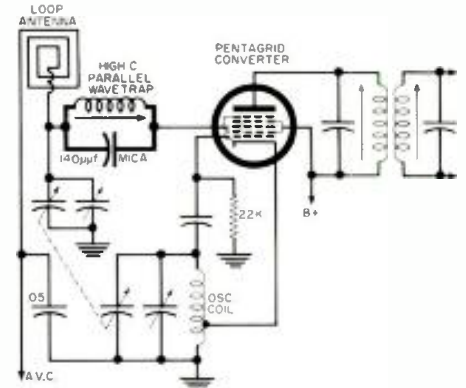

Fig. 3. A trap tuned to the undesired signal in the first-stage grid blocks interference entering through the antenna.

inductance can be quite broad. Trimmers that will tune from about 100 to 580 $\mu\text{f.}$ may be used for capacitors C_1 , C_2 , C_{11} , C_{12} , C_{21} , and C_{22} . Ferrite loop antennas, like Miller 2002, may be used as the inductors.

All traps are tuned to the frequency of the interfering signal. The configurations of Fig. 5B are also useful in a slightly more complicated type of situation. Sometimes more than one broadcast signal is giving trouble. Where two are involved, it is often possible to tune the series trap to one and the parallel trap to the other to achieve adequate rejection of both.

FM Reception

A common source for interfering signals that intrude on FM reception is a TV transmission, usually on the lower v.h.f. band, or a TV receiver tuned to such a signal. One interesting case involved an expensive combination that included AM, FM, TV, and a phono-

graph. Reception on several of the local FM stations was being ruined by the same interference source, which was evident as a buzzing sound accompanied by a distinguishable voice signal. It was not too difficult to identify the ultimate origin of the unwanted sound; it was recognized as audio from the local TV station on channel 6, only two miles away.

After considerable checking, it was noted that the r.f. stage of the FM section was broadly tuned, so much so that it did not adequately reject the strong TV sound transmission, just below the FM band (87.75 mc.), which was overloading the front end. Further investigation showed that the same antenna was being used for both TV and FM reception—a single-bay conical pointed right at channel 6—and it was doing the dirty work. The cure proved easier than finding the trouble. A little careful re-orientation of the antenna cleared up the interference. Although it was rotated so that it no longer faced the TV transmitter squarely, there was no deterioration of reception on this nearby channel.

Another case involved teletypewriter interference on a v.h.f. police-alarm set, which occurred throughout the received band. Since the set used a conventional 10.7-mc. i.f. and teletypewriter gear operates close to this frequency, the cause was easy to localize: entrance was by radiation directly into the i.f. system. The interesting point is that the cure was also easy. Such measures as trapping and shielding might prove effective—but why use an elaborate technique when a simple one will serve? A slight re-alignment of the receiver to shift the intermediate frequency a little way from the interfering signal tuned out the latter with no impairment in reception. There is no sense in turning a difficulty like this into a tough dog—and some tough dogs are made, not born.

A portable AM-FM transistorized radio was brought into the shop with the complaint of a heavy hum or buzzing sound interfering with reception of the favorite FM station. As happens frequently, the symptom did not occur at all in the shop. Further checking in the customer's apartment was needed, but this was hampered by the fact that the interference occurred only intermittently. After several repeat visits to the apartment, the service technician arrived when the set was acting up.

Since the receiver was a portable, it was used directly as the interference probe. It was noticed that the symptom was at its worst when the east wall of the customer's apartment was approached. An investigation of the neighbor's adjoining apartment revealed a 21-inch TV set was located right against the wall, on the other side, and interference occurred only when the TV was turned on.

The TV receiver's horizontal-output amplifier was the culprit. This is a familiar situation with respect to interference on AM reception, but here is evidence that it can occur on FM too.

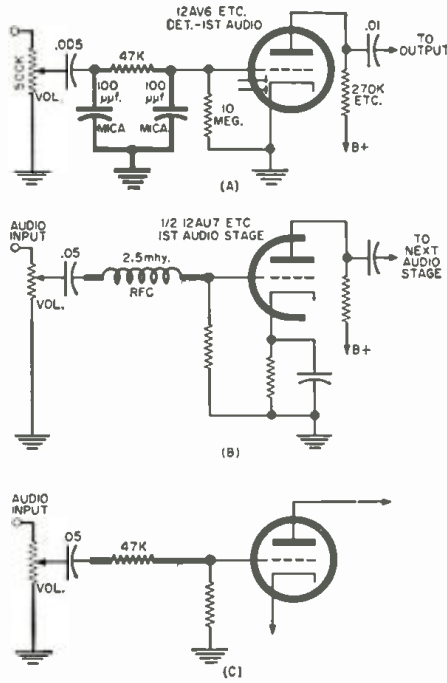

Fig. 4. Low-pass filters block audio-stage grid detection. One type (A) may be used in AM sets; others (B, C) preserve upper audio frequencies for hi-fi.

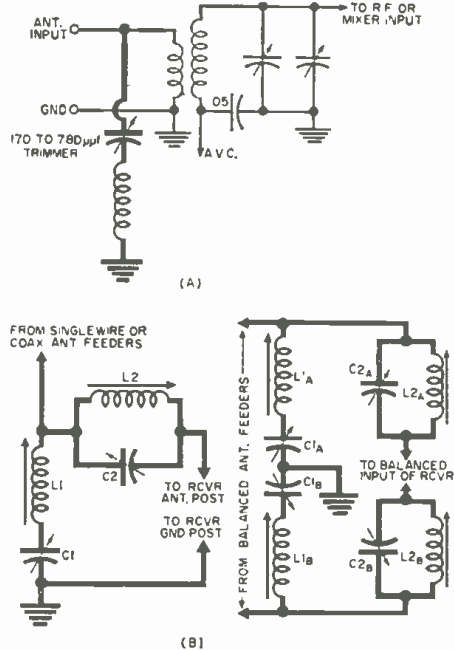

Fig. 5. Wave traps for short-wave sets: a single (A) series trap and combination series-parallel traps (B) for unbalanced (left) and balanced (right) antenna feed.

The most important step in effecting a cure was obtaining the cooperation of the neighbor. With his consent, a magnet was installed on the horizontal-output tube to eliminate Barkhausen oscillations, horizontal controls were re-adjusted, and the 300-ohm line inside the cabinet was re-dressed away from the horizontal circuit on the chassis.

A TVI Problem

An unusual and puzzling problem in interference on a TV set was encountered during a house call last spring.

The unit, a 21-inch console, exhibited severe cross-hatch interference at times on transmissions from the local channel 6. Since the problem was confined to the customer's home, it was thought that perhaps something inside the set itself was oscillating or that re-alignment might be needed. However, later on, the owner's 17-year-old son remarked that there was a ham operator living next door and wondered whether the latter could have anything to do with the problem.

The ham, a young fellow, was very cooperative. He permitted a portable TV set to be brought into his place as a probe and switched his transmitter to all ham bands during the process. Not a trace of interference could be induced on either the probing portable or the console next door. This possibility was abandoned and we returned to the home of the TV owner.

Almost at once, the interference returned. Acting strictly on a hunch, we made a return visit to the ham. His transmitter was turned off, but his communications receiver was on and tuned to a rock-and-roll broadcast on a local station operating on 1480 kc. When the portable TV probe was turned on in his home, the interference was clearly evident on this set, and the interference disappeared as soon as the communications receiver was turned off.

The amateur was using his 75-meter dipole as a receiving antenna for the communications receiver. When he tuned to any station other than the one on 1480 kc., the interference disappeared. When he was tuned to 1480 kc. but disconnected the dipole, the symptom also vanished. The cure was achieved when the ham agreed to switch in a shorter antenna for listening to the offending station. This also cleared up the problem.

What in blue blazes was happening? Why? How? With a mutually satisfactory solution already achieved on a practical basis, it was not possible to investigate further at the inconvenience of the people involved. However, one may speculate on possibilities. The dipole was obviously radiating some signal that wound up causing the interference, in one way or another. Was it being overloaded and re-radiating some high harmonic of the received 1480-ke. signal? It would take at least the 55th harmonic of this transmission to fall into the bandwidth of channel 6 directly. However, the dipole was pointed right at the troublesome AM station, which was only half a mile away. Perhaps the antenna, in conjunction with components in the input circuit of the receiver, set up a tuned circuit that was being forced into oscillation at some other frequency. Perhaps the local oscillator was in some way involved.

The many possibilities serve to illustrate the complex nature of interference problems, particularly where television is involved. This is a matter that cannot be covered briefly, as one part of a broad article. It merits a separate treatment, and perhaps it can be covered in a later article.

MAKING COLORS ELECTRONICALLY

Three carefully adjusted electron beams excite three primary phosphors to reproduce all colors.

ALTHOUGH all color combinations and tones recognizable to the eye can be produced with remarkable fidelity on a color-TV receiver, this is achieved with no more than three primary color sources. These are obtained by precisely aiming the beams from three electron guns in the neck of the color CRT so that each can excite only one of the three color phosphors deposited on the face of the tube. The three-gun assembly appears diagonally across this month's cover.

To obtain the high degree of color fidelity that is possible, the receiver must be adjusted carefully, as is being done by the technician in the lower, right-hand corner of the cover. Fortunately, he does not have to check all possible color combinations, which are infinite. He is assured that the set will do its job faithfully if he knows that the three primaries are balanced out in a given way. He can determine whether this balance exists, or adjust for it, simply with reference to a few colors that may be easily recognized and identified. The reference colors will generally be among those in the cover's background.

However, as produced by such conventional color generators as the RCA WR-64A being used by this technician, the comparison colors appear as separate stripes rather than blocks.

Fig. 1. The basic colors, including black and white, with the electron guns that must be emitting to produce them.

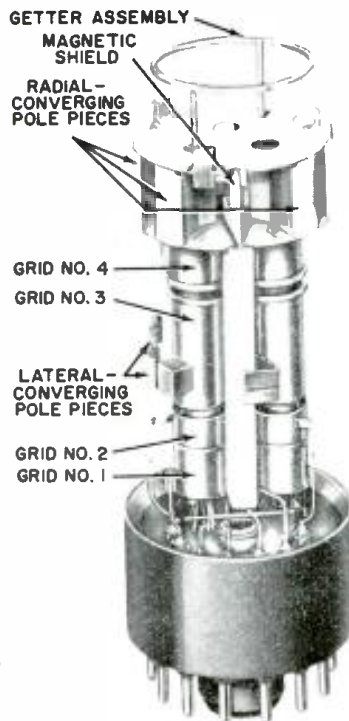
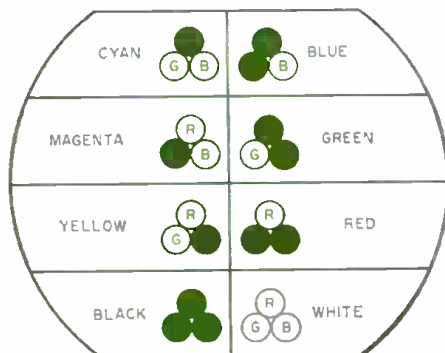

Fig. 2. The triple-gun assembly used in the neck of modern color picture tubes.

The electron gun on the cover is an assembly of three electrostatic-focus guns spaced 120 degrees apart when viewed head-on through the circular getter ring. The latter is identified at the top of Fig. 2. Although these guns appear to be parallel, each is tilted slightly inward toward the top, so that lines drawn from them would eventually converge at a single point. This point is actually slightly before the phosphor-coated faceplate of the tube. As a result, the three beams strike the faceplate at three separate but closely spaced points that form a tiny triangle. A shadow mask, covered with many minute, accurately placed holes, is located between the faceplate and the gun assembly, but closer to the faceplate to assure that each beam pro-

duces the appropriate primary color.

In a black-and-white picture tube, a single phosphor is used, and it is coated on the inside of the faceplate in a uniform film. A color CRT uses three phosphors, each of which will glow in a different primary color when excited. These are deposited, not as three separate films, but in a regular pattern of tiny dots covering the entire faceplate. The pattern consists of a series of triangles, each made up of three phosphor dots closely spaced to match the points at which the beams from the three guns will strike.

The radial-converging pole pieces of Fig. 2, one on each gun, are "aiming" devices. They are used to provide individual convergence control of each electron beam radially. Supplemental, horizontal control of the three beams is provided by the lateral-converging pole pieces. For the rest, design of each gun is quite similar to that of the single guns used in many monochrome picture tubes. The red, green, and blue guns are identified on the cover. The individual electron beams they produce speed screen-ward through the corresponding exit apertures.

All shades of white, gray, and black, as well as all colors, are obtained by controlling the relative intensities of the red, blue, and green beams, which

(Continued on page 121)

Fig. 3. RCA WR-64A generator produces color-bar, dot, or crosshatch patterns.



COVER STORY



Fig. 1. Motorola's "Private Line" vehicular 2-way radio, one of the Motrac series.

ADJUSTING COMMUNICATIONS TRANSMITTERS

PART 2

By EDWARD M. NOLL

How r.f. tuning is done on a specific unit, and how audio level is set to avoid overmodulation.

IN ORDER to properly service two-way radio equipment it is necessary that the electronic technician be capable of tuning transmitters. This knowledge is required in order to pass the radiotelephone license examination. Only a holder of a second-class radiotelephone license or better is permitted by the FCC to measure transmitter power, frequency, and modulation levels. In our previous article (March issue) we considered, in a general way, the steps involved in tuning the r.f. section of a transmitter. Let us now be more specific and follow the procedure recommended for commercial transmitters.

A *Motorola* mobile FM two-way radio unit is shown in Fig. 1. The schematic of the r.f. and modulator sections of the transmitter is shown in Fig. 2. The transmitter consists of a crystal oscillator, two doublers, a tripler, and a final power amplifier. Crystal frequencies fall into the range between 2.083 and 4.16 mc., and are multiplied by a factor of 12. The output frequency of the doubler-driver is somewhere in the 25

to 50 mc. band as a function of the crystal oscillator frequency. The power amplifier increases the FM-modulated signal to 30 or 50 watts as a function of the particular assignment. The output of the transmitter is coupled to the antenna system through a harmonic filter, Z_{in} . An antenna change-over relay switches the antenna from receiver to transmitter.

The output of the crystal oscillator is phase modulated by the voice-frequency components. The grid of the modulator is supplied with audio signal from a transistor audio amplifier and a clipper whose function is to limit modulation

peaks. By doing so a high average deviation can be obtained without exceeding 100% modulation on peaks. The level of the modulating audio is set by the IDC control.

Two crystal oscillators are employed to permit two-channel operation of the transmitter. A frequency control, capacitor C_{101} or C_{111} , is associated with each crystal. One of the first steps in tuning a transmitter is usually to set the oscillator to its precise frequency. A heterodyne frequency meter may be coupled to the oscillator and used to adjust capacitors C_{101} and C_{111} to secure the desired low frequency.

In most tune-up procedures it is customary to set the crystal oscillator as close as possible to the desired frequency. The final frequency check is made later by coupling the frequency meter to the transmitting antenna after the entire transmitter has been tuned. The frequency meter is then used to measure the actual center frequency of the radiated FM wave. If it is not in accordance with the assignment made, it is necessary to re-adjust C_{101} and C_{111} .

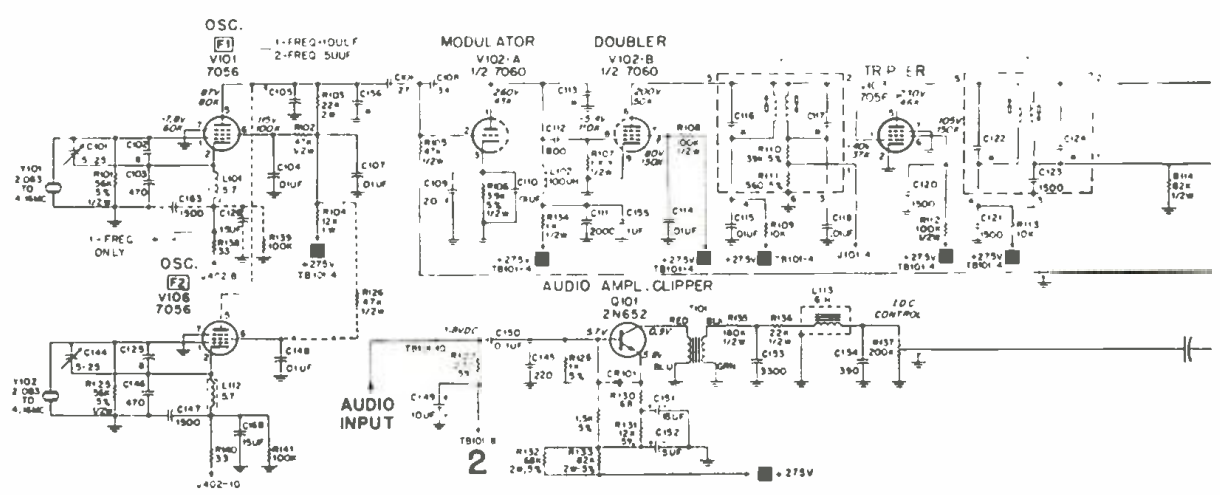

Fig. 2. Transmitter portion of the equipment shown in Fig. 1, including the r.f., speech, modulator, and output circuitry.

to place the transmitter precisely on its assigned frequencies.

A pentode crystal oscillator with an untuned output is employed. It supplies signal directly to the modulator and a following frequency doubler. No tuning adjustments are associated with the transmitter between the oscillator output and the input of the doubler.

The first tunable transformer is T_1 , located between the doubler and the following tripler stage. A test jack, J_{101-1} , is available for measuring the tripler grid current. The test meter evaluates the grid current by measuring the voltage drop across resistor R_{111} . The primary and then the secondary tuning slugs are adjusted for maximum current reading. Maximum grid current flows when there is maximum excitation to the grid of the tripler. The resonant circuits have some interaction on each other, and therefore the two slugs should be re-peaked carefully.

The meter is now inserted into jack J_{101-2} to measure the grid current of the doubler-driver stage. The primary and secondary tuning slugs of T_2 are adjusted for maximum grid current reading.

Next, the power amplifier grid current is measured by means of jack J_{101-3} . Inductor L_{103} is tuned for maximum grid current and then inductor L_{101} is adjusted for maximum grid current. As before, the two controls must be re-peaked several times because of interaction.

Next, the test meter is connected to test jack terminals J_{101-7} and J_{101-8} which connect the meter across a resistor (R_{121}) in the plate circuit of the power amplifier. The final stage is set for low power operation by using a reduced value of screen voltage. To do this, switch S_{101} is opened. Three adjustments are associated with the plate circuit of the power amplifier. These are the plate tank capacitor, C_{106} ; the antenna trimmer, C_{108} ; and the coupling between the plate tank coil, L_{106} , and the antenna coil, L_{107} .

In the initial adjustment, loose coup-

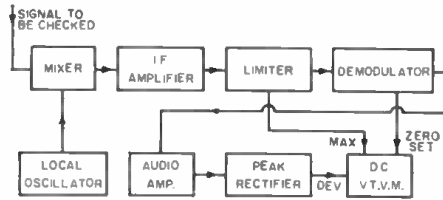

Fig. 3. An FM deviation meter, shown in block diagram, is a calibrated receiver.

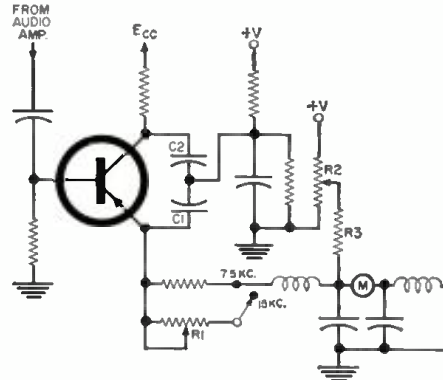

Fig. 4. Transistorized, peak-reading voltmeter used in instrument of Fig. 5.

ling is used between the two coils. (Although the schematic does not indicate it, the two coils can be moved apart.) The antenna trimmer is adjusted for minimum plate current reading. Next, the plate capacitor is adjusted for minimum plate current reading. The transmitter is switched to its high power output position. (Maximum screen voltage is applied to the power amplifier.) The plate voltage is set to the value that provides the desired power output. Note, if an output of 50 watts is to be obtained a plate voltage of 700 volts is needed. For 30 watts, 430 plate volts are needed. The plate tank capacitor and the antenna trimmer capacitor are again retuned for minimum plate current.

Final-Stage Tuning

The next step in tuning the transmitter is to peak the final stage with power

being delivered to the antenna. The antenna coupling is now increased by moving the coils closer together. The tank capacitor is retuned for minimum current. The antenna trimmer is now tuned for maximum plate current. The increase of plate current as the antenna is tuned indicates that power is being absorbed by the antenna as the trimmer brings it into resonance. Watch the plate current meter as this is being done. In the case of the *Motorola* transmitter, maximum current is 140 milliamperes for 30 watts output and 130 milliamperes for 50 watts output. To increase or decrease the amount of current drawn, increase or decrease the coupling and then retune the antenna trimmer for maximum and the plate tank for minimum.

In summary, the adjustment procedure for the final power amplifier involves the transfer of energy into the antenna system with the power amplifier drawing the rated plate current or less, and the plate tank capacitor tuned to exact resonance. Remember that plate power input is now the product of the plate current reading and the plate voltage supplied to the stage.

R.F. Output Indicator

Some form of r.f. indicator, such as a wattmeter or field-strength meter, is also helpful in tuning the final power amplifier and antenna system of a transmitter. The preferable wattmeter type is one that can be inserted in the transmission line between the transmitter and the antenna. This type of meter can be used for a reading without disturbing the match between the antenna and the transmitter, and permits the transmitter to operate in its normal manner. A field-strength meter also permits normal operation while measurements are being made. The output indication on the field-strength meter, however, is a relative measurement while the wattmeter actually measures the r.f. output of the transmitter in watts.

The tuning of a transmitter with the
(Continued on page 120)

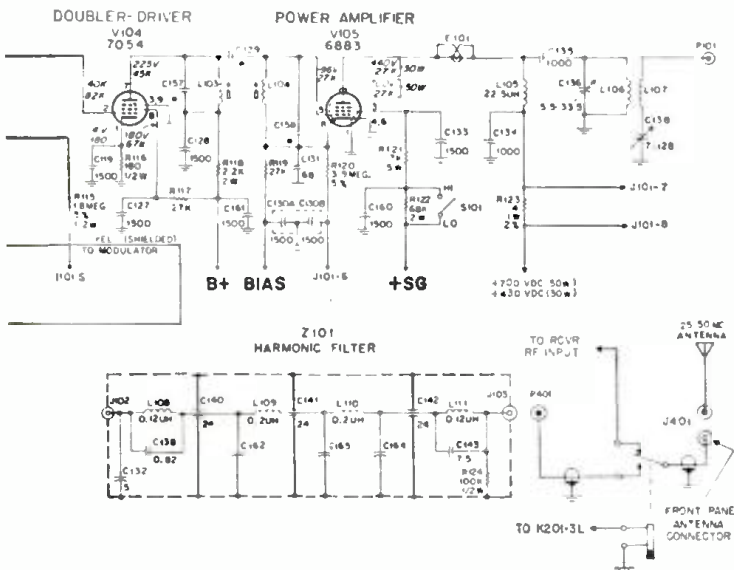

Fig. 5. The Gertsch Peak Modulation Deviation Meter, Model DM-3, is typical of deviation monitors used to set audio clip-pers. This setting keeps modulation within permissible limits.



Tube Inventory for Service Shops

By **ROBERT A. LARSEN**
Windsor Television, Inc.

**Make sure you have all needed types in the shop
and in the caddy without tying up too much cash.**

THE LARGEST, single capital investment for a television service shop is likely to be its stock of tubes. Due to a sharp decrease in over-the-counter sales in recent years, doubtless related to the growth in popularity of do-it-yourself tube checkers, tube movement or turnover for the average shop is not as good as it used to be. Wise shop owners therefore have all the more reason for keeping a careful watch over their inventory to avoid over-stocking of slow movers, in addition to the regular, also serious problem of not running out of stock on good movers.

The tube inventory listings shown here have been prepared from the actual records of a television service shop in a suburban, metropolitan v.h.f. area, and were carefully compared with such other statistics as stock-movement figures available to distributors. These listings have been devised to act as a guide not only for stocking and re-ordering for the shop itself, but also for the tube caddy.

There are two "quantity" figures following each tube type. The first indicates the number of tubes of the particular type moved in each thousand of tubes turned over. Actually this figure is based on a greater number of tubes moved than one thousand. The figure was averaged for a full year's activity. For instance, the first number following the listing for the 6BQ7 is 45. This indicates that 45 out of every

1000 tube sales were 6BQ7's. The amount the average shop turns over is probably something between 1500 and 2000 tubes per year. If this is true, the dealer could expect to sell about 68 to 90 6BQ7's during the year.

Some tubes have been deleted from the list as it appeared in earlier years because of obsolescence. Others are still carried because there is some movement although it is very low. For example, where the rate of turnover is only one in a few thousand, the tube type is still listed but the figure given in the first "quantity" column is a zero.

The second "quantity" figure gives the number of tubes of each type to be used in stocking the tube caddy. Since the average caddy holds only about 150 tubes, the second figure was drawn up with this capacity in mind. However, some alert dealers carry two tube caddies. One, for faster moving types, is brought into the customer's home on every outside call. The other, the slower movers, stays in the service truck so that, if a tube in it should be needed, there is no need for an extra trip to the shop. Optional types that may be put in the second caddy are designated by an asterisk (*).

Proper inventory control is one of those business details which, if adhered to, will help the shop owner realize greater return from a smaller investment. To make it easy on yourself, get into the habit of checking your inventory period-

Type	Quantity	Type	Quantity	Type	Quantity	Type	Quantity	Type	Quantity
0Z4	10	3CF6	1	5AV8	1	6AQ5	14	6BD6	0
1AX2	1	3CS6	2	5BK7	1	6AQ6	0	6BE6	5
1G3/1B3	15	3CY5	0	5BQ7	1	6AR5	0	6BF6	0
1R5	5	3DT6	1	5BR8	1	6AS5	2	6BG6	8
1S4	1	3Q4	0	5CG8	1	6AS7	0	6BH6	0
1S5	2	3Q5	0	5CL8	3	6AS8	4	6BH8	1
1T4	1	3S4	1	5CQ8	1	6AT6	2	6BJ6	1
1U4	3	3V4	1	5J6	1	6AT8	2	6BK5	1
1U5	3	4AU6	1	5T8	1	6AU4	15	6BK7	8
1V2	2	4BC5	0	5U4	100	6AU5	1	6BL7	6
1X2	15	4BC8	1	5U8	5	6AU6	30	6BN4	1
2BN4	1	4BN6	0	5V3	1	6AU8	3	6BN6	1
2CY5	4	4BQ7	3	5V4	2	6AV5	1	6BN8	0
3AL5	1	4BS8	1	5X8	1	6AV6	8	6BQ6	35
3AU6	1	4BU8	1	5Y3	5	6AW8	6	6BQ7	45
3AV6	0	4BZ6	2	6AB4	2	6AX4	28	6BR8	1
3BC5	1	4BZ7	1	6AC7	15	6AX5	1	6BS8	3
3BE6	0	4CB6	1	6AG5	8	6AX8	1	6BU8	1
3BN4	1	4CS6	1	6AH4	1	6AZ8	1	6BX7	1
3BN6	2	5AM8	1	6AH6	1	6BA6	7	6BY5	1
3BU8	1	5AN8	2	6AK5	1	6BA8	1	6BY6	0
3BY6	0	5AQ5	2	6AL5	16	6BC5	8	6BZ6	6
3BZ6	3	5AS4	1	6AM8	1	6BC7	1	6BZ7	10
3CB6	3	5AT8	1	6AN8	3	6BC8	3	6BZ8	1

1961

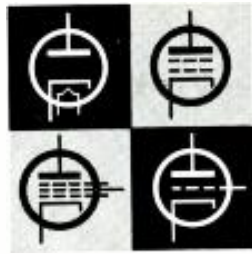

1961

ically, if you are not doing so now. Small shops will find it best to keep a master list of tubes to be stocked, based on the one shown here, and to re-order on a regular basis, filling in those used to meet their own minimum requirements.

EDITOR'S NOTE: Readers who have been following this annual feature regularly will note that it breaks with the approach followed in past years in more ways than one: The compiler of this reference is not the one who has traditionally done the job. The consistent trend toward an increase in the number of listings has, for the first time, been reversed. Two different sets of quantity ratings have been included. The order of magnitude of the ratings themselves has been changed drastically. What does all this mean?

As to the first point, Murray Barlowe, who has been the faithful keeper of this list since its inception, has moved on to a new career in the highly diversified world of electronics that has nothing to do with service. Taking his place is the capable Robert Larsen, owner of one of the most successful shops in his area and the respected holder of more than one office, past and present, in his local and state service associations. Bob has decided to handle the problem in a different way. The result is something that is certainly no less useful.

As to the reduced listing, Bob has already cited one good reason: the decrease in over-the-counter sales makes it more important than ever that the service dealer avoid tying up cash in over-stocking. This alone does not account for the fact that, after the *addition* of newer types, this year's total comes to 235 whereas last year's went to 268, not including a separate listing for hi-fi. Of course, there have been some drop-outs of obsolescent types, as in the past. But additions have always been greater.

The axe has been applied mercilessly to all "special" types, like those used primarily or exclusively in auto radios or in industrial, color, u.h.f., and hi-fi equipment. Does this reduce the guide's value? We think not. The deletion can be justified simply by recalling the reason for running the inventory to begin with. It was made necessary by the bewildering profusion of tube types that came into regular use. When only a few basic types existed, there was no need for guidance.

Altogether there have been about 60 deletions in the five categories mentioned, an average of about a dozen types in each group. No dealer should have trouble determining his own requirements, if any, in each category. In fact, an "average" listing would be meaningless. For example, one particular shop may do no industrial or u.h.f. work at all.

As noted, the first quantity figure in each case is based on turnover rate. Thus it is bound to be out of step with earlier listings, which were minimum-quantity figures. For example, the highest figure for any type last year was 10. This year the 5U4 comes in with a whopping rating of 100!

This does not mean you should carry 100 5U4's. No list is better than the judgment with which it is used. The total number of tubes you turn over in a year, weighted against the frequency with which you re-order, can give you a correction factor for adjusting the rating.

Dealers who liked the way the old method worked and are reluctant to give it up don't have to. A close approximation of the old ratings can be obtained easily in this way: Divide new ratings by 3, but allow no figure higher than 10. Raise any fraction to the next highest whole number.

A final word: stock only latest versions of each type, since it will replace its predecessors. For example, the 5U4GB will meet all electrical requirements for any 5U4 type and, physically, will create no space problem.

Type	Quantity		Type	Quantity		Type	Quantity		Type	Quantity		Type	Quantity	
6C4	3	1	6DT6	1	*	6X4	2	1	12AZ7	1	1	17AX4	5	*
6CB6	35	3	6EA8	2	1	6X8	7	1	12B4	2	1	17D4	1	
6CD6	10	2	6EB8	1	1	6Y6	0		12BA6	5		17DQ6	2	*
6CF6	2	1	6EM5	1		7AU7	2	1	12BD6	1		19AU4	1	*
6CG7	33	3	6EW6	1		8AW8	1	*	12BE6	5		19BG6	0	
6CG8	1	1	6J5	4	1	8CG7	1	*	12BF6	0		19T8	0	
6CL6	1	1	6J6	12	1	8CM7	0	*	12BH7	15	1	25AX4	1	*
6CL8	1		6K6	1	1	8CX7	0		12BK5	0		25BK5	0	
6CM6	0		6L6	1		9AU7	0	*	12BQ6	5		25BQ6	3	*
6CM7	7	2	6S4	10	2	9BR7	0		12BY7	5	1	25CD6	1	1
6CN7	0		6SA7	1		10DE7	2	1	12BZ7	1	1	25CV6	1	
6CQ8	5	1	6SJ7	1	*	12AD6	1		12CA5	1	*	25DN6	1	
6CR6	0		6SK7	1	*	12AF6	1		12CU5	1		25L6	5	*
6CS6	1	1	6SL7	1	*	12AL5	0		12D4	1		25W4	1	*
6CS7	0	1	6SN7	47	3	12AQ5	0		12DQ6	7	1	35B5	1	
6CU5	1		6SQ7	2	*	12AT6	2	1	12L6	1	1	35C5	2	
6CY5	2		6SR7	1		12AT7	6	1	12SA7	1		35L6	2	
6CZ5	0	1	6T8	13	2	12AU6	3		12SK7	2		35W4	10	
6DA4	1		6U8	40	4	12AU7	30	2	12SN7	1	1	35Z5	10	
6DE6	3	1	6V3	1		12AV6	5		12SQ7	1		50B5	1	
6DG6	0	*	6V6	10	1	12AV7	7	1	12V6	1	*	50C5	17	
6DQ6	23	2	6W4	15	2	12AX4	18	1	12W6	1	*	50L6	7	
6DS5	0		6W6	14	1	12AX7	2	1	12Y4	1		5642	1	

TV Commercial Silencer



By **ROBERT J. MACK**

Build this simple circuit that will kill TV sound for one minute when a remote button is depressed.

IT IS no longer necessary to "suffer" through television commercials. An inexpensive electronic device can silence the sound portion of the commercial and then automatically restore the sound when the "sponsor's message" is ended.

The device is simple to make and install and provides virtually "free" service as it consumes a negligible 3 to 6 watts. When listening to program material, the device is totally inoperative. It operates only when activated during commercials.

Operation

Operation of this device is based upon the use of a relay and a thermal-delay tube. When the unit is activated by a switch, the relay opens the TV sound circuit, cutting off the commercial. At the same time, the thermal-delay tube is activated. This is a heat-operated switch which becomes operative in

Circuit of the commercial killer shows the use of a thermal-delay relay tube which operates a relay that disconnects the loudspeaker from the TV set's output transformer. A dummy load is then switched into the circuit, taking the place of the normally used loudspeaker.

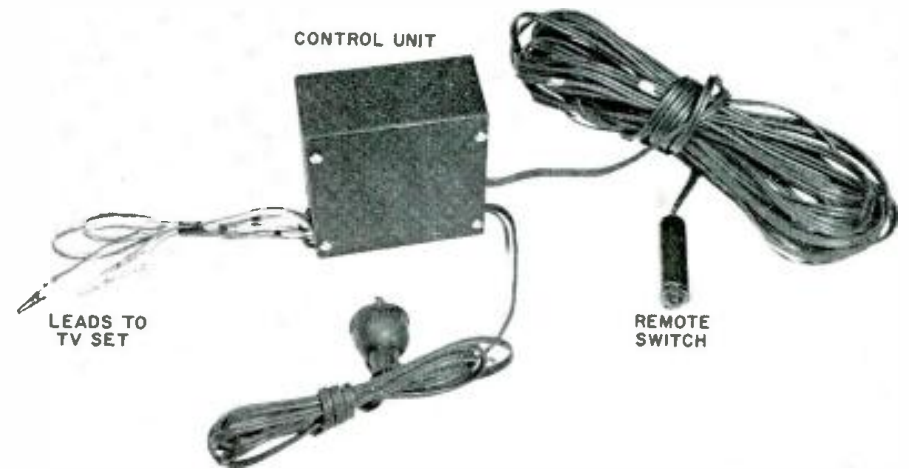
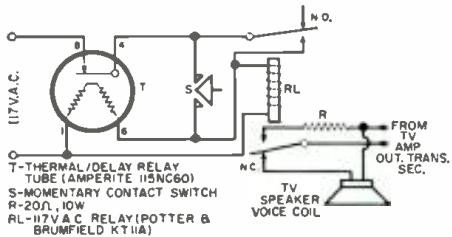

The control unit is housed in a small 4" x 4" x 2" metal cabinet with a built-in chassis. Three leads from the control unit connect it to the TV set. A.c. line cord is employed to connect the remotely located insulated push-button switch.

about one minute. After the minute is over, the heat switch opens, de-energizing the relay and restoring the television sound.

In normal operation of the TV set, the TV speaker voice-coil circuit is completed by the normally closed contacts (N.C.) of relay *RL*. The relay and the delay tube (*T*) are inoperative since switch *S* and the normally open (N.O.) relay contacts energizing them are open.

When a commercial comes on, switch *S* is closed momentarily. This activates *RL* which (1) closes the normally open contacts, maintaining *RL* in an energized condition and energizing the heat-

ing element of the thermal-delay tube *T*; (2) opens the normally closed contacts, opening the TV speaker circuit; and (3) closes the other set of contacts of the normally closed relay contacts, placing a resistive load across the TV amplifier output.

After about one minute, the delay-tube contacts open, breaking the relay coil circuit and the delay-tube heating element circuit. All conditions now reverse: the relay contacts in the speaker voice-coil circuit close, restoring the TV sound; the other relay contacts return to their normally open position. When the delay-tube heating element cools

sufficiently (usually in 10 to 20 seconds) the delay tube contacts return to their normally closed position. Conditions are now the same as they were initially. It should be noted that because of the presence of a heating element in the circuit, the device requires a cooling period before it will again provide the full one-minute delay time. This is not usually a problem, however, as commercials are normally adequately spaced. If the device is activated before it has cooled completely, the delay time will be less than one minute.

Construction

Construction of this silencer device is simple as there are few parts. These can be conveniently housed in one of the small (4" x 4" x 2") commercial-type metal cabinets. The type with a built-in chassis allows the parts to be easily mounted on a firm support.

Layout and wiring are not critical. The parts and cabinet specified allow adequate clearance for mounting and wiring. Before proceeding, it is well to observe two precautions: (1) Neither the metal chassis nor the metal case are part of the electronic circuit. No connection of any kind is to be made to these metal parts. (2) The number of the pins on the miniature 9-pin socket is given for the *bottom* view.

The first step is to locate and mount the relay and the thermal-delay-tube socket. Keep the relay bracket as far to one end of the chassis as possible to allow maximum clearance between the relay terminal strip and the delay tube when it is inserted in the socket. Next, move the delay tube socket as far toward the other end of the chassis as it can go and still have firm support.

After the relay and delay-tube socket are mounted, three 1/4" holes are drilled in the case. One is for the 117-volt a.c. line; the second is for the line to the switch, which is placed at the viewing position; and the third is for the speaker voice-coil leads. The power line and the switch line carry 117 volts a.c., so their holes are drilled in one end of the case. The voice-coil leads carry little current and this hole is drilled in the opposite end of the case. Each hole is grommeted

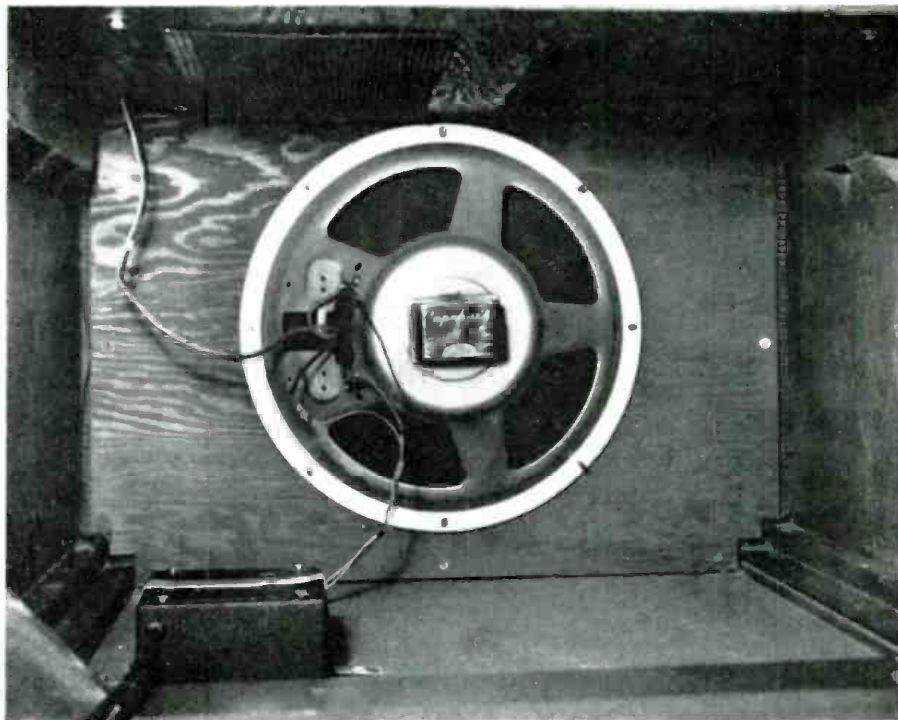

The control unit used by the author is shown here mounted inside and on the bottom of the TV cabinet. An aluminum strap holds the unit down. One lead is disconnected from the set's speaker and connections are made to the voice-coil circuit as described.

for safety. The parts are now ready to be wired.

Testing & Installation

The completed device can be tested as follows: Connect the two voice-coil leads from the normally closed relay contacts to a flashlight battery and bulb in series. The bulb should light. Now connect the a.c. power and press S. The relay should close and the bulb go out. After about one minute, the relay should open and the bulb light again. If this sequence occurs, the device is wired correctly and is ready for installation. If any part of the sequence fails to occur, the wiring should be rechecked.

Installation is easy. The box will usually fit inside the TV speaker compartment. If it does not, it may be placed anywhere in the TV cabinet except near components which generate excessive

heat. Observe the usual precaution of first disconnecting the TV set. If desired, the box may be mounted external to the TV cabinet.

To connect the voice-coil circuit, unsolder (or cut if necessary) one of the leads from the secondary of the TV set's output transformer to the speaker voice-coil lug. Connect this lead to the armature of the relay. Connect the lead from the voice coil to the normally closed relay contact. The lead from the load resistor is connected to the other side of the voice coil (which is still connected to the output transformer). To install the switch, merely run the switch line under the rug or along the baseboard to the viewing position. When the a.c. plug is connected, the device is ready for use. You are now ready to enjoy television without commercials—at the press of a button!

-30-

The thermal-delay tube, relay, and resistor are first mounted on the small chassis bracket that is affixed to cabinet panel.

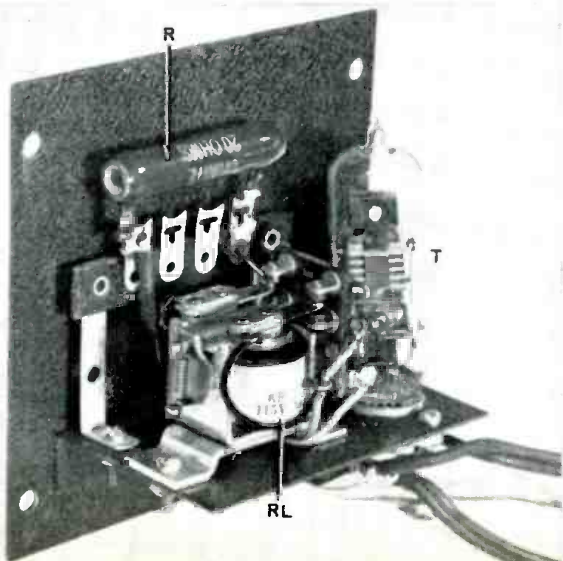

The control unit is shown here with the cabinet cover removed. Note that only three components are utilized in the unit shown.

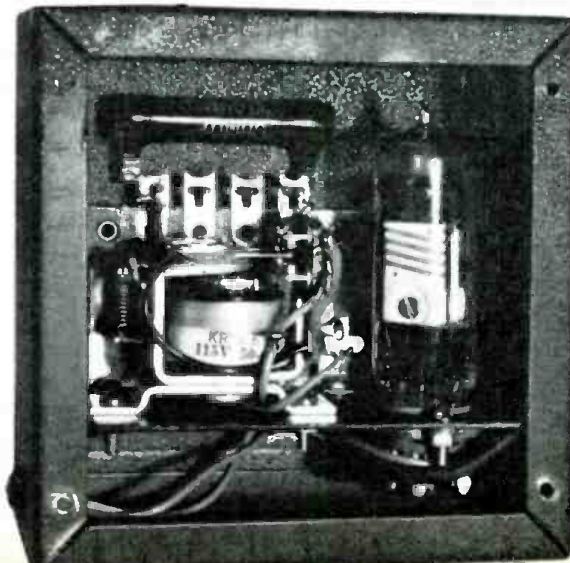

DIODES ARE DIFFERENT

By J. H. HAZLEHURST / **Some good advice for the experimenter or audiophile who wants to substitute silicon diodes for rectifier tubes.**

THE USE of silicon diodes in power rectification has grown greatly in the last few years. This, of course, is due to the obvious advantages of compactness, reduced heat, relatively high current ratings, and competitive cost. In bridge circuits there is the additional benefit of saving the cost of separate filament transformers.

These diodes, however, have some peculiarities which are not widely known, specifically with respect to back resistance. As a result, some people have had what appears to be bad luck with them, particularly when they are used in series strings. A knowledge of these problems is necessary for the proper application of these devices.

A Practical Example

Let's illustrate this with a practical example. Figure 1A shows a power supply that is typical in many hi-fi amplifiers. Now, if the rectifier tube gets old and tired, probably the cheapest and easiest thing to do is replace it. However, this is the point at which many do-it-yourself enthusiasts decide that the time is at hand to try semiconductor diodes and perhaps reduce the cabinet heat about 25 per-cent.

Now the first thing is to decide how many rectifiers to buy. Most of the low-cost diodes are rated to supply 200 or

500 milliamperes, and have a peak inverse voltage rating of 400 volts. In this case the decision is to use the 200-ma. units. Then our experimenter knows that in a full-wave supply such as this, the peak inverse voltage that the diode must withstand is 2.8 times the supply voltage, so he multiplies 2.8 by 375 and gets 1050 volts. Certainly three diodes each with a 400 p.i.v. rating ought to do this nicely with plenty of safety factor. So he makes up the supply shown in Fig. 1B. Now, as a matter of fact, this supply may work just fine, but sometimes not, because there are three serious mistakes made here. Two of these should be easy to spot, but the third is likely to be missed by all but those who are very familiar with the characteristics of silicon diodes.

In the first place, silicon or selenium diodes should work into a choke-input filter for best results. In this case, taking out the first filter capacitor might drop the output voltage of the filter too far for proper operation of the circuits. To meet this difficulty, a protective resistor should be installed between the diodes and the first filter capacitor. This resistor should be about 30 ohms per diode on one side of the supply. With three diodes 100 ohms would be a good value. This will cause a voltage drop, but this is about offset by the fact that

the voltage drop across the diodes is less than across the tube which is being replaced. Without this protection, the initial current surge into the first filter capacitor which, momentarily, looks like a short circuit, may exceed the rating of the diode. It is amazing, though, to see how diodes sometimes stand up under this beating when the capacity into which they feed is not unusually high.

The second mistake our friend made was in computing the peak inverse voltage. This is *not* based on the output voltage of the filter, but on the a.c. voltage across the diodes. In this particular case, it would probably be in the neighborhood of 425 or 430 volts. When we multiply this by 2.8, we are right at 1200 volts which should be maximum for three diodes each with 400 p.i.v. rating. So there goes our safety factor that we might have thought actually existed.

When designing a supply of this sort with a transformer that we might have on hand, a good rough rule-of-thumb is to measure the open circuit voltage across half the transformer secondary, multiply this by .95 and then by 2.8 in order to compute the peak inverse voltage applied to the diodes.

Now we have our protective resistor, and while our diodes are operating at their limit, this limit is not being materially exceeded, so won't this supply work all right? Well, it may, and then again it may perk along for a while and then fail. When we check it out, we may find all three diodes on one side are short-circuited. When this happens, we may decide that maybe we shouldn't have worked so close to the p.i.v. limit and should use four diodes on a side. This runs up the expense and we begin to wonder if we should have stayed with

(Continued on page 98)

Fig. 1. Typical power supply using (A) a rectifier tube and (B) substitute diodes.

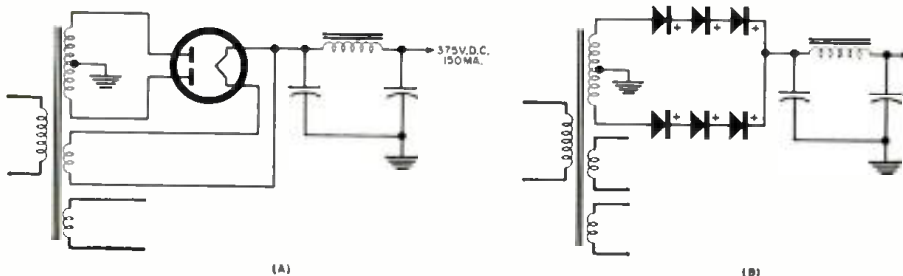

Changes In WWV Standard Broadcasts

Bureau of Standards transmissions now include a special time code for use in world-wide scientific observations.

AT THE BEGINNING of this year, the National Bureau of Standards retarded the time signals broadcast from radio stations WWV and WWVH by 5 milliseconds, and at the same time started broadcasting on a permanent basis from WWV a special timing code which gives the day, hour, minute, and second (Universal Time) coded in binary form. The 5-msec. retardation brought the time signals into closer agreement with other standardized frequency broadcasting stations throughout the world.

The United Kingdom and the United States began coordinating their time and frequency transmission early in 1960. Coordination was begun to help provide a more uniform system of time and frequency transmissions throughout the world, needed in the solution of many scientific and technical problems in such fields as radio communications, geodesy, and the tracking of artificial satellites. The transmitting stations which are included in the coordination

plan are GBR and MSF at Rugby, England; NBA, Canal Zone; WWV, Beltsville, Maryland; and WWVH, Hawaii. In 1961 it is planned to maintain the frequency stable to 1 part in 10^{10} and at the same offset value as before, i.e., -150 parts in 10^{10} with reference to the U. S. Frequency Standard.

Timing Code

The timing code provides a standardized timing basis for use when scientific observations are made simultaneously at widely separated locations. It can be used, for example, where signals telemetered from a satellite are recorded along with these pulse-coded time signals; subsequent analysis of the data is then aided by having unambiguous time markers accurate to a thousandth of a second. Astronomical observations may also benefit by the increased timing potential provided by the pulse-coded signals.

These signals are in the form of a 36-bit, 100 pulse-per-second time code, car-

ried on 1000-cps modulation, all on WWV's carrier frequencies of 2.5, 5, 10, 15, 20, and 25 mc. The code is broadcast for 1-minute intervals, 10 times each hour as shown on the diagram below. Time-of-year information (Universal Time), given in seconds, minutes, hours, and day of year, which is locked in phase with the frequency and time signals, is given. The code is binary-coded decimal consisting of 9 binary groups each second in the following order: 2 groups for seconds, 2 groups for minutes, 2 groups for hours, and 3 groups for day of year. Code-digit weighting is 1, 2, 4, and 8 for each group, multiplied by 1, 10, or 100.

The code is a spaced code format; that is, a binary group follows each of the 10-per-second index markers. The last index marker is followed by a presently unused 4-bit group of "0" pulses just preceding the 1-second reference marker. The "0" pulses are 2 milliseconds wide (that is, 2 cycles at 1000 cps) and the "1" pulses are 6 milliseconds wide (6 cycles at 1000 cps). —30—

Details of the time-code transmissions from radio station WWV. For this particular example, the signals indicate the 50th second of the 23rd minute, of the 10th hour, of the 121st day of the current year. One second later, the first of the "units" pulses in the group designating "seconds" will change from "0" (a 2-millisecond pulse) to "1" (a 6-millisecond pulse), indicating the 51st second.

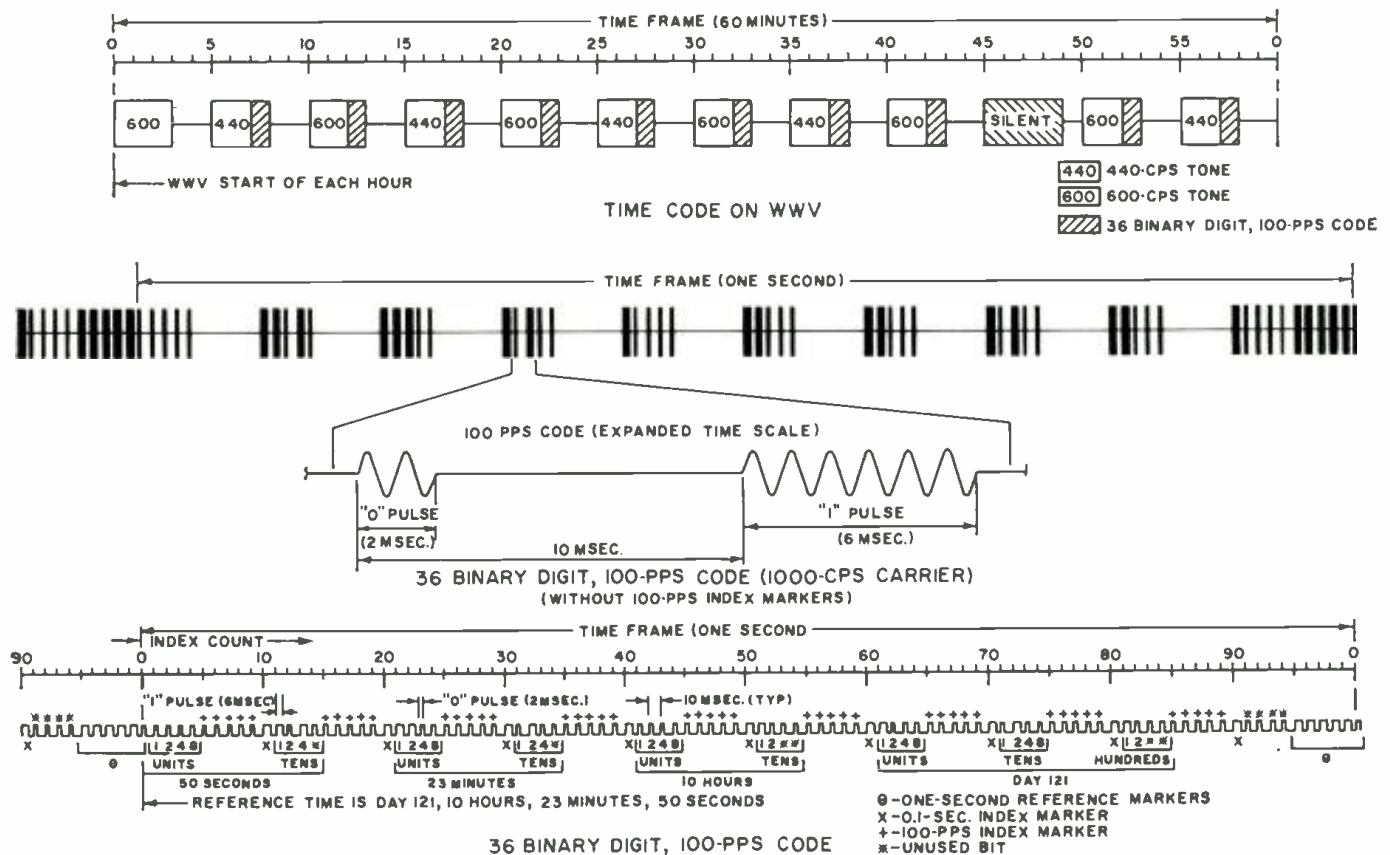

HA VE YOU, as a service dealer, ever asked yourself such questions as, "How much am I actually earning? How much am I really worth?" Or perhaps you have found it necessary to make such information available to someone else for business purposes and have, as a result, been surprised at your inability to come up with the facts in concrete form. In "Determine Your True Income" (December, 1960), we provide a means—the Income Statement—for answering the first question. Much of the information turned up then will be useful in answering the second question here.

The Income Statement, as was pointed out in the preceding article, is a prime accounting document. Another of equal importance is the *Balance Sheet*, which is a means for determining your net worth. If you have followed the preparation of the Income Statement, you will find that the Balance Sheet is even easier—yet, without the latter, you have little means for showing just how well your business is doing or what your ability to secure and pay back a loan is.

A finished example is shown in Table 1. We will explain the entries and their significance as we go along. The first three terms of importance are **Assets, Liabilities, and Capital.**

Assets, which may be considered the things used in the normal course of your business, fall into two subdivisions: **Current Assets** and **Fixed Assets**. **Current Assets** are those which are constantly being exhausted as a result of sales and service. **Fixed Assets** are those which are, more or less, a permanent part of the business.

Liabilities: A portion of your assets may not be wholly your own. For example, you may owe money on some of them. On the Balance Sheet, they will be regarded as Liabilities.

Capital: That portion of the assets that is entirely yours. (This Capital is also called *Net Worth*.) With just these three terms, the Balance Sheet can develop important information, and can express what it has to say in more than one way. The basic relationship among these three can be stated in a formula:

$$\text{Assets} = \text{Liabilities} + \text{Capital} \dots (1)$$

Now that we have an equation, we also have considerable flexibility. The formula may be manipulated, for ex-

ample, so that any one of its elements can be expressed in terms of the other two. In other words, we need know only two of them; the third can be computed.

Those who have read the preceding article will recall that we created an imaginary service dealer, Joe Smith, who went through the motions of accumulating data for his first Income Statement. It is only fitting that we allow him this privilege for the Balance Sheet as well. In fact, practically all the information he will now need has already been obtained with the earlier document.

Assets

Joe must first consider **Current Assets**. What is it that is constantly being exhausted as a result of his doing business? He decides there are three: money, merchandise, and shop supplies. The first is easy; he has a check-book balance of \$300 and \$100 in the cash drawer. The second is also easy, since he has drawn up an Income Statement for which he has had to take an inventory. Final inventory for June 30, 1960—the same period after which the Balance Sheet is being made up—was \$1700. The third item is not so easy. Joe Smith must evaluate all of his shop supplies (light bulbs, stationery, solder, and the like) that are now on hand. If he has drawn up his Income Statement properly, however, he has most of the needed information on hand. He finds that these supplies come to \$100 not in-

cluded as merchandise already listed in the inventory. As shown in Table 1, the sum of all these **Current Assets** comes to \$2200.

He finds there are only two groups of permanent (fixed) assets: his truck and his shop equipment. The latter includes all test equipment, tools, and accessories. As his Income Statement showed, the truck and all shop equipment each were valued at \$600 for a Total Equipment figure of \$1200, which is now entered on the Balance Sheet (Table 1). But there is a complication: What about depreciation? The Income Statement showed that both his truck and his total shop equipment depreciated \$60.00 each for a six-month period. Since he has had each of these for one year (purchased July 1, 1959), the accumulated depreciation for each is now \$120, or \$240 for both. So we have another formula:

$$\text{Total Fixed Assets} = \text{Total Equipment} - \text{Accumulated Depreciation} \dots (2)$$

Deducting the depreciation figure from the value of the equipment, we accordingly come up with Total Fixed Assets of \$960. For the final determination of Total Assets, we add the figure just obtained to that for Total Current Assets (\$2200) and come up with \$3160. This last calculation can also be put into a convenient formula:

$$\text{Total Assets} = \text{Total Current Assets} + \text{Total Fixed Assets} \dots (3)$$

Liabilities

In Joe's particular case, his Liabilities consist only of the money he still owes on two items, his truck and his shop equipment. Since a short-term loan is involved in each case, these are called **Current Liabilities**, and are so entered on the Balance Sheet of Table 1. If he happened to owe money on his shop supplies or merchandise, these would be additional entries under **Current Liabilities**. If he owned his own shop building and owed money (a mortgage) on that, the entry would be somewhat different. The building would be another Fixed Asset, but the money owed, which is a long-term debt, would be a **Non-Current Liability**. However, Joe is renting.

Joe's Total Liabilities then consist of nothing more than the \$100 he still owes on his truck and the \$60 he owes on equipment, or \$160 altogether. Another complication: this figure should not in-

Understanding the Balance Sheet

By JOHN E. FLIPPIN

**Aside from the income it provides you with, do you really know
how much your business is worth? Here is how you can find out.**

SMITH TELEVISION BALANCE SHEET

ASSETS		
Current Assets:		
Cash (In the Bank)	\$ 300.00	
Cash (On Hand)	100.00	
Inventory (June 30, 1960)	1700.00	
Shop Supplies	100.00	
Total Current Assets		\$2200.00
Fixed Assets		
Truck	\$ 600.00	
Shop Equipment	600.00	
Total Equipment	1200.00	
Less Depreciation	— 240.00	
Total Fixed Assets		960.00
Total Assets		\$3160.00
LIABILITIES		
Current Liabilities		
Truck	100.00	
Shop Equipment	60.00	
Total Liabilities		— 160.00
CAPITAL		
Capital		3000.00
Total Liabilities Plus Capital		\$3160.00

Table 1. A Balance Sheet, not hard to draw up, gives you a picture of Net Worth.

clude interest on the loan or loans. The Balance Sheet is only concerned with principal. Joe has accordingly made certain that this is the figure he enters here. But it would be unrealistic for him to ignore interest altogether in assessing an over-all financial picture, and he has not overlooked this expense. It belongs on the Income Statement as Interest Expense. In Joe's case, since only a small amount was involved, he was not so formal: he included it under the category of Miscellaneous Expense.

Reviewing what has been done, we see that Joe has arrived at figures for Assets and Liabilities. How can he determine his Capital? Simply by transposing formula (1) as follows: *Assets - Liabilities = Capital*. In other words, \$3160 - \$160 = \$3000. The job is done. Joe has a Balance Sheet showing his Net Worth.

Statement of Capital

When you make up your first Balance Sheet, a Statement of Capital will not be necessary. However, you will want to make one up for each succeeding period, to help you see how things are going. Joe Smith had made up his first Balance Sheet after the period ending January 1, 1960, at which time his Capital came out to \$2900. So he makes out a Statement of Capital for the period ending June 30, 1960 (Table 2) and the first item is the amount for Capital he determined on the earlier Balance Sheet, for the beginning of the year.

At that time, his Capital came to \$2900. He wants to find out his net Increase in Capital since then. To do this, he subtracts his Withdrawals (which will be explained later) during the intervening period from his Net Income (Income Statement, June 30, 1960). Since the former was \$1100 and the latter \$1200, his Income exceeded his

Withdrawals by \$100. This amount is the net Increase in Capital for the six-month period. Had his Withdrawals exceeded his Income, he would have had a net Decrease in Capital. However, this has not been the case, and he may add the increase to his Capital on January 1, 1960 to show that his Net Worth or Capital on June 30, 1960 is \$3000.

The only new term found here was Withdrawals. A Withdrawal is the amount of money that Joe takes out of his business for personal needs. We see, in the Statement of Capital, that Joe allowed \$100 of his income to remain in the business. Perhaps he used this to increase his supply of cash for use in the business or to pay on his truck or equipment. Whichever of these he did, he either increased Assets (the first case) or decreased Liabilities (the second).

The last paragraph should point out Joe's need for separating his personal business from that of the shop. If he allows them to mix willy-nilly, the Statement of Capital will not work out; but there is a way of keeping such matters under control—maintain two, separate checking accounts, one for his shop and one for personal use. This may sound as though it would make things more complicated rather than less so, since there will be some interaction between the two accounts, but an example shows that this is not so.

Let's start with the two accounts. The business account will be Smith Television and the personal one Joseph Smith. If Joe takes money out of the business for his own use or to pay his own salary, he draws a check on Smith Television and makes it out to Joseph Smith. For the Statement of Capital, this will be a Withdrawal. Should he decide to buy something for the business or pay on a loan from his personal account (add to Assets or subtract from

Liabilities), he makes out a check from Joseph Smith to Smith Television, then uses the money as intended. Since this amount will show up on the next Balance Sheet as either an increase in Assets or decrease in Liabilities, it must also be reflected as an Increase in Capital. Won't this maneuver, then, throw his records out of kilter? Not if he *subtracts* this amount he has put back into the business from Withdrawals on the Statement of Capital. This too will be an increase in Capital, and his record will balance out.

Thus we can see two important functions of the Statement of Capital: It shows Joe the amount he puts back into his business and it acts as proof to show that the Income Statement is in agreement with the Balance Sheet. Obviously if Joe had done a careless job of computing his Income Statement, to begin with, the amount for Capital shown

**Statement of Capital
For Period Ending June 30, 1960**

Capital (Jan. 1, 1960)	\$2900.00
Net Income for the Period	\$1200.00
Less Withdrawals	—1100.00
Increase in Capital	100.00
Capital (June 30, 1960)	\$3000.00

Table 2. A Statement of Capital will check accuracy of your Balance Sheet.

on the Statement of Capital on June 30, 1960 would not agree with the separately computed entry under Capital on the Balance Sheet of the same date. If this were to happen, he would immediately be aware that something had gone wrong. He would have to go back and compare his check stubs to his invoices and other records to find errors.

For every dollar spent or received, there must be a corresponding change in Income, Expenses, Assets, or Liabilities. If these records have been kept properly they will coincide, and the Statement of Capital will have to agree with the Balance Sheet.

If you have never drawn up business records of the kind described here, you are now ready for your first Income Statement and Balance Sheet. You have surely concluded by this time that keeping track of inventories and accumulating data can be a tough job. This can be made a great deal easier using the classic "journal" and "ledger" of the double-entry bookkeeping system. But what you have learned from trying to make your first statements will help you absorb this with little effort.

What we have done is to start at the end of the accounting procedure, with the Income Statement and Balance Sheet, and suggest working back to the beginning. Why? Because, as you work back, you have the opportunity to see how each business transaction will affect the two important statements that are the end products of all accounting procedures.

New Products for the Radio and TV Service Technician

- 1 Test Equipment
- 2 Tools
- 3 Components



1 *Chicago Standard Transformer* has announced three new exact-replacement transformers for *Admiral* TV sets. A total of 108 models and chassis is covered by these newly released flyback transformers.

2 *Heath Co.* has available a new isolation transformer, Model IP-10, which features several improvements, including higher power rating, improved meter accuracy, and new styling.

Designed for the service technician, the new unit provides complete isolation from the a.c. power line and allows exact control of line voltage to the equipment under test. Output voltage is variable from 90 to 130 volts in .75-volt steps by means of two 8-position switches. Power rating is 300 watts continuous.



3 *Winegard Co.* has just introduced what it claims is the world's first electronic TV receiving antenna, the "Powertron." The new unit, an all-channel yagi design, incorporates a built-in electronic r.f. amplifier.

The antenna is being offered in three models: a 14-element unit; a 21-element version; and a 30-element design. A compact isolation transformer unit plugs into the 117-volt power line, lowers the voltage to 24 volts for safe operation.

4 *Radio Shack Corp.* has introduced a dual-trace scope in kit form for the service fraternity. Response is flat from 10 cps to 5 mc., useful to 9 mc. The circuit features push-pull vertical and horizontal amplifiers, cathode-follower inputs, and 5" screen.

Over-all size of the scope is 13 1/4" x 8 3/4" x 18 1/2". The kit comes complete with detailed assembly and operating instructions.

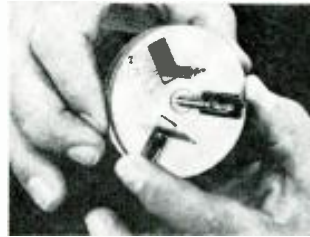

5 *Zoron, Inc.* is marketing a new "Z-Saw" hole cutter which is adjustable for cutting holes of any diameter from 1 1/8" to 2 1/4" in wood, plastic, or aluminum. An extra set of blades for cutting metal is supplied. It is designed for use with power hand drills.

6 *CBS Electronics* has added a new tool to its service tool line, the "Kwik-Klip" for quick and easy TV antenna lead replacement.

The tool eliminates unnecessary danger for technicians when working on roof tops. Simple, one-hand, clip-on operation eliminates the bother of removing rusted or corroded nuts and bolts to replace the antenna lead-in. According to the company, the "Kwik-Klip" can improve reception and restore original strength in many older antenna installations. These new tools are being offered through *CBS* tube distributors.

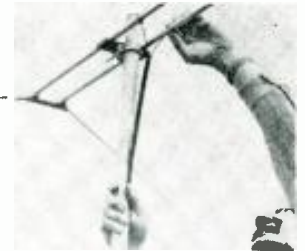

7 *RCA's Electron Tube Division* has introduced a new "do-it-yourself" kit for its "Senior VoltOhmyst," featuring a pre-assembled and pre-soldered etched-circuit board. Designated WV-98B (K), the major sections of the kit are factory assembled, cutting construction time in half.

All of the components that go on the extra-thick, etched-circuit board are factory mounted and soldered to the board. In addition, a completely assembled input cable and probe, with built-in a.c./d.c.-ohms switch, is provided with each kit.

The unit features a 6 1/2" wide, easy-to-read meter; separate color-coded scales; 200- μ a. meter movement; precision $\pm 1\%$ multiplier resistors; and rugged die-cast aluminum case with leather carrying handle.



8 *Sprague Products Co.* has assembled a specially selected assortment of its "Difilm Orange Drop" radial-lead dipped tubular capacitors for the service technician. Two "file-drawer" groups are available.





9 *Aerovor Corp.* has announced a new electrolytic capacitor kit, AK-510, for transistor radio servicing applications.

Packaged in a handy, reusable plastic box, the kit contains 18 miniature Type PTT-PWE electrolytics covering over 90% of the replacement requirements for personal transistor radios and personal portable TV sets.

10 *Sencore-Service Instruments Co.*, Addison, Ill. is now offering a new substitution unit, the "Big 20". The unit has 20 power resistors for fast substitution of all power resistors; for service work or experimenting.

Each power resistor can be substituted in circuits that dissipate up to 20 watts and for all values between 2.5 and 15,000 ohms. It can also be used as a substitute for fuse resistors in TV repairs.



11 *National Radio Institute* is now a voltmeter and 40" leads, marketing its "Professional Model 2 Battery Eliminator" designed for transistorized equipment.

The unit supplies clean, filtered d.c. fully variable from 0-15 volts. Output is sufficient for receivers up to 22½ volts. The unit cannot be damaged by short-circuits.

The instrument is shipped complete with plug-in jacks for external voltmeter, and 40" leads.



12 *The Beryllium Corp.* has added a group of miniature safety pliers to its line of non-sparking safety tools.

The line includes curved needle-nose, duck-bill, long-nose, and diagonal cutting types.



13 *Waldom Electronics, Inc.* has released a "point-of-purchase" display rack featuring a wide assortment of small electronic hardware items.

In order to attract buyers, the company has packaged its hardware in a new series of boxes, all of similar front dimensions and design. All boxes come with a window for product visibility.

The boxes are light blue and maroon for the "Blue-Line" (100 pack) Series and light green and maroon in the "Green-Line (small-pack) Series.

The packages are provided with a sturdy tab for hanging on the 118 hooks in the 30" x 65" x 18" wire hardware rack.

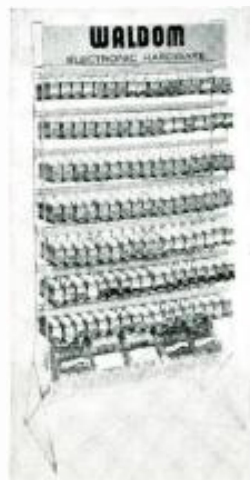

14 *Mercury Electronics'* new Model 700 transistor tester is "obsolete-proof," according to the manufacturer of this unit.

Designed for the service industry, the new instrument will check all r.f., i.f., audio, power output, and industrial transistors as well as diodes for forward-reverse ratio.

The unit is battery powered and has a special protective circuit arrangement to prevent transistor damage and excessive battery drain.

15 *Union Carbide* has come out with a new "Battery Displayer" to handle its line of "Eveready" hobby batteries in compact form.

The blonde wood and metal counter fixture displays a pre-tested assortment of 52 batteries in a little more than a square foot of counter space. It is free with a suggested order of the firm's hobby batteries.



16 *Electric Storage Battery Co.* is offering the "Aetivertter" which provides 110-volt a.e. power any place where a 12-volt battery is available or can be taken.

The unit can be used to operate a variety of electric equipment and is offered in four models with from 150 to 500 watts output.

The unit can also be used as a fast or slow charger for 6- or 12-volt batteries.



17 *Cornell-Dubilier* is offering a free "Pik-A-Pak" display rack, which holds 5000 capacitors, to distributors and jobbers who purchase a selection of C-D's most popular capacitors.

Occupying less than 3 sq. feet of floor space, the decorative and colorful display is designed to stimulate the sale of capacitors in quantity to service technicians.



USE THIS COUPON FOR ADDITIONAL DETAILS

ELECTRONICS WORLD

Att: Editorial Dept., Room 1021
One Park Avenue
New York 16, New York

Please send me additional details on the products whose code numbers I have circled below. I understand that there is no charge and no obligation.

1	2	3	4	5	6	7	8	9
10	11	12	13	14	15	16	17	

Mr.

Address

City Zone State

Please print clearly. Offer expires April 30, 1961.

A DIMENSION CONTROL

FOR STEREO

By **RALPH GLASGAL**
Consulting Audio Engineer

A new circuit and control that adjusts stereo separation ratio.

This technique enhances the stereo effect, cancels crosstalk, and compensates for poor loudspeaker placement.

WHY ANOTHER CONTROL? Isn't stereo complicated enough as it is?

For the more casual music listener, perhaps it is, but for the perfectionist and the experimentally minded much can be accomplished through the use of this special control circuit to enhance the stereophonic effect, to increase separation, to cancel crosstalk in cartridge or amplifiers, and to compensate for disadvantageous speaker placement. With this control, an audiophile can be his own recording engineer without being present at a recording session.

Ever since the inception of mass-produced stereo home sound systems, a flood of books, technical essays, magazine articles, and even cartoons have stressed the importance of placement of reproducers and listeners to achieve any semblance of stereophonic effect. The resultant well-publicized need for logistics in the living room has made weightlifters out of countless devoted audiophiles.

Stereo is the creation of the electronics engineer, and its problems should be solved by electronics, and not by the heavy moving industry. It is pleasant to report that some audio engineers have met this challenge and that the critical listener can now permit his wife to arrange the furniture to suit her aesthetic taste and still not interfere with his ability to obtain as much, or as little, stereo separation as he desires, with

only the effort involved in turning a knob.

The stereo separation ratio control, sometimes called a "dimension control," is not a gadget or a toy for special effects or stunts. It is a logical and much needed extension of the recording studio equipment into the home, enabling the listener to add his own taste and experience to the judgment of the recording engineer. How this is accomplished will be made apparent as we examine the applicable electronic and acoustic principles.

Recording in Stereo

To properly understand the purpose and function of the circuits described in this article, the layman must first rid himself of a widespread misconception. A stereo record is *not* an arbitrary division into right and left channels corresponding to the right and left sides of a stage or platform. It is, rather, a complex combination and division of sound compounded electronically at a console by a human musician-engineer and is offered as his best artistic expression of stereo music as he hears it, subject to the acoustic conditions peculiar to his own monitoring systems. To alter his interpretation during playback in the home is not sacrilege, nor does it constitute tampering with a fixed mathematical ratio. It is merely the addition of one more artistic judgment to a whole series of such judgments.

That it is quite possible to season the stereophonic effect to taste can be seen if we examine a typical stereo recording setup. Consider the MS (middle-side) recording method widely used in Europe (see Fig. 1). Two microphones are mounted coaxially at a center location in front of the orchestra. One microphone is capable of picking up sound equally from all parts of the orchestra. Let us represent its signal output as left+right+center or $(L+R+C)$. The other microphone, usually a ribbon type, has some rather unusual directional properties. A signal reaching the microphone from the extreme right produces a signal of opposite polarity from that of a sound source at the extreme left. Sounds which come from neither the right nor left produce no output at all. Therefore, we may represent the output from this microphone as left-right or $(L-R)$.

It is now the recording engineer's job to reduce these two microphone outputs to simple left- and right-channel outputs, which can then be recorded onto the master tape and used to cut two-channel stereophonic discs. This is accomplished by a process known as matrixing. The two outputs are added, $(L+R+C) + (L-R) = 2L+C$, to produce a signal containing left information with a reduced center signal com-

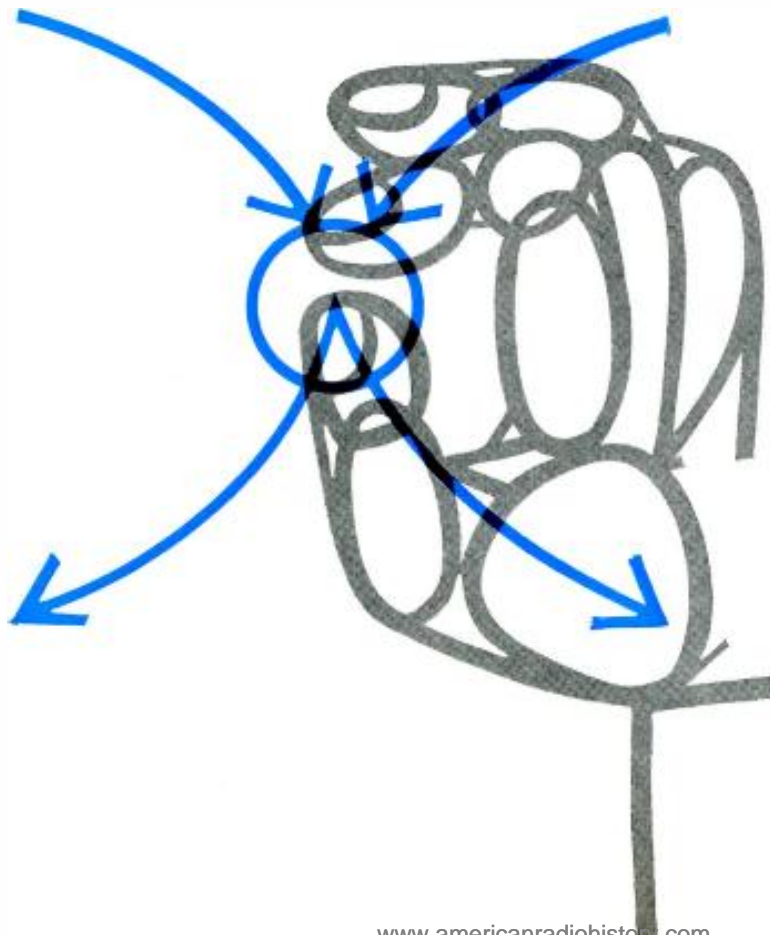

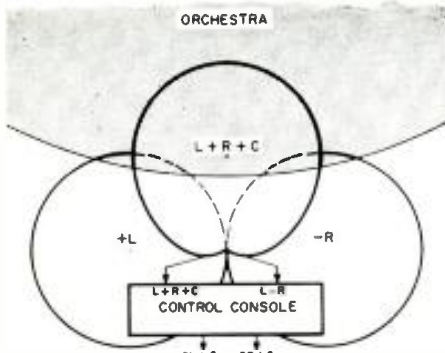

Fig. 1. The MS method of stereo recording.

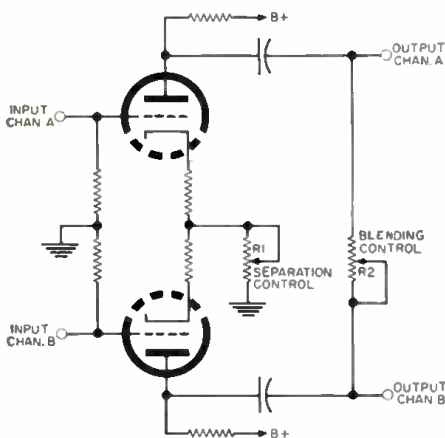

Fig. 2. Dimension control circuit that has been employed by Nippon Columbia Co.

ponent. The right-channel signal is obtained by subtracting the two microphone outputs to produce $(L+R+C) - (L-R) = 2R+C$. Hence, the required left and right signals have been separated out and there is some center information in both outputs. In actual practice, the addition and subtraction is accomplished by the recording engineer at the recording console on the basis of his experience and what he hears over a monitoring system.

The difference signal, $(L-R)$, represents the separation or stereo portion of the signal. By boosting this signal at the expense of the sum signal, increased separation is obtained. If the difference signal is attenuated by the recording engineer, soloists or center instruments become emphasized and the stereo dimension is reduced.

The engineer carefully adjusts the mixing and matrixing levels, blends in other solo or reverberation microphones until he obtains what he and a committee of professional musicians and recording executives consider to be optimum. Generally speaking, the combined judgment of these gentlemen can be relied upon, but they are only human and cannot be expected to compensate the recordings in advance so that they will sound realistic over all the myriad speaker systems and placements found in homes. Their judgment is of necessity based on what they hear through a limited number of monitoring systems, and represents a compromise to achieve results that will sound best over the greatest number of home systems, to

the greatest number of listening ears.

The apparent amounts of sum and difference signals are also affected by speaker placement, room acoustics, and listening position. Thus, if loudspeakers are placed very close together, the ear will hear mainly a sum signal and the stereo effect will be minimized. Also, a listener a great distance from the loudspeakers will hear only a monophonic signal. At the other extreme, the listener with stereophonic earphones or excessive speaker separation will hear more difference signal than the committee of experts intended him to. The effect will be pronounced separation.

Purpose of the Control

What is needed then is a control which the listener can adjust in his own home to achieve exactly the ratio of sum to difference signal required to match his particular listening environment or artistic predilections.

In the MS system of recording, we have seen how the sum and difference signals are produced directly by the recording microphones. In other stereo recording systems, the sum and difference signals never actually exist as such, though their ratio is carefully controlled by a proper multiple microphone placement and judicious choice of mixing

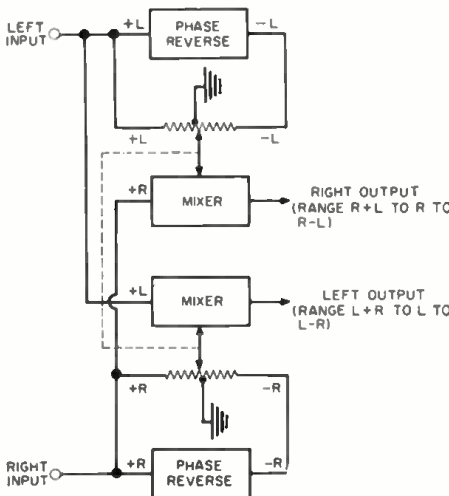

Fig. 3. Block diagram of the new stereo separation ratio control circuit described.

levels. Most of the better stereo recordings show a separation ratio of difference to sum signal of about 9 to 10; thus a good stereo recording is just slightly more monophonic than binaural.

A stereo dimension control is not a new idea. Such a control is included in most of the new multiplex adapters for use in the Crosby system of FM stereo broadcasting. Here, the sum and difference signals are actually being broadcast and it is therefore necessary to dematrix the signal to get a left and right signal. If one starts with a left and right signal as from tape or disc, and then desires to alter the separation ratio, it is possible to make sum and difference signals electronically, alter their ratio by means of controls, and then subtract and add them again to recover the new left and right signals. This is however a

cumbersome and rather parts-consuming method of altering the separation ratio.

A little simple arithmetic will show that it is not necessary to actually make sum and difference signals to alter the separation ratio. Suppose we desire to double the separation ratio of difference to sum signals in order to compensate for close-together speakers. We start with

$$\frac{\text{Diff.}}{\text{Sum}} = \frac{L-R}{L+R} = 1, \text{ and we then in-}$$

crease the ratio, $\frac{2(L-R)}{L+R} = 2$. By in-

creasing the difference signal to two times its former value, we achieve the desired ratio. Now let us reclaim the left and right signals and see how they have been altered. The right signal is the $\text{Sum} - \text{Diff.} = L+R - 2(L-R) = 3R - L$. The left signal is the $\text{Sum} + \text{Diff.} = L+R + 2(L-R) = 3L - R$.

This result shows that to alter the separation ratio it is only necessary to add to each channel an out-of-phase signal from the other. In this case, to double the separation ratio, an out-of-phase signal of 1/3 the amplitude must be combined with the signal of the opposite channel.

Figure 2 shows a portion of a circuit first proposed in print by Toshio Hirota of Nippon Columbia Co., Ltd. By increasing the value of the common cathode resistor R_1 , the difference signal is amplified, and by decreasing the value of R_1 blending is achieved. This circuit is extremely simple and easy to install

(Continued on page 116)

Fig. 4. Complete schematic of the control circuit that can be inserted into the pre-amp or just ahead of the power amplifier.

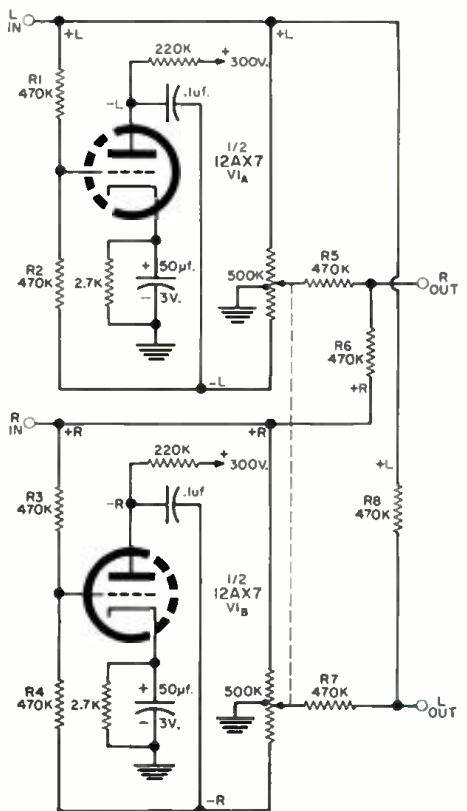

PLAYBACK Four-Track Tape System PREAMPS

PART 2-

By **KENNETH F. BUEGEL**

Complete construction info on the electronics portion of stereo record playback system. Final adjustments as well as complete operation of the home-built system are covered in this final part.

IN PART 1, we covered the construction of the recording preamplifiers and the power supply for the four-track tape system. Now we will take up the matter of the playback preamp and adjustment of the system.

Playback Preamps

If the playback preamps are built on a separate chassis from that of the recording amplifiers another $\frac{1}{4}$ " bonding strap must be added from the jack panel ground to the chassis. The playback-head signal grounds are carried through an insulated jack and connected to the chassis only at the ground point for R_{20} and R_{21} .

Proper ground techniques are an *absolute must*. The output signal from the playback head is only 2 millivolts and

common grounds will certainly create a hum problem. For this same reason, a premium-type 7025 tube is used in the first two stages although if a number of 12AX7 tubes are available, it would be possible to hand pick one for minimum hum. See Fig. 4.

The signal appearing at J_1 is amplified twice in V_{11} and V_{12} before it is applied to the "Playback Gain" control, R_{23} . V_{11} again amplifies the signal which is applied to V_{12} , a low-impedance cathode-follower. The output signal at J_1 may be adjusted over a range of 0-3 volts. Most stereo control centers work well with about .5 to 1 volt signals into the "auxiliary" inputs.

The combination of R_{23} and C_{20} feeds back more of the high frequencies from the plate of V_{12} to the cathode of V_{11} to equalize the playback response. This preamplifier was originally used with two-track heads but the increased high-frequency response of the laminated four-track heads necessitated the addition of C_{20} between the plates of V_{11} and V_{12} to maintain flat response over the 50 to 10,000-cycle range. This capacitor may be omitted if the older two-track heads are used.

Most stereo control centers follow the general outline shown in Fig. 5A. The addition of a d.p.d.t. switch, as shown in Fig. 5B, will allow listening to the signal being recorded on the tape. When recording from a disc, a piece of lint caught under the stylus and producing distortion is immediately apparent. There is no need to rewind and playback the tape to determine the quality of the recording.

The input impedance of the recording

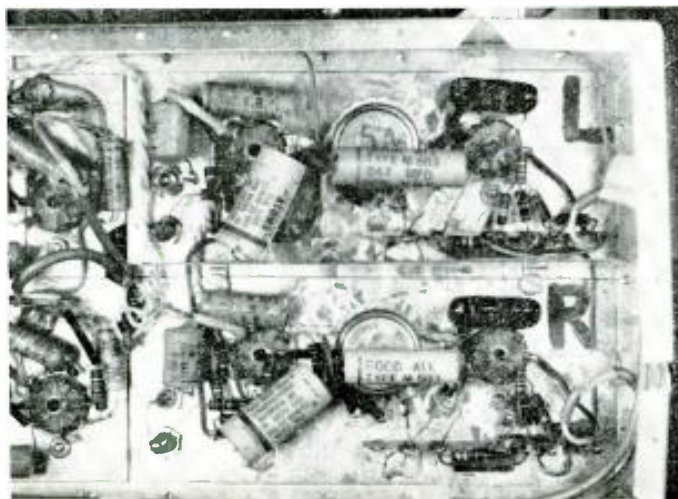

Under-chassis view of the playback preamp portion of the tape system. Two identical circuits are employed, one for the left channel and the other for the right channel. Shielding is used between the two sections in order to minimize the possibility of some crosstalk.

preamps is high and should not affect the cartridge preamp output. The playback preamp output impedance is low and may be applied directly to a level control, if one is ahead of the first amplifier following the selector switch. Almost all stereo control centers have the recorder output jacks connected prior to any tone-control circuitry. Connection of the output of the playback preamps to jacks designed to accommodate a tape-head input is not recommended since these inputs are usually equalized and will operate only on very low signals.

Adjustments

Alignment of the completed system is easily accomplished with a standard alignment tape, a v.t.v.m., and a signal source—preferably an audio oscillator. Physical alignment of the heads is mandatory before any other adjustments are attempted. First, remove the oxide coating from a section of Mylar tape for about six inches. Then thread this tape from one reel to the other with the clear section over the heads. For better visibility, the pressure pad may be removed. Mylar tape will have less "curl" after removal of the oxide with lacquer thinner or nail polish remover than will acetate tape. In tape decks with the reels beneath the heads, such as the *Viking*, the left track is closest to the front panel.

Demagnetize all tools used in adjusting the head positions. As shown in Fig. 6, the tape heads should meet the tape squarely and the lower edge of the tape should just be even with the outside edges of the pole pieces nearest the tape-deck panel. Thoroughly demagnetize the heads before proceeding! Place the alignment tape on the deck and advance R_{25} on both channels to about mid-position. Set the v.t.v.m. to a low a.c. range and connect it between J_2 and ground of either channel. While playing the section of tape with the high-frequency head alignment tone, set the azimuth adjusting screw on the playback head for maximum output, as indicated by the v.t.v.m. Now, connect the recording head windings to the playback inputs and set its azimuth adjustment in the same manner.

Return the head connections to normal and play the 1000-cycle level-set tone while adjusting R_{25} in each playback channel for the desired output level. Remember that this tone, as recorded on the test tape, will probably be about 15 db below saturation. In any event, the setting of R_{25} should be such that when the stereo selector switch is in the tape position, the level is about the same as that of the other inputs.

To set up the recording amplifiers, first measure the average output appearing at the recorder output jacks on the stereo control center. Then connect J_1 on both channels to an audio oscillator, set for this output, at a frequency of 1000 cycles. Set R_{15} , the "Record Level" control, to mid position and adjust R_{16} on each channel until the a.c. voltage read by the v.t.v.m. at J_2 is 1.8 volts. For this adjustment S_1 must be in

the "Record" position but do not depress the "Push-to-Record" button or the bias voltage on J_2 will cover the audio voltage-age reading.

After setting R_{16} adjust R_{14} on each channel until each meter reads 70% of full scale. With the levels set to these values, your recordings will be about 3 db under tape saturation when the meter reading is at full scale. Recording at levels this close to saturation will not adversely affect performance. One definition of tape saturation is "that level at which a pure 400-cycle tone applied to the tape is reproduced with 1% distortion." While it is not the author's desire to enter into any of the arguments about the theory of tape recording and reproduction, just one comparison between a tape made with this system and any pre-recorded four-track tape will serve as testimony to the effectiveness of recording at this level. A word of caution, however. In use, set the

"Record Level" until most peaks just hit the 70% point, with an occasional peak of 100%.

To correctly set the "Noise Balance" control, R_{19} , thread a new tape on the deck and connect the v.t.v.m. to J_2 of either channel. Set the "Record Level" to minimum and adjust R_{19} for a minimum reading with the system recording. This bias oscillator will completely erase a saturated tape in one pass when used with the recommended double-gap erase head.

When using the system for recording from a stereo broadcast source, output levels of the tuners may be conveniently balanced by reference to the meters. The meters are operating any time the "Record Level" control is advanced. If used to determine the relative signal per channel on playback only, be sure S_1 is not in the "Record" position or an unpleasant reverberation will be added to the tape.

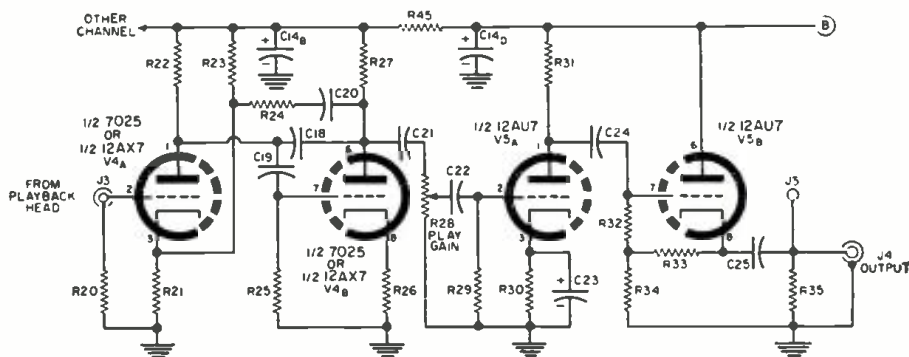

- $R_0, R_9, R_{11}, R_{12}, R_{13}, R_{14}, R_{15}, R_{16}, R_{17}, R_{18}, R_{19}, R_{20}, R_{21}, R_{22}, R_{23}, R_{24}, R_{25}, R_{26}, R_{27}, R_{28}, R_{29}, R_{30}, R_{31}, R_{32}, R_{33}, R_{34}, R_{35}$ — $1\text{ megohm}, \frac{1}{2}\text{ w. res.}$
 R_{21} — $1000\text{ ohm}, \frac{1}{2}\text{ w. res.}$
 R_{22} — $330,000\text{ ohm}, \frac{1}{2}\text{ w. res.}$
 R_{23}, R_{24} — $220,000\text{ ohm}, \frac{1}{2}\text{ w. res.}$
 R_{25} — $100,000\text{ ohm}, \frac{1}{2}\text{ w. res.} \pm 5\%$
 R_{26} — $3.3\text{ megohm}, \frac{1}{2}\text{ w. res.}$
 R_{27} — $1200\text{ ohm}, \frac{1}{2}\text{ w. res.}$
 R_{28} — $500,000\text{ ohm audio taper pot}$
 R_{29}, R_{30} — $10,000\text{ ohm}, \frac{1}{2}\text{ w. res.}$
 R_{31} — $68,000\text{ ohm}, \frac{1}{2}\text{ w. res.}$
 R_{32} — $5600\text{ ohm}, \frac{1}{2}\text{ w. res.}$
 R_{33}^* — $5200\text{ ohm}, 1\text{ w. res.}$
 C_{19}^* —See record preamp parts list, Fig. 1, Part I
 C_{20} — $220\text{ }\mu\text{f. disc ceramic capacitor} \pm 10\%$

- C_{21} — $.03\text{ }\mu\text{f. } 400\text{ v. paper capacitor}$
 C_{22} — $.820\text{ }\mu\text{f. } 600\text{ v. mica capacitor} \pm 5\%$
 C_{23} — $.047\text{ }\mu\text{f. } 400\text{ v. paper capacitor}$
 C_{24} — $.01\text{ }\mu\text{f. } 200\text{ v. paper capacitor}$
 C_{25} — $50\text{ }\mu\text{f. } 10\text{ v. elec. capacitor}$
 C_{26} — $.02\text{ }\mu\text{f. } 400\text{ v. paper capacitor}$
 C_{27} — $.1\text{ }\mu\text{f. } 200\text{ v. paper capacitor}$
 J_1, J_2 —Phono jack
 J_3 —Pin jack
 V_1 —7025 or 12AX7 tube (see text)
 V_2 —12AU7 tube
 *Parts so marked are used once in the circuit. All other parts must be duplicated for the second channel of the stereo setup.

Fig. 4. Two identical playback preamps like this one must be constructed.

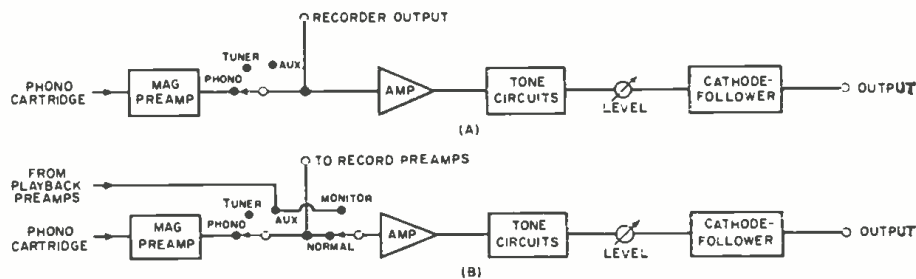
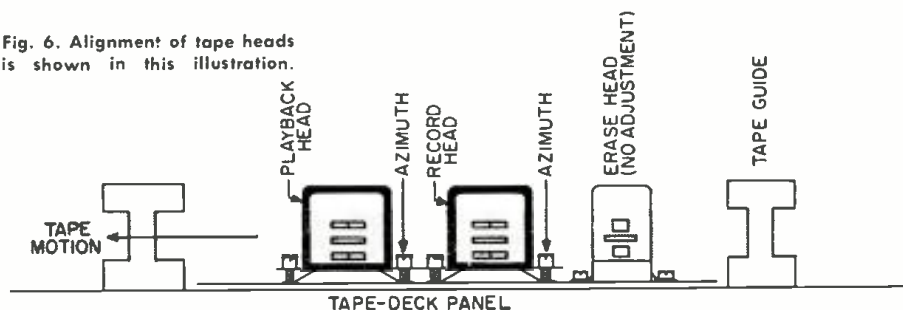
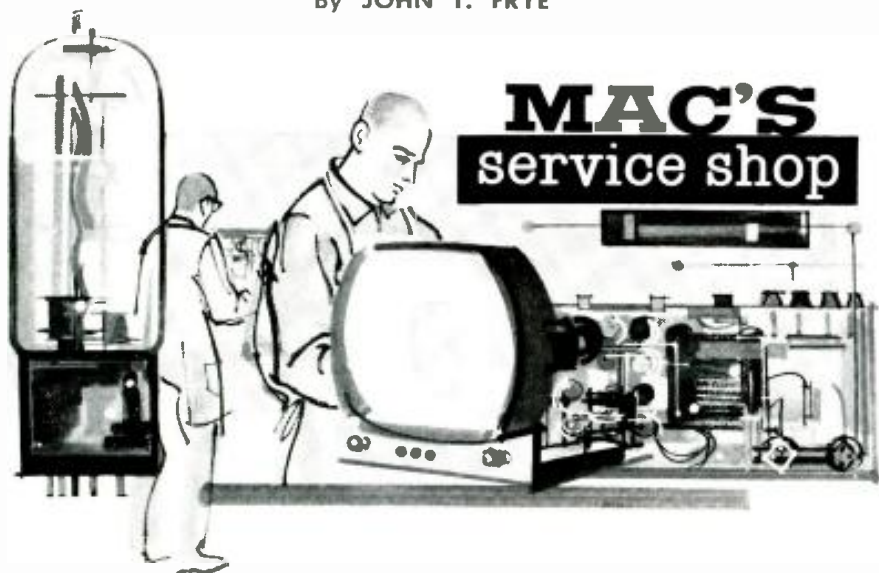

Fig. 5. Block diagram illustrating the modification of the stereo control center.

Fig. 6. Alignment of tape heads is shown in this illustration.





Problems!

It was a perfect spring day. A warm breeze from the south gently nudged fleecy white clouds across an azure sky. Robins braced themselves on the green sod polka-dotted with yellow dandelions and yanked inch after reluctant inch of elastic worms from the warm earth. Tulips, jonquils, and redbud delighted the eye; the ears rang with the exciting lifting chorus of the birds; and the sweet fragrance of hyacinths made simply breathing a heady pleasure.

Inside Mac's Service Shop, Barney hummed happily to himself as he worked at the bench beside his employer.

"I don't need to stick my head outside to tell it's spring," the older man said with a grin. "You're certainly in tune with the season. I can almost see your fancy lightly turning to thoughts of you-know-what."

"Huh?" Barney said as he looked up with a puzzled frown. "Oh! I dig you, but you're out of phase. I'm just happy because I finally have all my transmitting beam antenna problems licked."

"Didn't know you had any problems."

"That's because I'm the strong silent type and seldom complain," Barney said with an impish look. "It all started when the ten-meter band began to fold up early this year. As you know, the sunspot cycle is rapidly going down hill. That means conditions on the higher frequencies will get progressively worse for the next few years; and good old ten meters, my favorite band, will be just about *Kaput* as far as consistent DX is concerned. For long distance work, a fellow is going to have to retreat first to fifteen meters and then, when that goes out, to twenty. The wise boys say even twenty will likely be pretty poor during the worst part of the eleven-year cycle.

"I decided the smart thing would be to take down my faithful old ten-meter beam and put up a tri-bander that would still let me work ten when it was open but would also let me operate fifteen and twenty when ten was blacked out. So I got myself a good four-element tri-

bander and made my first mistake: I put it up on the same heavy-duty TV rotator that had carried the old antenna. After all, that rotator had never failed to hold or turn the ten-meter job, even with a half-inch of ice frozen on the elements; so maybe it would handle the much-larger tri-bander.

"I should have known better. Instructions accompanying the beam said a heavy-duty TV rotator would hold the antenna only in winds up to twenty-five miles per hour. The jokers who wrote that must have actually checked it out, for the very first time we had gusts up to 25 mph, the wind turned the beam up against the stop and kept banging it there. Considering it has a sixteen-foot boom and a longest element of thirty-one feet and weighs nearly forty pounds without a mast, I had no reason to be disappointed.

"Anyway, the motor couldn't take much of that, and neither could I. I found myself cringing every time a breeze sprang up. Finally I did what I should have done in the first place: I replaced the TV rotator with a heavy-duty rotator especially designed for turning and holding heavy beams and arrays. This one has an arrangement that locks the two major parts of the rotator solidly together when the beam is at rest. When power is applied to the rotating motor, this brake is disengaged by a solenoid. That took care of my turning and holding problems."

"You had others?"

"Yep! But let me tell you how my 'antenna farm' is laid out. The rotator is mounted on the end of a six-foot length of 1½" galvanized pipe bolted to the top of a forty-foot telephone pole. The motor sits two or three feet above the top of the pole, and a five-foot 1¼" pipe mast holds the beam. One end of my all-band trap antenna is fastened to the 1½" pipe right at the top of the pole. The end insulator of this wire antenna is only about four feet from the pole and six or seven feet below the beam elements. I know this isn't the best arrangement in the world; but

Mom says flatly one mast is all we're going to have on the front of our lot, and that's that.

"The length of the control cable is very close to sixty feet—which is about a quarter-wavelength long on 75 meters. My old rotator control used lamps arranged around a compass pattern to indicate the beam direction, and when I first put up the ten-meter beam I discovered that when I was on 75 meters all the indicating lamps lighted up simultaneously. Parallel wires in the control cable were acting as resonant quarter-wave lines, and the r.f. across the bottom ends was sufficient to light the bulbs. I could have cured this by bypassing each bulb with a small ceramic capacitor, but I accidentally found that if I pulled the control unit a.c. plug from the socket when I was on 75 meters, the situation was no longer present. Doing this shifted the standing waves on the control wires enough so that the current loop moved away from the bulbs.

"The heavy-duty rotator uses a current meter in the control unit that works in conjunction with a potentiometer in the motor section to indicate direction. Two wires carry direct current up to the potentiometer, and one of these wires is fused with a 1/16-amp fuse in the control unit so that if a short-circuit accidentally occurs in the cable the precision potentiometer will not be damaged. Well, after I had the beam up and had checked everything out on the higher frequencies, I decided to tune up on 75 and report into our state traffic net. After I had tuned up, I reached over to rotate my pride and joy one more time and got a nasty shock. The beam turned all right, but the direction-indicating pointer never moved off the left-hand 'South.'

"I suspected the little fuse had blown, and it had. I also suspected, thanks to my experience with the other rotator, that r.f. had blown the fuse; so I put a pilot lamp in place of it and quickly found that when my transmitter was putting out 100 watts on 75 meters better than 125 ma. of current was going through the fuse rated to blow at around 85 ma. A .05-μf. ceramic capacitor connected across the two wires carrying the d.c. voltage up to the potentiometer cured the difficulty completely by bypassing the r.f. right at the terminals before it ever got inside the control box.

"While a certain set of circumstances had to exist in my antenna system for this to happen, my set-up really is not too unusual. Lots of fellows use the same mast to support a beam and carry one end of a low-frequency antenna, and lots of them use a length of control cable that can become a resonant line at a low operating frequency. Under such circumstances, the mysterious blowing of that fuse could present a puzzling problem, especially if the r.f. current was marginal so that the fuse only blew now and then."

"Yeah, I can see the puzzled ham running up and down his tower like a

(Continued on page 112)

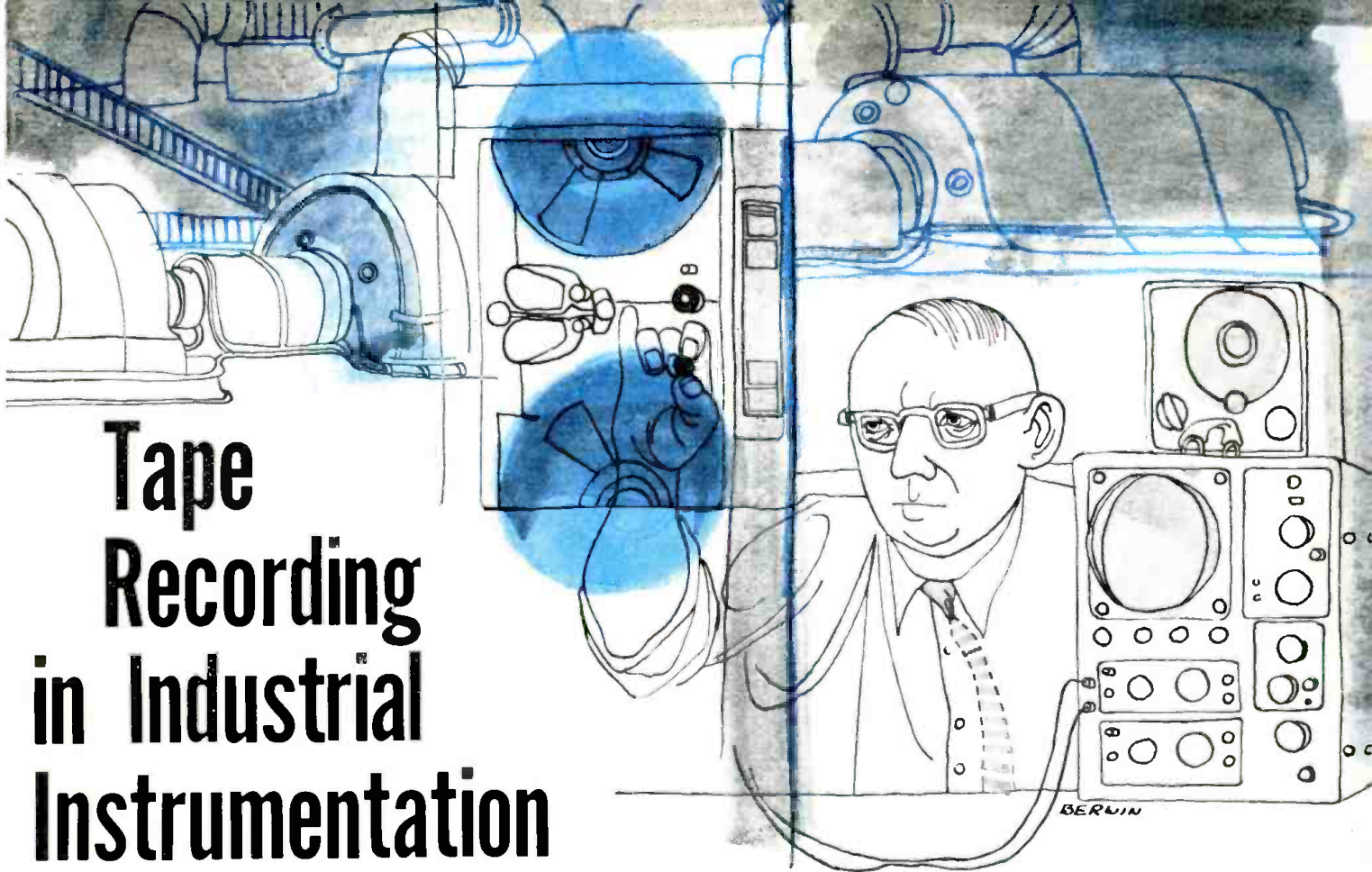

Tape Recording in Industrial Instrumentation

By RAY A. SHIVER
& WILLIAM STILLWELL

Instrumentation Laboratory
AiResearch Mfg. Co. of Arizona

A large variety of useful information can be gathered, recorded, stored, and then reproduced by this method.

WHILE magnetic tape recording is well known in computer technology, automatic programming, and missile telemetry systems, its application to industrial instrumentation is a comparatively new field. With the introduction of high-speed turbo machinery and supersonic flight, design engineers became necessarily interested in frequencies above the audio range. To meet this need, instrumentation magnetic tape recorders were developed with a direct record frequency response to 100 kc. This has proved to be a valuable tool to the development engineer in the design of high-speed turbine wheels, bearings, and related components in the industrial field.

Recorders for Instrumentation

Fig. 1 shows one of the first types of recorders used in instrumentation. This proved valuable but was limited by its narrow (for instrumentation applications) frequency response and the availability of only two channels. Fig. 2 illustrates one of the types of recorders in general use today. Note that both types are designed to be "mobile" since the job seldom is able to come to the recorder. The recorder shown is an *Ampex FR-*

100-A, providing facilities for recording and reproducing seven channels of data. Six tape speeds are available from 60 ips to 1 7/8 ips. The frequency response is a direct ratio of tape speed from 100 kc. direct-record and 10 kc. FM at 60 ips to 6250 cps direct-record and 312 cps FM at 1 7/8 ips. The top half of the console shown in the photograph of Fig. 2 contains meters, preamplifiers, and input-output attenuators for maximum flexibility. Included in the lower section of the control panel is a v.t.v.m., a pulse generator for supplying timing markers, two bridge-balance circuits for strain gage calibration, and a variable d.c. supply and meter for calibrating d.c. channels. Outboard equipment includes a dual-beam oscilloscope, a high-frequency oscillator, and a frequency counter. An indispensable item is a microphone for recording a running commentary during a test and for providing reference points to be used in data reduction.

Recording Systems and Their Uses

The *Ampex FR-100-A* is equipped to record by any combination of four different methods: Direct-record, FM, PWM, and NRZ digital recording. Since our application concerns the recording of high-frequency and d.c. data, we shall concern ourselves with the direct-record and FM systems only. The direct-record method is similar to that used in home tape recorders in that the signal to be recorded is amplified, mixed with a bias oscillator signal, and applied directly to the record head. Of course, the instrumentation recorder has a much greater frequency response; more rigid tolerances for skew, wow, and flutter; and a

more elaborate system for playback equalization. Since this type of recording is most useful in recording high-frequency amplitude information, the problem becomes one of obtaining as flat a curve as possible from the reproduce amplifiers. The I.R.I.G. standard is ± 3 db, but with careful attention to equalization, much greater accuracy can be obtained. The section on a typical recording problem also indicates how this can be compensated for in the calibration process. If greater accuracies are required, a standard tape is reproduced for each direct-record channel and a frequency response curve drawn by an X-Y plotter. This allows any point on the curve, once the frequency has been established, to be corrected. Frequency reproduction accuracy on this particular recorder is better than 1%, being limited only by the stability of the tape transport system.

Fig. 3 shows some of the types of transducers that are applicable to direct recording. At left center is a speed pickup which is used in conjunction with a multi-tooth gear to provide an indication of unit rpm. As the gear revolves, each tooth in passing the pole piece of the pickup generates a pulse which is recorded on the tape as a function of rpm. At lower left is an accelerometer which, when properly attached to a member under test, will produce an a.c. output voltage proportional to vibration amplitude. Also pictured in Fig. 3, at the extreme right, is a strain gage shown bonded to a metal member. A strain gage consists of a special high-resistance wire or foil which when stretched or compressed produces a proportionate change in resistance and therefore out-

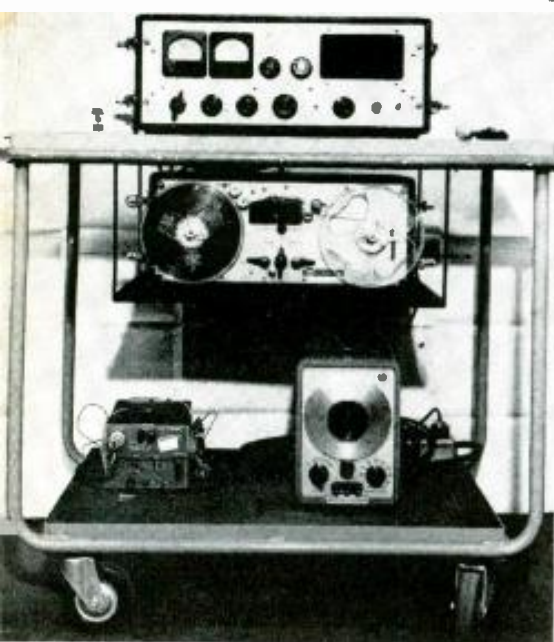

Fig. 1. In the early days of this technique, the audio tape recorder was pressed into service for some industrial instrumentation.



Fig. 2. Later, specialized recorders were developed specifically for this purpose. This setup handles seven channels of data.

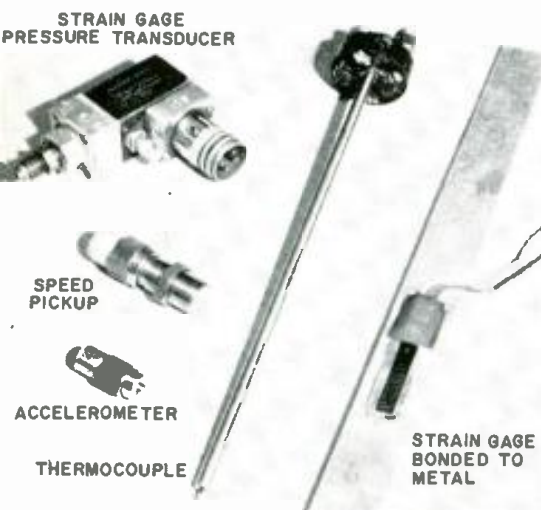

Fig. 3. Here are some of the special-purpose transducers that convert various characteristics into usable electrical signals.

put voltage. When the gage undergoes a resonant strain condition a sinusoidal voltage is produced which is amplified and recorded as a peak-to-peak strain signal.

The FM system is useful for recording low and medium frequencies (d.c. to 10 kc.) with extreme accuracy. This type of recording is not limited by equalization considerations and is dependent upon frequency accuracy—not amplitude only. The signal to be recorded is used to frequency modulate a center carrier frequency in the record amplifier and this, in turn, is recorded on tape. Since the level of the signal applied to the tape is designed for tape saturation, no bias signal is needed in FM recording. The function of the FM reproduce amplifier is to take the frequency-modulated carrier signal from the tape and convert it to conform to the original signal. This is done with conventional limiter and discriminator circuitry. At top left in Fig. 3 is a strain gage pressure transducer that would be applicable to FM recording. The "inards" of the transducer consist of a temperature-compensated strain-gage bridge circuit coupled to a movable diaphragm. With suitable excitation voltage applied to the transducer, a pressure applied to the diaphragm will produce an output signal proportional to the amount of pressure applied. This is applied through a suitable balance and control circuit directly to the FM-record amplifier. At the center in Fig. 3 is shown a thermocouple for measuring temperature. A thermocouple produces a feeble d.c. voltage that varies directly with a change in temperature. The temperature range to be recorded determines which type of thermocouple will be used, since a particular type will work well only over a limited temperature range. The most common types used in instrumentation work are cop-

per-constantan for extremely low ranges (-300°F to $+200^{\circ}\text{F}$), iron-constantan for medium ranges (0°F to $+1000^{\circ}\text{F}$), and chromel-alumel for the higher ranges ($+600^{\circ}\text{F}$ to 2000°F). After the thermocouple signal is applied to a suitable reference junction, it is amplified by a d.c. amplifier to a level suitable for recording.

While at the present time the frequency response of the FM-record system is limited to 10 kc., there will be available shortly in the industry FM recording systems that are flat to 20 kc. and beyond. This will allow recording of amplitude information with very good accuracy and simplicity. In general, tape recording as applied to industrial instrumentation, is concerned only with the recording of medium- and high-frequency information. Therefore, d.c. and slow time-response information, except for purposes of correlation, is best left to other types of recording. For example, pressure transducers, thermocouples, and static strain gages, would be more suitable to high-sensitivity galvanometer recorders where many channels of such information can be recorded simultaneously with a minimum of electronic circuitry.

A Typical Recording Problem

A typical recording problem is illustrated in the block diagram of Fig. 4. In this case it was desired to measure the stresses present on a gas turbine compressor wheel along with bearing oil temperature, compressor discharge pressure, unit vibration, and compressor-wheel rpm. Three dynamic strain gages suitable for the temperatures to be encountered were bonded to the compressor wheel at the desired locations and brought out to a slip-ring unit. The wheel was then balanced and installed in the gas turbine. Direct-record channels 2, 3, and 4 were used for this appli-

Fig. 4. An illustrative problem setup is shown here in block-diagram form. See text.

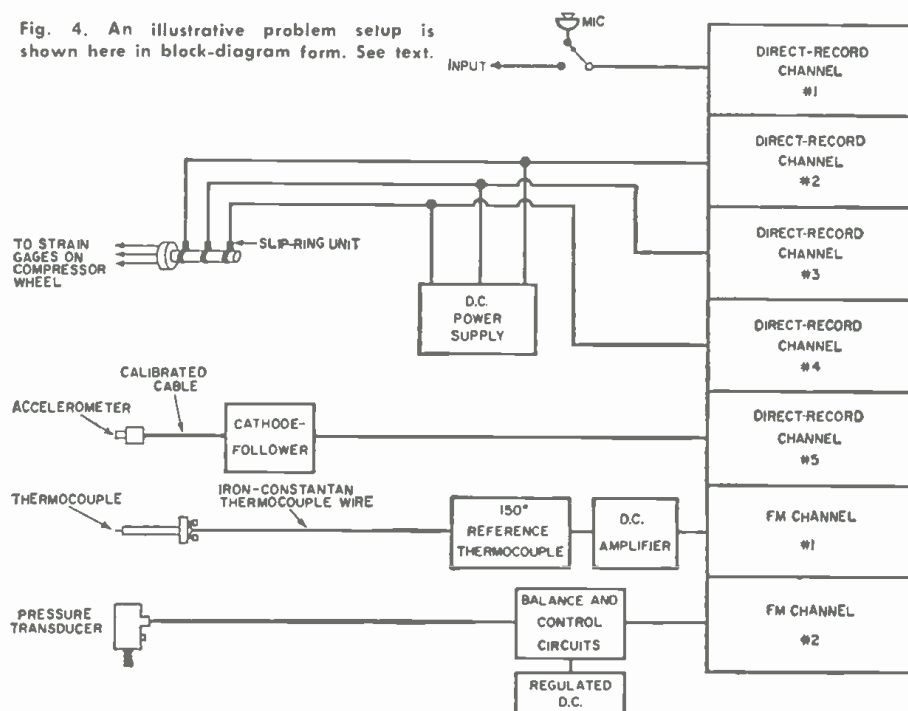

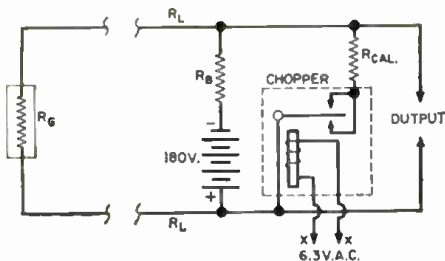

R_g = STRAIN-GAGE RESISTANCE 120 Ω , GAGE FACTOR 2.0
 R_L = LINE RESISTANCE 5 Ω
 R_{CAL} = CALIBRATE RESISTOR REQUIRED FOR ϵ
 R_c = CURRENT-LIMITING RESISTOR FOR STRAIN GAGE 10K, 10W.
 ϵ = CALIBRATION VALUE IN MICROINCHES/INCH

Fig. 5. Dynamic strain gage channel circuit.

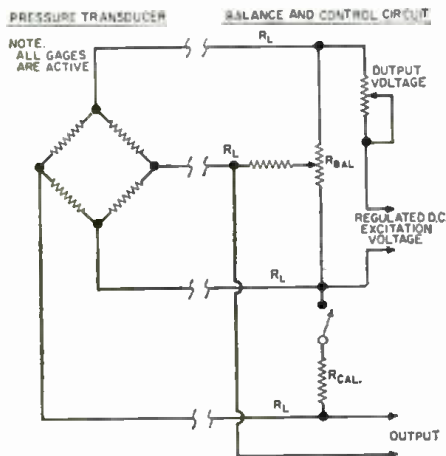

Fig. 6. Control and calibration circuitry.

calibration along with the associated circuitry shown in the block diagram. Direct-record channel 5 was used for the accelerometer signal and channel 1 for the voice commentary. Note that the microphone may be switched out of this channel so that it can be used for data recording as well. Bearing oil temperature was assigned to FM channel 1 and compressor discharge pressure to FM channel 2.

Once proper circuitry has been established, the next important step before recording data is to establish calibration points for each channel of information. This is to be used later in data reduction. Fig. 5 shows the complete circuit of a dynamic strain gage channel. We shall assume the values shown as a basis for calculating the calibrate resistor, R_{cal} . The gage, or "sensitivity," factor of a strain gage is the ratio of output signal to supply voltage when the gage is stressed within its operating range. This is supplied by the strain gage manufacturer and varies for different types of gages. Another important consideration is the line resistance in the lead wires since this will affect the gage factor. Calculating the new gage factor to allow for line resistance is done as follows:

$$\frac{G.F.}{G.F. (new)} = \frac{R_g + R_L}{R_g}$$

$$\frac{2.0}{G.F. (new)} = \frac{120 + 5}{120}$$

$$G.F. (new) = \frac{240}{125} = 1.92$$

Substituting the new gage factor in the general strain calibration formula and solving, we arrive at a calibration re-

sistance value to produce a simulated strain of 1000 microinches/inch on the gage.

$$R_{cal} = \frac{R_g}{G.F. (new) \times \epsilon} - R_g$$

$$= \frac{125}{1.92 \times 1000 \times 10^{-6}} - 125$$

$$= \frac{1.25 \times 10^2}{1.92 \times 10^{-3}} - 125 = 64,975$$

where: ϵ denotes strain in microinches/inch.

However, simply shunting the strain gage with this calibrate resistor will produce nothing as far as the direct-record channels are concerned since they will record only a.c. voltage. Therefore, we must convert the signal into a "dynamic" form in order to record it on tape. This is accomplished by rapidly switching or chopping the calibration resistance in and out of the circuit to produce a square wave, as shown in Fig. 5. However, this is still not quite good enough since the direct-record channel will distort the square wave somewhat and make it difficult to measure. Therefore, we simply apply the square-wave calibration signal to an oscilloscope, match its amplitude with a sine wave from an oscillator, and record the sine wave on the direct-record channel. We now have a reliable calibration signal on the tape for each strain gage. This is done for several different frequencies within the range of interest in order to

ity of circuitry makes accelerometer signals easy to record, but they are difficult to analyze as we shall see in the section on data reduction.

Strain gage pressure transducers require the control and calibration circuitry of Fig. 6 for proper utilization. The transducer is first balanced for zero output voltage by R_{bal} . The calibrate resistor is then switched into the circuit which simulates a known pressure. Since the d.c. unbalance voltage is applied to an FM channel in this case, it is not necessary that the calibrate resistor be chopped as before. As a double check, a known static pressure may be applied to the pressure transducer and checked against the calibrate resistor. This is often done when critical tolerances are required. Values of calibrate resistors for pressure transducers are arrived at very conveniently with the aid of a pressure-indicating meter and an accurate variable air supply by direct reading of the amount of unbalance voltage produced by the calibrate resistor. No calculations are necessary in this case. Pressure transducers are available in the ranges from a fraction of a p.s.i. to special types that will read thousands of pounds of pressure.

To arrive at a calibration for temperature it is only necessary to refer to a set of tables for the particular type of thermocouple and reference temperature being used (in this case the reference thermocouple temperature is 150

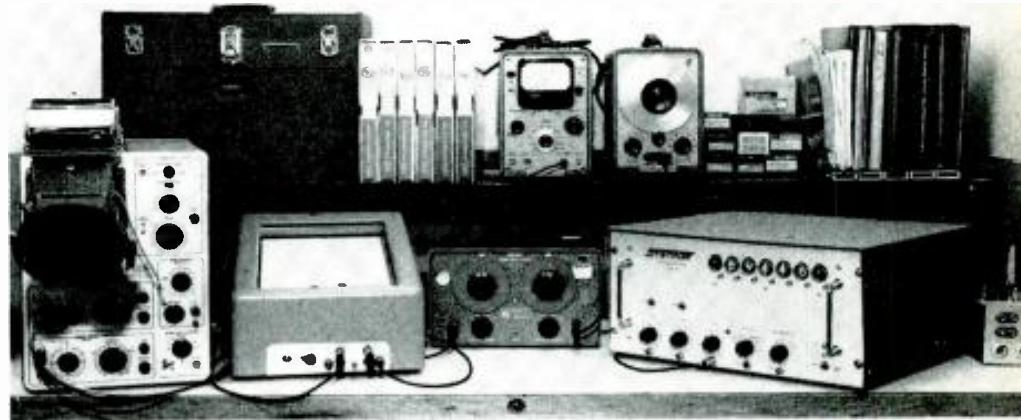

Fig. 7. A typical data-reduction setup for one particular industrial test procedure.

insure maximum possible accuracy.

Fig. 4 is a line diagram for recording vibration. The accelerometer and connecting cable come from the manufacturer complete with a calibration chart. The chart indicates how many millivolts r.m.s. or p.p. that will be generated for each G of acceleration. To record a calibrate signal of 100 G 's on the tape, we insert a sine-wave signal from an oscillator at some frequency within the accelerometer range (usually 1000 cps) into the cathode-follower input and set the level for the calibration point by reading the oscillator signal on a v.t.v.m. For example, if the chart indicated that the accelerometer produces five millivolts r.m.s. for each G of acceleration, the calibration voltage for 100 G 's would be 100 x .005 volt, or .5 volt. The simplic-

degrees). For example, if we wish to use an iron-constantan type thermocouple and place a calibrate signal of 500 degrees Fahrenheit on the tape, we refer to the appropriate table and find that an iron-constantan thermocouple with a 150-degree reference temperature will produce an output of 10.71 millivolts d.c. at 500 degrees. An accurate millivolt source is then used to apply this value to the d.c. amplifier and the gain set to provide a suitable level for recording on the FM channel. This completes the calibration for temperature and the thermocouple may now be connected.

The calibration of unit rpm is probably the simplest of all since it is only necessary to know the number of gear teeth coupled to the speed pickup. Knowing this, the formula for the cali-

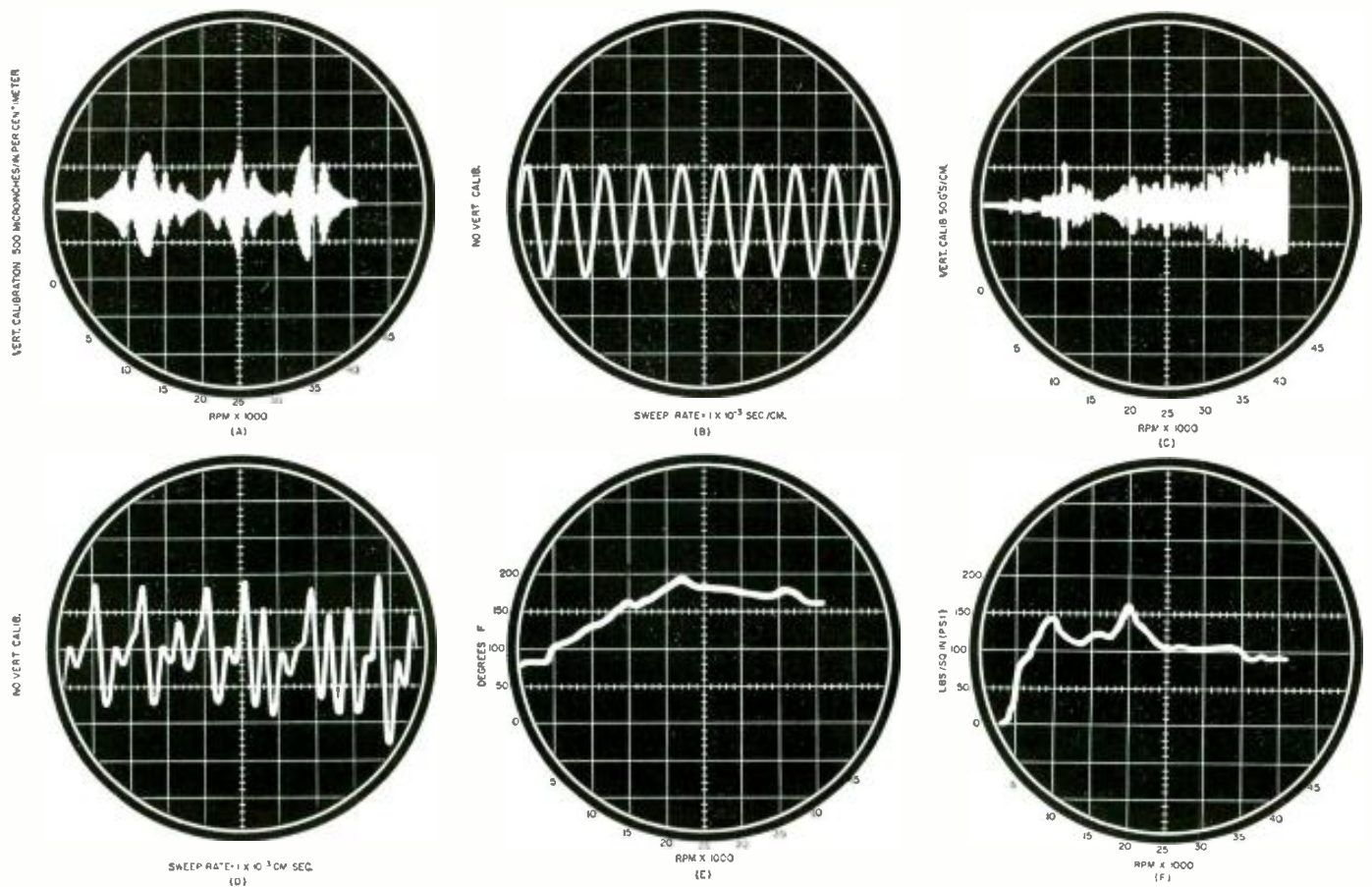

Fig. 8. This is what the information looks like as it appears on the scope. Note that each division equals 1 cm. (A) Dynamic strain amplitude (peak-to-peak) vs rpm. (B) Single sweep of strain point of part A. (C) Unit vibration (peak-to-peak) vs rpm. (D) Single sweep of vibration point of part C. (E) Bearing oil temperature vs rpm. (F) Compressor discharge pressure vs rpm.

brate frequency becomes the following:

$$\text{Calibration Frequency} = \frac{N \times S}{60} = \text{cps}$$

Where: N = number of teeth on the gear and S = speed calibration point (rpm).

An oscillator coupled to a digital frequency counter is used to apply the calibrate signal to the direct-record channel. No special precautions are necessary in the use of speed pickups except to monitor the input level of the signal to the tape recorder during the test to see that it does not become high enough to distort the waveshape. During the actual test run it is very important to keep an accurate record of each event to refer back to during the data reduction process. Information is worthless no matter how accurate, if a log is not maintained as to the conditions, time, sequence, and tape check points during the run. It is also necessary during the test run to watch the input meters carefully for any sign of abnormal readings that may indicate trouble in connecting cables or transducers.

Methods of Data Reduction

Although it sometimes requires only a few minutes of actual recording time for a test, it may require many hours of intense study and work to reduce the data to a usable form. We shall investigate a few of the methods employed

for reducing the information on the tape. Any type of information can be read out in the form of an X-Y plot. In this particular test rpm or time would be used for the X axis and the amplitude of the signal to be measured would be the Y variable. Since we need a very high response type of plotter for the strain gage and accelerometer information, we shall plot these two channels on the oscilloscope while photographing the complete test run. Polaroid projection-type film is used in the camera in order that standard 8 1/2" x 11" prints can be made. Fig. 7 shows a typical data reduction set up. On the left can be seen a dual-beam oscilloscope with the camera attached. To the right of the oscilloscope is an X-Y plotter which, in this case, is used to plot the temperature and pressure traces. Located in the center of the table is a variable band-pass filter which allows a bandpass of any width through the range of 0-200 kc. Immediately above the filter is a frequency meter which provides a d.c. analogue output voltage for frequency input. On the far right is a digital frequency counter which reads both cps and period measurement. Located above the counter is a sine-wave oscillator which is flat up to 600 kc. This represents only a partial listing of the equipment that may be used for data reduction depending on the requirements of the particular test.

Fig. 8 shows what the information

will look like once it is reduced to a usable form. Fig. 8A shows one of the strain gage signals on the compressor wheel with all the stress points from light-off of the unit to maximum speed. Note that there are three large stress points. These points would be of great interest to the design engineer since they represent critical points where damage to the wheel might occur. Therefore, we must be able to determine their exact magnitude and frequency. The magnitude can be read directly from the photograph as well as the speeds where they occur. However, to determine the exact frequency of each point, we must use another method. We first set the scope sweep to a convenient range to acquire an approximation of the frequency. Fig. 8B shows one sweep and it is observed to be near 20 kc. We then place an oscillator signal on the second channel of the oscilloscope and adjust the frequency for 20 kc. As we re-run the point on the tape we shift the frequency slightly each time until we have a stationary Lissajous pattern indicating the frequencies are at zero beat. Since the oscillator dial reading will not be accurate enough for our purposes, we now apply the oscillator signal to the digital frequency counter and read it out to within one cps. This process is repeated for each of the three stress points. We now have arrived at frequency and magnitude for one of the

(Continued on page 111)

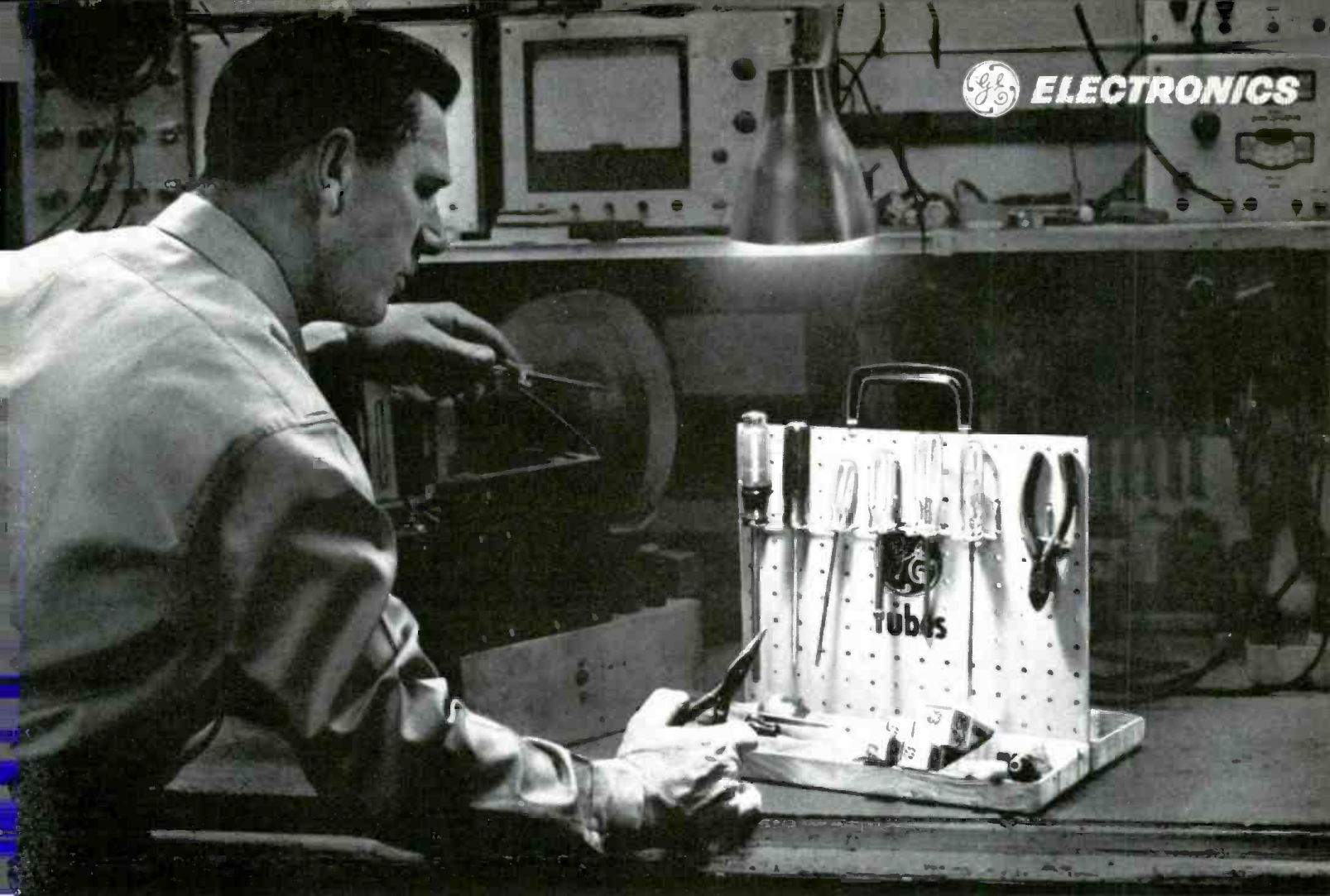

New G-E Tool Toter puts tools and parts at your fingertips

No more digging for the right tool—not with this handy new G-E Service Aid. The Tool Toter. Measures just 11" x 14", 12" high. It's especially designed to go along wherever tools are needed: on the bench, on the counter, on the job or for general maintenance. Pegboard with tool holders keeps screw drivers, pliers, nut drivers, etc., clearly visible and easily removed or replaced. High-impact plastic trays hold screws, nuts, lockwashers, fuses, and other small tools or parts that are needed on-the-spot. Order your Tool Toter today—helps make service calls more profitable. Saves your time and your temper. ETR-2338 Tool Toter.

These are the three newest in the series of G-E Service Aids which can make your work more pleasant and more profitable. Useful tools especially designed by service technicians for service technicians. Get them from your General Electric tube distributor, or mail coupon to Chicago warehouse address given. Distributor Sales, Electronic Components Division, General Electric Company, Owensboro, Kentucky.



Two More in the Series of G-E Service Aids

Four-Edged Wire Stripper Saves Time—Handles All Wire Sizes
Here's the easy way to strip off insulation, without nicking the wire: Press insulated wire into cutting channel—rotate wire stripper around wire and pull. Easy! 4" plastic handle. ETR-2376 Wire Stripper.

New Forked Soldering Tool Easy to Use in Tight Spots
Plastic handle makes it easy to hold and use • 6" long • Rod seated in plastic—will not pull out • Forked tool best for re-wiring and pull. Easy! 4" plastic handle. ETR-2377 Soldering Tool.



Progress Is Our Most Important Product

GENERAL  ELECTRIC

GENERAL ELECTRIC COMPANY, DEPT. B
3800 N. Milwaukee Ave., Chicago 41, Illinois

Please ship, prepaid:

..... ETR-2338 Tool Toter, \$3.00 ea. or \$2.50 plus
10 G-E 6 volt series tube carton tops.

..... ETR-2377 Soldering Tool, 60¢ each.

..... ETR-2376 Wire Stripper, 50¢ each.

My check or money order is enclosed for the required amount plus any sales or use tax applicable in my area.

Name.....

Address.....

City..... Zone..... State.....

voices
from
outer space!

SPECIAL
OFFER,
25¢

Dramatic Events Recorded First
Time From Short Wave Radio!

President's voice from outer space... police capture of a gunman... radio contact with record altitude flight! Many other fascinating, historic events—ships, planes, foreign stations—all transcribed on a limited-edition recording, "The Amazing World of Short Wave Listening," narrated by world-famous newscaster Alex Dreier. If you're alert, adventuresome, send for this remarkable recording today!

As heard on Hallicrafters precision receivers, \$59.95 to \$395.00.



hallicrafters Department 20,
Chicago 11, Ill.
Enclosed is 25¢. Please rush "The Amazing World of Short Wave Listening."

NAME _____
ADDRESS _____
CITY _____ STATE _____

KUHN "LEADERS IN SPECIALIZED RECEIVING EQUIPMENT"

MOBILE
FIXED
CONVERTERS

- POLICE
- FIRE
- COMMERCIAL
- CITIZEN'S BAND



331B
Complete
\$24.95
Crystal controlled. Requires no high voltage supply. For transistor car radios. Can be connected in moments for emergency use. 2-54 MC
Other models for 108-162 MC available

315A

A practical converter for emergency use with home or auto sets. Easily installed. Tunable over 12 MC in 26-54 MC or 30 MC in 108-174 MC band.



Complete
\$13.95

315AC Crystal controlled up to 54 MC. COMPLETE \$18.95
315AD Crystal controlled up to 165 MC. COMPLETE \$22.95
315AD Crystal controlled. For use with transistor car radios. 2-54 MC. COMPLETE \$17.95
316A VARIABLE CONVERTER. Front panel tuning permits rapid change between separated signals over 10 MC range in 26-54 MC or 108-174 MC band. COMPLETE \$19.95

CONVERTERS
ALL EQUIPPED
WITH SELF
CONTAINED
SWITCHING
AND LEADS
FOR RAPID
CHANGE-OVER

ORDER TODAY or
SEND FOR FREE
CATALOG... containing complete information on a full line of CONVERTERS AND RECEIVERS FOR EVERY APPLICATION



326B
Complete
\$44.95
SUPER CONVERTER. Crystal controlled. For transistor car radios. Ultra high gain. Self contained ANL. 2-54 MC.

30 GLENWOOD
CINCINNATI 17,
OHIO

Hi-Fi-Audio

Product Review

TUNER AND STEREO AMPLIFIER

Sargent-Rayment Co., 4926 E. 12 St., Oakland 1, Calif. has brought out an FM tuner and stereo amplifier combination which features a pre-switched input



channel that accommodates other units for all types of stereo broadcasts, such as AM/FM, FM/FM, or FM/multiplex, depending on what other unit (tuner or multiplex adapter) is fed into that channel.

Designated as Model SR-1040, the new set includes a stereo amplifier with controls, rated at 10 watts per channel. Among its features are stereo inputs for phono and tape, a "center channel" output jack, and a "stereo separation" control.

NEW AUDIO KITS

Radio Shack Corp., 730 Commonwealth Ave., Boston 17, Mass. has announced two new audio kits. Shown here is the "Realistic" FM tuner, Model 200, a kit version of the company's Model FM-3 tuner. The tuner uses a three-gang tuning capacitor, separate tuned



r.f. stage; cascode front end, and a.f.c. Response is given as 20 to 20,000 cycles.

Another new kit is the "Realistic" stereo integrated amplifier, featuring built-in preamp and controls as well as rated power of 20 watts per channel.

NEW CERAMIC CARTRIDGE

Sonotone Corp., Elmsford, N.Y. has introduced its "Velocitone," an assembly that consists of the company's new "9T" stereo ceramic cartridge and two matched equalizers. The equalizers plug into the velocity or magnetic inputs of an amplifier to convert the output of the "9T" to a flat velocity response tailored for RIAA equalization.

Response of the new cartridge is said

to be flat, $\pm 1/2$ db, from 20 to 6000 cycles, and 1 db to 17,000 cycles with "deliberate roll-off" to 20,000 cycles. Output voltage is 11 millivolts. Compliance is stated at 3.5×10^{-6} cm. dyne; tracking pressure given is 2 grams for professional tone arms and 3 grams for changers.

NEW TURNTABLE KIT

Fairchild Recording Equipment Corp., 10-40 45th Ave., Long Island City 1, N.Y. has entered the kit field with the release of its new Model 440-2K turntable in do-it-yourself form.

The unit is similar to the Model 440 two-speed turntable introduced by the company last year. The kit is furnished with all parts, instructions, and a pre-cut mounting board.

TRANSISTOR STEREO AMPLIFIER

Polar Electronics, Ltd., 1514 Oak St., So. Pasadena, Calif. has brought out an



all-transistor stereo preamplifier-amplifier, offering control facilities and a rated power output of 15 watts per channel. A unique feature of the unit is its complete circuit encapsulation which protects it from rough usage, dust, and moisture. Said to have no problems of heat, hum, or microphonics, the unit is fully guaranteed for 30 months.

First in a new line of transistorized stereo components being manufactured by the firm, the new amplifier can be operated on a.c. or d.c. power. Response is given as 20 to 20,000 cycles with less than 1 per-cent distortion. The unit measures 3 inches high by 12 inches wide by 7 inches deep and comes in a furniture-finished wood cabinet.

COMPACT SPEAKER SYSTEM

Erconu Corp., 16 W. 46 St., New York, N.Y. is distributing a new Swedish speaker system of compact proportions. Known as the "Nordic I," the system includes woofer, tweeter, and crossover network pre-assembled in a furniture-finished enclosure.

A unique feature of the drivers is the use of a multi-layered free-floating cone, described as a "sandwich" and said to reduce harmonic distortion. Each layer of the speaker cone, from the edge sus-

It's taking the country by storm

THE MIGHTY MITE



With thundering applause... here's what they say...

- "It is the best tube tester I have ever owned."
F. M., MONROE, LA., TV TECHNICIAN
- "It's a real asset to any serviceman." (35 years in servicing)
C. H. W., EAST PRAIRIE, MO., TV TECHNICIAN
- "This is the best checker I have ever used."
E. L. R., HASTINGS, MICH., TV TECHNICIAN
- "A must for every serviceman. A real Time Saver at a reasonable price."
W. P., ERIE, PA., TV TECHNICIAN
- "The most complete and reliable instrument I ever bought for this price."
H. P. R., QUEBEC, CANADA, TV TECHNICIAN
- "I already own one. This is my second Mighty Mite."
PHILCO DISTRIBUTOR, ST. LOUIS, MO.
- "Mighty Mite has paid for itself the first month."
W. C., UNIONTOWN, PA., TV REPAIR
- "I have found the Mighty Mite all that you say it is and more. It tests tubes that my other tester, costing twice as much, will not test."
L. K. E., W9PWQ, CHICAGO, HAM

Don't be misled... there's only one Mighty Mite!

MAGAZINE TEST LABS SAY...

PF Reporter, Nov., 1960, page 65...
"When putting the Model TC109 to work in the lab, I tried to 'trip up' the tester by throwing a few curves at it. Using my prized collection of rejected tubes that have mostly 'tough dog' defects, I proceeded with the tests given in the Sencore instructions. The results: The Mighty Mite found every trouble, even the toughest."

Les Deane

Electronics World, Jan., 1961, page 103...
"We checked two dozen tubes known to be defective. Many had been passed as 'good' by other testers. Each failed at least one of the three tests provided by the TC109. On the other hand, every new tube previously known to be in good condition checked good on the Mighty Mite."

In a nut shell... here's why the Mighty Mite finds them all. It checks tube grid circuits with the same high sensitivity as the indispensable Sencore LC3 Leakage Checker; yet it checks emission, leakage and shorts just like the big, expensive testers. That's why we call it the Mighty Mite... you can't miss!

ONLY
59
DEALER
NET

Your Distributor

has them in stock

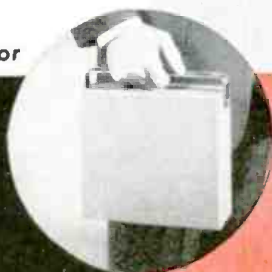

ALL PARTS MADE **SENCORE** IN AMERICA

SENCORE
ADDISON 2, ILLINOIS

It's so easy to carry on every service call. The Mighty Mite is the smallest, most compact complete tester made. Smaller than a portable typewriter and with an all-steel case to protect it. Weighs less than 8 lbs.

Schober
 captures
 magnificent
 pipe organ
 tone
 in a
 tiny
 electronic
 tube

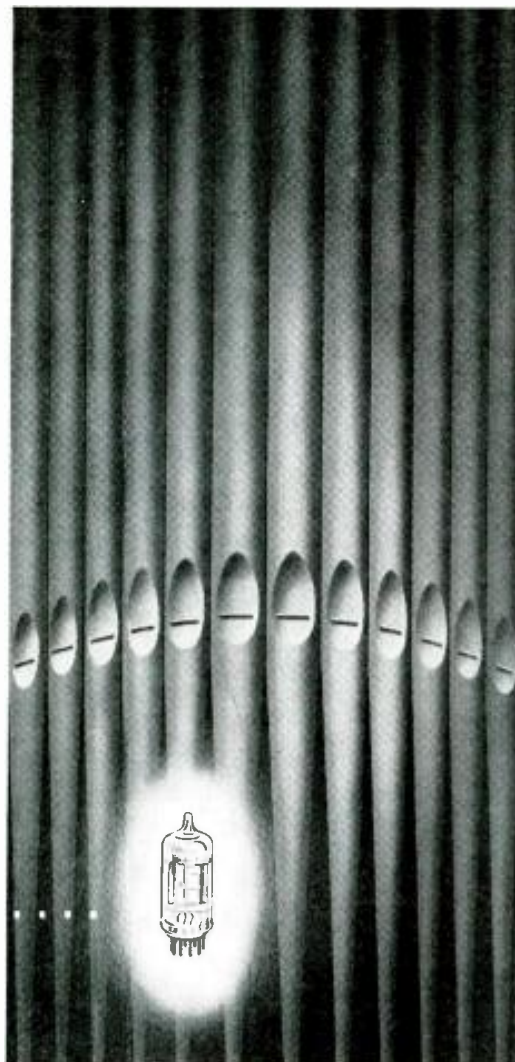

Here is magnificent Pipe Organ tone: tremendous tonal color range; two 61-note pipe-organ keyboards; hand-rubbed cabinetry in the finish of your choice. Taken together they comprise a superlative electronic instrument comparable to organs selling for \$2,500 to \$6,000.

Yet, when you assemble the Schober of your choice, you save more than half the normal cost and create a superb instrument to bring the delightful gift of music to your family.

Matched kits and printed circuitry make it possible.

Work requiring knowledge and experience is eliminated. All that remains is the pride and pleasure of watching a fine musical instrument take shape under your own hands. The Schober organ you assemble will equal or surpass any factory-built organ for quality, reliability and circuitry.

And the Schober electronic Organ is so easy to play!

From the very first day even novices will transform simple tunes into deeply satisfying musical experiences — because unlike a piano whose tone dies away almost as soon as the keys are struck, organ tones continue to sing out as long as the key is held down. Then, by simply moving your right foot, you change the volume so that the sound becomes rich and alive.

The coupon brings you full details on how you can start building the Schober of your choice with an investment of as little as \$18.95. In addition, you may have an exciting 10" LP record demonstrating Schober's full range of tones and voices. The \$2 charge for the record is refunded when you order your starting kit. No salesman will call.

MAIL THIS COUPON TODAY

THE Schober Organ CORPORATION
 Dept. RN-11, 43 WEST 61ST STREET, NEW YORK 23, N.Y.

The Schober Organ Corp., Dept. RN-11
 43 West 61st Street, New York 23, N.Y.

- Please send me FREE full-color booklet and other literature on the Schober organ.
- Please send me the Hi-Fi demonstration record. I enclose \$2 which is refundable when I order my first kit.

name _____
 address _____
 city _____ zone _____ state _____

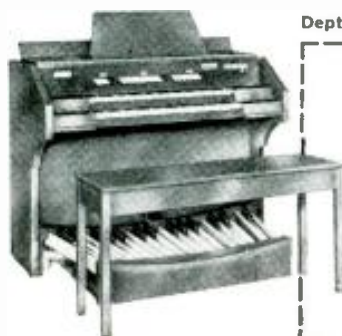

pension, through the damping layer, and then to the sound generating layer, is made of a different fibre. Claimed response is 45 to 18,000 cycles. The tweeter cuts in at 5000 cycles with crossover occurring at 7500 cycles.

STEREO TAPE DECKS

Ampex Audio Co., 1020 Kifer Rd., Sunnyvale, Calif. has announced two tape players that contain the basic mechanism used in the company's Model 960 equipment.

Model 934 is supplied without playback preamplifiers, the signal being taken directly from the heads and fed to suitable inputs on an external pre-amplifier. Model 936 includes self-contained playback preamplifiers, equalized for connection to power amplifiers and/or an audio control unit.

Both tape decks are two-speed (3¾

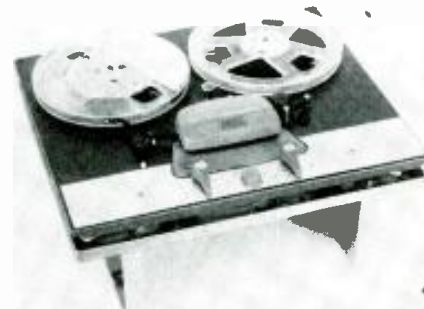

and 7½ ips) units, and will play quarter-track stereo, half-track stereo, full-track, and monophonic.

STEREO AMPLIFIER KIT

Allied Radio Corp., 100 N. Western Ave., Chicago 80, Ill. has introduced a 70-watt integrated stereo amplifier in kit form. Designated by stock number 83-YU-934, the unit delivers 35 watts power per channel, with an IHFM music-power rating of 96 watts. Featured is a blend control to regulate channel separation, as well as a "center channel" output.

Response is stated as +1 db, 20 to



35,000 cycles at 35 watts output on each channel. At this level, harmonic distortion is given as under 0.5% and IM distortion as under 1%. Hum and noise are better than 75 db below rated output.

Printed circuit switches, printed circuit boards, and special plug-in assemblies of resistors and capacitors are offered as time-saving and error-reducing features for the kit builder.

AUDIO INPUT TRANSFORMERS

Chicago Standard Transformer Corp., 3501 W. Addison St., Chicago 18, Ill. has introduced three new audio input transformers which are claimed to have a wide variety of applications in both original equipment and as replacements.

All three transformers have a primary impedance of 600/500 ohms center-

tapped. *Stancor* unit A-4778 is a line-to-grid transformer. Model A-4779 is for line-to-single or push-pull grid applications. Model A-4780 is for line-to-push-pull applications. Additional information can be obtained by writing to the manufacturer, requesting *Stancor* Bulletin 575.

TRANSISTORIZED COMPONENTS

Johnson Electronics, Inc., P.O. Box 1675, Casselberry, Fla. is offering tran-



sistorized components designed specifically for the background music industry.

Shown here is Model JE 25 MA, a 25-watt amplifier, with response from 30 to 7500 cycles, ± 3 db. The multiplex tuner features sensitivity of 2 mv. for 20 db of quieting. Audio response is between 50 and 9000 cycles. The tuner is crystal controlled. For more details, write to the manufacturer.

STEREO SERVICE KIT

Motorola Inc., 4545 W. Augusta Blvd., Chicago 51, Ill. has introduced a "stereophono service kit" for service dealers and technicians. The kit includes three different ceramic cartridges, a *Motorola* idler wheel replacement, a strobe disc, a stylus pressure gauge, and a manual covering the latest record-changer servicing techniques.

The three phono cartridges are exact replacements for units employed in 1961 *Motorola* stereo sets, but reportedly can be used in most changers requiring ceramic pickups. All employ a diamond/sapphire stylus.

"STEREO ONLY" CARTRIDGE

Benjamin Electronic Sound Corp., 97-03 43rd St Ave., Corona 68, N. Y. announces a new magnetic phono cartridge designed for use with stereo records only. According to the New York importer and distributor of *ELAC* products, the new cartridge "is the standard playback cartridge used by broadcast studios throughout Europe."

Called the "Studio" and designated as Model ST-310D, the new cartridge comes with a 0.52-mil diamond stylus. Stated specifications include: frequency range of 20 to 20,000 cycles; crosstalk damping of 24 db; tracking force, 3-5 grams.

"TRI-HELIX" SPEAKER

Lafayette Radio Corp., 165-08 Liberty Ave., Jamaica 33, N.Y. has brought out a 10-inch three-way speaker designed expressly for "bookshelf" enclosures. Designated as the "Tri-helix," stock No. SK-180, the new speaker utilizes three mechanically and electronically independent speakers mounted within a single 10-inch frame. The two-inch tweeter and the five-inch mid-range speaker are fed by a built-in

BREAKTHROUGH IN KIT DESIGN!



LK-72 72-Watt stereo complete amplifier kit (left), \$149.95. LT-10 Wide-Band FM Tuner kit \$89.95.*

H. H. Scott takes totally new approach . . . makes kits easier-to-build, better performing!

BREAKTHROUGH! Here, for the first time, are kits with the performance, features and handsome good looks of H. H. Scott factory-assembled components . . . kits that are a real pleasure to build and so expertly designed that you can achieve professional results in just a few hours.

H. H. Scott assures you the performance of factory-built units with these innovations:

1. All mechanical parts such as terminal strips and tube sockets are firmly pre-ripped to the chassis thus assuring sturdy professional construction and eliminating the bother of this time-consuming operation.
2. Every wire and cable is already cut to exact length and pre-stripped. This saves you time and assures professional performance because exact lead length is automatic.
3. To take the guesswork out of assembly, electronic parts are mounted on special cards in the order in which they are used. No loose bags of parts to confuse you.
4. Full color diagrams in easy-to-follow instruction book simplify assembly and reduce errors because you match the part to the color diagram.

HERE'S WHAT ENTHUSIASTIC OWNERS SAY:

" . . . designed to professional standards; sound absolutely clean; very sensitive; instruction book of outstanding clarity." — Major B. W. Cotton, Jacksonville, Ark.

"Looked long for the best kit — and found it . . . best instructions I ever saw, unbelievably simple to build." — M. Greenfield, White Plains, N. Y.

" . . . I would run out of superlatives if I tried to adequately state how I feel about this tuner . . ." — Samuel R. Harover, Jacksonville, Ark.

" . . . without a doubt the easiest kit I have ever built (out of 11) . . ." — B. P. Loman, Jr., Rochester, N. Y.

" . . . finest kit I have ever built. And one of the finest tuners I have heard, kit or otherwise." — A. J. Zilker, Houston, Texas.

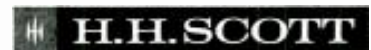

H. H. Scott Inc., 111 Powdermill Road
Maynard, Mass. Dept. 160-04

Rush me complete technical specifications on H. H. Scott kits. Include your new "1961 Guide to Custom Stereo."

Name _____

Address _____

City _____ Zone _____ State _____

*Prices slightly higher West of Rockies.

Export: Telesco International Corp., 171 Madison Ave., N.Y.C.

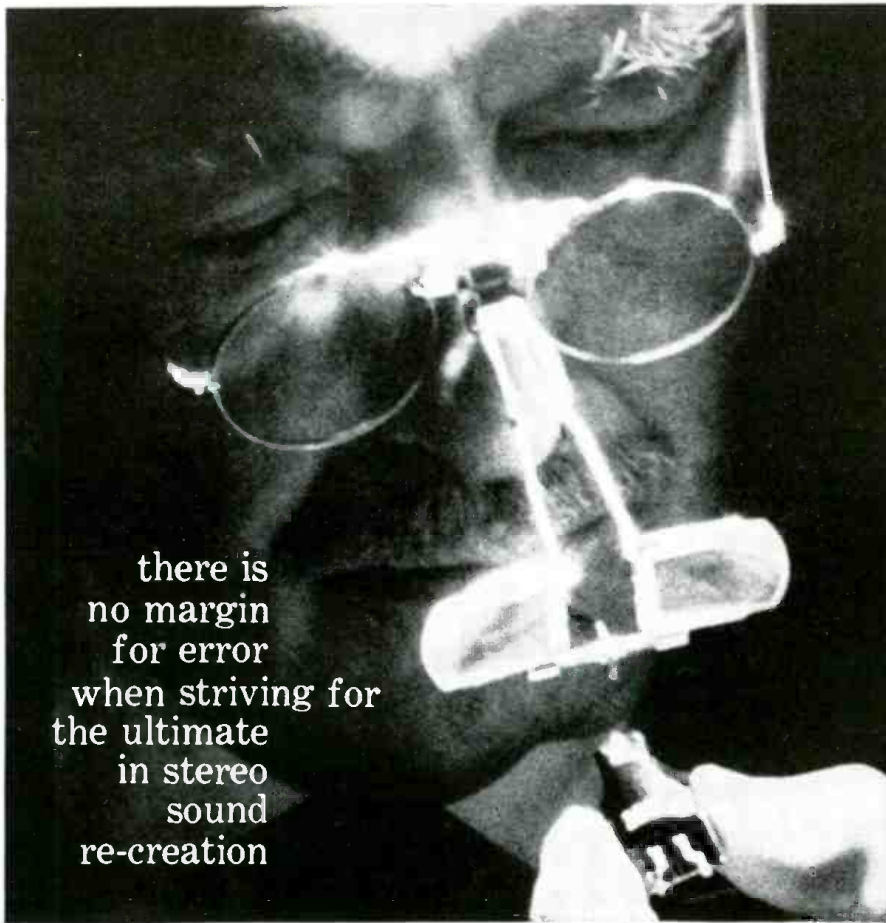

there is
no margin
for error
when striving for
the ultimate
in stereo
sound
re-creation

SHURE

Stereo Dynamic

HI-FI PHONO CARTRIDGES

Tiny though it is, the cartridge can make or break a stereo system. For this breathtakingly precise miniaturized electric generator (that's really what it is) carries the full burden of translating the miles-long undulating stereo record groove into usable

CARTRIDGES

- Standard M8D. A superb blend of quality and economy... \$16.50
- Custom M7D with N21D stylus. Widely acclaimed... \$36.75
- Professional M3D with N21D stylus. Choice of the critics... \$47.25
- Laboratory Standard Model M3LS. Individually calibrated, limited quantity... \$75.00



TONE ARMS

- Studio Dynamic. Integrated arm and cartridge. Cannot scratch records... \$89.50
- Professional Independent Tone Arm. For any quality cartridge... stereo or mono... \$29.95



electrical impulses... without adding or subtracting a whit from what the recording engineer created. Knowing this keeps Shure quality standards inflexible. Shure Brothers, Inc., 222 Hartrey Avenue, Evanston, Illinois.

engineering degree in 27 mos.

Become an Electronics Engineer. Share rewards of college degree... more income, rapid advancement. Important firms interview seniors. They like Tri-State graduates. Qualify faster here. Bachelor of Science Degree in 27 Months in Electrical (Electronics or Power major). Mechanical, Chemical, Aeronautical, Civil Engineering. In 36 Months in Business Administration (General Business, Accounting, Motor Transport Management majors). For earnest, capable, mature students. Small classes. More professional class hours. Well-equipped labs. Dorms. Campus. Modest costs. Enter June, Sept., Jan., Mar. Founded 1884. Write J. H. McCarthy, Director of Admissions for Catalog and "Your Career" Book.



TRI-STATE COLLEGE

1641 College Ave., Angola, Indiana

**PACKAGE HI FI
or SINGLE COMPONENTS**

You'll find our prices low and service fast.

Write for our quotation.

CENTER INDUSTRIAL ELECTRONICS, Inc.
74-L Cortlandt Street, New York 7, N. Y.

MAIL ORDER HI-FI

You can now purchase all your HI-FI from one reliable source and be assured of perfect delivery. We deliver most hi-fi components, recorders & tape within 24 hours. SEND US YOUR LIST OF HI-FI REQUIREMENTS FOR OUR WHOLESALE QUOTATION and FREE catalogue. WE WILL NOT BE UNDERSOLD. Write us for proof of this statement.

CARSTON

125-TD E. 88 St.

New York 28, N. Y.

electrical network with crossover frequencies at 1500 and 5,000 cps. To minimize interaction among the three cones, the mid-range and tweeter units are mounted eccentrically or off-center with relation to the woofer. Additionally, they are completely enclosed in their own baffles.

MATCHED CABINETS

Homewood Industries, 26 Court St., Brooklyn, N.Y. has introduced matched equipment and speaker cabinets for

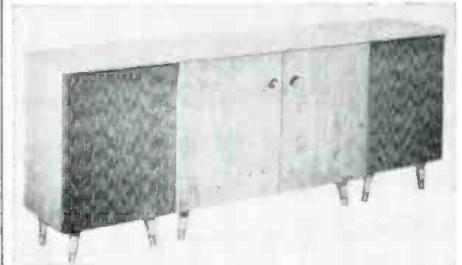

housing various combinations of stereo components. The cabinets are fully assembled and ready to finish by the purchaser. The speaker enclosure unit has an adjustable bass-reflex port that can accommodate either 12-inch or 8-inch speakers.

The equipment cabinet is well-vented. Both units are of lowboy design and are fitted with 5-inch brass-ferruled legs.

STEREO TUNER

Electronic Instrument Co., Inc., 33-00 Northern Blvd., Long Island City 1, N.Y. has introduced a new Eico FM/AM stereo tuner, available in factory-wired or kit form. Two completely independent sets of controls allow the tuner, Model ST96, to be used for separate FM and AM reception, or for AM/FM stereo, or—with the addition of an adapter—for FM-multiplex.

Both the AM and FM sections have pre-wired, pre-aligned r.f. and i.f. stages to facilitate building the unit from the



kit. The FM section uses switched a.f.c., as well as a.g.c., stabilized low limiting threshold for weaker signals, and broad-band ratio detector for "improved capture ratio and easier tuning." FM frequency response is given as 20 to 15,000 cycles.

The AM section features switched "wide" (to 14 kc.) and "narrow" (to 7 kc.) bandpass. AM frequency response is stated as 20-9000 cycles (wide) or 20-4500 cycles (narrow).

QUARTER-TRACK STEREO HEAD

Robins Industries Corp., Flushing 54, N.Y. has announced a new M/M quarter-track stereo record/playback tape head, designed as an exact replacement for a number of popular tape recorders. Known as Model 5Q17-105, the new

head serves as replacement on the following models: Bell T-200, T-201, T-203, BT205-1B, T-206, T-207S, T-211, BT205-0B; *Ektape* 250, 360, 362; and VM 714 and 750A.

COMMUNICATIONS-RADIO SYSTEMS

Webster Productomatic Corp., 795 Monroe Ave., Rochester 7, N.Y. has announced a line of "communications-radio" systems for a number of uses in the home, such as answering the door, minding the baby, playing music throughout the house, communicating from room to room, and clock radio applications.

A variety of basic units and accessories is available in this new "Guardian" line. For full particulars, write to the manufacturer.

STEREO CONTROL AMPLIFIER

Sherwood Electronic Laboratories, Inc., 4300 N. California Ave., Chicago 18, Ill. has announced a new stereo amplifier-preamplifier rated at 80 watts, music-power rating. Designated as Model S-5000 II, the new instrument is said to be an improved model of the



firm's S-5000 amplifier. Power output of the new version is 36 watts per channel.

Included on the new amplifier are new 12 db-per-octave scratch and rumble filters, ten two-channel controls, stereo normal/reverse switch, phase inversion switch, and dual amplifier monophonic operation with either set of inputs. Hum and noise are listed as 60 db below rated output. Phono sensitivity is 1.8 mv. The amplifier provides for a "third channel" output.

STEREO REMOTE CONTROL

Sun Radio Service, 320 Chestnut St., Kearny, N.J. has announced a remote control unit for use in stereo systems that employ a separate preamp and power amp.

Controls include balance, channel, and volume. A special low-capacitance cable minimizes high-frequency loss. The unit may be used up to 30 feet away from the rest of the system. It is available in a metal enclosure or in a walnut or mahogany cabinet.

"CITATION" FM TUNER

Harman-Kardon, Inc., Plainview, Long Island, N.Y. has announced the



"Citation III" FM tuner, available as a kit or factory-assembled. Reportedly,

2 for the money

circuit by



tubes by

Amperex®



EICO described the Amperex tubes used in their new HF89 100-Watt Stereo Power Amplifier with the word, "unsurpassed." And with good reason. The HF89 delivers 100 RMS watts undistorted from 20 to 20,000 cps. 1M distortion at normal listening levels (even with low-efficiency speakers)... less than 0.1%!

To achieve these standards, EICO chose 4 Amperex 6CA7/EL34's for the HF89's output stage and 1 Amperex 12AX7/ECC83 for its voltage amplifier stage. The results: full-rated power output, inaudible distortion, low hum and noise, and the absence of microphonics.

These and many other Amperex 'preferred' tube types have proven their reliability and unique design advantages in virtually all of the world's finest audio components.

Write today for the *Audio Designers Handbook*, new 33-page booklet featuring 14 pages of complete schematics of mono and stereo preamplifiers and amplifiers. Price, \$1.50. Amperex Electronic Corp., Special Purpose Tube Division, 230 Duffy Ave., Hicksville, Long Island, N. Y.



about hi-fi tubes
for hi-fi circuitry

AMPEREX TUBES FOR QUALITY HIGH-FIDELITY AUDIO APPLICATIONS

POWER AMPLIFIERS

6CA7/EL34: 60 w. distributed load
7189: 20 w., push-pull
6BQ5/EL84: 17 w., push-pull
6CWS/EL86: 25 w., high current, low voltage
6BM6/ECL82: Triode-pentode, 8 w., push-pull

VOLTAGE AMPLIFIERS

6267/EF86: Pentode for pre-amps.
12AU7/ECC81: Twin triodes, low hum, noise and
12AX7/ECC83: J microphonics
6BL8/ECF80: High gain, triode-pentode, low hum, noise and microphonics

RF AMPLIFIERS

6ES8: Frame grid twin triode
6ER5: Frame grid shielded triode
6EH7/EF183: Frame grid pentode for IF, remote cut-off
6EJ7/EF184: Frame grid pentode for IF, sharp cut-off
6AR5/ECC85: Dual triode for FM tuners
6DC8/EBF89: Duo-diode pentode

RECTIFIERS

6V4/EZ80: Indirectly heated, 90 mA
6CA4/EZ81: Indirectly heated, 150 mA
5AR4/GZ34: Indirectly heated, 250 mA

INDICATORS

6FG6/EM84: Bar pattern
1M3/DM70: Subminiature "exclamation" pattern

SEMICONDUCTORS

2N1517: RF transistor, 70 mc
2N1516: RF transistor, 70 mc
2N1515: RF transistor, 70 mc

1N542: Matched pair discriminator diodes

1N67A: AM detector diode, subminiature

Lag-55 Audio Generator Sine Square

new "LEADER" test instrument

A multi-purpose generator for measurements on audio equipment-amplifiers, speakers, networks. Three waveforms: sine, square and complex for all types of measurements including response, distortion, transient and I-M distortion checks. Full range is from 20 to 200,000 cps, output 5 volts with minimum amplitude variation throughout whole range.



OHMATSU ELECTRIC CO. LTD.

850 Tsunashima-Cho, Kohoku-Ku
Yokohama, Japan.

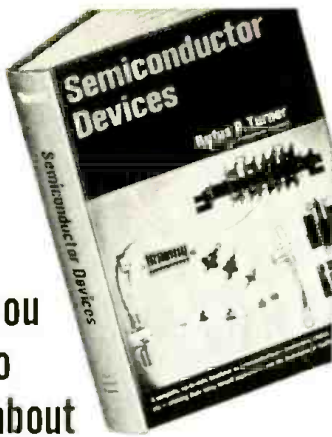

Here's
what you
need to
know about

SEMI- CONDUCTORS!

- DIODES • TRANSISTORS
- THERMISTORS • VARISTORS
- Power and controlled RECTIFIERS
- ZENER DIODES • PHOTO CELLS
- PARAMETRIC and MAGNETIC DEVICES, etc.

plus
using, testing and
measuring
semiconductors

Here at last is a down-to-earth 278-page book that gives you a practical working knowledge of semiconductor—from transistors to diodes, power and controlled rectifiers, ZENER diodes, varistors, thermistors, photo cells, parametric and magnetic devices and all the rest! It answers your questions about these remarkable little devices—equips you with the complete know how of their types, construction, circuit applications, testing and use.

No other field of electronics in recent years has experienced such remarkable growth. SEMICONDUCTOR DEVICES by Rufus Turner gives you a clear understanding of the entire subject—and does it without a lot of complicated mathematics. It has been specifically written for electronic technicians, servicemen, experimenters who are finding it increasingly important to have more than just a casual knowledge of these little devices which are literally revolutionizing electronic circuitry and design.

Standard and special-purpose types and their uses are fully explained. Over 250 illustrations demonstrating semiconductor circuitry and operational and construction features greatly simplify your understanding of the subject. Of particular importance, methods of testing and measuring semiconductor devices are spelled out in detail. Price \$6.95 on 10-day money-back guarantee basis.

10-DAY FREE EXAMINATION

Dept. RN-41, Technical Division,
HOLT, RINEHART and WINSTON, Inc.,
383 Madison Ave., New York 17, N. Y.

Send Turner's big, 278-page SEMICONDUCTOR DEVICES Manual for 10-day free examination. If I decide to keep book, I will then promptly send you \$6.95 in full payment. If not, I will return book postpaid and owe nothing.

(SAVE! Send \$6.95 with order and we pay Postage. Same 10-day return privilege with money promptly refunded.)

Name _____

Address _____

City, Zone, State _____

OUTSIDE U.S.A.—\$7.45, cash only. 10-day return privilege with money refunded.

the new tuner has no measurable distortion or station drift, "breaks the noise barrier" of 5 db by using a 4 db RCA nuvistor tube for the front-end circuit (which is also claimed to increase sensitivity), and has an audio range stated as three octaves above and below human hearing.

As in other "Citation" units, the tuner uses terminal-board construction. To facilitate the work of the kit-builder, most of the critical tuner elements are pre-wired and aligned in a newly developed "FM cartridge" which includes the third r.f. stage, mixer, oscillator, i.f. sections, and a.f.c. With this cartridge as a "standard," the hobbyist can use the two tuning meters provided to maintain alignment of other sections of the tuner.

The tuner embodies many other advanced circuit and design features; for full details, write to the manufacturer.

4-TRACK STEREO RECORDER

North American Philips Co., Inc., High Fidelity Products Div., 230 Duffy Ave., Hicksville, Long Island, N.Y. has announced the *Novelco* "Continental 300" (Model EL3542), a 4-track stereo playback and monophonic record/playback tape recorder.

Completely self-contained, the "Continental 300" includes a tape drive mechanism, recording/playback pream-

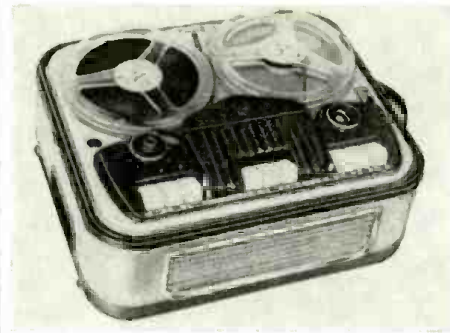

plifier, power amplifier, and a wide-range speaker. Also furnished is one of the firm's dynamic microphones.

The unit plays standard 4-track stereo tapes through an external preamplifier/amplifier, the signal being taken direct from the head. The machine will also record and play 4-track mono tapes through its own facilities or through an external sound system.

NEEDLE ASSORTMENT

Astatic Corp., Conneaut, Ohio, which recently announced the "Asta-Stock" system for distributors of its needle line, is now supplying dealers with a complete stocking and merchandising center for its needles.

The "center" consists of an attractive cabinet that contains 50 needles of 43 different types, as well as replacements for all new phonographs including 1960 stereo sets plus all popular mono replacements. Complete cross-reference information is provided.

"LANGUAGE LAB" RECORDER

Telectro Industries Corp., 35-16 37th St., Long Island City 1, N.Y. has announced its Model TR-922-C, designed

primarily for "language laboratory" applications. Its purpose is to assist an instructor teaching students a foreign language in group or individual instruction.

Special features of the TR-922-C include: a "record-practice" switch which permits the student to listen and record simultaneously; individual controls for instructor and student; dual headphone jacks; tape indexer; dual-track operation; and three speeds—1½, 3¼, and 7½ ips.

ELECTROSTATIC SPEAKER KIT

Neshaminy Electronic Corp., Neshaminy, Pa. has announced a wide-range speaker system "kit," consisting of an electrostatic mid- and high-range speaker, and a matching dynamic woofer pre-mounted on a rigid 19½" x 16" panel designed for installation in existing furniture, walls, or into custom-built units.



Known as the "JanKit 41," it employs a *JansZen* electrostatic speaker with two push-pull radiators responding from 700 to beyond 30,000 cycles. The woofer is a *Neshaminy* Model 350 speaker, a high-compliance, 11-inch cone woofer with response reported down to 30 cycles.

The system is supplied with instructions for mounting, or for building a shelf-type enclosure to house the system.

NOVEL SPEAKER SYSTEM

Polycooustic Co., 958 Arguello Drive, San Leandro, Calif. has introduced a speaker system that employs a total of 28 speakers, specially treated and installed in an enclosure described as a "vented infinite baffle." Six of the speakers are hard-cone tweeters.

The system is said to provide exceptionally wide sound dispersion, has a claimed response of 30 to 15,000 cycles ± 2 db, an efficiency of 20 per-cent, impedance of 8 ohms, and distortion of 1 per-cent at 100 db output.

The speaker is being offered in kit form or fully assembled.

AUDIO CATALOGUES

BOGEN PORTABLES

Bogen-Presto Div., Box 500, Paramus, N.J. is offering a six-page brochure and engineering specification sheets on the new *Bogen* VP-20 and VP-40 portable transcription players. The brochure (Catalogue No. 702) and the spec sheets (ES-VP-20 and ES-VP-40) are available on request to the manufacturer.

ROCKFORD CABINETS

Rockford Special Furniture Co., 1803 W. Belle Plaine, Chicago 13, Ill. has issued Bulletin R-19, describing new cabinets for housing stereo or mono high-fidelity components. Write to the company for a free copy.

CHANNEL MASTER

harps on one theme: PERFORMANCE!



To make the most, feature the best — sky-high quality products by Channel Master. Channel Master moves the goods because it delivers the goods. It's the brand that gives you those heaven-sent little "extras". Top quality and top performance for your customers — maximum volume and profits—you get the best of both. Just follow your "growth line" — Channel Master.

CHANNEL MASTER
SUPER 10 T-W ANTENNA

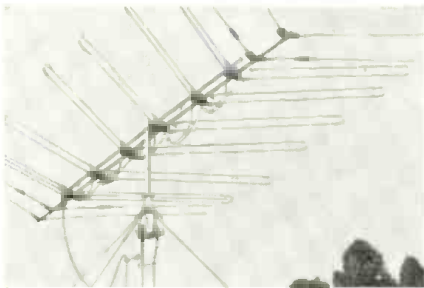

The most powerful super-fringe antenna yet developed. Based on Channel Master's unique Traveling Wave principle, it has 10 elements and offers up to 78% more power for picture-poor homes.

CHANNEL MASTER
TENN-A-LINER ROTATORS

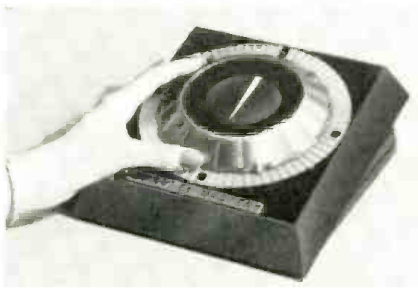

The only automatic rotator that can be aimed within one degree of the required direction. Unsurpassed accuracy, plus great repeatability and easier, quieter operation.

CHANNEL MASTER
PREMIUM QUALITY TUBES

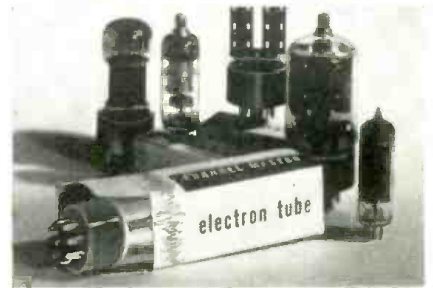

America's fastest growing line! Longer-lasting, uniformly dependable, with minimum call-backs. No other tube make offers greater opportunity for profits than these fully proved performers.

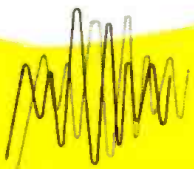

CHANNEL MASTER works wonders in sight and sound
ELLENVILLE, N. Y.

COYNE'S New Complete Pin-Point TROUBLE SHOOTING Series

See All 4 Books On 7-Day FREE TRIAL! Takes Headaches Out Of All Servicing Problems!



Pin-Point
TRANSISTOR TROUBLES
IN 12 MINUTES!

Trouble-shoot every type of circuit in ALL transistorized equipment! 525 pages; hundreds of illustrations; 120 check charts! \$5.95



Pin-Point
RECORD CHANGER TROUBLES
IN 5 MINUTES!

Locate mechanical and electronics troubles fast. Covers all makes. 320 pages; 450 photos; 58 check charts! \$3.95

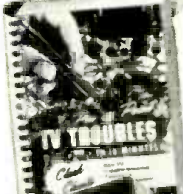

Pin-Point
TV TROUBLES
IN 10 MINUTES!

Find the exact sound or picture trouble in any TV set from 700 possibilities! 300 pages; 300 diagrams, check charts! \$4.95



Pin-Point
COLOR TV TROUBLES
IN 15 MINUTES!

Covers every type of color TV and picture tube! 530 pages; 362 check charts, diagrams, picture patterns! \$5.95

Simple Check Chart System Saves Time

These amazing practical handbooks with an ENTIRELY NEW METHOD, show you how to find the trouble in ANY tv, record changer or transistor circuit FAST! Index tells you where to look; famous Check-Charts help you pin-point the exact trouble in minutes! These on-the-job books quickly pay for themselves in profitable new business and valuable time saved!

SEND NO MONEY!

Just mail coupon for 7 DAY FREE TRIAL. If you keep all 4 books, pay only \$3.00 per month until \$21.35 plus postage is paid. Cash price for Set only \$18.95. Or return books and pay nothing. Either way, FREE BOOK IS YOURS.

VALUABLE FREE GIFT!
 Send for FREE TRIAL OFFER of all 4 Pin-Point books and get FREE book, "Bigger Profits in TV" whether you keep series or not!

FREE TRIAL OFFER...Mail Coupon Now!

Educational Book Publishing Div.
 COYNE ELECTRICAL SCHOOL, Dept. 41-RT
 1455 W. Congress Pkwy., Chicago 7, Ill.

- Rush 4-Book PIN-POINT Series for 7-day FREE TRIAL per offer. For individual books, check below.
- TV (\$4.95 plus postage)
- RECORD CHANGER (\$3.95 plus postage)
- COLOR TV (\$5.95 plus postage)
- TRANSISTORS (\$5.95 plus postage)

Name..... Age.....

Address.....

City..... Zone... State.....

- \$18.95 Cash Price enclosed for 4 books.
- Send 4 books C.O.D. for \$18.95 plus M.O. fee. COYNE PAYS POSTAGE ON ALL CASH & C.O.D. ORDERS. 7-Day money-back guarantee on Cash or C.O.D. orders.

Within the Industry

(Continued from page 22)

operated as a division of the parent firm under the direction of its present president, Charles George... **THOMSON RAMO WOOLRIDGE INC.** has moved to acquire **RADIO CONDENSER COMPANY** of Camden, N.J. by exercising its option to buy more than 90 per-cent of the New Jersey firm's outstanding stock.

WILLIAM J. SLAWSON has joined the sales staff of the *Weston Instruments Division, Daystrom, Incorporated*, as product sales manager of "Vamistors."



Mr. Slawson brings to his new job some twenty-one years of experience in electronic and industrial sales. Before coming to *Weston* he was general sales manager for the industrial division of *Telectro Industries*, and prior to that he held positions with *PRD Electronics*, *Pyramid Electric*, and *ITT Federal Division*.

Mr. Lawson attended New York University and is a member of the Institute of Radio Engineers.

BELL TELEPHONE LABORATORIES has received the annual "Industrial Science Achievement Award" given by the American Association for the Advancement of Science. (AAAS)

The award was made, in part, for *Bell Labs'* work with signals reflected from the passive satellite, Echo I; their work with an optical maser; their work with the first electronic telephone switching system; and other research and development projects.

CHARLES A. VOLZ, JR., has been elected president of *Olympic Products*. He succeeds **JOSEPH B. SCHAEFER** who becomes chairman of the board of directors.

RICHARD J. STONE has been named supervisor of the Delay Line section of the *Corning Glass Works* research department.... **GEORGE E. SPAULDING, JR.**, has been elected to the newly created post of vice-president in charge of engineering operations, Photo Products Division of *Bell and Howell Company*.

Hoffman Electronics Corporation has named **DR. GEORGE WERTWIJN** as engineering head of its Evanston plant.

ROBERT D. SCHMIDT has been promoted to director of engineering by *Telemeter Magnetics Inc.*... **EVERETT TIBBETS** has been named general manager of *Exact Engineering and Manufacturing Inc.*... **JOHN P. HASTINGS** has joined the staff of *Cunoga Electronics Corporation* as manager, special projects.... **DR. JOHN C. R. KELLY, JR.** has been named director of the newly created centralized technical services of *Westinghouse* central laboratories.

PALMER M. CRAIG has been appointed director of operations of *Philco Corporation's* Western Development Labora-

tories.... *Texas Instruments* reports that **ROBERT C. DUNLAP, JR.** has been elected vice-president succeeding **FRED J. AGNICH** who has resigned.

EMIDIO A. DeLOLLIS has been appointed engineering manager of *Raytheon Com-*



pany's Receiving Tube Operations. Mr. DeLollis joined *Raytheon* as a design and development engineer in 1946, and has been assistant head of the receiving tube design department since 1957. He

will now direct design and specifications, product development, production engineering, and engineering services for the Operation.

During World War II, he was a major in the U. S. Marine Corps. He graduated from Clark University, received his M.A. from Boston University, and is a member of the American Physical Society.

Mr. DeLollis replaces Niles P. Gowell, who has been promoted to division engineering manager for *Raytheon's* Industrial Components Division.

JOHN F. MORTEN has been appointed to the new post of manager of marketing services for the *Weston Instruments Division* of *Daystrom*. He was formerly director of product planning for the division... *Motorola Semiconductor Products Inc.* has appointed **EDWARD C. MEHM** to the newly created post of distributor merchandising manager, eastern area. He will make his headquarters in Clifton, N.J.... **THOMAS P. CLEMENTS** has been promoted to the post of sales manager for the distributor division of *The Hickok Electrical Instrument Com-*

pany. He was formerly national service manager for the *Admiral Corporation* before joining the instrument firm in 1958... The Electronics Division of *Elgin National Watch Company* has named **E. C. SPEVAK** engineering manager and **DUANE C. MANNING** marketing manager. Both men will headquarter at the division's plant in Burbank, California.

WALTER H. CHUDLEIGH, Jr., staff engineer for *General Atronics Corporation*, has been appointed a vice-president of the firm's subsidiary, *Atronic Products Inc.*



Prior to joining the firm in 1957, he taught at Rice, spent two years as a radar maintenance officer in the Navy, a year at guided missile research for the Naval Air Material Center at Johnsville, seven years at research for the *Philco Corporation*, and two years as a section manager with *Westinghouse*.

At *Philco* he did pioneer work in color television and traveling-wave tubes. He is co-inventor of a probability ratio-sequential detector for search radar and holds several other patents in addition.

**FROM GULFPORT
MISSISSIPPI:**

"Color reception is amazing. For the first time we will really be able to sell color television."

**FROM GREAT BEND
KANSAS:**

"I've tested and used about every fringe antenna. Your Powertron gives the sharpest reception I have ever seen here."

**FROM FARGO
NORTH DAKOTA:**

"It's fantastic! We're getting several stations with Powertron we've never seen before."

FIRST DEALER REPORTS ON THE WINEGARD POWERTRON

World's First Electronic TV Antenna

The Powertron antenna has caused more letters to flow into Winegard's offices than any thing we have ever made. TV service-technicians who have tried one are amazed at the tremendous reception and advantages of this new antenna.

The Powertron is an all channel yagi antenna with a built-in high gain RF amplifier in one integral unit. It comes equipped with a power supply that lowers 117 V. AC to a safe 24 volts which is fed up the lead-in to the antenna. It is 5 to 9 times more powerful than any other antenna made.

With the Powertron, you can get your customers many channels they couldn't even see before. For example, in Burlington, Iowa, we easily pull in 9 channels where we used to pull in only 5 with a Color'Ceptor—our finest antenna before we developed the Powertron.

You can run 10 TV sets with a Powertron and all of them will have a better picture than you now get on one set with your present antenna.

You can make your installations 30 to 40% lower in height with a Powertron without affecting reception, in most cases.

You can remote the Powertron antenna 1/4 mile away from the TV set and get a better picture than with an ordinary antenna mounted next to the set.

You can deliver the clearest, sharpest, truest, color TV you've ever seen because the Powertron's extremely linear response makes it the only antenna that should be installed with a color receiver.

In short, this antenna is amazing. But don't take our word for it—test one and see for yourself. Ask your distributor or write today for free technical bulletin.

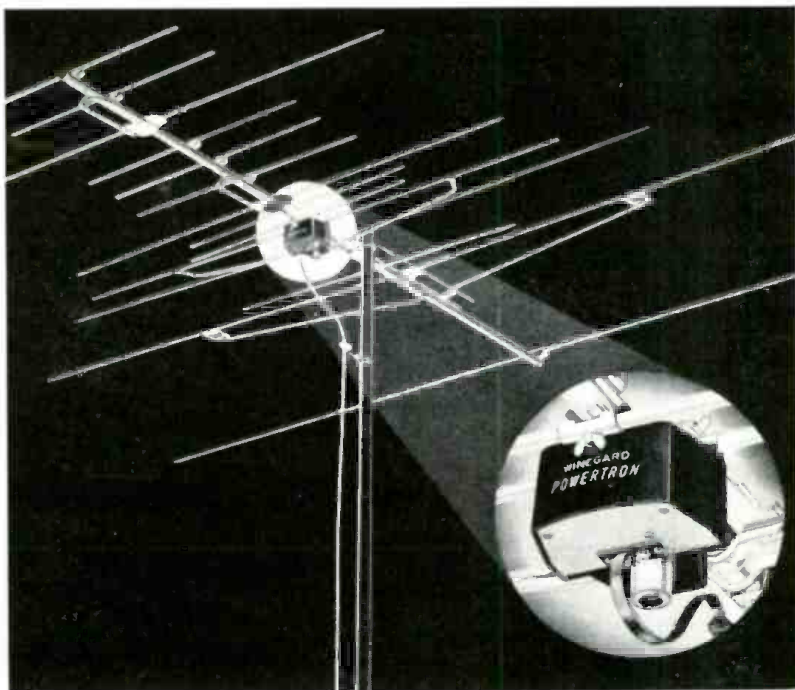

Model P-44 Powertron — \$74.95 list, 14 elements. 5 times more voltage gain than Color'Ceptor.



Model P-44X Powertron with Pack — \$91.90 list, 21 elements. Up to 54% more gain, higher front to back ratio than Model P-44.

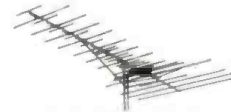

Model SP-44X Super Powertron — \$104.95 list, 30 elements. Twice the gain of Model P-44.



Winegard

3003-4 Scotten Boulevard • Burlington, Iowa

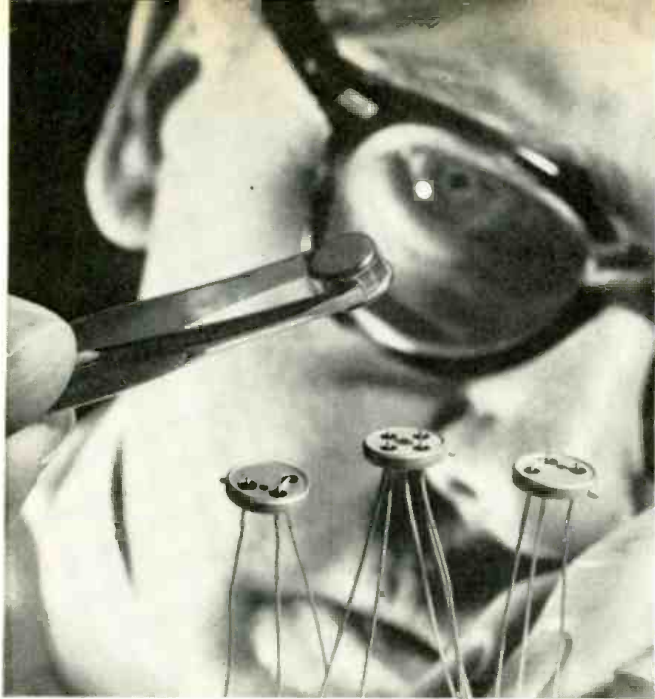

“Siamese-Twin” Transistor

A valuable addition to RCA's line of transistors is a novel device dubbed the "Siamese-twin." The design incorporates two identical transistors within a single housing. The transistors are two silicon types sharing a common collector. Initially, the unit will be offered as a d.c. chopper amplifier, a device that converts d.c. to a.c., so that it can be easily amplified or rectified to produce higher-voltage d.c. The selling price will be under \$25 per unit in lots of a thousand or more.

Televised X-ray Pictures

X-ray studies are televised and recorded for repeated viewings with this new "Televex" x-ray system developed by the Westinghouse Electric Corp. Demonstrating the new system for the first time is Dr. Bertram R. Girdany, chief radiologist at Children's Hospital of Pittsburgh, who proposed the system. At the right is the TV monitor where the x-ray image appears on the screen. Advantages of the system include improved visualization for the doctor, and reduced radiation exposure for the patient.



Recent Developments in Electronics

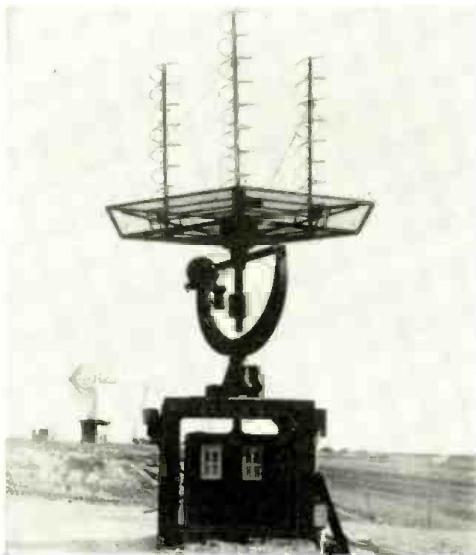

“Discoverer” Tracking Antenna

This Philco-built tri-helix antenna array is used in the communications and control system of the "Discoverer" satellite program. The antenna receives v.h.f. doppler and telemetry information and permits simultaneous telemetry reception and doppler read-out to provide tracking data for the satellite.

Computer-Designed Computer

Bell Telephone Laboratories' engineer is shown here checking out design information for the first computer built from complete information furnished by another computer. A subassembly of the computer is on the table. The computer will be used with the target-track radar for the Army's "Nike-Zeus" anti-missile defense system.

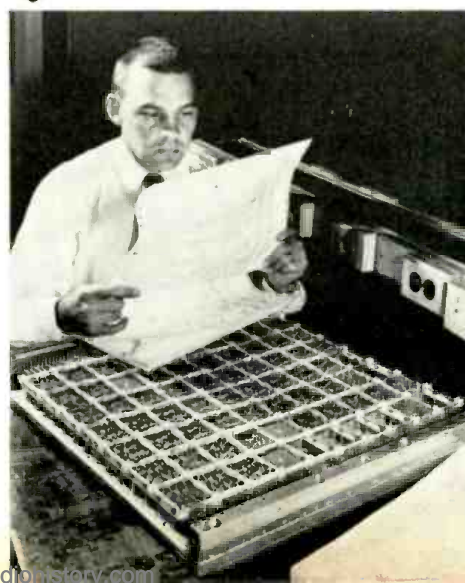

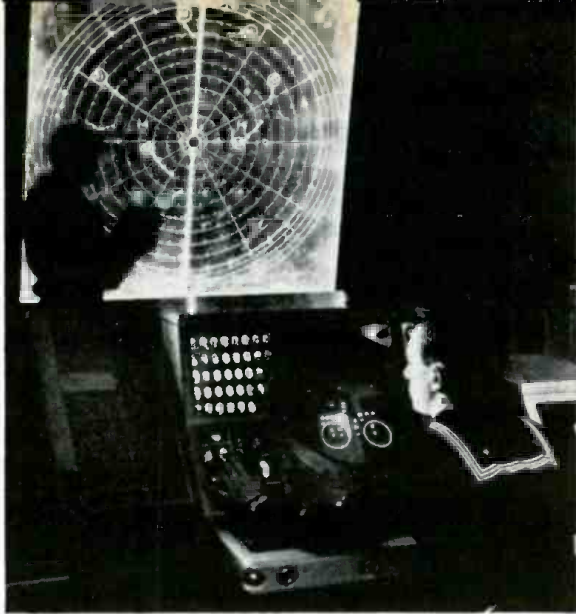

Data Displays for Missile Ships

Old, slow grease-pencil method of plotting aircraft seen in the upper portion of the photograph contrasts very sharply with the new U. S. Navy display console in the foreground. Developed by the *Hughes Aircraft Co.*, the console displays graphically all aspects of aerial, sea-surface, and submarine warfare for combatant ships within a fleet task force. Soon to be installed in Navy ships, the display system will eliminate human error and delays which often plagued the old system and will provide lightning-fast battle intelligence at a central point aboard each ship where prompt counter-action may be initiated.

Jeep-mounted SSB Radio

The first production units of a highly mobile jeep-mounted single-sideband communication system, designed and manufactured by *Collins Radio Co.*, rolled into Camp Pendleton, Calif., ready for Marine Corps field use. The unit includes a 1-kw. transceiver, mounted in a water-tight encasement, with over 28,000 automatically tuned voice, c.w., and teletype-writer channels.



Private Outer-Space Listening Post

Space communication scientists at *ITT Federal Laboratories* will use this 40-foot antenna to beam signals at outer space and to receive satellite signals. The company has received the first "earth-space" radio license granted by the FCC to a private concern, permitting experimental work in satellite and related space communications. One of the research goals is to collect data that will aid in development of a future world-wide satellite telephone-TV system.

Quartz Crystals Grown Commercially

The world's first factory built to mass produce, synthetically, quartz crystals for communications purposes went into production on a commercial basis recently at the Merrimack Valley Works of the *Western Electric Co.* The step signified the emergence of the U. S. from dependence upon a foreign supply of quartz. A strategic material, quartz was in critically short supply during World War II. The entire crystal-growing process, which is done in closed vessels at a temperature of 700° F. and a pressure of 25,000 lbs./sq. in., is completely automatic. The operation requires 3-weeks' time, after which the crystals are withdrawn as shown in the photograph.

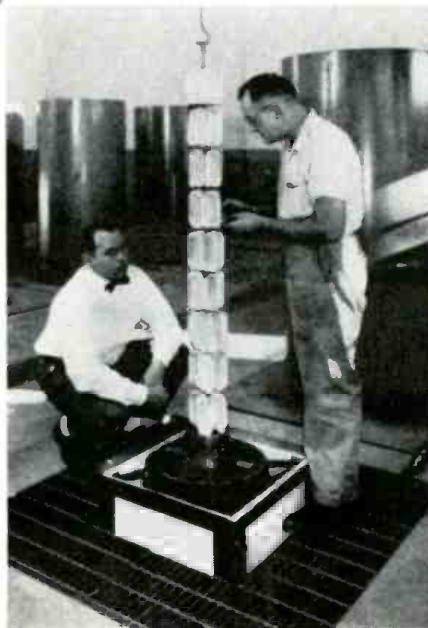

50-WATT STEREO AMPLIFIER AND CONTROL CENTER

Get the most from your stereo system with this superb unit; power-packed 50 watts (25 w. per channel); complete tone, balance and stereo /mono function controls; five dual-stereo inputs plus separate monophonic mag. phono; mixed-channel center speaker output; luggage-tan vinyl clad steel cover. 31 lbs.

Kit Model AA-100 **\$84.95**
 Assembled Model AAW-100..... **144.95**



GET BIG STEREO SOUND AT LOWEST COST WITH THIS COMPLETE STEREO-PHONO CONSOLE . . . NOW IN ASSEMBLED OR KIT FORM FROM \$129.95 UP

Modest only in size and price, this new Heathkit Stereo-Phono Console amazes every listener with its room-filling, true-to-life stereo sounds. Proportioned to fit any room, it's less than three feet long and only end-table height, yet it houses a complete stereo-phono system with features usually found only in much larger consoles. There's *six* speakers . . . two 12" woofers for smooth "lows," two 8" speakers and two 5" cone-type tweeters for "mid-range" and "highs". The 4-speed automatic stereo /mono record changer is equipped with an "anti-skate" device and a turn-over diamond and sapphire styli cartridge. On the front panel are separate, dual bass and treble controls plus a concentric volume control. The handsome cabinet with solid genuine walnut frame, walnut veneer front panel, and matching "wood-grained" sliding top measures just 31 3/4" L x 17 5/8" D x 26 3/4" H. Whether you buy the ready-to-play or kit form, the cabinet is factory assembled and finished. 70 lbs.

Kit Model GD-31 **\$129.95**
 Assembled Model GDW-31 **149.95**



COMPLETE 28-WATT AND 50-WATT STEREO CONSOLES

Enjoy incomparable Heathkit stereo with factory wired components in beautiful preassembled, prefinished cabinets . . . ready to use! The consoles are available in both 28 and 50 watt models, with money-saving optional kit plans. The 28-watt model (HFS-26) contains the Heathkit AJ-10 stereo AM/FM tuner, SA-2 stereo amplifier, AD-50A stereo record changer and two US-3 12" coaxial hi-fi speakers. The 50-watt model (HFS-28) contains the Heathkit AJ-30 deluxe stereo AM/FM tuner; AA-100 deluxe stereo amplifier; AD-60B deluxe stereo record changer; and two Jensen H-223F coaxial 2-way 12" hi-fi speakers. Specify walnut or mahogany.

Assembled Model HFS-26 . . . 215 lbs. **\$475.00**
 Kit Model HFS-27 . . . 215 lbs. **370.00**
 Assembled Model HFS-28 . . . 264 lbs. **675.00**
 Kit Model HFS-29 . . . 264 lbs. **550.00**
 (Cabinets available separately, write for information)



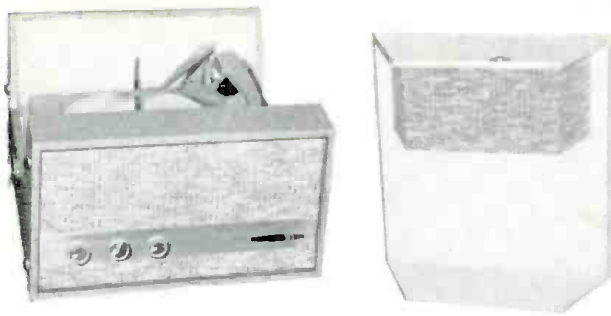

STEREO/MONO PORTABLE PHONOGRAPH

Now you can thrill to magnificent stereo wherever you are, wherever you go! The smartly-styled cabinet with two-tone aqua and white durable vinyl covering comes completely preassembled. In closed carrying position the speaker wing and main cabinet blend into a single handsome unit in dazzling aqua and white vinyl. In use, the detachable speaker-wing top may be spaced at any distance for maximum stereo effect. The completely preassembled automatic changer plays your favorite stereo and mono records at speeds of 16, 33 1/3, 45 and 78 rpm, while controls on the amplifier section give you complete command of volume, stereo-balance and tonal quality. 28 lbs.

Kit Model GD-10..... **\$69.95**

look forward to the happy months ahead
of outdoor living with Heath equipment



PORTABLE 4-TRACK STEREO TAPE RECORDER

Plays and records 4-track stereo tape for endless hours of delight! Can even be used as a hi-fi center to amplify and control tuners, record players, etc. Has "record," "play," "fast-forward" and "rewind"; 2 speeds (3 3/4 and 7 1/2 IPS); tone balance and level controls; monitoring switch for each channel to let you hear programs as they are recorded; pause button for editing; and two "eye-tube" recording level indicators. Speaker wings are detachable. Cabinet and tape mechanism are preassembled; all amplifiers and speakers included. 49 lbs.

Kit Model AD-40..... **\$179.95**



NEW LOW COST STEREO RECORD CHANGER KIT

Here's fine changer features at a budget price . . . oversized 11" turntable, "anti-skate" device, jam-proof mechanism and plug-in cartridge head. 4 speeds with automatic shutoff. Assembles easily, quickly with no special tools. Complete with your choice of three different, famous-name, diamond-styli stereo cartridges. 15 lbs.

Model AD-80C,
Sonotone 8TA4-SD cartridge... **\$37.95**
Model AD-80A, GE VR-227 cartridge. **41.95**
Model AD-80B, Shure M8D cartridge. **42.95**



REVERBERATION SYSTEM

Add a thrilling new "cathedral" dimension to listening! Reverberation supplies the dimension of spaciousness to sound, as heard in concert halls, etc. where "echoes" enrich and reinforce the original sounds. The GD-61 adds reverberation acoustically, not by electronic mixing, thus it doesn't disrupt your present system and it may be placed anywhere for best listening effect. Can be connected to speaker terminals of hi-fi systems, radios, TV sets, etc. Control lets you add just the right amount of reverberation. The GD-61 consists of Hammond type IV reverberation unit, amplifier with power supply and 8" speaker. Pre-assembled birch cabinets in mahogany or walnut finishes. Measures 11 1/2" H x 23" W x 11 3/4" D. 30 lbs.

Kit Model GD-61M (mahogany) or GD-61W (walnut) each..... **\$69.95**

NOW ONLY
HEATH
BRINGS YOU
ALL 3!

1. HEATHKIT for do-it-yourself hobbyists.

2. HEATHKIT factory-built, ready to use.

3. HEATHKIT learn-by-doing Science Series for youngsters.

HEATH COMPANY / Benton Harbor, Michigan

TWO AND SIX METER TRANSCEIVERS

The "ham on the go" will find the new Heathkit "Shawnee" 6-meter and "Pawnee" 2-meter transceiver kits irresistible! Both of the handsome units offer complete AM and CW facilities with: single knob tuning . . . tracked VFO and exciter stages; 10 watt output; built-in low pass filter; three-way power supply built-in for 117 VAC, 6 VDC or 12 VDC with separate DC and AC plugs and cables included; dual-purpose modulator . . . 10 watts for high level plate modulation or 15 watts for PA operation; double conversion receiver . . . crystal controlled first oscillator; tuning meter . . . auto-switched for received signal strength or relative power output; VFO or crystals . . . front panel switch of VFO or four crystals for novice, CAP, MARS or net operation; "spotting" switch; complete shielding of power supply, final and receiver front end; ceramic microphone . . . push-to-talk with coiled cord. And many more outstanding features . . . write for information. 34 lbs.
Kit Models HW-10 (6 meter) and HW-20 (2 meter) each . . . \$199.95



look forward to the happy months ahead
of outdoor living with Heath equipment



6-TRANSISTOR PORTABLE RADIOS

These award-winning, smartly-styled portables are ready to go anywhere! Both feature vernier tuning; 6-transistor circuit; 4" x 6" speaker for big set tone; prealigned transformers. 6 flashlight cells furnish power. (less batteries).
Kit Model XR-2P (plastic) . . . 6 lbs. . . . \$29.95
Kit Model XR-2L (sim. leather & plastic) . . . 7 lbs. . . . \$34.95



**"WALKIE-TALKIE"
 CITIZEN'S BAND TRANSCEIVER**

Ideal companion for the outdoorsman . . . talk to friends up to a mile away. No license required . . . anyone can use it . . . Features 4-transistor circuit, superregenerative receiver, crystal controlled transmitter. Powered by single long-life battery. Case included. 3 lbs. (less battery)
Kit Model GW-30 each . . . \$32.95
Assembled Model GWW-30 each . . . \$50.95

**"WARRIOR" GROUNDED-GRID
 KILOWATT LINEAR**

Attention Amateurs! Compare it feature for feature, the Warrior paces KW rigs at double this low price! Completely self-contained, the amplifier, HV, filament and bias supplies are built-in. Drives with 50 to 75 watts, no matching or swamping network required. Stable g-g circuit with up to 70% efficiency. Oil-filled capacitor and 5-50 henry swinging choke. Bands: 80 through 10. Max. power input; SSB—1,000 watts PEP; CW—1,000 watts; AM—400 watts (500 using controlled carrier mod.); RTTY—650 watts. Write for information.
Kit Model HA-10 . . . 100 lbs. . . . \$229.95

TRANSISTOR DEPTH SOUNDER

For summer boating fun and safety, the MI-10 is your best buy by far in a dependable depth sounder . . . and you can buy it in kit form or factory wired and tested, ready to use. Gives reliable depth indications to 100' or more over "hard" bottoms; somewhat less over "soft" bottoms. Rotating neon light gives clear indications on hooded dial face. Six long-life flashlight batteries are used for power. Transducer may be mounted through hull, or temporarily outboard. 10 lbs. (less batteries).
Kit Model MI-10 . . . \$ 69.95



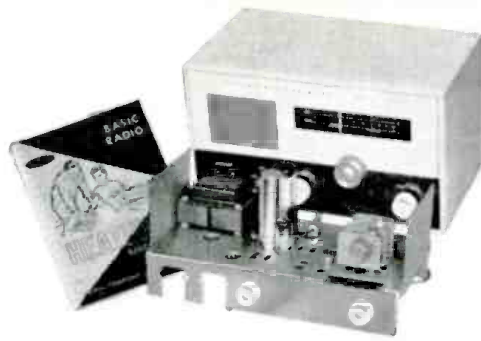

HEATHKIT BASIC RADIO COURSE

Here's a new 2-part series in basic radio for youngsters and adults. "Basic Radio—Part I" teaches radio theory in everyday language, common analogies, and no difficult mathematics. Experiments performed with radio parts supplied result in a regenerative radio receiver. "Part II" of the series advances your knowledge of radio theory and supplies additional parts to extend your Part I receiver to a 2-band superheterodyne.

- Model EK-2A . . . "Part I" . . . 8 lbs. **\$19.95**
- Model EK-2B . . . "Part II" . . . 4 lbs. **\$19.95**
Available March 24.
- Model AK-8 . . . Cabinet for Part II Receiver . . . 4 lbs. **\$3.95**
Available March 24.



DELUXE CITIZENS BAND TRANSCEIVER

Get the GW-10 for superior 2-way communication: superheterodyne receiver with switch selection of crystal control of any one channel or continuous vernier tuning of all 23 channels; automatic "series gate noise limiter"; adjustable squelch control; press-to-talk mike with coil cord; illuminated dial. Crystal controlled transmitter has switch selection of 3 crystals (one furnished). Hardware supplied for under dash mounting. Built-in power supply, 117 V. AC and 6 or 12 V. DC models 11 lbs.

- Kit Model GW-10 **\$62.95**
- Assembled Model GWW-10 . . . **99.95**



3-BAND RADIO DIRECTION FINDER

Now, at big savings, a deluxe completely transistorized portable RDF in your choice of kit or assembled models. The DF-3 operates on marine beacon, standard broadcast and ship-to-shore bands to offer you both portable radio entertainment and reliable direction finding facilities. Featured are: 9-transistor circuit; 6 flashlight battery power supply; preassembled prealigned tuning section; new sense antenna for non-ambiguous bearings; lighted dial and tuning meter. 13 lbs.

- Kit Model DF-3 **\$ 99.95**



HEATHKIT by **DAYSTROM**

SEND MY FREE COPY OF YOUR COMPLETE CATALOG

HEATH COMPANY / Benton Harbor 15, Michigan

ORDERING INSTRUCTIONS: Fill out the order blank. Include charges for parcel post according to weights shown. Express orders shipped delivery charges collect. All prices F.O.B. Benton Harbor, Mich. A 20% deposit is required on all C.O.D. orders. Prices subject to change without notice. Dealer and export prices slightly higher.

Please send the following items:

ITEM	MODEL NO.	PRICE

NAME _____

ADDRESS _____

CITY _____ ZONE _____ STATE _____

Order direct by mail or see your Heathkit dealer.
Ship via Parcel Post Express C.O.D. Best Way



REPEATING MESSAGE TAPE RECORDER

Mfd. by largest USA company. Original Cost \$175.00—Handsome metal case—Repeats a 3½ minute message at 3¾ I.P.S.—Relay controlled. 3 tube Amplif. Selenium Rect.—Size: 13"x 13"x 6"—Ideal for Hams, Advertisers, Etc. Requires external PM speaker and Recording Adaptor.
PRICE \$19.95

(If needed) Recording Adaptor. \$9.95

BC 442 ANTENNA BOX (ARC 5)

Contains RF Meter (750 MA. sens.) relay, etc. See "Coax Relay Conv." in CQ
 mar. March 1960 Ea. \$2.95

CARDWELL TRANSMITTING VAR. COND.

Dual Section 211 UUF per section. 5700 Volts AC Each \$5.95

DYNAMOTOR SPECIALS

12 Volts Input-Output 440V. @ 200MA. 12 Volts Input-Output 225V. @ 100MA. 1 in. Ea. \$5.95

BRAND NEW CARTER DYNAMOTOR

INPUT 5.9 VOLTS, OUTPUT 405 V. @ 270 MA. SMALL SIZE Ea. \$4.95

NEW VACUUM CAPACITORS

50 MMF-5KV95
 25 MMF-10KV 2.25
 EIMAC VC 12 MMF-32KV 6.95
 EIMAC VC 25 MMF-32KV 7.95
 EIMAC VC 50 MMF-32KV 8.95
 JENNINGS 500 MUF 12.95
 JENNINGS JHC-150 MMF-50KV 24.95

POWER TRANSFORMER

Primary 110V. 60 cy. Sec. 385-0-385V. @ 300 MA., 5 V. @ 6 Amps., 6.3V. @ 7.5 Amps., 6.3V. @ 2.5 Amps. Ea. \$4.95
Write for quantity prices

CHOKES—FULLY CASED

5 HENRY @ 200 Ma 1.95
 5 HENRY @ 250 Ma 2.25
 10 HENRY 300 MII 3.00
 4 HENRY 400 MII 3.95
 12 HENRY 500 MII 4.95
 4 HENRY 900 MII 8.95
 6 HENRY 600 MII 7.95
 4 HENRY—1 amp 11.95

BRAND NEW OIL CONDENSERS

50 MFD 200 VDC 4.50	4 MFD 2000 VDC 3.50
2 MFD 400 VDC .50	6 MFD 2000 VDC 4.95
3 MFD 400 VDC .60	8 MFD 2000 VDC 5.95
4 MFD 600 VDC .75	2 MFD 7500 VDC 2.95
5 MFD 600 VDC .80	1 MFD 3000 VDC 1.85
6 MFD 600 VDC .85	2 MFD 3000 VDC 3.50
8 MFD 600 VDC .95	1 MFD 1000 VDC 2.95
10 MFD 600 VDC 1.19	2 MFD 1000 VDC 6.25
12 MFD 600 VDC 1.50	3 MFD 1000 VDC 8.95
15 MFD 600 VDC 1.70	4 MFD 1000 VDC 4.50
3x8 (24 MFD) 2.50	1 MFD 5000 VDC 4.50
1 MFD 1000 VDC 2.50	2 MFD 3000 VDC 8.50
2 MFD 1000 VDC .70	15 MFD 5000 VDC 39.50
4 MFD 1000 VDC 1.35	1 MFD 7500 VDC 6.95
8 MFD 1000 VDC 1.95	2 MFD 7500 VDC 17.95
10 MFD 1000 VDC 2.50	1 MFD 1000 VDC 2.95
12 MFD 1000 VDC 2.95	1 MFD 12,500 VDC 19.95
15 MFD 1000 VDC 3.50	2 MFD 12,500 VDC 34.50
1 MFD 2000 VDC 4.25	1 MFD 1000 VDC 2.95
1 MFD 1500 VDC .75	5 MFD 25,000 VDC 34.95
2 MFD 1500 VDC 1.10	1 MFD 25,000 VDC 69.95
4 MFD 1500 VDC 1.95	1 MFD 300 VDC 1.95
6 MFD 1500 VDC 2.95	20 MFD 330 AC 5.95
1 MFD 2000 VDC .85	50 MFD 330 AC 5.95
2 MFD 2000 VDC 1.50	8 MFD 400 AC 2.95

RELAYS

WARD LEONARD Heavy duty relay coil 220V 60cy., 2 phase, 5 HP. \$6.95
 3 Pole ST, 25 Amp contacts Ea.
 SIGMA SENSITIVE SF Relay WS 800 Ohm coil SPDT. Operates on as little as 2.5V Ideal: Burglar Alarms, Transistor Control. Ea. \$2.49
 GUARDIAN 110V AC, 2 Pole Single Throw 11 N.O. & 1 N.C. Repl. 10 V. D.C. Ea. \$2.50
 Potter-Brumfield SMSLS 5000 ohm Ea. \$2.25
 4 Ma. Sens. Ea.
 110 Volt AC Relay-DPST 60 cy. Ea. \$1.50
 10 Amp. Contacts Ea.
 6 Volt DC DPDT H.S. Ea. 99¢
 12 Volt DPDT DC Relay Ea. \$1.35
 SIGMA type 5221C 5000 ohm SPDT, small sealed relay Ea. \$2.49
 Sealed Relay, SPDT, 6,000 ohm coil Ea. \$1.95
 G.E. Relay Control, contains 8000 ohm relay, sensitivity 2 mls., 10 for \$3.25 Ea. \$1.10
 SIGMA SF—16,000 ohm SPDT, operates on 500 Microamperes or less Ea. \$3.95

PANEL METERS

STANDARD BRANDS
 1½" METERS
 0-100 Micro 3.95
 0-500 Micro 2.95
 0-500 V. DC 3.95
 0-150 V. AC 4.50
 0-15 Amps RF 4.50
 0-50 Micro Amps 5.95
 0-15 Volts AC 3.95
 REED Freq. Meter
 63 Cy 9.95
 110V. AC 380.
 Reed—110 V. AC—380.
 420 Cy 10.95
 4" METERS
 0-100 Microamps 6.50
 0-2500 V. DC 6.95
 3" METERS
 0-50 Microamps (Scale 0-100) 4.50

All merchandise sold on a 10 day money back guarantee Min. Order \$3.00—25% with Order—F.O.B. New York

PEAK

ELECTRONICS COMPANY
 66 W. Broadway, New York 7, N. Y., WO-2-2370

Sound on Tape

By BERT WHYTE

EDITOR'S NOTE: Our reviewer has been intimately connected with the recording industry for many years. Therefore, the opinions expressed below are mainly from the viewpoint of the quality record producer who has the critical listener and hi-fi purist in mind. From that point of view, we cannot argue with the following statements. On the other hand, reverberation units may fill a definite need for experimenters, for those doing home recording, for owners of old 78-rpm records, or for audiophiles interested in showmanship and dramatic (although perhaps artificially so) effects. For a statement of our position on this subject, see the editorial "Reverberation or Not" in our November, 1960 issue.

THE world of audio can be a maddening and frustrating place to inhabit. In recent years, it has seemed to be compounded of one crisis after another. A new development supersedes the "revolutionary" one of the previous week. Fortunately, today's audiophile is somewhat more sophisticated than his predecessor and thus a reasonable degree of stability has been attained.

Nowadays, most new items are subjected to thorough scrutiny and a healthy skepticism is the prevailing attitude until a product has been thoroughly proven in the field. One can only hope that such mature evaluation will be accorded the latest "gimmick" that has been foisted on the audiophile. . . . I refer, of course, to the various instruments that manipulate reverberation. They have all been given catchy trade-names but no matter what they are called, speaking from the standpoint of one who has made hundreds of stereo recordings, they are the sort of thing that makes my hair turn gray!

Most conscientious recordists spend a great deal of time looking for halls and auditoriums which have an optimum reverberation period for various types of music. Thus, if the music of Tchaikovsky or one of the other Romantics is to be recorded, one seeks a hall with the capacity for fairly lush acoustics and longer reverb periods. On the other hand, the sharper "dry" orchestration of a Stravinsky or other Modernist calls for a hall with either shorter reverb periods or one in which the reverb can be controlled to produce a "tighter" and more detailed recording. Obviously, such halls are not easy to find and thus compromises must be made in the reverb content, usually by altering the orchestral positioning or the microphone placement, or by a combination of the two. In any case, this kindling of reverb is a very painstaking and difficult job in which a recordist must utilize all the knowledge and experience he possesses.

The top engineers are also aware of

the many variables that can affect their auditory perception of the degree of reverb content. Chief among these is the acoustics of the room in which the recording is monitored. More often than not, these rooms are haphazard affairs—either much too small or too large, with atrocious acoustics which must be corrected with either damping or reflective material—as the case may be. Needless to say, the type of speaker used in monitoring has a bearing on the character of the recorded sound. I might add here that there are very few recordists who have extensive stereo recording experience (two to three years of stereo hardly equals 15 to 20 years of mono recording) but most are rapidly learning to cope with the specialized requirements of stereo and to treat with respect the tricky handling of reverb.

So what happens? The manufacturers of stereo "packages" and consoles, looking for some gimmick to apply to sales and merchandising, have really outdone themselves by putting at the disposal of Joe Doakes a new control with which Joe can change the reverb characteristics of the stereo discs in his library. It is also claimed to alter the acoustics of the room in which Joe is listening!

Here we spend thousands of dollars making recordings, utilizing the best engineering talent that knows how to handle reverb and now we have what may be a totally untrained listener twiddling his new control and turning his stereo recording into a caricature of the original!

Several component manufacturers have produced reverb units for integration into a components system. There is more engineering caution in evidence with these units and undoubtedly the audio experimentalists are having a ball with them. That is where these units, for the most part, should remain . . . with the experimenters. About the only really valid excuse for using these units is when a person owns a number of old 78-rpm records which have the utterly dry, non-resonant characteristics (such as the Toscanini-Studio 8H discs) quite barren of any reverb. Used intelligently and with discretion, these old recordings can be made to exhibit some improvement. It is extremely doubtful, however, that there are many people who own stereo systems and who also have many of these old 78-rpm records.

Thus to an already confused public, just beginning to acquire a faint understanding of stereo, a new toy is given.

Needless to say, this new confusion can hardly be expected to have a salutary effect on record sales.

For the amateur tape recordist and those who buy recorded tapes, the reverb units will have the least effect. Tape users are, as a rule, more sophisticated than their record-playing brethren and tape playback units are usually found only in the higher-priced, lower-volume stereo consoles. Few of these units are likely to be equipped with reverb controls. The amateur recordist can make the only other valid use of the component-type reverb unit. He is often restricted to a given recording location and must accept the acoustics as they exist. With proper use of a reverb unit, he can overcome the usual compressed, "dry" sound and add considerable "liveness and presence" to his recordings.

To summarize, one can only hope that, like most gimmicks, the "reverbs" are just a passing fad and that their passing shall be swift and unmourned.

GERSHWIN
RHAPSODY IN BLUE
CUBAN OVERTURE

Eugene List, pianist, with Eastman Rochester Orchestra conducted by Howard Hanson. Mercury 4-track Stereo STA90138. Price \$5.95.

It was nice to receive this tape from Mercury, who for some reason has been very slow in releasing its vast backlog of stereo recordings in the 4-track format. At least, this is true of the classical recordings. If you will recall, back in the old two-channel days, Mercury was one of the most prolific suppliers of stereo tape, and it is to be hoped that the tempo of releases will increase in this new medium.

Of the many "Rhapsodies" now available on tape, this is to me the most satisfactory. The sound is very clear and crisp, recorded with great forward projection and possessing all the stereo virtues. Directionality is easily perceived and the ghost image piano stays put in the middle. The dynamic range is unrestricted and allows for great climaxes which are never distorted.

Add to this the fine performance of List. His tempi are faster than most, to be sure, but he gives the work an electric excitement that lifts it above the efforts of most of his contemporaries. His technique is not faultless, but this can be accepted for the rich expressiveness of his playing.

Dr. Hanson is a conductor well grounded in the American jazz idiom and his accompaniment is exemplary on all counts. The tape is filled out with the gay and spritely "Cuban Overture," a sonic memento of happier times and happier relations with Cuba.

HAYDN
CLOCK SYMPHONY, No. 101
SURPRISE SYMPHONY, No. 94
 Vienna Symphony Orchestra conducted by Pierre Monteux. Victor FTC2030. Price \$8.95.

While Papa Monteux is more generally associated with Ravel and Berlioz



It's the new
Sonotone Ceramic "Velocitone"

No stereo cartridge—not even the finest magnetic in the world—outperforms it!

Listen! with your own magnetic... or with any magnetic you can buy today—at *any* price. Then replace it *directly* in your component system with Sonotone's new "VELOCITONE" STEREO CERAMIC CARTRIDGE ASSEMBLY. Listen again! We challenge you to tell the difference. Experts have tried...in dozens of A-B listening tests. And, in every single one, Sonotone's "VELOCITONE" performed as well as or better than the world's best magnetic.

Listen! perfectly flat response in the extreme highs and lows (better than many of the largest-selling magnetics).

Listen! excellent channel separation—sharp, crisp definition.

Listen! highest compliance—considerably superior tracking ability.

Listen! absolutely no magnetic hum—quick, easy, *direct* attachment to any magnetic inputs.

Listen! remarkable performance characteristics unexcelled anywhere. (Write Sonotone Corporation for specifications.)

Now listen to the price. Only \$23.50...about one-half the price of a good stereo magnetic cartridge. Yet Sonotone's "VELOCITONE" stereo ceramic cartridge system cannot be outperformed by any magnetic—regardless of price.



Sonotone® CORP.

ELECTRONIC APPLICATIONS DIVISION, ELMSFORD, N. Y., DEPT. C1-41
 IN CANADA, CONTACT ATLAS RADIO CORP., LTD., TORONTO

LEADING MAKERS OF CARTRIDGES • SPEAKERS • TAPE HEADS • MIKES • ELECTRONIC TUBES • BATTERIES



Here's where Soundcraft Tapes with FA-4 outperform any other tape you can buy!

There is no fooling a recording head...it knows! It can reproduce only that which your tapes are capable of recording. To thousands of professional and amateur tape recordists, one tape has proven its ability to reproduce sound with a quality that is unmatched. That tape is Soundcraft with FA-4—the exclusive frequency adjusted formulation that captures the full dynamic range of sound. It costs no more to discover how well your tape recorder can perform.

REEVES SOUND CRAFT CORP.

Great Pasture Rd., Danbury, Conn. ■ Chicago: 28 E. Jackson Blvd.
Los Angeles: 342 N. LaBrea ■ Toronto: 700 Weston Rd.

P.S. Your recording head will appreciate Soundcraft's permanent lubrication.

and Stravinsky and the Ballet, it should come as no surprise to find that he is equally at home in the classic tracteries of Papa Haydn. After all, in 86 years, you can learn to conduct almost any kind of music!

There is nothing really sensational in the music and Monteux conducts the works in equally straightforward manner, hewing to the score and imposing no "interpretation" on the music.

As to sound, here is a case where I am positive we are dealing with a two-channel master. This, even though I don't think this tape is so old, but is two-channelled merely because there just didn't happen to be a three-channel machine available in Vienna at the time of the recording. Otherwise the sound is good with an exceptional pick-up on the first and second strings. Stereo is necessarily "left and right" but isn't objectionable. The wind pick-up was not the best and the strings often smother them. The tympani sound is also a bit muddy as a result of slightly too much reverb. But I am splitting hairs and the tape really sounds acceptable and has the virtue of having very little crosstalk.

KHACHATURIAN MASQUERADE SUITE KABALEVSKY THE COMEDIANS

RCA Victor Symphony Orchestra conducted by Kiril Kondrashin. Victor FTC2028. Price \$8.95.

Mr. Kondrashin gained fame in this country as the conductor who accompanied Van Cliburn in his time of victory. While he was here for a repeat of the Van Cliburn Moscow concert, *Victor* hied him to a studio to record this tape.

There is nothing world shaking here, but the works are obviously in his milieu and his performances of them outstanding. Oddly enough, although this was a spur-of-the-moment type of recording, we are treated to one of the finest recordings *Victor* has done. The stereo effects are all one could want in the way of directionality and perception of depth, the ghost central image is rock-steady. Dynamic and frequency range is very wide and the over-all sound is crisp clean and bright.

This had the lowest tape hiss I've heard in ages and crosstalk was, for all practical purposes, absent. Perfection would have been achieved had there been a little better projection of brass and woodwind, but as it stands, one of the best tapes in the 4-track format.

OFFENBACH GAITE PARISIENNE KHACHATURIAN GAYNE BALLETS SUITE

Boston Pops Orchestra conducted by Arthur Fiedler. Victor FTC2045. Price \$8.95.

After abandoning its ill-starred tape cartridge, *Victor* went to the 4-track reel-to-reel medium and although, at first, the releases were very slow, now they are beginning to flow in something like the abundance that made *Victor* the leader in the two-channel days.

One word of caution is in order how-

R-146

For High Efficiency Point-to-Point or Base-to-Mobile ...

Hy-gain Citizens Band GROUND PLANES

All Hy-gain Ground Planes are furnished with complete instructions for easy, quick assembly. Each antenna is precision tuned and matched for 52 ohm coax, either RG-8/U or RG-58/U. All will ship parcel post. Complete with SO-239 coax receptacle. Finest construction of heat treated aluminum tubing and iridite treated hardware for maximum weather ability.

HEAVY DUTY GROUND PLANE

For commercial duty. Radiator and radials use $\frac{3}{8}$ " to $\frac{3}{4}$ " OD aluminum tubing, telescoping. Departure angle of ground plane radials adjusted for perfect 50 ohm match. Unbreakable Cycloc plastic base assembly accepts up to 1 $\frac{1}{2}$ " masts.

Model GP-1
\$43.75 List

STANDARD GROUND PLANE

Delivers maximum efficiency at minimum cost. Radiator and radials constructed of heavy wall $\frac{3}{8}$ " and $\frac{7}{16}$ " OD tubing. Cycloc plastic and steel base assembly accepts masts up to 1 $\frac{1}{2}$ " OD.

Model SGP
\$26.95 List

COAXIAL ANTENNA

Designed for inconspicuous roof top or side mounting. Heavy wall $\frac{3}{8}$ " and $\frac{7}{16}$ " OD aluminum radiator and 2" OD sleeve. Easy to mount either std. 1 $\frac{1}{4}$ " OD mast or 1" ID plumbers pipe. No threading necessary.

Model CXL
\$33.25 List

Hy-gain antenna products

1135 NO. 22ND • LINCOLN NEBRASKA

COMPLETE CATALOG AVAILABLE

ever. Some of the more successful two-channel tapes are being reprocessed and made available on 4-track. Nothing wrong with this, except that certain of the old tapes were made quite a way back . . . before *Victor* started using 3-channel/half-inch masters. Thus you have a two-channel tape with no ghost central image, so don't go crazy trying to create that which isn't there!

This "Gaité Parisienne" is a good recording and while I believe it is a three-channel original, the ghost central image is down in level and rather hard to perceive and keep focussed. This is generally clean and the score being what it is, is full of sonic fireworks. Plenty of

cymbal clashes and heavy bass drum shots, along with bright boisterous brass and sizzling strings. The "Gayne" ballet is much in the same character.

Performances by the redoubtable Fiedler are among the best, and his tempestuous, headlong pace, kindles lots of sonic sparks. My quibble with this recording is an odd one . . . I feel as though a compressor may have been used in some of the climaxes and there is the feeling that too great a volume of sound is being contained in too small a space. There is a lot of reverb but there is so much sound it seems to fill up and spill, thus unfortunately blunting the climaxes. -30-

SIMPLE CRYSTAL MIXER

By JENNINGS DAVID

Build this circuit for use in making measurements and adjustments on r.f. circuits. Can also be employed to check the activity and frequency of quartz transmitting crystals.

THIS MIXER has proven handy when making measurements and adjustments on high-frequency circuits. It is useful, in conjunction with an external signal generator, in determining the frequency of an oscillator or transmitter or the frequency and activity of quartz crystals. It has been used over a frequency range from less than 100 kc. to above 200 mc.

Fig. 1 is the diagram of the simple mixer that can be built from parts to be found in almost every "junk box." The crystal used by the author was a 1N64, however any one of the popular types, such as the 1N34, may be used with equal success. The 5- μ f. coupling capacitors may be three or four turns of insulated hookup wire tightly wound around the connection to the hot end of the r.f. choke. The layout of the components is not critical.

To use the mixer in conjunction with a signal generator for determining the frequency of an oscillator or transmitter, couple the signal generator to the mixer at point "A" and the oscillator at point "B". The ground lead of the signal generator and oscillator should be connected to point "G". With a pair of earphones inserted in the phone jack, tune the signal generator until a beat note is heard. Adjust the signal generator until zero-beat is obtained; this frequency will, of course, be the frequency of the oscillator or transmitter provided the approximate frequency of the oscillator is known. If the approximate frequency is not known, proceed as follows:

1. Record the frequency of the signal generator at which the first beat note is obtained. This frequency will be F_1 .

2. Carefully increase the frequency of the signal generator until the next beat note is heard. Be sure not to miss the next higher frequency beat note. Record this frequency as F_2 .

3. The frequency of the oscillator or

transmitter can be determined from the following formula: $F_x = F_1 \times F_2 / F_1 - F_2$.

When measuring the frequency of a transmitter it will probably only be necessary to couple the transmitter to point "B" by means of a short antenna. If excessive power is coupled into the crystal circuit, the crystal will probably be burned out.

To determine the activity or frequency of quartz crystals or to use crystals to spot-check the accuracy of signal generators, connect the crystal in series with the signal generator and point "A" and connect a 50- μ a. meter in place of the phones (Fig. 2). As the signal generator is tuned through the crystal frequency there will be a very sharp rise in the current through the meter.

Many other uses for this inexpensive instrument will undoubtedly occur to the experimenter as he becomes familiar with the circuit. -30-

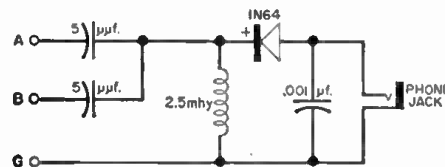
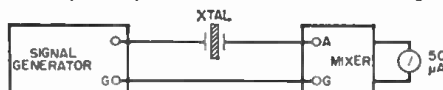

Fig. 1. Circuit diagram of the crystal mixer. Any of the popular general-purpose crystals, such as the 1N34, may be used in place of the crystal shown. The 5- μ f. capacitors are actually three or four turns of insulated hookup wire tightly wound around the connection to the r.f. choke.

Fig. 2. Circuit arrangement used to check activity or frequency of quartz crystals. As the signal generator is tuned through the crystal frequency, there will be a very sharp rise in the meter reading.



Tape Recorder Owners!

**CUT TAPE COSTS
IN HALF**

with a 4-Track

**STEREO
CONVERSION KIT**

by *Northronics*

WR-60 STEREO KIT

Be up-to-date, and save on tape costs, whether you use raw tape or tape records. Don't obsolete your present monophonic or 2-track Stereo tape recorder . . . Convert it at low cost to 4-track stereo playback or stereo playback/recording. Install the Kit yourself easily in about one-half hour—or see your service dealer.

WOLLENSAK-REVERE

WR-60 Converts all 2-track models to 4-track stereo. Includes 3 position head dash shifter for 2-track stereo and 4-track mono operation. Allows stereo recording with additional amplifier (not included) . . . \$49.50
WR-35 Converts 2-track stereo machines to 4-track stereo playback . . . \$25.50
WR-40 Converts monophonic machines to 4-track stereo playback . . . \$32.50

WEBCOR

W-6 Converts monophonic and 2-track stereo machines to 4-track playback (includes head-shifter). For all 2800, 2900, and 2000 series, except 2020 series \$36.00

VM

V-6 Converts machines to 4-track stereo playback . . . \$25.50
V-7 Stereo erase kit for machines. Works with V-6 kit described above to permit 4-track stereo recording . . . \$15.00

PENTRON

P-6 Converts all machines to 4-track Stereo playback . . . \$29.70
P-7 Stereo erase kit for machines. Works with P-6 kit described above to permit 4-track stereo recording . . . \$15.00

OTHERS

If your tape equipment is not covered by the kits listed above,

**WRITE FOR OUR FREE
STEREO CONVERSION CHART**

which will assist you in converting your machine, or see your dealer

THE Northronics CO., INC.
"Pacesetters in Sound Electronics"

1313 South Sixth St., Minneapolis 4, Minn.

Send more information _____

Send Free Conversion Chart _____

Name _____

Address _____

City _____ Zone _____ State _____



COYNE
TRAINS YOU
IN SPARE TIME
AT HOME

COYNE
QUALITY
TRAINING
AT LOWEST
COST

TELEVISION
RADIO-COLOR TV

Only from famous COYNE do you get this modern up-to-the minute TV Home Training. Easy to follow instructions—fully illustrated with 2150 photos and diagrams. Not an old Radio Course with Television tacked on. Includes UHF and COLOR TV. Personal guidance by Coyne Staff. *Practical Job Guides* to help you EARN MONEY QUICKLY IN A TV-RADIO SALES AND SERVICE BUSINESS—part time or full time. COSTS MUCH LESS—pay only for training—no costly "put together kits."

SEND COUPON FOR FREE BOOK
SEND COUPON BELOW for Free Book and full details including EASY PAYMENT PLAN. NO COST OR OBLIGATION—NO SALESMAN WILL CALL.

B. W. COOKE, Jr., Pres. **COYNE** FOUNDED 1899
ELECTRICAL SCHOOL

CHARTERED AS AN EDUCATIONAL INSTITUTION NOT FOR PROFIT
1501 W. Congress Pkwy., Dept. 41-H6, Chicago 7, Ill.

COYNE Television Home Training Div.
New Coyne Building, Dept. 41-H6
1501 W. Congress Pkwy., Chicago 7, Ill.
Send FREE BOOK and details of your Television Home Training offer.

Name _____
Address _____
City _____ State _____



CROWN
Professional Tape Recorder

GUARANTEED PERFORMANCE

"800" Series

"SUPRA" PROFESSIONAL

World's most magnificent recorder and greatest performance value per dollar!

CROWN GUARANTEED PERFORMANCE

FREQUENCY RESPONSE	IPS SPEED	FLUTTER & WOW	NOISE RATIO
± 2 db 30 to 30,000 CPS	15	.06%	58 db
± 2 db 20 to 22,000 CPS	7½	.09%	55 db
± 3 db 30 to 15,000 CPS	3¾	.18%	51 db

Some dealer franchises available. Write Dept. EW-4 or phone JA 3-4919 for full information.

CROWN INTERNATIONAL
Division of
INTERNATIONAL RADIO & ELECTRONICS CORP.
ELKHART, INDIANA

Sun	Mon	Tue	Wed	Thu	Fri	Sat
			2	3	4	5
						12
						19
						26

CALENDAR of EVENTS

MARCH 20-23

1961 IRE International Convention. Waldorf-Astoria Hotel and New York Coliseum. Details from IRE Headquarters, 1 E. 79th St., New York 21.

MARCH 27-31

1961 Symposium on Temperature. Sponsored by American Institute of Physics, Instrument Society of America, and National Bureau of Standards. Columbus, Ohio. Program information available from V. W. Sikorn, ISA, 313 Sixth Ave., Pittsburgh 22, Pa.

APRIL 4-6

Symposium on Electromagnetics and Fluid Dynamics of Gaseous Plasma. Sponsored by Polytechnic Institute of Brooklyn, IRE, Institute of Aeronautical Sciences, and U.S. Defense Agencies. Engineering Societies Bldg., 33 W. 39th Street, New York City. Details from PIB, 55 Johnson St., Brooklyn, N.Y.

APRIL 4-7

Spring Convention and Exhibit. Sponsored by the Audio Engineering Society. Ambassador Hotel, Los Angeles. Details from AES, P.O. Box 12, Old Chelsea Station, New York 11, N.Y.

APRIL 4-9

1961 Los Angeles High Fidelity Music Show. Sponsored by the Institute of High Fidelity Manufacturers. Ambassador Hotel, Los Angeles. Details from IHFM, 125 E. 23rd St., New York 10.

APRIL 5-7

Symposium on Materials and Electron Device Processing. Sponsored by American Society for Testing Materials. Benjamin Franklin Hotel, Philadelphia, Pa. Information from ASTM, 1916 Race St., Philadelphia 3, Pa.

APRIL 12-13

Third Symposium on Information and Decision Processes. Sponsored by IRE-PGIT and Purdue University. Purdue campus, Lafayette, Ind. Dr. Robert E. Machol, School of Electrical Engineering, Purdue University, Lafayette, Ind. for complete details.

15th Annual Spring Technical Conference. Sponsored by Cincinnati Section of IRE and Southern Ohio Section of American Rocket Society. Hotel Alms, Cincinnati. Technical papers and exhibits. Information from R. P. Schlemmer, c/o Engineering Specialties, 8115 Camargo Road, Madeira, Cincinnati 43.

APRIL 19-21

SWIRECO. Sponsored by the S.W. (Region 6) Section of IRE. Dallas Memorial Auditorium and Baker Hotel, Dallas, Texas. Program information available from Dr. L. D. Strom, Texas Instruments, 6000 Lemmon Ave., Dallas, Texas.

APRIL 26-28

Seventh Region Technical Conference and Trade Show. Sponsored by Region 7 of the IRE. Westward Ho Hotel, Phoenix, Ariz. Program information from H. W. Welch, Jr., Motorola Inc., P.O. Box 1417, Scottsdale, Arizona.

APRIL 29

Tenth Annual Dayton Hamvention. Sponsored by Dayton Amateur Radio Association, Inc. Dayton Biltmore Hotel, Dayton, Ohio. Varied program of events has been scheduled. Contact Harry E. Covault, K8GCS, 4820 Archmore Drive, Kettering 40, Ohio for details.

MAY 2-4

Electronic Components Conference. Sponsored by PGCP, AIEE, EIA, WEMA. Jack Tar Hotel, San Francisco, Calif. Details from Daniel Breeding, Fairchild Semiconductors Inc., Palo Alto, Calif.

MAY 4-5

Second National Symposium on Human Factors in Electronics. Sponsored by PGHFE of IRE. Marriott Twin Bridges Motor Hotel, Arlington, Va. Details from R. R. Riesz, Bell Telephone Labs, 2D-452, Box 262, Murray Hill, New Jersey.

MAY 6

Workshop in Graph Theory. Sponsored by PGCT of IRE. University of Illinois, Urbana, Illinois. Prof. M. E. Van Valkenburg, Department of Electrical Engineering, University of Illinois, Urbana, Ill. for program information.

MAY 8-9

Fifth Midwest Symposium on Circuit Theory. Sponsored by PGCT of IRE. Allerton Park & Urbana Campus, University of Illinois. Prof. M. E. Van Valkenburg, Department of Electrical Engineering, University of Illinois, Urbana, Ill. for program information.

MAY 8-10

Thirteenth Annual National Aerospace Electronics Conference. Sponsored by the IRE. Biltmore & Miami Hotels, Dayton, Ohio. Program details from Ronald G. Stimmel, 809 Larrivood Ave., Dayton 29, Ohio.

MAY 9-11

Western Joint Computer Conference. Sponsored by PGEC, AIEE, and ACM. Ambassador Hotel, Los Angeles, Calif. Prof. Cornelius Leondes, Department of Electrical Engineering, UCLA, 405 Hilgard Ave., Los Angeles 24 for program details.

MAY 15-17

1961 National Symposium on Microwave Theory & Techniques. Sponsored by PGMTT of IRE. Sheraton Park Hotel, Washington, D.C. Information on program from Gustave Shapiro, NBS, Washington, D.C.

MAY 22-24

1961 Electronic Parts Distributor Show. Conrad Hilton Hotel, Chicago. Closed Show. Hours 9 a.m.-6 p.m. Details from Electronic Industry Show Corporation, Suite 1501, 11 S. LaSalle St., Chicago 3, Illinois.

National Symposium on Global Communications. Sponsored by the AIEE and IRE. Sherman Hotel, Chicago. Details from Donald G. Campbell, ITT Kellogg, 5959 S. Harlem Ave., Chicago, Ill.

National Telemetering Conference. Sponsored by PGSET, AIEE, IAS, ARS, ISA. Sheraton Towers Hotel, Chicago. Jack Becker, AC Spark Plug Div., General Motors, Milwaukee, Wisc. for program information.

Home-Call TV Diagnosis

(Continued from page 35)

with a low-impedance device. To avoid loading, a 100,000-ohm isolating resistor should be connected to the test probe of the voltmeter, but in a typical v.o.m. this will reduce the measured voltage. In many stages of the TV receiver, grid bias confirms the presence of a signal from the preceding stage. If a grid bias of -40 volts appears at the horizontal-output tube, we know that the horizontal oscillator is working. Similarly, if a.g.c. bias is measured at about -3 volts, this is a good indication that a signal is amplified and passed at least to the a.g.c. section.

D. Estimating Repairs. The three logical steps for determining the symptoms, analyzing what can cause them, and troubleshooting further will usually result in the accurate location of the defective part. Often the technician will realize somewhere along the way that the service job is more complex than can be handled within the half-hour time limit well before that limit is reached. Only rarely will the entire half hour be consumed without producing at least a very strong indication of what the defect is.

If it is decided that the repair can be made at once or if a defect has been cleared up in the course of the 30 minutes allotted, there will be no problem in determining price. Most technicians will compute the bill by using their regular labor charge plus the list price of the defective part.

When the repair involves replacement of a component which the technician does not have at hand or when the exact defect is not known after the 30 minute troubleshooting period it becomes more difficult to determine the price. Many technicians will give an estimate at this point which includes the fee for a house call, one half-hour of troubleshooting time, one half-hour of alignment and adjustment time, and the list price of the most expensive component in the suspected trouble area. The picture tube is usually excluded from this type of estimate because it is almost always possible to determine quickly if it is defective. Experience shows that, after the recommended 30-minute procedure, very few cases will be real "tough dogs," so that by following this pricing policy the technician is bound to average a legitimate profit and the majority of his customers will have no reason to complain of overcharges.

The method outlined eliminates a lot of the uncertainty and guesswork which plague the TV technician making house calls. While some assumptions and simplifications made here do not always hold true, a technician following this method is bound to be more efficient than if a haphazard approach is taken. Experienced operators will be able to add many refinements to the method and will know how to modify it to suit local conditions and particular circumstances.

-36-



sensitive



responsive



good-looking



versatile



dependable



rugged

That's a University Modular Microphone!

...the dynamic professional microphone with dynamic performance...dynamic features...dynamic styling.

And there's a dramatic story behind this new line of omnidirectional, cardioid and lavalier microphones... the complete inside story that every professional sound man should read.

It's yours, free. Just write to Desk S-4, University Loudspeakers, Inc., 80 South Kensico Avenue, White Plains, New York.



IMPORTANT NEW SAMS BOOKS

ALL YOU WANT TO KNOW ABOUT CB RADIO!

Citizens Band Radio Handbook

by David E. Hicks



A practical guide to Citizens Band radio for owners, prospective owners and technicians. Tells how to get a license and select equipment. Fully describes CB circuits, antennas, installation, operating procedures, troubleshooting and maintenance. PLUS VALUE—

included at no extra cost to you are complete FCC rules and regulations all CB licensees must have on hand. It's the complete book on CB radio. \$2⁹⁵

192 pages; 5 1/2 x 8 1/2". Only

NOW YOU CAN UNDERSTAND RADAR!

ABC's of Radar

by Alan Andrews



A complete, easy-to-understand explanation of radar—basic principles, how it works, types of systems, radar uses, microwave principles, antenna systems, receivers and indicators, tuners and modulators, basic transmitter-receiver theory and operation. Want to know more about radar? Preparing for the FCC Radar

Endorsement Exam? This is the book for you! \$1⁹⁵

112 pages; 5 1/2 x 8 1/2". Only

SOLVES YOUR VERTICAL-SWEEP TROUBLES!

101 Key Troubleshooting Waveforms for Vertical-Sweep Circuits

by Robert Middleton



Covers the 4 vertical-sweep circuits: multi-vibrator driving a vertical-output tube; multi-vibrator with 2nd triode used as VO tube; blocking oscillator driving VO stage; sawtooth blocking oscillator-output. Pictures 101 abnormal waveforms, with accompanying circuit symptoms, tests, evaluations of results. Helps you

quickly pinpoint and solve vertical-sweep defects! 128 pages; 5 1/2 x 8 1/2". Only \$2⁰⁰

NOW COVERS ALL LATEST AGC CIRCUITS!

Servicing AGC Systems

by Carter & Lesh



This long-time favorite with service technicians, now fully revised, is more valuable than ever. Describes how all types of AGC systems operate, why AGC is needed; explains theory and design. Numerous case histories, pictures of typical AGC defects, and troubleshooting procedures will help you

quickly solve troubles in this tricky circuit. \$2⁰⁰

128 pages; 5 1/2 x 8 1/2". Only

HOWARD W. SAMS & CO., INC.

Order from your Sams Distributor today, or mail to Howard W. Sams & Co., Inc., Dept. D-11 1720 E. 38th St., Indianapolis 6, Ind.

- Send me the following books:
- Citizens Band Radio Handbook (CBH-1)
 - ABC's of Radar (ABR-1)
 - 101 Waveforms V-S Circuits (WFM-3)
 - Servicing AGC Systems (AGC-2)

\$.....enclosed. Send Free Book List

Name _____
 Address _____
 City _____ Zone _____ State _____
 IN CANADA: A. C. Simmonds & Sons, Ltd., Toronto 7
 (Outside U.S.A. priced slightly higher)

SERVICE INDUSTRY

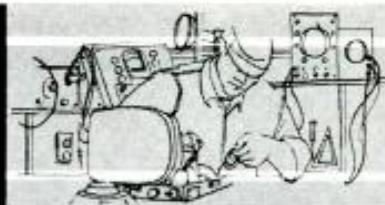

NEWS

THOSE OF US who look for meaningful patterns in the industry sometimes become a shade too eager to build large conclusions on small clues. Let us hope that is the case with an item from that respected service group, the Radio TV Guild of Long Island, N.Y.

A front-page story in our latest copy of "Guild News," captioned "Help Wanted," pleads for members to fill key executive positions so that the association may continue its record of accomplishment. They are needed, not to undertake new tasks, but to fill the gaps left by the loss of effective executives over the past couple of years. The Guild has lost at least five good men. Why? These people have gone on to greener fields.

Most of them are still in some aspect of electronics. One, for example, is a design engineer with a leading hi-fi manufacturer. We know of other cases where former shop owners have gone into manufacturing plants, or taken jobs with distributors. In still another case, a shop owner who has had the same business for 14 years is giving up although he does not have a definite, alternate job.

As compared to their fellows, each of these would be reckoned a successful dealer. Then why the defections? Some of these people did not take the initiative themselves: they were offered opportunities for improvement that they simply could not refuse. The fact is that these men had reached an end point as service dealers, even successful ones, at which full use of their capabilities was not being made and beyond which they could not go to better themselves. They now have better financial reward and more prestige.

Government statistics shed additional light on this situation. The average factory worker in the electronics industry gets about twice as much per hour as a man in a service shop. This does not mean that the individual who does wiring and routine assembly work on a TV chassis always gets paid more than the skilled analyst who later chases the tough dogs out of the equipment, but there is an obvious inequity here.

Good men are needed to render good service. They must be paid accordingly. If the industry cannot do something to improve its own condition, the entire field may eventually be yielded to the screwdriver mechanics by default. Recognition of the fact that cheap service cannot be good service must come, if this is to be prevented. Manufacturers and users of home electronic equip-

ment have as much at stake here as the service industry.

But perhaps things are not that bad. We know another officer of the same Guild that has been hit by a loss of leadership who was recently offered another position. He turned it down. He may just be a mule, he says, but he refuses to surrender the hope that his chosen field can be brought to the stature it deserves.

What Service Thinks

The "Raster," official publication of the Electronic Service Council of the Ozarks, is going right to the source to find out what service people think. On the matter of the effect of electronic equipment imported from Japan, for example, this monthly draws interesting comment from two technicians. E. D. Muhleman, the first, says, "I have been puzzled to figure out what replacement parts I can get. Delay in the delivery of the repair job to the customer results, or I turn down the job with, 'Sorry sir, I just can't help you out on it now.'

"What to do about it? Well, what can we do about it? In time some of our American producers will make replacement parts available to us or else the importers will. Another possibility—by the time the customer has gone to several shops for service and gets the same answer, he will swear never to buy another Japanese-made item. My answer to the problem? Fix the ones that come in that we can fix and let time work out the answer."

Another respondent, W. A. Pryor, does not believe that importation will be permitted to continue to the point where it would seriously hurt domestic economy. He points out that such imports are under a Japanese export control program, and concludes with: "I would say that this is not a problem of the service technician. We have our own problems—let the manufacturer take care of his."

The "Raster" also queried readers on what they thought of printed circuits and whether their opinions had changed for the better since the printed boards were first encountered. James Rathbun realistically supposes that "we are going to have to live with printed-circuit boards inasmuch as most manufacturers are using them. My opinion of them has not changed much." He acknowledges improvements in the later boards (increased strength, better marking, easier parts location) and concedes that his continuing prejudice may partly be

due to the fact that most of his service experience is with older sets, therefore older boards. However, he feels that certain inherent problems in parts mounting and parts replacement continue—"like having to replace tube sockets after a tube had been pulled out two or three times and not being able to replace a part until I had removed a section of the printed board."

TV Promotion of TV Service

Broadcasters are becoming increasingly cooperative in advancing the cause of service. William Finnerty, president of the San Francisco Television Service Association, was interviewed by Ira Blue, Bay Area sportscaster, just before the Army-Navy football game this fall on KGO-TV, channel 7. In response to questions, Finnerty explained the correct adjustment of customer controls on the TV set for optimum viewing.

"We programmed this public-service interview," said the general manager of KGO-TV. "in the hope that those who have been dissatisfied with their TV picture will avail themselves of this opportunity to correctly adjust their sets. We have found that most complaints about 'transmitter trouble' stem, instead, from inaccurately adjusted receiving sets." The program ended with a full-screen display of the association's emblem.

Providing less instantaneous impact but more long-term effectiveness is the campaign in Indianapolis. Recognizing that good service is essential to maintain the largest possible viewing audience, WFBM-TV (channel 6) of that city is running daily spots showing the emblem of the Indiana Electronic Service Association, according to the organization's "Hoosier Test Probe," and explaining what IESA stands for. In return for this boost, members pass out literature supplied by the station on service calls, display bumper stickers, make sure that channel-6 reception is optimized on every job, and promptly report any reception problems to the broadcaster.

Advanced Radio Service

"More than 10 million radios were purchased by the American public in 1960," says George C. Isham, manager of marketing services for Sylvania's Electronic Tube Division, "and in 1961, the total should be just as high." The obvious conclusion, for service dealers, is that they are missing good business opportunities if they are neglecting the expanding number of such receivers in current use.

With this in mind, Sylvania offers "Advanced Techniques of Radio Servicing," a 12-lesson correspondence course, through authorized distributors. Does this course sound superfluous? Not if you consider what "radio" means today. Coverage includes AM-FM, transistorized, short-wave, auto, and foreign-made receivers, marine-radio gear, and other types. There's much here never dreamed of in the simple, table radio.

-30-

"PHOTOFACT-like switching on the light in a pitch dark room"

"Opening a Sams schematic to me is like switching on the light in a pitch dark room. It actually pinpoints the 'needle in the haystack'—many times in *one minute*...I have a complete set of PHOTOFACT from the beginning...can't see how any technician could possibly do...without it...as necessary as the VTVM and soldering iron...I would like to thank you for having chosen my shop as one of your "PEET" memberships. I'm grateful...and honored my shop and myself measure up to the standards you have set in order to qualify."

—Joe Perkins
Elwood, Indiana

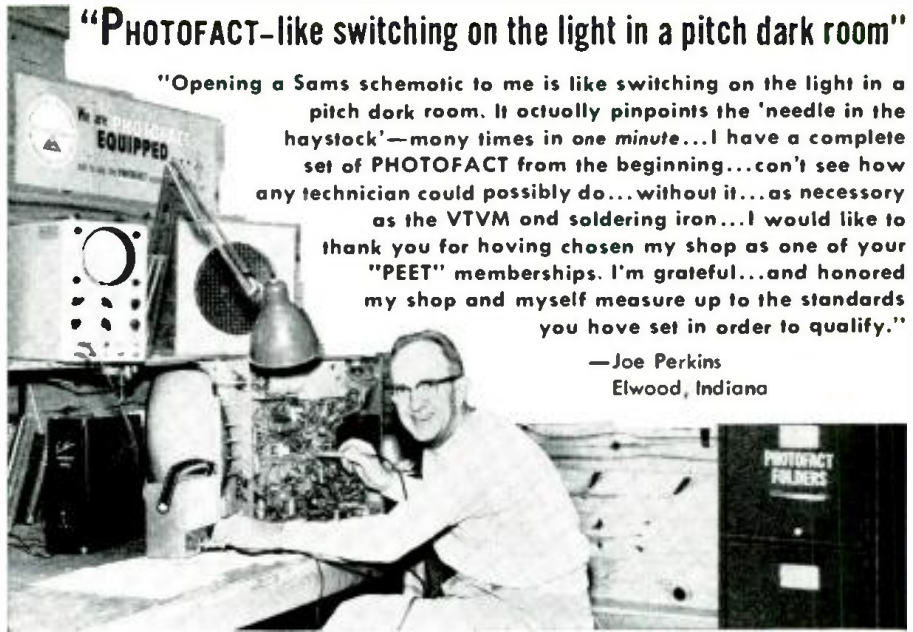

Service Technicians! YOU EARN MORE... YOU RATE with the public when you own the PHOTOFACT® service data library!

You enjoy maximum earnings as the owner of a complete PHOTOFACT Service Data Library! It's inevitable, because no matter how expert you are, you can always *save more time on any job, get more jobs done daily*—EARN MORE, DAY IN AND DAY OUT...

What's more—as the owner of a complete PHOTOFACT Library, you know your customers' sets *best*. You can actually show each customer you have the PHOTOFACT Folder covering his very own set. Result: You command public respect and acceptance which paves the way to more business and earnings for you.

HOW TO STAY AHEAD...

Yes, the truly successful Service Technicians are those who own the complete PHOTOFACT Library, who can meet and solve any repair problem—faster and more profitably. And these men *keep ahead* because they're on a Standing Order Subscription with their Distributors to receive all new PHOTOFACTS as they are released monthly. (They're eligible for the benefits of membership in PEET, too—see below!)

For PHOTOFACT Library Easy-Buy Plan details and Standing Order Subscription, see your Sams Distributor today, or write to Howard W. Sams...

NOW IS THE TIME TO JOIN "PEET"

THE POWERFUL NEW PROGRAM FOR QUALIFIED TECHNICIANS

If you now own a PHOTOFACT Library or plan to own one, you can apply for membership in "PEET." It's the first industry program really designed to build powerful public acceptance for the Service Technician who qualifies. Builds enviable prestige and business for its members. Benefits cost you absolutely nothing if you qualify. Ask your Sams Distributor for the "PEET" details, or mail coupon today.

HOWARD W. SAMS & CO., INC.
1724 E. 38th St., Indianapolis 6, Ind.

Send me full details on the new "PEET" Program. Include full information on the Easy-Buy Plan and Free File Cabinet deal.

I'm a Service Technician full-time; part-time

My distributor is _____

Shop Name _____

Attn: _____

Address _____

City _____ Zone _____ State _____



83 YX 929. Stereo Tape Record-Play Preamp Kit. \$79.95 (less case)

One of the many great Knight-Kit stereo component kits. Professional quality; superb performance with virtually any 3-head tape transport; separate dual-channel recording and playback preamps; permits tape monitoring, sound-on-sound and echo effects. Packed with quality features for every possible stereo and monophonic function...

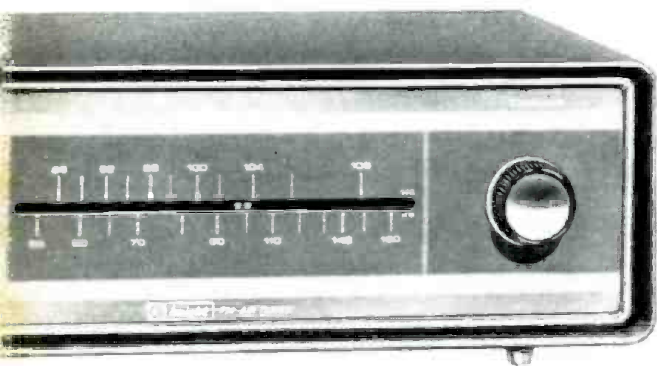

83 YX 928. FM-AM Hi-Fi Tuner Kit. \$49.95

Typical Knight-Kit hi-fi value—incomparable at the price. With AFC, tuned RF stage on FM, multiplex jack. Straight FM tuner kit also available at \$38.95. For deluxe Stereo FM-AM and FM tuner kits, see the Allied catalog...



83 YX 927. 20-Watt Stereo Hi-Fi Amplifier Kit. \$39.95

Biggest bargain in quality Stereo hi-fi. Has special clutch-type dual-concentric level control; simplified control facilities; DC preamp filaments. Similarly styled 32-Watt Stereo Amplifier Kit with full frequency center channel available at a low, low \$59.95...

83 YU 934. Deluxe 70-Watt Stereo Hi-Fi Amplifier Kit. \$119.95



Super-power to drive any of today's speakers, a do-it-yourself stereo masterpiece, featuring: special "blend" control; full-range center channel; tape-source monitor; dual phasing switches; Stereo paralleling switch. For deluxe 40-watt Stereo amplifier at only \$76.95, and 60-watt Stereo amplifier, see the Allied catalog...

Simply

these and 59

knight
A PRODUCT

a pleasure to build...

The most satisfying do-it-yourself experience awaits you when you build a Knight-Kit! You'll marvel at the sheer ease of assembly, absolutely assured by exclusive "show-how" manuals, wall-sized picture diagrams, step-by-step do-and-check instructions, pre-cut wire, "visi-packed" parts and an engineering perfection that eliminates guesswork. You'll get perfect results. You'll enjoy with pride a true custom-built electronic product, professionally engineered and styled—the best you can own. And to top off your pleasure, you'll save substantially at the unbeatable Knight-Kit price...

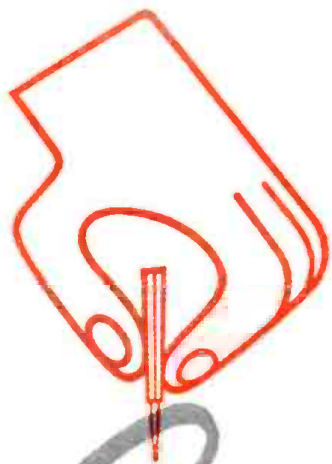

83 YX 712-2. Superhet
Citizen's Band
Transceiver Kit.
\$79.95



Dual-conversion for highest sensitivity and selectivity; crystal-controlled operation on any 2 channels, plus manual tuning. Another Knight-Kit Citizen's Band Transceiver is available at an amazing low \$39.95—see the Allied catalog for full details...

Great!

other money-saving

-kits[®]

OF ALLIED RADIO

and you own the best

money back guarantee

Every Knight-Kit is unconditionally guaranteed to meet our published specifications for performance or your purchase price is refunded in full.

only \$2 down

It's easy to buy any Knight-Kit: only \$2 down on orders up to \$50; \$5 down up to \$200; \$10 down over \$200—up to 24 months to pay.

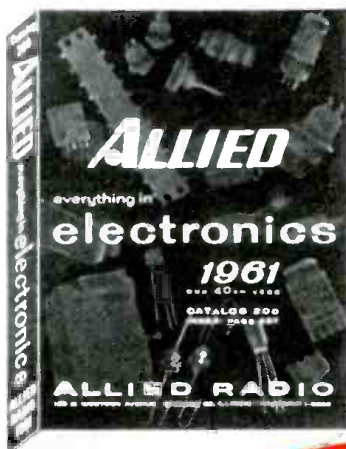

Featured

IN THIS VALUE-PACKED 1961
444-PAGE ALLIED CATALOG

Send coupon today for the 1961 Allied electronics catalog (the world's biggest), featuring the complete Knight-Kit line. See the best in electronic kits—save on *everything* in Electronics. Send for your FREE copy now!

sold exclusively by

ALLIED RADIO

pioneer in electronic kit development

our 40th year



also available
in Canada



83 YX 258. 4-Band "Span Master"® Receiver Kit. \$25.95

Fabulous performer for world-wide reception; thrilling shortwave adventures, plus fine Broadcast; band-switching, 540 KC to 30 MC; with cabinet. For additional receiver kits, radio-intercom, clock-radio, transistor radios, intercom systems, electronic labs and other great hobbyist Knight-Kits, see the Allied catalog...

83 Y 125. Electronic VTVM Kit. \$25.75

High sensitivity general-purpose VTVM; 11 meg input resistance; balanced-bridge circuit; 4½" meter. One of many fine instrument kits including 5" scopes, AC VTVM, tube checkers, signal tracer, audio generator, sweep generator, and others, described in detail in the Allied catalog...



send coupon today!

ALLIED RADIO, Dept. 10-D1
100 N. Western Ave., Chicago 80, Ill.

Send Free 1961 Allied Catalog No. 200

Name _____
PLEASE PRINT

Address _____

City _____ Zone _____ State _____



SAVE OVER 50% AT McGEE
GENERAL ELECTRIC STEREO AMPLIFIER

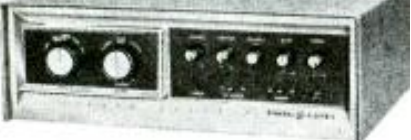

REG. \$169.95 — SALE PRICE \$79.95
MS-4000A General Electric 56 watt (28 watt per channel) stereo amplifier. Save over 50%. Regular net is \$169.95. Price includes grey vinyl covered metal case 15x12x5" high, input selector for tape heads, monaural or stereo phono or tuner. Bass and treble tone controls, volume phono and rumble filter. Output matches 4, 8 and 16 ohms. Push-pull 12B output tubes for each channel. 12 tubes in all. Response 20 to 20,000 cps. Sngp. wt. 31 lbs. Regular audio net, \$169.95
McGee Sale price, only **\$79.95**

COMPLETE STEREO SYSTEM \$199.95
Stock No. MSA-88, complete stereo system includes the 56 watt G.E. stereo amplifier described above, the famous Type A Garrard record changer with Shure M7D stereo cartridge and two Electro-Voice SP-8B, super 8" high fidelity speakers. Reg. net, \$332.95.
Special sale price **\$199.95**
Stock No. MSA-12B, complete stereo system, same as above, but includes two Electro-Voice SP-12B, 12" high fidelity speakers instead of 8" speakers. Reg. \$209.95 net, \$243.95. Special sale price **\$209.95**
Wood base for Garrard changer, \$4.95. LRS3, 45 RPM spindle, \$3.80 extra.

NEW FM TUNER
SALE PRICE **\$29.95**
\$69.95 LIST

New Model FM-220 imported FM tuner in attractive gold enamel metal case, 3 1/2" x 10 1/2" x 6" deep. Designed with exceptional care. Response flat from 30 to 15,000 cps. AFC for exceptional stability. Distortion less than 1%. Tunes 88 to 108 MC. Output jack for recording direct from tuner. Sensitivity: 31.2 microvolts for 20 db quieting. Output: 0.1 volt. Slide rule dial. Operates on 115 volts, 60 cycle AC. Ideal for use with the systems described above. Shipping wt. 7 lbs. Model FM-220, FM tuner, list value \$69.95.
Sale Price **\$29.95**

16-5 IN. HI-FI SPEAKERS FOR \$24.00

BUILD YOUR OWN "SWEET 16" SPEAKER SYSTEM
When 16 speakers are used in a group, audio response goes down to 20 cps and up above normal audible range. (Refer to Popular Electronics Jan. 1961, Page 58) 16 "all alike" Heavy duty 5" Cleveland Electronics 1 1/2 oz. Alnico V PM's, (twice as heavy magnet as used in the Popular Electronics model) with 8 ohm aluminum voice coils. McGee offers the speakers, you supply the wood. 5" speaker, Sweet 16 Model 147, \$5.00 list value. Net price, \$1.95 each, 16 for \$24.00.
Sweet 16 Model 316, \$6.00 list 5" speaker with 8 ohm, 1" aluminum voice coil and 3.16 oz. Alnico V magnet. Net \$2.49 each, 16 for \$32.00.

Write for McGee's 160 page 1961 catalog
McGEE RADIO CO.
1901 McGee St., Kansas City 8, Missouri

Guaranteed! Crystals!

BUY NOW AND SAVE!!

overtones: 10 to 30 Meg... Tol. .005%... \$2.50
AMATEUR & NOVICE Fundamental... Tol. .005%
HC-6 Herm. Sealed... \$2.50
HC-6—6 Meters (5th Overtone)..... \$3.75
MARINE FREQ. HC-6 (Herm. Sealed)
Tol. .005%..... \$3.50

ALL MARINE FREQ.—FT-243, DC-34 Hold Tol. .005%... \$2.00
POLICE, C.A.P., CD, MARS. Tol. .01%..... \$1.60
CITIZENS BAND—11 METERS—.005% TOL.
26.965 to 27.225 MC, 3rd Over. Herm. Seal. or
FT-243..... \$2.50
13.4825 to 13.6125 MC, 2nd Harm. Herm. Seal. or
FT-243..... \$2.50
6741.25 to 6806.25 Kc, 4th Harm. FT-243 only \$2.00

**SPECIAL!
STOCK CRYSTALS**

59¢ ea.

FT-243 Holders 5700 KC to 8650 KC in steps of 25 KC's
SEND FOR FREE CATALOG
OC-34 Hold. 1690 KC to 4440 KC steps of 10 KC, ea. 79c

NOVICE BAND FT-243 Fund. ea.

86¢

80 Met. 3701-3748—Steps of 1 KC. FT-243
40 Met. 7150-7198—Steps of 1 KC. FT-243
Dbl. to 40 Met. 3576-3599. Steps of 1 KC. FT-243
15 Met. 5276-5312—7034-7082 Steps of 1 KC. FT-243
FT-243—2 Meters (Steps of 1 KC)..... \$.93
FT-243—6 Meters (Steps of 1 KC)..... \$.93
FT-243—From 3000-4000..... \$.93
FT-243—From 1005-2999 (Steps of 5 KC)..... \$2.39
FT-243—.005% Tol. From 3000-8750..... \$2.00
FT-243—.01% Tol. From 3000-8750..... \$1.60
FT-241 SSB Low Xtals 370 to 540 KC
(Steps of 1,852 and 1,388)..... \$.49
FT-241 SSB Matched Pairs..... \$1.95
FT-241—AM/TRC-1-721,167 KC-1040-625
(Steps of 1,042 KC—Except 1000 KC)..... \$.65

Include 5c per crystal postage. (U.S. only). Calif. add 4% tax. No C.O.D. Prices subject to chg. Ind. 2nd choice, sub. may be necessary. Min. Order \$2.50

Open Friday Evenings until 9 P.M.

"The House of Crystals"

U. S. CRYSTALS, Inc.

1342 S. La Brea Ave. Los Angeles 19, Cal.

Product Test Report

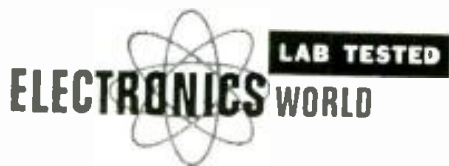

"Citation IV" Stereo Control Center Channel Master CM-10 Speaker System Pickering Model 381A Stereo Cartridge Eico Model 723 Amateur Transmitter Kit

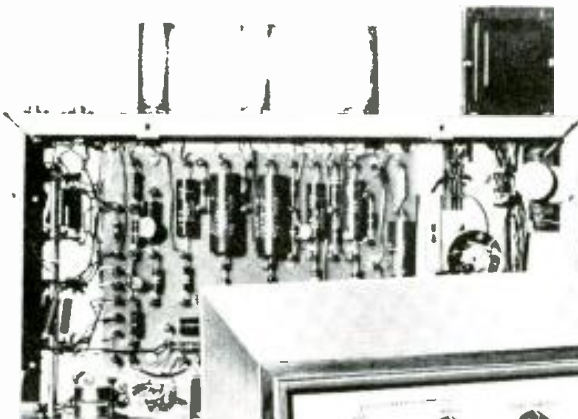

"Citation IV"
Stereo
Control Center

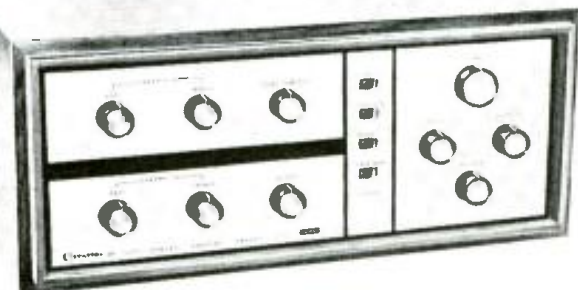

WE HAVE just completed assembling and testing *Harman-Kardon's* "Citation IV" stereo preamplifier and control center. Although the controls and input and output facilities are not unusual or different from many other preamplifiers on the market today, the performance of this unit comes pretty close to the ideal. There are only a few competitive designs that can match its low distortion and certainly none that we know of that can surpass it in this regard. Its mechanical and electrical design leaves no doubt in our mind that many, many hours of continuous operation should be obtained without maintenance problems. This is the first time that this reviewer has built a kit that employs military-type terminal boards. Such construction is much more rigid and professional appearing than is the case with many of the printed-circuit assemblies now in use. In addition, one has greater assurance that the soldering connections will be properly made.

The "Citation IV" is a stereo preamplifier employing six 12AX7/ECC83 tubes plus two selenium-rectifier assemblies. The front panel controls are quite conventional and include volume, balance, blend, and bass and treble controls for each channel. Slide switches are included for high- and low-frequency filters along with separate switches for contour (loudness) and tape monitor. A mode switch is incorporated to permit selection of straight stereo or reverse stereo, both A and B channels through

both speakers, mono channel A through both speakers, and mono B through both speakers. The function switch provides selection of six different inputs: auxiliary, tape, tuner, phono RIAA, phono LP, and tape head. A somewhat unusual, yet convenient, switch is incorporated that disconnects both bass and treble tone-control circuits completely in order to eliminate any distortion that these circuits might generate. This switch must be "on" when using either the scratch or rumble filters. A continuously variable "blend" control is also provided to obtain center "fill" as required. The control can be switched out of the circuit completely when not needed.

To those particularly interested in tape, this preamplifier's design is such that stereo tape can be played back using its equalizing circuits for the tape head. Any program material can be switched to the tape recorder to record a stereo tape. Also a tape-monitor switch permits monitoring of tape while recording.

With regard to the actual performance of this preamplifier, we found the frequency response to be within $\pm .1$ db from 20 to 20,000 cps. The contour, bass, and treble controls were found to be extremely effective.

A very sharp cut-off rumble filter is incorporated. Our tests showed that at 100 cps, the response was only down .2 db, while at 20 cps it was -17.8 db. The scratch filter proved to have a more

gradual cut-off. Starting at 400 cps, the roll-off action was gradual, and it extended to -29 db at 20,000 cps. The RIAA magnetic phono equalizing circuit was found to be within ± 1.3 db from the standard. This represents so slight a deviation as to be not discernible when listening.

The sensitivity is much better than is required, being .186 v. for 1-v. output for all high-level inputs. For magnetic phono input, the sensitivity was 3.15 mv., for tape head 2.68 mv., and for ceramic phono input .1 v.; all for 1-v. output.

Our harmonic-distortion measurements were taken under two different conditions; first, at 1-v. output with a 1-v. input signal, and then at 2-v. output with a .5-v. input signal. This measurement was taken through a high-level input. We believe that any preamplifier should be capable of producing at least 2 volts output without excessive distortion. Our harmonic-distortion figures proved to be so low that one can almost claim distortion-free performance from this preamplifier. The actual figures, with 1-v. output, were .05% at 20 cps, .07% at 1000 cps, and .01% at 20,000 cps. There was no marked change in these figures at an output of 2 volts. Incidentally, we have subtracted the residual distortion of our test equipment in order to arrive at these figures. This may or may not be valid depending on the nature of the residual distortion.

The intermodulation distortion, taken at 60 and 6000 cps through the high-level circuit, proved to be only .009% (after having deducted the residual distortion in our test equipment) with the volume control adjusted to produce 2 volts output with a signal input of .5 volt.

In order to obtain some comparison between various preamplifiers when testing for noise and hum, we adjust the volume control to produce 1 volt output with an input signal of .006 volt into the magnetic input jack. At this volume-control setting, we found that for all high-level inputs, the hum and noise were down 71 db from a 1-v. output level. The magnetic tape head circuit showed hum and noise of -48 db, and the magnetic phono input circuit showed hum and noise of -60 db under the same conditions.

The channel separation, at 1000 cps, proved to be 49.5 db and, being curious, we checked channel separation at 15,000 cps. At this frequency, channel separation was 31 db, which is far beyond that required of any top-quality preamplifier.

It is disconcerting that even though amplifiers may test alike in the laboratory, they may not sound alike. This occurs because there are many not-too-well-known and not-too-easily-measured characteristics in an amplifier that affect quality of reproduction. Therefore, a listening test is required. This preamplifier provides no audible coloration in sound reproduction. One has the feeling of listening to a live musical performance instead of through a hi-fi system.

now for the first time
**A COMPREHENSIVE COMPILATION OF 4500
 DIRECT TRANSISTOR SUBSTITUTIONS**

INTERNATIONAL TRANSISTOR SUBSTITUTION GUIDEBOOK

(Direct Substitutions Only) by Keats A. Pullen, Jr., Eng. D.

Only an engineer with the experience of the author—Keats A. Pullen Jr. (member of the scientific staff, Ballistics Research Laboratories, Aberdeen Proving Grounds) could possibly have compiled the transistor substitutions data contained in this guidebook. Everyone who works with transistors in repairing, maintaining or designing—must have this time-saving tool. Here's why:

COMPLETE AND COMPREHENSIVE

International in coverage, it lists 4500 direct substitutions comprised of American, Japanese, British, French, German, Dutch and Italian transistor types. Includes both triodes and tetodes.

**PROVIDES DIRECT SUBSTITUTIONS
 ELECTRICAL AND PHYSICAL**

Not only are the direct electrical substitutions shown, but case styles and dimensions also are given for maximum substitution flexibility.

**COVERS TRANSISTORS USED IN ALL TYPES
 OF ELECTRONIC EQUIPMENT**

The guidebook is universal in its application. It covers transistor substitution for radios, television receivers, all sorts of military, industrial, communication and computer equipments.

#276, 64 pp. \$1.50

NEW RIDER BOOKS

CITIZENS BAND RADIO by Allen Lytel. This book has a three-fold purpose: to tell the story of citizens band radio equipment to the prospective buyer, to the user and to the man who will repair it. For those new to the subject, early chapters describe the historical development of citizens band radio, its applications, classifications, and types of equipment. FCC Rules and Regulations, important to the citizens band user, are discussed. There is the detailed discussion on different types of transmitting and receiving equipment; comparison of them with emphasis on single-channel and multi-channel transceivers and receivers. Other highlights are: descriptions of portable units, kits and standard transceivers, antennas and power supplies. The installation and repair of citizens band radio equipment is covered in detail. #273, \$3.90.

FILTERS & ATTENUATORS, Edited by Alexander Schure, Ph.D. (No. 36 in the Electronic Technology Series.) This book will make filters, attenuators—their functions, the wide variety of types, circuitry and applications understandable. Both narrative and mathematical presentations are used. The characteristics of the capacitor-input type filter in power supplies is analyzed with problems and solutions. Numerous other filter types used in power supplies also are discussed in similar manner. Audio and video filters, wave filters and specialized types, are covered thoroughly—a chapter being devoted to each.

The text devoted to attenuators and equalizers is illuminated by means of numerical examples and solutions. The calculations include the determina-

tion of their component parts. Variable attenuators are also covered, as well as phase equalizers. This is an outstanding technical text for those interested in the configuration and analysis of filter and attenuator circuitry. Review questions appear at the end of each chapter. #166-36, \$2.25.

TRANSFORMERS, Edited by Alexander Schure, Ph.D. (No. 37 in the Electronic Technology Series) The transformer as it is used in electronic equipment is examined in a highly analytical manner with numerous mathematical examples. The examples give the reader a theoretical as well as a practical view of the transformer. Starting with a discussion of the magnetic principles underlying the operation of the transformer, it progresses to transformer design and construction, discussing efficiency and coil currents, flux density, core losses, leakage inductance, distributed capacitance and current as well as voltage waveforms. Power transformers are studied in full depth from the simple color coding of the leads to the relation of power transformers to rectifier-filter systems. Audio transformers are covered with emphasis on such important topics as impedance ratios, broad-band audio transformers and transistor transformers. In the area of high frequency transformers, the text treats the tuned and untuned primary and secondary windings in different combinations. It discusses in detail such special transformer items as saturable reactors, voltage regulating transformers, video transformers, pulse transformers and balancing transformers (baluns). Review questions appear at the end of each chapter. #166-37, \$2.00.

We guarantee satisfaction or return to us within 10 days for a full refund.

These and many other Rider titles are available of bookstores, electronic parts distributors, dept. stores or direct. Send for new catalog. EW-4



JOHN F. RIDER PUBLISHER, INC., 116 West 14th Street, New York 11, N. Y.
 Canada: Chas. W. Pointon, Ltd., 86 Racine Rd., Rexdale, Ont.
 Export: Acme Code Company, Inc., 630 9th Ave., N. Y. C.

RECORDING TAPE

* Side Guaranteed not to rub off or streak—or money back. Compare ours with other "Bargain" tapes. You'll find it's more than just "price" when you deal with us. We are original pioneers in the tape recorder business and our reputation means everything to us.

1000' new (plastic) 7"	2.95
1000' MYLAR (red) 7"	3.15
900' MYLAR (blue) 5"	1.15
1200' MYLAR 1/2 mil (cel) 7"	3.25
1200' Acetate (plastic) 7"	3.25
200' MYLAR, 1 1/2 mil (strone)	1.95
1500' acetate (plastic) 7"	3.25
1800' MYLAR 1 mil thick, 7"	3.25
2400' MYLAR, ventanized, 7"	3.65
400' MYLAR, ventanized, 7"	3.45

Studio Large Large Extra Lower

NORELCO SPEAKERS

Famous 9777—successor to 9710M twin-core speaker—original list \$9.95, now NET \$3.97. NOW while they last by off set \$1.98 plus postage. (discontinued model). Frequency 40-20,000 cy. Other 2-1/2" x 1 1/2" x 1 1/2" NATIONAL Speaker reductions on a first come, first served basis.

SEND FOR SPEAKER SPECIFICATION SHEET.

COMMISSIONED ELECTRONICS CO.
 1776 COLUMBIA ROAD WASHINGTON, D. C.

Learn Transistor Electronics At Home!

■ Prepare now for a profitable career in this growing field. Learn theory, construction and applications of all types of transistors with this proven home-study course from the Philco Technological Center.

FOR FREE INFORMATION PLEASE WRITE TO:

PHILCO TECHNOLOGICAL CENTER
 P.O. Box 4730, Dept. W1, Philadelphia 34, Pa.

SEND ELECTRONICS WORLD EVERY MONTH



name _____

address _____

city _____ zone _____ state _____

Check one:

- 3 years for \$12 2 years for \$9
 1 year for \$5

In the U. S., its possessions, and Canada

- Payment enclosed Bill me

Foreign rates: Pan American Union countries, add .50 per year; all other foreign countries, add \$1.00 per year.

Mail to: **ELECTRONICS WORLD**
 Dept. EW 461H, 434 S. Wabash Ave.
 Chicago 5, Ill.

ELECTRONIC TECHNICIANS!

Raise your professional standing
and prepare for promotion!

Win your diploma in
**ENGINEERING
MATHEMATICS**

from the
Indiana Home Study Institute

We are proud to announce two great new courses in Engineering Mathematics for the electronics industry.

These unusual courses are the result of many years of study and thought by the President of Indiana Home Study, who has *personally* lectured in the classroom to *thousands* of men, from all walks of life, on mathematics, and electrical and electronic engineering.

You will have to see the lessons to appreciate them!

NOW you can master engineering mathematics, and actually *enjoy* doing it!

WE ARE THIS SURE: you sign no contracts—you pay only **AFTER** you have completed each Unit of your course.

In plain language, *if you aren't satisfied you don't pay*, and there are no strings attached.

Write today (a postcard will be fine), for more information and your outline of courses.

You have nothing to lose, and everything to gain!

The INDIANA Home Study Institute
 924 E. Columbia Avenue, Fort Wayne, Indiana

This is not only one of the best units on the market but, as mentioned previously, we enjoyed immensely putting the kit together because of its military-type construction. It took us 17½ hours

to build the kit. The preamp is available at \$119.95 in kit form, and \$189 factory-wired. Neither of these prices include the walnut wood outer cabinet, which is available separately at \$29.95. —30—

Channel Master CM-10 Speaker System

THIS is a compact bookshelf-type loud-speaker system consisting of an 8-inch woofer and 2-inch coaxially mounted cone tweeter, in a ducted-port reflex enclosure. The crossover is at 3000 cps and the tweeter's level is non-adjustable. The system is rated at 10 watts power-handling capacity (continuous or program not specified) and 8 ohms impedance. The enclosure measures 10 inches

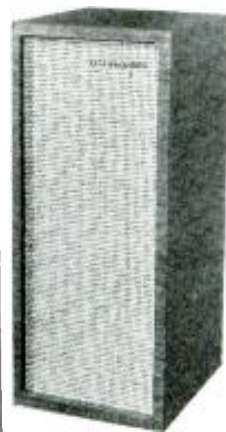

wide by 23½ inches high by 11 inches deep.

Sweeping a test tone through the audible range (with the speaker located in a corner, for maximum bass radiation), the CM-10 was found to have subjectively smooth, linear response from 100 to 15,000 cps, with a drop in the range between 1 kc. and 2 kc., and a broad, shallow dip between 200 and 600 cps. Above 2 kc. there was not a trace of audible deviation until 7 kc., at which point there was a slight dip, followed by a rise back to normal at 8 kc. Then there was another mild dip at 10 kc., and smooth, flat response from there out to 14 kc. Above that, a slow roll-off set in, but a significant contribution was observed to beyond 16 kc.,

at which point this reviewer's ears fail him. No distortion was audible at any frequency, even at fairly high listening levels.

On program material, the CM-10 was sharply brilliant. Over-all definition was excellent; details were very well reproduced, and there was some tendency toward spotlighting of brass instruments and soprano voices. String tone was reproduced cleanly and smoothly, although with a subtly cold, brittle quality. It was immediately obvious that the CM-10's treble performance was superior to its bass response which, although clean and well defined, was somewhat lacking in foundation. This effect is not altogether unusual, and it is not quite fair to expect the same fullness in the bass that would be produced by a somewhat larger woofer in a larger and more expensive enclosure.

Despite its modest power rating, the CM-10 proved able to handle considerable bass boost without audible strain, and a moderate amount of boosting was all that was needed to bring the system's sound into a good semblance of natural musical balance.

The addition of a second CM-10, for stereo pairing, might well augment the low range enough to provide good bass balance without external boosting, and the tweeter's broad high-frequency distribution (estimated at about 80 degrees) should enable the system to yield excellent stereo spread and fill in most listening rooms.

The CM-10 is priced at \$44.95. —30—

Pickering Model 381A Stereo Cartridge

ALTHOUGH the new *Pickering* 381A stereo cartridge looks identical to the manufacturer's Model 380A, its performance is different. The 381A is much more expensive and has less output voltage, but its over-all reproduction quality makes it one of the very best stereo cartridges we have tested to date.

The 381A was specifically designed for use by recording engineers, not only for calibrating their audio amplifiers,

but for playback equipment to determine the quality of recordings. All cartridges are individually calibrated at the plant and the results are tabulated and shipped with each unit. It is *Pickering's* hope that this cartridge will be recognized as a standard for the recording industry and they have had some degree of success along these lines to date.

All this does not preclude the use of the cartridge in the home if quality is

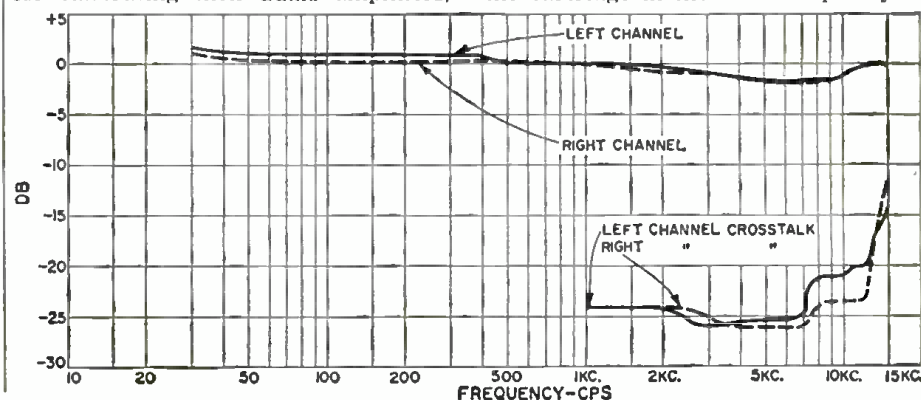

most desired and price is no object. The frequency response and channel separation characteristics are shown in the accompanying graph. It is interesting to note the smoothness of the response, being ± 1.8 db from 30 to 15,000 cps, the limits of our test record.

This response is good in that it betters all other stereo cartridges we have checked recently by about a db or so. What is unusual and we feel extremely important is the channel separation. Both channels show a crosstalk down 24 db at 1000 cps. (We cannot measure much below this using the *Westrex* 1A test record.) The manufacturer claims 35-db channel separation, and it is quite possible that this is actually achieved. As pointed out in our report on the

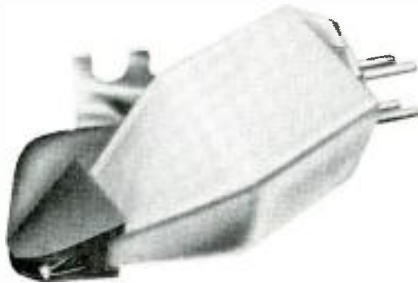

Model 380A cartridge, *Pickering* has a specially designed test record which has a much greater signal-to-noise ratio than ours. Unfortunately, this record is not available to us for testing.

Greater separation than 20 db is not necessary for home listening, but, for best results, separation should not drop much below this figure out to 10 or 15 kc. Some recent studies conducted by *Bell Telephone Laboratories* indicate that full separation is required for home listening only out to about 8 kc. This conclusion was reached with the use of presently available stereo tapes and discs. In spite of this, it is still nice to know that we have some equipment available whose performance exceeds the needs for present-day in-home use. We can also foresee the possibility that future tapes and discs will have even more strict requirements for reproduction.

Many of the early cartridges had an opposite channel output voltage at 10,000 to 15,000 cps that was greater than the voltage from the proper channel. It is interesting to note that this new cartridge not only keeps the channels where they belong without interchanging them but, in addition, has good separation out to 15,000 cycles.

The output voltage measured was 4.55 mv. for the left channel, and 4.9 mv. for the right channel for 5 centimeters per second recording at 1000 cycles. The recommended load is from 47,000 to 100,000 ohms, and stylus pressure should be maintained between 2 and 3 grams. A .7 mil easily replaceable diamond stylus is used. A stylus is also available for 78-rpm records.

The listening quality of this cartridge is smooth and clean, and does not have an extreme brilliance nor a strident response. We encountered no tracking problems, even with extremely loud passages, and we were particularly pleased



Prepare for your career in
ELECTRONICS
ELECTRICAL ENGINEERING
RADIO-TV
COMPUTERS

Through study at the Milwaukee School of Engineering, you can gain a sound technical education — and open the door to a rewarding career in the space age as an engineer or engineering technician.

At MSOE, new classes begin quarterly. Previous educational, military, and practical experience evaluated for advanced credit. Veteran approved. Write for more information today.

Associate in Applied Science degrees — 2 years

- Electronics Communications Technology
- Electrical Power Technology
- Computer Technology
- Air Conditioning Technology
- Industrial Technology
- Metallurgical Technology

Bachelor of Science degrees—4 years

- Electrical Engineering
 - Communications option
 - Electrical Power option
- Mechanical Engineering

Pre-technology program, scholarships, financial aid, and placement service available.



NEW!
FREE
 "Your Career"
 booklet.
 •
MAIL
 coupon today!

MILWAUKEE SCHOOL OF ENGINEERING
 Dept. EW-461, 1025 N. Milwaukee St., Milwaukee 1, Wis.
 (Please Print)

Name Age.....
 Address
 City State.....
 Course interest.....

MILWAUKEE SCHOOL OF ENGINEERING
 1025 NORTH MILWAUKEE STREET • MILWAUKEE 1, WISCONSIN



SERVICEMEN KNOW!
 Here they pay less and get the best
HUSH®

Chemically-Electronically, engineered for Tuners and Switching Mechanisms.

When New HUSH is applied it will wash-away that dirt, leaving clean and positive contacts protected by a lasting lubricant. New HUSH is made from the finest solvents and it contains Electro-Silicone oils.

Also available—2 oz., 6 oz. Spray can **\$2.25 net**
 8 oz., 32 oz. containers

EVER - QUIET®
 Since 1949

VOLUME CONTROL AND CONTACT RESTORER
 EVER-QUIET is a free-flowing liquid that leaves no powder residue. Scientifically designed to seep around the shaft and penetrate the control or potentiometer, cleaning the contacts and leaving a safe protecting film. Harmless to metals, wire or carbon.

Also available— 6 oz. Spray can **\$1.59 net**
 32 oz. containers
 2 oz. Bottle & dispenser **79c net**



CHEMICAL ELECTRONIC ENGINEERING, INC. Matawan, New Jersey

SAVE MORE with

SONAR

TUBES

- Tested for mutual conductance in our labs!
- 1 Year FREE replacement guarantee!
- Prompt refunds on defective merchandise!

SPEC. PUR. & TRMTG. AND IND. TUBES

Type	Price	Type	Price	Type	Price	Type	Price
6A2	.80	6CJ	8.50	8T2A	1.00	5Y20	.40
6A3	.70	6A1WA		884	.80	5Y21	.40
6A4	.70			885	.75	5Y21A	.40
6BE	.45	218	1.10	951	.50	5Y21A	.40
6BE	.65	5J20		952	.50	5Y21A	.40
6C3	.50	730TI		953	.50	5Y21A	.40
6C4	.40			954	.50	5Y21A	.40
6E21	.50	807	22.00	955	.50	5Y21A	.40
6E20	1.95	811	1.00	956	.50	5Y21A	.40
6A4	.45	815	2.50	957	.50	5Y21A	.40
6X100A	8.50	820B	1.70	958	.50	5Y21A	.40
6R10Y	1.00	842	3.00	959	.50	5Y21A	.40
		842A	3.00	960	.50	5Y21A	.40
		899A	1.00	961	.50	5Y21A	.40
				962	.50	5Y21A	.40
				963	.50	5Y21A	.40
				964	.50	5Y21A	.40
				965	.50	5Y21A	.40
				966	.50	5Y21A	.40
				967	.50	5Y21A	.40
				968	.50	5Y21A	.40
				969	.50	5Y21A	.40
				970	.50	5Y21A	.40
				971	.50	5Y21A	.40
				972	.50	5Y21A	.40
				973	.50	5Y21A	.40
				974	.50	5Y21A	.40
				975	.50	5Y21A	.40
				976	.50	5Y21A	.40
				977	.50	5Y21A	.40
				978	.50	5Y21A	.40
				979	.50	5Y21A	.40
				980	.50	5Y21A	.40
				981	.50	5Y21A	.40
				982	.50	5Y21A	.40
				983	.50	5Y21A	.40
				984	.50	5Y21A	.40
				985	.50	5Y21A	.40
				986	.50	5Y21A	.40
				987	.50	5Y21A	.40
				988	.50	5Y21A	.40
				989	.50	5Y21A	.40
				990	.50	5Y21A	.40

RECEIVING TUBES

Type	Price	Type	Price	Type	Price	Type	Price
6Z4	.42	6AR	.60	7A4 JX1	1.00	6X4	.44
1A7GT	.45	6AR1	.60	7B3	.44	12BH7	.44
12X6GT	.52	6AR2	.60	7C3	.44	12BH7A	.44
12X6GT	.52	6AR3	.60	7D3	.44	12BH7B	.44
114	.45	6AR4	.60	7E3	.44	12BH7C	.44
116	.42	6AR5	.60	7F3	.44	12BH7D	.44
12X6GT	.52	6AR6	.60	7G3	.44	12BH7E	.44
12X6GT	.52	6AR7	.60	7H3	.44	12BH7F	.44
12X6GT	.52	6AR8	.60	7I3	.44	12BH7G	.44
12X6GT	.52	6AR9	.60	7J3	.44	12BH7H	.44
12X6GT	.52	6AR10	.60	7K3	.44	12BH7I	.44
12X6GT	.52	6AR11	.60	7L3	.44	12BH7J	.44
12X6GT	.52	6AR12	.60	7M3	.44	12BH7K	.44
12X6GT	.52	6AR13	.60	7N3	.44	12BH7L	.44
12X6GT	.52	6AR14	.60	7O3	.44	12BH7M	.44
12X6GT	.52	6AR15	.60	7P3	.44	12BH7N	.44
12X6GT	.52	6AR16	.60	7Q3	.44	12BH7O	.44
12X6GT	.52	6AR17	.60	7R3	.44	12BH7P	.44
12X6GT	.52	6AR18	.60	7S3	.44	12BH7Q	.44
12X6GT	.52	6AR19	.60	7T3	.44	12BH7R	.44
12X6GT	.52	6AR20	.60	7U3	.44	12BH7S	.44
12X6GT	.52	6AR21	.60	7V3	.44	12BH7T	.44
12X6GT	.52	6AR22	.60	7W3	.44	12BH7U	.44
12X6GT	.52	6AR23	.60	7X3	.44	12BH7V	.44
12X6GT	.52	6AR24	.60	7Y3	.44	12BH7W	.44
12X6GT	.52	6AR25	.60	7Z3	.44	12BH7X	.44
12X6GT	.52	6AR26	.60	8A3	.44	12BH7Y	.44
12X6GT	.52	6AR27	.60	8B3	.44	12BH7Z	.44
12X6GT	.52	6AR28	.60	8C3	.44	12BH8	.44
12X6GT	.52	6AR29	.60	8D3	.44	12BH9	.44
12X6GT	.52	6AR30	.60	8E3	.44	12BH10	.44
12X6GT	.52	6AR31	.60	8F3	.44	12BH11	.44
12X6GT	.52	6AR32	.60	8G3	.44	12BH12	.44
12X6GT	.52	6AR33	.60	8H3	.44	12BH13	.44
12X6GT	.52	6AR34	.60	8I3	.44	12BH14	.44
12X6GT	.52	6AR35	.60	8J3	.44	12BH15	.44
12X6GT	.52	6AR36	.60	8K3	.44	12BH16	.44
12X6GT	.52	6AR37	.60	8L3	.44	12BH17	.44
12X6GT	.52	6AR38	.60	8M3	.44	12BH18	.44
12X6GT	.52	6AR39	.60	8N3	.44	12BH19	.44
12X6GT	.52	6AR40	.60	8O3	.44	12BH20	.44
12X6GT	.52	6AR41	.60	8P3	.44	12BH21	.44
12X6GT	.52	6AR42	.60	8Q3	.44	12BH22	.44
12X6GT	.52	6AR43	.60	8R3	.44	12BH23	.44
12X6GT	.52	6AR44	.60	8S3	.44	12BH24	.44
12X6GT	.52	6AR45	.60	8T3	.44	12BH25	.44
12X6GT	.52	6AR46	.60	8U3	.44	12BH26	.44
12X6GT	.52	6AR47	.60	8V3	.44	12BH27	.44
12X6GT	.52	6AR48	.60	8W3	.44	12BH28	.44
12X6GT	.52	6AR49	.60	8X3	.44	12BH29	.44
12X6GT	.52	6AR50	.60	8Y3	.44	12BH30	.44
12X6GT	.52	6AR51	.60	8Z3	.44	12BH31	.44
12X6GT	.52	6AR52	.60	9A3	.44	12BH32	.44
12X6GT	.52	6AR53	.60	9B3	.44	12BH33	.44
12X6GT	.52	6AR54	.60	9C3	.44	12BH34	.44
12X6GT	.52	6AR55	.60	9D3	.44	12BH35	.44
12X6GT	.52	6AR56	.60	9E3	.44	12BH36	.44
12X6GT	.52	6AR57	.60	9F3	.44	12BH37	.44
12X6GT	.52	6AR58	.60	9G3	.44	12BH38	.44
12X6GT	.52	6AR59	.60	9H3	.44	12BH39	.44
12X6GT	.52	6AR60	.60	9I3	.44	12BH40	.44
12X6GT	.52	6AR61	.60	9J3	.44	12BH41	.44
12X6GT	.52	6AR62	.60	9K3	.44	12BH42	.44
12X6GT	.52	6AR63	.60	9L3	.44	12BH43	.44
12X6GT	.52	6AR64	.60	9M3	.44	12BH44	.44
12X6GT	.52	6AR65	.60	9N3	.44	12BH45	.44
12X6GT	.52	6AR66	.60	9O3	.44	12BH46	.44
12X6GT	.52	6AR67	.60	9P3	.44	12BH47	.44
12X6GT	.52	6AR68	.60	9Q3	.44	12BH48	.44
12X6GT	.52	6AR69	.60	9R3	.44	12BH49	.44
12X6GT	.52	6AR70	.60	9S3	.44	12BH50	.44
12X6GT	.52	6AR71	.60	9T3	.44	12BH51	.44
12X6GT	.52	6AR72	.60	9U3	.44	12BH52	.44
12X6GT	.52	6AR73	.60	9V3	.44	12BH53	.44
12X6GT	.52	6AR74	.60	9W3	.44	12BH54	.44
12X6GT	.52	6AR75	.60	9X3	.44	12BH55	.44
12X6GT	.52	6AR76	.60	9Y3	.44	12BH56	.44
12X6GT	.52	6AR77	.60	9Z3	.44	12BH57	.44
12X6GT	.52	6AR78	.60	0A3	.44	12BH58	.44
12X6GT	.52	6AR79	.60	0B3	.44	12BH59	.44
12X6GT	.52	6AR80	.60	0C3	.44	12BH60	.44
12X6GT	.52	6AR81	.60	0D3	.44	12BH61	.44
12X6GT	.52	6AR82	.60	0E3	.44	12BH62	.44
12X6GT	.52	6AR83	.60	0F3	.44	12BH63	.44
12X6GT	.52	6AR84	.60	0G3	.44	12BH64	.44
12X6GT	.52	6AR85	.60	0H3	.44	12BH65	.44
12X6GT	.52	6AR86	.60	0I3	.44	12BH66	.44
12X6GT	.52	6AR87	.60	0J3	.44	12BH67	.44
12X6GT	.52	6AR88	.60	0K3	.44	12BH68	.44
12X6GT	.52	6AR89	.60	0L3	.44	12BH69	.44
12X6GT	.52	6AR90	.60	0M3	.44	12BH70	.44
12X6GT	.52	6AR91	.60	0N3	.44	12BH71	.44
12X6GT	.52	6AR92	.60	0O3	.44	12BH72	.44
12X6GT	.52	6AR93	.60	0P3	.44	12BH73	.44
12X6GT	.52	6AR94	.60	0Q3	.44	12BH74	.44
12X6GT	.52	6AR95	.60	0R3	.44	12BH75	.44
12X6GT	.52	6AR96	.60	0S3	.44	12BH76	.44
12X6GT	.52	6AR97	.60	0T3	.44	12BH77	.44
12X6GT	.52	6AR98	.60	0U3	.44	12BH78	.44
12X6GT	.52	6AR99	.60	0V3	.44	12BH79	.44
12X6GT	.52	6AR00	.60	0W3	.44	12BH80	.44

All adv. tubes not adv. new, but may be elec. perf. factory records or used, clearly marked. Postage paid. 25¢ handling charge on orders under \$5. 25¢ ship. on \$5.00. Send approx. post. on adv. & foreign orders. Write for complete list of tubes & spec. purp. tubes.

SONAR ELECTRONIC TUBE CO.

112 Martin St., Paterson 3, N. J.

GET INTO ELECTRONICS



V.T.I. training leads to success as technicians, field engineers, specialists in communications, guided missiles, computers, radar and automation. Basic and advanced courses in theory and laboratory. Associate degree in electronics in 20 months. B.S. in electronic engineering obtainable. ECEP accredited. G.I. approved. Graduates in all branches of electronics with major companies. Start September, February, Dumas campus. High school graduate or equivalent. Catalog.

VALPARAISO TECHNICAL INSTITUTE
Dept. RD Valparaiso, Indiana

with the freedom from hum pickup and the low needle talk.

The cartridge is designed to fit any

conventional tonearm. The Model 381A is priced at \$48.00 and is being handled by established audio outlets. -30-

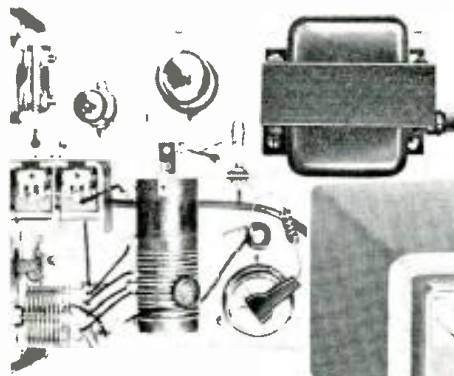

Eico Model 723 Amateur Transmitter Kit



FREE!

LAFAYETTE'S 1961 CATALOG 324 GIANT SIZED PAGES

The Complete Catalog Featuring
"The Best Buys In The Business"

- Stereophonic Hi-Fi Equipment
- Public Address Systems
- Tape Recorders
- Radio and TV Tubes and Parts
- Citizen Band Equipment
- Amateur Equipment
- Industrial Supplies

Send for Lafayette's FREE Catalog—the most complete, up-to-the-minute electronic supply catalog crammed full of everything in electronics at our customary down-to-earth money-saving prices.

CONTAINS HUNDREDS OF EXCLUSIVE LAFAYETTE ITEMS NOT AVAILABLE IN ANY OTHER CATALOG OR FROM ANY OTHER SOURCE—SEND FOR YOUR COPY NOW!

A "must" for the economy-minded hi-fi enthusiast, experimenter, hobbyist, engineer, technician, student, serviceman and dealer.



Our 40th Year

EASY PAY PLAN—the simplest, and quickest way to get what you want when you want it. As little as \$2 down . . . up to 24 months to pay.

<p>NEW!</p> <p>29.95</p> <p>2.00 Down</p>  <p>RK-125 Transistorized Portable Tape Recorder with Built-In Speaker</p>	<p>19.95</p>  <p>TE-15 Tube Checker</p>	<p>99.50</p> <p>3.00 Down</p>  <p>HE-20 Deluxe Citizens Band Transceiver</p>
<p>13.50</p>  <p>RW-60 20,000 Ohms Per Volt Multitester</p>	<p>64.50</p> <p>5.00 Down</p>  <p>KT-200, Kit</p> <p>HE-10, Wired</p> <p>79.95</p> <p>5.00 Down</p>  <p>Communications Receiver 4 BANDS—550 KC to 31 MC</p>	<p>49.95</p> <p>2.00 Down</p> <p>NEW!</p>  <p>HE-29</p> <p>"Walkie-Talkie" 9-Transistor Portable Citizens Band</p> <p>Two for 96.50</p> <p>5.00 Down</p>

Mail the coupon today for your FREE copy of Lafayette Radio's 1961 Catalog.

LAFAYETTE RADIO

165-08 LIBERTY AVENUE, JAMAICA 33, N. Y.

OTHER LOCATIONS

NEW YORK 13, N. Y.	BRONX 58, N. Y.	NEWARK 2, N. J.
PLAINFIELD, N. J.	PARAMUS, N. J.	BOSTON 10, MASS.

FREE!



LAFAYETTE RADIO
Dept. RD-1, P.O. Box 190
Jamaica 31, N. Y.

Send me the FREE Lafayette 324 page
1961 catalog 610

Name.....

Address.....

City..... Zone..... State.....

NEW BASE STATION

27 Megacycle Citizen Band ANTENNA from MARK MOBILE

**Exclusive close spaced
side mounting for
tall existing towers**

The new C.S.M.-11 antenna is designed to produce greatly increased transmitting and receiving range for the Class D Citizen Band commercial user. Improved results are obtained by conveniently close mounting the C.S.M.-11 on tall existing radio, T.V. or communications towers. Mounts less than one foot from the tower leg and tower structure forms part of antenna circuit. This assures mechanical stability, low V.S.W.R. and reduces distortion of radiation pattern.

Two C.S.M.-11 Units stacked on opposite sides of tower produce 3 db gain... stacking on same side produces directional pattern with 5 db gain.

HELIWHIP* and BEACON ANTENNAS

Carry the full Mark Mobile line of famous high efficiency mobile and fixed station antennas for amateur and Citizen Band services. User-approved and consistently advertised to build sales action for you! *U.S. Patent 2,966,679; U.S. Process Patent 2,938,210.

All Mark Mobile Antennas are available at leading parts and equipment distributors. For name of nearest distributor, write—

MARK MOBILE inc
Dept. EW-4
5441 W. Fargo Ave., Skokie, Ill.

Diodes Are Different

(Continued from page 50)

the tube in the first place. But by now we are hooked, so we buy five new diodes and put four on a side. The chances are that this supply will stand up. But once in a while, if luck is against us, it goes too, and we find four shorted diodes.

Back Resistance

The villain here is back resistance. The back resistance of diodes varies enormously. Anyone who has several silicon diodes on hand can get his eyes opened and increase his education by performing a very simple experiment. This consists of setting up the circuit shown in Fig. 2A. Any handy voltage

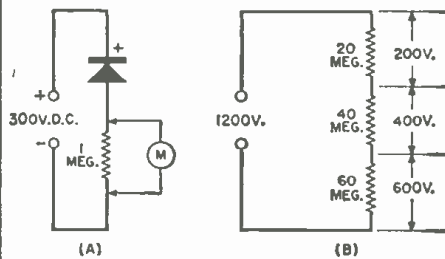

Fig. 2. (A) Simple setup to check back resistance of diodes. (B) The way that back voltage is distributed across diodes that have different back resistance values.

under the rated p.i.v. of the diode will do. The voltmeter shown reads the voltage drop across the 1-meg. resistor. This will be the back current through the diode in microamperes. In other words, one volt across the resistor means one microampere of back current.

The writer has made this test on 27 diodes, all with 400 p.i.v. rating. About half had 150- or 200-ma. ratings and the other half a 500-ma. rating. They represented five different styles of diodes from three different manufacturers.

Among the 27, the back current varied from 2 to 80 microamperes. This is a total range of back resistance of approximately 4 to 150 megohms. The range within one style was not so great, but in many cases covered a 3 to 1 range.

Now this has a serious effect when diodes are used in strings. Let's go back to the case of our hi-fi friend and his power supply. Suppose, as might very easily be the case, he had three diodes in one string with back resistances of 20, 40, and 60 megohms. When the 1200-volt peak is placed across these diodes, we have the situation illustrated in Fig. 2B. The voltage drop across the 20-meg. diode is 200 volts; across the 40-meg. diode, 400 volts; and across the 60-meg. diode it is 600 volts, or about 50 per-cent over rating. If this diode is operating near full current capacity, this high stress coupled with the heat generated at the junction on the forward-current pulse will set up a destruction cycle, and this diode will short out. Then the 1200 volts divides across the remaining diodes in the ratio of their resistances and the second diode shorts. Almost immediately the third one will go.

If four diodes are used, the chance of this sort of thing is greatly lessened, but again, if a high-resistance diode gets in the string with a couple of low-resistance diodes, even in this case there may be a failure. Now when single diodes are used across fixed low impedance sources that are less than rated p.i.v., this will not happen because the low resistance diode merely passes more back current. It is the series operation that causes the trouble.

The Solution

The solution to this problem is a simple one and is quite familiar to those who use electrolytic capacitors in series. You equalize the voltages with shunting resistors. Values of 100,000 to 200,000 ohms will swamp out the variations among the diode back resistances.

Now, finally, we can set up our power

BOGEN SOUND SYSTEMS

exclusive Bogen Flex-Pak offers:

- wall-mount bracket
- rack panel mount
- carrying case, with or without speakers
- plus: tamper-proof locking plate • E-Z Service removable cover • easily-mounted turntables... and many other optional features.

Bogen Flex-Pak® Series

Bogen-Presto, world's leading manufacturer of packaged P.A. and sound products, serves all sound needs... "across the board." All 13 exclusive Bogen Flex-Pak models offer the very finest sound equipment available... featuring award-winning styling* and many special features designed to meet all requirements.



MX60 Deluxe 60-watt Amplifier.
• master gain control • built-in remote gain control circuit • 4 mike channels (one converts to phono).



MO100 100-watt Booster Amplifier.
Exceptional wide-range frequency response. Ideal wherever undistorted high power is required.

*Styling plus! MX60 is the winner of the Milan Triennial Gold Medal for design excellence.

For information on the complete line, write for **FREE Sound Systems file TODAY.**

BOGEN-

supply for the hi-fi addict who has spent so much money buying diodes. This is shown in Fig. 3. There are two things

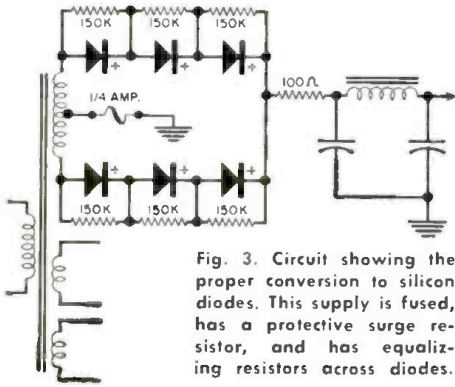

Fig. 3. Circuit showing the proper conversion to silicon diodes. This supply is fused, has a protective surge resistor, and has equalizing resistors across diodes.

that might be mentioned. First off, these resistors will pass some raw a.c. around the rectifiers. Will this affect hum? The answer is no; it won't be detected by the ear, although it can be noticed on the oscilloscope if it is cranked up. The second point is that the resistors generate heat—perhaps a couple of watts of it.

As a result of this we can make up a few simple rules by way of a summary:

1. Don't forget that protective resistor with diodes. Better yet, use a choke input and improve regulation at the same time.

2. Fuse the power supply. This is always good advice, but especially with diodes because they are more prone than tubes to short out rather than open up.

3. Always use equalizing resistors when you put two or more diodes in series.

4. Provide ventilation. Diodes don't run cold, remember. Between equalizing resistors and junction heat, air circulation is needed.

Follow these simple rules and enjoy the very real benefits to be derived from the use of diodes in that ham transmitter or hi-fi amplifier.

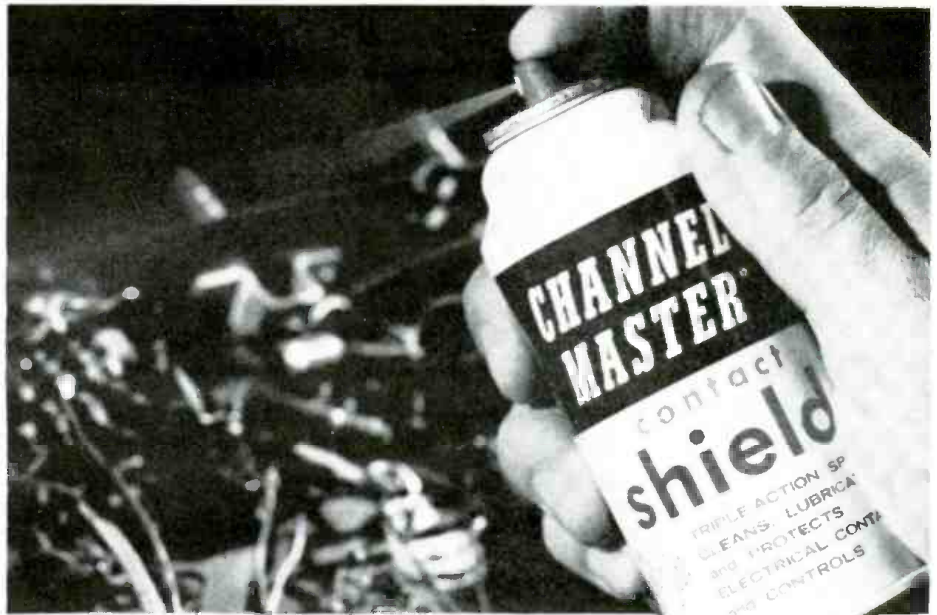

BEST OF ALL CONTACT SPRAYS

As reported by independent product-testing laboratory

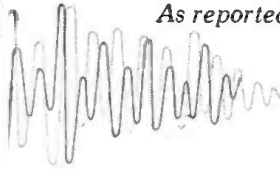

Triple-action Contact Shield cleans, lubricates, and protects electrical controls and switches in seconds. Most effective, safest product of its kind as proved by laboratory tests.

CHANNEL MASTER works wonders in sight and sound

Ellenville, New York



-- then you need us!

GET STARTED RIGHT by writing for **FREE** 8 page catalog illustrating over 30 business forms and systems designed specifically for TV-Radio Service. ON SALE AT YOUR PARTS JOBBER

Delrich Publications • 4308 N. Milwaukee • Chicago 41, Ill.



BARGAIN HUNTING?

TV SERVICEMEN!

Write for SENSATIONAL CATALOG
HENSHAW RADIO SUPPLY
3619 TROOST KANSAS CITY, MO.

ACROSS THE BOARD !!!

Bogen Challenger Series

Engineering precision and peak performance make the famous Bogen CHALLENGER series the sound choice of many organizations and institutions. Designed and assembled with all the care and quality of the exclusive Flex-Pak line, the CHALLENGER series offers performance, versatility and value in all nine models.



CHA75A 75-watt Amplifier features a modern high-gain circuit with specifications equal to amplifiers that cost far more.



CHA620Y 20-watt Mobile Amplifier ... with 3-speed phono top. Designed to operate on 110v AC, 6v DC, or 12v DC.

a sound product for ANY application

- P.A. Systems
- Office and Home Intercoms
- Internal Telephones
- School Consoles
- Portable Transcription Players
- Hi-Fi & Stereo Components
- Professional Studio Equipment

PRESTO **CHALLENGER**

DESK 611, PARAMUS, N. J.

A DIVISION OF THE SIEGLER CORPORATION

EXAMINE ANY OF THESE TESTERS BEFORE YOU BUY!!

Yes, we offer to ship at our risk
one or more of the testers
described on these pages.

SUPERIOR'S NEW MODEL 770-A

VOLT-OHM MILLIAMMETER



FEATURES:

- Compact—measures 3 1/8" x 5 7/8" x 2 1/4".
- Uses "Full View" 20,000 accurate 850 Microampere D'Arsonval type meter
- Housed in round-cornered, molded case.

SPECIFICATIONS:

- 6 A.C. VOLTAGE RANGES: 0-15/30/150/300/1500/3000 Volts.
- 6 D.C. VOLTAGE RANGES: 0-7.5/15/75/150/750/1500 Volts.
- 2 RESISTANCE RANGES: 0-10,000 Ohms, 0-1 Megohm.
- 3 D.C. CURRENT RANGES: 0-15/150 Ma., 0-1.5 Amps.
- 3 DECIBEL RANGES: -6 db to +18 db, +14 db to +38 db, +34 db to +58 db.

The Model 770-A comes complete with test leads and operating instructions. Price is \$15.85. Terms: \$3.85 after 10 day trial then \$4.00 monthly for 3 months.

SUPERIOR'S NEW MODEL 79

SUPER-METER

WITH NEW 6" FULL VIEW METER



- SPECIFICATIONS:**
- D.C. VOLTS: 0 to 7.5/15/75/150/750/1,500.
 - A.C. VOLTS: 0 to 15/30/150/300/1,500/3,000.
 - D.C. CURRENT: 0 to 1.5/15/150 Ma. 0 to 1.5/15 Amperes.
 - RESISTANCE: 0 to 1,000/100,000 Ohms. 0 to 10 Megohms.
 - CAPACITY: .001 to 1 Mfd. 1 to 50 Mfd.
 - REACTANCE: 50 to 2,500 Ohms. 2,500 Ohms to 2.5 Megohms.
 - INDUCTANCE: .15 to 7 Henries. 7 to 7,000 Henries.
 - DECIBELS: -6 to +18, +14 to +38, +34 to +58.

The following components are all tested for QUALITY at appropriate test potentials. Two separate BAD-GOOD scales on the meter are used for direct readings.

All Electrolytic Condensers from 1 MFD to 1000 MFD.
All Selenium Rectifiers. All Germanium Diodes.
All Silicon Rectifiers. All Silicon Diodes.

Model 79 comes complete with operating instructions, test leads and carrying case. Price is \$38.50. Terms: \$8.50 after 10 day trial then \$6.00 monthly for 3 months.

SUPERIOR'S NEW MODEL 77

VACUUM TUBE VOLTMETER

WITH NEW 6" FULL VIEW METER

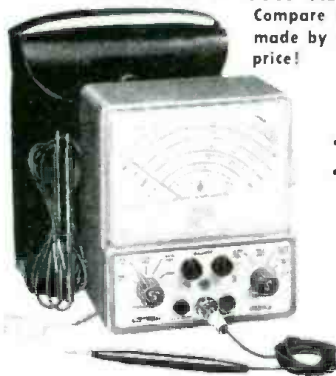

Compare it to any peak-to-peak V.T.V.M. made by any other manufacturer at any price!

SPECIFICATIONS:

- DC VOLTS—0 to 3/15/75/150/300/750/1500 volts at 11 megohms input resistance.
- AC VOLTS (RMS)—0 to 3/15/75/150/300/750/1500 volts.
- AC VOLTS (Peak to Peak)—0 to 8/40/200/400/800/2000 volts.
- ELECTRONIC OHMMETER—0 to 1000 ohms/10,000 ohms/100,000 ohms/1 megohm/10 megohms/100 megohms/1,000 megohms.
- DECIBELS—10 db to +18 db, +10 db to +38 db, +30 db to +58 db. All based on 0 db = .006 watts (6 mw) into a 500 ohm line (1.73v).
- ZERO CENTER METER—For discriminator alignment with full scale range of 0 to 1.5/7.5/37.5/75/150/375/750 volts at 11 megohms input resistance.

Model 77 comes complete with operating instructions, probe and test leads and carrying case. Price is \$42.50. Terms: \$12.50 after 10 day trial then \$6.00 monthly for 3 months.

SUPERIOR'S NEW MODEL 80

20,000 OHMS PER VOLT ALLMETER



6 INCH FULL-VIEW METER provides large easy-to-read calibrations. No squinting or guessing when you use Model 80.

MIRRORED SCALE permits fine accurate measurements where fractional readings are important.

SPECIFICATIONS:

- 3 D.C. VOLTAGE RANGES: (At a sensitivity of 20,000 Ohms per Volt) 0 to 15/75/150/300/750/1500/7500 Volts.
- 6 A.C. VOLTAGE RANGES: (At a sensitivity of 5,000 Ohms per Volt) 0 to 15/75/150/300/750/1500 Volts.
- 3 RESISTANCE RANGES: 0 to 2,000/200,000 Ohms. 0-20 Megohms.
- 2 CAPACITY RANGES: .00025 Mfd. to 3 Mfd. .05 Mfd. to 30 Mfd.
- 5 D.C. CURRENT RANGES: 0-75 Microamperes, 0 to 7.5/75/750 Milli-amperes, 0 to 15 Amperes.
- 3 DECIBEL RANGES: -6 db to +18 db, +14 db to +38 db, +34 db to +58 db.

NOTE: The line cord is used only for capacity measurements. Resistance ranges operate on self-contained batteries.

Model 80 Allmeter comes complete with operating instructions, test leads and portable carrying case. Price is \$42.50. Terms: \$12.50 after 10 day trial then \$6.00 monthly for 3 months.

SUPERIOR'S NEW MODEL 70 UTILITY TESTER

FOR REPAIRING ALL ELECTRICAL APPLIANCES MOTORS * AUTOMOBILES

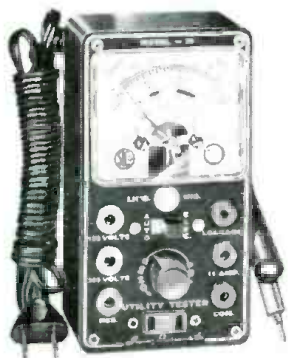

Written in simple, easy-to-understand style.

INCLUDED FREE

64 page condensed course in electricity. Profusely illustrated.

As an electrical trouble shooter the Model 70:

- Will test Toasters, Irons, Broilers, Heating Pads, Clocks, Fans, Vacuum Cleaners, Refrigerators, Lamps, Fluorescents, Switches, Thermostats, etc.
- Measures A.C. and D.C. Voltages, A.C. and D.C. Current, Resistances, Leakage, etc.
- Incorporates a sensitive direct-reading resistance range which will measure all resistances commonly used in electrical appliances, motors, etc.
- Leakage detecting circuit will indicate continuity from zero ohms to 5 megohms (5,000,000 ohms).

As an Automotive Tester the Model 70 will test:

- Both 6 Volt and 12 Volt Storage Batteries • Generators • Starters • Distributors • Ignition Coils
- Regulators • Relays • Circuit Breakers • Cigarette Lighters • Stop Lights • Condensers • Directional Signal Systems • All Lamps and Bulbs • Fuses • Heating Systems • Horns • Also will locate poor grounds, breaks in wiring, poor connections, etc.

Model 70 comes complete with 64 page book and test leads. Price is \$15.85. Terms: \$3.85 after 10 day trial then \$4.00 monthly for 3 months.

DID YOU EVER?

- ▶ Order merchandise by mail, including deposit or payment in full, then wait and write...wait and write?
- ▶ Purchase anything on time and sign a lengthy complex contract written in small difficult-to-read type?
- ▶ Purchase an item by mail or in a retail store then experience frustrating delay and red tape when you applied for a refund?

Obviously prompt shipment and attention to orders is an essential requirement in our business... We ship at our risk!

NO

**CONTRACT TO SIGN
CO-MAKERS
EMPLOYER
NOTIFICATION**

The simple order authorization included in this offer is all you sign. We ask only that you promise to pay for or return the goods we ship in good faith.

**EXAMINE ANY ITEM YOU SELECT
IN THE PRIVACY OF YOUR OWN HOME**

Then if completely satisfied pay on the interest-free terms plainly specified. When we say interest-free we mean not one penny added for "interest" for "finance" for "credit-checking" or for "carrying charges." The net price of each tester is plainly marked in our ads—that is all you pay except for parcel post or other transportation charges we may prepay.

SUPERIOR'S NEW MODEL 82A
MULTI-SOCKET TYPE

TUBE TESTER



- SPECIFICATIONS:**
- Tests over 1000 tube types.
 - Tests OZ4 and other gas-filled tubes.
 - Employs new 4" meter with sealed air-damping chamber resulting in accurate vibrationless readings.
 - Use of 22 sockets permits testing all popular tube types and prevents possible obsolescence.
 - Dual Scale meter permits testing of low current tubes.
 - 7 and 9 pin straighteners mounted on panel.
 - All sections of multi-element tubes tested simultaneously.
 - Ultra-sensitive leakage test circuit will indicate leakage up to 5 mesohms.

Model 82A comes housed in handsome, portable, saddle-stitched Texon case. Price is \$36.50. Terms: \$6.50 after 10 day trial then \$6.00 monthly for 5 months.

SUPERIOR'S NEW MODEL TW-11
STANDARD PROFESSIONAL

TUBE TESTER



- Uses the new self-cleaning Lever Action Switches for individual element testing. Because all elements are numbered according to pin-number in the RMA base numbering system, the user can instantly identify which element is under test.
- Free-moving built-in roll chart provides complete data for all tubes. All tube listings printed in large-easy-to-read type.
- **NOISE TEST:** Phono-jack on front panel for plugging in either diodes or external amplifier will detect microphonic tubes or noise due to faulty elements and loose internal connections.
- **SEPARATE SCALE FOR LOW-CURRENT TUBES**—Previously, on emission type tube testers, it has been standard practice to use one scale for all tubes. As a result, the calibration for low-current types has been restricted to a small portion of the scale. The extra scale used here greatly simplifies testing of low-current types.

The Model TW-11 comes housed in a handsome, portable, saddle-stitched Texon case. Price is \$47.50. Terms: \$11.50 after 10 day trial then \$6.00 monthly for 6 months.

SUPERIOR'S NEW MODEL 83A

C.R.T. TESTER

**Tests and Rejuvenates
ALL PICTURE TUBES**

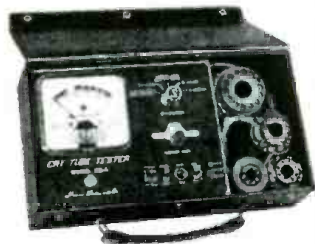

- ALL BLACK AND WHITE TUBES**
From 50 degree to 110 degree types—
from 8" to 30" types.
- ALL COLOR TUBES**
Test ALL picture tubes—in the carton
—out of the carton—in the set!

Model 83A provides separate filament operating voltages for the older 6.3 types and the newer 8.4 types.

Model 83A properly tests the red, green and blue sections of color tubes individually—for each section of a color tube contains its own filament, plate, grid and cathode.

Model 83A will detect tubes which are apparently good but require rejuvenation. Such tubes will provide a picture seemingly good but lacking in proper definition, contrast and focus.

Rejuvenation of picture tubes is not simply a matter of applying a high voltage to the filament. Such voltages improperly applied can strip the cathode of the oxide coating essential for proper emission. The Model 83A applies a selective low voltage uniformly to assure increased life with no danger of cathode damage.

Model 83-A comes housed in handsome portable saddle-stitched Texon case—complete with socket for all black and white tubes and all color tubes. Price is \$38.50. Terms: \$8.50 after 10 day trial then \$6.00 monthly for 5 months.

SUPERIOR'S NEW MODEL 85
TRANS-CONDUCTANCE TYPE

TUBE TESTER

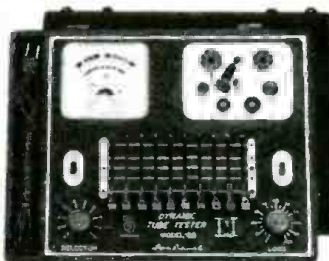

- Employs latest improved **TRANS-CONDUCTANCE** circuit. Test tubes under "dynamic" (simulated) operating conditions. An in-phase signal is impressed on the input section of a tube and the resultant plate current change is measured as a function of tube quality. This provides the most suitable method of simulating the manner in which tubes actually operate in radio, TV receivers, amplifiers and other circuits. Amplification factor, plate resistance and cathode emission are all correlated in one meter reading.
- **SYMBOL REFERENCES:** Model 85 employs time-saving symbols (*, •, ▲, ■) in place of difficult-to-remember letters previously used. Repeated time-studies proved to us that use of these

scientifically selected symbols speeded up the element switching step. As the tube manufacturers increase the release of new tube types, this time-saving feature becomes necessary and advantageous.

- **"FREE-POINT" LEVER TYPE ELEMENT SWITCH ASSEMBLY** marked according to RETMA basing, permits application of test voltages to any of the elements of a tube.
 - **FREE FIVE (5) YEAR CHART DATA SERVICE.** Revised up-to-date subsequent charts will be mailed to all Model 85 purchasers at no charge for a period of five years after date of purchase.
- Model 85 comes complete, housed in a handsome portable cabinet with slip-on cover. Price is \$52.50. Terms: \$12.50 after 10 day trial then \$8.00 monthly for 5 months.

SUPERIOR'S NEW MODEL TV-50A

GENOMETER 7 Signal Generators in One!

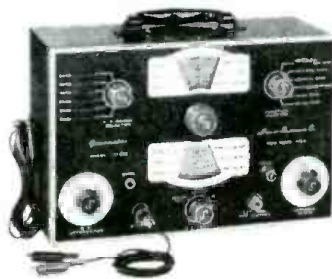

- ✓ R.F. Signal Generator for A.M.
- ✓ R.F. Signal Generator for F.M.
- ✓ Audio Frequency Generator
- ✓ Bar Generator
- ✓ Cross Hatch Generator
- ✓ Color Dot Pattern Generator
- ✓ Marker Generator

A versatile all-inclusive **GENERATOR** which provides **ALL** the outputs for servicing:

- A.M. Radio • F.M. Radio • Amplifiers
- Black and White TV • Color TV

The Model TV-50A comes absolutely complete with shielded leads and operating instructions. Price is \$47.50. Terms: \$11.50 after 10 day trial then \$6.00 monthly for 6 months.

SUPERIOR'S NEW MODEL 88

TESTS ALL TRANSISTORS AND TRANSISTOR RADIOS



AS A TRANSISTOR RADIO TESTER

An R.F. Signal source, modulated by an audio tone is injected into the transistor receiver from the antenna through the R.F. stage, past the mixer into the I.F. Amplifier and detector stages and on to the audio amplifier. This injected signal is then followed and traced through the receiver by means of a built-in High Gain Transistorized Signal Tracer until the cause of trouble is located and pin-pointed.

AS A TRANSISTOR TESTER

The Model 88 will test all transistors including NPN and PNP, silicon, germanium and the new gallium arsenide types, without referring to characteristic data sheets. The time-saving advantage of this technique is self-evident. A further benefit of this service is that it will enable you to test new transistors as they are released!

Model 88 comes housed in a handsome portable case. Complete with a set of Clip-on Cables for Transistor Testing; an R.F. Diode Probe for R.F. & I.F. Tracing; an Audio Probe for Amplifier Tracing and a Signal Injector Cable. Complete—nothing else to buy! Price is \$38.50. Terms: \$8.50 after 10 day trial then \$6.00 monthly for 5 months.

Try any of the instruments on this or the facing page for 10 days before you buy. If completely satisfied then send down payment and pay balance as indicated on coupon. No interest or finance charges added! If not completely satisfied return unit to us, no explanation necessary.

MOSS ELECTRONIC, INC., Dept. D-874 3849 Tenth Ave., New York 34, N. Y.

Please send me the units checked on approval. If completely satisfied I will pay on the terms specified with no interest or finance charges added. Otherwise, I will return after a 10 day trial positively cancelling all further obligations.

- | | |
|--|---|
| <input type="checkbox"/> Model 770-A Total Price \$15.85
\$2.85 within 10 days. Balance
\$4.00 monthly for 3 months. | <input type="checkbox"/> Model TW-11 Total Price \$47.50
\$11.50 within 10 days. Balance
\$6.00 monthly for 6 months. |
| <input type="checkbox"/> Model 79 Total Price \$38.50
\$8.50 within 10 days. Balance
\$6.00 monthly for 5 months. | <input type="checkbox"/> Model 82-A Total Price \$38.50
\$8.50 within 10 days. Balance
\$6.00 monthly for 5 months. |
| <input type="checkbox"/> Model 77 Total Price \$42.50
\$12.50 within 10 days. Balance
\$6.00 monthly for 5 months. | <input type="checkbox"/> Model 78 Total Price \$15.85
\$3.85 within 10 days. Balance
\$4.00 monthly for 3 months. |
| <input type="checkbox"/> Model 80 Total Price \$42.50
\$12.50 within 10 days. Balance
\$6.00 monthly for 5 months. | <input type="checkbox"/> Model 82-A Total Price \$36.50
\$6.50 within 10 days. Balance
\$6.00 monthly for 5 months. |

- | |
|--|
| <input type="checkbox"/> Model 85 Total Price \$52.50
\$12.50 within 10 days. Balance
\$8.00 monthly for 5 months. |
| <input type="checkbox"/> Model TV-50A Total Price \$47.50
\$11.50 within 10 days. Balance
\$6.00 monthly for 6 months. |
| <input type="checkbox"/> Model 88 Total Price \$38.50
\$8.50 within 10 days. Balance
\$6.00 monthly for 5 months. |

Name
Address
City Zone State

All prices net. F.O.B. N.Y.C.

Export Division: Roeko International Corp.,
13 East 10th St., New York 16, N. Y.

Save TIME and DOLLARS with "INSTANT 2-WAY RADIO CONTACT"



Talk and listen to persons "on the job"...at home...at play
New 2-way radio actually fits into your pocket. Exclusive, rechargeable battery lasts year or more. Range—1/2 to 1 mile. No license required.

GLOBE ELECTRONICS Pocketphone

THE FINEST 2-WAY RADIO AVAILABLE TODAY

Ideal for office, factory, stores, surveying, construction, sports, recreation, home. Finest quality available. Makes handy paging system. Use with Globe Electronics CB-100A or CB-200 for longer range systems.
• Actual size—1 1/2" x 2 1/4" x 6 1/4" • Weight—13 oz. • High impact Cyclocac case • All Transistorized. \$125.00 each

FOR LONGER RANGE COMMUNICATION

- CITIZENS BROADCASTER CB-100A**... Complete 3 channel, 2 way station. Fixed or mobile installation. Easy to install, operate. Range 5-15 miles. \$139.95 each
- BROADCASTER DELUXE CB-200**... A rugged transmitter for commercial use. Transmits on 5 channels. Receives on all 22. Adapts to selective calling system. \$189.95 each

CLIP AND MAIL COUPON TODAY FOR INFORMATION

GLOBE ELECTRONICS
A Division of Teatron Electronics, Inc.
22 30 So 34th St., Council Bluffs, Iowa

Please send me complete information on the new Globe Electronics Pocketphone CB-100A CB-200

NAME _____
ADDRESS _____
CITY _____ STATE _____

EW-4

**SUPERIOR QUALITY
BETTER PERFORMANCE
OUTSTANDING DEPENDABILITY**

"TAB" SILICON 750MA* DIODES TOP HATS

General Purpose 400 PIV at 300 MA
Special 2 for \$1

rms/piv 17/25 14c	rms/piv 35/100 19c	rms/piv 70/100 29c	rms/piv 140/200 34c
rms/piv 210/300 43c	rms/piv 280/400 55c	rms/piv 350/500 70c	rms/piv 420/600 \$1.00
rms/piv 490/700 \$1.25	rms/piv 560/800 \$1.50	rms/piv 630/900 \$1.70	rms/piv 700/1000 \$2.00

Low Priced *T200 Silicon Diodes rated 380 piv/266rms in 200 MA @ 100°C 36c each; 10 for \$3.25; 100 for \$27; 1000 for \$230.

* CAPACITOR INPUT DERATE 20%
(85 or more this item we pay P.P./U.S.A.)

SPECIAL! TRANSISTORS & DIODES!!!

FULL LENGTH LEADS
Factory Tested & Guaranteed!

- 2N123 PNP 45c ea., 12 for \$5, 100 for \$37.
- 2N292 NPN 45c ea., 12 for \$5, 100 for \$37.
- 2N293 NPN 45c ea., 12 for \$5, 100 for \$37.
- 2N223 PNP 80c ea., 12 for \$9, 100 for \$65.
- 2N597 PNP \$1.90 ea., 6 for \$10.
- 2N598 PNP \$1.90 ea., 6 for \$10.
- 2N599 PNP \$3.50 ea., 3 for \$10.
- 2N670 PNP 300MW 95c ea., 8 for \$5, 100 for \$48.
- 2N671 PNP 1W \$1.15 ea., 5 for \$4, 100 for \$69.

GENERAL PURPOSE—PNP—COMPUTER GRADE!
Use as Amplifier—Oscillator—HiFi Logic—Servo-amp—Power Supply Pulse Amplifier or High Current Switch Vcb, Vce, Vcb Approx. 40V
GP3C rated 300 Milliwatts 65c ea., 10 for \$5, 100 for \$39.
GP10C rated one watt 90c ea., 6 for \$5, 100 for \$63.

- 2N111 \$2.80, 2N112 \$4.50, 2N177 \$4, 2N278 \$5, 2N155 \$1.39, 2N170 \$1.80, 2N177 \$1, 2N178 \$1.75, 2N217 \$1.50, 2N255 \$1.20, 2N270 95c, 2N271 \$1.25, 2N108 80c, 2N311 \$1.20, 2N324 \$1.80, 2N370 \$2.20, 2N381 \$1.25, 2N382 \$2.10, 2N171 \$8.50, 2N172 \$6.50, 2N173 \$1.60, 2N174 \$2, DIAMOND BASE MICA MOUNTING KIT, .5-30 DELCO ROUND BASE MICA MOUNTING KIT, .30 DELCO POWER HEAT SINK WITH FINS 80.50, \$1.25 KIT GLASS DIODES COMPUTER 205 ea., 8 for \$1, KIT TRANSISTORS NPN 39c ea., 3 for \$1, KIT TRANSISTORS PNP 39c ea., 3 for \$1.

(\$10 or more this item we pay P.P./U.S.A.)

"SUNTAB" BATTERY-SELENIUM PHOTOCELL
2BP 75Ma 3 x 3 1/2" 40c ea., 11 for \$4, 5 AP 1 1/2" Rd. 5BP/50c Rect 220Ma, 55c ea., 12 for \$6, 15AP 750Ma, 1 3/4" Dia, 45c ea., 4 for \$5, 10BP 350Ma, 1 1/16" Rect. 75c ea., 10 for \$7, 10 CP 750Ma, 1 7/8 x 1 3/8" \$1.45 ea., 4 for \$5, (Kit) Self Generating PhotoCells 4 for \$1.

This Item Shipped Postpaid Orders \$10 & Up
TERMS: Money Back Guarantee! Ship 17th year, \$2 min. order F.O.B. N.Y.C. Add ship charges or for C.O.D. 25% Dep. Prices shown subject to change.

"TAB"
111-WD LIBERTY ST., N.Y. 6, N.Y.
Send 25¢ for Catalog
PHONE: RECTOR 2.6245

Ask By Name For GENUINE

"NO NOISE" PRODUCTS

your assurance of brand name quality

No-Noise VOLUME CONTROL and Contact Restorer
• Cleans • Lubricates • Protects
Not a Carbon Tet Solution
2 Oz. Bottle \$1.00
6 Oz. Spray Can \$2.25
Net to Servicemen

No-Noise TUNER-TONIC with PERMA-FILM
• Cleans, lubricates, restores all tuners, including wafers type
• Non-toxic, non-inflammable
• For TV, radio and FM use.
• Economical—just a little does a lot.
6 oz. Aerosol Can \$3.25
Net to Servicemen

FREE at your jobbers
5" PLASTIC EXTENDER included with each can

- Push Button Assembly
- For Pin-Point Applications
- Does Not Cause Shorts

ELECTRONIC CHEMICAL CORP.
813 Communipaw Avenue Jersey City 4, N. J.

Technical BOOKS

"WORLD RADIO TV HANDBOOK" Edited and published by O. Lund Johansen. Copenhagen, Denmark. Distributed in the U.S. by Gilfer Associates, P.O. Box 239, Grand Central Station, New York 17, N.Y. 218 pages. Price \$2.70 postpaid. Soft cover.

This is the 15th edition of a work that has become virtually a standard reference guide to international radio and television. It supplies detailed and authoritative information on broadcasting in every country in the world, listing call letters, frequencies, hours, as well as relevant information such as location and administration for stations listed.

In addition to regular broadcasts, the book lists special, religious, and short-wave frequencies over the globe, and provides up-to-the-minute information on several related subjects, such as world time in all countries, survey of world television, likely s.w. conditions for the coming year. The book is recommended by a number of official and trade organizations throughout the world.

"BASICS OF ANALOG COMPUTERS" by Thos. D. Truitt & A. E. Rogers. Published by John F. Rider Publisher, Inc., New York. 400 pages. Price \$12.50.

This is an unusually good treatment of a difficult subject. Presented as a one-volume training course, it explains in simple, clear detail the concepts, devices, and applications of the analog computer. The text is liberally enhanced with clever drawings that combine the familiar with the unfamiliar, to help guide the reader through the material. The reader with no previous knowledge of this subject should have little or no difficulty in learning a good deal from this book. The reader with some knowledge will find it a concise, easy-to-read review which should consolidate, and perhaps extend, his grasp of the field. Maintenance technicians and computer programmers should find it particularly interesting. Review questions and a glossary are provided.

"SERVICING TRANSISTOR RADIOS" by the Sams Engineering Staff. Published by Howard W. Sams & Co., Inc., Indianapolis. 160 pages. Price \$2.95. Soft cover.

Vol. 7 in this series covers 48 transistor radios produced in 1959 and 1960. Like the preceding volumes, it features "Photofact" schematics, dial-cord stringing arrangements, cabinet and chassis photos, alignment instructions, parts lists, and replacement data.

"SCIENCE PROJECTS HANDBOOK" edited by Shirley Moore. Published by Science Service, Inc., Washington, D.C. and Ballantine Books. 254 pages. Price 50 cents. Soft cover.

Numerous projects, used in the teaching of science, are summarized. Subjects

covered include botany, chemistry, electronics, entomology, geology, mathematics, medical sciences, physics, space sciences, and zoology. Discussion ideas and a lengthy bibliography are also included.

* * *
"ELECTRICITY AND ELECTRONICS—BASIC" by William B. Steinberg & Walter B. Ford. Published by *American Technical Society*, Chicago. 262 pages. Price \$4.50.

This is the second, revised edition of a basic text that has been used in industrial arts, vocational, and technical training programs. The explanations of basic theory and simple applications are straightforward and clear and the many photographs and drawings are carefully chosen and executed. Review questions are included.

The main sections of the book consist of "this electrical and electronic age," magnetism, basic circuits, "electricity for everyday living," communications, basic formulas, standard symbols, soldering hints, and supplementary projects for the trainee to work on.

* * *
"RAPID AUTO RADIO REPAIR" by G. Warren Heath. Published by *Howard W. Sams & Co., Inc.*, Indianapolis. 158 pages. Price \$2.95. Soft cover.

The vast number of auto radios in use, as well as the changes in the receivers themselves add up to the need for a book such as this. Written primarily for the service technician, it is a practical servicing guide, containing hundreds of trouble symptom cures. What's more, it

contains a good deal of basic auto radio theory and circuit explanations. Chapters 1 through 3 cover types of receivers, circuits, and components. Chapters 4 through 6 cover servicing problems from A to Z—or at least from A to W, specifically, starting with alignment and ending with "weak reception."

* * *
"BUILDING UP YOUR HAM SHACK" by Howard S. Pyle. Published by *Howard W. Sams & Co., Inc.*, Indianapolis. 128 pages. Price \$2.50. Soft cover.

Of interest to the veteran ham as well as the Novice, this book discusses the equipment to use in an amateur station, as well as how to arrange it. A wide range of subjects is covered, including receivers, transmitters, antennas, miscellaneous gear, planning the station, testing and measuring equipment, the Novice workshop, supplies, clubs and other organizations, preparing for advancement, ham bands, the amateur's code, Conelrad information, and data on the "C" and "E" frequencies. Numerous photos and drawings supplement the text.

* * *
"SATISFYING CUSTOMERS FOR PROFIT" An Electronic Industries Association Project. Published by *Howard W. Sams & Co., Inc.*, Indianapolis. 96 pages. Price \$1.25. Soft cover.

Herein are presented 25 case-histories, said to be typical of those confronting the radio-television service dealer. The situations are told in story form, and points highlighted to empha-

size the techniques used to fulfill the technician's goal, as suggested by the book's title. The book thus answers many questions of a business relations nature, often as important in this field as the technical problems themselves.

INVITATION TO AUTHORS

Just as a reminder, the Editors of *ELECTRONICS WORLD* are always interested in obtaining outstanding manuscripts, for publication in this magazine, covering the fields of audio and high-fidelity and radio-TV-industrial servicing. Articles in manuscript form may be submitted for immediate decision or projected articles can be outlined in a letter in which case the writer will be advised promptly as to the suitability of the topic. We can also use short "filler" items outlining worthwhile shortcuts that have made your servicing chores easier. This magazine pays for articles on acceptance. Send all manuscripts or your letters of suggestion to the Editor, *ELECTRONICS WORLD*, One Park Avenue, New York City 16, New York.

News of SUPREME Radio & TV Manuals

20 RADIO VOLUMES

RADIO DIAGRAMS



Your best source for all needed RADIO diagrams and service material. Covers everything from most recent 1961 radios to pre-war old-timers: home radios stereo, combinations, transistor portables, FM, auto sets. Only \$2 for many volumes. Every manual has large schematics, all needed alignment facts, printed boards, voltages, dial striking, trimmers, and hints. Volumes are big, 8 1/2 x 11 inches, about 190 pages. Amazing values at special low prices. See coupon below for list of these popular radio manuals.

TELEVISION SERVICING COURSE



Let this new course help you in TV servicing. Amazing bargain complete, only \$3 full price for all lessons. Giant in size, mammoth in scope. Topics just like a \$200.00 correspondence course. Lessons on picture faults, circuits, adjustments short-cuts, UHF, alignment facts, hints, antenna problems, trouble-shooting, test equipment, picture analysis. Special, only **\$3**

SIMPLIFIED RADIO SERVICING BY COMPARISON

Fix any radio easily. New, different COMPARISON method finds faults quickly. Covers every radio set—new and old models. Introductory training included. Simple picture suggestions tell you where to look for faults. No testers needed for most jobs. Explains parts, transistors, etc. Manual form, large pages, 8 1/2 x 11". Special price, only **\$1.50**

PRACTICAL RADIO COURSE



Here is your amazing bargain in radio training. For only \$3.95 (full price) you can obtain a practical radio and electronics course of 35 easy-to-follow lessons. Review fundamentals, learn new servicing tricks. Compares lesson-by-lesson with the best \$150.00 home-study-type correspondence course. Large size, 8 1/2 x 11". New 1960 edition. Answer booklet to self-test questions included free. Amazing value, only... **\$3.95**

Just Out



New 1961 TV manual covers all important sets of every make. Includes all data needed for fast TV servicing. Amazing bargain. A whole year of service manual for only **\$3**

ALL NEEDED TV DATA

Use *Supreme TV* manuals for faster, easier repairs. All needed material on every popular TV set of every important make. Easy-to-use, practical, factory-prepared data simplify TV servicing and adjustment. These giant TV manuals have complete, accurate double-page schematics, needed alignment facts, printed board views, recommended changes, waveforms, voltage charts, etc. Only \$3 per large volume. The choice of 174,000 wise servicemen. Get the best and save money with *Supreme*.

AMAZING BARGAIN

Here are your error-free service instructions to help you do expert work quicker, and priced at only \$3 for a mammoth yearly manual. Greatest bargain in service data. Repair any TV model ever made by having in your shop all 14 volumes listed in coupon. Special price for all 14, only \$40. Or try the new 1961 TV manual for only \$3. See no risk coupon below.

NO-RISK TRIAL ORDER COUPON

SUPREME PUBLICATIONS, 1760 Balsam Rd., Highland Park, ILL.

- 1961
- 1960
- 1959
- 1958
- 1957
- 1956
- 1955 Radio Manual, only \$2
- 1954
- 1953
- 1952
- 1951
- 1950
- 1949
- 1948
- 1947
- 1946
- 1945
- 1944
- 1940
- 1926-1938 Manual, \$2.50

Rush RADIO and TV manuals checked in coupon.
 * New *Television Servicing Course*, complete... **\$3**
 * *Simplified Radio Servicing by Comparison*... **\$1.50**
 * *Practical Radio Course* (all 35 lessons)... **\$3.95**
 * New 1961 TV Manual, \$3. 1960 TV, \$3.
 * Additional 1959 TV, \$3. Early 1959 TV, \$3.
 * 1958 TV Manual, \$3. Additional 1957 TV, \$3.
 * Early 1957 TV, \$3. 1956 TV Manual, \$3.
 * Additional 1955 TV, \$3. Early 1955 TV, \$3.
 * 1954 TV, \$3. 1953 TV, \$3. 1952 TV, \$3.
 * 1951 TV, \$3. Master Index to all Manuals, 25c

These annual RADIO volumes specially priced at only **\$2.50** each...
THIS GROUP ONLY
\$2 EACH

I am enclosing \$..... Send postpaid.
 Name:
 Address:

Supreme Publications
 Sold by All Leading Parts Jobbers

YOUR PROFITS CAN ZOOM FROM THE CITIZENS BAND BOOM

Right now . . . Citizens Band occupancy totals more than 200,000 transmitters . . . the growth rate is over 8,000 installations per month! Only properly licensed and equipped servicemen can make frequency adjustments on these transmitters. PREPARE YOURSELF NOW FOR THIS BUSINESS IN YOUR AREA! To learn more, use coupon below.



Reliable . . . since 1938!

Citizens Band (CB) is just one part of booming mobile radio. There are over TWO MILLION other mobile radios, each needing regular maintenance. Your free copy of "How to Make Money in Mobile-Radio Maintenance" will show you how to start!

The LAMPKIN 105-B MICROMETER FREQUENCY METER is a natural for CB work. Small, portable and rugged. Guaranteed accuracy of 0.0025% is ample for CB. Calibration readings supplied free on request for all 23 Class D channels. Immediate delivery. Price only \$260.00, net.

MAIL COUPON
TODAY!



LAMPKIN LABORATORIES, INC.
MFM Division, Bradenton, Florida

At no obligation to me, please send free booklet and information on Lampkin meters.

Name _____
Address _____
City _____ State _____

NEW: THE PPM METER, an accessory for the Type 105-B. Accuracy better than 0.0001%, for split-channel transmitters above 50 MC (not CB). PPM Meter price: \$147.00 net, immediate delivery

LAMPKIN LABORATORIES, INC. MFM DIVISION BRADENTON, FLA.



INTER-COM-PACT

The newest Transistorized Intercom in the Guardian Series

A completely portable, wireless unit that plugs into any A.C. circuit for instant communication. So light—it weighs just 1½ lbs. Built-in squelch circuit minimizes interference. Instantaneous 24 hour operation. Volume control. Unlimited station capacity. At home it's mother's helper. In offices it's a tireless liaison for busy business executives. Smooth contemporary style complements every decor. Smart Desert Sand finish. Write us for name of nearest supplier.

WEBSTER PRODUCTOMATIC CORPORATION
MANUFACTURERS OF ELECTRONIC EQUIPMENT, ROCHESTER 21, N.Y.

Voltage Regulator Diode-Tube Combinations

By DAVE STONE

Zener diodes with VR tubes prevent surges and permit various outputs.

ZENER voltage-regulating diodes and VR tubes can be used in efficient combinations for power-supply regulation applications. The lower-priced, low-voltage zener diodes can be connected in series with a VR tube when the power supply output may not be high enough to "fire" a VR tube alone.

For example, a VR-90 which requires 125 volts for firing can be replaced by an OA3 VR tube and a 15-volt, 1-watt diode. This combination will fire at 105 volts and regulate at the desired 90 volts. For 150-volt regulation, an OA2 VR tube which requires a firing voltage of 185 volts can be replaced with an OB2 and a 45-volt, 2-watt diode in series across the power supply. This pair will fire at 133 volts and regulate at 150 volts.

A diode-tube combination can be used to supply regulated voltages at levels which cannot be obtained with standard VR tubes. If a regulated 125 volts is needed, for instance, an OB2 and an 18-volt, 1-watt diode can be used. This combination will fire at 133 volts and regulate at 125 volts. A 200-volt regulated output can be obtained with an OA2 and a 50-volt, 2-watt zener which produces a pair that fires at 185 volts and regulates at 200 volts. The zener diode has no voltage drop until the VR tube conducts.

In general, the diode-VR tube pair is desirable because it never permits the output voltage to exceed the regulated level, which occurs when a VR tube alone is initially fired.

The table below lists several combinations of easily obtained components for the regulating applications described. Although the diode's cost is normally three to six times the cost of the VR tube, its long and almost indestructible life will insure little or no replacement problems in standard power supplies.

REGULATED VOLTAGE	FIRING VOLTAGE	VR TUBE TYPE	ZENER DIODE TYPE
90	105	OA3	15 v., 1 w. Motorola 1.5M15Z Hoffman 1N1775 Int. Rect. 1N1514
125	133	OB2 OC3	18 v., 1 w. Hoffman 1N1777 Int. Rect. 1N1526
150	133	OB2 OC3	45 v., 2 w. Motorola 10M45Z Hoffman 1N1366
200	185	OA2 OD3	50 v., 2 w. Motorola 10M50Z Hoffman 1N1368

RAY

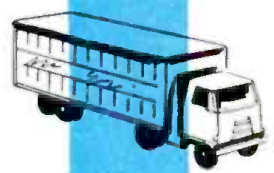

THE

the most significant step forward in Citizens Band Radio

Now, for the first time, a personal 2-way radio you can depend on under all types of operating conditions. Yours from Raytheon – the world's largest electronic manufacturer of marine radiotelephone equipment. Raytheon's proven skill in military-industrial communications and navigational aids... superlative quality, too . . . have been utilized to bring you the outstanding RAY-TEL Citizens Band transmitter-receiver.

RAY-TEL features: extreme reception sensitivity • maximum talk power • versatile, vibrationproof mounting • high-effect noise limiter and squelcher • battery saver switch • automatic transmitter performance indicator • Radar type duplexing circuits – and more. Before you make or receive your first call – look to Raytheon for the most significant step forward in Citizens Band Radio. Write for the name of the RAY-TEL retailer nearest you.

SPECIAL OFFER!

Identify your CB call letters with this attractive Scotch-Lite Bumper Strip. Only \$1.00 for a complete set of letter and numbers. Please use coupon.

21W4561

THIS CAR EQUIPPED WITH RAYTHEON RAY-TEL

RAYTHEON, Box 100, Westwood, Mass.
Gentlemen: Please send me _____ Bumper Strips. I have enclosed \$1.00 for each strip.
My Call Letters are: _____

Name _____
Address _____
City _____ Zone _____ State _____

Note: Available for U.S. Citizens Band Call Letters Only.
(Offer expires September 31, 1961)

RAYTHEON DISTRIBUTOR PRODUCTS DIVISION • 411 PROVIDENCE TURNPIKE • WESTWOOD, MASS.



RAYTHEON COMPANY

DISTRIBUTOR PRODUCTS DIVISION

Hum Elimination

By CHARLES E. DIEHL

A simple, external control.



DUAL RANGE — DUAL POWER — COMMERCIAL RADIOTELEPHONE MODEL MC-3

RECEIVER: Selectivity 5 kilocycles. Sensitivity better than $\frac{1}{2}$ uv. Edge lighted dial face with luminous phosphor numerals. Cascade Dual Triode R-F Amplifier. Two gong tuning condenser tracks oscillator and mixer circuits. Exclusive tubeless Crystal Mixer circuit lowers noise level and eliminates current drain of tube. Two High-'Q' I.F. amplifier stages. Dual noise clippers. Sensitive squelch circuit with Auto-Time delay to minimize noise bursts breaking in. Self-contained 'S' meter. Four channel receive crystal selector plus 22-channel tuneable. External speaker plug. Each unit individually inspected and precision aligned for accurate calibration to assure low adjacent channel interference.

TRANSMITTER: Five channel Transmitter. Built-in Field Strength meter indicates loading and function. All coils wound of Moisture Proof wire. Built-in protection against obsolescence by use of oversize Power Transformer, Modulation Transformer, and Hi-Power tubes. Designed to operate at up to 15 watts input with no strain. Power Amplifier and Modulation tubes use high efficiency EL84 tubes for long life and stable output under the most rugged operating conditions. Tone signal generator for ringing remote units. G R C Plated Crystals for permanent frequency accuracy and output. Two-stage High-level Modulator. Antenna matches all low impedance antennas. Loading adjustment accessible externally.

FREQUENCY RANGE: 26.965-27.225 mc. **TUBES:** 6AN8, 6BQ5, 6BK7, 12AU7, 6BH6. 3 Germanium diodes, 5 Silicon diodes and 1 Dual Selenium diode. **POWER:** 40W/115V; 3.5A/12V; 7A/6V. Nominal. Complete Self-contained Power Supply for 6, 12 and 115 volts. **RELAY:** Hermetically Sealed for life. **SIZE:** 4.25"H x 8"W x 10.5"D. **WEIGHT:** 14 lbs. **FINISH:** Black wrinkle military finish over marine prime. Panel is Gold Anodized heavy aluminum. Chassis is triple plated with Cadmium, Copper, and Iridite gold finish. Moisture Fungus lacquer on underside of chassis. Brass and lacquer finished cabinet handles. Each set comes complete with 115 volt cord, crystal for one transmitting channel, Microphone (Ceramic, Chromed case, Push-to-talk switch), Instruction Guide, Form 505 for license, also Service Data is included for conversion to 15 watts. Parts and service Warrantied for 90 days. Model MC-3 Net Price \$199.95; 6v or 12v cord \$4.95; Mounting Rails \$1.95; Crystals, transmit or receive \$2.95 ea; FOB Burbank. Specifications subject to change without notice. Your Dealer or write:

GENERAL RADIOTELEPHONE COMPANY
2806 West Burbank Boulevard
Burbank, California, U.S.A.

*Under present rules Part 19.32 the FCC does not provide for more than five (5) watt input in the Citizens Radio Service (26.965—27.225 mc band).

ELECTRONICS WORLD HAS A BUYER FOR YOUR USED EQUIPMENT OR COMPONENTS!

The 245,000 purchasers of ELECTRONICS WORLD are always in the market for good used equipment or components. So if you have something to sell, let EW readers know about it through our classified columns. It costs very little: just 60¢ a word, including name and address. Minimum message: 10 words.

For further information write: Martin Lincoln
ELECTRONICS WORLD
One Park Avenue
New York 16, N. Y.

THE circuit shown in the accompanying diagram has produced very good results when it comes to eliminating hum from a variety of electronic gear. A similar circuit, in which the filament leads are bridged with a low-resistance potentiometer with its center-tap grounded, can also be used with varying degrees of success. By using a pot across the 117-volt supply, two things are accomplished: first, a much higher bucking voltage for phasing out the hum is obtained and complete isolation from the equipment circuit is achieved; second, it can be applied externally and tested for effectiveness. This circuit is also useful in emergency situations where the test setup has so much interference, from the ever-present a.c. potential, that measurements or other results are jeopardized.

It is often difficult to locate the exact point at which 60 cycles or a harmonic of 60 cycles is entering an amplifier circuit. This method facilitates locating the pickup point and applying the necessary correction.

Good results have been achieved in about 90 per-cent of the cases where it has been tried. The technique was used successfully on an audio generator which was unstable near 60 cycles or multiples of 60-cycle outputs. It enabled a frequency of 60.1 cycles to be produced without any of the previous jockeying to 60 cycles. It also cancelled the off-scale reading of an a.c. v.t.v.m. on the .01-volt full-scale position, when the meter was not connected to any circuit. This circuit is effective on some high-fidelity preamps but not effective on others. In recording on tape, it has helped most setups.

Different values of resistance from that shown in the diagram can be tried along with different capacities. It is desirable to use mica capacitors exclusively in this application because of their better leakage factor. Paper 600-volt capacitors will work, however, if they must be used. One thing to note is that a potentiometer across the 117-volt supply must have a high enough wattage rating to stand the load drawn. With the one-half-watt volume-control-type pot, about 50,000 ohms is the lowest feasible value. Anything up to 250,000 ohms will usually work in this circuit.

The values shown in the diagram have been found to be suitable in most cases. In use, of course, the technique involves variation of the potentiometer setting until the point of least hum pickup is found.

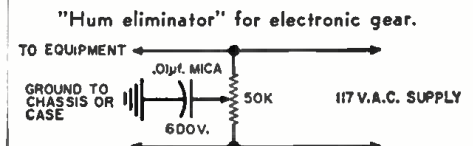

ELECTRONICS WORLD

“ THE CITATION SOUND ” “...FOR THE SAKE OF MUSIC AND OUR DEMANDING LOVE OF IT.”

“Over and above the details of design and performance, we felt that the Citation group bore eloquent witness to the one vital aspect of audio that for so many of us has elevated high fidelity from a casual hobby to a lifelong interest: the earnest attempt to reach an ideal—not for the sake of technical showmanship—but for the sake of music and our demanding love of it.”

Herbert Reid, Hi Fi Stereo Review

A truly remarkable commentary about a truly remarkable group of products—the Citation Kits by Harman-Kardon.

Mr. Reid's eloquent tribute to Citation is one of many extraordinary reviews of these magnificent instruments. We are proud to present a brief collection of excerpts from Citation reviews written by outstanding audio critics.

“When we first heard the Citations our immediate reaction was that one listened through the amplifier system clear back to the original performance, and that the finer nuances of tone

shading stood out clearly and distinctly for the first time . . . The kit is a joy to construct.”

C. G. McProud, Editor, Audio Magazine

“The unit which we checked after having built the kit, is the best of all power amplifiers that we have tested over the past years.”

William Stocklin, Editor, Electronics World

“Its listening quality is superb, and not easily described in terms of laboratory measurements. Listening is the ultimate test and a required one for full appreciation of Citation . . . Anyone who will settle for nothing less than the finest will be well advised to look into the Citation II.”

Hirsch-Houck Labs, High Fidelity Magazine

“At this writing, the most impressive of amplifier kits is without doubt the new Citation line of Harman-Kardon . . . their design, circuitry, acoustic results and even the manner of their packaging set a new high in amplifier construction and performance, kit or no.”

Norman Eisenberg, Saturday Review

PRESENTING THE NEW 1961 CITATION LINE

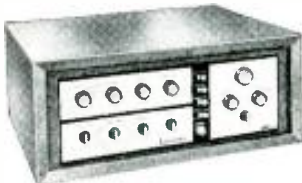

**The CITATION I,
Stereophonic Preamplifier Control Center**

The many professional features and philosophy of design expressed in Citation I permit the development of a preamplifier that provides absolute control over any program material without imparting any coloration of its own. The Citation I—\$159.95. Factory Wired—\$249.95.



**The CITATION II,
120 Watt Stereophonic Power Amplifier**

Will reproduce frequencies as low as 5 cycles virtually without phase shift, and frequencies as high as 100,000 cycles without any evidence of instability or ringing. Because of its reliability and specifications the Citation II has been accepted by professionals as a laboratory standard. The Citation II—\$159.95—Factory Wired \$229.95.



**The CITATION III,
Professional FM Tuner**

The world's most sensitive tuner. But more important—it offers sound quality never before achieved in an FM tuner. Now, for the first time Harman-Kardon has made it possible for the kit builder to construct a completely professional tuner without reliance upon external equipment.

The Citation III's front end employs the revolutionary Nuvistor tube which furnishes the lowest noise figure and highest sensitivity permitted by the state of the art. A two-stage audio section patterned after Citation II provides a frequency response three octaves above and below the range of normal hearing. The Citation III is styled in charcoal brown and gold to match all the other Citation instruments. The Citation III—\$149.95—Factory Wired—\$229.95.

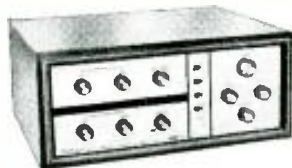

**The CITATION IV,
Stereophonic Preamplifier Control Center**

A compact stereophonic preamplifier designed in the best Citation tradition. It offers performance and features rivaled only by Citation I. The control over program material provided by the new Citation IV enables the user to perfectly recreate every characteristic of the original performance. The Citation IV—\$119.95—Factory Wired—\$189.95.



**The CITATION V,
80 Watt Stereophonic Power Amplifier**

A compact version of the powerful Citation II. Designed with the same lavish hand, it is conservatively rated at 40 watts RMS per channel with 95 watt peaks at less than 0.5% distortion. The availability of rated power at the extreme ends of the frequency range enables the unit to effortlessly drive the most inefficient speakers. The Citation V—\$119.95. Factory Wired—\$179.95.

For complete information on the new Citation Kits, including reprints of independent laboratory test reports, write to: Dept. EW-4, Citation Kit Division, Harman-Kardon, Inc., Plainview, New York.

All prices slightly higher in the West.

CITATION KITS by

harman kardon

LEKTRON'S celebrating its anniversary with a GIANT



BIRTHDAY GIFT SALE!

OFFERING NOT 1, NOT 2, NOT 3, but



OF OUR POPULAR POLY PAKS combined in **BIRTHDAY PAK***

GIVEN FREE with ea \$15 order

*Our Birthday Pak will include 400 pcs. of ceramics, discs, tubulars, resistors!

60 RADIO 'N' TV KNOBS

Ass't colors, sizes, shapes; some worth \$1 each. Worth \$1

1 1/2 LBS. HARDWARE
Screws, bolts, etc. Wide variety. Handy shop asst. Worth \$1

40 Two-Watt Resistors
Incl. 1% tolerance. Ass't. values. Worth \$1

40 Transistor Resistors
Ass't. to 3 megs. 1% watt rating. Color coded. Worth \$5

2000 OHM PHONE
With cord & plug. Hearing aid type, with ear loop. Worth \$1

CRYSTAL PHONE
Sens-itive! 100's trans. Star prof., wired & plug. Worth \$1

\$25 SURPRISE PAK
Wide variety of usable radio-TV-hobby parts \$1

10 RCA PLUG-N-JACK
Sets for amps, tuners, recorders, etc. Worth \$2

40 TUBE SOCKETS
1 to 12 prongs, some ceramic & mica filled, & metal types. Worth \$8

3 HOBBY TRANSISTORS
PNP's, etc. Similar to CK-722. Worth \$3

10 "POLY" BOXES
Snap-on covers; sizes to 1". For parts & radio tests. Worth \$1

60 Plugs & Receptacles
Incl. power, audio, battery, etc. Worth \$8

100 Ceramic Condensers
Incl. discs, too. Wide variety of types & values. Worth \$10

12 GERMANIUM DIODES
Glass-sealed, similar to 1N41 hobbyists note! Worth \$1

100 Half Watt Resistors
Pop. ass't. values. Some 1% too. Worth \$18

35 POWER RESISTORS
Ass't. 1/2 to 50W. 100-1000 ohms. Vitreous types, too. Worth \$12

70 MICA CONDENSERS
Incl. silver, and .001 to .025 to .01 in. 600V. Worth \$20

10 Electrolytic C'nd'n'rs
Incl. can & paper types. Dials from 10 to 1000 mfd to 150 V. Worth \$12

70 Tubular Condensers
Paper, multi-disc, mica, ceramic. Dials to 1 mfd to 600V. Worth \$10

30 SILVER MICAS
1 & 2% ass't. values. Finest micas made. Worth \$8

300-FT. HOOKUP WIRE
Ass't. colors, insulation, sizes. Worth \$5

2 PNP's

2 power transistors. \$1

60 TERMINAL STRIPS
1 to 19 for points. Used in every type of shop asst. Worth \$5

70 COILS & CHOKES
RF, ant. (see shop asst. Worth \$16

70 One-Watt Resistors
Carbo-films, 1 & 5% 1/2 watt. Worth \$20

65 Condenser Special
Incl. discs, ceramics, mica, paper, oils, etc. Worth \$12

15 ROTARY SWITCHES
Ass't. gangs, contacts for power & control changing. Worth \$17

50 DISC CONDENSERS
Ass't. values, 10 to 1000V. Worth \$10

4 Output Transformers
1 to 19 for various types. Worth \$8

2 NPN TRANSISTORS
Worth \$2. 100's of uses. \$1

10 115 VAC SWITCHES
Toggle type, SPST, DPDT, etc. A shop must have! \$1

Transistor Radio Basic
Incl. transistor, socket, loop-leads, diode. \$1

70 Insulated Resistors
IRC, Allen Bradley, Stackpole, makers. 2 1/2W. 100 ohms to 1 meg. 1% to 5% too. Worth \$15

10 PANEL SWITCHES
Merits, toggle, rotary types, 1SP, variety. Worth \$10

65 RESISTOR SPECIAL
Carbon, precision, 1/2 to 50W, 1% too. Worth \$10

10 VOLUME CONTROLS
Ass't. to 1 meg. Some with switch. Worth \$15

15 AC-DC LINE CORDS
2-conductor with molded plugs, rubber insulated short lengths. \$1

30 PRINTED CIRCUITS
Combination resistor & condenser coupling networks for submini. work. Worth \$15

50-PC. COBALT MAGNET
SPT for 100's of magnetic hobbys. For home & shop. too! \$1

2 SUN BATTERIES
For 100's of the best five pins, 241" size. Unmounted. Worth \$4

8 Transistor Sockets
Fit all types of transistors, inc. \$1

NEW DISTRIBUTOR FLIERS

Seasonal fliers, announcing latest products and special bargains in components and electronic equipment, have been issued by three major mail-order houses. From *Lafayette Radio*, 165-08 Liberty Ave., Jamaica 33, N.Y. comes Catalogue 612, containing 64 pages. *Olson Radio*, 260 S. Forge St., Akron 8, Ohio has published a 32-page issue, designated as Catalogue 161. *Radio Shack Corp.*, 730 Commonwealth Ave., Boston 17, Mass. has released its 40-page flier, Catalogue No. 102.

For a free copy of any of these publications, write to the respective company.

NEW RCA PUBLICATIONS

Radio Corporation of America, Commercial Engineering, Semiconductor and Materials Division, Somerville, N.J. has issued two application booklets on transistors, and two for new tube types.

Application Guide No. 1CE-215 describes the special features and use of 16 RCA medium-power, intermediate-power, and high-power silicon transistors. Copies of this booklet may be obtained from the company's distributors or by sending 50 cents to the manufacturer.

Application Guide No. 1CE-228 describes the unique capabilities of RCA silicon v.h.f. transistors. These units—types 2N1491, 2N1492, and 2N1493—are intended for use in critical industrial and military applications at frequencies up to 300 mc. Copies may be obtained from distributors or by sending 50 cents to the manufacturer.

Application Note AN-189 describes two complements of newly developed tubes specially designed for series-string applications in either 4-tube or 5-tube home radio receivers. In addition, the Note describes and evaluates an experimental 4-tube economy receiver using a new 100-ma. complement consisting of tube types 18FX6, 20EQ7, 50FK5, and 36AM3-A.

Application Note AN-190 describes the performance of three recently developed power-output tubes. These tubes—types 34GD5, 50FK5, and 60FX5—are high-power-sensitivity miniature types especially designed for use in series-heater-string circuits operating at a total heater voltage of 120 volts and heater current of 100 ma. This Note also describes and evaluates the performance of three series-string stereo amplifiers utilizing the new tubes. These amplifiers provide maximum power outputs ranging from 1.0 to 1.25 watts per channel.

Copies of the Application Notes may be obtained from the manufacturer.

LEE CATALOGUE

Lee Electric, Inc., 566 52nd St., West New York, N.J. has issued a new catalogue, available to the trade, covering signaling devices, transformers, push-buttons, and other devices.

WIRE BOOKLET

Anaconda Wire & Cable Co., Dept. EFL, 25 Broadway, New York 4, N.Y. has published a 12-page booklet containing condensed data on the complete line of electronic hook-up wire manufactured by *Sequoia Wire & Cable Co.*, a new subsidiary.

For a copy of the booklet (DM-S-6014), write direct to the manufacturer.

OPTICAL MASERS

Bell Telephone Laboratories, Inc., Murray Hill, N.J. has announced a booklet describing the theory and design of the solid-state optical maser. Copies may be obtained by writing to H. W. Mattson at the laboratories.

MULLARD PUBLICATION

Mullard International Electronics Corp., 81 Spring St., New York 12, N.Y. has announced that copies of issue No. 45 of its publication "Mullard Technical Communications" are available on request.

The articles in this issue describe new developments in transistor-resistor logical circuits; a new approach to the design of ferrocube cores for wide-band h.f. transformers; a three-watt tape amplifier circuit; and transistor circuits for magnetic matrix stores.

SEMICONDUCTOR PACKAGES

Frenchtown Porcelain Co., Frenchtown, Pa. is offering its Bulletin 1060 free on request to its sales department. This bulletin contains information on tunnel diode enclosures and insulated stud-type diode mounts.

Included is data on two bodies: Amadox R 4462, and Body 787.

ERA BOOKLET

The Electronic Representatives Association, 600 So. Michigan Ave., Chicago 5, Ill. has published a brochure entitled "The Right Return," which describes some 15 current services and activities as well as future projects of the ERA.

The booklet is intended to aid ERA Chairman Joseph Marsey, and the various membership chairmen of ERA's 21 local chapters, in reaching their 1961

BUY 'EM BY THE POUND JUMBO PAKS!

1 lb. Precision Resistors, worth \$100, NOW \$100 per lb.
 1 lb. Disc Condensers, worth \$50, NOW \$50 per lb.
 1 lb. Ceramic Condensers, worth \$85, NOW \$85 per lb.
 1 lb. Discs & Ceramics, worth \$75, NOW \$75 per lb.
 1 lb. Discs, Ceramics, Precision \$70, NOW \$70 per lb.

BUY 4 PAKS & PICK 5th FREE

400-1000 pcs. per pound
 COMPLETE SATISFACTION—MONEY BACK GUARANTEE

LEKTRON 243 EVERETT AVE. CHELSEA 50, MASS. Write for free catalog.

HOW TO ORDER: Avg. wt. per pak 1 lb. Return ad with check or M.O. including postage; excess returned. C.O.D. orders, 25% down; rated, net 30 days. Include Postal Zone in address. CLIP OUT & MAIL!

goal of 825 members. The organization now has 752 member firms, which represents a growth from 1959's total of 624.

SERVICING DATA

Supreme Publications, 1760 Balsam Road, Highland Park, Ill. announces it is now maintaining a complete library and file of other publishers' material and factory data covering radio and TV sets of all makes.

Charges for the material range from 40 cents to \$1.00, depending on the number of pages involved. For additional information as to which schematics are available, write to the company. Give complete details on the make, model number, and year of the set in question.

TUBE DIRECTORY

Metropolitan Supply Co., 1133 Broadway, New York 10, N.Y. is offering a complete directory of electron tubes, listed by tube number and followed by the firm's price. For a free copy, write to the company on your own letterhead.

THYRATRON BULLETINS

CBS Electronics, Information Services, 100 Endicott St., Danvers, Mass. has published two new bulletins in its "Tech Tip" series. Bulletin PA-223 is entitled "Thyratrons Are Different" and Bulletin PA-503, "The Care and Control of Thyratrons."

Both bulletins are available through the firm's distributors or from the manufacturer direct.

RELAYS CATALOGUE

Potter & Brunfield, Princeton, Indiana, announces a 16-page, 2-color catalogue showing its complete line of electro-magnetic relays. Forty-two different series of relays are described. They are divided into four major groups: telephone, military, power, and general purpose types.

Copies of the catalogue are available free from company sales representatives or from the manufacturer's Technical Information Center.

LOUDSPEAKER STANDARD

The American Standards Association, Dept. PR 198, 10 E. 40 St., New York 16, N.Y. is offering, at \$1.20 per copy, its new "IEC Publication 124: Recommendations for the Rated Impedances and Dimensions of Loudspeakers." This publication applies to single moving-coil (dynamic) loudspeakers of the direct-radiator type.

P-C RESISTORS

Reon Resistor Corp., 155 Saw Mill River Rd., Yonkers, N.Y. is offering free a two-page bulletin describing a complete line of encapsulated printed-circuit type resistors. Write to the manufacturer, requesting Bulletin P-3-7/60.

SEMICONDUCTOR DIRECTORY

Newark Electronic Corp., 223 W. Madison St., Chicago 6, Ill. has issued a 24-page industrial electronic parts directory, geared specifically to the

April, 1961

Get ALL Basic Color-TV Test Patterns From This ONE Low-Cost Generator



RCA WR-64A

COLOR-BAR / DOT / CROSSHATCH GENERATOR

Here is the low-cost, lightweight, high-quality instrument that gives you all essential Color-TV test patterns; Color-bar signals for checking, adjusting and troubleshooting Color-TV circuits; dot and crosshatch pattern signals for adjusting convergence in color receivers and for adjusting linearity and overscan in either color or black-and-white receivers. Designed for in-the-home or shop servicing.

ONLY **\$189.50***

*User Price (Optional)

SIMPLICITY: Only three operating controls! Provides RF output... connects directly to antenna terminal of receiver. No external sync leads needed.

STABILITY: Crystal controlled signals assure accuracy and dependability. Patterns are rock-steady, free from "jitter" and "crawl".

PORTABILITY: Weighs only 13 pounds. The ideal test instrument for proper in-the-home color-TV adjustment and servicing.

FLEXIBILITY: Extra wide range on chroma control... "standby" position on function switch... fixed number of dots and bars... "on-off" control on sound-carrier.

GENERATES:



Color-Bar Pattern... Ten bars of color including R-Y, B-Y, G-Y, I and Q signals spaced at 30° phase intervals for checking phase and matrixing, and for automatic-frequency and phase alignment.



Crosshatch Pattern... A crosshatch of thin sharp lines for adjusting vertical and horizontal linearity, raster size, and overscan. Dot Pattern (not illustrated) permits accurate color convergence.

GET ALL THE FACTS ON THE NEW RCA WR-64A

RCA Electron Tube Division
Commercial Engineering, Dept. EW
Harrison, N. J.

Please send me your folder (1Q1017) on the new RCA WR-64A Color-Bar/Dot/Crosshatch Generator.

Name _____ Title _____

Company _____

Address _____

City _____ Zone _____ State _____

-----Or see it at your Authorized RCA Test Equipment Distributor-----



The Most Trusted Name in Electronics
RADIO CORPORATION OF AMERICA

SURPLUS

SILICON RECTIFIERS. All rectifiers listed at maximum peak inverse voltage ratings; approximate forward voltage drop, 1.5 volts.

1N1446	.750 amp.	100 volts	.65
1N1447	.750 amp.	200 volts	.75
1N1448	.750 amp.	300 volts	.85
1N1449	.750 amp.	400 volts	1.00
1N1551	1 amp.	100 volts	.80
1N1552	1 amp.	200 volts	.95
1N1553	1 amp.	300 volts	1.10
1N1450	5 amp.	100 volts	1.00
1N1451	5 amp.	200 volts	1.25
1N1452	5 amp.	300 volts	1.50
1N1453	5 amp.	400 volts	2.00
1N1454	25 amp.	100 volts	3.00
1N1455	25 amp.	200 volts	3.50
1N1456	25 amp.	300 volts	4.50
1N1458	35 amp.	100 volts	3.50
1N1459	35 amp.	200 volts	4.00
1N1460	35 amp.	300 volts	4.50
1N1461	35 amp.	400 volts	5.00
1N0597	50 amp.	50 volts	6.00
1N1462	50 amp.	100 volts	7.00
1N0597	75 amp.	50 volts	9.00
1N1466	75 amp.	100 volts	10.00
1N1467	75 amp.	200 volts	11.00
1N1468	75 amp.	300 volts	12.50
10T7	100 amp.	100 volts	13.00
00T7	100 amp.	150 volts	13.50
1N05V7	150 amp.	50 volts	16.50
1N1474	150 amp.	100 volts	17.00



ARC 1 TRANSCEIVER (RT-18/ARC-1)

Complete with tubes, 24 volt dynamotor, and mounting rack. Frequency range 100-156 mc. Provisions are made for the remote selection of a two-way operating frequency which may be any one of nine pre-set frequencies in the band or a guard-channel frequency which is fixed within a restricted band. Used, in good condition.

PRICE \$25.00

X-BAND POWER LEVEL TEST SET, TS-36/AP

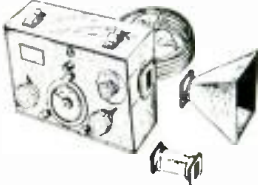

Brand new, in original packing, with accessories. Measures 10 to 30 dbm, 8700-9500 mc.

PRICE \$14.95 each

SIGNAL GENERATOR I-130-A

Frequency range 100-156 mc. Modulation frequency 1000 cycle. Output: variable 0-5000 microvolts. Excellent condition.



PRICE \$12.95 each

FIELD STRENGTH METER I-95-A

100-156 mc. Designed to register voltage induced in its variable length antenna.



PRICE \$9.95 each

IDEAL STRIPMASTER WIRE STRIPPERS

Like new condition. For use on wire sizes 16-26 ga. Regular list \$8.95 each.

PRICE \$1.95 each



Strippers for use with Teflon wire 16-26 ga.

PRICE \$2.95 each



TS-102/AP RANGE CALIBRATOR

This crystal controlled pulse generator produces a square-topped, 30-volt synchronizing pulse of .8 microseconds at a rate of 400, 500, 1000 or 2000 pps, and a triangular marker pulse of 0.1 microseconds duration at a rate corresponding to a pulse-repetition distance of 1500 ft. The phase between the marker and sync pulses is continuously variable from -180 to +180 degrees.

PRICE \$12.50 each

NO C.O.D.'S. REMIT FULL AMOUNT WITH ORDER.

C & H SALES CO.

2176 E. Colorado St. - Pasadena 8, Calif.

needs of the industrial semiconductor user, and now available to the general electronic industry.

Called "Semiconductor Directory No. 3," the publication lists the company's entire semiconductor stock.

NBS MEASUREMENTS HANDBOOK

Boulder Laboratories, National Bureau of Standards, Boulder, Colorado has announced publication of a handbook on precision measurement. It consists of three volumes, totalling almost 3000 pages and includes information on the measurement of such quantities as electricity, heat, optics, and radiation. Material for a large section on electronics was furnished by the NBS Radio Standards Laboratory in Boulder.

Advance orders for these volumes may be placed now with the Chief, Special Service Section, United States Government Printing Office, P. O. Box 1533, Washington 13, D.C. The cost of each book is: Vol. I, "Electricity and Electronics," \$6.00; Vol. II, "Heat and Mechanics," \$6.75; Vol. III, "Optics, Metrology, and Radiation," \$7.00.

AMP BULLETIN

AMP Incorporated, Harrisburg, Pa., has published a two-page product information bulletin (Series 701) to describe its line of high-voltage power supplies with output voltages of from 40 to 40,000 volts.

Specifications for a representative group of six of these power units are given. The data includes input, output,

ripple, regulation, temperature, size, weight, and special features.

INSTRUMENT TUBES

CBS Electronics, 100 Endicott Street, Danvers, Mass. has announced the availability of an 8-page booklet which describes the uses and characteristics of a new line of special instrument tubes.

In addition to these ruggedized tubes, the brochure describes frame-grid tubes and a new secondary-emission tube.

For a free copy of this publication, write the manufacturer on your business letterhead and ask for Bulletin PA-391.

NBS' SERVICES DATA

National Bureau of Standards has recently published a 5-page booklet entitled "Standard Frequencies and Time Signals from NBS Stations WWV and WWVH."

Publication 236 is available for 10 cents from Superintendent of Documents, U.S. Govt. Printing Office, Washington.

WALSCO CATALOGUE

Walsco Electronics Mfg. Co., Rockford, Illinois has just published a 68-page guide to its service products for the electronic industry.

The catalogue contains complete descriptions of phono drives, exact replacement transformers, tools, chemicals, and electronic hardware. For a copy, write the company and ask for Catalogue FR-61-W.

There is always an avid audience on hand for each TV program scheduled for transmission in Nigeria. Here a group of friends and neighbors have gathered in anticipation of an evening's entertainment. Although there are only about 6000 TV sets in use, the actual viewing audience in the region may be on the order of 100,000 or more. It is not uncommon for crowds up to 100 to assemble before sets on display and family gatherings of 20 are commonplace in homes where TV is on. There are also "TV Shops" where the owner of the set makes a small charge for viewing. The government has arranged for its employees to obtain loans for the purchase of sets and many commercial firms in the area have similar arrangements. Some distributors also have easy-payment schemes. TV programs are transmitted for about five hours daily. This includes two hours of public-service material, of which one hour is devoted to special educational material. Programming is to be increased.



Tape Recording in Industry
(Continued from page 64)

gages. The other two would simply be a repeat of the methods used for the first strain-gage channel. Often, because of brush noise or bounce in the slip-ring unit, the signal may be of such inferior quality that filtering and other methods may be needed to obtain any usable information. However, valuable information can usually be obtained except in cases of complete failure of the gages themselves.

Fig. 8C is an example of a photographic X-Y plot of the vibration channel. This is made in exactly the same manner as the strain-gage plots. Determining the frequency of the vibration points presents a much more complicated problem since vibration signals are usually a combination of many frequencies. It usually suffices to locate the frequency band in which most of the signal lies. This is accomplished with a variable bandpass filter by boxing in the point while a series of playbacks are made. In the majority of cases the energy will lie in a band of a few hundred cps. Occasionally, a predominant fundamental frequency will occur in a test which makes the job much easier since conventional means can be used to determine frequency.

Temperature and pressure signals are simple to reduce since they are taken directly from the FM channels and connected to the X-Y plotter. Once the input levels on the plotter are adjusted to the calibrate signals, it will trace out the information in one play of the tape. Figs. 8E and 8F illustrate what this information would look like. Note that compressor wheel rpm is used for the X axis in both cases.

At times it is useful to know the acceleration time for any point during the test run. The time-pulse generator would be used for this purpose by applying timing markers to the tape during the run. The timing mark would be placed on one channel of the dual-beam oscilloscope during the photographic plot for a ready timing reference.

Another feature of the tape recorder that is important in data reduction is the ability to slow down the tape speed in order to better examine fast time response information. In this case, frequency will be an even multiple of tape speed while the calibrate signal for amplitude will serve the same function as it would for the original recording speed. This technique is very useful in oscilloscope photography.

Thus we can see the large variety of information that can be gathered and reproduced by the instrumentation tape recorder. This data, once recorded, can be stored indefinitely and is a ready reference that can be called upon at any time to reproduce the original test conditions. Judging from recent improvements made in tape recorders, the surface would hardly seem to be scratched in producing new uses for this versatile machine.

Now... assemble the finest:
A Professional Quality
CUSTOMIZED
TV KIT

ON EASY
"PAY AS YOU WIRE" TERMS *

- ☆ Designed for the perfectionist seeking maximum performance.
- ☆ Easy to assemble; no technical knowledge required.
- ☆ An ideal "Learning" Kit with a complete Course of Study is available.

Professional Quality Features

The Transvision "Professional" Model TV Kit (or Assembled Chassis) is designed to satisfy those video-and-audiophiles who seek the best possible performance of which the art is capable. Nevertheless, the kit builder can assemble this chassis for less than the cost of an ordinary receiver.

Note these unique features:

- Hi-Fi Audio (with 2 EL-84 output tubes, oversize audio output transformer, Woofer-Tweeter Speaker System with heavy magnets and crossover; Extended Range Tone Control).
- Ultra-linear sweep circuits; D.C. restoration; Standard Coil Guided Grid Turret Tuner with provisions for UHF and special low noise tubes; 4 megacycle picture bandwidth; 10 microvolt sensitivity.
- Heavy-duty power supply (power transformer, two low voltage rectifier tubes — no silicon rectifiers).

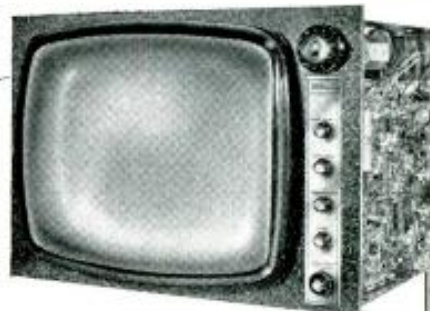

The TRANSVISION
"Professional"

* Only \$15 for the Starting Package!
ALSO AVAILABLE AS AN ASSEMBLED CHASSIS
for custom installations

- Heavy-duty ruggedized construction, no printed circuits; built to give trouble-free performance for many years.
- Includes newest reflection-free 23" tube with bonded face, or the 24" or 27" CRT.
- Selected because of superior performance for use in Educational TV by over 3000 schools and colleges and U.S. Armed Services.

Interested in Electronics?

Learn the basic principles of electronics from the Complete Course of Study which is available with the Kit.



As a preliminary, order the Assembly Instructions for only \$2.00; to be refunded if you purchase kit.

TRANSVISION

NEW ROCHELLE, N. Y.

Pioneers in Television Kits

NEW Rochelle 6-6000

----- START NOW --- MAIL THIS COUPON ----- Dept. EW

- TRANSVISION, New Rochelle, N. Y.
- Send Free 8-page Catalog Enclosed is \$2. for Assembly Instructions so that I might see how easy it is to assemble the Transvision Kit. I understand that this will be refunded if I purchase a kit.
- Enclosed is \$15 for the Starting Package. I understand that I can buy packages one at a time as I wire. (Models range from \$119 to \$199.)

Name..... Address.....
City..... Zone..... State.....



YOU'LL BE AMAZED...

of our low, low hi-fi prices. Write for FREE discount catalog A-12, or send for our special quotations on your component needs.

KEY ELECTRONICS COMPANY
120 LIBERTY ST., NEW YORK 6, N. Y.

PRECISION RESISTORS

Carbon deposit precision resistors
Hi Stability—Low Loss—Guaranteed 1% Accuracy—Most Ohmages Available

prices 1/2 Watt 5c
1 Watt 8c
2 Watt 10c

Immediate Delivery
R. C. CAGAN SALES
PO # 1152, Rochester 3, N. Y.

ENGINEERING DEGREE IN SCIENCE MATH 27 or 36 MOS.



B.S. degree - 36 mos. • B.E. degree - 27 mos. Accelerated year-round program prepares for early employment in fields of Science and Engineering. Regular 4-year program for B.S. Degree completed in 36 months. special engineering degree program in 27. Classes start - June, July, September, January, March. Quality education. Graduates employed from coast to coast. Government approved for veteran training. Students from 30 states, 40 countries. 20 buildings; dorms, gym, Campus. Save time and money. Earn board while studying. Write for catalog and complete information.
941 E. Washington Blvd., Fort Wayne 2, Indiana

INDIANA TECHNICAL COLLEGE

U.S. #1 ELECTRONICS

a division of AMBER INDUSTRIAL CORP.

1922 E. EDGAR ROAD (Right on Highway U.S. 1) LINDEN, N. J.—across from ESSO RESEARCH LABS

PLENTY OF FREE PARKING!

30 minutes by Public Service from N. Y. C.

TERRIFIC BARGAINS! GO-9 Xmttr, 100 w. 0.3-18 mcs. BRAND NEW..... only \$59.50

BC-603 RCVR L/New	17.95
BC-604 XMTR W/Tubes, New	8.50
FT-237 Mount for above, used	3.50; new 5.50
BC-458 5.3-7mc W/Tubes, New	7.50
SCR-522 XCVR W/Tubes Exc.	22.50
BC-1206 Beacon RCVR W/Tubes	8.95
BC-620 Tranceiver, used	10.95
BC-659 Tranceiver, used	10.95
PE-120, PE-117— Vib. power sup. for BC-620, 659	3.45

R-8/ARN-8—75mc beacon xcvr w/tubes 6.00
AN/CRY-1—Sonobuoy 70-90 mc new 12.95
RT45/ARQ-1—Rec-xmtr, 14-50 mcs, w/ counter and 0-200 ma meter; 80 or 115v, 400-2500 cps.....NEW 34.50

BC-375—xmtr, 100 w..... used	12.50
DM-21—12v. \$5.95	DM-28—28v. 3.75
DM-34—12v. 5.00	DM-36—28v. 4.95
DM-35—12v. 7.95	DM-37—28v. 5.95
PE-98—12v. 9.95	PE-94—28v. 7.95
PE-103—6/12v. to 500v. @ 160 ma.	\$14.50
BD-77—12v. to 1000 v. @ 350 ma.	12.95
PE-73—28v. to 1000v. @ 350 ma.	12.95
800-1—24v. dc to 115 ac 400 cps 1kva	9.95
DY-17—27v. dc to 750v. 350 ma. exc.	12.95
PE-237—vib. power sup. 6/12/24v. exc.	12.95
T-26 Mobile Chest Mike, New, 1.00 ea.	2/1.75
HS-30 Headphones, new ... 1.50 ea.	4/ 5.00
TS-9 Handsets, new	3.75
TS-11 Handsets, new	3.95
TS-13 Handsets, new	4.25

WRITE FOR QUANTITY PRICES
THOUSANDS OF ITEMS—
THOUSANDS OF BARGAINS!

25% deposit on C.O.D. orders—Minimum order \$5.
All Prices for Linden, N.J. Prices subject to change without notice.

Mac's Service Shop (Continued from page 60)

monkey on a stick trying to locate the non-existent short circuit in his control cable," Mac agreed. "Probably he would finally decide it *had* to be inside the rotator and take it down. I should think changing rotators on a beam that size is a little different than changing rotators on a TV antenna."

"And you're so right! I knew better than try to do it myself or even with other ham help. Two antenna specialists used a sixteen-foot gin pole clamped to the telephone pole and carrying a block and tackle at the top. One guy worked on top of the pole, and the other stood on the ground and did the lifting and lowering of the beam with a long rope. Even so, I chewed my fingernails down to the first joint just watching them." "Well, the important thing is you finally whipped all your problems," Mac said with a sigh. "I wish I could say the same about my problems with printed circuits."

"What's wrong now? I thought you were getting pretty hot on the Tinfoil Terrors."

"Oh I'm getting better," Mac said defensively; "but lately I've run into a rash of printed circuit a.c.-d.c. sets with a most annoying form of intermittent. They develop noise along with changes in volume when they're in the cabinet;

but take that board out of the cabinet and the set may play all day without a bobble. Inside the cabinet, expansion produced by heat or mechanical stresses induced in the board by the supports cause the edges of a microscopic fracture of a printed lead to pull apart just enough to inject varying resistance, causing erratic performance.

"Not once have I been able to spot one of these tiny breaks with light shining through the board, with the illuminated magnifier, with the freon gas spray, with the heat lamp, or with any of the other dodges that are usually successful in pinpointing more clean-cut fractures. Tapping on the board or flexing it just *anywhere* will usually make a change in the noise level, but of course that is no help in isolating the break."

"So what system have you worked out to lick 'em?" Barney asked.

"Let's be accurate and say to *help* lick 'em," Mac answered with a wry smile. "First I know that printed leads are most likely to break around the edges of the board, in the vicinity of the tuning capacitor or the volume control, near any large heavy object mounted on the board, or close to support points. I concentrate on leads in these areas with a pair of sharp-pointed prods connected together with a test lead. While the noise is going or the volume is down, I span a considerable length of a suspected conductor with the prods. If this stops the noise or restores the volume, I move the leads closer together. The

We Trade Higher!



See How Walter Ashe
Always Saves You
More on Amateur
Equipment, Hi-Fi Systems,
Parts and Supplies
... everything you need!

FREE NEW 144-Page Walter Ashe Catalog

Get our "Surprise" Trade-In allowance on any new 1961 equipment ... yours on Walter Ashe's famous E-Z Terms! Ask for our reconditioned list, too!

*On Amateur and Recrds. made since 1945

RUSH COUPON—You'll hear from us double quick ...

Phone:
CHestnut 1-1125

WALTER ASHE RADIO CO.
Dept. R-4-61
1125B Pine St.
St. Louis 1, Mo.

WALTER ASHE RADIO COMPANY
Dept. R-4-61, 1125B Pine Street, St. Louis, Missouri

I am interested in _____

What is the Ashe "Surprise" allowance on _____

Name _____

Address _____

City _____ Zone _____ State _____

Send 1961 Catalog Send Reconditioned Bulletin

RADIO PARTS STORES & HI-FI SALONS!

Hundreds of dealers across the nation profit by selling **ELECTRONICS WORLD** each month to their customers. Are you one of them? **ELECTRONICS WORLD** helps build store traffic ... keeps customers coming back month after month for the merchandise you sell—and, best of all, you earn a neat profit on each copy sold—No RISK INVOLVED.

So get details on selling **ELECTRONICS WORLD**, the world's largest selling technical electronics magazine. Or, order your copies now. Just use the handy coupon.

Retail Sales Department
Electronics World
One Park Avenue
New York 16, New York

Att: Jerry Schneider

Send me copies of **ELECTRONICS WORLD** for resale in my store each month. No risk involved on my part.
 Send me details on selling **ELECTRONICS WORLD** in my store.

STORE NAME _____

ADDRESS _____

CITY _____ ZONE _____ STATE _____

SIGNATURE _____

EW 461

process is continued until I eventually have the poor connection bracketed between the test prods resting quite close together. Then I simply run solder along the lead between these final test prod positions. I don't even bother to try to see the tiny crack I know is there."

"I'd think it would be a little tricky being sure you didn't get those shorting prods across two separate conductors," Barney suggested.

"True, but then a good technician is always careful about where he touches his test prods. Experience has taught me a very high percentage of these troubles are caused by a break in the ground lead that runs around the edge of the board with conducting fingers going in to sockets and other ground potential points. Checking this lead out first, in the last three cases I've managed to run down the trouble and correct it in just over twenty minutes per set—which is about par for printed circuit intermittents in my book. The best part of this method is that when you can make the trouble go and come by bridging a section of a conductor with your probes, you're *sure* you've located the trouble—and that means a lot in time saved and peace of mind when working with intermittents."

"You can say that again!" Barney heartily agreed. "Working with intermittents is like spelling 'banana': the trick is to know when you're through. Bananananana—"

"Enough!" Mac interrupted. "I get the idea. And now that we've given our personal problems a good airing, let's get back to work. I'd like to take off a little early this evening and drive past a certain mushroom spot I know. If you think you can keep that big flannel Irish mouth of yours shut, you can go along."

Barney pressed his lips tightly together and made a sign of agreement as he grabbed up his solder gun. —30—

METER SHIELDS FROM OLD SETS

By KENT A. MITCHELL, W3WTO

DON'T be in too great a hurry to turn down any offers of old radio sets made by your non-electronic-minded friends. Many old radios of the 1930's contain parts which are usable in unique applications.

The accompanying photograph illustrates one such "find." Here three-inch diameter, solid-copper coil shields, salvaged from an old set, are perfect for meter shielding in r.f. circuits—sometimes necessary to prevent television interference.

In addition, the shields may also be used as coil shields or to house complete circuits in this age of miniaturization.

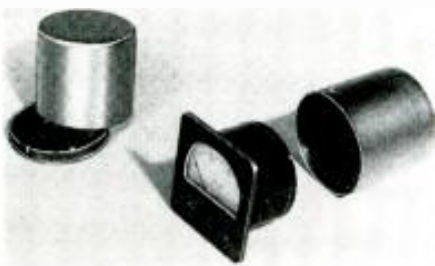

April, 1961

IF IT'S ELECTRONIC, GET IT FROM GOODHEART!

LATE-MODEL LOW-FREQUENCY MICROVOLTER

5C-44/URM-25 super-sensitive Signal Generators TS-317, TS-590/U, 10 kc to 50 mc in 8 ranges, all dial-calibrated, accurate to 1% with 1000 \times prox. 950 vernier dial divisions on logging scale for each band. VTVM and the multiplier calibrate output continuously 0.1 μ V to 0.1 V at 500 ohms, and second jack gives 2 V at high imped., both accurate to 10%. CW or internal modulation at 400 and at 1000 cy \pm 5%, or external mod. 100-15,000 cy is adjustable and read on VTVM. 0-80% mod. \pm 10%. Input 100-2420 V, 50-1000 cy, 1 ph. AC. Neat, compact, and lightweight. Only 10 1/4" x 10 1/4" x 13", including storage cover, all self-contained. \pm 35 lbs. in all new tubes, aligned, guaranteed, certified & guaranteed Perfect operating & calibration, with instructions, fob Los Angeles \$199.50

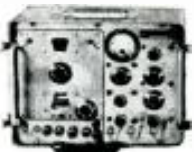

Time Pay Plan: \$49.50 down & 12 mos. at \$13.75. Letter-suffixed model of above has 1 mc crystal calib. osc. ckt., heating ckt., and vernier on the vernier to get accuracy 10 mc. & above, by interpolating between 1 mc zero-heat points. \$249.50
Time Pay Plan: \$62.50 down & 12 mos. at \$17.14.

RADIOMARINE CORP. COMMUNIC. RECEIVER

AR-8506-B, regularly \$690.00! 10-tube superhet 85-550 kc & 1.9-25 mc. AM CW & MCW. Input 115 V AC or DC. Clean, all new tubes, aligned, guaranteed w/instr. book, fob Charleston. \$135.00
Time Pay Plan: \$35.00 cash & 12 mos. at \$9.33.

RT-18/ARC-1

10-channel xtl-controlled Autotune xmit-rcvr 100-156 mc. Favorite for flight, now available to amateur. Export packed by NavAer in absolutely like-new condition. With schematic & instr. book, fob Corpus Christi, Texas. \$49.50



RADIO RCVR AND/OR SPECTRUM ANALYZER

AN/APR-4 Receiver Unit, ready to accept plug-in tuning units from 38 to 4000 mc. This is the 30-mc i.f. amp. with choice of 0.6 or 8 mc pass band, for communications or for Noise & Spectrum analysis. Has built-in 120 v. 60 cy power supply, Panadapter output, Video output, Phones outputs, S-Meter, BFO, and Volume control. DO NOT CONFUSE with the much earlier model APR-1; this is APR-4! Electrically checked and certified, less tuning units, 40 lbs fob Los Angeles \$69.50

Add \$25.00 ea. for electrically-certified TN-16, 17, & 18/APR-4; takes you 38-1000 mc. Add \$59.50 for electrically certified TN-19, 1000-2200 mc.
Time Pay Plan rcvr & T.U., 38-1000 mc as above, \$36.50 dn & 12 mos at \$9.90. To 2200 mc, \$54.00 down and 12 mos at \$13.75.

SCHEMATICS/CONVERSIONS, SURPLUS GEAR

Ask us for your needs: send stamped addressed envelope. Add 25¢ for chart explaining AN Nomenclature. Examples of available literature: 20-page book on i-17, with diagram of MX-949 U socket adapter, & tube data compiled to March 1957, \$5.00. RT-18 ARC-1 schem., & tune-up instr. \$2.00.



NAVY'S PRIDE COMMUNICATIONS RECEIVER

RBS, 2 to 20 mc, 14-tube Superhet made by Stromberg-Carlson to exacting Bu-Ships specs, strictly for communications. Low-pass filters cut off above 3500 cy, which is ideal for Voice and CW intelligence. Special Output Limiting ckt saves op's ears, keeps a 3 mw output same at 100,000 μ V as at 5 μ V, 4 bands. Vernier dial has 10-tube 0-1000 logging calibrator for each band; receiver divisions range from 0016 to .086 mc. Sensitivity 2.5 to 4.3 μ V. Average Selectivity: Signal 7.53 kc away must be 10 times as strong. Image and I.F. Rejection: Average 100 db. Has noise limiter, AVC-MVC, BFO, Pitch, RF & AF Gain controls, RF Mixer, 2 i.f.'s, are 125G7's. Osc., BFO, & 2nd AF are 125J7's. Det./Noise-limiter & AVC are 12A6's. 1st AF & AF Phons output (600 ohms) are 125K7 & 12A6. 8-watt AF output (600 ohms) is P-P 6V6's. Rect. is 5U4G. Input 115 V, 50/60 cy, 1 ph. Use your 8-watt-band rcvr for double-superheterodyning if you wish because i.f. is 1255 kc. Receiver is 35 lbs, 14" wd, 10" high. Per sp/AF amp. is 56 lbs, may be placed anywhere convenient and out of the way. In excellent used condition. Each has been put through a shop, checked out and aligned. Comes to you complete, ready to plug in and use. Perfect operation guaranteed. With schematic & instructions. Ship wt 120 lbs fob Charleston, S.C. A Best Buy! Only \$99.50
Time Plan: Order w/another item \$35 or more. Example: Add TS-34 (\$39.50), pay \$35 dn & 12 x \$9.53.

California Buyers Add 4% Sales Tax

R. E. GOODHEART CO. P. O. BOX 1220-A BEVERLY HILLS, CALIFORNIA

535% IMPROVEMENT FOR YOUR RECEIVER!



C. J. Riordan, radio op., Fla. Hwy Patrol wrote: "I . . . improved spurs, select. much more than that . . . tuning, new razor sharp. 7-tube superhet rcvr with RF conv., 2 stages 85 kc i.f., det/hbt, AF, & xirm-type pwr. sply ready to plug in and use. 190-550 kc includes your i.f. of 655 kc . . . so feed it into ant. of QX-535, add 2nd conversion! New, 15 lbs fob Los Ang. \$37.50 by RailEx only

BC-348 RECEIVERS

Exc. cond., unmodified, with schematics & ckt's for AC Power, Air Force's & NAF's old faithful superhet, 200-500 kc & 1.5-18 mc. 2 RF & 3 IF stages! FOB Los Angeles or Charleston. . . . \$69.50



TS-34/AP Test Scope is in use today in many Navy shops for general-purpose and radar service. Ready to use on 120 V, 50/60 cy. Sweeps 10-50,000 cy. Video flat 40 cy-21 mc, useful to 4 mc. Attenuators so accurate can use as VTVM. Has switch position in which each pulse to be studied, pos. or neg., triggers its own sweep, delays itself, then shows up station ary, 1 per sweep, with sweep duration choices of 5, 50, or 250 usecs. Ideal for TV pulses. Built-in lens enlarges 2 screens to 5" image; light shield shows vertical rises in carrying case. w/print of 17 book pages, less cords, checked for sweep & deflection. 50 lbs fob Los Angeles, only . . . \$39.50
(Add \$10.00 for set of cords & MV Probe.)

0.1% SORENSEN Line Voltage Regulator

=5000's. Brand new at low surplus price! Input 95-130 V, 1 ph., with taps for 50 or 60 cy. Use for any power up to 5000 watts. Output adjustable 110-120 V and holds to \pm 0.1%, at line frequency, or to \pm 0.25% if line frequency drifts 5%. Regulates against line changes of 95-130 V and against load changes from 0 to 5 KVA. Maximum harmonics less than 3%! Recovery time 0.15 seconds. Input to the control section can be moved to the point where you will use the power, thus compensating for line drop. In rack cabinet 28" h, 22" wd, 15" dp. Net wt 190 lbs. SHRP wt 285 lbs. FOB Utica, N. Y. In original factory pack, suitable for export, including SPARE PARTS group. Sorensen catalog net price is \$695.00 \$349.50 less spares. Our price. WITH SPARES. . . .



CUT OUT AND MAIL TODAY

FREE BIG ISSUES CATALOGS

TYPICAL VALUE

Butane Pocket Size BLOW TORCH KIT

\$219 Includes 2 Butane capsules, blow torch tip, soldering iron tip and solder. 6" long.

No. TL-362

We will send you a new issue every 6 weeks for a full year—NO CHARGE! Compare our World Famous Values

MAIL TO: **OLSON ELECTRONICS** (Formerly Olson Radio)
618 S. Forge St., Akron 8, Ohio

SEND FREE CATALOGS

Send Blow Torch Kit @ \$219. plus postage

NAME _____ ADDRESS _____

CITY _____ ZONE _____ STATE _____

will send you your choice of these selected electronics and hi-fi books for a 7-DAY FREE EXAMINATION!

Here are some of the world's greatest electronics and hi-fi books... chosen carefully by Ziff-Davis Electronics Book Service as among the best in their fields. You'll find top-notch texts and manuals on theory and instruction...important volumes covering radio and TV servicing, electricity and appliances...reference books to help you understand such fields as computers, electronics experimentation and books on hi-fi and tape.

Each volume is designed to help you get more know-how, greater enjoyment from your electronics specialty and hi-fi hobby—and *each is yours for 7 days FREE!* Simply write your choices on the coupon below and mail it today. When your books arrive, read and enjoy them for seven full days. If, after that, you don't agree that they are everything you want, return them and owe nothing. Here is the perfect way to build the library every man in electronics must have.



2500. BASIC ELECTRONICS, Grob
An introductory text on the fundamentals of electricity and electronics for technicians in radio, television and industrial electronics. \$9.25



2511. UNDERSTANDING RADIO, 3rd Ed., Watson, Welch and Eby
For those with little or no technical knowledge who wish to know the fundamentals of radio theory and servicing. \$8.25



2404. FM RADIO SERVICING HANDBOOK, King
A practical guide to FM V.H.F. receivers, their design, construction, alignment and repair. \$5.00



2425. ELEMENTS OF TELEVISION SERVICING FOR BENCH AND FIELD, Marcus and Gendler
Up to date discussion of installation, servicing and repair of T.V. receivers, designed for the practicing serviceman. \$8.15



2519. HANDBOOK OF BASIC CIRCUITS, Mandl
A basic guide to circuitry combining comprehensive coverage of major circuits with detailed information on circuits used in TV, FM and AM. Simply written and easy-to-understand. \$7.95

2804. RADIO AND TELEVISION MATHEMATICS, Fischer

Whenever you need to look up the use of a formula or the correct substitution of numbers, you can find it here—rapidly. More than 700 step-by-step solutions of the usual problems encountered in radio, television and industrial electronics including all those needed for FCC exams. \$6.95

2017. ELECTRONIC EXPERIMENTER'S HANDBOOK 1961

A do-it-yourself goldmine! Includes 40 all-new projects — 20 data charts and tables on circuits, resistors, transformers, capacitors, ham and citizens band radio, sound levels — and more. Projects for your shop, for your hi-fi and audio systems, for the ham and SWL and for fun. \$1.00



2415. MANDL'S TELEVISION SERVICING, Mandl
This standard text book in the T.V. servicing field provides clear descriptions of the fundamentals of T.V., and practical instruction on the diagnosis and correction of typical troubles. \$7.50

2803. BASIC MATHEMATICS FOR ELECTRICITY, RADIO AND TELEVISION, Singer

Here, mathematical principles are presented as dynamic tools for solving electrical problems. A practical course for students as well as an excellent refresher course for skilled technicians. \$8.25



2651. MAJOR APPLIANCE SERVICING, Brockwell
Gives essential information for a career in major appliance servicing. Explains methods of repairing appliances, organizing and managing a service business. \$5.95

2407. HOW TO GET AHEAD IN THE TELEVISION AND RADIO SERVICING BUSINESS, Marcus

Shows the easy way to get started as a TV-Radio repairman, how to earn while you learn, how to get and keep customers. \$3.50

2652. HOW TO REPAIR HOME APPLIANCES, Campbell

For the do-it-yourselfer, a handy, easy-to-read reference book with chapters on all kinds and types of appliances. Concise, thorough instructions with many useful illustrations. \$2.50



2011. STEREO & HI-FI DIRECTORY, 1961, Ziff-Davis
New! Complete buyers' guide of over 1200 component listings, 800 photos; latest models, prices! World's most complete reference. Entire sections on every phase of stereo and monaural high fidelity. \$1.00



2752. HIGH QUALITY SOUND REPRODUCTION, Moir
A perfect manual for both the professional engineer and the serious amateur in high fidelity. Complete coverage of sound reproduction in 591 pages. \$15.00



2755. THE PRACTICAL HI-FI HANDBOOK, King
A guide to high fidelity sound reproduction for the service engineer and amateur. Chapters on amplifiers, loudspeakers, pickups, microphones, record players, disc, tape and stereo. \$5.95



2765. YOUR TAPE RECORDER, Marshall
Based on 2500 experiments with almost every type of recorder, this book helps to eliminate trial and error under all conditions. Includes illustrations of 55 magnetic recorders with specifications. \$4.95



2750. ELEMENTS OF MAGNETIC TAPE RECORDING, Haynes
All aspects of this recording medium are described in easy-to-understand detail. 416 pages, \$7.95



2753. LOW-COST HI-FI, Hoefler
Hundreds of hints for budget hi-fi will be found in these fourteen chapters with over 300 detailed photographs, drawings and diagrams. Will save you money in starting or improving your system. \$2.50



2010. AUDIO YEARBOOK, 1961, Ziff-Davis

Brand new edition. By the editors of Electronics World. Advanced discussions and instructions on every phase of audio. Special features make this an excellent guide for the advanced audiophile. \$1.00



2004. HI-FI ANNUAL & AUDIO HANDBOOK, Ziff-Davis

1960 edition. Prepared by the editors of Electronics World. An excellent advanced guide to theory, construction and circuitry. Over 40 pages on stereo amplifiers and equipment. \$1.00



2000. STEREO HI-FI GUIDE, 1960, Ziff-Davis

1960 edition features 60-page exclusive by Joseph Marshall on components and how they work. Includes "what you should know before buying stereo". Complete, interesting, invaluable! \$1.00

2002. ELECTRONIC KITS DIRECTORY, Ziff-Davis Publishing Company

New 1960 edition lists over 750 kits, latest models, prices and features for hi-fi, ham radio, SWL, shop improvement, Citizen's Band, fun and education. \$1.00

2501. ELEMENTS OF ELECTRONICS, Hikey and Villines

This basic electronics text offers an excellent course for training radio and electronics technicians and for students in television, radar and sonar. \$6.95

2901. HAM RADIO, Hertzberg

Tells exactly how to become a "ham"—how to obtain a ham "ticket," how to learn code, how to select receivers and transmitters—everything you need to know is between the covers of this handy guidebook. \$2.50



2006. ELECTRONIC EXPERIMENTER'S MANUAL, Findlay

With a few dollars worth of basic tools and this book to guide you, you can explore electronics experimentation more completely than ever before. 10 big sections. \$4.95



2008. CLASS D CITIZENS RADIO, Sands

First complete book on Citizens Radio operation. Covers Class D history, rules, applications, how it works. Many illustrations. \$4.95



2007. COMPUTERS AND HOW THEY WORK, Fahnestock

A fact-filled guidebook to electronic computers. Explains the workings of every major computer system. Must reading for all who want a more complete knowledge of this important field. \$4.95

2351. RADIO PROJECTS, Marcus

10 easy to construct radios described in this book cover the field thoroughly and completely, progressing in difficulty from the simple crystal detector to the superheterodyne receiver. \$3.85

2907. RADIO OPERATING QUESTIONS AND ANSWERS, Hornung & McKenzie

Presents specific information on radio law, operating practices and theory for those studying to pass the FCC commercial radio operator exams of the various license grades. \$6.25

2601. TRANSISTORS IN RADIO, TELEVISION AND ELECTRONICS, Kiver

A descriptive, non-mathematical text for radio, television, electronics technicians and for those who want a working knowledge of transistors and circuits. \$7.95

2012. JOBS & CAREERS IN ELECTRONICS, 1961

Your key to a top-paying position in electronics! Describes interesting jobs for engineers, technicians, technical writers. Includes five big sections on opportunities in electronics, planning a career, testing your aptitude, case histories of careers and spare time electronics. \$1.00



2600. TRANSISTORS, Gillie

Describes and analyzes semi-conductors and transistors and how they behave. 300 pages, illustrated. \$7.95

2358. MECHANICS VEST POCKET REFERENCE BOOK

Over 200 fact-filled pages including tables, charts, formulas, for every aspect of mechanical work. Also includes logarithm table, conversion factors on gears, U.S. versus foreign measurements, and more. \$2.50

See Your Parts Jobber Or Use This Coupon Today!

Leading radio and electronics parts jobbers, hi-fi dealers and salons are making their stores headquarters for books on every electronics subject. You can take this list to your favorite dealer for immediate purchase.

If your local parts jobber or dealer does not carry books, use the coupon for prompt delivery from ELECTRONICS BOOK SERVICE, on a 7-day free trial basis.

ELECTRONICS BOOK SERVICE
One Park Avenue, New York 16, N. Y.



Please send me the book(s) I have listed below for a FREE 7-day Trial Examination. I understand that if I am not completely satisfied, I may return my selection(s) and I'll owe you nothing. Otherwise, I will send you payment for the book(s) of my choice, plus postage and handling.

NUMBER	TITLE	PRICE
*TOTAL		

*New York City Residents, please add 3% sales tax.
(If you need more space to list other titles, attach a sheet of paper with additional list.)
 SAVE MONEY! Enclose payment in full for the book(s) of your choice and we will pay shipping charges. Same return privileges and prompt refund guaranteed. EF551
 Please send me FREE CATALOG when published.

NAME _____ PLEASE PRINT CLEARLY
ADDRESS _____
CITY _____ ZONE _____ STATE _____
(7-Day Free Trial offer good only in U.S.A. and Canada. Foreign customers must enclose payment in full. Satisfaction guaranteed or money refunded.)

**Barry's "Greensheet" Values
are out of this World**



**NEW 1961
BUYER'S
Catalog**

*A complete catalog of specialized industrial Electronic **TUBES and COMPONENTS**... featuring Barry Electronics' savings to Industry, servicemen and Experimenters.

38 TUBE ELECTRONIC CONTROL UNIT

Unit contains many precision parts including following tubes: (1) 6AV6, (1) 2E21, (1) 6AM5, (2) 6AV6, (1) 6AS6, (2) 6AR5, (3) 6X4, (2) 12AX7, (3) 12AX7, (2) 5051, (1) 5070, (1) 5725, (3) 5726, (8) 600576M5W. Parts include: (6) tube 200 Mc. I. P. strip, 28 AC or DC dual shielded surge blower with R. P. filter, (5) hermetically sealed relays, (11) pots, (5) BNC connectors, 5 & 10% air resistors, Metallized and silver mica capacitors, 1% resistors and many other parts. Good used condition.
Order = PE191JAP630. \$15.95 with tubes
P.O.B. Atlanta or ADD \$3.05 P.P. Prepaid, U.S.A.

42 TUBE COMPUTER

Unit has following tubes: (1) 6AR5, (1) 6AV6, (1) 12AX7, (1) 6AV6, (1) 12AX7, (2) 6AM6, (3) 12AX7, (2) 12AX7, (1) 6AR5, (2) 6AS6. In addition, unit has (10) compact hermetically sealed relays, (10) each "RNC" Type Cated Coax connectors, more than (15) "Pots" and several Delay Lines. You also get over (100) Mica capacitors, and over (100) Resistors, plus 12 Seattle Min. Tube sockets, UHFs are in good used condition, with all tubes. Many other valuable parts such as connectors, blowers, AMPS, VLE, Q Capacitors, etc. \$19.95 with tubes
P.O.B. Atlanta or ADD \$3.05 P.P. Prepaid U.S.A.

Bring these values to yourself! Complete and mail the coupon below for your copy of the "Greensheet," Winter-Spring '61 Edition.

BARRY ELECTRONICS CORP.,
512 Broadway, NYC 12, N.Y.
Dept. EW4, Walker 5-7000

Name Title
Company
Address
City State

Stereo Dimension Control

(Continued from page 57)

in many existing preamps and amplifiers. However, it suffers from two disadvantages. The bias voltages on the triodes change as R_1 is varied, introducing possible distortion at some settings of the control. Also, the amount of increase in the difference signal is rather limited, being on the order of 1½ times. This may not be enough difference signal though it is sufficient for many applications.

The Improved Circuit

Figures 3 and 4 show a new circuit that can also accomplish this signal transfer. V_1 and V_2 are unity-gain phase inverters, sometimes called plate-followers. R_1 and R_2 , R_3 and R_4 are adjusted so that the signal voltages at the plates are the same as at the respective input jacks. Both sections of the ganged pot have their center taps returned to ground. As the sliders move from ground, they pick up increasing amounts of either in-phase or out-of-phase signals, which are then combined through isolating resistors R_5 , R_6 , R_7 , and R_8 with the in-phase signal of the opposite channel. With the pots all the way to one side, complete blending is achieved and only the sum signals are available at both outputs. With the control all the way over to the other side, only the difference signals are available at both outputs. This produces a highly exaggerated separation effect as no center or sum signals are present. With the pots at their mid-positions, the outputs are strictly left and right signals at their respective outputs with neither blending nor more separation.

Additional Benefits

The modern stereo preamplifier is an extremely versatile instrument, capable of many more functions than are indicated by the necessarily limited nomenclature on its panel. Likewise, the separation ratio control in the hands of the knowledgeable audiophile will perform the following additional services: (1) cancellation of crosstalk in cartridge and/or amplifier; (2) electronic balance of preamps, amplifiers, and/or cartridges; and (3) an aid in setting up microphones for a stereo recording session.

Although the control can be very useful if used with discretion and understanding, it is not a cure-all. Just as you cannot make a grand piano out of a spinet, so a monophonic record must remain single-channeled. For monophonic program material the difference signal is zero, so that as you advance the separation control toward maximum separation the volume simply decreases to zero.

The control may be used to counteract crosstalk that occurs in other parts of the system, including preamps, power amplifiers, tape recorders, stereo cartridges, and even stereo cutting heads, for crosstalk simply means that a little

signal from one channel has leaked into the other. Crosstalk can therefore be cancelled by the introduction of a suitable amount of out-of-phase crosstalk which is, of course, exactly what this control does. It should be understood, however, that cartridge and amplifier crosstalk are not usually constant with frequency, so that it is difficult to get complete separation over the entire audio frequency range, though improvements of over 10 db in average crosstalk are quite possible. If further improvement is desired, capacitors can be added to the circuit so that the separation ratio becomes a function of frequency.

To adjust the control for minimum system crosstalk, readily available test records may be used in which only one channel of the cartridge is activated at a time. The control is then adjusted for minimum output in the opposite channel.

To electronically balance preamps and cartridges with the help of this control, simply rotate the control to the extreme separation position, play a monophonic record, and adjust the balance or channel-level controls until minimum sound is heard in the loudspeakers.

Stereo recording enthusiasts may wish to note that by rotating this control between its extremes, the sum and difference signals may be monitored and microphone levels and spacing adjusted to produce the optimum stereo separation ratio.

Installation

The stereo separation control, while primarily intended for inclusion in new equipment, may be readily installed and used in existing stereo systems. The circuit shown is useful at signal levels from .1 volt to 10 volts and so can handle most any signal level to be found in a stereo control system.

Those with tape-monitoring facilities in their preamps or control amplifiers, can easily install a stereo separation control by connecting their recorder output jacks to the separation control inputs and the control outputs to their monitoring input jacks. The tape-monitoring switch in this case serves as an on-off switch for the separation control. The circuit may also be easily inserted between a control preamplifier and its power amplifiers, but in either case, since the output impedance of the circuit is fairly high, the output lead lengths should be limited to a few feet.

If there is extra space on the preamp or control amplifier chassis, the stereo separation ratio control can be built right into such equipment. The lead going to the top of the volume control is removed and connected to one of the inputs of the control circuit. The output is then connected to the now empty volume control terminal.

While all the uses indicated previously add to the versatility of this type of control, its primary purpose is to make every home listener the final arbiter of stereo realism, and to substitute the muscles of thumb and forefinger for those of the back and arms when speakers must be moved about.

ENGINEERING DEGREES

E.E. Option Electronics or Power
Civil, Mechanical, Physics.
Also in Liberal Arts

Earned through Home Study
Specify course desired
Pacific International
College of Arts & Sciences
Primarily a Correspondence School
Resident classes also available

5719-R Santa Monica Blvd., Hollywood 38, Calif.

SUPER-VALUE!
10 WATT G.E. AMPLIFIER
17.95

2 for 34.95
By G.E. in Canada!

10 Watt AC Hi-Fi amplifier chassis, 6V6 P.P. Output, 4 or 8 Ohm speaker output. With chrome name plate & knobs. Remit 10% with C.O.D. orders. F.O.B. Albany, N. Y.
5 Tube Kit: \$6.49 10 Tube Kit: \$11.95

Send for
CATALOGUE OF BEST BUYS!
GREYLOCK Electronics
438 Central Ave., Albany 6, N. Y.

ELECTRONIC CROSSWORDS

By BRUCE BALK

(Answer on page 127)

ACROSS

1. Time standard (abbr.).
4. Phillips, Allen, for example.
9. Born (Fr.).
12. Describing coils without iron cores.
13. Small amount of coupling between two coils.
14. Voltage-resistance-current (abbr.).
15. Type of movable contact.
17. Crystal.
19. Authoritative instruction.
21. Youngster (slang).
22. Prevailing custom.
24. Radio receiver (colloq.).
26. It comes in "male" versions.
29. Large body of water.
31. Type of generator.
33. Greek letter.
34. Opposite of left (abbr.).
35. Plate current at resonance.
37. Animal foot.
39. You (Fr.).
40. Undermine.
42. Shelter.
44. Coaxial cables (colloq.).
46. Impetuous ardor.
48. Early transmitter.
50. Iranian (former abbr.).
51. Part of Morse Code.
53. 3000-30,000 mc. h.f. band.
55. Adjustable attenuator network.
58. Angle at which arc length is equal to radius.
61. Engineering society (abbr.).
62. Unit of equivalent absorption.
64. Resistance unit.
65. At the rate of.
66. Numerical value of orange in the color code.
67. "Legal Eagle" (abbr.).

DOWN

1. Form of matter used in tubes.
2. One-thousandth of an inch.
3. A type of vacuum tube.
4. Snow vehicle.
5. Centers of coils.
6. An artificial language.
7. D.c. screen-grid voltage (symbol).
8. Frail.
9. Stylus.
10. Sea eagle.
11. It used to be RETMA.
16. Fear.
18. Type of mike worn on face.
20. Color code for two.
22. Inventor of the telegraph.
23. Tube base.
25. Peak.
27. Speak.
28. Flux density is measured in this unit.
30. Nothing.
32. Connection point made in body of resistor or coil.
36. Small, low-voltage incandescent lamp.
38. Rubbed lightly with a cloth.
41. Small capacitor in series with main capacitor.
43. Bitter vetch.
45. Time of cycle of an oscillating quantity.
47. Doze off.
49. Unit of radioactivity.
52. Examination.
54. Window glass.
55. Facial feature.
56. Exists.
57. Cheer.
59. Exclamation of surprise.
60. Southwestern state (abbr.).
63. Pertaining to Great Britain (abbr.).

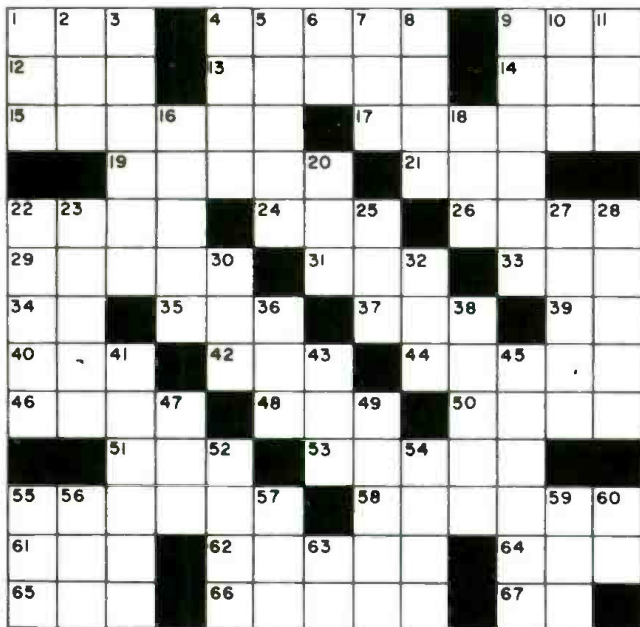

from **EICO** ... a completely new CITIZENS BAND TRANSCEIVER



Model 760: 117 VAC
Kit \$59.95 Wired \$89.95
Model 761: 117 VAC & 6 VDC Kit \$69.95
Model 762: 117 VAC & 12 VDC (Wired \$99.95
incl. mtg. bracket (Pat. Pend.))

*EICO premounts, prewires, pretunes, and seals the ENTIRE transmitter oscillator circuit to conform with FCC regulations (Section 19.71 sub-division d). EICO thus gives you the transceiver in kit form that you can build and put on the air without the supervision of a Commercial Radio-Telephone Licensee!

Highly sensitive, selective SUPERHET (not regenerative) receiver with 5 1/2 dual function tubes and RF stage. Continuous tuning over all 23 bands. Exclusive Super-Hush® noise limiter. AVC. 3" x 5" PM speaker. Detachable ceramic mike. 5-Watt crystal-controlled transmitter. Variable "pi" network matches most popular antennas. 12-position Posi-Lock® mounting bracket. 7 tubes and 1 crystal (extra xtals \$3.95 each). Covers up to 20 miles. License available to any citizen over 18—no exams or special skills required, application form supplied free. Antennas optional.

TOPS IN DESIGN . . . QUALITY



All-Transistor Portable RA-6
Kit \$29.95 Wired \$49.95
High sensitivity & selectivity. New type plug-in transistors. 4" x 6" speaker; push-pull audio. Prealigned RF & IF transformers. Less battery, incl. FET.



New! 60-Watt CW Transmitter #723
Kit \$49.95 Wired \$79.95
Ideal for novice or advanced ham needing low-power, stand-by rig. 60W CW, 50W external plate modulation. 80 through 10 meters.



90-Watt CW Transmitter* #720
Kit \$79.95 Wired \$119.95
"Top quality"—ELECTRONIC KITS GUIDE. Ideal for veteran or novice. 90W CW, 65W external plate modulation. 80 through 10 meters.
*U.S. Pat. No. D-184,776



High-Level Univ. Mod-Driver #730
Kit \$49.95 Wired \$79.95
Delivers 50W undistorted audio. Modulates transmitters having RF inputs up to 100W. Unique over-modulation indicator. Cover E-5 \$4.50.



Grid Dip Meter #710
Kit \$29.95 Wired \$49.95
Includes complete set of coils for full band coverage. Continuous coverage 400 kc to 250 mc. 500 ua meter.

Compare — judge for yourself — at your neighborhood EICO distributor. For FREE catalog on over 70 models of easy-to-build professional test instruments, hi-fi and ham gear, fill out coupon on Page 27

Most EICO distributors offer budget terms.

EICO

3300 N. Blvd., L.I.C. 1, N. Y.
Add 5% in the West



SURPLUS RADIO CONVERSION DATA

now 4 volumes . . . hundreds of instructions, diagrams and photographs.

SURPLUS RADIO CONVERSION MANUALS—3 Volumes—\$3.00 ea. Conversion data in these volumes has become standard for the most commonly available surplus items. Each conversion shown yields a useful piece of equipment . . . is practical, and proved by testing.

VOLUME I—BC-221; BC-342; BC-312; BC-348; BC-412; BC-645; BC-946; SCR-274 (BC-453A Series); SCR-274 (BC-457A Series); SCR-522 (BC-625, 624); TBY; PE-103A; BC-1068A/1161A; Electronics Surplus Index; Cross Index of A/N Vac. Tubes; Amateur Freq. Allocations; TV and FM Channels.

VOLUME II—BC-454 or ARC-5; AN/APS-13; BC-457 or ARC-5; ARC-5 V.H.F.; GO-9/TBW; BC-357; BC-946B; BC-375; LM Freq. Meter; TA-12B; AN/ART-13; Simplified Coil-Winding Charts; Selenium-Rectifier Power Units; AVT-112A; AM-26, AIC; Surplus Beam Rotating Mechs.; Prim. Power Req. Chart; ARB Rcvr. (Diagram only).

VOLUME III—701-A; APN-1; APN-4; ARC-4; ARC-5; ART-13; ATA; BC-191, 312, 342, 348, 375, 442, 456-459, 609, 624, 696, 950, 1066, 1253; COL-43065; CRC-7; DM-34; DY-2; DY-8; FT-241A; LM; MBF; MD-7/ARC-5; R-9/APN-4; R-28/ARC-5; RM-52; RM-53; RT-19/ARC-4; RT-159; SCR-274N, 508, 522, 528, 538, T-15 to T-23/ARC-5; URC-4. Diagrams only: APA-10; APT-2; APT-5; ARR-2; ASB-5; BC-659; BC-1335A; CPR-46ACJ.

THE SURPLUS HANDBOOK (Receivers and Transceivers) \$3.00

VOLUME I—Schematic Diagrams and large photographs only—APN-1; APS-13; ARB; ARC-4; ARC-5 (L.F.); ARC-5 (V.H.F.); ARN-5; ARR-2; ASB-7; BC-222, 312, 314, 342, 344, 348, 603, 611, 624, 652, 654, 659, 669, 683, 728, 745, 764, 779, 794, 923, 1000, 1004, 1066, 1206, 1306, 1335; BC-AR-231; CRC-7; DAK-3; GF-11; Mark II; MN-26; RAK-5; RAL-5; RAX-1; SCR-522; Super Pro; TBY; TCS.



*Order from your favorite electronic parts distributor
If he cannot supply, send us his name and your remittance, and we will supply; foreign, add 10%.

EDITORS and ENGINEERS, Ltd. Summerland 2, California

Dealers: Electronic distributors, order from us. Bookstores, libraries, newsdealers order from Baker & Taylor, Hillside, N.J. Export (exc. Canada), order from H.M. Snyder Co., 440 Park Ave. So., N.Y. 16.

ELECTRONICS

PREPARE FOR A GOOD JOB!
BROADCAST ENGINEER
RADIO SERVICING AUTOMATION

TELEVISION SERVICING
BLACK & WHITE—COLOR

APPROVED FOR VETERANS AND SURVIVORS
OF VETERANS
BUILDING AIR CONDITIONED
SEND FOR FREE LITERATURE

BALTIMORE TECHNICAL INSTITUTE
1425 EUTAW PLACE, BALTIMORE 17, MD.

TAPE RECORDERS



HI-FI COMPONENTS
SLEEP LEARN KITS

UNUSUAL VALUES
FREE 1961
Catalog
DRESSNER
1523 Jericho Tpke, New Hyde Park, N.Y.

MERITAPE. Low cost,
high quality record-
ing tape, in boxes or
cans.



OUT OF SPACE?

You bet we'd be . . . if we were
to tell you all about AUDION'S
'Out of this World Hi Fi Values'

Write for
free
Catalog
audion
25-W Oxford Road
Massapequa, New York

Hear 'Em — Work 'Em Better with BROWNING CB Equipment

Make your CB base station a real communications center with this Browning team. Highly sensitive and selective R-2700 Receiver delivers sharp, noise-free reception on all CB channels. Overcomes even the most severe atmospheric and man-made interference. Browning S-NINE Transmitter allows full power transmission on all channels — introduces new features and advanced design never previously utilized in CB communications.

SATISFACTION GUARANTEED



R-2700 CB
RECEIVER
\$149.00

S-NINE CB
TRANSMITTER
\$119.50

Also Available
R-2700 Receiver PLUS
T-2700 Transmitter
SPECIAL PACKAGE PRICE



browning
102 UNION AVE., LACONIA, N.H.

Send for Free Literature

FOUR CONVENIENT PURCHASE PLANS

Color TV Service Today

(Continued from page 31)

line. When this is done, slide the switch back to its "Normal" position.

The next step is vertical convergence, and for this a cross-hatch pattern is preferred. Since most dot generators also produce a cross-hatch, a flick of the instrument's switch is all that is necessary. Now the convergence-control board on the set is used. Normally, this is suspended at the back of the cabinet. Swing it up to the top of the cabinet, facing front (Fig. 6), so that you can make adjustments while watching the screen. The layout of controls on this board is shown in Fig. 7.

Adjust controls in accordance with the specific instructions in the service manual—but don't do any more than you have to. In effect, what you do is touch up, in tiny increments, only as many controls as necessary to get all the lines in the pattern sharp, untitled, and white, from top to bottom and from left to right. If you can do this by turning only two or three controls just a snip—as will often be the case—stop right there. You do not have to go through the business of turning every single control an appreciable amount just because the full procedure, in case it is needed, appears in the service manual. Furthermore, you will have to do less adjusting of whichever controls are involved. Nowadays there is less interaction between circuits (and controls) than there used to be. Back-and-forth time is reduced or eliminated.

This simplification in adjustment procedure over what was required a few years ago is not due to the increased use of multi-function tubes, but to an honest saving in circuitry. Compared to a 525-watt dissipating 1955 RCA color chassis draws only 330 watts. The 1955 set had red, blue, and green adder circuits (and tubes); the new sets do not. Instead they use X and Z demodulation directly into a R-Y, G-Y, and B-Y amplifier matrix (Fig. 8) such as has been used in recent years. No d.c. restorers either, with this matrix system. However this simplification in circuitry, like the reduction from five picture i.f. amplifiers to three and from two audio amplifiers to one is not that new; it has been in effect for the past four years. What is new is the constant improvement in circuit parameters to make the individual circuits more stable—less critical. This is what makes the service technician's job simpler and more predictable.

Another interesting touch that makes the service technician's life a little easier on the new sets is a circuit breaker whose re-set button is accessible at the rear of the chassis. This replaces the fuse in the "B+" power supply which formerly blew with momentary overloads and, in addition, protects the high-voltage circuits. It is now anticipated that the service technician will not be called as often for nuisance

fuse replacements as was formerly the case.

How about receiver service? The major trouble will continue to be faulty tubes, as is the case in black-and-white sets. This is especially true in color sets because all manufacturers use high-grade, industrial type components in all critical areas in the color set. Printed-wiring boards and transformer power supplies are used in all chassis. The new RCA chassis use a nuvistor r.f. amplifier in the tuner. Limited use of this new type vacuum tube has indicated that long life can be expected of it. This is true because of its rugged construction and also because of the lower operating voltages fed to the nuvistor. It also serves the purpose of increasing the sensitivity of the tuner, making the antenna less of a problem. In most cases now, the antenna already in use for the black-and-white set in the home will be good enough for color.

To anyone who has used a scope and sweep generator for monochrome TV alignment, the instructions for color-circuit alignment will be very familiar. The only additional circuitry to be considered includes the chroma bandpass, phasing, and demodulator circuits. All that can be said here is follow the instructions in the service manual and be certain that your scope and generators are accurately calibrated. As a practical note, however, you can be sure that you will be called upon to align these circuits about as often as you do a complete alignment of the typical mono-

chrome receiver. Try not to get rusty and, as a mental exercise, read over the instructions in the manuals for the new color receivers.

It has not been our intention here to close our eyes to the facts or sell a bill of goods: We do not say that color sets are so easy to service that any fool can handle the job. The technician who has had no practical experience at all in this direction will not look like a great authority on his first two or three jobs—although he might, depending on what has gone wrong. He may be able to replace a faulty tube with as much flair as he does on any other set. However, there is much less to worry over in the newer color sets than in the earlier models. The color-channel circuitry has reached much the same level of stability and reliability as the old-fashioned video and sound channels. Most important, the increasing number of sets reaching homes and the already developing service-seeking patterns of the owners make it likely that, at long last, the independent technician is in the picture.

Another factor, not yet mentioned, is the imminent entry of Japanese electronic fabricators into the U.S. color TV market. Sets shown so far are similar to those already made in this country. If the merchandising and pricing methods that have made Japanese transistor radios such a great success here carry over into color TV, the market will swell still more. And there will be few people to service these imported sets aside from independent dealers.

SILENT SERVICE
with
QUIETROLE

the first, the quality, the proved silencing "Lubri-Cleaner" for noisy controls and switches on TV, radio and electronic instruments. **SPRAY IT OR DROP IT . . . it's easy—efficient—effective.** Make QUIETROLE your silent partner in providing satisfactory service.

manufactured by
QUIETROLE Company
SPARTANBURG, South Carolina

In Canada: CROSS CANADA ELECTRONICS
12 Laurel St., Waterloo, Ont.

Buy With Confidence At Lowest Prices!
FAMOUS MAKE

40 ACCRATRON TV & RADIO TUBES

Each EA.

Tubes listed below are in stock now and available for immediate delivery to you! Each and every tube is individually boxed in a handsome carton and all are pre-tested for accuracy and peak performance!
Every Tube Is Backed With Our Famous ONE YEAR FREE REPLACEMENT GUARANTEE Against All Operating Defects, Plus, A FIVE-DAY MONEY BACK GUARANTEE!
And remember, The GUARANTEE YOU GET FROM "TUBE-A-RAMA" IS IN WRITING!
Order 100 tubes . . . price is only 37¢ each!

FREE BONUS GIFT! FREE CHEATER CORD INCLUDED WITH ANY ORDER OF \$7 OR MORE!

SPECIAL SALE ON THESE TYPE TUBES: NOW 35¢ each
(\$29.95 per 100 in any assortment) 6A7 6AC7 6W4GT 6SN7GT

BRAND NEW PORTABLE TUBE TESTERS
Tests all radio and TV tubes in use PLUS 6 and 12 volt new tube types available as they become obsolete. Tests will never be obsolete. In handsome leatherette carry case. Shipped Prepaid \$38.95

TUBE CADDY WITH BUILT-IN TUBE CHECKER
Here is the serviceman's dream companion. Holds up to 150 tubes. Contains huge specially designed compartment for large and small tools, solder, etc. Highly accurate tube checker, built right into the caddy, is easiest to use. F.O.B. Harrison, N.J. \$53.95

RECONITIDNED CONSOLE SELF-SERVICE TUBE TESTERS
Customers can check own tubes. Complete with attractive back panel and safety partition. F.O.B. Harrison, N.J. \$38.95 Weight Approx. 45 Lbs.

37 PER 100 TUBES

TUBES MAY BE USED OR FACTORY SECONDS
Get More USE Out Of Our USED Tubes. We Put The USE IN USED. TUBE-A-RAMA will replace FREE any tube that becomes defective in use within 1 year from date of purchase!

0Y4	3B6	5V4C	6AU6GT	6BQ7	6CU6	6S7	7B4	12A8	12CN5	19T8
0Z4	3BZ6	5V6GT	6AU8	6BR8	6G6	6SC7	7B5	12AB5	12D4	24A
1A7GT	3CB6	5Y8	6AV5CT	6BS8	6DE6	6SH7	7B6	12A0S	12F5	25Z6GT
1B3GT	3Q4	5Y3	6AV6	6D6GT	6D6GT	6S7	7B7	12A5	12H8	27
1H5GT	354	6A6	6AW8	6BZ6	6DF6	6SK7	7B8	12A7	12K5	35A5
1L4	3V4	6AB4	6AX4CT	6BZ7	6E5	6SL7	7C4	12A0G	12K7	35B5
1L6	4BQ7A	6AF4	6AX5CT	6C4	6F6	6S7	7C5	12A7	12L6	35C5
1NSGT	4B5B	6AG5	6B8	6C8A	6F5	6SR7	7C6	12AV6	12Q7	35W4
1R5	4BZ7	6AH4CT	6B8	6CB6	6H6	6T4	7C7	12AV7	12R5	35Z5
1S5	4CB6	6AM6	6B8	6CC8	6J4	6T8	7C8	12AX4CT	12S7	36
1T4	5AMB	6AK5	6B8C	6CC7	6J5	6U5	7E6	12AX7	12S7J	38
1U4	5ANB	6AL5	6B8D	6CC8	6J7	6U8	7E7	12A27	12S7K	39/44
1U5	5AT8	6AM8	6B8E	6CC8	6J7	6V6GT	7F7	12A7	12S7LCT	41
1V2	5AV8	6AN8	6B8F	6CM8	6K6CT	6WG6T	7F8	12BA6	12S7Q	42
1X2	5AZ4	6AQ5	6B8G	6CL6	6K7	6X4	7F8	12BA7	12S7R	43
2A4	5BR8	6AQ6	6B8H	6CM6	6K7	6X5CT	7H7	12BA7	12S7S	43
2B4	5CC8	6AQ7	6B8I	6CM7	6K7	6X6	7H7	12BA7	12S7T	43
2C7S	5J6	6AR5	6B8J	6CM7	6K7	6Y6	7Q7	12RF6	12S7U	43
3A5	5R4	6AS5	6B8K	6CQ8	6S7	7A4/XXL	7S7	12B06	12S7V	43
3AL5	5Y8	6AT6	6B8L	6CQ8	6S7	7A6	7X7	12B06	12S7W	43
3AU6	5U4	6AU6	6B8M	6CS7	6S7	7A7	7Y4	12B06	12S7X	43
3BC5	5U8	6AU6GT	6B8N	6CUS	6S7	7A8	7Z4	12B06	12S7Y	43

ALL PARTS SHIPPED POSTAGE PAID UNLESS OTHERWISE STATED.

ALL TUBES INDIVIDUALLY BOXED, CODE DATED & BRANDED "ACCRATRON"
PRODUCERS OF ACCRATRON
TUBE-A-RAMA HU 4-9848
NATIONWIDE BUILDING HARRISON, NEW JERSEY

GUARANTEE! "TUBE-A-RAMA" GUARANTEES COMPLETE SATISFACTION OR YOUR MONEY BACK!
Our tubes are guaranteed against all operating defects for a period of 1 YEAR, starting from the date of purchase. . . . YOUR MONEY BACK IN FIVE (5) DAYS!

TV PICTURE TUBES AT LOWEST PRICES

ALL ALUMINIZED GLASS TYPES

Tube Type	Price With Old Tube	Tube Type	Price With Old Tube	Tube Type	Price With Old Tube
10BP4	7.95	17BP4	11.50	21CP4	21.00
12LP4	8.95	17CDP4	11.50	21CX4	15.75
14AJ4	14.00	17CK CA BZ		21DE4	21.00
14AT4	14.00	17CR4	17.00	21DF4	21.00
14B E CP4		17DL4	17.00	21EL4	21.00
	10.00	17H RP4	12.50	21DS4	21.00
14HP4	11.00	17L VP4	12.50	21EP4	14.25
14QP4	11.00	17OP4	11.50	21FP4	14.50
14RP4	11.00	20C DP4	13.50	21WP4	16.00
14W ZP4	11.00	20H MP4	14.50	21XP4	16.50
14XP4	11.60	21AC BS/		21YP4	16.00
16DP4	12.00	AMP4	15.75	21ZP4	15.50
16K RP4	9.95	21AL/ATP4		24C VP4	23.50
16LP4	12.50		16.75	24EP4	24.50
16TP4	9.95	21AU AVP4		24HP4	26.50
16WP4	12.00		15.75	24MP4	24.50
17AT/AVP4		21AWP4	15.75	27EP4	39.95
	12.50	21BP4	17.75	27FP4	39.95
17BP4	9.95	21CBP4	16.75	27SP4	40.95
		METAL TYPES			
12UP4	12.00	16GP4	14.50	19AP4	16.00
16AP4	13.50	17GP4	17.00	19DP4	19.75
16EP4	14.00	17CP4	17.60	21MP4	20.75
		17TP4	17.60		

TEST TUBES

8XP4	16.07	8YP4	16.07
------	-------	------	-------

1 year warranty

Prices include the return of an acceptable similar tube under vacuum. These tubes are manufactured from reprocessed used glass bulbs. All parts and materials including the electron gun are brand new.

All PRICES FOB CHICAGO, ILLINOIS. Depo-It required, when old tube is not returned, refundable at time of return, 25% deposit required on (OEM) shipments. Old tubes must be returned prepaid. Tubes shipped (R) Express. Shipped only to Continental U.S. and Canada. WRITE FOR COMPLETE LIST

PICTURE TUBE OUTLET
2922 MILWAUKEE AVE., CHICAGO 15, ILLINOIS
Dickens 2-2648

Adjusting Transmitters

(Continued from page 45)

aid of an r.f. output indicator is quite similar to that described previously. The coupling is increased to a point at which an output indication can be obtained. The antenna trimmer is adjusted for maximum reading on the r.f. indicator. The plate tank is then tuned for a plate current dip (minimum). Coupling is increased until maximum r.f. output is indicated. It should be noted that maximum r.f. output does not necessarily follow maximum coupling but may occur at some point below maximum coupling. The coils are over-coupled when the antenna trimmer cannot be peaked (assuming that the antenna can be peaked at reduced coupling). It should also be noted that in some transmitters maximum power output occurs at some value less than maximum rated plate current. Under no circumstances should the transmitter be operated with higher than maximum rated-power amplifier plate current. According to FCC regulations, the power input should not exceed the rated value for a particular transmitter by more than 10%.

A final frequency check is now advisable. In the case of the 25 to 50 mc. transmitter just described, the frequency tolerance is 0.002%. Make certain that the frequency meter that you use has an accuracy substantially better than this figure. Use the crystal oscillator trimmer capacitor to set the transmitter on its exact assigned frequency.

Modulation

In the previous paragraphs we discussed the proper tuning of the r.f. section of the transmitter, the special care required to provide the proper power input, and the correct operating wavelengths. The third factor with which the FCC is greatly concerned is the modulation level. The modulation level of the Motorola transmitter is a function of the operation of the transmitter's limiter circuit and the setting of the IDC control. This control regulates the amplitude of the modulating signal supplied to the grid of the phase modulator.

The function of the clipper stage is to "clip" off the sharp audio peaks that rise above the general level of the audio frequencies. The clipper, however, must not clip too sharply or distortion of the voice frequencies will result and spurious frequency components may be radiated by the transmitter. If the IDC control is set too high too much audio will be fed to the modulator, consequently there will be too severe clipping of the voice signals and possibly distortion. If the IDC control is set too low there will be insufficient audio power for proper modulation.

In summary, the over-all objectives of the adjustment of transmitter modulation is to keep the transmission within the frequency deviation limits required by the FCC, to obtain efficient peak clipping to prevent overmodulation, and at the same time to maintain a reason-

ably high average modulation percentage.

Checking Frequency Deviation

An oscilloscope is most useful in the adjustment of modulation because it permits visual observation of peak clipping and the audio signal before clipping.

To check actual signal frequency deviation of the transmitter under broadcasting conditions an FM deviation meter can be used. An FM deviation meter is an FM receiver that is accurately tuned to the transmitting frequency, and contains a calibrated meter that reads peak detector-voltage output. As will be recalled, a fixed frequency, i.e., an unmodulated FM carrier signal produces no output voltage at an FM detector. Detector output voltage is developed only when the FM signal deviates from its base frequency. By proper design, it is possible to calibrate the forementioned output meter so that it reads directly in kc. deviation. Fig. 3 is a functional block diagram of this type of deviation meter while Fig. 4 is the circuit diagram of the transistorized peak-reading voltmeter used in the Gertsch deviation meter.

The Gertsch Peak Modulation Deviation Meter, Model DM-3, illustrated in Fig. 5, is typical of deviation meters of this type. This is the way it may be used.

The meter (antenna connected) is turned on and set to transmitter frequency. The switch to the left of the meter is turned to the position marked "Limiter Current." The transmitter is turned on and keyed, that is to say, the press-to-talk button is depressed, but no sound is applied to the mike. The transmitter now produces a fixed signal. The meter needle should now be exactly on 5—"Limiter Current" position. If not, move the deviation meter closer or farther away from the transmitting antenna.

The left-hand switch is now turned to "Frequency Set." The meter needle should remain exactly at the same point. If the needle is above or below 5 on the meter, the frequency control on the local oscillator (not the transmitter) should be adjusted until the needle is on 5. The left-hand switch is now moved to "Zero." The zero-set control to the right of the meter is used to set the needle to zero. The "Deviation Range" toggle switch is set to the desired range.

With the transmitter still keyed, the microphone is excited with audio of good amplitude. (A healthy, sustained "Ahhh" will do it.) Now, while "ahhing," the IDC control is adjusted until the desired deviation is secured. This figure will be indicated on the meter scale directly in kilocycles.

It should be noted that the FCC has ruled that all new mobile equipment be limited to "narrow-band" transmission, which is ± 5 kc. of the assigned frequency. Existing equipment may be operated at the bandwidth that was originally granted. However, should a new frequency be desired, or should a new license be required, the new narrow-band rule must be obeyed. —50—

TOP
SILICON



HAT
RECTIFIER

FROM 250 MA TO 6-12-18 & 35 AMP.
FACTORY DIRECT. Exclusive Distributors for Name Brand. Immediate Delivery. All Types

750 MA. RECTIFIERS GUAR.

Input Working Range RMS/ACV Res. or Cap.

PIV/RMS	PIV/RMS	PIV/RMS	PIV/RMS
50/35	100/70	200/140	300/210
15 ea.	.25 ea.	.30 ea.	.40 ea.
PIV/RMS	PIV/RMS	PIV/RMS	PIV/RMS
400/280	500/350	600/420	700/490
.45 ea.	.65 ea.	.75 ea.	.90 ea.
PIV/RMS	PIV/RMS	PIV/RMS	PIV/RMS
800/560	900/630	1000/700	1100/770
.95 ea.	1.15 ea.	1.55 ea.	1.75 ea.

SPECIAL!!!

All Purpose Rectifier 400 piv @ 250ma
.35 ea. 25 for 7.50

DISTRIBUTORS—OEM—EXPORTERS

WRITE QTY PRICES

- SPECIALS: 100 Different Pres. Res. 1/2W. 1W-2W 1%, 1%. Tot. Only \$1.70/c NEW
- 100ma Selenium Rectifiers @ .29 NEW
- 100 ASST. RADIO & TV KNOBS Push-ons \$1.00 NEW

All material guaranteed. \$2.00 min. order. Orders F.O.B. NYC. Include check or money order. Shpg. charges plus. C.O.D. orders 25% down.

WARREN DIST. CO.

NYC 7, NY 87 Chambers St. WD 2-5727



BEAT?

Troubled with cold solder joints?

World's Finest
ERSIN Multicores
FIVE-CORE SOLDER

Sold only by Radio Parts Distributors.

Making Electronic Colors

(Continued from page 43)

determine the relative intensities with which the correspondingly struck "dots" of phosphor will glow. White light is produced by a correctly proportioned mixture of red, blue, and green light. As shown in Fig. 1 (lower, right-hand corner), this means that all three guns are "on" for white.

Fig. 1 will serve to identify the color blocks that make up the cover background. It also gives some idea as to which primaries are used to obtain basic color combinations. In each color block, the guns that must be "on" to obtain that color are indicated by white circles. However, there is no indication of the relative beam intensity required from the "on" guns. The importance of intensity can be demonstrated in the following way: To represent a neutral shade of gray, the relative intensity of each gun with respect to the others would be the same as it is for white, with all three guns on. However, the absolute intensity of all guns would be reduced, in the same proportion. Finally, if all guns are cut off, we have the absence of light. This is black, as shown in the lower, left-hand corner of Fig. 1. The guns that must be "on" or "off" for other colors shown on the cover are also indicated here.

Unless the naked eye is extremely

close to the viewing screen of the picture tube, it cannot see the individual color dots; the latter tend rather to blend together to produce the effects desired. A notion of their size can be obtained by noting that there are approximately 1 million individual phosphor dots serving as colored-light sources on the face of the current color CRT, the 21CYP22A—about 333,000 dots for each primary.

The generator being used by the technician on the cover, shown more clearly in Fig. 3, has already been identified as the RCA WR-64A. It is a crystal-controlled source that combines the functions of a color-bar generator with those of a dot-and-cross-hatch generator. Dot and cross-hatch outputs provide monochrome patterns that are important in making critical convergence adjustments on color sets (see "Color TV Service Today," page 29), but are also useful for linearity adjustment on all types of TV receivers.

The color-signal output consists of ten separately identified and accurately controlled color bars, ranging from yellow-orange on the extreme left and proceeding through orange, red, magenta, reddish-blue, blue, greenish-blue, cyan, bluish-green, and green at the extreme right. The man on the cover is getting correct color balance, but the receiver is adjusted for somewhat excessive width. As a result, he is pushing color bars at either extreme of the display off the sides of the CRT screen. —30—

QUICKLY CUT HOLES

in metal, plastics,
hard rubber...



GREENLEE CHASSIS PUNCHES

Make smooth, accurate openings in 1½ minutes or less . . . for sockets, plugs, controls, meters, panel lights, etc. Easy to use . . . simply turn with wrench.

Many sizes and models.

Write for literature.



GREENLEE TOOL CO.
1916 Columbia Ave., Rockford, Illinois

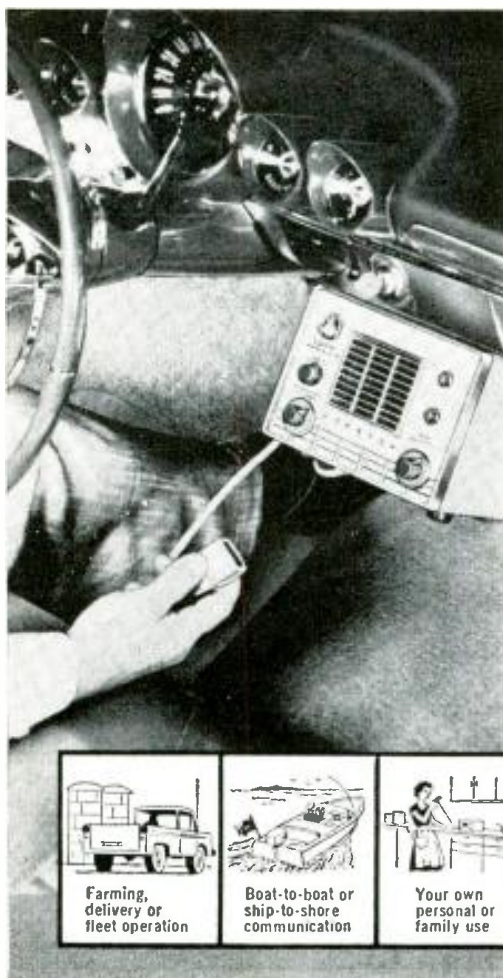

"More than Citizens' Radio" ...

a complete, fully engineered "industrial-type" transceiver!

VIKING *Messenger*

Anyone can operate—license issued by the FCC on request

from

\$134⁹⁵

- Complete 23 channel Citizens' Band coverage—choose 1 of any 5 channels by the flip of a switch.
- Maximum legal power—excellent range—meets all FCC requirements.
- Excellent receiver sensitivity and selectivity—full fidelity voice reproduction.

"More than just 2-way Citizens' Radio equipment"—the Viking "Messenger" will deliver the finest performance of any equipment available in the field. Designed throughout for 10 watt power level—limited to 5 watts for Citizens' Radio. Easy to install anywhere in your home, business location, car, truck or boat . . . offers many unique features found only on more expensive communications systems. Built-in Squelch, Automatic Volume Control, and Automatic Noise Limiter. Compact, modern styling—only 5 3/4" high, 7" wide, and 11 3/4" deep. Complete with tubes, push-to-talk microphone, and crystals for one channel.



Available from authorized Johnson Electronic or Marine Distributors. Installation and service coast-to-coast at all General Electric Communications Service Stations.



Farming, delivery or fleet operation



Boat-to-boat or ship-to-shore communication



Your own personal or family use

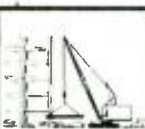

Construction or "off-the-road" equipment



FREE
Color Brochure

WRITE TODAY



E. F. JOHNSON COMPANY

2510 10th Ave. S.W. • Waseca, Minnesota

• Please rush me your full color brochure describing the Viking "Messenger" Citizens' Transceiver.

NAME _____

ADDRESS _____

CITY _____ STATE _____

Manufacturers of the world's most widely used personal communications transmitters



FREE Catalog Of The WORLD'S FINEST GOV'T SURPLUS ELECTRONIC BARGAINS



BC-923 FM RECEIVER 27-38.9 MC

Four pre-set channels or continuous tuning; one micro-volt sensitivity; power output 3 watts; call signal & squelch circuit; 4 PM speaker & phone jacks; crystal callibrator as easy as plugging in; sets easy and accurate.



rate setting of channels. Complete with 16 tubes: 1/VR-150, 2/6AC7, 1/6H6, 1/6S7, 2/6SL7, 1/6V6, 1/12SA7, 3/12SC7, 2/12SG7, & 2/12SJ7. A180 1000 KC Crystal. Operates from 12 or 24 VDC, B + volt. age required: 275 VDC 150 MA. Size: 1 1/2 x 6 1/2 x 12 1/2". Wt.: 42 lbs. (similar to BC-683 Rec. only better) Price: **\$34.95**

Spare tubes, fuses & lamps for BC-923—one of each type tube (10): \$5.00 when purchased with Receiver; otherwise: \$7.50.

DM-64 DYNAMOTOR—12 volt F/BC-923—NEW: \$6.95
BC-603 FM REC.—20—27.9 MC..... Re-New: \$16.95
BC-683 FM REC.—27—39.1 MC..... Re-New: \$34.95
BC-604 FM Transmr. 20-27.9 MC..... Re-New: \$ 7.05
BC-684 FM Transmr. 27-39.1 MC..... Re-New: \$ 8.05
FT-346 MOUNTING for Receiver only. Re-New: \$ 4.95
DM-34 DYN. 12V. 1/BC-603-683—U: \$1.95—R-N: \$4.95
DM-35 DYN. 12V. 1/BC-604-684—U: \$1.95—R-N: \$ 9.95
AC POWER SUPPLY—F/BC-603-683—Output: 220 VDC 80 MA & 24 VAC 2 Amps. Transformer & Tube type. Chassis not hot. Mounts on rear Plug of BC-603-683. Can be adapted to other Receivers. WIRE: \$14.95
KIT: \$10.00

BC-620 \$12.95 RE-NEW	BC-659 \$14.95 RE-NEW	PE-120 \$7.95 RE-NEW
-----------------------------	-----------------------------	----------------------------

BC-620 FM Rec. Transmr. Ju to 27.9 MC..... Re-New: \$12.95
BC-659 FM Rec. Transmr. 27—39.1 MC..... Re-New: 14.05
PE-120 Power Supply for BC-659 or BC-620; with vibrator for 12 Vt. operation. Re-New: 7.95
BA-41 Bias battery for BC-659-620..... New: 4.95
AN-29 Telescoping Antenna F/BC-659..... New: 2.05
AN-45 Telescoping Antenna F/BC-620..... 1.95

Address Dept. EW • All Prices F.O.B. Lima, Ohio, \$5.00 Minimum Order. 25% Deposit on all C.O.D.'s.

FAIR RADIO SALES
2133 ELIDA RD. • P.O. Box 1105 • LIMA, OHIO

PURCHASING A HI-FI SYSTEM?

TIME PAYMENTS AVAILABLE
Up to 2 years to pay!

Send Us
Your List Of
Components
For A
Package
Quotation

YOU CAN BUY
WITH CONFIDENCE
AT AIREX

All merchandise is brand new, factory fresh & guaranteed.

Free Hi-Fi Catalog

AIREX RADIO

CORPORATION
85-R Cortlandt St., N.Y. 7, WO 4-1820

- Jim Lansing*
- Altec Lansing
- Electrovoice
- Hartley*
- University
- Acoustic Research
- Janszen • Jensen
- Wharfedale
- USI Citizen Band
- Ganset • Mallcrofter
- Texas Crystals
- Concertone • Viking
- Bell • G.E.
- Weathers
- Harmo—Kardon
- Eico • Pilot
- Sherwood*
- EST
- Quad Ampl-Sprks*
- Dual Changer
- Bogen • Leak
- Dynakit • Fisher
- H. H. Scott
- Thorns*
- TEC. Transistor Amps
- DeWald
- Superscope
- Sony • Roberts
- Challenge
- Wallenok
- Garrard • Norelco
- Miracord
- Gloster-Steers
- Rek-O-Kut
- Components
- Tandberg*
- Fairchild • Conrac
- Pickering • Gray
- Audio Tape
- Magnecord*
- Rockford Cabinets
- Artizan Cabinets
- *Fair Traded

FM RECEIVER R-48 A/TRC-8

FM RADIO RECEIVER R-48A/TRC-8—Designed for high fidelity FM reception, this set has variable frequency control from 23.0 to 25.0 MC 1 Band 115/230 V. 60 CYS. Complete with 15 tubes: 8/6AG5, 1/9002, 1/5U4, 1/0D3/VR-150, 1/6V6, 1/6SN7, 1/6N7, & 1/6AL5. Test switch enables checking outputs of various stages on 2 1/2" meter which has micro amp & dB scale. Also has squelch circuit with adj., tune test switch, 4" PM speaker, Vol. Control, coaxial antenna input, 6" headset jack. Size: 20 x 9 x 16". Wt.: 67 lbs. Price: **\$18.95**



RECEIVERS:

R-23/ARC-5 RECEIVER—190 to 550 KC..... U: \$12.95
BC-654 RECEIVER—2 to 8 MC..... New: 14.95
NAVY ARB/CRV 46151—190 to 9050 KC..... U: 18.95
R-77/ARC-3 AM REC.—100 to 150 MC..... U: 14.95
BC-733 LOCATOR REC.—100.0—110.0 MC..... U: 4.95
R-4/ARR-2 RECEIVER—540 to 880 KC..... Re-New: 6.95
230 to 250 MC..... Re-New: 6.95
BC-1206 Beacon Receiver..... Re-New: 9.95
300 to 300 KC..... Re-New: 19.95
BC-652 RECEIVER—2 to 8 MC—Less Dyn..... U: 19.95

TRANSMITTERS:

T-17/ARC-5 TRANS.—1.3 to 2.1 MC..... New: \$14.95
T-18/ARC-5 TRANS.—2.1 to 3 MC..... New: 8.95
T-20/ARC-5 TRANS.—3 to 4 MC..... Used: 5.95
T-21/ARC-5 TRANS.—4 to 5.3 MC..... New: 8.95
T-22/ARC-5 TRANS.—5.3 to 7 MC..... New: 9.95
T-23/ARC-5 TRANS.—7 to 10.1 MC..... New: 12.95
T-67/ARC-3 TRANS.—100 to 150 MC..... Used: 16.95

TELEPHONES, HEADSETS, MICS., Etc.:

TS-9 Handset..... Used: \$2.95—New: \$ 3.95
TS-13 Handset w/PL-55 & PL-68..... U: \$2.95—N: 3.95
T-17 Microphone..... New: 6.95
E-E-8 Field Telephone..... Used: \$12.95—Recond.: 18.95
BD-71 Switchboard—6 Line..... U: \$14.95—New: 24.95
RM-29 Control Unit..... New: \$6.95—W/Handset: 8.95
RM-32 Control Unit (Patch Found.) U: \$1.85—N: 2.95
H-15/U Headset—8000 ohm..... New: 2.95
HS-33 Headset—300 ohm..... U: \$4.95—New: 7.95

SEND FOR FREE CATALOG!

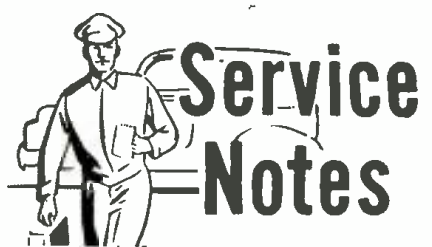

Service Notes

RCA TV: REMOTE PROBLEMS

RCA sends these tips along. CTP7A remote receiver; motor reverse relay chatters when actuated. Try connecting a .01- μ f., 500-volt capacitor between terminal 1 of the motor reverse relay (K1001) and terminal 2 of the channel relay (K1003). See Figs. 1A and 1B.

CTP7A and CTP9A are remote-control receivers used in black-and-white and color-TV sets. When the TV receiver changes stations in response to a remote-control signal calling for a

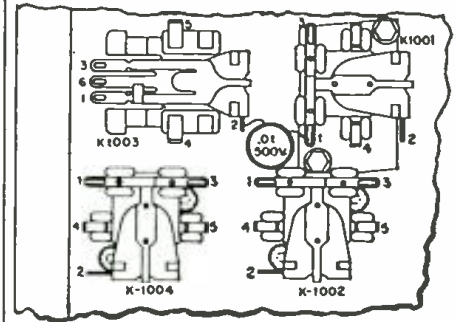

(A)

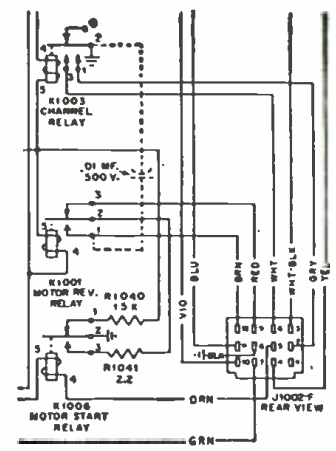

Fig. 1 (B)

MOVING?

Make sure you notify our subscription department about any change of address. Be sure to include your postal zone number as well as both old and new addresses. Please allow four weeks' time for processing.

ELECTRONICS WORLD
434 South Wabash Avenue
Chicago 5, Illinois

Watch R W "Monthly Specials"

BC-603 FM Receiver 20-27.9 **\$14.95**
Mc. Complete. New!
DM-34 Dynamotor 12v. New \$2.95
BC-604 FM Transmitter 20-27.9 Mc. New \$4.95
DM-35 Dynamotor 12 v. New \$7.95

COLLINS ARC-2 Transceiver 2-9 Mc. Acquisition Cost \$2250.00. Shipping Weight 100 lbs. WHILE THEY LAST! **\$59.50**

All items F.O.B. Chicago or Los Angeles
Send Money Order or Check with order.
Write for Flyer—LOADS OF BARGAINS!
R W ELECTRONICS
2430 S. MICHIGAN AVENUE • DEPT. N.
Phone: Calumet 5-1281 CHICAGO 16, ILL.

A NOTE TO THE HI-FI BUYER

AIR MAIL us your requirements for an IMMEDIATE LOWEST PRICE QUOTATION
Components, Tapes and Recorders
SHIPPED PROMPTLY AT LOWEST PRICES
WRITE TODAY FOR FREE CATALOG
AUDIO UNLIMITED 190-W Lexington Ave.
New York 16, N. Y.

change in volume, or responds in some other erratic and incorrect way, the cause of the trouble may be that the relay contacts are faulty. Actual relay contact is made by small points that are welded to the leaves of the relays. When these points loosen or separate from the leaf of the switch, erratic signal response results.

CTP7, 8, and 9; the remote control will actuate the receiver only when brought close to the TV receiver. This may be due to a loose tube shield on the 12AX7 (V1001) used in the remote-control receiver. When this shield is improperly grounded, it picks up random signals and noise causing a high bias

level which, of course, reduces the remote-control receiver sensitivity.

When the channel selector on a remotely controlled receiver is jammed, do not try to force the selector free or damage may result. Jamming may have been caused by the station selector having moved of its own accord into the engaged position. This may have happened during shipment or storage when the receiver was placed on its side. To clear, use the remote control to actuate the motor and disengage the shaft from the gear box.

G-E: NO REMOTE CONTROL

No change in volume level in response to control signal. Check possibility of

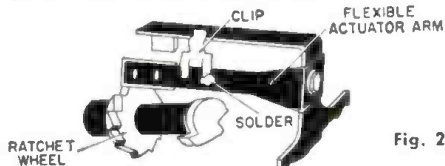

Fig. 2

the stepping relay in the remote receiver being stuck. To do this it is necessary to open the remote receiver chassis and inspect the relay and its ratchet wheel. If the flexible arm (Fig. 2) is jammed, move it gently back to its normal position. To prevent this trouble from repeating, solder a small clip on the arm as indicated in Fig. 2. Later runs of these sets have this modification incorporated.

DELCO AUTO RADIO

1959 Pontiac PB; low volume motor-boating at low end of the volume control setting, or set may motorboat only when operated on a battery supply. Try a new 12DS7 tube, and then try a new electrolytic by simply shunting the new capacitor across the old.

ADMIRAL: TONE IMPROVEMENT

The tone quality of the Admiral transistor clock radio using the 8S1A chassis can be improved with two simple modifications. Resistor R_{21} , 6800 ohms, is reduced in value by shunting it with a 1/2-watt 27,000-ohm resistor. R_{24} goes from the center tap of the output side of the push-pull driver transformer (tap 5) to the battery side of the input winding of the same transformer (tap 2). The push-pull audio output transistors, Q_3 and Q_4 , are separated by cutting the metal foil on the board with a razor. The two leads coming from R_{23} and R_{25} have to be un-

Fig. 3

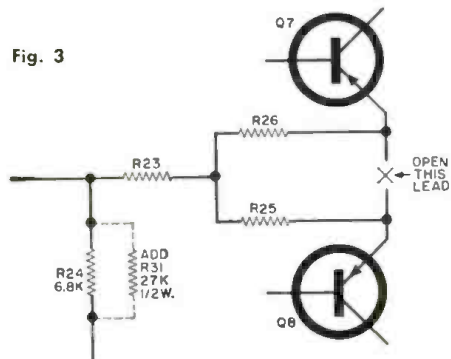

soldered, and then reconnected to their individual transistors. See Fig. 3. -30-

FREE GIANT 1961 204 PAGE CATALOG

B-A 1961
ANNUAL CATALOG #11
SINCE 1927
Guarantee

A Complete Buying Guide for Everything in
RADIO TV ELECTRONICS

for DEALERS, SERVICE MEN, REMODELERS, MANUFACTURERS, INDUSTRIALS, HOBBYISTS, MANUFACTURERS, CHURCHES, HOTELS, PUBLIC UTILITIES, LABORATORIES, ENGINEERS, INVESTIGATORS, AMATEURS

INDEX PAGE 201-202 PHONE 848-1111

BURSTEIN-APPLEBEE 1012-14 McGEE ST., KANSAS CITY 6, MO.

BURSTEIN-APPLEBEE CO. Dept. M,
1012-14 McGEE St., Kansas City 6, Mo.

Send Free 1961 B-A Catalog No. 611

NAME _____
ADDRESS _____
CITY _____ STATE _____

RUSH COUPON TODAY!

YOUR COPIES OF ELECTRONICS WORLD ARE VALUABLE!

Keep them neat... clean... ready for instant reference!

Now you can keep a year's copies of **ELECTRONICS WORLD** in a rich-looking leatherette file that makes it easy to locate any issue for ready reference. Specially designed for **ELECTRONICS WORLD**, this handy file—with its distinctive, washable Kivar cover and 16-carat gold leaf lettering—not only looks good but keeps every issue neat, clean and orderly.

So don't risk tearing and soiling your copies of **ELECTRONICS WORLD**—always a ready source of valuable information. Order several of these **ELECTRONICS WORLD** volume files today. They are \$2.50 each, postpaid—3 for \$7.00, or 6 for \$13.00. Satisfaction guaranteed, or Order direct from:

JESSE JONES BOX CORP.
Dept. EW (Established 1843), Box 5120, Philadelphia 41, Pa.

COLUMBIA GEMS!

ARC-2 COLLINS TRANSMITTER-RECEIVER
2-9 Mc., 50 W. Xmitr. and Recvr. Uses Collins PTO oscillator. Includes 22 tubes and 100 Kc. crystal, built-in 21 V. d.c. Compact, table-top unit. P. H. for marine, amateur, mobile use. Excellent. **\$49.95**

APN-4 MARINE LORAN REC'V & INDICATOR
gives exact fix in relation to Loran station. Works on 12 or 24 V. If you own a boat, this is the cheapest life insurance you can buy! Like new. **\$49.50**
Used, but in excellent condition, only **\$39.50**

APT-5 UHF RADIO TRANSMITTER
50W. Uses 30 22 LIGHTHOUSE TUBE in tuneable 300-1,000 Mc. cavity. Makes terrific rig for 432 Mc. ham transmitter, or hi-powered signal generator. Excel. **\$19.95**

RT-18 ARC-1 VHF TRANSCEIVER
100-156 Mc. 11-channel, crystal controlled. Makes sweet aircraft or ham radio. Excel. **\$39.95**
24 V. DYNAMOTOR: for above. **9.95**
Excellent

MOUNTING RACK: for above. **4.95**
Excellent cond.
CONTROL BOX: for above. Excel. **4.95**
Special at
SCHEMATIC: for above. Yours for **1.50**

NEW TRANSMITTING TUBES
4-65A \$ 7.50 4CX250B \$22.50
4-125A 19.95 4-400A 25.00
832 2.95 4-1000A 75.00
825B/3E29 4.95 2C39WA 12.95

BC-603 RECEIVER
20-27 Mc. Tunable. Built-in speaker. Squelch control. Reconditioned, like new. **\$14.95**
AC POWER SUPPLY: For above. New. **\$11.95**
THIS AC POWER SUPPLY in kit form. **7.95**
12 V. DYNAMOTOR: New. Bargain at only **3.95**

ARC-5 VHF & UHF EQUIPMENT SPECIALS!

R-28/ARC-5 RECEIVER: 100-156 Mc., 4 channels. Crystal controlled. Excel. cond. Only **\$19.95**
T-23 ARC-5 TRANSMITTER: Companion to above. Same freq., 4-chann. crystal controlled. **12.95**
R-23 ARC-5 RECEIVER: 100-555 kc. Excellent. This is the Q-5'er! **9.95**
R-25 ARC-5 RECEIVER: 1.5-3 Mc. Excellent. **14.95**
R-26 ARC-5 RECEIVER: 3-6 Mc. Excellent. **7.95**
R-27 ARC-5 RECEIVER: 6-9 Mc. Excellent. **7.95**
T-18/ARC-5 TRANSMITTER: 2.1-3 Mc. Excellent. **4.95**
T-19/ARC-5 TRANSMITTER: 3-4 Mc. Excellent. **6.95**
T-20/ARC-5 TRANSMITTER: 4-5 Mc. Excellent. **4.95**
T-21/ARC-5 TRANSMITTER: 5-6 Mc. Excellent. **4.95**
T-22/ARC-5 TRANSMITTER: 7-9 Mc. Excellent. **9.95**
MD-7/ARC-5 MODULATOR: For all of the above Transmitters. Excellent. Bargain @ only **4.95**

IMPORTERS—EXPORTERS!
We have quantities of: PRC-6, -8, -9, -10, -14, CRC-3, -8, -9, -26, GM-58, SCR-399, BC-375. **WRITE US YOUR NEEDS!**
PE-73 DYNAMOTOR FOR ABOVE: Input 24 V. Output, 1000 V., @ 200 mill. Whittier base. Excel. cond. **\$7.95**. Good cond. **\$4.95**
BC-306 ANTENNA TUNER for above BC-375. Excel. **\$19.95**
TUNING UNITS TO COVER ABOVE FREQS: TU-3, TU-6, TU-7, TU-8, TU-9, TU-10. **\$1.95** Excel. Ea. **\$1.95**
SET OF PLUGS: For any of above. Only **\$2.00**
RACKS: For any of above. Each **\$1.50**

WRITE IN for new Bargain Bulletin!
All orders FOB Los Angeles. 25% deposit required. All items subject to prior sale. **NOTE: MINIMUM ORDER \$3.00. WRITE TO DEPT. R.**

Columbia ELECTRONICS
4365 WEST PICO BLVD.
LOS ANGELES 19, CALIF.

CITIZEN BAND CLASS "D" CRYSTALS

TEXAS HCG/U
3rd Overtone. Hermetically Sealed .005% tolerance—Meet FCC requirements. 1/2 pin spacing—650 pin diameters. (.093 pin) available, add 15c per crystal. **\$2.95 EACH**
ALL 22 Frequencies in Stock!
(add 5c per crystal for postage and handling)

The following Class "D" Citizen Band frequencies in stock (frequencies listed in megacycles): 26.965, 26.975, 26.985, 27.005, 27.015, 27.025, 27.035, 27.055, 27.065, 27.075, 27.085, 27.105, 27.115, 27.125, 27.135, 27.155, 27.165, 27.175, 27.185, 27.205, 27.215, 27.225.

Matched crystal sets for Globe, Gonset, Citi-Fone and Hallicrafters Units. **\$5.90 per set.** Specify make.

RADIO CONTROL CRYSTALS in HCG/U HOLDERS—SIX FREQUENCIES

In stock for immediate delivery (frequencies listed in megacycles): tolerance .005%—1/2 pin spacing—650 pin diameters. (.093 pin) available, add 15c per crystal. Specify frequency desired. **\$2.95 EACH**
26.995, 27.045, 27.095, 27.145, 27.195, 27.255. (add 5c per crystal for postage and handling)

NOW! Engineering samples and small quantities for prototypes now made either at Chicago or at Ft. Myers Plant. 24 Hour Service. **IN CHICAGO, PHONE GLADSTONE 3-3555**

Send for **FREE CRYSTAL CATALOG #860 WITH OSCILLATOR CIRCUITS**

ASK YOUR PARTS DEALER FOR TEXAS CRYSTALS See big red display . . . if he doesn't stock them, send us his name and order direct from factory.

Rush your order to:
TEXAS CRYSTALS
Dept. R-41—1000 Crystal Drive, Fort Myers, Fla.
All orders shipped 1st Class Mail.
For faster service phone WE 6-2100

New Products for CB-Amateur and Communications

NEW S.W. RECEIVER
Hallicrafters Co., 4401 W. Fifth Ave., Chicago 24, Ill. has announced its Model



S-120, a new short-wave receiver featuring three antennas, an adjustable b.f.o. on the front panel, and compact, slim-line styling. The set includes a built-in ferrite loop antenna for the standard broadcast band, and a collapsible whip antenna for s.w., as well as the normal connections for an external wire antenna. Its three s.w. bands cover the range from 1600 kc. to 30 mc.

Controls include: band selector, main tuning, bandspread tuning, standby/receive, b.f.o./selectivity, a.c. on/off and volume. According to the company, the S-120 is a "step-up version" of the manufacturer's Model S-38E, still in production.

MOBILE RECEIVER

Autovox Corp. of America, 250 W. 57 St., New York 19, N.Y. has introduced the "Transmobil," an 8-transistor receiver for standard broadcasts and international short-wave bands.

The set can be used in cars, boats, in the home, or as a portable. It may be operated from an engine battery—6 or 12 volts—or on four regular or mercury penlite cells. Engineered in Europe, the set is claimed to be a "truly universal radio."

MINIATURE TRANSCEIVERS

Seisacor Div., Seismograph Service Corp., Box 1590, Tulsa, Oklahoma has introduced two transistorized transceivers for use on CB frequencies. One is the "Telepath" Model PM-A, which uses a combination speaker/microphone, telescoping antenna, and weighs only 12½ ounces with standard 9-volt battery. Its range is given as ½ mile or better, depending on the surrounding area. Standard units operate on a frequency of 27.085 mc. Other frequencies between 27 mc. and 27.255 mc. are also available.

The second of the new units is the "Telepath" Model SC-A, a portable miniature base-station transceiver, said to make a perfect mate for the pocket-

model PM-A as well as for other "Telepath" industrial two-way models. The SC-A has a range of one mile or better. Choice of power supply is optional including a variety of batteries, line voltage, or low d.c. supplies. The transmitter has a full 100 mw. input to the r.f. amplifier.

The unit is available for operation on any single channel between 20-55 mc., with no license required for 27-mc. operation when the attached telescoping antenna is used. The receiver is a crystal-controlled type with a built-in PM speaker. For more information, contact the manufacturer.

NEW CB UNITS

Lafayette Radio, 165-08 Liberty Ave., Jamaica 33, N.Y. has announced two new Citizens Band transceivers. Shown here is Model HE-20, described as a "no compromise" unit. Featured are a 5-watt-input crystal-controlled transmitter and a superheterodyne receiver. The transmitter may be operated on any four of 23 channels; the receiver has four crystal-controlled channels and is tunable over all 23 channels, with a



sensitivity of 1 μv. The unit has a built-in squelch and series-gate noise limiter. An "S" meter, switched, measures incoming signal strength and final amplifier wattage. Push-to-talk operation is used.

A more economical model is the HE-29, a portable set with a range from 1.5 to 7 miles, depending on terrain and conditions. This pocket-size instrument uses two controls, a telescoping antenna, and a built-in speaker that doubles as a microphone when transmitting.

HAM POWER SUPPLY

Heath Co., Benton Harbor, Mich. has introduced its new Model HP-20 power supply which furnishes filament, plate, and bias voltages for converting Heathkit "Comanche" and "Cheyenne" or other mobile amateur gear to fixed station operation. The HP-20 delivers 6.3 volts a.c. at 8 amps. or 12.6 volts a.c. at 4 amps for filaments; and 120 watt ICAS d.c. plate power of 500 volts d.c. at

BEFORE You Buy Tubes . . .

COMPARE
Rad-Tel's
money-saving
low prices . . . **UP TO 75% OFF**

COMPARE
Rad-Tel's
dependability. . . **BRAND NEW TUBES**

COMPARE
Rad-Tel's
reliable . . . **ONE FULL YEAR
GUARANTEE**

COMPARE
Rad-Tel's . . . **RELIABLE PERFORMANCE**

SERVICEMEN: Now speedy one-day service.

Rad-Tel sells only Brand New Tubes, not used, not pulled out of old sets . . . reduce costly call backs.

THE SIGN OF RAD-TEL'S RELIABILITY



Qty. Type	Price
0Z4M	.79
1AX2	.62
1B3GT	.79
1DN5	.55
1G3	.79
1J3	.79
1K3	.79
1LN5	.59
1R5	.62
1S5	.51
1T4	.58
1U4	.57
1U5	.50

Qty. Type	Price
5CL8	.76
5EA8	.80
5EU8	.80
5J6	.68
5T8	.81
5U4	.60
5U8	.81
5V6	.56
5X8	.78
5Y3	.46
6AB4	.46
6AC7	.96

EACH TUBE INDIVIDUALLY & ATTRACTIVELY BOXED

Qty. Type	Price	Qty. Type	Price	Qty. Type	Price
6AU7	.61	6SK7	.74	12CN5	.56
6AU8	.87	6SL7	.80	12CR6	.54
6AV6	.40	6SN7	.65	12CU5	.58
6AW8	.89	6SQ7	.73	12CU6	1.06
6AX4	.65	6T4	.99	12CX6	.54
6AX7	.64	6U8	.78	12D85	.69
6BA6	.49	6V6GT	.54	12DE8	.75
6BC5	.54	6W4	.54	12DL8	.85
6BC7	.94	6W6	.69	12DM7	.67
6BC8	.97	6X4	.39	12DQ6	1.04
6BD6	.51	6X5GT	.53	12DS7	.79
6BE6	.55	6X8	.77	12DZ6	.56
6BF6	.44	7AU7	.61	12EL6	.50
6BG6	1.66	7A8	.68	12EG6	.54
6BH6	.65	7B6	.69	12EZ6	.53

6BH8	.87	7Y4	.69	12F8	.66
6BJ6	.62	8AU8	.83	12FM6	.45
6BK7	.85	8AW8	.93	12K5	.65
6BL7	1.00	8BQ5	.60	12SA7M	.86
6BN4	.57	8CG7	.62	12SK7GT	.74
6BN6	.74	8CM7	.68	12SN7	.67
6BQ5	.65	8CN7	.97	12SQ7M	.73
6BQ6GT	1.05	8CX8	.93	12U7	.62
6BQ7	.95	8EB8	.94	12V6GT	.53
6BR8	.78	11CY7	.75	12W6	.69
6BU8	.70	12A4	.60	12X4	.38
6BY6	.54	12AB5	.55	17AX4	.67
6BZ6	.54	12AC6	.49	17BQ6	1.09
6BZ7	.97	12AD6	.57	17C5	.58
6C4	.43	12AE6	.43	17CA5	.62

RAD-TEL TUBE CO.

NOT AFFILIATED WITH ANY OTHER MAIL ORDER TUBE COMPANY

Qty. Type	Price
1X2B	.82
2AF4	.96
3AL5	.42
3AU6	.51
3AV6	.41
3BA6	.51
3BC5	.54
3BE6	.52
3BN6	.76
3BU8	.78
3BY6	.55
3BZ6	.55
3CB6	.54
3CF6	.60

Qty. Type	Price
3CS6	.52
3DK6	.60
3DT6	.50
3Q5	.80
3S4	.61
3V4	.58
4BC8	.96
4BN6	.75
4BQ7	.96
4BS8	.98
4BU8	.71
4BZ6	.58
4BZ7	.96

Qty. Type	Price
4CS6	.61
4DE6	.62
4DK6	.60
4DT6	.55
5AM8	.79
5AN8	.86
5AQ5	.52
5AT8	.80
5BK7A	.82
5BQ7	.97
5BR8	.79
5CG8	.76

Qty. Type	Price
6AF3	.73
6AF4	.97
6AG5	.65
6AH6	.99
6AK5	.95
6AL5	.47
6AM8	.78
6AQ5	.50
6AR5	.55
6AS5	.60
6AT6	.43
6AT8	.79
6AU4	.82
6AU6	.50

Qty. Type	Price
6DB5	.69
6DE6	.58
6DG6	.59
6DQ6	1.10
6DT5	.76
6DT6	.53
6EU8	.79
6EA8	.79
6H6GT	.58
6J5GT	.51
6J6	.67
6K6	.63
6S4	.48
6SA7GT	.76

Qty. Type	Price
12AX4	.67
12AX7	.63
12AZ7	.86
12B4	.63
12BA6	.50
12BD6	.50
12BE6	.53
12BF6	.44
12BH7	.73
12BL6	.56
12BQ6	1.06
12BY7	.74
12BZ7	.75
12C5	.56

Qty. Type	Price
25DN6	1.42
25EH5	.55
25L6	.57
25W4	.68
25Z6	.66
35C5	.51
35L6	.57
35W4	.52
35Z5GT	.60
50B5	.60
50C5	.53
50DC4	.37
50EH5	.55
50L6	.61
117Z3	.61



SEND FOR FREE TROUBLE SHOOTER
GUIDE AND NEW TUBE & PARTS CATALOG

RAD-TEL TUBE CO.

DEPT. EW461 55 CHAMBERS STREET, NEWARK 5, N. J.

TERMS: 25% deposit must accompany all orders, balance COD. Orders under \$5; add \$1 handling charge plus postage. Orders over \$5; plus postage. Approx. 8 tubes per 1 lb. Subject to prior sale. No COD's outside continental USA.

QUANTITY USERS • MACHINE OPERATORS
• MANUFACTURERS • EXPORTERS

HUGE STOCKS !!
OVER 175 TYPES SPECIALLY PRICED !

All tubes fully Guaranteed — Brand New!

MINIMUM ORDER . . . 500 PER TYPE . . . NO ASSORTMENT
Write, Wire, Types Needed; get our Low "Large Quantity" price

ENJOY THE ETHEREAL MUSIC of the THEREMIN Kits ... only \$49.95

Play the THEREMIN without touching it—the movements of your hands around the THEREMIN control both pitch and volume. You, and your friends, will like the fascinating sound of the THEREMIN—the most mysterious, the most modern of musical instruments.

Kit features quality in components and appearance. Parts made by well-known manufacturers. Powered by a single small 6 volt battery. Solid hardwood cabinet with walnut finish. Size: 22 1/2" x 6" x 3 3/4". Antennas of solid aluminum, polished and anodized gold. Pitch range: 5 octaves. Can be used as a sound source with any hi-fi system.



Your THEREMIN is easily assembled from illustrated directions. Also included are suggestions on playing.

This transistorized THEREMIN kit, featured in the Jan. 1961 issue of this magazine, is only \$49.95 plus shipping costs for 9 lbs. Send check or money order to



R. A. MOOG CO., BOX 263, ITHACA, N. Y.

200 ma., or 600 volts d.c. at 150 ma. and 300 volts d.c. at 100 ma. A separate bias supply furnishes 130 volts d.c. at 30 ma.

Designed to be built in one evening, the HP-20 kit can power SSB and c.w. transmitters requiring fixed bias for linear stages or grid-lock keying. The a.c. ripple is said to be less than 1 percent.

TWO-WAY BUSINESS RADIO

Hammarlund Manufacturing Co., Inc., 460 W. 34 St., New York 1, N.Y. has announced what it calls the first, full-powered, business two-way radio system in a low-cost, versatile unit. Com-



pletely self-contained, the "Outercom" is a transceiver for use on 6- or 12-volts d.c. or 117-volts a.c.

The same basic unit may be switched around, from vehicle-to-vehicle or vehicle-to-office by minor re-connections made by the user. Complete details are available from the manufacturer.

CB TOWER ANTENNA

Mark Mobile, Inc., 6441 W. Fargo Ave., Skokie, Ill. has introduced its Model C.S.M.-11 antenna, designed exclusively for 27-mc. class D Citizens Band commercial system applications. It is said to enable the licensee to gain substantially greater and more reliable coverage while complying fully with FCC regulations.

The new antenna is designed for convenient side-mounting on existing or proposed TV, broadcast, or communications towers. It may be used in a single-bay or in stacked versions. Full information is available from the manufacturer.

CB RADIOPHONE

Rutherford Electronics, 8930 Lindblade St., Culver City, Calif. announces its new Model R-400 Citizens Band radiophone. The receiver features three

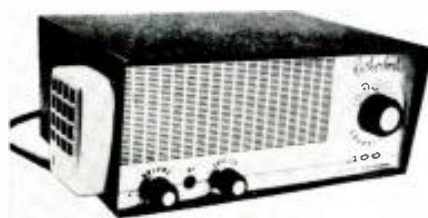

stages of amplification, automatic noise limiting, and adjustable squelch. The transmitter and receiver use six crystal-controlled channels, with an illuminated dial indicating which channel is in use.

A removable microphone with press-to-talk switch operates the transmitter.

The set may be operated from 6- or 12-volts d.c. or 117-volts a.c.

METER FOR CB USE

Crown Electric Products Co., P.O. Box 171, Orange, N.J. has announced a new "power output and modulation indicator" for use with Citizens Band transmitters.

Two models are available. One, the Model LS, gives the user a continuous indication of his set's power output and modulation. The other, Model TS, is similar except that it is used to check the set without its being on the air. The Model TS comes with a 50-ohm built-in dummy antenna. An accessory test cable, for connecting the set to the test meter, is also available.

FM MOBILE FILTERS

Collins Radio Co., Western Div., 2700 W. Olive Ave., Burbank, Calif. has announced two new mechanical filters designed for FM mobile radio equipment. One, the Model F455YA-120, has a 45.5 kc. center frequency and a passband of 12 kc. With it, FM mobile receivers can be designed to match systems using the ± 5 kc. transmitter deviation specified under the FCC split-channel ruling.

The other filter, Model F455YA-320, has a 32-ke. bandpass and is suited for wideband mobile equipment applications.

AIRCRAFT COMMUNICATOR

Gonset Div., Young Spring & Wire Corp., Burbank, Calif. has announced a new communications unit designed for use by airport ground vehicles, flying



schools, fixed-base operators, and in Unicom applications. It offers relatively high power output for two-way communications in the 108- to 136-mc. aircraft band in a completely self-contained package.

Designated Model G-150, it is available in 6-, 12-, or 28-volt d.c. or 117-volt a.c. versions. Transmit and receive frequencies are crystal-controlled. No external tuning is required. Complete technical data is available from the manufacturer.

COMPACT CB TRANSCEIVER

Sonar Radio Corp., 3050 W. 21 St., Brooklyn 24, N.Y. has introduced a compact, battery-operated CB transceiver that may be held in the hand.

Named the "Sonarcom," the two-way set uses a crystal-controlled transmitter and receiver and has been designed to suit the industrial market where two-way communication can facilitate the

KEEP CANDEE HANDEE!

FAMOUS Q 5'ER !!!

This is the fabulous one! 190-550 kc. The receiver you've been looking for... **\$9.95**
 BC-454: 305 Mc. ... **7.95**
 BC-455: 69.1 Mc. ... **7.95**
 MD-7 MODULATOR: Special ... **3.95**

A TRIO OF HEADSET BARGAINS!

HS-23: Hi impedance. Leather covered headband. Brand new. Great buy. Only **\$4.95**
 HS-33: Low impedance. Leather covered headband. Brand new. A J. J. Candee Special. Only **5.95**
 Hi Fi Headset: 15,000 cycles. Brand new with phono earbuds. It's terrific! Only **8.95**
 CD-307A Headset Extension Cord: Approximately 5 ft. length. Only **49c**

APN-1 FM TRANSCEIVER

120-140 Mc. Compl. with tubes. 15w. P.A. **\$2.95**
 Approx. Shp. wt. per unit 25 lbs. TWO for **\$5.00**

YOU GOT IT! WE WANT IT! LET'S DEAL?
 We're paying top \$\$\$ for GRC-9; PRC-6, -8, -9, -10; GN-58A; All electronic test equip. Write us today!

APX-6 TRANSPONDER

A midlevel warehouse of parts! Blowers, three-voice tone counters, I.F. strips, cavity wav. tubes, etc. Includes 3E29 tube. Good comp. A STEAL AT ONLY 12 for **\$19.00** **\$9.95**

R-4A/ARR-2 RECEIVER

230-258 Mc. 11 tubes. 1 HE. Inaudible receiver. Aug 59 C.O. Magazine for conversion. **\$2.95**
 Excellent cond. TWO for **\$5.00**. Each

I-208 FM SIGNAL GENERATOR

Freq. ranges: 1.9-1.7 Mc. and 19.45 Mc. Frequency deviation may be adjusted 0.5 kc. for 1.9-1.7 Mc. and 0.20 kc. each side for the 19.45 Mc. band. With output meter and speaker. 11.5v. 90 cycles or 12 VDC input. Excellent condition. **\$49.95**

All items FOB Burbank, Calif., subject to prior sale. In Calif. add 4%. Min. order \$3.95.

J. J. CANDEE CO. Dept. EW
 509 No. Victory Blvd., Burbank, Calif.
 Phone: Victoria 9-2411

A DO-IT-YOURSELF GOLDMINE!



40 ALL-NEW PROJECTS! 20 DATA CHARTS & TABLES! ALL IN THE 1961 ELECTRONIC EXPERIMENTER'S HANDBOOK

If you're an electronics hobbyist, you'll welcome the 1961 ELECTRONIC EXPERIMENTER'S HANDBOOK. It's packed with over 40 all-new projects you can build yourself, plus more than 20 information-packed charts and tables on circuits, resistors, transformers, capacitors, ham and citizens band radio, sound levels, and much more!

PROJECTS FOR:

- HI-FI
- AUDIO
- HAM
- SWL
- SHOP
- FUN

Only \$1.00

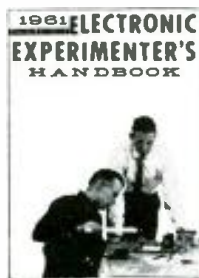

The new 1961 ELECTRONIC EXPERIMENTER'S HANDBOOK is now on sale at your favorite newsstand or electronic parts store —or order now by handy coupon.

Ziff-Davis Publishing Company
1 Park Avenue
New York 16, N. Y.

Please send me a copy of the 1961 ELECTRONIC EXPERIMENTER'S HANDBOOK. I enclose \$1.00 plus 10¢ to cover mailing and handling charges. (Canada and Foreign \$1.25 plus 10¢ postage.)

NAME _____

ADDRESS _____

CITY _____

ZONE _____

STATE _____

EF2303

2017

control of material handling, transportation, warehousing, and other applications.

Employing eight transistors and one diode, the set is said to operate over 100 hours on inexpensive leak-proof batteries. The receiver can be tuned to each of 22 channels by a single switch. Range is given as over 2 miles on land and considerably more when used over water.

"ON CALL" SYSTEM

General Electric Company's Communication Products Dept., Lynchburg, Va. reports that a base-station transceiver, linked by a network of personal portable receivers, has helped personnel at Ormond Beach Hospital, Florida to make better use of their "on-call" time and still maintain instant contact with the hospital.

Personnel carry the lightweight voice communications receivers which receive messages from the transceiver at the hospital. To return the call, the staff member then telephones in, although staff physicians have standard two-way sets installed in their cars. The same hospital base-station transmitter is used for the vehicular network. —30—

PHOTO CREDITS

Page	Credit
29, 30, 31, 43, 76 (top)	Radio Corporation of America
44	Motorola Inc.
45	Gertsch Products, Inc.
62, 63, 64	AiResearch Mfg. Co. of Arizona
76 (center)	Westinghouse Electric Corp.
76 (bottom left)	Philco Corporation
76 (bottom right)	Bell Telephone Laboratories
77 (top)	Hughes Aircraft Co.
77 (center left)	ITT Federal Laboratories
77 (center right)	Collins Radio Co.
77 (bottom)	Western Electric Co.
92	Harman-Kardon
94 (top)	Channel Master Corp.
94 (bottom)	Pickering
96	Electronic Instrument Co.

Answer to Puzzle Appearing
an Page 117



WEAK

TV signals get STRONG with new all-AC Winegard WBC-4X signal booster



Here's a sure, easy way to deliver better TV reception to your customers — sell them a Winegard WBC-4X Signal Booster. Get new distance, cut snow, get more picture contrast. Winegard WBC-4X has one tube, 4 sets of no-strip lead-in terminals, on-off switch, antenna disconnect plug. Runs 1 — 4 sets. It's all AC — no "hot" chassis. Only \$27.50 list. Ask your distributor or write for technical bulletin.



Everything from
antenna to set

Winegard

ANTENNA SYSTEMS
3003-4 Scotten, Burlington, Iowa

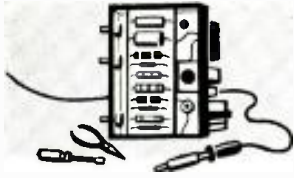

ELECTRONICS MARKET PLACE

RATE: 60¢ per word. Minimum 10 words. June issue closes April 3rd. Send order and remittance to: ELECTRONICS WORLD, One Park Ave., N. Y. C. 16, N. Y.

RADIO ENGINEERING & INSTRUCTION

ELECTRONICS! Associate degree—29 months. Technicians, field engineers, specialists in communications, missiles, computers, radar, automation. Start September, February. Valparaiso Technical Institute, Dept. N, Valparaiso, Indiana.

ENGINEERING Education for the Space Age. Northrop Institute of Technology is a privately endowed, non-profit college of engineering offering a complete Bachelor of Science Degree Program and Two-Year accredited technical institute curricula. Students from 50 states, many foreign countries. Outstandingly successful graduates employed in aeronautics, electronics, and space technology. Write today for catalog—no obligation. Northrop Institute of Technology, 1183 West Arbor Vitae Street, Inglewood 1, California.

USED Correspondence Courses and Books sold and rented. Money back guarantee. Catalog free. (Courses Bought.) Lee Mountain, Pisgah, Alabama.

BARGAIN List Technical Publications and Magazines Box 124, Shrewsbury, New Jersey.

"Repair TV'S. Complete Course \$10.00 Certificate, Guaranteed. Bacone, Portageville, Mo."

HIGHLY Effective Home-Study Review For FCC Commercial, Phone Exams. Free Literature. Wallace Cook (EG4) Box 10634, Jackson 9, Miss.

"DRAW, understand Schematics, Blueprints. Send \$2.00. Prior 23-09 169th Street, Whitestone 57, New York.

FOR SALE

BALANCE Your Stereo From Across The Room—How it sounds where you sit—that's what counts! Remote volume and balance control works with any system using separate preamplifier and power amplifier or any tape deck with cathode follower outputs. Small control (5 x 3 x 2 inches) can be placed as far as 30 feet away. \$19.95 in walnut or mahogany housing. \$15.95 in metal. Sun Radio Service, 320 Chestnut Street, Kearny, New Jersey WY 1-0564.

TV Tuners—Rebuilt or Exchanged \$9.95 complete—all types—fast, guaranteed service. Send tuner with all parts to: L. A. Tuner Exchange, 4611 West Jefferson Blvd., Los Angeles 16, California.

TUBES—TV, Radio, Transmitting And Industrial Types At Sensibly Low Prices. New. Guaranteed, 1st Quality, Top Name Brands Only. Write For Free Catalog or Call WALKER 5-7000. Barry Electronics Corp., 512 Broadway, New York 12N, N. Y.

SOMETHING for sale? Place a classified ad in this section. Low-cost, fast results. It's easy.

DIAGRAMS for repairing radios, Television \$2.00. Give make, model. Diagram Service, Box 672-E, Hartford 1, Conn.

GOVERNMENT Surplus Receivers, Transmitters, Snooperscopes, Parabolic Reflectors, Picture Catalog 10¢. Meshna, Malden 48, Mass.

RADIO & TV Tubes at Manufacturer's prices! 100% Guaranteed! Brand New! No re-brands or pulls! United Radio, Box 1000-W, Newark, N. J.

AUTO Radio Distributor Selling Servicing Becker Blaupunkt, FM-AM, other European, American Sets. Save 30% +. Square Electronics, 150-60 Northern Blvd., Flushing, N. Y.

GOVERNMENT Sells Surplus— Electronics; Oscilloscopes; Transceivers; Test Equipment; Radar; Sonar; Walkie-Talkie; Boats; Jeeps; Aircrafts; Misc.—Send for "U.S. Depot Directory & Procedures"—\$1.00—Brody, Box 425(RT), Nanuet, New York.

INFRA-Red!! Snooperscopes, Optics, Lamps, Parts. World's largest stock infra-red components. Write for Free Infra-red Catalog. McNeal Electric & Equipment, Dept. EW-3, 4736 Olive, St. Louis 8, Mo.

SYLVANIA Diodes—1 N 34 A. List price 70¢. Our price 10¢ for \$1; 100 for \$9; 1000 for \$80. Perfect condition. Money back guarantee. Shipped postpaid. Send cash, check or money order. Master Electronics, 161 High St., Boston, Mass.

USED operating condition, ASD self service tube testers: Model 340 \$20.00. Model 1000 \$25.00. Data. United Electronics, Box 3836, Tulsa, Okla.

COMPLETE Parts For The B C 683 and 603 Rec's Tubes and Manuals. Send 10¢ For Parts Listed. Also new and used Rec's 28 to 40 MC 12 or 110 Volts or 33 to 47 MC. Murray Bros. Short Wave Radio, 12 Adams Street, Charlestown 29, Mass.

WRITE Martin Lincoln. Electronics World, 1 Park Avenue, New York 16, N. Y. for information on how to place a classified ad in this section.

RADIO Television Servicemen. . . . A new concept in electronic parts and equipment supply. Get lowest dealer prices on nationally advertised products. No minimum quantities. Write for details. KPC Dept. E, Box 235, Westfield, N.J.

BUY-Sell-Trade Cameras, Lenses, Telescopes, Amateur Radio Equipment, Denson Electronics, Box #85, Rockville, Conn.

PROFESSIONAL Electronic Projects—Organs, Timers, Computers, Industrial, etc.—\$1 up. List Free. Parks, Box 1665 Lake City, Seattle 55, Wash.

FREE: 1961 catalogs for newest, best electronic bargains available. Stereo, hi-fi, ham radio, 1000 other items. Alco Electronics, Lawrence 7, Mass.

SAVE on Citizens Radio . . . Full Dealer Discounts. Write: Promotion Engineering, Waseca, Minnesota.

GOVERNMENT Surplus Receivers, Transmitters, Test Equipment, Original Size Schematics For Repairing, Converting, \$1.00 Each. Give Model, Free List, Bill Slep Company, Drawer 178EW, Ellenton, Florida.

WANTED

TRIGGER-W9IVJ. We Buy Short-Wave Ham & Citizens Receivers, Transmitters For Cash. 7361 W. North Ave. River Forest, Ill. Chicago # Tuxedo 9-6429. Mon-Fri. 12N-9PM, Sat. 9AM-5PM.

QUICKSILVER, Platinum, Silver, Gold, Ores Analyzed. Free Circular. Mercury Terminal, Norwood, Massachusetts.

CASH Paid! Sell your surplus electronic tubes. Want unused, Clean radio and TV receiving, transmitting special purpose, Magnetrons, Klystrons, broadcast types. Want military and commercial lab test equipment such as G.R.H.P., AN UPM prefix. Also want commercial Ham Receivers and Transmitters. For a Fair Deal write: Barry Electronics Corp., 512 Broadway, New York 12, N. Y. (Walker 5-7000).

INVENTIONS Wanted for immediate promotion! Patented, unpatented. Outright cash; royalties! Casco, Dept. BB Mills Building, Washington 6, D.C.

WANT to buy good equipment and accessories? Place a low-cost classified ad in this space.

1 RCA Type WR39 or WR89 Television Calibrator. Popular Electronics, Box 106, One Park Avenue, New York 16, N. Y.

HIGH-FIDELITY



DISGUSTED with "Hi" Hi-Fi Prices? Unusual Discounts On Your High Fidelity Requirements. Write. Key Electronics, 120 Liberty St., New York 6, N. Y. Cloverdale 8-4288.

RECORDERS, Components. Free wholesale catalogue. Carston 125-R, East 88, N.Y.C. 28.

PROMPT Delivery. We Will Not Be Undersold. Amplifiers, Tape Recorders, Tuners, Etc. No Catalogs. Air Mail Quotes. Compare. L. M. Brown Sales Corp., Dept. W, 239 E. 24 St., N. Y. 10, N. Y.

PRICES? The Best! Factory-sealed Hi-Fi Components? Yes! Send for free catalog. Audion, 25T Oxford Road, Massapequa, N.Y.

SOUNDSTASTIC! That's what our customers are saying upon receiving our prices on our latest High Fidelity Stereo and Monaural, amplifiers, tuners, turntables, speakers, tape recorders, kits. All brand new with factory guarantee. Individual quotations only. No catalogues. Audio World, 2037 Coney Island Avenue, Brooklyn 23, New York. Dept. HR

OVER 245,000 buyers and sellers will read your ad when placed in this space. It costs only 60¢ per word; minimum of 10 words including your name and address.

TAPE & RECORDERS

DON'T Buy Hi-Fi components, kits, tape, tape recorders until you get our low, low return mail quotes. "We Guarantee Not To Be Undersold." Wholesale catalog free. Hi-Fidelity Center, 1797NC First Avenue, New York 28, N.Y.

AMPEX, Concertone, Magnecord, Presto, Bogen, Tandberg, Pentron, Sherwood, Rek-O-Kut, Scott, Shure, Dynakit, others, Trades. Boynton Studio, Dept. RT, 10 Pennsylvania Ave., Tuckahoe, N. Y.

SELF-Hypnosis tape. New! Free literature. McKinley-Smith Co., Dept. T6, Box 3D38, San Bernardino, Calif. **TAPE Recorders, Hi-Fi Components, Sleep Learning Kits, Tapes. Unusual Values.** Free Catalog. Dressner. 69-02R 174 St., Flushing 65, N. Y.

RENT Stereo Tapes—over 2,000 Different—all major labels—free catalog. Stereo-Parti, 811-G, Centinela Ave., Inglewood 3, California.

REPAIRS & SERVICING

DIFFICULT product, circuitry design engineering. Encapsulations. Detail your problem. Farris, Williamsbury, New Mexico.

BOOKS

BOOKS—All 10¢. 2000 titles, all subjects, catalog free. Cosmae, Clayton, Ga.

SHOPPING GUIDE Classified

A HANDY GUIDE TO PRODUCTS, NOT NECESSARILY ELECTRONIC, BUT OF WIDE GENERAL INTEREST.

PHOTOGRAPHY—FILM, EQUIPMENT, SERVICES

OPTICAL—Science—Math Bargains—Request Free Giant Catalog "CJ"—144 pages—Astronomical Telescopes, Microscopes, Lenses, Binoculars, Kits, Parts. Amazing war surplus bargains. Edmund Scientific Co., Barrington, New Jersey.

FREE! New 1961 Catalog of all Photographic Books Available. For your copy, send Postcard with Name and Address to Catalog. Popular Photography Book Service. One Park Avenue, New York 16, N.Y.

STAMPS & COINS

COIN Collectors Largest Newspaper, Twice Monthly. Sample 25¢, \$2.00 yearly. Numismatic News, 232 Water Street, Iola, Wis.

TERRIFIC Stamp Bargain! Israel—Iceland—Vatican Assortment—plus exotic triangle set—also of fabulous British Colonial Accumulation—Plus large stamp book—All four free—Send 10¢ to cover postage. Empire Stamp Corp., Dept. 22, Toronto, Canada.

HELP WANTED

HIGH Paying Jobs in Foreign Lands! Send \$2.00 for complete scoop! Foreign Opportunities, Box 172, Columbus 16, Ohio.

EARN Extra money selling advertising book matches. Free Samples furnished. Matchcorp, Dept. MD-41, Chicago 32, Ill.

WRITE Martin Lincoln, Electronics World, 1 Park Avenue, New York 16, N.Y. for information on how to place a classified ad in this section.

WANTED—One Ham in every state willing to invest 8 hours total time against a one year commission. For details, write—The J & M Company, Box 8, Stratford, Conn.

BUSINESS OPPORTUNITIES

MAKE \$25-\$50 Week. clipping newspaper items for publishers. Some clippings worth \$5.00 each. Particulars free. National, 81-DG, Knickerbocker Station, New York.

I Want A Man who wants a business of his own. I will train you, supply the equipment, give you credit, help you get rolling. This is not a risky-get-rich-quick scheme. It is a legitimate business, an exclusive protected franchise, proved successful by hundreds throughout the country. Write for an interview. Marion Wade, 2117 North Wayne, Dept. 24M, Chicago 14, Illinois.

MISCELLANEOUS

"WINEMAKING." "Beer, Ale." Strongest methods. Illustrated. \$2.20. Eaton Bookstore (Supplies), Box 1242-X, Santa Rosa, California.

SOMEONE "borrowing" your personal copy of Electronics World each month? You ought to be taking advantage of Electronics World convenient re-sale plan. Sell copies in your store . . . perform a good service for your customers . . . with no risk involved. For details, write: Direct Sales Department, Electronics World, One Park Avenue, New York 16, New York.

BUILD THE BEST HI-FI

save 1/2 with **EICO** KITS

Model HFT94 AM Tuner



Model HFT90 FM Tuner

AM TUNER HFT94

Kit \$39.95 Wired \$65.95

INCLUDES COVER & FET

- monaural AM reception, and/or
- STEREO AM-FM reception with matching EICO FM Tuner HFT90 or equivalent

NO technical experience is necessary. Each EICO kit comes complete with easy step-by-step instructions and picture diagrams — plus exclusive LIFETIME guarantee for service adjustment.

Come in for a no-obligation demonstration.

NOW AVAILABLE AT

Almo RADIO CO.

913 ARCH ST., PHILADELPHIA, PA.
201 CALHOUN ST., TRENTON, N. J.
219 LANDIS AVE., VINELAND, N. J.
1122 FRENCH ST., WILMINGTON, DEL.

INDEX OF

Advertisers

APRIL
1961

ADVERTISER	PAGE NO.	ADVERTISER	PAGE NO.
Airex Radio Corporation	122	Key Electronics Company	111
Allied Radio	7, 90, 91	Kuhn Electronics, Inc.	66
Almo Radio Co.	130	Lafayette Radio	97
Amperex Electronic Corp.	71	Lampkin Laboratories, Inc.	104
Ashe Radio Co., Walter	112	Lektron	108
Audio Unlimited	122	McGee Radio Co.	92
Audion	118	Mark Mobile, Inc.	98
B & K Manufacturing Co.	13	Milwaukee School of Engineering	95
Baltimore Technical Institute	118	Moog Co., R. A.	126
Barry Electronics Corp.	116	Moss Electronic, Inc.	100, 101
Bell Telephone Laboratories	Third Cover	National Radio Institute	1
Bogen-Presto	98, 99	National Technical Schools	21
British Industries Corp.	120	Nortronic Company, Inc., The	85
Browning	118	Oelrich Publications	99
Burstein-Applebee Company	123	Ohmatsu Electric Co. Ltd.	71
C & H Sales Co.	110	Olson Electronics	113
Cagan Sales, R. C.	111	Pacific International College of Arts & Sciences	116
Capitol Radio Engineering Institute, The	23	Paco Electronics Co., Inc.	10, 11
Candee Co., J. J.	126	Peak Electronics Company	82
Carston	70	Philco Technological Center	93
Center Industrial Electronics, Inc.	70	Picture Tube Outlet	120
Channel Master Corp.	73, 99	Quietrol Company	119
Chemical Electronic Engineering, Inc.	95	RCA Electron Tube Division	109
Cleveland Institute of Electronics	5	RCA Institutes, Inc.	14, 15
Columbia Electronics	124	R W Electronics	122
Commissioned Electronics Co.	93	Rad-Tel Tube Co.	125
Coyne Electrical School	74, 86	Radio Corporation of America	Fourth Cover
DeVry Technical Institute	16, 17, 18, 19	Radio-Television Training School	9
Dressner	118	Raytheon Company	105
Editors & Engineers, Ltd.	118	Reeves Soundcraft Corp.	84
EICO	27, 28, 117	Rek-O-Kut Company, Inc.	12
Electro-Voice, Inc.	25	Rider Publisher, Inc., John F.	93
Electronic Chemical Corp.	102	Sams & Co., Inc., Howard W.	88, 89
Electronic Book Service	114, 115	Schober Organ Corp., The	68
Fair Radio Sales	122	Scott Inc., H. H.	69
Fisher Radio Corp.	6	Sencore	67
G & G Radio Supply Co.	128	Shure Brothers, Inc.	70
General Electric Company	65	Sonar Electronic Tube Co.	96
General Radio & Telephone Company	106	Sonotone Corp.	83
Globe Electronics	102	Sprague Products Co.	26
Goodheart Co., R. E.	113	Superscope, Inc.	8
Grantham School of Electronics	3	Supreme Publications	103
Greenlee Tool Co.	121	Sylvania Electric Products, Inc.	Second Cover
Grylock Electronics	116	TAB	102
Hallicrafters	66	Texas Crystals	124
Harman-Kardon, Inc.	107	Transvision	111
Heath Company	78, 79, 80, 81	Tri-State College	70
Henshaw Radio Supply	99	Tube-a-Rama	119
Holt, Rinehart and Winston, Inc.	20, 72	U.S. Crystals, Inc.	92
Hy-Gain Antenna Products	84	U.S. #1 Electronics	112
Indiana Home Study Institute, The	94	University Loudspeakers, Inc.	87
Indiana Technical College	111	Valparaiso Technical Institute	96
International Radio & Electronics Corp.	86	Warren Dist. Co.	120
Jerrold Electronics Corporation	4	Webster Productomatic Corporation	104
Johnson Co., E. F.	121	Weller Electric Corp.	22
		Winegard	75, 127

Printed in U.S.A.

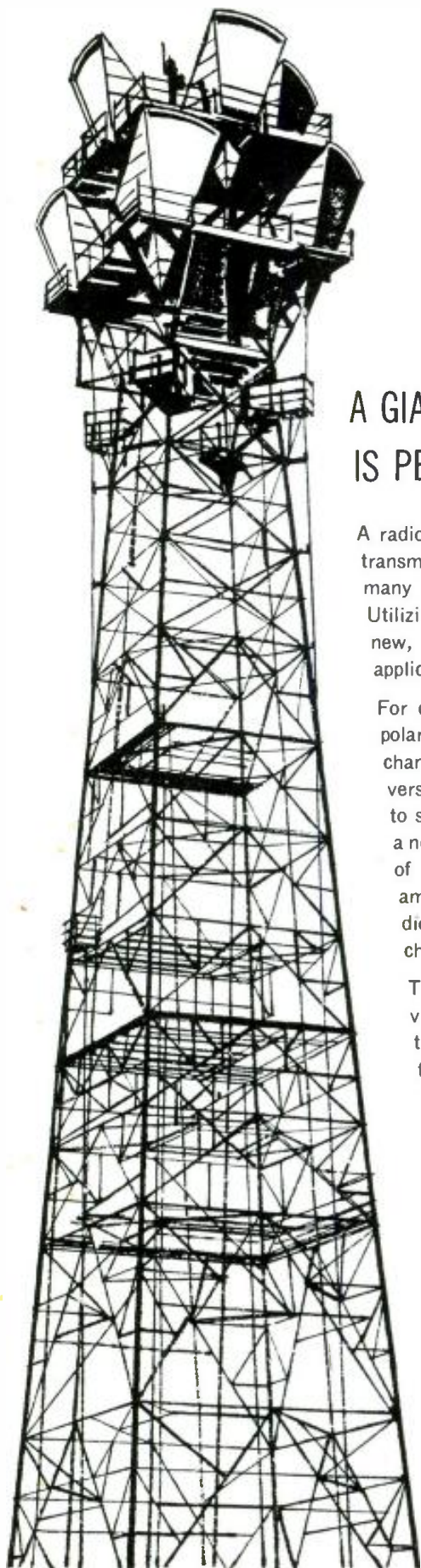

A GIANT RADIO HIGHWAY IS PERFECTED FOR TELEPHONY

A radio relay system operating at 6 billion cycles per second and able to transmit 11,000 voices on a single beam of microwaves—several times as many as any previous system—has been developed at Bell Laboratories. Utilizing the assigned frequency band with unprecedented efficiency, this new, heavy-traffic system was made possible by the development and application of new technology by Bell Laboratories engineers and scientists.

For example, they arranged for the waves in adjacent channels to be polarized 90 degrees apart, thus cutting down interference between channels and permitting the transmission of many more telephone conversations in the same frequency space. They developed ferrite isolators to suppress interfering wave reflections in the waveguide circuits; and a new traveling wave tube that has ten times the power handling capacity of previous amplifiers and provides uniform and almost distortionless amplification of FM signals. They devised and applied a new high-speed diode switching system which instantly switches service to a protection channel when trouble threatens.

To transmit and receive the waves, the engineers applied their invention, the horn-reflector antenna. Elsewhere, this versatile antenna type is brilliantly aiding space communication research in the reception of radio signals from satellites. For radio relay, a single horn-reflector antenna can efficiently handle both polarizations of the 6000 megacycle waves of the new system; at the same time it can handle 4000 and 11,000 megacycle waves used for existing radio relay systems. Thus it enables all three systems to share economically the same radio towers and routes.

Produced by the Bell System's manufacturing unit, Western Electric, the new system is now in operation between Denver and Salt Lake City, and will gradually be extended from coast to coast. This new advance in radio technology is another example of how Bell Telephone Laboratories works to improve your Bell communication services.



BELL TELEPHONE LABORATORIES

World center of communications research and development

How do your customers rate you?



Your reputation is based largely on what happens *after* you leave the scene of each service call. For this reason the name on the tubes you install makes a world of difference. RCA tubes are designed and manufactured to assure customer confidence in you as well as in RCA.

RCA tube quality is your best insurance against call-backs due to premature tube failure.

RCA tube performance puts your workmanship in the best light and protects it through rigid quality control.

RCA's trademark symbolizes a name and reputation customers have respected for decades.

Your customers know that those red-white-and-black RCA tube cartons in your tube caddy represent the most trusted name in electronics. Remember, customer confidence is the cornerstone of your business.

To protect your service reputation before, during and after every service call, make sure your next tube order specifies... RCA TUBES.

RCA ELECTRON TUBE DIVISION, HARRISON, N. J.



SIGN OF A SERVICE JOB WELL DONE



The Most Trusted Name in Electronics
RADIO CORPORATION OF AMERICA