

# ELECTRONICS WORLD

MAC 8

50 CENTS

**ELECTRONICS IN CRIME DETECTION**

**CITIZENS BAND SERVICE PROBLEMS**

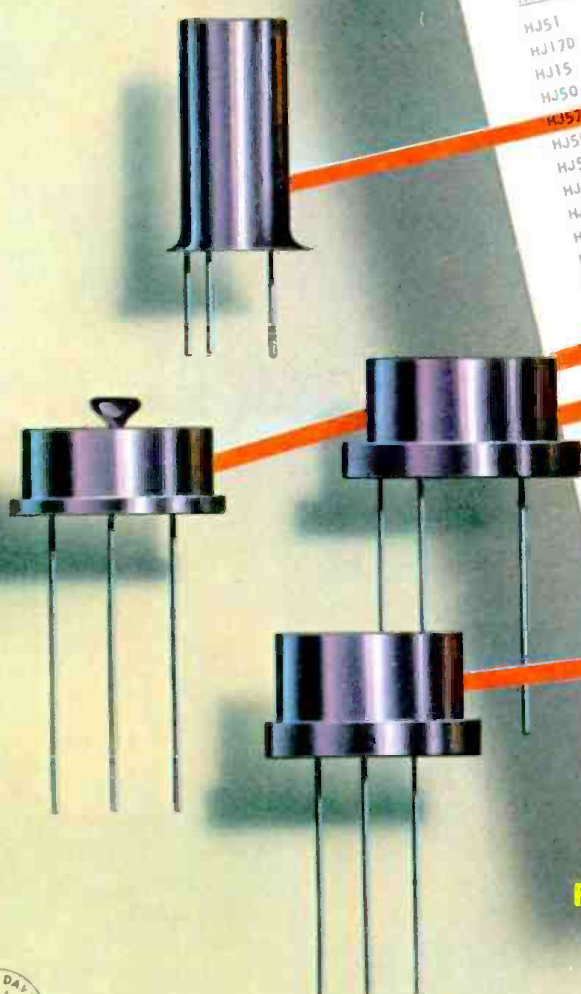
**BUILD YOUR OWN 40- OR 60-WATT HI-FI AMPLIFIER**

**HOW TO RECORD LIVE STEREO**



Japanese No.      Similar US type      Japanese No.      Similar US type

Hitachi		TEN	
HJ51	2N408	2530	2N411, 2N412
HJ17D	2N217	2531	2N409, 2N410
HJ15	2N215	2532	2N405, 2N406
HJ50	2N215	2533	2N407, 2N408
HJ57	2N412	2534	2N270
HJ55, HJ60, 25144	2N219	2535	2N140, 2N219
HJ56	2N410	2536	2N139, 2N218
HJ23D	2N219	2537	2N109, 2N217
HJ34, HJ34A, 2591	2N218	2538	2N270
HJ35	2N270	2539	2N175, 2N220
HJ32, HJ70, 25141	2N301	2540	2M269
HJ37, HJ71, 25141	2N370	2543	2N247
HJ72, 25147	2N371	25109	2N370
HJ73, 25143	2N372	25112	2N371, 2N372
HJ74, 25144	2N373	2541	2N372
HJ75, 25143	2N374	2542	2N301
	2N544		2N301A
NEC		Sony	
ST162	2N145, 2N146	2T66	2N365
ST163	2N147, 2N293	2T65	2N366, 2N217
ST173	2N168A	2T76	2N147
ST28C	2N309	2T64	2N366
ST37D	2N252		
Toshiba			
2544	2N217		
2545	2N218		
2552	2N219		
2556	2N270		



**REPLACEMENT GUIDE FOR JAPANESE TRANSISTORS**  
(See Page 46)



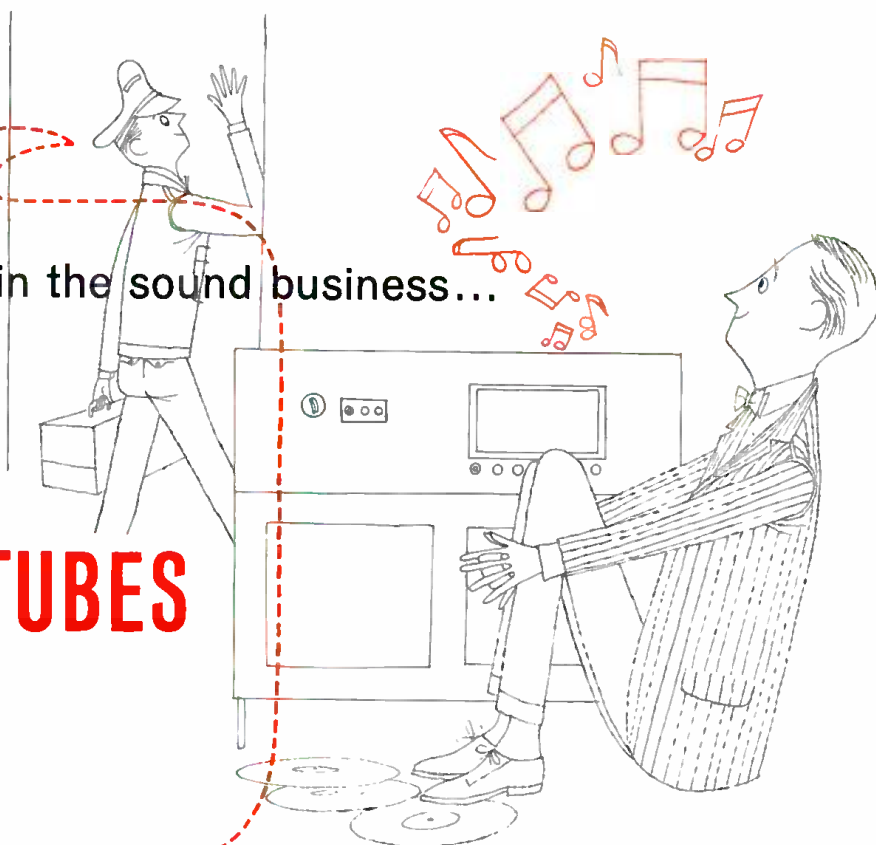
*H.V. Kelvin*

For **sound profits** in the sound business...

replace defective  
audio tubes with

**SYLVANIA TUBES**

**FOR HI-FI!**



Hi-Fi set owners are a "finicky" lot. Won't compromise with audio quality. It's easy to help them get the fine sound reproduction they want. When the trouble is a tube, do what profit-minded dealers have been doing for years with radio and TV sets. Replace defective tubes with SYLVANIA superior-quality TUBES.

**ESPECIALLY FOR HI-FI AUDIO**



**SYLVANIA 6BQ5**... power pentode used in many medium-to-high power output stages.

**SYLVANIA 6973**... power pentode popular in medium-to-low power output stages.

**SYLVANIA 12AX7**... high-mu twin triode used in many high-gain preamplifiers.

**SYLVANIA 7025**... a "sophisticated" 12AX7, featuring exceptionally low noise and low microphonics.

**SYLVANIA 7199**... triode-pentode, featuring low hum and low microphonics, used in high-gain preamplifier and phase inverter stages.

**TOP PERFORMANCE AND LONG LIFE...**

that's what your customers get with SYLVANIA TUBES! What do you get? Fewer callbacks and satisfied customers who send you more customers. Yes, there's no doubt about the "sound profits" that are yours when you use SYLVANIA TUBES. Electronic Tubes Division, Sylvania Electric Products Inc., 1740 Broadway, New York 19, N. Y.

# SYLVANIA

Subsidiary of **GENERAL TELEPHONE & ELECTRONICS**



# NOW READY

# The NEW NRI Home Study Course in **ELECTRONICS**

PRINCIPLES — PRACTICES — MAINTENANCE

## SPECIAL TRAINING EQUIPMENT

No extra cost. In NRI Electronics training especially developed training kits bring to life theory you learn in easy, illustrated lessons. You get practical experience with Thyatron Tube circuits, Multivibrators, Capacitors, Diodes, Transistors, Telemetry, Computer Circuits and other basic circuits and components.



**KIT 1** Get practical experience measuring voltage, current, building circuits.

**KIT 2** Build d'Arsonval type Vacuum Tube Voltmeter. Test power line frequencies, high audio, radio frequency signals, resistances.

**KIT 3** Practice with resistors, capacitors, coils. Work with half-, full-wave, bridge, voltage doubler and pi-type filter circuits.

**KIT 4** Build circuits with pentode tubes, selenium resistors, transistors. Build oscillator, check signal phase shift with oscilloscope.

**KIT 5** Experiment with thyatron tube circuits. Lissajous patterns. Study basic amplitude detector circuits, modulation, demodulation.

**KIT 6** Get practical experience with magnetic amplifiers, learn to use modified Prony brake; determine motor torque. Use strobe disc to measure motor speed.

**KIT 7** Learn effects of positive and negative feedbacks (used in analog computers). Practice varying polarizing voltage and illumination.

**KIT 8** Experiment with multivibrators used as timing generators in binary counters, and as frequency dividers. Learn to use blocking oscillators, thermistors.

**KIT 9** Practical experience in telemetry circuits used in earth satellites, remote control devices. Work with basic circuits used in digital and analog computers.

**KIT 10** Assemble circuits in electrical and electro-mechanical systems, make valuable practical electronic circuits.

**MAIL COUPON**—New 64-Page Catalog pictures and describes Training Kits, explains what you learn.

NRI is America's oldest, largest home study Radio-Television-Electronics school. For over 45 years NRI has been training men without previous experience for success in Radio-Television Servicing and Communications. Now, expanded uses of Electronics in industry, business and defense are increasing the demand for Electronic Technicians. Four to seven Technicians are needed for every engineer. To meet this demand NRI announces a complete, comprehensive course in **ELECTRONICS**—Principles, Practices, Maintenance.

This training stresses basic fundamentals because so many Electronic devices are built around identical Electronic principles. It is for beginners, or for Technicians who wish to expand their knowledge.



This is the Electronic Age. Electronic Equipment is already being used to count, weigh, control flow of liquids, solids,

gases. Control exposure in photography, detect fumes, or fire. Inspect at remote points. Supervise traffic. Survey land areas and ocean contours. Search for oil, miles beneath the surface. Measure radiation and control power levels in atomic installations. Control air traffic. Translate one language into another. The **MILITARY** applications of Electronics . . . particularly in space rockets and missiles, tracking devices, etc., . . . probably equal all of the uses above. Electronic equipment is used to machine parts through complex cycles. It is used in business to process data, control inventory, prepare payrolls, post, calculate, and in medicine for electrodiagnosis, measure body characteristics, electro-surgery.



**Job Counselors Recommend**  
Right today a career in Electronics offers

unlimited opportunity. Job Counselors know the pay is high, jobs interesting, advancement opportunities great. They advise ambitious, aggressive men who want higher pay now and a better future: "For an interesting career, get into Electronics."

## Learn More to Earn More

Simply waiting and wishing for a better job won't get you ahead. You have to decide you want to succeed and *you must act*. NRI can provide the training you need at home in spare time. No need to go away to school. You don't need a high school diploma or previous Electronic experience. This course is planned to meet the needs of beginners. You work and train with components and circuits you will meet throughout your Electronics career. You get especially developed training kits for practical experience that make Electronics easy, simple to learn.



## Oldest and Largest School

Training men to succeed, is the National Radio Institute's *only* business. The NRI Diploma is respected and recognized. NRI graduates are everywhere throughout U.S. and Canada. Mail the coupon today. New, FREE 64-page Catalog gives facts, opportunities about careers in Industrial and Military Electronics, also shows what you learn, facts about NRI's other courses in Radio-Television Servicing and Radio-Television Communications. Monthly payments available.

OLDEST & LARGEST HOME STUDY RADIO-TV SCHOOL  
**National Radio Institute**  
WASHINGTON 16, D.C. ESTABLISHED 1914

**MAIL THIS COUPON NOW**

NATIONAL RADIO INSTITUTE OHE  
Washington 16, D. C.

Send me full information without cost or obligation. No salesmen will call.  
(Please print.)

Name ..... Age .....

Address .....

City ..... Zone ..... State .....

ACCREDITED MEMBER NATIONAL HOME STUDY COUNCIL

# ELECTRONICS WORLD

AUGUST, 1960  
VOL. 64 ■ NO. 2

**Publisher**  
**OLIVER READ, D. Sc., WIET**

**Editor**  
**WM. A. STOCKLIN, B. S.**

**Technical Editor**  
**MILTON S. SNITZER, W2QYI**

**Service Editor**  
**SIDNEY C. SILVER**

**Associate Editor**  
**P. B. HOEFER**

**Industrial Consultant**  
**WALTER H. BUCHSBAUM**

**Art Editor**  
**MILTON BERWIN**

**Art and Drafting Dept.**  
**J. A. GOLANEK**  
**K. W. PAUL, JR.**

**Advertising Director**  
**JOHN A. RONAN, JR.**

**Advertising Manager**  
**GEORGE E. MORRISSEY**

**Midwest Adv. Manager**  
**GILBERT J. JORGENSEN**

**Western Adv. Manager**  
**DON CENA**



**ZIFF-DAVIS PUBLISHING COMPANY**  
William Ziff, President; W. Bradford Briggs, Executive Vice-President; Michael Michaelson, Vice-President and Circulation Director; Marshal B. Sarbin, Vice-President; J. L. O'Donnell, Treasurer.

Editorial and Executive Offices  
One Park Avenue  
New York 16, N. Y. OR. 9-7200



Member  
Audit Bureau of  
Circulations

MEMBER  
INSTITUTE OF



**BRANCH OFFICES:** Midwestern Office, 434 S. Wabash Ave., Chicago 5, Ill.; Western Office, 9025 Wilshire Blvd., Beverly Hills, Calif.; James R. Pierce, manager.

**FOREIGN ADVERTISING REPRESENTATIVES:** D. A. Goodall Ltd., London; Albert Milhado & Co., Antwerp and Dusseldorf.

*First in radio-television-audio-electronics*

## CONTENTS

### GENERAL ELECTRONICS AND INDUSTRIAL

The Strategic Air Command (SAC) (Editorial)	W. A. Stocklin	6
Spot News	Washington Correspondent	21
Electronics in Crime Detection	Walter H. Buchsbaum	29
BMEWS—Ballistic Missile Early Warning System		33
Computer Memory Devices (Part 2)	Ed Bukstein	42
Radio Aids to Aircraft Navigation (Part 2)	Francis A. Gicca	56
Recent Developments in Electronics		60
Calendar of Events		114

### HIGH FIDELITY AND AUDIO

Record Live Stereo at Home	Norman H. Crowhurst	34
Transistorized Mike Mixer	Lyman E. Greenlee	38
40- or 60-Watt Hi-Fi Amplifier with Tertiary Feedback	Thomas F. Burroughs	43
Hi-Fi—Audio Product Review		76
"Reverbaphonic Sound" System		82
New Audio Test Report (Argus Model X-4, University T-202, Dynaco TA-12 "Stereodyne")—EW Lab Tested		84
The Decibel Without Pain	Bob Eldridge	96
Certified Record Revue	Bert Whyte	122
Sound on Tape	Bert Whyte	124

### TELEVISION-RADIO

Transistor Replacement in Japanese Radios (Cover Story)	Don Lewis	46
Remodeling Your Shop? Plan Ahead	Ernest W. Fair	52
Ultrasonic TV Remote Controls	William Feingold	54
Mac's Service Shop	John T. Frye	66
Service Industry News		74
Hams, TVI, and Technicians		90

### TEST EQUIPMENT

A Transistorized Instrument Preamplifier	Charles Caringella	72
Transistorized Tachometer Pickup	Paul S. Lederer	88
Improving A.C. Voltmeter Accuracy	Howard Q. Duquid	116
New Tube Tester Data		118

### COMMUNICATIONS AND AMATEUR

What's Your Citizens Band Frequency?	Donald L. Stoner, 11W1507	36
How to Service CB Equipment	Leo G. Sands	39
Has Ham Radio Construction Improved?	Howard S. Pyle, W7OE	49
Railroad Radio		62
Operating Mobile in Canada	J. E. Kitchin	104

### ELECTRONIC CONSTRUCTION

Simple Touché Indicator for Fencers	Leon A. Wortman	48
A Solder-Gun Temperature Control	Peter Vogelgesang	53
A.C. Supply for Transistor Preamp	David R. Steele	80

### DEPARTMENTS

Within the Industry	8	Technical Books	100
Letters from Our Readers	22	Manufacturers' Literature	109
What's New in Radio	126		

Circulation (Jan.-June) 251,750 (Publisher's Estimate)

Radio & TV News • Radio News • Television News Trademarks Reg. U. S. Pat. Off.  
Copyright © 1960 by Ziff-Davis Publishing Company. All rights reserved.

**SUBSCRIPTION SERVICE:** Forms 3579 and all subscription correspondence should be addressed to Circulation Department, 434 South Wabash Avenue, Chicago 5, Illinois. Please allow at least four weeks for change of address. Include your old address as well as new—enclosing if possible an address label from a recent issue.

**CONTRIBUTIONS:** Contributors are advised to retain a copy of their manuscripts and illustrations. Contributions should be mailed to the New York Editorial Office and must be accompanied by return postage. Contributions will be handled with reasonable care, but this magazine assumes no responsibility for their safety. Any copy accepted is subject to whatever adaptations and revisions are necessary to meet the requirements of this publication. Payment covers all author's, contributor's, and contestant's rights, title, and interest in and to the material accepted and will be made at our current rates upon acceptance. All photos and drawings will be considered as part of the material purchased.

**NOW...GET EVERYTHING YOU NEED TO PREPARE TO EARN REAL MONEY IN**

# ELECTRONICS

**From RADIO • TELEVISION • RADAR To GUIDED MISSILE CONTROL, etc.**

**One of Today's BRIGHTEST Opportunity Fields!**



Today's great Electronics field offers you a chance of a lifetime to prepare for highly interesting work and a wonderfully promising future! With so many new developments coming up in Electronics, opportunities for trained men were never brighter. Send coupon for details.

Right in your own home you may now get one of today's most interesting . . . PRACTICAL WAYS to prepare for a good job or your own business in Electronics. No previous technical experience or advanced education are needed! DeVry Tech brings you a unique 3-WAY COMBINATION of texts, home movies and real equipment—the same type of basic equipment as found in our well-equipped Chicago and Toronto Laboratories.

**EMPLOYMENT SERVICE** . . . helps you get started toward a good job, or toward advancement in the company you now work for. FREE to all graduates.

**EARN WHILE YOU LEARN** DeVry Tech's practical program helps you to earn EXTRA MONEY in your spare time, servicing Radio and TV sets.

## Your Guide

### to PROFITABLE JOB OPPORTUNITIES

See how YOU may get ready for Jobs as:

- TV-Radio Broadcast Technician
- Color Television Specialist
- Radar Operator • Laboratory Technician
- Airline Radio Man • Computer Specialist
- Quality Control Manager

Your Own Sales & Service Shop...**PLUS MANY OTHERS**

## SEND FOR FREE BOOKLET!

"One of North America's Foremost Electronics Training Centers"



Accredited Member of National Home Study Council

# DeVRY TECHNICAL INSTITUTE

CHICAGO 41, ILLINOIS

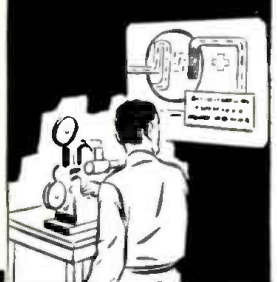
### 300 EXPERIMENTS

Build over 300 practical projects from many shipments of Radio-Electronic parts. You build and operate TV-Radio circuits . . . wireless microphone . . . and many other major projects—all designed to provide outstanding practical experience at home.



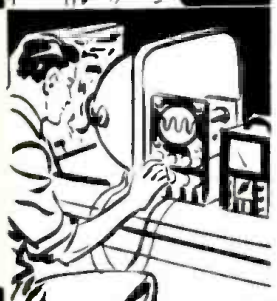
### HOME MOVIES

Thanks to this exclusive home training aid, many important fundamentals quickly become "movie clear." Now you can actually see electrons on the march and other "hidden actions"—a wonderful advantage that is almost like having a teacher at your side.



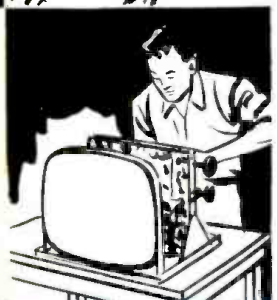
### BUILD YOUR OWN TEST EQUIPMENT

As part of your home laboratory projects, you BUILD and KEEP a fine quality 5-inch COLOR OSCILLOSCOPE and a Jewel Bearing VACUUM TUBE VOLTMETER. You will find this equipment ideal for helping you earn in your spare time while a student—and later when working full time in the field.



### BUILD AND KEEP A BIG 21-INCH TV SET

For added practical experience, you can also build and keep this quality 21-inch TV SET that provides TV reception at its finest (DeVry Tech also offers another home training without the TV set).



## MAIL COUPON TODAY!

DeVRY TECHNICAL INSTITUTE  
4141 Belmont Avenue, Chicago 41, Ill., Dept. EW-8-Q

Please give me your FREE booklet, "Electronics in Space Travel," and tell me how I may prepare to enter one or more branches of Electronics.

Name \_\_\_\_\_ Age \_\_\_\_\_

PLEASE PRINT

Street \_\_\_\_\_ Apt. \_\_\_\_\_

City \_\_\_\_\_ Zone \_\_\_\_\_ State \_\_\_\_\_

2046 Canadian residents address: DeVry Tech of Canada, Ltd.  
970 Lawrence Ave. West, Toronto, Ont.

**NEW WAYS RCA CAN HELP YOU**

# set up for greater profits

**RCA's big continuing program to improve your business is now bigger than ever!**

Today you'll find available to you through your Authorized RCA Electron Tube Distributor a variety of new methods, means and materials to help you SET UP FOR GREATER PROFITS. These new aids and services represent the latest phase of RCA's tailor-made program to help you build your business. They include:

- **New equipment** for store improvement—to bring added attractiveness to your sales area and greater efficiency to your service area;
- **New ideas** for successfully selling your service;
- **New informative material** to help you open up a whole new area of business: COLOR TV SERVICING.
- **New conveniences** to speed home service calls;

Check with your Authorized RCA Electron Tube Distributor today. Find out how you can get in on these new aids and services to improve your business, build your position in the community, and increase your profits.

RCA Electron Tube Division, Harrison, N. J.



The Most Trusted Name in Electronics  
RADIO CORPORATION OF AMERICA

ELECTRONICS WORLD

# improve YOUR PLACE OF BUSINESS



Attractive sales and service areas are invaluable business assets. Plan yours with components from the RCA Store Improvement Program—all available through your RCA Distributor.

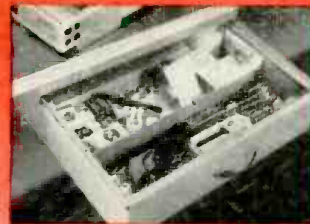
**NEW Space-Saving Shelving Units** help you make use of space over doors & windows, under counters.



**NEW RCA Accessory Bar Kit** attaches to wall or shelf-unit standards. Movable hooks support anything from wire spools and tools to test instruments.

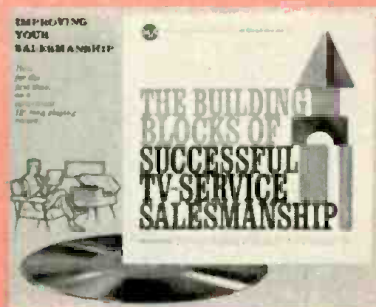


**NEW RCA Special Drawer Unit** provides a three-way benefit. Attaches under counter as utility drawer in service shop, cash drawer in sales area; or several drawers can be stacked together as a separate stand-up unit.



# strengthen YOUR SALESMANSHIP

Here for the first time on a convenient 12" LP record are proven ideas on how to sell your services more effectively. Just sit and listen. Discover how you can apply successful selling techniques to the every-day aspects of your business.



Down-to-earth tips on: • Your Store • Handling Store Customers • Telephone Techniques • Home Service Calls • Advertising—and much more.

# develop NEW BUSINESS

Profitable new business awaits you in **COLOR TV SERVICING**—provided you're ready to take advantage of it. Now RCA—world's foremost color TV authority—offers you a **FULL 11-LESSON HOME STUDY COURSE** to make you the color TV expert of your community. Prepared by RCA Institutes, it's a complete education in principles and practices of color TV servicing. **ACT NOW:** the course is a limited-time offer through your RCA Tube Distributor.



And to supplement the course, the famous **RCA COLOR TV PICT-O-GUIDE** makes an ideal refresher and quick reference on color-TV problems and how to correct them.



# speed YOUR SERVICE

Make your home service calls faster, easier. This new lightweight, compact "Quick Call" Tube Caddy has a rugged wooden construction with two-color leatherette covering. This perfect mate to the big RCA "Treasure Chest" is just the thing for service calls that don't require a full tube complement.



New Lightweight "Quick Call" Tube Caddy



Standard "Treasure Chest" Tube Caddy

# FIX ANY TV OR RADIO ever made!



## COMPLETE TRAINING FOR BETTER RADIO-TV SERVICE JOBS

These two giant Ghirardi home training manuals make it easy for you to be an expert on ALL types of TV-AM-FM service . . . at only a fraction of the price you might expect to pay for such complete training. Almost 1500 pages, over 800 clear illustrations and dozens of procedure charts explain each detail of every service job as clearly as A-B-C. Each book contains up to the minute data. Each is based on approved professional methods. You learn time-saving shortcuts. You learn to work better, more profitably. Ideal as complete training for beginners or as a handy reference library for experienced servicemen who want to look up puzzling jobs or develop new and faster methods.

### A complete guide to TROUBLESHOOTING & REPAIR

① This 820-page **Radio & TV TROUBLESHOOTING AND REPAIR MANUAL** guides you through each service procedure . . . from locating troubles to making repairs fast and right. Step-by-step charts cover practically every type of troubleshooting from Television problems to AM and FM realignment to IF and Detector Sections, cat radios, record players, communications receivers, etc. 417 illustrations. Price \$7.50 separately. (Outside U.S.A. \$8.00.)

### The complete "know how" of SET CIRCUITS & OPERATION

② Learn all about circuits and their peculiarities and watch your service "headaches" disappear! This 660-page **Radio & TV Receiver CIRCUITRY AND OPERATION** manual covers all basic circuits and circuit variations used in modern home equipment; explains their likely trouble spots; teaches you to go right to the seat of trouble without useless testing; helps you develop fast, truly professional service techniques. Price \$6.75 separately. (Outside U.S.A. \$7.25.)

### SAVE \$1.25—Pay As You Learn!

If sold as a course and sent to you in lesson form, you'd regard these two famous manuals as a bargain at \$75.00 or more. Instead, you buy them complete in handy book form for only \$13.00 for the two (regular price \$14.25). You save \$1.25 . . . and you have 3 months to pay if desired. No lessons to wait for! Everything is at your finger tips. You learn fast! Everything you learn right! OUR MONEY-BACK GUARANTEE PROTECTS YOU FULLY!

### STUDY 10 DAYS FREE!

Dept. RN-80, RINEHART & CO., Inc.  
232 Madison Ave., New York 16, N. Y.

#### MONEY-SAVING OFFER ON BOTH BOOKS!

Send Radio & TV TROUBLESHOOTING AND REPAIR and Radio & TV CIRCUITRY & OPERATION home training manuals for 10-day free examination. If I decide to buy books, I agree to pay \$13.00 (plus postage) for the two . . . a saving of \$1.25 over the regular price of \$14.25. I will pay \$4 (plus postage) after 10 days and \$1.00 a month thereafter until \$13.00 has been paid. Otherwise I will return books and owe you nothing. (SAVE! Send \$13 with order and we pay postage. 10-day money-back guarantee if you're not more than satisfied.)

Name .....

Address .....

City, Zone, State .....

(Outside U.S.A.—\$14.00 for both books. Cash with order only, but same return privilege with money refunded.)

# ...for the Record

By W. A. STOCKLIN  
Editor



## THE STRATEGIC AIR COMMAND (SAC)

SOME may find SAC's slogan "Peace Is Our Profession" a bit strange. Yet, after our most interesting two-day visit to Offutt Air Force Base Headquarters of SAC, and after actually seeing all their facilities and talking to key officers, one can get a much clearer picture of the reasons behind this slogan. The "deterrent concept" is followed, and this is to maintain a force so capable of quick, devastating retaliation that no nation would dare to attack. The two main requirements are strength and readiness.

SAC's operation is global in nature. It has over 1500 B-47 and 450 B-52 bombers. In addition, its force consists of over 1000 refueling planes. SAC aircraft alone consumed 228,000 gallons of fuel hourly last year.

Our interest, of course, was directed towards electronics, and particularly the communications system. There is no doubt that theirs is one of the most comprehensive and reliable nets in all the world. Every intercontinental cable terminates at their home base, and these are available to them on emergency basis. We saw acres of antennas of almost every conceivable type at their nearby receiving station, and similarly at their transmitter base some 20 miles away. Single-sideband is widely used as it is, in their opinion, the most reliable of all communication techniques. Ionospheric skip is one of their main problems. We saw a TV-like piece of equipment which is used to determine the best operating frequency to use to communicate with any point in the world.

At their control center at Offutt Base, we saw the famous red telephone. It is nicknamed "hot line" and is used to alert SAC's entire combat force in seconds. This phone is a direct wire to each of their attack bases throughout the world. And, when an alert is given, all bases receive the instructions simultaneously. In a test made during our visit, each base was to acknowledge receipt of the message, and it was interesting to note that some 35 bases throughout the world, after a count-down of 5, acknowledged receipt simultaneously. All lines connecting every base are pulsed every three seconds in both directions and, if any particular line misses three pulses, an automatic signal is received indicating an inoperative condition.

Included at this base are a tremendous number of teletype machines and an IBM 704 computer. SAC's entire attack plan is in readiness on IBM cards and if, for example, Guam were to be knocked out, the computer can

advise within seconds what planes are in flight and scheduled to refuel at Guam, or even what planes still on the ground are scheduled to refuel at the same place.

Even with the most formidable electronic and communications system that science can produce today, it was evident to us that all SAC officers realize that this may be inadequate in years to come. With this thought in mind, they are constantly improving systems and planning improvements in their attack force. SAC will, as quickly as possible, convert its force to a true aerospace operation. "Atlas" and "Snark" missiles are already operational and the "Titan" and "Minuteman" missiles will be incorporated. In time, it is hoped the B-70 supersonic strategic bomber will be added to their jet fleet.

SAC is strictly an attack force. For warning, it is dependent on early warning networks that are under the jurisdiction of the North American Air Command (NORAD). This Command is currently strengthening its operations. The most recent announcement in this regard pertains to plans for erecting a third Ballistic Missile Early Warning System (BMEWS) Station at Flingdales Moor, Yorkshire in England. Other such installations are at Clear, Alaska and Thule, Greenland. (See page 33 for more details on this development.) All three of these bases will employ the most powerful radars in the world, which will feed information to SAC to increase the effectiveness of our retaliatory capability. Information of any enemy ICBM's will be supplied by digital computers, and such information will be projected on graphic visual displays at SAC Headquarters within seconds. In addition to this, the first of a series of early warning satellites—the experimental "Midas II," which is equipped with infrared sensors to detect missiles upon take-off—has been successfully launched from Cape Canaveral.

Although SAC officials can send their entire attack force aloft headed toward foreign bases, there is only one man who can make the final decision to attack. And that man is, rightfully, the President of the United States.

Our sincere appreciation to all officers and men at Offutt Base who made our trip interesting, and particularly to Lt.-Gen. Francis H. Griswold, Vice-Commander and Chief of the Strategic Air Command and to one of his communications experts, Lt.-Col. Joe Beler. Both men are familiar personalities to a good many members of the amateur fraternity.



# 2 Great *knight-kit* Citizens Band Transceiver Kits

A PRODUCT OF ALLIED RADIO

YOUR CHOICE OF THE FINEST VALUES IN 2-WAY RADIO EQUIPMENT



For Auto-to-Auto  
or Auto to  
Home or Office



For Farming  
Operations



Local Trucking,  
Delivery,  
Construction Work



Boat-to-Boat,  
Ship-to-Shore

YOU BE THE JUDGE OF  
*knight-kit* VALUE!

**FREE Examination Privilege**

We invite you to take advantage of our exclusive free examination offer. Order a Knight-Kit Transceiver. Examine it on arrival. Inspect the quality of the components, the circuitry, the easy-assembly manual. We're so confident you'll want the kit, we can make this offer: If you're not COMPLETELY SATISFIED, just return the kit for full refund!



Ultra-Selective  
Super-Sensitive  
*The Very Finest*

Lowest Cost  
*Quality*  
2-Way Radio

## Citizens Band Superhet Transceiver Kit

Y-712L BEAUTIFUL STYLING... UNEXCELLED PERFORMANCE

**\$79<sup>95</sup>**

**\$5**

Have dependable, economical 2-way radio communication with this top-rated, do-it-yourself transceiver. Has two crystal-controlled transmitting positions; operates at maximum FCC legal power input of 5 watts fully modulated. Superhet receiver is continuously tunable over the full 22 channel band; also has two optional crystal-controlled fixed frequency positions. Works just like press-to-talk intercom—speaker also serves as mike.

Ultra-selective, highly sensitive dual-conversion superhet receiver features built-in adjustable squelch and noise limiter. Sensitivity (manual) is better than 1  $\mu$ v for 10 db S/N; crystal, 1/2  $\mu$ v. Includes built-in AC power supply. Easy to assemble; has dependable printed circuitry and pre-aligned IF transformers. With distinctively styled high-impact case, 5 x 12 x 12". Complete with all parts, wire-type doublet antenna, and one transmitting crystal (available for any channel from 1 to 22—specify preference). FCC application form is included (license is available to any citizen over 18—no exams to take). See below for DC mobile supply, vertical antenna, etc. Wt., 20 lbs.

Model Y-712L. \$5 Down. ONLY **\$79<sup>95</sup>**

- Y-729L. 3 Ft. Vertical Antenna. 2 lbs. NET 6.50
- Y-714L. Mobile Mounting Bracket. 4 lbs. NET 5.35
- Y-723L. 6-12 V. Mobile Power Supply. 6 lbs. NET 10.95
- Y-769L. Optional Receiving Crystal (specify frequency) 1.99
- Y-719L. Optional Hand-Held Mike. 1 lb. NET 9.50

Manufactured and  
sold exclusively by

**ALLIED RADIO**

## Top Buy Citizens Band Transceiver Kit

Y-713L

**\$39<sup>95</sup>**

**\$2**

Now have your own private 2-way radio system at an amazingly low cost! Consists of easy-to-assemble superregenerative receiver and 5-watt transmitter. Readily fits car, boat or desk. Single, one-switch operation permits talk or listen. Receiver tunes all 22 channels continuously. Built-in AC power supply. Handsomely styled case, 7x10x8". With mike, doublet antenna, and transmitting crystal (specify channel —1 to 22—if you have a preference). See below for antenna, mobile power supply, etc. Shpg. wt., 10 lbs.

Model Y-713L. \$2 Down. ONLY **\$39<sup>95</sup>**

- Y-729L. 3 Ft. Vertical Antenna. 2 lbs. NET 6.50
- Y-723L. 6-12 V. Mobile Power Supply. 6 lbs. NET 10.95
- Y-724L. Mobile Mounting Bracket. 4 lbs. NET 5.35

**ORDER NOW**

ALLIED RADIO CORP., Dept. 72-H  
100 N. Western Ave., Chicago 80, Ill.

Please ship:  Y-712L Transceiver.  Y-713L Transceiver.

Y-729L  Y-723L  Y-714L  Y-724L  
 Y-769L  Y-719L \$\_\_\_\_\_enclosed

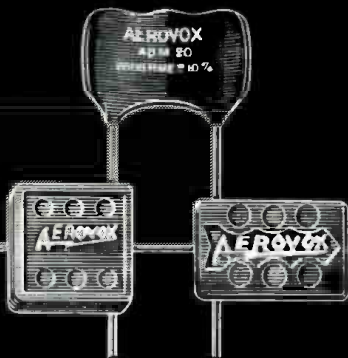
Send latest catalog describing Knight-Kits.

Name \_\_\_\_\_

Address \_\_\_\_\_

City \_\_\_\_\_ Zone \_\_\_\_\_ State \_\_\_\_\_

# CUT BACK on CALL BACKS



## AEROVOX MICA CAPACITORS

Why risk call backs when dependable Aerovox Mica Capacitors insure a stay-put repair job. Smart servicemen and technicians everywhere use and depend on Aerovox mica capacitors for "trouble-free" operation. **POSTAGE STAMP MICAS** . . . for all those applications where only the smallest axial lead units will do. Perfect for horizontal and vertical oscillator requirements. All units color-coded and stamped.

**HIGH VOLTAGE MICAS** . . . designed especially for TV and low power transmitters. You'll find the highest voltages available in these small case sizes. Every unit is tested at twice the rated voltage to insure long-life. Units color-coded and stamped. **DIPPED-MICAS** . . . superior in many cases to conventional molded units. High operating temperatures, excellent long-life characteristics. Perfect for printed-wiring assemblies. Smallest physical sizes with unsurpassed performance and stability features.

For "off-the-shelf" delivery on all your capacitor requirements see your local Aerovox Distributor.

**AEROVOX CORPORATION**  
DISTRIBUTOR DIVISION  
NEW BEDFORD, MASS.

# Within the Industry

**LELAND W. AURICK** has been appointed Manager, Advertising and Sales Promotion, Industrial Market, *RCA* Electron Tube Division. In his new post, Mr. Aurick will be responsible for all phases of the advertising and sales promotion programs of the Division's industrial products. Mr. Aurick joined *RCA* in 1957 as Administrator, Industrial Advertising, and has been engaged in directing industrial advertising in both the renewal and original equipment markets.



Active as an amateur radio operator for many years, Mr. Aurick is the author of many technical articles. He is a member of the American Radio Relay League and was issued his present call letters, W2QEX, in 1946. He also has directed the founding of many Civil Defense Communications organizations throughout New England.

**NEWARK ELECTRONICS CORPORATION** is the new name of the electronic parts and equipment firm formerly known as **NEWARK ELECTRIC COMPANY**. The company will retain its headquarters at 223 W. Madison Street in Chicago under the management of Sam and Abe Poncher, the founders. . . **JAMES VIBRAPOWR COMPANY** has changed its name to **JAMES ELECTRONICS INC.** to more accurately reflect its product diversification. . . **GENERAL TELEPHONE & ELECTRONICS CORPORATION** has announced the formation of a wholly owned subsidiary, **GENERAL TELEPHONE & ELECTRONICS LABORATORIES INCORPORATED**, which will engage in a wide range of scientific research activities in the communications and electronics field. Headquarters will be in Bayside, N. Y. . . Merger of the corporate management of **UNGAR ELECTRIC TOOLS, INC.** into the **ELDON MANUFACTURING COMPANY** group has been announced as a step designed to strengthen the tool company's research and product development position. . . **RCA INSTITUTES** has opened a new permanent school in Los Angeles to train technicians for the rapidly growing electronics industry in California. The school started operation March 1st and is located in the Pacific Electric Railway Building in downtown Los Angeles. Irwin A. Shane is director of the LA school. . . **HATHAWAY INSTRUMENTS, INC.** announces the formation of a new special products division which will develop, design, and manufacture trans-

sistorized inverters and converters and special purpose filters. The new division will make its headquarters in Denver, Colorado.

**SUPERSCOPE, INC.**, exclusive distributor of *Sony* stereo tape recorders and professional sound equipment, has moved into a new 25,000-square-foot building at 8150 Vineland Ave., Sun Valley, Calif. . . **TRIPLETT ELECTRICAL INSTRUMENT COMPANY** is now building a new addition to its Bluffton, Ohio plant which will more than double meter production when completed in early Fall. . . **ELGIN MICRONICS** has broken ground for a new 15,000-square-foot research and engineering laboratory in Rolling Meadow, Ill. . . **RADIO SHACK CORPORATION** has opened a new 15,000-square-foot distribution center in Stamford, Conn. Located on High Ridge Road at Bull's Head, Stamford, the new center is the company's fourth in New England. . . **SUPREME PUBLICATIONS** has acquired new and larger warehouse facilities at *Western Warehousing Co.*, operated by the *Pennsylvania Railroad* in Chicago. . . **LAFAYETTE RADIO ELECTRONICS CORP.** has opened a store in Paramus, N. J. Located on Route 17, less than a mile north of Route 4, in the heart of Bergen County, the 8000-square-foot store offers a complete electronic product line. . . **ACOUSTICA ASSOCIATES, INC.**, with main offices and plants in Los Angeles, has opened an eastern marketing and engineering division at Roosevelt Field, Long Island. The address is 600 Old Country Road, Garden City, Long Island. . . **MACHLETT LABORATORIES, INC.**, a division of **RAYTHEON COMPANY**, is building an expandable 120,000-square-foot plant at Winsted, Conn. . . **SPRAGUE ELECTRIC COMPANY** is adding 20,000 square feet of space to its main factory building at Lansing, North Carolina.

**L. BERKLEY DAVIS**, vice-president of *General Electric* and general manager of its Electronic Components Division, has been elected president of the Electronic Industries Assn., succeeding David R. Hull, a vice-president of *Raytheon Co.* Mr. Hull was first elected to the EIA presidency in 1958 and served two terms.



The president-elect has been a member of EIA's board of directors, a director of the association's tube and semiconductor division, and a member

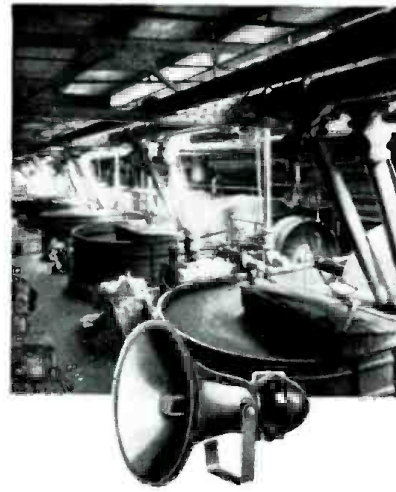
ELECTRONICS WORLD

# SELL UNIVERSITY SPECIAL PURPOSE SPEAKERS AND PROFIT

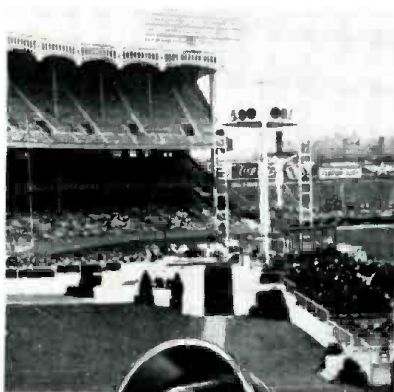
... with this complete range of speakers that give you the right speaker for every sound requirement



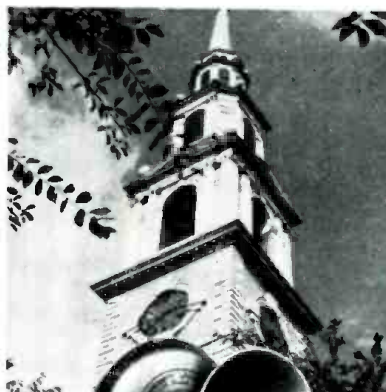
**PORTABLE POWRPAGES** ... powerful, ultra-compact, self-contained sound-casting systems for police, firemen, marine, sports, camps, construction ... wherever instructions must be projected clearly and instantaneously over long distances. New transistorized models extend choice of power from 5 to 25 watts. (Shown: new Model PP-1T with fully transistorized 25 watt amplifier)



**EXPLOSION-PROOF** ... Underwriters Laboratory approved for industries otherwise unable to enjoy advantages of sound paging systems. 100% safe for use in locations near volatile or flammable liquids, gases, dusts or other combustibles, either in air or on surfaces. (Shown: Model 7101,2 which complies with all government safety regulations)



**OUTDOOR WEATHERPROOF HIGH FIDELITY** ... genuine dual range systems with separately driven woofers and tweeters for highest quality reproduction of voice and music, indoors or outdoors. Three exceptionally efficient models: for small areas such as patios; general coverage as in shopping centers; heavy duty use as in concert halls and stadiums. (Shown: Model WLC, widely used for full-range reproduction at higher levels)



**SUPER-POWER PROJECTORS** ... deliver the greatest possible concentration of output from a single compact unit. Widely used in church and municipal towers, carillons, race tracks, stadiums, aviation, electronic warning devices. Three models give you a choice of 4, 6, or 12 drivers in one mixing chamber ... a total range of power from 120 to 1200 watts! (Shown: new Model B-6P, which takes six 25-60 watt drivers)



**MULTI-DUTY** ... MM-2 series for completely reliable and trouble-free operation under frequent or constant exposure to dampness, live steam, salt spray, dust, fungus, shock, vibration ... even occasional submergence under water. Wide choice of standard models for mounting on walls, swivels, bulkheads, ceilings. Also, high power models for electronic warning devices. (Shown: new Model MM-2FUW, specifically designed for underwater installations)

University public address speakers, drivers, trumpets and accessories are approved for Civil Defense applications. All are fully described, complete with technical data, in the new Spring-Summer 1960 edition of the University Product Catalog. Write for your copy today. Desk S-1, University Loudspeakers, Inc., 80 So. Kensico Ave., White Plains, N. Y.



A Division of Ling-Altec Electronics, Inc.

**RESIDENT SCHOOL COURSES  
IN LOS ANGELES AND NEW YORK CITY**



Industry needs Electronic Technologists!

**LET RCA  
TRAIN YOU IN  
General Electronics  
Technical Writing  
TV, Communications**

Countless career opportunities are open to you in such fields as automation, guided missiles, radar, television, computers, and other industrial electronic applications. RCA Institutes Resident Schools in New York City and Los Angeles offer you comprehensive courses that prepare you for the field of electronics you may choose. No previous technical training required. Introductory courses in Math and Physics available.

Coeducational Day and Evening classes. Free placement service. Applications now being accepted.



The Most Trusted Name  
in Electronics

RADIO CORPORATION OF AMERICA

Send to the school nearest you  
**RCA Institutes, Inc. Dept. EWR-80**

350 West Fourth Street Pacific Electric Building  
New York 14, New York 610 S. Main St., L.A. 14, Calif.

Please send me your FREE catalog of Resident School courses.

Name \_\_\_\_\_

(PLEASE PRINT)

Address \_\_\_\_\_

City \_\_\_\_\_ Zone \_\_\_\_\_ State \_\_\_\_\_

For Home Study Courses See Ad On Opposite Page

of the membership and scope committee. He will serve as the 28th president of the 36-year-old association.

\* \* \*

**DR. VICTOR J. YOUNG** has been elected vice-president of *Hazeltine Electronics Division*. He has been with the firm since 1949 . . . **HERBERT W. CLOUGH**, vice-president of marketing for *Belden Manufacturing Co.*, has been elected to the company's board of directors . . . **EDWARD MEAGHER** has been promoted to the post of product manager, entertainment tubes and semiconductors, for *Amperex Electronic Corp.* . . . **JOSEPH F. WITKOWSKI**, electronics consultant and technical writer, died recently following a heart attack. Before his retirement in November, 1958, following 38 years of service, he was director of the school of electrical communications, *International Correspondence Schools*, Scranton, Pa. . . . **LESTER L. KELSEY** has joined *Tru-Ler Radio Corporation* as vice-president and merchandising manager . . . **DR. STEWARD S. FLASCHEN** has been promoted to the post of manager of research and advanced development for the semiconductor products division of *Motorola Inc.* He was formerly associated with *Bell Telephone Labs.* . . . **ROBERT C. SPRAGUE**, chairman of the board of *Sprague Electric Company*, has been elected a fellow of the American Academy of Arts and Sciences . . . **WILLIAM DJINIS** has been appointed chief engineer in charge of all scientific activities of *Electro-Sonic Laboratories, Inc.* of Long Island City, N. Y. . . . **RONALD G. DAVIS** has been named senior design engineer by *International Resistance Co.* He was formerly associated with *Curtiss-Wright Corp.* . . . **IRA MOLAY** has been named product manager, audio components, for *CBS Electronics Div.* of *Columbia Broadcasting System* . . . *Elgin Electronics* has named **ERIC FIRTH** to the post of national sales manager with headquarters in Burbank, California . . . **ALEXIS BADMAIEFF** is the new chief engineer, acoustics-transducers, and **WILLIAM H. JOHNSON** is manager of engineering and technical information for *Altec Lansing Corp.* . . . **WALTER A. KIRSCH** has joined *Telechrome Mfg. Corp.* as defense products manager and assistant to the vice-president and director of sales . . . **HENRY MANDLER** has been named to the newly created post of assistant general sales manager of *University Loudspeakers, Inc.* . . . *Vocaline Corporation of America* has appointed **T. H. BLANER** works manager. He was formerly with *ITT* . . . **HILMER LINDAHL** is the new vice-president in charge of radio broadcast equipment at *International Radio & Electronics Corp.*

\* \* \*

**DR. WOLFGANG W. GAERTNER**, a well-known figure in the field of semiconductor materials and devices, has joined the staff of *CBS Laboratories* as manager of electronic semiconductor research and development.

A native of Austria, Dr. Gaertner received his Ph.D. in Physics from the University of Vienna in 1951. He completed additional graduate engineering studies in Vienna in 1955.

Before joining *CBS*, he served as chief scientist of the Solid State Devices Division, U. S. Army Research and Development Lab. at Fort Monmouth, N. J. He is the author of a number of papers in the field of solid-state physics and a book.



\* \* \*

**VEGA ELECTRONICS CORPORATION** has been established in Cupertino, California and will specialize in the electro-acoustical and electro-mechanical fields with emphasis on digital and analogue magnetic recording equipment. Heading the new firm is Russell J. Timkham a long-time *Amperex* executive. Joining him in the new venture are seven other former *Amperex* personnel: Walter C. Hironimus, A. Arthur Foy, R. Z. Langevin, F. A. Dicus, R. L. Brown, R. S. French, and W. E. Magnie . . . **JBL INTERNATIONAL, INC.** has been organized to market component hi-fi equipment for both *Lansing* and other firms. Headquarters are at 3249 Casitas Ave., Los Angeles . . . **PACKARD BELL SALES CORP.** has been organized as a wholly owned subsidiary to handle the products of the parent company's home products division. The firm will have quarters in a modern 7200-square foot

**ELECTRONICS WORLD**

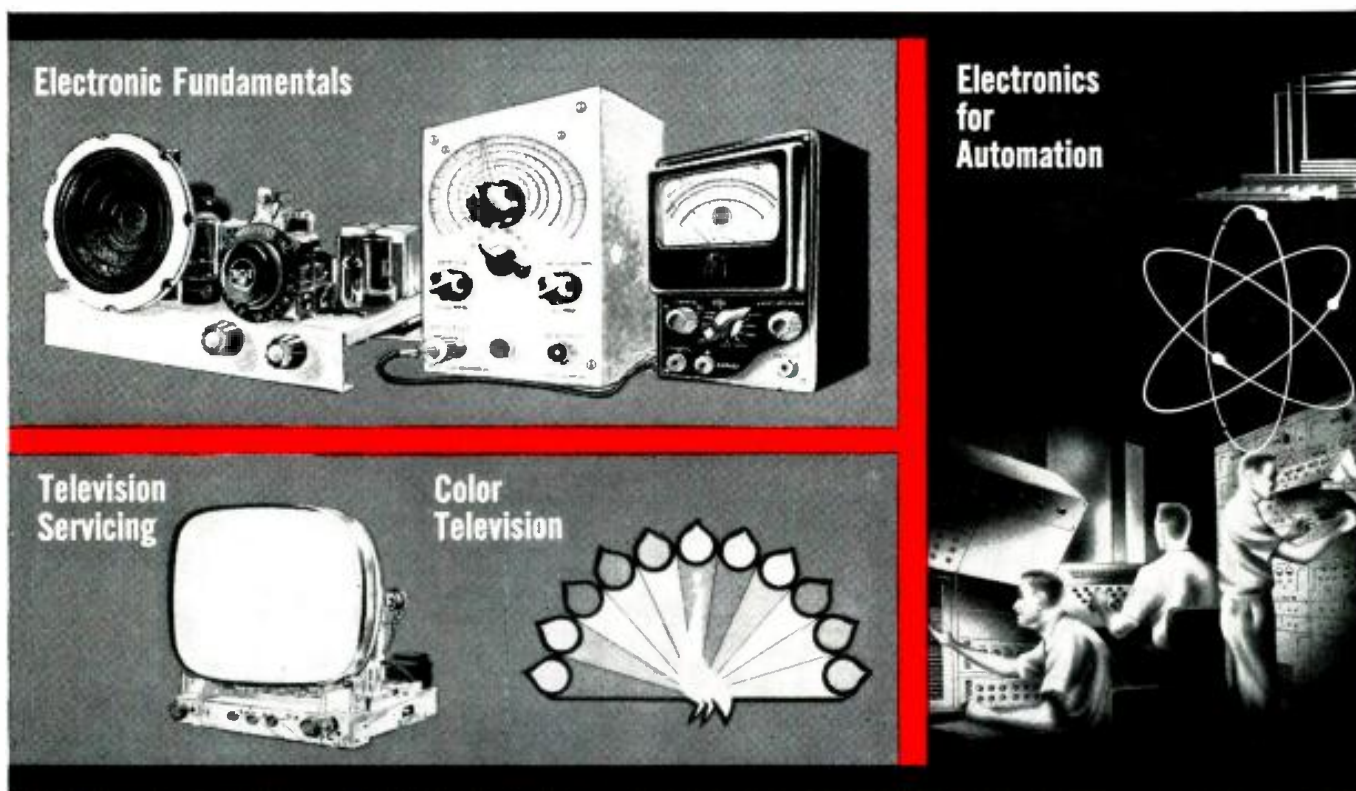


# LET RCA TRAIN YOU IN ELECTRONICS

*RCA Institutes, one of the world's leading electronic technical schools, offers a Home Study Course in . . .*

## ***ELECTRONICS FOR AUTOMATION***

. . . Now you have *four* comprehensive courses for your electronic training . . . from basic electronic theory to the more advanced principles of color TV and Automation.



Send for our  
64 page Home  
Study Catalog

**FREE!**

FOR  
RESIDENT SCHOOL COURSES  
SEE AD ON  
OPPOSITE PAGE.



Practical work with the very first lesson. Pay-as-you-learn.  
You need pay for only one study group at a time.

**RCA INSTITUTES, Inc.** Home Study School, Dept. EW-80  
A Service of Radio Corporation of America  
350 West Fourth Street, New York 14, N. Y.

Please rush me your FREE illustrated 64-page book "Your Career in Electronics,"  
describing your home training programs. No obligation. No salesman will call.

Name ..... Age .....  
Please print

Address .....

City ..... Zone ..... State .....

Veterans: Enter discharge date .....

**CANADIANS** — Take advantage of these same RCA courses at no  
additional cost. No postage, no customs, no delay. Send coupon to:  
RCA Victor Company, Ltd., 5581 Royalmount Ave., Montreal 9, Quebec  
To save time, paste coupon on postcard.

# Designed with the Serviceman in Mind!



## **JERROLD** magic carpet\* antenna

**NEW** TV-FM indoor antenna with outdoor performance . . .  
**NEW** profitable business for you . . .

Servicemen everywhere are discovering a whole new market with this revolutionary new indoor TV-FM antenna. Now for the first time you can obtain signal gain across all frequencies, within 30 miles of the transmitter, that is comparable to that of a standard conical antenna.

In addition to strong gain characteristics, the Magic Carpet Antenna has an exceptionally low V.S.W.R. (Impedance Match) that assures maximum transfer of signal to the viewer without ghosting or smearing. Your customer avoids the expense and unsightliness of a rooftop antenna and the nuisance of ugly "rabbit ears"—you save time, trouble, and eliminate rooftop hazards with the quality-engineered, and profitable Jerrold "Magic Carpet" antenna. Get the details today!



In the Attic  
Garage or Utility  
Room Ceiling

In the Closet



*For full information and samples of selling promotional material prepared specifically for you see your Jerrold Distributor or write*

**JERROLD** **ELECTRONICS CORPORATION, Distributor Sales Division**  
 Dept. IDS-46 The Jerrold Building, Philadelphia 32, Pa.  
 Jerrold Electronics (Canada) Limited, Toronto  
 Export Representative: CBS International, New York 22, N.Y.

\*Trademark Patent Pending

office building at 8745 W. Third St. in Los Angeles where all marketing, advertising, and promotional activities of the firm will be grouped . . . **LORAL ELECTRONICS CORP.** has acquired **ALPHA WIRE CORP.**, which will operate as an independent subsidiary. Peter Bercoe continues as president . . . **NATIONAL ELECTRONICS, INC.** has been consolidated with **INDUSTRIAL TUBES, INC.** The two companies will operate under the name of **NATIONAL ELECTRONICS, INC.** The organization is a wholly owned subsidiary of **EITEL-McCULLOUGH, INC.** . . . **TRANSITRON ELECTRONIC S.A.** has been formed as a European sales subsidiary of **TRANSITRON ELECTRONIC CORP.**, with headquarters in Zug, Switzerland, subsidiary sales offices in London, Paris, and Munich, and warehouse facilities in Amsterdam, Holland. Two additional sales offices are planned in Dusseldorf, Germany and Milan, Italy . . . **CLEVITE CORP.**, Cleveland, Ohio has acquired the assets of the **SHOCKLEY TRANSISTOR CORP.**, Palo Alto, Calif., a subsidiary of **BECKMAN INSTRUMENTS INC.** Terms of the transaction were not disclosed . . . **ALLIED RADIO CORP.**, Chicago, has extended its operations to the West Coast with the acquisition of **ELECTRONIC SUPPLY CORP.** of Pasadena and Long Beach, Calif., which now becomes a wholly owned subsidiary with Don Dressen continuing as president and general manager.

\* \* \*

**WORKMAN TV PRODUCTS, INC.** of Sarasota, Florida has moved into its new 20,000-square-foot, air conditioned plant which has enabled the firm to increase its production by 25 per-cent . . . **INTERNATIONAL RESISTANCE COMPANY** of Philadelphia will expand the space it occupies in the 11-story building at 401 N. Broad Street by some 27,000 square feet to give it a total of 281,000 square feet for the manufacture of a complete line of resistors . . . **GOULD-NATIONAL BATTERIES, INC.** has completed a 27,500-square-foot facility at 831 N. Vandalia St., St. Paul, Minn. The factory will be used for the production of miniature, hermetically sealed and rechargeable nickel-cadmium cells and batteries to be sold under the "Nicaid" tradename . . . **CHEMTRONICS INC.**, manufacturer of a line of chemicals for the electronics industry, has moved to a new plant-site at 870 E. 52nd Street, Brooklyn, N. Y. The new building doubles the space formerly occupied by the firm . . . Ground has been broken on a 26-acre site near Santa Cruz, California for a 32,000-square-foot computer component manufacturing plant to be occupied by **SYLVANIA ELECTRIC PRODUCTS INC.** . . . **LITTON INDUSTRIES** has opened a new 43,000-square-foot addition to its electron tube division facilities at 960 Industrial Road, San Carlos, California . . . **MILO ELECTRONICS CORP.** of New York City has established a New England sales office at 18 Button Ball Drive in Newtown, Conn.

-50-

**ELECTRONICS WORLD**

# MAKE MONEY



# IN

# ELECTRONICS . . .

## Through HOME STUDY

Grantham training is the easy way to learn more quickly—to prepare more thoroughly—for F. C. C. examinations. And your first class license is the quick, easy way to prove to your employer that you are worth more money.

This correspondence course is directed toward two major objectives—(1) to *teach* you a great deal about electronics, and (2) to prepare you to *pass* all of the F. C. C. examinations required for a first class commercial operator's license. We teach you step by step and have you practice with FCC-type tests which you send to the school for grading and comment. You prepare for your F. C. C. examinations under the watchful direction of an instructor who is especially qualified in this field.

## In RESIDENT CLASSES

Grantham *resident* schools are located in four major cities—Hollywood, Seattle, Kansas City, and Washington, D. C. Regularly scheduled classes in F. C. C. license preparation are offered at all locations. New *day* classes begin every three months, and new *evening* classes begin four times a year. The day classes meet 5 days a week and prepare you for a first class F. C. C. license in 12 weeks. The evening classes meet 3 nights a week and prepare you for a first class license in 20 weeks. For more information about the Grantham resident schools, indicate in the coupon which city of your choice and then mail the coupon to the School's home office in Hollywood, Calif. Free details will be mailed to you promptly.

## GET your first class commercial F. C. C. LICENSE

To get ahead in electronics, you must have the proper training and your employer must know that you have that training. Your F. C. C. license is a "diploma" in communications electronics granted by the U. S. Government, and it is recognized as such by employers. Grantham School of Electronics specializes in preparing you to earn this diploma.

By attending one of the Grantham resident schools, you can prepare for your first class F. C. C. license in as little as 12 weeks. Or, through the Grantham home study course you can prepare at your own pace. Either way (in a resident class or by home study) your training is in capable hands at Grantham.

If you are interested in details concerning our training, indicate in the coupon below whether you prefer home study or resident classes, and mail the coupon to the School's home office at 1505 N. Western Avenue, Hollywood, California—the address given in the coupon. Our free booklet will be mailed to you promptly.

Get your First Class Commercial F. C. C. License by training at

# GRANTHAM SCHOOL OF ELECTRONICS

HOLLYWOOD

SEATTLE

KANSAS CITY

WASHINGTON

This booklet **FREE!**

This free booklet gives details of our training and explains what an F. C. C. license can do for your future. Send for your copy today.



for **FREE** Booklet **CLIP COUPON** and mail in envelope or paste on postal card.

for **FREE** Booklet **CLIP COUPON** and mail in envelope or paste on postal card.



To: **GRANTHAM SCHOOL OF ELECTRONICS**  
1505 N. Western Ave., Hollywood 27, Calif.

Please send me your free booklet telling how I can get my commercial F. C. C. license quickly. I understand there is no obligation and no salesman will call.

Name \_\_\_\_\_ Age \_\_\_\_\_

Address \_\_\_\_\_

City \_\_\_\_\_ State \_\_\_\_\_

I am interested in:  Home Study,  Kansas City classes,  M  
 Hollywood classes,  Seattle classes,  Washington classes

# AIWA

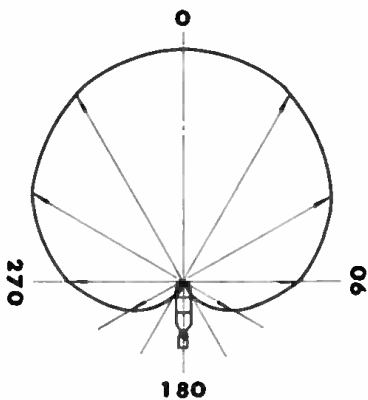
**INTRODUCES  
A NEW  
SMALL-SIZE  
BI-DIRECTIONAL  
RIBBON  
MICROPHONE  
MODEL VM-16**

**UNI-DIRECTIONAL  
RIBBON  
MICROPHONE  
MODEL VM-18**



**Features:**

- \* Small size and slim shape facilitate handling.
- \* Comparatively high sensitivity and fine response characteristics.
- \* Sturdy construction with short ribbon diaphragm.
- \* Humming minimized.
- \* Equipped with a low frequency attenuation circuit.



VM-18



**Specifications:**

- \* Type: Ribbon Microphone
- \* Impedance: 600 ohm  $\pm$  20% (At 1000 c/s at 0 point of the switch)
- \* Sensitivity: 75 db (0db = 1V/m bar 1000 c/s)
- \* Directionality: Uni-directional
- \* Noise Level: Below 30 db
- \* Dimensions: 9 5/8" (length) 1 1/2" (dia.) Weight 2.2 lbs. (9 feet-cord & plug included)



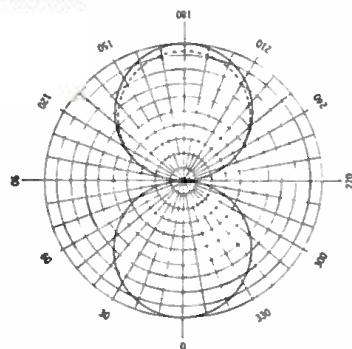
VM-16

**Features:**

- \* Superlative high quality response characteristics.
- \* Engineered in collaboration with the Technical Research Laboratory of the Japan Broadcasting Corporation (NHK).
- \* Outstanding results when used for FM broadcasting and high fidelity recording because of its exacting quality of tone reproduction.
- \* Because of the above superior characteristics, small size and non-reflecting satin-chrome finish is ideally suited for TV broadcasting.

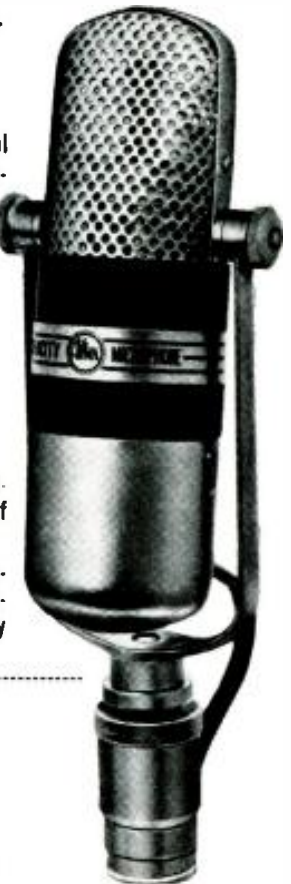
broadcasting and high fidelity recording because of its exacting quality of tone reproduction.

\* Because of the above superior characteristics, small size and non-reflecting satin-chrome finish is ideally suited for TV broadcasting.



VM-16

Directional Characteristic  
— 500 c/s, 1000 c/s, ... 8000 c/s



**Specifications:**

- \* Frequency Response: 50-15,000 c/s  $\pm$  3 db
- \* Output Level: 80 db (150 ohms/1,000 c/s)
- \* Impedance: 150 ohms, 250 ohms or 600 ohms
- \* Directional Characteristics: Bi-directional
- \* S/N 20 db or below (in parallel field at 1 m gauss)

**AIWA CO., LTD.**  
601 West 26th Street, New York 1, N.Y.





*Here is the new Standard Coil Tuner Replacement and Repair Program that enables you to offer better service to your customers at greater profit. Now Standard Coil Products provides the tools that will enable you to cash in on the profitable tuner repair and replacement market.*

#### **TUNER REPLACEMENT LISTING IN SAMS PHOTOFAC**

Starting in January, Standard Coil tuner replacement listings will appear in all Sams TV Photofact. Tuner replacement information will be right at your finger tips. Standard Coil is the *only* manufacturer ever to provide this service.

#### **NEW TV TUNER REPLACEMENT GUIDE**

Lists original equipment TV tuners with the Standard Coil equivalent replacement for each. Also includes major mechanical replacement parts for all Standard Coil Tuners—those used in original equipment as well as the universal replacement. Eliminates all guesswork—minimizes your tuner repair and replacement problems.

#### **48 HOUR FACTORY GUARANTEED REPAIR SERVICE**

Standard Coil's special service department set-up assures factory guaranteed repairs—*on a 48 hour in-plant cycle!* All repaired tuners carry a *six month warranty* on defective workmanship and parts failure (excluding tubes). Gives you more time for additional service calls—promptly returns your customer's set to like new operating condition.

#### **DEFECTIVE TUNER TRADE-IN ALLOWANCE**

Tuners which can *not* be repaired can be traded in against a new replacement tuner which carries a *full twelve month factory guarantee*. See your Standard Coil Distributor for complete details on how trade-ins can increase your tuner sales and profits—create greater customer satisfaction.

#### **JUMP ON THE STANDARD COIL PROFIT WAGON TODAY!**

For additional details, see your authorized Standard Coil Distributor or write to:

*Standard*

**Coil Products Co., Inc.**

2085 North Hawthorne Avenue, Melrose Park, Illinois

A CREI college-level extension program in advanced electronic engineering technology that offers you ...

# high professional status and better income



## **DYNAMIC EXPANSION OF ELECTRONICS INDUSTRY CREATES OUTSTANDING JOB OPPORTUNITIES.**

No other major field of engineering has enjoyed a more rapid growth or promises a more brilliant future than electronics. New developments in space exploration, guided missiles, automation, computers, and many other fields create new jobs daily, jobs which have to be filled by men with a modern advanced education in electronics. The shortage of competent electronic personnel will grow more acute over the next decade, and salaries and professional stature of technical men are expected to reach new highs.

The fact that new positions must be filled by men with an up-to-date education is evidenced by the experience of the CREI Placement Bureau, where the demand for graduates and advanced students has far exceeded the supply for several years. It is of interest to note that

many leading companies regularly visit CREI strictly for the purpose of recruiting CREI graduates and students.

Many CREI students have learned that they do not have to complete the program to realize considerable increases in their status and income. Their own employers realize that if you are ambitious enough to pursue this college-level program, you are a better candidate for rapid promotion. Professional people in supervisory positions recognize the value of CREI education.

## **HOME STUDY IS CONVENIENT AND TIME SAVING.**

You will find more than 20,500 CREI students working in most every phase of electronics in all 50 states and in most foreign countries of the free world. Just like them, you can pursue the CREI

**CREI's Extension Division now offers you a college-level program in electronics comparable in technological content to advanced residence courses.**

CREI offers college-level opportunity to the man who wisely realizes that the recognition and rewards in electronics are now going to other men—especially the man with modern advanced education.

Within two to four years, depending on the courses you select and amount of stick-to-itiveness brought to bear, you can complete the CREI program in advanced electronic engineering technology. The program was developed hand-in-hand with leading private companies and government agencies contributing to the Nation's efforts in electronics, communications, missiles and space exploration.

---

**OFFICIALS OF PRIVATE COMPANIES AND GOVERNMENT AGENCIES APPROVE CREI FOR THEIR OWN PERSONNEL.**

The quality and advanced standing of the CREI educational program is readily seen in the appreciation expressed for it by both industry and government. At present there are 5,240 U. S. Navy electronics personnel enrolled in CREI extension programs. More than fifty leading electronics organizations in this country and in foreign nations actually pay all or part of the tuition for employees taking CREI courses. The list below comprises a few of these organizations:

National Broadcasting Company • Jerrold Electronics Corporation • Pan American Airways • Radio Corporation of America • Canadian Aviation and Electronics • Federal Electric Corporation • The Martin Company • Voice of America • Canadian Broadcasting Corporation • Northwest Telephone Company • Commercial Cable, Incorporated • Canadair Limited • Columbia Broadcasting System • All America Cable and Radio • Canadian Marconi • Mackay Radio • United Air Lines • Gates Radio Company • Mohawk Airlines • Florida Power and Light Company • British Air Force, Army, Navy

---

program while you continue your regular full-time job. You study at home during hours chosen by you, and you are not rushed. Also, you do not have to waste valuable time traveling to and fro but can concentrate on your studying at the hours most convenient to you.

The courses are prepared in easy-to-understand format, and your progress is guided all along the way by the CREI staff of experienced instructors. These instructors always stand ready to give you personal assistance and help whenever you may need it.

*ECPD Accredited Technical Institute Curricula • Founded in 1927*

**The Capitol Radio Engineering Institute**

3224 16th Street, N.W., Washington 10, D.C., Dept. 1108-G

**TO THE SERIOUS-MINDED MAN, CREI OFFERS THESE IMPORTANT BENEFITS:**

- \* You gain a solid college-level education in electronics; you keep abreast of continuous new developments and sophistications in the field of electronics.
- \* You can gain higher status and enjoy the increased respect of your associates.
- \* You facilitate more rapid professional advancement and corresponding increases in pay.
- \* You gain the personal satisfaction that comes from working and communicating intelligently with technical colleagues and superiors.

**The accredited program is designed to meet your present and future employment requirements and to increase your professional status and earning power.**

---

**PROFESSIONAL STANDING**

CREI was founded in 1927 and is one of the oldest technical institutes in America. We co-founded the National Council of Technical Schools, and we were among the first three technical institutes whose curricula were accredited by the Engineers' Council for Professional Development. The U. S. Office of Education lists CREI as "an institution of higher education."

**QUALIFICATIONS FOR CREI**

You qualify for CREI study if you have a high school diploma or equivalent, and if you have had basic electronic training and practical experience in some phase of electronics. Tuition is reasonable and may be paid monthly, if you wish. Veterans qualify for this program under the GI Bill.

**CREI RESIDENCE SCHOOL**

CREI conducts a residence school in Washington, D.C. for those who can attend classes. Day and evening classes start at regular intervals. Graduates earn AAS Degree in 27 months of study. Electronics experience or training is not required for admission.

---

**SEND FOR THIS FREE 48-PAGE BOOK TODAY... USE POSTAGE-PAID CARD ATTACHED.**

Write for the detailed and informative book "Insurance for Your Future in the New World of Electronics." It is yours for the asking without cost or obligation. The book gives details about curricula and CREI and answers several searching questions about the future in electronics. The book is of vital interest to every man employed in electronics.





## Looking for quality in Citizens Radio Equipment?

Select International's 2-way Communication power packages . . .

The International Traveler . . . a new ALL transistor portable transceiver especially engineered to meet the most demanding requirements where "truly" portable short range communication is required. Compact: 4" x 6" x 7 $\frac{3}{4}$ ". Weighs less than 5 lbs.

The Traveler's 15 transistors provide maximum "talk power" and "reception." Built-in speaker plus separate phones jack. Dual con-

version receiver. Truly effective noise limiter and squelch. Two channel crystal controlled receiver and transmitter. Push-to-talk operation. Powered by built-in nickle cadmium battery and charger.

Complete with battery, charger, microphone, 2 sets crystals, whip antenna, carrying strap, and mobile mounting bracket. .only **\$249.50**

*Write for International's Complete Catalog.*



The EXECUTIVE, complete with one channel 9 transmit crystal, AC power cord, microphone, and operating instructions

. . . only **\$169.95.**

**The International Executive . . . ideal for a fixed base station or mobile use.**

Push-to-talk operation, 3 crystal controlled transmit positions, two crystal controlled receive positions, dual conversion super-hetrodyne receiver tuning all 23 channels.

Five watts plate input. Series Gated automatic noise limiter. Fifteen tube performance. The Executive has 10 tubes and 1 diode. Four tubes are multi-purpose.

Universal built-in power supply for 6 VDC, 12 VDC, and 115 VAC. Size: 5 $\frac{1}{2}$ " x 8 $\frac{1}{2}$ " x 9". Weighs 12 lbs.

**INTERNATIONAL  
CRYSTAL MFG. CO., INC.**

18 NORTH LEE — OKLA. CITY, OKLA.

**ELECTRONICS WORLD**



**Latest Information  
on the Electronic Industry**

*Spot News*

By **ELECTRONICS WORLD'S  
WASHINGTON EDITOR**

**SPACE SUNLIGHT-COMMUNICATIONS SYSTEM ENVISIONED BY AIR RESEARCH TEAM**—In some future year when cruising space vehicles communicate with other space vehicles or orbiting stations, a beam of light may be used instead of conventional radio. So predicts the Air Research and Development Command's Wright Air Development Division. The Division is now developing an experimental system—operating on the heliograph principle—which will collect sun rays, run them through a modulator and direct the resultant light wave in a controlled beam to a receiver. There the wave will be put through a detector, transposed into an electrical impulse, and be amplified to a speaker either as a dot-dash or voice message. The theoretical aspects have already been worked out.

**EXPERIMENTAL TIMING CODE ADDED TO WWV BROADCASTS**—An experimental timing code has recently been added to the regular broadcasts of the National Bureau of Standards' radio station WWV. This code provides a standardized timing basis for use when scientific observations are made simultaneously at widely separated locations. The code designates the day, hour, minute, and second (Universal Time) and will indicate the broadcast accuracy (at the WWV transmitter) within one-thousandth of a second. As the code is experimental, details of its transmission are subject to change. Currently, the code is broadcast for one-minute intervals, ten times per hour. It immediately follows the standard audio frequencies of 440 and 600 cps except at the beginning of each hour. The standard frequencies are given alternately as before but their duration, when the code is given, is two minutes instead of three. The code is a thirty-six bit, 100 pps, binary coded system. A complete time frame is one second. Nine binary groups per second appear in the following order: 2 groups for seconds, 2 groups for minutes, 2 groups for hours, and 3 groups for day of year. The code also contains blank spaces which may be used to transmit additional types of information in the future.

**TRANSISTORIZED SONAR DEVELOPED FOR NAVY FROGMEN AS UNDERWATER "EYES"**—A completely transistorized sonar, powered by standard flashlight batteries, has been developed for Navy frogmen. Jointly designed by the U.S. Navy Electronics Laboratory and Stromberg Carlson, the new system will be particularly valuable to divers and underwater demolition teams operating in dark or murky waters where visibility is zero. Designated the AN/PQS-1, the object locator is a 20-pound sphere, has an aluminum casing and is a cubic foot in volume. Earphones provide operator with audio information on objects detected by the searching sonar beam.

**WORLD'S LARGEST RADIO TELESCOPE TO BEGIN OPERATION IN FALL**—A radio telescope, 600-feet long, 400-feet wide, and 62½-feet deep—specially designed to pick up faint sources outside our own Milky Way galaxy, will go on the air early in the Fall near Danville, Illinois. The telescope, to be operated by the University of Illinois for the Navy, covers 5½ acres and has 160,000 square feet of receiving area, more than twice that of the Jodrell Bank installation in Manchester, England. Unlike the British instrument, however, this unit is non-steerable.

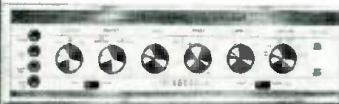
**ELECTRONIC RUSSIAN TRANSLATOR DESIGNED**—The answer to the age-old problem of international tongue-twisting appears to have been resolved by Air Force engineers who have developed an electronic translator that can turn Russian into English at a rate of 35 wpm. Heart of the translator is the photoscopic memory—a transparent disc 10 inches in diameter—that can store 550,000 Russian-English words in an area the size of a postcard.

**ALL-WEATHER ELECTRONIC LANDING SYSTEM TO BE BUILT**—An electronic aircraft landing system, employing a combination of radar, radio, and computers, to provide all-weather, including heavy fog and rain, operation for the U.S. Navy's Task Forces, has been ordered from Bell Aircraft. Two radar antennas mounted on the superstructure of a carrier will serve to track an incoming plane. Two visual displays will provide precise information about the location of the plane with respect to the carrier deck, and electronic computers will be used to determine whether a plane is on the proper descent course. The new system is said to have the capability of flying a plane to touchdown on deck without pilot control.

—30—

only for those who want the ultimate

**SHERWOOD**  
"TOP RATED"  
again and again  
—and NOW AGAIN!



Model S-5000, 20+20 watt "stereo"  
Dual Amplifier-Preamplifier, Fair Trade Price—\$189.50



Model S-2200, FM-AM-MX Stereo Tuner,  
Fair Trade Price—\$179.50



**AMERICAN  
AUDIO INSTITUTE**

294 EAST 19th ST. PATERSON 4, N. J.

October 27, 1959

Sherwood Electronic Labs., Inc.,  
4300 North California Avenue  
Chicago 18, Illinois

Gentlemen:

We find that the incorporation  
of a center-channel output and  
a damping factor selector in  
July 1959, increases the  
Summary Rating of the Sherwood  
S-5000 to the highest of all  
18 Stereo Amplifiers tested in  
the AAI Evaluation Test Reports.

Sincerely,

AMERICAN AUDIO INSTITUTE

*Felix R. Breyer*  
Felix R. Breyer  
Executive Director

The "Most honored of them all" S-5000 stereo amplifier-preamplifier is joined by the S-2200 stereo tuner. As with its "Top Rated" predecessors, the S-2200 features FM "Interchannel Hush" plus push button selector, internal plug-in adaptor for Stereo FM Multiplex, 2 "Acro-beam" tuning indicators, simulcast FM/AM stereo. All Sherwood tuners feature FM sensitivity below 0.95 microvolts and 1/3% distortion @ 100% FM. For further details write: Sherwood Electronic Laboratories, Inc., 4300 N. California Avenue, Chicago 18, Illinois.

For complete specifications write Dept. EW-8

atures with consistency invariably were rather expensive as compared to vacuum diodes. Lately there have been a few diodes announced which approach in price the cost of half a vacuum tube and still do a good job.

One very important consideration not covered by Dusina is the advisability of taking the control voltage from the screen of the first i.f. stage when more than one i.f. stage is employed. If this is not done, strong ignition pulses will feed into the audio system via the squelch circuit and cause difficulty unless additional decoupling circuitry is employed.

I have always been somewhat proud of the simplicity of this circuit and, therefore, was rather dismayed to find that someone else recently "invented" it.

W. W. SMITH  
Gonset Div.  
Young Spring & Wire Corp.  
Burbank, California

*Regardless of who used the diode squelch first, the circuit is still a good one and worthy of coverage. Thanks to Woody Smith for giving us the above additional information.—Editors.*

\* \* \*

#### MULTIPLEX WITH ONE RECORDER

To the Editors:

The article entitled "Multiplexing Music with One Recorder" in your April issue is of special interest to me. But where does point "Y" on your schematic diagram get oscillations to feed to the erase head? According to the article and diagram, it seems that when I remove the old mono erase head for replacement, I would have the two leads feeding it just left hanging out in open space.

DAVID M. HOUSE  
Dallas, Texas

*Regarding point "Y" in Fig. 2, actually a lead should have been shown connected here. This lead is the one that previously went to the erase head. Such a connection is actually described in the text (at the bottom of the first column on that same page) as well as being shown in Fig. 1. However, it was unfortunately omitted from Fig. 2.—Editors.*

\* \* \*

#### CITIZENS BAND BEAM

To the Editors:

I would like to congratulate your magazine, and especially Mr. Hartland B. Smith, for the article "A Compact Beam for the Citizens Band" in your November issue.

My main purpose in using the 11-meter Citizens Band was to establish contact with another station in Gardena, California, which is 22.8 airline miles distant and line-of-sight. Using a ground-plane antenna at both ends, we were unable to establish any communications. The other station purchased a commercial 3-element beam, which didn't help.

Upon seeing Mr. Smith's article, I constructed his beam. Well, we now have 100 per-cent contact at any time of day or night between these two sta-

tions. This is not an easy trick considering the low 5-watts input allowed on the 11-meter Citizens Band, plus the added handicap that about 75 per-cent of the 22.8 miles is directly over the heart of downtown Los Angeles, which is perhaps one of the noisiest cities for radio communications, and line-of-sight puts us no more than 300 feet above the city. I hope the foregoing answers the question of your reader's letter in the March, 1960 issue.

Even with the complete and detailed instructions, plus making sure the materials purchased were exactly as outlined in the article, I was unable to solder the droppers to the elements and had to fall back on Mr. Smith's alternative of using bolts. If this alternative is an "inferior one which should be accepted only as a last resort," I would be amazed to see how well this beam would work soldered.

ROBERT L. SHANNON  
Altadena, California

*Our readers are quick to let us know when they are having problems with some of the projects that we run, but it is not too often that they take the time to let us know how pleased they are with some of them. Therefore, the above letter is especially welcome.—Editors.*

\* \* \*

#### NOVEL NEON-LAMP OSCILLATORS

To the Editors:

In the May, 1960 issue is an article entitled "Novel Neon-Lamp Oscillators." There is an old proverb which says: "There is nothing new under the sun."

I found an identical schematic including the patent number in a publication "Die Glimmlampe und ihre Schaltungen" by Dr. Fritz Schroeter. This publication is dated 1932. The same booklet also deals with two-lamp and three-lamp intermittent arrangements, similar to the arrangements in Figs. 4, 6, and 7. This little booklet is very old, but it even gives the formula for these circuits.

When (around 1930) the neon lamp came to be appreciated, there were many more uses. Many of these are still in my scrapbooks. To name a few, one neon lamp with a long cylindrical glass envelope had a rod cathode of 100 mm and a graduation on the outside. It could be used on 60 cps a.c. to give direct readings of R and C. Another lamp in conjunction with rotating mirrors was used in demonstration of the sinoidal curve of the alternating current.

As a young engineer, I built an installation for auctions. Each bidder had his own press button, corresponding to a neon lamp on a wall. The circuit was such that only one lamp could be energized revealing the bidder, but excluding all others.

H. E. WOLF  
San Bruno, California

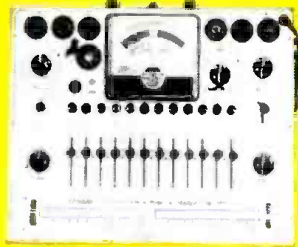
*Brand new or not, the novel circuits described should certainly be of considerable interest to our readers.—Editors.*

—30—

The specs prove it...your best buy is



**B**  
TV-FM SWEEP GENERATOR  
AND MARKER #368  
KIT \$69.95 WIRED \$119.95



**A**  
DYNAMIC CONDUCTANCE  
TUBE & TRANSISTOR  
TESTER #666  
KIT \$69.95 WIRED \$109.95  
Complete with steel cover & handle

RF SIGNAL GENERATOR #324  
KIT \$26.95 WIRED \$39.95



**D**  
PEAK-TO-PEAK  
VTVM #232 &  
UNIPROBE  
KIT \$29.95  
WIRED \$49.95



**E**  
COLOR & MONOCHROME  
OC TO 5 MC LAB & TV  
5" OSCILLOSCOPE #460  
KIT \$79.95 WIRED \$129.50  
5" PUSH-PULL  
Oscilloscope #425:  
Kit \$44.95 Wired \$79.95

**A** Tests all receiving tubes (picture tubes with adapter), n-p-n and p-n-p transistors. Composite indication of Gm, Gp & peak emission. Simultaneous selection of any one of 4 combinations of 3 plate voltages, 3 screen voltages, 3 ranges of continuously variable grid voltage (with 5% accurate pot.). Sensitive 200 ua meter. 10 six-position lever switches: freepoint connection of each tube pin. 10 pushbuttons: rapid insert of any tube element in leakage test circuit. Direct reading of inter-element leakage in ohms. New gear-driven rollchart. CRA Adapter \$4.50.

**B** Entirely electronic sweep circuit with accurately-biased inductor for excellent linearity. Extremely flat RF output. Exceptional tuning accuracy. Hum and leakage eliminated. 5 fund. sweep ranges: 3-216 mc. Variable marker range: 2-75 mc

In 3 fund. bands, 60-225 mc on harmonic band. 4.5 xtal marker osc., xtal supplied. Ext. marker provision. Attenuators: Marker Size, RF Fine, RF Coarse (4-step decade). Narrow range phasing control for accurate alignment.

**C** 150 kc to 435 mc with ONE generator in 6 fund. bands and 1 harmonic band!  $\pm 1.5\%$  freq. accuracy. Colpitts RF osc. directly plate-modulated by K-follower for improved mod. Variable depth of int. mod. 0-50% by 400 cps Colpitts osc. Variable gain ext. mod. amplifier: only 3.0 v needed for 30% mod. Turret-mounted, slug-tuned coils for max. accuracy. Fine and Coarse (3-step) RF attenuators. RF output 100,000 uv, AF output to 10 v.

**D** Uni-Probe — exclusive with EICO — only 1 probe performs all functions: half-turn of probe tip selects DC or AC-Ohms. Calibration without re-

moving from cabinet. Measure directly p-p voltage of complex & sine waves: 0-4, 14, 42, 140, 420, 1400, 4200. DC/RMS sine volts: 0-1.5, 5, 15, 50, 150, 500, 1500 (up to 30,000 v. with HVP probe, & 250 mc with PRF probe). Ohms: 0.2 ohms to 1000 megohms.  $4\frac{1}{2}$ " meter, can't-burn-out circuit. 7 non-skip ranges on every function. Zero center.

**E** Features DC amplifiers! Flat from DC to 4.5 mc, usable to 10 mc. Vert. Sens.: 25 mv/in.; input 2-3 megohms; direct-coupled & push-pull throughout. 4-step freq.-compensated attenuator up to 1000:1. Sweep: perfectly linear 10 cps — 100 kc (ext. cap. for range to 1 cps). Pre-set TV V & H positions. Auto sync. lim. & ampl. Direct or cap. coupling; bal. or unbal. inputs; edge-lit engraved lucite screen with dimmer control; plus many more outstanding features.

FREE CATALOG shows you HOW TO SAVE 50% on 65 models of top quality professional test equipment. MAIL COUPON NOW!



New Transistor  
Portable Radio RA-6  
Kit \$29.95  
Wired \$49.95  
Incl. F.E.T.; less 9V batt.  
Prealigned RF, IF  
xfmrs; push-pull  
audio; 6" spkr.



NEW Power & Bias  
Supply for  
Transistorized  
Eqt. #1020  
Kit \$19.95  
Wired \$27.95



NEW Tube &  
CRT Fil.  
Tester #612  
Kit \$3.95  
Wired \$5.95  
Fast-checks  
radio/TV tubes,  
pilot lamps, etc.



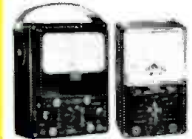
Series/Parallel  
R-C Combination  
Box #1140  
Kit \$13.95  
Wired \$19.95



Tube Tester #625  
Kit \$34.95  
Wired \$49.95  
• tests 600 mil  
series string type  
tubes  
• illuminated  
roll-chart  
Pix Tube Test  
Adapter..... \$4.50



6V & 12V Battery  
Eliminator  
& Charger #1050  
Kit \$29.95  
Wired \$38.95  
Extra-filtered for  
transistor equipt.  
#1060 Kit \$38.95  
Wired \$47.95



20,000 Ohms/Volt  
V-O-M #565  
Kit \$24.95  
Wired \$29.95  
1000 Ohms/Volt  
V-O-M #536  
Kit \$12.90  
Wired \$14.90

SEE OUR OTHER ADVERTISEMENT ON PAGE 111



33-00 Northern Blvd. L. I. C. 1, N. Y.

Add 5% in the West.

TURN PAGE FOR MORE EICO VALUES



R-C Bridge & R-C-L  
Comparator #950B  
Kit \$19.95  
Wired \$29.95  
Reads 0.5 ohms-  
500 megohms,  
10 mmfd-5000 mfd,  
power factor



VTVM Probes

	Kit	Wired
Peak-to-Peak	\$4.95	\$6.95
RF	\$3.75	\$4.95
High Voltage Probe-1		\$6.95
High Voltage Probe-2		\$4.95
Scope Probes		
Demodulator	\$3.75	\$5.75
Direct	\$2.75	\$3.95
Low Capacity	\$3.75	\$5.75

EICO  
33-00 Northern Blvd.  
L. I. C. 1, N. Y.

EW-8

Show me HOW TO SAVE 50% on  Test Instruments  
 Hi-Fi  Ham Gear.  Send free Stereo Hi-Fi  
Guide.  Send FREE Short Course for Novice License.  
Send me FREE Catalog, name of neighborhood dealer.

Name .....

Address .....

City ..... Zone ..... State .....



IF YOU LOVE TO CREATE... BUILD **EICO** KITS

In **STEREO** and

Mono Hi-Fi...  
the experts say  
your Best Buy  
is EICO



Stereo Amplifier-Preamplifier HF81†



Stereo Preamplifier HF85††



FM Tuner HFT90††  
AM Tuner HFT94††  
FM/AM Tuner HFT92††



100W Stereo Power Amplifier HF89  
70W Stereo Power Amplifier HF87  
28W Stereo Power Amplifier HF86



Stereo Integrated Amplifier AF4††



3-Way Speaker System HFS3  
2-Way Bookshelf Speaker Systems  
HFS5 and HFS1



Stereo Automatic Changer/  
Player 1007



Over 2 MILLION EICO instruments in use throughout the world. Add 5% in the West.

- Exclusive advanced systematized engineering
- Latest and finest quality parts
- Exclusive "Beginner-Tested" easy step-by-step instructions
- Exclusive TRIPLE quality control
- Exclusive LIFETIME guarantee at nominal cost

**IN STOCK** — Compare, then take home any EICO equipment — right "off the shelf" — from 1500 neighborhood EICO dealers throughout the U. S. and Canada.

**HF81 Stereo Amplifier-Preamplifier** selects, amplifies, controls any stereo source & feeds it thru self-contained dual 14W amplifiers to a pair of speakers. Provides 28W monophonically. Ganged level controls, separate balance control, independent bass and treble controls for each channel. Identical Williamson-type, push-pull EL84 power amplifiers. "Excellent!" — SATURDAY REVIEW. "Outstanding... extremely versatile." — ELECTRONICS WORLD. Kit \$69.95. Wired \$109.95. Incl. cover.

**HF85 Stereo Preamplifier:** Complete master stereo preamplifier-control unit, self-powered. Distortion borders on unmeasurable. Level, bass, & treble controls independent for each channel or ganged for both channels. Inputs for phono, tape head, mike, AM, FM, & FM-multiplex. One each auxiliary A & B input in each channel. "Extreme flexibility... a bargain!" — HI-FI REVIEW. Kit \$39.95. Wired \$64.95. Incl. cover.

**New HF89 100-Watt Stereo Power Amplifier:** Dual 50W highest quality power amplifiers. 200W peak power output. Uses superlative ultra-linear connected output transformers for undistorted response across the entire audio range at full power, assuring utmost clarity on full orchestra & organ. 60 db channel separation. IM distortion 0.5% at 100W; harmonic distortion less than 1% from 20-20,000 cps within 1 db of 100W. Kit \$99.50. Wired \$139.50.

**HF87 70-Watt Stereo Power Amplifier.** Dual 35W power amplifiers identical circuit-wise to the superb HF89, differing only in rating of the output transformers. IM distortion 1% at 70W; harmonic distortion less than 1% from 20-20,000 cps within 1 db of 70W. Kit \$74.95. Wired \$114.95.

**HF86 28-Watt Stereo Power Amp.** Flawless reproduction at modest price. Kit \$43.95. Wired \$74.95.

**FM Tuner HFT90:** Prewired, prealigned, temperature-compensated "front end" is drift-free. Prewired exclusive precision eye-tronic® traveling tuning Indicator. Sensitivity: 1.5 uv for 20 db quieting; 2.5 uv for 30 db quieting, full limiting from 25 uv. IF bandwidth 260 kc at 6 db points. Both cathode follower & FM-multiplex stereo outputs, prevent obsolescence. Very low distortion. "One of the best buys in high fidelity kits." — AUDIOCRAFT. Kit \$39.95\*. Wired \$65.95\*. Cover \$3.95. \*Less cover, F.E.T. incl.

**AM Tuner HFT94:** Matches HFT 90. Selects "hi-fi" wide (20-9000 cps @ -3 db) or weak-station narrow (20-5000 cps @ -3 db) bandpass. Tuned RF stage for high selectivity & sensitivity. Precision eye-tronic® tuning. "One of the best available." — HI-FI SYSTEMS. Kit \$39.95. Wired \$69.95. Incl. cover & F.E.T.

**New FM/AM Tuner HFT92** combines renowned EICO HFT90 FM Tuner with excellent AM tuning facilities. Kit \$59.95. Wired \$94.95. Incl. cover & F.E.T.

**New AF-4 Economy Stereo Integrated Amplifier** provides clean 4W per channel or 8W total output. Kit \$38.95. Wired \$64.95. Incl. cover & F.E.T.

**HF12 Mono Integrated Amplifier** (not illus.): Complete "front end" facilities & true hi-fi performance. 12W continuous, 25W peak. Kit \$34.95. Wired \$57.95. Incl. cover.

**New HFS3 3-Way Speaker System Semi-Kit** complete with factory-built ¾" veneered plywood (4 sides) cabinet. Bellows-suspension, full-inch excursion 12" woofer (22 cps res.) 8" mid-range speaker with high internal damping cone for smooth response, 3½" cone tweeter. 2¼ cu. ft. ducted-port enclosure. System Q of ½ for smoothest frequency & best transient response. 32-14,000 cps clean, useful response. 16 ohms impedance. HWD: 26½", 13¾", 14¾". Unfinished birch. Kit \$72.50. Wired \$84.50. Walnut or mahogany. Kit \$87.50. Wired \$99.50.

**New HFS5 2-Way Speaker System Semi-Kit** complete with factory-built ¾" veneered plywood (4 sides) cabinet. Bellows-suspension, ¾" excursion. 8" woofer (45 cps. res.) & 3½" cone tweeter. 1¼ cu. ft. ducted-port enclosure. System Q of ½ for smoothest freq. & best transient resp. 45-14,000 cps clean, useful resp. 16 ohms.

HWD: 24", 12½", 10½". Unfinished birch. Kit \$47.50. Wired \$56.50. Walnut or mahogany. Kit \$59.50. Wired \$69.50.

**HFS1 Bookshelf Speaker System** complete with factory-built cabinet. Jensen 8" woofer, matching Jensen compression-driver exponential horn tweeter. Smooth clean bass; crisp extended highs. 70-12,000 cps range, 8 ohms. HWD: 23" x 11" x 9". Kit \$39.95. Wired \$47.95

**HFS2 Omni-Directional Speaker System** (not illus.) HWD: 36", 15¼", 11½". "Fine for stereo" — MODERN HI-FI. Completely factory-built. Mahogany or walnut \$139.95. Blond \$144.95.

**New Stereo Automatic Changer/Player:** Jam-proof 4-speed, all record sizes, automatic changer and auto/manual player. New extremely smooth, low distortion moisture-proof stereo crystal cartridge designed integrally with tonearm to eliminate mid-range resonances. Constant 4½ grams stylus force is optimum to prevent groove flutter distortion. No hum, turntable attractions, acoustic feedback, center-hole enlargement. Only 10¾" x 13". Model 1007D: 0.7 mil diamond, 3 mil sapphire dual styli, \$59.75. 1007S: 0.7 mil, 3 mil sapphire, \$49.75. Incl. FET.

†Shown in optional Furniture Wood Cabinet WE7: Unfinished Birch, \$9.95; Walnut or Mahogany, \$13.95.

††Shown in optional Furniture Wood Cabinet WE7D: Unfinished Birch, \$8.95; Walnut or Mahogany, \$12.50.

EICO, 33-00 N. Blvd., L.I.C. 1, N. Y. EW-8  
Show me how to SAVE 50% on easy-to-build top-quality Hi-Fi. Send FREE catalog, Stereo Hi-Fi Guide plus name of neighborhood EICO dealer.

Name.....  
Address.....  
City..... Zone..... State.....

Listen to the EICO Hour, WABC-FM, N.Y., 95.5 MC. Mon. to Fri. 7:15-8 P.M. Sat. 11-12 P.M.

© 1960 by EICO, 33-00 N. Blvd., L. I. C. 1, N. Y.





**S**HERLOCK HOLMES and his present-day counterparts—the sleuths of fiction, the movies, and TV—would hardly be a match for the sinister characters who often grace the police blotter today. The truth is like with rhinoceros hunting and polar exploration, technology has converted a romantic and haphazard procedure into a systematic scientific effort. Chasing the rhino in a truck and crossing the poles by plane and submarine have replaced the native beaters and the dog sled respectively.

In crime detection, too, technology has supplanted older methods and electronics, especially, has been applied to good advantage. Probably the most obvious is the use of the two-way radio police cruiser in place of the beat-pounding patrolman. But this is only one aspect of electronics in police work. Many more electronic devices are used. They range from the complex equipment of the police lab which

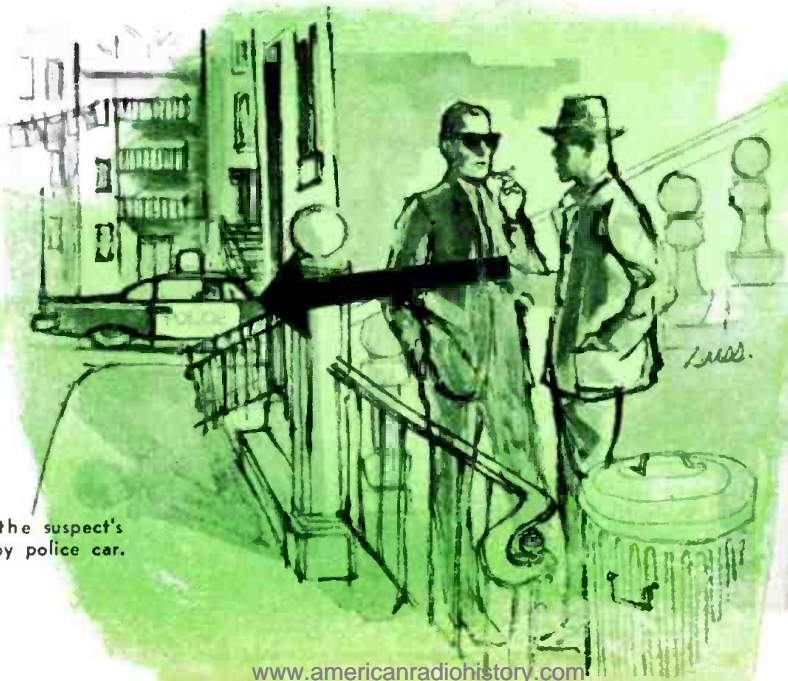
can analyze unknown materials to the subminiature surveillance equipment which can be carried on the person of the "wireless stool pigeon" (in a situation such as is depicted in the drawing below).

A recent survey indicates that in the City of New York over 30,000 phone taps are made annually. The police dispute that any more than the about 3000 legal taps (with court order) were made, but even this number indicates a technical achievement. Actually, over 60% of all arrests for prostitution, gambling, and conspiracy to defraud are the direct or indirect result of phone taps. Since street-walkers in New York have been hunted down like the buffalo at the turn of the century, most of the vice in the city is arranged by phone and in such cases wiretapping is invariably a prelude to the raid. Gambling similarly depends on the phone, especially the arrangements connected

## Electronics in Crime Detection

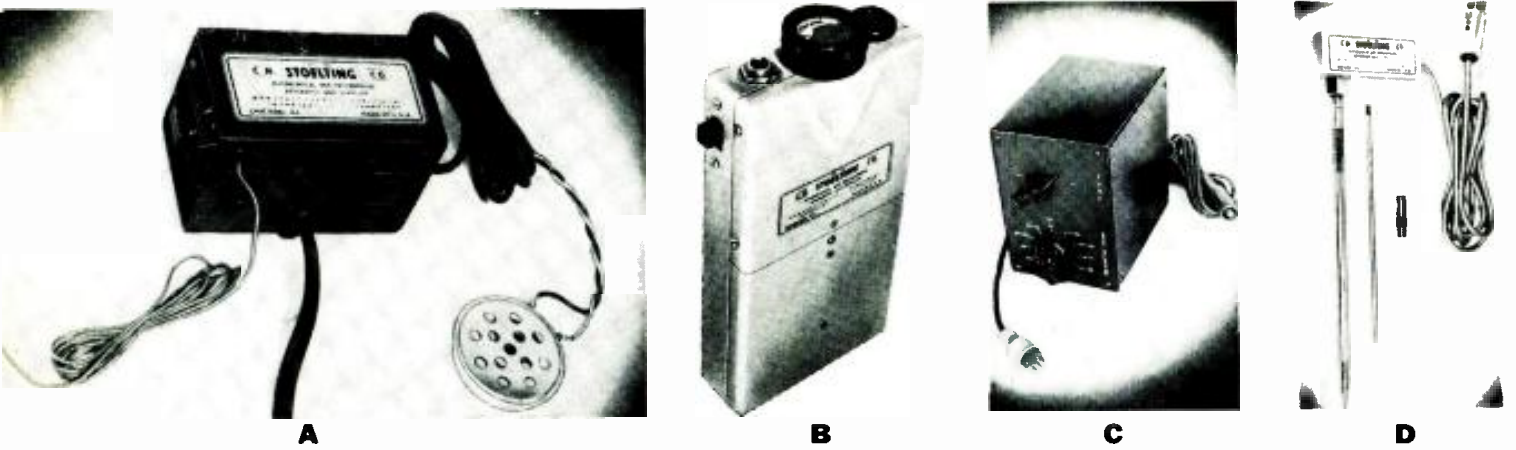
By **WALTER H. BUCHSBAUM**  
Industrial Consultant, **ELECTRONICS WORLD**

**Phone taps, "bugging" equipment, drunk testers, and lie detectors are some of the electronic tools provided by present technology to aid the modern crime fighter.**



A concealed miniature radio transmitter carried inside the coat pocket of the "wireless stool pigeon" sends the suspect's words to receiver in a nearby police car.

August, 1960



with improving the breed of horses running at some distant track. Where suspicion of a fraudulent scheme of some sort exists, wiretapping serves to establish the extent of the fraud and helps to pinpoint individuals connected with it.

Before going into technical details, a brief classification of the various applications of electronic equipment is indicated. Because of the general knowledge and familiarity of our readers with the communications applications, we intend to skip over two-way radiotelephone, teletypewriter, and facsimile transmissions. These fields are not peculiar to police work although their use is of great importance. Nor will we go into details on the use of closed-circuit TV in jails, because it is technically the same as the system used in department stores and steel mills. The unique applications of electronics can be divided into surveillance, investigation of clues, questioning, and countermeasures against surveillance.

Surveillance includes the tapping of phones, "bugging" of rooms, planting of listening devices, the "wireless stool pigeon," and the infrared night-time viewing device. The countermeasures to this activity generally consist of checking out phone lines, locating hidden microphones, and detecting concealed transmitters.

Clue investigation involves electronics in the form of x-ray machines, infrared and ultraviolet analysis, and the many electronic devices the police laboratory uses to identify unknown substances. The questioning of suspects by means of the "third degree" is often replaced by the lie detector or polygraph—as the professionals prefer to call this instrument.

Since "degree" of intoxication is often a point of law, electronic equipment is now available to determine impartially just how drunk a suspect is. All of these electronic devices will be described here but the reader must understand that law enforcement officers are naturally reluctant to have some of their tricks publicized. For this reason we have had to use some discretion and must keep some of the information received in confidence.

The author is indebted to New York City's Deputy Commissioner Walter Arm, Lt. Paul Walker, and Lt. J. Finney for their cooperation in obtaining access to the police laboratory and learning how clues can be analyzed scientifically. Some of the material on surveillance and countermeasures was obtained from equipment manufacturers and newspaper sources.

### Surveillance Equipment

Until the advent of electronics, surveillance was carried out either by having a suspect shadowed or else by trying to plant detectives in places where conversations could be overheard. The "tail" is still used, but less frequently since the suspects' phone calls and conversations in "bugged" rooms are usually sufficient to reveal his criminal schemes. But even the "tail" can use a pocket transmitter to direct other officers without losing sight of his quarry.

Listening in on phone conversations is technically very simple. Legally, however, it is not so simple since phone companies forbid any foreign attachments to their lines

whether or not a direct electrical connection is made. Police authorities may, however, upon presentation of additional evidence, obtain a court order permitting a legal tap to be made.

Every reader of radio supply house catalogues has seen the telephone pickup coils offered for a few dollars. They pick up the electromagnetic radiation from the phone itself and, with suitable amplification, reproduce both parts of the conversation. Naturally, police officers cannot attach such devices to the phones of suspects, but the same principle will work anywhere along the phone wires. Most legal phone taps are made by connecting a set of earphones or a tape recorder direct to the wires going to the suspect's phone. This is usually done with the knowledge of the phone company and the tap can be made at an exchange or at some convenient junction point.

In some cases all that is required is a spare set of wires in the cable and these are then connected in parallel so that the eavesdroppers can be "staked out" at a distance. Illegal wiretapping is often done by electromagnetic pickup or, in some cases, by splicing additional wires into the tapped line at some place difficult to spot. Investigators looking for taps always watch for the place where two wires go into a wall and four come out, because the extra wires are very likely going to a secret listening post. It is possible to check out the resistance of phone wires between points and determine from that if a tap is present, but where a pickup coil is buried in the wall, possibly taped right to the wires, such a tap is difficult to locate.

Only earphones and a recorder are needed in the way of electronic equipment or, where pickup coils are used, a sensitive audio amplifier is added to the equipment lineup. Such an audio amplifier must have a low hum level and

Fig. 2. Operators examining tracing by infrared spectrophotometer.



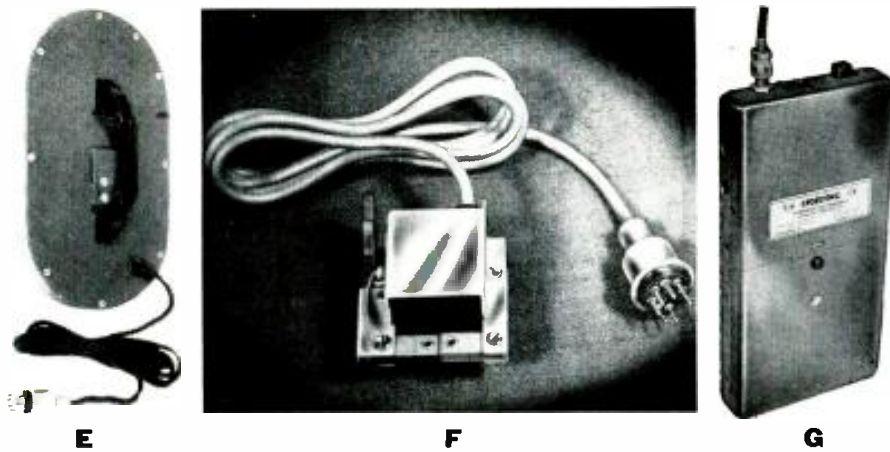


Fig. 1.

- A** Concealed transmitter and microphone.
- B** Miniature audio amplifier.
- C** Radio-frequency detector.
- D** Contact mike and vibration pickup.
- E** Metal detector.
- F** Clamp-on induction coil for phone taps.
- G** Pocket-sized FM transmitter.

provide a good impedance match with the pickup coil used.

A typical amplifier is shown in Fig. 1B and this is a completely self-contained unit. The meter shows the signal strength and can also be switched to indicate the operating voltages. Either earphones, a small speaker, or a tape recorder can be connected to the amplifier output, while its input can come from an induction coil like the one shown in Fig. 1F. This coil has a hinged core so that one of the two phone wires can be slipped through without any need to cut or strip the wire. Actually, the amplifier can be used for other surveillance work as well and is part of a complete kit offered by the *C. H. Stoelting Co.* of Chicago, one of the major suppliers of police and intelligence equipment.

A recent refinement in phone taps is a tape recorder which automatically turns on whenever the ringing signal of the tapped phone is detected. This is done by using the listening amplifier to actuate a relay which controls the tape transport. Another refinement is an audio amplifier and FM transmitter which can be hidden in the wall or in a closet and transmit the tapped phone conversations to a nearby receiver.

Next to eavesdropping on telephone conversations the "bugging" of rooms is the most widely used method of electronic surveillance. A "bug" is simply a hidden microphone which transmits the sound in the room to a remote listening post. This may be done with concealed wires to an adjoining room or by radio transmission to a nearby building or vehicle.

Naturally, such a transmitter has to be properly concealed. For only \$100.00, the *Fargo Company* of San Francisco sells a complete microphone and transmitter concealed in a regular picture frame. No wires show since the unit is battery-operated and, unless a receiver is tuned to the correct frequency, no indications of the "bug's" presence can be detected.

Here we should point out that most of the transmissions by commercially available police apparatus take place in the 40-mc. band set aside for this purpose. Transmitters operate on narrow-band FM, with crystal control. Often battery-type receivers are not necessary because there is access to a power line. Where this is the case, the miniature transmitter shown in Fig. 1G can be used, possibly concealed in the wall with the antenna wire well hidden. While some of the miniature surveillance equipment uses transistors, most of the transmitters still use tubes and therefore require both "A" and "B" batteries. Output power is in the milliwatt range, but this is usually sufficient for reliable transmission within a few miles.

When it is impossible to secrete a microphone successfully, conversations can still be overheard by means of a vibration pickup and contact microphone of the type shown in Fig. 1D and the audio amplifier of Fig. 1B. The proper size pickup is held against either an inner wall, door, or other vibrating surface, but a good spot must be found if extraneous noises are not to drown out the conversation. Actually, there is a great deal of technical "know-how" involved in "bugging" a room since the directivity of the microphone, the room acoustics, and the location of noise

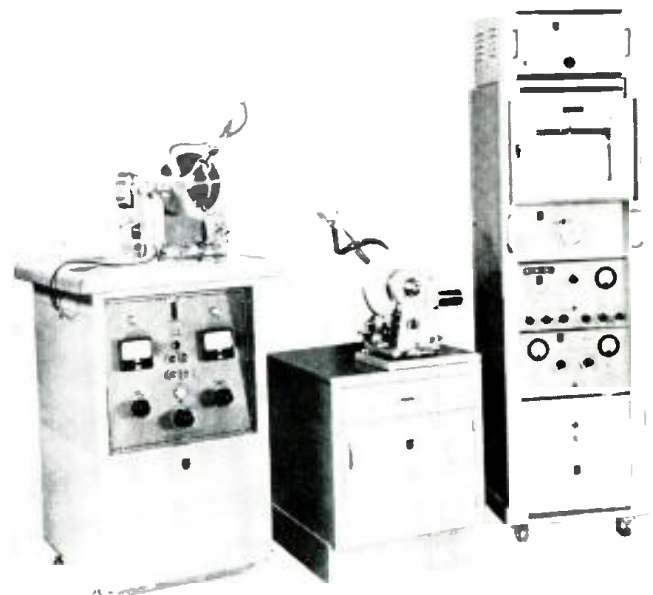
sources all play an important part. A picture-frame microphone, for example, should be almost non-directional, but locating the picture over a steam radiator or next to a radio or TV set would not provide good surveillance. A lamp-concealed microphone should be fairly directional, but well isolated from its case since the jarring of furniture can give really horrible sounds. The audio amplifiers used are mostly transistorized—with low hum but limited frequency response. Wide-band response would be a drawback since this would amplify such noises as the rustle of clothing and the squeaking of shoe leather. Most voices are pitched in the 200-4000 cps region and this bandwidth is sufficient to reproduce clearly identifiable speech.

The "wired stool pigeon" is commonly used to obtain convictions in narcotics and extortion cases. A likely looking detective will make a contact with a dope addict or pusher and will then arrange for a purchase. At the appointed time he carries a miniature pocket transmitter like the unit shown in Fig. 1G while an associate in a nearby car receives and tapes the entire conversation. When the suspect later hears himself describing the quality of the "snuff" and arguing about the price, a full confession often follows.

### Countermeasures

Just as in warfare, each measure has a countermeasure and each countermeasure can have a counter-countermeasure. Since some criminals might use wiretapping and "bugging" to snoop on other criminals or on law enforcement officers, the same companies which make surveillance equipment also manufacture a variety of countermeasure

Fig. 3. Example of laboratory-type x-ray diffraction equipment.



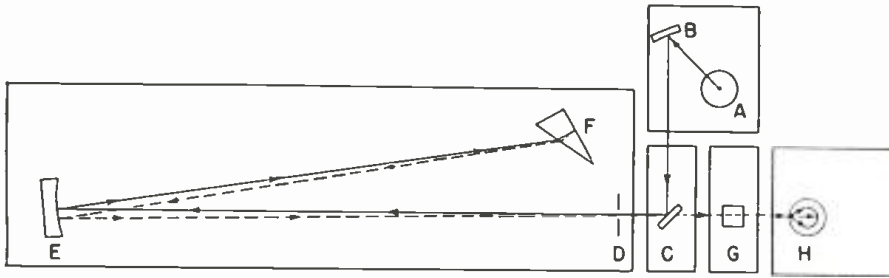


Fig. 4. Principle of the spectrophotometer. Source of light (A) may be tungsten lamp whose light is reflected and collimated through set of special mirrors (B, C, E). Prism (F) is aluminized at back surface and breaks up light into different wavelengths. By rotating prism only the desired wavelength can pass through slit (D) and be absorbed to some degree by unknown substance (G). Phototube (H) registers light passing through unknown substance and the output of the phototube is then amplified and recorded.



Fig. 6. Instrument to check drunkenness.

r.f. detecting receivers are available which can be concealed on the wearer. Small direction-finding receivers are also available for locating illegal transmitters.

### Clue Investigation

The heart of any investigation of clues is the police laboratory which provides the technical experts and the necessary equipment to track down and analyze even the simplest and most casual clues. A visit to the New York City police lab proved to be a real eye-opener. In addition to an elaborate photographic arrangement and complete chemical laboratory, such advanced devices as an electron microscope and a full set of radiation monitors are available.

Basically most investigation of clues centers around the identification of the famous "unknown substance." This may be a suspected narcotics, poison, dried blood, seminal fluid, underpaint of the hit-and-run car, dust from a DOA's trouser cuffs, or literally anything else. The lab's job is to find out what the substance is and, if possible, where it comes from. Chemical analysis may not be sufficient to identify the material and then, if the substance is inorganic, a sample of it goes into the spectrograph. There it is burned in an electric arc while the burning current is observed on a scope and the color spectrum recorded on a photographic plate. The resulting color lines often indicate what basic ingredients the material contains.

Organic substances are tested by an infrared spectrophotometer, like the one shown in Fig. 2. This device indicates the relative absorption of infrared radiation by the unknown material. By comparing the absorption figures with known substances, it is possible to identify at least some of the components of the material under test. Actually, this test is most useful in identifying narcotics because, no matter how the drug has been adulterated, its infrared characteristics will indicate in which group it belongs and its relative dilution.

Gasoline is also often checked by the infrared method. On the other end of the visible spectrum, the quartz spectrophotometer is also very useful in narcotics cases and in particular serves to identify morphine and heroin. Both spectrophotometers use the same operating principle, as shown in Fig. 4. A light of known wavelength is passed through the sample and its intensity measured by a phototube sensitive to that wavelength. The output of the phototube can be presented on a meter or graph and, by using a range of wavelength, a spectrographic picture of the unknown substance is obtained. The absorption characteristics of most commercial substances are known and by comparison the police can determine the composition of the unknown material.

For crystalline materials, such as unknown powders and most narcotics, x-ray diffraction equipment (see Fig. 3) often yields additional identification data. Here the sample is bombarded with x-rays and the result activates a photographic plate. Again certain diffraction patterns are well known and identification is made by comparison.

(Continued on page 111)

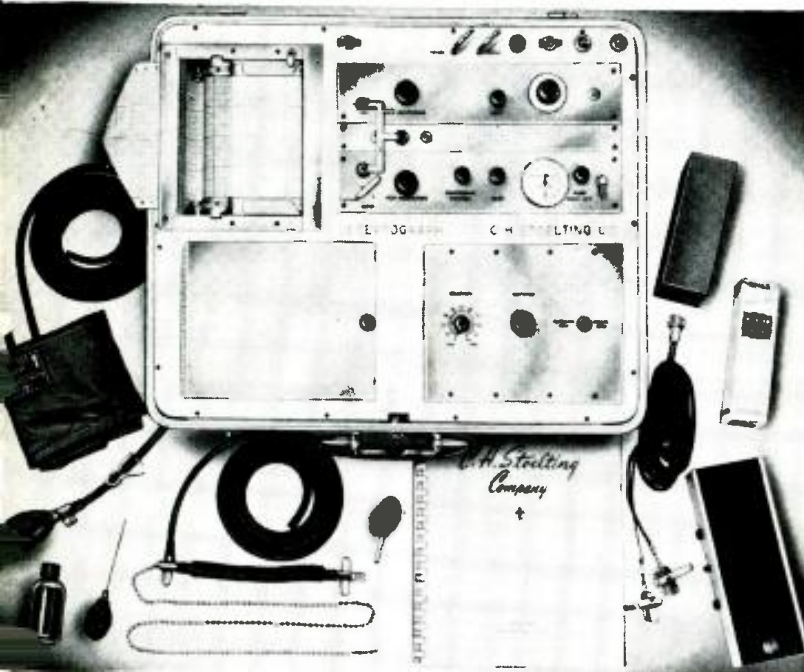


Fig. 5. A portable polygraph, or lie detector, along with its accessories.

devices. The *Mosler Research Corporation* of New York City, for example, sells a special communications cable which is wiretap-proof. The inner group of wires is surrounded by an electrostatic and magnetic (Mu-metal) shield and this, in turn, is surrounded by a ring of wires which carry a white-noise signal and are connected to a bridge circuit. The entire assembly is molded in plastic and covered with steel braiding. Any tampering with the outer wires sets off the bridge circuit alarm. Induction coupling is not possible since the white-noise drowns out any of the radiation which might leak through the double shield.

The most widely used countermeasures, however, depend on locating a phone tap or a bug. An experienced detective equipped with the latest electronic devices can usually establish the presence of any surveillance gear. Phone taps are located by bridge measurements of resistance. Induction coils are found either by visual search of the phone wires or else, if they are buried in the wall, by using a metal detector of the type shown in Fig. 1E, connected to the audio amplifier. This unit also helps to find microphones or other metallic objects hidden in wood or plaster walls. Transmitters are located by means of a small r.f. detector, connected to the basic audio amplifier. One such r.f. detector is shown in Fig. 1C and this unit covers from 50 kc. up to 410 mc. in nine bands. Nine tuned networks and a variable capacitor select the frequency. A long clip lead or r.f. probe serves as the antenna. Accurate frequency or high sensitivity is not needed since only the presence of an illegal transmitter in close proximity must be indicated. Other

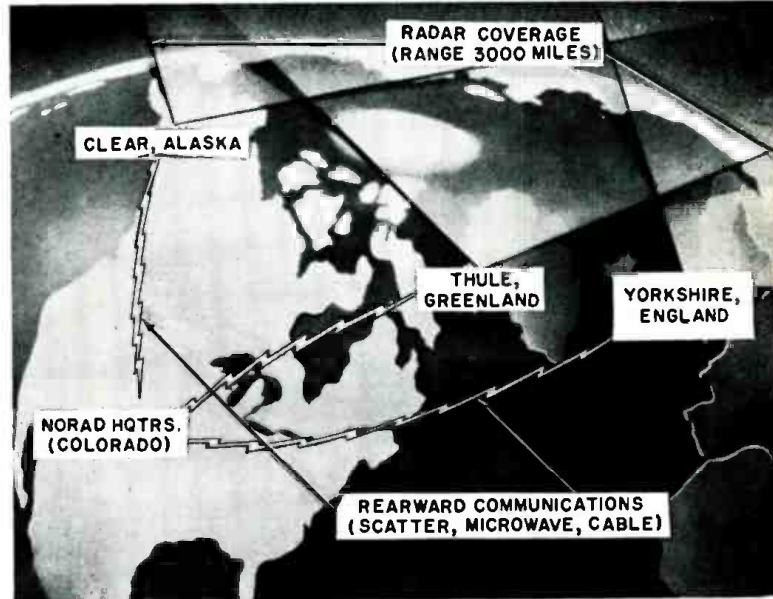
# BMEWS

## Ballistic Missile Early Warning System

America's primary early warning system for attacks by enemy missiles approaching over Northern Hemisphere is taking shape.

**T**HE MOST POWERFUL radars in the world, the gigantic detection radars of the U.S. Air Force Ballistic Missile Early Warning System, are now sending their beams out over the polar wastes as part of an exhaustive test program to ready the first of the BMEWS sites at Thule, Greenland for operation this fall. The radars have been designed to have a range up to 3000 nautical miles toward Eurasian skies to detect ballistic missiles aimed at the United States, Great Britain, and southern Canada. Warning of an attack by enemy ICBM's will be flashed to North American Air Defense Command (NORAD) Headquarters in Colorado Springs and to Strategic Air Command (SAC) Headquarters at Omaha. The entire system will provide approximately a 15-minute warning in case of missile attack.

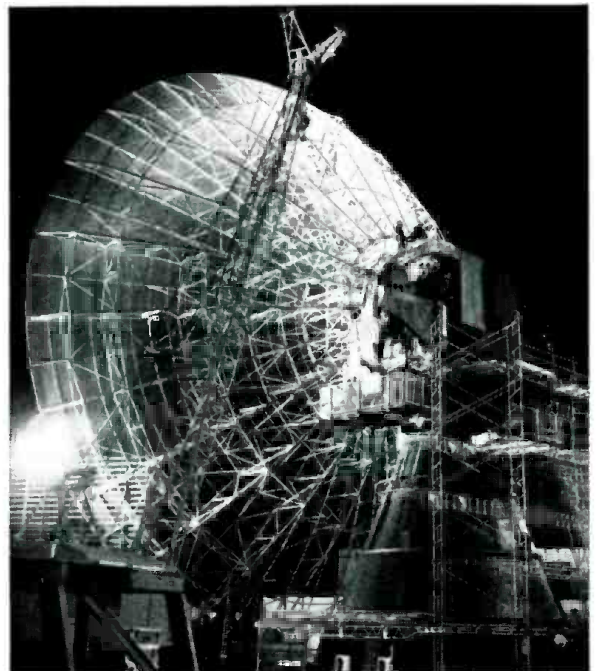
The four huge fixed-surveillance radar antennas already installed at Thule, Greenland and to be installed at Clear, Alaska radiate narrow fans of powerful r.f. energy at two different elevations. When a missile passes through the lower fan, radar pulses will bounce off it and be detected by super-sensitive receivers. From these radar echoes, the position and velocity of the missile will be determined. Seconds later, as the missile passes through the upper fan, radar echoes again will be picked up, and position and



(Top) Powerful radars at these three sites will scan the skies over the polar region and Eurasian land mass. The Thule base is just about ready for full operation; the Alaska base is well along in construction; the Yorkshire base is just being started.

(Left) One of the four huge radar antennas that has been installed at the Thule site. Each of these giant reflectors is 400 feet long and 165 feet high. Two separate feed systems for each reflector produce two fan-shaped radar beams at different elevations. Radar range is up to 3000 nautical miles.

(Below) The radar tracking antenna to be installed at Yorkshire, England, is shown here during final construction. Reflector is 84 feet in diameter and it will be installed in 140-foot radome.



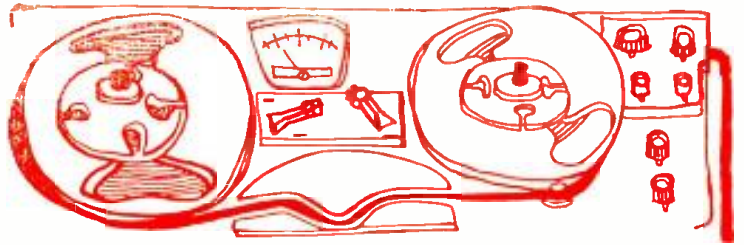
velocity will be measured. The missile's trajectory can then be calculated from these coordinates since it will be in "free flight" (unpowered) as it passes through the fans. Calculation of the trajectory will permit prediction of the impact area, impact time, and point of launch. Data processing equipment will rapidly compute this data and flash a warning to NORAD Headquarters in the U.S. So powerful will the multi-megawatt radar beams be that personnel must travel between buildings in the active missile-detecting area through shielded passageways. These are large enough to permit truck passage.

BMEWS Arctic bases will be thriving "small cities" complete with comfortable living quarters, good meals, medical facilities, and a variety of recreational outlets. The Thule site will house about 1000 men, while the Clear site will house about 600 men.

Prime contractor for the over-all system design is *RCA*. *Western Electric* is supplying the rearward communications. The giant radars at Thule were designed by *General Electric*. The complete installation and maintenance for at least two years will be handled by the *RCA Service Company*.

-30-

# RECORD



# LIVE STEREO AT HOME

By **NORMAN H. CROWHURST**

## Microphone requirements and techniques that may be used to make good stereo tape recordings at home.

**M**ONOPHONIC high-fidelity—and now hi-fi stereo—can bring some wonderful entertainment into your home; a tape recorder can be used to capture permanently stereo broadcast programs but the ultimate realization to be derived from a stereo tape recorder comes from making recordings of a "live" program—your own family and friends performing in your own living room.

Some readers may feel that they do not do anything worth recording. They'd be surprised at the talent which can be unearthed around their own homes. Remember the fun a monophonic tape recorder engendered when each person heard his own voice recorded for the first time! It was good of everyone else, but "that's not me!" was the common reaction. This is nothing to what stereo can provide in the way of surprises.

If you record stereo correctly and reproduce the tape in the same room, the realism is fantastic. It will have you looking at the spot where someone stood when the recording was made—only to discover that he is not there now. His recorded voice is so real you'd think he left his ghost on the spot. If a member of your family or some of your friends are musical—so much the better. You can capture the fun of learning to play, musical evenings, and a host of other memories permanently and so realistically it will be like re-living them.

Don't worry about formalities such as getting everyone to keep absolutely quiet during the recording session. Incidental remarks in the background merely add to the realism. A stereo

tape recorder with the proper microphone setup is just like a time machine. With it you can put back the clock and re-live what happened yesterday—or years ago.

The proviso of using proper microphone setups is important—a fact that has not received sufficient attention, in

our estimation. Monophonic tape recorders were supplied with an inexpensive microphone which enabled you to record your own voice and anything you wanted with tolerably good quality. However, two such microphones are quite useless for stereo for two reasons: (1) the frequency response is not good enough, and (2) they have little directionality.

Both these items are important if you want to achieve the realism we've just been discussing. You don't have to get microphones of professional quality, costing hundreds of dollars, but you do need microphones that suit the job—something better than the type normally supplied with the single-channel tape recorders, microphones that may cost the recorder manufacturer less than \$5.00.

For this reason few of the newer tape recorders, incorporating stereo recording as well as stereo playback facilities, come equipped with microphones. Up until now, at any rate, the cost of the microphones would up the total price of the machine considerably. So they leave it to the user to make his own choice of microphones but this chore has proven to be a real deterrent to getting the fun we're talking about. You need advice about picking the right microphone.

### Microphones

Undoubtedly the best recordings are made with the best microphones. While the best microphones generally cost more than inferior ones, a high price, in itself, is no guarantee of quality. There are good buys at low prices and some of the high priced ones perform

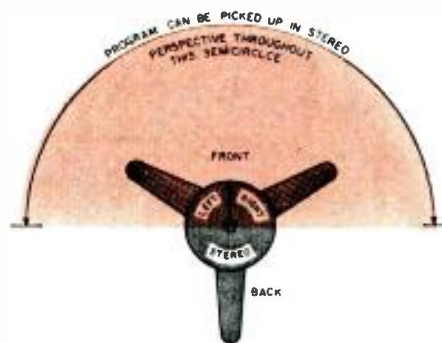
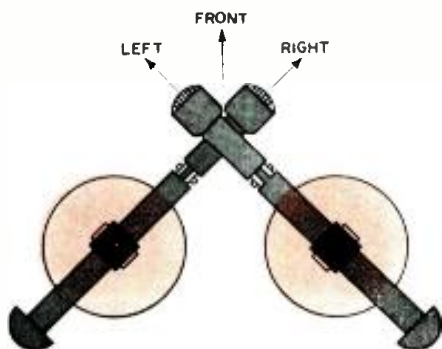


Fig. 1. Range of useful pickup angle in front of the dual-dynamic stereo microphone.

Fig. 2. Method of placing separate cardioid microphones to get the effect of Fig. 1.



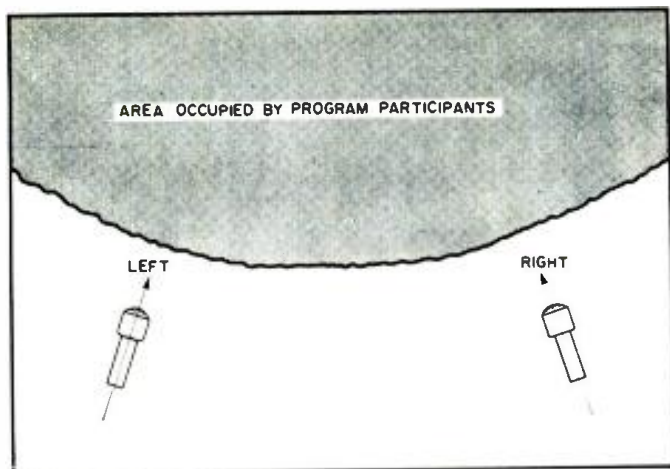


Fig. 3. Alternate placement of separate mikes to record stereo.

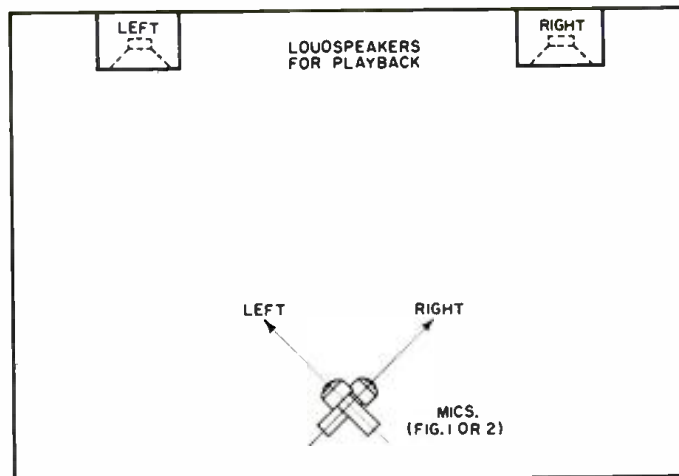


Fig. 4. With close mikes, separated playback speakers are best.

no better. So it is worth shopping carefully for your microphone.

While a good, smooth frequency response is highly desirable and the quality of the recording will directly reflect the uniformity of frequency response of the mikes, it is important to have properly matched microphones and to have the proper directional characteristics, correctly used.

Matched microphones for stereo are now on the market. Recently *Electro-Voice* announced that any of its microphones bought in pairs for stereo applications will be laboratory matched at no extra cost. This is a big help. In addition, *Shure*, *Turner*, and others are making matched stereo microphones available. Now you only have to decide which type of microphone is best—for you!

If you take enough pains, a pair of any good microphone type can be used for stereo recording. But omnidirectional types (which unfortunately include practically all the lower cost models) are more difficult to use. To achieve realism, everyone has to stand much closer to microphones of this type. You may be able to achieve this "closeness" for deliberate, planned pick-up but incidental sounds will not have realism. Someone making comments over on the other side of the room will sound as if he were out in the kitchen or some remote part of the house. It is surprising how much this falsification of incidental background spoils the whole effect.

This is why it is much easier, as well as giving much more natural and realistic results, to use directional-type microphones. You can use bidirectional ribbons with very good effect if you know how to utilize their unique "figure-8" directivity pattern to best advantage. But it is easier to get natural results without any particular care if you get microphones with a cardioid, or unidirectional, pattern.

Thus far, most of the unidirectional microphones have been in the higher price brackets. However, *Norelco* has recently started importing a moderately priced double microphone incorporating two cardioid elements. It comes with a ring-tip-sleeve jack that fits the stereo mike socket on the company's tape recorder. It can be used on other machines by removing the single jack from the double lead and fitting a pair of jacks to suit the recorder sockets.

#### Mike Placement

A good feature of the single double-element microphone is that the placement problem is eased considerably. The mike has an arrow pointing toward the front with the words "left" and "right" indicating the directions to occupy so sound will come from these speakers on playback. In trying it out, we found it entirely practical to spread our performers over a semi-circle around the front (Fig. 1). And, if someone happens to speak from the back, it comes through realistically as

a sound that is in the background.

If you use separate cardioid microphones, you have a little more flexibility in placement. You could use an arrangement similar to that built into the *Norelco* (Fig. 2), or you could separate them to cover the spacing, as shown in Fig. 3. The way you place the recording mikes will influence the arrangement of the playback speakers.

If you use the double-element microphone or two microphones close together, the speakers should be spread apart in the conventional fashion (Fig. 4). But if you have your mikes widely spaced, you may find that directional speakers (either in a single or separate enclosures), radiating outwards from a central position, give a better effect, as indicated in Fig. 5. Alternatively, any of the single-cabinet units may provide the solution.

Speaker arrangement for best stereo reproduction depends, to some extent, on room size. All of the previous remarks have assumed an average living room area with dimensions in the range from 12 to 25 feet each way. Rooms smaller than 12 feet or larger than 25 feet each way (somewhat dependent on furnishings too) may need different treatment for best realism.

Very small rooms produce best results when both microphones (either a double-element one or two placed together) and speakers are placed close together. Very large rooms yield good recordings when the microphones and

(Continued on page 120)

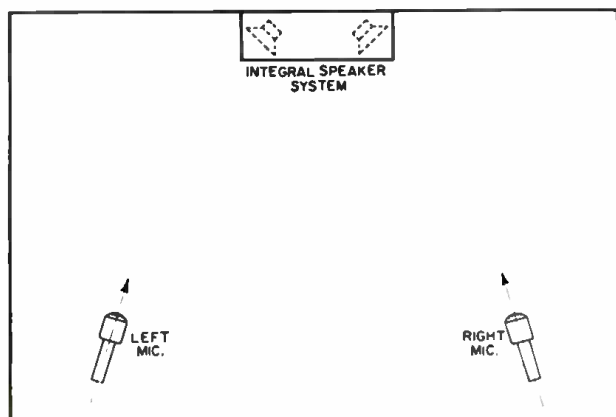
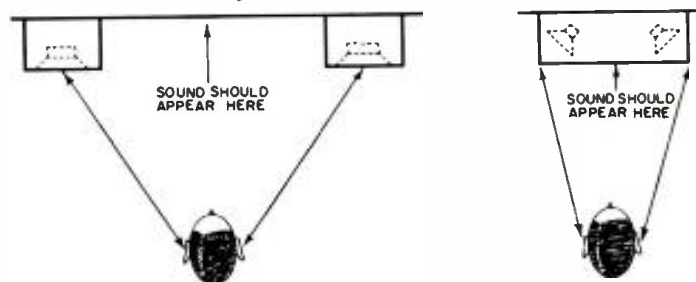
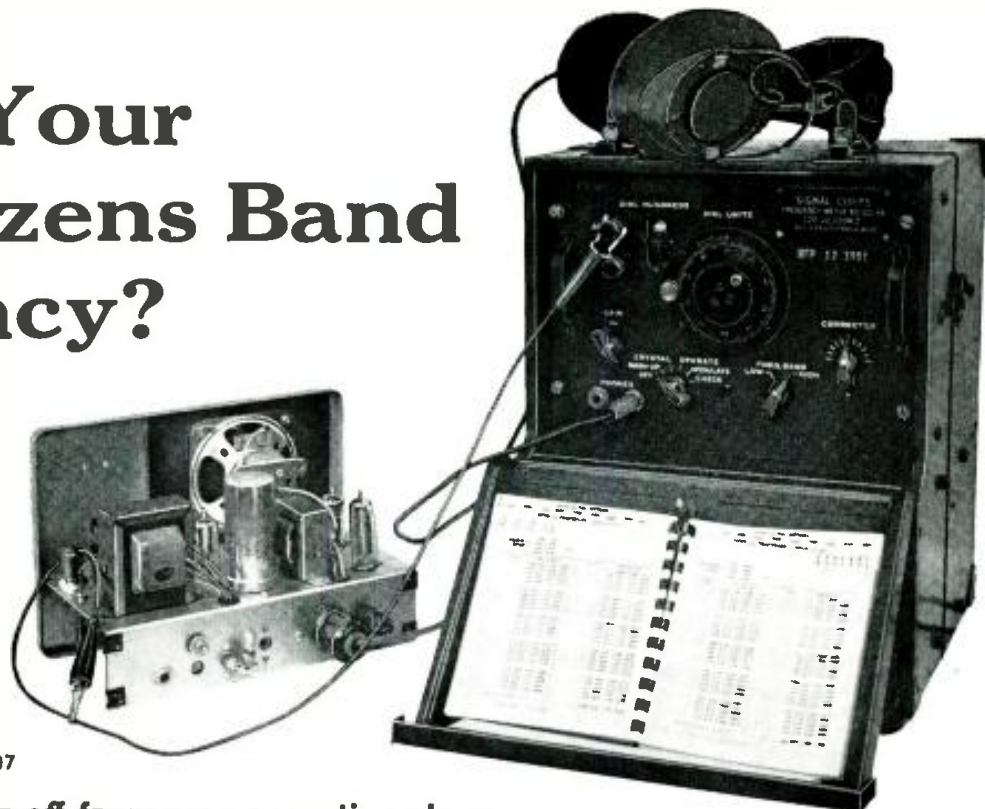


Fig. 5. When widely separated microphones are used to record, closely spaced speakers are usually better during the playback.

Fig. 6. Check phasing with tape made of sound source directly in front of mike. During playback, sound should be centered.



# What's Your Citizens Band Frequency?



By  
DONALD L. STONER, 11W1507

## Causes and remedies for off-frequency operation along with tests for frequency tolerance of CB transmitter.

Set-up used by author to check frequency.

**A** CONSIDERABLE number of citations have been handed out for violation of frequency tolerance on the class D Citizens Band. Section 19.33 of the Citizens Radio Service Regulations (part 19) specifies that all class D stations must operate within .005 per-cent of the assigned channel frequency. This point confuses some, for .005 per-cent of the operating frequency is actually .00005 times the operating frequency. As an example, at 27 mc., a carrier frequency tolerance of  $\pm 1350$  cycles is allowed. Thus a station on 27.005 mc. could operate between 27.00365 and 27.00635 and be just barely legal. The permissible frequency variation, with respect to the adjacent channels, is shown in Fig. 1.

After the initial shock of receiving a citation wears off, the CB operator will probably turn a blazing eye towards his Citizens Band rig and speculate what went wrong.

Well, what did go wrong? If the transmitter is crystal-controlled why doesn't it transmit in the channel stamped on the crystal? At this point

let it be stated emphatically that a guaranteed 0.005% tolerance crystal is capable of off-frequency operation, even if the advertisement states that it has been certified, verified, or homogenized!

Assuming that the crystal is not defective, there are two possible sources of error. First, and foremost, the crystal is calibrated for a particular frequency (by etching) and for use in a specific circuit. If the crystal is used in any other circuit, it may be off-channel. The second point to remember is that even though the recommended circuit is used, it can be misadjusted to produce off-frequency operation.

### Crystal Capacity

Fig. 3 shows the schematic of a typical crystal oscillator that might be found in a Citizens Band transceiver. The crystal is connected between grid and ground. A tuned circuit is connected to the plate and energy from this circuit is coupled to the next stage. When the coil is resonated slightly higher than the crystal frequency, the

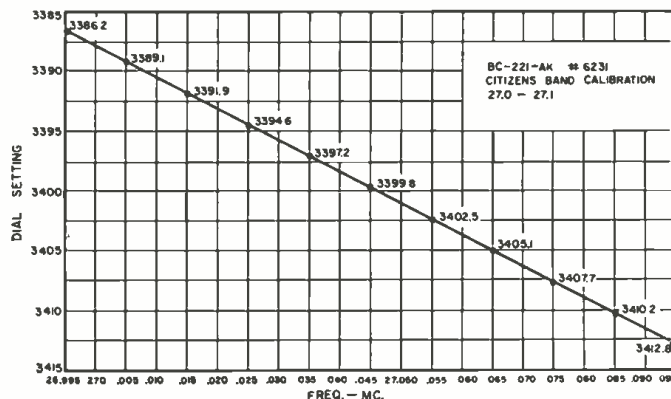
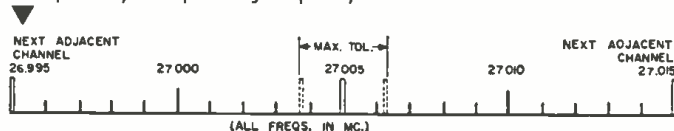
stage will oscillate because of the feedback from plate to control grid. If the coil is tuned to the crystal frequency, or below, the phase angle of the feedback will be incorrect and the stage refuses to oscillate.

During manufacture, the crystal is etched to operate in conjunction with a particular amount of capacity shunting the crystal. This value has been standardized at  $32 \mu\text{f}$ . In Fig. 3 this capacity is a combination of the tube input capacity and the wiring capacity and the capacitor,  $C$ , which would be approximately  $25 \mu\text{f}$ . The sum of all capacities provides a total of  $32 \mu\text{f}$ , which is correct for shunting most crystals. In some CB units, capacitor  $C$  is a 3-30  $\mu\text{f}$ . adjustable device to put the crystal "on the money."

Some transceiver designs do not include capacitor  $C$  in the oscillator circuit. In these units only the grid and stray capacities appear across the crystal. The crystal, then, must be calibrated for use in this circuit (approximately 8  $\mu\text{f}$ . shunt capacity) or the transmitted frequency may be outside

Fig. 2. Shown at the right is the calibration curve of the frequency meter employed by the author to check the exact operating frequency of his CB transceiver.

Fig. 1. Chart showing maximum frequency deviation allowed at 27 mc. Remember when making calculations that the .005% tolerance allowed by FCC is actually .00005 multiplied by the operating frequency used.





the tolerance band. If a crystal designed for use in a low-capacity circuit is used in Fig. 3, it will quite likely be off-frequency. By the same token, if you order crystals designed to "see" 32  $\mu\text{f}$ . shunt capacity, they may be off-frequency in the low-capacity circuit as well.

It is safe to assume that when you order a Citizens Band unit it will be in tolerance. But what about changing frequency? You would be wise to order additional crystals from the same firm that sold the transceiver. You are more likely to receive a replacement crystal designed for that unit.

If your unit has capacitor C, you can safely order crystals from any company producing crystals for use in "standard" capacity circuits. If capacitor C is not included in your oscillator circuit (Fig. 3), you can still order standard capacity crystals by adding an external capacitor, as shown in Fig. 4. This "trick" adds the necessary capacity without making circuit changes. Be sure to use an NPO (no drift) capacitor and insert the crystal so the capacitor is positioned away from heat-producing components. Also be careful when soldering to the pins not to overheat the crystal. Only a small amount of solder is necessary.

Don't be tempted to add too much capacity to the circuit! The classic example of this situation is the fellow repeatedly cited for off-frequency operation. Investigation showed he had modified his transceiver by installing a 10-position crystal switch at the end of a three-foot piece of coaxial cable. The cable alone had almost 100- $\mu\text{f}$ . capacity!

### Pulling

The second reason for off-frequency operation, mentioned earlier, is known as crystal "pulling" and is caused by misadjustment of the oscillator plate coil. Since the tuning of this coil plays a large part in creating the oscillations, it can be expected to influence the frequency of the oscillator. Fig. 5 shows a graph of frequency *versus* oscillator coil tuning for a typical CB transceiver kit. When the slug is properly positioned in the coil (as explained in the instruction manual) the operating frequency will be the same as shown on the crystal. This is indicated as zero, or nominal, in Fig. 5. As the slug is turned counterclockwise (ccw) the frequency increases and the output, or drive to the amplifier, starts to fall off. As the core is turned clockwise (cw), the frequency drops, reverses slightly, then suddenly quits oscillating. If the slug is left between nominal and one or two turns clockwise, the oscillator performance will not be reliable, even though it may be on-frequency. The graph, Fig. 5, plainly shows that a misadjusted oscillator coil can shift the frequency more than 1600 cycles from the nominal and well outside the tolerance of 1300 cycles.

### Testing Your Station

Again referring to Part 19 of the

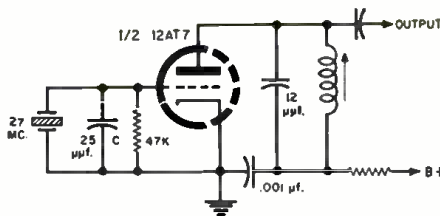


Fig. 3. Typical crystal overtone oscillator found in many CB transceivers. Capacitor "C" may be omitted. Refer to text.

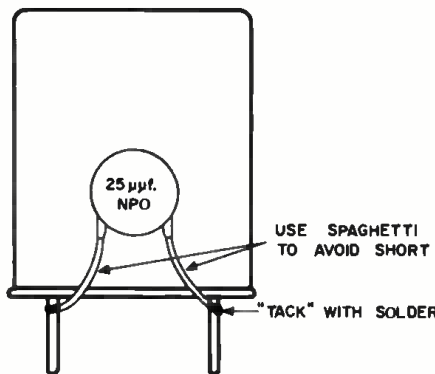


Fig. 4. Standard crystals can be used in low-capacity oscillator circuits by "tacking" capacitor to crystal pins, using spaghetti-covered wire to avoid short circuits.

rules, section 19.54(b) says in part: ". . . the Commission may require the applicant to certify that the frequency stability of the crystal-controlled transmitter is within the tolerance specified. . . ." You may be called on to prove that your station is within the specified 0.005% tolerance at any time.

At the moment there are only a few Citizens Band service shops and only a small percentage of these are equipped to certify a transmitter frequency. How, then, can the Citizens Band operator make sure his transmitter is well within his transmitting channel?

If an amateur radio operator in your area owns a Collins 75A series receiver, he can use it to check your frequency on the old 11-meter ham band. When properly calibrated, and in the hands of a skilled operator, this receiver is capable of  $\pm 100$ -cycle accuracy! The following procedure should be closely adhered to: Warm up the receiver and Citizens Band transceiver for at least 15 minutes. Then check the 100-kc. frequency standard in the receiver against WWV. Wait until an unmodulated period occurs and "zero in" the calibrator. When you can no longer hear a beat note, but the meter swings slowly back and forth, you are within a few cycles and close enough for our purpose. Set the receiver dial at exactly 27.0 mc., turn on the b.f.o. and set the pitch control to zero beat. Then check the calibration accuracy at 27.1 and 26.9 mc. The dial should be within 100 cycles. If it is not you will have to take this error into account when measuring the transmitter frequency. Finally, connect a 52-ohm dummy load to the transmitter, turn the transmitter on, and tune the receiver to zero beat. You can

then read the transmitter frequency directly from the receiver dial. If you want to know how many cycles the transmitter is off, set the receiver to the channel frequency and compare the beat difference with an audio oscillator.

Whether the FCC would accept such a test as a "certification" of frequency, the author is not prepared to say. However, this is not the point. The measurement just described should be used before a citation arrives! You will be able to determine your frequency quite closely but more important, the test will tell you if the transmitter is dangerously close to the channel edge.

Enterprising groups of CB operators would be well advised to invest in a surplus BC-221 or LM frequency meter, to check the accuracy of transmitters in the group. Although these frequency meters only go to 20 mc., they will generate super-accurate signals on the Citizens Band by using the second harmonic of a 13.5 mc. signal.

The author uses a late model BC-221-AK for testing Citizens Band transmitters. It was calibrated in the fol-

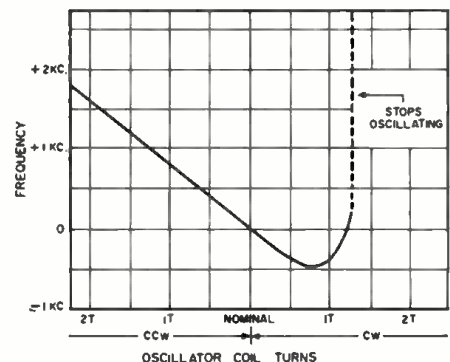


Fig. 5. Curve of frequency plotted against oscillator coil turns for typical transceiver kit. When the coil is adjusted as per the manual instructions, the frequency will be approximately at the nominal point.

lowing manner. All frequencies between 13.48 and 13.63 mc. (one half of the CB spectrum) listed in the BC-221 calibration book were plotted on a piece of graph paper with quarter-inch squares. Actually four sheets, with 100 kc. on each sheet, were used for greater accuracy. The points were connected and the result was a graph of frequency *versus* BC-221 dial reading. By making the graph large it is possible to interpret to 100 cycles. A typical graph is shown in Fig. 2 and covers the range between 27.0 and 27.1 mc. (For simplicity, some of the divisions have been omitted from the curve reproduced here.)

### Repairing Your Transmitter

What about the CB operator we left dangling with a defective transmitter? He certainly doesn't need to test the transmitter. He knows it is off-frequency, and in writing too!

Section 19.71(c) has this to say about the situation . . . "all transmitter adjustments or tests during or co-

(Continued on page 95)

# Transistorized Mike Mixer

By LYMAN E. GREENLEE

**Construction of simple circuit that will handle up to four low-impedance dynamic p.a. microphones.**

THE technician who rents sound equipment often has requests for multiple-mike setups. As a general rule, these requests are for coverage of round-table discussions where the mikes are used for speech by persons of widely varying vocal characteristics. Good dynamic mikes have a low output level to start with and when several are coupled together, it is a virtual necessity to have preamplifiers to adjust the volume of each mike to a satisfactory level.

This little 4-channel job is built into a 7" x 7" x 2" aluminum chassis base and powered by 3 penlite cells. *Raytheon* 2N133A low-noise a.f. transistors are used in a conventional preamp circuit. The circuit is shown in Fig. 1 and the layout of parts can be seen from the photographs.

The resistors are connected from the pins on the transistor sockets to eyelets in a 1/16" Bakelite sub-panel. Resistors  $R_1, R_2, R_3, R_6, R_7, R_8, R_{11}, R_{12}, R_{13}, R_{16}, R_{17}$ , and  $R_{18}$  are mounted underneath the sub-panel with the transistor socket base so that the coupling capacitors,  $C_1, C_2, C_5$ , and  $C_{15}$ , can be connected through the eyelets. The photograph showing the inside of the mixer should also make this method of assembly clear. All parts are mounted and wired to the sub-panel before it is installed

in the case. Wrap all of the electrolytics with cellophane tape for insulation. Note that all ground connections are to be made to a common point.

The four *Mallory* U24 20,000-ohm pots ( $R_4, R_6, R_{11}$ , and  $R_{16}$ ) are mounted on the sub-panel but the shells and shafts should be grounded to the case. Mount these controls on a separate piece of thin aluminum, 1 1/2" wide and 6" long, which will be grounded when the sub-panel is mounted. The whole assembly is mounted in the case on five 6-32 bolts, 1" long with suitable spacing washers which can be cut from scraps of tubing.

(Continued on page 119)

- $R_1, R_2, R_{12}, R_{17}$ —1500 ohm, 1/2 w. res.
- $R_3, R_6, R_{11}, R_{16}$ —330,000 ohm, 1/2 w. res.
- $R_4, R_8, R_{13}, R_{18}$ —39,000 ohm, 1/2 w. res.
- $R_5, R_7, R_9, R_{10}, R_{14}, R_{15}$ —20,000 ohm pot (*Mallory* U24)
- $R_{19}, R_{20}$ —270 ohm, 1/2 w. carbon res.
- $C_1, C_2, C_5, C_7, C_9, C_{11}, C_{13}, C_{15}$ —5  $\mu$ f., 6 v. elec. capacitor
- $C_3, C_4, C_{12}, C_{16}$ —50  $\mu$ f., 6 v. elec. capacitor
- $C_6, C_8, C_{10}, C_{14}$ —10 to 50  $\mu$ f., 5 v. elec. capacitor (optional, see text)
- $S_1, S_2, S_3, S_4$ —5-p.s.t. toggle switch
- $J_1, J_2, J_3, J_4, J_5$ —Mike connector
- $B_1$ —Three 1.5 volt penlite cells
- $V_1, V_2, V_3, V_4$ —2N133A a.f. transistor (*Raytheon*)
- 1—7" x 7" x 2" aluminum chassis
- 1—Base for 7" x 7" chassis
- 1—4" x 6" x 1/16" piece of linen Bakelite

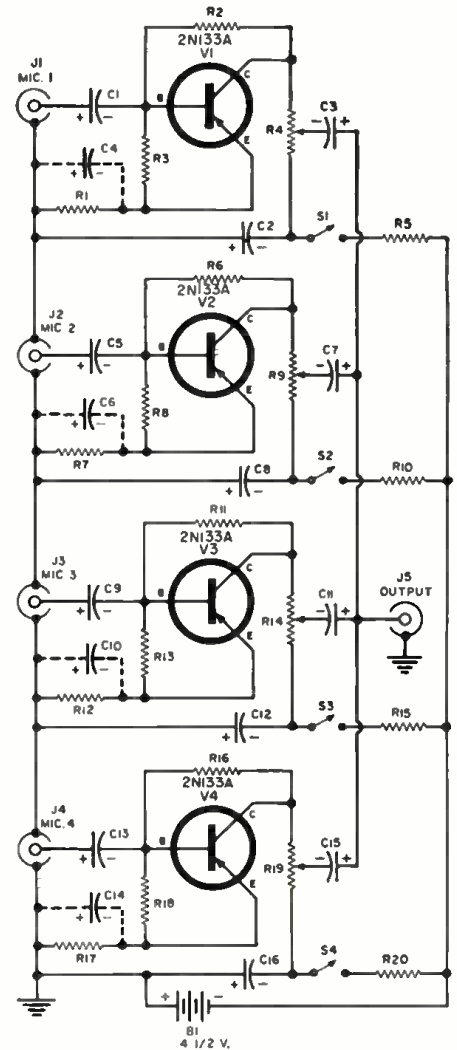
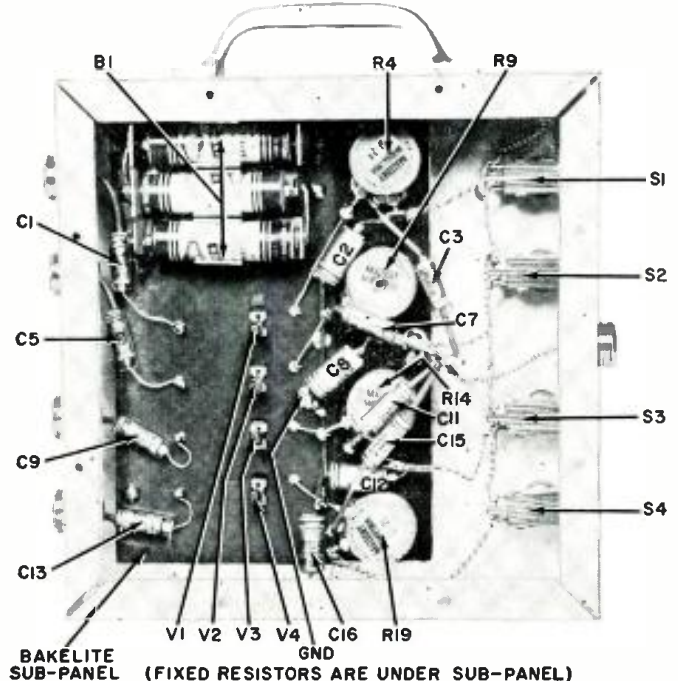
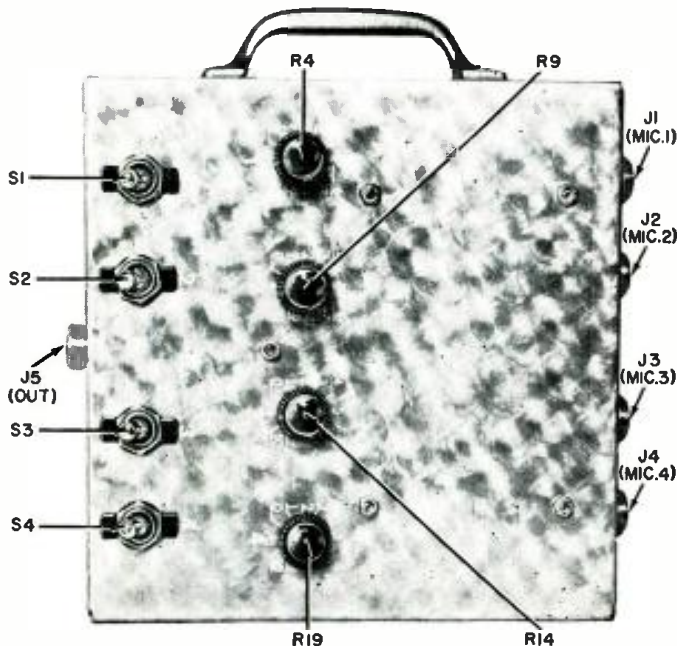


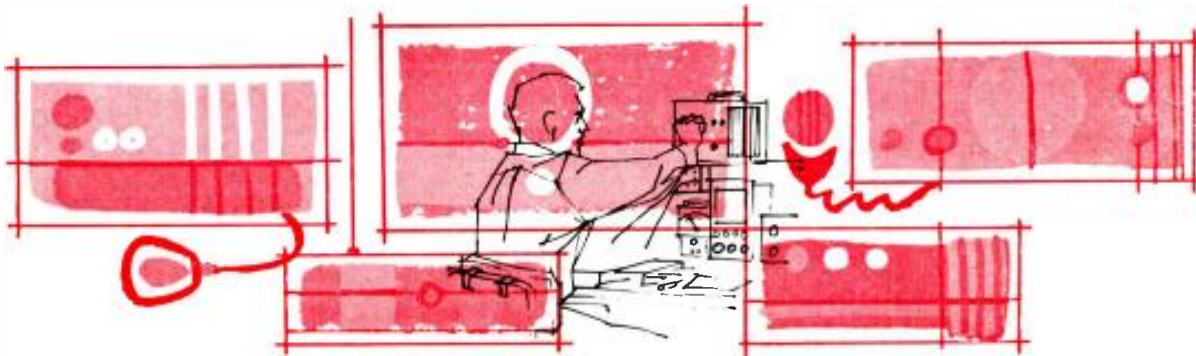
Fig. 1. The circuit employed by the author is seen to consist of four identical microphone preamps. If only speech is to be amplified, then the four dashed capacitors are omitted.

Front-panel view of mixer, showing level controls and switches.

Interior view shows the locations of the components employed.



# How to Service CB Equipment



By **LEO G. SANDS**  
Author, "Class D Citizens Radio"

**Service and maintenance in shop or on field calls:  
techniques, equipment used for Citizens Band gear.**

**S**ERVICE on CB equipment always runs into "extra" requirements. For example, both the customer and the FCC must be satisfied. While the latter might not take direct action against a technician whose work results in unlawful operation of a transmitter, FCC action against the owner would reflect on the ability of the technician who does the work.

We are dealing with receivers that must provide the "extra" sensitivity to work on signals from transmitters that put out only one to three watts, instead of many kilowatts. We are dealing with transmitters that cannot afford to put out much less than their full rated power (but no more), without overmodulation, that must be right on frequency, and must not interfere with other services.

Service will require such conventional procedures as replacing defective tubes and parts. In addition, there are certain chores that must become routine on any set brought to the shop. On the transmitter, these include the measurement of frequency, power input, power output, and modulation percentage. On the receiver, this means a check on sensitivity and also on frequency (with some receivers). In either portion of the equipment, retuning or re-alignment will follow a discovery of frequency error and, if transmitter output or receiver sensitivity is below rated value, it may be necessary to replace tubes that are weak although not otherwise defective.

Where the equipment is not brought into the shop—on field service calls—the technician should be prepared to measure efficiency of the antenna sys-

tem, tune the transmitter for optimum performance with its antenna connected, and make on-the-air performance tests of both transmitter and receiver, including a check on operating frequency.

## The Test Equipment

To carry out the procedures mentioned, the technician should have a minimum complement of test equipment. On field service calls, this will include an r.f. power meter, a tube tester, a v.o.m., and a dummy antenna. In the shop, he might have a battery eliminator (6-12-volt d.c. supply), a v.t.v.m., a v.o.m., at least one dummy antenna, appropriate signal generators (i.f. and r.f.), a frequency meter, an r.f. power meter, a general-purpose tube tester, and a grid emission tester.

As to the shop d.c. source, this could very well consist of a pair of 6-volt storage batteries floated across a charger. However, an adjustable supply will make it possible to simulate more closely the conditions of use encountered in the field. In a vehicle equipped with a 6-volt battery, for example, input to the equipment may vary from 5.5 to 7.5 volts; in a 12-volt system variation may be from 11 to 15 volts. On the bench, it is often important to test equipment at the extremes. For example, while performance should be satisfactory with the lowest input voltages, transmitter output should not be driven above legal limits with the highest input voltages.

Few test instruments will be more important than the frequency meter. It should be capable of measuring in the 27-mc. band to an accuracy of .0025%

or better. There are three available types that are suitable. In the heterodyne frequency meter, a tunable oscillator is zero beat with the transmitter signal and frequency is read directly from the instrument dial or a referenced calibration chart. Another type measures the difference between the unknown frequency and a known reference frequency, giving this difference in kilocycles on the scale of the meter. The reference frequency is that of an internal crystal. The third type is an electronic counter that counts the number of cycles per second.

The signal generator (or generators) should cover the range from 450 kc., or less, to 30 mc. to take care of all operating and i.f. possibilities. It should be possible to attenuate signal down to less than 1 microvolt.

A dummy antenna can be made up by attaching a No. 47 lamp to an antenna connector. Better than this is a load consisting of ten 510-ohm carbon resistors in parallel. Still better is the purchase of a professional dummy load like the *Sierra* 160-5N, which is fully shielded to prevent radiation and will handle up to 5 watts.

Transmitter input power can be measured with a v.o.m., but output measurement requires other instrumentation. A termination-type r.f. power meter, such as the *Sierra* 185A-100FN or *Bird* 611, measures transmitter power while also serving as a dummy load. Fig. 1 is a schematic of such a unit.

A directional or bi-directional r.f. power meter has some additional uses. Connected between a transmitter and its antenna (or dummy load), it not only measures output but tells you how

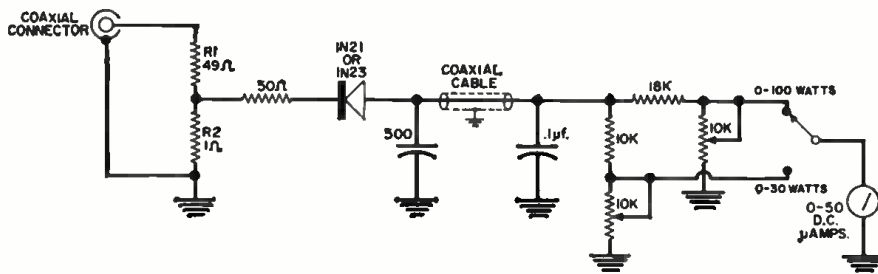


Fig. 1. This schematic of a Sierra termination-type r.f. wattmeter is typical.

much of this power is actually being absorbed by the antenna.

### Transmitter Check-Out

One of the principal tasks to be performed in the shop that is different from conventional service procedure is the check on the transmitter. This is begun by connecting the transmitter's antenna jack to a termination-type r.f. wattmeter, or bi-directional r.f. power meter terminated in a 50-ohm dummy load. Use a coaxial jumper cable (RG-8/U or RG-58/U) equipped with suitable connectors at each end. If neither of these instruments is on hand, a relative indication may be had with a field-strength meter placed nearby.

With power applied to the CB unit, turn the transmitter on and note the level of power output on the meter. It should be somewhere between 1.5 and 3 watts. Whistling into the microphone should produce an increase in this reading. At 100% modulation, power output should increase 50% when the modulating signal is a sine wave. Percentage of modulation is approximately equal to  $141 \sqrt{(P_m/P_{c.c.}) - 1}$  when  $P_m$  is the power output, in watts, during modulation and  $P_{c.c.}$  is the power, in watts, of the unmodulated carrier. Ordinarily, a typical CB transmitter is modulated about 80-85% during speech transmission.

If the transmitter passes the tests made so far, we know that it works, but we do not know if it meets FCC requirements.

Measure transmitter plate voltage with a d.c. voltmeter with the transmitter turned on. Measure the cathode or plate current of the r.f. power-amplifier stage. Multiply the plate voltage by the plate or cathode current (in amperes) and you should come up with a figure between 4 and 5 watts. If it is less than 4, the transmitter may need a new tube or retuning. If it is more than 5, it must be reduced since 5 watts is the maximum allowable input power.

Some sets are provided with a metering jack to enable measurement of r.f. power-amplifier cathode current (combined plate and screen current). If not, it will be necessary to determine plate current by other means. In the circuit shown in Fig. 2, the d.c. voltage drop across  $R_1$  can be measured and translated into current. If this voltage is 75 volts, the current through  $R_1$  is 30 milliamperes since  $I = E/R$  or  $75/2500 = .03$  ampere. But, this also includes screen current. If the measured voltage drop across  $R_2$  is 15 volts, then the screen current is 2.2 milliamperes. The

plate current alone is therefore 27.8 milliamperes. If the plate voltage is 175 volts, the power input is 4.86 watts. In multi-channel transmitters, make these checks on each channel.

Before measuring frequency, make sure that the frequency meter has been warmed up for a sufficiently long period as prescribed in the instrument's instruction book. Connect a short piece of wire to the antenna post of the frequency meter to provide adequate pick-up of the transmitter signal. If the frequency meter is of the continuously tunable type, adjust it to zero beat with the transmitter signal. Check the instruction book to make sure you are using the correct beat note. Note the dial reading at zero beat and read the frequency from the dial or the calibration chart.

When using a difference-type frequency meter, set the instrument's channel selector and tuning adjustment to the desired frequency. Turn the transmitter on and read the difference between the transmitter frequency and the reference frequency as indicated by the meter. If the meter reads "2 kc.," for example, the transmitter is off by more than the allowable .005%. At 26.965 mc., the frequency must not be more than 1.348 kc. higher or lower. At 27.255 mc. the tolerance is 1.36 kc.

Allowance must be made for error in the frequency meter. If the latter is accurate to .0025%, transmitter frequency should be within .0025% to in-

This frequency meter (A. B. DuMont Laboratories) can also be used as a signal generator. It can be equipped with crystals for all 23 CB channels.



sure the .005% tolerance. If the set is equipped for multi-channel operation, measure all the frequencies used for transmission.

As further insurance that the transmitter will meet FCC requirements under nearly all operating conditions; power output, modulation, power input, and frequency should be checked when operating the transmitter at the highest and lowest power-supply voltages. If a variable-voltage transformer is available, an a.c.-operated transmitter may be checked out with input voltage varied between 100-130 volts. Power input should remain under 5 watts, frequency should stay within limits, and overmodulation should not occur. Battery-operated sets should be checked out at approximately 87% and 120% of rated input voltage.

### Transmitter Troubles

When plate and filament voltages are normal, inadequate power output can be caused in either the oscillator or r.f. power-amplifier stage. If the oscillator stage is not functioning properly, grid drive to the r.f. amplifier will be below normal. In the circuit shown in Fig. 2, grid drive can be measured at point A with a volt-ohmmeter or v.t.v.m. Its normal value should be noted in the set's instruction book. If it is known or suspected to be below normal and tuning of  $L_1$  does not produce enough drive, the trouble could be due to a weak oscillator tube or an insufficiently active crystal.

The r.f. power-amplifier plate current (or cathode current) should drop sharply as the plate tank circuit is tuned to resonance at the operating frequency, particularly when an antenna or dummy load is not used. If it doesn't and grid drive is adequate, try a new tube. With the transmitter output terminated in a dummy load, the dip at resonance may not be as sharp, depending upon the setting of the antenna loading capacitor ( $C_2$ ).

If the transmitter output varies or is intermittent, the trouble could be due to oscillator instability. Try adjusting  $L_1$  for somewhat lower grid drive, leaving it set at the point where the oscillator takes off every time that the transmitter is keyed.

### Receiver Check-Outs

Although the FCC isn't particularly concerned, it is always important that a receiver be tuned to the right frequency for satisfactory reception, and this is particularly critical with fixed-tuned units. A frequency meter should be used for this check rather than a signal generator, which is less accurate. Even a tunable receiver should be checked to make certain that it can pick up the frequency extremes of 26.965 and 27.255 mc.

To check a fixed-tuned superregenerative receiver, set the frequency meter to the appropriate frequency and trim the receiver detector tuning slug for maximum quieting of background noise. To check a fixed-tuned, crystal-controlled receiver, set the frequency meter and then rock its tuning dial

while metering a.v.c. voltage to determine that maximum a.v.c. voltage is obtained at the correct frequency. For multi-channel sets, repeat for each channel.

It is imperative, because of the low power, that receiver sensitivity be up to rated value. To measure, connect the output of a signal generator through a 51-ohm resistor to the set's antenna socket. While metering audio-output voltage, and with the receiver's volume control set to maximum and its squelch control (if there is one) set for fully un-squelched condition, tune the signal generator to the receiver frequency. Turn on the signal generator modulation (30% AM) and rock its tuning dial until maximum audio output is indicated, keeping the signal generator output low enough to prevent overloading. While alternately turning the signal generator modulation on and off, adjust the signal generator output until a level is found where the audio output voltage drops 50% when modulation is turned off.

When modulation is off, the meter indicates noise level. When modulation is on, the meter indicates signal level. When signal voltage is twice as great as noise, we have a 6-db signal-to-noise ratio. At this point, note the setting of the signal generator output attenuator. If calibrated in microvolts, the sensitivity of the receiver can be said to be 50% of the indicated microvolts for 6 db signal-to-noise ratio. (Because of the 51-ohm series resistor, the signal at the receiver antenna input is approximately 50% of the actual output of the signal generator.)

There is nothing difficult about aligning the receiver of a CB unit. If it is a tunable superregenerative type, there are usually no alignment adjustments to make, except possible trimming of the broadly tuned r.f. stage. Both the r.f. amplifier and detector fixed-tuned superregenerative receivers, of course, should be aligned for maximum audio output (modulated signal) or noise quieting (unmodulated signal) against a very weak signal from a signal generator or frequency meter.

Procedures for alignment of a single-conversion superheterodyne receiver are the same as for any AM broadcast receiver. When the receiver employs dual conversion, however, there are two intermediate frequencies.

Remove the receiver crystals at the start of the alignment procedure to disable the local oscillators. Connect the output of the signal generator through a .001- $\mu$ f. capacitor to the grid of the second mixer, and tune the signal generator to the i.f. (usually 455 kc.). Either a.v.c. voltage (d.c.) or audio-output (a.c.) may be monitored. Turn down the signal-generator output so that only a little a.v.c. or audio voltage exists. Adjust the i.f. transformers, working back from the secondary of the last transformer toward the second mixer, to obtain a maximum reading. (When monitoring audio-output voltage, it is a good idea to ground the a.v.c. bus during the

alignment for clearest indication.)

After the i.f. and detector stages have been aligned, re-install the second-oscillator crystal. Connect the signal generator (through a .001- $\mu$ f. capacitor) to the grid of the first mixer and tune it to the second i.f. Now adjust the i.f. transformer between the first and second mixer for maximum output indication.

Re-install the first-oscillator crystal (or crystals). Feed the signal-generator output to the antenna terminal through a 51-ohm series resistor. Tune the signal generator carefully to the operating frequency and reduce its output so that only a very small signal is present. After determining that the signal generator is set correctly (check with a frequency meter if not sure), tune the first mixer and r.f. amplifier trimmers for maximum output indication. In the case of multi-channel, fixed-tuned sets, these trimmers are usually average-tuned so that the sensitivity on all channels to be used is about the same. Tunable receivers may be aligned at some channel near the high end of the band. If sensitivity at the high and low ends of the band differs greatly, try re-aligning the receiver front end at some frequency near the middle of the band. Procedures for aligning single-conversion superheterodynes are similar except that there are fewer steps.

*Squelch sensitivity* determines the effective sensitivity of a receiver for most applications. Since most users of squelch-equipped CB sets operate their receivers with the squelch control set to eliminate background noise between incoming signals, the full sensitivity of the receiver will not be utilized. The squelch threshold is variable, as determined by the adjustment of the control. To check squelch sensitivity, apply a modulated signal to the receiver, increasing the level of the signal until the squelch opens (the modulating tone is heard through the loudspeaker) and note how many microvolts (50% of indicated value) of signal are required to trip the squelch. In the reverse direction, reduce the signal level until the squelch closes. Usually, the squelch requires a bigger signal to open it than to close it.

### Other Receiver Checks

With the signal generator connected

as for sensitivity checks, the *selectivity* of a receiver can be measured. Tune the signal generator 10 kc. above the operating frequency and advance the output-level attenuator until the audio-output voltage is the same as for an on-frequency signal. If, for example, the reference output level is obtained with a one-microvolt signal at the operating frequency, but a 10-microvolt signal is now required to produce the same output indication, it can be said that the receiver attenuates signals 10 kc. above the operating frequency by 20 db. Now set the signal generator 10 kc. below the operating frequency. The amount of signal to produce the identical output at +10 kc. and -10 kc. off the operating frequency should be the same. If not, the receiver should be re-aligned to obtain a symmetrical selectivity pattern.

Receiver performance should be checked at the highest and lowest anticipated supply voltages to insure customer satisfaction.

### Service Calls

While it is more convenient to service equipment in a shop, it is often necessary to tune up the equipment so it will work at maximum efficiency when connected to the customer's antenna.

To obtain maximum range, the transmitter should be tuned with the customer's antenna connected. Here is where a bi-directional r.f. power meter comes in handy. Connect the instrument between the set and the set end of the antenna transmission line. Set the meter to read *incidental* power and tune the transmitter for maximum power indication. Then set the meter to read *reflected* power, which is the energy that is produced by the transmitter but which is reflected back from the antenna. Subtract the reflected-power reading from the incidental-power reading and you will know how many watts are being absorbed by the antenna.

Of the complaints from customers (which include noisy reception, insufficient range, interference from other stations, and distortion), the most common is usually noisy reception. Sometimes there is very little, if anything, that can be done about it. The trouble may be caused by excessive signal absorption (by foliage, for example) or

(Continued on page 121)

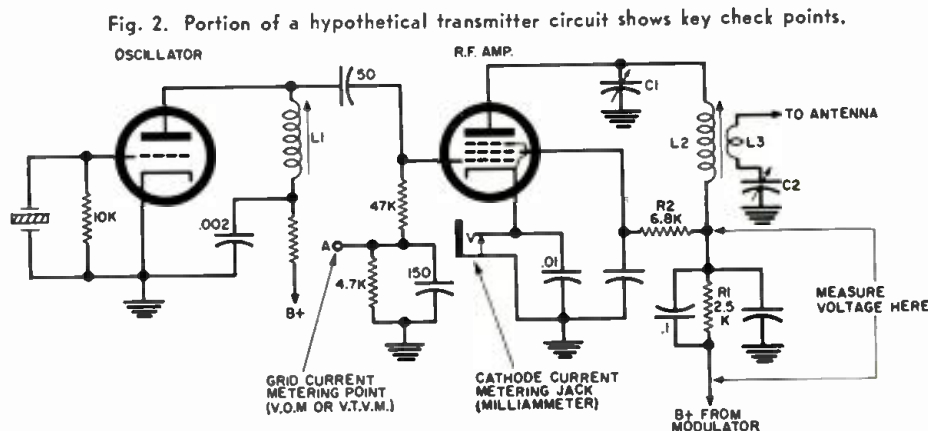


Fig. 2. Portion of a hypothetical transmitter circuit shows key check points.

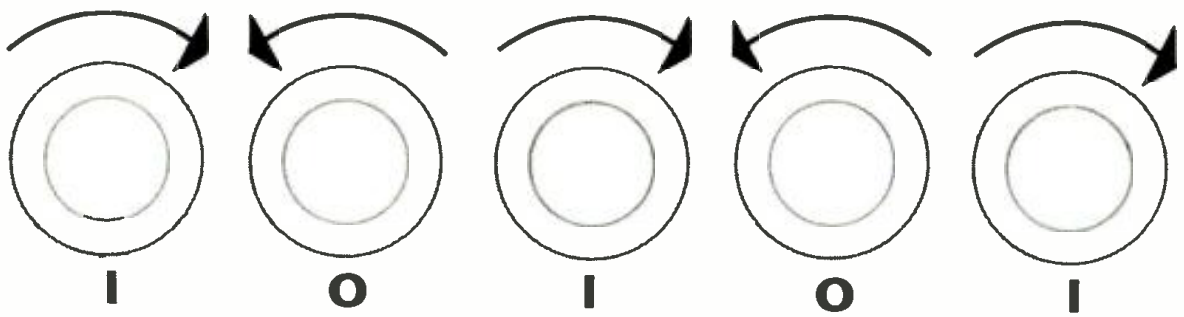


Fig. 11. Direction of core magnetization determines whether binary 1 or 0 is stored.

**O**F THE VARIOUS means for magnetically recording and storing data in the "memory" sections of electronic computers, two were described in the first portion of this article. These two, magnetic tape and magnetic drums, were found to complement each other. While the former provides the greater storage capacity, the latter permits quicker access to any desired portion of the information being held for use.

Because of these characteristics, many computers use these two in combination, with the drum serving as the main memory and the tape providing back-up storage. Blocks of information are transferred from the tape to the drum at some time prior to the need for that data in the computer. After the computer has made use of this data, other blocks of information can be transferred to the drum. However, there are some applications where it is desirable to have even shorter access time than that provided by drums. In these, magnetic cores are used for the main memory. In fact, the drum may then become the back-up storage device.

The magnetic core is a ring-shaped piece of magnetic material. Since the core can be magnetized in either of two directions (clockwise or counterclockwise), it can be used to store a bit of binary information. Magnetization of the core in one direction can be used as a representation of binary 1, and magnetization in the opposite direction can represent binary 0. The binary number 10101, for example, can be stored in five magnetic cores as shown in Fig. 11. Here the arrows indicate direction of magnetization.

Physically, the magnetic cores are small—0.08 inch outside diameter is representative—and are placed on an array of perpendicular sets of wires, as shown in Fig. 12. For simplicity, a 3-by-3 array of cores is shown here, but 32-by-32 and 64-by-64 arrays are commonly used in practice.

Information is written into a core by passing currents through the wires on which the core is mounted. Assume, for example, that all of the cores in Fig. 12 are initially magnetized in the 0 direction, and that it is desired to store a 1 in the core located at the intersection of wires  $X_1$  and  $Y_2$ . This would be accomplished by passing currents through wires  $X_1$  and  $Y_2$  simultaneously. The values chosen for these two currents are such that either one individually is not sufficient to reverse the magnetization of the core, but the combined effect of both at the intersection  $X_1Y_2$

# Computer Memory Devices

By ED BUKSTEIN

Northwestern TV & Electronics Inst.

**Not limited by mechanical delays, magnetic cores provide speedier access time than tape or drums.**

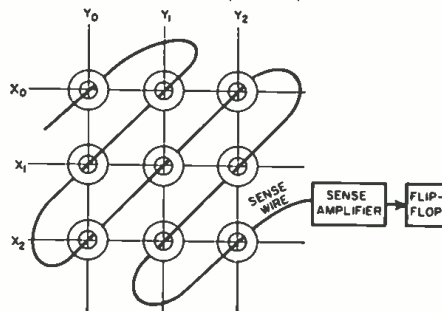
## PART 2

is sufficient to reverse the core at this location.

The individual currents are frequently referred to as *half-currents* because each has a value equal to half of the total current required to reverse the magnetization of the core. This technique, known as *coincident-current switching*, makes it possible to write a 1 in any selected core by passing half-currents through the appropriate  $X$  and  $Y$  wires.

The process of reading a core is somewhat similar to the writing process, except that the currents are passed through the  $X$  and  $Y$  wires in a direction opposite that used for writing. Assume, for example, that the core at  $X_1Y_2$  is to be read. This would be accomplished by passing half-value "read" currents through wires  $X_1$  and  $Y_2$  simultaneously. These read currents are always in such direction as to switch the selected core to the 0 direction of magnetization. The read currents will therefore switch core  $X_1Y_2$  to the 0 direction, and the reversing magnetic field will induce voltage in the sense

Fig. 12. Perpendicular wires magnetize cores, sense wire picks up the data.



wire. This output, which is a few millivolts in amplitude, is amplified (by the sense amplifier in Fig. 12) and then used to trigger a flip-flop stage. As a result, the flip-flop stage is now switched to the 1 condition, and the 1 which was previously stored in core  $X_1Y_2$  has now been transferred to the flip-flop.

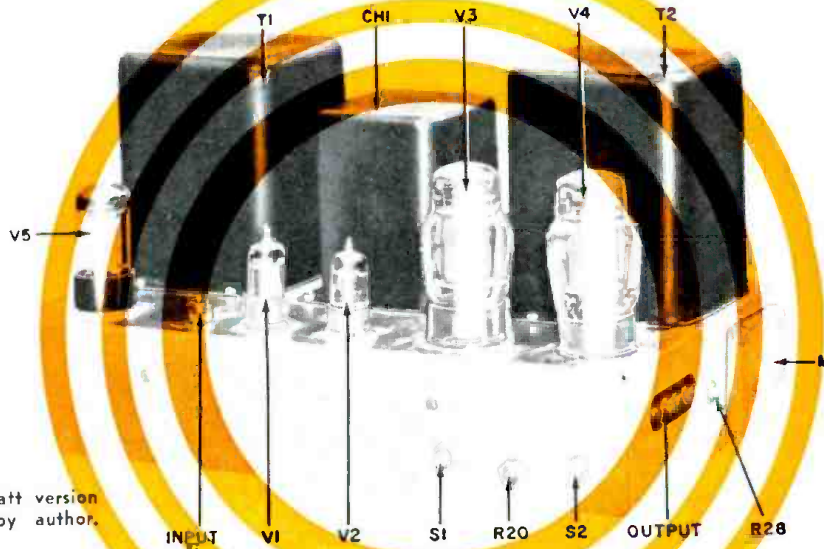
If core  $X_1Y_2$  had been in the 0 rather than the 1 condition, the read currents would not have reversed this core's magnetization. Under these conditions, there would have been no output from the sense wire and the flip-flop would have remained in the 0 condition. The read currents therefore cause the flip-flop, in either case, to assume the condition (0 or 1) of the core being read.

Since reading a core which has a 1 stored in it causes this core to switch to the 0 condition, the read-out process destroys the information in the core (although the information is still available in the flip-flop). For this reason, the reading operation is followed by a writing operation to switch the core back to the 1 condition, so that it may retain stored data.

In addition to the wires shown in Fig. 12, one other wire, not shown, is threaded through all of the cores in the array. This is known as an *inhibit* wire and is used during the process of writing. As explained previously, a 1 can be written into a selected core by passing currents through the associated  $X$  and  $Y$  wires. If however, a 0 is to be written into the core, something must be done to prevent the write currents from switching this core to 1. This is accomplished by passing a half-current through the inhibit wire at the same time the two half-currents are passed through the  $X$  and  $Y$  wires. The inhibit current is in such direction that it opposes the write currents and therefore prevents the selected core from being switched to 1. At first consideration, it may seem more reasonable to write a 0 into a core simply by preventing the write currents from passing through the  $X$  and  $Y$  wires. It happens that the associated circuitry, however, is much simpler if the write currents are used but nullified by an inhibit current.

Since the cores in an array are selected for reading or writing on a one-at-a-time basis, this type of storage would be relatively slow if all of the bits of a given number were stored in the same array. Under these conditions, a number would have to be written (or read) one bit at a time. For this reason, each bit of a number is stored in a separate array of cores. Each of these ar-

(Continued on page 86)



Over-all view of the 40-watt version of hi-fi amplifier built by author.

## 40- or 60-Watt Hi-Fi Amplifier with Tertiary Feedback

By THOMAS F. BURROUGHS / Complete construction details on a stable, high-power audio amplifier with output-stage cathode feedback.

FOR years the most popular power amplifier circuit design was based on the famous "Williamson." Some of the factors leading to its popularity are its low distortion, simplicity, straightforward design, and the rising interest in high-fidelity reproduction. Even today a "Williamson" amplifier that is carefully constructed and tested with the speaker with which it is to be used will give top quality results.

Of late the trend in amplifier design has been toward higher power and, as the trend has developed, use of the "Ultra-Linear" output stage has grown with it. In this circuit the primary winding of the output transformer is tapped at approximately 40 per-cent of the primary turns. These taps are con-

needed to the screens of the output, thus providing the inherent advantages which have been adequately covered in the literature.

Some interest has been shown in tertiary feedback, which has been called "super Ultra-Linear." Up to this time, there have been very few circuits published using this type of feedback, but it is believed that its popularity will grow as more transformers become available. Some of the advantages of tertiary feedback are the lack of problems involving instability—which may occur when feedback is taken around three or four stages. In fact, an amplifier with tertiary feedback seems to be more tolerant of an over-all feedback loop. It is very effective

in reducing distortion and helps to lower the internal impedance of the amplifier.

While the distortion of present-day amplifiers is very low when measuring a sine wave, it is only of late that attention has centered on the stability of the amplifier. In a feedback amplifier instability will occur when the feedback becomes regenerative. This regeneration takes place when the phase shift reaches 180 degrees at some point where the gain of the amplifier has not dropped by an amount equal to the feedback. Sometimes instability will appear when a transient signal is fed to the amplifier. This transient instability is one of the reasons why an amplifier often shows up on test in-

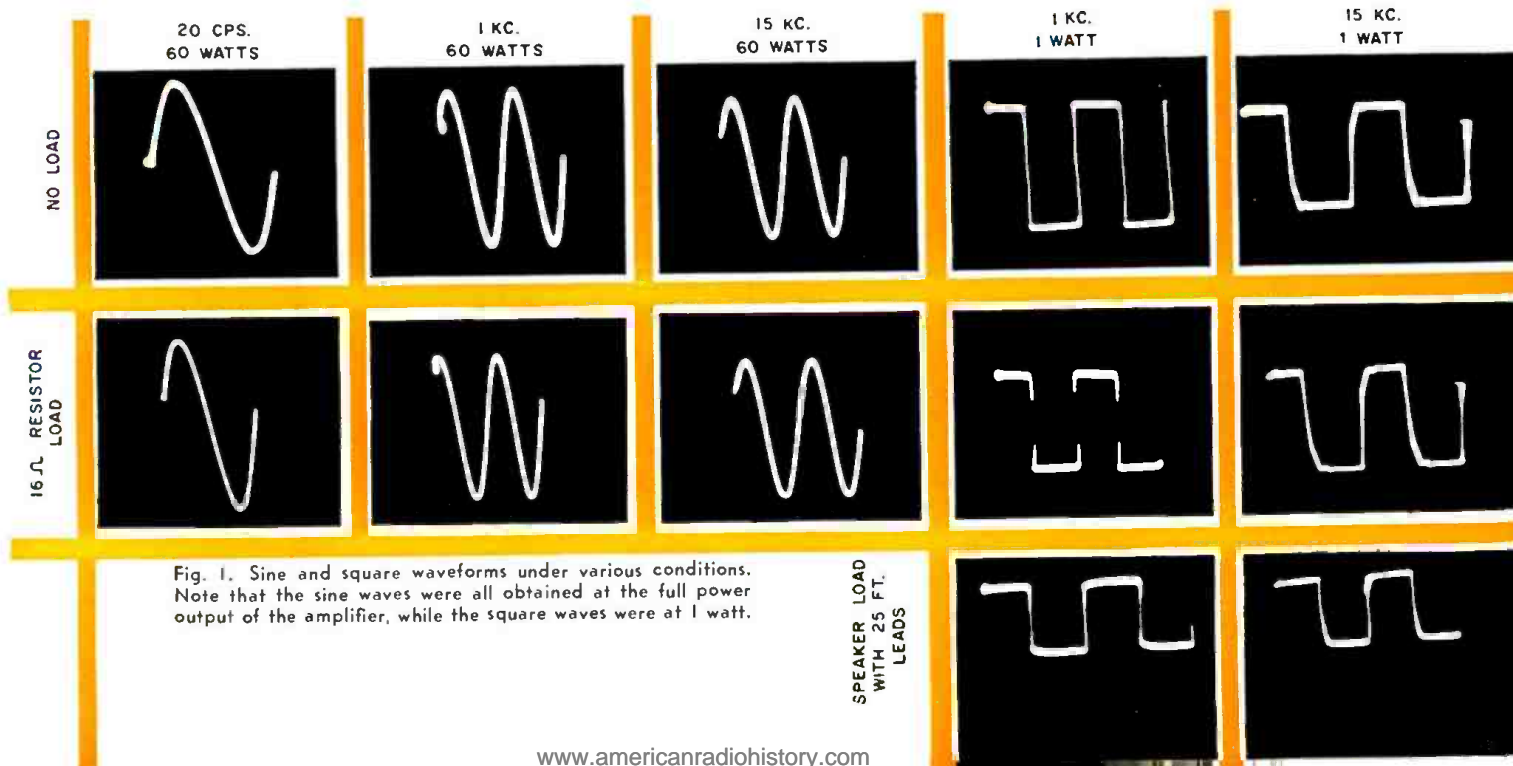


Fig. 1. Sine and square waveforms under various conditions. Note that the sine waves were all obtained at the full power output of the amplifier, while the square waves were at 1 watt.

struments a lot better than it actually sounds.

### Circuit Used

The circuit of Fig. 2 is a very stable 40-watt amplifier (or a 60-watt amplifier with the higher voltage power supply in Fig. 4), using a new transformer made by Chicago Standard Transformer Corp.—the BO-15. This transformer was designed for 6550's, EL34's, or KT88's using screen taps plus 11 db of tertiary feedback in the output stage. There is also 12 db of feedback taken around the whole amplifier. Many configurations were tried and discarded for one reason or another before the present design was arrived at.

The first problem which arose was the high signal needed to drive the 6550's when using tertiary feedback. The required signal is 135 volts r.m.s. grid-to-grid. The need for this high signal arises because the voltage must be increased by the feedback factor in the output stage. This ruled out the use of a 6SN7 as a driver. The tube found best suited for this purpose was the 5687, a dual-triode used extensively in electronic computers. It is capable of exceptional output into the low impedance necessary when using fixed bias. When used in the Mullard circuit as a phase-splitter/driver, as it is here, it will deliver 180 volts r.m.s. grid-to-grid into a 50,000-ohm load. The outputs

from the plates are almost perfectly balanced and the impedance looking back into the tube is the same. This stage is quite degenerative and very little distortion is introduced by it.

The EF86 is a low-noise pentode used as a voltage amplifier. This is direct-coupled to the phase-splitter/driver, thus eliminating some phase shift that would be introduced by a coupling capacitor.

Stability of the amplifier is very good under practically any type of load, as can be seen by the oscillograms of Fig. 1. Over 20 db more of over-all feedback could be added before instability in the form of ringing or motorboating sets in. If the amplifier is to be used

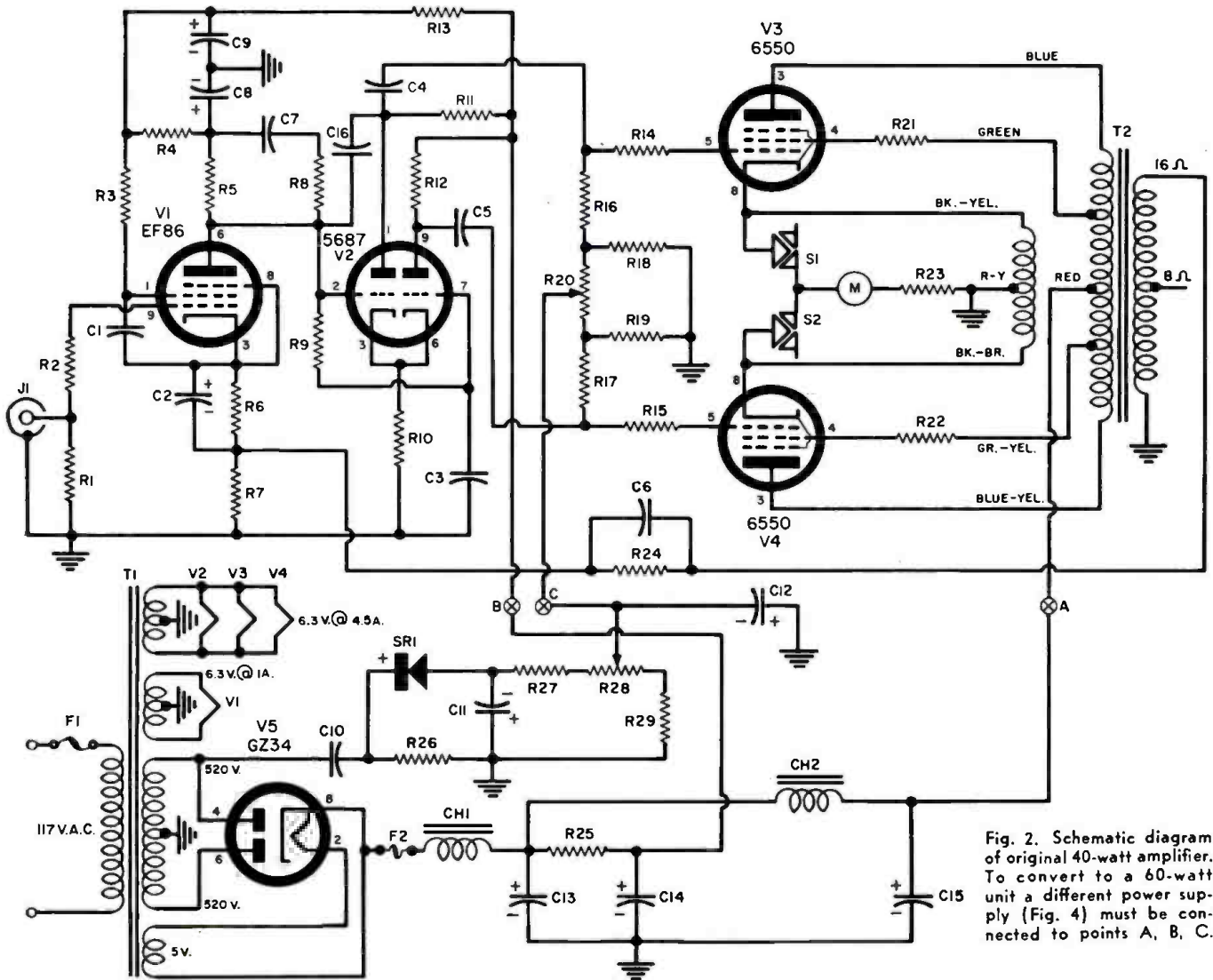


Fig. 2. Schematic diagram of original 40-watt amplifier. To convert to a 60-watt unit a different power supply (Fig. 4) must be connected to points A, B, C.

- R<sub>1</sub>, R<sub>2</sub>—1 megohm, 1/2 w. res.
- R<sub>3</sub>—3300 ohm, 1 w. res.
- R<sub>4</sub>—330,000 ohm, 1 w. res.
- R<sub>5</sub>, R<sub>6</sub>, R<sub>7</sub>, R<sub>8</sub>—47,000 ohm, 1 w. res.
- R<sub>9</sub>—1800 ohm, 1 w. res.
- R<sub>10</sub>—510 ohm, 1 w. res.
- R<sub>11</sub>—4700 ohm, 1 w. res.
- R<sub>12</sub>—8000 ohm, 4 w. carbon res. (see text)
- R<sub>13</sub>—25,000 ohm, 4 w. carbon res. (see text)
- R<sub>14</sub>—30,000 ohm, 4 w. carbon res. (see text)
- R<sub>15</sub>—180,000 ohm, 1 w. res.
- R<sub>16</sub>, R<sub>17</sub>, R<sub>18</sub>, R<sub>19</sub>—1000 ohm, 1/2 w. res.
- R<sub>20</sub>, R<sub>21</sub>—100,000 ohm, 1 w. res.
- R<sub>22</sub>, R<sub>23</sub>—10,000 ohm pot
- R<sub>24</sub>—680 ohm, 1/2 w. res. (see text)
- R<sub>25</sub>—2200 ohm, 1 w. res.
- R<sub>26</sub>—600 ohm, 2 w. res.

- R<sub>27</sub>—25,000 ohm, 10 w. wirewound res.
- R<sub>28</sub>—560 ohm, 1 w. res.
- R<sub>29</sub>—27,000 ohm, 1 w. res.
- C<sub>1</sub>—0.05 μf., 400 v. capacitor
- C<sub>2</sub>—50 μf., 25 v. elec. capacitor
- C<sub>3</sub>—25 μf., 400 v. capacitor
- C<sub>4</sub>, C<sub>5</sub>—5 μf., 600 v. capacitor
- C<sub>6</sub>, C<sub>7</sub>—50 μf., ceramic capacitor
- C<sub>8</sub>, C<sub>9</sub>—40 μf., 350 v. elec. capacitor
- C<sub>10</sub>—0.04 μf., 1000 v. capacitor
- C<sub>11</sub>, C<sub>12</sub>—50 μf., 150 v. elec. capacitor
- C<sub>13</sub>, C<sub>14</sub>, C<sub>15</sub>—40 μf., 500 v. elec. capacitor
- C<sub>16</sub>—25 μf., ceramic capacitor
- T<sub>1</sub>—Power trans. 520-0-520 v. @ 200 ma.; 6.3 v. @ 4.5 amps.; 6.3 v. @ 1 amp.; 5 v. @ 3 amps. (Chicago Standard PCR-200 or equiv.)

- T<sub>2</sub>—Output trans. 4300 ohms c.t., with screen taps and cathode feedback winding; 8, 16 ohms sec.; 65 watts (Chicago Standard BO-15 or equiv.)
- CH<sub>1</sub>—8 hy., 200 ma. filter choke (Chicago Standard RC8200 or equiv.)
- CH<sub>2</sub>—2 hy., 200 ma., 60 ohms d.c. or less filter choke (Stancor C-2325 or equiv.)
- SR<sub>1</sub>—20 ma., 130 v. selenium rectifier
- F<sub>1</sub>—2 amp. fuse
- F<sub>2</sub>—225 ma. fuse
- S<sub>1</sub>, S<sub>2</sub>—S.p.s.t. push-button switch, normally open
- M—1 ma. d.c. meter
- J<sub>1</sub>—Phono jack
- V<sub>1</sub>—EF86 tube
- V<sub>2</sub>—5687 tube
- V<sub>3</sub>, V<sub>4</sub>—6550 tube
- V<sub>5</sub>—GZ34 tube



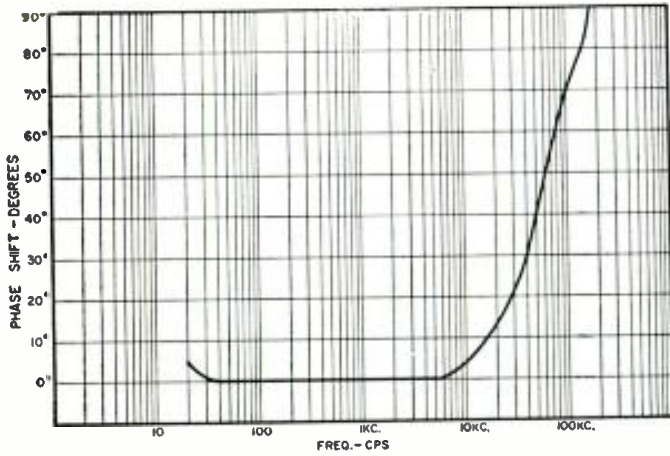
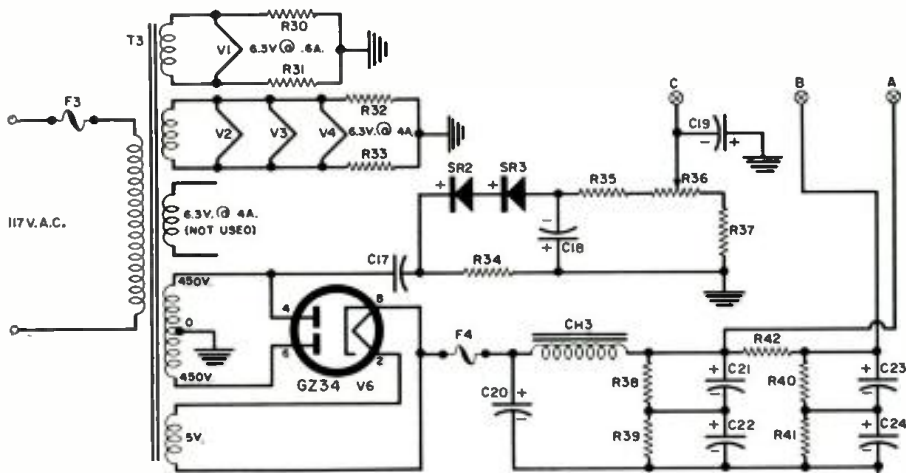
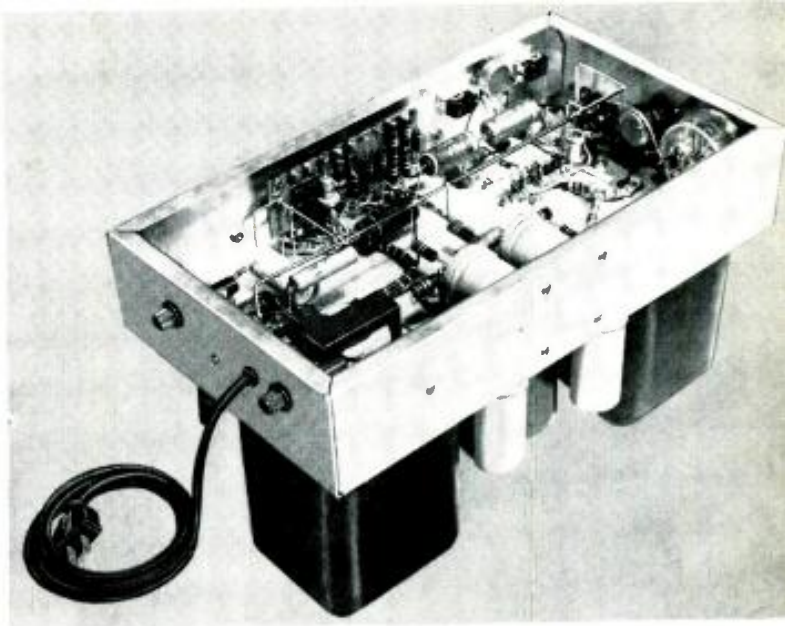


Fig. 3. Phase characteristics of the high-fidelity amplifier as measured between frequencies of 20 cps and 200 kc. by author.

Under-chassis view of the home-built unit showing the use of a ground bus, laced wiring, and the terminal board construction. ▶

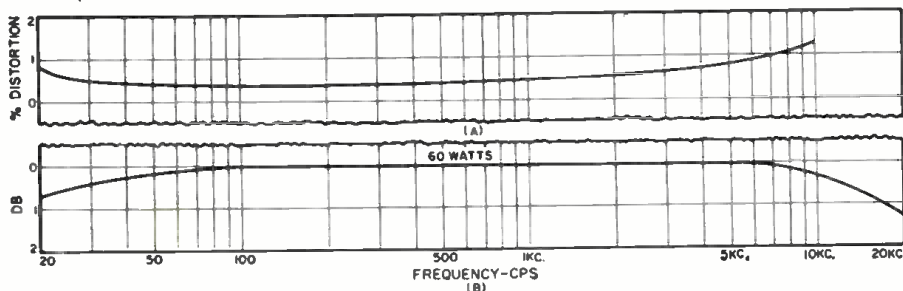


- $R_{30}, R_{31}, R_{32}, R_{33}$ —47 ohm, 1 w. res.
- $R_{34}$ —25,000 ohm, 10 w. wirewound res.
- $R_{35}$ —560 ohm, 1 w. res.
- $R_{36}$ —10,000 ohm pot.
- $R_{37}$ —27,000 ohm, 1 w. res.
- $R_{38}, R_{39}, R_{40}, R_{41}$ —68,000 ohm, 2 w. res.
- $R_{42}$ —600 ohm, 2 w. res.
- $C_{17}$ —.075  $\mu$ f., 600 v. capacitor
- $C_{18}$ —40  $\mu$ f., 250 v. elec. capacitor
- $C_{19}$ —50  $\mu$ f., 150 v. elec. capacitor
- $C_{20}$ —20  $\mu$ f., 600 v. elec. capacitor
- $C_{21}, C_{22}, C_{23}, C_{24}$ —80  $\mu$ f., 350 v. elec. cap.

- $CH_3$ —2 hy., 200 ma. filter choke (Stancor C-2325 or equiv.)
- $SR_2, SR_3$ —20 ma., 130 v. selenium rectifier
- $F_3$ —2 amp. fuse
- $F_4$ —225 ma. fuse
- $T_3$ —Power trans., 450-0-450 v., @ 200 ma.; 6.3 v., @ 4 amps.; 6.3 v., @ .6 amp.; 5 v., @ 2 amps. (Chicago Standard PSC 205 or equiv.)
- $V_6$ —GZ34 tube

Fig. 4. Circuit of the capacitor-input power supply used to obtain the higher voltage necessary for the 60-watt version of the amplifier. Filter capacitors are series-connected and bleeder resistors are used to equalize voltage drops. Because of this arrangement, the negative terminals (usually the cans) of  $C_{21}$  and  $C_{23}$  must be insulated from the chassis and these capacitors must be separate units. Also for safety they should be mounted beneath the chassis. The 47-ohm resistors across the 6.3-volt heater windings are required since the windings are not center-tapped.

Fig. 5. (A) Total harmonic distortion of the 60-watt amplifier at an output within  $\pm 1$  db of full output. (B) Power-response curve of the 60-watt. Full-power response of the 40-watt version is just a little flatter at the frequency extremes.



with a highly capacitive load, such as an electrostatic speaker and a woofer calling for a low damping factor, it might be advantageous to omit  $R_{21}$  and  $C_{11}$ . This leaves out the over-all feedback loop, but there will still be 11 db of feedback in the output stage where it is most needed. This will give a lower damping factor and an amplifier that is very sensitive.

### Construction

Construction of the amplifier is fairly standard, being built on a single  $8\frac{1}{2} \times 15 \times 3$ " chassis. Most of the parts are mounted on a terminal strip to facilitate testing and easy access. All signal-carrying leads, including the feedback loop, were kept as short as possible. A ground bus was used and connected to the chassis at one point.

In the top chassis view of the amplifier you will notice a meter mounted on the side panel, with push-buttons by each output tube for balancing the current in the output stage. The meter is connected so as to read the voltage drop across the tertiary winding. A 1-ma. meter is used and  $R_{23}$  selected so that with 100 ma. flowing through the tertiary winding the meter will read full-scale. In this way the tertiary winding acts as the meter shunt. The value of  $R_{23}$  will vary, depending on the d.c. resistance of the tertiary winding and the meter used. This was an extra "frill" on the original amplifier but can be very handy if you have an old meter in the junk box that can be utilized.

The parts list calls for some 4-watt carbon resistors. The 8000-ohm unit was made up of two 16,000-ohm, 2-watt resistors in parallel. The 25,000-ohm unit is 12,000- and 13,000-ohm, 2-watt resistors in series while the 30,000 ohms is made up of two 15,000-ohm, 2-watt resistors, also in series.

All of the parts are conservatively rated and should give long, trouble-free performance. The "B+" supply bus was fused to prevent damage to the

(Continued on page 91)



nearly 1.3 ma. This is quite close to our rule-of-thumb 1 ma. of current given earlier.

To see how a substitution is made, let's assume a customer brings in an unidentifiable Japanese radio, on which no service information is available, for repair. Signal substitution or tracing shows the fault is in the second i.f. amplifier. A voltmeter check shows the stage has collector and base voltage, but no emitter voltage. Conclusion? The i.f. transistor is probably open.

To make the example specific, let us say that the defective transistor in the hypothetical receiver is identified as a type 2S31 (TEN). Table 1 gives the 2N410 as the nearest domestic equivalent. (This has wire leads, as has the original, but is otherwise the same as the plug-in 2N409.)

Install the substitute, reduce the supply voltage to one half its normal value, and check emitter voltage. Then calculate emitter current by Ohm's law. It should be no more than half the estimated, 1-ma. rule-of-thumb current, or 500 microamperes. If this current is less than expected, it means the collector is drawing less current than it did with the original transistor. It is thus safe to restore full supply voltage and again calculate emitter current.

If emitter current is considerably higher than 500 microamperes, it would indicate that the wrong type of transistor (i.e., p-n-p for n-p-n) was installed or that bias is excessive. Assuming that the replacement has been carefully established to be of the same type as the original, we proceed to change the bias. This is done by adjusting the base circuit.

The base's forward bias resistor (15,000 ohms, shown by an asterisk in Fig. 1) is removed. In this condition, emitter voltage and current drop to very small values, since the transistor draws little current without bias. A potentiometer of considerably higher value than the original bias resistor is used to replace the latter, and it is adjusted so that its full resistance is in the circuit. Adequate resistance must be used to limit base current for, if the latter is permitted to become excessive, the transistor can be destroyed.

The potentiometer is now carefully adjusted with the voltmeter connected to point X until emitter voltage is reduced to the value at which emitter current (determined by Ohm's Law)

JAPANESE NO.	SIMILAR U.S. TYPE	JAPANESE NO.	SIMILAR U.S. TYPE
<b>HITACHI</b>		<b>TOSHIBA</b>	
HJ15	2N215	2S44	2N217
HJ17D	2N217	2S45	2N218
HJ22D	2N218	2S52	2N219
HJ23D	2N219	2S56	2N270
HJ32, HJ70, 2S141	2N370	<b>TEN</b>	
HJ34, HJ34A, 2S91	2N270	2S30	2N411, 2N412
HJ35	2N301	2S31	2N409, 2N410
HJ37, HJ71, 2S141	2N371	2S32	2N405, 2N406
HJ50	2N215	2S33	2N407, 2N408
HJ51	2N408	2S34	2N270
HJ55, HJ60, 2S146	2N219	2S35	2N140, 2N219
HJ56	2N410	2S36	2N139, 2N218
HJ57	2N412	2S37	2N109, 2N217
HJ72, 2S142	2N372	2S38	2N270
HJ73, 2S143	2N373	2S39	2N175, 2N220
HJ74, 2S144	2N374	2S40	2N269
HJ75, 2S145	2N544	2S41	2N301
<b>NEC</b>		2S42	2N301A
ST28C	2N309	2S43	2N247
ST37D	2N252	2S109	2N370
ST162	2N145, 2N146	2S110	2N371, 2N372
ST163	2N147, 2N293	2S112	2N372
ST173	2N168A	<b>SONY</b>	
		2T64	2N366, 2N228
		2T65	2N366, 2N228
		2T66	2N365
		2T76	2N147

Table 1. Nearest U.S. equivalents of Japanese transistors used in popular radios.

MAXIMUM RATINGS (at 25° C)	CHARACTERISTICS
<b>TOSHIBA 2S44</b>	
$V_c$ — 25 volts	$I_{c0}$ $I_{Vc} = -12$ v. — 10 $\mu$ a.
$I_c$ — 50 ma.	$F_{\alpha}$ not given
$P_r$ 30 mw.	Alpha > 0.9
$T_c$ 50° C	
<b>COMMON EMITTER OPERATION</b>	
$V_c = -6$ volts, $I_c = 1$ ma., $R_{in} = 1K$ , $R_{\alpha} = 30K$ , $P_E = 37$ db	
<b>TOSHIBA 2S45</b>	
$V_c$ — 16 volts	$I_{c0}$ $I_{Vc} = -12$ v. — 3 $\mu$ a.
$I_c$ — 5 ma.	$F_{\alpha}$ 3 mc.
$P_r$ 20 mw.	Alpha 0.95
$T_c$ 50° C	$C_c$ 13 $\mu$ u.
<b>COMMON EMITTER OPERATION</b>	
$V_c = -6$ volts, $I_c = 1$ ma., $R_{in} = 500$ ohms, $R_{\alpha} = 30K$ , $P_E = 30$ db	
<b>TOSHIBA 2S52</b>	
$V_c$ — 16 volts	$I_{c0}$ $I_{Vc} = -12$ v. — 10 $\mu$ a. max.
$I_c$ — 5 ma.	$F_{\alpha}$ 7 mc.
$P_r$ 20 mw.	Alpha 0.985
$T_c$ 50° C	$C_c$ 12 $\mu$ u.
<b>COMMON EMITTER OPERATION</b>	
$V_c = -6$ volts, $I_c = 1$ ma., $R_{in} = 900$ ohms, $R_{\alpha} = 50K$ , $P_E = 30$ db	
<b>TOSHIBA 2S56</b>	
$V_c$ — 25 volts	$I_{c0}$ $I_{Vc} = -12$ v. — 10 $\mu$ a.
$I_c$ — 50 ma.	$F_{\alpha}$ 1 mc.
$P_r$ 75 mw.	Alpha 0.98
$T_c$ 50° C	$C_c$ 2.5 $\mu$ u.
<b>COMMON EMITTER OPERATION</b>	
$V_c = -6$ volts, $I_c = 1$ ma., $R_{in} = 2.5K$ , $R_{\alpha} = 200$ ohms, $P_E = 31$ db (at 250 mw. output)	

Table 2. Some Toshiba transistors are available in this country. Here are characteristics of four popular types for use by service technicians and experimenters.

will be 1 ma. In the case of Fig. 1, for example, this would mean -0.47 volt at the emitter. The amount of the potentiometer's resistance that is in the base circuit is then measured, and a fixed

resistor of suitable value is used instead.

### Audio Output Replacements

The great exception to our stated rule-of-thumb occurs in the widely used class-B push-pull output stages of transistor radios. The collectors almost always have full supply voltage applied and there is little or no emitter resistance. These stages are also very sensitive to the amount of applied forward bias. With too little bias, there will be considerable audio distortion. Excessive bias will drain the batteries prematurely and even destroy the transistors. Although no quicker rules-of-thumb can be followed, the following pointers will be helpful.

Whenever a transistor in a class-B push-pull stage must be replaced, both

(Continued on page 86)

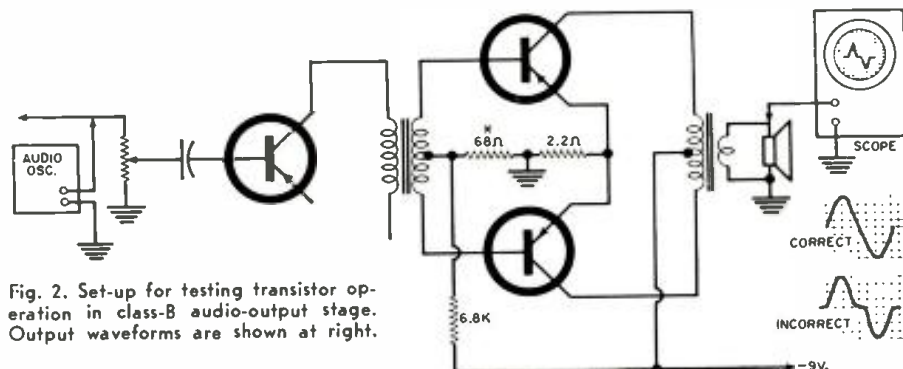
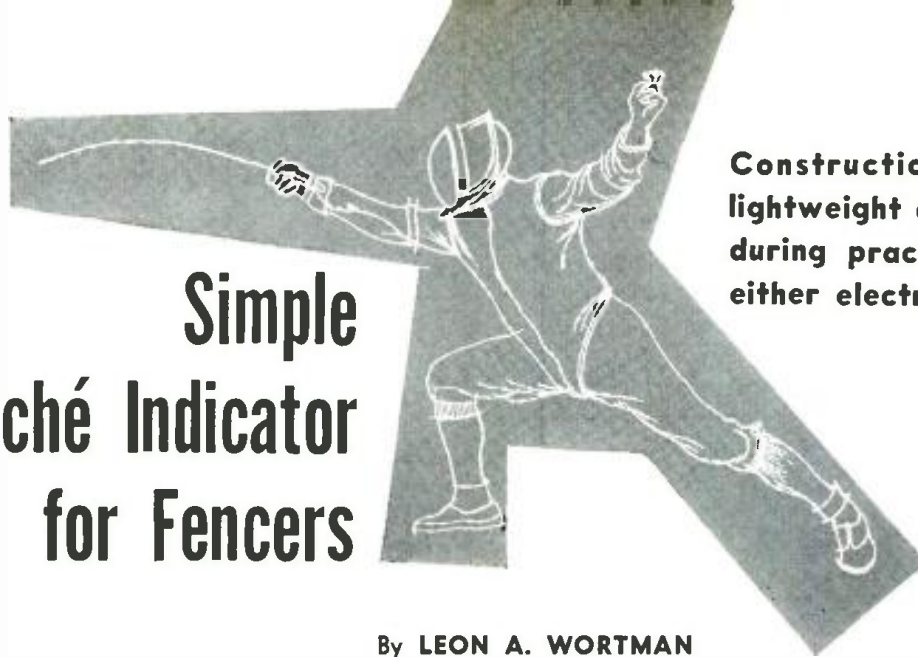


Fig. 2. Set-up for testing transistor operation in class-B audio-output stage. Output waveforms are shown at right.

# Simple Touché Indicator for Fencers



Construction of a compact, lightweight device to be used during practice session with either electrical foil or épée.

By **LEON A. WORTMAN**

Chairman, Electrical Weapons Comm. of Amateur Fencers League of America

**T**HE objective in fencing with the foil as the weapon is to "hit" in such a manner that, if the point were really sharp, it would penetrate the opponent's skin. To achieve this "hit," the point must be moving forward at the very instant it contacts the opponent. This is opposed to a lateral or slapping

sure must be exerted in order to actuate the switch and cause a "hit" or "touch" to be registered. The rules for electrical épée require that the pressure be at least 750 grams. The point of the electrical foil is a s.p.s.t. normally closed switch. The electrical-épée point is a s.p.s.t. normally open switch.

Official touch-indicators are expensive and, because they require storage batteries and spring-loaded reels in their operation, they become a bit unwieldy for practice sessions. But, a competitive fencer must practice proper blade movements to assure that he "hits" with a forward movement. To provide a simple and accurate means of touch-practice the compact, self-contained unit described here was developed. It is used by a number of members of the U. S. Olympic Squad and college teams, including the U. S. Naval Academy intercollegiate championship team. It is being introduced this year in Europe.

Fig. 1 shows the basic circuit of an electrical-foil touch-indicator. In this basic circuit the buzzer sounds only

while the point is *open* and held open by pressure against the opponent. Resistor *R* limits the current in the circuit to protect the battery from a short circuit. Because the point-switch is normally closed, and the circuit draws current at all times, switch *S* is required to turn the unit off.

Fig. 2 shows the basic circuit for an electrical-épée touch-indicator. Depressing the point against the opponent gives an instantaneous sound at the buzzer. Again, the buzzer will sound only while the point is depressed against the opponent. The circuit draws current from the battery only when a touch is made.

As was noted earlier, the point of the weapon may touch the target for a duration of a few milliseconds. This is hardly long enough for the buzzer to get started. Further, in a *salle d'armes* there often is a great deal of noise caused by the fencers shouting as they "fight," and by the vigorous clashing of steel blades. In order to make certain the buzzer has sounded a touch,

(Continued on page 102)

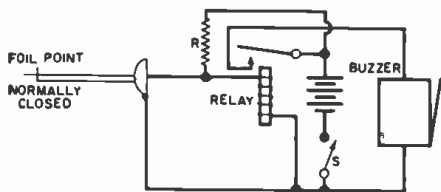


Fig. 1. Basic circuit used with the foil.

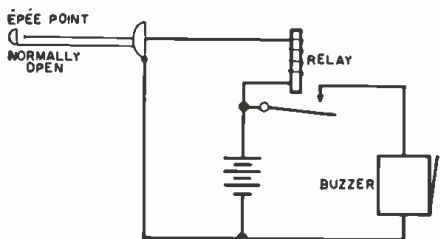
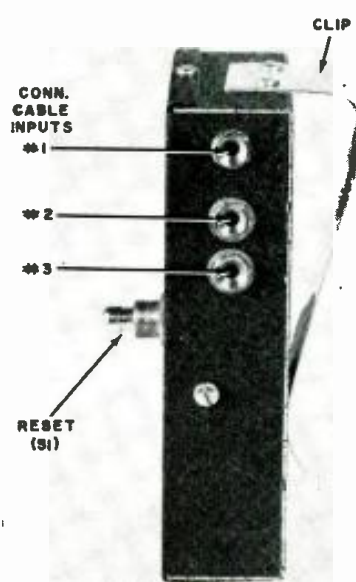


Fig. 2. Basic arrangement with an épée.

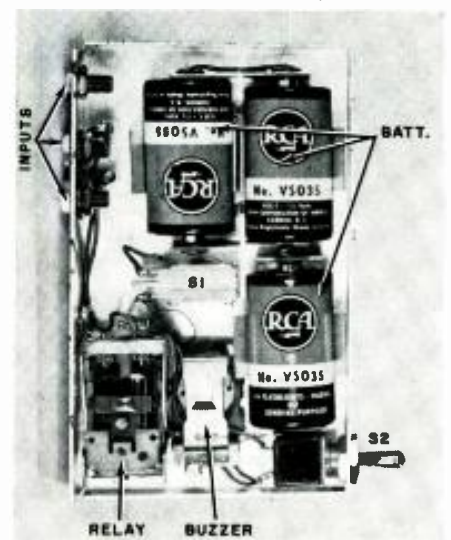
movement at the moment of the "hit." It has been determined that the point frequently remains in contact with the target for a duration of mere milliseconds. That's fast, too fast for visual judging of a "hit." Electrical touch-indicators used in championship foil contests, in fact, are required to register a "hit" when the point makes a contact for at least 5 milliseconds. Some commercial units will operate on a touch as fast as 2 milliseconds (.002 second). Electrical touch-indicators for épée must register "touches" that last for at least 10 milliseconds.

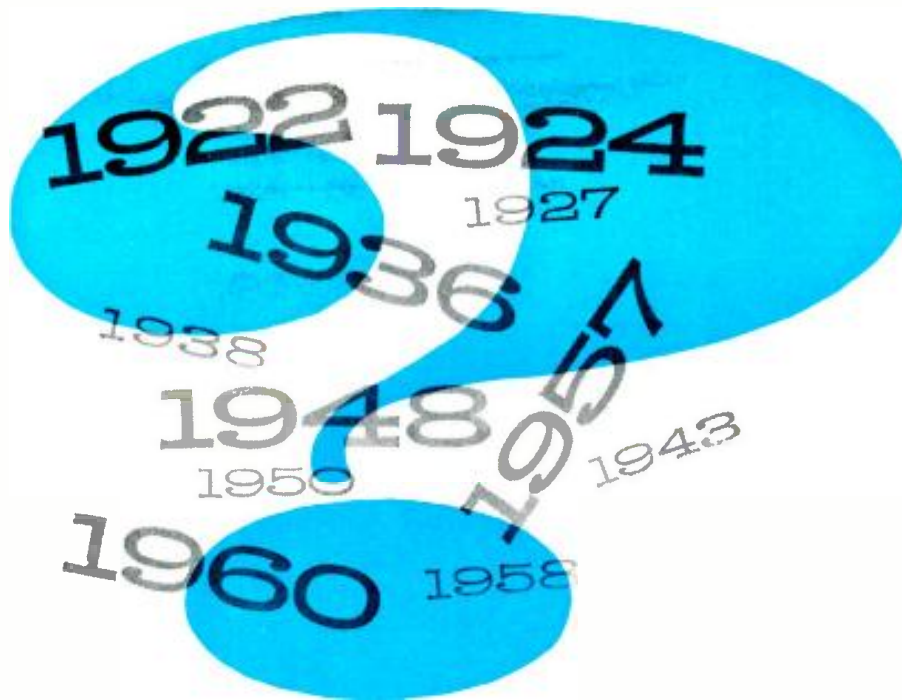
Special weapons are used in electrical fencing. They are fitted with plunger points. The points are wired and behave as switches. Only forward pressure, not lateral pressure, will actuate the point-switch. The international and U. S. rules for electrical foil require that at least 500 grams of pres-



◀ Side view of author's touché indicator.

▶ Inside view of batteries and components.





# Has Ham Radio Construction Improved?

By HOWARD S. PYLE, W7OE

**This "old timer" answers "yes" to this question and gives some interesting reminiscences on early ham gear.**

IN THE era of handle-bar mustaches, button shoes, high starched collars, and derby hats, Guglielmo Marconi set the scientific world afire with the transmission of three dots (the letter "S" in the "wireless telegraph code") across the Atlantic Ocean. Not only did this offer a challenging field to scientists and "wire" communication companies, but a spark was struck in the breasts of hundreds of private experimenters . . . forerunners of the radio amateur or "ham" of today. If Marconi could transmit intelligence through space with no visible means of connection—so could they!

## Old-Time Equipment

Marconi's equipment was composed of individually mounted items. Hertz' spark coil was self-contained on its own independent base. The "condenser" of Faraday was enclosed in a rack or perhaps a box or cabinet; the "jars" of Leyden—the Dutch version of concentrated capacity—were just that . . . individual jars sometimes "racked" together, often just lined up in a convenient row. "Spark gaps" were frequently an integral part of the induction coil . . . just a couple of rods mounted between the secondary terminals. More often they were simply a pair of bars independently mounted and connected by wire to the secondary.

The "tuning coil," if any, was a helix of wire or metal tubing also mounted on its individual supporting form, generally of wood. The early ham stations followed suit. Transmitting inductances

were air-wound coils of heavy wire or tubing formed around wooden dowel uprights and fitted with wooden end plates. Later, they became spirally wound, air-spaced coils of flat edgewise metal ribbon. "Loose" coupling soon followed; it called for *two* such coils, one of which could slide within the other or, by ingenious mechanical means, could be moved closer together or farther apart on a hinging principle. Rotating spark gaps appeared before long; they, too, were independent pieces of equipment connected by wire or metallic tubing to other components in the set.

Wireless receivers followed the same pattern—first a "tuning coil," breadboard mounted and wired, together with a crystal detector and a fixed condenser. A short time later "loose-

couplers" replaced the tuning coil; they too were initially mounted breadboard style, with other components, on a common wooden base. Meanwhile, a few manufacturers had appeared on the horizon offering several items of amateur wireless equipment. These caught the fancy of those hams who were tiring of the tedious task of winding coils and performing other relatively intricate operations to produce acceptable loose couplers, transmitting helixes, and similar items. Soon the more professional appearing, commercially produced equipment spurred the home constructor to take more pride in the appearance of his own "home-brewed" equipment. Woodwork was stained and varnished; mounting bases of the breadboard type were beveled, sanded, and finished. Using factory-made equipment as a criterion, early amateur stations began to take on a more "professional" and a more finished over-all appearance.

Meanwhile commercial wireless operating companies were waging a losing battle in their attempts to squeeze their massive transformers, helixes, condenser banks, and similar bulky items of equipment into the confines of the "closets" which served as "wireless rooms" on many vessels. They then were forced to give serious consideration to the problem of "compacting" their equipment. Receivers, then scattered items requiring considerable space on the operating table, were given priority. *United Wireless* was first in the field with a compact re-

Fig. 1. Ham construction in pioneer days was crude with few commercial parts. This receiver, with "two-slide tuner," used a corundum crystal detector, home-made fixed capacitor, and single 75-ohm "watchcase" telephone receiver. A hand-sawed breadboard base mounted all the components.



ceiver, self-contained in a small cabinet. *Wireless Specialty Apparatus Co.* developed and marketed its IP-76 receiver, also cabinet contained. Other commercial interests soon followed suit.

### What About the Ham?

What about the amateur while all this was going on in the commercial field? Were they to allow commercial design developments to pass them by? Soon the few current periodicals devoted to the amateur hobby began offering construction articles embodying the cabinet type of receiver assembly and it was not long before the up-to-date amateur station was expected to be equipped with such compact receiving equipment. True, the battery, headphones, antenna, and ground had to remain external accessories but all of the radio-frequency detection and tuning circuits were soon combined in one compact, self-contained unit.

Transmitters, though, were another problem to both commercial users and the amateur. The *United Wireless Company's* 2-kw. open-core transformer,

floor-mounted individual items of rather impressive weight and bulk.

It was not too long, however, before the *Marconi Wireless Telegraph Co. of America*, in tackling this problem, designed and introduced the P-8 2-kw. marine transmitter for shipboard use. "Pancaking" of the oscillation transformer and loading coils, the recent development of the "quenched" type of spark gap, and reduction in the physical size of Leyden jar condensers all contributed to "compacting." An even smaller *Marconi* type, in ½-kw. size, appeared next. *Kilbourne and Clarke Mfg. Co.* followed suit with marine transmitters; *Federal Telegraph Co.* did likewise. All of these offerings were assembled on a floor-mounted angle iron frame with an insulated front panel which served to mount the various meters, switches, and controls.

And the amateur? Always attuned to technical developments, soon wooden frame racks and often wooden front panels began to appear in "modern" ham shacks. Oscillation transformers, following the commercial lead, were

fine style. Those who *could* lay it on the line for a 500-cycle alternator soon found that they also required a 60-cycle a.c. motor to drive it. These, too, were costly and beyond the reach of most hams. Consequently, the familiar rotary spark gap was often squeezed into the remaining space behind the panel or, in many instances, the driving motor was mounted behind the panel through which the motor shaft extended to drive the rotary disc on the panel face. This was not the final answer, though; rotary gaps were noisy, bulky, and, to a large extent, dangerous with their exposed spark and high voltage. The solution, however, was forced to wait. The ominous war threats, which had been rumbling for some time, materialized and the United States became a combat nation in World War I.

### World War I

Thousands of amateurs joined the armed services in radio operating and technical capacities, with the closing down of all amateur stations for the duration of hostilities (and for a long



Fig. 2. This receiver, built in 1922 by Author Pyle, employed a wooden cabinet with a hard-rubber front panel. Machine engraving had come into vogue and enhanced the set's appearance.

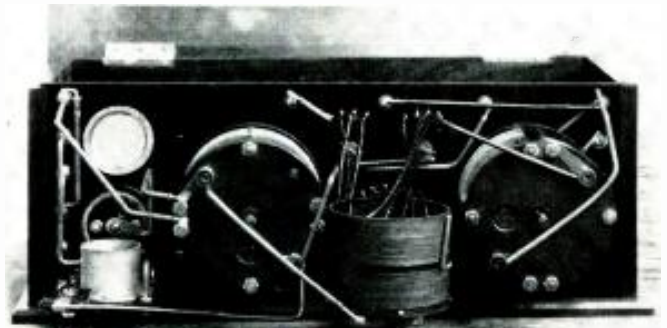


Fig. 3. Interior view of the receiver shown in Fig. 2. Heavy bus-bar wiring, covered with spaghetti sleeving, and coils hand-wound on large-diameter Bakelite tubing, were in very common use.

weighing several hundred pounds and of a size approaching that of a small "coffin" (which incidentally became its nickname), the copper tubing helix some two cubic feet in size, the bank of Leyden jar condensers almost as large as the transformer, hardly lent themselves to confinement within a single, compact cabinet. And the twenty- to thirty-thousand volts running around these weird devices offered a real challenge to confinement. Amateurs as well, despite their traditional ingenuity, were in the same boat. The heavy, bulky high-voltage transformers, the rotating spark gaps, glass-plate condensers, and the helixes, and later "oscillation transformers" simply could not be squeezed into a box. For some time transmitters, both commercial and amateur, remained as wall, table, or

pancaked and placed behind the panel; the Leyden jar condensers in commercial use were costly but alternate glass plates and tinfoil, compressed into a compact bundle, enclosed in a wooden box and immersed in melted paraffin, made an excellent condenser which could easily be contained within the rack.

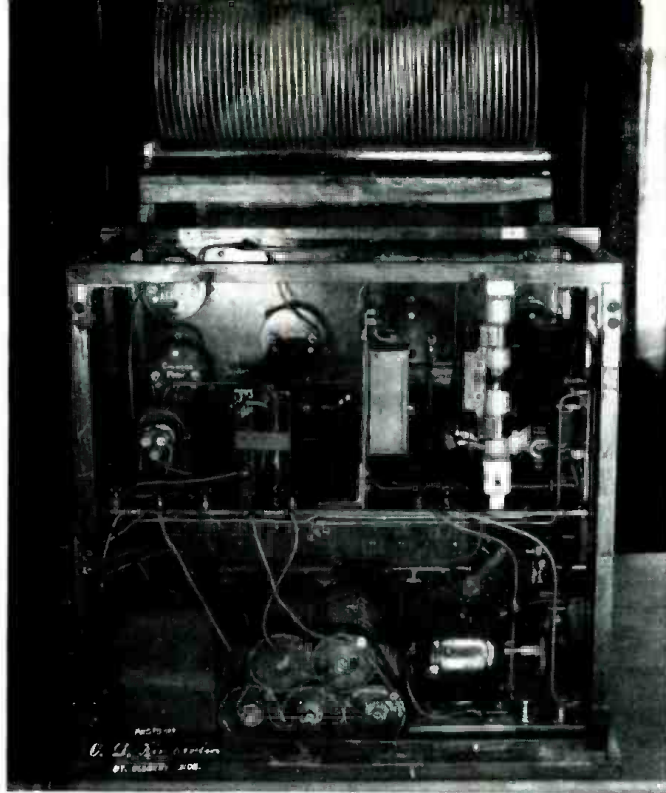
The spark gap was another story. While a few quenched gaps were being offered on the amateur market, it was soon found that with the 60-cycle current supply available in most homes, the resulting tone or note of the signal was almost unbearable. Few hams could afford the intricate motor-alternator sets used by the commercial companies to produce the 500-cycle note which was pleasing to copy and cut through static and interference in

time afterward). The impetus given to radio development by reason of combat activities had resulted in unbelievable scientific progress in the art—developments to which the military hams were thoroughly exposed. Perhaps the most significant development was in the greatly expanded use of de Forest's little audion. Among other uses, it was found that with proper circuitry and components, the "Aladdin's Lamp" of radio was a most effective generator of radio-frequency oscillations and that they were so confined to narrow channels as to make their use unbelievably more effective than any existing "spark" type of radio transmission. Improvement in audio characteristics made even radiotelephony a practical matter.

With the restoration of amateur radio operation on October 1, 1919, the avalanche started. No longer were huge, cumbersome, high-voltage transformers and great banks of Leyden jars or glass-plate condensers essential for radio transmission. Gone were the rotary spark gaps; any kind of gap was no longer a requirement. The tiny glass "bottles" with their small transformers, condensers, and modest-sized coils

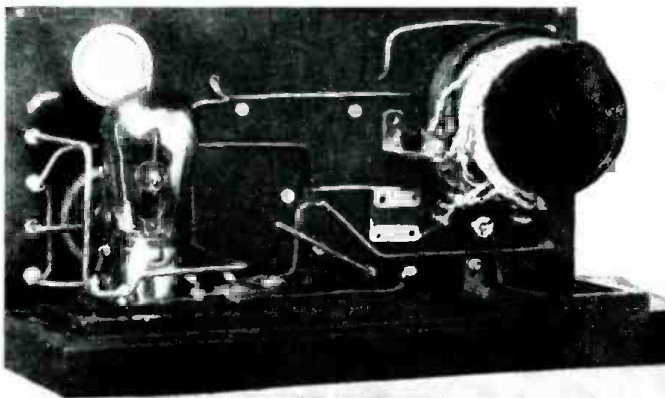


Fig. 4. Ham phone transmitter built by author in 1924. This 5-watt rig used "loop modulation," produced by wrapping single turn around tuning coil and connecting it to microphone through a mike battery.



◀ Fig. 5. Early rack-mounted 200-meter phone and c.w. transmitter. Rack frame was made of wood. Dry cells were used for the mike and relay circuits. Small motor beside dry cells was used to drive a "chopper wheel" then employed to transmit interrupted c.w.

Fig. 6. Here is an internal view of the 5-watt radiotelephone transmitter shown in Fig. 4. Rig used a 200-meter coil wound on Bakelite tubing with taps taken off to switch contacts on the front panel. Heavy bus-bar wiring was employed throughout.



which, properly connected, would provide previously unheard of transmission range, could all be easily dropped into an apple box.

Much smaller, table-mounted "rack and panel" equipment was possible. Neat angle-iron racks and Bakelite panels replaced the awkward, oversized wooden frames in pre-war use. Small nameplates, as well as equipment accessories, became available from radio manufacturers. The amateur began to dress up his gear and more professional ham stations began to replace the "horse and buggy" installations.

Receivers, too, came in for their share of attention. No longer did receiving components occupy an exposed place on top of the wooden cover of a cabinet which enclosed inert items such as fixed condensers, the body of variable condensers, and such gear but *everything* except actual shafts, knobs, dials, and switches was concealed. Rather than mounting these on a *top* cover plate, which made for awkward adjustment and reading, the controls were now placed on a *vertical* front panel, directly within the operator's line of sight.

Construction continued to improve. It could not go backward in such a progressive nation as the United States. Many and ingenious were the modifications and improvements introduced into amateur construction practice. Commercial development had progressed as well but due to the peculiar nature of the requirements could not make the rapid strides which the versatility of amateur operation made possible.

#### In Recent Years

In recent years, perhaps the greatest contribution to improvement in amateur construction methods has been the introduction of the "kit" by a number of national manufacturers. Embracing not only radio transmitters, receivers,

and accessory items but test equipment, hi-fi and related apparatus, such kits come to the purchaser with all of the hard work done. Chassis are formed, drilled and punched; coils are wound; panels and cabinets—all of metal—nicely finished and labeled; and all of the components, down to the last screw and nut and including tubes are supplied. Detailed pictorial diagrams and step-by-step assembly and wiring instructions are included. It is almost impossible for a careful home constructor, even with no previous electronic construction experience, to do a *poor* job.

It is of course true, as in everything else, that a hastily assembled, carelessly wired job can result unless the builder is willing to perform his operations carefully and conscientiously. By so doing, assembly and wiring of the kit will not only be fun but the builder will realize a substantial saving by eliminating the largest item of cost in factory wired equipment . . . labor. Nevertheless, for those who would rather not tackle the job, most companies supply factory wired versions of their kits at a commensurately higher cost.

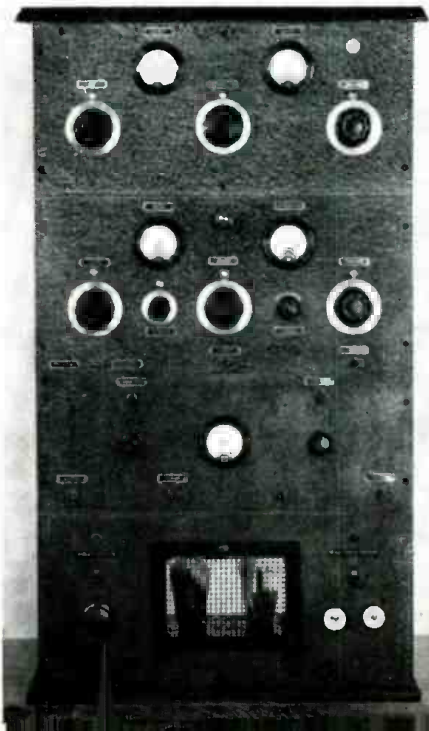
Not only is great improvement evident in amateur radio construction by reason of the introduction of kits but so-called "home-brew" equipment has been vastly improved as a result of the challenge offered by commercial kits and wired units. Most home-brew builders accept this challenge and meet it but some "hedge," it's true. The author has seen many a piece of ham gear hurriedly constructed and carelessly wired in the builder's haste to get on the air. This is especially true of the newly licensed novice. Too much eagerness to "make it work" and "get going" has literally butchered even a well-designed kit to say nothing of "home-brew" constructions. It is far better to

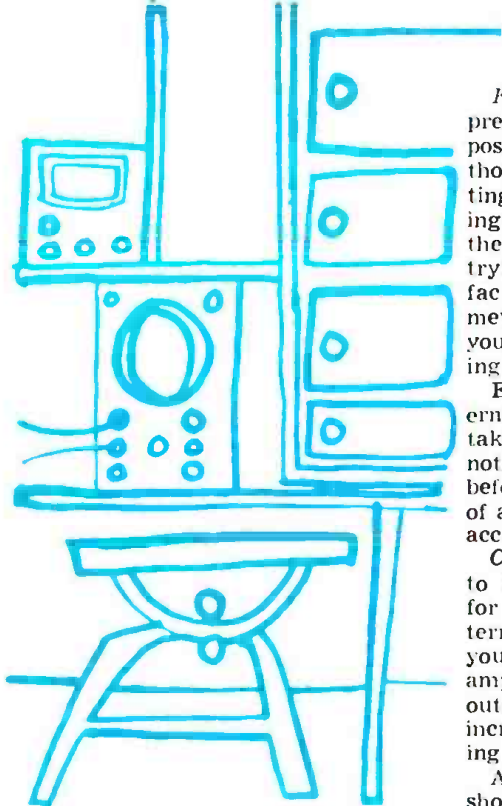
take a few extra days and do the job *once*; it will probably save countless heart-breaking hours of troubleshooting in the future. Your time is *well* spent in properly mounting your components and in routing and forming your wiring. Not only will such action result in a piece of equipment in which you can take justifiable pride but should you someday wish to trade your gear in for new equipment, you will find that the resale or trade-in value has been enhanced considerably by time well-spent.

Amateur radio construction *has* improved, definitely! May it continue to do so!

-30-

Fig. 7. Progress toward more professional-looking ham gear is illustrated by this home-built transmitter of 1936. "Unit" construction, with various parts of the transmitter made of separate chassis and panels, was employed in this transmitter.





*Know your objectives.* Is your major, present problem the fact that you can't possibly handle more customers although you would have no trouble getting them? Is it a question of expanding your facilities to enable you to do the same work at less cost? Are you trying to reorganize already adequate facilities to streamline your work methods? Are you remodeling because you expect that business will be growing larger?

Every item that goes into the modernization plan should be the result of taking into account the factors just noted and any others that apply. Long before you have decided on the location of a single shelf, you should have been accumulating a list of definite goals.

*Consider operating costs.* In addition to the substantial, immediate outlay for the alteration, you must think in terms of how the changes will affect your continuing overhead. For example, you may end up by cancelling out any advantages you hope for by increased costs for such items as heating and lighting.

Actually, for many reasons, you should be trying for the opposite—a reduction in operating costs made possible by the introduction of greater efficiencies. One reason for reducing overhead is the fact that this will help pay off the expense of remodeling. Another reason is that the cost of doing business will probably continue to rise, as it has for the past several years. Protect yourself against the possibility of marginal operation with this built-in safety factor, especially in areas where there is good reason to believe that costs will go up. For example, if local utilities are pressing for rate boosts, you might do well to consider the most efficient use of lighting (type and location of fixtures) rather than just getting more of it. More efficient heating systems or changes in the type of fuel

used, for example, may be considered.

*Put it on paper.* Many a business man has fallen into a pitfall by "mentally" visualizing how he will change around one section of the shop or another without realizing how the changes in this area will adversely affect some other important section. Work it all out on paper first. Be sure that, in incorporating needed changes, you are not taking away facilities that are needed just as much but that may be getting overlooked because it is easy to take for granted what is already there. In expanding work space to handle more jobs, for example, are you taking away the area where you should be accommodating the customers who must provide this extra business?

Planning on paper will also give you a better chance of visualizing how the completed job will look, aside from efficiency. Appearance and atmosphere are an important part of any business. So are arrangement and convenience for the customer as well as for yourself. Don't forget the location of every item of equipment and stock with respect both to its appearance and its frequency of use.

*Get expert advice.* If word gets out that you are planning to modernize, you will not have to look for advice. It will come at you from every direction, and much of it will be from armchair experts. This will be the time not to listen to anyone but men who know what they are talking about. Even if it takes a little more time and money, make sure you are paying attention to experienced people.

This applies to contractors, architects, and other shop owners in and out of the service business. If you are going to have outside builders do your work and help you plan it, take a look at some jobs they have already handled. From other shopkeepers, you may get

(Continued on page 115)

ELECTRONICS WORLD

**I**S THE remodeling of your shop's layout long overdue? Do you feel that you can't put the job off any longer? Go ahead, but don't be one of those many shop owners who wish, after the work is completed, that they could tear everything down and start all over again. Unable to meet the costs of a dual remodeling job, you will probably be forced into the unhappy position of having to live with your mistakes for quite a while.

If you are going to meet the individual requirements of your own operation as well as the general ones, and if you are going to take care of present needs as well as future ones, you will have to plan carefully before a single nail is driven. The suggestions given here include recommended steps and also point up pitfalls that, based on the experience of others, you are most likely to run into.

*Plan for the future, too.* One of the leading mistakes made in a modernization program often results at the same time that careful attention is given to current needs—and current needs only. It can happen that, in another year, changes are again badly needed but are out of the question because there has not been sufficient economic recovery from the previous alteration.

Present requirements, of course, must be carefully worked out at the start. But they have come into being because there have been changes in your business during the past year or two. Try to understand the direction of these changes so that you may project them another year or two ahead. What sort of equipment will you be servicing and for whom next year? No matter how carefully the new layout is planned, enough flexibility should be allowed so that equipment and fixtures can be changed about somewhat, without great expense, to take care of the unknown.

## Remodeling Your Shop? Plan Ahead

By ERNEST W. FAIR

**Before you go ahead, make sure you know exactly why you are seeking changes and what these should be.**



# A Solder-Gun Temperature Control

By PETER VOGELGESANG

Plug-in regulator permits continuous soldering on bench, protects transistors and printed wiring.

**B**ECAUSE of the speed with which it heats or cools, the soldering gun has become one of the technician's handiest tools. For soldering just one or a few connections, or for carrying about on service calls, it has many advantages. It is hot enough to use almost immediately, yet it can be packed up in the tool kit or deposited on such a surface as a carpet without danger of burning just a short time after use. Also the danger of damage due to overheating by forgetting to pull the plug when the job is done is eliminated, since the gun is off when not in use.

In spite of these advantages, the soldering gun is seen less often than the iron on the benches of service shops or laboratories. Lately, with the increased use of semiconductors and printed circuits, the guns have suffered additional restrictions. The drawbacks result from two principal problems—temperature overshoot and heating time.

Transistors and diodes can be damaged by excessive heat applied during soldering, as is borne out by the familiar admonition to use an adequate heat sink on the lead between the component and the point being soldered. Although this is a good general rule, it is essential only when the temperature of the soldering instrument is considerably above that needed to make the solder flow. If temperature is controlled, the precautionary techniques are generally unnecessary. Thus the soldering gun is risky because the low mass of its tip can easily overshoot the safe temperature range if its trigger is held a moment too long. A similar problem is encountered with printed wiring, where excessive heat may lift or dissolve the deposited pattern.

As to heating time, the few seconds required to bring the tip to operating temperature, while insignificant in the total time taken in a repair job, must be repeated constantly during an assembly procedure or other task requiring extensive soldering. Here the iron is generally preferred. Thus many technicians find they must have both a gun and an iron.

Both problems that prevent the gun from being used as a universal instrument can be solved by automatically stabilizing temperature of the gun's tip. If this is limited to a pre-determined value without regard to how long the trigger is depressed, it will

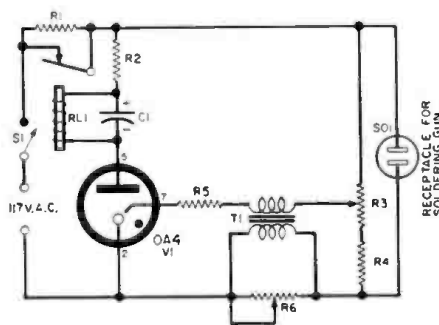
also be possible to lock the trigger of the gun to keep the tip hot for long periods without exceeding the recommended duty cycle of the instrument.

Although this sounds like a complicated requirement, it can be accomplished with a simple and inexpensive circuit for the bench. An important feature of this circuit is the complete avoidance of any additions, attachments, or modifications to the soldering gun itself. The control unit plugs into the a.c. line—and the soldering gun plugs into the unit. Thus the gun can be removed at any time for independent use in the regular fashion, as on service calls, without delay.

Control is based on the fact that the resistance of a soldering gun's tip varies directly with temperature: as the latter rises, so does the former. This is true of both the copper and steel tips in general use. Thus at any specific temperature the tip has a specific resistance, and draws a specific current from the gun's transformer. In fact, if the primary current of the transformer is monitored, a variation of more than 25 per cent can be observed between the cold and hot conditions. Temperature stabilization can be effected, then, by sensing and controlling this primary current. A circuit that does this is shown in Fig. 1.

When the trigger of the gun is depressed, current through  $R_2$  causes a voltage drop that also appears across the low-impedance winding of transformer  $T_1$ . The high-impedance winding steps up this voltage and uses it as a control voltage to prevent the gas-discharge tube,  $V_1$ , from firing by bucking out the triggering voltage. Relay  $RL_1$  remains unenergized, and a.c. power is applied through its normally

(Continued on page 94)



- $R_1$ —5000 ohm, 10 w. wirewound res.
- $R_2$ —1000 ohm, 1 w. carbon res.
- $R_3$ —10,000 ohm linear-taper pot
- $R_4$ —10,000 ohm, 1 w. carbon res.
- $R_5$ —47,000 ohm, 1/2 w. carbon res.
- $R_6$ —2 ohm linear-taper pot (IRC  $\pm$  WP2, 4-watt or equiv., see text)
- $C_1$ —40  $\mu$ f., 150 v. elec. capacitor
- $T_1$ —Audio output trans., 5000 ohms to 4 ohms (any power rating)
- $RL_1$ —S.p.d.t. plate-circuit type relay, 10,000 ohm coil (Leach  $\approx$  1032 or equiv.)
- $S_1$ —S.p.s.t. toggle switch
- $SO_1$ —A.C. receptacle
- $V_1$ —0A4 or 5823 tube (see text)

Fig. 1. Gas-discharge tube with relay keeps gun within its rated duty cycle.

Fig. 2. The compact control. Gun unplugs for separate use.

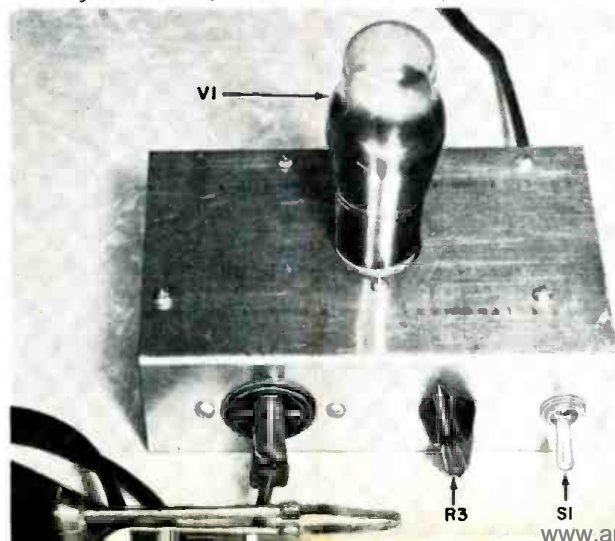
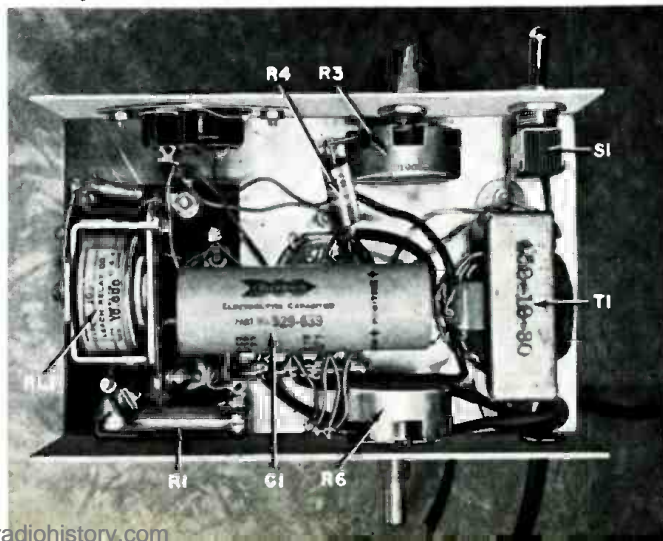
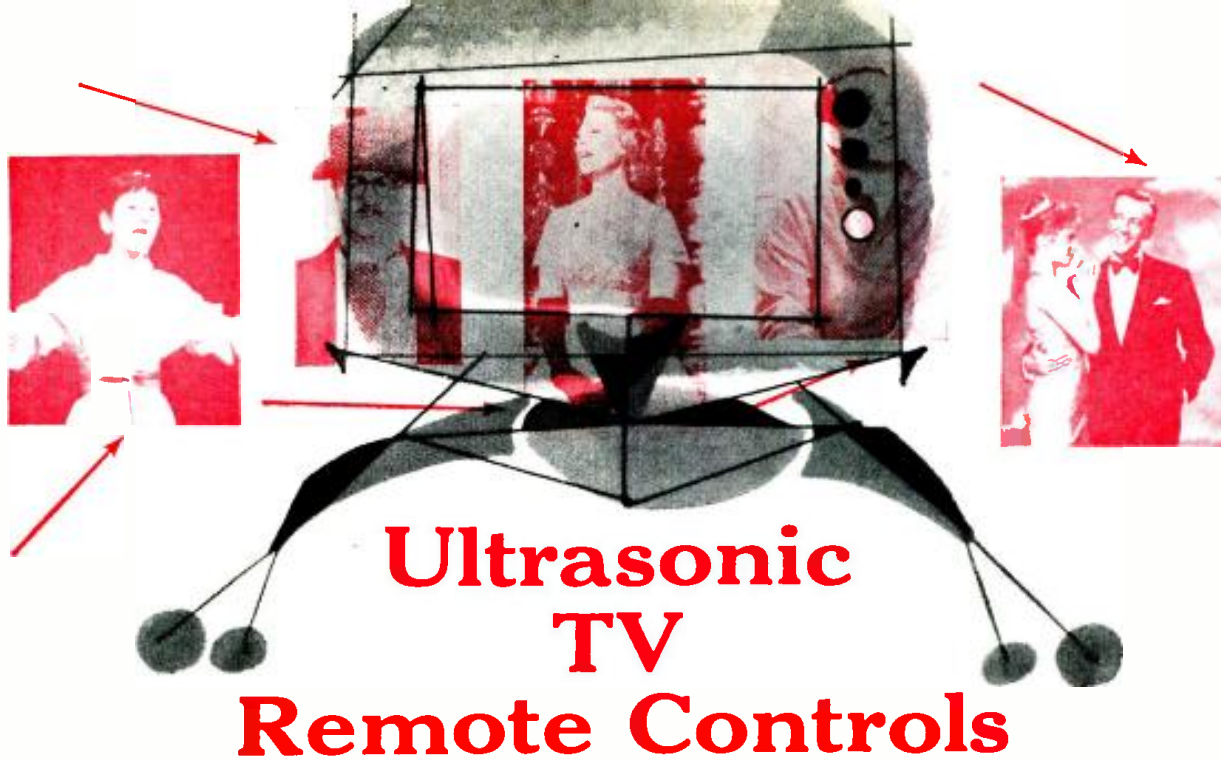


Fig. 3. Layout is not complicated by small chassis size.





By **WILLIAM FEINGOLD** / **Variety notwithstanding, popular types have enough in common so that they can be studied as a group.**

**A**LTHOUGH many types of remote-control devices for television have come into being during the past few years, those using ultrasonic signals seem to have done the best job of capturing the public fancy. Attesting to this is the fact that most remote units in current production are ultrasonic and they seem to sell best. Despite many variations within the type, there is enough "family resemblance" to make a general description of operation possible. This is fortunate for the service technician, who may run into enough problems in remote systems even when he is not handicapped by the lack of a general picture of how they work.

As the term is employed here, ultrasonics refers to the use of acoustical energy (mechanical vibration transmitted through the air) above the hearing range, rather than electromagnetic radiation. Normally, frequencies in the region of 40 kc. are used. Why should controls relying on such signals be preferred to wired, r.f., or photosensitive light-beam devices? As to wires, there is little question that any scheme freed of connecting cables trailing about the floor is neater and more convenient.

Some r.f. systems do very acceptable jobs. The difficulty here is that operating frequency and transmitted power level have to be selected and maintained carefully to stay below FCC limits on radiation from "unlicensed transmitters" and avoid interference with other services. Also, since walls are not effective barriers to r.f. energy, it is possible for two sets in adjacent apartments to suffer from undesired mutual control.

The light-beam system, in which a hand-held lamp is directed toward photosensitive cells at the receiver,

suffers from sporadic operation due to uncontrolled ambient illumination. It also requires a degree of marksmanship that is annoying for unsteady hands.

Ultrasonics reduces these problems. Relatively non-directional, it avoids the need for careful aiming; yet, severely attenuated by ordinary walls as are all acoustic waves, it has almost no interference potential. In addition, a system can be designed that has virtually no susceptibility to interference.

In this discussion, little attention will be given to the various mechanical means for executing the specific functions at the receiver end once the remote signals have been picked up and detected. Individual systems vary greatly in how they use relays, one-way or two-way motors, clutches, gears, and other devices. Despite such differences, they adhere to the basic plan of Fig. 1. Pressing a function button on the transmitter releases a burst (or continuous wave) of energy in the 40-kc. region. This "sound" is picked up by the transducer on the remote-control receiver in the TV cabinet, amplified to a useful level, and used to operate a tube-controlled relay. The latter controls the device that produces the functional change desired.

#### Functions Provided

Most plans provide some type of re-

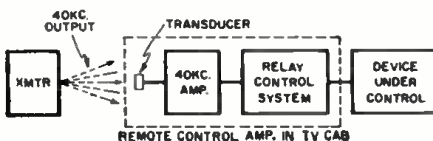
mote control over station selection, volume, and "on-off" switching. At the economy end of the line, some set makers offer single-button controls that change channels and usually also turn the set on and off. This is done by rotating the channel selector in one direction only and turning the set off each time the tuner goes through the 13th position, which would otherwise be used for u.h.f. reception. This scheme is obviously not applicable where u.h.f. reception is desired.

The next step up the line is a two-button control offering channel selection, volume adjustment, and "on-off" switching. One button is for the unidirectional tuner selector. The other one usually operates a step-type ratchet relay that goes through a sequence of perhaps four positions. These may include three positions of "TV-on" at low, medium, and high volume, plus a "TV-off" position. There are some sophisticated arrangements, with perhaps four buttons, that offer such added conveniences as rotation of the channel selector in either direction (two buttons) and a separate button for the "on-off" function. Some deluxe units offer gradual increase or decrease of volume to any desired level by ultimately controlling a motor that rotates the shaft of a volume control. In fact, some even offer a "permanent-off" feature, which is not quite the same as the usual switch-off arrangement. More of this later. Different functions are usually controlled by signals of different frequency but within the same fairly narrow range.

#### Transmitter Types

As a rule, the transmitters fall into two design categories. One uses resonant bars or rods, which function in

Fig. 1. All systems use a compact transmitter with acoustic output, followed by a receiver-amplifier at the TV set that has a pickup transducer.



the manner of tuning forks, to produce the output tones directly. Depressing a button causes an impact hammer to strike the end of the rod, setting it into vibration for a short period. Carefully cutting a rod to a prescribed length will make it resonant at the desired pitch, usually in the range from 38 to 41 kc. *Zenith* and *Admiral* use such systems.

In the second group, electrical output is provided by carefully tuned oscillators, usually transistorized, and fed to an output transducer, which may be a small loudspeaker of either the ceramic or capacitor type. For linear operation, the capacitor-type tweeter requires a polarizing voltage. It is interesting to note that a manufacturer can deliberately omit the polarizing voltage (as does *RCA*), drive the transducer with electrical energy in the 20-kc. range, and thus obtain harmonic, acoustic output in the 40-kc. band.

### Receiver Systems

Broadly speaking, there are three types of remote-control receiver-amplifier designs now being produced for use at the TV set. All use another transducer, functioning as a microphone, to sense the "sound." The simplest receives, amplifies, and rectifies the transmitted signal to obtain a d.c. control voltage, as in Fig. 2A. However, this system has the poorest immunity to the one problem that may occur with ultrasonics: "sounds" or their unheard harmonics from door hinges, rattling keys, rocking chairs, spray cans, and other sources may accidentally trigger the receiver at the wrong time.

Two schemes of more refined design have been conceived to minimize this possibility. One uses two oscillators in the transmitter that operate simultaneously when a button is depressed. The two frequencies are always a specific distance from each other, say 2-kc. apart. As in Fig. 2B, they may be 40 kc. and 42 kc. The receiver accepts and amplifies both signals, demodulates both (usually by simple diode action), separates the 2-kc. difference frequency, and rectifies the latter to obtain a control voltage. Since the receiver input will not accept a direct acoustic output at this low frequency, spurious triggering is avoided.

Another method relies on a single tone (Fig. 2C), but applies it to a frequency discriminator after amplification. The response of such a discriminator, which is similar to the types used in FM reception, is an "S" curve like the one shown in Fig. 3. This one is so aligned that its peak output at one end of the curve is at 40 kc. A signal at this frequency can then be used to operate a tube-controlled relay. Note that, with a balanced discriminator exhibiting this type of response, the same detector can be used to separate another signal at 39 kc. The two outputs can be used to control different functions or rotate the same motor in two different directions in connection with the same function. For example, signals for increasing and decreasing vol-

ume level, or for turning the tuner clockwise and counterclockwise, can be differentiated in this way.

### "On-Off" Switching

It must be recognized that all of these systems involve the addition of a control-amplifier chassis to the TV receiver itself and that, unless this added circuit is on and operating, there can be no remote operation—including that of turning the TV set itself on. Obviously, the user must either turn the amplifier on manually, at the TV set itself, prior to using the remote control and turn it off afterwards, or he must leave it on 24 hours a day. Although the cost of power consumed in following the latter procedure may not be considered high, the continuous-duty life of components is a limiting factor.

One manufacturer approaches the problem by transistorizing the control receiver-amplifier. The low power consumption and absence of significant heat renders continuous operation acceptable. Others feature a partial solution by requiring the user to turn the circuit on at the set before use, but allowing him the privilege of remotely turning the TV set itself on or off while retaining the option of leaving the amplifier on or turning it off also. This involves an extra "off" position sometimes called the "Permanent Off." Using it, however, means that the amplifier must again be turned on at the receiver before remote operation can be resumed.

One way of achieving this is to mount two power switches on the shaft

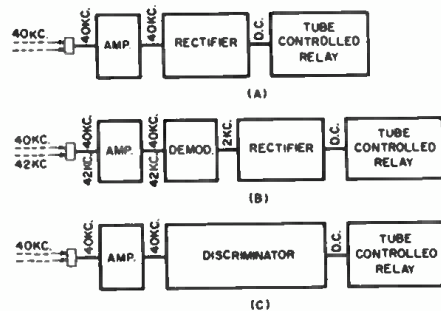
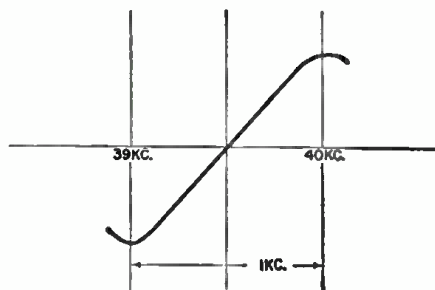


Fig. 2. All receivers convert signal to electrical energy. Simplest ones (A) rectify this signal directly for d.c. control voltage. Others (B) use beat note between two transmitted signals. Some (C) use frequency discriminators to distinguish between tones.

Fig. 3. The response curve of a discriminator type receiver is an "S" curve like that found in FM detectors.



of a motor-driven volume control. One switch, as is the case with ordinary, combination "on-off"-volume controls, is actuated by the extreme counterclockwise rotation of the shaft. The other is operated about 45 degrees before this extreme is reached. The extreme switch controls power to the remote amplifier; the other, power for the TV chassis.

In use, the remote transmitter controls volume continuously. The user keeps the "Volume-Decrease" button depressed until the volume control's counterclockwise rotation turns off only the TV set. If he now releases the button, he can again turn the set on by calling for an increase in volume. He can also call for decreasing volume until the remote amplifier is turned off along with the TV set.

### Other Features

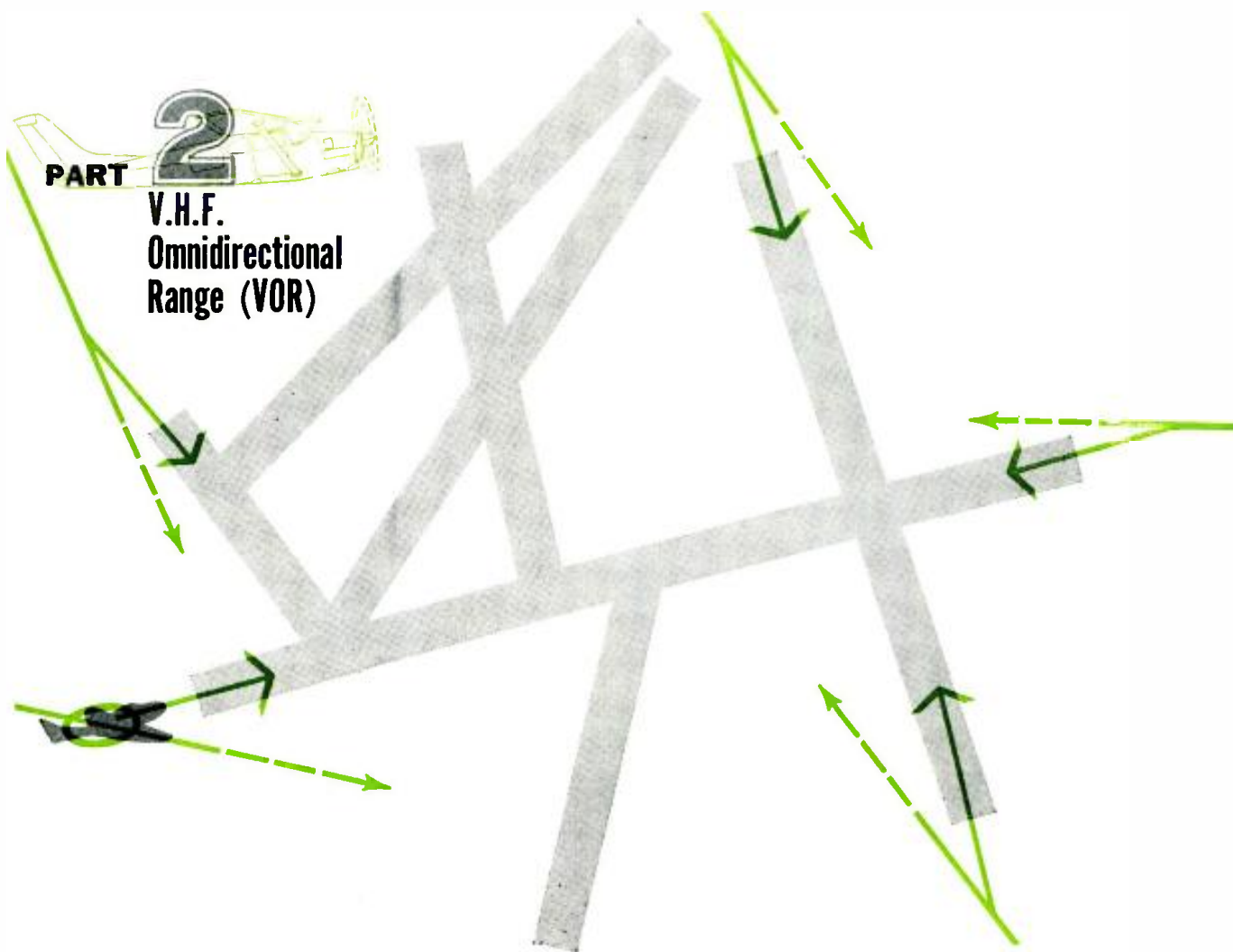
This type of continuous variation from the remote position brings up an interesting point. Such smooth operation is possible only when the user can maintain a steady output tone by keeping a button depressed and stop at any desired point by releasing the button to interrupt the tone. (In this arrangement the receiver continues to operate a motor as long as it receives a signal with which to develop a control voltage.) This type of c.w. operation is achieved with transmitters using electronic oscillators. Where mechanical-rod transmitters are used, as a rule, the short-duration bursts they generate operate step-type controls at the other end.

Many variations of the techniques outlined here are possible. For example, it is possible to obtain some sort of continuous operation even with bursts. In one method, an instantaneous signal could be used to start a motor that drives a channel selector which continues to operate as long as it passes inactive channels. When an active channel is reached, one of several possible sensing methods is used to stop the motor. Detected signal or a mechanically pre-set indexing arrangement can do this. However, the many possible mechanical and electro-mechanical devices used to carry out these functions at the TV set are beyond the scope of the present discussion.

Ultrasonic remote-control systems offer many advantages. For the consumer, they offer light, rugged, hand-held transmitters that may require no power at all, as is the case with the tuning-bar units, or operate on inexpensive batteries that require replacement only infrequently because of the low drain by the transistorized circuits they power.

In addition, the problems involving radiation of interference, mutual interaction of different units, and susceptibility to interference are kept to a minimum.

For the technician, although he may lack enthusiasm about remote controls in general, he will find that his difficulties with acoustic-output units are fewer and simpler.



## Radio Aids to Aircraft Navigation

By **FRANCIS A. GICCA**  
Senior Engineer, Raytheon Co.

**Description and use of the most flexible, accurate, and simple widely used navigation system for planes.**

**L**AST month we discussed the two low-frequency systems of long-range navigation. The low-frequency radio ranges and direction finding are capable of guiding an airplane along the civil airways, but not without some serious disadvantages and limitations. Radio ranges are limited by their inability to provide more than four navigational courses. Direction finders and the radio ranges both suffer from the poor propagation characteristics of low frequencies which causes navigation errors due to static and atmospheric bending of the beams.

The radio-range and direction-finding systems of aircraft navigation were developed at a time when low frequencies were the only frequencies practical for broadcasting. As time passed and higher frequencies became usable it was obvious that v.h.f. transmissions for navigation would be highly desir-

able since v.h.f. is relatively static-free and not susceptible to bending as lower frequencies are. Engineers could have developed a v.h.f. radio-range system similar to the low-frequency ranges, but they realized that the four-course limitation was a serious one. They felt that whatever system they developed for v.h.f. navigation should be similar to ADF and include 360 radio courses, a course for every degree on the compass.

The result was VOR, short for V.h.f. Omnidirectional Range, sometimes also known as "Omni." Without a doubt, VOR is the most flexible, accurate, and simple widely used navigation system. The receiver is relatively simple and inexpensive and is generally a part of v.h.f. communications equipment.

### VOR

In order to understand the operation of the VOR system, it is first necessary

to understand the operation of a VOR transmitter. In essence, the operation of a VOR transmitter can be likened to that of a light beacon rotating at a uniform rate. If the beacon revolves at 1 rpm and if a fixed red light atop the beacon is flashed as the beam points North, an observer with a stopwatch can determine his bearing from the beacon merely by starting the watch when the red light flashes and stopping it when the beacon's beam flashes past him. The azimuth angle measured from North is then directly proportional to the elapsed time measured by the stopwatch.

A VOR transmitter functions in a manner similar to the rotating beacon and flashing red light. In the VOR transmitter, the rotating beacon is replaced by a signal whose phase rotates from zero to 360 degrees as the signal is beamed and rotated clockwise in a

narrow beam from magnetic North. When the electronic beam points North the phase is at zero degrees, as the electronic beam passes East the phase is at 90 degrees, and so on for all points of the compass. Every degree of the compass corresponds to an equal amount of phase shift in the beacon signal.

The reference flashing red light is electronically replaced by a reference signal whose phase remains at zero degrees irrespective of direction. In order for a pilot to determine his azimuthal angle from the transmitter it is only necessary to measure the phase shift of the beacon signal in comparison to the phase of the reference signal. The number of degrees of phase shift measured corresponds exactly to the number of azimuthal degrees from North referred



VOR receiver. "Left-Right" meter with "To-From" indication, is at left. The course-selector dial is at the bottom.

to the transmitting station employed.

For example, if an airplane is located due North from the station, it will receive the beacon and reference signals in-phase. If the pilot somehow measures the phase difference between these two signals he will find it to be zero degrees. The pilot then knows he must be on a line at zero degrees, or due North, from the station. If the airplane is located due South from the station, it receives the beacon and reference signals out-of-phase. If the pilot again measures the phase difference he finds it to be 180 degrees. The pilot knows he must now be on a radial at 180 degrees, or due South, from the station. In a similar manner, a pilot can determine his position along any radial from the station.

The purpose of a VOR transmitter is to broadcast the beacon and reference signals as well as voice communications. A complex antenna array transmits this information in the v.h.f. band of 108 to 118 megacycles. The v.h.f. carrier is first amplitude-modulated at 30 per-cent with a 10 kc. (actually 9960-cycle) signal. In turn, this 10 kc. signal is frequency-modulated with a 30-cycle reference signal with a maximum deviation of  $\pm 480$  cycles above and below 10 kc. This 30-cycle signal which has been coded onto the 10 kc. subcarrier forms the reference signal of the VOR system and remains fixed in phase.

August, 1960



VOR and TACAN transmitter site. The main VOR antenna array is housed in the base of the cone on top of the building. It is a four-loop antenna assembly. The cylinder on top of the cone is the antenna for the Air Force-developed TACAN navigation system. The vertical antenna on the pole to the right of the main building is a distance-measuring equipment (DME) antenna. DME is currently being discontinued.

The beacon signal could be created by transmitting the unmodulated v.h.f. carrier from a highly directional antenna and then rotating this antenna 30 times each second. This would, in essence, amplitude-modulate the v.h.f. carrier at a 30-cycle rate whose relative phase varies as a function of antenna position. When the antenna points directly at an observer, the v.h.f. signal which he receives has maximum strength. However, when the antenna is pointed directly away from the observer, the signal is received with minimum strength. The amplitude of this received signal, then, varies as the antenna rotates and the signal detected by the receiver is identical to one amplitude-modulated at a 30-cycle rate. Note, however, that the amplitude maximum always occurs when the antenna is pointed directly at the receiver, irrespective of the receiver's azimuthal position from the transmitter. The result is that the phase of the amplitude modulation with respect to a fixed phase reference signal varies with azimuth around the station.

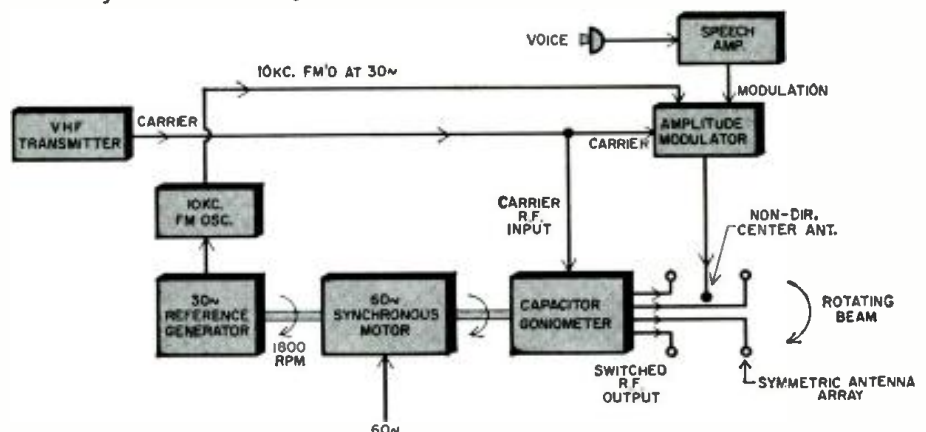
It is apparent that it would be extremely difficult to physically rotate a

heavy antenna 30 times each second, which corresponds to 1800 rpm. The solution to this problem is shown in Fig. 5, which shows a simplified block diagram of a VOR transmitter. A complex antenna array is used to create the rotating v.h.f. radiation pattern. This antenna array consists of a series of directional antennas spaced evenly around the transmitter site. These antennas are connected to a rotating goniometer which, in turn, is connected to the v.h.f. transmitter output. The goniometer is essentially a capacitive switch which successively switches v.h.f. carrier energy from antenna to antenna. This goniometer is rotated at 1800 rpm by a synchronous motor in order to effectively rotate the beacon signal at a 30-cycle rate whose phase varies as a function of azimuth. A central non-directional antenna transmits the 10 kc. frequency-modulated reference signal and voice modulations.

### VOR Reception

Fig. 6 is the block diagram of *National Aeronautical Company's* "Mark II," a popular, low-priced VOR receiver. The r.f. section of the "Mark II" is

Fig. 5. Basic block diagram of the v.h.f. omnidirectional range (VOR) transmitter.



a fairly conventional v.h.f. superheterodyne receiver plus v.h.f. transmitter for communications. The VOR converter section begins at the detected audio output of the receiver. Remember that the reference 30-cycle signal is coded as frequency-modulation on a 10 kc. subcarrier which, in turn, is amplitude-modulated on the main v.h.f. carrier. Since the audio detector of the v.h.f. receiver detects all amplitude modulation present on the carrier, the 10 kc. subcarrier is detected by the receiver and appears as a 10 kc. audio signal. In order to recover the 30-cycle reference signal which is frequency-modulated on this subcarrier, it is first necessary to separate the 10 kc. subcarrier from other audio frequencies present in the audio output of the receiver. A 10 kc. high-pass filter achieves this separation. The clean 10 kc. signal is then amplified and limited in amplitude to remove all stray amplitude modulation present. The limited signal is then applied to a ratio detector which frequency detects the 30-cycle reference signal from the 10 kc. carrier. In this manner, the fixed-phase reference is extracted.

The 30-cycle variable-phase beacon signal is already present at the audio output of the receiver since it was simply amplitude-modulated on the v.h.f. carrier. The variable-phase, or beacon, channel of the "Mark II" consists first of a 60-cycle rejection filter. The purpose of this filter is to remove 60-cycle components present in the audio output which are generated by single-blade propellers rotating at approximately 1800 rpm. Unless removed, this 60-cycle spurious signal can cause errors in the final readings and cause slow oscillations of the meter needles. Following the rejection filter, a 30-cycle bandpass filter removes voice frequencies and the 10 kc. reference subcarrier from the beacon channel. After amplification and further filtering, the beacon signal is applied to a phase-splitter which generates two equal voltages 180

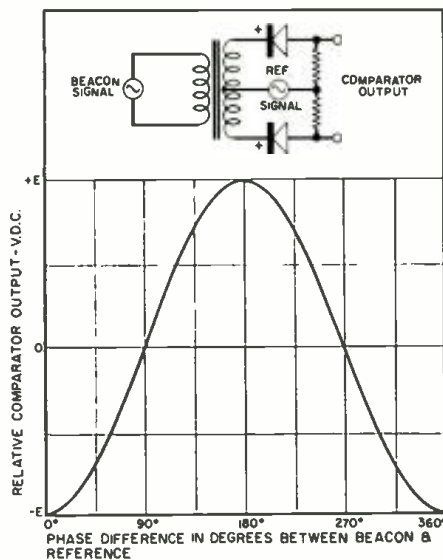


Fig. 7. Phase comparator characteristics.

degrees out-of-phase. These push-pull voltages then drive a phase-splitting bridge which produces four output voltages, each delayed an additional 90 degrees in phase than the previous voltage. This circuit consists of two resistors and capacitors connected in a bridge and arranged so that each corner of the bridge has equal beacon signal voltages, but at exactly 90-degree intervals of phase. These four voltages are connected to four cathode-followers in order to obtain four low-impedance beacon signal sources.

Since azimuthal position will be determined by measuring the phase of the beacon signal in comparison to the reference signal, the remainder of the circuits are designed to measure this phase difference. In the "Mark II," the four cathode-followers feed a symmetrically tapped potentiometer known as the "Course Selector." Since each tap of this potentiometer is connected to the four beacon signals which are each 90 degrees out-of-phase, the course selector functions as a continuously

variable phase shifter. The output of the course selector is the beacon signal whose phase can be continuously varied through 360 degrees depending upon the position of the potentiometer arm.

Following amplification of the 30-cycle beacon signal, it is applied to two phase comparators. Each of these comparators consists of two diodes which are switched on and off by the 30-cycle reference signal. When conducting, these diodes allow the beacon signal to pass through. When non-conducting, the diodes reject the beacon signal. Since this action occurs in synchronism with the reference signal, which is also at 30 cycles, the phase comparator performs as a rectifier of the beacon signal. However, the magnitude and polarity of the rectified d.c. voltage thus produced is a function of the phase differ-



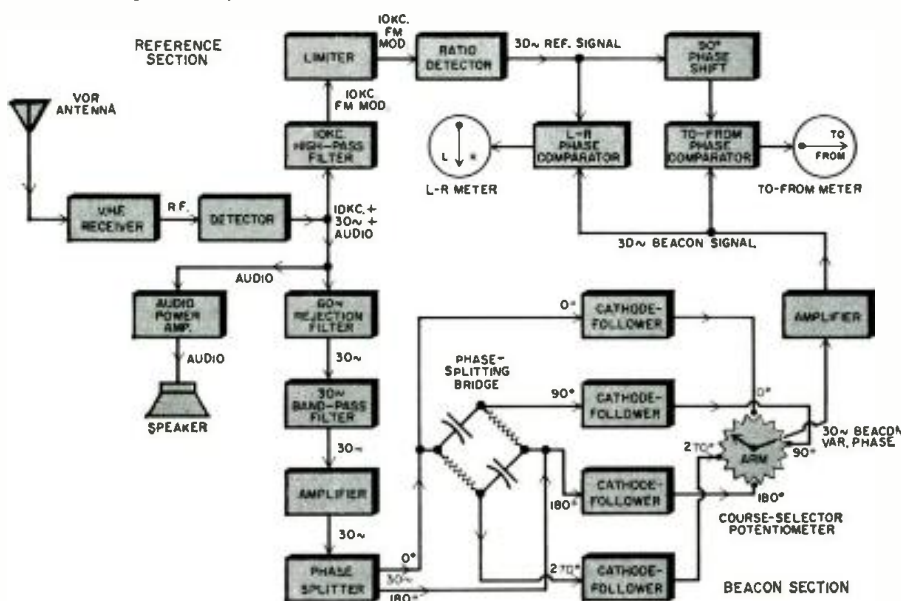
Single-unit VOR indicator/course selector.

ence between beacon and reference signals. If the two signals are exactly 90 or 270 degrees out-of-phase, no d.c. voltage is produced. If the phase shift is between 91 and 269 degrees, a positive d.c. voltage is produced which reaches maximum amplitude at 180 degrees. If the phase shift is between 89 and 271 degrees, a negative d.c. voltage is produced which reaches maximum amplitude at 0 degrees. Fig. 7 shows the d.c. produced by a phase comparator as a function of phase difference between the two voltages.

Consider the "Left-Right" phase comparator of Fig. 6. This is driven by beacon and reference signals. When a VOR signal is received, an azimuthal phase difference will exist between beacon and reference signals which produces a d.c. voltage proportional to this phase difference from the phase comparator. This d.c. voltage is applied to a "Left-Right" meter which is deflected by this voltage. If the course selector dial is rotated, the phase of the beacon signal can be adjusted until it is 90 degrees out-of-phase with the reference signal. At this point, the output of the phase comparator is zero and the "Left-Right" meter centers.

If the course selector dial is calibrated in degrees of phase shift introduced, then the course-selector dial in-

Fig. 6. Complete block diagram of the VOR receiver discussed in the text.

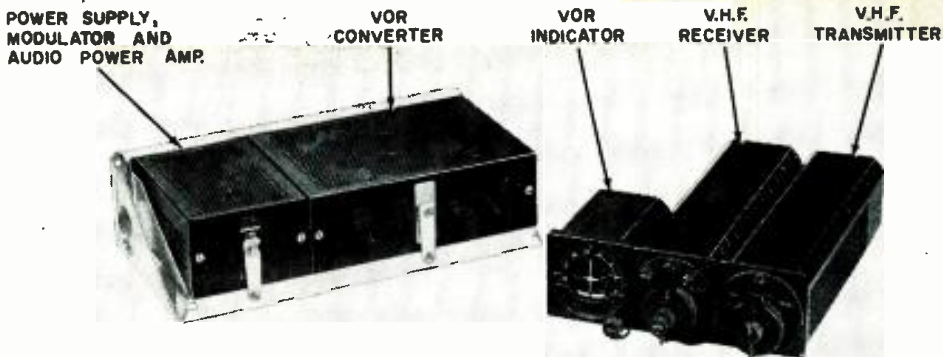


dicates directly the azimuth radial along which the aircraft is located. Unfortunately, the reading is ambiguous since the "Left-Right" meter will center at a phase shift of 270 degrees, as well as 90 degrees (refer to Fig. 7). The purpose of the "To-From" phase comparator and meter is to resolve this ambiguity.

Note that the reference signal that is used for the "To-From" phase comparator is shifted in phase so as to lag by 90 degrees the reference of the "Left-Right" comparator. Assume that the beacon signal has been adjusted to lag the standard reference signal by 90 degrees thereby centering the "Left-Right" meter. Since the "To-From" reference lags the standard reference by 90 degrees, the "To-From" comparator sees two signals which are exactly in-phase. This produces maximum negative d.c. voltage and deflects the "To-From" meter fully into the "To" region. If the beacon signal has been phase shifted 270 degrees rather than 90 degrees, again centering the "Left-Right" meter, the "To-From" comparator now sees that the two signals are exactly 180 degrees out-of-phase. This produces maximum positive d.c. voltage which fully deflects the "To-From" meter into the "From" region. In this manner, the "To-From" meter indicates which of the two possible "Left-Right" zero meter readings has been selected.

VOR receivers have been designed so that when the "Left-Right" meter is centered and the "To-From" meter reads "To," the course selector indicates the magnetic heading that will lead the aircraft towards the VOR station. Conversely, a "From" reading indicates the heading which will lead the aircraft away from the VOR station. In following a course to a VOR station, the "Left-Right" meter is arranged so that it will deflect in a direction that indicates which direction to fly in order to stay on course. Assume that a VOR station is to be approached along an 80-degree radial. The VOR receiver is tuned to the station and the course selector dial set at 80 degrees. The "Left-Right" meter will center and the "To-From" meter indicate "To" when the plane is on course. If the "Left-Right" meter reading drifts off center towards the left, this indicates that the pilot must execute a turn to the left in order to stay on course. In this manner, a pilot can easily remain on course by merely keeping the "Left-Right" needle centered. If the pilot is approaching the VOR station on an 80-degree radial as just described, as the flight goes on the "To-From" needle will flicker and finally swing to "From." At this point, the station has been passed and the airplane is now heading away from the VOR station.

The operation of the "Mark II" just described helps indicate the great versatility of the VOR system of navigation. In contrast to its closest relative, ADF, any radial can be flown and is indicated directly in degrees on the course-selector dial. ADF cannot



VOR receiving and communications system. Indicator, receiver and transmitter are installed on the cockpit flight panel.

achieve this without resort to a magnetic compass for proper heading. Furthermore, the "Left-Right" meter indicates directly the plane's deviation off its planned course. As can be seen in the photo (page 55), the "Mark II" VOR receiver is small and compact. The course selector dial is horizontal and at the bottom of the receiver. The "To-From" meter is arranged to show either the word "To" or "From" at the center of the "Left-Right" meter.

The Lear "Navcom 100" VOR navigating system is unique in its presentation of navigation information. A single 3-inch-square meter contains the course selector dial, "Left-Right" meter, and "To-From" indicator. The course-selector variable phase shifter uses a servo resolver rather than a tapped potentiometer. A rotating coil in the resolver picks off the proper phase beacon signal from two fixed coils electrically 90 degrees out-of-phase. A resolver is more accurate as a phase shifter than a tapped potentiometer, but it is more expensive. Since the "Mark II" was designed for absolute minimum cost, it uses the tapped-potentiometer type of phase shifter.

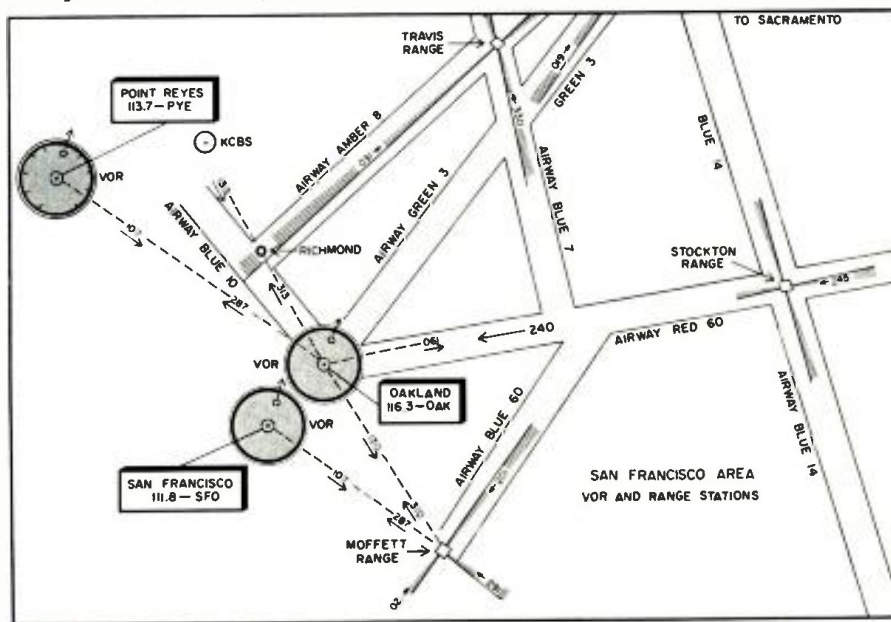
VOR is accurate. The maximum angular error permitted by the Federal Aviation Agency is plus or minus four

degrees. Most VOR receivers are far more accurate than this, generally better than two degrees. Ironically, the principal weakness of VOR is due to its very use of v.h.f. frequencies. Although v.h.f. is static free, it propagates by "line of sight." That is, if the transmitter can be seen from the aircraft, the VOR signal can be received. Unfortunately, this means that there can be no obstructions between the transmitter and navigating aircraft to deflect the VOR signals. In turn, this requires that the aircraft fly at an altitude sufficient to guarantee that no mountains or other obstructions intervene. Therefore, VOR is practically useless below about two thousand feet. Since most air navigation is conducted well above two thousand feet, this restriction is not serious except when an airplane must fly low, as it must when preparing to land. All things taken into account, VOR presents less drawbacks than any other system in use and remains the backbone of U.S. long-range navigation.

### Navigating with VOR

Fig. 8 shows a simplified radio navigation chart for the San Francisco area similar to that of Fig. 4, Part 1, but in-  
(Continued on page 114)

Fig. 8. Simplified navigational chart showing VOR stations and low-frequency ranges.





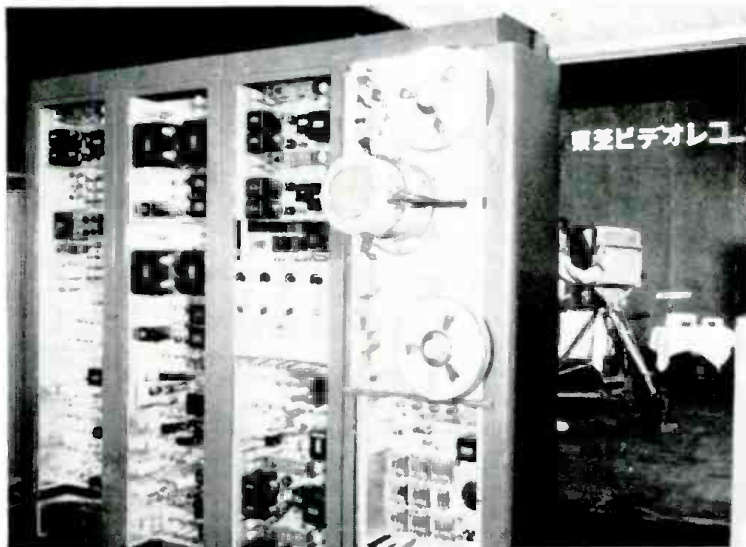
### Largest Three-Axis Antenna

This precision antenna, built for the U. S. Air Force by *Philco*, is to be used for reception of telemetered information and other data from satellites and missiles in any phase of their flight. The antenna is the largest three-axis structure and boasts exceptional rigidity and high performance. The aluminum reflector is 60 feet in diameter and weighs about 15 tons. The unit responds to tracking commands to an accuracy of plus-or-minus two milliradians (about 0.11 degree). More than 30,000 aluminum alloy blind rivets are used in the assembly.

### Japanese Video Tape Recorder

At the recent convention of the Society of Motion Picture and Television Engineers, a technical paper was given by Dr. N. Sawazaki of the *Tokyo Shibaura Electric Co.* describing the features of the *Toshiba* video tape recorder. This recorder won the "Japan Best Ten New Products Prize" for 1959. A unique feature of the *Toshiba* system is that it records the whole picture of one television field in one long track on the tape, using only one rotating head. The tape is made to run in a helical loop around a cylinder against which a high-speed rotating head operates. A tape speed of 15 inches-per-second is employed, and the signals are recorded on 2-inch wide tape. The video tracks are recorded at an angle of a little more than 4 degrees with respect to the tape edge, while the audio track is recorded in the conventional manner near one edge and parallel to it. Along the other edge a control track is recorded to maintain speed and synchronization. An experimental model of the tape recorder has a video frequency response flat up to about 1 mc. at which point a gradual roll-off occurs to a level that is down 6 db at 4 mc. Video signal-to-noise ratio is said to be 35 db. A filmed demonstration was also shown in which the performance of the video tape recorder was illustrated.

## Recent Developments in Electronics

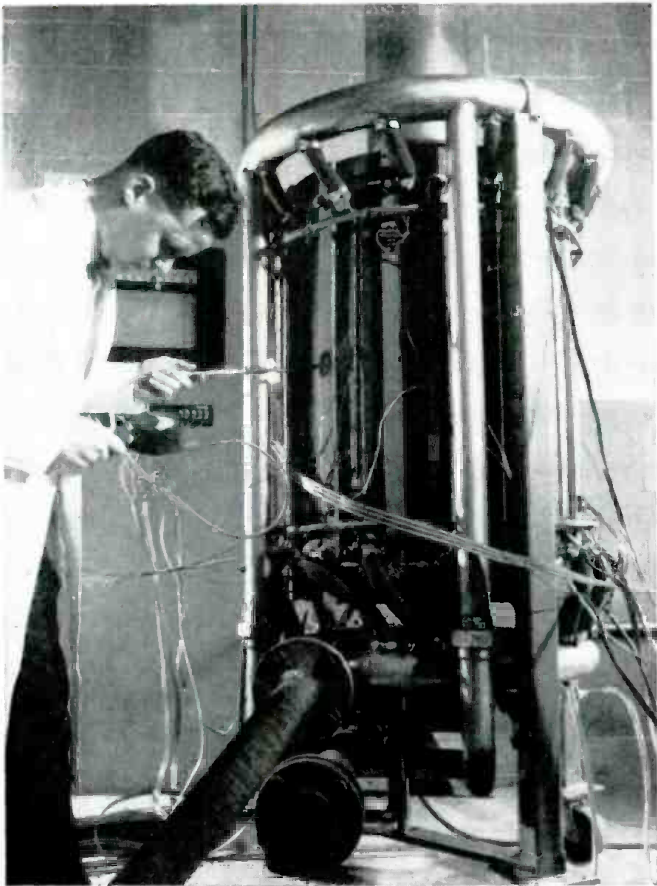


### Precision Inspection Via TV

A new inspection method that greatly reduces the time required for making a complete dimensional check of aircraft parts is being used by *Convair*. A "universal inspection machine," built around a closed-circuit TV system made by *Kim Tel* (Div. of *Cohu Electronics Co.*), is used. The inspection machine has an open interior so that aircraft sections can be placed on a table within it. A movable carriage holding a TV camera is over the table. The distance the camera travels as well as its position can be determined very precisely. A TV monitor is used to show the exact position of the camera over the part to be inspected.





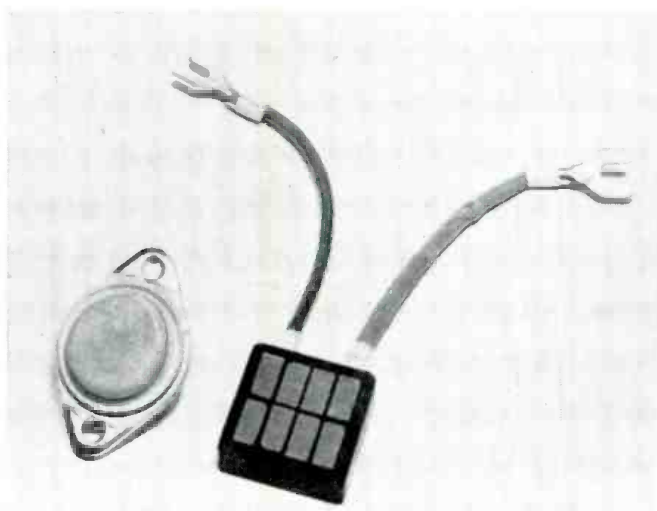


### Giant Thermoelectric Power Generator

One of the two 2500-watt sub-generators which make up the largest thermoelectric power plant ever constructed is shown under test at the *Westinghouse* new products laboratories. Developed for the Bureau of Ships, U. S. Navy, the generator is intended as an experimental unit for materials evaluation and generates enough electric power to carry the full lighting load of 8 to 10 average homes. No major moving parts are used and the electric power is produced by direct conversion from heat.

### "Frigistors" For Electronic Cooling

An eight-thermocouple "Frigistor" module is compared in size with a typical power transistor. The "Frigistor," which uses a new highly efficient semiconductor material being marketed by *General Thermoelectric Corp.*, Princeton, N. J., can produce effective cooling without moving parts when current is passed through the material.



August, 1960



### Military Video Tape Recorder

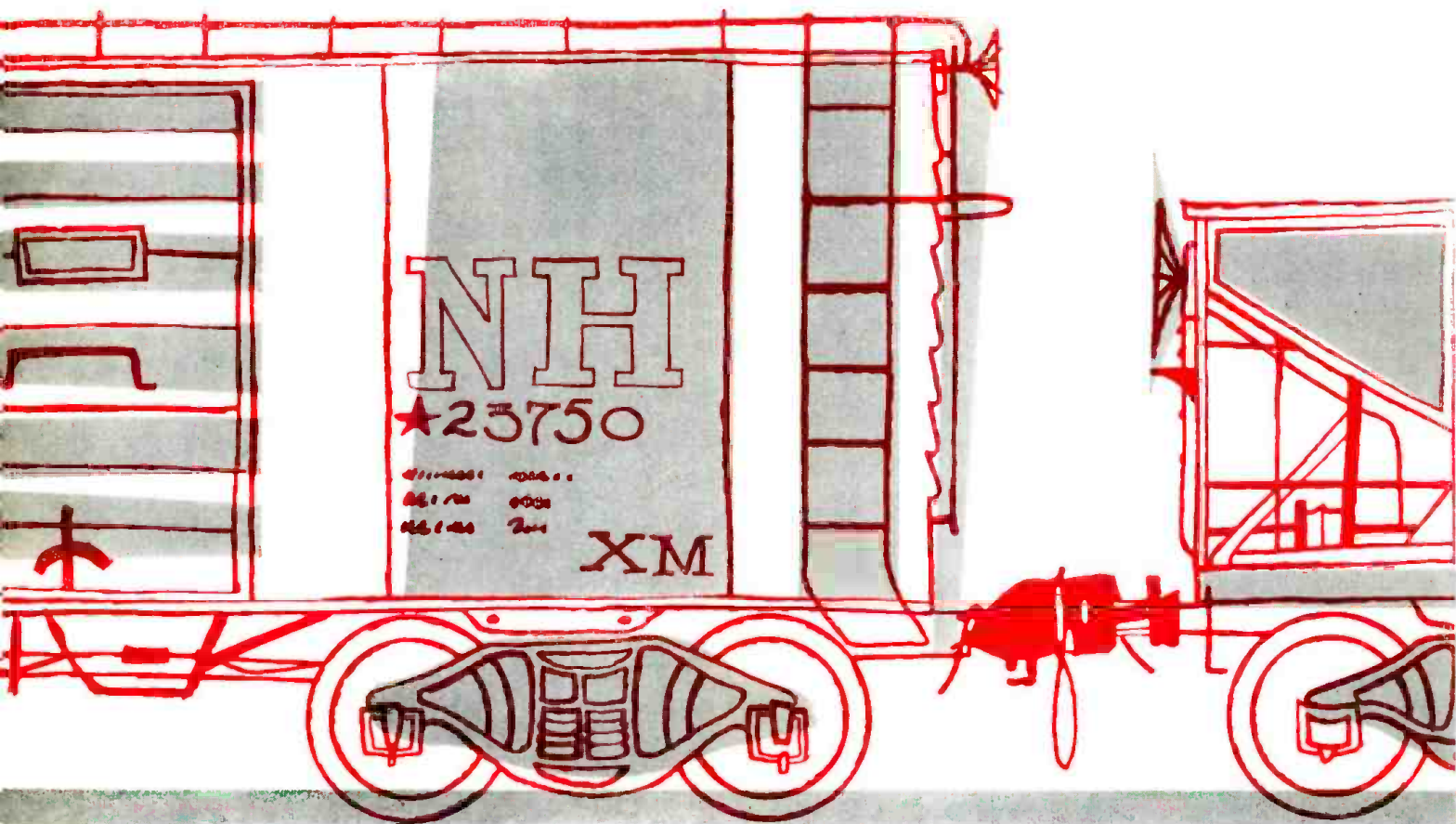
The Air Force is receiving militarized versions of the *Ampex* video tape recorder to be used by the Air Reconnaissance Laboratory. Both airborne and ground units are involved with a bandwidth of 10 cps to 4 mc. ( $\pm 3$  db). Commercial video tape recorders have an effective response out to 3 mc.



### R.F. Anechoic Room For Antenna Tests

Electronics engineers in this bizarre room simulate outer space in order to test the capabilities of an air navigation antenna. A specially constructed anechoic room at *ITT Federal Division* reduces radio reflections to a minimum so that only signals beamed at the receiving antenna affect the highly accurate measurements being taken. Porous plastic material covering the walls, ceiling, and floor, combined with sharply angled interior baffles make unwanted signal reflections and other interference negligible. The baffles, running the length of the 60-foot room, are designed so that random reflected radio waves take at least three bounces before reaching the detecting antenna.

61



# RAILROAD

**R**ADIO has not obsoleted the lantern. The lantern is still a very useful tool in railroad operations but radio has made life much more pleasant for railroad personnel and has contributed much to the more efficient operation of railroads. It is radio plus the diesel-electric locomotive which made it possible to haul longer trains, faster. It is in freight service, not in the operation of passenger trains, that railroads earn most of their income. And, it is in the operation of freight trains and the handling of freight cars that radio is of the greatest value to the railroads.

The most important application of radio in railroading is on freight trains to enable crews in the locomotive and the caboose to communicate with each other. Before radio, if the conductor wanted to stop the train he had no means of notifying the engineer. His only recourse was to open an air valve which applied the brakes. This often resulted in damage to the train. The engineer could communicate one way by tooting his whistle if the conductor could hear it. If you have ever ridden in a caboose, you can understand why this is an almost impossible feat.

Today, the conductor picks up his microphone to tell the engineer to "high ball" (go ahead) as soon as the flagman is back on board after pro-

tecting a standing train. When the engineer has a mechanical problem, he too can pick up his microphone and tell the conductor of his troubles. Before radio, the conductor might have had to walk a mile or more to the head end of the train to talk things over with the engineer.

Now, when a defect such as a "hot box" occurs, the defective car can be set on a siding and the train can get under way in minutes compared to sometimes several hours in pre-radio days. Train crews are often provided with "walkie-talkies" which are extremely valuable in coordinating such tricky maneuvers. And the lucky flagman who has a walkie-talkie won't get left in the wilderness, which has often happened in the past. He can use his radio to tell the engineer to get ready to go but wait until he is actually on board.

Before radio, train crews were out of touch with the outside world except when they picked up written messages as they passed wayside towers. Radio has not obsoleted the written train order, but radio has certainly simplified the passage of vital information.

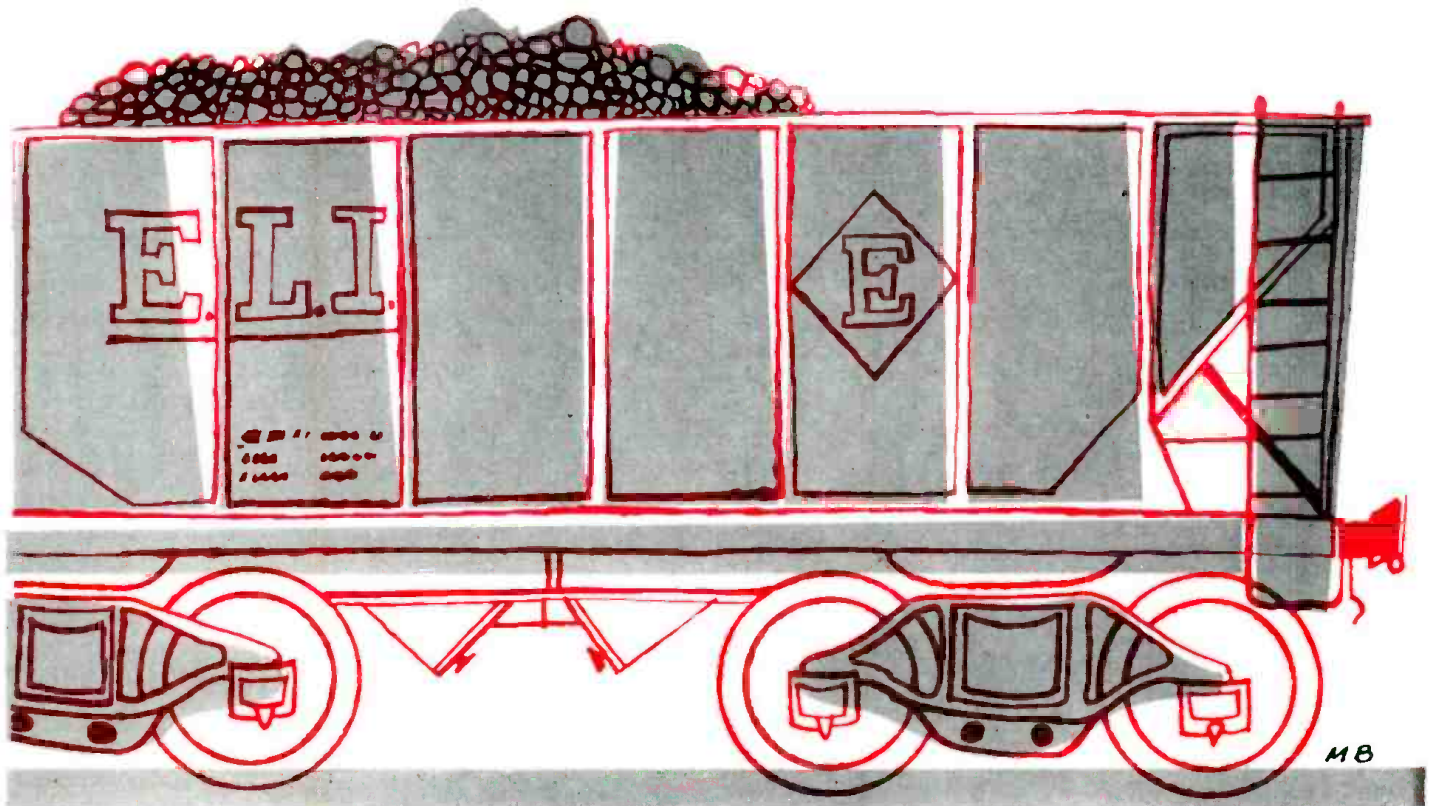
Railroad radio received its initial impetus when the *Rock Island Line* applied for a permit to experiment with two-way operation. This applica-

tion, filed in April of 1944, was granted in February 1945. The first permanent authorization for railroad radio service was issued to the *Denver & Rio Grande Western* in February 1946. Permission for hump-yard communications was granted in August 1946 to the *Baltimore & Ohio* for its New Castle, Pa. yards.

Now thousands of miles of railroad trackage are covered by radio communication with base stations spaced 10 to 50 miles apart along the right-of-way. Train crews can now keep in touch with wayside tower operators and sometimes directly with the dispatcher many miles away. And, when wire lines are down, wayside towers can use their radio stations for communicating with each other.

## Main Line Radio

A decade ago, radio was installed by the short but progressive *South Shore Line* which operates high-speed electric passenger service as well as freight trains between Chicago and South Bend. It was a newsworthy event because it was a case of the tail wagging the dog. This short-line railroad was the first in the United States to provide radio communication from one end of its system to the other. The installation was also significant because it was the first to use automatic relay stations to



# RADIO

Communications by radio is increasing the speed and efficiency with which our rail freight is handled.

extend coverage. No wire lines were required for interconnecting the three base stations, as is ordinarily the case in such installations.

The example set by the *South Shore Line* probably had an effect on the thinking of some of the larger systems who saw how valuable radio could be to a railroad. Today, many of the major roads have extensive right-of-way radio systems. While these radio stations are often controlled locally or from a nearby telegraph tower, many roads use wire lines for interconnecting wayside radio stations with the dispatcher's office. Various techniques are used for selecting wayside radio stations individually from the dispatcher's office. The dispatcher may push a button or dial a number to select a radio station nearest the train with whose crew he wishes to communicate.

One of the first long-haul, right-of-way radio systems utilizing selective control of base stations was installed by the *Northern Pacific Railway*. The *Erie* was the first to install a radio system on the run between Chicago and New York.

## Yard Communications

Communication within a railroad marshalling yard before the electron era consisted of direct word of mouth, sometimes augmented by colored light

This railroad yardmaster has complete communications at his finger tips. From his perch high above the Air Line Yard in Milwaukee, Wis., he can see freight yard operations. By operating switch keys on the console before him, he is able to talk with personnel on foot by means of two-way loudspeakers. He also has radiotelephone equipment for talking with crews on the engines. In addition, telephone lines are interconnected with the control console. At the left of the desk is a teletypewriter unit used to type out important messages. The over-all system thus represents an integration of radio, loudspeaker, telephone, and teletypewriter communications, all of which make for most efficient operation.





Yardmaster's tower in Barr Yard of B & O railroad near Chicago with its intercom, radio, and complete paging facilities.



The modern train dispatcher can keep in touch with commuter trains as well as profit-making freights with two-way radio.

signals. Electronics first made its appearance in the form of loudspeaker paging systems. This was one-way communication. However, two-way communication is required in order to affirm that an order has been received so telephones were used by yard personnel for replying.

Today's modern railroad yard is a maze of electronic gear. The one-way loudspeaker paging system is still there but personnel now reply through tiny hand-carried portable radio transmitters called "Dick Tracy" units by railroaders. The yardmaster switches on the paging loudspeakers in the specific area where he expects to locate the desired individual. Or, if he is apt to be almost anywhere, the yardmaster might page over the entire yard area.

When a yard employee hears his name called over the paging system, he merely holds the "Dick Tracy" unit near his lips and acknowledges the page. The feeble radio signal is picked up by a nearby remote radio receiver whose audio output is fed to the yardmaster's office. Thus, a two-way conversation may be held, using audio to talk out and radio to talk in.

In addition to a paging system, the modern railroad yard is provided with a gigantic intercom system, some con-

sisting of as many as 200 or more remote talk-back loudspeakers. These remote talk-back speakers are connected through underground cables to one or more control consoles, which resemble a pipe organ.

The yardmaster may page over the intercom system too. He flicks selector keys which group several talk-back speakers together, permitting low-level paging over selected areas. The paged person, in replying, merely steps up to the nearest talk-back speaker and pushes a signal button. This lights an identification lamp on the yardmaster's control console. The yardmaster then flicks the key associated with that lamp, switching that specific talk-back speaker into the circuit. The yardmaster talks out by speaking into a microphone and stepping on a foot switch under the console. To listen, he relieves the pressure on the foot switch.

The yardmaster can locate crews working in the yard area by flicking talk-back speaker selector keys on his console, one at a time, judging the location of the crew by listening to the incoming sounds.

There are several base radio stations in a typical, modern rail yard. One may be used for supervision of operations at the northbound hump,

another at the southbound hump, a third for communicating with trains approaching or leaving the yard and still another for communicating with work crews and motor vehicles.

Generally, each of the base stations has its own control point since each is used in its own individual operation. However, in order to give the yardmaster complete control of all operations, the control console in one or more yard towers may also serve as an additional control point for all of the radio stations.

In the modern yard, the yardmaster has his own office on the top floor of a tall tower, not unlike an airport control tower, from which vantage point he can see the entire yard. He sits at a giant console which opens avenues of communication to yard personnel via a paging system, intercom system, two-way radio, and telephone circuits. Each group of paging speakers, individual talk-back speakers, base radio stations, and several telephone circuits all terminate in the console and may be activated by merely flicking the appropriate selector key.

### Checking Cars

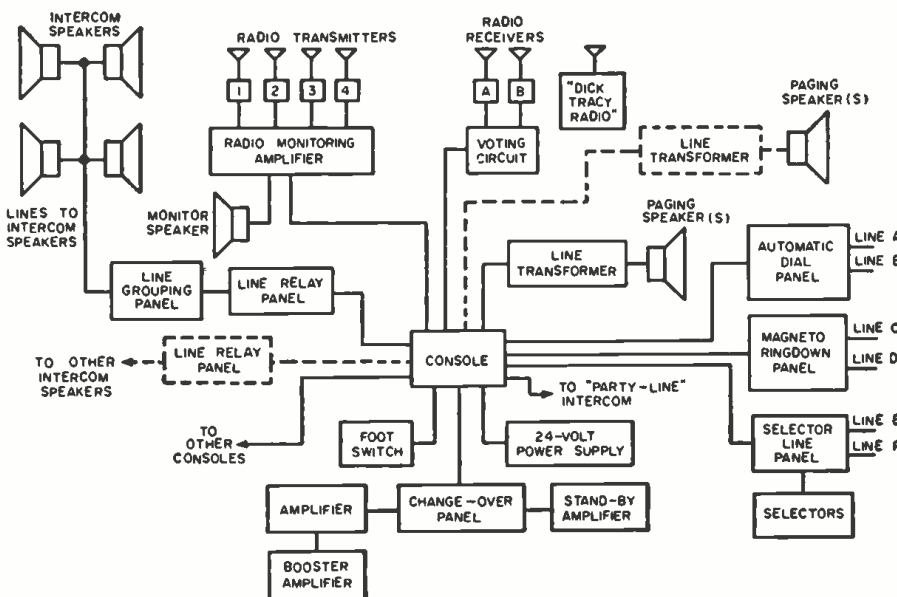
A few years ago, the car checker, who notes the numbers of all freight cars entering a yard, often had a miserable time trying to write down numbers in the rain or snow. Today, he carries a walkie-talkie with him and reads off the numbers which are taken down by a clerk inside a warm, cozy office, who sometimes tape records them for future reference. Here again, a separate base station is used for car checking so as not to clutter radio channels that are needed for other operations.

### Equipment

Railroad radio equipment is packaged in single-unit as well as in three-unit assemblies. The single-unit combines transmitter, receiver, and power supply in a single enclosure. The three-unit sets consist of a separately housed transmitter, receiver, and power supply.

While electrically similar to mobile radio equipment for use in motor vehicles, railroad radio equipment has to be more ruggedly constructed. The audio power output of a vehicular ra-

Block diagram of a typical railroad yard communications system.





Train engineers can keep in touch with wayside towers and can summon aid when needed if they have two-way radio installation.



Radiotelephone handset being used by engineer of diesel-electric freight locomotive on the B & O's radio traffic control system.

dio unit is about one to two watts, whereas railroad radio units deliver from five to ten watts of audio, required to override the ambient noise encountered in cabooses in particular. The modern diesel locomotive, on the other hand, rides almost as smoothly as a Pullman car and is very quiet compared to the obsolete "iron horse."

#### Power Sources

The typical diesel locomotive is equipped with a 64-volt battery which is used as the source of power for radio equipment. Early locomotive installations used radio units designed for operation from 117-volts a.c. A rotary or vibrator type converter is used for converting the 64-volts d.c. to 117-volts a.c. Later, railroad radio units were introduced which contain a vibrator power supply that permits direct operation from the 64-volt battery, eliminating the need for a converter.

The *Erie* railroad equipped its cabooses with 32-volt batteries of the same type as used on passenger coaches. An axle-driven generator keeps the battery charged. Because of the high cost of 32-volt batteries, the *Gulf, Mobile & Ohio Railroad* experimented with 6-volt automobile batteries kept charged by an ordinary automotive generator which was driven by the wheels of the caboose. Later, most of the railroads settled on using a 12-volt truck battery and an axle-driven rectifier-alternator.

Passenger cars and baggage cars are generally provided with a 32-volt battery and an axle-driven generator. Some cars, however, are equipped with 64-volt or 110-volt batteries.

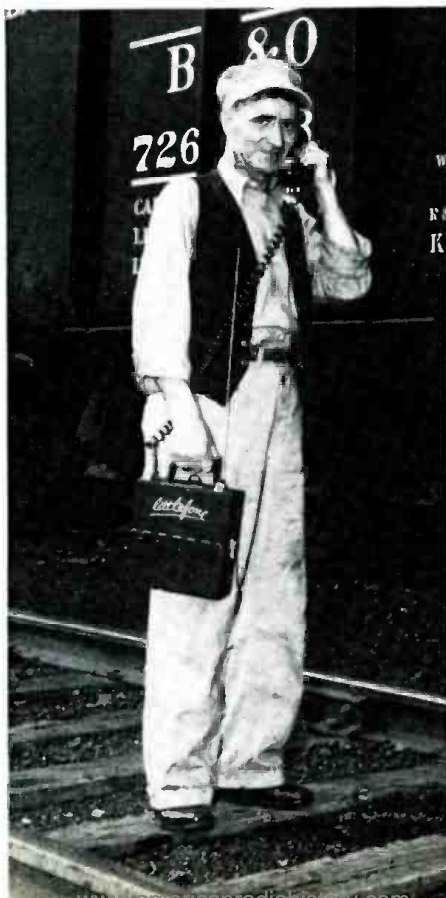
#### Communicating Frequencies

Most of the railroad radio systems in service operate in the 152-162 mc. band where 91 channels have been allocated to the Railroad Radio Service. Four channels are available in the 450-460 mc. band for use by the railroads and five channels are available in the 27 mc. band, but as this is written, so far there have been few takers. The reason for this is that the railroads prefer maximum interchangeability of equipment and do not want to mix brands or types. For example, a railroad that installs one brand of equipment generally sticks with the same brand when expanding.

While the railroads have been extremely fortunate in having so many channels assigned to them, the 152-162 mc. band does not offer a wholly satisfactory solution under all conditions. In some mountainous, densely wooded areas, for example, the range achieved when operating in the 152-162 mc. band is inadequate. Police radio systems operating in the same areas in the 25-50 mc. band enjoy much greater coverage. Sometimes such special installations are impractical because of cost and incompatibility with 152-162 mc. systems in use on the rest of the railroad.

Some railroads are, however, making use of the 450-470 mc. band in freight pick-up and delivery operations. Trucks, operated by railroad subsidiaries, are equipped with conventional, vehicular-type 450 mc. mobile radio units for communicating with dispatchers and expediting the handling

The walkie-talkie radio permits freight train conductor to remain in constant touch with the train's crew when the train stops.



of freight that is less-than-carload-lot.

#### Maintenance

Most railroads buy their own radio equipment which is installed and maintained by railroad personnel. A few have leased equipment from telephone companies or independent distributors of radio equipment. While most railroads handle their own radio maintenance, even those with extensive communications departments sometimes farm out radio servicing in certain areas to independent service dealers.

Radio equipment is seldom serviced on board a train. Instead, spare equipment is installed and the original equipment is brought into a shop for overhaul. Field servicing is generally limited to checking of the antenna system and electric power source.

Now that the railroads are making wide use of electronic devices, there are opportunities within the railroad industry for electronic technicians and engineers. The pay rate is good compared to many other industries but the biggest attraction is the security offered by the railroads. There is a pension plan which has deterred many from leaving railroad jobs for other fields. Those interested in railroad employment should get in touch with the superintendent of communications of the railroad with which they would like to become associated.

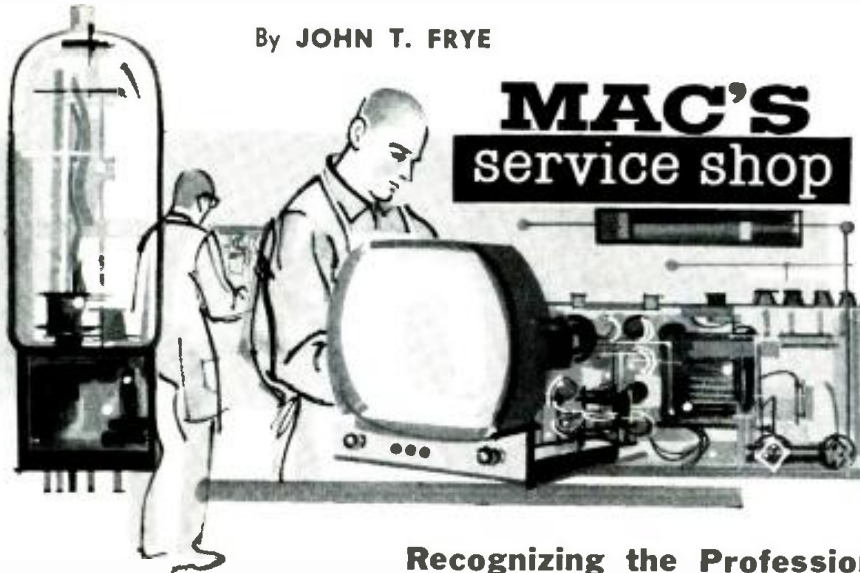
#### The Future

In the not-too-distant future, crews of terminal switching locomotives will be able to dial a number on an ordinary telephone dial when approaching a siding protected by a gate. When dialing, the radio transmitter in the locomotive sends out a combination of pulses which are picked up by a radio receiver near the closed gate. The pulses unlock a decoder which starts an automatic gate opening mechanism. The locomotive moves into the plant area through the open gate without first having to stop and wait until the gate is opened manually. Upon completion of the work in the plant area, the crew dials another number and the gate closes automatically.

Closed-circuit television is already being used in some yards, obviating the need for having a car checker stand out in the weather to read car numbers.

(Continued on page 83)

By JOHN T. FRYE



## Recognizing the Profession

**M**AC was just back from his Florida vacation, and he had the sun-burned, peeling skin to prove it. He was already whistling cheerily at the service bench when Barney, his red-headed assistant who had kept the store in his absence, came down to open up the shop.

"Hi, boss," the youth greeted him. "I'm glad to see you back, but I didn't expect you to be so eager to hit the ball. It's only a quarter of eight."

"Hi, Flame-head," Mac returned affectionately. "I just couldn't wait another minute to find out if you had run me completely out of business in two weeks. How did everything go?"

"Just like downtown," Barney said cheerfully. "I'll not lie and say we didn't miss you, especially when the dogs were giving me a hard time; but Matilda and I kept the doors open anyway, and the shop still has a few dollars in the bank. But where did you get that transistor set you're working on? It wasn't here when I closed up last night."

"I brought it back with me, and there's kind of a story goes with it if you have time to listen."

"I got all the time in the world," Barney said promptly as he hopped up on the bench; "but you know something? When I was in charge, I couldn't enjoy loafing at all. I felt guilty. But now you're back, gold-bricking is just as much fun as ever. Tell me about the radio, and take your time."

Mac favored him with a fierce scowl before he continued: "A few days before I got there my cousin's husband was fishing over at Sebastian Inlet and had this receiver playing on the front of the boat. In the excitement of landing a large fish, the set toppled over and fell into two or three inches of salt water accumulated in the bottom of the boat from waves and spray. It soaked there unnoticed for at least thirty minutes before it was rescued. The owner, not knowing what else to do, took it home and dried it out for an hour or so, but the transistor set still didn't play.

"When I arrived, he placed it trustingly in my hands and asked me to 'fix' it. After all, I was a radio man, wasn't I? When I took off the back, I saw a very sorry sight. That sea water is about the most corrosive stuff you ever saw, and it had really gone to work on the inside of this receiver. Batteries, printed circuit conductors, shield cans—in fact, every metallic surface—was covered with a thick and growing furry green coat of corrosion. I explained this was something technicians in our area never encountered and suggested I talk with a local technician to see what the treatment and prognosis was on a receiver dunked in salt water.

"I picked a radio and TV shop at random from the Orlando phone book and asked for the service manager. He was out to coffee. So were the service managers of the next four shops I called! Apparently the mid-morning coffee break is a flourishing institution in Southern service shop circles. The manager of the next service store was in. I started to explain to him that I was a service technician down there on vacation and would appreciate a little advice on a problem peculiar to the area. He interrupted me to say that I was not fooling him one bit! He knew I was just leading up to an attempt to sell him something and that if I wanted to talk business with him I could call at his shop; and he slammed down the receiver. Apparently my 'dam-yankee' accent made him suspect me.

"By this time I was growing a little discouraged, but I made one more call to *Dodson's Radio & TV Service* on E. South Street. I was connected to Mr. Royal Dodson himself, and he listened patiently to my story. Then he told me that salt water soaked radios were a very common service problem in the area. He went on to say that if the radios were thoroughly cleaned with carbon tetrachloride within a very short time after the immersion, they usually could be restored to playing condition; but if they were allowed to lie around for several days with that hygroscopic, corrosive salt in them, the

possibility of their ever playing again was small. He was most pleasant and cordial and invited me out to see his establishment. I explained my Orlando relatives had almost every minute of the vacation planned and that it was doubtful if I could break away; but we did have a nice chat about mutual problems and those peculiar to our respective localities. His warm friendliness made me truly sorry I did not get to meet him and see his shop.

"The experience carried me back to when I was a small boy in Weiner, Arkansas, and my dad operated a pioneer movie house. By modern standards, it was certainly crude. The customers sat on long benches instead of individual seats; we had only one projector and had to stop at the end of each reel and put in a new one; and, of course, there was no sound except the enthusiastic advice or criticism given the actors by the small boys occupying the front rows. Mom sold tickets; I took them in; my brother operated the projector; and dad kept the 32-volt d.c. *Delco* generator going to provide power for the theater. (As you can see, the Gem Theater was a family operated affair.) But it was the only public entertainment for miles around, and it was regarded with far more affectionate awe than even the scientific marvel of color television can inspire in the blasé audiences of today.

"One day a small travelling circus with a mangy lion and a moth-eaten camel pitched its tent in our little town. That night mother suddenly saw a pair of small grubby hands appear at the edge of the ticket window, and a very small and dirty boy pulled himself up to where she could see him. 'Can I see the manager?' he asked gravely.

"Mom summoned dad with a buzzer, and the little boy looked him straight in the eye and asked, 'Do you recognize the profession, mister?'

"'We certainly do!' my father instantly replied. 'Go right on in—no, wait a minute. Take this box of Crack-erjack with the compliments of the house. We hope you enjoy the show.'

"'Thank you kindly, mister; and we'd be mighty proud to have all of you as our guests at the circus tomorrow,' the little fellow said as he walked into the show. We went, too, and were treated as though we were the salt of the earth.

"That incident made a deep impression on me, and it always pops into my mind when I see a demonstration of professional courtesy between service technicians. I do not hold with the idea we are supposed to regard our competitors with jealousy, suspicion, and contempt. I am very proud of the fact that we are on good terms with all our competitors. As you know we often get calls from them asking to borrow a component temporarily out of stock; and we do not hesitate to call them under the same circumstances. On several occasions I have had service technicians from another area drop into

(Continued on page 98)

# SUCCESSFUL SERVICEMEN



**SAVE  
CUSTOMERS**



**SELL MORE  
TUBES**

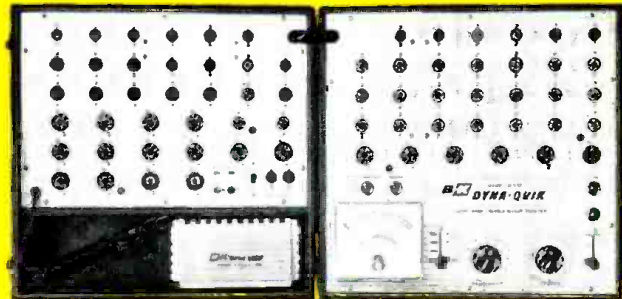


**MAKE  
MORE MONEY**

WITH **B&K**  
**DYNA-QUIK**  
DYNAMIC MUTUAL CONDUCTANCE  
**TUBE**  
AND TRANSISTOR  
**TESTERS**

Many thousands of servicemen today insure their professional reputation and make each job more profitable—with B&K testers. Each model is based on actual servicing experience, and combines both speed and accuracy. Each is designed to meet individual servicing needs. Each is a top value, with features that mean more for your money.

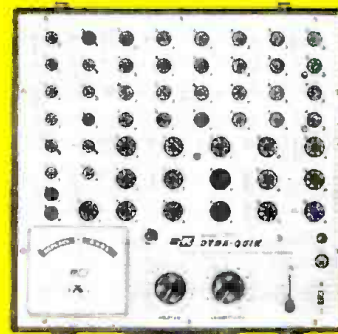
Measures true dynamic mutual conductance— not just emission. Makes complete tube test under the actual dynamic operating conditions of the TV set. Tests complete set in minutes. Shows your customer the true tube condition. Sells more tubes right-on-the-spot. Saves costly call-backs. Pays for itself over and over again. It's good business to choose B&K.



**MODEL 650.** Fastest and most complete portable Tube and Transistor Tester. Checks over 99% of the tubes most widely used in television receivers. Tests each section of multiple tubes separately for Gm, Shorts, Grid Emission, Gas, and Life. Includes spare sockets and filament voltages for future new tube types. Tests transistors, too. Net, **\$179<sup>95</sup>**



**MODEL 675.** Completely reliable, long-service Automatic Tube and Transistor Tester. Only 60 indexed phenolic Dyna-Cards test over 99% of tubes most widely used in television receivers. Tests each section of multiple tubes separately for Gm, Shorts, Grid Emission, Gas, and Life. Easily kept up-to-date with extra cards and punch included. Tests transistors, too. Net, **\$169<sup>95</sup>**



**MODEL 550.** Low-cost professional model for limited budgets. Provides 52 tube sockets to test more tubes faster, easier. Accurately quick-checks most of the television tubes usually encountered in everyday service work. Tests each section of dual tubes separately for shorts, grid emission, gas content, and leakage. No multiple switching. Big value. Net, **\$119<sup>95</sup>**



See Your B&K Distributor or Send for Bulletin AP15 N

**B & K MANUFACTURING CO.**  
1801 W. BELLE PLAINE AVE • CHICAGO 13, ILL.

Canada: Atlas Radio Corp., 50 Wingold, Toronto 10, Ont. • Export: Empire Exporters, 277 Broadway, New York 7, U.S.A.

HEATH  
PRESENTS  
**18**  
NEW  
ITEMS  
for  
your  
summertime  
enjoyment

a subsidiary of  
**DAYSTROM, INCORPORATED**



**"ECONOMY" STEREO AM/FM TUNER KIT (AJ-10)**

Full fidelity AM and FM reception, plus up-to-the-minute design features are yours at minimum cost with this new Heathkit stereo tuner. Features include: 2.5uv sensitivity for 20 db quieting; individual flywheel tuning; separate magic-eye tuning indicators for AM and FM; AM bandwidth switch; 3-position (off-half-full) automatic frequency control (AFC); FM multiplex adapter output. 14 lbs.

AJ-10 **\$59<sup>95</sup>**

\$6.00 dn., \$6.00 mo.

**HI-FI RATED 25/25 WATT STEREO AMPLIFIER (AA-50)**

In one handsome package, you get both stereo power and control, with a host of deluxe features. Hi-fi rated at 25 watts per stereo channel (50 watts mono), this new Heathkit design includes channel separation control; new mixed center speaker output; stereo reverse and balance controls; separate tone controls for each channel with ganged volume controls; five switch-selected inputs for each channel (stereo "mag. phono," tape head, 3 hi-level). Extra input for mono "mag. phono." Special outputs for tape recording. Ease of assembly assured by two circuit boards. 30 lbs.

AA-50 **\$79<sup>95</sup>**

\$8.00 dn., \$8.00 mo.

**MIXED LOWS  
STEREO CROSSOVER KIT (AN-10)**

Permits using one bass woofer and more economical "wing" speakers for stereo. Delivers non-directional bass of both channels below 250 cps to one woofer; passes higher frequencies to wing speaker. Takes 25 watts per channel; 8, 16 ohm woofers; 8 ohm high freq speakers. 10 lbs.

AN-10 **\$19<sup>95</sup>**

*Player Kit by Heath—  
Mechanism by Garrard*

**MANUAL  
STEREO RECORD PLAYER KIT (AD-10)**

Rubber matted heavy turntable is shock mounted, and idler wheels retract to prevent flat spots. 4-pole motor; 16, 33 $\frac{1}{3}$ , 45 and 78 RPM; Sonaone 8TA 4-SI ceramic stereo turnover cartridge with diamond and sapphire styli; preassembled mechanism and base. 10 lbs.

AD-10 **\$33<sup>95</sup>**





**Quality Stereo at Minimum Cost**

**ECONOMY STEREO PREAMPLIFIER KIT (AA-20)**

A low-cost, versatile stereo preamp-control center. Four inputs each channel accept magnetic cartridge, crystal or ceramic cartridge, and tuner, tape, TV, etc. Six position function switch gives flexible stereo or monophonic use. Features cathode follower outputs plus hi-level outputs for tape recorder drive, calibrated Baxandall-type tone controls for each channel, clutch-type volume controls, filament balance controls, and accessory AC sockets. Self-powered. Styled in black and gold. 8 lbs.

AA-20 **\$34.95**

**PROFESSIONAL RATED 35/35 WATT BASIC AMPLIFIER KIT (AA-40)**

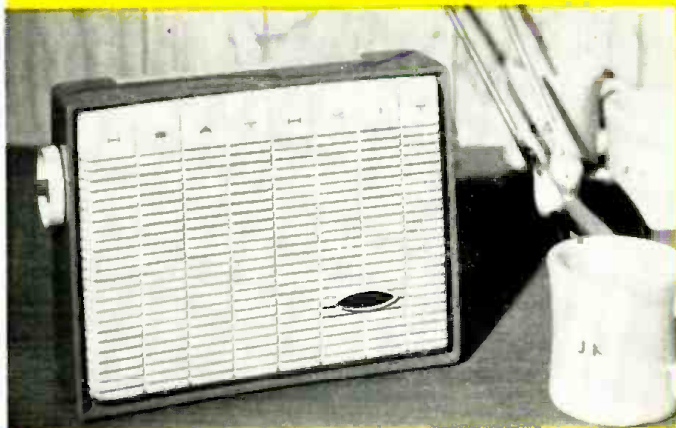
Doubles as a superb dual 35 watt stereo amplifier or a full-fledged 70 watt monophonic amplifier. Features a mixed-channels center speaker output for fill-in sound, and individual level controls for stereo. "Stereo-Mono" switch ties both amplifiers to one level control for monophonic use. Dual outputs for 4, 8, 16, and 32 ohm speakers. Paralleling outputs for 70 watt monophonic use matches 2, 4, 8, and 16 ohm speakers. 41 lbs.

AA-40 **\$79.95**  
\$8.00 dn., \$8.00 mo.

**HI-FI RATED 14/14 WATT BASIC STEREO AMPLIFIER KIT (AA-30) (not illustrated)**

14 watts per channel, separate level controls, local/remote power switch, circuit board. Styled like AA-40 above. 21 lbs.

AA-30 **\$45.95**



**Perfect for Summer Sun and Fun!**

**6-TRANSISTOR PORTABLE RADIO KITS (XR-2 Series)**

Assembled in only a few hours, both of these models incorporate superior design, features that will give you portable-listening enjoyment day after day. Vernier tuning control gives smooth, easily-separated station tuning. Large 4" x 6" PM speaker with heavy magnet provides "big set" richness of tone. Operates on standard size "D" flashlight batteries. Six Texas Instrument transistors.

XR-2P (plastic) 6 lbs. **\$29.95**  
XR-2L (simulated leather) 7 lbs. **\$34.95**

**MOBILE PA SOUND EQUIPMENT**

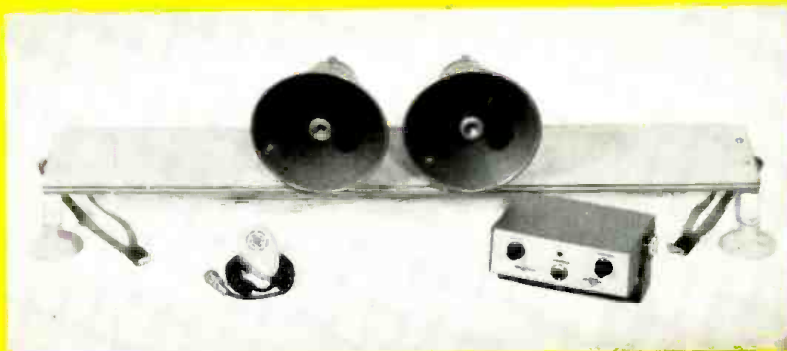
Perfect for political campaigns, advertising, sporting events... hundreds of PA applications. The 10 watt amplifier operates from any 12 to 15 volt battery. Features an all-transistor circuit for rugged, dependable performance and long life. No warm-up time required. Mounts easily under auto dash. Inputs for microphone and music source. Two channel mixing circuit "fades" auxiliary input when used with microphone supplied... lets you override music with voice without changing control settings. Outputs for 8 and 16 ohm speakers.

**MOBILE PA AMPLIFIER KIT (AA-80) 7 lbs. \$39.95**

**COMMERCIAL SOUND SYSTEM (CSS-1)** consists of AA-80 Amplifier; microphone; ear-top carrier; one 16 ohm, 15 watt outdoor speaker. 19 lbs. **\$84.95**

**COMMERCIAL SOUND SYSTEM (CSS-2)** same as above except with 2 speakers. 25 lbs. **\$99.95**

**EXTRA HORN SPEAKERS (401-38):** As described above 6 lbs. **\$19.95**

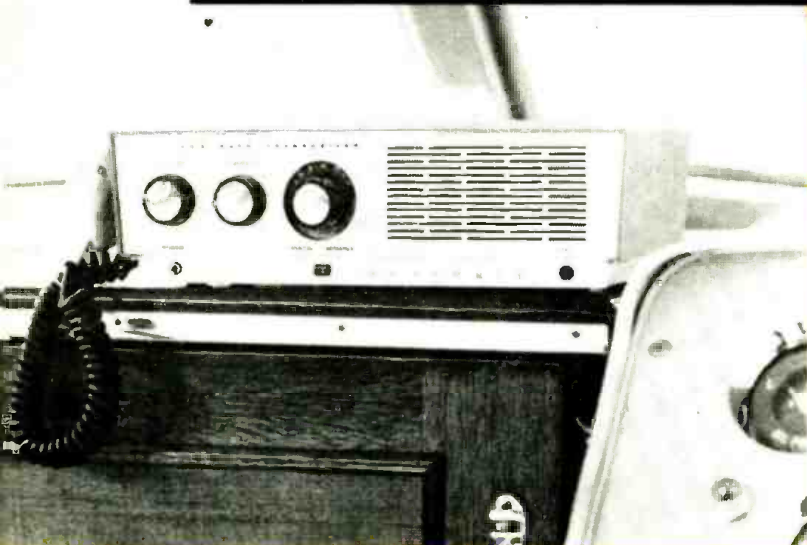


**FREE CATALOG**

Send for your free Heathkit catalog today... describes over 150 hi-fi, ham, test, marine, and general kits.



# NEW! Citizens Band Transceiver...



## CITIZENS BAND TRANSCEIVER KIT (GW-10)

Now, from Heath, a new 2-way Citizens Band Transceiver with every modern improvement for clear, noise-free operation. The superheterodyne receiver section may be either crystal controlled on any one predetermined channel, or all 23 channels may be continuously tuned by the front panel tuning knob; a front panel switch selects either crystal or variable control. An automatic "series gate" noise limiter minimizes impulse-type noises (ignition interference, etc.). Adjustable squelch control silences the receiver during "stand-by." Press-to-talk microphone features a coil-cord connection to the transceiver. Transmitter is crystal controlled on any one of 23 assigned channel frequencies chosen. Order model GW-10A for 117v AC operation; order GW-10D for 6 and 12v DC operation, both with self-contained power supply, 11 lbs.

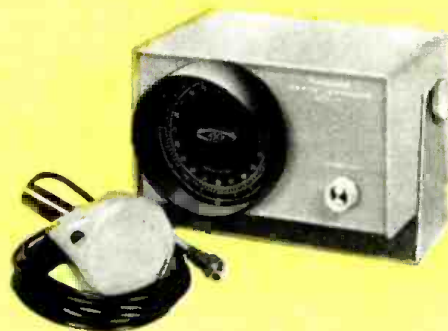
GW-10A or GW-10D **\$62<sup>95</sup>** each  
\$6.30 dn., \$6.00 mo.



## 3 band "Mariner"™ TRANSISTOR DIRECTION FINDER KIT (DF-3)

Features nine-transistor circuit, flashlight battery power supply, pre-assembled, pre-aligned tuning section, three bands (beacon-aeronautical, broadcast and marine-telephone), and a new "sense" antenna system that eliminates 180° ambiguity in bearings. Splash resistant, 13 lbs.

DF-3 **\$99<sup>95</sup>**  
\$10.00 dn., \$9.00 mo.



## For Boating, Fishing, Skindiving

### TRANSISTOR DEPTH SOUNDER KIT (DS-1)

Completely transistorized. Indicates depth, type of bottom, and submerged objects, from 0 to 100 feet. Powered by 6 flashlight batteries for complete portability. Transducer included may be mounted through hull, or temporarily outboard. Rugged, splash-resistant cabinet. Adjustable mounting bracket, 10 lbs.

DS-1 **\$69<sup>95</sup>**  
\$7.00 dn., \$7.00 mo.



## Ten-transistor "Mohican"™ GENERAL COVERAGE RECEIVER KIT (GC-1)

First kit of its kind to use ceramic IF "Transfilters." Covers 550 to 30 mc on 5 bands, with 5 separately calibrated bands to cover amateur frequencies (including 11 meter citizens band). Powered by 8 flashlight batteries. Built-in 54" whip antenna, tuning meter, headphone jack, 20 lbs.

GC-1 **\$109<sup>95</sup>**  
(Less Batteries)  
\$11.00 dn., \$10.00 mo.

## First of a Series

### EDUCATIONAL KIT (EK-1)

Teaches, as you build, the basic "yardsticks" of electronics... opens up fascinating areas of study for youngsters and adults alike. The combination kit and text-workbook gives you a practical demonstration of the principles of voltage, current and resistance, the theory and construction of direct current series and parallel circuits, voltmeter, ammeter and ohmmeter circuits and the application of ohms law to these circuits. The completed meter is used to verify ohms law and the maximum power transfer theorem, one of the most important theorems in electronics. The finished kit, a practical volt-ohm-milliammeter, may be used in a variety of applications. Procedures for checking home appliances and automobile circuits included with the kit. The EK-1 will serve as a prerequisite to following Heathkit Educational kits; get started NOW in this "learn-by-doing" series, 4 lbs.

EK-1 **\$19<sup>95</sup>**



Outstanding Professional Quality...

**MUTUAL CONDUCTANCE  
TUBE TESTER KIT (TT-1)**

An impressive list of electronic and mechanical features make this tube tester one of the finest values in the electronics industry. Test Gm (amplifiers) from 0 to 24,000 micromhos. Emission, Leakage, Grid Current (¼ microampere sensitivity). Voltage Regulators (built-in variable DC power supply). low power Thyatron and Eye tubes. Features 300, 450 and 600 ma constant current heater supplies. Life test. Hybrid tube test, built-in switch-operated calibration circuit. Large, easy-to-read meter. Constant tension, free rolling illuminated chart. Kit includes 7 wiring harnesses. Assembly skill of technician or higher recommended. assembly time, 40 hours average. Black leatherette case with white trim, nylon feet, removable top. A specialized tool of unusual value that will pay for itself many times over. 27 lbs.

TT-1 **\$134<sup>95</sup>**

\$13.50 dn., \$12.00 mo.

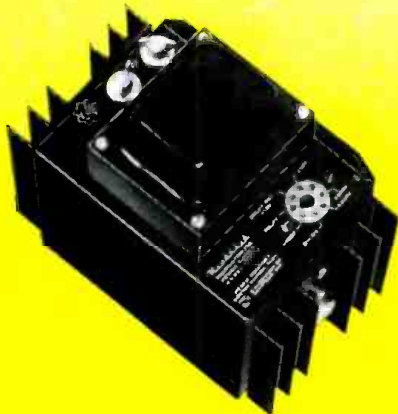


*New Improved Design*

**TRANSISTOR MOBILE  
POWER SUPPLY (HP-10)**

All transistor circuit! Operates from 11 to 15VDC input; at 12VDC provides 600 VDC @ 200ma, or 600VDC @ 150ma & 300VDC @ 100ma simultaneously, at 120 watts. Negative 125V @ 30 ma also provided. Max. ambient temp. 150° @ 120 watts ICAS. Input required: 2 amps idling; 13 amps full output. Includes heavy filtering, remote relay primary control, silicon rectifiers, aluminum heat sinks. 10 lbs.

HP-10 **\$44<sup>95</sup>**



*NEW Six and Ten Meter*  
**TRANSCIVER KITS  
(HW-19 and HW-29)**

Combination crystal controlled transmitters and variable tuned receivers operating fixed or mobile on the 6 and 10 meter amateur bands (50-54 mc for HW-29 and 28-29.7 mc for HW-19). Superregenerative receiver pulls in signals of 1 microvolt; transmitter input approximately 5 watts. Built-in 117 VAC power supply, metering jack, press-to-talk switch. 10 lbs.

HW-19 (10 meters) **\$39<sup>95</sup>**  
HW-29 ( 6 meters) **\$39<sup>95</sup>**

Less crystal



send today for Your  
**FREE HEATHKIT® CATALOG**

Over 150 items of hi-fi,  
marine, amateur, test and general  
equipment are illustrated  
and described in the complete  
Heathkit catalog.



**Heathkit® gives you more  
in these 10 ways**

1. BUILDING A HEATHKIT IS EASY—Check-by-step instruction manuals make it virtually impossible for you to fail.
2. BUILDING A HEATHKIT IS QUICK—No complicated, technical jargon for you to decipher; at most, a Heathkit takes only a few evenings to assemble.
3. BUILDING A HEATHKIT IS ECONOMICAL—Mass production and purchasing economies are passed directly along to you, our customers.
4. BUILDING A HEATHKIT IS EDUCATIONAL—As you build, you learn . . . more about electronics, more about the component units and when and where to add them.
5. BUILDING A HEATHKIT IS FUN—Nothing quite equals the sense of achievement you receive when you successfully complete a Heathkit unit and "tune-in" for the first time.
6. YOUR HEATHKIT IS GUARANTEED—Every Heathkit unit is guaranteed to meet advertised performance specifications . . . or your money will be cheerfully refunded.
7. YOUR HEATHKIT IS AVAILABLE ON CONVENIENT CREDIT—Our time payment plan makes it possible for you to order now . . . pay later.
8. YOUR HEATHKIT IS TOPS IN QUALITY—The very finest in electronic equipment comes to you in kit form from the Heath Company.
9. HEATHKIT DEALERS CAN SERVE YOU LOCALLY—Carefully selected Heathkit representatives are available in many localities. The convenience of local Heathkit sales and service costs but a few dollars more.
10. HEATHKIT SERVICE IS CUSTOMER SERVICE—Our staff of technical experts is always ready to answer your questions or help you if you have any difficulty.

A



a subsidiary of  
**DAYSTROM, INCORPORATED**

**ORDERING INSTRUCTIONS**  
Fill out the order blank below. Include charges for parcel post according to weights shown. Express orders shipped delivery charges collect. All prices F.O.B. Benton Harbor, Mich. A 20% deposit is required on all C.O.D. orders. Prices subject to change without notice.

**HEATH COMPANY, Benton Harbor 15, Michigan**

Please send the following HEATHKITS:

ITEM	MODEL NO.	PRICE

Ship via ( ) Parcel Post ( ) Express ( ) COD ( ) Best Way

( ) SEND MY FREE COPY OF YOUR COMPLETE CATALOG

Name \_\_\_\_\_

Address \_\_\_\_\_

City \_\_\_\_\_ Zone \_\_\_\_\_ State \_\_\_\_\_

Dealer and export prices slightly higher.

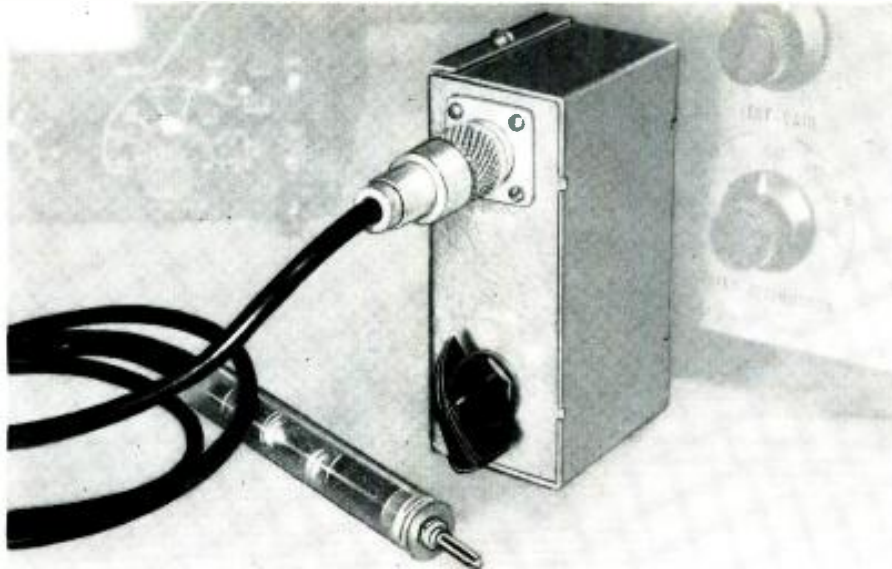


Fig. 1. The hand-sized signal booster with the probe that houses the first stage.

# A Transistorized Instrument Preamplifier

By CHARLES CARINGELLA

Avoiding tubes eliminates many of the problems that occur with these low-level test accessories.

THE OCCASION for measuring a.c. signals that are very low in level, in the millivolt range and sometimes even in microvolts, is not an unusual one in the service shop, on the experimenter's bench, or in the laboratory. This is borne out by the fact that preamplifiers to bring these low-amplitude signals up to a sufficient level so that they may be handled by oscilloscopes and v.t.v.m.'s of ordinary sensitivity are always being described in print.

Despite their number, these signal boosters are generally built to use tubes. Developing a transistorized amplifier for such use presents problems, but the potential advantages make the effort worthwhile. The problems chiefly

involve obtaining a reasonably high input impedance and adequate frequency response. The obvious advantages are reduced size, lower power requirements, and the flexibility in use permitted by the fact that a line cord to be plugged into an external power source is not involved. Perhaps more important than any of these is another advantage. Tube microphonics are always a serious handicap where low-level signals are involved, as is the possibility of hum, and tube selection is not a permanent solution. Transistor's get away from microphonics. Battery power eliminates hum. The preamp described here has proven itself, in use, as a satisfactory reconciliation

between advantages and disadvantages.

The plug-in preamp along with a companion input probe is shown in Fig. 1. The schematic diagrams for both probe and preamp are in Fig. 2. The probe consists of an emitter-follower circuit, which is somewhat analogous to a cathode-follower. The emitter-follower,  $V_1$ , is essentially a common-collector amplifier having a high input impedance and a low output impedance. The voltage gain is nearly unity.

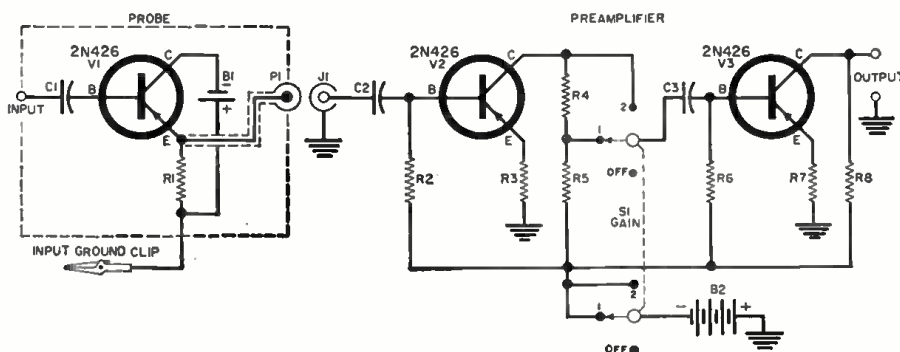
The common-collector configuration was chosen in order to raise the input impedance of the system to a useful value. Thus the input impedance of the emitter-follower probe is .5 megohm as compared to 15,000 ohms for the amplifier itself. The output impedance of the emitter-follower is 1500 ohms, and the frequency response for this part of the circuit is flat from 10 cycles to 2.5 megacycles.

The probe is powered by its own small 1.34-volt mercury battery. The latter was soldered directly into the circuit, since the current drain is only 125 microamperes and the cell should therefore last the equivalent of its shelf life. Transistor  $V_1$ , capacitor  $C_1$ , emitter resistor  $R_1$ , and the battery are all mounted in the probe housing.

Succeeding the emitter-follower is a two-stage RC-coupled amplifier employing two transistors in a common-emitter configuration. A voltage gain of either approximately 100 or 400 is attained by the amplifier depending on the position of "Gain" switch  $S_1$ .  $S_1$  also serves as the power switch for the amplifier.

Emitter resistors  $R_2$  and  $R_3$ , which are not bypassed, provide degenerative

Fig. 2. The emitter-follower probe has high input impedance, broad bandwidth.



- $R_1$ —4700 ohm,  $\frac{1}{2}$  w. res.  $\pm 5\%$
- $R_2, R_3$ —1.6 megohm,  $\frac{1}{2}$  w. res.  $\pm 5\%$
- $R_4, R_7$ —47 ohm,  $\frac{1}{2}$  w. res.  $\pm 5\%$
- $R_5$ —680 ohm,  $\frac{1}{2}$  w. res.  $\pm 5\%$
- $R_6$ —6100 ohm,  $\frac{1}{2}$  w. res.  $\pm 5\%$
- $R_8$ —6600 ohm,  $\frac{1}{2}$  w. res.  $\pm 5\%$
- $C_1, C_2, C_3$ —1  $\mu$ f., 200 v. metallized paper capacitor
- $J_1$ —Coax chassis connector (Amphenol 83-1R)

- $P_1$ —Coax cable plug (Amphenol 83-1SP with reducer for small coax)
- $S_1$ —D.p. 3-pos. rotary switch (Centralab PA-2002)
- $B_1$ —1.34 v. mercury cell (Mallory RM-401R)
- $B_2$ —4 v. mercury cell (Mallory TR-233R)
- $V_1, V_2, V_3$ —2N426 switching transistor (Motorola)
- 1— $1\frac{1}{8}$ " x 2" x 4" chassis box

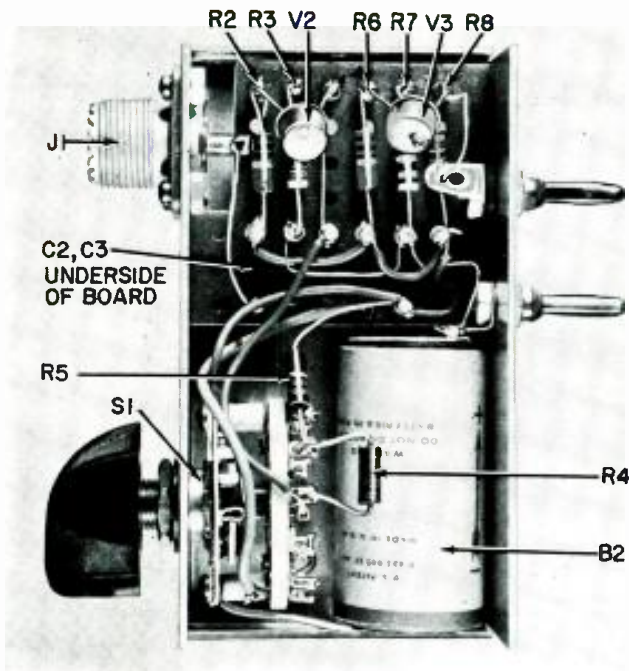


Fig. 3. Despite the exceptionally small housing, the two stages of the main amplifying circuit can be laid out without overcrowding with the use of a section of perforated chassis board. The location of all components except two is indicated clearly here.

feedback. This stabilizes each transistor and prevents thermal runaway when the junction temperature rises. This feedback also results in uniform voltage gain throughout the bandwidth of the amplifier. The response of the amplifier is thus flat from 50 cycles to 100,000 cycles. Coupling capacitors  $C_1$ ,  $C_2$ , and  $C_3$  can be increased in value if coverage below 50 cycles is desired. Total current drain from the amplifier section is 1 ma. Thus the power provided by a 4-volt, 2200-ma.-hour mercury battery will last for three months even if the amplifier is in constant use.

### Construction

The preamplifier was assembled in a chassis box measuring  $1\frac{1}{2} \times 2 \times 4$  inches. Coax connector  $J_1$  and the "Gain" switch are located on the front side. A sub-chassis was fashioned from a piece of perforated chassis board. The components were anchored to tie-points on the sub-chassis, including the transistors, which were soldered directly into the circuit. Caution must be exercised when soldering directly to transistors. It is recommended that the lead being soldered be held with a pair of needle-nose pliers as close to the transistor as possible to conduct most of the heat away.

The location of most of the components in the preamp can be seen in Fig. 3. Capacitors  $C_2$  and  $C_3$  are not visible here, as they are located on the underside of the sub-chassis. The package was designed so as to plug into any of those oscilloscopes having standard 5-way binding posts for input connections. Two banana plugs were mounted on the back side of the chassis box. These plugs, of the stud-mount type, were spaced  $\frac{3}{4}$  inch from each other, as are the binding posts on the scope. While this arrangement was most satisfactory for the author's particular conditions of use, those who own scopes

with different input arrangements or who wish to make allowances for connection to meters can alter the output arrangement.

The emitter-follower probe is housed in a piece of plastic tubing which is approximately  $5\frac{1}{2}$  inches in length. End caps were fashioned from plastic and cemented to the tubing. A hole was drilled in one of the end pieces for the coax cable. A third stud-mount banana plug is mounted on the remaining end piece, and serves as the input tip for the probe. The inside diameter of the plastic tubing is dependent upon the physical size of the input capacitor,  $C_1$ . This capacitor may have to block fairly high values of d.c. if the a.c. voltage being measured is "riding" on such a d.c. voltage. A compromise between physical size and voltage rating is

necessary in order to keep the probe to a reasonable size. In most applications, a 200-volt capacitor will be sufficiently large. In that case, the capacitor specified in the parts list can be used and the tubing should have an inside diameter of no less than  $\frac{5}{8}$  inch. If the need for a larger capacitor is anticipated, then the diameter of the tubing should be increased accordingly. A pictorial wiring diagram of the probe is shown in Fig. 4 to indicate how interconnections are made. After this has been done, it is a simple matter to fit the components into the housing as seen in Fig. 5.

### Conclusion

The preamplifier has proven itself as a reliable and rugged instrument on the bench and in the lab. The probe and the preamp both are relatively inexpensive to construct. Standard, readily available components have been used throughout, and construction can be accomplished without the need for elaborate equipment—an advantage to newcomers to transistor work.

Uses for the transistorized booster need not be restricted to the oscilloscope, of course, although the author has found it most valuable for him in that application. When the preamp is used with a v.t.v.m., the voltage being measured can be read directly on the meter scale in most cases. For example, with the v.t.v.m. or v.o.m. set for 1.5 volts full scale and the preamp set for a voltage gain of 100, the actual full-scale reading would be 15 millivolts. The useful range of input voltages to the preamp is from approximately 1 microvolt to 100 millivolts. One closing word of caution: Be careful not to exceed the voltage rating of the probe input capacitor when making measurements.

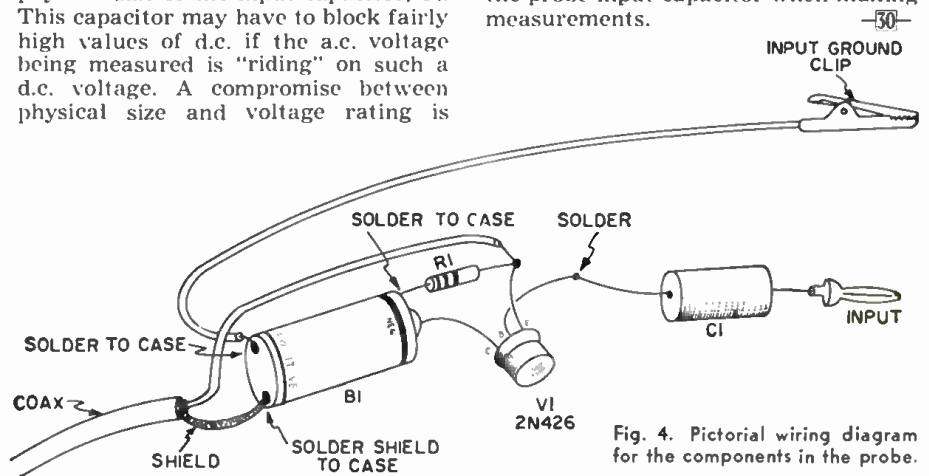
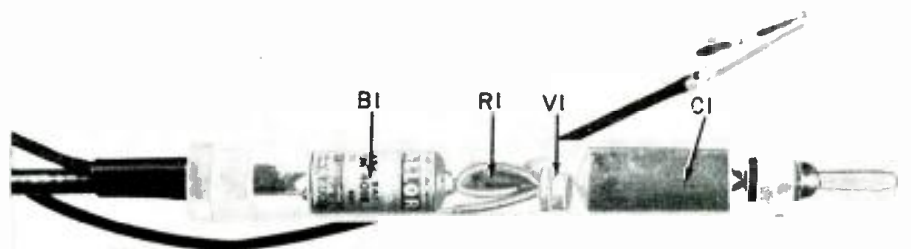


Fig. 4. Pictorial wiring diagram for the components in the probe.

Fig. 5. Once wired together, probe components fit into their housing like this.



# 4 GREAT NEW SAMS BOOKS

## "Tube Substitution Handbook"

Compiled by the engineering staff of Howard W. Sams & Co., Inc. Lists over 1500 American receiving tubes, including more than 300 which can be replaced by European receiving tube types. Also lists 400 picture tubes; 179 European types that can be replaced by American tubes, and 78 receiving tubes replaceable by industrial types. Includes helpful facts on tube substitution. Invaluable reference for technicians. Handy 5½ x 8½" size. Only.....



\$1.50

## "Practical Transistor Servicing"

by William C. Caldwell

The latest word on how transistors and transistor circuits operate—shows how to signal-trace and diagnose portable and auto-radio troubles. Tried and tested procedures are based on the premise that "time saved is money earned." Concentrates on the practical in 8 fact-filled chapters; tells clearly how transistors work; describes circuit components and their functions; shows how to isolate troubles; indicates normal transistor voltages and explains meanings of defective voltages; tells how to test transistors; shows how to troubleshoot auto radios; gives actual case histories. Profusely illustrated; 5½ x 8½" Only.....



\$2.95

## "Rapid Printed Circuit Repair"

by G. Warren Heath

Printed circuit boards, now being used in more and more electronic devices, can be a headache to the technician unless he understands their function and how to repair them. This practical book avoids complicated theory; it clearly describes and illustrates the fundamentals of printed circuitry and the components used by various manufacturers. Servicing and repair techniques and the various types of defects likely to be encountered are listed in alphabetical order for easy reference. 5½ x 8½". Only.....



\$1.95

## "Electronic Tips and Timesavers"

by John Comstock

Includes over 300 ingenious time- and money-saving tips—solving just about any problem the technician, engineer, builder or experimenter might face. Simply written and supported by illustrations, these bench-tested hints will save you much effort and frustration. You'll want to keep this book handy for constant reference use. Eight sections include tips on bench and field servicing, shop and truck equipment, soldering, tools, test equipment, construction and experimentation. 5½ x 8½". Only.....



\$1.50

### HOWARD W. SAMS & CO., INC.

Order from your Sams Distributor today, or mail to Howard W. Sams & Co., Inc., Dept. H-10 1720 E. 38th St., Indianapolis 6, Ind.

Send me the following books:

- "Tube Substitution Handbook" (TUB-1)
- "Practical Transistor Servicing" (PTC-1)
- "Rapid Printed Circuit Repair" (PC-2)
- "Electronic Tips and Timesavers" (TSC-1)

\$..... enclosed.  Send Free Book List

Name.....

Address.....

City..... Zone..... State.....

(outside U.S.A. priced slightly higher)



ONCE MORE, as is not unusually the case, service legislation is making news around the country. On the individual level, there is a letter from L. F. of Macks Creek, Mo., who wants no part of government control. To illustrate how a provision in an apparently innocuous bill, acceptable to members of the service industry, can turn into a hooby trap, he points to legislation pending in New York State. (This bill, which is intended to eliminate fraud and misrepresentation in the sale of electron tubes, has since been passed and goes into effect this fall. It does not deal with licensing.)

Among other things, claims L. F., it would become unlawful for a technician to operate or even own a combination CRT tester-rejuvenator. The writer owns such an instrument, which he uses only for testing. He would hate to have to throw away his investment in a useful item of equipment, he says, if he happened to live in New York.

Although his interpretation of the law appears to be wrong, L. F. nevertheless has an interesting point concerning the possible pitfalls of regulation. As to the actual meaning of the law, Mr. Robert Larsen, top man for the Radio-TV Guild of Long Island and the Empire State Federation of Electronic Technicians Associations on legislative matters, says things work this way: Possession of a rejuvenator is entirely legal. Furthermore, use of the instrument to repair a picture tube is also legal—provided the service dealer lets the customer know exactly what is going on. A violation would occur only if fraud were attempted—for example, if the technician were to repair the old tube and then tell the set owner that he had actually put in a new one.

Concerning licensing itself, L. F. has much else to say, including the following: "I would certainly hate to have my continuance in business depend upon a group of my competitors."

Elsewhere on the licensing front, the village of Inkster, Mich. has adopted a TV licensing ordinance. Although the community is not a large metropolis, the move has definite significance. Inkster, west of Detroit, has modeled its bill after the one now in force in the larger city. This appears to be part of a trend for other Michigan municipalities, failing passage of a statewide law, to follow the Detroit lead.

A similar pattern of acceptance of licensing may be evident in Louisiana, where a statewide law does exist. Although communities below a certain size are exempted, service dealers in these areas are reported to be registering voluntarily. There is also some

action toward broadening the state law to cover all areas. In the meantime, action to throw out the license bill in Kansas City, Mo., is now going through the courts.

### NATESA Directors Meet

Preliminary reports on the meeting of NATESA directors held in Tulsa indicate activity on a number of fronts. There were committee reports on captive and factory service, selective buying, DIY tube testers, licensing, acceptance of employed technicians into membership in addition to shop owners, advertising codes, and other matters. Administratively, there was discussion of an amendment to permit the NATESA directorate to refuse to accept specific directors, and an evaluation of obligations to NATESA directors by membership. There was also some talk of once more considering cooperative buying.

A number of non-members were permitted to sit in on the Tulsa sessions. These included Tilman Babb and Len Smith of TEA-Texas. This will doubtless revive talk of a possible reconciliation of interests between TEA and NATESA, although it was pointed out that Babb and Smith were present on a personal basis rather than as representatives of their state group.

### Philadelphia "Retail" Pact

Independent service dealers in Philadelphia have concluded an important agreement with 14 parts distributors concerning distributor sales to the general public. The wholesalers have agreed to discourage sales to retail customers by charging full retail price and crediting the difference between that price and dealer cost to the service dealer nearest the customer's address. All cash purchase slips will carry the name and address of purchaser instead of being made out to "cash." Distributors will continue to sell high-fidelity equipment at prevailing prices, but will charge full retail prices for replacement components for such units. All literature mailed to service dealers by distributors will be in sealed envelopes.

### Two-Way & CB Radio

Although there is a trend to letting the independent get more of the service business on two-way mobile communications equipment rather than depending on factory service, equipment manufacturers prefer to "authorize" these independents. For entry into this field, then, the service technician is likely to make the best progress by approaching the manufacturer rather than the equipment owner.

# PHOTOFACT — "There Is No Other..."

General Electric is now actively disseminating service information on mobile radio to authorized dealers through its "Datafile" system. Data is sent regularly for incorporation into a set of alphabetical file folders provided to cover two main sections. The first section is for information on Antennas and Transmission lines, FCC Regulations, Interference, Service Aids, Test Equipment, Service-Maintenance Techniques, and other subjects. The second section holds details on specific equipment models. The service is available without charge to authorized stations from G-E's Communications Products Dept., Lynchburg, Va.

Concerning Citizens Band equipment, although there appears to be no attempt by manufacturers to provide service directly, independents would also do well to begin by making contact with equipment makers. Literature on hand from the *Vocaline Co. of America*, intended for "authorized service stations," illustrates the point. There are complete details on warranty policy, processing of parts under warranty, billing to the manufacturer for service performed under warranty, parts procurement, and other important matters.

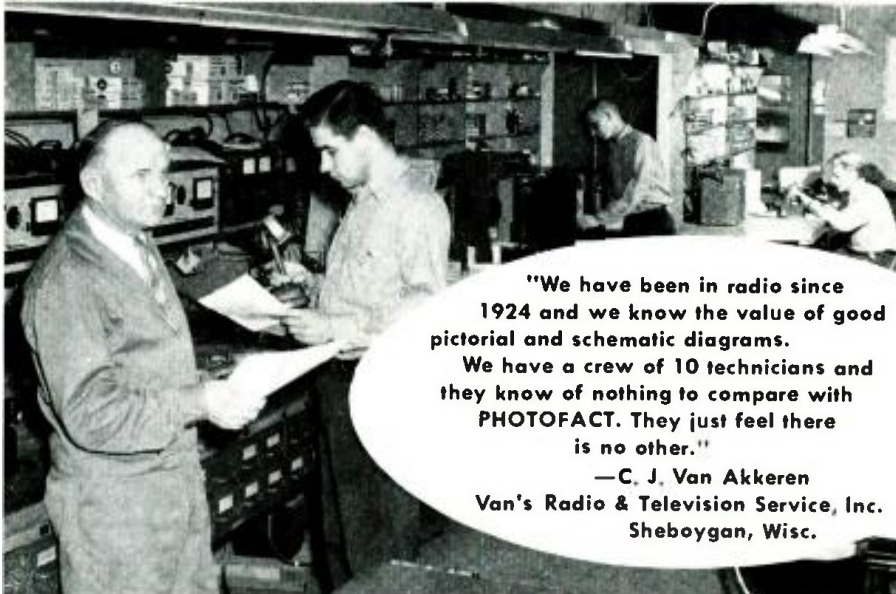
## Sears "Silvertone" Service

An item from TSA of Delaware Valley proves once more that you can't get results unless you're willing to take action. There has been much resentment throughout the independent industry concerning the service policies of *Sears-Roebuck*, a leading national purveyor of TV sets under its own brand name, "Silvertone." Not only does *Sears* maintain its own service departments, but there has been difficulty getting service data and parts for sets by independents.

After TSA brought the matter directly to the main *Sears* offices for its electronic division in Chicago, a directive from the latter city was sent out to the *Sears* service manager for the Philadelphia area. The letter authorized a 20 per-cent discount on "Silvertone" parts to all independents who registered with *Sears* by written request on their own stationery. While service notes are still not individually available, registered independents are free to examine such data at *Sears* offices and service shops. Although this compromise may not be considered an ideal solution, it represents a distinct improvement brought about by concerted action.

## Diversification in Calif.

The California State Electronics Association is surveying members to learn which ones are prepared to handle "plus" service (in addition to radio and TV). It is also compiling a list of manufacturers seeking authorized service shops to install and maintain special equipment. In fact, it already has solicitations on hand from some such companies who are seeking agencies to handle after-sale maintenance. CSEA hopes to serve as a liaison agency. Sounds like a sensible idea. —30—



"We have been in radio since 1924 and we know the value of good pictorial and schematic diagrams. We have a crew of 10 technicians and they know of nothing to compare with PHOTOFACT. They just feel there is no other."

—C. J. Van Akkeren  
Van's Radio & Television Service, Inc.  
Sheboygan, Wisc.

## Service Technicians! YOU EARN MORE... YOU RATE with the public when you own the PHOTOFACT® service data library!

You enjoy maximum earnings as the owner of a complete PHOTOFACT Service Data Library! It's inevitable, because no matter how expert you are, you can always *save more time on any job, get more jobs done daily—EARN MORE, DAY IN AND DAY OUT...*

What's more—as the owner of a complete PHOTOFACT Library, you know your customers' sets *best*. You can actually show each customer you have the PHOTOFACT Folder covering his very own set. Result: You command public respect and acceptance which paves the way to more business and earnings for you.

## HOW TO STAY AHEAD...

Yes, the truly successful Service Technicians are those who own the complete PHOTOFACT Library, who can meet and solve any repair problem—faster and more profitably. And these men keep ahead because they're on a Standing Order Subscription with their Distributors to receive all new PHOTOFACTS as they are released monthly. (They're eligible for the benefits of membership in PEET, too—see below!)

**ONLY \$10 DOWN** puts the complete PHOTOFACT Library in your shop—and you have up to 30 months to pay. See your Sams Distributor today, or write to Howard W. Sams

## NOW IS THE TIME TO JOIN

# "PEET"

### THE POWERFUL NEW PROGRAM FOR QUALIFIED TECHNICIANS

If you now own a PHOTOFACT Library or plan to own one, you can apply for membership in "PEET." It's the first industry program really designed to build powerful public acceptance for the Service Technician who qualifies. Builds enviable prestige and business for its members. Benefits cost you absolutely nothing if you qualify. Ask your Sams Distributor for the "PEET" details, or mail coupon today.

### HOWARD W. SAMS & CO., INC.

1724 E. 38th St., Indianapolis 6, Ind.

- Send me full details on the new "PEET" Program.
- Send full information on the Easy-Buy Plan and Free File Cabinet deal.
- I'm interested in a Standing Order Subscription.
  - I'm a Service Technician  full-time;  part-time

My distributor is \_\_\_\_\_

Shop Name \_\_\_\_\_

Attn: \_\_\_\_\_

Address \_\_\_\_\_

City \_\_\_\_\_ Zone \_\_\_\_\_ State \_\_\_\_\_



# Hi-Fi-Audio

## Product Review

### MILLER FM RECEIVER

J. W. Miller Co., 5917 S. Main St., Los Angeles 3, Calif. has announced two new kits containing "hard-to-get" parts for building what is termed a high-performance, transistorized FM receiver.

Kit No. 777-1 contains three i.f.



transformers, one ratio detector transformer, a variable capacitor, antenna, r.f. and oscillator coils, complete set of knobs, and six transistors.

Kit No. 777-2 contains all the above parts plus an attractive metal cabinet and panel. The completed receiver has a sensitivity of 2.5  $\mu$ v. and includes a.f.c., vernier tuning, and a push-pull audio stage. Full instructions are given for alignment and operation.

A bulletin, "The Coil Forum," Vol. 1, describing this receiver, is available at company distributors or direct from the factory.

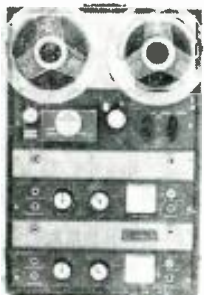
### STROBE AND LIGHT KIT

Robins Industries Corp., 36-27 Prince St., Flushing 54, N. Y. is offering a strobe and light kit designed to check the accuracy of the speed of a turntable. The kit includes a strobe disc, which is placed on the turntable, and a strobe light, for connecting to any household power source. The light, shining on the strobe disc, provides an accurate and easily determined indication of turntable speed.

### STEREO RECORDER

Roberts Electronics, Inc., 829 North Highland Ave., Los Angeles 38, Calif.,

is offering a versatile new stereo tape system. Designated the Model 990 the new equipment provides four-track record/playback, four monophonic tracks record/playback, and two-track playback.



A new head assembly, which provides precise vertical movement of both

the erase and the record/play heads, makes it easy to identify and locate each of the four quarter-track recordings. According to the manufacturer, excellent fidelity is assured in recording four-track stereo as well as in the machine's other functions.

The Model 990 includes monitoring stereo speakers, as well as dual outputs from the heads, dual preamplifier outputs, and dual power amplifier outputs. Both channels are equipped with vu meters.

### NEW LINE OF ACCESSORIES

Jensen Industries, Forest Park, Ill. has introduced a new line of phonograph parts, including plastic spindle plugs, tone-arm lifters, phonograph oil, record covers, needle inspection microscopes, 45 rpm universal spindles, and metal 45 rpm inserts.

Of interest to dealers, these new items are displayed, along with other Jensen items—needles, record brushes, and "Silcloth,"—on a new six-sided, 2-foot high display rack, suitable for placement on store counters.

### SHURE STEREO ARM

Shure Brothers, Inc., 222 Hartrey Ave., Evanston, Ill., has announced a new tone arm with design and adjustment features said to keep record wear



to a minimum. Called the "Professional," the arm accepts practically all cartridges now available. A micrometer counterweight and direct-reading stylus force gauge maintain balance and accurate tracking on both monophonic and stereo records. No soldering is required for installation.

The M232 arm is for 12-inch records; the model M236, for 16-inch records.

### NEW STEREO EQUIPMENT

Viking of Minneapolis, Inc., 9600 Aldrich Ave. So., Minneapolis 20, Minn. has introduced a low-cost, compact stereo recorder. Known as the "Stereo Compact," the new equipment is available in two models. The RMQ provides quarter-track recording; the ESQ, half-track erase and recording. Both models play quarter-track and/or half-track stereo tapes.

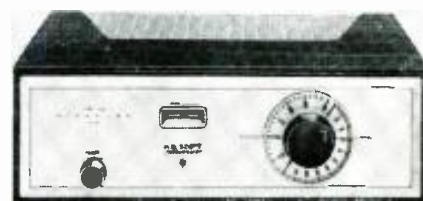
Frequency response of the new line is stated to be 40 to 12,000 cps, flat within  $\pm 3$  db. Tape speeds are 7½ or 3¾ ips, selected by front-panel control. The quarter-track head may be used for half-track playback by a shift adjustment provided.

The company has also announced that its 75 series is now adaptable for 4-track tapes with the addition of a new head assembly. One new head assembly adapts the 75 for 4-track playback; another provides playback as well as 4-track erase and record.

### NEW SCOTT TUNER

H. H. Scott, Inc., 111 Powdermill Rd., Maynard, Mass., has introduced a moderately priced FM tuner, the Model 314. Incorporating the company's wide-band design, the Model 314 boasts a usable sensitivity of 2.5  $\mu$ v. by IHFM standards. According to the firm, tuning is drift-free without the need for conventional automatic frequency control.

A silver-plated front end is said to provide minimum circuit losses on even the weakest signals. Temperature-compensated components provide maximum stability. A new wide-band circuit



incorporates 2-megacycle detector and limiter bandwidth. Two effective stages of full limiting insure rejection of AM interference.

Also provided is a multiplex output. An accessory knob kit is available at slight extra cost to make the 314 a perfect match to the Model 299 amplifier. For additional information, write Department P at the company address.

### MINIATURIZED ENCLOSURE

Karlson Associates, Inc., 433 Hempstead Ave., West Hempstead, N. Y. announces the

"Rocket," a new, patented miniature speaker system. Easily connected, the new system is said to make it possible to hear complete stereo in all parts of the room. Over-all sound is claimed to be "remarkably big and impressive" despite the extremely small size of the unit.



Dispersion pattern is rated as wide as 140°, and the system is considered highly efficient. According to the manufacturer, the "Rocket" is suitable for mounting wherever decor is highly important and wide-range, wide-angle sound dispersion is desired.

### TAPE RECORDER CLEANER

Chemtronics, Inc., 870 E. 52 St., Brooklyn, N. Y. has introduced a new kit for cleaning parts of tape recorders.

Packaged in a 2-ounce bottle, with felt applicator, the fluid is said to effectively clean tape heads as well as capstan and pressure rollers, thus elimi-

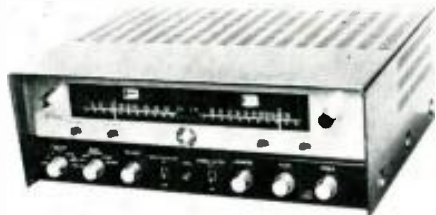


nating the wow and squeal that may develop in recorders.

Additionally, the manufacturer claims that use of the chemical, termed TR-2, will increase the life of the tape and the heads, improve fidelity, and reduce distortion. The felt applicator will not stain or mar plastic parts.

#### 45-WATT STEREO AMP-TUNER

Monarch International, Inc., 7035 Laurel Canyon Blvd., No. Hollywood,



Calif. is offering a complete stereo unit featuring dual amplifiers with controls and completely separate AM and FM tuners, including FM multiplex adapter. The entire system, housed in a black and gold cabinet, is designated Model STA-245.

Basic amplifier power is rated at 45 watts. Features include friction clutch tone controls, phasing switch, rumble and scratch filters, mode switch, and other facilities.

The complete unit has 18 tubes, four silicon power diodes, and a germanium diode. FM sensitivity is rated at 1.9  $\mu\text{v./}$  -20 db. AM range covers 535 to 1605 kc. Its input sensitivity for magnetic cartridges is 3 mv./1 kc.; for tape, 1.5 mv./250 cps.

#### UNIQUE PHONO ACCESSORY

Duotone Company, Inc., Keyport, N. J. has introduced "Selecto," a combination hand selector and record brush. Actually, the new device is made up of two older Duotone items, a record brush and the "Magic Finger" cueing device.

The combination unit, fastened to a tone-arm, permits the arm to be set on the record with a very light touch due to spring action, while the brush remains in contact with the record during playing.

#### NEW GRADO ARM

Grado Laboratories, Inc., 4614 Seventh Ave., Brooklyn 20, N. Y. has announced its new "Laboratory Series"



tone arm to be sold in three versions, as a "universal" arm for use with any make of cartridge, with a matched custom cartridge, and with a matched "master" cartridge.

The arm itself boasts a very small rear overhang for cabinet installation, vertical and lateral balance adjustments, linear tracking force adjust-



*the cybernetically engineered professional stereo tape recorder by*

# NEWCOMB

You now have your choice of either quarter-track (Model SM-310-4) or half-track (Model SM-310) versions of the exciting new stereophonic tape recorder by Newcomb. Specifications for the two are identical. They are deeply satisfying to work with because they are cybernetically engineered. That is, controls are so arranged that the natural thing to do is the right thing to do. Tape movement is controlled by a central joystick... the easiest machines to operate you've ever tried... easiest on tape, too. Broken, spilled, stretched tape are things of the past when you work with a Newcomb recorder. And few, if any, machines include such a wealth of features. Newcomb recorders take any reel size - 3" to 10 $\frac{1}{2}$ ". They have twin, illuminated recording level meters arranged pointer-to-pointer for instant comparison, four digit counters, mixing controls for "mike" and "line" for both channels, balance control, ganged volume control, two speeds - 7 $\frac{1}{2}$  or 3 $\frac{3}{4}$  inches-per-second with automatic compensation for 3 $\frac{3}{4}$ ". The Newcomb tape machine is designed to be an inseparable, dependable, indispensable companion for the serious recordist. Write for the complete story contained in Bulletin SM-3.

NEWCOMB AUDIO PRODUCTS CO., Dept. F-8, 6824 Lexington Ave., Hollywood, Calif.

**NEW PORTABLE STEREO TAPE MUSIC SYSTEMS**

**PORTABLE STEREO SPEAKER SYSTEMS** - Four choices are offered, varying in size and efficiency. The latest techniques are used to reproduce big bass in a compact space and to achieve unprecedented audience coverage. Speakers have kickproof metal grilles, carrying handles, and are covered in scratchproof, washable, warm gray fabricoid to match the SA-80 and SM-310.

Model SA-80 portable 2 channel amplifier is a powerful and worthy companion to the Newcomb Recorders... 40 watts peak per channel... ganged controls - bass, treble, volume, balance... reels store in cover.

## TUBE PROBLEM:

The Armed Forces needed a new version of the 6J4 reliable tube type which would provide a tube life of almost 1000 hours. Existing tubes of this type had an average life of only 250 hours. In addition, this new tube had to be produced under ultra-high quality control standards.

## SONOTONE SOLVES IT:

By making improvements in the cathode alloy and setting up extremely tight controls in precision, manufacture and checking, Sonotone engineers produced a 6J4WA with a *minimum* life of 1000 hours... most running *much longer*.

## RESULTS:

The Sonotone 6J4WA is one of three reliable tubes now being manufactured under U. S. Army Signal Corps RIQAP (Reduced Inspection Quality Assurance Program), monitored by the U. S. Army Signal Supply Agency. And the same rigid quality standards apply to Sonotone's entertainment type tubes as well.

Let Sonotone help solve *your* tube problems, too.

# Sonotone.

Electronic Applications Division, Dept. T1 80  
**ELMSFORD, NEW YORK**  
Leading makers of fine ceramic cartridges, speakers, microphones, tapeheads, electron tubes.  
In Canada, contact Atlas Radio Corp., Ltd., Toronto

ment, interchangeable cartridge shell, and other features. No solder connections are needed in the arm and it may be installed without the use of a screw-driver.

## "THIN-LINE" SPEAKERS

Lafayette Radio Corp., 165-08 Liberty Ave., Jamaica 33, N. Y. has announced a new "Thin-Line" ceiling and wall-haffle loudspeaker that measures only 2½ inches deep. Designed to



mount in a wall, ceiling, closet, or conventional enclosure, the new speaker, Model SK-175, features an inverted magnet that places the 12-ounce magnet structure in front of the speaker rather than behind it.

The voice coil is 1 inch in diameter. Impedance is 8 ohms. Reported response is 90 to 9000 cps.

## MIDGET RECORDER

Radio Shack Corp., 730 Commonwealth Ave., Boston 17, Mass., has announced a two-speed, pocket-size portable tape recorder. Using five transistors, the new "Realistic" Model TR-730 plays and records at either 3¾ or 1⅞ ips speeds. It operates on low-cost batteries (included), uses 3-inch reels, plays up to 60 minutes, and has a built-in speaker and amplifier.

It can perform its functions, includ-



ing record, play, rewind, and erase, with the lid closed since all controls, switches, and input jacks are externally located. A built-in d'Arsonval vu meter is used for indicating both recording level and condition of the batteries.

Included with this unit is a microphone, zippered vinyl carrying bag, batteries, and reels. Dimensions are 2½" x 7½" x 5½", and the TR-730 weighs less than 5 pounds.

## BULK TAPE ERASER

Amplifier Corporation of America, 398 Broadway, New York 13, N. Y. has introduced the "Magneraser," a device that may be used for erasing tape in quantity as well as for demagnetizing tape heads to reduce distortion and background noise.

The "Magneraser," weighing 2½ pounds, may be hand-held when in use. Its power cord must be connected to a suitable a.c. outlet. Model 200C is de-

signed for use on 100 to 130 volts a.c.; Model 220C, for 200 to 260 volts a.c. The unit is furnished with an 8-foot line cord and operating instructions.

## CARDIOID MICROPHONE

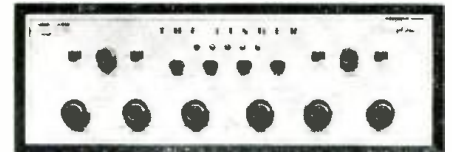
Allied Radio Corp., 100 N. Western Ave., Chicago 80, Ill. announces "Knight" Model KN-4550, a dynamic cardioid microphone. Employing a directional, heart-shaped sound pickup pattern to obtain a high front-to-back ratio, the KN-4550 is said to reduce the effects of audience noise and other extraneous sounds. Frequency response is stated at 60 to 13,000 cps. Output level is -57 db. Output impedance can be adjusted at the connector for either 150 ohms or high impedance.

The microphone is supplied with "on-off" switch, an 18-foot cable, and a screw-type connector. Length is 7¼ inches.

## STEREO MASTER CONTROL

Fisher Radio Corp., 21-21 Forty-fourth Drive, Long Island City 1, N. Y., has introduced a new stereo preamplifier control unit.

Designated as Model 400-CX, the



unit features great flexibility, including a means of balancing channels with an aural null. Also provided is a stereo dimension control for blending signals from both channels. A "center channel" output, for use with a third power amplifier and speaker, is also furnished. The 400-CX may be fitted with a special RK-1 remote control unit for operation from the listener's position.

Eighteen input jacks are provided. Response is claimed to be 20 to 20,000 cps ± ½ db. The unit uses ten tubes and weighs 18 pounds. Dimensions are 15½" x 11½" x 4¾".

## ELECTRIC ORGAN

American Audion Corp., 200 Fifth Ave., New York 10, N. Y., has announced its new "Caprice," a decorator-styled electric chord organ. The "Ca-



price" has 37 standard, full-size white and black keys, over three chromatic octaves. These, together with the 49 chords (8 alternate, 8 bass, 8 major, 8 minor, 8 seventh's) and basses, are said

ELECTRONICS WORLD

to provide rich full-bodied organ tones, with rhythm accompaniment. Volume may be regulated by means of a foot pedal.

According to the manufacturer, an exclusive "Audion Key Selector" enables anyone to play this instrument without lessons. A book of 45 musical selections, using this system, is supplied with the organ.

#### NEW FISHER TUNER

Fisher Radio Corp., 21-21 44th Drive, Long Island City 1, N. Y. has announced the FM-50, a new wide-band FM tuner.

The instrument boasts high sensitivity, broad audio bandwidth, and FM multiplex and recording outputs. Said



to be exclusive with the FM-50 is its dual-purpose "MicroRay" tuning indicator which facilitates tuning and, at the turn of a switch, also serves as a recording level indicator.

The sensitivity of the FM-50 is said to be 1.3 microvolts for 20 db of quieting, with a 300-ohm antenna. It uses four i.f. stages; the last two also serve as limiters. A wide-band ratio detector is used. Frequency response is listed as 20 to 20,000 cps = 1 db (including standard 75  $\mu$ sec. de-emphasis). Harmonic distortion is rated at less than 0.8% at full one-hundred per-cent modulation.

Write the manufacturer for additional details.

#### AUDIO CATALOGUES

##### SPEAKERS AND ENCLOSURES

Federated Industries, Inc., 4477 Elston Ave., Chicago 30, Ill., is offering an 8-page catalogue describing the "Crescent" line of speakers, speaker systems, and enclosures. The brochure gives details and prices on units for high-fidelity, public address, and automotive applications.

##### NEW ASTATIC LITERATURE

Astatic Corp., Conneaut, Ohio, announces three new catalogues. Catalogue No. 33-4 deals with cartridges, pickups, and original needles manufactured by the firm. All items are illustrated and vital information is given. Catalogue CRC-60 is a comprehensive cross-reference of cartridges and needles manufactured by Astatic and other companies. All stock numbers are listed as well as the numbers of the company's units suitable for replacements.

The firm's line of microphones and accessories is described in Catalogue No. M10. All catalogues have been punched for insertion into binders.

# TIME TO CLEAN UP YOUR SYSTEM . . .

## Norelco® T-7 LOUDSPEAKERS

with voice coil magnets of Ticonal-7 steel (30% more efficient\* than Alnico V)

\* . . . 30% more efficient response to the full signal range of your amplifier . . . WHETHER ITS RATED OUTPUT is 10 WATTS or a HUNDRED . . . at any listening level from a whisper to a shout!

Guild-crafted by Philips of the Netherlands to give you

### THE CLEANEST SOUND AROUND

Ask for a demonstration wherever good sound is sold or write to:

NORTH AMERICAN PHILIPS CO., INC.

High Fidelity Products Division, 230 Duffy Avenue, Hicksville, L. I., N. Y.



## PURCHASING A HI-FI SYSTEM?

Send Us Your List Of Components For A Package Quotation

WE WON'T BE UNDERSOLD!

All merchandise is brand new, factory fresh & guaranteed.

# AIREX RADIO

CORPORATION

64-R Cortlandt St., N. Y. 7, CO 7-2137

#### PARTIAL LIST OF BRANDS IN STOCK

J'm Lansing  
A.t.ec Lansing  
Electrovoice  
Je isen  
Hartley • Stephens  
University  
Acoustic Research  
Janszen  
Wharfedale  
Karlson Cabinets  
Viking  
Concertone  
Bell • G.E.  
Weathers  
Harmon-Kardon  
Eico • Pilot  
Sherwood  
Acrosound  
Quad Ampl-Spkrs  
Dual Changer  
Bogen • Leak  
Dynakit • Fisher  
H. H. Scott  
Uher Recorder  
Thorens  
Pentron • Revere  
Amplex • DeWald  
Sony • Roberts  
Challenger  
Wollensak  
Garrard • Norelco  
Miracord  
Glaser-Steers  
Rek-O-Kut  
Components  
Tandberg  
Fairchild  
Pickering • Gray  
Audio Tape  
Magnecord  
Rockford Cabinets  
Artizan Cabinets  
\*Fair Traded



Only from famous COYNE do you get this modern up-to-the minute TV Home Training. Easy to follow instructions—fully illustrated with 2150 photos and diagrams. Not an old Radio Course with Television tacked on. Includes UHF and COLOR TV. Personal guidance by Coyne Staff. Practical Job Guides to help you EARN MONEY QUICKLY IN A TV-RADIO SALES AND SERVICE BUSINESS—part time or full time. COSTS MUCH LESS—pay only for training—no costly "put together kits."

#### SEND COUPON FOR FREE BOOK

SEND COUPON BELOW for Free Book and full details including EASY PAYMENT PLAN. NO COST OR OBLIGATION—NO SALESMAN WILL CALL.



B. W. COOKE, Jr., Pres. **COYNE ELECTRICAL SCHOOL** FOUNDED 1899

CHARTERED AS AN EDUCATIONAL INSTITUTION NOT FOR PROFIT  
1501 W. Congress Pkwy., Dept. CO-H6, Chicago 7, Ill.

COYNE Television Home Training Div.  
New Coyne Building, Dept. CO-H6  
1501 W. Congress Pkwy., Chicago 7, Ill.

Send FREE BOOK and details of your Television Home Training offer.

Name \_\_\_\_\_  
Address \_\_\_\_\_  
City \_\_\_\_\_ State \_\_\_\_\_

**SPECIAL MICROAMMETER**  
2 Inch—100-0-100 ..... **\$3.95**  
Ea. ....

**DYNAMOTOR SPECIAL**  
2 Inputs 12 Volts—2 Outputs (440 V. @ 200  
Ma., 225 V. @ 100 Ma.) Cont. Duty. **\$7.95**  
BRAND NEW. Ea. ....

**BRAND NEW CARTER DYNAMOTOR**  
INPUT 5.9 VOLTS, OUTPUT 405 V. @  
270 MA. SMALL SIZE. .... **\$4.95**  
Ea. ....

**COAX CABLE**  
RGSU—52 Ohm Impedance—Fresh Stock—500  
feet on sealed wooden spools **\$32.50**  
Each  
RG62A U—92 ohm impedance—Fresh Stock—1000  
Foot Spools. .... **\$38.50**  
Ea. ....  
Smaller quantities 7 1/2¢ per ft. Min. order 25 ft.

**NEW VACUUM CAPACITORS**  
EIMAC VC 12 MMF-32KV ..... ea. **\$6.95**  
EIMAC VC 25 MMF-32KV ..... ea. **7.95**  
EIMAC VC 50 MMF-32KV ..... ea. **8.95**  
JENNINGS JMC-150 MMF-50KV ..... ea. **24.95**  
JENNINGS 100 MMF-20KV ..... ea. **12.95**  
50 MMF-5KV ..... ea. **2.25**  
25 MMF-10KV ..... ea. **2.25**

**POWER TRANSFORMER**  
Primary 110V. 60 cy. Sec. 445-0-445V. @ 150  
Ma. 6.3V. @ 6 Amps. 5V. @ 3 Amps.  
Fully shielded. .... **\$3.95**  
Write for quantity prices

**FILAMENT TRANSFORMERS**  
Primary 110 volts 60 cycle. Secondary  
2 1/2 V. 10 Amps. 10,000 V. insulation. **\$3.95**  
Primary 110V. Sec. 6.3V. @  
60 Amps ..... **\$8.95**  
Ea. ....

**CHOKE—FULLY CASED**  
5 HENRY @ 200 Ma ..... 1.95  
5 HENRY @ 250 Ma ..... 2.25  
4-12 HY (Swinging) @ 300 MA ..... 3.95  
4 HENRY 400 Mil ..... 3.95  
12 HENRY 500 Mil ..... 8.95  
4 HENRY 900 Mil ..... 12.95  
6 HENRY 600 Mil ..... 8.95

**BRAND NEW OIL CONDENSERS**  
3 MFD 600 VDC .60 ..... 4.95  
4 MFD 600 VDC .75 ..... 5.95  
5 MFD 600 VDC .85 ..... 6.95  
6 MFD 600 VDC .85 ..... 1.85  
8 MFD 600 VDC .95 ..... 2.50  
10 MFD 600 VDC 1.10 ..... 3.50  
12 MFD 600 VDC 1.50 ..... 6.25  
15 MFD 600 VDC 1.70 ..... 8.95  
3x8 (24 MFD) ..... 30.50  
300 VDC ..... 2.80  
1 MFD 1000 VDC .60 ..... 2.95  
2 MFD 1000 VDC .85 ..... 3.95  
4 MFD 1000 VDC 1.35 ..... 4.95  
8 MFD 1000 VDC 1.95 ..... 5.95  
10 MFD 1000 VDC 2.50 ..... 6.95  
12 MFD 1000 VDC 2.95 ..... 7.95  
15 MFD 1000 VDC 3.50 ..... 8.95  
1 MFD 1500 VDC .45 ..... 1.95  
1 MFD 1500 VDC .75 ..... 2.95  
2 MFD 1500 VDC 1.10 ..... 3.95  
4 MFD 1500 VDC 1.95 ..... 4.95  
8 MFD 1500 VDC 2.95 ..... 5.95  
10 MFD 1500 VDC 3.50 ..... 6.95  
1 MFD 2000 VDC .85 ..... 3.95  
2 MFD 2000 VDC 1.50 ..... 4.95  
4 MFD 2000 VDC 3.50 ..... 6.95  
6 MFD 2000 VDC 4.95 ..... 5.95  
8 MFD 2000 VDC 5.95 ..... 6.95  
10 MFD 2000 VDC 6.95 ..... 7.95  
1 MFD 3000 VDC 1.85 ..... 3.95  
2 MFD 3000 VDC 2.50 ..... 4.95  
3 MFD 3000 VDC 3.50 ..... 5.95  
4 MFD 3000 VDC 4.95 ..... 6.95  
5 MFD 3000 VDC 5.95 ..... 7.95  
6 MFD 3000 VDC 6.95 ..... 8.95  
7 MFD 3000 VDC 7.95 ..... 9.95  
8 MFD 3000 VDC 8.95 ..... 10.95  
9 MFD 3000 VDC 9.95 ..... 11.95  
10 MFD 3000 VDC 10.95 ..... 12.95  
11 MFD 3000 VDC 11.95 ..... 13.95  
12 MFD 3000 VDC 12.95 ..... 14.95  
13 MFD 3000 VDC 13.95 ..... 15.95  
14 MFD 3000 VDC 14.95 ..... 16.95  
15 MFD 3000 VDC 15.95 ..... 17.95  
16 MFD 3000 VDC 16.95 ..... 18.95  
17 MFD 3000 VDC 17.95 ..... 19.95  
18 MFD 3000 VDC 18.95 ..... 20.95  
19 MFD 3000 VDC 19.95 ..... 21.95  
20 MFD 3000 VDC 20.95 ..... 22.95  
21 MFD 3000 VDC 21.95 ..... 23.95  
22 MFD 3000 VDC 22.95 ..... 24.95  
23 MFD 3000 VDC 23.95 ..... 25.95  
24 MFD 3000 VDC 24.95 ..... 26.95  
25 MFD 3000 VDC 25.95 ..... 27.95  
26 MFD 3000 VDC 26.95 ..... 28.95  
27 MFD 3000 VDC 27.95 ..... 29.95  
28 MFD 3000 VDC 28.95 ..... 30.95  
29 MFD 3000 VDC 29.95 ..... 31.95  
30 MFD 3000 VDC 30.95 ..... 32.95  
31 MFD 3000 VDC 31.95 ..... 33.95  
32 MFD 3000 VDC 32.95 ..... 34.95  
33 MFD 3000 VDC 33.95 ..... 35.95  
34 MFD 3000 VDC 34.95 ..... 36.95  
35 MFD 3000 VDC 35.95 ..... 37.95  
36 MFD 3000 VDC 36.95 ..... 38.95  
37 MFD 3000 VDC 37.95 ..... 39.95  
38 MFD 3000 VDC 38.95 ..... 40.95  
39 MFD 3000 VDC 39.95 ..... 41.95  
40 MFD 3000 VDC 40.95 ..... 42.95  
41 MFD 3000 VDC 41.95 ..... 43.95  
42 MFD 3000 VDC 42.95 ..... 44.95  
43 MFD 3000 VDC 43.95 ..... 45.95  
44 MFD 3000 VDC 44.95 ..... 46.95  
45 MFD 3000 VDC 45.95 ..... 47.95  
46 MFD 3000 VDC 46.95 ..... 48.95  
47 MFD 3000 VDC 47.95 ..... 49.95  
48 MFD 3000 VDC 48.95 ..... 50.95  
49 MFD 3000 VDC 49.95 ..... 51.95  
50 MFD 3000 VDC 50.95 ..... 52.95  
51 MFD 3000 VDC 51.95 ..... 53.95  
52 MFD 3000 VDC 52.95 ..... 54.95  
53 MFD 3000 VDC 53.95 ..... 55.95  
54 MFD 3000 VDC 54.95 ..... 56.95  
55 MFD 3000 VDC 55.95 ..... 57.95  
56 MFD 3000 VDC 56.95 ..... 58.95  
57 MFD 3000 VDC 57.95 ..... 59.95  
58 MFD 3000 VDC 58.95 ..... 60.95  
59 MFD 3000 VDC 59.95 ..... 61.95  
60 MFD 3000 VDC 60.95 ..... 62.95  
61 MFD 3000 VDC 61.95 ..... 63.95  
62 MFD 3000 VDC 62.95 ..... 64.95  
63 MFD 3000 VDC 63.95 ..... 65.95  
64 MFD 3000 VDC 64.95 ..... 66.95  
65 MFD 3000 VDC 65.95 ..... 67.95  
66 MFD 3000 VDC 66.95 ..... 68.95  
67 MFD 3000 VDC 67.95 ..... 69.95  
68 MFD 3000 VDC 68.95 ..... 70.95  
69 MFD 3000 VDC 69.95 ..... 71.95  
70 MFD 3000 VDC 70.95 ..... 72.95  
71 MFD 3000 VDC 71.95 ..... 73.95  
72 MFD 3000 VDC 72.95 ..... 74.95  
73 MFD 3000 VDC 73.95 ..... 75.95  
74 MFD 3000 VDC 74.95 ..... 76.95  
75 MFD 3000 VDC 75.95 ..... 77.95  
76 MFD 3000 VDC 76.95 ..... 78.95  
77 MFD 3000 VDC 77.95 ..... 79.95  
78 MFD 3000 VDC 78.95 ..... 80.95  
79 MFD 3000 VDC 79.95 ..... 81.95  
80 MFD 3000 VDC 80.95 ..... 82.95  
81 MFD 3000 VDC 81.95 ..... 83.95  
82 MFD 3000 VDC 82.95 ..... 84.95  
83 MFD 3000 VDC 83.95 ..... 85.95  
84 MFD 3000 VDC 84.95 ..... 86.95  
85 MFD 3000 VDC 85.95 ..... 87.95  
86 MFD 3000 VDC 86.95 ..... 88.95  
87 MFD 3000 VDC 87.95 ..... 89.95  
88 MFD 3000 VDC 88.95 ..... 90.95  
89 MFD 3000 VDC 89.95 ..... 91.95  
90 MFD 3000 VDC 90.95 ..... 92.95  
91 MFD 3000 VDC 91.95 ..... 93.95  
92 MFD 3000 VDC 92.95 ..... 94.95  
93 MFD 3000 VDC 93.95 ..... 95.95  
94 MFD 3000 VDC 94.95 ..... 96.95  
95 MFD 3000 VDC 95.95 ..... 97.95  
96 MFD 3000 VDC 96.95 ..... 98.95  
97 MFD 3000 VDC 97.95 ..... 99.95  
98 MFD 3000 VDC 98.95 ..... 100.95  
99 MFD 3000 VDC 99.95 ..... 101.95  
100 MFD 3000 VDC 100.95 ..... 102.95  
101 MFD 3000 VDC 101.95 ..... 103.95  
102 MFD 3000 VDC 102.95 ..... 104.95  
103 MFD 3000 VDC 103.95 ..... 105.95  
104 MFD 3000 VDC 104.95 ..... 106.95  
105 MFD 3000 VDC 105.95 ..... 107.95  
106 MFD 3000 VDC 106.95 ..... 108.95  
107 MFD 3000 VDC 107.95 ..... 109.95  
108 MFD 3000 VDC 108.95 ..... 110.95  
109 MFD 3000 VDC 109.95 ..... 111.95  
110 MFD 3000 VDC 110.95 ..... 112.95  
111 MFD 3000 VDC 111.95 ..... 113.95  
112 MFD 3000 VDC 112.95 ..... 114.95  
113 MFD 3000 VDC 113.95 ..... 115.95  
114 MFD 3000 VDC 114.95 ..... 116.95  
115 MFD 3000 VDC 115.95 ..... 117.95  
116 MFD 3000 VDC 116.95 ..... 118.95  
117 MFD 3000 VDC 117.95 ..... 119.95  
118 MFD 3000 VDC 118.95 ..... 120.95  
119 MFD 3000 VDC 119.95 ..... 121.95  
120 MFD 3000 VDC 120.95 ..... 122.95  
121 MFD 3000 VDC 121.95 ..... 123.95  
122 MFD 3000 VDC 122.95 ..... 124.95  
123 MFD 3000 VDC 123.95 ..... 125.95  
124 MFD 3000 VDC 124.95 ..... 126.95  
125 MFD 3000 VDC 125.95 ..... 127.95  
126 MFD 3000 VDC 126.95 ..... 128.95  
127 MFD 3000 VDC 127.95 ..... 129.95  
128 MFD 3000 VDC 128.95 ..... 130.95  
129 MFD 3000 VDC 129.95 ..... 131.95  
130 MFD 3000 VDC 130.95 ..... 132.95  
131 MFD 3000 VDC 131.95 ..... 133.95  
132 MFD 3000 VDC 132.95 ..... 134.95  
133 MFD 3000 VDC 133.95 ..... 135.95  
134 MFD 3000 VDC 134.95 ..... 136.95  
135 MFD 3000 VDC 135.95 ..... 137.95  
136 MFD 3000 VDC 136.95 ..... 138.95  
137 MFD 3000 VDC 137.95 ..... 139.95  
138 MFD 3000 VDC 138.95 ..... 140.95  
139 MFD 3000 VDC 139.95 ..... 141.95  
140 MFD 3000 VDC 140.95 ..... 142.95  
141 MFD 3000 VDC 141.95 ..... 143.95  
142 MFD 3000 VDC 142.95 ..... 144.95  
143 MFD 3000 VDC 143.95 ..... 145.95  
144 MFD 3000 VDC 144.95 ..... 146.95  
145 MFD 3000 VDC 145.95 ..... 147.95  
146 MFD 3000 VDC 146.95 ..... 148.95  
147 MFD 3000 VDC 147.95 ..... 149.95  
148 MFD 3000 VDC 148.95 ..... 150.95  
149 MFD 3000 VDC 149.95 ..... 151.95  
150 MFD 3000 VDC 150.95 ..... 152.95  
151 MFD 3000 VDC 151.95 ..... 153.95  
152 MFD 3000 VDC 152.95 ..... 154.95  
153 MFD 3000 VDC 153.95 ..... 155.95  
154 MFD 3000 VDC 154.95 ..... 156.95  
155 MFD 3000 VDC 155.95 ..... 157.95  
156 MFD 3000 VDC 156.95 ..... 158.95  
157 MFD 3000 VDC 157.95 ..... 159.95  
158 MFD 3000 VDC 158.95 ..... 160.95  
159 MFD 3000 VDC 159.95 ..... 161.95  
160 MFD 3000 VDC 160.95 ..... 162.95  
161 MFD 3000 VDC 161.95 ..... 163.95  
162 MFD 3000 VDC 162.95 ..... 164.95  
163 MFD 3000 VDC 163.95 ..... 165.95  
164 MFD 3000 VDC 164.95 ..... 166.95  
165 MFD 3000 VDC 165.95 ..... 167.95  
166 MFD 3000 VDC 166.95 ..... 168.95  
167 MFD 3000 VDC 167.95 ..... 169.95  
168 MFD 3000 VDC 168.95 ..... 170.95  
169 MFD 3000 VDC 169.95 ..... 171.95  
170 MFD 3000 VDC 170.95 ..... 172.95  
171 MFD 3000 VDC 171.95 ..... 173.95  
172 MFD 3000 VDC 172.95 ..... 174.95  
173 MFD 3000 VDC 173.95 ..... 175.95  
174 MFD 3000 VDC 174.95 ..... 176.95  
175 MFD 3000 VDC 175.95 ..... 177.95  
176 MFD 3000 VDC 176.95 ..... 178.95  
177 MFD 3000 VDC 177.95 ..... 179.95  
178 MFD 3000 VDC 178.95 ..... 180.95  
179 MFD 3000 VDC 179.95 ..... 181.95  
180 MFD 3000 VDC 180.95 ..... 182.95  
181 MFD 3000 VDC 181.95 ..... 183.95  
182 MFD 3000 VDC 182.95 ..... 184.95  
183 MFD 3000 VDC 183.95 ..... 185.95  
184 MFD 3000 VDC 184.95 ..... 186.95  
185 MFD 3000 VDC 185.95 ..... 187.95  
186 MFD 3000 VDC 186.95 ..... 188.95  
187 MFD 3000 VDC 187.95 ..... 189.95  
188 MFD 3000 VDC 188.95 ..... 190.95  
189 MFD 3000 VDC 189.95 ..... 191.95  
190 MFD 3000 VDC 190.95 ..... 192.95  
191 MFD 3000 VDC 191.95 ..... 193.95  
192 MFD 3000 VDC 192.95 ..... 194.95  
193 MFD 3000 VDC 193.95 ..... 195.95  
194 MFD 3000 VDC 194.95 ..... 196.95  
195 MFD 3000 VDC 195.95 ..... 197.95  
196 MFD 3000 VDC 196.95 ..... 198.95  
197 MFD 3000 VDC 197.95 ..... 199.95  
198 MFD 3000 VDC 198.95 ..... 200.95  
199 MFD 3000 VDC 199.95 ..... 201.95  
200 MFD 3000 VDC 200.95 ..... 202.95  
201 MFD 3000 VDC 201.95 ..... 203.95  
202 MFD 3000 VDC 202.95 ..... 204.95  
203 MFD 3000 VDC 203.95 ..... 205.95  
204 MFD 3000 VDC 204.95 ..... 206.95  
205 MFD 3000 VDC 205.95 ..... 207.95  
206 MFD 3000 VDC 206.95 ..... 208.95  
207 MFD 3000 VDC 207.95 ..... 209.95  
208 MFD 3000 VDC 208.95 ..... 210.95  
209 MFD 3000 VDC 209.95 ..... 211.95  
210 MFD 3000 VDC 210.95 ..... 212.95  
211 MFD 3000 VDC 211.95 ..... 213.95  
212 MFD 3000 VDC 212.95 ..... 214.95  
213 MFD 3000 VDC 213.95 ..... 215.95  
214 MFD 3000 VDC 214.95 ..... 216.95  
215 MFD 3000 VDC 215.95 ..... 217.95  
216 MFD 3000 VDC 216.95 ..... 218.95  
217 MFD 3000 VDC 217.95 ..... 219.95  
218 MFD 3000 VDC 218.95 ..... 220.95  
219 MFD 3000 VDC 219.95 ..... 221.95  
220 MFD 3000 VDC 220.95 ..... 222.95  
221 MFD 3000 VDC 221.95 ..... 223.95  
222 MFD 3000 VDC 222.95 ..... 224.95  
223 MFD 3000 VDC 223.95 ..... 225.95  
224 MFD 3000 VDC 224.95 ..... 226.95  
225 MFD 3000 VDC 225.95 ..... 227.95  
226 MFD 3000 VDC 226.95 ..... 228.95  
227 MFD 3000 VDC 227.95 ..... 229.95  
228 MFD 3000 VDC 228.95 ..... 230.95  
229 MFD 3000 VDC 229.95 ..... 231.95  
230 MFD 3000 VDC 230.95 ..... 232.95  
231 MFD 3000 VDC 231.95 ..... 233.95  
232 MFD 3000 VDC 232.95 ..... 234.95  
233 MFD 3000 VDC 233.95 ..... 235.95  
234 MFD 3000 VDC 234.95 ..... 236.95  
235 MFD 3000 VDC 235.95 ..... 237.95  
236 MFD 3000 VDC 236.95 ..... 238.95  
237 MFD 3000 VDC 237.95 ..... 239.95  
238 MFD 3000 VDC 238.95 ..... 240.95  
239 MFD 3000 VDC 239.95 ..... 241.95  
240 MFD 3000 VDC 240.95 ..... 242.95  
241 MFD 3000 VDC 241.95 ..... 243.95  
242 MFD 3000 VDC 242.95 ..... 244.95  
243 MFD 3000 VDC 243.95 ..... 245.95  
244 MFD 3000 VDC 244.95 ..... 246.95  
245 MFD 3000 VDC 245.95 ..... 247.95  
246 MFD 3000 VDC 246.95 ..... 248.95  
247 MFD 3000 VDC 247.95 ..... 249.95  
248 MFD 3000 VDC 248.95 ..... 250.95  
249 MFD 3000 VDC 249.95 ..... 251.95  
250 MFD 3000 VDC 250.95 ..... 252.95  
251 MFD 3000 VDC 251.95 ..... 253.95  
252 MFD 3000 VDC 252.95 ..... 254.95  
253 MFD 3000 VDC 253.95 ..... 255.95  
254 MFD 3000 VDC 254.95 ..... 256.95  
255 MFD 3000 VDC 255.95 ..... 257.95  
256 MFD 3000 VDC 256.95 ..... 258.95  
257 MFD 3000 VDC 257.95 ..... 259.95  
258 MFD 3000 VDC 258.95 ..... 260.95  
259 MFD 3000 VDC 259.95 ..... 261.95  
260 MFD 3000 VDC 260.95 ..... 262.95  
261 MFD 3000 VDC 261.95 ..... 263.95  
262 MFD 3000 VDC 262.95 ..... 264.95  
263 MFD 3000 VDC 263.95 ..... 265.95  
264 MFD 3000 VDC 264.95 ..... 266.95  
265 MFD 3000 VDC 265.95 ..... 267.95  
266 MFD 3000 VDC 266.95 ..... 268.95  
267 MFD 3000 VDC 267.95 ..... 269.95  
268 MFD 3000 VDC 268.95 ..... 270.95  
269 MFD 3000 VDC 269.95 ..... 271.95  
270 MFD 3000 VDC 270.95 ..... 272.95  
271 MFD 3000 VDC 271.95 ..... 273.95  
272 MFD 3000 VDC 272.95 ..... 274.95  
273 MFD 3000 VDC 273.95 ..... 275.95  
274 MFD 3000 VDC 274.95 ..... 276.95  
275 MFD 3000 VDC 275.95 ..... 277.95  
276 MFD 3000 VDC 276.95 ..... 278.95  
277 MFD 3000 VDC 277.95 ..... 279.95  
278 MFD 3000 VDC 278.95 ..... 280.95  
279 MFD 3000 VDC 279.95 ..... 281.95  
280 MFD 3000 VDC 280.95 ..... 282.95  
281 MFD 3000 VDC 281.95 ..... 283.95  
282 MFD 3000 VDC 282.95 ..... 284.95  
283 MFD 3000 VDC 283.95 ..... 285.95  
284 MFD 3000 VDC 284.95 ..... 286.95  
285 MFD 3000 VDC 285.95 ..... 287.95  
286 MFD 3000 VDC 286.95 ..... 288.95  
287 MFD 3000 VDC 287.95 ..... 289.95  
288 MFD 3000 VDC 288.95 ..... 290.95  
289 MFD 3000 VDC 289.95 ..... 291.95  
290 MFD 3000 VDC 290.95 ..... 292.95  
291 MFD 3000 VDC 291.95 ..... 293.95  
292 MFD 3000 VDC 292.95 ..... 294.95  
293 MFD 3000 VDC 293.95 ..... 295.95  
294 MFD 3000 VDC 294.95 ..... 296.95  
295 MFD 3000 VDC 295.95 ..... 297.95  
296 MFD 3000 VDC 296.95 ..... 298.95  
297 MFD 3000 VDC 297.95 ..... 299.95  
298 MFD 3000 VDC 298.95 ..... 300.95  
299 MFD 3000 VDC 299.95 ..... 301.95  
300 MFD 3000 VDC 300.95 ..... 302.95  
301 MFD 3000 VDC 301.95 ..... 303.95  
302 MFD 3000 VDC 302.95 ..... 304.95  
303 MFD 3000 VDC 303.95 ..... 305.95  
304 MFD 3000 VDC 304.95 ..... 306.95  
305 MFD 3000 VDC 305.95 ..... 307.95  
306 MFD 3000 VDC 306.95 ..... 308.95  
307 MFD 3000 VDC 307.95 ..... 309.95  
308 MFD 3000 VDC 308.95 ..... 310.95  
309 MFD 3000 VDC 309.95 ..... 311.95  
310 MFD 3000 VDC 310.95 ..... 312.95  
311 MFD 3000 VDC 311.95 ..... 313.95  
312 MFD 3000 VDC 312.95 ..... 314.95  
313 MFD 3000 VDC 313.95 ..... 315.95  
314 MFD 3000 VDC 314.95 ..... 316.95  
315 MFD 3000 VDC 315.95 ..... 317.95  
316 MFD 3000 VDC 316.95 ..... 318.95  
317 MFD 3000 VDC 317.95 ..... 319.95  
318 MFD 3000 VDC 318.95 ..... 320.95  
319 MFD 3000 VDC 319.95 ..... 321.95  
320 MFD 3000 VDC 320.95 ..... 322.95  
321 MFD 3000 VDC 321.95 ..... 323.95  
322 MFD 3000 VDC 322.95 ..... 324.95  
323 MFD 3000 VDC 323.95 ..... 325.95  
324 MFD 3000 VDC 324.95 ..... 326.95  
325 MFD 3000 VDC 325.95 ..... 327.95  
326 MFD 3000 VDC 326.95 ..... 328.95  
327 MFD 3000 VDC 327.95 ..... 329.95  
328 MFD 3000 VDC 328.95 ..... 330.95  
329 MFD 3000 VDC 329.95 ..... 331.95  
330 MFD 3000 VDC 330.95 ..... 332.95  
331 MFD 3000 VDC 331.95 ..... 333.95  
332 MFD 3000 VDC 332.95 ..... 334.95  
333 MFD 3000 VDC 333.95 ..... 335.95  
334 MFD 3000 VDC 334.95 ..... 336.95  
335 MFD 3000 VDC 335.95 ..... 337.95  
336 MFD 3000 VDC 336.95 ..... 338.95  
337 MFD 3000 VDC 337.95 ..... 339.95  
338 MFD 3000 VDC 338.95 ..... 340.95  
339 MFD 3000 VDC 339.95 ..... 341.95  
340 MFD 3000 VDC 340.95 ..... 342.95  
341 MFD 3000 VDC 341.95 ..... 343.95  
342 MFD 3000 VDC 342.95 ..... 344.95  
343 MFD 3000 VDC 343.95 ..... 345.95  
344 MFD 3000 VDC 344.95 ..... 346.95  
345 MFD 3000 VDC 345.95 ..... 347.95  
346 MFD 3000 VDC 346.95 ..... 348.95  
347 MFD 3000 VDC 347.95 ..... 349.95  
348 MFD 3000 VDC 348.95 ..... 350.95  
349 MFD 3000 VDC 349.95 ..... 351.95  
350 MFD 3000 VDC 350.95 ..... 352.95  
351 MFD 3000 VDC 351.95 ..... 353.95  
352 MFD 3000 VDC 352.95 ..... 354.95  
353 MFD 3000 VDC 353.95 ..... 355.95  
354 MFD 3000 VDC 354.95 ..... 356.95  
355 MFD 3000 VDC 355.95 ..... 357.95  
356 MFD 3000 VDC 356.95 ..... 358.95  
357 MFD 3000 VDC 357.95 ..... 359.95  
358 MFD 3000 VDC 358.95 ..... 360.95  
359 MFD 3000 VDC 359.95 ..... 361.95  
360 MFD 3000 VDC 360.95 ..... 362.95  
361 MFD 3000 VDC 361.95 ..... 363.95  
362 MFD 3000 VDC 362.95 ..... 364.95  
363 MFD 3000 VDC 363.95 ..... 365.95  
364 MFD 3000 VDC 364.95 ..... 366.95  
365 MFD 3000 VDC 365.95 ..... 367.95  
366 MFD 3000 VDC 366.95 ..... 368.95  
367 MFD 3000 VDC 367.95 ..... 369.95  
368 MFD 3000 VDC 368.95 ..... 370.95  
369 MFD 3000 VDC 369.95 ..... 371.95  
370 MFD 3000 VDC 370.95 ..... 372.95  
371 MFD 3000 VDC 371.95 ..... 373.95  
372 MFD 3000 VDC 372.95 ..... 374.95  
373 MFD 3000 VDC 373.95 ..... 375.95  
374 MFD 3000 VDC 374.95 ..... 376.95  
375 MFD 3000 VDC 375.95 ..... 377.95  
376 MFD 3000 VDC 376.95 ..... 378.95

at 50 ma. by selecting the value of  $R_1$  and  $R_2$  so that 10 to 10.5 volts is developed across  $R_3$  and  $R_4$  with no external load on the supply.

It has been found that even with the large value of output capacitors, occasional transients from the power line will get through. The preamplifiers will produce transients up to 0.5 volt peak if a heavy inductive load such as a 1-hp motor is switched on and off at the same a.c. outlet. Turntable motors are not at all bothersome. If the installation warrants the added cost, line transients can be eliminated by using zener diodes in place of  $R_3$  and  $R_4$ . A 10-watt, 9-volt zener, such as the Hoffman 1N1808, should be used, preferably with a small heat sink.

Only one precaution need be observed during the installation of the a.c. power supply. The 24-volt transformer should be located and/or oriented so the 60-cps field from the core is not induced into the magnetic cartridge.

-30-

### OSCILLATION IN PORTABLE

By ROBERT JONES

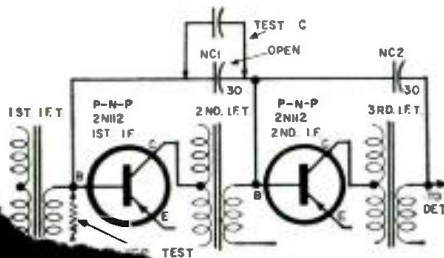
**T**ELL-TALE "birdies" on every station indicated oscillation in a Raytheon portable transistor radio, model FM-101A. The following technique was found to localize the defect quickly:

Jumper tests were made with a 1000-ohm resistor across all i.f. transformer secondaries, as shown in the partial schematic. The damping resistor killed the oscillation at all points from the detector input back to the input of the first i.f. transistor. Consequently, the trouble was in the first i.f. stage, the mixer, or the feedback loop entailed in these circuits.

Rather than perform a "butcher" job by permanently wiring a damper resistor across a secondary, each neutralizing capacitor (NC) was shunted in turn. Shunting NC<sub>2</sub>, connected between the base of the second i.f. transistor and the detector, produced no results. Shunting neutralizing capacitor NC<sub>1</sub>, between the base of the first i.f. transistor and the base of the second i.f., stopped the birdies and restored normal operation.

To eliminate the possibility that hand capacitance was responsible for a misleading indication, the shunt was temporarily pinched into place around the leads of NC<sub>1</sub>, thus avoiding the use even of clips that might contribute a loading effect. Finally, although the defective capacitor had been shunted for testing, it was removed and replaced for the final repair. Although the faulty unit was obviously open, it may have made intermittent contact later on, and circuit gain could have been reduced by too much neutralizing capacitance.

Resistor and capacitor test probes localized a problem in i.f. oscillation.



# more

...so much more for everyone... for every application... in the complete line of Stanton Stereo Fluxvalves\*.

Here is responsible performance... in four superb models... for all who can hear the difference. From a gentle pianissimo to a resounding crescendo—every movement of the stylus reflects a quality touch possessed only by the Stereo Fluxvalve.



 <p><b>STANTON Calibration Standard: Model 383</b> — An ultra-linear professional pickup for recording channel calibration, radio stations and record evaluation by engineers and critics. From \$48.00</p>	 <p><b>Collectors Series: Model 380</b> — A precision pickup for the discriminating record collector. From \$29.85</p>	 <p><b>Pro Standard Series: MK II</b> — A professional pickup outstanding for quality control. From \$24.00</p>	 <p><b>StereoPlayer Series: Stereo 90</b> — A fine quality stereo magnetic pickup for the audiophile... \$16.50</p>
--	--	--	--

LISTEN!... and you will agree Pickering has more for the best of everything in record reproduction—mono or stereo. More Output—More Channel Separation—More in Response—More in Record Life! In short... more to enjoy... because, there's more quality for more listening pleasure. \* U.S. Patent No. 2,917,590

FOR THOSE WHO CAN HEAR THE DIFFERENCE



PICKERING & CO., INC., PLAINVIEW, NEW YORK  
STEREO FLUXVALVE, STEREOPLAYER, COLLECTORS SERIES, PRO STANDARD SERIES, CALIBRATION STANDARD AND TRADEMARK

LISTEN!—Ask for a Stereo FLUXVALVE demonstration at your Hi-Fi Dealer today!  
Send for Pickering Tech-Specs—a handy guide for planning a stereo high fidelity system... address Dept. F80





\* Fill in Coupon for a FREE One Year Subscription to OLSON RADIO'S Fantastic Bargain Packed Catalog—Unheard of LOW, LOW, WHOLESALE PRICES on Brand Name Speakers, Changers, Tubes, Tools, Hi-Fi's, Stereo Amps, Tuners and thousands of other Electronic Bargains.

NAME \_\_\_\_\_  
ADDRESS \_\_\_\_\_  
CITY \_\_\_\_\_ ZONE \_\_\_\_\_ STATE \_\_\_\_\_

If you have a friend interested in electronics send his name and address for a FREE subscription also.

**OLSON RADIO CORPORATION**

610 S. Forge St. Akron 8, Ohio

the new **RECORD LIFE SAVER**  
(Patent Pending)

saves the life of phonograph records!

**TELLS WHEN TO CHANGE THE NEEDLE**

**NO. RLS-101**  
**\$4.95** List

**SIMPLE INSTALLATION**  
Just connect 2 wires to phono motor lead wires!



If your dealer doesn't have a supply yet, send check for \$4.95 postpaid to

**DEALERS:**  
Send for full information.

**PREMIER ELECTRONICS, INC.**  
Dept. E • 341 Manida St., New York 59, N. Y.

# LEKTRON'S WORLD FAMOUS POLY PAKS®

AT-FACTORY-TO-YOU PRICES!

NOW for the first time

# 91¢

Each in Lots of 12

88¢ Each in Lots of 24

91¢ Each in Lots of 12

96¢ Each in Lots of 6

LIMITED TIME ONLY

# FREE!

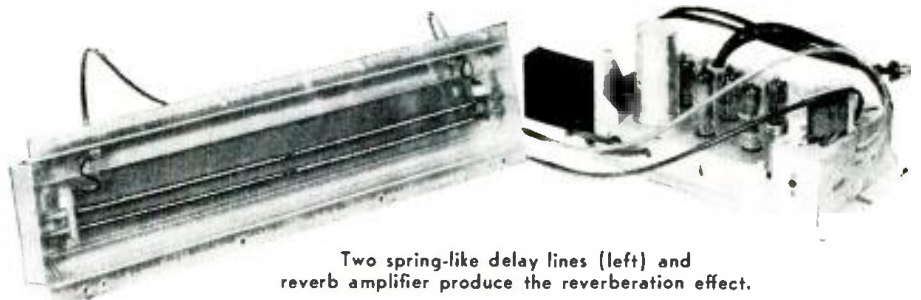
Choose Any Item \$1 or Less With Any \$10 Order

- 100 1/2-WATT RESISTORS  
Ass't. values, some 1%  
1% Worth \$18. \$1
- 10 3-SEC. TIMERS  
Precision geared. \$1
- 10 INSTRUMENT KNOBS  
Pointer types, black,  
brass insert & set \$1
- 8-PC. NUTDRIVER SET  
Plastic handle, 3/16  
thru 7/16 nutdrivers  
in handy case. Worth \$3. \$1
- 35 POWER RESISTORS  
Ass't. 1/2 to 50W to 10,  
000 ohms. Various  
types too. Worth \$12. \$1
- 70 MICA CONDENSERS  
INCL. 500V. 100V.  
0.0025 to .01 in  
GUM. Worth \$20. \$1
- 10 ELECTROLYTICS  
Incl. can, paper types.  
Dual too. To 1000  
to 150V. Worth \$12. \$1
- 80 TUBULAR COND'N'RS  
Paper, mica, oil,  
ceramic. 0.001 to 1  
mf to 100V. Worth \$10. \$1
- 40 SILVER MICAS  
1 & 1/2% ass't. values.  
Finest made. \$1
- 300-FT. HOOKUP WIRE  
Ass't. colors, insula-  
tion sizes. Worth \$5. \$1
- 60 RADIO TV KNOBS  
Ass't. colors, sizes.  
Ships some \$1 ea. \$1
- 1500 PCS. HARDWARE  
Nuts, bolts, etc. wide  
variety. Handy shop \$1
- 30 MOLDED COND'N'RS  
Oils too. Lasts for  
life. Worth \$8. \$1
- 40 2-WATT RESISTORS  
Incl. 1% too. Ass't.  
values. \$1
- 8 SILI'N' M' XTAL DI'D'S  
1N21, 1N21, etc. \$1
- 4 1N34 DIODES  
Or equal; glass-sealed.  
New mini types. \$1
- 50 DISC CONDENSERS  
Ass't. 0.001 to .01 to  
1000V. Worth \$10. \$1
- 4 OUTPUT TRANS'N'RS  
50L6, etc. Open frame  
types. Worth \$8. \$1
- 6 115VAC SWITCHES  
Panel, toggle type,  
SPST, DPDT, etc. A  
shop must. \$1
- 70 INSULATED RES'T'RS  
IRC, Allen Bradley,  
stockpole makers. 1/2  
1W, 100 ohms to 1 meg. \$1
- 10 PANEL SWITCHES  
Ass't. sizes, power,  
rotary types. Worth \$1  
\$10. \$1
- 25 PANEL PILOT LITES  
Mini bay & screw  
types. Worth \$5. \$1
- 60 RESISTOR SPECIAL  
Carbons, precisions, hi-  
Q, W.W. carbo-films, to  
50W, 1% too. \$1
- 10 VOLUME CONTROLS  
Ass't. to 1 meg. Some  
with switch. \$1
- 3 HOBBY TRANSISTORS  
PNP's, etc. Similar  
to 6A05. Worth \$8. \$1
- 125 RESISTORS  
Ass't. values, incl 1%  
too to 1 meg. \$1
- 15 "POLY" BOXES  
Snap-top covers; sizes  
to 4" for parts, etc.  
etc. Worth \$3. \$1
- 4 I.F. TRANSFORMERS  
456 kcs. Only 1/2 sq.  
Transistor ekt. \$1
- 60 PLUGS & REC'PTS  
Incl. power, auto, bat-  
tery, etc. Worth \$8. \$1
- 125 CERAMIC COND'N'RS  
Incl. discs too! Wide  
variety of types & val-  
ues. Worth \$10. \$1
- 12 GERMANIUM DIODES  
Glass-sealed, similar to  
1N48; hobbyists. \$1
- 3 AC-DC RECTIFIERS  
SELENIUM, 110V, 65 &  
100 ma; half wave. \$1
- NEEDLE, STAMP CH'CK'R  
battery-operated. Checks  
needles, stamps, etc. \$1
- 10 RCA PLUG 'N' JACK  
Sets for amps, tun-  
ers, phonos, etc. \$1
- 13-IN-1 PAK  
Diodes; carbon, W.W.,  
precision, hi-Q resistors;  
disc, ceramic, molded, oil-  
paper, mica condensers; \$1
- 40 TUBE SOCKETS  
8 to 12 prongs, mica  
filled too! & mini \$1
- 7 SILICON DIODES  
1N21, 1N22, 1N23, etc.  
Some worth \$10 ea. \$1
- 4 AC & DC CHOKES  
Power & radio types to  
300 mA; 100 ohm  
frame types. Worth \$10. \$1
- 50-FT. 'ZIP' CORD  
For speaker extensions.  
AC/DC, 2-round, pp-  
rally. Worth \$5. \$1
- 60 TERMINAL STRIPS  
1 to 10 tie points. Used  
in every type of \$1
- 70 COILS & CHOKES  
RF, ant. osc. slug-tuned,  
I.F. Wonderful shop  
ass't. Worth \$10. \$1
- 70 1-WATT RESISTORS  
Incl. precisions, W.W.,  
carbo-films, 1 &  
5% too. \$1
- 60 CONDENSER SPECIAL  
Incl. discs, ceramics,  
moldeds, mica, papers,  
oils, etc. Worth \$12. \$1
- 15 ROTARY SWITCHES  
Ass't. gangs, con-  
tacts. Worth \$17. \$1
- 3 FERRITE LOOPSTICKS  
Adjustable; 540 to \$1  
1600 kcs. Worth \$2. \$1
- 40 TRANSFORMER RES'T'RS  
Ass't. to 3 megs. 1-5  
watt rating. Color \$1
- 20-PC. TWIST-DRILL SET  
In case. 1/16 thru 1/4-  
drills. For all types of \$1
- 24 ARTISTS BRUSHES  
100% pure bristles. \$1
- \$25 SURPRISE PAK  
Wide variety of usable  
radio-tv-hobby parts. \$1
- TRANS'N' RADIO BASIC  
Incl. transformer, socket,  
coupler, diode. \$1
- 50 PRECISION RES'T'RS  
1/2% ass't. values. \$1
- 8 NEON INDICATORS  
For 110 VAC; mini  
bay, types. \$1

MINIMUM ORDER \$2.00—Avg. wt. 1 lb. per pak

**HOW TO ORDER** Check items. Return ad w/ check or M.O., including sufficient postage; excess returned. C.O.D. orders 25% down; rated, net 30 days. Print name, address WITH POSTAL ZONE in margin.

**LEKTRON** 133 Everett Ave. CHELSEA 50, MASS.



Two spring-like delay lines (left) and reverb amplifier produce the reverberation effect.

## "Reverbaphonic Sound" System

Electro-mechanical reverberation unit to be included in Philco and Zenith packaged phonograph consoles.

In an effort to insert some "concert-hall reverberation" into stereo or mono sound that is reproduced in the home, two manufacturers of packaged phonographs are including, in some of their new models, an electro-mechanical reverberation unit similar in principle to the reverb unit used in *Hammond* electronic organs. Both *Philco* and *Zenith* have announced the use of the *Hammond*-designed reverberation unit in some of their new console models under the name of "Reverbaphonic Sound," for *Philco* units, or "Reverba-Tone," for *Zenith* units.

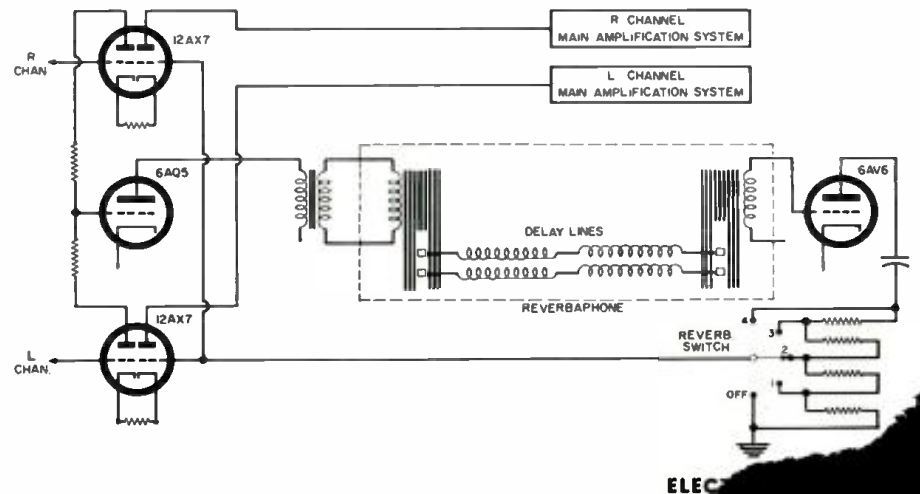
We recently attended a press demonstration of the *Philco* system and were quite impressed at the great difference in reproduced sound when the reverberation unit was switched in. A very definite and noticeable reverberation effect was heard on both stereo and mono signal sources. There may be those who argue that this is really a "gimmick" that compromises the true stereo effect, but it must be admitted that it does make for a very striking demonstration. The phonograph employed for the demonstration had its speakers for both stereo channels housed in the console. In addition, two outboard 4-inch speakers were placed

in the corners of the listening room some distance away from the console. If desired, the outboard speakers, which handle signals from 200 to 300 cps and upward, may be placed in the main console. A five-position switch on the phonograph provides four degrees of reverb along with an "off" position.

Close examination of the reverberation unit disclosed what appeared to be two springs somewhat over a foot long and perhaps 3/16 inch in diameter stretched loosely between two supports (see photo above). The springs are anchored at both ends onto a pair of ferrite armatures, around which were wound a pair of coils. One of these is used for the input, and the other is used for the output.

The block diagram of the *Philco* system, shown below, indicates just where the reverberation unit fits into the over-all audio system. The time delay produced by the two springs is on the order of 30 to 40 milliseconds. The two springs have slightly different delays in order to obtain a relatively smooth delay characteristic. Because the lines are not terminated, echo signals continue to bounce back and forth for a period of up to approximately 2 seconds.

The combined left and right signals are applied through a coupling transformer to a coil wound on a ferrite armature. This armature then moves mechanically in accordance with the audio signal. The mechanical motion is transmitted along the length of the two spring-like delay lines, causing the armature at the other end of the springs to be vibrated. This, in turn, produces a signal at the output winding that may then be recombined with the original left- and right-channel signals.



## Railroad Radio

(Continued from page 65)

TV is also being used for inspecting the mechanical condition of cars as well as observing the over-all movements in a yard.

Further railroad automation is coming. Still unsolved is the problem of identifying freight cars automatically as they enter a yard. While push-buttons are used for controlling the movements of freight cars as they roll down the hump, it is still necessary to have human beings identify individual freight cars. This is often difficult when the number is almost, if not completely, illegible.

It has been suggested that cars be marked with colored strips in different combinations. The coded combinations are read by a photocell and the information is either stored or displayed by a computer. Another proposed system would provide for coding of cars with radio-active paints using a Geiger counter for reading the numbers.

The use of microwave systems by railroads is expected to expand materially. Much of the open-wire pole line plant operated by the railroads, about 250,000 miles of lines, will require replacement or rehabilitation. Maximum use of these wire lines is being made by many railroads which have installed modern telephone and telegraph carrier systems. One pair of wires, equipped with a modern carrier system, can handle up to a dozen telephone conversations simultaneously. But, even this is not sufficient to accommodate the growing need for communications. Hence, microwave systems which can handle up to 200 voice channels offer freedom from communications congestion.

It is the transistor, however, which is expected to revolutionize railroad communications for the second time since World War II. Transistorized telephone carrier and voice repeaters, which can be operated from batteries, can be installed in remote locations where reliable utility power is not available. Even the smallest yards and some sidings where electric power is not available can be equipped with paging and intercom systems utilizing battery-operated transistorized amplifiers.

Partially transistorized railroad equipment is already available. Transistors are being used in audio output stages and in lieu of vibrators in power supplies. But it is the all-transistorized railroad radio that is being awaited by the industry. Imagine a caboose radio the size of a portable typewriter, perhaps even smaller, which will operate from a pair of lantern batteries or even solar cells. The vibrator, axle-drive assembly, storage battery, and charging generator will then be only memories. Based on observations of the present rate of progress of the electronics art, the all-transistorized railroad radio is not far away.



MODEL 580

## MILLER FM high fidelity tuner — top performance at a moderate price

Miller has designed every quality feature into this tuner, to bring you big value.

There's a tuned R.F. stage for good image rejection. There's ultra-stable permeability tuning. Dual limiters provide maximum noise control. The oscillator stage is completely shielded to maintain radiation well below FCC requirements. Tuner has AFC with defeat control, and cathode-follower audio output. Multiplexing outlet provided.

**SPECIFICATIONS:** A six-tube unit, it has a tuning range of 86 to 110 Mc. Typical sensitivity is 1.0  $\mu$ v for 20 db quieting; 2.1  $\mu$ v for 30 db quieting. Typical selectivity: 200 kc at 6 db. Frequency response: 15 to 25,000 cps. Distortion is less than 1/2% at rated output, and warmup drift is negligible. Size: 9" wide, 4" high and 7" deep.

Model 580 — in attractive 2-tone cabinet . . . . PRICE: \$69.50  
Model 579 — sub-assembly only, completely wired . . . . \$37.50



Write for literature and name of nearest dealer.

### J. W. MILLER COMPANY

5917 South Main Street, Los Angeles 3, California

Manufacturers of Quality Radio and TV Equipment Since 1923

Ask By Name For  
**GENUINE**  
your assurance  
of brand name  
quality

**"NO-NOISE"  
PRODUCTS**

**NO-NOISE  
TUNER-TONIC**  
With PERMA-FILM

- Cleans, lubricates, restores all tuners, including wafer type.
- Non-toxic, non-inflammable.
- For TV, radio and FM use.
- Economical — a little does a lot.

6 Oz. Aerosol Can  
**\$3.25**  
Net to Servicemen

**NO-NOISE  
VOLUME CONTROL and  
CONTACT RESTORER**

- Lubricates
- Cleans
- Protects

Net a Carbon Tet Solution  
2 Oz. Bottle      6 Oz. Spray Can  
**\$1.00 \$2.25**  
Net to Servicemen      Net to Servicemen

At Your  
**FREE** Jobbers

**5" PLASTIC  
EXTENDER**

- Push Button Assembly
- For Pin-Point Applications
- Does Not Cause Shorts

**ELECTRONIC CHEMICAL CORP.**  
813 Communipaw Avenue Jersey City 4, N. J.

**P.S.** Be Sure to Ask for  
**NO-NOISE  
RUBBER COAT** 6 Oz. Spray Can **\$3.25**

**Special Offer 25¢**

Hear these  
authentic recordings  
of dramatic events  
from

**"The Amazing World of  
Short Wave Listening"**  
narrated by Alex Dreier, Radio-TV "Man on the Go"

- President's voice from outer space!
- Actual capture of a desperate criminal!
- Radio amateur at Little America!
- Ships at sea . . . aircraft in action!

**S-107**  
receiver  
**\$94.95**

4 short wave bands plus standard broadcast. Phono and headset jacks, built-in speaker.

**MAIL COUPON TODAY!**

**hallicrafters.**  
DEPT. 20, CHICAGO 11, ILL.

Gentlemen: Please rush by return mail my recording, "The Amazing World of Short Wave Listening." I enclose 25¢

NAME \_\_\_\_\_  
ADDRESS \_\_\_\_\_  
CITY \_\_\_\_\_ STATE \_\_\_\_\_

# New Audio Test Report

(A) LAB TESTED  
**ELECTRONICS WORLD**  
 (S)

**Argus Model X-4 Speaker System**  
**University T-202 "Sphericon" Tweeter**  
**Dynaco TA-12 "Stereodyne" Tone Arm and Cartridge**



## Argus Speaker System

**W**E have just completed our tests on the Argus Model X-4 speaker system which is described by the distributor as "an over-sized bookshelf system designed for floor placement primarily." Although certainly not of bookshelf size, the unit is fairly compact so that a pair of them would not occupy too much space in an average room. The speaker enclosure itself is 2-feet high by 1½-feet wide by 1½-feet deep, and this enclosure is mounted on a 3-inch matching base. The system uses a single wide-range 12-inch speaker that employs a special suspension of latex-like material that is claimed to control cone excursion and improve transient response. This speaker has a fairly low

cone resonance. The high frequencies are produced by a separate dispersion cone that is attached to the same voice coil. No electrical crossover network is required as this function is accomplished mechanically.

The speaker is mounted in a simple infinite-baffle enclosure, a completely closed box, that is lined on all inside surfaces with a 2-inch layer of fiber glass. Three-quarter-inch stock is used for the enclosure. The inside volume is just over 3 cubic feet and no ducts or ports are employed.

In order to test the speaker system, we employed acoustic measurements and listening tests. Fig. 1 shows the response measured at a power level of 5 watts. The calibrated microphone used was located on the speaker's axis at a distance of 6 feet from the front panel. Averaging out the curve shows that the response is down about 6 db at 48 cps and down about 12 db at 35 cps. At the high end, the woofer section of the speaker begins to fall off at 1500 cps, at which point the tweeter section takes over. However, instead of the high frequencies continuing on out at the mid-range level, a definite high-frequency plateau exists from 2000 cps to 13,000 cps that averages about 6 db higher than the mid-range level. Output waveforms were observed, and within the limits of the system's power rating, there was very little distortion at the low end.

Our listening tests served to double-check our acoustic measurements. We found the mid-range and lows full-bodied and clean. Although the highs were also clean, because of their high level, the system sounded somewhat strident. Had we been able to bring down the high-frequency level, the system would

have so indeed better balanced. We have been informed by the system's manufacturer that they have taken steps to lower the output level of the high end in order to obtain a more balanced output. The future units with this modification should do a good job as a high-fidelity reproducer. Also worthy of comment is the fact that the speaker system has very good dispersion of the high frequencies and appears to have good over-all transient performance.

The Model X-4 is an 8-ohm system that will handle 30 watts of power. The cabinet is oil-stained walnut and the unit is priced at \$180. It is available from the exclusive sales agency *Hi-Fi Supply*, 1069 First Ave., New York 22, N. Y.

-30-

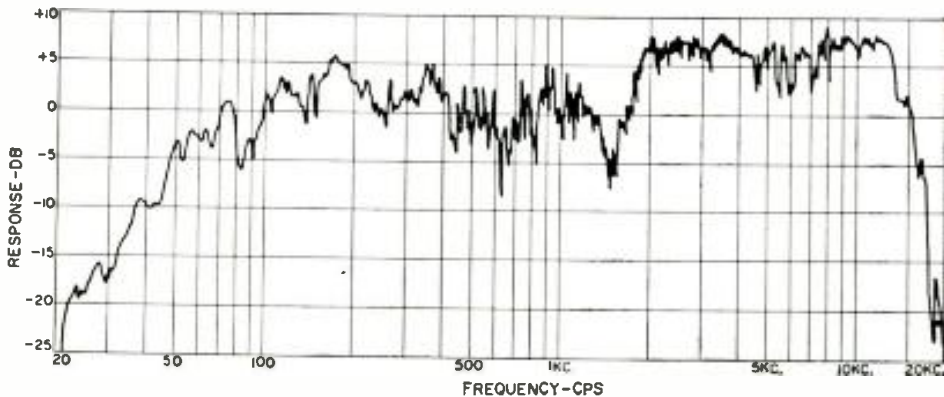


## University Tweeter

**T**HE problem of adding a tweeter to a speaker system that is deficient in highs is not an easy one to solve. Should the user select the highly efficient horn-type tweeter which is fairly directional, or should he select a much lower efficiency cone tweeter or an electrostatic tweeter with less output and more dispersion? Evidently, *University* has taken a position right down the middle with its new Model T-202 "Sphericon" tweeter. This unit is less efficient than a horn tweeter, but it has better dispersion. On the other hand, the "Sphericon" has considerably more output than do most cone or electrostatic tweeters.

Examination of the tweeter shows that the manufacturer has combined some of the physical features of both horn and cone speakers. For example, the diaphragm is dome-shaped and made of phenolic material just as in many horn tweeters. However, instead of using a fairly long directive horn in front of the diaphragm, a very shallow plastic horn is used. This has the appearance of a small cone on a conventional cone tweeter, except that it is fixed and does not move with the diaphragm. A small diffractor sphere in front of the diaphragm is used to widen the dispersion pattern to approximate-

Fig. 1. Response measurements at 5 watts with a microphone spacing of 6 feet. Since the curve was taken in a normal listening room, there are many peaks and valleys in response. These should be averaged out to eliminate effects of the room.





ly 120 degrees both horizontally and vertically.

We checked the tweeter both by listening tests and by acoustic measurements with an audio generator and a wide-range microphone whose output was connected to a high-gain oscilloscope. In comparing the unit with both electrostatic and cone tweeters, the greater acoustic output of the "Sphericon" was clearly evident. When we observed the waveform on our scope, no distortion could be seen over the entire range of our tests. Using as an arbitrary reference the output at 5000 cps, we found that the level dropped at the low end by 6 db at 2500 cps. This was caused not only by the characteristics of the tweeter itself but also because of the built-in crossover network whose nominal cut-off frequency is 3000 cps. When we ran our audio generator up to 20 kc., we were still obtaining output on our scope. However, because of the limited response of our microphone at this high frequency, we did not attempt to measure the output. The manufacturer has obtained a response that is down somewhat less than 4 db at 20 kc. and even specifies output as far up in frequency as 40 kc.

We then swept our audio oscillator throughout the range in an effort to detect any irregularities in response. Of course, the simple method of placing a microphone in front of the tweeter in an ordinary live room, as we did, and observing the response is fraught with many difficulties. For one thing, standing waves within the room and reflections from the room surfaces may permit a sound maximum to occur at a given frequency where the microphone happens to be located. A slight change of mike position may cause this maximum to become a minimum value at this same frequency. Also different room sizes and different room acoustic treatments will alter the distribution of sound materially. In spite of these problems, we went ahead and located our microphone about 2 feet directly in front of the tweeter in order to get some measurable results to report. Under these conditions, we noted acoustic peaks of about 3 db at 3000 cps, 6 db at 3600 cps, and 6 db at 6400 cps with respect to the level at 5000 cps. It should be pointed out here that the manufacturer recommends that the tweeter be mounted on a flat panel with sound absorbing material surrounding it to prevent mounting-surface reflections. For our measurements, we simply used the tweeter's small carton for mounting. Undoubtedly, mounting the tweeter in accordance with the manufacturer's recommendations would alter the acoustic response.

The tweeter is completely enclosed in the back. All that need be done to mount it is to make a 3<sup>1</sup>/<sub>16</sub>-inch opening in the baffle board. The unit comes with a "brilliance control" which allows the user to vary the level of the high-frequency output from maximum to no output at all. The impedance is 8 ohms so that it may be used in hi-fi systems of from 4 to 16 ohms. The power to the

tweeter will be reduced somewhat if the lower impedance value is used, and it will be increased if the higher value is used. The "Sphericon" will handle about 30 watts of integrated program material. It is available with the built-in network and adjustable brilliance control for \$24.95.

### Dynaco Arm and Cartridge

IN AN effort to augment his excellent line of amplifiers and preamplifiers, Dave Hafer of *Dynaco Inc.* has been marketing a Danish-made stereo cartridge and integrated tone arm. The cartridge is a moving-iron magnetic type using four coils arranged in two push-pull pairs. This design is said to provide equal lateral and vertical compliance along with hum and noise cancellation because of the hum-bucking arrangement. Complete magnetic shielding with Mumetal is also effective in reducing hum pickup.

Although the cartridge can be used in any standard tone arm, the pickup that we tested was mounted in the company's matching arm—the combination is known as Model TA-12. The arm has several interesting features. For example, the main bearing is a low-inertia gyroscope-like gimbal movement which allows free vertical and horizontal movement. Also, there is an adjustable collar that may be slid along the arm to regulate the tracking pressure. This collar pulls on a spring the other end of which is anchored at the bearing assembly. Calibrating marks are on the arm at 1-gram intervals up to 4 grams. In checking this calibration we found that it was necessary to align the back edge of the collar (nearer the main bearing) to the calibration mark in order to get an accurate adjustment. Recommended tracking pressure with the "Stereodyne" cartridge is between 2 and 3 grams. In making our tests, we used an adjustment of 2 grams. The recommended load is 47,000 ohms.

The curves shown here were obtained using the *Westrex* 1-A stereo test rec-

ord. Note how closely the outputs of both channels follow each other—being within about 1 db of each other over the entire frequency range of 30 to 15,000 cps. The response is quite uniform above 1000 cps, with a very slight rising characteristic at the very high end. Below this frequency, the response also rises.

At 30 cps, the response was up approximately 6<sup>1</sup>/<sub>2</sub> db. We know that the *Westrex* record is up about 2 db at this frequency, which would leave us with a rise of 4<sup>1</sup>/<sub>2</sub> db. We had an opportunity of visiting *Dyna's* laboratory, and using the same arm, test record, and even the same v.t.v.m., we found that the over-all rise was only 4<sup>1</sup>/<sub>2</sub> db. The only thing changed was the turntable and the mounting board. Similar tests were made using other turntables and all of them gave us basically the same result. Under these conditions, the actual rise at 30 cps can be considered to be 2<sup>1</sup>/<sub>2</sub> db.

The separation between the channels is quite good over the frequency range we tested. Separation is about 21 db at 1000 cps, and this increases to a maximum of about 29 db around 4000 to 5000 cps. Even at 10,000 cps, the separation averages around 19 db. The output voltage from each channel is 7 mv. at a recorded velocity of 5 cm./sec. at 1000 cps.

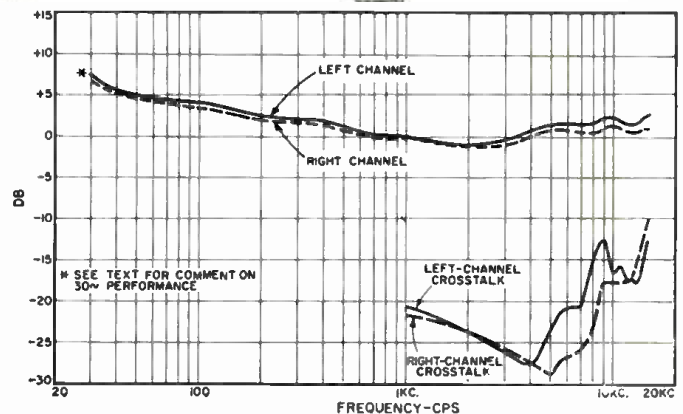
The cartridge comes equipped with a .7-mil diamond stylus that may be replaced easily. Although the unit is a stereo cartridge, it may be used on monophonic records by simply strapping together the two hot output leads. This, of course, may also be done by a switch to the preamplifier.

A listening test proved that this new cartridge and tone arm assembly provided a clear, pleasing response that was smooth without annoying peaks. It was able to track extremely loud stereo and mono passages.

The Model TA-12 integrated tone arm and cartridge is available for \$49.95, or the cartridge may be obtained separately for \$29.95.



Response using the *Westrex* 1-A test record is up 6<sup>1</sup>/<sub>2</sub> db at 30 cps. About 2 db of this is caused by the record. Upon checking the same arm and cartridge with same v.t.v.m. and test record at *Dyna's* lab, but with a different turntable and mounting board, we found only a 4<sup>1</sup>/<sub>2</sub>-db rise. Checks with other turntables showed similar results. Hence, 30-cps response can be considered to be about +2<sup>1</sup>/<sub>2</sub> db.



prepare for your career in

# ELECTRICAL ENGINEERING ELECTRONICS COMPUTERS RADIO-TV

At MSOE, you can equip yourself for a career in many exciting, growing fields: **MISSILES  
RADAR • AUTOMATION  
RESEARCH • DEVELOPMENT  
ELECTRICAL POWER  
AVIONICS • ROCKETRY**

When you graduate from the Milwaukee School of Engineering, you are prepared for a dynamic career as an Electrical Engineer or Engineering Technician. Under a faculty of specialists, you gain a sound technical education in modern, completely equipped laboratories and classrooms. As a result, MSOE graduates are in great demand and highly accepted by industries nationally.

At MSOE you will meet men from all walks of life and all parts of the country — some fresh out of high school or prep school, others in their twenties — veterans and non-veterans.

You can start school in any one of four quarters and begin specializing immediately. Engineering technicians graduate in 2 years with an Associate in Applied Science degree. For a Bachelor of Science degree in Engineering, you attend 4 years. A 3-month preparatory course also is available.



**FREE CAREER BOOKLET**  
If you're interested in any phase of electronics, radio or television, be sure to look into the programs of study offered by the Milwaukee School of Engineering. Just mail the coupon.

## MILWAUKEE SCHOOL OF ENGINEERING

Dept. EW-860, 1025 N. Milwaukee St.  
Milwaukee, Wisconsin

Please send FREE Career Booklet. I'm interested in  Electrical Engineering;  
 Electronics  Computers  
 Electrical Power  Radio-TV  
 Mechanical Engineering

PLEASE PRINT

Name \_\_\_\_\_ Age \_\_\_\_\_

Address \_\_\_\_\_

City \_\_\_\_\_ Zone \_\_\_\_\_ State \_\_\_\_\_

I'm eligible for veterans education benefits.  
MS-123

## Transistor Replacement

(Continued from page 47)

transistors should be replaced as a pair for best results. Adjustment of forward-bias resistance can best be achieved by connecting an audio oscillator to the first audio stage and an oscilloscope at the output of the system, as shown in Fig. 2.

The value of the bias resistor (68 ohms in this case, as indicated by asterisk) is adjusted for minimum crossover distortion. High distortion will show up in the form of the waveform labeled as incorrect in Fig. 2. Use as little resistance as possible, consistent with low distortion at adequate volume levels, determined by listening for volume while checking distortion on the scope. This will keep battery drain down. A test tone of 1000 cps is satisfactory.

### Neutralization

While the technique for replacing r.f. and i.f. transistors already described will work out right in most instances, there is a possible fly in the ointment, so to speak. American transistors tend to have more gain and less collector-to-base capacitance than similar Japanese types. In some cases, replacement may cause the stage to oscillate.

Here's why: Our typical i.f. amplifier (Fig. 1) has a neutralization circuit to cancel out the r.f. signal fed from the collector back to the base through the transistor's junction capacitance. This loop consists of the 20- $\mu$ f. capacitor between the secondary of the i.f. transformer and the base of the transistor. The connection is such that the signal fed back to the base is out-of-phase with signal passed by the transistor junction. Thus, if the two signals are equal in amplitude, the capacitive feedback provides perfect cancellation and the stage is neutralized.

Let's assume that the replacement transistor has less junction capacitance than the Japanese original. Since the amplitude of the feedback signal is greater than necessary for cancellation, the stage oscillates. If the value of the feedback capacitor is slightly off but close, the problem might be even worse. Oscillation itself might not occur in the service shop, but the tendency for it would be increased. Thus, when the stage is operating at increased gain (due to a temperature change or when a weak signal reduces a.v.c. voltage), the set might "take off." The unaware technician could have quite a time of it trying to figure out why the radio oscillated (or quit working) when the customer took it on a trip but worked perfectly in the shop! In any event, neutralization should be checked whenever r.f. or i.f. transistors are replaced with units that are not exact equivalents.

The chief instrument for making this check is a small trimmer capacitor whose range extends above and below that of the original neutralizing capacitor, which is used to determine the cor-

rect value needed. Bias is removed from the stage involved (as described earlier) and the radio is driven with a fairly strong, modulated r.f. signal from a suitable generator. The injection point is not particularly important as long as a signal can be forced through the unbiased stage under test.

A means of measuring the signal that passes through the stage is also necessary. An oscilloscope or audio voltmeter connected between collector and ground of an output transistor works very well—but be sure to keep the volume control wide open. With this setup, replace the neutralizing capacitor with the trimmer and adjust the latter while observing the output indicator for minimum signal. When this null is found, replace the trimmer with a suitable fixed capacitor (silver mica or NPO) of the correct value. If an instrument for measuring capacitance is not at hand, a calibrated substitution box or individual capacitors of known value could be used for the test instead of the trimmer.

Some radios use an RC neutralizing network to correct both phase and amplitude. In these, it may also be necessary to adjust the value of the resistor for proper nulling of the signal.

In some cases, a part of the primary winding of the i.f. transformer is involved in the neutralizing loop. Procedure here is the same as that already outlined, but the value of the neutralizing capacitor is usually much smaller. The circuit is thus more critical with respect to such factors as lead length and hand capacitance.

With the steps outlined here, the technician can reduce most problems involving replacement of Japanese transistors to routine jobs. —30—

## Computer Memory Devices


(Continued from page 42)

rays is known as a *plane*. Each of the cores shown in Fig. 11 would therefore be placed at corresponding locations in five different planes and could be read or written simultaneously. The total storage capacity of a core memory is determined by (1) the number of cores in each plane and (2) the number of planes. A twelve-plane 64-by-64 memory would, for example, be capable of storing 4096 twelve-bit numbers.

Magnetic drum and tapes are *cyclic* storage devices, involving mechanical motion of the recording surface with respect to the heads. Recorded data passes the reading heads in the order in which the data is located on the surface of the drum or tape. By contrast, magnetic cores constitute a *random-access* type of storage. This means that the cores can be read in any order at once simply by pulsing the appropriate X and Y wires. It is for this reason that the access time is very short as compared to tape or drum storage, and magnetic cores are frequently used in the main memory of high-speed computers. —30—

**TS-100AP 'SCOPE**  
(WORTH \$750) **\$2950**  
OUR LOW PRICE


Can be used with linear sweep or general purpose test scope. Cables included. Also used with circular sweep as precision range calibrator. Self-contained in metal case 8 1/2" x 12 1/2" x 10" deep. For 110 V 50 to 1200 cycles AC. Excellent used, like new. All tubes including crystals and C. R. Tube.



**BC-929 3-INCH SCOPE**

Low cost station monitor or bench scope. Has Horiz. Focus, sweep, intensity controls. Tubes: 2-6N7, 2-6H6, 1-6X5, 1-6H6, 1-2N2, 3BP1 CR Tube. Voltage req. 115V 400 cy. and 24 Volt Dyn. Complete with tubes, exc. \$9.95 used.

**BRAND NEW** Conversion instructions for 110V 60 cy. AC ..... 65c



**LORAN R-65/APN-9 RECEIVER & INDICATOR**

Used in ships and aircraft. Determines position by radio signals from known transmitters. Accurate to within 1% of distance. Complete with tubes and crystal. Exc. used. Value \$1200.00. **\$79.50**

Our Price: Use less tubes, crystal and vis. or, but with 3BP1 C.R. tube ..... \$29.50  
12 Volt Inverter Power Supply for above. (BRAND NEW) ..... \$22.50  
28 Volt Inverter Power Supply, exc. cond. .... \$49.50  
Shock Mount for above ..... \$2.95  
Circuit diagram and connecting plugs available.



**BENDIX DIRECTION FINDERS**  
For commercial navigation on boats.

MN20V 150-325 Kc; 325-605 Kc; 3-4.7 Mc. Complete with tubes, dynamotor. **\$26.95**

**BRAND NEW**

MN28Y Receiver Control Box ..... 4.95  
MN28C Receiver 150-1500 Kc continuous tuning with 12 tubes and dynamotor. Used ..... \$18.95  
MN20K Receiver as above, BRAND NEW ..... 27.50  
MN20K Rotatable Loop for above ..... 4.25  
MN22 Azimuth Control Box ..... 2.95  
Flexible Mechanical Cable for Above ..... 3.95  
MN28C Receiver Control Box ..... 4.95  
Other Accessories available from stock.



**LORAN APN-4 FINE QUALITY NAVIGATIONAL EQUIPMENT**

Determine exact geographic position of your boat or plane. Indicator and receiver complete with all tubes and crystal.

**INDICATOR ID-68/APN-4, and RECEIVER R-98/APN-4, complete with tubes. Exc. used \$49.50**  
Receiver-Indicator as above, BRAND NEW. **\$79.50**

12V Inverter Power Supply. (BRAND NEW) ..... \$32.50  
28V Inverter Power Supply, exc. cond. .... \$49.50  
Shock Mount for above ..... \$2.95




**BC-906 FREQ. METER—SPECIAL**  
Cavity type, 145 to 235 Mc. **BRAND NEW, complete with antenna. Manual included. OUR LOW PRICE \$10.88**



**BC-221 FREQUENCY METER**

**SPECIAL BUY!** This excellent frequency standard is equipped with original calibration charts, and has ranges from 125 Kc to 20,000 Kc with crystal check points in all ranges. Excel. Used with original Calibration Book, Crystal, and all tables. **\$59.50**



**STANDARD TUBES**  
Removed from Brand New Gov't Equipment RECEIVING

6AG5	35	6J5	65	6X4	75	6X4	80	6X4	85
12AT7	45	6H6	55	814	2.25	814	2.25	814	2.25
6A4	40	6S7	40	826	2.45	826	2.45	826	2.45
6C4	25	12AG6	45	826	4.4	826	4.4	826	4.4
6AL5	38	SPECIAL PURP.		1625	2.29	1625	2.29	1625	2.29
6AC7	55	2C39	3.50	4X-150	5.95	4X-150	5.95	4X-150	5.95
6AG	65	3E29	4.25	1P25A	7.95	1P25A	7.95	1P25A	7.95
6V6	65								

**MOBILE-MARINE DYNAMOTOR**  
Model DM35  
Input 12V DC. Output: 825 V DC @ 223 Ma. For recharging intermittent operation. Shpg. wt. 14 lbs. OUR LOW PRICE, BRAND NEW, \$8.45

**OTHER DYNAMOTOR VALUES: Excellent BRAND**

Type	Input	Output	Used	NEW
DM-25	12V 2.2A	250V .050A	\$4.50	
DA-1A	28V 1.6A	230V .100A	3.25	
DM-28	28V	224V .07A	2.75	4.75
DM-32A	28V 1.1A	250V .05A	2.45	4.45
DM-33A	28V 5A	575V .16A	1.95	3.75
	28V 7A	540V .25A	1.95	3.75
DM-34D	12V 2A	220V .080A	4.15	5.50
DM-53A	28V 1.4A	220V .080A	3.75	5.45
DM-64A	12V 5.1A	278V .150A	7.95	
PE-73C	28V 20A	1000V .350A	7.95	10.50
PE-86	28V 1.25A	250V .050A	2.75	3.85

8D-77 DYNAMOTOR, Input 14V @ 39A. Output 1000V @ 350A with starting solenoid. Filter Box and Mounting Base ..... Like New \$14.95

**SCHEMATIC DIAGRAMS** For any equipment on this page, each. **65c**

**AN/ART-13 100-WATT XMTR**  
11 CHANNELS  
200-1500 Kc  
2 to 18.1 Mc  
**\$4850**

Complete with Tubes

Famous Collins Autotune Aircraft Transmitter. AM, CW, MW. Quick change to any of ten preset channels or manual tuning. Speech amplifier/clipper uses carbon or magnetic mike. Highly stable, highly accurate VFO. Built in Xtal controlled calibrator. PPM1s modulate 813 in final up to 90% class "B". A Real "HOT" Ham buy at our low price! **\$48.50**

Orig. cost \$1800 Exc. Used


0-16 Low Freq. Osc. Coil for ART-13 ..... 7.95  
24V Dynmotor for ART-13 ..... 11.95  
Same as above less meter ..... 39.50

**BC-652A RECEIVER—Hot Special!** 2000 to 4000 Kc AM Receiver, 2-band, complete with all tubes, 200 Kc Xtal Calibrators, and 12 V Dynmotor. Tube for 80-meter Ham band. Marine, etc. Provisions for CW, AVC, AVC, Speaker Jack and two Headphone Jacks. Shpg. Wt. 50 lbs. Like new, only **\$22.50**


**POWER SUPPLY for BC-620, 659, available for 6, 12 or 24 Volts DC. Specify. \$8.95**

**BC-659 TRANSMITTER & RECEIVER**  
27 to 38.9 Mc. F.M. Two preselected channels crystal controlled. 5 watts. Complete with speaker. **\$10.95**

Less tubes, used ..... \$5.95  
Antenna for BC-659, Telescoping 20' to 8' Ft. .... \$2.95



**NAVY AIRCRAFT RADIO RECEIVER**  
ARB/CRV 46151—190 to 9050 Kc in 4 bands. 6 Tube Superhet communications receiver, with local and remote tuning, band change, Sharp and broad tuning, AVC, CW, Illuminated dial. Complete with tubes and dynamotor. **BRAND NEW \$34.50**  
Like New ..... \$26.50  
Power Supply 110 V. AC. Wired. .... \$8.50



**RADIO RECEIVER NAVY TYPE RAY-3**  
Model AN-PRGN is for 14V DC operation. These receivers are supplied complete with built-in dynamotor, 11 tubes, Weston output meter on front panel, as well as coax antenna and output connection, phono jack, on-off switch. For 14V or 24V, please specify.  
Like New Condition ..... Our Price **\$14.95**

**FAMOUS SCR-510 COMPLETE SET**  
Consisting of BC-620 FM TRANSCIEVER, 20-28 Mc., with Power Supply for 6 or 12 Volt DC operation, including all components: Antenna, Mast base and sections, Handset, Technical Manual and all other accessories, ready for operation. **BRAND NEW, in original packing. \$59.50**  
OUR LOW PRICE, While They Last!



**SCR-522 2-METER RIG!**  
Terrific buy! VHF Transmitter-receiver, 100-150 Mc, 4 channels, Xtal-controlled. Amplitude modulated voice. They're going fast! Excellent condition.  
SCR-522 Transmitter-Receiver, complete with all 18 tubes, top rack and metal case. **\$29.50**  
COMBINATION, Exc. Used

**MICROPHONES**

Model	Description	Used	BRAND NEW
T-17	Carbon Hand Mike	\$2.19	\$5.45
T-30	Carbon Throat Mike	\$.34	.74
T-45	Army and Navy Lip Mike	1.25	3.88
TS-9	Handset	3.95	4.95
TS-11	Handset	3.95	4.95
TS-13	Handset	3.95	4.95
TS-38	Handset	4.25	5.25

None Tested

**HEADPHONES**

Model	Description	Used	BRAND NEW
HS-23	High Impedance	\$2.19	\$4.65
HS-33	Low Impedance	2.69	4.65
HS-30	Low Imp. (leatherw.)	.90	1.95
4-16 U.	High Imp. (2 units)	3.75	7.95

TELEPHONES—600 ohm Low Impedance HEAD-SETS, BRAND NEW, PER PAIR: JK26 Jack ..... \$3.25  
CD-27A Cord, with PL55 Plug and JK26 Jack ..... .50  
Earphone Cushions for above—pair ..... .50

**SCR-522 2-METER RIG!**  
Terrific buy! VHF Transmitter-receiver, 100-150 Mc, 4 channels, Xtal-controlled. Amplitude modulated voice. They're going fast! Excellent condition.  
SCR-522 Transmitter-Receiver, complete with all 18 tubes, top rack and metal case. **\$29.50**  
COMBINATION, Exc. Used

**MG-34A CODE KEYS**  
Self-contained automatic unit, reproduces code practice signals recorded on paper tape. By use of built-in speaker, provides code-practice signals to one or more persons at speeds from 6 to 25 WPM. Checked out, exc. used. **\$18.95**  
Single Rows of Tape, Each \$1.85

**WILLARD 6-VOLT MIDGET STORAGE BATTERY**  
3 Amp. Hour, BRAND NEW, 3 1/2" x 1 1/2" x 1 1/2". Uses Standard Plug-in Style ..... Only **\$2.95**

**2 VOLT BATTERY "PACKAGE"**  
1-2V, 20 Amp. Hr. Willard Storage Battery, Model #20-2, 3" x 4" x 5 1/2" high ..... \$2.79  
1-2V, 7 Bronze Synchronous Plug-in Vibrator ..... 1.49  
1-Quart Bottle Electrolyte (for 2 cells) ..... 1.45  
ALL BRAND NEW! Combination Price ..... **\$5.45**



**SCR-274 COMMAND EQUIPMENT**  
ALL COMPLETE WITH TUBES

Type	Description	Used	Like NEW
BC-451	Receiver 150-550 KC.	\$12.95	\$14.95
BC-454	Receiver 300 Mc.	9.45	12.45
BC-455	Receiver 6-9 Mc.	11.50	13.95
BC-450	3-Receiver Control Box	1.25	1.75


110 Volt AC Power Supply Kit, for all 274-280 ARC-5 Receivers, Complete with metal case, instructions ..... **\$7.95**  
Factory wired, tested, ready to operate ..... \$11.50

**SPLINED TUNING KNOB** for 274-280 and ARC-5 RECEIVERS. Fits BC-453, BC-454 and others. Only **49c**

BC-457 TRANSMITTER—4-5.3 Mc. complete with all tubes and crystal. **BRAND NEW \$7.85**  
BC-458 TRANSMITTER—5.3 to 7 Mc. Complete with all tubes and crystal. **BRAND NEW \$9.75**  
BC-459 TRANSMITTER—7-9.1 Mc. complete with all tubes and crystal. **BRAND NEW \$13.95**  
BC-456 Modulator ..... USED 3.45 NEW 5.95  
BC-451 Transmitter Control Box ..... 1.25 NEW 1.49

**ALL ACCESSORIES AVAILABLE FOR COMMAND EQUIPMENT.**

**234-258 MC RECEIVER**  
AN/ARR-2  
BRAND NEW 11-tube UHF Tunable Receiver with automatic. Only a few at this low price! **\$8.88**  
Complete with tubes



**G & G Radio Supply Co.**  
Telephone: CO 7-4605  
51 Vesey St., New York 7, N. Y.

**BC-603 FM RECEIVER**  
20 TO 27.9 MC. **\$1495**  
Excellent Used ..... \$10.95  
**BRAND NEW ..... \$16.95**

10 Channel, pushbutton tuning or continuous tuning. Complete with speaker, tubes, speaker.

12 or 24V Dynamotor for Above. **\$5.50**  
Exc. Used \$4.25 ..... Brand New \$10.95

**BC-604 TRANSMITTER—Companion Unit for BC-603**  
Rev above. With all tubes. **BRAND NEW ..... \$4.95**  
With Tubes, Used ..... \$4.95

**SPECIAL! BC-603 FM RCVR CONVERTED FOR ANY FREQUENCY FROM 30 TO 50 MEGACYCLES!**

**BRAND NEW!** Checked out, perfect working condition, ready for operation. Specify Frequency desired (between 30-50 Mc) when ordering. **\$2750**

**AC POWER SUPPLY for BC603, 683**  
Interchangeable, replaces dynamotor. Has On-Off Switch. NO RECVR. CHANGE NEEDED. Provides 220 V. AC, 2-IVAC @ 2 Amps. **\$10.49**  
Complete 240-page Technical Manual for BC603, 604 ..... \$3.95

**APR-5A UHF RECEIVER**

The APR-5A is a superb receiver with 2 frequency ranges: (1) from 1000 to 3100 megacycles, (2) from 3000 to 8000 megacycles continuous by means of interchangeable mixers using a single dial tuning control. It has a 10 meg. I.F. band with 30 megacycles coverage. Operating from 80-115 V. 1 phase, 60-240 cycles. Variable I.F. gain by use of a pot. Use for frequencies above 1000 megacycles to supplement range of APR-4 receivers. Like New, with all tubes ..... **\$59.50**  
BRAND NEW ..... \$69.50

**AN APR-4 RECEIVER** only, 38 to 3000 Kc in 5 tuning unit ranges. High precision laboratory instrument with its range. Includes wide and narrow band IF strip selected from panel. Outputs provided for at least 10 pulse analyzers, panel adapter. **\$69.50**  
Tuning Units: TU16, TU17, TU18 ..... each \$39.50  
TU19 ..... each \$59.50

**RECEIVER SPECIALS!**

BC-312 MOBILE RECEIVER 8 Bands, 1500 Kc to 18 Mc. With Tubes and 11V Dynamotor **\$59.50**  
Exc. Used

BC-342 RECEIVER 1.5 to 18 Mc. AC units. **\$89.50**  
Used

BC-348 SUPERHET Receiver 100 to 500 Kc and 1.5 to 1800 Mc. Voice, Tone, CW. Self-contained dynamotor for 14V. Like New. **\$89.50**

**BC1206-C BEACON RECEIVER**  
195 to 420 Kc. made by Setchel-Carlson. Works on 24-28 volts DC. 135 Kc. IF. Complete with 5 tubes. Size 4" x 4" x 6", Wt. 4 lbs. **\$9.99**  
BRAND NEW, less tubes. **\$5.95**  
Used, with tubes ..... 2.95  
USED, less tubes ..... 2.95



**ARC-5/R28 RECEIVER**  
2-meter Superhet, 100 to 150 Mc in 4 crystal channels. Complete with 10 Tubes. **BRAND NEW \$24.45**  
110V AC Power Sup. Kit for above \$9.75

**ARC-5/T-23 TRANSMITTER**  
100-150 Mc Includes 2-832A, 2-1825 Tubes, BRAND NEW **\$21.50**  
**SPECIAL** Limited quantity ARC-5/T23 transmitters. **OFFER!** Excellent Used, less tubes. **\$5.95**  
MD-7 MODULATOR for T-23, complete with 4 tubes. LIKE NEW **\$9.95**

**ARC-5 MARINE RECEIVER-TRANSMITTER**  
Navy Type Comm. Receiver 1.5 to 3 Mc BRAND NEW with 6 tubes. **\$16.95**  
Navy Type Comm. Transmitter 2.1-3 Mc BRAND NEW with 4 tubes and Xtal MODULATOR for above, new with tubes. **\$12.45**  
MODULATOR for above, new with tubes. **\$5.95**

**SCR-274 COMMAND EQUIPMENT**  
ALL COMPLETE WITH TUBES

Type	Description	Used	Like NEW
BC-451	Receiver 150-550 KC.	\$12.95	\$14.95
BC-454	Receiver 300 Mc.	9.45	12.45
BC-455	Receiver 6-9 Mc.	11.50	13.95
BC-450	3-Receiver Control Box	1.25	1.75

110 Volt AC Power Supply Kit, for all 274-280 ARC-5 Receivers, Complete with metal case, instructions ..... **\$7.95**  
Factory wired, tested, ready to operate ..... \$11.50

**SPLINED TUNING KNOB** for 274-280 and ARC-5 RECEIVERS. Fits BC-453, BC-454 and others. Only **49c**

BC-457 TRANSMITTER—4-5.3 Mc. complete with all tubes and crystal. **BRAND NEW \$7.85**  
BC-458 TRANSMITTER—5.3 to 7 Mc. Complete with all tubes and crystal. **BRAND NEW \$9.75**  
BC-459 TRANSMITTER—7-9.1 Mc. complete with all tubes and crystal. **BRAND NEW \$13.95**  
BC-456 Modulator ..... USED 3.45 NEW 5.95  
BC-451 Transmitter Control Box ..... 1.25 NEW 1.49

**ALL ACCESSORIES AVAILABLE FOR COMMAND EQUIPMENT.**

**234-258 MC RECEIVER**  
AN/ARR-2  
BRAND NEW 11-tube UHF Tunable Receiver with automatic. Only a few at this low price! **\$8.88**  
Complete with tubes

Send Name, Address on Post Card for **FREE CATALOG** of Wonderful Surplus Buys!

# Transistorized Tachometer Pickup



By PAUL S. LEDERER

## Construction of simple photoelectric tach that produces indication proportional to shaft speed.

THE tachometer, a device which measures the speed of a rotating shaft, is a very important industrial and laboratory tool. When it is necessary to monitor the rotational speed of a shaft continuously, a tachometer in the form of a generator is usually permanently attached to the end of the shaft. There are many cases, however, where it is desirable to check speed only occasionally. Using a permanently attached tachometer under these conditions would become prohibitively expensive.

Portable, mechanical revolution counters are available commercially. They require direct contact with the rotating shaft, which at times may be dangerous. When applied to low-power devices, such a mechanical tachometer can seriously affect the speed of the shaft. It is possible to devise a tachometer which does not need any mechanical linkage to the shaft whose speed it measures. A magnet radially embedded in the shaft will induce a voltage whenever it passes a coil placed in proximity and radially to the shaft. Another method uses a light shining through a hole drilled in the diameter of the shaft. It impinges on a photocell

and generates a pulse whenever all three are in line, thus producing a number of pulses proportional to the speed of shaft rotation.

Another technique, employing a light and photocell, uses light reflected from alternately dark and light colored areas along the shaft's circumference. If half of the shaft's circumference is painted black and the other half white and a light is shining on it, whenever the white area is lighted, most of the light will be reflected. Whenever the light shines on the black area, most of the light will be absorbed and very little reflected. If the photocell is mounted next to the lamp, but shielded from its direct light and facing the painted areas on the shaft, the current flowing will depend on the amount of light reflected from the painted areas to the cell. One complete revolution of this shaft would generate one cycle of a (probably squared-off) sine wave at the photocell output. The speed of a slowly turning object can be determined by dividing the circumference into many dark and light areas so that one revolution will generate many cycles.

In practice, it is seldom necessary to actually paint adjacent areas black and white. Clean, bright metal reflects sufficient light; a piece of black electrical tape can serve as the non-reflecting (black) area.

A number of commercial tachometers operate on this principle. Most are designed to operate with electronic frequency counters from which they derive their power. They are fairly big and expensive.

The transistorized tachometer pickup to be described is self-contained in a 2 1/4" x 2 1/4" x 4" aluminum box. It employs a cadmium selenide photocell operating as a reflected-light pickup. A pre-focused flashlight bulb supplies the light and a grounded-emitter amplifier completes the device, which is powered by two small batteries.

The photocell used in this circuit is a photoresistive device. Its resistance decreases when light impinges on the face of the photocell. The unit used by the author is the *Clairex CL-3* which has a diameter of approximately 1/4" and is about 1/2" long. It nets for \$3.50. The cell is mounted in a piece of copper tubing about one inch long and with an i.d. of about 1/4", sufficient for the photocell to slide in. The front face of the photocell is recessed about 3/8" in-

side the tube. The tube, besides keeping the photocell aligned, also serves as a light shield. This makes it possible to operate the tachometer pickup under adverse ambient light conditions.

The copper tube is attached to a bracket fastened to and protruding through the 2 1/4" x 2 1/4" surface of the box. The other end of the bracket carries the socket for the light bulb. This light bulb is a pre-focused "penlite" bulb (*G-E #112*) designed to operate from a 1.2-volt battery. The copper tube and the light bulb socket are inclined toward each other and to the box surface at about a 60-degree angle. Their axes intersect about 1 1/2" in front of the box surface. This means that for optimum operation, the portable tachometer pickup should be held so that its front surface is about 1 1/2" away from the surface of the rotating object whose speed is being measured.

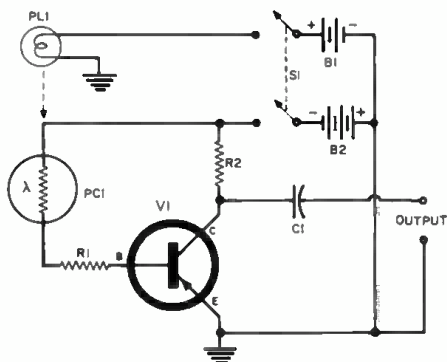
The circuit of the transistorized tach is shown in Fig. 1. The switch turns on both the lamp battery and the battery-energizing photocell and transistor amplifier. When light strikes the front of the cell, its resistance decreases and the battery pushes more current through it and the 82,000-ohm resistor,  $R_1$ , into the base circuit of the transistor. The amplified signal generates a voltage across the 47,000-ohm load resistor,  $R_2$ , which is picked off at the collector of the grounded-emitter transistor amplifier. It is fed to the output cable through a 0.1  $\mu$ f. paper capacitor,  $C_1$ . It is not possible to give much information on the output voltage obtained because it will depend on such factors as distance from the rotating object, frequency of light variation, ambient light, and light reflecting qualities of the rotating surface.

In the case of a rotating anodized aluminum disc, half of which was covered with black electrical tape, the output was 1 volt peak-to-peak at about 110 cps (corresponding to a rotational speed of 6600 rpm) at a distance of 1 1/2 inch. The output increases at lower frequencies. This is a characteristic of many of the crystal-type photocells. The output is adequate for frequency measurement by Lissajous figures on an oscilloscope (using a calibrated audio oscillator to feed the scope's horizontal amplifier). For industrial use, the output appears sufficient to drive the electronic counters of many frequency meters.

This tachometer can be used to measure rotational speed of electric fans if it is recalled that there will be as many cycles put out per revolution as there are fan blades.

Total construction cost of this unit is less than \$10.00. The batteries are held against the inside of the box by means of a home-made bracket. The switch serves to hold the 15-volt battery by pushing it against a spring-loaded screw in the end of the box which serves as ground terminal for the battery. A small plastic block holds the 1.5-volt cell against a similar spring-loaded screw. The d.p.s.t. switch,  $S_1$ , is the only control. —30—

Fig. 1. Single transistor amplifies output of photocell. This output may be applied to an oscilloscope, to a sensitive a.c. voltmeter, or to a frequency-meter circuit.



- $R_1$ —82,000 ohm, 1/2 w. res.
- $R_2$ —47,000 ohm, 1/2 w. res.
- $C_1$ —0.1  $\mu$ f., 100 v. paper capacitor
- $S_1$ —D.p.s.t. switch
- $B_1$ —1.5-volt "C" cell
- $B_2$ —15-volt hearing-aid battery (Burgess V-10 or equiv.)
- $PC_1$ —Cadmium selenide crystal photocell (Clairex CL-3)
- $PL_1$ —1.2-volt pre-focused screw-base bulb (G-E #112)
- $V_1$ —"p-n-p" germanium transistor (Raytheon CK722)

**NEW**

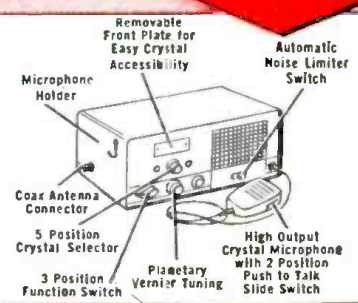
# LAFAYETTE HE-15 CITIZENS BAND 11 METER 2-WAY SUPERHETERODYNE TRANSCEIVER

MADE IN U.S.A.



**COMPLETELY WIRED  
NOT A KIT!**

# 64.50



**ONLY 5.00 DOWN**  
**Not Superregenerative but SUPERHET!**

The Lafayette HE-15 meets all FCC requirements and operates in much the same manner as police and other short wave communications systems. The Transceiver features 5 crystal controlled transmitting channels operating at a maximum legal power input of 5 watts fully modulated. RF stage in both transmitter and receiver. Any one of 5 transmitting frequencies may be instantly selected by the 5 position crystal selector on the front panel. These 5 crystals are readily accessible by means of a removable front plate and this may be easily interchanged with any 5 crystals of the remaining 22 allocated citizens band frequencies.

The Superheterodyne receiver is tuneable over the full 22 channel band with 3 watts audio output. Controls include a 3 position function switch (transmit, receive, and transmit with spring return), planetary vernier tuning plus squelch noise limiter control switch. All coils are ferrite tuned. Output impedance matches 52 and 72 ohm antenna with Amphenol type coax connector for operating into dipole, ground plane or rod antenna. Has large 4" PM speaker; input jack for crystal or ceramic microphone; power receptacle in rear for AC line and 6 or 12 volt external power supply. Transceiver is supplied with single transmitting crystal for channel 9. Complete high output with crystal microphone, and brackets for easy mounting of unit in auto, boat, etc. Operated on 115 volts AC. Addition of 6 or 12 volt power supply (separately supplied) adapts transceiver for mobile operation. Size 5 1/2" H x 6 3/8" D. Shpg wt., 11 lbs.

HE-15 Factory Wired and Tested (Less antenna). 5.00 Down..... Net 64.50  
 HE-19 Whip Antenna..... Net 3.95  
 HE-16 Power Supply For 12 Volts..... Net 11.95  
 HE-18 Power Supply For 6 Volts..... Net 11.95



- 5 CRYSTAL CONTROLLED TRANSMITTING POSITIONS
- SUPERHETERODYNE TUNEABLE RECEIVER OVER FULL 22 CHANNEL BAND
- 4 DUAL FUNCTION TUBES, PLUS 2 SINGLE FUNCTION TUBES, PLUS 2 RECTIFIERS FOR 12 TUBE PERFORMANCE
- PLANETARY VERNIER TUNING
- COMPLETE WITH TRANSMITTING CRYSTAL FOR 27.065MC
- MEETS ALL FCC REGULATIONS
- REMOVABLE FRONT PLATE FOR EASY ACCESSIBILITY OF CRYSTALS
- UNEXCELLED RECEPTION ON LAND AND SEA... COMPARES WITH UNITS COSTING 3 TIMES AS MUCH

## NEW! LAFAYETTE TELESCOPIC CITIZENS BAND WHIP ANTENNA

- Chrome Plated
- Telescopes From 16 1/2" to 40"
- Mounts Vertically or Right Angle

# 3.95



An outstanding antenna value. This high quality three section telescoping antenna is designed for attachment directly to your citizens band transceiver. Ideal for point to point service over short distances. Molded base loading coil has a threaded stud with a PL-259 plug—connector for vertical or right angle mounting. Shpg. wt.; 1 lb. HE-19..... Net 3.95

## NEW! LAFAYETTE "Tiny"

### 6 Transistor Radio

**SENSATIONAL PERFORMANCE**  
*In a Small Package!*

- 6 Transistor Plus a Germanium Diode
- Superheterodyne Circuit • Vest Pocket Size
- Built In Earphone Jack For Private Listening
- Trouble-Free Printed Circuit

Engineered and constructed with the jewel like precision of a fine watch... true superhet circuit, with push-pull audio output powers either the built-in dynamic speaker or the personal-type earphone. Extremely sensitive... built in ferrite—rod antenna brings in distant stations like locals. Employs standard 9 volt battery for economical service. Housed in smart black and gold rugged plastic case. Measures only 4" x 2 1/2" x 1 1/4" and weighs a mere 10 ounces. Complete with battery, carrying case and earphone. Shpg. wt., 2 lbs. FS-208 "Tiny" 6-Transistor Radio... Net 19.95



# 19.95

## NEW! LAFAYETTE RADIO FIELD INDICATOR

**A Must For Ham & Citizens Band Operators**

- Provides a Continuous Indication of Transmitter Output • Rugged 200 ua Meter Movement • Completely Portable—Requires no Electricity, Batteries or Transmitter Connection.
- With this rugged, new radio field indicator you can check performance of your marine, mobile or fixed transmitter... actually measures the RF field generated by any transmitter between 100KC and 250MC regardless of power. Features a 200 ua meter movement with a variable sensitivity control. Phone jack at rear of indicator accepts earphones thus providing an aural check of transmitter output. Antenna extends from 3 1/4" to 10 3/4". Powerful magnet on bottom plate allows easy mounting on car dashboard or metal surfaces. Use anywhere... requires no electricity or batteries. Dimensions: (less antenna) 3 1/8" W x 2 1/4" H x 2" D. TM-14..... Net 7.95

# 7.95



**PLEASE RUSH ITEMS CHECKED!**

- HE-15 CITIZENS BAND TRANSCEIVER
- TM-14 RADIO FIELD INDICATOR
- FS-206 "TINY" 6 TRANSISTOR RADIO
- HE-19 WHIP ANTENNA
- FREE 308 PAGE CATALOG 600

Enclosed Find \$.....(Please include postage to cover shipping)

**FREE 308 Giant Size Pages!**



Name.....  
 Address.....  
 City..... Zone..... State.....

Everything in Hi-Fi and Electronics

**LAFAYETTE RADIO,**  
**P. O. BOX 222, JAMAICA 33, N.Y. Dept. RH-6**

*Lafayette* LOCATIONS—NEW YORK, N. Y.; BRONX, N. Y.; BOSTON, MASS./NEWARK, N. J./PLAINFIELD, N. J.

# Coaxial Cable Less Than 3¢ Per Foot

RG-54 A/U CABLE—Designed for long life and constant attenuation, with polyethylene jacket, 58 ohms .250 OD— \$10.95  
 370 FOOT ROLL ..... \$10.95  
 70 FOOT ROLL ..... \$1.95  
 RG-8/U—8 Ft. w/PL-259 ea. end. .... 3.95  
 RG-8/U—50 Ft. w/PL-259 ea. end. .... 3.95

**COAXIAL ANTENNA CHANGE-OVER RELAY:**  
 12/24 VDC with 3 SO-239 Connectors. Mounted in metal box 3 x 3 1/2 x 2" ..... Ea.: \$1.55  
 Connector for Power Plug ..... 2.00



**BC-659**  
**\$16.95**  
**RE-NEW**

**PE-120**  
**\$7.95**  
**RE-NEW**

BC-659 FM RECEIVER-TRANSMITTER—27 to 39.1 MC FM.; 5 Watt.; Crystal Control on Two Pre-Set Channels; with Tubes and Speaker—Re-New. \$16.95  
 PE-120 POWER SUPPLY for BC-659 or BC-620; with Vibrator for 12 Volt operation—Re-New. \$7.95  
 BA-41 BIAS BATTERY F/BC-659-620... New: 2.95  
 AN-29 Telescoping ANTENNA F/BC-659... New: 2.95  
 FT-250 SHOCK MOUNT'G F/BC-659-PE-120—U: 4.95

**BC-603 • \$14.95 • RE-NEW**

BC-603 FM RECEIVER—20 to 27.9 Mc. .... Re-New: \$14.95  
 BC-604 FM TRNSMTR—20 to 27.9 MC. U: \$14.95—Re-N: 7.05  
 BC-684 FM TRNSMTR—27 to 39.1 MC. U: \$7.95—New: 12.95  
 FT-237 MOUNTING for Rec. .... Re-New: 2.95  
 Trans. Price ..... Re-New: 7.95  
 FT-346 MOUNTING—For Receiver only ..... Re-New: 4.95  
 DM-34 DYN. 12 V f/BC-603-683 ..... U: \$2.95—R-N: \$4.95  
 DM-35 DYN. 12 V f/BC-604-684 ..... U: \$6.95—R-N: 9.95  
 AC POWER SUPPLY—F/BC-603-683—Output: 220 VDC 80 MA & 24 VAC 2 Amps. Transformer & Tube type. Chassis not hot. Mounts on rear Plug of BC-603-683. Can be adapted to other Receivers. \$14.95  
 KIT: \$10.00 ..... WIRED: \$14.95



**GROUND PLANE ANTENNA  
 CITIZEN—COMMERCIAL**

Made from sturdy surplus Insulated Base and Screw-in type Elements. For use in the 25 to 50 MC Bands. Specially cut to your operating frequency. (Specify Freq. when ordering.) With Adapter for 1" pipe mounting. \$14.95

**TELEPHONES, HEADSETS, MICS., Etc.:**

TS-9 Handset ..... Used: \$2.95—New: \$ 3.95  
 TS-13 Handset, w/PL-55 & PL-68. U: \$2.95—N: 3.95  
 T-17 Microphone ..... Used: \$3.95—New: 6.95  
 EE-8 Field Telephone—Used: \$12.95—Recond.: 16.95  
 BD-71 Switchboard—6 Line... U: \$14.95—New: 24.95  
 RM-29 Control Unit... New: \$6.95—W/Handset 8.95  
 RM-52 Control Unit (Patch Found.) U: \$1.95—N: 2.95  
 H-16/U Headset—8000 ohm... U: \$1.95—New: 2.95  
 H-33 Headset—300 ohm... U: \$4.95—New: 7.95  
 1-45 Tel. Key—with cord and plug ..... New: 1.50

**BC-221 FREQUENCY METER**



Frequency 125 to 20,000 KC Crystal Calibration in all ranges. Can be used as a signal generator and VFO. Complete with original crystal & calibration book. Voltage required 6 VDC @ .9 amp. & 135 VDC 20 MA. Price—Used—less Modulation \$79.50  
 TS-175 FREQUENCY METER—Same as BC-221, only covers the range of 85 to 1000 MC. With Modulation—Price. \$99.50  
 Used. Excellent!

**RECEIVERS:**

NAVY ARB/CRV 46151—190 to 9050 KC... U: \$14.95  
 ARC-3 AM Rec. 100 to 156 MC. .... Used: 24.95  
 BC-733—Localizer Rec.—108.3 to 110.3 MC. Used: 4.95  
 R-23/BC-453 Rec.—190 to 550 KC. .... Used: 14.95  
 R-4/ARR-2 Rec.—540-830 KC; 230-258 MC. R-N: 8.95  
 BC-1206 Beacon Receiver—200 to 400 KC. R-N: 9.95  
 BC-652 Receiver—2 to 6 MC—Less Dyn. .... Used: 24.95  
 BC-342 Receiver—1.5 to 18 MC For AC op. Used: 69.50  
 BC-312 Receiver—1.5 to 18 MC—Less Dyn. Used: 59.50  
 BC-344 Rec.—150 to 1500 KC—For AC op. Used: 49.50

**PREVIOUSLY ADVERTISED  
 ITEMS STILL AVAILABLE:**

DATA RECORDER 16 mm CAMERA ..... \$ 16.95  
 T-7 TRANSMITTER—Navy Type ..... New: 150.00  
 YS-108/APN TEST SET—w/case ..... Used: 15.00  
 1-166 VOLTOHMMETER ..... New: 16.95  
 1-176 VOLTOHMMETER ..... Used: 19.95

**SEND FOR FREE CATALOG!**

Address Dept. EW • All Prices F.O.B., Lima, Ohio.  
 Minimum Order \$5.00, & 25% Deposit on all C.D.'s

**Fair Radio Sales**  
 2133 ELIDA ROAD  
 P. O. BOX 1105 LIMA, OHIO

# Hams, TVI, and Technicians

**Amateurs and CD officials in New Rochelle call local service dealers to interference symposium in response to wrath over scrambled TV reception.**

THERE IS nothing new in the fact that the radio amateur is made the popular scapegoat, usually with little justification, when TV set owners encounter any sort of interference problems. In fact, even when the interfering signal can be clearly identified as originating from a ham transmission, the chances are that the amateur himself is not at fault. What is new is a recent educational program undertaken in New Rochelle, N. Y. to clarify the TVI problem, in the face of strong, local feeling against amateur broadcasting.

The situation's background begins with the fact that New Rochelle has a goodly number of active amateurs and a goodly portion of the local population found their TV viewing hopelessly scrambled when hams were on the air. Matters reached the unhappy stage where pressure developed for local regulations to restrict ham activity. The legality of such restrictions is open to question, considering the fact that the FCC is already in the business of regulating broadcast activity, but the unfavorable public attitude convinced local amateurs that they had to do something.

Principals in this drama included the members of the Communications Club of New Rochelle, 281 Washington Ave., New Rochelle, N. Y. Also concerned were local Civil Defense officials, who value highly the voluntary CD efforts of some 40 amateurs in the community. Those involved got together in organizing a TVI symposium, conducted this past spring, to which all local service dealers and technicians were invited.

The decision to work through the service industry was made because most consumer difficulties with TVI result in a call for service. While many service people, especially those who themselves hold FCC licenses, know exactly how to handle such complaints, others do not. As a result, the technician may end up by advising his customer "There's nothing I can do about it," "Call the ham and tell him to cut it out," or "Tell the FCC to run the guy off the air."

The symposium consisted of lectures and demonstrations on TVI, including films showing actual cases and their solutions, literature on the subject, and lists of available materials for relieving problems. Mr. George Bartels, former CD director and incumbent assistant city manager of New Rochelle, presided. He was assisted by a panel that included CCNR members Alan Mason (president), Graham Berry (secretary), Al Hook, and Tom Heaton. Dave McAlley, also on the panel, is New

Rochelle's CD radio director. The lecture and demonstration were followed by answers to specific questions from the audience. The symposium stressed several points not always completely understood, with supporting evidence:

1. As FCC investigations of interference complaints show, it is seldom the amateur himself who is responsible for the interference. As a rule, he transmits in a completely legal manner that would not cause interference. In fact, he is an amateur only in the sense that he obtains no direct monetary gain from his activity. In knowledge and ability, he is of professional caliber, having passed difficult tests to obtain licenses and being under the constant, strict control of the federal government.

2. The conditions that result in TVI from "clean" amateur transmissions generally exist outside the ham's equipment or method of operation, and are generally outside his direct control. As often as not, these conditions involve deficiencies or outright defects in the TV receivers.

3. With proper repair or with the use of proper filtering and shielding techniques, TVI can be eliminated successfully.

4. The job of suppressing interference belongs to the service industry. The amateur himself may be completely capable of handling the problem, but he does not wish to undermine the livelihood of the service professional. However, he will cooperate with a service technician on a TVI problem.

5. As a rule, TV manufacturers will supply service technicians (frequently at no cost) with materials needed to eliminate interference that were not incorporated in the original design.

The demonstration involved an operating ham transmitter set up near an operating TV set that had been rendered TVI-proof. Despite the proximity, there was no interference. As the added protection was progressively removed, the resulting deterioration in TV reception was noted. Specific points raised included inadequately shielded TV i.f. systems using the old 21-mc. i.f. (right in an authorized ham band), and the absence of suitable high-pass filtering of TV antenna inputs. Nonlinear action in and out of the TV receiver that produced interfering harmonics from "clean" amateur transmissions were also covered, as were effects blamed on hams though totally unrelated to amateur activity, such as oscillator-radiation interference caused by another TV set or an FM tuner, oil-burner motors, kitchen appliances, passing cars, and others.

# 500 ELECTRONIC KITS

WHAT THEY ARE!

WHAT THEY COST!

WHAT THEY DO!

Yours in the brand new 1960



Here it is -- the only complete, comprehensive directory covering the exciting world of electronic kits! It's yours in the 1960 ELECTRONIC KITS DIRECTORY -- over 160 pages -- listing over 500 kits of all kinds. Each listing gives you manufacturers, specifications, prices, everything you need to know about kits!

You'll find such informative features as:

• **GIANT KIT BUILDERS GUIDE**

Gives you the latest improvements, and innovations in kits...helps you select the right kit...identifies parts for you, too!

• **COMPLETE SURVEY AND DIRECTORY OF:**

Kits for HI-FI --make your own amplifiers, pre-amps, speakers, turntables, stereo control units, and tone arms.

Kits for COMMUNICATIONS--Rundowns on kits for oscilloscopes, tube testers, power supplies, transmitters, receivers, transceivers.

Kits for EDUCATION--Coverage of radio kits and many other special projects.

NOW ON SALE  
AT YOUR  
FAVORITE  
NEWSSTAND OR  
ELECTRONIC  
PARTS  
STORE

ONLY  
\$1.00



Don't miss 1960 ELECTRONIC KITS DIRECTORY Now on sale at newsstands, electronic parts stores and hi-fi salons! Buy your copy today, or order by using the handy coupon below.

Only \$1.00.

Ziff-Davis Publishing Company  
Department EW-86  
434 S. Wabash Ave., Chicago 5, Illinois

Please send me a copy of the 1960 ELECTRONIC KITS DIRECTORY. I enclose \$1.00 plus 10¢ to cover mailing and handling charges. (Canada and Foreign \$1.25 plus 10¢ postage).

Name \_\_\_\_\_  
Address \_\_\_\_\_  
City \_\_\_\_\_ Zone \_\_\_\_\_ State \_\_\_\_\_

August, 1960

## Hi-Fi Amplifier

(Continued from page 45)

6550's if anything goes wrong with the bias supply. An RC voltage divider was used to obtain the bias voltage. It is a simple, yet effective, method of obtaining the desired voltage and one that dissipates very little heat. A choke-input power supply was chosen for the 40-watt version because of its excellent voltage regulation as compared to a capacitor input. With a swing in current from 165 to 220 ma., the d.c. voltage will drop less than 20 volts. In the case of the 60-watt version, capacitor input was used to get the higher voltage needed for the extra 2 db of power output.

The bias adjustment ( $R_{b1}$ ) should be such as to produce a cathode current for each output tube of about 75 ma. for the 40-watt amplifier and about 55 ma. for the 60-watt version. The balancing pot ( $R_{b2}$ ) should be adjusted for equal currents in both output tubes.

When connecting the output transformer, careful attention should be paid to the color coding of the primary leads. When the winding is connected properly, it will take approximately 70 volts r.m.s. on the grids of the 6550's for 60 watts of output. When the over-all feedback loop is connected, the output should drop by some 12 db. If motor-boating or oscillation occur, you can correct the phasing by reversing the transformer leads or transposing the connections of the coupling capacitors at the driver.

A word might be said here about how the amplifier sounds, since the final word on any amplifier is whether it pleases the ear and sounds good after prolonged listening sessions. The highs sound clean and the instruments well delineated. The bass is solid and well damped. A large measure of the quality obtained with this circuit should be attributed to the outstanding characteristics of the output transformer and its ability to reproduce full output over such a wide frequency range. —30—

### D. C. VOLTAGES

PIN	1	2	3	4	5	6	7	8	9
$V_1$	110	—	2.5	—	—	82	—	2.5	—
$V_2$	240	76	92	—	—	92	82	—	250
$V_3, V_4$	—	—	410	410	—48	—	—	—	.5

Table 1. Voltages measured by author in 40-watt unit. Voltages in 60-watt version are fairly similar except for somewhat higher "B-plus" and bias on tubes  $V_3, V_4$ .

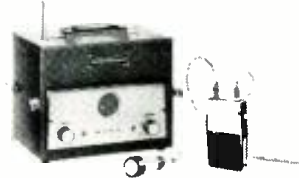
Table 2. Important specs of both versions.

Output	40 watts	60 watts
Sensitivity	.7 volt for full output	1 volt for full output
Response	Down .1 db at 20 cps; down .5 db at 20,000 cps (at 40 watts)	Down .7 db at 20 cps; down 1.3 db at 20,000 cps (at 60 watts)
Feedback	12 db over-all 11 db tertiary	12 db over-all 11 db tertiary
Feedback Stability Margin	20 db	20 db
Damping Factor	10	10

## THE REMARKABLE SONY RADIO WIRELESS MICROPHONE

The convenience and variety of uses for this remarkable instrument are almost beyond the imagination. The Sony CR-4 mike and radio transmitter can be slipped into a coat pocket for completely wireless on-the-street interviewing, studio audience interviewing or on-the-spot broadcasting from awkward places. It gives complete freedom to active singers, dancers, comedians, performers with electric instruments and actors, eliminating the need for cumbersome mike booms and entangling wires.

Microphone, transmitter, receiver and carrying case, \$250. For information or literature, write: Superscope, Inc., Dept. 6, Sun Valley, California.



# SONY

**SUPERSCOPE** The Tape-way to Stereo



**SUPERIOR'S  
NEW MODEL 77**

# VACUUM TUBE VOLTMETER

## WITH NEW 6" FULL-VIEW METER

Compare it to any peak-to-peak V. T. V. M. made by any other manufacturer at any price

- ✓ Model 77 completely wired and calibrated with accessories (including probe, test leads and portable carrying case) sells for only \$42.50.
- ✓ Model 77 employs a sensitive six inch meter. Extra large meter scale enables us to print all calibrations in large easy-to-read type.
- ✓ Model 77 uses new improved SICO printed circuitry.
- ✓ Model 77 employs a 12AU7 as D.C. amplifier and two 9006's as Peak-to-Peak voltage rectifiers to assure maximum stability.
- ✓ Model 77 uses a selenium-rectified power supply resulting in less heat and thus reducing possibility of damage or value changes of delicate components.
- ✓ Model 77 meter is virtually burn-out proof. The sensitive 400 microampere meter is isolated from the measuring circuit by a balanced push-pull amplifier.
- ✓ Model 77 uses selected 1% zero temperature coefficient resistors as multipliers. This assures unchanging accurate readings on all ranges.

**SPECIFICATIONS**

• DC VOLTS—0 to 3/15/75/150/300/750 1,500 volts at 11 megohms input resistance. • AC VOLTS (RMS)—0 to 3/15/75/150/300/750/1,500 volts. • AC VOLTS (Peak to Peak)—0 to 6/30/200/400/800/2,000 volts. • ELECTRONIC OHMMETER—0 to 1,000 ohms/10,000 ohms/100,000 ohms/1 megohm/10 megohms/100 megohms/1,000 megohms • DECIBELS—10 db to + 18 db, + 10 db to + 38 db + 30 db to + 58 db. All based on 0 db = 1000 watts (6 mw) into a 500 ohm line (1.73v). • ZERO CENTER METER—For discriminator alignment with full scale range of 0 to 1.5/7.5/37.5/75/150/375/750 volts at 11 megohms input resistance.

**Model 77—VACUUM TUBE VOLTMETER**  
Total Price \$42.50—Terms: \$12.50 after 10 day trial, then \$6.00 monthly for 5 months if satisfactory. Otherwise return, no explanation necessary!

**AS A DC VOLTMETER:** The Model 77 is indispensable in Hi-Fi Amplifier servicing and a must for Black and White and color TV Receiver servicing where circuit loading cannot be tolerated.

**AS AN AC VOLTMETER:** Measures RMS values if sine wave, and peak-to-peak value if complex wave. Pedestal voltages that determine the "black" level in TV receivers are easily read.

**AS AN ELECTRONIC OHMMETER:** Because of its wide range of measurement leaky capacitors show up glaringly. Because of its sensitivity and low loading, intermittents are easily found, isolated and repaired.

Model 77 comes complete with operating instructions, probe and test leads. Use it on the bench—use it on calls. A streamlined carrying case, included at no extra charge, accommodates the tester, instruction book, probe and leads. Operates on 110-120 volt 60 cycle. Only.....

**\$42.50  
NET**



**SUPERIOR'S  
NEW MODEL 80**

# 20,000 OHMS PER VOLT ALLMETER

THE ONLY 20,000 OHMS PER VOLT V.O.M. SELLING FOR LESS THAN \$50 WHICH PROVIDES ALL THE FOLLOWING FEATURES:

- ✓ 6 INCH FULL-VIEW METER provides large easy-to-read calibrations. No squinting or guessing when you use Model 80.
- ✓ MIRRORED SCALE permits fine accurate measurements where fractional readings are important.
- ✓ CAPACITY RANGES permit you to accurately measure all condensers from .00025 MFD to 30 MFD in addition to the standard volt, current, resistance and decibel ranges.
- ✓ HANDSOME SADDLE-STITCHED CARRYING CASE included with Model 80 Allmeter at no extra charge enables you to use this fine instrument on outside calls as well as on the bench in your shop.
- A built-in Isolation Transformer automatically isolates the Model 80 from the power line when capacity service is in use.
- Selected, 1% zero temperature coefficient metalized resistors are used as multipliers to assure unchanging accurate readings on all ranges.

**SPECIFICATIONS:**

7 D.C. VOLTAGE RANGES:  
(At a sensitivity of 20,000 Ohms per Volt)  
0 to 15/75/150/300/750/1,500 7500 Volts.  
6 A.C. VOLTAGE RANGES:  
(At a sensitivity of 5,000 Ohms per Volt)  
0 to 15/75/150/300/750/1,500 Volts.  
3 RESISTANCE RANGES:  
0 to 2,000/200,000 Ohms. 0-20 Meg.ohms.  
2 CAPACITY RANGES:  
.00025 Mfd. to .3 Mfd., .05 Mfd. to 30 Mfd.  
5 D.C. CURRENT RANGES:  
0-75 Microamperes, 0 to 7.5/75/750 Milliamperes, 0 to 15 Amperes.  
3 DECIBEL RANGES:  
- 6 db to + 18 db + 34 db to + 58 db + 14 db to + 38 db

**Model 80—ALLMETER**... Total Price \$42.50—Terms: \$12.50 after 10 day trial, then \$6.00 monthly for 5 months if satisfactory. Otherwise return, no explanation necessary!

**NOTE:** The line cord is used only for capacity measurements. Resistance ranges operate on self-contained batteries.

Model 80 Allmeter comes complete with operating instructions, test leads and portable carrying case. Only..... **\$42.50 NET**



**Model TV-50A—Genometer**  
Total Price .....\$47.50  
Terms: \$11.50 after 10 day trial, then \$6.00 monthly for 6 months if satisfactory. Otherwise return, no explanation necessary.

# GENOMETER

## 7 Signal Generators in One!

- ✓ R.F. Signal Generator for A.M.
- ✓ R.F. Signal Generator for F.M.
- ✓ Audio Frequency Generator
- ✓ Bar Generator
- ✓ Cross Hatch Generator
- ✓ Color Dot Pattern Generator
- ✓ Marker Generator

A versatile all-inclusive GENERATOR which provides ALL the outputs for servicing:

**A.M. Radio • F.M. Radio • Amplifiers • Black and White TV • Color TV**

**R. F. SIGNAL GENERATOR:** The Model TV-50A Genometer provides complete coverage for A.M. and F.M. alignment. Generates Radio Frequencies from 100 Kilocycles to 60 Megacycles on fundamentals and from 60 Megacycles to 180 Megacycles on powerful harmonics.

**VARIABLE AUDIO FREQUENCY GENERATOR:** In addition to a fixed 400 cycle sine-wave audio, the Model TV-50A Genometer provides a variable 300 cycle to 20,000 cycle peak wave audio signal.

**BAR GENERATOR:** The Model TV-50A projects an actual Bar Pattern on any TV Receiver Screen. Pattern will consist of 4 to 16 horizontal bars or 7 to 20 vertical bars.

**THE MODEL TV-50A comes absolutely complete with shielded leads and operating instructions.**

**CROSS HATCH GENERATOR:** The Model TV-50A Genometer will project a cross-hatch pattern on any TV picture tube. The pattern will consist of non-shifting, horizontal and vertical lines interlaced to provide a stable cross-hatch effect.

**DOT PATTERN GENERATOR (FOR COLOR TV):** Although you will be able to use most of your regular standard equipment for servicing Color TV, the one addition which is a "must" is a Dot Pattern Generator. The Dot Pattern projected on any color TV Receiver tube by the Model TV-50A will enable you to adjust for proper color convergence.

**MARKER GENERATOR:** The Model TV-50A includes all the most frequently needed marker points. The following markers are provided: 189 Kc., 262.5 Kc., 456 Kc., 600 Kc., 1000 Kc., 1400 Kc., 1600 Kc., 2000 Kc., 2500 Kc., 3579 Kc., 4.5 Mc., 5 Mc., 10.7 Mc., (3579 Kc. is the color burst frequency)

**\$47.50  
NET**

**EXAMINE BEFORE YOU BUY!**  
**USE APPROVAL FORM ON NEXT PAGE**





SUPERIOR'S NEW MODEL TW-11

STANDARD PROFESSIONAL

# TUBE TESTER

★ Tests all tubes, including 4, 5, 6, 7, Octal, Lock-in, Hearing Aid, Thyatron, Miniatures, Sub-miniatures, Novals, Subminars, Proximity fuse types, etc.

★ Uses the new self-cleaning Lever Action Switches for individual element testing. Because all elements are numbered according to pin-number in the RMA base numbering system, the user can instantly identify which element is under test. Tubes having tapped filaments and tubes with filaments terminating in more than one pin are truly tested with the Model TW-11 as any of the pins may be placed in the neutral position when necessary.

★ The Model TW-11 does not use any combination type sockets. Instead individual sockets are used for each type of tube. Thus it is impossible to damage a tube by inserting it in the wrong socket.

★ Free-moving built-in roll chart provides complete data for all tubes. All tube listings printed in large easy-to-read type.

**NOISE TEST:** Phono-jack on front panel for plugging in either phones or external amplifier will detect microphonic tubes or noise due to faulty elements and loose internal connections.

### EXTRAORDINARY FEATURE

**SEPARATE SCALE FOR LOW-CURRENT TUBES:** Previously, an emission-type tube testers, it has been standard practice to use one scale for all tubes. As a result, the calibration for low-current types has been restricted to a small portion of the scale. The extra scale used here greatly simplifies testing of low-current types.

Model TW-11—Tube Tester  
Total Price \$47.50  
Terms: \$11.50 after 10 day trial, then \$6.00 monthly for 6 months if satisfactory. Otherwise return, no explanation necessary.

The Model TW-11 operates on 105-130 Volt 60 Cycles A.C. Comes housed in a handsome, portable Saddle-Stitched Texon Case. Only **\$47.50**

SUPERIOR'S NEW MODEL 82A

Multi-Socket Type

# TUBE TESTER



**TEST ANY TUBE IN 10 SECONDS FLAT!**

- 1 Turn the filament selector switch to position specified.
- 2 Insert tube into a numbered socket as designated on our chart (over 600 types included).
- 3 Press down the quality button—

**THAT'S ALL! Read emission quality direct on bad-good meter scale.**

### SPECIFICATIONS

- Tests over 600 tube types
- Tests OZ4 and other gas-filled tubes
- Employs new 4" meter with sealed air-damping chamber resulting in accurate vibrationless readings
- Use of 22 sockets permits testing all popular tube types and prevents possible obsolescence
- Dual scale meter permits testing of low current tubes
- 7 and 9 pin straighteners mounted on panel
- All sections of multi-element tubes tested simultaneously
- Ultra-sensitive leakage test circuit will indicate leakage up to 5 megohms

Production of this Model was delayed a full year pending careful study by Superior's engineering staff of this new method of testing tubes. **Don't let the low price mislead you!** We claim Model 82A will outperform similar looking units which sell for much more — and as proof, we offer to ship it on our examine **before** you buy policy.

To test any tube, you simply insert it into a numbered socket as designated, turn the filament switch and press down the quality switch — **THAT'S ALL!** Read quality on meter. Inter-element leakage if any indicates automatically.

Model 82A—Tube Tester  
Total Price \$36.50  
Terms: \$6.50 after 10 day trial, then \$6.00 monthly for 5 months if satisfactory. Otherwise return, no explanation necessary.

Model 82A comes housed in handsome, portable Saddle-Stitched Texon case. Only **\$36.50**

SUPERIOR'S NEW MODEL 83

# C. R. T. TESTER

TESTS AND REJUVENATES ALL PICTURE TUBES

### ALL BLACK AND WHITE TUBES

From 50 degree to 110 degree types — from 8" to 30" types.

### ALL COLOR TUBES

Test ALL picture tubes—in the carton—out of the carton—in the set!

• Model 83 is not simply a reshaped black and white C.R.T. Tester with a color adapter added. Model 83 employs a new improved circuit designed specifically to test the older type black and white tubes, the newer type black and white tubes and all color picture tubes.

• Model 83 provides separate filament operating voltages for the older 6.3 types and the newer 8.4 types.

• Model 83 employs a 4" air-damped meter with quality and calibrated scales.

• Model 83 properly tests the red, green and blue sections of color tubes individually—for each section of a color tube contains its own filament, plate, grid and cathode.

• Model 83 will detect tubes which are apparently good but require rejuvenation. Such tubes will provide a picture seemingly good but lacking in proper definition, contrast and focus. To test for such malfunction, you simply press the rej. switch of Model 83. If the tube is weakening, the meter reading will indicate the condition.

• Rejuvenation of picture tubes is not simply a matter of applying a high voltage to the filament. Such voltages improperly applied can strip the cathode of the oxide coating essential for proper emission. The Model 83 applies a selective low voltage uniformly to assure increased life with no danger of cathode damage.

Model 83—C.R.T. Tube Tester  
Total Price \$38.50  
Terms: \$8.50 after 10 day trial, then \$6.00 monthly for 5 months if satisfactory. Otherwise return, no explanation necessary.

Model 83 comes housed in handsome portable Saddle-Stitched Texon case—complete with sockets for all black and white tubes and all color tubes. Only **\$38.50**

# SHIPPED ON APPROVAL NO MONEY WITH ORDER — NO C. O. D.

Try any of the instruments on this or the facing page for 10 days before you buy. If completely satisfied then send down payment and pay balance as indicated on coupon. **No Interest or Finance Charges Added!** If not completely satisfied return unit to us, no explanation necessary.

**MOSS ELECTRONIC, INC.**  
Dept. D-790 3849 Tenth Ave., New York 34, N. Y.

Please send me the units checked on approval. If completely satisfied I will pay on the terms specified with no interest or finance charges added. Otherwise, I will return after a 10 day trial positively cancelling all further obligations.

<input type="checkbox"/> Model 77 . . . . . Total Price \$42.50 \$12.50 within 10 days. Balance \$6.00 monthly for 5 months.	<input type="checkbox"/> Model TW-11 . . . . . Total Price \$47.50 \$11.50 within 10 days. Balance \$6.00 monthly for 6 months.
<input type="checkbox"/> Model 80 . . . . . Total Price \$42.50 \$12.50 within 10 days. Balance \$6.00 monthly for 5 months.	<input type="checkbox"/> Model 82A . . . . . Total Price \$36.50 \$6.50 within 10 days. Balance \$6.00 monthly for 5 months.
<input type="checkbox"/> Model TU-50A . . . . . Total Price \$47.50 \$11.50 within 10 days. Balance \$6.00 monthly for 6 months.	<input type="checkbox"/> Model 83 . . . . . Total Price \$38.50 \$8.50 within 10 days. Balance \$6.00 monthly for 5 months.

Name .....

Address .....

City ..... Zone ..... State .....

All prices net, F.O.B., N. Y. C.  
Export Division: Rocke International Corp.  
13 East 40th Street, New York 16, N. Y.



**SIZZLING HOT  
SURPLUS  
ITEMS FOR AUGUST**



**A**



**B**



**C**

**(A) HIGH FREQUENCY TRANSMITTER**

Type CAV 722-09, Frequency Range 5000 to 15,000 KCS. Input Volts DC 12, 2000, 5000, Amperes: 5.0, 0.17, 0.2. A Unit of Model THW-1 radio transmitter. Mfg. Washington Electric & Mfg. Co. WGT. 30 Lbs. Excellent Cond. **\$12.95**

**(B) LOW FREQUENCY TRANSMITTER**

THW Type CAV 722-08, Input vol. 7.5, 10, 15, 20V AC, 500-2000, vol. DC, Mfg. Washington Electric & Mfg. Co. WGT. 44 Lbs. Excellent Cond. **\$9.95**

**(C) POWER SUPPLY FOR ABOVE TRANSMITTERS**

WGT. 40 Lbs., Excellent Cond. **\$7.95**

CABLE FOR ABOVE TRANSMITTERS ..... Ea. **\$1.00**



**WATER PROOF SPEAKERS**

U. S. Navy, Horn Type, Heavy Duty, All New Outdoor Permanent Magnet Speakers, with Universal Output Transformer, Voice Imp. 6 Watts; 11.40 Ohms, 10 3/4 Dia., 8 3/16 Depth. Weight, in original Cases—23 lbs. **\$12.95**

Our Low Price ..... Ea.

**TELESCOPIC AND ANTENNA MASTS**

For Citizen Band, Amateur and FM Radio, Television, etc. Made of Heavy Duty Aluminum in 4 Foot, 1/2 Inch Sections, 1/2, 3/4, 1, 1 1/4, 1 1/2, 2, 3, 4, 5, 6, 7, 8, 9, 10, 11, 12, 13, 14, 15, 16, 17, 18, 19, 20, 21, 22, 23, 24, 25, 26, 27, 28, 29, 30, 31, 32, 33, 34, 35, 36, 37, 38, 39, 40, 41, 42, 43, 44, 45, 46, 47, 48, 49, 50, 51, 52, 53, 54, 55, 56, 57, 58, 59, 60, 61, 62, 63, 64, 65, 66, 67, 68, 69, 70, 71, 72, 73, 74, 75, 76, 77, 78, 79, 80, 81, 82, 83, 84, 85, 86, 87, 88, 89, 90, 91, 92, 93, 94, 95, 96, 97, 98, 99, 100. Weight of each section is about 3 Lbs. Make the Mast as high as you wish as each section fits the other.

All New ..... Per Section **\$1.45**

**RECORDING BLANKS**

16" Recording Blanks, Make your own Recordings. Aluminum base, Latigued with sides. Professional quality, All New Stock. **50c**  
Package of 10 ..... **\$3.50**  
Package of 100 ..... **\$30.00**

**DIAL TELEPHONES**

French type phone made by Crompton, Tel. & Tel. Can be used for standard extension phone. With Dial, Excellent Cond. Wgt. 7 lbs. Ea. **\$4.95**

**RESET COUNTERS**

Unit Counter, changes by one digit. Resetting by Push. Ideal for counting items when weighing. Coils, Transmitters, and General Counting Work. Size is small, 1 1/2" x 3/4" x 1 1/2". Ea. **\$2.50**

**REVERSIBLE MOTOR**

1/40 H.P. Ball-bearing 3450 RPM in blast-proof case. Needs only a capacitor for starting. All Brand New 1 1/2" x 1" x 1" (1/2") Special Low Price. Ea. **\$2.95**  
Starting Capacitor ..... **\$0.48 Ea.**  
WGT. Approx. 8 Lbs.

**FIELD PHONES**

Type EE-8, Magneto Ringing Phones. Use 2 Flashlite Batts. for Power. Operate over wire, Approx. 2 Miles. Excellent Condition. **\$25.00**  
Pair

**SURPLUS METER SPECIALS**

Miniature Meter 0 to 1 Ma. DC ..... Ea. **\$2.50**  
1 In. 0 to 1 AC Amp. Meters ..... Ea. **2.50**  
2 In. 0 to 1 1/2 Volt Meters—600—800—Cy. Ea. **1.80**  
2 In. 0 to 150 Decibel Meters ..... Ea. **2.50**  
2 In. Dual Scale—0 to 50—0 to 100 MA. DC ..... Ea. **2.50**  
3 In. 0 to 50 MA. DC Meter ..... Ea. **2.95**  
3 In. 0 to 100 MA DC Meter ..... Ea. **2.95**  
3 In. 0 to 200 MA. DC Meters ..... Ea. **2.95**  
3 In. 0 to 200 Microamp. Meters ..... Ea. **4.95**

See our previous ad for Special Surplus Items. All prices F.O.B. S. F., Calif. orders add 3% Tax. No COD's. Remit Full Amount with All Orders.

**STANDARD SURPLUS**

1230 Market St., San Francisco 3, Calif.  
Telephone HEMlock 1-3106

**A Solder-Gun Control**

(Continued from page 53)

closed contacts to the soldering gun. As the soldering tip heats, current through it decreases, reducing the voltage drop across  $R_2$ , and thus reducing the control (bucking) voltage to the tube.

When the tip reaches the desired temperature,  $V_1$  is permitted to fire and pull in the relay. This places  $R_1$  in series with the supply voltage to the gun, reducing current and voltage in the latter to a negligible value. Conduction of the tube also charges capacitor  $C_1$ . The relay remains pulled in until the capacitor discharges, which takes about half a second.

If, during this brief interval, the tip has cooled sufficiently so that it draws more current, the relay will de-energize and its closed contacts will again permit full supply voltage to reach the gun to bring tip temperature back to the desired level. However, if the tip has not cooled, the tube will fire again immediately to remove power from the tip. Thus, in actual use, the gun goes through repeated cooling cycles when the relay keeps turning off the gun for half-second intervals. The spacing of the "on-off" action not only controls tip temperature closely but also keeps the gun within its rated duty cycle.

The temperature at which the relay will open is dependent upon the settings of  $R_2$  and  $R_3$ . Potentiometer  $R_2$  is adjusted to calibrate a particular make and size of soldering gun, and need not be re-adjusted unless a different gun is used. After calibration,  $R_3$  is adjusted to the specific temperature desired. Less than one volt is usually dropped across the combination of  $R_2$  and the low-impedance winding of  $T_1$ . Thus the maximum heating capability of the soldering gun is not noticeably impaired.

When the trigger of the soldering gun is not depressed, virtually no current flows through  $R_2$ , and an electrical condition similar to that of a hot tip prevails. In this case, the relay would open and close continuously, just as though the tip had been sufficiently heated. This effect would not be undesirable except for the irritation of continuous clacking of the relay. The problem is solved with  $R_1$ , which, when the gun trigger switch is open, supplies sufficient current to the tube circuit to keep the relay energized, but will not sustain this current when the trigger switch is closed to place the gun in the circuit.

The starter anode of the gas-discharge tube (pin 7) is actually triggered by the a.c. voltage appearing on the wiper of potentiometer  $R_2$ . To prevent triggering when the soldering-gun tip is cold, the voltage developed on the high-impedance winding of  $T_1$  has to be out-of-phase with this triggering voltage to cancel the latter. If the relay continues to operate even when the soldering-gun tip is cold, then either the primary or secondary leads

of  $T_1$  must be reversed in polarity.

The unit illustrated was tried with three different soldering guns—a 100-watt Weller, a 250-watt Weller, and a 100-watt Wen gun. After calibration by adjustment of  $R_2$ , the three guns performed almost identically. Temperature was found to be adjustable from a value just slightly above the boiling point of water to the maximum temperature capability of the gun.

Temperature calibration of the unit could be accomplished in a variety of ways, but the melting point of solder is probably as good a gauge as any. To calibrate, first place temperature control  $R_3$  about 90 degrees from the minimum resistance position. Hold down the trigger of the soldering gun and adjust  $R_2$  until solder touched to the tip of the gun just melts. From this starting point (which may be marked), higher temperatures can be obtained by additional rotation of  $R_2$ .

The unit illustrated (Figs. 2 and 3) is considerably larger than required, principally because of the rather large relay used. A smaller relay would facilitate smaller packaging, but the relay contacts should be capable of handling several amperes to withstand the continuous operation. Also, the 0A4 gas discharge tube could be replaced by the 5823, which is the 7-pin, miniature counterpart of the larger tube. A second unit was constructed using the 5823, and identical performance was observed.

Because line voltage within the unit is not isolated by a transformer, no connections should be made to the chassis, and the latter should be sealed to prevent bench objects from contacting any of the parts of the circuit. The unit illustrated, an experimental model, has since been replaced by one contained in a closed box.

Most circuit components can be found in the junk box or at the surplus counter, or adequate substitutions can be made. For example, although  $R_2$  is not expensive, other available parts may serve the purpose. A tubular adjustable resistor with the same ratings will be less convenient to set, but this adjustment is not required regularly. Such a resistor will be especially feasible if the control is intended for use with only one gun or guns of similar characteristics.

If only a high-resistance (100,000 ohms to 1 megohm) potentiometer is on hand, a slight modification accommodates it. A fixed, 2-ohm resistor (a 2-watt carbon unit will do in most cases) is used in place of  $R_2$ , and the potentiometer is connected with its full resistance directly across the high-impedance winding of  $T_1$ . The connection to  $V_1$  through  $R_3$  is then made to the wiper of the potentiometer. As to  $T_1$  itself, many widely used audio-output transformers meet the requirements.

For those who prefer the soldering gun, or require safe control of temperature, the small cost at which this unit can be built will be quickly recovered in the prevention of possible damage to transistors and printed wiring. —30—

## Citizens Band Frequency

(Continued from page 37)

incidental with the installation, servicing, or maintenance of a radio station, which may affect the proper operation of such station, shall be made by or under the immediate supervision and responsibility of a person holding a first or second-class commercial radio operator license. . . ."

Fortunately the current interpretation of the rules will allow oscillator adjustments to be made to a transmitter providing a dummy antenna load is used. Unless you have such a license never tune up the transmitter "on the air." Always use a dummy load, such as a  $\approx 47$  pilot lamp, or better yet, two 100-ohm, 2-watt resistors connected in parallel.

When servicing an off-frequency transmitter, first check the tuning of the oscillator plate coil. If the frequency is still "out" make sure the correct type of crystal is being used. A defective capacitor coupling the oscillator to the amplifier can also cause trouble. If everything seems to be normal, try a "known-to-be-good" crystal and again check the frequency. Another defect to be on guard against is the drifting crystal. During measurement tests, the author found a crystal that was "on the money" for approximately 45 seconds of each transmission. After three-quarters of a minute the frequency took off for the hills and wound up about 6 kc. *Outside* the tolerance! Moral—always leave the transmitter on for at least three minutes during a frequency test.

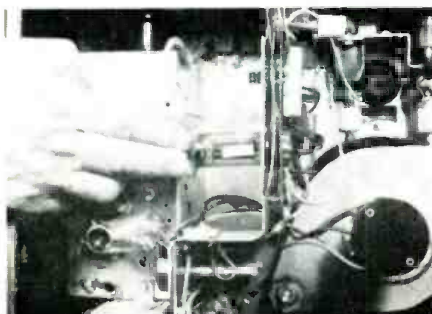
Weak or defective tubes can also cause off-frequency operation. A gassy tube has been known to pull the frequency about 2 kc. A weak tube will only pull the frequency a few hundred cycles, but should be changed "on general principles." Tube defects can also cause the frequency to drift. —30—

## TUBE HELP

By ROBERT HERTZBERG

A SMALL strip of tape of any kind, positioned on a miniature tube to indicate the indexing space between pins 1 and 7 or 1 and 9, is of great help in getting the tube into its socket without mashing the pins. Leave it there; it might be useful again some other time.

Masking tape, friction tape, or even the end of a Band-Aid serve the purpose nicely. —30—



RADIO • TV • HI-FI • HAM • BROADCASTING • INDUSTRIAL • LAB

# RCA KITS

FOR VALUE, QUALITY AND PERFORMANCE!



RCA WV-38A (K)

## VOLT-OHM-MILLIAMETER

only **\$29.95\*** (includes batteries, probe and cable with slip-on alligator clip, ground lead and clip, assembly and operating instructions) (available factory-wired and calibrated—only \$43.95\*)

Exclusive features make this RCA VOM kit the buy of a lifetime! Extra 1-volt and 0.25 volt (250 mv) ranges for wider usage in transistor servicing—new handle clip accommodates probes and test leads for extra carrying convenience. Assembles in a breeze!

FEATURING: ohms-divider network fuse-protected • easier-to-read scales • extra-large 5 1/4 inch meter • polarity reversal switch • excellent frequency response • full-wave bridge rectifier • low circuit loading • standard dbm ranges.

SPECIFICATIONS: Input Resistance—20,000 ohms per volt on DC; 5,000 ohms per volt on AC • Accuracy— $\pm 3\%$  DC,  $\pm 5\%$  AC (full scale) • Regular Scales—2.5, 10, 50, 250, 1000, 5000 volts, AC and DC; 50  $\mu$ A 1, 10, 100, 500 ma, 10 amps (DC) • Extra Scales—250 mv. and 1 volt (dc) • Frequency Response—AC-flat from 10 cycles to 50 Kc (usable response at 500 Kc) • Ohms—3 ranges: Rx1—(0-2,000 ohms); Rx100 (0-200,000 ohms); Rx10,000 (0-20,000,000 ohms) • Dimensions—W. 5 1/4", H. 6 7/8", D. 3 1/8"

RCA WO-33A (K)

## 3-INCH OSCILLOSCOPE

only **\$79.95\*** (complete with Low-Cap, Direct Input Probe and Cable) (also available factory-wired and calibrated—only \$129.95\*)

The first "scope kit with "get-up-and-go!" Use it for practically everything—video servicing, audio and ultrasonic equipment, low level audio servicing of pickups, mikes, pre-amps, radios and amplifiers, troubleshooting ham radio, hi-fi equipment, etc.—and you can take it with you, on the job, anywhere!

FEATURING: voltage-calibrated frequency-compensated, 3 to 1 step attenuator • scaled graph screen and calibrating voltage source for direct reading of peak-to-peak voltages • "plus-minus" internal sync... holds sync up to 4.5 Mc • shielded input cable with low capacitance probe included • weighs only 14 pounds • includes built in bracket to hold power cord and cables.

SPECIFICATIONS: Vertical Amplifier (Narrow Band Position)—Sensitivity, 3 rms mv/inch; Bandwidth, within -3 db, 20 cps to 150 Kc • Vertical Amplifier (Wide Band Position)—Sensitivity, 100 rms mv/inch; Bandwidth, within -3db, 5.5 cps to 5.5 Mc • Vertical Input Impedance—At Low-Cap cable input... 10 megohms, 10  $\mu$ F (approx.); At Direct-cable input... 1 megohm, 90  $\mu$ F (approx.) • Sweep Circuit—Sawtooth Range, 15 cps to 75 Kc; Sync, external,  $\pm$  internal; Line Sweep, 160° adjustable phase.



RCA WV-77E (K)

## VOLT-OHM-MYST

only **\$29.95\*** (also available factory-wired and calibrated only \$43.95\*)

Think of it—an RCA VoltOhmyst Kit at this low, low price! You get famous RCA accuracy and dependability, plus the easiest to assemble kit you've ever seen!

FEATURING: ohms-divider network protected by fuse • ultra-slim probes and flexible leads • sleeve attachment on handle stores probes, leads, power cord • separate 1 1/2 volts rms and 4 volts peak-to-peak scales for accuracy on low ac measurements • front-panel lettering acid-etched.

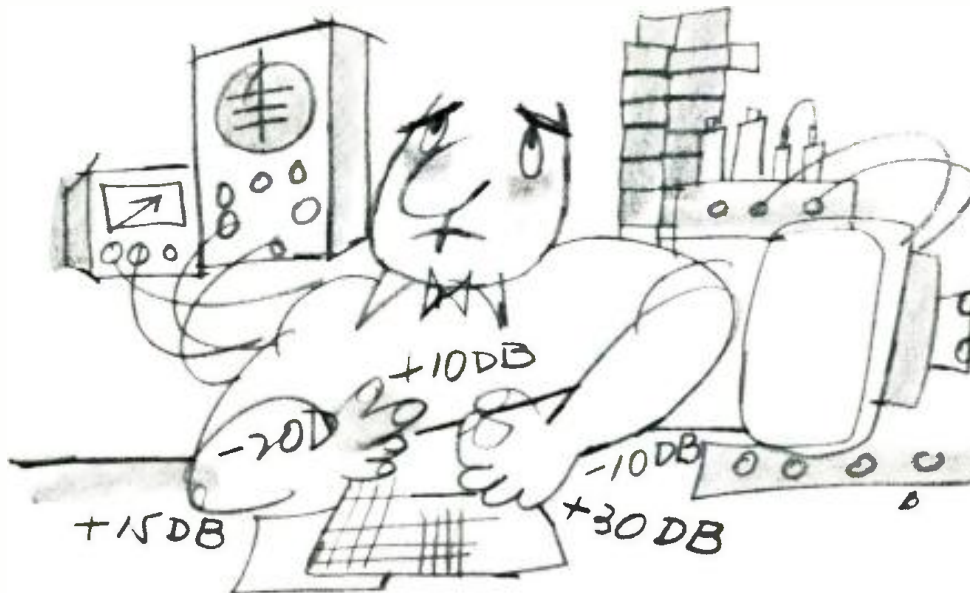
SPECIFICATIONS: Measures: DC Volts—0.02 volt to 1500 volts in 7 overlapping ranges; AC Volts (RMS)—0.1 volt to 1500 volts in 7 overlapping ranges; AC Volts (peak-to-peak)—0.2 volt to 4000 volts in 7 overlapping ranges; Resistance—from 0.2 ohm to 1000 megohms in 7 overlapping ranges. Zero-center indication for discriminator alignment • Accuracy— $\pm 3\%$  of full scale on dc ranges;  $\pm 5\%$  of full scale on ac ranges • Frequency Response—flat within  $\pm 5\%$ , from 40 cycles to 5 Mc on the 1.5, 5, and 15-volt rms ranges and the 4, 14, and 40-volt peak-to-peak ranges • DC Input Resistance—standard 11 megohms (1 megohm resistor in probe).

\*User Price (Optional)

See them all at your local RCA Test Equipment Distributor!



**RADIO CORPORATION OF AMERICA**  
ELECTRON TUBE DIVISION  
HARRISON, N. J.



# The Decibel Without Pain

By **BOB ELDRIDGE** / Practical hints on understanding and using these strange units, by someone who actually likes them.

**B**Y NOW, we are all supposed to know that the decibel is a *ratio* between two quantities of power (or voltage, or current), not a quantity of power, voltage, or current itself. Thus we should not express any known electrical quantities as being simply "so many db"—unless we are in the advertising business. The copywriter may state, "Sudso is 20 per-cent faster" and get away with it before anyone asks, "Faster than what?" However, if a technician should state, "The power at this point is 30 db," someone will invariably want to know, "30 db above or below what?"

In other words, there must be a reference level.

Sometimes this level may be understood. In the telephone industry, for example, this reference is the input level to the switchboard from a subscriber line. Other levels throughout the system, expressed simply in db, are referred to this input, with the telephone engineer primarily concerned with the magnitude of the losses in the various portions of the path between the microphone of one telephone and the receiver of another.

He is also interested in the gain in db of each amplifier in the chain that will restore the losses: what goes down must be brought back up again if Mom in New York is to hear Johnny's plea from camp for just another few dollars. In the detailed engineering of the circuit, he also becomes interested in the actual rather than relative power present at various points in the path, but that is a matter for db's twin brother, dbm, of whom more will be heard later.

For the moment, let's consider only that the db is a ratio. An amplifier that produces 100 watts of output when 1 watt is fed into it is a 20-db amplifier.

But so is another that produces 100 milliwatts out from 1 mw. in. From this comparison, we see that a 20-db amplifier is one that has a power gain of 100 times without regard to its actual power-handling capacity.

## What About Logs?

The key to the whole db business, as many technicians unhappily acknowledge, is a working familiarity with logarithms. A great deal can be done in handling decibels without using logarithms, as will be noted later. However, those practical men who have been getting along without logs for years just don't realize what they are missing. Logs are very easy to use—they make multiplication and division less of a chore. In fact, logs literally *turn* multiplication *into* addition, and division into subtraction. This same great advantage is present in the use of db. Although a full discussion of

the use of logs in general calculations will be avoided, it will be useful to review some facts concerning the logarithm to the base 10 before getting to the meat of the dog biscuits (db).

The logarithm of a number is the power to which 10 must be raised to obtain that number. 100 is 10 squared ( $10^2$ ), or 10 to the power of 2. Therefore, the power to which 10 must be raised to make 100 is 2; so the log of 100 is 2. To take another example. 2 is 10 to the power of .3 (to be precise, .3010, but who wants to be precise at a time like this?). To find this value, or to convert a number to a log or the reverse, either a table of logarithms or a slide rule may be used.

To multiply several numbers together, we merely find their logs, add these together, and translate the new log thus obtained back to a number again. Thus, using the two logs we have already examined, let us multiply  $100 \times 100 \times 100 \times 2 \times 2$ . With logarithms, this becomes  $2+2+2+.3+.3$ , which quickly adds up to 6.6, the new logarithm. An antilog table or a slide rule tells us that the number of which is 6.6 is the logarithm is  $4 \times 10^6$ , or 4,000,000.

Now for tying up logarithms with decibels—in formula:  $db=10 \log P_1/P_2$ .

"Which means?" as the straight man might say to his partner.

"A decibel is ten times the log of the ratio between two power levels."

"Why ten times?"

"Because the bel, the first unit for measuring the relative level between two sounds, was too large to handle; so they chopped it into ten parts and called each a decibel ( $1/10$  bel)."

From the formula it is obvious that the db is logarithmic. In this fact lies many great advantages. Power ratios of millions to one can be expressed in

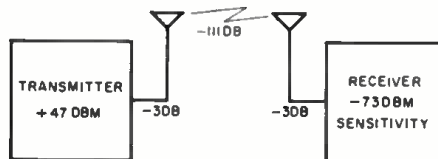
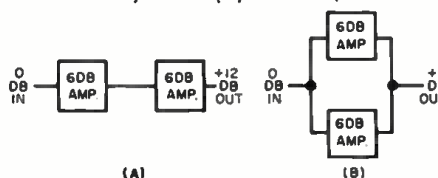


Fig. 1. Gains and losses in a transmission link are represented as shown to determine adequacy of signal level.

Fig. 2. Two identical amplifiers connected (A) in series yield greater gain than they would (B) when in parallel.



simple numbers and vast products can be obtained by merely adding simple numbers together. If you think that this is rarely necessary, consider that a difference of only 60 db represents a power ratio of a million to one.

Table 1 shows some of the easily remembered and frequently used power ratios, expressed as numerical ratios and in equivalent db. With these figures, many complicated calculations can be reduced to mental arithmetic. For example, whenever a given power level is multiplied by 10, we add 10 db (or, when it is divided by 10, subtract 10 db). To double any power, add 3 db. Since quadrupling a power is doubling it twice, this comes to 6 db (3+3). Just by manipulating this table, many other ratios can be deduced. For example, to increase a power ratio 20 times, we must increase it 10 times (10 db) and then double it (3 db). Calculation will show that a power increase of 20 times is indeed a change of 10+3, or of 13 db.

Other examples: To obtain 5 times a power, we can find 10 times that power and then halve it. In db, this would be +10-3, or +7 db. To increase by 50 times, we could increase by 10 times (+10 db) and then by 5 times (+7 db). The answer would be +17 db. To find 25 times (half of 50 times), we know that +17-3=+14 db.

### The Dbm

The standard test tone used in the telephone industry is a 1000-cps signal with a power of 1 milliwatt. Since this is a convenient reference level, the term dbm, meaning "db with reference to 1 milliwatt," is now in widespread use. Since there is a specific reference point (1 milliwatt is always zero dbm), any figure given in dbm is *not* a ratio. It is a definite quantity of power. Thus 1 watt (1000 mw.) can be written as +30 dbm; and 1 microwatt is -30 dbm.

The dbm is very useful in system calculations. For example, let us take an imaginary u.h.f. link that must be set up. We have the following: 1. a 50-watt transmitter, 2. a receiver that requires an input of 50 microvolts of signal for efficient operation, 3. antenna feeders and connectors that entail a loss of 3 db at each end, 4. a required safety margin of 20 db to allow for fading, and 5. attenuation of the signal in the air path between transmitter and receiver shown to be 111 db. We draw a block diagram, as in Fig. 1.

A 50-microvolt signal across the 50-ohm input impedance of our receiver tells us we need a power here of -73 dbm. This is another way of stating the receiver's sensitivity. The transmitter output, already given in watts, can be restated as +47 dbm. If we forget everything else (losses) in between transmitter and receiver, the *ratio* between the transmitter output and the power required at the receiver input is 120 db (not dbm). This is the *difference* between transmitter output and receiver input, which is +47-(-73).

This 120 db is called the system gain, and represents the maximum amount of attenuation that could be tolerated

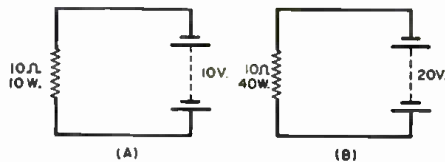


Fig. 3. Doubling voltage (B) applied across a circuit (A) also doubles current. Thus the power drop quadruples.

between transmitter and receiver without degrading performance. Now, on the debit side, we have: 3-db loss in the transmitter antenna feeder system, 111-db loss in the air path between these stations, and 3-db loss in the receiver antenna feeder system. These losses add up to -117 db.

Thus, if the antennas used show unity gain (such as conventional dipoles), the system will work with 3 db to spare. However, we are looking for a 20-db safety margin to allow for fading. We must therefore use antennas that will give us a total gain of 17 db. Antennas at each end with a gain of 8.5 db each will do the trick.

Now here is a point worth thinking about: If we left the unity-gain antenna at the transmitter and stacked two 8.5-db antennas at the receiver without losses, we would fall short of the gain requirement. We would get, not 17 db, but only 11.5 db! Let's consider this statement in a more familiar form—the case of the two amplifiers in Fig. 2. In series, with one amplifier *multiplying* the output of the other, the logarithmic increase is such that, expressed in db, we get twice the gain of one amplifier. In parallel (Fig. 2B), we only double the power. This (Table 1) is a gain of only 3 db over the use of one amplifier—or antenna. In the case of the amplifiers, this could easily be measured.

To return to the dbm—it is so useful precisely because it indicates a definite power and yet can be manipulated in a logarithmic manner along with ordinary decibels. Transmitters, amplifiers, receivers, microphones, and loudspeakers can all be rated, as to sensitivity or output, in dbm, even though the impedance of each type of unit may be different. Other units similar to the dbm include dbw (referred to a level of 1 watt), dbk (in reference to a kilowatt), and dbx, a unit of crosstalk between two circuits. There are also others.

### Voltage, Current Ratios

So far, we have talked about the ratio between two powers. The ratio between two voltages, or between two currents, can also be expressed in db, where these are the quantities that are known—but the formula is different. This stems from the fact that, when you relate a given power to the voltage or current that is involved with it, the relationship is not linear. There is always a square involved (power, in watts, is  $I^2R$  or  $E^2/R$ ). Again, we look at the matter in practical terms, with the help of Fig. 3.

If we put a 10-ohm resistor across a 10-volt supply, 10 watts of power (Fig.

3A) will be dissipated in the resistor. If the voltage is doubled (Fig. 3B), the power in the resistor is not doubled—it is quadrupled. This is because, following the rule made public by Mr. Ohm, the current is doubled as well as the voltage.

This brings us to another principle in the use of logarithms: to square any number, multiply its log by 2, then find the antilog of this product. Since a square is involved when we go from a power to a voltage or a current, we go back to our old db formula (Ugh! There he goes again!) for power ratios and multiply the logarithm by 2. Thus, for converting two voltages to a db ratio, the formula is  $db=20 \log E_1/E_2$ . However, a db is a db. If you compare two specific signals, the respective powers will be different from the respective voltages, but the db ratio will always be the same.

The point may be further illustrated by reference to Table 2, where the db equivalents for many voltage ratios are given. If the voltage across a given load is doubled, there is an increase of 6 db. Note that doubling the voltage across the load will have quadrupled the power. Thus a 4-time increase in power (Table 1) is a gain of 6 db.

### Reading a Db Meter

A word of caution is necessary when reading db directly on a meter. The latter is actually a voltmeter, not a power meter, and is therefore calibrated for readings across a specific impedance. For relative readings, this is not much of a problem. For instance, if one should start out with a reading of +5 db across any circuit, and this reading should change to +3 db during tests across the same impedance, the change will always be a difference of 2 db.

For reading dbm however, the impedance for which the meter was calibrated must be known. In most cases, this is "0 db—1 mw. in 600 ohms," usually printed on the meter face. However some older meters are calibrated to make zero db equal to 6 mw. in 500 ohms. In either case, this direct reading is obtained on one range,

POWER RATIO	DB	POWER RATIO	DB
One thousandth	-30	One eighth	-9
One hundredth	-20	One quarter	-6
One tenth	-10	One half	-3
Unity	0	Unity	0
Ten times	+10	Doubled	+3
One hundred times	+20	Quadrupled	+6
One thousand times	+30	Eight times	+9

Table 1. Common power ratios in db.

Table 2. Common voltage ratios in db.

VOLT. RATIO	DB	VOLT. RATIO	DB
One hundredth	-40	One fourth	-12
One tenth	-20	One half	-6
Unity	0	Unity	0
Ten times	+20	Doubled	+6
One hundred times	+40	Quadrupled	+12

and direct readings on other ranges are corrected by adding or subtracting so many db, as specified by the manufacturer, where separate db scales are not used.

If the impedance at which the db scales have been calibrated is in doubt, a check can be made against the voltage scales. For example, if .775 volt corresponds to zero db, the meter has been calibrated to the modern standard, and powers in a 600-ohm circuit can be read directly off the meter in dbm. Such readings can be made across other impedances too, simply by applying a correction factor. For example, let us suppose the meter is calibrated for 600 ohms. In reading across a 1200-ohm circuit, one would simply subtract 3 db from the scale reading to obtain the power in dbm. Across a 300-ohm circuit, add 3 db to the reading; across 150 ohms, add 6 db; and across 75 ohms, add 9 db. Correction factors can be worked out for any impedance.

The important thing is to start using db wherever possible, even when they are not needed. The familiarity thus acquired will simplify matters when db becomes essential. -30-

**Mac's Service Shop**  
(Continued from page 66)

the shop and explain they were visiting relatives in town and had been forced into 'just looking' at a radio or TV set. They usually wanted to look

at a diagram or to buy a resistor, capacitor, or tube. Invariably, I sold them the wanted item at cost, for I felt deep sympathy for them. The technician who has never been put in this spot while visiting has either not been a technician very long or has some peculiarly considerate relatives and friends. In this shop, we 'recognize the profession,' and we'll keep right on doing so as long as we're in business."

"How did you come out with the salty little radio?"

"Since it had already been out of commission several days, I suggested to the owner I bring it home with me to where I would have something to work with; but I was careful not to hold out much hope. Last night at home I gave it a good going over with carbon tetrachloride out on the cook-out table in the back yard where the breeze would carry off the poisonous fumes of the chemical—and I was darned careful not to get the stuff on my skin or in my eyes. With a toothbrush dipped in carbon tet, I scrubbed all the corrosion off the printed circuit wiring and the other metal parts. Then I squirted the chemical very liberally into the i.f. and oscillator cans with an eye-dropper. Contact cleaner was used on the volume control, the battery contacts, the earphone jack contacts, and the wiping contacts of the tuning capacitor. New batteries were installed, but the thing still wouldn't play. The oscillator in that little monster just would not take off.

"I suspected that the salt was shorting out the tuning capacitor; so this morning I removed the capacitor from the printed circuit board and measured the resistance between the stator sections and ground. In both instances, the resistance was only a few dozen ohms. I washed the tuning capacitor very thoroughly in warm, soapy water, squirted some more carbon tet between the plates, and then dried the capacitor under the heat lamp. I've just finished putting it back; so let's see what gives. The resistance between either set of stator plates and the frame of the capacitor is now infinite at any position of the rotor plates—which is as it should be."

As he said this, Mac turned on the receiver, and it instantly began to play with good volume and surprisingly good clarity.

"Well now! The patient is responding to treatment!" he said with a pleased grin as he tuned in several different stations. "Naturally I'll re-align all the tuned circuits and spray a new protective coating over the printed circuit. We'll keep the radio playing for a week or so and see if anything else shows up. If not, I'll send it back with a warning to the owner not to be surprised if trouble does pop up later. I hate to be so pessimistic, but I'm afraid it's next to impossible to get all the salt out of the thing; and a minute amount of that stuff will draw dampness and form a corrosive, short-circuiting solution that can put the set

# TRU-VAC 1-YEAR GUARANTEED RADIO and TV TUBES

EACH

**Factory Used or Factory Second Tubes! TRU-VAC will replace FREE any tube that becomes defective in use within 1 year from date of purchase!**

**ALL TUBES INDIVIDUALLY BOXED! CODE DATED & BRANDED "TRU-VAC"**

Partial Listing Only . . . Thousands More Tubes in Stock!

**SPECIAL! 6SN7GT . . . . . 30¢ 6W4GT . . . . . 30¢**

0Y4	3CB6	GAG	6BC8	GCH8	GQ7	7A4/XXL	12A8	12F5	26	56
D24	3Q4	6AB4	6BD6	GCL6	654	7A5	12AB5	12K7	27	57
1A7GT	354	6AF4	6BE6	GCM6	657	7A6	12AQ5	12L5	35	58
1B3GT	3V4	6AW4GT	6BF8	GCN7	658GT	7A8	12AT6	12Q7	35A5	71A
1M5GT	4BQ7A	6AM6	6BG6G	GCN7	65D7GT	7B4	12AT7	12S47	35B5	75
1L4	4B5B	6AK5	6BH6	GCQ8	65F5	7B5	12AU6	12S7	35C5	76
1L6	4B77	6AL5	6BJ6	GC88	65H7	7B6	12AV6	12SK7	35W4	77
1NSGT	4CB6	6AM8	6BK5	GC56	65G7	7B7	12AV7	12SN7GT	35Z5	78
1R5	5AM8	6AN8	6BK7	GCUS	65H7	7B8	12AX4GT	12S07	36	80
1S5	5AM8	6AQ5	6BL7GT	GC16	65J7	7C6	12AK7	12V6GT	38	84, 6Z4
1T4	5AT8	6AQ6	6BN6	GD6	65K7	7C7	12AZ7	12W6GT	39/44	117Z3
1U4	5AV8	6AQ7	6BQ6GT	GD6E	65L7	7E5	12B4	12X4GT	41	
1U5	5AZ4	6AR5	6BQ7	6D6CGT	65Q7	7E6	12B6	14A7/12H7	42	
1V2	5BR8	6AS5	6BR8	GDQ6	65R7	7E7	12B7	14B6	43	
1X2	5CC8	6AT6	6B58	GE5	6T4	7F7	12BD6	14Q7	45	
2AF4	5J6	6AU4GT	6BY5G	GF5	6T8	7F8	12BE6	19AU4GT	50A5	
2BN4	5R4	6AU5GT	6BZ6	GF6	6U5	7G7	12BM7	19BG6G	50B5	
2CY5	5T8	6AU8	6BZ7	GF6	6U8	7H7	12BQ6	19J6	50C5	
3A5	5U4	6AV5GT	6C4	6J4	6V6GT	7Q7	12BR7	19T6	50L6	
3AL5	5U8	6AV6	6CA8	6J5	6W6GT	757	12B7	24A		
3AU6	5V4G	6AW8	6CB6	6J6	6X4	7X6	12CA5	25Z6GT		
3BC5	5V6GT	6AX5GT	6CD6G	6J7	6X5GT	7X7	12D4			
3BN6	5X8	6B8	6CF6	6K7	6X8	7Y4				
3BZ6	5Y3	6BC5	6CG8	6N7	6V6G	7Z4				

**Any Tube Not Listed Also Available at 35¢ Each! BRAND NEW 1-YEAR GUARANTEED TV PICTURE TUBES**

Below Listed prices do not include duty. Add Additional \$5.00 Deposit on tube sizes to 20" on 21" and 24" tubes—\$20. Deposit refunded immediately when tube is returned prepaid. Aluminized tubes—\$4.00 extra.

Picture tubes shipped only to continental USA and Canada—All tubes F.O.B. Harrison, N. J.

10B14	7.99	10K14	11.99	17H14	16.99	20H14	17.99	21AW4	17.49	21P4	17.49
12L14	10.49	16L14	12.19	17I14	16.99	21A14	21.49	21E14	17.29	21Y14	18.39
14I14	11.99	16R14	11.99	17Q14	13.89	21AL14	18.79	21F14	18.39	21Z14	17.49
16A14	16.09	17A14	15.49	17T14	16.99	21AT14	18.79	21G14	18.39	24A14	28.49
16D14	12.19	17B14	13.49	19A14	18.39	21AM14	17.99	21H14	22.39	24C14	27.79
16G14	16.09	17C14	18.89	20C14	15.89	21A14	18.79	21V14	18.39	24D14	29.79
16H14	5.19	17G14	17.89	20D14	15.89	21A14	18.79	21W14	12.49		

**ATTENTION QUANTITY USERS! Big Discounts Are Yours . . . Call or Write For Our 1000 Tube "Private Label" special! Attention Framing Dept. MGR.**

**Money Cheerfully Refunded Within Five (5) Days, if Not Completely Satisfied!**

**TRU-VAC PAYS YOUR POSTAGE**—On orders of \$5 or more in U.S.A. and Territories. Send approximate postage on Canadian and foreign orders. Any order less than \$5 requires 25¢ handling charge. Send 25¢ on C.O.D.'s. All orders subject to prior sale. Complying with Federal regulations, the following statement appears in all Tru-Vac advertising: Tubes appearing in this ad may be FACTORY SECOND (S) or USED (U) tubes and are clearly marked.

1 Month Special!  
16 INCH Used TV CONSOLES

\*RCA, EMERSON, ADMIRAL, Other Famous Makes! All in excellent condition. Worth much more! **\$29.95**

All sets shipped in double cartons to prevent breakage. Shipped express in continental USA & Canada. F.O.B. Harrison, N. J.

**FREE HUNTS OF HARBOR EARR ANTENNA (REG. \$7.95) Sent FREE with each set!**

1 Month Only!

**TRU-VAC 1-YR. GUARANTEED RADIO AND TV TUBES**

Get 2 Tubes for the Price of 1 Plus 3 Pennies!

**35¢** EACH TUBE

**33¢** EACH PER 100 TUBES

\*Buy all the tubes you want for 35¢ each and get extra tubes for 1¢ each.

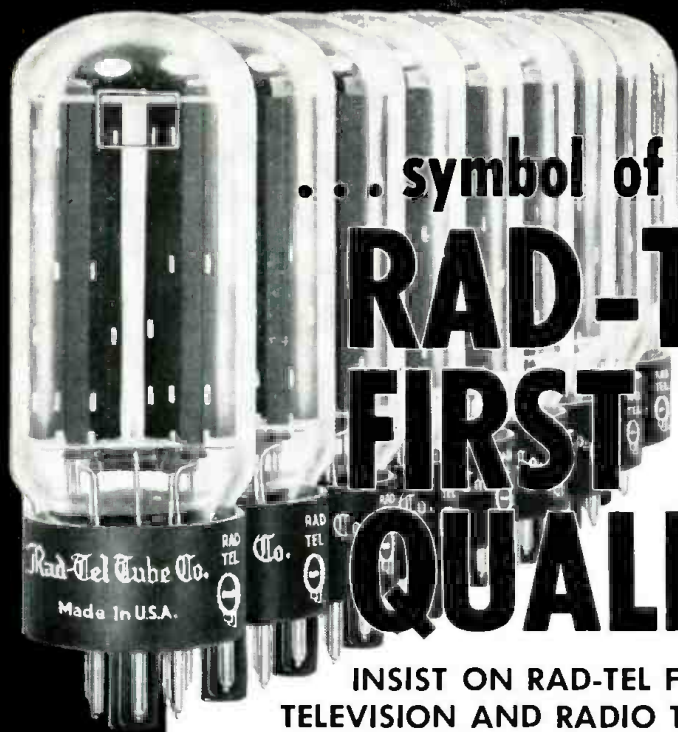
\*Buy 100 tubes for 33¢ each and get 100 extra tubes for 33¢.

mix of  
6AG5 6CQ7 7C4 12CN6  
6AU6 6CS7 7C5 12KA5  
6AX4GT 6XGT 7N7 12F6  
6BAG 7A7 12AF6 12G5

Sale

# TRU-VAC

Harrison Avenue • Box 107 • Harrison, N. J. HUMBOLDT 4-9770



... symbol of  
**RAD-TEL**  
**FIRST**  
**QUALITY**

INSIST ON RAD-TEL FOR EVERY TELEVISION AND RADIO TUBE NEED

**Super-Special!**

**KIT OF 100**  
**Bi-Pass**  
**CONDENSERS**

Over 50% Are 600V

at  
**LESS**  
**THAN \$3.95**  
 4¢ each

**Goodall**  
**Semi-Molded**  
**Paper and**  
**MYLAR**

Made up of approx.  
 16-200V, 20-400V and  
 64-600V.  
 Values .001 to 1 mf

**Up to 75% OFF on BRAND NEW TUBES**

**GUARANTEED ONE FULL YEAR!**

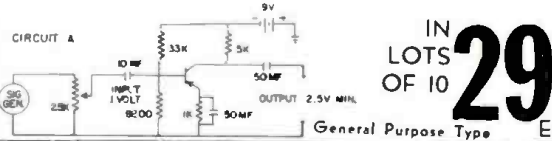
You Can Rely On Rad-Tel's Speedy One Day Service!

Not Used — Not Pulled Out Of Old Sets • Each Tube Individually and Attractively Boxed!

Qty.	Type	Price	Qty.	Type	Price	Qty.	Type	Price	Qty.	Type	Price	Qty.	Type	Price	Qty.	Type	Price	Qty.	Type	Price						
—	0Z4M	.79	—	3D76	.50	—	6AB4	.46	—	6B16	.62	—	6E08	.79	—	12A4	.60	—	12B06	.50	—	12EG6	.54	—	198G6	1.39
—	1AX2	.62	—	3Q5	.80	—	6AC7	.96	—	6BK7	.85	—	6EA8	.79	—	12AB5	.55	—	12BE6	.53	—	12E26	.53	—	19T8	.80
—	1B3GT	.79	—	3S4	.61	—	6AF3	.73	—	6BL7	1.00	—	6HG7	.58	—	12AC6	.49	—	12BF6	.44	—	12F5	.66	—	21EX6	1.49
—	1DM5	.55	—	3V4	.58	—	6AF4	.97	—	6BN4	.57	—	6J5GT	.51	—	12AD6	.57	—	12H7	.73	—	12F8	.66	—	25B06	1.11
—	1G3	.73	—	4BC5	.56	—	6AG5	.65	—	6BN6	.74	—	6J6	.67	—	12AE6	.43	—	12BL6	.56	—	12FM6	.45	—	25C5	.53
—	1J3	.73	—	4BC8	.96	—	6AH6	.99	—	6BQ5	.65	—	6K6	.79	—	12AF3	.73	—	12BQ6	1.06	—	12K5	.65	—	25CA5	.59
—	1K3	.73	—	4BN6	.75	—	6AK5	.95	—	6BQ6GT	1.05	—	6S4	.48	—	12AF6	.49	—	12BY7	.74	—	12SA7M	.86	—	25C06	1.44
—	1L6	1.05	—	4BQ7	.96	—	6AL5	.47	—	6BQ7	.95	—	6SA7GT	.76	—	12AJ6	.46	—	12BZ7	.75	—	12SK7GT	.74	—	25C06	1.11
—	1LM5	.59	—	4BS8	.98	—	6AM8	.78	—	6BR8	.78	—	6SK7GT	.74	—	12AL5	.45	—	12C5	.56	—	12SN7	.67	—	25DN6	1.42
—	1R5	.62	—	4BU8	.71	—	6AN4	.95	—	6BU8	.70	—	6SL7	.80	—	12AL8	.95	—	12CA5	.59	—	12SQ7M	.73	—	25EH5	.55
—	1S5	.51	—	4BZ6	.58	—	6AN8	.85	—	6BY6	.54	—	6SN7	.65	—	12A05	.52	—	12CN5	.56	—	12U7	.62	—	25L6	.57
—	1T4	.58	—	4BZ7	.96	—	6AQ5	.50	—	6BZ6	.54	—	6SQ7	.73	—	12AT6	.43	—	12CR6	.54	—	12V6GT	.53	—	25W4	.68
—	1U4	.57	—	4CS6	.61	—	6AR5	.55	—	6BZ7	.97	—	6T4	.99	—	12AT7	.76	—	12CU5	.58	—	12W6	.69	—	25Z6	.66
—	1U5	.50	—	4D6	.62	—	6AS5	.60	—	6C4	.43	—	6U8	.78	—	12A06	.50	—	12C06	1.06	—	12X4	.38	—	35C5	.51
—	1X2B	.82	—	4DK6	.60	—	6AT6	.43	—	6CB6	.54	—	6V6GT	.54	—	12A07	.60	—	12CX6	.54	—	17AX4	.67	—	35L6	.57
—	2AF4	.96	—	4DT6	.55	—	6AT8	.79	—	6CD6	1.42	—	6W4	.75	—	12AV5	.97	—	12DB5	.69	—	17B06	1.09	—	35W4	.52
—	2CY5	.71	—	5AM8	.79	—	6AU4	.82	—	6CF6	.64	—	6W6	.69	—	12AV6	.41	—	12DE8	.75	—	17C5	.58	—	35Z5GT	.60
—	3AL5	.42	—	5AN8	.86	—	6A06	.50	—	6CG7	.60	—	6X4	.39	—	12AV7	.75	—	12DL8	.85	—	17CA5	.62	—	50B5	.60
—	3AU6	.51	—	5AQ5	.52	—	6A07	.61	—	6CG8	.77	—	6X5GT	.53	—	12AX4	.67	—	12DM7	.67	—	17D4	.69	—	50C5	.53
—	3AV6	.41	—	5AT8	.80	—	6A08	.87	—	6CM7	.66	—	6X8	.77	—	12AX7	.63	—	12DQ6	1.04	—	17DQ6	1.06	—	50DC4	.37
—	3BA6	.51	—	5BK7A	.82	—	6AV6	.40	—	6CN7	.65	—	7AU7	.61	—	12AZ7	.86	—	12DS7	.79	—	17L6	.58	—	50EH5	.55
—	3BC5	.54	—	5BQ7	.97	—	6AW8	.89	—	6CR6	.51	—	7A8	.68	—	12B4	.63	—	12DZ6	.56	—	17W6	.70	—	50L6	.61
—	3BE6	.52	—	5BR8	.79	—	6AX4	.65	—	6CS6	.57	—	7B6	.69	—	12BA6	.50	—	12EL6	.50	—	19AU4	.83	—	117Z3	.61
—	3BN6	.76	—	5CG8	.76	—	6AX7	.64	—	6CU5	.58	—	7Y4	.69	—			—								
—	3BU8	.78	—	5CL8	.76	—	6BA6	.49	—	6CU6	1.08	—	8A08	.83	—			—								
—	3BY6	.55	—	5EAB	.80	—	6BC5	.54	—	6CY5	.70	—	8AW8	.93	—			—								
—	3BZ6	.55	—	5EU8	.80	—	6BC7	.94	—	6CY7	.71	—	8BQ5	.60	—			—								
—	3CB6	.54	—	5J6	.68	—	6BC8	.97	—	6DA4	.68	—	8CG7	.62	—			—								
—	3CF6	.60	—	5T8	.81	—	6BD6	.51	—	6DB5	.69	—	8CM7	.68	—			—								
—	3CS6	.52	—	5U4	.60	—	6BE6	.55	—	6DE6	.58	—	8CN7	.97	—			—								
—	3CY5	.71	—	5U8	.81	—	6BF6	.44	—	6DG6	.59	—	8CX8	.93	—			—								
—	3OK6	.60	—	5V6	.56	—	6BG6	1.66	—	6DQ6	1.10	—	8EB8	.94	—			—								
—			—	5X8	.78	—	6BH6	.65	—	6DT5	.76	—	10DA7	.71	—			—								
—			—	5Y3	.46	—	6BH8	.87	—	6DT6	.53	—	11CY7	.75	—			—								

**TRANSISTORS**

ICBO  $\leq$  6V IEBO  $\leq$  3V hfe ckt A  
 10 pa max. 10 pa max. 25 min.



IN  
 LOTS  
 OF 10  
**29¢**  
 EA.

SEND FOR FREE TROUBLE SHOOTER GUIDE AND NEW TUBE & PARTS CATALOG.

NOT AFFILIATED WITH ANY OTHER MAIL ORDER TUBE COMPANY.

**RAD-TEL TUBE CO.**

55 Chambers St  
 Newark 5, N. J.

TERMS: 25% deposit must accompany all orders — balance C. O. D.  
 \$1 HANDLING CHARGE FOR ORDERS UNDER \$5. Subject to prior sale.  
 Please add postage. No C. O. D.'s outside continental U. S. A.

EW 860

# Operating Mobile in Canada



By J. E. KITCHIN \* / Inspector, Telecom. Canada

**Here are the simple requirements to be met by the ham who wants to operate mobile across our northern border.**

**O**PERATING mobile in Canada may include a flat tire on highway 999 and a picnic where the ants and mosquitoes win the battle, as well as a few other pleasantries, but it also must include a Canadian mobile permit.

Perhaps your own vacation plans aren't settled as yet but inquiries are received at Canadian Radio Inspection offices all year round and some of the points outlined here may assist you in case of projected visits to Canada. Inquiries range all the way from a telephone call from a harassed amateur at a border point with a car full of kilowatts to a QSL card from the "deep south" stating: "I am leaving tomorrow for Canada, please send me a Canadian license COD."

To start at the beginning, it is necessary to consider the agreement between the United States and Canada covering mobile radio, known as a "Reciprocal Agreement." This means that each country agrees to extend the privileges specified in the Agreement to the citizens of the other country. Reciprocal agreements also exist with regard to other things and, in general, if one country wishes to terminate such an agreement then, naturally, the other country withdraws the privileges extended to citizens of that country. The radio agreement which is now in force specifies in Article 2: "The respective countries agree that mobile radio stations properly licensed in one country are permitted to be operated in the territory of the other country (except that the provisions of this Article do not apply to ship or aircraft stations and are not intended to change or modify the terms of any agreements or treaties relating to such stations) subject to local operating conditions. . . ."

Note that only *mobiles* are specified so there is no use applying for a permit to operate a portable or a fixed station in Canada. A mobile station is defined in the International Convention Radio Regulations as: "A station in a mobile service intended to be used while in

motion or during halts at unspecified points." Under Canadian regulations a licensed amateur may have his mobile station either in his car or his pleasure boat and Americans visiting Canada may possibly wish to take advantage of the "amateur maritime mobile" aspect. An amateur station on a pleasure boat is still an amateur station and not a "ship station" as such. With regard to automobiles, a much discussed point is whether or not an auto is a mobile vehicle or a fixed station while the car is on a ferry! So, if ferries are part of the highway system, as they usually are, the vehicle retains its status as a mobile and the fact that the wheels are not turning has no bearing on the matter because a mobile may be operated while stationary.

Telephone calls from border states sometimes ask an Inspector to mail a permit to a border crossing point "as I am leaving home now." This cannot be done as mobile permits are obtainable only from the Department of Transport in Ottawa, Ontario (for Americans), and from the Federal Communications Commission in Washington (for Canadians wishing to mobile in the U.S.A.). The proper procedure is for the amateur to plan at least a month ahead and write to Ottawa or Washington, as the case may be, and ask for a mobile permit card—FCC form 410-1. DOT form 2190. There is no charge for these permits so do not enclose postage stamps—which cannot be used in the other country anyway. The cards are in two parts, both of which must be filled out by the applicant and mailed back to the office from which the card was obtained. The following information is required: Name of licensee; home mailing address and also any semi-permanent address in the country for which the permit is requested; radio station license number and date of expiration; call sign (don't just put "ZZZ," use the prefix too!); authorized communication service (for this simply put "amateur"); proposed area of operation, and approximate dates you will be visiting the other country.

The two parts of the card are then mailed back to Ottawa or to Washington, as the case may be, where one part is retained on file. The other part is "validated" and returned to the applicant and constitutes his border crossing permit. Customs officers at the border may seal the equipment unless the permit is produced and if you haven't one you may be unable to talk your way out of it—either the gear may have to be unloaded or sealed, at the option of the Customs officials. Neither will your offer to "report to the nearest Radio Inspector's office" be accepted.

That's all there is to it. Mobile operation can be a lot of fun but, amateur radio being what it is, there are regulations and this is one of them if you intend to go mobile in the other country. And, speaking of regulations, don't forget that both the United States and Canada have their own separate regulations and they are not identical in all respects. Consequently, in accordance with the agreement which specifies "local operating conditions and regulations," you must observe the regulations of the country you are visiting as soon as you cross the border. This may entail a frequency change and it would be well to consider this before starting out. As a hint to American amateurs, you might ask for form AR-5-80 when writing to Ottawa for the permit card. This form outlines the Canadian frequency bands, permissible powers, and types of emissions as well as general operating conditions. However, the portion of the form dealing with "portable" operation applies only to Canadian stations in Canada and should otherwise be ignored. The Canadian amateur writing to the FCC for a permit will find it profitable to also write to the Superintendent of Documents, Government Printing Office, Washington, D. C., and ask for the FCC rules, part 12, governing the amateur radio service. The price is ten cents which should be sent either by money order or United States coin. Stamps are not acceptable.

One more point—about Certificates, which are called "Operator's Licenses" in the United States. It is required that a prospective visitor to Canada who wishes to operate amateur mobile shall have an operator qualification equal to Canadian, therefore holders of Novice and Technician licenses are not eligible for Canadian mobile permits. This is because the minimum Canadian amateur operator qualification calls for ten words per minute in code speed. The Novice and Technician class licenses are, of course, below this standard in the matter of code speed. Commercial companies may be interested in knowing the same agreement covers car radio telephones which work into a public carrier terminal but, in this case, the type of service will be "public carrier" and as operation is only on fixed phone frequencies no operator's certificate is required.

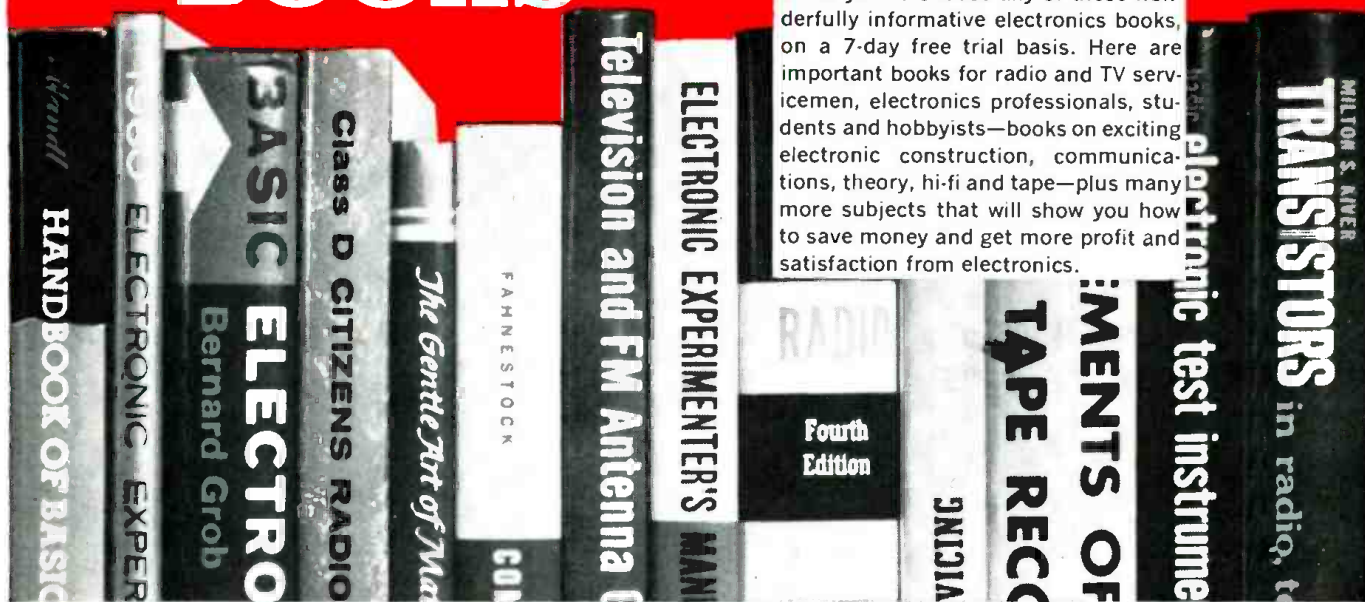
So happy holiday, much DX, and many QSO's and don't phone the RI from the Customs for a permit! —30—

\* 309 Nizef Ave., Vancouver 10, B. C.



ELECTRONICS WORLD ANNOUNCES A  
**SPECIAL SUMMER  
 SALE OF 57  
 ELECTRONICS  
 BOOKS**

The publishers of ELECTRONICS WORLD invite you to choose any of these wonderfully informative electronics books, on a 7-day free trial basis. Here are important books for radio and TV servicemen, electronics professionals, students and hobbyists—books on exciting electronic construction, communications, theory, hi-fi and tape—plus many more subjects that will show you how to save money and get more profit and satisfaction from electronics.



**THEORY AND INSTRUCTION**

Get started in radio, TV, communications, by using these simple basic guides to electronic principles, functions, and operations!



**2500. BASIC ELECTRONICS, Grob**  
 An introductory text on the fundamentals of electricity and electronics for technicians in radio, television and industrial electronics. \$9.25

**2512. PRIMER OF ELECTRONICS AND RADIANT ENERGY, Caverly**  
 Clear and simple explanation of electronics and electronic tubes and circuits for all concerned with the manufacture, application, operation of household or industrial electronic devices. \$7.50



**2521. BASIC ELECTRONICS, Daly and Greenfield**  
 Here in twelve chapters is a complete general introduction to electronics for technicians who make use of complex electronic equipment in modern laboratories. \$9.00

**2501. ELEMENTS OF ELECTRONICS, Hikey and Villines**  
 This basic electronics text offers an excellent course for training radio and electronics technicians and for students in television, radar and sonar. \$6.95



**2511. UNDERSTANDING RADIO, Watson, Welch and Eby**  
 For those with little or no technical knowledge who wish to know the fundamentals of radio theory and servicing. \$7.95

**2412. TELEVISION AND FM ANTENNA GUIDE, Noll & Mandl**  
 Two antenna experts tell you their secrets of antenna choice and installation for best reception in any area. Loaded with useful tips on improving reception in fringe and difficult areas. \$5.25



**2519. HANDBOOK OF BASIC CIRCUITS, Mandl**  
 A basic guide to circuitry combining comprehensive coverage of major circuits with detailed information on circuits used in TV, FM and AM. Simply written and easy-to-understand. \$7.95

**2522. ELEMENTS OF RADIO, Hellman**  
 A thorough grounding in all basic principles of radio, radio communication, with a review of electricity and magnetism. Also includes chapter on transistors. \$5.50



**2502. ELEMENTS OF RADIO, Marcus & Marcus**  
 Now in its 4th edition. More than a million copies sold! Follows proved method of exposition, proceeds from the simple to the complex. \$7.00

## HI-FI AND TAPE

Special references for the sound enthusiast to help him select, build, and improve his hi-fi and stereo recording system.



**2000/60. STEREO HI-FI GUIDE,**  
Ziff-Davis Publishing  
Company

Just published! 1960 edition features 60-page exclusive by Joseph Marshall on components and how they work. \$1.00

**2757. RIBBONS OF SOUND,** Barleben

A perfect introduction to tape recording principles and practices. Paper. \$2.50; 2757C Cloth. \$3.50

**2760. HI-FI STEREO FOR YOUR HOME,** Whitman

Tells what stereo is, how it works, affects home listening habits, and how to install and maintain it. \$3.50



**2750. ELEMENTS OF MAGNETIC TAPE RECORDING,** Haynes

All aspects of this recording medium are described in easy-to-understand detail. 416 pages, \$7.95

**2004/60. HI-FI ANNUAL & AUDIO HANDBOOK,**  
Ziff-Davis Publishing Company

1960 edition. Prepared by the editors of Electronics World. An excellent advanced guide to theory, construction and circuitry. \$1.00



**42. REVERE TAPE RECORDER GUIDE,**  
Tydings

The first non-technical book to provide useful information on the Revere Tape Recorder. Also a basic guide to the entire field of tape. Will show you new uses and add to your enjoyment of tape recording. \$1.95

**2005/60. HI-FI DIRECTORY & BUYERS' GUIDE,**  
Ziff-Davis Publishing Company

1960 edition. World's only complete listing of all hi-fi and stereo equipment, components and accessories. Five big sections. Over 1,000 illustrations. \$1.00



**2753. LOW-COST HI-FI,** Hoefler

Hundreds of hints for budget hi-fi will be found in these fourteen chapters with over 300 detailed photographs, drawings and diagrams. \$2.50

**49. TAPE RECORDING GUIDE,** Marshall

Designed to help you get the most out of your tape recorder, whether for business, pleasure or professional use. A handy guide to have around, no matter what type of equipment you own or plan to purchase. \$1.95



**2752. HIGH QUALITY SOUND REPRODUCTION,**  
Moir

A perfect manual for both the professional engineer and the serious amateur in high fidelity. Complete coverage of sound reproduction in 591 pages. \$15.00

Save time and labor in radio and TV maintenance by referring to professional handbooks!

## RADIO AND TV SERVICING



**2415. MANDL'S TELEVISION SERVICING,** Mandl

This standard text book in the T.V. servicing field provides clear descriptions of the fundamentals of T.V., and practical instruction on the diagnosis and correction of typical troubles. \$6.95

**2429. TELEVISION RECEIVER SERVICING,** Kiver

New (fourth) edition is a carefully written complete handbook for the television serviceman. New chapter discusses color T.V.—operation and servicing. \$5.95



**2442. BASIC ELECTRONIC TEST INSTRUMENTS,**  
Turner

Over 60 instruments described, their uses fully explained, and valuable work-saving short-cuts outlined. \$4.95

**2416. LABORATORY MANUAL FOR BASIC TELEVISION AND TELEVISION RECEIVER SERVICING,**  
Zbar and Schildkraut

55 experiments covering fundamental skills in T.V. receivers and T.V. receiver servicing. \$4.50

**2422. HANDBOOK OF TV REPAIR,**  
Hertzberg

A basic guide to do-it-yourself T.V. repairs for the amateur. \$2.50

**2400. PROFITABLE RADIO TROUBLESHOOTING,** Marcus and Levy

Explains in easy-to-understand manner the use of simple and advanced test instruments, opening a radio servicing business, pitfalls, and successful procedures for a full-grown business. \$5.95

**2408. ESSENTIALS OF ELECTRICITY FOR RADIO AND TELEVISION,**  
Slurzberg and Osterheld

Provides necessary background of principles for understanding T.V., FM and radio circuits. \$8.00



**2425. ELEMENTS OF TELEVISION SERVICING FOR BENCH AND FIELD,**  
Marcus and Gendler

Up to date discussion of installation, servicing and repair of T.V. receivers, designed for the practicing serviceman. \$8.15

**2407. HOW TO GET AHEAD IN THE TELEVISION AND RADIO SERVICING BUSINESS,** Marcus

Shows the easy way to get started as a TV-Radio repairman, how to earn while you learn, how to get and keep customers. \$3.50



**2404. FM RADIO SERVICING HANDBOOK,** King

A practical guide to FM V.H.F. receivers, their design, construction, alignment and repair. \$5.00

## ELECTRICITY AND APPLIANCES

Brush up on electrical theory, repair any electrical appliance by using these simple manuals!



### 2651. MAJOR APPLIANCE SERVICING, Brockwell

Gives essential, overall information for a career in major-appliance servicing, explaining methods of repairing appliances, organizing and managing a service business. \$5.95

### 2653. PRACTICAL ELECTRICITY, Croft

What electricity is, how it is generated and how it is used. Simply written with many graphic examples. \$8.50

### 2667. ELECTRIC MOTOR REPAIR, Rosenberg

All details of modern motor repair work. Actual demonstrations of what to do and why. Designed for bench use with a duospiral binding that lies flat. \$6.95

### 2660. BEGINNING ELECTRICITY, Eaton

Principles, construction and operation of basic electrical devices and appliances. A thorough foundation of electricity. \$6.00

### 2652. HOW TO REPAIR HOME APPLIANCES, Campbell

For the do-it-yourselfer, a handy, easy-to-read reference book. \$2.50

Be eligible for the higher paying jobs by mastering math needed in electronics — quickly and easily.

## MATHEMATICS

### 2802. MATHEMATICS FOR ELECTRICIANS, Kuehn

A review of the fundamental processes of arithmetic, logarithms, and alternating current work. Includes chapter on the concept of work and horsepower. Material is arranged to provide a logical teaching sequence. \$6.75



### 2807. THE GENTLE ART OF MATHEMATICS, Pedoe

A fresh slant on things mathematical, a stimulating glimpse into the fascinating world of numbers. You will read and enjoy this diverting as well as instructive book. \$3.95

### 2803. BASIC MATHEMATICS FOR ELECTRICITY, RADIO AND TELEVISION, Singer

Here, mathematical principles are presented as dynamic tools for solving electrical problems. A practical course for students as well as an excellent refresher course for skilled technicians. \$8.25

## TRANSISTORS AND TUBES

Keep abreast of the latest designs and concepts in both transistors and tubes by using the charts, diagrams, and photographs in these practical books!



### 2600. TRANSISTORS, Gillie

Describes and analyzes semi-conductors and transistors and how they behave. 300 pages, illustrated. \$7.95

### 2602. TRANSISTOR AUDIO AMPLIFIERS, Shea

Fundamental considerations, transistor parameters, basic amplifier design, coupled stages, preamps, Class A and Class B power amplifiers, examples of practical design and much more. \$7.00

### 2603. VACUUM-TUBE AND SEMICONDUCTOR ELECTRONICS, Millman

The first book to integrate vacuum tubes and transistors. Teaches electronic circuit theory to provide an intimate understanding of the vacuum-tube and semiconductor device as a circuit element. \$10.00

### 2604. BASIC ELECTRON TUBES, Geppert

A text for a first course in electronics. It covers the tubes themselves, not the circuit applications. Basic principles governing operation of specialized tubes are explained. \$7.50

### 2607. TRANSISTORS, Coblenz & Owens

Treats theory, practical applications and manufacture of transistors in a way useful to technicians, engineers and advanced workers. Silicon and germanium transistors—how they are made, used, how they work. \$6.50

### 2605. FUNDAMENTALS OF VACUUM TUBES, Eastman

A text midway between the purely descriptive and the purely mathematical. Discusses the principal types of vacuum tubes. \$10.50

### 2606. ELECTRON-TUBE CIRCUITS, Seeley

A clear analytical method in the study of electron-tube circuits. Provides a broad background in preparing for work in radio and electronic engineering. \$10.50



### 2601. TRANSISTORS IN RADIO, TELEVISION AND ELECTRONICS, Kiver

A descriptive, non-mathematical text for radio, television, electronics technicians and for those who need to gain a working knowledge of transistors and transistor circuits. \$7.95



## COIL DATA

The J. W. Miller Co., 5917 S. Main St., Los Angeles 3, Calif. is now issuing an 8-page publication entitled "The Coil Forum." Intended for the experimenter, the new house organ supplies timely information on circuits and theory as well as on how to select coils for various uses.

The first issue contains construction information on a transistorized FM receiver, including how-to-build-it data, and hints on testing and alignment. Copies of the new publication are available free at the company's distributors or direct from the manufacturer.

## PRODUCT DATA

Schweber Electronics, 60 Herricks Rd., Mincola, New York has issued two 4-page brochures covering two electronic components.

The first is a buyers' and engineers' guide to Advance Elgin relays and provides detailed information on applications, performance, and specifications. The second brochure describes Vitramon capacitors. Included are details and illustrations of axial and axial-radial series as well as new micro-miniature types.

For copies of either or both of these brochures, write the company direct.

## TRANSLATOR TV SYSTEMS

Trio Manufacturing Co., Griggsville, Ill. has issued an 8-page booklet entitled "Translator Television Systems", a guide to better TV reception in "shadowed" communities.

The booklet defines translator stations, discusses who can own and operate such stations, translator station advantages, costs, TV set requirements, comparative costs between translator systems and other methods of improving TV reception, the importance of a good antenna, and the application of an efficient u.h.f. converter. The text material is illustrated by line drawings.

Copies of this booklet are available without charge upon direct application to the company.

## FILM RESISTORS

Daystrom, Inc., Weston Instruments Div., 614 Frelinghuysen Ave., Newark 12, N. J. has announced Bulletin 04-101-A, which gives technical data on the "Vamistor," a precision metal film resistor. This resistor is said to combine the best features of both wire-wound and film types and to meet every requirement where either type is specified.

## DEALER DISPLAY

Saxton Products, Inc., 4320 Park Ave., N. Y., N. Y. announces the availability of a new display card to the trade, showing a complete line of u.h.f.-v.h.f. 300-ohm transmission wire. Samples of line are attached to the card, alongside a description. For information, contact the company.

## TRANSISTOR HANDBOOK

Sylvania Electric Products Inc., P. O. Box 37, Buffalo 9, N. Y. has issued a handbook that contains construction



information on 30 circuits using battery-powered transistors.

Included are high-frequency, audio, instrumentation, and entertainment equipment. According to the company, the transistors specified are low enough in cost to permit hobbyists to build the circuits at an average cost of \$5.

Copies of the new handbook may be obtained at 50 cents a copy from company distributors or direct from the manufacturer.

## PACKAGED CIRCUIT GUIDE

Centralab, Division of Globe-Union Inc., 900 East Keefe Ave., Milwaukee 1, Wis. has published the sixth edition of its "PEC Packaged Circuit Guide." The 16-page booklet contains complete replacement data covering over 250 equipment brands and over 1400 replacement applications.

In addition to the data on packaged circuits in the line, the Guide includes a cross-reference chart showing the appropriate Centralab part number corresponding to units of other packaged circuit manufacturers.

Copies of the Guide are available free from distributors or direct from the manufacturer.

## "STANCOR" COILS

Chicago Standard Transformer Corp., 3501 W. Addison St., Chicago 18, Ill. has issued a new 28-page catalogue describing the complete line of Stancor coils. The book gives detailed electrical and physical specifications on over 600 units, as well as complete application information.

A special feature of the catalogue is the inclusion of 79 schematic diagrams covering every coil type in general use. Copies are available free at Stancor distributors or direct from the manufacturer.

## SELENIUM RECTIFIERS

Radio Receptor Co., Inc., subsidiary of General Instrument Corp., 240 Wythe Ave., Brooklyn 11, N. Y. has released a new catalogue, EL-316, covering all product lines of selenium diodes and rectifiers. The 8-page bulletin describes units that are designed to meet applications in the electronics, entertainment, and special products fields.

Included is technical data, circuit diagrams, and other information. For a copy, write to Dept. EL at the manufacturer's address.

## TUBES AND TRANSISTORS

The Electron Tube Information Council, 554 Fifth Ave., New York 36, N. Y. has issued a fact book, "Tubes and Transistors: A Comparative Study." This 64-page treatise discusses

the advantages and limitations of both components and is intended to assist manufacturers and design engineers in selecting one or the other in specific applications.

Formed in March 1959, the Council is composed of representatives of CBS Electronics, General Electric, Radio Corporation of America, Raytheon, Sylvania, Tung-Sol Electric Inc., and Westinghouse.

According to the Council, copies of the fact book have been mailed to engineers, purchasing agents, and distributors.

## TV XFOMER REPLACEMENTS

Chicago Standard Transformer Corporation, 3501 W. Addison St., Chicago 18, Ill. has published a new Stancor "Part-to-Part TV Transformer Replacement Guide." The 52-page, pocket-size volume contains a complete listing of all TV set manufacturers, their transformer part numbers, and the part numbers of Stancor equivalents. Also included are nine pages of descriptive data on the Stancor units mentioned.

Copies are available free from company distributors or by writing direct to the manufacturer.

## TWIST-PRONG CAPACITORS

Cornell-Dubilier Electronics Division, South Plainfield, N. J. has made available a new edition of its "Television Twist-Prong Capacitor Replacement Guide." Listed in the 56-page guide are over 3500 original part numbers used by 100 TV set manufacturers. A C-D replacement part number is given for each listing.

The Guide also contains complete data covering C-D twist-prong and "Blue Beaver" tubular electrolytic capacitors. Copies of the Guide (CDE Bulletin TVR-7C) are available from dealers or direct from the manufacturer.

## CAPACITOR DATA

Aerovar Corp., New Bedford, Mass. has issued a 4-page catalogue, No. 215/B2-1, detailing technical and engineering information on "Aerotan" solid tantalum capacitors.

Included are curves, reference tables, and a listing of standard stock values in all capacitance and voltage combinations presently available. Copies may be had by writing direct to the manufacturer.

## REPS ROSTER

Electronic Representative Association, 600 So. Michigan Ave., Chicago 5, Ill. has issued its Membership Roster which contains names and addresses

## QUICKLY CUT HOLES

in metal, plastics,  
hard rubber...



### GREENLEE CHASSIS PUNCHES

Make smooth, accurate openings in 1½ minutes or less... for sockets, plugs, controls, meters, panel lights, etc. Easy to use... simply turn with wrench. Many sizes and models.

Write for literature.



**GREENLEE TOOL CO.**  
1916 Columbia Ave., Rockford, Illinois

## BUILD YOUR OWN Concert Quality ELECTRONIC ORGAN SAVE 50%



- Step by step instructions
- Pay as you build
- Over 14 models

THE *Artisan* ELECTRONIC ORGAN

Send for free literature

### ELECTRONIC ORGAN ARTS

4349 YORK BLVD., LOS ANGELES 42, CALIF.

Please send me free information



NAME \_\_\_\_\_  
ADDRESS \_\_\_\_\_  
CITY \_\_\_\_\_ ZONE \_\_\_\_\_  
STATE \_\_\_\_\_  
DEPT. 1-8

of chapters of the Association, as well as an alphabetical listing of individual members.

### U.S.-FOREIGN TUBE CHART

General Electric Co., Schenectady 5, N. Y. has issued a wall chart listing interchangeability information for American and foreign receiving tubes. The chart, No. ETR-1916B, is 11 inches wide and about 28 inches long. Approximately 300 American tube types, interchangeable with about 100 foreign types, are listed.

The chart is available through G-E distributors as an aid to service and maintenance technicians who may not have an exact replacement on hand when immediate service is required.

### PILOT LIGHTS

Dialight Corp., 60 Stewart Ave., Brooklyn 37, N. Y. has issued the "Dialco Handbook of Pilot Lights," a comprehensive manual to aid in the selection of the pilot lights to accommodate the required lamps. The handbook contains 256 pages, measures 8½ x 11 inches, is printed in two colors and bound in hard covers. Detailed text and life-size illustrations cover all aspects of this subject.

According to the company, the limited publication of this manual necessitates a review of prospective recipients. To apply for a copy, write to the manufacturer, attention: "Handbook Dept."

### EIA 1960 FACT BOOK

The Electronic Industries Association, 1721 DeSales St. N.W., Washington 6, D. C. has published its "1960

Fact Book," copies of which have been mailed to about 350 member companies of the EIA. Individual copies may be obtained by sending 75 cents to the Association.

The book provides an annual statistical review of the industry, surveying in detail production and sales during 1959. The present edition is the sixth in the yearly series issued by the Marketing Data Department of EIA. New material, not included in earlier editions, covers important historical, technological, and market developments.

### "TANTALYTIC" CAPACITORS

General Electric Co., Schenectady 5, N. Y. announces Bulletin GEA-7065, a four-page brochure describing this company's new lightweight, high-voltage "Tantalytic" capacitors for both 85°C and 125°C applications in computers, missiles, ground support equipment, and airborne electronic systems.

The bulletin gives mechanical and electrical specifications, performance characteristics, and curves for the new line. "Tantalytic" is a registered trademark of General Electric.

### MILLER COIL GUIDES

J. W. Miller Co., 5917 S. Main St., Los Angeles, Calif. has published a new 176-page general catalogue and coil replacement guide. A consolidation of four catalogues in one, the book is divided into the following sections: general catalogue, listing nearly 1500 items; TV coil replacement guide, which cross-references TV set part numbers with corresponding Miller numbers; auto radio replacement guide; and home radio guide. -30-

## TRANSISTOR MOUNT

By HOWARD S. PYLE

VARIOUS methods for mounting transistor types with circular body shapes, such as the G-E 2N107, Sylvania 2N68, and others, have been devised in both the commercial and amateur fields. The majority of such mountings have consisted merely of leading the three wires to a terminal strip and soldering them in place. "Forming" of the wires then provides a method of support, of sorts.

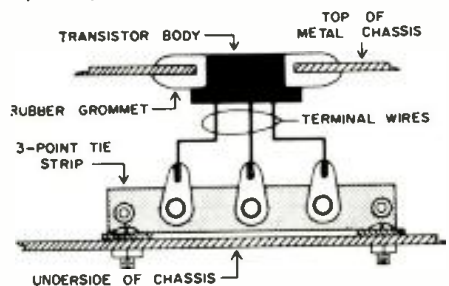
While such an arrangement does offer some measure of shock mounting by reason of the natural tendency of the wires to absorb any abrupt motion, such as might occur in mobile equipment, it is most unworkmanlike. With even slight vibration of equipment, one or more of the terminal wires soon breaks either at the tie-point or on the base of the transistor body itself.

The accompanying sketch illustrates a substantial, neat, and all-around satisfactory mounting for these little semiconductor. A simple rubber grommet of appropriate size, inserted in a suitably sized hole in the equipment chassis, makes an ideal mount and provides a good measure of protection to the body itself. Standard size grommets available at any radio parts distributor or amateur radio supply house, are a "natural" for such a cushion mount. Normally, with proper choice of grommet size, a snug fit will result between the body of the transistor and the standard grom-

met available. Should the occasional one be a bit on the loose side, a drop or two of clear fingernail lacquer placed in the seam between the transistor body and the grommet will effectively seal it. Such a seal is readily broken should occasion arise for replacement of the transistor.

A conventional "tie-point" should be mounted on the underside of the chassis and the three wires from the transistor soldered to it. Place the tie-point in close proximity to the transistor so that some slight slack will remain in the wires after connection. The usual precaution of holding each wire with pliers while soldering, to divert heat from the transistor body, should be observed.

This mounting can be used to support various types of crystal diodes as well, by proper choice of grommet size and by using a two-terminal tie-point. -30-



ELECTRONICS WORLD

## Electronics in Crime Detection

(Continued from page 32)

The electron microscope has been described in detail in the literature and its function as a crime-fighter is that of magnification. The RCA unit installed in the New York City Police Lab is capable of magnifying 50,000 times and is used frequently to observe crystalline structures, paint samples, cell structures, etc. One of the instruments which is also found in medical laboratories is the colorimeter. This device analyzes the colors of the unknown substance and is largely used for blood samples, narcotics, and the materials used to dilute the narcotics.

Among the portable clue-detecting devices which can be taken to the scene of the crime are the "black light," or ultraviolet lamp, and the x-ray machine. The latter is especially helpful in examining suspected packages and suitcases but is also used occasionally to detect loaded dice and other crooked gambling equipment. A "soft x-ray" machine is used in homicide cases where it shows the unburned powder particles in the wound and this permits a surprisingly accurate determination of the distance from which the shot was fired.

Needless to say, the men who operate the various equipment in the police lab are highly trained experts and, in difficult cases, consultants from various universities are called in to add their knowledge to the problem of combating crime.

### Questioning

One of the questions most frequently asked of a suspect, especially in accident and traffic cases, is "how much have you had to drink?". Walking the chalk line at the station house is outmoded. Today's drunken-driver suspect merely breathes into a plastic tube and the alcoholic content of his breath is clearly shown and can be recorded.

The "Breathalyzer" shown in Fig. 6 depends on the discoloration due to alcohol's chemical reaction with potassium dichromate and the exact amount of discoloration is measured with a phototube. Because all of the test conditions such as temperature and actual discoloring are electronically regulated, the precision of this device is beyond question and the resultant answer in per-cent of alcohol is rarely challenged in court. Previous methods involved blood analysis which required the services of a physician or else the breath analysis was so inaccurate it was often thrown out as evidence. Electronics now pins down the degree of drunkenness beyond the shadow of an argument.

Many of our readers are aware of the device popularly known as the "lie detector." Actually there are a number of different polygraphs available and their application appears to be a science in itself.

Space does not permit us to describe polygraphs in detail, but basically all of these instruments measure one or more body characteristics. The galvanic skin response (G.S.R.) is the original electric "lie detection" criterion but blood pressure, breathing, and skin temperature changes are also important details which are recorded. In most polygraphs the changes in G.S.R. are amplified which drives the recording pen while the breathing and blood pressure are recorded through a bellows linkage on the other pens. The amplifier is usually a chopper-stabilized, high-gain circuit since it must amplify the small voltage variations due to changes in G.S.R. as the subject responds to questions. Skin temperature changes of as little as 1 degree F can be detected in some instruments by means of a thermistor and bridge circuit.

Fig. 5 shows one of the available portable units which records G.S.R., breathing, and blood pressure. It takes a lot of technical "know-how" to operate such equipment because good results can only be obtained if all of the characteristics are properly set up at the beginning. Each of the pens has to be balanced out since only changes are recorded and, in galvanic skin response, for example, different people have different basic skin characteristics.

The selection of questions and finally the interpretation of the polygraph results can only be handled by an expert.

August, 1960

## Build the BEST BUY in CITIZENS BAND TRANSCEIVERS...

**EICO**

#760 (117 VAC) less bracket.  
Kit \$59.95. Wired \$89.95.



#761 (117 VAC & 6 VDC): Kit \$69.95. Wired \$99.95.

#762 (117 VAC & 12 VDC): Kit \$69.95. Wired \$99.95.

A thoroughly useful and reliable citizens band transceiver of exemplary electronic, mechanical, & industrial design. Consists of a powerful 5-watt as defined by FCC, crystal-controlled transmitter & extremely sensitive, highly selective superheterodyne receiver with RF stage & noise limiter. Includes built-in speaker & detachable ceramic microphone. Features pre-set & sealed crystal oscillator circuit elements. Broad tuning permits shifting from any of the 23 citizen band channels to any other simply by changing crystals - no adjustments needed. Built-in variable "pi" network matches most popular antennas. Directly attached base-loaded portable whip, & ground plane (roof) antennas available. The quality & precision of this transceiver is very necessary for consistently dependable operation increasingly so in the future when citizens band is put to greater use. No exams or special skill needed - any citizen 18 years or older may obtain station license by submitting FCC form, supplied by EICO.

### Build the Best 6-TRANSISTOR RADIO RA-6

Kit \$29.95 Wired \$49.95

includes FET, less 9V battery

American-made with finest quality parts. High sensitivity and selectivity. New plug-in type transistors easily removable for checking. Big-set volume and tone with 4" x 6" PM speaker & 250 mw push-pull audio output stage. Built-in Ferrite rod antenna. Pre-aligned RF & IF transformers. Planetary vernier tuning (7:1 reduction) for easy station selection & tuning. High-impedance earphone jack for private listening. Attractive tan leatherette case, retractable handle. Compact: 8½" w, 4½" h, 2½" d. Only 3 lbs.



### Build the Best HAM GEAR

New Code Practice Oscillator #706

Kit \$8.95 Wired \$12.95

Rugged battery-operated transistor oscillator circuit with built-in 3" speaker. Front panel (deep-etched satin aluminum) has flashing light, phone jack, pitch control (500-2000 cps), external key terminals, "temporary" key. Panel switch selects Tone, Light, or both Tone & Light. 6½" h, 3¾" w, 2¾" d.



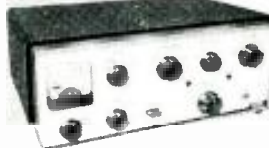
90-WATT CW

TRANSMITTER\* #720

Kit \$79.95 Wired \$119.95

\*U.S. Pat. No. D-184,776

"Top quality" - ELECTRONIC KITS GUIDE. Ideal for veteran or novice. 90W CW, 65W external plate modulation. 80 through 10 meters.



HIGH LEVEL UNIVERSAL  
MODULATOR-DRIVER #730

Kit \$49.95 Wired \$79.95

Cover E-5 \$4.50

Delivers 50W undistorted audio. Modulates transmitters having RF inputs up to 100W. Unique over-modulation indicator.



GRID DIP METER #710

Kit \$29.95 Wired \$49.95

Includes complete set of coils for full band coverage. Continuous coverage 40 kc to 250 mc. 500 ua meter.

Compare - judge for yourself - at your neighborhood EICO dealer. For FREE catalog on over 70 models of easy-to-build professional test instruments, hi-fi and ham gear, fill out coupon on Page 27.

Add 5% in the West. © 1960

**EICO**

3300 N. Blvd., L.I.C. 1, N.Y.

# Full Color Giant Fold-Out Charts Still Available!

Here's a complete series of colorful, authoritative fold-out wall-charts (originally appearing in the pages of **ELECTRONICS WORLD**)—yours for only 15¢ each. All in full-color—each suitable for framing.

1. **V.H.F. TV Spectrum and Interference Chart:** Servicing aid for TV technicians and hams—saves hours by tracking down interference.
2. **Hi-Fi Crossover Network Design Charts:** Tells how to build speaker nets for any crossover frequency. Complete coil-winding data, capacitor values given.
3. **Color Codes Chart:** Gives you coding for capacitors, resistors, transformers, resistance control tapers—all in easy-to-use form.
4. **Bass-Reflex Design Charts:** Complete data on building own bass-reflex enclosures for any speaker, including ducted-port enclosures.
5. **Radio Amateur Great Circle Chart:** For Hams and short-wave listeners—gives complete listing and map of amateur prefixes by calls and countries.
6. **Sound:** Fundamental data on all phases of Sound: frequency ranges, sound levels, equal loudness curves. A must for all audiophiles.

ALSO AVAILABLE:

Reprints of:

7. **"Build a Citizens Band Transceiver"**—complete details on building an 11-meter transceiver for Citizens Band service.
8. **"Electrical Shock: Fact and Fiction"**—must reading for everyone whose work or hobby involves electricity. Ideal for utility companies . . . service associations.

IMPORTANT: ORDER BY NUMBER! OUR SUPPLY OF ALL GATEFOLDS AND REPRINTS IS LIMITED. OFFERED ONLY ON A FIRST COME, FIRST SERVED BASIS.

Send 15¢ per selection to

**ELECTRONICS WORLD, Dept. N 860**

Box 378, Church Street Station

New York 8, New York

# FREE

Full Year's Subscription to  
**RADIO SHACK'S**  
Sensational  
**ELECTRONICS CATALOGS**

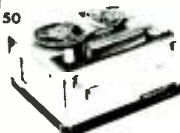


Send coupon today! See world's largest and best line of electronic equipment! Invaluable to pros, exciting for hobbyists. Over 100,000 items—stereo, hi-fi, ham radio, tapes — at money-saving prices. 15-day home trial on any item. Satisfaction Guaranteed.

**TYPICAL RADIO SHACK VALUE!**

"Realistic" 2-speed  
Tape Recorder \$49.50

Radio Shack dual-track portable! Wt. only 17 lbs. Has separate record, playback, erase heads. Mike, 5" reel.



**MAIL COUPON NOW**

Radio Shack Corp., 730 Commonwealth Ave.  
Boston 17, Mass. Dept. 60H6

Without further request, send latest catalog plus every issue for year—all FREE.

Name \_\_\_\_\_

Address \_\_\_\_\_

Post Office \_\_\_\_\_

or City \_\_\_\_\_ Zone \_\_\_\_\_ State \_\_\_\_\_

## TUNE ELECTRONIC ORGANS ACCURATELY-QUICKLY WITH A NEW

### Schober AUTOTUNER

Every organ owner and service technician requires this valuable aid to precision organ tuning. This instrument enables anyone to quickly tune any electronic-oscillator organ (except Thomas) without previous knowledge or skill.

An automatic stroboscopic indicator visually shows true pitch to an accuracy of 1/100 of a semitone (more accurate than human hearing), yet you pay about 1/3 the price of other tuning devices of similar precision.

Black plastic case with etched satin aluminum front panel. So lightweight it may be carried in your pocket. Size 4 1/4" x 5 1/4" x 2 1/4". Detailed instructions included.

**\$6950**

{completely assembled}

**\$4950** (in assemble-it-yourself kit)

(N.Y.C. Residents add 3% Sales Tax)

MAIL ORDERS FILLED PROMPTLY • FULLY GUARANTEED

**THE SCHOBER ORGAN CORPORATION, DEPT. NR**

43 West 61st Street, New York 23, N. Y.

Manufacturers of the World-Famous Schober Organ Kits.



In New York City the police department is not allowed to use polygraphs, but in many other locations this method is used on practically any suspect who claims innocence. The subject's full cooperation is required before any lie-detector can be used and in all cases, statements to that effect are obtained.

Private operators give polygraph tests, usually in cases of employees suspected of theft who protest their innocence and offer to undergo a lie-detector test. Studies are now under way to add electrocardiograms (heart-signal measurements) and encephalograph (brain-wave measurements) to the present polygraph characteristics to provide further clues to the subject's reactions to the questioning.

Electronics has brought the precision of scientific effort into many phases of crime detection. In the field of surveillance, electronics now permits law enforcement officers to locate the suspect's accomplices, record his criminal activities, and arrange for arrest at the critical moment. In narcotics cases especially, electronic equipment is a great help. This type of crime has grown in recent years but with the help of electronic surveillance equipment and the clue-analyzing devices in the police laboratory, convictions in narcotics violations have been more frequent. The drunken driver can now be pinned down to the exact degree of intoxication, thanks to electronics. Gambling and vice are fought with electronic devices, suspects are tested as to their veracity, and in many other phases of police work, electronics is lending the crime fighter a helping hand.

EDITOR'S NOTE: *The equipment described and discussed in this article is designed for use by law enforcement agencies and is not available to the general public. We would like to advise our readers that we do not have schematic diagrams and other technical details on this equipment. It is not intended to be duplicated by the layman.*

-30-

## IHFM COMMITTEE NAMED

The Institute of High Fidelity Manufacturers has announced the formation of an Industry Promotion Committee, chaired by Arthur M. Gasman, Marketing Director of British Industries Corp.

The committee is made up of Thomas Dempsey, Reeves Soundcraft; Sidney Harman, Harman-Kardon, Inc.; Howard Harwood, Shure Bros.; Leon Knize, Stromberg-Carlson; H. L. Morris, Altec Lansing; and Lee Solomon, St. Regis Publishing Co.

According to the chairman, the committee will seek to inform the public of the advantages of component high-fidelity music reproduction in the home. The group hopes to develop means of identifying quality components made by IHFM members so that the public can know what it is buying. It will also undertake an over-all educational program to teach the consumer the finer points of hi-fi equipment.

-30-



IN SEPTEMBER

## ELECTRONICS WORLD

FEATURES ON:

RATING TRANSISTOR CAPABILITIES

CHOOSING MICROPHONES

SERVICING CASCODE CIRCUITS

USING CITIZENS BAND EQUIPMENT

September **ELECTRONICS WORLD** presents a selection of features designed for service technicians, audiophiles, hams, everyone whose job or special interest is electronics:

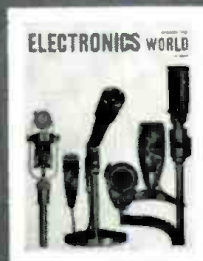
- **DON'T UNDERRATE TRANSISTORS—**  
Here's an explanation of maximum ratings of junction transistors and how to determine maximum operating capabilities.

- **HOW TO CHOOSE THE PROPER MIKE—**  
Audiophiles will want to read this complete rundown on all types of microphones covering a variety of uses.

- **CASCODE CIRCUITS: HOW AND WHY—**  
Widely used in TV tuners, FM, and other r.f. circuits, this amplifier configuration still puzzles many technicians. Here's a simplified treatment of operation, circuit variations, and hints for servicing.

- **APPLICATIONS OF CITIZENS BAND RADIO EQUIPMENT—**  
Complete rundown of all possible legal applications of CB gear—important factors to know in choosing the proper equipment for your needs—and other key data.

Whether electronics is your business or hobby, you won't want to miss these important articles—coming your way in September **ELECTRONICS WORLD**.



# RADIO PARTS STORES & HI-FI SALONS!

Hundreds of dealers across the nation profit by selling **ELECTRONICS WORLD** each month to their customers. Are you one of them? **ELECTRONICS WORLD** helps build store traffic . . . keeps customers coming back month after month for the merchandise you sell—and, best of all, you earn a neat profit on each copy sold—**No Risk Involved.**

So get details on selling **ELECTRONICS WORLD**, the world's largest selling technical electronics magazine. Or, order your copies now. Just use the handy coupon.

Direct Sales Department  
**Electronics World**  
 One Park Avenue  
 New York 16, New York  
 Att: Jerry Schneider

Send me . . . . . copies of **ELECTRONICS WORLD** for resale in my store each month. No risk involved on my part.

Send me details on selling **ELECTRONICS WORLD** in my store.

STORE NAME \_\_\_\_\_

ADDRESS \_\_\_\_\_

CITY \_\_\_\_\_ ZONE \_\_\_\_\_ STATE \_\_\_\_\_

SIGNATURE \_\_\_\_\_ EW 860

## HI-FI RECORDING TAPE

7" Spools—30-15KC Freq. Resp.—15 Day Money-Back Guarantee  
 1200' Acetate 3 For \$3.87 1800' Mylar 3 For \$6.27  
 1800' Acetate 3 For 5.37 2400' Mylar 3 For 9.87  
 Lots—12—Less 10% Lots—24—Less 15% any Ass'tment permitted for Quantity discount.  
 Add 15c per spool or 10c 24 and over—Parcel Post.  
**HI-FI COMPONENTS**  
 All Standard brand components. Kits and Tape Recorders in Stock. Brand New Factory sealed cartons. **WE GUARANTEE "We Will Not Be Undersold."**

Dear Sirs:  
 Please send at once your wholesale catalog Quotation; Hi-Fi component list enclosed.

Name \_\_\_\_\_

Address \_\_\_\_\_

City & State \_\_\_\_\_

**Hi Fidelity**  
 CENTER  
 1797P 1st Avenue New York 28, New York

## MAIL ORDER HI-FI

You can now purchase all your Hi-Fi from one reliable source and be assured of perfect delivery. Carston makes delivery from NY stock on most Hi-Fi Recorders and Tape within 24 hours. **SEND US A LIST OF YOUR HI-FI REQUIREMENTS FOR OUR WHOLESALE QUOTATION and our FREE wholesale catalogue.**

**CARSTON STUDIOS**  
 125-TO East 88 St. New York 28, N.Y.

**LOOK**

NO FURTHER . . . IF YOU'RE UNHAPPY WITH "HI" HI-FI PRICES. WRITE FOR OUR UNUSUAL AUDIO CATALOG.

**KEY ELECTRONICS CO.**  
 120-C Liberty St., N. Y. 6.  
 Phone C:overdale 8-4288



## Radio Aids to Navigation (Continued from page 59)

cluding VOR stations. Three VOR transmitters are shown: Point Reyes VOR (identified by the letters "PYE" on 113.7 mc.), Oakland VOR (OAK on 116.3 mc.), and San Francisco VOR (SFO on 111.8 mc.). Generally, VOR stations are located on the civil airways to allow VOR flight along the airways. Many stations are also strategically located off the airways in order to facilitate short range point-to-point travel and allow the taking of running fixes on the airways.

Suppose an airplane wishes to fly from the east along airway **RED 60** to Oakland VOR. A magnetic heading of 240 degrees towards Oakland VOR from the east will place an airplane along the center radial of airway **RED 60**. The pilot tunes his VOR receiver to Oakland VOR at 116.3 mc. and sets the course selector dial to 240 degrees. When the "Left-Right" meter is centered and the "To-From" indicator shows "To," the pilot knows he is on the center of airway **RED 60**. However, this will be true irrespective of the aircraft's heading since VOR relays position along a radial from the station and does not indicate heading. Of course, if the plane's heading is away from the radial, the "Left-Right" needle will deflect as the plane leaves the radial. However, it is unnecessary for the aircraft to head aimlessly in the wrong direction since the course selector indicates the magnetic heading which corresponds to the VOR radial.

Thus the pilot will begin approaching Oakland VOR by flying a magnetic compass heading of 240 degrees. After a while, though, the "Left-Right" needle will begin to deflect to one side or the other. Why does the needle deflect if the proper magnetic heading was chosen? The most common cause is wind which is drifting the plane off the radial. When the pilot re-adjusts his heading to center the needle he is heading his airplane into the wind to correct for drift. Thus, VOR corrects for the pilot's biggest navigational problem, wind drift. ADF does not correct for drift since ADF cannot determine along which radial the aircraft is

flying as VOR can. An aircraft approaching a station with ADF will fly a wide curve to the station as wind pushes the plane off course.

As with low-frequency navigation aids, navigation can be made considerably easier if several types of equipment are used simultaneously. Flying from Travis Range to Oakland VOR *via* airways **AMBER 8** and **BLUE 10** can be easily accomplished by an aircraft equipped with a VOR receiver and a radio-range or ADF receiver. The pilot can either home on Richmond beacon with his ADF or use the on-course signal from Travis Range to place him on airway **AMBER 8**.

The inbound radial to Oakland VOR along airway **BLUE 10** corresponds to a magnetic heading of 133 degrees. Therefore, the pilot tunes his receiver to Oakland VOR and sets the course selector to 133 degrees, the final radial he wishes to fly on **BLUE 10**. As the aircraft flies along **AMBER 8**, the "Left-Right" meter will point to the right indicating that the 133 degree radial is farther to the South, and the "To-From" indicator will indicate "To." As the junction of the two airways is approached the "Left-Right" needle will start centering until it finally centers at the junction. At this point the pilot turns his plane inbound to a magnetic heading of 133 degrees and follows the VOR signal to Oakland VOR.

As can be seen, ADF and the radio ranges are good navigational aids in themselves, but when used with VOR they help make long-range navigation simplicity itself. Today most fliers rely on VOR as their primary navigational aid and supplement VOR with ADF and the ranges to provide fixes along the course which allows exact determination of position along this course.

Unfortunately, long-range navigation is only one of a pilot's many navigational problems. VOR, ADF, and the radio ranges will lead a pilot to his final destination, but they won't get the airplane on the ground. How does a pilot land his airplane when the visibility is less than two miles which is less than twice the length of many runways?

Next month we shall conclude this series by examining the various electronic systems designed to allow an aircraft to perform a safe instrument landing. (Concluded next month)

Sun	Mon	Tue	Wed	Thu	Fri	Sat
			1	2	3	4
						5
						12
						19
						26

**CALENDAR of EVENTS**

**AUGUST 15-26**

*Institute on Nondestructive Testing.* Sponsored by Sacramento Chapter of the Society of Nondestructive Testing. Sacramento State College, Sacramento, Calif. Details from G. H. Beaumariage, Jr., Asst. Prof. of Engineering, % Sacra-

mento State College, 5000 Jay St., Sacramento.

**AUGUST 23-26**

*WESCON (Western Electronic Show and Convention).* Sponsored by the Los Angeles and San Francisco Sections of the IRE, West Coast Electronic Manufacturers Association, and IRE Professional Groups. Ambassador Hotel and Memorial Sports Arena, Los Angeles. Technical sessions, field trips, exhibits. Show office at 1435 S. La Cienega Blvd., Los Angeles 35, Calif., for program details.

**AUGUST 24-SEPTEMBER 3**

*British Radio and Television Exhibition.* Earls Court, London. Special preview August 23rd for special guests.

## Remodeling Your Shop? (Continued from page 52)

ideas on how certain changes affected subsequent costs and methods of doing business.

*Don't copy blindly.* It's always a good idea, as just noted, to see what others in your field have done by way of modernization, but it's seldom a good idea to duplicate someone else's arrangement no matter how well it seems to be working out for him. Perhaps you can improve even on a good plan by avoiding a pitfall or two that it contains. Besides, no two shops are exactly alike; nor do any two owners do everything in exactly the same way. What is bringing exceptional success to someone else may flop dismally for you. If you are considering the adoption of unusual features someone else is using, discuss details thoroughly.

*Do it all at once.* To spread out the high cost, there is always the temptation to go about renovation one step at a time. Here are some of the problems you may run into: By the time you are through, total cost will have been greatly increased, perhaps doubled; your business may end up by being in an indefinite state of confusion and inefficiency, more so than it was under the conditions that prompted the remodeling; and you may never wind up with a carefully planned improvement over existing facilities.

An effective plan, as mentioned, must be a total plan. If you work piecemeal, you will probably plan the same way. Don't try to rationalize this approach to the problem by saying that a partial job gives you a chance to test changes and see how they work out. You can't tell how a change fits into the finished plan until the pattern is complete.

*Don't pinch pennies.* You cannot plan sensibly if your exclusive yardstick is what the various portions of the plan cost. You will probably do better by waiting until you can afford what you know is necessary. The last few hundred dollars you spend may make the difference between a successful job and one that gives you marginal improvement. Settling for a good layout with a shoddy appearance, for example, can be reflected in your customers' estimates of your skills.

*Don't delay.* If you are convinced you can profit from the change, know exactly what you want, and can handle it financially, don't save money by putting it off "for another year." This is false economy. After all, the purpose in making changes is to provide increased profits and other benefits. You will be throwing away these benefits for another year, without any reduction in what the change will cost when you do make it.

Once your mind is made up, start to act on your plan. Don't sit around and let a worked-out scheme go stale. After a full evaluation of your situation is complete, don't vacillate. Go ahead, and good luck.

-30-

LEARN ALL ABOUT THESE VITAL SUBJECTS  
EASILY... COMPLETELY... ECONOMICALLY

# GYROSCOPES VIDEO TAPE RECORDING CARRIER TELEPHONY MAGNETIC AMPLIFIERS

## BASICS OF GYROSCOPES ('Pictured-Text' Course)

by Carl Machover — 2 Volumes

An informative, complete and dramatic presentation of gyroscopes by a man who has spent his whole life in this field.—Nothing like it has ever been published! This book is written primarily for the non-specialist: not for the gyro engineer, but for the student, technician, or engineer who comes in contact with the gyroscope in his studies or work. The text is primarily descriptive and mathematics are kept to a minimum. Only a basic knowledge of algebra and trigonometry is needed for an understanding of the material.

The material upon which this book is based has been proven successful in teaching engineers, technicians and technical sales people at one of the nation's leading gyroscope firms.

Every effort has been made to keep the book technically accurate, while simplifying all explanation. Much of the material in this book, such as the sections on stable platforms, and error sources has never appeared before in book form. It is up-to-date and some of it has only recently been declassified.

CHAPTERS: VOL. I—What a Gyro is... How it works... Vertical Gyro... Directional Gyro Components... Directional Gyro. VOL. II—The Rate Gyro... The Integrating Gyro... Stable Platforms... Inertial Navigation... Difficulties of Gyro Construction... Other Gyro Applications.

#251, 2 vols., soft cover, \$6.60; #251H, cloth, \$7.75.

## BASIC CARRIER TELEPHONY ('Pictured-Text' Course)

by David Talley (radio engineer General Telephone Service Corp., div. General Tel. & Electronics)

This 'pictured-text' course clearly presents the fundamental principles of carrier telephone systems. It describes the basic equipment elements making them readily understandable to telephone technicians, maintenance personnel and engineering students. The book also will acquaint telephone and radio engineers and others in the communication fields with the carrier multiplexing technique as applied to microwave circuits.

CHAPTERS: The Telephone System; Telephone Carrier Definitions; Wire Transmission Principles; Telephone Transmission Practices; Carrier System Fundamentals; Modulation and Demodulation Process; Electrical Filters; Carrier System Operation; Carrier Transmission and Signaling Features; Cable Carrier Systems; Carrier Applications to Radio Systems. #258, 1 vol. soft cover, \$4.25; #258-H, cloth, \$5.75.

## VIDEO TAPE RECORDING

by Julian Bernstein

If you're a broadcast engineer or technician, this book makes the theory and circuitry of all existing video tape equipment completely understandable so that you'll be better able to operate and maintain it. If you're a film editor, projectionist, advertising man, this book clearly explains the advantages, characteristics and limitations of this new medium so that you can use it most effectively. The author makes every

phase of video tape recording completely understandable—techniques, equipment and circuitry. The author has succeeded in providing a book that is absolutely indispensable to all who have an interest in this growing field. The lack of a formal engineering background to benefit does not prevent you from deriving the maximum value from this book.

#251, cloth, \$8.95.

## MAGNETIC AMPLIFIERS—Principles & Applications

by Paul Mali (director of education and training, The Electric Boat div., General Dynamics Corp.)

This is a most practical book... a most timely one. For it is published at a time when the use of magnetic amplifiers in industrial and military applications is growing rapidly. Only a basic knowledge of electricity and electronics is required to build a thorough knowledge of magnetic amplifiers. The book starts by providing a firm foundation in the fundamentals underlying magnetic amplifiers—magnetism, electromagnetism and magnetic circuitry—before it progresses to the saturable reactor, the heart of this field. It discusses the different types of magnetic amplifiers with emphasis on principles or operation—

self-starting and three-legged core magnetic amplifiers; compensating magnetic amplifiers; polarized magnetic amplifiers; and variations of these. The text then covers amplifier gain, feedback, general uses and construction. The maintenance and trouble shooting of magnetic amplifiers is covered from a most practical viewpoint. A vast number of practical applications of magnetic amplifier circuitry are fully described and diagrammatically shown in the section on system applications. This book is must reading for engineers, engineering students, technicians

#261, \$2.45

We guarantee satisfaction no matter where you purchase these books. If you are not fully satisfied, return them to us within 30 days of purchase for full refund. Write for FREE 1960 catalog EW-8. There are more than 200 Rider titles covering every area of electronics from basic electricity to space age electronics. At your electronic parts distributor, bookstore or write direct:

JOHN F. RIDER PUBLISHER, INC. 116 West 14th Street, New York 11, N. Y.  
Canada: Chas. W. Pointon, Ltd., 66 Racine Rd., Rexdale, Ont.  
Europe & British Isles: Chapman & Hall Ltd., 37 Essex St., London, India: Asia Publishing House, Bombay and other cities.



## QUIETROLE LUBRI-CLEANER

The first of its kind and still best for silencing noisy controls and switches in TV, Radio & all Electronic Equipment.

### Spray it or Drop it

Just Press and whoosh... aerosol QUIETROLE quickly and easily cleans as it lubricates.

Or, if you prefer, use this handy eye-dropper and just a drop or two of quality QUIETROLE does the job perfectly.

Either way, make sure it's QUIETROLE

## QUIETROLE

Company, Inc.

Spartanburg, South Carolina

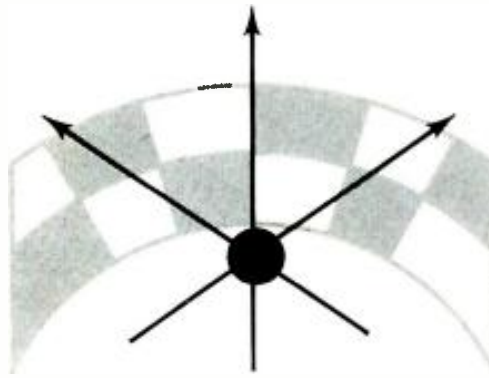


In Canada:  
CROSS CANADA ELECTRONICS  
67 Ontario St., S., Kitchener, Ont.

# Improving A. C. Voltmeter Accuracy

By

HOWARD Q. DUGUID



**Non-linear meter-rectifier action can throw down-scale readings off considerably, but adjustment is possible.**

**M**OST POPULAR voltmeters obtain a.c. readings by using a rectifier system to produce indication with a d.c. meter movement. Accuracy can become very questionable as the readings taken fall away from the full-scale point. This is due to the non-linear characteristics of the rectifier diodes used (Fig. 1A), for which the instrument manufacturer may not always compensate accurately. More will be said about this characteristic later. Our present concern is the fact that the meter owner can detect and correct this error himself.

A preliminary check of part-scale tracking can be made by measuring the same sine-wave voltage at the high end of one a.c. meter range and then again at the lower end of a higher range. A difference in reading indicates room for improvement.

Another check method is to shunt both the rectifier-type instrument and a moving-vane meter (or other type of known accuracy) across a variable voltage source and to compare accuracy. In fact, if it turns out that re-calibration of the rectifier-type unit is desirable, this set-up is the recommended one for the next step. An accurately calibrated, variable-voltage supply or other source of various known a.c. voltages can also be used as the reference.

Before adjustments of the rectifier system are considered, check full-scale readings on each a.c. range. If any of these are in error, range resistors in the voltage divider are probably off-value and must first be corrected. Once these values are known to be accurate, the entire instrument should be re-calibrated in accordance with the manufacturer's instructions. Although meter circuitry may vary from one instrument to another, the procedure is generally the same.

Four common circuit configurations for the a.c. function are shown in Fig. 2. They are (from A to D) the full bridge, the opposed half-bridge, the series half-bridge, and the half-wave. In each of these, typical re-calibration involves adjustment of meter resistor  $R_m$  for accurate full-scale reading on the highest range and of the series resistor in the divider,  $R_s$ , at full scale on the lowest range. If these full-scale ad-

justments cannot be achieved, it may be necessary to replace the rectifier diodes. This will be discussed later, as will the role of  $R_s$  (Figs. 2A and D), which is not generally found in these circuits.

The meter manufacturer, when he first drew up the a.c. scales, based them on a particular rectifier system, which includes other components in addition to the diodes. In production, however, small accumulated differences in components within the system may produce different behavior between one sample of a meter model and another. Correction of such deviation may be realized by adjusting resistors, in many cases, rather than the diodes.

Assuming that full-scale readings have been corrected, part-scale readings may now be checked. If these are either higher or lower than the desired accuracy as compared to the reference voltmeter, adjustment of the rectifier system is the next step.

Concerning the copper-oxide or germanium diodes used in meters, no two are exactly identical, but they will all exhibit electrical characteristics roughly similar to that shown in Fig. 1A. In

the forward direction (+ volts), they will have little resistance and permit considerable current (in milliamperes) to flow. A voltage applied in the reverse direction (- volts) however, is opposed by high resistance, and a small current (in microamperes) will be passed.

A diode that is theoretically perfect would have no forward resistance and no reverse leakage (infinite reverse resistance). Thus it is possible to represent a practical diode by the equivalent circuit of Fig. 1B, in which two "perfect" diodes are combined as shown with two resistors,  $R_f$ , representing the forward resistance of the combination, is shown variable because it decreases as forward voltage and current are increased. Reverse or leakage resistance, which is very large, is shown fixed because it varies little over the range of applied voltages in the systems of Fig. 2.

At some very low applied a.c. voltage,  $R_f$  may be as large as  $R_s$ . The relationship between these two ( $R_s/R_f$ , sometimes known as the *ratio of rectification*) changes in operation. As voltage across a diode increases, forward resistance  $R_f$  decreases and the ratio of rectification increases. This is important because the reverse current through a diode offsets a portion of the forward current, and the magnitude of this effect has an influence on another characteristic of the system, the *rectification efficiency*, concerning which more will be said later.

Since the rectification ratio becomes lower and reduces the effective rectification efficiency as applied voltage is reduced, this efficiency will be progressively lower at part-scale voltmeter readings than at full scale. It is this *change* in rectification efficiency across the scale, rather than the fact of rectification efficiency itself, that affects scale linearity. Correcting scale tracking, in practice, involves starting with a relatively high rectification efficiency and adjusting it downward until the *rate of change* of efficiency corresponds with calibration of the meter scales.

Commonly all ranges of a rectifier-type a.c. voltmeter except the lowest follow a single scale, with a separate scale provided for the lowest range. The latter is necessary because, on the

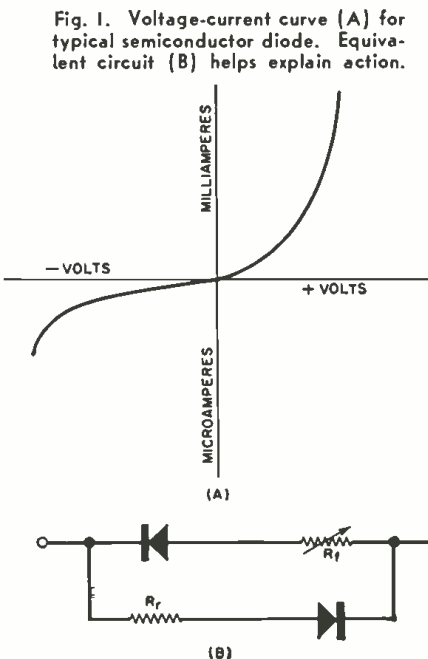


Fig. 1. Voltage-current curve (A) for typical semiconductor diode. Equivalent circuit (B) helps explain action.

lowest a.c. range, the change in forward resistance  $R_f$  of the diodes is large compared to the ohmic value of the single, relatively small range resistor ( $R_s$  in Fig. 2). The combination of this effect with the progressive loss of rectification efficiency as readings proceed down-scale will result in considerable compression of readings at the lower end of this range. On higher ranges, the total series resistance of the voltage divider is great enough so that the change in forward resistance with respect to this divider resistance has little effect on scale linearity. Hence the non-linearity is less severe, being caused only by the manner in which the changing ratio of rectification influences the efficiency.

For a diode, the rectification efficiency may be defined as the relationship between the direct (average) output current and the alternating (r.m.s) input current. Since the average value of a sine wave is .636 of peak value, and the r.m.s. value is .707 of peak, the highest efficiency obtainable with theoretically perfect diodes is 90 per-cent (.636/.707). The efficiency of an entire rectifying system, including the meter movement, is less than this because not all of the rectifier output current goes through the movement, some being shunted around it.

The over-all efficiency for a system including the meter, at full-scale reading, can be determined by comparing the d.c. sensitivity rating in ohms-per-volt with the rating for a.c. In a unit rated at 20,000 ohms/volt d.c. and 10,000 ohms/volt a.c., this efficiency would be 50 per-cent. If the a.c. rating is 5000 ohms/volt, efficiency at full scale is 25 per-cent. Shunting the meter movement would increase the efficiency required of the rectifier section alone, or decrease the efficiency of the entire system including the movement.

Considering efficiency of the rectifying systems alone of Fig. 2, with perfect diodes, the maximum possible efficiency for the full-wave bridge of Fig. 2A would be 90 per-cent. In the next two systems, bridges are used in which resistors take the place of diodes. Maximum theoretical efficiency would be 72 per-cent for B and 45 per-cent for C.

All arrangements shown load the a.c. source equally on both halves of the sine wave, but arrangement D is called a half-wave configuration because only one half of the total rectified current, from one diode, passes through the meter movement. Maximum full-scale efficiency is 45 per-cent for this circuit.

Concerning adjustment of these circuits, Fig. 2A does not generally include the resistor identified as  $R_s$ . If part-scale readings happen to fall too far down scale, the progressive change in efficiency with lower readings is too great. If  $R_s$  is indeed present, its resistance can be increased to correct down-scale readings. If it is already at maximum or is not present, the bridge of diodes,  $D_1$  through  $D_4$ , must be replaced. A smaller rectifier bridge, working at a higher current density, will show less of a change in efficiency as

current through it is reduced. Such a change may now shift the part-scale readings too far up the scale, but now it is simple to proceed as though these readings were too high to begin with.

If part-scale readings are too far up scale, the setting of  $R_s$ , if originally present, is reduced. If it is not there, it is a simple matter to insert such a resistance to bypass the bridge. This will make it necessary to increase the ohmic value of  $R_m$  and also re-adjust  $R_f$  for correct full-scale readings. Back-and-forth adjustment of  $R_m$  and  $R_f$  for proper full-scale reading and  $R_s$  for proper part-scale tracking are then performed for highest accuracy.

In Fig. 2B, two equal resistors,  $R_3$  and  $R_4$ , replace diodes  $D_3$  and  $D_4$ . If part-scale readings are too high, decrease the values of  $R_3$  and  $R_4$ , keeping them equal, and increase  $R_m$ . If readings are too low, increase these two resistors. If this does not correct the error, it will be necessary to replace the two diodes. In extreme cases, it is possible to replace the opposed half-bridge with a full bridge. This provides a higher basic efficiency that permits more range of adjustment. A change in the value of any resistor requires

to be increased in a series arrangement but decreased in a shunt arrangement.

In Fig. 2D, one half-wave of the rectified a.c. passes through diode  $D_1$  and meter movement  $M$ . The other half-wave bypasses the movement through  $D_2$ . To correct tracking,  $R_s$ , not usually present, may be added. As shown across  $D_1$ ,  $R_s$  reduces efficiency because it permits part of the unrectified a.c. to flow through  $M$ . This is equivalent to reducing the ratio of rectification by reducing the diode's reverse resistance (increasing leakage). If an increase in efficiency is needed,  $R_s$  can be shunted across  $D_2$ .

Variable resistors or calibrated substitution boxes can be used for experimenting with resistance values. Fixed resistors of the values chosen can then be used permanently. However, some voltmeters simplify the problem by making  $R_m$  or  $R_s$ , or both, adjustable.

If there are two a.c. scales (one for the lowest range), it may be necessary to favor the scale for the upper ranges in obtaining best part-scale tracking. In any case, it may be possible to obtain excellent tracking for all of the scale except the lowest portion of about

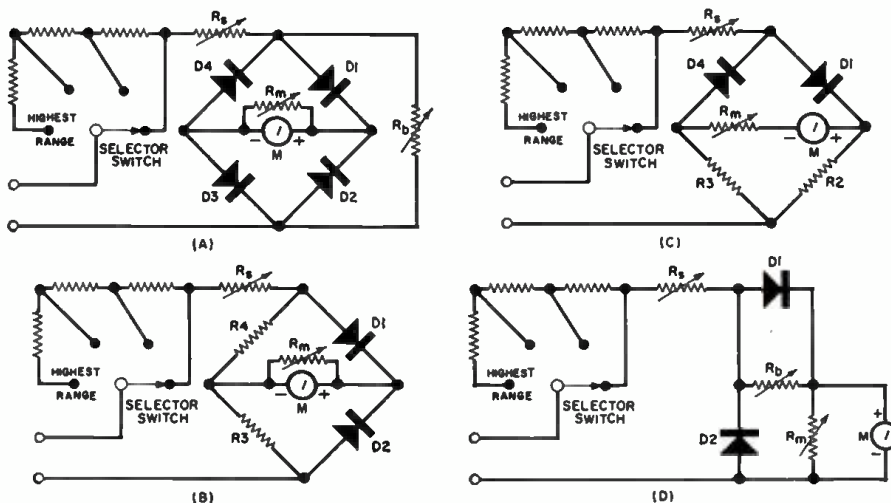


Fig. 2. Common meter rectifier systems include (A) the full bridge, (B) the opposed half-bridge, (C) the series half-bridge, and (D) the half-wave.

re-calibration at full-scale, of course, using  $R_m$  and  $R_s$ .

The series half-bridge of Fig. 2C, replacing diodes  $D_2$  and  $D_3$  with resistors  $R_2$  and  $R_3$ , also involves changes in the values of the two resistors to correct part-scale tracking, with a compensating adjustment of  $R_m$  and  $R_s$  at full scale. Again, if part-scale readings remain too low, the diodes themselves can be replaced. As in the preceding circuit, the highest initial efficiency can be obtained by removing the two resistors and using four diodes in a full bridge rectifier.

The fact that  $R_m$  is in series with meter movement  $M$  in Fig. 2C, rather than across it, is worth a note. In either case,  $R_m$  is used to adjust current through  $M$ . When a decrease in meter current is desired (as in offsetting high rectifier efficiency for full-scale accuracy), resistance of  $R_m$  would have

5 or 10 per-cent. Actually, it is not wise to use this lowest portion for a.c. measurements, as irregularities in the characteristics of the diodes used show up in this area of operation. Wherever possible, use the next lower range. Replacement rectifiers, where they are necessary, should be obtained from the original manufacturer for best results. Although the rectifiers that require replacement may have strayed from their original characteristics, the fresh ones should be close enough to the ones used for the manufacturer's initial calibration so that minimum revision will be needed.

The adjustments described here are time-consuming and painstaking. However, they can bring accuracy at least up to the manufacturer's claim, and perhaps improve on it. If this accuracy is considered important, the effort is worthwhile.

# ONE CENT SALE

BUY ONE AT OUR REGULAR LOW PRICE  
and GET the SECOND for ONLY 1¢ MORE

**CITIZENS BAND TRANSMITTER (27 MC)** 5 watt chassis, complete with crystal, \$14.99 each; two for \$15.00.

**CITIZENS BAND RECEIVER** chassis tunable through all 22 channels. Complete with audio amplifier. \$9.99 each, two for \$10.00.

**AMATEUR BAND TRANSCEIVER (144-148 MC)** chassis with dual VHF triodes for walkie-talkie radiophone, \$9.99 each, two for \$10.00.

**TRANSCEIVER TRANSFORMER:** Mike to grid limit and plate to low impedance headphone output. Good for telephone handsets. \$1.99 pair, two for \$2.00.

**SIGNAL BOOSTER** chassis for 27 MC. High gain (20dB) double tuned RF pentode amplifier. Improves performance of any Citizen Band receiver. Complete with tube \$11.99 each - 2 for \$12.00.

**COILED CORD** 1 conductor 11" telephone cord. Extends to over 4 ft. \$3.99 each, two for \$4.00.

**KIT OF PARTS** for AM-FM VHF radio receiver. Tunable from 80-200 mc, which includes U.S. satellite frequencies. \$6.99 each, two for \$7.00.

**TRANSISTOR AUDIO AMPLIFIER** gives 50X voltage gain on low level signals. Operates on 1 1/2 volts. \$3.99 each, two for \$4.00.

**CONVERTER** (crystal controlled) for 27 Mc Citizens Band. Adapts any standard broadcast radio to 27 Mc band. Tunes all 22 channels. Complete with tubes and crystal. \$14.99 each, 2 for \$15.00.

ALL MERCHANDISE GUARANTEED

LIMITED QUANTITY—

NO LITERATURE OR CATALOG

Remit in full. Include sufficient postage.

No C.O.D.'s.

**VANGUARD ELECTRONIC LABS**

Factory & Mail Order: 190-48 99th Ave.,

Retail Store: 196-23 Jamaica Ave.,

Dept. EW-8 Hollis 23, N. Y.



**ELECTRONICS WORLD HAS**

**A BUYER FOR YOUR USED  
EQUIPMENT OR COMPONENTS!**

The 245,000 purchasers of **ELECTRONICS WORLD** are always in the market for good used equipment or components. So if you have something to sell, let EW readers know about it through our classified columns. It costs very little: just 60c a word, including name and address. Minimum message: 10 words.

For further information write:

Martin Lincoln  
**ELECTRONICS WORLD**  
One Park Avenue  
New York 16, N. Y.

# New Tube Tester Data

Supplementary settings for owners of Sylvania tube testers to help keep roll charts up to date.

## SYLVANIA MODELS 139 AND 140

TYPE	A	B	C	D	E	F	G	TEST
1DN5	1.4	2	4	48	1	016	49	T
	1.4	2	4	48	7	—	55	T
1J3	1.4	0	2457	0	8	—	69	V
2EA5	2.5	0	2	0	4	36	25	W
2EN5	2.0	0	—	0	1	—	41	T
	2.0	0	—	0	3	—	41	T
3EA5	3.3	0	2	0	4	36	22	W
4DE6	5.0	0	—	0	4	36	22	V
5CR8	5.0	0	9	0	3	35	37	V
	5.0	0	6	0	1	5	32	X
5EA8	5.0	0	—	0	3	36	40	V
	5.0	0	—	0	1	5	22	X
5EH8	5.0	0	4	0	5	3	23	X
	5.0	0	4	0	4	79	85	T
5FV8	5.0	0	—	0	2	2	24	X
	5.0	0	—	0	3	57	40	V
6AF3	6.3	0	3	0	4	—	18	Y
6CA5	6.3	0	5	0	3	26	20	X
	6.3	0	2	0	3	56	20	X
6CY7	6.3	0	3	0	1	6	16	W
	6.3	0	3	0	3	7	64	W
6DE4	6.3	0	7	1	3	—	18	Y
6DN7	6.3	0	678	1	7	5	50	Y
	6.3	0	278	1	3	3	80	W
6DR7	6.3	0	6	0	1	3	29	U
	6.3	0	3	0	1	6	29	U
	6.3	0	3	0	3	7	45	T
6DT5	6.3	0	4	0	4	026	25	Y
	6.3	0	6	0	4	024	25	Y
6DT8	6.3	0	—	0	1	3	24	W
	6.3	0	—	0	3	7	24	W
6DW5	6.3	0	4	0	4	026	20	Y
	6.3	0	6	0	4	024	20	Y
6EA5	6.3	0	2	0	4	36	22	W
6EA8	6.3	0	—	0	3	36	38	V
	6.3	0	—	0	1	5	32	U
6EB5	6.3	0	—	0	1	—	49	T
	6.3	0	—	0	3	—	49	T
6EH8	6.3	0	4	0	5	3	23	X
	6.3	0	4	0	4	79	29	V
6ER5	6.3	0	4	0	4	2	29	X
	6.3	0	3	0	4	2	29	X
6ES5	6.3	0	4	0	4	2	27	X
	6.3	0	3	0	4	2	27	X
6FV6	6.3	0	—	0	4	36	26	X
6FV8	6.3	0	—	0	2	2	24	X
	6.3	0	—	0	3	57	40	V
8BQ5/X684	7.5	0	2	0	6	35	23	Y
8EB8	7.5	0	—	0	4	79	35	Y
	7.5	0	—	0	5	3	47	T

## Transistorized Mike Mixer

(Continued from page 38)

The chassis base used as the cabinet was engine-turned to provide a professional look. This was accomplished by mounting a piece of sandpaper on a rubber washer (1/2" diameter) glued to a short length of 1/4" shaft from an old volume control. This will fit the chuck on a 1/4" hand drill. Experiment with a scrap of aluminum before working on the chassis itself.

If the preamp is to be used primarily for speech, C<sub>1</sub>, C<sub>6</sub>, C<sub>10</sub>, and C<sub>11</sub> may be omitted entirely. For music these capacitors may range in value from 10 to 50 μf., 6 volts. The actual value selected will depend on the mikes used and the amount of bass emphasis desired. The preamp, as can be seen from Fig. 1, consists of four identical circuits.

This circuit is designed for use with low-impedance dynamic mikes exclusively. If crystal microphones are to be used, they could be coupled through an input transformer. The output level of high-gain crystal mikes will, however, overload this preamp circuit on loud signal peaks and produce distortion.

The output can feed directly into the mike input on an average p.a. amplifier or into a matching transformer. The signal will feed into a line or directly to the p.a. amplifier. Gain may be varied by adjusting R<sub>1</sub>, R<sub>2</sub>, R<sub>11</sub>, and R<sub>12</sub>. Some noise can be expected in the output if the pots are moved during programming so these controls should be pre-set to the desired level and then left alone.

Switches S<sub>1</sub>, S<sub>2</sub>, S<sub>3</sub>, and S<sub>4</sub> may be used to turn off the stages not being used. These switches should not be flipped during the program however because of the noise that would be introduced into the system.

The preamp is very quiet even with all four stages in operation. Operation is hum-free, of course. Current drain is low enough so that the penlite cells have excellent life characteristics even with continuous use although the batteries should be checked and replaced before the end of their expected life.

When wiring the preamp, it is important to observe correct polarity of batteries, transistors, and electrolytic capacitors. Failure to observe proper polarity will result in ruined parts.

For those who have access to a stock of the 2N133A transistors, it is recommended that they be matched for gain. While present production of these transistors runs quite uniform in quality, there is an occasional one not quite up to specs.

This amplifier/mixer has been used for three years without trouble. During that time it has been necessary to replace one transistor. No other trouble or expense has been incurred except for replacement of the batteries. All in all, the unit has proven a worthwhile addition to the author's stock of commercial sound equipment.



# TELTRON

## leading VALUES in TUBES and PARTS

**FREE EICO TUBE TESTER**

This brand new EICO tube tester in your absolutely FREE with every receiving tube order of \$1.00 or more within 30 days. EICOTS all new tubes and gas tubes. Also for sale from TELTRON for \$34.95.

**SAVE ON ALL TUBES**

Here's a Partial List of Most Often Used Tubes

Quan.	Type	Price
.....	6X4	.43
.....	6X5	.45
.....	6X6	.48
.....	6X7	.51
.....	6X8	.54
.....	6X9	.57
.....	6X10	.60
.....	6X11	.63
.....	6X12	.66
.....	6X13	.69
.....	6X14	.72
.....	6X15	.75
.....	6X16	.78
.....	6X17	.81
.....	6X18	.84
.....	6X19	.87
.....	6X20	.90
.....	6X21	.93
.....	6X22	.96
.....	6X23	.99
.....	6X24	1.02
.....	6X25	1.05
.....	6X26	1.08
.....	6X27	1.11
.....	6X28	1.14
.....	6X29	1.17
.....	6X30	1.20
.....	6X31	1.23
.....	6X32	1.26
.....	6X33	1.29
.....	6X34	1.32
.....	6X35	1.35
.....	6X36	1.38
.....	6X37	1.41
.....	6X38	1.44
.....	6X39	1.47
.....	6X40	1.50
.....	6X41	1.53
.....	6X42	1.56
.....	6X43	1.59
.....	6X44	1.62
.....	6X45	1.65
.....	6X46	1.68
.....	6X47	1.71
.....	6X48	1.74
.....	6X49	1.77
.....	6X50	1.80
.....	6X51	1.83
.....	6X52	1.86
.....	6X53	1.89
.....	6X54	1.92
.....	6X55	1.95
.....	6X56	1.98
.....	6X57	2.01
.....	6X58	2.04
.....	6X59	2.07
.....	6X60	2.10
.....	6X61	2.13
.....	6X62	2.16
.....	6X63	2.19
.....	6X64	2.22
.....	6X65	2.25
.....	6X66	2.28
.....	6X67	2.31
.....	6X68	2.34
.....	6X69	2.37
.....	6X70	2.40
.....	6X71	2.43
.....	6X72	2.46
.....	6X73	2.49
.....	6X74	2.52
.....	6X75	2.55
.....	6X76	2.58
.....	6X77	2.61
.....	6X78	2.64
.....	6X79	2.67
.....	6X80	2.70
.....	6X81	2.73
.....	6X82	2.76
.....	6X83	2.79
.....	6X84	2.82
.....	6X85	2.85
.....	6X86	2.88
.....	6X87	2.91
.....	6X88	2.94
.....	6X89	2.97
.....	6X90	3.00

Send for FREE complete list of most often used tube types

**Heavy Duty Solder Gun**

Professional solder gun for any size joints. Job Spotlights. Heat meter on when gun is on. Extra Tip & Solder Free With Each Gun. Guaranteed Replacements or Serviced One Year by TELTRON. Prepaid \$5.95

**Channel Master Conical Antenna**

Local or fringe. Incl. 8' rot. antenna with cord. 8' stand. 50' 300-ohm wire. List \$15.95. Immediate delivery. TELTRON, Harrison, N.J.

**Switch-Type Indoor Antenna**

Shipped Postage Paid. New 6 Position Switch for use on UHF, VHF, FM sets. Next Pkg. \$2.99. Buy 6, \$2.49

**PARALLEL PICTURE TUBE BRIGHT-ENER**

Series 1000... \$9.95  
Series 1001... \$1.39

**AUTO VIBRATORS**

6 Volt 4 Prong Universal... \$1.50  
12 Volt 4 Prong Standard... \$1.75  
12 Volt 4 Prong Standard... \$1.99

**NEW LIBERAL TERMS:** No minimum order. Free postage on all tubes & parts orders over \$5.00 in U.S.A., Alaska & Territories. 25% deposit required on orders. Please send approximate postage on Canadian and Foreign shipments. Excess will be refunded. All picture tubes and outdoor antennas shipped FOB Harrison, New Jersey.

# TELTRON ELECTRIC CO.

428 Harrison Ave.    Harrison, N. J.    Phone HUmboldt 4-9848

Dept. EW-8

# SEND ELECTRONICS WORLD EVERY MONTH

name \_\_\_\_\_

address \_\_\_\_\_

city \_\_\_\_\_ zone \_\_\_\_\_ state \_\_\_\_\_

Check one:


3 years for \$12     2 years for \$9

1 year for \$5

In the U. S., its possessions, and Canada

Payment enclosed     Bill me

Foreign rates: Pan American Union countries, add .50 per year; all other foreign countries, add \$1.00 per year.



Mail to: ELECTRONICS WORLD, Dept. EW 86, 434 S. Wabash Ave., Chicago 5, Ill.

**NEW PACKAGE  
for the Industry**

**FM** the *hy-gain*  
**HALO**  
PRIMARY AREA  
OMNIDIRECTIONAL  
ANTENNA  
Model FMH \$995 LIST  
**ATTACHES EASILY  
TO WOOD SURFACE  
OR EXISTING MASTS**

An extremely efficient 1/2-wave dipole in unique halo configuration producing the most uniform omni-directional response pattern of any FM antenna system. Eliminates fading; decreases background noise; to increase fidelity of your home FM reception. Universal mounting bracket included. Mounts easily in minutes. Rugged construction of heat-treated aluminum alloy tubing, high impact Cycolac plastic and flite treated hardware. Weighs only 11 ounces. Designed for std. 300 ohm twin-lead.

**FM** the *hy-gain*  
**HY-LOG**

FRINGE AREA  
LOG PERIODIC ANTENNAS

Tremendous forward gain developed and maintained through use of revolutionary new log periodic antenna concept. Uniform impedance characteristics over entire FM radio spectrum of 85 to 108 MCS. These Hy-Logs perform equally well in receiving ANY FM STATION on ANY FM CHANNEL and are guaranteed to outperform any straight Yagi of equivalent size. Heavy wall 1 1/2" dia. aluminum boom, 7/16" elements heat-treated aluminum alloy. For 72 ohm coax or 300 ohm twin-lead.

**6 ELEMENT  
9 DB GAIN**  
Model FM-6  
\$2295 LIST

For medium fringe area reception. Boom length 7 ft. Net weight only 3 1/2 lbs.

**11 ELEMENT 12 DB GAIN**  
Highest gain antenna system commercially manufactured for FM reception. Boom length, 12 ft. Net weight, 5 1/2 lbs.

Model FM-11 \$3795 LIST

*hy-gain*  
antenna products

1135 NO. 22nd ST. • LINCOLN, NEBRASKA

**Record Live Stereo at Home**  
(Continued from page 35)

speakers are spaced, but the amount of the spacing will depend on the acoustics of the room. If you have a large room, the only reliable way to determine the recording and playback arrangement is to try different combinations of microphone and speaker placement.

**Phasing**

If you use a double-element mike with its own recorder or any of the matched pairs with any recorder built to record stereo, you don't need to worry about phasing. In all other cases it is well to check phasing because wrong phasing can spoil stereo completely.

Microphones of the same type should be connected identically but there is no guarantee of this. If they differ, you'll encounter the problem of your system being phased correctly for playing back pre-recorded tapes but wrong for your home recordings. If possible, switch the mike connections (up at the microphone head) so they conform and the whole system is consistent so far as phase is concerned.

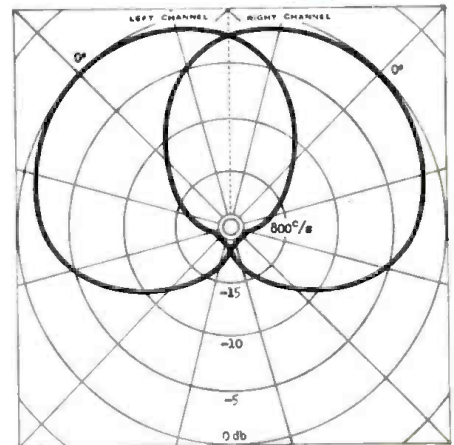
If you have to check phasing, the easiest way is to pick a spot representing center-front of your microphone set-up and make a length of test tape with speech. Play it back and stand mid-way between the speakers (Fig. 6) and listen. Correctly phased, and with the balance control properly adjusted, the sound should come from a spot mid-way between the units. Incorrectly phased, the correct setting of the balance control results in confusion of sound—no definite location at all.

If you are uncertain about phasing, try such a piece played back, reversing the connections to one of the speakers. You will soon know which way is right. If your system has a reversing switch, the simplest thing may be to note

which is the correct position of this switch for everything you have to play. Without this refinement (and often with it, too), the best thing is to alter the mikes, if necessary, so their phasing is consistent with pre-recorded material.

By exercising a little care in setting things up, you'll get some real surprises at the uncanny realism of such home-recorded stereo tapes. It is a fact that recordings played back in the same room in which they were recorded display a realism superior to anything you have ever heard.

The Norelco stereo microphone is shown here with its dual cardioid response.



**HAM RADIO IN RUSSIA** / By JOSEPH ZELLE, W8FAZ

ACCORDING to the "Soviet Union," a picture magazine published in Moscow, there are several hundred thousand radio amateurs who belong to radio clubs in the USSR. They use International Morse Code to establish contacts all over the world.

In 1958 alone, for example, over 854,000 QSL cards were received by Russian hams. Best DX contacts were with radio amateurs in New Zealand, Australia, and Antarctica. Top DX honors for 1958 went to UB5WF, Vladimir Ghoncharkey, member of the Lvov Radio Club.

Radio amateurs in the Soviet Union are allowed a maximum of 200 watts operating power. The amateur bands are as follows: 3.5-3.65 mc.; 7.0-7.1 mc.; 14.0-14.35 mc.; 21.0-21.45 mc.; 28.0-29.7 mc.; 144-146 mc.; and 420-435 mc.

In the 28-mc. band, stations of the III category are allowed 10 watts, II category, 40 watts, and in the I category 50 watts of power. Only 5 watts is permissible in the 420-mc. band. These powers apply to beginners who are also allowed

to operate in the 7.0 to 7.1 mc. band.

All the radio clubs of the USSR are affiliated with the Central Radio Club, the address of which is P.O. Box 88, Main Post Office, Moscow. All QSL's and communications with Russian hams should be sent to the Central Radio Club for distribution in the USSR.

The table below lists the Amateur Band frequencies and the types of transmission permitted on each band. This information was obtained from "Radio," the official organ of ham radio in the USSR.

FREQ. (kc.)	TRANSMISSION
3500-3650	Telegraphy, telephony
7000-7100	Telegraphy, telephony
14,000-14,100	Telephony
14,100-14,300	Telephony
14,300-14,350	SSB telephony
21,000-21,150	Telephony
21,150-21,350	Telephony
21,350-21,450	SSB telephony
28,000-28,200	Telephony
28,200-28,500	Telephony
28,500-29,700	SSB telephony
144,000-146,000	Telegraphy, telephony
420,000-435,000	Telegraphy, telephony



**YOUR COPIES OF**  
**ELECTRONICS WORLD**  
**ARE VALUABLE!**



**Keep them neat . . .  
 clean . . . ready for  
 instant reference!**

Now you can keep a year's copies of **ELECTRONICS WORLD** in a rich-looking leatherette file that makes it easy to locate any issue for ready reference.

Specially designed for **ELECTRONICS WORLD**, this handy file—with its distinctive, washable Kivar cover and 16-carat gold leaf lettering—not only looks good but keeps every issue neat, clean and orderly.

So don't risk tearing and soiling your copies of **ELECTRONICS WORLD**—always a ready source of valuable information. Order several of these **ELECTRONICS WORLD** volume files today. They are \$2.50 each, postpaid—3 for \$7.00, or 6 for \$13.00. Satisfaction guaranteed, or your money back.

(Be sure to specify whether you want lettering to be Electronics World or its former title, Radio & TV News.)

Order direct from:  
**JESSE JONES BOX CORP.**  
 Dept. EW  
 (Established 1843)  
 Box 5120, Philadelphia 41, Pa.

**CITIZEN BAND**  
 CLASS "D"  
**CRYSTALS**



3rd Overtone: Hermetically Sealed .005% tolerance—Meet F. C. C. requirements, 1/2" pin spacing—0.50 pin diameters. (.093 pins available, add 15c per crystal.)

**\$2.95 EACH**  
 ALL 22 Frequencies In Stock!  
 (add 5c per crystal for postage and handling)

The following Class "D" Citizen Band frequencies in stock (frequencies listed in megacycles): 26.965, 26.975, 26.985, 27.005, 27.015, 27.025, 27.035, 27.055, 27.065, 27.075, 27.085, 27.105, 27.115, 27.125, 27.135, 27.155, 27.165, 27.175, 27.185, 27.205, 27.215, 27.225.

Matched crystal sets for Globe, Gonset, Citi-Pone and Hallicrafters Units . . . \$5.90 per set. Specify equipment make.

**RADIO CONTROL CRYSTALS**  
 in HC6/U HOLDERS—SIX FREQUENCIES

In stock for immediate delivery (frequencies listed in megacycles): tolerance .005%, 1/2" pin spacing, .050 pin diameter, (.093 pins available, add 15c per crystal.) Specify frequency desired.

26.995, 27.045, 27.095, 27.145, 27.195, 27.255 . . . **\$2.95 EACH**  
 (add 5c per crystal for postage and handling)

Send for **FREE CRYSTAL CATALOG #860**  
**WITH OSCILLATOR CIRCUITS**

**ASK YOUR PARTS DEALER FOR TEXAS CRYSTALS**  
 See big red display . . . if he doesn't stock them, send us his name and order direct from factory.

**ALL ORDERS SHIPPED FROM OUR NEW  
 FLORIDA PLANT 1st CLASS MAIL!**  
 Rush your order to:  
**TEXAS CRYSTALS**  
 Dept. R-80—1000 Crystal Drive, Fort Myers, Fla.  
 For even faster service phone WE. 6-2100

**Servicing CB Equipment**  
 (Continued from page 41)

just by expecting too much of a 5-watt transmitter. If the trouble is in the equipment, look for off-frequency transmitter or receiver crystals. If there is noise, the receiver is probably fairly sensitive, but perhaps not at exactly the right frequency. Or, if the antenna systems, at either or both ends of the radio circuit, are not effective enough, the signal may be too weak to override the noise. In a vehicle, ignition noise is a major problem and the proper installation of suppressors and bonding is important.

The second most common complaint is "I can't talk far enough." Under some circumstances, one mile is all the customer can cover. Fortunately, the typical range is from 3-5 miles and, under favorable conditions, it can be even more. It is the antenna system, more than anything else, that determines range. There is generally not a great deal of difference in the performance capabilities of the various CB transmitters.

Co-channel as well as adjacent-channel interference can sometimes be reduced in intensity or even eliminated through the use of directional antennas. Adjacent-channel interference, however, is generally caused by inadequate receiver selectivity but, because of the low power, it seldom occurs except when caused by stations in very close proximity to the offended receiver. A possible cure, short of selling the customer a more selective receiver, is to try a directional antenna oriented to minimize pick-up from the offending station. Crosstalk from stations on various other frequencies is sometimes caused by more complex factors, such as intermodulation.

**Getting Started**

Technical information is available from most of the many manufacturers of CB equipment, who are dependent on service dealers for their own success. Unless customers are kept satisfied, future sales will suffer. Nearly all manufacturers publish comprehensive service manuals and make them available.

Information about test equipment is also available from instrument manufacturers. Some of the specialized instruments needed for servicing CB equipment are not available from parts jobbers and may have to be obtained direct from the factory or through the manufacturer's rep.

The most important information required at the outset is a copy of FCC Rules and Regulations, part 19, governing the Citizens Radio Service. You can get a copy of volume VI, FCC Rules and Regulations, which contains part 19, from the Superintendent of Documents, U. S. Government Printing Office, Washington 25, D. C. for \$1.25. At that price, you can't afford to be without it.

**NEW PACKAGE**  
 for the Industry

**FM** the *Hy-gain*  
**Butterfly**



**RINGS ONLY 6" IN DIAMETER**  
 Model FMB  
**\$995 LIST**

**ATTACHES IN SECONDS TO EXISTING WHIPS**

This new Hy-Gain automobile Butterfly antenna is specifically designed to improve FM radio reception in automobile FM-AM receivers or AM receivers using converters. It increases range, eliminates fading and decreases background noise, tremendously improving reception.

The Butterfly converts existing AM whips to 1/4-wave length antennas at FM frequencies. Since 1/2-wave length portion is in the same horizontal plane as FM broadcast station antennas, the losses due to cross-polarization are eliminated. A gain of approximately 3 db results.

The Hy-Gain Butterfly attaches easily to any standard automobile whip in 30 seconds. No holes to drill, no wires to connect, no adjustments to make. Polished anodized aluminum, high impact Cyclo-lag plastic and chrome plated brass fittings. The Butterfly is extremely rugged yet weighs less than 2 ounces. Guaranteed to improve FM reception and enhance AM antenna efficiency.

**COMPLETE TECHNICAL INFORMATION AVAILABLE  
 WRITE TO DEPT. EW,**

*Hy-gain*  
 antenna products

1135 NO. 22nd ST. LINCOLN, NEBRASKA

By  
**BERT WHYTE**



## CERTIFIED RECORD REVUE

EVERY August presents the same problem . . . what can one report on in the lull before the September and October hi-fi storms? This season there are less rumors than usual, and what things one does hear are more concerned with tape developments than disc. Indeed, there is much talk about "where do we go from here" regarding discs. Some take a defeatist attitude that the disc has just about run its course of utility. Others are hoping for some genius to come up with a truly compatible stereo disc, playable with monaural pickups. The so-called "compatible" discs now on the market have been rejected by the vast majority of engineers as "neither good stereo nor good monophonic."

Actually there are many avenues of improvement on the stereo disc which can be followed, for example, the development of a record pressing material which will possess the properties of being completely anti-static, have less plasticity which would permit wider frequency response and higher recorded levels and at the same time have a wear factor in excess of present materials. I have heard some trial cuts on a similar new material and the results were quite successful, although it is too early to draw any hard and fast conclusions.

Finally, even though it may smack of the impossible . . . some preliminary work has been done on the production of a true *three-channel stereo disc*. Thus far, no obstacle to this goal appears to be insurmountable by proper application of known techniques or new techniques if certain practical situations and costs can be controlled.

### TCHAIKOVSKY

SUITE FROM SWAN LAKE  
SUITE FROM SLEEPING BEAUTY  
POLONAISE (Eugen Onegin)

Sinfonie Orkester der Nationalen Philharmonie Warschau conducted by Stanislaw Wislocki. Deutsche Grammophon Stereo 136036. Price \$5.98.

This is one of the first new releases from *Deutsche Grammophon*, in which the records are manufactured, pressed, and packaged in Germany. This policy is to be followed in all future *Deutsche Grammophon* records, which will, however, be released as usual through American *Decca*.

Let us take a look at and a listen to these imported recordings. Point one is laudable enough . . . the record is factory sealed in a sort of vinyl plastic that completely protects against dust, etc. Point two . . . not so good . . . the record jacket is rather flimsy, being constructed of a thin cardboard that bends far too easily. Point three . . . the record itself is thicker than most others and is superbly finished.

Now, from the listening viewpoint, there is bound to be some controversy with all *Deutsche Grammophon* records. For one

thing their recording philosophy is quite different from that generally espoused in America. They strive more for an actual re-creation of concert hall effects by use of more distant pickups and by the use of longer or more spacious reverberations. Thus detail is rather less than one expects in American recordings. Then they use the M/S stereo recording technique exclusively. This, as you know, affords a very fine middle but somewhat at the expense of left and right stereo directionality. On the credit side, they achieve a superb sense of depth in their recordings.

Of course there are variances between records and many times the type of scoring will dictate a different approach. One quality they have which is absolutely marvelous is their surfaces. These are positively the smoothest, quietest, most "tick" and "pop" free I have ever heard and would that other companies' products were this quiet! Now as to this particular record . . . I have heard from several people whose opinions I value very highly that the Warsaw Philharmonic is one of the finest orchestras in Europe today. This would seem to be borne out in the exemplary playing on this record, particularly in precision of ensemble. I know very little about the conductor, Wislocki, but in these Tchaikovsky works he acquires himself well without achieving any real distinction.

Soundwise this is the broad type of pickup, a pleasant sound, but not as crisp and sparkling as we are accustomed to expect. The bass end was a mite heavy and the top end somewhat restricted. Dynamics were reasonably broad. The M/S stereo here was predominantly middle with directionality, even with the first and second violins difficult to pinpoint. As noted (and it is an enhancement that can make up for a lot of deficiencies) the surfaces were dead quiet.

### MOZART

PIANO CONCERTO #20 (K. 466)

Sviatoslav Richter, pianist with Sinfonie Orkester der Nationalen Philharmonie Warschau conducted by Stanislaw Wislocki.

### PROKOFIEV

PIANO CONCERTO #5

As above with Witold Rowicki as conductor. Deutsche Grammophon Stereo 138075. Price \$5.98.

Whew! It is titles like this that make a reviewer's life tough. You must admit that is quite a mouthful to say, let alone write. Richter is acknowledged a master pianist by most responsible critics yet oddly enough his reputation is founded entirely on his recordings. This is truly a formidable talent and nowhere is this more in evidence than in his imposing performance of the Prokofiev "5th Concerto." While not as well known as the 2nd or 3rd, its craggy nature and atonalities offer a challenge to the abilities of any pianist

**A**... Always  
**B**... Buy  
**C**... Columbia

**CITIZENS BAND SPECIALS!**  
BC-620 TRANSCEIVER: With spare tubes, Govt. re-conditional. Includes 6 or 12 V power supply. Makes F.H. Citizens' Band! Freq. \$19.95  
20-27.9 Mc. This month ONLY  
Accessories for above:  
TS-13 HANDSET: Like brand new. A steal @ only \$ 3.95  
RA-120 POWER PACK: This is the 110 V. 22.50  
Like new  
P-17 MICROPHONE: Excellent cond. Excellent buy! 3.95

BC-604 TRANSMITTER  
20-28 Mc. 30 W. New condition \$4.95  
DM-35 DYNAMOTOR: 12 V. for above BC-604 like new 8.95  
Set of 80 crystals. For above New 4.95

CRYSTAL CASE CS-137  
Two layers construction; Holds 1-20 FT-243 crystals. Felt lined. Excellent condition. TWO for only \$1.75. EACH 95c

VRC-2 FM TRANSMITTER-RECEIVER COMBO!  
30-40 Mc. A terrific 6 Volt installation! Consists of 30 W. transmitter and dual conversion receiver, both crystal controlled! This is the Army equivalent to Motorola Model FM 30-D. Excellent cond. Per combo only \$39.95

ALL PURPOSE ARB COMMUNICATION RECEIVER  
195-9,000 kc. 4 bands. Built-in, directly calibrated tuning control. Ideal for home, mobile or marine! Excellent cond. \$17.50  
CONTROL BOX & PLUGS: For above. Only \$4.95

APR-1 RECEIVER SPECIALS!  
30 Mc. IF. 115 V. 60 cps. Like new cond. \$24.50  
Plug-In Units For Above  
TN-1: 30-90 Mc. \$14.95 COMBO DEAL!  
TN-2: 90-300 Mc. 14.95 Apr-1 Receiver PLUS  
TN-3: 300-1000 Mc. 14.95 TN-1, TN-2, TN-3 \$24.50

APR-4 TUNERS—WILL WORK WITH ABOVE REC'R  
TN-18: 30-90 Mc. \$14.95  
TN-17: 90-300 Mc. 14.95  
TN-18: 300-1000 Mc. 19.95 COMBO DEAL!  
TN-18, TN-17, TN-18, TN-19 \$35.00  
TN-19: 1000-3300 49.95

TS-34 OSCILLOSCOPE: 10,50,000 cycles. Sweeps at 5, 50 or 250 microsecs. Good cond. \$34.95  
TS-34A AP: Same as above but sweeps can be varied @ 4 1/2-8, 20-50, 120-280 microsecs. \$39.50

BC-638 2-METER FREQUENCY METER:  
110-156 Mc. AM. Excellent condition. \$8.95

GENERAL RADIO VARIAC: 30 V. 400 cycles. 5 amp. BRAND NEW. Reduced to \$1.95

CY-139/CPS-1 RANGE AND AZIMUTH INDICATOR  
This is an offbeat special! 8" Scan 7" diam. Calibrated vertical and horizontal lines. Rugged metal cabinet encloses a treasurehouse of tubes: 4-807, 7-8N7GT, 2-6AG7, 5-6Y6, 3-6Y4G, 3-VR150, 1-VR105, 1-6N7J. Lots of other extras. With regulated AC supply. Wt. 300 lbs. Used. \$34.95  
Good 4 ft. h approx 11" wlt

SCR-625 MINE DETECTOR BARGAIN  
Locate that hidden pipe, metal, treasure! Use for parts! With case. Excellent. \$22.50

ART-13 XMT'R: Model T-47. Freq. 1.7 Mc. Excellent. Only \$34.50

APT-1 TRANSMITTER: 100-200 Mc. 10 TUBES in all including 63A driver, 829B final and 631 photo. tube. New cond. \$12.95

VHF SPECIALS!  
R-19/TRC RECEIVER  
70-100 Mc. Crystal controlled. Dual conversion. FBI. Built-in speaker and 110 VAC 60 cps. power supply. Self-contained table-top model which may be rack mounted. Companion to T-14/TRC Transmitter below. Excellent cond. \$24.50

T-14/TRC TRANSMITTER  
JUST REDUCED! For action this month!  
70-100 Mc. 50 W. input power on phone. Single channel. Built-in 110 V. 60 cps power supply. Table top size. Easily converted to 6 meters. Complete. Good condition, excellent buy! \$19.95  
COMBO DEAL! Both units for only \$39.50

**ELECTRONICS**  
2251 W. WASHINGTON BLVD.  
LOS ANGELES 18, CALIF.

**A NOTE TO THE HI-FI BUYER**  
AIR MAIL us your requirements for an IMMEDIATE LOWEST PRICE QUOTATION  
Components, Tapes and Records  
SHIPPED PROMPTLY AT LOWEST PRICES  
**WRITE TODAY FOR FREE CATALOG**  
**AUDIO UNLIMITED** 714-W Lexington Ave.  
New York 22, N. Y.

**BARGAIN HUNTING?** **TV SERVICEMEN!**  
Write for SENSATIONAL CATALOG  
**HENSHAW RADIO SUPPLY**  
3619 TROOST KANSAS CITY, MO.

and it is immediately apparent from the very opening that Richter is fully in charge. His tone is rock-steady, his phrasing and dynamics are broadly expressive and all other elements of his technique are extremely facile and well thought out.

In the Mozart, the playing is of the same high order, but is just a shade too introspective and intellectual and would benefit from more expressive warmth.

As to sound, this is a fine example of *Deutsche Grammophon* at work . . . the Mozart has the more typical concert hall sound, but faced with an entirely different type of scoring, the Prokofiev is recorded much closer, and the M/S stereo modified so that we have a beautifully clean recording, well detailed, yet with enough reverb to soften the harder contours. Directionality is much more pronounced here and, in general, this is the type of stereo recording that will appeal to American tastes. Now couple this fine clean recording with the fabulous D-G surfaces and the result is better than many tapes!

**BEETHOVEN  
PIANO CONCERTO #3  
("Emperor")**

**Wilhelm Backhaus, pianist with Vienna Philharmonic conducted by Hans Schmidt-Isserstedt. London Stereo CS-6156. Price \$5.95.**

Joy and Hallelujah! Here is a recording of an old standard warhorse which pleases at once from every aspect. The performance is in the grand old tradition and Backhaus thunders his way through the score with serene conviction and confidence in his approach. The excitement he generates is electric, one is caught up in the swirl and flow of the music and carried along to the triumphant finale.

The stereo sound is magnificent and is the sort which secured *London* its reputation. I have said on a number of occasions recently that *London* seemed to have gone to a new recording technique, and one which I did not think as good as the old. I do not know when this was made . . . possibly before the change to the new technique and they have been holding it. However if this is fairly new and betokens a return to the older techniques . . . I say it is time to rejoice.

Even if you own three versions of this work, be sure to hear this one. It is a real winner!

**BETHOVEN  
SYMPHONY #6 ("Pastorale")  
PROMETHEUS OVERTURE**

**L'Orchestre de las Suisse Romande conducted by Ernest Ansermet. London Stereo CS6160. Price \$5.95.**

When *London* first gave Ansermet some Beethoven to record, many people raised their eyebrows. But Ansermet fooled them by turning in some fine performances, notably the Beethoven 1st and 5th.

Alas, lightning did not strike twice in the same place, for in this "Pastorale" Ansermet is too intellectual and detached and never affords the piece the warm lyricism of a Bruno Walter. Less attention to dotting all the "i's" and crossing all the "t's" would have helped.

But if performance values are not overly important to you, you can find here just about the finest stereo "Pastorale" yet issued. It flows with a lovely clean line and with such felicitous acoustics that one is quite captivated. And the storm here really does storm, with splendidly robust percussion, strings, and brass. Ade all the stereo virtues reproduced in just the right balance and you have a great sound. Now if we could just get a performance to match the sound . . . Oh, well!

-30-



from stand



to hand . . . instantly



introducing the  
world's smallest  
cardioid dynamic  
microphone

**UNIDYNE III**  
by  
**SHURE**

EVERYTHING YOU WANT IN A  
QUALITY CARDIOID MICROPHONE  
. . . AND THEN SOME!

Compact size . . . modern design . . . wide response . . . superior feedback suppression . . . uniform cardioid pattern . . . ruggedness . . . reliability; you name it, SHURE has designed it into the dramatic new Unidyne III.

**50% SMALLER** — Less than 6" x 1 1/4", 0.6 lb.!

**PERFECTION IN PERFORMANCE** — moving coil design with truly uniform cardioid pick-up pattern. Response: 50 to 15,000 cps. Up to 75% greater distances from sound source. Impressive feedback suppression.

**MAXIMUM VERSATILITY** — unobtrusive size, dual impedance, light weight, instant change from stand to hand, and wide-range response make it ideal for faithful reproduction of voice or music, indoors or out, for P.A., tape recording . . . anywhere fine quality is required.

**RUGGED AND RELIABLE** — Famous SHURE quality. Takes 6-foot drop-tests and still performs according to specifications!

Literature available:

SHURE BROTHERS, INC.  
222 Hartrey Ave., Evanston, Ill.

**\$51.00**

Professional Net

SAY YOU SAW IT IN  
**ELECTRONICS WORLD**



\*\*\*\*\*  
\* **KEEP CANDEE HANDEE!** \*  
\* **FREE!** *Bargain-filled Summer Flyer!* \*  
\* **Get your copy today!** \*  
\* **J. J. CANDEE CO.** \*  
\* 509 N. Victory Blvd. Burbank Calif. \*  
\*\*\*\*\*

**GET INTO  
ELECTRONICS**



V.T.I. training leads to success as technicians, field engineers, specialists in communications, guided missiles, computers, radar and automation. Basic and advanced courses in theory and laboratory. Associate degree in electronics in 24 months. B.S. in electronic engineering obtainable. ECPD accredited. G.I. approved. Graduates in all branches of electronics with major companies. Start September, February. Dorms, campus. High school graduate or equivalent. Catalog.

**VALPARAISO TECHNICAL INSTITUTE**  
Dept. RD Valparaiso, Indiana

## TOP-HAT NEW SILICON RECT.

PIV/RMS  
50/35  
20 ea.  
10 for 1.90  
PIV/RMS  
100/70  
30 ea.  
10 for 2.90  
PIV/RMS  
200/140  
35 ea.  
10 for 3.40



PIV/RMS  
300/210  
45 ea.  
10 for 4.35  
PIV/RMS  
400/280  
.55 ea.  
10 for 5.25  
PIV/RMS  
500/350  
.65 ea.  
10 for 6.25

**FACTORY DIRECT**  
Exclusive Distributors for  
Name Brand, Immediate  
Delivery on All Types

PIV/RMS  
600/420  
.85 ea.  
10 for 8.00  
PIV/RMS  
900/630  
1.30 ea.  
10 for 12.50

PIV/RMS  
700/490  
1.00 ea.  
10 for 9.50  
PIV/RMS  
1000/700  
1.75 ea.  
10 for 17.00

PIV/RMS  
800/560  
1.10 ea.  
10 for 10.50  
PIV/RMS  
1100/770  
2.10 ea.  
10 for 20.00

**500 MA RECTIFIERS GUARANTEED**  
Input Working Range RMS/ACV Res. or Cap.  
Designed for Bridge or C.T. up to 750ma D.C.  
**SPECIAL!!! All Purpose Rectifier 400 piv @ 250ma**  
.40 ea. 25 for 9.00

**ELECTRONIC SPECIALS: 100 Different Pre. Res.**  
Mecpo, Shalicon, etc. 1/2w, 1W, 2W, 1/2p, 1p, 2p, 1p, 2p, 1p, 2p.  
Only \$1.90/c; JAN SWITCH, NEW 5F42D S.P.D.T.  
A H-W C-W Bat Handle .25 ea. 10 for \$2.40 w/hdw;  
100 Assl. RADIO & TV RIMS \$1.90—all new.  
Distributors O.E.M. Exporters. Write Quantity Prices.  
All Material Guaranteed. \$2.00 min. order. Orders  
F.O.B. NYC. Include check or money order. Shpg.  
charges plus. C.O.D. orders 25% down.

### WARREN DIST. CO.

NYC 7, NY 87-89 Chamber St. WO 2-5729

## TV PICTURE TUBES At Lowest Prices

10BP4 \$ 7.95	17BP4 \$ 9.95	21AMP4\$15.75
12LP4 8.50	17CP4 17.00	21ATP4 15.75
14B/CP4 9.95	17GP4 17.80	21AUP4 15.75
16DP4 12.00	17HP4 12.50	21EP4 13.50
16EP4 12.75	17LP4 11.50	21FP4 14.50
16GP4 14.50	17QP4 9.95	21WP4 14.00
16KP4 9.95	17TP4 17.00	21YP4 14.50
16LP4 10.95	19AP4 16.00	21ZP4 13.50
16RP4 9.95	20CP4 13.50	24CP4 23.50
16WP4 12.00	20HP4 14.50	24DP4 24.50
16PT4 9.95	21AP4 22.10	27P4 39.95
17AVP4 12.50	21ALP4 15.75	27RP4 39.95

1 Year Warranty  
Aluminized tubes \$3.00 for 21" \$5.00 for 21" and 27" additional. Prices include the return of an acceptable similar tube under vacuum.  
These tubes are manufactured from reprocessed used glass bulbs. All parts and materials including the electron gun are brand new.

**ALL PRICES FOB CHICAGO, ILLINOIS.** Deposit required, when old tube is not returned, refundable at time of return. 25% deposit required on C.O.D. shipments. Old tubes must be returned prepaid. Tubes shipped Rail Express. Shipped only to Continental U.S. and Canada.

WRITE FOR COMPLETE LIST.

**— PICTURE TUBE OUTLET —**  
2922 NORTH MILWAUKEE AVENUE  
CHICAGO 18, ILLINOIS  
Dickens 2-2048



**ENGINEERING DEGREE IN  
SCIENCE 27 or 36 MOS.  
MATH**

Accelerated year-round program prepares for early employment in fields of Science and Engineering. Regular 4-year program for B.S. Degree completed in 36 months, special engineering degree program in 27. Classes start quarterly — September, January, March, June. Quality education. Graduates employed from coast to coast. Government approved for veteran training. Students from 50 states, 40 countries. 20 buildings; dorms, gym. Campus. Save time and money. Earn board while studying. Write for catalog and complete information.  
980 E. Washington Blvd., Fort Wayne 2, Indiana

## INDIANA TECHNICAL COLLEGE

New Isotronic Training Method

### LEARN TV REPAIR IN ONE SHORT WEEK!

Now, after 5 year's research—a streamlined training system that obsoletes all others! In just 7 days you may earn \$150 weekly, without paying up to \$250 for training, studying long months! Developed by electronic scientists in cooperation with major TV mfr's., the new isotronic method is the most practical ever devised! For conclusive proof, write for details and FREE SAMPLE LESSON. Use it on your own set or a friend's—repair it & convince yourself you can make big money immediately in your own TV business! Hurry—Free Lesson supply limited. Write: TV Servicing Systems, Dept. D-768

1088 So. La Brea Ave., Los Angeles 19, Calif.

# S Sound on Tape

By BERT WHYTE

AS you know, I have been complaining that although four-track stereo tape seems well on the way to becoming the standard tape playback medium, comparatively little classical material was being released in this format. I've also complained that what has been issued has been difficult to obtain . . . that four-track production evidently was inadequate.

Now I'm happy to report that the situation has changed for the better. Classical material has been announced by *London*, *Decca*, *Capitol*, and now *Victor* is back in the reel-to-reel tape business with important classical issues. But best of all, four-track production seems to have overcome its initial inertia and tapes are beginning to arrive with something of the regularity and quantity that marked the heyday of the old two-track stereo. So I'll cautiously predict that from here on, there should be tapes to review!

I have been doing a great deal of traveling by boat in the last two years and on making the acquaintance of many of the officers and crewmen, found that they constitute one of the most rabidly enthusiastic groups of "tape fanciers" I've ever encountered. On the super-fast "S.S. United States," there are over 35 crew members with seagoing stereo . . . ranging from the more common popular-priced units all the way to *Ampex* 350-2! On a recent trip to Puerto Rico, on a much smaller boat, I found that over 20 per-cent of the crew had stereo tape outfits. The reasons for all these tape machines are easy to see . . . at sea when the watch system is observed there is plenty of time for listening. In the days before tape, many crewmen had elaborate radio receivers of the *National*, *Collins*, *Hallcrafters* variety, which gave them some measure of entertainment but, like any radio, allowed no freedom of choice in the selection of musical material. Then there have been many attempts at seagoing record players. The trouble here of course was the motion of the ship and tendency of the stylus to jump the record groove. Many elaborate systems of suspension on "gimbals" and other systems were devised, and while many worked remarkably well, they were cumbersome and, past a certain point, nothing was entirely satisfactory.

With tape, the problem of ship motion was for all practical purposes, overcome. Providing the tape unit it-

self was secured to prevent sliding, it would take a frightening roll or plunge to affect the smooth continuity of tape motion.

While stereo tape might appear to be the whole answer to seagoing entertainment, there are a number of things that should be improved upon in present units to make them really "seaworthy". Even though the tape units are used in cabins, a certain amount of exposure to salt sea air is inevitable. You would be amazed how corrosive sea air is to metals! Steel and iron rust with alarming ease and while brass and aluminum oxidize more slowly, it is still a rather fast process. I watched an aluminum idler wheel get crusted with white oxidation in 4 days at sea! Now add to the sea air the dampness and high humidity encountered by ships in the tropics, and the ease with which mold and fungus can grow, and you have another headache. There is a trend towards stereo tape entertainment on private boats, even relatively small ones, and it would seem that some alert manufacturer would turn out a "tropicalized" seagoing model of his unit, made of non-corroding materials. I think there is a big enough market to support such a unit and although the price would have to be higher I don't think the average seafarer would balk for the protection to his investment this would constitute.

What does the seagoing stereophile listen to? . . . his tastes are just as catholic as the landlubber . . . he plays everything from bebop to Bach . . . but, at least according to my observations, he enjoys most the classical repertoire and is especially addicted to Broadway hit shows.

Next month ends the usual "summer recess" in the music business, and I know there will be many important new items that will be released.

### FALLA NIGHTS IN THE GARDENS OF SPAIN

Gonzalo Soriano, pianist with National Orchestra of Spain conducted by Ataulfo Argenta.

### RODRIGO CONCERTO FOR GUITAR AND ORCHESTRA

As above with Narcisco Yepes, guitarist. London 4-track Stereo I.C.L.80010. Price \$7.95.

This was an outstanding stereo disc in both sound and performance values, and here we have it on tape with con-

ELECTRONICS WORLD

siderable enhancement of dynamics and an over-all response that is definitely broader and cleaner. In the piano work, there are much improved transients and a much more sonorous bass line. The same improvement in transient response can be noted in the guitar concerto. The over-all sound in both works is of the moderately close-up variety, well detailed and with a medium reverb time that lends smooth roundness without blur. The aspects of stereo directionality and depth are present to a more heightened degree here than on the disc.

**HITS I MISSED**

**Ted Heath and his Orchestra. London 4-track Stereo LPM70007. Price \$7.95.**

How a clever band leader like Ted Heath could miss such hits as "Three Coins in the Fountain", "High Noon", "Ebb Tide", "Secret Love", and "My Foolish Heart" among others presented on this tape I don't know . . . but that is what the jacket claims.

Anyhoo . . . this is a very choice collection done to a turn in the familiar high-powered Heath style. Plenty of heavy bright brass and smooth saxes along with clean hard drivin' percussion. As with most big band recordings there is not much dynamic variation . . . they just pile level on the tape, and of course this makes for a minimum of tape hiss.

**THE MAGIC ISLANDS**

**Alfred Newman and his Orchestra with Ken Darby Choir. Decca 4-track Stereo ST79048. Price \$7.95.**

While this tape will undoubtedly be labeled pure corn by many, there will be many others who are just mad about the same thing. This is a potpourri of songs and dances mostly of Hawaiian and South Sea origin. There will probably be much doubt cast on the authenticity of some of them . . . be that as it may . . . with the exotic scoring for orchestra and the lilting ministrations of the Ken Darby Choir this makes for good innocuous listening in August. The over-all sound is quite clean.

**HAMFESTS SCHEDULED**

**THE** Wabash Valley Amateur Radio Association will again sponsor the Turkey Run VHF Picnic on July 31, just as they have done for the past twelve years.

Last year more than 400 amateurs, representing 13 states, attended the affair and the sponsors are hoping to top the record this year.

Ken Mier, K9EFO, and Charles Hoffman, W9ZHL, are serving as co-chairmen for the affair. Those wishing complete details can call either Ken or Charles or write Ken at 2030 Liberty Ave., Terre Haute, Indiana.

**A** HAMFEST has been scheduled by the Radio Association of Erie, Pa., Saturday, September 10th, at the Sportsmen's Athletic Club, Erie, Pa.

Registration will be from 10 to 12 AM at the Club. For advance registrations, contact Dick Millhouse, K3ENE, 1143 E. 40th St., Erie, Pa.

**DOES YOUR BUSINESS SLUMP AS TEMPERATURES SOAR?**

**DIVERSIFY WITH 2-WAY MOBILE-RADIO MAINTENANCE!**

Hundreds of progressive radio servicemen are filling the summer slump in entertainment radio—by adding mobile-radio maintenance! Actually, mobile-radio service is business 12 months out of the year—often on contract basis—paid for by going organizations. So rise above competition—and end that summer slump—send coupon below for "How to Make Money in Mobile-Radio Maintenance". It's free!

THIS BOOKLET IS BASED UPON A CAREFUL SURVEY OF THE ACTUAL OPERATING PRACTICES OF SUCCESSFUL MOBILE-RADIO ENGINEERS. IT SHOWS TYPICAL CONTRACT PROVISIONS . . . MONTHLY FEES . . . INSTALLATION CHARGES . . . LABOR RATES . . . ETC.

Lampkin instruments are the most popular mobile-maintenance meters.

**MAIL COUPON TODAY** ➔

**LAMPKIN LABORATORIES, INC.**  
BRADENTON, FLA.



LAMPKIN 105-B  
FREQUENCY METER  
RANGE 0.1 TO 175 MC AND UP  
PRICE \$260.00 NET



LAMPKIN 205-A  
FM MODULATION METER  
RANGE 25 TO 500 MC  
PRICE \$270.00 NET

LAMPKIN LABORATORIES, INC.  
MFM Division, Bradenton, Florida  
At no obligation to me, please send  
 Free booklet  Data on Lampkin meters  
Name \_\_\_\_\_  
Address \_\_\_\_\_  
City \_\_\_\_\_ State \_\_\_\_\_

**C.E.I. CITIZEN'S BAND**

Two-Way Transceiver Kits Complete—  
New Low Price

No examination required for use of this equipment. Made from parts of finest quality. Meets F.C.C. Requirements. Kits are complete, including Cabinet, Pre-punched Chassis, Power Transformer, all components, Mike, Crystal, Easy to follow instructions and schematic. F.C.C. form 505 furnished with each order.

**SPECIFICATIONS**

Superheterodyne Receiver with the 1000 DK has RF Stage. One micro volt sensitivity, over two watts Audio Transmitter 5 Watts of RF, 100% AM Modulated, 40 to 80 Ohms Antenna Output. Power Transformer operates on 6VDC, 12VDC and 117VAC. All units can be operated as base or mobile.



Special One Time Offer at this Price

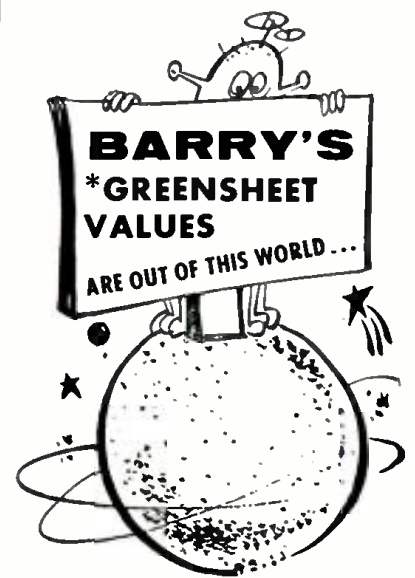
**MODEL 1000 DK**

Has Tuneable Receiver. Receives all 22 channels and 10 meter band. Has fixed squelch and noise limiter. **45.95**  
In Kit . . . . .

This model can be easily converted to 6 Meter operation by changing coil winding and crystal. This new price offer is limited. Order now.

All units complete. 15% deposit required with all C.O.D. orders or send cash and take 2% discount. F.O.B. Chickasha. Prompt shipment.

**CHICKASHA ELECTRONICS, Inc.**  
Chickasha, Oklahoma



\*A complete catalog of specialized industrial Electronic TUBES and COMPONENTS . . . featuring Barry Electronics savings to Industry, Hams and Experimenters.

Prove these values to yourself! Complete and mail the coupon below for your copy of the \*Greensheet.

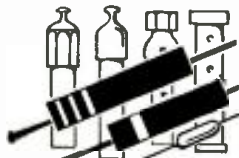
We'll also purchase your equipment and unused tubes. Send details.

**BARRY ELECTRONICS CORP.**  
512 Broadway, New York 12, N. Y. Dept. EW8

Please send me a copy of the \*Greensheet and add my name to your mailing list.

(EW8)  
Name \_\_\_\_\_ Title \_\_\_\_\_  
Company \_\_\_\_\_  
Address \_\_\_\_\_  
City \_\_\_\_\_ State \_\_\_\_\_

# What's



# New in Radio

## DEPTH SOUNDER TRANSDUCER

*Clevite Electronic Components*, a division of *Clevite Corp.*, 3405 Perkins Ave., Cleveland 14, Ohio, has introduced a new transducer, designed for use with small-boat depth finders.

Designated Model DS-1, the transducer radiates ultrasonic energy in an optimized, conical-shaped pattern. Capacity is 2300  $\mu$ f.; receiving sensitivity, minus 85 db with respect to 1 volt/microbar; transmitting sensitivity, plus 90 db with respect to 1 microbar/yard/watt; beam width, 16 degrees at 10 db down; impedance, 340 ohms resistive and 330 ohms reactive; and frequency, 195 kc.

Additional information on this transducer is available from the manufacturer on request.

## SOLDERING IRON HOLDER

*Ungar Electric Tools, Inc.*, 4101 Redwood Ave., Los Angeles 66, Calif. has introduced its new Model 8000 soldering iron holder.

Said to protect the soldering iron user against burns from accidentally brushing against an exposed iron, the holder may be attached to the top of a work bench, to a wall or side of the bench, or to the underside of the bench. Additionally, the operator can adjust



the angle of the holder so that the iron will be positioned for ready use. For further information, write to the manufacturer.

## CITIZENS BAND MIKES

*American Microphone Mfg. Co.*, 400 South Wyman St., Rockford, Ill. has introduced a new series of microphones designed for use in Citizens Band installations.

Claimed to offer the only "slide-lock" switch available in this field, the new "208" series may be hand held, placed on a table top, or hung on a wall. Six models are offered, including three each crystal and ceramic types.

## COLORED CABLE JACKETS

*Lenz Electric Manufacturing Co.*, 1751 No. Western Ave., Chicago 47, Ill. has announced a new line of plastic cable jackets in the standard colors adopted by the industry.

The jackets are available with any

size and number of conductors. Color coded in this way, the cables connecting the units of electronic equipment can be identified quickly to facilitate installation and servicing. More complete information may be obtained from the manufacturer.

## NIBBLING TOOL

*Adel Tool Co.*, 4730 Ronald St., Chicago 31, Ill. is offering a hand-operated nibbling tool which cuts round, square, or keyed holes of any size or shape over



$\frac{1}{16}$ -inch in radio chassis and other sheet metal.

According to the manufacturer, the metal remains flat and straight after cutting. The capacity of the nibbling tool is stated as 18 gauge (.046-inch) maximum for steel, and  $\frac{1}{16}$ -inch for aluminum, copper, or plastic mat. Further information is available from the manufacturer.

## RAYTHEON CB TRANSCEIVER

*Raytheon Company*, Waltham 54, Mass. has introduced a new Citizens Band radiotelephone for two-way communication on the 27-megacycle band. Known as the "Ray-Tel," the set is a 23-channel, crystal-controlled transceiver for use between fixed or mobile installations.

It operates from a 117-volt or 12-volt source, features a "battery saver" switch that conserves battery power while the unit is on stand-by or listen, and transmits at the maximum legal power of 5 watts.



The receiver section is said to be highly selective for maximum rejection of unwanted signals and includes a full-range a.v.c. to prevent blasting and distortion on strong local signals. Radar-type duplexing circuits are claimed to have eliminated the need for troublesome relays. Included with the "Ray-Tel" is a press-to-talk microphone, instruction manual, FCC license application and regulations, and set of transmitting and receiving crystals.

## GLOBE FOR HAMS AND SWL'S

*Allied Radio Corp.*, 100 N. Western Ave., Chicago 80, Ill. is offering a 12-inch, full-color world globe as an accessory for the ham station or short-wave listening post. The globe has indicating devices which tell the user the direction in degrees and the distance of any country being tuned in. A special feature permits "customizing" the globe for this purpose from any location.

The globe also features call letter prefixes for each country, as well as a time-differential disc that tells the user the time anywhere in the world. A special swivel mount permits rotating the globe in either the polar or the equatorial plane. *Allied's* stock number for this item is 77 S 325.

## POCKET SIZE CB RADIO

*Globe Electronics*, Division of *Textron Electronics, Inc.*, 22-30 South 34 St., Council Bluffs, Iowa has introduced the "Pocketphone," a completely portable two-way radio for receiving and transmitting at distances up to one mile on the Citizens Band. Measuring 1 $\frac{1}{2}$ " x 2 $\frac{3}{8}$ " x 16 $\frac{1}{4}$ ", the "Pocketphone,"

uses a built-in "Power-Pak" battery as well as its own microphone and loudspeaker, and extendable antenna. It weighs only 13 $\frac{1}{2}$  ounces.

The 9-volt battery has a life expectancy of one year, based on continuous use 8 hours daily, 5 days a week for 50 weeks. The set is said to meet all FCC requirements. Power input to the final r.f. amplifier in the transmitting mode is just under the 100-mw. limitation for non-licensed operators. Spurious and incidental radiation is claimed to be better than 30 db down. Printed circuits and transistors are used in the design.

## COMPACT TUBE TESTER

*Service Instruments Corp. (Sencore)*, 171 Official Rd., Addison, Ill. has announced a compact tube tester. Called the "Mighty Mite," the new instrument measures 8" x 9" x 2 $\frac{1}{2}$ " and weighs less than 8 pounds. It will check over 1300 tubes for cathode emission, interele-



ment shorts, gas, grid emission, and grid leakage as high as 100 megohms. Set-ups are made from a small attached booklet. New charts are pro-



vided free of charge by registering with the company.

The "Mighty Mite" features a 3½-inch d'Arsonval meter that glows in the dark, and a stainless steel mirror in the cover to facilitate TV set adjustments during servicing. The unit has a separate inner chassis so that it may be slipped out of its carrying case and installed in a tube caddy or on a counter or wallboard.

#### ELECTROLYTIC ASSORTMENT

*Sprague Products Co.*, North Adams, Mass. has made available a specially selected assortment of "Atom" electrolytic capacitors packaged in a plastic job tray.

Known as the "EK-3 Atom Assortment," the new item features 15 tubular electrolytics in the twelve most frequently used ratings for radio and TV servicing.

The trays, which measure 9" x 6" x 1½" each and may be stacked, have built-in card holders to facilitate quick identification of the contents. Trays are free to the service dealer who pays only for the capacitors.

#### TRANSISTOR TESTER

*B & K Manufacturing Co.*, 1801 W. Belle Plaine, Chicago 13, Ill. is now producing a low-cost transistor tester for servicing, lab, and industrial use.

Designated as Model 160, the new unit is said to provide direct readings in *beta*, giving an accurate indication of current gain, not a relative indication. All transistors are automatically biased to standard 1 ma. collector current. The Model 160 makes tests in the

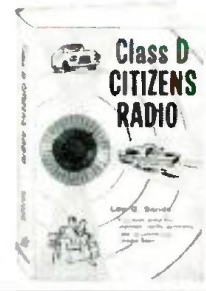


circuit configuration in which most transistors are used. It will provide direct meter readings on shorted, open, and leaky junctions, as well as test gain and leakage current of power

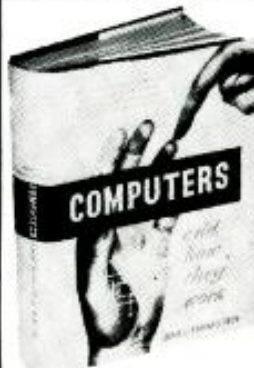
## We'd like to send you these important new books for a 7-day free trial examination

### Class D CITIZENS RADIO by Leo G. Sands

Here is the first complete book on Citizens Radio Operation. Ever since the initial use of 2-way radiotelephone by police departments, this field has been growing in importance and application. Now, with more than a million vehicles equipped for its use, Citizens Radio is a major phase of the electronics field. This important new volume covers every aspect of the field—its history, rules, and everything about how it works—in seven big chapters with one hundred major sections. You'll learn exactly what Citizens Radio is, its applications, what equipment you need, the full story on receiver circuits and transmitters, antennas, installation, and maintenance, full FCC rulings, how to apply for licenses, etc. Many illustrations. **\$4.95**



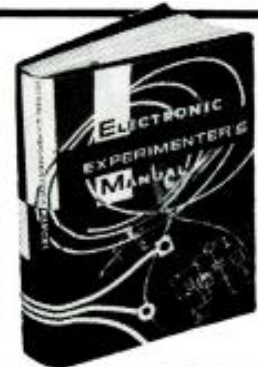
### COMPUTERS AND HOW THEY WORK by James D. Fahnestock



Here is a fact-filled exciting guidebook to the wonderworld of electronic computers, with more than 110 illustrations and easy-to-follow tables in 10 big chapters. Step by step, you'll see and understand the workings of many types of computing machines. This important new book illustrates the basic principles of computers in methods that require no knowledge of electronics. You'll learn all about computer memories, flip-flops and the binary counting system. You'll learn the mathematical language of computers where  $1 + 1 = 10$ . Other chapters show you how computers use tubes and transistors to make complex logical decisions in thousandths of a second. **COMPUTERS AND HOW THEY WORK** is must reading for career minded students and for electronics pros who want a more complete knowledge of this field. **\$4.95**

### THE ELECTRONIC EXPERIMENTER'S MANUAL by David A. Findlay

With a few dollars worth of basic tools, and this book to guide you, you can explore the magic of electronics experimentation more completely than ever before. In a few short hours, you'll start your first project. You'll learn about every component used in experimentation, every tool, its function and why it is used. There are 8 big sections, each covering a specific phase of construction. There is a giant section of projects you can build, test equipment you'll construct and use in your future work. **THE ELECTRONIC EXPERIMENTER'S MANUAL** will give you the professional know-how you must have no matter what phase of electronics is your specialty. **\$4.95**



## 7-DAY FREE EXAMINATION

When your books arrive, read and enjoy their diversity of contents, their thoroughness of coverage. Then after seven days examination, if you decide that they are not everything you want, send them back and receive a complete refund of the purchase price.

### USE THIS CERTIFICATE FOR 7-DAY FREE EXAMINATION

#### ELECTRONICS BOOK SERVICE

434 South Wabash Avenue, Chicago 5, Ill.

Please send me \_\_\_\_\_ copies of **CITIZENS RADIO** and bill me at only \$4.95 a copy plus a few cents postage.

Please send me \_\_\_\_\_ copies of **COMPUTERS AND HOW THEY WORK**, and bill me at only \$4.95 a copy plus a few cents postage.

Please send me \_\_\_\_\_ copies of **THE ELECTRONIC EXPERIMENTER'S MANUAL** and bill me at only \$4.95 a copy plus a few cents postage.

If I don't agree that this is one of the best electronics investments I've ever made, I may return the book(s) within seven days and get a full refund.

\$ \_\_\_\_\_ enclosed. (SAVE MONEY! Enclose payment with your order and we'll pay the postage.)

Name \_\_\_\_\_

Address \_\_\_\_\_

City \_\_\_\_\_

Zone \_\_\_\_\_ State \_\_\_\_\_



ZEW80

**\* RECORDING TAPE**  
Tape Recorders



1200' Acetate (plastic) 1.25  
1200' MYLAR I, 1.85  
1800' Acetate (plastic) 1.75  
1800' MYLAR I, 2.35  
2400' MYLAR (Polyester) 3.49  
(Studies, large sizes even lower)

\*We guarantee not to run off or soak — or damage your tape. Compare ours with other "cheap" tape. You'll find it's more than just "cheap" when you deal with us. We are original manufacturers of the best tape recorders, and our reputation is growing. Send For Free Catalog.

**NORELCO SPEAKERS**

Famous AT-5000M two-cone, 8" speaker, original but to 50, usual NEI 900, NOW available for 4.55 ea. (discontinued model)

Other sensational speaker reductions on a first come, first served basis. Send for speaker specifications sheet.

**COMMISSIONED ELECTRONICS CO.**  
1775 Columbia Road Washington, D. C.

5,000 ohm 20 watt resistors W.W. @ 15c each. Insulated type.

1 mfd— 100 V.D.C. @ 30c each  
1 mfd— 500 V.D.C. @ 50c each  
5 mfd— 600 V.D.C. @ 75c each—oil filled  
1 mfd—1600 V.D.C. @ \$1.10 each  
.005-600 V.D.C. 7 FM mica @ 40c each  
Non-Polarized .01-.005-.002-.01-.1-600V @ 40c each

10 mfd 220-V.A.C. Motor running capacitors (crystals) @ 25c each  
6610,000 K.C., 7580,000 K.C., 7180,000 K.C.  
54P1 Cathode Ray tubes made by Dumont. Brand new @ \$1.00 each  
21 V. Dynamotors, small  
21 V. in 1.0 Amps  
250 V. DC out— 90 Ma. @ \$2.95 each  
Removed from brand new surplus receivers.  
All items F.O.B. Hershey, Pa.

**WILLIARD ELECTRONICS**  
62 East Derry Road Hershey, Penn.

**TWO 3" GALVANOMETERS**—Test Leads. Multiplier Switch in hinged carrying case. G.E. Servo Testmeter. BRAND NEW \$9.95

**X-BAND POWER LEVEL TEST SET, TS-36/AP.** BRAND NEW, in original packing, with accessories. Measures 10 to 30 dbm. 8700-9500 mc. (Acq. cost \$177.00). ONLY \$14.95

**METER—3"—0-5 Ma.** 270° indication. By-Pass Shunt and add scale. Excellent condition. \$1.29

**TELEGRAPH KEY—J 17.** New. \$1.29


**ART-13 TRANSMITTER** with tubes and meters \$29.95

Send M.O. or check with order. Write for Bargain Flyer

**R W ELECTRONICS**  
2430 S. MICHIGAN AVE. DEPT. N  
Phone: Calumet 5-1281 Chicago 16, Ill.

**engineering degree in 27 mos.**

Become an Electronics Engineer. Share rewards awaiting college men . . . higher income, rapid advancement. Important firms visit Tri-State to interview seniors. *Bachelor of Science Degree in 27 months* in Electrical (Electronics or Power major), Mechanical, Civil, Aeronautical, Chemical Engineering. *In 36 months* a B.S. in Business Administration (General Business, Accounting, Motor Transport Management majors). For earnest, capable students. Small classes. More professional class hours. Well-equipped labs. Dorms. Campus. Modest costs. Year-round operation. Enter Sept., Jan., Mar., July. Founded 1884. Write J. H. McCarthy, Director of Admissions, for Catalog and "Your Career" Book.



**TRI-STATE COLLEGE**  
1680 College Ave., Angola, Indiana

**PACKAGE HI FI or SINGLE COMPONENTS**

You'll find our prices low and service fast.

Write for our quotation.

**CENTER ELECTRONICS Co., Inc.**  
74-L Corlandt Street, New York 7, N. Y.

transistors. It also tests tetrodes, automatically providing proper bias for Base 2.

Claimed to be burn-out proof, the Model 160 is supplied with a reference chart listing transistor types, as well as socket and clip leads. For complete information, write to the manufacturer, requesting Bulletin No. 160.

**TINY COMMUNICATIONS SET**  
*General Electric Co., Communication Products Department, Lynchburg, Va.,* has announced a new all-transistor shirt-pocket personal radio communications receiver. Named the "Voice Director," the new set weighs only 12 ounces with battery. It is said to require 35 percent less battery power than previous hand-carried units of its type and, at the same time, boosts audio efficiency. Receiver selectivity and sensitivity is claimed to be comparable to mobile sets many times heavier and larger.

A ferrite-core antenna is built into the receiver's case. The listening "horn" may be clipped to the wearer's lapel. If complete message privacy is desired, an ear-piece may be used. The "Voice Director" operates on a single mercury-cell battery and features a crystal-controlled, superheterodyne FM circuit.



**RANDOM NOISE GENERATOR**  
*H. H. Scott, Inc., Investment Division, 111 Powder Mill Rd., Maynard, Mass.* has introduced a new random noise generator.

Designated as Model 811-B, the new instrument features high, uniform output and a new "pseudo-r.m.s." metering circuit which reads identically on sine waves and white noise.

The 811-B has an output of at least



2.5 volts r.m.s. on all ranges, and response from 2 cps to 1.5 mc. A meter input jack enables its meter to be used for measuring other signals. For complete technical information, write to the manufacturer.

**FILAMENT TESTER**  
*PACO Electronics Company, Inc., Glendale, L. I., N. Y.* has announced its model T-5 Rapid Filament Tester Kit. (model T-5W, factory-wired), a portable battery operated unit for locating tubes with open filaments in series-string receivers. The T-5 also

can be used for making continuity tests of any low resistance electrical circuit.

The device is equipped to check filaments of all tube types directly. A pair of universal connector "minigator" clips are used for connection to non-standard tubes, or tubes whose filaments terminate in other than the usual pins. Continuity is indicated by the glow of a pilot lamp on the panel. The T-5 is operated by two penlite (1.5-volt) cells.

**NEW TOOL KIT**  
*Xcelite, Inc., Orchard Park, N. Y.* has announced a 23-piece "Service Master" tool kit (Model 99SM) that is said to provide every tool required by radio, TV, and electronic technicians on 99% of their calls.

The set, housed in a plastic-coated canvas carrying case, contains 12 snap-in nutdrivers, 3 screwdrivers, 2 reamers, a 7-inch extension blade, long-nose and diagonal pliers, and an adjustable 6-inch thin wrench.

Additional information can be obtained from the manufacturer.

**CITIZENS BAND RIG**  
*Miratel, Inc., 1080 Dionne St., St. Paul 13, Minn.* has announced a new transmitter-receiver for Citizens Band operation.

Designated as Model CR-117, the

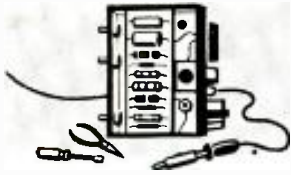


unit includes an 8-tube receiver and 5-tube transmitter. Each has five crystal-controlled channels. The superhet receiver provides an audio output of 5 watts; the transmitter features a front-panel modulation meter. Additional details may be obtained from the manufacturer.

**PHOTO CREDITS**

Page	Credit
30 (top), 31 (top), 32 (left)	C. H. Stoelting Co.
30 (bottom)	Perkin-Elmer Corp.
31 (bottom)	North American Phillips
32 (top right)	Stephenson Corp.
33	RCA Service Company
40	Allen B. DuMont Laboratories, Inc.
54 (left)	CBS
54	NBC
57 (left)	National Aeronautical Co.
57 (top right)	Federal Aviation Agency
58, 59	Lear, Incorporated
63	Milwaukee Road
64 (left)	Electronic Communication Equipment Co.
64 (right)	Motorola Inc.
65 (top right)	Baltimore & Ohio RR
84 (left)	Hi-Fi Supply
84 (right)	University Loudspeakers
85	Dynaco





# ELECTRONICS MARKET PLACE

RATE: 60¢ per word. Minimum 10 words. October issue closes August 10th. Send order and remittance to: Martin Linekin, ELECTRONICS WORLD, One Park Ave., N. Y. C. 16, N. Y.

## FOR SALE

SAMS Photofacts 1 thru 281. With file cabinet \$450, without \$420. Box 205, Mentone, Indiana.

TUBES—Radio & Television. All tubes individually boxed & guaranteed, at manufacturer's prices. Send for free complete tube list & order blank. Your inquiry will put you on our mailing list. Tel-Vue Electronics, 295 Chestnut St., Camden, N. J.

SOMETHING for sale? Place a classified ad in this section. Low-cost, fast results. It's easy.

GOVERNMENT sells: Surplus Electronics; Test Equipment; Oscilloscopes; Transceivers; Jeeps; Boats; Aircrafts; Misc.—Send for U. S. Depot Directory & Procedure \$1.25—"Brody Surplus," Box 425—RT, Nanuet, N. Y.

AUTO Radio Distributor Selling Servicing Becker Blaupunkt, FM-AM, other European, American Sets. Save 30% + Square Electronics, 150-60 Northern Blvd., Flushing, N. Y.

GOVERNMENT Surplus Receivers, Transmitters, Snooperoscopes, Parabolic Reflectors, Picture Catalog 10¢. Meshna, Malden 48, Mass.

TUBES—TV, Radio, Transmitting and Industrial Types at Sensibly Low Prices. New Guaranteed, 1st Quality, Top Name Brands Only. Write for Free Catalog or Call Walker 5-7000, Barry Electronics Corp., 512 Broadway, New York 12N, N. Y.

RADIO & TV Tubes at Manufacturer's prices! 100% Guaranteed! Brand New! No re-brands or pulls! United Radio, Box 1000W, Newark, N. J.

DIAGRAMS for repairing radios \$1.00. Television \$2.00. Give make, model. Diagram Service, Box 672-RN, Hartford 1, Conn.

VECTRON SA20 X-band Spectrum Analyzer. Excellent. \$600. Holliday, 444 Park, Mahtomedi, Minnesota.

TUBES—T.V. and Radio tubes. Guaranteed—Save up to 80%—Write: Emkay Electronics, P. O. Box 142, Blythebourne Station, Brooklyn 19, N. Y.

## WANTED

CASH for used Short-Wave Ham Receivers, Transmitters and Accessories. Tregor, W91VJ, 2023 N. Harlem Ave., Chicago 35C, Tuxedo 9-6429.

WANTED: Military and Commercial laboratory test instruments, communications and broadcast equipment, tubes, etc. Electronicraft, Mt. Kisco, N. Y.

CYLINDER and old disc phonographs. Edison Conqueror, Idelia, and Oratorio models. Berliner Gramophones and Zono-o-phones, Columbia cylinder Graphophones, and coin-operated cylinder phonos. Want old catalogues and literature on early phonos prior to 1919. Will pay cash or trade late hi-fi components. Classified, Box 50, Electronics World, 1 Park Ave., New York 16.

WANT to buy good equipment and accessories? Place a low-cost classified ad in this space.

WANTED: Cash Paid! Sell your surplus electronic tubes. Want unused, Clean radio and TV receiving, transmitting special purpose. Magnetrons, Klystrons, broadcast types. Want military and commercial lab/test equipment such as G.R.H.P., AN/UPM prefix. Also want commercial Ham Receivers and Transmitters. For a Fair Deal write: Barry Electronics Corp., 512 Broadway, New York 12, N. Y. (Walker 5-7000.)

WANTED: Surplus Measurement model 78 or 80 signal generators. Also Federal 804 or used Motorola two-way equipment. State quantity, price, and condition. Communications Service, Inc., 3209 Canton Street, Dallas, Texas.

WE will buy your radio and TV receiving tubes. Must be unused and clean, for top price, write Lukacs, Dept. E, Box 353, Jersey City, N. J.

WANTED: Teletype printers, accessories. Cash or trade for new radio equipment. Alltronic-Howard Co., Box 19, Boston 1, Mass.

WANTED: "I E-17 Test Set." 1219 N. 16, McAllen, Texas.

WANTED: Tubes, Diodes, Transistors. Top prices for Klystrons, Thyratrons, Power, TV, and Receiving Tubes. Must be unused. Wanted: Laboratory-Grade Test

Equipment. Oscilloscopes, Bridges, Signal Generators (microvolts) RF & Audio, Recorders, Etc. Commercial (Hewlett Packard, etc.) and military (TS & UPM prefixes). Write us detailed description. Bob Sanett, WGEX, V & H Radio & Electronics, 2053 Benice Blvd., Los Angeles 6, California.

## RADIO ENGINEERING & INSTRUCTION

ELECTRONICS! Associate degree—29 months. Technicians, field engineers, specialists in communications, missiles, computers, radar, automation. Start September, February. Valparaiso Technical Institute, Dept. N, Valparaiso, Indiana.

ENGINEERING and Art Degrees earned through home study. Electronics, Electrical, Mechanical, Civil, Physics, Business Administration, Accounting, Liberal Arts. When writing, specify course desired. Pacific International College of Arts & Sciences, primarily a correspondence school. Resident classes also carried. 5719-C Santa Monica Boulevard, Hollywood 38, California.

USED Correspondence Courses and Books sold and rented. Money back guarantee. Catalog Free. (Courses Bought). Lee Mountain, Pisgah, Alabama.

AMATEURS, Hi-Fi, electronic fans, expert kit construction, reasonable rates, our work guaranteed, write for complete details. Bailey—K5VTI, Krebs, Oklahoma.

LEARN Code. Qualify for Amateur or Commercial License. Free Book. Candler System, Dept. EW-8, Box 9226, Denver 20, Colo.

## TAPE & RECORDERS

TAPE Recorders, HI-FI Components. Sleep Learning Kits, Tapes. Unusual Values. Free Catalog. Dressner, 69-02R 174 St., Flushing 65, N. Y.

AMPEX, Concertone, Magnecord, Presto, Bogen, Tandberg, Pentron, Sherwood, Rek-O-Kut, Scott, Shure, Dynakit, others, Trades, Boynton Studio, Dept. RT, 10 Pennsylvania Ave., Tuckahoe, N. Y.

RENT Stereo Tapes—over 1,500 different—all major labels—free catalog. Stereo-Parti, 811-L, Centinela Ave., Inglewood 3, California.

LOW Quotes on everything Hi-Fi & Stereo Tapes. Bargain List: HiFi, Dept. E3, Roslyn, Pa.

## HIGH-FIDELITY



INDUCTORS for Crossover Networks. 118 types in stock. Send for brochure. C & M Coils, 3016 Holmes Ave., N.W., Huntsville, Ala.

RECORDERS. Components. Free Wholesale Catalogue. Carston, 125-R East 88, N.Y.C. 28.

PRICES? The Best! Factory-sealed Hi-Fi Components? Yes! Send for free catalog. Audion, 25T Oxford Road, Massapequa, N. Y.

DISGUSTED with "HI" HI-Fi Prices? Unusual Discounts On Your High Fidelity Requirements. Write. Key Electronics, 120 Liberty St., New York 6, N. Y. CLoverdale 8-4288.

## BUSINESS OPPORTUNITIES

FOR Sale—Precision Frequency Measurement, service business in booming Central Florida. Box 753, Maitland, Florida.

MAKE \$25-\$50 Week, clipping newspaper items for publishers. Some clippings worth \$5.00 each. Particulars free. National, 81-DG, Knickerbocker Station, New York.

## SHOPPING GUIDE Classified

A HANDY GUIDE TO PRODUCTS, NOT NECESSARILY ELECTRONIC. BUT OF WIDE GENERAL INTEREST.

### MUSIC

SONGS into Dollars! Share 33 million dollars yearly for New Songwriters, Songpoets. Any subject. Songs composed, published, promoted by largest firm. Information, appraisal Free. Send Nordyke Music Publishers, 6000 Sunset, Hollywood 283, California.

POEMS Wanted for musical setting and recording. Send poems. Free examination. Crown Music, 49-TM West 32, New York 1.

### STAMPS & COINS

GIGANTIC Collection Free! Includes triangles, early United States, animals, commemoratives, British Colonies, high value pictorials, etc. Complete collection plus big illustrated magazine all free. Send 5¢ for postage. Gray Stamp Company, Dept. Z2, Toronto, Canada.

### HELP WANTED

MANUFACTURERS' representatives wanted for rear deck car speaker line. Please state territory covered. Byron Spark King Corporation, 4756 N. Clark St., Chicago 40, Illinois. Phone—Longbeach 1-6860.

HIGH Pay Overseas. Domestic Jobs. Men, Women. Generous Benefits. Companies Pay Transportation. For info, write: World Wide, Dept. E, 149 N. Franklin St., Hempstead, N. Y.

OVERSEAS Employment. American Firms and United States Government. Comprehensive job information \$2.00. Foreign Opportunities, Box 172, Columbus 16, Ohio.

EARN Extra money selling advertising book matches. Free Samples furnished. Matchcorp, Dept. MD-80, Chicago 32, Ill.

### MISCELLANEOUS

"WINEMAKING." "Beer, Ale Brewing." "Cider." Methods, Illustrated. \$3.00. Eaton Books, Box 1242-X, Santa Rosa, California.

KEY Chains, personalized ashtrays, smoke sets. Useful novelties for home, office and gifts. Inexpensive items. Send 10¢ for illustrated brochure. House of Brand, Dept. EW-4, 3458 Fish Avenue, New York 69, N. Y.

BUSINESS Cards \$3.75 Thousand. Postpaid, Free Samples. Imagination, Box 761, Hollywood 28, Calif.

FREE! New 1960 catalog of all photographic books available. For your copy, send postcard with name and address to Catalog Popular Photography Book Service, One Park Ave., New York 16, N. Y.

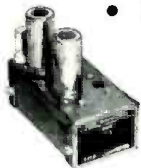
GOLF Clubs Wholesale Free Price List. Crystal Golf Sales, Crystal, Mich.

DIESEL Injector parts and fuel pumps wanted. GM51-53-71-110. 2093 East 19 Street, Cleveland 15, Ohio.

EMBOSSER Business Cards \$3.95 Per 1000 Edward Printing Service, 7430 Selwick Dr., Parma 29, Ohio.

### CRYSTAL CONTROLLED CONVERTERS

- POLICE • FIRE • COMMERCIAL
- CITIZENS' BAND •



For use with  
12 V. Transistor type  
car radios  
26-50 MC  
**\$24.95**

Complete with crystal and tubes. Requires no high voltage supply. Operates on 12 volts DC. Can be self installed in seconds. Other models for 108-162 MC available.

A practical converter for emergency use with powered home or auto sets. Tunable over 12 MC 26-54 MC or 108-174 MC.  
**\$13.95**



Also available crystal controlled up to 54 MC. **\$19.95**

Full line of converters & receivers for every application.

**ORDER TODAY or WRITE for LITERATURE**

### KUHN ELECTRONICS

20 GLENWOOD CINCINNATI 17, OHIO

### POLICE RADIO—30-50 MC

BC-603 FM receivers, brand new, precision converted to cover police, fire, etc. **\$39.95**

Precision converted coil set to convert your BC-603 receiver to cover above services in minutes complete with instructions **\$6.95**

DM 34 12v Dynamotor for BC-603 Receiver **\$4.95**  
Diagrams & Pictorials conversion Kit for BC-603 Receivers **\$2.95**

Raytheon 24TR 2-way radio complete & ready to go in 152-174 MC band **\$19.95**

BC-624 Receivers, 100-157 MC, with squelch & in brand new cond. **\$18.95**

PE-117-C Power Supply for BC-620/659 Two-way unit-6/12 vta., New Boxed **\$10.95**

J-38 Code Keys, Brand new boxed **\$1.29**

ORDERS OVER \$50.00 deduct 10%. All shipments FOB low cost truck line.

### DIAL-FLITE Electronics

P. O. Box 1134 Salisbury, N. C.

## ELECTRONICS

PREPARE FOR A GOOD JOB!  
BROADCAST ENGINEER  
RADIO SERVICING AUTOMATION

TELEVISION SERVICING  
BLACK & WHITE—COLOR

APPROVED FOR VETERANS AND SURVIVORS  
OF VETERANS  
BUILDING AIR CONDITIONED  
SEND FOR FREE LITERATURE

BALTIMORE TECHNICAL INSTITUTE  
1425 EUTAW PLACE, BALTIMORE 17, MD.

## TAPE RECORDERS



HI-FI COMPONENTS  
SLEEP LEARN KITS

MERITAPE Low cost, high quality recording tape, in boxes of 500 or 1000.  
UNUSUAL VALUES FREE 1960 Catalog or card.  
DRESSNER, 69-02 RA, 174 St., Flushing 65, N.Y.



### OUT OF SPACE?

You bet we'd be... if we were to tell you all about AUDION'S "Out of this World Hi Fi Values"

Write for free Catalog

**audion**  
25-W Oxford Road  
Massapequa, New York



-- then you need us!

GET STARTED RIGHT by writing for FREE 8 page catalog illustrating over 30 business forms and systems designed specifically for TV-Radio Service.

ON SALE AT YOUR PARTS JOBBER

Delrich Publications • 4308 N. Milwaukee • Chicago 41, Ill.

## INDEX OF

# Advertisers

AUGUST  
1960

ADVERTISER	PAGE NO.	ADVERTISER	PAGE NO.
Aerovox Corporation	8	Miller Company, J. W.	83
Airex Radio Corporation	79	Milwaukee School of Engineering	86
Aiwa Co. Ltd.	14	Moss Electronic, Inc.	92, 93
Allied Radio Corp.	7	National Radio Institute	1
Ashe Radio Co., Walter	102	National Schools	25
Audio Unlimited	122	Newcomb Audio Products Co.	77
Audion	130	North American Philips Co., Inc.	79
B & K Manufacturing Co.	67	Oelrich Publications	130
Baltimore Technical Institute	130	Ohmatsu Electric Co. Ltd.	102
Barry Electronics Corp.	125	Olson Radio Corporation	81
Candee Co., J. J.	123	Peak Electronics Company	80
Capitol Radio Engineering Institute, The	16, 17, 18, 19	Pickering & Co., Inc.	81
Carston Studios	114	Picture Tube Outlet	124
Center Electronics Co., Inc.	128	Premier Electronics	81
Centralab	24	Quietrol Company, Inc.	115
Channel Master	THIRD COVER	RCA Institute, Inc.	10, 11
Chickasha Electronics, Inc.	125	R W Electronics	128
Cleveland Institute of Electronics	23	Rad-Tel Tube Co.	103
Columbia Electronics	122	Radio Corporation of America	4, 5, 95, FOURTH COVER
Commissioned Electronics Co.	128	Radio Shack Corp.	112
Coyne Electrical School	79	Rider Publisher, Inc., John F.	115
DeVry Technical Institute	3	Rinehart & Co., Inc.	6
Dial-Flite Electronics	130	Sams & Co., Inc., Howard W.	74, 75
Dressner	130	Sarkes Tarzian, Inc.	99
EICO	27, 28, 111	Schober Organ Corp., The	22, 112
Electronic Chemical Corp.	83	Sherwood Electronic Laboratories, Inc.	26
Electronic Organ Arts	110	Shure Brothers, Inc.	123
Electronics Book Service	105, 106, 107, 108, 127	Sonotone Corp.	78
Fair Radio Sales	90	Standard Coil Products Co., Inc.	15
G & G Radio Supply Co.	87	Standard Surplus	94
Grantham School of Electronics	13	Superscope, Inc.	91
Greenlee Tool Co.	110	Sylvania Electric Products, Inc.	SECOND COVER
Hallicrafters	83	TV Servicing	124
Heath Company	68, 69, 70, 71	Teltron Electric Co.	119
Henshaw Radio Supply	122	Texas Crystals	121
Hi Fidelity Center	114	Tri-State College	128
Hi-gain Antenna Products	120, 121	Tru-Vac Electric Company	98
Indiana Technical College	124	University Loudspeakers, Inc.	9
International Crystal Mfg. Co., Inc.	20	Valparaiso Technical Institute	123
Jerrold Electronics Corporation	12	Vanguard Electronic Labs.	123
Key Electronics Co.	114	Warren Dist. Co.	124
Kuhn Electronics	130	Weston Instruments Division	101
Lafayette Radio	89	Williard Electronics	128
Lampkin Laboratories, Inc.	125		
Lektron	90		

NEW ILLUMINATED DEALER SIGNS!

# pick

the one for your store!



14" x 50" with clock and changeable copy panel

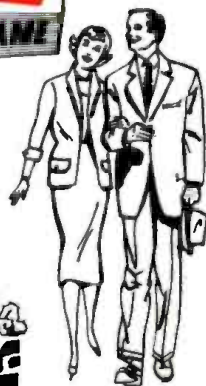
14" x 37" with changeable copy panel



ALL THREE SIGNS IN BRILLIANT BLUE AND RED ON A WHITE BACKGROUND



Double-faced 3' x 6'  
Deluxe outdoor sign



Channel Master's big, bright spectaculars increase your sales. Day and night, they:

- IDENTIFY YOU IMMEDIATELY AS A CHANNEL MASTER DEALER
- STIMULATE STORE TRAFFIC
- HELP YOU CAPITALIZE ON CONSUMER PREFERENCE FOR CHANNEL MASTER PRODUCTS
- ADD TO THE APPEARANCE OF YOUR STORE

Call your Channel Master distributor today

NOW'S THE TIME TO GET IN ON

# RCA's giant new sales promotion program for SILVERAMA PICTURE TUBES

**THE BIGGEST, MOST COMPREHENSIVE PICTURE TUBE PROMOTION IN THE INDUSTRY!**

Here at last is the all-in-one picture tube promotion program you have been waiting for! Five strong sales-building elements in a single package put you ahead of competition, help you reap greater profits by selling RCA Silverama Picture Tubes.

Silverama, as you know, is RCA's all-new premium tube that can command premium price and profit on every sale!

**PROMOTE YOUR SERVICES BY ANY MEDIUM YOU CHOOSE—**



**1**  
**BILLBOARD POSTERS**

Full-color billboard posters in 6- or 24-sheet size with space for your imprint to link your name with the most trusted name in television: RCA.



**2**  
**FILMED TV COMMERCIALS**

30- and 60-second spots with open end for your name. The first filmed TV commercials by a major manufacturer designed for dealer use.



**3**  
**RECORDED RADIO COMMERCIALS**

Pre-recorded 30-second and 60-second open-ended spots let you reach your customers at home, out-of-doors, in cars, everywhere!



**4**  
**NEWSPAPER AD MATS**

Seven different mats with space for your name allow you to take advantage of a consistent, well integrated newspaper advertising campaign.



**5**  
**PROMOTION AND DIRECT MAIL**

Window streamers, sales promotional postcards, miniature billboards, consumer literature, all to augment your other promotion activities.

**ALL BACKED BY RCA'S HEAVY NATIONAL ADVERTISING CAMPAIGN IN TV GUIDE AND ON NETWORK TV**

Check with your Authorized RCA Tube Distributor NOW for full facts on this exciting new program.  
RCA Electron Tube Division, Harrison, N. J.



The Most Trusted Name in Television  
RADIO CORPORATION OF AMERICA

