

JANUARY, 1960

# ELECTRONICS WORLD

Formerly

**RADIO  
& TV NEWS**

*Rush Lynch  
CB PH*

50  
CENTS

## SPECIAL FEATURE

### Room Acoustics for Stereo

*The first of an important series on the effects of room acoustics on hi-fi reproduction in the home.*



**AIR TRAFFIC CONTROL IN  
THE JET AGE**  
(See page 37)

PHILADELPHIA 33 PA  
2244 N 10TH ST  
SAMUEL SACHS  
RNB871830



from the  
audio research center  
of the world



# HI-FI COMPONENTS

developed and guild-crafted by  
Philips of the Netherlands

**Norelco**

## FULLY AUTOMATIC 4-SPEED STEREO RECORD CHANGER

MODEL AG 1024 — AG1124

A rugged, versatile, low cost record changer offering years of dependable and trouble-free stereophonic or monophonic reproduction ♦ both manual and automatic operation ♦ 4 speeds ♦ automatic 7", 10" and 12" record intermix ♦

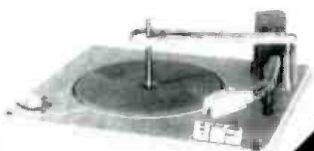

## STEREO- PLAYBACK VERSION

MODEL EL3516/G53

Provides every feature of the world-famed original monaural 'Continental' Model EL3516—plus stereophonic playback and mixing facilities for monaural recording.

Add the matching Stereo Companion Piece, Model SCP-1 (to your Norelco EL3516/G53) and you have the all important "second voice for completely self-contained stereophonic playback.

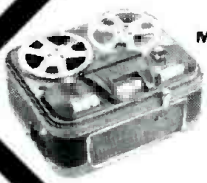

## Norelco "CONTINENTAL" TAPE RECORDERS

Music lover, recordist, high fidelity enthusiast... there's a professional quality "Continental" tape recorder ideally suited to your specific recording requirements.

- ♦ SIMPLE PIANO KEY CONTROLS
- ♦ THREE SPEEDS: 7½, 3¾ AND 1⅝ I.P.S.
- ♦ FULL FREQUENCY RECORDING... BROADCAST FIDELITY PLAYBACK
- ♦ SPECIAL NARROW-GAP HEADS (0.0002 IN.) FOR EXTENDED FREQUENCY RESPONSE
- ♦ SELF-CONTAINED WITH DYNAMIC MICROPHONE AND WIDE RANGE NORELCO LOUDSPEAKER
- ♦ EASILY PORTABLE... RUGGED... STYLED BY THE CONTINENTAL'S TOP DESIGNERS
- ♦ CAN ALSO BE PLAYED THROUGH EXTERNAL HI-FI SYSTEM

**NEW**



## THE CONTINENTAL "400" 4-TRACK STEREO RECORD/PLAYBACK

MODEL EL3536

♦ four-track stereophonic recording and playback ♦ four-track monophonic recording and playback ♦ self-contained including dual hi-fi preamps, recording and playback amplifiers and Norelco wide-range loudspeaker ♦ compatible with conventional pre-recorded tapes ♦ can also be used as a conventional self-contained phono/P.A. amplifier and speaker system.

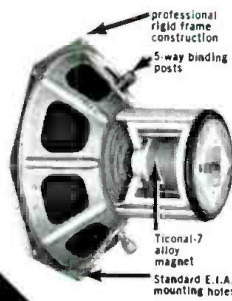

THE  
**T-7**  
LINE

A NEW LINE OF **Norelco**  
5"-12" LOUDSPEAKERS  
FEATURING NEW  
**TICONAL VIII**  
MAGNETS (30%  
more powerful  
than alnico)

## ORIGINAL MONAURAL VERSION

MODEL EL3516

Still the greatest buy in a monaural tape recorder... the favorite of the nation's schools, and voice and music teachers... regarded as the world's most advanced, most versatile, all-in-one, portable tape recorder.

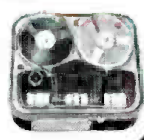

**Norelco**

## 'EXHIBITION' SPEAKER ENCLOSURES

Acoustically designed to achieve moderate size without loss of bass response or wideness of dispersion. Characterized by compact size... outstanding performance... and beautifully styled and handcrafted workmanship. Perfectly matched for the bass response of the new NORELCO T-7 speakers... ideal for most other quality 8" to 12" speakers. Available in 3 sizes in beautiful, hand-rubbed Mahogany, Walnut, Blond or Cherry finishes. "Van Gogh" and "Vermeer" models can be used either vertically or horizontally.



The "HAGUE": Completely integrated quality speaker system. Incorporating two high-efficiency T-7 NORELCO loudspeakers in acoustically matched enclosure. Designed for optimum dispersion... maximum efficiency... extremely wide-range, flat response... and that unexaggerated "European," clean sound. **FOR FURTHER DESCRIPTIVE LITERATURE WRITE TO:** 230 Duffy Avenue, Hicksville, L. I., N. Y.



**NORTH AMERICAN PHILIPS CO., INC.**  
High Fidelity Products Division



You asked for more!  
Since introduction of the  
Duals, demand has been  
so great we've extended these  
famous speakers into 6" x 9"  
and 15" sizes as well as  
the 8's and 12's!

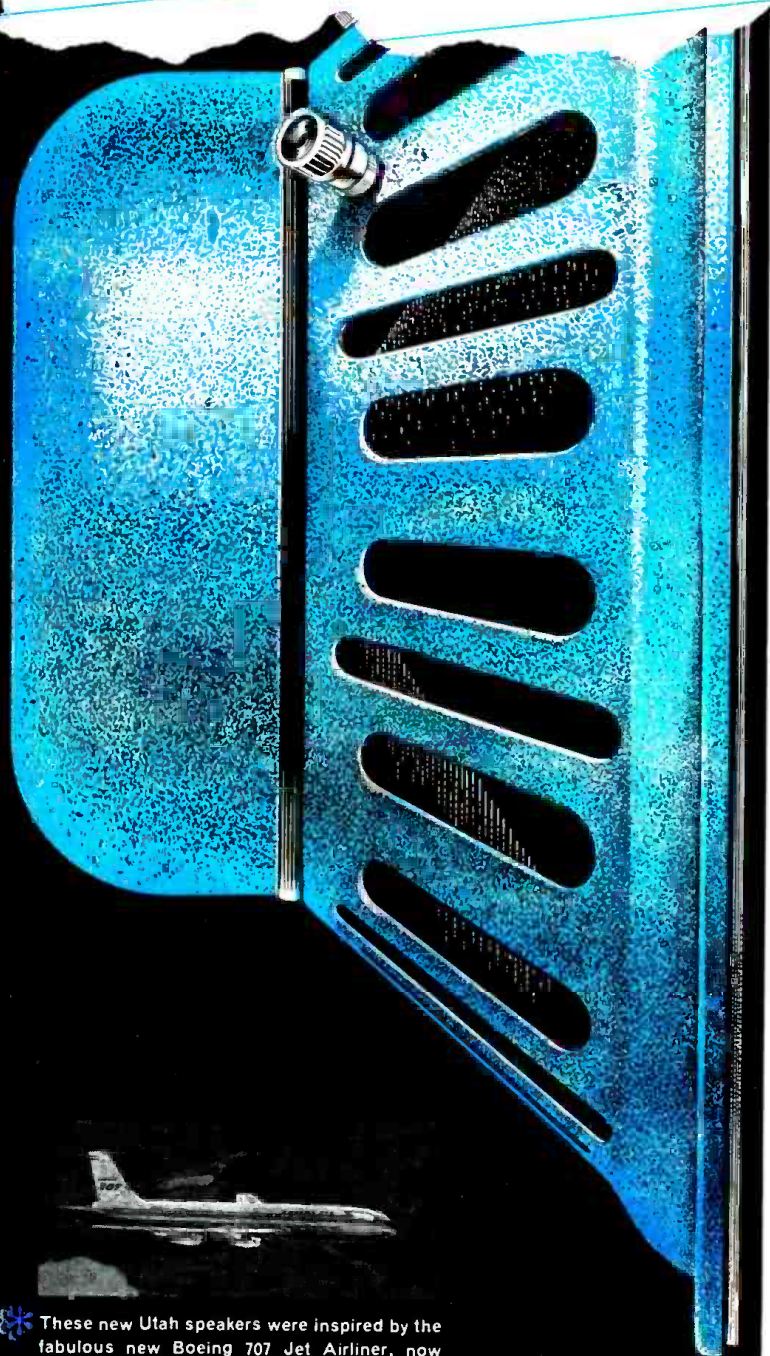

# MORE POWER PER POUND

in the  
ALL-NEW

# UTAH\*

**dual-diameter  
speakers**

... Never before such *concentrated power!* The secret is in Utah's brand new dual-diameter magnetic circuitry and dynamic Uni-coils. By ingeniously combining two magnetic material structures into one, Utah has produced the greatest power per pound in a loud-speaker since the advent of Alnico V. See the all new Utah speakers now — 8" full range model D8LA and 12" full range model D12LA — they're as "hot" as a Jet Airliner!

\* These new Utah speakers were inspired by the fabulous new Boeing 707 Jet Airliner, now streaking coast to coast in just 4½ hours! Utah speakers, too, pack more power per pound, feature Jet Airliner slim-line design to meet modern demands for more compact Stereo and High Fidelity applications.

**Utah**  
SPEAKERS 

Utah Radio & Electronic Corp., Huntington, Ind.

# ELECTRONICS WORLD

JANUARY, 1960  
VOL. 63 ■ NO. 1

**Publisher**  
**OLIVER READ, D. Sc., WIETI**

*First in radio-television-audio-electronics*

**Editor**  
**WM. A. STOCKLIN, B. S.**

## CONTENTS

**Technical Editor**  
**MILTON S. SNITZER, W2QYI**

### ELECTRONICS—GENERAL

**Service Editor**  
**SIDNEY C. SILVER**

Industrial Electronics (Editorial).....	W. A. Stocklin	8
Spot News .....	Washington Correspondent	32
Air Traffic Control by Electronics.....	James A. Niland	37
Recent Developments in Electronics.....		42
The Photomultiplier and Its Uses.....	Ed Bukstein	84
Calendar of Events.....		135
Product Report (ELECTRONICS WORLD Lab Tested).....		145
Micro-Circuits for Miniaturization.....		150

**Associate Editor**  
**P. B. HOEFER**

**Assistant Editor**  
**J. JUSTER**

**Industrial Consultant**  
**WALTER H. BUCHSBAUM**

### HIGH FIDELITY AND AUDIO

**Art Editor**  
**MILTON BERWIN**

High-Fidelity Anagram.....	John A. Comstock	30
Room Acoustics for Stereo—Basic Principles (Part 1).....	Abraham B. Cohen	44
Extended Stereo System.....		50
New Hi-Fi Amplifier Standards.....	Milton S. Snitzer	51
Dual 20-Watt Amplifier Kit (ELECTRONICS WORLD Lab Tested).....		60
Hi-Fi Applications of New Triode-Pentode.....	Wayne Austin	64
Transistors or Tubes for Mobile P.A. Systems.....	Samuel Curchack	66
Some Thoughts on Amplifier Design.....	Stewart Hegeman	69
Hi-Fi—Audio Product Review.....		88
Sound on Tape.....	Bert Whyte	116
Certified Record Revue.....	Bert Whyte	122

**Art and Drafting Dept.**  
**J. A. GOLANEK**  
**A. J. LICHOTA, JR.**  
**K. W. PAUL, JR.**

**Advertising Director**  
**JOHN A. RONAN, JR.**

**Advertising Manager**  
**GEORGE E. MORRISSEY**

**Midwest Adv. Manager**  
**W. ROBERT WOLFE**

**Western Adv. Manager**  
**DON CENA**

### TELEVISION-RADIO

What Set Owners Think of Service.....		48
Horizontal Deflection Circuits.....	Kenneth Bramham	52
How a Pool Telecast Works.....	Richard H. Moss	54
Direct Mail Promotion for Service.....	William Leonard	57
Do You Know Enough About Capacitors?.....	Sol Heller	62
Mac's Service Shop.....	John T. Frye	68
"Grounds" for Confusion.....	Robert Gary	70
Service Notes .....		82
A New Antenna Rotator.....	Harry Greenberg	112
Service Industry News.....		128
Transistor Radio Circuits (Part 3).....		132

### TEST EQUIPMENT

Wide-Band A.C. Millivoltmeter.....	Lyle E. Sharpe	58
The Resonance Meter.....	Joseph L. Reiffin, W5CWP	94

### AMATEUR AND COMMUNICATIONS

A "Rush Suppressor" for Citizens Radio.....	James D. Green	41
Meteor Burst Communication System.....		114

### DEPARTMENTS

Letters from Our Readers.....	16	What's New in Radio.....	142
Within the Industry.....	24	Manufacturers' Literature.....	148
Technical Books.....	158		

Net Paid Circulation 242,396

Radio & TV News • Radio News • Television News Trademarks Reg. U. S. Pat. Off.  
Copyright © 1959 by Ziff-Davis Publishing Company. All rights reserved.

**SUBSCRIPTION SERVICE:** Forms 3579 and all subscription correspondence should be addressed to Circulation Department, 434 South Wabash Avenue, Chicago 5, Illinois. Please allow at least four weeks for change of address. Include your old address as well as new—enclosing if possible an address label from a recent issue.

**CONTRIBUTIONS:** Contributors are advised to retain a copy of their manuscripts and illustrations. Contributions should be mailed to the New York Editorial Office and must be accompanied by return postage. Contributions will be handled with reasonable care, but this magazine assumes no responsibility for their safety. Any copy accepted is subject to whatever adaptations and revisions are necessary to meet the requirements of this publication. Payment covers all author's, contributor's, and contestant's rights, title, and interest in and to the material accepted and will be made at our current rates upon acceptance. All photos and drawings will be considered as part of the material purchased.



**ZIFF-DAVIS PUBLISHING COMPANY**  
William Ziff, President; W. Bradford Briggs, Executive Vice-President; Michael Michaelson, Vice-President and Circulation Director; Marshal B. Sarbin, Vice-President; J. L. O'Donnell, Treasurer.

Editorial and Executive Offices  
One Park Avenue  
New York 16, N. Y. OR. 9-7200



**BRANCH OFFICES:** Midwestern Office, 434 S. Wabash Ave., Chicago 5, Ill.; Western Office, 215 W. 7th St., Los Angeles 14, Calif.; James R. Pierce, manager.

**FOREIGN ADVERTISING REPRESENTATIVES:** D. A. Goodall Ltd., London; Albert Milhado & Co., Antwerp and Dusseldorf.

**ELECTRONICS WORLD**



6-5-4-3-2-1...

DON'T LET TIME RUN OUT ON YOUR BIG CHANCE

to Prepare At Home for a Profitable Job in

# Electronics

Guided Missile Control—Radar—TV—Radio, etc.

**NO ADVANCED EDUCATION NEEDED!**

A breath-held hush! Dramatically the cold voice completes the count-down: "... 3 ... 2 ... 1 ..." And with a mighty roar, a missile rises from its launching pad, picking up speed that quickly lifts it out of sight. Another rocket thunders into space ... a triumph of ELECTRONICS and ASTRONAUTICS. You may have a future in this fascinating field—with DeVry Tech's help. You—if you are 17-55—can train at home in your spare time. You, may be in that picture some day—a trained man with a fascinating job, a good future, making real money. You, as an electronic technician, can back the men who launch the missiles!

With DeVry's thorough training, you get on-the-job type of know-how. You handle tools, you build and operate instruments. You learn by following clear-cut directions, by viewing training movies AT HOME! It's thorough. It's proved. Get into this exciting field without taking your feet off the ground. Send the coupon NOW for details.



## TRAIN IN CHICAGO OR TORONTO LABORATORIES

Full time day and evening training programs in our well-equipped Chicago and Toronto Laboratories are also available.

## EMPLOYMENT SERVICE

helps you get started toward a good job or your own service shop when you complete the program.



### CHECK THESE EXCITING JOB OPPORTUNITIES!

Communications Technician • Computer Specialist  
Remote Control Operator • Instrument Technician  
Radar Man • Micro-Wave Technician • TV-Radio Specialist . . . PLUS MANY OTHERS

## **DeVry TECHNICAL INSTITUTE**

4141 Belmont Avenue, Chicago 41, Illinois  
ACCREDITED MEMBER OF NATIONAL HOME STUDY COUNCIL



### GET THIS FREE BOOKLET!

A copy of "ELECTRONICS IN SPACE TRAVEL" is yours for the asking. Mail the coupon NOW. See for yourself how YOUR future may fit into this exciting field.

No Previous Technical Experience Needed!

## MAIL COUPON TODAY!

DeVRY TECHNICAL INSTITUTE 2070  
4141 Belmont Ave., Chicago 41, Ill., Dept. EW-1-G

Please give me a FREE copy of "Electronics in Space Travel" and tell me how I may prepare for a start in the Electronics field.

Name \_\_\_\_\_ Age \_\_\_\_\_  
Please Print

Address \_\_\_\_\_ Apt. \_\_\_\_\_

City \_\_\_\_\_ Zone \_\_\_\_\_ State \_\_\_\_\_

Check here if you face military service.

Canadian residents address DeVry Tech of Canada, Ltd.,  
626 Roselawn Ave., Toronto 12, Ont.

DAVE GARROWAY  
"Today"  
NBC-TV

JOHN PAYNE  
"Restless Gun"  
ABC-TV

GALE STORM  
"The Gale Storm Show"  
ABC-TV

BOB CUMMINGS  
"Love That Bob"  
ABC-TV



# "4 STARS" for the CHANNEL MASTER® T-W

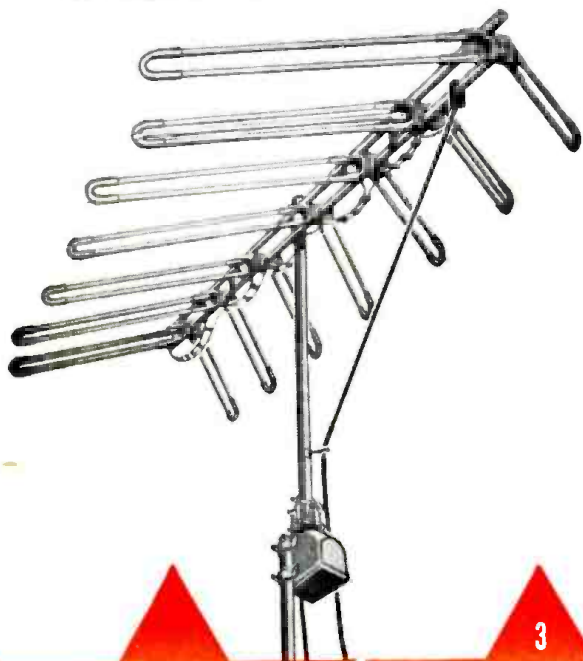

"4 STARS" — recognized symbol for superb performance.

"4 STARS" — going all-out to help you sell more antennas.

Who doesn't recognize these top-rated TV stars? Their audience numbers millions. And hard-hitting commercials are telling these millions... over and over again... to replace their old, worn-out antennas with the powerful Channel Master T-W.

On network TV... in the top farm publications... in best-selling mass magazines... Channel Master is using the power of *all-out National Advertising* to help you do a bigger, MORE PROFITABLE, antenna installation business.

That's why it makes good sense for you to promote and install the Channel Master T-W... the one antenna that has never been equalled for brilliant performance and rugged construction.

FULL  
NETWORK  
TV

3  
TOP  
FARM  
PUBLICATIONS

2  
BEST-SELLING  
GENERAL  
MAGAZINES

NEW  
DISPLAY  
POSTERS

FOUR TOP SHOWS  
2 MAJOR TV  
NETWORKS  
210 TV STATIONS

The Progressive Farmer  
Successful Farming  
Farm Journal

The Saturday  
Evening Post  
Coronet



Available from your Channel Master distributor.

**CHANNEL MASTER** works wonders in Sight and Sound



# CHANNEL MASTER advertising works 'Round the Clock

...to make friends and customers for the full line of Channel Master products.

Aluminum and Steel Mastjng

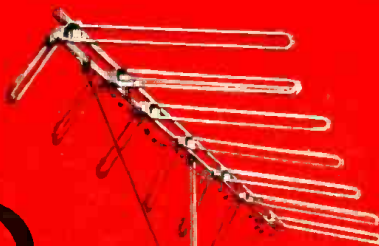

Indoor and outdoor antennas



2-set couplers



TV, Wire



Inglators, mounts, and hardware



Transistor radios



Electron Tubes



Stereo turntable



Minstrel Speakers



High Fidelity Amplifiers



Automatic and compass rotators



AM/FM Tuner

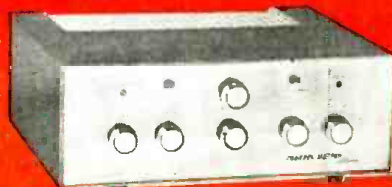

Get the profit story. Call your Channel Master distributor today.

CHANNEL MASTER CORP ELLENVILLE, N. Y.

Operate your...

- tape recorder
- P. A. system
- portable TV set
- hand tools

FROM YOUR CAR, Boat or Plane!

with

**ATR**

**INVERTERS**



for changing your storage battery current to A.C. HOUSEHOLD ELECTRICITY Anywhere... in your own car!



**OPERATES**  
PORTABLE TV SET  
directly from your car!

**OPERATES**

- RADIOS
  - RECORD PLAYERS
  - MIXMASTERS, ETC.
- directly from your car!



MAKE YOUR CAR, BOAT OR PLANE  
"A ROLLING OFFICE!"



**OPERATES**

- TAPE RECORDERS
  - DICTATING MACHINES
  - PUBLIC ADDRESS SYSTEMS
  - ELECTRIC SHAVERS
- directly from your car!



mounted out of sight under dash or in trunk compartment

**ATR UNIVERSAL INVERTERS**

Especially designed to change 6 or 12 volt D.C. to 110 volt A.C. 60 cycles.

for...

- EXECUTIVES
- SALESMEN
- OUTDOOR MEN
- POLICEMEN
- REPORTERS
- FIREMEN
- PUBLIC OFFICIALS

MODELS 6U-RHG (6 volts) 125 to 150 watts. Shipping weight 27 lbs. List Price.....\$99.50  
DEALER NET PRICE.....\$66.34

12U-RHG (12 volts) 150 to 175 watts. Shipping weight 27 lbs. List price.....\$99.50  
DEALER NET PRICE.....\$66.34

Write for literature on other Sizes and Models of ATR INVERTERS, priced as low as \$11.95 list.

SEE YOUR JOBBER OR WRITE FACTORY

- ✓ NEW MODELS ✓ NEW DESIGNS ✓ NEW LITERATURE
- "A" Battery Eliminators • DC-AC Inverters • Auto Radio Vibrators

**ATR**

AMERICAN TELEVISION & RADIO CO.  
Quality Products Since 1931  
SAINT PAUL 1, MINNESOTA, U. S. A.

...for the Record

By W. A. STOCKLIN  
Editor



## INDUSTRIAL ELECTRONICS

INDUSTRIAL electronics seem to be "magic words" today. No matter where one looks—magazines, newspapers, etc.—one will find articles, promotion pieces, and even ads concerning the part played by service and maintenance personnel in the field of industrial electronics.

It is gratifying, in a sense, to feel that *ELECTRONICS WORLD* may have played some part in stimulating this interest. Why so many other publications have jumped on the bandwagon so late is rather hard to understand since it is not a field of interest that has developed overnight. Actually, the servicing and maintenance of electronic equipment could be readily foreseen directly after World War II in the increased development of computers and data processing equipment for business applications, along with the startling advances in all forms of telemetering equipment.

We at *ELECTRONICS WORLD* have been fully aware of the rapid growth in this field, not only as it pertains to dollar volume covering initial equipment sales and salaries but in the total cost of replacement parts. The trend was obvious and, as a result, *ELECTRONICS WORLD* has published many articles covering the industrial applications of electronics. Just to highlight a few that appeared this past year: "Industrial Tubes & Their Uses," "Ultrasonics—and its Uses," "Infrared—A New Field of Electronics and Optics," "Induction Heating," "Dielectric Heating," etc.

In the case of circuit diagrams, troubleshooting techniques, and test procedures, these are unique with each individual piece of equipment and, since most of this information is made available to service technicians through service manuals or direct special training programs on the part of initial equipment manufacturers, we have not attempted to cover this aspect. Our goal is to provide information on industry-wide techniques and to cover applications and theory of operation in such a way that every technician obtains a much broader picture of the specific industry in which he is em-

ployed at present or in the future.

For a service or maintenance technician to be considered qualified in his field, it is our belief that he should know not only basic service techniques but should be an authority in the field in which he operates—an authority not necessarily in the sense that he is an engineer and could design equipment, but a person who can talk intelligently about the various phases of the industry itself.

No one has any specific figures on the number of men who service and maintain industrial equipment. Our guess is that the number is between 35,000 and 50,000. We know, for example, that *RCA* alone has some 3000 technicians at Cape Canaveral for servicing and maintaining equipment. Many other manufacturers have similar groups at the Cape. of 100 men each month to this force.

*IBM*, as another example, has some 9000 field technicians on the payroll whom they refer to as "repairmen customer engineers." *Remington-Rand* has some 1700 maintenance men and their present plans call for the addition

It is interesting to note that whereas the radio and TV service technician is an independent operator, the industrial service technician is not. The latter is usually employed by the original equipment manufacturer; however, some plants that have a considerable amount of electronic equipment find it more advantageous to have their own service and maintenance departments.

Another extremely important point of interest is that the industrial technician is not concerned directly with cost. His chief function is maintenance of equipment in use and to develop better customer-manufacturer relations. Since most companies refer to these men as field engineers or customer engineers, they initially carry the prestige that goes with such a title. They must, however, earn this prestige, and only by continued professional service can they command the respect due them. It is our goal to continue keeping them abreast of developments in their field so that they can be true professionals.

-30-

ELECTRONICS WORLD



**FREE**

# ALLIED'S 1960

## ELECTRONIC SUPPLY CATALOG

*it's value-packed...  
send for it!*

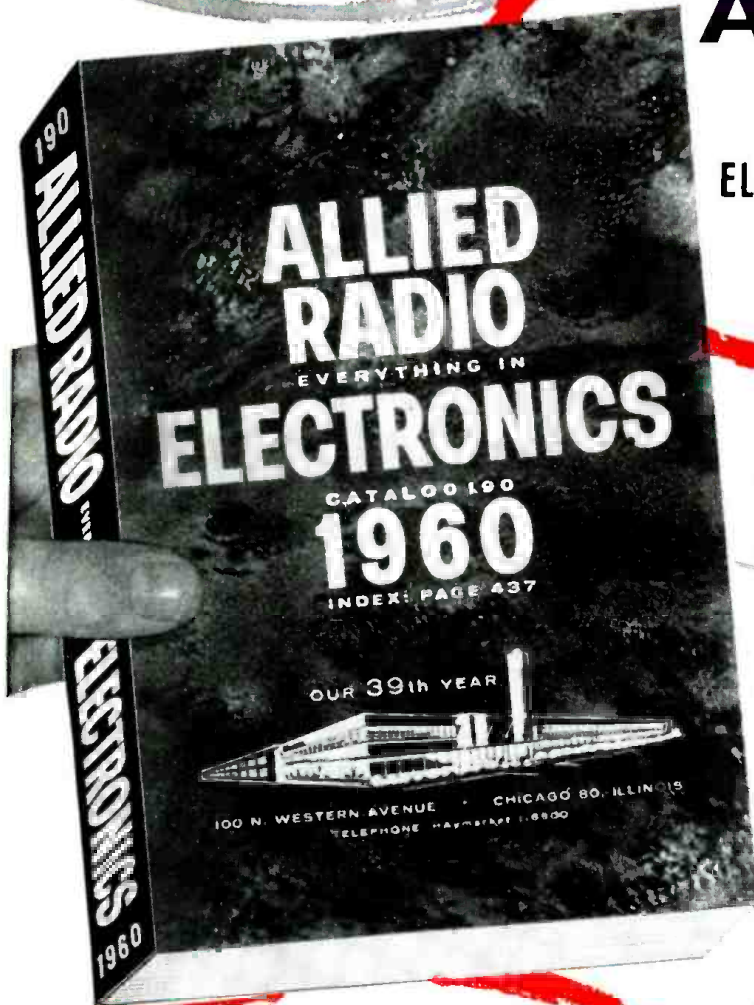

*your complete money-saving  
guide to everything in electronics*

### WORLD'S LARGEST STOCKS

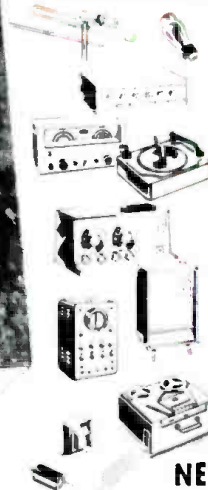

- Latest Stereo Hi-Fi Systems—Everything in Hi-Fi Components
- Money-Saving, Build-Your-Own KNIGHT-KITS for Every Need
- Values in Recorders and Supplies
- Latest Public Address Systems, Paging and Intercom Equipment
- Amateur Receivers, Transmitters and Station Gear
- Test and Laboratory Instruments
- TV Tubes, Antennas, Accessories
- Huge Listings of Parts, Tubes, Transistors, Tools, Books

*featuring  
these ALLIED exclusives:*

**MONEY-SAVING KNIGHT-KITS**®—the very best in build-your-own electronic equipment—designed to save you up to 50% "Convenience Engineered" for easiest assembly; the only kits covered by Money-Back Guarantee. Complete selection of Stereo hi-fi kits, Hobbyist kits, Test Instrument and Amateur kits. KNIGHT-KITS are an exclusive ALLIED product.

**KNIGHT® STEREO HI-FI**—truly "honored for value"—the best you can buy, yet far lower in cost. Select super-value KNIGHT components or complete systems and save most. Also see the world's largest selection of famous name hi-fi components and money-saving ALLIED-recommended complete systems.

**NEW LOW EASY PAY TERMS**  
Only \$5 down (or less) on orders up to \$200. Up to 24 months to pay.  
Fast handling—no red tape.

Get every buying advantage at ALLIED: lowest money-saving prices, fastest shipment, expert personal help, guaranteed satisfaction...

*send for the leading  
electronic supply guide*

**FREE**

ALLIED RADIO CORP., Dept. 1-A  
100 N. Western Ave., Chicago 80, Ill.

Send FREE 1960 ALLIED Catalog.

Name \_\_\_\_\_

Address \_\_\_\_\_

City \_\_\_\_\_ Zone \_\_\_\_\_ State \_\_\_\_\_

## ALLIED RADIO



*our 39th year*  
World's Largest Electronic Supply House

# HOW TO BUILD A STEREO CONSOLE THAT REPRODUCES MUSIC AS FAITHFULLY AS SEPARATELY MOUNTED COMPONENTS

For many years, serious music lovers have searched for a way to enclose high quality high-fidelity equipment in a cabinet that would match their finest furniture.

Until now, there was no practical solution. You had to compromise. You had to sacrifice the best possible music reproduction if you wanted a good looking cabinet. If you insisted on high quality reproduction, you chose components, some of which may not have been quite so appealing to the eye.

If you dislike compromise, Stromberg-Carlson's new kind of console will interest you. We call them Integrity Series Component Ensembles—and to an uncompromising music lover each word in that name will be significant.

At the start, we faced the same problem that every console manufacturer has tried to overcome: when full-range speakers were rigidly mounted in the same console as high quality components, there was a serious loss of sound quality.

This loss—most often recognized as muddy or boomy noise—is caused by “feedback.” It occurs because sensitive components can detect the speaker vibrations which are fed back through the body of the cabinet. These vibrations are amplified with the music and reproduced as noise.

If you own a console now, but do not hear these noises, it is not because your ears are insensitive.

You do not hear them because we and every other console manufacturer had to eliminate them by compromising the musical reproduction of your console. You do not hear them because the sound you hear is not complete.

## HOW TO BUILD A CONSOLE THAT ELIMINATES FEEDBACK NOISES

As we analyzed the problem, we realized there were seven projects that we had to accomplish before

we could bring you this new kind of console.

**PROJECT #1** The first consideration was given to our components. They had to have high quality reproduction. The standards we set for them can be most simply described by the phrase “Integrity in Music Reproduction.” If you are familiar with Stromberg-Carlson stereo tuners, amplifiers, turntables and speakers, we believe you will agree they earn this description.

**PROJECT #2** Speaker systems were the next important project. For our new kind of stereo console we needed two speaker systems of unquestionable quality. We were fortunate here, because we

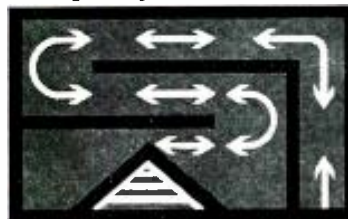

had already developed a system that met the quality requirements, the well-regarded Acoustical Labyrinth® Speaker System. Its quarter

wavelength duct enclosure, properly coupled to a low-frequency radiator, achieved a system resonance lower than the un baffled free air cone resonance of the radiator itself. This is the kind of quality we knew you wanted.

**PROJECT #3** To reduce the size of high quality speaker systems so that they would fit into a stereo console of reasonable dimensions. We were certain that component-quality sound in a console could only be achieved with speaker systems that

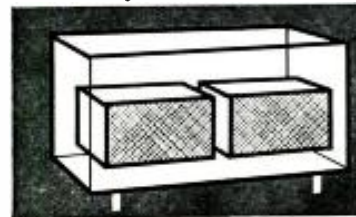

did not depend on the console cabinet for their enclosure. This meant that we had to reduce the size of the Acoustical Labyrinth enclosure.

ELECTRONICS WORLD



sure so that we could fit two separate speaker enclosures within a cabinet that had reasonable dimensions. It was not easy, but we did it. After many, many trials and tests we achieved the correct size without sacrificing one iota of the extremely linear and extended response of the system.

## NOW THE MOST DIFFICULT PROBLEM HAD TO BE FACED

**PROJECT #4** To effectively eliminate feedback by effectively eliminating the mechanical coupling that allows it to occur. Instead of treating the symptoms, we treated the cause. We developed a method of effectively isolating the speaker systems from the sensitive components. (As a result, Stromberg-Carlson Integrity Series Ensembles are the first successful uncompromised ensembles.)

The key development is what we call ISO-COUSTIC SPEAKER SYSTEM MOUNTING. This mounting, in which the resistance and compliance to vertical and horizontal pressures have been carefully engineered, has solved the problem. It allows Stromberg-Carlson to create a cabinet-within-cabinet suspension system which prevents transmission of speaker vibrations to the sensitive components. If you component owners could put your equipment into a cabinet whose speaker systems have our ISO-COUSTIC Mounting, the quality of the sound you'd hear would be as good as your component system is now. In fact, the components we use are the same ones you would choose for your separately mounted component system. They are interchangeable.



## INTEGRITY SERIES WILL NEVER BECOME OBSOLETE

**PROJECT #5** To assure the purchaser of an Integrity Ensemble that his choice would never be obsolete, we designed the units in accordance with a modular concept. All of the components are completely interchangeable. You can replace any component in the ensemble to keep pace with new developments—without ever replacing your fine cabinetry.



## CABINETRY HAD TO BE EXCEPTIONAL, TOO

**PROJECT #6** To design cabinets with the permanent beauty of fine furniture. Federico responded to the challenge by creating cabinetry in Traditional, Contemporary, Early American, Italian Provincial, French Provincial and Oriental

styling. You choose from 16 basic models in these styles, in a choice of finishes. These cabinets, like a fine painting, best describe themselves. They must be seen.

**PROJECT #7** To give you maximum flexibility in your enjoyment of an Integrity Series Ensemble. Every ensemble provides for your listening tastes and room acoustics by including the Stereo Choice Switch for precise regulation of stereo separation, with or without separate matching speaker systems. All ensembles provide space for adding a tape deck.

You may select your own Stromberg-Carlson stereo components or choose a recommended component complement—in any case Stromberg-Carlson components are always interchangeable.

If you now own a console or components, we invite you to exercise your critical judgment by listening to an Integrity Series Ensemble. (You will find that the better component shops—as well as the better department and music stores—have chosen to feature this new kind of stereo console.) Listen carefully. Look closely. Ask questions. Then accept not our judgment, but your own.

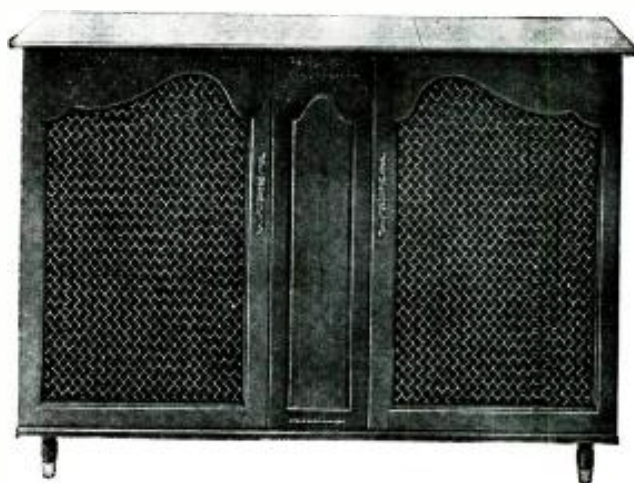

## INTEGRITY SERIES COMPONENT ENSEMBLES

—three hundred and fifty dollars to about six thousand dollars. You may choose from 16 models in Traditional, Contemporary and Period stylings, each tastefully designed by Federico. You may select your own Stromberg-Carlson components or choose a recommended Stromberg-Carlson component complement—in any case Stromberg-Carlson components are always interchangeable.

For a complete color catalog of Integrity Series Component Ensembles and components write STROMBERG-CARLSON, Special Products Division, 1477 N. Goodman St., Rochester 3, New York.

*“There is nothing finer than a Stromberg-Carlson”*

**STROMBERG-CARLSON**  
A DIVISION OF GENERAL DYNAMICS

*For integrity in music...*

# A NEW STROMBERG-CARLSON SINGLE-SPEED TURNTABLE

*...in component systems  
...in Integrity Series Ensembles*



PR-500

**PR-500 SINGLE SPEED** Here is a revolutionary concept in turntable design: a dual-drive system consisting of two hysteresis-synchronous motors operating one belt drive.

The motors are spaced exactly 180° apart. Any variation of speed is automatically corrected by the interaction of the motors and the impregnated belt. Rumble and noise are virtually eliminated by the belt drive and a unique suspension system in which the tone arm and table, as a unit, are isolated from the mounting board.

Single, 33 $\frac{1}{3}$  speed. Includes tone arm. PR-500, black and brushed chrome . . . . . \$69.95\*

**PR-499 "PERFECTEMPO" ALL SPEEDS** The "Perfectempo" incorporates every valid, time-proven design principle: belt drive; continuously variable cone drive (14 to 80 rpm); stroboscopic speed indicator; dynamically balanced, weighted table; precision motor; plus Stromberg-Carlson's original double-acting motor and table suspension system that effectively eliminates unwanted noise. Performance proves it: Wow 0.14% rms; Flutter 0.09% rms; Rumble -55 db re 20 cm/sec at 1 kc. PR-499, morocco red with aluminum trim . . . . . \$99.95\*



PR-499

**RA-498 TONE ARM** The Stromberg-Carlson Tone Arm uses the most valid engineering concepts of tone arm design. Single pivot point suspension, true viscous damping and high moment of inertia result in extremely low resonance and consequently yield flat response below the limits of audibility. A calibrated counterweight is adjustable to provide any needle point force. For stereo operation, complete with mounting base, viscous fluid, rest, and cartridge clip. Fits all standard turntables. RA-498 . . . . . \$24.95\*



RA-498

\*Prices audiophile net, turntables less bases.

**"THERE IS NOTHING FINER THAN A STROMBERG-CARLSON"**



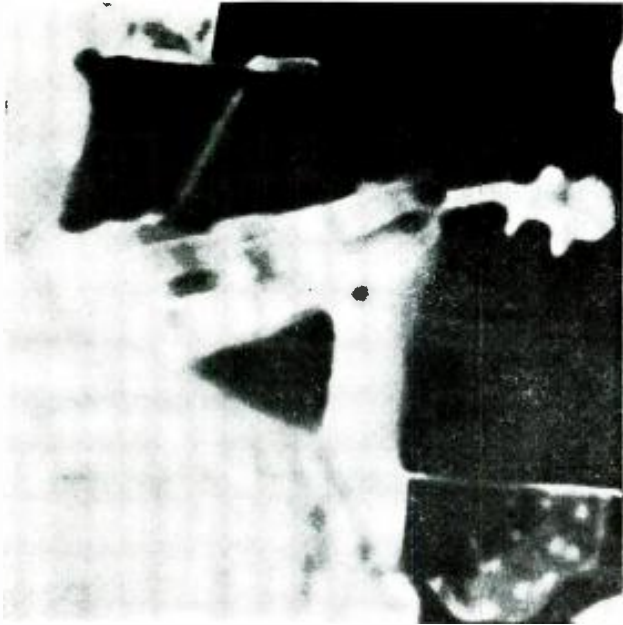

*For integrity in music...*

## THREE NEW STROMBERG-CARLSON TUNERS

*...in component systems*

*...in Integrity Series Ensembles*

**SR-445 AM-FM STEREO TUNER** The SR-445 is actually two separate and complete units which have been placed together for convenience of mounting and use. They have individual circuitry in which no duplicate use of tubes or circuits is involved. Operate as an AM tuner, an FM tuner or together as an AM-FM stereo tuner. The SR-445 combines the separate AM and FM tuners described below. The specifications are exactly the same as listed for these two units. SR-445 . . . \$129.95\*

*All three tuners are available in gold and white or black and brushed chrome. Top cover in white, black, tan or red available at extra cost.*



SR-445



FM-443

**FM-443 FM TUNER** Exceptionally sensitive, low noise reception due to the wide peak-to-peak separation (475 kc) and long, linear slope (350 kc) of the balanced ratio detector, and the grounded grid cascode front end. Sensitivity is 2 uv for 20 db quieting, 4 uv for 30 db quieting (300 ohm). Local-Distant Switch results in 2 uv for 40 db quieting on local stations. Dial station selector and "hair-trigger" tuning eye. Temperature controlled circuits eliminate drift. Includes switched AFC circuit. Tuning Range: 88-108 mc. Bandwidth: 200 kc. Frequency Response: 20-20,000 cps. Self-powered with auxiliary power for AM-441 tuner. Provision for multiplex adapter. FM-443 . . . . . \$79.95\*

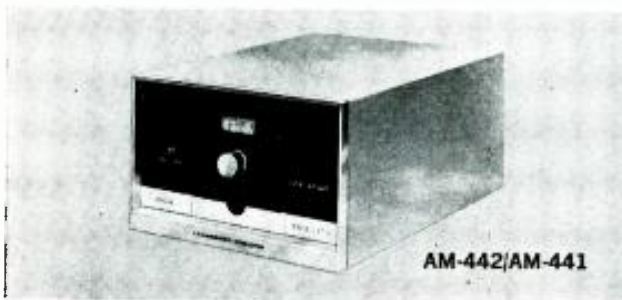

AM-442/AM-441

**AM-442 AM TUNER** For exceptional AM reception, this tuner has a frequency response of 20-7,000 cps, down 7 db at 7,000 cps. It features a tuned RF stage and 3-gang variable tuning condenser. Its tuning range is 540 to 1,600 kc; Bandwidth is 9 kc. Local-Distant Switch adds 20 db quieting on local stations. Adjustable ferrite loop and external antenna. AM-442 . . . . . \$59.95\*

**AM-441 AM TUNER** Same as above, but without its own power supply . . . . . \$49.95\*

*\*Prices audiophile net, zone 1, less cover*

# STROMBERG-CARLSON

A DIVISION OF **GENERAL DYNAMICS**

January, 1960

*For integrity in music...*

## STROMBERG-CARLSON STEREO CONTROL AMPLIFIERS

*...for component systems*

*...for Integrity Series Ensembles*



**ASR-433**

**ASR-444 STEREO "60" CONTROL AMPLIFIER** offers all desirable controls, plus high power. Each channel provides 30 watts of balanced power. It features separate bass, treble and volume controls for each channel, a master gain and loudness control, and the "Stereo Tone Balance" signal. Specifications: frequency response 20-20,000 cps; harmonic distortion less than 0.7% at full output, IM distortion less than 1% at program level. Same inputs as ASR-433. In gold and white or black and brushed chrome. ASR-444 ..... \$169.95\*



**ASR-444**

**ASR-333 STEREO CONTROL AMPLIFIER**, and a fine ceramic cartridge, give you quality performance at a low price. This amplifier—with 12 watts per channel—was designed for optimum reproduction with ceramic cartridges. It features tone and volume controls for each channel, plus a loudness control. Frequency response, noise level, distortion, same as ASR-433. Inputs: ceramic phono, tuner, tape/auxiliary. In black and brushed chrome. ASR-333 ..... \$99.95\*

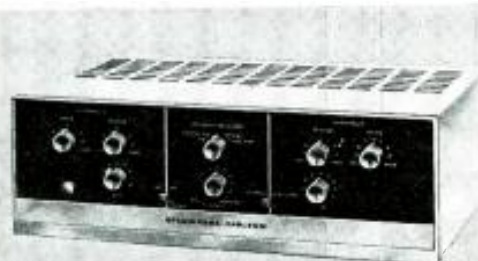

**ASR-333**

\*Prices Audiophile net, Zone 1, less top covers, which are available in white, black, tan or red.

**"THERE IS NOTHING FINER THAN A STROMBERG-CARLSON"**



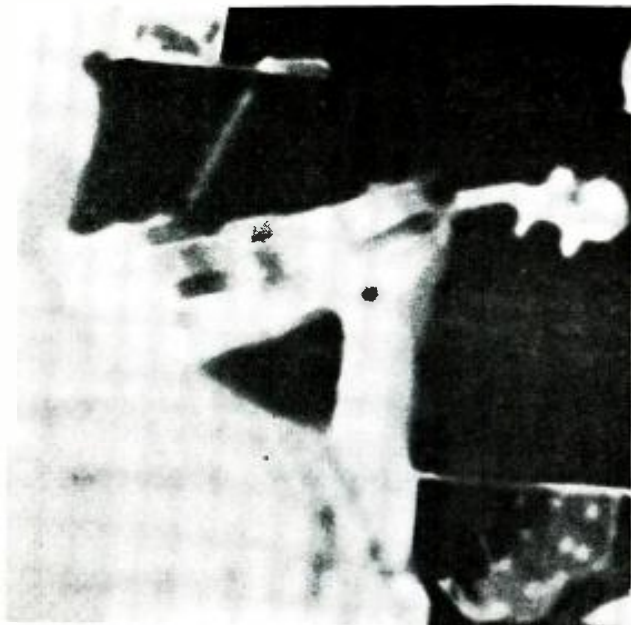

*For integrity in music...*

## STROMBERG-CARLSON SPEAKERS AND SYSTEMS

*...for component systems*

*...for Integrity Series Ensembles*

Stromberg-Carlson manufactures a full line of speakers and the famous Acoustical Labyrinth® Speaker System. This system enclosure achieves a system resonance that is lower than the un-baffled free air cone resonance of the low frequency radiator. It utilizes mass loading and frictional damping as acoustical devices to extend the low frequency range of the system with extreme flatness of response. Five new complete speaker systems with a variety of decorator housings are now available. We suggest that you compare the quality of their performance with similar equipment. You be the judge.



DECORATOR HOUSING  
RH-469



SPEAKER SYSTEM  
RS-405



RW-486



RT-477



RF-484

**SPEAKERS** Stromberg-Carlson loudspeakers include tweeters, woofers, coaxials and mid-range transducers. They are available in all popular sizes and price ranges.

The unusual Stromberg-Carlson "Slimline" feature allows maximum versatility in installation, and is made possible by another feature: the new "Barite" ceramic magnet, which is used to insure excellent transient response over the full effective frequency range.

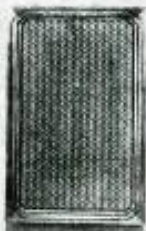

RH-465



RH-467

**ENCLOSURE KITS** Acoustical Labyrinth enclosures are now available as unassembled kits. All pieces are precision-cut to size, ready to assemble. Nails, glue, complete instructions—everything you need is included. Enclosures are available for 8", 12" and 15" systems. The same decorator housings available for factory assembled systems may be used. Write for full details on speakers and housings available.

For full details on Stromberg-Carlson components, write Stromberg-Carlson, a Division of General Dynamics, 1477 N. Goodman St., Rochester 3, N. Y.

# STROMBERG-CARLSON

A DIVISION OF **GENERAL DYNAMICS**

January, 1960

# Handle any Radio-TV Service Job

**EASIER-BETTER-FASTER!**



## COMPLETE SERVICE TRAINING

... written so you can understand it!

No complicated theory or mathematics! These famous Ghirardi books get right down to brass tacks in showing you how to handle all types of AM, FM, and TV service work by approved professional methods. Almost 1500 pages and over 800 clear illustrations show how to handle every phase of troubleshooting and servicing. Each book is co-authored by A. A. Ghirardi whose manuals have helped train more servicemen than any other books or courses of their kind!

### 1—Radio and Television Receiver TROUBLESHOOTING & REPAIR

A complete guide to profitable professional methods. For the beginner, it is a comprehensive training course. For the experienced serviceman, it is a quick way to "brush up" on specific jobs, to develop improved techniques or to find fast answers to puzzling service problems. Includes invaluable "step-by-step" service charts. 820 pages. 417 illustrations, price \$7.50 separately.

### 2—Radio and Television Receiver CIRCUITRY AND OPERATION

This 669-page volume is the ideal guide for servicemen who realize that it pays to know what really makes modern radio-TV receivers "tick" and why. Gives a complete understanding of basic circuits and circuit variations; how to recognize them at a glance; how to eliminate guesswork and useless testing in servicing them. 417 illus. Price separately \$6.75.

### Special low price ... you save \$1.25

If broken into lessons and sent to you as a "course," you'd regard these two great books as a bargain at \$7.50 or more!

Under this new offer, you save \$1.25—you get both big manuals for only \$13—and have the privilege of paying in easy installments while you use them! No lessons to wait for. You learn fast—and right!

### —STUDY 10 DAYS FREE!—

Dept. RN-10, RINEHART & CO., Inc.  
232 Madison Ave., New York 16, N. Y.

Send books below for 10-day FREE EXAMINATION. In 10 days I will either remit price indicated (plus postage) or return books postpaid and owe you nothing.

Radio & TV Receiver TROUBLESHOOTING & REPAIR (Price \$7.50 separately)

Radio & TV CIRCUITRY & OPERATION (Price \$6.75)

Check here for MONEY-SAVING COMBINATION OFFER ... Save \$1.25. Send both of above big books at special price of only \$13.00 for the two. (Regular price \$14.25 ... you save \$1.25.) Payable at rate of \$4 plus postage after 10 days if you decide to keep the books and \$3 a month for 3 months until the total of \$13.00 has been paid. SAVE! Send \$13 with order and we pay postage. 10-day return privilege with money refunded.

Name .....  
Address .....  
City, Zone, State .....

Outside U.S.A.—\$8.00 for TROUBLESHOOTING REPAIR; \$7.25 for CIRCUITRY and OPERATION; \$14.00 for both. Cash only, but money refunded if you return books in 10 days.



### HISTORIC P.A. EQUIPMENT

To the Editors:

I am the honorary librarian of the Association of Public Address Engineers, and am attempting to locate sufficient written matter, photos, etc., of early p.a. work to enable us to have a little historic exhibit at our 1960 Exhibition.

It occurred to me that there may be other old-time p.a. operators among your readers who might care to assist us. We particularly require photos of gear, operating instructions, and circuits.

My father is one of the p.a. pioneers in this country, handling his first job in 1919, with home-made gear!

HAYDON G. WARREN  
Warren Public Address  
Equipment  
88 Wellington St.  
Luton, England

Perhaps some of our readers can help Mr. Warren in setting up his exhibit.—  
Editors.

### "SPUTNIK III"

To the Editors:

In your article "Electronics in Outer Space" (August, 1959 issue), there was a table of recent satellites and space probes. I note that under "Sputnik III," the radio lifetime is listed as one month.

I can assure you that I picked up "Sputnik III's" radio while I was reading your August issue after it made its 6500th revolution around the earth. As far as I can determine, the radio was working almost as well for tracking purposes as it did a year ago.

Note also that the Russians are using chemical batteries plus solar cells to keep radio transmitters going over long intervals.

CHARLES H. SMILEY  
Brown University  
Providence, Rhode Island

When Reader Smiley's letter was forwarded to Author Jordan McQuay, he replied as follows.—Editors.

Dear Mr. Smiley:

The tabular data contained in the chart on page 37 of the August issue of ELECTRONICS WORLD was listed primarily in terms of the purpose intended for each satellite or space probe. For purposes of transmitting space data, there was a length of about one month. Naturally, solar-powered transmissions, which have since continued, are useful for tracking purposes and, in that special sense, the solar-powered transmitter has continued to operate (as has our own "Vanguard").

In a subsequent installment of this article (October, 1959 issue), power sources—including solar-powered devices—were further discussed. Of course, there can be no denying that Russia has also used solar cells in tandem with chemical or other batteries. While not overemphasized in the chart, there was certainly no effort made to conceal this fact.

JORDAN MCQUAY  
Falls Church, Virginia

### HI-FI TRIODE AMPLIFIER

To the Editors:

I wish to congratulate you on the hi-fi triode amplifier described in your July issue. I have wired four of these amplifiers for myself and friends, and they have outperformed any that we have had, including more expensive types.

J. N. MANN  
Elizabeth, New Jersey

We are always pleased to hear of our readers' success with some of the projects that we run.—Editors.

### METER MOVEMENT PROTECTION

To the Editors:

Mr. Pruitt's article "Protection for Your Meter Movement" in your August issue struck us close to home. We have a large number of Triplet 630's and Simpson 215's in use, and meter burn-out, or pointer bending, is our greatest headache. We have tried Sarkes Tarzian diodes M150, M500, and 1442, as well as International Rectifier type 5E4 for meter protection. They performed satisfactorily on all ranges except on a.c. volts, where a substantial error in reading resulted.

We are going to keep trying to find a diode or some other means of protection that will not induce this error in measuring a.c.

JOHN H. WENDT, ET1  
U. S. Naval Schools Command  
U. S. Naval Station  
Meter Repair, Teletype  
Maintenance School C1  
Norfolk 11, Virginia

Perhaps some of our readers can help solve the problem. If so, we suggest they contact Mr. Wendt directly.—Editors.

### THREE-BAND MOBILE CONVERTER

To the Editors:

I have received some correspondence finding fault with the resistance of  $R_2$  in my article dealing with the three-band mobile converter (March, 1959 issue).

I had originally designed the con-

**ELECTRONICS WORLD**



# Do you WISH you were EMPLOYED in ELECTRONICS?

## F.C.C. LICENSE — THE KEY TO BETTER JOBS

An F.C.C. *commercial* (not amateur) license is your ticket to higher pay and more interesting employment. This license is Federal Government evidence of your qualifications in electronics. Employers are eager to hire *licensed* technicians.

## WHICH LICENSE FOR WHICH JOB?

The **THIRD CLASS** radiotelephone license is of value primarily in that it qualifies you to take the second class examination. The scope of authority covered by a third class license is extremely limited.

The **SECOND CLASS** radiotelephone license qualifies you to install, maintain and operate most all radiotelephone equipment except commercial broadcast station equipment.

The **FIRST CLASS** radio telephone license qualifies you to install, maintain and operate every type of radiotelephone equipment (except amateur) including all radio and television stations in the United States, its territories and possessions. This is the highest class of radiotelephone license available.

## GRANTHAM TRAINING PREPARES YOU

The Grantham course covers the required subject matter completely. Even though it is planned primarily to lead directly to a first class FCC license, it does this by **TEACHING** you electronics. Some of the subjects covered in detail are: Basic Electricity for Beginners, Basic Mathematics, Ohm's and Kirchhoff's Laws, Alternating Current, Frequency and Wavelength, Inductance, Capacitance, Impedance, Resonance, Vacuum Tubes, Transistors, Basic Principles of Amplification, Classes of Amplifiers, Oscillators, Power Supplies, AM Transmitters and Receivers, FM Transmitters and Receivers, Antennas and Transmission Lines, Measuring Instruments, FCC Rules and Regulations, and extensive theory and mathematical calculations associated with all the above subjects explained simply and in detail.

## OUR GUARANTEE

If you should fail the F.C.C. exam after finishing our course, we guarantee to give additional training at **NO ADDITIONAL COST**. Read details in our free booklet.

# Get Your First Class Commercial F.C.C. LICENSE QUICKLY!

## CORRESPONDENCE OR RESIDENCE CLASSES

Grantham School of Electronics *specializes* in F.C.C. license preparation. Correspondence training is conducted from Hollywood, Seattle, Kansas City and Washington; also, resident **DAY** and **EVENING** classes are held in all four cities. Either way, by correspondence or in resident classes, we train you quickly and well.

This booklet **FREE!**

This free booklet gives details of our training and explains what an F.C.C. license can do for your future.

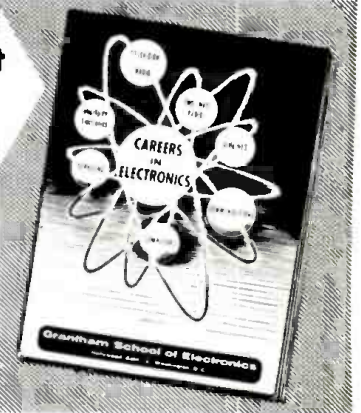

## HERE'S PROOF...

that Grantham students prepare for F.C.C. examinations in a minimum of time. Here is a list of a few of our recent graduates, the class of license they got, and how long it took them:

	License	Weeks
Richard M. Wilhoit, 2104 Santa Paula, Las Vegas, Nev.	1st	12
Larry R. Perrine, 7 Normandy Place, Champaign, Ill.	1st	15
Emerson F. Lawson, 111 Excelsior Ave., Union, S. C.	1st	12
Harold W. Johnson, 5070 Hermosa Ave., Los Angeles, Calif.	1st	15
Arthur W. Hardy, 66 Dresser Ave., Great Barrington, Mass.	1st	12
Ralph Frederick Beisner, 2126 Grand, Joplin, Mo.	1st	12
N. B. Mills, II, 110 So. Race St., Statesville, N. C.	1st	12
Dean A. Darling, 403 S. Chase Ave., Columbus 4, Ohio	1st	12
Paul D. Bernard, 408 First Ave., N.E., Watertown, S. D.	1st	18
Gerald L. Chopp, 518 Audubon Road, Kohler, Wisc.	1st	12

# Grantham School of Electronics

- Hollywood Division**  
1505 N. Western Ave.  
Hollywood 27, Calif.  
(Phone: HO 7-7277)
- Seattle Division**  
408 Marion Street  
Seattle 4, Wash.  
(Phone: MA 2-7227)
- Kansas City Division**  
3123 Gillham Road  
Kansas City 9, Mo.  
(Phone: JE 1-6320)
- Washington Division**  
821-19th Street, N. W.  
Washington 6, D. C.  
(Phone: ST 3-3614)

## MAIL COUPON TO SCHOOL NEAREST YOU



(Mail in envelope or paste on postal card)

To: **GRANTHAM SCHOOL OF ELECTRONICS**

1505 N. Western Hollywood • 408 Marion Seattle • 3123 Gillham Rd. Kansas City • 821-19th, NW Washington

Gentlemen:

Please send me your free booklet telling how I can get my commercial F.C.C. license quickly. I understand there is no obligation and no salesman will call.

Name \_\_\_\_\_ Age \_\_\_\_\_

Address \_\_\_\_\_

City \_\_\_\_\_ State \_\_\_\_\_

I am interested in:  Home Study,  Resident Classes **08-A**

A QUARTER-CENTURY OF **PRECISION** KNOW-HOW IS YOURS IN

# PACO

## QUALITY ELECTRONIC EQUIPMENT IN KIT FORM

**FOR:**  
 electronic hobbyists and amateur radio  
 hi-fi custom building and service  
 science education and technical schools  
 industrial testing and quality control

PACO is the only line of test instrument kits engineered and produced under the auspices of a leading test equipment and meter manufacturer.

and, you pay nothing extra for the convenience of buying PACO kits directly from your own local parts distributor.

**COMPARE PACO** against any other kits for performance, appearance, ruggedness, ease of operation and simplicity of assembly and wiring.

**COMPARE PACO's** superbly detailed, step-by-step instruction manuals and giant size wiring diagrams, against any you have ever seen.

**SEE HOW PACO** sets an entirely new standard in electronic instrument kit design and kit assembly instruction.

- Available and on display at leading electronic parts distributors.
- Write for latest, complete catalog.



**Electronics Co., Inc.,**  
 70-31 84th St., Glendale 27, L. I., N. Y.  
 Export: 458 B'way, N. Y. 13, U.S.A.,  
 Canada: Atlas Radio Corp., Toronto 19.  
**A DIVISION OF**  
**PRECISION APPARATUS CO., INC.**

 <b>MODEL B-10</b> Battery Eliminator Kit • less than 0.3% ripple output • no external filters required Kit Net Price: .....\$41.95 Factory Wired: .....\$49.50	 <b>MODEL S-55</b> Wideband 5" Oscilloscope • response DC to 5 Mc • push-pull V and H amplifiers Kit Net Price: .....\$87.50 Factory Wired: .....\$139.50
 <b>MODEL C-20</b> Res-Cap-Ratio Bridge Kit • 10 mmfd to 2000 mfd • 1/2 ohm to 200 megs Kit Net Price: .....\$20.95 Factory Wired: .....\$31.50	 <b>MODEL T-60</b> Tube Checker Kit • full free-point lever • selector system • built-in roll chart Kit Net Price: .....\$38.75 Factory Wired: .....\$54.50
 <b>MODEL G-30</b> RF Signal Generator Kit • 160 Kc to 240 Mc in 8 bands • 120 Mc fundamental output Kit Net Price: .....\$28.50 Factory Wired: .....\$39.95	 <b>MODEL T-65</b> Transistor and Crystal Diode Tester Kit • tests Icbo, gain, leakage, etc. • tests both p-n-p and n-p-n types Kit Net Price: .....\$39.95 Factory Wired: .....\$59.50
 <b>MODEL M-40</b> High Sensitivity V-O-M Kit • 20,000 ohms/volt DC • 10,000 ohms/volt AC Kit Net Price: .....\$31.50 Factory Wired: .....\$37.50	 <b>MODEL V-70</b> Vacuum Tube Voltmeter Kit • wide-range • peak-to-peak Kit Net Price: .....\$31.50 Factory Wired: .....\$47.50
 <b>MODEL S-50</b> 5" Cathode Ray Oscilloscope Kit • push-pull vertical and horizontal amplifiers Kit Net Price: .....\$49.50 Factory Wired: .....\$84.50	 <b>MODEL Z-80</b> RF-AF Signal Tracer Kit • high gain RF and AF amplifier • visual and audible indicator Kit Net Price: .....\$29.50 Factory Wired: .....\$42.50
 <b>MODEL SA-40</b> 40-Watt Stereo Preamp-Amplifier • silicon diode • low impedance power supply • 14 controls for optimum flexibility Kit Net Price: .....\$ 79.95 Factory Wired: .....\$129.95	 <b>COMING SOON!</b> <b>MODEL ST-45</b> AM/FM Stereo Tuner Kit Matching companion for the SA-40

# PACO

verter using a 6BA6 tube as the r.f. amplifier. This tube has a 300-ma. filament, and the 42-ohm resistor is correct for 12-volt operation. After the converter was completed, I tried using various other tubes in the r.f. section in an attempt to maximize the performance. These other tubes included the 6CB6, 6AU6, 6BC5, and the 6BI16. These tests were made with 6 volts as the filament supply. All of the tubes mentioned have 300-ma. heaters with the single exception of the 6BI16, and that is the one that seemed to perform best. I thought I checked it for filament current, but apparently I did not do so.

Using the converter on 12 volts with the 42-ohm resistor in parallel with the 6BI16 filament would certainly degrade the performance of the unit since there will be only approximately 5 volts on the 6U8 filament. This would probably result in low oscillator output, especially on the 4th overtone for 10 meters. A 21-ohm resistor used in place of the 42-ohm resistor will solve this problem completely.

In addition, pins 3 and 4 were indicated as the heater connections for  $V_2$ . The proper heater connections are pins 4 and 5.

Many have inquired about how to change the converter to operate on the Citizens Band. The changes are quite simple. However, it would be necessary to sacrifice the 10-meter ham band in order to accomplish this modification.

A 6575-kc. crystal (available on the surplus market for about 75 cents) is used in place of the crystal normally used for ham-band operation. A 100- $\mu$ f. capacitor (silvered mica) is installed across the 18-turn secondary winding of  $L_1$ , the 10-meter r.f. coil. The Citizens Band will then be found between 600 kc. and 1000 kc. on the broadcast receiver dial. The slugs in coils  $L_1$  and  $L_2$  should be adjusted for maximum response on any signal found near the center of the Citizens Band—approximately 800 kc. on the broadcast receiver.

JOSEPH L. REIFFIN  
 Biloxi, Mississippi

*A good many of our readers have asked about the conversion of the above unit to Citizens Band operation. The comments given by Author Reiffin should adequately answer these requests.—Editors.*

### TUBE-TRANSISTOR CARRIER SWITCH

To the Editors:

With reference to your article on the "Tube-Transistor 'Carrier Switch'" (October, 1959 issue). I would like to know the specifications for coil  $L_2$  used in the receiver.

FAY D. BRUNING  
 Chuluota, Florida

*Coil  $L_2$  in the receiver is exactly the same as coils  $L_1$  and  $L_2$  used in the transmitter, that is, a Stancor type WC-10. Our apologies for omitting this information from the parts list.—Editors.*



# Learn Radio-TV Electronics

*by Practicing  
at Home in  
Spare Time*

**Without Extra  
Charge You Get**

special NRI kits developed to give actual experience with Radio-TV equipment. You build, test, experiment with receiver or broadcasting circuits. All equipment yours to keep.

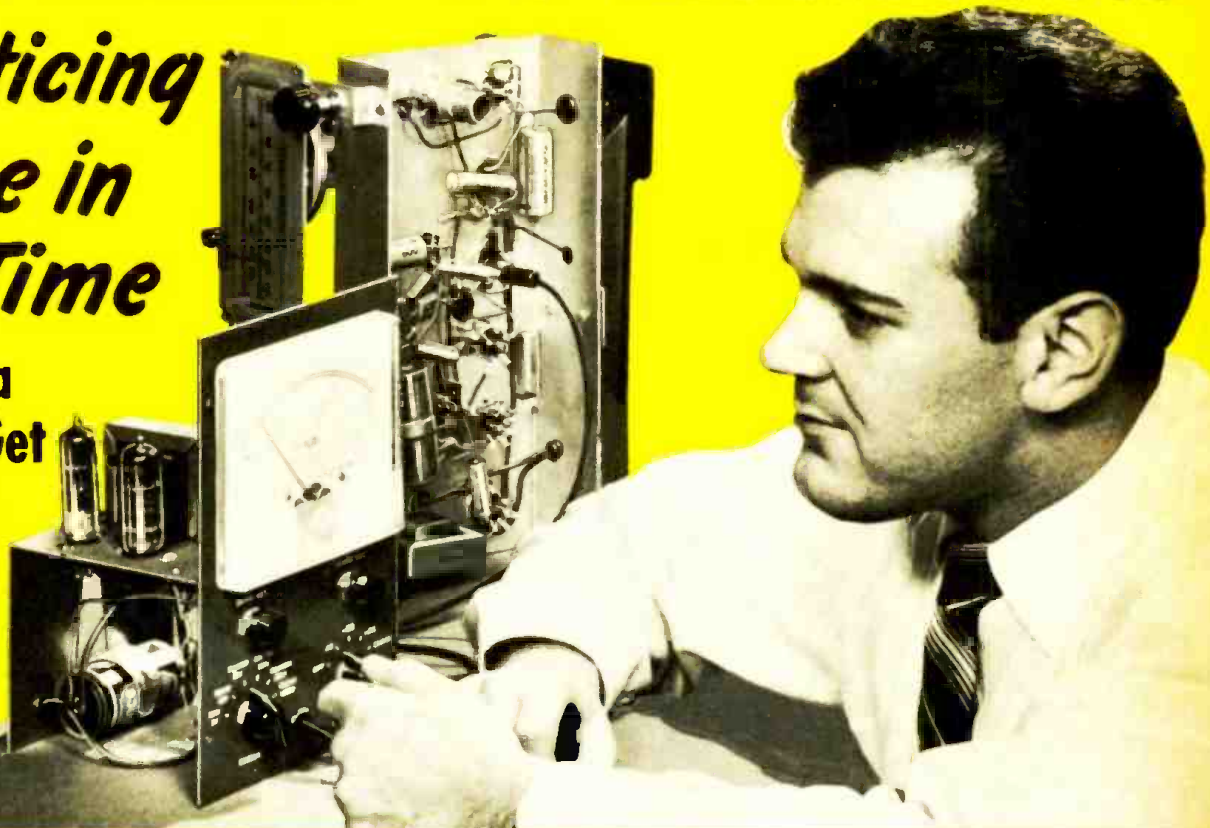

## Have High Pay, Prestige, Good Future as a Skilled Radio-TV Electronic Technician

People look up to and depend on the Technician, more than ever before. Offices, plants, homes everywhere are obliged to buy his knowledge and services. His opportunities are great and are increasing. Become a Radio-TV Electronic Technician. At home, and in your spare time, you can learn to do this interesting, satisfying work—qualify for important pay. To ambitious men everywhere here in the fast growing Radio-TV Electronic field is rich promise of fascinating jobs, satisfaction and prestige as well as increasing personal prosperity.

## Increasing Opportunities in Growing Field

A steady stream of new Electronic products is increasing the job and promotion opportunities for Radio-Television Electronic Technicians. Right now, a solid, proven field of opportunity for good pay is servicing the tens of millions of Television and Radio sets now in use. Color TV, Hi-Fi is growing. The hundreds of Radio and TV Stations on the air offer interesting jobs for Operators and Technicians.

## More Money Soon—Make \$10 to \$15 a Week Extra Fixing Sets in Spare Time

NRI students find it easy and profitable to start fixing sets for friends and neighbors a few months after enrolling. Picking up \$10, \$15 and more a week gives substantial extra spending money. Many who start in spare time soon build full time Radio-Television sales and service businesses—enjoy security.

## Act Now—See What NRI Can Do for You

NRI has devoted over 40 years to developing simplified practical training methods. You train at home in spare time. Get practical experience, learn-by-doing.

**NATIONAL RADIO INSTITUTE**  
Washington 16, D.C.



## NRI Has Trained Thousands for Successful Careers in Radio-TV



**Studio Engr., Station KATV**  
"I am now Studio Engineer at Television Station KATV. Before enrolling, I was held back by limitation of a sixth grade education." **BILLY SANCHEZ**, Pine Bluff, Ark.



**Has All the Work He Can Do**  
"I have repaired more than 2,000 TV and Radio sets a year NRI training certainly proved to be a good foundation." **H. R. GORDON**, Milledgeville, Georgia.



**Has Good Part Time Business**  
"Early in my training I started servicing sets. Now have completely equipped shop. NRI is the backbone of my progress." **E. A. BREDA**, Tacoma, Washington.

▶▶▶▶ **SEE OTHER SIDE** ▶▶▶▶

**Cut Out and Mail This Card—No Stamp Needed**

## Sample Lesson and Catalog Both Sent FREE

OLDEST & LARGEST HOME STUDY RADIO-TV SCHOOL  
**National Radio Institute**  
Dept. F, Washington 16, D.C.

Please send me sample lesson of your Radio-Television Training and Catalog FREE. (No salesman will call.)

Name..... Age.....

Address.....

City..... Zone..... State.....

ACCREDITED MEMBER NATIONAL HOME STUDY COUNCIL





**NRI SUPPLIES LEARN-BY-DOING KITS WITHOUT EXTRA CHARGE**  
**Technical Know-How Pays Off in Interesting, Important Work**



**YOU BUILD AC-DC Superhet Receiver**

NRI Servicing Course includes all needed parts. By introducing defects you get actual servicing experience practicing with this modern receiver. Learn-by-doing.



**YOU BUILD This 17 Inch Television Receiver**

As part of your NRI course you can get all components, tubes, including 17" picture tube, to build this latest style Television receiver; get actual practice on TV circuits.

**YOU BUILD Broadcasting Transmitter**

As part of NRI Communications Course you build this low power Transmitter, learn commercial broadcasting operators' methods, procedures. Train for your FCC Commercial Operator's License.



**YOU BUILD Vacuum Tube Voltmeter**

Use it to earn extra cash fixing neighbors' sets; bring to life theory you learn from NRI's easy-to-understand texts.



**For Higher Pay, Better Jobs**  
**Be a Radio-TV Electronic Technician**



**Servicing Needs More Trained Men**

Portable TV, Hi-Fi, Transistor Radios, Color TV are making new demands for trained Technicians. Good opportunities for spare time earnings or a business of your own.



J. E. Smith, Founder

**Train at Home the NRI Way Famous for Over 40 Years**

NRI is America's oldest and largest home study Radio-Television school. The more than 40 years' experience training men for success, the outstanding record and reputation of this school—benefits you in many ways. NRI methods are tested, proven. Successful graduates are everywhere, from coast to coast, in small towns and big cities. You train in your own home, keep your present job while learning. Many successful NRI men did not finish high school. Let us send you an actual lesson, judge for yourself how easy it is to learn.

**Broadcasting Offers Satisfying Careers**

4000 TV and Radio stations offer interesting positions. Govt. Radio, Aviation, Police, Two-Way Communications are growing fields. Trained Radio-TV Operators have a bright future.



**No Experience Necessary—NRI Sends Many Kits for Practical Experience**

You don't have to know anything about electricity or Radio to understand and succeed with NRI Course. Clearly written, well-illustrated NRI lessons teach Radio-TV Electronic principles. You get NRI kits for actual experience. All equipment is yours to keep. You learn-by-doing. Mailing the postage-free card may be one of the most important acts of your life. Do it now. Reasonable tuition. Low monthly payments available. Address: NATIONAL RADIO INSTITUTE, Washington 16, D. C.

**NRI Graduates Do Important Work**



**New Quality Control Chief**  
 "Had no other training in Radio before enrolling, obtained job working on TV amplifiers before finishing course. Now Quality Control Chief." T. R. FAVAROLO, Norwich, N. Y.

**NRI Course Easy to Understand**  
 "I opened my own shop before receiving my diploma. I have had to hire extra help. I am independent in my own business." D. P. CRESSEY, Stockton, Cal.

**Works on Color-TV**  
 "NRI changed my whole life. If I had not taken the course, probably would still be a fireman, struggling along. Now Control Supervisor at WRCA-TV." J. F. MELINE, New York, N. Y.

FIRST CLASS  
 Permit No. 20-R  
 (Sec. 34.9, P. L. & R.)  
 Washington, D.C.

**BUSINESS REPLY CARD**  
 No Postage Stamp Necessary if Mailed in the United States

POSTAGE WILL BE PAID BY

**NATIONAL RADIO INSTITUTE**  
 3939 Wisconsin Avenue  
 Washington 16, D.C.

**SAMPLE LESSON**  
**64-page CATALOG**  
**both FREE**

**SEE OTHER SIDE**



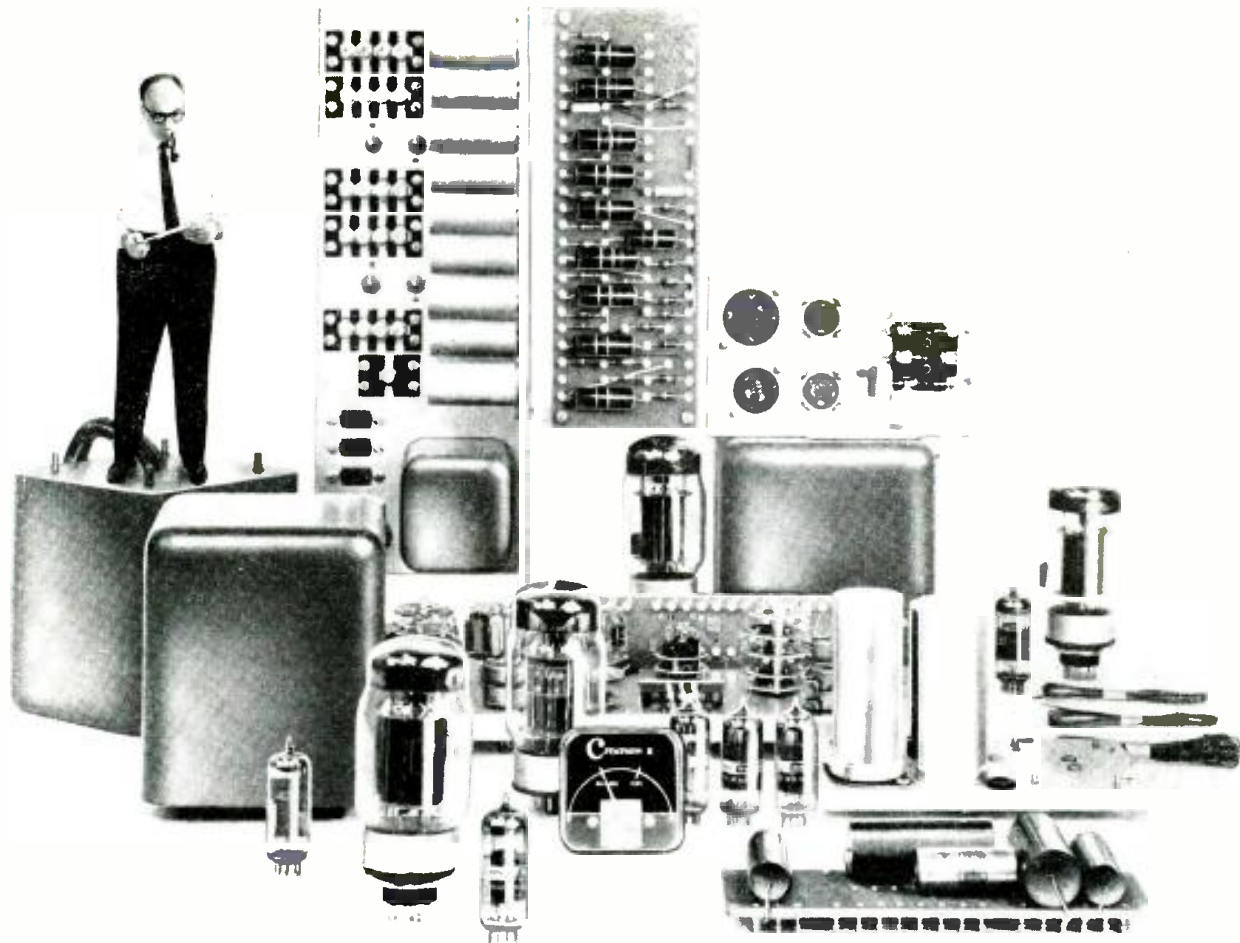

## We don't pack an engineer into each new Citation Kit but...

... the engineering built into each kit is so precise that the unit constructed in the home will be the equal of the factory-produced instrument.

It is far more difficult to design a kit than to produce a completely manufactured product. In the plant the engineer can control his design from the moment of inception until the final packaging. The kit builder has only his tools, his ingenuity and little, if any, test equipment.

Therefore, the complex process of in-plant production and control which guarantees the fine finished product must somehow be *embedded* in the kit design. The Citation engineering group at Harman-Kardon, headed by Stewart Hegeman, has succeeded in doing just this in the design of the new Citation I, Stereophonic Preamplifier Control Center and Citation II, 120 Watt Stereophonic Power Amplifier.

Only heavy duty components, operating at tight tolerances, have been selected for the Citation Kits. As a result, even if every component is operated at its limit — remote as this possibility is — the instruments will perform well within their specifications.

Rigid terminal boards are provided for mounting resistors and condensers. Once mounted, these components are suspended tightly between turret lugs. Lead length is sharply defined. The uniform spacing of components and uniform lead length insure the overall stability of the unit.

Improper routing of leads, particularly long leads, can result in unstable performance. To prevent this, the Citation II is equipped with a template to construct a Cable Harness. The result: each wire is just the right length and in just the right place to achieve perfect performance.

These truly remarkable achievements in Control Engineering are only a few of the many exciting new developments in kit design from the Citation Division of Harman-Kardon.

**THE CITATION I.** *Stereophonic Preamplifier Control Center*, is a brilliantly designed instrument, reflecting engineering advances found only in the best professional equipment. The control over program material offered by the new Citation I enables the user to perfectly re-create every characteristic of the original performance. (The Citation I — \$139.95; Factory-Wired — \$239.95; Walnut Enclosure, WW-1 — \$29.95.)

**THE CITATION II.** *120 Watt Stereophonic Power Amplifier*, has a peak power output of 260 Watts! This remarkable instrument will reproduce frequencies as low as 5 cycles virtually without phase shift, and frequencies as high as 100,000 cycles without any evidence of instability or ringing. *At normal listening levels, the only measurable distortion in this unit comes from the laboratory testing equipment.* (The Citation II — \$159.95; Factory-Wired — \$219.95; Charcoal Brown Enclosure, AC-2 — \$7.95.) All prices slightly higher in the West.

Harman-Kardon has prepared a free detailed report on both of these remarkable new instruments which we will be pleased to send to you. Simply write to Dept EW-1, Citation Kit Division, Harman-Kardon, Inc., Westbury, L. I.

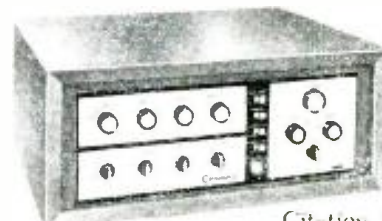

Citation I

Build the Very Best **CITATION KITS** by

**harman kardon**



TWO TINY SATELLITES ... ONE SMALL CABINET ...

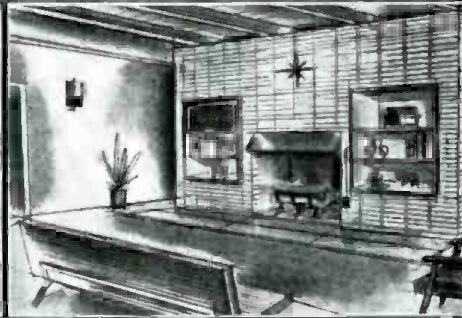
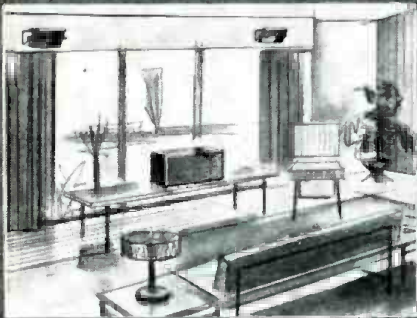

IT'S YOUR DECOR-DESIGNED STEREO SPEAKER SYSTEM!

the exciting new **GALAXY\*II**

by  
**Jensen**

The stereo speaker system designed with your home in mind.

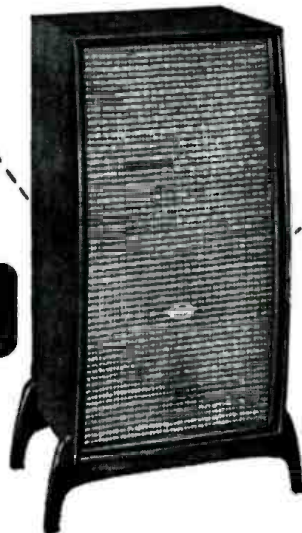

You've never seen a stereo speaker system like this ... an inspired merging of function with decor ... that takes less than a square foot of floor space (or can be off-the-floor entirely) ... yet gives you big speaker dual 3-way system performance with wide panoramic stereo sound for an entirely new listening thrill! For living room, or any room in your home ... Jensen Galaxy II is the most livable stereo speaker system ever.

WRITE FOR BROCHURE BY

**\$169<sup>50</sup>** complete in choice of Walnut, Mahogany or Tawny Ash



GALAXY II is the equivalent of two complete 3-way speaker systems with the added feature of a "derived third channel" for center-fill. Bookshelf-size Bass-Center Unit in handsome fine hardwood cabinet, contains the new dual channel 8" FLEXAIR\* woofer (which handles all bass and center-fill middle frequencies from both stereo channels), dividing networks for both channels and terminal-receptacle panel. Two Satellite Units each with yokes and wall-mounting hardware, plus 20-foot cord, plug into terminal-receptacle panel on Bass-Center Unit. Satellites may be mounted high or low on end, side or adjacent walls or placed on horizontal surfaces up to 20 or more feet apart for wide panoramic stereo sound.

**Jensen**

DIVISION OF THE MUTER CO.

**MANUFACTURING COMPANY**

6601 South Laramie Avenue · Chicago 38, Illinois

In Canada: Renfrew Electric Co., Ltd., Toronto  
In Mexico: Radios Y Television, S.A., Mexico D.F.

\*T.M.



**WE'RE MAKING IT EASIER THAN EVER TO BECOME A WELL PAID RADIO-TELEVISION SERVICE TECHNICIAN**

**NOW - Just \$6 Starts You Training in**

# **RADIO-TELEVISION**

**the SPRAYBERRY "Learn-by-Doing" Way . . .**

## **25 BIG, COMPLETE KITS of PARTS & EQUIPMENT**



To help you learn *fast* the practical side of Radio-Television, we send you expertly engineered training kits to test and assemble for interesting, valuable shop-bench practice!

• The new Sprayberry Training Television Receiver, built and tested in 5 sections.

• Now offered . . . this fine modern oscilloscope.

• You build this powerful two-band superheterodyne radio receiver.



**Big New CATALOG AND Sample Lessons FREE!**

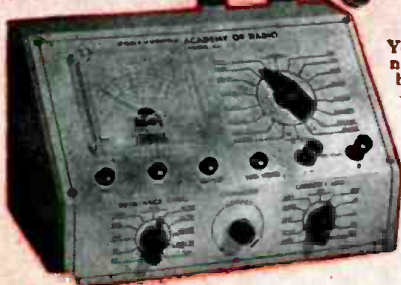

You build the new Sprayberry tester—a complete 18-range Volt-Ohm-Milliammeter test meter.

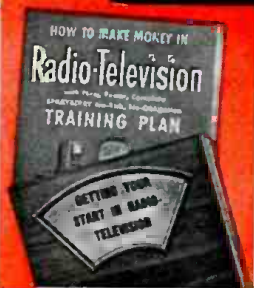

★ ★ ★ ★ This great industry is begging for trained men . . . to step into good paying jobs or a profitable business of their own! Our new plan opens the doors of Radio-Television wide to every ambitious man who is ready to act at once!

Men by the thousands . . . trained Radio-Television Service Technicians . . . are needed at once! Perhaps you've thought about entering this interesting, top paying field, but lack of ready money held you back. Now—just \$6 enrolls you for America's finest, most up to date home study training in Radio-Television! Unbelievable? No, the explanation is simple! We believe Radio-Television *must* have the additional men it needs as quickly as possible. We are willing to do our part by making Sprayberry Training available for less money down and on easier terms than ever before. This is your big opportunity to get the training you need . . . to step into a fine job or your own Radio-Television Service Business.

### **Complete Facts Free—Act Now; Offer Limited**

Only a limited number of students may be accepted on this liberal and unusual basis. We urge you to act at once . . . mail the coupon below and get complete details plus our big new catalog and an actual sample lesson—all free. No obligation . . . no salesman will bother you.

### **HOME STUDY TRAINING IN SPARE TIME**

Under world-famous 27-year old Sprayberry Plan, you learn entirely at home in spare time. You keep on with your present job and income. You train as fast or as slowly as you wish. You get valuable kits of parts and equipment for priceless shop-bench practice. And everything you receive, lessons and equipment alike, is all yours to keep.

### **LET US PROVE HOW EASILY YOU CAN LEARN!**

Radio-Television needs YOU! And Sprayberry is ready to train you on better, easier terms, that any ambitious man can afford. *Just \$6 starts you!* Mail coupon today . . . let the facts speak for themselves. You have everything to gain. Let us prove the kind of opportunity that's in store for you!

**SPRAYBERRY Academy of Radio-Television**  
1512 Jarvis Avenue, Dept. 25-F, Chicago 26, Illinois

### **Mail This Coupon Now—No Salesman Will Call**

**Sprayberry Academy of Radio-Television**  
Dept. 25-F, 1512 W. Jarvis Ave., Chicago 26, Ill.

Please rush all information on your ALL-NEW Radio-Television Training Plan. I understand this does not obligate me and that no salesman will call upon me. Include New Catalog and Sample Lesson FREE.

NAME..... Age.....

ADDRESS.....

CITY..... ZONE..... STATE.....

Complete Your Citizens Band Line with the Leading

# HY-GAIN BANDERS

COMPLETE ANTENNAS ENGINEERED & DESIGNED FOR TOP



## CITIZENS MOBILE

MODEL CM

Chrome plated, stainless steel telescoping whip extends to 73" down to 23" for easy parking. Weatherproof, polyethylene enclosed, hi-efficiency base loading coil with exclusive fly-cap "L" matching net for perfect 50 ohm match. Complete with universal swivel body mount. Drill one hole for mounting.

\$1195 List

## CITIZENS GROUND PLANE

MODEL COP

Base station antenna kit designed for hi-efficiency point-to-point or base-to-mobile operation. Complete with 7 1/2" to 3 1/2" OD telescoping aluminum radiator, copper clad steel stranded radials and strain insulators, screw hooks, 1 1/2" OD 3-ft. mast and universal swivel roof mount for flat or peaked roofs. Less feed line.

\$1895 List

## HEAVY DUTY GROUND PLANE

MODEL GP-1

Commercial duty 1100 mph rating, citizens ground plane for hi-efficiency point-to-point or base-to-mobile use. Complete with base 7 1/2" to 3 1/2" OD telescoping aluminum radials and radiator. Boreing radials adjusted for 50 ohm match. Nylon base insulator and casting fits masts to 1 1/2" diameter. Complete with SO-239 coax receptacle less feed line.

\$3250 List

## CITIZENS BEAM

MODEL 113-G

3-Element Citizens Beam provides X-500 forward gain, multiplying effective power 7 times. 2800 long range point-to-point use. Commercial duty construction of 7/8" 3" OD aluminum elements and 1 1/2" OD galvanized steel boom. Factory pre-adjusted and gamma matched for perfect 52 ohm match. Boom: 8'. Longest element: 16.5". Positive 1/2" bolt grip for masts up to 1 1/2" diameter.

\$3495 List

- Citizens Dipole, Model CD, for transmitter/receiver mounting .....\$12.95
- Citizens Whip, Model CW, for transmitter/receiver mounting .....\$ 6.95
- Auto Door Mount, Model ADM, with SO-239 receptacle for mounting CW to top of auto door .....\$ 4.95
- Model ADT Adapter, connects VHF coax plug type PL259 to Automotive type plug .....\$ 1.95
- Factory Pre-Assembled Coaxial Cable Kits
  - Model CC-12, 12 ft. ....\$ 3.95
  - Model CC-25, 25 ft. ....\$ 5.95
  - Model CC-50, 50 ft. ....\$ 8.95

SEE YOUR HY-GAIN DISTRIBUTOR OR WRITE FOR LITERATURE DIRECT TO

HY-gain antenna products  
1135 NO. 22ND • LINCOLN NEBRASKA

# Within the Industry

JOHN W. MURPHY has been appointed manager for *Weston Instruments Division of Daystrom, Inc.*



Mr. Murphy will be directly responsible for engineering, manufacturing, and industrial relations activities for the company in addition to having complete charge of the firm's main plant in Newark, N. J.

Prior to this appointment, Mr. Murphy was associated with the *International Business Machines Corporation* for fourteen years.

**ELECTRONIC INDUSTRY ASSOCIATION** has approved a complete re-organization of the parts division. A second vice-chairman for the division also was approved, as well as ten subdivision chairmen, division committee chairmen and members, and a new member of the executive committee.

William S. Parsons, president of *Centralab*, a division of *Globe Union Inc.*, is division chairman and Allen K. Shenk, vice-president, marketing, *Erie Resistor Corp.*, has been named second vice-chairman. Messrs. Parsons, Shenk, and vice-chairman W. Myron Owen, president of *Aerovox Inc.*, will administer the activities of the re-organized parts division. The following are the committee chairmen: Russell Cramer, Jr., *Radio Condenser Co.*; E. W. Butler, *Speer Carbon Co.*; and Allen K. Shenk, *Erie Resistor Corp.*

The following subdivision chairmen have also been approved by the executive committee: J. H. Stackpole, *Stackpole Carbon Co.*; Neal Welch, *Sprague Electric Co.*; I. Allen Mitchell, *United Transformer Corp.*; Jack D. Hughes, *Littelfuse, Inc.*; R. G. Zender, *Lenz Electric Mfg. Co.*; John Bentia, *Alliance Mfg. Co.*; Allen W. Dawson, *Corning Glass Works*; Harold C. Buell, *P. R. Mallory & Co., Inc.*; Wilbert H. Steinkamp, *Weston Instruments*; and J. A. Milling, *Howard W. Sams & Co., Inc.*

J. Rodney Reese, component products manager, *Texas Instruments Inc.*, has been elected to the executive committee.

**MAX F. BALCOM**, director-consultant of *Sylvania Electric Products Inc.*, has been re-appointed chairman of the EIA legislative policy committee. The committee directs the Association's legislative activities as authorized by the board of directors.

Members of the committee are: B. Adler, *Adler Electronics, Inc.*; E. C.

Anderson, *RCA*; W. F. Ballhaus, *Northrop Corp.*; R. M. Bixler, *J-B-T Instruments, Inc.*; S. R. Curtis, *Stromberg-Carlson*; L. B. Davis, *General Electric Co.*; P. Dechert, *Philco Corp.*; J. B. Elliott, *Tele-Dynamics Inc.*; R. W. Galvin, *Motorola Inc.*; H. L. Hoffman, *Hoffman Electronics, Corp.*; W. F. Joyce, *Texas Instruments Inc.*; R. C. Sprague, *Sprague Electric Co.*; and D. R. Hull (*ex officio*) president, EIA.

**DR. WILLIAM L. WHITSON** has been named a vice-president of *Daystrom, Inc.* . . . *Hazeltine Technical Development Center, Inc.*, has announced the election of **W. M. McFARLAND** as vice-president and **D. M. STUART** as vice-president and general manager . . . **CECIL STOWE** has been named manager of the newly created customer relations section of *Orr Industries* . . . **WILLIAM C. COOMBS** has been named chief of the systems analysis section, radio communication and systems division, National Bureau of Standards . . . **MAURICE R. EASTIN** has been appointed manager of *Clevite "Walco"* . . . **GENERAL H. FRANKLIN GREGORY** has been named to the board of directors of *Midwestern Instruments, Inc.* . . . **JOHN H. WATKINS** has been named wood products sales manager of *Packard Bell Electronics* . . . **LESLIE H. WARNER** and **ROBERT E. KENOYER** have been elected a member of the board of directors and controller, respectively, of *Sylvania Electric Products Inc.*

**DON KIRKENDALL** has been appointed assistant manager of advertising and sales promotion for *Electro-Voice, Inc.* He will assist Everett Leedom, advertising manager, and the firm's product and sales managers in preparing advertising and promotional materials for the company's complete product line.



Prior to joining the Buchanan, Michigan concern, Mr. Kirkendall was advertising manager for *Interstate Electronics Supply Corp.* He also taught English composition, literature survey, and creative writing courses at the Universities of Missouri and Oklahoma from 1948 to 1951.

**ELECTRONIC PARTS DISTRIBUTORS SHOW** has announced the following committee chairmen for the 1960 show. They are: Carter W. Dunlap, *Dunlap Wholesale Radio Co.*, entertainment; Roy J. Schneider, *Walder Radio and Appliance Co.*, housing; John Brown,

ELECTRONICS WORLD



**NOW!**  
at a price  
you can afford!

# MAKE MORE MONEY in TELEVISION RADIO-ELECTRONICS

**BETTER...MORE COMPLETE...LOWER COST...  
WITH NATIONAL SCHOOLS SHOP-METHOD  
HOME TRAINING!**

**BETTER...** Training that is proved and tested in Resident School shops and laboratories, by a School that is the **OLDEST** and **LARGEST** of its kind in the world.

**MORE COMPLETE...** You learn **ALL PHASES** of *Television-Radio-Electronics*.

**LOWER COST...** Other schools make several courses out of the material in our **ONE MASTER COURSE** . . . and you pay more for less training than you get in *our course* at **ONE LOW TUITION!**

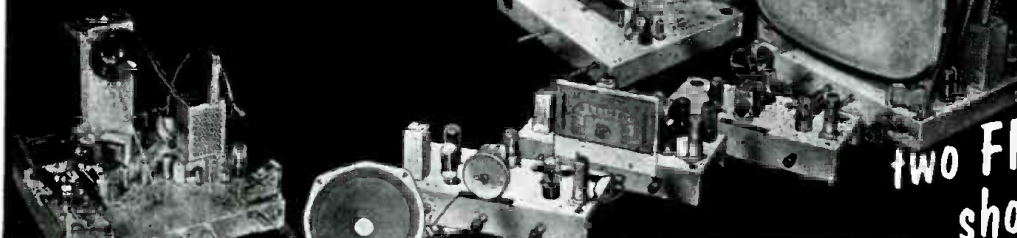

These  
**two FREE books** will  
show you how!

You get all information  
by mail . . . You make  
your own decision . . . at  
home! **NO SALESMAN  
WILL CALL**

## TOP PAY... UNLIMITED OPPORTUNITIES LIFETIME SECURITY CAN BE YOURS!

You are needed in the Television, Radio, and Electronics industry! Trained technicians are in growing demand at excellent pay—in **ALL PHASES**, including Servicing, Manufacturing, Broadcasting and Communications, Automation, Radar, Government Missile Projects.

**NATIONAL SCHOOLS SHOP-METHOD HOME TRAINING**, with newly added lessons and equipment, trains you in your spare time at home, for these unlimited opportunities, including many technical jobs leading to supervisory positions.

**YOU LEARN BY BUILDING EQUIPMENT WITH KITS AND PARTS WE SEND YOU.** Your National Schools course includes thorough *Practical* training—**YOU LEARN BY DOING!** We send you complete standard equipment of professional quality for building various experimental and test units. You advance step by step, perform more than 100 experiments, and you build a complete TV set from the ground up, that is yours to keep! A big, new TV picture tube is included at no extra charge.

**EARN AS YOU LEARN.** We'll show you how to earn extra money right from the start. Many of our students pay for their course—and more—while studying. So can you!

### RESIDENT TRAINING AT LOS ANGELES

If you wish to take your training in our Resident School at Los Angeles, the world's TV capital, start **NOW** in our big, modern Shops, Labs and Radio-TV Studios. Here you work with latest Electronic equipment - - professionally installed - - finest, most complete facilities offered by any school. Expert, friendly instructors. Personal attention. Graduate Employment Service. Help in finding home near school - - and part time job while you learn. Check box in coupon for full information.

**LESSONS AND INSTRUCTION MATERIAL ARE UP-TO-DATE, PRACTICAL, INTERESTING.** Every National Schools Shop-Method lesson is made easy to understand by numerous illustrations and diagrams. All instruction material has been developed and tested in our own Resident School Shops, Laboratories and Studios.

**SEND FOR INFORMATION TODAY . . .** it can mean the difference between **SUCCESS** and failure for you! Send for your **FREE BOOK** "Your Future in Television-Radio-Electronics" and **FREE Sample Lesson.** Do it **TODAY**, while you are thinking about your future. It doesn't cost you anything to investigate!

### GET THE BENEFITS OF OUR OVER 50 YEARS EXPERIENCE

Approved for  
GI Training



**NATIONAL SCHOOLS**

Los Angeles 37, Calif.

### YOU GET...

- 19 Big Kits—**YOURS TO KEEP!**
- Friendly Instruction and Guidance
- Job Placement Service
- Unlimited Consultation
- Diploma—Recognized by Industry
- **EVERYTHING YOU NEED FOR SUCCESS!**

### SHOP-METHOD HOME TRAINING COVERS ALL PHASES OF INDUSTRY

1. Television, including Color TV
2. Radio AM & FM
3. Electronics for Guided Missiles
4. Sound Recording and Hi-Fidelity
5. FCC License
6. Automation and Computers
7. Radar & Micro-Waves
8. Broadcasting and Communications

**NATIONAL TECHNICAL SCHOOLS**  
WORLD-WIDE TRAINING SINCE 1905

MAIL NOW TO

**NATIONAL SCHOOLS, Dept RH-10**

4000 S. FIGUEROA ST. LOS ANGELES 37, CALIF.

Rush free TV-Radio "Opportunity" Book and sample lesson. No salesman will call.

NAME \_\_\_\_\_ AGE \_\_\_\_\_

ADDRESS \_\_\_\_\_

CITY \_\_\_\_\_ ZONE \_\_\_\_\_ STATE \_\_\_\_\_

Check if interested **ONLY** in Resident School training at Los Angeles

**VETERANS:** Give date of Discharge \_\_\_\_\_

JB Distributing Co., publicity; Helen S. Quam, Quam-Nichols Co., ERA Show Corp., liaison; Jack D. Hughes, Littelfuse, Inc., educational and program; George E. Wedemeyer, Wedemeyer Electronic Supply Co., credentials; Robert E. Svoboda, Amphenol-Borg Electronics Corp., space and arrangements; Edward Rothenstein, Arco Electronics, Inc., finance and show study.

\* \* \*

**HENRY LEHNE** has been elected a senior vice-president of *Sylvania Electric Products Inc.*, a subsidiary of *General Telephone & Electronics Corporation*.



In his new duties, Mr. Lehne will have over-all responsibility for *Sylvania Electronic Systems*, a major division of the company. He has been associated with the company since 1953 and prior to that served with *Republic Aviation Corporation* for fourteen years.

Mr. Lehne is an engineering graduate of *Carnegie Institute of Technology* and has done graduate work in the advanced management field at the *Harvard Graduate School of Business Administration*.

\* \* \*

**DAVID A. McGALLIARD** has been appointed distributor sales manager for the *Daystrom-Weston Sales Div.*, *Daystrom, Inc.* . . . **REED WALDRON** is now sales promotion manager of the distributor division of *International Resistance Company* . . . The Cedar Rapids division of the *Collins Radio Company* has named **HERBERT J. PYLE** to the newly created position of director of service . . . **S. GEORGE LAWSON** has been appointed to the newly created post of operations manager for the semiconductor division of *Sylvania Electric Products Inc.* . . . The appointment of **EDWARD J. KEENAN** as director of home study for *FCA Institutes* has been announced . . . *Vocaline Company of America* has named **DONALD G. FERTMAN** sales coordinator . . . **S. I. NEIMAN** has resigned as public relations counsel for the *Association of Electronic Parts & Equipment Manufacturers, Inc.*

\* \* \*

**ELECTRONIC INDUSTRIES ASSOCIATION** has issued a report on the activities of Panel 1 (System Specifications), under Charles J. Hirsch, *Hazeltine Research Corp.*, of the *National Stereophonic Radio Committee (NSRC)*.

Murray Crosby, *Crosby Labs.*, has agreed to set up tests in collaboration with Harold Parker, *Calbest Electronics*, and William N. Halstead, *Multiplex Services Corp.*, to determine the minimum bandwidth required for good stereophonic broadcasting and the optimum compromise bandwidth for combined stereo and background music broadcast.

Another group reported on the characteristics of FM-AM. It appears that at this time the best signal-to-noise

(Continued on page 144)

# How to Get

## An FCC License can be

## Get Your FCC License

**We Guarantee**  
to train you until you receive  
**Your FCC License**  
— or your money back

The Master Course in Electronics will provide you with the mental tools of the electronics technician and prepare you for a First Class FCC License (Commercial) with a radar endorsement. When you successfully complete the Master Course, if you fail to pass the FCC examination, you will receive a full refund of all tuition payments.

**Cleveland Institute Training Results in success with commercial FCC examinations . . . easily . . . and quickly.**

# Free!

**FIND OUT HOW:**

1. The new electronic devices can be handled by you
2. To solve the problems that will stump your fellow technicians
3. Training is Job Insurance when employment is tough to find . . . and more money for you when times are good

**Mail Coupon NOW . . .**



(Commercial)

# an FCC License

## your Guarantee of Success in Electronics

### in a Minimum of Time



here's proof of good jobs

Irving Laing:

"Your lessons are helping me a lot in my Navy work. You cover topics that were not presented by the Navy at the E.T. School. . . . Your course has helped greatly to get my 2nd class FCC ticket. I am now a radio and T.V. engineer at WTVS and WDTR in Detroit, Michigan."

*Irving L. Laing,  
15887 Robson,  
Detroit 27, Michigan*

## Get all 3 FREE



Accredited by The National Home Study Council

**Cleveland Institute of Electronics**

Desk RN-37, 4900 Euclid Ave., Cleveland 3, Ohio



Please send FREE Booklets prepared to help me get ahead in Electronics. I have had training or experience in Electronics as indicated below:

- |   |   |
|---|---|
| <input type="checkbox"/> Military           | <input type="checkbox"/> Broadcasting       |
| <input type="checkbox"/> Radio-TV Servicing | <input type="checkbox"/> Home Experimenting |
| <input type="checkbox"/> Manufacturing      | <input type="checkbox"/> Telephone Company  |
| <input type="checkbox"/> Amateur Radio      | <input type="checkbox"/> Other.....         |

In what kind of work are you now engaged?.....

In what branch of Electronics are you interested?.....

Name..... Age.....

Address.....

City..... Zone..... State.....

Special Tuition Rates to Members of Armed Forces Desk RN-37

## Receive All These Booklets FREE!

why  
the most  
advanced  
professional  
cartridge...



**Electro-Voice**® NEW MAGNERAMIC \* 31 MD7

has ceramic  
elements!

For more than 35 years, Electro-Voice has been a leader in the development and manufacture of dynamic microphones and loudspeakers. Why then, with this extensive experience in designing and producing electro-magnetic devices, is Electro-Voice introducing the new Magneramic 31 Series stereo cartridge using ceramic elements?

The reason is that Electro-Voice is genuinely convinced that a precision ceramic cartridge is the finest type that can be made today . . . definitely superior to the magnetic type. The superiority of the Magneramic 31 is demonstrated in these three areas.

**GREATER FLEXIBILITY** — The 31 Series cartridge will operate perfectly at any stylus pressure from 2 to 20 grams. The same stylus assembly can be used for operation on both turntable and record changers; performance need not be compromised by using a special, stiff stylus assembly for record changers. Record wear is the only criterion in setting stylus pressure — cartridge operation is not affected. Thus, when converting from a changer to a turntable, or vice versa, replacement of the stylus assembly is not necessary when using the Magneramic 31.

**HIGHER OUTPUT** — Along with the trend toward less efficient speaker systems, more amplifier power has become a necessity. While most stereo amplifiers are now designed with input sensitivities to match the typical 5-millivolt output of magnetic stereo cartridges, nearly all monaural amplifiers were designed for at least 8-millivolt input. These cannot be driven to full output with a magnetic stereo cartridge. The Magneramic 31 develops a full 8-millivolt output and couples directly into any "magnetic" preamp unit. This higher output should especially be considered by those planning conversion to stereo utilizing existent monaural amplifiers.

**FREEDOM FROM HUM** — The increased amplifier gain required to satisfactorily drive low-efficiency speakers coupled with decreased cartridge output has significantly increased system hum problems. Also, conventional methods of hum elimination used in monaural magnetic cartridges become difficult or impossible to apply to stereo magnetics. The Magneramic 31 completely eliminates these problems — it is non-inductive and has adequate output.

The Electro-Voice Magneramic 31 MD7 cartridge directly replaces any monophonic or stereophonic magnetic cartridge now on the market. It feeds into the preamp input-jack specified for magnetic cartridges and does not require adaptors or circuit modifications.

**SPECIFICATIONS — MAGNERAMIC 31 MD7**

*Response Range:* 20 to 15,000 cps  $\pm$  2 db  
*Compliance, Vertical:*  $3.5 \times 10^{-6}$  cm/dyne  
*Compliance, Lateral:*  $3.5 \times 10^{-6}$  cm/dyne  
*Isolation:* 28 db @ 1000 cycles  
*Tracking Force:* 2 to 4 grams in transcription arms  
4 to 6 grams in changer arms  
*Styli:* .7 mil diamond  
*Output:* 8 millivolts  
*Recommended Load:* 22,000 to 47,000 ohms  
(Magnetic phono inputs)  
*Elements:* 2, Lead Zirconium Titanate (Ceramic)  
*Weight:* 8 grams  
*Terminals:* 4, standard .050" connectors  
*Mounting Centers:*  $\frac{1}{2}$ " and  $\frac{3}{8}$ " fits both  
*Audiophile Net:* \$24.00

Want more information? Write to Dept. 10N for the booklet entitled, "FACTS ABOUT THE ELECTRO-VOICE MAGNERAMIC CARTRIDGE"

**Electro-Voice**® INC.

BUCHANAN, MICHIGAN

ELECTRONICS WORLD



Hey...  
I've  
got  
new  
coil heaters!

(GOODBYE TO YOUR  
FRONT-END TROUBLES)



"All 6BQ7A's used to have folded heaters . . . and gave you plenty of trouble. Now, all of us CBS 6BQ7A tubes have new coil heaters for our new improved cathodes . . . and *you* don't have heater burnouts, shorts or slumping gain."

Yes, the new CBS 6BQ7A offers you *total reliability* . . . proved in performance by leading TV and radio set manufacturers. You, too, can profit from the *total reliability* of CBS tubes. Prove it to yourself. Replace with CBS.

**TOTAL RELIABILITY...proved in performance**

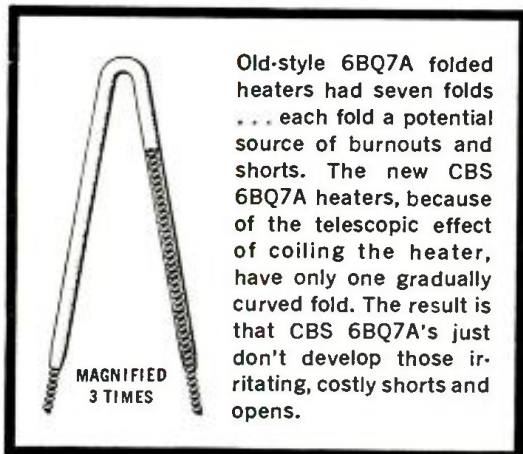

*Receiving, industrial  
and picture tubes •  
transistors and diodes •  
audio components •  
and phonographs*

**CBS ELECTRONICS**

Danvers, Massachusetts

A Division of Columbia Broadcasting System, Inc.

RESIDENT SCHOOL COURSES

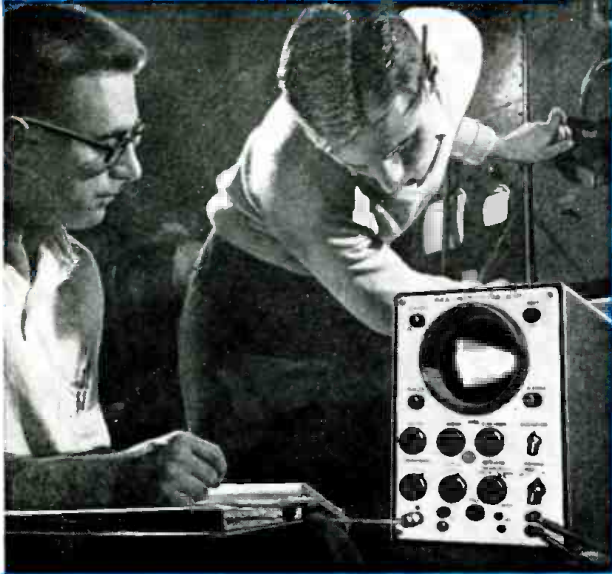

Industry needs Electronic Technicians!

# Let RCA train you in Advanced Electronics

This is the college-level training you need to work with professional engineers on research, development or production projects in such fields as: automation, guided missiles, radar, television, computers and other advanced electronic applications.

RCA Institutes Resident School in New York City offers this comprehensive course that prepares you for any field of electronics you may choose. Other courses in TV & General Electronics, Radio & TV Servicing, and Radio Telegraph Operating.

Classes start four times each year. Applications now being accepted. Approved for Veterans.



## RCA INSTITUTES, INC.

SCHOOLS OF TELEVISION  
AND ELECTRONIC TECHNOLOGY  
A Service of Radio Corporation of America  
ANOTHER WAY RCA SERVES EDUCATION THROUGH ELECTRONICS

RCA INSTITUTES, DEPT. EWR-10  
350 W. Fourth St., N.Y. 14, N.Y.

Please send me your FREE catalog of  
Resident School courses in New York.

NAME ..... please print

ADDRESS .....

CITY ..... ZONE ..... STATE .....

For Home Study Courses see ad on opposite page

# HIGH-FIDELITY ANAGRAM

By JOHN A. COMSTOCK

(Answer on page 160)

ACROSS

1. Network of component parts in a hi-fi system used to separate the high from the low frequencies, sending them to different speakers for reproduction.
9. A single pulse of recording signal.
10. To remove program material from a recording tape.
12. A device that plays records (Colloq.).
13. A small woodwind that sounds an octave higher than an ordinary flute.
14. Unit used to express magnetic tape recording speed. (abbr.).
16. An \_\_\_\_\_ amplifier makes sound louder.
17. Music often induces restful \_\_\_\_\_.
19. A slow fluctuation in turntable speed that causes a fluctuating pitch in program material.
21. A melody for a particular voice or instrument.
22. Accentuation of a bass note by resonance.
23. Abbreviation for a number of interconnected electronic components.
25. An interval of silence between musical notes.
28. Quality or character of sound.
29. Vibration of this small piece of cane or metal gives a woodwind its characteristic sound.
30. Wind instrument of the oboe family.
32. The \_\_\_\_\_ result to be achieved in any hi-fi system is realism.

33. Type of radio transmission (abbr.).
34. Public musical performance.

DOWN

2. Wind instrument in the form of a slender conical tube in which the tone is produced by a double reed.
3. A music lover may consider it a \_\_\_\_\_ to criticize the music of the masters.
4. The button depressed on a tape recorder to cut off operation.
5. To regulate the tones of, as the pipes of an organ.
6. To put sound on a magnetic tape or disc.
7. Measurement of sound intensity which corresponds to the characteristics of human hearing.
8. Large drum.
11. Science of sound.
15. Component in reproduced sound not in original program material.
18. Familiar name for disc recording.
20. Hi-fi speaker especially designed to handle the lowest audio frequencies.
23. Bulb-type of record level indicator used in some types of tape recorders.
24. Musical tones corresponding to vibrations greater than 260 cps.
26. Note equal in time value to one-half of a semibreve.
27. "Baritone" of the violin family.
31. Marks the measure between two divisions in a musical manuscript.

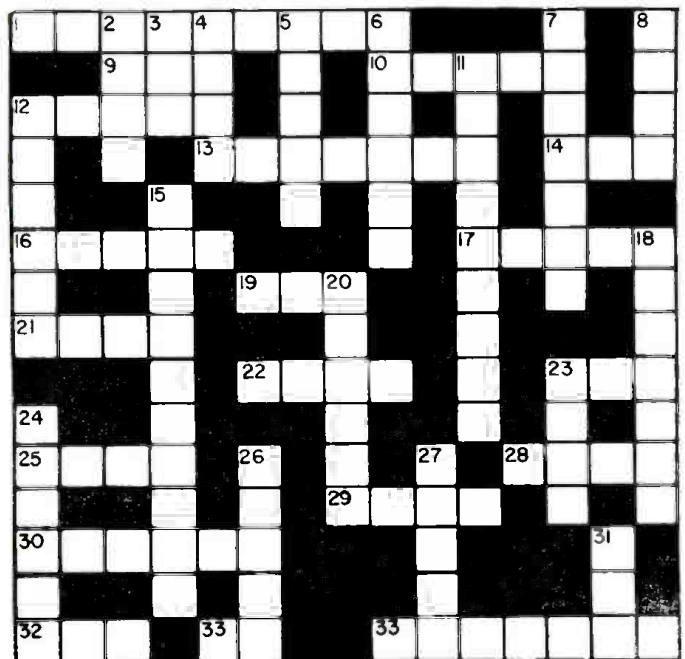



ANOTHER WAY RCA  
SERVES EDUCATION  
THROUGH  
ELECTRONICS

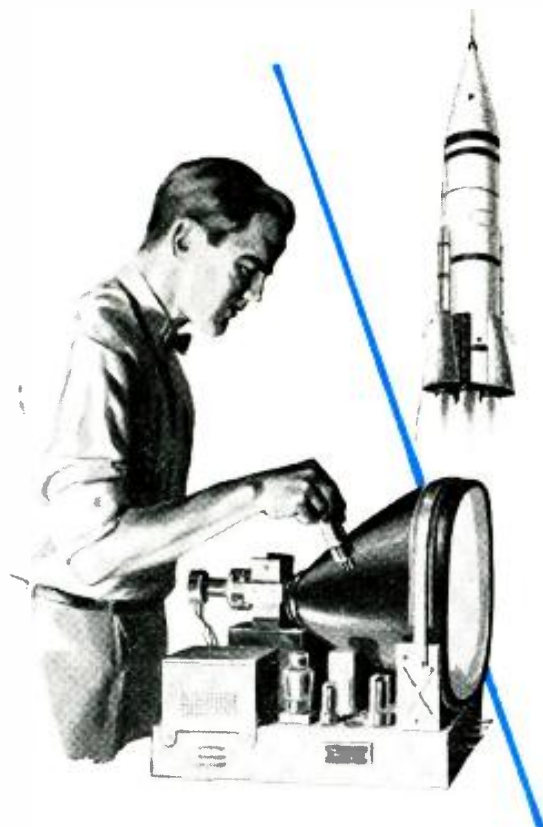

# 6 REASONS WHY RCA TRAINING IN ELECTRONICS can be the smartest investment you'll make in your *entire lifetime!*

**1. You get the finest training-at-home** under the supervision of the RCA INSTITUTES, experts in technical training for over 50 years. The very name "RCA" means dependability, integrity, and scientific advance.

**2. You get comprehensive training** in your choice of four complete, up-to-date Courses . . . from basic electronics theory to Color TV and Automation.

**3. You get an evaluation of your aptitude** for advanced training. RCA determines, for your benefit, whether you have the requirements for a career in the electronics field.

**4. You get prime quality equipment** as a regular part of your Course . . . equipment that you keep and use on the job. You never have to take apart one piece to build another.

**5. You get each study group on a pay-as-you-go basis.** Should you wish to interrupt your training at any time, you will not owe RCA Institutes a penny more, unless and until you decide to resume the Course.

**6. You get top recognition — worldwide.** Graduates of RCA Institutes now work for leaders in the electronics field; many have their own businesses. This record is true tribute to the high quality of RCA Institutes training.

Send for this  
64-page Home  
Study Catalog  
**FREE!**

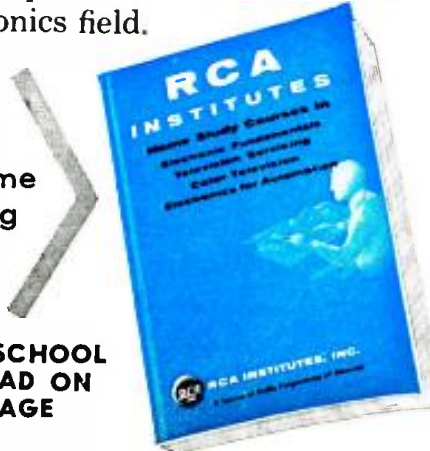

**FOR RESIDENT SCHOOL  
COURSES SEE AD ON  
OPPOSITE PAGE**

## RCA INSTITUTES, Inc. Home Study School EW-10

A Service of Radio Corporation of America  
350 West Fourth Street, New York 14, N. Y.  
Without obligation, send me **FREE** 64-page CATALOG on Home Study Courses. No salesman will call.

Name ..... Age.....  
please print

Address .....

City ..... Zone..... State.....

Korean Vets! Enter discharge date.....

**CANADIANS** — Take advantage of these same RCA courses at no additional cost. No postage, no customs, no delay. Send coupon to: RCA Victor Company, Ltd., 5001 Cote de Liesse Rd., Montreal 9, Quebec  
To save time, paste coupon on postcard.



Latest Information

on the Electronic Industry

*Spot News*

By ELECTRONICS WORLD'S  
WASHINGTON EDITOR

**ADDITIONAL FREQUENCIES PROPOSED FOR SPACE COMMUNICATION**—At the suggestion of the Executive Branch of the government, the FCC has issued a proposal to amend its rules re-allocating the 118-136 mc. band so as to provide additional frequencies, on a protected basis, for earth-space and space communication and for air-traffic control in the interest of air safety. The proposed changes, contemplated to become effective July 1, 1960, would place the 135-136 mc. band in the earth-space category. Three megacycles, 132-135 mc., from the present 132-144 mc. government band would be allocated for aeronautical and aircraft-station use. Two additional megacycles (126.825-128.825) from the existing 126.825-132 mc. band now used primarily by airlines, would be re-allocated for air-traffic control communications.

**UNDERWATER TV NOW BEING USED BY NAVY TO STUDY OCEAN BOTTOM**—Operational use of a remote-control underwater closed-circuit TV system in deep-water surveys (at depths of more than 600 feet) has been announced by the Navy. This is the first time that a continuous visual survey has been achieved at such depths. Primarily designed for salvage and search, the setup includes an underwater lighting system and a movable camera-housing capable of training 70 degrees in any direction. A propulsion system enables the underwater vehicle to hover at any desired depth in currents and tides of several knots.

**MULTI-MILLION-DOLLAR 1000-FT. RADAR ANTENNA SYSTEM UNDER CONSTRUCTION**—A vertically directed ionospheric radar probe, equipped with a 1000-foot diameter spherical antenna, to study the mid-course effects of atmosphere on ballistic missiles, is now being built for installation in Puerto Rico. Total cost of the installation, including the land (70 acres) and site development, is estimated at \$4.5-million. The device will be capable of using incoherent backscatter radar to obtain radar echoes from Mars and Venus and to map areas of the moon and sun.

**TV-TORPEDO RETRIEVING DEVICE TO BE BUILT**—A combination mobile deep-water TV system and a retrieving device for spent torpedoes is being designed for use by the U.S. Naval Torpedo Station, Keyport, Washington, at the Torpedo Test Range in Dabob Bay, an arm of Puget Sound. A self-propelled unit, making use of closed-circuit TV, it will feature deep-water lights to illuminate the camera's field of view. An operator in a surface vessel will be able to guide the unit and view the underwater area over a TV screen. When a torpedo is sighted, the operator will guide the unit to it and a pair of claws will clamp the torpedo and bring it to the surface.

**HIGH-POWERED SUN BATTERIES ON EXPLORER VII FOR TRANSMITTERS**—Sun batteries, 100 times as powerful as those on Vanguard I, capable of generating a minimum of 5 watts continuously, are in the 91.5-pound Explorer VII now in orbit. The batteries have over 2000 solar cells imbedded in ceramic cement, which in turn fills aluminum trays covered with fused silica windows held in place by aluminum frames and sealed by a rubber gasket. To insure constant flow of current, irrespective of spin or tumble, the cells have been grouped in six power units, any one of which can provide the necessary power. Thus, at least one group will be in full sunlight at all times the satellite is not in the earth's shadow.

**ARMY SCIENTISTS SHARE \$25,000 AWARD FOR MINIATURIZATION ROLES**—Five Army scientists from the Diamond Ordnance Fuze Laboratory in Washington, D.C., whose breakthrough in miniaturization has made it possible to pack five times as much electronic gear into missile nose cones, recently shared a \$25,000 award. At a Pentagon ceremony, Secretary of the Army Wilbur M. Brucker presented the awards (\$5000 each) to Thomas A. Prugh, Mrs. Edith M. Olson, Norman J. Doctor, James R. Nall, and Dr. Jay W. Lathrop.

**AVIATION AGENCY SEEKS METHOD TO IMPROVE VOICE OVER RADIO**—A \$55,000 contract has been awarded to Blonder-Tongue Labs by the Federal Aviation Agency for research on radio transmission of the human voice and the development of an experimental device to improve the intelligibility or ease of understanding of voice communications in aviation. The project will involve study of the human voice and the acoustical environment in which air-traffic control activities are conducted.

-30-





HERE'S A **COMPACT** DESIGN

that's preferred among all modern designs!

IT'S THE SLIM, TRIM NEW 330 MICROPHONE SERIES  
Dynamic, Ceramic and Crystal Models

BY **ASTATIC**

never before such quality of performance and versatility of application at such low price

Yes, here's a classic design in modern, compact microphones—small, slender, unobtrusive, a beauty in simplicity. But the greatest achievement is in the magnificent performance quality of the Series among a great host of applications.

The Dynamic Models 335H (high impedance) and 335L (low impedance) operate with highest quality characteristics in TV and radio broadcast usage, in professional or home recording, public address, almost unlimited other lavalier, hand or stand applications.

The Ceramic Model 331 is a voice range unit specifically engineered for excellence in communications applications, 27 megacycle citizens' band use, and paging.

Ceramic Model 333 is a wide-range microphone offering a similarly high new level of perfection for tape recording, P. A. Systems, etc.

Crystal Model 332, with satin chrome body and cap, black grille, is already famous through widespread use. Performance throughout the series is of the highest order. **THUS, THE GREATEST NEWS OF ALL CONCERNING THESE NEW ASTATIC UNITS IS THEIR AMAZINGLY LOW COST!** Check out these new Astatic Microphones at your first opportunity.

ACTUAL SIZE



GO BY BRAND...  
GO BUY ASTATIC

Model	Type	Output	Frequency Range	Impedance	Finish	List Price
331	Ceramic	-56 db	300-5,000	High	Black Body and Grille, Chrome Cap	\$17.90
333	Ceramic	-58 db	30-12,000	High		17.90
335H	Dynamic	-56 db	50-12,000	High	TV Grey Body, Chrome Cap and Grille	26.50
335L	Dynamic	-57 db	50-12,000	Low		23.50

NOTE: Model 331 has momentary-on, spring-return switch, is furnished with hang-up bracket. Cable provides for audio and relay connections. All other models have slide switch with "lock-on" position, are complete with lavalier and stand adaptor with 3/8"-27 thread.

THE **Astatic** CORPORATION, CONNEAUT, OHIO

KNOWS THE WORLD OVER



In Canada: Canadian Astatic Limited, Toronto, Ontario  
Export Sales: Roburn Agencies, Inc., 431 Greenwich St., N. Y. 13, N. Y., U. S. A.

# DIFILM<sup>®</sup>



## BLACK BEAUTY<sup>®</sup> CAPACITORS BEAT HEAT AND HUMIDITY

New DIFILM Black Beauty Capacitors lead the way in tubulars! The operating temperature range of these new capacitors goes up to 105 C (221 F) *without voltage derating*. **Capacitance tolerance is held to  $\pm 10\%$ .**\*

• The new dual dielectric used in DIFILM Capacitors combines the proven long life of paper capacitors with the effective moisture resistance of polyester plastic film capacitors . . . to give you performance that can't be beat.

• Here's the kind of performance you can expect from DIFILM: very high insulation resistance, low power factor, moderate capacitance change with temperature,

excellent retrace under temperature cycling, and superior long-term stability . . . *all at regular prices!*

• This high performance is fully protected by HCX<sup>®</sup>, an exclusive Sprague hydrocarbon material which impregnates the windings, filling all voids and pinholes before it polymerizes. The result is a solid rock-hard capacitor section. These capacitors are further protected by an outer molding of humidity-resistant, non-flammable phenolic.

*For complete technical information on DIFILM Black Beauty Capacitors, write for Bulletin M-759 to Sprague Products Company, 51 Marshall St., North Adams, Mass.*

\*From .001  $\mu$ F up

The major capacitor improvements come from

# SPRAGUE<sup>®</sup>

*world's largest capacitor manufacturer*

SPRAGUE RESEARCH IS CONSTANTLY PRODUCING NEW AND BETTER CAPACITORS FOR YOU



In  
**STEREO**  
**STEREO**

and Mono Hi-Fi... the experts say  
your best buy is

**EICO**

"The overall design of the HF-81 is conservative, honest and functional. It is a good value considered purely on its own merits, and a better one when its price is considered as well."

— Hirsch-Houck Labs (HIGH FIDELITY Magazine)

- Advanced engineering • Finest quality components
- "Beginner-Tested," easy step-by-step instructions
- LIFETIME service & calibration guarantee at nominal cost
- IN STOCK — compare, then take home any EICO equipment — right "off the shelf" — from 1500 neighborhood EICO dealers.



**Stereo Amplifier-Preamplifier HF81**

**HF81 Stereo Amplifier-Preamplifier** selects, amplifies, controls any stereo source & feeds it thru self-contained dual 14W amplifiers to a pair of speakers. Provides 28W monophonically. Ganged level controls, separate balance control, independent bass & treble controls for each channel. Identical Williamson-type, push-pull EL84 power amplifiers. "Excellent" — SATURDAY REVIEW; HI-FI MUSIC AT HOME. "Outstanding quality... extremely versatile." — ELECTRONICS WORLD LAB-TESTED. Kit \$69.95. Wired \$109.95. Includes cover.

**HF85 Stereo Preamplifier** is a complete, master stereo preamplifier control unit, self-powered for flexibility & to avoid power-supply problems. Distortion borders on unmeasurable even at high output levels. Level, bass, & treble controls independent for each channel or ganged for both channels. Inputs for phono, tape head, mike, AM, FM, & FM-multiplex. One each auxiliary A & B input in each channel. Switched-in loudness compensator. "Extreme flexibility... a bargain." — HI-FI REVIEW. Kit \$39.95. Wired \$64.95. Includes cover.

**New HF87 70-Watt Stereo Power Amplifier:** Dual 35W power amplifiers of the highest quality. Uses top-quality output transformers for undistorted response across the entire audio range at full power to provide utmost clarity on full orchestra & organ. IM distortion 1% at 70W, harmonic distortion less than 1% from 20 to 20,000 cps within 1 db of 70W. Ultra-linear connected EL34 output stages & surge-protected silicon diode rectifier power supply. Selector switch chooses mono or stereo service; 4, 8, 16, and 32 ohm speaker taps, input level controls, basic sensitivity 0.38 volts. Without exaggeration, one of the very finest stereo amplifiers available regardless of price. Use with self-powered stereo preamplifier-control unit (HF85 recommended). Kit \$74.95. Wired \$114.95.

**HF86 28W Stereo Power Amplifier Kit \$43.95. Wired \$74.95.**

**FM Tuner HFT90:** Prewired, prealigned, temperature-compensated "front end" is drift-free. Prewired exclusive precision eye-tronics traveling tuning indicator. Sensitivity: 1.5 uv for 20 db quieting; 2.5 uv for 30 db quieting. Full limiting

from 25 uv. IF bandwidth 260 kc at 6 db points. Both cathode follower & FM-multiplex stereo outputs, prevent obsolescence. Very low distortion. "One of the best buys in high fidelity kits." — AUDIOCRAFT. Kit \$39.95. Wired \$65.95. Cover \$3.95. Less cover, F.E.T. Incl.

**New AM Tuner HFT94.** Matches HFT90. Selects "hi-fi" wide (20c — 9kc @ —3 db) or weak-station narrow (20c — 5kc @ —3 db) bandpass. Tuned RF stage for high selectivity & sensitivity; precision eye-tronics tuning. Kit \$39.95. Wired \$65.95 Incl. Cover & F.E.T.

**New FM/AM Tuner HFT92** combines the renowned EICO HFT90 FM Tuner with excellent AM tuning facilities. Kit \$59.95. Wired \$94.95. Includes cover & F.E.T.

**New AF-4 Stereo Amplifier** provides clean 4W per channel or 8W total output. Inputs for ceramic/crystal stereo pick-ups, AM-FM stereo, FM-multi stereo, 6-position stereo/mono selector. Clutch-concentric level & tone controls. Use with a pair of HFS-5 Speaker Systems for good quality, low-cost stereo. Kit \$38.95. Wired \$64.55.

**HF12 Mono Integrated Amplifier** provides complete "front-end" facilities and true high fidelity performance. Inputs for phono, tape head, TV, tuner and crystal ceramic cartridge. Preferred variable crossover, feedback type tone control circuit. Highly stable Williamson-type power amplifier circuit. Power output: 12W continuous, 25W peak. Kit \$34.95. Wired \$57.95. Includes cover.

**New HFS3 3-Way Speaker System Semi-Kit** complete with factory-built 3/4" veneered plywood (4 sides) cabinet. Bellows-suspension, full-inch excursion 12" woofer (22 cps res.), 8" mid-range speaker with high internal damping cone for smooth response. 3 1/2" cone tweeter. 2 1/4 cu. ft. ducted-port enclosure. System Q of 1/2 for smoothest frequency & best transient response. 32-14,000 cps clean, useful response. 16 ohms impedance. HWD: 26 1/2", 13 7/8", 14 3/8". Unfinished birch \$72.50. Walnut, mahogany or teak \$87.50.

**New HFS5 2-Way Speaker System Semi-Kit** complete with factory-built 3/4" veneered plywood (4 sides) cabinet. Bellows-suspension, 5/8" excursion,



**Stereo Preamplifier HF85**



**70W Stereo Power Amplifier HF87  
28W Stereo Power Amplifier HF86**



**FM Tuner HFT90 FM/AM Tuner  
AM Tuner HFT94 HFT92**



**Stereo Integrated Amplifier AF4**



**12W Mono Integrated Amplifier HF12  
Other Mono Integrated Amplifiers:  
50, 30, & 20W (use 2 for stereo)**



**2-Way Bookshelf  
Speaker System HFS1  
3-Way Speaker System HFS3  
2-Way Speaker System HFS5**

tion, 8" woofer (45 cps res.), & 3 1/2" cone tweeter. 1 1/4 cu. ft. ducted-port enclosure. System Q of 1/2 for smoothest frequency & best transient response. 45-14,000 cps clean, useful response. HWD: 24", 12 1/2", 10 1/2". Unfinished birch \$47.50. Walnut, mahogany or teak \$59.50. **HFS1 Bookshelf Speaker System** complete with factory-built cabinet. Jensen 8" woofer, matching Jensen compression-driver exponential horn tweeter. Smooth clean bass; crisp extended highs. 70-12,000 cps range. 8 ohms. HWD: 23" x 11" x 9". Price \$39.95.

**HFS2 Omni-Directional Speaker System** (not illus.) HWD: 36", 15 1/4", 11 1/2". "Eminently musical" — HIGH FIDELITY. "Fine for stereo" — MODERN HI-FI. Completely factory-built. Mahogany or walnut \$139.95. Blond \$144.95.

**IMPORTANT NOTE:** All EICO kits built according to our instructions, and all EICO factory-assembled equipment, conform to the high standards and specifications as published in EICO literature and advertisements. All EICO factory-assembled equipment is completely and meticulously hand-wired throughout — no printed circuitry; each factory-assembled unit is 100% final-tested throughout for each feature and function — no "spot" or "partial" checking. In EICO's final-test techniques, nothing is left to chance.

Fill out coupon on next page for FREE CATALOG. Ask your dealer about EICO's exclusive STEREO RECORD BONUS

The specs prove it...your best buy is



**B**  
TV-FM SWEEP GENERATOR  
AND MARKER #368  
KIT \$69.95 WIRED \$119.95

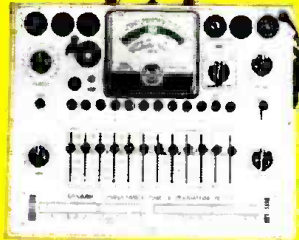

**A**  
DYNAMIC CONDUCTANCE  
TUBE & TRANSISTOR  
TESTER #666  
KIT \$69.95 WIRED \$109.95  
Complete with steel cover & handle

**C**  
RF SIGNAL GENERATOR #324  
KIT \$26.95 WIRED \$39.95



**D**  
PEAK-TO-PEAK  
VTVM #232 &  
UNI-PROBE (pat. pend)  
KIT \$29.95  
WIRED \$49.95



**E**  
COLOR & MONOCHROME  
DC TO 5 MC LAB & TV  
5" OSCILLOSCOPE #460  
KIT \$79.95 WIRED \$129.50  
5" PUSH-PULL  
Oscilloscope #425  
Kit \$44.95 Wired \$79.95

**A** Tests all receiving tubes (picture tubes with adapter), n-p-n and p-n-p transistors. Composite indication of Gm, Gp & peak emission. Simultaneous selection of any one of 4 combinations of 3 plate voltages, 3 screen voltages, 3 ranges of continuously variable grid voltage (with 5% accurate pot.). Sensitive 200 ua meter. 10 six-position lever switches: freepoint connection of each tube pin. 10 pushbuttons: rapid insert of any tube element in leakage test circuit. Direct reading of inter-element leakage in ohms. New gear-driven rollchart. CRA Adapter \$4.50.

**B** Entirely electronic sweep circuit with accurately-biased inductor for excellent linearity. Extremely flat RF output. Exceptional tuning accuracy. Hum and leakage eliminated. 5 fund. sweep ranges: 3-216 mc. Variable marker range: 2-75 mc

in 3 fund. bands, 60-225 mc on harmonic band. 4.5 xtal marker osc., xtal supplied. Ext. marker provision. Attenuators: Marker Size, RF Fine, RF Coarse (4-step decade). Narrow range phasing control for accurate alignment.

**C** 150 kc to 435 mc with ONE generator in 6 fund. bands and 1 harmonic band!  $\pm 1.5\%$  freq. accuracy. Colpitts RF osc. directly plate-modulated by K-follower for improved mod. Variable depth of int. mod. 0-50% by 400 cps Colpitts osc. Variable gain ext. mod. amplifier: only 3.0 v needed for 30% mod. Turret-mounted, slug-tuned coils for max. accuracy. Fine and Coarse (3-step) RF attenuators. RF output 100,000 uv, AF output to 10 v.

**D** Uni-Probe — exclusive with EICO — only 1 probe performs all functions; half-turn of probe tip selects DC or AC-Ohms. Calibration without re-

moving from cabinet. Measure directly p-p voltage of complex & sine waves: 0-4, 14, 42, 140, 420, 1400, 4200. DC/RMS sine volts: 0-1.5, 5, 15, 50, 150, 500, 1500 (up to 30,000 v. with HVP probe, & 250 mc with PRF probe). Ohms: 0.2 ohms to 1000 megs.  $4\frac{1}{2}$ " meter, can't-burn-out circuit. 7 non-skip ranges on every function. Zero center.

**E** Features DC amplifiers! Flat from DC to 4.5 mc, usable to 10 mc. Vert. Sens.: 25 mv/in.; input Z 3 megs; direct-coupled & push-pull throughout. 4-step freq.-compensated attenuator up to 1000:1. Sweep: perfectly linear 10 cps — 100 kc (ext. cap. for range to 1 cps). Pre-set TV V & H positions. Auto sync. lim. & ampl. Direct or cap. coupling; bal. or unbal. inputs; edge-lit engraved lucite screen with dimmer control; plus many more outstanding features.

FREE CATALOG shows you HOW TO SAVE 50% on 65 models of top quality professional test equipment. MAIL COUPON NOW!



**New Transistor Portable Radio RA-6**  
Kit \$29.95  
Wired \$49.95  
Incl. F.E.T.; less 9V batt. Prealigned RF, IF xfms; push-pull audio; 6" spkr.



**NEW Power & Bias Supply for Transistorized Eqt. #1020**  
Kit \$19.95  
Wired \$27.95



**NEW Tube & CRT Fil. Tester #612**  
Kit \$3.95  
Wired \$5.95  
Fast-checks radio/TV tubes, pilot lamps, etc.



**Series/Parallel R-C Combination Box #1140**  
Kit \$13.95  
Wired \$19.95



**Tube Tester #625**  
Kit \$34.95  
Wired \$49.95  
• tests 600 mil series string type tubes  
• illuminated roll-chart  
Pix Tube Test Adapter.....\$4.50



**6V & 12V Battery Eliminator & Charger #1050**  
Kit \$29.95  
Wired \$38.95  
Extra-filtered for transistor equipmt. =1060 Kit \$38.95  
Wired \$47.95



**20,000 Ohms/Volt V-O-M #565**  
Kit \$24.95  
Wired \$29.95  
1000 Ohms/Volt V-O-M #536  
Kit \$12.90  
Wired \$14.90

SEE OUR OTHER ADVERTISEMENT ON PAGE 106



33-00 Northern Blvd. L.I.C. 1, N.Y.

Add 5% in the West. © 1959

TURN PAGE FOR MORE EICO VALUES

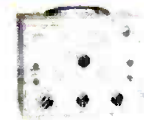

**R-C Bridge & R-C-L Comparator #950B**  
Kit \$19.95  
Wired \$29.95  
Reads 0.5 ohms-500 megs, 10 mmfd-5000 mfd, power factor



**VTVM Probes**

	Kit	Wired
Peak-to-Peak	\$4.95	\$6.95
RF	\$3.75	\$4.95
High Voltage Probe-1		\$6.95
High Voltage Probe-2		\$4.95
Scope Probes		
Demodulator	\$3.75	\$5.75
Direct	\$2.75	\$3.95
Low Capacity	\$3.75	\$5.75

EICO  
33-00 Northern Blvd.  
L.I.C. 1, N.Y.

EW-1

Show me HOW TO SAVE 50% on  Test Instruments  
 Hi-Fi  Ham Gear.  Send free Stereo Hi-Fi Guide. Send me FREE Catalog, name of neighborhood dealer.

Name.....  
Address.....  
City..... Zone..... State.....



# Air Traffic Control by **ELECTRONICS**

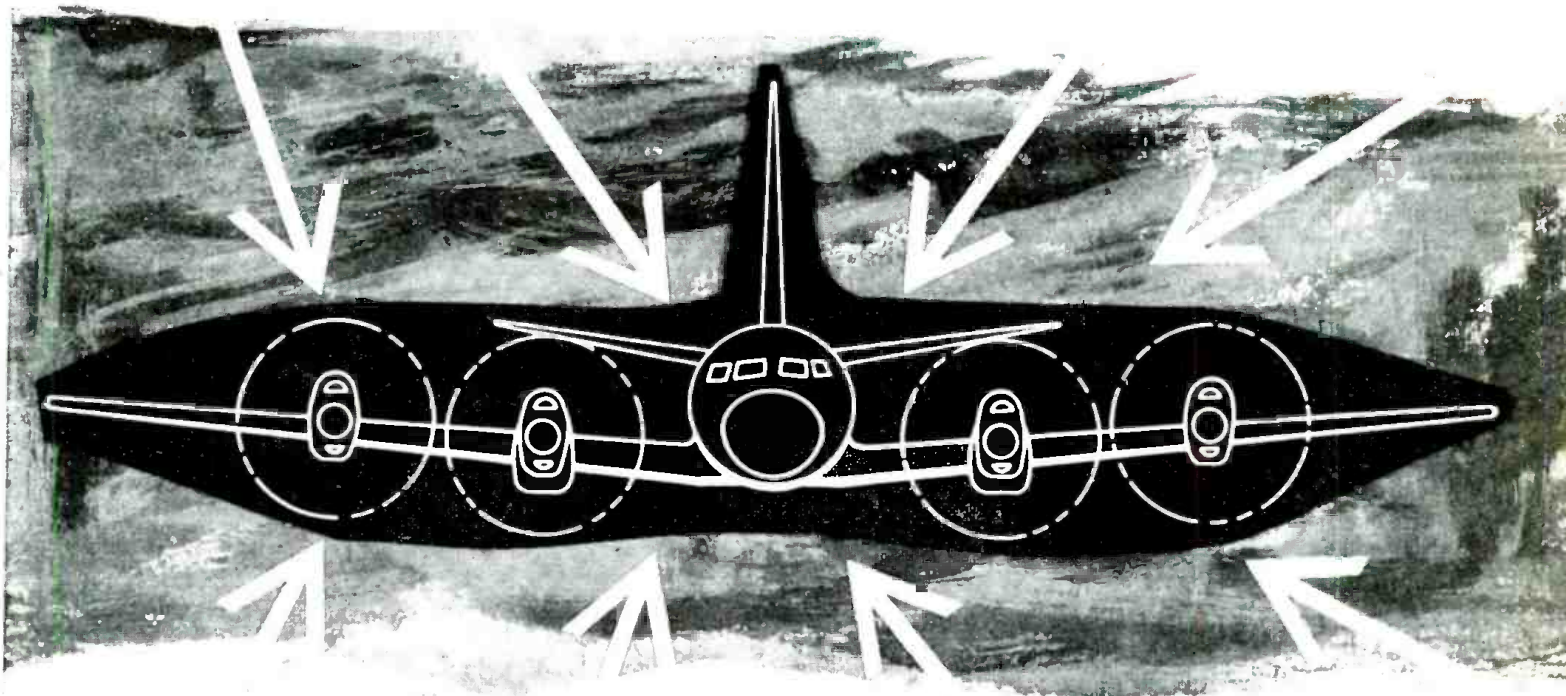

By **JAMES A. NILAND**

Former Assistant to the Administrator, Region I, Federal Aviation Agency

**With more and faster planes, the control of air traffic must be a precise task with no margin for error. The job is being done by electronics.**

**M**ANY of us have forgotten that less than 20 years ago, air travelers "zipped" through the sky at what was then the fantastic speed of approximately 150 miles-an-hour. Not only the speed, but the altitude of 18,000 to 20,000 feet was sufficient to identify one as a seasoned air traveler.

In the short span of the past two decades, aviation has literally leaped from the two-engine aircraft to the four-engine jets flying five to six miles above the earth's surface at better than 500 miles-an-hour.

And while the speed of aircraft has increased, so has the number of aircraft flying the airways criss-crossing the United States. In 1939 there were approximately 29,000 licensed aircraft; there were upwards of 110,000 licensed to fly in 1959. Approximate figures in the various categories are: military 42,000, air carrier 2000, and general aviation over 65,000. The latter category includes all aircraft either privately or corporately owned. In short, it accounts for all aircraft except military and airline aircraft.

More and faster airplanes have posed a gigantic problem in air traffic control. It's not as simple as red and green lights on railroads or highways. There are no "caution lights" on the airways. It's a precise task with no margin for error, and the job is being accomplished by electronics.

The essential tools of air traffic control are radio and

radar. Radio was first, and then radar became the second tool of the air traffic controller after World War II.

### Air Route Traffic Control Centers

Control of aircraft is under two basic sets of rules: IFR (instrument flight rules) and VFR (visual flight rules). Under IFR control, the aircraft is guided by an Air Route Traffic Control Center (ARTC). This guidance assures the pilot that his aircraft is being monitored along its entire course. An aircraft flying VFR is operating on a "see and be seen" basis.

Airways, like highways on the ground, are the core of the air traffic control system. Just as a motorist follows a numbered highway, the pilot follows a numbered airway between terminal points. The numbered airways are just as exact as to turns and direction as are the highways on a road map.

Unlike the driver who selects his numbered route from a gas station road map, the aircraft pilot files a flight plan with an ARTC maintained by the Federal Aviation Agency. There are 31 such control centers (see Fig. 1) in the U. S. linked together by leased telephone lines.

Air Traffic Control Centers differ from airport control towers. Centers direct traffic between terminal areas; control towers guide air traffic in a radius of approxi-



View taken from inside an airport traffic control tower. The tower controls air traffic within about 20 miles of airport.



A New York area traffic controller keeping track of aircraft movements by noting flight location on flight progress strip.

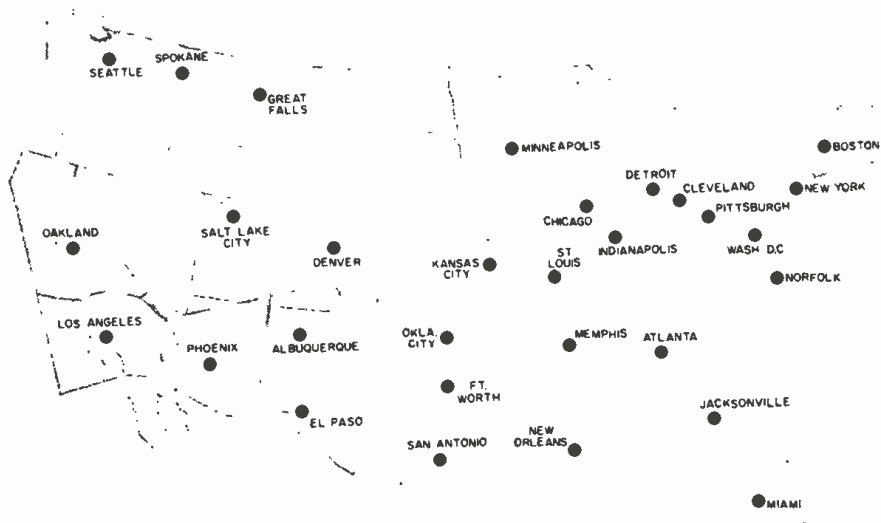

Fig. 1. The FAA air route traffic control center areas are shown above.

mately twenty miles of the airport.

An ARTC is a facet of air travel not known to most plane passengers. Unlike the airport control tower visible to all, the FAA ARTC is usually some distance from the ramps and runways. At New York's International (Idlewild) Airport, it is housed in Hangar 11 about two miles distant from the passenger terminal and control tower. Although designated as a "hangar," it is actually a three-story building with more than half its area given over to air traffic control and electronic equipment.

The New York ARTC guides IFR air traffic between Salisbury, Maryland and Montauk Point on the eastern tip of Long Island. Inland its area of control extends west to Phillipsburg, Pennsylvania and northwest to Elmira, New York. To the east the ocean control section guides traffic over the Atlantic Ocean in an area bounded by Nova Scotia, the Azores, and Bermuda.

All IFR traffic landing or departing from Idlewild, La Guardia, and Newark airports clears through the New York ARTC. To accomplish this seven-day-a-week, around-the-clock job, more than 500 people are employed, working in three eight-hour shifts.

#### Communication

Communication is, of course, the heart of air traffic control. New York's

air traffic controllers have at their disposal air-to-ground and ground-to-air radiotelephone circuits for communication with aircraft, leased telephone land-lines for communication with other Air Traffic Control Centers, and remote communication stations along the airways. Land-line teletypewriters provide flight-plan information and weather reports.

The direct radiotelephone communication between pilots and air route traffic controllers is accomplished by means of 45 separate channels of individual frequencies, both u.h.f. and v.h.f.

For ocean control there are two high-frequency channels. The ocean control transmitter is located at Sayville, Long Island, the receiver at Barnegat, New Jersey, and both are connected to the New York Center by radio relay.

Within the Center there are 260 miles of wiring involved in the interconnection and interlocking of switching controls, microphone connections, earphones, and speakers. Added to this are 1700 miles of land-line circuits linking remote transmitters and receivers. The Center has 115 leased telephone circuits.

#### The Flight Plan

In New York, as in all other Air Traffic Control Centers, the pilot files an instrument flight plan at least one hour before departure. The plan indicates his departure time, destination, requested altitude, and airway. This is almost like planning a cross-country trip by motor car. First you decide the time you start, and you have your numbered highway route marked in advance. The big addition, of course, is altitude.

From departure to destination, the aircraft flying an IFR flight plan is under positive control. An aircraft flying from New York to Cleveland is controlled by the New York Center until it passes Phillipsburg, Pennsylvania, where it is turned over to the FAA Air Traffic Control at Cleveland. Before the plane departed from New York, the

Controllers check computer-prepared flight data and weather findings in the computer room of FAA's New York area Traffic Control Center at International Airport.





Cleveland Center was advised of its flight plan and had reserved the requested altitude and airway for the aircraft when it was scheduled to enter the Cleveland control area. This fundamental principle is carried on in non-stop transcontinental flights, or anywhere within the U. S. and its territories.

### VOR and ILS

There was a time many years ago when aircraft on cross-country flights were guided in the daylight by arrows painted on roofs of barns, and at night by rotating beacons on mountain tops. Although there are a few beacons still in operation and some air-minded citizens still paint arrows on their rooftops pointing to the nearest airport, navigation of aircraft from the ground both night and day is now being accomplished by electronics.

Spaced approximately every hundred miles along the airways are v.h.f. omnirange (VOR) stations. Wherever located, they are an object of curiosity. Their location, dependent on the straight-line airway, might place them in a remote mountain spot, the edge of a town, or near an airport. They are painted in a red and white checkerboard style and have an unusual appearance.

The system is an all-directional range station, giving bearings for the entire 360 degrees around the compass.

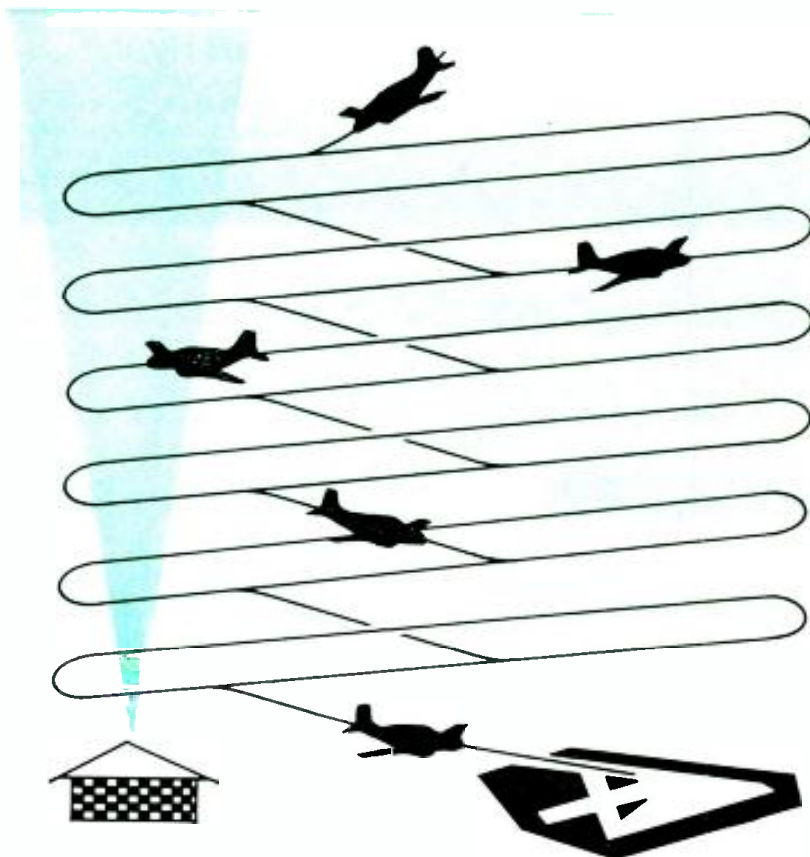

This is a stack. Depending on the amount of traffic, an airport may have one or many stacks. Stacks are used in bad weather when planes cannot land as frequently as in good weather. They are also used in good weather when heavy traffic prevents a plane from landing immediately. Stacks, resembling race track patterns, are permanently established near an electronic "fix," which may be a VOR, a low-frequency range station, or a homing beacon. Each leg is designated as either one or two minutes before turn at the standard rate of five degrees per second. In the New York area most holding patterns are one minute per leg because of the heavy traffic.

Stacks are "built" from the bottom up by the Air Route Traffic Control Center. The New York Air Route Traffic Center, in building its various stacks (some twenty-five in all), coordinates its work with the control towers at Idlewild, LaGuardia and Newark airports. In essence, the center builds the stack and the tower unloads it.

Stacks are built at thousand-foot levels starting from 3000 feet and ranging up to 10,000 feet altitude. Jets with their high rate of fuel consumption prefer to be held at higher altitudes, which are most economical for fuel consumption. Jets are usually given expeditious handling when placed in a holding pattern.



Air route surveillance radar (ARSR) antenna.

Fig. 2. Radar signal (left) reflects from clouds, buildings as well as from plane to produce scope clutter. Beacon (right) transmits interrogating signal which triggers plane's transponder into transmitting strong answering signal on different frequency. Beacon receiver does not pick up reflected signals, hence clouds, buildings will not produce any indication on the beacon scope.

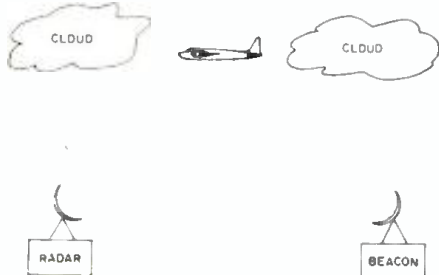

Traffic controllers at display scopes of airport surveillance radar (ASR) equipment.





VOR transmitter building located at New York's International Airport (Idlewild).

The VOR sends out static-free radio signals for the guidance of pilots, transmitted on frequencies between 112 and 118 mc.

Each VOR transmits repeated identification signals either in code or recorded voice. These signals enable the pilot to establish his course along an airway. From time to time the identification signals go off the air in order to broadcast weather reports. The weather reports are broadcast 15 and 45 minutes after the hour. Within the last few years this weather data was made public. As a result, farmers, operators of small marine craft, and

trucking concerns have been tuning to their nearby VOR for weather reports.

The Instrument Landing System (ILS) now in use at most airports has been an electronic boon to air travelers and airlines. Although not specifically identified as a safety measure, the ILS System has enabled airlines to make scheduled landings under adverse weather conditions.

The system consists of two radio transmitters at an airport sending out radio beams to guide the aircraft on its instrument approach and landing. One beam, called the localizer, tells the pilot whether he is to the right or left of the centerline of the runway. The other beam, the glide slope, shows him the correct angle of descent. This information is displayed in the cockpit of the aircraft by two needles on a single meter face, one vertical, the other horizontal. The vertical needle moving right to left indicates the plane's position in relation to the centerline of the runway. The horizontal needle tilting up or down indicates the position of the aircraft on the glide slope, either low or high. With both needles crossed at right angles, the aircraft is on course and making an accurate landing, even though the pilot may not be able to see

the tips of his own plane's wings.

### Computers in Control Centers

The final decisions in air traffic control are made by the air traffic controllers in the control centers and airport towers. Their responsibility is heavy. The present and future tools of the air traffic controller are electronic instruments. The Federal Aviation Agency, which is responsible for the nation's air traffic control system, has pointed out that modernization of the airways involves "increased installations of radar and other electronic equipment."

The FAA has installed in the past six months "Univac" File-Computers in its air traffic control centers in New York, Washington, Boston, Pittsburgh, and Cleveland. The computers will not replace the air traffic controllers but will relieve them of their "bookkeeping chores," and lessen fatigue.

The computer performs the necessary calculations of an aircraft's passage along the airways. Instead of the air traffic controller computing speed of the aircraft and estimating time of arrival over various check points, the electronic computer does it for him. All

(Continued on page 152)

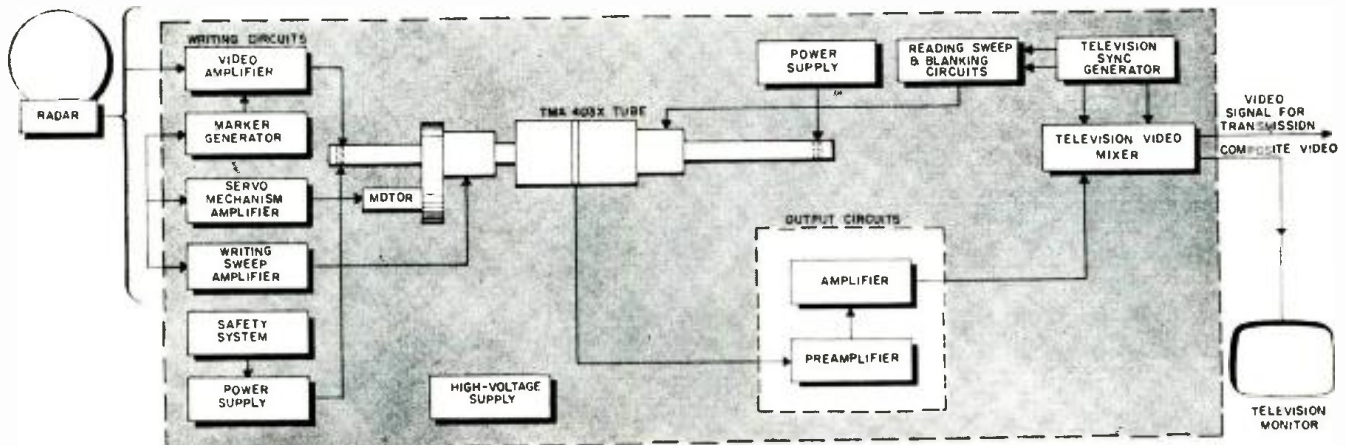

Fig. 3. Functional block diagram of the scan conversion system. Heart of unit is special cathode-ray tube (TMA 403X) that writes radar information on internal target grid with one electron beam and reads TV information with another electron beam.

## COVER STORY

**ELECTRONICS WORLD**

RADIO & TV NEWS



SYMBOLIC of the Jet Age, our cover shows a portion of one of American Airlines' new 707 Jet Flagships along with the new Newark (N.J.) Airport control tower. The \$5-million jet plane is crammed full of electronic gear, not only for communications and radar, but also for air-conditioning control, automatic pilots, fuel-injection control, and many other special uses. It has been estimated that the total cost of all the electronic equipment in the 707 is \$500,000.

The nose cone has been raised in order to show the antenna of the weather surveillance radar. This equipment has proved to be so valuable that the FAA has recently proposed a new safety regulation calling for the installation of this type of gear on all airliners. The particular radar installed in the plane on our cover is an RCA AVQ-10, operating in the 5-cm. band. The radar has a maximum range of 150 miles. The antenna rotates through 360 degrees, although the radar beam is cut off toward the rear by the plane's fuselage. The normal coverage angle is therefore

from wingtip to wingtip, or about 210 degrees. The antenna can also be tilted downward or upward for better coverage. The nose cone is made of special material that is transparent to the radar beam.

The Newark control tower, recently built by the Port of New York Authority at a cost of \$1¼-million, is one of the most modern and well-equipped structures of its type. Although Newark does not handle jet flights, except in an emergency, this tower is symbolic of the importance of electronics in air traffic control. About \$1-million of electronic equipment is installed here, including 29 transmitters, 22 receivers, direction finding, and air surveillance radar gear. In addition, the tower controls two instrument-landing systems, one omniradio range, distance measuring equipment, and a telecommunication network. To maintain and operate this complex network, the FAA has staffed the tower with 16 highly skilled electronic specialists and 58 air traffic controllers.

(Tower photo by Bob Loeb; plane photo courtesy American Airlines.)



CITIZEN'S BAND TRANSCEIVER

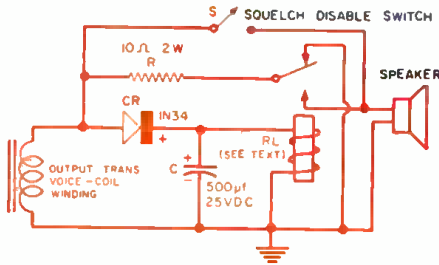

Fig. 1. Simple circuit modification used.

MICROPHONE



VOLUME



TUNING



The added squelch-disable switch is a rotary type mounted on the front panel.

# A "Rush Suppressor" for Citizens Radio

By **JAMES D. GREEN**  
Chief Engineer, WELO

**A simple modification that will provide a noise squelch for all receivers, including even the superregenerative.**

**H**AVE you ever listened to a superregenerative receiver for a fairly long time and wished you had a "rush suppressor" or some such gadget? This problem has long since passed with the advent of the more modern superhet receiver, or has it? With the opening of the new Citizens Band service, the superregen is again becoming popular and, for some, a headache. Oh, if we could only quiet that infernal noise!

We recently purchased two of the new Heathkit Citizens Band transceivers for communicating with one of our engineers living in a rural area devoid of telephone facilities. This transceiver, like many others on the market, has a superregen receiver and, consequently, no squelch. After the units were assembled, the author began an immediate search for some means of quieting these "rush boxes." We planned to keep them in operation (standby) at least eighteen hours a day and the noise simply could not be tolerated.

Like most superregens the first audio tube has quite a bit of quench signal on its elements (even with filtering). This eliminated the first audio tube as a point for obtaining control voltage for any type of squelch circuit. Besides, using the noise quieting property of a signal to operate a squelch circuit would involve the use of more tubes. It was decided that any squelch for the superregen should be in keeping with the circuit itself—simple, cheap, and relatively foolproof.

After some deliberation the simple

circuit of Fig. 1 was devised. The circuit utilizes the voice-control principle for operation. It was found that any voice signal of comfortable listening level will have stronger audio peaks during modulation than the residual rush-level heard in the receiver. By picking off the audio from the voice-coil winding of the output transformer and rectifying it, we now have a d.c. control voltage that can be used to operate a sensitive relay. The audio present on the voice-coil winding of the output transformer, along with the resultant d.c., is indirectly controlled

by the normal volume control on the receiver. By setting the volume control with no signal (normal set rush-level only) just to the point that the relay releases, the speaker is cut off. Ah, dead silence at last!

When a carrier is picked up by the receiver, the d.c. across the relay actually drops and, of course, nothing happens since we have already set the relay to the release point. When the carrier is modulated things change abruptly. The peak audio on the voice winding is greater than the normal  
*(Continued on page 140)*

Top-chassis view of the transceiver showing the location of the added components.

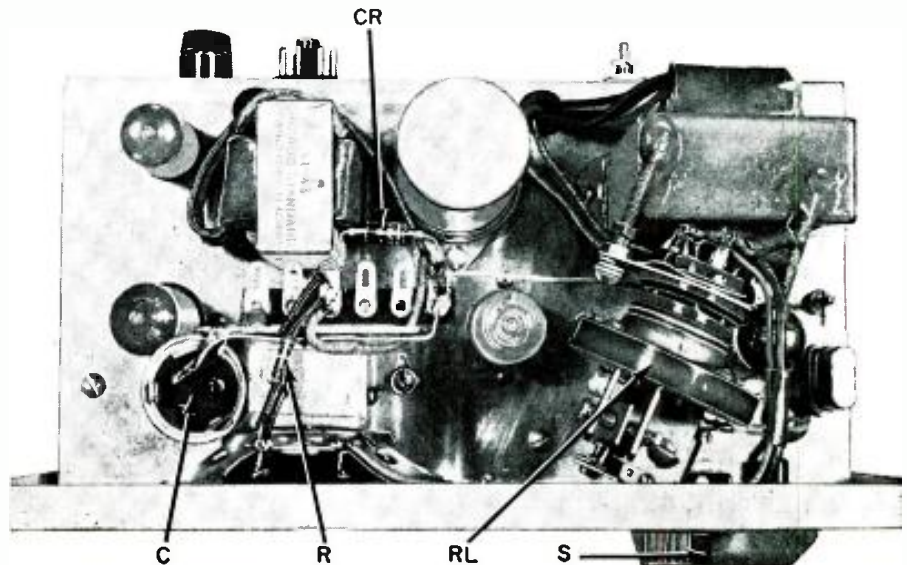

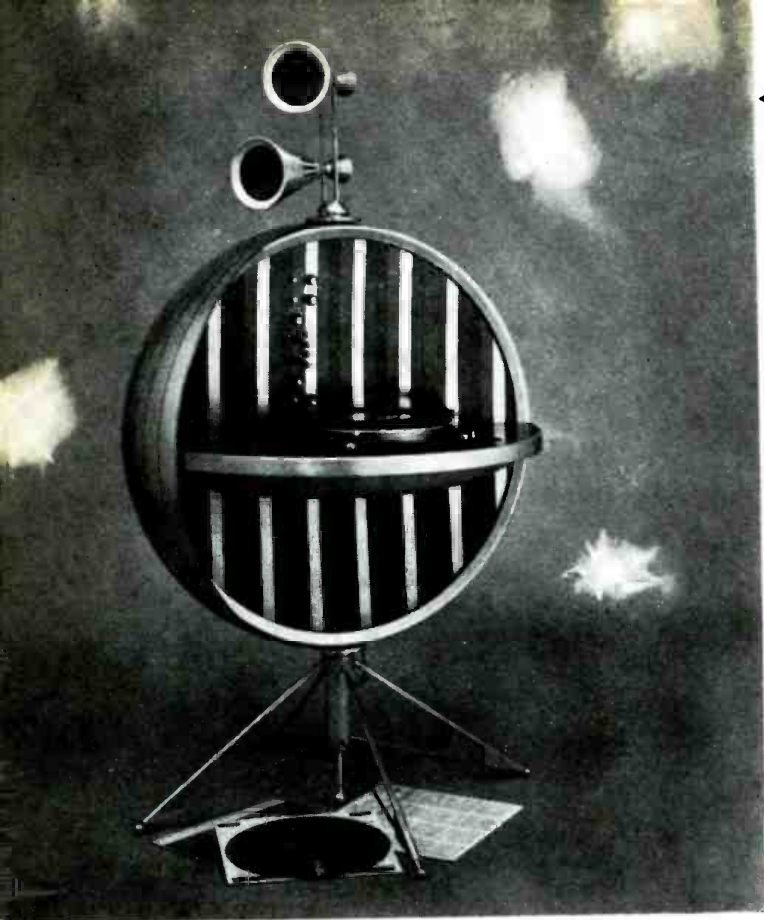

#### ◀ Aluminum Music Sphere

From the world of tomorrow comes this "Forecast Music Sphere," created by Lester Beall for the *Aluminum Co. of America*. The novel enclosure houses a stereo music system with extending satellite speakers which telescope into the aluminum body shell. The front hemisphere is opened to reveal turntable and amplifier controls. The prototype design represents a design concept. It is not on the market, and there are no immediate plans to place it in production.

#### Stratovision Goes Educational

Pictured is the experimental *Westinghouse* Stratovision station which first demonstrated the feasibility of airborne telecasting—a technique that will be utilized by the Midwest Council on Airborne Television Instruction to make available instructional television programs over a six-state area. Programs will be transmitted from ground-based facilities at Purdue University in Lafayette, Ind. to the circling four-engine aircraft some distance away. Retelecast will take place from the plane to schools and colleges which choose to participate in the project. Estimated coverage will be a circle 300-400 miles in diameter, reaching from Milwaukee and Detroit to Cincinnati and Louisville. ▼

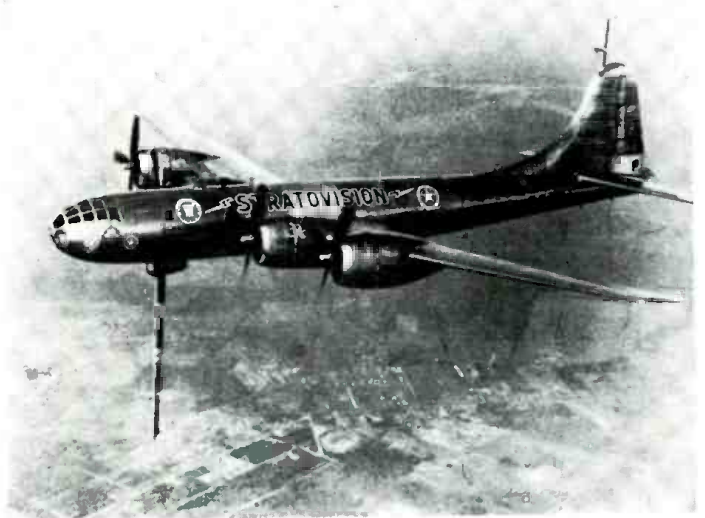

## Recent Developments in Electronics

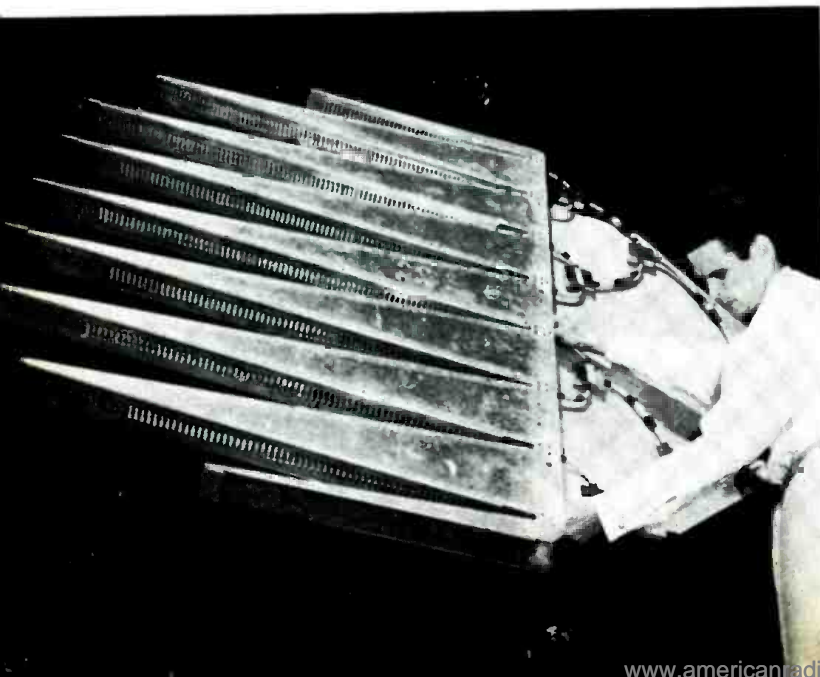

#### ◀ Retarded Surface Wave Antenna

A retarded surface wave antenna with high gain and low silhouette has been developed by *Chance Vought Electronics Division* for use in airborne early warning radar as well as ground based and shipboard radar. Initial tests showed such good performance characteristics that the company devoted additional efforts to perfecting the design. Most airborne radar antennas are so large in diameter and thickness that they present aerodynamic and weight problems for the aircraft designer. A 33-foot retarded surface wave antenna would be only 1½ feet in thickness and weigh 2400 pounds, compared to 8 feet and 5030 pounds for a parabola-type antenna. At the same time the new antenna would equal or exceed a conventional antenna in electrical performance. The design is adaptable to various sizes and configurations.



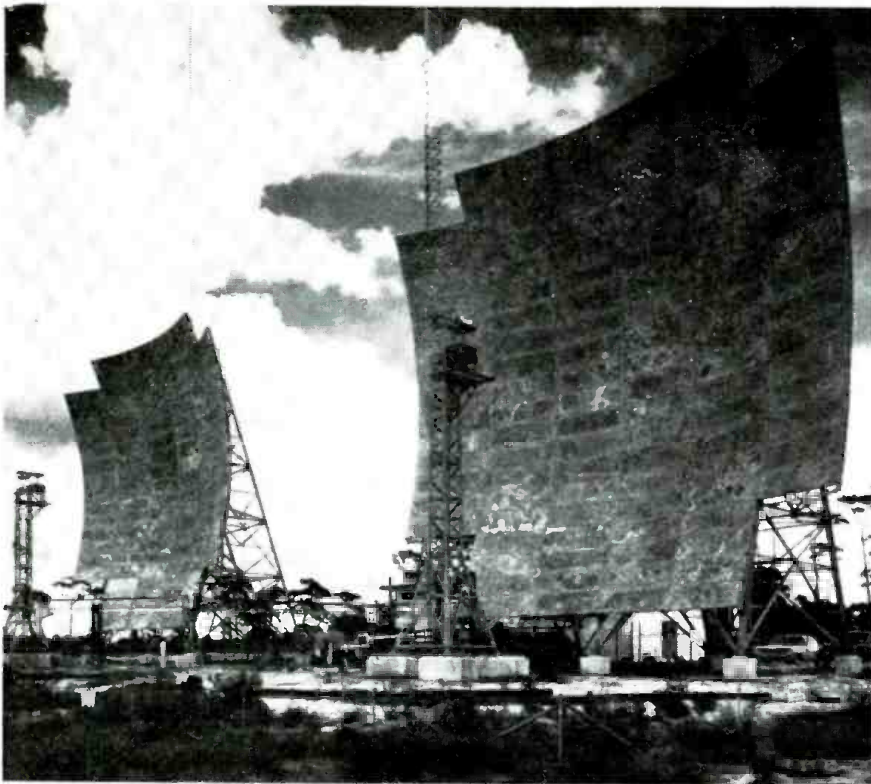

### ◀ Twin Tropo Scatter Antennas

A pair of 60-foot tropospheric scatter antennas, specially mounted at opposite ends of a 180-mile long section of the Gulf of Mexico, form a vital link in a new communications network built for the U. S. Air Force's Eglin Gulf Test Range. Built at a cost of \$6-million, the entire 565-mile long network is being used for high-speed transmission of timing, telemetering, radar data, and voice signal information along the missile range. The antennas were built by *Blaw-Knox Co.* and erected by *Philco Corp.*

### Boxcar-shaped Radar Antenna

A rotating 50-ton radar antenna, 104 feet long, will warn against enemy air attack when it joins the nation's SAGE defense network in the near future. Developed for the Air Force by *Raytheon Co.* under a \$20-million engineering program, the super sentry will detect invaders hundreds of miles away to give early warning.



### ▲ Ticker-Tape TV

At the modern new offices of *Goodbody & Co.*, New York City, a network of strategically located closed-circuit TV receivers flashes pictures of stock ticker tapes to customers, partners, and employees in all executive and sales areas. The TV equipment, designed by *General Precision Laboratory Inc.*, enables the firm to provide faster and more efficient service for clients.



### Automatic Testing of TV Picture Tubes ▶

Latest innovation in the manufacture of black-and-white television picture tubes is a new automatic testing machine which has been installed at the *RCA Electron Tube Division's* plant in Marion, Ind. This precision instrument performs 26 different tests on the tubes at a rate of 600 per hour.

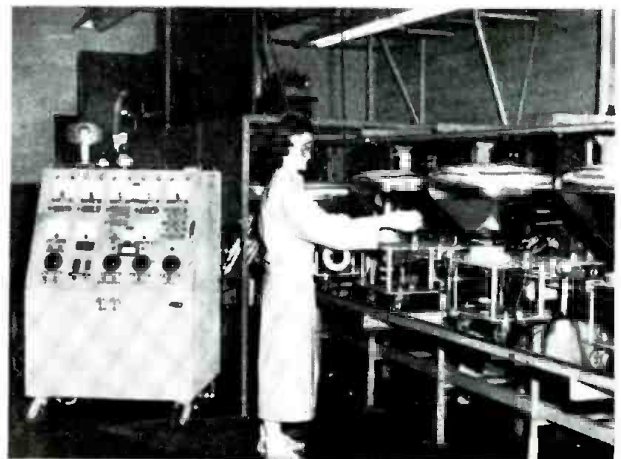

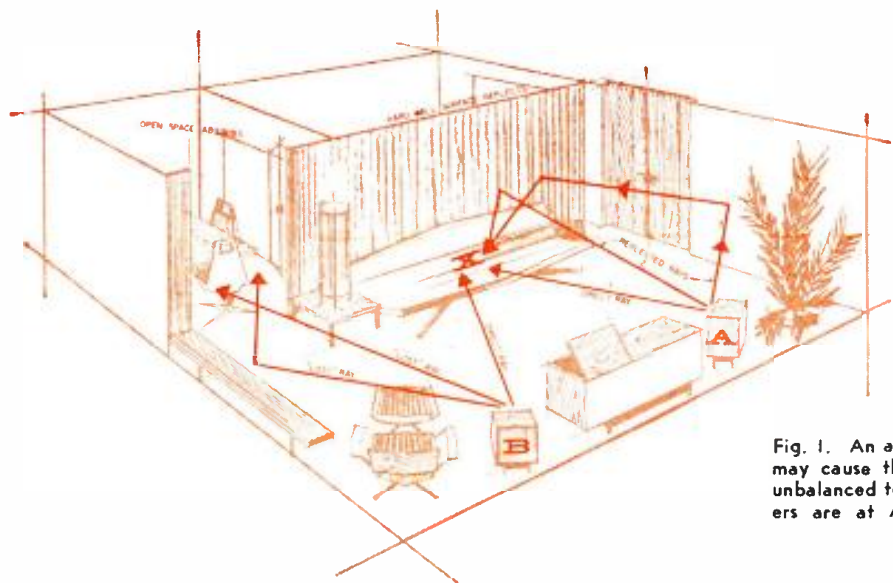

Fig. 1. An acoustically unbalanced room may cause the speaker system to sound unbalanced to the listener. Stereo speakers are at A and B, listener is at X.

# Room Acoustics for Stereo

## PART 1 BASIC PRINCIPLES

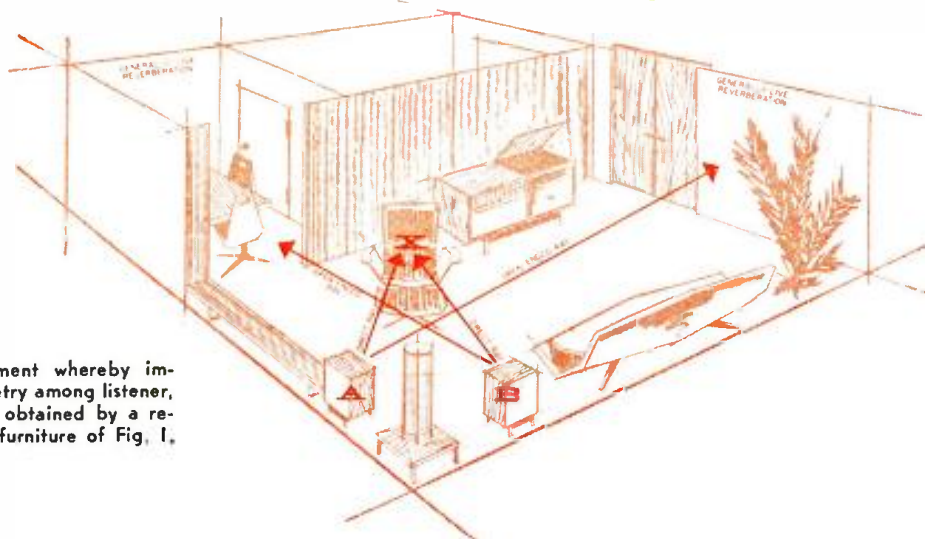

Fig. 2. An arrangement whereby improved acoustic symmetry among listener, speakers, and room is obtained by a rearrangement of room furniture of Fig. 1.

By **ABRAHAM B. COHEN** / Advanced Acoustics Corp.

**There is an intimate relation between the stereo speaker system and the listening room. Here are the general principles to be followed for best results.**

**G**OOD sound reproduction requires controlled acoustics in the listening room. For stereo listening, the room acoustic problem becomes even more critical because the reverberant room conditions and reflective wall surfaces may either greatly enhance the stereo effect or completely destroy it.

In achieving optimum stereo effect, there is an intimate relationship between the type of stereo speaker system used and the acoustic conditions of the room. Because of the many different types of speaker systems and the innumerable types of listening rooms, a simplified approach to the speaker-room combination will be covered. This approach may then be extended to di-

verse types of loudspeaker systems.

Proper speaker placement for high-fidelity stereo reproduction is considerably more complex than for high-fidelity monophonic program material. In single-channel reproduction we have but one problem as far as the loudspeaker is concerned, i.e., at which spot in the room will the loudspeaker perform best? With stereo we have a compound problem which involves: (a) how far apart shall the speakers be? and (b) how shall they be angled toward the listening area? This leads to the next point (c) which involves the best place to sit, stand, or recline to get the best stereo effect. Unfortunately, many articles in the stereo literature

treat only lightly one additional factor that influences all of these considerations. This factor is the effect of the acoustical condition of the room in which the "stereorama" is displayed.

### Psycho-Acoustic Enlargement

The conditions which characterize a good listening room, whether for monophonic or stereo service, involve two simple factors. The first is that the room be reverberant to the proper degree to give the reproduced sound "liveness." The room should not be too reverberant for then the reproduced sound would appear too cavernous, hollow, and indistinct. Nor should the room be overstuffed for then it would



sound dead and somber. To a considerable degree, stereo systems themselves produce a psycho-acoustical revision of the absolute acoustic properties of the listening room. This, in effect, may make a room seem larger than it really is simply because of the apparent discrete localization of different sections of a large orchestra to separated areas within the room. The very essence of stereo sound reproduction thus "pushes" the walls of the room apart. Our minds automatically tend to convert this "spread out" reproduced orchestra into a "stage" for the orchestra.

Such psycho-acoustic enlargement, when listening to monophonic, or single-channel, program material radiated from one central speaker opening, would be virtually impossible. Some efforts are made to produce artificial enlargement of monochannel recordings at the recording studio by the judicious injection of controlled amounts of reverberation. There have been many "pop" selections recorded with this artificial reverberation added—but in many instances so poorly done that the music and singer are all but lost in the muddled "barrel of sound."

Thus, in monochannel reproduction, size of the room in "undirectional," that is, controlled in a "reverberation direction" but only by the reverberation inserted at the source. This is in contrast to stereo recording where spaciousness is not only injected at the source but is, moreover, under the control of the listener with respect to placement of the speakers and their acoustical environment.

The fact that there has been a fad for injecting reverberation into monophonic recordings, even though overdone, is indicative of the feeling that "spaciousness" does add psychological "depth" to our listening area. There are even electrical reverberation devices, intended for home use, which are designed to "liven up" (psycho-acoustically) the monochannel reproduction. In the case of monophonic reproduction, however, where the original source of the reproduced sound is a single cabinet, it is more difficult to get a wide-stage psycho-acoustic effect without resorting to these highly accentuated effects incorporated in the original selection. It would be considerably better to make the recording under natural reverberation conditions and let the acoustic enlargement be obtained by means of the listening room environment. This, however, is a rather utopian ideal. Perhaps someday the standard living room will come with adjustable sound-conditioning facilities similar to the air-conditioning systems now in widespread use.

In the early days of stereophony, it was frequently noted that, when a switch was made from monophonic to stereophonic playback, to get the same "loudness" effect, the total gain of the amplifiers had to be reduced. Perhaps these were the first straws in the (acoustic) wind that tended to show that with monophonic reproduction the

ear needed more re-enforcement from its surroundings to get the same loudness effect as for the stereo reproduction. From this we may possibly conclude that a "live-r" reverberation condition is desirable for monophonic reproduction than for stereo reproduction. This leads us to the thought that it would be desirable not only to be able to correct our listening rooms in general so as to present the proper acoustic environment but to make this acoustic adjustment variable to accommodate changing conditions of playback methods, types of programs, or number of people in the room.

Stereo has the latent power to really put us in the concert hall, spatially, without monophonically overdone artificial effects if the speaker system is properly balanced in performance and is judiciously installed in a manner consistent with *good concert hall practice*. This means that we must look to our living room for the last link in the "realism" chain, with the aim of bringing it as close to good musical acoustic practice as possible.

#### Reverberation Adjustment

In bringing the concert hall into the stereo room there is nothing we can do about the actual physical dimensions—in terms of feet and inches—of the listening room to approximate the concert hall. However, there is much we can do to change the psycho-acoustic dimensions of the room through adjusting its reverberation characteristics to a satisfactory "concert hall" level. Once this has been done, we can place the speakers so that they function best with the adjusted room conditions to heighten the illusion of expanded acoustic space.

The general principles of room acoustics are easily grasped. We sound very stentorian and robust when we sing in the bathroom because the hard, smooth surfaces bounce the sound around and around with little absorp-

tion so that the sound seems to persist loud (but not necessarily clear) as we continue to bellow to our heart's content. On the other hand, if we were enmeshed deep in a well-stocked clothes closet, we could shout until we turned blue with exertion and would still sound weak and feeble. The hard reflective surfaces of the bathroom make the room "live." The soft, absorbent "stuffing" of the clothes closet makes the closet "dead." In between these acoustical extremes lies an acceptable mean for good concert hall—or for that matter—listening room liveness. Our acoustic goal is to achieve a room condition which is live enough to give fullness and body to all the musical resonances yet not so live that recurrent echoes will blur the original rich sound. There have been many determinations as to the optimum degree of liveness for the concert hall, and these same principles may be readily applied to your own stereo listening area. However, before we illustrate the application of "acoustic room conditioning," with emphasis on stereo speaker placement, it would be helpful to examine the reverberation units with which we will be concerned.

#### Room Interior Surfaces

If a room is "live," its boundary surfaces are very reflective. If it is "dead," they are highly absorptive. The common factor is, then, absorption. The great body of research that has laid the foundation for dealing with this factor of absorption (and reverberation) was done by Sabine. He proposed that the very logical, and very understandable, unit of absorption be, literally, an open window. Obviously, if sound is generated in a room and some of that sound reaches an open window, that portion of the sound that falls on the open window will leave the room entirely, as shown in Fig. 3. As far as the interior of the room is concerned, the open window completely "ab-

Fig. 3. Room acoustics are controlled by absorption properties of material surfaces.

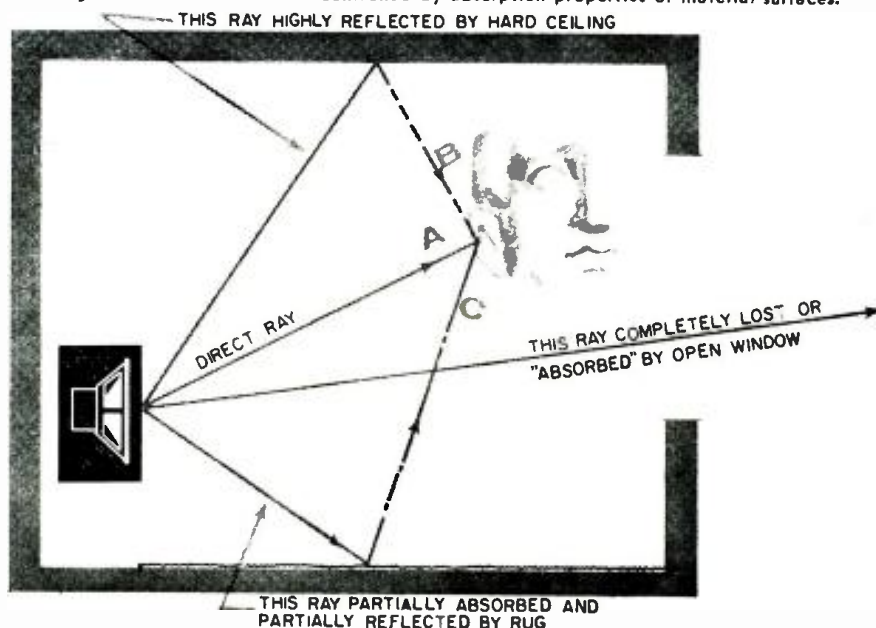

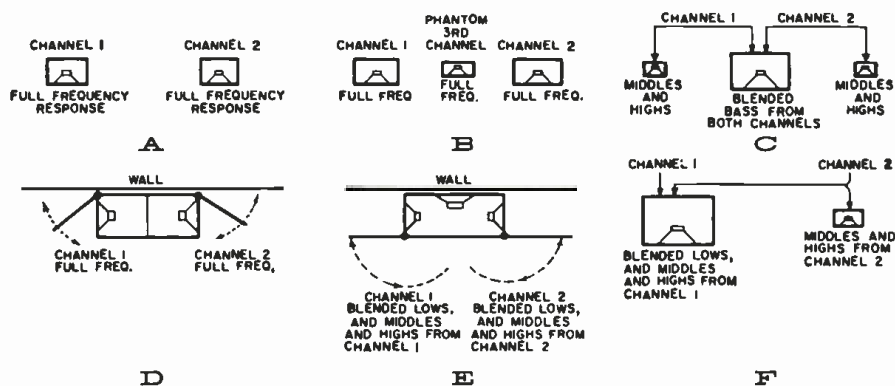

Fig. 4. There are many stereo speaker systems in use today as is shown above.

sorbed" the sound that hit it—for none of that sound found its way back into the room. A square foot of open space in a wall thus becomes an "absorption unit."

Nothing, but nothing, can quite equal the absorption of a hole in a wall looking out into the world. Whatever the material may be, if it is physical, if it can be weighed, calipered, touched—it will absorb some sound, reflect some sound, and transmit some sound. Substantive materials thus have individualistic absorption characteristics defined by their "absorption coefficient" in relation to "open space." Whatever the material being considered, its absorption is always less than "open space," a square foot of which is considered to have "unit absorption." Thus, the absorption coefficient of any material is always less than 1.

Referring to Fig. 3, the sound from the speaker system that finds its way out of the window will be completely lost as far as further usefulness to the room is concerned. It has, in effect, all been absorbed by the open window. On the other hand, the sound from the loudspeaker which hits the carpet is partly absorbed and partly reflected back into the room. Likewise, the sound hitting the plastered walls and ceiling is absorbed to a lesser degree and is reflected back into the room with more intensity than is the case with sound striking the carpet. As far as the listener is concerned, the aggregate sound that reaches him is composed of the direct ray A, the highly reflected ray B, and the somewhat reflected ray C. It is obvious, then, that the degree of liveness, or "concert-hall-ism," presented to the listener by his room is controlled by the absorptive properties of his surroundings.

### Special Stereo Needs

This problem of the room condition is important for any type of sound reproduction but for stereo it is doubly important (no pun intended). For the sake of preliminary illustration of the effect of the acoustics of a room on the resultant sound field of a stereo speaker system, we will use as the stereo sound source two speakers, 6 to 8 feet apart, oriented toward the central listening area by approximately 15 degrees each and we will assume that the speakers are as nearly balanced in

their performance as is possible.

Now, even though we accept this "paired speaker" condition as being most suitable for our illustration, it should not be inferred that it is the only acceptable stereo speaker configuration. Much definitive work still needs to be done on speaker pairs (or trios), balanced or unbalanced, and we shall have considerable comment to offer concerning this problem after we have explored the preliminary example of the effect of room acoustics on the reproduced sound from the balanced and separated speaker system.

Suppose, now, that we place our perfectly balanced speakers, at the previously specified distance and angular relationships, in a room typical of many new home constructions where the living room and the dining area form a sort of an "L," as shown in Fig. 1. The speakers are neatly balanced on either side of the equipment cabinet. At the opposite wall is a foam rubber settee backed up against a hard plasterboard wall (decoratively papered, of course) with probably an arrangement of picture miniatures hung above the couch (a large, heavy picture would probably rip its supporting hooks right out of the plasterboard). In any event, small pictures or large, the backing wall will be rather "hard" acoustically—it will reflect quite a bit of the sound that hits it.

We turn on our stereo system, lower ourselves onto the comfortable settee and listen. But although our reproducing speakers are balanced, phased, separated, and angled properly, the listening system is no longer balanced. Not even the channel-balancing control on the amplifiers or "stereo control center" will correct this acoustically unbalanced room.

Speaker "A" sends a direct sound to the listener via ray 1 and considerable wall-reflected sound to the listener via rays 2 and 3. On the other hand, Speaker "B," while it may transmit direct sound to the listener, sends very little reflected sound to his ears for there is the "open space" of the dining ell in front of it. Thus the sound from Speaker "A" will be louder to the listener. A second effect is that there will be considerable high-frequency loss from Speaker "B" as heard by the listener. The high frequencies from Speaker "B" that continue on straight ahead are al-

most completely lost to the listener while the highs from Speaker "A" come to him directly and by reflection. Consequently, although the speakers may have been perfectly balanced acoustically, their reproduction at the ear's location is unbalanced, with the unbalance being preponderantly in the high-frequency range, due to the differential reflective conditions bridging two speakers and the listener. This is unfortunate because much of the stereo effect is contributed by the higher frequencies. If we lose the highs, we lose the directional sense of the system.

We may overcome these deleterious effects of the distortion of the direction of the sound by one of two methods—or preferably—a combination of both. The first obvious method is to re-arrange the furniture; the second method is to alter the reflective properties of the room. Either of these problems may prove difficult to overcome unless one finds some way of convincing the lady of the house that it is actually her idea to re-arrange the furniture, or to hang a drape here or there, or to install acoustic tiles hither and yon. Having thus easily (!) surmounted this first "managerial" problem, let us see what might be done with the furniture arrangement shown in the room of Fig. 1 to provide a better acoustic balance among the speakers, room, and the listener.

Fig. 2 shows one alternate arrangement of the speakers where almost complete acoustic symmetry among the speakers, room, and listener is available. The listener is in the direct way of each speaker. Each speaker also faces almost equivalent open-ended spaces, that is, Speaker "B" radiates into the dining ell and Speaker "A" radiates into the living room. To the listener, then, there is presented a condition wherein there is a balance between the direct rays from each speaker and the reflected rays.

There is also a second-order effect, but a desirable one. If the rooms are moderately "live" and the program is played at good volume (who ever heard of low volume?)—then an additional acoustic enlargement of the room takes place. The sound components from the speakers that travel into the dining ell area and into the living-room area find themselves bouncing around within these somewhat live end spaces. A "liveness" effect—or reverberance—is thus produced which adds to the direct rays received at the listening area. This partly gives rise to a psycho-acoustical enlargement of the listening room in a way that somewhat simulates the larger chamber music room—provided, of course, that the sound is reproduced loud enough to energize these reflective areas. This arrangement of Fig. 2, though quite severely limiting the effective stereo listening area, does provide a solution (for illustrative purpose) of balanced stereo listening.

### Some Different Approaches

Before we opened the discussion of the above problem of the acoustics of



an unbalanced room upon a balanced speaker system, we deferred our comments about other types of speaker systems and configurations for stereo application. It would now be well to give this matter some consideration before going into the specific problem of room acoustical analysis and adjustment where these different types of speaker systems are used.

There are in use today speaker systems of many types which, as shown in Fig. 4, although greatly different, yield discernible and psycho-acoustically acceptable stereo. In addition to the two separate speaker systems (Fig. 4A), there are systems which consist of two full-range end systems with a "phantom fill" as a third channel in the middle (Fig. 4B). There is a system where the major bass information is all blended in one central system and the higher frequency stereo-determining components are displayed by end-placed outboard speaker components (Fig. 4C). There is also a system which is enclosed in one cabinet where the stereo effect is produced by reflecting into the room—from each of its back hinged end doors—the full program content of each channel respectively (Fig. 4D). In addition, there is a system where the lows are blended in one woofer and dispersed by the rear wall, and the high-frequency components of each channel are guided by the front hinged end doors to be randomly reflected by the room walls (Fig. 4E). Finally (at this writing, at least), there is the system where the blended lows and highs from one channel radiate from one system and only the highs from the other channel have a separate speaker (Fig. 4F).

Obviously, not all these systems are "best" systems. They each have their individual merits and drawbacks. And obviously, they cannot all produce exact replicas of the original sound coming out of the instruments. But one thing they all do. They give *some* impression of the stereo effect, whether it be a correct or an incorrect one, to which we then add our own personally devised psycho-acoustic image of what we think the stereo reproduction should sound like—and we then have "stereo."

The question then arises how do we treat all these systems when integrating them to the acoustical condition of a particular room. Unfortunately, there is no definite and rigorously circumscribed "best" relation between the speakers of these various systems and any room at random. The number of solutions would obviously approach infinity, depending upon room size, shape, acoustic condition, speaker system, and the listening habits of the auditor, and the type of music being played.

To briefly illustrate the complexity of the problem, take the last item just noted—the type of music being reproduced in relation to speaker system and room acoustics. If the stereo program material were that of a string quartet, we would expect, for stereo realism, that the stereo effect encom-

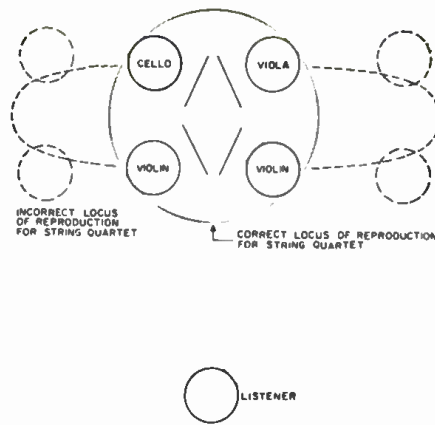
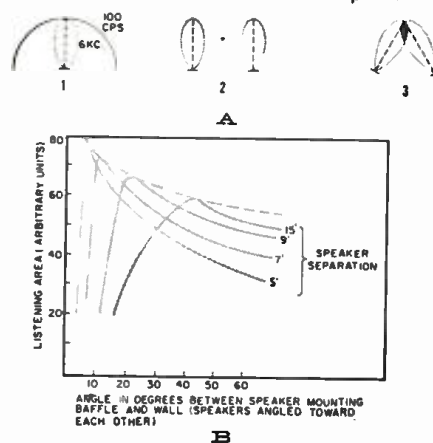

Fig. 5. A stereo reproducing system should be able to "place" the instruments in a manner duplicating their original location.

pass a rather small area governed by the usual intimate geometrical relation among the two violins, viola, and cello, as shown in Fig. 5. If the speaker system were an adjustable one in the matter of speaker separation and speaker orientation—as would be possible with the units of Figs. 4A, 4B, 4C, and 4F—then after auditing a few programs the listener might be able to strike an arrangement where the stereo effect produced would be fairly close to the original sound distribution. The arrangement in Fig. 4D could also be acceptably adopted so that the doors, hung from the back edges, and properly angled, would project the quartet image into a centrally confined area with a minimum of deteriorating acoustic splash from the side walls which would otherwise tend to swell the "size" of the quartet. Fig. 4E would probably not be as adaptable to this type of music for, at best, even with the front-hung doors completely closed (onto the front) the stereo-determining middle- and high-frequency components would still be strongly projected towards the side walls of the room and would reach the listener with strong reflected level from these compara-

Fig. 6. (A) Higher frequency radiation should overlap for best results. The overlap area is determined by speaker separation and angular orientation. (B) Graph of maximum stereo listening area as a function of speaker separation and orientation, based on radiation from 12" loudspeakers.



tively distant areas with the result that, again, the quartet's geometrical reproduction would be "swelled."

On the other hand, if the reproduced program were a full-bodied and large symphony orchestra, then this last system with its doors wide open, would direct the sound toward the outer reflecting wall to give a resultant enlarged acoustical image more in keeping with the original effect. The same effect could, of course, be obtained with the other systems through greater separation of the individual speakers, controlled center fill, and system angling. Perhaps this brief dissertation on the correlation of the reflecting properties of the room, the speaker system philosophy, and the program material will bring home the difficulty of achieving one perfect solution—obviously a single solution to suit all conditions is out of the question. But, despite the complexity of the problem, or rather because of its complexity, we must make some simplifying assumptions in an effort to approach analytical results which may then be applied to more complex systems.

### Balanced Speaker System

Even if we limit ourselves to analysis of the stereo effect of two identical systems, we may run into an imponderably large number of physical geometrical relationships between the two loudspeakers that do not necessarily bear any definite relation to the room characteristic. In order to resolve this matter of the placement of two identical systems in order to get the maximum stereo effect, the writer undertook to examine the matter in an analytical fashion in a paper which was presented before the Audio Engineering Society Convention in September 1958. The analysis endeavored to determine how far apart two identical speakers should be placed and how they should be angled toward each other in order to obtain the maximum area in which the stereo effect would be perceived when the individual speaker system consisted of a simple 12" speaker. One of the results of this analysis is shown in Fig. 6 from which it is seen that for such a system the maximum stereo listening area will exist when the speakers are placed about 7 feet apart and are both toed-in by about 15 degrees from the wall against which they are mounted. Now, obviously, this result cannot be accepted as gospel truth for all of the other types of speaker systems previously illustrated but it does at least give us a toe-hold on a premise that will permit us to discuss the acoustics of a room and its adjustment in terms of a frequency space pattern of which we can be reasonably sure.

After we have gone more intensively into the study of the room itself and its acoustics, we may then be able to convert these findings for the balanced system for application to those situations where the composite type of system is to be employed.

(To be continued)

# What Set Owners Think

1		Time of Last Repair		3		Opinion of Repair Charge	
		PERIOD	PER-CENT			RESPONSE	PER-CENT
		Last year (1958)	46.7			About right	84.0
		Since Christmas	30.7			Too high	11.3
		Before 1958	13.2			Too low	3.1
		Never	9.3			Don't know	1.6
		Don't know	.1				

2		Repair Agency Used		4		How Agency Is Chosen	
		AGENCY	PER-CENT			METHOD	PER-CENT
		Local shop	43.2			Friend	33.9
		Free-lance service	16.3			Neighborhood shop	22.5
		Store of purchase	11.2			Dealer recommendation	21.9
		Immediate family	11.2			Yellow pages	9.4
		Factory agency	10.1			Mail advertising	1.5
		Friend	.8			Other	10.8
		Others	7.2				

SEVERAL months ago a research team at Wayne University, Detroit, Michigan, reported on a study of TV receiver ownership, repair, and related subjects. Directing the survey was Dr. H. Webster Johnson, under whom 15 students canvassed hundreds of homes in Detroit itself and the surrounding metropolitan area. The statistical findings, which have appeared before, are of obvious interest to TV owners, as well as to those who make their livings from the fact that sets do break down now and then. Of greater interest than the cold figures, however, is the significance that may be attributed to them. What do they mean?

As soon as an attempt is made at interpretation, however, problems arise. For example, the wording and intent of some questions become unclear, casting doubt on the validity of the answers. However, it is foolish to criticize a pilot study undertaken with little precedent for guidance. Even as the data stands, we are in debt to the Wayne University investigators for an informative and useful survey.

The thirteen accompanying tables are adaptations of the ones released by Dr. Johnson and, although accurate, are not to be construed as exact duplications. We have ignored some of his tables, re-organized or consolidated others where we felt interpretations would be aided thereby, and changed the sequence.

One may wonder whether the survey, taken over a limited area, would be valid for the entire country. There is reason to believe that it is. The figures on receiver brand preference and hours of use, not shown here, correspond to those turned up in more widespread studies. Multiple ownership of sets and types of sets in use (Tables 12 and 13) also tend to agree with other estimates.

Another question: Are the patterns of set owners and patterns of service in the combined metropolitan-suburban area around Detroit typical? After all, there are many rural and other areas not at all like the one sampled. Nevertheless, the great majority of TV ownership and service is accounted for by just such population centers. In addition, the Wayne University team sampled a wide and varied cross-section of the local population to insure proper distribution.

Probably of least value are the statistics on sets under warranty (Table 10) or covered by TV insurance (Table 11). In the former case, nearly 14 per-cent of the people interviewed did not know whether they were still protected—a fairly large grouping. Consumer confusion on warranty terms and periods is not surprising. It is probable that many respondents who gave definite yes or no answers were in error. As to the ownership of TV insurance, it does not seem likely that nearly 11 per-cent of set owners still carry the type of prepaid, parts-and-labor annual contract that

was very common ten years ago but has dwindled to insignificance since. The use of the non-specific term, insurance, may have caused some trouble. It has probably permitted confusion between insurance and warranties, and also with such other practices as separate, extended warranties on picture tubes, limited parts-only contracts, and shorter-term, post-repair guarantees on repair work done.

As to frequency of repair (Table 1), set owners seemed to be much more aware of the nature of things. Only .1 per-cent couldn't recollect when they had last had to call for service! With the survey actually conducted before the mid-point of 1959 (the Christmas referred to in Table 1 being that of 1958), slightly over 77 per-cent of the set owners had needed service of some kind over the preceding period of nearly a year and a half. More than 22 per-cent had required no service at all over that period, or had never required service.

Table 1 provides a clue to one contradiction that often shows up in studies of the service industry. We are generally told that the number of sets in use has increased, over the last decade, at a much greater rate than the number of people in the business of repairing these sets. For this reason, it is frequently assumed that average income per shop or per man from service has multiplied considerably. Yet all too many service technicians insist that this is simply not so. Evidently a sharp decrease in the frequency of repair has helped balance out the number of sets to a considerable degree. Ten years ago, a set covered by a service contract would be involved in several service calls per year. Today a large percentage of sets can go a year and a half or more without a single call.

As to repair agencies (Table 2) and the manner in which they were selected (Table 4), all the data turned up was interesting, but rather mixed with respect to the happiness it will generate in the independent service industry. Only a little over 54 per-cent of set owners turn to a local service shop or the store of purchase when they have trouble.

The picture is probably somewhat better than the figures show, however. Not every operator who falls into the "free-lance service" category, handling more than 16 per-cent of all calls, is also necessarily in the questionable "night crawler" class. While factory agencies account for a sizeable portion of the service business, the meaning of this category is not clear, especially in the Detroit area. At least one set manufacturer (*Philco*) is using a special plan, worked out in cooperation with many local independents, in which calls made to the manufacturer's agency are referred to participating independent shops.

Nevertheless, a discouragingly large number of defective sets, sidetracked by one means or another, are never seen



# Of Service

5	Nature of Service			
	TYPE	YES	NO	DON'T KNOW
	Removed set from home	32.2	65.2	2.6
	Completed work promptly	91.3	6.3	2.4
	Replaced tubes	84.8	7.7	7.5
	Replaced other parts	32.1	55.3	12.6

6	Set Owners' Reactions			
	RESPONSE	YES	NO	DON'T KNOW
	Dealt honestly	88.1	7.4	4.5
	Acted courteously	94.3	3.0	2.7
	Satisfied	83.5	16.5	

by the independent service industry. Do-it-yourself service (combining the "immediate family" and "friend" categories) accounts for 12 per-cent of all service work. This trend, not likely to reverse itself, lends force to those who argue that service shops should set up to accommodate the do-it-yourself group rather than to ignore it.

If Table 4 is any indication, the service shop that wishes to prosper will generally fare better by clinging to such established practices as operating a local, limited-area business, maintaining good relations with his customers, establishing a good reputation, and working cooperatively with TV dealers who do not maintain their own service departments. More than 78 per-cent of the people interviewed go to the neighborhood shop or ask a friend or dealer for a recommendation when their sets act up. Advertising in the yellow pages or by mail accounts for a relatively small per-cent of direct business. However, a 10 per-cent difference in volume can spell the difference between success and failure, and very few shops will conclude that all advertising is a waste of time.

With respect to mail advertising, Table 4 may be somewhat misleading. As commonly employed by the majority of independent shops, this medium is quite ineffective. Studies of individual dealers who have instituted modest but sustained, carefully planned, direct-mail campaigns after years of fumbling with the method, generally report notable and gratifying increases in volume as a result of such efforts. Table 4, then, may simply confirm the fact that few service shops know how to get the most out of their mailings or just don't bother with the method at all.

Some fairly well-known facts are confirmed by Table 5—but a fallacy inherent in one of the most widely accepted of these facts is clarified. Nearly 85 per-cent of all instances where service was required involved the replacement of tubes. The promoters of drug-store testers and other schemes for diverting service business away from the service professional have made much of this point, but the statistics are often given a misleading and sinister twist: it does *not* follow, as usually stated, that 85 per-cent of all TV troubles can be cured by tube replacement. Nearly one-third of the service calls involved replacement of other parts, whether new tubes were needed or not. Also a like percentage of calls involved removal of the set to the shop, scarcely necessary where tube-only defects exist.

Primary reliance on tube replacement by non-professionals to keep a set going obviously leaves much to be desired. The practice can have unfortunate effects not only on the service professional, but on the set owner and the set itself. It is difficult to guess at the number of defects that should be corrected which are concealed by tube re-

**Do you agree with these conclusions drawn from the raw data turned up in a survey of consumer behavior and reactions concerning service techs, charges, and quality of repair work?**

7	Opinion on Fair Price	
	PRICE	PER-CENT
	\$2.00	1.6
	2.50	.5
	3.00	22.9
	3.50	1.6
	4.00	26.6
	5.00	24.3
	6.00	.5
	Other	4.8
	Don't know	17.1

8	Use of "Drug-Store" Checkers	
	RESPONSE	PER-CENT
	Have not used	63.5
	Have used	35.8
	No answer	.7

9	Satisfaction with "Drug-Store" Checkers	
	RESPONSE	PER-CENT
	Satisfied	60.7
	Not satisfied	35.7
	Other	3.6

placement, especially by repeated tube replacement, and the poor economy this practice represents as compared to a check by a qualified technician. Here is a point worth publicizing.

Also of interest in Table 5 is the fact that over 91 per-cent of respondents felt they had received prompt completion of work. We can relate this to Table 6, which shows that only 7.4 per-cent of the owners felt that they had not been dealt with honestly, only 3 per-cent sensed any discourtesy, and 16.5 per-cent were not satisfied. In a sense, all of the reactions separately listed in these tables relate to customer satisfaction, which is generally high, on the order of 90 per-cent. Evidently the industry can afford to be far less on the defensive and far less self-conscious about consumer acceptance than it usually is. This has a great deal of bearing on the next point.

What does the set owner consider a fair price for a service call? The average price developed from Table 7 is about \$4. A *reasonable* price would be higher, but the consumer

(Continued on page 138)

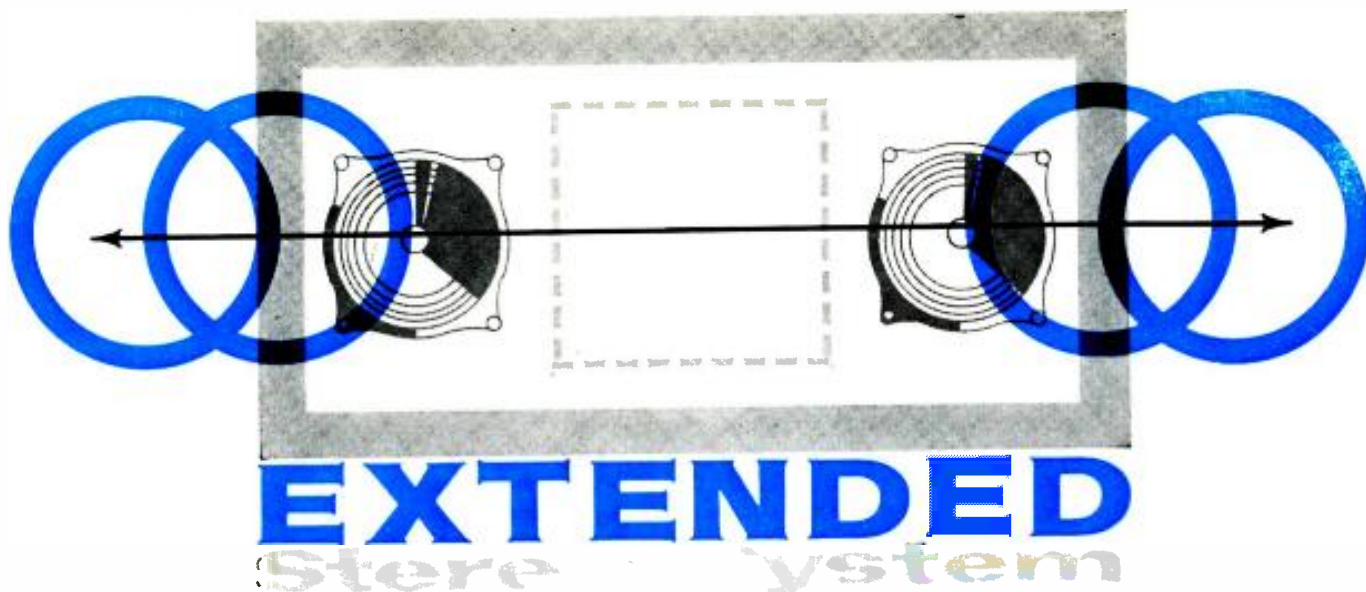

## Method employed in Zenith's 1960 models to control and extend the apparent separation in stereo reproduction.

**EDITOR'S NOTE:** Some of our readers may argue that the technique to be described below is an artificial method of producing an exaggerated stereo effect. Others will claim that since stereo itself is an illusion, then any method employed to enhance the illusion is justified. In any case, the system is claimed to be particularly effective when left and right speaker systems are contained in the same enclosure. We feel sure that our readers will be interested in the circuit and method used.

**T**HE following circuit is used in Zenith's new stereo models in order to enhance the stereo effect. According to the manufacturer, the system eliminates the need for the usual small area center listening position and permits the user to control the degree of apparent separation produced. The method is said to be particularly useful in cases where all the speakers are contained in a single enclosure. As will be seen below, a sum and difference technique is used. By controlling the amount of the difference channel various degrees of the stereo effect can be produced.

The block diagram in Fig. 1 shows the basic principle of operation. The stereo cartridge supplies separate left (L) and right (R) channel signals. These signals are then applied through an automatic balance control circuit to a mixer preamplifier. Out of the mixer two types of information are obtained. These are the sum signal (L + R), which is applied to the sum amplifier, and the difference signal (L - R), which is applied to the difference amplifier. A stereo control in the difference channel determines the degree of stereo effect produced. Outputs from both amplifiers are applied to a transformer matrixing circuit. Here the information is separated and applied to the two sets of speakers used.

### Mixer Preamp Circuit

The controlling circuit governing the degree of stereo is the mixer preamp shown in Fig. 2. For the sake of convenience assume that the signals coming from the stereo cartridge are -L and -R. These signals are applied to

the wiper arms of two 3-meg. potentiometers that are ganged together. These pots are in the grid circuits of the 12AZ7 twin-triode. The controls are so wired that when the signal is increased at one grid, it is decreased at the other grid, and *vice versa*. In this manner, satisfactory balance can be obtained. The twin-triode acts as a preamp as well as a mixer so that we can obtain the sum and difference information.

With a -L signal supplied by the cartridge, there will be +L at the plate of the left preamp because of phase reversal of the tube. If we assume that the left preamp has a gain of 2, then there will be +2L at the plate. This 2L signal is applied through the 68,000-ohm resistor and the .1- $\mu$ f. capacitor to the output. Also at the plate of the left preamp is a voltage divider consisting of a 15,000-ohm resistor and a 6800-ohm resistor. At the junction of these two resistors there will be some +L signal.

(Continued on page 156)

Fig. 1. Block diagram of arrangement used for "extended stereo."

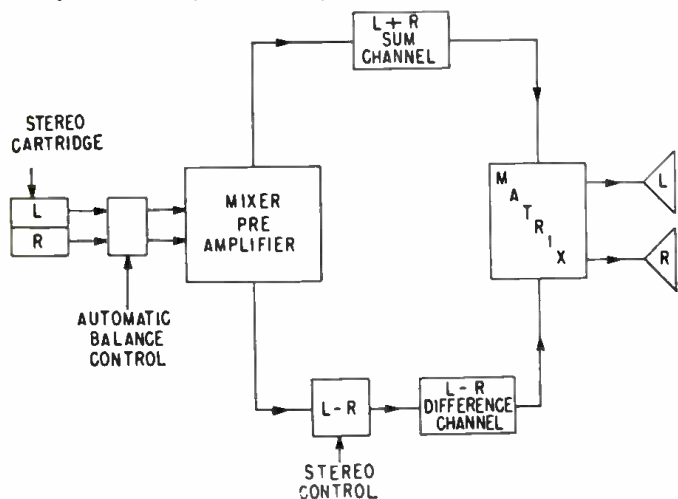
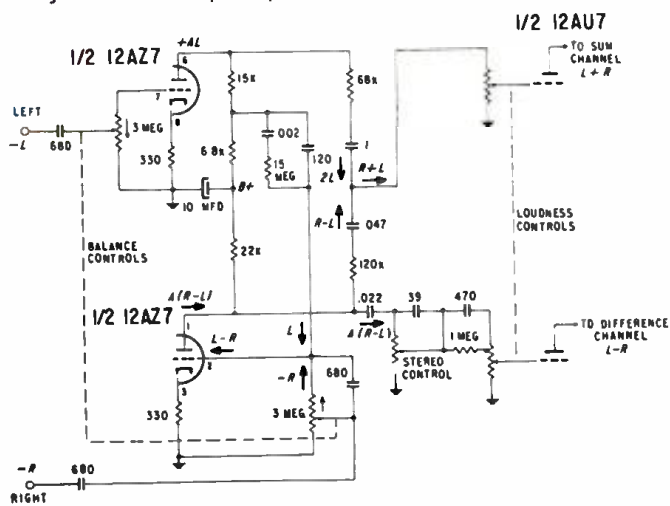

Fig. 2. The mixer-preamplifier circuit employed in Zenith sets.







# New Hi-Fi Amplifier Standards

By MILTON S. SNITZER / Technical Editor, ELECTRONICS WORLD

## Important features of recently released Institute of High Fidelity Manufacturers standard IHFM-A-200.

**EDITOR'S NOTE.** After reading the following description of some of the measurement techniques to be used for rating hi-fi amplifiers, our readers are sure to wonder just how the measurements we take on the equipment we review compare with the new standards. In some cases our methods follow the new standards quite closely. In other cases, our measurements are somewhat more comprehensive than is required by the standard. It is a bit too early for us to determine whether we will continue with our fairly elaborate tests in the future or whether we will test just those items outlined in the new standard.

Another big question is how the industry as a whole will go along with the new standards in quoting their own products' specifications. Some manufacturers of top-quality components that we have talked to think that the new standards will probably have little effect.

**R**ECENTLY, the Institute of High Fidelity Manufacturers issued its "Standard Methods of Measurement for Amplifiers (IHFM-A-200)," the second in a series of standards designed to establish comprehensive measurement techniques for high-fidelity components. The first standard, released last year, was devoted to high-fidelity tuners. (Refer to article "New FM-AM Tuner Standard" by D. R. von Recklinghausen in our October, 1959 issue.) The new standard defines terms and test conditions and lists tests and ratings for amplifier output, sensitivity, frequency response, distortion, hum and noise, and damping factor.

Those who are looking for limits of distortion, acceptable hum and noise figures, and other performance criteria for hi-fi amplifiers will not find them in the new publication, nor does the standard tell what performance an amplifier must have in order to be classed as a "high-fidelity" unit. Instead the standard gives specified methods of making a number of important measurements which, if all manufacturers follow the procedures given, will permit an accurate comparison to be made among the performances of various amplifiers.

The chief engineers of nearly every company manufacturing hi-fi amplifiers contributed to the standard. Mr. Richard Shottenfield of *Pilot Radio Corp.* served as chairman of the Institute's Sub-Committee on Amplifiers, which actually drafted the publication. It is to be submitted to the Electronic Industries Association, Institute of

Radio Engineers, and the Audio Engineering Society for their information and investigation toward acceptance by them as a common standard.

### Test Conditions

All the amplifier tests are to be performed under certain "standard test conditions" that are defined exactly. Line voltage is to be 117 volts and the amplifier is to be preconditioned by operating at one-third rated power output for at least one hour before any test is made. Power amplifiers are terminated by a resistance load that is essentially non-reactive and within 1 per-cent of proper resistance. Voltage amplifiers designed to be connected to a subsequent amplifier are terminated by a .1-megohm, 5 per-cent resistor shunted by a 1000- $\mu$ f., 5 per-cent capacitor to simulate the input circuit of the following amplifier. Any gain or level controls are set for maximum gain, while any control affecting frequency response (such as tone or loudness controls) are set for flattest electrical frequency response. Note that this is not necessarily at the mechanical mid-positions of the tone controls.

### Output Ratings

Power amplifiers are rated in terms of *continuous power* output and/or *music power* output at 1000 cps at a certain rated total harmonic distortion. Continuous power output is the conventional steady-state sine-wave power measurement obtained by squaring the output voltage and dividing this value by the resistance of the dummy load. Music power output is measured the same way except that the input signal is applied suddenly and the measurement is taken immediately, before the supply voltages have changed from their no-signal values. Because of the difficulty in taking this measurement quickly enough, especially with amplifiers having poor voltage regulation, it is necessary to maintain the voltages at their high no-signal values artificially.

One way of doing this is to substitute for the amplifier's own power supply, another supply with excellent voltage regulation that will maintain the voltages steady under full-load conditions.

Another way is to insert a variable autotransformer at the input and raise the line voltage sufficiently to bring the amplifier's power supply voltages back to their no-load values. Usually, amplifiers with well-regulated supplies and with fixed bias (such as from a separate rectifier system) will show little difference between continuous power and music power ratings. On the other hand, amplifiers with poor power-supply regulation and self-bias may show a substantial difference. In any case, the music power rating will be higher than the continuous power rating.

Another output measurement specified for power amplifiers is that of *power bandwidth*. This is simply the continuous power-handling ability at rated distortion between the half-power (-3 db) points measured on the frequency scale.

With voltage amplifiers, the output is rated in terms of a certain output voltage across the .1-megohm load mentioned previously.

### Sensitivity & Frequency Response

The sensitivity characteristic is the amount of input voltage, at 1000 cps, required to produce rated power output with a power amplifier or rated voltage output with a voltage amplifier.

The performance of the amplifier with respect to frequency is measured at an output level no higher than 10 db below rated output and no lower than 20 db above the residual noise. For example, when checking the frequency response of a 10-watt amplifier, the measurement should be taken at a level no higher than 1 watt. In the case of a voltage amplifier rated at 1-volt output, the measurement should be taken at a level no higher than .32 volt. The response, expressed in db, is to be plotted on semilog paper with a 20 db change in level corresponding to the length of one frequency decade. By using this standardized presentation, it is impossible for some curves to look better than others simply because of the manner of drawing them. In rating the frequency response the maximum positive and negative deviations are to be given with respect to the response

(Continued on page 127)

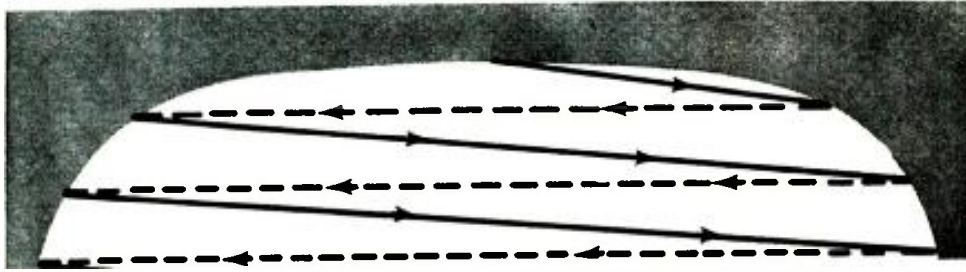

# Horizontal Deflection Circuits

By **KENNETH BRAMHAM** / Haziness about some fine points in this circuit's operation is the real cause of many "dog" jobs.

**A**LTHOUGH the purpose and over-all operation of the TV receiver's scanning circuits are well known, some of the inner details, particularly in the horizontal scanning circuits, have eluded many technicians. This is particularly unfortunate since some of the fine points have bearing on the interpretation of faults and the logic of troubleshooting.

The purpose of a TV scanning circuit is not difficult to understand: the normal path of the CRT's undeflected beam is to the center of the viewing screen. The beam must be made to scan the entire screen area in a given pattern 30 times each second. Modern receivers use wide deflection angles (70 to 110 degrees), which are more readily obtained with magnetic rather than electrostatic deflection. The electron beam passes through a varying electromagnetic field set up by a varying current in coils of copper wire (the deflection yoke) mounted on the neck of the CRT.

If we mount a pair of deflection coils vertically on a CRT (one coil above the neck and one below) and allow current to flow through them, the dot of light produced on the viewing screen by the electron beam will move from its normal position and take up a new position to one side of the screen. Increase the current in the coils and the dot moves over still farther until, with enough coil current, it moves off one side of the screen.

Suppose we rotate the coils through

90 degrees, so that they are disposed horizontally, with one on either side of the CRT neck. Changes in coil current will now cause the dot to move up or down vertically. Thus the TV deflection yoke has its two pairs of coils to produce both types of motion. To scan a single, horizontal raster line on a TV screen, the electron beam must go through the following sequence: it must move from the center of the screen, the electron beam must go right-hand side; retrace, at a much higher speed, back to the center and past it to the left-hand side; and then, resuming its initial, constant speed, move back to the center of the screen.

To produce this sequence of movement or deflection of the beam, the controlling magnetic field must go through a corresponding cycle of change, which means that the current flowing through the coils must also go through a similar pattern of change, represented by a saw-tooth current waveform. This requirement for the current cycle would appear to be a fairly simple one. However, at the frequencies involved with TV scanning, matters become rather more involved.

It is interesting to note that, while a complete horizontal scanning cycle takes 1/15750 sec., no more than 1/3 of this time (1/78750 sec.) is ordinarily used for the retrace portion of the cycle. The minimum raster width of a 21-inch picture tube is at least 1.5 feet. To cover this distance in the allotted time, the retracing spot must travel at

a speed of about 1000 miles per minute, or about 60,000 mph!

A practical indication of the effect of scanning frequency on required scanning power is provided by a comparison of vertical and horizontal deflection circuits. There is not much difference between these two in the distance to be scanned, the vertical distance being three quarters of the horizontal. Nevertheless, a TV receiver that uses a miniature triode to handle a watt or two for vertical deflection may have a heavy-duty pentode handling 50 watts or more for horizontal scanning. The difference in power is like that between the output stage of a table radio and the amplifier of an expensive hi-fi system!

Vertical-circuit damping is generally performed by a pair of half-watt resistors across the yoke windings. The resistors dissipate unused energy remaining in the yoke field at the end of each vertical scan. If a similar damping arrangement were used in the horizontal circuit, large power resistors would have to be used, and a water cooling system might be a good idea, in addition! Instead of resistors, a damping tube is used. This is a better way for more than one reason: instead of wasting the considerable energy in the field at the end of the scanning cycle, this energy is returned to the circuit by the damper to be used for a good part of the next scanning cycle.

The typical horizontal-output circuit shown in Fig. 1 is reduced to a simplified form in Fig. 2. In the latter, the horizontal-output transformer (T) is shown without added windings for high-voltage supply, a.g.c., phase comparison, or other purposes, while a capacitor (C<sub>1</sub>) is added to represent the shunt capacitance due to the windings of the transformer. In conformity with modern design practice, the yoke is shown connected across a part of the transformer winding, rather than being in series with the transformer (direct drive) or being connected to a separate secondary winding, as in many older designs. The 6AU4 damper tube is seen to be in series with the transformer and boost capacitor (C<sub>1</sub>); while the 6CD6 output tube, the output transformer, the boost capacitor, and "B+" supply form an additional series circuit.

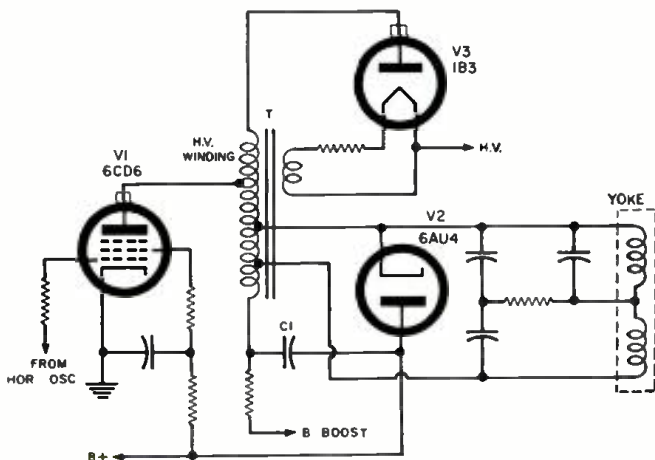

Fig. 1. Wide-angle TV sets of modern design typically use horizontal-output circuits, like the one shown here, with an autotransformer.



A feature of this arrangement is that the output tube conducts for less than half of each cycle, reducing the ratings needed for this tube.

A horizontal-output system bears more resemblance to a pulse circuit, in which the tubes are only required either to conduct fully or to cut off, than it does to the many familiar circuits where the output current follows slight variations of input (grid) voltage. For this reason, it is convenient to regard both output and damper tubes as high-speed switches. This is shown in the equivalent circuits of Fig. 3. Switch  $S_1$ , representing the 6CD6 of Figs. 1 and 2, is shown closed when the drive voltage to the grid is positive, and open when the tube is cut off by a negative grid voltage.  $S_2$ , representing the 6AU4 damper tube, is closed when its cathode voltage is negative with respect to its plate. When this tube is cut off by a cathode voltage that is positive with respect to the plate,  $S_2$  is shown open.

Circuit conditions in the first part of the scanning cycle are shown in Fig. 3A. The output tube grid voltage, charted below the circuit diagram, has become positive, closing the equivalent switch,  $S_1$ . The supply potential, consisting of the "B+" voltage plus the charge on  $C_1$ , causes a current ( $I_b$ ) to flow through the transformer ( $T$ ), and  $S_1$ , inducing a much higher current ( $I_y$ ) at a lower voltage in the yoke.

Also in Fig. 3A, a back e.m.f. producing a current opposing that of the supply current will be noticed. This is produced in the transformer by the sudden surge of supply current at the start of the cycle and it gradually decreases, allowing a steady increase of  $I_b$  and  $I_y$ . As  $I_y$  increases from zero, the magnetic

field around the yoke increases and moves the scanning beam to the right, as shown by the solid line in the scanning diagram of Fig. 3A. During this part of the cycle, the damper tube cathode is held positive with respect to its plate by the charge on  $C_1$ , and the position of the damper-tube tap on the transformer. The equivalent switch ( $S_2$ ) is therefore open.

The relation between grid voltage, yoke current, and scanning dot position for the second part of the cycle is shown in Fig. 3B.  $S_1$  is now opened by the grid voltage, which has become negative. As  $I_b$  is cut off by the now open  $S_1$ , the magnetic fields built up around the transformer and yoke decay rapidly and induce a rapidly decreasing current,  $I_c$ , in the transformer and  $I_r$  in the yoke. The latter current is in the same direction as the original  $I_b$  in the first part of the cycle.  $I_c$  charges the winding capacitance ( $C_s$ ) of the transformer while the scanning beam retraces to its original position in center screen. Thus, at the end of this

part of the cycle, both switches are open, no magnetic field exists, and all the energy in the circuit is stored in  $C_s$ .

Refer now to Fig. 3C. The winding capacitance ( $C_s$ ) now discharges and allows current ( $I_d$ ) to flow in the transformer winding, which induces a current in the yoke ( $I_r$ ) in the opposite direction to the current of the previous part of the cycle. The magnetic field thus created around the yoke moves the scanning beam to the left of the screen. Furthermore, the speed at which this action occurs, like the speed of the first part of the retrace cycle depicted in Fig. 3B, is much greater than the speed of the normal scanning action described in Fig. 3A. This higher retrace speed is determined by the resonant frequency of the tank circuit made up of transformer  $T$ , shunted primarily by its own winding capacitance ( $C_s$ ) and also by the values of other components in the circuit. The self-resonant frequency of this tank is several times the 15,750-cps rate of normal scan generally being in the order of 70,000 cps.

If there were nothing to stop it, the transformer tank would continue to oscillate until the energy in it, moving back and forth between the transformer's inductance and its capacitance ( $C_s$ ), was dissipated in heat. However, another element in the circuit prevents  $C_s$  from being recharged in the final part of the scanning cycle (Fig. 3D). The potential developed across the transformer in the preceding portion of the cycle has made the cathode of the damper tube negative with respect to its plate, and the tube is able to conduct. This is shown by the closed

(Continued on page 110)

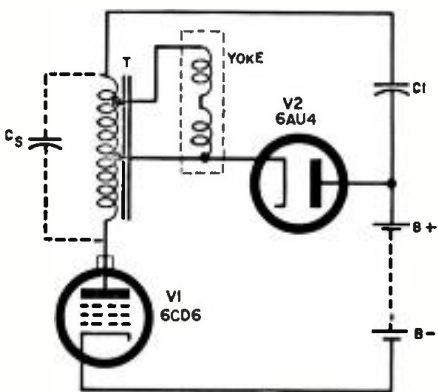
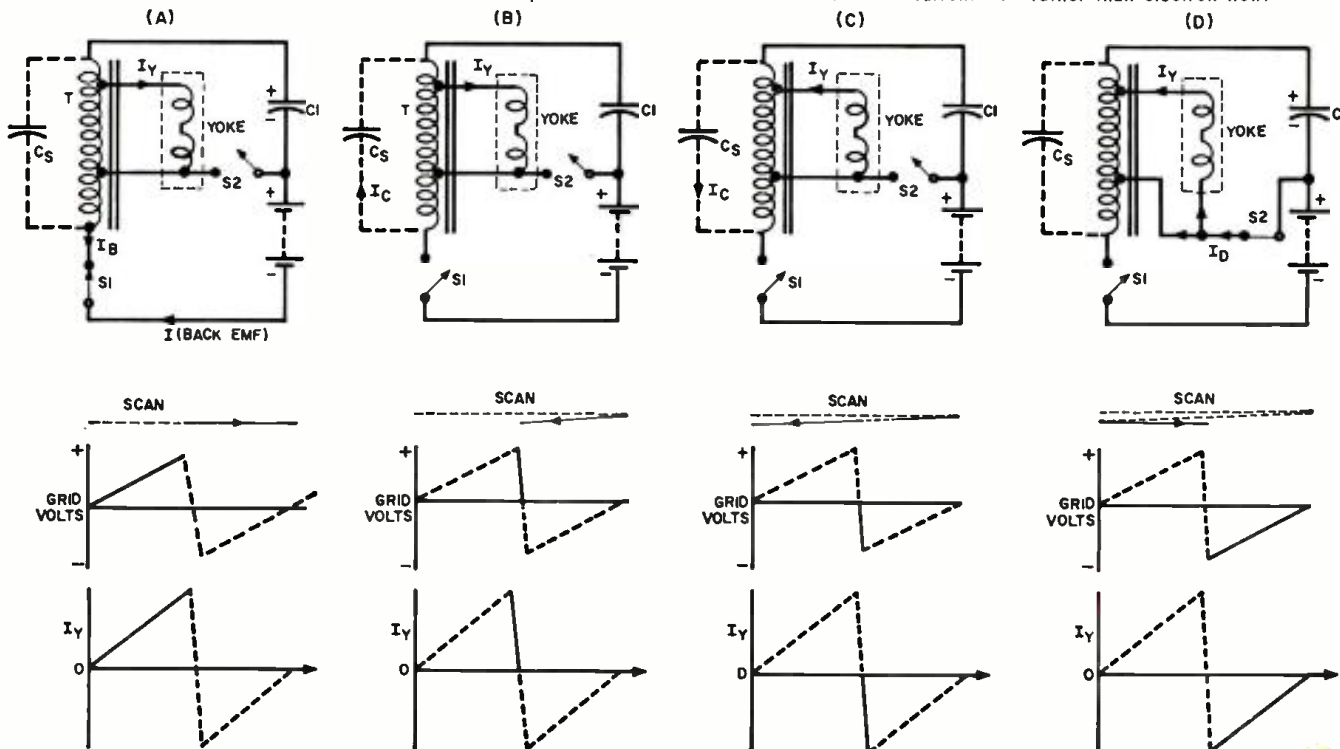
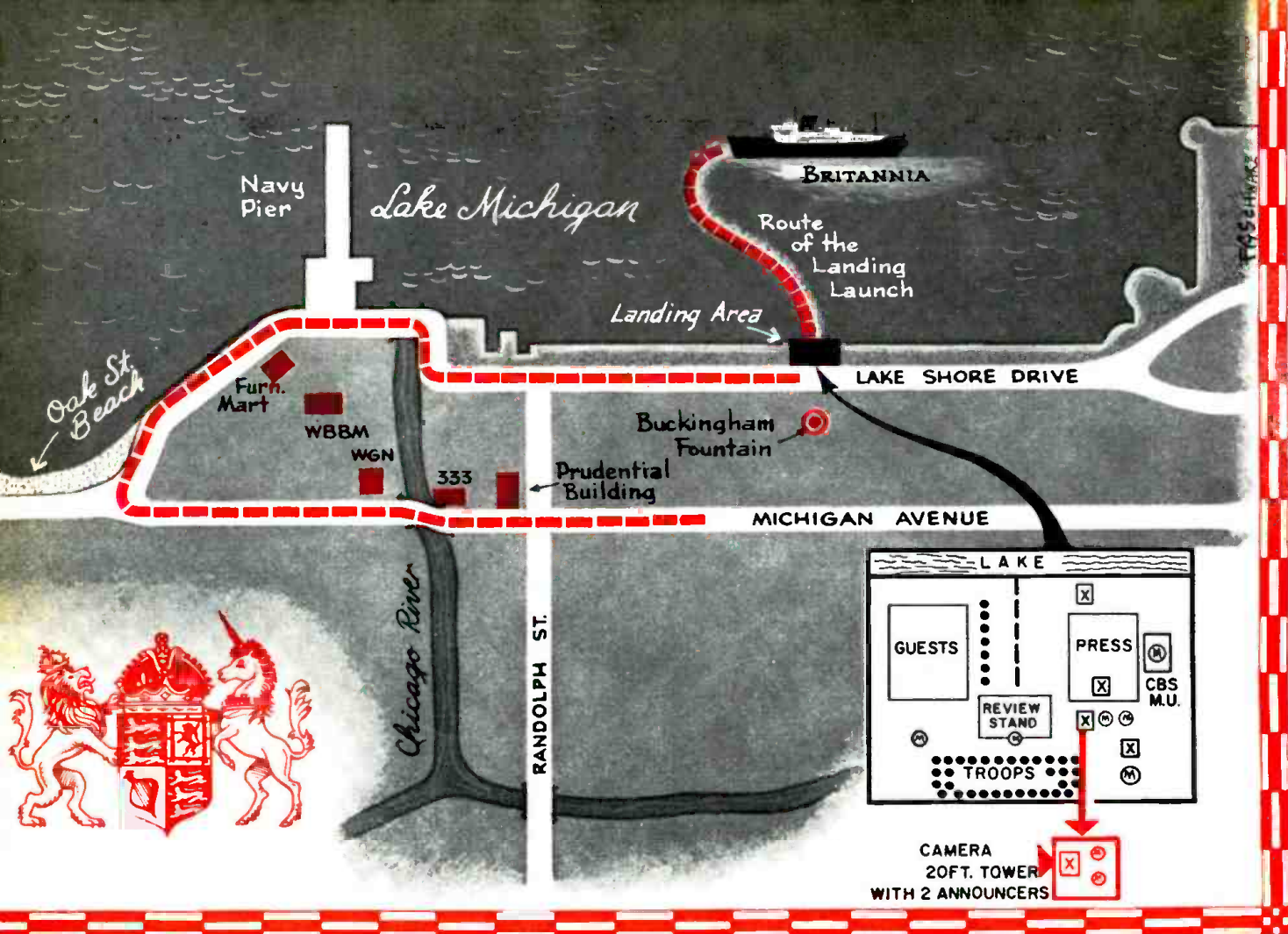

Fig. 2. Simplification of Fig. 1 circuit.

Fig. 3. Circuit conditions, beam movement, and waveforms for the four phases of one scanning cycle. Switches replace tubes to depict conditions of conduction as "on-off" positions. Arrows indicate conventional current flow rather than electron flow.





Outline map, showing route of Queen's entry and the locations of TV cameras. The inset shows the technical setup at landing area with its cameras (X) and mikes (M).

# How A Pool Telecast Works

By **RICHARD H. MOSS**  
NBC Television

Technical details on how Chicago TV stations combined their facilities to cover the visit of Queen Elizabeth.

**Q**UEEN ELIZABETH'S thirteen-hour visit to Chicago last July was perhaps the most gala occasion in that city's recent memory. An estimated half-million Chicagoans turned out to greet the Queen and Prince Phillip at lake-front welcoming ceremonies and during a colorful motorcade along Lake Shore Drive and famed Michigan Boulevard to the Loop, Chicago's downtown area. Three and a half million more viewed on TV screens their entry into the city as the Windy City's four TV stations joined to provide full coverage of the pageantry with the second "pool" telecast in the city's history.

## Early Arrangements

The TV pool had its beginnings at a meeting in the office of Chicago's mayor, Richard J. Daley, about a month before the royal visit. Arrangements for the occasion had been known for some time and at least two of the TV stations, WBBM (CBS) and WBKB (ABC), were planning full-scale coverage of the events on an independent basis. Their plans were changed by the

Mayor's announcement. At the site of the Queen's arrival, space was limited and security would be tight. Every news agency in the country wanted to be there. Daley visualized a news gathering stampede that might leave the Queen trampled. For these reasons, only one station would be permitted to set up at the welcoming ceremonies. The others could take a feed from that station. A coin toss by the Mayor's representative gave the privilege to WBBM.

With natural competitive instincts channeled into a cooperative effort, telecasting plans took on more concrete form in a series of meetings during the next few weeks. Although a planned-to-the-minute day was in store for the royal party, practical considerations and other programming commitments limited the pool TV coverage to the events surrounding the Queen's arrival. The royal yacht, *Britannia*, was to drop anchor east of Buckingham Fountain, the Queen coming ashore in a 40-foot launch to land at a specially built dock at Buckingham Plaza. There

would be greetings from Governor Stratton of Illinois and the Mayor, remarks by the Queen, and a parade into the city.

The events to be televised were to occur within a two-and-a-half square mile area along the lake shore, with the parade following a hairpin-shaped route roughly four miles long. With the CBS mobile unit slated to do the key pickup at the landing point, WBBM was a natural as the pool control station, and its staff, with "Sis" Atlass as producer, assumed the burdens of organization. Accessibility of camera sites along the parade route and availability of special equipment were the deciding factors in assigning other pickups. WGN's locations at Tribune Tower and the Prudential Building afforded unbeatable prospects. WBBM's permanent remote point at the Furniture Mart provided a good view of about a mile of the parade route. NBC's WNBQ could deliver on-the-move coverage of any part of the ceremony with the network's radio-linked parade car. Ironically, the sta-



tion with the most aggressive early plans. WBKB, was not physically located to provide suitable camera positions.

### Final Plans

Final plans called for ten cameras at five remote locations. Two remotes were to feed the WBBM control center direct. WGN's two pickups would be routed through a sub-control studio at Tribune Tower, thence to the pool control. The fifth "location," NBC's parade-following *Cadillac*, was to beam its signal to a microwave receiver on top of a Michigan Avenue building for relay by wire to the central control room.

Each remote location would be staffed by a director and announcers from the participating stations, switching cues coming from the CBS director at the pool control studio. All positions were to be linked into a single communications circuit. The output of the program control studio would be fed to the TV master control rooms of all four Chicago telecasters. Some planned to mix the pool feed with audio and/or video originations from their own studios. WNBQ (NBC), for example, was going to video-tape portions of the pool feed for delayed network broadcast, and elected to originate a separate audio feed from Buckingham Plaza in-

stead of using pool audio from that point.

As the participating stations laid their own plans and set about collecting all the long lenses they could put their hands on, *Illinois Bell Telephone Company* got to work on the man-sized job of linking stations and camera locations with a maze of special lines. For the television coverage, nine coax lines and about forty audio pairs, a third of them equalized, were required. At the same time, *Telco* was busily supplying the interconnections for twelve radio pickup points and four additional radio stations, as well as setting up radio feeds to *Bell of Canada* and to Great Britain. The *Canadian Broadcasting Company* was to get a video feed *via* Buffalo.

Some of the equipment to be used on the telecast had to be shipped to Chicago from other locations. The largest single "import" was NBC's *Cadillac* mobile unit which was driven in from New York, arriving three days before the Queen. Upon its arrival, the WNBQ crew assigned to it spent two days in setting up and in practice runs along the parade route. Special attention had been paid to selection of the best location for its microwave receiver. The roof of the 333 N. Michigan Building, adjacent to the Chicago River, was found to afford optimum

line-of-sight location for the welcoming events. Signals from the mobile unit were usable over most of the motorcade path except the extreme north end, where buildings intervened, and along a portion of Lake Shore Drive, where microwave fade was caused by trees. Engineers handling the parabolic reflectors of the roof-top receiver and the mobile transmitter were, of course, required to "pan" the equipment to maintain usable signals. Some difficulty

Columbia Broadcasting System television cameras were employed to cover the actual landing of the Queen. Note Buckingham Fountain in background.



January, 1960



WGN's Prudential Building location provided cover shots for the telecast. This early morning view shows cameramen checking shots.

was encountered at the receiver location in distinguishing the distant *Cadillac*, a problem which was resolved by supplying the operator with a hand-held monocular. The *Cadillac* crew was slated to do double duty, incidentally, originating a special pickup for Garro-way's "Today" as well as taking part in the pool.

### The Big Event

The day of the big event began early for the engineering crews involved. Earliest birds, the CBS lake-front crew, checked in at the closely guarded Buckingham Plaza with their mobile unit at 3:15 a.m. Four cameras were located here, at positions in and around bleachers set up for an expected 500-man press corps. An eighteen-foot scaffold accommodated one camera and two announcers. This site afforded an excellent all-round view of the proceedings and a good shot toward the *Britannia* moored about  $\frac{3}{4}$  of a mile to the east. Use of a *Bach* 6:1 Zoomar with adapter provided the required flexibility and a maximum focal length equivalent to a forty-inch lens. The announcers were supplied with video monitoring facilities and double head-sets—pool audio on one earpiece, cue circuit on the other.

Other cameras were placed at different levels and situated (see map) to





This WGN camera got a 40-foot boost from Bureau of Electricity truck. Camera was provided with 6:1 Zoomar with 40" adapter.

give close-up coverage of specific parts of the ceremonies with standard lens complements supplemented by long lenses as necessary. Two additional Zoomar lenses, and 40- and 60-inch lens adapters were also available.

Audio-wise, the main problem to be solved was distribution from the Queen's microphone located on the reviewing stand. To obviate the forest of microphones so often seen before prominent speakers, WBBM manufactured a distribution box which provided twenty-eight 50-ohm mike-level feeds for use by all parties concerned—radio, TV, and newsreel. These feeds were available, by pre-arrangement, on *Hubbell* twist plugs installed at the mobile unit.

The remaining audio setup was comparatively simple, with two hand mikes provided for announcers, two stand mikes for pickup of band music, and a parabolic mike set up atop the mobile unit to re-inforce the band coverage and to cover other areas of interest.

A 60-ampere, 120/240-volt power source was provided by the Chicago Park District and a standby mobile generator was put on the scene by WGN.

The setup at the Prudential Building (the first TV pickup from this location, incidentally) was simplified to some extent by the fact that it is WGN's transmitter location and afforded a ready source of power as well as existing audio and video lines to the WGN sub-control studio. However, it was necessary to "strip" a mobile unit, moving and setting up audio and video control and switching equipment at a temporary control room adjacent to the camera locations on the 39th floor roof, 450 feet "up" and .8 mile from

the landing location. Two cameras and two hand mikes for announcers were located here, with, of course, video monitoring facilities for the announcers.

The WGN crew at this location was to provide the pool with "cover" shots of the beautiful lake front and harbor areas surrounding the ceremonies as well as views of the motorcade as it passed along Lake Shore Drive,  $\frac{3}{8}$  mile to the east of the building. The "cover" camera used a 35-mm. lens which produced, for the viewer, a field of vision akin to "being there in monochrome." The same turret accommodated a WGN-built "folded" 25-inch lens for closer views. The second camera utilized a 6:1 Zoomar with adapter for shots of the *Britannia* in the harbor, the Queen's launch approaching the landing, and the passing parade.

During the latter stages of the procession, the Prudential Building cameras were moved to the north side of the roof to get further cover shots of

the motorcade coming southward on Michigan Avenue.

At the southeast corner of the Furniture Mart roof, thirty-two floors directly above Lake Shore Drive, WBBM placed a single camera to cover the portion of the parade route which was inaccessible video-wise to other units. WBBM maintains a permanent remote studio at this building, so that setup involved only extension of existing cables. Audio for shots from this location was provided by an announcer in the WBBM studios.

WGN's second position, on the street in front of Tribune Tower, was covered by two cameras and an announcer. Once again, the engineering problem was minimized by the fact that terminal facilities existed for a regular "man-on-the-street" pickup. One camera was located at sidewalk level with a standard lens complement. The second was boosted forty feet above street center on the elevator platform of a  
(Continued on page 154)



NBC Cadillac used microwave relay atop the car for good on-the-move coverage.

Block diagram showing interconnections required for the pool telecast described.

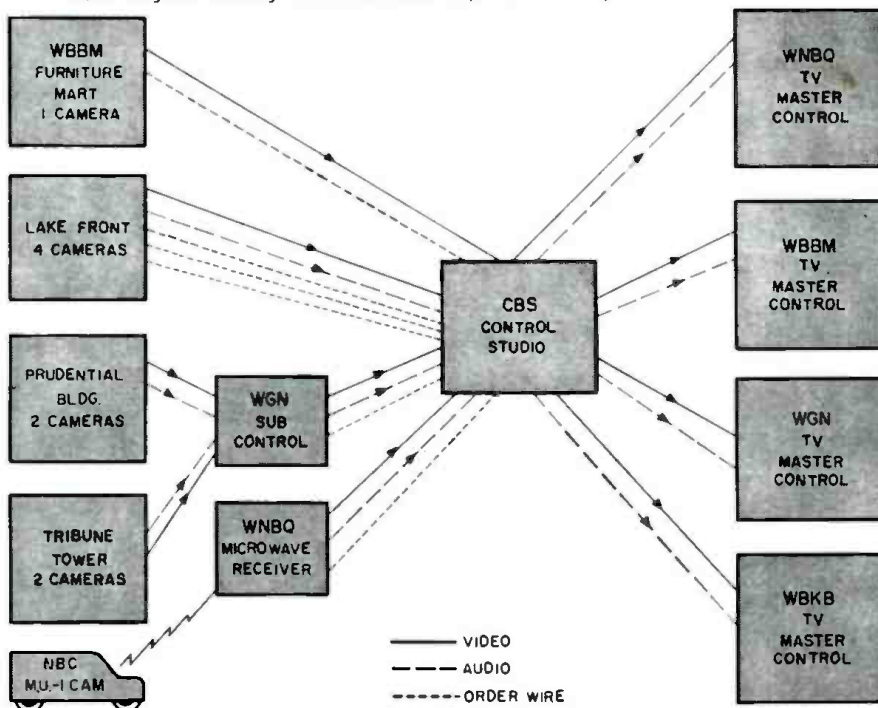





## Promotion for Service

By **WILLIAM LEONARD** / For a business that operates only in a specific area, selective promotion gives the best result.

**T**HE CONSTANTLY shifting tides of business make it necessary for every service dealer to systematically re-appraise the relative merits of the advertising he is using to keep his name and the work he can perform in front of the general public. He cannot afford to let his business slip into a rut. He must stay alert for ideas that will continue to regenerate the interest in his business that will inspire set owners to call him when they need service on their electronic products.

One dealer, who almost lost his business because he failed to maintain adequate communication between his shop and potential customers, recounted how circumstances forced him into a promotion plan that put his business back on a stable basis.

"I had no serious trouble," he said, "in getting adequate charges for my work. My problem was that I just was not getting enough work to fill the hours I had available to do it. If you can't keep your hours filled with profitable work in a service business, you cannot pay your bills and make a decent living at it."

"How did you solve your problem of insufficient volume?" he was asked. "As I look back on it now," he replied, "the solution was relatively simple. I merely put something to work for me that had been available to me for a long time. I rebuilt my business volume through the studied and consistent use of direct mail."

"What prompted you to turn to direct mail?" "It started out as an emergency measure," he explained. "My income dropped to the point where I had to have more business—or else. One day, as I was mulling over my problem, I found an interesting promotion piece in my mail. As I studied it, it occurred to me that I could adapt the idea to my own business. I went to see a printer whose set I had taken care of and discussed the idea with him. He developed a very striking flyer in the form of what is known as a 'self-mailer.' I ordered two thousand of them. When they came in, my wife and I addressed these mailers to every customer who had ever called us for service. We staggered the addressing

and mailing over a thirty-day period. "The results were really astonishing," he continued. "Our calls for service soon climbed back to a normal level. We found that mailing about four hundred pieces per week brought in the maximum volume I could handle without adding another man.

"Since then, it has been our regular program to mail a promotion flyer to approximately four hundred households every week. We have added to our mailing list, of course. We used the first flyer for about three months. After going through our own customer mailing list, we used a cross-indexed directory to make a house-to-house mailing to all residents in our normal working area. This brought us a lot of new customers.

"We have gotten a big bang out of looking for new ideas to use in these promotion pieces. We are carefully avoiding the rut of mailing something just to be making a mailing.

"On the basis of my experience," he concluded, "I feel that carefully planned direct mail material, consistently used, is the only type of advertising that will really pay off for a small, independent, electronic service dealer. In my case, I was fortunate to find a promotion-minded printer who is able to take ideas and crystalize them into effective mailing pieces specifically designed for my business in my own community. It has really paid off for us."

The service dealer should constantly keep in mind that, unlike the self-service laundry, he does not see the same people again and again on a regular weekly basis. A particular customer may need service only once every six months or a year. Therefore, the customer does not get a chance to form the habit of going to one shop.

A dealer can no longer depend on the sign on his store front and the ads he carries in the directory pages of the phone book to keep him supplied with the new business he needs to keep his shop going. He must keep every radio and TV set owner in his immediate trade area continually aware of the fact that he is ready to take care of the service anytime the owner's set goes

haywire. A single mailing is usually practically worthless, although an ingenious one will sometimes pay off. A postal card, a small mailing piece, or a letter once a month or every other month, is the type of promotion that will do the most good.

The mailing program should not be confined just to contacting people to solicit new business. The dealer who does not use a mail follow-up on the customers for whom he has performed service is missing a good bet. A letter or card with a return post card should be sent to a customer a few days or, at most, a week after a job is completed. This card should carry two or three questions which the set owner is to answer and send back to the dealer.

In this type of customer-checking follow-up, ask the questions that are important to you and your business. Don't be afraid to ask frank questions. Effective questions would be something like these: "Was your set serviced to your satisfaction?" "Was the work turned out in a reasonable time?" and "Do you feel our charges were fair and equitable?" Always leave a space for "comments and criticisms," and make it optional with the customer to sign it. Of course, cards can be simply coded so you will know the name of a customer who sends in a criticism without signing the complaint.

The most important part about this type of customer follow-up is the impression it leaves with the set owner. It will inspire him to think "He really cares about the kind of job he does!" The few cents spent on this small bit of customer relations creates good will whether or not the card is returned.

A dealer should not go into any kind of direct-mail promotion without having a definite plan and purpose in mind. The reason will determine what type of mailing you should use in your program. Unless you have an unusual "gimmick," do not look for spectacular results from the first mailing to your selected list. Here are a few "motives" you could use as the basis for pieces prepared for a long-range mailing program:

1. Let people know you are around.

(Continued on page 149)

# Wide-Band A.C. Millivoltmeter

By LYLE E. SHARPE

**Reading only 10 millivolts full-scale on its low range, this meter is handy for audio and other low-level measurements.**

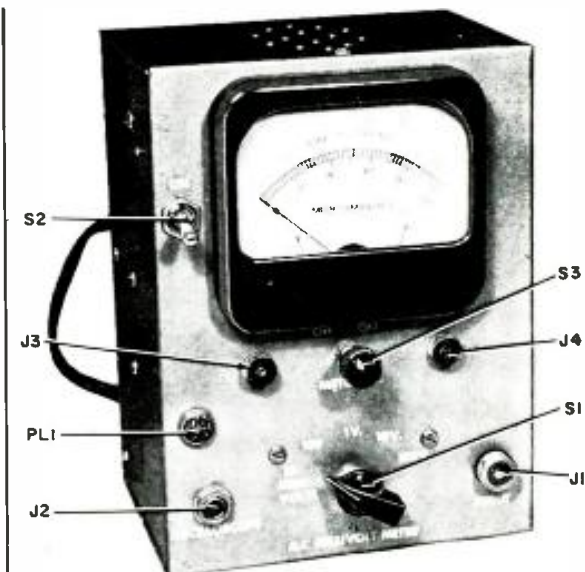

The meter need not be larger than a conventional v.t.v.m.

**T**HE NEED to check out audio circuits is a good enough reason in itself for wanting a wide-band a.c. millivoltmeter, and there are other applications in addition. The absence of such instruments on the benches of service technicians and experimenters is due to the relatively high cost of laboratory units rather than to a feeling that the instrument is not necessary. Thus the cost and effort of putting together the unit described here is well worth while.

The meter is flat within 1 db from 10 cycles to 400 kc. on all scales. For comparative measurements, it is useful to

better than 2 megacycles with a 10-millivolt input. Voltage may be read directly on the existing scale of the 0-100 microammeter used, the five ranges being 0 to 10 millivolts (.01 volt), to 100 millivolts (.1 volt), to 1 volt, to 10 volts, and to 100 volts. These are provided by the range switch (S<sub>1</sub> in Fig. 3) and the voltage divider comprising resistors R<sub>1</sub> to R<sub>5</sub> inclusive. S<sub>1</sub> is a single-pole, 5-position, shorting type switch so that the input grid of the circuit will not be open when going from one range to another.

The circuit consists essentially of an audio amplifier with a suitable rectify-

ing system for the 0-100 microammeter. Ten millivolts on the grid of V<sub>1A</sub> will provide the 1.7 volts required at the input of the meter bridge rectifier to produce full-scale deflection of the movement.

Due to high inverse feedback and degeneration from the unbypassed cathode resistors, the circuit achieves excellent stability and linearity. The entire instrument was housed in a box 4½ inches deep, 6 inches wide, and 8 inches tall, with several holes drilled in each end for air circulation. This type of cabinet lends itself to use particularly well, as the back and ends

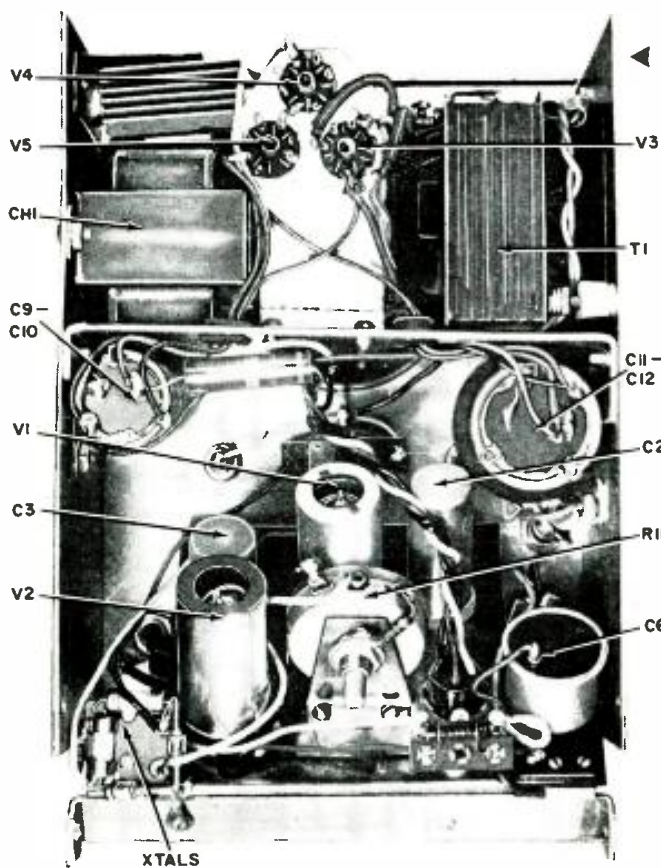
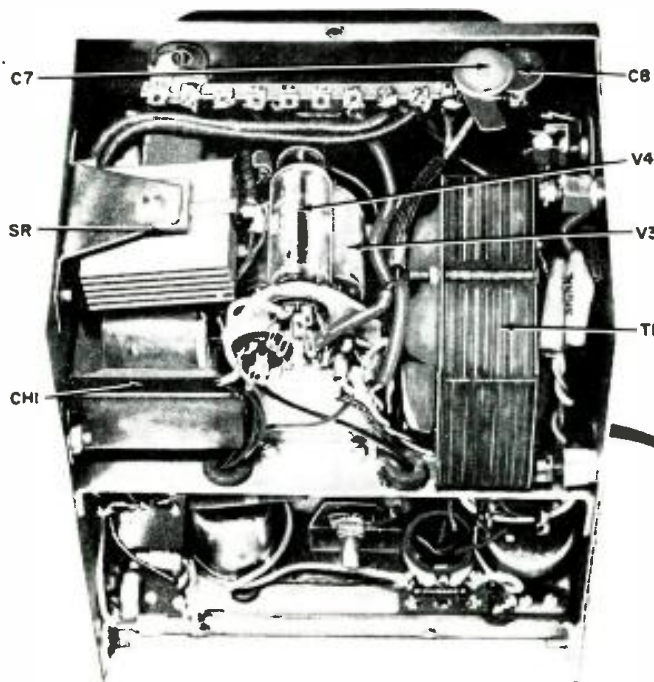

Fig. 1. Rear view with amplifier section dropped down at the bottom to expose layout. Power supply shelf is at the top.

Fig. 2. This view from the top down highlights the arrangement of components in the power-supply section.





are removed in one piece giving access to both the amplifier and power supply. Of course, the instrument may be constructed in any available, shielded cabinet, but be careful to isolate the amplifier from the transformer field.

### Power Supply

The power supply uses 3 miniature tubes to obtain 255 volts of regulated voltage, the 6X4 filament being operated from the 5-volt filament winding of the power transformer. When operated in this manner, it takes longer for the rectifier's heater to reach its operating temperature, giving a gradual rise to the operating voltages on the amplifier tube plates. For this reason, smaller units may be used as filter capacitors. The 6.3-volt winding of the power transformer is wired "back to back" with a 6.3-volt, 3 amp. filament transformer ( $T_2$ ) to produce 110 volts of a.c. that is isolated from the power line. This voltage is rectified and dropped through  $R_{20}$  to give 24 volts of d.c. for the amplifier filaments operated in series ( $V_1$  and  $V_2$ ).

Figs. 1 and 2 show the manner in which the power supply is mounted on a shelf in back of the meter, 3 1/2" from the top of the cabinet. The filter capacitors ( $C_7$  to  $C_{10}$ ) are mounted underneath the shelf as shown after taping the cans to insulate them from the chassis. The high-voltage supply is grounded to the chassis at  $J_1$ . A bus bar is run from this point to the amplifier tubes for ground connections. The filament supply (point  $Y$ ) is grounded to the chassis at pin 4 of  $V_1$ .

### Amplifier

The amplifier proper utilizes two dual triodes, a 12AX7 and a 12AU7. The input stage ( $V_{1A}$ ) is a cathode follower and is cathode-coupled to the second section ( $V_{1B}$ ), which operates with a grounded grid. The signal is then coupled through  $C_1$  to the 12AU7, which is a cascaded voltage amplifier.  $R_{15}$  feeds back some of the voltage from the plate of  $V_{2B}$  to the cathode of  $V_{2A}$ . The signal then passes from the output tube ( $V_{2B}$ ) through  $C_6$ , the closed-circuit jack  $J_2$ , and  $R_{21}$  to four 1N34 diodes connected in a full-wave bridge circuit. The bridge is returned to ground through the cathode resistors of  $V_{2A}$  ( $R_{11}$  and  $R_{12}$ ), providing approximately 15 db of feedback. Meter sensitivity is controlled through potentiometer  $R_{17}$ .

The amplifier was mounted on a small copper chassis 7/8" x 4" x 4". The front lip of the chassis was bent past the 90-degree angle to approximately 110 degrees and the center of the lip was trimmed out to provide clearance for the range switch. The amplifier was then fastened to the back of the front panel with the grid of  $V_{1A}$  as close as possible to its connection on  $S_1$ . When mounted in this manner, the chassis slopes toward the rear, giving easy access to the amplifier deck.  $C_2$  and  $C_3$  are miniature can type electrolytics mounted on the amplifier deck. Potentiometer  $R_{17}$  mounts on a bracket on top and at the rear of the chassis, where it is accessible for adjustment. The amplifier chassis was secured by two screws in the front panel and a bracket on the rear which fastens to each side. This is shown in Fig. 1 where the four screws are removed and the amplifier dropped out of the case somewhat. The copper chassis, power-supply shelf, and rear bracket may all be formed in a small bench vise.

All rules applying to high-gain amplifier construction should be observed. Make all amplifier ground returns to the bus bar, which is grounded to the chassis at  $J_1$ . No shielded wiring is used, as this would result in a loss of high frequencies. Instead, tube sockets are oriented in such a way that straightforward point-to-point wiring is used with all signal leads kept as short as possible. Precision resistors (1 per-

cent) were used for all units in the voltage divider except one and elsewhere as specified. Because of their low inductive reactance, the author used "Noblecoy" metal-film resistors made by Continental Carbon Co. While the lowest-value resistor in the divider ( $R_{21}$ , 111 ohms) should also be a precision unit, this is not a readily available value. However, it can be made up from standard-value units in conjunction with an accurate device for measuring resistance. The author filed a notch in a 100-ohm, 1-watt, carbon resistor to raise its value, checking the increase with a bridge. (Precision resistors at 110 ohms are available.)

### Adjustment

Before the millivoltmeter is set up for operation, wiring is completed with two exceptions: the "B+" lead at pin (Continued on page 130)

Fig. 3. In addition to main schematic, r.f. probe circuit is at lower right.

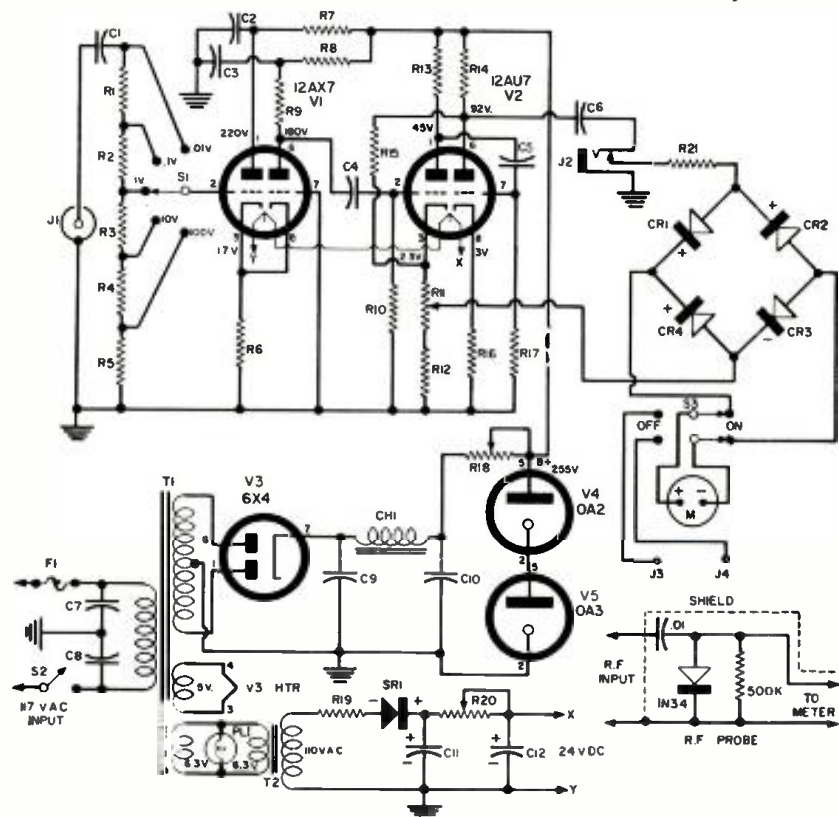

- $R_1$ —1 megohm, 1/2 w. res.  $\pm 1\%$ ; (see text)
- $R_2$ ,  $R_9$ —100,000 ohm, 1/2 w. res.  $\pm 1\%$ ; (see text)
- $R_3$ —10,000 ohm, 1/2 w. res.  $\pm 1\%$ ; (see text)
- $R_4$ —1000 ohm, 1/2 w. res.  $\pm 1\%$ ; (see text)
- $R_5$ —111 ohm, 1 w. carbon res. (see text)
- $R_6$ —1500 ohm, 1/2 w. res.
- $R_7$ —25,000 ohm, 1/2 w. res.
- $R_8$ —22,000 ohm, 1/2 w. res.
- $R_{10}$ —500,000 ohm, 1/2 w. res.
- $R_{11}$ —1000 ohm, linear pot. wire-wound
- $R_{12}$ —500 ohm, 1/2 w. res.
- $R_{13}$ —270,000 ohm, 1/2 w. res.
- $R_{14}$ —33,000 ohm, 1 w. res.
- $R_{15}$ —150,000 ohm, 1/2 w. res.
- $R_{16}$ —1000 ohm, 1/2 w. res.
- $R_{17}$ —1 megohm, 1/2 w. res.
- $R_{18}$ —2000 ohm, 10 w. adjustable res.
- $R_{19}$ —25 ohm, 1 w. res.
- $R_{20}$ —400 ohm, 20 w. adjustable res.
- $R_{21}$ —10,000 ohm, 1/2 w. res.
- $C_1$ ,  $C_3$ ,  $C_6$ —1  $\mu$ f. paper capacitor
- $C_2$ ,  $C_4$ —10  $\mu$ f., 400 v. min. elec. capacitor (Sprague EL-10)

- $C_5$ —2  $\mu$ f. paper capacitor.
- $C_7$ ,  $C_8$ —0.01  $\mu$ f. paper capacitor.
- $C_9$ ,  $C_{10}$ —20/20  $\mu$ f., 450 v. elec. capacitor
- $C_{11}$ ,  $C_{12}$ —200/80  $\mu$ f., 150 v. elec. capacitor
- CH—12 hys., 50 ma. filter choke
- CR1-CR4—1N34 crystal diode
- M—0-100  $\mu$ a. meter
- SR1—150 ma., 150 v. selenium rectifier
- T1—Power trans. 300-0-300 v., @ 60 ma.; 5.0 v., @ 2 amps.; 6.3 v., @ 3 amps.
- T2—Fil. trans. 6.3 v., @ 3 amps.
- F1—2 amp. fuse
- J1—Coax. mic. chassis connector (Amphenol type)
- J2—Closed-circuit jack
- J3, J4—Pin jack
- S1—S.p. 5-pos. switch (shorting type)
- S2—S.p.s.t. switch S3—D.p.d.t. switch
- PL1—6.3 v. pilot light
- V1—12AX7 tube
- V2—12AU7 tube
- V3—6X4 tube
- V4—0A2 tube
- V5—0A3 tube

A new hi-fi integrated amplifier system for quality reproduction.

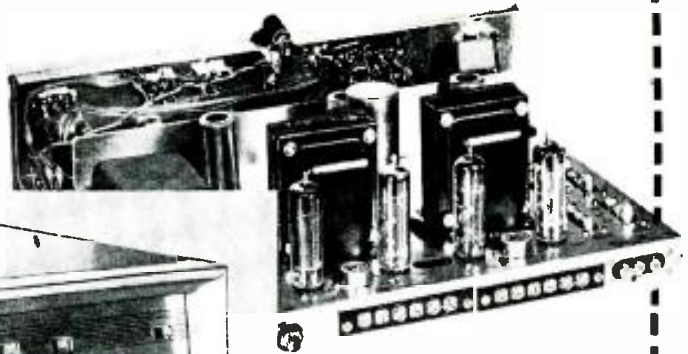

Front and rear views of the PACO Model SA-40 integrated stereo amplifier.

**ELECTRONICS** **LAB TESTED**  
**WORLD**

## Dual 20-Watt Amplifier Kit

IT CERTAINLY is of interest to note the progress made by the high-fidelity component industry during the past years. Some feel that the industry actually started with the introduction of the Williamson 15-watt amplifier approximately twelve years ago. From this point the development progressed rapidly both in quality of reproduction and, most noticeably, in the increase in power output. Just prior to the stereo disc, power amplifiers were being marketed with power output ratings as high as 75 watts. In fact, we published an article about a high-fidelity amplifier with an output of 120 watts. These were in monophonic days when power amplifiers were not usually integrated with their preamplifiers and their quality of sound reproduction, particularly as far as distortion was concerned, was the best available.

The stereo disc brought about economic changes. We then required two of everything, bringing the price to a point beyond the reach of the average high-fidelity enthusiast. The industry quickly realized the situation and the need for cutting cost of components. As a result the integrated amplifier became the vogue. Power output ratings also dropped considerably. Since price reduction was the keynote, quality no longer could equal the much higher-priced individual components in fashion during the monophonic era. The industry did not err and the tremendous sale of integrated systems today has proven them correct.

PACO Electronics Co., Inc., a division of Precision Apparatus Co., Inc., is a recent newcomer to the list of high-fidelity component manufacturers. They are following the trend in announcing their Model SA-40, a dual 20-watt integrated stereo amplifier system. This new unit com-

bines in a single package practically all the basic controls and flexibility of operation that anyone would desire in a high-fidelity system. One can use it strictly for monophonic as well as for stereophonic reproduction. It includes some 14 different inputs; three dual high-level and four dual low-level.

The results of our lab tests are as follows:

**Frequency Response:**  $\pm 2$  db from 30 cps to 15 kc. This flat frequency response was obtained by adjusting the tone controls slightly from their mechanical mid-positions. The correct settings for tone controls were as follows: bass (left and right channel) at approximately an 11:30 o'clock position; treble (right channel) at mid-position and treble (left channel) at approximately a 1:00 o'clock position.

**Rumble Filter:** down 7.6 db at 30 cps.

**Loudness Control:** this is operated by a separate slide switch and is quite effective at the low frequencies only.

**Bass Control:**  $-19.5$  db and  $+16.6$  db at 30 cps.

**Treble Control:**  $-15$  db and  $+17.5$  db at 15 kc.

**RIAA Equalization:** flat within  $\pm 1.6$  db from 100 cps to 15 kc. Below 100 cps it drops off to  $-3.3$  db at 30 cps. According to the manufacturer this was purposely done since many tone arms have their resonant frequencies in this range. By reducing the gain, the resonance effects are reduced. For those who have high-quality tone arms, flat response can be obtained by adjusting the bass tone control slightly.

**Channel Separation:**  $-44$  db at 1000 cps.

**Sensitivity:** for 20-watt output—tape head, 4.8 mv.; phono 1, 4.5 mv.; phono 2, 121 mv.; microphone, 2.68 mv.; and auxiliary 1, 2, and tuner, 610 mv.

**Hum and Noise:** all high level inputs approximately  $-55$  db for both open and shorted input conditions. Phono 1 and microphone,  $-47$  db for shorted input and  $-36$  db for open circuited input. Phono 2,  $-28$  db for shorted input and  $-27.7$  db for open circuited input. Tape head,  $-39.5$  db for shorted input and  $-27.2$  db for open circuited input. All of these figures are down from 2 watts. By adding 10 db to each figure, the characteristics would be relative to 20 watts output.

**Harmonic Distortion:** The test results obtained are all shown in Fig. 1. The results are extremely good, being for the greater part below our 2% limit. The only critical point is the sharp rise at 35 cps for 20 watts output.

**IM Distortion (60-6000 cps at a 4:1 ratio):** .98% for 2 watts output; 2.88% for 5 watts; 3.6% for 10 watts; 3.02% (Continued on page 139)

Fig. 1. Distortion characteristics of the amplifier for 2-, 10-, and 20-watt conditions. 30 cps to 15 kc. were the limits of our tests.

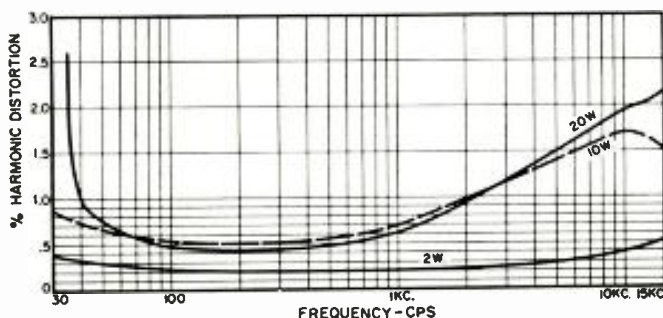



Right Tone Amp  
6X4ZAZ/7025

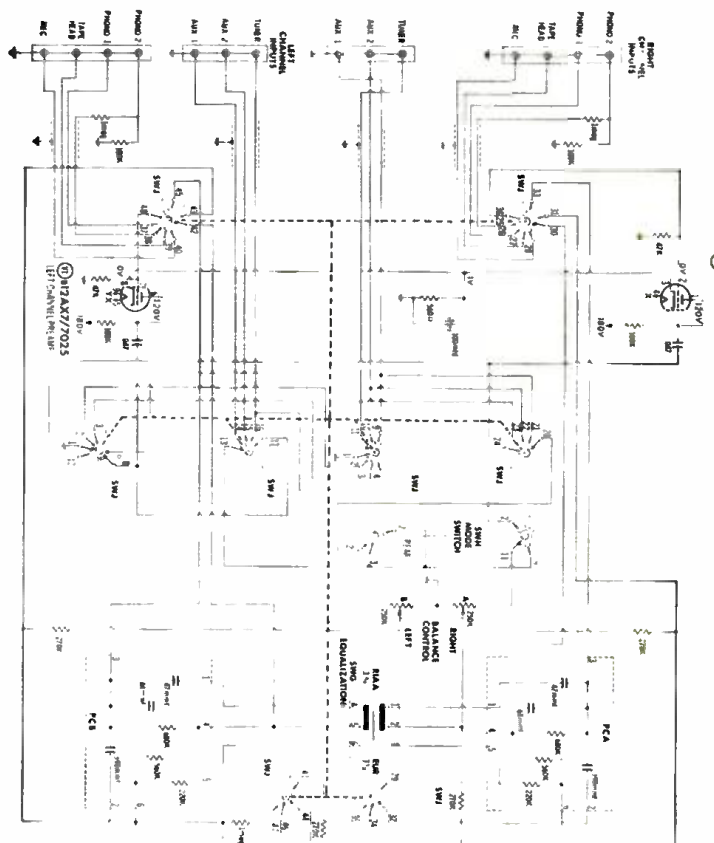

Right Tone Amp  
6X4ZAZ/7025

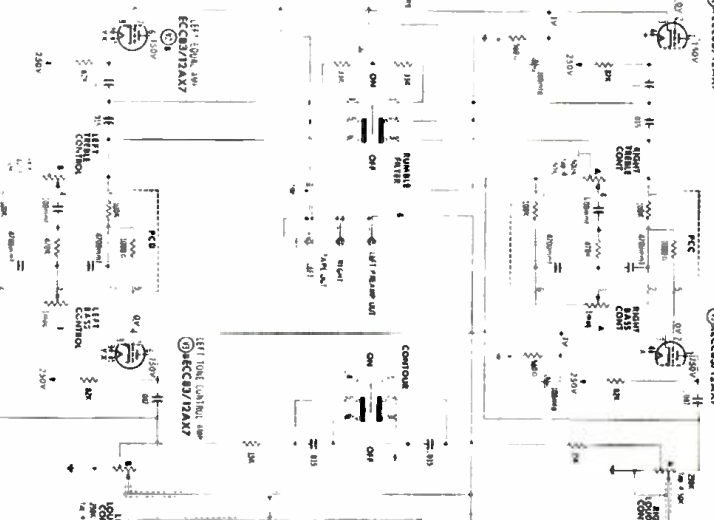

Right Tone Amp  
6X4ZAZ/7025

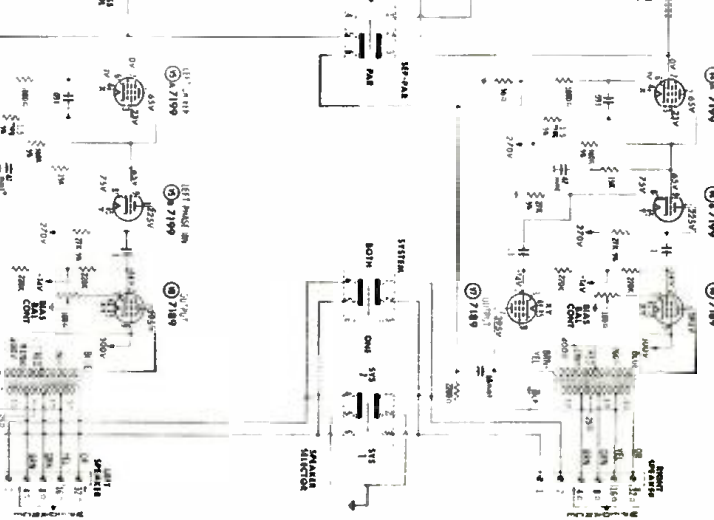

Right Tone Amp  
6X4ZAZ/7025

SWITCH POSITION  
1. ALL OFF  
2. TONE  
3. STEREO  
4. MONO  
5. CHAN LEFT

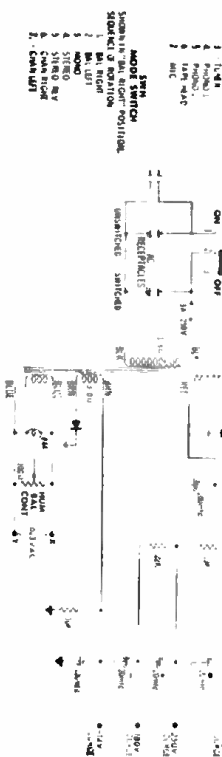

MODE SWITCH  
SUBSTITUTIONAL POINT POSITION  
1. ALL OFF  
2. TONE  
3. STEREO  
4. MONO  
5. CHAN LEFT

RESISTOR VALUES  
1. 1% tolerance  
2. 5% tolerance  
3. 10% tolerance  
4. 20% tolerance  
5. 50% tolerance  
6. 100% tolerance

RESISTOR VALUE	RESISTOR VALUE	RESISTOR VALUE	RESISTOR VALUE	RESISTOR VALUE	RESISTOR VALUE	RESISTOR VALUE	RESISTOR VALUE	RESISTOR VALUE	RESISTOR VALUE
100K	100K	100K	100K	100K	100K	100K	100K	100K	100K
10K	10K	10K	10K	10K	10K	10K	10K	10K	10K
1K	1K	1K	1K	1K	1K	1K	1K	1K	1K
100Ω	100Ω	100Ω	100Ω	100Ω	100Ω	100Ω	100Ω	100Ω	100Ω
10Ω	10Ω	10Ω	10Ω	10Ω	10Ω	10Ω	10Ω	10Ω	10Ω
1Ω	1Ω	1Ω	1Ω	1Ω	1Ω	1Ω	1Ω	1Ω	1Ω

RESISTOR VALUES  
1. 1% tolerance  
2. 5% tolerance  
3. 10% tolerance  
4. 20% tolerance  
5. 50% tolerance  
6. 100% tolerance

Complete schematic diagram of the PACO Model SA-40 integrated high fidelity amplifier system. Nine tubes are used, with the output tubes being 7189's operated in push-pull with fixed bias.

# Do You Know Enough About Capacitors?

By SOL HELLER

In these "simple" troubleshooting and replacement problems, would you proceed correctly every time?

**DO YOU FEEL** there is nothing to replacing a defective capacitor except substituting a similar unit? Or do you have the capacity to recognize that there is more to a capacitor than capacitance? Here is a quiz that may turn up some surprises for you. On the other hand, getting all the answers right should give you a charge.

**QUESTION:** A service technician hesitates to use a .01- $\mu$ f. paper capacitor as a replacement because it has been lying around (unused) on his shelf for ten years. Is his hesitation justified?

**ANSWER:** With the exception of electrolytic units, capacitors deteriorate only during the time voltage is applied to them. The technician should show no hesitation about using the capacitor. Besides, if he does so little business that he still stocks a component he bought ten years ago, how can he afford to do anything else?

**QUESTION:** Under what conditions is it preferable to connect an audio power output tube plate capacitor between plate and screen, rather than plate and ground, or plate and cathode?

**ANSWER:** When a capacitor of the proper working voltage is not available, or when concern is felt, for some reason, regarding the possibility of a breakdown in the replacement capacitor, the plate-to-screen connection may be used. The d.c. voltage across the capacitor is much smaller in the latter case than it would be if the negative end of the capacitor were connected to ground, or to the cathode of the audio power output tube.

**QUESTION:** Can a conventional 10- $\mu$ f. electrolytic capacitor be used to replace  $C_{2-1}$  in the circuit shown in Fig. 1?

**ANSWER:** No. When the receiver is fully warmed up, the negative side of the capacitor is at "B+" potential, while the positive side is at the higher boosted "B+" voltage. A conventional capacitor could be used if this condition prevailed at all times, since the negative side of the capacitor would always be at a lower potential than the positive side. The condition does not prevail at all times, however. During the time the receiver is warming up, the boost voltage is lower than "B+." The negative side of  $C_{2-1}$  is consequently connected to a higher positive potential than the positive side. The capacitor operates at this reversed polarity for about 10 to 15 seconds. A conventional electrolytic capacitor would bite the dust prematurely if exposed to such topsy-turvy conditions. A special semi-polarized unit is used by some set makers and available from them.

**QUESTION:**  $C_1$  in the vertical oscillator circuit shown in Fig. 2 is a ceramic disc

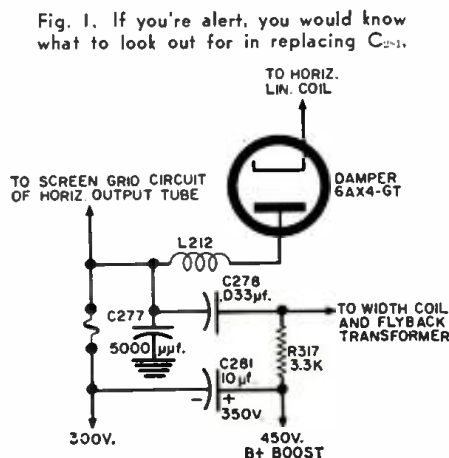

coupling capacitor. What type of capacitor can be substituted for it when vertical drift is a problem, and tests have indicated that the vertical oscillator tube is not responsible?

**ANSWER:** Substitution of a silver mica capacitor would be a logical procedure. The mica type has a very high electrical stability. A 1000- $\mu$ f. unit, for instance, will exhibit a capacitance change of less than .1% over a frequency range extending from low frequencies to 2 mc. The effect of a 1°C change in temperature is a change in capacitance of only 60 parts in a million. The tolerance of the replacement capacitor is not important—the vertical hold control setting will produce the correct frequency of operation even if the capacitor is 10 or 20% off its nominal capacitance. The important thing is that the capacitance, whatever it is, doesn't change with temperature.

**QUESTION:** What harm, if any, is there in using a somewhat larger value of capacitance than called for in replacing the coupling capacitor between horizontal oscillator and horizontal output tube ( $C_1$ , Fig. 3).

**ANSWER:** A larger value of coupling capacitance will increase the amount of horizontal sweep signal applied to the horizontal output tube. The horizontal drive control may have to be reset to some point close to one end of its range, leaving an insufficient margin for readjustments necessitated by aging or replacement of tubes or components in this circuit.

**QUESTION:** Why is it undesirable to mount an electrolytic capacitor in an area where considerable heat is likely to develop during receiver operation?

**ANSWER:** Heat is bad because it pro-



notes drying out of the electrolyte. This increases the series resistance offered by the capacitor; and the power factor (ratio of resistance to impedance in the capacitor) goes up in consequence. A higher power factor is undesirable, since larger  $I^2R$  losses occur across the increased resistance of the capacitor, and produce still further heating of the unit. Heat also tends to increase the leakage current of the capacitor (see Fig. 4), which promotes greater  $I^2R$  losses in the capacitor, and additional heating of the unit.

Excessive heating spells death to electrolytic capacitors. In some types, every  $10^\circ\text{C}$  increase in temperature causes a 50% decrease in life expectancy; others are less affected by temperature. In general, however, keeping cool is as important for capacitors as it is for people.

**QUESTION:** A technician, in replacing a power supply electrolytic capacitor that has failed prematurely, decides to leave off the insulating cardboard that was present around the original unit. Does this procedure make sense?

**ANSWER:** It does. The cardboard insulation prevented the capacitor from dissipating heat adequately, and could be responsible for premature failure. But watch for exposed voltage.

**QUESTION:** What kind of electrolytic capacitor will function more satisfactorily than other kinds under high-temperature conditions?

**ANSWER:** A capacitor that has a hermetically sealed metal can for its container. This construction minimizes loss of electrolyte, and therefore increases life expectancy. Any capacitor with a voltage rating 50 to 100 volts higher than the operating voltage can be used at temperatures up to  $185^\circ\text{F}$ . Temperatures in excess of  $140^\circ\text{F}$  may damage a conventional capacitor if its voltage rating is not much above the operating voltage.

**QUESTION:** Are there any applications in which it would make a difference whether an electrolytic capacitor was fabricated with an etched-foil anode or a plain-foil anode?

**ANSWER:** Yes. Dry electrolytic capacitors have anodes made of plain, etched, sprayed, or fabricated foil. An etched-foil anode is one that has been made very rough by special processing. The resultant surface undulations give the anode (which forms one plate of the capacitor) a much larger effective area. The electrolyte (which forms the second plate of the capacitor) follows the undulations. The capacitor, in consequence, has a much larger capacitance than a plain-foil unit of the same size would have, permitting compactness.

However, an etched-foil capacitor will have a considerably higher total impedance than a plain-foil equivalent, making the former inferior for certain applications. A unit that does not have an etched foil would be preferable for bypassing and decoupling in audio-

frequency and vertical sweep circuits. The catalogues of parts supply houses are often useful in determining whether a specific electrolytic capacitor does or does not use an etched-foil anode.

**QUESTION:** What effects, if any, do low temperatures have on electrolytic capacitors?

**ANSWER:** For most conventional types, the capacitance decreases rapidly below temperatures of  $-5^\circ\text{C}$ . We can conceive of a situation where a battery portable in which an electrolytic capacitor has been replaced is returned to the service technician for further work

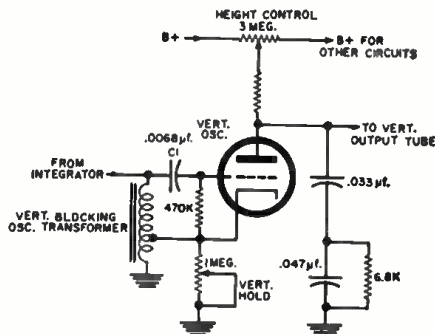

Fig. 2. The proper replacement for one capacitor here can lick vertical drift.

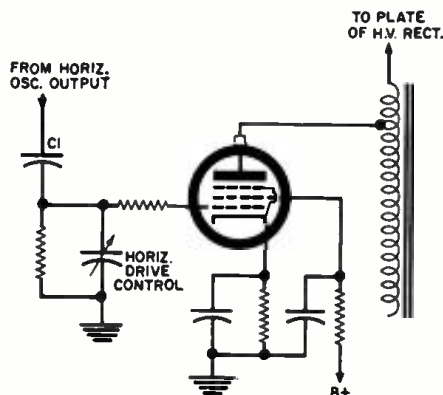

Fig. 3. A common procedure used in replacing  $C_1$  could cause later difficulty.

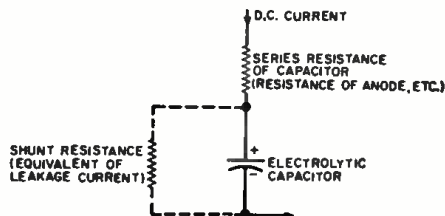
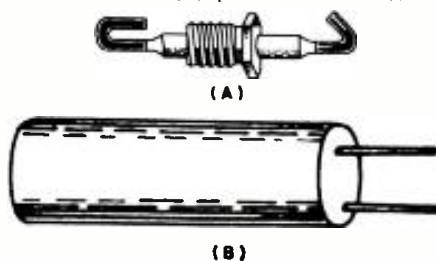

Fig. 4. An improperly mounted electrolytic may start a vicious trouble cycle.

Fig. 5. Special problems go with special units, like (A) the ceramic feed-through and (B) parallel-lead tubular.



because it didn't operate satisfactorily outdoors in very cold weather. This temporary condition clears up when the receiver and its owner sensibly return to a comfortable position by the fireside, or when the weather gets a little warmer. If necessary, higher-cost tantalum capacitors may be used. Some of these are rated for operation at  $-55^\circ\text{C}$ , or even lower.

**QUESTION:** In the case of a ceramic feedthrough type of capacitor (as shown in Fig. 5A), are there any visual indications that might point to the need of replacement?

**ANSWER:** This type should be replaced if the silver-coated surface is peeled, or if the ceramic is cracked, or if the center conductor of the unit is loose.

**QUESTION:** Does it make a difference in which position an electrolytic capacitor is mounted?

**ANSWER:** It may, especially if the unit is a wet electrolytic. An incorrect mounting position may reduce the effective capacitance. The unit should be mounted in an upright position in such a way that the vent (for escaping gas) is unobstructed.

**QUESTION:** True or False: When an electrolytic capacitor begins to cause circuit malfunction, it is always necessary to replace it.

**ANSWER:** False. Take the case where the only change causing the trouble is an increase in r.f. impedance of the unit, impairing its ability to bypass higher frequencies. Bridging it with a non-electrolytic type of smaller value but of the proper voltage rating (for example, a  $.1\text{-}\mu\text{f}$ . paper unit) will generally eliminate the trouble.

**QUESTION:** True or False: If a replacement filter capacitor doesn't function properly as soon as it is put into a radio (i.e., hum is heard), it should be replaced immediately.

**ANSWER:** False. It should be given a chance to re-form. When an electrolytic capacitor has been idle for several months, initial leakage current may be high enough to introduce hum because the component has de-formed while not in use. If the receiver is left in operation for 20 minutes or so, the capacitor will generally be restored to normal functioning.

**QUESTION:** True or False: When a capacitor that is mounted on a printed board is to be replaced, it may become necessary to consider more of its characteristics than is ordinarily the case.

**ANSWER:** True. The physical configuration may become important in addition to the electrical properties. Take the paper tubular capacitor with phenolic case shown in Fig. 5B. Parallel leads permit the unit to be plugged into a printed board, after which it is soldered in place. It would be quite difficult to fit a conventional capacitor of the same nominal value with axial leads into the proper space, in most cases.

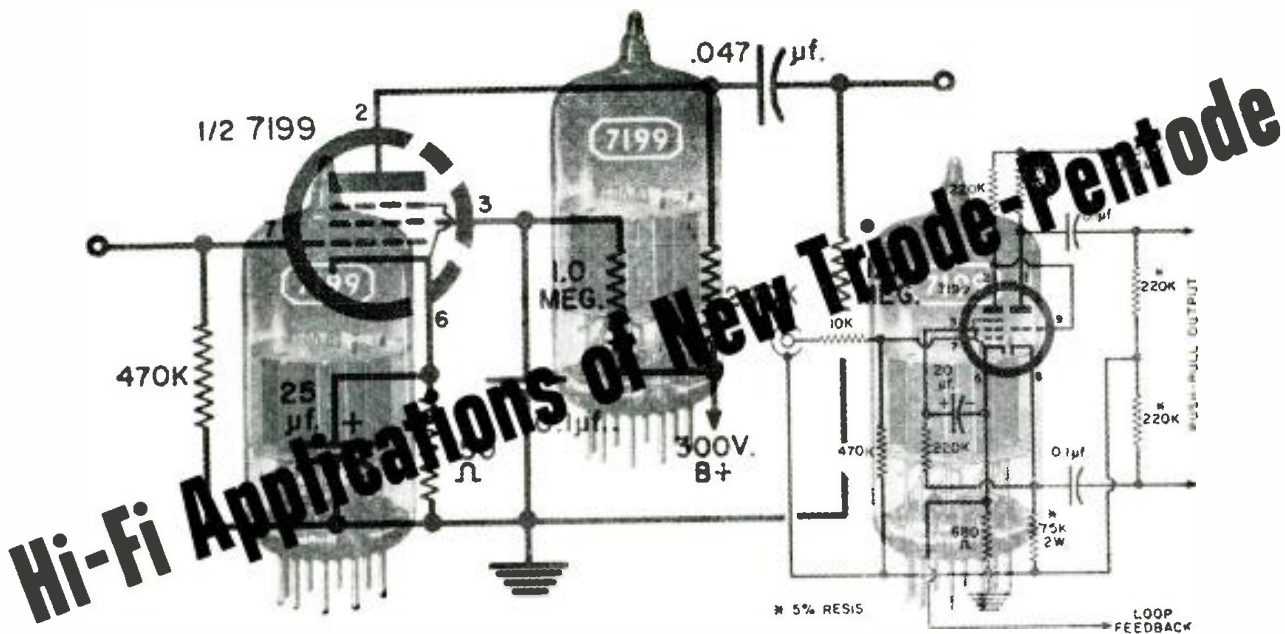

By WAYNE AUSTIN / Electron Tube Div., Radio Corp. of America

## Low-noise 7199 tube provides more gain and other advantages in voltage-amplifier, phase-splitter, and tone-control stages.

A NOTABLE trend in high-fidelity-amplifier design has been the use of triode-pentode types in voltage-amplifier/phase-splitter circuits, tone-control circuits, and other circuits operating at low and moderate signal levels which have heretofore been the domain of twin-triode types. The reason for this trend is a simple one. A triode-pentode provides the same space economy and wiring convenience as a twin-triode and offers the designer of high-fidelity audio equipment several additional advantages. For example, the greater voltage gain available allows the designer wider latitude in the use of inverse feedback, corrective networks, and other means for obtaining low harmonic distortion, good frequency-response characteristics, and stability. A pentode also produces less intermodulation distortion than a triode operating at a comparable signal level and introduces fewer Miller Effect problems because of its extremely small grid-plate capacitance.

Until recently, practically the only triode-pentodes available to the designer of high-fidelity equipment were types designed primarily for r.f., i.f., and converter service, such as the 6AN8, 6BH8, 6BR8, 6CQ8, and 6U8-A.

Although these types have been used in a number of well-designed high-fidelity amplifiers, their performance has left something to be desired, because they do not have the extremely low leakage noise, freedom from heater hum, and anti-microphonic construction which are essential in tubes for high-fidelity a.f. service.

### New Tube Type

Recently, however, a triode-pentode specifically designed and controlled in manufacture for high fidelity a.f. service was brought out by RCA. This tube, the RCA-7199, is a 9-pin miniature type containing a medium- $\mu$  triode and a sharp-cut-off, high-transconductance pentode. It employs a specially designed electrode and mount structure having very low microphonism, an internal-lead and basing arrangement designed to minimize interelectrode leakage noise, and special heaters designed to produce extremely low magnetic hum.

The maximum hum and noise for the 7199, expressed as equivalent voltages at the control grids of the two units are 100 microvolts for the pentode unit and 150 microvolts for the triode unit. Median values for the type are only

35 microvolts for the pentode unit and 10 microvolts for the triode unit. These hum and noise voltages are for grid-circuit resistances of 50,000 ohms.

Because of its high transconductance (7000  $\mu$ mhos), the pentode unit of the 7199 can provide large voltage gains (values of 100 to 350 are typical). It can also deliver output signals as large as 90 volts peak-to-peak with low distortion. The triode unit has a  $\mu$  of 17, and can handle large signal voltages. This combination of characteristics, together with its very low hum and noise, make the 7199 especially suitable for use as a voltage amplifier and cathode follower, or a voltage amplifier and phase splitter (the phase splitter is a form of cathode follower). It is also extremely useful in tone-control circuits of the Baxandall type.<sup>2</sup>

### Hum and Noise Performance

The hum-and-noise performance that can be expected from the 7199 when precautions are taken in circuit layout and wiring to eliminate hum and noise from other sources is illustrated by the following example:

Assume that the pentode unit of the 7199 is to be used in the input stage of an amplifier having a sensitivity of 100 millivolts r.m.s. (The rated power output or voltage output of the amplifier need not be specified.) The amplifier has an input resistance of 50,000 ohms. Based on the maximum value of hum and noise for the pentode unit (100 microvolts), the signal-to-noise ratio at the amplifier input, in decibels, will be:

$$20 \log \frac{0.1}{0.0001} = 20 \log 1000, \text{ or } 60 \text{ db.}$$

Fig. 1. Frequency response curve of the amplifier at a 4-watt power level.

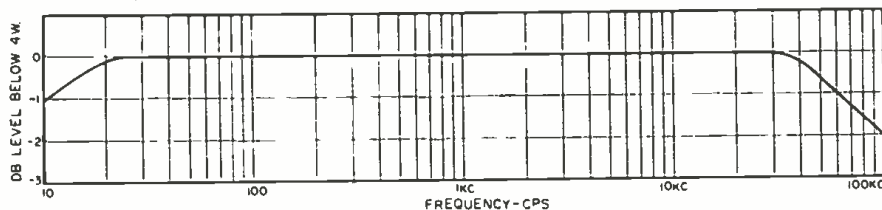



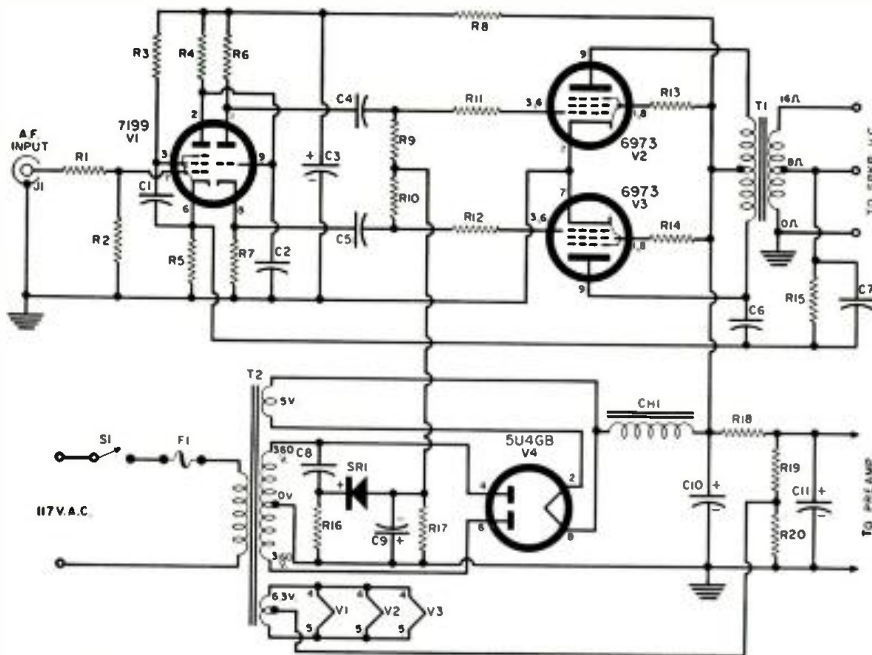

- R<sub>1</sub>—10,000 ohm, 1/2 w. res.
- R<sub>2</sub>—470,000 ohm, 1/2 w. res.
- R<sub>3</sub>—820,000 ohm, 1/2 w. res.
- R<sub>4</sub>—220,000 ohm, 1/2 w. res.
- R<sub>5</sub>—820 ohm, 1/2 w. res.
- R<sub>6</sub>, R<sub>7</sub>—15,000 ohm, 2 w. res. ± 5%
- R<sub>8</sub>—3900 ohm, 2 w. res.
- R<sub>9</sub>, R<sub>10</sub>—100,000 ohm, 1/2 w. res. ± 5%
- R<sub>11</sub>, R<sub>12</sub>—1000 ohm, 1/2 w. res.
- R<sub>13</sub>, R<sub>14</sub>—100 ohm, 1/2 w. res.
- R<sub>15</sub>—8200 ohm, 1/2 w. res.
- R<sub>16</sub>—15,000 ohm, 1 w. res.
- R<sub>17</sub>—68,000 ohm, 1/2 w. res.
- R<sub>18</sub>—4700 ohm, 2 w. res.
- R<sub>19</sub>—270,000 ohm, 1 w. res.
- R<sub>20</sub>—47,000 ohm, 1/2 w. res.
- C<sub>1</sub>, C<sub>2</sub>, C<sub>3</sub>—.25 μf., 600 v. paper capacitor
- C<sub>4</sub>, C<sub>5</sub>—3.3 μf., 400 v. mica capacitor
- C<sub>6</sub>, C<sub>7</sub>—40 μf., 450 v. elec. capacitor
- C<sub>8</sub>—150 μf., 400 v. mica capacitor

- C<sub>9</sub>—0.02 μf., 600 v. paper capacitor
  - C<sub>10</sub>—100 μf., 50 v. elec. capacitor
  - C<sub>11</sub>—80 μf., 450 v. elec. capacitor
  - CH<sub>1</sub>—Filter choke, 3 hy. @ 160 ma., 75 ohms (Triad C13X or equiv.)
  - F<sub>1</sub>—3 amp., 150 v. fuse
  - SR<sub>1</sub>—20 ma., 135 v. selenium rectifier
  - T<sub>1</sub>—Output trans to match speaker v.c. to 6600-ohm plate-to-plate tube load (Stancor A8056 or equiv.)
  - T<sub>2</sub>—Power trans., 360-0-360 v. @ 120 ma.; 5 v. @ 3 amps.; 6.3 v. @ 3.5 amps. (Stancor PC 8410 or equiv.)
  - S<sub>1</sub>—S.p.s.t. switch
  - J<sub>1</sub>—Phono jack
  - V<sub>1</sub>—7199 tube (RCA)
  - V<sub>2</sub>, V<sub>3</sub>—6973 tube (RCA)
  - V<sub>4</sub>—5U4GB tube
- NOTE: Values for C<sub>1</sub>, C<sub>4</sub>, C<sub>7</sub> are matched to the Stancor A8056 transformer only.

Fig. 2. A 15-watt amplifier using the 7199 as voltage amplifier and phase splitter.

Based on the median value of hum and noise for the pentode unit (35 microvolts) this ratio will be:

$$20 \log \frac{0.1}{0.000035} = 20 \log 2850, \text{ or approximately } 69 \text{ db.}$$

If the pentode stage has a gain of at least 20 db (a voltage gain of 10), hum and noise originating in the grid circuits of succeeding stages can be neglected and the signal-to-noise ratio at the amplifier output will be the same as that at the input. Since the pentode unit of the 7199 can easily provide voltage gains of more than 100, this assumption is justified. Hum and noise at the output of the amplifier, therefore, will be at least 60 db below rated output. This value is the accepted minimum for high-fidelity reproduction.

It is evident from the foregoing example, that if the pentode unit of the 7199 tube is used in the input stage of a preamplifier, or in any other application where the input signal level is only a few millivolts, the hum and noise at the output of the following amplifier may be substantially less than 60 db below rated output. For high-fidelity reproduction, therefore, the pentode unit of the 7199 should not be used in any stage where the input-

signal level is substantially less than 100 millivolts.

### Applications

An example of the use of the 7199 as a voltage amplifier and phase splitter is shown in Fig. 2. In this high-fidelity 15-watt power amplifier, designed by Leonard Kaplan of the Electron Tube Division of RCA, (See "A Low-Cost Hi-Fi Amplifier" in the May 1958 issue) the pentode unit of the 7199 (the voltage amplifier) is direct-coupled to the triode unit (the phase splitter), which drives a pair of 6973 high-fidelity beam power tubes operating in class AB<sub>1</sub> with fixed bias. The amplifier uses 18 db of degenerative feedback between the voice coil and the voltage-amplifier cathode. At 15 watts output, total harmonic distortion (measured at 1000 cps) is less than 0.5 per-cent, and intermodulation distortion is less than 0.5 per-cent. Hum and noise are extremely low: 84 db below rated output with input shorted. As shown in Fig. 1, the frequency response of the amplifier at 4 watts output is flat over the entire audio spectrum and down less than 2 db at 10 cps and 60,000 cps; at 15 watts output it is flat from 20 cps to 15,000 cps, and down less than 1 db at

15 cps and 20,000 cps. The amplifier has a sensitivity (input voltage required for full output) of 1.2 volts r.m.s. and a damping factor of 12.

A slightly different voltage-amplifier—phase-splitter circuit which is also capable of very good performance is shown in Fig. 3. In this circuit grid-No. 2 voltage for the pentode unit of the 7199 is obtained through a 220,000-ohm resistor from the cathode of the triode unit. Since the voltage at the triode cathode contains a.f. signal components which are in-phase with those at grid-No. 2 of the pentode, this arrangement provides positive feedback between the two units which can be used to obtain increased over-all gain at the lower audio frequencies. The frequency at which this feedback becomes effective depends on the value of the grid-No. 2 bypass capacitor. If this frequency is higher than the ripple frequency in the "B" supply circuit, it may be necessary to increase the value of the capacitor or use additional filtering in the "B" supply circuit to prevent motorboating.

The pentode and triode units of the 7199 tube can, of course, be used independently. The circuit of a general-purpose voltage amplifier stage, using the pentode unit, is shown in Fig. 4. This circuit provides a voltage gain of approximately 300, and can deliver output voltages of 90 volts peak-to-peak with very low distortion.

### REFERENCES

1. "Radiotron Designer's Handbook," Fourth Edition, Edited by F. Langford-Smith, Chapter 12, page 511.
2. *Ibid.*, page 1183.

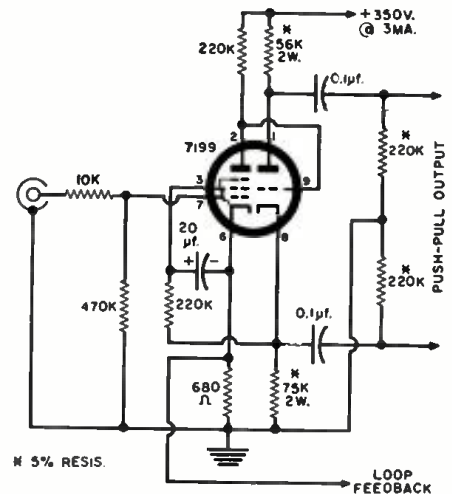
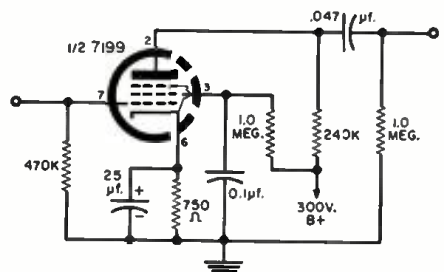

Fig. 3. Another combined pentode voltage amplifier and triode phase-splitter circuit.

Fig. 4. General purpose voltage amplifier.





Close-up view of the 25-watt mobile transistorized amplifier designed for p.a. work.

# TRANSISTORS OR TUBES

## For Mobile P.A. Systems

By **SAMUEL CURCHACK**,  
Project Engineer, Bogen-Presto Co.  
Div. of The Siegler Corp.



Author is pointing to one of output transistors mounted on chassis of BT25 amplifier.

**For compact equipment that must be light and sparing of battery power, here is why transistors have the edge.**

**W**HEN discussing high-fidelity or public-address systems, there is much that can be said in favor of *both* transistor and tube amplifiers. However, when we speak of *mobile* amplifier systems, until such time as power and space become unlimited, we feel that the future belongs entirely to the semiconductor.

There are some good reasons for taking this point of view. Mobile use, in most cases, demands that the equipment be compact, light in weight, and sparing of battery power.

If the amplifier is to be operated from an automotive vehicle, space is often at a premium. An amplifier that can be mounted in and controlled from a compartment in the dashboard is certainly to be preferred to equipment that requires storage in the trunk of a car. A p.a. system that during stand-by draws from the battery the same amount of current as is drawn by a panel lamp certainly offers advantages over one that demands, when idling, that the vehicle's engine be kept idling too in order to charge the battery.

If the p.a. system is entirely self-contained and is to be hand-held and operated, there is, of course, more reason why it should be small, lightweight, and draw only the minimum amount of current required for most efficient operation.

For the home or auditorium, this reduction in weight and size hardly

justifies the added expense of high-power transistorized audio systems; and electric power is so inexpensive that we rarely worry about efficiency. However, in portable p.a. systems, it is this efficiency factor that makes the use of a transistorized power amplifier mandatory, in the author's opinion. In addition to saving battery power, the high efficiency feature contributes considerably both to the compactness of the equipment and reduction of its weight. It is for this reason that it might be worthwhile to examine this factor just a little more thoroughly than is usually done when comparing the operation of transistor and tube equipment.

"Efficiency," simply stated, is the ratio of the amount of power realized from the amount of power consumed. When we talk of "speaker efficiency," we want to know how many acoustical watts we get out as compared to the electrical watts delivered by the amplifier. When we speak about "amplifier efficiency," we are interested in the amount of power delivered by the amplifier as compared to the power drawn from the power line or battery. This "amplifier efficiency," expressed as an equation is equal to:  $\frac{\text{Watts}_{\text{output}}}{\text{Watts}_{\text{input}}} \times 100\%$ .

Often, in comparing transistors with tubes, this question of "over-all" efficiency, which is a true measure of the performance of the equipment, is over-

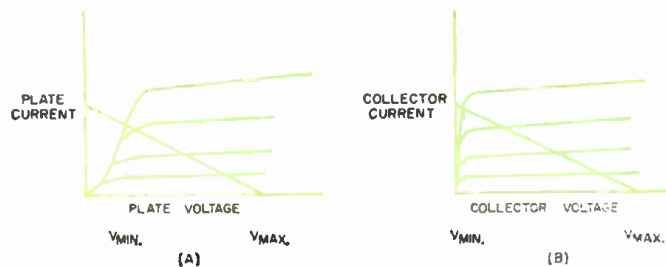
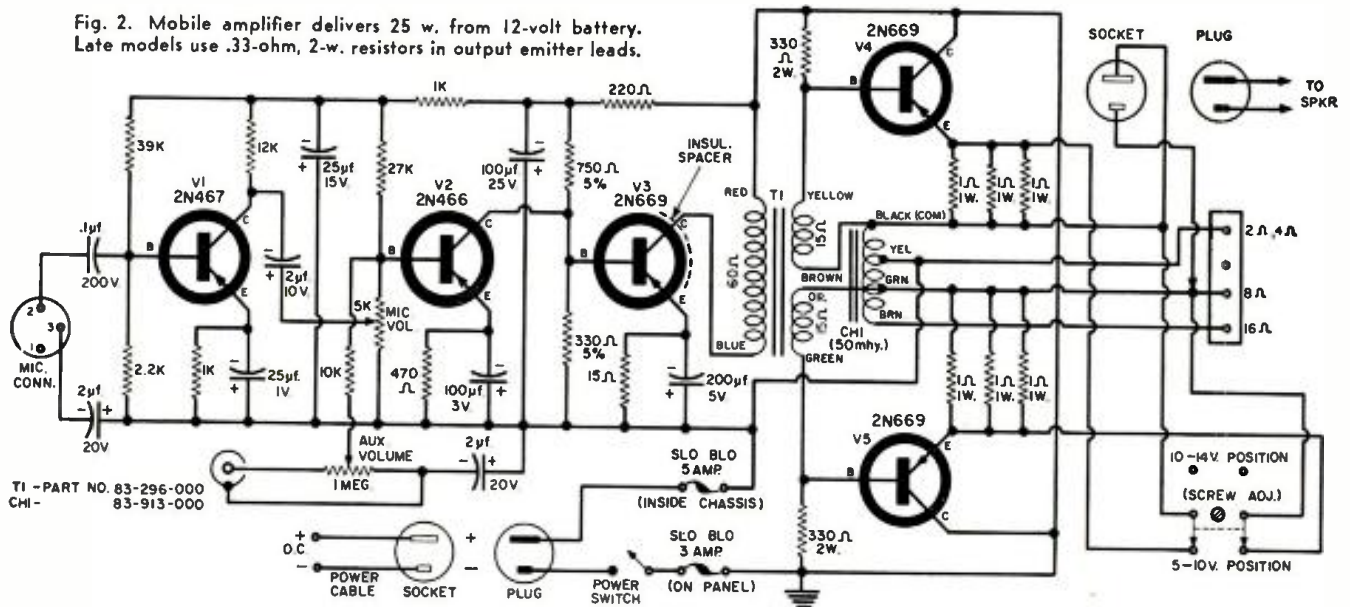

Fig. 1. Load lines for (A) power pentode and (B) power transistor. Note that  $V_{\text{min}}/V_{\text{max}}$  approaches zero in the case of the transistor.



Fig. 2. Mobile amplifier delivers 25 w. from 12-volt battery. Late models use .33-ohm, 2-w. resistors in output emitter leads.



looked. What we usually see instead is the formula for the efficiency of an amplifier operated in class B. Push-pull class B operation is almost always chosen for mobile equipment because, theoretically, it is 57% more efficient than class A. Inasmuch as this contributes, in part, to the overall efficiency, we will investigate it first. For simplicity, we will consider only the case of true class B operation.

In practice, class B can be used only for speech reproduction. Since "center clipping" occurs when the load is transferred from one of the push-pull pair to the other, a slight forward bias is usually applied to the tubes or transistors. This eliminates crossover distortion which is extremely objectionable for musical reproduction. The resultant mode of operation is termed class AB, but since the bias applied is usually of minor proportions, the formula for true class B operation may be applied.

This formula may be reduced to almost identical form for both transistors and vacuum tubes. It then reads:  $N_p = 78.5 (1 - V_{min}/V_{max})^2\%$ ; where  $N_p$  = efficiency,  $V_{max}$  = supply voltage (plate or collector voltage at current cut-off), and  $V_{min}$  = voltage drop across the tube or transistor when it is delivering peak power to the load.

When we compare load lines for a power pentode (Fig. 1A) and a power transistor (Fig. 1B), we see that the ratio  $V_{min}/V_{max}$  can be appreciable for the vacuum tube and negligible for the transistor. It is for this reason that efficiencies closely approaching the theoretical maximum are possible with the latter.

The figure  $N_p$  is often quoted when comparing the two devices. Thus, a typical practical figure for tubes might be on the order of 55% and for transistors, 75%. In both cases, transformer losses have been neglected and put the tube in a better light than it actually deserves.

Consider first the amount of current required by the heaters. This is taken direct from the battery and for a 25-watt mobile p.a. tube amplifier about 40 watts may be drawn just to heat the filaments. This energy is being used whenever the amplifier is on, irrespective of whether or not it is producing sound. Thus, the transistor, requiring no heater power, is already "ahead" by relieving the battery of a large drain.

In addition, tubes require high anode voltages to generate appreciable amounts of power. Thus, in vehicular operation, where the supply is usually 12 volts, conversion to high voltage must take place first. In most cases, this requires at least three more major components than does the transistor supply—a vibrator, a transformer, and a rectifier tube with its associated filtering circuit. In addition to the lowered efficiency incurred by losses in each of these components, this extra circuitry imposes other disadvantages: the vibrator is always a possible source of noise—it may require replacement several times during the life of the equipment; the rectifier tube, which is also subject to failure, generates additional heat; all of these components

(which do not exist in the transistorized circuit) go to increase the size of the equipment.

It might be interesting to compare the losses incurred in the two types of amplifiers—each producing 25 watts of output power. Some typical figures are given in Table 1. From these representative values we can see that when full power is realized from the output, the tube amplifier may draw almost three times as much current from the batteries as will the transistorized device.

However, the duty cycle of speech is roughly 20%. Thus, the amplifier is being used only one-fifth of the time that the battery power is on. It is during this remaining 4/5th time that the vacuum-tube p.a. system is most wasteful of power; even though no current is being used to produce speech, the filaments and power supply must remain activated. From Table 1 we can see that it is possible to draw, during this period, about 20 times the amount of current that is drawn by the semiconductor device.

There are other reasons why the transistor is to be preferred for mobile applications. For emergency purposes

(Continued on page 126)

Table 1. Comparison between power requirements, efficiency of tubes and transistors.

	TUBE CIRCUIT	TRANSISTOR CIRCUIT
Power required at output stage to yield 25 watts of signal. A 10% transformer loss is assumed for both circuits.	55 watts	38 watts
Battery drain to provide 25 watts of signal at power supply output.	69 watts	38 watts
Filament power required.	40 watts	0 watts
Other standby or bias power required.	5 watts	2 watts
Total power required for full output.	114 watts	40 watts
Over-all efficiency at full output.	$25/114 = 22\%$	$25/40 = 62\%$
Power consumption during standby (approx.).	45 watts	2 watts

By JOHN T. FRYE

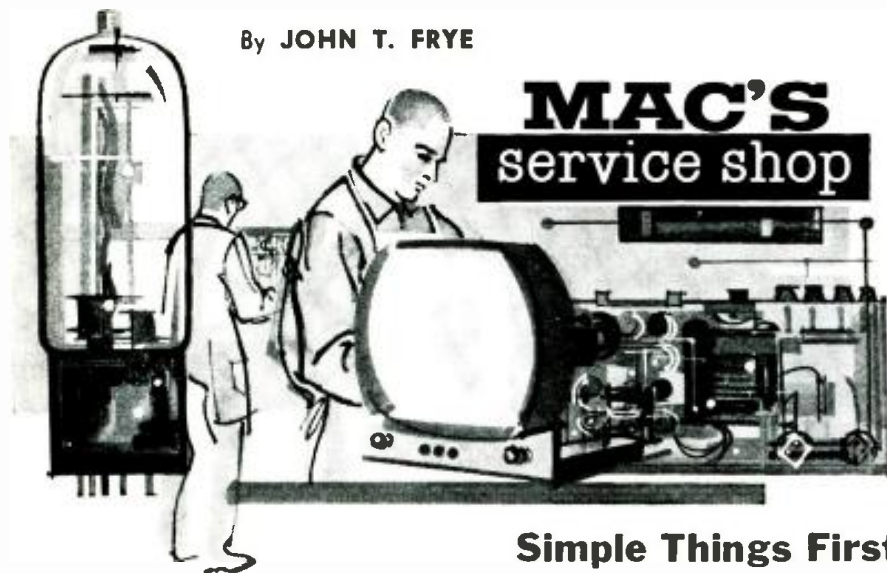

## MAC'S service shop

### Simple Things First

**B**ARNEY had been muttering to himself for the past quarter of an hour, and finally Mac, his employer, walked over to the boy's end of the bench to see what all the fuss was about.

"Oh how I hate intermittents!" Barney said fervently. "One time this little a.c.-d.c. receiver will play okay for hours on end; the next time it won't even start. Right now the only sound you can get out of it is a low hum. I've changed all the tubes one at a time; so I know tubes are not the trouble, but look at this reading on the oscillator grid of the 12BE6."

He touched the probe of the v.t.v.m. to the grid lug of the socket, and the meter indicated some forty positive volts.

"When the radio's playing, I get seven or eight negative volts here," the red-headed youth continued. "That's the normal grid-leak voltage developed by oscillator action across this 22,000-ohm resistor between grid and ground. But when the radio goes dead, this voltage suddenly switches from minus eight to plus forty volts. I was sure it was an intermittent internal short in the tube, but the same thing happens with a new tube. Now I've decided it has to be an intermittent breakdown in the socket insulation; so I guess I may as well start changing the socket—and that's a job I despise."

"Easy, boy, easy!" Mac said mildly. "Have you checked the diagram?"

"Oh come now, Mac," Barney said with a superior smile; "I'm a big boy now, remember, and this is just a little a.c.-d.c. receiver. Its simple diagram is tattooed on my brain. Think of how many hundreds of these things I've serviced."

"I'm thinking; and for every one you've serviced, I've serviced ten; but I'm still going to look at the diagram," Mac said with a disarming grin.

He took the service sheet from the file and merely glanced at it before he slid it across to his assistant. As Barney stared down at the diagram, a brick-red flush crept up out of his collar and spread over his face, dim-

ming his freckles to invisibility.

"Well what do you know!" he exclaimed. "That grid leak returns to the cathode instead of to ground, and the cathode goes to ground through the primary of a two-winding oscillator coil. I'll bet a nickel that primary is opening up leaving the cathode floating, and the high cathode voltage under these circumstances is conveyed through that 22,000-ohm grid leak to the oscillator grid."

A simple check with the ohmmeter confirmed this suspicion, and Barney was lucky enough to find the primary winding break right at the end where it tied to a terminal. A drop of solder solved the problem. As the crestfallen boy replaced the receiver in the cabinet, Mac observed:

"I don't know what I'm going to do with you if you don't learn to go to the service literature when the going gets tough. Here I've invested hundreds of dollars in that literature with the sole aim of helping us to do our job better and faster, and then you blithely ignore the whole thing and depend upon your alleged omniscient knowledge of how the circuit must be. Actually this business of returning the grid resistor to the cathode instead of directly to ground is very, very common; but your preconceived notion that it *had* to return to ground kept you from even thinking about that possibility. You were looking for a 'far-out' cause of the trouble, such as a defective tube socket. I'll bet you haven't found more than three tube sockets with broken-down insulation in all the time you've been working for me."

"I have in transmitters," Barney defended himself lamely.

"We're working on receivers, not transmitters," Mac relentlessly pointed out; "and I've told you over and over always to look for simple causes of trouble first. Save the odd-ball, freakish possibilities for investigation until after all the ordinary, likely things have been checked out. Hey! Wait a minute. What was that whistle?"

Barney had the set back in the cabinet and was tuning it back and forth

across the band as a final check. As he crossed a station near the middle of the band a heterodyne was heard so loud that it blocked out reception of the station.

"That's just the second harmonic of the 455-kc. i.f. beating with the station on 910 kc.," Barney explained. "You can hear that little heterodyne on lots of sets. Probably this one doesn't have enough decoupling in the detector circuit and some of the i.f. is feeding back through the a.v.c. system to the receiver input."

"I wouldn't call that screech 'a little heterodyne,'" Mac observed acidly. "You'll never convince me a manufacturer would let a receiver go out in that condition. Take off the back."

When two screws were removed and the back, carrying the antenna, was pulled away from the cabinet, the heterodyne disappeared and the station could be heard clearly.

"Apparently the signal is being radiated directly into the loop," Mac said as his gentle fingers probed around in the receiver. Suddenly he held up the end of the broken little copper-ribbon ground lead of the 12AV6 tube shield and stared quizzically at the other technician.

"This just ain't my day," Barney sighed as he reached for the solder gun. "I must have broken that lead when I was changing tubes. It's easy to do. With the shield floating, the 455-kc. signal on the diode plates of the 12AV6 could radiate directly into the loop winding only an inch or so away. Once more I was looking for a more complicated cause of trouble than an ungrounded tube shield. Why don't you fire me?"

"Don't tempt me," Mac answered as he tried to scowl. "I probably would if it weren't for that Japanese radio sitting over there on my end of the bench."

"What's that got to do with it?"

"Well, a little old lady brought that in yesterday with the explanation that her son, quartered in Japan, had sent it home to her. It was a nice-looking little two-band, three-way portable. She had unpacked it and plugged it in, and it started to play right off, but after a few minutes it quit. She was sure some little thing had shaken loose in transit."

"Well, as we both know, almost every time we get tangled up with one of these foreign sets we lose money. Most of the time there is no adequate service literature on the set; the parts arrangement and circuitry are frequently different from that with which we are familiar; and we often run up against defective parts for which substitutes cannot be obtained. I explained this to the woman, but she said her son had written that one of the selling points of this receiver was that he had been told that all parts for it could be readily obtained in the United States. Against my better judgment, I took the set."

"When I plugged it in, there was only hum. I raised the line voltage a bit,

(Continued on page 151)



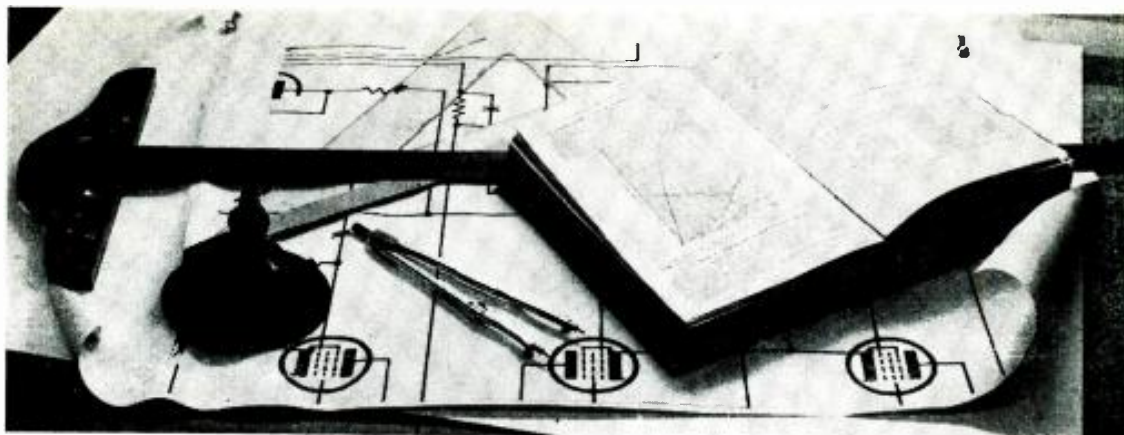

# Some Thoughts on Amplifier Design

By **STEWART HEGEMAN** Dir. of Eng., Citation Kit Div., Harman-Kardon, Inc.

**Multiple feedback loops with up to 32 db of feedback with stability, extended frequency response, and low impedance power supply are used in new hi-fi kit line.**

**M**UCH of the author's professional listening experience as a recording engineer has been involved in detecting flaws. When monitoring an original recording one cannot take time to listen to the performance, for all attention is given to listening to imbalances between instruments due to microphone placement. This type of critical auditioning is continued through all the steps of the manufacturing process, from the master tape to the completed recording. The emphasis in this type of listening is on distortion, noise, dynamic and frequency range, and over-all tone quality. It is usually days before one has the opportunity to relax and listen to the *performance* in the quiet surroundings of his own living room.

When professional monitoring is done over extended periods of time, listening fatigue becomes a very important factor. Small amounts of dis-

tortion, which might be tolerated under ordinary listening conditions, not only become annoying but actually affect one's judgment; and it is for this reason that the author has become increasingly concerned with the development of superior sound equipment. This form of professional listening generates very specific and personal requirements in terms of over-all performance of the sound reproducing chain and, as a result, the author has come to recognize the basic importance of two principles.

## Distortion & Frequency Response

The first principle concerns distortion. It is interesting to note that the relatively high level of distortion in some components in the system does not mask the possibly minute level of distortion in other components. Therefore, although speakers, cutters, and cartridges have higher inherent dis-

tortion than amplifiers, the listening quality of the system can benefit from the reduction of distortion in any part of the chain. It may be important, at this time, to indicate what is meant by "distortion." In the broad sense, distortion is any deviation from the original. Not only does it include harmonic and intermodulation distortion, but also restricted dynamic range, restricted frequency response, deviation in phase response, restrictive distribution patterns of both microphones and speakers, and transient distortion.

The second and equally important principle concerns frequency response. The bandwidth required for satisfactory reproduction is considerably beyond the single-frequency hearing capabilities of the human ear. Components of several octaves below 20 cycles are of great importance to musical perception and unquestionably contribute to more realistic, sharper, and more transparent reproduction.

Since the basic amplifier forms the foundation of any complete component line, we thus decided to start off with a 120-watt (dual 60-watt) stereo amplifier as the introductory item in our new line of kits. To produce a top-quality power amplifier in kit form, it is necessary to use high-quality materials and carefully engineered assembly and wiring techniques. It is also necessary to realize the improved performance possible with increased degrees of feedback.

## Feedback Techniques

Current conventional power-amplifier design is based on "single loop" feedback techniques. "Linearization" is obtained by over-all feedback from the voice-coil terminals to the cathode of the input tube and, due to stability

(Continued on page 106)



The introductory unit in Harman-Kardon's new "Citation" line of kits is this 120-watt (dual 60-watt) stereo power amplifier.

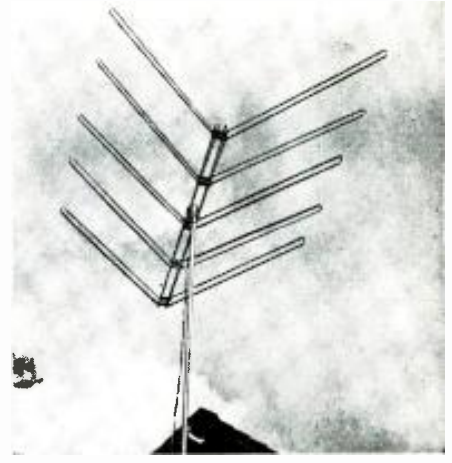

TV set, train, and antenna—each has a reference “ground,” but this ground may be a different concept in each case.

## “Grounds” for Confusion

By ROBERT GARY / One word, many meanings: the type of equipment or type of voltage involved may decide what ground is.

**A** WELL-KNOWN quote by a well-known writer informs us that “a rose is a rose.” Is not a ground also a ground? And, if that is the beginning and the end of the matter, why should any confusion exist about so simple a concept? However, if you choose even the clear-cut rose as a theme and let your mind play with it idly for a minute, you can come up with a surprising range of variety in associated ideas. “Sweet Rosie O’Grady,” for example, has little to do with the legendary rose fields of Bulgaria that provide essential oils for the perfume industry. Start with the word “ground” and you will come up with an even greater variety of notions, even if you limit yourself to what this word means in the language of electronics.

You may think of the concept as it appears in manuals on telegraphy. This is the earth ground or ground return, in which a single-wire line is used, with earth ground being used as the second line. This also ties in with the notion of the lightning arrester developed by Ben Franklin, the device being basically a good conductor to ground. Yet the concept seems a far cry from that of a TV receiver chassis, which had better be a good ground for the r.f. and other signals circulating in the receiver—but which may be “hot” or “cold” with respect to the ground on which the technician stands.

Even if we confine ourselves to the ground within a single item of electronic equipment, such as a radio, audio amplifier, or TV chassis, we may run into confusing effects. For example, two points may both appear to be at ground potential on a schematic diagram; yet, if these two are too close physically—or perhaps too far apart—oscillation

may develop. If they are both at ground, why should it matter how near or far apart they are? Why does touching a “grounded” chassis sometimes detune a circuit using this ground? If an a.c.-d.c. receiver has a resistor and capacitor network going from the chassis to the grounded side of the power line, can the chassis be considered as a ground? Does a power transformer ground a set just because its center tap is connected to the chassis? Why do certain broadcast receivers operate better if a wire is connected to a water-pipe ground? These questions may certainly puzzle the layman and sometimes even confuse the student of electronics or the technician.

The problem arises because ground may be one or many things to different people in the same or different electrical circuits. A good starting point is the fact that electric current must have a complete circuit in order to flow, and we usually regard this circuit as being divided into a double path. In d.c. work, for example, we say that current goes from the generator or other source to the load over one path and then returns through the other. An oversimplified understanding of this action leads many of us to think that the return path is “cold” because the current has done its work and no longer has any energy left. We then begin to assume a “safe” return or ground path containing no power, which can be overlooked.

A quick look at the popular schematic representation of this action (Fig. 1A) may mislead some people. However, if we re-draw the circuit as in Fig. 1B, we take into account the fact that, between any point in the circuit and any other point—even if both

points are on the same “ground” line—there are inevitably some electrical factors introduced, such as resistance, capacitance, and inductance, no matter how small they may be. Thus some form of circuit action may take place between any two points, however slight it may be, and the energy within the circuit may be active anywhere.

A good example of this can be observed by a study of the tracks of any electrified railroad. The “hot” power is delivered through a suspended overhead cable or an insulated third rail, while the return path goes through the tracks. The tracks are, of course, “grounded.” However, where rails are joined, heavy bronze cables carry the “cold” return current across the junction. Should there ever be a gap in the metal return path, the arcing across it will be every bit as severe as if the top wire were broken.

A ground, in this sense, is simply one side of a two-wire system. For our purposes, we usually choose the side to which the electrical resistance from the ground (earth, or its equivalent) on which we stand is the least. A good example of this is the automobile. Its battery, radio, and other electrical equipment are all grounded to the car body; but, because of the nonconductive rubber tires, the car itself is not connected to the earth at all. This sometimes causes shocks or small arcs when a conductor—such as a person—supplies the connection between the “grounded” car and the actual ground. For this reason, some autos use ground straps which drag along under the vehicle and electrically connect the car body to the pavement.

To further illustrate the problem of clearly defining a ground point, con-



sider the case of a u.h.f oscillator circuit, as shown in Fig. 2. The circuit is shown in Fig. 2A as it would appear on a schematic diagram. Fig. 2B is the true electrical equivalent of all portions of the circuit outside the tube envelope. For convenience's sake we have lumped the stray and wiring inductances, capacitances, and resistances that would actually be significant at these frequencies together. The obvious components are still identified for us ( $C_1$ ,  $L_1$ ,  $R_1$ , etc.) but they are heavily outnumbered by the inevitable resistances, capacitances, and inductances that are nevertheless present—and we have not necessarily shown all of the latter.

Already, in comparing Fig. 2A with Fig. 2B, we can see how two different engineers, each concerned with various aspects of the circuit, could take divergent viewpoints concerning the nature of ground. Let us see how the same circuit would be viewed by still another person—a safety engineer whose sole business is the question of shock hazard. To him, everything but the plate and supply voltages (Fig. 2C) could conveniently be assumed as being at "ground" potential. We can simplify even further if we think in terms of grounding the receiver to protect against lightning hazards. Here the chief circuit element to be considered would be the insulation resistance between the primary and secondary of a transformer.

### Shock Hazards and Ground

Much has been written in the past on the subject of the shock hazard of electrical appliances. Like the weather, this topic has received a lot more discussion than earnest attempts at a cure. But before we can think of eliminating shock hazards we should understand exactly what they are. Basically there are three ways one can get an

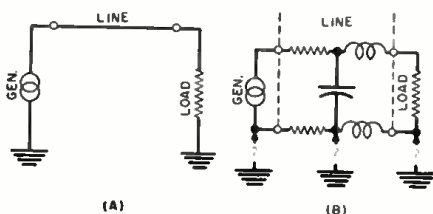

Fig. 1. Notion of ground (A) as unipotential return path. However, no two ground points (B) are actually the same.

electrical shock and, although this may seem facetious, they are by touching one side of the line, by touching the other side of the line, or, through special talent, by touching both sides. If we could assume that one side of the power line is properly connected to the earth on which our body stands, then it would be perfectly safe to touch that grounded side of the line, but the other side would still be "hot." We see that grounding one side of the power line immediately reduces the shock hazard by 50 per-cent. All appliances that operate directly from the power line, such as toasters, broilers, and the

like, could have their case and chassis connected to the grounded side of the line, and this would limit the hazard to contact with the "hot" side. Should a "hot" wire accidentally touch the grounded chassis, this would cause a short circuit and the nearest fuse would blow, but there would be no danger to any human. Similarly, if radio and TV receivers could be grounded directly to the power line, there would be no shock hazard in touching the chassis, metal cabinet, or uninsulated controls.

It has long been proposed that all house wiring make use of polarized outlets and plugs so that the correctly grounded side of the line is always connected to the chassis or cabinet. Some progress has been made in this direction in that most newly designed sockets and plugs use one wide and one narrow contact blade. But, since so much unpolarized wiring exists and since the correct grounding of one side of the power line is not always guaranteed, the introduction of polarized wiring still seems to lie in a nebulous future. The military services have standardized all of their specifications so that polarized plugs and grounded power lines are required in all new equipment.

Recently many TV manufacturers have returned to the use of power transformers to effectively isolate the receiver power supply from the a.c. power line. Fig. 3A shows the a.c. voltages on a typical full-wave rectifier circuit and indicates why there is no shock hazard here between the chassis and the earth, regardless of whether one side of the power line is grounded or not. The capacitors  $C_1$  and  $C_2$  represent the leakage of the transformer. Since this is usually quite low, a very high impedance isolates the secondary from the a.c. power line. A few TV receivers use simple, isolation transformers. These perform the same function as the isolation transformer that every safety-conscious service technician keeps around. The voltages on such a transformer are shown in Fig. 3B. It is true, in any electrical device,

that the power-line wires themselves must be properly insulated, but, as we showed before, a short circuit would merely blow the fuse.

Having observed the voltage relationships with respect to ground when a power transformer is used, consider now the arrangement of Fig. 4, which shows a technique used with many so-called "hot" chassis in a.c.-d.c. sets. This is a rather elegant approach, because some attempt has been made here to isolate the chassis from the power line. The network of the resistor and the capacitor (220,000 ohms and .01  $\mu$ f., in Fig. 4A) helps keep 60-cps voltages off the chassis while providing a low-impedance path for r.f. and i.f. signals to one side of the power line, which is therefore essentially at ground for these higher frequencies.

The problem with this arrangement can be seen by inspecting Fig. 4B, in which the RC network has been reduced to an equivalent impedance of 170,000 ohms (calculated for 60 cps) for simplification. Some potential does indeed continue to exist between one side of the power line and the chassis. However, even if the receiver involved happens to be plugged in with the polarity shown, the chassis will not be quite as hot as would be the case without the network. The impedance of 170,000 ohms will be in series with any person who accidentally contacts the chassis and a point at earth ground potential at the same time. This impedance will serve to drop a good deal of the voltage, so that a full 117 volts would not be impressed across the unfortunate individual, and will also serve to limit the maximum amount of current that would flow through him. Also, if the capacitor should break down, a direct connection to one side of the power line becomes possible.

In many other receivers, the chassis is actually connected directly to one side of the line, and then all metal portions of the chassis, controls, mounting hardware, and the like must be covered with insulation. This usually protects the customer from shock, but the service technician must use an isolation

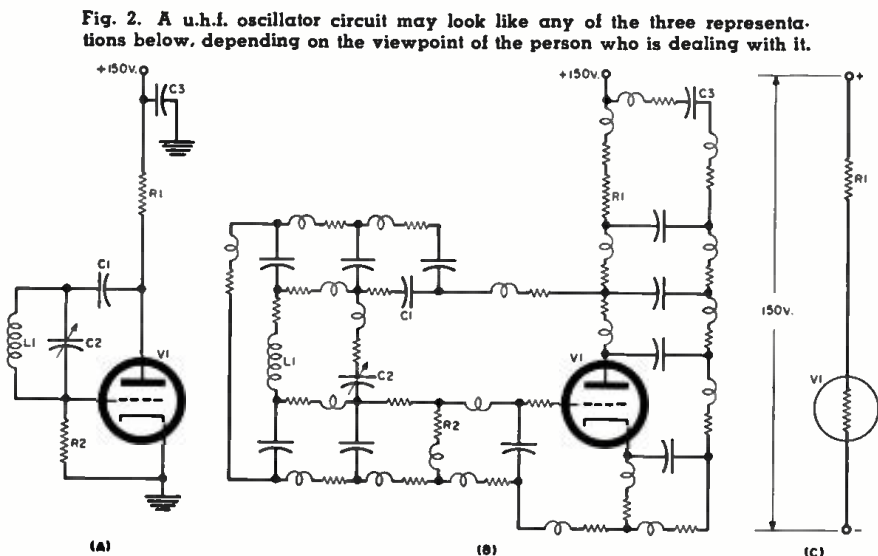

Fig. 2. A u.h.f. oscillator circuit may look like any of the three representations below, depending on the viewpoint of the person who is dealing with it.

transformer as soon as he needs to handle the chassis.

It is true that rubber-soled shoes insulate the body from ground and thereby eliminate some of the hazard, but it is always possible to touch some grounded object inadvertently while touching the "hot" chassis. While most such accidents are not lethal, technician time can be spent in better ways than in recovering from electric shock.

### Grounding Antennas

In looking over the signal-input circuit of most TV receivers, we notice that neither of the two conductors of the 300-ohm antenna lead-in is grounded. The elements of the antenna themselves are also ungrounded, except possibly for some parasitic portions such as reflectors and directors through the mast. At the tuner, however, the center tap of the antenna-input circuit is connected to the chassis ground. This makes both sides of the transmission line "hot" for r.f., but grounds them as concerns low frequencies. If lightning should strike, the path would be through both conductors, the TV chassis, and the power line to earth ground.

To avoid this hazard, most outdoor antenna installations include—or should include—a lightning arrester, which short-circuits the path from the antenna to a ground, but presents sufficient impedance for r.f. so that the signal path is still direct to the receiver. A typical equivalent circuit of such a protected installation is shown in Fig. 5. Simply, an alternate path to earth is provided for lightning through two resistances. These may be actual resistors or high-resistance spark gaps, as indicated by the broken lines. In either case, the resistance prevents bypassing of r.f. to the earth but breaks down and shorts out under the stress of lightning.

Some TV installations still use a coaxial cable from the antenna to the receiver and then the outer conductor is usually grounded at the receiver chassis. If the TV set uses a power transformer it would be perfectly safe to connect the shield of the coaxial cable directly to a water pipe, drain, or other good external ground.

The phenomenon of grounding one side of an a.c.-d.c. radio's loop antenna will work safely only if the loop is connected to the set through capacitors, or is otherwise isolated. Then the grounding merely serves to establish one of the loop terminals at external ground, making the other side "hot." It will usually be noticed that, depending on the side connected to ground, the tuning controls and the radio chassis itself will become more or less sensitive to body capacity.

The aforementioned practice of grounding one side of an antenna to improve signal pick-up raises still another point for consideration. Why does this work and how can we get along without this type of ground in the case of aircraft radios, battery portables, automobile receivers, and other units that do not normally come into actual

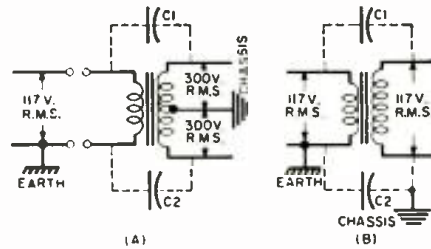

Fig. 3. How power transformers serve to isolate earth ground from chassis ground.

contact with the earth? The magic word that begins to provide the answers is "counterpoise." For an antenna to work best, it must have the greatest possible signal voltage developed across it. This means that, in effect, the "top" of an antenna system (that portion which is normally farthest from the earth) must be at the greatest possible potential difference from the "bottom" of the system. To establish this relationship, we seek a large body as a counterpoise that is not likely to be at or near the same potential with respect to transmitted signal that will appear at the "top" of the antenna. Where it may be used, the earth itself serves very well as such a counterpoise. Thus, the required counterpoise has come to be known as ground, because earth ground is the frequently used medium.

However, where it is not convenient to use earth ground, some other body of reasonable size is chosen as the counterpoise. This may be the body or shell of an orbiting satellite, of an airplane, or of a car—or it may simply be the chassis of a portable radio serving as its own "ground"—or should we say counterpoise? Actually, the confusion

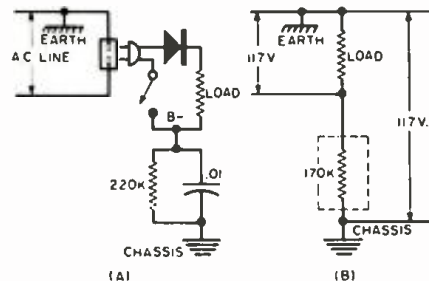
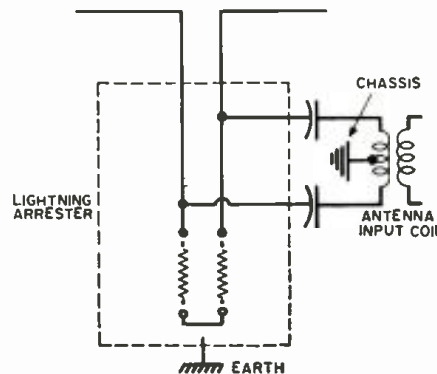

Fig. 4. An RC network (A) provides only partial earth-to-chassis isolation, as equivalent circuit at 60 cps (B) demonstrates.

Fig. 5. Arrester provides lightning with a breakdown path to earth-ground.



arises from the fact that, since earth ground was once the almost universally used counterpoise, we have come to call every such counterpoise a ground—whether it is or not.

When these "grounds" are brought near the earth's ground, the tuning as well as the set's sensitivity changes. Another effect observed with such devices is the accumulation of a static electric charge. Airplanes have short wire strips attached to their trailing wing edges to discharge such static electricity into the surrounding air during flight. During landings, the aircraft is carefully grounded to the runway to avoid, on a more violent scale, the shocks we often experience during dry winter days when getting out of a car.

### Grounding in the Shop

Although technicians, experimenters, and hams should be well aware of the shock hazards around the home, and especially in their work, trivial as well as serious accidents do happen. In presenting the following suggestions, we hope to help in reducing the number of electrical accidents, and also make the work of the technician easier.

Some of our readers may think that rubber mats on the floor or the wearing of rubber soles insulate a man from ground so that, if he touches something "hot," he will feel no shock. This is true to some extent, and the wearer of rubber soles is definitely somewhat safer than the barefoot technician. But there are usually a host of other grounded items with which the "safe" person may make inadvertent contact while believing he can touch the "hot" points with impunity. We feel that a properly grounded and carefully fused a.c. power line, a grounding strap within easy reach, and an isolation transformer are the best insurance against shock. The antenna lines, all test equipment, and metal shelves should be grounded. Although not essential, we favor a grounded piece of sheet metal as a base on which to put sick chassis.

If there are portions of the set which should be insulated, we add the necessary insulation in the form of cardboard and Bakelite strips. This has the advantage that it pinpoints any "hot" danger spots and reminds us of them during work. Metal parts that lie loosely on an insulator can get a static charge from nearby high-voltage fields and then, when the unsuspecting hand reaches for them, nasty "bites" result. The author has a half-inch scar to illustrate this particular effect and therefore is now well supplied with ground clips, sheet-metal work bases, and other protective devices.

One last word to those who can touch a 117-volt line with apparent immunity. Body-moisture content varies with age, climate, living habits, and a host of other factors. If you were getting no more than a mild tingle from 117 volts three years ago, don't believe that you have life-long immunity to electric shock. Even a lion tamer may wind up his career with a "bite."



# SAVE 1/2 THE TIME

## Make Twice The Profit!

in TV  
Trouble-Shooting

**THIS EASY**  
SIGNAL INJECTION  
POINT-TO-POINT  
DIRECT VIEWING  
**WAY**

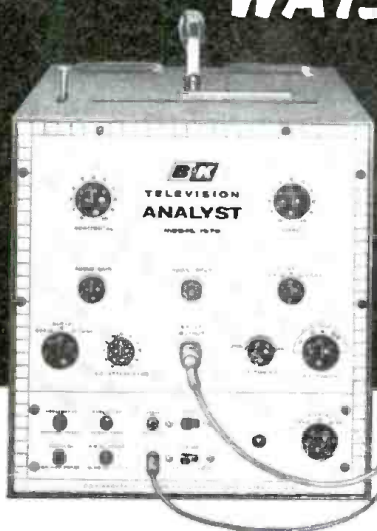

## MODEL 1075 TELEVISION ANALYST

Solve Rough Sweep Output Problems



### NEW Model A107 DYNA-SWEEP CIRCUIT ANALYZER

Saves many hours of service work. Provides vertical and horizontal sync and driving pulses that enable you more easily and quickly to check out every stage in the sync and sweep sections of a television receiver.

Tracks down troubles in the horizontal and vertical output circuit including defective output transformer and yoke; checks for shorted turns, leakage, opens, short circuits, and continuity. Includes unique high-voltage indication. Eliminates trial and error replacements.

**Model A107 Dyna-Sweep.** Companion unit for use only with B&K Model 1075 Television Analyst for driving source.  
Net, \$49.95

**Model 1070 Dyna-Sweep.** Same as Model A107 but has its own horizontal and vertical driving pulse, and is used independently of the Model 1075.  
Net, \$69.95

### New Technique Makes TV Servicing Easier, Faster, More Profitable

Thousands of service technicians already save thousands of hours every day with the amazing B&K TELEVISION ANALYST. Enables you to inject your own TV signal at any point and watch the resulting test pattern on the picture tube itself. Makes it quick and easy to isolate, pin-point, and correct TV trouble in any stage throughout the video, audio, r.f., i.f., sync, and sweep sections of black & white and color television sets—including *intermittents*. Makes external scope or wave-form interpretation unnecessary. Enables any serviceman to cut servicing time in half, service more TV sets in less time, really satisfy more customers, and make more money. Color generator provides both rainbow pattern and color bars.

**MODEL 1075 TELEVISION ANALYST.** Complete with standard test pattern, white dot, white line, and color-bar slide transparencies, and one clear acetate. Net, \$259<sup>95</sup>

See your B&K Distributor or Write for Bulletin ST24-N

**B & K MANUFACTURING CO.**  
1801 W. BELLE PLAINÉ AVE • CHICAGO 13, ILL.

Conodo: Atlas Radio Corp., 50 Wingold, Toronto 10, Ont.  
Export: Empire Exporters, 277 Broadway, New York 7, U.S.A.



# New Transistor Clock Radio Kit

**HEATHKIT**



## EVERYTHING A CLOCK-RADIO CAN OFFER ... AND PORTABLE TOO!

- Completely portable, all-transistor circuit
- Runs up to 500 hours on standard batteries
- Deluxe features at half the cost
- Easy to assemble

HEATHKIT TCR-1  
**\$45<sup>95</sup>**

### "YOUR CUE" TRANSISTOR CLOCK RADIO KIT (TCR-1)

Take all the deluxe features found in the most expensive clock-radios, add the convenience of complete portability, plus a modern 6-transistor battery operated circuit . . . then slash the price at least in half, and you have the new Heathkit "Your Cue" Transistor Portable Clock Radio.

Packing every modern clock-radio feature into a compact, beautifully styled turquoise and ivory plastic cabinet, "Your Cue" lulls you to sleep, wakes you up, gives you the correct time and provides top quality radio entertainment in and out-of-doors. It can also be used with the Heathkit Transistor Intercom system, opposite page, to provide music or a "selective alarm" system for one or more rooms covered by the intercom system.

An "Alarm-set" hand, hour hand, minute hand and sweep second hand grace the easy-to-read clock dial. All controls are conveniently located and simple to operate. The "lull-to-sleep" control sets the radio for up to an hour's playing time, automatically shutting off the receiver when you are deep in slumber. Other controls set "Your Cue" to wake you to soft music, or conventional "buzzer" alarm. A special earphone jack is provided for private listening or connection to your intercom or music system. At all times crystal-clear portable radio entertainment is yours at the flick of a switch.

The modern 6-transistor circuit features prealigned IF's for ease of assembly. A tuned RF stage and double tuned input to the IF stage assure top performance. The built-in rod-type antenna pulls in far-off stations with outstanding clarity while a large 4" x 6" speaker provides tonal reproduction of unusual quality.

Six easily obtainable penlight-size mercury batteries power the radio receiver up to 500 hours, while the clock operates up to 5 months from a single battery of the same type. Ordinary penlight cells may also be used with reduced battery life.

The handsome two-tone cabinet, measuring only 3½" H. x 8" W. x 7½" D. fits neatly into the optional carrying case for beach use, boating, sporting events, hunting, hiking, or camping.

Wherever you are, you'll find "Your Cue" your constant companion. Shpg. Wt. 5 lbs.

LEATHER CARRYING CASE

HEATHKIT

NO. 93-3

**\$4<sup>95</sup>**

Shpg. Wt. 2 lbs.



**HEATH COMPANY**/Benton Harbor, Mich.

 a subsidiary of Daystrom, Inc.

**ELECTRONICS WORLD**



# New Transistor Intercom Kit

## TALK WITH ANY OR ALL FIVE STATIONS WITH YOUR OWN INTERCOM SYSTEM

- Battery Power Permits Placement Anywhere
- Versatile Unit has Many Important Uses
- Complete Privacy of Conversations Assured

### TRANSISTOR INTERCOM KIT (XI-1 and XIR-1)

A flexible, versatile transistor intercom, has been developed by Heath engineers to enable you to set up your own communications system at an unbelievably low price.

Consisting of a master unit (XI-1) and up to five remote stations (XIR-1), the system is designed for any remote unit to call the master, for any remote station to call any other remote station, or for the master unit to call any single remote unit or any combination of remote units. Complete privacy is assured, since a call to a remote station cannot be interrupted or listened to while the remote unit is in operation unless switched in by the master unit. Used with clock-radio, opposite page, it can serve as a music or "selective alarm" system.

Transistor circuitry means long life, instant operation and minimum battery drain. Eight ordinary, inexpensive "C" flashlight batteries will run a unit for up to 300 hours of normal "on" time. Circuitry is especially designed for crisp, clear intelligible communication and the instant operation feature allows tuning of the units off between calls, extending battery life. Use of battery power does away with power cords, allowing each unit to be placed where most convenient. Only two wires are required between the master unit and each remote station. Beautifully styled, the Heathkit Intercom presents a new approach in design. Both master and remote stations have two-piece cases in ivory and turquoise for a rich, quality appearance. Batteries not included. Shpg. Wt. 6 lbs.

### AC POWER SUPPLY (XP-1)

A permanent power supply for 24-hour operation of the XI-1 Intercom on household current. Converts 110 V. AC to well filtered 12-volt DC output, eliminating the need for batteries. Power supply is small, compact and fits in space normally occupied by batteries.

HEATHKIT XP-1.....\$9.95



HEATHKIT XI-1 (Master)

**\$27<sup>95</sup>**

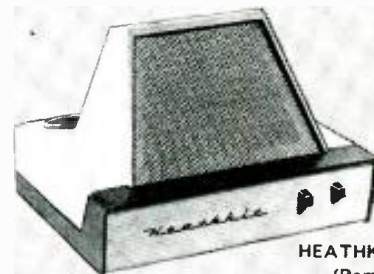

HEATHKIT XIR-1 (Remote)

**\$6<sup>95</sup>**

Shpg. Wt. 4 lbs.

## NEW IMPROVED DESIGN

### STEREO-MONO PREAMP KIT (SP-2A, SP-1A)

Get the SP-2A Stereo Preamp kit now, or the SP-1A monophonic version which you can easily convert to stereo whenever you choose by assembling the second channel (C-SP-1A) and plugging it into your SP-1A.

The SP-2A permits stereo, two channel mixing, or either channel monophonic use, and includes a remote balance control.

Six inputs (12 in the stereo version) accommodate tape, magnetic phono and microphone, plus three separate high level inputs. Level controls provided on "mag. phono" and high level inputs. Switch selects NARTB equalization for tape head input, and RIAA, LP or 78 RPM compensation for mag. phono input

HEATHKIT SP-1A (monophonic) Shpg. Wt. 13 lbs.....\$37.95

HEATHKIT C-SP-1A (not shown) (converts SP-1A to SP-2A) Shpg. Wt. 4 lbs.....\$21.95

**New**

HEATHKIT SP-2A (stereo)  
Shpg. Wt. 15 lbs.

**\$56<sup>95</sup>**

\$5.70 down. \$6.00 mo.



## THE WORLD'S BIGGEST BARGAIN IN A HI-FI AMPLIFIER

### 55 WATT HI-FI AMPLIFIER KIT (W-7A)

Utilizing advanced design in components and tubes to achieve unprecedented performance with fewer parts, Heathkit has produced the world's first and only "dollar-a-watt" genuine high fidelity amplifier. Meeting full 55-watt hi-fi rating and 50-watt professional standards, the new improved W-7A provides a comfortable margin of distortion-free power for any high fidelity application.

The sleek, modern styling of this unit allows unobtrusive installation anywhere in the home. The clean, open layout of chassis and precut, cabled wiring harness makes the W-7A extremely easy to assemble. Shpg. Wt. 28 lbs.

**SPECIFICATIONS**—Power output: Hi-Fi rating, 55 watt; Professional rating, 50 watt. Power response: ±1 db from 20 cps to 20 kc at 55 watt output. Total harmonic distortion: Less than 2% from 30 cps to 15 kc at 55 watt output. Intermodulation distortion: Less than 1% at 60 watt output at 100 cps and 6 kc signal mixed 4:1. Hum and noise: 80 db below 55 watt unweighted. Damping factor: Switch on front panel for selecting either maximum (0-1) or unity (1-1). Output impedances: 4, 8, and 16 ohm, and 70-volt line. Power requirements: 117 volts, 50/60 cycles, 90-160 watt. Dimensions: 8" D. x 11" H. x 15" W.



HEATHKIT W-7A

**\$54<sup>95</sup>**

New



# Stereo Amplifiers

**YOUR BEST DOLLAR VALUE  
IN STEREO...**

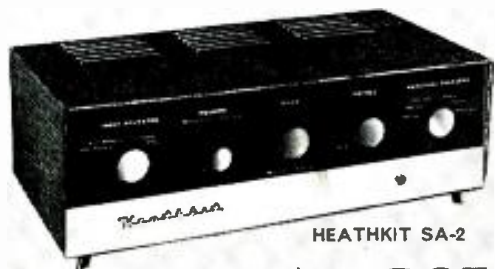

HEATHKIT SA-2

**\$52<sup>95</sup>**

## 14/14 WATT STEREO AMPLIFIER KIT (SA-2)

Complete control is at your fingertips with this versatile Stereo Amplifier-Preamplifier. Providing 14 watts per stereo channel, or 28 watts total monophonic, the SA-2 offers every modern feature in a master stereo control center at a price to please the budget minded. The unit offers selection of dual channel stereo operation, monophonic operation using both channels simultaneously, or using either channel for monophonic program material independent of the other channel. A 4-position input selector switch provides choice of mag. phono, crystal phono, tuner, and high level auxiliary input for tape recorder, TV, etc. Other features include RIAA equalization on mag. phono, channel reversing function, clutched volume control, ganged dual tone controls, speaker phase reversal switch and two AC outlets. Handsomely styled black and gold vinyl-clad steel cabinet. Shpg. Wt. 23 lbs.

**SPECIFICATIONS**—Power output: 14 watts per channel "hi-fi"; 12 watts per channel "professional"; 16 watts per channel "utility." Power response:  $\pm 1$  db from 20 cps to 20 kc at 14 watts output. Total harmonic distortion: less than 2% 30 cps to 15 kc at 14 watts output. Intermodulation distortion: less than 1% at 16 watts output using 60 cps and 6 kc signal mix 4:1. Hum and noise: mag. phono input, 47 db below 14 watts; tuner and crystal phono, 63 db below 14 watts. Controls: dual clutched volume; ganged bass, ganged treble; 4-position selector; speaker phasing switch. AC receptacle: 1 switch; 1 normal. Inputs: 4 stereo or 8 monophonic. Outputs: 4, 8 and 16 ohm. Finish: black with gold trim. Dimensions: 4 $\frac{1}{2}$ " H. x 15" W. x 8" D. Power requirements: 117 volts, 50/60 cycle, AC, 150 watts (plus-c).

New



HEATHKIT SA-3

**\$29<sup>95</sup>**

## ECONOMY STEREO AMPLIFIER KIT (SA-3)

This amazing performer delivers more than enough power for pure, undistorted room-filling stereophonic sound at the lowest possible cost. Featuring 3 watts per stereo channel and 6 watts as a monophonic amplifier, the SA-3 has been proven by exhaustive tests to be more than adequate in volume for every listening taste.

You will find its ease of assembly another plus feature. Heathkit construction manuals, world famous for their clarity and thoroughness, lead you a simple step at a time to successful completion of the kit. Larger than life-size diagrams show you exactly what each part looks like, where it goes, and how it is installed.

The amplifier is tastefully styled in black with gold trimmed control knobs and gold screened front and rear panel. A tremendous buy at this low Heathkit price! Shpg. Wt. 13 lbs.

**SPECIFICATIONS**—Power output: 3 watts per channel. Power response:  $\pm 1$  db from 50 cps, 20 kc at 3 watts out. Total harmonic distortion: less than 3%; 60 cps, 20 kc. Intermodulation distortion: less than 2% @ 3 watts output using 60 cycle, 4.6 kc signal mix 4:1. Hum and noise: 65 db below full output. Controls: Dual clutched volume, ganged treble, ganged bass, 7-position selector; speaker phasing switch; on-off switch. Inputs (each channel): tuner, crystal or ceramic phono. Outputs (each channel): 4, 8, 16 ohms. Finish: black with gold trim. Dimensions: 12 $\frac{1}{2}$ " W. x 6 $\frac{1}{2}$ " D. x 3 $\frac{1}{2}$ " H.

New



HEATHKIT XR-2P  
(6 lbs.)

**\$29<sup>95</sup>**



HEATHKIT XR-2L  
(7 lbs.)

**\$34.95**

## 6-TRANSISTOR PORTABLE RADIOS (XR-2P and XR-2L)

New, improved styling, new vernier tuning, up to 1,000 hours on flashlight batteries... are just a few of the plus features you get with these new transistor portables. Carry them with you wherever you go; to the beach, on trips, boating, etc. These new, improved models bring you the outstanding performance of the preceding models plus brand new styling and the additional convenience of vernier tuning for smooth, effortless station selection. The XR-2P features a mocha and beige high-impact plastic case. The XR-2L has a sun-in color leather case with an identical beige plastic front. Six Texas Instrument transistors are used for high sensitivity and selectivity. A large 4" x 6" PM speaker with heavy magnet provides excellent tone quality. The roomy chassis makes it unnecessary to crowd components, adding greatly to ease of construction. The six standard size "D" flashlight batteries used for power provide extremely long battery life and can be purchased anywhere. Fun to build, and fun to use... order one today!

New



HEATHKIT DS-1

**\$69<sup>95</sup>**

\$7.00 DN., \$7.00 MO.

- Indicates Depth and Type of Bottom From 0 to 100 Feet
- Detects Submerged Objects (fish, logs, etc.) and Their Depth
- Completely Transistorized... Operates From Flashlight Batteries

## TRANSISTOR DEPTH SOUNDER (DS-1)

Weekend boatman or professional... fisherman or skindiver... here's the depth sounder for you. Depth is indicated by a flashing neon lamp rotating behind a transparent circle in the molded black plastic dial face. A large hose around the dial enables the viewer to easily read the indicator in bright light or sunshine. The transducer uses a barium titanate element mounted in a fitted, molded epoxy resin housing with solid brass through-hull fitting and mounting hardware. While designed for permanent mounting on the bottom of the boat, temporary outboard mounting of the transducer is also possible. The completely transistorized circuit operates from 6 flashlight cells and one long-life battery. Comes complete with splash-proof cabinet, hardware and gimbal-type mounting bracket. Shpg. Wt. 10 lbs.



# New



# Amplifiers & Tuners

## A NEW AMPLIFIER AND PREAMP UNIT PRICED WELL WITHIN ANY BUDGET

### 14-WATT HI-FI AMPLIFIER KIT (EA-3)

This thrilling successor to the famous Heathkit EA-2 is one of the finest investments anyone can make in top quality high fidelity equipment. It delivers a full 14 watts of hi-fi rated power and easily meets professional standards as a 12-watt amplifier.

Rich, full range sound reproduction and low noise and distortion are achieved through careful design using the latest developments in the audio science. Miniature tubes are used throughout, including EL-84 output tubes in a push-pull output circuit with a special-design output transformer. The built-in preamplifier has three separate switch-selected inputs for magnetic phono, crystal phono or tape, and AM-FM tuner. RIAA equalization is featured on the magnetic phono input. Shpg. Wt. 15 lbs.

**NOTE THESE OUTSTANDING SPECIFICATIONS—Power output:** 14 watts. Hi-Fi: 12 watts. Professional: 16 watts. Utility. **Power response:**  $\pm 1$  db from 20 cps to 20 kc at 14 watts output. **Total harmonic distortion:** less than 2%, 30 cps to 15 kc at 14 watts output. **Intermodulation distortion:** less than 1% at 16 watts output using 60 cps and 6 kc signal mixed 4:1. **Hum and noise:** mag. phono input, 47 db below 14 watts; tuner and crystal phono, 63 db below 14 watts. **Output impedances:** 4, 8 and 16 ohms.



HEATHKIT EA-3

**\$29<sup>95</sup>**

## NEVER BEFORE HAS ANY HI-FI AMPLIFIER OFFERED SO MUCH AT SO LOW A PRICE

### "UNIVERSAL" 14-WATT HI-FI AMPLIFIER KIT (UA-2)

Meeting 14-watt "hi-fi" and 12-watt "professional" standards, the UA-2 lives up to its title "universal" performing with equal brilliance in the most demanding monophonic or stereophonic high fidelity systems. Its high quality, remarkable economy and ease of assembly make it one of the finest values in high fidelity equipment. Buy two for stereo. Shpg. Wt. 13 lbs.

**SPECIFICATIONS—Power output:** Hi-Fi rated, 14 watts; Professional rating, 12 watts. **Power response:**  $\pm 1$  db from 20 cps to 20 kc at 17 watts output. **Total harmonic distortion:** Less than 1% from 20 cps to 20 kc at 14 watts output. **Intermodulation distortion:** Less than 1% at 14 watt output using 60 cps and 6 kc signal mixed 4:1. **Hum and noise:** 73 db below 14 watts. **Output impedances:** 4, 8 and 16 ohms. **Damping factor:** Switched for unity or maximum; maximum damping factor 15:1. **Input voltage for 14 watt output:** .7 volts. **Power requirements:** 117 volts 50/60 cycles, 55 watts. **Dimensions:** 10" W. x 6 1/2" D. x 4 3/4" H.

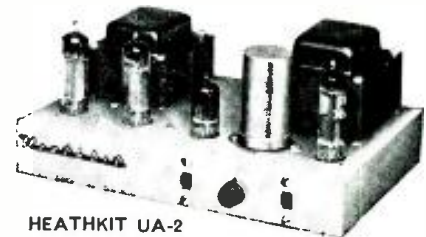

HEATHKIT UA-2

**\$22<sup>95</sup>**

## MORE STATIONS AND TRUE FM QUALITY ARE YOURS WITH THIS FINE TUNER KIT

### HIGH FIDELITY FM TUNER KIT (FM-4)

This handsomely styled FM tuner features better than 2.5 microvolt sensitivity, automatic frequency control (AFC) with on-off switch, flywheel tuning and prewired, prealigned and pretested tuning unit. Clean chassis layout, prealigned intermediate stage transformers and assembled tuning unit makes construction simple—guarantees top performance. Flywheel tuning and new soft, evenly-lighted dial scale provide smooth, effortless operation. Vinyl-covered case has black, simulated-leather texture with gold design and trim. Multiplex adapter output also provided. Shpg. Wt. 8 lbs.

**SPECIFICATIONS—Tuning range:** 88 to 108 mc. **Quieting sensitivity:** 2.5 uv for 20 db of quieting. **IF frequency:** 10.7 mc. **Image ratio:** 45 db. **AFC correction factor:** 75 Hz per volt. **AM suppression:** 25 db. **Frequency response:**  $\pm 2$  db 20 to 20,000 cps. **Harmonic distortion:** Less than 1.5%, 1100 uv, 400 cycles, 100% modulation. **Intermodulation distortion:** Less than 1%, 60 cycles and 6 kc mixed 4:1 1100 uv, 30% modulation. **Antenna:** 300 ohms unbalanced. **Output impedance:** 600 ohms (cathode follower). **Output voltage:** nominal 1.2 volt (with 30% modulation, 20 uv signal). **Power requirements:** 105-125 volts 50/60 cycle AC at 25 watts. **Overall dimensions:** 4 1/2" H. x 13 1/2" W. x 5 1/2" D.



HEATHKIT FM-4

**\$34<sup>95</sup>**

**HEATH COMPANY/Benton Harbor, Mich.**

 a subsidiary of Daystrom, Inc.

January, 1960

# New



# Tape Recorders



- Choice of 3 Outstanding Models
- Compare With \$350-\$400 Machines
- Preassembled Tape Mechanism

- Choice of Monophonic or Stereo models
- Complete versatility
- Easy to assemble, easy to use

## PROFESSIONAL QUALITY TAPE RECORDER KITS (TR-1 Series)

Enjoy the incomparable performance of these professional quality tape recorders at less than half the usual cost. These outstanding kits offer a combination of features found only in much higher priced professional equipment, generally selling for \$350 to \$400. Not the least of these special features is the handsome styling which characterizes the kits... a semi-gloss black panel is set off by a plastic escutcheon in soft gold, which is matched by black control knobs with gold inserts. The mechanical assembly, with fast forward and rewind functions, comes to you completely assembled and adjusted; you build only the tape amplifier. And, you'll find this very easy to accomplish, since the two circuit boards eliminate much of the wiring. Separate record and playback heads and amplifiers allow monitoring from tape while recording and a "pause" control permits instant starting and stopping of tape for accurate cueing and tape editing. A digit counter is provided for convenient selection of any particular recording. Push-pull knob provides instant selection of 3 3/4" or 7 1/2" IPS tape speed. Safety interlock on record switch reduces possibility of accidental erasure of recorded tapes. Shpg. Wt. 30 lbs.

**SPECIFICATIONS—Tape speed:** 7.5" and 3.75" per second. **Maximum reel size:** 7". **Frequency response (record-playback):** ±2.5 db, 30 to 12,000 cps at 7.5 IPS; ±2.5 db, 30 to 6,500 cps at 3.75 IPS. **Harmonic distortion:** 1% or less at normal recording level; 3% or less at peak recording level. **Signal-to-noise ratio:** 50 db or better, referred to normal recording level. **Flutter and wow:** 0.3% RMS at 7.5 IPS; 0.35% RMS at 3.75 IPS. **Heads (3):** record, and in-line stereo playback (TR-1C, monophonic playback). **Playback equalization:** NARTB curve, within ±2 db. **Inputs (2):** microphone and line. **Input impedance:** 1 megohm. **Model TR-1D & TR-1E outputs (2):** A and B stereo channels. **Model TR-1C output (1):** monophonic. **Output levels:** approximately 2 volts maximum. **Output impedance:** approximately 600 ohm (cathode followers). **Recording level indicator:** professional type db meter. **Bias erase frequency:** 60 kc. **Timing accuracy:** ±2%. **Power requirements:** 105-125 volt AC, 60 cycle, .35 watts. **Dimensions:** 15 1/2" W, x 13 1/2" D. Total height 10 1/2". **Mounting:** requires minimum of 8 1/2" below and 1 1/2" above mounting surface. May be operated in either horizontal or vertical position.

**MODEL TR-1C Monophonic Tape Deck:** \$159.95 \$16.00 DWN. Monophonic Record and Playback. \$14.00 MO.

**MODEL TR-1D Two Track Stereo Tape Deck:** Monophonic Record and Playback, plus Playback of 2-track Pre-recorded Stereo Tapes (stacked). \$169.95 \$17.00 DWN. \$15.00 MO.

**MODEL TR-1E Four Track Stereo Tape Deck:** Monophonic Record and Playback, plus Playback of 4-track Pre-recorded Stereo Tapes (stacked). \$169.95 \$17.00 DWN. \$15.00 MO.

**MODEL C-TR-1C Conversion Kit:** Converts TR-1C to TR-1D (see TR-1D description above). Shpg. Wt. 2 lbs. .... \$19.95

**MODEL C-TR-1D Conversion Kit:** Converts TR-1D to TR-1E (see TR-1E description above). Shpg. Wt. 2 lbs. .... \$14.95

**MODEL C-TR-1CQ Conversion Kit:** Converts TR-1C to TR-1E (see TR-1E description above). Shpg. Wt. 2 lbs. .... \$19.95

## STEREO-MONO TAPE RECORDER KITS (TR-1A Series)

Here are the tape recorders the avid hi-fi fan will find most appealing! Their complete flexibility in installation and many functions make them our most versatile tape recorder kits. This outstanding tape recorder now can be purchased in any one of three versions. You can buy the new two-track (TR-1AH) or four-track (TR-1AQ) versions which record and play back both stereo and monophonic programming, or the two-track monophonic record-playback version (TR-1A) and later convert to either two-track or four-track stereo record-playback models by purchasing the MK-4 or MK-5 conversion kits. The tape deck mechanism is extremely simple to assemble. Long, faithful service is assured by precision bearings and close machining tolerances that hold flutter and wow to less than 0.35%. Power is provided by a four-pole, fan-cooled induction motor. One lever controls all tape handling functions of forward, fast-forward or rewind modes of operation. The deck handles up to 7" tape reels at 7.5 or 3.75 IPS as determined by belt position. The TR-1A series decks may be mounted in either a vertical or horizontal position (mounting brackets included). The TE-4 Tape Electronics kits supplied feature NARTB equalization, separate record and playback gain controls and a safety interlock. Provision is made for mike or line inputs and recording level is indicated on a 6E5 "magic eye" tube. Two circuit boards simplify assembly.

**MODEL TR-1A:** Monophonic two-track record/playback with fast forward and rewind functions. Includes one TE-4 Tape Electronics kit. Shpg. Wt. 24 lbs. \$99.95 \$10.00 DWN. \$9.00 MO.

**TR-1A SPECIFICATIONS—Frequency response:** 7.5 IPS ±3 db 50 to 12,000 cps; 3.75 IPS ±3 db 50 to 7,000 cps. **Signal-to-noise ratio:** better than 45 db below full output of 1.5 volts/channel. **Harmonic distortion:** less than 2% at full output. **Bias erase frequency:** 60 kc (push-pull oscillator).

**MODEL TR-1AH:** Two-track monophonic and stereo record/playback with fast forward and rewind functions. Two TE-4 Tape Electronics kits. Shpg. Wt. 36 lbs. \$149.95 \$15.00 DWN. \$13.00 MO.

**TR-1AH SPECIFICATIONS—Frequency response:** 7.5 IPS ±3 db 40 to 15,000 cps; 3.75 IPS ±3 db 40 to 10,000 cps. **Signal-to-noise ratio:** better than 45 db below full output of 1.5 volts/channel. **Harmonic distortion:** less than 2% at full output. **Bias erase frequency:** 60 kc (push-pull oscillator).

**MODEL TR-1AQ:** Four-track monophonic and stereo record/playback with fast forward and rewind functions. Two TE-4 Tape Electronics kits. Shpg. Wt. 36 lbs. \$149.95 \$15.00 DWN. \$13.00 MO.

**TR-1AQ SPECIFICATIONS—Frequency response:** 7.5 IPS ±3 db 40 to 15,000 cps; 3.75 IPS ±3 db 40 to 10,000 cps. **Signal-to-noise ratio:** 40 db below full output of .75 volts/channel. **Harmonic distortion:** less than 2% at full output. **Bias erase frequency:** 60 kc (push-pull oscillator).

## HEATH COMPANY/Benton Harbor, Mich.

a subsidiary of Daystrom, Inc.

ELECTRONICS WORLD



# New "Acoustic Suspension" Hi-Fi Speaker System Kit

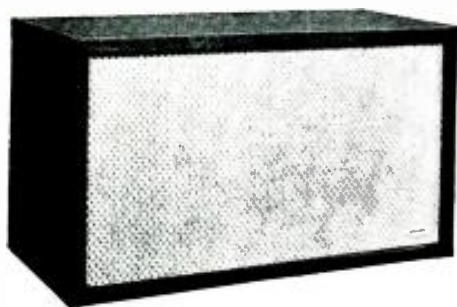

HEATHKIT AS-2U (unfinished)

**\$69<sup>95</sup>**

HEATHKIT AS-2M (mahogany) **\$79.95**  
HEATHKIT AS-2B (birch) **EACH**

**NOW—FOR THE FIRST TIME  
—EXCLUSIVELY FROM HEATH**

## ACOUSTIC SUSPENSION HI-FI SPEAKER SYSTEM KIT (AS-2)

A revolutionary principle in speaker design, the Acoustic Research speaker has been universally accepted as one of the most praiseworthy speaker systems in the world of high fidelity sound reproduction. Heathkit is proud to be the sole kit licensee of this Acoustic Suspension principle from AR, Inc., and now offers for the first time this remarkable speaker system in money-saving, easy-to-build kit form.

The 10" Acoustic Suspension woofer delivers clean, clear extended-range bass response and outstanding high frequency distribution is provided by the specially designed "cross-fired" two-speaker tweeter assembly.

Another first in the Heathkit line is the availability of preassembled and prefinished cabinets. Cabinets are available in prefinished birch (blond) or mahogany, or in unfinished birch suitable for the finish of your choice. Kit assembly consists merely of mounting the speakers, wiring the simple cross-over network and filling the cabinet with the fiberglass included. Shpg. Wt. 32 lbs.

**SPECIFICATIONS—Frequency response (at 10 watts input):**  $\pm 5$  db, 42 to 14,000 cps; 10 db down at 30 and 16,000 cps. **Harmonic distortion:** below 2% down to 50 cps, below 3% down to 40 cps at 10 watts input in corner room location. **Impedance:** 8 ohms. **Suggested amplifier power:** 20 watts minimum. **Suggested damping factor:** high (5:1 or greater). **Efficiency:** about 2%. **Distribution angle:** 90° in horizontal plane. **Dimensions:** 24" W. x 13½" H. x 11½" D.

# New Test Equipment



HEATHKIT FMO-1 Price to be announced

## AN INSTRUMENT LONG-AWAITED BY SERVICE TECHNICIANS EVERYWHERE!

### HEATHKIT FM TEST OSCILLATOR KIT (FMO-1)

Here in one compact, easy-to-use instrument are provided all the test signals and sweep frequencies required for fast, easy alignment and troubleshooting of RF, IF and detector sections of FM tuners and receivers. An instrument unique in the test equipment field . . . being the only one of its type designed especially for FM service work.

**SPECIFICATIONS—Output frequencies:** for RF alignment, 90 mc (FM band low end), 100 mc (FM band middle range), 107 mc (FM band high end). **Modulation:** 400-cycle incidental FM. **IF and detector alignment:** 10.7 mc sweep. **Sweep width markers:** 200 kc to over 1 mc, variable, 10.7 mc (crystal), 100 kc sub-markers. **Modulation:** 400-cycle AM. **For other applications:** 10.0 mc (crystal) and harmonics, 100 kc, 400-cycle audio. **Controls:** main frequency selector, modulation switch/concentric level control, marker oscillator switch/concentric level control, sweep width—power switch, output control, AF-RF (source impedance) switch. **Power supply:** transformer, selenium rectifier. **Power requirements:** 105-125 V, 50/60 cycles, 1½ watts. **Cabinet size:** 7¾" H. x 4¾" W. x 4¾" D.



HEATHKIT RF-1

**\$27<sup>95</sup>**

## PREASSEMBLED AND ALIGNED BANDSWITCH/COIL ASSEMBLY

### RF SIGNAL GENERATOR KIT (RF-1)

Moderately priced, and capable of precision performance the RF-1 provides highly accurate and stable RF signals for trouble-shooting and aligning RF and IF circuits of all kinds. Modulated or unmodulated RF output of at least 100,000 microvolts is available, controlled by both fixed-step and continuously variable controls. A built-in 400 cycle audio generator with 10-volt output provides internal modulation of RF signal and is available separately for audio tests. A preassembled bandswitch and coil assembly, aligned to factory precision standards, eliminates the need for special alignment equipment. Shpg. Wt. 7 lbs.

**SPECIFICATIONS—Frequency range:** Band A, 100 kc to 320 kc; Band B, 310 kc to 1.1 mc; Band C, 1 mc to 3.2 mc; Band D, 3.1 mc to 11 mc; Band E, 10 mc to 32 mc; Band F, 32 mc to 110 mc. **Calibrated harmonics:** 110 mc to 220 mc. **Accuracy:** 2%. **Output:** impedance, 50 ohms, voltage, in excess of 100,000  $\mu$ v on all bands. **Modulation:** internal, 400 cycles approx. 30% depth, external, approx. 3 V across 50 k ohm for 100% 400 cycles audio output; approx. 10 V open circuit. **Tube complement:** V1 12AT7 RF oscillator, V2 6AN8 modulator and output. **Power requirements:** 105-125 V 50/60 cycles AC, 15 watts. **Aluminum cabinet dimensions:** 6½" W. x 9½" H. x 5" D.

New



# Ham Radio Gear

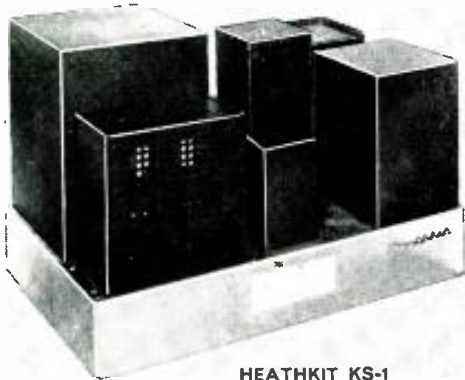

HEATHKIT KS-1  
\$169<sup>95</sup>

## TOP POWER WITH ECONOMY AND SAFETY

### KILOWATT POWER SUPPLY KIT (KS-1)

The KS-1 is designed as a companion to the "Chippewa" Linear Amplifier and is also suitable for supplying plate power to most other RF amplifiers in the medium to high power class. The KS-1 features an oil-filled, hermetically sealed plate transformer to minimize corona, a swinging choke in the filter circuit for good regulation, and a 60-second time delay relay to permit adequate heating of the mercury vapor rectifiers before application of plate voltage. All components are conservatively rated and well insulated for long life and dependable service. Shpg. Wt. 105 lbs.

**SPECIFICATIONS**—Maximum DC power output: 1500 watts. Nominal DC voltage output: 3000 or 1500 volts. Maximum DC current output: Average 500 ma, peak 1000 ma. Regulation: 180 to 600 ma (typical linear amplifier), 8%: 0 to 300 ma (typical class C amplifier), 10%: 0 to 500 ma, 15%. Ripple: Less than 1%. Tube complement: (2) 866A mercury vapor rectifiers in a full wave, single-phase configuration with swinging choke input filter/no. Line power requirements: 115 V, 50/60 cycles, 20 amprns; 230 V, 50, 60 cycles, 10 amperes. Chassis size: 17 1/2" W, x 12" H, x 13" D.

## MOVE TO THE TOP IN TRANSMITTING POWER

### "CHIPPEWA" KILOWATT LINEAR AMPLIFIER KIT (KL-1)

The KL-1 operates at maximum legal amateur power inputs in SSB, CW or AM service using any of the popular CW, SSB and AM exciters as a driver. Premium tubes (4—400's) push the "Chippewa" to top performance levels while a centrifugal blower provides more than adequate cooling. Shpg. Wt. 70 lbs.



HEATHKIT KL-1  
\$415<sup>00</sup>

**SPECIFICATIONS**—RF section: Driving power required (10 meters): Class AB1 (tuned grid) 10 watts peak; Class C (tuned grid) 40 watts; Class AB1 (swamped grid) 60 watts peak. Power input: Class AB1 (SSB-voice modulation) 2000 watts PEP; Class AB1 (SSB-two tone test) 1300 watts; Class AB1 (AM linear) 1000 watts; Class C (CW) 1000 watts. Power output (20 meters): Class AB1 (SSB-voice modulation) 900 watts PEP; Class AB1 (SSB-two tone test) 550 watts; Class AB1 (AM linear) 300 watts; Class C (CW) 750 watts. Output impedance: 50 to 72 ohms (unbalanced). Input impedance: 50 to 72 ohms (unbalanced). Band coverage: 80, 40, 20, 15 and 10 meters. Panel metering: 0 to 50 ma, grid current; 0 to 100 ma screen current; 0 to 5000 volt plate voltage; 0 to 1000 ma plate current. Tube complement: Final tubes, (2) 4-400A; clamp tube, (1) 6DQ6; voltage regulators, (4) OD3, (2) OC3. Power requirements: AC (power supply primary circuit), 250 watts, 115 volt, 50/60 cycles; DC, 3000 to 4000 volts, 450 ma. Cabinet size: 19 1/2" W, x 11 1/2" H, x 16" D.

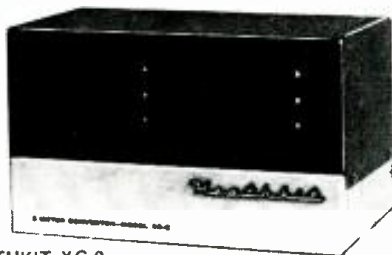

HEATHKIT XC-2  
\$36<sup>95</sup>

### 2-METER CONVERTER KIT (XC-2)

Extends coverage of the Heathkit "Mohawk" Receiver to the 2-meter band. May also be used with receivers tuning a 4 mc segment between the frequencies of 22 and 35 mc when appropriate crystal is used. Shpg. Wt. 7 lbs.

**SPECIFICATIONS**—Noise figure: 4.5 db; 1 uv signal provides 20 db thermal noise quieting. Sensitivity: approx. .1 uv input will provide a signal better than 6 db over noise level. Gain: approx. 40 db. Pass band: essentially flat 144 to 148 mc; approx. 35 db down at 143 and 149 mc. Image rejection: better than 100 db (tunable). Output impedance: 50 to 75 ohms. Input impedance: 50 to 75 ohms; 300 ohms with balun. Frequency: input, 144 to 148 mc; output, 22 to 25 mc with crystal supplied. Tubes: 6AM4, 6BS8, 6EA8, 12AT7. Crystal: .005% 3rd overtone. Power requirements: 150 volts DC at 50 ma (dropping resistor supplied for 210 VDC RX-1 operation) 6.3 volts AC/DC at 1.375 amps. Size: 9" W, x 5 1/2" H, x 4 3/4" D.



HEATHKIT UT-1  
\$28<sup>95</sup>

### "BEST BUY" UTILITY POWER SUPPLY KIT (UT-1)

This power supply is ideal for converting the Heathkit "Cheyenne" and "Comanche" mobile transmitter and receiver to fixed station operation; or may be used to provide necessary filament and plate voltage for a wide variety of amateur equipment. Features silicon diode rectifiers, high capacity filters for superior dynamic regulation, and line filtering to minimize TVI and reduce receiver line noise. On ICAS basis, provides 150 watts DC plus filament power for 6.3 volt or 12.6 volt filament applications (6.3 VAC., 8 amps, or 12.6 VAC., 4 amps.; 600 VDC., 250 ma nr 600 VDC., 200 ma and 300 VDC., 100 ma). Less than 1% ripple; excellent regulation. Housed in attractive green and gray-green cabinet measuring 9" long, 4 3/4" wide, 6" high. Shpg. Wt. 15 lbs.

ELECTRONICS WORLD



# New Citizen's Band Transceiver

## WIRED OR KIT FORM

**HEATHKIT CB-1**  
**\$42<sup>95</sup>**  
(kit model)

**HEATHKIT W-CB-1**  
**\$60<sup>95</sup>**  
(wired model)  
\$6.10 dwn., \$6.00 mo.



Both models include transceiver, crystal, microphone and two special power cords.

- No Tests to Take—No Operator's License Required
- Any Citizen 18 or Older Can Have Own Station
- Hundreds of Business and Personal Uses

### CITIZEN'S BAND TRANSCIVER KIT (CB-1)

The Heathkit CB-1 Citizen's Band Transceiver is a compact radio transmitter and receiver combination designed to operate on the new 11-meter "Citizen's Band". No tests to take, no special knowledge or operator's license required... you need only fill out forms we supply, and mail them to FCC to apply for station license. Operates just like any short wave radio used by police and other communication services. Front panel switch selects both "transmit" and "receive". Two or more Heathkit Transceivers provide you with your own 2-way radiotelephone system for making necessary business and personal contacts with family, friends or associates. A Heathkit accessory power supply makes the CB-1 completely portable for use in cars, trucks, boats, etc., using 6 or 12 volt batteries. With appropriate accessory antenna, the CB-1 can be used for communicating between truck and office, home and automobile, boat and shore, farm-house and field... literally hundreds of useful applications. Comes complete with microphone, 2 power cords for mobile or fixed operation, station ID card, call letters, and crystal for one channel and FCC application form. Order power supply and antenna separately. Attractively styled in two-tone "mocha" and "beige". Shpg. Wt. 10 lbs.

**SPECIFICATIONS**—Receiver type: Superregenerative detector w/rl stage. Power Input: 5 watts maximum to plate of final RF amplifier (FCC requirement). Transmitter frequency control: Third overtone type quartz crystal operating within 0.005% of marked channel frequency between -20° and +130° F. Modulation: AM plate and screen modulation automatically limited to less than 100% (FCC requirements). Power supply: Internal 117 V. 50/60 cycles, AC (35 watts). For 6 V battery power, use Model VP-1-6 Vibrator Power Supply (6.5 amps); for 12 V battery power, use VP-1-12 (4 amps). Total B+ requirements: 260 volts at 60 ma; total heater requirements, 6.3 volts at 1.8 amps, or 12.6 volts at 0.9 amps. Power rectifier: 2 silicon diodes in full wave voltage doubler circuit. Microphone: Combination hand-held and desk type, ceramic element, plastic case, with cord and connector. RF output impedance: 50 ohms. Speaker size: 3 3/4" (round). Undistorted audio power output: Approximately 1 watt. Line cords: Two supplied, one for AC operation, one for battery operation. Power circuits automatically switched when appropriate line cord is plugged in. Cabinet dimensions: 8" H. x 6" D. x 9 1/2" W.

### SPECIFY FREQUENCY CHOICE (1st and 2nd choice)

#### CLASS D CITIZEN'S BAND FREQUENCIES

26.965 mc	27.035 mc	27.115 mc	27.185 mc
26.975 mc	27.055 mc	27.125 mc	27.205 mc
26.985 mc	27.065 mc	27.135 mc	27.215 mc
27.005 mc	27.075 mc	27.155 mc	27.225 mc
27.015 mc	27.085 mc	27.165 mc	*27.255 mc
27.025 mc	27.105 mc	27.175 mc	

\*This channel shared with Class C Radio Control.

#### ANTENNAS

##### CBU-1 "UTILITY" ANTENNA.....\$9.95

Good coverage, portable antenna for temporary mobile or fixed installations. 45 1/2" base-loaded antenna, 12' connecting cable, mounting bracket and clip. 3 lbs.

##### CBM-1 "MOBILE" ANTENNA.....\$19.95

Best coverage mobile installation. Easy to install spring base, 1/4 wave, 9' whip; 15' connecting cable and necessary hardware. 7 lbs.

##### CBF-1 "FIXED LOCATION" ANTENNA...\$19.95

Excellent coverage, 1/4 wave "ground plane", 9' elements; 50' connecting cable and mounting bracket. 7 lbs.

#### WIRED AND KIT FORM

##### POWER SUPPLIES FOR MOBILE USE

6 volt Vibrator Power Supply for use with 6 volt batteries.

KIT—Model VP-1-6. Shpg. Wt. 4 lbs.....\$7.95

WIRED—Model WVP-1-6. Shpg. Wt. 4 lbs.....\$11.95

12 volt Vibrator Power Supply for use with 12 volt batteries.

KIT—Model VP-1-12. Shpg. Wt. 4 lbs.....\$7.95

WIRED—Model WVP-1-12. Shpg. Wt. 4 lbs.....\$11.95



### ORDER BLANK

NOTE: all prices and specifications subject to change without notice. Enclosed find ( ) check ( ) money order. Please ship C.O.D. ( )

On Express orders do not include transportation charges—they will be collected by the express agency at time of delivery.

On Parcel Post Orders include postage for weight shown. All prices are NET F.O.B. Benton Harbor, Michigan, and apply to Continental U.S. and Possessions only. 20% Deposit required on all C.O.D. orders.

## HEATH COMPANY BENTON HARBOR 15, MICH.

 a subsidiary of Daystrom, Inc.

Name \_\_\_\_\_  
Address \_\_\_\_\_  
City & Zone \_\_\_\_\_ State \_\_\_\_\_  
(PLEASE PRINT)

SHIP VIA

- Parcel Post  
 Express  
 Freight  
 Best Way

QUANTITY	ITEM	MODEL NO.	PRICE

SEND FREE HEATHKIT CATALOG

POSTAGE

TOTAL

HEATHKITS are also available at your Dealer

see listing on next page



# Here's where to buy your HEATHKIT® locally...

... through any of the carefully selected Heathkit Dealers listed below. This service has been established in answer to hundreds of requests, and we think that you, too, will welcome the availability of convenient "over-the-counter" delivery.

Although you will find your local dealers' price somewhat higher than the advertised direct mail

price, we're sure you'll agree that this increase is justified... as your dealer has absorbed all transportation costs, provides a reliable source for parts and service, offers local display and demonstration facilities, stands ready to counsel or advise you on any problems that might arise... and, of course, carries a complete stock of kits for immediate delivery.

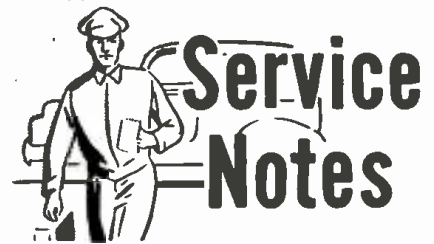

## R.F. INTERFERENCE IN HI-FI

In high-gain audio-amplification systems, undesired detection of r.f. signals can take place in one or more stages. This is especially noticeable when using such signal sources as low-level phonograph cartridges or magnetic tapes. The following procedure for locating the stage or stages where the detection occurs and eliminating it has been worked out specifically for *Magnavox* high-fidelity instruments, but the general technique is applicable to all similar equipment:

With the function control set to "Phono" or "Tape," rotate the "Loudness" control to determine whether it has any effect on the volume of the interfering signal. If it does, the offending stage is narrowed down to those preceding the control. If it has no effect, the unwanted detection is taking place beyond this point. Next, disconnect the signal lead between the radio chassis and the power amplifier. If the interfering signal disappears with this lead disconnected, detection is taking place in the audio-amplification stage or stages of the tuner. If the signal does not disappear, a stage in the power amplifier is at fault.

Once the offending stage has been located, a suppressor resistor inserted in series with its grid should eliminate the symptom. To accomplish this, remove connections made at the grid, solder a resistor (a satisfactory value will usually be between 50,000 and 100,000 ohms) directly to the grid, and solder the removed leads and components to the opposite side of the resistor.

## HOFFMAN: RECTIFIER FAILURE

In some cases, there are repeat failures of the 5AU4 in 1957 models. The cause is generally high line voltage. However, the best remedy is replacement of the 5AU4 with a 5V3 rectifier.

Fig. 1

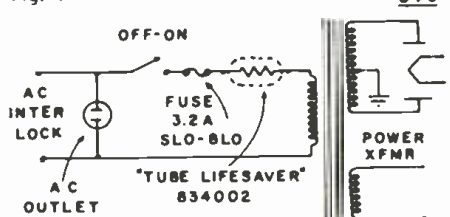

since the latter has higher maximum ratings.

For maximum protection, two additional changes are also advisable. A new thermistor device (*Hoffman* Part No. 834002) should be wired in series with the a.c. line cord. This will pro-

### CALIFORNIA

BERKELEY, CALIF. Inckit Corp.  
CHICO, CALIF. Dunlap Radio & TV Supply Co.  
EL CAJON, CALIF. Tetrad Electronics  
FRESNO, CALIF. Dunlap Radio & TV Supply Co.  
LOS ANGELES, CALIF. Kierulff Sound Corp.  
LOS ANGELES (WEST), CALIF. Kierulff Sound Corp.  
LONG BEACH, CALIF. Kierulff Sound Corp.  
MARYSVILLE, CALIF. Dunlap Radio & TV Supply Co.  
MERCED, CALIF. Dunlap Radio & TV Supply Co.  
MODESTO, CALIF. Dunlap Radio & TV Supply Co.  
PALO ALTO, CALIF. Zack Electronics  
PASADENA, CALIF. Kierulff Sound Corporation  
RIVERSIDE, CALIF. Kierulff Sound Corp.  
SACRAMENTO, CALIF. Dunlap Radio & TV Supply Co.  
SAN DIEGO, CALIF. Tetrad Electronics  
SAN FERNANDO VALLEY Kierulff Sound Corp.  
SAN FRANCISCO, CALIF. Zack Electronics  
SANTA ANA, ORANGE, CALIF. Kierulff Sound Corp.  
SANTA BARBARA, CALIF. ZKRT Corp.  
STOCKTON, CALIF. Dunlap Radio & TV Supply Co.  
VISALIA, CALIF. Dunlap Radio & TV Supply Co.

### COLORADO

DENVER Radio Products Sales Corp.

### DELAWARE

WILMINGTON, DELAWARE Radio Electric Service Co.

### HAWAII

HILO, HAWAII Radio-Television Corp., Ltd.  
HONOLULU, HAWAII Radio-Television Corp., Ltd.

### ILLINOIS

ALTON, ILLINOIS Radonics-Alton, Inc.

### INDIANA

FT. WAYNE, INDIANA Ft. Wayne Electronic Supply, Inc.  
INDIANAPOLIS, INDIANA Graham Electronic Supply, Inc.  
LAFAYETTE, INDIANA Lafayette Radio Supply, Inc.  
MUNCIE, INDIANA Muncie Electronic Supply, Inc.

### IOWA

DES MOINES, IOWA Radio Trade Supply Co.  
FT. DODGE, IOWA Radio Trade Supply Co.  
MARSHALLTOWN, IOWA Radio Trade Supply Co.  
WATERLOO, IOWA Radio Trade Supply Co.

### LOUISIANA

HOUMA, LOUISIANA Crescent Electronic Supply  
LAFAYETTE, LOUISIANA Sterling Electronics, Inc.  
NEW ORLEANS, LOUISIANA Crescent Electronic Supply  
NEW ORLEANS, LOUISIANA Hi-Fi, Inc.

### MARYLAND

BALTIMORE, MARYLAND American Distributing Company (2 locations)  
The Hi-Fi Shop

### MASSACHUSETTS

BOSTON, MASS. Audionics, Inc.

### MICHIGAN

ALLEN PARK, MICHIGAN Volta Electronics  
DETROIT, MICHIGAN High Fidelity Workshop  
PONTIAC, MICHIGAN High Fidelity Workshop

### MINNESOTA

DULUTH, MINN. Low Bonn Company  
MINNEAPOLIS, MINN. Low Bonn Company  
Hi-Fi Sound  
ST. PAUL, MINN. Low Bonn Company  
Hi-Fi Sound

### MISSISSIPPI

GULFPORT, MISS. Crescent Electronic Supply

### MISSOURI

KANSAS CITY BA High Fidelity (2 locations)  
Burnstein-Applabee Co., (2 locations)  
ST. LOUIS, MO. Radonics-Easton  
Radonics-Jefferson  
Radonics-West, Inc.  
Radonics-Gravois, Inc.

### NEW JERSEY

ATLANTIC CITY, N.J. Radio Electric Service Co.  
CAMDEN, N.J. Radio Electric Service Co.  
MOUNTAINVIEW, N.J. Federated Purchaser, Inc.  
NEWARK, N.J. Federated Purchaser, Inc.

### NEW YORK

ALBANY, NEW YORK Ft. Orange Radio Distributing Co.  
BATH, NEW YORK Rochester Radio Supply Co., Inc.  
BELLEROSE, NEW YORK Cross Island Electronics, Inc.  
BINGHAMTON, NEW YORK Stack Electronics, Inc.  
BROOKLYN, NEW YORK Acme Electronics, Inc.  
ELMIRA, NEW YORK Stack Electronics, Inc.  
FARMINGDALE, NEW YORK Gem Electronics Dist., Inc.  
FOREST HILLS, NEW YORK Beam Electronics, Inc.  
GENEVA, NEW YORK Rochester Radio Supply Co., Inc.  
HERKIMER, NEW YORK Herkimer Electronics Co., Inc.  
HICKSVILLE, NEW YORK Gem Electronics Dist., Inc.  
MINEOLA, NEW YORK Arrow Electronics, Inc.  
MT. VERNON, NEW YORK Davis Radio Distributing Co.  
NEW YORK, NEW YORK Arrow Electronics, Inc.  
Harvey Radio Company, Inc.  
ROCHESTER, NEW YORK Rochester Radio Supply Co., Inc.

### NEW YORK (Cont.)

SYRACUSE, NEW YORK Syracuse Radio Supply Co., Inc.  
UTICA, NEW YORK Genesee Electronics Company  
VALLEY STREAM, NEW YORK Elm Electronics, Inc.  
WATERLOO, NEW YORK Waterlown Electronics, Inc.

### NORTH CAROLINA

CHARLOTTE, NORTH CAROLINA Southeastern Radio Supply Co.  
FAYETTEVILLE, NORTH CAROLINA Southeastern Radio Supply Co.  
GREENSBORO, NORTH CAROLINA Southeastern Radio Supply Co.  
WINSTON, NORTH CAROLINA Southeastern Radio Supply Co.  
PALEIGH, NORTH CAROLINA Southeastern Radio Supply Co.

### OHIO

AKRON, OHIO Sun Radio Company  
CHILLICOTHE, OHIO Buckeye Electronics Dist., Inc.  
CLEVELAND, OHIO Pioneer Electronic Supply Co. (2 locations)  
COLUMBUS, OHIO Buckeye Electronics Dist., Inc.  
DAYTON, OHIO Srecco, Inc.  
HAM'N Hi-Fi, Inc.  
LORAIN, OHIO Pioneer Electronic Supply Co.  
MAPLE HEIGHTS, OHIO Pioneer Electronic Supply Co.  
NEWARK, OHIO Buckeye Electronics Dist., Inc.  
SANDUSKY, OHIO Pioneer Electronic Supply Co.  
SPRINGFIELD, OHIO Standard Radio-Springfield, Inc.  
TOLEDO, OHIO Lifetime Electronics  
YOUNGSTOWN, OHIO Radio & TV Parts Company  
ZANESVILLE, OHIO Buckeye Electronics Dist., Inc.

### OREGON

MEDFORD, OREGON Veri G. Walker Company  
PORTLAND, OREGON Eccles Electric Co.  
SALEM, OREGON Cecil Farnes Co.

### PENNSYLVANIA

ALLENTOWN, PA. Federated Purchaser, Inc.  
EASTON, PA. Federated Purchaser, Inc.  
ERIE, PA. J. V. Duncombe Co. (2 locations)  
PHILADELPHIA, PA. Austin Electronics, Inc.  
Radio Electric Service Co. (3 locations)  
PITTSBURGH, PA. House of Audio  
WILLOW GROVE, PA. Radio Electric Service Co.  
YORK, PA. Radio Electric Service Co.

### RHODE ISLAND

PROVIDENCE, R. I. Audionics, Inc.

### SOUTH CAROLINA

ANDERSON, S.C. Dixie Radio Supply Co. of Greenville  
CHARLESTON, S.C. Radio Laboratories  
COLUMBIA, S.C. Dixie Radio Supply Co. of Columbia  
ELORENCE, S.C. Dixie Radio Supply Co. of Florence  
GREENVILLE, S.C. Dixie Radio Supply Co. of Greenville  
SPARTANBURG, S.C. Dixie Radio Supply Co. of Greenville  
SUMTER, S.C. Dixie Radio Supply Co. of Columbia

### TENNESSEE

JOHNSON CITY, TENNESSEE Chemcity Electronic Distributors  
KINGSPORT, TENNESSEE Chemcity Electronic Distributors  
KNOXVILLE, TENNESSEE Chemcity Electronic Distributors

### TEXAS

BEAUMONT, TEXAS Sterling Electronics, Inc.  
BRYAN, TEXAS Sterling Electronics, Inc.  
DALLAS, TEXAS Hilested Records & Hi-Fi  
HOUSTON, TEXAS Sound Equipment, Inc.  
Sterling Electronics, Inc.  
LUFKIN, TEXAS Sterling Electronics, Inc.

### VIRGINIA

ARLINGTON, VIRGINIA Key Electronics, Inc.  
NEWPORT NEWS, VIRGINIA Cain Electronics Co., Inc.  
NORFOLK, VIRGINIA Cain Electronics Co., Inc. (2 locations)  
PORTSMOUTH, VIRGINIA Cain Electronics Co., Inc.  
RICHMOND, VA. Meridian Electronics, Inc.  
ROANOKE, VA. McKnight Electronics, Inc.

### WASHINGTON

SEATTLE, WASHINGTON Seattle Radio Supply, Inc.  
SPOKANE, WASHINGTON Northwest Electronics, Inc.

### WEST VIRGINIA

RECKLEY, W. VA. Chemcity Electronic Distributors  
BLUEFIELD, W. VA. Meyers Electronics  
CHARLESTON, W. VA. Chemcity Electronic Distributors  
POINT PLEASANT, W. VA. Chemcity Electronic Distributors

### WISCONSIN

LA CROSSE, WIS. Low Bonn Company  
MADISON, WIS. Hi-Fi Corner  
Satterfield Electronics, Inc.  
MILWAUKEE, WIS. Hi-Fi Center  
PORTAGE, WIS. Satterfield Electronics, Inc.  
WISCONSIN RAPIDS, WIS. Satterfield Electronics, Inc.

## New York Service Representative

Empire State Electronic Serv., Inc.

180-14 Union Turnpike, Flushing 66, Long Island, New York

HEATH COMPANY / Benton Harbor, Mich.

a subsidiary of Daystrom, Inc.





fect the entire receiver against surges occurring before warm-up. Since the device whose number is given is designed for the 1957 receivers, it should be wired in after the accessory plug on receivers having such a plug. A 3.2-ampere time-delay fuse will also protect against surges after warm-up. Both changes are shown in Fig. 1.

#### G-E: SHRUNKEN RASTER

When the raster on a TV receiver using the M-4 chassis shows reduction in both the horizontal and vertical directions, and a check shows that second-anode voltage for the picture tube is also low, a likely cause is not apt to be apparent. The trouble may lie in the vertical-output circuit—specifically, in the retrace-blanking network connecting to the grid of the CRT. If capacitor  $C_{211}$  in Fig. 2 (.01  $\mu$ f., 1600 volts)

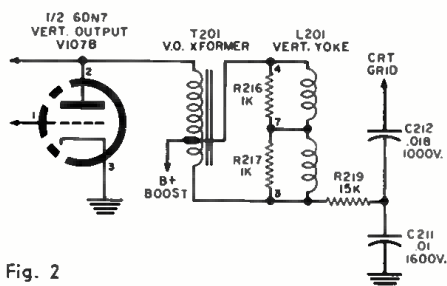

Fig. 2

shorts, the boosted "B+" supply will be loaded, and this will affect the high-voltage circuit as well as the horizontal sweep. When this defect occurs, resistor  $R_{219}$  (15,000 ohms) should also be checked after the capacitor is replaced. The latter may also have been damaged as the short will cause excessive current to pass through it.

#### RCA: POOR FOCUS, COLOR TV

If, in the 800 series of color receivers, poor focus not due to a defective focus control is encountered together with some evidence of irregular horizontal linearity, check for leakage or partial shorting in capacitor  $C_{117}$  (560  $\mu$ f.,  $\pm 10\%$ , 2000 v.) in the yoke. If it must be replaced, also check resistor  $R_{117}$ , as excessive current resulting from leakage in the capacitor may have damaged the resistor.

#### EMERSON: PIX OVERLOAD

When TV receivers using the 1203-41H and 120342R chassis are operated in areas where the signal strength is high, there may be a tendency for the picture to pull, jitter, or show other signs of video overload. This condition may be minimized by changing the value of one resistor and adding another, to improve a.g.e. action. Resistor  $R_{25}$ , originally a 1-megohm unit, may be changed to 470,000 ohms,  $\frac{1}{2}$  watt. A 22-megohm resistor ( $\frac{1}{2}$  watt) should also be connected between pin 9 of  $V_{25}$ , the sync separator, and the junction of  $C_{11}$ ,  $R_{25}$ , and the i.f. board. The latter resistor should be designated  $R_{25}$  on the schematic, to correspond with this change, as described, made in later production.

-30-

**YOU PAY A LITTLE MORE FOR  
VOCALINE CITIZENS BAND RADIO BUT  
you get a lot more performance!**

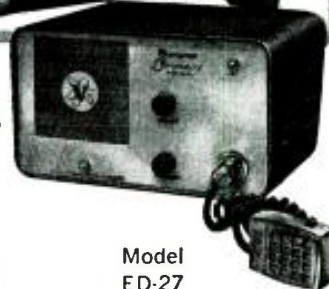
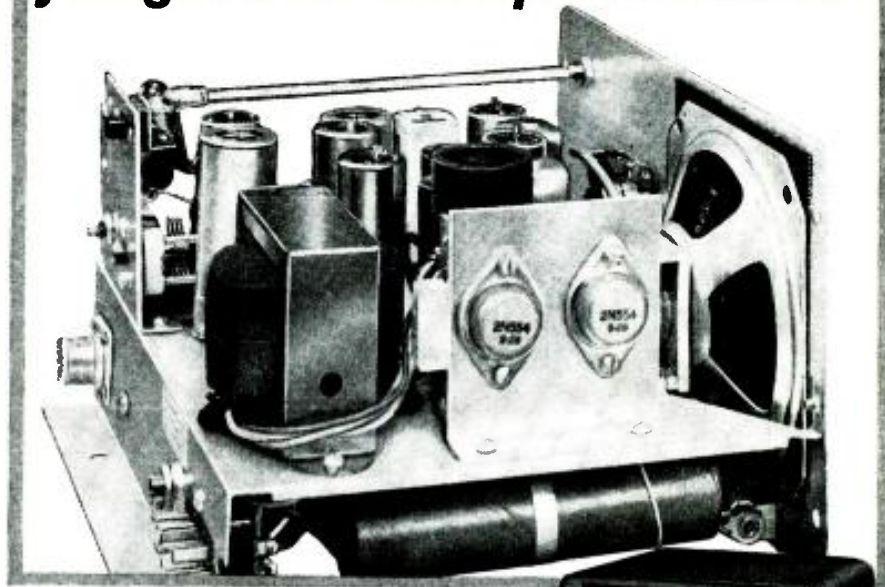

Model  
ED-27

\$179.50 each

The real worth of equipment is measured by its performance—and that's where Vocaline's ED-27 Commaire outdistances them all. If you're serious about Class D Citizens Band communications, then be equally serious about your choice of equipment. Compare Commaire's superlative (and, in most cases) exclusive features with competitive equipment. It makes sense to spend a little more to get so much more!

**THE MOST SELECTIVE  
& SENSITIVE RECEIVER**

Crystal-controlled—double conversion superhetrodyne. Selectivity:  $\pm 5$  kc at points 6 db down. Sensitivity: 0.1 mv. PLUS twice the audio output of any other class D receiver—4.5 watts!

**SILENT-AIRE SQUELCH  
U.S. PAT. 2,632,812**

At last a squelch that really works!... Combines with exclusive noise suppression to assure complete silence in stand-by.

**$\frac{1}{2}$  MORE OUTPUT**

5 watts input, 3 watts output—for greater range!

**TRANSISTORIZED  
POWER SUPPLY**

Assures service-free, reliable operation.

**UNMATCHED AUDIO  
CIRCUITRY**

Combined with the above features—results in the best-performing class D radio on the market... unequalled for range, signal-to-noise ratio, audio fidelity and dependability.

Supplied with push-to-talk microphone with coiled cord, hanger, universal mount, antenna loading light. 2 models—115 VAC and 12 VDC; 115 VAC and 6 VDC. Ask for Vocaline Antennas and Accessories.

WRITE FOR COMPLETE DATA  
Commaire Dept. A

**VOCALINE**

COMPANY OF AMERICA, INC.  
OLD SAYBROOK, CONN.

# The Photomultiplier and its uses

By ED BUKSTEIN / Northwestern TV & Electronics Inst.

**An extremely sensitive version of the phototube, the photomultiplier is employed in medicine, in the scientific research lab, and in industry.**

IN A medical clinic, a doctor positions an instrument to study the heart action of his patient. In a research laboratory, a scientist adjusts an electronic device to measure the age of a fossil bone fragment. In an ordnance plant, an electronic instrument detects an improperly filled fuse and energizes a rejection mechanism. All of these instruments, and many more, are designed around the photomultiplier tube—an extremely sensitive version of the phototube.

The basic phototube is a diode. It contains a chemically coated cathode which emits electrons when illuminated and an anode to collect these electrons.

of electrons is increased at each dynode, millions of electrons may eventually reach the plate for each electron emitted from the cathode. It is for this reason that considerable plate current will flow even with very little illumination of the cathode. The electron multiplication or current gain of the photomultiplier depends upon the number of dynodes and the ratio of secondary-to-incident electrons for each dynode.

Mathematically, the current gain of the photomultiplier is expressed as:  $G = R^n$  where  $R$  is the ratio of secondary-to-incident electrons for each dynode and  $n$  is the number of dynodes.

A ten-dynode tube having a 4 to 1

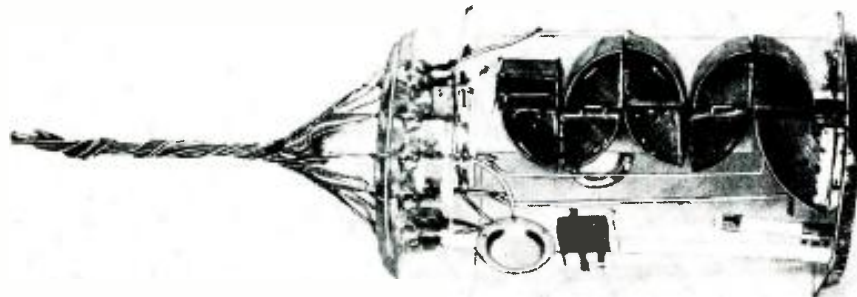

Fig. 1. The General Electric 931-A photomultiplier. The grille structure visible in photo allows light to pass to cathode and provides electrostatic control field.

Fig. 2. The dynode structure of the DuMont type 6292 photomultiplier is visible in photo. This is a 10-dynode tube that can provide a current gain of 2 million.

The plate current of the tube therefore depends upon the presence and quantity of light. This is the tube used in burglar alarm systems, automatic door openers, and foul detectors in bowling alleys. It is a useful tube and a reliable one, but its operation requires relatively high levels of light intensity. For those applications involving extremely low levels of light intensity, the photomultiplier is used.

As shown in Fig. 3, electrons emitted from the cathode do not go directly to the plate. Instead, they go in succession to a series of intermediate electrodes known as "dynodes." The characteristic feature of the dynode is that it emits several secondary electrons for each electron striking it. One electron from the cathode, for example, may release four secondary electrons from the first dynode. Each of these four will then release four electrons from the next dynode, bringing the total to sixteen. When these sixteen strike the next dynode, 64 secondary electrons will be emitted, etc. Since the number

ratio of secondary emission will therefore have a gain of 4<sup>n</sup> or approximately one million.

Each dynode of the photomultiplier is operated at a higher positive potential than the preceding dynode, usually about 100 to 150 volts higher. This, and the geometry of the tube, cause the electrons to move in succession from one dynode to the next. The dynode structure of the type 6292 photomultiplier is visible in the photograph of Fig. 2. This is a ten-dynode tube capable of providing a current gain of 2,000,000 when operated at 145 volts-per-dynode. At 105 volts-per-dynode, the current gain is 215,000. As these figures indicate, the gain of a photomultiplier can be controlled by varying the dynode voltages. Most of the commercially available photomultipliers have either nine or ten dynodes and provide current gains ranging from 200,000 to 2,000,000. The characteristics of several types are listed in Fig. 4. The wavelength (color) of maximum response is determined by the chemical

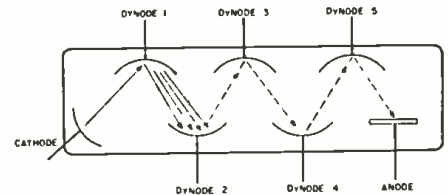

Fig. 3. Electrons emitted from the cathode of the photomultiplier tube pass in succession from one dynode to the next. Because each dynode emits more electrons than it receives, the number of electrons reaching the anode is much greater than the number leaving the cathode. Five dynodes are shown here for simplicity; most photomultipliers have either 9 or 10 dynodes.

composition of the cathode and is listed for each type in Fig. 4. Also shown is the relationship between color and wavelength in angstroms. The angstrom is a subdivision of the meter and is commonly used to specify the wavelength of infrared, visible light, ultraviolet, and x-rays. Ten billion angstroms are equivalent to one meter.

The type 931-A photomultiplier is shown in Fig. 1. The grille structure



visible in the photograph permits light to pass through to the cathode and also serves to establish an electrostatic field to control the electron paths. In the 931-A, the cathode faces the side of the glass envelope, but many photomultipliers are constructed with a *head-on* or *end-window* type of cathode. In these types, the cathode is a semi-transparent coating deposited on the inside of the glass envelope at the end of the tube opposite the base. This type of construction is particularly useful in those applications in which the photomultiplier is mounted in a probe, as in the scintillation counter used for measuring radioactivity.

Because each electrode in the photomultiplier must be more positive than the preceding electrode, a high-voltage power supply is required. A voltage divider connected across the power supply provides the required voltage for each electrode. Voltage regulator tubes are sometimes connected across the high-voltage supply to improve stability. Half-wave, full-wave, and voltage-doubler rectifiers are commonly used in the high-voltage supply. As shown in Figs. 5 and 6, grounded-positive supplies are often used to permit the anode to be operated close to ground potential.

### Applications

In many of its applications, the photomultiplier is used in conjunction with x-ray equipment. It may, for example, be used as an automatic x-ray exposure control. A chemical screen, similar to those used in cathode-ray tubes, is excited to fluorescence by the x-ray bombardment it receives. The resulting light illuminates the cathode of the photomultiplier and the plate current is used to charge a capacitor. This charge eventually overcomes the bias of a thyatron which operates a relay to terminate the exposure. Since the light produced by the fluorescent screen is proportional to the x-ray intensity, the exposure time is automatically controlled with respect to the intensity of radiation. A vacuum-tube voltmeter connected to the anode of the photomultiplier converts the circuit to an x-ray measuring instrument. Variations of this circuit are used for thickness measurement of sheet metal. Here, the sheet of metal moves between the x-ray tube and the fluorescent screen. Since the thickness of the metal determines the extent to which the x-rays penetrate, the scale of the v.t.v.m. may be calibrated to read in thousandths of an inch or any other convenient unit. The combination of x-ray tube, fluorescent screen, and photomultiplier is also widely used for inspecting packages for proper filling. In this application, each package is inspected as it moves along a conveyor belt. An improperly filled package, by allowing more x-radiation to reach the fluorescent screen, causes a reject device to energize and remove that package from the conveyor. This technique has recently been applied to the problem of inspecting fuses in ordnance manufacture.

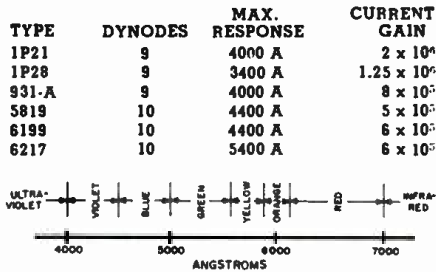
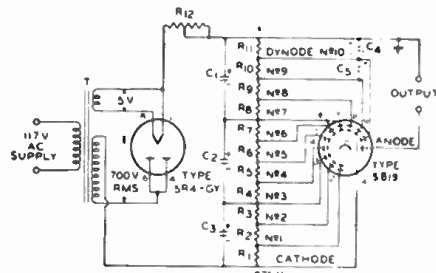
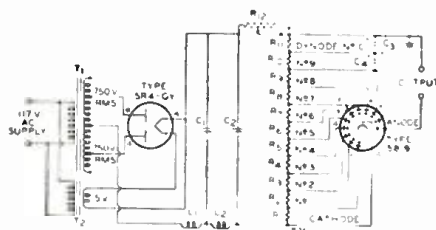

Fig. 4. Tabulation shows characteristics of several commercially available photomultipliers. Also shown below is the relationship between color and wavelength.



- $R_1$ —100,000 ohm,  $\frac{1}{2}$  w. res.
- $R_2, R_3, R_4, R_5, R_6, R_7, R_8, R_9, R_{10}$ —50,000 ohm,  $\frac{1}{2}$  w. res.
- $R_{11}$ —33,000 ohm,  $\frac{1}{2}$  w. res.
- $R_{12}$ —100,000 ohm, 1 w. adj. res. (Centralab A122 or equiv.)
- $C_1, C_2, C_3$ —16  $\mu$ f., 450 v. elec. capacitor
- $C_4$ —8  $\mu$ f., 150 v. elec. capacitor
- $T_1$ —Power trans. 350-0-350 v. @ 70 ma.; 5 v. @ 3 amps. (UTC R-102 or equiv.)

Fig. 5. Half-wave power supply for photomultiplier tube.  $R_{12}$  controls dynode voltages and therefore varies the current gain of tube. A meter, relay, or load resistor may be connected across output terminals, depending on the use. (Courtesy: RCA)



- $R_1$ —39,000 ohm, 2 w. res.
- $R_2, R_3, R_4, R_5, R_6, R_7, R_8, R_9, R_{10}$ —18,000 ohm, 1 w. res.
- $R_{11}$ —12,000 ohm, 1 w. res.
- $R_{12}$ —200,000 ohm, 12 w. adj. res. (General Radio Type 471-A or equiv.)
- $C_1, C_2$ —2  $\mu$ f., 1000 v. capacitor
- $C_3, C_4$ —8  $\mu$ f., 150 v. elec. capacitor
- $L_1, L_2$ —20 hy., 40 ma. filter choke
- $T_1$ —Plate trans. 900-750-0-750-900 v. @ 200 ma. (UTC S-45 or equiv.)
- $T_2$ —Fil. trans. 5 v. c.t. @ 3 amps (UTC FT-6 or equiv.)

Fig. 6. Full-wave power supply for photomultiplier. Two-section choke-input filter gives better regulation. (Courtesy: RCA)

Fig. 7. Scintillation counter probe. Flashes of light produced by crystal are coupled to photomultiplier through Lucite "light pipe." Mu-metal is for magnetic shielding.

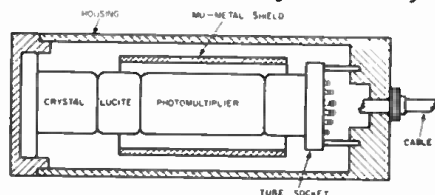

The photomultiplier is also widely used for measuring the density of photographic plates and films. In this application, the instrument is known as a photoelectric densitometer. Light passing through the photographic negative illuminates the cathode of the photomultiplier. The reading of the v.t.v.m. connected to the photomultiplier is therefore determined by the density of the negative. This technique is used not only in photographic darkrooms but also in scientific laboratories for measuring the density of spectrographic plates. Used in conjunction with a time-delay relay, the photomultiplier can be used to automatically control exposure time for photographic printing processes.

The scintillation counter, big brother to the Geiger counter, also uses a photomultiplier. As shown in Fig. 7, the photomultiplier is used in conjunction with a crystal, usually thallium-activated sodium iodide. The crystal produces a brief flash of light each time it is bombarded by a particle or gamma ray emitted from a radioactive substance. The light, coupled through a lucite "light pipe," illuminates the cathode of the photomultiplier. The resulting pulses of plate current are amplified and applied to a meter or counting circuit. This instrument is so sensitive that it can be used for aerial prospecting. It is also useful for contamination studies and hazards monitoring, as well as other similar type applications.

Medically, the scintillation counter is used in thyroid studies. Radioactive iodine-131, injected into the body, tends to accumulate in the thyroid glands. The scintillation counter is then used to measure the concentration of this substance in the region of the thyroids. Other radio-isotopes show an affinity for other parts of the anatomy. Radio-di-iodo-fluorescein, for example, tends to concentrate in brain tumors, which can then be localized by exploring the surface of the scalp with the scintillation probe.

The scintillation counter is also useful for determining the age of biological specimens. Living substances absorb radioactive carbon from the atmosphere. At the time of death, this process of absorption ceases and the amount of radioactivity begins to decrease. Since the rate of decrease is known, age can be determined by measuring the remaining radioactivity. This technique, known as *carbon-14 dating*, permits dating of objects excavated from the ruins of early civilizations.

In the flying-spot scanner, an instrument used for generating a television picture signal for test purposes, the photomultiplier is illuminated by light passing through a slide or transparency. As shown in Fig. 8, a cathode-ray tube is used as the light source. Vertical and horizontal sweep circuits, similar to those used in a TV receiver, cause the spot of light to sweep across the transparency in a standard scanning pattern. The varying densities

# CLIMB THE PROFIT TOWER

## in 2-WAY MOBILE-RADIO MAINTENANCE

Mobile radio communications are booming! All around... you can see the vertical radiators going up... each one is a definite lead to more and higher profits for qualified service men.

To learn more about contract fees... labor rates... and upping YOUR profits... mail the coupon below for your free copy of: "HOW TO MAKE MONEY IN MOBILE-RADIO MAINTENANCE."

LAMPKIN INSTRUMENTS ARE THE MOST POPULAR MOBILE-MAINTENANCE METERS.



LAMPKIN 105-B FREQUENCY METER. RANGE 0.1 TO 175 MC AND UP. PRICE \$260.00 NET.



LAMPKIN 205-A FM MODULATION METER. RANGE 25 TO 500 MC. PRICE \$270.00.



MAIL COUPON TODAY

LAMPKIN LABORATORIES, INC.  
MFM Division, Bradenton, Florida  
At no obligation to me, please send  
 Free booklet  Data on Lampkin meters  
Name \_\_\_\_\_  
Address \_\_\_\_\_  
City \_\_\_\_\_ State \_\_\_\_\_

LAMPKIN LABORATORIES, INC.  
MFM Division BRADENTON, FLORIDA

## HANDLE JOBS TWICE AS FAST WITH YOUR OSCILLOSCOPE!

A complete guide to when, where and exactly how to use the handiest instrument of all

Learn to use your 'scope on all types of work—and see how much faster and more accurately you get things done! This 346-page revised edition of MODERN OSCILLOSCOPES AND THEIR USES teaches you all about these versatile instruments. You learn to locate AM, FM or TV troubles quickly. Methods of handling tough realignment jobs are clearly explained. Every detail is outlined—from making connections to adjusting components and setting scope controls. And you learn to analyze patterns fast and right! Includes data on quantitative measurements, the slickest way to diagnose many color TV troubles and align circuits. Also covers scope uses in lab work, industrial electronics and teaching. 370 illustrations.

PRACTICE 10 DAYS FREE

Dept. RN-10, RINEHART & CO., INC.

232 Madison Ave., New York 16, N. Y.

Send MODERN OSCILLOSCOPES for 10-day no risk examination. If I like book I will then send you \$6.50 (plus postage) promptly in full payment. If not, I will return book promptly and owe you nothing. (SAVE! Send \$6.50 with order and Rinehart pays postage. Same 10-day return privilege with money refunded promptly.)

Name \_\_\_\_\_

Address \_\_\_\_\_

City, Zone, State \_\_\_\_\_

OUTSIDE U.S.A.—\$7.00 cash only. 10-day money-back guarantee.

## YOUR OWN 2-WAY RADIO FOR BUSINESS OR PLEASURE!



VIKING Messenger FROM \$12975

Anyone can operate—license issued by the FCC on request!

- Complete 23 channel Citizens' Band coverage—choose any 5 channels by the flip of a switch!
- Excellent receiver sensitivity and selectivity—full fidelity voice reproduction!

"More than just 2-way Citizens' Radio equipment"—the Viking "Messenger" offers the finest performance of any equipment available. Meets all FCC requirements. Maximum legal power. Designed for high reliability and easy installation in your home, business location, car, truck, or boat. Built-in Squelch, Automatic Volume Control, and Automatic Noise Limiter. Compact, modern styling—only 5 3/8" high, 7" wide, and 1 1/8" deep. Complete with tubes, push-to-talk microphone, and crystals for one channel.

WRITE TODAY FOR FULLY ILLUSTRATED BROCHURE



E. F. JOHNSON CO

102 Second Ave. S. W. • Waseca, Minnesota

Please rush me your full color brochure describing the Viking "Messenger" Citizens' Transceiver.

NAME \_\_\_\_\_

ADDRESS \_\_\_\_\_

CITY \_\_\_\_\_

STATE \_\_\_\_\_

encountered by the spot of light as it scans the transparency modulate the illumination reaching the photocathode. The output signal of the photomultiplier therefore contains the picture information. Cathode-ray tubes especially designed for this application are characterized by high brilliance and very short persistence.

The photomultiplier tube has become familiar to the automotive industry as a result of its use in the automatic headlight dimmer. Here, the photocathode is illuminated by the headlights of an on-coming car. The output of the photomultiplier is amplified and used to control the light-dimming relay.

In chemical and industrial plants, the photomultiplier is used to measure the concentration of toxic gases in the air and to sound an alarm when the concentration approaches the danger level. In this application, an ultraviolet-sensitive photomultiplier is illuminated by a source of ultraviolet radiation. Toxic agents, such as mercury vapor and carbon disulphide, absorb the ultraviolet rays and decrease the illumination of the photocathode. Dust measuring instruments are similar in design except that visible light rather than ultraviolet is employed.

In summary then, it can be seen that the photomultiplier tube, which is an extremely sensitive phototube, has many uses in medicine, in the research laboratory, and in industry. —30—

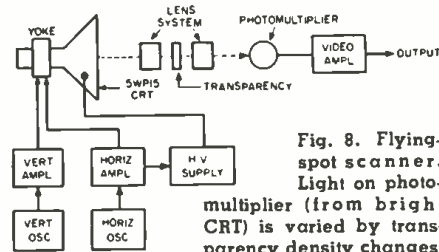
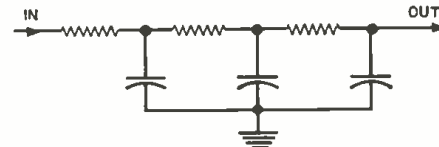

Fig. 8. Flying-spot scanner. Light on photomultiplier (from bright CRT) is varied by transparency density changes.

## VERTICAL-HORIZONTAL FAULT

By ROBERT JAMES

THE TIME this puzzler took was worth the lesson. A TV set came into the shop with vertical roll, which was traced to the printed-circuit vertical-integrating network. With the latter replaced, vertical hold was restored—but the horizontal became critical. It was finally found that the integrator, shown correctly wired in the illustration, had been put in backwards. Thus the capacitor on the output



side directly shunted horizontal pulses from the sync section. The fault was corrected by reversing input and output leads. The network works one way only. While inadvertent reversal of input and output leads will still provide adequate integration of vertical pulses, the isolating resistor is needed at the input to block horizontal pulses. —30—





## NEW EXPERIMENT IN TELEPHONY

*It could speed up "dialing." Bell Laboratories people created it—and now it's being tested.*

The telephone you see above embodies an important new concept. It "dials" by means of push buttons—promises more convenient telephoning. Bell System engineers are currently testing it for public reaction. Bell Telephone Laboratories developed it.

The Laboratories' invention of the transistor makes it possible. For the transistor permits a new kind of calling signal generator, mounted within the instrument.

To insure ease of operation, psychologists studied human reactions to various finger pressures and sizes and arrangements of buttons. All factors affecting speed and accuracy were thoroughly evaluated. Electrical and mechanical engineers brought together the human and physical factors, created a practical piece of apparatus. Industrial designers worked out the functional shape.

The new instrument sends a calling signal quite different from that of your present telephone. This poses a problem. Complex automatic switching must be changed to handle the new signals as well as the old ones. Switching engineers must devise ways to make this change in *thousands* of central offices—economically.

Most of the challenges have been met. Final judgment on this new concept depends on the outcome of field tests. Meanwhile, Bell Laboratories continues in its task of originating and developing devices to improve your Bell System telephone service.



**BELL TELEPHONE LABORATORIES**

WORLD CENTER OF COMMUNICATIONS RESEARCH AND DEVELOPMENT

an  
unprecedented achievement  
in stereo...

awe-inspiring  
realism...  
unparalleled  
record  
protection



Shure announces a stereo arm and cartridge that re-creates sound with incredible fidelity, transparency, and smoothness throughout the audible spectrum. Even elusive middle-range nuances emerge clearly. Tracks at a hitherto impossibly light 1½-2½ grams and will not scratch or damage records, even if carelessly handled! Eliminates surface wear, preserves record fidelity indefinitely!

the magnificent

**SHURE**  
**STUDIO**

*Stereo Dynamic*  
High Fidelity Integrated Tone Arm and Cartridge



For Audiophiles: Hum-free; 20-20,000 cps  $\pm$  2½ db. Channel sep.: over 20 db at 1000 cps. Output per channel: 4.5 mv. Vert. & lat. compliance: 9 x 10<sup>-6</sup> cm per dyne. Individually tested. With .0007" Shure precision diamond stylus\*. \$89.50 net. FREE BROCHURE: Shure Brothers Inc., 222 Hartrey Ave., Evanston, Ill.

\*WHEN REPLACING STYLUS, don't accept inferior imitations. They can seriously degrade performance.



### STEREO FM TUNER

Karg Laboratories, Inc., South Norwalk, Conn. has added a new FM tuner, the Model CT-1, to its line of audio gear.

The new unit offers front-panel switching facilities for monophonic or stereo-FM broadcasting and features twin audio channels for stereo; a socket for plugging in a companion multiplex

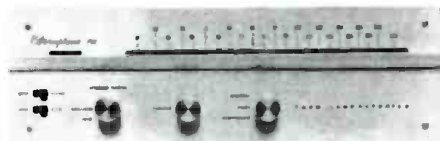

adapter for FM stereo; r.f. and oscillator coils printed on a phenolic base for stability; and a.f.c. which includes a d.c. amplifier in the control circuit to insure adequate hold even on weak signals. There is also a switched muting circuit; flywheel tuning; a 10" dial calibrated in single megacycles; filtered fluorescent bar tuning indicator at dial level; and a dial ratio of 11:1.

Sensitivity is 1.5 microvolt by the new IHFM standard provided by the use of a low-noise r.f. amplifier followed by three high-gain i.f. stages and a new dual-function limiter design. A catalogue on this new CT-1 stereo FM tuner is available on request.

### ARKAY STEREO CONSOLE

Arkay International, Inc., 88-06 Van Wyck Expressway, Richmond Hill 18, N. Y. has recently introduced a new stereo console which has been designated as the "Fantasia."

Acoustically engineered, the console houses a complete hi-fi stereo system

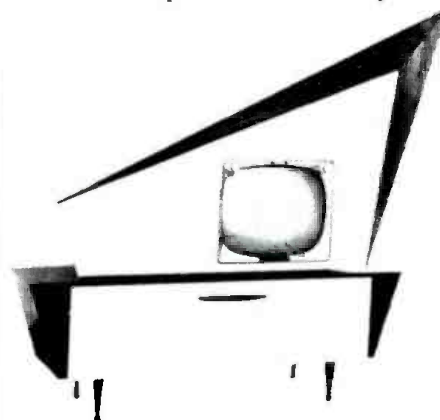

(including the stereo AM-FM tuner, stereo amplifier and preamp, record changer, tape deck, and stereo speaker system) plus a 21" television receiver. The console is supplied completely assembled although all of the stereo components can be had in either kit or wired form.

## Product Review

Over-all dimensions of the console are 72" high, 66" wide, and 18" deep. The upper wing-shaped section, which houses the television set, swivels in any direction for comfortable viewing and can be separated from the lower section if desired. The console is in satin-finished walnut with contrasting white drop-down door with walnut handle and trim.

### EICO'S STEREO AMP

Electronic Instrument Co., Inc., 33-00 Northern Blvd., Long Island City 1, N. Y. has added the Model HF-87 stereo amplifier to its line of audio components available in kit and wired form.

The amplifier uses the cathode-coupled phase-inverter-driven circuit with a preceding direct-coupled voltage amplifier. The output stage uses "Ultra-

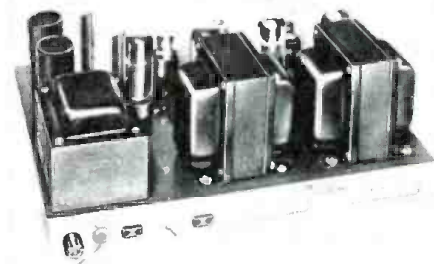

Linear" connected, self-biased push-pull EL34's. The amplifier is characterized by low distortion (IM distortion is 1% at 70 watts and harmonic distortion is less than 1% from 20-20,000 cps within 1 db of 70 watts) and stability (stability margin is the same as the feedback—17 db).

The HF-87 can be used as a dual 35-watt amplifier for stereo applications or as a single 70-watt mono amplifier. A service selector switch on the chassis permits choice of mode. Other convenience features include an input level control for each channel to permit adjustment of sensitivity and a power "on-off" switch.

The kit comes complete with detailed step-by-step wiring instructions and copious pictorials. Write the manufacturer direct for additional details and prices.

### S. ZAKER-CONE DOPE

Porter & Dietsch, Inc., 2459 University Ave., St. Paul 14, Minn. has developed a new chemical which, applied to the cone of any speaker, is said to lower cone resonance from 10 to 40 cps, thus improving bass frequency response of the unit.

The treatment consists of applying the contents of three clearly marked bottles by means of a brush which



comes with the kit. One "Flexicone" kit will treat one 15" speaker, two 12" speakers, four 8" speakers, or six 6" units. The company guarantees the product to be harmless to the hands, clothing, and the speaker. The principle involved is one of softening the speaker cone, allowing it to move more freely.

The product is designed for audio service shops as well as for the "do-it-yourself" audiophile. For a booklet on this product, write the manufacturer direct.

#### STEREO ANALYZER

Winston Electronics, division of Jetronic Industries, 4000 N.W. 28th St., Miami 42, Fla. is now offering a new



multi-purpose "Hi-Fi Stereo Analyzer" for the servicing and testing of audio systems.

The Model 800 includes an audio signal generator with ranges from 20 to 30,000 cps; an a.c. vacuum-tube voltmeter with six ranges from .01 to 300 volts r.m.s. full scale; an audio wattmeter with scales from .15 milliwatt to 150 watts full scale; IM and harmonic distortion measurements; 4-, 8-, 16-, and 600-ohm terminations rated at 32 watts; and decibel meter ranges from -40 to +52 db.

Built-in switching provides complete flexibility. For additional information on the Model 800, including price, contact the manufacturer direct.

#### STEREO AMPLIFIER KIT

Heath Company of Benton Harbor, Mich. has just added a "deluxe" 14-watt stereo amplifier to its line of "Heathkits."

The SA-1 is a two-channel amplifier-preamplifier combination that incorporates six switch-selected inputs for



each channel to accommodate records, tapes, tuners, etc. Two magnetic phono inputs are featured, one for monophonic cartridge and the other for a stereo cartridge, each RIAA equalized. The tape head input is NAB (NARTB) equalized. The remaining three inputs are designated as Auxiliary 1, 2, and

January, 1960

# Individually Selected FOR ABSOLUTE RELIABILITY

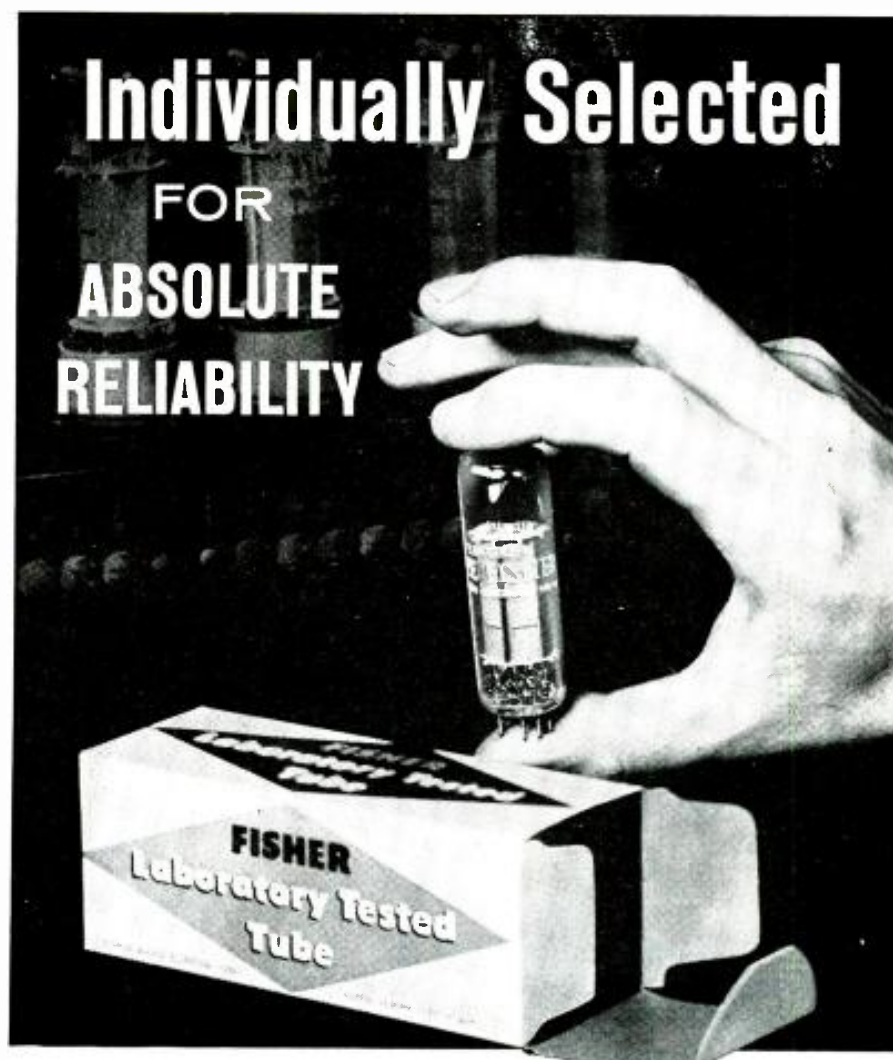

## THE FISHER Laboratory Matched Tubes

At FISHER RADIO, the age of mass production is still on the 'outside looking in.' FISHER Laboratory Tested and Matched Tubes are still individually selected, and *guaranteed* to fulfill the maximum requirements of your high fidelity components.

For absolutely minimum hum, noise and distortion — choose FISHER Tubes. For high fidelity performance free of disturbing microphonics and intermittents — choose FISHER Tubes. For perfectly matched power output tubes designed specifically for stereo reproduction — choose FISHER Tubes. You will find no 'variables' — nothing less than the best in every box.

Audio-Fans, Servicemen, Dealers

WRITE TODAY FOR COMPLETE INFORMATION

FISHER RADIO CORPORATION, 21-40 44th Drive, L. I. C. 1, N. Y.

I want to know more about FISHER Laboratory Matched TUBES!

NAME \_\_\_\_\_

STORE NAME \_\_\_\_\_  
(If a serviceman or dealer)

ADDRESS \_\_\_\_\_ CITY \_\_\_\_\_ STATE \_\_\_\_\_

The Spotlight of Leadership is on.

AWARD WINNING

**arkay**

Kits and Wired.

**HI-FI STEREO**

TODAY'S BEST QUALITY BUY



the Arkay/Harting MS-5  
**STEREO Record TAPE DECK**  
Playback

Precision-engineered to the highest professional standards... a new achievement in tape deck design and performance... Hailed by audio engineers and music lovers alike for its surpassing performance, simplicity of design and operation.

**FEATURES:** Combination head (mu-metal shielded) for 2 or 4 track stereo at both 3 3/4 and 7 1/2 IPS • All-metal tape fingers—no cushions to wear out tape • All-metal tape guards for vertical tape control • Double shoe brakes for positive non-slip stops—minimizes tape stretch • Simple, positive-acting 5-button operation: drop-in loading • Large (1/2" diam.) capstan insures constant tape speed—virtually eliminates wow, flutter, distortion • Automatic interlock prevents accidental erasure • Ultra-narrow (1.2-microns wide) gap heads assure maximum fidelity during record and playback.

**SPECIFICATIONS:** Record and playback frequency response: 7 1/2 IPS, 30-10,000 cycles ± 2 db. Signal-to-noise ratio: better than -55 db. Flutter and wow: at 7 1/2 IPS, 1/4 of 1%; at 3 3/4 IPS, 1/5 of 1%. Rewind time: 110 seconds for 1200 feet. Size: 12-3/16" x 14 1/2" x 6 1/2" deep.

2 Track Only \$129.95 • 4 Track Slightly Higher

**NEW! MUSIC MASTERPIECE**



**ARKAY CS-28**  
**STEREO AMP/PRE-AMP**  
**COMPLETE CONTROL CENTER**

Fulf 28 watts stereo or monaural, 60 watts peak • 14 watts each channel • reverse stereo • balance control • two-channel gain control • full range bass and treble controls • IM distortion, 4 to 1 • harmonic distortion, 1% 30-20,000 cps • dual pre-amp 2V output jacks • speaker outputs, 4, 8, 16, 32 ohms • response, 20-20,000 cps • push-pull EL84 Williamson circuit • beauty of design that won Fashion Foundation's coveted Gold Medal! Many other incomparable features.

Wired and tested \$99.95 Easy-to-build Kit \$64.95



**ARKAY CS-12**  
**STEREO AMP/PRE-AMP**

12 watts of clean power with dual inputs and outputs for excellent stereo reproduction • operates from ceramic or crystal cartridge, tape, tuners, auxiliary equipment • push-pull outputs for each channel.

Easy-to-build Kit \$36.95

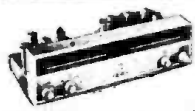

**ARKAY ST-11 AM-FM**  
**STEREO TUNER**

Here, for the first time, is an AM-FM STEREO Tuner within the reach of every audiophile. Unmatched by units costing twice the price, the ST-11 is two distinct receivers in one featuring 4 uV. for 20 db quieting. Variable AFC. Single front panel switch controls AM, FM or STEREO selection.

Wired and tested \$74.50 Easy-to-build Kit \$49.95

**SPA-55 STEREO AMP** 55 watts stereo-monaural. 27 1/2 watts each channel. Wired \$79.95 Kit \$64.95

See and hear ARKAY Kits at your dealer. FREE! Stereo booklet and catalog. Write Dept. EW

**arkay**



88-06 Van Wyck Expressway Richmond Hill 10, N.Y.

3 and may be used for any high-level sources. All inputs, except for the "tape head," feature individual level controls.

A four-position function switch selects "Stereo Normal," "Stereo Reverse," "Channel A," or "Channel B" operation. Thus, any monophonic source can be fed to either channel individually or to both channels simultaneously. Adjustment of the individual channel controls gives a pseudo-stereo effect to monophonic sources.

The circuit incorporates low-noise EF-86's in the input stages and individual hum-balance controls for each channel. Cathode follower outputs are provided for tape recording from any stereo or mono source. The output transformers are tapped for 4-, 8-, and 16-ohm speakers.

Three printed circuit boards make assembly of this amplifier-preamp easy and foolproof.

**PORTABLE TAPE RECORDER**

Ercona Corporation, 16 W. 46th Street, New York 36, N. Y. is handling the U. S. distribution of the Austrian-



built "Stuzzi Magnette" transistorized tape recorder.

Weighing only 8 pounds, the new unit includes a self-contained high flux loudspeaker system which is driven by a 7-transistor, 2-diode amplifier circuit. The double-track, dual-speed (3 3/4 and 1 1/2 ips) unit offers push-button control of stop, record, replay, fast-forward, reverse, and amplifier-only functions. A three-digit counter with zero setting, vu level indicator, plus a pause button and safety control to prevent accidental erasure are also included.

Frequency response is 50 to 9000 cps at 3 3/4 and 60-4000 cps at 1 1/2 ips. Battery life is up to 100 hours and up to two hours of material may be recorded on a single reel. The recorder comes equipped with a moving-coil microphone, reel of tape, empty reel, shielded connecting cable with plugs, and a book of operating instructions.

**28-WATT STEREO AMPLIFIER**

Allied Radio Corporation, 100 N. Western Ave., Chicago 80, Ill. has announced the release of a 28-watt stereo amplifier in its "Knight" line of audio equipment.

The KN-728 provides 28 watts of stereo or monophonic sound with a peak rating of 56 watts. An input-parallel switch permits instant switching from stereo to mono operation.

The dual preamp control section features complete control facilities including master volume, single-knob balance, stereo reverse, and rumble filter. Frequency response is 30 to 18,000 cps ± 1 db. Harmonic distortion



is 1% at 1000 cycles, measured at 14-watt output while IM distortion is 3% maximum. Hum and noise is 70 db below full output on each channel. There are five inputs per channel (NAB tape head, magnetic phono, ceramic or crystal phono, tuner, and auxiliary). Two tape recorder outputs permit "off-the-air" stereo recordings.

For additional information on the KN-728, write the manufacturer.

**NEW LAFAYETTE TUNERS**

Lafayette Radio Corporation, 165-08 Liberty Ave., Jamaica 33, N. Y. has recently introduced two new tuners for the audiophile.

The Model LT-80 is an FM-only tuner which provides a sensitivity of 1.5 μv. for 20 db quieting. The circuit features an Armstrong grounded-grid, low-noise front-end; triode mixer; tuned dual limiters; Foster-Seeley discriminator; and three-gang tuning capacitor. It also includes a.f.c. and a.f.c. defeat along with a precision tuning meter to assure pin-point tuning accuracy. Frequency response is 20 to 20 000 cps ± .5 db.

The second unit, the Model LT-77, is an AM-FM stereo tuner. The AM and FM sections are completely independent permitting the reception of simulcasts or monophonic AM and FM broadcasts. A multiplex output has been provided for the reception of stereo FM.

Controls provide for every tuner function including individual volume

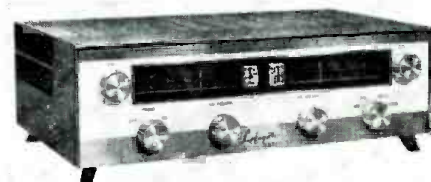

controls, function switch, and flywheel tuning. Sensitivity on FM is 1.5 μv. for 20 db quieting. Radiation meets FCC requirements, while twin tuning meters assure pin-point tuning accuracy. The Model LT-77 is housed in a low silhouette enclosure finished in gold and white with contrasting dial face.

Write the company for full specifications and prices on either or both of these tuners.

**NEW G-E STEREO AMPS**

The Audio Components Section of General Electric Company, Bridgeport, Conn. has recently introduced two new stereophonic amplifiers featuring dual

**ELECTRONICS WORLD**



concentric bass and treble controls.

The Model G-7700 series is available in white vinyl-on-steel case with gold and ivory control panel or in beige vinyl-on-steel case with gold and beige control panel. The Model G-7600 is styled in saddle brown vinyl-on-steel case with gold and brown control panel.

Both series include a balance control to adjust for different speaker efficiencies and for variations in channel levels from the signal source; an input selector for stereo or mono tape, phono, tuner, or auxiliary; a mode selector for stereo channel reverse, normal or parallel, and monaural two channels or either channel only; a contour control to automatically boost bass response at lower loudness levels, and a rumble filter.

#### FISHER SPEAKER SYSTEM

Fisher Radio Corporation, 21-21 44th Drive, Long Island City 1, N. Y. is now offering a new "wide-surround" speaker system which is designed to be used

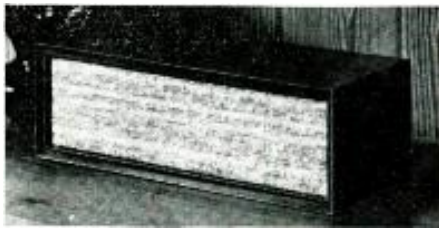

with hi-fi systems where space is at a premium.

The Model WS-1 units reproduce essentially only the middle and high frequencies (250 to 15,000 cps) but, because of the non-directional character of bass frequencies, the illusion of bass frequency reproduction is sustained.

The speaker system can be used with any stereo console or amplifier equipped 4-, 8-, or 16-ohm speaker terminals. The enclosure measures 11 1/2" x 3 7/8" x 4 3/8". It can be used horizontally or vertically for table, floor, or wall installation. It is available in walnut, mahogany, teak, or cherry finishes and priced by the pair. Write the manufacturer for complete details.

#### AUDIO CATALOGUES

##### SCOTT STEREO BOOKLET

H. H. Scott, Inc.'s Architectural Division at 111 Powdermill Road, Maynard, Mass. has issued a new booklet, entitled "How to Use Stereo Components in Your Decorating Plans," which is available without charge on request.

The booklet includes photographs of actual installations, room plans, decorating plans, and suggestions for converting many different kinds of furniture to house audio components. Both contemporary and traditional settings are pictured.

-30-

On page 88 of our November 1959 issue, we inadvertently gave an incorrect address for Sola Electronics Co. in connection with the item on "Turntable Speed Indicator." The correct address is 545 West End Ave., New York 23, N.Y. instead of Chicago. Our apologies for any inconvenience we may have caused our readers.

Now... from Sonotone—

# 4 Big Improvements

in the quality stereo cartridge

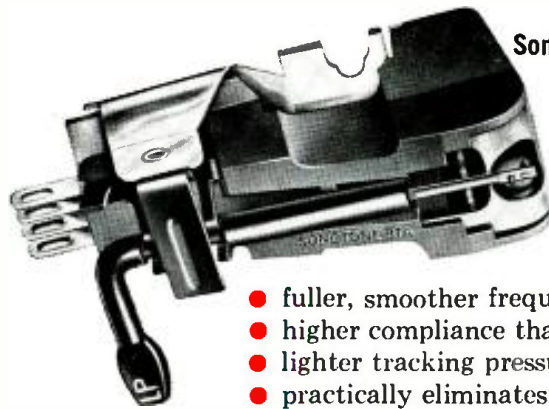

Sonotone 8TA cartridge replaces 8T as industry standard

The new Sonotone 8TA cartridge gives greater than ever stereo performance... has 4 big extras:

- fuller, smoother frequency response
- higher compliance than ever before
- lighter tracking pressure
- practically eliminates dust pile-up

ONLY  
\$1450\*

#### Sonotone 10T unitized stereo at lowest price ever

New 10T cartridge sells at record low price of \$6.45.\* And it covers the complete high fidelity range. 10T's unitized construction makes it easiest to install, easiest to replace. Low price means more sales—more profits.



#### SPECIFICATIONS

	8TA	10T
Frequency Response	Smooth 20 to 20,000 cycles. Flat to 15,000 with gradual rolloff beyond.	Flat from 20 to 15,000 cycles ± 2.5 db.
Channel Isolation	25 decibels	18 decibels
Compliance	3.0 x 10 <sup>-6</sup> cm/dyne	1.5 x 10 <sup>-6</sup> cm/dyne
Tracking Pressure	3-5 grams in professional arms 4-6 grams in changers	5-7 grams
Output Voltage	0.3 volt	0.5 volt
Cartridge Weight	7.5 grams	2.8 grams
Recommended Load	1-5 megohms	1-5 megohms
Stylus	Dual jewel tips, sapphire or diamond.	Dual jewel tips, sapphire or diamond.

\* including mounting brackets

Sonotone makes only 6 basic ceramic cartridge models... yet has sold over 9 million units... used in over 662 different phonograph models. For finest performance, replace worn needles with genuine Sonotone needles.

# Sonotone

CORP.

Electronic Applications Division, Dept. C1-10  
ELMSFORD, NEW YORK



Leading makers of fine ceramic cartridges, speakers, tape heads, microphones, electronic tubes.  
In Canada, contact Atlas Radio Corp., Ltd., Toronto

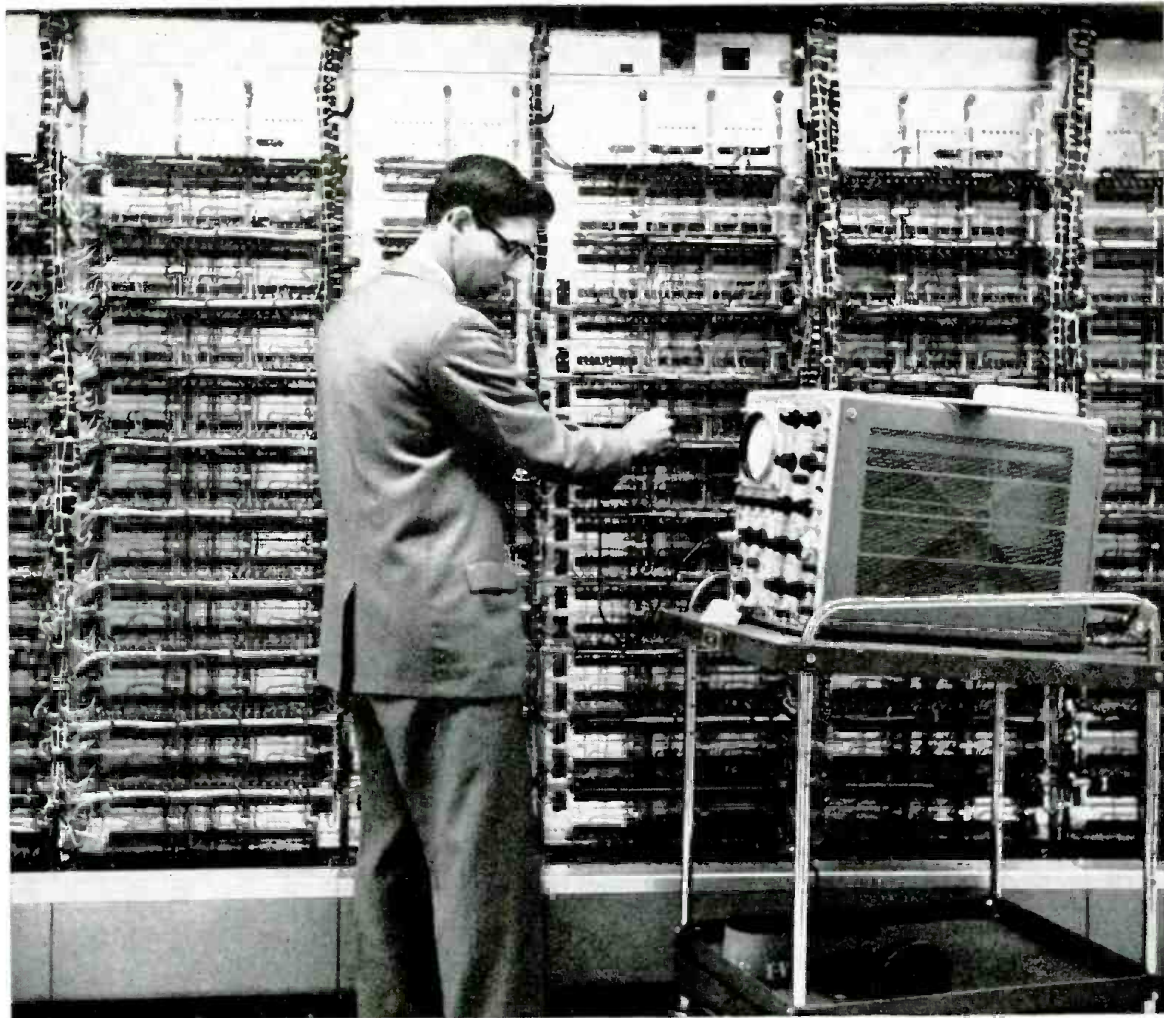

Watching oscilloscope, Bill Wilkerson tests SAGE computer circuitry.

Adjusting SAGE computer operating console.

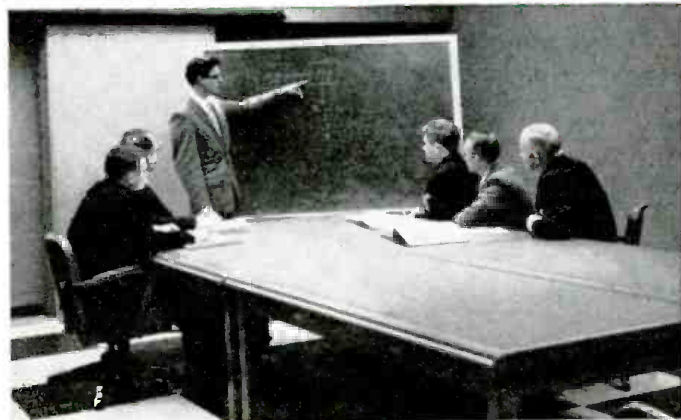

Bill Wilkerson instructs Field Engineers on new computer program.



# How far can you go in electronics... without a degree?

Three years ago, young Air Force veteran William H. Wilkerson set out to find a career in electronics, but he had no industrial experience and no engineering degree. Today, he has a solid electronics education, he is supervising the maintenance of a highly advanced electronic computer, and his future is bright. Here's how it happened...

## SOUGHT ELECTRONICS CAREER

"I was anxious to go to college when I left the service in 1956," recalls Bill Wilkerson. "The Air Force had given me some fine training in electronics, enough to arouse my interest and make me want to learn a lot more. An engineering education seemed to be the answer, but family responsibilities made college impossible.

"I still wanted to work in electronics, however, so I started looking into technician jobs. Most big companies offered me no more than a seat at a test bench eight hours a day—dull, routine work that provided little or no opportunity to learn and grow. All the interesting assignments, it seemed, called for a college degree. Then I had an interview with IBM and found just what I was looking for in the SAGE Field Engineering Program."

## WHAT IS SAGE?

SAGE is a vital part of our country's air defense. To help guard against surprise aerial attacks, SAGE partitions America into several defense sectors. At the heart of each sector is one of the fastest and most reliable electronic computers in the world. This computer receives radar data from many points, checks this against known air traffic in its sector, and makes it possible for Air Force operators manning the computer to identify immediately all flying objects as friendly or hostile. If need be, the computer can also guide a BOMARC missile to an enemy target.

## THOROUGH COMPUTER TRAINING

On joining IBM, Bill Wilkerson was given 20 weeks' computer training as a Field Engineer. He learned how to maintain the various electronic units used in a SAGE computing system, how the SAGE computer itself helps diagnose and locate problem areas, and how to make fast, precise repairs without interfering with computer operation. "It was an excellent education—both in the theoretical and practical aspects of electronics," he says. "Furthermore, you have plenty of opportunities to keep up with new developments in this fast-changing field. After assignment to a SAGE site, for example, you may take courses—during regular working hours—on such subjects as improved output methods or new magnetic 'memory' devices. You may also be selected for additional training to learn the total functioning of a large-scale electronic data processing system."

## ASSIGNMENTS ROTATED

Bill Wilkerson is now a Field Engineering Group Supervisor at a SAGE site. "I help my Group Manager keep the computer in top working condition," he explains. "Together, we provide technical supervision to the Field Engineers in our group and schedule daily maintenance checks to spot computer problems before they develop into breakdowns. An important part of my job is to make up daily assignment sheets, carefully rotating responsibilities so that each Field Engineer moves from one computer unit to another. This 'cross-training' gives each man a chance to become familiar with all the parts of a large-scale computing system and helps him add to his general electronics knowledge."

## RAPID ADVANCEMENT

"When I was first interviewed, I was told that IBM promotes from within," Bill Wilkerson says. "I've found this to be true. In the SAGE computer program, you begin as a Units Field Engineer. Then, depending on your abilities, you can advance rapidly to Systems Field Engineer, Group Supervisor, Group Manager, and on up the line. Every employee receives frequent career counseling to review his progress and to chart his future. In this Company, there are plenty of opportunities for the man who wants to grow and is willing to apply himself."

Bill Wilkerson cites his own career as an example. Since joining IBM three years ago, he's had several promotions, culminating in his present supervisory post. "It's a wide-open field," he says.

## A BRIGHT FUTURE

Although other areas for promotion are open to him, Bill Wilkerson would like to stay in technical management because, as he says, "Frankly, I hardly believed back in '56 that a man like myself without a college education could go so far so fast, have still higher goals—and find such solid help in reaching them."

\* \* \* \*

If you have a minimum of 3 years' technical schooling—or equivalent experience—you may be eligible for advanced training for 20 weeks as a Computer Units Field Engineer. Starting salaries are based on your education and experience. While training you will also receive a living allowance.

From then on, you can go as far as your abilities and ambition will take you. And, as you may already know, at IBM you receive company-paid benefits that set standards for industry today.

**WRITE TODAY TO: Mr. N. H. Heyer, Dept. 650-M  
Federal Systems Division  
IBM Corporation  
Kingston, N. Y.**

You'll receive a prompt reply. Personal interviews arranged in all areas of the United States.



INTERNATIONAL BUSINESS MACHINES CORPORATION

# The Resonance Meter

By JOSEPH L. REIFFIN,  
W5CWP

This easily built unit does many jobs in ham shack or service shop normally provided only by laboratory instruments.

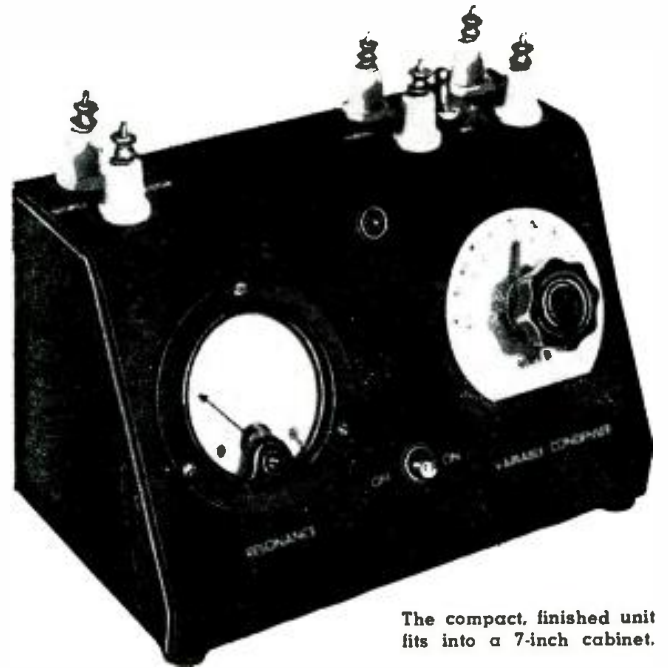

The compact, finished unit fits into a 7-inch cabinet.

OF ALL the phenomena of electronics, that of resonance is one of the most widely used and observed and many instruments for the measurement of resonance have been devised. Some are inexpensive and simple to operate, while others are both expensive and complicated. One would suspect that the inexpensive and simple devices are lacking in some degree, else there would be no need for the more elaborate units. That is true and

the "Resonance Meter" described here is intended to bridge the gap. It is quite inexpensive to build, simple to operate, and provides a number of functions that are not easily performed by the less costly instruments now available.

The grid-dip meter is probably the most popular instrument in current use for measuring resonance. Many radio amateurs, serious hobbyists, and service technicians have a "grid-

dipper" available for measurements of resonance involving coils, r.f. chokes, antennas, and the like. This relatively simple instrument does a fine job but has a number of limitations that somewhat restrict its use.

For example, it is extremely difficult, if not impossible, to measure the resonant frequency of a coil that is completely shielded, with a grid-dip meter. Also the degree of accuracy of the resonance reading is dependent, to a great extent, on the amount of coupling between the circuit being measured and the instrument. This introduces a variable that is difficult to control.

The "Q" meter is one of the most accurate devices available for the measurement of resonance of combinations of inductance and capacitance. Those who have ever used a "Q" meter will readily attest to the ease and accuracy with which the resonant frequency of an unmarked i.f. transformer is found, to cite one example. Or, to use another example, how easy it is to find how much capacitance is required to tune a given coil to a desired frequency. Like most good things, unfortunately, good "Q" meters are quite expensive.

The "Resonance Meter" described here can be built for less than \$20, using all new components. The well stocked "scrounge-box" could reduce that cost considerably.

Basically, the "Resonance Meter" is an amplifier so designed and constructed that the frequency-determining inductance and capacitance can be conveniently plugged into the circuit. The output of this amplifier is fed to a cathode-follower stage, and then to a meter that measures the output voltage. By careful selection of the values of resistance and capacitance used in the amplifier circuit, the usable frequency range extends all the way from the higher audio frequencies to above 50 megacycles. Particular care is re-

Fig. 1. The frequency-measuring device is designed around a single tube.

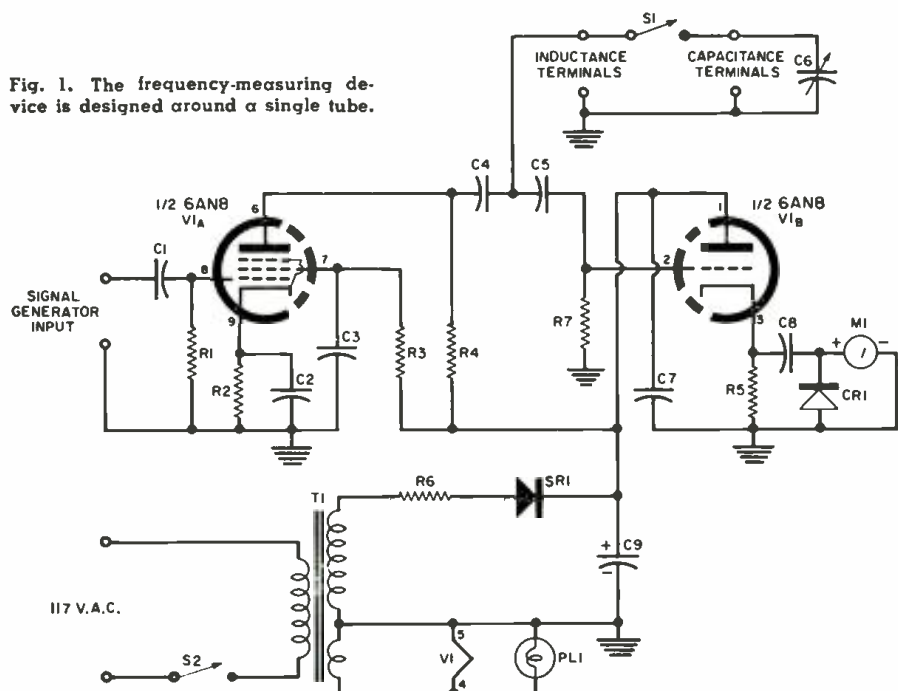

- R<sub>1</sub>—470,000 ohm, 1/2 w. res. R<sub>2</sub>—150 ohm, 1/2 w. res. SR<sub>1</sub>—Silicon rectifier (Sarkes Tarzian M150, Texas Instruments 1N2069 or equiv., see text)
- R<sub>3</sub>—47,000 ohm, 1/2 w. res. S<sub>1</sub>—S.p.s.t. toggle switch ("Capacitance In-Out," see text)
- R<sub>4</sub>—33,000 ohm, 1 w. res. S<sub>2</sub>—S.p.s.t. toggle switch ("Power On-Off")
- R<sub>5</sub>—1000 ohm, 1 w. res. R<sub>6</sub>—22 ohm, 1 w. res. M<sub>1</sub>—0-1 ma. meter, 2" dia.
- R<sub>7</sub>—1 megohm, 1/2 w. res. T<sub>1</sub>—Power trans. 115 v. pri. to 150 v. sec. and 6.3 v. fl. winding (Merit P-3046 or equiv.)
- C<sub>1</sub>, C<sub>2</sub>, C<sub>3</sub>—1500 μf. disc ceramic capacitor PL<sub>1</sub>—#40 or #47 pilot lamp V<sub>1</sub>—6AN8 tube
- C<sub>4</sub>, C<sub>5</sub>, C<sub>7</sub>, C<sub>8</sub>—.01 μf. disc ceramic capacitor 1—7" wide, sloping panel utility box (Bud C-1605)
- C<sub>6</sub>—5-100 μf. var. capacitor (Hammarlund HF-100)
- C<sub>9</sub>—50 μf., 250 v. elec. capacitor
- CR<sub>1</sub>—1N34 germanium diode



quired in the placement of the various components in order to reduce stray capacitance to a minimum.

A 6AN8 tube is used in this circuit. The pentode section makes a good amplifier and the triode section serves very nicely as the cathode-follower. The output of the cathode-follower is rectified by the germanium diode (CR) in Fig. 1) and the resultant voltage is read directly on the output meter.

The "Resonance Meter" is entirely self-contained with a built-in power supply using a small plate and filament transformer to provide safe isolation from the line. It is built into a sloping-panel utility box (Bud C-1605) seven inches wide. The entire amplifier is assembled on an easily constructed aluminum chassis and this is mounted within the utility box.

The tube is mounted upside down in order to keep the leads to the coil terminals and the capacitor terminals as short as possible. Figs. 2 and 3 give some idea as to how this is managed.

It will be noted that the terminals for the signal-generator input and the terminals for the external coil and capacitor are the porcelain feedthrough type commonly used for high-voltage applications. The original model used standard binding posts made of some Bakelite compound. These proved to be unacceptable in this application, since they added so much capacitance and inductance to the circuit that a false frequency reading was obtained. Many different types of binding posts were tried, but it was impossible to find any entirely free from this effect. The use of the high-voltage feedthroughs minimized the added capacitance and inductance effects to the point where they were acceptable.

The toggle switch (S<sub>1</sub>) that enables the calibrated capacitance to be inserted into the circuit also produced this problem and actually no real solution was found. There is evidently a need for a switch with very low capacitance and inductance in a size small enough for this application. If one could be found, it is recommended that it be used in place of the toggle switch the author employed in his model.

The chassis that contains most of the components of the "Resonance Meter" is made from a piece of aluminum stock approximately 2" wide, 5½" long, and ¼" thick, bent into a sort of "L" shape. See Fig. 2. The 9-pin socket for the 6AN8 tube is mounted in the center of the top part of this chassis. The socket is mounted so that the pin terminals face up and the tube, when inserted in the socket, will be upside down. On the top side of the chassis, two tie-point strips are mounted along the edges next to the bottom side of the socket. These provide handy connecting points for the various capacitors and resistors used in the circuit.

The power transformer is mounted on a 2" x 2½" strip of aluminum (Fig. 2) that has a ½" lip on one end for mounting to the main chassis. This is mounted to the right side—looking at the chassis from the rear of unit.

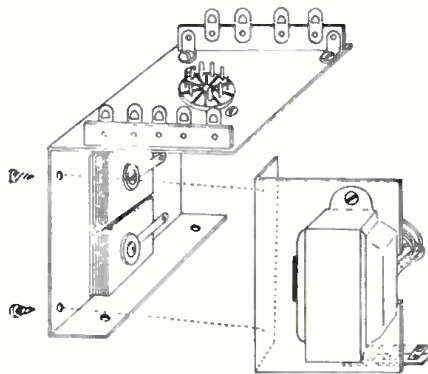

Fig. 2. Layout for two chassis plates and main parts. Two selenium units may replace single silicon diode of Fig. 1.

In the original model, the power rectifier consisted of two 60-ma. selenium rectifiers, connected in series, as shown in Fig. 2. Two were used because the r.m.s. voltage output of the power transformer is 150 volts whereas the maximum r.m.s. voltage rating of the selenium rectifiers is 130 volts each. From a safety standpoint, the use of two rectifiers in series was indicated to take care of the full voltage more than adequately without danger of breakdown. It would doubtless be more convenient and less costly to use one of the newer silicon rectifiers now available, as indicated in the parts list. These rectifiers take up very little space and have r.m.s. voltage-breakdown ratings in excess of 200 volts, which makes them a natural for this application.

The variable capacitor used for external tuning (C<sub>s</sub>) is mounted on the sloping panel of the utility box. The one used was a *Hammarlund* type HIF-100, which is designed to have a straight-line characteristic. The plates of this capacitor are so formed that there is a linear change of capacitance with a given amount of rotation of the

rotor plates. It is, therefore a relatively easy matter to draw a calibrated capacitance scale for this external adjustment. The minimum capacitance is 5 μf. and the maximum is 100 μf. The 180 degrees of rotation between the minimum and maximum is then divided into ten equal divisions and marked with the appropriate capacity values. This may not be an absolutely precise calibration but it is certainly close enough for all practical purposes. It would not vary much more than about 3 or 4 μf. at the very most, and that tolerance is well within the anticipated needs of most users.

The meter, M<sub>1</sub>, is also mounted on the sloping panel of the box. A 0-1 ma. meter provides ample sensitivity and, fortunately, units of this type are readily available at low cost.

The "Resonance Meter" performs many functions. The one that will probably find the greatest application is the determination of the resonant frequency of a coil when tuned either by circuit capacitance or by any size capacitor desired. Specifically, you may want to find out what frequency will be covered by a 20-turn coil of 1-inch diameter when tuned with a 50 μf. capacitor. Or you may want to find out what frequency range will be covered by a slug-tuned coil of any given number of turns by running the slug up and down. These measurements are very simply made in the following manner.

A calibrated signal generator is connected to the input terminals of the "Resonance Meter." This connects the signal to the grid of the pentode section of the 6AN8 tube. The coil under measurement is connected to the inductance terminals. This puts the coil in the plate circuit of the pentode, which circuit is designed so that there is no d.c. present at these terminals—making it safe at all times. The fre-

(Continued on page 100)

Fig. 3. Main chassis ready for mounting in case and location of terminals.

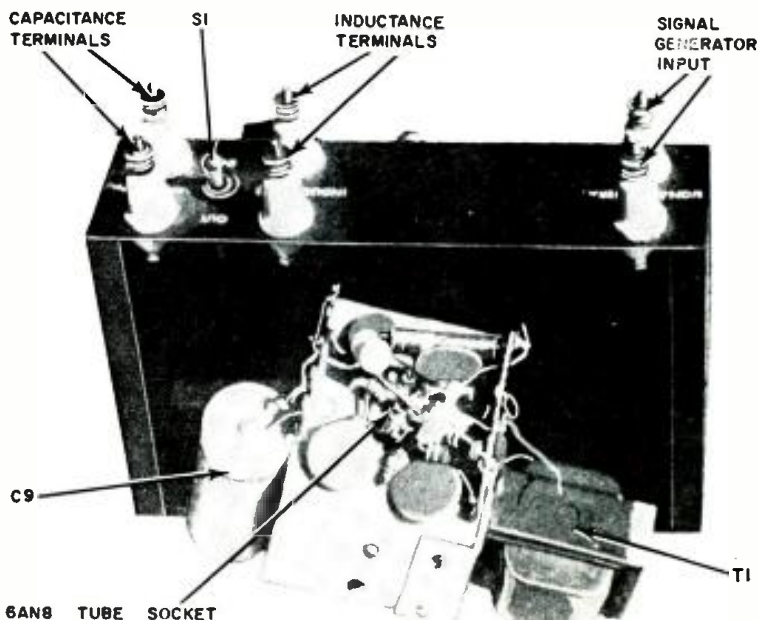

# Plain Facts about ELECTRONICS and CREI

*—why you need advanced  
electronics education*

*—how you can get it without  
quitting your present job*

**N**O DOUBT you know what is happening in electronics. You know that the electronics industry is growing with extraordinary rapidity. You know that regardless of the ups and downs of the business cycle, openings are always found for men with solid, advanced electronics education.

You know that every computer needs installation and maintenance. You know that every missile carries the end result of years of electronics planning and development. You know that every piece of radar equipment, every servomechanism, every astronomical device, requires not only electronics designers and builders but also electronics maintenance personnel as well. You know that our new awareness of outer space is founded on the inner workings of satellites. Rockets make them possible and elec-

tronics guides them and makes them intelligible.

And you know that the day of the mediocre electronics man is done. Added responsibilities and salary increases go to men with both theoretical and practical knowledge.

CREI home study courses make you eligible for positions which require advanced electronics education. You need not quit your present job. You can meet your family responsibilities while gaining knowledge of electronics engineering technology so essential for career advancement.

## CREI'S QUALIFICATIONS

We are now in our 34th year. 1958 marked the start of CREI Atomics, a division of CREI devised to meet the need for advanced home study education in nu-

clear engineering technology. 1958 also marked the opening of our European Division, bringing advanced professional electronic education to Western Europe.

Since 1927 we have directed technical education of thousands—individuals and in groups—in electronics engineering technology. We developed the first civilian pilot course for radio mechanics for the Army Signal Corps in 1941, supplied 300,000 texts to the U. S. Navy in a special course for radio technicians in the South Pacific in 1943, trained hundreds of technicians during World War II for the Signal Corps. We co-founded the National Council of Technical Schools, which first established scholastic and business standards for the technical school field. We were among the first three technical institutes whose curricula were accredited by the Engineers' Council for Professional Development. In 1946 we instituted the group training programs now used by companies which represent the cream of the electronics

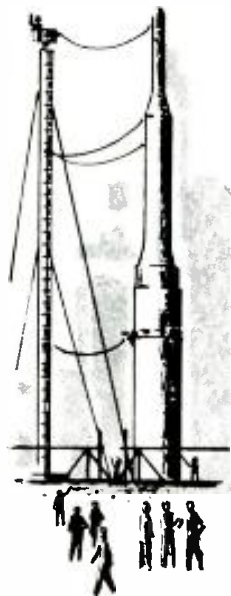



and aviation industries. In 1957 we initiated a plan which permits direct personal supervision for home study final exams.

What does this record of achievement mean to you as a CREI student? It means that industry and the Armed Services alike respect CREI men. It means that your CREI diploma is a door opener.

Significantly, Help Wanted ads often specify "CREI education or equivalent required." Our Placement Bureau, which helps graduates and advanced students find more desirable positions, is always available to CREI men. While no placement guarantees will be made by CREI or any other reputable institution, for many years the demand for CREI graduates and advanced students has far exceeded the supply.

Paul S. Lewis, Jr., a research assistant in an AEC-sponsored nuclear physics research program—and a CREI student—writes, "Like most large-scale physics projects, this machine (a proton accelerator) is largely electronics. The need for electronics technicians on basic scientific research projects will no doubt continue to grow."

Charles E. Lawson, another CREI student, brings out another point: "The fact that I am enrolled with CREI was met with enthusiasm on the part of my employer, Wright Airborne Electronics. A former student of CREI is now chief engineer for the company."

### CREI HOME STUDY ADVANTAGES

Technical education is accomplished on your own time, during hours chosen by you. You waste no time in travel. You have plenty of time to do your best. Your work is under the supervision of a regular staff instructor who guides your progress step by step. Courses are prepared by experts, presented in easy-to-understand form, kept up to date by periodic revision. Experience in more than three decades of home-study teaching, during which



time we have corrected and commented on many hundreds of thousands of examinations, enables us to avoid difficult-to-understand text matter in our lessons.

### CREI STUDENTS

Our active home study roster today numbers more than 20,400 professional electronics engineers and technicians, all over the world and in every phase of electronics, about one-third military, the rest civilian. Their median age is 28. Last year they devoted approximately 1,572,465 hours to 104,831 lesson texts, answered (and were individually graded upon) 1,048,310 searching questions and engineering problems. They studied electronics engineering technology—transistors, microwaves, forward scatter, computers, servomechanisms, radar, electronic navigational devices, and the entire field of modern electronics. New students enrolled during the year



are on the missile ranges of Vandenburg AF Base and Cape Canaveral. They are at Alamogordo and China Lake, at SAC bases around the world. They are in the research laboratories and manufacturing plants where the latest electronic equipment is designed and produced. They maintain electronic equipment for United Air Lines and Trans-Canada Air Lines. They share in electronics at All-America Cables and Radio, Inc., and The Martin Co. They work for U.S.I.A. (Voice of America) and Columbia Broadcasting System, for Gates Radio and Federal Electric, to name but a few. All of the firms mentioned offer their personnel CREI technical education under company plans. CREI men are found by the hundreds among field engineers of major electronic manufacturers. They're across the world—and across the street. They are the men you must compete with to hold your place in the electronics profession. Wouldn't you like to be as well qualified?

### QUALIFICATIONS FOR CREI

College degree is not essential. If you have had basic electronic education, practical experience in electronics, and a high school education, you can probably qualify. A good way to find out: Use the postage-paid card. It will bring you the free book which has launched thousands on their advanced careers: "Insurance For Your Future in the New World of Electronics." Please fill out the card carefully, checking appropriate items and providing essential data. Tuition is reasonable and may be paid monthly. It takes just one \$10-a-week raise to repay your investment in CREI education and leave you a substantial bonus the first year. Available to veterans under GI bill.



Future in the New World of Electronics." Please fill out the card carefully, checking appropriate items and providing essential data. Tuition is reasonable and may

### LATEST CREI COURSE

Automation and Industrial Electronics Engineering Technology. Complete course, covering all electronic phases of automation. Special emphasis on theory, functioning and applications of servomechanisms and computers. Also noteworthy—lessons on machine control, instrumentation, data processing and telemetry.



### RESIDENCE SCHOOL

For those who can attend classes, CREI operates residence programs in Washington, D. C. Day and evening classes start at regular intervals. Qualified graduates earn AAS degree in 27 months. Electronics experience not required for admission.

### CAPITOL RADIO ENGINEERING INSTITUTE

Founded 1927  
EOPD Accredited Technical Institute Curriculum  
Dept. 1101-G1  
3224 16th St., N.W.  
Washington 10, D. C.

You can . . .

**PICK UP A HUMAN HAIR with  
These Precision-Machined Points**

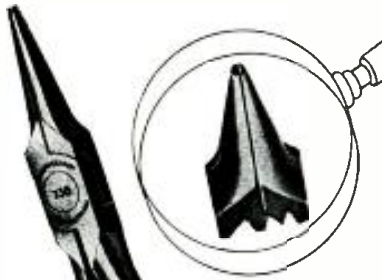

# 738  
LONG-REACH  
ROUND-NOSE  
PLIER

*Specially Designed*

**CHAN NEL LOCK**

## **ELECTRONICS PLIERS**

You'll do hundreds of electronics jobs easier, faster with these specially designed pliers by Channellock. You'll like the l-o-n-g reach . . . the precision-matched jaws . . . the hand-honed, specially hardened cutting edges . . . the easy-to-handle "feel" of the blue plastic grips. And you'll appreciate the quality of Channellock pliers . . . they're forged from high grade steel, properly heat treated. Ask your Electronics Equipment Supplier for Channellock Electronics Pliers . . . or write us direct for further information.



# 718 LONG-REACH FLAT-NOSE PLIER



# 728 LONG-REACH DIAGONAL CUTTER



# 748 LONG-REACH END CUTTER.

Channellock Pliers are made only by

**CHAMPION DEPARTMENT TOOL COMPANY**  
Meadville, Pennsylvania

### **The Resonance Meter**

*(Continued from page 95)*

quency of the signal generator is then varied until a reading is obtained on the output meter. The frequency that produces the peak reading on the meter is the resonant frequency of the coil.

If it is desired to tune this coil with any given amount of capacitance, all that is necessary is for the capacitance switch to be thrown to the "in" position. This connects the 100  $\mu\text{f}$ . variable capacitor across the coil and any desired amount of capacitance can be inserted. The frequency of the signal generator that produces the peak reading of the output meter is the resonant frequency of the coil and capacitor combination. If more capacitance than the 100  $\mu\text{f}$ . built into the meter is desired, it is a simple matter to connect the required additional capacitor to the capacitor terminals on the meter. This automatically puts the added component in parallel with the 100  $\mu\text{f}$ . variable, and there is no limit to the amount of capacitance that can be inserted in this way.

The meter readings obtained are very sharp and clearly defined. Due to the sensitivity of this instrument, care must be taken to insure that a false reading is not obtained through inadvertent peaking on a harmonic of the signal generator. This is very easily checked out, however, by tuning the signal generator through the next higher frequency range and, if no peaking is obtained, then the highest frequency that did produce the peaking is the correct reading. In actual practice, the readings obtained from the fundamental frequencies are considerably higher than those obtained from the harmonic frequency due to the greater fundamental output from the signal generator. This fact will also help to avoid error.

#### **Operating Techniques**

Some of the many special functions that this device will perform include the relative measurement of the "Q" of a coil or capacitor and a check of the bandpass characteristics of a tuned circuit. The methods involved will be discussed subsequently. However, to the author, one of the most gratifying uses has been the determination of the proper combination of coil and capacitor to provide a desired range of tuning. Specifically, this is of interest in arriving at suitable values for the right amount of bandspread in a ham receiver or a transmitter v.f.o.

It is quite simple to insert a coil of a given size in the meter experimentally and to determine how much capacitance is required to tune it to a desired frequency. Once the capacitance is determined, the latter may then be varied to see how much the resonant frequency changes with capacitance variations. By changing the value of the coil experimentally, it is then pos-

sible to arrive at the right combination of values of inductance and capacitance that will provide the exact amount of bandspread required.

While this determination usually constitutes a knotty problem, the suggested method not only provides a simple solution but an accurate one, as well. The amplifier used in the meter simulates closely, as a rule, the stray circuit and tube capacitances in those circuits of conventional receivers and similar equipment in which the coil-capacitor combination will be used. Thus there is very little change when the tested components are transferred to the circuit for which they have been selected.

It is also a very simple matter to measure the relative "Q" of a coil or capacitor. Since "Q" is a figure of merit, a coil having a high "Q" will give a higher meter reading than one having a lower "Q". The same is true of a capacitor. The relative "Q" of a capacitor can be quickly determined by substituting various capacitors of the same nominal value across the test coil. The capacitor that gives the highest meter reading has the highest "Q" of those being tested. This test will graphically illustrate how important it is to use high-quality components in tuned circuits, especially at the higher frequencies, if any reasonable efficiency is desired.

It is also possible to measure the bandpass characteristics of a given tuned circuit. Most bandpass characteristics are measured on the resonance curve at a point 6 db down from maximum. Using the coil and capacitor combination under test in the "Resonance Meter," the frequency of the signal generator is varied until a peak reading is obtained on the meter. This is the center frequency of this resonance curve. If there is an attenuator on the signal generator, vary the output until a convenient reading of, say, .8 ma. is obtained on the meter. The frequency of the signal generator is then shifted higher in frequency until the meter reads exactly one half of the center frequency reading; in this case, .4 ma. This frequency is noted. Then the frequency of the signal generator is changed again, this time to the low-frequency side of the center frequency, until the meter once again reads half of the maximum reading. These "half-maximum" readings are the "6 db points" down the slope of the resonance curve. The frequency spread between the high-frequency reading that gave the .4 ma. meter reading and the low-frequency reading that gave the same .4 ma. meter reading is the bandpass of that particular coil and capacitor combination at 6 db down.

The number of uses to which the "Resonance Meter" can be put seems to be unlimited. It has proven itself invaluable many times and has taken a well-deserved place right next to the author's overworked and uncomplaining v.t.v.m. Build it and see if you don't agree. —30—



# "best 35¢ I ever spent"...

From every corner of the electronics world comes this unanimous report:

**RADIO SHACK'S NEW "KING SIZE" CATALOG — A 312-PAGE "GUIDE TO ELECTRONIC BUYING" — is the most comprehensive, most exciting publishing achievement in electronics history. Send for your copy today. It's a typical Radio Shack bargain!**

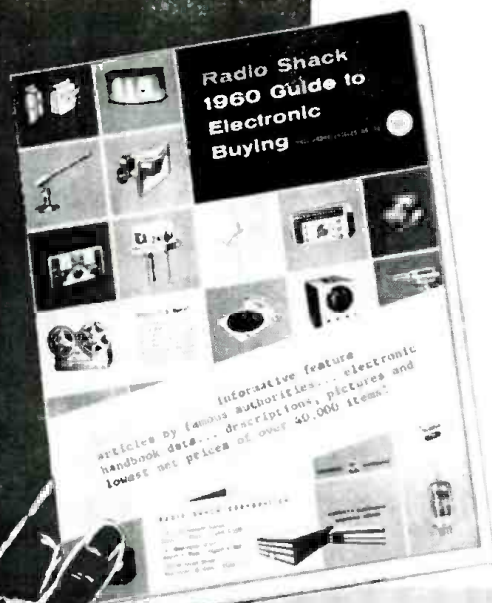

look what  
you get:

OVER 300 JUMBO  
8½ x 11 PAGES

Thousands of electronic and hi-fi items. Detailed "specs" and illustrations. Fine rotogravure printing.



"Outstanding in the industry . . .", comments a Pennsylvania hi-fi enthusiast. "Tops! . . .", says a Michigan radio amateur. A University Professor asks, ". . . is it available in quantities for our students as a supplement to our textbook?" A hi-fi manufacturer writes, ". . . congratulations . . . excels all others I have ever seen". A laboratory notes, ". . . and we were pleased with the fine illustrations and informative listings".

84,000 copies of this valuable new Radio Shack Guide have already been sold in the two short months since its publication! By phone, letter and wire, hundreds of unsolicited "testimonials" tell us that we've published not merely another "free catalog", but literally an electronics education worth many dollars. Everything new, everything you need to know — everything that represents value — in today's wide world of electronics is yours in its 312 rotogravure 8½ x 11 pages.

Over 40,000 products are listed — test equipment, laboratory supplies, stereo and high fidelity components and accessories, products for industry, public address, nam gear, optical goods, electronic textbooks, records, tape, tools — with lowest net prices, clearly written specifications, fine quality halftone illustrations. There's not only a complete Product Index, but a Manufacturer Index that amounts to practically a "Who" of Electronics.

You'll find stimulating articles and helpful engineering data, too. On pages 8-9, for example, is an article entitled "Selecting Your Stereo System" written by an expert in the field. On pages 41-42 the internationally known authority G. A. Briggs explains his latest theories on "Room Acoustics". And beginning on page 301 you'll see Radio Shack's quick-reference "Handbook" of electronic specifications, symbols, schematic diagrams and formulas for students, experimenters, laboratories and engineers.

Fill out the coupon right now. You'll agree it's the best 35¢ YOU ever spent.

### ARTICLES BY LEADING AUTHORITIES

Expert opinion and latest theories about Stereo, Room Acoustics, Speaker Placement, Amplifiers, Cartridge Design — many more!

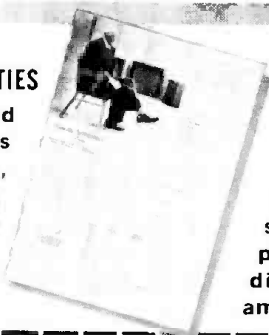

### USEFUL FORMULAS, SYMBOLS, DIAGRAMS

Hundreds of them — for students, engineers, laboratories, industry, schools, shops, experimenters, audiophiles, radio amateurs.

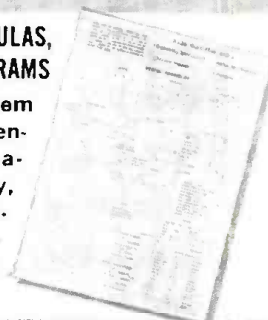

**RADIO SHACK CORPORATION**

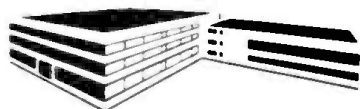

167 Washington St., Boston 8, Mass.  
730 Commonwealth Ave., Boston 17, Mass.  
230-234 Crown St., New Haven 10, Conn.  
January, 1960

**MAIL THIS COUPON NOW!**

RADIO SHACK CORPORATION, Dept. 1F, 730 Commonwealth Avenue, Boston 17, Mass.

Please send **POSTPAID** the new 1960 Radio Shack Guide to Electronic Buying. I enclose 35¢

Name.....  cash

Address.....  check

City.....Zone.....State.....  money order

New Guide also on sale in our 3 stores



newest **knight-kits**® ... years-ahead  
A PRODUCT OF ALLIED RADIO



incomparable **knight-kit** stereo hi-fi saves you up to 50%

**DELUXE 40-WATT STEREO AMPLIFIER KIT**

Y-774D

**\$7950**

\$5 Down

Finest hi-fi stereo amplifier you can buy in money-saving kit form. Features special full-frequency range, extra center-channel output for 3-speaker systems. Dual built-in equalized preamps accommodate every existing sound source; exceptional control versatility, including single knob channel balance and separate dual concentric tone controls for each channel. Outputs for stereo tape recording. Exclusive printed circuit switches and plug-in units for easy assembly. Custom-styled in Cordovan gray vinyl plastic bonded to steel; Desert Beige and Sand Gold extruded solid aluminum escutcheon; 4 1/8 x 15 1/2 x 11 1/4". Shpg. wt. 24 lbs.

Model Y-774D. 40-Watt Stereo Amplifier Kit.

**\$5**

DOWN

**DELUXE STEREO FM-AM TUNER KIT**

Y-731D

**\$8750**

\$5 Down

Distinguished for quality and styling, years-ahead in features. Has completely independent FM and AM sections, each with moving-bar "magic eye" tuning indicator. Only tuner kit with Dynamic Sideband Regulation (DSR) on FM for purest, distortion-free reception. Sectionalized construction permits easy addition of "built-in" multiplex. Has 2 1/2 μv sensitivity. Double limiter-discriminator FM circuits—adjustable AFC. Separate cathode-follower outputs on FM and AM with level set controls. Precisely aligned RF and IF transformers in FM section. Printed circuit boards for fastest, easiest assembly. Styling matches the 40-watt amplifier; 4 1/8 x 15 1/2 x 12". Shpg. wt., 18 lbs.

Model Y-731D. Stereo FM-AM Tuner Kit.

**\$5**

DOWN

there is a money-saving **knight-kit** for every hi-fi need



**20-Watt Stereo Amplifier**  
Truly a super-value. Built-in equalized preamps; single-knob selector switch for control convenience; dual concentric, clutch-type level control. 17 lbs.  
Y-773D. \$2 Down. Only **\$4450**

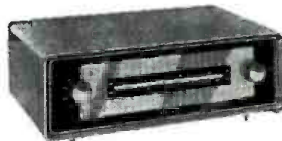

**FM-AM Hi-Fi Tuner Kit**  
Amazing buy, featuring: Tuned RF stage; high sensitivity; AFC; flywheel tuning; pre-aligned IF and RF coils; cathode follower output. Truly great value. 14 lbs.  
Y-787D. \$2 Down. Only **\$4995**



**18-Watt Hi-Fi Amplifier Kit**  
A brilliant performer at unbelievable savings. 18 watts at only 0.5% distortion; RCA 6973 audio output tubes; 8 inputs; 7 record equalization settings. 15 lbs.  
Y-797D. \$2 Down. Only **\$3995**

**SEE THEM ALL**  
See the impressive selection of Hi-Fi Knight-Kits (including speaker systems) in the money-saving 1960 ALLIED Catalog. If you haven't a copy, send for it today.

**FREE**

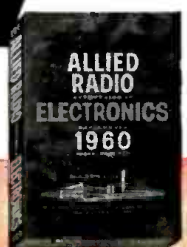

**ONLY \$5 DOWN (OR LESS)** on orders up to \$200; up to 24 months to pay. Fast handling—no red tape—take advantage of these easiest-pay terms...



for you who want to build the very best for less...



IDEAL FOR HOME,  
AUTO OR BOAT



all-new **knight-kit** citizens band transceivers... 2-way radio everyone can afford

**CITIZENS BAND SUPERHET TRANSCEIVER KIT**

**Y-712D**  
**\$79<sup>95</sup>**  
 \$5 Down

A high-sensitivity do-it-yourself transceiver for efficient, economical 2-way radiotelephone communication. Any citizen, 18 or older, can get a license—no exam required. For mobile or stationary use. Covers up to 20 miles, depending on antenna height and terrain. Works just like an intercom, with talk-listen operation. Receiver is sensitive superhet; tunes all channels continuously. 5-watt transmitter section. Built-in AC power supply. With transmitting crystal (available for any channel from 1 to 22—specify preference) and doublet antenna. Extras available: Y-723, 6-12 v. DC power supply, \$10.95; Y-729 vertical antenna, \$6.50; Y-714 mobile mounting bracket, \$5.35. Distinctive high-impact styrene case; 5 x 12 x 12". Shpg. wt., 20 lbs.

**Model Y-712D.** Superhet Transceiver Kit.

**\$5**  
DOWN

**CITIZENS BAND TRANSCEIVER KIT**

**Y-713D**  
**\$39<sup>95</sup>**  
 \$2 Down

Low-cost super-regenerative receiver and 5-watt transmitter kit. Readily fits car, boat or desk. Simple, one-switch operation permits talk or listen. Receiver tunes all 22 channels continuously. Built-in AC power supply. With mike, transmitting crystal—specify channel (1 to 22) if you have a preference—and doublet antenna. Handsomely styled case; 6 x 10 x 8". Designed for easy assembly and dependable operation. Available extras: Y-723, 6-12 v. DC power supply, \$10.95; Y-729 vertical antenna, \$6.50; Y-724 mobile mounting bracket, \$5.35. Shpg. wt., 10 lbs.

**Model Y-713D.** Transceiver Kit.

**\$2**  
DOWN

dozens of exciting hobbyist kits available



**"Span Master" 4-Band Radio Kit**  
 Famous for world-wide short-wave and broadcast reception. True band-switching; continuous 4-band coverage from Broadcast to 30 mc. Sensitive regenerative circuit; 4" PM speaker. With cabinet. 8 lbs.

**Y-258D.** \$2 Down. Only..... **\$25<sup>95</sup>**

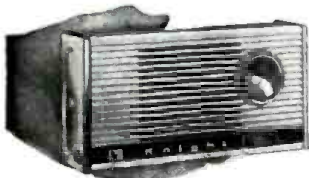

**5-Transistor Portable Radio Kit**  
 Popular, low-cost personal portable. Fun to build; superhet circuit; only 22 ounces; big 3 1/2" speaker; built-in ferrite loopstick; phone jack. (Less battery, \$1.30.) 2 lbs.

**Y-771D.** \$2 Down. Only..... **\$25<sup>95</sup>**



**"Ranger" Clock-Radio Kit**  
 Easiest superhet of all to build—plug-in modules and printed circuit board eliminate small parts assembly. Excellent AM broadcast reception. Telechron clock has "sleep" switch. With appliance outlet. 6 lbs.

**Y-737D.** \$2 Down. Only..... **\$24<sup>95</sup>**

**SEE THEM ALL:** Knight-Kits offer the most exciting hobbyist kits available. See the complete selection in the 1960 **ALLIED** Catalog. Write for it now—use coupon on page following.

**FREE**

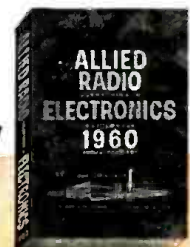

manufactured and sold exclusively by **ALLIED RADIO** 100 N. WESTERN AVE., CHICAGO 80, ILL.





newest **knight-kits**® ... years-ahead  
A PRODUCT OF ALLIED RADIO



**knight-kits** break through the professional instrument price barrier

**5" LAB DC SCOPE KIT WITH IVA**

**Y-611D** For the first time in easy-to-build kit form—a triggered sweep DC precision quality lab scope with plug-in interchangeable vertical amplifiers (IVA). Brilliantly engineered with an impressive array of professional features, including: crystal-controlled timing markers; DC amplifiers in both horizontal and vertical channels; electronically regulated power supply; sweep timing adjustable to 1%; built-in voltage regulated peak-to-peak calibrator. Three interchangeable vertical preamplifiers are available: high-gain differential, \$35.95; wide-band (to 10 mc), \$24.95; dual-trace, \$48.95. **There is no other instrument like this in kit form**—here is laboratory precision quality and reliability at far less than the cost of any comparable factory-built unit. Shpg. wt. 50 lbs.  
**Model Y-611D, Lab DC Scope Kit.**

**\$285<sup>00</sup>**  
(less preamps)

**\$10**  
DOWN

Available in March—reserve yours now

**LAB AUTOMATIC AC VTVM KIT**

**Y-608D** A major achievement in instrumentation! This all-new AC VTVM features **automatic range selection**—by means of an electronically-actuated self-seeking mechanism which automatically selects the proper range when you touch probes to the circuit under examination. Simultaneously, a front panel light indicates the range in use. Covers 11 ranges from 3 millivolts to 300 volts full scale; frequency response to 2.5 mc. Reads as low as 100  $\mu$ v. Highly stable 3-stage amplifier has cathode follower output; ideal for use as preamp for other test equipment or for connection to scope for simultaneous wave form observation. Includes precise trigger circuits; regulated power supply; latest printed circuitry for easy assembly and quality performance. An exclusive Knight-Kit development—there is no other instrument like it on the market, in any form or at any cost.  
**Model Y-608D, AC VTVM Kit.**

**\$99<sup>50</sup>**  
\$5 Down

**\$5**  
DOWN

save on every instrument need with **knight-kits**... best by design



**Famous-Value VTVM Kit**  
Measures DC voltage (11 meg. input) and resistance; AC voltage, rms and peak-to-peak. 4½" meter. Push-pull balanced bridge circuit. 7 lbs.  
**Y-125D. \$2 Down. Only \$25<sup>75</sup>**



**Deluxe Tube Checker Kit**  
Checks over 700 receiving type tubes. 16 filament voltages. Tests cathode emission as well as shorts, open elements, etc. 15 lbs.  
**Y-143D. \$2 Down. Only \$32<sup>95</sup>**



**5" Wide-Band Scope Kit**  
Top versatility. 5 mc bandwidth; DC coupled p-p output amplifiers; 25 mv/inch vertical amplifier sensitivity. Outstanding value. 29 lbs.  
**Y-144D. \$5 Down. Only \$65<sup>75</sup>**

**SEE THEM ALL**  
You'll find dozens of other fine quality Knight-Kit instrument values fully described in the 1960 ALLIED Catalog. If you haven't a copy, write for it now—use coupon on opposite page.

**FREE**

send for the value-packed 1960 ALLIED CATALOG



electronic achievements at half the factory-built cost



years-ahead *knight-kit* amateur gear

**T-400 AMATEUR 400-WATT TRANSMITTER KIT**

Y-716D  
**\$395<sup>00</sup>**  
400-Watt CW  
Transmitter

Truly the "dream" transmitter—has what it takes to punch out a QRM-busting SSB, AM, or CW signal. 600 watts P.E.P. input on SSB; 400 watts on AM and CW. Covers 80, 40, 20, 10, and 15 or 6 meter bands. Start with the basic CW kit— then add AM and SSB accessory units and other "add-ins" whenever you wish. Has heterodyne VFO to assure a signal which "stays put." Tremendous 14" dial is precision-calibrated for all bands, 80 through 6 meters. SSB features: front panel controls—VOX, anti-trip and adjustable speech compression. Smooth, chirpless screen-clamp keying, plus VFO keying for complete CW break-in. Has 7034/4X150A final—coasts along well within its CCS ratings; silicon rectifier power supply runs cool. Dozens of advanced features put this job in a class all its own. Shpg. wt. 140 lbs.

Model Y-716D. T-400 CW Transmitter Kit.

Available in March—reserve yours now

"Add-In" Accessories: SSB Generator Kit, \$69.95 • AM Modulator Kit, \$24.95 • Speech Amplifier Kit, \$9.95 • Monitor Scope Kit, \$37.95 • 6-Meter Conversion Kit, \$7.50.

**\$10**  
DOWN

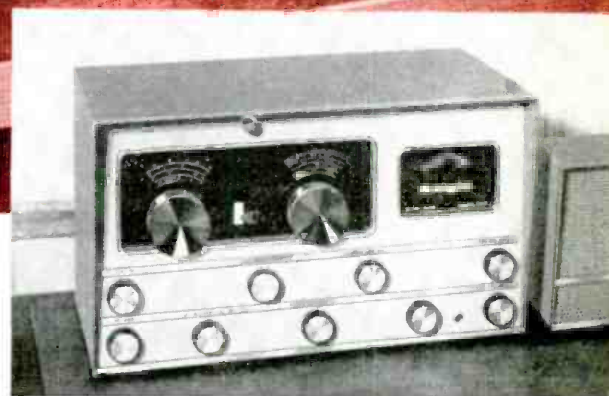

**R-100 AMATEUR RECEIVER KIT**

Y-726D  
**\$104<sup>50</sup>**  
\$5 Down

Incomparable receiver kit with all the features, selectivity and sensitivity of high-priced commercial units. Tunes 540 kc to 30 mc in 4 bands; calibrated bandspread on all Ham bands; 300 cps to 4.5 kc selectivity; exclusive printed-circuit bandswitch; built-in Q-multiplier; constant-running HFO—dozens of other professional features. Truly superior kit value. 30 lbs.

Model Y-726D. R-100 Receiver Kit. **\$5** DOWN

Y-727D. S-Meter Kit for above, only..... \$10.75  
Y-728D. 4" Matching Speaker, only..... 7.50

**FREE** Send for the 1960  
**ALLIED CATALOG**

Describes the complete KNIGHT-KIT line in detail—the leading Buying Guide for everything in Electronics. Send for your FREE copy. Use coupon at right.

**ALLIED  
RADIO**

pioneers in quality electronic kit development

OUR 39th YEAR

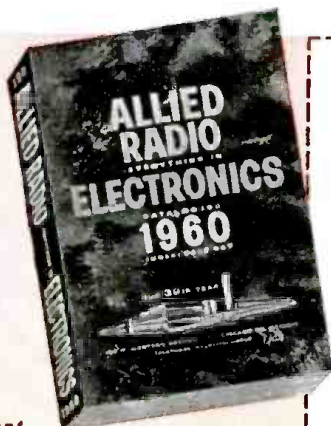

**ALLIED RADIO CORP., Dept. 131-A**  
100 N. Western Ave., Chicago 80, Ill.

Ship me the following KNIGHT-KITS:

Quantity	Description	Model No.	Price

\$..... enclosed. (For parcel post include postage; express shipped collect)

Send **FREE 1960 ALLIED CATALOG**

Name \_\_\_\_\_

Address \_\_\_\_\_

City \_\_\_\_\_ Zone \_\_\_\_\_ State \_\_\_\_\_



...Build the Best

Portable... **EICO**



**6-TRANSISTOR RADIO RA-6**

Kit \$29.95 Wired \$49.95

INCLUDES F.E.S., LESS 9V BATTERY

Easy creative fun to build... a lifetime of big-set entertainment wherever you go... designed so that even the novice can build it & obtain a handsome professional assembly & outstanding performance. American-made modern super-heterodyne all-transistor circuitry, plus finest quality parts throughout, assure you of highest durability & stability.

- high sensitivity & selectivity • big-set volume & tone quality with 4" x 6" PM speaker & 250 mw push-pull audio output stage
- built-in Ferrite rod antenna for good reception in any location • pre-aligned RF & IF transformers • planetary vernier tuning (7:1 reduction) for easy station selection & tuning
- high-impedance earphone jack for private listening; eliminates drain of output stage when using earphone • attractive tan leatherette case, retractable handle • compact: 8 1/2" w, 4 1/2" h, 2 1/2" d. Only 3 lbs.

Build the BEST BUYS in

"HAM" gear... **EICO**



**90-WATT CW TRANSMITTER #720**  
Kit \$79.95 Wired \$119.95

"Ideal for veteran or novice" — ELECTRONIC KITS GUIDE. "Top quality" — POPULAR ELECTRONICS. "Well designed" — ELECTRONIC WORLD. 80 thru 10 meters with one-knob band-switching. Full "clean" 90W input, 65W external plate mod. Matches loads 50 to 1000 ohms. May be used as basic exciter unit. TVI shielded. Tubes: 6146, 6CL6, 2-6AQ5, GZ34. Attractive "living room" low-silhouette design. 15" w, 5" h, 9" d.

**UNIVERSAL MODULATOR-DRIVER #730**

Kit \$49.95 Wired \$79.95 Cover E-5 \$4.50

Delivers 50W undistorted audio. Modulates transmitters having r.f. inputs up to 100W. Unique over-modulation indicator. Output transformer matches 500-10,000 ohms. Low-level speech clipping & filtering. Inputs for xtal or dynamic mikes, phone patch, etc. 7 tubes. 6" h, 14" w, 8" d.

**GRID DIP METER**

Kit \$29.95 Wired \$49.95 #710

Includes complete set of coils for full band coverage. 400 kc-230 mc in 8 overlapping ranges. 500 ua meter. Plug-in coils are pre-wound, pre-calibrated to 0.5% accuracy. Transformer-operated power supply. 2 1/4" h, 2 3/4" w, 6 7/8" l.

Compare—judge for yourself—at your neighborhood EICO distributor. For free catalog on 65 models of EICO test instruments, hi-fi & "ham" gear, fill out coupon on Page 36

**EICO** ELECTRONIC INSTRUMENT CO., Inc.  
3300 N. Blvd., L. I. C. I., N. Y.

Thoughts on Amplifier Design

(Continued from page 69)

problems. application of this method is limited to 20-26 db of usable feedback, which represents a 10:1 to 20:1 reduction of distortion products.

Careful listening tests of amplifier performance prove that extremely stable amplifiers with high degrees of feedback provide a noticeable improvement in sound quality and a definite reduction in listening fatigue. This improvement can be attributed to lower harmonic and intermodulation distortion products, more linear phase characteristics, and improved transient response.

A "multiple loop" approach to increasing the degree of usable feedback is the most logical solution to the problem of providing lower distortion without sacrificing stability. Multiple loops become additive if their ratio is adjusted to the relative degree of distortion produced. Thus, if one stage has twice the distortion of another, it should have twice as much feedback around it. Experiment has shown that the equivalent of 32 db over-all feedback with unconditional stability is safely achieved with this technique.

Extension of Response

Extensive listening experience has revealed an interesting fact. As mentioned earlier, the behavior of an amplifier several octaves above and below the normal range of hearing affects the sound quality of the amplifier. Amplifiers which offer a frequency response extending at usable power levels to below 5 cycles are found to have a tight and clearly defined low-frequency response. This is particularly noticeable in the 40-100 cps region. This characteristic improves the amplifier's ability to damp speakers, even those having a tendency to sound muddy; and this improvement of the low frequencies is distinctly audible.

A similar example is the performance at the high-frequency end of the spectrum. Amplifiers which limit their high-frequency range to slightly above the limit of human hearing have a tendency toward strident reproduction and poor differentiation of instruments in the higher overtones. Conversely, amplifiers which offer a frequency response beyond 100,000 cps without any evidence of ringing or instability with reactive loads will provide clean and transparent tone qualities in the higher frequencies with excellent separation of individual instruments.

To realize this extended frequency range, pulse amplifier techniques may be applied to the low-level stages of the amplifier. 12BY7 video power pentodes feeding into low-impedance loads provide a flat frequency and phase response beyond the capabilities of the output transformer. KT88's, in a distributed-load circuit, were selected for the output stage because of their ability to operate into a low-impedance

**A**... Always  
**B**... Buy  
**C**... Columbia

**SPECIAL !! THIS MONTH ONLY!**  
**BC-348 COMMUNICATIONS RECEIVER**  
Freq.: 200-500 kc. and 1.5-18 Mc. in 6 bands. Built-in crystal filter. This is the U. S. Air Force rig so you know it's top! 8 tubes including 2 stages HF. Operates on 110 V AC with ad. condition of power supply. Like new. ONLY **\$69.95**

**APR-4 TUNING UNITS**  
Make terrific converters! Use with any 30 amp. receiver.  
**TN-16:** Frequency: 38-95 Mc. Excellent cond. \$19.95  
**TN-17:** Frequency: 90-300 Mc. Excellent cond. 24.95  
**TN-18:** Frequency: 300-1000 Mc. Excellent cond. 29.95

**APN-9 MARINE LORAN RECEIVER**  
Gives exact fix in relation to Loran Station. V. 0, 12 or 24 V. The cheapest insurance \$49.50 a float owner can have. Excellent cond.

**TECHNICIANS! GENERALS! NOVICES!**  
**S C R 2 2** Here 'tis! The oldest, most reliable VHF Transmitter/Receiver in ham history, the greatest 2-Meter rig ever built on 12 or 24 VDC or 115 V 60 cye. AC. (See below). Covers 100-150 Mc.—naturally! Crystal controlled. Transmitter has 2-812 tubes, etc. Complete in case, with ALL TUBES. Easily converted to 6 meters. Excellent condition. \$12.50  
\*CR-522-C: Same as above but has electronic squelch. \$17.00

**REGULATED AC POWER SUPPLY** for above. 39.95  
**12 VDC DYNAMOTOR POWER SUPPLY** for above. Very condition. 8.95  
**24 VDC DYNAMOTOR POWER SUPPLY** for above. Good condition. 3.95  
**BC-1303 LOCAL ADAPTOR CONTROL BOX** for above. Like new. 4.95  
**ANTENNAS, OTHER ACCESSORIES FOR AHO** WRITE IN FOR DATA  
**SET OF PLUGS:** For SCR-522 and PE-98. \$4.95

**IMPORTERS & EXPORTERS**  
WE HAVE THE FOLLOWING GUARANTEED. READY FOR IMMEDIATE DELIVERY! CONTACT COLUMBIA TODAY!  
GRC-26 BC-348 ART-13  
GRC-27 BC-312 ARC-27  
GRC-32 BC-375 ARN-6  
GRC-33 ARC-1 BC-610  
GRC-39 ARC-3 & ALL ACCESSORIES

**CITIZENS' BAND, ETC.**

**BC-603 RECEIVER**  
Covers 20-28 Mc. FM. Terrific for citizens' band. 10 push-buttons. Built-in speaker and automatic cont. May be operated mobile on 12 v. with dynamotor (see prices below) or 110 VAC with power pack. Converts in minute to 110 VAC. All into submitted. New condition. \$9.95  
**12 V. DYNAMOTOR** for above. \$3.95  
**115 V. VAC PACK** for above. \$11.95  
**24 V. DYNAMOTOR** for above. \$7.95  
**115 V. KIT** for above. \$7.95  
**CRYSTAL SET FOR ABOVE—No tubes. New. \$5.95**  
**MATCHING TRANSMITTER FOR ABOVE—BC-604**  
30 W. 10-channel, push-button FM crystal controlled. 20-27 Mc. New condition. \$5.95  
complete with tubes. Glass vuvu. New. \$13.95  
**COMBO DEAL:** Above BC-603 & BC-604. New cond. BOTH for \$13.00

**BC-620 RECEIVER-TRANSMITTER**  
20-28 Mc. 4-watt. Similar to BC-603. New. \$14.95

**RA-120 AC POWER SUPPLY**  
For BC-620 or BC-650. 110V. in 60 cye. New. \$19.95  
**TELEPHONE HANDSET.** Brand new. Special 3.95  
**TELESCOPING ANTENNA.** New. 2.95  
This is a lulu!  
**PE-97 VIBRATOR PACK FOR BC-620** above. 6-12 V. New. 3.95

**SCR-625 METAL MINE DETECTOR**

Beats that hidden pipe, search for treasure, use for parts or have a ball! With carrying case. Excellent. \$22.50

**M-M-M! LOOKIT THESE 12 V. DYNAM-M-M-OTORS!**  
DM-35: 625 V. @ 225 ma. output. Like new. \$8.50  
**WINCO:** 50SS TCS. Output 440 V. @ 200 ma. \$4.50  
**DM-65:** Output 340 V. @ 400 MA. New. \$8.50  
**EICOR:** Type 100 TCS Output 400 V. @ 180 MA. New. \$4.95  
**DM-40:** Output 170 V. @ 135 MA. New. \$2.95  
**DY-65:** 6 VAC in. Output 600 V @ 175 MA. New. \$4.95

**T-14/TRC TRANSMITTER**  
JUST REDUCED! For action this month! 70-100 Mc. 50 W. input power to phone. Single channel. Built-in 110 V. 60 cps power supply. Table top size. Easily converted to 6 meters. Complete. Good condition. Excellent. \$24.95

**WANTED!** R-540 ARN-14C Receiver and ANY GRC or PRC Equip. Top \$\$\$ price!  
**WRITE FOR FREE BARGAIN BULLETIN!**  
All orders FOR Los Angeles. 25% deposit required. All items subject to prior sale. NOTE: MINIMUM ORDER \$3.00. WRITE TO DEPT. R

**ELECTRONICS**  
Columbia 2251 W. WASHINGTON BLVD.  
LOS ANGELES 18, CALIF.

**SENDING RECEIVING SPEED**

Be a "key" man. Learn how to send and receive messages in International Morse code. Communicate with operators around the globe. Learn at home quickly through famous Candler System. Used by best operators. Quality for Amateur or Commercial license. Write for FREE BOOK!  
**CANDLER SYSTEM CO., Dept. 2-A**  
Box 9226, Denver 20, Colo., U.S.A.



load, thus extending the usable frequency range of the output transformer.

To maintain the stability of an amplifier carrying a low-frequency cut-off of approximately 2 cycles, the power supplies must meet very special requirements in terms of regulation and low source impedance. These requirements may be met by using a silicon rectifier voltage-doubler circuit. This circuit takes advantage not only of the low internal impedance of the silicon rectifiers but also of the very low copper loss in the power transformer, thus providing the necessary regulation and low source impedance.

A special output transformer is required in order to take advantage of the broad-band circuitry. By minimizing the leakage inductance and distributed capacity of the primary halves, the resonant frequency of the transformer used has been raised to the 270,000 cps range. The massive design, utilizing the highest grade core materials, lowers the effect of core distortion, due to magnetizing current, to a region well below the limit of human hearing.

#### Kit Design

It is far more difficult to design a kit than a manufactured product. On a production line, special facilities and skilled help are available to assemble the amplifiers and subject them to elaborate test procedures. The kit builder, however, cannot be expected to have any but the simplest tools and most elementary test equipment, if any. The kit, therefore, must be simple to assemble and its performance must be "built-in." This involves careful attention to the mechanical design and the layout of components.

The problem can thus be stated quite simply: How can professional results be achieved by people with considerably less-than-professional assembly skills? One solution to the problem was found in the use of military-type terminal boards and cable harnesses. As the development of our kits progressed, we found this type of construction yielding additional benefits to the builder. The kit construction resolved itself into different phases, each requiring a different form of activity. The completion of a loaded terminal board or a laced harness presents milestones in the construction of the instrument, providing within themselves a substantial measure of satisfaction both in terms of technical accomplishment and aesthetic value. Thus, the pleasure of kit building is considerably enhanced.

Much time was invested in critical listening to this amplifier. Program sources varying from 15 ips tape originals to 78 rpm records were used. The sound fully confirmed our concepts and expectations. Poor program material was considerably enhanced when played through the new amplifier while the better program sources exhibited a surprising improvement in listening quality.

-30-

# MORE PICTURE POWER

new

## BLONDER-TONGUE B-24 POW-R BOOSTER



\$24<sup>95</sup>  
list

*it's a powerful booster  
...or an amplified coupler!*

**provides sharp, clear TV pictures on  
1, 2 or more TV sets with only 1 antenna**

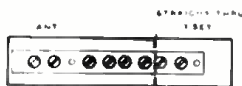

'straight-thru' circuit provides up to 10 db gain as a powerful one-set booster



'couple-two' circuit provides up to 5 db gain (per set) as an amplified two-set coupler

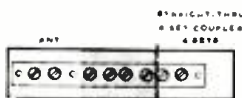

'straight-thru' circuit and B-T 4-set coupler provide no-loss 4-set distribution system

Employs new frame-grid tube 6DJ8 new circuitry to achieve highest signal gain and "lower-than-cascode" noise factor. Provides full broadband amplification covering low and high VHF channels. May also be used as FM-TV coupler. Features "NO-STRIP" 300 ohm terminals for positive, electrical contact in seconds. Has "on/off" switch.

Improve TV reception today on 1, 2 or more TV sets with a single antenna.



Available at parts distributors. For details write Dept. EW-1  
**BLONDER-TONGUE LABORATORIES, INC.**

9 Alling Street • Newark 2, N. J.

In Canada: Telegquipment Mfg. Co., Ltd., London, Ont. Export: Morhan Export Corp., N. Y. 13, N. Y.  
Hi-fi components • UHF converters • master TV systems • industrial TV cameras • FM-AM radios

# Lafayette Superior Quality HI-FI KITS!

The *FINEST* . . . through research . . . engineered by *LAFAYETTE!*



**KT-250**  
IN KIT FORM  
**64.50**

**LA-250 89.50**  
COMPLETELY WIRED

## 50 WATT INTEGRATED STEREO AMPLIFIER

- RESPONSE 17-21,000 CPS  $\pm$  1 DB (at normal listening level)
- UNIQUE "BLEND" CONTROL
- PREMIUM EL86 OUTPUT TUBES
- 50 WATTS MONAURAL—25 WATTS EACH STEREO CHANNEL
- CLUTCH-OPERATED VOLUME CONTROL
- SEPARATE BASS & TREBLE CONTROLS

A completely new stereo high fidelity amplifier with a high quality of reproduction, remarkable versatility and new distinctive styling. Full range of controls include a unique "blend" control for continuously variable channel separation—from full monaural to full stereo, 4-position Selector, Mode, Loudness and Phasing switches plus outputs for 4, 8 or 16 ohm speakers. Harmonic distortion less than 0.25%, 1M distortion less than 1%. Hum and Noise 74 db below full output. Assembly is simple—no special skills or tools required. Complete with deluxe cabinet and legs, all parts, tubes and detailed instruction manual. Shpg. wt., 26 lbs.

KT-250 WX Stereo Amplifier Kit ..... 5.00 Down ..... Net 64.50  
LA-250 WX Stereo Amplifier, wired & tested ..... 5.00 Down ..... Net 89.50



**KT-600**  
IN KIT FORM  
**79.50**

**LA-600 134.50**  
COMPLETELY WIRED

## PROFESSIONAL STEREO CONTROL CENTER

- RESPONSE 5-40,000 CPS  $\pm$  1 DB
- UNIQUE STEREO & MONAURAL CONTROL FEATURES
- PRECISE "NULL" BALANCING SYSTEM
- CONCENTRIC INPUT LEVEL CONTROLS

A truly professional stereo preamplifier and master audio control center—solves every stereo monaural control problem. Features unique Bridge Control for variable cross-channel feed for elimination of exaggerated channel separation effects—plus controlled 3rd channel output. Has all-concentric controls—including clutch-operated Volume Balance control. Provides complete and advanced facilities for accepting, controlling and providing undistorted gain for any and all program sources. Sensitivity 2.2 mv for 1 volt out [low level inputs]. Dual low impedance "plate follower" outputs 1500 ohms. Response 5-40,000 cps  $\pm$  1 db. Less than .03% IM distortion. Less than .1% harmonic distortion. Hum and noise 80 db below 2 volts (high level inputs). Uses 7 new 7025 low-noise dual triodes. Size: 14" x 4 1/2" x 10 1/2". Shpg. wt., 16 lbs. Complete with all parts, tubes, deluxe cabinet and detailed instruction manual.

KT-600 WX Stereo Preamplifier Kit ..... 5.00 Down ..... Net 79.50  
LA-600 WX Stereo Preamplifier, wired and tested ..... 5.00 Down ..... Net 134.50



**KT-310**  
IN KIT FORM  
**47.50**

**LA-310 72.50**  
COMPLETELY WIRED

## STEREO/MONAURAL POWER AMPLIFIER KIT

- 36 WATT STEREO AMPLIFIER—18 WATTS EACH CHANNEL
- EMPLOYS 4 PREMIUM-TYPE 7189 TUBES
- 2 PRINTED CIRCUIT BOARDS FOR SIMPLIFIED WIRING
- RESPONSE BETTER THAN 35-30,000 CPS  $\pm$  1/2 DB AT 18 WATTS
- LESS THAN 1% HARMONIC OR IM DISTORTION

A superb basic stereo amplifier in easy-to-build kit form. Unit may be used with a stereo preamplifier to provide two 18 watt stereo channels or, at the flick of a switch, as a fine 36 watt monaural amplifier. Controls include 2 input volume controls, Channel Reverse switch and Monaural Stereo switch. Dual outputs for 4, 8, 16 or 32 ohm speakers. Input sensitivity .45 volts per channel for full output. Tubes are 2-6AN8, 4-7189, GZ-34 rectifier. Size 10-9/16" d x 5 1/4" h x 13 1/4" w. Complete kit with cage, all parts, tubes and detailed instruction manual. Shpg. wt., 22 lbs.

KT-310 WX Stereo Power Amplifier Kit ..... 2.00 Down ..... Net 47.50  
LA-310 WX Stereo Power Amplifier, wired and tested ..... 5.00 Down ..... Net 72.50

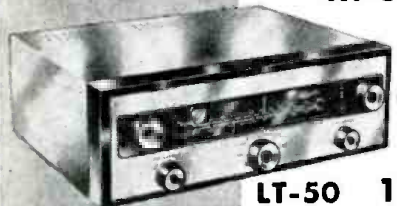

**KT-500**  
IN KIT FORM  
**74.50**

**LT-50 124.50**  
COMPLETELY WIRED

## FM-AM STEREO TUNER KIT

- 11 Tubes (4 dual-purpose) + Tuning Eye + Selenium rectifier provide 17 tube performance
- Multiplex Output for new Stereo FM
- Armstrong Circuit with Dual Limiters and Foster-Seely Discriminator
- Extreme Sensitivity and Wide Frequency Response

A precision engineered, highly stable tuner—perfect for lifelike stereo FM-AM broadcast reception. FM reception and/or AM reception. Features separate tuning and volume controls for AM and FM. Magic eye on AM and FM, plus automatic frequency control on FM for accurate tuning—stations are "locked" in. Other deluxe features include cathode follower outputs and 5-position Function Selector. Efficient, broadband circuitry on AM with built-in antenna. FM section features include 2 microvolts sensitivity for 30 db quieting, frequency response 20-20,000 cps  $\pm$  1/2 db, and full 200 KC bandwidth. Two printed circuit boards make wiring simple—even for such a complex unit. Complete kit includes all parts, deluxe cabinet and detailed instruction manual. Size is 13 1/4" W x 10 3/4" D x 4 1/2" H. Shpg. wt., 22 lbs.

KT-500 WX FM-AM Stereo Tuner Kit ..... 5.00 Down ..... Net 74.50  
LT-50 WX Same as above, wired & tested ..... 5.00 Down ..... Net 124.50

**NEW!**



**KT-236 52.50**  
IN KIT FORM

## LAFAYETTE 36-WATT INTEGRATED STEREO AMPLIFIER KIT

- 36-WATTS MONAURALLY—18 WATTS PER CHANNEL
- FREQUENCY RESPONSE 15-30,000 CPS  $\pm$  1 DB
- UNIQUE "BLEND" CONTROL
- CONCENTRIC CLUTCH-OPERATED VOLUME CONTROL
- DUAL CONCENTRIC BASS AND TREBLE CONTROLS
- 4-EL84 TUBES IN PUSH PULL

This exciting new amplifier kit combines dual preamplifiers and dual 18 watt power amplifiers on one compact chassis. Instant selection from monophonic to stereophonic is provided by the turn of a switch. An amazing new "Blend" control gives continuously variable channel separation from full monophonic to full stereo. The concentric clutch-operated volume control offers independent or simultaneous level adjustments of both channels. Dual concentric bass and treble controls furnish 4 independent tonal adjustments. Harmonic distortion less than 0.15% at normal listening level. 1M distortion is less than .3%. Hum and noise 70 db below rated output. Complete with cage, legs and detailed instructions. Shpg. Wt., 24 lbs.

KT 236 WX Stereo Amplifier Kit ..... 5.00 Down ..... Net 52.50

**LAFAYETTE RADIO**

165-08 LIBERTY AVE., JAMAICA 33, N. Y.  
AXtell 1-7000

NEW YORK, N. Y.  
100 6th Ave.  
Worth 6-5300

BOSTON, MASS.  
110 Federal St.  
Hubbard 2-7850

BRONX, N. Y.  
542 E. Fordham Rd.  
Fordham 7-8813

NEWARK, N. J.  
24 Central Ave.  
Market 2-1661

PLAINFIELD, N. J.  
139 W. 2nd St.  
Plainfield 6-4718



# NEW! *Lafayette* 50 Watt Complete Stereo Phono System



LA-250



GARRARD RC121/11

WOOD BASE

(OPTIONAL)

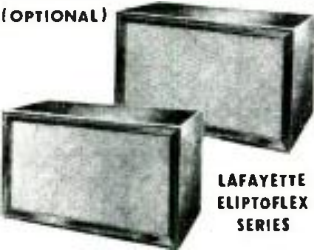

LAFAYETTE ELIPTOFLEX SERIES



NEW GE VR-22

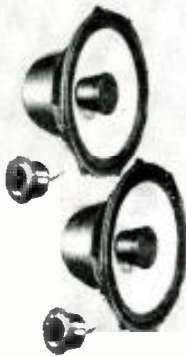

2-LAFAYETTE SK-58

## COMPONENTS

LAFAYETTE LA-250 50-WATT STEREO AMPLIFIER . . .	89.50
GARRARD RC121/11 STEREO CHANGER . . . . .	41.65
NEW GE VR-22 (.7 MIL) DIAMOND STEREO CARTRIDGE . . .	24.45
LAFAYETTE PK-111 WOOD CHANGER BASE . . . . .	3.95
2-LAFAYETTE SK-58 FAMOUS FREE EDGE	
12" COAXIAL SPEAKERS at 29.50 . . . . .	59.00
<b>Regular Catalog Price</b>	<b><del>218.55</del></b>

## COMPLETE STEREO SYSTEM

# 174.50

**YOUR GUARANTEED BEST STEREO SYSTEM BUY!  
YOU SAVE 44.05**

This superb system will add a new dimension in living to your home with all the excitement and realism of a live concert. The new Lafayette LA-250, 50-watt stereo amplifier (25 watts each channel) forms the heart of this outstanding stereo hi-fi phanograph music system—the features, versatility and advanced circuitry of this unit are second to none. Also included is the famous Garrard RC121/11 intermix 4-speed automatic record changer with full manual or automatic operation supplied with your choice of stereo cartridges—the new GE VR-22 (.7 Mil) diamond stereo cartridge, Pickering 371-7D (.7 Mil) diamond stereo cartridge, Shure M7D (.7 Mil) diamond stereo cartridge or the new Electro-Voice 31 MD7 (.7 Mil) diamond stereo cartridge. Supplied with the Lafayette wood base cut for the RC121 in your choice of finishes. These outstanding components are coupled

with the 2 famous free edge Lafayette SK-58 12" Coaxial speakers with built-in crossover network and brilliance level control. System supplied with plugs, cables and simple instructions. Shpg. wt., 67 lbs.

**MF-681WX HI-FI STEREO PHONO SYSTEM** with choice of cartridge and mahogany, walnut or blond changer base (please specify) 5.00 Down **Net 174.50**

**MF-683WX** Same as MF-681, but with 2 Lafayette Eliptoflex Series Bookshelf Enclosures (please specify finish). Shpg. wt., 143 lbs. 10.00 Down **Net 229.95**

**MF-682WX Stereo AM-FM-Phono System.** Same as MF-681 but including the Lafayette LT-50 stereo tuner. Shpg. wt., 85 lbs. 28.75 Down, 10.00 Down **Net 287.50**

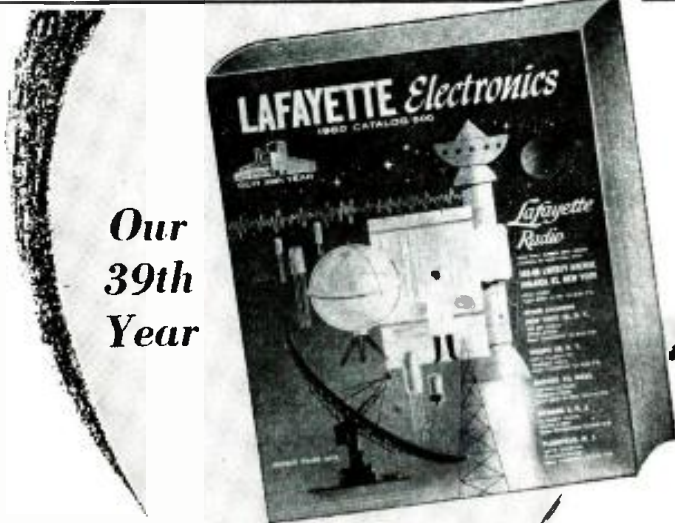

**Our 39th Year**

## Leaders in Hi-Fi

The most complete selection and largest stocks of hi-fi components and systems—available for immediate delivery at the lowest possible prices. Save even more on Lafayette endorsed "best-buy" complete systems.

*"Everything in Electronics"*  
**Lafayette Radio**

# FREE! 1960 CATALOG 308 GIANT SIZED PAGES

**The Complete Catalog Featuring  
"The Best Buys In The Business"**

FOR THE NEWEST AND FINEST IN STEREPHONIC HI-FI EQUIPMENT AND SYSTEMS

- TAPE RECORDERS ● PUBLIC ADDRESS SYSTEMS
- AMATEUR EQUIPMENT ● INDUSTRIAL SUPPLIES
- MINIATURE COMPONENTS ● RADIO & TV TUBES AND PARTS
- EXCLUSIVE LAFAYETTE TRANSISTOR & HI-FI KITS

Send for Lafayette's FREE Catalog—the most complete, up-to-the-minute electronic supply catalog crammed full of everything in electronics at our customary down-to-earth money-saving prices.

A "must" for the economy-minded hi-fi enthusiast, experimenter, hobbyist, engineer, technician, student, serviceman and dealer.

**FREE** LAFAYETTE RADIO, Dept. RA-6  
P.O. Box 222, Jamaica 31, N. Y.  
308 GIANT SIZED PAGES — FREE

Name .....

Address .....

City..... State.....

Choose ...

**XCELITE**

Hand Tools ... the Professionals do!

You need the BEST TOOLS to do the BEST JOB . . .

Your Radio, TV and Electronic  
Parts Distributor has them!



Check the "SEIZER"

Provides the necessary  
"third hand" in so many  
tricky situations!

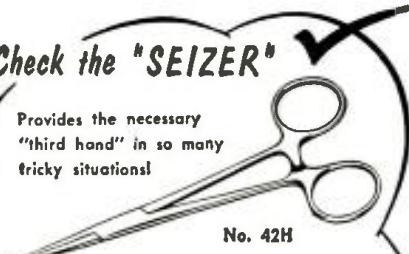

No. 42H

- Clamps on as a Heat Sink.
- Holds wires etc. while soldering.
- Holds dial cords when stringing them.
- Retrieves small items from awkward places.
- Out-reaches and out-holds needle nose pliers.



Select from the Complete Line of Quality Tools and Handy Kits . . .

**XCELITE, INCORPORATED**  
ORCHARD PARK, NEW YORK  
Canada: Charles W. Poynton, Ltd., Toronto

**XCELITE**  
Quality Hand Tools  
PREFERRED BY THE EXPERTS



**RESIST-O-ROUND**

IT REVOLVES!

FREE! with any of 4 Handy-Pak  
Carbon Resistor Assortments  
20 Values

\$14<sup>40</sup> to \$28<sup>80</sup> Dealer Net

Finger-tip Convenience • All-Metal



Order from  
your IRC  
Distributor

INTERNATIONAL RESISTANCE COMPANY  
DISTRIBUTOR SALES DIVISION  
414 N. 13th STREET • PHILADELPHIA 8, PA.

WHO NEEDS  
**MILES OF WIRE?**

GET  
**HOME ELECTRICITY  
ANYWHERE**  
WITH A

*terado*  
**CONVERTER**

Change 6 or 12 volt D.C. to  
110 volt, 60 cycle A.C.

No Installation—Just plug into  
cigarette lighter of car, truck,  
or boat, and it's ready to go!

Operate lights, elec-  
tric shavers, dictation  
machines, record  
players, small electric  
tools, portable TV, and  
testing equipment.

Models from 15 to 200  
watts, with prices as  
low as \$12.95.

"Chief": 75-125 watts,  
for 6 or 12 volt batteries . . .



\$64.95 LIST

See Your Electronic Parts Dealer or Jobber  
**terado COMPANY**  
DESIGNERS & MFRS. OF ELECTRONIC EQUIPMENT SINCE 1927  
1058 RAYMOND AVE., ST. PAUL 14, MINNESOTA  
IN CANADA: ATLAS RADIO CORPORATION LTD. ONTARIO

**Horizontal Deflection**

(Continued from page 53)

condition of the switch  $S_2$  in Fig. 3D.

The decaying magnetic fields allow the electron beam to return at normal scanning speed to center screen (scanning the left half of the screen) and allow currents  $I_1$  and  $I_2$  to flow. The damper current ( $I_d$ ) charges the boost capacitor ( $C_1$ ), and the cycle is complete. The circuit energy is now stored in the boost capacitor ( $C_1$ ) to be used in the next scan cycle, which will start as soon as the grid saw-tooth voltage becomes positive.

It would appear from the foregoing description that all the energy circulated in the scanning circuit is restored to the boost capacitor after each completed cycle and is available to power the circuit again without additional power being drawn from the receiver "B+" supply. However, losses due to circuit resistance, imperfect dielectric, and the use of boosted "B+" supply by other parts of the receiver must be replaced. Thus a relatively small amount of power is drawn from the regular "B+" supply in the first part of each cycle.

A smooth transition from scanning of the left-hand part of the screen by the damper to scanning of the right-hand part by the output tube is essential for good raster linearity. This is achieved in two ways. In designing the circuit, the transformer tap to the damper tube is positioned to provide correct biasing for the conduction cycle of that tube, while control of the output tube's conduction period is achieved by grid sawtooth amplitude, variable in many receivers by way of the familiar drive control.

A high-voltage supply for the picture tube's second anode is provided by the horizontal-output circuit of all modern TV receivers. An over-winding on the transformer giving a high-voltage step-up ratio makes use of the strong, rapidly varying field during retrace time to produce an a.c. voltage that, after rectification, is fed to the picture tube. The high impedance of this supply does lead to poor voltage regulation, which may lead to considerable voltage variation with changes in picture-tube current. However, as the high voltage is "pulled down" causing an increase in raster size due to reduced scanning beam velocity, this added drain on the horizontal-output circuit causes a corresponding reduction in deflection current. The latter results in reduced width, which tends to compensate for the increased raster size. For the same reason, it is common practice to take the vertical scanning supply voltage from the boost capacitor, again providing compensation (in the form of changed vertical size) for high-voltage supply variations that affect raster size.

While the winding capacitance of the output transformer is useful in providing an LC circuit for high-speed re-



tracing, other similar LC circuits in the deflection coils and high-voltage over-wind tend to cause oscillations that are not desirable. These unwanted oscillations, or "ringing," may show on the screen as vertical bands of varying brightness and linearity if not damped out in the circuit design. A resistor-capacitor network across the deflection coils and the use of resistance wire in the high-voltage over-wind provide the necessary damping for these resonances.

#### Service Hints

Servicing of the modern horizontal-output circuit, as with any other, depends on a good understanding of the circuit, but a brief review of some of the more common faults will not be amiss:

**Drive line visible on the screen.** In the modern receiver using the type of circuit described, the position of a drive line will be in the center of the screen, or even a little to the right of center, rather than towards the left as in earlier designs. In some receivers, a slight drive line under no-signal conditions is normal, so the symptom should be checked on an active channel. An abnormal line in this position (output tube taking over the scan at the wrong time) will likely be due to incorrect operation of the output stage. Specific possibilities include a defective tube, incorrect drive control setting, poor oscillator output amplitude, and incorrect screen voltage. In many receivers, the drive control and horizontal hold interact. If so, both should be adjusted for correct drive and frequency.

**Reduced width.** This again is likely to be caused in or around the output tube, but the possibility of an abnormally low "B+" supply should not be overlooked. If a capacitor is included in series with the yoke windings, it should be checked for a possible short.

**Loss of high voltage.** Perhaps the quickest procedure in this case is to remove the lead from the cap of the high-voltage rectifier tube and to check here for high voltage. If a normal arc can be obtained at this point, the output circuit is probably functioning correctly and the trouble lies in the rectifier tube or its associated circuit. If a good arc cannot be drawn, the fault must lie in or ahead of the horizontal-output circuit. Even the sync circuits should not be overlooked, as a defective phase-detector diode is a frequent cause of trouble that appears to originate in the output circuit.

**Keystone shaped raster.** This is the classic example provided in most service texts of a deflection yoke suffering from a shorted coil. The chances of seeing this condition are diminishing as deflection power increases—shorts of this kind become more and more likely to blow a fuse or burn out some other circuit component.

A final word of caution when servicing horizontal-output circuits: unless you are immune to shock, keep one hand in your pocket.

-30-

RADIO • TV • HI-FI • HAM • BROADCASTING • INDUSTRIAL • LAB

# RCA KITS

FOR VALUE, QUALITY AND PERFORMANCE!



## RCA WV-38A (K) VOLT-OHM-MILLIAMETER

only **\$29.95\*** (includes batteries, probe and cable with slip-on alligator clip, ground lead and clip, assembly and operating instructions) (available factory-wired and calibrated—only \$43.95\*)

Exclusive features make this RCA VOM kit the buy of a lifetime! Extra 1-volt and 0.25 volt (250 mv) ranges for wider usage in transistor servicing—new handle clip accommodates probes and test leads for extra carrying convenience. Assembles in a breeze!

**FEATURING:** ohms-divider network fuse-protected • easier-to-read scales • extra-large 5 1/4 inch meter • polarity reversal switch • excellent frequency response • full-wave bridge rectifier • low circuit loading • standard dbm ranges.

**SPECIFICATIONS:** Input Resistance—20,000 ohms per volt on DC; 5,000 ohms per volt on AC • Accuracy—± 3% DC, ± 5% AC (full scale) • Regular Scales—2.5, 10, 50, 250, 1000, 5000 volts, AC and DC; 50  $\mu$ a 1, 10, 100, 500 ma, 10 amps (DC) • Extra Scales—250 mv, and 1 volt (dc) • Frequency Response—AC-flat from 10 cycles to 50 Kc (usable response at 500 Kc) • Ohms—3 ranges: Rx1—(0-2,000 ohms); Rx100 (0-200,000 ohms); Rx10,000 (0-20,000,000 ohms) • Dimensions—W. 5 1/4", H. 6 7/8", D. 3 1/8"

## RCA WO-33A (K) 3-INCH OSCILLOSCOPE

only **\$79.95\*** (complete with Low-Cap, Direct Input Probe and Cable) (also available factory-wired and calibrated—only \$129.95\*)

The first 'scope kit with "get-up-and-go!" Use it for practically everything—video servicing, audio and ultrasonic equipment, low level audio servicing of pickups, mikes, pre-amps, radios and amplifiers, troubleshooting ham radio, hi-fi equipment, etc.—and you can take it with you, on the job, anywhere!

**FEATURING:** voltage-calibrated frequency-compensated, 3 to 1 step attenuator • scaled graph screen and calibrating voltage source for direct reading of peak-to-peak voltages • "plus-minus" internal sync... holds sync up to 4.5 Mc • shielded input cable with low capacitance probe included • weighs only 14 pounds • includes built in bracket to hold power cord and cables.

**SPECIFICATIONS:** Vertical Amplifier (Narrow Band Position)—Sensitivity, 3 rms mv/inch; Bandwidth, within -3 db, 20 cps to 150 Kc • Vertical Amplifier (Wide Band Position)—Sensitivity, 100 rms mv/inch; Bandwidth, within -3db, 5.5 cps to 5.5 Mc • Vertical Input Impedance—At Low-Cap cable input... 10 megohms, 10  $\mu$ f (approx.); At Direct-cable input... 1 megohm, 90  $\mu$ f (approx.) • Sweep Circuit—Sawtooth Range, 15 cps to 75 Kc; Sync, external,  $\pm$  internal; Line Sweep, 160° adjustable phase.

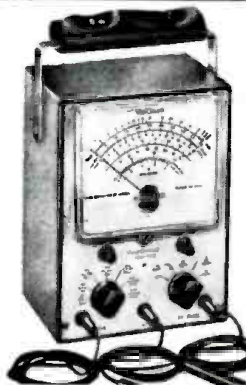

## RCA WV-77E (K) VOLTOHMYST®

only **\$29.95\*** (also available factory-wired and calibrated only \$49.95\*)

Think of it—an RCA VoltOhmyst Kit at this low, low price! You get famous RCA accuracy and dependability, plus the easiest to assemble kit you've ever seen!

**FEATURING:** ohms-divider network protected by fuse • ultra-slim probes and flexible leads • sleeve attachment on handle stores probes, leads, power cord • separate 1 1/2 volts rms and 4 volts peak-to-peak scales for accuracy on low ac measurements • front-panel lettering acid-etched.

**SPECIFICATIONS:** Measures: DC Volts—0.02 volt to 1500 volts in 7 overlapping ranges; AC Volts (RMS)—0.1 volt to 1500 volts in 7 overlapping ranges; AC Volts (peak-to-peak)—0.2 volt to 4000 volts in 7 overlapping ranges; Resistance—from 0.2 ohm to 1000 megohms in 7 overlapping ranges. Zero-center indication for discriminator alignment • Accuracy—± 3% of full scale on dc ranges; ± 5% of full scale on ac ranges • Frequency Response—flat within ± 5%, from 40 cycles to 5 Mc on the 1.5, 5, and 15-volt rms ranges and the 4, 14, and 40-volt peak-to-peak ranges • DC Input Resistance—standard 11 megohms (1 megohm resistor in probe).

\*User Price (Optional)

See them all at your local RCA Test Equipment Distributor!



**RADIO CORPORATION OF AMERICA**  
ELECTRON TUBE DIVISION

HARRISON, N. J.

**COYNE'S New Complete**  
**Pin-Point TROUBLE SHOOTING Series**  
 Takes Headaches Out Of All Servicing Problems!

See All 4 Books On 7-Day FREE TRIAL!



**Pin-Point TRANSISTOR TROUBLES IN 12 MINUTES!**

Trouble-shoot every type of circuit in ALL transistorized equipment! 525 pages; hundreds of illustrations; 120 check charts! \$5.95



**Pin-Point RECORD CHANGER TROUBLES IN 5 MINUTES!**

Locate mechanical and electronics troubles fast. Covers all makes. 320 pages; 450 photos; 58 check charts! \$3.95



**Pin-Point TV TROUBLES IN 10 MINUTES!**

Find the exact sound or picture trouble in any TV set from 700 possibilities! 300 pages; 300 diagrams; check charts! \$3.95



**Pin-Point COLOR TV TROUBLES IN 15 MINUTES!**

Covers every type of color TV and picture tube! 550 pages; 362 check charts, diagrams, picture patterns! \$5.95

**Simple Check Chart System Saves Time**

These amazing practical handbooks with an ENTIRELY NEW METHOD, show you how to find the trouble in ANY tv, record changer or transistor circuit FAST! Index tells you where to look; famous Check-Charts help you pin-point the exact trouble in minutes! These on-the-job books quickly pay for themselves in profitable new business and valuable time saved!

**SEND NO MONEY!**

Just mail coupon for free trial. After 7 days, send only low price or return books and pay nothing! If you keep all 4 books, send only \$3.00 after 7 days, and \$3.00 a month until \$19.80 plus postage is paid.

**VALUABLE FREE GIFT!**  
 Send for FREE TRIAL OFFER of all 4 Pin-Point books and get FREE book, "Bigger Profits in TV" whether you keep series or not!

**FREE TRIAL OFFER... Mail Coupon Now!**

Educational Book Publishing Div.  
 COYNE ELECTRICAL SCHOOL, Dept. 10-RT  
 1501 W. Congress Pkwy., Chicago 7, Ill.

- Rush 4-book PIN-POINT Series for 7-day FREE TRIAL per offer. For individual books, check below.
- RECORD CHANGER (\$3.95 plus postage)
- TRANSISTORS (\$5.95 plus postage)
- TV (\$3.95 plus postage)
- COLOR TV (\$5.95 plus postage)

Name..... Age.....

Address.....

City..... Zone... State.....

Check here if enclosing full price; we pay postage. 7-day money-back guarantee.



Fig. 1. Control unit (above) of the Tenn-A-Liner and motor housing (right).

By **HARRY GREENBERG**  
 Chief Electronics Engr., Channel Master Corp.

Better accuracy and reliability are objects of this automatic design approach.

# A New Antenna Rotator

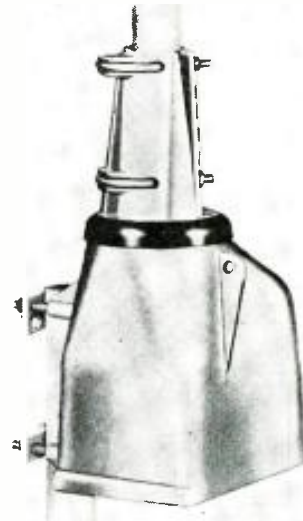

Fig. 2. How an automatic rotator control moves an antenna into position.

FOR THOSE many TV installations in which the rotator has become a necessary component, the most popular has been the automatic type since its introduction several years ago. The user simply sets the control dial to the best position for the particular channel he wishes to receive and then sits back as the rotator is moved to that position. However, dealers and consumers soon discovered that these automatic units had shortcomings.

Because they used solenoids, such rotators produced a noisy "clack-clack" during operation. They got out of step, requiring frequent service. They also produced electrical interference visible on the TV screen. Also, because they moved in step-by-step mechanical stops instead of continuous rotation, they could be set in position only in increments of, say, six or ten degrees. The latter limitation can be important in installations with reception problems using highly directional antennas to obtain maximum picture clarity, and more especially important with color TV. To meet the problems noted, Channel Master has introduced the Automatic Tenn-A-Liner (Fig. 1), using a dual-synchronous motor de-

sign without solenoids. It works without producing noise or interference, relieves the service problem, and permits orientation of antennas within one degree of desired direction.

In conventional automatic rotator systems, operation of the roof-top antenna depends on whether two independently rotating discs in the control box are lined up ("off" position) or not lined up ("running" position). When the discs are lined up (Fig. 2A) a switch is held in an open position, preventing operation of the motors ( $M_1$  and  $M_2$ ).

When the user moves his control dial, one of two discs (the manual disc) moves with the dial. This disturbs the alignment between the manual disc and the rotator-controlled disc (Fig. 2B) and applies power through the switch so that motion of the rotator begins in the desired direction. Just as the manual disc moves with the control knob, the rotator-controlled disc must move in unison with the rotor, until they reach the position set by the viewer. When this position is reached (Fig. 2C), the two discs are once more in alignment and the switch again opens, stopping all motion. The antenna,



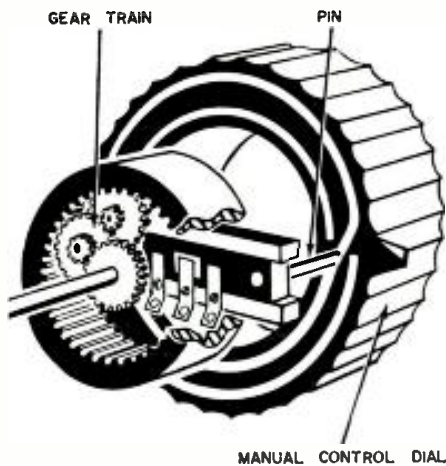

Fig. 3. This synchronizing system permits continuous movement rather than the stepped motion provided by an escapement.

fixed to the rotor, is now properly oriented.

During this operation, the normally open switch in the rotor housing keeps closing momentarily, sending pulses of current to a solenoid in the control box. Through a mechanical linkage, the rotor-controlled disc slips through an escapement movement, like one used in a clock, permitting motion one step at a time. Thus each pulse permits motion of the rotor-controlled disc through a step of six or ten degrees at a time. Sometimes the linkage may jam, or a pulse may fail to move the disc, upsetting synchronism.

The system used for maintaining synchronization between the rotor and the rotor-controlled disc in the Tenn-A-Liner eliminates the need for the step-by-step intervals of movement, provided by the action of a solenoid and an escapement. Instead, the rotor-controlled disc is moved by the continuous action of a motor.

When the viewer sets his control dial, a pin (Fig. 3) is moved from its neutral position into a groove that rotates with the control dial. The movement of this pin closes a normally open circuit and simultaneously starts the rotation of two identical motors, one in the rotor and one in the control box. These two move the rotator and rotor-controlled disc in synchronism. The control-box motor moves the latter disc through a fine-meshed gear train. The pin moves in the groove of this disc until it can fall back into its neutral position, stopping the action. After the rotator and antenna have reached their pre-set position, more precise (one degree) adjustments may be made, if necessary.

Rotators are conventionally powered through a 29-volt stepdown transformer rather than directly from the a.c. line. However, before this voltage reaches the motor, it must generally pass through a potentiometer in the indicating device, through which about 6 volts is lost. Since there is no potentiometer in the new system, the full 29 volts is used to produce higher torque in the motor.



## FIX OLD RADIOS IN A JIFFY!

Fix 'em good as new . . . without lost time or needless testing

Often it takes more time than it's worth to fix old radios . . . but NOT when you own this 3 1/2 pound, 744-page Ghirardi RADIO TROUBLESHOOTER'S HANDBOOK! The only service guide of its kind still in print! Gives common trouble symptoms and remedies for over 4,800 old-time receiver models made by 202 manufacturers prior to 1942—also auto radios. Even beginners can use it to repair old sets that might otherwise be thrown away because service data is lacking or because testing takes too long.

### CUTS SERVICE TIME IN HALF

This famous Handbook more than pays for itself the first time you use it. Covers 85% of the things that are apt to go wrong. Shows exactly where the trouble is likely to be. Explains step by step how to fix it without lost time or useless testing.

Gives full service details on old sets made by Airline, Apex, Arvin, Atwater Kent, Belmont, Bosch, Brunswick, Clarion, Crosley, Emerson, Eada, G-E, Kolster, Majestic, Motorola, Philco, Pilot, RCA, Silvertone, Sparton, Stromberg and dozens more. Includes hundreds of pages of old tube, transformer and other component data.

### 10 DAY FREE EXAMINATION

Dept. RN-10, RINEHART & CO., Inc.  
232 Madison Avenue, New York 16, N. Y.

Send RADIO TROUBLESHOOTER'S HANDBOOK for 10-day examination. If I decide to keep book, I will then send \$6.95 plus postage. Otherwise, I will return book promptly and owe you nothing. (SAVE! Send \$6.95 with order and we pay postage. Same 10-day return privilege with money refunded.)

Name .....

Address .....

City, Zone, State.....  
OUTSIDE U.S.A.—Price \$7.45 cash with order only.  
Money back if you return book in 10 days.

# IT'S THE NEW MARK II FROM WESTON:



an advanced new design for the  
WORLD'S FINEST PORTABLE ANALYZER

Here's an all-new version of the famous WESTON MODEL 980 Volt-Ohm-Milliammeter . . . engineered to offer you

- **INCREASED RANGE.** High-voltage range has been extended to 4000 volts.
- **INCREASED SENSITIVITY.** D-C sensitivity of 20,000 ohms/volt; accuracy within 2% of full scale.
- **IMPROVED SHIELDING.** Cormag® mechanism assures positive magnetic shielding; housing shields against electrostatic interference.
- **GREATER RUGGEDNESS.** Spring-backed jewel movement resists shock, vibration; case is impact-resistant. Ohm-ranges are fuse-protected.
- **SIMPLIFIED CONTROL.** Single dial control for range and function switching.
- **NEW COMPACTNESS.** Size and weight are reduced for maximum convenience and portability.

Order from your local Weston distributor. For information, write to Daystrom-Weston, Sales Division, Newark 12, N. J. In Canada: Daystrom, Ltd., 840 Caledonia Rd., Toronto 19, Ont. Export: Daystrom Int'l., 100 Empire St., Newark 12, N. J.

## WESTON

*Instruments*

WORLD LEADER IN MEASUREMENT AND CONTROL

January, 1960

113

# Now! SOLVE CIRCUIT PROBLEMS FAST!

Goodbye to trial-and-error methods. Every circuit calculation you need can now be done accurately with  
**THE ALGEBRA OF ELECTRONICS**



**YOU'LL BE AMAZED** at how easy it is to figure resistances, load inductances, impedances, etc. for ANY part of ANY electronic circuit. With this new book, **THE ALGEBRA OF ELECTRONICS**, you will quickly gain a knowledge of the tools, techniques and shortcuts needed.

### Three Great Books in One!

**First, it's a textbook.** All practical mathematical techniques explained clearly step-by-step; easy to follow by those with no more math training than high-school algebra and simple differential calculus.

**Second, it's a handbook.** Graphs and tables answer common electronic problems for those not wishing to work out complex derivations themselves.

**Third, it's a review.** Every equation is discussed, along with its practical on-the-job applications. 100 problems are shown with methods and answers provided.

**THE ALGEBRA OF ELECTRONICS** was written by Chester H. Page, Consultant to the Director of the National Bureau of Standards. Dr. Page discusses basic laws and fundamental principles, practical methods of solving simultaneous equations. He develops elementary Fourier waveform analysis, shows effects of frequency selectivity, modulation, and analyzes tubes, transistors and power supplies.

**Try it FREE for 10 Days**

Whether you're a repairman, technician, or engineer, you'll find **THE ALGEBRA OF ELECTRONICS** both profitable and interesting. Send coupon for a **FREE 10-DAY EXAMINATION**. No obligation—unless you want to keep the book. Mail coupon today to

D. Van Nostrand Co., Inc.  
Dept. 371, Princeton, N. J.  
Established 1848

- 127 TOPICS**  
340 Pages  
252 Illustrations
- Nonlinear Resistance
  - Network Topology
  - Mesh Currents
  - Kirchoff's Law
  - Voltage Variables
  - Triangularization
  - Simultaneous Equations
  - Kramer's Rule
  - Thevenin's Theorem
  - Wheatstone Bridge
  - Conductance
  - Black Box Variables
  - Image Impedances
  - Attenuators
  - Capacitance
  - Dieteries
  - Sinusoidal Voltage
  - Energy Storage
  - Series-Tuned Circuits
  - Series Resonance
  - Complex Phasors
  - Mutual Inductance
  - Transformers
  - Critical Coupling
  - F-M Discriminator
  - Impedance Matching
  - Hyperbolic Functions
  - Diodes
  - Amplifiers
  - Transistors
  - Thermal Noise
  - Demodulation
  - many more

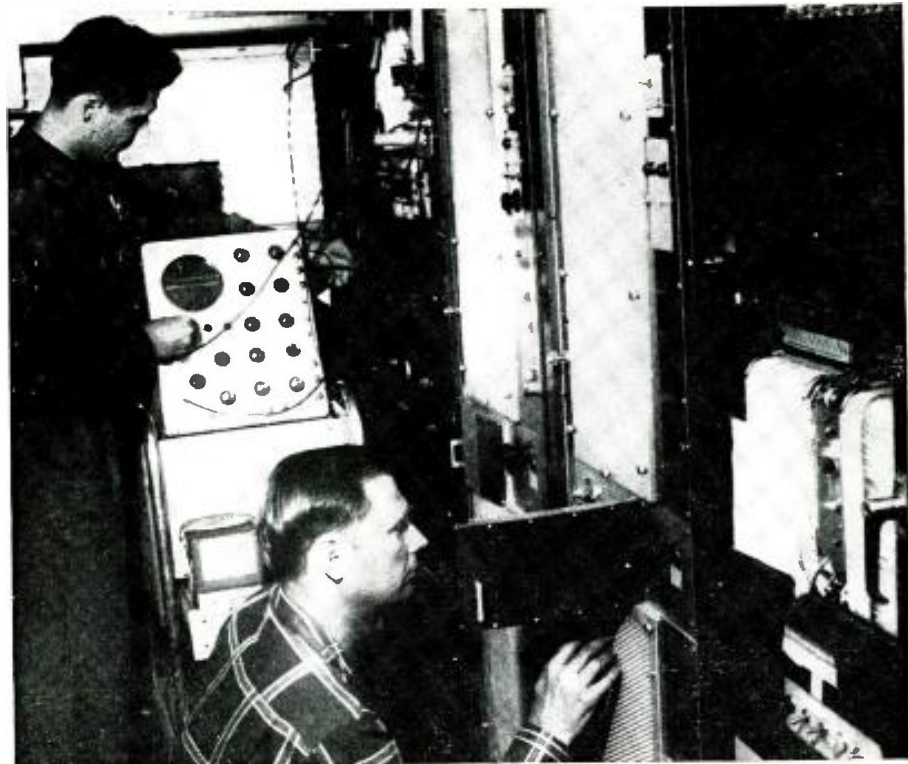

Part of automatic message handling equipment employed in the meteor burst system.

## Meteor Burst Communication System

**Two-way system using intermittent communication transmits messages at speeds up to 4800 wpm.**

**A**N EXPERIMENTAL radio communication system that uses meteor trails has been developed by the National Bureau of Standards Boulder (Colo.) Laboratories under the sponsorship of the Air Force Cambridge Research Center. With this system, messages have been sent at speeds up to 4800 wpm—80 times the present speed of transmission by teletypewriter. The system resulted from a 3-year investigation to determine the feasibility of a long-distance v.h.f. communication system based on

reflections from ionized meteor trails. Results of the study indicate that intermittent meteor burst communication can compete effectively with other long-distance systems, and that it is relatively free from ionospheric disturbances which affect long-distance communication in the h.f. range.

An 800-mile path from Kilbourne, Ill., to Erie, Colo. was used for most of the tests. Transmitters used are commercial units operating at a frequency of 49 mc. with a power output of 2 kilowatts.

—30—

Block diagram of system developed by National Bureau of Standards Boulder Labs.

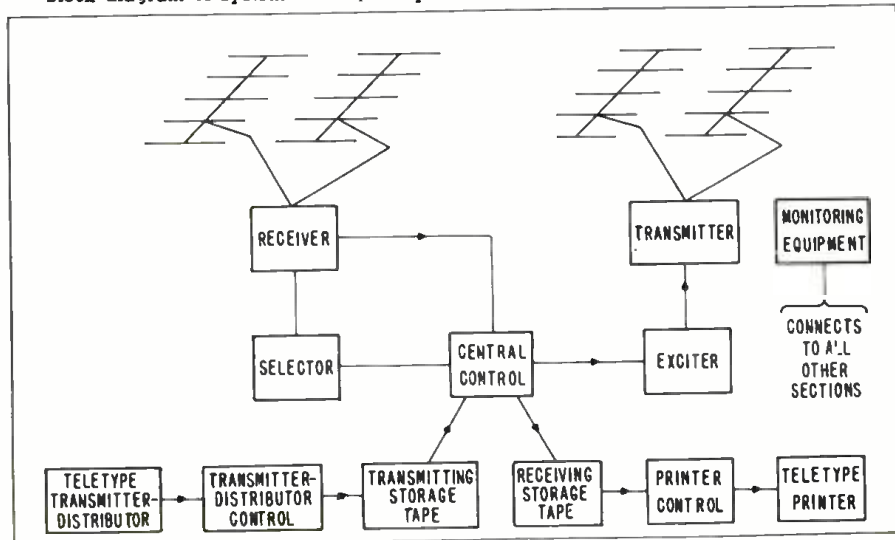

**D. VAN NOSTRAND COMPANY, INC.,**  
Dept. 371, PRINCETON, N. J.  
(In Canada: 25 Hollinger Rd., Toronto 16)

Send for free examination—**THE ALGEBRA OF ELECTRONICS**. If I don't feel it can make electronic calculations clearer, easier, and faster, I may return it within 10 days; owe nothing. Otherwise, I will pay \$2.75 down, plus small delivery cost, and \$1 per month for 2 months.

Name .....  
(Please Print Plainly)

Address .....

City ..... Zone ..... State .....

**SAVE!** Enclose \$2.75 WITH coupon and we will pay ALL shipping costs. Same ten day money-back privilege.



**DEALERS SERVICEMEN  
TUBE TESTER ROUTE OPERATORS  
EXPERIMENTERS  
HAMS**



with **ZALYTRON** QUALITY BRAND  
**RADIO & TELEVISION RECEIVING TUBES**

**BRAND NEW**  
**INDIVIDUALLY BOXED**  
In Famous Green & Black Carton

**GUARANTEED  
FOR ONE YEAR**

We will replace all defective tubes within 12 months from date of purchase, excepting only burned out or broken tubes. Standard Customer Warranty 90 Days.

**SEND IN A TRIAL ORDER TODAY!** You'll be delighted with our speedy service — and in due time you will join our host of customer friends who rank ZALYTRON as a First Class Source of Supply for Tubes. Your Trial Order will be shipped on our **FULL MONEY BACK GUARANTEE!** Try ZALYTRON Tubes at **OUR** Risk, and **JUDGE FOR YOURSELF!**

TYPE	EACH	TYPE	EACH	TYPE	EACH	TYPE	EACH	TYPE	EACH	TYPE	EACH
OZ4	\$.85	5CQ8	1.30	6BF5	1.35	6DQ6	1.10	12AV6	.60	12F8	.65
1AX2	.70	5J6	.75	6BF6	.55	6DT6	.60	12AV7	.85	12K5	.70
1B3	.95	5T8	.86	6BG6	2.25	6J5	.70	12AX4	.95	12L6	.65
155	.60	5U4G	G8 .75	6BH6	.70	6J6	.60	12AX7	.65	12S47	1.00
1T4	.55	5U8	.75	6BH8	.90	6K6	.80	12B4	.70	12SK7	.85
1U4	.45	5V6	.55	6BJ6	.65	6L6	1.15	12BA6	.60	12SN7	.90
1U5	.55	5Y3GT	.55	6BK5	1.40	654	.60	12BD6	.60	12SQ7	.90
1X2A/B	.95	6AB4	.55	6BK7A	B .90	65A7	.80	12BE6	.60	12V6	.55
2AF4	1.00	6AC7M	.90	6BL7	1.55	65C7	.80	12BH7	.80	12W6	.75
3AF4	1.05	6AF4	1.05	6BN6	.75	65K7	.75	12BQ6	1.10	12X4	.45
3AL5	.46	6AG5	.65	6BQ5	.70	65L7	.90	12BY7	.80	19AU4	.85
3AU6	.55	6AG7M	1.25	6BQ6	1.10	65N7	.85	12C5	.60	19T8	1.00
3AV6	.45	6AH4	1.30	6BQ7A	1.10	65O7	.85	12C6	.60	25AX4	1.15
3BN6	.75	6AH6	1.35	6BR8	.95	6T4	1.00	12C8	.60	25BQ6	1.10
3BU8	.75	6AK5	.85	6BU8	.70	6T8	.95	12CU5	.60	25CD6	1.50
3BY6	.60							12CU6	1.10	25CU6	1.10
3BZ6	.60							12DQ6	1.10	25DQ6	1.10
3C86	.60							12F8	.65	25L6	.85
3CF6	.65							12K5	.70	25Q6	1.10
3CS6	.60							12L6	.65	25S4	1.10
3DT6	.55							12S47	1.00	35C5	.65
3Q4	.65							12SK7	.85	35L6	1.00
3S4	.65							12SN7	.90	35W4	.50
3V4	.70							12SQ7	.90	35Z5	.70
4BC8	1.00							12V6	.55	50C5	.70
4BN6	.75							12W6	.75	50L6	.75
4BQ7A	1.10							12X4	.45		
4B58	1.00							19AU4	.85		
4BZ7	1.10							19T8	1.00		
4CB6	.60							25AX4	1.15		
4DT6	1.00							25BQ6	1.10		
5AM8	.80							25CD6	1.50		
5AN8	.85							25CU6	1.10		
5AQ5	.55							25DQ6	1.10		
5AT8	.85							25L6	.85		
5AU4	.95							25W4	1.10		
5BK7	.90							35C5	.65		
5BQ7	.98							35L6	1.00		
5CG8	.85							35W4	.50		
5CL8	.80							35Z5	.70		

**WE PAY ALL SHIPPING CHARGES**

on all orders accompanied by remittance in full.

Above is only a partial listing of our huge tube stocks. Send today for FREE Complete up-to-date Tube Price List and Catalog. We Ship all Orders COMPLETE Same Day Received! C.O.D. ORDERS: 25% Deposit with order, balance C.O.D. plus all shipping charges. **MINIMUM ORDER (Special for This Ad) \$5.00.**

**ZALYTRON TUBE CORPORATION**  
220 West 42nd Street New York 36, N. Y.  
Telephone: BRyant 9-2542 **DEPT. EW-1**

**FREE!**  
Giant New Wholesale Catalog of Radio & TV Receiving Tubes, Electronic Components. Free on Request.

**THIS MONTH'S SPECIAL**

GET THIS DELUXE SHELL 102  
**TEST-O-MATIC  
SELF-SERVICE  
TUBE TESTER**

(Nationally Advertised by the  
Factory at a Net Cost of \$199.95)

PLUS ZALYTRON "PACKAGE DEAL" OF  
**150 RADIO & TV  
RECEIVING TUBES**

COMPLETE **\$24500** F.O.B.,  
FOR ONLY **\$24500** NYC.

When you buy our "Package Deal" you are, in effect, getting with it a Stock of Tubes, worth \$450 retail, FOR ONLY \$45.00 — which is actually 90% discount!

Quan.	Type	Quan.	Type	Quan.	Type	Quan.	Type
1	024	5	6AQ5	5	6CB6	2	12AT7
3	1B3	1	6A55	1	6CD6	5	12AU7A
1	1R5	1	6AT6	1	6CG7	1	12AV6
1	1S5	1	6AT8	1	6CM7	1	12AX7
1	1T4	5	6AU6	2	6CU6	1	12B4
1	1U4	1	6AU8	1	6DQ6	3	12BA6
1	1U5	1	6AV6	5	6J6	1	12BE6
3	1X2A B	1	6AW8	1	6K6	2	12BH7
1	3CB6	2	6AX4	1	654	1	12BQ6
1	3V4	3	6BA6	1	65A7	1	12BY7
1	5AM8	1	6BC5	1	65K7	1	12CU6
1	5AQ5	1	6BC8	5	65N7	1	12SA7
1	5J6	2	6BE6	1	65Q7	1	12SK7
3	5U4G	1	6BG6	1	6T8	1	12SN7
1	5U8	1	6BH6	5	6U8	1	12SQ7
2	5Y3	1	6BJ6	2	6V6	1	12S8Q6
1	6AC7M	1	6BK7A	2	6W4	1	12SCU6
3	6AG5	1	6BN6	1	6W6	1	12S16
1	6AH6	2	6BQ6	1	6X4	2	12SW4
1	6AK5	2	6BQ7A	1	6X5	1	12S25
5	6AL5	1	6BZ6	2	6X8	2	12S5C5
1	6AM8	2	6BZ7	1	7AU7	2	12S16
1	6AN8	1	6C4	1	12AT6		



102  
SOCKETS

To ZALYTRON Tube Corp., **DEPT. EW-1**  
220 West 42nd Street, New York 36, N. Y.  
 Send FREE 1960 Catalog.

NAME \_\_\_\_\_  
ADDRESS \_\_\_\_\_  
CITY \_\_\_\_\_ ZONE \_\_\_\_\_ STATE \_\_\_\_\_



## dapper?

Down to a point, though hardly well suited for public appearance or public address. If you want real top-to-bottom coverage, we suggest a selection from University's complete line of well-groomed speakers and accessories. They're all stylishly described in our new product catalog. It's FREE. Also, invest \$1 in the all-new 64-page University Technilog, the authoritative reference book for planning P.A. speaker installations. See your local distributor, or write Desk S-8, University Loudspeakers, Inc., 80 So. Kensico Ave., White Plains, N. Y.



THE WORLD'S MOST COMPLETE LINE  
 RADIAL • HIGH FIDELITY WEATHERPROOF • PAGING  
 WIDE-ANGLE • SUPER-POWER • SUBMERGENCE-PROOF  
 DIRECTIONAL • EXPLOSION-PROOF • TALK-BACK

116

# SOUND ON TAPE

By BERT WHYTE

THE 1959 High Fidelity Show is history now and, as far as the tape people are concerned, they fared quite well and the tape renaissance continues apace. Four-channel tape seems to have gotten over its earlier hurdles and now seems to be fairly well accepted, although it must be admitted there is quite a considerable corps of two-channel die-hards who stick by their guns that *their* baby is best.

I still feel that it is too early to give any hard and fast evaluation on this medium and that we must wait for the bugs to be ironed out. Because believe me, friends, there are bugs! Needless to say there was a plenitude of 4-channel tape playback equipment displayed, from very modest units to the most elaborate and expensive. It is obvious that any excuse that 4-channel tape equipment is hard to obtain at all price levels no longer has any validity.

And for those many thousands who own two-channel equipment, a large variety of 4-channel conversion kits now exists, many of them at extremely modest prices.

The cartridge machines were very much in evidence and many were operating with seemingly no difficulties. And it appears that several fairly prominent recording companies will soon issue cartridge productions. The big drawback at present with the cartridge concept is that the cartridges seem to be fairly expensive in the raw state—and that with all other cost factors added in, there seems to be some doubt as to whether cartridge music can be sold as cheaply as its advocates insist.

The other thing, of course, is the old chicken and egg story . . . in other words, recording companies might be encouraged to go into cartridges if a sizable proportion existed and, conversely, many people who would like the cartridge music won't buy machines because there isn't enough music in the new medium on the market. Ho hum, it seems to me I've gone through this deal before . . . stereo tape . . . stereo disc . . . I'm afraid it is always the same story and it is never resolved until someone comes along who has the courage to buck this obstacle and to go it alone for a while.

Now, getting back to the 4-channel bugs. You will probably have noticed that there has been a dearth of classical tapes reviewed here lately . . . and your old reporter pleads innocent. At the moment there are not too many companies producing four-channel classical tapes and, unfortunately, whether it is in the duplication equipment or

## RADIO ELECTRONIC SURPLUS



### SILICON RECTIFIERS

1N1454	25 amp. 100 volts	\$3.00
1N1455	25 amp. 200 volts	\$3.50
1N1456	25 amp. 300 volts	\$4.00
1N1457	25 amp. 400 volts	\$4.50
1N1450	5 amp. 100 volts	\$1.00
1N1451	5 amp. 200 volts	\$1.25
1N1452	5 amp. 300 volts	\$1.50
1N1453	5 amp. 400 volts	\$1.75
1N1446	.750 amp. 100 volts	\$.65
1N1447	.750 amp. 200 volts	\$.75
1N1448	.750 amp. 300 volts	\$.85
1N1449	.750 amp. 400 volts	\$1.00



### BC603 FM RECEIVER

20.-27.9 mc. Equipped with 10 push buttons for selecting channels. Cont. variable tuning over the entire range. Unit complete with tubes, built-in loud speaker, squelch circuit, head phone jacks, schematic diagram on bottom of case. Approx. weight 34 lbs.

Used Good.....\$9.95

Like New.....\$12.95

DM-34 Dynamotor 12 or 24-volt D.C. . . . each \$3.95

BC-604 Transmitter, 20.-27.9 mc NEW.....\$4.95

Crystals (set of 80) for BC604 transmitter, 20 to 27.9 mc

Price.....\$3.00 per set

Schematic for BC603 BC604.

Price.....\$1.00 each

DM35 DYNAMOTOR: 12 Volt input, output 625V. .225A

Used with BC-604.....\$9.95

12V Eicor Dynamotor: Output 440V, 200A. NEW \$7.95

### PE120 POWER SUPPLY

6, 12 or 24-volt (specify voltage).

Used with BC659 and 620.....\$6.95 each

NO C.O.D.'s. REMIT FULL AMOUNT WITH ORDER. ALL PRICES F.O.B. PASADENA.

## C & H SALES CO.

2176 E. Colorado St. - Pasadena 8, Calif.

# PURCHASING A HI-FI SYSTEM?

Send Us Your List Of Components For A Package Quotation

WE WON'T BE UNDERSOLD!

All merchandise is brand new, factory fresh & guaranteed.

FREE Hi-Fi Catalog Available on Request.

# AIREX RADIO

CORPORATION  
 64-R Cortlandt St., N. Y. 7, CO 7-2137

### PARTIAL LIST OF BRANDS IN STOCK

Altec Lansing  
 Electrovoice  
 Jensen  
 Hartley - Stephens  
 University  
 Acoustic Research  
 Janszen  
 Wharfedale  
 Karlson Cabinets  
 Viking  
 Concertone  
 Bell • G.E.  
 Weathers  
 Harman-Kardon  
 Eico • Pilot  
 Sherwood  
 Acrosound  
 Fisher  
 Dual Changer  
 Bogen • Leak  
 Dynakit  
 H. H. Scott  
 Ferrograph  
 Tanberg  
 Pentran  
 Ampex • DeWald  
 Revere  
 Challenger  
 Wallensak  
 Garrard  
 Miracord  
 Glaser-Steers  
 Rek-O-Kut  
 Components  
 Norelco  
 Fairchild  
 Pickering • Gray  
 Audio Tape  
 Conrac TV

Full Line of Wellcar Cabinets

ELECTRONICS WORLD



whatever, many of the tapes already announced have not appeared.

There are troubles . . . the nature of which cannot be pinpointed, but I have been waiting for some months now for certain classical 4-channel items and they have not reached me yet. There are some on the market which, unfortunately, I cannot review because of my affiliation with the company which produced them.

I hope some new material will be forthcoming or next month's column will return to that sad, bare look it had during the darkest days of the tape recession. Well, here goes the last of the 4-channel supply!

#### THE MILLION SELLERS

**Billy Vaughn and his orchestra. Bel Canto ST58. Price \$9.95.**

As the name implies, this is a collection of songs which at one time were million-selling hits . . . such items as "In the Mood," "High Noon," "Tonight We Love," "Holiday for Strings," "Moonglow," etc. This record is liberally sprinkled with these and quite a few others of the same genre.

Billy Vaughn plays these hits well enough, in more or less stock arrangements. They are all very pleasant and innocuous and certainly will satisfy the needs of most people interested in background music.

The recording is very well done of its type, with excellent directivity, not overdone as is the case with so many pop stereo recordings, and a good acoustic perspective which is something still more rare in pops. The brasses and reeds are clean and well projected and there is good instrumental separation. In other words, a 4-channel stereo tape that meets all of the requirements of this medium—but on a minimal plane. As in two-channel stereo, the real acid test of the capabilities of the 4-channel stereo can only be assessed with some really good classical material.

#### GEORGE WRIGHT'S GENIUS

**HiFi Tape R713. Price \$7.95.**

George Wright aided by some top engineering from this small West Coast company, has probably sold more pop organ records than all the rest of the field combined. He is, as the title insists, a genius in his chosen work and has an easy, ingratiating style and a sure, deft capacity for using just the right registration and arrangements.

Here he works his magic with such evergreens as "If I Had You," "Song of The Islands," "Tea For Two," "Strike Up the Band," and others of similar ilk. Through intelligent engineering HiFi obtains a stereo organ sound that deserves to be called stereo . . . far too often most stereo organ recordings degenerate into a big blur in which the attributes of directionality and depth are washed out. Here there is plenty of power and big pedal, but nonetheless all the various stops are clearly articulate and the melodic line is never lost. For pop organ aficionados, this is a winner.

-30-

from England . . .

where the finest is a tradition

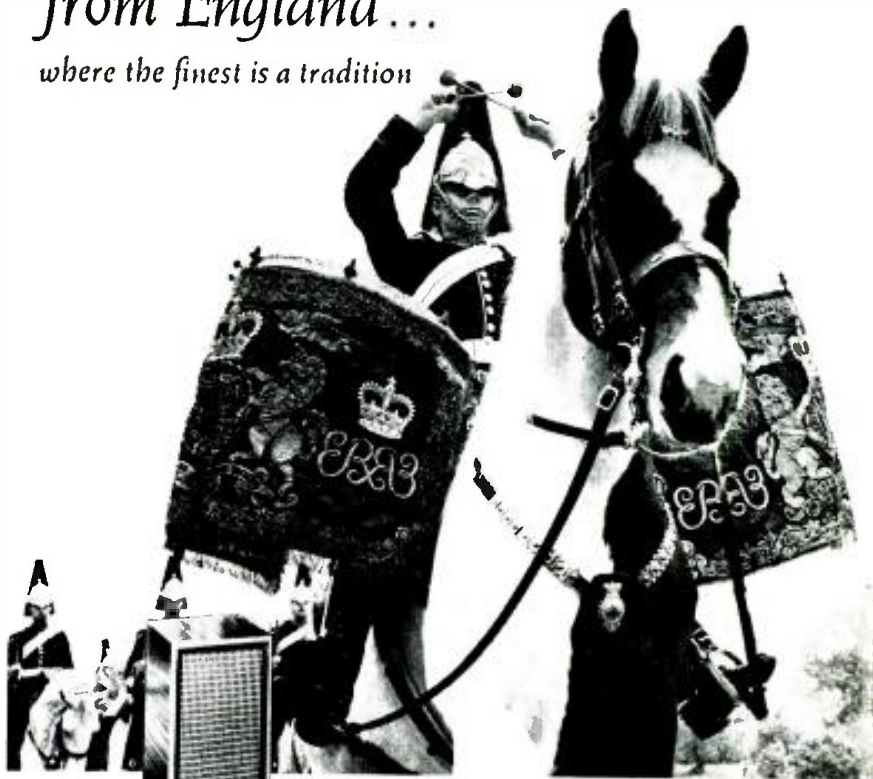

Model SL 71  
Stereo Two  
Speaker  
System  
40-20 cps  
complete.  
\$89.95  
Audio Net



## Stereophonic High-Fidelity by *Beam-Echo*



Model SPA 21—50-watt Stereo High Fidelity "3-D" Amplifier. \$229.95 Audio Net



Model BM611—Deluxe Automatic FM-AM Tuner, 8 tubes plus rectifier; magic eye; neon balancing; illuminated panel. \$149.95 Audio Net



Model SPA 11—30-watt Stereo High Fidelity "3-D" Amplifier. \$149.95 Audio Net

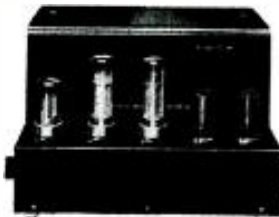

Model DL 7-35 Basic 50-watt Amplifier (100 watts peak). With 2 units: 100-watt stereo with SP 21; 200 watts peak stereo. \$159.95 Audio Net



Model SP 21 Stereophonic-Mono-Phonic Pre-Amplifier Control Unit. \$159.95 Audio Net

traditionally the finest—and very likely the only sound reproducing equipment to represent a lifetime investment in timeless listening enjoyment. The rewards of owning Beam-Echo are many; among them the knowledge that yours is—and will remain—the best quality stereophonic-high fidelity ever produced.

**1 YEAR FULL WARRANTY ON ALL COMPONENTS;  
TUBES 90 DAYS.**

Prices slightly higher west of the Rockies.

**BEAM-ECHO INTERNATIONAL, LTD., Dept. E1  
820 Greenwich St., New York 14, N. Y.**

**PLEASE SEND ME FREE CATALOG  
AND NAME OF NEAREST DEALER.**

Name \_\_\_\_\_

Address \_\_\_\_\_

City \_\_\_\_\_ Zone \_\_\_\_\_ State \_\_\_\_\_

SUPERIOR'S NEW MODEL 77

# VACUUM TUBE VOLTMETER

## WITH NEW 6" FULL-VIEW METER



**Model 77 — VACUUM TUBE VOLTMETER**  
 ... Total Price \$42.50—Terms: \$12.50 after 10 day trial, then \$6.00 monthly for 5 months if satisfactory. Otherwise return, no explanation necessary!

Compare it to any peak-to-peak V. T. V. M. made by any other manufacturer at any price

- ✓ Model 77 completely wired and calibrated with accessories (including probe, test leads and portable carrying case) sells for only \$42.50.
- ✓ Model 77 employs a sensitive six inch meter. Extra large meter scale enables us to print all calibrations in large easy-to-read type.
- ✓ Model 77 uses new improved SICO printed circuitry.
- ✓ Model 77 employs a 12AU7 as D.C. amplifier and two 9006's as peak-to-peak voltage rectifiers to assure maximum stability.
- ✓ Model 77 uses a selenium-rectified power supply resulting in less heat and thus reducing possibility of damage or value changes of delicate components.
- ✓ Model 77 meter is virtually burn-out proof. The sensitive 400 microampere meter is isolated from the measuring circuit by a balanced push-pull amplifier.
- ✓ Model 77 uses selected 1% zero temperature coefficient resistors as multipliers. This assures unchanging accurate readings on all ranges.

**AS A DC VOLTMETER:** The Model 77 is indispensable in HI-FI Amplifier servicing and a must for Black and White and color TV Receiver servicing where circuit loading cannot be tolerated.

**AS AN AC VOLTMETER:** Measures RMS values of sine wave, and peak-to-peak value of complex wave. Pedestal voltages that determine the "black" level in TV receivers are easily read.

**AS AN ELECTRONIC OHMMETER:** Because of its wide range of measurement leaky capacitors show up glaringly. Because of its sensitivity and low loading, intermittents are easily found, isolated and repaired.

Model 77 comes complete with operating instructions, probe and test leads. Use it on the bench—use it on calls. A streamlined carrying case, included at no extra charge, accommodates the tester, instruction book, probe and leads. Operates on 110-120 volt 60 cycle. Only.....

### SPECIFICATIONS

• DC VOLTS — 0 to 3/15/75/150/300/750/1,500 volts at 11 megohms input resistance. • AC VOLTS (RMS) — 0 to 3/15/75/150/300/750/1,500 volts. • AC VOLTS (Peak to Peak) — 0 to 8/40/200/400/800/2,000 volts. • ELECTRONIC OHMMETER — 0 to 1,000 ohms/10,000 ohms/100,000 ohms / 1 megohm / 10 megohms / 100 megohms/1,000 megohms. • DECIBELS — 10 db to + 18 db, + 10 db to - 38 db + 30 db to + 58 db. All based on 0 db = .006 watts (6 mw) into a 500 ohm line (1.73v). • ZERO CENTER METER—For discriminator alignment with full scale range of 0 to 1.5/7.5/37.5/150/375/750 volts at 11 megohms input resistance.

**\$42.50**  
NET

SUPERIOR'S NEW MODEL 80

# 20,000 OHMS PER VOLT ALLMETER



**Model 80 — ALLMETER** ... Total Price \$42.50—Terms: \$12.50 after 10 day trial, then \$6.00 monthly for 5 months if satisfactory. Otherwise return, no explanation necessary!

THE ONLY 20,000 OHMS PER VOLT V.O.M. SELLING FOR LESS THAN \$50 WHICH PROVIDES ALL THE FOLLOWING FEATURES:

- ✓ 6 INCH FULL-VIEW METER provides large easy-to-read calibrations. No squinting or guessing when you use Model 80.
- ✓ MIRRORED SCALE permits fine accurate measurements where fractional readings are important.
- ✓ CAPACITY RANGES permit you to accurately measure all condensers from .00025 MFD to 30 MFD in addition to the standard volt, current, resistance and decibel ranges.
- ✓ HANDSOME SADDLE-STITCHED CARRYING CASE included with Model 80 Allmeter at no extra charge enables you to use this fine instrument on outside calls as well as on the bench in your shop.

### SPECIFICATIONS:

- 7 D.C. VOLTAGE RANGES:  
(At a sensitivity of 20,000 Ohms per Volt)  
0 to 15/75/150/300/750/1500/7500 Volts.
- 6 A.C. VOLTAGE RANGES:  
(At a sensitivity of 5,000 Ohms per Volt)  
0 to 15/75/150/300/750/1500 Volts.
- 3 RESISTANCE RANGES:  
0 to 2,000/200,000 Ohms. 0-20 Megohms.
- 2 CAPACITY RANGES:  
.00025 Mfd. to .3 Mfd., .05 Mfd. to 30 Mfd.
- 5 D.C. CURRENT RANGES:  
0-75 Microamperes, 0 to 7.5/75/750 Milliamperes, 0 to 15 Amperes.
- 3 DECIBEL RANGES:  
- 6 db to + 18 db + 14 db to + 38 db + 34 db to + 58 db

### FEATURES:

- A built-in Isolation Transformer automatically isolates the Model 80 from the power line when capacity service is in use.
- Selected, 1% zero temperature coefficient metalized resistors are used as multipliers to assure unchanging accurate readings on all ranges.

Model 80 Allmeter comes complete with operating instructions, test leads and portable carrying case. Only.....

**\$42.50**  
NET

NOTE: The line cord is used only for capacity measurements. Resistance ranges operate on self-contained batteries.

**SHIPPED ON APPROVAL**  
**NO MONEY WITH ORDER—NO C.O.D.**

Try for 10 days before you buy! If completely satisfied, send down payment after trial and pay balance at indicated monthly rate — NO INTEREST OR FINANCE CHARGES ADDED. If not completely satisfied, return to us, no explanation necessary.

SEE PAGE 121 FOR COMPLETE DETAILS

MOSS ELECTRONIC, INC.

3849 TENTH AVE., NEW YORK 34, N. Y.



SUPERIOR'S NEW MODEL TV-50A



**Model TV-50A—Genometer**  
 Total Price .....\$47.50  
 Terms: \$11.50 after 10 day trial, then \$6.00 monthly for 6 months if satisfactory. Otherwise return, no explanation necessary.

# GENOMETER

## 7 Signal Generators in One!

- ✓ R. F. Signal Generator for A. M.
- ✓ R. F. Signal Generator for F. M.
- ✓ Audio Frequency Generator
- ✓ Bar Generator
- ✓ Cross Hatch Generator
- ✓ Color Dot Pattern Generator
- ✓ Marker Generator

A versatile all-inclusive GENERATOR which provides ALL the outputs for servicing:  
**A.M. Radio • F.M. Radio • Amplifiers • Black and White TV • Color TV**

### Specifications

**R. F. SIGNAL GENERATOR:** The Model TV-50A Genometer provides complete coverage for A.M. and F.M. alignment. Generates Radio Frequencies from 100 Kilocycles to 60 Megacycles on fundamentals and from 60 Megacycles to 180 Megacycles on powerful harmonics.

**CROSS HATCH GENERATOR:** The Model TV-50A Genometer will project a cross-hatch pattern on any TV picture tube. The pattern will consist of non-shifting, horizontal and vertical lines interlaced to provide a stable cross-hatch effect.

**VARIABLE AUDIO FREQUENCY GENERATOR:** In addition to a fixed 400 cycle sine-wave audio, the Model TV-50A Genometer provides a variable 300 cycle to 20,000 cycle peaked wave audio signal.

**DOT PATTERN GENERATOR (FOR COLOR TV)** Although you will be able to use most of your regular standard equipment for servicing Color TV, the one addition which is a "must" is a Dot Pattern Generator. The Dot Pattern projected on any color TV Receiver tube by the Model TV-50A will enable you to adjust for proper color convergence.

**BAR GENERATOR:** The Model TV-50A projects an actual Bar Pattern on any TV Receiver Screen. Pattern will consist of 4 to 16 horizontal bars or 7 to 20 vertical bars.

**MARKER GENERATOR:** The Model TV-50A includes all the most frequently needed marker points. The following markers are provided: 189 Kc., 262.5 Kc., 456 Kc., 600 Kc., 1000 Kc., 1400 Kc., 1600 Kc., 2000 Kc., 2500 Kc., 3579 Kc., 4.5 Mc., 5 Mc., 10.7 Mc. (3579 Kc. is the color burst frequency).

THE MODEL TV-50A comes absolutely complete with shielded leads and operating instructions.

**\$47.50 NET**

SUPERIOR'S NEW MODEL 79

# SUPER-METER — WITH NEW 6" FULL-VIEW METER

*A Combination* VOLT-OHM MILLIAMMETER.

*Plus* CAPACITY, REACTANCE, INDUCTANCE AND

DECIBEL MEASUREMENTS

*Also Tests* SELENIUM AND SILICON RECTIFIERS, SILICON AND GERMANIUM DIODES.



**Model 79—SUPER-METER** . . . Total Price \$38.50—Terms: \$8.50 after 10 day trial, then \$6.00 per month for 5 months if satisfactory. Otherwise return, no explanation necessary!

The Model 79 represents 20 years of continuous experience in the design and production of SUPER-METERS, an exclusive SICO development.

In 1938 Superior Instruments Co. designed its first SUPER-METER, Model 1150. In 1940 it followed with Model 1250 and in succeeding years with others including Models 670 and 670-A. All were basically V.O.M.'s with extra services provided to meet changing requirements.

Now, Model 79, the latest SUPER-METER includes not only every circuit improvement perfected in 20 years of specialization, but in addition includes those services which are "musts" for properly servicing the ever increasing number of new components used in all phases of today's electronic production. For example with the Model 79 SUPER-METER you can measure the quality of selenium and silicon rectifiers and all types of diodes—components which have come into common use only within the past five years, and because this latest SUPER-METER necessarily required extra meter scale, SICO used its new full-view 6-inch meter.

Model 79 comes complete with operating instructions and test leads. Use it on the bench—use it on calls. A streamlined carrying case included at no extra charge accommodates the tester, instruction book and test leads. . . . Only

**Specifications**  
 D.C. VOLTS: 0 to 7.5/15/75/150/750/1,500.  
 A.C. VOLTS: 0 to 15/30/150/300/1,500/3,000.  
 D.C. CURRENT: 0 to 1.5/15/150 Ma. 0 to 1.5/15 Amperes.  
 RESISTANCE: 0 to 1,000/100,000 Ohms. 0 to 10 Megohms.  
 CAPACITY: .001 to 1 Mfd. 1 to 50 Mfd.  
 REACTANCE: 50 to 2,500 Ohms, 2,500 Ohms to 2.5 Megohms.  
 INDUCTANCE: .15 to 7 Henries. 7 to 7,000 Henries.  
 DECIBELS: -6 to +18, +14 to +38, +34 to +58.

The following components are all tested for QUALITY at appropriate test potentials. Two separate BAD-GOOD scales on the meter are used for direct readings.

All Electrolytic Condensers from 1 MFD to 1000 MFD.  
 All Selenium Rectifiers. All Germanium Diodes.  
 All Silicon Rectifiers. All Silicon Diodes.

**\$38.50 NET**

**SHIPPED ON APPROVAL**  
**NO MONEY WITH ORDER—NO C.O.D.**

Try for 10 days before you buy! If completely satisfied, send down payment after trial and pay balance at indicated monthly rate — **NO INTEREST OR FINANCE CHARGES ADDED.** If not completely satisfied, return to us, no explanation necessary.

SEE PAGE 121 FOR COMPLETE DETAILS

MOSS ELECTRONIC, INC.

3849 TENTH AVE., NEW YORK 34, N. Y.

SUPERIOR'S NEW MODEL 82A

Multi-Socket Type

# TUBE TESTER

**TEST ANY TUBE IN 10 SECONDS FLAT!**



- ① Turn the filament selector switch to position specified.
- ② Insert tube into a numbered socket as designated on our chart (over 600 types included).
- ③ Press down the quality button —

**THAT'S ALL! Read emission quality direct on bad-good meter scale.**

**Model 82A — TUBE TESTER . . . Total Price \$36.50 — Terms: \$6.50 after 10 day trial, then \$6.00 monthly for 5 months if satisfactory. Otherwise return, no explanation necessary.**

Primarily, the difference between the conventional tube tester and the multi-socket type is that in the latter, the use of an added number of specific sockets (for example, in Model 82A the noval is duplicated eight times) permits elimination of element switches thus reducing testing time and possibility of incorrect switch readings.

To test any tube, you simply insert it into a numbered socket as designated, turn the filament switch and press down the quality switch—THAT'S ALL! Read quality on meter. Inter-element leakage, if any, indicates automatically.

Production of this Model was delayed a full year pending careful study by Superior's engineering staff of this new method of testing tubes. Don't let the low price mislead you! We claim Model 82A will outperform similar looking units which sell for much more—and as proof, we offer to ship it on our examine before you buy policy.

....FEATURES....

- Tests over 600 tube types.
- Tests OZ4 and other gas-filled tubes.
- Employs new 4" meter with sealed air-damping chamber resulting in accurate vibrationless readings.
- Use of 22 sockets permits testing all popular tube types and prevents possible obsolescence.
- Dual Scale meter permits testing of low current tubes.
- 7 and 9 pin straighteners mounted on panel.
- All sections of multi-element tubes tested simultaneously.
- Ultra-sensitive leakage test circuit will indicate leakage up to 5 megohms.

**\$36<sup>50</sup> NET**

Model 82A comes housed in handsome, portable Saddle-Stitched Texon case. Only.....

SUPERIOR'S NEW MODEL TW-11

STANDARD PROFESSIONAL

# TUBE TESTER



**Model TW-11—TUBE TESTER . . . Total Price \$47.50—Terms: \$11.50 after 10 day trial, then \$6.00 per month for 6 months if satisfactory. Otherwise return, no explanation necessary!**

- ★ Tests all tubes, including 4, 5, 6, 7, Octal, Lack-in, Hearing Aid, Thyatron, Miniatures, Sub-miniatures, Novals, Sub-minars, Proximity fuse types, etc.
- ★ Uses the new self-cleaning Lever Action Switches for individual element testing. Because all elements are numbered according to pin-number in the RMA base numbering system, the user can instantly identify which element is under test. Tubes having tapped filaments and tubes with filaments terminating in more than one pin are truly tested with the Model TW-11 as any of the pins may be placed in the neutral position when necessary.
- ★ The Model TW-11 does not use any combination type sockets. Instead individual sockets are used for each type of tube. Thus it is impossible to damage a tube by inserting it in the wrong socket.
- ★ Free-moving built-in roll chart provides complete data for all tubes. All tube listings printed in large easy-to-read type.
- ★ NOISE TEST: Phono-jack on front panel for plugging in either phones or external amplifier will detect microphonic tubes or noise due to faulty elements and loose internal connections.

**EXTRAORDINARY FEATURE**

SEPARATE SCALE FOR LOW-CURRENT TUBES. Previously, an emission-type tube testers, it has been standard practice to use one scale for all tubes. As a result, the calibration for low-current types has been restricted to a small portion of the scale. The extra scale used here greatly simplifies testing of low-current types.

The Model TW-11 operates on 105-130 Volt 60 Cycles. Comes housed in a handsome, portable Saddle Stitched Texon case. Only.....

**\$47<sup>50</sup> NET**

**SHIPPED ON APPROVAL**

**NO MONEY WITH ORDER—NO C.O.D.**

Try for 10 days before you buy! If completely satisfied, send down payment after trial and pay balance at indicated monthly rate — NO INTEREST OR FINANCE CHARGES ADDED. If not completely satisfied, return to us, no explanation necessary.

SEE FOLLOWING PAGE FOR COMPLETE DETAILS

MOSS ELECTRONIC, INC.

3849 TENTH AVE., NEW YORK 34, N. Y.



**SUPERIOR'S  
NEW MODEL 83**

# C.R.T. TESTER

**Tests and Rejuvenates ALL PICTURE TUBES**

**ALL BLACK AND WHITE TUBES**

From 50 degree to 110 degree types—from 8" to 30" types.

**ALL COLOR TUBES**

Test **ALL** picture tubes—in the carton—out of the carton—in the set!



Model 83—C.R.T. TUBE TESTER . . . Total Price \$38.50—Terms: \$8.50 after 10 day trial, then \$6.00 monthly for 5 months if satisfactory. Otherwise return, no explanation necessary!

Model 83 comes housed in handsome portable Saddle Stitched Texon case—complete with sockets for all black and white tubes and all color tubes. Only . . . .

**\$38<sup>50</sup>**

- ✓ Model 83 is not simply a rehashed black and white C.R.T. Tester with a color adapter added. Model 83 employs a new improved circuit designed specifically to test the older type black and white tubes, the newer type black and white tubes and all color picture tubes.
- ✓ Model 83 provides separate filament operating voltages for the older 6.3 types and the newer 8.4 types.
- ✓ Model 83 employs a 4" air-damped meter with quality and calibrated scales.
- ✓ Model 83 properly tests the red, green and blue sections of color tubes individually—for each section of a color tube contains its own filament, plate, grid and cathode.
- ✓ Model 83 will detect tubes which are apparently good but require rejuvenation. Such tubes will provide a picture seemingly good but lacking in proper definition, contrast and focus. To test for such malfunction, you simply press the rej. switch of Model 83. If the tube is weakening, the meter reading will indicate the condition.
- ✓ Rejuvenation of picture tubes is not simply a matter of applying a high voltage to the filament. Such voltages improperly applied can strip the cathode of the oxide coating essential for proper emission. The Model 83 applies a selective low voltage uniformly to assure increased life with no danger of cathode damage.

## RCA

INDICATES RADIOACTIVITY IN 3 WAYS!

- 1—BY NEON
- 2—BY PHONE
- 2—BY METER



RADIOACTIVE SPECIMEN

RCA Radiation Counter

Total Price . . . . . \$47.50

Terms: \$11.50 after 10 day trial, then \$6.00 monthly for 6 months if satisfactory. Otherwise return, no explanation necessary.

## RADIATION COUNTER

MADE TO SELL FOR \$15000—OFFERED FOR ONLY \$47<sup>50</sup>  
(Much less than cost of Manufacture.)

Endless experiments and discoveries in the new exciting field of nuclear energy are made possible when you acquire this finely built and engineered device. In the past, a rugged counter which was suitable for the prospecting of radioactive ores such as uranium, thorium and radium, was unsuitable for laboratory work due to the inability of combining accuracy with ruggedness. Conversely, a laboratory counter, while being extremely sensitive, could not withstand use in the field where it would be subjected to abuse and abnormally hard knocks. The Model WF-10AWB combines the laboratory and field counter in one rugged instrument. The use of phones and a visible lamp permits the operator greater freedom of operation as he no longer has to keep his eyes on a relatively small indicator.

In the laboratory where determinations of intensity (counts) of a reading are necessary, the WF-10AWB provides sensitivity far surpassing many laboratory counters.

- Employs the extra sensitive 1BB5 Bismuth Type Geiger Counter tube. Sensitivity is .05 Roentgens per hour (1 MR/HR—2000 counts per minute).
- Three counting ranges: 0-100/1,000/10,000 counts per minute.
- Handy reset button.
- Ideal for survey work as the complete unit weighs only 5½ lbs.
- Sight and sound indications by neon flashes and headphones. Then when an indication is obtained you switch to meter reading for exact measurements.
- Decontamination easy with damp cloth applied to the weatherproofed aluminum case.
- A radioactive specimen is included for instrument checking and experiments.
- Included at no extra charge—U.S. Atomic Energy Commission booklet titled "Prospecting with a Counter."

**SPECIFICATIONS**

Three counting ranges are available—0-100 counts per minute—used in cosmic ray and extremely low activity determinations. 0-1,000 counts per minute—used for average activity and normal work. 0-10,000 counts per minute—used for tracer and high activity determinations. High accuracy is assured by the handy reset button, located on the front panel, which permits compensation for variations of battery voltages and background count. A rugged weather-proof aluminum case houses this light economical unit. The batteries will provide over 200 hours of intermittent operation from the two 67½ volt batteries and 50 hours from the three flash light batteries. Comes with complete set of batteries, carrying strap, headphone, radio-active specimen and A.E.C. booklet. . . . . Only

**\$47<sup>50</sup>**

# SHIPPED ON APPROVAL NO MONEY WITH ORDER — NO C.O.D.

MOSS ELECTRONIC, INC.  
Dept. D-706 3849 Tenth Ave., New York 34, N. Y.  
Please send me the units checked on approval. If completely satisfied I will pay on the terms specified with no interest or finance charges added. Otherwise, I will return after a 10 day trial positively cancelling all further obligation.

Name .....

Address .....

City ..... Zone ..... State .....

All prices net, F.O.B., N.Y.C.

- Model 77 . . . . . Total Price \$42.50
- \$12.50 within 10 days. Balance \$6.00 monthly for 5 months.
- Model 80 . . . . . Total Price \$42.50
- \$12.50 within 10 days. Balance \$6.00 monthly for 5 months.
- Model TV-50A . . . . . Total Price \$17.50
- \$11.50 within 10 days. Balance \$6.00 monthly for 6 months.
- Model 79 . . . . . Total Price \$38.50
- \$8.50 within 10 days. Balance \$6.00 monthly for 5 months.
- Model 82A . . . . . Total Price \$36.50
- \$6.50 within 10 days. Balance \$6.00 monthly for 5 months.
- Model TW-11 . . . . . Total Price \$17.50
- \$11.50 within 10 days. Balance \$6.00 monthly for 6 months.
- Model 83 . . . . . Total Price \$38.50
- \$8.50 within 10 days. Balance \$6.00 monthly for 5 months.
- RCA Radiation Counter . . . . . Total Price \$17.50
- \$11.50 within 10 days. Balance \$6.00 monthly for 6 months.

# PICK THE BEST FOR YOUR STEREO PICKUP SYSTEM by WEATHERS

These are the same components which play an important role in producing Weathers TrioPhonic Stereo—the sound that outmodes conventional stereo.

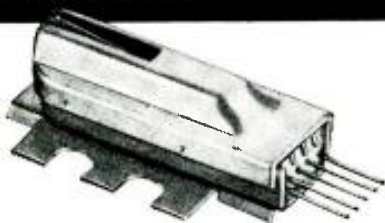

## StereoRamic Cartridge C-501

The first ceramic cartridge to outperform the finest magnetic pickups.

### SPECIFICATIONS

Frequency Response.....	15-30,000 cps
Compliance.....	6 x 10 <sup>-6</sup> cm/dyne
Dynamic Moving Mass.....	1.0 milligrams
Recommended Tracking Force	
Professional Arms.....	1-2 grams
Changers and other type arms.....	2-6 grams
Stylus.....	0.7 mil diamond or sapphire
Separation.....	25 db
Signal-to-noise Ratio.....	-60 db
Output per channel.....	0.25 Volts 7 cm/sec

Audiophile Net

C-501-D—Diamond....	\$17.50
C-501-S—Sapphire....	\$9.75



## StereoRamic Pickup System

MC-1. Features the StereoRamic cartridge and the Micro-Touch Tonearm. Leads plug directly into the phono magnetic input of all preamplifiers.

### SPECIFICATIONS

Arm Bearing System.....	Viscous Damping
Tracking Force.....	Easily adjusted 1 to 8 grams
Finish.....	Ebony with gold trim
Overall Length.....	13 inches
Pivot to Stylus Tip Length.....	.9% inches
Recommended Overhang.....	1/2 inch

Audiophile Net

MC-1-D—(Diamond)....	\$55.95
MC-1-S—(Sapphire)....	\$48.25

For more information about Weathers components, write for "The Audiophile's Album"

## WEATHERS INDUSTRIES

Division of Advance Industries, Inc.

66 E. Gloucester Pike, Barrington, N.J.  
Export: Jos. Plasencia, Inc., 401 Broadway, N. Y.



By  
BERT WHYTE

## CERTIFIED RECORD REVUE

WELL, friends, seems like the new year is upon us and in the world of audio 1960 may be remembered as the year of the Big Change. By this I mean that there are going to be some drastic changes in the record and high-fidelity equipment buying habits of the public. For one thing, the stereo disc has come along as a market entity at a much more rapid pace than anyone ever dreamed of. Dollar volume sales of stereo discs has now reached impressive proportions as compared to monophonic LP's and in 1960 there is every indication that the dollar volume of stereo discs may over-shadow its mono cousin, at least in the classical field.

Mono appears to be holding its own percentage-wise in the pop field, but even here the die is cast and although the stereo encroachment may be slower than in the classical, it will be as inevitable.

In matters of equipment, stereo is being sold at an almost fantastic level. Even if much of this stereo equipment is of the packaged variety and of marginal quality, by the end of this year some eight or nine million stereo sets will be in use. As any record company sales manager can tell you, this alone makes a very large and attractive market. Yes, there is little doubt that America is "going stereo."

Of course, such a movement is bound to have a profound effect on both record and equipment manufacturers. Many companies who are equipped with stereo recording apparatus of rudimentary or sub-standard quality will have to make heavy investments in some of the newer and more sophisticated stereo recording equipment and, in addition, will have to use a combination of luck and sufficient monetary inducements to secure the services of really knowledgeable first-class stereo recording engineers. There are very few engineers who fall into this category and it wouldn't be too surprising if some lively "pirating" went on! Much the same can be said of the equipment manufacturers. As far as the component type manufacturer is concerned, he has the dual task of holding on to the high-fidelity market that has been created over the last ten years and of somehow making his admittedly more technical and formidable looking equipment more palatable to a potentially much larger market, this market being those members of the general public who, having become more sound-conscious through stereo and then ultimately more discriminating, decide to "graduate" into the higher quality, more refined equipment of the component type.

There is really a very funny situation building up. Some of the component manufacturers are beginning to espouse some of the ideas and gimmicks in both styling and merchandising that have been the province of the package manufacturers and, conversely,

the package manufacturer is being forced to adopt a more sophisticated approach to his amplifier, preamplifier, tuner, and loud-speaker design because of the exigencies of stereo. It is not so much a matter that the package manufacturers feel compelled to furnish their mahogany monstrosities with components which are actually of any better quality, but with those which in this space age look more technical and therefore must be better. The situation becomes still more ludicrous when one realizes that there might be some sort of voluntary intermarriage between the component and the package manufacturers. In other words, it could conceivably be to the advantage of a component manufacturer to hire a stylist or engineer who has been with a package manufacturer and, obviously, the reverse might hold true for the package manufacturer who would feel that a stylist or engineer from a component manufacturer may furnish him with the sophistication he thinks his products need.

It is quite a "ring around the rosy" with some of the components people wanting what they think is the package manufacturers' approach to a mass market and the package manufacturers wanting what they think will be sufficiently impressive looking, from the component approach, in order to give their products "class."

I have said this before, but it bears repeating. The package manufacturer is an old "pro" when it comes to merchandising. He knows all the tricks, he knows all the angles, he has a high-powered sales staff, and mass distribution facilities. He also has a thing called "money" . . . and lots of it. For the average component manufacturer to engage these colossi in battle, especially at their own game, seems to me a very risky proposition. The component manufacturer has been a synonym for quality in an age when most manufactured articles are made to the standard of the lowest common denominator of quality. He has enjoyed a reputation for honesty and craftsmanship like that once enjoyed by the old Guilds. He has kept alive an individualistic approach to design and has steadfastly refused to be dictated to by the exigencies of mass taste. He has earned the respect and enjoyed the income derived from many thousands of people who saw in his product an escape from conformist mediocrity.

Yes, the grass always looks greener on the other side and despite all these sterling qualities, the component manufacturer is human. No one can blame him for wanting to turn an extra dollar. My own feeling is that a component manufacturer who tries to embrace mass market techniques without the formidable armamentarium of the package manufacturer is asking for a great deal of trouble.

ELECTRONICS WORLD



I think 1960 is a year in which a lot of people can get badly burned by sticking their fingers in the wrong pie. This applies equally to package and component manufacturers. Actually, the component manufacturer, if he sticks by his guns and maintains his standards of quality, is in a better position to increase sales than ever before. I believe this is true because the package boys, with all their facilities of merchandising, advertising, etc. are doing a tremendous selling job on the American public. They are making the American public very aware of stereo and, in turn, stereo is educating many people in the greater delights of records and music. Inevitably, many of these people will become more discriminating and then, at that time, they become the prime target for the component manufacturer's product. It is up to the component people to make sure that their products reflect this higher quality and, through an industry coordinated advertising effort, that these people seeking higher quality will know where it can be purchased.

This preamble I thought necessary for reporting on the New York High Fidelity Show since the most evident thing about the Show was that here was the beginning of the Big Change. These changes were to be noted in the over-all dominance of stereo and the other changes, those insidious ones, between component and package manufacturers were everywhere in evidence. It seems that the whole nature of this show has been changing. It's a different type of crowd now than in the old days when it used to be called "The Audio Fair." There seems to be a higher proportion of the "man in the street" and less of the knowledgeable audiophile.

Even the musical tastes and manner of demonstration have changed. There were still remnants of the old block-buster sound spectacular type of demonstration, but for the most part the material was of a light or pop variety engendering little dynamic change and the levels at which the music was played were positively "polite."

In the larger-proportion-than-usual of couples, the attention of the wife was most often drawn to furniture and styling and what she saw and liked was rather heavily impressed on poor hubby. Thus in the logical order of events, more attention was paid to small speakers than large, packaged amplifiers rather than larger preamp and amplifier combinations, and, of course, the combination stereo tuner, preamp, amplifier, and gosh-knows-what-else all wrapped up most attractively in smaller and smaller packages, was looked upon favorably.

There were few really new items, however, most of the apparatus being ultra-refinements of tried and true components. And that brash upstart—four-channel tape—was much in evidence and tape in general was enjoying a renaissance. There were more companies displaying tape cartridge playback equipment, some of which was actual playing and, despite the discomfiture this will cause in certain tape circles, it was obvious that the cartridge concept was beyond the "gimmick" stage and nothing that could be flippantly dismissed.

Among the packages were some that were outright shams, which did very little of what they were purported to do. Certainly this type of equipment is an insult to the intelligence of even the greenest specimen of the average public. Fortunately, this group was in the minority and it is nice to report that many of the more conscientious manufacturers were displaying package units that were audibly improved. I guess in the package field it is more true than ever that "you gets what you pays for." So went the Show.

As I said, the seeds of the Change were sown at the 1959 Show and the Show in 1960 should be one of the most interesting in many years. For the decisions will have

# With DYNAKIT you KNOW you have the BEST!

*The finest high fidelity you can buy at any price*

## DESIGNED FOR STEREO

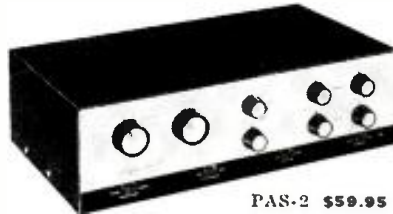

PAS-2 \$59.95

- New stereo control preamp with complete flexibility, fastest construction, and simplest operation
- Only 8 hours to build
- Truly unmeasurable distortion — below 0.05%



Stereo 70 \$99.95

- Two outstanding 35 watt channels (160 watts peak) to power any speaker
- Unequaled transient response
- Absolute stability with every loudspeaker without restriction of bandwidth.

## STEREO IN EASY STEPS

*Start with a superb monophonic system*

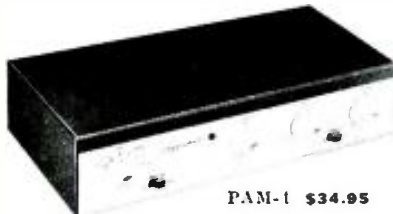

PAM-1 \$34.95

- History-making "no-distortion" pre-amplifier which has never been equalled
- 6 hour assembly



Mark IV \$59.95

- Either the renowned 60 watt Mark III or its new little brother, the 40 watt Mark IV
- 3 hours to build

*Expand to matchless stereo*

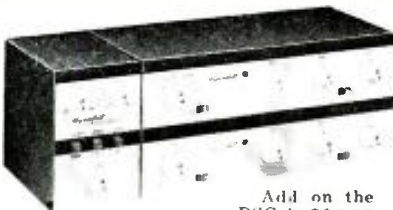

Add on the DSC-1 \$12.95

- Every stereo function at your fingertips
- Unsurpassed flexibility
- Unitized panel or cabinet mount available as an accessory



Two Mark III's \$79.95 each

- Just add on the second Mark III or Mark IV and you can have the most highly recommended, most desired stereo amplifier ensemble for less than 20 hours of your time.

*See and hear Dynakits at your local dealer*  
A post card will bring complete specifications

**DYNACO, INC. 3916 Powelton Ave. Phila. 4, Pa.**

why your next speaker system should be

# THE NEW AUDAX PARAFLEX

• Only Audax incorporates the Patented Paraflex Foam Suspension to give longer travel to the cone, resulting in honest bass without boom or hangover. You get bass with real bottom!

• New Styrofoam Radial Strut-Bracing reinforces cone, assures rigid piston action, preventing cone break-up. Eliminates distortion, provides clean reproduction up to the full-rated power output. Needs as little as 10 watts output. You get greater amplifier economy in stereo installations.

• New Oriented Grain-Processed Magnet gives 20% more efficiency than standard Alnico V.

• New Ducted-Slot Enclosure specifically designed to enhance the depth and striking realism of the Paraflex high-compliance speaker units. Speakers are located symmetrically on each side of the ducted slot, resulting in clean bass without trace of boom or unnatural heaviness.

• New, dramatic enclosure styling by George Nelson—featuring new, three-dimensional Dynel "Acoustiscreen" grille, removable for cleaning!

• Audax Paraflex Speakers are lab-tested and a performance seal on each unit indicates its resonant frequency  $\pm 1$  cycle.

Model CA-80 12" x 12" x 24" with two full range speakers—\$99.95

Model CA-100 15" x 12" x 25" with two 10" full range speakers and 2 matching cone tweeters—\$139.95

Also full line of component speakers

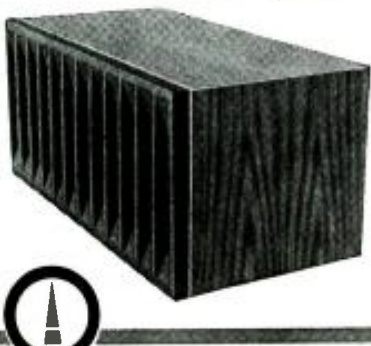

Write for free catalog and specifications, to: AUDAX Division of the Rek-O-Kut Co., Inc. Dept. EW-1, 38-19 108th St., Corona 68, N. Y.

Name \_\_\_\_\_  
Address \_\_\_\_\_  
City \_\_\_\_\_ State \_\_\_\_\_

Export: Morhan Exporting Corp., 458 Broadway, New York 13  
Canada: Atlas Radio Corp., 50 Wingold Ave., Toronto 19, Ont.

been made, the battles will have been fought and won or lost, and in the aftermath and the sorting out process, the Change will have taken place and we will have entered a new era in audio.

## SESSIONS BLACK MASKERS SUITE McPHEE TABULI-TABULIAN

Eastman Rochester Symphony Orchestra conducted by Howard Hanson. Mercury Stereo SR90103. Price \$5.95.

Both of these works have appeared previously in mono format and at the time of their issue created quite a stir with their exotic scoring and tremendous sound. The McPhee piece is programmatic in content and is derivative in the sense that it uses some elements of the gamelan orchestras of the East. The inspiration, in McPhee's own words, is South Seas, most likely Balinese in origin. It is an attractive little work with a wonderful rhythmic figure in the opening bars and this same sense of rhythm and vitality is maintained throughout the work. As noted, there are gamelan elements here, so there is some interesting use of high percussives.

The important work on this disc is the suite from the "Black Maskers." This is a very powerful, very stark work and, in spite of the fact that it is full of dissonance and atonality, it will have a strong appeal for many people who normally do not take to modern music. This is masterful writing with superb orchestration and constitutes a real virtuoso exercise for any orchestra.

Howard Hanson is completely at ease with this idiom and turns in a very vital, strong-lined performance and his fine orchestra follows his urgings with great spirit and wonderful accuracy.

For lovers of the big sound, this is a must. There are some great resounding tympani and bass drum smashes, high percussives galore, ultra-brilliant and very forceful brass, and a pedal organ passage of very low frequency and great power that will truly be appreciated by owners of king-size speaker systems.

As an example of stereo recording, the "Black Maskers" ranks among the very best thus far. It has those qualities of directivity and instrument delineation which are usual in Mercury's three-channel, half-inch technique, but beyond this is a feeling of depth as well as a very strong sense of acoustic projection which is quite unusual and is one of the few stereo recordings that really display this phenomenon. The acoustics of the Eastman Rochester Theater are, of course, among the finest in the United States and probably it was a happy combination of these acoustics plus the type of scoring and the microphone pickup which has given us such a superlative recording.

A final note. These works were coupled differently in their mono format, but I think this is all to the good as they complement each other very well in this coupling.

## LISZT PIANO CONCERTOS #1 & #2 Phillipe Entremont, pianist, with Philadelphia Orchestra conducted by Eugene Ormandy. Columbia Mono ML5389. Price \$4.98.

Some people may be a little confused by our young friend Entremont and the Liszt "Piano Concertos Nos. 1 and 2." You see this is a brand-new recording which has just been issued by Columbia in both mono and stereo and yet if you were to consult your Schwann catalogue you would find Entremont performing these same two concertos, but this time accompanied by Walter Goehr and the Zurich Radio Orchestra on a Urania label

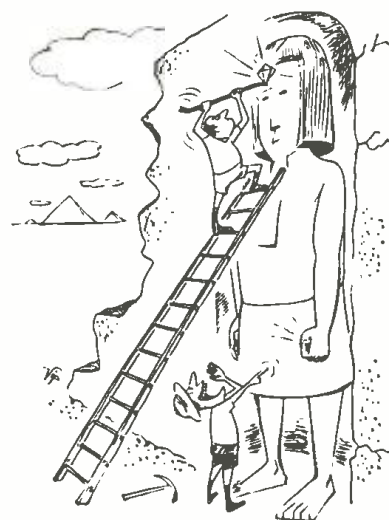

"Forget that lousy ruby, Ed. Let's pry this Jensen cartridge loose."

EASIEST TO BUILD LAYER BUILT COLOR GUIDE

# Grommes

## DE LUXE HI-FIDELITY KITS



101GTK  
FM TUNER

Finest tuner kit offered! "Standard Coil" tuning unit is pre-wired, pre-aligned and can be tuned-in as soon as completed, without professional adjustments. Better reception than tuners costing 2 or 3 times as much. Latest circuits, matched crystal diode detector, Foster Seeley Discriminator, AFC, Electronic Tuning Eye, Quiet, drift-free. Simply and successfully assembled by anyone with screwdriver, pliers and soldering iron. Step-by-step instructions. Model 101GTK, only \$59.50



20 WATT STEREO AMP.  
De Luxe stereo at half the cost! Two 10 watt channels with 2 pre-amps, 40 watts peak. Freq. Res.  $\pm 1$ dB, 20-20,000 CPS. 4 inputs. Output: 4, 8, 16 ohms. Automatic Loudness Control. LJK ..... \$59.50



10 WATT AMPLIFIER  
With built-in pre-amp. 20 watts peak. Freq. Res.  $\pm 1$ dB, 20-20,000 CPS. 4 inputs. Output: 4, 8, 16 ohms. Automatic Loudness Control. LJK ..... \$24.95

Many other kits available—  
At dealers or sent prepaid with check or M.O.

..... FREE!

GROMMES Div. of Precision Electronics, Inc.  
9101-G King Ave., Franklin Park, Ill.  
Please rush details on Grommes Kit Line.

Name \_\_\_\_\_  
Address \_\_\_\_\_  
City \_\_\_\_\_ State \_\_\_\_\_  
Your Dealer's Name \_\_\_\_\_

ELECTRONICS WORLD



and in mono and stereo to boot, by gad! Since it is the usual practice of recording companies to restrict an artist from recording the same work for some other company within a five-year period, either the *Urania* recording is very old or something's rotten in Denmark—or Switzerland in this case.

Since Entremont has been with *Columbia* about two years now, we could calculate that, if a five-year clause exists, the recording must have been made in 1954 or earlier. However, *Urania* was not recording in stereo in 1954, but further checking reveals that this was originally recorded for the *Concert Hall Society* and was issued as a stereo tape. Subsequently, this and other *Concert Hall* masters were sold to *Urania* and thus this crazy mix up.

In any case, Entremont has a very ingratiating way with these well-riden war horses, and his bright, fresh readings, full of youthful exuberance, are a delight to the ear after so many ponderous statements on these concertos. A comparison between Entremont's old and his new recording reveals the progress of the artist . . . certainly his touch is more facile and he seems to have a much more assured and positive attitude in his approach to these works.

In terms of sound, even though my copy was mono, it sounded a great deal better than the poorly recorded stereo of *Concert Hall*. The piano is splendidly balanced against the orchestra and is particularly clean in its transient response. The favorable acoustics give a fine impression of spaciousness and the sympathetic accompaniment of Ormandy and his superlative Philadelphians add greatly to the attractiveness of these performances.

**BARTOK  
CONCERTO FOR ORCHESTRA  
TWO PORTRAITS**

Royal Philharmonic Orchestra conducted by Rafael Kubelik. Capitol Stereo SG7186. Price \$5.95.

This is a magnificent recording, worthy of the attention of anyone who has a fondness for modern music. I heard Kubelik perform this wonderful music when he was with the Chicago Symphony and recall how impressed I was with the power and vitality of his reading. This, if anything, is an improvement over that memorable performance and most notable is Kubelik's superb handling of dynamics . . . one of the most important elements in this work. Couple this with judiciously chosen tempi, which neither drag nor rave, and a fine rhythmic proportion which is beautifully accurate yet buoyantly expressive . . . and you have a reading of rare excitement.

Sound-wise this is a fairly well balanced recording, except for the brasses which seem somehow subdued and not projected well enough forward. All elements are quite clean and Kubelik's dynamics are well realized. Stereo is good if you favor the M-S type of pickup, in other words, excellent middle somewhat at the expense of directionality. However, depth is well maintained through intelligent handling of the spacious acoustics.

Kubelik must have worked the Royal Philharmonic very hard for this virtuoso piece as they play with much more verve and accuracy than I've heard from them for some time. On strict comparison, the Dorati version still has the edge in over-all sound quality, even though it is mono. But the stereo version has its own particular merits in the smoothness and naturalness of its strings and the woodwind. Dorati's reading is also an exceptional job, although stressing rhythm more than most.

Summing up, kudos to Kubelik for this thrilling recording . . . he is a conductor whose talents are much more considerable than many critics would have you believe.

**A PLEASURE TO BUY** at your franchised Thorens dealer's

**A PLEASURE TO OWN** . . . more features, more craftsmanship, more superb music-making quality for monaural or stereo

**A PLEASURE TO RECOMMEND** to friend or favored customer, with the confidence-inspiring Thorens 1-year guarantee

**THE THORENS TD-124 TRANSCRIPTION TURNTABLE**

**More rotating pounds than any comparable 12" turntable!**

**More features per pound! Look at them:**

- 4 speeds . . . 16 $\frac{2}{3}$ , 33 $\frac{1}{3}$ , 45, 78
- 11 $\frac{1}{2}$  pound table for smooth running
- Exclusive double-table with clutch for fast starts
- Precision, hairline adjustment for all speeds
- Built-in illuminated strobe
- Easy arm installation or change . . . no metal drilling, no unsightly holes after arm change
- Built-in precision circular level
- Large, knurled, leveling screws
- Motor operates on 50/60 cps, any voltage from 100 to 250. o.2

. . . and many more. See the TD-124 at your franchised Thorens dealer's today.



**TD-124**  
**\$99.75 net**  
(Base only \$9.00)

**Guaranteed for one full year.**

**Sold only through carefully selected franchised dealers.**



**THORENS**

**SWISS MADE PRODUCTS**  
HI-FI COMPONENTS • LIGHTERS  
SPRING-POWERED SHAVERS  
MUSIC BOXES  
NEW HYDE PARK, NEW YORK

"IT TAKES TWO TO STEREO" \*



... the perfect team for stereo!  
 For matchless reproduction of stereo recordings  
 — the Model 196 UNIPOISE Arm  
 with integrated Stanton Stereo FLUXVALVE pickup  
 and the GYROPOISE 800 airborne Stereotable.  
 Only the Stanton Stereo FLUXVALVE  
 has the exclusive "T-GUARD" stylus assembly  
 with the parallel reproducing element so important for stereo...  
 only the GYROPOISE Stereotable revolves on a bearing-of-air  
 — in magnetic suspension...  
 only the Stereo FLUXVALVE is warranted for a lifetime.  
 In plain truth, here is more to enjoy —  
 from both stereophonic and monophonic records.  
 Fine quality high fidelity products  
 by PICKERING & Co., Inc., Plainview, N. Y.



FOR THOSE WHO CAN HEAR THE DIFFERENCE

FLUXVALVE, GYROPOISE STEREO TABLE, T-GUARD UNIPOISE  
 © NEWLY REVISED — "IT TAKES TWO TO STEREO" — ADDRESS DEPT F-10 FOR YOUR FREE COPY

## Mobile P.A. Systems

(Continued from page 67)

we should be able to use the equipment as soon as it is turned on. The transistor, with no filament, requires no warm-up time. Then, because there are no separate elements in the same sense as those in a tube, the transistor can operate under conditions of extreme shock or vibration. To keep a tube amplifier from becoming or exhibiting microphonic tendencies would require shock-mounting, further increasing the size and weight of the equipment.

The circuit diagram of a modern mobile transistor amplifier that delivers 25 watts from a 12.6-volt battery is shown in Fig. 2. This is the circuit of the *Bogen* BT25 which can be driven to full output from a low-impedance microphone input, an auxiliary input, or a combination of both.

It is interesting to observe the output stage where both transistors of the push-pull pair are mounted directly to the aluminum chassis to provide maximum heat dissipation. In addition, the output is choke-coupled to the speaker (or speakers) from the emitters of these transistors. However, this is not an emitter-follower arrangement as might be imagined at first glance but the familiar grounded-emitter in an unconventional form. The drive to the transistors of this stage is accomplished between base and emitter through individual secondary windings of the driver transformer. The a.c. output is taken between collector and emitter, through the power supply.

The earlier stages are conventional; there is RC coupling between  $V_1$  and  $V_2$ ; the second stage is direct-coupled to the driver,  $V_3$ . These early stages have good stability factors to give reliable operation within fairly large temperature excursions. This also makes the circuit non-critical as far as transistor replacement is concerned.

Over-all efficiency of this amplifier is about 62% at full output. This includes losses due to transformers and biasing and means that the battery is required to provide only 40 watts when the amplifier delivers 25 watts to the speaker load. When operated from a 6-volt battery source, 6 watts are available from this amplifier, making it suitable for most p.a. applications. More than 30 watts can be obtained from a 15-volt battery. Higher voltage operation is not recommended because of possible damage to the driver or output transistors.

The commercial version of this amplifier weighs 3 pounds, including its metal cage, and can fit into the glove compartment of most cars. In addition, it is priced below most comparable mobile tube amplifiers.

### REFERENCE

1. Millman, Jacob: "Vacuum Tube & Semiconductor Electronics" McGraw-Hill, New York.



## SPEAKER

when it's in an enclosure. So why make it with fancy frills that may look good, but costs more and adds nothing to the performance?

**wigo**  
 PRONOUNCE IT WEEGO

SPEAKERS put the emphasis on quality, which is on the inside where you can't see it, but can sure hear it. See what we mean? For literature, write...

**united Audio**

PRODUCTS OF DISTINCTION  
 202-4 East 19th St., N. Y. 3, N. Y.

## ENGINEERING HOME STUDY COURSES

Courses written by world authorities in all branches of engineering and science and proved successful by thousands of our graduates. One hour each day in your spare time will start you off to higher pay, security and prestige. Personalized instruction methods ensure rapid progress. Fill in the coupon and indicate the course of interest. We will send you a complete outline of the course and a booklet describing the Institute and our advanced teaching methods.

RADIO  
 ELECTRONICS  
 TELEVISION  
 CIRCUIT  
 MATHEMATICS  
 ELECTRICAL ENG.  
 TELEPHONY  
 CIVIL ENG.  
 SURVEYING  
 ARCHITECTURE  
 FORESTRY  
 MINING  
 STRUCTURAL  
 MECHANICAL ENG.  
 INDUSTRIAL ENG.  
 & MANAGEMENT  
 REFRIGERATION  
 DRAFTING  
 PLASTICS  
 AERONAUTICAL  
 ENG.  
 HIGH SCHOOL  
 CHEMICAL  
 MATHEMATICS  
 JOURNALISM  
 ACCOUNTING

### MAIL THIS COUPON TODAY

CANADIAN INSTITUTE OF SCIENCE & TECHNOLOGY LIMITED  
 737 Century Bldg., 412, 5th St. N.W., Wash., D.C.

NAME.....

ADDRESS.....

CITY.....STATE.....

COURSE OF INTEREST.....

Canadians: Send to C.I.S.T., 737 Garden Bldg.,  
 263 Adelaide St. West, Toronto, Ontario.



**C. I. S. T.**



## New Amplifier Standards

(Continued from page 51)

at the standard test frequency of 1000 cps.

### Distortion

The only distortion measurement specified in the new standard is that of *single-tone* distortion, which is basically a measurement of total harmonic distortion. A 1000-cps signal is applied, the amplifier is adjusted to full rated output, and an output voltage measurement is taken across the load. Then the fundamental component is removed from the output and the remaining harmonics and residual noise and hum are measured. The relation between these two voltages, expressed as a percentage, gives the per-cent distortion. In addition to rating amplifiers at rated output, it is standard to rate them at 3 and 20 db below rated output as well. This corresponds to half power (.7 voltage) and one-hundredth of the power (1/10 voltage) respectively. It is interesting to note that no standards were set up for IM distortion tests.

### Hum and Noise

Hum and noise factor is the ratio in db of the hum and noise voltages in the output with respect to the rated output at 1000 cps. Measurements are to be taken with the input terminals open circuited and short circuited. If gain or level controls are provided, these are then adjusted to reduce the output by 20 db, and then 40 db. The hum and noise factor is then expressed as the lowest numerical value in db determined by all the above tests. The standard also specifies that the measuring instrument be weighted to follow the 40 db (A) curve of ASA Standard Z 24.3-1944. It is interesting to note that this curve, usually employed in sound-level meters for low-level measurements, is down 27 db at 60 cps.

### Damping Factor

This term, designated by the symbol DF, is the ratio of the rated or nominal load impedance to the actual internal impedance of the amplifier. The measurement is taken with a 1000-cps signal applied and with the amplifier unloaded and producing a 1-volt output across the 8-ohm output terminals. Then an output load is applied, and is then adjusted until the output voltage falls to half the no-load value. Under these conditions the value of the load resistor is equal to the value of the amplifier's internal impedance. The ratio can now be set up and the damping factor calculated.

For additional details on the methods of measurements and standard conditions specified, we refer our readers to the complete publication "IHF Standard Methods of Measurement for Amplifiers (IHF-A-200)." This is available directly from the Institute, 125 East 23rd Street, N. Y., N. Y. at a cost of \$1 each.

-30-

# Mullard TUBES for STEREO CIRCUITS

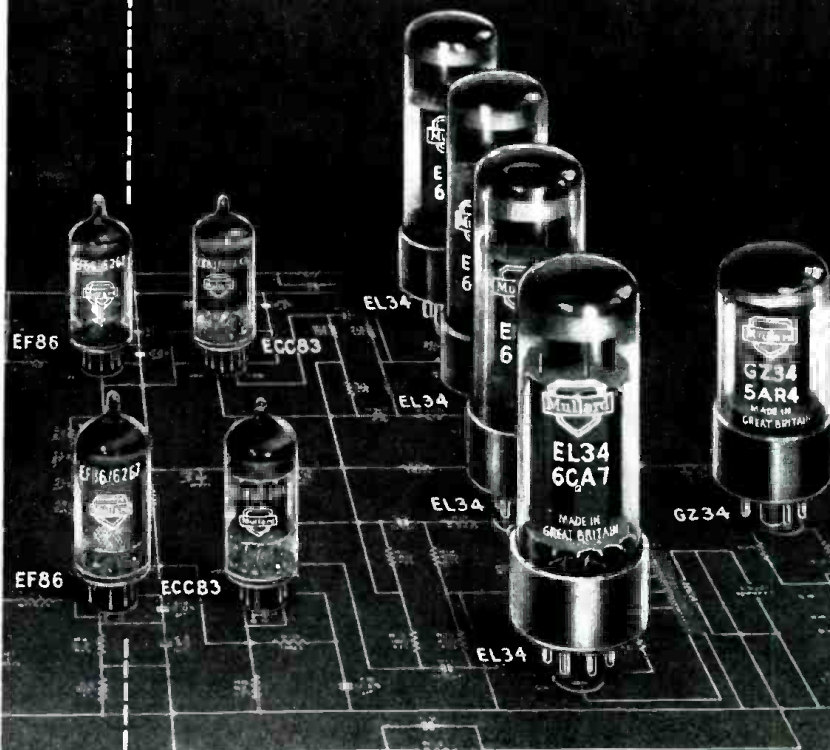

MULLARD tubes and circuits, already acclaimed throughout the world for their advanced engineering and reliability, are in great demand for today's stereo amplifiers.

Heading the preferred list for power output tubes is the MULLARD EL-34/6CA7. This extremely linear output pentode which is capable of 60 watts push-pull in Class AB<sub>1</sub> (60 watts per channel stereo—120 watts monophonic) gives a special superiority even to the finest components. This linearity coupled with a uniformity that is already well known make the MULLARD EL-34/6CA7 the first choice for superb sound reproduction.

Design and build your stereo equipment around MULLARD. Circuit and interchangeability data for all MULLARD Electron Tubes are available at your distributor or write to Technical Services Division.



Trade Mark  
Mullard Ltd.

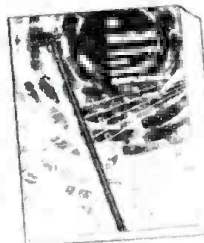

"Circuits for Audio Amplifiers" is a new MULLARD publication in which the wide range of MULLARD high quality audio circuits is presented conveniently in one book. Four introductory chapters are devoted to theoretical and practical considerations of high quality sound reproduction with monophonic equipment or with stereophonic systems. The rest of the book comprises circuit descriptions, constructional details, and some performance figures of 12 MULLARD circuits. These circuits include well-known MULLARD designs, some modifications and improvements to these circuits, and a number of completely new ones. Only \$2.50 from your dealer or by mail from our Technical Services Division.

INTERNATIONAL ELECTRONICS CORP.  
81 SPRING ST., NEW YORK 12, N. Y.

NEW FROM HOWARD W. SAMS

## "From Tinfoil to Stereo"

The Evolution of the Phonograph



by Oliver Read  
& Walter L. Welch

Here is the most complete history of the phonograph ever written—from the use of tinfoil to the revolutionary stereo record—the whole exciting story of the men and events responsible for the development of the phonograph!

You'll be fascinated by this masterful account of the evolution of the phonograph. Covers everything: man's earliest dreams of imitating sound; the Edison tinfoil phonograph and the development of the earliest prototypes; the patent struggles; the development of cylinders and discs; the coin-slot phonograph; the introduction of the internal horn; the beginnings of radio and its contribution to recording and reproduction; sound pictures and the phonograph; the war of the record speeds; growth of component systems; tape vs. discs—right down to today. Includes dozens of rare photographs. A wonderful book for every hi-fi enthusiast and phonograph connoisseur. 525 pages, 6 x 9", fully illustrated. Only **\$9.95**

MORE NEW SAMS BOOKS

## "101 Ways to Use Your Ham Test Equipment"



by Bob Middleton

A practical "how-to-do-it" book for amateur radio operators and service technicians who specialize in the repair of ham radio equipment. Gives concise applications for grid dip meters, antenna impedance meters, oscilloscopes, bridges, simple noise generators and reflected power

meters. Each use is clearly described, with full data on connections required, proper test procedures and evaluation of results. 144 pages; 5½ x 8½" x **\$2.00** 8½"; illustrated. Only

## "Servicing Hi-Fi and FM in the Customer's Home"



by Milton S. Kiver

Describes a wide range of quick, easy test methods for hi-fi amplifiers, AM-FM receivers, record changers, turntables and tape recorders. Includes several unusual new methods, such as the use of an AM detector probe to trace FM circuits. Methods are selected for their quick, practical application and their ability to locate actual and potential trouble spots in hi-fi equipment. Indispensable to anyone interested in servicing hi-fi.

176 pages; 5½ x 8½"; illustrated. Only **\$2.95**

### HOWARD W. SAMS & CO., INC.

Order from your Sams Distributor today, or mail to Howard W. Sams & Co., Inc., Dept. A-10 1720 E. 38th St., Indianapolis 6, Ind.

Send me the following books:

- "From Tinfoil to Stereo" (EPR-1)  
 "101 Ways to Use Your Ham Test Equip." (TEM-6)  
 "Servicing Hi-Fi in the Customer's Home" (SHK-1)  
 \$..... enclosed.  Send Free Book List

Name \_\_\_\_\_

Address \_\_\_\_\_

City \_\_\_\_\_ Zone \_\_\_\_\_ State \_\_\_\_\_

(outside U.S.A. priced slightly higher)



IT HAS BEEN some time since the issue of licensing generated as much attention as it is currently receiving. The matter can never be considered dead, but it often goes into periods of relative inactivity. Spearheading the renewed interest is the adoption of a licensing ordinance in Kansas City, Mo. This community now joins such others as Detroit, St. Paul, and the State of Louisiana in using some legal instrument for passing on the qualifications of TV service technicians.

In communities where such regulatory legislation has been rejected recently, advocates of licensing have not taken such actions as defeats, but rather as steps toward the goal. For example, president Bob Larsen of the Empire State Federation of Electronic Technicians Associations has resigned his office to devote his concentrated energies to the fight for a licensing law in New York State. This follows the rejection by the legislature of a certification proposal by only a few months. Opposing the trend, one association is behind a move to test the legality of the Kansas City ordinance.

In many localities where licensing has been rejected, legislators have given as a reason the fact that existing laws should be sufficient to deal with unethical service businesses. Basing their strategy on this point, many associations are reporting questionable operators who may be violating sales tax laws, general businesses-licensing regulations, business zoning rules, and other local requirements.

Related to the matter of questionable operators, there is an increasing tendency to consider the role of the part-timers and to establish standards with respect to them. This includes an increased willingness to recognize that a part-time service technician is not necessarily the same as a "night crawler."

Also in the news: a growing wave of thefts from service shops, often giving the appearance of organized activity; the question of what is a fair price for service calls; and electron tube pricing.

#### Tube Prices: Cincinnati

President Stan Shaffer of Cincinnati-TESA has something to say on proposals to reduce the mark-up on tubes to make these items less profitable for the drug stores to handle: "First of all the druggist, etc., couldn't care less if the list price of tubes is lowered because his total investment is approximately 4 square feet of floor area and, if he made nothing on tube sales, he is still creating store traffic he normally

wouldn't have. Secondly the illegitimate part-timer can't be hurt because his income, after the cost of parts, is all profit and losing 50 cents or so per tube isn't going to slow him up at all. Thirdly, to get an idea just how this will 'help' you, mentally deduct half your tube profit from your net income last year."

#### Louisiana Licensing

Harold J. Yuratic, director for the Louisiana State TV Service License system, reports that state officials, the public, and the service industry are all satisfied with the way in which the statute has been working out. Louisiana can claim a "first": as far as licensing on a state-wide basis is concerned, it is a pioneer.

#### TEAM Fights License Law

The Electronic Association of Missouri, one of the most articulate of those established service associations that is opposed to licensing in principle, has elected to do something about the passage of such legislation in its home state. At the request of TEAM, two principals have filed suit against the mayor, the commissioner of revenue, the chief of police, and other officials of Kansas City. They question the validity of the recently passed law.

Says John V. Glass in "TEAM News," "Your business will be regulated by four of your competitors. There is not one word of protection for you from false accusation, personal animosity, and discrimination from a board dominated by politics. No provision is made for appeal from decisions of the Board or the Commissioner of Revenue."

#### Tax Evasion, California

Television Service Dealers Association of San Mateo County, Calif., has been scrutinizing local ordinances carefully to turn up some interesting angles on do-it-yourself tube checkers located in non-service businesses. Most cities in the county require the licensing of vending machines and other such devices, but it has not been the practice of owners of these tube checkers to comply with the requirement. Also there is some question as to the evasion of property and other business taxes with respect to these testers. TSDA points out that, since established service businesses do indeed pay such taxes, they are at a competitive disadvantage.

#### Texas Tax Law

Revisions in the state tax laws are being used by TEA of San Antonio and



other Texas groups as the basis for strategy in combating illegitimate service technicians and drug-store checkers. One provision of the law requires that a sales slip be written on each transaction giving the customer's name, items sold, and the tax collected. The TEA affiliate is prepared to report violators in the area of radio-TV service.

RTTG-TESA of Miami, following a plan similar to that being used in Texas, says, "Help put the illegitimate part-timer in business—report his activities to the license bureau, tax collector, and zoning board."

In some areas where there are effective laws to control weights, measures, and similar standards, another technique is being used on questionable tube testers. Service groups are asking that such devices be checked for their accuracy in providing measurements of tube quality and that they be controlled where it is found that they give misleading readings.

#### Part-Timers

NATESA has been giving serious attention to defining the role of the part-timer. As reported by the "Newsletter" of the Television Service Association of Northeastern New York, the National Alliance recognizes two types of part-timers: the properly qualified one who has had sufficient background and experience, and the one "who may be your mailman, garbage collector, *et al.*, who has never had training" but who "owns a tube caddy and a lot of nerve." NATESA is attempting to establish standards that will help in differentiating between these two groups.

In a related endeavor, members of the service industry have met in Indianapolis, Ind. to set up standards for recruitment, training, and testing at a regional apprenticeship conference.

In areas where TV service licensing does not exist, urges NATESA's Frank Moch, the local industry should adopt "self-licensing" either to force the part-timer out or put him legitimately in business: "Use every applicable tax, and other agencies, to force the part-timer to assume his proper business burdens. This office will be more than happy to cooperate with you and make available to your group data gathered on both of these plans (licensing and self-licensing)."

#### Bait Advertising, Pasadena

The *Independent Star-News* of Pasadena, Calif., will no longer accept television service advertising in which the price of a house call is mentioned in the copy. This newspaper joins a long list of other media that have adopted such a policy, usually as a result of the efforts of local service groups. Says the *Star-News*, "Decisions of this sort are based on public reaction and the desire of newspapers to maintain the highest standards of truth in advertising." Copies of the daily's notification went out to 22 service firms in the Pasadena area.

-30-

January, 1960

# Service Technicians! YOU EARN MORE... YOU RATE with the public when you own the PHOTOFACT® service data library!

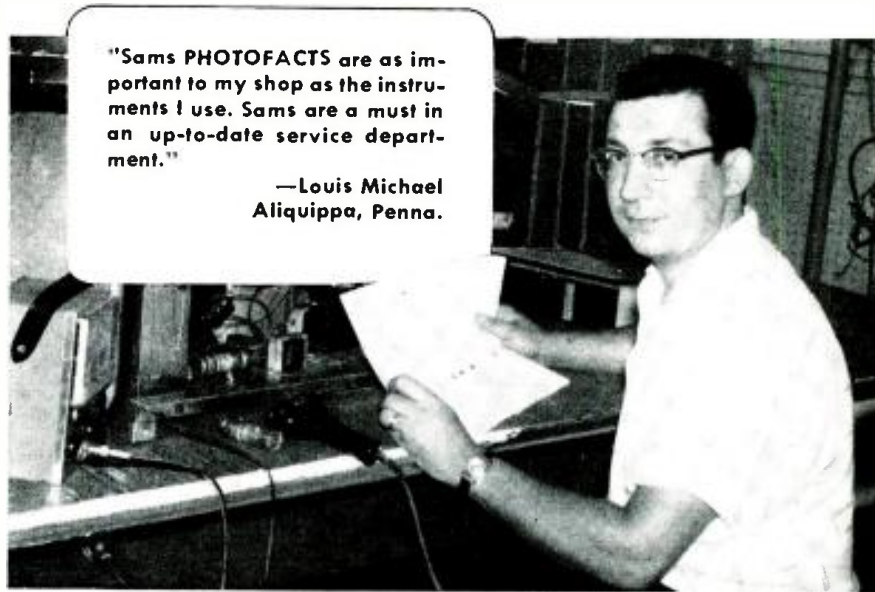

"Sams PHOTOFACTS are as important to my shop as the instruments I use. Sams are a must in an up-to-date service department."

—Louis Michael  
Aliquippa, Penna.

YES, if you are one of the thousands of owners of a complete PHOTOFACT Service Data Library, you are enjoying maximum earnings. It's inevitable, because no matter how expert you are, you can always *save more time on any job, get more jobs done daily—EARN MORE, DAY IN AND DAY OUT...*

Moreover—as the owner of a complete PHOTOFACT Library, *you know your customers' sets best.* You can actually show each customer you have the PHOTOFACT Folder covering his very own set. Result: You command public respect and acceptance which paves the way to more business and earnings for you...

#### HOW TO STAY AHEAD...

Today, the truly successful Service Technicians are those who own the complete PHOTOFACT Library, who can meet and solve any repair problem—faster and more profitably. And these men *keep ahead* because they're on a Standing Order Subscription with their Distributors to receive all new PHOTOFACTS as they are released monthly.

For PHOTOFACT Library Easy-Buy Plan details and Standing Order Subscription, see your Sams Distributor today, or write to Howard W. Sams...



#### BIG NEW PLUS!

get the  
details

If you now own a PHOTOFACT Library, you can apply for membership in the powerful new "PEET" program, designed to build prestige and business for the Service Technician who qualifies. Ask your Sams Distributor for the "PEET" details, or mail coupon today!

**HOWARD W. SAMS & CO., INC.**  
1724 E. 38th St., Indianapolis 6, Ind.

- Send me full details on the new "PEET" Program. Include full information on the Easy-Buy Plan and Free File Cabinet deal.
- I'm a Service Technician:  full-time;  part-time

My Distributor is: \_\_\_\_\_

Shop Name \_\_\_\_\_

Attn: \_\_\_\_\_

Address \_\_\_\_\_

City \_\_\_\_\_ Zone \_\_\_\_\_ State \_\_\_\_\_



## ALL NEW HEADPHONES

HS-30 Low Imp. (feather wt.)	\$ 1.50
H-16/U High Impedance	25.00
TELEX Boom Headset with Cord	10.00
TELEX Twinset with Cord, 3 oz.	12.00
AVIOMETER Boom Headset w/Mike, Cord, Cushions	12.00
M-46/UR Boom Headset w/Mike, Chamois Cup, Cords	18.00
Earphone Cushions, Chamois	1.50
T-17 Carbon Hand Mike	5.25
T-30 Carbon Hand Mike	7.99
T-45 Army and Navy 1/4" Mike	1.33
T-24 Carbon Mike w/Retrax Cord	3.95
F-3 Handset	8.00
RS-38 Navy Type	6.95

SYNCHROSCOPES MODEL TS-34/AP.....\$49.00  
SOUND-POWERED DYNAMIC PHONES.....Pr. 4.75  
REC. MICROWAVE R-111 APR-S.....39.00  
ARB RCA-SIX TUBE RECEIVER.....17.50

TEST SET AN ARM-30 for testing URC-4 Hand-Talkies, new, complete.....\$ 25.00  
BC-659 TRANSCEIVER with PE-120 Power.....\$ 24.00  
ARM-7 COMPASS, complete.....\$195.00  
ARM-6 COMPASS, complete.....\$125.00  
ARC-3 TRANSCEIVER, complete.....\$125.00  
SQUARE 1 1/2 "5"-METER.....2.50

BC-603 AC-SUPPLY  
AC Power Supply for BC-603 Receiver and BC-683 no modification needed, plugs directly into Jones Receptacle.....\$9.95

T.47/ART-13 TRANSMITTERS  
100 Watt 2-18 MC Autotune, excellent cond., with tubes.....\$39.00

TS-328/U FREQUENCY METER, 300 cycle, vibrating reed type, bakelite case with test leads, excellent condition, checked.....\$22.50

MOBILE & FIXED VHF SETS  
Complete set for 110-v operation including SCR-522 Transceiver, RA-62 Rectifier, J-type ground control box, mounts, connectors, tubes (less crystals). Excellent condition CAA.....\$124.00

Same as above but 12 or 24" operation including PE-68 (12-v) or PE-14 (24-v) dynamotor instead of rectifier. Excellent condition CAA.....\$89.00

Both Mobile and Fixed Sets purchased together, limited time only.....\$194.00

RA-62-C POWER SUPPLY A-C for SCR-522 VHF 110/60 cyc. Like new LTD QTY.....\$59.50  
KITS only for above. Contains special x-former, rectifier, regulator and connectors w/schematic.....\$17.00  
SPECIAL ONLY.....\$17.00

GROUND-PLANE VHF ANTENNAS \$9.95  
GOOD FOR CITIZENS BAND FROM 30-200 MC-NEW

PERT VACUUM SWITCH, SP21 or 1Y24103 or G.E. GL-34, new, factory boxed.....\$1.25 Each  
Cost—\$1.50.....Special \$1.25 Each  
\$12.00 dozen—\$85.00 hundred

SEND FOR NEWEST FREE CATALOG  
\$5.00 Min. - 25% Dep. C.O.D.'S - F.O.B. Conn.  
**HI-MU ELECTRONICS**  
133 HAMILTON ST., NEW HAVEN, CONN.

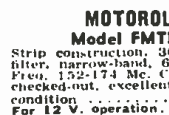

**SPECIAL!**  
UNIVERSAL 6/12 VOLT  
VIBRATOR POWER SUPPLY  
WIRED, fig. by DUMONT.  
Rating 300 V. @ 100 milli.  
Ideal for all types of mobile  
applications. Chassis measures  
5 1/4" x 5 1/4" x 8"  
Brand New.....\$11.95

### MOTOROLA TRANSCEIVER

Model FMTRU 80D (A) DSP13

Strip construction, 30 W. power output, Permakay filter, narrow-band, 6 V. Dynamotor power supply, Freq. 152-174 Mc. Complete with cables, antenna, checked-out, excellent condition.....\$199.50

For 12 V. operation.....\$239.50

**MOBILE RADIO EQUIPMENT**



2 PIECE MODEL FMTR 30-50 MC ED. 7 FM MOBILE TRANS. & REC.—6 VOLTS  
Unit complete with Peak Modulation control head, mike, antenna cables & crystals ground to your specific frequency. Modified for 20F3 emission.....\$109.95

MODEL FMTR-12V. operation.....\$149.95

MODEL 2210 152-162 MC FM MOBILE TRANSMITTER & RECEIVER—6 VOLTS  
Trans. modified in accordance with latest FCC Reg. for 20F3 emission. Complete with antenna, cables, control head, mike & crystals ground to your specific frequency. Ready for immediate installation. Specially priced.....\$139.50

MODEL 2210-12V. operation.....\$162.50

Model 50 UFS 60 Watt 30-50Mc Base Station  
Housed in a 3 1/2" upright cabinet, modified for 20F3 emission. Operates on 110AC. Recon. diltuned, checked out.....\$249.50

Include 25% deposit with order—balance COD. 50c handling charge on all orders under \$5.00. All shipments FOB our warehouse, NYC.

**PLATT ELECTRONICS CORP.**  
20 MURRAY ST., NEW YORK 7, N. Y.  
Telephone: COrtlandt 7-2575

## Wide-Band Millivoltmeter

(Continued from page 59)

5 of  $V_1$  and the ground connection from pin 2 of  $V_2$  are left open. All tubes are placed in their sockets except for rectifier  $V_3$ , and the slider on  $R_3$  is set so that the entire resistance of 400 ohms is in the circuit. Connect a d.c. voltmeter between point X and ground, plug the instrument into an a.c. source, and turn on power switch  $S_2$ . The reading will doubtless be below the 24 volts required for the heaters. Keep reducing the resistance of  $R_3$  (with power off) until the desired 24 volts is read.

With power off, plug rectifier  $V_3$  into its socket and set the slider on  $R_1$ , so that the full resistance of 2000 ohms is in the circuit. Connect an ammeter (0-100 milliamperes scale) between pin 2 of  $V_2$  and ground. Turn on the power and note the reading.  $R_1$  should be adjusted for a reading of 35 milliamperes. Since this concludes power-supply adjustments, the amplifier "B+" lead may now be connected to pin 5 of  $V_1$  and the ground connection made from pin 2 of  $V_2$ .

Turn meter switch  $S_3$  off, turn on power switch  $S_2$ , and allow several minutes for the tubes to warm up. Check the heater, plate, and cathode voltages (shown in Fig. 3). If an oscilloscope is available, it may be plugged in at  $J_2$  and the amplifier output checked for any spurious signals while switching the range switch through its various positions. If any signal is present at the output, the offending stage may be found by successively shorting each grid to ground. If a scope is not available, headphones may be used. It may be necessary to place the cover on the instrument when checking the 10-

millivolt scale to prevent any external a.c. pickup.

If the output is clean, pull the scope plug, set the range switch to the 100-volt position, turn meter switch  $S_3$  on, and rotate the range switch down through the lower scales. The meter should remain at zero on all scales. The instrument is now ready for calibration. Set the range switch to its 10-volt position and apply, through shielded test leads from an accurately known source, exactly 10 volts r.m.s. (preferably at 1000 cycles).  $R_{11}$  is then adjusted so the meter reads full scale, and the instrument is completed and ready for operation.

### Other Facilities

The meter switch ( $S_3$ ) and pin jacks ( $J_1$ ,  $J_2$ ) provide for use of the microammeter itself as a bench meter. The switch is also useful for taking the meter out of the circuit, when changing inputs, to prevent any damage.

The signal may be observed on an oscilloscope at the same time it is being metered by inserting a plug all the way in at  $J_2$ . This cuts out the meter circuit and its associated 15 db feedback, providing approximately 9.5 volts output with 10 millivolts on the grid of  $V_1$ , a voltage gain of almost 60 db.

It will be necessary to make up a shielded probe with a shielded lead for audio signal tracing. The instrument may also be used as an r.f. signal tracer by using a crystal-detector probe at the input, and the signal may be taken out at  $J_2$  to headphones or an audio amplifier for aural tracing. The circuit for such an r.f. probe is shown in the lower right-hand corner of Fig. 3. —30—

## HANDY FILAMENT CHECKER

By NICHOLAS B. COOK

THE IDEA of series-string filaments has come a long way since their use in Christmas-tree lighting. Today, in addition to the common a.c.-d.c. radios, a large number of TV sets use such filament strings, with special lines of tubes designed for the purpose. However, when the lights go out, the old problem remains: "Which one is open?" Testing the heaters of individual tubes is still the most reliable way of getting the answer, but also the most time-consuming.

Compact, multi-socket filament checkers are probably the most convenient solution to the problem, but most available types have limitations. Dependence on an a.c. supply through a line cord limits mobility and introduces the hazard of a live circuit in a metal box. Battery-operated checkers have the disadvantage that the flashlight type of bulb ordinarily used limits battery life, especially if the light weight and compactness of the smaller cells are desired. Also such bulbs often limit the range of filament voltages that can be checked. However, these handicaps can be overcome by using No. 48 (or 49) panel lamps.

With either of these bulbs, a self-contained checker small enough to fit in the

palm of the hand or pocket can be built for about a dollar, including two tiny penlight cells. The lamps are rated at only 60 ma. If wired as shown below, using only three sockets, the majority of currently popular types can be tested. The 15-ohm dropping resistor limits current to the rated value even on short circuits. It also helps make it safe to test even 1.5-volt tubes, with the pilot bulb giving a bright glow. The glow is still perceptible with such 50-volt tubes as the 50L6. The upper limit is a filament or other load of about 75 ohms. Test leads connected to the jacks permit checks on picture tubes, locals, speakers, coils, switches, and other low-resistance components. —30—

Cost and parts requirements are modest.

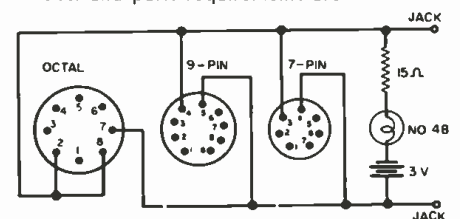



### LORAN R-65/APN-9 RECEIVER & INDICATOR



Used in ships and aircraft. Determines position by radio signals from known stations. Accurate to within 100 feet. Complete with tubes and crystal. Exc. used.

Value \$1200.00. **\$79.50**

Price. Includes 12V Inverter Power Supply for above. BRAND NEW. \$32.50

Circuit diagram and connecting plugs available.

### SCR-AR-283 Transmitter-Receiver

Consists of RECEIVER, 201 to 398 Kc and 2500 to 7550 Kc. TRANSMITTER, 2500 to 7700 Kc. for unmodulated, tone-modulated, or voice. Here's what you get, at this fantastically low price: Receiver complete with 6 tubes; transmitter complete with 4 tubes; Dynamotor for 24 V DC operation, 5 coil sets 2 control boxes, antenna switching relay, operating manual. ALL BRAND NEW. **\$16.95** and All Yours, for only.....

### NAVY AIRCRAFT RADIO RECEIVER

ARB/CRV 46151—190 to 9050 Kc in 4 bands. 6 Tube Superhet communications receiver, with local and remote tuning, band change, sharp and broad tuning, AVC, CW, Illuminated dial. Complete with tubes and dynamotor, used..... **\$17.95** Like New..... **\$26.50**

### BC-733 VHF 10-TUBE AIRCRAFT RECEIVER.

6-channel xtal control. Freq. 108.3 to 110.3 Mc. Dual filter range. Easily converted for tracking Sputniks. **\$7.95**

Exc. used. Complete with tubes..... **\$8.95**

Brand New complete with tubes..... **\$9.95**

Dynamotor for above 12 or 24 V.—New **\$5.95**

### AN/APA-38 PANORAMIC ADAPTER

And Wave Analyzer. 30 Mc Center Frequency. 2 Mc Band Width. Total scan 10 Mc at one clip. Regular saw-tooth sweep. Variable sweep freq. control 1600 cycles. Use it as regular service scope! Including 11 tubes and 3 scope tube type 3DF1. LIKE NEW. **\$19.50**

### ASB-5 SCOPE INDICATOR

BRAND NEW, including all tubes, together with 5 BPF 1 Scope Tube. Originally used in Navy Aircraft RADAR equipment. Easily converted for AC operation. **VALUE \$250.00! OUR LOW PRICE \$15.95**

### SCR-522 2-METER RIG!

Terrific buy! VHF Transmitter-receiver, 100-150 Mc. 4 channels. Xtal-controlled. Amplitude modulated voice. They're going fast! Exc. used.

SCR-522 Transmitter-Receiver, complete with all 18 tubes, top rack and metal case. **\$32.32**

COMBINATION..... Special

Receiver only, with all tubes..... **\$19.50**

Transmitter Only, with all tubes..... **\$17.50**

Accessories for above available.

### LORAN APN-4 FINE QUALITY NAVIGATIONAL EQUIPMENT

Determine exact geographic position of your boat or plane. Indicator and receiver complete with all tubes and crystal.

INDICATOR ID-69/APN-4, and RECEIVER R-9B/APN-4, complete with tubes. Exc. used **\$49.50**

Receiver-Indicator as above. BRAND NEW. **\$69.50**

Inverter for above unit available from stock.

### LORAN APN/4 OSCILLOSCOPE

Easily converted for use on radio-TV service bench. **Completely Assembled**

LIKE NEW: Supplied with 5" Scope, type **\$14.95**

Brand New..... **\$19.50**

### BC-906 FREQ. METER—SPECIAL

Cavity tube, 145 to 235 Mc. BRAND NEW, complete with antenna. Manual included. **OUR LOW PRICE \$9.88**

#### STANDARD TUBES

Removed from Brand New Gov't Equipment

RECEIVING	6AG5.....35	6AC7.....55	315.....2.15
12AT7.....45	6J6.....32	1625.....29	
6AK5.....35	SPECIAL PURP.	1629.....29	
6CA.....25	3E29.....4.25	2013.....39	
6AL5.....33	807.....95	2014.....39	
6J4.....35	813.....6.95	4X-150.....5.95	
6X5.....35	814.....2.25	3BP1.....1.49	

### REMOTE CONTROL RM-52

Direct remote control for radio equipment. Uses 4 flashlight units. Provides bias for Microphone and sidetone to headset. Hi or Lo Imp. Mike and Phone Jacks. Makes good phone patch unit. BRAND NEW. **\$2.49**

**SCHEMATIC DIAGRAMS** For any equipment on this page, each..... **65c**

SEND FOR FREE CATALOG, many more Wonderful Surplus Buys!

### AN/ART-13 100-WATT XMTR



**11 CHANNELS 200-1500 Kc 2 to 18.1 Mc \$48.50** Complete with Tubes

Famous Collins Automatic Aircraft Transmitter, AM, CW, MCW. Quick change to any of ten preset channels of manual tuning. Speech amplifier clipper (no carbon or magnetic tube). Highly stable, highly accurate VFO. Built in Xtal controlled calibrator. PFC's to modulate 813 in final up to 100% class "B" A Real "HOT" Ham buy at our low price! **\$48.50**

Orig. cost \$1800. Exc. Used

0-16 Low Freq. Osc. Coil for ART-13..... **7.95**

NAV Dynamotor for ART-13..... **11.95**

Accessories available for xmtr. Inquiries invited.

### THIS MONTH'S SPECIAL

#### MARINE/MOBILE DYNAMOTOR

DC INPUT: 12V @ 10A and 24V @ 5A. DC OUTPUT: 300V @ 200 mA continuous. 400A intermittent. Change to either voltage by simple switching. BRAND NEW in original case. Complete with filter base, shock mount, spare brushes, TERRIFIC PRICE

SHADE: Res. \$24.00. THIS MONTH ONLY **\$16.50** Reg. \$24.50

#### DYNAMIC BOOM MIKE M-33/AIC.

Low impedance. With mounting bracket for attachment to headsets. A REAL VALUE at..... **\$3.95**

DYNAMIC HANDMIKE with "Press-to-talk" switch on handle, cord and plug—BRAND NEW..... **\$2.95**

DYNAMIC HANDMIKE, aircraft, made by Telephones Corp. Press-to-talk switch on mike. BRAND NEW..... **\$4.95**

#### Hi-Fi DYNAMIC HEADSET with Cushions

Freq. Range: 40-14000 CPS. No Distortion. **\$7.85**

BRAND NEW

#### MICROPHONES

Model	Description	Excellent Used BRAND NEW
T-17	Carbon Hand Mike	\$5.45
T-30	Carbon Throat Mike	34.....74
T-45	Army and Navy Lip Mike	1.25
TS-9	Handset	3.88
TS-11	Handset	3.95
TS-13	Handset	4.25
RS-38	Navy Type	4.75

#### HEADPHONES

Model	Description	Excellent Used BRAND NEW
HS-23	High Impedance	\$2.19.....\$4.65
HS-33	Low Impedance	2.69.....4.65
HS-30	Low Imp. (featherwt.)	.90.....1.65
H-16/U	High Imp. (2 units)	3.75.....7.95

TELEPHONICS—600 ohm Low Impedance HEADSETS, BRAND NEW, PER PAIR **\$3.25**

CD-307A Cords, with PL55 plug and JK26 Jack..... **.99**

Earphone Cushions for above—pair..... **.50**

### MOBILE-MARINE DYNAMOTOR



Input 12V DC. Output: 625 V DC @ 225 Ma. for press-to-talk intermittent operation. Smpg. wt. 3 1/2 lbs. **OUR LOW PRICE \$6.45**

#### OTHER DYNAMOTOR VALUES: Excellent BRAND

Type	Input	Output	Used	BRAND NEW
DM-25	12V 2.2A	250V .050A		\$4.50
DA-1A	28V 1.6A	230V .100A		3.95
DM-28	28V	224V .07A	2.75	4.75
DM-32A	28V 1.1A	250V .05A	2.45	4.45
DM-33A	28V 5A	575V .16A		
	28V 7A	540V .25A	1.95	3.75
DM-34D	12V 2A	220V .080A	4.15	5.50
DM-53A	28V 1.4A	220V .080A	3.75	5.45
DM-64A	12V 5.1A	275V .150A		7.95
PE-73C	28V 20A	1000V .350A	7.95	10.50
PE-86	28V 1.25A	250V .050A	2.75	3.85

### TG-34A CODE KEYS



Self-contained automatic unit, reproduces code practice signals recorded on paper tape. By use of built-in speaker, provides code-practice signals to one or more persons at speeds from 5 to 25 WPM. **\$16.88**

Please include 25% deposit with order—Balance C.O.D. or Remittance in Full. 50c Handling Charges on all orders under \$5.00. All shipments F.O.B. Our Warehouse, N.Y.C. All Merchandise subject to Prior Sale and Price Change.

### G & G Radio Supply Co.

Telephone: CO 7-4605

51 Vesey St., New York 7, N. Y.

### FM TRANSMITTER-RECEIVER



APN-1, 120 to 460 Mc Aircraft Radio altimeter equipment. Tubes: 4—6X5, 3—128J7, 4—128H7, 2—12H6, 1—VR150. Complete with all tubes and mount. For 27 V DC. **\$8.95**

BRAND NEW Original operating manual for above..... **\$1.00**

### ARC-5/R28 RECEIVER



2-meter Superhet. 100 to 150 Mc in 4 crystal channels. Complete with 10 Tubes. BRAND NEW **\$24.45**

110V AC Power Sup. Kit for above **\$9.75**

### ARC-5/T-23 TRANSMITTER

100-150 Mc Includes 2—832A, 2—1025 Tubes. BRAND NEW **\$21.50**

SPECIAL limited quantity ARC-5/T23 xmtr. OFFER! Excellent Used, less tubes..... **\$3.95**

MO-7 MODULATOR for T-23, complete with 4 tubes. LIKE NEW..... **\$9.95**

### ARC-5 MARINE RECEIVER-TRANSMITTER

Navy Type Comm. Receiver 1.5 to 3 Mc BRAND NEW with 6 tubes..... **\$16.95**

Navy Type Comm. Transmitter 2.1-3 Mc BRAND NEW with 4 tubes and Xtal MODULATOR for above, new with tubes..... **\$3.95**

### 234-258 MC RECEIVER AN/ARR-2



BRAND NEW 11-tube UHF Tunable Receiver with schematic. Only a few at this low price! Complete with tubes **\$8.88**

### SCR-274 COMMAND EQUIPMENT

ALL COMPLETE WITH TUBES

Type	Description	Used	Like New
BC-453	Receiver 190-550 KC.	\$14.50	\$16.50
BC-454	Receiver 3-8 Mc.	9.45	12.45
BC-455	Receiver 8-9 Mc.	10.45	12.45
BC-500	3-tube Control Box	1.29	1.75

110 Volt AC Power Supply Kit, for all 274-N and ARC-5 Receivers. Complete with metal case, instructions, Factory wired, tested, ready in operation..... **\$7.95**

SPUNNED TUNING KNOB for 274-N and ARC-5 Receivers. Fits BC-453, BC-454 and others. Only **49c**

BC-457 TRANSMITTER—4-5.3 Mc. complete with all tubes and crystal. BRAND NEW..... **\$7.85**

BC-458 TRANSMITTER—5.3 to 7 Mc. Complete with all tubes and crystal. BRAND NEW..... **\$9.75**

BC-459 TRANSMITTER—7-9.1 Mc. complete with all tubes and crystal. BRAND NEW..... **\$13.95**

ARC-5 T-19 TRANSMITTER—3 to 4 Mc. BRAND NEW complete with all tubes & crystal..... **\$8.85**

BC-456 Modulator..... **Used \$3.45 NEW \$5.95**

BC-451 Transmitter Control Box..... **1.25 NEW 1.49**

ALL ACCESSORIES..... **SEE PRICE LIST FOR COMMAND EQUIPMENT.**

### BC-603 FM RECEIVER



20 to 27.9 Mc. **\$12.95**

Used..... **\$12.95**

Like New..... **\$14.95**

BRAND NEW..... **\$16.95**

Convert to 20-50 Mc., and A.M. (See ad next page)

10 Channel, pushbutton tuning or continuous tuning. Complete with speaker, tubes, switch

12 or 24V Dynamotor for Above..... **Brand New \$5.50**

Exc. Used \$1.25

BC-683 same as above except 27 to 34.9 Mc. **\$23.50**

Brand New..... **\$27.50**

### AC POWER SUPPLY FOR BC603, 683

Interchangeable, replaces dynamotor. Has On-Off Switch. NO RECV. CH. CHANGE NEEDED. Provides 220 VAC @ 80 Ma. 21VAC @ 2 Amps. **\$10.45**

Complete 240-page Technical Manual for BC-603, 604..... **\$2.95**

### BC-604 TRANSMITTER

Companion unit for BC-603 Revr above. With all tubes. BRAND NEW..... **\$10.95**

### BC-684 TRANSMITTER

Companion unit for BC-683 Revr above. Complete with all tubes. Like NEW..... **\$7.95**

BRAND NEW..... **\$12.95**

### POWER SUPPLY for BC-620, 659, available for 6, 12 or 24 Volts DC. Specify..... **\$8.95**

### BC-659 TRANSMITTER & RECEIVER

27 to 34.9 Mc. F.M. Two produced channels, crystal controlled. 5 to 10 watts. Complete with speaker, tubes, Enc. Used..... **\$11.95**

### WILLARD 6-VOLT MIDGET STORAGE BATTERY



3 Amp. Hour. BRAND NEW. 3 1/2" x 1-13/16" x 2 3/8". Uses Standard Electrolyte. **Only \$2.95**

### 2 VOLT BATTERY "PACKAGE"

1-2V, 20 Amp. Hr. Willard Storage Battery, Model 20-2, 3" x 4" x 5 1/2" high..... **\$2.79**

1-2V, 7 Bronie Synchronous Plug-in Vibrator..... **1.49**

1-Quart Bottle Electrolyte (for 2 cells)..... **1.45**

ALL BRAND NEW! **\$5.45**

Combination Price..... **\$5.45**

# CHALLENGE

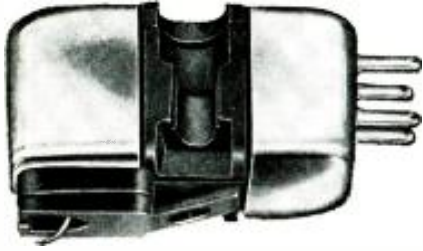

this is ALLIED's  
exclusive new

**KNIGHT**  
A PRODUCT OF ALLIED RADIO **KN**  
**500**

stereo  
magnetic cartridge...  
it sells at \$16<sup>85</sup>

and we say it will equal  
or outperform cartridges  
selling at far higher cost

### HIGHLIGHTS:

- 4-Coil Moving Magnet Design
- Precision Diamond LP Needle
- Record-Saving Low Dynamic Mass
- Front and Back Mu-Metal Shield

The KN-500 features high compliance, wide-range response, low distortion, superior separation, high output—no transformer needed. Effective mass at stylus tip less than 1/40,000 of an ounce—lightest ever for low, low record wear. Equal, clean response from each channel; virtually humfree. Response  $\pm 3$  db, 20-20,000 cps. Has .0007" diamond needle compatible for monophonic LP's and all stereo records. Fits all tone arms with standard 1/2" mounting centers.

### enjoy this RISK-FREE proof:

Try the KN-500 Cartridge on our 15-day trial plan...prove its superiority and amazing value under your own operating conditions. Unconditionally guaranteed by Allied—you must be completely satisfied or we refund your money!

order from

**ALLIED RADIO**

ALLIED RADIO, Dept. 184-A  
100 N. Western Ave., Chicago 80, Ill.

FREE  
catalog

I accept your challenge. Ship me \_\_\_\_\_ KN-500 Cartridge(s) at \$16.85 each. If after 15 days I am not completely satisfied I understand I may return for refund of purchase price.

I am interested in saving money on everything in Hi-Fi. Send me your FREE 1960 Catalog.

Name \_\_\_\_\_

Address \_\_\_\_\_

City \_\_\_\_\_ Zone \_\_\_\_\_ State \_\_\_\_\_

# Transistor Radio Circuits

Part 3. The i.f. stage, a.g.c. control circuit, and the audio detector are discussed in this article.

Editor's Note: This material on transistor circuits, appearing here and in subsequent issues, is being reproduced with the kind permission of the DeLoe Radio Division of General Motors Corporation. Although originally prepared and distributed to those servicing DeLoe auto radio receivers, much of the information is also applicable to other types of transistorized radios and we believe it worthwhile to present this material to our readers.

## I.F. Stage

The i.f. amplifier is one of the most important stages in the receiver from the standpoint of good sensitivity. In vacuum-tube sets, the voltage gain of the i.f. amplifier is often as much as 100 times, but when transistors are used, it is difficult to obtain gain values of this magnitude at the r.f. and i.f. frequencies. Therefore, it is common practice to use two or three i.f. stages in high-gain receivers to obtain the required sensitivity.

Shown in Fig. 4 is a typical i.f. amplifier stage, employing a 2N149 *n-p-n* transistor in a common-emitter circuit. The i.f. signal output from the mixer stage is shown directly coupled to the transformer input in a conventional manner. The primary and secondary windings may be separated and mounted in individual cans in some cases and capacity coupled by  $C_1$ . Note that the base connection is at a tap on the sec-

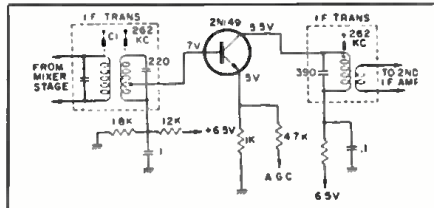

Fig. 4. The first i.f. stage of car radio.

ondary winding near the ground end or low-impedance part of the coil for proper matching. A capacitor gives the bottom end of the secondary a ground for a.c. signal voltages but not a d.c. ground because a positive base voltage is needed for forward bias on the input diode section of the transistor. The base voltage of about .7 volt is supplied by the voltage divider resistors at the bottom of the winding.

Voltage drop across the 1000-ohm emitter resistor supplies positive emitter voltage and helps to control the static collector current which is on the order of .5 ma. This voltage is supplemented by a.g.c. voltage which drives the emitter more positive on strong signals and reduces forward bias toward the point of cut-off. This tends to keep receiver sensitivity fairly level since it reduces stage gain while tuned to strong signals and allows it to return to normal on weak signals.

The collector circuit is tuned to resonance by a 262 kc. transformer primary, slug-tuned to the i.f. frequency. The amplified signal voltage induced in this winding is coupled to the next stage by an untuned secondary tickler winding with enough turns for proper matching to the next stage. This method of coupling can be used whenever there are a sufficient number of other tuned circuits in the receiver to attain the desired amount of selectivity. This would be especially true in receivers employing more than two intermediate-frequency stages.

## A.G.C. Control Circuit

To keep the receiver output fairly constant for various strength signals and to prevent signal overloading of the amplifier stages, a.g.c. is employed. The a.g.c. voltage is commonly taken from the last i.f. transformer primary or secondary circuit and in the circuit of Fig. 5 the primary signal voltage is used. It is coupled into the a.g.c. detector circuit by the tickler winding. When the signal voltage here is in the direction shown, the 1N295 crystal detector conducts through detector load resistors  $R_1$  and  $R_2$  producing a voltage drop across the load at the polarity indicated.

The i.f. signal pulsations are removed from the detector load by capacitor  $C_1$  and the resulting output is direct-coupled to the base of the a.g.c. amplifier transistor. This causes the base of the transistor to go positive, driving it into conduction and sending electron current through the path indicated by the arrows. Further examination of the emitter current path for the a.g.c. amplifier will reveal that resistors  $R_1$ ,  $R_2$ , and  $R_3$  all provide ground returns for the R63 emitter and the current drawn by the a.g.c. amplifier will therefore produce a voltage drop across these resistors. Since each of these three resistors also functions as the emitter resistor for the r.f., mixer, and i.f. stage respectively, the additional voltage drop produced by a.g.c. amplifier current causes the emitter of each stage to go more positive. This reduces the for-

Fig. 5. A.g.c. control of amplifier stages.

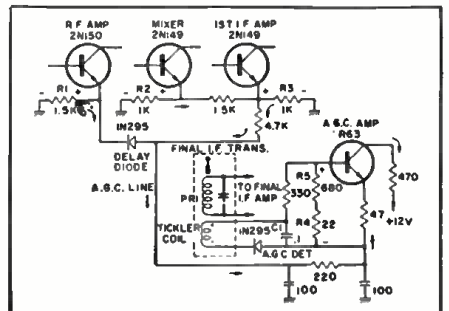



your best buy . . .

# TRU-VAC®



REMARKABLE TUBE VALUES AT 1950 PRICES

ALL TUBES INDIVIDUALLY BOXED, CODE DATED AND BRANDED "TRU-VAC"

Typical TRU-VAC® Bargains!

THIS IS A PARTIAL LIST  
Thousands More Always In Stock

6SN7GT	ALWAYS 30c
6W4GT	ALWAYS 30c
OY4 3AU6 6A6 688 6C8H 657 784 12AT6 12SA7 36	
OZ4 3BC5 6AB4 68A6 6CL6 658GT 785 12A7 12S7 38	
1A7GT 3BN6 6AC7 6BC5 6CM6 65A7 786 12AU6 12SK7 39/44	
1B3GT 3BZ6 6AF4 6BC8 6CM7 65D7GT 787 12A07 12SN7GT 41	
1C6 3CB6 6AG5 6BD6 6CN7 65F5 788 12AV6 12SO7 42	
1C7 3Q4 6AH4GT 6BE6 6COB 65F7 7C4 12AV7 12V6GT 43	
1F4 3J4 6AH6 6BF5 6CR6 65G7 7C5 12AX4GT 12W6GT 45	
1F5 3V4 6AK5 6BG6G 6C56 65H7 7C6 12AX7 12X4 50A5	
1G4 4B07A 6AL5 6BH6 6CU5 65J7 7C7 12AZ7 14A7/12B7 50B5	
1HSGT 4B5B 6AM8 6BJ6 6CU6 65K7 7E5 12B4 14B6 50C5	
1L4 4B27 6AN8 6BK5 6D6 65L7 7E6 12BA6 14O7 50L6	
1L6 4CB6 6AO5 6BK7 6DE6 65O7 7E7 12BA7 19 56	
1NSGT 5AM8 6AO6 6BL7GT 6DG6GT 65R7 7F7 12BD6 19AU4GT 57	
1R5 5AN8 6AO7 6BN6 6DO6 6T4 7F8 12BE6 19BG6G 58	
1S5 5AT8 6AR5 6BO6GT 6F5 6U8 7G7 12BF6 19J6 71A	
1T4 5AV8 6A55 6BO7 6F6 6V6GT 7H7 12BH7 19T8 75	
1U4 5AZ4 6AT6 6BR8 6H6 6W6GT 7N7 12BO6 24A 76	
1U5 5BR8 6AU4GT 6BS8 6J4 6X4 7O7 12BR7 2526GT 77	
1V2 5J6 6AU5GT 6BY5G 6J5 6X5GT 757 12B7 26 78	
1X2 5R4 6AU6 6BZ6 6J6 6X8 7X6 12CA5 27 80	
2AF4 5U4 6AU8 6BZ7 6J7 6Y6G 7X7 12CN5 35 84/624	
2BN4 5U8 6AV5GT 6C4 6K6GT 7AA/XXL 7Y4 12D4 35A5 11723	
2CY5 5V4G 6AV6 6CB6 6K7 7A5 7Z4 12F5 35B5	
3A4 5V6GT 6AW8 6CD6G 6N7 7A6 12A8 12K7 35C5	
3A5 5X8 6AX4GT 6CF6 6O7 7A7 12AB5 12L6 35W4	
3AL5 5Y3 6AX5GT 6CG7 654 7A8 12AO5 12O7 35Z5	

# 35¢ ea.

## 1 YEAR GUARANTEED PICTURE TUBES

Brand New\* Allied A-1 Tubes Brand New  
Below Listed prices do not include dud. Add Additional \$5.00 Deposit on tube sizes to 20"; on 21" and 24" tubes - \$7.50. Deposit refunded immediately when dud is returned prepaid. Aluminized tubes - \$4.00 extra.

Picture tubes shipped only to continental USA and Canada - All tubes F.O.B. Harrison, N. J.

10BP4 7.99 16HP4 12.19 17CP4 16.99 19AP4 18.39 21AP4 18.79 21FP4 18.39 21YP4 18.39
12LP4 10.49 16KP4 11.99 17CP4 17.89 20CP4 15.89 21AP4 18.79 21MP4 18.39 21EP4 17.49
14B/CP4 11.99 16LP4 12.19 12HP4 16.99 20DP4 17.89 21AP4 18.79 21MP4 22.39 24AP4 29.49
16AD4 16.09 16RP4 11.99 17IP4 16.99 20HP4 17.89 21AVP4 18.79 21YP4 18.39 24CP4 27.99
16DP4 12.19 17AVP4 15.49 17QP4 13.89 21AP4 21.49 21AWP4 17.49 21WP4 17.49 24DP4 29.79
16GP4 16.09 17BP4 13.49 17TP4 16.99 21ALP4 18.79 21EP4 17.29 21XP4 17.49

\$ 33 PER HUNDRED

For any used or factory second tube!

**ATTENTION!**  
Get More For Your Money  
Get Quality And Bigger Selection  
Get Truly Remarkable Tube Values  
When You Buy At TRU-VAC

**FREE FUSE CLIP!**  
Sent With Any Order Of \$5 Or More

**GUARANTEE**  
Only TRU-VAC guarantees to replace free any tube which becomes defective in use within one year of date of purchase.

**USED TV CONSOLES GUARANTEED To Work When You Receive Them**

10" & 12"	\$29
14" & 16"	\$37
17"	\$45
19"	\$59
20" & 21"	\$70

All sets shipped in two cartons to avoid breakage. Sets shipped express to continental U.S.A. and Canada only. F.O.B. Harrison, New Jersey.

**FREE BONUS—RABBIT EARS**  
\$7.95 Value  
FREE with each set purchased

**ATTENTION QUANTITY USERS!**  
Big Discounts Are Yours . . . Call or Write For Our 1000 Tube "Private Label" Special! Attention Branding Dept. MGR.

**MONEY CHEERFULLY REFUNDED WITHIN FIVE (5) DAYS, IF NOT COMPLETELY SATISFIED!**

**TRU-VAC® PAYS YOUR POSTAGE**  
On orders of \$5 or more in U.S.A. and Territories. Send approximate postage on Canadian and foreign orders. Any order less than \$5 requires 25c handling charge. Send 25% on C.O.D.'s. All orders subject to prior sale.

Complying with Federal regulations, the following statement appears in all Tru-Vac advertising: Tubes appearing in this ad may be FACTORY SECONDS or USED tubes and are clearly marked.

# TRU-VAC®

Harrison Avenue Box 107 Harrison, New Jersey  
HUMboldt 4-9770

Write Dept. 1 For FREE LIST Of Other Tube Types and Products Sold By TRU-VAC®  
**Electric Company**

visit Our Huge Testing Dept. In The Heart Of Harrison, N. J.'s Electronics Industry

These men are getting practical training in...

## ELECTRICITY ELECTRONICS

**ON REAL**

Motors • Generators  
Switchboards • Controls  
Modern Appliances  
Automatic Electronic  
Control Units

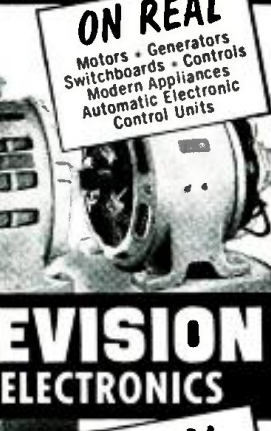

---

## TELEVISION RADIO ELECTRONICS

**ON REAL**

TV Receivers  
Black & White and Color  
AM-FM and Auto Radios  
Transistors • Printed  
Circuits • Test Equipment



# Train in NEW Shop-Labs of COYNE

In Chicago—Electrical and Electronic Center of the World. Prepare for a better job and a successful future in a TOP OPPORTUNITY FIELD. Train on real full size equipment at COYNE where thousands of successful men have trained for 60 years—largest, oldest, best equipped school of its kind. Professional and experienced instructors show you how, then do practical jobs yourself on more than a quarter of a million dollars worth of equipment. No previous experience or advanced education needed. Employment Service to Graduates.

**Start Now—Pay Later—Liberal Finance and Payment Plans.** Pay most of tuition after graduation. Part-time employment help for students. Choose from nine yearly Starting Dates.

**Mail Coupon or Write to Address Below for Free Book—"Guide to Careers."** Whether you prefer ELECTRICITY, TELEVISION-RADIO or COMBINED ELECTRONICS, which includes both fields, this book describes all training offered.

**Information comes by mail. No obligation and NO SALESMAN WILL CALL.**

B. W. Cooke, Jr., Pres. Founded 1899  
**COYNE ELECTRICAL SCHOOL**  
 Chartered as an Educational Institution Not For Profit  
 1501 W. Congress Pkwy., Chicago 7, Ill., Dept. 10-6C

**MAIL COUPON** OR WRITE TO ADDRESS BELOW

**COYNE ELECTRICAL SCHOOL**  
 New Coyne Building Dept. 10-6C  
 1501 W. Congress Pkwy., Chicago 7, Ill.

Send BIG FREE book and details of all the training you offer. I am especially interested in,

Electricity  Television  Both Fields

Name.....  
 Address.....  
 City..... State.....

*(I understand no Salesman will call)*

ward bias on these stages, driving the transistors toward cut-off and reducing their gain.

Stronger signals produce more i.f. voltage at the tickler winding which, in turn, produces more a.g.c. detector output and a more positive a.g.c. amplifier base voltage. This drives the a.g.c. amplifier into stronger conduction causing an increase in current through  $R_1$ ,  $R_2$ , and  $R_3$ , producing a greater voltage drop across these resistors, and more positive emitters in the r.f., mixer, and first i.f. stages. This further reduces the receiver gain, which is necessary to keep the volume level at the speaker relatively constant for various signal strengths.

Note that a 1N295 crystal diode is inserted in series with the a.g.c. connection to the r.f. amplifier emitter. This delays the application of a.g.c. voltage to the r.f. stage because the crystal diode offers a high resistance to current flow until the a.g.c. line becomes more positive than the r.f. amplifier side of the diode. At this time, the diode resistance drops and a.g.c. current begins to flow through  $R_1$  and the diode, producing a.g.c. voltage at the r.f. amplifier emitter. The delay is desired to keep the r.f. stage operating efficiently over a wider range of signals than the other two stages, which keeps selectivity, image rejection, and signal-to-noise ratio at a high level.

### Audio Detector

After sufficient amplification of the signal is obtained in the i.f. stages, the audio intelligence must be removed or detected from the signal carrier. This is a function of the audio detector stage, such as the one shown in Fig. 6.

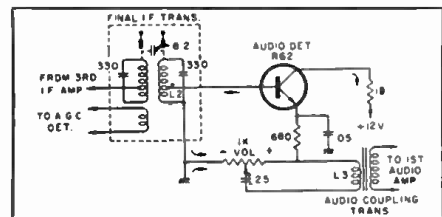

Fig. 6. Simplified audio detector diagram.

The i.f. signal is taken from the last i.f. transformer and applied to the base of the R62 audio detector transistor. Note that there is no forward-biasing network in this circuit and the transistor remains cut off until signal is applied. As signal voltage is developed across secondary winding  $L_2$ , it is applied to the base of the audio detector. During the half cycle that the base voltage swings positive due to applied signal, the transistor input is driven in the forward direction, causing electron current to flow as indicated by the arrows in Fig. 6.

Since the ground return for the emitter is at the left end of the volume control, both the collector current and base current must flow through the control, producing a voltage at the control as shown. During the half cycle when the i.f. signal reverses polarity at secondary winding  $L_2$ , the transistor

\*\*\*\*\*

**KEEP CANDEE HANDEE!**

**APN-1 FM TRANSCIEVER**  
 420-400 Mc. Compl. with Tubes, Exp. Ea. \$2.95  
 Save by buying two for..... \$5.00

**BC-603 FM RECEIVER**  
 This Special Buy! Popular Demand!  
 20-27.9 MC. 10 push-button for channel selection. Continuous tuning. Sanelec circuit. Complete with tubes, speaker, 165 dynamo. THIS IS BRAND NEW AND ONLY Two for \$18.95.  
 DM-34 12 V. DYNAMOTOR for above..... \$3.95

**APR-1 RECEIVER**  
 Just removed from aircraft so you know it's good! Has self-contained 110 V. 60 cycles power supply. Input 110 V. 60 cycle. Excellent..... \$22.50

**PLUG-IN TUNING UNITS FOR ABOVE:**

TN-1, 38-50 Mc.	15.00
TN-2, 80-300 Mc.	15.00
TN-3, 300-1000 Mc.	19.95

**AN/APA 38 PANADAPTOR**  
 115 VAC. Single phase. 400-2700 cycles. 30 Mc. adaptor. Approx. 10 Mc. band width. For conversion, drop size July 30 C.Q. Magazine. Excellent cond..... \$14.95

**MODEL 84 MEASUREMENTS CORP. SIGNAL GENERATOR**  
 Frequency 300-1000 MC in one band. Individually calibrated direct reading dials. Frequency Accuracy = 0.5%. Output voltage continuously variable from 0.1-100,000 microvolts. Output impedance 50 ohms. Modulation 0-30%. Choice of 400, 1000, 250 cycles. Pulse frequency 60-100 kc. in three ranges: 60-1,000, 600-10,000; and 0-100, 100,000 pulses per second. Power supply 117 V., 50/60 cycles. Dim.: 13 x 24 x 12 1/2". Approx. ship. wt. 160 lbs. \$149.95  
 Excellent. Checked out..... \$100.00  
 AS IS. Not checked out..... \$100.00

**LP-5 SIGNAL GENERATOR**  
 Freq. 0.5-30,000 Kc. = 1/2 in 7 bands. 30-50 Mc. = 37% (extended range) Output 100. 10 ohms. Amplitude modulated. With 60 power supply. Excel. Checked out..... \$195.00

**NEW TS-13 HANDSET Ea. \$3.95; Two for \$6.95**

**YOU GOT IT! WE WANT IT! LET'S DEAL!**  
 We're paying top \$\$\$ for GRC-1; PRC-6, -8, -9, -10; GNC-58K. All elect. test equip.

**BC-611 HANDIE-TALKIE CHASSIS**  
 Crystal controlled. 3-6 Mc. Brand new. With antenna, less tubes. \$6.95  
 coils. Only..... \$6.95

**APX-6 TRANSPONDER**  
 A midsize warehouse of parts! Blowers, three Veeder-Root counters, I.F. strips, cavity, over 30 tubes, etc. Includes 3E29 tube. Good cond. A STEAL AT ONLY..... \$14.95

**BC-733 RECEIVER**  
 A spunkin' tracker! C.Q. Magazine Oct/50 for conversion. VHF. 10 tubes. 6-channel, crystal controlled. Freq. 108.3-110.3 Mc. Dual filter range. Excellent condition..... \$6.95

**R-4A/ARR-2 RECEIVER**  
 234-278 Mc. 11 tubes. CHF. Tunable receiver. See Aug. C.Q. Magazine for conversion. Excellent cond. TWO for \$5.00. Each..... \$2.95

**2 SPECIALS FOR MARINERS**

**R 25 ARC-5 MARINE RECEIVER-1.5-3 Mc.**  
 Excellent condition. With tubes..... \$14.95

**T-18 ARC-5 MARINE TRANSMITTER-2.1-3 Mc.**  
 Excellent condition. With tubes..... \$9.95

**FAMOUS Q 5'ER RECEIVER**  
 100-550 kc. Excellent. With tubes..... \$9.95

**SCR-522 TRANSCIEVER**  
 4-channel. Crystal controlled. 100-150 Mc. Ideal for 2 meters. Complete with 14 Mc. tubes. Excel..... \$14.95

All items FOB Burbank, Calif., subject to prior sale. In Calif. add 4%. Min. order \$3.95.

**J. J. CANDEE CO.** Dept. R  
 509 No. Victory Blvd., Burbank, Calif.  
 Phone: Victoria 9-2411

\*\*\*\*\*

## AN/ART-13 100-WATT TRANSMITTER

(Government original cost \$1,000.00)

Designed to provide radio communication by voice, (MCW) or CW telegraphy. Class "B" audio modulator system capable of modulating the carrier at least 90% on voice or MCW. Incorporates automatic tuning mechanism which may be used to select any one of 11 frequencies, range 2000 KC to 18,000 KC. Frequencies 200 KC to 1500 KC range is provided by addition of oscillator 0-16/ART-13-A. Shipping weight 90 pounds.

With Tubes and Meters—	Condition Fair	<b>\$29.50</b>
Less Meters but with Tubes—	"	\$20.00
Less Meters and Tubes—	"	\$10.00
0-16 Low Frequency Oscillator.....		\$ 5.95
<b>AN/ART-13-T47</b> with Tubes and Meters Condition Good.....		<b>\$39.50</b>
<b>T47</b> with Tubes and Meters. Condition Excellent.....		<b>\$49.50</b>

Write for Bargain Flyer

## R W ELECTRONICS

2430 S. MICHIGAN AVE., DEPT. N  
 Phone: CALumet 5-1281 Chicago 16, Illinois



current cuts off and the voltage drop across the volume control disappears. Thus rectification has taken place but the i.f. component must be removed before undistorted audio detection is completed. This is accomplished by the .05- $\mu$ f. emitter capacitor which is connected across the detector load resistance, consisting of the 680-ohm emitter resistor and the volume control. This capacitor is large enough to filter the i.f. pulsation across these resistors but allows the audio signal fluctuations to remain. This audio signal voltage at the volume control is coupled through the 25- $\mu$ f. capacitor to winding  $L_2$  of the interstage audio coupling transformer, for transfer to an audio-amplifier stage.

This detector circuit offers minimum "loading" of the last i.f. transformer since the transistor input impedance is high when operated with no d.c. forward bias. Further isolation between the i.f. transformer and the detector transistor is sometimes obtained by adding a crystal diode in series with the base lead of the transistor. This added isolation may be necessary in signal-seeking auto radios where any signal dampening at this point may interfere with normal triggering action.

(To be continued)

Sun	Mon	Tue	Wed	Thu	Fri	Sat
		1	2	3	4	5
						12
						19
						26

## CALENDAR of EVENTS

### JANUARY 6-9

1960 High Fidelity Music Show. Sponsored by Institute of High Fidelity Manufacturers. Shrine Exposition Hall, Los Angeles, Calif. Open to public.

### JANUARY 11-13

Sixth National Symposium on Reliability and Quality Control. Sponsored by IRE, AIEE, EIA, and ASQC. Statler-Hilton Hotel, Washington, D. C. Program information available from C. M. Ryerson, RCA, Camden, N. J.

### JANUARY 22-25

1960 High Fidelity Music Show. Sponsored by Institute of High Fidelity Manufacturers. Brooks Hall, Civic Center, San Francisco, Calif. Open to public.

### FEBRUARY 1-4

Instrument-Automation Conference and Exhibit. Sponsored by the Instrument Society of America. Rice Hotel and Sam Houston Coliseum, Houston, Tex. Full details available from ISA at 313 Sixth Ave., Pittsburgh 22, Pa.

### FEBRUARY 3-5

1960 Winter Convention on Military Electronics. Sponsored by IREPGME and Los Angeles Section of IRE. Biltmore Hotel, Los Angeles, Calif. Exhibits, field trips, and papers.

January, 1960

**NEW!**

# JERROLD ANTENNA MIXING NETWORKS

**MODEL TX-(\*)**

**Give Multi-Channel, All-Direction Reception Simultaneously...for FM, TV, UHF and Color!**

Now multi-set families can have all-direction reception at the same time on one common line! No more rotators or switches . . . the versatile Jerrold Model TX-(\* ) can be used individually or in any combination to reject unwanted channels and to bring in weaker stations bright and clear. They will mix cut-to-channel antennas with a single broad band antenna . . . separate individual channels . . . mix or separate VHF and UHF . . . and mix or separate VHF TV and FM . . . all without loss of signal.



Model TX-(\* )  
\$5.95 list

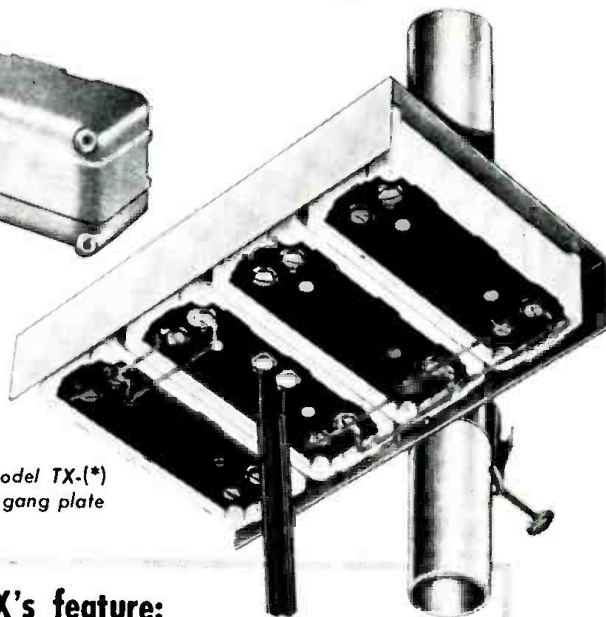

4 Model TX-(\* )  
with gang plate

### Jerrold TX's feature:

- up to 9 antennas on a single down lead
- high Q band-pass circuit for highest rejection
- negligible feed-thru loss . . . less than a knife switch
- matched mixing jumpers . . . for low VSWR
- unbreakable attractive housing, complete with hardware
- universal mounting . . . indoor or outdoor

\*SPECIFY UNITS DESIRED: any TV channel from 2 through 13; FM; H-L (VHF high-low) or VHF-UHF

**JERROLD**

**ELECTRONICS CORPORATION**, Distributor Sales Division,  
Dept. PD 193, The Jerrold Building, Phila. 32, Pa.

Jerrold Electronics (Canada) Limited

Export Representative: CBS International, New York 22, N. Y.

**LOOK TO JERROLD FOR AIDS TO BETTER TELEVIEWING**

# SHIPPED ON APPROVAL

**NEW**

## CRT TESTER-REACTIVATOR Model CRT-2

**NOW . . .** a TESTER-REACTIVATOR really designed to test, repair and reactivate EVERY PICTURE TUBE MADE — whether black and white or color . . . with exclusive features never before found in picture tube testers.



Housed in hand-rubbed oak carrying case — complete with MULTI-HEAD\*

Model CRT-2  
**\$57.50**  
Net

TERMS: \$13.50 within 10 days. Balance \$11 monthly for 4 months.

The CRT-2 steps in and solves the limitations and shortcomings of the present day CRT Testers. Unlike ordinary CRT testers that keep entering the field with a limited range of operation, the CRT-2 employs a new brilliantly engineered circuit designed to test, repair and reactivate every black and white or color picture tube made. The CRT-2 eliminates the guesswork and risk that until now, has always been present when a picture tube is reactivated. It accomplishes this by providing perfect control of either the 'Boost' or 'Shot' method of reactivation.

**THE CRT-2 DOES ALL THIS RIGHT IN THE CARTON, OUT OF THE CARTON OR IN THE SET**

### TEST

- ✓ for quality of every black and white and color picture tube
- ✓ for all inter-element shorts and leakage up to one megohm
- ✓ for life expectancy

### REPAIR

- ✓ Will clear inter-element shorts and leakage
- ✓ Will weld opens between any two elements in the tube gun

### REACTIVATE

- ✓ The unique controlled 'SHOT' (high voltage pulse) method of reactivation provided by the CRT-2 will restore picture tubes to new life in instances where it was not possible before. Furthermore the high voltage is applied without danger of stripping the cathode as you always have perfect control of the high voltage pulse.
- ✓ The 'BOOST' method of reactivation also provided by the CRT-2 is used effectively on tubes with a superficially good picture but with poor emission and short life expectancy. It will improve definition, contrast and focus greatly and add longer life to the picture tube.

1. **THE MULTI-HEAD** (patent pending) . . . A SINGLE PLUG IN CABLE AND UNIQUE TEST HEAD — A tremendous advance over the maize of cable and adapters generally found with other testers. Enables you to test, repair and reactivate every type of picture tube with greater convenience than ever before . . . 50 degree to 110 degree types from 8" to 30", whether 12 pin base, 8 pin base, 14 pin base . . . even the very latest 7 pin base. A special color switch on the MULTI-HEAD enables you to test, repair and reactivate each of the red, green and blue color guns separately.
2. **WATCH IT REACTIVATE THE PICTURE TUBE** — You actually see and control the reactivation directly on the meter as it takes place, allowing you for the first time to properly control the reactivation voltage. This eliminates the danger of stripping the cathode of the oxide coating. It enables you to see the speed of reactivation and whether the build-up is lasting. You will see if the cathode contamination is too great and if the picture tube is too far gone to be reactivated.
3. **CONTROLLED "SHOT" WITH HIGHER VOLTAGE FOR BETTER REACTIVATION** — Stronger than any found in other testers . . . high enough to really do the job — yet controlled to avoid damage to the picture tube.
4. **UNIQUE HIGH VOLTAGE PULSE CIRCUIT** — Will burn out inter-element shorts and weld open circuits with complete safety to the picture tube.
5. **VISUAL LIFE TEST** — Enables both you and your customer to see the life-expectancy of any picture tube right on the meter. The fact that your customer can see the results of your tests as you make them virtually eliminates resistance to picture tube replacement when necessary.
6. **TESTS, REPAIRS AND REACTIVATES SPECIAL LOW SCREEN VOLTAGE TUBES** — Many new type picture tubes use special low voltage of approximately 50 volts. The CRT-2 will test, repair and reactivate these types with the same thoroughness as the regular types with complete safety.
7. **SEPARATE FILAMENT VOLTAGES** — Including the very latest 2.35 volt and 8.4 volt types as well as the older 6.3 volt types.
8. **TESTS, REPAIRS AND REACTIVATES 'SF' PICTURE TUBES** — found in the newest Sylvania and Philco TV sets. These picture tubes have different base pin connections than standard picture tubes and there is always an element of risk that the tube may be burned out when tested with ordinary picture tube testers. The CRT-2 is designed to accommodate this new base pin arrangement and will test the tube with no danger of damage.

### ADDITIONAL FEATURES

- Employs the time proven dynamic cathode emission test principle
- Large 4 1/2" meter with heavily damped movement for smooth action, accuracy and long life
- Provides separate shorts test for each element in the picture tube
- Filament continuity is shown on a separate glow indicator
- An easy to read instruction manual contains all the latest testing information on old and new type picture tubes
- Housed in handsome hand-rubbed oak carrying case with special compartment for MULTI-HEAD and line cord.

\* patent pending

## IN-CIRCUIT CONDENSER TESTER Model CT-1

Here is an IN-CIRCUIT CONDENSER that DOES THE WHOLE JOB! The CT-1 actually steps in and takes over where all other in-circuit condenser fail. The ingenious application of a dual bridge principle gives the CT-1 a tremendous range of operation . . . and makes it an absolute 'must' for every serviceman.

### in-circuit checks:

- ✓ Quality of condensers even with circuit shunt resistance . . . (This includes leakage, shorts, opens, intermittents)
- ✓ Value of all condensers from 200 mmfd. to .5 mfd.
- ✓ Quality of all electrolytic condensers (the ability to hold a charge)
- ✓ Transformer, socket and wiring leakage capacity

### out-of-circuit checks:

- ✓ Quality of condensers . . . (This includes leakage, shorts, opens and intermittents)
- ✓ Value of all condensers from 50 mmfd. to .5 mfd.
- ✓ Quality of all electrolytic condensers (the ability to hold a charge)
- ✓ High resistance leakage up to 300 megohms
- ✓ New or unknown condensers . . . transformer, socket, component and wiring leakage capacity

### OUTSTANDING FEATURES

- Ultra-sensitive 2 tube drift-free circuitry
- Multi-color direct scale readings for both quality and value . . . in-circuit or out-of-circuit
- Simultaneous readings of circuit capacity and circuit resistance
- Built-in hi-leakage indicator sensitive to over 300 megohms
- Cannot damage circuit components
- Electronic eye balance indicator for every greater accuracy
- Isolated power line
- Housed in sturdy hammertone finish steel case . . . comes complete with test leads

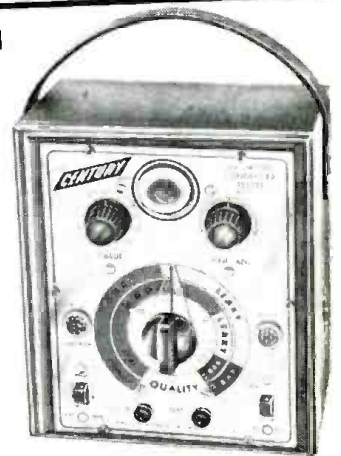

Model CT-1  
**\$34.50**  
Net

TERMS: \$9.50 within 10 days. Balance \$5 monthly for 5 months.

**EASY TO BUY IF SATISFIED — see order form on facing page**



**FOR 10 DAY FREE TRIAL**

convince yourself at no risk that CENTURY instruments are indispensable in your every day work. Send for instruments of your choice without obligation... try them for 10 days before your buy... only then, when satisfied, pay in easy-to-buy monthly installments — without any financing or carrying charges added.

**NOW** a Battery Operated **VACUUM TUBE VOLT METER** Model VT-1  
**Peak-to-Peak** WITH LARGE EASY-TO-READ 6" METER —

featuring the sensational new **MULTI-PROBE** \* Patent Pending

No extra probes to buy! The versatile MULTI-PROBE does the work of 4 probes

- ① DC Probe ② AC-Ohms Probe ③ Lo-Cap Probe ④ RF Probe

The VT-1 is a tremendous achievement in test equipment. With its unique MULTI-PROBE it will do all the jobs a V.T.V.M. should do without the expense of buying additional probes. No longer do you have to cart around a maze of entangled cables, lose time alternating cables or hunting for a misplaced probe. With just a twist of the MULTI-PROBE tip you can set it to do any one of many time-saving jobs. A special holder on side of case keeps MULTI-PROBE firmly in place ready for use.

**FUNCTIONS**

**DC VOLTMETER** ... Will measure D.C. down to 1.5 volts full scale with minimum circuit loading, and give accurate readings of scale divisions as low as .025 volts ... Will measure low AGC and oscillator bias voltages from .1 volts or less up to 1500 volts with consistent laboratory accuracy on all ranges ... Zero center provided for all balancing measurements such as discriminator, ratio detector alignment and hi-fi amplifier balancing.

**AC VOLTMETER** ... True Peak-to-Peak measurements as low as 3 volts of any wave form including TV sync, deflection voltages, video pulses, distortion in hi-fi amplifiers, AGC and color TV gating pulses ... Scale divisions are easily read down to .1 volts ... Measures RMS at 1/20th the circuit loading of a V.O.M. ... Unlike most other V.T.V.M.'s there is no loss in accuracy on the lowest AC range.

**ELECTRONIC OHMETER** ... Measures from 0 to 1000 megohms ... Scale divisions are easily read down to .2 ohms ... Will measure resistance values from .2 ohms to one billion ohms ... Will detect high resistance leakage in electrolytic and by-pass condensers.

**RF and LO-CAP MEASUREMENTS** ... With these extra VT-1 functions you can measure voltages in extremely high-impedance circuits such as sync and AGC pulses, driving saw tooth voltages, color TV gating pulses, mixer output levels, i.F. stage-by-stage gain and detector inputs.

**OUTSTANDING FEATURES**

- Completely portable — self powered with long life batteries — permits use everywhere
- New advanced pentode amplifier circuit, assures amazingly low battery drain
- Large 6" 100-microampere meter, many times more sensitive than meters used in most V.T.V.M.'s
- Laboratory accuracy performance — 2% of full scale on DC, 5% of full scale on AC
- Simplified multi-color easy-to-read 4-scale meter
- No heat operation assures rigid stability and accuracy
- Immune to power line fluctuations
- Amplifier rectifier circuit with frequency compensated attenuator — a feature found only in costly laboratory instruments
- Meter completely isolated — practically burnout proof
- Hand-crafted circuitry eliminates the service headaches of printed circuitry
- 1% resistors used for permanent accuracy
- Separate RF ground return for low-loss RF measurement
- Micro-telephone type co-axial connector
- Matching cover protects instrument face — snaps on and off instantly.

**SPECIFICATIONS**

- DC Volts — 0 to 1.5/6/30/150/300/600/1500 volts
- AC Volts (RMS and Peak-to-Peak) — 0 to 3/12/60/300/1200 volts
- Ohms — 0 to a billion ohms, 10 ohms center scale — Rx1/10/100/1K/10K/100K/1M
- RF — Peak reading demodulator supplied for use on all DC ranges
- Zero Center — available on all DC volt ranges with zero at mid-scale
- Decibels — from -10 Db to +10, 22, 36/50, 62 based on the Dbm unit: DDb.
- IMW in 600 ohms
- Impedance — 11 megohms DC, 1 megohm AC, 10 megohms Lo-Cap
- Input Capacity — 130 mmfd. RMS, 250 mmfd. Peak-to-Peak, 25 mmfd. Lo-Cap



Housed in hammer-tone steel-case — complete with MULTI-PROBE

Model VT-1  
**\$58.50** Net  
 TERMS: \$14.50 within 10 days. Balance \$11 monthly for 4 months.

**FAST-CHECK TUBE TESTER** Model FC-2

Simply set two controls ... insert tube ... and press quality button to test any of over 700 tube types completely, accurately ... **IN JUST SECONDS!**

Over 20,000 servicemen are now using the FAST-CHECK in their every day work and are cutting servicing time way down, eliminating unprofitable call-backs and increasing their dollar earnings by selling more tubes with very little effort. See for yourself at no risk why so many servicemen choose the FAST-CHECK above all other tube testers.

**PICTURE TUBE TEST ADAPTER INCLUDED WITH FAST-CHECK**

Enables you to check all picture tubes (including the new short-neck 110 degree type) for cathode emission, shorts and life expectancy ... also to rejuvenate weak picture tubes.

**RANGE OF OPERATION**

- ✓ Checks quality of over 700 tubes types, employing the time proven dynamic cathode emission test. This covers more than 99% of all tubes in use today, including the newest series-string TV tubes, auto 12 plate-volt tubes, OZ4s, magic eye tubes, gas regulators, special purpose hi-fi tubes and even foreign tubes.
- ✓ Checks for inter-element shorts and leakage.
- ✓ Checks for gas content.
- ✓ Checks for life-expectancy.

**SPECIFICATIONS**

- No time consuming multiple switching ... only two settings are required instead of banks of switches located inside cover. New listings are added without costly roll chart replacement
- 41 phosphor bronze beryllium tube sockets never need replacement
- 7-pin and 9-pin straighteners line voltage variation
- 12 filament positions
- Special scale on meter for low current tubes
- Compensation for no shock hazards
- Long lasting etched aluminum panel
- Separate gas and short jewel indicators
- Line isolated

**NOTE:** The Fast-Check positively cannot become obsolete ... circuitry is engineered to accommodate all future tube types as they come out. New tube listings are furnished periodically at no cost.



Housed in hand-rubbed oak carrying case complete with CRT adapter

Model FC-2  
**\$69.50** Net  
 TERMS: \$14.50 within 10 days. Balance \$11 monthly for 5 months.

**CONVENIENT TIME PAYMENT PLAN — NO FINANCING CHARGES**

ALL CENTURY INSTRUMENTS ARE GUARANTEED FOR ONE FULL YEAR

The extremely low prices are made possible because you are buying direct from the manufacturer.

**CENTURY ELECTRONICS CO., INC.**

**CHECK INSTRUMENTS DESIRED**

- Model CRT-2 CRT TESTER REACTIVATOR ..... \$57.50  
 \$13.50 within 10 days. Balance \$11 monthly for 4 months.
- Model CT-1 In-Circuit Condenser Tester ..... \$34.50  
 \$9.50 within 10 days. Balance \$5 monthly for 5 months.
- Model VT-1 Battery Vacuum Tube Volt Meter ..... \$58.50  
 \$14.50 within 10 days. Balance \$11 monthly for 4 months.
- Model FC-2 Fast-Check Tube Tester ..... \$69.50  
 \$14.50 within 10 days. Balance \$11 monthly for 5 months.

Prices Net F.O.B. Mineola, N. Y.

111 Roosevelt Avenue, Dept. 201, Mineola, New York

Please rush the instruments checked for a 10 day free trial. If satisfied I agree to pay the down payment within 10 days and the monthly installments as shown. If not completely satisfied I will return the instruments within 10 days and there is no further obligation. It is understood there will be NO INTEREST or FINANCING charges added.

Name \_\_\_\_\_  
 Address \_\_\_\_\_  
 City \_\_\_\_\_ State \_\_\_\_\_  
 Please print clearly

**"TAB" Tubes Tested, Inspected, Boxed**  
**Six Months Guarantee! No Rejects!**  
**NEW & Used Gov't & Mfgs. surplus!**

Orders \$10 or more. Receiving type only. *pl. 48 states*

0A2	.80	6B16	.08	12A75	.50	1851	1.00
0B2	.85	6BK7	.08	12AT7	.80	3876	1.00
0C3	.70	6BL7	1.25	12AU6	.80	465A	1.00
0D3	.55	6BN6	.08	12A7	.08	2021	2.50
0Z4	.50	6BQ6	1.15	12AX7	.75	3023	2.50
1A7	.70	6BZ7	1.25	12BA6	.80	417A	2.50
1B3	.70	6C5	.08	12BA7	.08	4-125	10.00
1R5	.70	6CS	.08	12BD6	.08	4-250	10.00
1S4	.70	6CB6	.08	12BE6	.08	4-250	10.00
1T4	.70	6CD6	1.40	12BF6	.08	4PR60	20.50

*Send 10¢ for Catalog*

1U4	3/81	6H6	3.81	12BH7	.08	4X150	5.00
1U5	.70	6J5	.52	12BY7	.08	4X250	10.00
1X2A	.08	6K7	.48	12C6	1.45	58P1	4.98
3Q4	.08	6K6	.70	12CUC	1.45	58P4	4.98
3Q5	.80	6K7	.71	12SA7	.94	58P4	4.98
3S4	.08	6L6	1.10	12SC7	.80	100T	7.00
3V4	.80	6SA	.08	12SH7	.08	35T	4.00
SR4	.08	6S8	.08	12SJ7	.75	316A	7.81
SU4	.50	6SA7	.08	12SK7	.08	41	41.68
SV4	.80	6SB7	1.10	12SL7	.08	41	41.68

*Wanted: surplus Elctronics from individuals & F's*

5Y3	.70	6SC7	.70	198G6	2.15	450T	42.00
6B4	.50	6SG7	.70	19T8	1.16	80T	1.00
6AC7	.70	6SH7	.08	2580E	.08	809	2.00
6AG7	.70	6SK7	.70	2580E	.08	81	4.40
6AM6	.80	6SK7	.72	25W4	.77	812	1.00
6AK5	.80	6SL7	.80	25Z5	.80	813	0.00
6AL5	2.81	6S6	2.81	25Z6	.70	814	2.45
6AQ3	.80	6SQ7	.74	EL34	3.44	815	2.75
6AS7	3.00	6SR7	.70	EL37	2.40	826	.50
6AT6	.40	6T8	.70	5L5	.40	828	8.00

*Wanted: 500 Ma Rectifiers*

6AU4	1.10	6US	.08	35W4	.40	832A	7.00
6AU5	1.10	6V6GT	.70	35Y4	.08	866A	2.75
6AU6	.08	6W4	.70	35Z5	.60	1625	5.80
6AX4	.70	6W6	.80	50A5	.08	6146	4.00
6B4	.70	6X4	2.50	50B5	.08	5879	5.80
6B7	1.00	6X5	.40	50C5	.08	5881	2.70
6BD6	.08	6Y6	.08	50D5	.08	5882	2.70
6BE6	.70	6Y7	.08	K766	3.20	5654	1.00
6BG6	1.50	12AL5	.08	75	.80	5894	12.00
6BH6	.72	12AQ6	.75	80	.50	7193	10.80

**TUBES WANTED! WE BUY! SELL & TRADE!**

**\*New Silicon 500Ma Rectifiers**

rms piv	rms piv	rms piv	rms piv
35 50	70 100	140 200	210 300
30c	45c	200	65c
rms piv	rms piv	rms piv	rms piv
280 400	350 500	420 600	490 700
78c	\$1.00	\$1.26	\$1.50
rms piv	rms piv	rms piv	rms piv
560 800	630 900	700 1000	770 1100
\$1.59	\$1.89	\$2.58	\$3.12

Use in Bridge or C.T. up to 750ma dc  
 \*Silicon 500Ma, 1. V. at 250 Ma Rectifiers. Hi-Temp 100°C at 250V RMS. Special 2 for \$1; 25 for \$10.  
 \*Postpaid 48 States

**TRANSISTORIZED DC POWER!**  
**HIGH EFFICIENCY DC UP TO 45VDC**  
**"TABSTAT" KIT or BUILT!**

Output 45v & Tap 25vdc @ up to 150 MA Up to 70 Watts 80% efficiency. Ripple 0.2%; low hih. current one amp silicon rectifier, electrolytic filter, fused & short circuit proof. Regulation 5% at 20 to 100% load! Small in size! Light wgt! Low priced gld "TABSTAT" TR1245B built \$35. Pre-Assembled U-Built kit TR1245CK Only \$30. Six V Imp. TR145CB \$35. Kit TR145CB \$30. Kit STAY 25VDC @ 100MA 12V. TR1225CB \$27. Kit TR1225CK \$24. 0V Imp TR125CB \$27. Kit TR125CK \$24.



- KITS! "TAB" THE BEST KITS!**  
*All kits contain most popular tubes & more*
- |                            |                            |
|----------------------------|----------------------------|
| Kit 2 Eng. Parallel Rules  | Kit 5 Sub-Min Tubes        |
| Kit 35 Precision Resistors | Kit 40 Standoff Insulators |
| Kit 10 Switches            | Kit 35 Power Resistors     |
| Kit 75 Resistors 1/2 1/2W  | Kit 75 Mica Condensers     |
| Kit 150 Carbon Resistors   | Kit 5 Crystal Diodes       |
| Kit 25 Panel Lamps         | Kit 100 Fuses, Assorted    |
| Kit 12 Electrolytic Cond's | Kit 100 Ceramic Cond's     |
| Kit 56 Tube Sockets        | Kit 10 Germanium Diodes    |
| Kit 65 Tubular Cond's      | Kit 5 FT243 Xtal Holders   |
| Kit 500 Lug & Eyelets      | Kit 8 Silicon Diodes       |
| Kit 10 Bathing Oil Cond's  | Kit 5 Microswitches        |
| Kit 5 lbs. Surprise Pkgs.  | Kit 4 Ass'd Rectifiers     |
| Kit 10 Xmtr. Mica Cond's   | Kit 2 P11T Transistors     |
| Kit 3 Phone Patch Xfms     | Kit 4x50 Ft Hookup Wire    |
| Kit 3 Searchlights         | Kit 2 Vee'dr Counters      |
| Kit Circular Slide Rule    | Kit 2-Computer Toroids     |
| Kit 12 Algrt Clip Ass'd.   | Kit High Gain XTAL Mike    |

**BUY 10 KITS—GET ONE FREE EACH KIT 99c**

**NEW DC POWER for TRANSISTORS!!**  
 New low-cost 25 volt one amp filtered 1% Ripple Power Supply. Same as specified in Transistor Manuals G.E., RCA, CBS. Ideal for powering transistor circuits, rugged & small in size! Pre-assembled kit U-Built B25VACK \$10 or assembled B25VACH \$12



**NEW Selenium Radio & TV Rectifiers! GTD.**  
 65Ma 45c. @ 6 for \$2; 100Ma 45c. @ 12 \$5;  
 250Ma 65c. @ 10 \$8; 300Ma 88c. @ 10 \$8;  
 500Ma \$1. @ 10 \$8; 25 \$18

**\*NEW "TEKSEL" SELENIUM RECTIFIERS**  
**FULL WAVE BRIDGE RECTIFIERS. ONE YEAR GTD!**

AMP.	18VAC	36VAC	72VAC	144VAC
CONT.	14VDC	28VDC	56VDC	112VDC
1AMP	\$ 1.30	\$ 2.00	\$ 4.90	\$ 9.45
2AMP	2.15	3.00	6.25	12.30
3AMP	2.90	4.00	8.60	16.75
6AMP	4.15	6.00	12.75	26.15
10AMP	6.10	12.15	26.30	48.90
15AMP	9.90	19.00	40.00	106.60
24AMP	15.00	29.45	57.50	168.60



**FOR BEST BUYS! "TAB" for BARGAINS**  
 AN-ARR2 Revr As Is Good for Parts \$1.59  
 RDZ-USN 200-400 Mc's Revr less Tubes \$25.00  
 BC653 100 to 200W Xmtr. Pkgs or Cw 2 to 4.5  
 Mc's includes 12V Dynmr 5 Channels \$39.00  
 "Irish" Tape 1200' HqQty Gld \$1.59 @ 6 for \$9  
 "Irish" Tape Mylar 2400 ft Best Qlty \$4.49, 3 \$12  
 Sniperscope Tube 2' \$5 @ 3 \$12  
 2N277 \$4.50; 2N278 \$5.50; 2N441 \$3; 2N442 \$5

**"TAB"** TERMS: Money Back Guarantee! Our 14th year. \$2 min. order F.O.B. N.Y.C. Add shpg charges or for C.O.D. 25% Dep. Prices shown subject to change.  
 111-WA LIBERTY ST., N.Y. 6, N.Y.  
 Send 10¢ PHONE: RECTOR 2-6245

**What Set Owners Think**  
 (Continued from page 49)

has obviously been influenced by the fact that the industry has traditionally underestimated its own worth. What other guide does he have for determining a fair price? A rather high number of set owners (17 per-cent) admit they do not know what a fair price is. Also, they seem to be getting suspicious of the lower prices (Table 7) characteristic of "bait" advertising. Firmness on the part of the service shop may work better than indecision: a "compromise" fee (\$2.50, \$3.50, \$4.50, etc.) does not seem to re-assure the customer as much as a flat figure that is fifty cents higher! Whatever the price may be, few set owners (11.3 per-cent in Table 3) are likely to gripe about it. In fact, a few think charges are not high enough. There is very little reason for any professional to delude himself with the thought that he can add much volume by pricing himself out of business.

The gloomy specter of the "drug-store" checker is not a mere fancy, according to Tables 8 and 9. Most people have never bothered with them, but the minority that has (35.8 per-cent) is quite substantial. Fortunately, this figure seems to be somewhat higher than the national average. *Tung-Sol's* merchandising manager, Robert M. Andrews, estimates that 12 per-cent of tube sales are through vending machines nationwide. Some comfort is provided by the fact that more than one-third of the people who had used

such testers were not satisfied with the results. This means that, of all persons interviewed whether they had used such testers or not, only about 23 per-cent were satisfied. The principal reason given for dissatisfaction was "not accurate." Thus, although the drug-store tester has made serious inroads on tube sales by service shops, the practice is vulnerable. It is noteworthy that many consumers indicated they used the non-professional outlets only when regular service shops were closed, as on weekends or holidays.

Another point on these testers: not all who are "satisfied" involve lost business to shops. Where the checkers indicate that no tubes are defective, the set owner may turn to other channels while still feeling he has received a fair deal. Although complacency is a mistake, there is a clear limit to how much checkers can do and how much business they can take away.

The first general conclusion we may draw is that the independent service industry has one great Achilles' heel: a great deal of the business on which it must rely is being siphoned off in other directions. On the other hand, there is far less consumer resistance to its practices and prices than it realizes. In addition to continuing to render honest and competent service, it must be more confident and aggressive than in the past in insisting on realistic charges, in promoting its own stature in the eyes of the public, and in articulating the point that it should be the first resort, rather than the last, when sets need service. In short, act like a professional if you want to be treated like one.

<b>10</b>	Sets under Warranty	
	RESPONSE	PER-CENT
	Yes	15.5
	No	70.8
	Don't know	13.7
<b>11</b>	Ownership of TV Insurance	
	RESPONSE	PER-CENT
	Yes	10.7
	No	80.8
	No answer	8.5
<b>12</b>	Multiple Ownership of Sets in Family	
	NUMBER OF SETS	PER-CENT
	1	75.8
	2	23.7
	3	.5
<b>13</b>	Types of Sets in Use	
	MODEL	PER-CENT
	Console	56.2
	Table model	25.4
	Portable	9.3
	Combination	9.1



**20-Watt Amplifier**  
(Continued from page 60)

for 15 watts; and 2.7% for 20 watts. These figures are high compared to the 1% figures that we were able to obtain from many of the individual high-power amplifiers during the pre-stereo days. The results in this case, however, are not a true indication of the IM distortion alone as other factors are actually included in such a measurement.

IM distortion measurements are a deep concern to the industry at present. The new Institute of High Fidelity Manufacturers standards for testing amplifiers have excluded IM distortion tests for the time being. Their hope is to provide time for further analysis before additional standards are determined. (See page 51.)

Basically, the 60- and 6000-cps frequencies are the customary ones to use, but any combination of any two frequencies in the audio range could be applied. IM distortion figures would vary considerably depending on the combination used, and the 60-cps signal provides an extremely severe test, particularly for integrated amplifiers of today. For amplifiers having a flat frequency response from 30 to 15,000 cps at maximum power output, the 60-cps characteristic is not severe. However, for the more economical integrated packages, saturation of the iron of the output transformers does occur at the frequencies below 100 cps (depending on the design) resulting in loss of power output at the low end. The IM distortion figures in such cases now become a characteristic that combines erroneously the IM distortion with the characteristic of loss of power output at low frequencies. Suffice it to say that this is a problem at the moment and we will reserve decision until later as to whether we will continue taking IM distortion measurements.

The kit is not difficult to assemble if one follows closely the detailed construction manual. We actually assembled the kit in 13½ hours. This may seem like a ridiculously low figure to many. However, things seemed to click off rather rapidly so that we did not run into any lost motion.

We know of another case where this kit was built in 18 hours and this may be a more realistic average figure. We did run into one unusual problem. The multi-deck selector switch, as it turned out, had one of its decks rotated 180 degrees. This was a mis-assembly on the part of the supplier of the control switch. We feel sure that this is an unusual situation and the chances are one in a thousand of its recurring. We had no other problems with the unit. In our opinion this integrated amplifier will provide true high-fidelity performance.

The kit is available for \$79.95 and a factory pre-wired version is available at a price of \$129.95.

—50—

# Full Color Giant Fold-Out Charts Still Available!

Here's a complete series of colorful, authoritative fold-out wall-charts (originally appearing in the pages of ELECTRONICS WORLD)—yours for only 15¢ each. All in full-color—each suitable for framing.

1. **V.H.F. TV Spectrum and Interference Chart:** Servicing aid for TV technicians and hams—saves hours by tracking down interference.
2. **Hi-Fi Crossover Network Design Charts:** Tells how to build speaker nets for any crossover frequency. Complete coil-winding data, capacitor values given.
3. **Color Codes Chart:** Gives you coding for capacitors, resistors, transformers, resistance control tapers—all in easy-to-use form.
4. **Bass-Reflex Design Charts:** Complete data on building own bass-reflex enclosures for any speaker, including ducted-port enclosures.
5. **Radio Amateur Great Circle Chart:** For Hams and short-wave listeners—gives complete listing and map of amateur prefixes by calls and countries.
6. **Sound:** Fundamental data on all phases of Sound: frequency ranges, sound levels, equal loudness curves. A must for all audiophiles.

**ALSO AVAILABLE:**

Reprints of the following authoritative articles:

7. **"Build a Citizens Band Transceiver"**—complete details on building an 11-meter transceiver for Citizens Band service.
8. **"Electrical Shock: Fact and Fiction"**—must reading for everyone whose work or hobby involves electricity. Ideal for utility companies . . . service associations.

**IMPORTANT: ORDER BY NUMBER! OUR SUPPLY OF ALL GATEFOLDS AND REPRINTS IS LIMITED. OFFERED ONLY ON A FIRST COME, FIRST SERVED BASIS.**

Send 15¢ for each order to  
**ELECTRONICS WORLD, Dept. S160**  
 Box 378 Church Street Station New York 8, New York

**IMMEDIATE "IN STOCK" SHIPMENT**  
 from "the house the hams built" . . . the

## CITIZENS BROADCASTER CB-100

- \* TOP TRADE-INS
- \* PERSONALIZED SERVICE
- \* FAST SHIPMENT FROM THE CENTER OF THE U.S.A.

low cost,  
 smartly styled,  
 practical and sturdy  
**2-way 3-channel  
 Radio Station**  
 complete \*

**NO CODE!  
 NO TESTS!  
 NO EXAMS!**

ONLY \$129.95

**\$1300** down  
**\$760** per mo.

\* with microphone and crystals for one channel



**FREE 1960 CATALOG**  
 200 Pages - Hundreds of Bargains for the Ham.



**send for FREE DETAILED BROCHURE TODAY**



Please send me Free Catalog . . . and complete info on the CB-100.

Name: \_\_\_\_\_  
 Address: \_\_\_\_\_  
 City & State: \_\_\_\_\_

EW 1



**Olson**

**FREE**

Fill in coupon for a FREE One Year Subscription to OLSON RADIO'S Fantastic Bargain Packed Catalog—Unheard of LOW, LOW, WHOLESALE PRICES on Brand Name Speakers, Changers, Tubes, Tools, Hi-Fi's, Stereo Amps, Tuners and thousands of other Electronic Bargains.

NAME \_\_\_\_\_  
 ADDRESS \_\_\_\_\_  
 CITY \_\_\_\_\_ ZONE \_\_\_\_\_ STATE \_\_\_\_\_

If you have a friend interested in electronics send his name and address for a FREE subscription also.

**OLSON RADIO CORPORATION**  
 603 S. Forge St. Akron 8, Ohio



**pe** AMPLIFIERS OF QUALITY

**SIGNAL TRACER**

Checks all stages from Antenna to Speaker or Picture Tube. Tests microphones, appliances, pickups, transformers, speakers, resistors, condensers, etc.

Model 202 (with AF Probe) ..Net \$37.50  
 Model A Probe (RF Demodulator) .....Net 4.50  
 Model B Probe (RF Demodulator, Amplifier) .....Net 7.50

**pe** AMPLIFIERS OF QUALITY

**VTVM KIT**

Easily assembled! Solves numerous problems. Sensitive voltage measurements with negligible circuit loading. Accurate AC voltage ranges for checking line voltages, amplifier power output, frequency response. Positive and negative DC voltage ranges. Checks resistance. Radio, TV servicing; maintenance of electronic equipment; many other uses. Net \$27.95.

**PRECISION ELECTRONICS, INC.**  
 9101-Q King Ave., Franklin Park, Illinois

### "Rush Suppressor"

(Continued from page 41)

rush-level which was used as a reference point in setting the operating point of the relay. The d.c. across the relay is now at its maximum, causing it to energize. The speaker is now on and operating.

Once the relay receives enough voltage for operation, the long time-constant of the circuit created by *C* holds the relay in during entire words and short pauses. During extended pauses, the speaker is silent. Resistor *R* was added to increase the amount of available voltage for relay control and, with the resistance shown, does not seriously affect the amount or quality of audio on the speaker. It also serves as a load for the voice-coil winding when the speaker is off.

A single-pole, single-throw switch was added to disable the voice-control circuit. This is not absolutely necessary, but it does free the volume control for normal use once communication has been established.

The particular relay used is a sur-

plus item with a d.c. resistance of 2200 ohms and, in actual operation, would energize with 1 ma. and release with .75 ma. Any sensitive relay with similar characteristics will work satisfactorily.

Location and mounting of components is not at all critical and may be accomplished wherever there is room. The top view photograph shows the location of the additional circuit components. The only reason for mounting the relay as shown was to provide access to receiver and transmitter tuning adjustments. Much smaller relays are readily available and they could be mounted directly on the chassis. It can be seen from the front-panel view that the squelch disable switch is a rotary canopy type mounted between the two neon lamps, thus retaining the symmetry of the front-panel layout.

This circuit has been in use eighteen hours a day for some time with the transceivers operating over a four-mile air path with excellent results. The circuit is not critical to adjust and can be applied to most superregenerative receivers with a minimum of chassis and front-panel disfiguration. At last, a quiet superregen!

## TRANSISTOR ALARM GENERATOR

By DAVE STONE

HERE is a useful and interesting circuit which produces pulses of audio tones at intervals of less than one-per-second to about eight-per-second. When it is connected to an audio amplifier the resulting output sounds like a series of "beeps" much like the busy signal on the telephone, or "whoops" similar to the emergency call which summons crews to combat stations aboard a battleship.

The self-quenched superregenerator is an old standby in the radio-frequency range. Feedback for regeneration is obtained from the split primary winding of the audio output transformer (*Triud* A-65J) and the circuit produces a normal audio tone at a frequency determined by *C*'s capacity and the primary inductance of *T*. It is approximately 600 cps with the values indicated on the schematic.

*C*<sub>1</sub> is connected so as to provide cut-off bias to the base-emitter circuit when it has sufficient charge. During oscillation it charges high enough to "quench" the oscillator and when no oscillator current is flowing, discharges until the cut-off bias is reduced and the circuit begins to oscillate again. The "tone-on," "tone-off" action is repeated at a rate determined by the values of *C*<sub>1</sub> and *L*<sub>1</sub>. The "Pulse Rate" control, *R*<sub>2</sub>, changes the bias and charging conditions which, in turn, affect the repetition rate.

The values of *C*<sub>1</sub> or *L*<sub>1</sub> can be altered to obtain faster cycling—up to a rate of about fifteen-per-second, if desired. The optimum values for *L*<sub>1</sub> were found to lie between 500 to 700 millihenrys. The 50-200 ohm windings of a low-to-high-impedance transformer—such as

the mike-to-grid or line types—will fill the bill. Several transformers of this type were measured and the low-impedance windings were within the desired inductance range. The *UTC* A-10 audio transformer provides several low-impedance combinations.

The tone of the audio frequency can be varied by changing the value of *C*<sub>2</sub>—the larger the capacitor, the lower the tone while a smaller capacitor will produce a higher frequency output. *C*<sub>3</sub> and the 600-ohm secondary of the A-65J transformer will work well into a moderate- to high-impedance p.a. system input.

Use this stage to generate an alarm or warning signal with the higher pulsing rates. A burglar alarm relay can be connected to apply power to the alarm generator when it is activated. The resulting noise is guaranteed to command attention. Use it as an audible "count-down" signal over the p.a. system, by adjusting the pulses to exactly one-per-second.

Complete schematic of alarm generator. All parts are standard, intervals are adjustable.

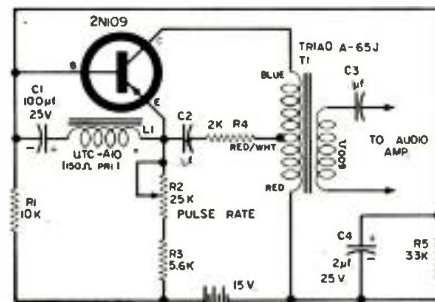



# DON'T

throw  
your  
money

## Get Rad-Tel's First Quality

# Brand New TUBES

BETTER  
THAN  
70%  
OFF!

GUARANTEED ONE FULL YEAR

down the drain . . .  
ON USED AND "PULL OUT" TUBES!

EACH TUBE INDIVIDUALLY AND ATTRACTIVELY BOXED! YOU CAN RELY ON RAD-TEL'S SPEEDY ONE DAY SERVICE!

Qty.	Type	Price	Qty.	Type	Price	Qty.	Type	Price	Qty.	Type	Price	Qty.	Type	Price	Qty.	Type	Price
—	0Z4M	.79	—	4BA6	.51	—	6AN4	.95	—	6CD6	1.42	—	7A8	.68	—	12AU7	.60
—	1AX2	.62	—	4BC5	.56	—	6AN8	.85	—	6CF6	.64	—	7B6	.69	—	12AV5	.97
—	1B3GT	.79	—	4BC8	.96	—	6AQ5	.50	—	6CG7	.60	—	7Y4	.69	—	12AV6	.41
—	1DN5	.55	—	4BE6	.54	—	6AR5	.55	—	6CG8	.77	—	8AU8	.83	—	12AV7	.75
—	1G3	.73	—	4BN6	.75	—	6AS5	.60	—	6CM7	.66	—	8AW8	.93	—	12AX4	.67
—	1J3	.73	—	4BQ7	.96	—	6AT6	.43	—	6CN7	.65	—	8BQ5	.60	—	12AX7	.63
—	1K3	.73	—	4BS8	.98	—	6AT8	.79	—	6CR6	.51	—	8CG7	.62	—	12AZ7	.86
—	1L6	1.05	—	4BU8	.71	—	6AU4	.82	—	6CS6	.57	—	8CM7	.68	—	12B4	.63
—	1LA6	.69	—	4BZ6	.58	—	6AU6	.50	—	6CU5	.58	—	8CN7	.97	—	12BA6	.50
—	1LC6	.79	—	4BZ7	.96	—	6AU7	.61	—	6CU6	1.08	—	8CX8	.93	—	12BD6	.50
—	1LN5	.59	—	4CB6	.59	—	6AU8	.87	—	6CY5	.70	—	8EB8	.94	—	12BE6	.53
—	1R5	.62	—	4CS6	.61	—	6AV6	.40	—	6CY7	.71	—	10DA7	.71	—	12BF6	.44
—	1S5	.51	—	4DE6	.62	—	6AW8	.89	—	6DA4	.68	—	11CY7	.75	—	12BH7	.73
—	1T4	.58	—	4DK6	.60	—	6AX4	.65	—	6DB5	.69	—	12A4	.60	—	12BK5	.70
—	1U4	.57	—	4DT6	.55	—	6AX7	.64	—	6DE6	.58	—	12AB5	.55	—	12BL6	.56
—	1U5	.50	—	5AM8	.79	—	6BA6	.49	—	6DG6	.59	—	12AC6	.49	—	12BQ6	1.06
—	1X2B	.82	—	5AN8	.86	—	6BC5	.54	—	6DQ6	1.10	—	12AD6	.57	—	12BY7	.74
—	2AF4	.96	—	5AQ5	.52	—	6BC7	.94	—	6DT5	.76	—	12AE6	.43	—	12BZ7	.75
—	2BN4	.60	—	5AT8	.80	—	6BC8	.97	—	6DT6	.53	—	12AF3	.73	—	12C5	.56
—	2CY5	.71	—	5BK7A	.82	—	6BD6	.51	—	6EU8	.79	—	12AF6	.49	—	12CA5	.59
—	3AL5	.42	—	5BQ7	.97	—	6BE6	.55	—	6EA8	.79	—	12AJ6	.46	—	12CN5	.56
—	3AU6	.51	—	5BR8	.79	—	6BF6	.44	—	6EB8	.94	—	12AL5	.45	—	12CR6	.54
—	3AV6	.41	—	5CG8	.76	—	6BG6	1.66	—	6H6GT	.58	—	12AL8	.95	—	12CU5	.58
—	3BA6	.51	—	5CL8	.76	—	6BH6	.65	—	6J5GT	.51	—	12AQ5	.52	—	12CU6	1.06
—	3BC5	.54	—	5EA8	.80	—	6BH8	.87	—	6J6	.67	—	12AT6	.43	—	12CX6	.54
—	3BE6	.52	—	5EU8	.80	—	6BJ6	.62	—	6K6	.58	—	12AT7	.76	—	12DB5	.69
—	3BN4	.63	—	5J6	.68	—	6BK5	.80	—	6S4	.48	—	12AU6	.50	—	12DE8	.75
—	3BN6	.76	—	5T8	.81	—	6BK7	.85	—	6SA7GT	.76	—			—		
—	3BU8	.78	—	5U4	.60	—	6BL7	1.00	—	6SK7GT	.74	—			—		
—	3BY6	.55	—	5U8	.81	—	6BN4	.57	—	6SL7	.80	—			—		
—	3BZ6	.55	—	5V6	.56	—	6BN6	.74	—	6SN7	.65	—			—		
—	3CB6	.54	—	5X8	.78	—	6BQ5	.65	—	6SQ7	.73	—			—		
—	3CF6	.60	—	5Y3	.46	—	6BQ6GT	1.05	—	6T4	.99	—			—		
—	3CS6	.52	—	6AB4	.46	—	6BQ7	.95	—	6T8	.80	—			—		
—	3CY5	.71	—	6AC7	.96	—	6BR8	.78	—	6U8	.78	—			—		
—	3DE6	.62	—	6AF3	.73	—	6BS8	.90	—	6V6GT	.54	—			—		
—	3DK6	.60	—	6AF4	.97	—	6BU8	.70	—	6W4	.57	—			—		
—	3DT6	.50	—	6AG5	.65	—	6BY6	.54	—	6W6	.69	—			—		
—	3Q5	.80	—	6AH6	.99	—	6BZ6	.54	—	6X4	.39	—			—		
—	3S4	.61	—	6AK5	.95	—	6BZ7	.97	—	6X5GT	.53	—			—		
—	3V4	.58	—	6AL5	.47	—	6C4	.43	—	6X8	.77	—			—		
—	4AU6	.54	—	6AM8	.78	—	6CB6	.54	—	7AU7	.61	—			—		

Brand New JAN 3BP1  
Cathode Ray Tube \$1.45

6.3v Deflect. Sensit.  
Five X 5BP1—Electrostatic  
Focus & Deflection

Use This As Your Order Blank

Rad-Tel Tube Co. 55 Chambers St. Newark, N. J.

NAME .....

ADDRESS .....

# RAD-TEL TUBE CO.

Est. 1945 55 Chambers Street  
Newark 5, N. J.  
Mitchell 2-3147

NOT AFFILIATED WITH ANY OTHER MAIL ORDER TUBE CO. . . . SPEEDY ONE-DAY SERVICE  
TERMS: 25% deposit must accompany all orders. balance C.O.D. Orders under \$5, \$1 handling charge. Subject to prior sale.  
All shipments F.O.B. Newark warehouse. No C.O.D.'s outside continental U.S.A.

# What's

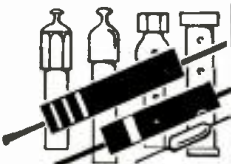

## New in Radio

### PRIVATE PLANE RADIO

King Radio Corp., 9700 W. 75th St., Merriam, Kansas has developed a new 10-watt transmitter-receiver which is



designed to provide light, medium, and executive planes with airline communications power.

Available with either 14-volt or 28-volt power supply, this 90-channel unit is compact and lightweight. Designed for easy custom panel installation, simply by the removal of faceplate, the KY-90 is only 3" high, 6 1/2" wide, and 8" deep. The complete unit, including power supply, weighs only 8 pounds.

The power supply/modulator is completely transistorized with line filter to minimize radio interference. Both side tone and mike gains are adjustable from the front panel.

### NEW SSB RECEIVER

Hammarlund Manufacturing Company, Inc., 460 W. 34th St., New York 1, N. Y. has announced the development of a new communications receiver which offers SSB tuning plus full dial coverage from 550 kc. to 30 mc.

The HQ-180 is entirely self-contained, with its own power supply and



requires only the addition of an external speaker or earphones. The circuit is an 18-tube superhet with automatic noise limiter. It is triple conversion from 7.85 to 30 mc. and dual conversion from 510 kc. to 7.85 mc. It offers the operator a choice, or combination, of slot filter, selectable sideband, tuned i.f., bandspread and separate linear detector in tuning the desired sideband signal.

A new high-frequency crystal filter is used at 3035 kc. to improve selectivity

and shape factor of the first i.f. amplifier. The slot filter is adjustable  $\pm 5$  kc. over the passband for up to 60 db attenuation.

The new receiver is designed for amateur, commercial, or military SSB operation. It is available in either cabinet or rack-mounted versions.

### POCKET V.O.M. KIT

Allied Radio Corporation, 100 N. Western Ave., Chicago 80, Ill. has just released a low-cost, pocket-sized v.o.m. which is hardly larger than a package of cigarettes.



The new unit reads in 13 ranges at 1000-ohms-per-volt d.c. sensitivity. The ranges are d.c. volts 0-5-15-50-150-500; a.c. volts 0-15-50-150-500; d.c. milliamps. 0-1-10-100; and ohms, 0-30,000 (1200 ohms mid-scale).

The instrument has a front-panel zero-adjust, 2 1/2" meter with two-color scale, and 5% shunts and multipliers. Only 2 3/8" x 3 3/4" x 1 1/2" when assembled, the kit comes complete with battery and test leads. It is catalogued as Stock No. 83 Y 708.

### TRANSISTORIZED POWER SUPPLY

Barker & Williamson, Inc., Bristol, Pa. is now offering a new standard line of transistorized d.c. converters and an inverter.

The converters include 25-, 60-, and 120-watt models. The 25-watt inverter delivers 115 or 26 volts at 400 cycles. All operate on 12- to 14-volt d.c. input.

Small in size and lightweight, the new units are designed to withstand severe environmental conditions. Current drain is small and the absence of moving parts eliminates wear.

Applications for the converters include mobile communications, Citizens Band radios, marine radiotelephones, and aircraft radios. The inverter can be used for synchro position indicators, gyro instruments, remote indicating compasses, and other aircraft and marine instruments.

### TRANSISTORIZED INTERCOM

Heath Company, Benton Harbor, Mich. is now offering an all-new transistor intercom system which is available as master and remote stations separately.

The master unit (XI-1) can call any one remote station, any combination, or up to five if desired. Any remote station (XIR-1) can turn the system on and initiate a call to the master; once

the master replies to a call, control of the system is taken over by the master and the remote unit need not be touched.

The circuit is completely transistor-

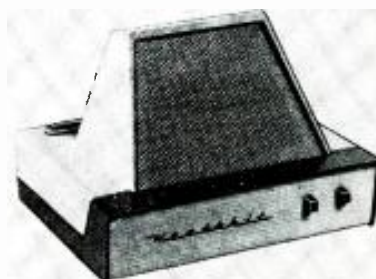

ized for instant operation and low battery drain. The intercom is powered by eight inexpensive "C" flashlight batteries that provide up to 300 hours of normal "on" time. The 4 1/2", 45-ohm PM speakers serve as both microphone and speaker on all stations.

For complete details and prices on these new kits, write the company direct.

### ANTENNA MIXING NETWORKS

Jervold Electronics Corporation, 15th and Lehigh Ave., Philadelphia 32, Pa. has developed a new series of antenna mixing networks which will permit multi-channel, all-direction reception simultaneously.

According to the company, the new low-loss, high-isolation TX models eliminate the need for rotors and switches normally required to bring in TV signals. With the TX series, multi-set homes are no longer limited to receiving only the channel or channels whose reception hinges on the direction the rotor faces.

One of the new units, the TX-FM, permits the connection of a TV set and an FM receiver to a single antenna without loss of signal to either set. The Model TX can be used individually or in any combination to mix cut-to-channel antennas with a single broadband antenna; separate individual channels from broadband antenna; mix or separate v.h.f. TV and FM signals; act as a splitter to feed v.h.f. TV signals to TV receivers; and FM signals to FM receivers from a single broadband antenna.

The components are housed in unbreakable plastic cases and use universal mountings.

### NEW EMC V.O.M.

Electronic Measurements Corp., 625 Broadway, New York 12, New York is now offering a new model v.o.m. which is available in both kit and wired forms.

The Model 109 incorporates a 40  $\mu$ a., 4 1/2" meter and features an a.c. voltage sensitivity of 10,000 ohms-per-volt. There are five d.c. voltage ranges (up to 3000 volts) at a sensitivity of 20,000



ELECTRONICS WORLD



ohms-per-volt; five a.c. voltage ranges to 3000 volts; three a.c. and d.c. current ranges; and three resistance ranges to 20 megohms.

The circuit is housed in a high impact molded Bakelite case. Write the manufacturer for prices on either or both versions.

### FM TEST OSCILLATOR

Heath Company, Benton Harbor, Mich. has just introduced a test oscillator kit which has been especially designed for FM servicing.

The Model FMO-1 covers all frequencies for r.f., i.f., and FM detectors; features 100 kc. bandwidth markers; a 10.7 mc. crystal marker; 10 mc. calibrating crystal; and incorporates a variable-width sweep oscillator.

The circuit is housed in a single compact, easy-to-use case and comes with



test leads. All test frequencies (except the sweep circuit) are fixed, assuring frequency accuracy dependent only on the actual accuracy of the coils and their initial alignment.

### SILICON POWER RECTIFIER

Westinghouse Electric Corporation,

P.O. Box 2088, Pittsburgh 30, Pa., is now offering a new silicon power rectifier for high-current, high-voltage applications.

The Type 439 can provide up to 240 amperes of forward current per cell with maximum peak inverse voltage ratings up to 600 volts. Maximum reverse leakage current is 50 ma. at the rated peak inverse voltage.

The unit may be operated at up to 190 degrees C at the junction. It features a solid copper base for ruggedness and small size (maximum cell length 3" and over-all weight 8 oz.).

A hermetically sealed cell, this power rectifier is nickel-plated to maintain low contact resistance and to prevent corrosion. Ceramic insulation between the anode and cathode provide a greater creepage distance than previously available on this type of silicon rectifier. Details on request.

-50-



### LOOK! \$49.50 BUYS A GOOD TEST SCOPE

Ready to use! TS-34 AP as illustrated, with power cord, carrying case, and 16-page illustrated booklet. Tested & guaranteed. Intern. sweep 10-50,000 cy. Video ampl. 11 cy to 2 1/2 mc. Also has Start-Stop sw. posit. in which TV or other pulses trigger sweep, with choice of 5, 50, or 250 u-secs. duration. Look into hood thru magnifying lens, see big picture and fast-rising traces.

Shpg wt 40 lbs FOB Los Angeles. Only **\$49.50**

TS-34A AP is same as above except that in Start-Stop you vary sweep durations 4 1/2-8, 20-50, and 120-280 u-secs. With same data booklet, less carrying case. Certified OK. FOB Los Angeles. Only **\$69.50**

### MEAS. CORP. #79B SQ.—WAVE GENERATOR

Generates 150 v pos. Pulses 60-100,000 cy. Width 1/2-40 u-sec. Decay not more than 1/4 of width. Also 40 v pos. synch pulses less than 3 u-sec. wide and delayed approx. 1/2 main-pulse width. Includes circuits to pulse-modulate ext. CW RF and to be synched to an ext. sine-wave source. Large direct-calibrated dials for width and for freq. X1, X10, X100. Input 117 v, 50 60 cy. Brand new in original pack, w instr. book.

40 lbs FOB Harrisburg, Pa. **\$99.50**

### VHF-UHF MICROVOLTER SIGNAL GENERATOR

LAF-2. 90-600 MC accurate to .9%; less than .1% drift. Bolometer-bridge-meter CALIBRATED 50-ohm output CW or mod., 1 uv to 1 v. Leads less than 1/2". Ext. pulse or sine mod., or int. rect-wave mod. 0-100%, 2-30 u-sec wd. 60-2500 pps. May also use ext. sync. with adj. delay 3-300 u-sec before sync. fires. Int. wave. May also be used to sync ext. equipment. 100 mA electrostatically-shielded 6.3 v, 50/60 cy. Exc. checked out, and reprint of the needed parts of the manual. FOB Los Angeles. Gross 100 lbs. **\$89.50**

Only **\$119.50**

LAE-2. Same as above specs except 520-1300 mc. NEW, original packing, with book, etc. FOB Charleston, S.C. Only **\$119.50**

### ISOLATE LIFE FROM DEATH, & STEP DOWN

Not a Sunday Sermon, but a 500-Watt Permafill Isolation Transformer that may save your life. Four 110 v, 50 60 cy pri's, for 110 220 440 v line. Isolated 4:1 a sec. is tapped for 95, 100, 104, 110, 116, 122, 130 v. A 3d winding gives 12.6 v, 2 1/2 A. With diagram. Shipped only by collect RailEx **\$7.95**

### FOUND! A NEAT & COMPACT SCOPE XFRMR!

Freed 12691. Spares for DAS Lorain. Supplied a 5" C-R tube, ampl. plates & hrs. Pri. 105-130 v, 50 60 cy. Sec's ins. 5 KV; 1490 and 1100 v, 5 ma; 390-0-390 v, 1 A; electrostatically-shielded 6.3 v, 8 A; 2-2 1/2 v, 2 A. Sec's ins. 1 1/2 KV; 2-6.3 v, 6 A; 8 v, 3 A; 2 1/2 v, 5 A. Soldering terminals come thru bakelite bottom plate. Case 5 1/2" x 5" x 7 1/2" above chassis. With diagram, New. Gov't acq. cost was \$35.00. Shipped only by collect RailEx **\$4.95**

Glass-sealed 1/2-wave Selenium rectifier 4 1/2" OA lg, 1/2 dia, forules, 9 1/2" max. OD. 1350 v ac max. input, 5 ma av, dc. A \$3.20 value, sold only with the above transformer at 98c ea., two for \$1.89.

### 12 V DYNAMOTOR FOR SOFT-TUBE FINALS

3H1514-27. Modern hi-efficiency design, late production. 4 leads. HV & LV are isolated, use for pos. or neg. ground systems. Nominally 13 v, 23 A in, 385 v, 500 ma out. 68% efficient. Regulation: 390 v at 400 ma, 19 A in; 397 v at 300 ma, 6 A in. Ideal for 2-6146 finals. Brand new. Shipped only by RailEx collect FOB Los Angeles. **\$4.95**

### \$11.95 BUYS A 2-METER ELECTRONIC-SQUELCH RCVR AND A 2/6/10 METER XMTR

SCR-522-C: Latest production! Receiver BC-624-C clean as new with all 12 tubes has electronic squelch, improved cascade AVC, more output. Transmitter BC-625-AM clean as new, with all 7 tubes, including the 832's. (Those who opened had 832A's, but we cannot select sets.) Both units mounted in rack and case. This Bendix set is 100-156 mc 4-channel xtl-control AM. Price \$11.95 top Los Angeles for set and \$3.00 for our Cat. 16C3, which is the original schematic with parts list, I.F., xtl formulas, and instructions for an AC power supply, for receiver continuous tuning, for xmtr 2-meter use, and for putting xmtr on 6 and 10 meters.

TEST INSULATION WITH 32,000 VOLTS DC Cond. Prod. Co. P530-1M60. Only 7" x 7" x 8" h plus terminals and anti-corona balls. Xfmr's, four 1A2 tubes, filter capacitors, and bleeder all inside the miniature oil-filled case. 1 ma dc with 1% ripple, 60 cy input 18 v to fl. pri. and 0-118 v to plate pri. for 0-32,000 v dc out. Certified OK, 26 lbs FOB Los Angeles. **\$69.50** shipped only by RailEx collect. Only

### TUNING-FORK STANDARD FREQUENCIES FROM AMERICAN TIME PROD. UNUSED MODULARS

Combination BENCH POWER SUPPLY & 400 CY Standard Model 400-A: 400 cy fork  $\pm .001\%$  & 2 GAUS supplied by VR50 & 5U4. Signal thru amplitude control to 6V6GT & xfrmr to Hi-Imped. 16, 8 & 4 ohm binding posts give: Filtered dc 390 v (no load) reducible by 1500 ohm rheostat in series with fixed 500 ohms effective internal resistance; take out to 120 ma. Also controls and outputs on front panel. 6" wd, 9" h, 14" dp. Input 50-60 cy at 95-117-130/190-210-234-260 v. NEW. Tested and guaranteed, with schematic. 40 lbs. RailEx FOB Los Angeles. **\$97.50**

400 cy  $\pm .001\%$  Modular subchassis only from the above unit, with the fork and 2-GAUS, wired, tested, ready to use upon application of 150 v dc at 20 ma, and 6.3 v ac at 600 ma. Output 6 v or 1 v, approx. sinusoidal. With schematic, 4 lbs. **\$37.50** parcel post FOB Los Angeles.

1000, 500, 250, 125, & 62 1/2 cy  $\pm .02\%$  7" x 4" 1 k plug-in fork  $\pm 200\%$ , 7 1/2A7's, and 4 Walkirt plug-in binary flip-flop count-downs, each usable from 25 kc to 0. NEW. Tested and guaranteed, ready to use. Requires external 250-300 v d.c., 35 ma, & 6.3 v a.c., 2 1/2 A, both handy at front panel of the 400-A described above. With schematic and circuit information. Shpg wt 4 lbs. FOB Los Angeles. **\$79.50**

TIME PAY PLAN: Purchases must total \$112.00 or more. Pay 25% down and balance in 12 monthly payments, each 7% of your purchase total. Send deposit and sales tax (if applicable) with your order.

### SCHEMATICS/CONVERSIONS, SURPLUS GEAR

List G. NEW! Send large stamped addressed envelope. Includes many Tech Manuals. Add 25c for chart explaining AN Nomenclature. Example of new listings, ready-to-use book, representing 100 man-hours of compilation, on 1-177 Tube Tester, MK-949. Sockets Adapter, with test data on all tubes to March, 1957; only \$5.00 postpaid.

Calif. buyers please add 4% when remitting.

**R. E. GOODHEART CO.**  
P. O. Box 1220-A Beverly Hills, Calif.

### ONLY \$79.50 FOR 5" DUMONT TEST SCOPE

241 as illustrated, with line cord, guard, and 16-page instruction book. 241 is a standard test scope you can use and be proud of. Has Z-axis ampli. for markers and X-axis ampli. for ext. sweeps or zero-beat frequencies. Internal sweep 15-30,000 cy. Video response flat 20 cy to 2 mc. Direct-to-plate terminals and all controls on front panel 10 1/2" wd x 15" h. With reprint of the Dumont Instruction Book. Checked out, certified. 75 lbs. **\$79.50**

FOB Los Angeles. **\$79.50**

### SPLATTER-FREE SPEECH-AMP/MOQUL/PWR-SPLY FOR XMTR OR FOR PUBLIC ADDRESS

Audio: 6-tube chassis with Class B 6P807's delivers 30 W rms at mod. xfrmr sec., which you put in series with 8+ to your final for standard plate or plate-screen modulation. AGC system holds output to  $\pm 4.8\%$  over an input range of  $\pm 78\%$ . It was designed to modulate 95% regardless of input. The F.C.C. will allow you for this! Includes 1 kc tone osc. and cutoff-biased tone ampli. operative when key shorts out the bias. Has sidetone output. Inputs for 600 ohm dyn. mike or 30-50 ohm carbon mike. For PA audio, a 5k-ohm-to-voicecoil xfrmr can be connected to the modulating output sec. of the mod. xfrmr without affecting the AGC system. Power supply: 115 v, 1 ph 50 60 cy input. Furnishes all voltages for above chassis plus power for your xmtr. A 390-0-390 v 735 ma xfrmr and 4 3C23 mercury thyratrons connected as diodes in FW bridge ckt furnish 600 volts filtered dc at 445 ma. Two of the tubes are also used with the xfrmr CT in standard CT ckt to furnish 300 V filtered dc at 175 ma. A separate xfrmr heats the 3C23's. A separate fl. xfrmr supplies the audio chassis and has plenty of 6.3 v windings for your other xmtr cks. For bias and any 17.5 amp. and slash \$97.50 off at surplus prices. All in their sec's, and two FW selenium bridges furnish 12 v DC at 1 A and -115 v DC at 1/2 A. A 115 v, 50 60 cy blower cools the 3C23's. And Neg. and Pos. adjustable bias voltages come from potentiometers in both the HV and the selenium supplies. You get all the above, nothing else to buy, plus 16-page instruction book, 16 tubes (worth \$32.00 at surplus prices), and with schematics, parts values, and AGC adjustment instructions. FOB Milpitas, **\$49.50** Calif. All for only

### a TERRIFIC BARGAIN in a

**SOLA CONSTANT-VOLTAGE TRANSFORMER**  
Ends fluctuating line voltage!  
Big Discount Off...

the factory price of a 1-input 2,000 VA unit! And here's another bonus! This Navy 2 KVA overstock, SOLA Cat. No. 30710, has 4 inputs! 95-125 v or 190-250 v, 60 cy or 50 cy. Isolated secondary's constant 115.0 v  $\pm 1\%$  from no-load to full-load of 17.5 amps. So, if you choose, use it as a 220-115 v step-down. And, if you choose, use it as a 220-115 v factory 1-input price! Brand new **\$147.50**

260 lbs FOB Harrisburg, Pa. Shpg wt 260 lbs. (Note: Same as above picture except capacitor box mounted above transformer; takes less floor space.)

SOLA 3080B, 500 VA, 60 cy, 95-125 v in, to isolated 115.0 v  $\pm 1\%$  out. Certified. **\$49.50** RailEx collect only. FOB Los Angeles

G.E. 23 KVA, 57-63 cy, 100-135 v in, to link-switch selected 113, 115, 117 v  $\pm 2 1/2\%$  out. NEW. 594 lbs FOB Seattle, Wn **\$97.50**

**CONSTANT VOLTS & NO HARM. DISTORTION**  
1 KVA, 60 cy. Superior 5620 Spec. Autom. or man. Output-sensing servo system turns Powerstat to null at no-load between 100-120 v. Line may vary 130 v. Adjust, sensiti. Metered. **\$125.00**  
FOB El Paso, Texas, only.

# Solve Rough Sweep Output Problems

**IN MINUTES**

**INSTEAD OF HOURS!**



## NEW **B&K** DYNA-SWEEP CIRCUIT ANALYZER

1. Provides composite synchronizing signals (negative or positive) to inject directly in each sync stage.
2. Provides plate drive signal to check complete vertical output circuit, including V.O. transformer.
3. Provides vertical yoke test signal to determine if vertical yoke windings are defective.
4. Provides horizontal plate driving signal to directly drive TV horizontal output transformer circuit.
5. Provides B+ boost indicator.
6. Provides unique high-voltage indicator.
7. Provides sensitive tests for each of the horizontal output components, including H.O. transformer and yoke. Immediately reveals their true condition, good or bad.

Quickly solves tough output servicing problems that have always plagued the TV serviceman. Provides horizontal and vertical sync and driving pulses that make it easy to check out every stage in the sync and sweep sections of a television receiver. Tracks down troubles in the horizontal and vertical output circuit, including defective output transformer and yoke. Checks for shorted turns, leakage, opens, short circuits, and continuity. Gives unique high-voltage indication. Eliminates trial and error replacements. Saves many hours of service work! Pays for itself over and over again.

Model 1070 Dyna-Sweep. Net, **\$699.95**

**MODEL A107 DYNA-SWEEP CIRCUIT ANALYZER**  
for use with B&K Model 1075 Television Analyst

Functions like the Model 1070 above, but is designed as a companion unit for use only with B&K Model 1075 Television Analyst for driving source. Makes your Television Analyst more useful and valuable than ever. Net, **\$49.95**



See your B&K Distributor or Write for Bulletin ST24-N

**B & K MANUFACTURING CO.**  
1801 W. BELLE PLAINE AVE • CHICAGO 13, ILL.

Canada: Atlas Radio Corp., 50 Wingold, Toronto 10, Ont. • Export: Empire Exporters, 277 Broadway, New York 7, U.S.A.



## Within the Industry

(Continued from page 26)

ratio for such system is given by systems using suppressed carrier amplitude modulation. This applies to some six system proposals. However, it does not apply to one other proposal which does not suppress the carrier but would result in an appreciably simpler stereo receiver. The evaluation of relative receiver complexity for these systems would be made by the receiver panel of the NSRC.

Bruce T. Bogert, *Bell Labs*, and Norman Parker, *Motorola*, head a separate study group to evaluate, on a theoretical basis, the relative merit of FM or AM subcarrier for FM stereo broadcasting.

B. F. Tyson, *Sylvania Electric Products Inc.*, was asked to bring his classification of AM systems up-to-date so that they can be evaluated in the near future. It was further decided that the value of an EMI proposal should be determined by comparison listening with other systems.

**RAY LANE** has been appointed to the post of director of research and engineering for *Pyramidal Electric Company*.



Mr. Lane was previously associated with *F & B Manufacturing Company* and *Ajax Condenser Corporation*. He has also served with *Solar Manufacturing Co.*, *Western Electric Co.*, *Westinghouse E & M Co.*, *Fadu Radio Co.*, and *Micamold Radio Corp.*

In his new position, Mr. Lane will be responsible mainly for the development of new capacitors for the avionic and consumer products markets.

**RADIO KITS, INC.** has changed its name to **ARKAY INTERNATIONAL, INC.** The officers and directors remain the same.

**INTERNATIONAL RESISTANCE COMPANY** and **CHICAGO TELEPHONE SUPPLY CORPORATION** have reached an agreement whereby the former firm becomes sales representative for the latter company's industrial and military variable resistor products in five major marketing areas.

**ARTLOOM INDUSTRIES, INC.** has acquired **EASTERN PRECISION RESISTOR CORPORATION**. Present management will be retained with Martin Green as president of the electronics manufacturing company.

**THOMPSON RAMO WOOLDRIDGE INC.** has acquired **BEL CANTO STEREO-PHONIC RECORDINGS, INC.** Russ Molloy, formerly executive director of the recording company, will serve as president of the new subsidiary.

**G-C ELECTRONICS COMPANY** has purchased **ELECTROCRAFT, INC.** The company will be moved to Rockford, Illinois and will be operated as a division of the parent concern.

### MAXIMUM PERFORMANCE 27 MC C-B EQUIPMENT

**A NEW & DIFFERENT C-B Transmitter-Receiver.** The very maximum in performance obtainable. Single unit 5 watt 24 watt output transmitter and 11 tube ultra sensitive-selective receiver. 3 stage RF circuitry using kumulator type tubes, stable compliance oscillator, dual conversion 23 channel tunable receiver, AVC, HFO, S meter. This unit has everything. **\$169.95**

**PRECISION FREQUENCY METER.** Allows you to measure your C-B XMTF freq. to accuracy better than FCC requirements. 21 channel direct reading dial. Stabilized XTAL. calibrator. Performance & accuracy equal to commercial units selling for 2 & 3 times our low price. **\$99.95**

**THE ESSCO BASE STATION XMTR.** Complete 3 stage RF unit & I.F. modulator. Handsome desk type cabinet with 3 position panel meter. Press-to-talk relay. 3 channels. Will reach those "hard to get to spots". **\$99.95**

**SAME UNIT less power supply.** **\$79.95**

**THE NEW ESSCO TINI-METER.** A sipetal compact 3 stage IF assembly with compliance loaded oscillator and 2 crystals. Use to pep up your present C-B gear. Easy to install anywhere. With single crystal. **\$34.95**

With 2 crystals factory installed. **\$39.95**

**CRYSTAL CONTROLLED CONVERTER.** Allows reception of 27 C-B channels with any broadcast receiver, tear home! Low drain dry battery powered simplifies installation. Sensitive, selective, low noise, equipped with 2nd crystal. **\$24.95**

The ESSCO HD-1, GP antenna, sturdy tempered steel elements. 3db power gain will double your present range. **\$27.95**

"THE C-B NEWS" a monthly info packed bulletin. Will help you obtain the mostest from C-B operation. Send self addressed #10 envelope for free copy.

**ESSCO C-B HQTS** 58 WALKER ST. NYC 13, N. Y.

## YOU

will make easy profits showing the TV Lifesaver® on Service calls. Sells automatically—just show it. \$4.95 List. See your jobber.



**WUERTH TUBE SAVER CORP.** Detroit 4, Michigan

### CLOSE-OUT! Government Surplus

**\$100 Worth of FOR ONLY**

OVER 28 Important Units! Brand New Plugs and connectors! Including 2 Aircraft 5 1/2" Antennas. Ideal for laboratories, Hobbyists, Repair Shops, etc.

**\$5** post paid

Packed in original government cartons. Postage paid anywhere in U.S.A.

**DIAMOND ELECTRIC COMPANY**

1230 LYELL AVE. ROCHESTER, N. Y.



# Product Report

LAB TESTED  
ELECTRONICS WORLD

## VOCALINE CB TRANSCEIVER

A HIGHLY sophisticated Citizens Band transceiver incorporating a double-conversion receiver section, conservatively rated transmitter, and an unusual squelch circuit is being offered by the *Vocaline Company of America, Inc.* Trade-named the "Commaire Model ED-27," this new unit is designed for optimum single-channel operation. Current production models are being shipped with the transmitter and receiver preset for channel-12 operation.

Tuning up the "Commaire" is a simple, positive operation. The loading indicator for the pi-network is a small dial lamp in series with the antenna. Although positioned in the rear of the cabinet, a Lucite rod directs the light to a bull's-eye on the front panel. Using a *Vocaline*-recommended antenna, the whole tune-up operation can be performed in just about 30 seconds.

On the air, the "Commaire" is distinguished by a healthy sounding signal with clean, full modulation. However, it is on "receive" that the "Commaire" really shines. The double-conversion superhet offers extremely good selectivity, a highly desirable characteristic in areas where a large number of stations are on the air. In our tests, a mobile unit operating on an adjacent channel could not be heard although it was only 100 yards away. Sensitivity is in keeping with the best design qualifications and seems to work hand-in-glove with the "Vocatron" squelch circuit, giving the feeling that the background noise level floats and that the weakest readable signal will easily open the squelch. This operation contrasts with many squelch circuits that operate on the block-busting principle. The delicacy and effectiveness of the squelch in the "Commaire" has to be used to be appreciated.

In normal operation—fixed station with ground-plane antenna to mobile unit—in and around metropolitan New York City, the full-reliability range was between 5 and 7 miles. Receiving range for the fixed station (as opposed to the mobile unit with inherent ignition and road static problems) was a surprising 15 miles.

The receiver section uses a 6BJ6 slug-tuned r.f. stage followed by a 6U8 mixer and 31.0-mc. oscillator. The frequency of this oscillator is crystal-controlled and is not changed when the "Commaire" must be set up on a new channel. The output from the 6U8 mixer (for channel 12 it would be 3895 kc.) is then fed to a 6BE6 second mixer,



affording double conversion down to 455 kc. The elimination of the receiver crystal interchange is accomplished by slug-tuning the input to the 6BE6 mixer. By varying this "fine tuning" adjustment the receiver section easily covers the entire Citizens Band with only one receiving crystal. The second mixer is followed by a conventional 455-kc. i.f. stage, 6AL5 detector and noise limiter, two stages of audio (6AQ6) and 6AQ5) and the patented "Vocatron" squelch circuit.

The transmitter utilizes a 6AQ5 crystal oscillator driving a conservatively rated 5763 power amplifier. The triode section of a 6AQ6 and a 6AQ5 pentode Heising-modulate the power amplifier. Silicon rectifiers and power transistors are used in the combination (117-volt a.c. and 12-volt d.c.) power supply. On a.c. the power supply is a voltage-doubler and on battery input the plate voltages are generated by a transistorized push-pull oscillator. —30—

## "SUPER CHARGER"

ONE of the most compact and effective battery chargers that has recently been called to our attention is *Terado Company's* Model 50181 "Super Charger." This is the deluxe version of the manufacturer's line of storage-battery chargers.

It is only 3 x 5 x 6 inches in size and incorporates a meter that shows charging current along with a scale showing the approximate condition of the battery. The unit has a maximum charging current of 10 amperes and it can

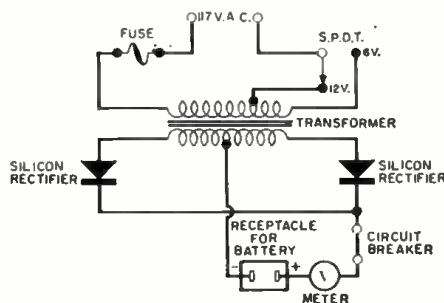

**BOGEN**  
the sound way  
to better business

## NEW POPULAR-PRICED STEREO LINE FROM THE TOP NAME IN HI FI!

### CHALLENGER COMPONENTS BY BOGEN

Now you can offer your budget-conscious customers top-quality stereo components at remarkable savings. It's the *Challenger* line by Bogen...and it's true high fidelity at truly low prices. Built to the same exacting engineering standards as the regular Bogen line, these *Challenger* components give you premium features you can sell with pride...sales-closing price tags you can push with profit! Look 'em over at your distributor. Or, mail the coupon.

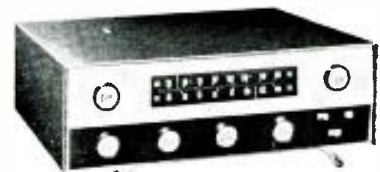

**RC412 Stereo Receiver.** An all-in-one stereo amplifier, stereo control center and stereo FM-AM tuner, the RC412 has dual volume controls to permit one-hand balancing of the two channels and built-in provision for a multiplex adapter. Power output: 12 watts (6 per channel). Frequency response: 30 to 15,000 cps  $\pm 1$  db. Price: \$169.50. Enclosure and legs: \$8.50.



**AC220 Stereo Control Center and Dual 10-Watt Amplifier.** An astonishing value, the AC220 features low-noise preamp, low distortion, dual volume controls, loudness switch, channel reversing switch, provision for tape deck and mono-stereo mode selector. Comes complete with enclosure. Price: \$79.95. Leg kit: \$1.85.

**TC322 FM-AM Stereo Tuner.** (Matches AC220) The sensitive TC322 receives stereo FM-AM, FM or AM broadcasts. It features: AFC, provision for multiplex adapter, automatic volume control, illuminated dial scale, and comes complete with enclosure. Frequency response: FM: 20 to 15,000 cps  $\pm 1$  db; AM: 20 to 3,500 cps  $\pm 1.5$  db. Price: \$109.50. Leg kit: \$1.35.

BOGEN-PRESTO, DEPT. EW-10, PARAMUS, N. J.  
A Division of the Sieglar Corporation  
Please send me more information on the new Challenger components.

Name \_\_\_\_\_  
Address \_\_\_\_\_  
City \_\_\_\_\_ Zone \_\_\_\_\_ State \_\_\_\_\_

	<b>BC-659</b> <b>\$16.95</b> <b>RE-NEW</b>	<b>PE-120</b> <b>\$7.95</b> <b>RE-NEW</b>
---	--	---

**BC-659 FM RECEIVER-TRANSMITTER**—27 to 99.1 MC FM.: 5 Watt.; Crystal Control on Two Pre-Set Chan. **\$16.95**  
 nels: with Tubes and Speaker—Re-New: \$16.95  
**PE-120 POWER SUPPLY** for BC-659 or BC-620; with Vibrator for 12 Volt operation—Re-New: \$7.95  
 BA-41 BIAS BATTERY F/BC-659-820—New: \$4.95  
 AN-29 Telescoping ANTENNA F/BC-659—New: \$2.95  
 FT-250 SHOCK MOUNTING F/BC-659-PE-120—U.: 4.95  
 SCHEMATICS F/BC-659-PE-120 w/voltage & Resistance: 2.00

<b>BC-603</b> <b>\$14.95</b> <b>RE-NEW</b>	<b>BC-683</b> <b>\$24.95</b> <b>RE-NEW</b>	
--	--	---

**BC-603 FM RECEIVER**—20 to 27.9 MC... Re-New: \$14.95  
**BC-683 FM RECEIVER**—27 to 99.1 MC U. \$19.95—Re-N: \$24.95  
**BC-604 FM TRANSMITTER**—20 to 27.9 MC. U.: \$4.95—Re-N: \$ 7.95  
**BC-684 FM TRANSMITTER**—27-39.1 MC... Used: \$ 7.95  
**FT-237 MOUNTING** for Rec. Trans... Re-New: \$ 7.95  
**FT-346 MOUNTING** for Receiver only. Re-New: \$ 4.95  
**DM-34 DYN. 12V. 1/BC-603-683**—U.: \$2.95—R-N: \$ 4.95  
**DM-35 DYN. 12V. 1/BC-604-684**—U.: \$8.95—R-N: \$ 9.95  
**FT-384 TEST ADAPTER** for BC-603-683-923—Used for testing various Voltages and Alignment of Receivers. Plugs into rear of set; has metering switch & provision for attaching output meter & V.T.V.M. Complete with 6 Ft. Battery Leads and Clips. Prices: USED: \$2.95... RE-NEW: \$4.95

**AC POWER SUPPLY**  
 F/BC-603-683 — Output: 220 VDC 80MA & 24VAC 2Amps. Tube Rectification; mounts on rear Plug of BC-603-683. Can be adapted to other Receivers. KIT: \$10.00—WIRED: \$14.95

**GROUND PLANE ANTENNA**  
**CITIZEN—COMMERCIAL**  
 Made from sturdy surplus Insulated Base and Screw-in type Elements. For use in the 25 to 50 MC Bands. Specially cut to your operating frequency. (Specify Freq. when ordering.) With Adapter for **\$14.95**  
 1" pipe mountings...

**TELEPHONES, HEADSETS, MICS., Etc.:**  
 TS-9 Handset... Used: \$2.95—New: \$ 3.95  
 TS-13 Handset, w/PL-55 & PL-68. U.: \$2.95—N: 3.95  
 T-17 Microphone... Used: \$3.95—New: 6.95  
 EE-8 Field Telephone... U.: \$12.95—Reced.: 16.95  
 BD-71 Switchboard—6 Line... U.: \$14.95—New: 24.95  
 RM-29 Control Unit... New: \$6.95—W/Handset 8.95  
 RM-32 Control Unit (Patch Found.) U.: \$1.95—N: 2.95  
 H-16/U Headset—8000 ohm... U.: \$1.95—New: 2.95  
 HS-33 Headset—300 ohm... U.: \$4.95—New: 7.95  
 J-45 Tel. Key—with cord and plug... New: 1.50

**COLLINS ART-13 TRANS. — \$49.50**  
**2 TO 18.1 MC—100 WATT—PHONE, CW, MCW**  
 The most desired Set on the surplus market—Easily converted to 10 Meters (See Surplus Conversion Manual No. 2—\$2.50). Automatic Tuning for selection of 11 Channels in the Freq. Range. Tube Line-Up: 1/837, 1/813, 2/1625, 1/125J7, 2/6V6, 2/811, 2/12SL7, 1/12SA7. AC Power Supply requirements: 28 VDC/10 A, 400 VDC/225 MA & 1250 VDC/250 MA. Size: 23% x 16 x 11%. Wt.: 70 lbs. Price, USED: \$49.50  
 Price—Same as above—except, Less Tubes... 30.00  
 DY.12/ART-13 24 V. Dyn. w/Filter & Relays—U.: 12.95

**ALL BAND RECEIVER**  
 NAVY ARB/CRV 46151—190 to 9050 KC—Four Band, 6 Tube Superhet—Local & remote tuning and band change; illuminated dial, sharp & broad tuning; AVC, CW, provisions for operation of DU-1 Loop. Complete with Tubes: 1/12SA7, 1/12A6, 4/12SF7 & 24 Volt Dynamometer. Size: **\$18.95**  
 8 x 7 x 16" Used:  
 ABOVE—Converted to 12 Volt. with Dynamometer (No electric band change) ... \$24.95  
 Conversion for 115 V 60 cycle with Spin Dial, Phone Jack, CW, Volume Control, On & Off Switch (All on front panel) —KIT of Parts with Instructions... \$10.00  
 Conversion—as Above—for 12 Volt DC—KIT of Parts, with Dynamometer... 10.00  
 Remote Control Box: \$2.00—Remote Control Shaft: 1.50  
 Remote Control Head... 2.00  
 Tuning Knob for large splined shaft... 1.00  
 T.Shaft Adapter for remote and local tuning... 1.50  
 PLUGS only—for Receiver or Control Box.. Each: 1.00

**RECEIVERS:**  
 BC-733 Localizer Rec.—108.3 to 110.3 MC. Used: \$ 4.95  
 R-23/BC-453 Rec.—190 to 550 KC... Used: 14.95  
 R-4/ARR-2 Rec.—540-830 KC: 230-258 MC.R-N: 8.95  
 BC-1206 Beacon Receiver—200 to 400 KC. Re-N: 9.95  
 BC-652 Receiver—2 to 6 MC. Less Dyn... Used: 19.95  
 BC-342 Receiver—1.5 to 18 MC For AC op. Used: 69.95  
 BC-312 Receiver—1.5 to 18 MC Less Dyn. Used: 59.50  
 BC-344 Rec.—150 to 1500 KC—For AC op. Used: 49.50

**SEND FOR FREE CATALOG!**  
 Address Dept. RN • All Prices F.O.B. Lima, Ohio. Minimum Order \$5.00, & 25% Deposit on all C.D.D.'s

**FAIR RADIO SALES**  
 132 SOUTH MAIN ST. • LIMA, OHIO

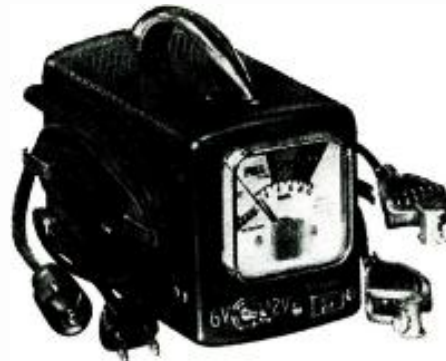

be used to charge 6- or 12-volt batteries. Two miniature silicon rectifiers are used in a full-wave circuit and the unit is equipped with an automatic overload circuit breaker.

The charger is sufficiently small in size and light in weight to make it ideal for use on small boats. An additional cable is supplied so that it can be plugged into the cigarette lighter receptacle of a boat or automobile, eliminating the necessity of making connections across the battery.

The unit lists at \$39.95 and is available at automotive distributors throughout the United States.

**AM TUNER KIT**

FM radio, with its excellent frequency response and static-free reception, is usually considered to be the true broadcasting medium for high-fidelity sound reproduction in the home. However, there are many areas not covered by FM and there are many individuals who still prefer AM broadcasting for special newscasts or specific programs. This type of transmission, of course, has its limitations. The high-frequency response available from many stations does not exceed 5 to 7.5 kc. There

are exceptions of course, as some stations do provide better high end performance than this indicates. Also, static disturbances and other noises are sometimes a problem. Not much can be done about either of these except to produce a receiver which will provide the best reproduction under these limitations.

With this thought in mind *Electronic Instrument Co., Inc. (EICO)* has recently placed on the market a high-fidelity AM tuner, the Model HFT-94. In addition to its generally high-quality performance, it features a choice of either wide or narrow bandpass. The latter is useful for the reception of low-power or distant stations.

The performance results obtained from one of the kits we assembled were as follows:

- Tuning range: 545 to 1650 kc.
- Frequency calibration: 20 kc. low at 1600 kc., and 5 kc. low at 550 kc.
- Over-all selectivity (-6 db): for wide bandpass, ±7.35 kc., and for narrow bandpass, ±4.2 kc.
- Frequency response (assuming -3 db at extremes): for wide bandpass, 15 cps to 9 kc., and for narrow bandpass, 15 cps to 5 kc. Note that for wide bandpass operation the highest modulation is 9 kc. This is just short of the 10-kc. AM channel separation. This tuner incorporates a whistle filter which eliminates (by a 20 db gain reduction) any between-station beat note.
- Usable sensitivity (assuming 20 db of quieting): for wide bandpass, 7 μv., and for narrow bandpass, 3 μv.



This AM tuner is completely a.c. operated, employing 6 tubes and a special DM70 type tuning eye. Output is a plate-follower type, having an impedance of 8000 ohms.

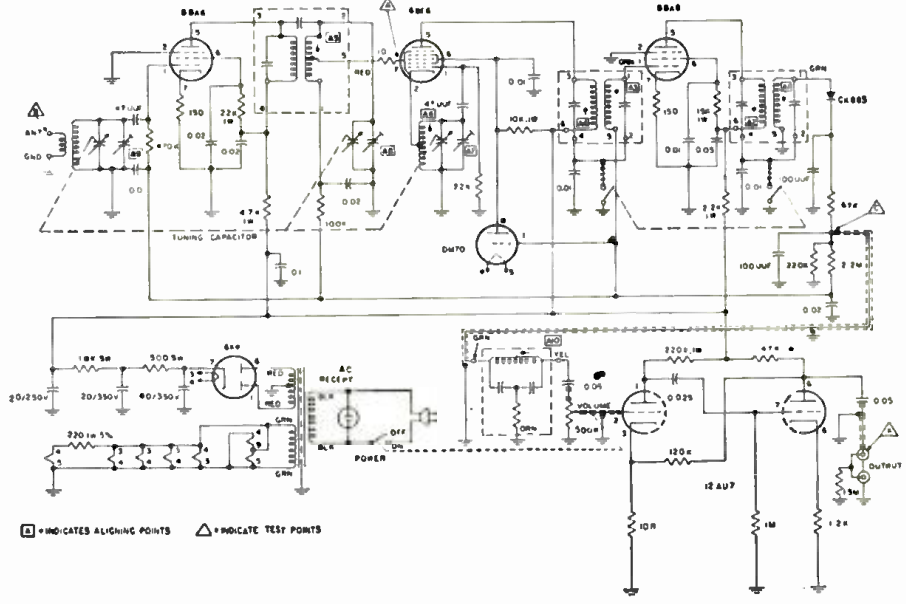



Sensitivity for 1 v. output: for wide bandpass, 4  $\mu$ v., and for narrow bandpass, .3  $\mu$ v.

The construction of the unit is extremely simple. The r.f. and i.f. coils are supplied pre-aligned and the antenna, r.f., and oscillator trimmers are all pre-set. This does, in a way, eliminate the need for test instruments to align the receiver for satisfactory operation. Needless to say, due to variations of lead placements by one building a kit, a final alignment, with proper test equipment, will provide the final touch to obtain perfection in performance.

With negligible hum level and distortion, this new tuner is one of the best available for its price. It is offered in both kit and assembled versions at \$39.95 and \$65.95, respectively. -30-

### MARS SCHEDULES FOR JANUARY

**THE** First Army MARS SSB Technical Net, which operates on 4030 kc. upper sideband, Wednesdays at 9 p.m. (EST), has announced the following speakers for January.

Jan. 6—"The Atomichron" by Philip Heath, manager, field service engineering department, National Company, Inc.

Jan. 13—"Antenna Multi-Couplers" by Carl G. Southemer, executive vice-president, CGS Laboratories.

Jan. 20—"Television and the Amateur Operator" by G. G. Lentzakis, chief instructor, TV course, radio division, USASCS, Fort Monmouth.

Jan. 27—"Basics and Applications of Re-Enforced Plastics in Communications Products" by Walter H. Greenberg, director of research, and J. Harvey McCoy, staff engineer, Riverside Plastics Corporation.

Director of the net is S. Edwin Piller, A2KPO. Contact him at 157-32 20th Ave., Whitestone 57, N. Y. for any further information required.

The 100-millionth packaged electronics circuit, a development which helped open the way to miniaturization of electronic equipment for space rockets, is presented to David R. Hull of Washington (left), president of the EIA, by William S. Parsons of Milwaukee, president of Centralab, a division of Globe Union, Inc. The tiny circuit, less than two inches long is mounted at the center of the plaque shown.



January, 1960

1551 pages

World's **LARGEST** Electronic Catalog

**\$3.50**

# 1960 RADIO-ELECTRONIC MASTER

now available at your distributor

NEW...STREAMLINED...28 EASY-TO-USE PRODUCT SECTIONS COVER ALL LATEST PRODUCTS

• Printed circuit components • Stereo equipment • Miniature and sub-miniature components • Silicon rectifiers • New transistor types • Citizen's band, SSB and new mobile ham gear • Components and equipment for microwave and telemetering.... Plus every new electronic product for servicing, experimenting, design, industrial and military applications.

• GREATER INCOME...SPEEDIER DESIGN & PURCHASING...MORE HOBBY FUN

#### SERVICE TECHNICIANS

More profitable operation. Covers all items necessary for Radio-TV-audio servicing. Offers thousands of products for extra income in hi-fi, sound and industrial servicing. You can buy, sell and bill direct from The MASTER...it shows list prices!

#### ENGINEERS & P.A.'s

Save time. Quickest way to get current factory-accurate data on all the products needed for research, design and production. Systematically organized in 28 product sections for rapid product comparison. Minute details so necessary for specifying

#### HAMS, HOBBYISTS, EXPERIMENTERS

Get the right product to do the job because you shop in the electronic supermarket - The MASTER. Specifications, descriptions, prices of receivers, transmitters, hi-fi gear, cabinets and hard-to-locate items not found in smaller catalogs.

No matter what product or component you require...

YOU'LL FIND IT FASTER IN THE

## 1960 MASTER

RADIO ELECTRONIC MASTER, 60E Madison Ave., Hempstead, N.Y.



FREE...FROM YOUR DISTRIBUTOR

26-page Foreign Tube Interchangeability Guide or write direct enclosing 25¢ for handling

**ALWAYS INSIST ON PROVED BRAND NAMES**  
Ask By Name For **GENUINE "NO NOISE"** PRODUCTS  
**BEWARE OF CHEAP SUBSTITUTES**

**NO-NOISE TUNER-TONIC**  
With PERMA-FILM

- Economical - a little does a lot.
- Cleans, lubricates, restores all tuners, including water type
- Non-toxic, non-inflammable
- Use for TV, radio and FM

6 Oz. Aerosol Can

**\$3.25**

NET to Servicemen



**NO-NOISE VOLUME CONTROL and CONTACT RESTORER**

- Cleans
- Lubricates
- Not a Carbon Wet Solution

2 Oz. Bottle \$1.00  
6 Oz. Spray Can \$2.25

NET to Servicemen

NOW AVAILABLE **FREE** AT YOUR JOBBERS **5" PLASTIC EXTENDER**



With Push Button Assembly For Pin-Point Applications Does Not Cause Shorts

**ELECTRONIC CHEMICAL CORP.**, 813 Communipaw Avenue Jersey City 4, N. J.

**COYNE offers**  
**LOW COST**  
**TELEVISION**  
Training in  
Spare Time **AT HOME**

**The future is YOURS in**  
**TELEVISION—RADIO**  
**COLOR TV!**

A fabulous field—good pay—fascinating work—a prosperous future! Good jobs, or independence in your own business!



Coyne brings you **MODERN—QUALITY** Television Home Training; training designed to meet Coyne standards. Includes **RADIO, UHF and COLOR TV**. No previous experience needed. Practical Job Guides to show you how to do actual servicing jobs—make money early in course. You pay only for your training, no costly "put together kits."

Send coupon or write to address below for **FREE Book**

and full details including easy Payment Plan. No obligation, no salesman will call.



B. W. Cooke, Jr., President

Coyne — the Institution behind this training... the largest, oldest, best equipped residential school of its kind now in its new home pictured here... Founded 1899.

**COYNE**  
**ELECTRICAL SCHOOL**

1501 W. Congress Pkwy., Chicago, Dept. 10-M6  
Chartered as an Educational Institution  
Not For Profit

COYNE Television, Home Training Division  
Dept. 10-M6, —New Coyne Building  
1501 W. Congress Pkwy., Chicago 7, Ill.  
Send Free Book and details on how I can get Coyne Quality Television Home Training at low cost and easy terms.

Name \_\_\_\_\_

Address \_\_\_\_\_

City \_\_\_\_\_ State \_\_\_\_\_

(It is understood no salesman will call)

**Booklet**  
**catalog**  
**Manufacturers' Literature**

**1960 HEATHKIT CATALOGUE**

Heath Company, Benton Harbor, Michigan, is now mailing copies of its 1960 catalogue of kits. Copies are available without charge upon request. Write to the company at the above-mentioned address.

A full-color, hard gloss cover brochure, it contains over 66 pages of electronic equipment in kit form, including high-fidelity components, test instruments, amateur radio gear, marine equipment, and hobby kits.

Spotlighting the high-fidelity section are three new stereo amplifiers and the new acoustic suspension speaker system, licensed in kit form exclusively by *Acoustic Research, Inc.* to the Michigan firm.

New in the ham radio line this year are a complete mobile rig, a kilowatt linear amplifier and power supply, and 6-and 2-meter conversion kits.

The test instruments section features an r.f. signal generator, an FM oscillator, and a new 5" d.c. oscilloscope.

A complete line of marine equipment is featured, including transistor radio direction finders and a host of accessories for safety and convenience afloat.

In the special interest category are a new educational electronic analogue computer and a new, improved electronic ignition analyzer, available in pre-assembled, ready-to-use form or as a kit.

**NEW TECHNICAL JOURNAL**

*Tung-Sol Electric Inc.*, semiconductor division, has announced publication of the first issue of a new semiconductor technical journal entitled, "The Lattice."

Complimentary subscriptions may be obtained by design engineers writing on their company letterhead to Department A, 1 Sumner Ave., Newark, N. J.

Published principally for use by design engineers interested in solid-state devices, "The Lattice" will be devoted entirely to the theory and practice of the semiconductor art.

**CLOSED-CIRCUIT TV**

*General Electric Company's* communication products department has published a new bulletin (GEA-6842 & ECL-74) describing the use of closed-circuit television for instantly transmitting high-resolution pictures of opaque or transparent weather charts, maps, and drawings from a central weather office to a number of remote receiving locations.

The bulletin explains how the equipment may be used at weather stations, air bases, and by the military. Performance data, dimensions, transmis-

sion system, remote receiving positions, and other specifications are given.

Write to the company, Closed-Circuit Television, Electronics Park, Syracuse, N. Y., for a copy.

**SEMICONDUCTOR DIRECTORY**

*Lafayette Radio*, 165-08 Liberty Ave., Jamaica 33, N. Y., is offering a new semiconductor directory, free of charge.

This listing is designed to give the engineer and scientist a comprehensive, easy-to-use listing of the latest in germanium transistors, silicon transistors, diodes, and rectifiers. All major manufacturers and types are numerically listed, complete with descriptions and applications.

The directory is suitable for loose-leaf insertion.

**COLOR TV**

*International Correspondence Schools*, Scranton, Penna., has issued a new correspondence course entitled, "Trouble Shooting Color Television Receivers."

Written by Donald C. Freeman, assistant to the national electronics service manager, *Admiral Corporation*, the course includes a simplified circuit description plus troubleshooting procedures for each stage in color television receivers.

The 150-page book contains 68 illustrations. Write the school for details.

**SEMICONDUCTOR DIODES**

*Sylvania Electric Products Inc.* has released a new characteristics and replacement guide for semiconductor diodes. Copies of the booklet may be obtained direct from the company, 1100 Main Street, Buffalo 9, N. Y.

The 13-page brochure contains complete data on the ratings and electrical characteristics of all of the firm's types as well as a replacement guide to virtually all Electronic Industries Association registered diodes.

The new booklet also features a section on the company's latest diode manufacturing equipment.

**NATIONAL BULLETIN**

*National Radio Co.*, Malden, Mass., has announced the availability of a new catalogue covering sockets, caps, and terminals. The new bulletin, No. 59-4, is available to purchasing agents and engineers by writing direct to the company.

The new catalogue, which is four pages, two-colors, describes and gives specifications for the various components and assemblies available for radio and electronic applications. —30—



**Direct Mail Promotion**

*(Continued from page 57)*

Less than five per-cent of the people who pass your shop pay any attention to the kind of business it is. Tell them about your shop and your equipment. Invite your customers in to see the facilities you have for keeping their TV sets and other electronic products in top operating condition.

2. Early spring special. With the budding of the leaves, people start to think about picnics, hours outdoors in parks and on the beach. Tell them they need their portables checked to be sure they are in peak condition when they are needed. (You should start to work on your spring business-promotion pieces and plans in January.)

3. Late summer, early fall. At this season, people start staying indoors more. Ahead of them are long hours before the TV set: a succession of interesting events climaxed by special programs during the Christmas season. This is the time to urge them to have their TV and radio sets checked for top performance. (Start to plan your fall programs in June.)

4. Have you ever seen anyone who was 100 per-cent satisfied with his TV reception? Occasionally take a shot in the dark. Suggest that your facilities will enable you to brighten his TV picture, remove annoying flicker, etc. It is amazing how many people put off a maintenance check-up, which they know a set can use, until they need total service. Often a simple promotion piece will trigger an owner's unexpressed desire to have his TV set serviced before it goes out completely. And don't forget the bonanza that is gradually building up in FM.

5. Community events offer the service dealer a golden opportunity to solicit business while identifying himself as an active participant in community affairs. They help to make people aware of the fact that you are a solid citizen, their neighbor, and a worker in the community.

Here are the major points to bear in mind when planning a long-range, business-building campaign by direct mail:

1. Set up your program to run for at least twelve months. 2. Arrange to handle the mechanics of the mailings so the program will move smoothly. 3. Plan to use a new mailing piece every two months. If you are unable to prepare copy for your own individual business, get one of the complete mailing campaigns that are available from the tube manufacturers. 4. In addition to your own customer mailing list, try to get a residential directory so you can focus your mailings in your normal or economical working area. 5. Set up the mechanics of your system to mail approximately fifty pieces per day. (This is based upon the business needs of a one-man shop.) 6. Carry out your program with dogged determination.



**YOU  
NEED  
THIS...**

**FREE GIANT  
ALL NEW 1960  
BA CATALOG**

*A Complete Buying Guide for Everything in*  
**RADIO 1960  
TV  
ELECTRONICS**  
ANNUAL CATALOG 601

**BA**  
SINCE 1927

**204 KING-SIZED PAGES**

**EVERYTHING IN RADIO TV AND ELECTRONICS**

**100'S OF NEW ITEMS LISTED HERE FOR 1st TIME**

**21 PAGES OF BARGAINS NOT IN ANY OTHER CATALOG**

**RUSH COUPON TODAY!**

**BURSTEIN-APPLEBEE CO. Dept. M,  
1012-14 McGee St., Kansas City 6, Mo.**

Send Free 1960 B-A Catalog No. 601.

NAME \_\_\_\_\_

ADDRESS \_\_\_\_\_

CITY \_\_\_\_\_ STATE \_\_\_\_\_

**SUPER POWERED SINGLE CHANNEL AMPLIFIER**

**Minimum 20V—5 Watts on All Channels**

This all new super powered unit has the highest output of any TV channel amplifier with sufficient power to cover large communities with ample signal voltage and deliver a strong signal thru many miles of cable. The unit was designed specifically for community television and is the only unit of its kind that does not produce power in fractions of a watt. For full rated output a high-powered commercial transmitting tube is used.



- C. C. S. Service
  - 26 db min. gain
  - 6-8 mcs. band width
  - Channels 2-13 as specified
  - Requires only 1 V input
  - Co-axial input and output connectors for 75 OHM Line
  - Linear class A operation
  - Low Power Drain (1 Amp.)
- MODEL SPA**  
**\$350**

Write for details today

**SEG Electronics • 1778E Flatbush Ave., Brooklyn 10, New York**

# CITIZEN BAND

## CLASS "D" CRYSTALS

All 22 Frequencies in Stock



3rd overtone. .005% tolerance—to meet all FCC requirements. Hermetically sealed HC6/U holders. 1/2" pin spacing—.050 pins. (.093 pins available, add 15c per crystal.) Add 5c per crystal for postage and handling. **\$2.95 EA.**

The following frequencies in stock (frequencies listed in megacycles): 26.965, 26.975, 26.985, 27.005, 27.015, 27.025, 27.035, 27.055, 27.065, 27.075, 27.085, 27.105, 27.115, 27.125, 27.135, 27.155, 27.165, 27.175, 27.185, 27.205, 27.215, 27.225.

**RADIO CONTROL CRYSTALS** in HC6/U holders in stock for immediate delivery (frequencies listed in megacycles) sealed crystals 26.995, 27.045, 27.095, 27.145, 27.195, 27.255, tolerance .005% 1/2" pin spacing . . . pin diameter .050. **\$2.95** ea. .093 pin spacing, add 15c.

**SEALED OVERTONE CRYSTALS** Supplied in metal HC6/U holders.

Pin spacing .486, diameter .050  
15 to 30 MC .005 tolerance **\$3.85** ea.  
30 to 45 MC .005 tolerance **\$4.10** ea.  
45 to 60 MC .005 tolerance **\$4.30** ea.

## QUARTZ CRYSTALS

for every service

All crystals made from Grade "A" imported quartz—ground and etched to exact frequencies. Unconditionally guaranteed! Supplied in:

FT-243 holders MC-7 holders  
pin spacing 1/2" pin spacing 1/4"  
pin diameter .093 pin diameter .125  
DC-34 holders FT-171 holders  
pin spacing 1/4" pin spacing 1/4"  
pin diameter .156 banana pins



### MADE TO ORDER CRYSTALS

1001 KC to 2600 KC:

.01% tolerance **\$2.00** ea. .005% tolerance **\$2.75** ea.

2601 KC to 9000 KC: .005% tolerance **\$2.30** ea.

9001 KC to 11,000 KC: .005% tot. **\$3.00** ea.

Specify holder wanted

### ANY AMATEUR, NOVICE, TECHNICIAN BAND CRYSTALS

80 meters 3701-3749 KC .01% tolerance  
40 meters 7152-7198 KC  
15 meters 7034-7082 KC  
6 meters 8335-8650 KC  
(within 1 KC) **1.50 ea.**

**MARINE FREQUENCY CRYSTALS**—All marine frequencies from 2000-3200 KC .005 tolerance **\$2.50** ea. (supplied in either FT-243, MC-7 or FT-171 holders)

**STOCK CRYSTALS** in FT-243 holders from 5675 KC to 8650 KC in 25 KC steps 79c each or 3 for **\$2.00**  
FT-241 Lattice Crystals in all frequencies from 370 KC to 540 KC (all except 455 KC and 500 KC) **50c** ea.  
Pin spacing 1/2" Pin diameter .093

Matched pairs — 15 cycles **\$2.50** per pair  
200 KC Crystals **\$2.00** ea.  
455 KC Crystals **\$1.30** ea.  
500 KC Crystals **\$1.30** ea.  
100 KC Frequency Standard Crystals in HC6 U holders **\$4.50** ea.

Socket for FT-243 crystal 15c ea.  
Dual socket for FT-243 crystals 15c ea.  
Sockets for MC-7 and FT-171 crystals 25c ea.  
Ceramic socket for HC6/U crystals 20c ea.

(Add 5c per crystal for postage and handling)  
Write for FREE Catalog Complete with Oscillator Circuits

### ASK YOUR PARTS DEALER FOR TEXAS CRYSTALS

See big red display . . . if he doesn't stock them, send us his name and order direct from nearest factory.

### OUR FLORIDA PLANT NOW IN OPERATION ORDER FROM NEAREST PLANT TEXAS CRYSTALS

Texas Crystals, Dept. R-110 8538 West Grand Ave. River Grove, Ill. Phone GL 3-3555  
OR  
Texas Crystals, Dept. R-110 1000 Crystal Drive Ft. Meyers, Florida Phone WE 6-2100  
All orders shipped first class mail

FILL OUT AND ATTACH THIS COUPON TO YOUR ORDER FOR SHIPMENT VIA 1ST CLASS MAIL AT NO EXTRA COST!

NAME .....

ADDRESS .....

CITY .....ZONE.....STATE.....

TERMS: All items subject to prior sale and change of price without notice. All crystal orders must be accompanied by check, cash or M. O. with PAYMENT IN FULL. NO COD'S. Add 5c per crystal for postage and handling charge. Dept. R-110

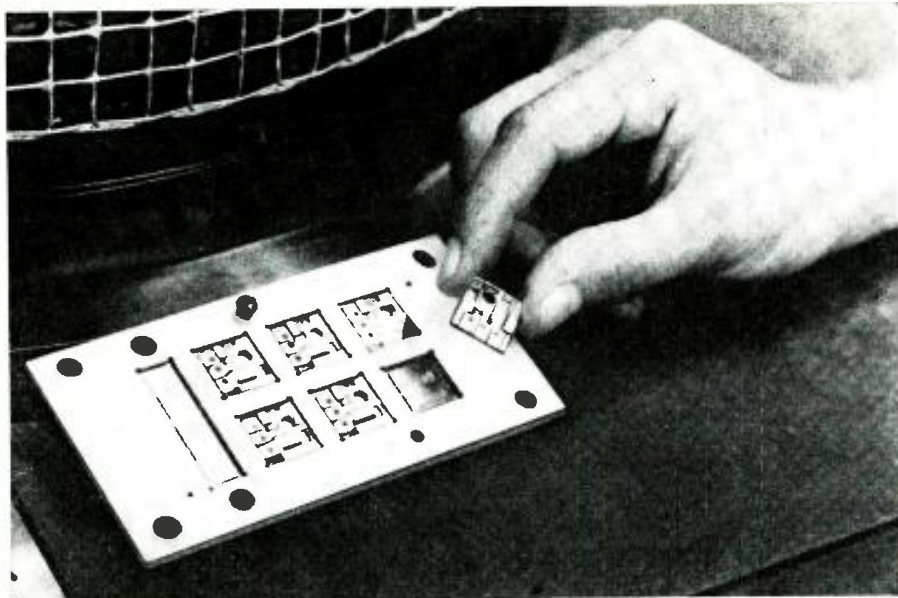

Partly completed "micro-Circuits" are shown in holding fixture used in manufacturing.

# Micro-Circuits for Miniaturization

New circuits used in missile-borne computers employ thin films of component material deposited on glass.

ELECTRONIC miniaturization, the goal of ever-smaller component parts for electronic assemblies, has taken a step forward with the perfection and practical use of "micro-Circuit" by *International Resistance Co.* Although "micro-Circuit" was specifically designed to fill an urgent need in ARMA's missile-borne computer program, it will find many other important applications.

The secret of the "micro-Circuit" is the deposition of exceedingly thin films of component material on a tiny substrate of glass, smaller than a postage stamp. Glass was chosen as the base material, in preference to ceramics or

plastics, because of its structural strength and exceedingly smooth surface. This smoothness assures greater accuracy of component values, and adherence to more rigid quality specifications generally. Resistive, capacitive, and inductive components are now being made using the new technique having value tolerances of plus-or-minus 5 per-cent. Even at the present state of the art these tolerances could be closer if required.

Such "micro-Circuits" are not in the laboratory, but are fully integrated into presently operating equipment. One example of such equipment is shown in the photo below. —30—

New circuits have been designed for use in new compact military digital computers.

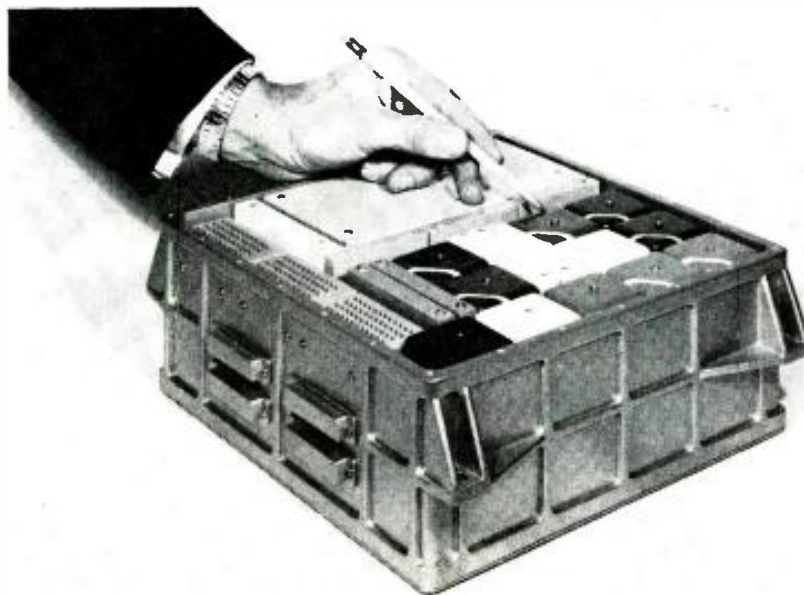



**Mac's Service Shop**  
(Continued from page 68)

and the set played. 'Aha, a bad selenium rectifier,' I told myself. After I finally found the rectifier tucked away on top of the tuning capacitor, I replaced it with a silicon unit and the proper additional surge resistance. Then I reduced the line voltage to 95 volts and plugged the set in. It played but, as I began increasing the line voltage, distortion started. At the same time, I noticed the filaments seemed to be burning brighter than they should. A check with the voltmeter revealed two volts across each one where there should have been 1.5 volts.

"At this point I happened to pick up the back of the set and glance at the very small printing on the label—no wonder most Japanese wear glasses!—and saw that the receiver was rated at 100 volts! I replaced the original selenium rectifier, set the line voltage at 100 volts, and checked the voltage across the filaments. It was a little below 1.5 volts, but the set would not play. I called some of the boys at the local radar station who were formerly in Japan, and they confirmed that 100 volts is a common nominal line voltage in Japan. In fact, less than 100 volts was usually present.

"What had happened was all too plain: when the lady plugged the set into her 120-volt line, it played for a

short while; but the excess current soon paralyzed the tubes and prematurely aged the selenium rectifier, and the set quit. When I put in a new rectifier, this pushed the filament voltage still higher, and the set started to play; but it would not have done so for long because those poor filaments would have given up the ghost.

"When I tried to check the tubes, I found they were not listed for my tester. I called the local distributor about my problem, and not a one of the new tube checkers in the store listed the tubes. Neither could I find them on my tube list in the shop or in any of the brand-new electronic catalogues. The worst blow of all came when I could not find them in the cross-reference lists showing foreign tubes and American equivalents."

"What are you going to tell the little old lady?"

"All I can do is suggest she write to the manufacturer in Japan and ask him to list American tube equivalents for the tubes in the set. If he cannot do this, perhaps he can tell her where she can obtain the tubes in this country, or he can send them to her direct. With new tubes in the set, she can operate it on batteries without damage. If she wishes, we can get her a step-down transformer that will permit her to use it on a.c. I prefer doing this to inserting a heat-radiating, voltage-dropping resistor inside the set or trying to locate and install a suitable resistor-type line cord." (Continued on page 152)

**Special Offer 25¢**

Hear these  
authentic recordings  
of dramatic events  
from



**"The Amazing World of Short Wave Listening"**  
narrated by Alex Dreier, Radio-TV "Man on the Go"

- President's voice from outer space!
- Actual capture of a desperate criminal!
- Radio amateur at Little America!
- Ships at sea... aircraft in action!

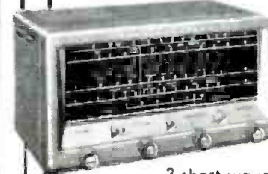

**S-38E**  
receiver  
**\$59.95**

3 short wave bands plus standard broadcast. Built-in speaker, head-set output.

MAIL  
COUPON  
TODAY!

**hallicrafters**  
DEPT. 20, CHICAGO 11, ILL.

Gentlemen: Please rush by return mail my recording, "The Amazing World of Short Wave Listening." I enclose 25¢.

NAME \_\_\_\_\_  
ADDRESS \_\_\_\_\_  
CITY \_\_\_\_\_ STATE \_\_\_\_\_

**MICRO**  
ELECTRON TUBE

INTRODUCES FOR THE FIRST TIME  
ANYWHERE A SELECT STOCK OF USED  
TUBES AT A FABULOUS LOW PRICE

**37¢** ea.

FOR any TUBE LISTED

**\$35** PER  
HUNDRED  
ASSTD.

ALL TUBES SENT POSTAGE PAID  
Please send 25¢ handling for orders under \$5. Send 25% deposit on C.O.D. orders. Send approximate postage on Canadian and foreign orders.

**MICRO**  
ELECTRON TUBE CO.

P.O. BOX 55 Park Station, Paterson 3, N. J.

- Each and every tube is tested in our own laboratory for mutual conductance and life test.
- We guarantee FREE replacement for one year of any tube purchased from us which fails to function efficiently under any or all operating conditions. Prompt refunds are made on any defective merchandise.
- The advertised tubes are not necessarily new, but may be electrically perfect factory seconds or used tubes—each is clearly so marked.

0A2	5X8	6BH6	6SF5	7Z4	19BG6G
0Z4	5Y3CT	6BJ6	6SF7	12A8	1916
1A7GT	5Y4G	6BK5	6SJ7	12AQ5	1918
1B3GT	6A7	6BK7	6SK7	12AT6	21A
1H4G	6A8	6HL7GT	6SL7GT	12AU6	2SAV5
1H5GT	6AB4	6BN6	6SN7GT	12AU7	25B06
1L4	6AC7	6BQ6GT	6S07	12AV6	25D06
1L6	6AF4	6BZ7	6S57	12AV7	25L6GT
1N5GT	6AG5	6C4	6T4	12AX4GT	25W4GT
1Q5GT	6AG7	6C5	6T8	12AX7	25Z5
1R5	6AH4GT	6C6	6U8	12AZ7	25Z6
1S5	6AH6	6C8	6V6	12B4	26
1T4	6AK5	6C8G	6W6GT	12BA6	35A5
1U4	6AL5	6CD6G	6X4	12BA7	35B5
1U5	6AL7	6CF6	6X8	12BE6	35C5
1V2	6AM8	6CG7	6Y6G	12BF6	35L6GT
1X2	6AN8	6CL6	7A4/XXL	12BH7	35W4
2A3	6A05	6CM6	7A5	12B06	35Y4
2AF4	6A06	6CM7	7A6	12BR7	35Z5GT
2B4	6A06	6CN7	7A7	12BY7	37
2B5	6A06	6CS6	7A8	12CA5	39/44
2B6	6A06	6CU6	7B4	12J5	42
2B7	6A06	6DE6	7B5	12K7	43
2B8	6A06	6DQ6	7B6	12L6	45
2B9	6A06	6F6	7B7	12M7	50A5
2C4	6A06	6H6	7B8	12SA7	50B5
2C5	6A06	6J4	7C4	12SG7	50C5
2C6	6A06	6J5	7C5	12S17	50L6GT
2C7	6A06	6K6GT	7C6	12SK7	50X6
2C8	6A06	6K7	7C7	12SN7GT	56
2C9	6A06	6K8	7E6	12SQ7	57
2D4	6A06	6L7	7E7	12V6GT	58
2D5	6A06	6M7	7F7	12W6GT	71A
2D6	6A06	6N7	7F8	12X4	75
2D7	6A06	6Q7	7H7	12Z3	76
2D8	6A06	6S4	7N7	14A7/12B7	77
2D9	6A06	6S8GT	7Q7	14B6	78
2E4	6A06	6SA7	7X7/XXFM	1407	80
2E5	6A06	6SC7	7Y4	19A4GT	84/6Z4
2E6	6A06				117Z3
2E7	6A06				117Z6

WRITE DEPT. EW-1 FOR OUR FREE COMPLETE LIST OF TUBES & SPECIAL PURPOSE TUBES



**NEW! ... MULTI-CHANNEL  
2-WAY RADIO**  
Low Cost **G-12**  
Citizens Communicator

A complete 4-channel radio station... for virtually unlimited business or personal use in vehicle, office, boat, plane

Operates on new 11-meter Citizens Band. Easy to obtain station license... no code, no exams. U.S. Citizens required only to complete simple F.C.C. form.

**HUNDREDS OF USES!**

units may operate together as a system. Examples: Industrials... buildings... yards... warehouses... aviation... branch businesses... fixed station to car or truck. Also for farm... ranch... mining... construction... sports... fishing... boating... hunting... sporting events... outdoors.

**RUGGED... DEPENDABLE...**

Full feature Citizens Band Radio. No tuning... has quartz crystal-controlled channels for highest stability, reliability. Easy, press-to-talk operation... has front panel channel selector, noise limiter, superhet receiver with RF stage, adjustable squelch, transmitter tuning indicator, built-in speaker. Is fully FCC type accepted.

Employs latest electronic design techniques. Compact! Only 4 1/2" H, 7" W, by 10" D. Weighs 11 lbs. Has gimbal mount, built-in 12VDC '117VAC universal power supply for fixed or mobile service.

**14995** per unit

WITH P-T-T MICROPHONE AND TRANSMITTER RECEIVER CRYSTALS FOR ONE CHANNEL.

Send coupon for FREE Citizens Band Booklet...

GONSET DIVISION Dept. EW  
Young Spring & Wire Corp.  
801 South Main Street, Burbank, Calif.

Gentlemen: Rush complete details on your Citizens Band radio, and free booklet

NAME \_\_\_\_\_

ADDRESS \_\_\_\_\_

CITY \_\_\_\_\_

ZONE \_\_\_\_\_

STATE \_\_\_\_\_

**GONSET**

Division of Young Spring & Wire Corporation

801 SOUTH MAIN ST., BURBANK, CALIFORNIA

"I've got a question, Doctor." Barney announced with a shrewd look. "While ago you said the tubes were supposed to have 1.5 volts on the filaments. Since you had no diagram and were unfamiliar with the tubes, how did you know this?"

"I've been waiting for that," Mac said with a chuckle; "and I'd have been disappointed if you'd let it pass. Really it's quite simple: the set used a single flashlight cell for an A battery in portable operation. Okay?"

"Okay," Barney grunted.

"But the main point," Mac said seriously, "is that I was guilty of doing exactly what I've told you not to do: I was ignoring the simple, logical possibility that a foreign set might be designed for a line voltage different from our standard 117 volts. If I had just glanced at that label right in the beginning, look at the time and trouble I could have saved myself. So-o-o-o. I can't very well fire you for being as dumb as I am, now can I?"

"No, I guess you can't," Barney said with a broad grin spreading across his pleasant, Irish face; "and you know something? I don't mind being chewed out nearly so much when the chewer admits he makes mistakes himself!"

**Air Traffic Control**

(Continued from page 40)

the information is punched out on a rectangular strip containing flight-plan information for each airplane. Under the old system the data was calculated by the controllers and recorded by hand.

**Radar Beacons**

While the computer is doing the bookkeeping, a radar beacon system recently installed at Newark, La Guardia, and Idlewild airports as well as in the New York Traffic Control Center, is aiding the traffic controller to identify aircraft on radar screens.

A refinement of radar, the radar beacon system (see Fig. 2) permits the positive identification of aircraft. When a controller has two or more aircraft on his radar screen, identification of each aircraft is vital to their safe passage through the area. Frequently an aircraft which is not identified will appear on the screen. Prior to the installation of the radar beacon system, the controller would request the aircraft to execute a 180-degree turn. This took some time—only minutes, of course—but in handling fast-moving aircraft, minutes are precious.

With the radar beacon, no turns are needed. The radar blip of a plane can be identified electronically. A controller asks a pilot to identify his plane. The pilot then pushes a button and the blip on the controller's radar screen blooms and expands into an oval shape.

The radar beacon system is the outgrowth of the World War II military identification ("friend or foe") problems. Since 1953 *Airborne Instruments*

**NEW PRICES FOR 1960 SURPLUS**

- DIAL TELEPHONES**  
French type phone made by Conn. Tel. & Tel. Can be used for standard extension phone. Used With Dial... Ea. **\$4.95**
- CAPACITOR SPECIAL**  
10 MFD 600 V. Oil filled Pyranol, Solar, Westinghouse, Etc.  
New... Ea. **75c**  
4 for... **\$2.50**
- SYNCHROSCOPE**  
11-59/APA-11. Use as test scope. Has sweep of 25 to 20,000 Cy. Use as synchroscope and pulse analyzer. Complete with all tubes. 115 V. 400 Cy operation. Exc. Condition... **\$16.95**
- LOW VOLTAGE TRANSFORMER**  
This Transformer produces 6, 7, or 8 Volts, AC 20 Amps. Input 115 Volt, 60 Cycles... Ea. **\$2.95**  
4 for... **\$10.00**
- RECORDING BLANKS**  
New 14" Record Blanks—make your own Recordings. Aluminum base. Lacquered both sides. Professional quality. Late Stock... Ea. **50c**  
Package of 10... **\$3.50**  
Package of 100... **\$30.00**
- METERS**  
**G.E.—WESTINGHOUSE—W.E.—WESTON, Etc.**
- |                                     |      |   |      |
|-------------------------------------|------|---|------|
| 2" R.F. Amp.<br>0 To 9A             | 1.95 | 3" Milliampere<br>0 To 1 DC<br>(Calib.) | 3.50 |
| 2" Milliampere<br>0 To 1 DC         | 2.95 | 0 To 2 DC<br>(Blank Face)               | 2.95 |
| 0 To 3 DC                           | 2.50 | 0 To 25 DC                              | 2.50 |
| 0 To 10 DC                          | 2.50 | 0 To 50 DC                              | 2.95 |
| 0 To 100 DC                         | 2.50 | 80-0-80 DC                              | 2.95 |
| 0 To 200 DC                         | 2.50 | 0 To 100 DC                             | 2.95 |
| 0 To 250 DC                         | 2.50 | 0 To 150 DC                             | 2.95 |
|                                     |      | 0 To 200 DC                             | 2.95 |
|                                     |      | 0 To 250 DC                             | 2.95 |
|                                     |      | 0 To 500 DC                             | 2.95 |
| 2" Volt Meters<br>0 To 15 DC (1 MA) | 2.95 | 3" Amp. Meters<br>0 To 1.5 DC           | 2.95 |
| 0 To 15 AC                          | 1.50 | 0 To 15 DC                              | 2.95 |
| 0 To 25 AC                          | 2.50 | 0 To 10 DC                              | 2.95 |
| 0 To 150 AC                         | 2.95 | 0 To 10 RF                              | 2.95 |
| 0 To 300 AC                         | 2.95 | 0 To 15 RF                              | 2.95 |
| 3" Volt Meters<br>0 To 15 AC        | 2.50 | 3" Microampere<br>0 To 50 DC            | 6.95 |
| 0 To 150 AC                         | 3.50 | 0 To 100 DC                             | 6.95 |
| 200-0-200 DC                        | 3.50 | 0 To 200 DC                             | 6.95 |
| 0 To 300 DC                         | 3.50 | Decibel Meters                          |      |
| 0 To 750 DC                         | 3.50 | 2"                                      | 2.50 |
|                                     |      | 3"                                      | 3.50 |
- See our previous ad for Special Surplus Items.  
All prices F.O.B. S. F., Calif. orders add 3% Sales Tax. 20% Dep. on all C.O.D.'s. Purchases under \$5.00 send full amount. Items subject to prior sale.

**STANDARD SURPLUS**  
1230 Market St., San Francisco 3, Calif.  
Telephone HEMlock 1-3106

**ELECTRONICS**

**PREPARE FOR A GOOD JOB!**  
**BROADCAST ENGINEER**  
**RADIO SERVICING AUTOMATION**

**TELEVISION SERVICING**  
**BLACK & WHITE—COLOR**

**APPROVED FOR VETERANS AND SURVIVORS OF VETERANS**  
**BUILDING AIR CONDITIONED**  
**SEND FOR FREE LITERATURE**

**BALTIMORE TECHNICAL INSTITUTE**  
1425 EUTAW PLACE, BALTIMORE 17, MD.

**ENGINEERING DEGREES**

E.E. Option Electronics or Power  
Civil, Mechanical, Physics.  
Also in Liberal Arts and Business Administration

**Earned through Home Study**

Pacific International  
College of Arts & Sciences  
Primarily a Correspondence School  
Resident classes also available

5719-R Santa Monica Blvd., Hollywood 38, Calif.

**ENGINEERING**

**B.S. DEGREE IN 27 MONTHS**

Prepare for unlimited opportunities in the Electronic Age!

Students study engineering under accelerated program leading to B.S. degree in 27 mo.; or standard 4-yr. program leading to B.E. degree in 36 mo. B.S. degree (36 mo.) in Math., Chem., Physics. Year-round classes. Comprehensive training in electronics, television, advanced radio theory and design, math., nuclear physics and electrical engineering. Also prep courses. Low rate. Earn board. G.I. approved. Enter March, June, Sept., Dec. Catalog.

**INDIANA TECHNICAL COLLEGE**  
910 E. Washington Blvd., Fort Wayne 2, Indiana

Please send me free information on B.S. ENGINEERING DEGREE IN 27 MONTHS as checked.

Electronics  Chemical  Aeronautical  
 Civil  Mechanical  Electrical

**B.E. DEGREE IN 36 MO. in:**  
 Aeronautical  Mechanical  Electrical (Power or Electronics)  
 Civil  Metallurgical  Physics

**C.S. DEGREE IN 36 MO. in**  Math.  Chem.  Physics

Name \_\_\_\_\_  
Address \_\_\_\_\_



Laboratory has been a consultant to FAA and its predecessor, the CAA, in the over-all analysis of the use of the beacon system in high-density terminal areas.

### Scan Converters

The most recent electronic aid to air traffic control is the radar-to-television converter. It is best known as the scan converter (see Fig. 3) and was recently commissioned at the New York Air Traffic Control Center. Although on order from *Intercontinental Electronics Corporation* since 1958, production and installation delayed the commissioning of the scan converters until a few months ago.

The basis of the scan conversion system is a cathode-ray tube that converts radar information to television signals. These signals can be seen in full daylight on horizontal monitors upon which are placed video maps.

Since being placed in use, air traffic controllers have commented that the scan conversion system has been less fatiguing. They add that working under normal light conditions is easier on the eyes, and is therefore an aid in promoting safety.

### The Future

This is but the start of many new uses of electronics in the field of air traffic control. The FAA Bureau of Air Traffic Management says that a computer is being developed that "will keep track of flights in progress and reject proposed paths that would conflict with those of aircraft already enroute."

Although this may appear to be automation in a sense, the final decision on the disposition of aircraft will always rest with the air traffic controller, aided by the accurate information provided him by the various electronic devices at his disposal.

-30-

Shown below is one of the horizontal consoles of the radar-to-television scan converters that have been installed in the enroute Air Route Traffic Control Center at New York's International (Idlewild) Airport. The system provides bright display of radar information that can be viewed in normal room light. Each plane has "tail" of light, allowing controller to determine speed, direction of turn.



January, 1960

IN 1492 CHRISTOPHER COLUMBUS

# DISCOVERED AMERICA

... if he'd made the trip today you can bet he would be out to discover—

## WALTER ASHE'S BIGGER "SURPRISE" TRADE-IN ALLOWANCE



Chris would have made a good "ham" . . . the kind of fellow who is always looking for new worlds to conquer! Old Columbus proved himself a tight man with a dollar (or was it Spanish doubloons?) when he went to see Queen Isabella. That means he'd want to cash in on the extra big savings of a Walter Ashe "Surprise" Trade-In Allowance! Follow old Chris Columbus' example . . . and see how much Walter Ashe will allow you towards your new transmitter or receiver!



### NEW 1960 CATALOG NOW READY!

The Only Radio Catalog Compiled and Designed Entirely With The Needs of The Amateur in Mind!

If you're an amateur, experimenter or a newcomer "coming up" . . . you're invited to ask for a copy of our brand new 1960 Walter Ashe catalog . . . just off the press. It's packed from cover to cover with everything that's new and needed . . . in mobile or fixed station equipment, parts and supplies, transmitters, receivers, test equipment and Citizen Band units. Incidentally, Walter Ashe is one of America's leading suppliers of High Fidelity equipment . . . and mail the coupon below . . . we'll rush your copy to you!

### You Can Be Sure . . .

that every piece of used equipment Walter Ashe takes in trade . . . and later sells . . . is checked thoroughly and guaranteed to work the same as new. Whether you're trading up to new or in the market for used equipment . . . you'll always be money and satisfaction ahead at Walter Ashe!

### TIME PAYMENT TERMS AVAILABLE ON ALL EQUIPMENT

#### "SURPRISE TRADE IN" COUPON

Walter Ashe Radio Co. • In Our 38th Year  
Your One-Stop Supermarket  
Dept. R-1-60, St. Louis 1, Mo.

Rush New Catalog  
 Send lists of guaranteed Used Equipment  
 Rush "Surprise Trade-in" offer on My \_\_\_\_\_

For \_\_\_\_\_  
(Show make and model of equipment desired)

Name \_\_\_\_\_  
Address \_\_\_\_\_  
City \_\_\_\_\_ Zone \_\_\_\_\_ State \_\_\_\_\_

*Walter Ashe*  
RADIO CO.

Dept. R-1-60, 1125 Pine Street St. Louis 1, Mo.

## RADIO PARTS STORES & HI-FI SALONS!

Hundreds of dealers across the nation profit by selling ELECTRONICS WORLD each month to their customers. Are you one of them? ELECTRONICS WORLD helps build store traffic . . . keeps customers coming back month after month for the merchandise you sell—and, best of all, you earn a neat profit on each copy sold—NO RISK INVOLVED.

So get details on selling ELECTRONICS WORLD, the world's largest selling technical electronics magazine. Or, order your copies now. Just use the handy coupon.

Direct Sales Department  
Electronics World  
One Park Avenue  
New York 16, New York

Att: Jerry Schneider

- Send me . . . . . copies of ELECTRONICS WORLD for resale in my store each month. No risk involved on my part.
- Send me details on selling ELECTRONICS WORLD in my store.

STORE NAME \_\_\_\_\_

ADDRESS \_\_\_\_\_

CITY \_\_\_\_\_ ZONE \_\_\_\_\_ STATE \_\_\_\_\_

SIGNATURE \_\_\_\_\_

EW 160

## VOLTMETER

4 inch Rectangular case. Range: 0-2.5 KV, 1% Mirror scale with ext. multiplier. (3 for \$22.50) ..... Each **\$7.95**

## POWER SUPPLY—BRAND NEW

PP326/U—Input 110V. AC—Output 24 Volts Filament DC. Rated 6 Amps. Capable 1 1/2 Amps. Rectifier. Size: 6 1/2" x 7" x 7". Adding a pot. makes ideal transistor supply. Ea. **\$9.95**

## NEW VACUUM CAPACITORS

EIMAC VC 12 MMF-32KV ..... ea. \$6.95  
EIMAC VC 25 MMF-32KV ..... ea. 7.95  
EIMAC VC 50 MMF-32KV ..... ea. 8.95  
JENNINGS JMC-15 cy MMF-30KV ..... ea. 19.95

## FREQUENCY METER

Vibrating REED type. Round 3 1/2" bakelite case. Range 57 to 63 cy. 110V. Ea. **\$10.95**

## BRAND NEW MOBILE DYNAMOTORS

MADE BY EICOR—SMALL SIZE  
Input 12 Volts. Output 40V. 180MA. Cont. Duty. 250 Mil. Int. Duty. ..... **\$4.95**  
Input 12V. Output 440V. 200MA Cont. Duty. 200 Mil. Int. Duty. ..... **\$6.95**

## POWER TRANSFORMER

Pri. 115V. Secs. 320-0-320V. @ 150 Ma. 5V. @ 2 Amps 6.3V. @ 3 Amps. 150 V. 110V. Sec. 445-0-445V. @ 150 Ma. 25V. @ 4 Amps. 6.3V. @ 6 Amps. 5V. @ 2 Amps. Fully shielded. Ea. **\$4.95**  
Write for quantity prices

## FILAMENT TRANSFORMERS

Primary 110V. 60 cy. Sec. 5V. @ 10 Amps. Ins. 10,000 V. Small size. 2 for \$7.50 ..... **\$3.95**  
Primary 110 Volts 60 cycle. Secondary 2 1/2 V. 10 Amps. 10,000 V. Insulation. Suitable for pair of 668 tubes. ..... **\$3.95**  
Primary 110V. Sec. 6.3V. @ 20 Amps ..... **\$3.50**  
Primary 110V. Sec. 6.3V. @ 60 Amps ..... **\$8.95**

## CHOKE—FULLY CASED

3 HENRY @ 200 Ma ..... 1.95  
3 HENRY @ 250 Ma ..... 3.95  
12 HENRY 500 Mil ..... 6.95  
4 HENRY 900 Mil ..... 12.95  
6 HENRY 600 Mil ..... 8.95

## BRAND NEW OIL CONDENSERS

2 MFD 600 VDC .50	4 MFD 2000 VDC 3.50
3 MFD 600 VDC .60	8 MFD 2000 VDC 5.95
4 MFD 600 VDC .75	8 MFD 2500 VDC 5.95
5 MFD 600 VDC .80	2 MFD 2500 VDC 2.50
6 MFD 600 VDC .85	1 MFD 3000 VDC 1.85
8 MFD 600 VDC .95	2 MFD 3000 VDC 3.50
10 MFD 600 VDC 1.19	4 MFD 3000 VDC 6.95
12 MFD 600 VDC 1.50	1 MFD 4000 VDC 3.25
3x8 (24 MFD) 600 VDC. .... 2.50	2 MFD 4000 VDC 6.95
1 MFD 1000 VDC .60	3 MFD 4000 VDC 2.95
2 MFD 1000 VDC .85	2 MFD 7500 VDC 17.95
4 MFD 1000 VDC 1.35	1 MFD 10,000 VDC 29.95
8 MFD 1000 VDC 2.50	1 MFD 12,500 VDC 19.95
10 MFD 1000 VDC 2.50	2 MFD 12,500 VDC 34.50
12 MFD 1000 VDC 2.95	1 MFD 15,000 VDC 42.50
15 MFD 1000 VDC 3.50	1 MFD 25,000 VDC 35.95
1 MFD 1200 VDC .45	1 MFD 25,000 VDC 69.95
1 MFD 1000 VDC .75	50MFD 125VAC 2.50
2 MFD 1500 VDC 1.95	4 MFD 300 AC. .85
4 MFD 1500 VDC 1.95	10 MFD 300 AC. 1.95
8 MFD 1500 VDC 2.95	50 MFD 300 AC. 4.50
1 MFD 2000 VDC .85	12 MFD 440 AC. 2.50
2 MFD 2000 VDC 1.50	

## SIGMA 5F RELAY

16,000 ohm in dual 8,000 ohm coils. SPDT adjustable silver contacts. Inlet temperature Operates on 500 Microamperes or less. Ea. **\$3.95**  
Write for quantity prices

## RELAYS

24V. AC 3PDT ..... ea. **\$1.65**  
24V. AC 4PDT ..... ea. **\$1.85**  
110V. AC 3PDT ..... Ea. **\$1.85**  
ALLIED 110V. AC 4PDT ..... Ea. **\$2.75**  
Potter-Brumfield 5MSLS 5000 ohm. 4 Ma. Sens. .... Ea. **\$2.25**  
Allied Relay 110 V. AC. DPST ..... **\$1.35**  
Hermetically Sealed Relay Coil 110V AC 60 cy SPDT Contacts 8 Amps. .... Ea. **\$1.50**  
6 Volt DC DPDT H.S. .... Ea. **99c**  
12 Volt DPDT DC Relay ..... Ea. **\$1.35**  
SIGMA type 22RJIC 8,000 ohm ..... **\$2.49**  
SPDT, small sealed relay ..... **\$1.95**  
Sealed Relay. SPDT, 6,000 ohm coil ..... **\$1.10**  
G.E. Relay control, contains 8000 ohm relay, sensitivity 2 mils. 10 for \$9.25. ea. LEACH ANT. RELAY 110V. AC. DPDT Ceramic Ins. .... Ea. **\$3.45**

## PANEL METERS

G.E. WESTINGHOUSE 1 1/2" METERS  
0-1 Mil ..... 2.95  
0-100 Micro ..... 3.95  
2" METERS  
0-50 Micro (0-5 scale) ..... 4.95  
0-300 Mil DC ..... 2.95  
0-10 Amps DC ..... 2.95  
0-20 Volts DC ..... 2.95  
15-25 Volts DC ..... 1.95  
0-150 V. AC ..... 3.49  
W.E. SIMPSON, etc.  
0-3 Amps RF ..... 2.95  
0-4 Amps RF ..... 2.95  
3" METERS  
100-0-100 Micro Amps DC ..... 5.95  
0-100 Mil DC ..... 3.95  
0-150 Mil DC ..... 3.95  
0-12 Volts AC ..... 3.95  
0-15 V. AC ..... 2.95  
0-2.5 KV DC ..... 5.50  
Running Time Meter, 15-25 Volts DC. 110V. 60 cy. .... 6.50

## MISCELLANEOUS SPECIALS

36 OHM 50 Watt Globar Non-Ind. Res. .... 60c ea.  
3-12 MMF Erie Ceramic Trimmers. 2 for \$1.00  
Murdock Headphones—BRAND NEW 10,000 ohm impd. with std. phone plug. .... ea. \$2.95  
Replacement 8' phone cord for Standard Headsets ..... 35c  
CUTLER-HAMMER TOGGLE SWITCH SPDT (ST42D) 4 for \$1.00. .... ea. **29c**  
WILLARD STORAGE CELL—2V. 28 Amp hrs. Clear plastic case. Shipped dry. Ea. **\$2.50**  
Write for quantity prices on all special items

All merchandise sold on a 10 day money back guarantee basis

Min. Order \$3.00—25% with Order—F.O.B. New York

# PEAK

ELECTRONICS COMPANY  
66 W. Broadway, New York 7, N. Y., WO-2-5439

## How a Pool Telecast Works

(Continued from page 56)

truck of the city's Bureau of Electricity—normally used for servicing street lights. Camera cable for this unit was run overhead, tying off on a streetlight pole and a boom on the truck. It was equipped with a Zoomar lens and adapter and had a clear field of vision extending a mile north and south on Michigan Avenue. This camera produced the best closeup views of the Queen seen during the parade, as her car passed directly under its position.

The camera mounted in WNBQ's Cadillac used a 6:1 Zoomar and successfully provided clear pictures of the Queen's car during the parade when other cameras were unable to cover it. The riding announcer had the unique advantage of being able to describe the proceedings from a participant's viewpoint. This unit was actually the leading vehicle of the motorcade, about five to ten car lengths directly in front of the Queen's automobile with a security vehicle intervening, an unfortunate position from a video standpoint. The only possible shot was head-on. When maximum focal length was employed for closeup attempts, the slightest road irregularities were quite apparent. Much better pictures would have resulted had the unit been free to move to right or left of the axis of the procession.

## Results and Costs

The pool telecast had a total duration of a little over an hour and was considered excellent by observers and participants. Complete and coherent coverage of a highly important and exciting civic event was provided as a public service and in a manner which no station acting alone could have realized in its wildest dreams. Some forty-five engineers and technicians, six announcers, and five directors were immediately involved in delivering the

pool feed to the outputs of the central control room, and uncounted others participated as individual stations mixed local studio originations with the pool feed to suit their individual needs. Chicago's only other pool telecast—of General MacArthur's parade through the city in 1951—employed more people and equipment, but was produced in palmier days.

Cooperation was generally the keynote of the endeavor, with interchanges of equipment and continuous consultation taking place on problems and details. All was not sweetness and light, however. Understandably irked at being deprived of a leading role in the proceedings by the turn of a coin, WBKB imported a 65-inch lens from San Francisco and went on the air fifteen minutes ahead of the pool from the top of their State Street studio building, a mile and a half from Buckingham Plaza, with a preview of the Queen's landing. This "scoop" had been preceded, the evening before, by a one-hour attention-getting summary of the events leading up to and surrounding the royal visit.

A factor which somewhat dimmed the afterglow of the successful pool was a verbal hassle which developed when one station managed to slip onto the air some live shots of the Mayor's banquet for the Queen which they were televising on a closed-circuit basis at the City's behest, for benefit of the press overflow. According to other stations, it had been jointly decided to bypass this event.

Exact costs of the pool telecast are hard to come by and will probably never be compiled, but educated guesses put the total out-of-pocket figure under \$10,000, about \$3000 of this going for line charges. All four stations will share the out-of-pocket tab. Regularly scheduled engineering crews were used, and careful planning held overtime to a minimum. Economy was effected in choice, where feasible, of camera locations which did not require augmentation of power and terminal facilities. —30—

Sencore sales manager Ed Flaxman and Mark Markman, Sencore's California rep. are shown conducting a Time-Saving Clinic with the Van Nuys (Calif.) Society of Radio and TV Technicians. Demonstrations showed time-saving advantages in troubleshooting with proper equipment. The highlight of the evening was a 45-minute film entitled, "The Sencore Time Saver Story." These time-saving clinics are available free of charge to service technician groups throughout the United States. Arrangements can be made through your local parts distributors.







coming in February *ELECTRONICS WORLD*:

# your complete guide to buying a **CITIZENS BAND RADIO**



More people every day are finding a Citizens Band Radio useful to own, fun to operate! If you've been thinking of investing in one, be sure to read this *ELECTRONICS WORLD* feature **FIRST**. It tells you all you need to know before buying a Citizens Band Radio: what's available, what to look for, how to buy. In addition, this valuable directory tells you the rules and regulations, the privileges and limitations governing the field of Citizens Band Service. Complete with photographs and technical data, you'll find this feature an indispensable guide to the purchase of your Citizens Band Radio!

You'll also enjoy these features in February *ELECTRONICS WORLD*:

- **ROOM ACOUSTICS FOR STEREO:** Reverberation and Room Treatment Part Two of this four-part series covers optimum reverberation... tells you how to control room resonances with acoustic material. Important material here for all stereo enthusiasts!
- **BUILD A TWO-METER TRANSISTOR TRANSMITTER**  
Here's an important project for radio amateurs—a 20-milliwatt, battery-operated transmitter that uses two transistors. Complete with diagrams and instructions.
- **KNOW YOUR ELECTRONIC CHEMICALS**  
An authoritative discussion of cleaners, lubricants, cements, sprays, and other chemicals that play significant roles in electronic service and repair. Their various functions and applications are explained in this informative feature.

All these features are coming your way in February *ELECTRONICS WORLD*—typical of the varied coverage you'll enjoy month after month in the world's most authoritative electronics magazine. That's why it's such a good idea to make sure that *ELECTRONICS WORLD* is delivered to your doorstep regularly.

Why not become an *ELECTRONICS WORLD* subscriber today?

## REGULAR SUBSCRIPTION RATES

**one year, \$5    two years, \$9    three years, \$12**

*ELECTRONICS WORLD*, 434 South Wabash Avenue, Chicago 5, Illinois

# FREE CAREER BOOKLET



to guide you to a successful future in

## ELECTRONICS RADIO-TV COMPUTERS ELECTRICAL ENGINEERING

This interesting pictorial booklet tells you how you can prepare for a dynamic career as an Electrical Engineer or Engineering Technician in many exciting, growing fields:

**MISSILES • RADAR • RESEARCH ELECTRICAL POWER • ROCKETRY AUTOMATION • AVIONICS SALES • DEVELOPMENT**

Get all the facts about job opportunities, length of study, courses offered, degrees you can earn, scholarships, part-time work — as well as pictures of the Milwaukee School of Engineering's educational and recreational facilities. No obligation — it's yours free.

### MILWAUKEE SCHOOL OF ENGINEERING

#### MAIL COUPON TODAY!

MILWAUKEE SCHOOL OF ENGINEERING  
Dept. EW-160, 1025 N. Milwaukee St.  
Milwaukee, Wisconsin MS-113

Please send FREE "Your Career" booklet  
I'm interested in  Electronics  Radio-TV  
 Computers  Electrical Engineering  
 Mechanical Engineering  
(PLEASE PRINT)

Name \_\_\_\_\_ Age \_\_\_\_\_

Address \_\_\_\_\_

City \_\_\_\_\_ Zone \_\_\_\_\_ State \_\_\_\_\_

I'm eligible for veterans education benefits.  
Discharge date \_\_\_\_\_

### Extended Stereo System

(Continued from page 50)

At the same time, -R information is being supplied to the element of the balance control that feeds the other section of the 12AZ7. Also being applied to this same element of the balance control is the L signal from the other section of the 12AZ7. Hence a composite signal, L-R, is impressed on the grid of the lower section of the mixer stage. This signal is also phase inverted by the tube so that it now becomes an (R-L) signal.

The (R-L) information is channelled into two paths. Part of this information is fed through the .022- $\mu$ f. capacitor to the stereo control, which is basically a gain control for the (R-L) difference channel. Also part of the information is fed through the 120,000-ohm resistor and the .047- $\mu$ f. capacitor and mixes with the 2L signal from the left preamp. At this point the (R-L) signal combines with the 2L signal to

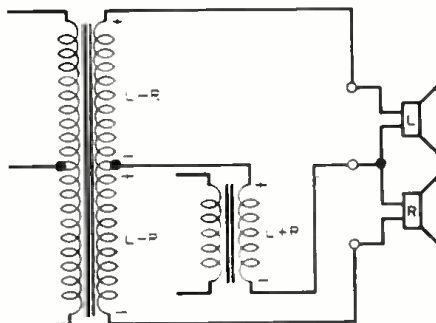

Fig. 3. Basic matrixing circuit used.

produce an (R+L) sum signal that is fed to the sum amplifier.

#### Stereo Control & Matrixing

For monophonic operation, the stereo control is at its minimum setting. Under this condition no difference signal is applied to the difference channel. All information that passes through the system is (L+R) which is subsequently channelled to both speaker systems.

For standard stereo operation, the stereo control is advanced until the sum amplifier and difference amplifier receive equal amplitude signals. Under these conditions, (L+R) and (L-R) information is supplied to the matrix and only the L information is applied to the left speaker and only the R information is applied to the right speaker. This is normal stereo operation.

For "extended stereo" operation, the stereo control is advanced further so that the (L-R) or difference-channel signal is greater than the signal applied to the sum (L+R) channel. This difference in relative level is maintained at different loudness settings since the loudness control for both sum and difference amplifiers are ganged and the gains of both channels are controlled simultaneously.

Output matrixing, or mixing of the

## PRE-PUBLICATION SPECIAL OFFER!

YOU MAY HAVE EITHER OR BOTH OF THESE BIG, HARD-COVER ELECTRONICS GUIDEBOOKS ON A

### 7-DAY FREE EXAMINATION



**COMPUTERS AND HOW THEY WORK**  
\$4.95

Here is a fact-filled, exciting guidebook to the wonder-world of electronic computers, with more than 120 illustrations and easy-to-follow tables in 10 big chapters. Step by step, you'll see and understand the workings of every type of computer ever used. This important new book illustrates the basic principles of computers with crystal-clear clarity. It's must reading for career-minded students and for electronics professionals who want a more complete knowledge of computers.

**THE ELECTRONIC EXPERIMENTER'S MANUAL**  
\$4.95



THE ELECTRONIC EXPERIMENTER'S MANUAL is a big, informative volume, containing hundreds of specially prepared diagrams and construction drawings. There are 10 individual sections, each covering a specific phase of electronic construction. One giant chapter shows projects, test equipment and special tools you can build, plus plans for a complete workshop! With just a few dollars worth of tools, and this book to guide you, you'll have the know-how you need to get started, or advance, in electronic experimentation.

**GET ONE OR BOTH FOR 7-DAY FREE EXAMINATION! MAIL THIS COUPON TODAY**

**ELECTRONICS BOOK SERVICE**  
A Division of the Ziff-Davis Publ. Co.  
One Park Avenue • New York 16, N. Y.

Gentlemen: Send me a copy of:

- COMPUTERS AND HOW THEY WORK  
 THE ELECTRONIC EXPERIMENTER'S MANUAL  
and bill me at only \$4.95 a copy plus postage. I understand that I may return the book(s) within 7 days and owe nothing.

\$\_\_\_\_\_ enclosed. (SAVE MONEY! Enclose payment now and we'll pay the postage.)

Name \_\_\_\_\_

Address \_\_\_\_\_

City \_\_\_\_\_ Zone \_\_\_\_\_ State \_\_\_\_\_

(N.Y.C. orders add 3% sales tax) EW160



sum and difference signals in order to get the desired outputs for the speakers, is accomplished by the output transformers (Fig. 3). The secondary winding of the difference-channel (L-R) transformer is center-tapped. To this center-tapped secondary is connected the untapped secondary winding of the sum-channel (L+R) transformer. We now have two windings that are connected in series-aiding (the sum winding and the top half of the difference winding) or in series-opposing (the sum winding and the bottom half of the difference winding). There are three possible conditions of operation as follows:

1. For monophonic operation, there is no difference signal so that both speakers will receive the sum signal.

2. For standard or normal stereo operation, the output of the difference channel is equal to the output of the sum channel. Under these conditions the upper speaker has applied to it (L+R) + (L-R), or 2L. Note that this is the left information only. The lower speaker has applied to it (L+R) - (L-R), or 2R. This is the right information only.

3. For "extended stereo" operation, the output of the difference channel is greater than the sum channel. Assuming there is twice the signal in the difference channel, or 2(L-R), the signal applied to the upper speaker is (L+R) + 2(L-R), or 3L-R. The signal applied to the lower speaker is (L+R) - 2(L-R), or 3R-L. Notice that the left speaker system receives an out-of-phase component of right information along with the left information, and the right speaker system receives an out-of-phase component of left information along with the right information. The magnitude of the out-of-phase components is what determines the apparent spread of the "extended stereo" system.

-30-

## CHRISTMAS TVI

By J. I. SWANSON

THE OFTEN strange nature of interference was dramatized again last Christmas. The second set of the house, working on its built-in antenna in the living room, began to show intermittent vertical sync and horizontal flashes a few days before the holiday. Just about any movement in the room would bring on the symptoms. Moving the set to another room eliminated the trouble. Decorations on the Christmas tree were prime suspects, but the symptoms persisted when the bulbs were unplugged.

The tree was also decorated with such metallic material as tinsel and "iceicles." Shaking a bunch of "iceicles" brought the symptoms in severe form. Experimentally, one iceicle was held in each hand and they were moved about to make intermittent contact. This induced the flashes and vertical slipping! Evidently these strips, with their invisible oxide coatings, acted as semiconductors when they made intermittent contact. They were probably detecting some strong, local signals and yielding a cross-modulation product that interfered with sync pulses.

-30-

## NEW FOR 1960! INTRODUCTORY OFFER

# FREE! CHOOSE 2 ANY PAKETTES

WITH EVERY 12 PAKETTE ORDER

6 PAKETTE ORDERS—CHOOSE ANY 1 PAKETTE FREE

Pick your FREE PAKETTES from this listing!



### WHAT IS LEKTRON'S PAKETTE?

It is Lektron's newest method of packaging radio-TV parts assortments in clear, lucite boxes. Each Pakette box features a "snap-top" cover and is easily stackable to fit any shelf or bench, yet your components are always clearly visible. This box alone is worth up to \$1.00. You save up to \$30 on parts, too—and get bigger quantities than ever before.

MINIMUM \$2.00 ORDERS! USE AS ORD-A-GRAM

- |   |   |   |  |
|---|---|---|--|
| <p><b>30 "SEALED" CIRCUITS</b><br/>Built-in resistor coupling networks. Reg. \$2.92. <b>\$1</b></p> <p><b>40 MOLDED CONDENSERS</b><br/>0.0001 to .1 to 1000 VDC. Oil, porcelain, black mounts. Reg. \$1.80. <b>\$1</b></p> <p><b>65 RESISTOR SPECIAL</b><br/>W.W. &amp; carbon, precision power, variable, mini. Types 100, 12W. Reg. \$1.75. <b>\$1</b></p> <p><b>40 POWER RESISTORS</b><br/>5 to 50W to 10,000 ohms. Reg. \$1.50. <b>\$1</b></p> <p><b>50 TRANSISTOR COND.</b><br/>Mini condensers, 0.00025 to 0.1 meg. In 100's, 50 trans. sets. Reg. \$1. <b>\$1</b></p> <p><b>100 HALF WATERS</b><br/>Resistors, carbon, 10 ohms to 2 meg. 1/2 W. Popular makes. Reg. \$1. <b>\$1</b></p> <p><b>15 "GRAIN-O-WHEAT"</b><br/>Lamps, by G.E. 1.5 W. 4 or 6 pin. 100's work. Worth 25¢ ea. <b>\$1</b></p> <p><b>70 MICA CONDENSERS</b><br/>Miniature, .001 to 1000 pF. 20 values. Reg. \$1.84. <b>\$1</b></p> <p><b>35 TWO WATERS</b><br/>100 radio &amp; TV values; 100 ohms to 500K. 277 top. Reg. \$8. <b>\$1</b></p> <p><b>15 ROTARY SWITCHES</b><br/>1, 2, 3 gang, long shafts. Popular types. Reg. \$1.5. <b>\$1</b></p> <p><b>15 VOLUME CONTROLS</b><br/>Long &amp; usable shafts. Up to 1 meg. Single, duals, switch types. Reg. \$2.0. <b>\$1</b></p> <p><b>2 SOLAR BATTERIES</b><br/>Generates power from sun &amp; bulbs. Lasts 100's of projects. Reg. \$4. <b>\$1</b></p> <p><b>20 TWIST DRILLS</b><br/>1/16" thru 1/4" calibrated case. For electric drills. Reg. \$2.50. <b>\$1</b></p> <p><b>24 ARTISTS BRUSHES</b><br/>All sizes, styles. Pure camel hair. <b>\$1</b></p> | <p><b>40 HI Q CONDENSERS</b><br/>NPO's, standard types 100 to 20 values. Exact one piece quality. Reg. \$9. <b>\$1</b></p> <p><b>60 TERMINAL STRIPS</b><br/>Solder type, 0.1 to 10 lugs. Used in every elec. proj. Reg. \$1. <b>\$1</b></p> <p><b>325 SURPRISE PAKETTE</b><br/>Wide variety of radio probe parts. Reg. \$1. <b>\$1</b></p> <p><b>70 TUBULAR CONDENSERS</b><br/>20 values, 0.0001 to 500 pf. to 1000 VDC. Reg. \$1. <b>\$1</b></p> <p><b>30 "SILVER" MICAS</b><br/>1 &amp; 2% Ass't. values. First made. Reg. \$1. <b>\$1</b></p> <p><b>70 INSULATED RESIST'S</b><br/>10 to 100 ohms to 10 meg. 30 values. 1/2, 1, 2W. Reg. \$1. <b>\$1</b></p> <p><b>10 RCA PLUG 'N' JACK SETS</b><br/>Matched pairs. For tuners, amps, etc. Reg. \$1. <b>\$1</b></p> <p><b>300-FT. HOOK-UP WIRE</b><br/>10 dia. 24. Plastic, glass, insulated. Ass't. colors. Popular. Reg. \$1. <b>\$1</b></p> <p><b>60 RADIO-TV KNOBS</b><br/>Type tool. Plastic 1/2" to 4" dia. Some \$1 ea. <b>\$1</b></p> <p><b>50 ONE PERCENT-ERS</b><br/>Precision carbon film resistors. Nifty kit case. 15 values. 100 ohms to 1 meg. Reg. \$2. <b>\$1</b></p> <p><b>60 CONDENSER SPECIAL</b><br/>Incl. molded, porcelain, disc. Reg. \$1.5. <b>\$1</b></p> <p><b>5 ROLLS MICRO-WIRE</b><br/>224 to 232. Ass't. colors. Insulation. Tinned. Reg. \$5. <b>\$1</b></p> <p><b>1500 PCS. HARDWARE</b><br/>Nuts, bolts, screws, washers, etc. Handy shop pakette. <b>\$1</b></p> <p><b>3 HOBBY TRANSISTORS</b><br/>For experimental &amp; shop use. Spares you know. Worth \$1 ea. <b>\$1</b></p> <p><b>WORLD'S SMALLEST RADIO</b><br/>Kit containing power, cred. lists, for life. Incl. all parts, instructions. Reg. \$2. <b>\$1</b></p> <p><b>12 GERMANIUM DIODES</b><br/>For radio &amp; TV detectors, limiters, rectifiers. Glass sealed. Reg. leaded. <b>\$1</b></p> <p><b>125 RESISTORS</b><br/>Non-insulated, 10 popular values; 1/2, 1, 2W. 100's, 100's, 100's, 100's. Reg. \$1.5. <b>\$1</b></p> | <p><b>10-IN-1 PAKETTE</b><br/>Incl. diodes, resistors, electros, sockets, lites, wire, knobs, potentiometers, condensers. <b>\$1</b></p> <p><b>TRANSISTOR RADIO BASIC</b><br/>Incl. transistor &amp; socket, diode, lamp, stick. In handy pakette. <b>\$1</b></p> <p><b>2 POWER TRANSISTORS</b><br/>Handles 10 watts. For audio circuits, in cars, etc. Worth \$10! <b>\$1</b></p> <p><b>2 SILICON RECTIFIERS</b><br/>300 mil. Axial leads. Size of 1W resist. Reg. \$3 ea. <b>\$1</b></p> <p><b>8-PC. NUTDRIVER SET</b><br/>Molded, lucite handle. Steel sockets, wrenches. 3/16, 7/32, 1/4, 5/16, 11/32, 7/16". In carrying case. <b>\$1</b></p> <p><b>10 PANEL SWITCHES</b><br/>115 VAC, micro, slide, etc. Some worth \$1. <b>\$1</b></p> <p><b>4 OUTPUT XFMR'S</b><br/>500A, 6V, 6K, etc. Open frame types. Reg. \$10. <b>\$1</b></p> <p><b>2 FLEA POWER MOTORS</b><br/>115 VDC. Powerful. 100's of control uses. <b>\$1</b></p> <p><b>40 TUBE SOCKETS</b><br/>4, 5, 6, 7, 8, 9 pins. Octals, mini types. Some shield, mica, ceramic. Reg. \$10. <b>\$1</b></p> <p><b>30 PILOT LITES</b><br/>Mini bay, &amp; screw types. "Grain-o-wheat" too. 1.5 to 1W. <b>\$1</b></p> <p><b>40 DISC CONDENSERS</b><br/>Incl. world's finest; only 14 x 10mm to 100VDC. <b>\$1</b></p> | <p><b>15 "POLY PAKETTES"</b><br/>Incl. poly boxes, vials, ass't. sizes. For radio, TV submini parts. <b>\$1</b></p> <p><b>15 ELECTROLYTICS</b><br/>2F &amp; tubular paper &amp; can types. Single, duals &amp; triple values. Up to 500 ml to 450 VDC. Reg. \$2. <b>\$1</b></p> <p><b>100 CERAMIC SPECIAL</b><br/>Incl. discs, NPO's, molded, tubular, dog bones. 25 values. <b>\$1</b></p> <p><b>75 ONE WATERS</b><br/>Resistors, incl. 1/2 &amp; 5% cartons. 20 popular values. Reg. \$1.84. <b>\$1</b></p> <p><b>2 POSTAGE STAMP MIKE</b><br/>Crystal. By Brush. 17 sq. Nifty, slide-away unit. 100 to 7000 cps response. <b>\$1</b></p> <p><b>7 SILICON DIODES</b><br/>Used in government &amp; "space" work. 1N21, 1N22, etc. Worth \$10! <b>\$1</b></p> <p><b>70 COILS &amp; CHOKES</b><br/>RF, ant., osc., slug-tuned, &amp; IF types. 15 types. Reg. \$2. <b>\$1</b></p> <p><b>60 PLUGS &amp; REC'T'L'S</b><br/>Power, battery, audio; 15 types. <b>\$1</b></p> <p><b>15 POLY VIALS</b><br/>For stocking submini &amp; transistor parts. 1/2 to 1/8" sizes. "Stack" 'em. Ass't. sizes. <b>\$1</b></p> <p><b>CRYSTAL PHONE</b><br/>Use as mike too. W/ cord &amp; plug set. Heavy duty type. 100 to 4000 cps resp. <b>\$1</b></p> |
|---|---|---|--|

### FREE! GIANT BARGAIN CATALOG

Due to a larger physical size of a few assortments, only 2000 are used.

Include check or M.O. with sufficient postage; excess returned. C.O.D. orders, 25% down; rated, net 30 days. INCLUDE POSTAL ZONE in address. (Canada postage, 48¢ 1st lb.; 28¢ ea. additional lb.)

My FREE PAKETTES are:

1. \_\_\_\_\_
2. \_\_\_\_\_

- Check each item wanted
- Return ad with order
- Avg. wt. 1 lb. per Pakette
- Each Pakette guaranteed

### BEST IN HI-FI VALUES!

NO DELAY SERVICE

All orders rushed to you in factory-sealed cartons.

Write for free catalog.

audion

25-W Oxford Road  
Massapequa, New York



## LOOK

NO FURTHER... IF YOU'RE UNHAPPY WITH "HI" HI-FI PRICES. WRITE FOR OUR UNUSUAL AUDIO CATALOG. KEY ELECTRONICS CO. 120-C Liberty St., N. Y. 6. Phone CLoverdale 8-4288

### engineering degree in 27 mos.

Become an Electronics Engineer. Share rewards awaiting college men... higher income, rapid advancement. Important firms visit Tri-State to interview seniors. Bachelor of Science Degree in 27 months in Electrical (Electronics or Power major), Mechanical, Civil, Aeronautical, Chemical Engineering. In 56 months a B.S. in Business Administration (General Business, Accounting, Motor Transport Management major). For earnest, capable students. Small classes. More professional class hours. Well-equipped labs. Dorms. Campus. Modest costs. Year-round operation. Enter Mar., June, Sept., Jan. Founded 1884. Write J. H. McCarthy, Director of Admissions, for Catalog and "Your Career" Book.



1610 College Ave., Angola, Indiana

# Advance JANUARY CLEAN-UP SALE!

RELAYS!	RELAYS!	RELAYS!
110 V AC DPDT W.L. . . . . \$2.35	24 V AC SPDT Sigma 41-F . . . 1.20 w/str for 110 V AC . . . 1.50	16,000 Ohm Plate, Sig- ma 5F SPDT— operate on 500 Mma . . . . . \$3.60
110 V AC DPDT Ceramic-Leach . . . 2.95		
12 V DC DPDT . . . 1.25		
6 V DC SPDT . . . 1.25		
Sigma 5000 ohm SPDT . . . . . 2.05		

LARGE STOCK AC, DC RELAYS

\*\*\*\*\* Solenoids \*\*\*\*\*  
115V 60 Cyc. cont. duty, 18 Lb. pull . . . each \$4.75  
8 lb. pull . . . . . each 2.30  
24V & 230V SOLENOIDS IN STOCK!

POWER TRANSFORMER	AC INPUT TEST METER
117 V Pri., 800 V C.T., 275 Ma. 8.3 V, 9 Amp; 5 V, 6 Amps. Flat mounting . . . SPECIAL 5.10 350 Mills . . . . . SPECIAL 6.95	4,000 ohms per V, 0-1.5 to . . . \$9.45 150 VAC . . . . .

CHOKES FULLY CASED	TUBE CHECKER I-777
6 hy, 100 Ma. . . \$ .95	135 VAC, mutual con- ductance . . . . . \$23.50 exc. cond. . . . .
8 hy, 100 Mt. . . 1.24	
8 hy, 200 Ma. . . 1.49	
10 hy, 150 Ma. . . 1.79	
20 hy, 300 Ma. . . 7.95	
22 hy, 100 Ma. . . 2.19	

### \*\*\*\*\* Transformers \*\*\*\*\*

ALL WITH 110 VOLT PRIMARY

6.3 V . . . . . SEC.	12 V SEC. 2 Amp . . . \$1.19
6.3 V SEC. 1 Amp \$1.09	24 V SEC. 1 Amp . . . \$1.09
Step up/down Transformer	
110 V-220 V 10 A . . . \$9.20	
110 V-220 V 110 V-440 V at 5 V . . . 5.20	
Primary 115, sec. 6 V-7 V-8 V, 75 VA . . . 4.05	
Plate 3100 V CT 300 MA . . . . . 17.75	
Sola constant voltage, 95-125 V @ 0.5 @ 10 Amps out. . . . . 8.45	

### CO-AX RELAYS!!

12 or 24 V DC (please specify). NEW. \$8.40 ea.

### RG CO-AX CABLE!

8/U, 52-ohm impd., 100 ft. length . . . \$7.75  
59 A/U (72-ohm) w/male and female  
connectors, 50 ft. coils . . . . . 2.45 ea.  
58/U, 100 ft. length . . . . . 4.25 ea.

### OIL CONDENSER BARGAINS

SPECIAL! 3x8 mfd 500 VDC	\$2.55
2 Mfd 600 VDC . . . 40	10 Mfd 1500 VDC 3.40
4 Mfd 600 VDC . . . 60	2 Mfd 2000 VDC 1.39
8 Mfd 600 VDC . . . 83	3 Mfd 2000 VDC 2.45
10 Mfd 600 VDC . . . 99	2 Mfd 2500 VDC 2.15
15 Mfd 600 VDC 1.75	1 Mfd 3000 VDC 1.50
16 Mfd 600 VDC 1.75	2 Mfd 4000 VDC 5.30
25 Mfd 600 VDC 3.25	2 Mfd 4000 VDC 14.75
20 Mfd 650 VDC 2.45	2 Mfd 10000 VDC 16.95
1 Mfd 1000 VDC . . . 52	1 Mfd 12500 VDC 27.90
2 Mfd 1000 VDC . . . 59	

### L-O-O-K! PANEL METERS

1" METERS	0-5 Milli . . . . . 3.25
0-1 MA . . . . . \$2.95	0-200 Milli . . . . . 3.25
0-200 Micro-amps 2.98	0-250 Milli . . . . . 3.25
2" METERS	0-5 Amp Ac (scale 0-50) . . . . . 2.95
0-3 amps, RF . . . . . 2.95	0-1 Mill (scale 0-50) . . . . . 4.10
0-200 Micro-amps 2.95	200 250 V DC . . . 3.25
0-50 Milli-amps. 2.95	0-300 Amps DC . . . 5.45
0-120 Ma RF w/ . . . 3.75	w/shunt . . . . . 5.45
ext. shunt . . . . . 5.45	-10.0 to +608 . . . 5.45
0-200 Milli-amps. 2.95	RUNNING TIME
0-300 V AC . . . . . 2.95	0-1000 METERS
0-7.5 V DC . . . . . 2.95	0-9999 J&T 230V 7.45
0-200 V DC . . . . . 2.95	0-9999 J&T 230V 9.50
0-300 V DC . . . . . 2.95	Comb w/freq. meter, J&T, 110 V AC . . . . . 17.95
3" METERS	Fram freq. meter 110-130 V 58- 62 c/cv . . . . . 9.95
0-100 Micro-amps 5.95	400 c/cv . . . . . 8.95
0-200 Micro-amps 5.95	
0-7.5 V AC . . . . . 3.25	
0150 V AC . . . . . 4.35	
0-1 Mill . . . . . 4.45	

### SELENIUM RECTIFIERS

FULL WAVE BRIDGE

130/110 VAC input	30/24 VAC input
150 milli . . . . . \$1.25	1/2 amp . . . . . 1.15
200 milli . . . . . 1.75	2 amp . . . . . 2.15
300 milli . . . . . 2.50	5 amp . . . . . 4.95
500 milli . . . . . 3.50	7 amp . . . . . 6.25
1 1/2 amps . . . . . 4.75	20 amp . . . . . 12.95
12 amps . . . . . 19.75	

### 110 VOLT 60 CYCLE BLOWER

3300 RPM, 22 CFH. Precision made. . . . . \$7.95

4 WIRE TELEPHONE COILED CORDS . . . . . 76c ea.  
7 for \$5.00  
STEPPING RELAYS 16 deck, 22 pos. 19.50

WESTERN ELECTRIC VOLUME INDICATOR	POWER SUPPLY KIT!
with Weston 2732 oh. meter. Var. . . . . \$14.25	Primary 115V, 60 Cy. Sec., 400- 400 V. @ 20 Ma., 5 VCT @ 4 Amp., 5 VCT @ 2 Amp. std. mounting plus 8 Hy. 200 Ma. chokes and two 600 V. oil con- densers. . . . . Kit \$7.10

PYROMETER POTENTIOMETER  
Single scale, electrically compensated  
made by Lewis Eng. in mahog. box. . . . \$49.50

M A R POWER SUPPLY  
115 V. 60 Cyc. input 12-14 VDC, 2  
Amp output filtered and fully housed \$8.30

Min. Order \$3.00—25% with order F.O.B. New York  
10 DAY GUAR. PRICE OF MDSE. ONLY

**Advance Electronics**  
E West Broadway • New York 7, N. Y. • REctor 2-0270



"ELECTRONICS REFERENCE DATA" compiled by Sams Staff. Published by Howard W. Sams & Co., Inc., Indianapolis. 118 pages. Price \$2.50. Soft cover. Vol. 2.

This is a second volume in an interesting publishing venture dedicated to making available in semi-permanent form outstanding articles in the electronics field.

This volume is an anthology of worthwhile articles which have appeared in various issues of "The Aero-vox Research Worker" and covers TV circuits and applications, u.h.f., audio, radar, meters and measurement, and specialized applications and development.

Extensive use of schematics and line drawings makes this text a reference work well worth keeping in a permanent electronics library.

"THE ELECTRONIC EXPERIMENTER'S MANUAL" by David A. Findlay. Published by Ziff-Davis Publishing Company, New York. 169 pages. Price \$4.95.

If our experience is any criterion, a very high percentage of the population is interested in some phase of electronics. From six to ninety-six, the miracle of the vacuum tube and its counterparts exerts an almost hypnotic pull on the average citizen.

For those with no background in electronics but endowed with a well-developed bump of curiosity, this volume should provide the answer to the problem of starting from scratch. The assumption is made that the reader is totally unfamiliar with the tools and techniques involved in electronic construction, hence the first three chapters cover, in detail, this basic material. The tools required, soldering, wire and wiring techniques, hardware, electronic parts and how to identify them, planning and making a chassis, etc. are all discussed and the subject amplified by a lavish use of photographs, line drawings, and symbols.

The remaining six chapters deal with the actual wiring and troubleshooting of circuits, making printed circuits, building a workshop to meet individual needs, special tools the experimenter can build, basic test equipment which can be constructed, with the final chapter covering eight interesting electronic projects (receivers, tuner, amplifier, an intercom, and a photoflash). Both tube and transistor circuits are represented by the suggested projects, giving the reader experience with both types of construction. Much of the material used in the preparation of the text originally appeared in the pages of POPULAR ELECTRONICS.

only 15c for this authoritative guide to building an inexpensive



record library!

reprinted from HiFi REVIEW

Now—you can build a record library of hi-fi classics from the steadily growing catalogue of \$1.98 releases! More than half a dozen big record companies are re-issuing great performances on the new \$1.98 labels. You can have a guide to the best of these for 15¢—by ordering this reprint of a recent article in HiFi REVIEW. Complete with catalogue number, artist, orchestra and conductor information—it's a fabulous guide to building up a high fidelity library of basic classics!

In addition, HiFi REVIEW's Music Editor, David Hall, gives you the background of the \$1.98 market . . . evaluates the discs being offered at this price . . . pinpoints the future of high-quality, low-price records.

If you've been thinking of starting a record collection or adding to the one you have—this reprint is your best guide! Order your copy today—simply mail 15¢ in coin or stamps with the coupon below. But the supply is limited, so order now!

**HiFi REVIEW EW 160**  
**Box 1778R**  
**Church Street Station**  
**New York 8, N. Y.**

Please rush my copy of the HiFi REVIEW reprint on building a library of \$1.98 records. I enclose 15¢ to cover postage and handling.

Name \_\_\_\_\_

Address \_\_\_\_\_

City \_\_\_\_\_ Zone \_\_\_\_\_ State \_\_\_\_\_





# BARRY BEST BUYS

- **Xmas Special—Imported European Antique Telephone.** Beautiful condition. Reconditioned. In working order. \$19.95 each (2 for \$30.00). Collector's Gem.
- **G. E. Capacitors 1 Mfd. @ 6 KV.** Original boxed, unused. . . . . \$4.95
- **Leach Power Relays 115 VAC.** 30 amp contacts (N.O.) . . . . . \$4.95
- **9 Ft. RG41/U Coax Cords,** with 83-ISP connectors on each end. . . . . each \$1.00
- **New Silicon Rectifier.** Input: 130 Volts at 500 Ma. Price 75¢ each (10 for \$7.00)
- **7 Conductor Intercom Cable (color-coded)** . . . . . 6¢/ft.
- **Sonotone Rechargeable Battery Cartridge Model FC-2.** Write for details. . . . . \$7.95
- **Raytheon Power Supply.** Input: 6 VDC. Output: 117 VAC @ 60 CPS (50 watts conservative). . . . . New \$16.95
- **TS-78/U Tune-Up "Dummy" Load.** Excellent for citizen BND, or VHF. . . . . \$1.00
- **Audio Devices type 20E5 Silicon Rectifier.** 750 Ma. (130 V.RMS) . . . . . 90¢
- **LM-21 Navy Freq. Meter (125 to 20,000 KCS).** . . . . . \$75.00
- **BC-221 Army Freq. Meter (125 to 20,000 KCS).** . . . . . \$85.00
- **Powell Announcer with Speaker.** This device plays a recorded message over & over again. Unused, original packing. Operates on 115 VAC . . . . . \$37.50
- **Westinghouse Scope Transformer.** Pri: 115 VAC @ 60 CPS (16.5 VA). Sec: 2.5 Volts @ 3 Amps. Sec: 3890 V. @ .0023 Amps. Brand new. Weight: 9 lbs. . . . . \$3.95
- **Aircraft-Lab Type Selenium Rectifier.** Full-wave bridge type. Input: 450 VAC (RMS). Output: 350 VDC @ 340 Ma. Encapsulated. Hermetically sealed. Oil Filled. . . . . \$7.95
- **Scintillation Counter.** Brand new. Orig. cartons. Ready to operate with fresh set of batteries. Reg. \$245.00. Special price \$49.95. Ten times more sensitive than usual Geiger Counter. Write for brochure.
- **HS-30 Headsets.** Hi-impedance (10,000 Ohms) with transformer, cord & plug. Used. Like-new cond. (10 for \$15.00). ea. \$1.59
- **Audio Devices Silicon Rectifier.** Input: 130 VAC @ 250 Ma. (10 for \$5.00). each 55¢
- **RCA Magic Brain Remote TV Control.** For remote control of many RCA TV sets. Complete in original RCA box. Write for details. Limited qty. Brand new. . . . . \$13.95
- **7 Ft. Relay Racks** with front and back doors. New. Beautiful grey. With hardware . . . . . \$49.95
- **Choke 50 Hy. @ 120 Ma.** Herm. sealed. 6½ lbs. . . . . \$1.00
- **Altec Lansing Hi-Fi Output Xfmr.** Pri: 3300 Ohms; Sec: 500/250 Ohms @ 20 Watts. ± 1 DB from 20 to 20,000 CPS. 10 lbs. \$4.95
- **TCS Noise Limiter Adapter Unit.** With spec. sheet. 1 lb. . . . . Price 99¢
- **Xmas Special — Deluxe \$29.95 Chrome plated Shoe-Dryer.** (115 VAC) Ideal for golfers, children, gardeners, etc. Special price . . . . . \$9.95
- **Xmas Special—Hands-Free Telephone Cradle-Amplifier.** No wires. Completely transistorized & battery operated. Free to speak and listen without holding phone. Time-saver. Beautiful beige finish. . . . . \$44.00
- **.35 Hy. 2 Amp Choke (2.2 Ohms DC resistance)** Hermetically sealed \$4.95. Open Frame . . . . . \$3.95
- **Hammarlund Super-Pro SP600 Receiver.** Excellent condition, lab tested. . . . . \$450.00
- **Ling Closed-Circuit TV Camera.** Brand new. Write for details. . . . . Approx. \$600.00
- **Evans Gasoline-Kerosene Heaters.** Value \$100.00. Brand new. Special. . . . . \$5.00
- **Geloso Tape Recorder** for Ham, entertainment, or business use. Brand new. 6½ lbs. Write for details.
- **Plate Transformer.** Sec: 6,000 -0- 6,000 VAC @ 400 Ma. Pri: 117 VAC @ 60 CPS. 108 lbs. Compact . . . . . \$70.00
- **Matching Choke** to above xfmr. 10 Hys. @ 750 Ma. . . . . \$13.00

Write for catalog. Largest, diversified, special-purpose, TV & Radio tube stock in USA at sensible prices. Prices F.O.B. NYC. Minimum order \$5.00. All mdse guaranteed for cost of mdse only.

## BARRY ELECTRONICS CORP.

512 Broadway, Dept. EW-1, New York 12, N.Y.  
Telephone Walker 5-7000

are described, along with observed results and conclusions, the material could also be of value to the audiophile with an extensive record or tape collection.

\* \* \*

**"SHORTWAVE PROPAGATION"** by Stanley Leinwoll. Published by *John F. Rider Publisher, Inc.*, New York. 147 pages plus a "Global Time Conversion Simplifier" insert. Price \$3.90. Soft cover.

This compact, information-crammed book will be of interest to both communications engineers and radio amateurs since it covers the basic principles of short-wave radio propagation and deals with all of the important theoretical as well as practical aspects of the subject.

The text material is divided into twelve chapters and covers the ionosphere, radio waves, the sky wave, measuring the ionosphere, ionospheric variations, circuit analysis, achievements of the radio amateur, the amateur bands around the cycle, forecasting, and the future.

The "Global Time Conversion Simplifier" which is included as a fold-out, wall-size chart is a "plus" feature which should prove exceedingly valuable to the SWL and the ham. —30—

### Answer to Puzzle Appearing on page 30



### PHOTO CREDITS

Page	Credit
38 (top & center), 39 (bottom right), 40 (top)	Federal Aviation Agency
38 (bottom)	Remington Rand
39 (left)	Airborne Instruments Laboratory
42 (top)	Aluminum Co. of America
42 (center)	Westinghouse Electric Corp.
42 (bottom)	Chance Vought Aircraft, Inc.
43 (top)	Philco Corp.
43 (center left)	General Precision Lab., Inc.
43 (center right)	Raytheon Co.
43 (bottom)	Radio Corp. of America
55 (top), 56 (top)	Station WGN
55 (bottom)	Russ Ogg
56 (center)	NBC
60, 61	PACO Electronics Co., Inc.
66	Bogen-Presto Co.
69	Harman-Kardon, Inc.
70 (top center)	New York City Transit Authority
84 (top)	General Electric Co.
84 (center)	Allen B. DuMont Labs.
112, 113	Channel Master Corp.
114	National Bureau of Standards
145 (top)	Vocaline Co. of America
146 (top)	Terado Company
146 (bottom)	EICO
147 (bottom)	Centralab
150	International Resistance Co.
153	Intercontinental Electronics Corp.
154	Sencore

## The Battery That's Used in Guided Missiles Now Released as Government Surplus

or Photography, Aircraft, Models, Searchlights, Radios, etc. **\$1.95 ea.** Postpaid



Sintered-plate Nickel-Cadmium alkaline storage batteries designed for "NIKE" Missile and now surplus due to design change. A lifetime battery with no known limit of service (over 5000 recharges on test without loss of capacity). Other features: Virtually indestructible, compact & lightweight, withstands heavy shock and vibration. Flat voltage curve during discharge retains charge year or more, high discharge rate up to 50 amps. for this cell, no corrosive fumes to harm clothing or equipment, spill-proof construction, discharge in any position, indefinite storage without deterioration, operates in temperatures -50° F to +200° F. Each cell is approx. 6 ampere hour capacity. Nominal voltage per cell is 1.2 volt. (A 6 V. battery requires 5 cells.) Cell size 6" H. x 2" W. x 1½" T. Wt. 6 oz. ea. Uses Potassium-Hydroxide (30% electrolyte). Negligible loss during lifetime service. Add only distilled water once a year. A fraction of Government cost.

Used Test Cells . . . . . \$1.95 ea. Postpaid  
Brand New Cells . . . . . 2.95 ea. Postpaid  
24 V. Battery (20 cells) in metal case used \$40.00 New \$60.00.

All cells guaranteed to your satisfaction or money refunded (less postage). Plastic battery cases may have slight cracks—repaired easily with household cement or you may add 25¢ to price of each to insure uncracked cases.

**ESSE RADIO COMPANY** Dept. J5  
42 W. South Street Indianapolis 25, Indiana

## CRYSTAL CONTROLLED CONVERTERS

POLICE • FIRE • COMMERCIAL



For use with  
12 V. Transistor type  
car radios—  
26-50 MC.

**\$24.50**

Can be self installed in seconds. Other models for 108-162 MC available. Also complete line of conventional powered converters, tuners and receivers.

A practical converter for emergency use with powered home or auto sets. Tuneable over 12 MC. 26-50 MC or 108-174 MC. . . . . **\$13.95**



Also available crystal controlled up to 54 MC. . . . . \$18.95

ORDER TODAY OR WRITE FOR LITERATURE

**KUHN ELECTRONICS**  
70 GLENWOOD CINCINNATI 17, OHIO

## TV PICTURE TUBES At Lowest Prices

10BP4	\$ 7.95	17BP4	\$ 9.95	21AMP4	\$15.75
12LP4	8.50	17CP4	17.00	21ATP4	15.75
14B/CP4	8.50	17GP4	17.60	21AUP4	15.75
16DP4	12.00	17HP4	12.50	21EP4	13.50
16EP4	12.75	17LP4	11.50	21FP4	14.50
16GP4	14.50	17QP4	9.95	21WP4	14.00
16KP4	9.95	17TP4	17.00	21YP4	14.50
16LP4	10.95	19AP4	16.00	21ZP4	13.50
16RP4	9.95	20CP4	13.50	24CP4	23.50
16WP4	12.00	20HP4	14.50	24DP4	24.50
16TP4	9.95	21AP4	22.10	27P4	39.95
17AVP4	12.50	21ALP4	15.75	27RP4	39.95

1 Year Warranty  
Aluminized Tubes \$5.00 more than above prices. Prices include the return of an acceptable similar tube under vacuum. These tubes are manufactured from reprocessed used glass bulbs. All parts and materials including the electron gun are brand new.

ALL PRICES FOR CHICAGO, ILLINOIS. Deposit required, when old tube is not returned, refundable at time of return. 25% deposit required on COD shipments. Old tubes must be returned prepaid. Tubes shipped Rail Express.

WRITE FOR COMPLETE LIST.  
**— PICTURE TUBE OUTLET —**  
3032 MILWAUKEE AVE.  
CHICAGO 18, ILLINOIS  
Dickens 2-2048





# ELECTRONICS MARKET PLACE

RATE: 60c per word. Minimum 10 words. March issue closes January 11th. Send order and remittance to ELECTRONICS WORLD, One Park Ave., N. Y. C. 16, N. Y.

## FOR SALE

SAMS Photofacts 1 to 352, 34 in book form, \$525.00. Box 3, West Redding, Conn.

ELECTRONICS Surplus—Wholesale and retail monthly, 12 issues, \$1. Box 784, Wash. 4, D.C.

DIAGRAMS for repairing radios \$1.00. Television \$2.00. Give make, model. Diagram Service, Box 672-RN, Hartford 1, Conn.

RADIO & TV Tubes at manufacturers prices. Guaranteed—Send for free price list. Edison Electronic Tube Co., Menlo Park, N. J.

PROFESSIONAL Electronic Projects—Organs, Timers, Counters, Intercoms, etc.—\$1. each. List Free. Parks, Box 1665, Lake City, Seattle 55, Wash.

TELEVISION Sets \$9.95, plus shipping. Jones TV, Sanatoga, Pa.

RADIO & TV Tubes at Manufacturers Prices! 100% Guaranteed! Brand New! No re-brands or pulls! United Radio, Box 1000, Newark, N. J.

TUBES—TV, Radio, Transmitting And Industrial Types At Sensibly Low Prices. New, Guaranteed, 1st Quality, Top Name Brands Only. Write For Free Catalog or Call WALKER 5-7000. Barry Electronics Corp., 512 Broadway, New York 12N, N. Y.

TELEVISION & Radio Tubes. Parts and Supplies Guaranteed. Hi-Quality Tube Co., Inc., 284 Lafayette St., Rahway, New Jersey.

GOVERNMENT SELLS: Surplus Electronics; Test Equipment; Oscilloscopes; Transceivers; Jeeps; Boats; Aircrafts; Misc.—Send for U. S. Depot Directory & Procedure \$1.00—"Government Surplus Sales," Box 425—RT, Nanuet, N. Y.

AUTO Radio Distributor Selling Servicing Becker Blaupunkt, FM-AM, other European, American Sets. Save 30% + Square Electronics, 150-60 Northern Blvd., Flushing, N. Y.

SURPLUS, Unused Shielded Hook-up wire, stranded, tinned copper, poly-vinyle chloride insulation, glass-braid, tinned copper shield, 1 conductor, AWG. 14. Recent manufacture—50 ft. 88c, 100 ft.—\$1.68—1,000 ft.—\$15.00. Shock mounts, Lord, flat, 1" O.D., 1/2" I.D., 4 mounting holes, 1 lb. and 2 lb. 12c ea. Switch, rotary, 4 sections, 5 positions, 4 pole, 4 moving contacts. Ceramic 49c. Relay Leach 9031-SS. 3 PDT, 24 28 VDC, Rating 10 Amps. Hermetically sealed—\$1.35. Relay, non-pileup, 1 PDT, 2u VDC, 5,000 Ohm 69c. Storage Battery, BB-52, 36 V at .08 Amp. Hr., Pin type terminals 49c. Relay, Leach, 2069, 3 PDT, 28 VDC, rating 12.5 Amps (removed from unused equipment) 79c. No C.O.D. Less than \$2.00 add 25c handling charge. E. K. O'Connor, Box 71, Round Lake, N. Y.

GOVERNMENT Surplus Receivers, Transmitters, Snooperscopes, Parabolic Reflectors, Picture Catalog 10c. Meshna, Malden 48, Mass.

TRANSISTOR and FM Radios. Lowest Prices. Free catalog. Myers Imports, 623 Gay, Knoxville, Tennessee.

TUBES—Radio and Television. Below manufacturers cost—Send for free price list—Orders shipped same day received. Standard Tube Distributors, 6810 Post Road, North Kingstown, Rhode Island.

MAKE Gizmos & Such, Still River, Mass. your headquarters for short wave radios, 25 varieties carried in stock, prices from \$50.00 to \$5000.00.

TECKTRONIX 515 Oscilloscope \$550.00. New Condition. Connecticut Instruments, Brookfield, Conn.

## RADIO ENGINEERING & INSTRUCTION

BACHELOR of Science in Electronics Engineering. Degree in 4 years of Home Study. No resident attendance necessary. Pacific International College of Arts and Sciences, Primarily a correspondence school. Resident classes also available if desired, 5719-U Santa Monica Boulevard, Los Angeles 38, California.

ELECTRONICS! Associate degree—29 months. Technicians, field engineers, specialists in communications, missiles, computers, radar, automation. Start February, September, Valparaiso Technical Institute, Dept. N, Valparaiso, Indiana.

C. LCOLUS, Powerful Modern Mathematics. Easy Practical Lessons, First Four \$1, Mathco, 4256-3 Minnor, Cincinnati 17, Ohio.

LEARN: Electronics. Radio & Television. Become a well-paid Technician in your own business, or in a good paying position. Either Residence or Home Study Course. American Technical School, P. O. Box 567, 923—8th. St., Des Moines, Iowa.

ENGINEERING and Art Degrees earned through home study. Electronics, Electrical, Mechanical, Civil, Physics, Business Administration, Liberal Arts. When writing, specify course desired. Pacific International College of Arts & Sciences, primarily a correspondence school. Resident classes also carried. 5719-C Santa Monica Boulevard, Hollywood 38, California.

USED Correspondence Courses and Books sold and rented. Money back guarantee. Catalog Free. (Courses Bought). Lee Mountain, Pisgah, Alabama.

DISGUSTED with "Hi" Hi-Fi Prices? Unusual Discounts On Your High Fidelity Requirements. Write. Key Electronics, 120 Liberty St., New York 6, N. Y. C. LOverdale 8-4288.

RECORDERS, Hi-Fi. Free Wholesale Catalogue. Carston 125-R East 88, NYC 28.

## REPAIRS and SERVICING

SPEAKERS repaired fast, any type, write for price list. JaMac, 8845 N.E. Sandy Blvd., Portland, Oregon.

ALL Makes High Fidelity Speakers Repaired. Amprite, 70 Vesey St., N.Y. 7, N.Y. BA 7-2580

## WANTED

CASH Paid! Sell your surplus electronic tubes. Want unused, clean radio and TV receiving, transmitting, special-purpose, Magnetrons, Klystrons, broadcast types. Want military and commercial lab test equipment such as G.R., H.P., AN UPM prefix. Also want commercial Ham Receivers & Transmitters. For a fair deal write: Barry Electronics Corp., 512 Broadway, New York 12, N. Y. (Walker 5-7000).

WANTED: Tubes-Special Purpose and Receiving. Top prices for Klystrons, Power Tubes, Thyratrons, T.V. and Receiving Tubes. Tubes must be unused. Also laboratory grade test equipment such as manufactured by HP and GR and AN UPM prefix. V. & H. Radio & Electronics, 2053 Venice Blvd., Los Angeles 6, California.

CASH For Used Short-Wave Ham Receivers, Transmitters & Accessories. Treger W9IVJ, 2023 N. Harlem Ave., Chicago 35. Tuxedo 9-6429.

CYLINDER and old disc phonographs. Edison, Conqueror, Idelia, and Oratorio models. Berliner Gramophones and Zono-o-phones, Columbia cylinder Graphophones, and coin-operated cylinder phonos. Want old catalogues and literature on early phonos prior to 1919. Will pay cash or trade late hi-fi components. Classified, Electronics World, Box 50, 1 Park Ave., N. Y. C. 16, N. Y.

WANTED: Surplus measurement model 78 or 80 signal generators. Also Federal 804 or used Motorola two-way equipment. State quantity, price and condition. Communication Service, Inc., 3209 Canton Street, Dallas, Texas.

## TAPE & RECORDERS

RENT Stereo Tapes—over 900 different—all major labels—free catalog. Stereo-Parti, 1608-L, Centinela Ave., Inglewood 3, California.

TAPE Recorders, Hi-Fi Components, Sleep Learning Kits, Tapes. Unusual Values. Free Catalog. Dressner, 69-02R 174 St., Flushing 65, N. Y.

AMPEX, Concertone, Crown, Ferrograph, Presto, Tandberg, Pentron, Bell, Sherwood, Rek-O-Kut, Dynakit, Others. Trades. Boynton Studio, 10RT Pennsylvania, Yonkers, N. Y.

RECORDERS, Stereo Tapes, Hi-Fi Components, Tremendous Values, Catalog, Efesco, 270-H Concord, West Hempstead, N. Y.

UNUSUAL Budget Values. Tape recorders, tapes and Hi-Fi components. Send for package quotations and free catalogue. Budget Hi-Fi Distributors, 83-06 Vieter Ave., Elmhurst, N. Y.

## HIGH-FIDELITY



INDUCTORS for Crossover Networks. 118 types in stock. Send for brochure: C & M Coils, 3016 Holmes Avenue N. W. Huntsville, Ala.

PRICES? The Best! Factory-sealed Hi-Fi Components? Yes! Send for free catalog. Audion, 25T Oxford Road, Massapequa, N. Y.

## STAMPS & COINS

TERRIFIC Stamp Bargain! Israel—Iceland—Vatican Assortment—plus exotic triangle set—also fabulous British Colonial Accumulation—Plus large stamp book—All four offers free—Send 10c to cover postage. Empire Stamp Corp., Dept. 22, Toronto, Canada.

THREE Brilliant uncirculated Mexican Silver Dollars \$1.00. Universal Services, Box 675, San Antonio 6-S1, Texas.

## SHOPPING GUIDE Classified

A HANDY GUIDE TO PRODUCTS, NOT NECESSARILY ELECTRONIC, BUT OF WIDE GENERAL INTEREST.

## BUSINESS OPPORTUNITIES

EARN Extra money selling advertising book matches. Free Samples furnished. Matchcorp, Dept. MD-10, Chicago 32, Ill.

MAKE \$25-\$50 Week, clipping newspaper items for publishers. Some clippings worth \$5.00 each. Particulars free. National, 81-0G, Knickerbocker Station, New York.

FOREIGN Employment Information—\$1 Parks, Box 1665A, Lake City, Seattle 55, Wash.

# PHOTOGRAPHY—FILM, EQUIPMENT, SERVICES

COLORFUL Autumn—New York State. Eight Color-slides \$1.00. Eddings. Roberts Ave., Corning, N. Y.

## HELP WANTED

WANT a good overseas or stateside job with higher pay?? Transportation paid. Men—Women. Free Information. Employment Headquarters, 79 Wall Street, Dept. R-4, New York 5.

OVERSEAS Employment. American Firms and United States Government. Comprehensive Job Information \$2.00. Foreign Opportunities, Box 172, Columbus 16, Ohio.

JOBS in Paris! Copenhagen! Rome, all Europe. Hi-paid jobs with American Companies thru Europe. Many jobs available. All Fields. Travel. Adventure in exciting Europe. Complete information, registration and six months' advisory service from Europe's oldest employment service: \$2.00 (\$2.50. Airmail). European Employment Service, P. O. Box 3973, Frankfurt/M. 1, Germany.

## MISCELLANEOUS

OPTICAL Bargains—Request Free Giant Catalog "CJ." 120 pages—Astronomical Telescopes, Microscopes, Lenses, Binoculars, Kits, Parts. Amazing war surplus bargains. Edmund Scientific Co., Barrington, New Jersey.

"WINEMAKING: Beer, Ale Brewing." Illustrated. \$2.00. Eaton Books, Box 1242-TC, Santa Rosa, California.

**ELECTRONICS WORLD**  
RADIO TV



**SEND  
ELECTRONICS  
WORLD  
EVERY  
MONTH**

name \_\_\_\_\_

address \_\_\_\_\_

city \_\_\_\_\_ zone \_\_\_\_\_ state \_\_\_\_\_

Check one:  3 years for \$12  
 2 years for \$ 9  
 1 year for \$ 5

In the U. S., its possessions, and Canada.

Payment enclosed  Bill me

Foreign rates: Pan American Union countries, add .50 per year; all other foreign countries, add \$1.00 per year.

Mail to: **ELECTRONICS WORLD**  
Dept. EW 160  
434 S. Wabash Ave., Chicago 5, Ill.

# INDEX OF

# Advertisers

JANUARY  
1960

ADVERTISER	PAGE NO.	ADVERTISER	PAGE NO.
Advance Electronics	158	International Resistance Company	110
Airex Radio Corporation	116	Jensen Industries, Inc.	124
Allied Radio Corp.	9, 102, 103, 104, 105, 132	Jensen Manufacturing Company	22
American Television & Radio Co.	8	Jerrold Electronics Corporation	135
Arkey	90	Johnson Co., E. F.	86
Ashe Radio Co., Walter	153	Key Electronics Co.	157
Astatic Corporation	33	Kuhn Electronics	160
Audax Division of Rek-O-Kut Co., Inc.	124	Lafayette Radio	108, 109
Audion	157	Lampkin Laboratories, Inc.	86
B & K Manufacturing Co.	73, 144	Lektron	157
Baltimore Technical Institute	152	Micro Electron Tube Co.	151
Barry Electronics Corp.	160	Milwaukee School of Engineering	156
Beam-Echo International Ltd.	117	Moss Electronic, Inc.	118, 119, 120, 121
Bell Telephone Laboratories	87	National Radio Institute	19, 20
Blonder-Tongue Laboratories, Inc.	107	National Schools	25
Bogen-Presto	145	North American Philips Co., Inc.	SECOND COVER
Burstein-Applebee Co.	149	Olson Radio Corporation	140
CBS Electronics	29	Pacific International College of Arts & Sciences	152
C & H Sales Co.	116	Paco Electronics Co., Inc.	18
Canadian Institute of Science & Technology Limited	126	Peak Electronics Company	154
Candee Co., J. J.	134	Pickering & Co., Inc.	126
Candler System Co.	106	Picture Tube Outlet	160
Capitol Radio Engineering Institute	96, 97, 98, 99	Platt Electronics Corp.	130
Carston Studios	159	Precision Electronics, Inc.	140
Century Electronics Co., Inc.	136, 137	RCA Institutes, Inc.	30, 31
Champion DeArment Tool Company	100	R W Electronics	134
Channel Master Corp.	6, 7	Rad-Tel Tube Co.	141
Cleveland Institute of Electronics	26, 27	Radio Corporation of America	111, FOURTH COVER
Columbia Electronics	106	Radio-Electronic Master	147
Coyne Electrical School	112, 134, 148	Radio Shack Corporation	101
DeVry Technical Institute	5	Rinehart & Co., Inc.	16, 86, 113
Diamond Electric Company	144	Sams & Co., Inc., Howard W.	128, 129
Dressner	159	Seg Electronics	149
Dual	126	Shure Brothers Inc.	88
Dynaco, Inc.	123	Sonotone Corp.	91
EICO	35, 36, 106	Sprague Products Company	34
Electro-Voice, Inc.	21	Sprayberry Academy of Radio-Television	23
Electronic Chemical Corp.	147	Standard Surplus	152
Electronics Division Book Service	156	Stromberg-Carlson	10, 11, 12, 13, 14, 15
Electronics World	155	TAB	138
Electronics World Direct Sales Dept.	153	Teltron Electric Co.	159
Electronics World Subscriptions	162	Terado Company	110
Electronics World Reprints	139	Texas Crystals	150
Esco C-B Hqts.	144	Thorens	125
Esse Radio Company	160	Tri-State College	157
Fair Radio Sales	146	Triplett Electrical Instrument Company	THIRD COVER
Fisher Radio Corporation	89	Tru-Vac Electric Company	133
G & G Radio Supply Co.	131	United Audio	126
Gonset Division	152	University Loudspeakers, Inc.	116
Goodheart Co., R. E.	143	Utah Radio & Electronic Corp.	3
Grantham School of Electronics	17	Valparaiso Technical Institute	159
Grommes Div. of Precision Electronics, Inc.	124	Van Nostrand Company, Inc., D.	114
Hallcrafters	151	Vocaline Company of America, Inc.	83
Harman-Kardon, Inc.	21	Weathers Industries	122
Heath Company	74, 75, 76, 77, 78, 79, 80, 81, 82	Weston Instruments	113
HiFi Review Reprints	158	Wigo	126
Hi-Mu Electronics	130	World Radio Laboratories	139
Hy-gain Antenna Products	24	Wuerth Tube Saver Corp.	144
Indiana Technical College	152	Xcelite, Incorporated	110
International Business Machines Corporation	92, 93	Zalytron Tube Corporation	115
International Electronics Corp.	127		



... the smartest move you can make

# is to TRIPLETT VOMs

... the world's most complete line of VOMs for every purpose!

**TRIPLET**  
Quality...  
First to last



**Model 639-N Case \$9.50.** Handsome, black cowhide leather. Center-cover flaps snap back for full view of scales and complete access to instrument without removal from case.

**Model Pt. T-225-A-33 Tester Stand \$0.50.** Metal, holds tester in approximately 45° angle; facilitates easy reading.

**Probe for High Voltage Testing \$14.50.** For models 630, 630-A, 630-PL, 630-APL, and 631. Completely insulated polystyrene; guard-type handle. 11¼" long; 48" hi-voltage wire lead with banana plug at tester end. Available in 0-12,000 AC or DC volts, and 0-30,000 AC or DC volts.

**Model 630-T \$54.50.** Specially designed for telephone maintenance. 2% accuracy on DC. Fused protected circuit protects resistors and meter in ohms ranges. Special neck strap holds instrument, freeing both hands. Banana jack connectors eliminate all shock hazard. Completely insulated case protects from ground.

**Model 666-R Pocket VOM \$29.50.** Hand size, ideal for electrical maintenance. With recessed range knob it fits easily into case. AC rectifier pre-calibrated unit for easy replacement. Banana jacks at panel top prevent leads falling over meter dial. Single king-size selector switch minimizes incorrect settings, burnouts. 20 ranges. Molded case streamlined, fully insulated.

**Model 666-HH Pocket VOM \$27.50.** Compact, hand-size, 3" meter integral with panel, adjusted to 400 microamperes at 250 millivolts. Only 3 jacks necessary for all ranges. 19 ranges.

**Model 625-NA \$54.50.** Dual sensitivity for extra ranges; large mirror scale for super readability. 3-color meter scale 5" long, 6" instrument. 0-50 microamp. AC volts at 10,000 Ω/V for checking many audio and high imped-

ance AC circuits usually requiring VTVM. 38 ranges. Molded insulated case.

**Interior View** showing advanced engineering features of all Triplett VOMs. Molded mounting for resistors and shunts allows direct connections without cabling. Eliminates shorts. Longer life.

**Model 630 \$44.50.** Popular, streamlined; long meter scales for easy reading. Outstanding linear ohm scale; low reading .1 ohm, high 100 megs. Single king-size selector-switch minimizes incorrect settings, burnouts. High sensitivity; 20,000 ohms per volt DC; 5,000 AC. Molded, fully insulated case.

**Model 630-A \$54.50.** Laboratory type; ½% resistors for greater accuracy. Long mirrored scale eliminates parallax. Banana jacks, low resistance connections; high flux magnet increases ruggedness. Single king-size selector switch minimizes incorrect settings, burnouts. Molded fully insulated case.

**Model 630-PL \$44.50.** Instant-vision, wider spread scales; streamlined case; handsome modern design. Unbreakable window. Outstanding linear ohm scale; low reading .1 ohm; high to 100 megs. Single king-size selector switch minimizes incorrect settings, burnouts. 5 to 500,000 cps frequency response in AC measurements. DC Polarity Reversing switch. High sensitivity; 5,000 ohms per volt AC; 20,000 ohms per volt DC.

**Model 10 Clamp-On Adapter \$14.50.** Checks line loads with model 310 (can also be used with 6 other models). Instant, accurate, safe. No circuit breaking or work interruption. Easy range switching. Available in 6 AC Ammeter ranges: 0-6-12-30-60-120-300. Clips around single wire to read AC. Amperes direct. Use with adapter 101 to instantly divide 2-conductor cords. Molded case fully insulated, black plastic with engraved white markings.

**Model 630-APL \$54.50.** Laboratory type with ½% resistors, more accurate movement. Long mirrored scales eliminate parallax. Unbreakable window. Single king-size switch minimizes incorrect settings, burnouts. 5 to 500,000 cps frequency response in AC measurements. DC Polarity Reversing switch. High sensitivity; 5000 ohms per volt AC, 20,000 ohms per volt DC. Molded case fully insulated.

**Model 630-NA \$74.50.** Super DeLuxe with 70 ranges; nearly double conventional types. Frequency compensated from 35 cps to 20 kc. Temperature compensated. Accurate within 1½% full scale reading on DC. Large open front meter easy to read. Unbreakable window. Mirrored scale. Meter protection against overloads. Molded fully insulated case.

**Model 631 Combination VOM and VTVM \$64.50.** Two fundamental units at the price of a single tester. The No. 1 instrument for all electronic men. Battery operation assures VTVM stability and long life. Sensitivity PLUS. 1.2 volt (VTVM) range is equal to more than nine million ohms per volt. Large easy to read meter with unbreakable face. Single king-size selector switch minimizes incorrect settings, burnouts. Molded case fully insulated.

**Model 310 \$34.50.** The only complete miniature VOM with 20,000 ohms per volt and selector range switch. Self-shielded against strong magnetic field. Rugged high torque, barring instrument. Unbreakable plastic meter window. Converts to common probe—frees one hand—by fitting interchangeable test prod into top. Standard sensitivity 20,000 ohms per volt DC, and 5,000 ohms per volt AC. Accuracy 3% DC. Molded fully insulated case.

**TRIPLET**  
Quality...  
First to last

TRIPLET ELECTRICAL INSTRUMENT COMPANY  
BLUFFTON, OHIO

The  
good  
news  
is getting  
around



Have you checked the big dealer profits  
on RCA Monogram Picture Tubes?

Head for your RCA Distributor...and get the facts firsthand!



**RADIO CORPORATION OF AMERICA**  
Electron Tube Division

Harrison, N. J.