

The How-To Book of ELECTRONICS

By the publishers of **ELECTRONICS ILLUSTRATED**

75c

Improve Your
CITIZENS BAND Performance



The ABC's of Transistors

- License-Free **WALKIE-TALKIES**
- How To Get Your **HAM RADIO** License
- New Low-Cost **STEREO** Amplifiers
- New **KITS** to Build
- Tips for Hotter **TV RECEPTION**

AMERICAN BASIC SCIENCE CLUB



Sensational LOW COST SCIENCE LAB

NOW over 110 fascinating projects with

SOUND **ELECTRICITY** **HEAT** **ELECTRONICS** **LIGHT** **ATOMIC ENERGY**

COMPLETE LABORATORY COMES IN 8 KITS, ONE A MONTH... SUPPLIES ALL THE EQUIPMENT FOR ALL THE FOLLOWING:

A REAL SCIENCE COURSE

Developed with World Famous
SOUTHWEST RESEARCH INSTITUTE

The 8 manuals are expertly written, clearly illustrated, excitingly different.

NO EXPERIENCE NECESSARY

You can complete every project and **GAIN A VALUABLE SCIENCE BACKGROUND** that will **ENRICH YOUR LIFE** and could **SHAPE YOUR FUTURE!**



Analyzing Glowing Gases with the **SPECTROSCOPE**

Trouble Shooting with the **SIGNAL TRACER**

PHOTOMICROGRAPH of a Fly's Wing made with Microscope and Photo Lab (Actual Size 5" diameter)

ELECTRICAL EXPERIMENTS
Educational fun with Electro-Magnets, Transformer, Galvanometer, Rheostat, Relay, Voltmeter, Wheatstone Bridge, and other electric equipment.

PHOTOELECTRIC EYE
Photoelectric Cell, Exciter lamp — complete outfit to learn to receive and transmit the Morse Code... the first step to a Ham License.

CODE PRACTICE SET
Signal Oscillator, Key and Flasher... the complete outfit to learn to receive and transmit the Morse Code... the first step to a Ham License.

RADIO SERVICE EQUIPMENT
All the parts to build your own Radio Signal Tracer and a Probe Light Continuity Tester. Both pieces are invaluable in radio servicing.

PHOTOGRAPHY LAB
Complete dark room equipment: Printer — Enlarger — Electronic Timer — Safe Light — Developing Trays and supply of paper and chemicals.

SPECTROSCOPE
Fascinating optical instrument used to identify and analyze substances by observing the spectrum of their flame. Spectrum charts are included.

ULTRAVIOLET LAMP
Produce dazzling color effects with invisible "black light". Used extensively for crime detection, mineralogy, and science. Fluorescent Ink, Crayon and Tracer Powder are included.

RADIO RECEIVER
Three Tube Short Wave (80 Meter) and Standard Broadcast Receiver. Sensitive Regenerative Circuit uses regular 115 volt AC. Complete with Head Set.

MICROPHONE
A sensitive carbon-button microphone that greatly amplifies unsuspected noise. Also adaptable for use with your radio transmitter.

STROBE LIGHT
A variable pulse neon lamp. "Freezes" motion of rapidly vibrating or rotating objects for close study and checking frequencies, RPM.

SOUND EXPERIMENTS
Laboratory demonstration of sound waves, resonance and pitch. Includes Variable Frequency Oscillator, Sonometer and Ripple Tank.

SLIDE PROJECTOR
Takes 16mm and 35mm slides, sharp focusing, convection cooled, G.E. Projection Lamp included. Also adaptable as a Projection Microscope.

ATOMIC RADIATION EXPM.
A variety of projects using Spintharoscope and sensitive Electroscopie. Sample sources of radioactive Uranium Ore and Radium are included.

HEAT EXPERIMENTS
Study the Molecular Theory of heat using 2 Thermometers, Thermostat, 3 Foot Gas Thermometer and special Microscope arrangement that shows the effect of Molecular Movement.

DC POWER SUPPLY
Power Transformer, Vacuum Tube Exciter and 20-20 mfd. Capacitor. Filter Circuit. Converts home AC to the DC required for Electronic Circuits.

ELECTRONIC EXPERIMENTS
Explore functions of vacuum tubes and other electronic components. Build an Electronic Switch—Amplifier, and other experimental circuits.

BROADCAST TRANSMITTER
Sends clear transmissions of both code and voice to nearby radios. Can be used with your microphone, record player, or code oscillator.

TELESCOPE
A mounted astronomical Telescope. High quality ground lenses enable you to examine details of the moon's surface and distant objects.

MICROSCOPE
High and low power, precision ground lenses, Substage Light and Polarizer. Adaptable for photomicrography in connection with Photo Lab.

ATOMIC CLOUD CHAMBER
See illuminated tracks of speeding nuclear particles emanating from radioactive Alpha source and mysterious cosmic rays from outer space.

WEATHER STATION
Aneroid Barometer, Cup Anemometer that electronically measures wind speed. Sling Psychrometer, Humidity Gauge, Cloud Speed Indicator, Cloud Chart and Weather Map.

ALL THE EQUIPMENT FOR ALL THE ABOVE—only \$29⁶⁰

SEND \$200 WITH COUPON ONLY **PAY \$345** FOR EACH KIT YOU RECEIVE (ONE A MONTH FOR 8 MONTHS) **FREE** SOLDERING IRON with second Kit

Your Satisfaction or Your Money Back... AND you may cancel at any time without obligation.

These "no risk" assurances because we know you will be...

SURPRISED! AMAZED! DELIGHTED!

A VALUABLE SCIENCE LAB
Containing Parts by **RCA, MALLORY, PYRAMID, STACKPOLE, TRIM** and other reliable manufacturers. Retail Value of Parts Alone is **over FIFTY DOLLARS**

FOR SAFETY!

Circuits are low voltage supplied by isolation transformer that comes with first kit.



FREE! These 6 Auxiliary Textbooks

MEMBERS ARE ENTHUSIASTIC!

I wish I could provide each of my Physics students with all of your enjoyable kits. You are doing a wonderful job.

Your course is very enjoyable and educational for all ages. I would not sell mine for twice the price.

Francis Pitzer
13 Friendship Dr.
Tivoli, New York

Allen T. Ayers, Physics Dept.
Jamestown High School
Jamestown, New York

AMERICAN BASIC SCIENCE CLUB

501 E. Crockett, San Antonio 6, Texas

Start sending me A.B.S.C.'s "Science Lab" in eight kits, one each month. If not satisfied on inspection of first kit I may return it for immediate refund. (I choose the plan checked.)
 I enclose \$2.00 and will pay \$3.45 plus COD postage on arrival of each kit. I may cancel unshipped kits at any time.
 I enclose \$29.60, full payment. Postage Paid, for all 8 kits. I may cancel any time and get full refund on unshipped kits.

NAME _____
 STREET _____
 CITY _____ STATE _____

MAIL COUPON TODAY

AMERICAN BASIC SCIENCE CLUB, Inc. San Antonio, Texas

**want to
double
your pay?**

**Move Ahead
in
ELECTRONICS**

*Get All
3 Free!*

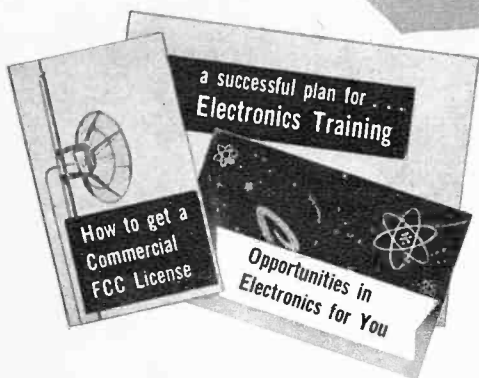

**Get This Handy Pocket
Electronics Data Guide**

Free...

Puts all the commonly used conversion factors, formulas, tables, and color codes at your fingertips. Yours absolutely free if you mail the coupon today. No further obligation!

**TO GET THIS FREE GIFT,
MAIL COUPON TODAY!**

FIND OUT how the FCC license helps you get a better job or increase your pay on your present job



MAIL COUPON TODAY

Cleveland Institute of Electronics

Cleveland Institute of Electronics
Desk EI-35, 1776 E. 17th St., Cleveland 14, Ohio

Please send Free Career Information prepared to help me get ahead in Electronics. I have had training or experience in Electronics as indicated below:

- | | |
|---|---|
| <input type="checkbox"/> Military | <input type="checkbox"/> Broadcasting |
| <input type="checkbox"/> Radio TV Servicing | <input type="checkbox"/> Home Experimenting |
| <input type="checkbox"/> Manufacturing | <input type="checkbox"/> Telephone Company |
| <input type="checkbox"/> Amateur Radio | <input type="checkbox"/> Other |

**Your FCC License
Or Your Money Back**

Completion of the Master Course (both Sections) will prepare you for a First Class Commercial Radio Telephone License with a Radar Endorsement. Should you fail to pass the FCC examination for this license after successfully completing the Master Course, you will receive a full refund of all tuition payments. This guarantee is valid for the entire period of your enrollment agreement.

**Cleveland Institute Announces
A New and Dynamic Technician Training Program in Computers, Servo Mechanisms, Magnetic Amplifiers, and Others.**

Other advanced fields covered include Basic Math, A. C. Circuit Analysis, Pulse Circuitry, Color TV, Radar, Advanced Measuring Techniques, Industrial Electronics, Instrumentation, Automation, Radio Telemetry. Send for information today.

**Accredited by the
National Home Study Council**

In what kind of work are you now engaged?

In what branch of Electronics are you interested?

Name Age

Address

City Zone State

EI-35

The How-to Book of Electronics

by Robert Hertzberg

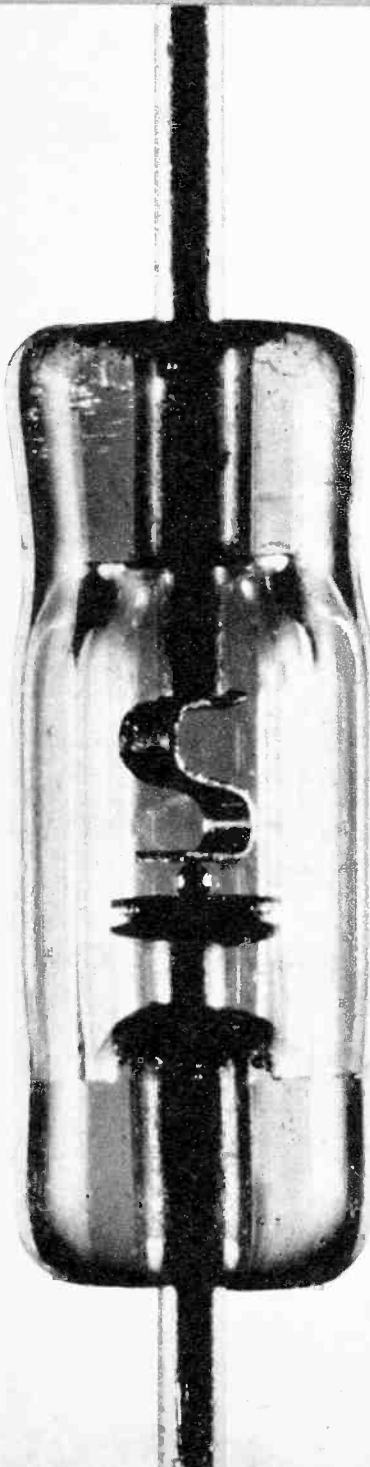

A FAWCETT BOOK • NUMBER 497
LARRY EISINGER • EDITOR-IN-CHIEF
GEORGE TILTON • MANAGING EDITOR
SILVIO LEMBO • ART EDITOR

W. H. Fawcett, Jr. President
Roger Fawcett General Manager
Donald P. Hanson . . . Assistant General Manager
Gordon Fawcett Secretary-Treasurer
Roscoe Fawcett Circulation Director
Ralph Daigh Editorial Director
James B. Boynton Advertising Director
Al Allard Art Director
Ralph Mattison Associate Art Director
George H. Carl Production Director

ROBERT D. FREED **EDITOR**
Susan B. Cole Editorial Assistant
Lou Rubsamen Layout

Staff Artists

NICK CARLUCCI **ASSOCIATE ART EDITOR**
Harold E. Price • Michael Gaynor
Bob Vatter • John S. Selvaggio
Ed Kaplan • Bill Miuccio
Richard Rhodes • Richard LoMonaco
Dan Ponte • John Rutig

Phyllis J. Bendremer Production Editor
Benita Rockwood Assistant Production Editor

THE HOW-TO BOOK OF ELECTRONICS, Fawcett Book 497, is published by Fawcett Publications, Inc., Greenwich, Connecticut. Editorial and Advertising Offices: 67 West 44th Street, New York 36, New York. General Offices: Fawcett Building, Greenwich, Connecticut. Printed in U.S.A. Copyright 1961 by Fawcett Publications, Inc.

Member of American Book Publishers Council

OUR COVER background was supplied by Sarkes Tarzian, Inc., Semiconductor Division. The Citizens Band transceiver is the Heath Model GW-10A and the Walkie Talkies are Lafayette Model HE-29. The Transistor Training Device is RCA Institutes' Model 601-T.

The Silicon Planar Diode on this page is manufactured by Fairchild Semiconductor, Mountain View, California. The background on page 6 was supplied by Texas Instruments Incorporated.

These men are getting practical training in **NEW Shop-Labs of**

ELECTRICITY

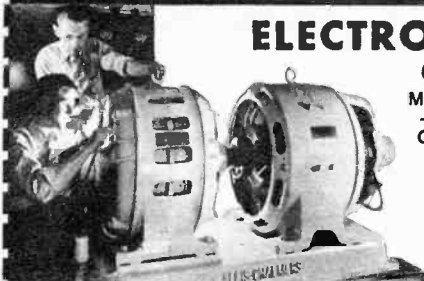

ELECTRONICS ON REAL

Motors—Generators
—Switchboards—
Controls—Modern
Appliances—
Automatic
Electronic
Control Units

TELEVISION



RADIO ELECTRONICS ON REAL

TV Receivers—
Black and White
and Color
AM-FM and
Auto Radios
Transistors
Printed Circuits
Test Equipment

COYNE

in Chicago—prepare for today's **TOP OPPORTUNITY FIELD**. Train on real full-size equipment at COYNE where thousands of successful men have trained for over 60 years—largest, oldest, best equipped school of its kind. Professional and experienced instructors show you how, then do practical jobs yourself. No previous experience or advanced education needed. Employment Service to Graduates.

START NOW—PAY LATER—Liberal Finance and Payment Plans. Part-time employment help for students. **GET FREE BOOK**—"Guide to Careers" which describes all training offered in **ELECTRICITY** and **TELEVISION-RADIO ELECTRONICS**—no obligation; **NO SALESMAN WILL CALL.**

Coyne Electrical School, 1501 W. Congress Parkway
Chartered Not For Profit • Chicago 7, Dept. 81-9C

MAIL COUPON OR WRITE TO ADDRESS BELOW

COYNE ELECTRICAL SCHOOL
Dept. 81-9C —New Coyne Building
1501 W. Congress Pkwy., Chicago 7, Ill.

Send **BIG FREE** book and details of all the training you offer. However, I am especially interested in:

Electricity Television Both Fields

Name _____

Address _____

City _____ State _____



COYNE offers
LOW COST

TELEVISION RADIO - COLOR TV

Training in
Spare Time **AT HOME**

The future is **YOURS** in **TELEVISION!**
A fabulous field—good pay—fascinating work—a prosperous future in a good job, or independence in your own business!

Coyne brings you **MODERN-QUALITY** Television Home Training; training designed to meet Coyne standards at truly lowest cost — you pay for training only — **no costly "put together kits."** Not an old Radio Course with Television "tacked on." Here is **MODERN TELEVISION TRAINING** including **Radio, UHF and Color TV.** No Radio background or previous experience needed. Personal guidance by Coyne Staff. **Practical Job Guides** to show you how to do actual servicing jobs — **make money early in course.** Free Lifetime Employment Service to Graduates.

COYNE
ELECTRICAL SCHOOL

CHARTERED AS AN EDUCATIONAL INSTITUTION
NOT FOR PROFIT

1501 W. Congress Parkway • Chicago 7, Dept. 81-H9



B. W. COOKE, Jr., President
Coyne—the Institution behind this training... the largest, oldest, best equipped residential school of its kind. Founded 1898.

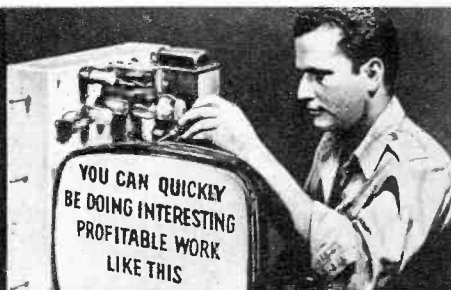

Send Coupon or write to address below
for **Free Book**

and full details,
including easy
Payment Plan.
**No obligation, no
salesman will call.**



COYNE Television Home Training Division

Dept. 81-H9 New Coyne Building
1501 W. Congress Pkwy., Chicago 7, Ill.

Send **Free Book** and details on how I can get Coyne Quality Television Home Training at **low cost and easy terms.**

Name _____

Address _____

City _____ State _____

CONTENTS

Semiconductors

Fundamentals of Transistors	12
Punch-Board Transistor Trainer	28
The Zener Diode	32
Practical Circuits for the 2N307 Transistor	40
Fixed Capacitors in Transistor Circuits	46

Ham Radio

How to Start in Ham Radio	58
You CAN Master the Code	66
QSL's Are a Hobby in Themselves	68
Propagation Pioneers Win Edison Amateur Award	70
Electronic Keys	74
Two Meters is Fun!	78

Citizens Band

The No-License Walkie Talkies	86
Peak CB Equipment Performance	92

Service Ideas

Bring Your TV Reception Up to Par	96
Tape Tips	132

Special Features and Projects

All About The Decibel	52
3-D Radar for Missile Ships	56
Fun on the Special Frequencies	84
New Tubes for Home-Radio Receivers	106
AC-DC Stereo Amplifiers	110
"Loud-Speaking" Telephone	116
Wireless Intercom	120
Isolation Transformer Shock-Proofs Electronic Equipment	126
News from the FCC	133
Potting Protects Parts	138

**In Spare Time at Home . . . PREPARE FOR A BETTER JOB
 . . . OR YOUR OWN BUSINESS in One of Many Branches**

of **ELECTRONICS**

RADIO - TELEVISION - RADAR



**NEW!
 NEW!
 NEW!**

Shown above is the valuable new combination oscilloscope and voltmeter which DeVry Tech men build during the new training program. But that's not all! New movies, new experimental projects—all prepare you thoroughly in this latest and greatest DeVry Tech training program.

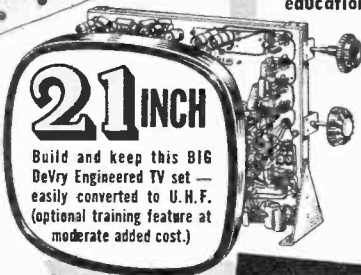

21 INCH

Build and keep this BIG DeVry Engineered TV set—easily converted to U.H.F. (optional training feature at moderate added cost.)

If you are seeking a better job or a business of your own, the appealing field of Television-Radio-Electronics offers **REAL PROMISE!**

In this fast-growing field, trained Electronic technicians find many good-paying, interesting jobs in manufacturing, installing, operating, servicing. Equally important is the fact that these are **GOOD JOBS**—offering the kind of a future that an untrained man often dreams about.

No previous technical experience or advanced education needed. Prepare for this profitable field in your spare time at home, or in our modern Chicago or Toronto Laboratories. Nothing else like it! Send for **FREE** details.

EARN WHILE YOU LEARN!

After you get part of DeVry Tech's training with equipment at home, you may then in your spare time, begin to earn real money servicing Radio and Television sets.

Your Guide to Profitable Job Opportunities!

- TV-Radio Broadcast Technician
- Color Television Specialist
- Radar Operator • Laboratory Technician
- Airline Radio Man • Computer Specialist
- Quality Control Manager
- Your Own Sales & Service Shop
- . . . PLUS MANY OTHERS

HOME MOVIES



. . . make important points crystal clear. Speeds your learning. It's almost like having an instructor at your side!

COLOR TV

DeVry Tech's program also includes training in Color Television

MILITARY SERVICE

If you are subject to military service, the information we have should prove very helpful. Mail coupon today.

YOU ALSO GET . . .

the same **EMPLOYMENT SERVICE** that has helped thousands of our graduates toward fine careers in Electronics.

You work over **300** Learn-By-Doing projects

Build over 300 practical projects from many shipments of Radio-Electronic parts. You build and operate TV-Radio circuits... wireless microphone... and many other major projects—all designed to provide outstanding practical experience at home.

Send for 2 FREE Booklets Now!

Accredited Member of National Home Study Council
 "One of North America's Foremost Electronics Training Centers"



ACT NOW! Get information-packed publication **FREE!** Mail coupon today.

DeVRY TECHNICAL INSTITUTE
 4141 Belmont Ave., Chicago 41, Ill., Dept. PRE-R
 Please give me your **FREE** booklet, "Electronics and YOU," and tell me how I may prepare to enter one or more branches of Electronics.

Name _____ Age _____
 PLEASE PRINT
 Street _____ Age _____
 City _____ Zone _____ State _____

For details of Canadian Training Programs, address DeVry Tech of Canada, Ltd., 2044-A 970 Lawrence Avenue West, Toronto 19, Ontario

DeVRY TECHNICAL INSTITUTE

CHICAGO 41, ILLINOIS





INTRODUCTION

The field of electronics has such infinite variety that is almost impossible for you, the experimenter, engineer, technician, or hobbyist not to be able to find a niche in which to completely indulge yourself.

A few areas that you'll read about here are transistors, amateur radio, Citizens Band radio, and stereo hi-fi. There are reports on the latest kits for your home, workshop, and the ham shack.

Semiconductors are explained in excellent theory articles on transistors and zener diodes. And if you've been thinking of studying transistor theory formally at home, read the article on RCA Institutes' Transistor Training Device on page 28.

Stereo hi-fi has not been overlooked. The article on low-cost AC-DC amplifiers on page 110 could give you a good start on your first budget system.

If you're a tinkerer at heart and occasionally supplement your income with service work, check the suggestions for improving TV performance and read the tips on tape recorder maintenance.

Want to become a ham? The construction of a complete station for the beginner is described and there's advice on learning the code easily and quickly. (We have the full story on a new compact two-meter transceiver kit.)

You CBers haven't been forgotten. There's news on license-free walkie talkies and hints on improving the performance of your transmitter.

Robert Hertzberg and the editors of Electronics Illustrated magazine have prepared this book with the expectation that each of you will find something new and valuable in its pages.

Cast your ballot for a successful future!

249 I.C.S. COURSES



I.C.S. is the oldest and largest correspondence school. 249 courses. Business, industrial, engineering, academic, high school. One for you. Direct, job-related. Bedrock facts and theory plus practical

application. Complete lesson and answer service. No skimping. Diploma to graduates.

Send for the 3 free booklets offered below and find out how I.C.S. can be your road to success.

ACCOUNTING

Accounting
Auditing
Cost Accounting
General Accounting
Junior Accounting
Practical Accounting
Public Accounting

ADVERTISING

Advertising
Magazine & Newspaper
Advertising

ARCHITECTURE

AND BUILDING CONSTRUCTION
Architectural Drawing & Designing
Architectural Interiors
Architecture
Building Contractor
Building Contractor with Drawing
Building Estimator
Building Maintenance
Carpenter-BUILDER
Carpentry & Millwork
House Planning
Lumber Dealer
Mason
Painting Contractor
Reading Arch. Blueprints
Reading Struct. Blueprints

ART

Advertising Layout & Illustration
Amateur Artist
Commercial Art
Commercial Cartooning
Fashion Illustrating
Figure Drawing & Painting
Magazine Illustrating
Show Card & Sign Prod'n
Sign Painting & Designing
Sketching & Painting

AUTOMOTIVE

Auto Engine Tune-up
Automobile
Automobile Body Rebuilding and Refinishing
Automobile Electrical Technician
Automobile Technician
Diesel Engines

Diesel-Gas Motor Vehicle Engines
Gas Engines
Internal Combustion Engines

AVIATION

Aero-Engineering Technology
Aircraft & Engine Mechanic
Aviation Engine Mechanic

BUSINESS

Business Administration
Business Correspondence
Business Law
Business Management
Business Management & Marketing
Business Management & Production
Business Psychology
Canadian Business Management
Clerk-Typist
Commercial
Condensed Business Practice
Federal Tax Course
Managing a Small Business
Marketing
Office Administrative Engineering
Office Management
Professional Secretary
Programming for Digital Computers
Purchasing Agent
Retail Business Management
Shorthand
Stenographic
Typewriting

CHEMICAL

Analytical Chemistry
Chemical Engineering
Chemical Engineering Unit Operation
Chemical Laboratory Technician
Elements of Nuclear Energy
General Chemistry
Industrial Analytical Chemistry
Industrial Chemistry
Professional Engineer—Chemical

PULP AND PAPER

Paper Making
Pulp & Paper Engineering

Pulp & Paper Making
Pulp Making

CIVIL ENGINEERING

Bridge & Building Foreman
Civil Engineering
Construction Engineering
Highway Engineering
Mine Surveying & Mapping
Principles of Mapping
Professional Engineer—Civil
Railroad Engineering
Roadmaster
Sanitary Engineering
Section Foreman
Sewage Plant Operator
Structural Engineering
Surveying and Mapping
Water Works Operator

DRAFTING

Aircraft Drafting
Architectural Drafting
Drafting & Machine Design
Electrical Drafting
Electrical Engineer Drafting
Electronic Drafting
Industrial Piping Drafting
Junior Mechanical Drafting
Mechanical Drafting
Sheet Metal Drafting
Structural Drafting

ELECTRICAL

Elec. Appliance Servicing
Electrical Contractor
Electrical Eng'g (Power Plant option)—Electronic option
Electrical Engineering Tech.
Electrical Instrument Tech.
Electric Motor Repairman
Illumination Eng'g Tech.
Industrial Electrical Tech.
Power-House Engineering
Power-Line Design and Construction
Practical Electrician
Practical Lineman
Professional Engineer—Electrical
Reading Electrical Blueprints

HIGH SCHOOL

Good English
High School Business
High School College Prep (Arts)

High School College Prep (Engineering & Science)
High School General
High School Mathematics
High School Secretarial
Modern Letter Writing
Short Story Writing

LEADERSHIP

Industrial Foremanship
Industrial Supervision
Personnel-Labor Relations
Supervision

MATHEMATICS

Mathematics and Mechanics for Engineers
Mathematics and Physics for Engineers
Mathematics and Physics for Technicians

MECHANICAL

Industrial Engineering
Industrial Instrumentation
Junior Mechanical Engineering
Mechanical Engineering
Professional Engineer—Mechanical
Quality Control
Introductory Technical Writing

PETROLEUM

Natural Gas Production & Transmission
Oil Field Technology
Petroleum Production
Petroleum Prod'n Eng'g
Petroleum Refinery Operator
Petroleum Refining
Petroleum Technology

PLASTICS

Plastics Technician

PLUMBING, HEATING,

AIR CONDITIONING
Air Conditioning
Air Conditioning with Draw'g
Air Conditioning
Maintenance
Domestic Heating with Oil & Gas
Domestic Refrigeration
Heating
Heating & Air Conditioning with Drawing

Heating, Drawing & Estimat'g
Plumbing
Plumbing, Drawing & Estimating
Plumbing & Heating
Plumbing & Steamfitting
Practical Plumbing
Refrigeration & Air Conditioning
Steamfitting

RAILROAD

Air Brake Equipment
Car Inspector & Air Brake Diesel Electrician
Diesel Engineer & Fireman
Diesel Locomotive Diesel Machinist
Railroad Administration
Railroad Car Repairer

SALESMANSHIP

Creative Salesmanship
Real Estate Salesmanship
Retail Merchandising
Retail Selling
Sales Management
Salesmanship
Salesmanship & Sales Management

SHOP PRACTICE

Boilermaking
Electrical Welding
Foundry Practice
Gas and Electric Welding
Gas Welding
Heat Treatment of Metals
Industrial Metallurgy
Machine Shop Inspection
Machine Shop Practice
Machine Shop Practice & Toolmaking
Metallurgical Engineering Technology
Physical Quality Control of Metals
Practical Millwrighting
Reading Shop Blueprints
Resistance Welding Technology
Rigging
Safety Engin'g Technology
Sheet Metal Worker
Tool Design
Tool Engineering Technology

Toolmaking
Welding Engineering Technology

STEAM AND DIESEL POWER

Combustion Engineering
Power Plant Engineering
Stationary Building Eng'g
Stationary Diesel Eng'g
Stationary Diesel-Electric Engineering
Stationary Fireman
Stationary Steam Eng'g
Steam Engine Operation

TEXTILES

Carding and Spinning
Carding
Cotton Manufacturing
Cotton Waring & Weaving
Dyeing & Finishing
Hosiery and Circular Knitting
Loom Fixing
Spinning
Synthetic Fabric Manufacturing
Synthetic Throwing, Waring & Weaving
Textile Designing
Textile Engineering
Textile Mill Supervisor
Woolen Manufacturing
Worsted Manufacturing

TRAFFIC

Motor Traffic Management
Railroad Rate Clerk
Traffic Management

TV-RADIO-ELECTRONICS

Gen'l Electronics Technician
Industrial Electronics
Practical Radio-TV Eng'g
Radio Operating
Radio Servicing
Radio Servicing with Practical Training
Radio & TV Servicing
Radio & TV Servicing with Practical Training
Servicing Electr'n'c Devices
Servicing Sound Equip't
Practical Telephony
Telephony and Radio Communications
TV Receiver Servicing
TV Technician

For Real Job Security—Get an I. C. S. Diploma! I. C. S., Scranton 15, Penna.

Accredited Member,
National Home Study Council

INTERNATIONAL CORRESPONDENCE SCHOOLS



BOX 84228K, SCRANTON 15, PENNA.

In Hawaii reply P.O. Box 418, Honolulu

Without cost or obligation, send me "HOW to SUCCEED," the opportunity booklet about the field I have indicated below, and a sample lesson (Math.)

Name of the course in which you are interested _____

Your Name _____ Age _____ Home Address _____

City _____ Zone _____ State _____ Working Hours _____ A.M. to _____ P.M. _____

Occupation _____ Canadian residents send coupon to International Correspondence Schools, Canadian, Ltd., Montreal, Canada. . . . Special low monthly tuition rates to members of the U. S. Armed Forces.

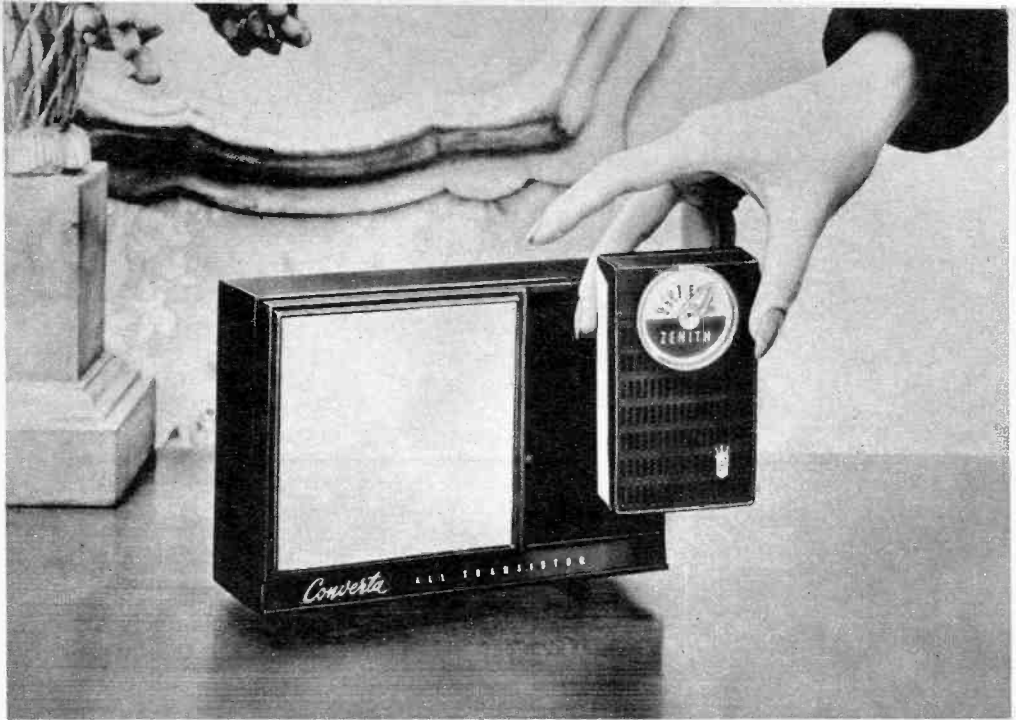

Improve Transistor-Radio Tone WITH LARGER SPEAKER

POCKET-SIZE transistor radios are a big commercial success because they are small, light, and can be conveniently carried anywhere. However, they do have one undeniable shortcoming: very limited tone quality. This is to be expected as long as their loudspeakers are 2" or less in diameter. Speech is intelligible but music usually sounds very tinny.

To improve the performance of its small radio when it is used indoors in the home, office, or shop, Zenith developed an ingenious auxiliary cabinet containing a larger speaker. As shown above, the receiver fits snugly in the right end of the "Converta" cabinet and becomes an integral part of it. Connection to the larger speaker is made automatically when the radio is pushed into position.

The overall dimensions of the "Converta" are 5 $\frac{3}{4}$ " high x 7 $\frac{3}{4}$ " wide x 3" deep. Being self-powered, the complete assembly is easily moved from place to place.

It should be obvious to any electronics technician that this idea is readily adapt-

able to a variety of transistor radios and even some of the small, hand-held Citizens Band transceivers. It is a simple job to pull out two wires from the existing small speaker and to extend and connect them to a larger external speaker. In some radios there already is an earphone jack to which connection can be made without disturbing the existing wiring at all.

Of course, it must be realized that the output power of the pocket-size radios is very low. Some radios with minimum circuitry may not sound any better even through a larger speaker. There's certainly no harm in making the experiment with 3" to 6" speakers.

It is also entirely practical to add a push-pull amplifier stage to boost the output. The amplifier can be transistorized and built into the speaker cabinet. And if you plan to use the radio and supplementary amplifier indoors it would certainly be practical to build a power supply to operate the amplifier on AC house current rather than on batteries. •

BREAK THROUGH TO HIGHER PAY

in ELECTRONICS

TV-RADIO

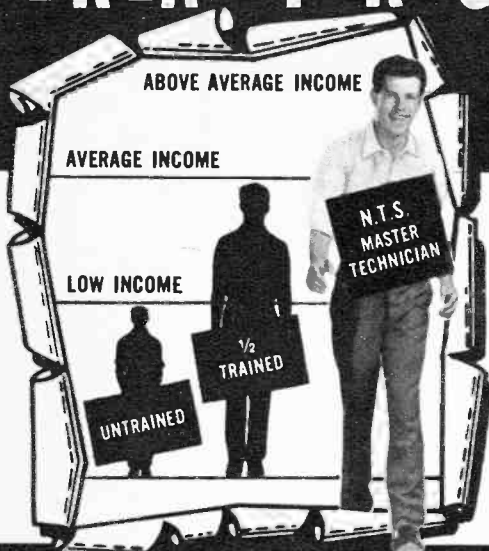

START NOW! Break through the Earning Barrier that stops half-trained men. N.T.S. "All-Phase" training prepares you — at home in spare time — for a high-paying CAREER in Electronics — TV — Radio as a **MASTER TECHNICIAN**. One Master Course at One Low Tuition trains you for unlimited opportunities in All Phases: *Service, Communications, Preparation F.C.C. License, Broadcasting, Manufacturing, Automation, Radar and Micro-Waves, Missile and Rocket Projects.*

A more rewarding job... a secure future... a richer, fuller life can be yours! As an **N.T.S. MASTER TECHNICIAN** you can go straight to the top in industry... or in your own profitable business.

You work on actual job projects

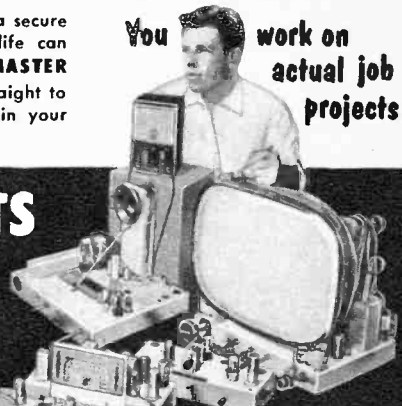

SUCCEED IN MANY HIGH-PAYING JOBS LIKE THESE...

- TV-Radio Sales, Service and Repair
- Profitable Business of Your Own
- Communications Technician — F.C.C. License
- Hi-Fi. Stereo & Sound Recording Specialist
- TV-Radio Broadcasting Operator
- Technician in Computers & Missiles
- Electronics Field Engineer
- Specialist in Microwaves & Servomechanisms
- Expert Trouble Shooter
- All-Phase Master Technician

19 BIG KITS YOURS TO KEEP

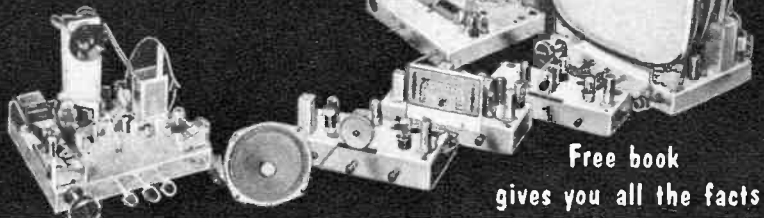

Free book gives you all the facts

NATIONAL TECHNICAL SCHOOLS

WORLD-WIDE TRAINING SINCE 1905
4000 SO. FIGUEROA ST., LOS ANGELES 37, CALIF., U.S.A.
Write Dept. R6E-111



N.T.S. Shop-Tested HOME TRAINING is **Better, More Complete, Lower Cost**... and it is your key to the most fascinating, opportunity-filled industry today!

YOU LEARN QUICKLY AND EASILY THE N.T.S. SHOP-TESTED WAY

You get lessons, manuals, job projects, unlimited consultation, graduate advisory service. You build a Short Wave-Long Wave Superhet Receiver, plus a large-screen TV set from the ground up, with parts we send you at no addi-

tional cost. You also get a Professional Multimeter for your practical job projects.

EARN AS YOU LEARN... WE SHOW YOU HOW!

Many students pay for entire tuition — and earn much more — with spare time work they perform while training. You can do the same... we show you how.

SEND FOR INFORMATION NOW... TODAY! IT COSTS YOU NOTHING TO INVESTIGATE.

RESIDENT TRAINING AT LOS ANGELES

If you wish to take your training in our Resident School at Los Angeles, the world's TV capital, start NOW in our big, modern Shops, Labs, and Radio-TV Studios. Here you work with latest Electronic equipment — professionally installed — finest, most complete facilities offered by any school. Expert friendly instructors. Personal attention. Graduate Employment Service. Help in finding home near school — and part time job while you learn.

WRITE FOR SPECIAL RESIDENT SCHOOL CATALOG AND INFORMATION



ACCREDITED MEMBER... the only nationally recognized accrediting agency for private home study schools.

N.T.S. HOME TRAINING is

- Classroom Developed
- Lab-Studio Planned
- Shop-Tested
- Industry-Approved
- Specifically Designed for Home Study.



MAIL COUPON NOW for

FREE BOOK and ACTUAL LESSON

NO OBLIGATION!
NO SALESMAN WILL CALL

NATIONAL TECHNICAL SCHOOLS

WORLD-WIDE TRAINING SINCE 1905

Mail Now To
National Technical Schools, Dept. R6E-111
4000 S. Figueroa St., Los Angeles 37, Calif.

Please rush FREE Electronics-TV-Radio "Opportunity" Book and Actual Lesson. No Salesman will call.

Name _____ Age _____
Address _____
City _____ Zone _____ State _____
 Check here if interested ONLY in Resident Training at Los Angeles.
VETERANS: Give date of discharge _____





Hold that bucket, bud! You can make yourself a candidate for electrocution and ruin the set and nearby furnishings if you're too free with water.

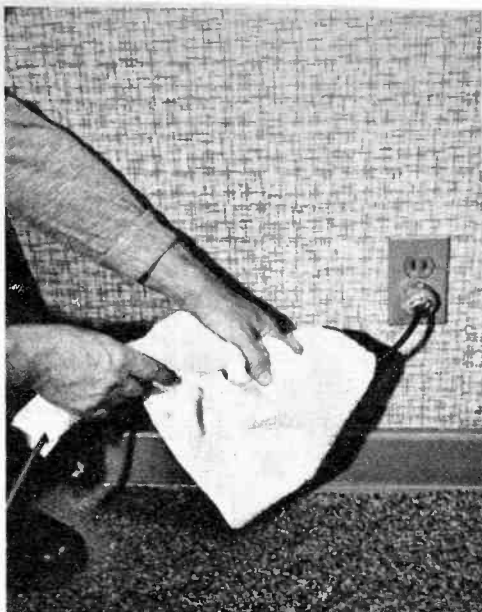

If a TV receiver, radio or other household appliance starts to smoke or smell bad, the first thing to do is pull the power cord out this way.

TV Safety

Blankstown, Pa., Sept. 24, 1960—John Elton, 50 years old, of nearby Smithtown, was electrocuted today when he tossed a bucket of water on a burning television set.

* * *

THIS paraphrase of an actual newspaper obituary tells of an utterly needless tragedy. In the second half of the twentieth century, people have grown so accustomed to appliances and entertainment devices of many kinds that they tend to forget that electricity is potentially very dangerous.

Many owners of TV receivers have the vague notion that high voltage is rampant on the chassis, and therefore contact with the chassis should be avoided. This is advisable as a general safety precaution, but actually it is the relatively low-voltage house power that is the real killer. While the higher voltages in the TV set may run from 7,000 to 15,000 volts, the maximum current that can flow even in a direct short circuit is limited by the design of the TV equipment to a few microamperes (millionths of an ampere). Experience indicates that electrocution occurs only when a much larger current, in the order of a few milliamperes (thousandths of an ampere) goes through the body and paralyzes the heart.

What makes a seemingly innocent wall outlet so lethal is its ability to furnish 15 or 20 amperes (15,000-20,000 milliamperes), with no strain at all. The water-throwing incident is easily explained. The water doused the TV set and the floor and undoubtedly ran quickly to the radiator pipes. The victim then attempted to move the set which was probably the hot-chassis (one side of the power line grounded to the chassis) type. A circuit was then established from the live side of the power line, through his body back to the grounded side of the line via the thoroughly wet rug causing electrocution.

The safety precautions to be observed in cases of electrical fire now appear to be pretty obvious:

1) Disconnect the appliance by pulling out the line cord. If it is dry, there's no danger in grasping it barehanded. For extra peace of mind, wrap it with a handkerchief, napkin, or towel. Cottons, linens, silks, synthetics, etc., are all excellent insulators.

2) If the fire is confined to the equipment, try to smother it with a blanket or large towel. Avoid using water unless house furnishings have caught on. Excessive water often does more damage than the fire itself.

3) If conditions really get out of hand, call the local fire department. •

ARE YOU "ON TARGET?"

Test Yourself.....

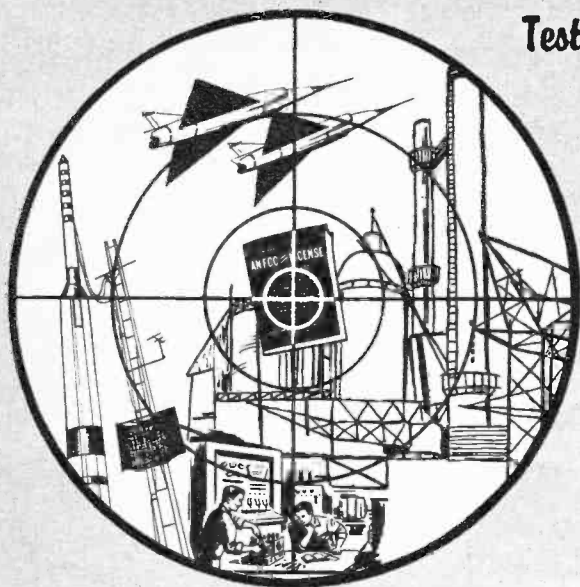

ANSWER THESE QUESTIONS:

- DO YOU want to get into **ELECTRONICS**?
- Do you have a **SPECIFIC OBJECTIVE** in mind ... Are you shooting at a particular target (such as an FCC License)?

NOTE: The First Class Commercial FCC License is a nationally recognized certification of electronics knowledge... **PROOF** of qualifications in meeting U. S. Government requirements for certain jobs. Many companies which employ industrial electronics technicians require them to have this license. If you want a job in electronics, set your sights on an FCC License as your No. 1 objective.

- Do you want the kind of training that will take you straight to this objective **QUICKLY**... without wasting valuable time on non-essentials?

Go Grantham Training for You?

CHECK THESE FEATURES:

- Grantham teaches the *theory* of electronics. Every basic concept of electronics fundamentals is covered in the Grantham course... whether you take it in resident classes or by home study. Grantham training "*makes electronics yours*."
- You can get your First Class FCC license **IN ONLY 12 WEEKS** in Grantham resident classes (or, in a correspondingly short time in the Grantham home-study program). **THINK OF IT!** A *commercial* U. S. Government license... **PROOF OF YOUR** qualifications in meeting these U. S. Government requirements as an electronics communications technician... a nationally recognized certificate. By preparing you for this license in only 12 WEEKS, Grantham conserves **YOUR TIME!**
- Mature men select Grantham Schools for electronics training. (The average age of Grantham Students is 28.8 years.) **MATURE MEN** want a definite objective (not a pot of gold at the end of the rainbow). Grantham training has this specific objective: To prepare you for your First Class FCC license and greater earning capability. The Grantham Course is for mature men who *know what they want*.

- Grantham Schools' tuition rates are low, yet the instructional service is not equalled by many of the *most expensive schools!* Grantham can do this because of highly efficient instructional methods and because Grantham has a sincere desire to out-do all others in service rendered per tuition-dollar. Grantham has established *reasonable* tuition rates. And, the percentage of students who successfully complete the Grantham course — and who get their FCC licenses — is one of the highest in the nation.
- YOU GAIN RESPECT** by showing your Grantham diploma, once you earn it. **YOU GAIN RESPECT** by showing and posting your First Class FCC License — a nationally recognized certification of your electronics knowledge. Many companies which employ industrial electronics technicians require them to have this license. **YOU CAN GET IT IN ONLY 12 WEEKS.** Let Grantham show you how!

HERE'S PROOF: Here is a list of a few of our recent graduates, the class of license they got, and how long it took them:

	License	Weeks
Thomas Schutte, 736 Clinton, Hamilton, Ohio	1st	12
Louis W. Pavak, 838 Page St., Berkeley 10, Calif.	1st	16
William F. Bratton, Jr., 435 Etna Street, Russell, Ky.	1st	12
Darrell E. Cloce, 25 E. 32nd St., Kansas City, Mo.	1st	12
P. B. Jernigan, Route 2, Benson, North Carolina	1st	12
Claude Franklin White, Jr., c/o Radio Sta. WJMA, Orange, Va.	1st	12
John M. Morgan, c/o KIRI-TV, 1530 Queen Anne Ave., Seattle, Wash.	1st	9 1/2

Get your First Class Commercial F. C. C. License Quickly by training at



GRANTHAM SCHOOL OF ELECTRONICS

1505 N. Western Ave.
Hollywood 27, Calif.
(Phone: HO 7-7727)

408 Marion Street
Seattle 4, Wash.
(Phone: MA 2-7227)

3123 Gillham Road
Kansas City 9, Mo.
(Phone: JE 1-6320)

821 - 19th Street, N.W.
Washington 6, D. C.
(Phone: ST 3-3614)

MAIL COUPON NOW — NO SALESMAN WILL CALL →

(Mail in envelope or paste on postal card)

To: **GRANTHAM SCHOOL OF ELECTRONICS**

1505 N. Western • 408 Marion • 3123 Gillham Rd. • 821-19th, NW
HOLLYWOOD SEATTLE KANSAS CITY WASHINGTON

Please send me your free booklet telling how I can get my commercial F.C.C. license quickly. I understand there is no obligation and no salesman will call.

Name _____ Age _____
Address _____
City _____ State _____

I am interested in: Home Study, Seattle classes
 Hollywood classes, Kansas City classes, Washington classes

G-1B

Fundamentals of Transistors



Many sizes and shapes, but all small. Collection of typical transistors in spoon for size comparison. Larger ones are used in high-power applications.

THE development of many new inventions in the field of electronics should not be startling to us. One new invention after another has led us to believe that this is the normal way of advancement of the electronics industry. We have accepted these inventions and proved to ourselves how they operate by applying our knowledge of basic theory. However, transistors are an entirely new concept and require more than just basic electronics to understand their operation.

The transistor has many advantages over the vacuum tube. Transistors are generally housed in tiny cylinders less than an inch long. They weigh a fraction of an ounce, have no filaments, consume very little power, have long operating lives, are solid in construction, rugged and are free from microphonics. In addition, transistors have no warm up time. They can be made impervious to the weather and in special applications can even operate under water. Their associated circuitry is greatly simplified. They can oscillate, amplify, function as an electronic switch, mixer, modulator and detector.

The study of the transistor is best begun by reviewing the structure of matter. We can best describe matter as that substance of which any physical object is composed.

Portions of this material copyrighted 1958 by Radio Corporation of America and reprinted with its permission.

Take water, for example. If we were to repeatedly divide a given quantity of water until we had the smallest amount of water and still not change its chemical characteristics, we would have one molecule of water. A molecule is, therefore, the smallest amount of a given substance. The single molecule of water can be further divided into elements of oxygen and hydrogen. The smallest subdivision of an element is called an atom. A molecule of water can be split into two atoms of hydrogen and one atom of oxygen. In the study of transistors we will be dealing with atoms of germanium, silicon, antimony, arsenic, aluminum and gallium. It will be necessary for us to consider the atomic structure of these atoms.

The Germanium Atom

Germanium is one of the elements commonly used in the manufacture of transistors. A germanium atom is graphically illustrated in Fig. 1a. It consists of a nucleus in the center and tightly bound electrons surrounding it. Upon closer examination it can be seen that the nucleus is composed of 32 protons which constitute the principal part of its mass. These protons exhibit a positive charge of electricity.

The nucleus is surrounded by 32 electrons which rotate in fixed orbits. The four electrons in the outer ring are not as tightly bound to the nucleus as those electrons in the inner rings. The electrons in this outer ring are called *valence electrons*. We are mainly concerned with the valence elec-

trons and therefore, we can simplify the diagram of the germanium atom as shown in Fig. 1b. Here we show a net charge of (+) four in the nucleus which is the total number of protons in the nucleus, minus the tightly bound electrons.

The Silicon Atom

Silicon is another element used in the construction of transistors. In Fig. 2a a silicon atom is illustrated. There are 14 protons in its nucleus and 10 tightly bound electrons surrounding it. The valence electrons are shown in the outer ring; as in the germanium atom, there are four.

The simplified diagram of a silicon atom is illustrated in Fig. 2b, showing only the net charge on the core and the valence

electrons. You will notice it looks exactly like the germanium atom. In fact, germanium or silicon can be used equally well in the making of transistors.

We mentioned earlier that antimony and arsenic, in addition to germanium and silicon, can be used in the making of transistors. In Fig. 3a are the simplified diagrams of these elements. Note that there are 5 valence electrons for these elements and a net charge of 5 protons. It is important at this time to realize that the number of valence electrons may differ for various elements.

The final two elements with which we shall deal are aluminum and gallium. In Fig. 3b we can see that there are 3 valence electrons and a net charge of 3 protons in

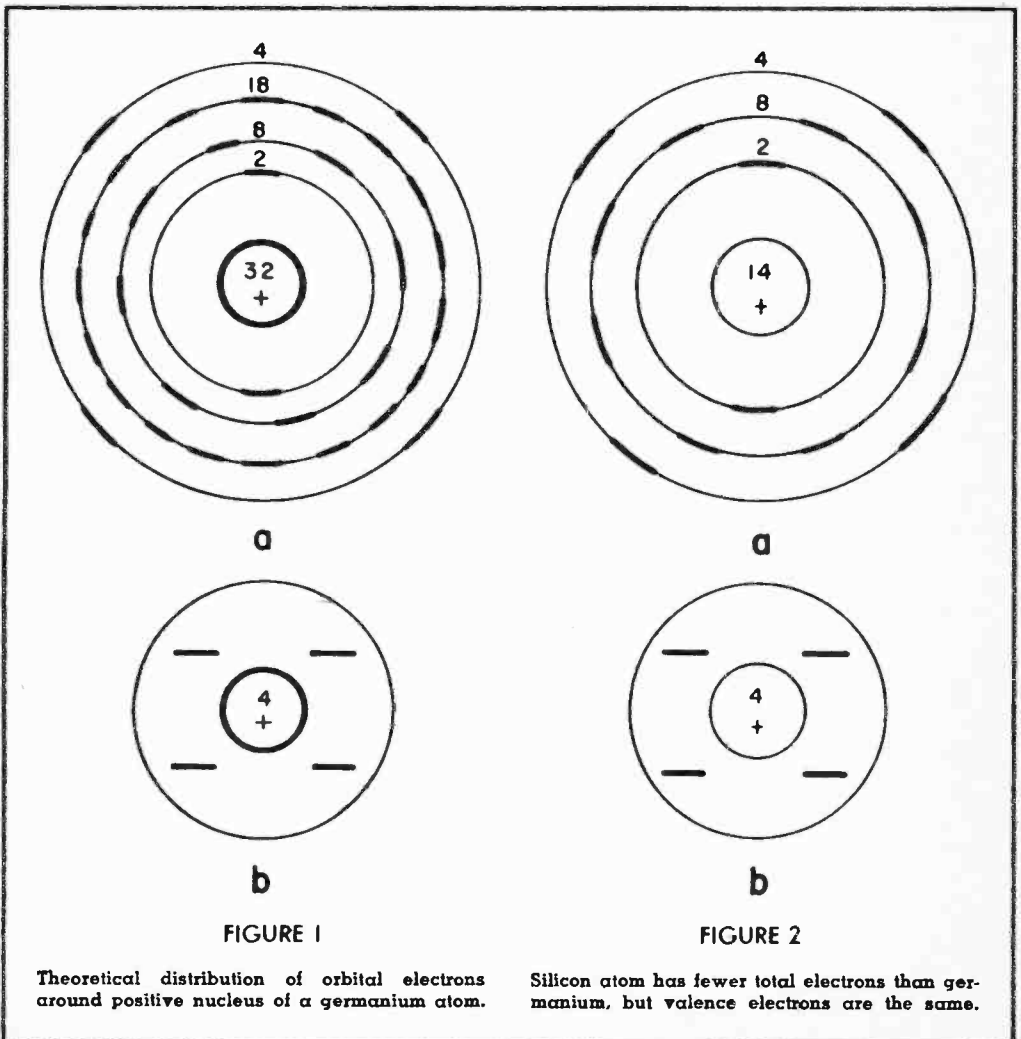

the nucleus. We shall see shortly how these atoms of various valences are put to use in the making of transistors.

Crystal Structures

Certain substances have the ability to take on a very stable crystalline form. The best known is the diamond. In this crystalline form valence rings of adjacent atoms interlock with each other. This action of binding the valence rings together is known as the formation of covalent bonds. Germanium also has the ability to form covalent bonds. Fig. 4 shows the plan by which a pure germanium crystal is formed. Upon examination of the structure you can see that electrons of neighboring atoms interlock with one another.

Keeping in mind the structure of the atom, specifically the valence electrons, we can say whether a particular element is classified as a conductor or insulator by the degree of difficulty with which the electrons can be dislodged from the outer ring. Those elements in which the electrons cannot be dislodged easily are called insulators. Those elements in which the electrons can be dislodged easily are good conductors. An element which falls somewhere between is a *semiconductor* and is the basic material of which transistors are made.

Semiconductors

The semiconductors most often used for transistors are germanium and silicon. For transistor action it is necessary to control the electrical properties of the semiconductor material. This control is achieved by the addition of minute quantities of impurities. The impurity can be any of several elements such as antimony, arsenic, aluminum or gallium. The ratio of impurity to germanium need be only 1 part to 10 million. Depending on the type of impurity used, two types of semiconductors will result; namely N-type or P-type.

N-Type Germanium

Impurities such as arsenic or antimony, having five electrons in their valence ring, may be added to germanium. Four valence electrons of the impurity atoms form covalent bonds with their neighboring germanium atoms. The fifth electron is free to drift through the crystal structure.

The effect of adding arsenic or antimony to the germanium or silicon crystal is illustrated in Fig. 5. Impurities that have a valence of five are called *pentavalent-type* impurities or *donors* because they donate electrons to the semiconductor crystal.

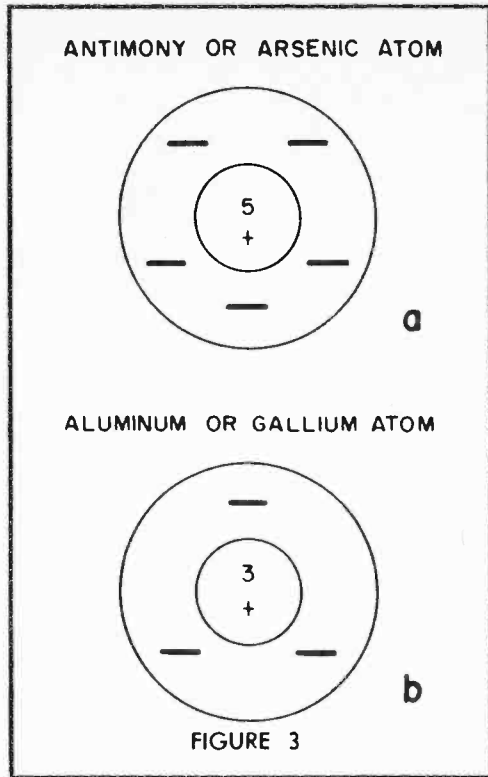

Quantitative distribution of valence electrons of antimony, arsenic, aluminum and gallium atoms.

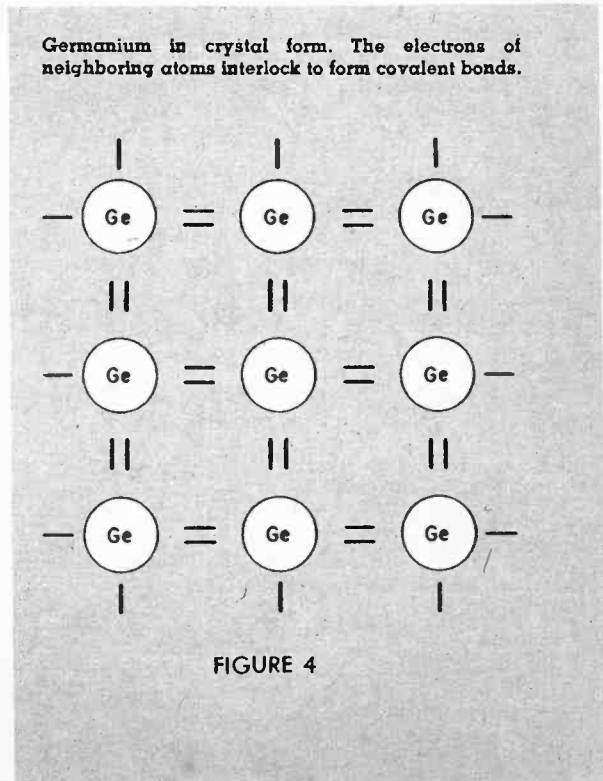

FIGURE 4

If we were to connect a battery across this type of semiconductor, conduction takes place. The free electron in the semiconductor is attracted by the positive potential and enters the positive terminal of the battery as shown in Fig. 6. Simultaneously, an electron leaves the negative terminal of the battery and enters the semiconductor. Thus, a continuous flow of electrons is maintained from the negative to positive terminal as long as the battery potential remains. This type of semiconductor is called N-type.

P-Type Germanium

A second method of modifying a semiconductor is by the addition of aluminum or gallium to germanium. In our discussion of elements we noticed that the aluminum and gallium atoms had a valence of three. Remember that the aluminum or gallium atom has one less valence electron than does the germanium or silicon atom. Therefore, one covalent bond is incomplete, resulting in a deficiency of an electron or the presence of a "hole." This is illustrated in Fig. 7. Impurities that create a hole in germanium or silicon are *trivalent*, meaning a valence of three and are called *acceptors* because they take electrons from the germanium crystal. This type of semiconductor with acceptor impurities is termed *P-type* germanium.

Let us examine how conduction takes

place in a P-type semiconductor. Fig. 8a illustrates a piece of P-type semiconductor with the hole shown near the center. In reality it may be located any place but for simplicity let us have it exist in the center. A battery is also shown. The instant the battery is connected, an electron from an adjacent covalent bond moves from its present position and fills the hole. This action is illustrated in Fig. 8b. The movement of this valence electron creates a vacancy in the covalent bond it just left. Once again an electron from a covalent bond nearer the negative terminal moves out of the bond and fills the hole. This action is illustrated in Fig. 8c. The hole is now located on the extreme end of the semiconductor. In this position there is room for an electron from the supply (negative terminal) to enter the semiconductor and fill the hole. The instant an electron enters the semiconductor from the battery an electron from a covalent bond nearest the positive terminal of the battery leaves the semiconductor and enters the positive terminal of the battery. The removal of this electron from a covalent bond results in the formation of a hole. An electron must leave the semiconductor in order to maintain the *original characteristic*; that is, to have a deficiency of one electron. This action is illustrated in Fig. 8d. It is possible for conduction to take place within the P-type semiconductor because by the ap-

Addition of a small amount of arsenic to germanium crystal increases number of free electrons.

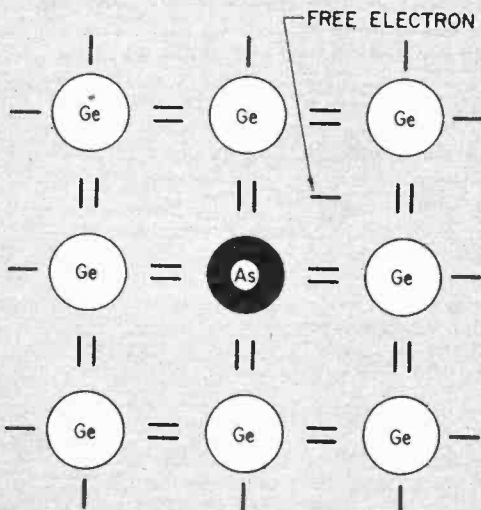

FIGURE 5

Free electrons in N-type crystal move under influence of battery and constitute current flow.

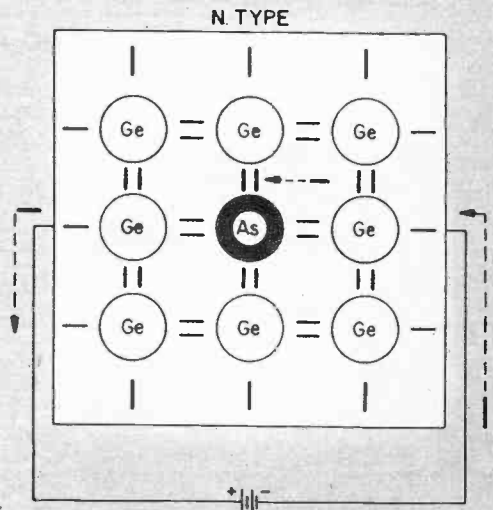

FIGURE 6

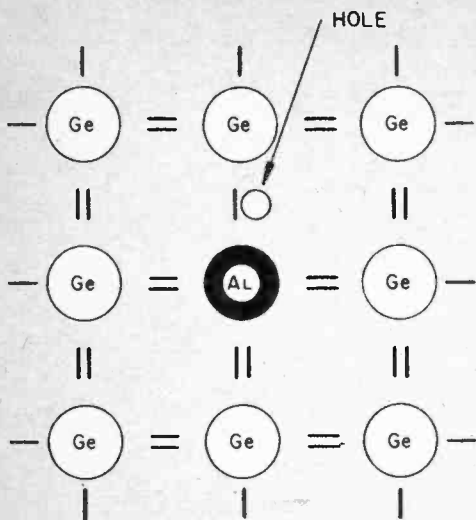

FIGURE 7

When aluminum is added to germanium crystal it takes electron from latter and creates a hole.

At right, electrons from battery fill holes and cause movement and current flow in the crystal.

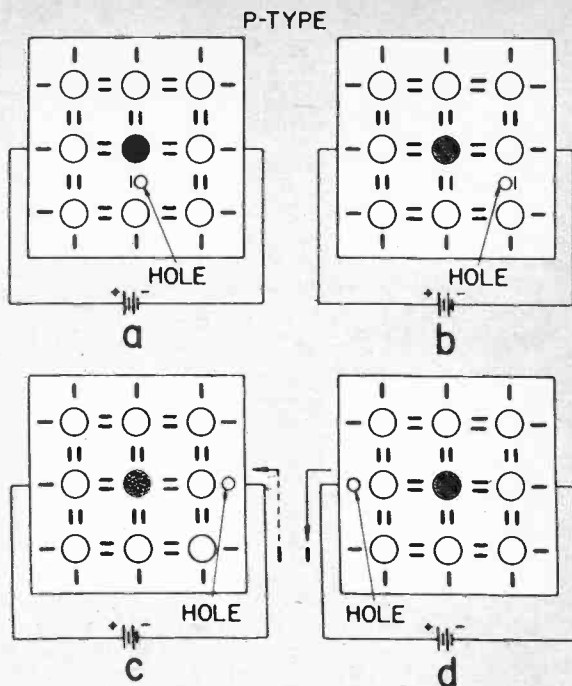

FIGURE 8

plication of an external supply (battery), valence electrons are made to move into the hole made by the preceding movement of the valence electrons from an adjacent covalent bond. This process is in effect as though the hole was moving toward the negative battery potential. Actually it is the valence electrons that are moving; however, for ease of explanation we will consider hole movement in preference to electron movement in P-type semiconductors.

Now we have two types of semiconductors, the N-type and the P-type. The N-type is formed by a donor when arsenic or antimony joins the crystal structure in which electrons are the principal current carriers. The P-type semiconductor is formed when an acceptor such as aluminum or gallium joins the crystal structure. In this instance holes are the principal current carriers.

Absolutely pure germanium or germanium having an equal number of donor and acceptor atoms, has an intrinsic characteristic. Conduction in this type of semiconductor can take place only if the covalent bonds are broken down by external energy in form of heat or light. Very pure germanium exhibits some intrinsic conductivity at normal room temperature.

The PN Junction

The electrons or holes in semiconductors of either N or P type are constantly on the move or drifting about in an irregular manner. This intrinsic activity takes place without the presence of an external potential. As we mentioned in discussing the manufacture of N-type semiconductors, the impurity atom is of the pentavalent type. Keep in mind that the nucleus of the impurity atom is +5 and there are a total of 5 electrons surrounding the impurity atom. This is equal in number to the nucleus and, theoretically, the impurity atom exhibits no charge. This is not always the condition, since the excess electrons are always on the move.

Consider the excess electron having moved from its present association with the impurity atom. This time the charge of +5 in the nucleus cannot be equaled by the 4 valence electrons surrounding it. Therefore, the impurity atom takes on a charge of +1.

It can be seen, then, that as long as the electron is associated with the impurity atom, the atom exhibits no charge and as soon as the electron moves away, the impurity atom takes on a +1 charge.

In the P-type semiconductor there is a

similar activity. The introduction of impurity atoms of the trivalent type into germanium results in a deficiency of an electron or the formation of a hole. This hole is not fixed in the crystal structure but in effect moves about. In considering the trivalent impurity atom, we know it has a charge of +3 in its nucleus. Because of its thieving nature it takes an electron from a neighboring valence bond to add to its own 3 valence electrons; as a result, there is one more electron than necessary to satisfy the +3 charge on the nucleus. The end result is that the impurity atom takes a -1 charge. As long as the hole is associated with the impurity atom, the atom exhibits no charge; as soon as the hole is filled, the impurity atom takes on a -1 charge.

Although this activity is going on within the semiconductor without an applied potential, the total mass of the N or P type semiconductors does not exhibit a charge. That is, we cannot measure a plus or minus charge on either type.

Keeping this in mind, let us form a piece of germanium with P-type semiconductor on one end and N-type on the other. This

is illustrated in Fig. 9, which shows the free holes in the P-region and free electrons in the N-region. The area in the center is designated as the P-N junction. It might appear that some of the free electrons would inadvertently diffuse across the junction, but because of the negative charge exhibited by the fixed impurity atoms in the P-region, they are repelled as illustrated in Fig. 10. This is caused by the simple fact that unlike charges attract and like charges repel. The free holes in the P-region remain there for the same reason. That is, the fixed donor atoms in the N-region exhibit a positive charge, thus repelling the holes. The potential which exists at the junction because of the unlike charges on either side is commonly called the *potential gradient* or *potential energy barrier*.

Current Flow

Let's connect a battery across a P-N junction as illustrated in Fig. 11, and examine the effects. The holes will move to the left toward the negative potential of the battery. Simultaneously, the electrons will move to the right toward the positive

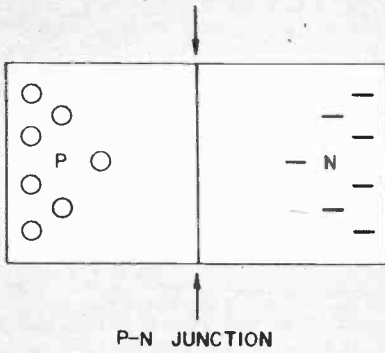
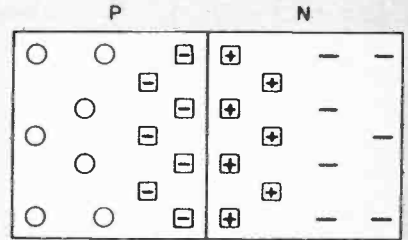

FIGURE 9



- FREE HOLES
- FREE ELECTRONS
- ⊖ NEGATIVE CHARGED ACCEPTOR ATOM
- ⊕ POSITIVE CHARGED DONOR ATOM

FIGURE 10

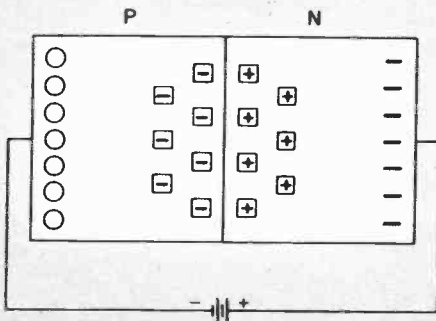

FIGURE 11

Fig. 9. PN junction is formed by joining of thin slices of P and N-type semiconductor material.

Fig. 10. Polarity relationships of charges in PN junction when no external voltages are applied.

Fig. 11. This battery connection reverse biases the PN junction and prevents the flow of current.

terminal of the battery. This movement of holes and electrons effectively increases the potential barrier at the junction and there is less chance for electron flow through the P-N junction. We can, therefore, conclude that the resistance to current flow has been increased. The battery connected in this manner is sometimes referred to as *reverse bias*.

Now let us take the same P-N junction and reverse the external battery connections. This is illustrated in Fig. 12. This method of connection effectively decreases the potential barrier at the junction and decreases the resistance to current flow.

The electrons present in the N-region move toward the junction due to the negative potential of the battery. Some of the electrons are forced across the junction and enter the P-region where they combine with existing holes. For each combination, a covalent bond in the P-region nearest the positive terminal of the battery breaks down and the liberated electron enters the positive battery terminal. This action creates a new hole which moves toward the junction. Simultaneously, for each electron that combines with a hole in the P-region, another electron enters the N-region from the negative terminal of the battery and moves toward the junction. The total current flowing through the semiconductor material is composed of electron flow in the N-region and hole flow in the P-region. The battery connected in this manner is sometimes referred to as *forward bias*.

It is obvious now that the junction formed by the N and P type semiconductors is capable of rectification. If an AC signal were applied across the P-N junction, as illustrated in Fig. 13, current would flow during the positive half cycle and there would be little or no current flow during the negative half cycle. This rectifying device is commonly referred to as a *junction diode*.

PNP and NPN Junction Transistors

Although there are many variations of a junction transistor, we can easily understand their operation if we consider them being assembled as a sandwich. The outside layers are relatively thick as compared to the very thin center layer. The important fact is that the semiconductor material is used alternately, such as NPN or PNP. These types are represented by the illustrations in Fig. 14. The leads are identified as the emitter, base and collector.

The transistor illustrated in Fig. 15 is of the NPN type. It is impossible for either holes or electrons to overcome the poten-

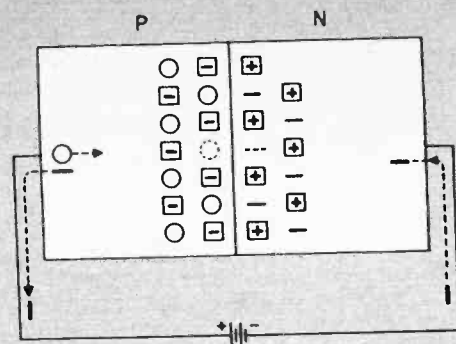

FIGURE 12

Battery is connected to forward bias PN junction causing an electron movement and current flow.

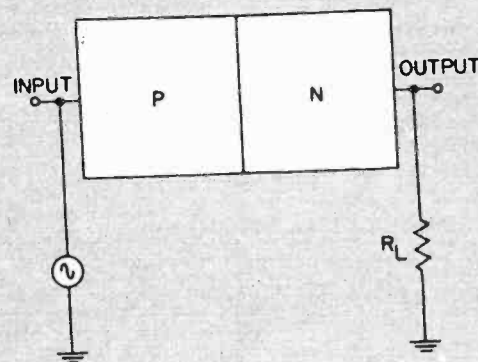

FIGURE 13

A PN junction is commonly referred to as a junction diode and is used to rectify alternating current.

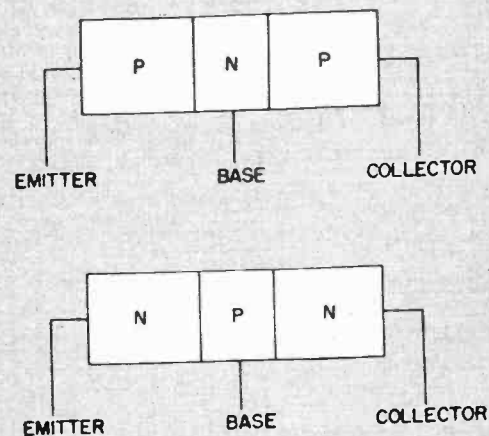

FIGURE 14

Sandwich construction of PNP and NPN transistors. Base section, not drawn to scale, is very thin.

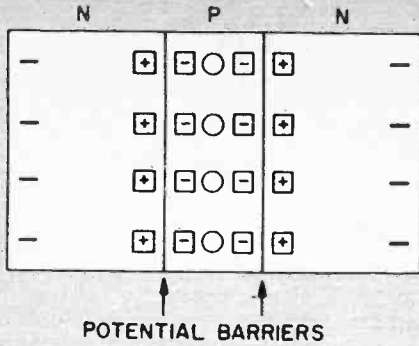

FIGURE 15

Because of the potential barrier at each PN junction, there normally will not be a current flow.

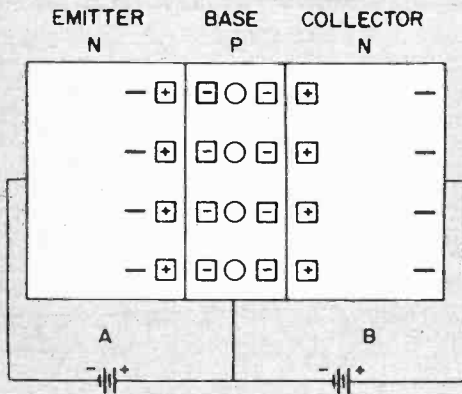

FIGURE 16

With the emitter-base junction forward biased, electrons pass through the base to the collector.

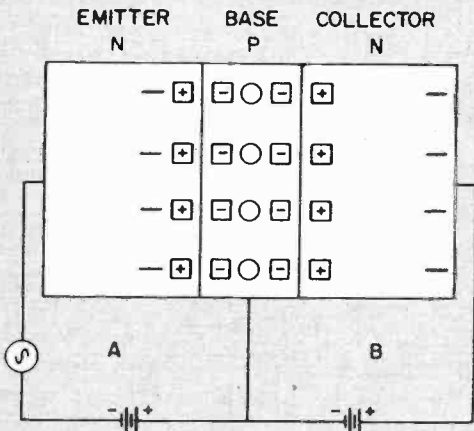

FIGURE 17

AC input signal, when added to emitter-base forward bias, causes a variation in collector current.

tial barriers formed at the two junctions. Consequently, current flow is not possible without the application of an external voltage source.

Now let us take the NPN transistor and connect the external voltage sources illustrated in Fig. 16. After studying the P-N junction we know that battery A connected as shown, will in effect, reduce the potential barrier between the emitter and base regions. Also, we know that battery B, connected as shown, will in effect increase the potential barrier between the base and collector regions. This battery arrangement will cause electrons to flow from the emitter into the base region. Because the base region is so very thin, most of the electrons will not combine with the holes in this region but will pass into the collector region. This electron passage is possible due to the fact that voltage source B, connected across the second P-N junction, is of such polarity that it favors the entrance of electrons from the base to the collector. Once in the collector (N-region), the electrons are attracted to the positive collector electrode, thereby completing their passage through the transistor.

Now let's see what takes place when an AC signal is applied to the emitter, as shown in Fig. 17. When the signal swings positive, it reduces the forward bias provided by the battery. This increases the potential barrier thereby reducing electron flow through the emitter. When the negative half cycle of the signal is present at the emitter it tends to reduce the potential barrier, increasing electron flow through the emitter. Again because the base region is so very thin, most electrons will pass through it without combining with the holes and find entrance to the collector.

A junction transistor of the PNP type is illustrated in Fig. 18. It consists of P and N semiconductors used alternately. In order to have conduction in such a transistor, it is necessary that the battery polarity to the emitter and collector be opposite to that used by the NPN transistor. With this connection the holes in the emitter region are repelled by the positive potential of the battery toward the PN junction. Since this reduces the potential barrier existing between the emitter and base, the majority of the holes pass through the relatively thin base area (N-region) into the collector region. A small number of holes are lost by combination with electrons in the base region. As each of the remaining holes enters the collector it is filled by an electron emitted by the negative terminal of the battery.

For each hole lost by combination within the base or collector region, an electron from one of the covalent bonds near the emitter electrode enters the positive terminal of the battery, resulting in the formation of a new hole. The new hole moves toward the junction area, thus maintaining a continuous flow of holes from emitter to collector.

Amplification in a Junction Transistor

Further investigation of conduction in a junction transistor will show that the emitter current is greater than the collector current. For example, let us consider a case where 1 ma of current flows in the emitter circuit, as illustrated in Fig. 19. The base current in this condition will be proportional to the number of hole and elec-

tron combinations that take place in the base region; also, this base current will be affected by the amount of voltage applied between the base and collector. Under normal operating conditions the voltages are adjusted so that 5% of the total emitter current will flow in the base circuit; the remaining 95% of the emitter current flows in the collector circuit. From this it can be seen that the collector current will be less than unity compared to the emitter current. The graph in Fig. 20 shows the relationship between the collector voltage and current. At A there is no current flow in the collector circuit when the collector voltage is zero. As we increase the collector voltage the collector current will increase linearly until a point of saturation is reached, as indicated by the letter B. If we

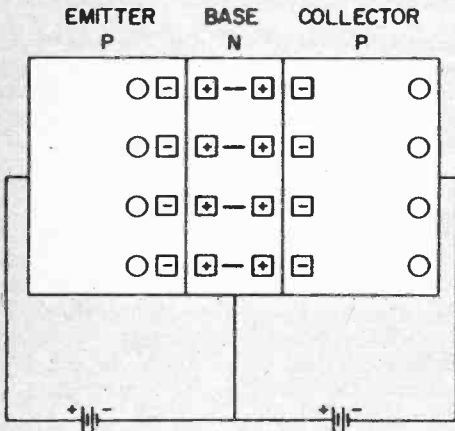

FIGURE 18

Hole flow in PNP transistor is from emitter through the base to the collector; note the battery polarities.

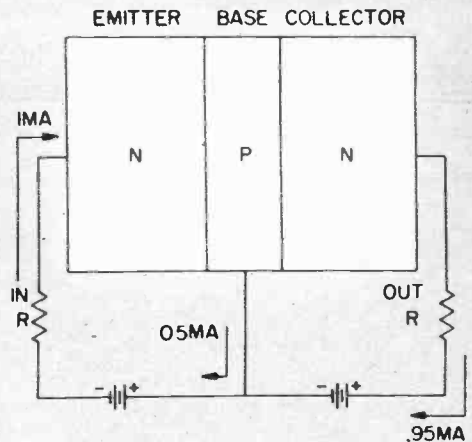

FIGURE 19

Transistor collector current is less than the emitter current; the difference is the base current.

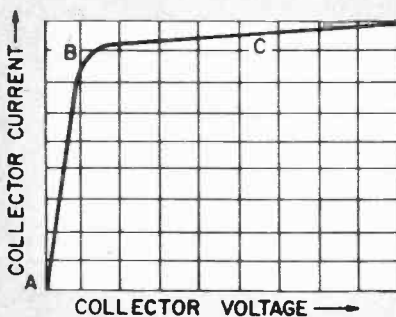

FIGURE 20

Characteristic curve shows the relationship between the transistor collector voltage and current.

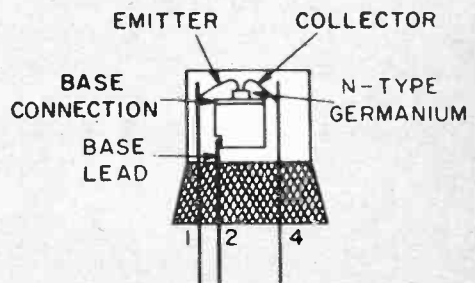

FIGURE 21

Point contact transistor. The emitter and the collector leads contact the N-type germanium surface.



Small size and low power requirements of transistors make possible compact, self-contained instruments. Here is a representative tape recorder (Lafayette RK-120); it is powered by just six standard penlight cells.

further increase the collector voltage the collector current will remain nearly constant. This characteristic curve is very similar to that of the plate current—plate voltage curve of a pentode vacuum tube. It can be seen that current flow within the collector region is independent of the collector voltage after the point of current saturation has been reached. Therefore, it is desirable to operate the collector circuit at a voltage indicated by the letter C in Fig. 20.

In order to understand how amplification can take place within a transistor, we must investigate the input and output resistance characteristics of the junction transistor. The battery in Fig. 19 is connected between the emitter and base with its polarity such that the potential barrier between the emitter and base is greatly reduced. Current readily flows through this junction, thereby reducing the input resistance to the emitter.

The battery connected between the collector and base is of such polarity that the potential barrier between the base and collector is greatly increased. Thus, the output resistance of the collector circuit is very high. Since we have a low input resistance and a high output resistance, voltage amplification can be effected by a junction transistor. Due to this resistance difference, a small voltage change in the emitter circuit will cause a relatively large voltage change in the collector output circuit. This is due to the fact that a small

voltage change at the input will cause a large current change within the emitter. The current change in the collector circuit is directly proportional to the current change in the emitter circuit. Since the output resistance of the collector circuit is relatively high, a change in collector current will produce a relatively large voltage change across this output resistance. This action can be closely related to a pentode vacuum tube circuit, where small grid voltage changes produce relatively large plate voltage changes. From the foregoing it can be seen that if we apply a small AC signal to the input of the transistor, this signal will be amplified in the collector circuit.

Another factor must be taken into consideration. The peak-to-peak voltage swing at the input of the transistor must not exceed the battery potential connected between the emitter and base; also the peak-to-peak voltage swing in the collector circuit must not exceed the battery potential between the collector and base. If the AC swing should exceed either of these battery potentials, the signal will be greatly distorted.

Both NPN and PNP type transistors may be used as amplifiers. The only basic difference is that the battery potentials are reversed.

The Point Contact Transistor

The point contact transistor is the result of early experimentation with the ger-

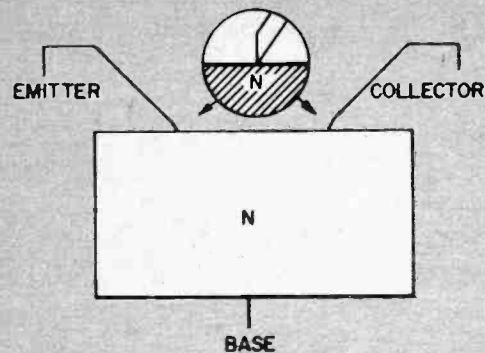

FIGURE 22

The emitter and collector leads of point contact transistor make light contact with germanium.

In B, which appears to be a reverse-biased junction, the current flow is much greater. See the text.

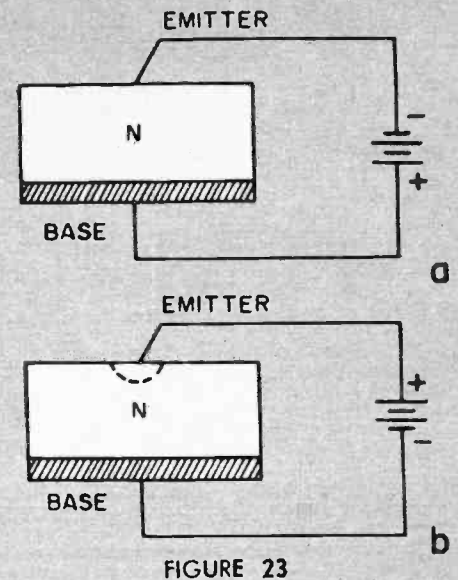

FIGURE 23

manium crystal. The construction of the point contact transistor is illustrated in Fig. 21. It consists of a piece of N-type semiconductor to which are attached leads known as the emitter, base and collector. An important matter in the construction of the point contact transistor is the method by which the leads are attached to the piece of semiconductor material. The base lead, as illustrated in Fig. 22, is a low-resistance connection, whereas the emitter and collector leads make contact by the sharp pointed ends of the leads. The emitter and collector leads are high resistance connections.

To understand transistor action in the point contact transistor let us begin by analyzing the emitter portion as illustrated in Fig. 23. We have learned that N-type semiconductor material has an excess of free electrons, and by the application of a potential across the semiconductor, electrons will flow through the semiconductor to complete the circuit. Fig. 23a illustrates a negative potential applied to the emitter and a positive potential applied to the base. Under these conditions electron flow will take place.

Let us change the polarity of the supply battery so that the emitter contact is now positive and the base is negative, as in Fig. 23b. Now the positive potential is applied to a small point, rather than distributed evenly along the entire base area as in Fig. 23a. The emitter, now positive in polarity,

attracts free electrons from the N-type semiconductor. Thus, electron flow takes place. However, because of the intense concentration of energy in the vicinity of the emitter, it not only attracts the free electrons present in the semiconductor but also withdraws valence electrons from the covalent bond structure in the immediate area. This action of removing valence electrons results in the formation of holes. These holes diffuse toward the base, which discharges additional electrons to fill them, with the result of increased electron flow.

It can then be seen that as long as the emitter is negative in polarity there is relatively little electron flow. However, if the emitter is made positive there is the formation of holes due to the concentration of energy present at the point contact, which results in an increase of electron flow. Rectification, therefore, is possible.

A simplified diagram of a point contact transistor is shown in Fig. 24. Consider the emitter and base as constituting one rectifier and the collector and base another rectifier. Battery A provides a positive potential to the emitter which effectively biases the emitter in the direction that results in the greatest electron flow. Battery B provides a negative potential to the collector which biases the collector in the direction of least electron flow. Let us consider what takes place in the point contact transistor with the emitter and collector biased in this manner. Fig. 25 illustrates

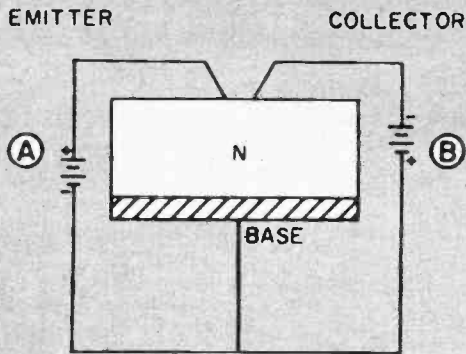

FIGURE 24

Simplified diagram of point contact transistor. The emitter is biased for the greatest electron flow.

Battery connections cause this movement of holes and electrons through a point contact transistor.

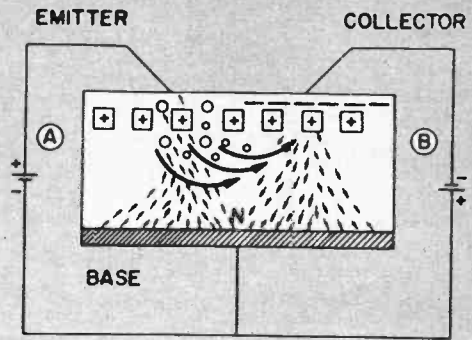

FIGURE 25

the emitter creating holes in its immediate area and in effect creates a space charge consisting of holes. Since the holes were created by virtually pulling an electron from a covalent bond, it is understandable why adjoining electrons want to fill the hole. Since the closest supply of electrons is present at the collector (negative), the holes tend to move toward the negative potential. During their movement toward the collector some holes are filled by electrons, but because of the very close spacing of the emitter and collector most of the holes reach the collector. Keep in mind that the collector is biased negatively and consequently very little electron flow takes place between the collector and base. However, with the presence of the holes in the vicinity of the collector many more electrons can leave the negative terminal of the battery and enter the collector region and fill the holes. Thus, the presence of the holes in the vicinity of the collector causes a marked reduction in the resistance of the collector region which results in an increase in electron flow.

From the above theory it can be seen how a signal varying in polarity can be fed to the emitter circuit with the result of corresponding holes being formed in the emitter area. These holes in turn control the resistance of the collector region and result in a corresponding change in electron flow in the collector circuit. Because it takes just a small variation in the elec-

tron flow in the emitter circuit to produce and control a greater electron flow in the collector circuit, amplification takes place.

In average point contact transistors, an increase in emitter electron flow of one milliampere will cause an increase in collector electron flow of 2.5 ma. The current gain factor of 2.5 is typical of point contact transistors. This figure may seem low when compared with the amplification factor of a vacuum tube. However, another factor, the input and the output resistances of the transistor, plays an important part. The input resistance is approximately 300 ohms, while the output resistance is approximately 20,000 ohms. It can be seen that there is another gain characteristic, namely the resistance gain. The transistor voltage gain equals the current gain times the resistance gain. Therefore, the voltage gain obtainable is comparable to that of a hi-mu vacuum tube. Point contact transistors are now obsolete.

Symbol and Lead Identification

The symbols used for transistors are illustrated in Fig. 26. The symbol in Fig. 26a is of the conventional type presently in widespread use. The heavy horizontal line represents the base and the two angular lines represent the emitter and collector. The arrow head drawn on the emitter indicates the direction of current flow. This provides an aid in identifying the type of transistor. In the case of a PNP junction

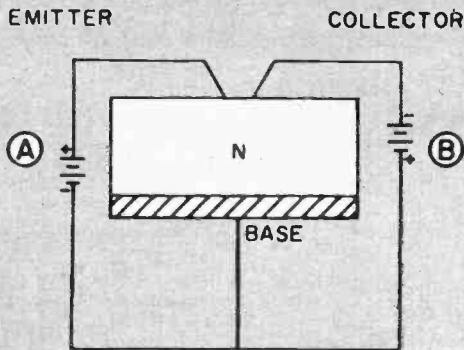
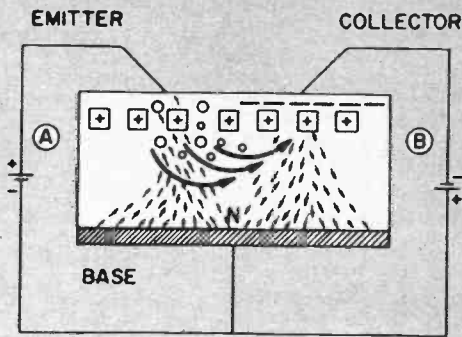

FIGURE 24

Simplified diagram of point contact transistor. The emitter is biased for the greatest electron flow.

Battery connections cause this movement of holes and electrons through a point contact transistor.



- ⊕ POSITIVE CHARGED DONOR ATOM
- FREE HOLES
- FREE ELECTRONS
- ELECTRON FLOW
- ⊕→ HOLE FLOW

FIGURE 25

the emitter creating holes in its immediate area and in effect creates a space charge consisting of holes. Since the holes were created by virtually pulling an electron from a covalent bond, it is understandable why adjoining electrons want to fill the hole. Since the closest supply of electrons is present at the collector (negative), the holes tend to move toward the negative potential. During their movement toward the collector some holes are filled by electrons, but because of the very close spacing of the holes reach the collector. Keep in mind that the collector is biased negatively and consequently very little electron flow takes place between the collector and base. However, with the presence of the holes in the vicinity of the collector many more electrons can leave the negative terminal of the battery and enter the collector region and fill the holes. Thus, the presence of the holes in the vicinity of the collector causes a marked reduction in the resistance of the collector region which results in an increase in electron flow.

From the above theory it can be seen how a signal varying in polarity can be fed to the emitter circuit with the result of corresponding holes being formed in the emitter area. These holes in turn control the resistance of the collector region and result in a corresponding change in electron flow in the collector circuit. Because it takes just a small variation in the elec-

tron flow in the emitter circuit to produce and control a greater electron flow in the collector circuit, amplification takes place.

In average point contact transistors, an increase in emitter electron flow of one milliampere will cause an increase in collector electron flow of 2.5 ma. The current gain factor of 2.5 is typical of point contact transistors. This figure may seem low when compared with the amplification factor of a vacuum tube. However, another factor, the input and the output resistances of the transistor, plays an important part. The input resistance is approximately 300 ohms, while the output resistance is approximately 20,000 ohms. It can be seen that there is another gain characteristic, namely the resistance gain. The transistor voltage gain equals the current gain times the resistance gain. Therefore, the voltage gain obtainable is comparable to that of a hi- μ vacuum tube. Point contact transistors are now obsolete.

Symbol and Lead Identification

The symbols used for transistors are illustrated in Fig. 26. The symbol in Fig. 26a is of the conventional type presently in widespread use. The heavy horizontal line represents the base and the two angular lines represent the emitter and collector. The arrow head drawn on the emitter indicates the direction of current flow. This provides an aid in identifying the type of transistor. In the case of a PNP junction

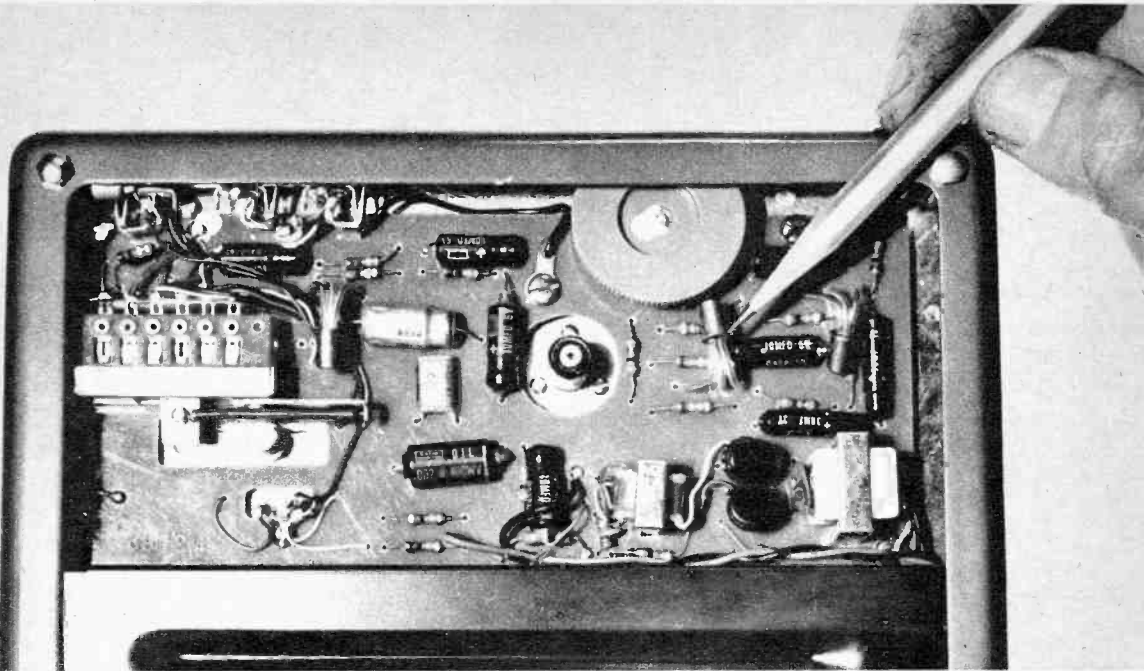

Underside of portable tape recorder. Parts are miniaturized and the transistors (pencil points to one of them) are about the size of peas. All of the transistor leads are wired directly to the printed-circuit board.

transistor, the arrow is drawn pointing toward the base. An NPN type is drawn with the arrow in the opposite direction.

Another symbol used to represent a transistor is illustrated in Fig. 26b. This is perhaps more representative of the actual transistor construction and relationship of the elements in comparison to the vacuum tube symbol. The arrow also shows the direction of current flow in the emitter.

The leads on an actual transistor are readily identified by their position and spacing. A "standard" transistor is illustrated in Fig. 27. The base lead is the center lead. The emitter and collector leads are on either side. The collector lead can be identified by the larger space existing between it and the base lead.

Methods of Operation

In general, the transistor can be compared to a vacuum tube. The illustration in Fig. 28 shows the similarities. The base is similar to the grid of the vacuum tube in that they both serve to control electron flow through the unit. The emitter and the cathode are the source of electrons. The collector of the transistor and the plate of the vacuum tube are similar in that they both are normally part of output circuit.

The transistor's input and output impedance can be varied by the method in which it is connected in a circuit. Fig. 29 illustrates various methods. A comparable connection of a vacuum tube is shown below each method. In each instance one electrode is common to both the input and output circuits. The common base type is illustrated in Fig. 29a. This configuration is similar to a vacuum tube used as a grounded grid amplifier. The advantage of using a transistor in this manner is that it has a low input impedance and a high output impedance.

The common collector type is illustrated in Fig. 29b. This is similar to a vacuum tube used as a cathode follower. In a common collector configuration, the input impedance is high and the output impedance is low.

The final configuration is the common emitter type and is illustrated in Fig. 29c. This is similar to a grounded cathode vacuum tube circuit. The input impedance is medium to low and the output impedance is medium to high. The grounded emitter is generally employed in conventional circuit applications. For use in special circuits the correct impedance match can be made by choosing the proper method of connec-

tion. Thus, almost any impedance ratio can be inserted to satisfy the circuit requirements.

Electrical Characteristics

The manufacturer of transistors generally supplies the mechanical and electrical characteristics in the form of a specification sheet.

Let us examine the specifications pertaining to an RCA type 2N109 junction transistor.

The manufacturer tabulates the specifications of transistor units in the following categories; general data, maximum rating, typical operating characteristics and characteristic curves.

General data includes the following:

Electrical:

Maximum DC collector current for DC collector-to-base voltage of -25 volts with emitter

open, and at ambient temperature of 25°C

-10 microamps

Maximum DC emitter current for DC emitter-to-base voltage of -25 volts with collector open, and at ambient temperature of 25°C

-10 microamps

Mechanical:

Mounting position any

Maximum overall length 0.697"

Maximum seated length 0.495"

Maximum diameter 0.260"

Case Metal, Insulated

Envelope seals Hermetic

Base Small-round linotetrar 3-pin (JETEC No. E3-25)

Maximum ratings are those values of voltage, current and temperatures that must not be exceeded when operating the units. The values given are important not only to the electronic engineer but also to

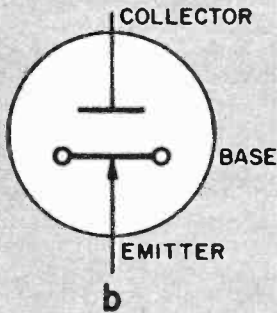
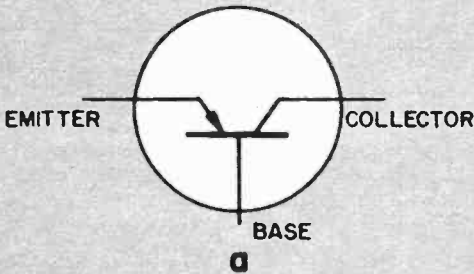

FIGURE 26

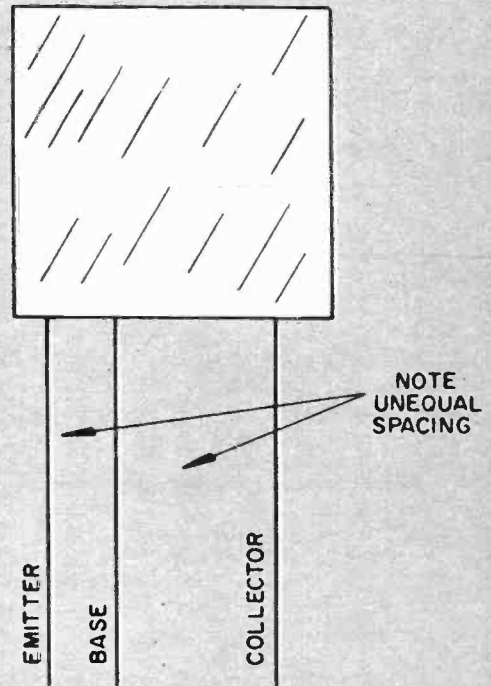

FIGURE 27

Schematic representation of a transistor. Top illustration (a) is more commonly used than the bottom.

Transistor leads usually are not marked, but can be easily identified by their relative spacing.

The illustration at the right shows how transistor and conventional triode vacuum tube elements correspond generally in function.

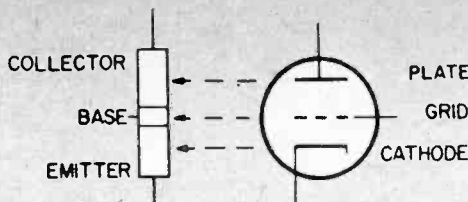

FIGURE 28

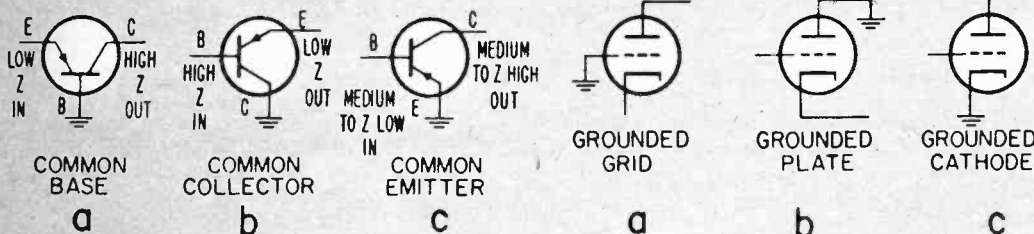

FIGURE 29

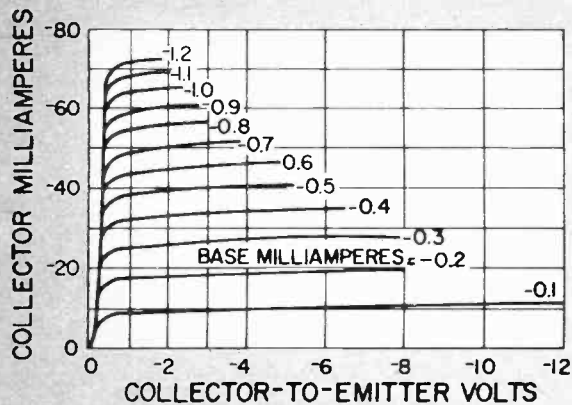

FIGURE 30

Figure 29 shows circuit configuration equivalents. Common base is similar to grounded grid, common collector to grounded plate (emitter follower), and common emitter to grounded cathode.

Left: Typical characteristic curves of a transistor with different values of collector-to-emitter voltage. Note the very strong resemblance to the characteristics of more familiar pentode vacuum tube.

the service technician. The maximum ratings for the RCA type 2N109 transistor are as follows:

Maximum Ratings:

Peak collector-to-base voltage	-25 max. volts
DC collector-to-base voltage (for inductive load)	-12 max. volts
Peak collector current ..	-70 max. ma
Average collector current	-35 max. ma
Peak emitter current	70 max. ma
Average emitter current	35 max. ma
Collector dissipation	50 max. mw
Ambient temperature (during operation) ..	50 max. °C
Storage-temperature range	-55 to +85°C

Characteristics:

DC collector-to-emitter voltage	-1 volt
DC collector current	-50 ma
Large-signal DC current transfer ratio	70

The voltages are generally given with respect to the base and the values indicated in volts. Current is given in ma or microamperes and the power dissipation values are given in watts or milliwatts.

Typical Operating Characteristics are also given to serve as a guide to the engineer who may be designing equipment or the technician servicing the equipment. The following information is for the RCA type 2N109 transistor. This transistor is used primarily for class B operation, and the operating characteristics are as follows:

Typical Push-Pull Operations:

DC collector-to-emitter supply voltage	-4.5	-9	volts
DC base-to-emitter voltage	-0.15	-0.15	volt
Peak collector current (per transistor)	-35	-40	ma
Zero-signal DC collector current (per transistor)..	-2	-2	ma
Max.-signal DC collector current (per transistor)..	-11.5	-13	ma
Signal-source impedance (base to base)	1500	1500	ohms
Load impedance (collector to collector)	400	800	ohms
Signal frequency ..	1	1	kc
Circuit efficiency ..	60	69	%
Power gain	30	33	db
Total harmonic distortion	7	7	%
Max.-signal power output	75	160	mw

Characteristic curves are also included as part of the specification sheet. These curves are similar to the curves furnished for vacuum tubes and serve a similar purpose. A typical curve is illustrated in Fig. 30.

Temperature Effects

All semiconductors are subject to temperature limitations. In well designed germanium transistors the maximum rated temperature is approximately 185°F (85°C). In most applications temperatures seldom exceed 150°F, so there is a sufficient margin of safety. In special applications, as in military equipment, it is desirable to operate the equipment over a wide range of temperatures. It is here that the silicon transistor plays an important role. Silicon transistors are available that operate with temperatures of 350°F with no destructive effects.

Frequency Cut-Off

The upper frequency limit of transistors is determined by the time required (transit time) for the electrons to pass from the emitter to the collector. By making the base of the transistor thinner, the element of time will be reduced and consequently a higher frequency cutoff obtained. It is along these lines that research engineers are constantly working.

In order to obtain transistor performance

which is equal to the vacuum tube, the maximum operating frequency should be about 20% of the frequency cutoff. Therefore, in applying this rule, it appears that the minimum cutoff frequency for a portable or home radio receiver with an IF of 455 kc is at least 2-2.5 mc. For mixer operation of the broadcast band a cutoff of 8 mc is required. A television VHF RF transistor amplifier operating at 200 mc would need a 1000 mc cutoff frequency. There are commercial transistors available that satisfy the requirements for radio and VHF television receivers.

Early transistors were encased in plastic. This afforded protection to the unit. Encased transistors used in hearing aids provided good service for over three years. There are several disadvantages, however, in this method of protection: the plastic units did not stand up well at high temperatures, nor could they survive under extreme moisture conditions. As a result, extensive effort was directed toward the development of hermetically sealed, metal-cased units. This method presented new problems. At first it was noticed that some units were subject to abrupt failure in varying percentages due to air leaks. Second, some of the units that were truly sealed died slowly as the result of the gradual release of internal contaminants. Today, due to experience gained in the past few years, these problems are practically eliminated. To insure the best possible service, accelerated life tests at high temperatures are used to predict long and useful transistor life. •

Vertical lines in drift transistor show regions of high and low conductivity, controlled by concentration of impurity atoms during manufacture. Electron density in base material is greatest in high-conduction region from which they drift leaving field with positive charge. Holes injected by emitter are accelerated by field to reduce transit time. Drift transistors are capable of oscillating well at frequencies up to 300 mc. and they can be used as amplifiers at VHF television frequencies.

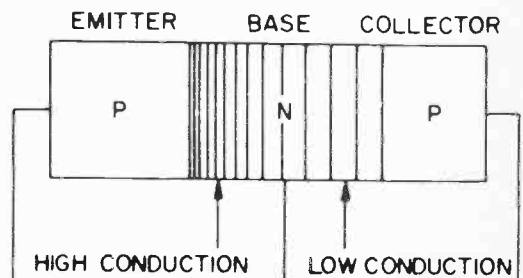

Punch-Board Transistor Trainer

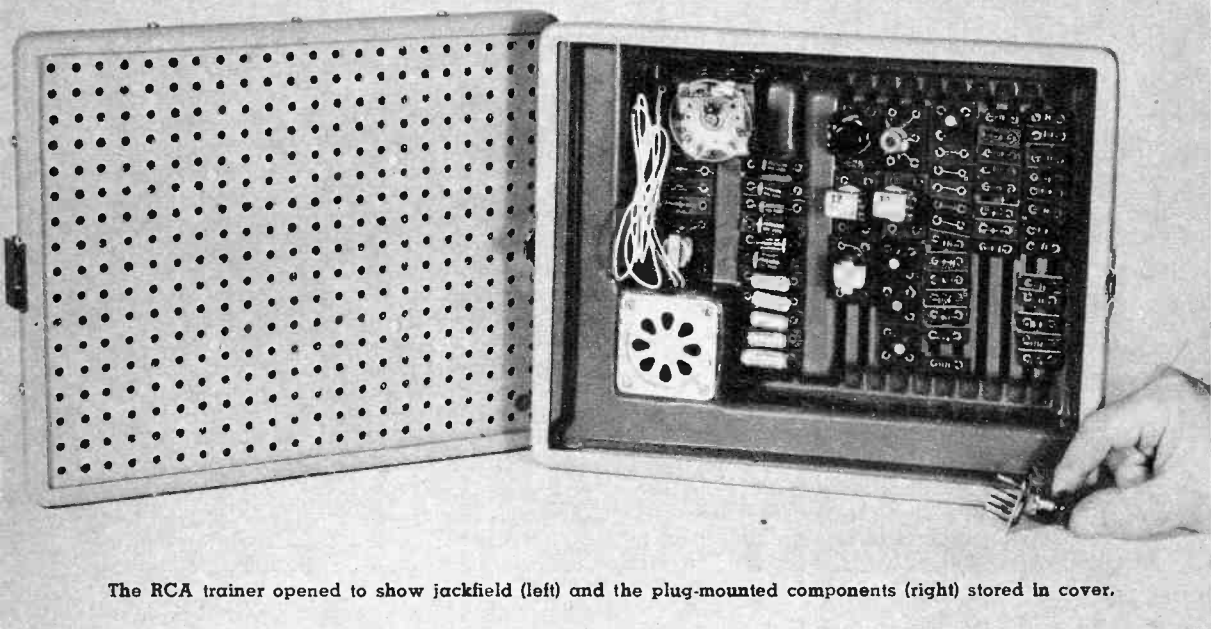

The RCA trainer opened to show jackfield (left) and the plug-mounted components (right) stored in cover.

FACED with the problem of providing its home-study students with a means of performing experiments in the transistor course, the Radio Corporation of America developed a versatile and flexible training device that allows the student to concentrate on the important circuit aspects of semiconductors without having to wrestle with tedious breadboard setups.

Transistors present something of a headache, from the educational standpoint, because of their infinite variety, lack of standardization, their awkwardly small size, and their susceptibility to both heat and excessive voltage. In most applications, transistors are soldered directly to a circuit board by means of their own leads; the mere mechanical job of removing and replacing them is often quite tricky and dangerous.

In this course, you get the knowledge necessary to understand the operation of transistor devices and circuits as well as future developments in this rapidly growing branch of electronic technology. There

is a minimum of mathematics, yet the course is not a superficial treatment of the subject. You learn about transistor ratings and parameters, equivalent circuits, impedance matching, and how to calculate operating voltages and currents, stage gains, high-frequency operation, etc.

Measuring only 12" x 9" x 5" and weighing less than five pounds, the trainer features a pre-wired "jackfield," consisting of 374 banana jacks on the underside of an 8½" x 11" perforated board. The holes are spaced uniformly on ½" centers. Resistors, capacitors, diodes, and other components are mounted on strips of laminated insulating material with plugs that match the jacks. The number of plugs varies from two to five depending on the component. The latter includes four transistors, 28 resistors, 13 capacitors, one diode, one oscillator coil for the AM broadcast band, two IF transformers, two audio transformers, two potentiometers, and a two-section variable tuning capacitor.

This is how a punched template is fitted over the holes in the jackfield. The individual components are simply plugged into place. No extra wiring, except for meters and other externally added accessories, is required.

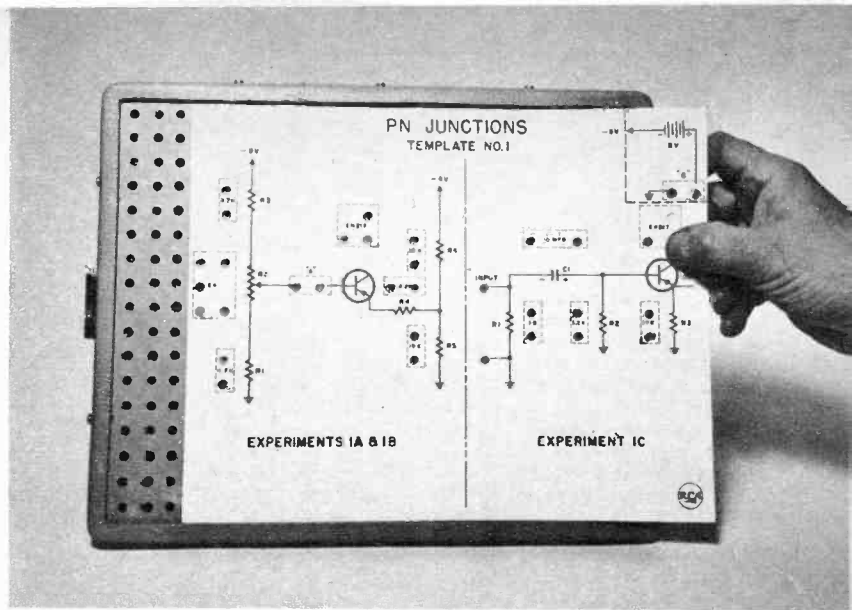

The parts are stored in the cover section of the trainer case. They are held in the slots by friction. Mounted permanently in this cover is a small permanent-magnet loudspeaker, whose leads terminate in a two-prong plug. The power source for all circuits and experiments is a battery, secured under the jackfield.

Twelve perforated cardboard templates are provided with the trainer. With any one of these fixed over the jackfield, you merely plug in the various components

called for and connect meters or other accessories. In a matter of minutes, without cutting or soldering wires, you have an operating circuit under observation. The templates start with basic transistor characteristics, and the final one produces a fully operating broadcast receiver.

Among the experiments that can be performed are the following: current flow across a PN junction; with a PNP transistor, measurement of current through the emitter, collector and base; characteristic

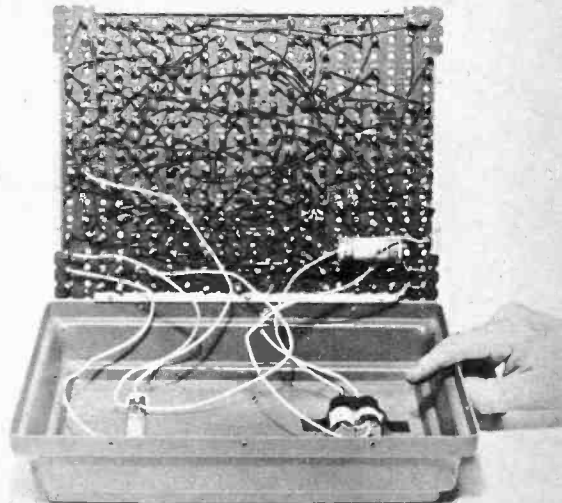

The two sections of the transistor trainer snap together at the short edges. The parts inside hold firmly and do not shake loose if carried.

The jackfield removed from its half of the carrying case to show the intricate cross wiring. In the lid are batteries and a loopstick antenna.

With a template in position for an experiment, all unused holes in the jackfield are covered. Since all the components are in one plane, it is easy to follow all the connections between them. This setup calls for an external VTVM (right) and for a low-range milliammeter (left).

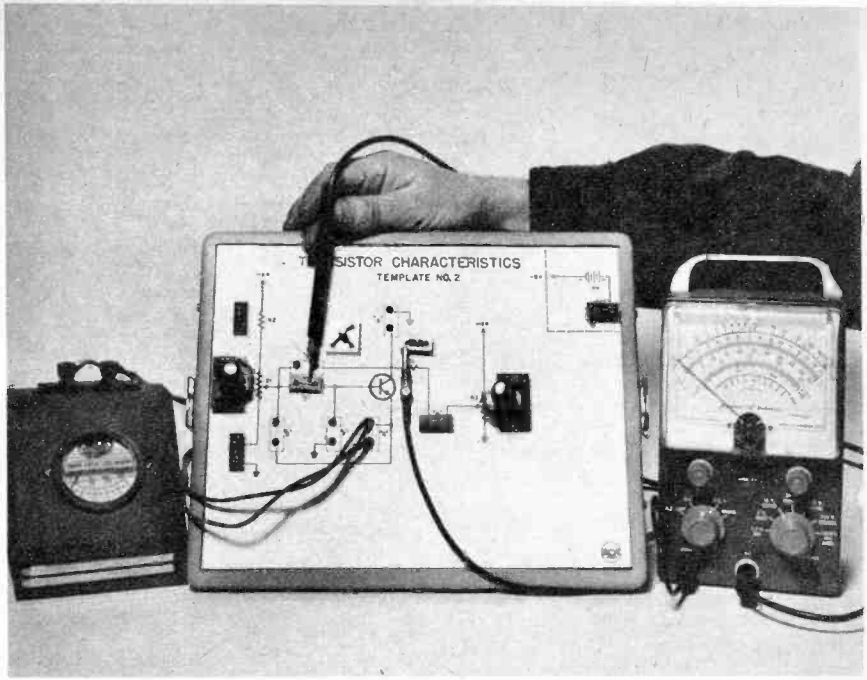

curves; voltage, current and power gain; small-signal response; bias stabilization; sensitivity to temperature changes; free-running multivibrator.

Next to each set of holes in a template is the schematic symbol of the part. When a setup is completed, entire circuit is in clear view, can be traced and seen readily.

A handful of blank connector plugs is included, to permit you to add parts of

different values or to change the circuits slightly. Also included is an elaborate 102-page instruction book, by means of which you can conduct all the experiments entirely on your own.

The external accessories are the standard instruments a student, experimenter, ham, engineer or service technician ordinarily acquires during his progress in the electronics game: vacuum tube volt-

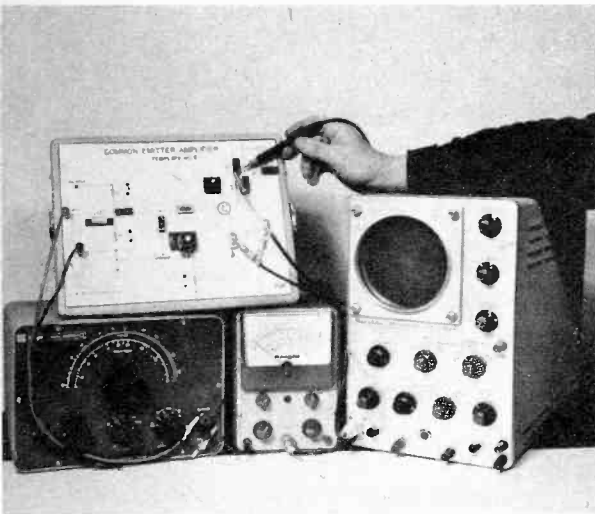

Operation of a common-emitter amplifier is studied with this setup. Each point in the circuit is accessible and parts may be substituted or removed to modify operating conditions of each circuit.

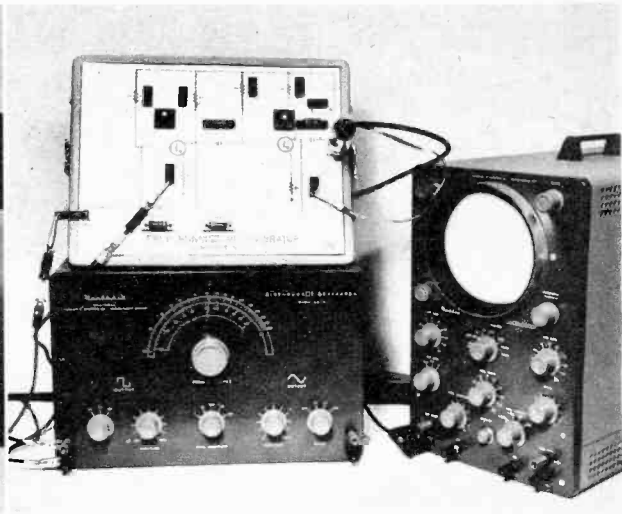

The leads from test equipment are easily clipped to each component of two-transistor free-running multivibrator. The part values may be changed to vary pulse width and pulse repetition rate.

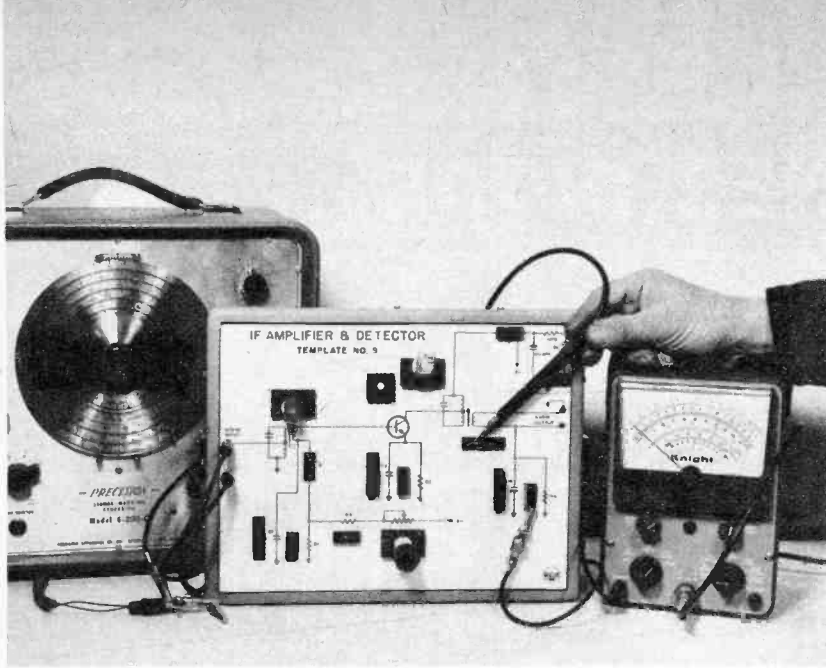

Operation and adjustment of typical IF amplifier and detector sections of a superhet receiver are clarified with an RF signal source (left, Precision E-200-C generator) and a VTVM (right). Probe from VTVM is touched to circuit.

meter, RF and AF signal generators, cathode-ray oscilloscope, etc.
 Because soldering is not required and also because a fixed, permanently-connected battery power source is used, the possibility of damage to the sensitive transistors is pretty much eliminated. There are two type 2N217's, one 2N218 and one 2N219. These semiconductors are much smaller than a pencil eraser.

The whole trainer closes to form a neat, easily carried box slightly smaller than a portable typewriter. The main problem it engenders is that everyone who sees it wants to borrow it.
 The RCA home-study course consists of ten lessons. These are furnished to the student in five study groups of ten lessons each. An assignment comes with each group. •

A complete, operating superhet broadcast receiver fills practically the entire jackfield of the trainer. Tuning capacitor is in upper left. Speaker is in lower left of cover (not shown). With this setup the entire circuit can be analyzed and studied stage by stage.

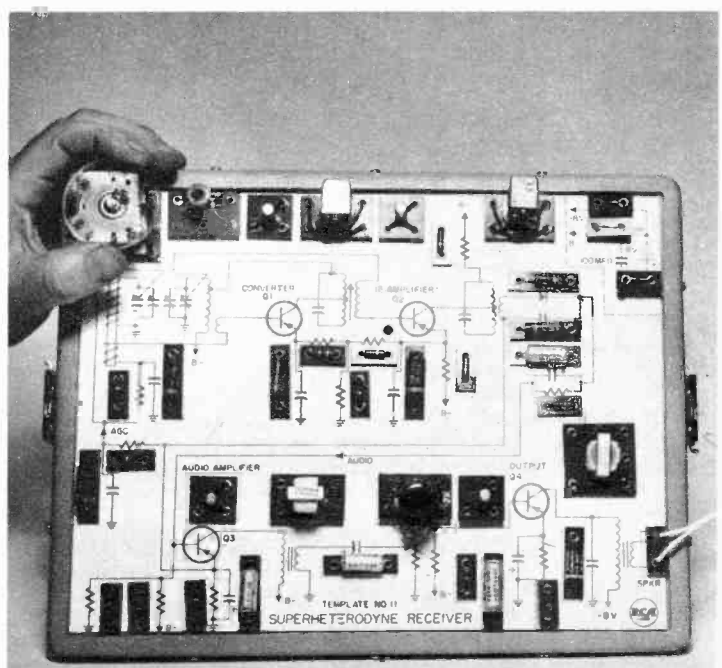

The ZENER DIODE...

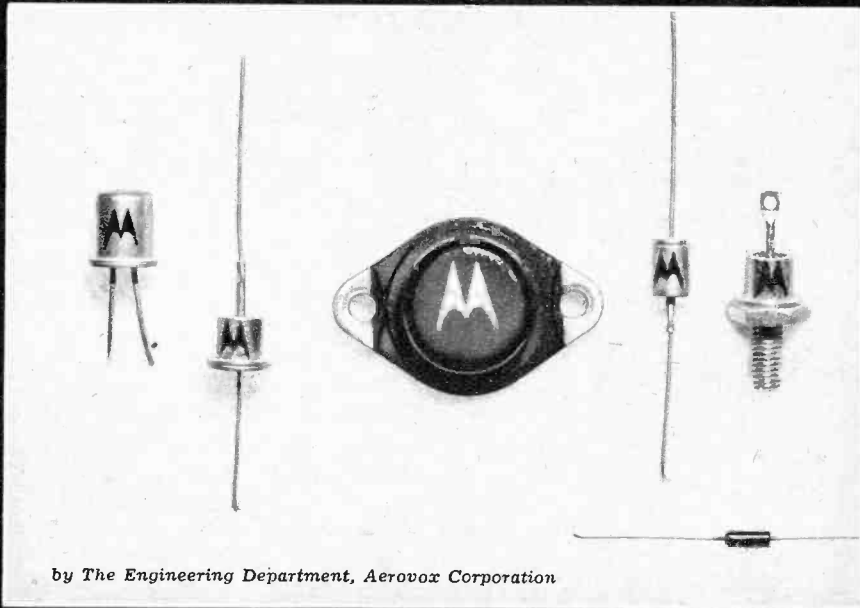

by The Engineering Department, Aerovox Corporation

What It Is and How It Works

Actual size of typical zener diodes. Their primary circuit function is a constant voltage reference.

THE silicon junction diode has opened many new areas of application formerly not fully exploitable with other semiconductor devices. Some of these applications afford considerable circuit simplification.

The special utility of the silicon junction results from its unusual conduction characteristic. Fig. 1 shows the general shape of the static volt-ampere characteristic. Note from this plot that the silicon junction exhibits a rather steep forward EI slope from 0 to A, indicating relatively low forward resistance; while the reverse slope from O to B first is quite slight, indicating very high back (inverse) resistance as far as C. Thus, higher front-to-back resistance ratios sometimes are obtainable with silicon than with germanium. In some small silicon junction diodes, the front-to-back resistance ratio at 1 volt may reach 100 million to 1.

The high back resistance disappears beyond Point B. At higher voltages, the reverse current increases sharply, as from B to C, for a small increase in reverse voltage. Thus, within a few tenths of a volt the back resistance may fall abruptly from several megohms to a few ohms. (The current increases from a fraction of a microampere to several ma.) The extreme steepness of segment BC suggests breakdown of the diode, and is so termed. But this high-conduction interval is non-destructive, provided maximum allowable power dissipation of diode is not exceeded.

Point B is termed the *zener voltage*. Silicon junction diodes may be processed to place the zener point at a desired voltage level. Units so processed are called *zener diodes*. In such commercially available diodes, the zener point (as specified for 25°C operation) may be held as closely as

$\pm 1\%$. The important characteristic of the zener region (BC) is the high dI/dE , as well as the low E/I quotient. This characteristic gives the diode low DC resistance and low dynamic impedance and suits it to voltage regulation, peak compression, signal limiting, signal expansion, switching, and similar applications. Zener diodes are available in both low- and high-power ratings and with zener points between 2 and 300 volts.

The features which are of chief interest in the application of zener diodes are (1) the sharp breakdown characteristic, (2) the high ratio of resistance between B and C to that between O and B, and (3) the low-resistance and impedance of region BC. Hence, it is the reverse conduction of the zener diode which is most important in typical applications of this component. The forward characteristic (O to A in Figure 1) seldom is of interest.

Gas-Diode Counterpart

In its operation and applications, the zener diode is similar to the 2-element gas tube in the following respects: (1) Both devices exhibit extremely high resistance until an applied voltage reaches a given breakdown potential. (2) The breakdown potential can be maintained closely by the manufacturer. (3) The breakdown is non-destructive. (4) Beyond the breakdown point, current increases abruptly. (5) As the current is increased, the voltage drop across the diode remains substantially constant over a broad range.

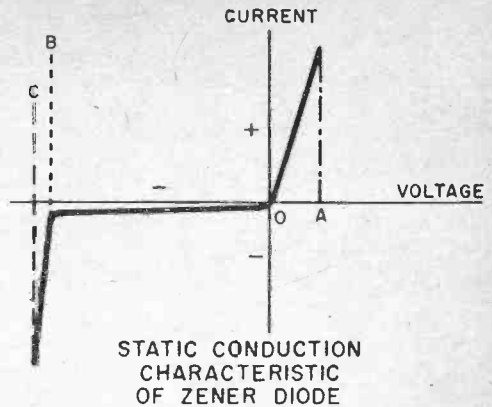

STATIC CONDUCTION CHARACTERISTIC OF ZENER DIODE

FIG. 1

The constant voltage drop may be utilized in voltage regulators, compressors, limiters, clippers or slicers, voltage reference units, and voltage standards. The sharp breakdown may be made the basis of wave-shapers, pulse formers, spike generators, switches, and discharge devices.

Gas diodes commonly are available for constant voltage drops from 75 V (Type OA3, VR75) to 150 V (Type OD3, VR150). These tubes may be series-connected for high-voltage service; however, the lower limit remains 75 volts. Less precise operation at slightly lower voltages can be obtained with some neon lamps. The zener diode, on the other hand, can be supplied for constant voltage drops as low as 2 volts

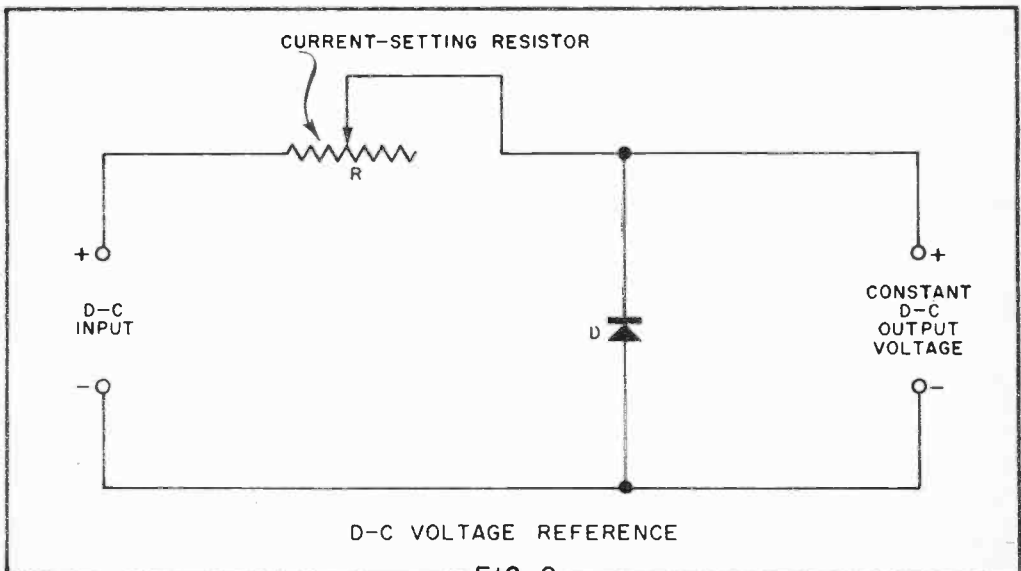
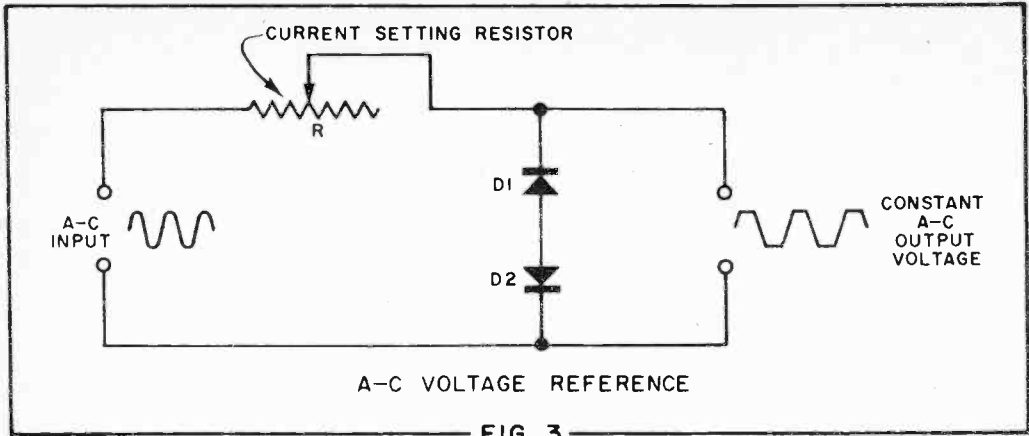

FIG. 2



and as high as 300 volts. Thus, this miniature component not only extends operation to lower levels than those afforded by the gas tube, but also permits high-voltage operation without having to series-connect several units in a regulator string. Still higher-voltage service is, of course, obtainable with the series connection.

The similarity between zener and gas-tube diodes ends with their comparable performance. The gas tube depends upon ionization for its behavior, while the semiconductor diode utilizes field effects upon

charge carriers within a semiconductor solid.

Typical Applications

The zener diode finds many applications requiring the constant voltage drop abrupt breakdown which are characteristic of this component. In some applications, the miniature size and mechanical ruggedness of the zener diode give it preference over a gas tube having similar electrical characteristics.

Several typical applications are de-

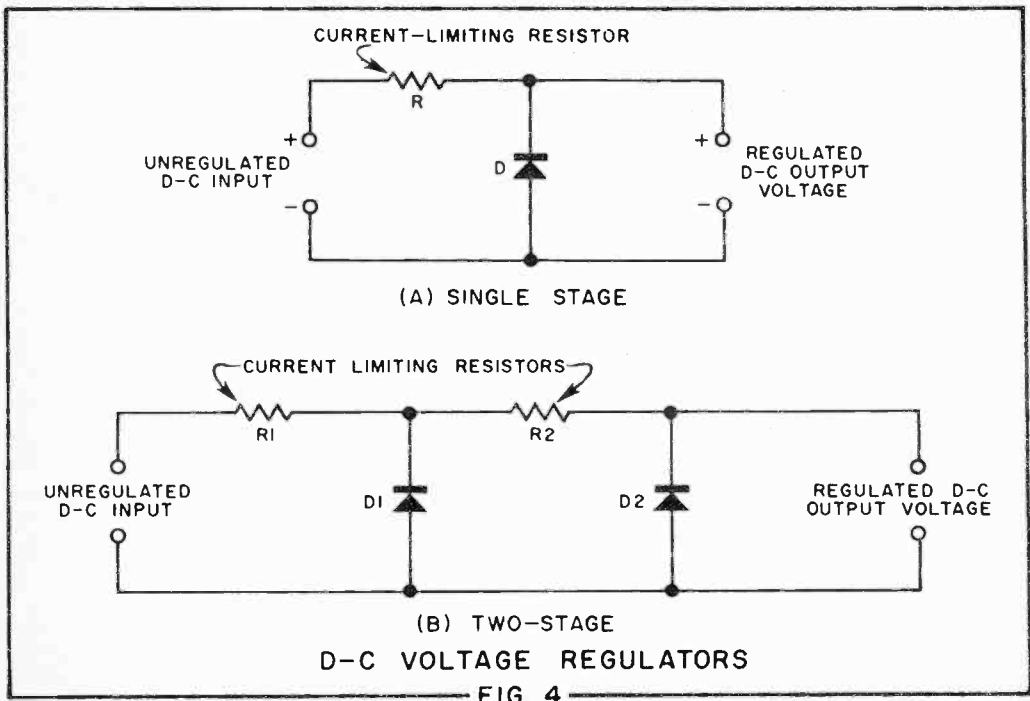

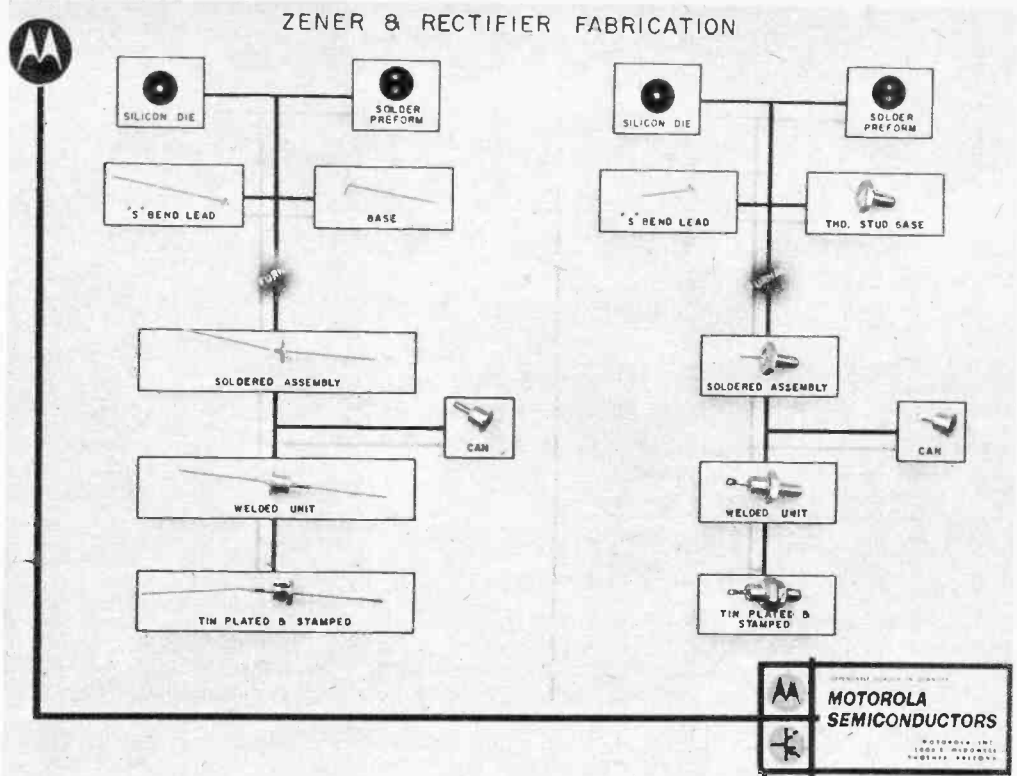

There's more to making semiconductors than meets the eye. Parts are tiny and undergo many operations.

scribed in the following paragraphs. These examples will suggest further uses, and they do not exhaust possibilities by any means.

Voltage References. The nearly constant voltage drop across a zener diode biased to its reverse high-conduction region can serve as a standard voltage for calibrating or referencing high-impedance circuits and instruments. The input voltage may be derived from an AC type power supply.

Fig. 2 shows the circuit of a simple DC voltage reference. The input voltage must be at least 4 times the voltage desired across the zener diode, D. Rheostat R is adjusted initially to set the diode current to the maximum value along the breakdown region (Point C in Fig. 1) which may be maintained steadily without exceeding the rated power dissipation of the diode. In its state of high conduction, the diode acts as a low-resistance output element. This provides a fairly "stiff" voltage source. Diode manufacturers are able to supply zener diodes with voltages specified within 1%.

Fig. 3 shows a similar circuit for an AC

standard voltage. Here, two zener diodes (D1 and D2) are connected back-to-back and limit both positive and negative output-voltage peaks to a predetermined amplitude. Except for the use of two diodes, the circuit is the same as the circuit of Fig. 2.

The output waveform DC shown in Fig. 3, is that of a sharply-clipped sine wave. In addition to other uses, this unit may be employed as a fixed-voltage calibrator for oscilloscopes.

DC Voltage Regulators. The constant voltage drop across the zener diode operating in its breakdown region may be utilized as a source of regulated voltage. The output voltage is regulated against supply and load variations. The circuit resembles a gas-tube regulator circuit.

Fig. 4(A) shows a simple DC voltage regulator. In this circuit, the value of current-limiting resistance R is chosen to set the diode current to the maximum breakdown value (Point C in Fig. 1) which may be maintained continuously without exceeding the rated power dissipation of

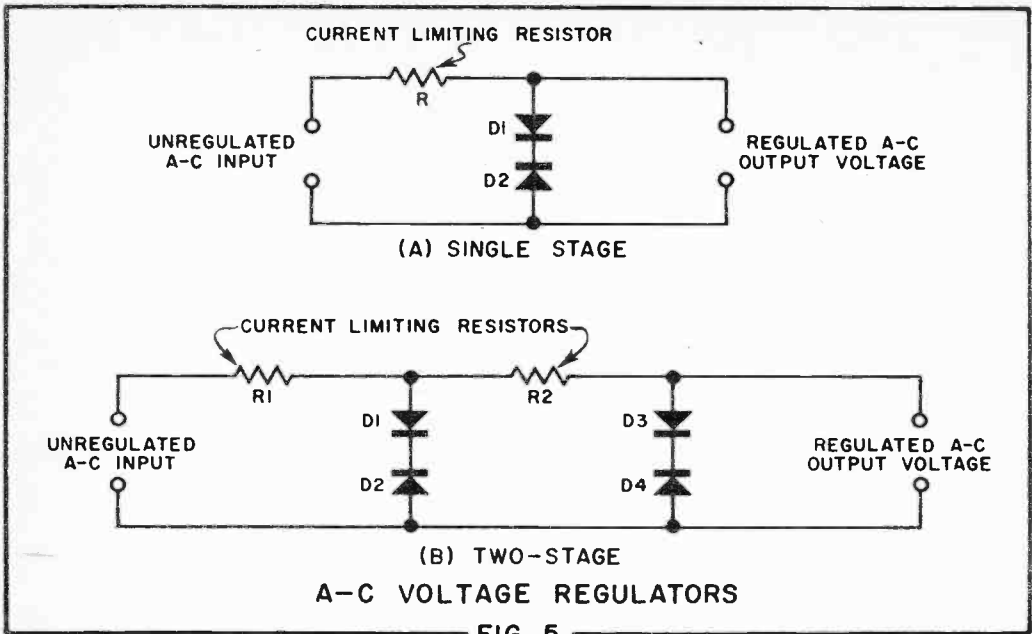

FIG. 5

the diode, thus preventing thermal damage.

From the breakdown characteristic (Fig. 1), it is seen that comparatively large input voltage swings, resulting in large current swings, will change the output voltage developed across diode D only slightly. Similarly, as the external load current increases, correspondingly less current flows through the diode. Good regulation is maintained as long as the diode current does not fall below that corresponding to Point B in Fig. 1.

Additional regulation may be obtained by cascading two or more of the simple diode regulators. Fig. 4(B) shows a 2-stage

regulator. In cascaded arrangements, the unregulated input voltage may need to be as much as one order of magnitude higher than the desired output voltage, since voltage division is encountered in the successive regulator stages.

A particular advantage of the diode-type voltage regulator is its ability to function at low voltages. Previously, the simplicity of diode regulation has not been available below 75 volts, the lower limit of commercial gas-tube regulators. At the same time, the zener diode regulator may be operated with a single diode, properly chosen regarding type, up to 300 volts, and

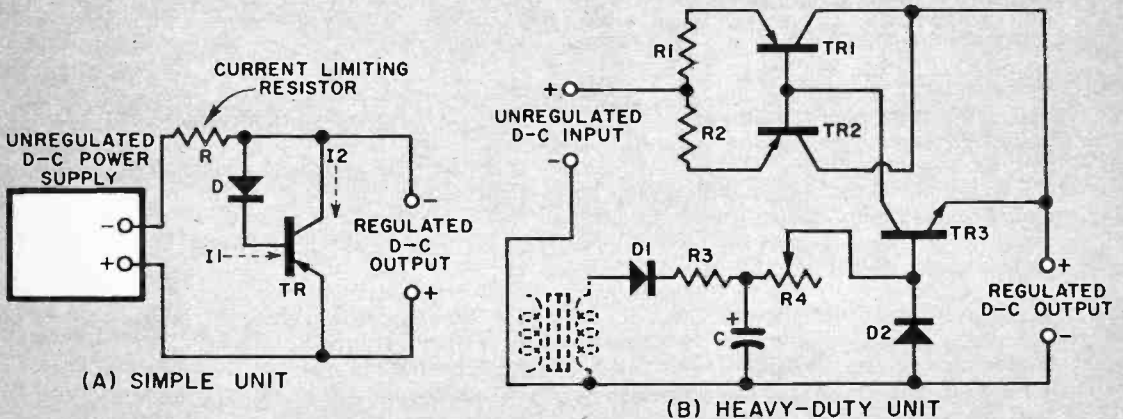

TRANSISTORIZED, VOLTAGE-REGULATED POWER SUPPLIES

FIG. 6

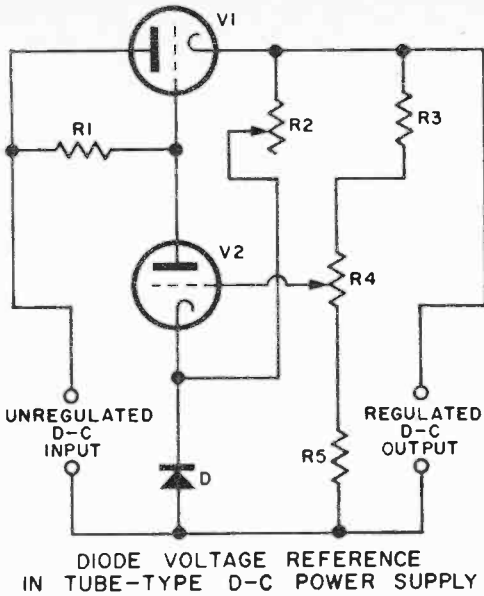

DIODE VOLTAGE REFERENCE
IN TUBE-TYPE D-C POWER SUPPLY
FIG. 7

higher with diodes connected in series.

AC Voltage Regulators. Similar simple arrangements may be employed for AC voltage regulation.

Fig. 5(A) shows a single-stage regulator, and Figure 5(B) a 2-stage cascaded regulator. Note that the only difference between these and the DC circuits are the double diodes in the AC units. Thus, in Fig. 5 (A), diodes D1 and D2 are connected back-to-back to accommodate both AC half-cycles. In Fig. 5(B), each stage of the cascaded regulator contains two diode pairs (D1-D2 and D3-D4). Either pairs of single diodes or double-anode diodes alone

may be used. The output of the AC regulators is clipped, as shown in Fig. 3. The sine-wave shape may be restored to some extent through suitable filtering to remove the harmonics.

Zener Reference Diode in Transistorized Power Supplies. The simple DC voltage regulator circuits shown in Fig. 4 are suitable only for light- and medium-duty applications, just as the gas-tube regulator is so limited. Furthermore, regulation closer than 5 to 10% is not usual.

Heavy-duty, closely-regulated operation at low DC voltages is afforded by transistorized power supplies. In these units, zener diodes are employed as voltage reference units. Typical transistorized regulator circuits are shown in Fig. 6.

Fig. 6(A) is a simple circuit employing a power transistor, TR, as a shunt-triode regulator. The base current I_1 , of this transistor passes through the zener diode, D. The anode of this diode is connected to the positive DC output terminal along with the collector of the transistor. Current I_1 , therefore is a function of the output voltage. Collector current, I_2 , flows in parallel with the external load current.

The current through D is adjusted such that it normally does not operate in its breakdown region. Current I_1 , therefore is quite low. If the output voltage rises, D passes heavy zener current into the base of transistor TR. This causes the transistor to draw heavy collector current, I_2 , and therefore to lower the output voltage by increasing the voltage drop across current-limiting resistor R. This is the mechanism whereby voltage regulation is obtained.

This scheme may be employed to regulate voltages up to 80 volts (depending upon the type of transistor employed) at

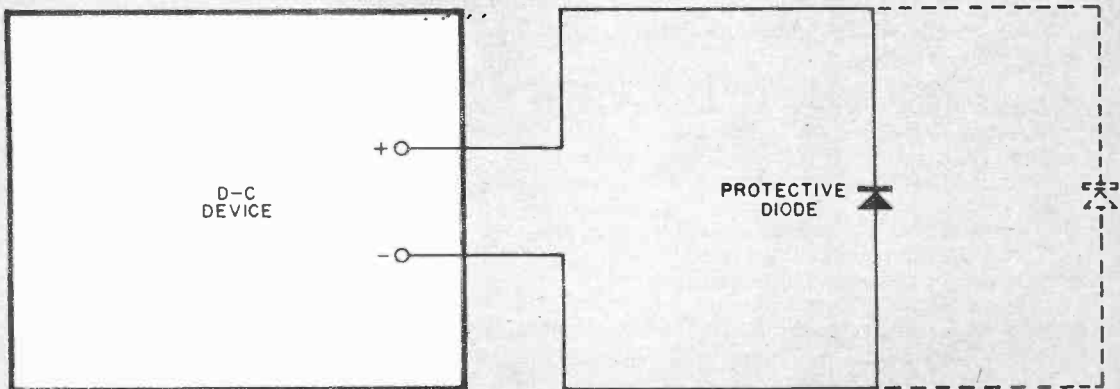

ZENER DIODE AS D-C PROTECTIVE DEVICE

FIG. 8

currents of several amperes. The power supply may be of the semiconductor type employing germanium, silicon, or selenium rectifiers. Because of the current amplification factor of the transistor, base current I_1 is small compared to collector current I_2 . Hence, D can be of the low-power type.

A heavier-duty, transistorized regulator circuit is shown in Fig. 6 (B). Unlike Fig. 6(A), this is a series-type regulator. The two parallel-connected power transistors, TR1 and TR2, serve as a voltage-variable series resistor for regulating the output voltage. The low-power transistor, TR3, samples the DC output voltage and alters the resistance of the TR1-TR2, combination to maintain the voltage at its proper level. The base of transistor TR3 is held at constant voltage developed by zener diode, D2. In this application, the diode is comparable to the gas tube used as a voltage reference in tube-type voltage regulators, the TR1-TR2 transistor combination corresponds to the power-type resistance tube, and transistor TR3 is comparable to the DC amplifier (voltage-sensing feedback tube).

The zener current for diode D2 is obtained from transformer T (or a winding on the power transformer of the supply unit). D1 is a diode or semiconductor rectifier of the conventional type for conversion of the input voltage of DC. Filtering action is provided by resistors R3 and R4 and capacitor C. The current through diode D2 is limited by R3 and R4 to the maximum zener value which may be handled without exceeding the rated power dissipation of the diode.

Zener Reference Diode in Tube-Type Power Supply. A zener diode may be employed, in place of the usual gas tube, as the voltage reference device in a conventional voltage-regulated DC power supply. This substitution can result in a substantial saving of space, since the diode is many times smaller than the tube. Furthermore, the diode requires no socket.

Fig. 7 shows such a connection in a conventional DC voltage regulator circuit. Here, the constant voltage drop across the zener diode, D, furnishes the voltage reference for the cathode of tube V2. Zener current through the diode is set initially by adjustment of rheostat R2, and the regulated DC output voltage is continuously variable by adjustment of potentiometer R. This regulator circuit is standard in every respect except the substitution of D for the usual gas tube.

Zener Diode as Protective Device. Fig. 8

shows how a zener diode may be employed as an overload protective device for DC circuits and components.

The diode is connected across the DC terminals of the device to be protected. The polarity must be such that the diode is reverse-biased; that is, anode negative and cathode positive. Connected in this way, the diode resistance is many megohms and will not affect operation of the device.

If the voltage of the device rises to the zener point, the diode will conduct heavily, absorbing the extra current which otherwise would pass through and damage the device. The lowered resistance of the diode will reduce the device voltage if the DC supply is not regulated. When the voltage falls to a lower, safe value, the diode conduction comes out of the zener region and the diode resistance returns to its former high value.

The diode must be chosen for a zener voltage corresponding to the maximum voltage which may be applied safely to the device which is to be protected. If the current drawn during the protection interval is too high for a single diode, several additional diodes may be connected in parallel, as indicated by the dotted lines in Fig. 8.

Some of the DC devices which may be protected in this manner include relays, lamps and other filaments, meters, and recorders.

Limiter, Clipper. The circuit given in Fig. 4(A) may be employed as a signal limiter when an AC signal is applied to its input terminals. With the diode connected as shown, the action will be positive peak-limiting. When the diode is reversed, negative peak-limiting will be obtained.

Similarly, the current given in Fig. 5(A) may be employed as a clipper for limiting both positive and negative peak amplitudes.

The zener diode limiter and clipper circuits have the advantage, over similar circuits employing conventional diodes, that no bias batteries are required. Either pulse or sinusoidal signals may be limited or clipped with these circuits. •

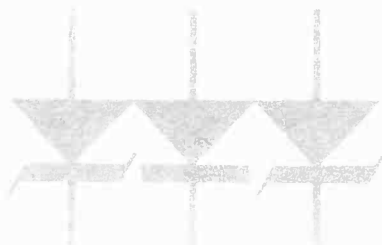

Tape solder is very thin and is coated with rosin. It is melted easily by matches or a lighter.



Soldering With a Match

YOU may have to solder some important connections when you're away from electric power or when the juice is off because you're working on the line somewhere in the house. The answer is solder

in tape or paste form. "Blonde" tape costs 17c a card from Allied Radio Corp. (Cat. No. 46N979). Hercules "Swif" paste is 69c a tube at hardware stores. A couple of matches will do the trick effectively. •

Wrap double layer of tape on joint. Dirt causes trouble; be sure wires and fingers are clean.

Hold match so center of flame envelops joint. Two or three matches may be needed for the job.

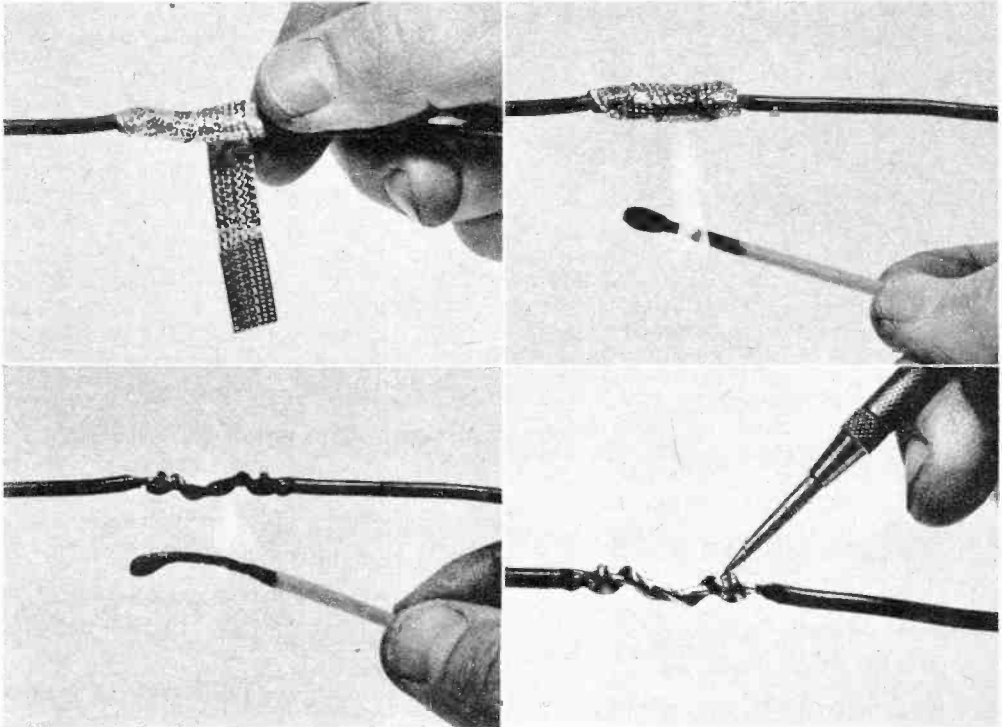

Excess solder may drip off as tape melts. If needed, put on second layer of tape and reheat.

Solder flows evenly into joint of clean wires to form good electrical and mechanical connection.

Practical Circuits for the 2N307 Transistor

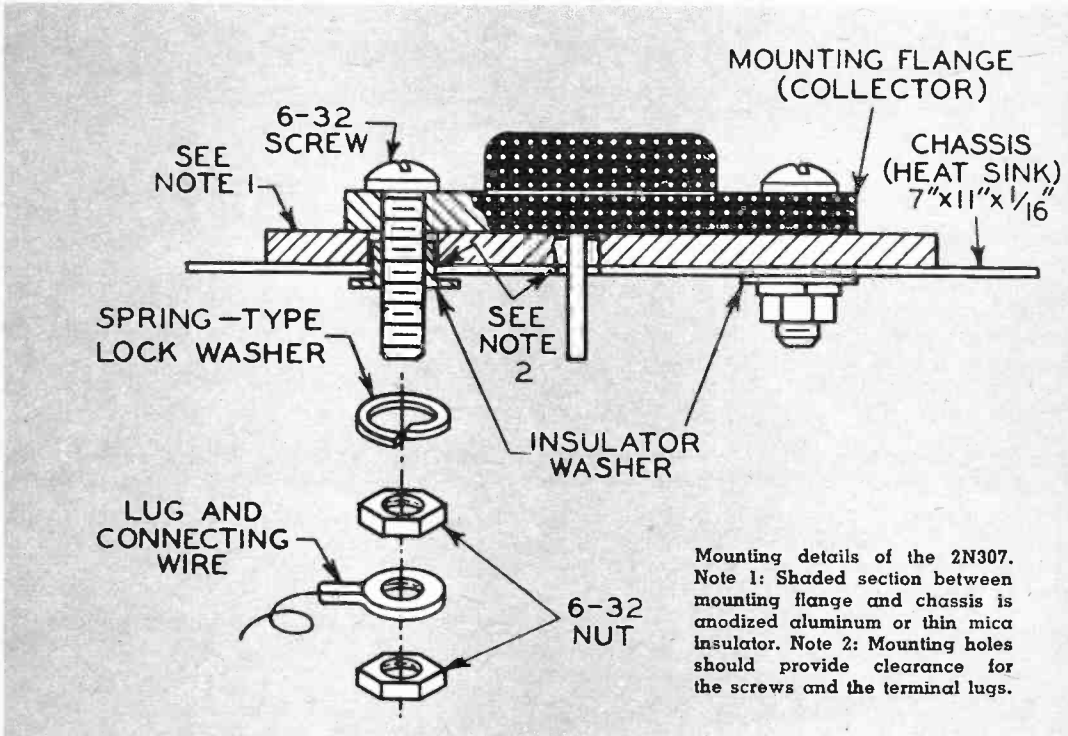

THE RCA-2N307 is a PNP germanium alloy-junction power transistor designed for use by hobbyists and experimenters in a wide variety of circuits such as class A or class B audio-frequency amplifiers, class-A driver amplifiers, low-frequency oscillators, converters, inverters, power supplies, light flashers, intercommunication systems, boat horn, and a strobe photoflash power supply.

General Data

ELECTRICAL:

Mounting-flange temperature of 25°C

Maximum DC Collector Cutoff Current:

For DC collector-to-emitter voltage of -35 volts and base-to-emitter circuit resistance of 30 ohms -15 ma

Maximum DC Collector-To-Emitter Saturation Voltage:

For DC base current of -20 milliamperes and DC collector current of -200 milliamperes -1 volt

Minimum DC Current Gain (h_{FE}):

For DC collector-to-emitter voltage of -1.5 volts and DC collector current of -200 milliamperes 20

Minimum Alpha-Cutoff Frequency

For DC collector-to-emitter voltage of -1.5 volts and DC collector current of -200 milliamperes 3 kc

Maximum Thermal Resistance5°C/watt

MECHANICAL:

Operating position Any
 Maximum overall height 0.980"

Maximum seated height 0.500"
 Case and mounting flange Metal
 Envelope seals Hermetic
 Terminal arrange-
 ment See Dimensional Outline

Transistor dissipation:
 At a mounting-flange temperature of
 25°C or below 10 max. watts
 Mounting-flange temperature
 (during operation) 75 max. °C
 Storage-temperature
 range -65 to +75 °C

AF Amplifier Service

Class A and B

Maximum Ratings, Absolute-Maximum Values

Peak collector-to-base
 voltage -35 max. volts
 Peak collector-to-emitter
 voltage -35 max. volts
 Peak collector
 current -1 max. ampere
 Peak emitter
 current -1 max. ampere

Operating Considerations

In class B push-pull amplifier service it is necessary to insulate the mounting flange (collector) of each transistor from the chassis and from each other to prevent short circuiting the collector load. A suggested mounting arrangement which will insure good electrical contact and maximum heat transfer is shown on page 40. This transistor utilizes The Loranger Mfg. Corp. Socket No. 2149 or equivalent.

Intercom Without Transformers

C1—25 mf, electrolytic, 6 v
 C2—100 mf, electrolytic, 6 v
 C3—25 mf, electrolytic, 12 v
 C4—25 mf, electrolytic, 12 v
 C5—50 mf, electrolytic, 3 v
 C6—25 mf, electrolytic, 12 v
 C7—50 mf, electrolytic, 3 v
 C8—100 mf, electrolytic, 12 v
 C9—25 mf, electrolytic, 12 v
 R1—20,000 ohms, 0.5 watt
 R2—2,000 ohms, 0.5 watt
 R3—5,600 ohms, 0.5 watt
 R4—5,600 ohms, 0.5 watt
 R5—560 ohms, 0.5 watt
 R6—22,000 ohms, 0.5 watt

R7—5,100 ohms, 0.5 watt
 R8—Volume-control potentiometer, 1,000 ohms, 0.5 watt
 R9—330 ohms, 0.5 watt; R10—750 ohms, 0.5 watt
 R11—330 ohms, 0.5 watt
 R12—75 ohms, 0.5 watt; R13—39 ohms, 0.5 watt
 R14—3900 ohms, 0.5 watt
 R15—91 ohms, 0.5 watt
 R16—10 ohms, 5 watt; R17—2 ohms, 1 watt
 S1—Switch, SPDT; S2—Switch, SPDT
 SP1—Speaker, master-station, 12 ohms, 1 watt
 SP2—Speaker, sub-station, 12 ohms, 1 watt
 Power Source—Rectified power-line supply or 12-volt automobile storage battery
 NOTE: "mf" represents microfarad.

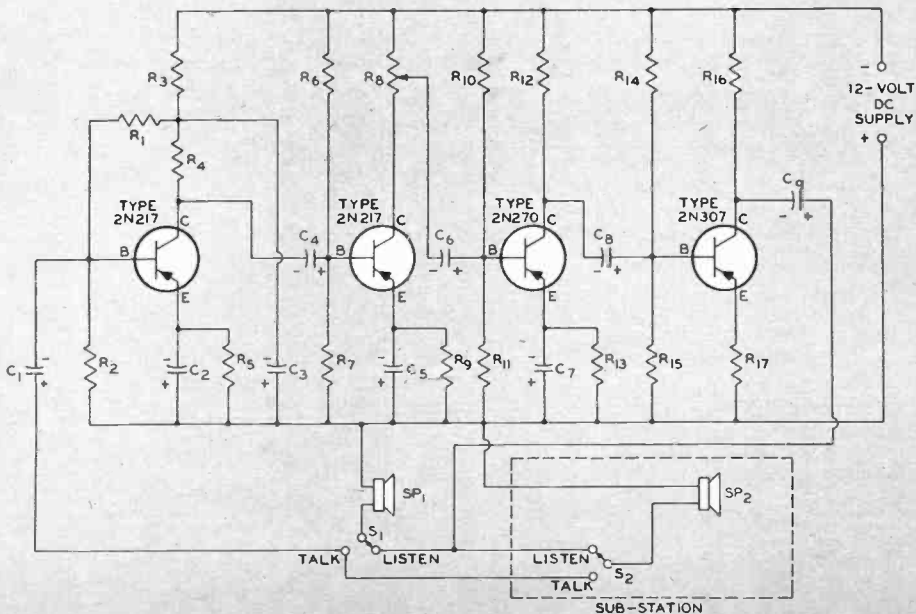

Electrical connection can also be made to the base and emitter pins by soldering directly to the pins. Soldering of connections to the pins may be made close to the pin seals provided care is taken to conduct excessive heat away from the pin seal, otherwise the heat of the soldering operation will crack the glass seals of the pins and damage the transistor.

In applications where the chassis is connected to the positive terminal of the voltage supply, it will be necessary to use an anodized aluminum insulator having high thermal conductivity, or a 0.002" mica insulator between the mounting flange and the chassis.

It is important that *the mounting flange which serves as the collector be securely fastened to a heat sink*. Depending on the application, the chassis (heat sink) may be connected either to the positive or negative terminal of the voltage supply.

It is to be noted that *the metal shell of this transistor operates at the collector voltage*. Consideration, therefore, should be given to the possibility of shock hazard if the metal shell of this transistor is to operate at a voltage appreciably above or below ground potential. In such cases, suitable precautionary measures should be taken. Under no circumstances should the mounting flange be soldered to the heat sink because the heat of the soldering operation will permanently damage the transistor.

The 2N307 should not be connected into or disconnected from circuits with the power on because high transient currents may cause permanent damage to the transistor.

The schematics are presented for the benefit of experimenters. No chassis or constructional data are included, because placement of parts is not critical. "Breadboard" layouts will serve.

12-Watt Power Amplifier

When transistors first appeared, a serious shortcoming was their inability to handle respectable amounts of audio output power. As a result, there were some unusual hybrid combinations of transistors in RF circuit positions with tubes in the AF stages.

This trend has been reversed sharply in many of the newer automobile radios in which tubes function in the RF, oscillator, and IF stages and a pair of transistors handles the audio output. When sets of this type are turned on, there is an immediate click in the loudspeaker, indicating the presence of AF transistors. Voice or music does not come through for about

eight or ten seconds, the normal warm-up time of the tubes.

As an indication of what can be done with transistors exclusively, RCA offers you the circuit shown on page 43. This six-transistor amplifier handles a whopping 12 watts, which is enough to rattle the windows if all of it is used. The circuit lends itself particularly to use as a phonograph amplifier with crystal pickup input. It also has applications as a portable public-address amplifier, operating from the storage battery in a car or truck.

Suitable transformers for this amplifier may not be available. However, it is a simple matter to revamp small filament transformers, which are widely sold at bargain prices. The instructions for T1, T2 and T3 follow.

T1—A 6.3-volt, 1-ampere (secondary center-tapped) filament transformer may be used as the interstage transformer although only one half of the secondary will be utilized. After the circuit has been constructed, reverse the primary lead connections. The reversed connections should be retained if more gain and better low-frequency response are provided. If reversing the connections decreases overall performance, return the primary leads to their original positions.

T2—Using the laminations and form of a 6.3-volt, 3-ampere filament transformer, the driver transformer should be wound as follows: Number each wire to be wound. Label one end of each wire with the letter "S" (for start) and the number assigned to the wire. Label the other end of each wire with the letter "F" (for finish) and the number assigned to the wire. For example, the first wire will have its ends marked "F1" and "S1", the ends of the second wire will be designated "F2" and "S2". Construct the windings according to the directions below.

Winding Number	Wire Type	Number of Turns
1	#22, Formex, Insulated	30
2	#22, Formex, Insulated	30
3	#26, Formex, Insulated	240

Clean the insulation from the wire ends. Connect S1 to the emitter lead of one of the type 2N307's. Connect F1 and S2 to ground. Connect F2 to the emitter lead of the other type 2N307. S3 and F3 are the primary leads.

T3—Using the laminations and form of a 6.3-volt, 3-ampere filament transformer, the output transformer should be wound as follows: Number and label each wire

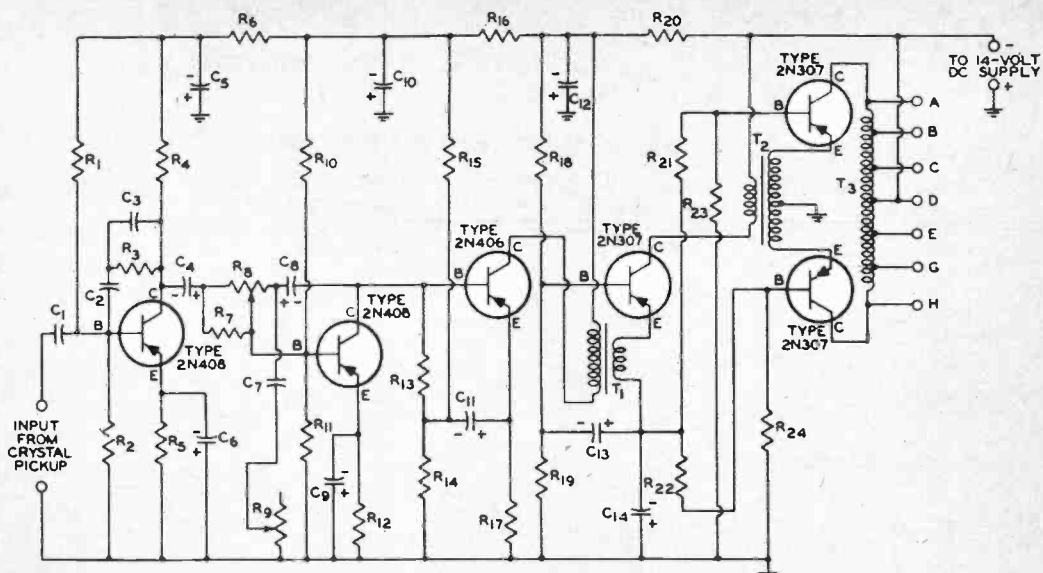

12-Watt Push-Pull Power Amplifier

- C1—0.01 mf, paper, 50 v
- C2—0.06 mf, paper, 50 v
- C3—0.01 mf, paper, 50 v
- C4—5 mf, electrolytic, 6 v
- C5—50 mf, electrolytic, 12 v
- C6—200 mf, electrolytic, 3 v
- C7—0.25 mf, paper, 50 v
- C8—5 mf, electrolytic, 3 v
- C9—200 mf, electrolytic, 3 v
- C10—200 mf, electrolytic, 12 v
- C11—100 mf, electrolytic, 3 v
- C12—200 mf, electrolytic, 12 v
- C13—200 mf, electrolytic, 3 v
- C14—500 mf, electrolytic, 3 v
- R1—56,000 ohms, 0.5 watt
- R2—6,800 ohms, 0.5 watt
- R3—12,000 ohms, 0.5 watt
- R4—5,600 ohms, 0.5 watt
- R5—1,200 ohms, 0.5 watt
- R6—1,000 ohms, 0.5 watt
- R7—12,000 ohms, 0.5 watt
- R8—Volume control, potentiometer, 500,000 ohms, 0.5 watt
- R9—Tone control, potentiometer, 25,000 ohms, 0.5 watt

- All resistors .5 watt
- R10—22,000 ohms
 - R11—3,300 ohms
 - R12—270 ohms
 - R13—680 ohms
 - R14—390 ohms
 - R15—270 ohms
 - R16—68 ohms
 - R17, R18—270 ohms
 - R19—100 ohms
 - R20—47 ohms
 - R21—15 ohms
 - R22—15 ohms
 - R23, R24—2 ohms
 - T1—Interstage transformer, primary impedance of 1,300 ohms, secondary impedance of 1.5 ohms.
 - T2—Driver transformer, primary impedance of 40 ohms (for a DC primary current of 250 ma), secondary impedance of 2.5 ohms (center-tapped). DC secondary resistance—0.2 ohm.
 - T3—Output transformer, primary impedance (tap A to tap H) of 32 ohms (center-tapped), secondary impedances: from tap B to tap G, 16 ohms; from tap C to tap G, 8 ohms; from tap D to tap G, 4 ohms. No connection is made to tap E.

according to the directions given for T2. Wind as instructed below.

- 5 #22, Formex, Insulated 45
- 6 #22, Formex, Insulated 45

Winding Number	Wire Type	Number of Turns
1	#26, Formex, Insulated	48
2	#26, Formex, Insulated	48
3	#22, Formex, Insulated	75
4	#22, Formex, Insulated	75

Do not provide insulation between windings. Clean the insulation from the ends of the wires. Connect Point A to S1, B to F1 and S3, C to F3 and S5, D to F5 and S6, E to F6 and S4, G to F4 and S2, and H to F2. Connect F6 and S4 at E. Point E is not

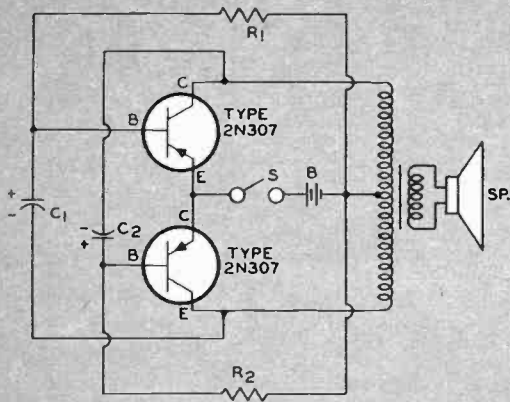

Electronic Boat Horn

Other skippers will really sit up and take notice when they hear the distinctive "beep" of this signal!

- B—12-volt boat battery
- C1—1 mf, electrolytic, 25 v
- C2—1 mf, electrolytic, 25 v
- R1—270 ohms, 0.5 watt
- R2—270 ohms, 0.5 watt
- S—Switch
- SP—Speaker, 8 ohms, 1 watt

Garage Light Actuator

Your garage will be lighted when you get out of your car, if you use this actuator. Shield photo-cell B1 so that only the headlights will hit it.

- B1—Sun battery, International Rectifier type B2M or equivalent
- B2—15 volts, two VS139 in series
- C1—50 mf, electrolytic, 15 v
- L—Bulb, 60 watt, 115 v
- R1—Potentiometer, 25,000 ohms, 0.5 watt
- R2—33,000 ohms, 0.5 watt
- R3—Potentiometer, 2 megohms, 0.5 watt
- R4—1,500 ohms, 0.5 watt
- S—Switch

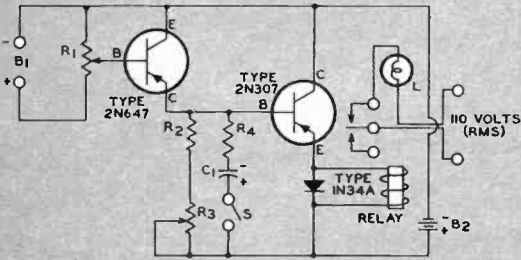

Photoflash Supply

Adjust R1 and R2 for best output.

- B1—RCA VS306 battery
- C1—0.1 mf, paper, 100 v
- C2—1,500 mf, electrolytic, 300 v
- R1—200-500 ohms, 0.5 watt
- R2—20-100 ohms, 0.5 watt
- S—Switch
- T1—United Transformer H-98 or equivalent.

Secondary-to-primary turns ratio = 15:1. For primary, use primary end tap and center tap. For feedback winding, use feedback center tap and feedback end tap.

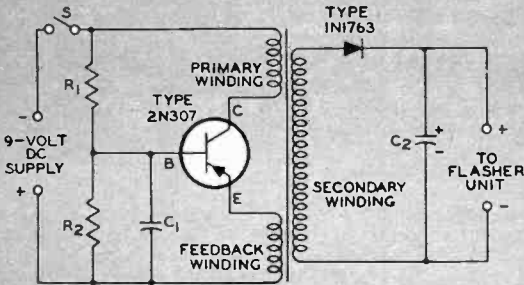

used as a tap and should be marked "NC" (no connection).

NOTE ONE: 120 feet of #22 wire and 120 feet of #26 wire are required for Transformers T1, T2, T3.

NOTE TWO: An audio taper potentiometer should be used for the volume control. A reverse audio taper potentiometer is preferred for use as the tone control, but a linear taper potentiometer may also be used.

NOTE THREE: If shielded cable is used for the speaker leads, it is recommended that cable containing two conductors and a shield be employed. Shielded cable con-

taining a single conductor may also be used, provided the shield is not grounded.

Power Supply

The DC power source for this amplifier can be a six-cell storage battery or an AC dry-disc rectifier combination, capable of furnishing two or three amperes at 14 volts. Experimenters working with transistors will find it expedient to have a bench unit of the latter type available at all times. Excellent for the purpose are some battery chargers, with large, low-voltage filter capacitors added to eliminate AC ripple. •

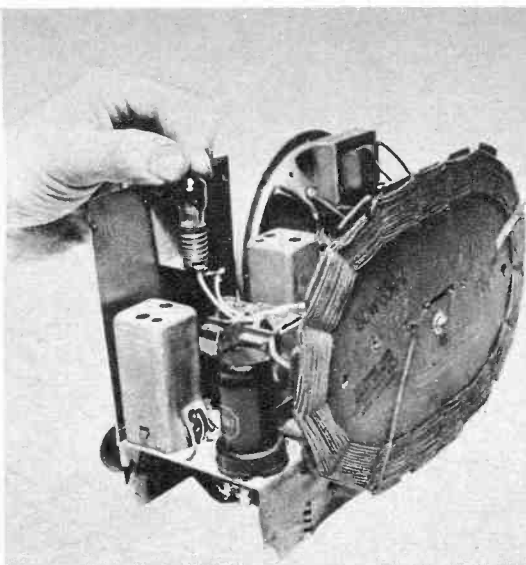

Improving the AC-DC Set

Good location for added pilot light is back of tuning dial. Drill large hole for easy viewing.



Finger points to hole in dial face through which pilot light can be easily seen in room lighting.

New switch takes little space and can be mounted on front panel. Push type is very convenient.

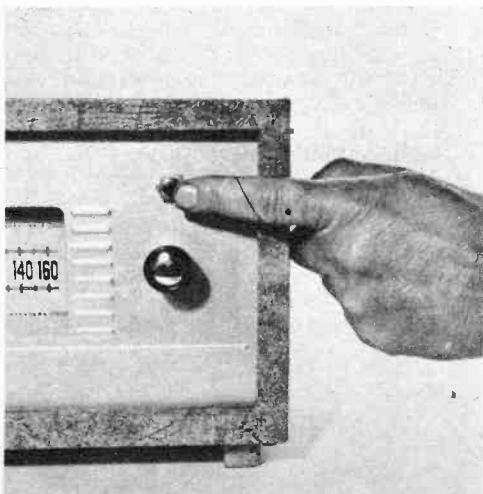

PRACTICALLY all table-model radio receivers produced in the 1950's and 1960's are of the AC-DC type. They are compact and reliable. While the quality of their tone is limited by hi-fi standards, they are satisfactory for most purposes.

Certain little refinements that are missing from factory-made sets can be added with very little work by any electronic technician or experimenter. The first is a pilot light that really can be seen in a normally illuminated room. This will remind you that the set is on so you will not allow it to run needlessly overnight or longer. The best lamp for the purpose is a tiny candelabra-base, 117-volt neon, added to the present series-string heater circuit so that it comes on when the line switch is snapped on. A small incandescent bulb similar to a Christmas tree lamp can also be used, but this gets very hot and may damage the dial face if it's too close to it.

Another convenience is a line switch that is physically independent of the volume control. This can be a toggle or push switch. With the volume control left at a setting suitable for normal listening volume, you will not have to readjust the volume control each time the set is turned on.

Mount the new switch on the front or top of the cabinet and provide it with a length of flexible wire so that the chassis can be pulled out easily for service. Make sure the body and the contacts of the switch do not interfere with components on the chassis. Unsolder the present wires to the volume switch control and splice them to the leads on the new switch.

Most AC-DC receivers tend to become quite hot. The air circulation around the chassis can be improved by drilling $\frac{1}{4}$ " dia. holes in the bottom of the cabinet. *

Fixed Capacitors in Transistor Circuits

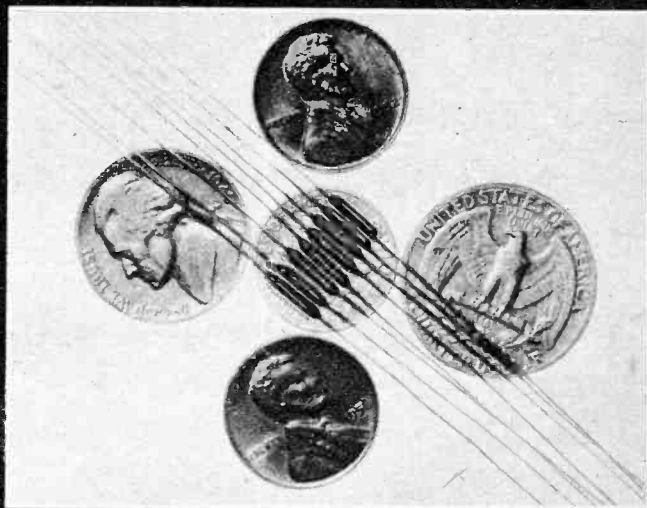

So small that eight of them fit across a dime, these miniature capacitors are apt companions for transistors.

by the Aerovox Corp.

TRANSISTORIZED equipment has created a large new application area for low-voltage capacitors. Since much of this equipment is miniaturized, it demands small-sized capacitors. The low impedances of the transistor necessitate much higher coupling and bypass capacitances, in many instances, than are employed in comparable tube circuits. In order to obtain these high capacitances in small packages, electrolytic capacitors are employed in transistor circuits in positions where they seldom are found in tube circuits. This is particularly true of audio-frequency circuits. In transistorized RF amplifiers and oscillators, and in flip-flops, multivibrators, and other switching circuits, many of the capacitances are very nearly the same as those found in similar tube circuits.

Figure 1 shows single-stage RC-coupled, common-emitter AF amplifiers circuits. This type of circuit is widely used in sound systems, audio amplifiers, instruments, and control devices. Figure 1(A) employs a PNP transistor, and Figure 1(B) an NPN transistor. Figures 1(C) and 1(D) show a simple decoupling filter which would be required in a multistage amplifier consisting of several cascaded RC-coupled stages. Figure 1(C) is used with the PNP circuit, and 1(D) with the NPN circuit.

All capacitors are electrolytic. Note that the polarity of *all* capacitors must be reversed when the transistor is changed from PNP to NPN. In Figures 1(A) and 1(B), C_1 and C_3 are coupling capacitors and C_2 and C_4 are bypass capacitors. DC base bias stabilization is supplied by the voltage divider R_1 - R_3 , and current limiting is provided by emitter series resistor R_4 . The R_1 - R_3 voltage division results in the application of a DC voltage that is somewhat lower than the supply voltage to the base of the transistor and to the inner terminal of C_1 . This voltage is negative in the PNP circuit and positive in the NPN. Unless degeneration is desired, R_1 must be heavily bypassed. This is accomplished by C_2 . In a preamplifier employing a conventional AF transistor and a 6-12-volt supply, typical circuit constants are: C_1 and C_3 1 to 10 mf (depending upon desired low-frequency response), C_2 100-200 mf, C_4 50 mf, R_1 100K, R_2 4.7K, R_3 10K, and R_4 1K. In the decoupling filters (Figures 1C and 1D), typical values are C 50 mf and R 220-330 ohms in a 3-stage voltage amplifier.

Capacitor C_1 looks into a relatively low resistance comprised of the internal base-emitter resistance of the transistor in parallel with bias resistor R_3 . This total resistance may be of the order of 1000

ohms. Hence, a high capacitance (1 to 10 mf) is required in C_1 to obtain the same low-frequency response and negligible phase shift afforded by a 0.1 mf looking into a $\frac{1}{2}$ megohm grid resistor in a comparable tube circuit. When RC-coupled stages are cascaded, each output capacitor (C_3) looks into the low base-emitter input resistance of the following stage. In a tube amplifier in which the coupling capacitance $C = 0.1$ mf and the grid resistance $R = \frac{1}{2}$ megohm, the time constant $t = 50$ milliseconds. To obtain this same value with the 1000-ohm input resistance of the transistor, $C = t/R = 50$ mf.

Even when the resistance of the AF signal source is low (as in the case of a reluctance pickup or dynamic microphone), Capacitor C_1 is required to withstand only the steady DC voltage developed at the junction of R_1 and R_3 . Since this potential is much lower than the supply voltage, a capacitor rated at a continuous DC working voltage equal to the supply voltage will provide more than adequate safety factor. Actually, a much lower DCWV rating may be tolerated here when minia-

turization demands a smaller-sized (lower-voltage) capacitor, since in the circuits shown in Figures 1(A) and 1(B), the transistor base voltage is about one tenth of the supply voltage.

The output coupling capacitor, C_3 , being connected directly to the collector of the transistor, must be rated to withstand continuously the DC supply voltage (less the drop across R_2) plus the peak value of the collector signal voltage. The DC voltage drop e developed across the emitter resistor, R_4 , is equal to $i_e R_4$, where i_e is the DC emitter current. Bypass capacitor C_4 accordingly must be rated to withstand continuous voltage e plus the peak value of the AF signal voltage developed across R_4 . The DCWV requirement of C_1 generally will be less than one half that of C_3 . For simplicity, however, capacitors of the same voltage rating often are used in both positions.

In a multistage circuit, the situation is slightly different. The interstage coupling capacitor (C_3 in Figure 2) has the negative collector voltage of transistor Q_1 applied to its negative terminal, and the lower

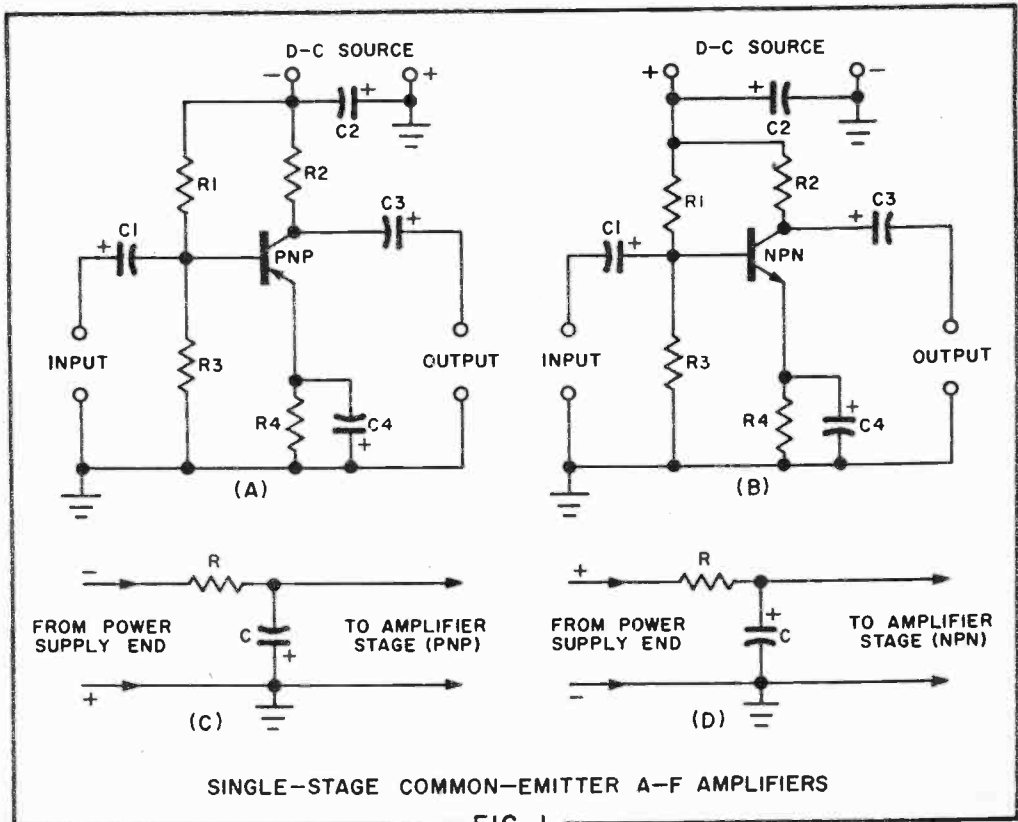

FIG. 1

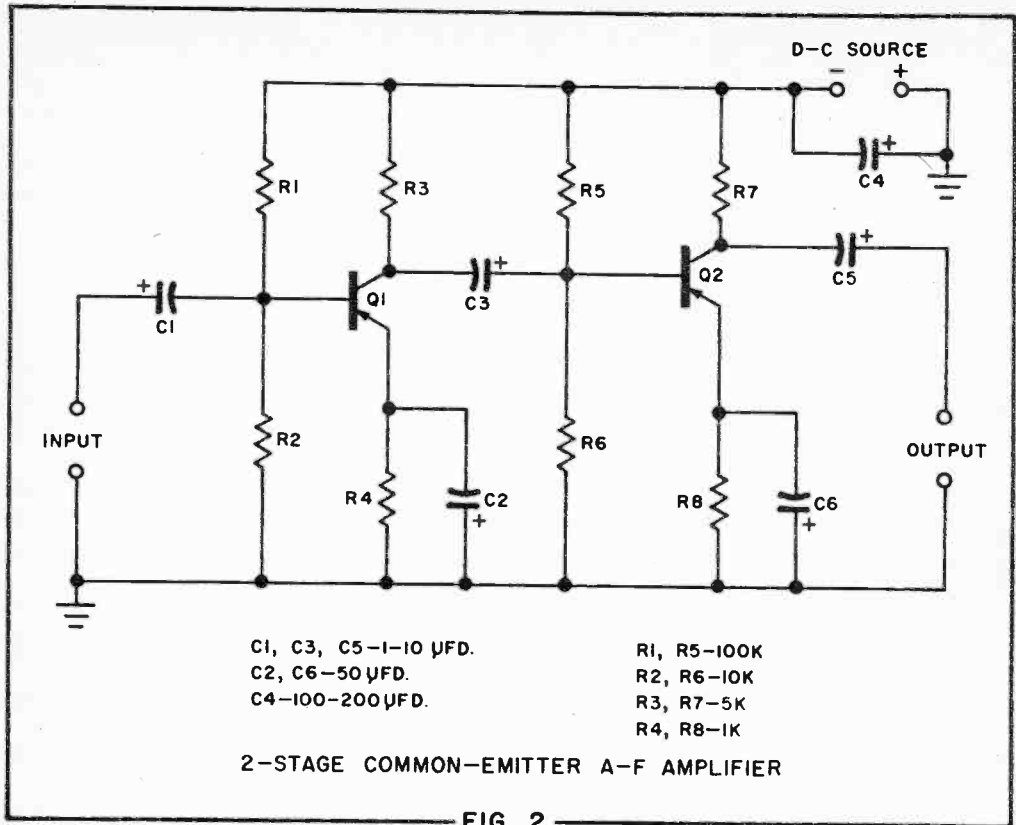

FIG. 2

negative bias voltage at the base of transistor Q_2 applied to its positive terminal. (If NPN transistors are used, all voltage and capacitor polarities are reversed.) Capacitor C_3 accordingly must be rated to withstand continuously the DC supply voltage (less the drop across R_3) plus the peak value of the Q_1 collector signal voltage. Capacitor C_5 must be similarly rated with respect to the DC and AF collector voltages of transistor Q_2 . The DCWV ratings of bypass capacitors C_2 and C_6 , like C_4 in the single-stage amplifier, are less than one half those of C_3 and C_5 ; but for simplicity, capacitors of the same rating often are used.

To prevent damage to coupling capacitors in circuits handling high signal-voltage levels, capacitors having sufficiently high DCWV ratings must be employed to insure a good safety factor. Since the total voltage applied to the capacitor is the sum of DC and signal voltages, the DC rating of the capacitor can be exceeded during the high signal-voltage peaks if the capacitor is selected only on the basis of the DC voltage expected in the circuit.

For good safety factor, the supply bypass capacitor (C_2 in Figure 1 and C_4 in Figure 2) should have a DCWV rating equal to twice the supply voltage. The filter capacitor in the decoupling network (C in Figures 1C and 1D) should be similarly rated.

Importance of Low Leakage

The necessity that leakage currents be low in miniature electrolytic coupling capacitors in transistor circuits is apparent from an inspection of Figure 2. The voltage divider networks (R_1 - R_2 and R_5 - R_6) stabilize the DC base bias of the transistors. This stabilization provides some temperature compensation, as well as minimizing changes in operation when transistors are interchanged or replaced. Very importantly, the DC bias also sets the operating point of the transistor along its characteristic curve, so that Class-A operation, for example, is secured. If the leakage of capacitor C_3 is high, the voltage at the junction of R_3 and R_6 will be raised to some value approaching the collector potential of transistor Q_1 . This change in voltage will

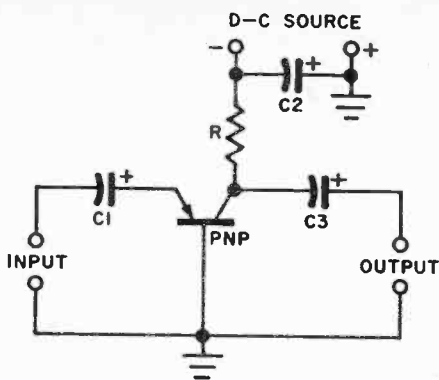

(A) COMMON BASE

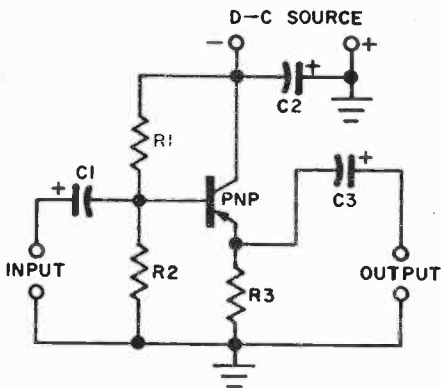

(B) EMITTER FOLLOWER

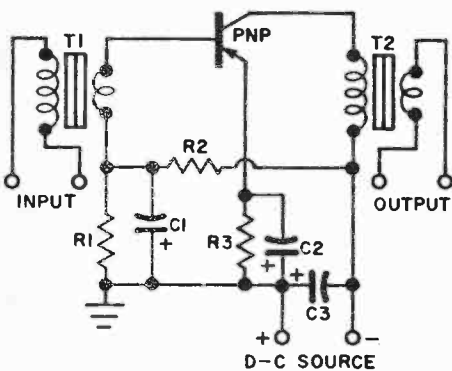

(C) TRANSFORMER-COUPLED COMMON EMITTER

ADDITIONAL A-F CIRCUITS

FIG. 3

shift the operating point of transistor Q_2 , resulting in distortion, and will alter the stabilization provided by the voltage divider. Additionally, the lowered impedance of C_2 will alter the gain and phase shift characteristics of the amplifier. High leakage in C_2 will also reduce the DC collector voltage of Q_1 .

High leakage in C_2 will cause a DC component to be applied to the load device (or following amplifier stage) connected to the OUTPUT terminals. In short, DC leakage must be low enough that a coupling capacitor does not transmit a significant DC component and that a bypass capacitor does not materially reduce the DC resistance of the path in which it is included.

Additional A-F Circuits

The RC-coupled common-emitter circuit presently is the most widely used in transistorized AC signal circuits. Its general appeal is due to its high power gain, fair-to-good frequency response, and moderate input impedance. Figure 3 shows additional circuit arrangements in which the correct polarity of electrolytic capacitors is indicated. PNP transistors are used, reverse all capacitor and voltage polarities.

Figure 3(A) shows a common-base stage. The input resistance of the transistor is very low (50 ohms with some transistors). The input coupling capacitor, C_1 , therefore must be quite high in order to obtain the same frequency response, phase shift, and gain supplied by comparable common-emitter and tube circuits. Whereas an input coupling capacitance of 1 to 10 mf (Figures 1 and 2) is suitable for the common-emitter circuit, C_1 will be 10 to 50 mf in the common-base circuit, depending upon type of transistor and desired low-frequency response. The capacitance of C_2 will not be so high (generally 1 to 10 mf) unless the load device has low resistance.

Figure 3(B) shows an emitter follower stage. This configuration provides high input impedance, low output impedance, wide frequency range, and no phase shift; and in these respects is similar to the cathode follower tube. Here, capacitors C_1 and C_2 have the same values specified earlier for the common-emitter circuit. Output coupling capacitor C_3 is effectively in series with the low emitter resistance (R_3) and the low resistance external load device. This capacitance accordingly must be high and usually is of the order of 50 to 1000 mf, depending upon the values of R_3 and R_L (external load), and the desired

low-frequency response that you wish to obtain from the stage.

Figure 3(C) shows a transformer-coupled common-emitter stage in which the DC bias, developed by the R_1 - R_2 voltage divider, is applied to the base of the transistor through the secondary winding of input transformer T_1 . This arrangement often is used in power transistor stages, the bias network being placed in this position instead of across the input terminals (as in Figures 1 and 2) because the lower resistor would absorb some of the input signal. Here, it is necessary to bypass heavily to prevent loss of signal voltage across the lower network resistor, R_1 . The bypass capacitance, C_1 , must be high, since R_1 usually is low (commonly 100 to 1000 ohms). C_1 will have a value between 50 and 500 mf, depending upon the transistor type and R_1 resistance. Bypass capacitor C_2 likewise must be high, since R_2 (especially in power transistor stages) may be only a few ohms. This capacitance will be 100 to 1000 mf, depending upon transistor type and R_2 resistance.

Capacitors in RF and Switching Circuits

The majority of the capacitances that are employed in RF amplifier and oscillator circuits, including intermediate-frequency devices, extend from 5 mmf to 0.1 mf. This is true also of switching circuits, including flip-flops, multivibrators, Schmitt triggers, pulse amplifiers and inverters, single-shots, etc. These capacitances are obtainable in miniature nonelectrolytic capacitors, such as mica, ceramic, and (in the higher capacitances) metallized paper types. Therefore, there is no polarity problem. These capacitors normally are rated to withstand much higher DC voltages than ordinarily are encountered in transistor circuits consequently, voltage rating is no problem either.

An occasional high capacitance, such as 10 mf, is required for AVC filtration or for DC supply bypassing, and a miniature electrolytic is employed in such instances. Here, the rules discussed earlier apply to this capacitor. That is, the DCWV rating of the capacitor must exceed the sum of the supply voltage and signal-voltage peak, and the polarity is determined by whether the transistor is NPN or PNP.

A wide selection of miniature mica and ceramic capacitors is available for use in RF and switching circuits. The choice of a particular type will depend upon space requirements and, to some extent, upon whether conventional or printed-circuit construction is employed. •

Tips



Ever blow the house fuse while experimenting with some equipment? At night, this can be both exasperating and dangerous. It is a good idea to keep an emergency source of light within reach on a shelf over the workbench. A flashlight or a short piece of candle stuck in a glass jar and a small box or book of matches should be handy. A flashlight is good for spot illumination, but a candle will light the whole room.

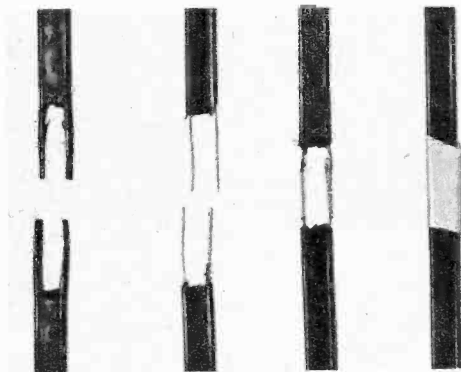

Have to make a splice in twin lead? It should be thin and flat if the wire is to be used as loudspeaker cable under a carpet or rug. The job is easy if you follow the picture sequence. Nip out center insulation with side cutters. Trim wires, clean with back edge of knife, and tin lightly. Place wires side by side and run iron over them. Cover joint with thin paper tape.



TINY-TALKIE

DICK TRACY in uniform? Buck Rogers back on a visit?

Neither. Just a ramp supervisor for United Airlines speeding up the loading and unloading of aircraft with the aid of a compact two-way radio carried in a belt holster. Formerly he had to run back and forth between a plane on the field and a telephone on a distant fence or building; now he is in constant touch with a central dispatching office. The arrangement saves hours of precious time every day, and helps to eliminate the disagreeable squabbles between passengers and company officials over unexplained delays in take-off.

The equipment is, of course, transistorized and battery operated. What catches the eyes of visitors to LaGuardia and Idlewild Airports in New York, and fields in other cities, is the little four-inch antenna mounted on a shoulder strap of the supervisor's uniform. The size of this antenna is a tip-off that a very high frequency is used. The sets are licensed in the Class "A"

Citizens Band, and work in the 450-megacycle range. This was the original CB assignment, available for years before the 27-megacycle channels were opened but not used very much because of the difficulty of making portable transmitters and receivers of satisfactory stability. The five-pound United Airlines' tiny-talkies are custom jobs, made by Radio Specialties Co., of Denver, Col., and cost several hundred dollars each. They are the first such portables to be employed commercially in the busy New York airports and are proving highly successful in all respects.

The effective range of the units is about a mile and a half. The user wears a lightweight earphone of the hearing-aid type. While he is on the field the receiver is kept on. A squelch circuit keeps background noise down and enables him to hear calls when they come through from the dispatcher. With fixed-frequency operation, there is no manual tuning of any kind. There's a press-to-talk button on mike. •

All About THE DECIBEL



How to understand and use this important unit of measurement.

by **E. H. Boden, Advanced Applications Engineer,**

Sylvania Electric Products, Inc.

THE increasing use of the decibel makes it more and more important that radio and television technicians and radio amateurs become acquainted with this unit of measurement and know how to properly use it. Catalogs and technical literature make use of the decibel to describe the performance of amplifiers, antennas and filter networks. Radio amateurs have for some time used decibels in giving signal strength reports.

The use of the decibel provides a convenient shorthand notation for power ratios and simplifies overall communication-system analysis.

At one time or another we have all prob-

ably read or heard it said that the human ear is nonlinear in response to changes in power or sound levels. For example, let's assume we have an audio amplifier that is delivering a pure tone and has an actual power output of 10 watts. Now, research has shown that for the ear to sense that the output has been doubled, the actual power output of the amplifier must be increased by 10 times to 100 watts. For the ear to sense an increase of four times, the output of the amplifier must be increased by 1000 times to 10,000 watts. Thus it can be seen that the ear becomes less sensitive to changes in power as the delivered power is increased.

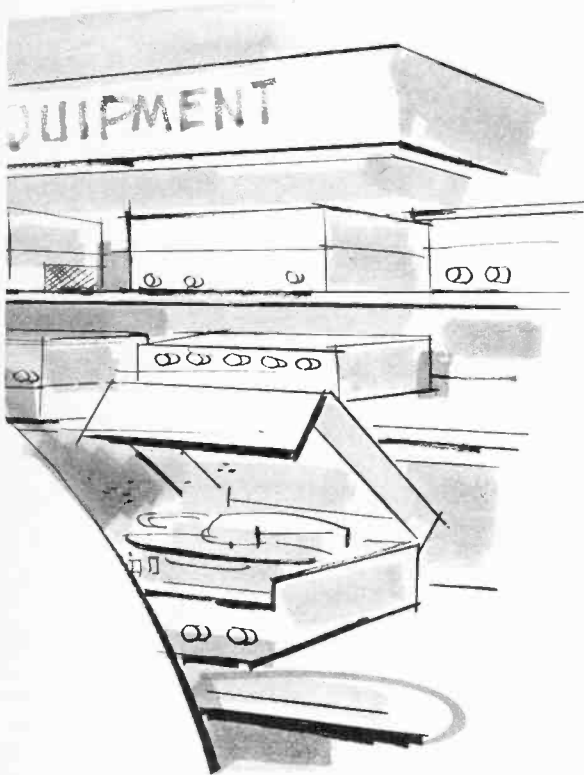

The decibel is simply a relative unit of measurement used to express changes in power based on the ability of the *human ear* to recognize these changes. As previously stated, application of the decibel as a unit of measurement is not limited to audio frequencies. The ease with which the decibel enables us to express power gain and/or power loss, through elimination of the necessity of handling large numbers, has resulted in wide-spread usage.

For those who are mathematically inclined, the decibel is defined by the equation:

$$\text{db} = 10 \log_{10} \frac{P_L}{P_S} \quad (1)$$

where P is always the larger power, in watts, P is always the smaller power, in watts.

The log function comes from the fact that the response of the ear to changes in power

is actually logarithmic. Although equation (1) may be written in a few slightly different forms, the decibel is never anything more or less than a ratio.

Using a Decibel Table

To find db we can use equation (1) or, for those who prefer to eliminate as much math as possible, we can refer to the decibel table on page 54. Let's assume we have a gain of 3 db. Referring to the table we find that the corresponding power ratio for a gain of 3 db is 1.99 to 1. In other words, the power output is 1.99 or approximately 2 times the power input. Referring again to the table we see that for a power output which is 5 times the power input the gain is 7 db; thus we can work from either direction.

Now, let's see how to handle a power gain of 26 db. First, we look opposite 6 db and find that the corresponding power ratio is approximately 4. In the same manner we find that 20 db represents a power ratio of 100. The power gain, therefore, corresponding to 26 db is 4×100 or 400 times.

To generalize, in Fig. 1 we have a "black box." P_1 is the input power in watts and P_2 is the output power in watts. If our box is an amplifier with gain, then P_2 will be greater than P_1 . Let's say by experiment it was found that when a power of 10 milliwatts was put into the amplifier we got 2000 milliwatts (2 watts) out. Let's now find the gain in db. The power gain of the amplifier is found by dividing the power output by the power input:

$$\frac{2000 \text{ mw}}{10 \text{ mw}} = 200$$

Since a power gain of 200 (power ratio of 200 to 1) cannot be read directly in db from the table, it must be broken down to 2×100 . Referring to the table we find that a power gain of 2 is 3 db and a power gain of 100 is 20 db. The db gain of the amplifier is simply the sum of 3 db and 20 db or 23 db.

Many times we find a minus sign in front of a decibel figure. This simply means that there is more power going in than coming out. Now let's say that our "black box," Fig. 1, is a network in which there is a loss, i.e., P_2 is less than P_1 . Let's say then that $P_1 = 10 \text{ mw}$ and $P_2 = 2 \text{ mw}$. In the

table we find that for a power ratio $\left(\frac{P_L}{P_S}\right)$ of $10/2 = 5$. A figure of 7 db is obtained. Since the power input is greater than the power output, we say the circuit has a loss of 7 db or a -7 db gain.

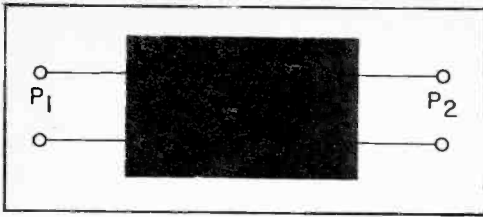

Fig. 1. "black box" amplifier or network whose power input is P_1 and whose power output is P_2 .

Transmission Lines and Boosters

Since the advent of directional television antennas we have become accustomed to seeing antennas listed with 5, 6 or 9 db gain. This seems to imply that we are getting some free power in the antenna someplace. What is really happening is we are making an antenna more sensitive in one direction at the expense of sensitivity in other directions. In most cases the gain is relative to a half-wave dipole, while at times it is relative to a point source (antenna with equal response in all directions). A half-wave dipole has a gain of 2 db over that of a point source.

A transmission line may be reduced to a simple network. For a given length, frequency and type of line, there will be a power loss. By taking ten times the logarithm of the sending-end power to the receiving-end power, we will have the db loss of the transmission line.

Before going on, let us see how we can use what we have learned so far. Let us suppose that we have an antenna, amplifiers and lengths of transmission line to bring the signal from a remotely located antenna to the receiver. Let us also assume that a satisfactory signal can be obtained at the antenna with a simple folded dipole. When using ordinary flat twin lead there is a transmission line loss of 40 db for the particular length involved. To make up for this 40 db loss, two 20 db boosters may be used. If an antenna of 10 db gain and possibly a tubular twin lead with 10 db less loss is employed, only one 20 db booster would be needed. What we are saying is that the db gains must add up to equal the db losses. In this way we can be certain of a good picture.

Voltage and Current Ratios

It was said earlier that equation (1) could be rewritten in a few slightly different forms. These new forms are derived by substituting the latter two fundamental power relationships in equation (1):

TABLE OF DECIBELS FOR
POWER AND VOLTAGE RATIOS

DB	POWER VOLTAGE*	
	RATIO	RATIO
1.0	1.26	1.12
1.2	1.32	1.15
1.4	1.38	1.17
1.6	1.44	1.20
1.8	1.51	1.23
2.0	1.58	1.26
2.2	1.66	1.29
2.4	1.74	1.32
2.6	1.82	1.35
2.8	1.91	1.38
3.0	1.99	1.41
3.2	2.09	1.44
3.4	2.19	1.48
3.6	2.29	1.51
3.8	2.40	1.55
4.0	2.51	1.58
4.2	2.63	1.62
4.4	2.75	1.66
4.6	2.88	1.70
4.8	3.02	1.74
5.0	3.16	1.78
5.2	3.31	1.82
5.4	3.47	1.86
5.6	3.63	1.91
5.8	3.80	1.95
6.0	3.98	1.99
6.2	4.17	2.04
6.4	4.36	2.09
6.6	4.57	2.14
6.8	4.79	2.19
7.0	5.01	2.24
7.2	5.25	2.29
7.4	5.50	2.34
7.6	5.75	2.40
7.8	6.03	2.46
8.0	6.31	2.51
8.2	6.61	2.57
8.4	6.92	2.63
8.6	7.24	2.69
8.8	7.59	2.75
9.0	7.94	2.81
9.2	8.32	2.88
9.4	8.71	2.95
9.6	9.12	3.02
9.8	9.55	3.09
10.0	10.00	3.16
20.0	100.00	10.00
30.0	1,000.00	31.60
40.0	10,000.00	100.00
50.0	100,000.00	316.00

*May be used only when input and output impedances are equal.

Fig. 2. Gain characteristics of the IF amplifier section of a color television receiver shows the gain is "52 db down" at the sound carrier of 41.25 mc.

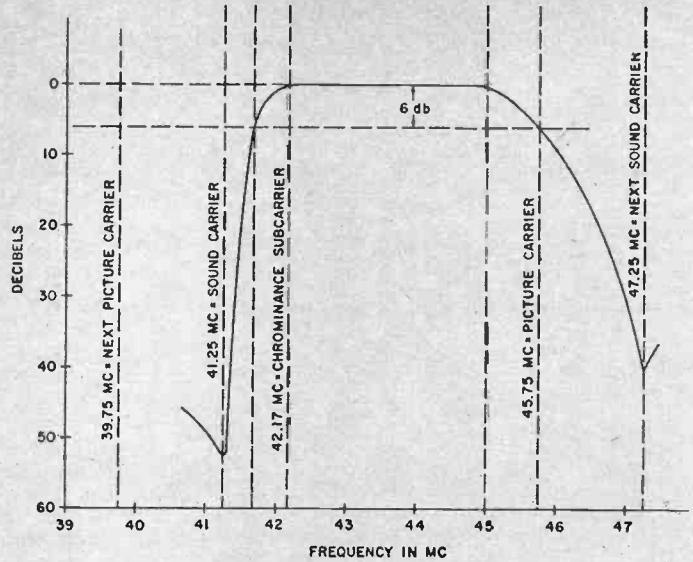

$$P = IE = \frac{E^2}{R} = I^2R \quad (2)$$

Skipping the mathematics involved, our new equations are:

$$\text{db} = 20 \log \frac{E_L}{E_S} \quad (3)$$

and

$$\text{db} = 20 \log \frac{I_L}{I_S} \quad (4)$$

These two relationships, however, hold true only if the input and output impedances of the circuit with which we are working are equal.

Although the application of equation (3) is limited by the fact that input and output impedances must be equal, it is still very handy. For example, if we have a booster with a 300 ohm input and output, the gain of the amplifier in db is simply 20 times the log of the input to output voltage ratio. The table also includes voltage ratios for various db levels, thus eliminating the necessity of handling logarithms.

Response Curves

Fig. 2 shows the gain characteristics of a typical IF amplifier of a color-TV receiver. Note that the 45.75 mc picture brightness carrier is -6 db. This means that the picture carrier power is one fourth the maximum response of the amplifier. The 42.17 mc chroma carrier is at zero db (that is, it is amplified fully) while

the 41.25 mc sound carrier is down 52 db (1/160,000 the power or 1/400 the voltage level).

The above method of describing the IF response curve is also used to describe the characteristics of a video amplifier, a hi-fi amplifier or even a VTVM.

At this point it is interesting to go back and think about some of the signal reports given out in amateur radio. "Your signal here, Joe, is 10 db over S-9." This tells Joe that he may decrease his power a factor of 10. Since Joe is running 1 kw to the final, the signal report tells him that he may reduce his power to 100 watts and still have an S-9 signal with a much reduced electric bill.

DBM

Occasionally one finds the use of dbm. This means decibel relative to one milliwatt power. Plus 30 dbm would then equal one watt of power while -3 dbm equals 0.5 milliwatt.

Microphone db ratings have not been standardized. For some, the zero db reference level is one volt at a sound pressure of one dyne per square centimeter while others use one milliwatt at 0.0002 dyne per square centimeter (threshold of hearing).

With practice and frequent use one will find the decibel a very convenient tool; i.e., it saves the handling of large numbers (50 db is 100,000 times), and many times, lengthy descriptions. •

3-D Radar for Missile Ships

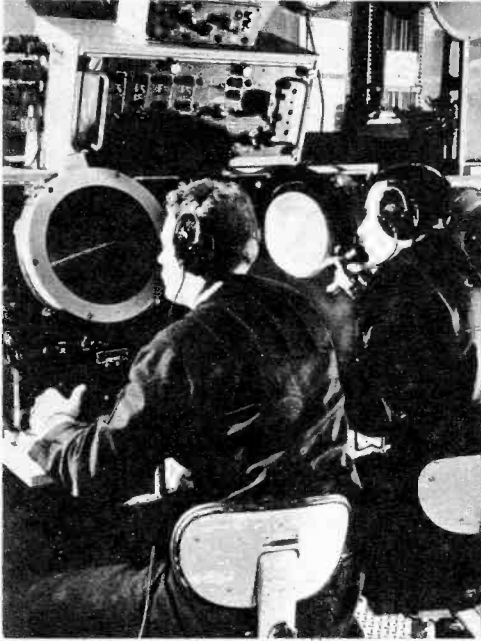

MODERN missile-armed cruisers and destroyers of the U. S. fleet have been equipped with the first seaborne electronic scanning radar capable of pinpointing and displaying simultaneously three essential target dimensions—range, bearings, and altitude—to retaliate against enemy airborne attack.

The U. S. Navy and Hughes Aircraft

Left: Three dimensional information (range, bearing and altitude) is displayed on these two indicators in the combat information center of the missile cruiser USS Galveston. Displays are part of Frescan radar system developed and produced for the Navy by Hughes Aircraft Co. Target bearing is shown on plan-position-indicator at left and range and height on scope at right.

Right: Towering more than 140 feet above the water on a masthead of the new missile carrier USS Galveston is scoop-like antenna of Frescan radar system. This lightweight antenna is electronically stabilized and does not require mechanical compensation for pitch and roll. Sailor is posed on platform only to show the comparative equipment size.

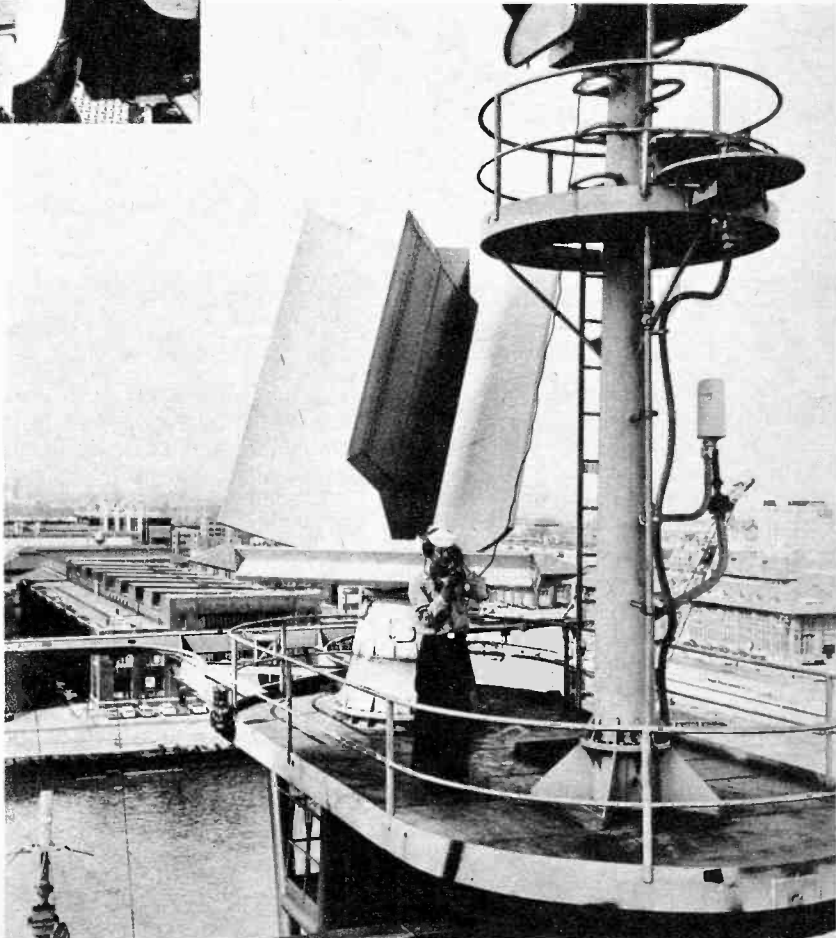

Company said that *Frescan*, a powerful, lightweight, all-weather radar, uses only a single antenna, transmitter and receiver and automatically flashes information on supersonic targets to information and control centers that fire intercepting Talos, Terrier, or Tartar missiles.

Conventional radar systems generally require combinations of several antennas, transmitters or receivers to provide three-dimensional target information, and heavy mechanical gyro-stabilizing equipment to compensate for pitch and roll of a ship at sea. *Frescan* does not require this. These are *Frescan*'s four basic attributes:

1. Instantaneous display of three-dimensional multiple target information.

2. *Electronic* pitch and roll stabilization, eliminating heavy masthead weight.

3. High degree of flexibility permitting changing the volume of space covered to conform to different tactical situations.

4. Single antenna, transmitter and receiver to provide 3-D target information.

Frescan concentrates all available power

in sharp, pencil-shaped beams of energy to pinpoint targets at great distance and with extreme accuracy. Range and height information is obtained by electronic scanning in a vertical plane in milliseconds while rapid rotation of the antenna supplies target bearing.

Conventional radars require heavy mechanical gyro-stabilization equipment above deck to keep the antenna platform level at all times. The *Frescan* antenna is affixed to the masthead and is allowed to roll and pitch with the ship.

This eliminates heavy mechanical stabilization equipment, reduces topside weight, and contributes to the ship's stability. For example, some above-deck equipment is up to 20 times greater than *Frescan*'s weight of about 2,800 pounds.

Roll and pitch signals from a ship's main gyro are supplied to a computer which instantly and automatically modifies the elevation beam scanning program and presents the true position of targets on the radar scopes. •

Drawing shows difference in operation between the conventional radar antenna and *Frescan* system.

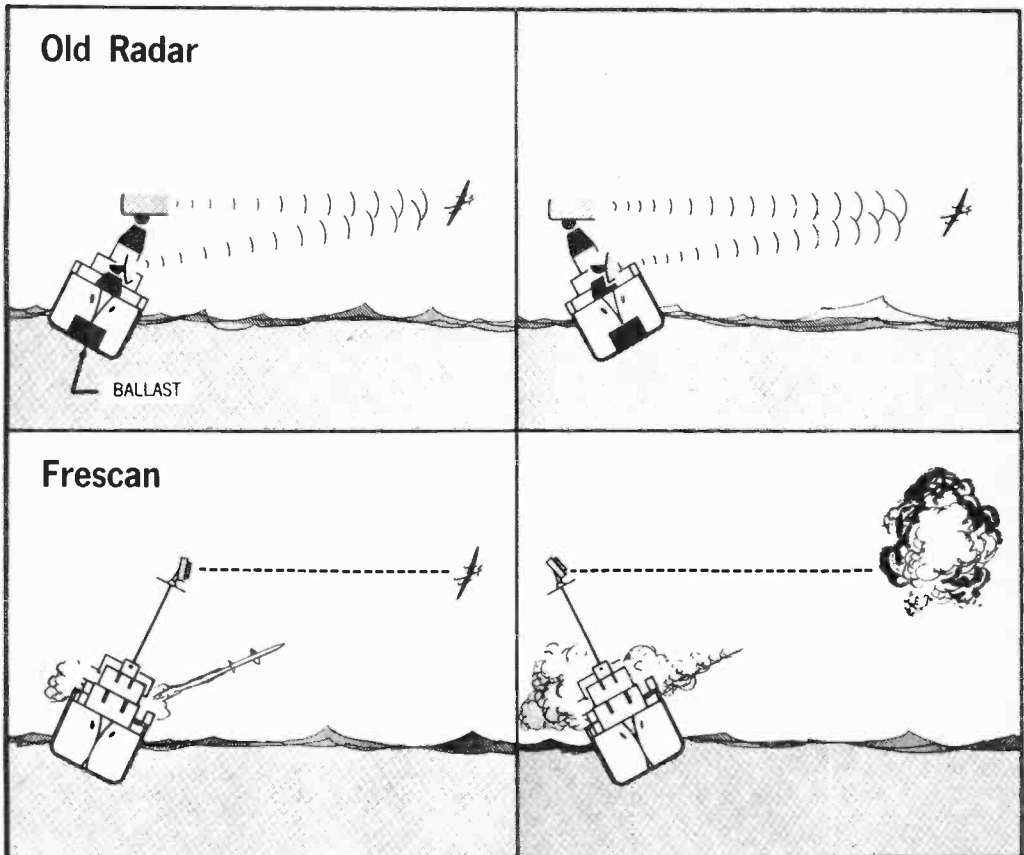

How To Start in HAM RADIO

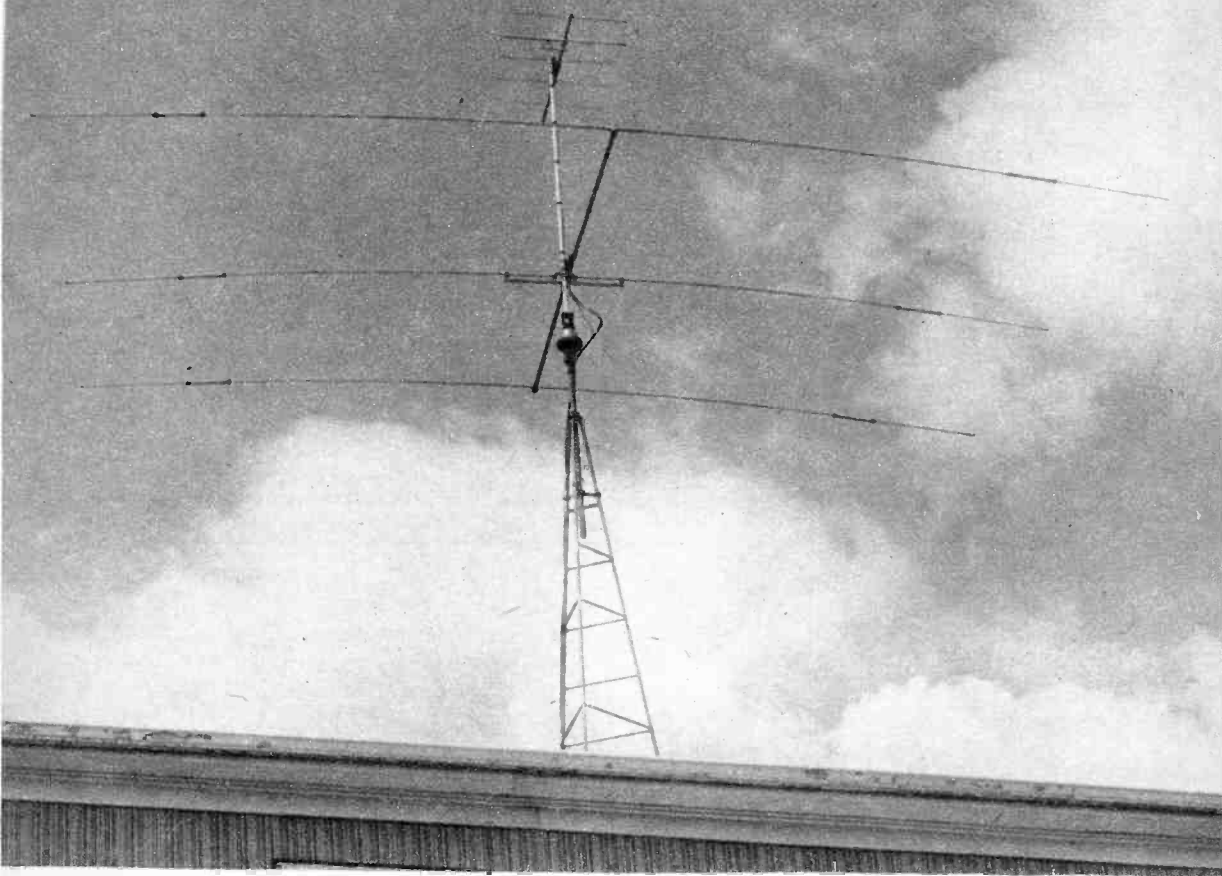

Typical ham antenna owned by K2DUX, Whitestone, N. Y. Tower supports a three-element beam for 10, 15, and 20 meters. On top is a separate six-element beam for two meters; single rotator is used.

THE ham gear displayed in dealers' stores and in mail-order catalogs is very inviting. There are enough knobs, dials, switches, lights, meters, etc., on the equipment to gladden the heart of the most ardent gadgeteer. The complexity of the equipment can be very confusing to people who are newly bitten by the amateur radio bug. They just don't know how to make a selection to fit their particular needs.

To assist newcomers in getting started, I'd like to make some specific suggestions about equipment with which I have had personal experience.

Prospective hams seem to fall into two pretty well defined categories: (1) they know nothing about radio, but have become interested by observing ham operation or reading about it. (2) they have had some electronic training in school or in one of the military services, or have dabbled in hi-fi, or have used the Citizens Band and realized its limitations.

If you are in the first group, you realize that ham radio is a very technical and complicated activity (that's part of its appeal) and that you must learn quite a bit about electronic circuits and equipment opera-



Excellent basic station setup for the beginner; Knight-Kit R-55 receiver with Eico 723 transmitter on top. Both are simple kit projects. The call book, key, and clock are necessary accessories in the ham shack.

tion not only to qualify for your FCC license but also to enable you to use your station properly. Therefore, regardless of how much money you have to spend, you should start your ham education by building a modest short-wave receiver *in kit form*. If you can handle basic hand tools you'll find the job interesting, instructive and satisfying. You'll learn the names of and how to identify components, how to mount them in position and solder their

connections, and how to read schematic diagrams. Since the metal chassis, panel, cabinet and other mechanical parts are prepunched and formed, you can concentrate on the more important electrical aspect of the job. You don't need an elaborate shop or even a workbench, although, of course, these are conveniences. A bridge table or a small desk, protected by a piece of plywood, hardboard or linoleum, is perfect.

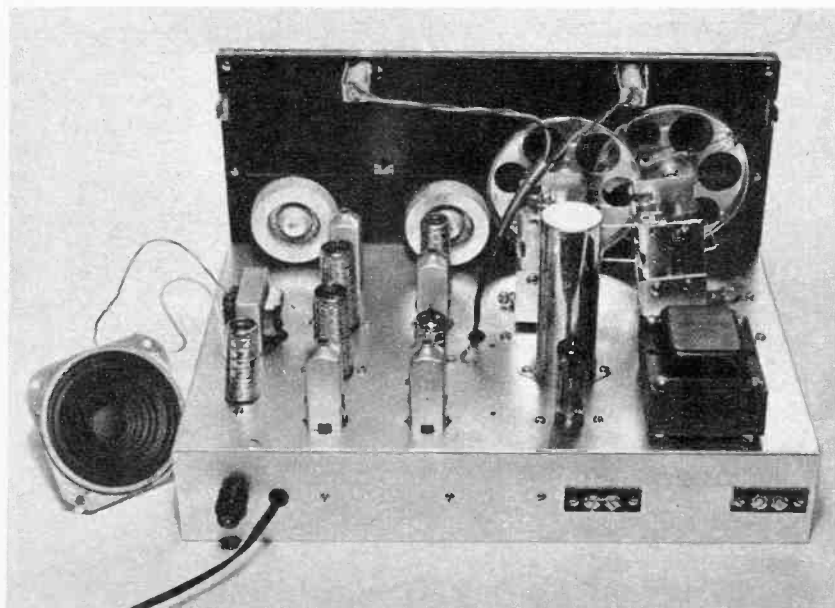

This view shows clean, uncluttered top chassis deck of Knight-Kit R-55 receiver. Loudspeaker, at left, mounts in end of receiver cabinet. Two round objects at junction of chassis and front panel are flywheels, part of dial control mechanism. Power circuit is protected by a line fuse in holder at bottom, left.

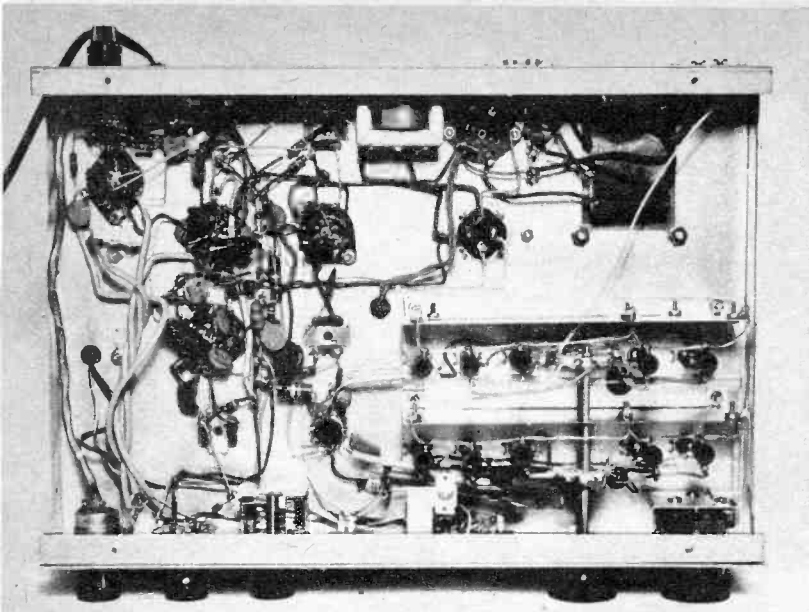

There's plenty of room for components and wiring on underside of R-55 chassis. At bottom right is a compartment that contains the tuning coils for the various bands. Detailed instruction book furnished with kit simplifies construction.

The receiver I recommend is the Knight-Kit Model R-55, which has a catalog price of \$67.50. This is a band-switching super-heterodyne, with self-contained loud-speaker and transformer power supply. It has continuous coverage from 530 kilocycles through 36 megacycles, and in addition, it covers the 50-54 mc. (six-meter) band. The ham bands are well distributed over band-spread scales.

I think the R-55 is ideal for a beginner

for three reasons: (1) the chassis and front panel are wide open, leaving plenty of room for parts mounting and wiring. (2) the instruction book is very well prepared, clear, and answers all questions before the builder asks them. (3) it works well!

While the R-55 cannot be compared with communications receivers (which cost from \$200 up), it has excellent sensitivity and selectivity, and even with a simple one-wire antenna it brings in stations from

Neat is the word for the Eico 723 transmitter. Crystal is plugged into its holder through panel.

Rear apron L to R: antenna coax, antenna load switch, key, accessory socket, fuse, line cord.



all parts of the world. It is a good investment as a "first" receiver, and will continue to serve as a supplemental receiver for Conelrad alarms, news and time broadcasts, background music in the ham shack, etc., when you graduate to a real communications receiver after six months or a year of experience.

While you're practicing the code by listening with your receiver, and reading up on theory, you'll want to think about a transmitter. Actually transmitters are simpler than receivers and are easier to put into operation. As a companion for the Knight-Kit R-55, I suggest the Eico Model 723 transmitter. This is a basic CW (continuous wave or code) transmitter that is rated at a very respectable 60 watts. It costs \$50, is about half the size of the receiver, has a very well laid out chassis, and an attractive appearance. With receiver experience under your belt, you can put the transmitter together in two evenings.

The Model 723 is band-switching from 10 through 80 meters, has a dual-range milliammeter for reading grid and plate current, and it incorporates an antenna tuning section. Frequency control within the individual bands is achieved with crystals that plug in through a front panel opening. A variable frequency oscillator (VFO) can be added at any time for more flexible frequency selection.

The rugged chassis is of copper-plated sheet iron. The overall shielding is very tight, and there is considerable filtering and by-passing in the circuit. Virtually all spurious signals that might cause interference to television receivers is suppressed.

A separate modulator can be connected at a later date for voice transmission. In kit form, a modulator costs \$50.

If you are in the second category of new hams, you don't need the initial training afforded by a receiver kit, and you should consider the purchase of either a new or a used communications receiver such as Collins, Hallicrafters, National, RME, Drake, Gonset, Hammarlund, etc. These sets have a high initial cost, a remarkably low depreciation rate, and a reputation for superb performance. The more you spend, the smarter your investment. Don't consider anything under \$200. Top price for a ham receiver is about \$900. A good median figure is around \$500. These prices are for new equipment.

The tags are somewhat less for used gear. For example, the current Hallicrafters SX-101-A, a very fine receiver, costs \$400 new; used ones appear occasionally in the ham marts for \$275 or \$250. Even some discontinued sets are eagerly sought. For example, the National NC-183D, which appeared shortly after World War II and sold for \$400 (without a loud-

Transmitter chassis is well filled with parts but not crowded; all components are accessible. Finger points to parasitic choke connected to grid of 6DQ8 RF amplifier; the tube fits in recessed chassis socket.

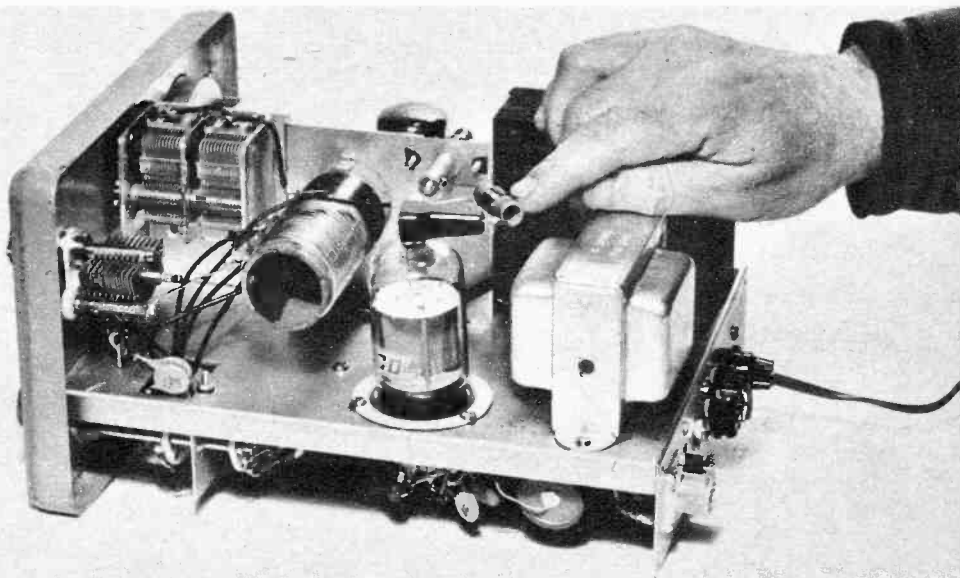

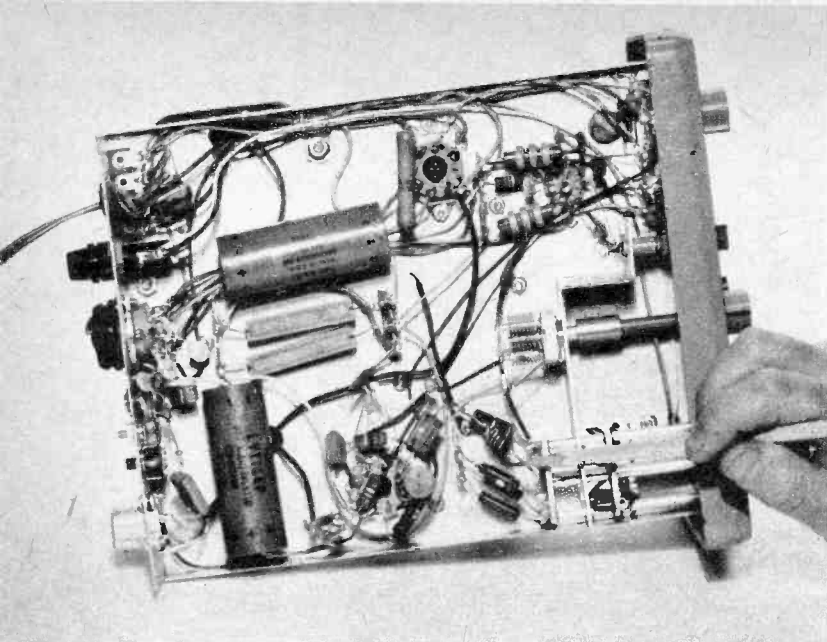

Most of the parts on the underside of the Eico 723 transmitter are supported by their own leads. Circuit is easy to trace because the wiring is not stacked.

speaker!), still brings \$225 or \$200. It is not really satisfactory for single side band reception, the method of voice transmission favored by advanced hams, but it still does a superb job on other signals.

As a prospective ham, you should undertake the construction of at least one transmitter to become familiar with the way they are built and operate. I recommend the Heathkit DX-60. This includes a modulator section and is considerably more complicated than the Eico 723. However, since you have done construction work before you will have no trouble putting all

the bits and pieces in their proper places.

The DX-60 is rated at 90 watts input, covers 10 through 80 meters, has four switched crystal positions, and costs \$83.00. An external VFO can be connected in readily. Heath makes a good one for only \$20.

Station Accessories

A receiver and a transmitter need certain accessories. The most important is an antenna to put your signals into space and to pick up the signals from other stations. The length of the transmitting antenna is

Fine station for a beginner ham with previous experience in electronics. Left, second-hand National NC-183D receiver; new Heathkit DX-60 transmitter. Cards attest to world-wide DX coverage with rig.



critical, and depends on the operating frequency. For 10, 15 and 20 meters, the bands in most active use, the most popular and successful antenna is a three-element beam, with loading coils strategically placed in the elements to make the antenna work on all three bands. The antenna should be mounted on a chimney or on the highest tower you can afford, and turned with a rotator. (See the chapter in this book entitled "Peak CB Equipment Performance," for a discussion of beam advantages.)

Beam erection is a mechanical rather than an electrical project, and requires careful study of the available roof or ground space. The antenna itself can cost from \$25 to \$125, the rotator about \$120, and the supporting structure from nothing, for an existing chimney, to several hundred bucks for a tower.

If these prices scare you, start with something more modest; for example, for a single frequency band, a folded dipole of strengthened flat two-conductor ribbon commonly used as TV lead-in. Amphenol makes antenna kits for four bands, from \$5.35 for a 10-meter antenna to \$11.25 for an 80-meter antenna. If you have the space, there's nothing to prevent you from putting up several such antennas for multi-band operation. Using TV fittings, you can switch the lead-ins at the transmitter with a plug-and-jack arrangement.

Where space is limited, increasing use is being made of vertical "trap" antennas, which are merely rigid aluminum pipes

with added loading coils. They are available for two, three and as many as six bands. They are easy to erect, require little or no guying; are relatively inconspicuous, an important factor in some residential areas; and are quite inexpensive. For example, the Gotham V80 vertical is only 23 feet high, does not need guys, works on 6 through 80 meters, and costs only \$17.00. It is omnidirectional and doesn't have the gain of a beam, but it is a great convenience and it does radiate well.

Where plenty of horizontal space is available, it is a simple matter to stretch out long wires for the 40- and 80-meter bands. Excellent supports are provided by the house chimney at the near end and a tree at the far end.

An antenna that is good for transmitting is just as good for receiving, so by all means add an antenna changeover relay to your rig. Many transmitters have power provisions for one. In its resting or de-energized position, the relay connects the antenna to the receiver. When you transmit the relay is energized and switches the antenna from the receiver input to the transmitter output.

For CW work you need a key, a simple device that costs from \$1.00 to \$5.00. For phone operation, you add a microphone, which can cost from \$2.00 to \$200.00. An inexpensive one for \$10 or \$15 is adequate for ham work, since it need respond only to the narrow range of voice frequencies, and not to music.

If your transmitter is crystal controlled,

This component assortment makes the Heathkit DX-60 transmitter an intriguing construction project for a man with kit background. Assembly and wiring job will average 35 to 50 hours for a good worker.

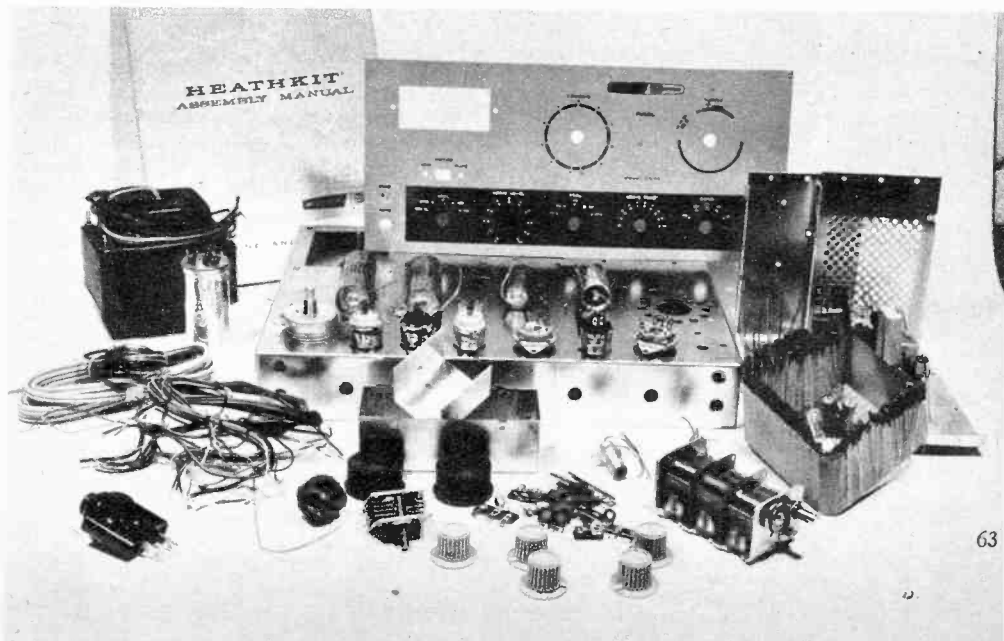

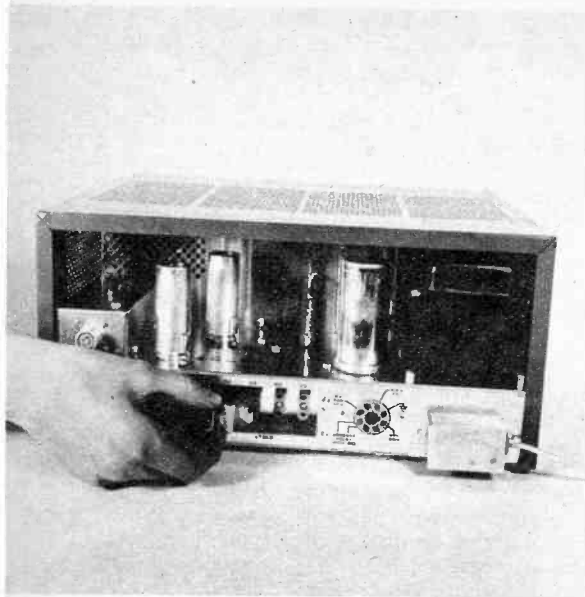

Compartment in back apron of DX-60 transmitter holds four crystals, switched from front panel. Power for VFO and relay is available at socket.

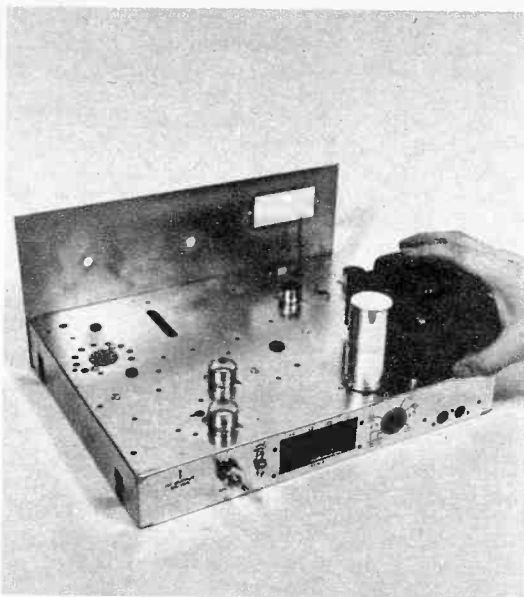

The DX-60 in the first stages of assembly. Power transformer and the filter capacitor of the high-voltage power supply are in position at the right.

Shaft extensions permit switches and tuning capacitors to be mounted close to their associated parts. This minimizes lead length and losses.

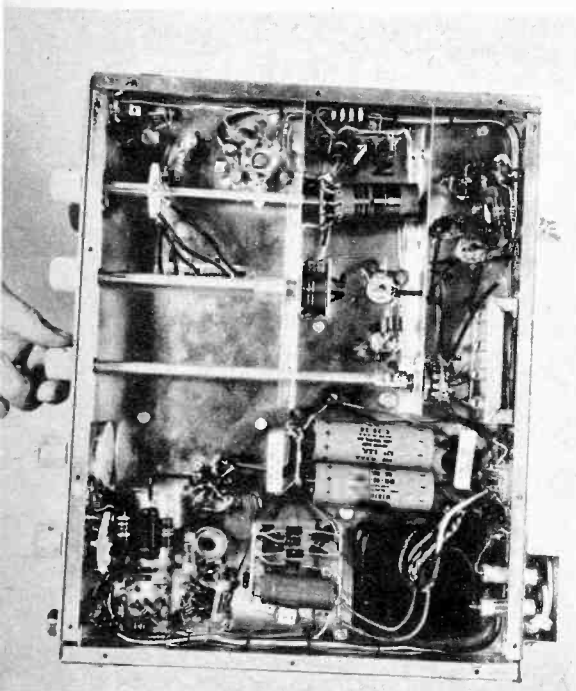

you obviously must have crystals. These, too, are inexpensive. Some perfectly good surplus military "rocks" can be picked up for less than a dollar each.

Finally, you should have a log book, to record all your transmissions and contacts; a clock, preferably of the 24-hour type; a copy of the latest Radio Amateur Call Book; and a pair of earphones, so that you can listen without disturbing others in the house.

Of prime importance in the layout of the station is the personal safety of the operator and his visitors. If there are small children in the house, steps should be taken to prevent their accidental contact with power leads of any voltage. A locked room is a fine idea, if it is possible, otherwise housing the transmitter and power supplies in metal cabinets is an excellent although expensive solution.

Another essential device in any station is a *shorting stick* for discharging any high voltage to ground before you do work to your transmitter. Even if interlocks are used, the failure of these components may leave the transmitter in a dangerous condition. Make the stick by mounting a small metal hook to one end of a dry stick or bakelite rod. Run a piece of ignition wire from the hook to ground.

Happy DXing! •

Brass- Pounding Brass Hat

SINCE radio is such an important part of military communications, it is not surprising that the Army Signal Corps is loaded with hams. One of the most active also happens to be one of the most highly placed. In his home in Arlington, Va., he is W4FZ, but when he reports for work at the Pentagon he is Major General Earle F. Cook, Deputy Chief Signal Officer of the Department of the Army.

General Cook's interest in amateur radio dates back to 1926, when, at 19, he became 8BVX. It continued unflagged while he attended the U.S. Military Academy, from which he graduated in 1931. Shifted around the world as he advanced up the ladder of rank and achievement, he always managed to stay on the air. He has held no less than ten different calls.

Earle became a ham when brass-pounding (i.e., sending code with a manual key) rather than on phone. This skill is still with him. Many a young Signal Corp recruit, operating in the Military Affiliate Radio System (MARS), is stunned to discover that the man behind the snappy Morse coming from W4FZ is an honest-to-goodness two-star general!

* * *

The term "brass hat" for high-ranking military personnel dates back to World War I, when British Army officers wore heavy gold braid on the peaks of their service caps. In the United States Navy this decoration is known less reverently as "scrambled eggs." •



You CAN Master the Code!

SURE you can. All you have to do is say to yourself, "The code consists only of combinations of short and long sounds. Learning them is merely a matter of practice."

There are no short cuts, no magic "systems." It's something like a game. You can read books and watch movies showing the correct positions, stances, attitudes and approaches in golf, tennis or bowling, but the only way to achieve code proficiency is to practice, practice, practice.

Initially, memorize the combinations of dots and dashes by sending them to yourself with a code-practice oscillator or buzzer of some kind; the ham supply catalogs list many at reasonable prices. Look at the code chart, and without saying *dot-dash* or *dit-dah*, make short and long sounds with the key. Your ear and brain must recognize these as sounds, not as the words *dot* and *dash*.

Take it easy. Allow perhaps fifteen minutes for the first session and concentrate on just eight or ten letters. The next time,

review these, add another group, and spend half an hour on the job. After you can send all the letters of the alphabet without looking at the chart, tackle the numbers, then the punctuation marks.

If you can find a partner whose determination to learn the code matches your own, fine. You can alternate with the key by copying what he sends. Sometimes, however, a partner may slow you down if his or her learning rate is slower than yours.

From here on, copying speed can be developed with listening practice and the best way to accomplish this is with your communications receiver. If you don't own one now, and are planning to eventually get one, it would be wise to consider advancing its purchase date. Regardless of the time of day, there are always CW (continuous wave) stations on the air. The amateur bands are never idle, and the other frequencies are filled with commercial stations sending messages to ships and overseas. Much of the transmission is by machines that make dots and dashes



automatically and therefore very uniformly. The trick merely is to tune around until you spot signals you can "read."

Keep a pencil and a pad or ruled paper handy, and write down as many letters or words as you can. You're bound to miss a lot of them at first, but don't let this bother you. Not everything will be in intelligible English; there are other languages, too, you know! You may also be confused for a while by cipher groups, usually of five letters, QWERT SDFGH ZXCVB, etc., which make no sense in themselves. These are not good for practice because you don't know if you're copying correctly.

Organized transmissions for code practice at accurately timed speeds are made by many amateur stations and particularly by W1AW, the station of the ham's national organization, the American Radio Relay League, in West Hartford, Conn. Schedules are published in QST magazine.

Code speed is figured on the basis of words per minute, each word being five letters. You'll discover quickly that the 5-w.p.m. requirement for the amateur novice license is ridiculously easy, and that you can reach 13 w.p.m., for the regular ticket, with little extra practice. •

INTERNATIONAL MORSE CODE

A	.-	N	— .
B	— ...	O	— — —
C	— . — .	P	— . . .
D	— ..	Q	— . — . —
E	. .	R	. — .
F	. — .	S	. . .
G	— — .	T	— —
H	U	. — —
I	. .	V	. . . —
J	— — — —	W	. — — —
K	— . —	X	. — . —
L	. — . .	Y	— . — —
M	— —	Z	— — . .
1	. — — — —	Period	. — . — . —
2	. — — — —	Comma	— — . — — —
3	. . . — —	Question	. . — — . .
4	. . . — —	Error
5	End of	
6	Communication	. . . — . —
7	— — . . .	End of Message	. — . — .
8	— — — . .	Wait	. — . . .
9	— — — — .	Go Ahead	— . — —
0	— — — — —	Received (OK)	. — .

There's only one thing different about this picture at the left of a ham "pounding brass" (sending code with a key) in his well-equipped shack; he has been totally blind from birth. He is Robert Gunderson, W2J10, of the Bronx, N. Y., who not only builds and uses the most complicated equipment but teaches other blind people how to become hams themselves. He won the 1955 General Electric Edison Radio Amateur Award.

Here's a good stunt (right). Tape record code practice transmissions from amateur stations and play them back as often as necessary until you can copy them perfectly. Use the tape to help other beginners who may not yet own a short-wave receiver.



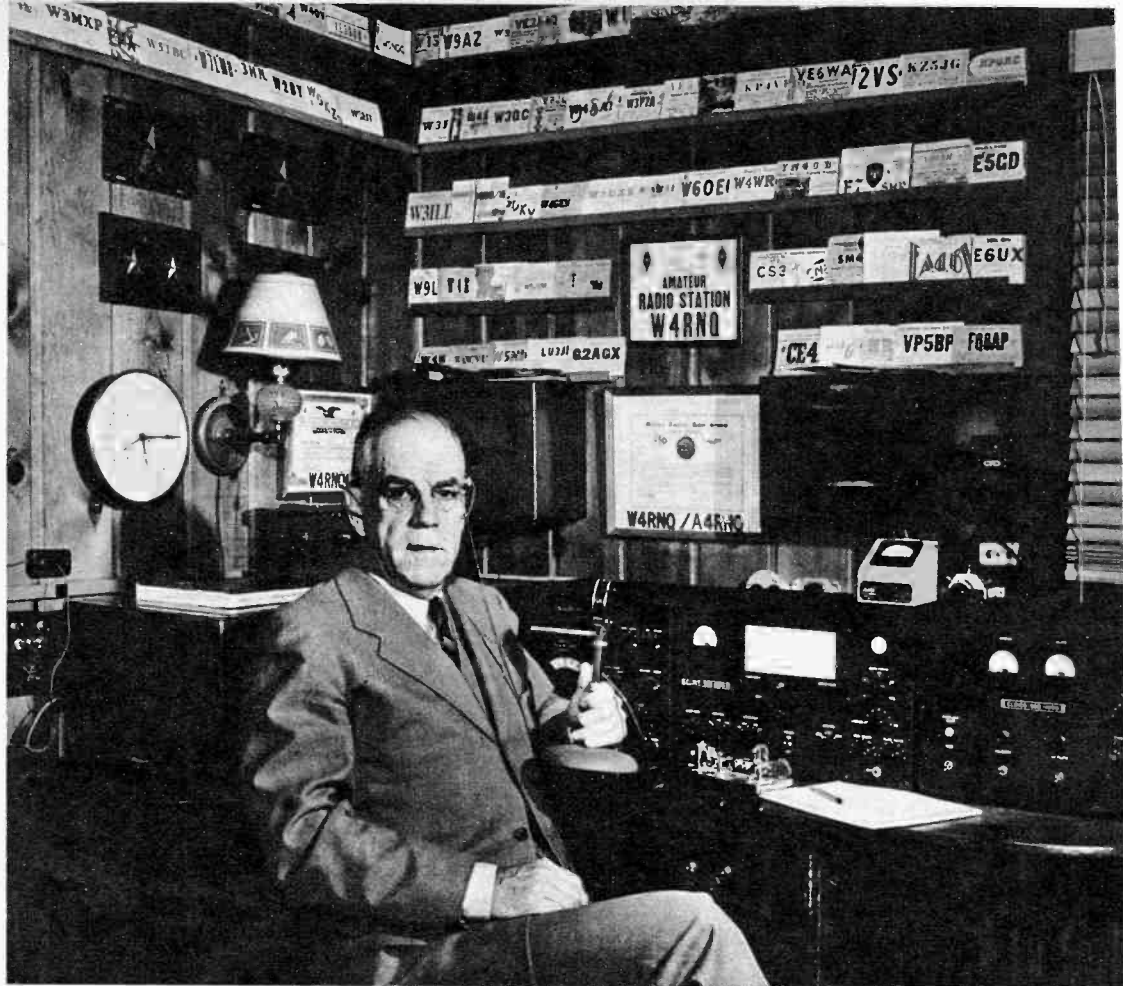

W4RNQ's many cards are tastefully displayed in open racks made of small-section L-shaped molding.

QSL's Are a Hobby in Themselves

IF you look up the international "Q" signals, you'll find QSL listed two ways: QSL?—Can you give me acknowledgement of receipt?

QSL—I give you acknowledgement of receipt.

In amateur communications and in short-wave listening, however, QSL has come to mean, specifically, a postcard that verifies an over-the-air contact. In recent years, the collecting of QSL's has become virtually a hobby in itself, especially among philatelists.

As soon as a new ham goes on the air, the second thing he does is to clear the walls (and in some cases the ceiling) of his

radio room in anticipation of heavy receipt of cards. The golden rule applies with full force to this activity; if you want to receive cards, get into the habit of sending them out yourself.

In this connection it is always advisable, when working another operator, to ask him if his address in the call book is correct. People are constantly moving about, and expired calls are constantly being reissued. It is disappointing to mail out cards and to have them returned with the notation, *moved, left no forwarding address.*

To speed the return of valuable foreign QSL's, many hams put their cards into envelopes, instead of mailing the card

alone, and include International Postal Coupons. You can buy these coupons at any post office. In countries that are members of the International Postal Union (and most are), the coupons can be exchanged for return airmail postage.

There is a lot more to collecting QSL cards than merely opening your mail. Ample time and consideration must be given to the subject matter of reception reports. A few basic rules must be followed in order to insure good returns.

To begin with, along with the name of the station, and its call letters, the time of reception of the particular station should be noted. That is, the times of the sign-on and sign-off, or whatever interval in which you happened to be listening. Of course, you must include the time zone that you are employing. Some SWL's prefer to use GMT (Greenwich Mean Time). Add five hours to this for Eastern Standard Time.

A QSL should have all pertinent data on one side, with the other used only for the name and address of the ham to whom it is going. Thus, the card can be displayed with all details in ready view.

As "wall paper," cards are colorful sure-fire conversation pieces for visitors. They should be arranged according to some simple system, possibly by country.

For example, reserve the most prominent and easily examined wall area for foreign QSLs. Logically, domestic cards can be in the order of the United States call area districts. To answer the inevitable questions about the meaning of \emptyset , some hams have a little sign reading, "This figure is read as 'zero,' not 'Oh,'" at the head of the cards from this district.

A really active ham can accumulate more cards than his walls can accommodate. A neat solution to this problem is the open rack arrangement (see photo at left) used by Major General Julian S. Hatcher, U. S. Army, Retired, W4RNQ, Falls Church, Va. Instead of tacking cards directly to the wall, he tips them into strips of L-shaped molding nailed to the wall. A lot of extra space is gained by overlapping the cards slightly without covering the call letters. He shuffles them around at any time as new ones arrive or old ones lose his interest.

Since one side of his shack is made of relatively soft wallboard, Dr. Harold H. Riker, K2JHA, Flushing, N. Y., finds it easy to attach his cards with a small stapler. His foreign collection, only part of which shows in the photo below, is enough to make ham visitors drool with envy. You name the country, it's represented here! •

K2JHA prefers to staple his cards directly to the wall. He is pointing to a card from SM7GC, Sweden.





Something for their shacks: L. Berkley Davis (left), General Electric vice-president, presents trophies to John T. Chambers, W6NLZ (center), and Ralph E. Thomas, KH6UK. They also shared a cash award.

“Propagation Pioneers” Win Edison Amateur Award

Record communications of over 2500 miles were achieved at 432 megacycles by means of the “tropospheric ducting” phenomenon.

TWO radio hams whose transpacific experiments set distance records and opened new horizons in UHF communications shared the 1960 Edison Radio Amateur Award sponsored by General Electric.

John T. Chambers, 40, of 2228 Via La Brea, Palos Verdes Estates, near Los Angeles, Calif., and Ralph E. Thomas, 57, of Kahuku, Oahu, Hawaii, were chosen joint winners by a panel of three judges.

A \$500 cash prize and a trophy have been awarded annually for the past nine years for outstanding public service by a radio amateur. The year 1960, however, marked the first time that the award was granted jointly to two amateurs, and also the first time for a scientific achievement. A presentation was made by L. Berkley Davis, awards chairman and a General Electric vice-president, at a banquet in

Washington, D. C., early in 1961. Frederick W. Ford, FCC chairman, was the principal speaker.

Chambers, W6NLZ, a satellite communications project leader for Hughes Aircraft Corp., and Thomas, KH6UK, engineer-in-charge of an RCA communications transmitting station in Hawaii, have long been conducting experiments with the radio phenomenon known as tropospheric ducting.

During trials on July 20, 1960, the pair set a one-way communications distance record of 2,540 miles on 432 megacycles. A bad tube in Thomas' AF amplifier prevented him from hearing Chambers, but his signals got through to Chambers.

This and earlier records set over the same California-to-Hawaii course, on 220 and 144 megacycles, confirmed the theory that UHF radio communications was not limited to line-of-sight, thanks to tropospheric ducting.

Thomas and Chambers, whose four years of patient and often fruitless experimentation paid off in the communication feats, were highly praised by the award judges.

Comparing the accomplishments to the first transatlantic radio communication early in the 1920's, the panel noted that the team had greatly enhanced the standing of ham operators in the scientific world. The judges were Federal Communications



Hawaiian palms make an appropriate setting for the big stick that supports some of KH6UK's antennas. He climbs to the top one step at a time.



W6NLZ's junior operator Glen, age three, and XYL Maureen, in the radio shack are briefed by the "old man" on one of his contacts with KH6UK.



Modest antennas on California home of W6NLZ put out potent signals. Radio is Chamber's work and his hobby. He's in communications at Hughes.



In lush Hawaiian setting, Thomas gets an assist from his wife in handling a "long John" antenna. He will continue experiments with new equipment.

Commissioner Rosel Hyde; Robert C. Edson, American National Red Cross; and F. E. Handy, American Radio Relay League.

Chambers, a ham since 1936, moved into the VHF frequencies 15 years ago, and has been going higher ever since. His main reason for launching into high-frequency experimentation was that the lower bands were already "too crowded" with hams to suit him.

Thomas, a native of New Brunswick, N. J., and a resident there until five years ago, has been a radio amateur for 45 years. He won the American Radio Relay League award in 1955 for his work during the three previous years with meteor scatter.

Tropospheric ducting occurs mainly during the summer inversion season. Chambers keeps his weather eye on the Los Angeles smog. When it lies low over the area, with church spires and hilltops protruding from it into clear air above, Chambers has the sign he's looking for. The inversion of hot, dry air over the damp smog close to the ground indicates that tropospheric ducting is likely.

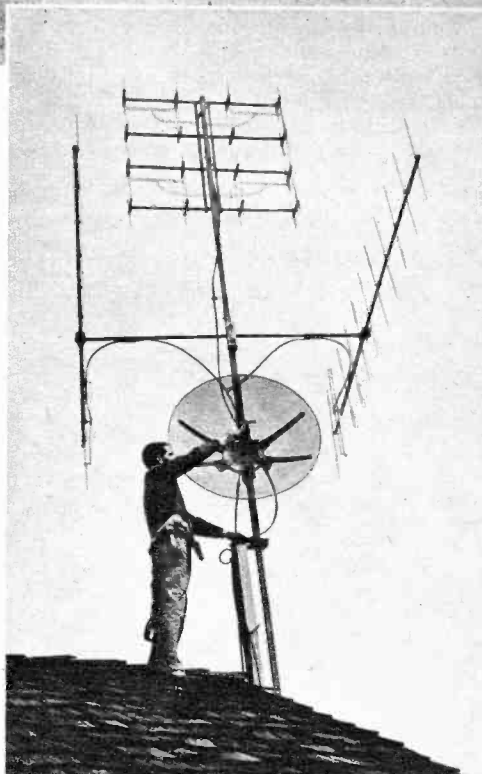

Chambers makes adjustments to the antennas on the roof of his home in California. They are all directed at KH6UK located across the Pacific.

In Hawaii, Thomas keeps his eye on the evening sky, looking for low hanging clouds with flat tops. When conditions are present in both Hawaii and California, tropospheric propagation of UHF signals is likely and the hams go to work. Even so, it took them nine months of painstaking efforts before their first 144 mc success.

The judging panel also voted special citations to six other American radio amateurs and commendation to a Chilean.

Those cited are:

Harry E. Phillips, W7CKV, 4626 East La Cienega Street, Tucson, Ariz., who conducts a program which permits hospitalized asthmatic children to talk with their parents in various parts of the country at Christmas time. He spent 40 hours a week handling more than 6,000 radio messages.

Donald Johnson, W6QIE, 222 Alta Vista Drive, South San Francisco, Calif., a Navy chief, who built, equipped, and operates a classroom for teaching radio and electronics to youths and blind persons.

Francis E. Ireland, K4UUO, 7425 South West 34th Street Road, Miami, Fla., for op-

erating 120 hours during Hurricane Donna, handling emergency radio messages.

Albert W. Parker, W4BAW, 227 South Front Street, New Bern, N. C., who operated several days and handled messages during Hurricane Donna.

Cesare P. Cavadini, W6GYH, 707 East Harvard Road, Burbank, Calif., who has handled more than 500 messages a month for the past several years, acting as liaison between amateur radio networks in the Far East and the continental United States.

Edwin S. Van Deusen, W3ECP, 3700 McKinley Street, NW, Washington, D. C., who was nominated for his exceptional voluntary accomplishments in serving in the television interference co-ordination program encouraged by the FCC.

Although nominations for the award normally are accepted only for public services performed by residents of the United States, the judges voted a special commendation to Mario Lagos, CE7BC, of Chiloe Island, Chile, for handling 3,744 official and welfare messages during his country's earthquake emergency in 1960. •

Would you like to have this antenna in the back yard? KH6UK (right) will try it on 1296 megacycles.

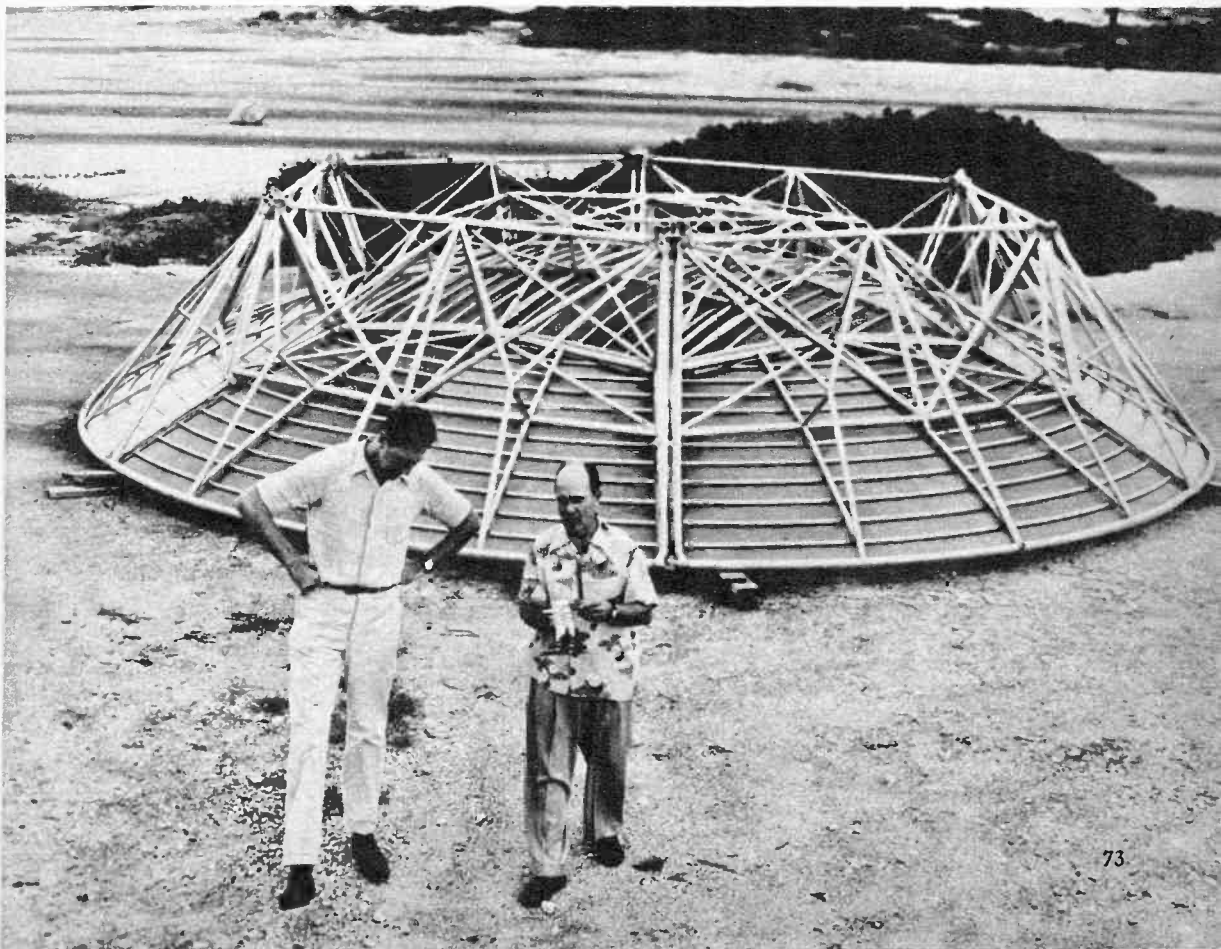

Electronic Keyers

What They Are
How They Work
What They Do

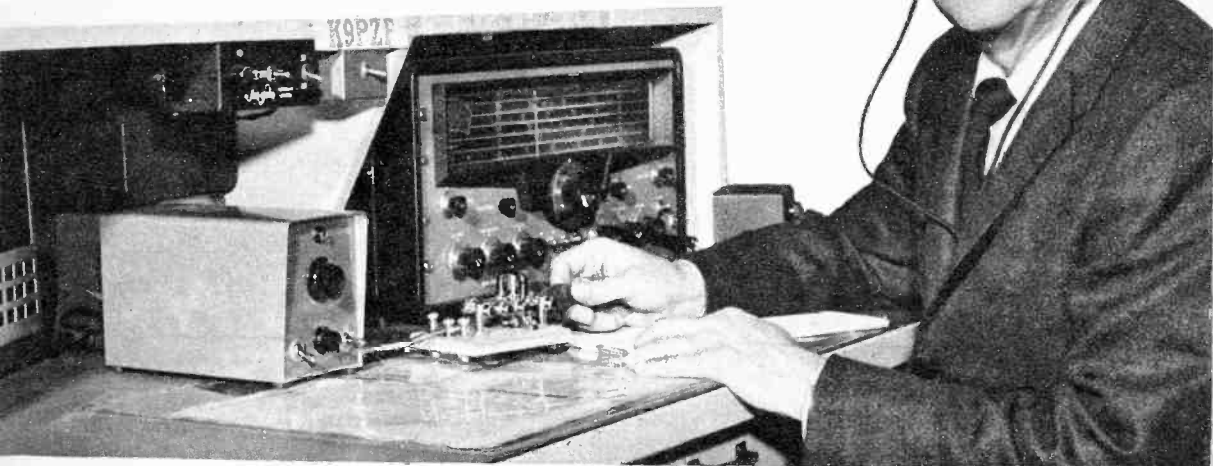

Automatic dot-and-dasher in shack of K9PZF is at left on table. He is A. F. Henninger of Chicago.

AUTOMATION is catching up with the ham-radio hobby. You still have to talk with your own voice if you operate on phone, but new devices called *electronic keyers* now make perfectly timed and spaced dots and dashes for those who prefer the privacy of CW (continuous wave, or code signaling).

These keyers represent the third and probably the ultimate stage of Code communication. The original hand key or straight key was merely a switch, and consisted of a hinged, spring-loaded lever with a small contact fastened to its underside. When the lever was depressed, this contact touched a fixed contact on the base of the instrument, closing the circuit. A dot was a very short pulse of current, a dash approximately three times longer. Keys of this type were in general use on wire telegraph circuits before the Civil War. They were adopted for wireless telegraphy at the turn of the century, and in virtually unchanged form they are still widely used today because they are simple, reliable and inexpensive.

Key-tapping can be tiring. The first real improvement in the technique came with

the appearance of the semiautomatic key, about the time of World War I. This had the trade name *Vibroplex* but was generally called *sideswiper* because of its method of operation. It had a two-section pivoted lever. The right side was just like a straight key, and was used for making dashes. The left side was a vibrating reed. Touching it with the thumb set it vibrating at a speed determined by the adjustable weights on its free end. This vibration caused a series of even dots to be made. Also still in popular use, the sideswiper is called semiautomatic because only the dots roll off by themselves.

The straight key and the sideswiper are purely mechanical devices. In the new keyers, advantage is taken of electronic tricks to produce both dots and dashes automatically. The circuits are a bit tricky, but generally they consist of two oscillators and timing components. The manual control looks like a sideswiper, but it has only a single hinged lever, without a vibrating element, and it functions as a single-pole, double-throw switch. When the finger paddle is pushed to the left with the thumb, one set of contacts closes and actuates an

oscillator adjusted to produce short pulses of current or dots. When the paddle is pushed the other way with the first finger of the hand, the second oscillator, adjusted to produce dashes, comes into play. Very little finger-tapping is required because the key continues to make dots and dashes as long as either side of the paddle is kept pressed in.

The sending speed is under the full control of the operator, and can be varied from five to fifty words per minute.

The short and long pulses generated by the oscillator circuits are fed to a sensitive relay, the contacts of which are connected to the key terminals of the transmitter.

The big feature of electronic keys is the absolutely uniform duration and spacing of the dots and dashes they generate. If a person has never before used either a straight key or a sideswiper, but learns the code with the aid of an electronic keyer, his sending will be machine-accurate after only a short practice period. These keyers are wonderful for code practice in general, because they provide "sidetone" or monitoring beeps which enable the operator



Auto-Mate K5/50 electronic keyer is compact unit. Controls vary speed and spacing of characters.

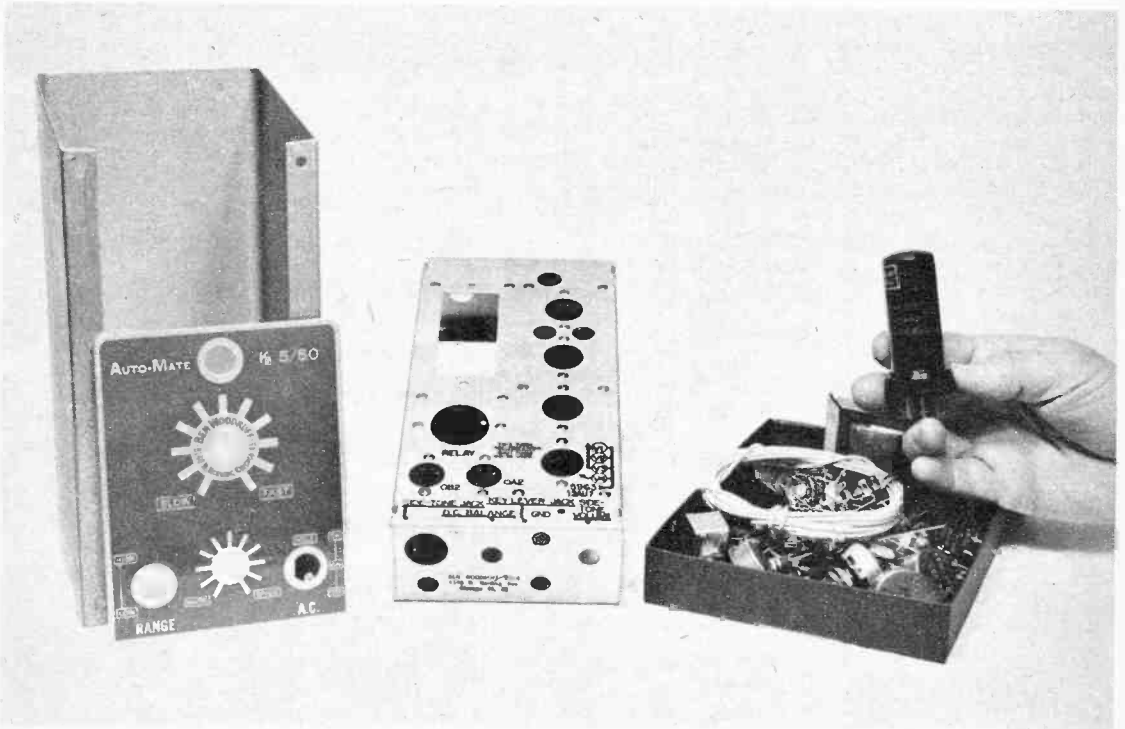

Auto-Mate is easy kit project. Made by Ben Woodruff, W9UE, 6140 N. Harding Avenue, Chicago 45, Ill.

to hear the dots and dashes as he works the key paddle.

Because of the different fingering technique involved, experienced CW operators have more initial difficulty with electronic keyers than do newcomers. The latter, in fact, have no difficulties at all because they have nothing to "unlearn." An old-timer, accustomed to pounding a straight key or controlling the shaky reed of a sideswiper, has to learn to relax, to touch the paddle lightly, and to let the keyer do the rest of the work for him.

Some very good comments on electronic keyers are offered by Ben Woodruff, W9UE, 6140 North Harding Ave., Chicago 45, Ill., who makes the popular "Auto-Mate K5/50." Here they are:

CW signals are the basic communication elements in radio.

In CW work, the dash signal is precisely equal to the sum of three dot signals. The space interval between signals, in any given letter or symbol, is equal to the length of a dot.

The highest compliment a CW operator can receive is to be told that his signals sound like tape transmissions.

Some operators distort their CW so badly that others may identify the operator by his poor CW ability, and may have difficulty reading the transmission. Good CW operators are identified by the call sign or by the content of his transmission, not by how badly he sends "personality" CW.

Electronic keyers have been associated with speed. This is not the full story. Electronic keyers, properly adjusted and used, are a great aid at any speed. In fact, slow CW signals are much more difficult to form exactly than medium and high-speed signals. Electronic keyers are associated with almost perfect CW signals, the kind the listening operators read with minimum effort, and greatest pleasure.

The code beginner who has to do much practice alone is greatly aided by the electronic keyer. At the very start he hears perfectly proportioned signals, which aid in forming good code sending habits. These habits tend to stay with an operator, whether he uses a straight hand key or any other type, at a later time.

Time was when most amateur gear was home-built. The present highly complex equipment is not so easily built. One remaining skill the genuine amateur can still master is good CW sending ability. •

The special key at the right is a SPDT switch without a vibrating element. Paddle moves left and right and rests in neutral center position.



Hallicrafters Model HA-1 electronic keyer occupies little space on shelf between loudspeakers. Poucel "Elkey" is on table in front of receiver.

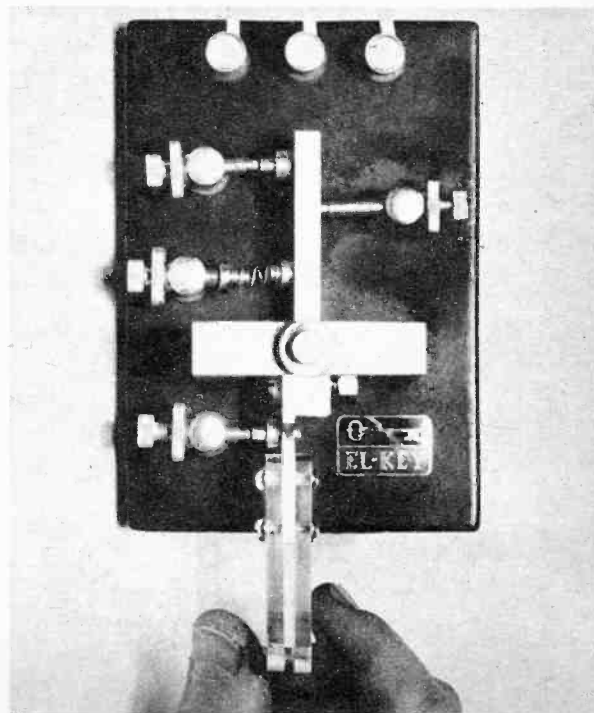

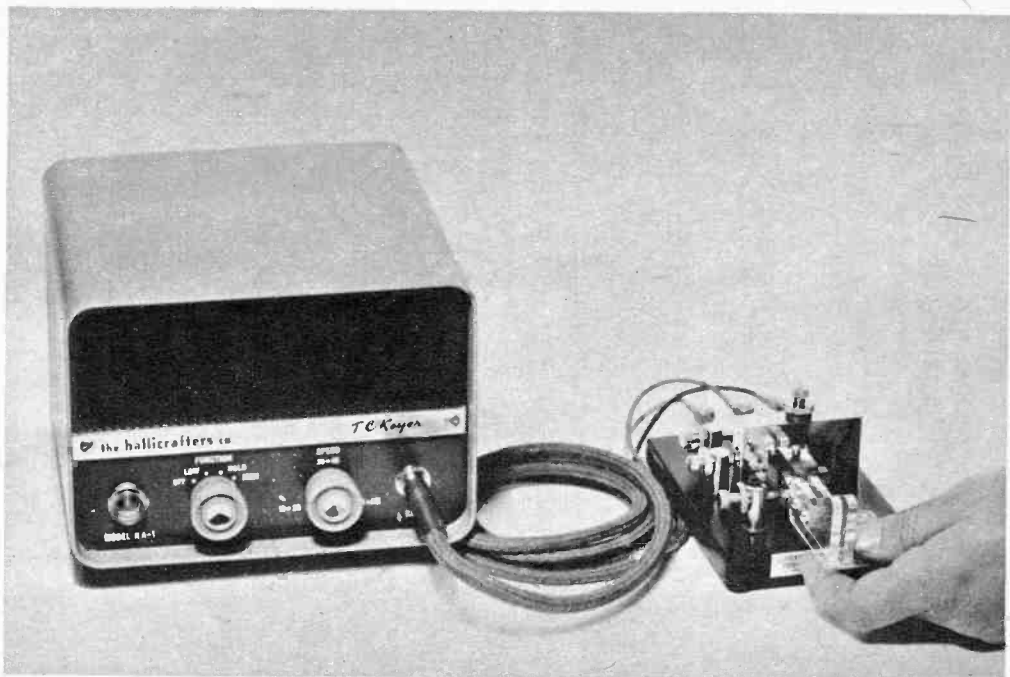

Note that keyer is connected to manual key with three leads. Key is the "Elkey," designed especially for the purpose. It has heavy base and stays on table. Made by Poucel Electronics Co., P.O. Box 181, Babylon, N. Y. Firm is run by Bob Poucel, W2AYJ, and Sid Shore, K2FC, both active on the air.

Hallicrafters electronic keyer out of its case. Finger points to special mercury relay which is connected to transmitter. The speaker is a monitor.

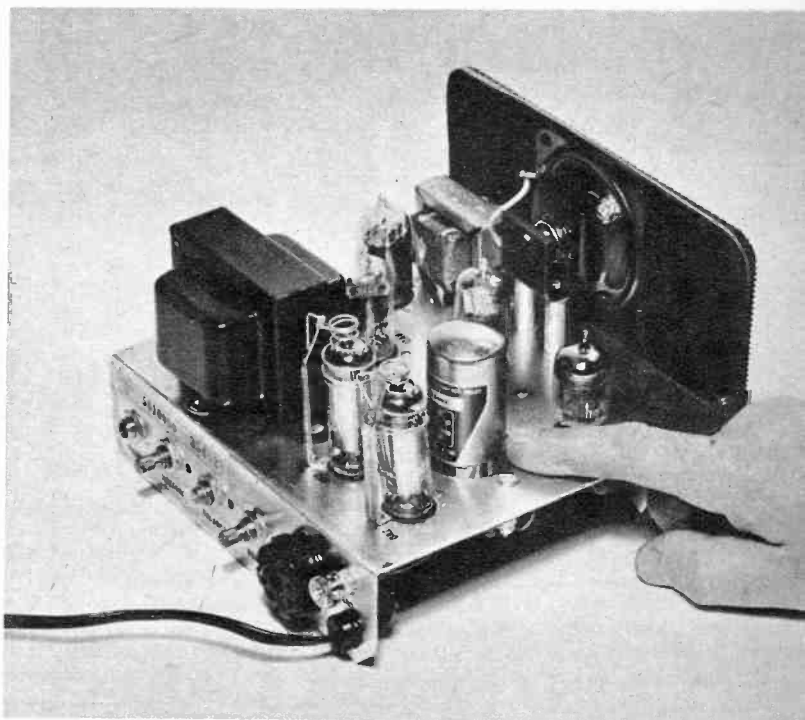



Two Meters is Fun!

... with this compact 10-watt mobile or fixed-station transceiver.

BECAUSE holders of novice-class amateur licenses are permitted to use voice operation only between 145 and 147 megacycles, many people have gotten the idea that the two-meter band is primarily a playground for beginners in the ham game. Not so at all!

Of the first ten operators I worked on two meters when checking out the equipment shown on these pages, three were members of the Quarter-Century Wireless Association, four were somewhat younger generals, and only three were novices, which goes to show you!

This band is also popular with general and technician licenses for several good reasons: (1) It is ideal for reliable local rag-chewing, up to about 25 miles. (2)

Very low power is adequate, five to 50 watts being the common rating of transmitters (3) Transmitters and receivers can operate with very small, inconspicuous antennas, the basic elements of which are a scant 19 inches long. (4) The chance of causing TVI (television interference) is greatly reduced.

The TVI situation is the result of a fortunate frequency relationship. The entire two-meter band spans 144 to 148 mc. Television channel 6 ends at 88 mc and channel 7 begins at 174, the minimum separations are thus 56 mc and 26 mc at the fundamental transmission frequencies. The second ham harmonics, between 288 and 296 mc, are way beyond the upper limit of TV channel 13, which is 216 mc, yet way

Underside of Pawnee chassis has six shielded compartments. Cover plate has been removed to show snug fit of components. The assembly and wiring jobs are for an expert and definitely not a beginner.

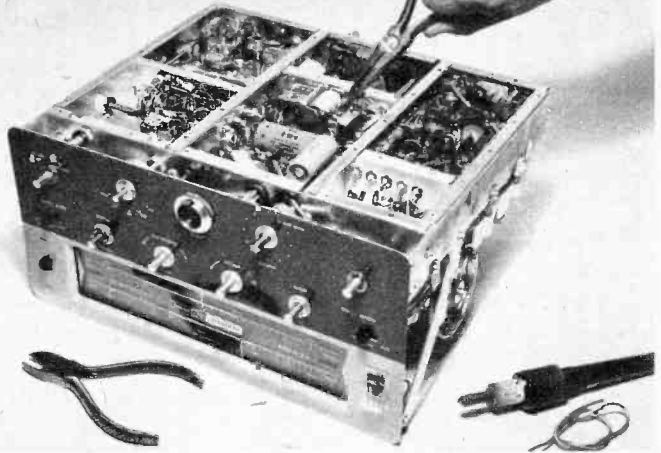

Receiver section of the Pawnee occupies the left side of the chassis, power supply center, and transmitter right. VFO is in virtually sealed compartment in right foreground. There is no wasted space!

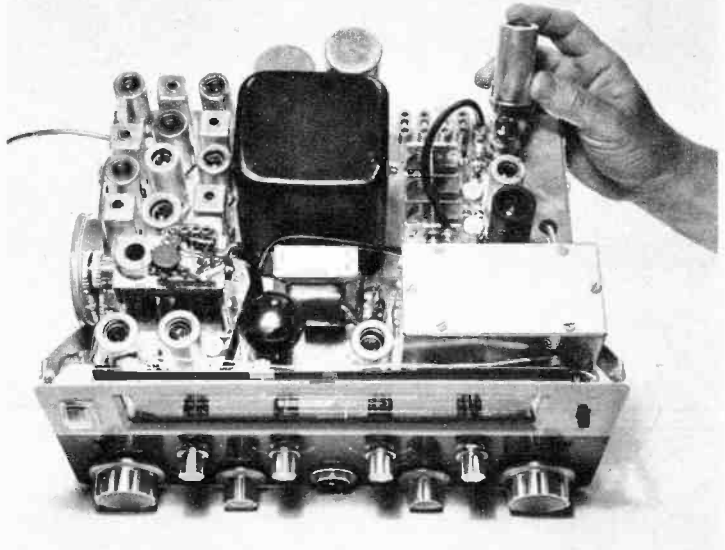

below the lower limit of the little-used ultra-high frequency TV channel 14, which is 470 mc. Contrast all this with the six-meter ham band, whose upper limit of 54 mc coincides unhappily with the lower limit of TV channel 2.

Further indication of the general appeal of the two-meter band is the appearance of Heath "Pawnee" \$200 transceiver. A compact, complicated 15-tube station in a package no larger than a hatbox, this kit project is intended specifically for experienced builders who know their way around in electronics. A novice licensee who is adept with tools could do the mechanical assembly, which, after all, is only nut and bolt work. However, it is extremely doubtful if he would ever get

beyond the first couple of alignment steps

The Pawnee is a versatile piece of ham equipment for two reasons: (1) By changing one power cord and one antenna cable, it can be used for either fixed or mobile operation. (2) By selecting one of three power cords, and without any changes in the set, it can be used on 6 or 12 volts DC or 117-volts AC. It performs equally well on either source of power.

Although Heath calls the Pawnee a transceiver, the radio-frequency sections of the receiver and transmitter are entirely independent. The only shared elements are the power supply and the audio amplifier/modulator.

The receiver is a double-conversion superheterodyne using the equivalent of

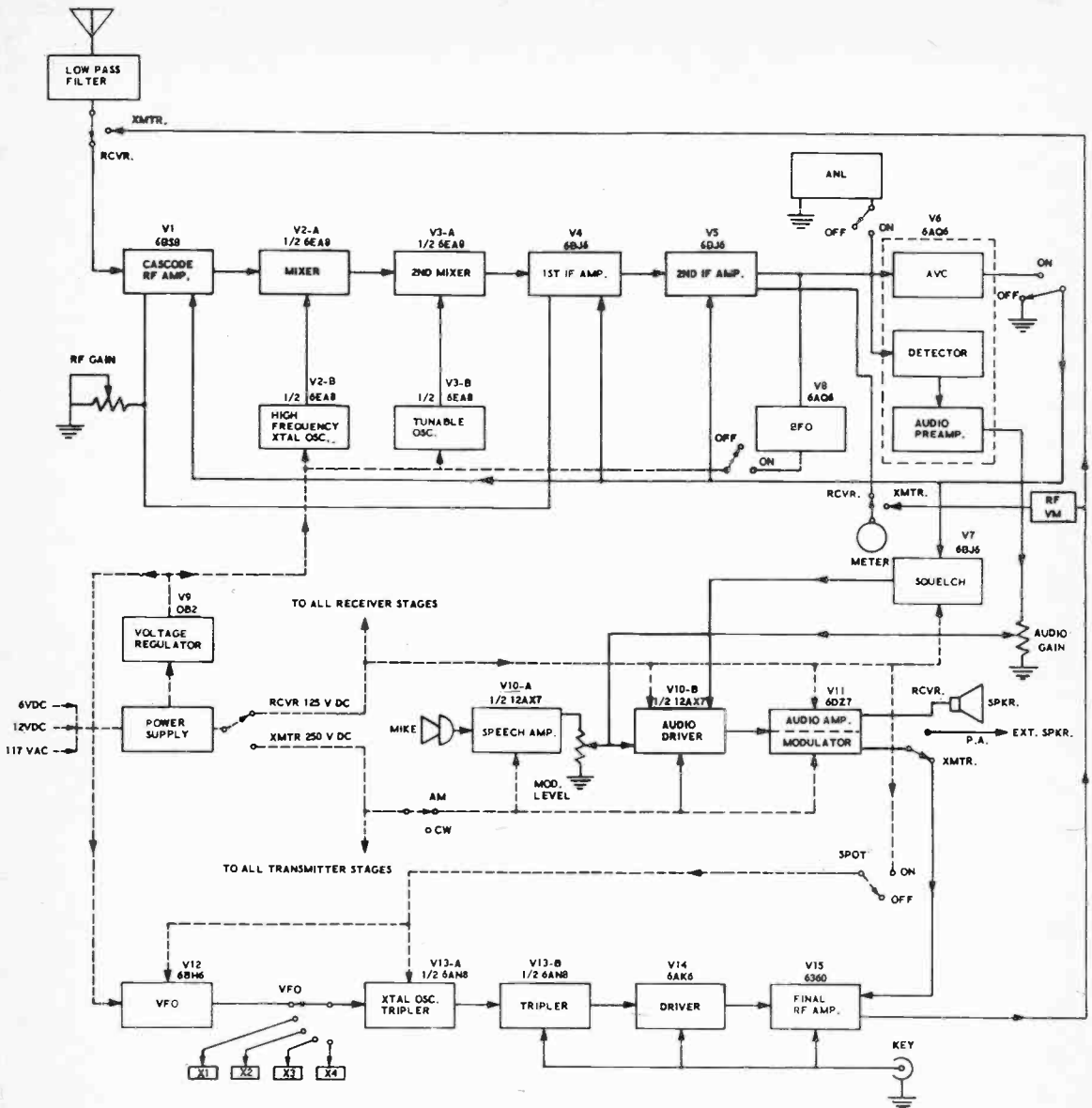

Block diagram of Pawnee 2-meter station shows the signal flow, tubes, and function of the various stages.

13 tubes. Refer to the block diagram. Beginning with the antenna, the circuit has a two-stage, broad-band RF amplifier (V1) consisting of two Cascode-connected triodes. All incoming signals between 144 and 148 mc are mixed with the second harmonic (122 mc), of a fixed 61-mc crystal oscillator (V2-B). The resulting heterodyne signal, now between 22 and 26 mc, goes to a second mixer stage (V3-A) where it is heterodyned with the 20-24 mc output of tunable oscillator V3-B. The difference in frequencies produces a 2 mc

IF signal regardless of the frequency of the incoming signal. Following the second mixer are two conventional 2 mc IF stages (V4, V5), second detector V6, beat frequency oscillator (BFO, V8), audio amplifier V11, and a small loudspeaker.

Two meters is largely a phone band, but there is some CW on it for code practice by novices, so the BFO is useful.

The combination of the crystal-controlled first oscillator and the relatively low frequency second oscillator makes the receiver highly stable. The sensitivity and

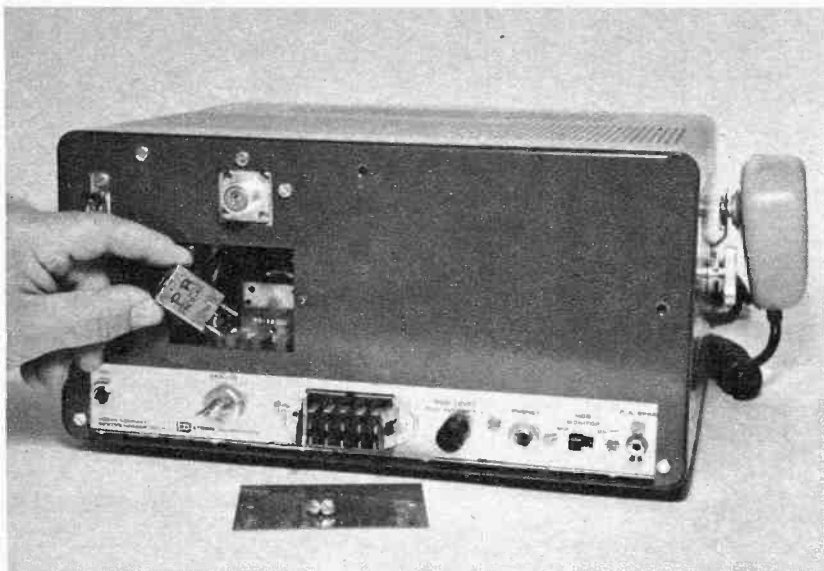

Rear view shows how crystals are plugged into chassis holders through trap door. Note how mike is clip-held on side of cabinet.

Twelve-volt cord for mobile use and AC cord for home station. Vertical rod is temporary antenna that is used for tune up purposes.

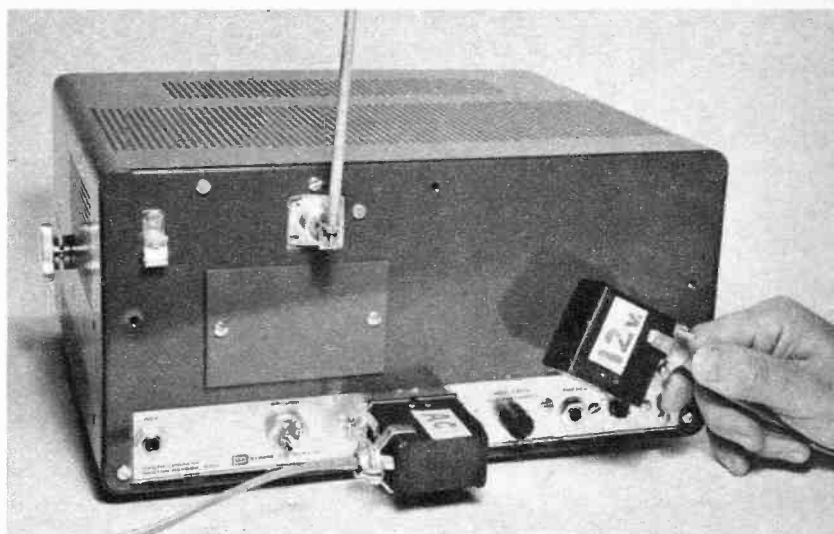

selectivity are very high. With the two-meter band spread over a seven-inch dial, it is easy to separate closely adjacent stations.

The transmitter uses the equivalent of six tubes. RF generation starts in a variable frequency oscillator (VFO) stage (V12) the range of which is 8.000 to 8.222 mc. This signal goes to a tripler stage (V13-A) which brings it up to 24.00-24.666 mc; to a second tripler stage (V13-B), which increases it to 72.00-73.998 mc; and to a doubler stage (V14) that raises it to

144-147.996 mc. The doubler in turn drives a push-pull RF amplifier (V15) at the same frequencies. DC power input to the final stage is about 18 watts, which results in an RF-power output of 8 to 10 watts.

Extensive temperature compensation is included in the VFO compartment to assure frequency stability. The tuning capacitors of the VFO, tripler and doubler stages are mechanically ganged to a single knob; the final stage has its own control. It takes seconds to shift operating frequency, provided, of course, the various

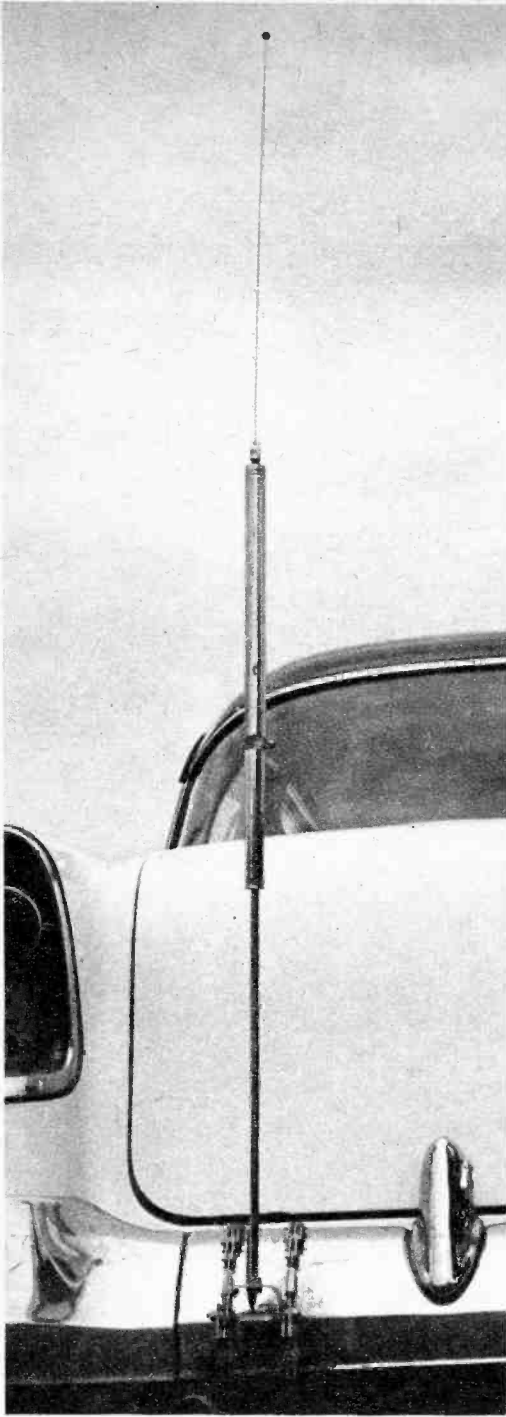

These are two popular types of mobile antennas for 2-meter operation. The left is a straight coaxial whip, which has advantages of slimness and minimum wind whip. At the right is a "halo," which is heavier and larger but operates like a beam in that it gives additional gain over a straight whip antenna.

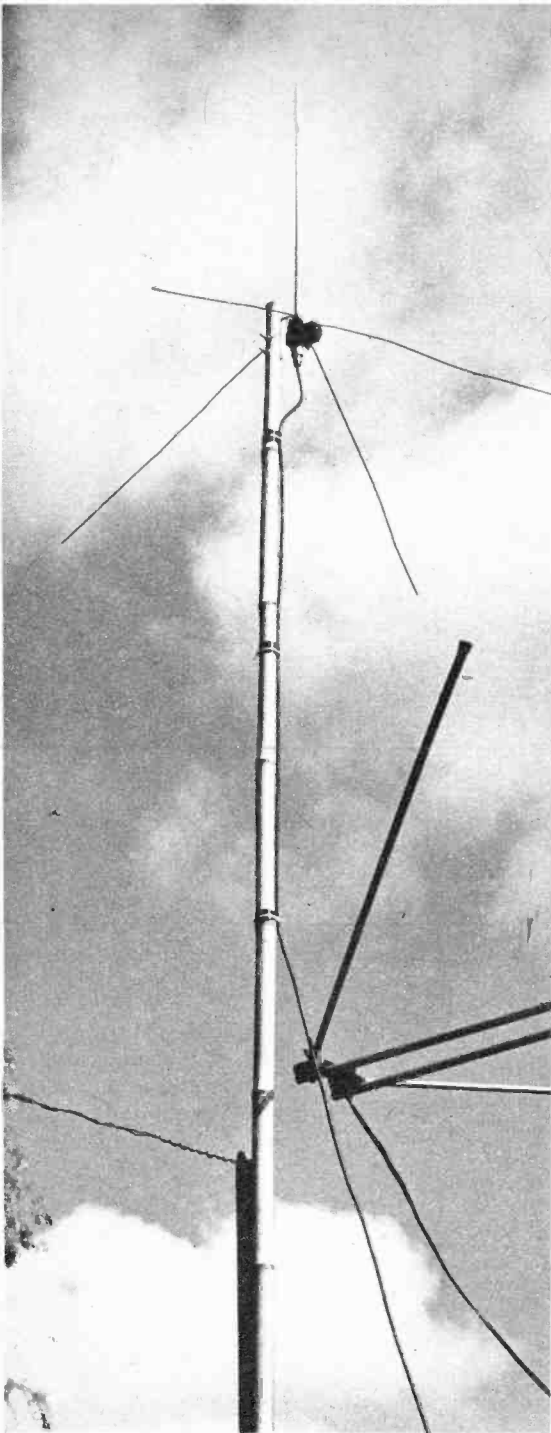

Vertical section and radials of ground plane antenna are 19 inches long. Used by W2DJI, it covers 30-mile radius and metropolitan New York.

circuits have all been aligned correctly.

The VFO can be disabled and any one of four switch-selected crystals substituted in its place. These crystals must be in the range of 8.000-8.222 mc to keep the output frequency within the limits of 144-148 mc. The VFO or crystal can be activated by a "spotting" control, to permit adjustment of the transmitter to the frequency of an incoming signal in the receiver. Included in the antenna circuit is a low-pass filter that effectively suppresses emissions above about 152 mc. This contributes to the reduction of TVI.

A small panel meter functions as a signal strength indicator when receiving and as a tuning indicator when transmitting.

The chassis of the Pawnee is dominated by a large power transformer of special construction. It has two primaries for DC operation with a vibrator and a third winding for AC. The DC windings are connected in parallel for 6-volt power and in series for 12. The tube heaters are likewise in a series-parallel hookup. The transformer has the usual high-voltage secondary, for B-plus power, and a low-voltage winding for the tube heaters which is used only when the operating power is AC.

It should again be emphasized that the Pawnee is an advanced piece of equipment. It is not an easy job; in fact, I'll come right out and say that it is a difficult one. There is virtually no wasted space anywhere on the chassis, and many of the parts have to be shoehorned in. The various sections are tightly shielded, which is desirable, though it causes extensive cramping. Two features make the transceiver practical as a kit project: (1) This is a single-band station, so there is no really complicated switching of coils and capacitors. (2) The chassis is shallow, and the parts and wiring on both sides of it are pretty much in one level.

What the builder needs, in addition to skill with a pair of long nose pliers and a thin soldering iron, is patience, a signal generator, a VTVM, and an understanding wife. If you work on the kit several hours an evening several evenings a week, you can figure on spending a cold winter on it.

The question naturally arises, "Is it worth all the work?" Happily, the Pawnee is a performer. The receiver is sharp and stays put. The transmitter is flexible and sends out a well modulated signal that invariably draws favorable comments. Overall operation is smooth and comfortable. The push-to-talk button on the hand mike actuates relays to switch over the antenna and power circuits. The set is great fun in every way! •



Endless hours of relaxed, interesting listening are possible with a LF-VHF receiver of this design.

Fun on the Special Frequencies

TWO extremely interesting frequency bands that are not covered by regular AM and FM broadcast receivers or conventional multiband short-wave receivers are 200 to 425 kc, a valuable source of up-to-the-minute United States Weather Bureau reports, and 109 to 130 mc, used by aircraft in flight and by ground control centers and towers.

Reports and forecasts are broadcast continuously in some areas and at half-hour intervals in others. These can be of vital

Controls of three-band receiver are conventional. Squelch circuit eliminates inter-station noise.



value to fliers, boat owners, campers, fishermen, farmers, etc. The conversations between pilots and control towers on the higher frequencies are often thrilling and exciting. In bad weather, with planes sometimes stacked one over the other miles into the sky, the band is alive with important directions.

Although both of these services have been in use for some time, it is only recently that manufacturers have awakened to the sales appeal of these receivers to the listening public. The set shown on these pages is representative of what the market offers. It is the Nova-Tech "Air-O-Ear," available from Lafayette Radio (catalog No. HE-900WX, about \$100). It covers not only the low-frequency (LF) and very high-frequency (VHF) bands, but also the regular AM-broadcast band, and is therefore the kind of radio that keeps the owner from eating, sleeping, or attending to his job! It is a straightforward seven-tube superheterodyne with built-in speaker. An excellent feature on the VHF band is a squelch control which eliminates background hash and static and keeps the set absolutely silent in the absence of signals. When a station does come on, it pops through loud and clear.

For best results on LF and VHF, separate antennas of proper size are recommended. A long wire, 50' or better, is suggested for LF and a small "ground plane" for VHF. A loopstick antenna inside the cabinet is provided for broadcast-band reception.

The VHF band is divided into a number of segments for specific purposes, as follows:

118.1 and 121.3 mc—Air-traffic control. Federal Aviation Authority towers talking

with aircraft either when the planes are in flight or on the ground.

121.5 mc—International emergency and distress frequency.

121.7 and 121.9 mc—Airport utility frequency for planes on the ground and airport ground vehicles.

122.1 and 122.3 mc—Private aircraft en route talking to FAA stations; latter may be on other frequencies.

122.5, 122.6 and 122.7 mc—Private aircraft to control towers; latter answer on 118.1 and 121.3 mc.

122.8 and 123 mc—"UNICOM" aeronautical advisory stations. Small airports without towers and plane-to-plane.

126.7 mc—Civil aircraft to FAA stations.

126.9-130 mc—All airlines en route.

It should be mentioned that the modulation used on the LF and VHF channels is AM.

It is very instructive for ham and CB operators to listen on VHF and to note how professionals handle their microphones. There is no wasted conversation; everybody is terse, snappy, and to the point. In fact, the exchanges between pilot and ground controllers are sometimes so short that you wonder if they really understand each other.

There is nothing less secret than radio transmission, and there is nothing to prevent anyone from eavesdropping on the VHF band for his own enlightenment. However, set owners should be reminded of Section 605 of the Communications Act of 1934, entitled "Unauthorized Publication of Communications" which says, in effect, that listeners must not let the intercepted messages go any further than themselves. •

Back of receiver has connections for various antennas, 'phones, record player, and bandswitch.

Receiver chassis is well filled. Finger points to loopstick antenna used for AM broadcast band.

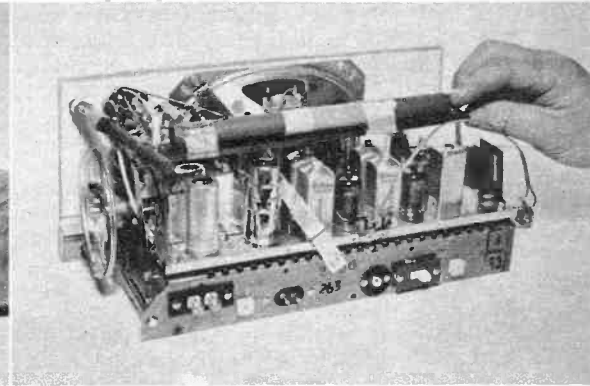
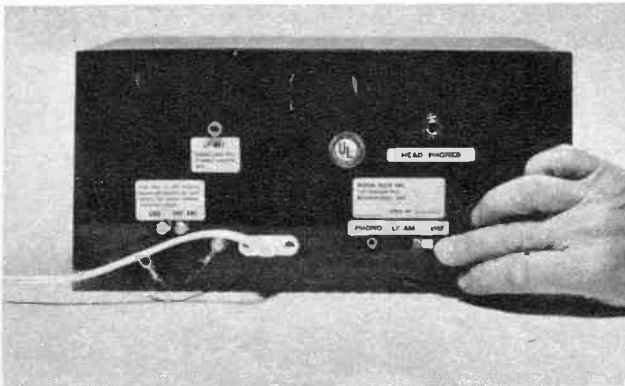

The NO-LICENSE WALKIE-TALKIES



Above: Instant push-to-talk communication over water is possible with hand-held, low-power transceivers. The Globe Electronics Pocketphone is representative of units.



CAN you really operate two-way radio-communication equipment without an FCC license of any kind? Very definitely, but within certain important and well-defined limits.

Part 15 of the Rules and Regulations of the FCC spells these out. This section deals with low power communication devices, and defines one as "a restricted radiation device, exclusive of those employing conducted or guided radio frequency techniques, used for the transmission of signs, signals (including control signals), writing, images and sounds or intelligence of any nature by radiation of electromagnetic energy."

Note carefully the phrase "sounds or intelligence of any nature." That clearly takes in voice transmission.

Another paragraph states: "A low power communication device may operate within the 26.97-27.27 mc band (27.12 mc plus or minus 150 kc), provided it complies with all of the following requirements: (a) The carrier shall be maintained within the 26.97-27.27 mc band. (b) All emissions, including modulation products, below 26.97 mc or above 27.27 mc, shall be suppressed 20 db or more below the unmodulated carrier. (c) The power input to the final transmitter stage (exclusive of filament power) shall not exceed 100 milliwatts. (d) The

antenna shall consist of a single element that does not exceed 5 feet in length."

Equipment that meets these specifications does not require licensing. The FCC apparently feels that because of the severe power limit (1/10 of a watt) the transmitter can cause little or no interference to other services.

It is no coincidence that the Part 15 frequency band coincides with the Citizens Band. If some CB operators think that their maximum power of 5 watts is rather low, let them remember that is still *fifty* times larger than the Part 15 limit.

Since users of 100-milliwatt stations do not need an FCC license, they do not have call letters. They just talk, and identify themselves in any way they wish. As long as they remain unlicensed they are permitted to talk only to other unlicensed 100-milliwatt users, and they are *not* permitted to engage in conversation with licensed CB operators. However, since the frequencies of the two services are the same, and CB crystals are universally used in all the flea-power transmitters on the market, there is nothing to prevent owners of the latter from obtaining a regular CB license. Of course, they must meet the eligibility requirements; mainly, that they be U. S. citizens and 18 years of age or older.

Because of their low-power requirement, and small size transistors lend them-

selves ideally to incorporation in compact, pocket-size transceivers; there is now a flood of them on the market. Some of the performance claims made for them in advertising are, unfortunately, wildly exaggerated. Although the input power is limited to 100 milliwatts, few units actually use as much as 50 or 60 milliwatts, and some of the cigarette-pack-size imported jobs run as low as 30 milliwatts. Even on the basis of 50 per cent operating efficiency, this means that the useful RF output is scarcely enough to agitate the electrons around the antenna, which itself is only half as long as it should be for the frequency.

This leads to a natural question, "Are these transceivers any good?" Of course they are, but only for short-range communication purposes. Simple four-transistor superregenerative sets work satisfactorily up to about a half or three-quarters of a mile, provided there are no large trees or buildings in the way. Sets containing as many as eight or nine transistors cover three to five miles, again depending on terrain. The superhet receivers are superior because they are quieter and more sensitive. Prices of transceivers of both types are still rather high. A pair of superregenerators in kit form costs about \$65; superhet models average close to \$200 for two. Some run as low as \$90 a pair and

Walkie-talkies are ideal for point-to-point communication at sports car rallies and similar events.



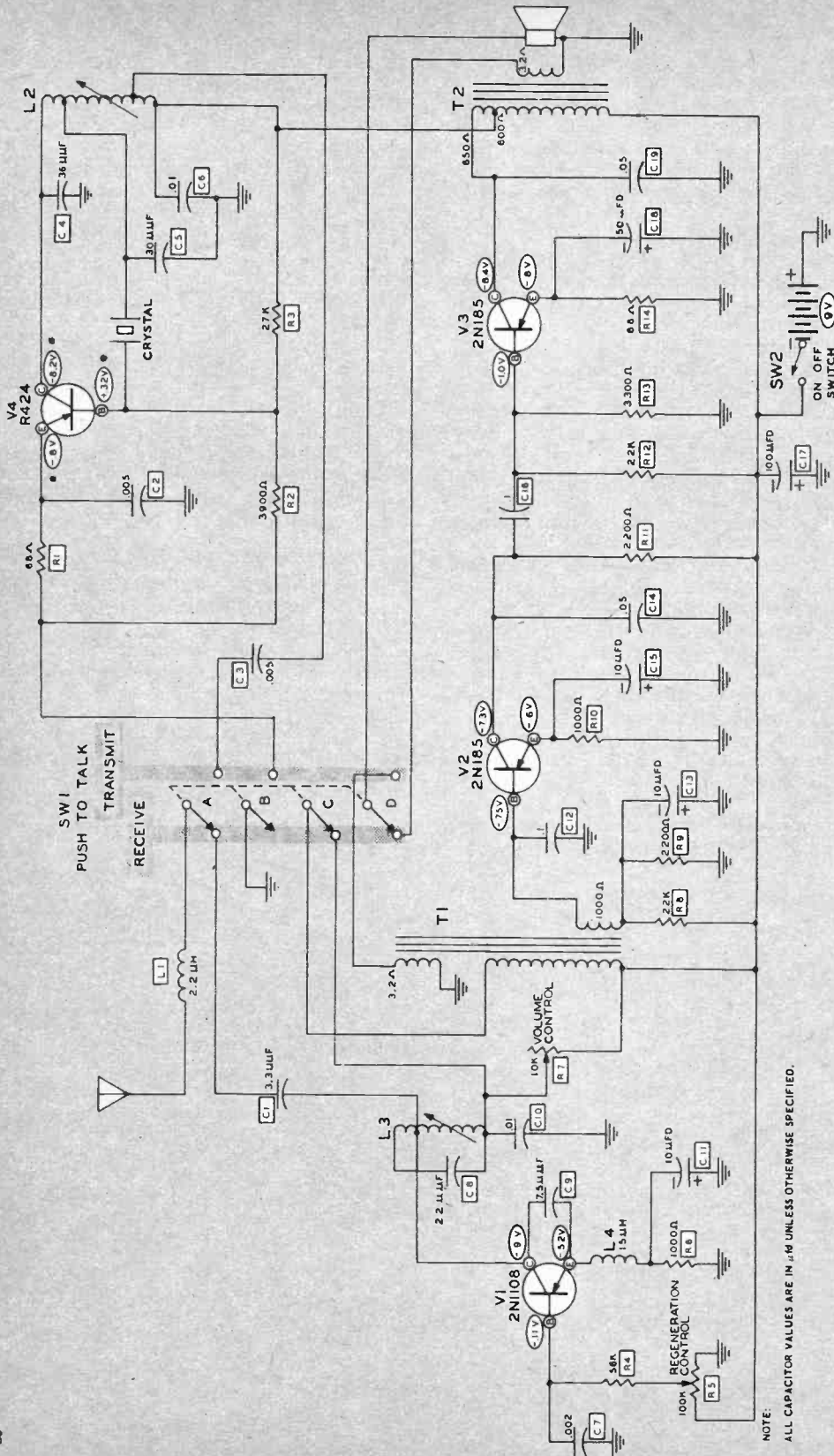

NOTE:
ALL CAPACITOR VALUES ARE IN μF UNLESS OTHERWISE SPECIFIED.

Schematic of Heath model GW-30. V1 is superregenerative detector. V2 and V3 are audio amplifier-modulator, V4 is transmitter oscillator. Loudspeaker functions as microphone when transmitting.



Volume control and push-to-talk switch are only controls on Heath GW-30. Antenna is collapsible.

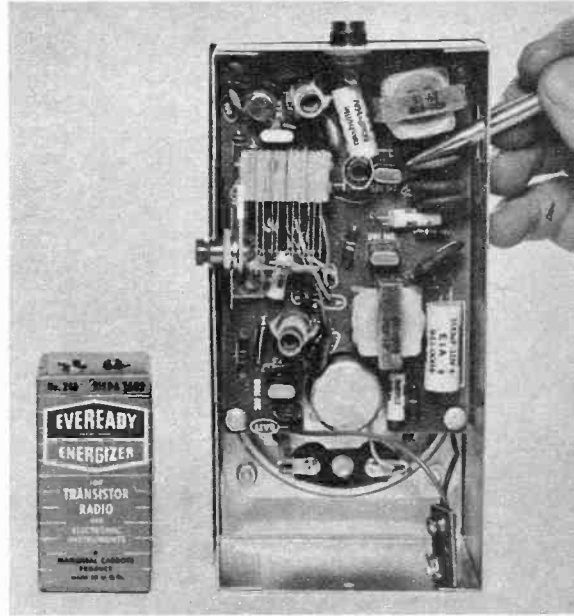

Pencil points to transmitter crystal of GW-30. Single battery occupies space at bottom of case.

others run to better than \$200 for one unit.

While Part 15 transceivers (as they are known in the trade) often operate poorly in crowded areas, they come into their own in the field of boating and water sports. With nothing to absorb or deflect the weak signals over the flat surfaces of lakes, rivers and oceans, communication between boats and between boats and the shore becomes practical. For this reason, the transceivers are especially popular at summer camps, where the center of activities is the water front. Any boy or girl old enough to go to camp can be taught to use a walkie-talkie in a matter of minutes. Kids of all ages have barrels of fun with the equipment.

If after you have operated Part 15 equipment you feel the need to increase your range with five-watt equipment, it is not at all difficult to obtain a license. The first thing to do is write to the FCC, in Washington, D. C. (or your regional office), and request a copy of form 505. Filling out the form for a CB license is not a complicated job at all. However, a tremendous number of applications received by the FCC are returned because they are incorrectly filled out.

Item 9 on the application causes the most difficulty. The question to be answered is, "How is radio to be used in connection with applicant's business or personal activities?" Never answer the question with merely the



RME 4304 transceiver control switch is at bottom, speaker at top. An earphone jack is also provided.

HE-29 "WALKIE-TALKIE"

All capacitors in mfd except those which are marked mmf

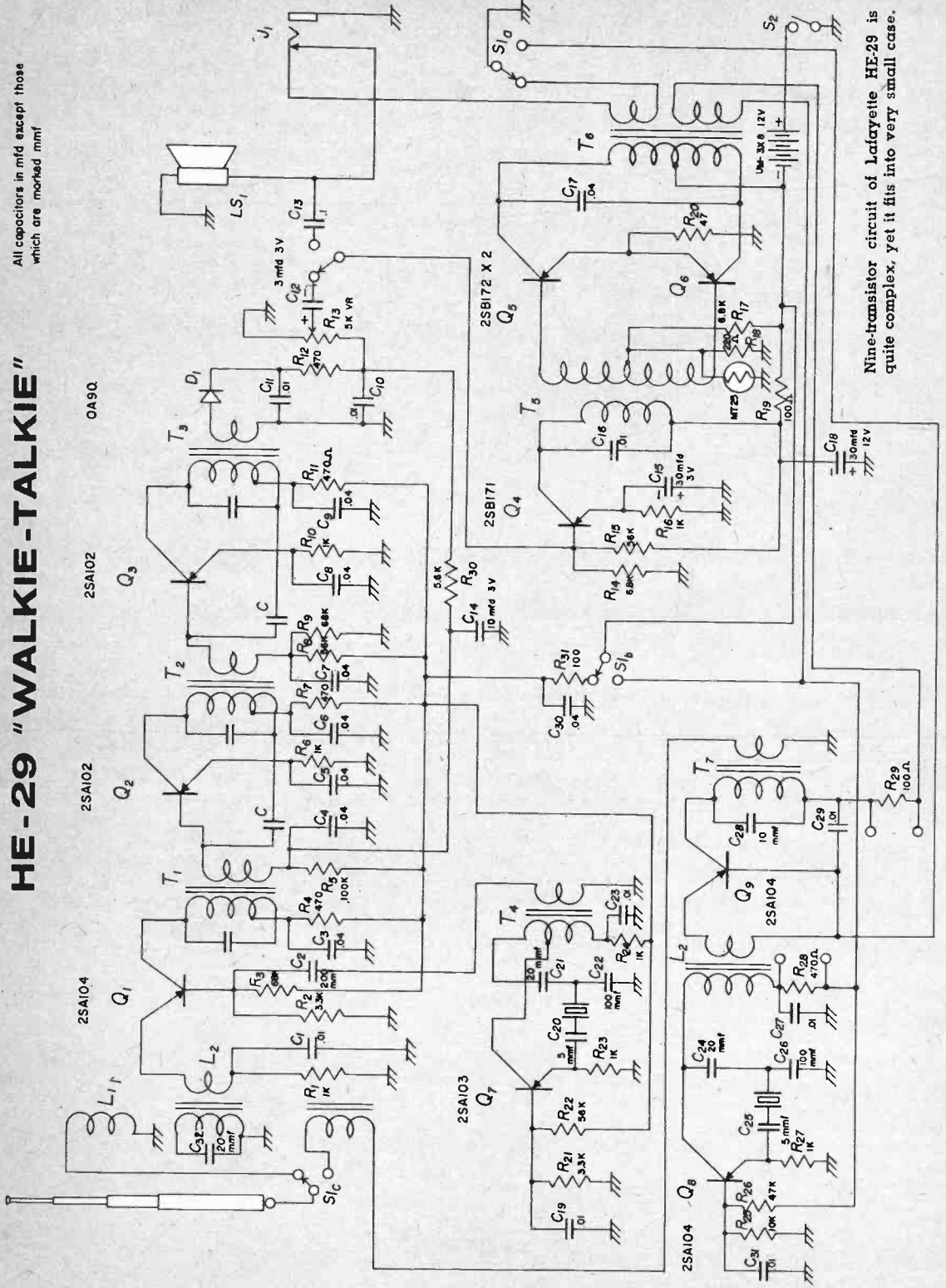

Nine-transistor circuit of Lafayette HE-29 is quite complex, yet it fits into very small case.

words "business" or "personal." This answer is much too vague and guarantees your application will bounce. In addition, any answer that suggests that CB radio is to be used as an end in itself—experimentation, hobby interest, or for pleasurable conversation—is contrary to the FCC's rules.

The correct answer is a brief but specific statement as to how CB communications is going to serve you.

The CB band is available to many different uses where a definite communication need exists: all the way from routing delivery trucks to running a sports event. It can also be used between home and auto, on a small boat, or carried on a hunting trip. If you can't think of a concrete application, then consider amateur radio rather than CB. The Citizens Band is regarded by the FCC as a *tool* of communication.

Item 11 on the application form asks if the transmitters are crystal controlled. When applying for the Class D (27 mc) band, a *no* answer makes the application unacceptable. Transmitters must be crystal controlled in this service. And don't forget to have the application form notarized before you send it back! •

License-free transceivers need not be pocket-size like the Seiscor Telepath (right). For business purposes, such as intra-plant paging, communication with messengers on foot or in vehicles, etc., the Telepath model SC-A base station (pictured below) is more versatile. It can be operated with a variety of power sources, from batteries to AC, and it takes advantage of these to develop the full 100-milliwatt input permitted by law for unlicensed service. This results in a transmitting range of one mile. Seiscor Div., Seismograph Service Corp., Tulsa, Okla.



Volume and push-to-talk controls of Lafayette HE-29 are on side of case, leaving front surface free to be placed against mouth for talking. It is powered by just eight standard penlight batteries.



This Cubex Quad antenna, an adaptation of a highly successful ham model, is designed to produce a sharply directional signal from Citizens Band transmitters. Its gain is equivalent to increasing the transmitter's power TEN times. It's a little less than ten feet square, weighs 16 pounds, and can be turned by a TV rotator. It is fed with standard RG-58U coaxial cable. It is made by the Cubex Co., of 3322 Tonia Ave., Altadena, Cal.

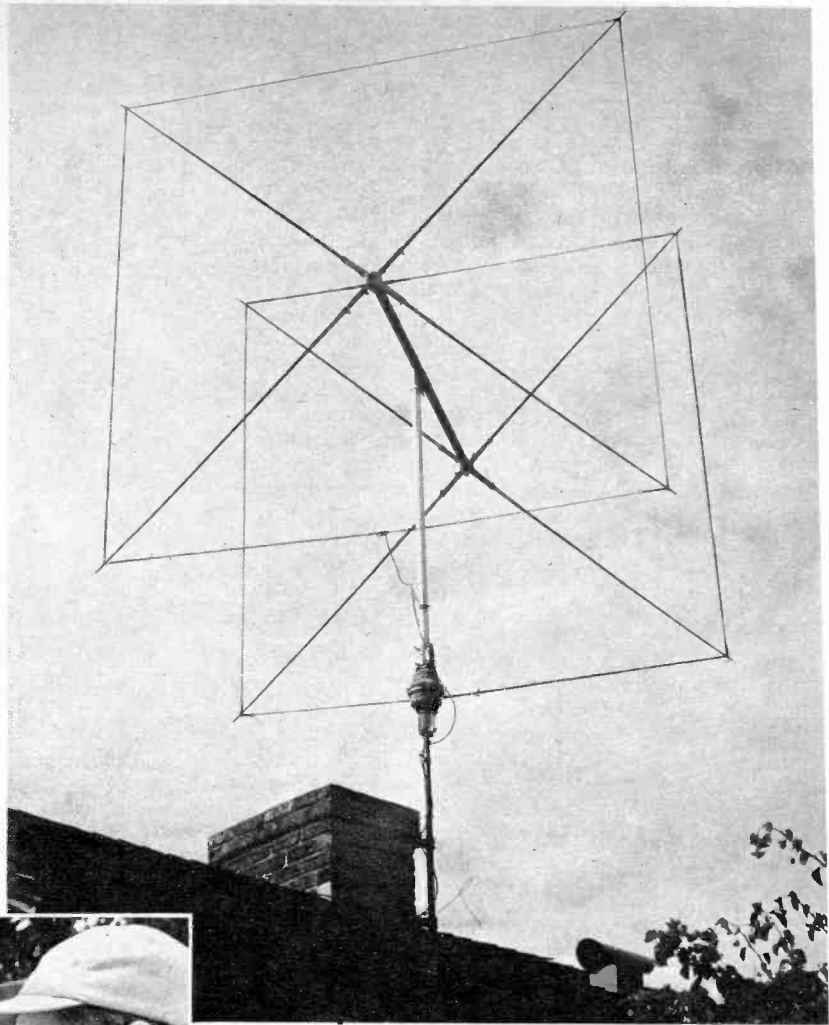

With a grid-dip meter, it takes only a few minutes to determine if a whip antenna is the right length for CB operation. The exploring coil is inductively coupled to single turn between mount and ground.

Peak CB EQUIPMENT Performance

THE input power to the final amplifier, either tube or transistor, of Citizens Band transmitters is limited by law to five watts because the band is intended strictly for local communications. The real effectiveness of the equipment, even over short distances, depends on the design of the antenna and how much of this energy is actually radiated.

Since CBers obtain operating licenses merely by asking for them, and are not required to have the faintest knowledge of electronics, they are pretty much prohibited by FCC regulations from experi-

menting or making adjustments that might possibly produce off-frequency transmission, over-modulation, and excessive harmonics. However, it is a fact that many CB users do have considerable technical know-how. Some operators are or were hams; others may have gone through the short-wave listening, hi-fi or radio-controlled model phases; and still others may be highly competent engineers, technicians, or repairmen. May they put their experience to use in the CB field and still remain within the law? Of course, and with perfectly clear consciences.

Little or nothing can be or need be done in the transmitter sections of the popular CB transceivers. They all look and work pretty much alike because they must be crystal controlled and the final stage input power must not exceed five watts. The only differences between low- and high-priced sets is in the number of crystal positions and the type of receiver circuit. Basic CB transceivers contain a single crystal (for any one of the 23 available channels, at the buyer's choice) and a superregenerative receiver. Better equipment has two or more switch-selected crystal frequencies and far superior superheterodyne receivers.

To assure maximum transfer of signal



CB base station has greatly increased output power when used with proper transmission line and an antenna of correct size and beam type.

Typical setup for determining characteristics of coax. Grid-dip meter, center, furnishes test signal, picked up by loop over coil. RF impedance bridge, with VTVM, left, gives direct impedance reading.

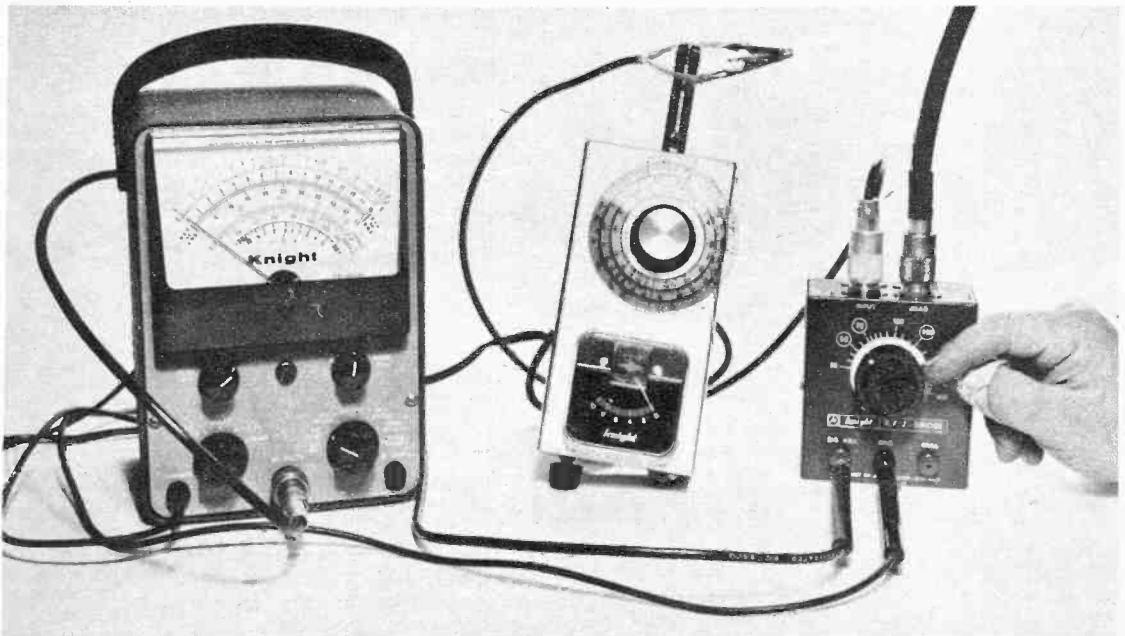

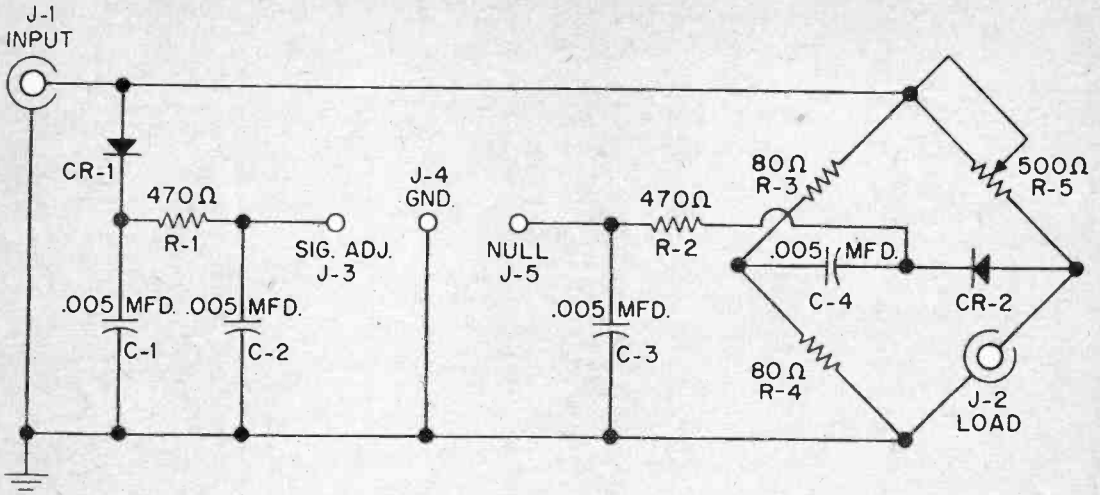

Schematic of Knight-Kit impedance bridge. J-1 and J-2 are coaxial cable fittings. Potentiometer R-5 is front-panel balance control. VTVM connects to posts J-3, J-4, and J-5. CR-1 and CR-2 are rectifiers.



Impedance bridge is useful device for checking elements of antenna system. It has one control.

energy from the antenna fitting on the back of the transceiver to the space surrounding the antenna, you can use several small pieces of test equipment to check the characteristics of the coaxial transmission line and the resonant frequency of the antenna itself.

The instruments required are a VTVM, a grid-dip meter and an RF impedance bridge; all are available in inexpensive kits. The grid-dipper and the bridge have long been used by hams to take most of the guesswork out of antenna adjustment. With their aid you can determine very quickly if your antenna is the correct length for the operating frequency (an inch or two difference makes a big difference at 27 megacycles), and if the coax transmission line is the right kind. The instruction books that come with the meters tell how to use them and interpret their readings; the information is too detailed to be repeated here.

The CB transmitter itself is not used for this work on the antenna. The RF energy needed to get an indication on the test meters is furnished by the grid-dipper, whose output is well below 100 milliwatts. (See the section entitled "The No-License Walkie-Talkies.") The entire operation is both legal and safe!

When striving for peak performance, few CBers recognize the enormous advantage afforded by beam antennas. An ordinary vertical whip antenna scatters signal in all

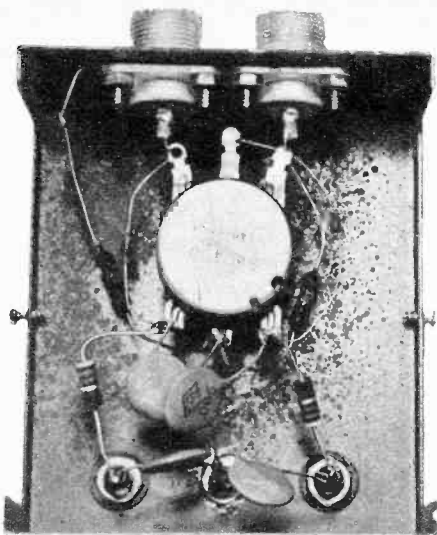

Inside wiring of Knight-Kit impedance bridge is direct. Assembly and soldering take an hour. Most components are connected by their leads.

directions, like a naked light bulb on top of a pole. A beam is a controlled reflector, and it concentrates a large part of the available energy in a specific direction, determined by the aiming of the structure. The signals received over these paths are much stronger than the scattered signals from a simple whip. A beam therefore increases the *effective* radiated power. This gain is quite real, and even some relatively simple beams can make a modest five-watt transmitter the full equivalent of a fifty-watter! This is almost but not quite like getting something for nothing.

While a beam costs more than a whip, because it has several elements, a supporting frame, and a rotator for aiming purposes, its initial cost will be more than justified by its performance.

Although hams are allowed a power of 1,000 watts, most of them use only a fraction of that amount yet enjoy its equivalent by using beams. In fact, many manufacturers of ham antennas are now putting out CB beams which are merely slight modifications of ham models. And they're perfectly legal. In the CB regulations, as in the ham rules, there are no restrictions on antennas except a common-sense one regarding height.

Beams are of special value in suburban and rural areas where the distance between a base station and mobile units may make communication difficult. The advantage is two-way even though only the base has the



This unit checks modulation percentage and RF power without removing CB chassis from cabinet. Seco Electronics, Inc., Minneapolis, Minn.

beam and the mobiles continue to use whips, because the beam is just as effective for receiving as for transmitting.

You might think that the interference problem is aggravated by a beam that makes a transmitter act with increased muscle. There is a compensating factor: the signals are stronger in one direction, but they are very much weaker than before in *other* directions.

While CB transmitters are of severely restricted design, CB receivers can be as big and as fancy as you can afford. It is easy to upgrade a fixed base station merely by ignoring the broad, noisy superregenerative receiver section of the transceiver and using instead a regular general-coverage communications receiver of the kind favored by short-wave listeners and hams. The improvement in all cases is startling, especially in the matter of disentangling what was formerly a glob of signals all seemingly on the same channel. In a mobile unit, superior sensitivity and selectivity are readily achieved with a CB converter working into the car's broadcast receiver, to form a "hot" double-conversion superhet. Hams have used this arrangement for years, with great success.

The converter does not have to include a power supply since B + is readily available from the car radio. A simple SPDT switch should be installed beneath the dashboard to connect the antenna to either the converter or to the car radio. •

Bring Your TV Reception Up To Paar

A couple of new tubes, some tightening of connections, or a new antenna can make the difference between a poor or good picture.



BRING your TV reception up to "Paar." Up to Jack Paar, of course. That's supposed to be funny, so at least smile! By rights, the picture on the screen of the receiver shown at the left should be of Jack, but Dinah Shore is much prettier, so we used hers instead.

Most set owners would be happy to enjoy pictures as sharp and clear as this one. Maybe you did at one time, but now the picture is just not satisfactory. What can be done about it? Plenty, and most of the steps require only household tools and a basic understanding of electronics.

Let's start with the set itself. First, arm yourself with the service instructions and notes for your model, the number of which usually appears on the chassis or the back cover of the cabinet. If the manufacturer is still in business (some once very "big name" firms aren't), address a letter to his service department giving the model number, and inquire if a service manual is available. If the reply is negative, try the nearest electronic parts distributor for a Howard W. Sams Co. folder of service notes. This firm has published service bulletins on the majority of sets manufactured since the start of commercial television just after World War II. To obtain the schematic you *must* specify the set manufacturer's name and model number as thousands of different models are in existence.

While the service notes are intended primarily to assist professional repair technicians, they contain other general information. Of particular value are instructions for removing knobs and dials, removing the chassis from the cabinet, and adjusting important controls that are often hidden behind tubes and other components.

Don't be discouraged if your expensive receiver turns out to be a discontinued and forgotten orphan. As the accompanying pictures indicate, there are still many small restorative measures you can apply that will improve your set's performance.

The very minimum you must have is a tube layout chart. In practically all sets this is on a small printed sheet glued somewhere inside the cabinet or to the back cover. If it was too near a hot rectifier or audio tube for very long it may now be charred and indistinct. Fortunately, there are many tube location guide books on the market at reasonable prices.

You're probably thinking of asking, "Why can't I just pull out the tubes one at a time, examine them, and make my own layout chart?" Of course you can do this, but don't be surprised if you find some

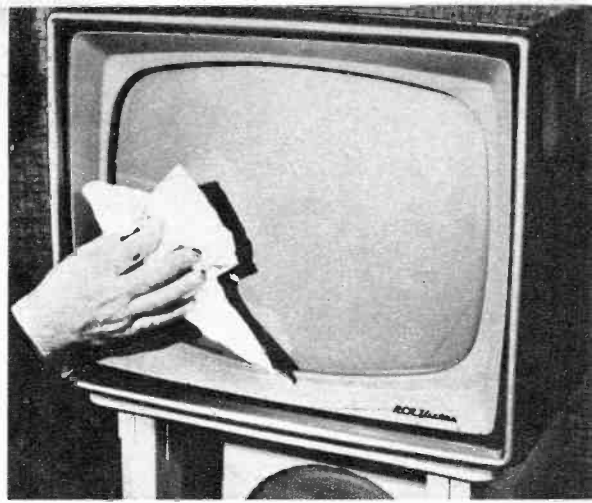

Pictures seem a bit hazy? You will be surprised to see how they improve if you clean the face glass. Use a soft, lint-free rag and plain water.

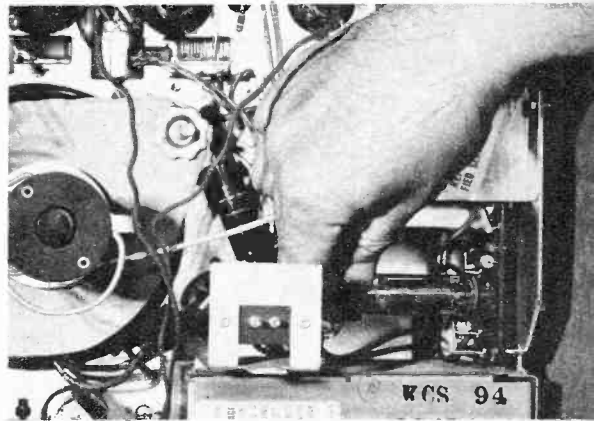

Moving tubes around in their sockets a few times often restores contact at terminals. Be sure to disconnect the power cord to allow tubes to cool.

If set is moved around much, antenna leads are likely to break off at terminal posts. Cut, strip, and twist both lead ends and secure them tightly.

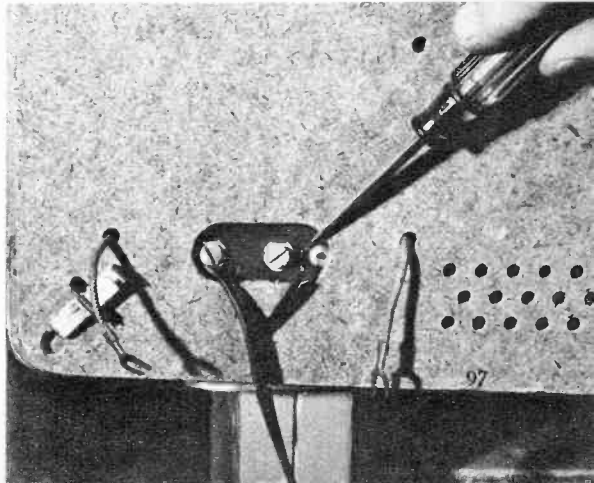

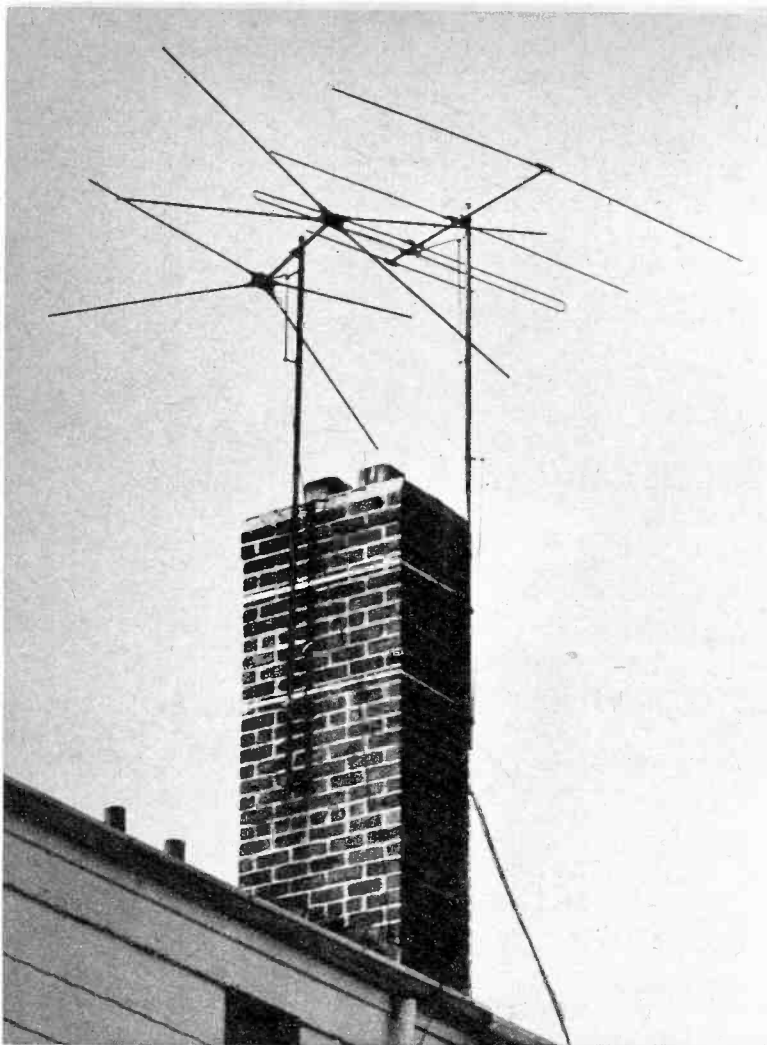

This antenna installation should be avoided as the proximity of the two will result in the oscillator radiation from one receiver to cause interference in the other. If one antenna is shifted by the wind, it is likely to damage the other. Life span of entire structure is shortened because of corrosive action of hot furnace gasses. Below: this installation of a double-V antenna is excellent because the mast and elements are away from the chimney. Lead-in is well anchored in three places on the mast and by stand-off insulators on side of the house. Open throat of V section points to the station.

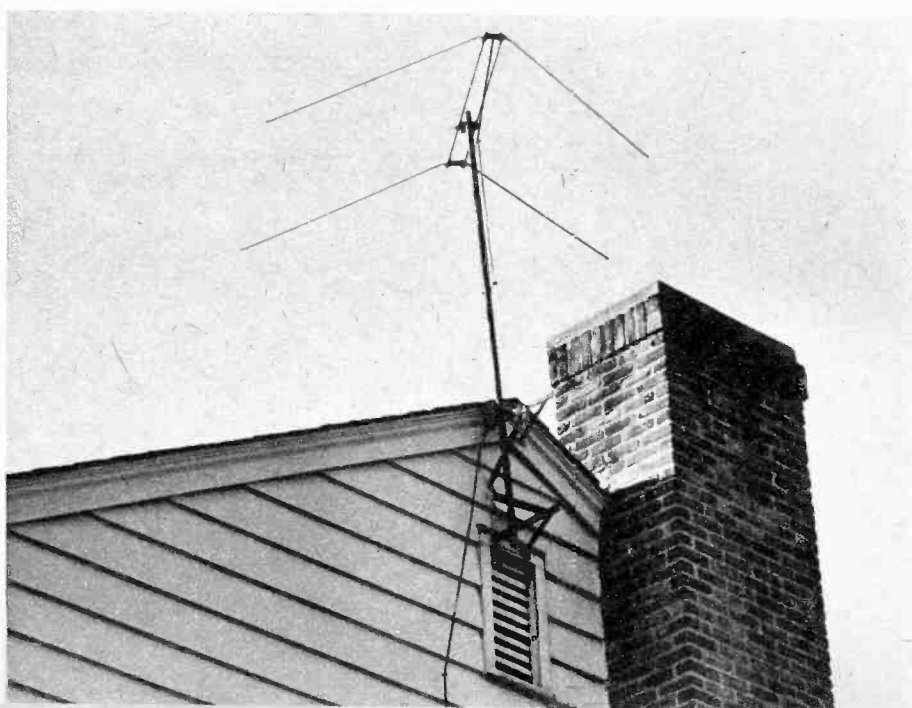

Antenna height is one solution to the problem of fringe area reception. How much is needed in a particular location is a matter of experiment. Here is a typical 50-foot triangular-cross-section mast topped by a multielement antenna that brings in stations over 100 miles away. A regular chimney antenna on the same roof just produced snow. This tower required guy wires but others are free-standing. Prices are proportional to height. Below: Connections to old antenna rusted or corroded? Make new ones in a jiffy with Kwik-Klips, manufactured by CBS Electronics, Danvers, Mass. These fit around elements and make good contact over most of the circumference of the rods and eliminate awkward rooftop soldering.

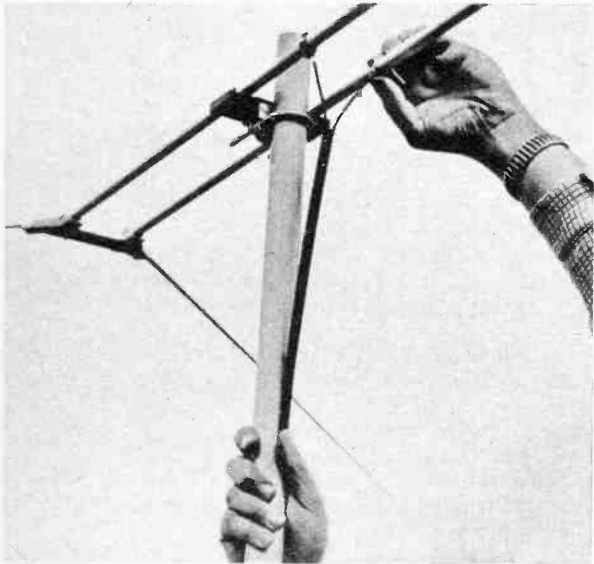
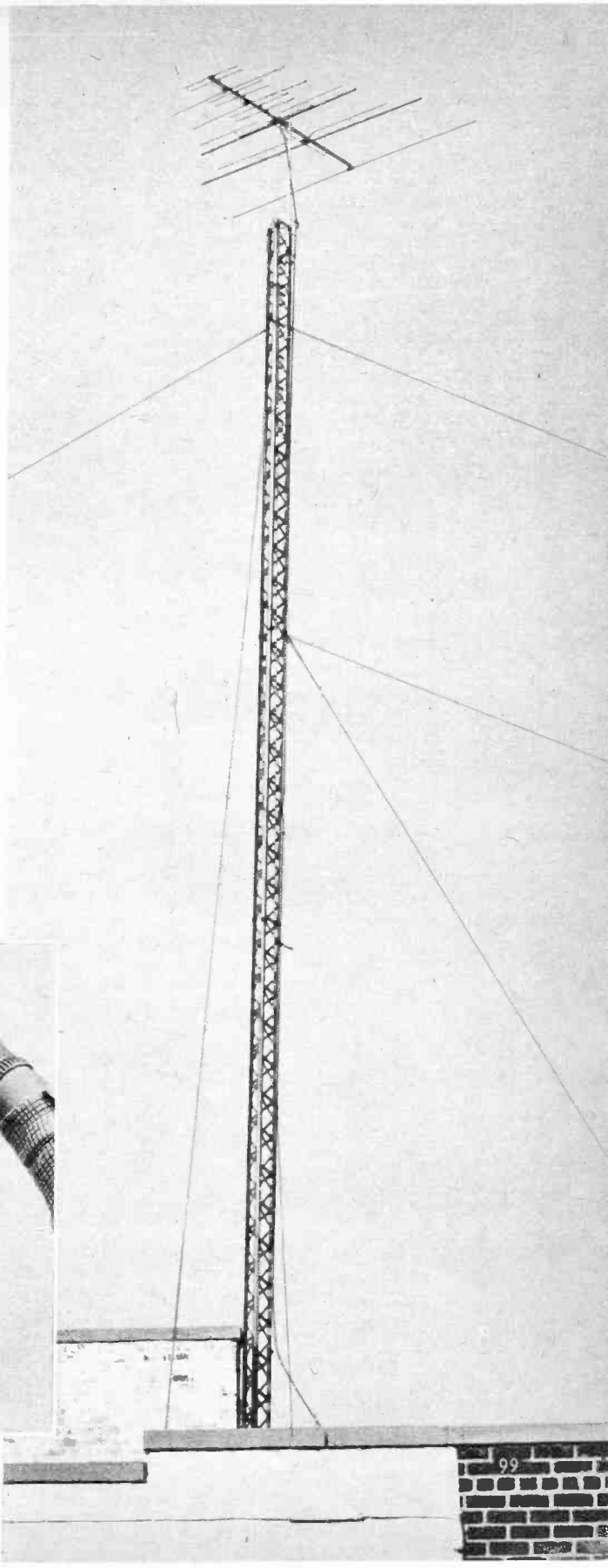

The addition of a booster amplifier at the antenna is an excellent way of increasing the signal strength for clean, bright pictures in fringe areas. Unit shown is the Powertron made by the Winegard Co., Burlington, Iowa. Weatherproof case contains two-stage amplifier. Regular twin-lead carries amplified signal to receiver and low-voltage AC up from the house. In many areas it's cheaper and more practical to use a booster like this with a relatively low antenna than to raise a very high tower. The installation takes minutes.

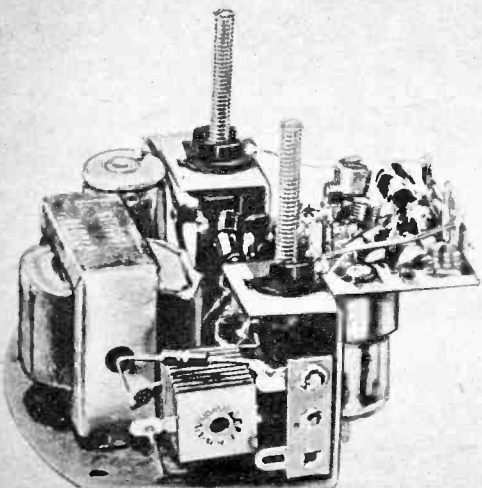
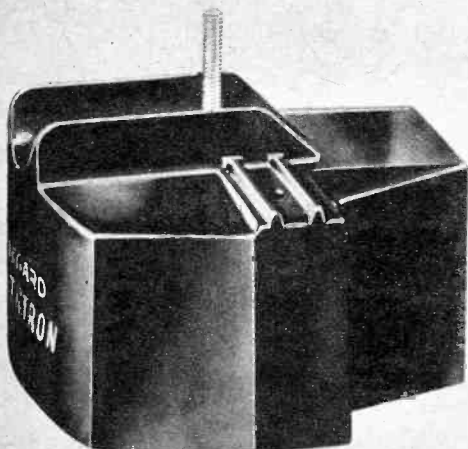
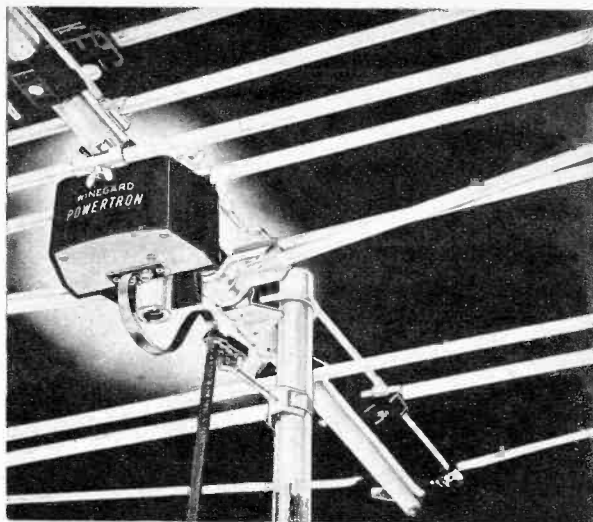

tubes without an identification number. All had type numbers on them once, but the markings, especially on glass tubes, tend to fade away rapidly because of the high operating temperatures.

A quick word of warning here. Before doing *anything* to a TV set, pull out the line cord. Many receivers (most small ones, in fact) are of the "hot chassis" AC-DC type, and are dangerous as long as they are plugged in. (See the section of this book entitled "TV Safety.") An additional safety measure is built into most sets in the form of an interlock receptacle attached to the back cover. When the cover is removed, the line cord comes along with it. To turn the set on with the cover off, it is necessary to use a "cheater cord" (obtainable at an electronic parts distributor). This is a length of flexible wire with a regular line plug on one end and a special receptacle on the other that fits a mating interlock connector on the back of chassis.

As with radios, tubes continue to be the number 1 cause of set failure. They either burn out or lose their pep. It is easy to test them for complete burnout, but difficult to check them for "strength." Most tube testers (the relatively simple self-service jobs found in drug stores) give very unreliable indications. Tubes that read as *weak* or *bad* on a colorful, impressive-looking meter are often good for years of service in certain noncritical circuits; some that read *good* prove to be duds in many circuits. No reading at all on a tester is the most positive reading; it means that the tube is burned out.

For years, RCA has been running this

nugget of honest information in its widely used *Receiving Tube Manual*:

"A tube-testing device can only indicate the difference between a given tube's characteristics and those which are standard for that particular type. Since the operating conditions imposed upon a tube of a given type may vary within wide limits, it is impossible for a tube-testing device to evaluate tubes in terms of performance capabilities for all applications. The tube tester, therefore, cannot be looked upon as a final authority in determining whether or not a tube is always satisfactory. An actual operating test in the equipment in which the tube is to be used will give the best possible indication of a tube's worth."

In other words, you just have to try 'em!

The Antenna Catches the Signals

Because good reception always starts with the antenna, and because the outside antenna takes a beating from rain, snow, ice, wind and furnace fumes, it pays to check it occasionally. If elements are bent, broken or corroded, and mounting hardware is red with rust, a new antenna is a smart investment. Antennas are cheap and in most cases easy to erect.

The flat twin-lead universally used to connect the antenna to the TV receiver contains rather thin wires. If the lead flaps too freely in the wind, the wire may break. If only one conductor gives way, pictures may still be received, but with poor quality.

Don't overlook the possibility of an attic for the antenna. It's certainly worth trying, and may save a lot of ladder and roof climbing. Once installed, an attic antenna will last forever without maintenance, since it is completely protected against the weather.

If you plan to use your TV in different rooms of the house, or if you have more than one receiver, you should install an antenna outlet at each location. If the home is new, it is a relatively simple matter to arrange to have 300-ohm twin-lead run from the attic through the walls to each room during construction. Special outlet boxes and plates are available at electronic parts distributors. And it's no great problem to snake the twin-lead between the beams of existing walls of an older home. •

Schematic of Powertron TV booster. AC house power is rectified by SLR for cascode amplifier V1. Amplified signal is kept out of T5 and SLR by RF chokes L4 and L5 and is fed to the receiver by C14 and C15. C14 and C15 keep AC from being fed to receiver antenna terminals.

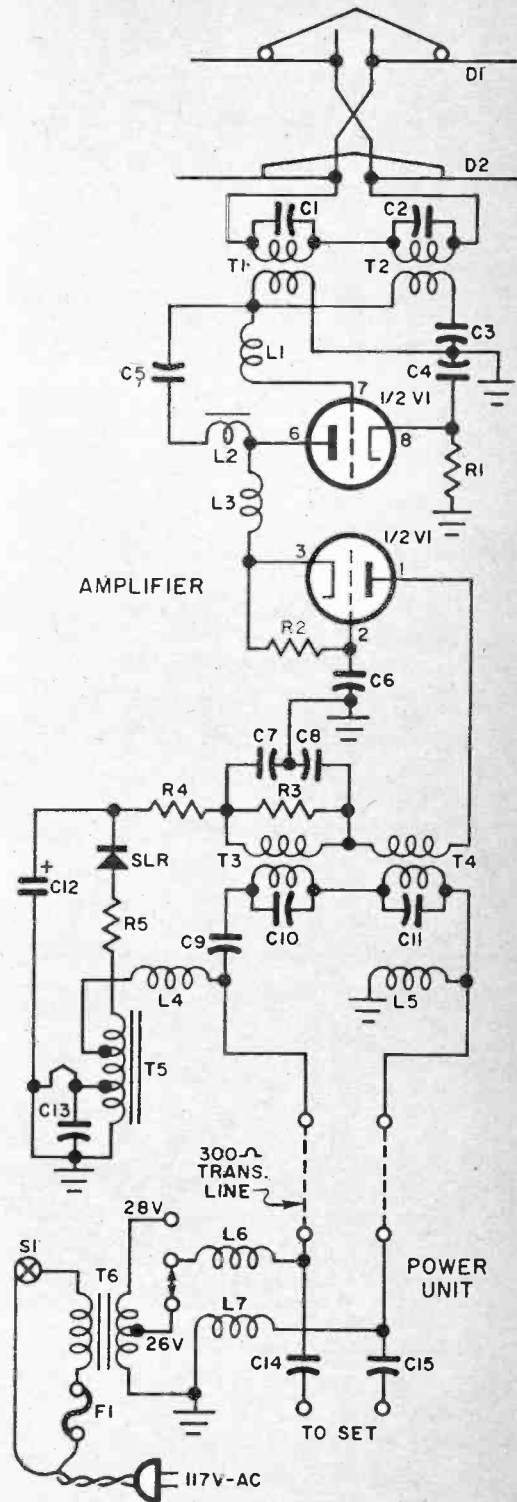

These multielement antennas are recommended for difficult and fringe areas. At right is the Channel Master Super 10-TW made by the Channel Master Corp., Ellenville, N. Y. It combines six driven dipoles of "hairpin" shape with four parasitic low-band co-linear high-band elements. Result is high sensitivity and directivity. The model illustrated is fitted with a rotator for accurate aiming at desired stations.

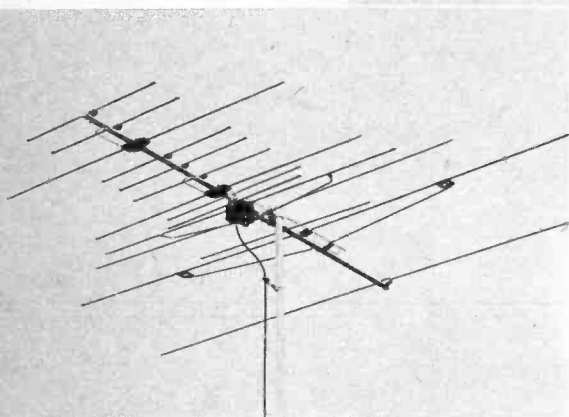
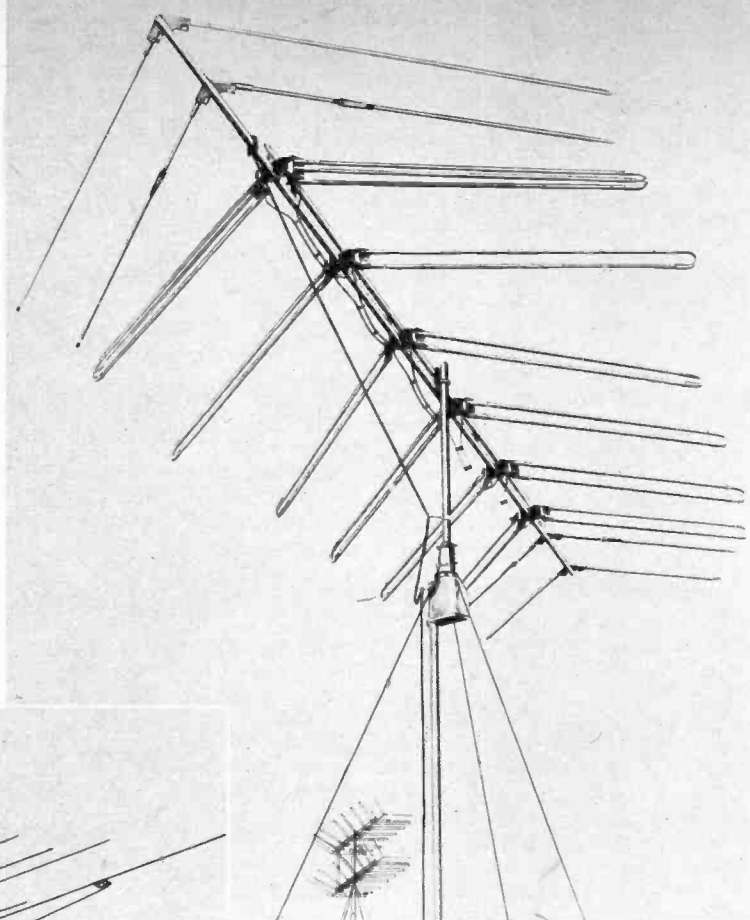

Left: Winegard model P-44 antenna with powertron booster attached. Structure contains fourteen elements and covers channels 2 through 13.

Thirty elements and Powertron booster make the Winegard SP-44X about as "hot" an antenna as can be had. Use a rotator for the reception of many widely separated TV stations.

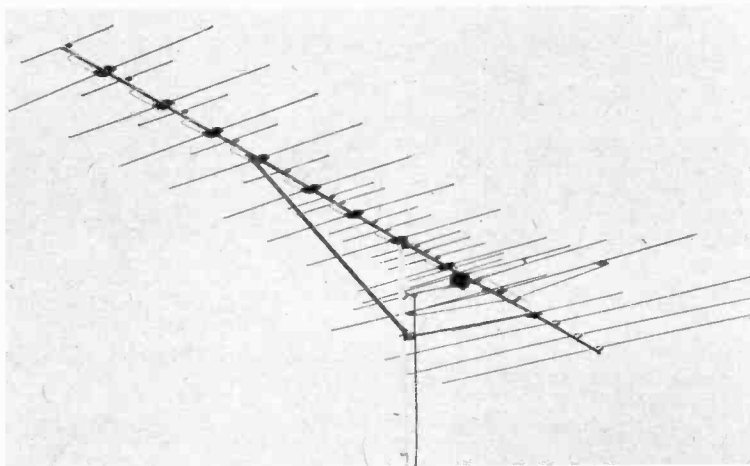

Electricity from Heat — Directly!

A NEW electronic device which produces electricity directly from the heat provided by ordinary fuels has been developed by scientists of the Radio Corporation of America for space vehicles and as a possible low-cost, mass-production power source for a wide range of earth-bound uses that might ultimately include even automobiles and homes.

The device is a major advance in research for economical methods of producing substantial power by direct conversion from solar energy in space and from conventional heat sources, such as burning gasoline and natural gas. The unit, known as a thermionic energy converter, has been developed at RCA Laboratories.

The tube has been operated in tests from heat sources of 1,100° Centigrade—equivalent to the temperatures produced by burning standard fuels—and has converted up to 14 per cent of the heat energy directly to electrical energy.

The new experimental device combines practical simplicity with the highest efficiency yet known to have been achieved by any thermionic device working at temperatures that can be produced by combustion of standard fossil fuels, such as gasoline and natural gas.

A major goal in work on thermionic conversion devices is to produce a simple unit capable of generating electrical energy directly and with reasonable efficiency from conventional heat sources. Until now, tubes of this type have been operated with acceptable efficiency only from special heat sources producing temperatures well over 2,000° Centigrade. At the same time, other thermionic devices capable of operating from lower temperature sources have had the disadvantage of extremely critical construction, raising serious problems from the standpoint of economical mass-production.

Under development primarily for converting solar heat to energy in space, the new tube also points the way toward economical electronic power units, suited to mass-production techniques. Operating in complete silence, without moving parts, such units would have widespread application as power generators in submarines, aircraft, missiles, and space vehicles, in

both military and industrial field installations, and ultimately even in electric automobiles and as stand-by power units for the home. Another potential application is in the direct conversion of heat from nuclear reactors, augmenting the power output of fixed installations and providing primary power in mobile nuclear reactors, such as shipboard and airborne units.

The experimental tube, developed by Dr. Karl G. Hernqvist, of the technical staff at RCA's David Sarnoff Research Center, is capable of generating either direct or alternating current at frequencies up to about one million cps, meaning that its power output could be suited to drive virtually all types of electrical equipment.

Such units could be fabricated in various forms and arrangements to produce whatever level of power might be required. In some cases thermionic tubes might be combined in assemblies with thermoelectric generating elements, which are solid materials in which heat at lower temperatures is converted directly to electricity at somewhat lower efficiency than can be achieved with thermionic units. He pointed out that such a combination might be used ultimately to run an automobile, producing electrical energy from a chemical flame heat source.

Discussing the concepts used in the new experimental tube, Dr. Hernqvist pointed out that thermionic tubes employ an electrode from which electrons are emitted when sufficient heat is applied, and an electrode to which these electrons flow to produce an electrical output. Such tubes are filled with cesium vapor which becomes ionized upon contact with the hot cathode, expediting the flow of electrons to the output electrode. In the earlier tubes, temperatures of more than 2,000° Centigrade were required to produce sufficient ionization for this process.

In the new experimental tube, a new arrangement of internal elements has been conceived and a different type of cathode has been used to emit electrons at considerably lower temperatures. The new approach permits a maximum flow of electrons without the earlier requirement for unduly high-temperature heat sources, leading in turn to longer operating life. •

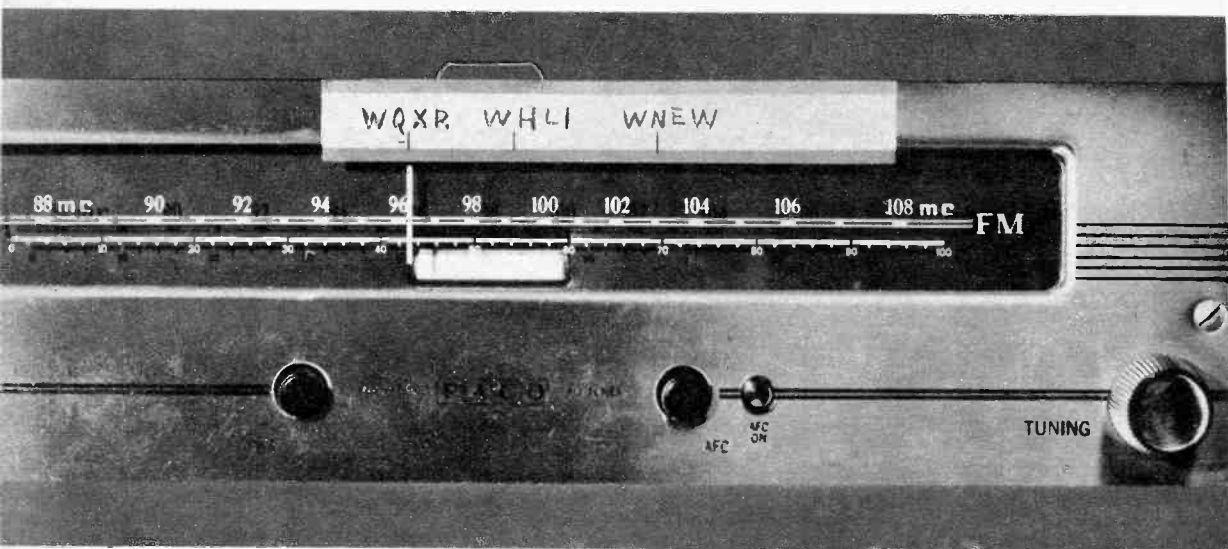

To facilitate accurate tuning of FM sets with slide-rule dials, mark the settings of each of the local stations.

Stick-On Labels

IT is often helpful to add identification labels or tags to electronic equipment. The problem that arises is that ordinary glue-type labels do not usually stick to metal and plastic surfaces of meters and chassis.

A simple solution is found in a trick tape called "Labelon," which is available in photo supply and stationery stores. It is $\frac{3}{4}$ " wide and consists of two layers. The bottom layer is colored red and has a sticky

undersurface that adheres firmly to anything; the top layer is white. When you write on the top surface with a sharp, hard pencil, the letters appear in vivid red and they can't be overlooked.

The tape comes in roll form on a convenient plastic stand. Some practical applications are shown in the photos on these pages. An advantage of "Labelon" is that it can be peeled off at any time without damage. •

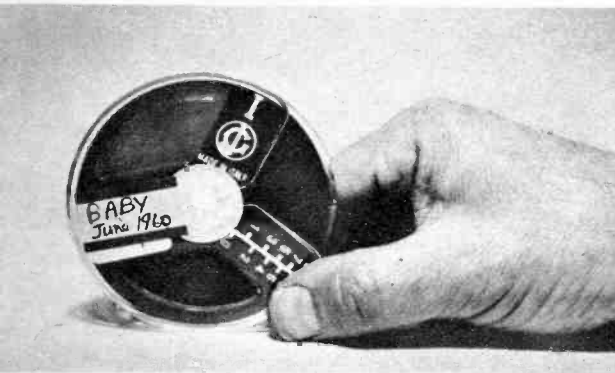

There's no mistaking the contents of a tape recording if you put a red label on the tape reel.

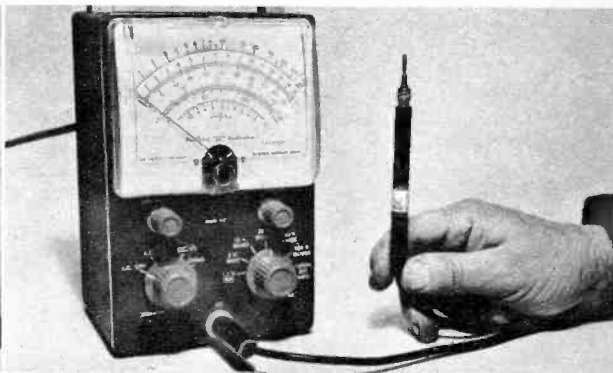

Most VTVMs use different probes for DC, ohms, and AC. Use labels for positive identification.

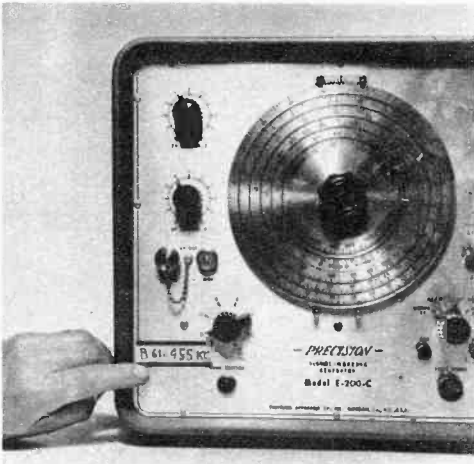

Most often used frequency of a signal generator is the IF. Mark exact dial setting on a label.



Also examine batteries about once a month to make sure that they are dry and are not leaking.

When did you install batteries in that meter? A label on the back of the meter will remind you.

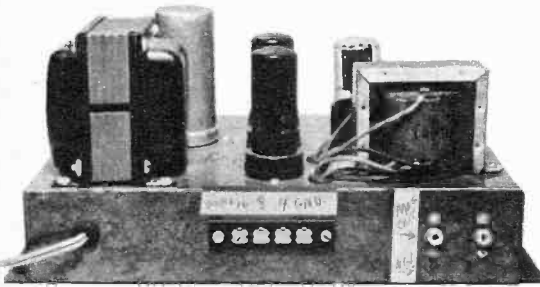

On homemade or experimental equipment, labels are valuable for identifying terminals and jacks. Use them for marking tube types on sockets.

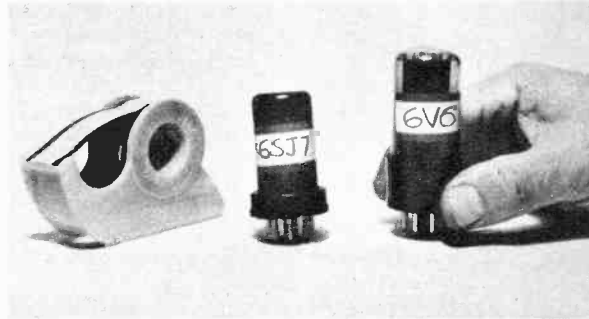

When tubes are still new, add labels. Original markings have an annoying habit of disappearing, due to handling, after short periods of time.



What channel is that CB transmitter operating on? After installing xtal, mark frequency on label.



To save time when retuning a transmitter, mark settings of frequently used frequencies on tapes.

New Tubes for Home Radio Receivers

Lower filament current increases heater life and lowers operating temperature of equipment.

THIS article describes a group of tubes for series-string applications in either five-tube or four-tube home radio receivers. Complements of these tubes operate at a total rated heater voltage of 120 volts and require heater current of only 100 ma. The performance of these new tubes in typical receivers is compared with conventional complements operating at a total heater voltage of 117 volts and a heater current of 150 ma. In addition, an experimental four-tube economy receiver using the new 100 ma tubes is described and evaluated.

Recent studies indicate that the average outlet voltage in the United States is about 117 volts. However, the number of homes having higher outlet voltages is increasing as a result primarily of better wiring systems and better primary-voltage regulation. Extensive tests have shown that the failure rate of electron tubes is considerably higher if they are operated at excessive heater voltage than if they are operated at slightly reduced heater voltage. Because these tubes are designed to operate at a line voltage of 120 volts, operation at slightly lower line voltage is expected to result in some improvement in tube life.

The reduction in heater power achieved by use of a 120-volt, 100 ma complement decreases the temperature of the hottest spots on the tops of the cabinets tested from 15 to 25 per cent. As a result, it is possible to design smaller cabinets or to obtain improved acoustic performance by reducing the number of ventilating holes. This heat reduction also lends new flexibility to the positioning of parts and printed-circuit boards, and reduces the possibility of cabinets warping or changing color.

Heater-power surges that occur when a radio is switched on are lower with the 120-volt complement because the cold re-

sistance of the 100-ma heater is inherently higher and tends to reduce the current surge. More even distribution of heater voltages in the 100-ma complement also tends to reduce the magnitude of the initial voltage surges across the 18- and 20-volt tubes. For example, the heater-surge voltage for the 12.6-volt tubes in the five-tube, 150-ma complement is approximately 70 per cent above the rated heater voltage; it is only about 10 per cent above the rated voltage for the 18-volt tubes in the five-tube, 100-ma complement. These lower surge voltages result in improved receiver reliability and longer tube life by minimizing the possibility of heater burnouts.

Five-Tube Radio Complement

The five-tube 120-volt, 100-ma complement provides performance equal to that of 117-volt, 150-ma complements in a typical commercial radio. This five-tube complement consists of an 18FX6 converter, an 18FW6 IF amplifier, an 18FY6 detector-first AF amplifier, a 34GD5 beam power tube, and a 36AM3-A rectifier tube.

These tubes are available at any electronic parts distributor. Their price is the same as their 150-ma counterparts.

Except for the adjustment in heater voltage and a slight reduction in heater power, the characteristics and performance of the 18FX6, 18FW6, and 18FY6 are similar to those of their 150-ma counterparts. The greatest reduction in heater power was made in the design of the beam power tube and the rectifier tube. Compared with the 35W4, for example, the heater power of the 36AM3-A is reduced by about 30 per cent over the entire heater. The 36AM3-A has a 32-volt main heater section and a 4-volt tap section. This tap section is used as a fuse and a surge-limiting resistor for the B+ supply. The table on page 107 lists the voltages for both the 35W4 and the 36AM3-A measured at the input and output of the filter circuit in a typical five-tube radio.

Portions of this material copyrighted 1960 by Radio Corporation of America and reprinted with its permission.

Voltage	36AM3-A	35W4
AC Line Voltage	120	117 volts
B+ Input to Filter	126	118 volts
B+ Output from Filter	100	95 volts

Note: Volume control at minimum position; tuning capacitor adjusted for minimum capacitance.

With slightly more grid-No. 1 drive, the 34GD5 provides the same power output as the 50C5 with considerably less heater power at the B+ voltages provided in a typical radio. The power sensitivity, therefore, is slightly lower than that of the 50C5. The next table presents data comparing the performance of the 34GD5 and 50C5 in a commercial radio.

Characteristic	34GD5	50C5
AC Line Voltage	120	117 volts
Plate Voltage	120	110 volts
Grid-No. 2 Voltage	100	92 volts
Cathode-Bias Resistor (Unbypassed)	120	150 ohms
Grid-No. 1 Resistor	0.47	0.47 megohms
RMS Grid-No. 1 Voltage (1)	9.7	9.0 volts
Load Impedance (2)	2500	2500 ohms
Maximum-Signal Power Output	1.1	1.1 watts
Total Harmonic Distortion	10	10 per cent

(1) Voltage applied to grid No. 1 through coupling capacitor.
(2) 2500-ohm output transformer terminated with 4-ohm resistive load.

The power drawn from the AC line during typical radio operation is about 20 watts with the 120-volt, 100-ma complement as compared with about 26 watts with the 117-volt, 150-ma complement at their nominal line voltages. *The 120-volt, 100-ma complement can be substituted directly for a 117-volt, 150-ma complement with no circuit changes in receivers not utilizing panel lamps.*

Four-Tube Economy Radio Complement

The four-tube complement consists of an 18FX6 converter, a 20EQ7 IF amplifier-detector, a 50FK5 power pentode, and a 36AM3-A rectifier tube. The 20EQ7 and 50FK5 were developed specifically for this four-tube complement. The 20EQ7 is a 20-volt version of the 6EQ7 and 12EQ7 tubes used in AM/FM radios and tuners. The pentode section of these tubes is similar to the 18FW6 except for slightly lower transconductance and considerably lower grid-No. 1-to-plate capacitance. The low-perveance diode section was especially designed to provide low capacitance between the plate of the diode section and grid No. 1 of the pentode section.

Because the suppressor grid (grid No. 3) and internal shields of the 20EQ7 are

connected to separate base pins, the tube may be used in a variety of circuit configurations. The nine-pin stem and improved shielding provide very low interelectrode capacitances to minimize instability due to feedback between the plates and grid No. 1.

Because the four-tube economy complement has only one stage of audio-frequency amplification, greater audio-power

Characteristic	50FK5	50EH5
AC Line Voltage	120	117 volts
Plate Voltage	120	110 volts
Grid-No. 2 Voltage	96	92 volts
Cathode-Bias Resistor (Bypassed)	56	56 ohms
Cathode-Bypass Capacitor	50	50 mf
Grid-No. 1 Resistor	0.47	0.47 megohms
RMS Grid-No. 1 Voltage (1)	2.05	2.3 volts
Load Impedance (2)	2500	2500 ohms
Maximum-Signal Power Output	0.85	1.0 watt
Total Harmonic Distortion	10	10 per cent

(1) Voltage applied to grid No. 1 through coupling capacitor.
(2) 2500-ohm output transformer terminated with 4-ohm resistive load.

sensitivity is required in the power-output stage. Although the 34GD5 beam power tube has higher power-output capabilities, the 50FK5 was designed for use in the four-tube complement to provide this increased audio-power sensitivity. A grid-No. 1 voltage of only two volts RMS is needed to drive the 50FK5 to full power output (at 10 per-cent distortion) under

actual operating conditions. The table below compares the performance of the 50FK5 in the 100-ma receiver with that of the 50EH5 in a 150-ma four-tube receiver.

Experimental Four-Tube Economy Complement

Fig. 1 shows a four-tube superheterodyne receiver which was designed to illu-

Fig. 1. Experimental four-tube receiver using 120-volt, 100-ma complement.

- C1, C4—Ganged tuning capacitors; C1, 10-310 mmf; C4, 7-115 mmf
- C2—Trimmer capacitor, 2-15 mmf
- C3—56 mmf, ceramic
- C5, C7, C8, C10—Fixed capacitors; usually part of IF transformer assembly
- C6—Trimmer capacitor, 2-15 mmf
- C9—0.047 mf, 400 v., paper
- C11—330 mmf, mica
- C12—0.01 mf, 400 v., paper
- C13—50 mf, 15 v., electrolytic
- C14—0.015 mf, 600 v., paper
- C15—40 mf, 150 v., electrolytic
- C16—20 mf, 150 v., electrolytic
- C17—0.047 mf, 400 v., paper
- C18—0.1 mf, 400 v., paper
- L—Ferrite rod antenna, 540-1650 kc

- R1—33,000 ohms, 0.5 watt
- R2—3.3 megohms, 0.5 watt
- R3—1.5 megohms, 0.5 watt
- R4—47,000 ohms, 0.5 watt
- R5—Volume control, potentiometer, 1 megohm
- R6—470,000 ohms, 0.5 watt
- R7—10,000 ohms, 0.5 watt
- R8—56 ohms, 0.5 watt
- R9—1200 ohms, 1 watt
- S—Switch; single pole, single throw
- T1—Oscillator coil for use with 7-115-mmf tuning capacitor and 455-kc IF transformer
- T2—Input IF transformer, 455 kc, tapped (see text)
- T3—Output IF transformer, 455 kc
- T4—Output transformer for matching impedance of voice coil to 3000-ohm tube load (Triad S-16X or equivalent)

Note: mf and mmf stand for microfarads and micromicrofarads, respectively.

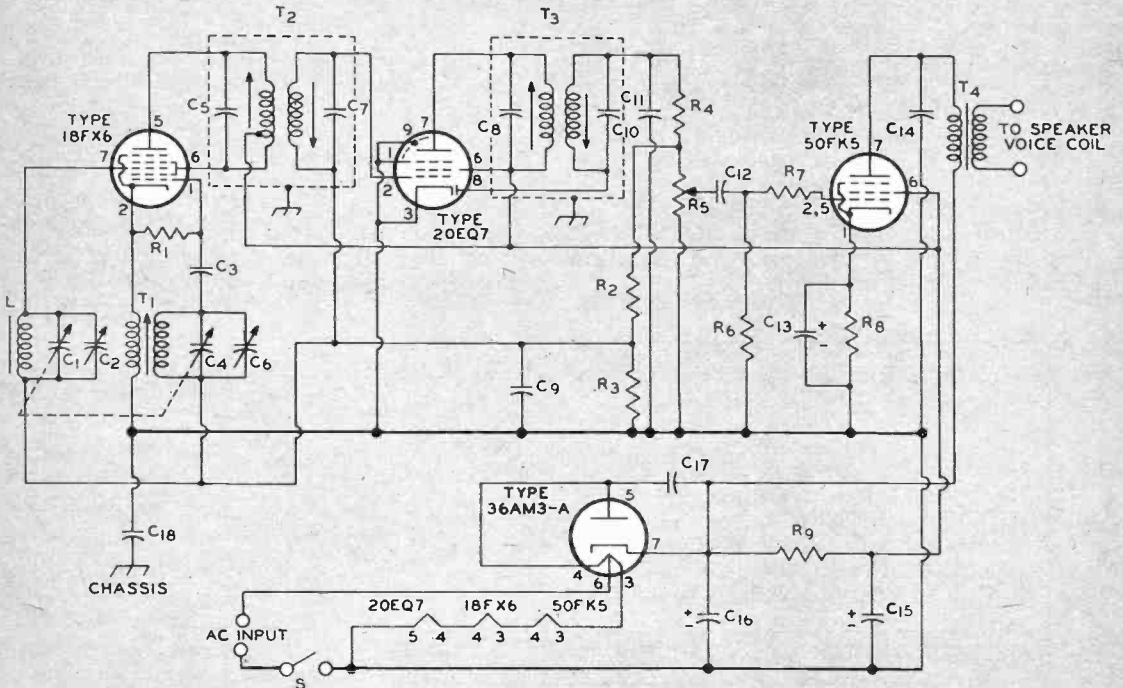

strate one possible arrangement of the economy complement. No special attempt has been made to optimize the values of the parts because the purpose of the circuit is only to act as a guide.

The converter stage of the four-tube receiver is conventional except for the addition of a tap to the primary of the first IF transformer. This tap furnishes increased gain from the converter stage by (1) providing neutralization which, in turn, reduces the loading on the antenna, and (2) introducing a small load impedance in the screen-grid circuit. The voltage developed across this impedance adds in phase with that developed in the plate circuit to supply some additional gain. When an antenna having relatively high Q is used, the overall increase in gain resulting from use of the tap approaches 2:1.

The IF and detector stages are also essentially conventional. The combination of high gain from the converter and IF stages and reduced audio gain causes the AVC voltage to be so large under strong-signal conditions as to limit the amount of audio voltage fed to the power-output stage. As a result, it is necessary to reduce the AVC voltage by means of a voltage divider in the AVC line. The value of the resistor used in the voltage-divider network should be chosen to provide a balance between strong-signal overloading and sensitivity for rated output.

A 10,000-ohm resistor is used in the grid-No. 1 circuit of the 50FK5 to reduce the likelihood of parasitic oscillations. Otherwise, the output stage is conventional.

The rectifier circuit is also conventional. Because measurements indicated reduced hum in the single-audio-tube circuit, the values of the filter capacitors were reduced from the usual 50- and 30-microfarad capacitors used in the five-tube receiver to 40 and 20 microfarads.

The experimental four-tube receiver has a sensitivity of approximately 500 microvolts per meter as compared with 150 microvolts per meter for the 100-ma five-tube receiver. Otherwise, performance of the two receivers is essentially the same. The action of the volume control is, however, slightly different. The increase in power output with rotation of the volume control is less than that of the five-tube receiver. The power drawn from the AC line is approximately the same. Some improvement in the over-all performance of the four-tube receiver can be realized by the use of plate or screen-grid reflexing of the audio signal through the IF-amplifier stage. •

Tips



Instead of trying to conceal the coffin-like speaker enclosure, one homeowner made it part of the room decor by using it as a support for an attractive display of plants. Reproduction is excellent because sound issues directly outward without interference from the furniture behind which it was concealed. Legs are available at hardware stores.

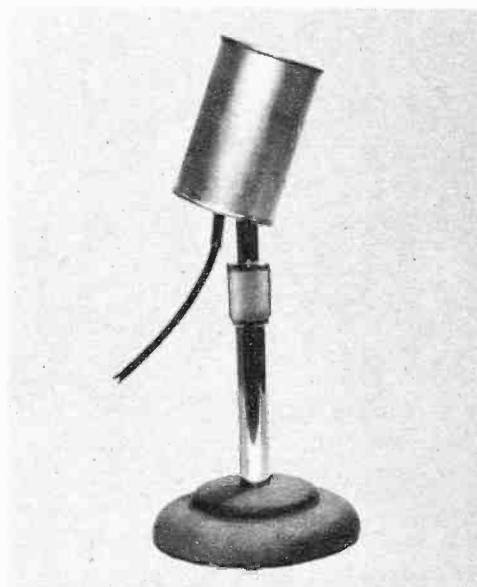

When it's not in use, protect a microphone with a cover. An excellent one is an ordinary tin can, well washed, of course. This is much better and more durable than a soft cover of translucent plastic.

AC/DC Stereo Amplifiers

New 100-milliamperere tubes are used in a series-string stereo amplifier circuit without a power transformer.

THREE recently developed power-output tubes have interesting applications in AC/DC stereo amplifiers. They are miniature types having high power sensitivity, and are especially designed for series-heater-string circuits operating at a total heater voltage of 120 volts and a heater current of only 100 milliamperes. This article describes and evaluates the performance of three amplifiers utilizing the new 34GD5, 50FK5, and 60FX5, which provide maximum power outputs ranging

Portions of this material copyrighted 1960 by Radio Corporation of America and reprinted with its permission.

- C₁—0.1 mf, 200 v., paper
- C₂—25 mf, 25 v., electrolytic
- C₃, C₄—0.047 mf, 150 v., paper
- C₅—50 mf, 25 v., electrolytic
- C₆, C₇—50 mf, 150 v., electrolytic
- R₁, R₅—Volume control, potentiometer, 1 megohm, ganged
- R₃, R₆—1 megohm, 0.5 watt
- R₄—3300 ohms, 0.5 watt
- R₆, R₇—220,000 ohms, 0.5 watt

- R₈, R₁₁—10,000 ohms, 0.5 watt
 - R₉—Balance control, potentiometer, 0.5 megohm
 - R₁₀—68 ohms, 1 watt
 - R₁₂—1500 ohms, 2 watts
 - S—Switch; single-pole, single-throw
 - T₁, T₂—Output transformer for matching impedance of voice coil to 3000-ohm tube load (Stancor A-3825 or equivalent)
- (Note: mf means microfarad.)

Fig. 1—Stereo amplifier utilizing 34GD5 beam power tubes.

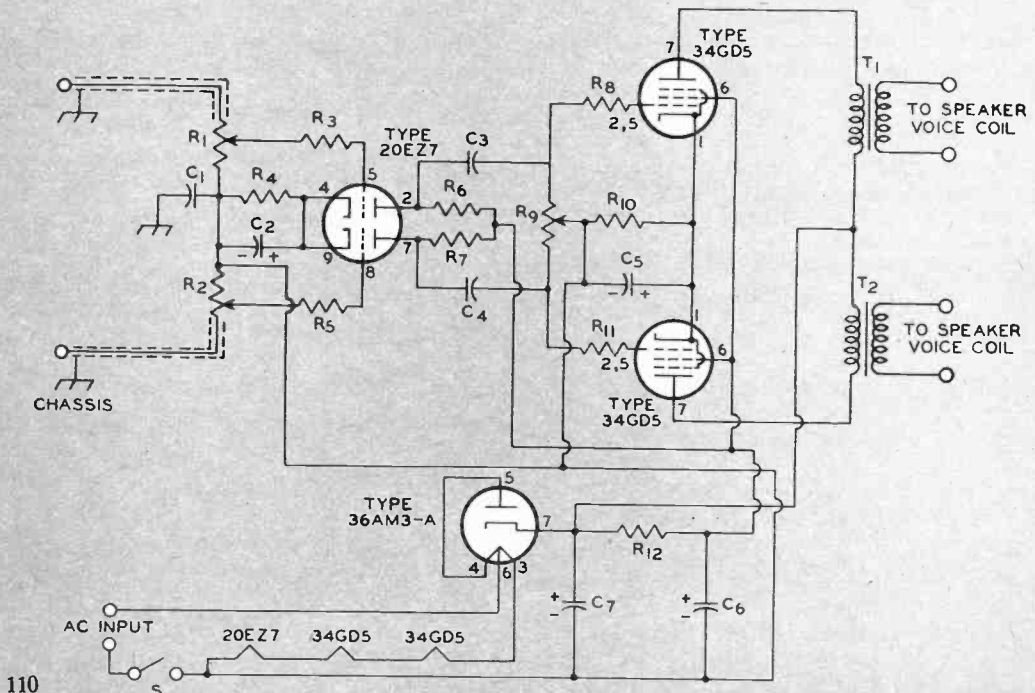

from 1.0 to 1.25 watts from each channel.

Fig. 1 is the circuit of an AC/DC stereo amplifier employing two 34GD5 beam power tubes in the output stages. At a plate voltage of 114 volts, a screen-grid (grid-No. 2) voltage of 99 volts, and a peak grid-No. 1 drive of 6.8 volts, each 34GD5 can provide a maximum power output of 1.0 watt at 10-per-cent total distortion to a 4-ohm voice coil. A peak input signal to each channel of 180 millivolts is required for maximum power output. The first column of Table I lists measured average operating characteristics for each output tube in this amplifier.

The circuit shown in Fig. 1 is, essentially,

a conventional resistance-coupled amplifier. Some special construction practices are necessary, however, as a result of the series-string arrangement. Because there is no transformer isolation in the amplifier, for reasons of safety the negative side of the power supply should be isolated from the chassis by means of a capacitor. This capacitance between B- and the chassis should not be greater than 0.1 microfarad. Although values as low as 0.03 microfarad cause no significant loss of gain from the cartridge input, hum pickup increases with low values of capacitance. When a 0.03-microfarad capacitor is used, for example, the AC voltage between the chassis and

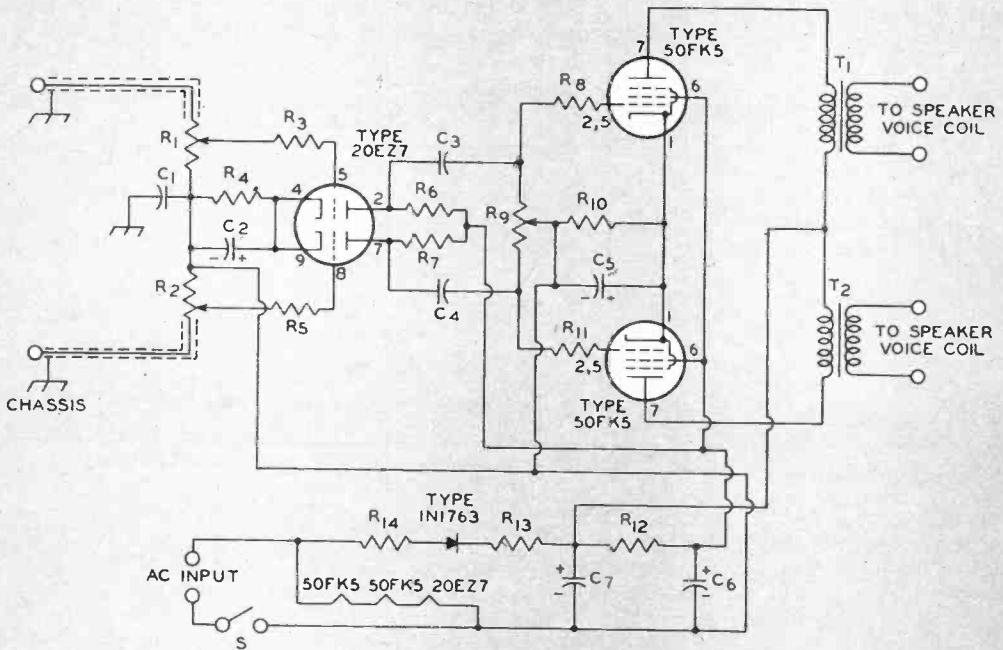

- C₁—0.1 mf, 400 v., paper
- C₂—25 mf, 25 v., electrolytic
- C₃, C₄—0.047 mf, 150 v., paper
- C₅—50 mf, 25 v., electrolytic
- C₆, C₇—50 mf, 150 v., electrolytic
- R₁, R₂—Volume control, potentiometer, 1 megohm, ganged
- R₃, R₆—1 megohm, 0.5 watt
- R₄—3300 ohms, 0.5 watt
- R₅, R₇—220,000 ohms, 0.5 watt

- R₈, R₁₁—10,000 ohms, 0.5 watt
- R₀—Balance control, potentiometer, 0.5 megohm
- R₁₀—33 ohms, 1 watt
- R₁₂—1000 ohms, 2 watts
- R₁₃—50 ohms, 10 watts
- R₁₄—6.8 ohms, 1 watt
- S—Switch; single-pole, single-throw
- T₁, T₂—Output transformer for matching impedance of voice coil to 3000-ohm tube load (Stancor A-3825 or equivalent)

Fig. 2—Stereo amplifier utilizing 50FK5 power pentodes.

B— is approximately 3 volts peak-to-peak. This voltage is picked up and amplified by the 20E7Z and appears as an AC hum at the speakers. Use of a 0.1-microfarad capacitor reduces this hum voltage to about 1 volt peak-to-peak.

Placement of the isolation capacitor is critical. One lead should be connected to the low-voltage end of the 20E7Z cathode-bias resistor at B— and the other lead to the point at which the shielded ground of the pickup cable enters the chassis. Both leads of the isolation capacitor should be as short as possible. Because the amplifier may have a tendency to oscillate in the 20-kilocycle region, depending on the placement of the isolating capacitor, a 10,000-ohm resistor in series with the control grid of each of the 34GD5's is used to suppress possible oscillations.

The 36AM3-A rectifier tube incorporates

and 3. Pin 6 should be tied directly to the line input. When the plate connection, pin 5, and pin 4 of the heater are connected together, AC voltage reaches the plate through the 4-volt section of the heater. This arrangement meets safety requirements for surge limiting in half-wave AC/DC rectifiers tied directly to the AC power line.

The two 1-megohm volume controls should be ganged on a single shaft to simplify balance. If desired, tone controls can be added to the circuit. Any output transformer providing 2500 ohms impedance to the 34GD5 may be used.

Because the gain of the amplifier is not sufficient to make external hum pickup critical, use of a cover for the bottom of the chassis is not necessary. The unshielded bottom of the amplifier chassis should not, however, be placed in the magnetic field of

Table I

CHARACTERISTIC	34GD5	50FK5
Plate Voltage	114	124 volts
Grid-No. 2 Voltage	99	109 volts
Maximum-Signal Plate Current	33	32 ma
Zero-Signal Plate Current	33.5	28 ma
Maximum-Signal Grid-No. 2 Current	3.9	11 ma
Zero-Signal Grid-No. 2 Current	1.8	8.5 ma
Peak AF Grid-No. 1 Voltage	6.8	3.2 volts
Power Output to 4-ohm load	1.0	1.25 watts
Power Output at 105 volts line	0.75	1.0 watts

NOTE: Peak grid-No. 1 input to the 20E7Z is 0.18 volt for the 34GD5 amplifier; 0.092 volt for the 50FK5 amplifier. Total harmonic distortion for both amplifiers is 10 per cent.

Average operating characteristics for each of the output tubes used in designs shown in Figs. 1 and 2.

a tapped heater having a section which can be used as a surge limiter and fuse for the B+ supply. This 4-volt fuse section is between pins 4 and 6. The 32-volt section of the heater is connected between pins 6

and an AC turntable motor. For minimum hum in the driver stage, the heater of the 20E7Z should be placed at the "cold" end of the string. Heater pin 1 of the 20E7Z should be tied to B— at the same point at which the

Fig. 3—The power output and total harmonic distortion as functions of frequency for the amplifiers shown in Figs. 1 and 2.

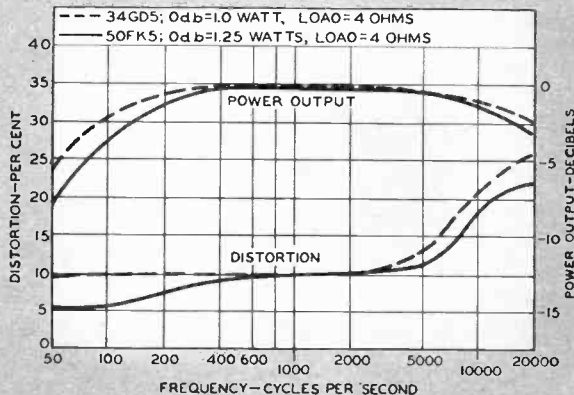

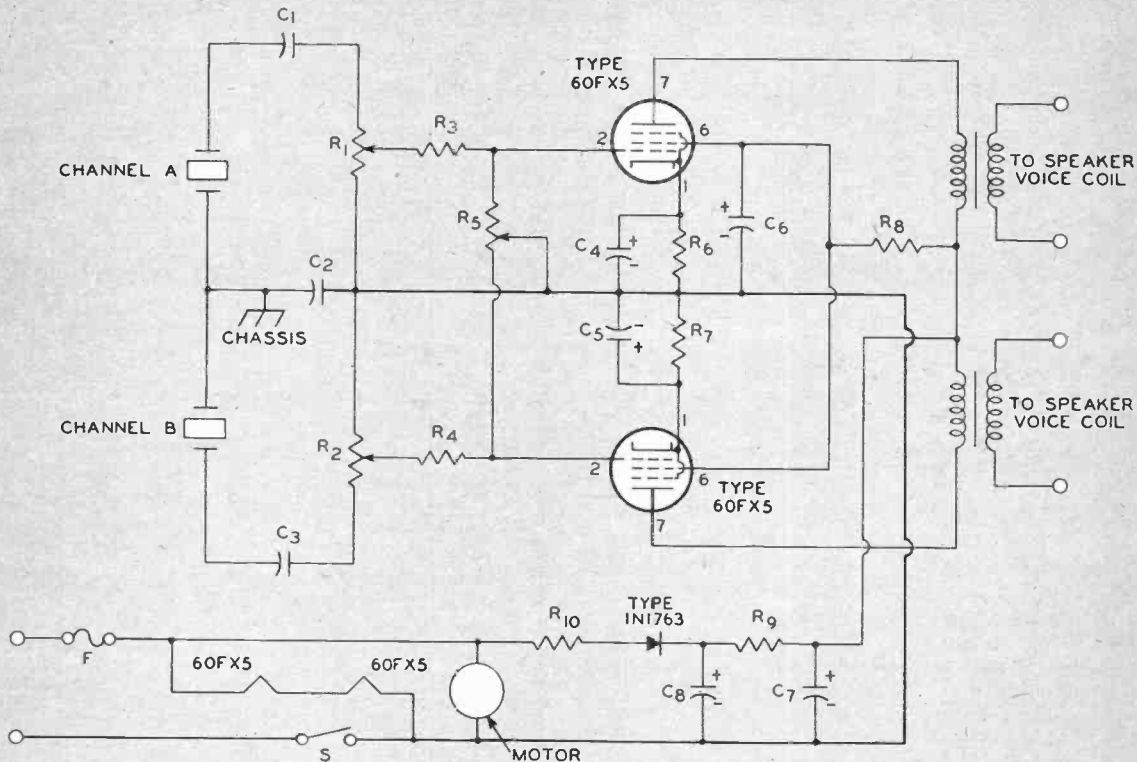

- C₁, C₃—0.022 mf, 400 v., paper
- C₂—0.1 mf, 400 v., paper
- C₄, C₅—50 mf, 25 v., electrolytic
- C₆—50 mf, 150 v., electrolytic
- C₇, C₈—50 mf, 150 v., electrolytic
- F—Fuse, 3 amperes
- R₁, R₂—Volume control, potentiometer, 1.5 megohms, ganged
- R₃, R₄—47,000 ohms, 0.5 watt

- R₅—Balance control, potentiometer, 2 megohms
- R₆, R₇—60 ohms, 1 watt
- R₈—220 ohms, 2 watts
- R₉—280 ohms, 2 watts
- R₁₀—12 ohms, 1 watt
- S—Switch; single-pole, single-throw
- T₁, T₂—Output transformer for matching impedance of voice coil to 3000-ohm tube load (Triad S-16X or equivalent)

Fig. 4—Low-cost portable stereo amplifier utilizing 60FX5 power pentodes.

cathode-bias resistor, the isolating capacitor, and the common-ground shield of the cartridge lead are tied.

Stereo Amplifier With 50FK5

In the circuit shown in Fig. 2, the higher voltage output of a silicon rectifier and the greater sensitivity of the 50FK5 (as compared with that of the 34GD5) are used to provide a power output of 1.25 watts per channel. Except for some differences in the power supply and in the value of the output-stage cathode-bias resistor, the circuit

design and construction are essentially the same as for the 34GD5 stereo amplifier.

The power supply of the 50FK5 amplifier requires a 6.8-ohm surge-limiting resistor for use in conjunction with the silicon rectifier and a 50-ohm series dropping resistor to limit the B+ voltage so that the maximum dissipation rating of the 50FK5 is not exceeded. The value of the filter resistor was reduced to 1000 ohms to raise the grid-No. 2 and plate-supply voltage of the 20EZ7 high enough so that the maximum total distortion does not exceed 10 per cent.

Fig. 5—Power output and total harmonic distortion as functions of frequency for the 60FX5 amplifier design shown in Fig. 4.

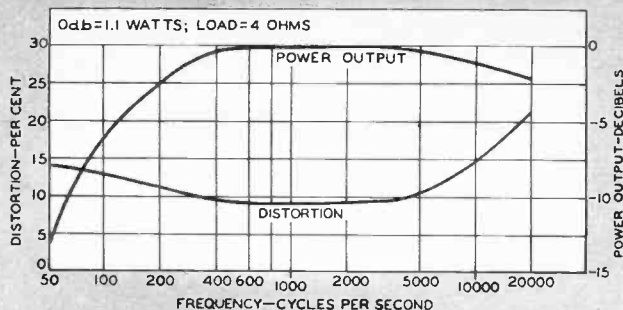

The second column of Table I lists measured operating characteristics for each output tube in this amplifier. Fig. 3 gives average curves of power output and distortion as functions of frequency for both the 34GD5 and 50FK5 amplifiers.

Low-Cost Portable Amplifier

Fig. 4 is the circuit of an AC/DC portable stereo amplifier employing two 60FX5 power pentodes. In stereo units utilizing high-output low-cost ceramic stereo cartridges, the high power sensitivity of the 60FX5 at low supply voltages eliminates the need for a preamplifying stage. The 60FX5 provides a power output of 1.3 watts to a 3000-ohm transformer primary with only 3 volts peak drive on grid No. 1. With a transformer having a good impedance match and 85 per cent efficiency, this circuit supplies 1.1 watts of useful power output at the speaker.

No special mounting or layout precautions are necessary for this amplifier other than the value and placement of the isolating capacitor between B— and the chassis. This capacitor should be connected to the same point on the chassis to which the common cartridge lead is tied. A value of 0.1 microfarad for the isolating capacitor is suggested so that full output is obtained from the pickup.

As with all single-ended amplifier circuits, especially AC/DC units, adequate screen-grid bypassing is necessary to minimize hum. Screen-grid filtering is obtained through use of a 220-ohm dropping resistor and a 50-microfarad electrolytic capacitor. Although separate cathode-bias resistors are used for better dynamic balance in the circuit shown, a single 30-ohm common cathode-bias resistor bypassed with a 50-microfarad electrolytic capacitor may also be used.

Measured operating conditions for each 60FX5 are listed in Table II; curves of power output and total distortion as func-

tions of the frequency are shown in Fig. 5.

Table II

Plate Voltage	111 volts
Grid-No. 2 Voltage	112 volts
Maximum-Signal Plate Current	32.5 ma
Zero-Signal Plate Current	36 ma
Maximum-Signal Grid-No. 2 Current	13.5 ma
Zero-Signal Grid-No. 2 Current	10 ma
Peak AF Grid-No. 1 Voltage	2.7 volts
Power Output to 4-ohm load	1.1 watts
Total Harmonic Distortion	9.3 per cent

These are the measured operating characteristics for each of the 60FX5 tubes in the low-cost portable AC/DC stereo amplifiers shown in Fig. 4.

And as long as we are on the subject of stereo we might just as well mention a few words about speaker placement. The ideal placement of the speakers is the same as that of the microphones where the sound was picked up. Unfortunately this can't always be achieved. Usually the layout and decor of the listening room must be considered because the average home cannot be "designed around" the hi-fi system.

Generally, though, the speakers should be placed along either the end wall, the side wall, or in two corners (for which there are special corner speakers) and aimed into the room to achieve maximum coverage. Keep in mind the fact that at the high frequencies the radiation beam of the speakers is the narrowest. If space is limited, the speakers can be mounted at the ends of a cabinet. Use doors at the cabinet ends to deflect the sound into the room. •

Electronic Short Cuts

The arms of most indoor TV antennas are too short for best reception of the lower channels. Lengthen the arms with straightened-out sections of coat hangers attached with twisted wire. Scrape paint off hanger for good contact. Lengthened antenna may be more directional.

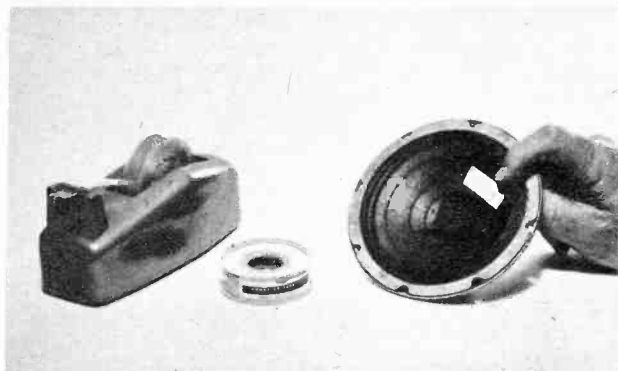
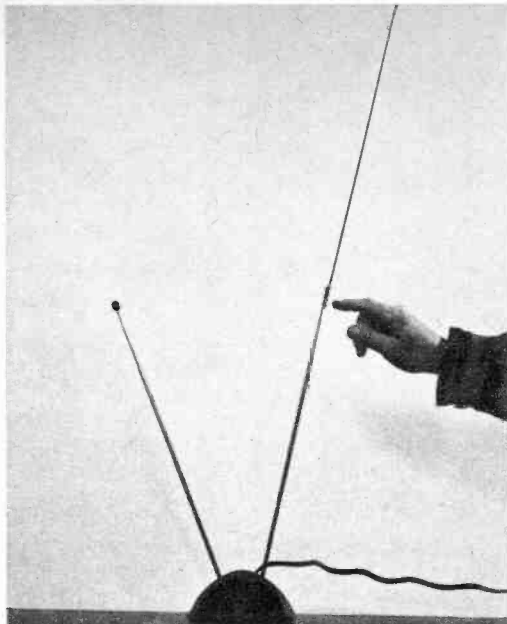

Speaker repair. Don't discard a speaker just because the cone is torn. It's easy to patch the rips with short lengths of $\frac{1}{2}$ "-wide adhesive tape. It is possible this will lower the resonant frequency of the speaker and improve the quality of the sound somewhat.

To save steps, fit the lamp near your TV watching position with a V-shaped double socket. In one section put a regular reading lamp; in other, put a $7\frac{1}{2}$ -watt "night light" in a candelabra adapter. Keep small light on for TV and screw in other for a brighter light.

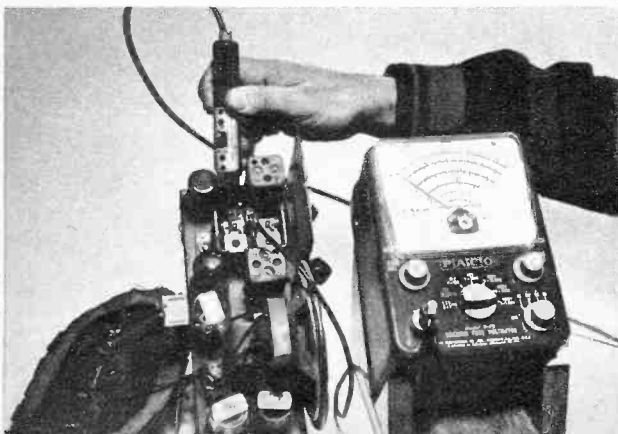
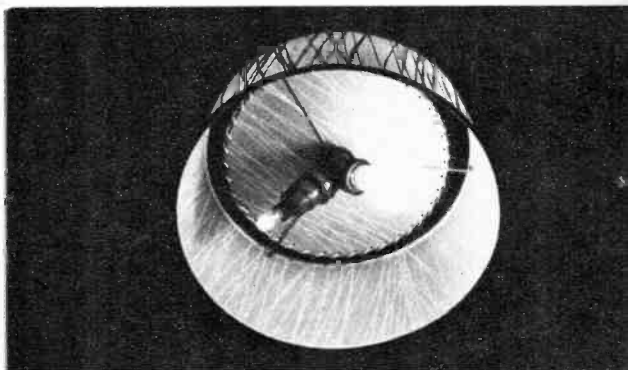

Bench stand for meter. A multimeter or VTVM is more easily read if mounted in an angled stand made out of $\frac{3}{4}$ " shelving. The meter is also more stable when mounted this way and is less likely to be accidentally pulled or knocked over when doing service work.

"Loud-Speaking" Telephone

You'll get back its cost from savings on conference and toll calls.

A LONG-DISTANCE call comes in from a friend or relative, and all the members of the family crowd around the telephone for a chance to talk to the caller. This can become pretty wearisome because the caller has to repeat his end of the conversation for each person who grabs the handset and commences with, "Well, how are *you*?" It can also become a bit expensive, as toll charges start to add up rapidly after the first three minutes.

For a rather steep installation fee and a monthly addition to the regular bill, the phone company will replace your present instrument with a special model with a built-in loudspeaker. While this is a great novelty, the investment and the continuing cost are hardly justified.

A much more practical approach is an inexpensive telephone amplifier put out by Heath in kit form. It uses three transistors mounted on a tiny printed-circuit board, is powered by a self-contained nine-volt battery, and is turned on and off automatically when the telephone handset is placed on top of its cabinet or removed from it. (Since the transistor was developed by the Bell Telephone Laboratories, its application in this device is particularly appropriate.)

There is no connection of any kind between the handset and the amplifier unit. This is important, because the telephone company is very fussy about attaching gadgets of any kind to their instruments. Unless very carefully engineered, an elec-

Precious conversations between families can be enjoyed by all when an amplifier is used with the telephone. Accustomed as they are to radio and TV loudspeakers, children take to the device readily.



trical device actually connected to a phone line usually shows up as "trouble" in the central office, and very quickly a repairman will come out looking for it.

Circuit Operation

As shown in the accompanying illustrations, the receiver or earpiece of the handset is placed in a shallow cup near the bottom of the molded case of the amplifier unit. On the inside of the case this cup holds a coil of wire about three inches in diameter.

The magnetic field surrounding the bobbins in the earpiece varies in accordance with the voice currents in them. This expanding and collapsing field cuts across the pickup coil and induces a current in it. This is classical electromagnetic induction, the principle upon which all transformers work.

The weak signal induced in pickup coil L1 is applied through volume R1 to the base of transistor X1 which is in a common-emitter configuration. The signal is further amplified and appears across the primary



This view shows the sound reflecting surface of the amplifier case in which the mike end of the handset should face. Position is reversed here.

This double-life size view of the printed circuit board shows simplicity of the amplifier layout. All component leads are soldered to the other side of the board. The circuit uses three 2N1274 PNP transistors.

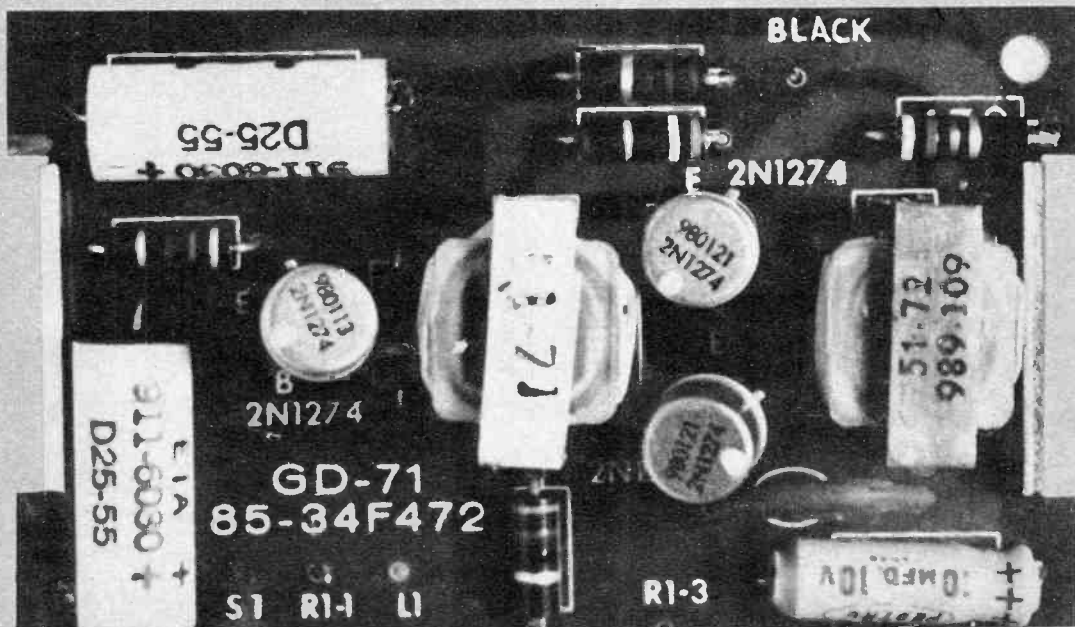

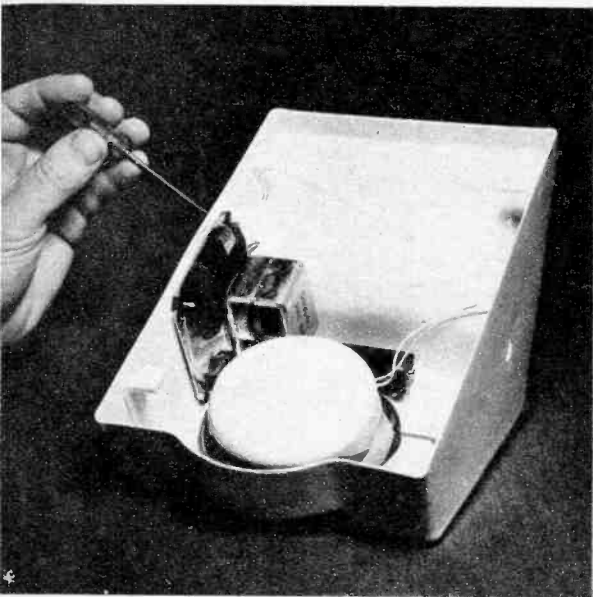

Underside view shows loudspeaker being mounted. Pickup coil is held to earpiece cup by rubber band. Correct position is determined by experiment.

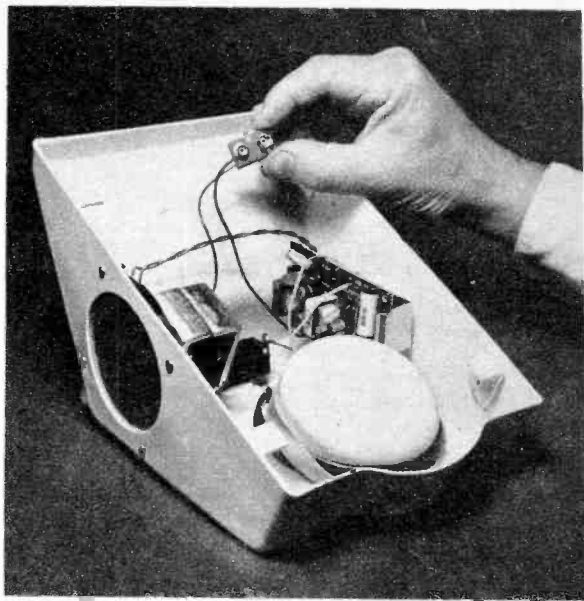

Battery connects to terminals held in fingers. Amplifier is clipped to the side of case. Microswitch is partially obscured by the loudspeaker.

of interstage-coupling transformer T1. T1 in addition to amplifying the signal provides two oppositely phased signals to drive each of output transistors X2 and X3. The push-pull output stage comprises two 2N1274 PNP transistors in a common-emitter configuration.

Capacitor C2 prevents loss of gain due to degeneration in the first stage. The possibility of AC signal voltages being developed across the battery (which would result in feedback) necessitates the use of decoupling capacitor C3.

Output transformer T2 couples the amplifier to the loudspeaker.

The weight of the handset actuates a sensitive microswitch set in the top of the amplifier case to turn on the power.

The transmitter or microphone end of the handset is placed against an angled surface of the plastic case. This acts as a sounding board to bounce the user's voice into the mike. It is necessary to speak up just a little more than usual to make an adequate impression on the party at the other end of the line.

A control in the amplifier circuit (potentiometer R1 in the schematic) is provided for volume adjustment. The volume is more than enough for a living room. Acoustic feedback, better described as howling, occurs if the gain is pushed too

Single 9-volt battery fits in recess in bottom cover of amplifier case and can be replaced easily. Knob at right is the volume control.

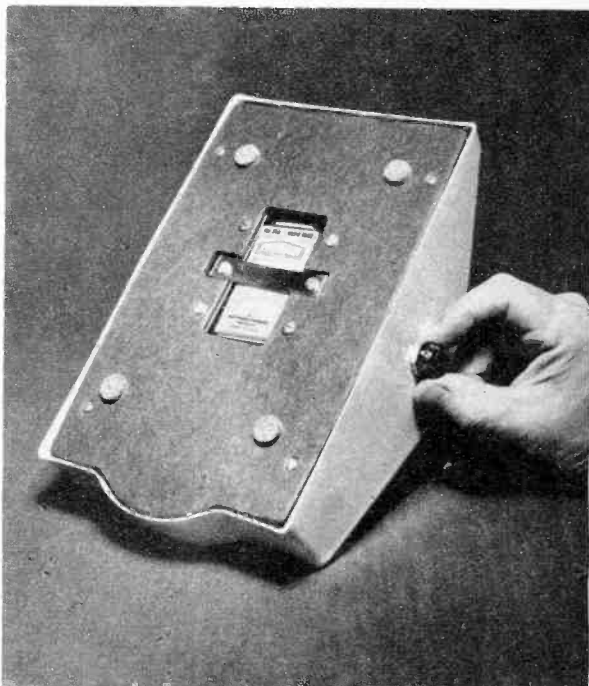

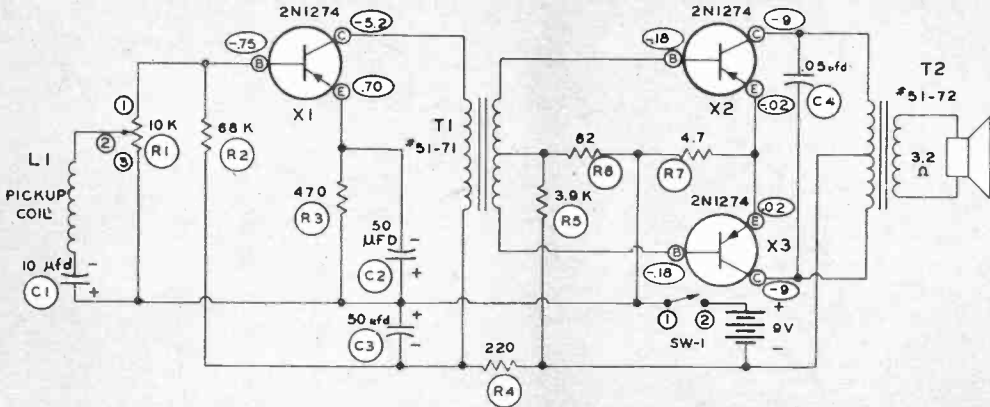

NOTES:

ALL RESISTORS 1/2 WATT.

ALL VOLTAGES MEASURED WITH 20,000 Ω/V OR VTVM.

VOLTAGES SHOWN ARE NEGATIVE WITH RESPECT TO POSITIVE BATTERY TERMINAL.

±20% VOLTAGE READING NORMAL.

GAIN CONTROL SET AT MINIMUM.

Complete schematic of Heathkit model GD-71 telephone amplifier. R1 is volume control and SW1, normally open, is microswitch mounted in the case. SW1 closes and turns on the amplifier when the handset is placed in position. The transistor circuit features transformer coupling and a push-pull output stage.

far beyond the normal volume setting.

The utter simplicity of the arrangement makes the amplifier a useful addition to the home or a small office. When the bell rings, you merely transfer the handset from one cradle to the other, and you're in business. And in business it proves unexpectedly valuable as a "third hand." Did you ever try to shuffle papers and jot down notes with one hand while holding the phone with the other? With both hands free you can even walk away from the desk and maintain a conversation, if you don't mind shouting just a little.

As a construction project this amplifier is kindergarten stuff. The whole thing takes about an hour and is entirely free of bugs.

The battery is used only intermittently, and therefore will last a long time. It is readily replaceable. Heath states that a standard nine-volt battery is good for about 2,000 three-minute calls. If the amplifier is to be almost constantly for business, it would pay to build a small AC operated supply to provide power.

If you want to record a telephone conversation, the output signal can be taken from the collector of X1 and made available at a phono pin jack installed in the side of the case. The price of the GD-71 telephone amplifier kit is \$19.95. •

Microswitch is positioned on amplifier case so plunger is depressed by weight of handset. This closes contacts and energizes circuit instantly.





Wireless Intercom

THE term "wireless intercom" is something of a misnomer. The intercom is not wireless in the sense that transmission and reception are accomplished by RF radiation in space; the medium of transmission between two stations or among several stations is the AC power line to which each station is connected. The term "wireless" simply means that *special* wires are not needed to interconnect the master station with substations or substations with each other.

A wireless intercom is a low-power transceiver tuned to a frequency of about 175 kc. Because the signals travel along the power lines instead of through space, the equipment does not constitute a radio transmitter and therefore does not require a license.

Wireless intercoms offer many interesting features. Though they have been available for years, they have never achieved the popularity they deserve for a very simple reason: they are considerably more ex-

pensive than wired intercoms. The master station of a wired intercom is a simple audio amplifier and the remote is merely a small speaker; a two-station wired system in kit form costs as little as \$15. However, all wireless intercom stations are masters with identical components and circuitry; the cost *per unit* runs from about \$50 up for assembled equipment.

The price barrier has now been broken by the equipment shown and described here; a pair of Knight-Kit wireless intercoms costs about \$40, which makes them practical for many applications in homes, business offices and workshops.

As construction projects the kits are simple to build and trouble-free. Because of the low RF frequency, neither the wiring nor the tuning is critical. The circuit is shown here in both block and schematic forms.

The ease with which a wireless intercom can be set up causes the first-time user to exclaim, "This is terrific!" You only have

RCA training at home can be the smartest investment you ever made

Look what you get in the Course in Radio and Electronic Fundamentals

40 Fascinating THEORY LESSONS



Containing all the basic principles of radio and electronics in easy-to-understand form.

40 EXPERIMENT LESSONS



Each containing absorbing, practical experiments bound together in 20 books.

40 SERVICE PRACTICES



Full of practical, time-saving and money-saving servicing tips, bound into 20 books.

PLUS ALL THIS AT NO EXTRA COST...

15 KITS

to build a Multimeter, AM Receiver and Signal Generator. Kits contain new parts for experiments, integrated so as to demonstrate what you learn in the lessons and to help you develop technical skills. Each kit is fun to put together!

MULTIMETER



A sensitive precision measuring instrument you *build* and *use* on the job. Big 4½" meter with 50 micro-amp meter movement. 20,000 ohms-per-volt sensitivity d-c, 6,667 a-c.

SIGNAL GENERATOR



AM RECEIVER



Have the satisfaction of building your own radio receiver with this high-quality 6-tube superheterodyne set. Big 5" speaker, fine tone!

SIGNAL GENERATOR

A "must" for aligning and trouble-shooting receivers. Build it for your own use. 170 KC to 50 MC fundamental frequencies for all radio and TV work.

Practical work with the very first lesson! Pay-only-as-you-learn! No long-term contracts to sign! No monthly installment payments. Pay only for one study group at a time if and when you order it!

Stake out your future in electronics now!

SEND FOR OUR FREE HOME STUDY CATALOG TODAY!



Just fill out this card and drop it in the mail—no postage needed.

RCA INSTITUTES, INC.

A Service of Radio Corporation of America • 350 W. 4th St., New York 14, N. Y. • 610 S. Main St., Los Angeles 14, Calif.



The Most Trusted Name in Electronics

RCA INSTITUTES INC. Home Study School, Dept. ED-61

A Service of Radio Corporation of America
350 West Fourth Street, New York 14, N. Y.

Without obligation, rush me the FREE 64-page illustrated book describing your electronic training program (check one). No salesman will call.

Home Study Los Angeles Resident School New York Resident School

Name (Please Print)

Address

City Zone..... State.....

Veterans: Enter discharge date.....

CANADIANS—Take advantage of these same RCA courses at no additional cost. No postage, no customs, no delay. Enclose this card in envelope and mail to: RCA Victor Company, Ltd., 5581 Royalmount Ave., Montreal 9, Quebec.



RCA TRAINING CAN BE THE SMARTEST INVESTMENT YOU EVER MAKE

With RCA Institutes Home Study training you set your own pace in keeping with your own ability, finances and time. You get prime quality equipment as a regular part of the course . . . and you never have to take apart one piece to build another. Perhaps most important, RCA's liberal Pay-As-You-Learn Plan is the most economical home study method *because you pay only for lessons as you order them* . . . one study group at a time! If you drop out at any time, for any reason, you do not owe RCA one penny! No other obligations! No installment payments required! Licensed by New York State Education Department.

Choose YOUR FUTURE from this list of courses:

- Radio and Electronic Fundamentals (see reverse side)
- Television Servicing
- Color Television
- Electronics for Automation
- Transistors

START YOUR CAREER IN ELECTRONICS NOW AT RCA INSTITUTES in Los Angeles-New York City

CHOOSE FROM THIS LIST...

	Course	Qualifications	Length of Course
A	Advanced Electronic Technology (T-3)	High School grad, with Algebra, Physics or Science	Day 2¼ yrs. (N.Y.) Eve. 6¾ yrs. (N.Y.) 4½ yrs. (L.A.)
B	Television and General Electronics (V-7)	2 yrs. High School, with Algebra, Physics or Science	Day 1½ yrs. (N.Y.) Eve. 4½ yrs. (N.Y.) 3 yrs. (L.A.)
C	Radio and Television Servicing (V-3)	2 yrs. High School, with Algebra, Physics or Science	Day 9 mos. (N.Y.) Eve. 2¼ yrs. (N.Y.) 1½ yrs. (L.A.)
D	Transistors	Radio background	Eve. 3 mos.
E	Electronic Drafting (V-11 V-12)	2 yrs. High School, with Algebra, Physics or Science	Eve. Basic: 1 yr. Advanced: 2 yrs.
F	Color Television	Television background	Eve. 3 mos.
G	Radio Telegraph Operating (V-5)	2 yrs. High School, with Algebra, Physics or Science	Day 9 mos. (N.Y.) Eve. 2¼ yrs. (N.Y.) 1½ yrs. (L.A.)
H	Computer Programming (C-1)	College Graduate or Industry sponsored.	Eve. 24 weeks (N.Y.) Sat. 30 weeks (L.A.)
I	Technical Writing (V-10)	High School Graduate	Eve. 2¼ yrs. (N.Y.) 1½ yrs. (L.A.)
J	Automation Electronics (V-14)	Background in Radio Receivers and Transistors	Eve. 9 mos. (N.Y.) Sat. 44 weeks (N.Y.)
K	Digital Computers	Electronics background	Eve. 3 mos. (L.A.)
L	Preparatory Math & Physics (P-0)	1 yr. High School	Day 3 mos.
M	Preparatory Mathematics (P-0A)	1 yr. High School	Eve. 3 mos.

BUSINESS REPLY MAIL

No Postage Stamp Necessary if mailed in U. S.

Postage will be paid by —

RCA INSTITUTES, INC., Dept. ED-61
350 West Fourth Street
New York 14, N. Y.

FIRST CLASS
PERMIT NO.
10662
NEW YORK, N. Y.



RCA Institutes is one of the largest technical institutes in the United States devoted exclusively to electronics. Co-educational Day and Evening classes. Free Placement Service. Applications now being accepted.

SEND FOR THIS
FREE ILLUSTRATED
BOOK TODAY

Fill in the other side of the postage-free card and check Resident School.



RCA INSTITUTES, INC.

A Service of Radio Corporation of America • 350 W. 4th St., New York 14, N. Y. • 610 S. Main St., Los Angeles 14, Calif.



The Most Trusted
Name in Electronics

Left: When husband brings work home from the office and relegates wife to another part of the house she won't feel neglected if she can say a few words to him now and then. This arrangement is easy with Knight-Kit wireless intercoms plugged into nearby wall outlets. "Squelch" circuit keeps them silent, permitting hubby to work and wife to read without distraction. The system will come to life instantly when either of them presses the switch to talk.

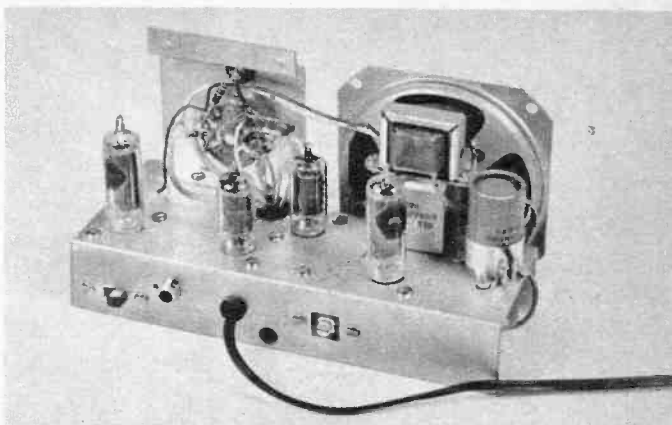

Above right: Simplicity of wireless intercom construction is evident in this above-chassis view. Loudspeaker at right end doubles as a dynamic microphone when control switch at the left end is set to transmit position. The four tubes are all inexpensive types found in conventional home-radio receivers.

Right: Wiring of wireless intercom (that almost sounds like a contradiction) is simple. Most of the components are held in place by their own leads and their positioning is not critical because of low frequency used by oscillator section. Note how chassis compares with size of hand. The wiring is uncrowded.

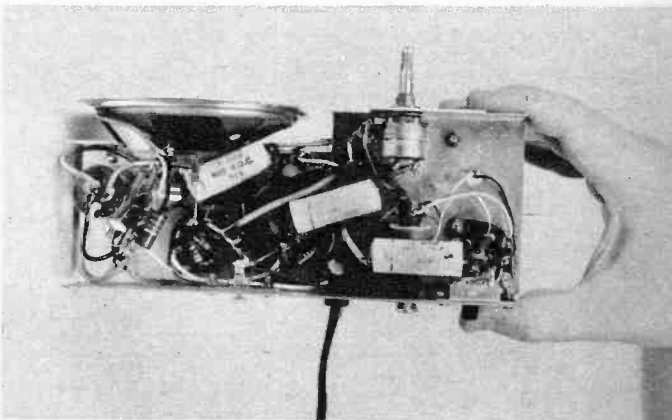

to plug in the units (after preliminary bench tune up, of course), snap on the line switch, and you're in business. Because the circuitry includes an effective *squelch* feature, the speaker is absolutely silent in the absence of a call. There is no background noise, and when a call from the other station does come through it is loud and clear.

The control switch on each unit is a lever-action, spring loaded type, commonly found on intercoms, and has three positions: (1) standby, (2) manual hold down for momentary speaking, and (3) locked up for continuous transmission—useful for baby sitting applications.

The one requirement for successful wireless intercom operation is that all the units of a system be connected to a power line on the same side of a single line step-down transformer. This is no problem, as the usual system is not likely to be used beyond the confines of a building or group of buildings.

The sample intercoms shown here were tried in several locations, and had astonishing range. They both still blasted away when installed in houses two long blocks apart, a distance of about 1,000 feet. In an apartment house they worked satisfactorily from the ground floor to the sixth.

One great advantage of the equipment is its flexibility. Temporary setups to meet special situations require exactly the same installation time as permanent systems: about three seconds at the most!

For emergency baby-sitting needs a wireless intercom is worth its cost in convenience and peace of mind to parents.

The baby sitter may remain in her own apartment or home near the home of the baby. With the function switch of the intercom near the baby's crib locked in the transmit position, the sitter will hear every sound and cry.

A system is not limited to two stations; any number can be used, provided they are all tuned accurately to the same fre-

RECEIVER

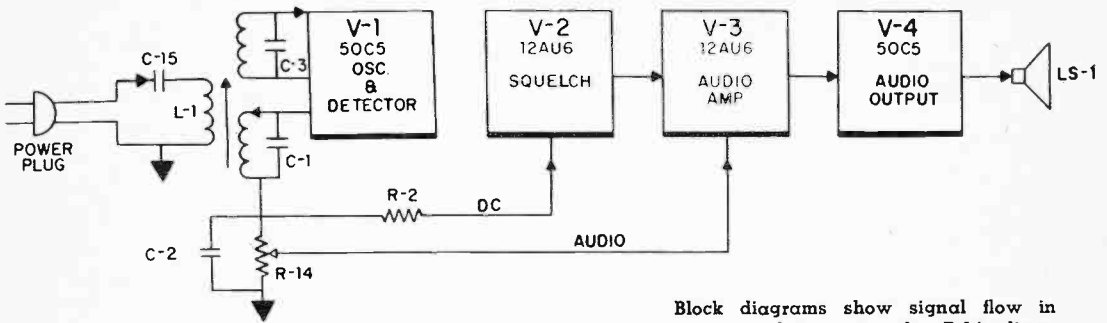

Block diagrams show signal flow in receive and transmit modes. R-14 adjusts receiving volume. There's no way of increasing or reducing transmitting power.

TRANSMITTER

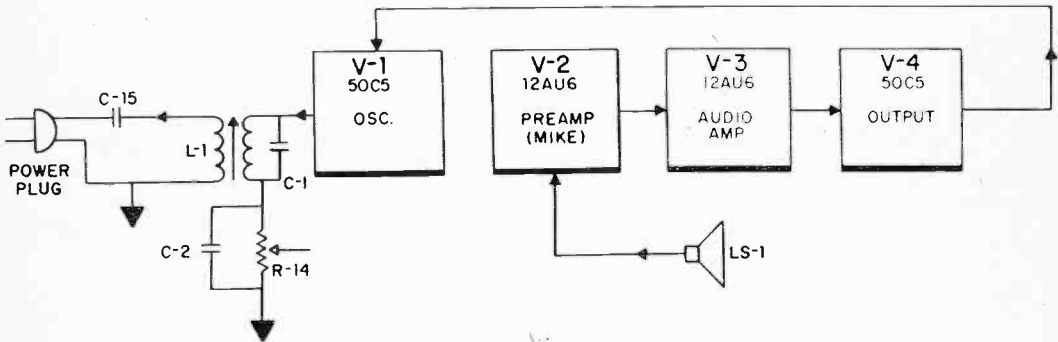

quency. However, the greater the number of stations, the less privacy, since all are always tuned to the master.

There is enough latitude in the adjustment of the tuning slugs to permit two independent systems to operate on the same power line without interference to each other. A little experimenting will quickly determine how much frequency separation is needed for each system.

One advantage afforded by battery-operated wired transistor intercoms not available in the wireless intercom is the ability to initiate a call from either station with the system completely turned off. With AC-operated intercoms both the master and the remote must be on to make communication possible. Under most circumstances this is no hardship, as intercoms are usually used by prearrangement. The total power drain of two units of the size illustrated is only about 60 watts, so electric energy cost in most areas is only pennies a day.

An interesting alerting system has been adopted by two related families living in different houses on the same street. When one party wishes to talk to the other, he turns on his unit, and while it is warming up he dials the other's telephone number, lets the bell ring once, and then hangs up. Upon hearing this signal, the called party turns on his intercom, and away they go. The arrangement greatly appeals to the teen-age members of the families, particularly since they can move the units into the privacy of their own rooms and not annoy their parents with their chatter.

Because of the variety of electrical appliances used in homes today, some interference from them may be experienced. Fortunately, most appliances operate intermittently rather than steadily, and in any event an offending appliance can be identified easily by means of a little plug-pulling. Simple plug-in filters to clear the interference are available from electronic parts houses. •

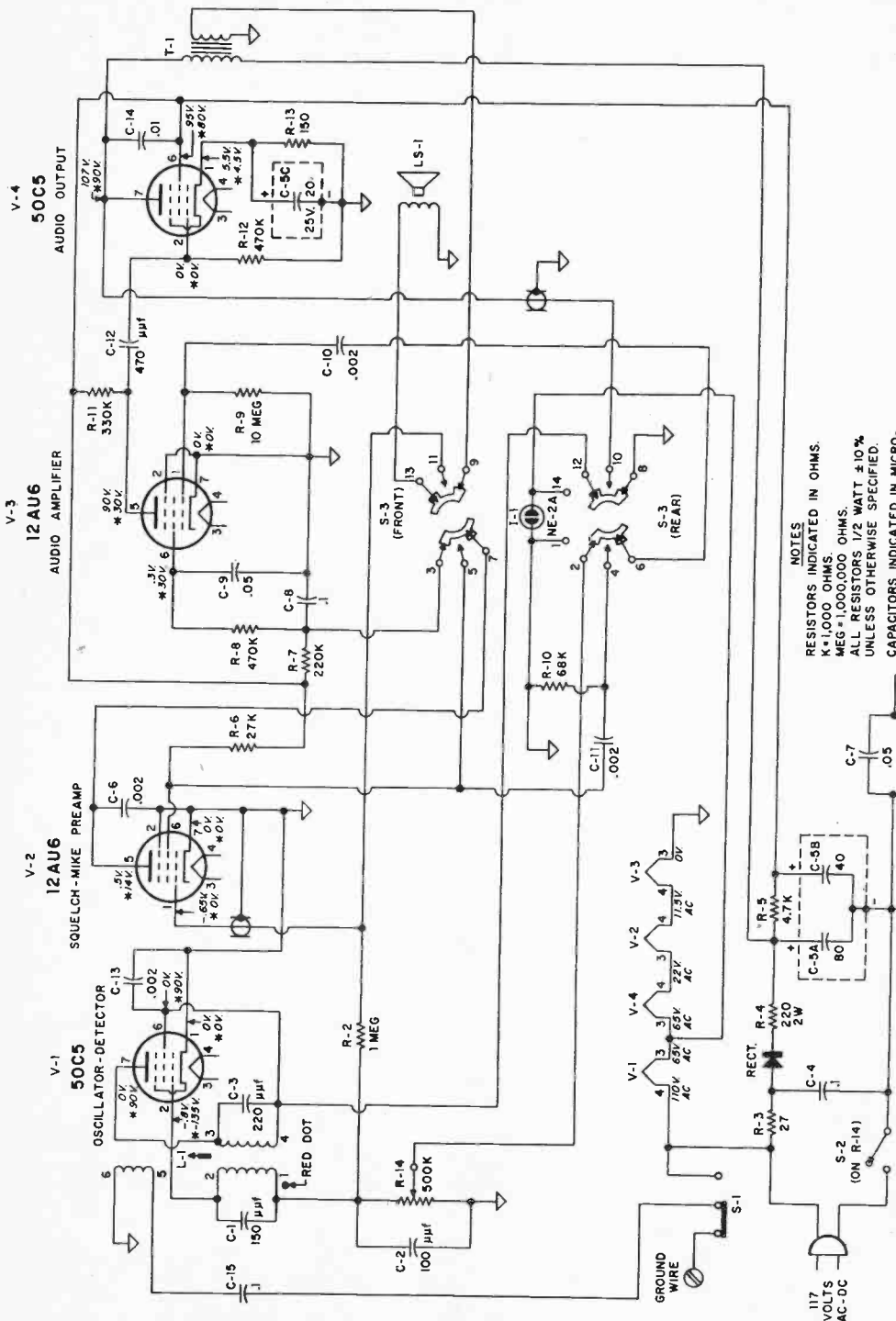

NOTES
 RESISTORS INDICATED IN OHMS.
 K=1,000 OHMS.
 MEG=1,000,000 OHMS.
 ALL RESISTORS 1/2 WATT ±10%
 UNLESS OTHERWISE SPECIFIED.
 CAPACITORS INDICATED IN MICRO-
 FARADS UNLESS OTHERWISE
 SPECIFIED.

↖ = COMMON GROUND (B-).
 rh = CHASSIS GROUND.
 SWITCH S-3 IN 'RECEIVE' POSITION.

VOLTAGE MEASUREMENTS
 VOLTAGES MEASURED WITH A 20KΩ/V DC VOLT-METER TO
 COMMON GROUND (B-). NO SIGNAL INPUT.
 * = VOLTAGES WITH S-3 IN 'TRANSMIT' POSITION.

Full schematic. Operating frequency is ad-
 justed by slug of L-1. Neon lamp connected
 to S-3 (rear) is the power-on indicator.



There are many places in the home where wireless intercoms are useful either on a permanent or temporary basis. In houses of two or more levels, it is expedient to provide one unit per floor, to be left fixed or moved around as needed. One will certainly be located on a work counter in the kitchen (photo right), as this is the focal point of family activity. Another surely belongs in dad's shop or hobby center in the basement (photo below), so he can be paged for meals. When a person is ill, it is comforting to have a unit within easy reach (top photo) so that he or she can call members of the family in other rooms. Signals are strong, and are heard readily above normal room sounds such as conversation or music. In these photos center control switch is in stand-by or listening position. Lower knob is combined on-off switch and volume control. Above the control switch is power-on indicator. Intercom is size of table-model radio, and occupies little space on a bench or shelf.



Electronic Short Cuts

Clean batteries often mean the difference between poor and good operation of transistor radios. Clean top and bottom of each cell with emery cloth or sandpaper. Put batteries in correctly or you'll destroy those transistors.

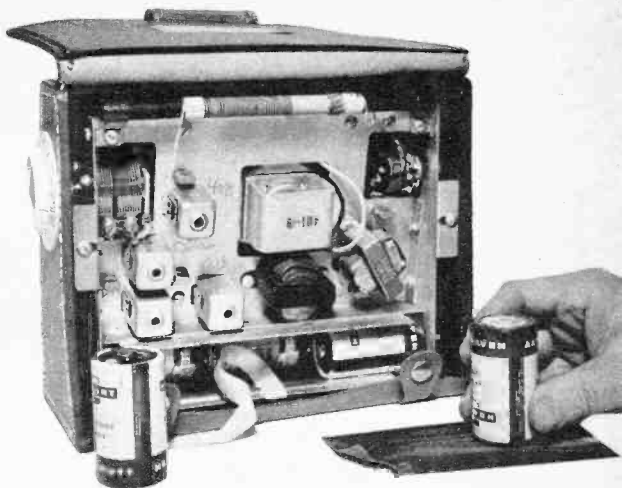

Measuring AC line voltage with a pair of test prods is often risky because exposed metal tips may touch. A short could weld the tips together. To be safe, use a short length of wire with a line plug on one end and tip jacks at the other. Use tape for extra protection.



Dial pointer slipping? First try tightening lips of pointer on dial cord without pinching. If lips cannot be bent further, apply a drop or two of model-airplane cement. Allow it to dry thoroughly before attempting to tune the set. Also lubricate all small dial pulleys.



Tuning eye difficult to see? A "magic eye" tube used as a null or tuning indicator is sometimes difficult to see in a normally lit room if it protrudes beyond a panel. Cut a shield of thin cardboard or stiff paper and slide it in or out until it shades effectively.

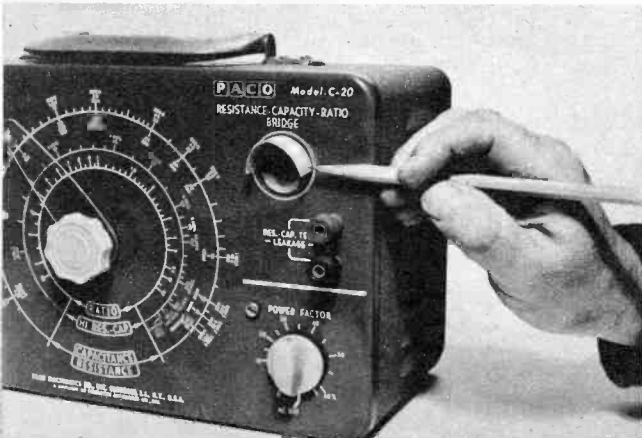



You couldn't touch this chassis and something grounded without impunity if this AC-DC set were plugged directly into an AC outlet. By using an isolation transformer, shorts to ground are eliminated.

Isolation Transformer Shock-Proofs Electronic Equipment

EVERY electronics experimenter who has gone beyond the second lesson in power distribution is aware that one side of all AC power lines is grounded and that this condition presents certain hazards when working on "hot chassis" equipment of many kinds. He knows that it is very easy, when troubleshooting such equipment, with the power on or even off, to get a nasty sting by touching a chassis when he is standing on a damp concrete floor.

Most men say they're very careful, but there comes a day, however, when they suffer a really bad shock, and then they moan, "Why didn't I use an isolation transformer?"

An isolation transformer is like an insurance policy: you must have it in advance of any calamity in order to benefit from it. And you must get into the habit of using

it regularly; a lapsed policy, you know, does not pay off!

A small transformer with fixed windings is not a very good investment. It is much wiser to look for one having these features:

1) Adequate load capacity; 250 or 300 watts continuously, 500 watts intermittently. This should take care of all radio and TV receivers and hi-fi equipment.

2) Variable output voltage; from about 90 to 130 volts.

3) Built-in meter for quick monitoring of both input and output voltages.

4) Primary fuse for line protection so the shop is not darkened by a short circuit in equipment under test or observation.

A metered, variable-output isolation transformer is useful for many other interesting applications besides straightforward protection. For example:



Career-minded Jay C. Douglass of Elizabethtown, Pa., asked...

“How should I get started?”

This year some 100,000 ambitious young people will answer this question the same way Jay Douglass did—they will become members of the Air Force. The road they will start upon leads straight into the Aerospace Age. And the organization of which they will become a part is the most important one in our world. For it is our country's first line of defense.

In time to come many of these young men will advance to the role of skilled technicians in such fields as airplane and missile maintenance, communications

equipment, computers, radar. A number of these young men will enter the vital support specialties—administration, supply, air police...to name a few. Any one of these career fields holds the promise of a bright and rewarding future—a future *you* should know about in detail right now.

Getting started in the right job, is important to any young man...or any young woman. To find out if your start might best be made in Air Force blue, clip and mail this coupon.

U. S. Air Force



Airman 2C Douglass is presently working as an electronics specialist at Duluth Air Base, Minnesota. As Air Force aptitude tests indicated, he finds he can handle his job well. He feels he has made a good start.



Career Information

Dept. MPE110, Box 7608
Washington 4, D. C.

I am a citizen (or resident) of the U.S.A. Please send me your illustrated booklet.

Name _____ Age _____

Address _____

City _____ County _____ State _____

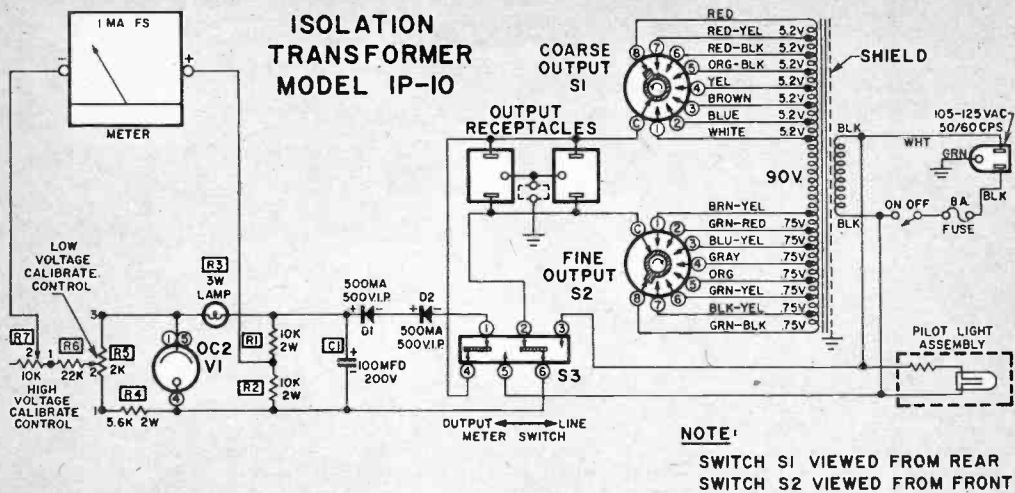

Voltage at the output of Heathkit isolation transformer IP-10 is adjusted by switches S1 and S2.

The circuit at the lower left of the schematic, which includes diode rectifiers D1, D2 and voltage regulator tube OC2, assures stable, linear readings on expanded-scale DC meter that is calibrated in terms of AC voltage from 90 to 140 volts.

In some older residential areas, where power lines are light and overloaded, regulation is poor. Line voltage is often well below the standard 117 volts for which most electronic equipment is designed. TV receivers are the most noticeable victims of low line voltage; with the horizontal and vertical drive controls at maximum, pictures sometimes do not fill the screen. With a variable-output isolation transformer, it takes but a few minutes to restore the pictures to normal size by increasing the line voltage.

One of the most aggravating troubles encountered in troubleshooting equipment of all types is the intermittent; that is, a set that works normally for a short period after being turned on, and then cuts out, sometimes only momentarily, at other times for minutes. This may be due to gassy tubes, which do not show up until they are thoroughly hot. If new tubes substituted one at a time do not help, the likelihood is that a resistor or more usually a capacitor is on the verge of complete failure. Jacking up the voltage to the set, well beyond the normal input, usually hastens component failure. Once the radio stays dead the de-

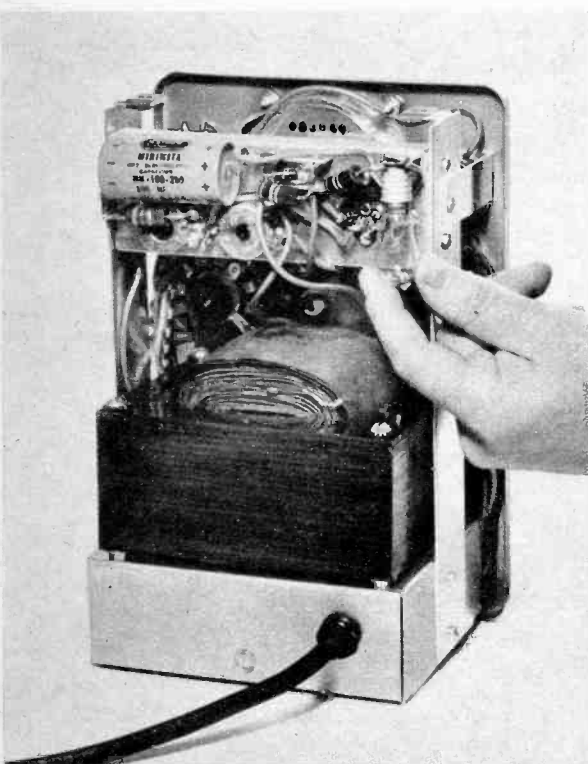

Internal view of isolation transformer shows open assembly and small subpanel on which are all the components of the rectifier-regulator circuit.

New Model 161 UTILITY TESTER® FOR REPAIRING ALL ELECTRICAL APPLIANCES MOTORS • AUTOMOBILES • TV TUBES

As an electrical trouble shooter the Model 161:



- Will test Toasters, Irons, Broilers, Heating Pads, Clocks, Fans, Vacuum Cleaners, Refrigerators, Lamps, Fluorescents, Switches, Thermostats, etc. (Both 110 Volt and 220 Volt lines).
- Will measure current consumption (amperes) while the appliance under test is in operation.
- Incorporates a sensitive direct-reading resistance range which will measure all resistances commonly used in electrical appliances, motors, etc.
- Will test all TV tubes (including picture tubes) for open filaments and burned out tubes.
- Measures A.C. and D.C. Voltages,

As an Automotive Tester the Model 161 will test:

- Both 6 Volt and 12 Volt Storage Batteries • Generators • Starters • Distributors • Ignition Coils • Regulators • Relays • Circuit Breakers • Cigarette Lighters • Stop Lights • Condensers • Directional Signal Systems • All Lamps and Bulbs • Fuses • Heating Systems • Horns • Also will locate poor grounds, breaks in wiring, poor connections, etc.

IT'S SO EASY!!



with tester's cord in outlet, current consumption of appliance is read direct on meter when line cord is connected to receptacle on panel. This typical iron takes 7 amperes (Good).

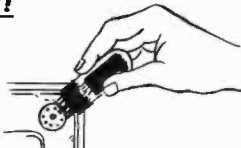

Simply insert tube in appropriate socket then follow procedure as outlined in our manual.



Control circuits of most furnaces use 24 volts obtained from step-down transformer. Here's how to check room thermostat to see if wires to it are live.



Small electric fan motor indicates 50 ohms (normal resistance).

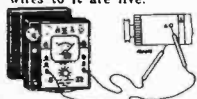

Test Generators
READ THIS!

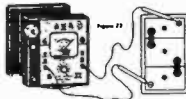

Test Storage Batteries
READ THIS!



Test Circuit Breakers
READ THIS!



INCLUDED FREE!!

This 56-page-book—practically a condensed course in electricity. Learn by doing.

Just read the following partial list of contents:

- What is electricity? • Simplified version of Ohms Law • What is wattage? • Simplified wattage charts • How to measure voltage, current, resistance and leakage • How to test all electrical appliances and motors using a simplified trouble-shooting technique.
- How to test all TV tubes; also simple procedure for determining which specific tube (or tubes) is causing the trouble.
- How to trace trouble in the electrical circuits and parts in automobiles and trucks.

Model 161 comes complete with above book and test leads. Only **\$22.50**

You don't pay for the Model 161 until AFTER you have examined it in the privacy of your home!

SEND NO MONEY WITH ORDER PAY POSTMAN NOTHING ON DELIVERY

Try it for 10 days before you buy. If completely satisfied then send \$5.00 and pay the balance at the rate of \$5.00 per month until the total price of \$22.50 (plus small P.P. and budget charge) is paid. If not completely satisfied, return to us, no explanation necessary.

ACCURATE INSTRUMENT CO.

Dept. D-143 911 Faile St., New York 59, N. Y.

Please rush me one Model 161. If satisfactory I agree to pay \$5.00 within 10 days and balance at rate of \$5 per month until total price of \$22.50 (plus small P.P. and budget charge) is paid. If not satisfactory, I may return for cancellation of account.

Name _____

Address _____

City _____ Zone _____ State _____

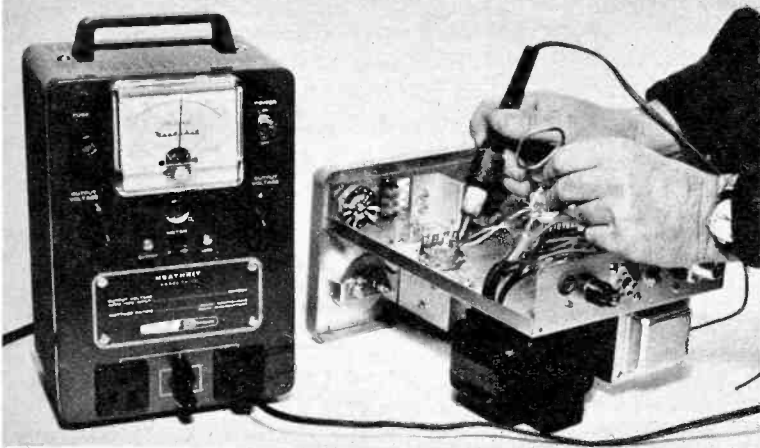

When soldering temperature sensitive components, use the isolation transformer to reduce the iron heat to the minimum required to melt the solder. Nearby parts will be less likely to be destroyed by excessive heat.

fective part can be located without much difficulty by conventional troubleshooting techniques.

Of course, there is some danger with boosted voltage, of damaging other components, but the risk is worthwhile if the intermittent can be found.

In some newer residential areas where the lines are new and the utility companies expect heavy power loads, the voltage can be appreciably higher than 117. All equipment will naturally run hotter than normal. A special problem arises with irons or guns used for soldering transistor leads and the tiny, heat-sensitive components found in transistorized equipment when the tools get too hot for the job. Here is where the adjustable isolation transformer can really be a help. Plug the iron into the transformer and adjust the voltage until it be-

comes just hot enough to melt small bits of solder. There is a fringe benefit: the tip of the iron lasts much longer!

On the other hand, it may be desirable to have an exceptionally hot iron for soldering a wire to a plated steel chassis. Boost the voltage for the minute or two it is needed, then bring it back down.

The IP-10, which is a new addition to the Heath line of test equipment, sells for \$54.95. Heath states that the IP-10 can also be used to isolate interference-radiating devices from the power line. Additional specifications are as follows: **Output:** Variable from 90-130 volts in steps of approximately .75 volt by means of transformer secondary tap switching. **Meter:** 90-140-volt scale, ± 1 volt accuracy. **Power Rating:** 300 watts continuous, 500 watts intermittent. •

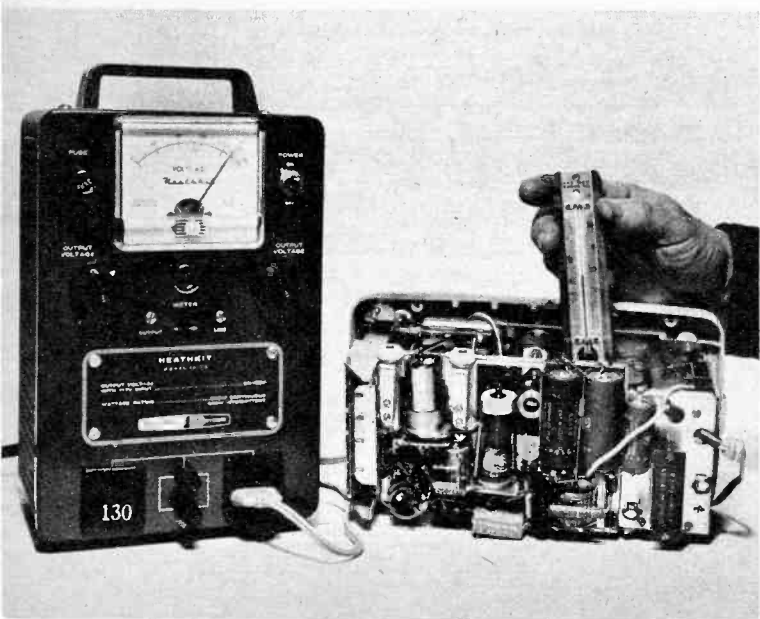

Cook-out, radio style. Voltage to intermittent tape recorder has been raised to 130 to hasten the failure of defective component. With chassis exposed, temperature rise can be observed with a standard outdoor thermometer.

BEST BUYS IN STEREO AND MONO HI-FI

New Transistorized Stereo/Mono 4-Track Tape Deck RP100 Semikit (electronics in kit form) \$299.95 Wired \$399.95



28W Integrated Stereo Amplifier HF81 Kit \$69.95 Wired \$109.95

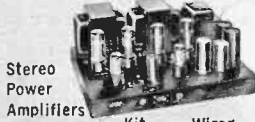

Stereo Power Amplifiers
 Kit Wired
 100W HF89: \$99.50 \$139.50
 70W HF87: \$74.95 \$114.95
 28W HF86: \$43.95 \$ 74.95



New FM-AM Stereo Tuner ST96 Kit \$89.95 Wired \$129.95 Incl. FET

FM Tuner HFT90 Kit \$39.95 Wired \$65.95 Incl. FET Metal Cover \$3.95



AM Tuner HFT94 Incl. FET Kit \$39.95 Wired \$65.95

New 70-Watt Integrated Stereo Amplifier ST70 Kit \$94.95 Wired \$149.95



New 40-Watt Integrated Stereo Amplifier ST40 Kit \$79.95 Wired \$129.95



Stereo Preamplifier HF85 Kit \$39.95 Wired \$64.95



Stereo/Mono Changer/Player 1007 with stereo cartridge and dual sapphire styli \$49.75



Bookshelf Speaker System HFS1 Kit \$39.95 Wired \$47.95

BEST BUYS IN CITIZENS TRANSCEIVERS, HAM GEAR, RADIOS

Citizens Band Transceivers from Kit \$59.95 Wired \$89.95



New 60W CW Transmitter #723 Kit \$49.95 Wired \$79.95



Transistor Portable Radio RA6 Kit \$29.95 Wired \$49.95 Incl. FET

BEST BUYS IN TEST EQUIPMENT

New Metered Variable AC Auto-Transformer Bench Supplies Model 1073 (3 amps) Kit \$35.95 Wired \$47.95 Model 1078 (7½ amps) Kit \$42.95 Wired \$54.95



Peak-To-Peak VTVM = 232 & Uni-Probe® Pat. = 2,790,051 Kit \$29.95 Wired \$49.95



VTVM = 221 Kit \$25.95 Wired \$39.95

DC-5 MC 5" Scope = 460 Kit \$79.95 Wired \$129.50



5" Push-Pull Scope = 425 Kit \$44.95 Wired \$79.95

Tube Tester = 625 Kit \$34.95 Wired \$49.95



RF Signal Generator = 324 Kit \$26.95 Wired \$39.95



1000 Ohms/Volt V-O-M = 536 Kit \$12.90 Wired \$16.90



6- & 12V Battery Eliminator & Charger #1050 Kit \$29.95 Wired \$38.95



Extra-filtered for transistor equip. #1060 Kit \$38.95 Wired \$47.95

NEW AC Volt-Watt Meter #260 Kit \$49.95 Wired \$79.95



Multi-Signal Tracer #145A Kit \$19.95 Wired \$28.95



EXCELLENCE IN CREATIVE ELECTRONICS

Over 2 MILLION EICO instruments in use throughout the world. Compare, take them home — right "off the shelf" — from 1500 neighborhood dealers, most of whom offer budget terms.



EICO, 3300 N. Blvd., L.I.C. 1, N. Y. FPE-61
 Send free Catalog describing over 80 top-quality products, free Stereo Hi-Fi Guide, free Short Course for Novice License, name of nearest EICO dealer. Send new 36-page GUIDEBOOK TO HI-FI for which I enclose 25¢ for postage & handling.

Name
 Address
 City Zone State
 Add 5% in the West

Tape Tips



When you're in a hurry to change reels, it's very easy for one to slip away and end up in the tangled mess shown above. Save your time and temper by using plastic tape clips on the edge of the reel.

LIKE the radio, the TV receiver, and the record player, the tape recorder is now a common electronic device in many homes. It is similar to the record changer and its associated amplifier in that it is a combination of electrical and mechanical equipment. From the standpoint of operating difficulties, service troubles, and routine maintenance, it presents comparable problems. Electrically, the recorder gives relatively little trouble.

A typical recorder consists of a conventional audio amplifier, an ultrasonic-bias oscillator, and a tape-drive mechanism. When the recorder is in the *record* mode of operation, the audio output tube functions as the ultrasonic-bias oscillator. This oscillator has two functions: First, it erases (by applying its output to the erase head) all previously recorded material on the tape just before the tape passes the record head. Second, its output is combined with the audio signal being recorded to form a composite recording signal.

A problem of many small recorders is heat dissipation. To achieve compactness, manufacturers often jam components on top of each other and close to heat producers such as the power transformer, tubes, and resistors. In some recorders the bottom end of the drive-motor shaft is

fitted with a fan blade. This keeps the operating temperature at a reasonable level, provided the ventilating slots in the cabinet are unobstructed. Except for short periods, a tape recorder should not be operated in a drawer or enclosed space.

In most tape recorders the normal wear and tear is physical rather than electrical. A small motor drives the tape at two, three, or even four different speeds through a series of belts, pulleys, and idler wheels. In time the belts and wheels require adjustment or replacement. However, it is advisable to check the manufacturer's service notes before applying wrenches or an oil can. Generally, there is a tendency toward over-lubrication. Even a small quantity of oil on some of the rubber or composition belts and wheels can cause them to slip, and can hasten their disintegration. For periodic maintenance, it is usually sufficient to clean out accumulations of dust with a soft paint brush and to check lubrication points for oozing and dripping. Rubber idlers, pulleys, belts, and drive wheels should be wiped dry of oil.

Like record players, tape recorders work best if placed on a level surface.

On these pages are some practical tape tips that make use of the accessories of Robins Industries Corp., Flushing, N. Y. •

News from the FCC

Citizens Radio Service. The mushrooming citizens radio service accounted for most of the special radio group's workload and headaches during the year. Its authorizations rose from slightly more than 49,000 stations and 206,000 transmitters in 1959 to over 126,000 stations with 441,000 transmitters at the end of 1960.

The citizens service is a reservoir for all radio uses not provided for in other services. This means that many of the individuals who have flocked to it do not understand, or ignore, the Commission's rules governing operation in this service. Many of them are teenagers (the minimum age limit is 12 years for one class of license) who do not seem to know what they can or cannot do. Some others of varying ages have mistakenly thought that the citizens service was an easier way to engage in distance "chit-chat" than attempting to qualify for an amateur license. And there have been cases where people have pur-



space
age
hobby

**BUILD-YOUR-OWN
ELECTRONICS
FOR MODERN LIVING**

IT'S FUN...IT'S EASY WITH MONEY-SAVING

knight-kits® 

A PRODUCT OF ALLIED RADIO

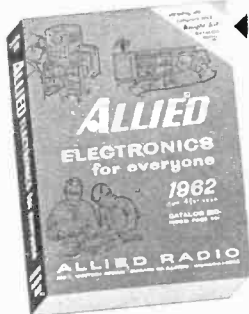

← featured in the 444 page

1962 **ALLIED**
ELECTRONICS
CATALOG

free send for it!



Dozens of new hobbyist kits, including amazing Electronic Science Lab—over 100 projects!

Select from more than 70 exciting Knight-Kits! See—Stereo hi-fi, including new Multiplex Stereo tuners and all-transistor stereo amplifiers, short-wave radios, intercoms, Citizens Band radios, electronic science labs, test instruments—all easy to build and a pleasure to own! Send today for your FREE 1962 ALLIED Catalog!



Everything in Stereo hi-fi components; new Multiplex Stereo FM tuners



New—tachometer kit and outstanding test instruments



New all-transistor intercom; many other kits for modern living

**SAVE ON EVERYTHING
IN ELECTRONICS**



Get the most for your money in: Stereo hi-fi systems and components • Recorders and tape • Citizens Band radios • Amateur station equipment • TV tubes, antennas, accessories • Electronic parts, tubes, transistors, tools, test instruments, books. Send today for your FREE 444-page 1962 ALLIED catalog!

NO MONEY DOWN
Easiest Terms

FREE CATALOG

ALLIED RADIO

ALLIED RADIO, Dept. 135-2
100 N. Western Ave., Chicago 80, Ill.

**WORLD'S
BIGGEST**

Rush FREE 1962 ALLIED Catalog

Name _____
PLEASE PRINT

Address _____

City _____ Zone _____ State _____

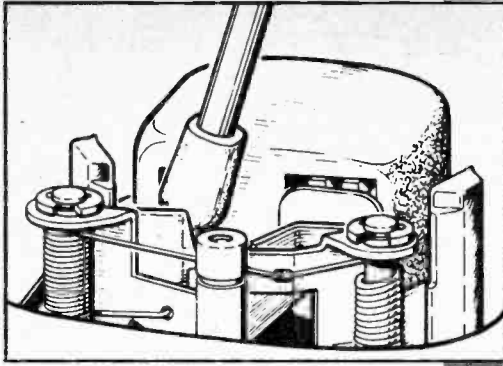

After extended use, the recording head may acquire a slight permanent magnetization that will adversely affect recording and playback performance. The magnetization can be removed with a head demagnetizer. Slowly move the plastic-covered tip over the pole pieces in the recording head.

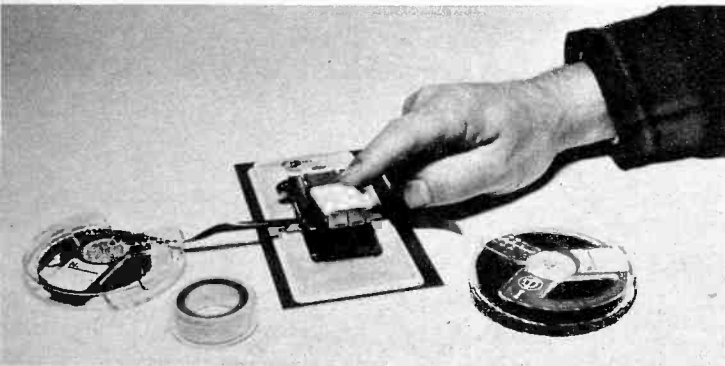
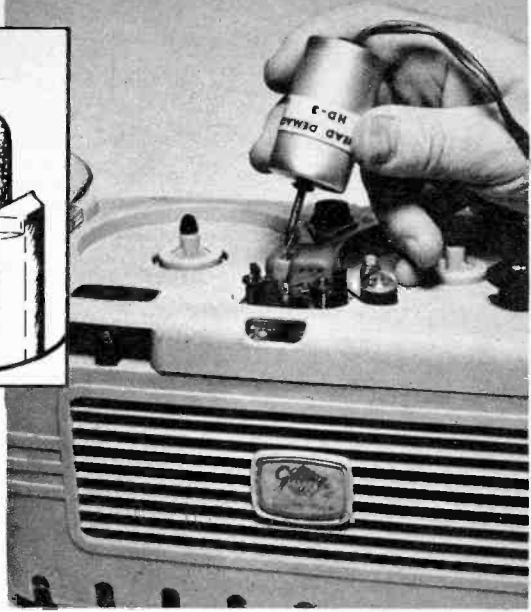

An indispensable accessory is a splicer. It speeds the editing process and assures precision alignment of tape splices. Its other advantage is that it holds the broken ends of the tape accurately and firmly in position when splicing tape is applied. When scissors or razor blades are used for a "free hand" job, it is difficult to make a joint that won't catch on the recording head or rollers. An uneven splice may produce a "blip" sound.

If you remember that the dull side of recording tape is coated with a thin layer of iron oxide, you will not be surprised to find the recording head covered with reddish dust after the machine has been used extensively. A sufficient deposit reduces volume or may make recording and playback impossible. If careful brushing with a fine camel's-hair brush doesn't loosen the film, use a chemical cleaner that does not contain acetone and apply sparingly.

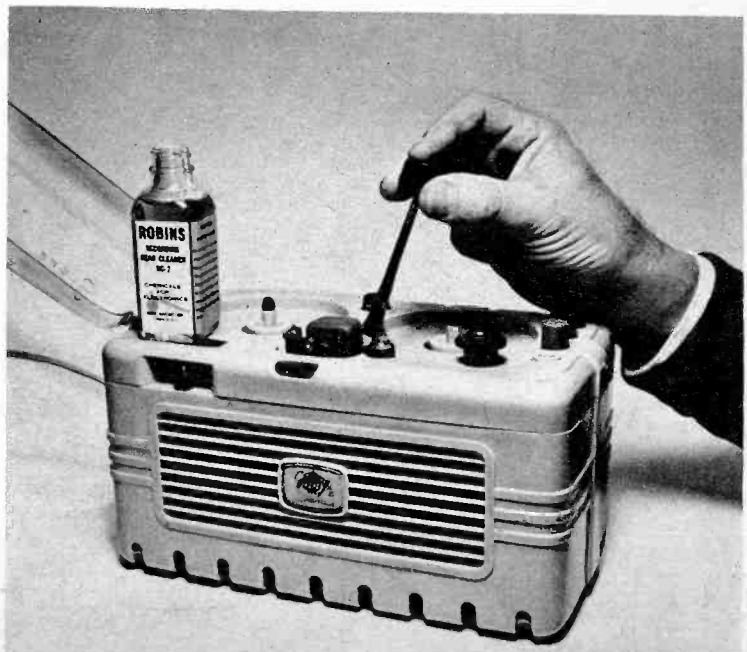

News from the FCC

chased and used citizen stations on a salesman's say-so that no license is needed for its operation. Still others have tried to use citizens stations for various unauthorized purposes. This misconception or wilful disregard of the rules has caused much policing trouble and made it necessary for the Commission to tighten its citizens regulations, take action against flagrant violators, and warn users in general about the necessity of abiding by the rules.

* * *

TV Towers. Most people have the idea that the Empire State Building in New York City is the tallest man-made structure in the world. Its 105 floors reach 1,250 feet into the sky. However, it is rapidly losing its pre-eminence to television towers. During 1960, eleven towers well over 1,000 feet high were put into operation, and the actual record was achieved by the 1,676-foot antenna of station KFVS-TV, in Cape Girardeau, Mo. Construction permits for two other towers in excess of 1,500 feet are outstanding. One of these, planned to reach 1,760 feet, will be used jointly by WRBL-TV and WTVM, in Columbus, Ga. A proposed 1,858-foot shaft for WHAS-TV, Louisville, Ky., was denied by the Commission because it would be an air hazard and for other reasons.

Since reception of TV frequencies is pretty much limited to line-of-sight, the higher the tower and the antenna, the greater the transmission distance.

* * *

Kilocycle Kops. With radio activities of various kinds constantly on the up-grade, interference is naturally a growing problem for users of the air waves and for the FCC. Some of the cases handled by the Commission's Field Engineering and Monitoring Bureau are interesting.

The Denver Field Office and a local power company were both deluged with telephone calls from a particular section of the city complaining of TV interference. Video reception was virtually impossible in a four-block area, and even AM and FM service was being disrupted. Power line connections to buildings were opened one at a time until the interference stopped. The culprit proved to be a neon sign at a gasoline service station. Bare secondary wires from a high-voltage transformer touched a brick wall that had been covered with aluminum [Continued on page 141]

news from hallicrafters



littlephone

CB-3 TRANSCEIVER

Only Hallicrafters offers 8-channel convenience and all these quality performance features.

The transmitter . . . output circuit matches 50 ohm antenna systems. Standardized CR23/U crystals (3rd overtone, series resonant) readily available. Output amplifier adjustable for max. legal input. 100% modulation on positive peaks. Series-tuned 2nd harmonic trap for excellent TV suppression.

The receiver . . . sensitivity less than 1.0 UV for 10 db. signal-to-noise ratio. Electronic squelch works on less than 6 db. signal strength change. 6 kc. selectivity. Image rej. 40 db. min. Audio output over 2 watts. Auto. noise limiter, series and shunt diodes. **\$149.50**

citizens band

Before you choose from the countless brands of CB equipment available, consider this fact: Nowhere in the field of communications is a manufacturer's experience, integrity and record of achievement more critical to performance and reliability than in citizen's band. Hallicrafters has built more precision communications equipment than *all other CB manufacturers.*

*the new ideas
in communications
are born at . . .*

 **hallicrafters**
Chicago 24, Illinois

Export Sales: International Div., Raytheon Mfg. Co., Waltham, Mass. Canada: Gould Sales Co. Montreal, P.Q.

Tapes that have been handled and played a great deal pick up grime and skin oil. The first sign of this condition is squeal and chattering. The tapes can be cleaned quite easily if they are run at normal speed through a folded "jockey cloth." Relieve the pressure pads on the recording head to minimize wear. This cloth not only cleans the tape thoroughly but leaves on it a microscopic silicone film. Cleaned tapes will be noticeably quieter when they're played.

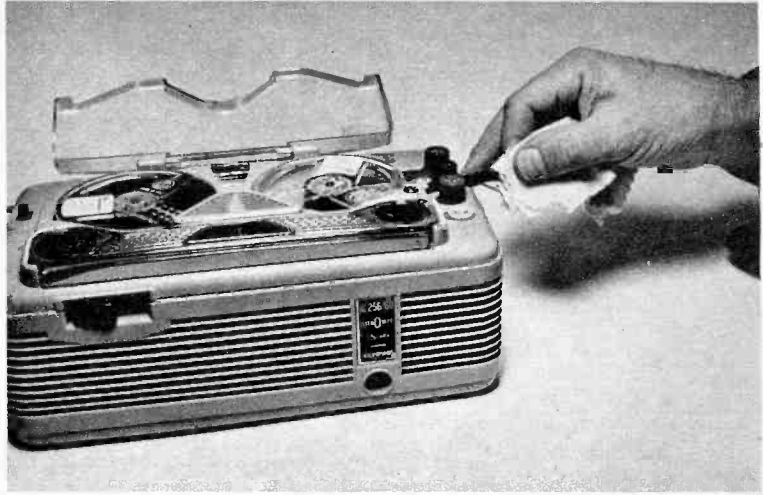

The advantages of compactness and portability outweigh the disadvantages of short battery life and poor fidelity in pocket-size tape recorders that are powered by penlight cells. It is therefore important to make frequent checks of the batteries with an accurate voltmeter. A battery tester that checks cells under a simulated load is even better. Transistor circuits are sensitive to reduced supply voltage and often fail to work even though the motor may be running.

Tapes often accumulate permanent magnetization. This is apparent as background noise which is not completely removed by the erase head during normal recording. If a number of reels of such tape are on hand and you want to salvage them, it is worthwhile to buy a bulk eraser. This is a large electromagnet powered directly from the AC line. The entire reel to be erased is placed on the spindle and turned slowly for a few seconds. The powerful 60-cycle field erases all residual magnetism.



**Your Biggest "How-To" Bargain
FAWCETT HOW-TO BOOKS**

Electronics
Photography
TV Repair
Ham Radio
Stereo
Automobiles
Hot Rods
Hi-Fi
Boating
Home Improvements
Wood Working
Bowling
Archery
Golfing

... and many others

**On Sale at your Local Newsstand
only 75 cents**

For a complete list of titles and to order direct, write to FAWCETT BOOKS, Dept. 497, Greenwich, Conn. Add 10 cents postage per copy when ordering by mail.

**NOW—Get this expert SELF-TRAINING in
RADIO SERVICING**

by ABRAHAM MARCUS



co-author of famous "Elements of Radio" which has sold over 800,000 copies!

Here is every detail you need to know about radio repair, replacement, and readjustment. Easy-to-understand, step-by-step self-training handbook shows you how to locate and remedy defects quickly.
Covers: Transistor Radios; Hi-Fi Amplifiers and Receivers; Hybrid Automobile Receivers; A-M and F-M Receivers; 3-Way Portable Receivers; Semi-Conductors; Power Supplies operated from AC, DC Batteries, Motor-Generators, etc. Tells you the HOW and WHY of: Electron Tubes (Diode, Triode, Pentode, Beam Power; Thyatron, Phototube, Cathode Ray, etc.); Rectifier Circuits (Half-wave, Full-wave, Bridge, Voltage-Doubler, etc.); Detector Circuits (Diode, Triode, Regenerative, Superregenerative, Infinite-impedance, etc.); Amplifier Circuits (Audio, Radio, I-F, Video, D-C, etc.); Oscillator Circuits (Hartley, Colpitts, Crystal, Transiron, Multi-vibrator, Sweep-circuit, etc.); Control Circuits (Volume, AVC, DVC, Tone, Noise-Suppression, Automatic Tuning, Automatic Frequency Control, etc.).
Explains how to use testing instruments such as: meter, vacuum-tube voltmeters, ohmmeters, bridges, multimeters, signal generators, tube checkers, cathode-ray oscilloscopes, etc. Over 100 pages and 69 illustrations in this section alone!

All in one big volume—easy to read.
16 Big Chapters.
121 Sections, 400 "Show-How" Diagrams, 649 pages of practical radio instruction.

Get this authoritative radio repair handbook today! Copson below brings you "Radio Servicing" on FREE trial for 10 days. Mail it NOW.

**PRENTICE-HALL, Inc., Dept. 5708-P3
Englewood Cliffs, N. J.**

Send me, for 10 DAYS' FREE TRIAL, "Radio Servicing," by Abraham Marcus. I will return it in ten days and pay nothing—or keep it and send \$1.95 down (plus postage) and \$2 monthly for 3 months.

Name

Address

City State.....

() SAVE! Send \$7.95 WITH COUPON—we pay postage.



**Learn TELEVISION
RADIO · RADAR
SONAR · ELECTRONICS**

THE MOST COMPLETE ELECTRONIC COURSE

Get COMPLETE training in all phases of Electronics. Why be satisfied with less? CHRISTY Shop Method Home Training System speeds your progress, makes learning fun.

**HOME LABORATORY SENT
19 TRAINING INSTRUMENTS INCLUDED**

Christy's Complete Course includes your receiving a Multi-Tester, Oscillator, Signal Generator, Electronic Timer, Regenerative Radio, Giant-sized Television Receiver (Optional). Do hundreds of exciting experiments and Earn as You Learn.

FREE BOOK—TWO SAMPLE LESSONS

together with Pay Later form sent on request.

SIGN, MAIL FOR THREE BOOKS

**Send for
FREE
BOOK**



**CHRISTY TRADES SCHOOL, Dept. T-374
3214 W. Lawrence, Chicago 25**

Please send two FREE lessons and new 24 Page Illustrated Book telling how I can get started right away in the big money field of Electronics.

Name Age.....

Address

City..... Zone..... State.....

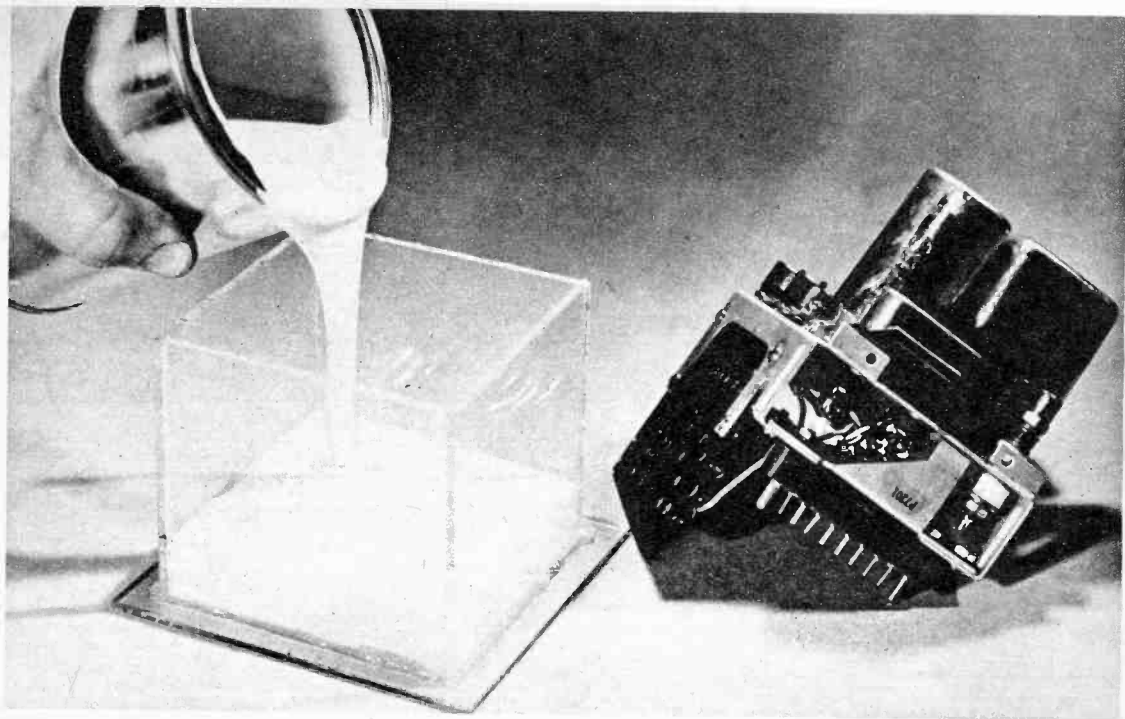

One method of using Silastic RTV601 potting compound is to fill a form with the proper amount of material and to immerse the assembly in it. The compound is fluid and pours readily from the can. The clear plastic form is treated on the inside so that the hardened block of compound does not adhere.

“Potting” Protects Parts

TO protect delicate electronic components against the effects of moisture, dirt and shock, etc., manufacturers are going in more and more for “potting.” In this process an assembly is filled with an insulating material which flows into all spaces. Some potting materials are white in color and make the potted assembly look like a big hunk of vanilla ice cream. Others are translucent or completely clear, and give a full view of the immersed parts. Typical potting applications are shown on these pages.

A free-flowing fluid silicone rubber that vulcanizes in sections of unlimited thickness at room temperature is produced by the Dow Chemical Corporation, Midland, Mich. Known as Silastic RTV601, this milk-like fluid preparation requires only the addition of a catalyst, and a 24-hour curing period, to set into a rubbery solid.

What makes RTV601 interesting is the fact that it cures without heat, pressure

or moisture, even under totally confined air-tight conditions. Variations in thickness have no significant effect on curing rate or uniformity. Venting during the curing step is not necessary because there are no volatile by-products from the vulcanization reaction.

Wide Temperature Range

After vulcanizing for a full day at normal room temperature of about 77° Fahrenheit, parts or sections using Silastic RTV601 are immediately ready for service over the wide temperature range of -100° (that is, 100° below zero) to 500° F. physical and electrical properties are consistent through all dimensions of a section.

Another feature of this RTV (for “room-temperature-vulcanizing”) silicone rubber is its response to setup time. Under normal conditions it becomes a tack-free solid within 12 hours after catalyzation. The actual setup time can be increased

Construction Kinks

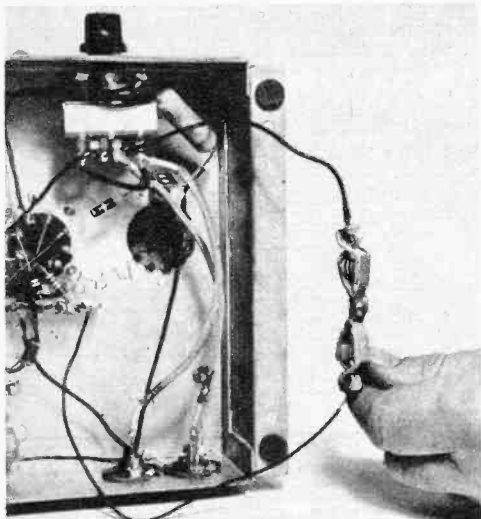

A very useful connector for experimental or temporary wiring is a pair of alligator clips that are joined end to end through their tapped holes. Pee-Wee clips are ideal for transistor circuits.

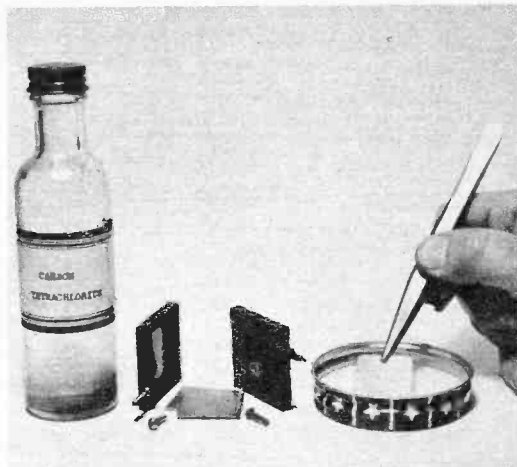

Quartz crystals that have been handled with your bare fingers may acquire a harmful coating of oil from the skin. Clean the crystals thoroughly by swishing them through carbon tetrachloride (dry cleaner) and then air dry them. Use a pair of tweezers so as not to get them dirty again.

MAKE YOUR INTEREST IN ELECTRONICS **PAY OFF**

Get
Into...

The HIGH PAY—PRESTIGE Field of TECHNICAL WRITING

HERE'S WHAT YOU GET . . .

- 50 Meaty Lessons
- Over 110 pages of Electronics
- Covers ALL Military Specifications
- Real, practical writing projects
- Full consultation privileges
- Many manuals, charts and diagrams
- Low tuition terms
- Employment Assistance
- State Approved Diploma
- Close personal supervision
- AND MUCH, MUCH MORE

ELECTRONICS WRITERS NEEDED NOW—ATWS will train you at home at low cost for a profitable career in **TECHNICAL WRITING**. Thousands needed in all areas. Get in on the ground floor of this fascinating new field. ATWS offers training specifically designed for the needs of industry. Course includes everything you need to become a top-notch Tech Writer.

YOU ARE JUST A STEP AWAY FROM TOP PAY—Yes, with your present interest in Electronics, you're just a step from the **BIG MONEY**. Technical Writing is one of the highest paying fields **NOT** requiring college training. It's tailor-made for **YOU**—but you must **ACT NOW**.

THIS COUPON CAN BE YOUR PASSPORT TO SUCCESS
Fill in your name and address and rush coupon for full information. We will prove to you that we can train you without interfering with your present income or job.

CAREER BOOK AND SAMPLE LESSON

TRAINING

AMBITIOUS

MEN FOR

INDUSTRY

American Technical Writing Schools, Inc.
5504 Hollywood Blvd.
Hollywood 28, Calif.

American Technical Writing Schools, Inc. Dept. PRE-1
5504 Hollywood Blvd., Hollywood 28, Calif.

Please **RUSH** full particulars.

Name _____ Age _____

Street _____

City _____ Zone _____ State _____

**BOTH
FREE**

NO SALESMAN WILL CALL ON YOU

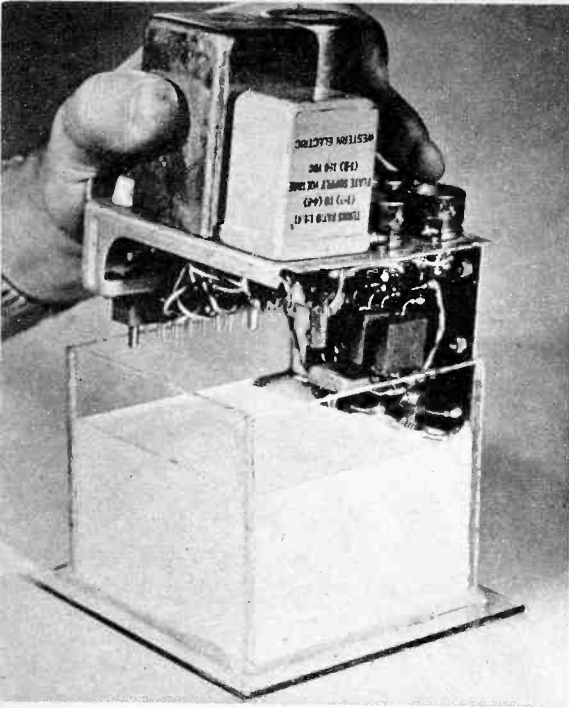

The assembly that is to be potted is first thoroughly cleaned and then gently lowered into the compound so that all of the air is pushed out. After a 24-hour curing period, the form is removed leaving a solid, self-supporting unit.

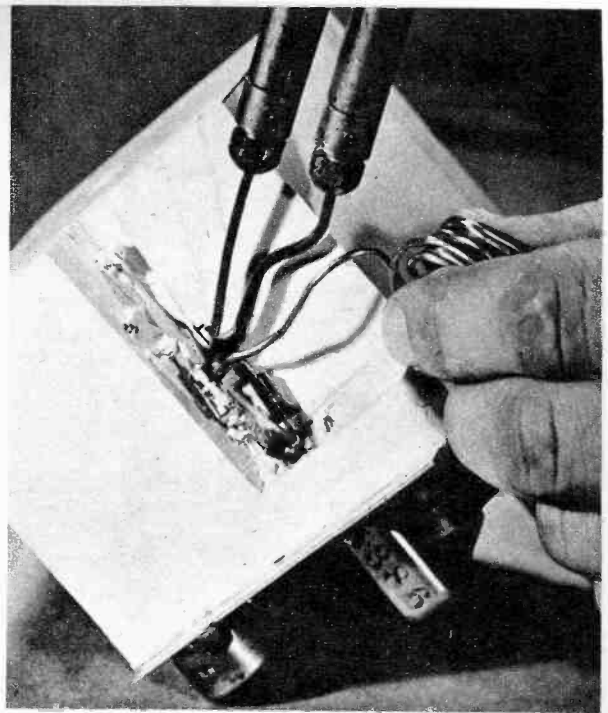

Getting to components inside the encapsulated block for replacement is not difficult; a sharp knife does the trick in a few minutes. Defective parts can then be removed and replacements soldered in place in the conventional manner.

After the repair has been completed, a temporary dam or mold is bound into place with plastic tape and fresh Silastic RTV601 is poured in to top off the cut-away section. This process can be repeated often without creating adverse effects.

by varying the catalyst concentration or the curing temperature; the properties of the cured parts are not affected.

The handling characteristics and properties of Silastic RTV601 suggest usefulness in a variety of applications, from the making of flexible molds and the casting of prototype parts to the potting and encapsulation of deep or totally enclosed components and assemblies. Supplied as a low viscosity fluid rubber, RTV601 flows into and around the most intricate designs and completely fills narrow cavities and hair-line cracks.

Clear Potting Compound

A clear silicone compound for similar embedding purposes is manufactured by General Electric Co., Waterford, N. Y., and is called LTV602 (for "low temperature vulcanizing"). It cures to a flexible, resilient solid, and provides protection against shock, vibration, moisture, ozone, corona



News from the FCC

paint; the combination made a first-class transmitter on a broad band of frequencies.

A piano factory in Michigan struck the wrong note twice in interfering with aviation radio facilities. Two months after the plant had corrected a defective electronic glue heater, which had bothered a Chicago airliner receiver, another complaint came in from an Air Force station in the area. A quick visit by FCC engineers located the troublemaker in the same factory.

A really "hot" case developed in Douglas, Ariz., where a local airport was being jammed. A mobile unit of the FCC traced the offending signals to a canning factory and pinned them on the spark gaps used to ignite gas furnaces for the cooking of chili peppers.

Some complaints of interference boomerang on the complainants. For example: Trouble in the control tower of a Tucson, Ariz., airfield was found to come from the neon lights that outline the structure. A manufacturing company reported disruption of communication on an industrial frequency, and specifically blamed a station 20 miles away. When the FCC reported that the latter station was operated by the same firm, the complaint was withdrawn with some understandable embarrassment, and the technical situation was adjusted internally. •

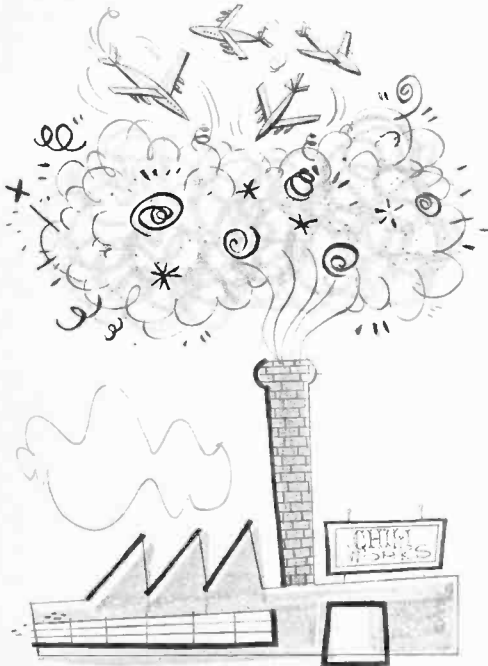

Free Trial Guarantees you can

FIX ANY TV FAST!

.. or pay not one cent!

**NO EXPERIENCE
OR HIGHER MATH NECESSARY!**

Let 10 days' free use of this book prove—at our expense—you can install and repair any TV set like an expert. You'll be amazed how easy it is to spot most troubles by eye and ear alone—how the clear, step-by-step instructions and illustrations reduce even the most complicated problems to simple a-b-c's. Quickly and easily, with this manual to guide you, you can turn your up-to-the-minute knowledge into plenty of spare-time cash or be your own boss in a profitable business.

In this new edition you get: The latest circuits—Troubleshooting techniques—Transistorized TV sets—Remote control tuning—Troubleshooting printed wiring—Module type construction—Packaged circuits—Newest servicing hints—Latest information on color TV and test equipment. . . every new advancement plus the basic know-how you need to put any set back in perfect working order. Mr. C. W. Morris of Charleston, W. Va., says: "I have paid as much as \$200.00 for courses that haven't given me the clear understanding this book has."



**All New!
3rd
Revised
Edition**

**TRANSISTORIZED TV
COLOR SETS
PRINTED CIRCUITS
DEFLECTION
METHODS
DC RESTORATION
ANTENNAS
POWER SUPPLIES
SYNCHRONIZATION**

— 10-DAY TRIAL COUPON—MAIL TODAY —

PRENTICE-HALL, INC., Dept. 6708-P4
Englewood Cliffs, New Jersey

Send me TELEVISION SERVICING for 10 days' FREE TRIAL. In that time I will either return it and owe nothing, or keep it and pay \$1.35 down (plus postage) and \$2 monthly for 3 months.

Name

Address

City Zone State

SAVE! Send \$7.35 now and we'll pay postage. Refund and same return privilege guaranteed.

YOU SAVE MONEY!

**RUSH US YOUR LIST
OF HI-FI COMPONENTS
FOR A VERY SPECIAL
GROUP QUOTATION**

**WRITE FOR FREE AUDIO
DISCOUNT CATALOG A-15**

*New low prices on tape re-
corders, amplifiers, tuners,
loudspeakers, cartridges, etc.*

KEY ELECTRONICS COMPANY
120 LIBERTY STREET
NEW YORK 6, N. Y.



Photo shows the cushioning protection that is afforded by General Electric's clear potting compound, LTV602. The test is not recommended if the subassembly includes delicate electronic parts.

LTV potting compound appears as clear glass, but actually it is resilient enough to yield under finger pressure. Note how readily the markings on batteries (upside down) can be distinguished.

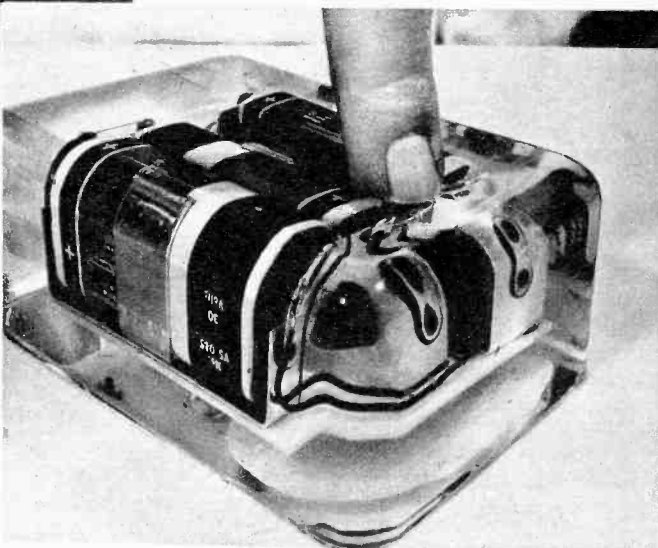

and other environmental hazards of the space age.

Components imbedded in LTV602 can be identified readily, and can be removed with the aid of a sharp knife for repair or replacement. After the repair has been made, new LTV602 is simply poured into the cavity, and joins with the rest of the mold with no evidence of joints. Shrinkage is negligible, so delicate parts are not damaged by stress during cure. The resilient properties of the compound prevent damage to potted assemblies subjected to thermal cycling.

The effect of high-temperature aging on LTV602 is a progressive increase in the firmness of the compound that to a degree, depends on the surrounding ambient temperature and the temperature at which the encapsulated equipment operates.

Cleanliness Important

To bond the compound to various materials of a subassembly (e.g., metal, plastic and glass), it is necessary that the surfaces be clean and dry. Some materials may require priming to ensure a bond; special chemicals for the purpose have been developed.

The following insulating materials accept LTV602 satisfactorily: silicone resins, silicone rubber, Alkanex wire, black varnished rag paper, epoxy glass, Mylar, kraft paper, asbestos with starch binder and polyester asbestos. Uncured phenolics and shellac show questionable compatibility.

Available in quantities, it is priced at \$10.50 per pound in single pound lots, and \$7.50 per pound in gallon lots. If you're planning to go into production you can buy it in drum quantities at \$7.00 per pound. •

Here's The Offer No Other Radio-TV School DARES MAKE!

LEARN AT HOME in Spare Time!

YOU DO MANY PRACTICAL JOBS with the kits we send you. That's right, you PRACTICE what we TEACH! You build a Signal Generator, AC-DC Power Pack, and AC-DC Superheterodyne Radio Receiver and top quality 21 inch TV Set. EARN AS YOU LEARN with the famous RTS 30 Day Income Plan. Full instructions provided. NO HIGH SCHOOL DIPLOMA NECESSARY. This is a COMPLETE course which starts with basic subjects and gradually advances to Radio-TV. . . . ALL FOR A PRICE YOU CAN AFFORD!

*THE ONLY VERTICAL MULTI-CHASSIS 21" TV KIT OFFERED BY ANY RADIO-TV SCHOOL



YOU BUILD THESE AND OTHER UNITS!



COMPLETE COLOR TV INSTRUCTION INCLUDED!

Each student is entitled to unlimited consultation service. All questions are answered promptly and completely by highly specialized instructors.

MULTIFESTER KIT INCLUDED!
*Tubes Excluded

RTS' Membership in The Association of Home Study Schools is your assurance of Reliability, Integrity and Quality of Training

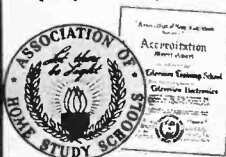

RADIO-TELEVISION TRAINING SCHOOL
815 EAST ROSECRANS AVENUE
LOS ANGELES 59 CALIFORNIA
L 1010 Est. 1922



RTS Will Train You at a Price You Can Afford and When You Are a Qualified Graduate Will Help You Open a Service Shop of Your Own and Supply You With Every Bit of Equipment You Need to Get Started - Plus an Inventory of Parts and Necessary Supplies.

ALL FINANCED WITHOUT INTEREST OR CARRYING CHARGES!!

You Also Receive . . . Advertising Help and Material, Shop Plans, Business Systems, Letterheads, Calling Cards and Much More!

Here's What Two of Many Business Plan Shop Owners Have to Say!

This business takes in between \$1500 and \$2000 a month. I've had to hire help to keep up with it.

CULLEN W. IRBY
Corpus Christi, Texas

The school lives up to its promises 100%. RTS does not lose interest in its students once they graduate.

HAROLD R. STANLAKE
Perry, Michigan

Rush Coupon for FREE FACTS!

DON'T LOSE OUT — FIND OUT!

RADIO TELEVISION TRAINING SCHOOL, Dept. EP-111
815 EAST ROSECRANS AVE • LOS ANGELES 59 CALIF.
Rush me full information by return mail. (Please Print)

NAME _____ AGE _____

STREET _____

CITY _____ ZONE _____ STATE _____

NO SALESMAN WILL CALL ON YOU!

BUY DIRECT FROM RAD-TEL!!

UP TO 75% OFF ON

RAD-TEL'S FIRST QUALITY

BRAND NEW TUBES

ONE FULL YEAR GUARANTEE

SERVICEMEN: Now speedy one-day service.

BUY DIRECT FROM RAD-TEL! YOU'LL SAVE PLENTY. YOUR ORDER SHIPPED WITHIN 24 HOURS AFTER RECEIVING AND PROCESSING. RAD-TEL SELLS ONLY BRAND NEW TUBES, NOT USED.

THE SIGN OF RAD-TEL'S RELIABILITY



GUARANTEED RAD-TEL TRANSISTORS SET TESTED

AF ST* AF Driver. Use as: Driver Low Power Output, Code Osc., DC Amp., Control, Test Instr., Pre-Amp., Timers, Organ, etc. **39c ea.**

RF ST* as Converter in an American set. Use as: Converter Sq. Wave Gen., RF Osc., Amp. Regen. Det., etc. **49c ea.**

IF ST* as 455kc IF in an Amer. set. Use as: IF Amp., Grid Dip Osc., Electronic Computer, RF Osc., Switch, Amp., etc. **49c ea.**

AUTO OUTPUT ST** as Audio Power Output into Speaker. 90% of Auto Radios so Powered. Use as Power Amp., Mobile Power Supply, Voltage Regulator, Osc., DC to DC Converters. **79c ea.**

HI POWER ST** as Hi Power AF Output. Ideal as DC to DC Converter, Multivibrator replaces Vibrator supply. **\$1.39 ea.**

HI CURRENT SILICON RECTIFIERS
15 AMPS
20 ma max
Reverse I at PIV

PIV	Lots of			
	Each	10	50	100
50	2.25	2.00	1.75	1.50
100	2.50	2.25	1.90	1.60
200	2.75	2.50	2.25	1.90
300	3.25	2.95	2.70	2.30
400	3.95	3.50	3.00	2.60

500 MA SILICON RECTIFIER Epoxy construction, size of 1-watt resistor
I reverse at 450 Volts .3 ma

30c ea.	lots of 20	35c ea.	lots of 10	45c ea.	lots of 5
---------	------------	---------	------------	---------	-----------

Each rectifier "Performance Tested" on an American TV Set

EACH TUBE INDIVIDUALLY - ATTRACTIVELY BOXED

Qty.	Type	Price	Qty.	Type	Price	Qty.	Type	Price
	0Z4M	.79		6B46	.50		12A66	.43
	1AX2	.62		6BC5	.61		12AF3	.73
	1B3GT	.79		6BC7	.94		12AF6	.49
	1G3	.79		6BC8	.97		12AJ6	.46
	1J3	.79		6BD6	.51		12AL5	.45
	1K3	.79		6BE6	.55		12AL8	.95
	1R5	.62		6BF6	.44		12AQ5	.52
	1S5	.51		6BG6	1.66		12AT6	.43
	1T4	.58		6BH6	.65		12AT7	.76
	1U4	.57		6BH8	.87		12AU6	.50
	1U5	.50		6BI6	.62		12AU7	.61
	1X2	.82		6BK7	.85		12AV5	.97
	2AF4	.96		6BL7	1.00		12AV6	.41
	2CY5	.71		6BN4	.57		12AV7	.75
	2EA5	.70		6BN6	.74		12AX4	.67
	3AL5	.42		6BQ5	.65		12AX7	.63
	3AU6	.51		6BQ6GT	1.05		12AZ7	.86
	3AV6	.41		6BQ7	1.00		12B4	.63
	3BA6	.51		6BR8	.78		12BA6	.50
	3BC5	.54		6BU8	.70		12BD6	.50
	3BE6	.52		6BY6	.54		12BE6	.53
	3BN6	.76		6BZ6	.55		12BF6	.44
	3BU8	.78		6BZ7	1.01		12BH7	.77
	3BY6	.55		6C4	.43		12BL6	.56
	3BZ6	.55		6CB6	.55		12BQ6	1.06
	3CB6	.54		6CD6	1.42		12BVT	.77
	3CF6	.60		6CF6	.64		12BZ7	.75
	3CS6	.52		6CG7	.61		12C5	.56
	3DB4	.85		6CG8	.77		12CN5	.56
	3DK6	.60		6CM7	.66		12CR6	.54
	3DT6	.50		6CN7	.65		12CU5	.58
	3S4	.51		6CR6	.51		12CU6	1.06
	3V4	.68		6CS6	.57		12DE8	.75
	4BC8	.96		6CU5	.58		12DL8	.85
	4BQ7	1.01		6CU6	1.08		12DQ6	1.04
	4B58	.98		6CY5	.71		12DS7	.79
	4BZ6	.58		6CY7	.71		12DW8	.89
	4BZ7	.96		6DA4	.68		12DZ6	.56
	4CB6	.56		6DB5	.69		12E05	.62
	4CS6	.61		6DE6	.58		12EL6	.50
	4CY5	.71		6DG6	.59		12EG6	.54
	4DE6	.62		6DQ6	1.10		12EZ6	.53
	4DT6	.56		6DT5	.76		12F8	.66
	5AM8	.79		6DT6	.53		12FM6	.45
	5AN8	.86		6DT8	.94		12K5	.65
	5A05	.52		6EA8	.79		12SK7GT	.74
	5AT8	.80		6EM7	.91		12SN7	.67
	5BK7A	.82		6EU8	.79		12SQ7M	.78
	5BQ7	.97		6E8	.79		12U7	.62
	5BR8	.79		6H6GT	.58		12V6GT	.53
	5CG8	.76					12W6	.69
	5CL8	.76		6J5GT	.51		12X4	.38
	5EA8	.80		6J6	.67		17AX4	.67
	5EU8	.80		6K6	.63		17BQ6	1.09
	5I6	.68		6S4	.51		17C5	.58
	5I8	.81		6SA7GT	.76		17CA5	.62
	5U4	.60		6SK7	.74		17D4	.69
	5U8	.81		6SL7	.80		17DQ6	1.06
	5V6	.56		6SN7	.65		17L6	.58
	5X8	.78		6SQ7	.73		17W6	.70
	5Y3	.46		6T4	.99		18AU4	.83
	6A84	.46		6U8	.83		19B6G	1.39
	6AC7	.96		6V6GT	.54		19T8	.80
	6AF3	.73		6W4	.60		21EX6	1.49
	6AF4	.97		6W6	.71		25BQ6	1.11
	6AG5	.68		6XA	.39		25C5	.53
	6AH6	.99		6X5GT	.53		25CA5	.59
	6AK5	.95		6X8	.80		25C06	1.44
	6AL5	.47		7AU7	.61		25CU6	1.11
	6AM8	.78		7A8	.68		25DN6	1.42
	6AQ5	.53		7B6	.69		25EH5	.55
	6AR5	.55		7Y4	.69		25L6	.57
	6AS5	.60		8AU8	.83		25W4	.68
	6AT6	.43		8AW8	.93		25Z6	.66
	6AT8	.79		8BQ5	.60		35C5	.51
	6AU4	.82		8CG7	.62		35L6	.57
	6AUG	.52		8CX8	.93		35W4	.42
	6AU7	.61		8EB8	.94		35Z5GT	.60
	6AUB	.87		11CY7	.75		50B5	.60
	6AV6	.41		12A4	.60		50C5	.53
	6AW8	.90		12AB5	.55		50DC4	.37
	6AX4	.66		12AC6	.49		50EH5	.55
	6AX7	.64		12AD6	.57		50L6	.61

*SET TESTED IN AMER. TRANSISTOR RADIO OF CURRENT MFR.
**SET TESTED IN AMER. AUTO RADIO OF CURRENT MFR. AT 16 VOLT BATTERY SUPPLY.

Rad-Tel eliminates complicated characteristics and numbers with their "SET-TESTED" Transistors. Transistors Tested to Rad-Tel's specifications—available on request. 100% Satisfaction Guaranteed. Substitute or replace with Rad-Tel Transistors on the basis of similar operating characteristics . . . at Low, Low Prices.

● NOT AFFILIATED WITH ANY OTHER MAIL ORDER TUBE COMPANY ●

SEND FOR FREE TROUBLE SHOOTER GUIDE AND NEW TUBE & PARTS CATALOG

RAD-TEL TUBE CO.

DEPT. F-1061 55 CHAMBERS STREET, NEWARK 5, N. J.

TERMS: 25% deposit must accompany all orders, balance COD. Orders under \$5: add \$1 handling charge plus postage. Orders over \$5: plus postage. Approx. 8 tubes per 1 lb. Subject to prior sale. Prices subject to change. No COD's outside continental USA.

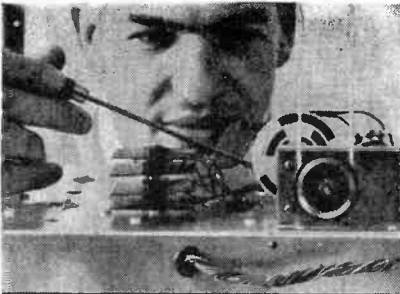

Special Training EQUIPMENT INCLUDED

Pick the field of your choice—and train at home with the leader—NRI. In addition to Industrial Electronics and FCC License training explained at the right, NRI offers comprehensive courses in Radio-TV Servicing and Radio-TV Communications. Except for the FCC course, all NRI courses include—at no extra cost—special training equipment for actual practice at home building circuits and working experiments. Makes theory you learn come to life in an interesting, easy-to-grasp manner.

Multiplexing, FM Stereo Broadcasting Included

NRI training keeps up with the times. New, additional profit opportunities exist for the Technician who understands the latest technical advances. Course material now covers FM Stereo Broadcasting, tells you about Multiplexing equipment, other recent developments.

Learn More to Earn More
Act now. The catalog NRI sends you gives more facts about the field of your choice, shows equipment you get and keep. No obligation. Cost of NRI training is low. Monthly payments. 60-Day Trial Plan. Mail postage-free card today.

NATIONAL RADIO INSTITUTE,
Washington 16, D.C.

NRI—Oldest and Largest Radio Television School Now Offers NEW HOME STUDY TRAINING IN INDUSTRIAL ELECTRONICS & MILITARY ELECTRONICS

This is the age of Electronics. Rapidly expanding uses for Electronic equipment in industry, business, the military demand more trained men. Prepare now for a career as an Electronic Technician to assure advancement or to profit from your hobby. NRI now offers a complete course in **ELECTRONICS**—Principles, Practices, Maintenance. Computers, telemetry, automation, avionics are changing our world, yet all employ the same basic principles... and that is what this NRI course stresses with illustrated lessons and special training equipment. Mail card below.



NEW HOME STUDY TRAINING FOR YOUR FCC LICENSE



An FCC Commercial License combined with NRI time-tested training can be the keys to a better future for you with higher pay, interesting work, more rapid advancement as the rewards. Prepare at home *quickly* for your FCC examinations through NRI's new, low-cost, special training. Like other NRI-trained men, you can be monitoring TV shows, radio broadcasts, operating shipboard and aviation radio, or holding down other important jobs. Get full details—mail the card below.

**TURN
PAGE**

Cut Out and Mail—No Stamp Needed



NATIONAL RADIO INSTITUTE
WASHINGTON 16, D. C.

Send me your Electronic, Radio-TV catalog without cost or obligation. I am interested in the course checked below: (No representative will call. Please PRINT.)

- | | |
|---|---|
| <input type="checkbox"/> Industrial Electronics | <input type="checkbox"/> Communications |
| <input type="checkbox"/> FCC License | <input type="checkbox"/> Servicing |

1KB9

Name _____ Age _____

Address _____

City _____ Zone _____ State _____

ACCREDITED MEMBER NATIONAL HOME STUDY COUNCIL

Send for
64-Page
CATALOG
FREE

The Amazing
Field of
Electronics



**ELECTRONICS NEEDS
4 TO 7
QUALIFIED TECHNICIANS**

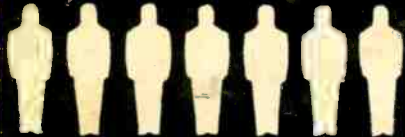

FOR EVERY ENGINEER



Choose from 4 Courses

- 1 INDUSTRIAL ELECTRONICS**
Learn Principles, Practices, Maintenance of Electronic equipment used today by business, industry, military, government. Covers computers, servos, telemetry, multiplexing, many other subjects.
- 2 FCC LICENSE**
Every communications station must have one or more FCC-licensed operators. New NRI course is designed to prepare you for your First Class FCC exams. You learn quickly, training at home in your spare time.
- 3 COMMUNICATIONS**
Training for men who want to operate and maintain radio and TV stations; police, marine, aviation, mobile radio, etc. Includes FM Stereo broadcasting. Course also prepares you for your FCC license exam.
- 4 SERVICING**
Learn to service and maintain AM-FM Radios, TV sets, Stereo Hi-Fi, PA systems, etc. A profitable, interesting field for a spare-time or full-time business of your own.

SEE OTHER SIDE

**Join The Thousands
Who Trained For
Advancement With NRI**

Thousands of NRI graduates throughout the U. S. and Canada are proof that it is practical to train at home. NRI graduates are in every kind of Electronics work: inspectors, maintenance men, lab technicians, testers, broadcasting and mobile communications operators, Radio-TV service technicians, or in essential military and government posts. Catalog tells more about what NRI graduates do and earn. Mail postage-free card.



"THE FINEST JOB I EVER HAD" is what Thomas Bilak, Jr., Cayuga, N. Y., says of his position with The G. E. Advanced Electronic Center at Cornell University. He writes, "Thanks to NRI, I have a job which I enjoy and which also pays well."



BUILDING ELECTRONIC CIRCUITS on specially-designed plug-in type chassis, is the work of Robert H. Laurens, Hammonton, N. J. He is an Electronic Technician working on the "Univac" computer. Laurens says, "My NRI training helped me to pass the test to obtain this position."



"I OWE MY SUCCESS TO NRI" says Cecil E. Wallace, Dallas, Texas. He holds a First Class FCC Radio-telephone License and works as a Recording Engineer with KRLL-TV.



MARINE RADIO OPERATOR is the job of E. P. Searcy, Jr., of New Orleans, La. He works for Alcoa Steamship Company, has also worked as a TV transmitter engineer. He says, "I can recommend NRI training very highly."



FROM FACTORY LABORER TO HIS OWN BUSINESS that rang up sales of \$158,000 in one year. That's the success William F. Kline of Cincinnati, Ohio, has had since taking NRI training. "The course got me started on the road," he says.

FIRST CLASS
PERMIT
NO. 20-R
(Sec. 34.9, P.L.&R.)
Washington, D.C.

BUSINESS REPLY MAIL

NO POSTAGE STAMP NECESSARY IF MAILED IN THE UNITED STATES

POSTAGE WILL BE PAID BY

**National Radio Institute
3939 Wisconsin Avenue
Washington 16, D.C.**



**Oldest and Largest
School of Its Kind**

Training men to succeed by home study has been the National Radio Institute's only business for over 45 years. NRI is America's oldest and largest Electronics home-study school. Don't delay. Cut out and mail **POSTAGE-FREE CARD**.

MAIL POSTAGE-FREE CARD