

**New! 24-HOUR WORLD-WIDE SHORT-WAVE SCHEDULE**

# **ELECTRONICS ILLUSTRATED®**

By the Publishers of MECHANIX ILLUSTRATED

**MARCH 1967**

**16** Extra  
Pages!

STILL ONLY 50¢

**BUILD:**

- CB ANTENNA FOR CAR WINDOW**
- 1-TUBE CW TRANSMITTER**
- RHOMBIC ANTENNA FOR SUPER TV**
- EAVESDROPPER FOR HEARING JET PILOTS**
- ALL-PURPOSE RECORDING MIXER**



**Will Fame Spoil Heinrich Hertz?**  
**ABCs of Color TV—Part II**  
**Knight-Kit vs EICO Engine Analyzers**  
**The Basics of Treasure Finding**

**BUILD THIS  
ELECTRONIC  
BONGO**



48714 388 A0528 500  
 1 DE FONE  
 BOX 1289 UNIVERSITA STA  
 ANES 10MA 50011

# The Magazine Advantage...



**T**HIS MAN is deciding on a car. He is a magazine reader. He has a good income—well above average. He does more, has more, buys more. (Frequent magazine readers are the big buyers of cars: 67% above the heavy TV viewers in new car purchases last year; 32% above average in ownership of more than one car.)

Like you, and most magazine readers, he knows how to buy and how to live. He knows this magazine knows him, that its editorial and advertising pages are created and designed with his progress in mind.

That's why he picks this publication—deliberately pays for it—constantly pays attention to it. It is his own personal choice . . . his own magazine. It's right for him.

## MAGAZINE READERS Read Much More Into Their Lives

**MAGAZINE ADVERTISING BUREAU OF MAGAZINE PUBLISHERS ASSOCIATION**

# TOM McCAHILL SAYS:

## “Good Appliance Repairmen are Scarce as Edsel Dealers!”

I don't think anything disturbs me as much as trying to find an appliance repairman . . . and finding out I'll have to wait my turn because he has more business than he can handle.

With over 400 million Appliances now in use, and more coming every year, there just are not enough repairmen around to take care of every Mrs. Jones who wants a broken Appliance mended in a hurry! And that's why a smart guy could really clean up in the Appliance repair field.

Some years back, almost anyone could do a fast repair on an iron or toaster with a bit of fancy tinkering. But today's complicated Appliances call for a special brand of know-how the average Joe doesn't have without training. Appliances are loaded with thermostat controls, solenoids, and special devices. Unless a repairman has a working knowledge of these parts, he won't even get to first base.

That's why I want you to take a good look at the home study course offered by the Appliance Division of the National Radio Institute. They show you all about repairing home and commercial Appliances—even farm Appliances and small gasoline engines. If you're interested, they also include a special package covering air-conditioning and refrigeration repairs. The cost is surprisingly low, and even includes a special Appliance Tester.

NRI is one of the biggest and best schools in the field, and has been around since 1914. They have a staff of 150 people in Washington, D.C., who are



equipped to guide you through the easy course with expert and personal instruction.

Take it from Tom . . . this is one of the easiest and most rewarding fields a guy can enter today. You don't need a college education, you don't even need to know the first thing about Electrical Appliances when you begin your training.

There's nothing to lose . . . except the price of a stamp on your letter or postcard. Fill out the coupon below *now*, before you turn the page. Get the full rundown on the training that can increase your spare time income or provide you with a business of your own a lot sooner than you think. In just a few short months you could be ready to take the first profitable step towards a new and rewarding career. Do it!

*Tom McCahill*

TOM McCAHILL

APPLIANCE DIVISION, NATIONAL RADIO INSTITUTE  
3939 Wisconsin Avenue, Washington, D. C. 20016

AVAILABLE UNDER NEW GI BILL.  
If you served since January 31, 1955  
or are in service, check GI line below.

504-037

OK—I want to see for myself. Send me the free book on Professional Appliance Servicing. No salesman will call.

Name \_\_\_\_\_ Age \_\_\_\_\_

Address \_\_\_\_\_

City \_\_\_\_\_ State \_\_\_\_\_ Zip Code \_\_\_\_\_

Accredited Member National Home Study Council.

Check for facts on new GI Bill.

# ELECTRONICS ILLUSTRATED

MARCH, 1967

A Fawcett Publication

Vol. 10, No. 2

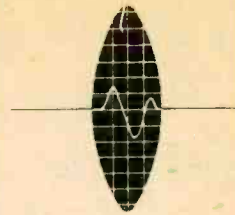

## ELECTRONIC MUSICAL INSTRUMENTS

Electronic Bongos .....	Fred B. Maynard	25
Go-Go Guitar Amp .....	Bert Mann	45

## SPECIAL FEATURES

The Secret of the New Electric Cars .....	J. K. Locke	41
Radio's Amazing Medicine Man .....	John Althouse	61

## YOUR CAREER

Q & A About the New GI Bill .....	Miles Dillard	92
-----------------------------------	---------------	----

## AMATEUR RADIO

1-Bottle Xmitter for 40 .....	James B. White, W5LET	100
40 Meters on 2 Wheels .....		118
Ham Shack: Mission .....	Wayne Green, W2NSD/1	124

## CITIZENS BAND

CB Corner: Famous Last Words .....	Len Buckwalter, KBA4480	60
The Win-Tenna for Walkie-Talkies .....	Fred Blechman, K6UGT	96
The Surprising Truth About CB Accessories .....	Herb Friedman, KBI9457	103

## SHORT-WAVE LISTENING

The Listener: Utility DX Crisis? .....	C. M. Stanbury II	69
24-Hour Short-Wave Schedule .....		77
Notes From EI'S DX Club .....		110
Jet Eavesdropper .....	Charles Green, W6FFQ	111
The Many, Many Voices of Africa .....	Alex Bower	115
Cute, Quaint, Kook QSLs .....	Howard S. Pyle, W7OE	122

## AUDIO & HI-FI

Wanted: A Good Tape Splicer .....	Herb Friedman, W2ZLF	57
All-Purpose Audio Mixer .....	Al Toler	65
Hi-Fi Today: What Price, Success? .....	John Milder	131

## THEORY & PRACTICE

The ABCs of Color TV: Part II, Colorimetry .....	John T. Frye, W9EGV	29
For Super TV Try a Rhombic Antenna .....	David Walker	38
Signal Tracer Built in a Probe .....	Clare Green, W6FFS	74
Will Success Spoil Heinrich Hertz? .....	Rufus Cartwright	98
Beginner's Corner: The Case of the Buried Treasure .....	H. B. Morris	119
The Amazing Rubber Ruler .....	Lawrence Glenn	128
Flying Skyhook .....		137

## KIT REPORTS

Experimenter's Power Supply .....		56
The Battle of the Engine Analyzers .....		94

## REGULAR FEATURES

Feedback .....	6	Good Reading .....	49
Broadsides .....	10	EI Picturescope .....	50
Electronic Marketplace .....	16	Electronics in the News .....	86
Electronic Swap Shop .....	22	Subscription Blank .....	139
Uncle Tom's Corner .....		Tom Kneitel, K2AES/KBG4303	12

Audit Bureau of Circulations



### MEMBERSHIPS



Magazine Publishers Association, Inc.



COVER—Ektachromes by John Capotosto (equipment) and Leonard Heicklen (background).

# LOOK!

## A New Electronics Slide Rule with Instruction Course



Front

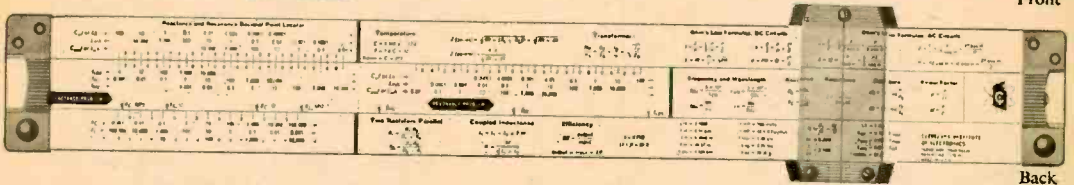

Back

This amazing new "computer in a case" will save you time the very first day. CIE's patented, all-metal 10" electronics slide rule was designed specifically for electronic engineers, technicians, students, radio-TV servicemen and hobbyists. It features special scales for solving reactance, resonance, inductance and AC-DC circuitry problems... an exclusive "fast-finder" decimal point locator... widely-used formulas and conversion factors for instant reference. And there's all the standard scales you need to do multiplication, division, square roots, logs, etc.

Best of all, the new CIE Slide Rule comes with an Instruction Course of four **AUTO-PROGRAMMED** lessons. It includes hundreds of illustrations, diagrams and practice problems. You'll learn ingenious short cuts... whip through exacting electronics problems quickly and accurately. This course alone is worth far more than the price of the entire package!

Electronics Slide Rule, Instruction Course, and handsome, top-grain leather carrying case... a \$50 value for less than \$25. Send coupon for **FREE** illustrated booklet and **FREE** Pocket Electronics Data Guide, without obligation. Cleveland Institute of Electronics, 1776 E. 17th St., Dept. EI-114, Cleveland, Ohio 44114.

\*TRADEMARK

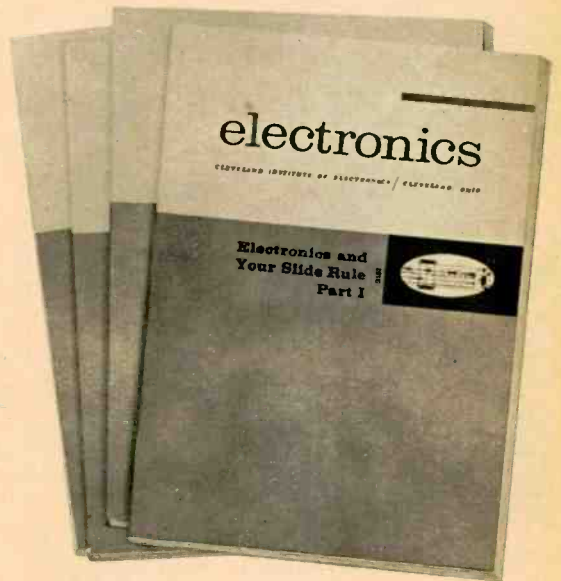

### GET BOTH FREE!



Send coupon today →

### Cleveland Institute of Electronics

1776 E. 17th St., Dept. EI-114, Cleveland, Ohio 44114

Please send **FREE** Illustrated Booklet describing your Electronics Slide Rule and Instruction Course.

**SPECIAL BONUS!** Mail coupon promptly... get **FREE** Pocket Electronics Data Guide too!

Name \_\_\_\_\_ (PLEASE PRINT)

Address \_\_\_\_\_ County \_\_\_\_\_

City \_\_\_\_\_ State \_\_\_\_\_ Zip \_\_\_\_\_

A leader in Electronics Training... since 1934.

Now there's a full line of

Weller®

## Soldering Tools for all soldering needs

Each model outperforms any other soldering tool of comparable size and price. All have replaceable tips of solid copper, instant heat, long reach, and rugged construction that means long-life, dependable performance.



### Weller Dual Heat Guns

Feature trigger-controlled dual heat, efficient double-barrel design, long-life tip, and work spotlight. Available in three wattage ratings, and in handy soldering gun kits. Priced from \$6.95 list.

### Weller MARKSMAN Irons

Best for intricate soldering or continuous-duty operation. Five sizes—all lightweights—with replaceable, premium-plated  $\frac{1}{8}$ " to  $\frac{5}{8}$ " tips. From \$2.98 list. Also in complete kit form with a soldering aid, solder and 2 extra soldering tips.



Try them all . . . at your electronic parts distributor!

**WELLER ELECTRIC CORP., Easton, Pa.**  
WORLD LEADER IN SOLDERING TECHNOLOGY

# ELECTRONICS ILLUSTRATED

By the Publishers of MECHANIX ILLUSTRATED

editor **ROBERT G. BEASON**  
managing editor **Robert D. Freed**  
feature editor **Robert Long**  
art editor **Lou Rubsamen**  
editorial associate **Alan R. Surpin**  
production editor **Rosanne Walsh**  
advertising mgr. **John F. Webster**  
eastern adv. mgr. **Don Daily, KBI0618**

### CONTRIBUTING EDITORS

amateur radio **Robert Hertzberg, W2DJJ**  
citizens band **Len Buckwalter, KBA4480**  
swi-dx **C. M. Stanbury II**  
special projects **Herb Friedman,**  
**W2ZLF/KBI9457**  
audio **Harry Kolbe**  
audio **John Milder**

### EXECUTIVE STAFF

president **W. H. Fawcett, Jr.**  
general manager **Roger Fawcett**  
secretary-treasurer **Gordon Fawcett**  
circulation director **Roscoe K. Fawcett**  
asst. general manager **Donald P. Hanson**  
vp., magazine div. **George H. Allen**  
vice president **Ralph Daigh**  
production director **George H. Carl**  
art director **Al Allard**  
associate art director **Ralph Mattison**

ELECTRONICS ILLUSTRATED is published bi-monthly by Fawcett Publications, Inc., Fawcett Bldg., Greenwich, Conn. 06830. Second-class postage paid at Greenwich, Conn., and at additional mailing offices.

EDITORIAL OFFICES: 67 W. 44th St., New York, N.Y. 10036 (phone 212-661-4000). Contributions must be accompanied by sufficient postage and will be handled with care, though the publishers assume no responsibility for return thereof.

ADVERTISING OFFICES: 67 W. 44th St., New York, N.Y. 10036 (phone 212-661-4000); 101 E. Ontario St., Chicago, Ill. 60611 (phone 312-DE 7-4680); 1532 Guardian Bldg., Detroit, Mich. 48226 (phone 313-WO 2-4860); 2978 Wilshire Blvd., Los Angeles, Calif. 90005 (phone 213-DU 7-8258); 851 Market St., San Francisco, Calif. 94105 (phone 415-EX 7-3441); 1430 W. Peachtree St., N.W., Atlanta, Ga. 30309 (phone 404-TR 5-0373); James B. Boynton, 370 Tesquesta Dr., Jupiter, Fla. 33458 (phone 305-746-4847); 123 S. Broad St., Philadelphia, Pa. 19109 (phone 215-PE 5-3636).

SUBSCRIPTIONS: \$3 per year (6 issues) in U.S. and possessions and Canada. All other countries \$4 for 6 issues. All subscription correspondence, including changes of address (Form 3579), should be addressed to ELECTRONICS ILLUSTRATED, Subscription Dept., Fawcett Bldg., Greenwich, Conn. 06830. Foreign subscriptions and sales should be remitted by International Money Order in U.S. funds payable at Greenwich, Conn.

COPYRIGHT © 1967 by Fawcett Publications, Inc. The title ELECTRONICS ILLUSTRATED is registered in the U.S. Patent Office. Reproduction in whole or in part is forbidden without written permission of the publishers; however, permission is hereby granted to quote from this issue of this magazine on radio or television, provided a total of not more than 1,000 words is quoted and credit is given to the title of this magazine and issue, as well as the statement, copyright 1967, by Fawcett Publications, Inc.

PRINTED IN U.S.A. BY FAWCETT-HAYNES PRINTING CORP., LOUISVILLE, KY. 40201. Microfilm copies of current and back issues are available from University Microfilms, 313 N. First St., Ann Arbor, Mich. 48103.

*Electronics Illustrated*

# 50,000 Men Who Filled Out DeVRY TECH COUPONS

During The Past 36 Years,  
Earned Diplomas As Qualified  
Electronics Technicians

How about you? If 50,000 men found a DeVry Coupon to be a start toward a new, wonderful world — a world with money-in-the-pocket, job-progress, and a real future — How about you? For many of those men were once like you: looking for a good field to get into, or an escape from a get-nowhere, low-income job. Some of them had no previous technical experience or advanced education; others didn't realize they had a talent for electronics! They were astonished, that after completing a few of the interesting experiments and assignments, how simple it all seemed and how interesting. (Some tell us they hated to leave their desks to go to bed!) For DeVry Tech teaches by showing; you learn by doing. Maybe you can come to one of our 2 modernly-equipped resident schools, maybe you'll find it convenient to keep your present job and prepare at home. Thousands of our graduates did one or the other; all had the ambition to go through with it. How about you? Mail the coupon for details.

ACCREDITED MEMBER OF NATIONAL HOME STUDY COUNCIL

**DeVRY TECHNICAL INSTITUTE · CHICAGO · TORONTO**

## DeVRY TECHNICAL INSTITUTE

4141 Belmont Ave., Chicago, Ill. 60641, Dept. 27-3-X

Please give me your two free booklets, "Pocket Guide to Real Earnings" and "Electronics in Space Travel"; also include details on how to prepare for a career in Electronics. I am interested in the following opportunity fields (check one or more):

- |  |   |
|--|---|
| <input type="checkbox"/> Space & Missile Electronics | <input type="checkbox"/> Communications         |
| <input type="checkbox"/> Television & Radio          | <input type="checkbox"/> Computers              |
| <input type="checkbox"/> Microwaves                  | <input type="checkbox"/> Industrial Electronics |
| <input type="checkbox"/> Automation Electronics      | <input type="checkbox"/> Broadcasting           |
| <input type="checkbox"/> Radar                       | <input type="checkbox"/> Electronic Control     |

NAME \_\_\_\_\_ AGE \_\_\_\_\_

ADDRESS \_\_\_\_\_ APT \_\_\_\_\_

CITY \_\_\_\_\_ ZONE \_\_\_\_\_ STATE \_\_\_\_\_

Check here if you are under 16 years of age.

HOME STUDY AND RESIDENT SCHOOL TRAINING

2096 AVAILABLE IN CANADA



### 5,000 FIRMS HAVE EMPLOYED DeVRY GRADUATES

Nearly every industry using electronics in many applications, employs DeVry trained men.

### 2,200 RESIDENT STUDENTS

Men 18-45, come to our Chicago or Toronto training laboratories, day-time or after work, to prepare for a job in electronics.

### EMPLOYMENT SERVICE

Many graduates who started by clipping our coupon are now on the jobs we helped them get; many consult us regularly on technical problems. They are DeVry men! Clip that coupon and join them.

# FEEDBACK

## from our readers



Write to: Letters Editor, Electronics Illustrated, 67 West 44th Street,

New York, N.Y. 10036

### ● ONLY ON SUNDAYS



It seems as though my state of West Virginia does not have enough radio stations. My town is left without any strong rock-and-roll signals all day Sunday. So I acquired a 32-watt transmitter, crystal-controlled at 1200 kc and have been on the air with WIRS every Sunday since August 1965.

The 6146 tube in the transmitter causes the fluorescent light over the wash basin to flicker in time to the music. But that tube must not have been sending a very strong signal to Fox Charlie Charlie. Where is he?

So far I have gotten records, public service messages and jingles from DJs at two local legit stations. Because of my good luck, I am now considering borrowing a friend's broadband linear amplifier to hook up to WIRS. Would 200 watts be too much power for a bootleg radio station?

Unsigned

*That should reach Fox Charlie, all right. Sorry it's been so tough to do.*

### ● QUICK, ILYA, THE DECODER!

From 1408 to 1425 EST on October 27, 1966. I overheard a transmission consisting of a series of numbers, four numbers per group, the number zero not being used. The broadcast was in Spanish with no sign-off

identification. (I didn't hear the station sign on.) It was on frequency slightly below 6.3 mc. At 1430 EST I overheard a station in Pittsburgh handling traffic just below this frequency.

I couldn't help remembering the article on How to Eavesdrop on Real Spies that appeared in EI earlier in 1966. Could it be?

Dennis M. Cole  
Indianapolis, Ind.

*Nobody here reads Spanish, amigo.*

### ● NOTE ON A NOTE

Re your DX Club note [Nov. 1966] on the VOA's mystery station, may I say this is a relay transmission from Greenville—specifically site B. Greenville consists of two transmitting sites, each one having two 10-kw PEP SSB transmitters. Site A operates with 0db to 20db of carrier suppression while site B operates with no suppression. This gives the effect of AM transmissions when in fact it is upper sideband plus carrier on 7650 kc.

Arthur Thompson  
Trans World Radio  
Bonaire, Neth. Antilles

### ● FROM THE FRONT

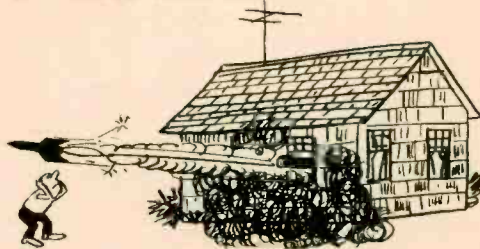

You speak slightly of neighbors who take pot shots at the insulators on the Press Wireless antennas [Jan. 1967]. What else can we do to stop all that TVI?

Frustrated Viewer  
Brentwood, N.Y.

[Continued on page 8]



# Build this famous *knight-kit*<sup>®</sup> Star Roamer<sup>®</sup> 5-Band Shortwave Receiver Kit



## and have the whole wide world at your fingertips!

Think of it!—even if you know nothing at all about electronics—in a few fun-filled evenings you can assemble the Knight-Kit Star Roamer that lets you listen to the four corners of the world!

You visit the famous cities of Europe, Asia, Africa . . . get continuous 24-hour-a-day aviation weathercasts . . . zero-in on Coast Guard LORAN signals . . . get the exact time from station WWV in Washington, D. C. . . listen in on the interesting conversations of Hams, Citizens Banders and Radio Telephoners—AND listen to your favorite programs on the standard AM band, too.

Thousands of folks of all ages have assembled the Star Roamer and have been amazed at how easy it is. All you do is follow crystal-clear, non-technical instructions and extra-large illustrations that show where every part fits . . . and almost

before you know it you're listening to exciting broadcasts from all over the world!

The Star Roamer covers 200 to 400 kc and 550 kc to 30 mc in 5 bandswitched ranges, and features a reliable superhet circuit . . . plus Automatic Volume Control to prevent fading and blasting, illuminated "S" meter for fine tuning, and many other features found only in shortwave receivers that cost many times more.

Complete with all parts, handsome 5½ x 12¼ x 8" charcoal gray and aluminum case, and easy-to-follow assembly instructions for only . . . . . **\$39<sup>95</sup>**

Read the unique money-back guarantee . . . exclusive in the industry . . . then rush coupon for full details and Special Introductory Offer.

### KNIGHT-KIT GUARANTEE

Build a Knight-Kit in accordance with our easy-to-follow instructions. When you have completely assembled the kit, you must be satisfied or we will return your money, less transportation charges, under the Allied guarantee of satisfaction.

**ALLIED RADIO**

**ALLIED RADIO, Knight-Kit, Dept. 4-88**  
P. O. Box 8528, Chicago, Ill. 60680

Please rush full details and Special Introductory Offer on the Knight-Kit Star Roamer 5-Band Shortwave Receiver.

Name \_\_\_\_\_ PLEASE PRINT

Address \_\_\_\_\_

City \_\_\_\_\_ State \_\_\_\_\_ Zip \_\_\_\_\_

OPPORTUNITIES IN ELECTRONICS

**LEARN**  
**Technical Writing**  
 for prestige, high pay,  
 advancement



**WRITE YOUR WAY TO SUCCESS.**

Electronics, aerospace, glamour industries need thousands of trained technical writers in all areas now! And Technical Writing is one of the highest paying careers NOT requiring college.

**ATWS WILL TRAIN YOU AT HOME AT LOW COST.** ATWS training is specifically designed to meet industry's needs. Everything is spelled out for you in fascinating, fast moving, easy-to-follow instructions. Everything you need to become a top-notch Tech Writer is included in the low cost.

**IT'S YOUR CAREER, SO DON'T WAIT.** No obligation. No salesman will call. Mail coupon now!

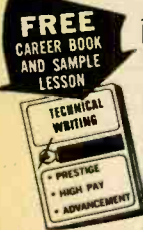

American Technical Writing Schools, Dept. E-27  
 5512 Hollywood Blvd., Hollywood, Ca. 90028  
 Rush information on how I can get into the big-pay Tech Writing field.

Name \_\_\_\_\_ Age \_\_\_\_\_  
 Address \_\_\_\_\_  
 City \_\_\_\_\_ State \_\_\_\_\_ Zip \_\_\_\_\_

APPROVED FOR VETERANS

**ONLY CCTV CAMERA KIT ON THE MARKET**

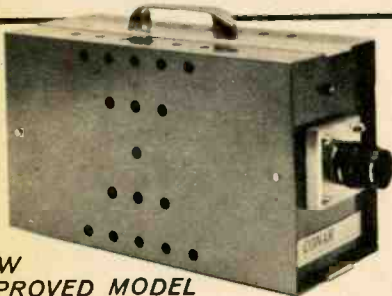

**NEW IMPROVED MODEL**

- Vidicon
- 25mm. f1.9 Lens
- Cable
- Instructions

**\$20950**

**\$20 DOWN**  
**\$10 MONTH**

The affordable answer to an easy-to-use, top performing surveillance camera. Hundreds of uses in home, store, plant, office, hospital, school. Connects instantly to any TV set. Gives excellent picture with light under normal room lighting. Operates up to six sets. Complete — nothing else to buy. Optional lenses and tripod available.

All parts guaranteed one year. Vidicon guaranteed 90 days. Make check or money order to CONAR. Shipped REA collect.

SEND FOR FREE CONAR CATALOG

**CONAR** Division of National Radio Institute, Dept. CE7C  
 3939 Wisconsin Ave., Washington, D.C. 20016

**FEEDBACK**

Continued from page 6

*Press Wireless tells us that they have had only one complaint (which they promptly cured) and that it was the TV receiver that turned out to be at fault.*

● **KNEW OF HIM WHEN?**

Your article last fall on the renegades of radio mentions amongst them former Lieut. Norman Baillie Stewart. This man was sentenced, as you stated, to five years in prison — though not in the Tower of London — for his espionage activities whilst still an officer in the Seaforth Highlanders. He was known as the Officer in the Tower as he was confined there during the hearing of his case. After promulgation of the sentence he was removed to Chelmsford Prison.

Sidney A. Searr  
 St. Laurent, Que.

● **R/C REVISITED**

I notice your article by Mr. E. L. Garrett about a 72 to 76-mc radio control receiver [Nov. 1966]. Apparently Mr. Garrett does not know that the receivers also have to be tested for radiation, in addition to the transmitters, which require FCC type acceptance.

Vernon C. Macnabb  
 Citizen-Ship Radio Corp.  
 Indianapolis, Ind.

*Yes, he does. Particularly now that several sharp-eyed readers have reminded him.*

● **FOR THE BIRDS**

You once said in an article on Chicken Banders that ham operators sit around wasting their time waiting for some thing to happen. I go to school with a lot of CBers (the difference between them and you is that they are my friends). They don't consider it to big a waste of time. And you said that CBers are supposed to just get the message across and sign off. All I can say is I'd hate to see a gab session.

A.L.F.  
 St. Louis, Mo.

*Yessir, ham radio sure keeps a fellow too busy to do his homework.*

# BIG 20 RADIO

Reg. U. S.  
Pat. Off.

**CIRCUITS AT HOME**  
with the New Improved  
**PROGRESSIVE RADIO "EDU-KIT"®**

only  
**\$26.95**  
**26**



Training Electronics Technicians Since 1946

## A Practical Home Radio Course

### Now Includes

- ★ 12 RECEIVERS
- ★ 3 TRANSMITTERS
- ★ SQ. WAVE GENERATOR
- ★ SIGNAL TRACER
- ★ AMPLIFIER
- ★ SIGNAL INJECTOR
- ★ CODE OSCILLATOR

- ★ No Knowledge of Radio Necessary
- ★ No Additional Parts or Tools Needed
- ★ EXCELLENT BACKGROUND FOR TV
- ★ SCHOOL INQUIRIES INVITED
- ★ Sold in 79 Countries

## YOU DON'T HAVE TO SPEND HUNDREDS OF DOLLARS FOR A RADIO COURSE

The "Edu-Kit" offers you an outstanding PRACTICAL HOME RADIO COURSE at a rock-bottom price. Our Kit is designed to train Radio & Electronics Technicians, making use of the most modern methods of home training. You will learn radio theory, construction, practice and servicing. THIS IS A COMPLETE RADIO COURSE IN EVERY DETAIL.

You will learn how to build radios, using regular schematics; how to wire and solder in a professional manner; how to service radios. You will work with the standard type of punched metal chassis as well as the latest development of Printed Circuit chassis. You will learn the basic principles of radio. You will construct, study and work with RF and AF amplifiers and oscillators, detectors, rectifiers, test equipment. You will learn and practice code, using the Progressive Code Oscillator. You will learn and practice trouble shooting, using the Progressive Signal Tracer, Progressive Signal Injector, Progressive Dynamic Radio & Electronics Tester, Square Wave Generator and the accompanying instructional material.

You will receive training for the Novice, Technician and General Classes of F.C.C. Radio Amateur License. You will build Receiver, Transmitter, Square Wave Generator, Code Oscillator, Signal Tracer and Signal Injector circuits, and learn how to operate them. You will receive an excellent background for television, Hi-Fi and Electronics.

Absolutely no previous knowledge of radio or science is required. The "Edu-Kit" is the product of many years of teaching and engineering experience. The "Edu-Kit" will provide you with a basic education in Electronics and Radio, worth many times the low price you pay. The Signal Tracer alone is worth more than the price of the kit.

## THE KIT FOR EVERYONE

You do not need the slightest background in radio or science. Whether you are interested in Radio & Electronics because you want an interesting hobby, a well paying business or a job with a future, you will find the "Edu-Kit" a worth-while investment. Many thousands of individuals of all

ages and backgrounds have successfully used the "Edu-Kit" in more than 79 countries of the world. The "Edu-Kit" has been carefully designed, step by step, so that you cannot make a mistake. The "Edu-Kit" allows you to teach yourself at your own rate. No instructor is necessary.

## PROGRESSIVE TEACHING METHOD

The Progressive Radio "Edu-Kit" is the foremost educational radio kit in the world, and is universally accepted as the standard in the field of electronics training. The "Edu-Kit" uses the modern educational principle of "Learn by Doing." Therefore you construct, learn schematics, study theory, practice trouble shooting—all in a closely integrated program designed to provide an easily-learned, thorough and interesting background in radio.

You begin by examining the various radio parts of the "Edu-Kit." You then learn the function, theory and wiring of these parts. Then you build a simple radio. With this first set you will enjoy listening to regular broadcast stations, learn theory, practice testing and trouble shooting. Then you build a more advanced radio, learn more advanced theory and technique. Gradually, in a progressive manner, and at your own rate, you will find yourself constructing more advanced multi-tube radio circuits, and doing work like a Professional Radio Technician.

Included in the "Edu-Kit" course are Receiver, Transmitter, Code Oscillator, Signal Tracer, Square Wave Generator and Signal Injector Circuits. These are not unprofessional "breadboard" experiments, but genuine radio circuits, constructed by means of professional wiring and soldering on metal chassis, plus the new method of radio construction known as "Printed Circuitry." These circuits operate on your regular AC or DC house current.

## THE "EDU-KIT" IS COMPLETE

You will receive all parts and instructions necessary to build twenty different radio and electronics circuits, each guaranteed to operate. Our Kits contain tubes, tube sockets, variable electrolytic, mica, ceramic and paper dielectric condensers, resistors, tie strips, hardware, tubing, punched metal chassis, Instruction Manuals, hook-up wire, solder, selenium rectifiers, coils, volume controls and switches, etc.

In addition you receive Printed Circuit materials, including Printed Circuit chassis, professional electric soldering iron, and a self-powered Dynamic Radio and Electronics Tester. The "Edu-Kit" also includes Code Instructions and the Progressive Code Oscillator. In addition to F.C.C. Radio License training, You will also receive lessons for servicing with the Progressive Signal Tracer and the Progressive Signal Injector, a High Fidelity Guide and a Quiz Book. You receive Membership in Radio-TV Club, Free Consultation Service, Soldering of Parts and Discount Privileges. You receive all parts, tools, instructions, etc. Everything is yours to keep.

## PRINTED CIRCUITRY

At no increase in price, the "Edu-Kit" now includes Printed Circuitry. You build a Printed Circuit Signal Injector, a unique servicing instrument that can detect many Radio and TV troubles. This revolutionary new technique of radio construction is now becoming popular in commercial radio and TV sets.

A Printed Circuit is a special insulated chassis on which has been deposited a conducting material which takes the place of wiring. The various parts are merely plugged in and soldered to terminals.

Printed Circuitry is the basis of modern Automation Electronics. A knowledge of this subject is a necessity today for anyone interested in Electronics.

## FREE EXTRAS

### • SET OF TOOLS

- SOLDERING IRON
- ELECTRONICS TESTER
- PLIERS-CUTTERS
- VALUABLE DISCOUNT CARD
- CERTIFICATE OF MERIT
- TESTER INSTRUCTION MANUAL
- HIGH FIDELITY GUIDE & QUIZZES
- TELEVISION BOOK & RADIO TROUBLE-SHOOTING BOOK
- MEMBERSHIP IN RADIO-TV CLUB: CONSULTATION SERVICE & F.C.C. AMATEUR LICENSE TRAINING
- PRINTED CIRCUITRY

## SERVICING LESSONS

You will learn trouble-shooting and servicing in a progressive manner. You will practice repairs on the sets that you construct. You will learn symptoms and causes of trouble in home, portable and car radios. You will learn how to use the professional Signal Tracer, the unique signal injector and the dynamic Radio & Electronics Tester. While you are learning in this practical way, you will be able to do many a repair job for your friends and neighbors, and charge fees which will far exceed the price of the "Edu-Kit." Our Consultation Service will help you with any technical problems you may have.

## FROM OUR MAIL BAG

J. Statistic, of 25 Poplar Pl., Waterbury, Conn., writes: "I have repaired several sets for my friends, and made money. The "Edu-Kit" paid for itself. I was ready to spend \$240 for a course, but I found your ad and sent for your kit."

Ben Valerio, P. O. Box 21, Magna, Utah: "The Edu-Kits are wonderful. Here I am sending you the questions and also the answers for them. I have been in Radio for the last seven years, but like to work with Radio Kits, and like to build Radio Testing Equipment. I employed every minute I worked with the different kits: the Signal Tracer works fine. Also like to let you know that I feel proud of becoming a member of your Radio-TV Club."

Robert L. Shuff, 1534 Monroe Ave., Huntington, W. Va.: "Thought I would drop you a few lines to say that I received my Edu-Kit, and was really amazed that such a bargain can be had at such a low price. I have already started repairing radios and phonographs. My friends were really surprised to see me get into the swing of it so quickly. The Trouble-shooting Tester that comes with the Kit is really swell, and finds the trouble, if there is any to be found."

## UNCONDITIONAL MONEY-BACK GUARANTEE

Please rush my Progressive Radio "Edu-Kit" to me, as indicated below:

Check one box to indicate choice of model

- Regular model \$26.95.
- Deluxe model \$31.95 (same as regular model, except with superior parts and tools plus Radio & TV Parts Jackpot worth \$15.)

Check one box to indicate manner of payment

- I enclose full payment. Ship "Edu-Kit" post paid.
- Ship "Edu-Kit" C.O.D. I will pay postage.
- Send me FREE additional information describing "Edu-Kit"

Name \_\_\_\_\_

Address \_\_\_\_\_

## PROGRESSIVE "EDU-KITS" INC.

1186 Broadway, Dept. 583AE, Hewlett, N. Y. 11557

# ELECTRONICS

Electronics Engineering Technology  
Electricity-TV-Radio  
Electrical Maintenance  
Refrigeration-Air Conditioning  
Industrial Electronics



## COYNE ELECTRONICS INSTITUTE

Founded  
1899

Learn on a quarter of a million dollars worth of equipment for top salaries and an Exciting Career. Many special finance plans. Part time employment service while in school. Also free graduate employment service.



★ VA APPROVED-G. I. BILL ★

Use this coupon to get our FREE BOOK  
"YOUR OPPORTUNITIES IN ELECTRONICS"

COYNE ELECTRONICS INSTITUTE, Dept. of Electronics 17-A  
1501 W. Congress Parkway, Chicago, Illinois 60607

Name \_\_\_\_\_ Age \_\_\_\_\_  
Address \_\_\_\_\_ Phone \_\_\_\_\_  
City \_\_\_\_\_ State \_\_\_\_\_ Zip \_\_\_\_\_

*I only want information on Home Study TV*



**CAMP ALBERT BUTLER INVITES  
HAM RADIO ENTHUSIASTS OF ALL AGES  
TO TRY FOR YOUR  
GENERAL CLASS TICKET  
THIS SUMMER! OUR 8TH SEASON**

**NOVICES, TECHNICIANS, AND C.B.'ers ESPECIALLY TAKE NOTE**

This co-ed Amateur Radio Camp, Y.M.C.A. owned and operated, can accommodate 60 campers. There is no age limit. We have had campers from 7 through 74 years of age. It is very helpful if you can copy Swpm or have a Novice or Technician ticket, but it is not necessary. Time is divided between radio classes in code and theory and the usual camp activities, such as swimming, archery, riflery, hiking, etc. Golf privileges are included at the beautiful New River Country Club course.

Entire staff consists of licensed hams who are instructors in electrical engineering in some of our finest colleges and universities. Camp opens August 5 and closes August 19. Tuition of \$175.00 includes all camp expenses: room, meals, notebooks, textbooks, and insurance. Send for our brochure.

C. L. Peters, K4DNJ  
General Secretary  
Gilvin Roth V.M.C.A., Eikin, North Carolina  
Please send me the Booklet and Application Blank for the Camp Albert Butler Radio Session.

NAME \_\_\_\_\_  
CALL \_\_\_\_\_  
ADDRESS \_\_\_\_\_  
CITY \_\_\_\_\_ STATE \_\_\_\_\_ ZIP \_\_\_\_\_

## BROADSIDES

Pamphlets, booklets, flyers, application notes and bulletins available free or at low cost.

**I**F YOU are interested in getting two-way radio for business or personal use—without having to pass an FCC exam—the User's Guide to Citizens Band 2-Way Radio tells how to select a CB transceiver and antenna for the application you have in mind. Included is a brief run-down of FCC rules and licensing requirements and a glossary of CB terms. A free copy is available by writing Amphenol Corp., Broadview, Ill. 60153.

**Career opportunities** for engineers and technicians with a major manufacturer of semi-conductors is the subject of an unusual (and handsome) booklet that might be called a job catalog. The company is a source of transistors, ICs, diodes and other components. For a free booklet write Marketing Services Dept., Fairchild Semiconductor, 313 Fairchild Dr., Mountain View, Calif. 94040.

If you're in the market for test equipment the VOM comparison chart in catalog 49-T provides an easy way to compare features of one manufacturer's line. Among the large selection is a VOM that doubles as a battery-powered VTVM. The catalog also includes an assortment of transistor and tube testers, signal generators and accessories. Free copy available from Marketing Dept., Triplett Electrical Instrument Co., Buffon, Ohio 45817.

A little folder gives specs and details of the TM4 omnidirectional dynamic microphone. One wrinkle: placing a finger over a port on one side of the microphone cuts down bass response for improved voice pickup. Write Tandberg Inc., 8 Third Ave., Pelham, N.Y. 10566.

The 1967 Guide To Custom Stereo describes a full line of hi-fi components and component kits. The guide includes a brief discussion of how stereo works and how FETs (field-effect transistors) are used in the company's products. Obtain a free copy by writing H. H. Scott Inc., Dept. P, 111 Powdermill Rd., Maynard, Mass. 01754.

Every buff will find something of interest among the 250 electronic kits illustrated in the 1967 Heathkit catalog. New kits include a transistor guitar amplifier, 12-in. b&w TV incorporating ICs, SB-series amateur station console and others. Free copy available from Heath Co., Benton Harbor, Mich. 49022.

# LAFAYETTE HB-525 Solid State Mobile 2-Way Radio

All Crystals Supplied!

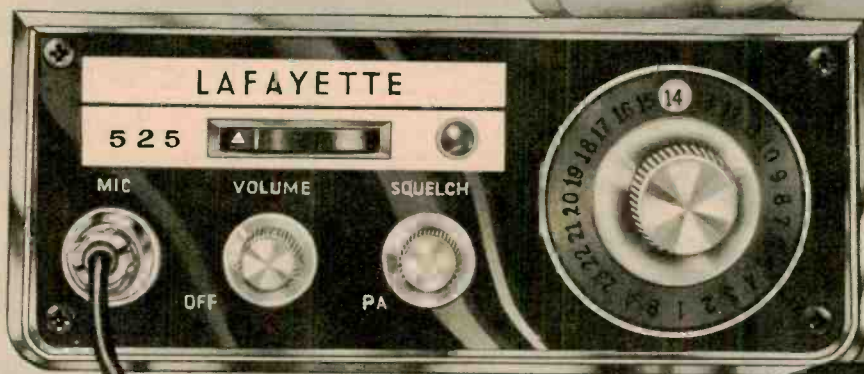

• Size: 2 $\frac{3}{8}$ " by 6 $\frac{1}{4}$ " 99 3076WX\*

All **23** CB Channels  
Crystal Controlled

Plus 2 Reserve Channels

**149<sup>95</sup>**  
NO MONEY DOWN

- 19 Transistors, 7 Diodes, Thermistor
- Dual Conversion Receiver for Extra Selectivity and Sensitivity
- Full 5-Watt Input
- Range Boost™ Circuitry for Added Power
- 3-Position Delta Tune—Provides Accurate Fine Tuning
- Mechanical 455KC Filter for Superior Selectivity

- Push-to-Talk Dynamic Microphone
- Variable Squelch plus Series Gate Automatic Noise Limiting
- Public Address System (with external speaker)
- 12-Volt DC Operation (pos. or neg. ground) 6-Volt DC (with optional DC Power Supply)
- Pi-Network for Optimum RF Output
- 117 Volt AC Operation with Optional Power Supply

\*Imported

**FREE**

Over 500 Pages

**1967 CATALOG NO. 670**

Featuring Everything in Electronics for

• HOME • INDUSTRY • LABORATORY

from the "World's Hi-Fi & Electronics Center"

LAFAYETTE Radio ELECTRONICS  
Dept. EIC-7 P.O. Box 10  
Syosset, L. I., N. Y. 11791



EIC-7

Send me the FREE 1967 LAFAYETTE Catalog 670

Name -----

Address -----

City ----- State ----- Zip -----



# UNCLE TOM'S CORNER

Uncle Tom answers his most interesting letters in this column. Write him at Electronics Illustrated, 67 West 44th St., New York, N. Y. 10036.

By TOM KNEITEL, K2AES/KBG4303

★ *Can you help me to pin down a station identifying itself as Ground Turkey each day at 1:30 P.M. (EST) on about 7800 kc. They mention a lot of (spy?) names and numbers.*

*Hank Majelowicz  
Dolthan, Ala.*

It looks as though your station is VSI6 on Grand Turk Island in the Caribbean, a perfectly legit operation at 8000 kc. They give out with ship names and arrival times in their daily broadcasts. Don't be disappointed because it wasn't a spy station. VSI6 is rare and seldom reported. If you want to try for a genuine spy station (in English), check in on 3210 kc around 11:35 P.M. (EST).

★ *I listen to the State Police on a VHF monitor receiver, but when my TV set is on it causes a loud buzzing sound right on the State Police channel. What can I do?*

*Bob Fast  
Haviland, Ohio*

You must be the notorious phantom jamming station the Ohio State Police are looking for.

★ *Although I've been an avid SWL for a number of years, I don't know anyone who has heard that famous Washington-Moscow hot line. Does a hot line really exist? What frequency?*

*John Rightson  
Glen Burnie, Md.*

Most of the Washington-Moscow hot line messages take place on a highly guarded and unlisted but nevertheless standard telephone circuit (relayed via cables or shortwave transmitters used for all regular overseas calls). If you want to have them dashing for

the Vodka bottle in Moscow sometime, place a call to 7-240555, the secret hot line number in the Kremlin.

★ **Entertainment Dept.** If, like me, you wince at the majority of singing and hard-sell radio commercials jammed down your Eustachian tubes by broadcasters, you'll probably wonder about the astonishing lack of public support when it comes to hearing broadcasts minus the commercials. Take the case of FM station WBAI in New York, for example. WBAI is one of many listener-supported non-commercial entertainment (as opposed to so-called educational) stations throughout the country. Creative (and sometimes controversial) programs are offered without a single commercial outburst, and listeners are asked to help support the non-profit station by sending in a few dollars per year. Despite the fact that a leading independent poll shows WBAI with 500,000 listeners at peak hours, only about 8,000 to 10,000 regularly help to keep them going. As a result, WBAI and many other no-commercials broadcasters cling to life by only the thinnest thread. Somehow, this seems wrong to me. If you have one of these stations in your area, see how refreshing it is to listen to programs without being constantly reminded of finance companies, potato chips, beer, and dandruff.

★ *What would you say if I told you that I've fully developed a revolutionary new concept in long distance communications which doesn't rely upon sound, radio, or light waves?*

*H. Charles Dalton  
Eccleston, Md.*

*[Continued on page 14]*



**Introducing EICO's New "Cortina Series"!**

Today's electro-technology makes possible near-perfect stereo at moderate manufacturing cost: that's the design concept behind the new EICO "Cortina" all solid-state stereo components. All are 100% professional, conveniently compact (3 1/8" H, 12" W, 8" D), in an esthetically striking "low silhouette." Yes, you can pay more for high quality stereo. But now there's no need to. The refinements will be marginal and probably inaudible. Each is \$89.95 kit, \$119.95 wired.

Model 3070 All-Silicon Solid-State 70-Watt Stereo

Amplifier: Distortionless, natural sound with unrestricted bass and perfect transient response (no inter-stage or output transformers); complete input, filter and control facilities; failure-proof rugged all-silicon transistor circuitry.

Model 3200 Solid-State FM/MPX Automatic Stereo Tuner: Driftless, noiseless performance; 2.4µV for 30db quieting; RF, IF, MX are pre-wired and pre-tuned on printed circuit boards — you wire only non-critical power supply.

# 7 New Ways to make Electronics more Fun!

Save up to 50% with EICO Kits and Wired Equipment.



You hear all the action-packed capitals of the world with the NEW EICO 711 "Space Ranger" 4-Band Short Wave Communications Receiver — plus ham operators, ship-to-shore, aircraft, Coast Guard, and the full AM band. 550KC to 30MC in four bands. Selective, sensitive super-het, modern printed circuit board construction. Easy, fast pinpoint tuning; illuminated slide-rule dials, logging scale; "S" meter, electrical bandspread tuning, variable BFO for CW and SSB reception, automatic noise limiter. 4" speaker. Headphone jack. Kit \$49.95. Wired \$69.95.



More "ham" for your dollar than ever — with the one and only 5SB/AM/CW 3-Band Transceiver kit, new Model 753 — "the best ham transceiver buy for 1966" — Radio TV Experimenter Magazine. 200 watts PEP on 80, 40 and 20 meters. Receiver offset tuning, built-in VOX, high level dynamic ALC, silicon solid-state VFO. Unequaled performance, features and appearance. Sentionally priced at \$189.95 kit, \$299.95 wired.



**NEW EICO 888 Solid-State Engine Analyzer**

Now you can tune-up, troubleshoot and test your own car or boat.

Keep your car or boat engine in tip-top shape with this completely portable, self-contained, self-powered universal engine analyzer. Completely tests your total ignition/electrical system. The first time you use it — just to tune for peak performance — it'll have paid for itself. (No tune-up charges, better gas consumption, longer wear) 7 instruments in one, the EICO 888 does all these for 6V and 12V systems; 4, 6 & 8 cylinder engines.

The EICO 888 comes complete with a comprehensive Tune-up and Trouble-shooting Manual including RPM and Dwell angle for over 40 models of American and Foreign cars. The Model 888 is an outstanding value at \$44.95 kit, \$59.95 wired.



New EICOCRAFT® easy-to-build solid-state electronic TruKits: great for beginners and sophisticates alike. As professional as the standard EICO line — only the complexity is reduced to make kit-building faster, easier, lower cost. Features:

pre-drilled copper-plated etched printed circuit boards; finest parts; step-by-step instructions; no technical experience needed — just soldering iron and pliers. Choose from: Fire Alarm; Intercom; Burglar Alarm; Light Flasher; "Mystifier"; Siren; Code Oscillator; Metronome; Tremolo; Audio Power Amplifier; AC Power Supply. From \$2.50 per kit.



There's more PUNCH in the new EICO "Sentinel-Pro" 23-channel Dual Conversion 5-watt CB Transceiver. New advanced Big-Reach "Range Plus" circuitry lengthens "talk-power" reach. Automatic noise limiter super-sensitizes for weak signals. "Finger Tip" antenna loading and transmitter tuning controls. 23 crystal-controlled transmit and receive channels — all crystals supplied. Rear-illuminated S/R meter. Transistorized 12VDC and 117VAC dual power supply. Wired only, \$169.95. Positive-Negative Ground/Mobile Marine Modification kit (optional \$5.95).



Model 460 Wideband Direct-Coupled 5" Oscilloscope. DC-4.5mc for color and B&W TV service and lab use. Push-pull DC vertical amp., bal. or unbal. Input. Automatic sync limiter and amp. \$99.95 kit, \$139.50 wired.

**FREE 1967 CATALOG**

EICO Electronic Instrument Co., Inc. EI-3  
131-01 39th Ave., Flushing, N. Y. 11352

Send me FREE catalog describing the full EICO line of 200 best buys, and name of nearest dealer. I'm interested in:

- test equipment
- stereo/hi-fi
- automotive electronics
- ham radio
- Citizens Band radio

Name \_\_\_\_\_  
Address \_\_\_\_\_  
City \_\_\_\_\_  
State \_\_\_\_\_ Zip \_\_\_\_\_



Model 232 Peak-to-Peak VTMX. A must for color or B&W TV and industrial use. 7 non-skip ranges on all 4 functions. With exclusive Uni-Probe. \$29.95 kit, \$49.95 wired.

## WANT A JOB? PART TIME— FULL TIME?

**No Boss! No Experience!  
No Capital! Your Own Hours!**

### WHAT A JOB ! ! ! !

And yet selling subscriptions to **ELECTRONICS ILLUSTRATED** and other leading publications is just like being in business for yourself.

But no business requires less capital, stock and space. The time you devote and the money you make is up to you. You need no experience to earn steady profits and you keep a cash commission on every sale. You operate in your own community by phone or personal calls. You will be authorized to sell new and renewal subscriptions along with special offers made by the publishers. You'll be amazed at the number of people wanting to take advantage of the convenience, service and savings you can offer them.

To get started immediately—send us your name (on a postal card) requesting *free* supplies and selling materials.

**Write to:** Subscription Dept. DE  
**ELECTRONICS ILLUSTRATED**  
Fawcett Bldg., Greenwich, Conn. 06830

# FREE!

**BIGGER... BETTER  
THAN EVER!**



**40th ANNIVERSARY  
1967 CATALOG**

**RADIO-TV  
ELECTRONICS**

**BA**  
1967  
ANNUAL CATALOG

**YOUR BUYING GUIDE  
FOR:** ● Stereo & Hi-Fi Systems & Components. ● Tape Recorders. ● Electronics Parts, Tubes, Tools. ● Phonos & Records. ● Ham Gear. ● Test Instruments & Kits. ● Cameras & Film. ● PA. ● Citizens Band. ● Radio & TV Sets. ● Musical Instruments.

**SEND FOR  
YOURS TODAY!**

**BURSTEIN-APPLEBEE CO.**

Dept. EI, 1012 McGee, Kansas City, Mo. 64106  
 Rush me the FREE 1967 B-A Catalog.

Name.....

Address.....

City..... State..... Zip Code.....

## UNCLE TOM'S CORNER

Continued from page 12

I'd probably say quite a bit. When you fully develop it be sure to let me know.

★ *Who do I complain to about a radio station that has taken over my receiver? No matter where I turn the dial indicator I still hear only this one station. At first they denied it but now they refuse to take my calls.*

Edgar G. Adams  
Wilmington, Del.

Complain to your local radio repair shop.

★ *While in New York last summer we took the kids to a museum. As soon as we entered one of the exhibit rooms both children began to cry and complain that their ears were hurting. My wife and I couldn't understand it but there were some pieces of quartz nearby that might have been rectifying radio signals which the kids were hearing. I didn't hear a thing myself. Does the quartz theory make sense?*

Ben Tollman  
Austin, Tex.

Quartz theory sounds good but it's the wrong guess. You were undoubtedly at the Morgan Gem and Mineral Hall of the Museum of Natural History. Following their famous jewel robbery they installed a super-sonic burglar detection system that operates at about 20,000 cycles. About 10 per cent of the population (mostly kids) can hear this gadget, with some listeners complaining of loud ringing noises, nausea, headaches, or even dizziness. A smart jewel thief would do well to hire a kid for his advance man.

★ *I would like to know if it is possible to connect a microphone to the key jack of an amateur transmitter.*

Mark Dombrowski  
Uniontown, Pa.

Sure, but you'll get better results if you use the microphone jack.

★ *I bought a war surplus BC-348 receiver to start out in SWLing, but many people have told me that I wasted my money on worn-out veteran. What say, Big Daddy?*

Mitchell Fleming  
Olympia, Wash.



Don't knock this old war horse. There are still countless numbers of them in wide use throughout the world. You'll note a marked improvement in its sensitivity if you replace its 6SK7 front end tube with a 6AB7/1853 or a little surplus tube called the 717A. You might even try 6AC7/1852 for the job, but it seems to be too much tube for some BC-348s I've tried it in.

★ *How can I find out which CB channels are monitored in each city across the country? I'm planning a trip to Florida and want to be able to get road and accommodations advice as I travel.*

*William McGhee  
Fargo, N.D.*

Channel 9 has been designated unofficially as the national CB calling and emergency channel and is being monitored by thousands of clubs and individual operators. If you need road assistance try giving a shout on 9. But don't be discouraged if you can't get through. There still are pinheads on CB who absolutely refuse to do their illegal blabbering on channels other than 9.

★ *I've heard that some foreign short-wave stations, such as an English-language broadcast from Peking, are jammed by Washington. Is this true?*

*Robert Rogers  
New York, N.Y.*

Old George may have been quite a rascal with that little hatchet but he never owned up to using the cherries for jam.

★ *Why isn't your call-sign, K2AES, listed in my Callbook? It's a winter '64/'65 edition.*

*David Weintraub, WN2RSC  
Huntington Station, N.Y.*

Some people have unlisted telephones; I have an unlisted call.

**GUARANTEED**

**FOR A LIFETIME**



**C/P CORPORATION**

RFD 3, COLUMBIA, S. C.

subsidiary of *Shakespeare*

PHONE (803) 787-8710

... its owners are  
up in the clouds ...



THIS No. 176

# "LONG RANGER"

with Shakespeare's fiberglass  
**WONDERSHAFT**

offers:

- protection from weather
- 125 MPH wind rating
- low background noise
- proven performance

The BIG STICK 176 is an excellent CB 18'6" — 27.1 mc fiberglass WONDERSHAFT antenna ... all direction coverage ... minimum of dead spots ... no ground radials ... independent of mounting location.

Paul Crouch (Crouch TV) Newark, Ohio says ... "A Shakespeare 176 BIG STICK, using identical heights, locations and radios outplayed a \_\_\_\_\_ antenna forty hilly miles away into a tough location. I think Long Rangers are the best antennas."

User approval of the 176 is so great ... the manufacturer guarantees the product for its lifetime against any defect in either workmanship or material.

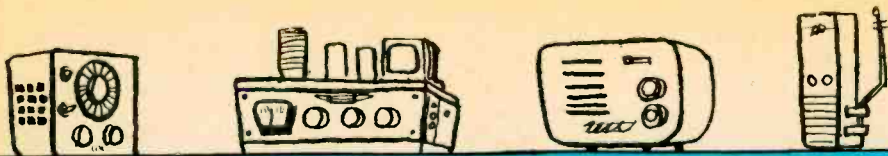

# Electronic Marketplace

**SHOW ON THE ROAD . . .** A new auto TV antenna (right) will attach to the edge of a window and slips into a car's trunk when not in use. It is a V-dipole designed for omnidirectional reception. Comes with a six-position channel-matching switch and 10 ft. of coax lead. A similar (but more expensive) model is designed for marine use. \$19.95. JFD Electronics Co., 15th Ave. at 62nd St., Brooklyn, N. Y. 11219.

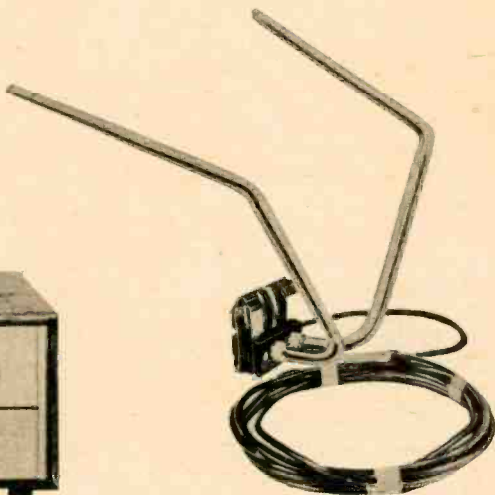

**FET-FM . . .** The Model 312C stereo FM tuner sports a silver-plated, 3-FET front end and all-silicon IF strip. Tuning meter doubles as field-strength meter and multipath indicator. Refinements include interstation muting, front panel output for tape recorder. \$294.95. H. H. Scott, Inc., 111 Powdermill Rd., Maynard, Mass. 01754.



**Two-way . . .** A new 5-band transceiver boasts 200-watt PEP SSB input on all bands (80 through 10 meters) plus CW operation plus AM operation with separate AM detection. A premixed crystal-controlled front-end and a single VFO tune the same range on all five bands for identical calibration and tuning rate. Push-to-talk or front-panel switching. \$359. National Radio Co., Inc., Washington St., Melrose, Mass. 02176.



**New number . . .** A tape recorder with a meaningful model number is the 423—a 4-track, 2-head, 3-speed (and also 3-motor)—unit. It is the first model from this manufacturer with straight-through threading path. It has no pressure pads; tape is held to hyperbolically-ground heads by swing-away pinch roller. \$249. Viking of Minneapolis, 9600 Aldrich Ave. S., Minneapolis, Minn. 55420.

*[Continued on page 20]*

**NEW!**  
**MASTER COURSE**  
**IN COLOR TV...**

**WITH NTS COLOR KITS**

Big 25" Color TV kits included in new Master Color TV Home Study program. Learn Color TV; keep the new 25" color TV receiver you build with exciting kits we send you. 10 million homes in this country will have color TV by the end of 1967. This industry needs technicians as never before, and NTS-trained men can move quickly into the big money.

**COLOR TV SERVICING BRINGS HIGH PROFITS**

New color sets need careful installation, precision tuning and skilled servicing. NTS home training can put you in this profit picture—prepare you for big pay, security, or start a business of your own.



**LIFT OFF...TO**  
**A "SPACE AGE"**  
**CAREER IN**  
**ELECTRONICS**

This is the "space age". It offers new opportunities in communications, industrial electronics, computer technology, and many others. Automation has increased the need for skilled electronics technicians in thousands of manufacturing plants. Only the well trained man makes it big. Industry wants and demands this kind of man... the NTS man. Pick your field. Let an NTS Project Method Program help you toward a well-paid career in Electronics wherever you travel.

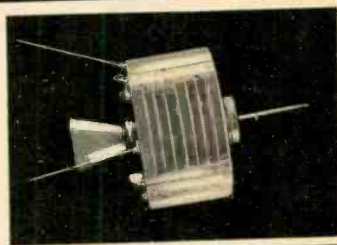

**NEW CAREER KIT... FAST, EASY START TO NTS HOME TRAINING**

The exclusive Project Method Career Kit helps you move quickly into your training program. Earn while you learn as you progress with your shop-tested Project Method lessons and kits.

Send for the New illustrated NTS Color Catalog. It shows the equipment and kits you work with and keep. Describes in detail the advantages of NTS Project Method Home Training. Tells you everything you need to know about starting your career in electronics.



**HIGH SCHOOL AT HOME**

National offers accredited high school programs. Take only subjects you need. Study at your own pace. Everything included at one low tuition. Check special High School box in coupon for full information & FREE catalog.

**CLASSROOM TRAINING AT LOS ANGELES**

You can take Classroom Training at Los Angeles in Sunny Southern California. NTS occupies a city block with over a million dollars in facilities devoted exclusively to technical training.

**MAIL REPLY CARD OR COUPON FOR NEW, FREE COLOR CATALOG AND SAMPLE LESSON.**



**NATIONAL TECHNICAL SCHOOLS**

World Wide Training Since 1905  
 4000 S. Figueroa St., Los Angeles, Calif. 90037  
 You enroll by mail under NTS "No Obligation" plan.  
 We have no salesmen! This means lower tuition for you.  
 Accredited Member National Home Study Council  
 Member: National Association of Trade & Technical Schools

**NATIONAL TECHNICAL SCHOOLS**

4000 S. Figueroa St., Los Angeles, California 90037

APPROVED FOR VETERANS



Please rush Free Color Catalog and Sample Lesson, plus detailed information on field checked below. No obligation. Dept. 213-27

- MASTER COURSE IN COLOR TELEVISION
- COLOR TV SERVICING
- MASTER COURSE IN ELECTRONICS-TV-RADIO plus ADVANCED TV and INDUSTRIAL ELECTRONICS
- ELECTRONICS-TV-RADIO SERVICING AND COMMUNICATIONS
- FCC LICENSE COURSE
- RADIO SERVICING (AM-FM TRANSISTORS)
- TELEVISION SERVICING (including color lessons)
- STEREO, HI-FI and SOUND SYSTEMS
- BASIC ELECTRONICS
- ELECTRONICS MATH  HIGH SCHOOL AT HOME

Name \_\_\_\_\_ Age \_\_\_\_\_

Address \_\_\_\_\_

City \_\_\_\_\_ State \_\_\_\_\_ Zip \_\_\_\_\_

- Check if interested in Veteran Training under new G.I. Bill.
- Check if interested ONLY in Classroom Training at Los Angeles.



## Electronic Marketplace

**Mobile . . .** An audio amplifier designed for use in your car and equipped with mike jacks for PA use is the Tiny Mite. It fits under the dashboard and delivers 16 watts of audio output, matches 8-ohm or 16-ohm speakers. The compact (1 3/8 x 3 5/16 x 5 7/8 in.) unit accepts tape



recorder, phono or radio in addition to dynamic, crystals or magnetic microphones. It can be used as the center of an auto-based PA system for rallies, sporting events or business purposes. Or it might drive an extension speaker when you're picnicking by the roadside. It will operate on 12-V negative or positive ground systems with a maximum current drain of 1.8 A, fused for overload protection. It is equipped with mike, plug, battery and speaker cables, mounting bracket. \$29.95. Lafayette Radio Electronics, Inc., 111 Jericho Tpke., Syosset, N.Y. 11791.

**Multi-Band . . .** Not only standard AM broadcasts but FM as well can be tuned on the S-210 receiver. In addition, there are four short-wave bands—49, 31, 25 and 19 meters—making this

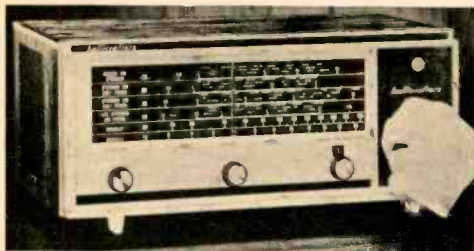

a sort of Compleat Broadcast-Listener's receiver covering the popular broadcast frequencies. An unusual feature for a short-wave receiver (aside from the inclusion of the FM band) is the styling—walnut-color vinyl cabinet with wood-grain inlay trim (as a result, it may be easier to wheedle a spot for it in plain sight even in the parlor). Short wave tuning is provided with bandspread. Controls include band selector/AFC, tuning, on/off/volume and a tone control. \$89.95. Hallicrafters Co., 4401 W. Fifth St., Chicago, Ill. 60624.

**Portable . . .** A power source you can take with you is said to offer operating economies by comparison with flashlight, alkaline or even nickel-cadmium cells. The CRL-1200, which contains two 6-V, 8-A-hour lead-silica cells, will power 12-V appliances either through a cigarette-lighter



type of plug or via standard battery contacts. With the CRL-1000 charger, which is included, the power pack will return to a 90 per cent charge in seven hours or to full charge in 12. It weighs 9 1/2 lbs. \$49.95. Centralab Electronics Div., Globe-Union, Inc., Box 591, Milwaukee, Wis. 53201.

**Square . . .** Square-wave frequencies from 60 to 30,000 cps or sine-wave frequencies from 20 to 20,000 cps can be produced with the Model TE-209 Audio Generator. Output has a level attenuator, delivers 7 V across a 1-megohm load.



Output impedance is 0-5,000 ohms. Frequency accuracy for the unit is listed at  $\pm 3$  per cent with distortion at less than 2 per cent. The unit comes in a gray wrinkle-finish steel case with a carrying handle and is provided with test leads. \$35.95. Olson Electronics, Inc., 260 S. Forge St., Akron, Ohio 44308.

# Electronic Marketplace

**Versatile . . .** The radio direction finder on the Nova CB receiver can be used as a navigation aid when tuned to radio beacons, broadcast stations and marine-band transmissions. It will tune

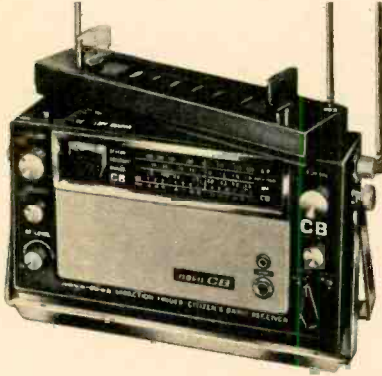

any of the 23 CB channels, the SW band between 1.5 and 4.5 mc or standard AM. With case, mounting bracket, antennas, batteries, miniature earpiece, adaptor cords for external DC or house current. \$149.95. Nova-Tech, Inc., 630 Meyer La., Redondo Beach, Calif. 90277.

**Testing . . .** Available in kit form is a 20,000-ohms-per-volt VOM with a taut-band meter movement. The Knight-Kit KG-640 provides 12 AC voltage ranges to 4,000 volts with another 12 for DC voltages. The eight output voltage ranges go to 400 volts. Resistance scales cen-



ter at 12, 1,200 and 120,000 ohms, with top readings at 10 megohms. There are ten DC current ranges. A range doubler switch is provided, as well as range/function-selector and polarity-reversing switches. Unit requires one C cell, four penlight cells. It is equipped with 48-in. test leads. Kit \$39.95; wired \$59.95. Allied Radio Corp., 100 N. Western Ave., Chicago, Ill. 60680.

March, 1967

PEARCE-SIMPSON'S

## WINNING TWO-WAY RADIO COMBINATION

**FOR MOBILE OPERATION**

The 23 channel DIRECTOR

OR The 11 channel ESCORT II

**AND FOR BASE STATION**

The 23 channel GUARDIAN

Performance matched for peak efficiency, the All Solid State Director or Escort II in your car, truck or tractor teams with the Guardian 23 base station command unit to give you the finest two-way radio communications network in the nation! SEE IT! TRY IT! BUY IT!

**ALL  
SOLID  
STATE  
CB'S**



**DIRECTOR —**

23 Channel CB • \$269.90

(complete with crystals for 23 channels)

**ESCORT II — 11 Channel CB • \$219.90**

(complete with crystals for 6 channels)



**GUARDIAN 23 — 23 Channel CB • \$269.90**

(complete with crystals for 23 channels)

PEARCE-SIMPSON, INC.

EI-367

P.O. BOX 800—Biscayne Annex, Miami, Florida 33152

Please send full information and model specifications on the Director, Escort II and Guardian 23.

Name \_\_\_\_\_

Address \_\_\_\_\_

City \_\_\_\_\_ State \_\_\_\_\_



**PEARCE-SIMPSON, INC.**  
MIAMI, FLORIDA

# ELECTRONIC Swap Shop

Individual readers (no commercial concerns) may swap electronic gear by sending one listing, name and address to Swap Shop, ELECTRONICS ILLUSTRATED, 67 W. 44th St., New York, N.Y. 10036. Space is limited; only most interesting offers are published.

LIONEL electric trains. Want SW receiver or test equipment. John Levy, 1400 Lenna, Mena, Ark. 71953.  
VAN de GRAAF 500 kv generator. Make swap offer. Norman Lederman, 11 Nottinghill Dr., Massapequa, N.Y. 11758.

KNIGHT C-577 audio compressor. Make swap offer. Joe Amiot, KKN4066, 2323 Druid Hills Blvd., Hendersonville, N.C. 28739.

GLOBE Patrol SW receiver. Swap for Knight Star Roamer. Charles Wiley, Rte. 1, Box 92, McIntosh, Ala. 36553.

JOHNSON II signal generator. Will swap for stereo gear. Edward Powers, 349 Kenilworth Rd., Louisville, Ky. 40200.

KNIGHT Span Master SW receiver. Want CB walkie-talkie. Mark Murphrey, Box 202, Sarepta, La. 71071.

AIRCRAFT receiver, CW-46051. Will swap for Heath Twoer or similar VHF gear. Bryan Ferguson, WN50FW, Box 614, Bastrop, Tex. 78602.

STROMBERG-CARLSON transmitter. Swap for test equipment. Mark Benussi, 1940 Rolling Hills Dr., Fullerton, Calif. 92631.

HEATH VTVM. Swap for guitar amplifier. L. Lindenbaum, 10320 Hayward Dr., Silver Spring, Md. 20900.

EMC 212 transistor checker. Want photo equipment. Charles Lamb, 4916 Spring St., Verona, N.Y. 13478.

GENERAL ELECTRIC facsimile transmitter FT-3. Will swap for tape recorder or best offer. George Knakal, 159 Asharoken Ave., Northport, N.Y. 11768.

ANTIQUE radios and parts. Make swap offer. Daniel Tiffany, 36747 Greenbush, Wayne, Mich. 48184.

LAFAYETTE CB transceiver. Will swap for SW receiver. Charles Davis, KMI2852, 6230 Walther Ave., Baltimore, Md. 21206.

HALLICRAFTERS S-120 SW receiver. Want SW or ham equipment. Paul Judkins, 1200 Stuart Rd., Herndon, Va. 22070.

SILVERTONE FM radio. Swap for VHF receiver or best offer. Bob Ashcraft, 3542 N. Utah St., Arlington, Va. 22207.

ASSORTED ELECTRONIC GEAR. Want Heath GR-64 or Knight Star Roamer, John Girard, 223 Marlow Dr., Oakland, Calif. 94600.

KNIGHT Star Roamer. Trade for grid dip meter or best offer. Jim Wilson, 5946 W. Iowa, Denver, Colo. 80200.

LAFAYETTE HA-150 transceiver. Will swap for Hallcrafters CRX-5 or similar. Donald Strickler, 835 S. Curson Ave., Los Angeles, Calif. 90036.

SLOT CAR TRACK. Will swap for amateur radio gear. James Kempf, 557 Ellen St., Hellertown, Pa. 18055.

ELECTRONICS books. Make swap offer. William Cooper, 700 E. Second St., Siler City, N.C. 27344.

KNIGHT Star Roamer. Swap for 2-meter gear. J. C. Gresham, 5799 Redan Rd., Rte. 1, Stone Mountain, Ga. 30083.

ASSORTED PARTS. Swap for antenna rotator. Steve Thurber, 234 E. Glen Ave., Ridgewood, N.Y. 07450.

EMC 208 Tube tester. Swap for EMC 106 VTVM. R. Wendel, 160-20 Grand Central Pkwy., Jamaica, N.Y. 11432.

STECHELL-CARLSON BC-1206-CM receiver. Trade for CB transceiver. Tim Meder, 1615 Wood St., Crete, Ill. 60417.

KNIGHT T-60, other items. Swap for HQ-129X or similar. Brian Harold, 230 N. Fourth St., Lewiston, N.Y. 14092.

SPECIAL AC plugs. Make swap offer. W. Weiler, Huntingdon, Pa. 16652.

ASSORTED TUBES. Other gear. Make swap offer. Tim Higgins, 118 Holliston St., Medway, Mass. 02053.

HALLICRAFTERS S-38 SW receiver. Will swap for

CB transceiver. Pat Bartol, 14 E. Chestnut St., Kulpmont, Pa. 17834.

RCA AR-812 SW receiver. Want CB transceiver. William Rude, 618 North St., Decorah, Ia. 52101.

CRYSTALS, 51.48 & 52.38 mc. Want crystals for any frequency between 50 & 51 mc. Robert Ganshirt, 48 Fletcher Ave., Lexington, Mass. 02173.

SIGNAL GENERATOR 300 to 1000 mc. Will trade for VHF or UHF gear. Bill Eslick, KØVQY, 2607 E. 13th, Wichita, Kan. 67214.

KNIGHT Ocean Hopper. Trade for Knight T-60 transmitter. Dave Frandin, Jr., 3115 44th St., San Diego, Calif. 92105.

FM RADIO. Will swap for SW receiver. James Sullivan, 531 W. 4th St., San Dimas, Calif. 91773.

VOM, pocket size. Swap for VHF receiver. David Barlow, Rte. 8, Box 5, Roanoke, Va. 24014.

PHILCO AM/FM portable radio. Trade for GW-30 transceivers. Fred Haines, 132 Rural Ave., Lewisburg, Pa. 17837.

VOLTAGE TESTER, 110-550 VAC, 125-600 VDC. Make swap offer. Wayne Johnson, 67 Hobart Ave., Bayonne, N.J. 07002.

RCA 19" TV. Swap for Allied R-100A communications receiver. Robert Saccardi, 18 Quail Dr., Brentwood, N.Y. 11717.

RCA CM-2A Mobile FM transmitter. Will swap for tape recorder or ham gear. Paul Hulse, 8801 Mohawk Way, Fair Oaks, Calif. 95628.

ALLIED Ocean Hopper. Want novice transmitter. Hisato Adachi, 13 Gerard Ter., Lexington, Mass. 01054.

HICKOK 560 tube tester. Will swap for CB transmitter. J. Rayden, 3920 Stone Cyn., Sherman Oaks, Calif. 91403.

HEATHKIT GW-21 walkie talkies. Swap for 2- or 6-meter transceiver. John Mazur, Jr., 894 S. Park, Buffalo, N.Y. 14210.

ASSORTED PARTS. Swap for guitar amplifier. Patrick Kelly, 55 Kingsley St., West Orange, N.J. 17052.

ROBINS converter, 155.25 mc. Trade for CB antenna, Lawrence Greenwood, KHCO711, 200 W. 6th St., Kaukauna, Wis. 51430.

HO & S Gauge trains. Want VTVM or best offer. Howie Jacob, 9546 S. Bensley, Chicago, Ill. 60617.

JOHNSON Viking transmitter. Swap for R-100A or similar receiver. Doug Raskin, WB2MDH, 353 N. Wellwood Ave., Lindenhurst, N.Y. 11757.

ASSORTED electronic equipment. Want SW gear. Marianne Epley, 242 S. Monroe, Denver, Colo. 80209.

KNIGHT Star Roamer. Swap for Heath Twoer. Charles Danniells, Jr., WNØNQE, 13 Pauline La., Rolla, Mo. 65401.

LAFAYETTE HE-30. Will swap for Ameco TX-62 transmitter. Richard Preves, WN9QBQ, 721 Raleigh Rd., Glenview, Ill. 60025.

AMERICAN FLYER TRAINS. Want Heath GW-12A CB transceiver. Donald Ratcliff, 3536 W. Gordon, Spring Arbor, Mich. 49283.

ASSORTED parts. Want tape recorder or test equipment. Edward Miccinati, 118 Pinetree Rd., Ithaca, N.Y. 14950.

HEATH STEREO COMPONENTS. Want SW receiver. Fred Philcox, 2953B Vermont, Homestead AFB, Florida.

RECORD CHANGER. Want golf cart. Jeff Barker, 1210 Birch, Richland, Wash. 99352.

TRANSFORMERS. Will trade for Heath Twoer or similar gear. Norm Raymond, WN8TXC, 1620 Annabelle, Ferndale, Mich. 48220.

SAM'S PHOTOFACT radio and TV folders. Swap for tape recorder. Jack Stollman, 259-12 149th Ave., Rosedale, N.Y. 11422.

HEATHKIT RF signal generator. Will swap for VHF receiver or converter. G. Linwood, 1413 Maryland Ave., Havertown, Pa. 19083.

ROCK COLLECTION. Will swap for electronics parts. Dave Harget, 8466 Sheridan Ct., Arvada, Colo. 80002.

ASSORTED ELECTRONICS MAGAZINES. Want 2- or 6-meter receiver. Don Trayes, 341 Miller St., Bangor, Pa. 18013.

ASSORTED TUBES. Make swap offer. Emil Barta, 3508 Harrison Ave., Brookfield, Ill. 60513.

ARMY TENT. Want novice transmitter. James Addler, 543 Natalie, Addison, Ill. 60101.

REGENCY PR-155A SW receiver. Will swap for Heath Twoer or best offer. Frank Penkava, WA4KFF, Rte. 7, Box 302, Lexington, N.C. 27292.

MOTOROLA AM radio. Will trade for Knight Ocean Hopper. Patrick Hardesty, Box 135, Whitesville, Ky. 42378.

FM WIRELESS MICROPHONE. Will swap for an-

tique radio equipment. Larry Rowan, 1800 E. 73rd Ave., Crown Point, Ind. 46307.

HEATH CB transceiver. Want portable TV or best offer. D. Platt, R#1, Cottage Grove, Wis. 53527.

MINIVAC 610 computer. Swap for SSB transceiver. Ronald Fukuhara, KH6FIY, 1312 Eighth Ave., Honolulu, Hawaii 96816.

AURORA racing models. Want 30-50 mc receiver. Daniel Kessler, 662 Barnes Ave., Baldwin, N.Y. 11510. STEREO, 100 watt solid state. Will swap for communications receiver. J. C. Dillon, R#3, Box 474, Lewistown, Pa. 17044.

GLOBE walkie-talkie. Swap for walkie-talkie or best offer. Jan Paulis, 6916 W. Fargo Ave., Niles, Ill. 60648.

KNIGHT Star Roamer. Swap for AM/FM radio or CB transceiver. James Long, Montreal, Mo. 65591.

ADMIRAL TV CHASSIS. Will swap for 100-mw walkie-talkie. Walt Neu, Copeland, Id. 83822.

CRYSTALS, 20 meter. Make swap offer. Avery Finn, KØHLA, 4804 W. 41st St., Minneapolis, Minn. 55416.

KODAK Stormite II camera. Want SW receiver or oscilloscope. Joseph DiVerdi, 160-35 26th Ave., Flushing, N.Y. 11358.

HEATH Q multiplier. Want Hallicrafters SX-130 receiver or similar gear. Francis Higson, 14 Foster Rd., Bedford, Mass. 01730.

WESTINGHOUSE tape recorder. Want CB transceiver. Ernest Damon, 257 Main St., Fairfield, Me. 04937.

NAVY RDZ radio manual. Make swap offer. Bob Archambault, 19273 Hamilton St., South Bend, Ind. 46637.

LAFAYETTE battery recharged. Trade for FM communications receiver or best offer. Michael Kramer, E. Mountain Rd., Hillside Lake, Wappinger Falls, N.Y. 12590.

EICO 753 transceiver and power supply. Make swap offer. John Satterlee, 760 Agate, San Diego, Calif. 92109.

LIONEL trains. Want Knight T-60 receiver. Joe Gensheimer, RD, Hamburg, N.J. 07419.

HICKOK signal generator. Will swap for 150-174-mc receiver or CB transceiver. Martin Gary, 807 Westham Pky., Richmond, Va. 23229.

HEATH AT-1 CW transmitter. Will swap for 6-meter transceiver. Ken Massie, 115 Woodlawn Dr., Ironton, Ohio 45638.

LAFAYETTE HA-130 walkie-talkie. Swap for Allied T-60 transmitter. Alan Todd, Box 562, Upton, Wv. 82730.

ASSORTED radio parts. Need parts for Hallicrafters S38C. William Annala, 1203 MacArthur Ave., Ashland, Wis. 54806.

E-V 664 MIKE, never used. Swap for novice equipment. D. Boule, WN8UCW, 58780 Romeo Plank Rd., Washington, Mich. 48094.

HAMMARLUND HQ-100 crystal calibrator. Want Heath HD-20 crystal calibrator. D. D. Hirst, 202 Birch St., Snyder, Tex. 79549.

HEATH GR-54 SW receiver. Will trade for ham receiver. Howard Gershman, 8433 Williams Ave., Philadelphia, Pa. 19150.

LAFAYETTE HA-60 walkie-talkie. Want National XCU-27 crystal calibrator. Bob Uimer, 53 Meadow La., Bloomfield, N.J. 07003.

NEWCOMB PA amplifier. Want EICO 221 or 232 VTVM. Barry Simpson, 4819 S. Fife St., Tacoma, Wash. 98409.

TRIPLET 630 VOM. Want Lafayette HB-555. Vernon Mulligan, Box 64, Springfield, W. Va. 26763.

KNIGHT R-55A transmitter tubes. Want CB transceiver. Frank Krupansky, WB2VEE, Walkie La., Waretown, N.J. 08758.

B&K 650 tube tester. Will swap for CB transceiver. Don Hoffman, Apt. 10, 1632 Hollenbeck Ave., Sunnyvale, Calif. 94087.

ASSORTED CRYSTALS. Will trade for walkie-talkie. Frank Wales, 9625 N. Central Ave., Phoenix, Ariz. 85000.

CAR RADIO, TV accessories. Need 4-band SW receiver. Ken Kelly, 16 E. Hilltop Rd., West Chester, Pa. 19380.

KNIGHT Span Master. Swap for record changer. Joe Renauer, 1147 W. Ann Arbor Tr., Plymouth, Mich. 48170.

LAFAYETTE 4-band SW receiver. Will swap for 5 in. oscilloscope. Bill Sherrick, 423 San Juan Dr., St. Charles, Mo. 63301.

EICO MULTIMETER, other test gear. Make an offer. J. R. Trone, RR 2, Box L 39, Durango, Colo. 81301.

ASSORTED CRYSTALS. Will swap for Drake 2B crystals. Nick Fiorentino, Jr., 60-B Newark Way, Maplewood, N.J. 07040.

# NOW

FROM



## A Complete Automotive and Ignition Tune-Up System



### MARK TEN

Capacitive Discharge Ignition System

\$44<sup>95</sup> Assembled

\$29<sup>95</sup> Kit Form

Get mileage you never dreamed of! 3 to 10 times spark plug life. Instant starts in all weather. Installs in only 10 minutes. Up to 20% gas savings. Dramatic increase in engine performance and acceleration.

## 2 NEW AUTO TUNE UP INSTRUMENTS



**DWELL**  
METER  
\$12.95  
Ppd.



**TACH**  
METER  
\$14.95  
Ppd.

These two new cousins to the world famous proven-MARK TEN now give you the capability to tune your own car inexpensively, easily, with remarkable precision. These separate instruments are low cost, portable and the easiest to read you've ever seen.

- Delta's famous printed circuit design
- Superior in precision, quality and performance to instruments selling for FIVE TIMES as much
- Large dial, high quality jewel D'Arsonval meters
- Operates with standard transistor or capacitive discharge systems as well as magnetos
- Instant readings — no confusing scales

Send Your Order Today



## DELTA PRODUCTS, INC.

P.O. Box 1147E • Grand Junction, Colo.

Enclosed is \$ \_\_\_\_\_ Ship prepaid.

Ship C.O.D.

Please send:

Dwell Meters @ \$12.95

Tach Meters @ \$14.95

Mark Tens (Assembled) @ \$44.95

Mark Tens (Delta Kit) @ \$29.95

(12 volt positive or negative ground only)

SPECIFY —  Positive  Negative

6 or  12 volt

Car Year \_\_\_\_\_ Make \_\_\_\_\_

Name \_\_\_\_\_

Address \_\_\_\_\_

City/State \_\_\_\_\_ Zip \_\_\_\_\_

DP 6-12



Some plain talk from Kodak about tape:

## The big squeeze— Multitrack Stereo

Remember the college fad a few years back—how many brawny brutes could be squeezed into a little car built for plain folks? For a while, it looked like a somewhat similar situation was about to take place in the tape-recording field—first monaural, then 2-track, then 4-track, and now even 8-track recording. Even though these developments continue at a fast clip, 4-track stereo is still the name of the game as far as high-fidelity applications are concerned. And very nice it sounds, too, thanks to the precision built

Thus, to make the most of what you can record, you need a tape with a high-powered oxide layer—one that's going to give you a high output with a good signal-to-noise ratio.

KODAK Sound Recording Tape, Type 34A, fills the bill—gives you 125% more undistorted output than conventional general-purpose tapes. You get practically the same per-channel output on 4-track stereo with Type 34A that the other tapes would give you on 2-track! But there's more to recommend Kodak tape.

signals completely, even pick up the signals on the tracks going the other way. Horrors! Lucky for you, you have nothing to worry about with Kodak tapes. We keep our tolerance to .001 inches. That's twice as close as industry standards. To make your life even easier, we also backprint all our tapes so you can always tell whether a reel has been wound "head" or "tail" first. Just note

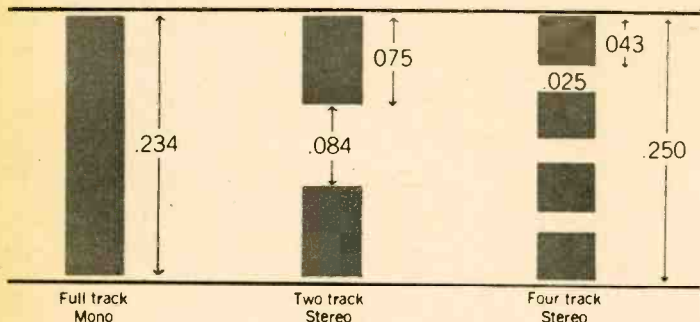

into modern heads. But you do have to watch yourself. Having double the information on a given length of tape means everything has to be just so—including the tape you use.

**4-track star.** The first thing to worry about in considering a tape for 4-track stereo is output. As you see in the chart above, adequate separation must be maintained between each track to prevent cross-talk. And as the actual width of the recorded tracks drops down, the output per channel on the tape drops in proportion.

### Staying on the right track.

Because everything gets smaller in proportion when you go to 4-track, dimensional precision becomes that much more important. Take a tape that suffers from a case of drunken slitting. (That's when the edges of the tape snake back and forth even though the width is constant.) It's not hard to see how this tape isn't going to "track" straight past the head. A slight case of this and you get alternating fluctuations in output on both channels. If the condition is bad enough, a poorly slit tape can cause your heads to drop out the

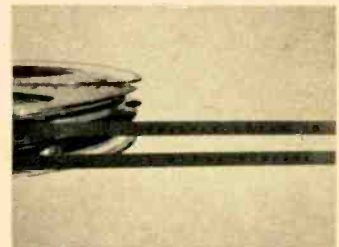

which comes first off the supply reel, the "E" of "EASTMAN" or the "O" of "CO"... and note it on the reel.

Kodak tapes—on DUROL and Polyester Bases—are available at most electronic, camera, and department stores. To get the most out of your system, send for free, 24-page "Plain Talk" booklet which covers the major aspects of tape performance.



EASTMAN KODAK COMPANY, Rochester, N.Y.



**T**HEY may laugh when you sit down at your pint-size bongos. But when you give them an earful of the wild, authentic sounds they produce, they'll gasp in amazement and grasp their bar stools firmly.

It's amazing what can be done electronically nowadays. Would you believe the percussive sounds of bongos, tom-toms, a bass drum, wood blocks, gongs and claves? It's a fact, and the next time the party's music needs more beat, bring out your miniature electronic bongo set. Used in conjunction with any amplifier, the electronic bongo set will produce the sound of practically any percussive instrument at a cost of about \$3 per instrument.

**And Now...**

# ELECTRONIC BONGOS!!!

By FRED B. MAYNARD



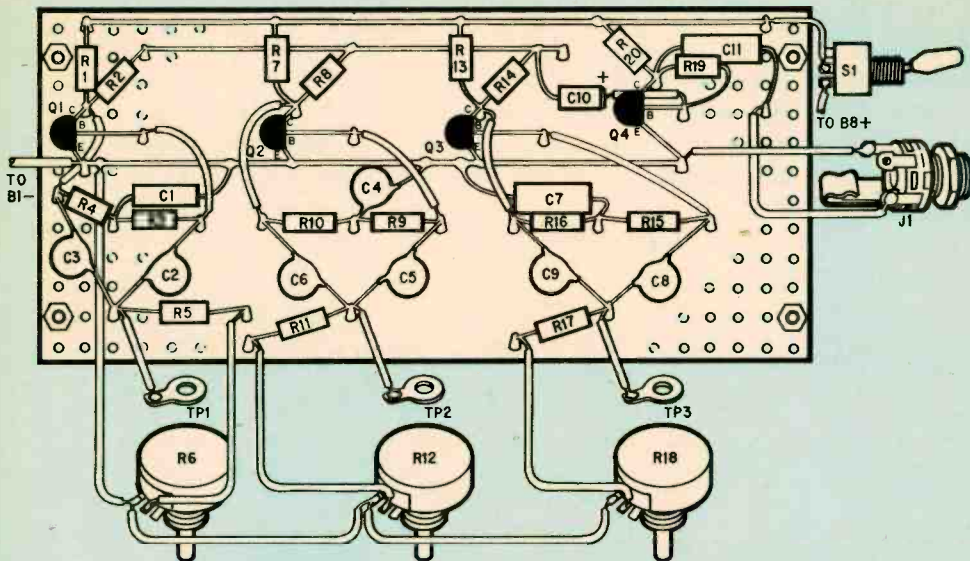

Fig. 1—Our model was built on a 3 x 7-in. piece of perforated board which allowed plenty of space for all parts. Components can be mounted more tightly if you plan to add extra oscillators. If needed, connect hand-clip lead to B1—buss. The lugs marked TP1, TP2, TP3 go to the touch plates.

## ELECTRONIC BONGOS!!!

The sounds are produced with electronic ringing circuits. A ringing circuit is simply an oscillator which is adjusted so it does not run continuously. However, when triggered, or shocked, by a transient, it will break into a short-term oscillation. The bongo set we show here uses three inexpensive, simple twin-T oscillators. If you want additional percussive sounds, simply keep on adding oscillator circuits.

Each oscillator is shocked into oscillation when you touch a sensitive part of its circuit. The actual shock comes from body potential picked up from stray AC fields in the room. Each oscillator can easily be adjusted for best sound with a potentiometer.

There's a possibility that when you tap a touch plate a sound won't be produced. Reason for this is that there may not be enough stray AC around.

The solution is simple. Connect a three or four-ft. length of wire to the negative buss. This is shown in the schematic. It is not shown in the pictorial, but is the wire to which the negative battery lead is connected.

Connect the other end of this lead, on

which you should attach a small alligator clip, to *you*. The simplest place is to a wrist-watch band. Or, you could hold it between your thumb and third finger. You would naturally use your second, or index, finger to strike the bongo.

### How It Works

The circuit shown in Fig. 3 produces sounds of tom-toms, high-pitched bongos and low-pitched bongos. It consists of three twin-T oscillators—associated with transistors Q1, Q2 and Q3. Transistor Q4 is a preamp whose output is coupled by C11 to output jack J1. You connect the output of the high-level input of any amplifier—the larger the better.

Look at the circuit associated with Q1. Resistor R1 is the collector load resistor. Resistor R3, R4 and C1, constitute one of the T-network branches. Components C2, C3, R5 and R6 constitute another T-network branch in parallel with the first branch.

When the values of the resistors and capacitors in the twin-T network are proportioned properly, the circuit will operate as a free-running oscillator or as a ringing circuit, depending on the resistance of R6.

Each oscillator's output, taken from the collector side of the T-network, is fed to a

Fig. 2—Inside view of our model. Notice how wide-open the board is. Potentiometers R6, R12 and R18 are installed in top of cabinet directly behind each bongo. The lug under each pot connects to the wire from the touch plate on top of each bongo.

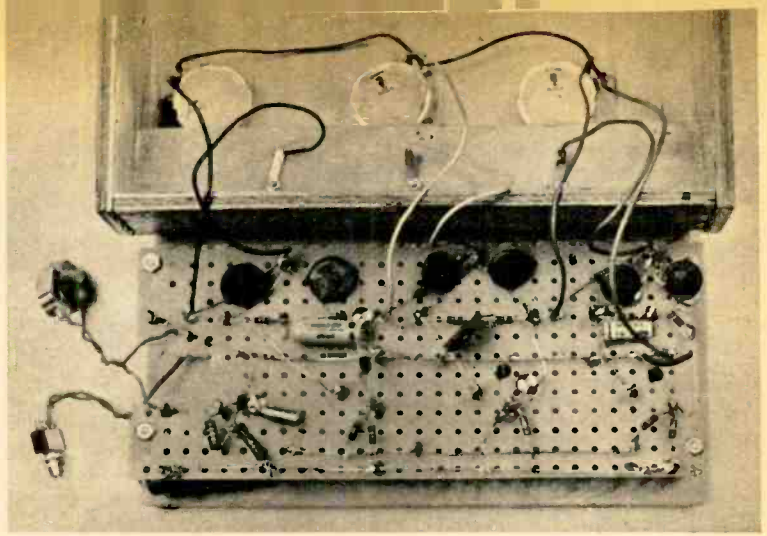

common line through resistors R2, R8, R14 then through C10 to Q4. Transistor Q4 amplifies the signal and feeds it to output jack J1.

Resistor values are the same from one oscillator to the next. Different frequencies are obtained by using different-value capacitors. The capacitor values in our Parts List

will produce tones for a tom-tom, low-pitched bongo and high-pitched bongo.

Other tones can be obtained. For bass drums, use larger capacitors. For higher-pitched bongos, wood blocks and claves, etc. use smaller capacitors.

You may try out or add any of these other sounds with other capacitors. When you add

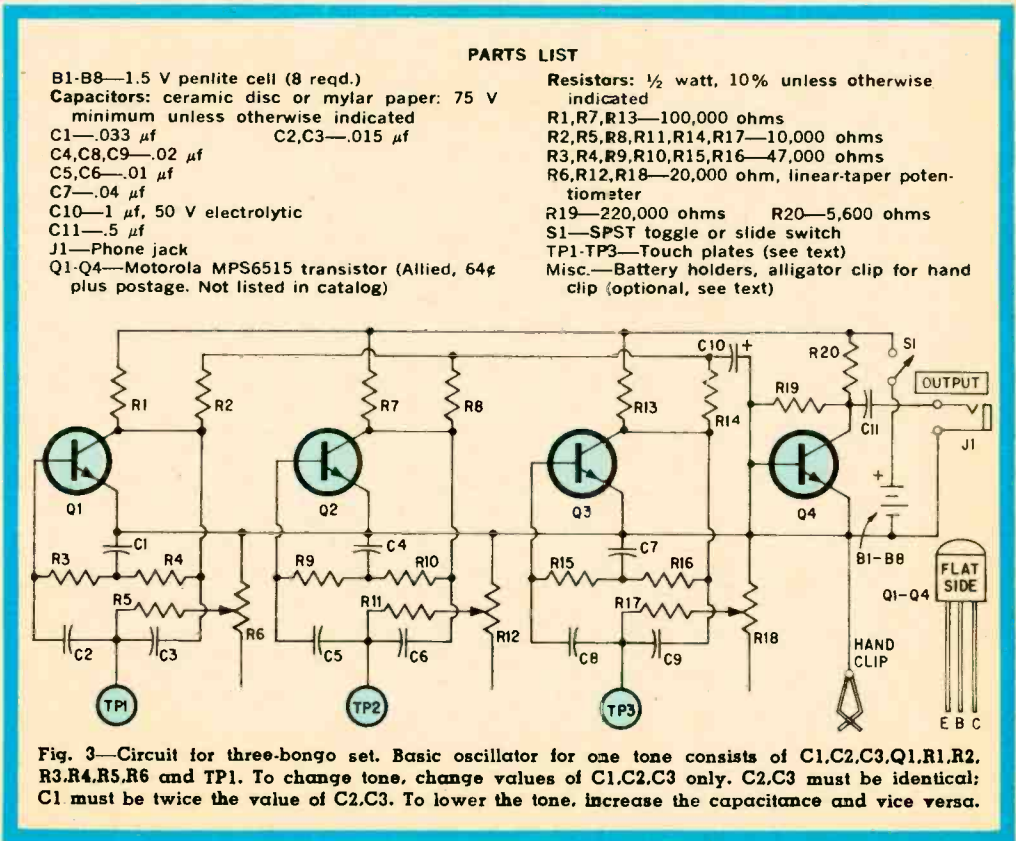

# ELECTRONIC BONGOS!!!

on another oscillator circuit, always remember that (using oscillator Q1 as an example) C2 and C3 must always be equal, and C1 must always be twice the value of either. If the capacitor values are cut in half, the frequency *increases* approximately one octave, and vice versa.

## Construction

You may use any type of construction you prefer; it is not critical. We built our bongo's circuit on a 3 x 7-in. piece of perforated circuit board. Not mounted on the board are the batteries, the three control pots (R6, R12, R18), battery switch S1, output jack J1 and touch plates TP1, TP2 and TP3.

A good-looking cabinet is shown in Fig. 5. You can get a better idea of what it looks like on our cover and on the first page of this article. Made of 1/2-in. walnut, it has a front step on which are mounted the three miniature bongos. On top of each bongo is a touch plate—a 1 1/2-in.-dia. metal disc.

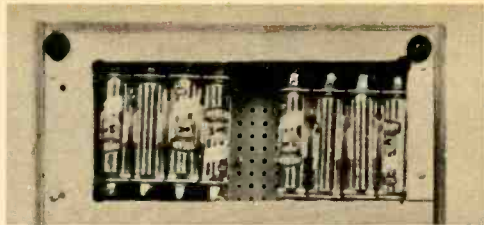
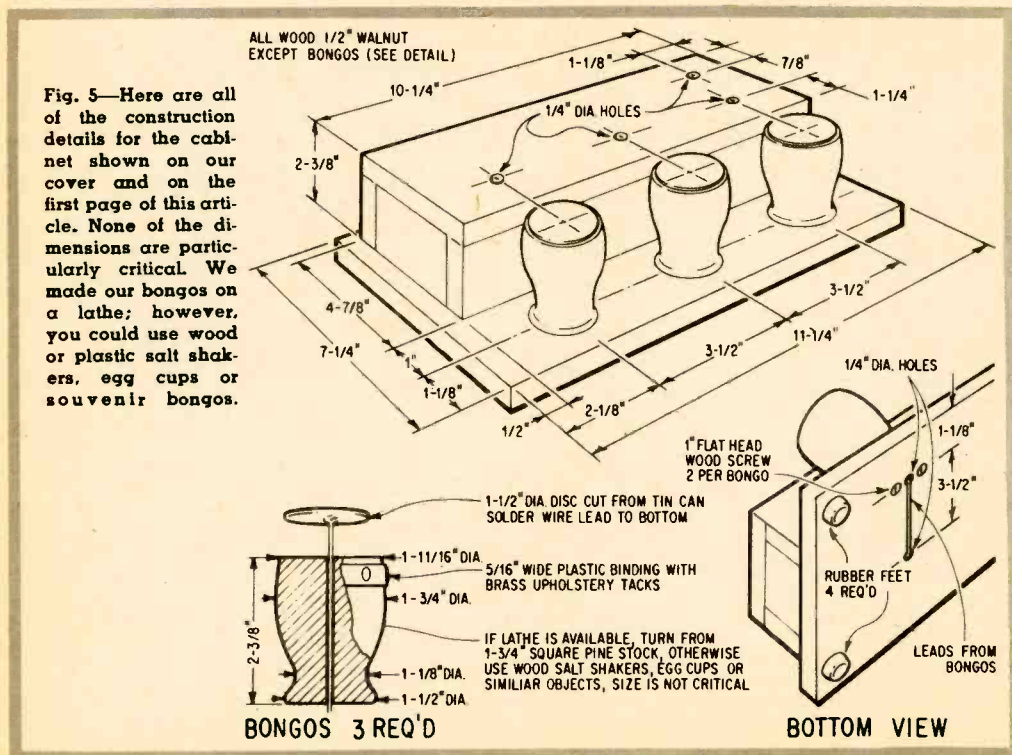

Fig. 4—Underside of our bongo set. Notice how eight penlite cells are mounted in two battery holders. If desired, you could use a 12-V battery.

Adjustment of pots R6, R12 and R18 is very simple and should be made from time to time because of drift due to voltage or temperature changes. Connect the output to an amplifier or earphones. Turn all the pots to their maximum-resistance position (full counterclockwise). One at a time turn each pot clockwise until oscillation starts. Then turn the pot counterclockwise until the oscillation just stops. Tap a touch plate quickly and you'll hear percussion-like sound.



# the ABCs of COLOR TV

By JOHN T. FRYE, W9EGV

## PART 2: COLORIMETRY

**T**HE aim of color TV is as easy to state as it is difficult to achieve—to reproduce faithfully the appearance of things as we see them in nature. That means it must concern itself with light, color, and human vision.

There is no point in trying to discuss color until we first understand light, for without light there is no color. Cervantes, in the 16th century, observed, "In the night all cats are gray." Stand in your garden on a dark night and notice how the green grass, the brightest flowers, and even the white sidewalk are merely shades of gray.

Light is one of the many forms of radiant energy, energy that travels by means of electromagnetic waves. The radiant energy spectrum from very low frequency radio waves (VLF) to cosmic rays is shown in Fig. II-1. Notice that they are arranged in order of frequency like a radio dial. But as the frequency increases, wavelength decreases. Wavelength in the higher frequencies is measured in millimicrons. A millimicron is one millionth of a millimeter (or about 0.000,000,039 in.) long. Visible light occupies the spectrum from 400 to 700 millimicrons.

Light can be *refracted*, or bent, when it passes from one medium, such as air, into some other medium, such as glass or water. The angle at which the light ray is bent varies slightly with the wavelength of the light. In Fig. II-2 a beam of white light is passed through a diffracting prism and made to fall on a screen.

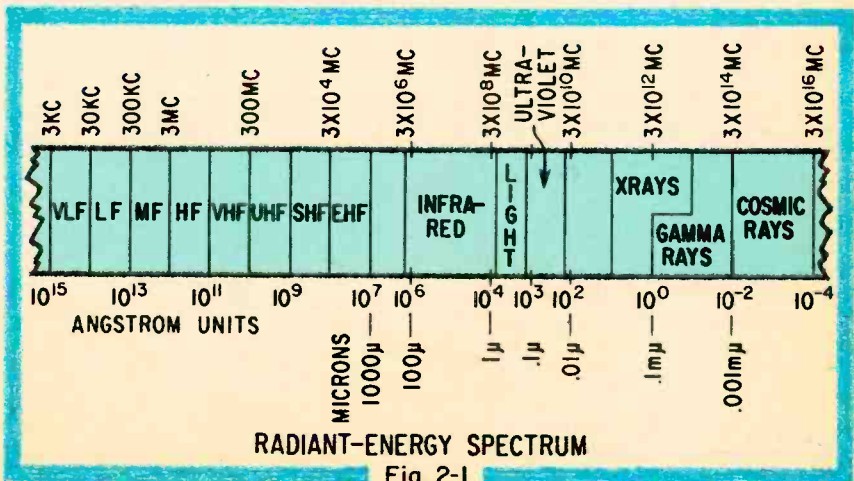

Fig. 2-1

Since white light comprises a mixture of various wavelengths, each is bent at a different angle, separating them into a multi-colored display like a rainbow.

The prism demonstrates that white light is actually a mixture of red, orange, yellow, green, blue and violet light. It also demonstrates how each color passes gradually into the next so that the theoretical number of colors is infinite. At least 125 can be identified over the visible spectrum.

Each one could be specified in terms of its particular wavelength, shown here in decreasing order as in Fig. II-1.

Now let's dissect a single color into its basic characteristics. The first characteristic is *hue*. Hue is what the layman means when he speaks of a color as being red, yellow, blue, etc. From the prism experiment we can see that it is actually a matter of wavelength. Next there is *saturation* or *chroma*. We recognize different shades of red varying all the way from crimson (high saturation) to dusty rose (low saturation). Saturation is purity, or freedom from grayishness. If our red is completely free of gray it is 100 per cent saturated.

Finally there is *brightness* or *luminance*. This is the overall intensity of the light given off by an object—whatever its color. Brightness would be the characteristic difference, for instance, between a pink and a deep red of similar saturation.

Possibly the best way to visualize these three characteristics as applied to any color is to picture the color solid shown in Fig. II-3. In this cylinder, hues are arranged around the circumference in order of their wavelength, with the red end of the spectrum joined to the violet end. Saturated hues are on the sides of the cylinder; zero saturation is at the center axis. The saturation of any color is determined by its position on a straight line connecting the saturated rim color with the desaturated center. The nearer the color is to the outside, curved surface, the greater is its saturation. Brightness is a function of vertical position. As a color sinks down through the solid, it gradually loses brightness. Along the center axis, white at the top goes through shades of gray to black at the bottom of the solid.

The trichromatic theory of color perception holds that each of the color-sensing elements in the retina (which is for the eye what film is for a camera) is terminated in three receptors each of which re-

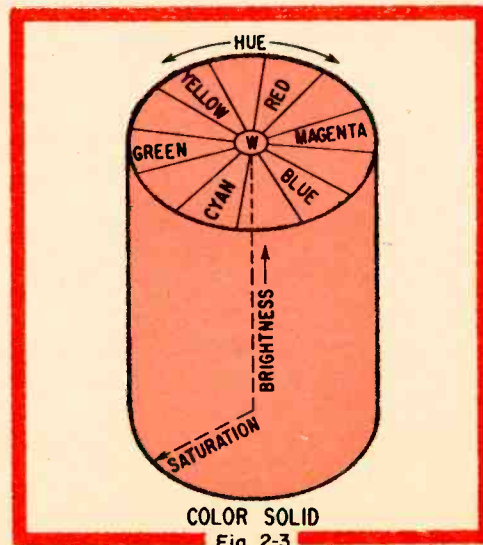
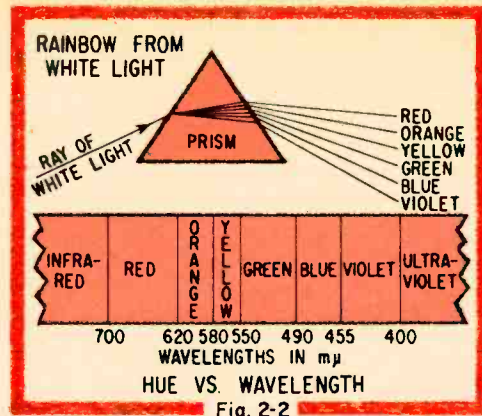

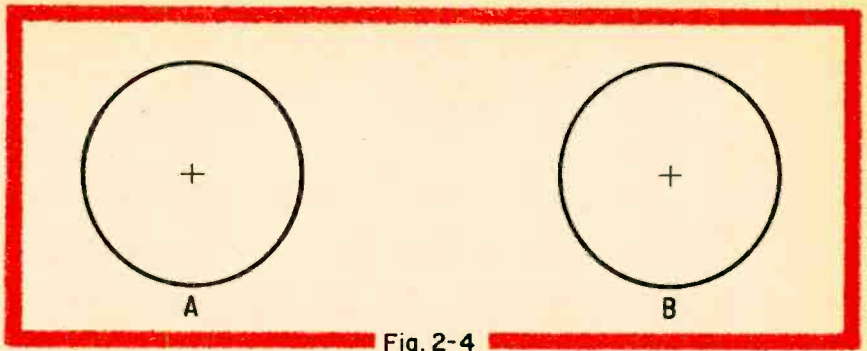

Fig. 2-4

sponds to a different portion of the visible spectrum, with respective peaks in the red, blue and green regions. The brain automatically analyzes the relative sensations from the three receptors into the sensation of color.

A simple experiment demonstrates this theory. Snitch one of your kid's deep yellow crayons and color circle A of Fig. II-4 with it. Now stare at the center of this circle for a full 30 unwavering seconds. The yellow, reflecting wavelengths to which red and green (but not blue) receptors are sensitive, will overexpose and desensitize those receptors.

Now suddenly shift your gaze to the center of circle B. For a moment this circle will be filled with a pale blue color as the non-desensitized blue receptors in the affected area of your retina respond to the blue component of the white light. Then the dulled receptors will recover and the blue tint will disappear.

You probably are already familiar with the process of mixing paint primaries to produce a desired shade, but there you are working with *subtractive primaries* and *reflected light*. In color TV we shall be working with *additive primaries* and *direct light*. Let's get the difference straight.

Suppose you are back in that dark garden staring at the shadowy outline of a rose. Suddenly a white spotlight shines on the rose, and it glows a brilliant crimson. Where does the color come from? You did not see the red in the dark. Did the light do something to the flower to make it red?

No, the flower did something to the light. That red rose has the ability to absorb, and so subtract, all the colors in the white light except red. So, when we mix paints together, we combine their individual abilities to absorb various

wavelengths (or hues) making up white light. The unabsorbed remainder is reflected and determines the color we see. If all the light is absorbed we see the object as black; if none is absorbed it appears white.

Light from the fluorescing phosphor of a TV screen, however, comes directly to our eyes. Its hue is determined by the phosphor that generates it. To study the mixing action of colored lights, we can shine tinted spotlights on a white screen that will reflect to our eyes all light, independent of hue (Fig. II-5).

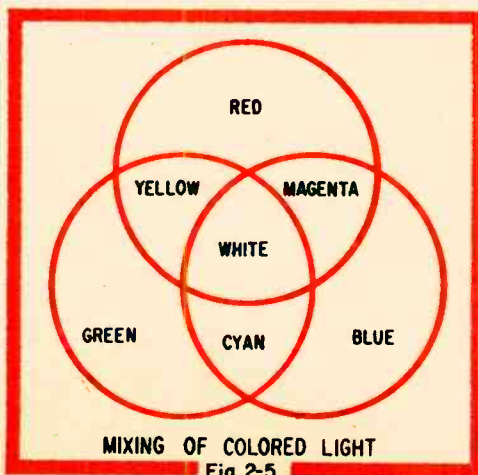

Fig. 2-5

Where red and green overlap—and so add together—the screen appears yellow. The red and blue combination produces a violet-red called *magenta*. Blue and green added together result in greenish-blue *cyan*. Where all three colors overlap and add together, we have white light. By dimming or brightening our individual spotlights we can make practically any color we want.

When all three spotlights are adjusted to produce perfectly white light where they overlap, we find that of the total brightness of our white, the green spotlight will contribute 50 per cent, red 30 per cent, and blue 11 per cent. Remember these percentages. They are explained by the graph of Fig. II-6, which reveals that the eye does not respond equally to different colors. It is most sensitive to 555 millimicrons, a greenish-yellow color, and is much less sensitive to blue or red.

As a color-detector, the eye has certain weaknesses on which we can capitalize. For example, viewing various-sized bits of different-colored paper side by side from varying distances will show that it is increasingly difficult to differentiate between hues as the color areas are reduced in size or are seen from farther away. Greens and blues look alike; browns are confused with crimson; and only reds remain distinct from blue-greens. This leads to the conclusion that in small color areas only two primaries, instead of three, are necessary to produce any recognizable hue.

If color areas are made still smaller, we find that the eye loses altogether its ability to distinguish color and sees only different degrees of brightness. When color areas are made small enough and are close enough to each other they need not actually overlap to be mixed together. Since the eye cannot resolve them, it adds them.

In 1931 the Commission Internationale de L'Eclairage (CIE) adopted standards for the specification of color. Light energy required for each primary color in the matching of spectral colors by many different observers were measured, recorded, and averaged. These average amounts, called the *tristimulus values*, are shown for the entire visible spectrum on the *color-mixture curves* of Fig. II-7. Each of these curves, therefore, represent average sensitivity of the red, blue and green receptors of the retina to all wavelengths.

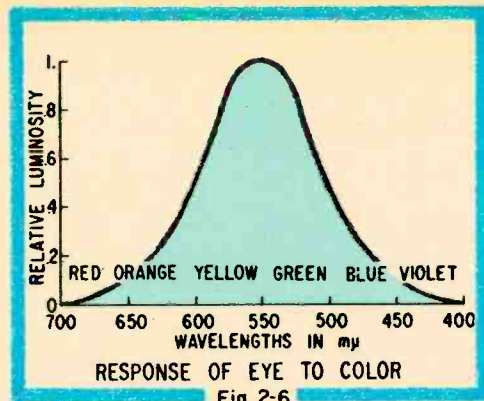

Fig. 2-6

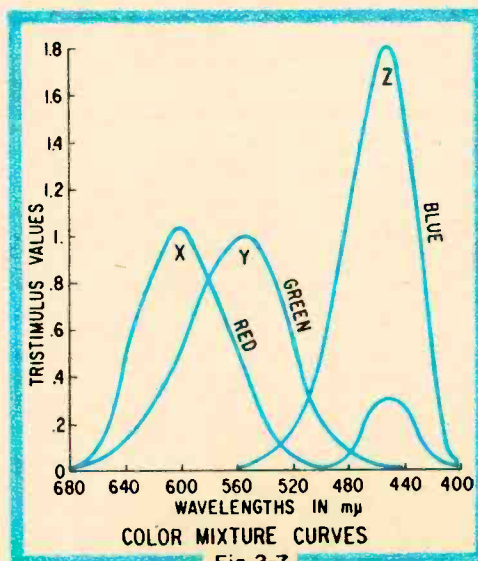

Fig. 2-7



These curves, while a necessary beginning, are of little practical value in themselves because they do not provide information necessary for matching de-saturated colors. But through the following mathematical equations information from the curves can be converted to a three-dimensional representation of hue:

$$X = \frac{x}{x + y + z}$$

$$Y = \frac{y}{x + y + z}$$

$$Z = \frac{z}{x + y + z}$$

The  $x$ ,  $y$ , and  $z$  are respective values on the red, green and blue mixture curves for a specified wavelength. For example, a color of 480 millimicrons yields

values of  $x = 0.1$ ,  $y = 0.15$ ,  $z = 0.78$ . Substituting these values in the equations gives:  $X = 0.097$ ,  $Y = 0.146$ ,  $Z = 0.757$ . This can be done for all color wavelengths and the results plotted on the three-dimensional graph of Fig. II-8, called the *Maxwell Triangle*.

Notice that the values found for  $X$ ,  $Y$  and  $Z$  in the preceding paragraph total 1. In fact, the sum of any set of values for  $X$ ,  $Y$ , and  $Z$  will always total 1 because the equations were purposely designed to accomplish this. A little reflection will show that we can always get the value of the one primary by subtracting the sum of the other two from 1.

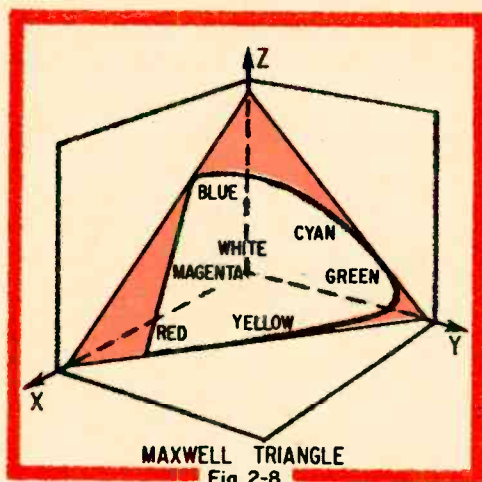

Therefore all values derived from the equations will lie in the plane that would be expressed mathematically by the equation  $X + Y + Z = 1$  (the triangle in Figure II-7). If you plot on the three-dimensional graph the values for all wavelengths from the color mixture curves, you will find that they all lie along the closed horseshoe curve inside the triangle. If we look down on this curve from above, along the  $Z$ -axis, we will see the two-dimensional graph called the *CIE Chromaticity Diagram* (Fig. II-9). Since we are sighting along the  $Z$ -axis, it will be seen as a single point at the intersection of the  $X$ -axis and the  $Y$ -axis.

The horseshoe-shaped curve, called the *spectrum locus*, is marked with the wavelengths of saturated spectral colors lying along this curve. Any point not on the curve but lying inside the diagram can be defined as a mixture of spectral colors. White, being such a color, lies at point E. Points on the curve are 100 per cent saturated; point E is zero per cent saturated; so any degree of saturation of a particular hue can be represented by a point on a straight line from the wavelength of that hue to E.

Point B represents the color of the blue phosphor in a color TV tube. Likewise, G and R represent the green and red phosphors. Therefore, triangle BGR encloses all the colors that can be produced using the blue, green, and red primaries of color TV. This seems to be a much smaller gamut of color than ideal primaries might produce, but actually color TV has a wider range of color than can be reproduced with modern printing inks. And colors outside the

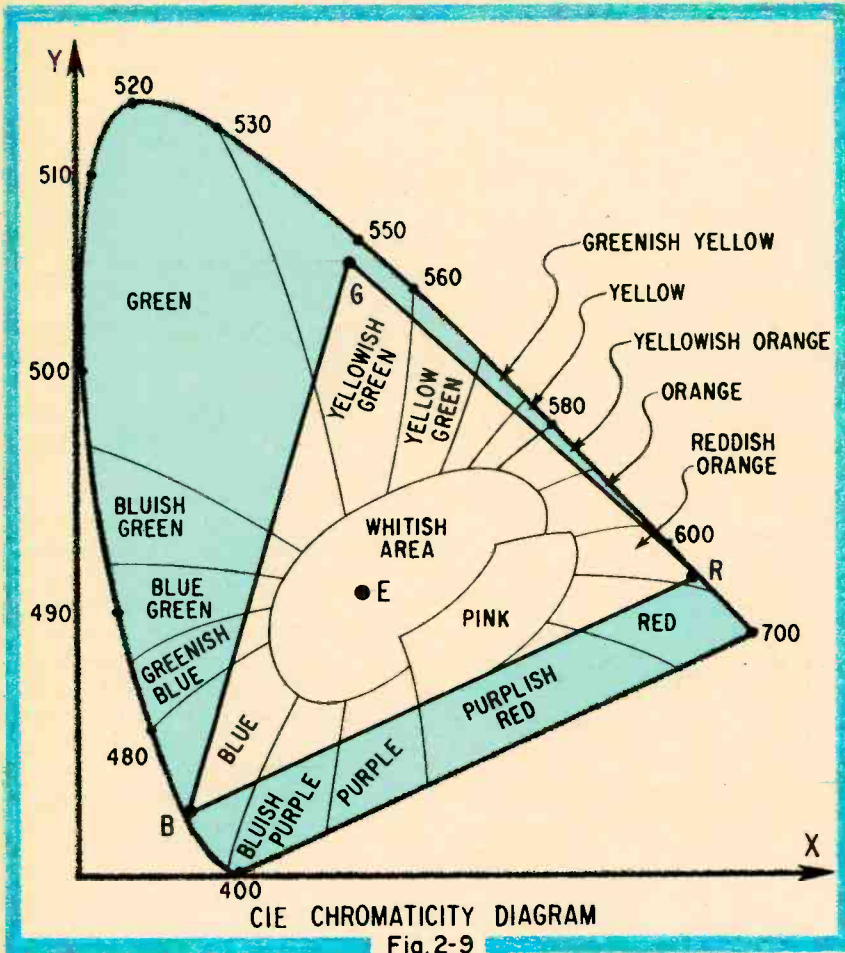

triangle are rarely seen in nature, making it unnecessary to reproduce them for a natural-looking picture of the great majority of subjects.

This CIE Diagram, the carpenter's square of the color worker, contains much more information than we can describe here. But let us review what we have learned about color.

1. Any color can be specified in terms of hue, saturation and brightness.
2. Practically any color can be reproduced by adding together proper proportions of red, green, and blue light.
3. Smaller colored areas can be matched by combining only two primaries.
4. For very small areas the eye is color-blind and sees only brightness.
5. Very small color areas close together are mixed in the eye.

In Part III we shall see how all this information is put to use in creating that miracle of modern science, the color picture tube. If you would like to read about a device that has all the complexity of a Rube Goldberg machine but that works surprisingly well, don't miss it!

**NEXT ISSUE: THE COLOR TUBE**

# Let I.C.S. equip you for success in radio-TV-electronics—

with professional equipment!



Brand-new "Electronic Laboratory," now being offered for the first time, can help you land in this big money-making field—FAST!

Here's an opportunity for you to turn spare time into cold cash, or begin a whole new career—in a field where the rewards have never been greater. And you *don't* need previous experience to do it!

International Correspondence Schools has just developed a new I.C.S. Electronic Laboratory you can construct in your own home. Includes series of training kits, plus the new I.C.S. VTVM—the professional quality vacuum tube voltmeter shown here. With it comes complete course instruction combining all the fundamentals with practical knowledge you can apply at once. And best of all, you build your own professional test instrument!

**I.C.S. instruction gets you going with equipment you can really use!**

A famous manufacturer of nationally known electronic testing equipment worked closely with I.C.S. to develop the Electronic Laboratory and the VTVM itself. Everything you get is geared to increase your skill and knowledge step by step. Until finally, you've completed a precision testing

unit you can use for practically any kind of experimentation, design or servicing work.

Here's how I.C.S. instruction works. You begin with basic study lessons. Texts are clearly worded and easy to follow. At the same time, you "act out" what you learn with simple experiments. Then, in 3 easy stages, you assemble your own precision testing unit. Throughout, your instructor gives you expert, professional help. You learn at home, in spare time, as fast as ability permits.

**Coupon brings full details on your future in this fast-growing field!**

Make up your mind right now to find out how I.C.S. training in Radio-TV-Electronics can pay off for *you*. See how it can help you cash in on the tremendous demand for men skilled in installation, maintenance and servicing of radios, TV sets, hi-fis, computers, automation systems and a host of other space-age devices. Clip and mail the coupon below. You'll receive 3 valuable *free* booklets—including sample lesson. They'll show how you can land in this big-money field *fast!*

**Coupon brings 3 valuable FREE booklets. MAIL IT TODAY!**

## INTERNATIONAL CORRESPONDENCE SCHOOLS I C S

Dept. 34035A, Scranton, Penna. 18515

(In Hawaii: P.O. Box 418, Honolulu. In Canada: I.C.S. Canadian, Ltd. In other countries: I.C.S. World, Ltd.)

Please rush me your new 64-page booklet "ElectronICS" which answers the most often-asked questions about preparing for an electronics career. Also send me "How to Succeed," and a sample I.C.S. lesson. I have indicated my field of interest below.

- |   |   |   |   |   |
|---|---|---|---|---|
| <input type="checkbox"/> Electronic Fundamentals    | <input type="checkbox"/> Hi-Fi/Stereo & Sound Systems | <input type="checkbox"/> Electronic Principles for Automation | <input type="checkbox"/> Industrial Electronics Engineering | <input type="checkbox"/> Industrial Electronics Telephone |
| <input type="checkbox"/> Electronic Instrumentation | <input type="checkbox"/> General Electronics          | <input type="checkbox"/> Semiconductor-Transistor Circuits    | <input type="checkbox"/> FCC Radiotelephone Licenses        | <input type="checkbox"/> Other (please specify) _____     |
| <input type="checkbox"/> Computer Fundamentals      | <input type="checkbox"/> Electronics Technician       |   |   |   |
| <input type="checkbox"/> Radio-TV Servicing         |   |   |   |   |

Name \_\_\_\_\_ Age \_\_\_\_\_

Address \_\_\_\_\_

City \_\_\_\_\_ State \_\_\_\_\_ Zip Code \_\_\_\_\_

Occupation \_\_\_\_\_ Employed by \_\_\_\_\_

Working Hours \_\_\_\_\_ A.M. to \_\_\_\_\_ P.M. Convenient payment plan \_\_\_\_\_ Training Programs for Industry \_\_\_\_\_

I am a member of U.S. Armed Forces. Send me facts about special low rates.

# FOR SUPER TV TRY A RHOMBIC ANTENNA

By  
DAVID WALKER

**Y**OU way out there in TV's fringes! Is your picture filled with snow? Or, maybe that's all you can get on several channels on which your neighbor gets good pictures.

If you're about to go back to listening to the radio, we have a way of snagging those weak TV signals without making you spend a lot of money for one of those giant, ugly super-skyhooks. Our antenna is a rhombic. All it takes to make one is about 150 ft. of copper wire, four insulators, and a resistor.

Shaped like a diamond, the rhombic is one of the best-known yet least-used antennas. The reason is real estate. Although it can provide a sizzling signal, it needs space in which to do it. A rhombic antenna can sock the receiver with a signal some 15db stronger than that from an ordinary dipole. And it does it over most of the band without retuning.

The rhombic's high gain may be just the thing to clear up snowy images, or snare a channel beamed to another city. The antenna is nothing more than wire in the shape of a diamond, or double-V, pattern supported at its four corners.

Here's what to consider before stringing one up. Since available space may be a limitation, we have plans for two basic types.

One, an all-band design, covers channels 2 through 13. The other is a high-band job for channels 7 through 13. The one to choose depends on available space and the reception you're now getting.

If your present TV antenna pulls in channels 2 through 6 without snow, but the high channels are weak, the high-channel rhombic is your best bet. It needs only an area of about  $32 \times 12$  ft. Its low-channel performance will produce somewhat less signal than a conventional TV antenna.

Channels 7 through 13, however, will be given a big boost. In our location (50 miles northeast of New York City) the high-channel rhombic completely cleaned up poor pictures on channels 7, 9, 11 and 13. If low-channel reception is your problem and you've got a  $64 \times 24$  ft. antenna site, the all-channel rhombic is the one to build.

There's some juggling you can do with these dimensions. Since the rhombic is directional, non-resonant and relatively wideband, you can select intermediate dimensions. Gain will vary according to length. The two sizes described, however, represent practical examples for TV reception. If made longer, the antenna's performance becomes critical and

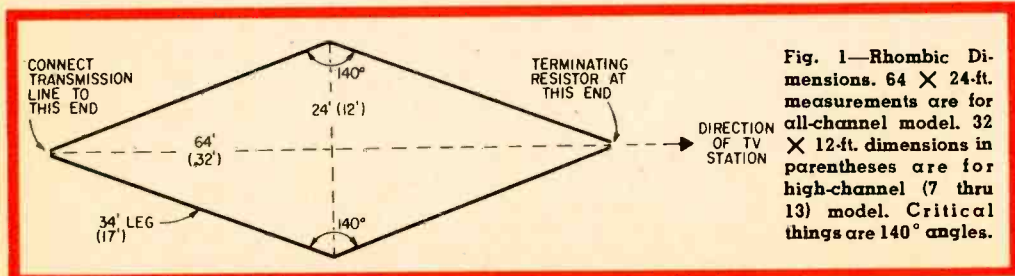

Fig. 1—Rhombic Dimensions.  $64 \times 24$ -ft. measurements are for all-channel model.  $32 \times 12$ -ft. dimensions in parentheses are for high-channel (7 thru 13) model. Critical things are  $140^\circ$  angles.

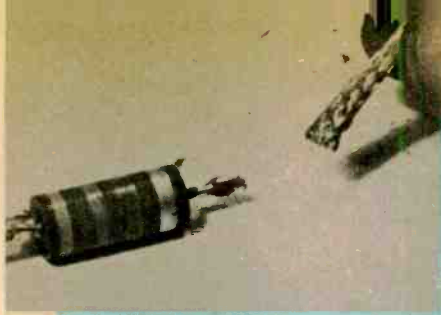
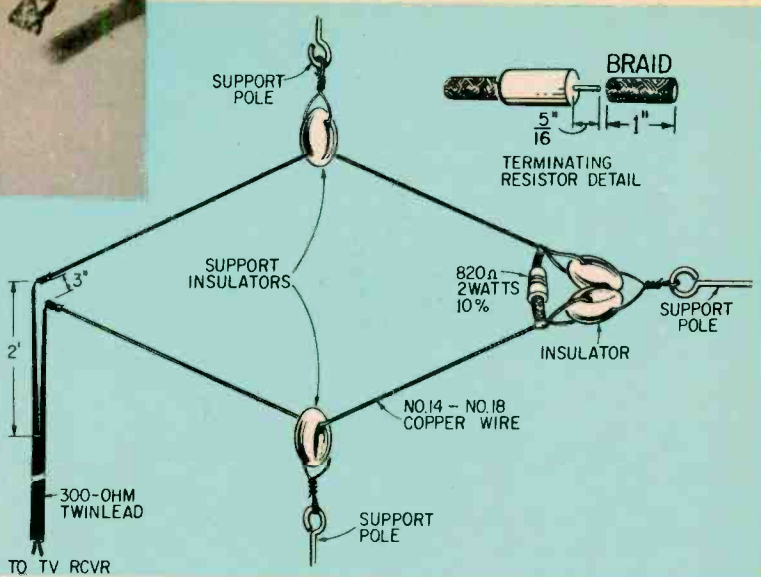

Fig. 2—Photo above shows how braid from coax is connected to 800-ohm, 2-watt carbon resistor. Diagram at right shows all construction details. Hooks at insulators go into poles, trees or the attic's beams.



the pickup pattern gets extremely narrow.

Shorter dimensions make a conventional TV antenna the more practical choice. It's also possible to use a high-channel rhombic to favor a certain direction and a regular TV antenna for other channels. A knife switch installed at the TV receiver will let you select either antenna.

Despite its simplicity, a rhombic requires careful construction and installation to get the correct angles and layout. The antenna (shown in Fig. 1) consists of four equal-length legs. Dimensions are given for both all-channel and high-channel models (the lat-

ter's dimensions are enclosed in parentheses).

Note that a terminating resistor is installed at one end; this is the end to be aimed to the TV station. At the opposite end you connect the TV transmission line. An important dimension, and one that remains the same for both models, is the 140° angle. But you won't have to hire a surveyor to lay out the rhombic on your site. There's a simple way to help find where to install supports, get the correct angles and aim the antenna in the desired direction.

**Construction.** Obtain a sheet of graph paper with 1/8-in. squares. Draw your rhombic on it, letting each square equal one foot. (If you don't have a protractor, use the 140° angle in Fig. 1 as a guide.)

Once you've drawn the rhombic to scale, obtain another piece of graph paper and sketch your house and property lines on it to the same scale.

Now decide where the rhombic is to be located on the site. If you have a frame house it may be possible, as shown in Fig. 6, to install all or part of the rhombic in the attic. (Nearby cables or metal gutters, however, could upset electrical performance.) Height above the ground should be at least 17 ft.

Once this is complete you'll be able to move the rhombic to various trial positions (on paper, that is) on the site for best installation. At this time, too, you must aim it in the desired direction. When you're satisfied that

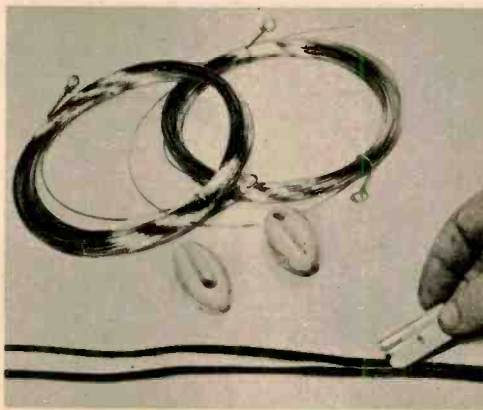

Fig. 3—This is all the material required for antenna: 150 ft. No. 14-18 copper wire and porcelain strain insulators. Slit 2 ft. of twinlead.



Fig. 4—Photo at right shows the resistor end of the antenna. Braid from coax must be added to resistor's leads to allow for flexing caused by wind.

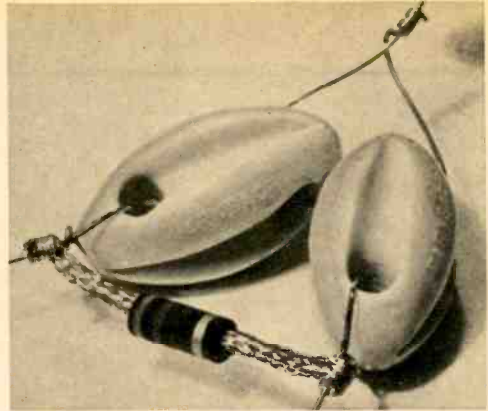
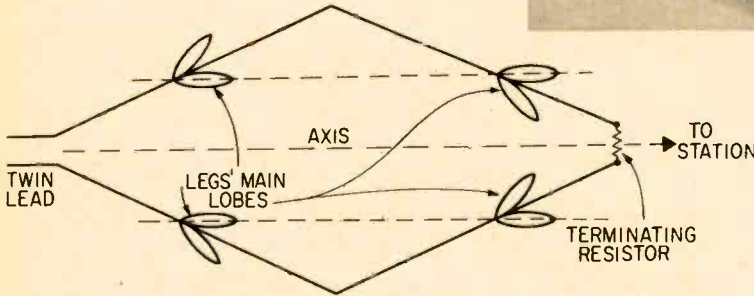

Fig. 5—When legs are longer than signal's wavelength, lobes (pick-up pattern) overlap, add signals along axis. Resistor absorbs energy after it has traveled through antenna to prevent it from reflecting back and changing pattern of the lobes.



the rhombic is situated correctly, clip the two pieces of graph paper together. You'll now have a guide for laying out various support locations and the 140° angle between legs.

Follow Fig. 2 and the photos when constructing the antenna. The transmission line is ordinary TV twinlead which is modified for proper matching where it is connected to the antenna. The impedance of a rhombic is approximately 800 ohms. To match 300-ohm twinlead to the antenna, you must slit the twinlead about 2 ft. and spread its ends 3 in. as in Fig. 2. This spacing increases line impedance to that of the antenna. Try to bring the twinlead straight down from its connection point at the antenna for at least several feet before bending it. The remaining line to the TV receiver may be any length.

The 800-ohm, 2-watt terminating resistor also gets special treatment. To prevent the resistor's leads from breaking because of antenna sway, solder two short lengths of wire braid to each lead as we show in Fig. 2. Wire braid (cut from shielded wire or coax) will flex readily. Do not use a wirewound resistor for the terminating resistor as it will introduce undesirable inductance.

The antenna must be supported by insulators at each corner and the twinlead may be held by TV stand-offs. If an attic is used for support points (the wood must be absolutely

dry) staple the wire directly to rafters at a few points as shown in Fig. 6.

**How it Works.** Take a look at Fig. 5. On each leg you see lobes, which represent pickup patterns and which add along the antenna's center line. Gain is proportionate to the number of wavelengths at the operating frequency. In the all-channel rhombic, the 34-ft. leg is approximately two wavelengths long on channel 2. This provides a theoretical gain over a half-wave dipole of about 8db. That same 34-ft. leg on channel 13 is 7 wavelengths long. Gain is now about 12db.

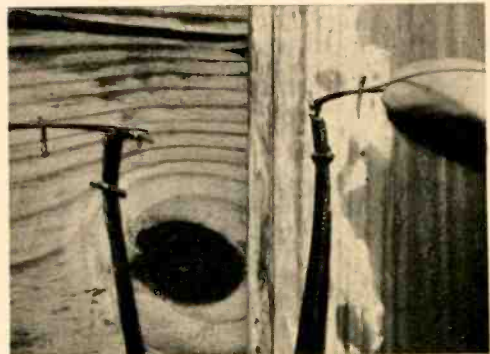

Fig. 6—Spread slit (so it matches rhombic's impedance) of twinlead 3 in. and attach to rhombic's legs. Shown here is our installation in attic.

# THE SECRET

BATTERY



MOTOR

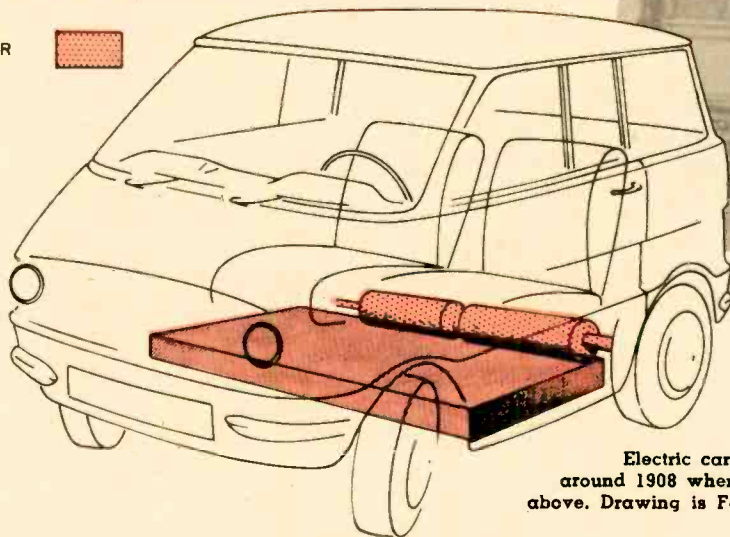

BETTMANN  
ARCHIVE

Electric cars were the cat's miaow around 1908 when Kimball made the one above. Drawing is Ford's idea for updating.

## OF THE NEW ELECTRIC CARS

By J. K. LOCKE

*New batteries challenge the range, speed and cost of gasoline.*

**O**NE DAY last fall in a Detroit laboratory, I watched physicist Neil Weber hook the leads from a small electric motor to a pair of wires sticking out of a glass bottle the size and shape of a straightened-out banana. As he made the connection, the motor began to spin.

The bottle was a new type of battery—a sodium-sulfur cell—developed by Dr. Neil Weber and Dr. Joseph Kummer of the Ford Scientific Laboratory. The battery (and the demonstration) looked ordinary enough. But this new super-power device, with 15 times the energy-storage capacity of the familiar lead-acid battery that starts your car, could be the most important development to hit the auto industry since the internal combustion engine. "With the invention of this battery," says Dr. Michael Ference, Jr., Ford vice-president in charge of scientific research, "we have surmounted one of the major problems—the lack of a sufficiently powerful battery—that must be resolved before an electric vehicle can become a commercial reality."

Ford isn't the only company working to pack more kilowatts into smaller, lighter packages. Gulton Industries of Metuchen, N.J. (a firm known for its

work on the now-common nickel-cadmium cell that powers most rechargeable cordless devices) has a super-high performance unit called the lithium cell. And two firms—Leesona Moos Laboratories of Great Neck, N.Y. (a firm that has pioneered in fuel cell work) and the General Atomic division of General Dynamics—are working on a new gadget called the zinc-air battery.

The impetus for the high-energy efforts toward high-energy battery development has come largely from efforts to do something about a growing problem: air pollution. Scientists say the air-borne gunk—millions of tons of it—hanging over our cities is responsible for everything from running nylon stockings to corroding stone statues. More important, many authorities believe increasing pollution is a principal cause of the soaring death rates from respiratory diseases. And more than half the pollution, say the experts, comes from automobile tailpipes.

Electric automobiles, with exhausts as pure as so many spring zephyrs, seems the obvious answer. The British have been working in this direction for several years and a bill to promote research on electric autos has been introduced into the U.S. Senate. Electric autos are, of course, nothing new—they enjoyed considerable popularity from the turn of the century to World War I—and electric utility vehicles are still used today.

But until now the electric has had one giant problem: range. A car simply couldn't carry enough conventional lead-acid batteries to drive it more than 50 miles or so, although M. G. Smith of the Electric Storage Battery Co., who make lead-acid batteries, has hinted that his company might team up with others in a joint development program.

The old standby lead-acid battery has what engineers call an energy density of 10 watt-hours per pound (wh/lb.). That means that every pound of battery can store enough energy to put out ten watts of power for one hour. A fully-charged ten-pound lead-acid battery, in other words, can light a 100-watt bulb for one hour.

Nickel-cadmium batteries, widely used in rechargeable electric gear such as portable tape recorders, have ratings of about 15 wh/lb. Even the prohibitively expensive silver-zinc batteries can store up to 50 wh/lb. (Yardney Electric Corp. of New York, who make them, have suggested *renting* the costly silver, which is not consumed in use.)

All three of the new systems, by way of

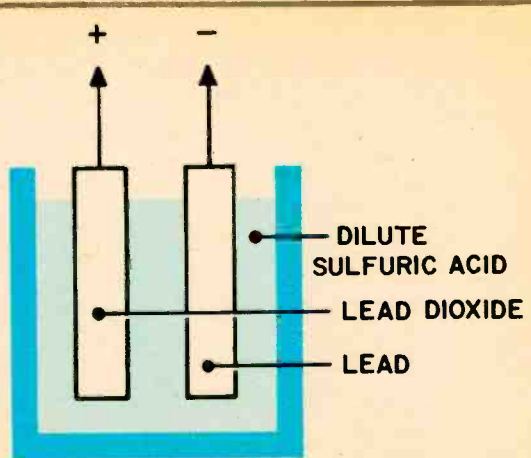

**DIAGRAM 1- LEAD-ACID CELL**

**HOW THE NEW BATTERIES WORK:**

ALL OF THE new batteries—in common with older batteries—work by extracting electrical energy from a chemical reaction. The familiar lead-acid cell (Diagram 1) demonstrates the principle:

The negative electrode is made of pure lead; the positive electrode is lead dioxide. The two are suspended in a dilute solution of sulfuric acid. In the solution each sulphuric acid molecule splits into two positively-charged hydrogen ions and one sulfate radical—a sulfur-oxygen ion carrying a double negative charge.

A sulfate ion finding its way to the negative electrode will combine with a lead atom to form a molecule of lead sulfate—and release two electrons in the process. Meanwhile another sulfate ion and the two hydrogen ions, finding their way to the positive plate, will combine with the lead oxide to make lead sulfate plus water—this time drawing two electrons from the electrode in the process.

The important thing about this process is that it is reversible. Apply a reverse (charging) current and the negative electrode turns back into lead, the positive one again becomes lead dioxide and the partially depleted sulfuric acid comes back to full strength.

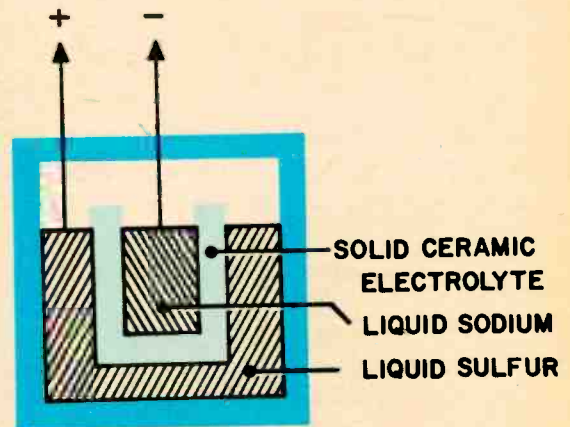

**DIAGRAM 3- SODIUM-SULFUR CELL**



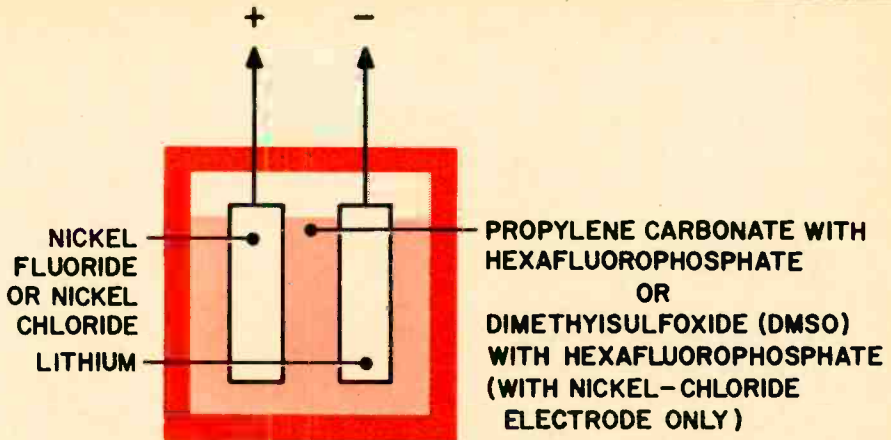

**DIAGRAM 2 - LITHIUM CELL**

Closest in operating principle to the lead-acid cell is the lithium cell (Diagram 2). During discharge, a fluoride ion from the electrolyte combines with an atom of lithium from the negative electrode to form lithium fluoride, simultaneously freeing an electron. Nickel fluoride from the positive electrode combines with two electrons from the external circuit to form pure nickel and two fluoride ions, which flow off in the electrolyte. The alternate reaction using a nickel chloride positive electrode is very similar.

The sodium-sulfur cell (Diagram 3) pulls a switch by using liquid electrodes and a solid electrolyte. The liquid sodium (negative electrode) is contained in a ceramic tube. The tube, in turn, is suspended in a bath of liquid sulfur (positive electrode). The ceramic material is the electrolyte. The atomic structure of the ceramic is impervious to liquid sulfur and liquid sodium. But it will let sodium ions (sodium atoms with an electron missing) through. When the sodium ions combine with the sulfur

on the other side of the ceramic sieve they form sodium sulfide. But the sodium sulfide is incomplete—it has one electron missing, hence the positive charge. The other electrode is negative because of the electrons left behind by the sodium that has passed through the sieve.

The zinc-air cell is somewhat more complicated, as Diagram 4 shows. Oxygen (or oxygen-containing air, pumped into the electrolyte in this version of the cell through a porous nickel positive electrode) is ionized in the electrolyte (potassium hydroxide) taking free electrons from the positive electrode in the process. The oxygen ions travel to the negative zinc electrode. There, the zinc and oxygen combine, forming zinc oxide and releasing electrons.

The circulating electrolyte is vented (to allow excess air to escape) and filtered (to keep zinc oxide from clogging the cell). When the battery is recharged the zinc oxide is pumped back and electroplated onto the negative electrode once more as metallic zinc.

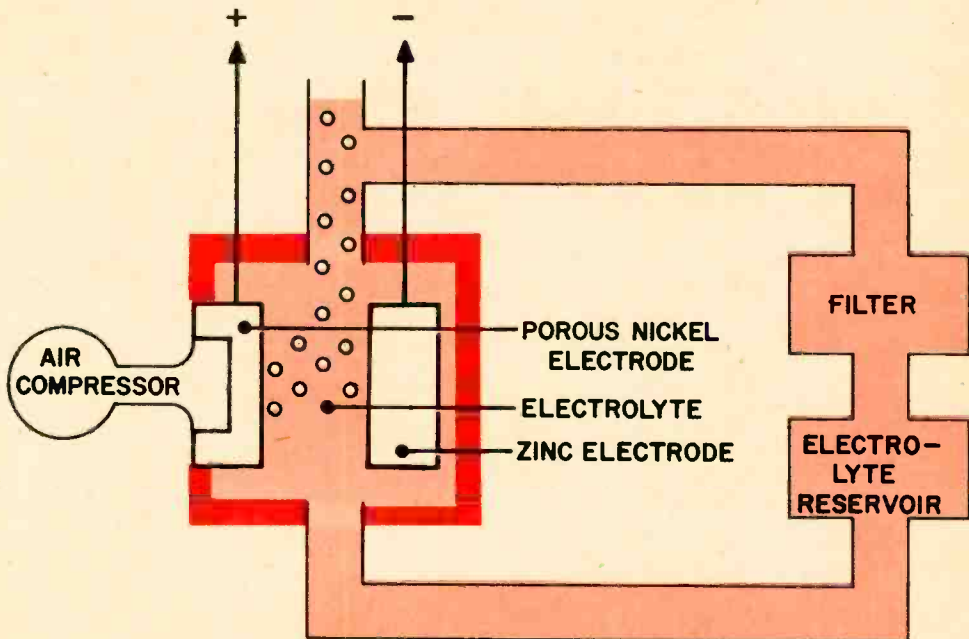

**DIAGRAM 4 - ZINC-AIR CELL**

contrast, show promise of future ability to pack in some 150 wh/lb.—15 times as much as the lead-acid battery.

While all three of the new systems look promising, problems remain. The lithium battery, for example, has been built only in small sizes; scale-up will present engineering and production problems that must be solved before it can be made into a commercial product. The sodium-sulfur battery must operate in the vicinity of 500°F. to keep the sodium and sulfur liquid. Ford engineers think they'll be able to design insulated containers to keep the units hot for weeks at a time. Waste heat

should keep temperatures high enough.

The main drawback of the zinc-air battery comes in designing auxiliary pumping and cooling equipment to make it work properly. Leeson Moos (who makes zinc-air batteries for military electronics) has one novel solution to the recharge problem. When the battery runs down—that is, when the zinc plates are used up—operators will simply slip new ones in. Only trouble with this technique for use in automobiles is that putting in new plates costs more than recharging.

Some of the new super-batteries will be available for use soon, however. A few of the Leeson Moos replaceable-electrode zinc-air batteries are now on the market. The smallest (25 ampere-hours) is about the size of a transistor radio and weighs less than two pounds. Largest one to date is smaller than a loaf of bread (5 x 5 x 7 in.), weighs eight pounds and puts out 100 ampere-hours—as much as an automobile battery weighing some 40 pounds. (Like any first-run item, it's expensive. A 12 V, 100-ampere-hour battery costs \$570. Large production runs would slash prices substantially.)

The General Atomic division of General Dynamics, together with a combine of 14 electric companies helping to bankroll the work, will plow \$150,000 into rechargeable zinc-air battery development work this year. The company has already built a 28-kilowatt prototype, and is getting ready to build one four times that size. This second unit would be powerful enough to run a delivery van.

To date, Gulton has built only a half-pound, 18-ampere-hour lithium battery. But, says Dr. Robert C. Shair, vice-president in charge of research, if some car maker were interested, a car-sized version would be ready quickly: "If some automobile company would like to do it on a joint basis—if they would engineer the car while we engineer the battery—it could be done in a year."

Ford is predicting rapid development, too. "We foresee no scale-up problems," says Dr. Jack Goldman, director of Ford's scientific laboratory. "It should be a straightforward engineering job. The first step will be a 2-kilowatt, 22-pound unit, which will be ready by this December (1967). Then scale-up to a size big enough to drive an automobile will take another year." Adds Dr. Ference, "We have the money, the manpower, and the desire to move ahead as rapidly as possible."



Dr. Weber (left above) holds sodium-sulfur cell he developed for Ford with Dr. Kummer, who sits next to model of 2,000-watt battery. Prototype of General Dynamics' zinc-air battery (below) was developed jointly with 14 electric utilities.

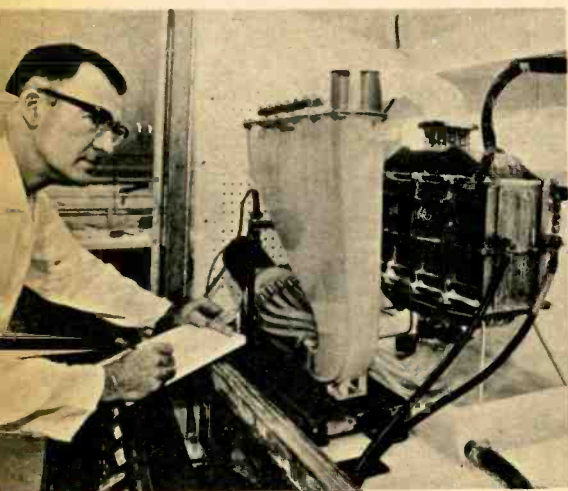



# Go-Go Guitar Amp

By BERT MANN

**N**OTHING swings, rocks, rolls or pulses like the sound of a hot electric guitar. But without the lifeline wire running to an AC outlet those steel strings are about as loud as a churchmouse doing a soft-shoe dance in tennis sneakers. Without an amplifier, the loudest string pickers have to make way for fainthearted folk singers. But with EI's AC/Battery Go-Go Guitar Amp you can make like George Harrison or Tony Matola anytime and anyplace—with or without AC power.

The rig, which includes batteries, AC power supply, amplifier, tremolo and 8-in. speaker fits an inexpensive (\$5) attaché case. The three-watt modular power amplifier will produce sound loud enough to pain your ears if you're playing at home. The case includes everything—and there's even room for the guitar's connecting cable, sheet music, two sandwiches and a bathing suit. The amplifier is wired and ready to go and the tremolo is a kit. The AC power supply has about ten components. Essentially, all you do is connect modular units.

The DC (portable) supply is two series-connected 6-V lantern batteries. While the amplifier's output isn't equal to that of a 100-pound rig,

# Go-Go Guitar Amp

on a quiet beach or park there's enough volume to attract the group on the other side of the hill. The tremolo's intensity is adjustable from off to a heavy pulsation. And the speed is adjustable, too. If desired, a foot switch can be used to turn the tremolo on and off.

## Construction

Purchase a cheap attaché case—the \$5 variety with a ¼-in. wood frame and cardboard front and back will do nicely. The speaker can be from 6 to 12 in. and either 8 or 16 ohms. The speaker we used and specify in the Parts List is designed especially for musical instruments.

Cut the speaker hole in the center of the front panel, making certain there is clearance for the two batteries on the side or bottom. A clean cut can be made in the cardboard with a saber-saw fitted with a *fine-tooth* metal-cutting blade. A hacksaw blade can also be used in a pinch. But don't use a wood-cutting blade as it will tear, rather than cut, the hole.

Next, build the AC power supply on a 3½ x 5-in. piece of perforated board. You can use flea clips or Vector T28 terminals for

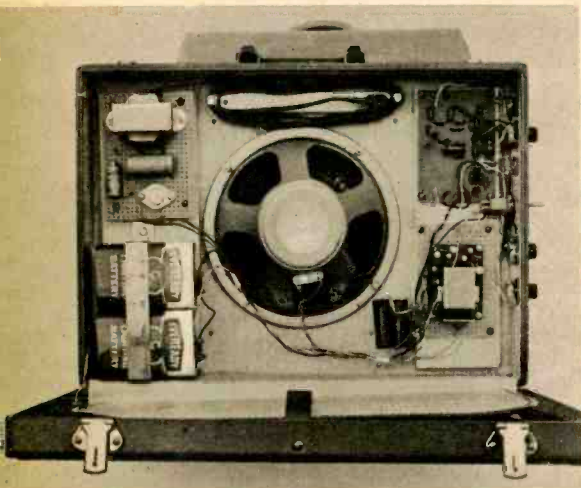
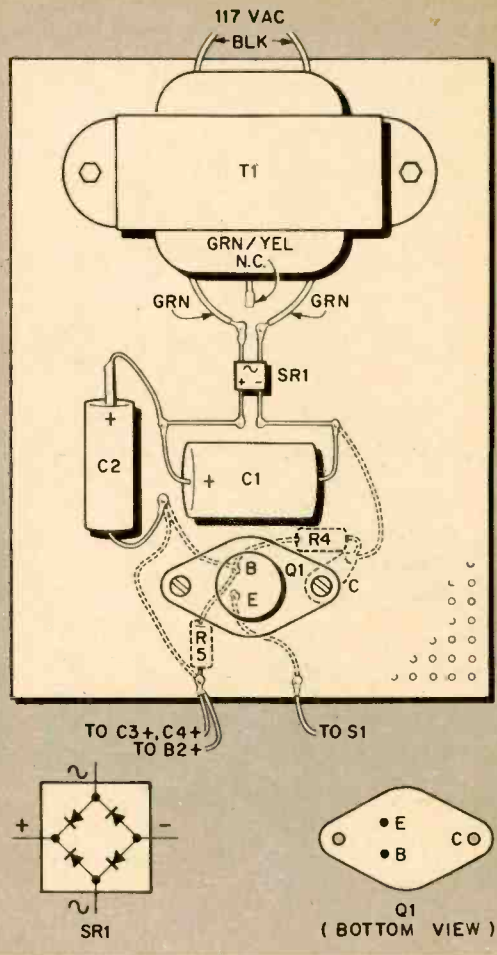

Fig. 1—AC power supply is in upper left corner. Tremolo board is in upper right corner and amplifier is under it. C3, C4 are next to amplifier.

tie points. Do not substitute a different transistor for the type specified.

SR1 is a single-unit bridge rectifier. Note carefully its markings. Connect T1's green leads to the two terminals on the side marked with the symbol  $\sim$ . The output terminals are marked + and -.

When completed, the power supply should be checked out before installation. Connect a DC meter set to read 10 V, or higher, across the supply's output and turn on AC power. The output voltage should be between 9.5 and 10 V. If it is higher than 10 V, substitute a resistor of slightly higher value for R4. If the voltage is less than 9.5 V decrease R4's value. Mount the power supply in the case with ½-in. wood spacers glued to the case at each corner of the perforated board.

The tremolo is a complete kit available

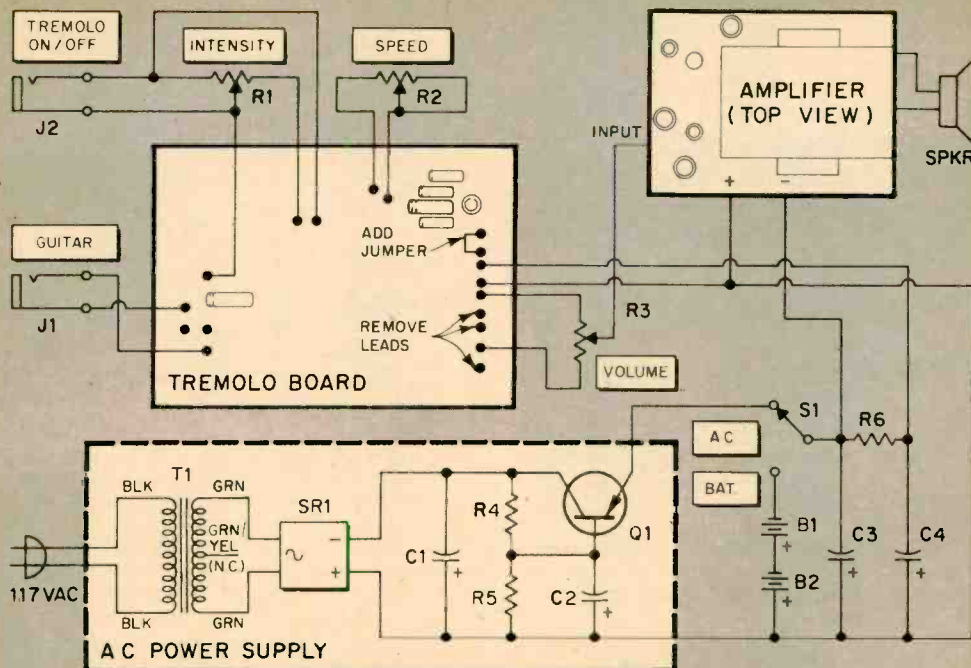

Fig. 2—Complete schematic. Sketch of tremolo board shows location of points to which wires are connected and from which they're removed. Instructions supplied with amplifier show connection points more exactly. Power supply layout on a 3½ x 5-in. piece of perforated board is shown at left. Watch the connections to SR1.

from most EICO distributors. If you have difficulty locating one, note a source of supply in the Parts List.

Assemble the tremolo kit following the instructions supplied with it. If the controls with the tremolo have clip mounts rather than a threaded bushing replace them with standard control which will be easier to install on the case's wood frame. To make final assembly as easy as possible make all connecting leads to the tremolo board at least 12-in. long. They will be cut to size later.

After the tremolo kit has been completely assembled and checked for proper operation (check-out information is supplied with the kit) make the following minor modifications: Cut off the two input switching leads, leaving only the direct-input lead. Cut off the two output-switching leads leaving only the di-

#### PARTS LIST

- AMPLIFIER—3 watt modular transistor (Lafayette 99 C 9132)  
 B1,B2—6 V lantern battery (Eveready 510S or equiv.)  
 C1—500  $\mu$ f, 25 V electrolytic capacitor  
 C2—100  $\mu$ f, 15 V electrolytic capacitor  
 C3,C4—1,000  $\mu$ f, 15 V electrolytic capacitor  
 J1,J2—Phone jack  
 Q1—Medium-power power transistor (Lafayette 19 C 1507)  
 Resistors: ½ watt, 10% unless otherwise indicated  
 R1—1,000 ohm potentiometer (supplied with tremolo kit). See text  
 R2—25,000 ohm potentiometer (supplied with tremolo kit). See text  
 R3—25,000 ohm, audio-taper potentiometer  
 R4—470 ohms (see text)  
 R5—560 ohms      R6—1,500 ohms  
 S1—SPDT toggle or slide switch  
 SR1—Silicon rectifier bridge; 1 A, 50 PIV (Motorola HEP-175. Available from Allied Radio for \$1.45 plus postage. Stock No. HEP-175)  
 SPKR: 8-in. musical instrument speaker (Utah MI-8JC. Lafayette 32 C 4922. Or, Jensen EM-801)  
 T1—Filament transformer; 12.6 V @ 2 A (Allied 54 A 1420 or equiv.)  
 TREMOLO—Tremolo kit, EICOcraft EC-500. (Available from EICO dealers or from Custom Electronics Co., P.O. Box 124, Springfield Gardens, N.Y. 11413. Price including postage is \$8.95. N.Y. state and city residents add sales tax.)

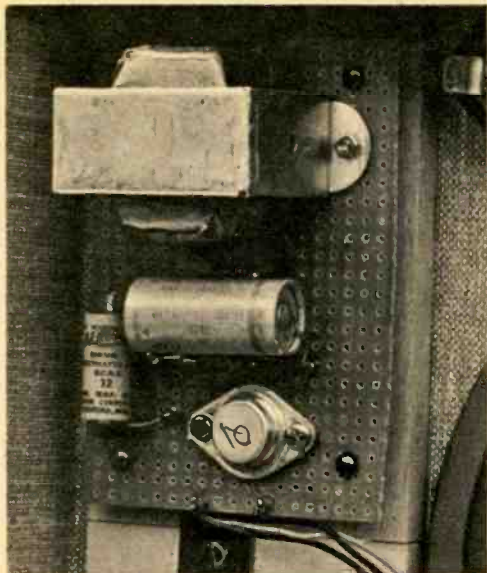

Fig. 3—To avoid putting mounting screws through front of case, glue strips or blocks of wood to inside of case. Then mount AC supply on them.



Fig. 4—Top jack is input, control below is volume. Next jack is for tremolo on/off foot switch. Bottom controls are tremolo speed and intensity.

# Go-Go Guitar Amp

rect-output lead. Finally, cut the two power on-off switching leads short and solder them together. The exact tremolo connections are shown in Fig. 2.

## The Amplifier

The modular amplifier is complete except for the connecting wires. Connect the hot input lead, the speaker leads and the power-supply leads to the points indicated on the amplifier's instruction sheet.

Although the amplifier is pre-drilled for mounting screws, mount it on a 2 x 5-in. piece of perforated board using grommet spacers. Then attach the perforated board to ½-in. blocks which should be glued to the case.

Temporarily mount the tremolo and amplifier boards and mark the positions for the jacks, power switch and controls. Remove the modules, drill the holes on the side and then mount the controls. It will be necessary to undercut the inside of the case because of the short bushings on the controls.

If you build the Amp as an AC-only system, C3 may be eliminated. If you build a battery-only Amp, (no AC power supply) C3 and C4 must still be used.

Note the connections to power switch S1. In one position the batteries are switched into the circuit. When S1 is switched off the AC power supply is automatically connected to the circuit. There is no AC on-off switch. When you're finished playing on AC power, simply pull the plug.

## Using the Tremolo

Setting intensity control R1 full counterclockwise shuts off the tremolo. To turn the tremolo on and off while playing, plug a normally-closed foot switch in J2. If the completed Amp fails to work, look for a reversed power connection to the AC and battery supplies.

If the amp breaks into oscillation (motor-boats) there is a defective capacitor in the power supply or decoupling network (C3, C4). As a final check, measure the total current consumption. With no input signal, current consumption is less than 25 ma. A loud chord will cause the current to rise to 600 ma. To keep distortion low (some guitar pickups could overload the tremolo), lower the volume with the volume control on the guitar.



By Tim Cartwright

# GOOD READING

**DESIGN AND CONSTRUCTION OF ELECTRONIC EQUIPMENT.** By George Shiers. Prentice-Hall, Englewood Cliffs, N.J. 362 pages. \$14

I have a suspicion (borne out in many conversations) that most young would-be electronics experts see themselves working finally at one of two extremes: either as an unpretentious serviceman having fun dealing with day-to-day problems in equipment or as a lofty R&D engineer in splendid isolation conceiving the amazing new circuits and machinery of tomorrow. But a fascinating and rewarding (financially and otherwise) range of careers lies in between those extremes—in the area usually called production engineering. The book at hand was conceived as a practical aid to anyone working in that field but its real value to my mind is the close-up view it gives of the equipment, techniques, ideas and problems involved in converting a circuit idea into a functioning and efficient piece of equipment. At \$14 this view is not cheap but it is such an excellent view—far better than in any similar kind of book I've seen—that it should be worth the cost to anyone who is about to get involved seriously in a career in electronics.

**RADIO OPERATOR'S LICENSE Q&A MANUAL, Supplement No. 3.** By Milton Kaufman. John F. Rider, New York. 153 pages. \$2.60

For anyone less interested in pure electronics than in the lure of radio for its own sake another interesting range of careers lies in radio operation—on the sea, in the air or behind the broadcast console. This Q&A

series is based on the new requirements for Radiotelephone operator licenses, specified by the FCC and still being updated. Although hardly an instructional text, this book is valuable for anyone about to face the test.

**BUILDING YOUR AMATEUR RADIO NOVICE STATION.** By Howard S. Pyle. Howard Sams & Bobbs-Merrill, New York & Indianapolis. 115 pages. \$3.50

Here is a book for would-be Novice operators who have complained about the lack of detailed material on construction of inexpensive equipment for a Novice station. It presents a healthy number of tested circuits (new and old) with step-by-step instructions. Actual-size layout drawings are given plus a complementary set of templates. Well organized and detailed, this book should be of real help to anyone wanting to build equipment and get on the air as a Novice.

**F<sup>M</sup> MULTIPLEXING FOR STEREO.** Second Edition. By Leonard Feldman. Howard Sams & Bobbs-Merrill, New York & Indianapolis. 176 pages. \$3.25

Leonard Feldman has updated his first, basically-fine book on stereo multiplexing (reported on in EI a while back) to include new transistor circuitry, test gear.

**And Make Note Of . . .**

**101 WAYS TO USE YOUR OSCILLOSCOPE.** By Robert G. Middleton. Sams. 192 pages. \$2.95

**ABC'S OF ELECTRONIC TEST PROBES.** By Rudolf F. Graf. Sams. 128 pages. \$2.25

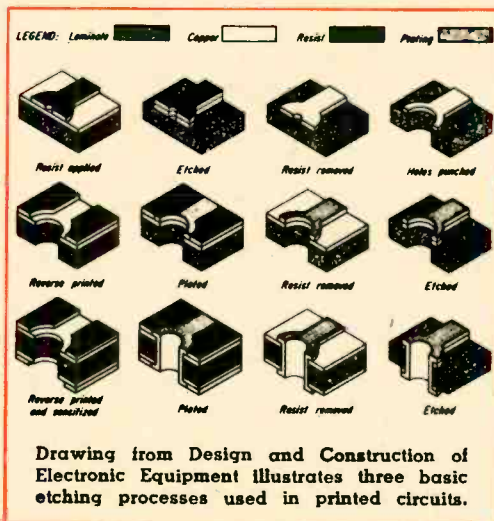

**NOW SHOWING**—What looks like three drive-in movie screens and a domed refreshments stand, isn't. The screens, each one the size of a football field strung up by one side, are part of the antenna system in the detection radar of this BMEWS (Ballistic Missile Early Warning System) installation in Clear, Alaska. The dome, a 140-foot sphere, covers newly-installed RCA long-range tracking radar that can predict point of impact of any hostile missile impinging on its field, even if it is thousands of miles from the installation.

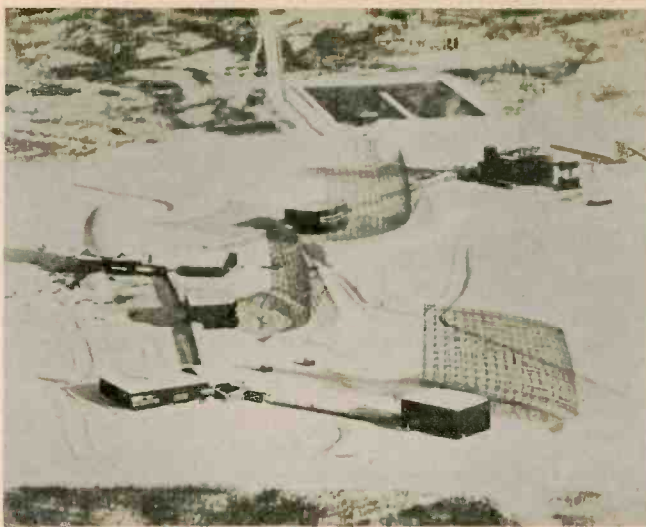

## EI Picturescope

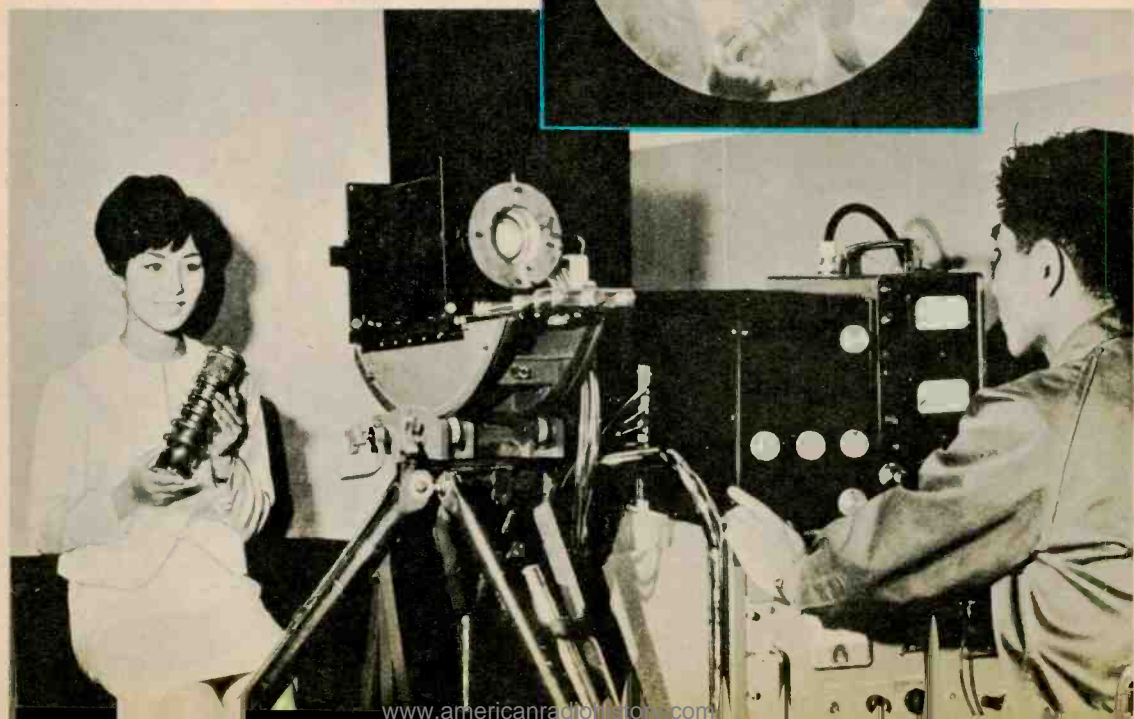



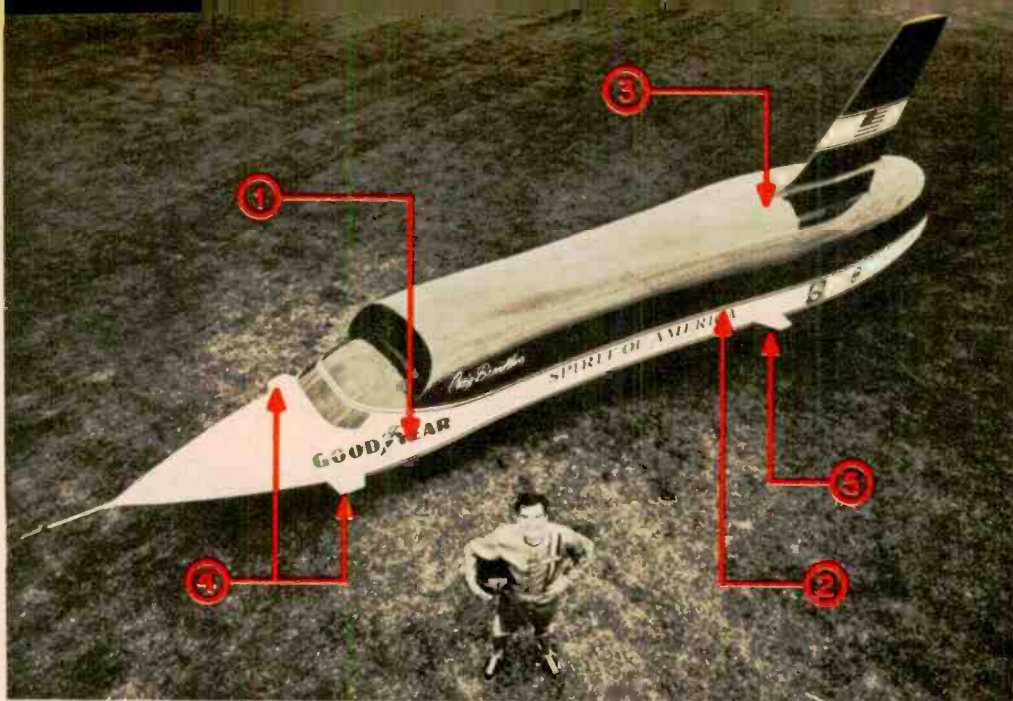

**HOW FAST IS UP?**—One of Craig Breedlove's problems in driving his Spirit of America to the land speed record of 600.6 mph was the possibility that, at those speeds, his \$250,000 racer might develop enough lift to take off—literally. The solution was provided through the use of a series of BLH strain gages attached to the front and rear torsion bars (No. 1 & 2 in the photograph) and on the anti-sway bar (No. 3). With the information they recorded about the car's behavior, it was possible to set canard fins (No. 4 & 5) to the exact angle for optimum control of lift.

**SEEING EYE**—Less than one per cent of the light that comes from a full moon is all the Toshiba multistage image tube needs to produce a picture on its screen. The image in the small insert at the top was picked up on the tube using only the stray light from the panel meters and elsewhere in the equipment itself. Unlike infrared devices, the tube uses visible light focused on the photoelectric surface of a screen that delivers electrons to a series of TSE (transmission secondary emission) multiplying dynodes. Output electron stream is focused on fluorescent screen. TSE dynodes are extremely thin metallic membranes that, in effect, add electrons to electron stream as it passes through.

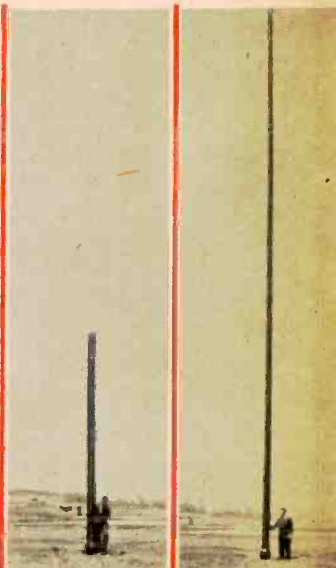

**HIGH WIRE ACT**—In Vietnam it's not so easy to drive around looking for a convenient hill to get DX. So Goodyear Aerospace came up with this way-out solution—an inflatable antenna mast that can be carried around in a back pack no larger than the burdens cheerfully assumed by Sunday hikers. In 15 minutes a foot pump can fill the plastic and cloth mast, driving it to a height of 60 feet. Built-in coax carries signal to radiating element, tunable to VHF or UHF.

# You get more for your money from NRI—

## America's oldest and largest Electronic, Radio-Television home-study school

Compare. You'll find—as have so many thousands of others—NRI training can't be beat. From the delivery of your first lessons in the remarkable, new Achievement Kit, to "bite size," easily-read texts and carefully designed training equipment . . . NRI gives you more value.

Shown below is a dramatic, pictorial example of training materials in *just one* NRI Course. Everything you see below is included in low-cost NRI training. Other major NRI courses are equally complete. Text for text, kit for kit, dollar for dollar—your best home-study buy is NRI.



## **GET A FASTER START WITH NRI'S NEW EXCLUSIVE ACHIEVEMENT KIT**

The day your enrollment is received your Achievement Kit will be on its way to you. It contains everything you need to make an easy, fast start in the Electronics training of your choice. This attractive, new starter kit is an outstanding, logical way to introduce you to home-study the way NRI teaches it . . . backed by a dedicated staff and the personal attention you should expect of a home-study school. It is your first special training aid . . . designed to make your adventure into Electronics absorbing, meaningful. Your Achievement Kit contains your first group of lesson texts; rich vinyl desk folder to hold study material; the industry's most complete Radio-TV Electronics Dictionary; valuable reference texts; lesson answer sheets; envelopes; pencils, pen; engineer's ruler—even postage. No other school has anything like it.

## **LEARNING BECOMES AN ABSORBING ADVENTURE WITH NRI TRAINING KITS**

What better way to learn than by doing? NRI pioneered and perfected the "home lab" technique of learning at home in your spare time. You get your hands on actual parts and use them to build, experiment, explore, discover. Electronics come alive! NRI invites comparison with training equipment offered by any other school. Begin NOW this exciting, practical program. It's the best way to understand the skills of the finest technicians—and make their techniques your own. Whatever your reason for wanting to increase your knowledge of Electronics . . . whatever your field of interest . . . whatever your education . . . there's an NRI instruction plan for you, at low tuition rates to fit your budget. Get all the facts about NRI training plans, NRI training equipment. Fill in and mail the attached postage-free card today.

NATIONAL RADIO INSTITUTE, Washington, D.C. 20016.

OVER 50 YEARS OF LEADERSHIP



IN ELECTRONICS TRAINING

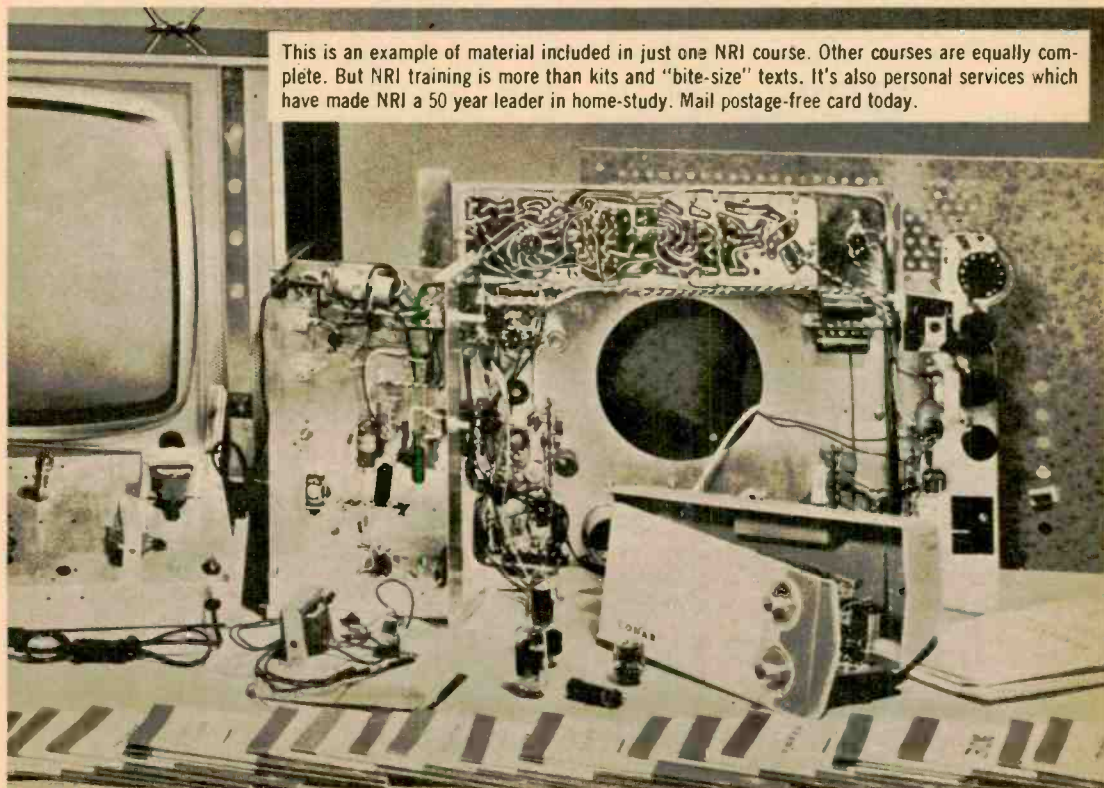

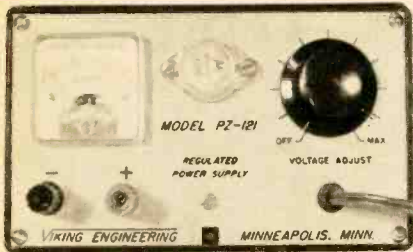

# Experimenter's Power Supply

**M**OST everyone who works with transistors and other solid-state devices is constantly shelling out money for batteries, batteries and more batteries. You need not, though, if you own a Model PZ-121 regulated power supply made by Viking Engineering of Mpls. (P.O. Box 9507, Minneapolis, Minn. 55440). The supply can be ordered directly from Viking for \$13.95 or \$19.95 (plus postage) for the kit or assembled versions, respectively.

The PZ-121 provides 0-15 VDC at 200 ma continuously. It can supply up to 250 ma intermittently for 30-second intervals. Consisting of a power transformer, bridge rectifier and a zener-diode regulator, the 6¼ x 2 x 3¾ -in. supply can withstand a shorted output for up to 15 seconds. Actually it is the transformer, not the transistor, that gets damaged by the short. Long-term overload will simply blow a fusing resistor. The output is available at two insulated 5-way binding posts and is metered.

Total assembly time should be about an hour—two, if you take it extra slow. We had no problem putting the kit together. The illustrations were excellent and there were only 19 construction steps.

**Performance.** The PZ-121's specs state that regulation is 0.2 V for current from 0 to 100 ma. This means that if you measure the output voltage under no load (zero current) and then draw up to 100 ma, the output voltage will fall no more than 0.2 V. We found the supply met this regulation spec but only at maximum output voltage. At 9 V and 6 V the regulation was 0.4 V—not exactly up to spec, but pretty good.

At 200-ma output, for which there was no claimed spec, regulation was 0.75 V at 15 V, 1.6 V at 9 V and 1.2 V at 6 V.

The AC ripple component was much better than the claimed 5 mv being 2.4 mv at 1.5, 3, 6, 9 and 15 V. (The ripple component

is the amount of residual AC at the output.

While the maximum output was listed at 15 V we were able to get only 14.5 V out of the supply. This slight difference was due to the tolerance of the zener diode. Allowing for a 10-per-cent tolerance, the output voltage could range from 13.5 V to 16.5 V.

Our model's meter was very inaccurate because the value of the multiplier resistor was wrong and the meter was defective.

We suggest you check your supply's output voltage with an accurate VOM. Set the supply for a 9-V output (on the VOM). Remove the meter's 15,000-ohm multiplier resistor (R4) and replace it with a lower-value resistor (around 12,000 ohms) to get the supply's meter to indicate 9 V. Then adjust the supply for different output voltages and use the VOM to check the accuracy of the supply's meter. If accuracy is still off, most likely the meter is defective. Viking will replace any defective component without question.

Except for the bad meter, which could have been a one-in-a thousand defect, the PZ-121 represents a mighty good buy and will pay for itself in no time as a bench battery substitute. ●

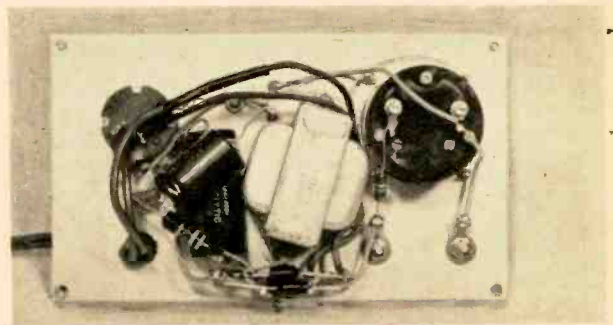

All parts mount on rear of panel. Rectifier diodes are at bottom. Filter capacitors are at left between voltage-adjust pot and the transformer.

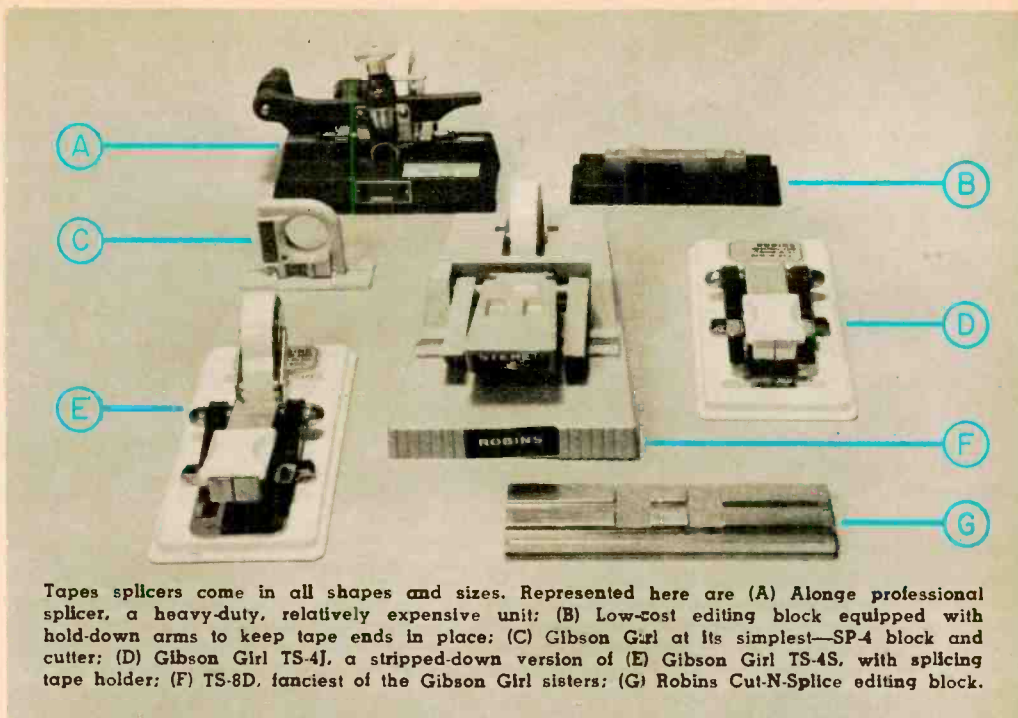

Tapes splicers come in all shapes and sizes. Represented here are (A) Alonge professional splicer, a heavy-duty, relatively expensive unit; (B) Low-cost editing block equipped with hold-down arms to keep tape ends in place; (C) Gibson Girl at its simplest—SP-4 block and cutter; (D) Gibson Girl TS-4J, a stripped-down version of (E) Gibson Girl TS-4S, with splicing tape holder; (F) TS-8D, fanciest of the Gibson Girl sisters; (G) Robins Cut-N-Splice editing block.

## WANTED: A GOOD Tape Splicer

By HERB FRIEDMAN, W2ZLF BACK in the days when there were still few amateur tape enthusiasts (and few tape brands) the first thing that struck your eye on opening a fresh box of tape was usually a set of instructions for making a tape splice. It all looked very simple. But when you got around to playing back your first splice, what you heard could be discouraging. Those hand-made splices, as you would soon learn, required a good eye, a steady hand—and lots of practice.

Anyone who has acquired sufficient skill can do a pretty good job by that method. But for the all-thumbs duffer there are on the market a number of products claiming to substitute gadgetry for dexterity. Do they make good splices? First we've got to know what makes a good splice good.

### Making a Good Splice

First, the ends of the recording tape must butt together perfectly, leaving no exposed adhesive to accumulate dust, dirt and oxide

particles. (A bad splice with tape ends that don't meet is illustrated in Example 1 on the third page of this article.)

Also (and most important) the adhesive used for the splice must not *bleed*—it must not flow from the patch to adjacent turns of tape on the reel so that the tape sticks as it unwinds during use, introducing disastrous wow. Adhesive that bleeds to the oxide coating of the tape will cause a sound drop-out as the bleed passes over the heads—and it will gum up the heads.

Bleeding is easily avoided by using standard splicing tapes such as Scotch type 41 which have a special adhesive that will not run or bleed under conditions normally encountered in use or storage. (The adhesive used on standard acetate mending tape runs like a leaky faucet and should never be used to splice tape, even in an emergency.) If the splice protrudes (Examples 2 and 3) exposed adhesive can cause similar problems.

The angle at which the recording tape is cut is not critical as long as the tape is cut on

# WANTED: A GOOD Tape Splicer

a *diagonal* and both ends are cut at the *same* angle. (Tape cut with a square end invariably makes a noisy splice. It also takes more of a beating as it passes over heads and idlers and is therefore more likely to fail.) Devices that offer an adjustable cutting angle give you no advantage and may introduce mismatch in the tape ends (Example 4).

As long as the tape ends are properly cut and barely touching, most splicing devices will successfully prevent the tape from slipping to one side (Example 5) or falling at an angle (Example 6). Some really cheap splicers that use a pressure-formed tape channel take on an angle where the tape-cutting slot is sliced through the channel.

Perfect *butt* is something else. If the joined tape ends are not absolutely flush, an accumulation of oxide flakes and other foreign matter in the gap will make a noisy, weak splice. In editing blocks, particularly, carelessness in positioning tape ends can easily produce an overlap (Example 7), ready to snag on just about anything.

In extreme cases, poor splicer design can even damage the tape. Ragged edges (in the channel of very, very cheap blocks) can snag and nick tape (Example 8) which soon will part. With thin polyester-base tapes, too, there is the danger that a device with too good a grip—plus a careless user—can yank the tape until it stretches or its edges curl (Example 9).

## What's Available

There are three basic types of splicers. The earliest model, one still popular, is the *Editall* type which may be a plastic or metal block with a channel slightly narrower than the recording tape and running the entire length of the block. Cutting across the channel at the center of the block is a thin diagonal groove (usually at 40 or 45 degrees). A razor blade pulled through the groove cuts the tape. The ends are joined either with a piece of splicing tape slightly narrower than the recording tape or with a large piece of splicing tape which must then be trimmed with scissors or a razor. To avoid protruding splicing tape, it is necessary to cut into the edge of the recording tape very slightly. Narrow splicing tape avoids the cutting but requires some practice to keep the splice from going

crooked, like the one in Example 2.

The second type of splicer is the *Gibson Girl*, which comes in many styles. They are alike in having two sets of blades which generally position themselves automatically. A diagonal blade cuts the tape, the splicing tape is applied and the trimming blade is pulled into position and pushed down. It automatically trims the splice to a slightly wasp-waisted contour (hence the *Gibson Girl* name).

The third type is the *Alonge* professional splicer, used by radio stations and recording studios. It is basically similar to the *Gibson Girl* type but is more rugged and trims the splice flush at the edge.

## Testing . . . Testing

To see which is really the best splicer regardless of price we obtained a model of every splicer we ran across and used them in an ordinary, routine manner. At times the test seemed more like an obstacle course.

We had planned to use the professional (and relatively costly) *Alonge* as the ultimate criterion since it is a beautiful piece of machinery. Unfortunately on all models tested the trimming blade went out of alignment after several cuts, leaving exposed adhesive. While the misalignment was not great we feel that under long-term storage the bleed would result in sticking. (Professional studios like to dub edited tapes immediately.)

Editing blocks (*Editall* and imitators) either use a slightly narrow channel to hold the tape in place or are equipped with hold-down clamps. All suffer from the same thing: they require a very sharp razor and a certain dexterity in trimming or positioning the splicing tape.

One block, the *Robins TS-5*, is supplied with self-stick patches that are not only difficult to remove from their protective backing, they were almost impossible to apply. Since the patch is the full width of the tape channel it ended up protruding on every try.

Similar in intent, although more elaborate in design, are the *Editabs*, made by the *Editall* people. Their backing runs down the channel beyond the splice to make the patch self-aligning. If you plan on a lot of editing, though, you'll find *Editabs* a relatively expensive way of doing it.

Also along the same lines are Prestapes, recently announced by Kodak. While they were not available in time to test side-by-side with other products, a quick check using the editing channel formed right into Kodak's tape reels turned up no problems. With editing devices that do not hold tape ends firmly in position or have an extra-deep tape channel (making it difficult to get at the Prestape's backing) they might be harder to use.

In terms of cutting and trimming, the most effective splicer we tested was the Gibson Girl. Most models are made by Robins but several other brands available from local distributors are almost identical. Their chief advantages are that they make an excellent splice and that the blades are adjustable and replaceable to allow for wear. Unfortunately, in terms of convenience they suffer from *upgraditis*.

Whether a Gibson Girl is advertised as just a plain splicer or a Stereo or a Stereo-4 splicer, it's used for the same job—editing ¼-in. magnetic tape. The basic Gibson Girl priced at about \$4 is just a cutter. Add another buck-and-a-half and it comes with a bracket that holds a roll of splicing tape (only the small roll—100 or 150 in. long—unfortunately). Robins recommends ⅜-in. splicing tape for this model but the wider ½-in. roll will fit and makes a stronger splice. Whichever splicing tape you use you'll have to pry it up from the base after each splice. If you do a lot of editing it can be infuriating.

Perhaps the easiest of the Gibson Girls to use is the Robins TS-8D priced at \$7.65. This model accommodates splicing tape ½ in. wide in rolls up to 66 ft. long. It has good tape hold-down and cutter systems and never sticks down the splicing tape. Well, hardly ever. Instead, it has a tendency to let the end of the splicing tape pop out of its guide and fall under the base.

Then there's the Robins SP-4 priced at \$1.50. This gem consists of a small adhesive-backed plastic block that mounts on the recorder and a hand-held cutter-trimmer. Place the recording tape in the channel of the block, place the cutter on the guide pins, press down and the cut is made. The trim works similarly. Since there is no splicing tape holder to untangle, it turned out to be the fastest and easiest splicer to use.

All in all we may sum up by saying that a difference in price generally represents a convenience which more often than not can turn out to be an inconvenience.

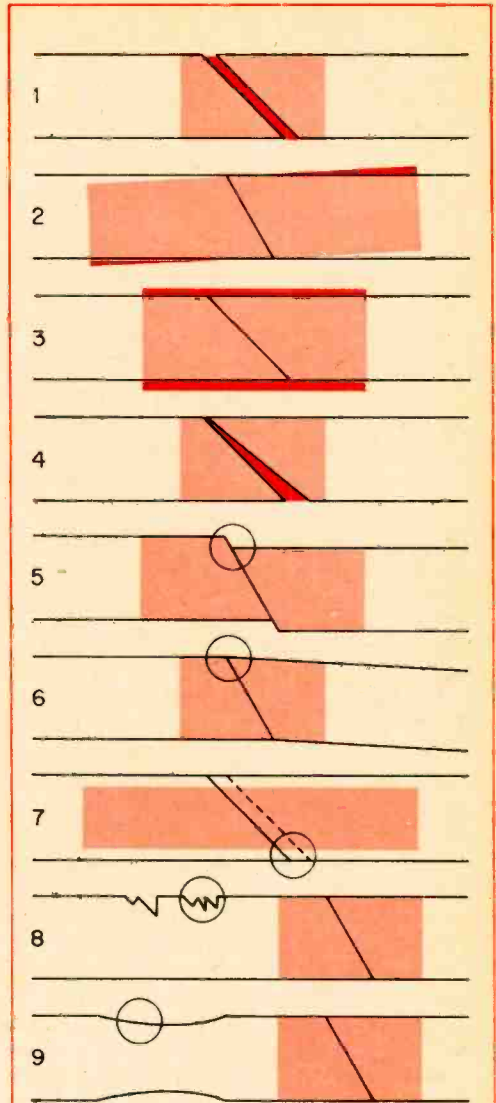

### ROGUES' GALLERY OF BAD SPLICES

Whatever splicer model you use, whatever type of splicing tape you prefer, these are the faults to watch for when you're editing tape: (1) Gap between tape ends; (2) Improperly-positioned splicing tape; (3) Improperly-trimmed splicing tape; (4) Mismatch in angle of cut; (5) Tape ends parallel but offset; (6) Tape ends form an angle; (7) Overlap of tape ends; (8) Fraying; (9) Stretching or curling of tape.



## FAMOUS LAST WORDS

**S**OAP operas on radio didn't die, they simply switched from BC to CB. A look through FCC transcripts exposes a sudsy cast of characters and their dialogue when intercepted by official monitors.

Our first character could be called the militant CBer. He was heard to say, "We decided around here in this area that we are going to continue to talk as we always have and we will use it as we always have and we won't get off until somebody makes us get off." (P.S.: Somebody did.)

Now for the modest type. He's always ready to pat the other guy on the back—maybe. "Sounds real good over here Joe," one was heard to say. But generosity wore thin when he added: "All I got now is a 40-foot mast here out in the back of the house here. So that's all I got for an antenna."

Then there's the quick-with-the-compliment operator who flavors his remarks with dramatics. For instance, "Just set my hand right on the crystal and when you transmitted it knocked me clear off the chair!" That's power for you.

Of course modest types are balanced by the braggarts. One said: "Yea, well, 10-4. I am giving you a 20-db [S-reading]. We got a mobile rig here. We ain't got no piece of junk." Another proud type gets his kicks by an act of patriotism: "Hah Hah . . . have pretty good modulation to it there. Don't believe you can beat American Modulation."

FM is Foreign Modulation?

**Four-bit Filter . . .** When your TV picture's got the rock from too much CB signal, try the filter shown in our photo. It costs about 50¢ and helps cure fundamental blocking. Symptom of this brand of TVI is trouble on all channels (not just channel 2 or 3). The filter connects to the TV antenna terminals and is tuned with a screwdriver for least interference.

To make it, install three solder lugs on a plastic board to form an L, as shown. The coil is 13 turns of No. 20 enameled wire

wound around a pencil, which serves as a temporary form. The capacitor is a 8-60  $\mu\text{mf}$  trimmer (Arco 404). A short piece of twin-lead runs to one capacitor tab and one side of the coil. Once the filter's installed and tuned, it detours the 27-mc signal before it horns in on the Hornet.

**Super Tubes . . .** New CB equipment boasts transistors, but many's the rig with old-fashioned bottles. And good practice says they should be yanked and checked about once a year. That way you'll catch flagging filaments, gassiness or partially shorted elements that could kill the rig when you're calling for help.

But which tube is best? Some CBers hopefully install special replacement types with an eye toward increasing transmitter power, perhaps raising receiver sensitivity. Are they worth the higher price tag?

In just about all cases the answer is negative. There is, however, one case where you can obtain a better version of a standard tube, often at no extra cost. The improvement is usually indicated by a change in the tube's suffix. For example, in the case of a TV set a 5U4G can be replaced by the superior 5U4GB. But it's not advisable to try the reverse—that is, replace the newer tube with its predecessor. If a CB circuit is designed to work with a 6AQ5A the earlier 6AQ5 may not be up to the job. —

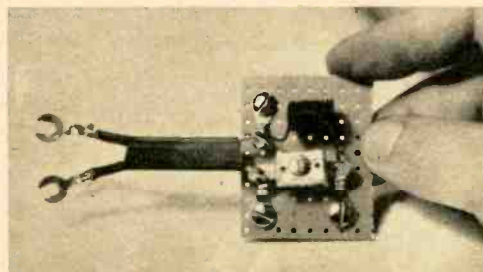

Filter to tune out excess CB signal on TV antenna is made easily from trimmer and hand-wound coil.





# RADIO'S AMAZING MEDICINE MAN

By

JOHN ALTHOUSE

“**A**H HA! Ah ha ha! This is the old early bird, the John R. Brinkley station KFKB, Kansas First Kansas Best.”

At the crack of dawn the early bird was starting another day of broadcasting for the fabulous Doctor Brinkley.

With a clear channel and a kilowatt of power, KFKB first appeared in 1923 and soon became one of the most listened-to and cursed-at radio stations in the U.S. But that was only the beginning. The old early bird was but one act of an 18-year extravaganza-on-the-airwaves that led to construction of the most powerful broadcast station the world ever had seen, extracted countless squeals of pain from the Federal Radio Commission and the FCC, almost gave the American Medical Association apoplexy, set the vice-president of the U.S. and the State Department at odds and came to a halt only when a foreign army marched in and closed down the station.

When John R. Brinkley (the man in our photo) moved to a tiny Kansas hamlet to start practice as a country doctor, there was no reason to believe anything world-shaking would result. But it was here that he had his inspiration.

Milford, Kansas, in 1917 had dirt streets and a population of less than 200. There were

no gold mines near so Doctor Brinkley invented his own. Before his lode ran out it had delivered some 10 million bucks worth of the yellow substance. But unlike most gold diggers, Brinkley didn't use a pick and shovel—just a scalpel, a large number of goats and, most important, a microphone.

The basic idea was reasonably simple and plausible. Nobody wants to get old. And everyone has dreamed of a fountain of youth. Brinkley didn't promise a fountain, but he did offer hope to men who were losing their steam.

It was a matter of glands, he said. He explained how worn-out glands could be revived by placing glands from young and virile goats in parallel with them. Among the many benefits he claimed for this technique were more productive marriages, more satisfied wives and a general feeling of youthfulness by the patient. Thus arose the famous goat-gland operation.

It's one thing to have a brilliant idea and another to sell it. Stories about the miracle operation that appeared in Sunday papers across the country helped a good deal. But Brinkley made the big time by using a new tool of modern technology—radio.

He got a license to operate a 1,000-watt station, KFKB. And



United Press

## RADIO'S AMAZING MEDICINE MAN

a thousand watts went a long way in those days. KFKB could be heard from the Mississippi to the Colorado; from the Dakotas to Texas. It soon became the most popular station in the Midwest with its mixture of cowboy song, gospel music and amateur talent. But the star performer and the magnet that drew the thousands of listeners was Doctor Brinkley himself.

He was kind, he was sympathetic, he was a family man, he was a religious man and above all he wanted to help his many friends in radio land. That was the image he projected over KFKB.

He invited ailing listeners to write him and describe their symptoms. He read their letters over the air and prescribed medicines. This service was free—on the surface, at least. Since it wasn't possible to read complete prescriptions over the radio, he gave each medicine a number. For backache he might prescribe No. 16 and No. 21. Just ask for those numbers at your drug store or mail your money to the Milford Pharmacy so that Doctor Brinkley could send the medicine to you direct.

The ingredients of the prescriptions were not known to all druggists—only those who were members of the Brinkley Pharmaceutical Association. To become a member a pharmacist had to agree to kick back a portion of the price of each prescription to Doctor himself. The prescriptions were simple, everyday remedies, but under Brinkley's scheme they sold at prices quite profitable both to Brinkley and the pharmacists. Thus was built up a lucrative business in the sale of drugs.

And KFKB made it pyramidal. No need to write a letter, just listen to Brinkley on the radio. Anyone who listened to Doctor for a while was pretty sure to hear a letter describing aches and pains just like his own. All the listener had to do was copy

down the numbers and buy the cures at his local Brinkley kick-back pharmacy.

But those who wrote in to KFKB were the most useful because they gave Doctor a mailing list. And by direct mail and radio he promoted his star moneymaker, the goat-gland operation. Patients flocked to Milford. Operations ran ten a day at \$750 each. In business terms, that's a gross of almost \$1,000 an hour.

He had a \$100,000 sanatorium, an apartment house for his employees, bungalows for his medical staff, his own pharmacy, a bank to keep the money in. He actually gave the town of Milford the Brinkley Memorial Church.

He even ran for governor of Kansas, promising paved roads throughout the state, free school textbooks, free automobile licenses and an artificial lake in every county (so that the water evaporating from the lakes would fall as rain to benefit farmers). Along with all this he also promised to reduce taxes.

He almost won the 1930 election with 183,000 votes—only 34,000 less than the winner. And he did this as a write-in candidate. He had filed too late to get his name on the ballot and thousands of ballots were



Greetings to my friends in Kansas and everywhere, ran the legend on the truck Doctor used during his campaign for governor of Kansas. Write-in candidate that he was, Doctor likely would have won had not thousands of ballots been invalidated.

thrown out because his name had been spelled wrong or written in the wrong place. Many knowledgeable Kansas politicians were convinced that if those ballots had been counted, Brinkley would have won. After all, he got 20,000 votes in Oklahoma and he wasn't even running there.

The one kilowatt of KFKB indeed had become gold-plated.

But his broadcasts were beginning to get some static, principally from the American Medical Association. The AMA takes a very dim view of diagnosing by mail and prescribing medicines over the radio. It never has believed that transplanted goat glands do anyone any good. And after looking at Brinkley's record it questioned the worth of his medical degree.

He had one all right—from the Eclectic Medical University of Kansas City—and he had licenses to practice medicine in Kansas and several other states besides. But the AMA didn't like that at all. Their president once wrote that Brinkley was "Without anything resembling a real medical education, with licenses purchased and secured through extraordinary manipulations of political appointees, and with consummate gall beyond

anything ever revealed by any other charlatan."

Brinkley fought back with libel suits and all the political power at his command. But the Kansas State Board of Medical Examiners revoked his license, and the FRC decided that his broadcasts were not in the public interest. In 1931 he lost KFKB.

In less than a year he was in operation in Mexico within eyesight of the U.S. border with a transmitter power that finally reached 250,000 watts and a directional antenna array to give it an effective radiated power (ERP) of a million watts.

The new station was XER. It had a favored frequency of 735 kc, half way between standard U.S. channels. It came in fine even on crystal sets. And on the old TRF broadcast radios, it was about all you *could* get between 700 and 800 kc.

One story goes that Brinkley once peeled 36 thousand-dollar bills off his bankroll for a single order of tubes.

The tubes were a good investment. With XER in operation, business boomed. His audience extended from coast to coast and from Texas to the Northwest Territories.

But the static got louder. U.S. broadcasters

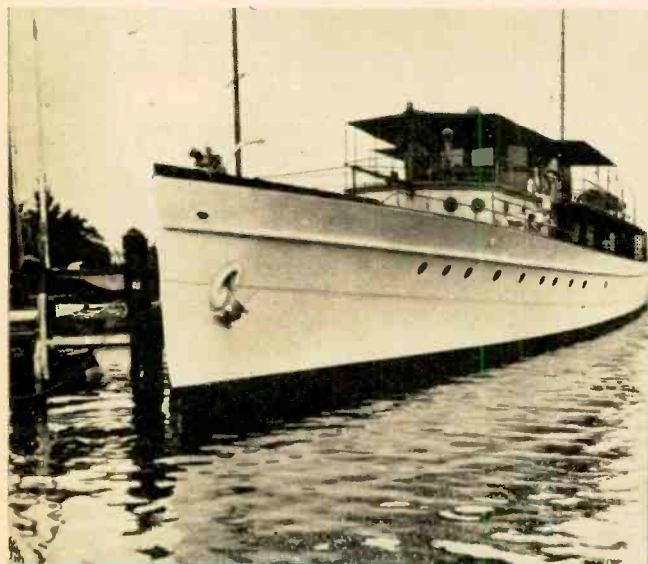

Yachts out of goat glands was Doctor's contribution to modern-day alchemy (glands from some goats became Cadillacs). That's John, Jr., next to Doctor at right, aboard the \$650,000 "Dr. Brinkley."

United Press



March, 1967

## RADIO'S AMAZING MEDICINE MAN

were complaining about the Goliath in their midst. And Brinkley knew he couldn't go on forever having his staff doctors perform his operations in a state where he had no license. So he got in his private plane and left for

Texas where his medical license still was good. Behind him in Milford, Kan., he sent in bulldozers to level his old hospital.

In Del Rio, Tex., he built a country estate so close to Mexico that he could see the towers of XER. His palatial house was red and his Cadillacs matched it. When his wife wanted to change the house to green, he simply bought new Cadillacs—green ones, of course. Someone once asked Doctor how many cars he owned. He had to stop and count up. "About a dozen," he replied.

The license for XER had been easy to obtain primarily because the sad state of U.S./Mexican relations at the time left Mexico really not caring what interference its stations caused those in the U.S. The U.S. State Department put up quite a squawk at first, but Vice President Charles Curtis, a Kansas politician who had campaigned over KFKB, is

Wide World



Doctor harbored hopes of being a Texas Senator in 1941, but the would-be politico again failed.

supposed to have had a talk with them. In any case, they quieted down.

However, in 1934 after XER had been on the air for about three years, the Mexican government had a change of heart and closed the station down. Peace and normalcy returned to the airwaves, but only temporarily. In the fall of 1935, Mexico relented and The Sunshine Station Between the Nations came back as XERA on 840 kc.

By this time Doctor had dropped the goat-gland operation in favor of a new development he called the compound operation, claimed to have all the benefits of the old operation and then some. Business was so good that in 1938 he sued the AMA for calling him a quack. He claimed that an article of theirs had cut his income from \$1,100,000 to miserable \$810,000 a year.

The trial was held in Del Rio, Tex. Brinkley had on hand a number of his patients, but the court did not allow them to testify. For the most part, his patients always thought they were helped by the operation. Medical opinion was that this psychological help was all the good Brinkley's operations ever did or could do. It was brought out during the trial that the goat-gland transplant was not a true transplant. But the most damaging evidence was that of the AMA's chemist who testified that one of Brinkley's prize rejuvenation medicines consisted of water, blue dye and a little hydrochloric acid, none of which possesses any rejuvenating properties.

The jury found for the AMA. And when the new international frequency allocation became effective in 1941, XERA was legislated off the air. Brinkley didn't stop broadcasting until Mexican troops closed him down.

To recover from this blow Brinkley planned to put a new and powerful station on his yacht. He then could operate in the Gulf of Mexico in international waters, beyond the reach of U.S. or Mexican radio authorities. But shortly after the closing of XERA death took John R. Brinkley.

His golden voice no longer is heard, but his legacy is with us still. For more than any other man, Doctor sparked the FCC to enforce the ruling that radio programming must be in the public interest. South of the border powerful stations still huckster in the Brinkley tradition. Floating radio stations, Doctor's idea, plague Britain today. But the gold-plated kilowatts of KFKB and XERA are gone. Few are dismayed by their passing.

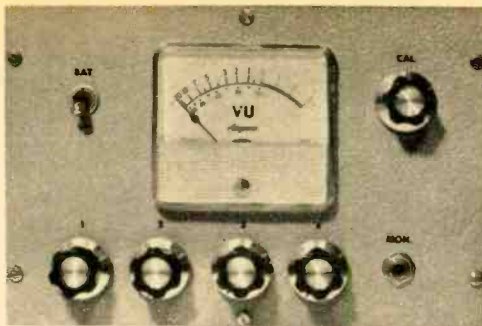

# All-Purpose Audio Mixer

By AL TOLER

ONCE the initial thrill of recording is over, the owner of a tape machine quickly realizes that a single mike input for each channel imposes severe limitations. For example, amateur musicians—even good ones—may sound like the kindergarten fife and wood-block corps when they are recorded in a living room and picked up by a single mike.

For professional-sounding tapes, you've got to be able to mix *several* sound sources. More than one mike is needed if you're recording a group of musicians or even a singer and accompanist. And if you're trying to record a group conference you need more than one mike or the group will sound as though it is meeting in a cave. To do all these things you need a mixer—a device that combines the outputs of several microphones, of a record player and of high-level inputs such as another tape recorder.

Our solid-state mixer has four low-level and two-high level inputs. Any combination of program sources can be mixed into a single output. There is a level control for each input. To insure proper output level, the mixer is equipped with a VU meter and a high-level headphone-monitoring jack. To make the mixer portable and hum-free, the circuit is battery powered. The VU meter doubles as a battery-condition meter.

Note in Fig. 2 that the input transistors are FETs (field-effect transistors). This means each channel's input impedance is high. In fact, almost as high as that of a vacuum tube, which means you can use crystal or ceramic mikes with the mixer. The input impedance of each mike channel is determined by R1, R5, R9 and R12, which are 2.2 megohms each. You may increase or decrease the value of these resistors to match the impedance of the mike.

For normal operation, capacitors C1, C2, C3 and C4 *do not* have to be installed. Without these capacitors the overall gain is about 5db at three-quarters settings of the level controls. This means that if your mike has an output level of  $-50\text{db}$  the signal at the mixer's output jack will be  $-45\text{db}$ . Without the capacitors the frequency response is almost ruler-flat from 10 to 20,000 cps. Distortion at normal mike levels is almost unmeasurable.

At input levels as high as 0.3 V (rms), distortion without the capacitors is slightly less than 1 per cent. If you need a little extra gain, an additional 5db to 7db can be obtained by installing C1, C2, C3 and C4. With them in the circuit, response will be flat from about 40 to 20,000 cps. Distortion at normal mike levels will be about 0.5 per cent. High-level signals (0.3 V rms) into J1 through J4 then will produce distortion somewhat in excess of 1 per cent.

You can build the entire mixer or any part you want. For example, if you don't need a VU meter, drop off all the components associated with Q5, Q6 and Q7 (this includes C9 and R32). The VU meter can be retained as a battery-condition indicator or it, too, can be dropped off, thereby eliminating R31, R32 and S2. If you have no need for high-level inputs you may drop off J5 and J6. Then connect C7 to R17 and C8 to R20. If you need only a two-channel mixer you may drop off all the circuitry associated with Q1 and Q2.

Before getting into construction note that Q1 thru Q4 have a *negative* ground—their sources (S) are connected to ground via R3, R7, R11 and R13. The positive supply feeds R2, R6, R10, and R14.

On the other hand, Q5 thru Q7 have a *positive* ground. That is, the emitters are returned to the positive supply voltage, which is

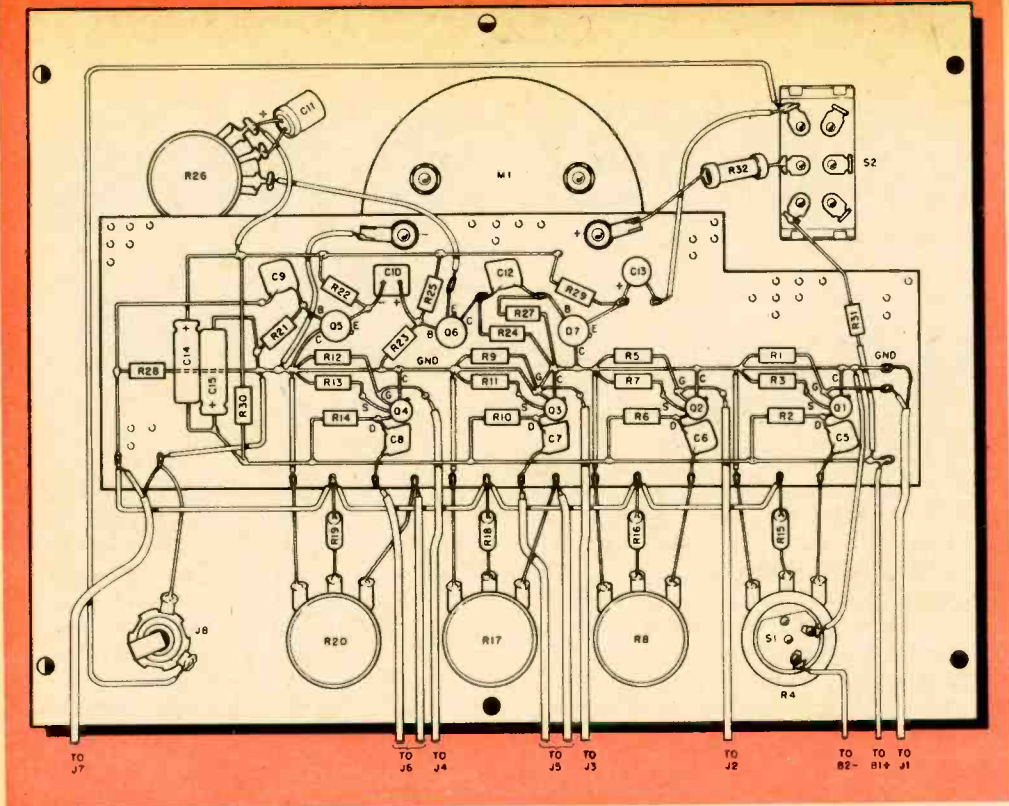
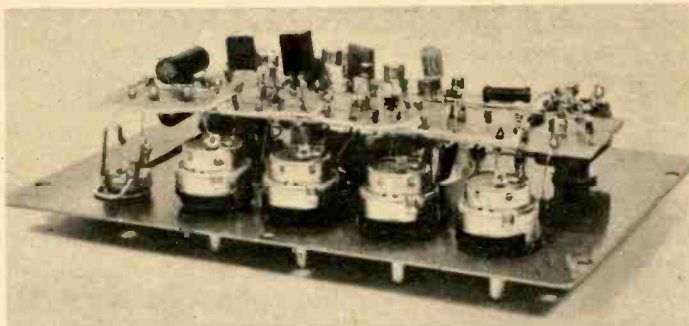

Fig. 1—In pictorial, the following parts are mounted on top of board: all transistors, C9, C10, C12, C13, C15, R28 and R31. All other parts are mounted on back of board. Board is mounted on M1's terminals.

## All-Purpose Audio Mixer



not connected to the chassis. Also note that the collector resistors of Q5, Q6 and Q7 are connected to true ground—the chassis—battery negative. Do not mix up the chassis ground connections.

**Construction.** Our mixer is built in a 9x6x5-in. aluminum utility cabinet—actually on the front and rear panels. The resistors, capacitors and transistors are mounted on a piece of perforated board on which flea clips or Vector T28 push-in terminals are used for tie points. All resistor and capacitor values are critical and no substitutions should be made. If money is no object, we suggest you use low-noise *deposited carbon* or *film-type* resistors for R1, R2, R3, R5, R6, R7, R9,

R10, R11, R12, R13 and R14.

Start construction by mounting all the front-panel components. Install level controls R4, R8, R17 and R20 and put monitor jack J8 as close to the bottom panel edge as is possible. VU meter M1 should be mounted close to the top panel edge. Install *Bat. VU* switch S2 and *VU Cal.* control R26 between M1 and the edges of the panel about 1/2 in. above M1's horizontal center-line. Orient level controls R4, R8, R17 and R20 so their terminals point straight up as shown in Fig. 1.

All controls are shown with a switch because the type specified in the Parts List comes with a switch and sells for half the usual price.

Next, install the rear-panel jacks and a metal bracket, made from scrap aluminum, to hold the two batteries. To keep costs down we show standard open-circuit jacks for J1 through J4. To avoid open-circuit noise, we suggest you use shorting-type jacks which will automatically ground the input when the

mike plug is removed. High-level jacks J5 and J6 are closed-circuit jacks that automatically disconnect mike amplifiers Q3 and Q4 when high-level plugs are inserted.

Cut a 2 x 7 $\frac{3}{4}$ -in. piece of perforated board. Notch the board as shown so that S2's terminals are in the clear. Before mounting any

#### PARTS LIST

B1,B2—9 V battery (Burgess C6X or equiv.)

#### Capacitors:

C1,C2,C3,C4,C11—30  $\mu$ f, 6 V electrolytic

C5,C6,C7,C8,C9,C12—.1  $\mu$ f, 75 V ceramic disc

C10—10  $\mu$ f, 15 V electrolytic

C13—30  $\mu$ f, 12 V electrolytic

C14—160  $\mu$ f, 15 V electrolytic

C15—50  $\mu$ f, 25 V electrolytic

J1,J2,J3,J4,J8—Phone jack (see text)

J5,J6—Closed-circuit phone jack

J7—Phono jack

M1—VU meter (Lafayette 99 C 5043)

Q1,Q2,Q3,Q4—HEP-801 transistor (Motorola.

Allied HEP-801. \$3.39 plus postage)

Q5,Q7—HEP-250 transistor (Motorola. Allied

HEP-250. 79¢ plus postage)

Q6—HEP-252 transistor (Motorola. Allied

HEP-252. 89¢ plus postage)

Resistors:  $\frac{1}{2}$  watt, 10% unless otherwise

indicated

R1,R5,R9,R12—2.2 megohms

R2,R6,R10,R14—560 ohms

R3,R7,R11,R13—6,800 ohms

R4,R8,R17,R20—500,000 ohm, audio taper potentiometer with SPST switch (Lafayette 32 C 7288)

R15,R16,R18,R19,R28,R31—100,000 ohms

R21,R27—470,000 ohms

R22,R29—4,700 ohms

R23—120,000 ohms

R24,R25—10,000 ohms

R26—1,500 ohm, linear taper potentiometer

R30—470 ohms

R32—3,600 ohms (supplied with M1)

S1—SPST switch on R4

S2—SPDT toggle or slide switch

Misc.—Perforated board, 9 x 6 x 5-in. aluminum

utility cabinet (Premier AC-695 or equiv.),

shielded wire, flea clips

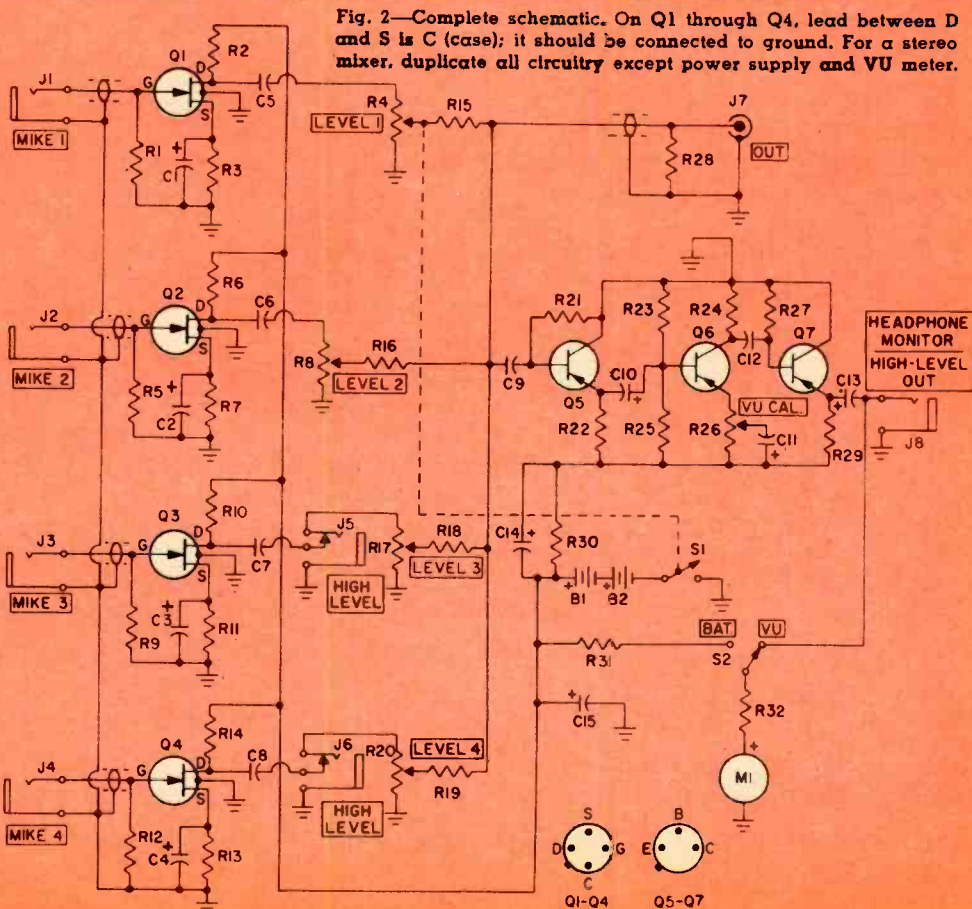

# All-Purpose Audio Mixer

Fig. 3—Photo at top is of top of circuit board. Photo at bottom is of underside of board. Triple-check your wiring as it will be difficult to remove the board to correct an error after the board is installed.

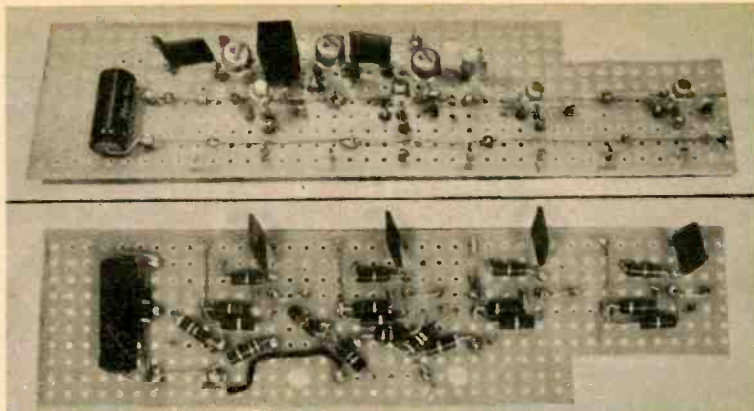

components on the board, install positive and negative buss wires across the full length of the board. The buss in the center of the board is the battery negative, or ground buss. It is connected to cabinet via J1's shielded lead. Next mount Q1 through Q4 and associated components. Resistors R15, R16, R18, R19, R31 and R32 are installed after the board is mounted on the meter terminals.

Use a 25-to 35-watt iron and use a heat sink, such as an alligator clip, on each transistor and resistor lead when soldering. To provide clearance for the meter case, keep the components on the underside of the board flat against the board.

After the board wiring is completed, install the board on the meter terminals as shown, using the hardware supplied with the meter. To provide clearance for the board components install a set of nuts on the metal terminals and then place the board over the terminals. Place the meter solder lugs on top of the board, install the original lockwashers, and then mount and tighten the mounting nuts. Complete the wiring to the front-panel components. Resistor R32, the meter multiplier, is provided with the meter.

The shielded leads from the front to the rear panel are 12-in. lengths of RG-174/U coax. Note that only the cable connected to J1 has the shield connected at both ends. One end is connected to J1's ground lug and the other end is connected to the board's ground buss. The remaining cable shields including the cable to J7 are connected only to the circuit-board ground buss. Tape the jack end of the cables to prevent a strand of wire from shorting the cable.

**Using the Mixer.** Connect the mixer via J7 to your tape recorder's mike input with

shielded wire. Connect the mikes to jacks J1 to J4. Set your recorder's volume control to the normal setting, then advance the level control of the channel to which a mike is connected and speak into the mike. Advance the mixer's level control until the recorder's volume indicator shows the usual or normal recording level. While still speaking, advance *VU Cal.* control R26 until M1 indicates the same level on speech peaks as the recorder's level meter. Then, tape or lock (with a shaft lock) R26 so it cannot be accidentally changed. If you have an AF signal generator, a more accurate adjustment of M1 can be made. Set the recorder's level control to normal, feed a 1,000-cps signal at about -45db into J1 and advance R4 until the recorder level meter indicates peak recording level. Then adjust R26 until M1 indicates 0 VU. Then lock R26.

[Continued on page 138]

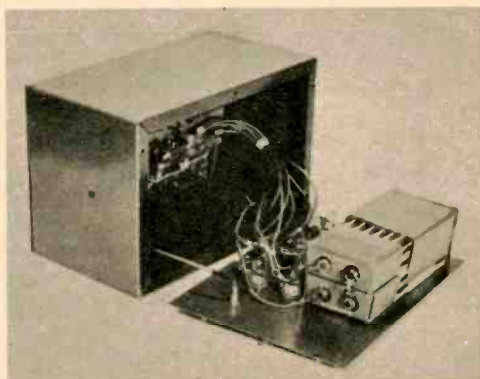

Fig. 4—Completed mixer. Note home-brew bracket which holds batteries. 12-in. leads to all jacks allow for easy installation of panels in cabinet.





**Utility DX Crisis?**  
 ... A little more than a year ago Cable & Wireless, one of the most extensive of all SW telephone and telegraph systems, announced that it would no longer

verify DX reports. As C&W transmits from a number of countries not blessed with international SWBC services—Bahrein, Barbados, Hong Kong and Jamaica among others—their QSLs were highly valued by SWLs. Subsequently several other, smaller international telephone-telegraph stations (technically, all in point-to-point service) followed C&W's lead.

Now a group of leading European utility DXers has blamed these disasters on *too much* interest, i.e.: too many utility-conscious SWLs sending out too many reports for these stations to answer. For one thing, the European PTPers contend that the more utility DXers there are, the better the chance that a few of them will violate the secrecy rule. As every DXer should know, it is illegal to repeat the content of any utility (non-broadcast, non-amateur) transmission. Your report proving reception should stick to such data as time (given as accurately as possible), date, frequency and station contacted or called. Even if the secrecy rule were never violated, though, almost no utility station is equipped to deal with a large volume of mail. And if it is swamped no one receives a QSL.

What is the solution? Well, what the European PTPers advocate seems to be as follows: no national publicity whatsoever for utility DX, a strict hands-off rule for general coverage SW clubs, utility coverage restricted to small clubs dedicated to PTP—and the smaller these clubs the better. Carried to its ultimate conclusion, utility DX would become an exclusive little world of its own, open only to the initiated and presided over by their sages—a kind of secret DX cult.

However, we think there's an alternate, preferable solution. Instead of being choosy about who DXes utilities, be more exclusive in what we DX for. Let's hunt only the rare ones. Take, for example, the Ontario Department of Lands and Forests station at White River, Ontario, shown on our photograph. It is used for both aeronautical and point-to-point purposes on frequencies just below 60

meters and can be picked up best, at a distance, around sunrise and sunset. We wouldn't be surprised if not one of our readers has ever heard this one. In any event, we're sure it will never be deluged with reports. Go ahead and try for it!

**Major-League Radio Clubs . . .** At the opposite extreme from those proposed utility cults are most North American radio clubs. Not only are they open to all, most are out for every member they can recruit. When you join, though, try to make it a *major-league* organization.

Basically there are two criteria. First, its members should be providing the club bulletin with important and *original* information (station news, frequency changes, DX tips, etc.). Second, a real club is governed by some sort of elective process. Otherwise it would really be just a little magazine—minus literary content. Based on one or both of our yardsticks, you might currently consider these the silver seven:

American SWL Club, 16182 Ballad La., Huntington Beach, Calif. 92647. (Dues, \$4.00. Specializes in adult SW coverage but also covers utilities, space. Lists BCB items having special interest for SWLs.)

[Continued on page 134]

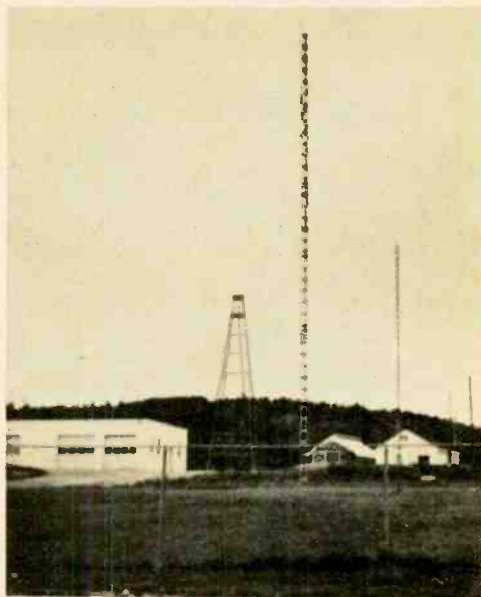

Utility DX north of Lake Superior is White River station of Ontario Dept. of Lands and Forests.

# FREE

MAIL  
CARD  
NOW!

## NEW 1967 ALLIED CATALOG

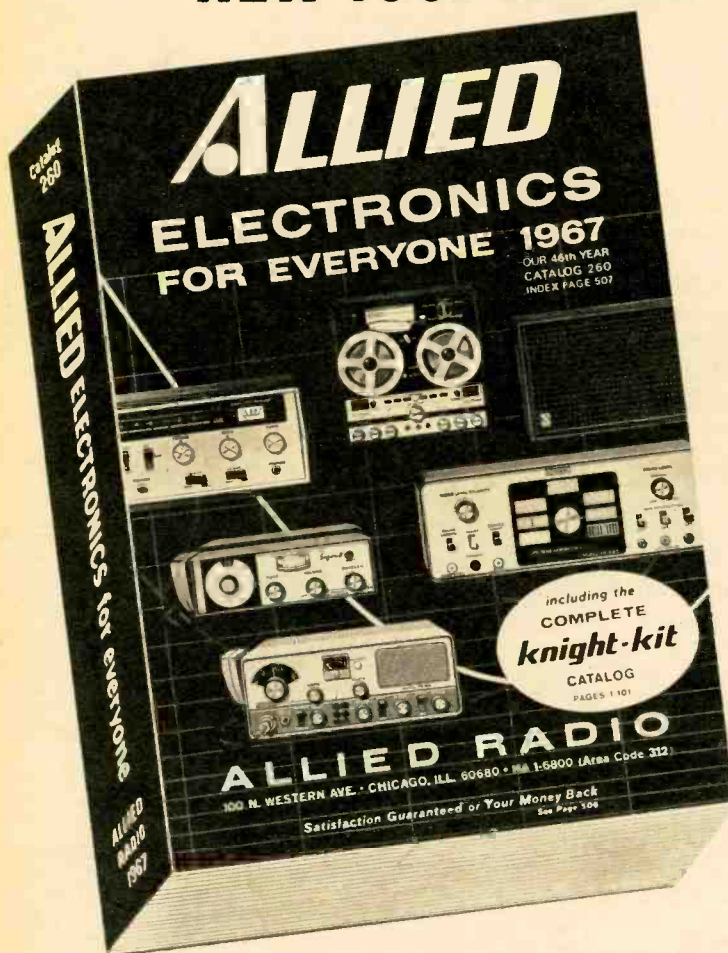

**514 Pages**  
of top savings  
on the best  
in electronics  
for everyone . . .

- Famous Knight-Kits
- Tape Recorders & Tape
- CB 2-Way Gear
- Walkie-talkies
- FM-AM & AM Radios
- Short-Wave Radios
- Portable TV
- Phonographs
- Amateur Gear
- Intercoms & P.A.
- Automotive Electronics
- Test Instruments
- TV Antennas & Tubes
- Power Tools, Hardware
- Tubes, Transistors
- Parts, Batteries, Books

# ALLIED RADIO

WORLD'S LARGEST ELECTRONICS HEADQUARTERS

*Electronics Illustrated*

**MAIL  
CARD  
NOW!**

# NEW 1967 ALLIED CATALOG

See everything new in electronics . . featured first at Allied, the world's largest electronics headquarters!

**New!** for the audiophile . .



Knight-Kit® Deluxe Stereo FM-AM Tuner. Easy-to-build solid-state design.

**New!** for the ham operator...



Knight-Kit® 6-Meter Amateur Transceiver with universal solid-state power supply.

**New!** for the serviceman . . .



Knight-Kit® Portable Solid-State Color/Bar Pattern Generator. A top value!

**New!** for the CB user . . .



KNIGHT® 2-Way Radio. Compact solid-state design at amazingly low cost!

**New!** for everyone . . .



Ampex 6200HVR Home Video-tape Recorder. Make video-tapes at home!

**New!** for the TV and FM owner . . .

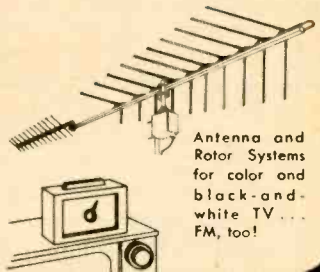

Antenna and Rotor Systems for color and black-and-white TV . . . FM, too!

**Plus** hundreds more new and exclusive items, and scores of special Allied values!

**NO MONEY DOWN! 24 MONTHS TO PAY!**

Enjoy the things you want now, while you take 24 months to pay for them on the convenient, easy-on-the-budget Allied Credit Fund Plan.

**P.O. Box 4398, Dept. 4-CC  
Chicago, Illinois 60680**

**FREE!**

Send for new 1967 ALLIED Catalog

ALLIED RADIO, Dept. 4-CC  
P.O. Box 4398, Chicago, Ill. 60680

Send FREE 1967 Allied Catalog

Name \_\_\_\_\_

PLEASE PRINT

Address \_\_\_\_\_

City \_\_\_\_\_ State \_\_\_\_\_ Zip \_\_\_\_\_

# Signal Tracer Built in a Probe

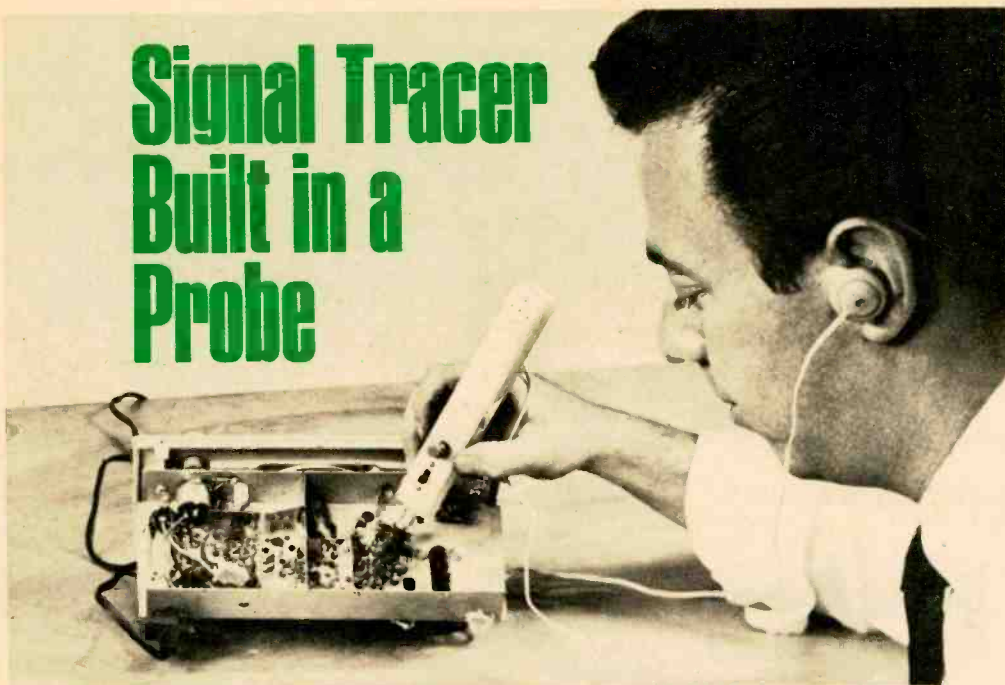

By  
CLARE GREEN, W6FFS

**I**T is difference of opinion that makes horse races," said Mark Twain. And we say when troubleshooting electronic equipment it's difference of opinion that makes for so many kinds of test instruments.

Truth of the matter is, you don't need a shop full of gear to track down troubles in amplifiers, tuners or receivers. All it takes is our handy little signal tracer. This pocket-size gadget will locate defective stages in any radio or amplifier, be it AM or FM, tube or transistor. And the tracer will also prove itself useful for tracking down sources of hum, noise and distortion. Because the tracer has a standard phono jack for its input, you can plug audio cables directly into it to check signals. Such cables would be those from your stereo system's record player, tuner or tape deck.

The tracer basically is a high-gain transistor audio amplifier. To trace audio signals, you set input-selector switch S1 to the *AF* position. The signal then goes via C1 and volume control R2 to input transistor Q1.

To trace RF signals, you set S1 to the *RF* position. The signal detected (converted to audio) by D1 and D2 is fed via R2 to input transistor Q1.

You listen for the signals with a miniature crystal earphone. An 8.4-V mercury battery supplies operating power. For economy, convenient handling and small size, we built our model in a plastic toothbrush case. You can slip the tracer into your pocket and never know it's there. The volume control, conveniently mounted on the cover of the case, varies the level of signals to the transistor amplifier. Such a control is necessary to prevent high-level signals from overloading the amplifier.

## Construction

The transistor amplifier is built on a  $\frac{3}{4} \times 2\frac{1}{8}$ -in. piece of perforated circuit board. First, temporarily position volume control R2, the battery and switch S1 inside the plastic case. Then check to make sure the board fits before you install parts on it. We used standard components for our amplifier but space can be saved by using low-voltage capacitors and  $\frac{1}{4}$ -watt resistors. To save even more space, use 1/10-watt resistors.

Wire the amplifier as shown in the pictorial, using flea clips to mount the parts. Cut off the ends of the flea clips sticking through the back of the board so the board will fit low in the case.

The holes in the case for J1 and S1 can

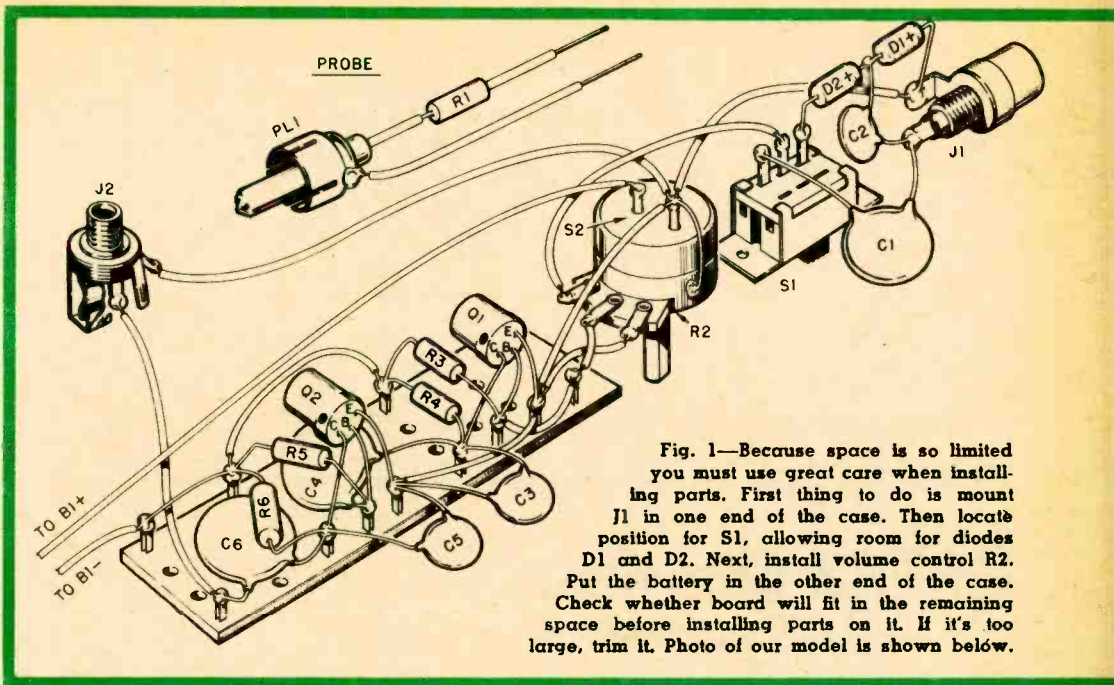
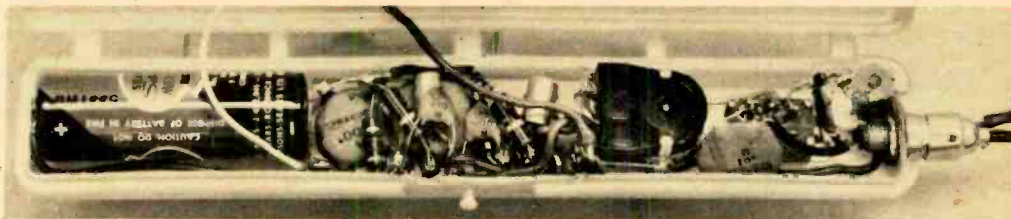

Fig. 1—Because space is so limited you must use great care when installing parts. First thing to do is mount J1 in one end of the case. Then locate position for S1, allowing room for diodes D1 and D2. Next, install volume control R2. Put the battery in the other end of the case. Check whether board will fit in the remaining space before installing parts on it. If it's too large, trim it. Photo of our model is shown below.



be made with a single-edge razor blade. Cut the front of the case's cover so it fits snugly around J1. Position J2 in the cover in such a way that it will not touch components on the board when the cover is closed.

Detector diodes D1 and D2 are held in place by their leads. Make the connections as short as possible and watch the heat when soldering since too much will destroy the diodes. Also, when bending the leads of D1 and D2, hold each lead with a pair of needle-nose pliers at the diode's body. It's then safe to bend the remaining lead.

#### Check Out

Plug a crystal phone into J2, set S1 to the AF position, turn the volume control full clockwise and touch the probe tip. You should hear a loud noise.

Try the tracer on a working radio. (Cau-

tion: if the radio is an AC/DC type use a neon lamp or VOM to make sure the chassis is at ground potential.) Connect the probe to the volume control (probe's center wire, which actually is R1, to center lug on the control and touch the outside probe wire to chassis). Turn the radio's volume control full up. With S1 in the AF position you should hear the signal. Move the probe to the plate of the first audio tube and you also should hear the signal. Set S1 to RF and touch the probe to the plate of an IF tube. You again should hear a signal. In both cases make sure the ground lead on the probe touches the chassis.

The tracer can be used to check any of a radio's circuits where a signal normally would be present. You also can connect an RF or AF signal generator to the receiver if strong signals are not available in your area.

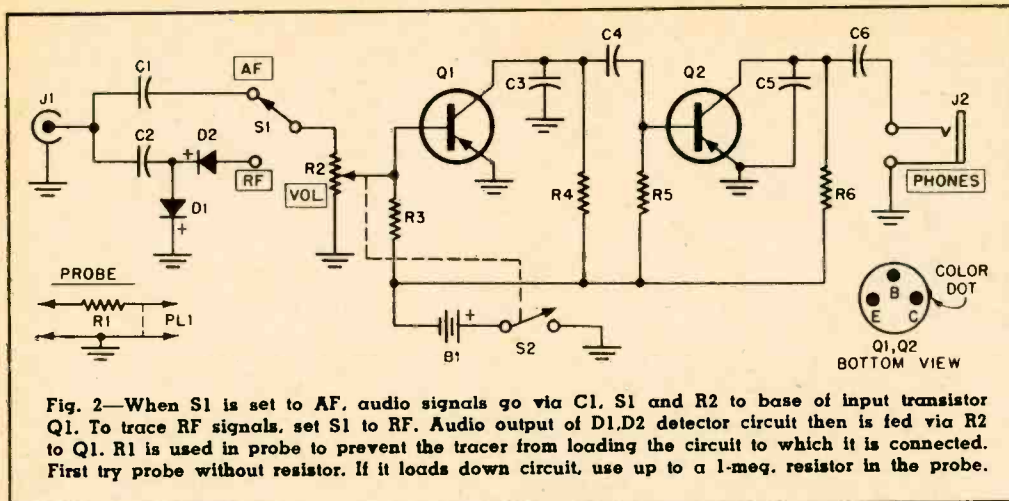

## Signal Tracer Built in a Probe

### How It Works

Signals from the probe, which is plugged into J1, are fed to C1 and C2. RF signals are fed through C2 to diode detectors D1 and D2. AF signals go via C1 to S1. S1 selects the input signal to be fed to the base of Q1. The amplified signal is fed through C4 to the next amplifier stage. Q2's output goes via C6 to earphone jack J2. The 8.4-V mercury battery supplies the power.

An excellent troubleshooting companion for the tracer is the Probe-Size Signal Injector which appeared in the Nov. '66 E1.

Generally speaking, you start troubleshooting at the output of a receiver or amplifier and work your way back to the input. Always feed the injector's signal to the grid of a tube or the base of a transistor. Touch the tracer's probe to the plate of the tube or the collector of a transistor. When you pick up the signal, you've found the defective stage.

### PARTS LIST

- B1—8.4 V mercury battery (Eveready E126 or equiv.)
- C1—.01  $\mu\text{f}$ , 1,000 V ceramic disc capacitor
- C2—100  $\mu\text{f}$ , 1,000 V ceramic disc capacitor
- C3,C5—470  $\mu\text{f}$ , subminiature ceramic disc capacitor (25 V minimum)
- C4—.01  $\mu\text{f}$  subminiature ceramic disc capacitor (25 V minimum)
- C6—.005  $\mu\text{f}$  subminiature ceramic disc capacitor (25 V minimum)
- D1,D2—1N34A diode
- J1—Phono jack (Switchcraft 371 or equiv.)
- J2—Miniature phone jack
- PL1—Phono plug
- Q1,Q2—2N2613 transistor (RCA)
- Resistors:  $\frac{1}{4}$  watt, 10% unless otherwise indicated
- R1—1 meg (see caption, Fig. 2)
- R2—50,000 ohm potentiometer with SPST switch (Lafayette 32 C 7367 or equiv.)
- R3,R5—820,000 ohms
- R4,R6—4,700 ohms
- S1—SPDT miniature slide switch
- S2—SPST switch on R2
- Misc.—Plastic toothbrush case, perforated board, flea clips, crystal earphone (Lafayette 99 C 2515 or equiv.)

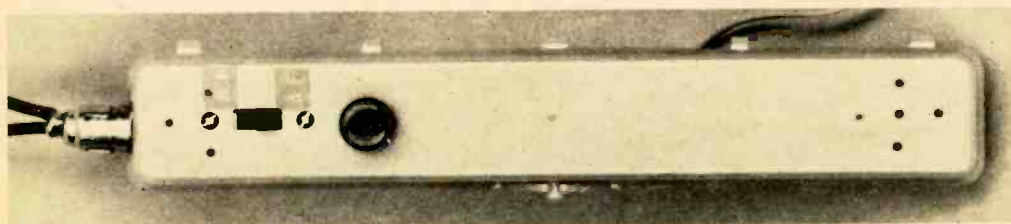

**Fig. 3—**Photo of underside of our model shows location of input-selector switch S1 and volume control R2.

# 24-HOUR SHORT-WAVE SCHEDULE

Here it is, in an up-to-date edition—El's prized tabulation of English language short-wave broadcasts for any time of the day or night. Keep it handy beside your receiver ready to help you tune in the world.

## ABBREVIATIONS USED IN THIS SCHEDULE

B.C.—Broadcasting Co.  
(or Corp.)  
Br.—British  
E.—East  
Is.—Island(s)

N.—North  
N.Z.—New Zealand  
Neth.—Netherlands  
R.—Radio (or  
Radiodiffusion)

S.—South  
V.—Voice (—of)  
(—of the)  
W.—West  
W.I.—West Indies

\*—Beamed to  
North America  
+—Beamed to  
western U.S.  
‡—Beamed to  
eastern U.S.

All times listed are Eastern Standard Time. To convert, subtract 1 hour for Central Standard Time, 2 hours for Mountain Standard Time, and 3 hours for Pacific Standard Time. All frequencies are in kilocycles.

TIME (EST)	FREQ.	CALL	STATION NAME	LOCATION
12 MIDN.	3370	—	Malawi B.C.	Blantyre, Malawi
	4855	—	E. Nigerian B.C.	Enugu, Nigeria
	6145+	DMQ6	Deutsche Welle	Cologne, W. Germany
	9590*	PCJ	R. Netherland	Hilversum, Netherlands
	9640	HLK5	V. Free Korea	Seoul, S. Korea
	9670	—	V. Vietnam	Hanoi, N. Vietnam
	9735+	—	Deutsche Welle Relay	Cologne, W. Germany
	9840	—	V. Vietnam	Hanoi, N. Vietnam
	11640	—	V. Vietnam	Hanoi, N. Vietnam
	11730*	PCJ	R. Netherland	Hilversum, Netherlands
15125	HLK41	V. Free Korea	Seoul, S. Korea	
12:15 A.M.	3985	—	R. Cordac	Bujumbura, Burundi
	4920	—	R. Cordac	Bujumbura, Burundi
12:30 A.M.	3240	—	Ghana B.C.	Accra, Ghana
	3270	—	R. Zambia	Lusaka, Zambia
	4985	—	V. Malaysia	Kuala Lumpur, Malaysia
	4990	—	R. Nigeria	Lagos, Nigeria
	5940	—	R. National Khmere	Phnom Penh, Cambodia
	7305	—	V. Malaysia	Kuala Lumpur, Malaysia
	7390	—	Damascus Calling	Damascus, Syria
12:45 A.M.	3270	—	R. Zambia	Lusaka, Zambia
	4911	—	R. Zambia	Lusaka, Zambia
1 A.M.	4990	—	R. Nigeria	Lagos, Nigeria
	9760	—	Ghana B.C.	Accra, Ghana
	11975	ELWA	R. Village	Monrovia, Liberia
	21535	ELWA	R. Village	Monrovia, Liberia
1:15 A.M.	4770	ELWA	R. Village	Monrovia, Liberia
1:30 A.M.	4911	—	R. Zambia	Lusaka, Zambia
	7090	—	Tirana Calling	Tirana, Albania
	7265	—	Tirana Calling	Tirana, Albania
	9555	—	BBC Relay	Monrovia, Liberia
1:45 A.M.	4911	—	R. Zambia	Lusaka, Zambia
	6165	—	R. Zambia	Lusaka, Zambia
	9545	—	Ghana B.C.	Accra, Ghana

TIME (EST)	FREQ.	CALL	STATION NAME	LOCATION
2 A.M.	3316	—	Sierra Leone B.C.	Freetown, Sierra Leone
	5980	—	Sierra Leone B.C.	Freetown, Sierra Leone
	6050	HCJB	V. Andes	Quito, Ecuador
	6055	—	R. Prague	Prague, Czechoslovakia
	7120	XZK4	Burma B.C.	Rangoon, Burma
	9505	—	R. Prague	Prague, Czechoslovakia
	9670	—	Swiss B.C.	Berne, Switzerland
	9745	HCJB	V. Andes	Quito, Ecuador
	11775	HER5	Swiss B.C.	Berne, Switzerland
	11915	HCJB	V. Andes	Quito, Ecuador
	15230	—	R. Prague	Prague, Czechoslovakia
2:30 A.M.	5990	CKNA	CBC	Montreal, Canada
	6130	—	R. Ceylon	Colombo, Ceylon
	7130	—	V. West	Lisbon, Portugal
	7295	—	Trans World R.	Monte Carlo, Monaco
	9555	—	BBC Relay	Monrovia, Liberia
	9630	CKLO	CBC	Montreal, Canada
	9645	—	V. West	Lisbon, Portugal
	9675	—	R. Warsaw	Warsaw, Poland
	11840	—	R. Warsaw	Warsaw, Poland
	15120	—	R. Warsaw	Warsaw, Poland
2:45 A.M.	3205	VQ03	Solomon Is. B.C.	Honiara, Solomon Is.
	3995	VQ04	Solomon Is. B.C.	Honiara, Solomon Is.
3 A.M.	2410	VL9CG	R. Goroka	Goroka, Papua
	3335	VL9CD	R. Wewak	Wewak, Papua
	3370	—	Malawi B.C.	Blantyre, Malawi
	3385	VL9BR	R. Rabaul	Rabaul, Papua
	6090	ELBC	Liberian B.C.	Monrovia, Liberia
3:15 A.M.	4770	ELWA	R. Village	Monrovia, Liberia
	7275	—	R. Pakistan	Karachi, Pakistan
	9645	—	R. Pakistan	Karachi, Pakistan
	17760	—	R. Pakistan	Karachi, Pakistan
3:30 A.M.	9675	—	R. Warsaw	Warsaw, Poland
	9715	DZF5	Far East B.C.	Manila, Philippines
	11840	—	R. Warsaw	Warsaw, Poland
	11890	—	Far East B.C.	Manila, Philippines
	15120	—	R. Warsaw	Warsaw, Poland
	15300	DZH9	Far East B.C.	Manila, Philippines
	15440	—	Far East B.C.	Manila, Philippines
	17810	DZ16	Far East B.C.	Manila, Philippines
21590	—	R. Pakistan	Karachi, Pakistan	
3:45 A.M.	1780	—	Swiss B.C.	Berne, Switzerland
	15305	—	Swiss B.C.	Berne, Switzerland
	21520	—	Swiss B.C.	Berne, Switzerland
4 A.M.	3225	ELWA	R. Village	Monrovia, Liberia
	4990	—	R. Nigeria	Lagos, Nigeria
	6080	ZL7	R. New Zealand	Wellington, N.Z.
	7255	—	R. Nigeria	Lagos, Nigeria
	7280	—	R. Tanzania	Dar es Salaam, Tanzania
	9540	ZL2	R. New Zealand	Wellington, N.Z.
	9552	—	Male Sinco R.	Male Is., Maldives Is.
	9640	—	BBC	London, England
	4:15 A.M.	4770	ELWA	R. Village
4865		—	R. Brunei	Brunei, Brunei
5980		—	R. Demarara	Georgetown, Guyana
6090		ELBC	Liberian B.C.	Monrovia, Liberia
7240		—	V. Kenya	Nairobi, Kenya
4:45 A.M.		15410	—	BBC
5 A.M.	3385	VL9BR	R. Rabaul	Rabaul, Papua
	7130*	BED7	V. Free China	Taipei, Taiwan
	7255	—	R. Nigeria	Lagos, Nigeria
	9515	CR6RM	R. Club Mocamedes	Mocamedes, Angola
	9560	VUD	All India R.	New Delhi, India
	9655*	BED91	V. Free China	Taipei, Taiwan
	9685*	BED73	V. Free China	Taipei, Taiwan
	9745	BEC62	V. Chinese Air Force	Taipei, Taiwan
	11710	VUD	All India R.	New Delhi, India
	11780	VUD	All India R.	New Delhi, India
	11825*	BED69	V. Free China	Taipei, Taiwan
	11860*	BED45	V. Free China	Taipei, Taiwan
	15105	VUD	All India R.	New Delhi, India
	15165	VUD	All India R.	New Delhi, India
	17840	—	Vatican R.	Vatican City
	17855	VUD	All India R.	New Delhi, India
	21485	—	Vatican R.	Vatican City
5:15 A.M.	9535	CR6RZ	R. Angola	Luanda, Angola
	9610	—	R. Ethiopia	Addis Ababa, Ethiopia
5:30 A.M.	5020	—	R. Ceylon	Colombo, Ceylon
	9640	HLK5	V. Free Korea	Seoul, S. Korea



TIME (EST)	FREQ.	CALL	STATION NAME	LOCATION	
6 A.M.	3370	—	Malawi B.C.	Blantyre, Malawi	
	4950	—	R. Malaysia Sarawak	Kuching, Sarawak	
	4970	9WD215	R. Malaysia Sabah	Jesselton, Sabah	
	7255	—	R. Nigeria	Lagos, Nigeria	
	9620	—	R. Sweden	Stockholm, Sweden	
	9865	YDF8	V. Indonesia	Djakarta, Indonesia	
	11715	YDF2	V. Indonesia	Djakarta, Indonesia	
	11795	ELWA	R. Village	Monrovia, Liberia	
	15195	—	R. Sweden	Stockholm, Sweden	
	15220	—	Springbok R.	Capetown, South Africa	
21535	ELWA	R. Village	Monrovia, Liberia		
6:15 A.M.	6100	—	V. Malaysia	Kuala Lumpur, Malaysia	
	6175	—	V. Malaysia	Kuala Lumpur, Malaysia	
	7110	—	V. Malaysia	Kuala Lumpur, Malaysia	
	9750	—	V. Malaysia	Kuala Lumpur, Malaysia	
	11820*	—	Trans World R.	Bonaire, Neth. Antilles	
	11900	—	V. Malaysia	Kuala Lumpur, Malaysia	
6:30 A.M.	2450	4VEH	V. Evangelique	Cap Haitien, Haiti	
	6120	—	V. Evangelique	Cap Haitien, Haiti	
	9770	—	V. Evangelique	Cap Haitien, Haiti	
	11835	—	V. Evangelique	Cap Haitien, Haiti	
6:45 A.M.	9665	—	Swiss B.C.	Berne, Switzerland	
	11865	HER5	Swiss B.C.	Berne, Switzerland	
7 A.M.	3300	—	R. Belize	Belize, Br. Honduras	
	7125	—	R. Warsaw	Warsaw, Poland	
	7255	—	R. Nigeria	Lagos, Nigeria	
	7275	—	V. America Relay	Colombo, Ceylon	
	9560	—	R. Prague	Prague, Czechoslovakia	
	9575	—	RAI	Rome, Italy	
	9755	—	VTVN	Saigon, S. Vietnam	
	11835	—	V. America Relay	Colombo, Ceylon	
	11840	—	R. Warsaw	Warsaw, Poland	
	11905	—	RAI	Rome, Italy	
	11960	—	R. Prague	Prague, Czechoslovakia	
	15120	—	R. Warsaw	Warsaw, Poland	
	15195	—	R. Sweden	Stockholm, Sweden	
	15285	—	R. Prague	Prague, Czechoslovakia	
	17845	—	R. Sweden	Stockholm, Sweden	
	7:15 A.M.	5955	—	CBC	Montreal, Canada
5970*		CKNA	CBC	Montreal, Canada	
6245		—	R. Pakistan	Karachi, Pakistan	
7130		—	R. Pakistan	Karachi, Pakistan	
9555		OIX2	Finnish B.C.	Pori, Finland	
9580†		—	R. Australia	Melbourne, Australia	
11720		CH5B	CBC	Montreal, Canada	
11805		OIX8	Finnish B.C.	Pori, Finland	
15185*		OIX4	Finnish B.C.	Pori, Finland	
15365		CKC5	CBC	Montreal, Canada	
17760		—	R. Pakistan	Karachi, Pakistan	
21590		CKNC	CBC	Montreal, Canada	
21590	—	R. Pakistan	Karachi, Pakistan		
7:30 A.M.	4870	—	R. Ceylon	Colombo, Ceylon	
	7145	—	R. National	Bamako, Mali	
	7280	—	R. National	Bamako, Mali	
	9745	—	R. National	Bamako, Mali	
	15165°	OZF7	R. Denmark	Copenhagen, Denmark	
7:45 A.M.	4770	ELWA	R. Village	Monrovia, Liberia	
	5940	—	R. National Khmere	Phnom Penh, Cambodia	
	7265	—	R. Togo	Lome, Togo	
	9505	DZH7	Far East B.C.	Manila, Philippines	
	15230	DZH9	Far East B.C.	Manila, Philippines	
	8 A.M.	4865	—	R. Brunei	Brunei, Brunei
4885		—	V. Kenya	Nairobi, Kenya	
4972		—	R. Yaounde	Yaounde, Cameroun	
6040		—	R. Yaounde	Yaounde, Cameroun	
6090		ELBC	Liberian B.C.	Monrovia, Liberia	
7125		—	R. Warsaw	Warsaw, Poland	
7255		—	R. Nigeria	Lagos, Nigeria	
9760		—	V. Vietnam	Hanoi, N. Vietnam	
9840		—	V. Vietnam	Hanoi, N. Vietnam	
11640		—	V. Vietnam	Hanoi, N. Vietnam	
11840		—	V. Vietnam	Hanoi, N. Vietnam	
11840		—	R. Warsaw	Warsaw, Poland	
11850		—	Ici Paris	Paris, France	
15120		—	R. Warsaw	Warsaw, Poland	
15245		—	Ici Paris	Paris, France	
21580		—	Ici Paris	Paris, France	
8:15 A.M.		9755	ETLF	R. V. Gospel	Addis Ababa, Ethlopia

TIME (EST)	FREQ.	CALL	STATION NAME	LOCATION
8:30 A.M.	4970	9WD215	R. Malaysia, Sabah	Jesselton, Sabah
	9820	—	R. Pakistan	Karachi, Pakistan
	11762	—	R. Pakistan	Karachi, Pakistan
	11810	VUD	All India R.	New Delhi, India
	11855	HER5	Swiss B.C.	Berne, Switzerland
	15100	—	R. Pakistan	Karachi, Pakistan
	15255	VUD	All India R.	New Delhi, India
	15305	HEU6	Swiss B.C.	Berne, Switzerland
	15410	ETLF	R. V. Gospel	Addis Ababa, Ethiopia
	17845	HER7	Swiss B.C.	Berne, Switzerland
	17910	—	Ghana B.C.	Accra, Ghana
	21520	—	Swiss B.C.	Berne, Switzerland
	21590	—	R. Pakistan	Karachi, Pakistan
8:45 A.M.	17895	—	V. West	Lisbon, Portugal
	21495	—	V. West	Lisbon, Portugal
9 A.M.	4950	—	R. Malaysia Sarawak	Kuching, Sarawak
	9745*	HCJB	V. Andes	Quito, Ecuador
	9750	—	Korean Central B.C.	Pyongyang, N. Korea
	13750	—	Korean Central B.C.	Pyongyang, N. Korea
	15115	HCJB	V. Andes	Quito, Ecuador
	15220	—	Springbok R.	Capetown, South Africa
	17840‡	—	R. Sweden	Stockholm, Sweden
21600	—	R. Tanzania	Dar es Salaam, Tanzania	
9:15 A.M.	9540	—	Ankhararai Ulanbatras	Ulan Bator, Mongolia
	11850	—	Ankhararai Ulanbatras	Ulan Bator, Mongolia
	17820	TAV	R. Ankara	Ankara, Turkey
9:30 A.M.	4911	—	R. Zambia	Lusaka, Zambia
	6035	XZK3	Burma B.C.	Rangoon, Burma
	9865	YDFB	V. Indonesia	Djakarta, Indonesia
	11715	YDFZ	V. Indonesia	Djakarta, Indonesia
	15350*	—	BBC	London, England
9:45 A.M.	9620	—	R. Sweden	Stockholm, Sweden
	15420‡	—	R. Sweden	Stockholm, Sweden
	17840‡	—	R. Sweden	Stockholm, Sweden
10 A.M.	6245	—	R. Pakistan	Karachi, Pakistan
	7010	—	R. Pakistan	Karachi, Pakistan
	7250	—	Vatican R.	Vatican City
	9610*	LLG	R. Norway	Oslo, Norway
	9645	—	Vatican R.	Vatican City
	9820	—	R. Pakistan	Karachi, Pakistan
	11672	—	R. Pakistan	Karachi, Pakistan
	11740	—	Vatican R.	Vatican City
	11850*	LLK	R. Norway	Oslo, Norway
	15125	HLK41	V. Free Korea	Seoul, S. Korea
	15165	OZF7	R. Denmark	Copenhagen, Denmark
	15175*	LLM	R. Norway	Oslo, Norway
	17825*	LLN	R. Norway	Oslo, Norway
	17910	—	Ghana B.C.	Accra, Ghana
21545	—	Ghana B.C.	Accra, Ghana	
21720	—	Ghana B.C.	Accra, Ghana	
21730*	LLQ	R. Norway	Oslo, Norway	
10:15 A.M.	9665	—	Swiss B.C.	Berne, Switzerland
	9735+	DMQ11	Deutsche Welle	Cologne, W. Germany
	11715	—	Swiss B.C.	Berne, Switzerland
	11795+	DMQ11	Deutsche Welle	Cologne, W. Germany
	11925+	DMQ11	Deutsche Welle	Cologne, W. Germany
	15130+	—	Swiss B.C.	Berne, Switzerland
15305	—	Swiss B.C.	Berne, Switzerland	
10:30 A.M.	3356	—	R. Botswana	Gaberones, Botswana
	6055	—	R. Prague	Prague, Czechoslovakia
	7130	BED7	V. Free China	Taipei, Taiwan
	7195	—	R. Japan	Tokyo, Japan
	7345	—	R. Prague	Prague, Czechoslovakia
	9505	DZH7	Far East B.C.	Manila, Philippines
	9525	—	R. Japan	Tokyo, Japan
	9550	—	R. Prague	Prague, Czechoslovakia
	9685	BED73	V. Free China	Taipei, Taiwan
	9705	—	R. Japan	Tokyo, Japan
	9720	BED8	V. Free China	Taipei, Taiwan
	9760	—	V. Vietnam	Hanoi, N. Vietnam
	9840	—	V. Vietnam	Hanoi, N. Vietnam
	11640	—	V. Vietnam	Hanoi, N. Vietnam
	11725	BED75	V. Free China	Taipei, Taiwan
	11735	—	R. Belgrade	Belgrade, Yugoslavia
	11825	BED69	V. Free China	Taipei, Taiwan
	11840	—	V. Vietnam	Hanoi, N. Vietnam
	11990	—	R. Prague	Prague, Czechoslovakia
	15125	—	V. Free China	Taipei, Taiwan
	15240	—	R. Belgrade	Belgrade, Yugoslavia
	15285	—	R. Prague	Prague, Czechoslovakia
	17810*	—	BBC	London, England
17890	BED40	V. Free China	Taipei, Taiwan	

TIME (EST)	FREQ.	CALL	STATION NAME	LOCATION
10:45 A.M.	5015	—	Windward Is. B.C.	St. George's, Grenada, W.I.
	6010	ETLF	R. V. Gospel	Addis Ababa, Ethiopia
	9550	—	Windward Is. B.C.	St. George's, Grenada, W.I.
	15155	ELWA	R. Village	Monrovia, Liberia
11 A.M.	5980	—	Sierra Leone B.C.	Freetown, Sierra Leone
	5995	—	Malawi B.C.	Blantyre, Malawi
	6040	—	R. Yaounde	Yaounde, Cameroun
	6090	ELBC	Liberian B.C.	Monrovia, Liberia
	7260	—	Trans World R.	Monte Carlo, Monaco
	9555	OIX2	Finnish B.C.	Pori, Finland
	11730*	PCJ	R. Nederland	Hilversum, Netherlands
	11805	OIX8	Finnish B.C.	Pori, Finland
	15185	OIX4	Finnish B.C.	Pori, Finland
	15220	—	Springbok R.	Capetown, South Africa
15425*	PCJ	R. Nederland	Hilversum, Netherlands	
11:15 A.M.	11705	—	R. Sweden	Stockholm, Sweden
	15420	—	R. Sweden	Stockholm, Sweden
11:30 A.M.	4911	—	R. Zambia	Lusaka, Zambia
	9765	—	R. V. Gospel	Addis Ababa, Ethiopia
	11975	ELWA	R. Village	Monrovia, Liberia
	21535	ELWA	R. Village	Monrovia, Liberia
11:45 A.M.	15285	—	Ghana B.C.	Accra, Ghana
12 NOON	3223	—	Male Sinco R.	Male Is., Maldive Is.
	3300	—	R. Belize	Belize, Brit. Honduras
	7235	—	R. Angola	Luanda, Angola
	9535	—	R. Angola	Luanda, Angola
	9555	—	BBC Relay	Monrovia, Liberia
	11910*	HSK9	Overseas B.C. of Thailand	Bangkok, Thailand
12:15 P.M.	7135	—	R. Niger	Niamey, Niger
	9565	ETLF	R. V. Gospel	Addis Ababa, Ethiopia
12:30 P.M.	5930	—	R. Prague	Prague, Czechoslovakia
	6030	DZH6	Far East B.C.	Manila, Philippines
	7195	—	R. Japan	Tokyo, Japan
	7230	DZL9	Far East B.C.	Manila, Philippines
	7285	—	R. Prague	Prague, Czechoslovakia
	7345	—	R. Prague	Prague, Czechoslovakia
	9525	—	R. Japan	Tokyo, Japan
	9715	DZF5	Far East B.C.	Manila, Philippines
	9795	—	R. Prague	Prague, Czechoslovakia
	11855	DZH8	Far East B.C.	Manila, Philippines
	11890	—	Far East B.C.	Manila, Philippines
11990	—	R. Prague	Prague, Czechoslovakia	
12:45 P.M.	15350	—	BBC Relay	Ascension Is.
	17920	—	United Arab B.C.	Cairo, Egypt
1 P.M.	4920	—	R. Cordac	Bujumbura, Burundi
	5995	—	Malawi B.C.	Blantyre, Malawi
	7120	—	R. Mogadishu	Mogadishu, Somali
	9710	—	Mauritius B.C.	Forest Side, Mauritius
	15165	—	Damascus Calling	Damascus, Syria
	17735	—	R. Habana	Havana, Cuba
1:15 P.M.	6190	—	Vatican R.	Vatican City
	7250	—	Vatican R.	Vatican City
	9645	—	Vatican R.	Vatican City
	15285	—	Ghana B.C.	Accra, Ghana
	15380	—	V. West	Lisbon, Portugal
	17880	—	V. West	Lisbon, Portugal
	21495	—	V. West	Lisbon, Portugal
	—	—	—	—
1:30 P.M.	3255	ELBC	Liberian B.C.	Monrovia, Liberia
	6100	—	R. Belgrade	Belgrade, Yugoslavia
	6135	—	R. Warsaw	Warsaw, Poland
	7125	—	R. Warsaw	Warsaw, Poland
	7200	—	R. Belgrade	Belgrade, Yugoslavia
	11720	CHSB	CBC	Montreal, Canada
	11810	—	Lebanese B.C.	Beirut, Lebanon
	11875	ETLF	R. V. Gospel	Addis Ababa, Ethiopia
	15320	CKCS	CBC	Montreal, Canada
	17820	CKNC	CBC	Montreal, Canada
1:45 P.M.	7110	—	Swiss B.C.	Berne, Switzerland
	7210	VUD	All India R.	New Delhi, India
	7235	VUD	All India R.	New Delhi, India
	9665	—	Swiss B.C.	Berne, Switzerland
	9690	VUD	All India R.	New Delhi, India
	9705†	—	R. Sweden	Stockholm, Sweden
	9915	VUD	All India R.	New Delhi, India
	11740	VUD	All India R.	New Delhi, India
	11865	VUD	All India R.	New Delhi, India
	15405	HCJB	V. Andes	Quito, Ecuador
	17890	—	V. Andes	Quito, Ecuador

TIME (EST)	FREQ.	CALL	STATION NAME	LOCATION
2 P.M.	5930	—	R. Prague	Prague, Czechoslovakia
	6005	—	R. Warsaw	Warsaw, Poland
	6540	—	Korean Central B.C.	Pyongyang, N. Korea
	7285	—	R. Warsaw	Warsaw, Poland
	7345	—	R. Prague	Prague, Czechoslovakia
	7580	—	Korean Central B.C.	Pyongyang, N. Korea
	9525	—	Springbok R.	Capetown, South Africa
	9705	ETLF	R. V. Gospel	Addis Ababa, Ethiopia
	9865	YDF8	V. Indonesia	Djakarta, Indonesia
	9875	—	Korean Central B.C.	Pyongyang, N. Korea
	11715	YDF2	V. Indonesia	Djakarta, Indonesia
	11750	—	Korean Central B.C.	Pyongyang, N. Korea
	15155	ELWA	R. Village	Monrovia, Liberia
	15165	OZF7	R. Denmark	Copenhagen, Denmark
2:15 P.M.	7195	—	R. Japan	Tokyo, Japan
	9525	—	R. Japan	Tokyo, Japan
2:30 P.M.	6070	—	R. Sofia	Sofia, Bulgaria
	6190	—	R. Bucharest	Bucharest, Rumania
	7195	—	R. Bucharest	Bucharest, Rumania
2:45 P.M.	3265	ZFY	R. Demerara	Georgetown, Guyana
	7125	VUD	All India R.	New Delhi, India
	7235	VUD	All India R.	New Delhi, India
	9615	—	R. Pakistan	Karachi, Pakistan
	9690	VUD	All India R.	New Delhi, India
	9915	VUD	All India R.	New Delhi, India
	11672	—	R. Pakistan	Karachi, Pakistan
	11705	—	R. Sweden	Stockholm, Sweden
	11740	VUD	All India R.	New Delhi, India
	11865	VUD	All India R.	New Delhi, India
	15350	—	BBC Relay	Ascension Is.
3 P.M.	7265	—	Tirana Calling	Tirana, Albania
	9390	—	Tirana Calling	Tirana, Albania
	9745	—	R. National	Bamako, Mali
	9760	—	Ghana B.C.	Accra, Ghana
	11800	—	Ghana B.C.	Accra, Ghana
	11810	—	R. Bucharest	Bucharest, Rumania
	11885	—	R. Bucharest	Bucharest, Rumania
	11940	—	R. Bucharest	Bucharest, Rumania
	15260	—	BBC	London, England
	15380	—	R. Bucharest	Bucharest, Rumania
	17740	—	BBC	London, England
	17870	—	BBC	London, England
	3:15 P.M.	6025	—	V. West
6050		—	RAI	Rome, Italy
6185		—	V. West	Lisbon, Portugal
7235		—	RAI	Rome, Italy
9360		—	R. Nacional	Madrid, Spain
9520		OZF5	R. Denmark	Copenhagen, Denmark
9540		ZL2	R. New Zealand	Wellington, N.Z.
9555		—	BBC Relay	Monrovia, Liberia
9710		—	RAI	Rome, Italy
15155		—	R. Habana	Havana, Cuba
15280		ZL4	R. New Zealand	Wellington, N.Z.
3:30 P.M.	6155	—	V. Revolution	Conakry, Guinea
	6175	—	Ici Paris	Paris, France
	7135	—	R. Iran	Tehran, Iran
	9650	—	V. Revolution	Conakry, Guinea
	11730	—	R. Iran	Tehran, Iran
	11950*	PCJ	R. Nederland	Hilversum, Netherlands
	15425*	PCJ	R. Nederland	Hilversum, Netherlands
3:45 P.M.	9009	4XB31	Kol Zion	Jerusalem, Israel
	9725	4XB51	Kol Zion	Jerusalem, Israel
	15290	—	United Arab B.C.	Cairo, U.A.R.
	15300	—	R. Habana	Havana, Cuba
4 P.M.	6120	OIX7	Finnish B.C.	Pori, Finland
	9525	—	Springbok R.	Capetown, South Africa
	9590*	PCJ	R. Nederland	Hilversum, Netherlands
	9640	HJK5	V. Free Korea	Seoul, S. Korea
	11730*	PCJ	R. Nederland	Hilversum, Netherlands
	11770	HCBJ	V. Andes	Quito, Ecuador
15405	HCBJ	V. Andes	Quito, Ecuador	
4:15 P.M.	5955	—	CBC	Montreal, Canada
	9630	CKLO	CBC	Montreal, Canada
	9725	4XB51	Kol Zion	Jerusalem, Israel
	11720	CHOL	CBC	Montreal, Canada
	11780*	—	BBC	London, England
	12095	—	BBC	London, England
	15140	—	BBC	London, England
	15155	ELWA	R. Village	Monrovia, Liberia
	15245	—	Trans World R.	Bonaire, Neth. Antilles
	15300*	—	BBC	London, England
	15320	CKCS	CBC	Montreal, Canada

TIME (EST)	FREQ.	CALL	STATION NAME	LOCATION
4:30 P.M.	6070	—	R. Sofia	Sofia, Bulgaria
	6135	—	R. Warsaw	Warsaw, Poland
	7125	—	R. Warsaw	Warsaw, Poland
	9540	—	Ankhararai Ulanbatras	Ulan Bator, Mongolia
	11850	—	Ankhararai Ulanbatras	Ulan Bator, Mongolia
11915	—	United Arab B.C.	Cairo, Egypt	
5 P.M.	6005	—	R. Warsaw	Warsaw, Poland
	6010	—	RAI	Rome, Italy
	6100	—	R. Belgrade	Belgrade, Yugoslavia
	7125	—	R. Warsaw	Warsaw, Poland
	7130	—	BBC	London, England
	7145	—	R. Warsaw	Warsaw, Poland
	7200	—	R. Belgrade	Belgrade, Yugoslavia
	7260	BEC71	V. China Air Force	Taipei, Taiwan
	7265	—	Tirana Calling	Tirana, Albania
	7285	—	R. Warsaw	Warsaw, Poland
	9390	—	Tirana Calling	Tirana, Albania
	9505	—	R. Belgrade	Belgrade, Yugoslavia
	9675	—	Vatican R.	Vatican City
	9710	—	RAI	Rome, Italy
	9765	—	BBC	London, England
	11735	—	Vatican R.	Vatican City
	11840	—	R. Warsaw	Warsaw, Poland
15160	TAU	R. Ankara	Ankara, Turkey	
15300	DZH9	Far East B.C.	Manila, Philippines	
17810	DZ16	Far East B.C.	Manila, Philippines	
5:15 P.M.	11900*	—	R. Moscow	Moscow, USSR
	11965*	—	R. Moscow	Moscow, USSR
5:30 P.M.	3225	ELWA	R. Village	Monrovia, Liberia
	5052	—	R. Singapore	Singapore, Singapore
	5950	—	R. Warsaw	Warsaw, Poland
	6190	—	R. Bucharest	Bucharest, Rumania
	7195	—	R. Bucharest	Bucharest, Rumania
	7305	—	V. Malaysia	Kuala Lumpur, Malaysia
	9540	—	R. Warsaw	Warsaw, Poland
	9670	—	Vatican R.	Vatican City
	11735	—	Vatican R.	Vatican City
	11940	—	R. Singapore	Singapore, Singapore
5:45 P.M.	3280	—	Windward Is. B.C.	St. George's, Grenada, W.I.
	6100	—	V. of Malaysia	Kuala Lumpur, Malaysia
	6175	—	V. of Malaysia	Kuala Lumpur, Malaysia
	7110	—	V. of Malaysia	Kuala Lumpur, Malaysia
	9750	—	V. of Malaysia	Kuala Lumpur, Malaysia
	11900	—	V. of Malaysia	Kuala Lumpur, Malaysia
	15110	ZL4	R. New Zealand	Wellington, N.Z.
6 P.M.	4950	—	R. Malaysia Sarawak	Kuching, Sarawak
	5990†	—	CBC	Montreal, Canada
	6540	—	Korean Central B.C.	Pyongyang, N. Korea
	7160	—	R. Malaysia Sarawak	Kuching, Sarawak
	7580	—	Korean Central B.C.	Pyongyang, N. Korea
	9625†	—	CBC	Montreal, Canada
	9745	BEC62	V. China Air Force	Taipei, Taiwan
	9875	—	Korean Central B.C.	Pyongyang, N. Korea
	11810†	—	CBC	Montreal, Canada
	15190	—	CBC	Montreal, Canada
6:30 P.M.	9755	—	VTVN	Saigon, S. Vietnam
	15110*	HCJB	V. Andes	Quito, Ecuador
	15115	HCJB	V. Andes	Quito, Ecuador
	15300	DZH9	Far East B.C.	Manila, Philippines
	17810	DZ16	Far East B.C.	Manila, Philippines
	17890	HCJB	V. Andes	Quito, Ecuador
6:45 P.M.	9510*	—	BBC	London, England
	15195	—	R. Sweden	Stockholm, Sweden
7 P.M.	3300	—	R. Belize	Belize, Brit. Honduras
	6070*	—	R. Sofia	Sofia, Bulgaria
	7150*	—	R. Moscow	Moscow, USSR
	7200*	—	R. Moscow	Moscow, USSR
	7250*	—	R. Moscow	Moscow, USSR
	7265*	—	Tirana Calling	Tirana, Albania
	7290*	—	R. Moscow	Moscow, USSR
	7310*	—	R. Moscow	Moscow, USSR
	7330*	—	R. Moscow	Moscow, USSR
	7360*	—	R. Moscow	Moscow, USSR
	9390*	—	Tirana Calling	Tirana, Albania
	9660*	—	R. Moscow	Moscow, USSR
	9690	LRA33	RAE	Buenos Aires, Argentina
	11780*	—	R. Japan	Tokyo, Japan
	15060*	—	R. Peking	Peking, China
	15095	—	R. Peking	Peking, China
	15135*	—	R. Japan	Tokyo, Japan

TIME (EST)	FREQ.	CALL	STATION NAME	LOCATION
7:30 P.M.	6234*	—	R. Budapest	Budapest, Hungary
	7220*	—	R. Budapest	Budapest, Hungary
	7225	VUD	All India R.	New Delhi, India
	9540*	—	R. Budapest	Budapest, Hungary
	9645	—	R. Pakistan	Karachi, Pakistan
	9715	DZH7	Far East B.C.	Manila, Philippines
	9765	VUD	All India R.	New Delhi, India
	9833*	—	R. Budapest	Budapest, Hungary
	11740	DZF5	Far East B.C.	Manila, Philippines
	11785	VUD	All India R.	New Delhi, India
	11885	—	R. Pakistan	Karachi, Pakistan
	15300	DZH9	Far East B.C.	Manila, Philippines
17810	DZI6	Far East B.C.	Manila, Philippines	
7:45 P.M.	17685	—	R. Peking	Peking, China
8 P.M.	5930*	—	R. Prague	Prague, Czechoslovakia
	5970‡	—	R. Berlin International	Berlin, E. Germany
	5970‡	CKNA	CBC	Montreal, Canada
	5985*	—	Vatican R.	Vatican City
	6010*	—	RAI	Rome, Italy
	6130	—	R. Nacional	Madrid, Spain
	6160‡	—	R. Berlin International	Berlin, E. Germany
	7110	—	V. America Relay	Colombo, Ceylon
	7115*	—	R. Prague	Prague, Czechoslovakia
	7250*	—	Vatican R.	Vatican City
	7345*	—	R. Prague	Prague, Czechoslovakia
	9525*	—	R. Habana	Havana, Cuba
	9615	—	R. Nacional	Madrid, Spain
	9625*	CKLO	CBC	Montreal, Canada
	9630*	—	RAI	Rome, Italy
	9645*	—	Vatican R.	Vatican City
	9795*	—	R. Prague	Prague, Czechoslovakia
	11720*	CHSB	CBC	Montreal, Canada
	11835	—	V. America Relay	Colombo, Ceylon
	11945	—	R. Peking	Peking, China
11990*	—	R. Prague	Prague, Czechoslovakia	
15220*	—	R. Australia	Melbourne, Australia	
15285	—	V. America Relay	Colombo, Ceylon	
15385	DZF3	Far East B.C.	Manila, Philippines	
17840*	—	R. Australia	Melbourne, Australia	
8:15 P.M.	6120‡	HER3	Swiss B.C.	Berne, Switzerland
	9535‡	HER4	Swiss B.C.	Berne, Switzerland
	11715‡	—	Swiss B.C.	Berne, Switzerland
8:30 P.M.	3300	—	R. Belize	Belize, Br. Honduras
	5020	—	R. Ceylon	Colombo, Ceylon
	5990	—	R. Bucharest	Bucharest, Rumania
	6035	XZK3	Burma B.C.	Rangoon, Burma
	6075‡	—	Deutsche Welle	Cologne, W. Germany
	6150	—	R. Bucharest	Bucharest, Rumania
	6190	—	R. Bucharest	Bucharest, Rumania
	6234*	—	R. Budapest	Budapest, Hungary
	7220*	—	R. Budapest	Budapest, Hungary
	9510	—	R. Bucharest	Bucharest, Rumania
	9540*	—	R. Budapest	Budapest, Hungary
	9590*	—	R. Nederland Relay	Bonaire, Neth. Antilles
	9590	—	R. Bucharest	Bucharest, Rumania
	9640‡	—	Deutsche Welle	Cologne, W. Germany
	9833*	—	R. Budapest	Budapest, Hungary
	11810	—	R. Bucharest	Bucharest, Rumania
	9 P.M.	4820	HRVC	R. Evangelica
5970‡		—	R. Berlin International	Berlin, E. Germany
6025‡		—	V. West	Lisbon, Portugal
6130		—	R. Nacional	Madrid, Spain
6160‡		—	R. Berlin International	Berlin, E. Germany
6185‡		—	V. West	Lisbon, Portugal
9615		—	R. Nacional	Madrid, Spain
9690		LRA33	RAE	Buenos Aires, Argentina
9715		DZH7	Far East B.C.	Manila, Philippines
9745*		HCJB	V. Andes	Quito, Ecuador
11740		—	Far East B.C.	Manila, Philippines
11780		—	R. Begrano (RAE Relay)	Buenos Aires, Argentina
11915*		HCJB	V. Andes	Quito, Ecuador
15115		HCJB	V. Andes	Quito, Ecuador
15385		DZF3	Far East B.C.	Manila, Philippines
17810	DZI6	Far East B.C.	Manila, Philippines	
9:15 P.M.	4980	—	R. Pakistan	Karachi, Pakistan
	6070	—	R. Pakistan	Karachi, Pakistan
	9645	—	R. Pakistan	Karachi, Pakistan
	11885	—	R. Pakistan	Karachi, Pakistan
9:30 P.M.	4985	CP75	Southern Cross R.	La Paz, Bolivia
	5970*	CKNA	CBC	Montreal, Canada
	9625*	CKLO	CBC	Montreal, Canada
	9710*	—	Lebanese B.C.	Beirut, Lebanon
	11820	—	Trans World R.	Bonaire, Neth. Antilles

TIME (EST)	FREQ.	CALL	STATION NAME	LOCATION
10 P.M.	4885	—	V. Kenya	Nairobi, Kenya
	5808	OAX7L	V. Altiplano	Puno, Peru
	5930*	—	R. Prague	Prague, Czechoslovakia
	5975	—	V. West	Lisbon, Portugal
	5990	—	R. Bucharest	Bucharest, Rumania
	6070	—	Ghana B.C.	Accra, Ghana
	6130*	—	R. Nacional	Madrid, Spain
	6140*	—	R. Budapest	Budapest, Hungary
	6185	—	R. Ceylon	Colombo, Ceylon
	6190	—	R. Bucharest	Bucharest, Rumania
	6234*	—	R. Budapest	Budapest, Hungary
	7115*	—	R. Prague	Prague, Czechoslovakia
	7130	BED7	V. Free China	Taipei, Taiwan
	7150	—	Male Sinco R.	Male Is., Maldive Is.
	7220*	—	R. Budapest	Budapest, Hungary
	7345+	—	R. Prague	Prague, Czechoslovakia
	9510	—	R. Bucharest	Bucharest, Rumania
	9525	—	R. Japan	Tokyo, Japan
	9550*	—	R. Norway	Oslo, Norway
	9570	—	R. Bucharest	Bucharest, Rumania
	9590	—	R. Bucharest	Bucharest, Rumania
	9610*	LLG	R. Norway	Oslo, Norway
	9615	—	R. Nacional	Madrid, Spain
	9690	LRA33	RAE	Buenos Aires, Argentina
	9715	DZH7	Far East B.C.	Manila, Philippines
	9795*	—	R. Prague	Prague, Czechoslovakia
	9833*	—	R. Budapest	Budapest, Hungary
	11740	DZFH	Far East B.C.	Manila, Philippines
	11780	—	R. Japan	Tokyo, Japan
	11780	LRV2	R. Belgrano (RAE Relay)	Buenos Aires, Argentina
	11810	—	R. Bucharest	Bucharest, Rumania
	11825	BED69	V. Free China	Taipei, Taiwan
	11850*	—	R. Norway	Oslo, Norway
	11860	BED45	V. Free China	Taipei, Taiwan
11990*	—	R. Prague	Prague, Czechoslovakia	
15125*	HLK41	V. Free Korea	Seoul, S. Korea	
15300	DZH9	Far East B.C.	Manila, Philippines	
15345	BED49	V. Free China	Taipei, Taiwan	
15385	DZF3	Far East B.C.	Manila, Philippines	
17810	DZ16	Far East B.C.	Manila, Philippines	
10:15 P.M.	4960	—	R. Mogadishu	Mogadishu, Somali
	7120	—	R. Mogadishu	Mogadishu, Somali
	11805+	—	R. Sweden	Stockholm, Sweden
10:30 P.M.	5052	—	R. Singapore	Singapore, Singapore
	6110*	—	Ghana B.C.	Accra, Ghana
	6135	—	R. Habana	Havana, Cuba
	11940	—	R. Singapore	Singapore, Singapore
10:45 P.M.	5970+	—	R. Berlin International	Berlin, E. Germany
	6025+	—	V. West	Lisbon, Portugal
	6160+	—	R. Berlin International	Berlin, E. Germany
	6185+	—	V. West	Lisbon, Portugal
11 P.M.	4845	—	BBC Relay	Francistown, Botswana
	6070*	—	R. Sofia	Sofia, Bulgaria
	6090	LRV1	R. Belgrano (RAE Relay)	Buenos Aires, Argentina
	9510	—	BBC	London, England
	9690	LRA33	RAE	Buenos Aires, Argentina
	9710	—	Mauritius B.C.	Forest Side, Mauritius
	11750	—	BBC	London, England
	11780	LRV2	R. Belgrano (RAE Rel.)	Buenos Aires, Argentina
	14520	—	Korean Central B.C.	Pyongyang, N. Korea
	15520	—	Korean Central B.C.	Pyongyang, N. Korea
11:15 P.M.	5965+	HER4	Swiss B.C.	Berne, Switzerland
	6190*	—	Overseas B.C. of Thailand	Bangkok, Thailand
	11715+	—	Swiss B.C.	Berne, Switzerland
	11910*	HSK9	Overseas B.C. of Thailand	Bangkok, Thailand
11:30 P.M.	6040	—	R. Yaounde	Yaounde, Cameroun
	6140*	—	R. Budapest	Budapest, Hungary
	6150	—	R. Bucharest	Bucharest, Rumania
	6190	—	R. Bucharest	Bucharest, Rumania
	6234*	—	R. Budapest	Budapest, Hungary
	7220*	—	R. Budapest	Budapest, Hungary
	9510	—	R. Bucharest	Bucharest, Rumania
	9545	—	Ghana B.C.	Accra, Ghana
	9570	—	R. Bucharest	Bucharest, Rumania
	9590	—	R. Bucharest	Bucharest, Rumania
	9760	—	Ghana B.C.	Accra, Ghana
	9833*	—	R. Budapest	Budapest, Hungary
	11810	—	R. Bucharest	Bucharest, Rumania
	15130	VUD	All India R.	New Delhi, India
17855	VUD	All India R.	New Delhi, India	
11:45 P.M.	5970+	—	R. Berlin International	Berlin, E. Germany
	6160+	—	R. Berlin International	Berlin, E. Germany

**TINIEST TV?** . . . That little gadget is a television receiver about the size of a miniature camera. Microvision, made by Sinclair Radionics Ltd. of Cambridge, England, was the hit of the British Radio & Television Show and is the tiniest on the market (smaller experimental sets have been built). It has 2-in. screen, weighs 10½ oz. Magnetic deflection and focus, magnet-less speaker, multi-vibrator oscillators help reduce weight, power drain. CRT neck is only ¼-in. thick. This model tunes only 13 channels.



# ELECTRONICS IN THE NEWS

**Pace setter . . .** They call it the Wizard at the University of Pennsylvania. It's a black box that sits in the stern (left foreground) of the rowing scull and by blinking its multi-color lights lets the coxswain know who's pulling his weight at the oar and who isn't. Key to operation is a set of spring devices fitted to the oarlocks. At a pressure of 215 lbs. one light on the Wizard's panel is triggered. At 240 lbs. the next fires, another at 265 lbs., the fourth at 285 lbs. A separate set of lights for each rower aboard lets the cox know exactly what each is doing. Says coach Joe Burk, "No matter who I put in with the Wizard they leave the other boat behind. Once we had two boats in a race begun without using the Wizard. I signaled the cox to turn it on in one of the boats and it was amazing—that boat just bolted out in front." At first the black box outraged rowing traditionalists—including team members. But the success of the device seems to have won a permanent berth for it aboard Pennsylvania sculls. Next goal for designer John McGinn of General Electric is to shave a lot of weight off its present 50 lbs. without changing performance.





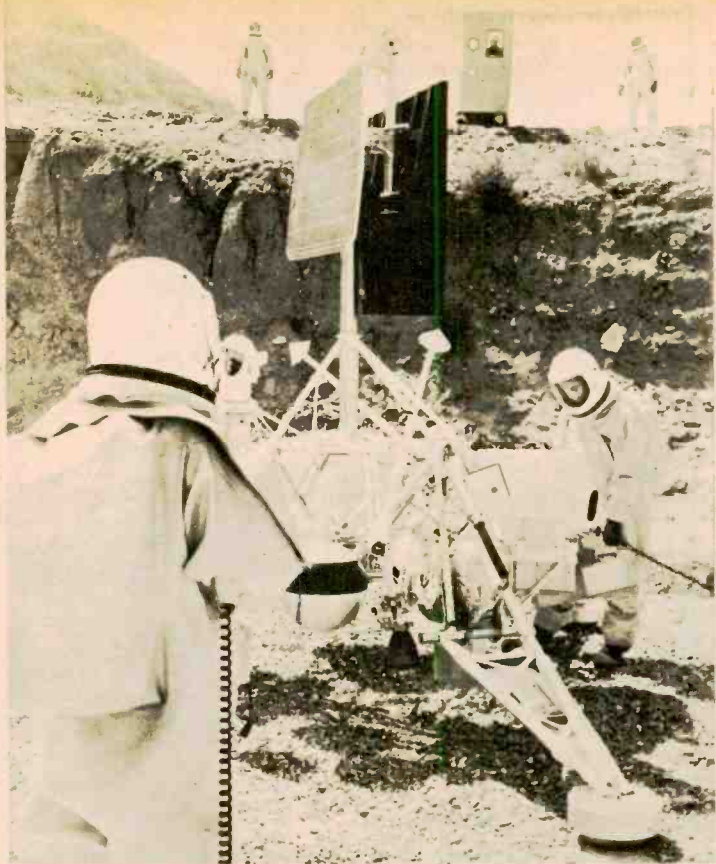

**Dress rehearsal . . .** It looks like the real thing when technicians (Hughes Aircraft Co., who employ them, call them spacialists) check out a Surveyor spacecraft. Here, in California's San Gabriel Mountains, Surveyor practices soft landings. Vernier engine and fuel supply are operative on this model. Mirror port for TV camera like the one aboard Surveyor I that took more than 11,000 photographs of the lunar surface is visible over right shoulder of technician in foreground. His suit, incidentally, is not for moon wear—it protects him from rocket fuel.

**Inside look . . .** Time was when it was hard to get any information at all about the Blue Eagle transmitter aircraft (see *The Fantastic Flight of the Blue Eagle*, May '66 EI). Then, last summer, the USIA, who operate the planes, began sowing publicity about their program to bring TV to South Vietnam. Finally, in this photograph, we have a look aboard the third Super Constellation to be pressed into service. It houses facilities for two TV channels, short wave, medium wave and FM. All can transmit at once

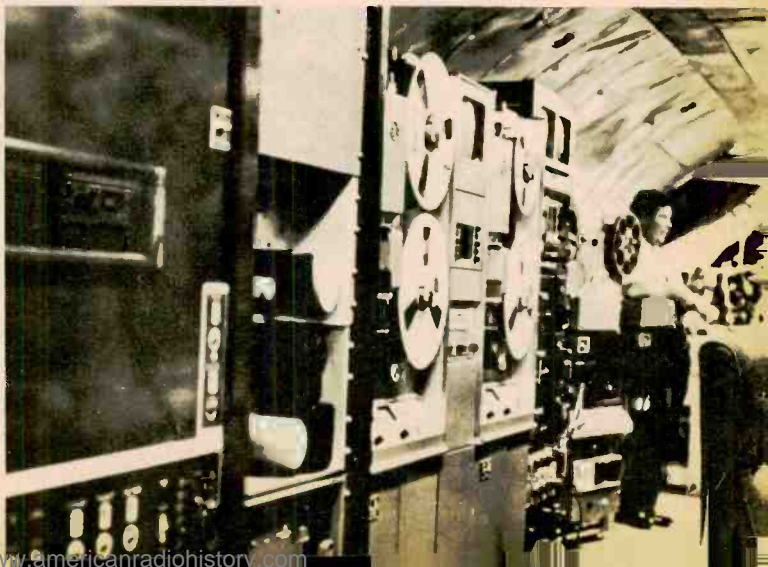

**Picnic . . .** One of the more unlikely photographs we've seen recently shows an ant climbing up a Lorenz bead-type tantalum capacitor. Why an ant? No reason except that somebody at Lorenz in Stuttgart wanted to dramatize the size of the capacitor. When we talked to a representative of ITT, who import Lorenz products, his only comment was, "I wonder where they got the plastic ant."

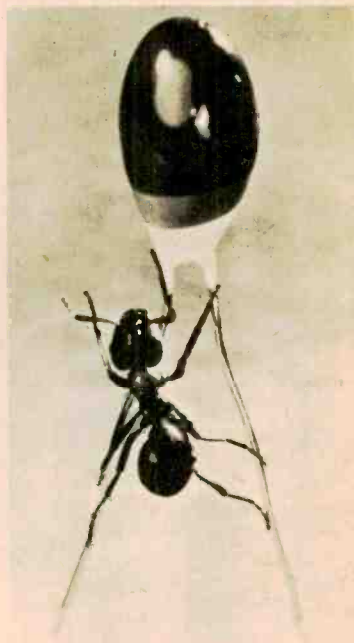

“He’s a good worker.  
I’d promote him right now  
if he had more  
education in  
electronics.”



# Could they be talking about you?

You'll miss a lot of opportunities if you try to get along in the electronics industry without an advanced education. Many doors will be closed to you, and no amount of hard work will open them.

But you can build a rewarding career if you supplement your experience with specialized knowledge of one of the key areas of electronics. As a specialist, you will enjoy security, excellent pay, and the kind of future you want for yourself and your family.

Going back to school isn't easy for a man with a full-time job and family obligations. But CREI Home Study Programs make it possible for you to get the additional education you need without attending classes. You study at home, at your own pace, on your own schedule. You study with the assurance that what you learn can be applied to the job immediately.

CREI Programs cover all important areas of electronics including communications, servo-mechanisms, even spacecraft tracking and control. You're sure to find a program that fits your career objectives.

You're eligible for a CREI Program if you work in electronics and have a high school education. Our FREE book gives complete information. Airmail postpaid card for your copy. If card is detached, use coupon below or write: CREI, Dept. 1725E, 3224 Sixteenth Street, N.W., Washington, D.C. 20010.

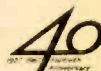

## The Capitol Radio Engineering Institute

Dept. 1725E, 3224 Sixteenth Street, N.W., Washington, D.C. 20010

Please send me FREE book describing CREI Programs. I am employed in electronics and have a high school education.

NAME \_\_\_\_\_ AGE \_\_\_\_\_

ADDRESS \_\_\_\_\_

CITY \_\_\_\_\_ STATE \_\_\_\_\_ ZIP CODE \_\_\_\_\_

EMPLOYED BY \_\_\_\_\_

TYPE OF PRESENT WORK \_\_\_\_\_  GI BILL

- I am interested in  Electronic Engineering Technology  
 Space Electronics  Nuclear Engineering Technology  
 Industrial Electronics for Automation  
 Computer Systems Technology

APPROVED FOR VETERANS ADMINISTRATION TRAINING

# Q&A about the

**L**AST spring, Congress passed and the President signed into law a new GI Bill of Rights similar to the ones available to veterans of World War II and the Korean conflict. Under the new law the government will help eligible veterans discharged since Korea buy homes, go into the farming business or get special counseling and career testing. But by far the most important provision is the one covering educational benefits.

If you want to get detailed information about the operation of the new GI Bill, you can always go to your regional Veterans Administration office—(there's at least one in each state). But here are answers to most of the basic questions that veterans and prospective veterans are asking.

*Who is eligible? If I'm a veteran of the Army, Navy, Marine Corps, Air Force or Coast Guard and was not dishonorably discharged do I qualify?*

Yes if, since the expiration of the last GI Bill on Jan. 31, 1955, you have 181 days of service or were discharged for a service-connected disability. So-called six-month reservists who spent six months in uniform and then went into the reserves or National Guard are *not* eligible.

*Can I study electronics under the GI Bill? And are there any courses I can't take?*

Electronics (or anything else that will train you for a job or improve your skills in your present job) is covered. But not subjects for fun or as a hobby. Photography, dancing or sports, for example, can be studied only if you can convince the VA that you intend to work in the field.

*Right now I'm an electronics technician for a big company. I don't want to go back to school full-time, but I certainly would like to take a few advanced courses to sharpen me up in some areas. Is that allowed?*

Definitely. Any kind of education that will help you make a better living is covered. If you just want to upgrade your overall educational level, your case will be decided on an individual basis. Most college-level courses will qualify. Chances are you could take a few English courses no matter what your line of work, for example. And of course you can take a general BA course—a college education doesn't have to be aimed at a specific job. One more point: you don't necessarily have to train for the kind of work you're in. A salesman who wants to get into electronics could study electronics under the GI Bill, either full-time or (if he wants to keep working as a salesman while he learns) part-time or at night.

*Are all accredited colleges and universities or technical institutes and trade schools open to me under the GI Bill?*

Yes. So are accredited high schools for people who don't have a high-school diploma. Only the state can accredit a school for inclusion under the GI Bill, though. Your state department of education or your regional VA office can provide information on approved schools. Incidentally, if you want study by mail, you will find home-study schools on the approved lists, too.

# new GI Bill

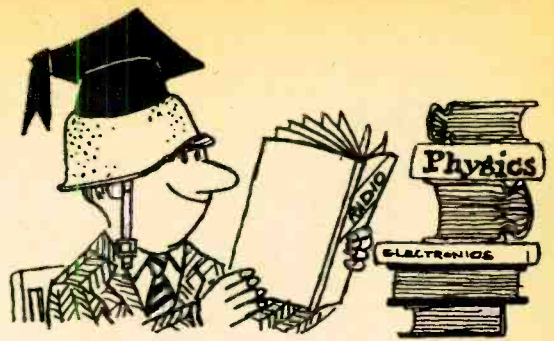

By MILES DILLARD

Q  
A

*How long can I go to school under the GI Bill? Does it depend on how long I spent in the service?*

Yes—you get one month of full-time study for every month you served up to a maximum of 36 months. For a three-year hitch you could get 36 months of schooling, for example—enough to attend four nine-month college years and get your degree. Going part time, you can spread your training over a longer period. For instance, if you have 24 months of school coming and attend only half-time, you can go for 48 months. If your benefits run out in the middle of a semester, by the way, the VA will keep mailing checks until the end of the term if your work is satisfactory.

Q  
A

*How much money do I get for going to school and how will it work out if I don't go full-time?*

For full-time schooling you get \$100 a month if you're single, \$125 with one dependent, \$150 with two or more. For less than full-time you get proportionately less—half pay for half-time schooling, for example. If you attend night school while keeping a full-time job the VA will work the pay out with you on an individual basis. But on-the-job training is not covered.

Q  
A

*Is there a time limit? How long after my discharge can I wait before using up the benefits I have coming?*

Eight years. If you were already a veteran when the bill went into effect last June 1st, you have eight years from then—until June 1, 1974.

Q  
Q  
A

*I got out of the service five years ago and worked my way through college when there wasn't any GI Bill. Can I get reimbursed for what I've spent?*

Unfortunately, no. But why not go back to school under the GI Bill and take some advanced courses that will help you qualify for an even better job?

Q  
Q  
A

*If I apply for admission under the GI Bill does the school of my choice have to take me?*

No. Your application will be handled just like that of any other student except that you will have extra forms to fill out (and once you are accepted you will be getting that monthly check). You will have to meet the school's regular requirements to get in and stay in—as long as your work satisfies the school, it's fine with the VA. Incidentally, most schools have the necessary forms (if they don't, the nearest VA office will) and some will even take care of the paperwork for you.

Q  
A  
Q

*I'd like to set up a radio-TV service shop after my schooling. Will the GI Bill help with that sort of thing?*

No. It will help a veteran buy land and equipment if he wants to become a farmer but no other business gets such a deal.

Q  
A

*One last question: I'm still in the service but would like to start my training now through home study. Can I?*

Yes, if you've been in two years or more. Of course, any part of your benefits you use up now will be subtracted from the total after you're out.



# THE BATTLE OF THE EICO 888 VS

**T**HERE'S no getting away from it. The do-it-yourself urge hooks more and more week-end auto mechanics every day. And for two good reasons—to save money and for the satisfaction of doing repair jobs themselves.

To tune up a car nowadays, you need more than a screwdriver and pliers. According to EICO and the Knight-Kit division of Allied Radio, you need an engine analyzer to get your mill running at top efficiency.

Just what is an engine analyzer and what can it do? Basically it's a special VOM with a tach circuit which tells you engine rpm and a dwell meter which tells you in degrees of rotation how long the breaker points remain closed. Oh, yes, it also includes a capacitor which you can substitute for the one in your car.

Essentially the EICO 888 and the Knight-Kit KG-375 analyzers measure voltage (0-3.2 and 0-16 V full scale), current (up to 90 A), engine rpm (1,200, 6,000) and re-

sistance to 20,000 ohms (1,000 ohms, center scale). True, these are only four fundamental measurements. But by means of the special meter scales and calibrations they reveal a lot about your engine's performance.

The analyzers can be used to check point settings, idle speed, alternator output, open circuits, poor plug leads, regulator and alternator performance, coil resistance, timing, spark output and several other things. But you really have to know how engines as well as ignition and electrical systems work to get full value out of the instruments. Though the analyzers indicate many things, you have to know what they mean.

Having decided to purchase one, which of the two kits on the market should you buy? The EICO sells for \$44.95 (\$59.95 assembled). The Knight-Kit is priced at \$49.95 (not available assembled). Are they the same or different?

Functionally they do exactly the same things. Electrically, they're practically iden-

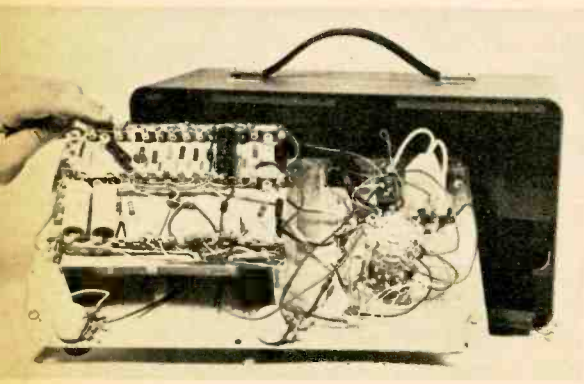

The majority of components in the Knight-Kit are mounted on terminal strips. The three-deck rotary function switch is located at right of panel.

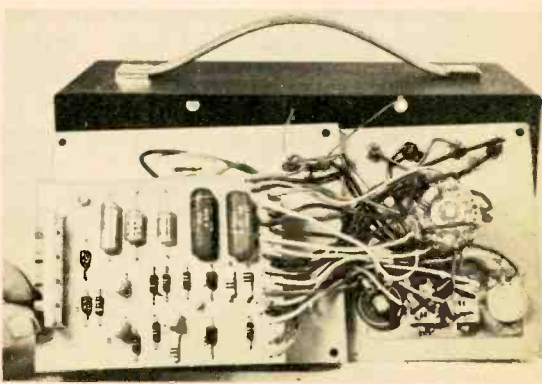

In the EICO, most of the parts are mounted on a printed-circuit board. The calibration pots are at extreme left. All other controls are at right.

# ENGINE ANALYZERS!

## Knight-Kit KG-375

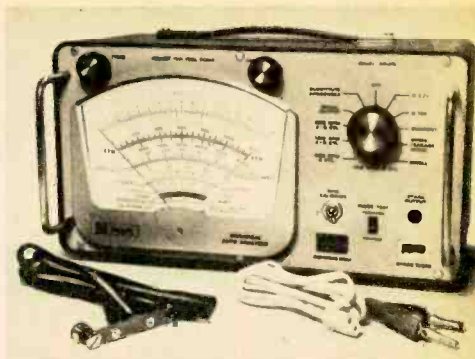

tical. In fact, you could almost use the schematic of one to troubleshoot the other. The differences are in appearance, construction, price and operating conveniences.

If you don't like to assemble your own gear, or if you have little background in kit building, you are far better off buying an assembled analyzer. The cost would still be considerably lower than other commercially-available instruments.

EICO uses a printed-circuit board. Knight uses terminal strips for mounting the parts. We put each kit together in around eight hours. Only problem with the EICO (which caused it not to work) was that the wafer in one section of the function switch did not seat properly, resulting in poor contact.

In the Knight-Kit there was a 12-conductor cable which caused trouble a couple of times. Because of the many wire colors, some are bound to appear similar. Result: a couple of connections to the selector switch had to be changed. The other problem, and a small one,

was seating the cap in the battery holder properly.

The Knight-Kit manual was well illustrated and the many excellent pictorials made for easy construction. The EICO manual (a first edition) had a number of errors which were corrected with supplied addenda sheets.

The EICO Operating Manual contains seven pages of idling speeds and dwell angles for most cars made since the early '50s. The Knight-Kit Operator's Manual doesn't contain such information, but it has a troubleshooting chart for automobiles which covers problems from backfire through slow-speed misfire.

Here are a few other features: The Knight-Kit has a storage compartment at the rear for the test leads and small tools. To protect the meter face, EICO has a recessed meter whereas the Knight-Kit has protruding front-panel handles. Both have a convenient carrying handle at the top. The EICO has a 6-in.

*[Continued on page 137]*

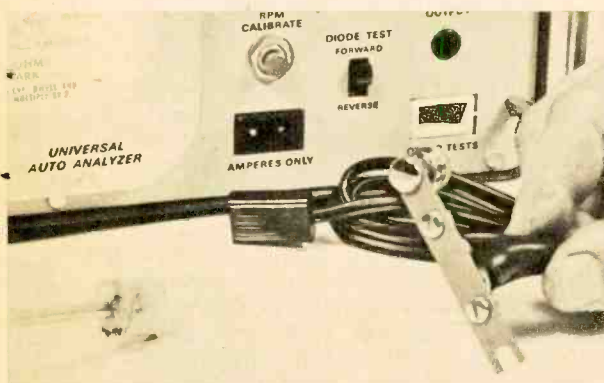

The Knight-Kit has different test-lead connectors and two sets of test leads. Shunt, in hand, is used to measure current (regulator tests) to 90 A.



EICO has two sets of identical connectors and comes with one pair of test leads. There were no instructions for assembling the current shunt.

# The Win-Tenna for Walkie-Talkies

By FRED BLECHMAN, K6UGT

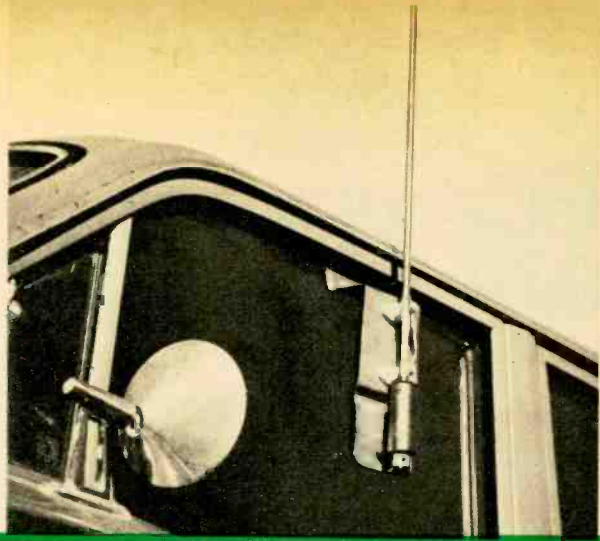

VACATION time often means going away with friends—and if it's a big crowd, two cars frequently must be used to carry the people, luggage, pets, pots, blankets, tents and other paraphernalia.

When traveling in caravan on vacations, moving day, to sports events or when double dating, it's oftentimes desirable and necessary to maintain communications between the cars. A pair of 5-watt CB transceivers would be the logical answer. However, installing such equipment for these rare occasions would be prohibitively expensive in light of their limited future use.

Next best thing is a pair of walkie-talkies. They're inexpensive, require no installation and have their own built-in power supply. But have you ever tried using one in a car? There's a whip antenna to contend with. If you haven't used a walkie-talkie on the road, take it from us, it's mighty inconvenient, if not impossible, to stick the whip antenna out the car's window. And it's dangerous too.

Obvious thing, you might think, is to remove the antenna from the walkie-talkie and temporarily fasten it to a car window. You might even try to connect the walkie-talkie to the car-radio antenna.

Not many people would want to butcher the walkie-talkie and even fewer would want to disable the car radio for the sake of occasional communications between cars.

The answer: the Win-Tenna. It's a base-loaded whip which you attach to your car's window with an adjustable home-made bracket. The cable from the antenna clips to your walkie-talkie's collapsed antenna. With this set-up in the car anyone in any seat can conveniently communicate with people in the other similarly-equipped car. Our diagram

is intended mainly as a guide, hence the lack of detailed and complete dimensions.

The window clip fits over the top of the window on the driver's or passenger's side of the car. You can use either the front or back windows. The window is then rolled up and the suction cup is moistened and pressed firmly against the glass. The adjustment slots in the window clip allow you to set the antenna so it's perpendicular to the ground. This feature is important since the windows of most cars slant inwards at the top.

## Construction

The first thing to do is bend the mounting bracket and window clip to suit the car on which it will be used, using our diagrams as guides. The material should be soft aluminum about 1/16 in. thick. The insulated stand-off posts are made of glazed ceramic and come in various sizes. They're supplied with all mounting hardware. We specify 1-in. posts, but you might have to use a different size. It depends on the window slant angle.

You'll also need one alligator clip, a solder lug, and about 4 ft. of insulated wire for each Win-Tenna. The suction cup can be salvaged from your junk box, an old toy, or it can be purchased at an auto-parts store. Even the Sears, Roebuck catalog includes a suction cup for 15¢ (it's number is 28 A 6010).

Attach the stand-off posts and window clip to the mounting bracket with screws, lock-washers and nuts. Use plastic cable clamps to hold the antenna to the posts. Solder an alligator clip on the end of the lead-in wire. On the other end of the wire solder a large ground lug. The lug can be either soldered to the bottom of the antenna or attached with a machine screw. Fasten the suction cup on



the mounting bracket and the job is complete.

### Installation

Feed the lead-in wire through the wing window or through the window on which the Win-Tenna is mounted. Attach the alligator clip to the top of the *collapsed* walkie-talkie antenna. A small metal bracket shaped as a holster can be made and used to hold the walkie-talkie to the window sash to keep it out of the way. Such a holder makes for operating convenience.

Don't expect fantastic range from the Win-

Tenna since some power is lost between the walkie-talkie and the antenna. Two cars with Win-Tennas and typical 100-mw walkie-talkies can communicate a few blocks depending on the terrain. Superregenerative-receiver walkie-talkies are relatively immune to ignition noise, and may be a better choice for auto use than more expensive superhets.

You can try any number of variations on the Win-Tenna—the idea here is to give you the basic plans. May you and your drive-talkies enjoy many chatty miles together.

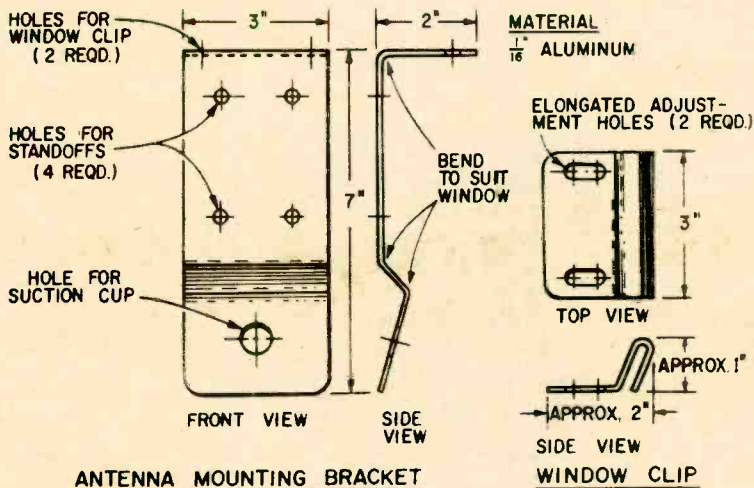

For most windows, the dimensions shown above will hold, but you may have to change a few for your car. Thing to keep in mind if you change dimensions is that bracket must provide plenty of support for antenna so wind won't bend it. Bracket should be adjusted with elongated holes in window clip to keep antenna vertical. Base-loaded whip antenna is available for \$3.95 plus postage from Radio Shack (catalog No. 21-907) or Lafayette (catalog No. 99 R 3015). Discard the PL-259 connector that comes with antenna. Stand-off insulators are E.F. Johnson No. 135-22. They're available from Allied (catalog No. 46 U 237) for 22¢ each plus postage.

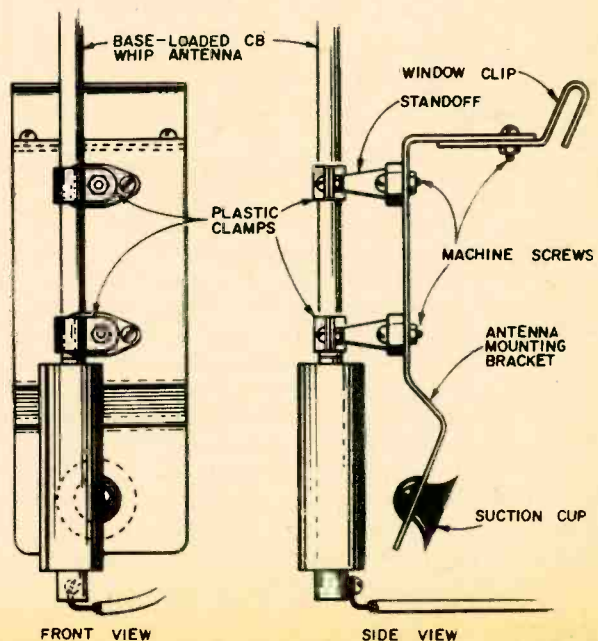

**W**HEN young Heinrich Hertz first told his Hamburg neighbors about his new scheme they invariably said the same thing. "Why, Heinrich, how wonderful!" they would exclaim. "To think you will have the very first car-rental agency in all Hamburg!" But then they would add: "What's a car?" And that depressed Heinrich. After all, it wasn't *his* fault that the car hadn't been invented yet.

That's just a sample of the Hertz stories you hear . . . and hear and hear until it hurts. Trouble is, most of them involve awful puns, such as Hertz and hurts. And confusing Heinrich Rudolph Hertz (1857-1894) with John D. Hertz (1879-1961). All of which makes for a type of humor usually called *eccch*.

Life was simpler in the old days—like a year ago. There was only one Hertz, a chap who once lived in Chicago, put together the Yellow Taxi fleet and then branched out into a car-rental business to which he promptly gave his name (perhaps after realizing that the name Yellow wasn't doing much for him in the social register). And the outfit wasn't really going anywhere, either, being only No. 1.

Alas, some zealous societies claiming to have something to do with electronics discovered—only seven decades too late—that Heinrich Hertz, a chap who once lived in Hamburg, put a couple of theories together and came up with a wave to which his name promptly was given, had never been honored enough for his contributions to science. So they took a term everybody in electronics knows—*cycles per second*—and turned into one that nobody knew—namely *hertz*. Furthermore, kilocycle had to become kilohertz and megacycle was, naturally, megahertz.

"I mean," said one friend of ours, "will Heinrich really care? He's only been dead since the last century."

Our friend is a cynic, of course, and soon enough he started referring to his Honda as a motorhertz. And said it was too bad that he had no children to ride trihertzes.

Heinrich's last name, it might be noted, isn't quite the same pun in his native German. Hurts in German becomes *schmerzt*. So one supposes if he had been born an American by the name of Henry Schmerzt, German DXers would be tuning in WNBC at 660 kiloschmerzts.

So why fight the trend? After all, one publication after another has been explaining that from now on that easy-to-remember kc just isn't going to be seen any more. Instead, readers now can look for khz or even kHz.

One publication absent from the hertzian rush was this one, not because of any lack of respect for Herr Hertz but, according to EI's editors, because of a certain respect for the true purpose of words. The real, last and only use for words, this gang says, is the communication of an idea from one head to another. Furthermore, they claim, taking a good,

easy-to-understand word and deliberately clonking (another good word) it on the head to honor somebody who had been sleeping peacefully 70 years is nine times worse than saying ain't while spitting on the sidewalk. Obviously, the office gang is a stuffy, green-eyeshade lot.

Needless to say, this epistle is far from the first to be written about the late, late and unexpected fame of Herr Hertz. From our perusal of some of these pieces, we are led to the inescapable conclusion that a lot of writers have been interviewing Heinrich

**WILL  
SUCCESS  
SPOIL  
HEINRICH  
HERTZ  
?**

Hertz in his grave. First they say he would be startled at the immense honor paid him, could he only be here today. Right away, however, it develops that surprise wouldn't be his main feeling. Instead, he would be saddened to think he had caused a controversy.

Actually, figuring out how Herr Hertz might feel upon instant reincarnation is just a bit difficult—like turning the Golden Gate Bridge end for end with an Erector set. Truth is, we don't really know that much about Heinrich Hertz. Relatively little was written about Hertz the man by anybody who knew what he was talking about. Hertz's own writings are meager and confined to—as one would expect—treatises dealing with his scientific theories. His most notable work to be found readily in English is *Principles of Mechanics*, the last word of the title being used in its broadest sense.

In addition to all these negatives, add the notation that Hertz died at the tragically young age of 36 so his attitudes probably still were forming. He did have great pride in his work — this we know—so perhaps to say he would be pleased by the recent revolution in the H section of the dictionary might make sense.

Heinrich Hertz was born in Hamburg in 1857, son of Gustav Hertz, a lawyer in a merchant family who eventually became a senator, and Elizabeth Pfefferkorn, daughter of a doctor said to be descended from Lutheran ministers. It also is said that we're lucky Elizabeth instead of Gustav changed names when they married. Can you imagine being told to tune in the BBC on 15 megapfefferkorns?

Young Heinrich apparently had a natural

interest in the sciences. He attended private grammar school for a while, then was tutored. At 16 he got hold of a lathe and made some equipment for experiments in physics and chemistry. At 17 he went to a secondary school, then at 18 worked for an engineering firm. After that came a year in the army, six months at a technical school in Dresden, then university study in Munich and Berlin. In 1880 he got a doctor's degree from the University of Berlin, where he began serious scientific experimentation.

Dr. Hertz, still only 23, launched his career of research and teaching (Kiel, Karlsruhe, Bonn) that 80 years later would put a khz on the face of broadcast radios to replace the familiar kc.

In Hertz's most famous experiment he took James Clerk Maxwell's equations of some years before which predicted the discovery of electromagnetic waves and turned them into reality. Every science-minded schoolboy has in his head a picture of the bearded Hertz operating a simple oscillator at one end of a room and seeing the flash of a spark in a spark gap at the other end.

Hertz married Elizabeth Doll in 1886. Not much is

known of the marriage from texts available in English. Hertz became ill not long after his marriage and remained in poor health until blood poisoning killed him in 1894. It could be described as a short but illustrious life.

Is the short, illustrious life of Heinrich Hertz any reason to change the English language? A quick answer is no, especially since herzian waves and antennas already honor him. But that may be the short view. Perhaps we must take the long view and see life as a complete hertz.—*Rufus Cartwright* —



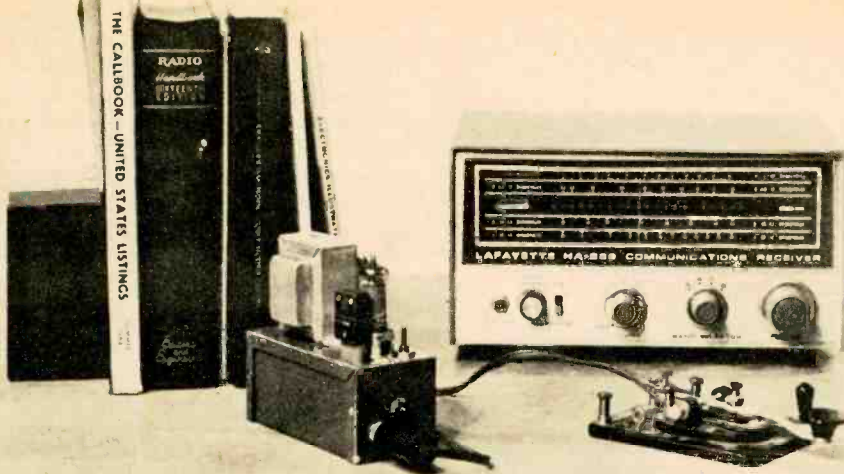

# 1-Bottle Xmitter for 40

*You'll be surprised at the reach of this 15-watter you can build for \$15.*

By JAMES B. WHITE, W5LET

**S**MALL? Why, man, you can hold it in the palm of your hand. In fact it might even disappear into the clutter of your operating table. But don't let it fool you. The signal our 1-bottle (tube) transmitter puts out is *big, big, big!* It will work stations far, far away.

The transmitter runs 15 watts (input power) on the 40-meter band. Power output of our model is six watts into a 50-70 ohm load. There are few parts—some two dozen counting the sockets, terminal strips, and other things like four capacitors and three resistors. The circuit features a transformer power supply, which reduces the possibility of shock considerably. Even if you have to buy everything from scratch it won't cost over \$15.

Our first CQ with it (from Louisiana) brought an answer from the midwest. During our first hour on the air, we worked both the east and west coasts. With a better antenna and operating at a time of the day when DX is coming in, there is no reason why the little rig couldn't work the world.

The transmitter will make a fine first rig

for the Novice, or because of its small size it's a perfect second rig for the oldtimer. Then again, it can be tucked away on a corner of the operating table and used as a standby transmitter when the big rig breaks down.

There is nothing difficult about putting it together. There is only one tube, a 6AQ5A operating as a straightforward crystal oscillator. To simplify things, there is no variable capacitor to tune the plate circuit to resonance.

Instead, tuning is accomplished by the plate-to-cathode capacity within the tube. This has the same effect as a fixed capacitor placed across plate coil L1. The resonant point of the tuned circuit is established with a slug-tuned coil (L1, L2). This coil is wound on a standard form made by the National Co. Neon lamp NLI serves as an RF indicator. It also provides a means of letting you monitor visually your sending.

The transformer power supply is a voltage doubler which uses two silicon rectifiers (SR1, SR2). These not only cut down on the size of the rig, but also eliminate most of the heat

that usually is produced at this point.

All of the parts are mounted in a 5 x 2¼ x 2¼-in. Minibox. On the top are the power transformer, coil, tube and crystal sockets. The coax antenna connector, SO1, AC power switch S1 and the line cord are on the transformer end of the cabinet. On the other end is the jack (J1) for the key as well as the neon RF indicator (NL1) and the AC pilot light (P1).

**Begin construction** by drilling all holes. Most of them are small. There is one exception—the hole for the tube socket which has a diameter of 5/8 in. RF indicator NL1 gets mounted in a small rubber grommet. This gives it a good firm mounting and provides capacitive coupling to ground.

Next, deburr the holes and mount the crystal and tube sockets. When mounting the tube socket, orient it so that pin 1 is near the crystal socket. Mount the transformer next, placing a four-lug terminal strip under each mounting screw's nut.

The coil is next. First, wind plate coil L1. It consists of 45 turns of No. 28 enameled wire. There is a space on the form for just this number of turns if you wind them closely and evenly. Over this coil (at the end near the mounting screw) wind four turns of No. 20 insulated solid hookup wire. Twist the ends so the turns are tight. Be sure that L2

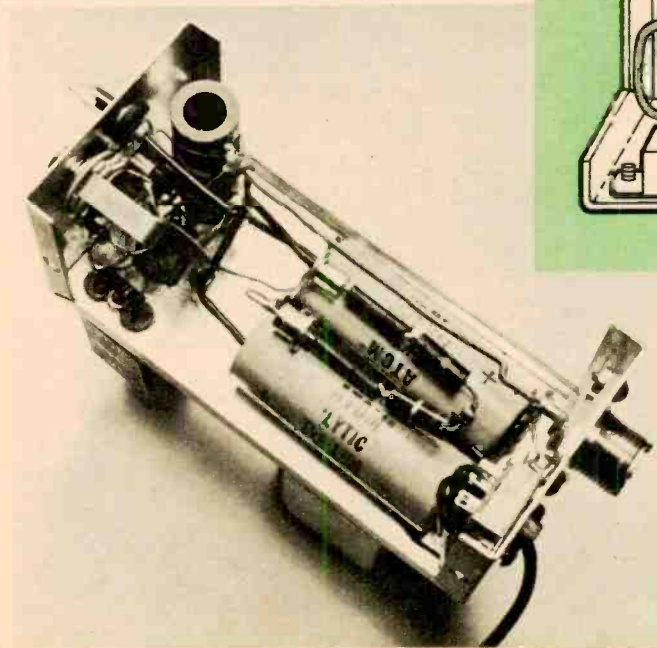
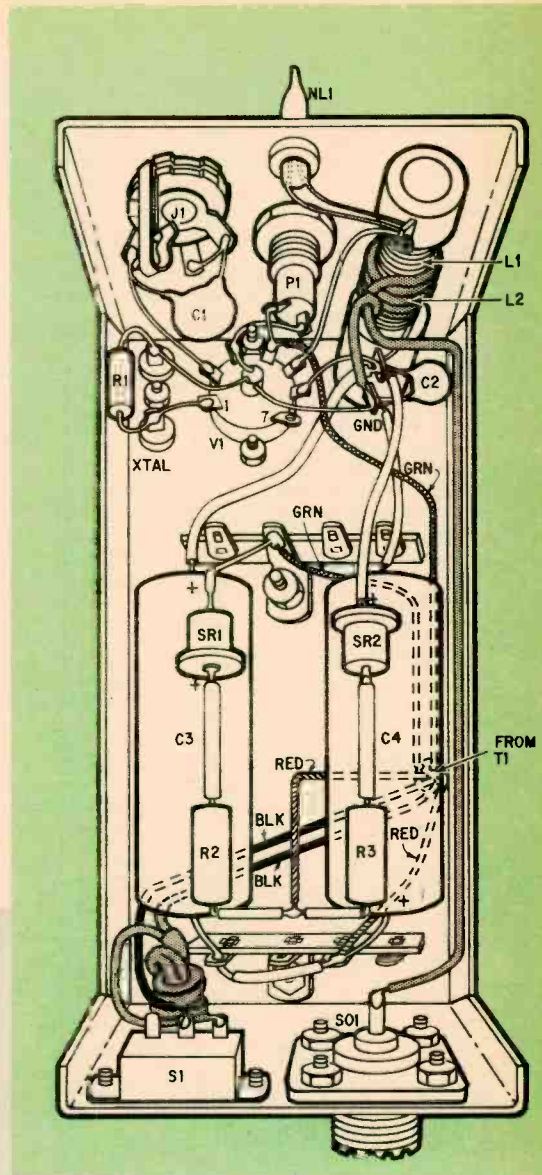

The underside of the cabinet is not particularly crowded. The two filter capacitors (C3,C4) take up most of the space. They are supported by two terminal strips which they fit between. Rectifiers SR1 and SR2 and current-limiting resistors R2 and R3 go on top of the capacitors. Be sure to use spaghetti on bare leads in the power supply. Note the location of the ground lug on the coil form.





## THE SURPRISING TRUTH ABOUT CB ACCESSORIES

By HERB FRIEDMAN,  
KB19457

AS A GENERAL RULE it takes about one day's operation before the owner of a spanking new CB transceiver gets the itch to hop up the performance with accessory equipment. If it's not a super-booster for more talk power it's an RF preamp for more sensitivity or a double-conversion adaptor for greater selectivity. Then there are CB test sets, noise suppressors, noise limiters, CB/AM couplers, TVI filters and panoramic adaptors. Fact is, if you add up the cost of all the CB accessories you can buy, the total price far exceeds that of even the most deluxe transceiver.

**Talk-Power Boosters** are a good starting point. The basic booster is simply a pre-amplifier, generally transistorized. By boosting the microphone's output to the transceiver, the so-called talk power is theoretically increased. But there's a catch. With one or two exceptions (the real budget models) most modern transceivers can be modulated to at least 85 per cent (100 per cent for all practical purposes) by a normal voice level into the *supplied microphone*. Adding additional preamplification can only overmodulate the transmitter (with resultant sideband splatter) if the transmitter is capable of overmodulation. If the transmitter is limited to 100 per cent modulation (as it should be) the preamp produces saturation of the modulator with resultant clipping distortion. Unfiltered clipping, no matter how it's sliced, is still distortion.

Many CBers equate distortion with increased talk power because distorted sound *sounds* louder than clean sound at the same level. But out where the signal is weak, overmodulation or saturation actually reduces intelligibility. Most often a booster will improve only those early transceivers that lacked sufficient microphone preamplification. If yours is a new rig, better check the modulation percentage before you buy.

**Compressors and Clippers** are something entirely different; they increase talk power by boosting the *average power* in the voice. However, 6db of compression—featured by many compressors—is next-to-nothing in increased performance. And improper



Compressor allows raising average level without raising peaks, hence increasing talk power.



Double-conversion adaptor (here a home-brew) adds IF stage, increases selectivity of some sets.

## CB ACCESSORIES

adjustment of the overall gain easily results in overmodulation. Really outstanding increases in talk power require about 10db of clipping or compression. Filtered clipping, by pruning of the voice waveform peaks at a pre-determined level, allows average level to be increased without overmodulation and introduces a ceiling at 100 per cent modulation (when adjusted properly). Raising your voice or shouting does not result in overmodulation, only an increase in average voice power (talk power).

A compression of about 10db is as effective as clipping at increasing talk power but has the advantage that there's no clipping to create distortion. Compressor gain must be very carefully adjusted, however, as there's no built-in ceiling to prevent overmodulation.

Since the terms compression and clipping are often used interchangeably in advertising, check carefully to be sure that the unit you buy really does what you want it to.

**Receiver Boosters or Preselectors** as they are generally called add an extra stage of RF amplification ahead of the receiver's antenna input. Problems? You bet.

Many early transceivers had no RF stage. The antenna was connected directly to the converter stage, giving a sensitivity in the vicinity of 10 to 20 microvolts—pretty bad. Tie a preselector to one of these bombs and you can get some acceptable performance, possibly a sensitivity of 1 to 2 microvolts.

But a modern transceiver already has a selectivity of 0.2 to 1 microvolt, with a front

end that's so hot just moving a wire 1/32 of an inch can cause the receiver to break into oscillation. In addition, many modern transceivers use electronic switching and therefore have no relays. How will you—assuming you're not a service expert—install the preselector? Another problem, particularly with solid-stage rigs, is overload. A normal antenna input can easily overload at 100,000 microvolts, a lot less than is delivered by a preselector amplifying a moderate or strong signal.

**Double-Conversion Adaptors** claim to give you super-selectivity. The idea here is that adding a low-frequency IF amplifier will increase selectivity. This is true, but whether it will do you any good is something else.

Selectivity refers to the IF amplifier's bandpass. While it can be made extremely narrow (say 400 cycles for interference-free code reception), it must be sufficiently wide to pass audio frequencies or the signal will not be intelligible. For communications, as a general rule, a bandpass of 2,500 cps at points 6db down (the usual reference) is minimum. If the bandpass is less than 2,500 cps the information-carrying voice frequencies are literally chopped off the signal and what comes out is muffled and bass-y. Of course, if the bandpass is too wide, (say 10 kc) it can include modulation from neighboring channels (adjacent channel interference).

As a general rule, two stages of IF amplification at 455 kc or one at 262 kc provide just about adequate selectivity, while virtually any normally-used high IF frequency (say 5 mc) combined with a mechanical or crystal filter or a ceramic filter provides even better selectivity. The bandpass is approxi-



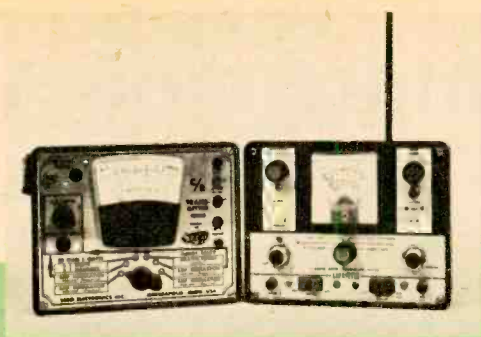

CB test units can check out transceiver many different ways but can't improve what they find.



Field-strength meter and combination antenna tester (wattmeter and SWR bridge) check output.

mately the same width as two stages of good 455-kc amplification at the reference points—but with steeper sides, giving great rejection of strong adjacent channel signals. (Strong adjacent channel signals from local stations generally will leak through two 455-kc stages or one 262-kc stage.)

It is only when a selective IF amplifier is added to a broad IF amplifier (say one or two 1,650-kc stages or a single 455-kc stage) that there is noticeable improvement. The bandpass is narrowed so as to reduce adjacent channel interference, but it is not made so narrow it cuts into the information-carrying sidebands.

**CB Test Sets** bristle with features. They provide an RF wattmeter, SWR bridge, modulation meter, crystal checker, and an RF signal generator. Some include a headphone monitoring jack for listening to the modulation, others double as a code practice oscillator and as an AF signal generator. But while a CB test set can show your rig's defects (if any) it can't make improvements.

Let's run down the features. The wattmeter will show the transmitter's power output into a dummy load of 50 to 54 ohms. Since the transmitter works into an antenna instead of a dummy load the wattmeter can only show if the transmitter's output has changed from the when-new value.

The SWR bridge shows the condition of the antenna system and whether the transmitter is peak-tuned into the system. This is valuable.

The modulation meter is something else. Is it adjusted for speech or tone waveform? Usually speech? Who's speech? No two people have the same speech waveform. And

most modulation meters indicate the *positive* modulation peak. Yet you and the FCC are only interested in the *negative* peak. The positive peak can be at 300 per cent modulation without splatter. But at 101 per cent negative modulation your signal starts spreading to adjacent channels. So an oscilloscope or a peak modulation meter calibrated to an individual transceiver is the only reliable modulation meter.

A crystal checker? Of some value, but if the transmitter output is as good as ever and the receiver still pulls in those weak ones, you can be darn certain your crystals are okay.

An AF signal generator is fine if you're troubleshooting a defective modulator. You will never use it, though, if you send your equipment out for repairs.

**Noise Limiters** are built into all CB transceivers. Some are good, some are not; but no add-on limiter will improve what you've already got. True, the TNS-type add-on limiter offered a major improvement on older transceivers. But the noise limiters in those transceivers were only slightly better than nothing at all. It is difficult to increase the amount of noise limiting in a modern transceiver without seriously distorting the audio output.

**Noise Suppressors** deliver the really big payoff. The noises generated by a gasoline engine can easily exceed the equivalent of a 20-microvolt signal at the transceiver's antenna terminals. Any CB signal weaker than the noise is completely masked. Any suppression device is valuable—and they add up. Start with a generator filter and you get a little noise reduction. Add a regulator filter and there's more suppression. Move up to full

[Continued on page 133]

# You can earn more money if you get an FCC License

...and here's our famous CIE warranty that you will get your license if you study with us at home

NOT SATISFIED with your present income? The most practical thing you can do about it is "bone up" on your electronics, pass the FCC exam, and get your Government license.

The demand for licensed men is enormous. Ten years ago there were about 100,000 licensed communications stations, including those for police and fire departments, airlines, the merchant marine, pipelines, telephone companies, taxicabs, railroads, trucking firms, delivery services, and so on.

Today there are over a million such stations on the air, and the number is growing constantly. And according to Federal law, no one is permitted to operate or service such equipment without a Commercial FCC License or without being under the direct supervision of a licensed operator.

This has resulted in a gold mine of new business for licensed service technicians. A typical mobile radio service contract pays an average of about \$100 a month. It's possible for one trained technician to maintain eight to ten such mobile systems. Some men cover as many as fifteen systems, each with perhaps a dozen units.

## Coming Impact of UHF

This demand for licensed operators and service technicians will be boosted again in the next 5 years by the mushrooming of UHF television. To the 500 or so VHF television stations now in operation, several times that many UHF stations may be added by the licensing of UHF channels and the sale of 10 million all-channel sets per year.

## Opportunities in Plants

And there are other exciting opportunities in aerospace industries, electronics manufacturers, telephone companies, and plants operated by electronic automation. Inside industrial plants like these, it's the licensed technician who is always considered first for promotion and in-plant training programs. The reason is simple. Passing the Federal government's FCC exam and get-

ting your license is widely accepted proof that you know the fundamentals of electronics.

So why doesn't everybody who "tinkers" with electronic components get an FCC License and start cleaning up?

The answer: it's not that simple. The government's licensing exam is tough. In fact, an average of two out of every three men who take the FCC exam fail.

There is one way, however, of being pretty certain that you will pass the FCC exam. And that is to take one of the FCC home study courses offered by the Cleveland Institute of Electronics.

CIE courses are so effective that better than 9 out of every 10 CIE-trained men who take the exam pass it... on their very first try! That's why we can afford to back our courses with the iron-clad Warranty shown on the facing page: you get your FCC License or your money back.

There's a reason for this remarkable record. From the beginning, CIE has specialized in electronics courses designed for home study. We have developed techniques that make learning at home easy, even if you've had trouble studying before.

## In a Class by Yourself

Your CIE instructor gives his undivided personal attention to the lessons and questions you send in. It's like being the only student in his "class." He not only grades your work, he analyzes it. And he mails back his corrections and comments the same day he receives your assignment, so you can read his notations while everything is still fresh in your mind.

## Mail Card for Two Free Books

Want to know more? The postpaid reply card found-in here will bring you free copies of our school catalog describing opportunities in electronics, our teaching methods, and our courses, together with our special booklet, "How to Get a Commercial FCC License." If card has been removed, just send your name and address to us.

Matt Stuczynski,  
Senior Transmitter  
Operator, Radio  
Station WBOE



"I give Cleveland Institute credit for my First Class Commercial FCC License. Even though I had only six weeks of high school algebra, CIE's AUTO-PROGRAMMED™ lessons make electronics theory and fundamentals easy. I now have a good job in studio operation, transmitting, proof of performance, equipment servicing. Believe me, CIE lives up to its promises."



Chuck Hawkins,  
Chief Radio  
Technician, Division  
12, Ohio Dept.  
of Highways

"My CIE Course enabled me to pass both the 2nd and 1st Class License Exams on my first attempt...I had no prior electronics training either. I'm now in charge of Division Communications. We service 119 mobile units and six base stations. It's an interesting, challenging and rewarding job. And incidentally, I got it through CIE's Job Placement Service."

Glenn Horning,  
Local Equipment  
Supervisor, Western  
Reserve Telephone  
Company



"There's no doubt about it. I owe my 2nd Class FCC License to Cleveland Institute. Their FCC License Course really teaches you theory and fundamentals and is particularly strong on transistors, mobile radio, troubleshooting and math. Do I use this knowledge? You bet. We're installing more sophisticated electronic gear all the time and what I learned from CIE sure helps."

## ENROLL UNDER G.I. BILL

All CIE courses are available under the new G.I. Bill. If you served on active duty since January 31, 1955, or are in service now, check box on reply card for G.I. Bill information.

**CIE** Cleveland Institute of Electronics  
1776 E. 17th St., Dept. EI-68, Cleveland, Ohio 44114

Accredited by the Accrediting Commission of the National Home Study Council, and the only home study school to provide complete coverage of electronics fundamentals plus such up-to-date applications as: Microminiaturization • Laser Theory and Application • Suppressed Carrier Modulation • Single Sideband Techniques • Logical Troubleshooting • Boolean Algebra • Pulse Theory • Timebase Generators...and many more.



Better than  
9 out of 10  
CIE men win  
their "ticket"  
the very first  
time they try  
**(NATIONAL AVERAGE  
IS ONLY 1 OUT OF 3)**

## Cleveland Institute of Electronics

# WARRANTY

## of success in obtaining a Government FCC License

The Cleveland Institute of Electronics hereby warrants that upon completion of the Electronics Technology, Broadcast Engineering, or First-Class FCC License course, you will be able to pass the FCC examination for a First Class Commercial RadioTelephone License (with Eadar Endorsement) ;

OR upon completion of the Electronic Communications course you will be able to pass the FCC examination for a Second Class Commercial Radio Telephone License ;

AND in the event that you are unable to pass the FCC test for the course you select, on the very first try, you will receive a FULL REFUND of all tuition payments.

This warranty is valid for the entire period of the completion time allowed for the course selected.

*G. O. Allen*

G. O. Allen  
President

# Notes from EI's DX CLUB

**D**AVE Siddall, WA1FEO (Massachusetts), reports that all Ascension Island hams can be addressed c/o Ascension Amateur Radio League, Box 4187, Patrick AFB, Fla. Dave recently worked ZD8RB, who is with the BBC down there.

A new station in the Dominican Republic is HIBE, R. Mil, on 4940 kc. Tom Guglielmi (Illinois) and William Sparks (California) note consistent reception until the station signs off around midnight EST (2100 PST).

Saudi Arabian Broadcasting currently is operating two different services simultaneously on the international SW bands. One is on 11950 and 9720 until 1730 EST sign-off. The other uses 11855, 9670 and 7230 with sign-off at 1815. Ace DXer Bob LaRose (N.Y.) says both are mostly in Arabic.

For its English transmissions at 0500 PST (0800 EST) and 0730 PST, R. Hanoi (and aliases) has replaced the 25-meter channel with 7215 kc, retained 9760 kc.

When conditions are good, both 60-meter channels used by Radiodiffusion du Senegal, 4890 and 4950 kc, can be heard from 0100 EST (2200 PST) sign-on. Each carries a different program. At that time you also might watch for the powerful BCB transmitter on 764 kc.

A real weird piece of DX available these days is R. Television Algerienne at various hours on 17910. This is actually the third harmonic of RTA's 5970-kc transmitter.

The big news from South America is that R. Nacional de Colombia has begun operations on the international bands—19 and 31 meters to be exact. Frequencies are around 15335 and 9635 with considerable drifting. Transmissions are in Spanish; times vary.

Further south, in Brazil, R. Clube de Ribeirao Preto is planning a major power

increase on 15415 kc. A letter to this effect was received from the station by H. L. Chadbourne (California).

Tom Guglielmi tells us that Emissora Regional at Ponta Delgada, Azores, sometimes can be heard in the Mid-West on 4865 kc prior to 1800 EST (1700 CST) sign-off.

R. Denmark has dropped its services for North Africa and the Near East due to "severe competition from higher-powered stations and poor reports."

According to a European source, Jordan has discontinued its North American transmission but continues to beam programs to South America on 15170 kc at 1830 EST (1530-1630 PST) where California's H. L. Chadbourne reports good reception. Programs are in Spanish and Arabic.

Bob Condor (North Carolina), tells us that Trans World Radio, Monaco, has moved its 0230-EST broadcast for Europe from 7260 to 7295 kc. This one probably will fade out shortly after sign-on.

*Propagation:* During years of high sunspot activity the number of severe ionospheric storms increases. As a result, radio conditions periodically become poor. Disturbed conditions tend to peak during the equinox months of March and September. Major storms can black out the entire high-frequency spectrum for a day or two at a time. In the early days of radio many listeners and amateurs dismantled their receivers because they thought something was wrong.

Most days of the forecast period are expected to be normal, however, and this means generally good-to-excellent DX. Daytime conditions will be good from 15 to 21 mc. During nighttime hours DX will be possible in all bands from 6 to 11 mc and some evenings to 15 and 17 mc. Broadcast-band DX will taper off as days grow longer and noise levels increase.

# Jet Eavesdropper



By CHARLES GREEN, W6FFQ

**S**ANDWICHED between the FM broadcast band and the 2-meter ham band is a slice of VHF spectrum filled with exciting listening. It's the 108-136 mc aircraft band. Tune in and you'll hear transmissions to and from control towers and commercial and private planes.

Aviation communications have come a long way since the early days when bonfires were used to light up runways and transmissions were via CW. The band is active around the clock—particularly in bad weather when flight and landing-pattern instructions are frequent and terse. You can listen in on the band with this 2-tube superregen receiver which features speaker output and a squelch circuit to eliminate background noise between transmissions.

**Construction.** The receiver can be built on a 7 x 7 x 2-in. aluminum chassis, as was our model, as shown in the pictorial and the photos. We used a 5 x 5-in. piece of sheet aluminum with a 1-in. mounting foot to hold the dial. Use a flexible coupling (Allied 47 A 2405) to connect tuning capacitor C5's shaft to the dial. Use a 3/8-in. spacer to attach C5's mounting foot to the chassis. Cut the hole for V1's socket about 1 in. to the side of C5. Then cut a 3/8-in.-dia. hole between the two holes for C4. C4 is connected between a 1-lug terminal strip under the chassis and C5, which is on top of the chassis.

Mount the speaker on two 3/4 x 3/4-in. brackets. To minimize microphonics, isolate the speaker's mounting screws from the brackets with grommets. Before wiring the chassis, cut a 1 5/8 x 2 3/4-in. piece of perforated board and install the squelch-circuit components on it with flea clips. Mount the board in the chassis with spacers to prevent

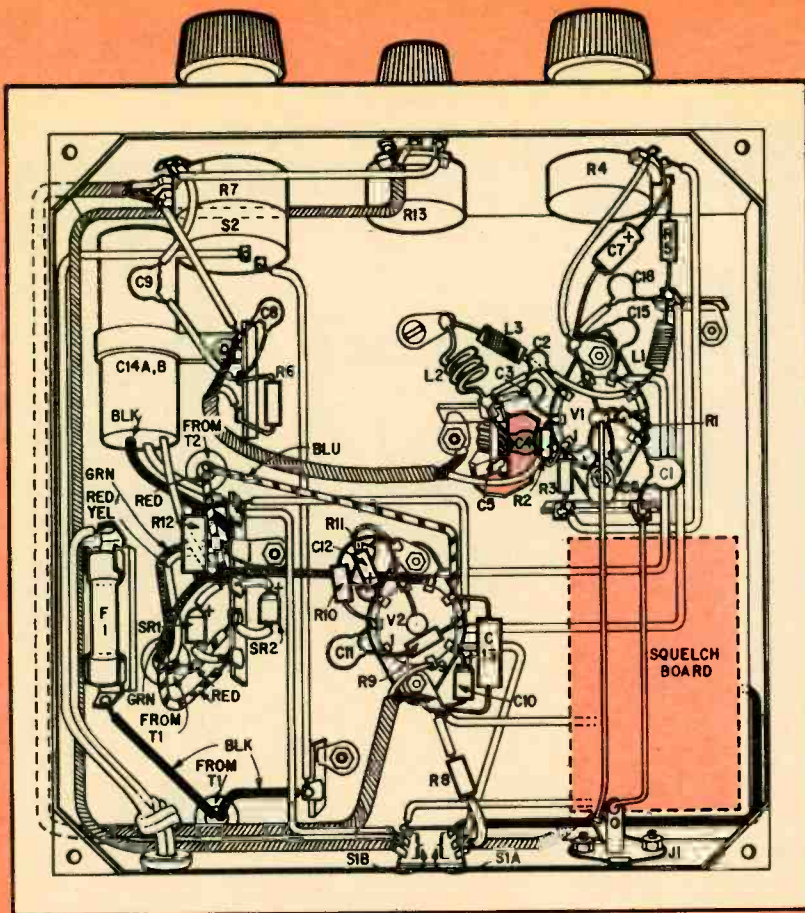

Fig. 1—Most critical part of the circuit is around V1 in upper right corner. Get parts and leads in positions shown or the receiver may not tune whole band.

# Jet Eavesdropper

shorts to the chassis. Keep the leads around V1 short and direct.

To make L2, wind three turns of No. 16 wire around a 3/8-in.-dia. twist drill. Space the turns out to a length of 3/8 in. Bend out 3/8-in. leads from the coil.

Mount J1 on the rear of the chassis in line with the center of V1's socket and high enough so its leads will clear the squelch circuit board. Position the leads from J1 to V1 as shown in the pictorial, keeping them approximately 1/8 in. apart. You can use the left-over No. 16 wire used to wind L2 for the leads to J1. Keep L3 away from L2 and the chassis.

**Operation.** A 6-ft. length of hookup wire is fine for an antenna but for best reception

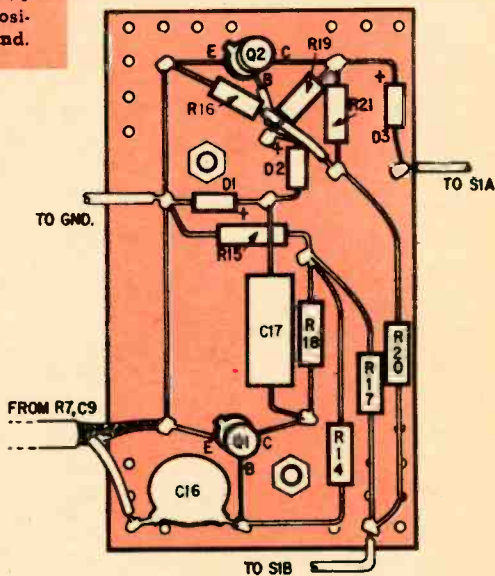

Fig. 2—Squelch board. Install all parts on board before mounting it on main chassis. Board fits in lower right corner of chassis as shown in Fig. 1. Watch the heat when soldering diodes D1,D2.

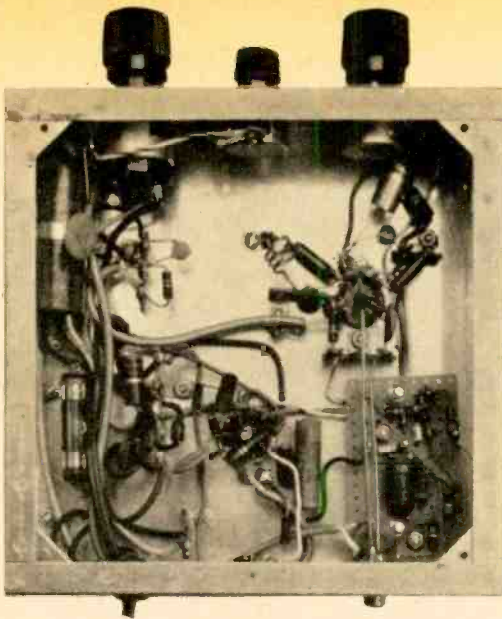

Fig. 3—Receiver underside. Install small components before connecting the shielded wires going from upper left corner to V2 and squelch board.

a vertical antenna, cut to length for the band, is best.

Connect the antenna to J1 and turn on the receiver. Set S1 to off and turn the *volume*, *squelch* and *regen* controls fully clockwise. If a signal generator is available, set it up to

produce a modulated 108-mc output. Couple the generator's output to the antenna lead by wrapping a few turns of the antenna wire around the generator's hot lead.

Tune C5 until you hear the signal. Its plates should be almost fully meshed. If you don't hear the signal, squeeze or spread L2's turns until you do. Then calibrate the dial with the generator.

If a signal generator is not available, try adjusting L2 so you can hear a station at the top of the FM broadcast band (108 mc) with C5's plates almost closed.

The tuning range will depend on your wiring job and component layout. Remove the signal generator and tune the receiver for aircraft calls on an active frequency. Then adjust the *regen* and *volume* controls for best reception.

Set S1 to *on* and adjust the *squelch* control until the background noise level disappears or is low. Transmissions should cause the squelch circuit to open and calls to come through. The *regen* control setting will affect squelch operation.

**The Circuit.** Take a look at Fig. 4. Signals from *ant.* jack J1 are coupled via C1 to the cathode of grounded-grid RF amplifier V1A. Amplified signals pass through C2 to the

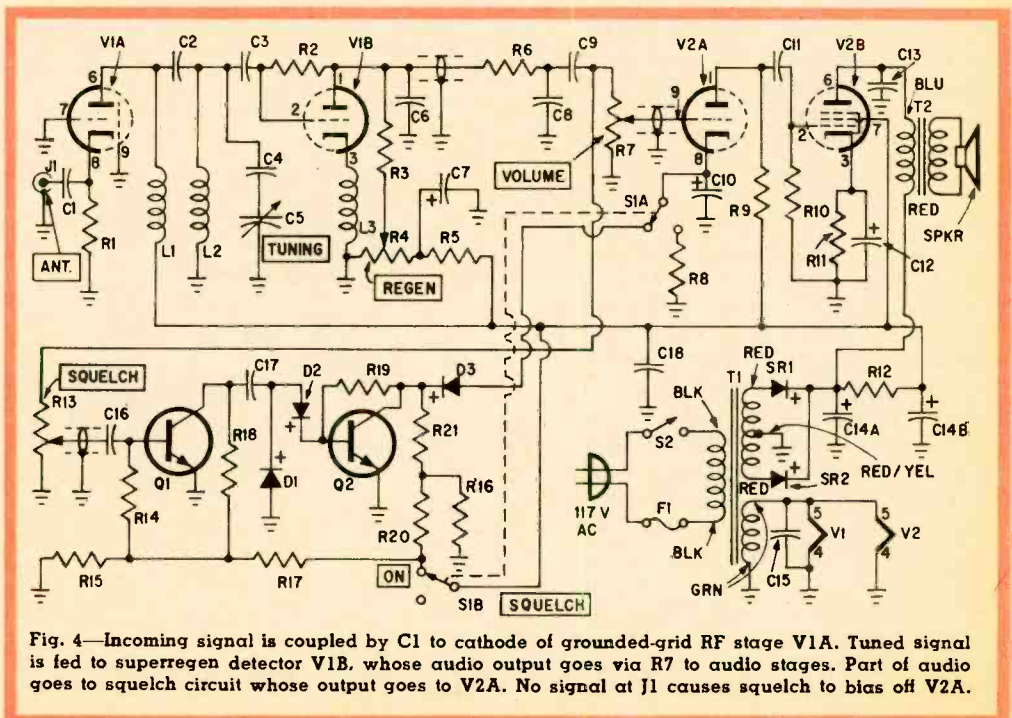

Fig. 4—Incoming signal is coupled by C1 to cathode of grounded-grid RF stage V1A. Tuned signal is fed to superregen detector V1B, whose audio output goes via R7 to audio stages. Part of audio goes to squelch circuit whose output goes to V2A. No signal at J1 causes squelch to bias off V2A.

## PARTS LIST

Capacitors: 1,000 V ceramic disc unless otherwise indicated  
 C1—47  $\mu\text{f}$   
 C2—4.7  $\mu\text{f}$   
 C3, C4—20  $\mu\text{f}$   
 C5—3.2-36  $\mu\text{f}$  variable capacitor (Hammarlund HF-35, Allied 43 A 3591)  
 C6—470  $\mu\text{f}$   
 C7—5  $\mu\text{f}$ , 150 V electrolytic  
 C8—.002  $\mu\text{f}$   
 C9, C11, C16—.01  $\mu\text{f}$   
 C10, C12—8  $\mu\text{f}$ , 12 V electrolytic  
 C13—.03  $\mu\text{f}$ , 400 V paper tubular  
 C14A, C14B—50/30  $\mu\text{f}$ , 150 V dual electrolytic  
 C15, C18—.001  $\mu\text{f}$   
 C17—25  $\mu\text{f}$ , 200 V paper tubular  
 D1, D2—1N198 diode  
 D3—HEP-157 silicon diode (Motorola, Allied HEP-157)  
 F1—1/5 A fuse and holder  
 J1—Phono jack  
 L1, L3—1.72  $\mu\text{h}$  RF choke (J. W. Miller RFC-144, Lafayette 34 C 8973)  
 L2—Coil: 3 turns No. 16 wire,  $\frac{3}{8}$ -in.-dia. x  $\frac{3}{8}$ -in.-long.  $\frac{3}{8}$  in. leads (see text)  
 Q1, Q2—HEP-50 transistor (Motorola, Allied HEP-50)  
 Resistors:  $\frac{1}{2}$  watt, 10% unless otherwise indicated  
 R1—220 ohms  
 R2—6.8 megohms  
 R3—100,000 ohms

R4—100,000 ohm, linear-taper potentiometer  
 R5—10,000 ohms, 2 watts  
 R6—82,000 ohms  
 R7—1 megohm, audio-taper potentiometer with SPST switch  
 R8—5,600 ohms  
 R9—220,000 ohms  
 R10—1 megohm  
 R11—120 ohms  
 R12—1,800 ohms, 2 watts  
 R13—1 megohm, linear-taper potentiometer  
 R14—820,000 ohms  
 R15, R21—15,000 ohms  
 R16—10,000 ohms  
 R17—120,000 ohms  
 R18—4,700 ohms  
 R19—1.5 megohms  
 R20—180,000 ohms  
 S1A, S1B—DPDT slide switch  
 S2—SPST switch on R7  
 SPKR— $\frac{3}{2}$ -in. 3.2-ohm speaker  
 SR1, SR2—Silicon rectifier; minimum ratings: 500 ma, 400 PIV  
 T1—Power transformer; secondaries: 250 V c.t. @ 25 ma, 6.3 V @ 1 A (Allied 54 A 2008 or equiv.)  
 T2—Output transformer; primary: 10,000 ohms; secondary: 4 ohms (Allied 54 A 1448 or equiv.)  
 V1—6JK8 tube  
 V2—6CM8 tube  
 Misc.—Vernier dial (Lafayette 99 C 2566), 7 x 7 x 7-in. aluminum chassis, 9-pin tube sockets, perforated board, shielded wire

# Jet Eavesdropper

L2/C5 tuned circuit. Variable capacitor C5 tuned our receiver from 106 to 148 mc.

Grid-leak capacitor C3 couples the signal to the grid of superregen detector V1B. Interelectrode capacitances of V1B feed back RF to cause oscillation. The time constant of R2/C3 interrupts the oscillation at an ultrasonic rate. This allows circuit gain to reach high level—hence the name *superregeneration*. Superregeneration is controlled by varying V1B's plate voltage with R5.

The detected audio signal passes through low-pass filter R6/C8 to attenuate the ultrasonic oscillation. The signal continues via C9 to the parallel-connected *volume* (R7) and *squelch* (R13) controls. When S1 is off, V2A amplifies the signals from R7. The signal is then fed via V2 to the speaker.

When S1 is set to *on* the cathode of V2A is connected to the squelch circuit. This circuit cuts V2 off when there's no audio signal at the junction of C9 and R7. The cathode of V2A is connected by D3 to Q2's collector. Normally little current flows between Q2's emitter and collector. This raises Q2's collector voltage high enough to reverse-bias D3.

A received signal sends audio to R13. The audio then is amplified by Q1 and rectified by D1 and D2. The DC bias fed to Q2's base lowers Q2's emitter-to-collector resistance, which in turn forward-biases D3. V2A's cathode now has a path to ground; therefore, V2A amplifies the signal. R13 controls the squelch threshold. —●—



Fig. 5—Plate at front supporting dial assembly is made of scrap aluminum. When mounting the speaker, isolate it from the chassis with grommets.



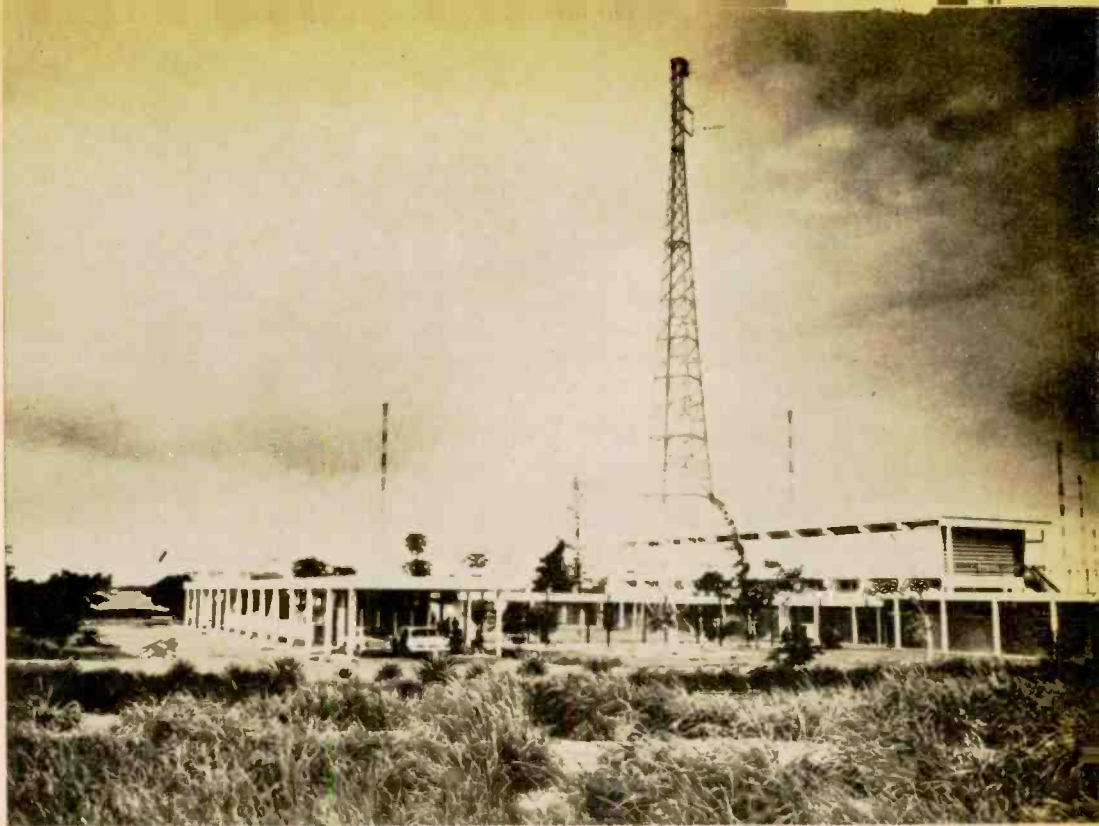

Installation near Accra for External Service of the Ghana Broadcasting Corp. is powered by four 100-kw transmitters, broadcasts in seven languages. Domestic service requires six African languages.

## THE MANY, MANY VOICES OF AFRICA

By **ALEX BOWER** FASTEST-changing of the world's continents, by far, is Africa. The stresses of African political existence may even have made some part of this article obsolete before you have a chance to read it—several changes occurred while it was in preparation. But the struggle going on in the background lends a sense of urgency to African DX.

Under heaviest fire from inside and outside Africa are the countries in which white-minority controls has been maintained. Recently the government-owned South African Broadcasting Corp. (SABC) began setting up a full-fledged international SW service to be known as Radio RSA. When completed it will include four brand new 250-kw transmitters and the most modern of antennas. While Prime Minister Vorster is widely known for his pro-Nazi activities during World War II (he was jailed as a result) and his avid implementation (as Minister of Justice) of former Prime Minister Verwoerd's apartheid policies, advance publicity indicates that the ini-

tial tone of Radio RSA's efforts will be soft sell. Broadcasts to North America during evening hours on 9675 and 11880 kc will use antennas intended for West Africa until the array designed for us is finished.

Similar to South Africa in political orientation is neighboring Rhodesia, which presently behaves like an independent country—whatever its theoretical status may be. According to one report the government-owned Rhodesian Broadcasting Corp. will put into operation during 1967 one 100-kw and two 250-kw transmitters—all brand new and beamed to Britain. Failing that, Rhodesia will continue to be difficult to hear in North America. You might try the RBC stations at Gwe'lo on 3306 and 3396 kc at their 2300 EST (2000 PST) sign-on. There is also a 120-meter outlet on 2425 kc.

It was, of course, the Portuguese contemporaries of Columbus who opened up the sea routes around Africa; and today Portugal still claims sizeable areas of Africa. Most of the propaganda effort to retain their African col-

# THE MANY, MANY VOICES OF AFRICA

onies is carried on by transmitters situated within Portugal itself, so logging the colonies falls in the category of pure DX. Easiest should be Mozambique. Privately-owned Radio Clube de Mocambique is operated by a group of businessmen in Lourenco Marques (the territorial capital). Best bet for this one is 11780 kc starting at 2300 EST. Through the QRM SWLs should be able to hear transmissions in English and Afrikaans (the Dutch-derivative language of South Africa). When spring comes you might also watch for their all-night service on 3218 kc in the early evening, our time.

(If you do make this catch, you might also try for the SABC all-night commercial service on 2376 kc. Since this is actually medium wave territory it would be DX you could be really proud of.)

In Angola the Portuguese government operates the Emissora Official at Luanda. This one signs on at midnight (EST) using 7225 and 4820 kc. Reception on both frequencies is reported from time to time in North America. Also operating in Angola are numerous privately-owned SWBC stations. Un-

fortunately a great mass of conflicting information is currently circulating about these transmitters—much of it, ironically, from a South African source. One Angolan private station whose activities are well-known, however, is Radio Diamang at the mining center of Dondo. It operates up on 11685 at 1300-1430 EST.

Further up the west coast of Africa lies Portuguese Guinea. Here the situation to watch for is the Emissora Provincial at the capital, Bissau. Despite its relatively low frequency (5041.5 kc) this one is often heard east of the Mississippi between 1700 and 1800 EST.

It should also be noted that while all Portuguese stations listed so far are liable to reflect the policies of Lisbon there is constant rebel activity in all three territories. (Should change overtake Portuguese Africa rebel radio could represent more than just fine DX.)

Another Portuguese colony is Sao Tome island in the Gulf of Guinea. Radio Clube de Sao Tome is received occasionally east of the Mississippi on 4807.5 kc prior to their 1705 EST sign-off.

## THE MANY, MANY VOICES OF AFRICA

FREQ. (kc)	STATION (& Country)	TIME (EST)	FREQ. (kc)	STATION (& Country)	TIME (EST)
3306	Rhodesia B.C.	2300 sign-on	5047	R. Togo	0030, 1700
3316	Sierra Leone B.C.	0100	6030	R. Rwanda	2300
3346	Zambia B.C.	2250	6250	R. Santa Isabel, Fernando Po	1700
3380	Malawi B.C.	2250	9540	ETLF, Ethiopia	2300 sign-on
3396	Rhodesia B.C.	2300 sign-on	9560	V. Revolution, Guinea	1800 sign-on
4777	R. Gabon	1700-1800	9690	V. Nigeria	1200-1705
4807.5	R. Clube, Sao Tome	1705 sign-off	9760	R. Ghana	1500-1600
4815	R. Ouagadougou, Upper Volta	0100	11685	R. Diamang, Angola	1300-1430
4835	R. Mali	0100	11780	R. Clube, Mozambique	from 2300
4845	R. Brazzaville, Congo	0130	11800	R. Ghana	1500-1600
4855	E. Nigeria B.C.	1800 sign-off	11820	R. Adibjan, Ivory Coast	1300 sign-on
4870	R. Cotonou, Dahomey	0030	11830	R. Kinshasa (Leopoldville), Congo	1300-1600
4904	R. Chad	0000	11895	R. Senegal	from 1300
4972.5	R. Yaounde, Cameroun	0300	11900	V. Nigeria	1200-1705
4976	R. Uganda	1600	15155	ELWA, Liberia	1615
5020	R. Niger	0300	15255	V. Nigeria	1200-1705
5035	Central African National R.	2330	15270	R. Malagasy	1100-1200
5041.5	Emissora Provincial, Portuguese Guinea	1730	15410	ETLF, Ethiopia	0830-0900
			17760	ELWA, Liberia	1115 sign-on

Most transmissions below 7000 kc are not intended for overseas reception and are generally difficult to log in North America.

Arrayed against South Africa, Portugal and Rhodesia are a host of nations stretching from the Sahara desert southward. Except for Ethiopia and Liberia, all recently emerged from colonial status and have generally inherited illiteracy, economic neglect and a burning desire to take their place in the 20th century. Many operate powerful international SWBC stations even though they really can't afford them.

At one time Kwame Nkrumah's potent Radio Ghana was virtually the voice of African nationalism itself. Since his downfall Nkrumah has taken refuge in Guinea where La Voix du Revolution (irregularly) beams broadcasts on his behalf back to Ghana. Meanwhile, Radio Ghana's own transmissions these days reflect a much more middle-of-the-road attitude.

Like Ghana, Nigeria is currently subject to strong political stress from within. The Voice of Nigeria, in Lagos, is widely heard in North America on 9690, 11900 and 15255 kc until 1705 EST. When conditions are good you might also watch for the Eastern Nigeria Broadcasting Service at Enugu on 4855 kc prior to their 1800 sign-off. Should Nigeria's internal friction result in partition, Enugu would probably emerge as a capital.

Tanzania's voice has been added to the SW bands since our table was prepared. They can now be logged way up on 21600 kc around 0900 EST.

Don't be surprised, incidentally, if your African listening turns up points of view that don't seem to jibe with our ideas of political right and left. For instance, Ethiopia—which is monarchist (and therefore rightist by North American standards)—is the home for ETLF, Radio Voice of the Gospel, probably the most progressive of SW missionary stations. Listen to their transmission to India at 0830-0900 EST on 15410 kc.

There are also some non-African voices to be heard from Africa. The VOA relay from Liberia can be picked up around 0100 EST on 9600 kc. The BBC, Botswana, uses 4845 kc at 2300 EST and 7295 kc at 0045. In the higher frequencies, ORTF is relayed from Brazzaville at 1400 EST on 15190 kc and the Deutsche Welle from Rwanda, 1245-1445 EST on 17765 kc.

Many African stations, as we have pointed out, are difficult to log in North America—particularly those below 7000 kc. And with sunspots on the increase, reception on the lower frequencies can be expected to be in-

[Continued on page 133]

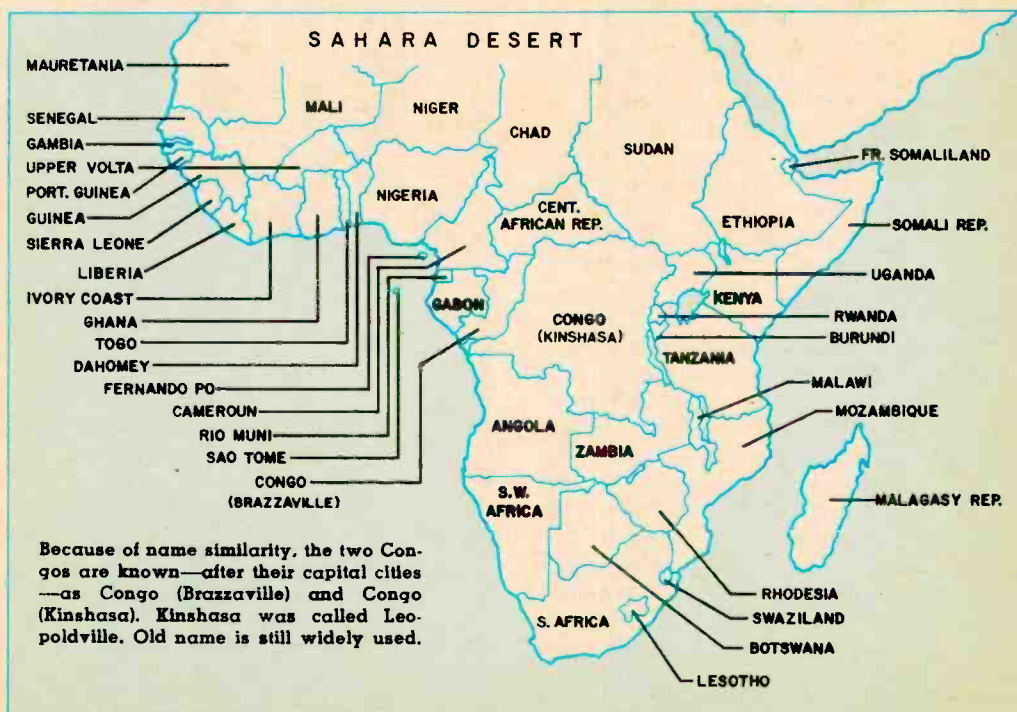

# 40 METERS ON 2 WHEELS



**Y**OU don't need a driver's license to take an amateur radio on the road. All you really need is your ham license. When Brad Good, WB6LUC, pedals his ten-speed bicycle around his home in Lakewood, Calif., the antenna on his 40-meter rig may draw double takes from passing motorists, but who cares? He can boast a 5-watt output that will reach out several miles from any convenient hilltop.

To climb the hill, Brad has to contend with the ten pounds his radio gear adds to the weight of the bicycle. He built the transmitter in an electronics class at Lakewood High School, using parts that cost him—all told—about \$50.

In the picture at right he inserts a 7293-kc crystal in the transmitter. The receiver can just be seen at the bottom of the picture, mounted on the diagonal bar below the transmitter. Dry-cell power supply is mounted on a rack over the bicycle's rear wheel.

One awkward element in his mobile rig, says Brad, is the antenna. It reaches 9½ ft. above ground level, snagging overhead trees if he is unwary. Any inconvenience, however, is offset by the fact that Brad's rig is—as far as he knows—the first bicycle mobile in use in the U.S. He also maintains a more conventional shack at home.

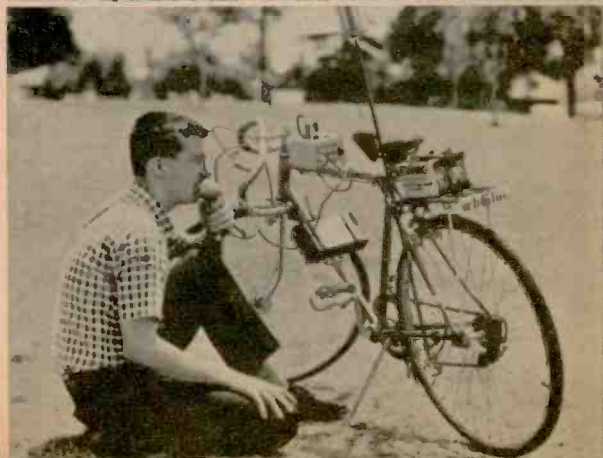
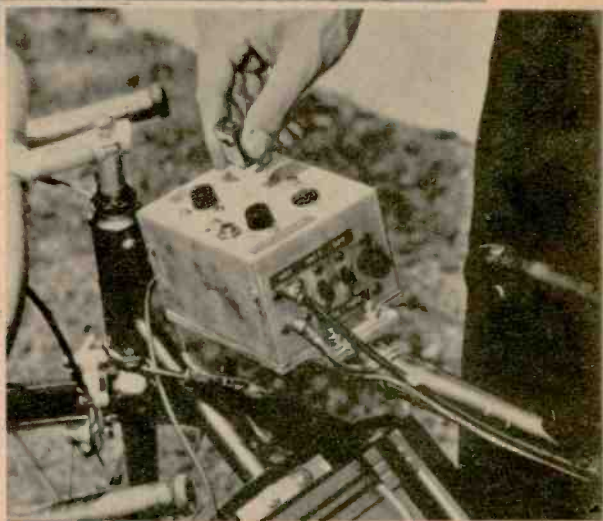

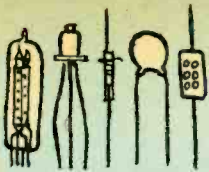

## BEGINNER'S CORNER

# The Case of the Buried Treasure

**P**IRATES and plumbers, attention! Here's a device that will boost business. It's a metal locator and it will find everything from buried treasure and hidden pipes to nails in the wall and hardware in your crackerjacks.

Because our locator is not complicated, its sensitivity is somewhat limited. However, our explanation of how metal locators work will enable you to design your own circuit so you can dig farther for riches—or way in for that elusive hot-water pipe. We'll first examine two important circuits used in these devices, then construct a simple, practical project.

First circuit is that of a proximity detector—a device once used in wartime to explode a shell at the most effective instant before it hit the target. Take a look at the left schematic in Fig. 1. It's of an oscillator which generates an RF signal. As the signal flows from tuned circuit to tube grid (along arrow marked *normal*) it sets up steady negative voltage on the grid. That's the oscillator's operating bias voltage produced by grid-leak action. Point is, when the tube oscillates, little plate current flows and the relay contacts remain open.

But bring metal near the sensing antenna and the RF signal will be pulled away from the grid. Now there's less signal available to produce negative bias; therefore, plate current increases. The relay pulls in (and explodes the shell).

This basic detector is also known as the capacity relay. It responds most strongly to metal, but a hand brought close to the sensing plate will also detune, or load down, the oscillator causing it to energize the relay.

Our second circuit (shown at the right in Fig. 1) is the beat-frequency metal locator.

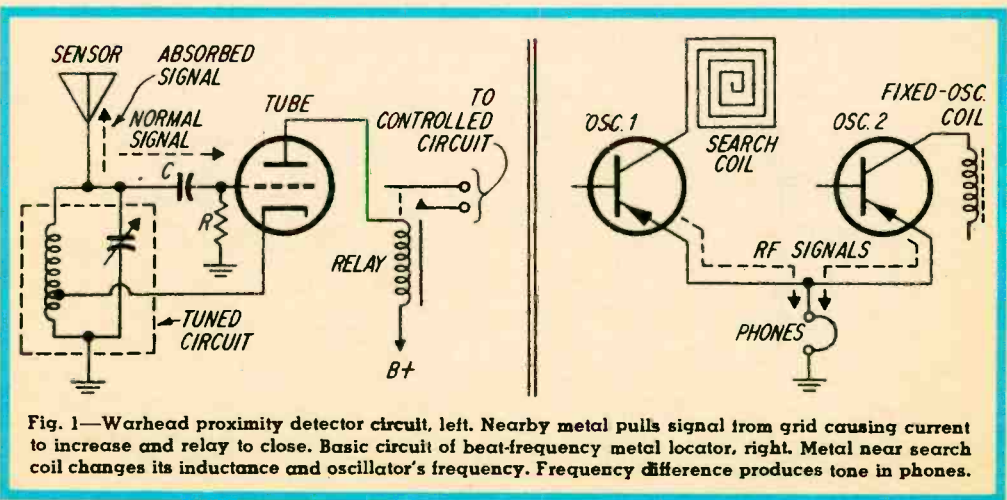

Fig. 1—Warhead proximity detector circuit, left. Nearby metal pulls signal from grid causing current to increase and relay to close. Basic circuit of beat-frequency metal locator, right. Metal near search coil changes its inductance and oscillator's frequency. Frequency difference produces tone in phones.

# Buried Treasure

Its operation is based on the heterodyne action between the outputs of two RF oscillators. Such action produces an audible signal. Instead of a relay, you listen with earphones for a change in tone, which reveals the presence of metal. Note that *Osc. 1* has a special loop called a search coil which gets moved over the area being inspected. When it passes over metal, the coil's inductance changes. This shifts the frequency of oscillation.

The other section of the device contains a similar fixed-frequency oscillator whose coil is shielded. Since both oscillators feed the earphones, signals mix and the difference is heard as an audible tone. For example, if both oscillators are set to generate a 1,000-kc signal you will hear no sound in the phones. But if the metal near the search coil reduces the frequency to 998 kc, you'll hear the 2,000-cps difference frequency.

In a practical metal locator, there's a mixer stage between the oscillators and phones. Although the basic circuit shown here can produce beat notes, it's plagued by pulling—a change in one oscillator's frequency tends to shift the other's frequency. The mixer stage introduces isolation between them.

Our metal locator's design is based on the beat-frequency principle. The circuit, however, has been greatly simplified by constructing just one oscillator with a search coil. You use any portable transistor radio to perform the remaining functions—mixing and producing the tone. The fixed-frequency signal is supplied by a broadcast station.

Start construction by winding the 3½-in.-dia. search coil around the perimeter of a

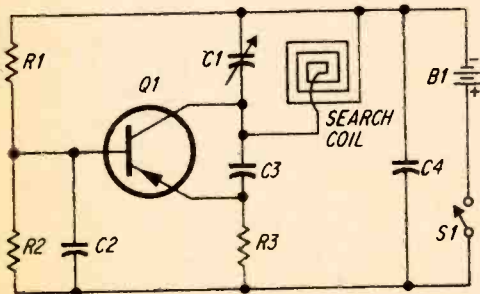

Fig. 2—Our metal locator's oscillator. Search coil and C1 determine frequency. Adjust C1 to produce heterodyne whistle with station tuned on radio.

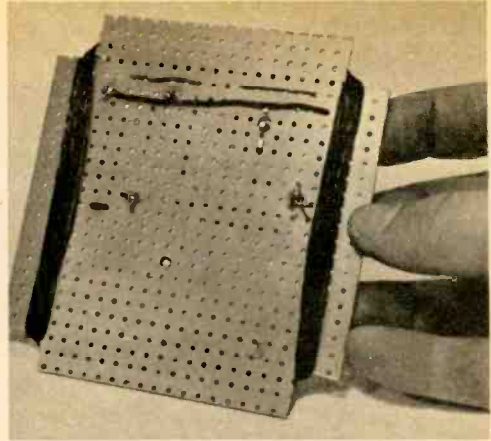

Fig. 3—Back of metal locator shows how the search coil (17 turns of No. 22 enameled wire) is wound on a 4½-in.-square piece of perforated board.

4½-in.-square piece of perforated board whose corners are notched. You'll have to enlarge three holes in the board to mount trimmer-capacitor C1. One center hole is to allow the tuning-screw threads to protrude through the board. Two others are for the mounting tabs. If the solder lugs on your trimmer are bent, straighten them so they remain on the component side of the board.

The battery can be taped or glued to the wood handle. You can mount an on-off switch in a free area on the board, if you wish. In our model we simply connected an alligator clip to the positive battery terminal.

The operating frequency of the oscillator falls in the upper portion of the BC band. If you wish to lower the frequency, either add more turns to the search coil, or connect an additional capacitor (about 100 μμf) across C1.

## PARTS LIST

- B1—9 V battery
- C1—25-280 μμf trimmer capacitor (Lafayette 34 C 6832 or equiv.)
- C2—.02 μf, 400 V tubular capacitor
- C3—100 μμf, 1,000 V ceramic disc capacitor
- C4—.05 μf, 400 V tubular capacitor
- Q1—PNP transistor, general-purpose RF (GE-1 or equiv.)
- R1—47,000 ohm, ½ watt, 10% resistor
- R2—10,000 ohm, ½ watt, 10% resistor
- R3—680 ohm, ½ watt, 10% resistor
- S1—SPST slide or toggle switch
- SEARCH COIL—17 turns No. 22 enameled wire wound 3½-in. square
- Misc.—4½-in. square perforated board, 1-in. square X 6-in. long piece of wood

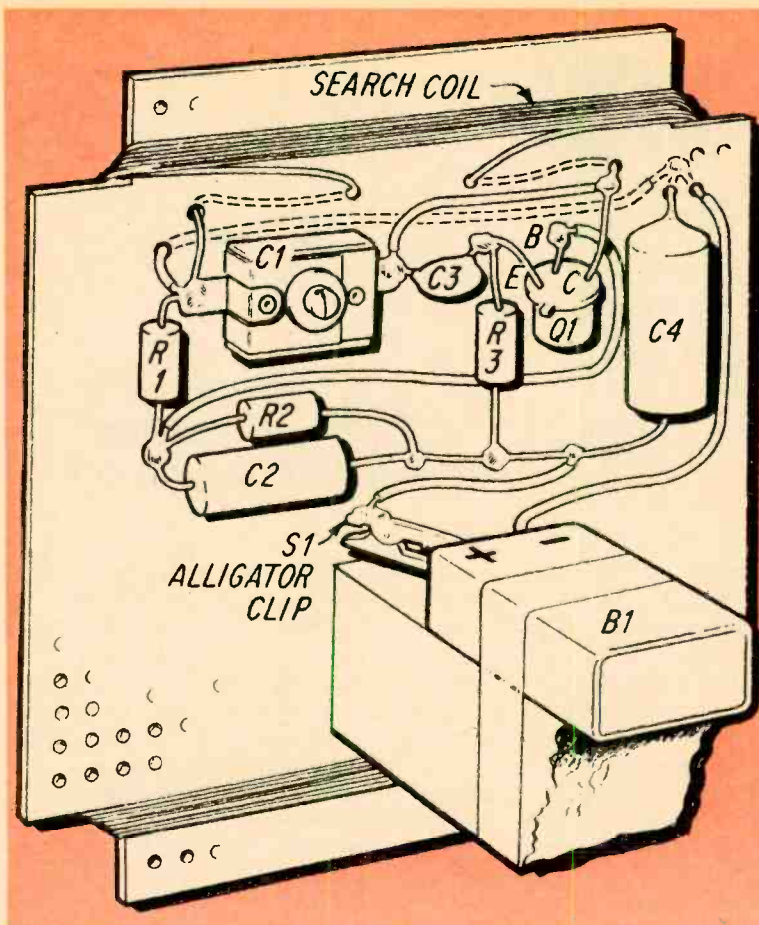

Fig. 4—On our model, parts are held on board by weaving wires through holes. However, you could use flea clips. To turn on locator, we simply attach an alligator clip to positive battery terminal. Switch S1, shown on schematic, would be connected between lead going to alligator clip and positive lug on B1.

To operate the locator, tune a BC radio to a station at the high end of the band. Next, adjust C1 until you hear steady tone from the radio.

As you move the search coil near metal objects, the tone should vary. Since your hand will also vary the tone (due to body capacity) hold the wood handle at the end.

After a little experience, you should be able to improve your skill. You'll find that the tone shifts in one direction for body capacity and in the reverse for metal. If you wish to convert the unit into a complete, portable instrument, devise some simple mounting arrangement for a transistor radio on the wood handle.

As a matter of fact, it would be best to mount the radio on the handle anyway so the radio's antenna always remains in a fixed position relative to the search coil. This will stabilize the tone. —H. B. Morris.

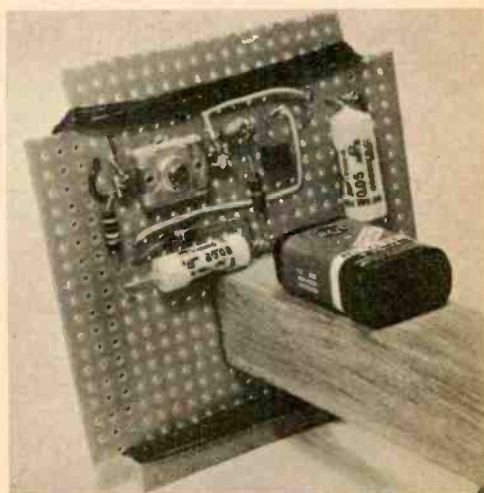
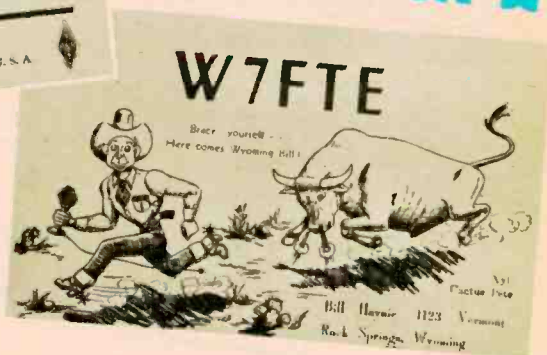

Fig. 5—Completed locator. Handle on our model is 6-in. long to keep hand away from circuit. This prevents hand from changing oscillator's frequency.



# QUAINT

# CUTE



THE QSL card, which merely is mail confirmation of a radio contact, was conceived originally by 8UX (see photo) and rapidly assumed as important a place in the ham station as the log and call book. These days, QSLs are such a must that no ham would be caught dead or alive without a stack. To be sure, nothing in federal laws or regulations makes them a legal requirement and rare is the club or group requiring either your own or somebody else's QSL card as qualification for membership (EI's own DX Club numbers among the rare ones since proof of having DXed various numbers of countries, states or provinces, or continents is its sole membership requirement). But a ham *without* QSLs? It just isn't done!

Design of the cards is wide open—so much so, in fact, that most anything acceptable to postal authorities goes. Imaginations run rampant and cards span the proverbial gamut. Fact is, the cute, quaint and kook among them range from simple, linoleum-block productions turned out by the ham himself to exceedingly elaborate, multi-colored offerings illustrated with photographs or drawings. The choice is yours though there is a point or two to keep in mind.

First let's consider size and shape. Postal regulations state that:

- a) Pieces less than 3 in. in width (height) or 4½ in. in length are not mailable
- b) Pieces having shapes other than rectangular are not mailable
- c) Pieces having a ratio of width (height) to length of less than 1 to 1.414 (1 to the square root of 2) are not recommended.

Though these regulations may seem harsh, there are two sides to every coin. Thing to remember is that the off-size card is at a disadvantage when it comes to display. If the recipient follows the popular practice of wallpapering his shack with QSL cards he is hard-put to fit the oddballs into his usually symmetrical arrangement. In some cases, of course, only the most attractive cards are displayed on the shack walls and they can be arranged a bit more artistically. By and large, however, it clearly is safest for QSLs to echo the standard, rectangular government post card, which measures 3¼ x 5½ in.

Next-most-important consideration in the design of a QSL is determining what information it is to convey. Obviously, your call letters should appear prominently either as a light (sometimes heavily bordered) overlay on top of other printed information or in relatively large letters either centered on the card or in one of the corners. The center placement often is preferable, since it lends a more balanced and more pleasing overall appearance to the card.

Also deserving consideration is pertinent data on the exchange of signals (certain of these items are absolute musts for contest entrants). The *basic* data include call letters of the station to whom addressed, date and time of communication, frequency or band and mode of transmission . . . fone, CW or teletype.

In addition to spaces for the above, most anything else can be included that suits the operator's fancy. An RST report on the other fellow's signals often is helpful. Space for a





# KOOK

# QSL

brief description of your transmitter and receiver and perhaps the antenna often are included. (Though this last has proven a pitfall to many hams, who now prefer merely to provide properly labeled blank spaces for such information. Reason is that the average ham frequently changes his equipment and a quantity of cards printed with data about gear well may be outdated before they are used up.)

If it doesn't crowd your card too much, you can add a bit of historical data or boast a bit about the advantages of the area in which you live (thus delighting your Chamber of Commerce). You also might choose to list the organizations to which you belong. The other fellow always is interested in any personal glimpses that will enable him better to know the OM he worked.

Such data ordinarily are placed on the

front of the card along with the call letters, though they also can be boxed on the reverse side of the card. Since any QSL ideally reflects the person it represents, this decision too strictly is up to the individual ham. However, it is well to bear in mind that if you and your contact post the cards on your shack walls you'll have to remove those of the two-sided type should you want to refer to the details of that particular QSO. Further, a two-sided card calls for a double press run which will cost you more at the print shop.

Speaking of cost, the firmest pinch on the penny calls for a more or less crudely made linoleum-block cut-out for call letters. This then is used with a stamp pad and hand printing, though other information also can be typed or written on the card. Point to remember is that no one loses face among the ham fraternity for a card of this type. After all, this procedure does provide for a perfectly adequate QSL card even if production of that card is by the slow and hard method.

Though mimeographing is another out for small-quantity production, in most cases it's more desirable to have a card printed from your own design. For while this is the most costly method, you can beat this higher cost substantially and still have a professional card (most often in two colors). Trick is to buy cards from various sources already printed with blank, titled lines for the QSO data and with your call letters inserted in some bright contrasting color.

Another good bet for keeping price completely under control is to take advan-

[Continued on page 135]



World's first QSL card, according to article in 1924 QST, was issued by station 8UX.

# THE HAM SHACK



BY  
WAYNE GREEN  
WZNSD/1

NOUMEA, NEW CALEDONIA

**M**ISSION . . . The hospitality of the amateurs in the 20 countries I have visited so far has been outstanding. And the sight-seeing has been fine. But the primary purpose for the trip was to see just where amateur radio stands in Africa and Asia. As you probably know, the balance of power in the ITU, the body that makes all basic frequency allocations, has swung to the Afro-Asian group. I wanted to know how many hams there were in these countries, what the prospects were for the future particularly with respect to local ham operators and what, if anything, might be done on our end to improve matters. I also wanted to find out how much support amateur radio might expect from these countries when we sit down to the frequency allocation table about three years hence.

All too often I found governments that had, at best, a hazy idea of amateur radio and little notion of why our hobby was of any value to their country. Those that do permit it seem to do so for lack of a reason to prohibit it. Since the frequencies have been allocated already, these governments see no harm in allowing amateurs to use their radio stations—so long as they don't cause trouble or interference to commercial and government services. This is not exactly the sort of attitude we need.

Amateur radio is of particular value to the growing countries, whose most fundamental need is for communications. College can provide engineers. But where, outside of amateur radio, are the great multitude of technicians going to come from to build, set up, operate and service the complex electronics that hold civilization together today? And engineers who come from the ham ranks seldom turn out to be the white-smocked scientist types that can work a computer but are lost when faced with a piece of equipment.

That's our message. If we get it across to the policy-makers in these developing countries in the next two years we may get the support we need to keep amateur radio going. If not . . . ?

We in the U.S. have been brought up on such an abundance of equipment that few of us realize what DX operators have in other parts of the world. At radio stores in India I found very little available—and that little at incredible prices. A resistor sells for about five dollars (taking wage-scale differences into consideration). And that five-dollar resistor is one that we would throw away in disgust—salvaged third-hand from old equipment. It is a wonder that there are so many Indian amateurs—over 400 of them. Only a handful of these can afford even a simple receiver. One of the most active amateurs in India is DXing with a Command receiver—one of those things we can buy for three or four dollars.

I have hopes that I will be able to organize an effort in the U.S. to collect old ham gear and send it to countries like India to help amateur radio grow. I've found the amateurs in Australia and New Zealand also quite anxious to help out, and expect that something world-wide may develop. The response to my idea in India was enthusiastic. The Amateur Radio Society of India (ARSI) quickly arranged an interview for me with the Secretary of the Ministry of Communications, who liked the plan and offered help in cutting cus-

*[Continued on page 134]*



Ray Naughton, VK3ATN, from whose shack Wayne Greene worked while in Australia, has successfully copied K6MYC via moon and 4-layer rhombic.

Exclusive with **RCA...**

# **AUTOTEXT** **faster, easier way** **toward a career** **in electronics**

**EXCLUSIVE WITH RCA.** "AUTOTEXT," developed by RCA and introduced by RCA Institutes, Inc., is a system of programmed instruction, accurately planned so that as you read a series of statements, questions, and answers, you learn almost without realizing it! It's fast! It's easy! It's fun!

**NEW TREND IN EDUCATION!** Programmed instruction has been proved with thousands of students. People who have had trouble with conventional home training methods in the past can now master the fundamentals of electronics almost automatically!

**PROVE IT TO YOURSELF NOW!** An interest or inclination in electronics is all you need. RCA "AUTOTEXT" will help you do the rest. And the future is unlimited; the jobs are available! The important thing is to get started now!

**COMPLETE COURSE AVAILABLE.** RCA Institutes now offers you a complete Home Training Course ("Introduction to Electronics") using the "AUTOTEXT" method. You get a complete set of theory lessons, service practice lessons, experiment lessons, and all the kits you need. You'll learn faster with less effort!

## **ATTENTION VETERANS!**

**All RCA Institutes Courses  
available under new G.I. Bill**

### **COMPLETE SELECTION OF HOME TRAINING COURSES**

- Communications Electronics
- FCC License Preparation
- Mobile Communications
- Automation Electronics
- Automatic Controls
- Industrial Applications
- Nuclear Instrumentation
- Digital Techniques
- TV Servicing (with new transistorized TV Receiver Kit)
- Color TV Servicing
- Transistors
- Electronics Fundamentals
- Electronics Fundamentals (in Spanish)
- Computer Programming
- Drafting

### **LIBERAL TUITION PLAN FOR ALL HOME TRAINING COURSES**

This plan affords you the most economical possible method of home study training. You pay for lessons only as you order them. If, for any reason you wish to interrupt your training, you can do so and not owe one cent. No other obligations! No installment payments required.

### **YOU GET PRIME QUALITY EQUIPMENT**

All kits furnished with home training courses are complete in every respect and the equipment is top grade. You keep all the equipment furnished to you for actual use on the job, and you never have to take apart one piece to build another!

Licensed by the New York State Department of Education.

Classroom Training Available in New York City, and Cherry Hill (near Camden) New Jersey.

**Send postcard for free illustrated book today! Specify home training or classroom training!**

Dept. E1-37  
**RCA INSTITUTES, INC.,**  
A Service of Radio Corporation of America  
350 West 4th St., New York, N.Y. 10014



**THE MOST TRUSTED NAME IN ELECTRONICS**

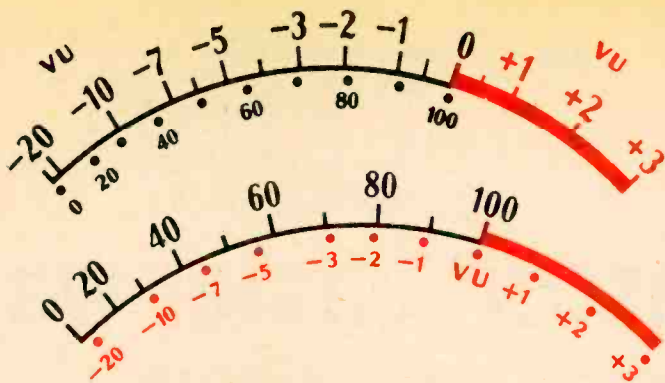

Fig. 1—VU meter scales are interchangeable. At top is A scale, standard on tape recorders. It emphasizes markings in db above or below reference level (0 VU). The B scale, below it, emphasizes markings for percentages of reference level or allowable modulation and is used primarily in broadcast gear.

# THE AMAZING RUBBER RULER

Think you know what VU meter readings mean? You may be in for a surprise!

By LAWRENCE GLENN

IMAGINE buying a ruler and finding that it stretches—that the size of an inch will change depending on where you take your measurement! And imagine taking the ruler back to that so-and-so who sold it to you and having him tell you that, for its intended use, the elastic ruler is considered the most accurate measuring tool available!

Nonsense? Of course, but our imaginary ruler is very similar to that amazing and sophisticated arbiter of audio, the VU meter. Originally the VU meter was intended for strictly professional audio use but today virtually every recorder above the toy class uses it for a recording level meter, many construction projects for hams and CBers use one as a modulation indicator. Strictly speaking, though, most of these are not VU meters.

A true VU meter is a *standard* volume level meter expressly designed for use with program material such as speech and music. (The letters VU stand for *volume unit*.) The VU meter takes its measurement directly from the power level on the line to which it is connected and indicates the difference between the line power and the standard reference level both as  $\pm$  so many db and as a percentage of the reference power, which normally represents maximum allowable modulation on the line.

Before we go any further perhaps we should explain how the *standard* meter—meaning one that is a *reference*—came into being in the first place. Up until the late 1930s there were a number of so-called VI meters—*volume indicators*. Though all had a scale marked in db the exact value of the calibration varied from meter to meter. On one type the 0db mark stood for the telephone standard of 6 milliwatts in a 500-ohm circuit. On others it stood for 12, 25 or 50 milliwatts—or whatever someone thought convenient.

Another problem was the meter ballistics—the way in which the meter pointer rises and falls. If the pointer were to follow the instantaneous line voltage from moment to moment, it would move much too fast to be seen. But if the needle moves too sluggishly, sharp transients will be gone before they can be registered. The *peak type*, for instance, registered audio waveform so fast the eye could hardly follow the pointer. Meters with light damping indicated somewhere between average and peak power, while others registered average power.

To bring some order out of this confusion an industry group designed the present VU meter to have specific characteristics that would be the standard for everyone concerned. Every single meter labeled a VU me-

# THE AMAZING RUBBER RULER

ter has the same characteristics *providing it is a true VU meter*. To begin with, the meter is damped so that when indicating the level of program material—not test tone—it indicates the average power. Also, the VU meter indicates absolute power in a 600-ohm circuit with a steady sine wave test signal.

A VU meter may be supplied with either of the scales shown in Fig. 1. Note that the two scales are the same except that the A scale, intended for service technicians, has a large-numeral db scale on top and a smaller percentage modulation scale below it. The B scale, used by broadcasters, has the large-numeral percentage modulation scale on top.

The key to their use is the 0 VU (or 100 per cent) mark. When the VU meter is connected to a 600-ohm circuit and the signal is a sine waveform, the 0 mark indicates a power level of 1 milliwatt—often called 0 dbm. The m stands for milliwatt and dbm simply means db referred to a milliwatt. If the power is doubled to 2 mw the pointer will rise to the +3 mark since doubling the power is a 3db increase. And if power is cut to 0.5 mw the meter will indicate -3 VU.

Since the top of the VU meter scale (+3 VU) represents 2 mw the pointer would pin over at higher values. Fig. 2, shows how the meter's calibration is changed to handle these power levels. Suppose you wanted the meter to indicate 0 VU when measuring a 10-watt circuit. From the standard power formula [ $db=10 \log (P1/P2)$ ]

to determine that 10 watts (P1) compared to 1mw (P2) represents a power increase of 40db. Therefore, if you connect a 40db pad ahead of the VU meter, as shown in Fig. 2, the meter will indicate 0 when the power level, using a sine-wave signal, is 10 watts. Similarly, if you wanted the meter to indicate 0 VU when the power level was 1 watt you would use a 30db pad as 1 watt, compared to 1 mw, this is a 30db increase.

Note that the db scale only represents actual power when the VU meter is connected to a 600-ohm circuit. Since the meter is voltage-sensitive a correction factor must be applied when using circuits of other than 600 ohms. As an example, when the VU meter is connected into a 300-ohm circuit the line voltage for 1 mw is 3db less than for a 600-ohm circuit, so the VU meter will indicate 1 mw in 300 ohms as -3 VU (3db less than 0). The following table gives correction factors for several line impedances:

Line Impedance	Correction Factor (add to reading for true VU or dbm value)
600 ohms	—
300	3.0
250	3.8
150	6.0
50	10.8
16	15.7
8	18.7

We have already said that the VU meter responds to the average power level of program material. This creates a problem. Suppose you have a recorder whose normal level for recording is obtained when the VU meter

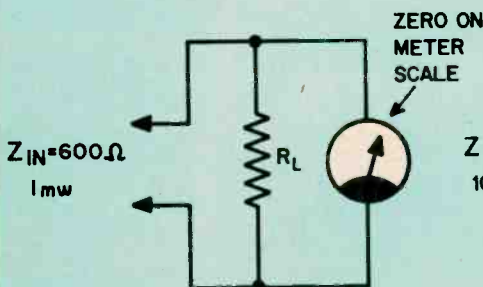

Fig. 2A—Basic VU meter indicates zero when connected to 600-ohm, 1-mw circuit. Impedance of 600 ohms equals load resistor ( $R_L$ ) in parallel with 3,900-ohm impedance of meter. Measured level is then said to be 0 VU or 0 dbm.

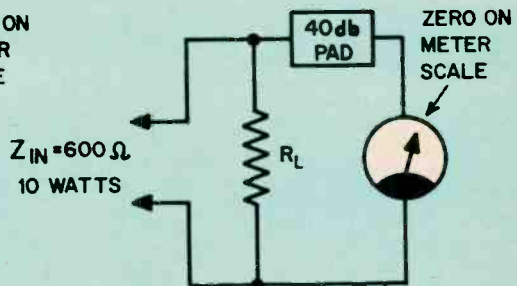

Fig. 2B—Meter will indicate zero on a 40-watt, 600-ohm circuit (40db greater than 1 mw) if a 40-db pad is connected in series with meter. Loss in pad plus meter indication is measured level. Hence, 40db+0=40 VU or 40 dbm.

indicates 0 on the peaks of *program material*, and you want to test the recorder's distortion in the usual way, with sine wave from an AF signal generator. If you think you adjust the test tone so the meter reads 0 (where distortion is assumed to pass beyond allowable limits) you are wrong and here's why. Since the meter indicates the *average* power of program material the *peak* level is actually higher—10db is the assumed difference though actual peak level may be 7 to 14db higher depending on the program material.

The VU meter's damping only affects rapid changes in pointer movement. Therefore, when the program material rises to 0, the normal recording level, the peaks of the waveform are some 10db higher than the meter reading. Since test tone is sustained, the pointer gets a chance to rise to its peak value, 10db higher than the 0 level. If your meter circuit is not adjustable, therefore, distortion on check will be difficult.

Now that we've given the VU meter a simplified once-over, a new question comes up: are those VU meters on hobbyist equipment really VU meters? Well, if we're willing to accept anything that has accurate db (power difference) calibration and some damping as a VU meter, the answer is yes. But as EI discovered in tests, the 0 mark on many so-called VU meters bears no particular reference to 1 mw in 600 ohms. Rather the 0 mark simply represents the equipment manufacturer's recommended recording (or reference) level. You could not expect the meter to behave like a *standard* VU meter.

Another difficulty, turned up in EI's VU

meter tests, is that budget-priced VU meters intended for the hobbyist have considerable variation in accuracy depending on the circuit impedance and the meter's load. Note the two photographs in Fig. 3. The meter on the left is a professional grade VU meter priced at over \$30. The model on the right is a hobbyist grade priced at under \$10. The professional meter has been checked to an accuracy of 0.5db. In both illustrations the input level has been adjusted so that both meters indicate 0 for the same line voltage.

In the first picture both meters are connected to the test line through an external multiplier—the professional meter through its supplied matching pad and the hobbyist meter through the 3,600-ohm resistor supplied with the meter. When the test level is reduced by 5db both meters give essentially the same reading. The professional meter indicates a reduction of slightly over 5db while the hobbyist meter shows a loss of nearly 6db.

But note what happens in the other photograph, when both meters are used with no matching pad or multiplier resistor and the 0 VU readings are readjusted to the new conditions. The pro meter still correctly indicates the 5db loss while the hobbyist meter indicates an 8db loss.

When it comes to VU meters, price and quality definitely go hand in hand, that is, assuming you deal in true VU meters. A meter salvaged from a tape recorder and labeled VU might well have accurate db calibration though its 0 reference is not 1 mw in 600 ohms. In that case, it is not a VU meter—it is a VI meter.

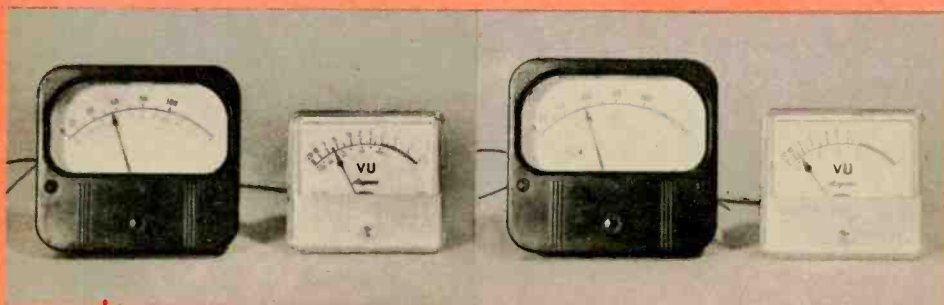
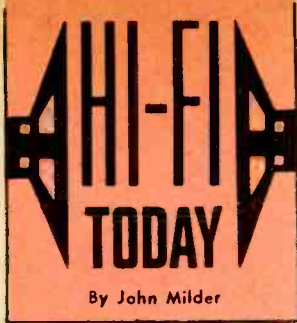

Fig. 3—When connected to a circuit through its recommended range multiplier (left), both the professional VU meter and smaller, hobbyist-grade version give essentially the same readings. Actual line test level is -5db. When the external range multiplier is removed (right) only the professional meter continues to read -5 with 0 reset. Hobbyist grade meter now reads -8db—still usable for general-purpose applications though inaccurate where lower half of the scale must be used.



✓ *What price, success?*

**B**EEN listening to FM lately? If so, you may realize that some strange things have been going on. FM, once called the good music medium, is becoming something else. And, ironically, an FCC decision that was intended to strengthen FM seems to be helping to make it the kind of radio broadcasting that turns people off.

FM was given a tremendous boost by the surge of interest in high fidelity and stereo sound. FM circuitry, once an optional (and even discouraged) extra in mass-market radio-phonographs, is now a standard feature—sometimes to the exclusion of AM. And commercial sponsors, once accustomed to thinking of FM listeners as impossible egg-heads who never bought anything, are becoming acutely aware that quality-conscious FM dialers are likely to be a selective and reasonably affluent audience.

So the sponsors are arriving and with them the push for the kind of soporific, bland, homogenized programming that makes the commercials more interesting than what comes in between them. There is also evidence that the suburbia set think that Mantovani is a lot nicer than Mozart for an evening of stereo and mah-jongg. After all, who buys stereo to *listen*?

With the push coming simultaneously from potentially lucrative sponsors and Muzak-minded mah-jonggers, FM stations are scrambling to convert from good-music programming to ping-pong pops and safely light classics. In Boston, the last commercial station (out of more than 20) broadcasting substantial classic programming during the day made the switch in June of last year. (Boston's magnificent educational station, WGBH, has put on special classical programming, but the commercial stations are all playing stereo lullabies.) This pattern is duplicated in smaller cities across the country.

In the meantime, the FCC decision to force stations to separate AM and FM programming for at least half of the broadcast-

ing day is not helping to strengthen FM programming in any way. Still allotting minimum staff for the FM side of their operations, stations are finding it much easier to throw in a giant glob of light programming (which can safely be interrupted at any time for a commercial) than to take the time and trouble to do anything really worthwhile. Some stations that program talk shows and such on AM are jumping into FM with rock-and-roll, complete with screaming announcers and acne commercials.

I don't mean that there isn't room on FM for the Beatles and Stanley Black. But something has to be done—and done quickly—about the now-proven process by which mediocrity takes over. If not, FM is going to become a sick joke on the people whose interest originally helped it to attract attention and money. If you would like to do something, I suggest you drop a line to FM stations, the FCC, or anybody else (including advertisers) who usually doesn't hear anything but the soft rustle of money.



Program bulletin from Chicago's culture-conscious Station WFMT reflects palmier days when FM (to steal somebody's slogan) really meant Fine Music.

# OVER AND OUT

By *Rodriguez*



"I thought you said transistors didn't heat up."

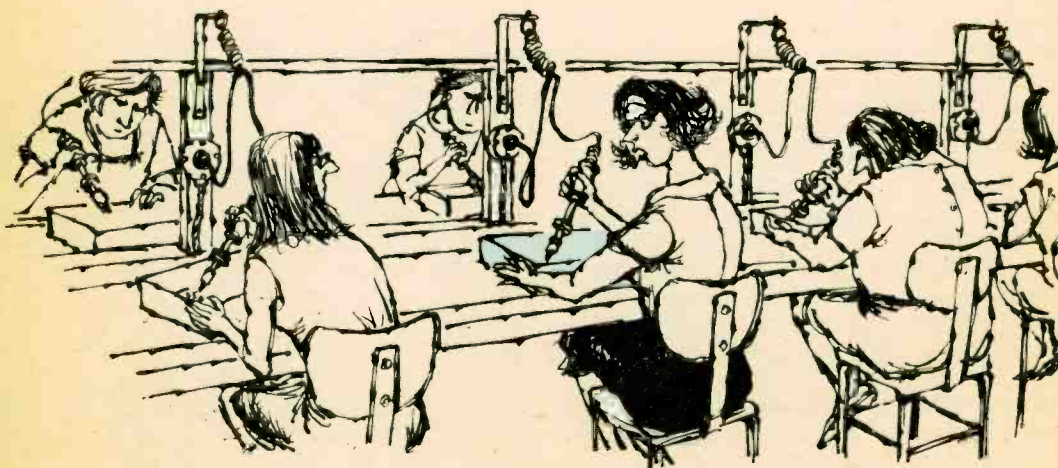

"Oh, I broke up with him. He only invited me up to his apartment so I could wire his tuner kit."



## The Many, Many Voices of Africa

Continued from page 117

creasingly difficult. You might nevertheless want to try for some of the really rare stations like Radio Djibouti (French Somaliland) on 4780 kc around 2130 EST, Radio Gambia on 4820 around 1530, Radio Kenya on 4885 around 2215, or Radio Cordac (in Burundi) around 0100.

At present no really reliable information is available on SW broadcasts from the Somali Republic or the newly-independent Lesotho. Rarest of all are South West Africa, Swaziland and the Spanish colony of Rio Muni. None has a regular SW station. 

## CB Accessories

Continued from page 105

shielding and things get really quiet. Add grounding contacts to wheel covers and the noise may go down even further. As a rule, more suppression means better reception.

**TVI Filters** aren't usually needed. With rare exceptions, CB transceivers are factory-equipped with a second-harmonic filter (TVI trap) that is generally more than adequate to prevent it from interfering with TV receivers if the transceiver is properly grounded. A low-pass TVI filter is only needed if the TV set or its antenna is so close to the CB antenna that the slightest harmonic radiation is more than enough to cause interference. Harmonic interference generally appears in the picture as a herringbone pattern. If the interference causes the picture to reverse it is the TV set that needs the filter.

**Panoramic Adaptors** give you a visual display on an oscilloscope of all the activity on the band, with each channel in use represented by a peak in the trace. If you're so anxious to know what channels are in use that you can't wait to tune the band, this one is for you.

**Summing Up:** Allowing for the good performance of the modern transceiver, few accessories outside of a power output meter and an SWR bridge or meter offer any real advantage in general terms. There are exceptions to any rule, of course, and somewhere there's a user who will receive substantial benefit from some accessory. But before you run out to buy one, think it over. Will it *really* improve *your* transceiver? 

# now there are 3 time & tool-saving double duty sets

New PS88 all-screwdriver set rounds out Xcelite's popular, compact convertible tool set line. Handy midgets do double duty when slipped into remarkable hollow "piggyback" torque amplifier handle which provides the grip, reach and power of standard drivers. Each set in a slim, trim, see-thru plastic pocket case, also usable as bench stand.



**PS88**  
5 slot tip,  
3 Phillips  
screwdrivers

### PS7

2 slot tip,  
2 Phillips  
screwdrivers,  
2 nutdrivers

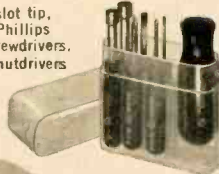

**PS120**  
10 color  
coded nutdrivers



# XCELITE

XCELITE INC. • 16 BANK ST., ORCHARD PARK, N. Y.  
Please send free literature N563.

name \_\_\_\_\_

address \_\_\_\_\_

city \_\_\_\_\_

state & zone \_\_\_\_\_

In Canada contact Charles W. Painton, Ltd.

## The Listener

Continued from page 69

Canadian DX Club, 1034, No. One Rd., Richmond, B.C. (Dues, \$4.00. Very interesting utility, BCB, FM/TV, amateur monitoring sections. Presently without electoral set-up.)

Canadian International DX Club, 44 Carmen Ave., Winnipeg 5, Manitoba. (Dues, \$3.50. Democratically-organized, all-band operation that is moving up fast.)

International Radio Club of America, Box 112, Englewood, Col. 80110. (Dues, \$4.00. Democratic organization covering MW band only. Publication issued weekly during BCB DX season.)

National Radio Club, P.O. Box 454, Houston, Tex. 77001. (Dues, \$5.00. Offers excellent MW band coverage. Publication issued weekly during BCB DX season.)

Newark News Radio Club, 215 Market St., Newark, N.J. 07101. (Dues, \$5.00. Oldest and definitely one of best all-band clubs. Especially fine utility, VHF, amateur monitoring sections.)

North American SW Assoc., 1503 Fifth

Ave., A2, Altoona, Pa. 16602. (Dues, \$4.00. A democratic organization devoted exclusively to SWBC with world-famed SWL Don Jensen — 190 countries verified — as SW editor.)

## Ham Shack

Continued from page 124

toms red tape. And the Institute of Telecommunications Engineers (counterpart of our IEEE) volunteered to receive and distribute the equipment.

India is a particularly good place to start something like this because they already have a number of Indian amateurs as a nucleus for future growth. Also, India has considerable influence with the other Asian countries. At the last ITU conference India was more opposed to amateur radio than any other country—and we don't want that to happen again. Their official proposals for our amateur bands would have reduced them to 20-kc widths.

Dr. Sarwate, an Indian, is the Secretary-General of the ITU now and I believe that amateur radio has a friend in Dr. Sarwate.



A completely Do-It-Yourself beam for 15 meters. Priced to fit your budget.

X-15 rated for Full Power (Novice or General). Readjust for 10 meters, if desired, when you become a General.

Please send FREE info. on X-15 Beam.

Name \_\_\_\_\_

Address \_\_\_\_\_

City/State \_\_\_\_\_

Zip Code No. \_\_\_\_\_

**Mosley Electronics, Inc.** # 121

4610 N. Lindbergh Blvd. Bridgeton Mo. 63042

## FOR SPEEDY SERVICE

1102171 647 98 24 0664

T M BROWN

5936 23rd PARKWAY

WASHINGTON, D. C. 20031

## WE'RE LOST WITHOUT THIS LABEL

Well, not really lost — but we can do things faster for you if you send along the ADDRESS LABEL from your magazine any time you write to us about your subscription.

### CHANGE OF ADDRESS

If you're moving, please let us know six weeks before changing your address. Better still, attach the magazine address label to this form, and print your new address here.

name \_\_\_\_\_

street \_\_\_\_\_

city \_\_\_\_\_

state \_\_\_\_\_

zip \_\_\_\_\_

attach  
label  
here

ELECTRONICS ILLUSTRATED Sub. Dept., Greenwich, Conn. 06830

When I talked to him in Delhi I found him quite enthusiastic about our hobby and its benefits.

**Before I wind up**, let me put in just a word for an old favorite of mine: 80 meters. While visiting Australia I had an opportunity to get on 80 meters from VK3ATN and had no difficulty whatever in working quite a long line of Ws. I was particularly interested to work my own station, operated by WA6BSO/1, and hear it coming through S-9. All I have for an antenna there is a dipole hung from the tower supporting the 20-meter beam—a drooping dipole. It works.

VK3ATN, by the way, has set up a rhombic for 2 meters and has been able to get signals back from the moon as well as copy signals from K6MYC via the moon. The signals on his tapes are quite readable. Ray figures his rhombic for a gain of about 34db. This is considerable. To do the same with a colinear or Yagi configuration would take about 2,400 elements by my count. I found that all I could tack on a 120-ft. tower was about 300 elements for 2 meters. The rhombic is obviously an excellent answer to this matter.

### Cute, Quaint, Kook, QSLs

Continued from page 123

tage of some of the free QSL card offerings. Chambers of Commerce in many places will supply a modest quantity of QSL cards without charge as they ordinarily will carry both photographs (often colored) and printed descriptive matter covering the area. Some airlines and other organizations do likewise. With any of these all you need do is to have your printer run them through his press and imprint your call letters, name and address on them in any standard color you choose.

Regardless of what you decide to do with your own cards, the stock you use should parallel closely that of government post cards, not only in size and general shape but in weight as well. Nothing thinner or thicker than the government card seems to withstand mail-handling. Matter of fact, the stamped government post card itself occasionally is used, though such practice frequently proves to be false economy. Reason is that the ham who chooses this course of action actually is paying postage in advance. And all too often he ends up junking or reprinting his entire stock when his address or call letters change.

—Howard S. Pyle, W7OE





Fill in coupon for a **FREE** One Year Subscription to **OLSON ELECTRONICS' Fantastic Value Packed Catalog—Unheard of LOW, LOW PRICES on Brand Name Speakers, Changers, Tubes, Tools, Stereo Amps, Tuners, CB, and other Values. Credit plan available.**

NAME \_\_\_\_\_  
 ADDRESS \_\_\_\_\_  
 CITY \_\_\_\_\_ STATE \_\_\_\_\_ ZIP \_\_\_\_\_

If you have a friend interested in electronics send his name and address for a **FREE** subscription also.

**OLSON ELECTRONICS**  
 INCORPORATED

576 S. Forge Street Akron, Ohio 44308

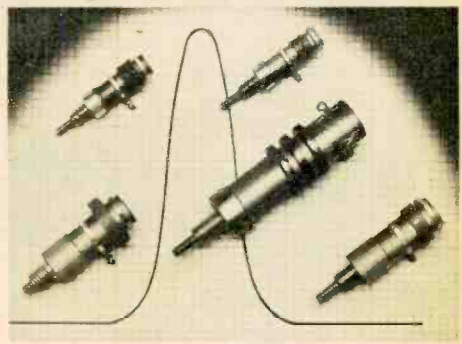

### Adjustable RF Coils On Resinite Forms

Moderately priced resinite coils are used frequently for construction projects in amateur and experimenter publications. These coils give dependable performance and are stocked nationwide.

Series 20A	.079 uh to 1.25 mh
Series 21A	.68 uh to 12.5 mh
Series 22A	5.7 uh to 125 mh

Write for full line catalog



**J. W. MILLER CO.**  
 5917 So. Main St. • Los Angeles, Calif. 90003  
 AVAILABLE NATIONALLY FROM  
 DISTRIBUTORS AND MAIL ORDER HOUSES.

**PUT THIS ON YOUR DESK AND SAVE! — AUTHENTIC REPLICA OF THE MASSIVE TURN-OF-THE CENTURY MOSLER SAFES**

# **\$1,000 Bank on Wheels-\$5<sup>95</sup>**

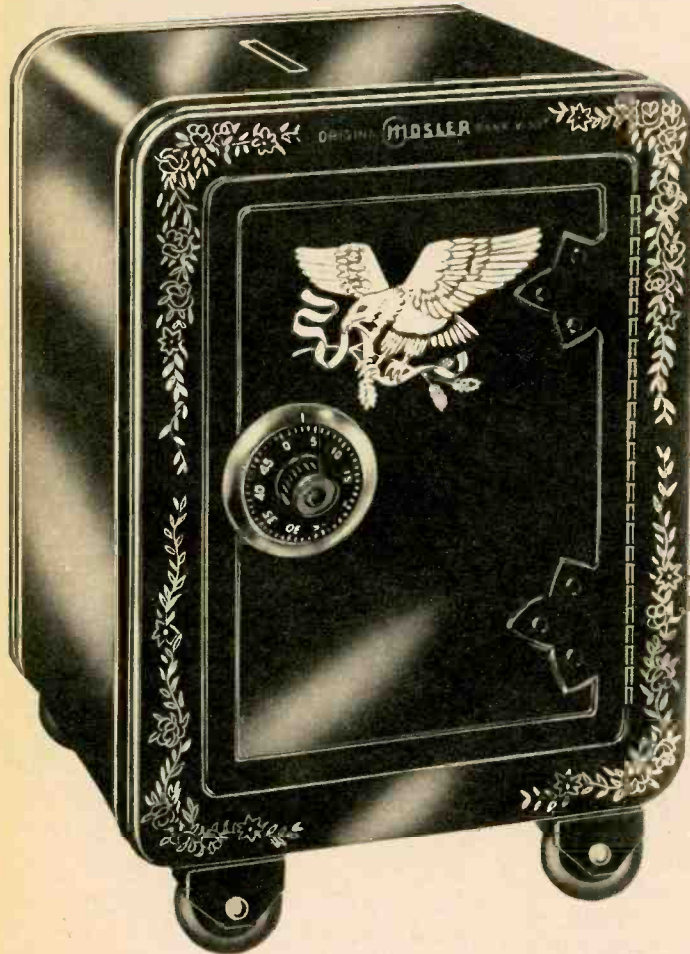

- **Stands 3/4 Ft. Tall**
- **Combination lock**
- **Holds \$1,000.00 in change**
- **Complete to rubber tires, eagle & gold leaf designs**

This is a fine scale replica of the massive Mosler safes considered impregnable 100 years ago. This all-steel black one has authentic colorful eagle and gold-leaf designs, handsome gold floral edging. Each has its own different combination lock and is big enough (6" x 7" x 9") to hold a full \$1,000 in change. Separate inside compartments hold money apart from valuable papers, letters, jewels, stamps, stocks, etc. If you have anything personal, or of value, this is small cost for big protection. Solid Americana right to the rubber tires. Nice way for young and old to save. New and a solid value for \$5.95.

**MAIL NO-RISK MONEY-BACK COUPON**

HAMILTON HOUSE, Dept. 32 L-2, Cos Cob, Conn. 06807

- Enclosed check or m.o. for \$\_\_\_\_\_ Rush me:
- Mosler Safe Banks @ \$5.95 ppd. I understand if I'm not completely satisfied, I can return it in 10 days for a full refund.

NAME \_\_\_\_\_

ADDRESS \_\_\_\_\_

CITY \_\_\_\_\_ STATE \_\_\_\_\_ ZIP \_\_\_\_\_

## Engine Analyzers

Continued from page 95

meter, the Knight-Kit has a 7-in. meter.

When working on a generator-regulator circuit, it is convenient to read voltage and then current without shifting around test leads as is necessary with the EICO. You could get a second set of leads but this is not mentioned in EICO's manual.

The Knight-Kit has two sets of test leads whose different connectors make it impossible to plug the current leads into the voltage socket and vice versa. A good feature of both instruments is that the dwell and tach positions of the function switch are next to each other. This enables you to observe quickly dwell angle and then rpm.

On the EICO you must double the meter indications on the 8-cylinder range when working on a 4-cylinder engine. The Knight-Kit meter is calibrated for a 4-cylinder engine. The dwell and tach ranges are conventional and the same on both instruments. The dwell-meter circuit measures duty cycle (ratio of point's open to closed time). The tach is a schmitt-trigger pulse counting circuit whose full-scale ranges are 1,200 and 6,000 rpm.

Both analyzers gave identical indications, as they should, since the circuits were practically the same.

Having a diode-check function only adds to the confusion of reading the meter scales. And no one is going to replace alternator diodes. It doesn't pay as you would have to invest a fair amount in special tools to do the job. In a service station, a quick test immediately reveals if the alternator or regulator is faulty. If it is, it's usually replaced with a new or rebuilt unit.

Do you own a V-8 or slant six? Did you ever try getting your finger or a wrench on one of the plugs buried under a power-steering pump, an air-conditioning compressor or hot manifold? The spark-output test on both analyzers requires you to insert a thin wire under a plug's rubber cover. It is virtually impossible, and secondly why bother. An engine that runs a little rough or misses can usually be diagnosed by removing one plug lead at a time at the distributor with a pair of non-metallic pliers.

The voltmeter ranges are very useful for checking cables and connections. The 3.2-V range is excellent for these checks as it measures voltage drop. The 16-V range has sufficient scale divisions for all normal voltage-

## FLYING SKYHOOK

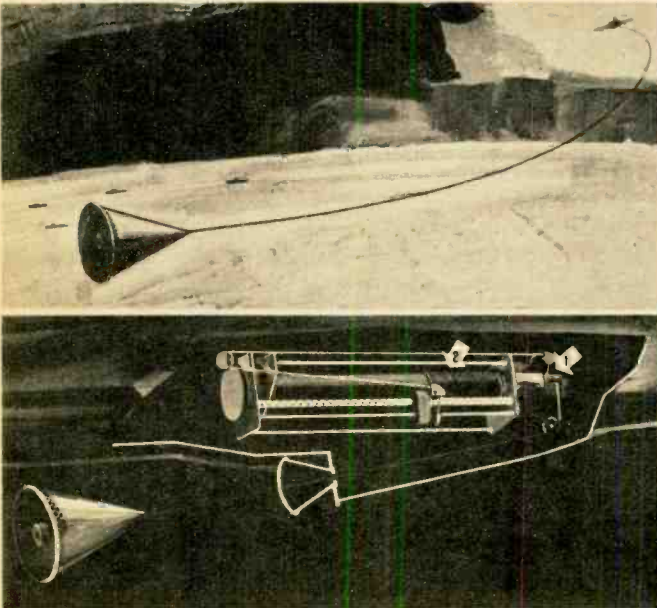

TRANSMITTING in the low-frequency (LF) and very-low-frequency (VLF) ranges while tooling in the blue yonder once seemed impossible to the Air Force. Reason was that at such frequencies an antenna several thousand feet long is required.

Such a backup low-frequency communications system was needed by the Strategic Air Command in the event normal radio contact with SAC bombers failed. Collins Radio Co. developed a system with a trailing-wire antenna.

At one end of the antenna is a conical drogue (shown in top drawing). A hydraulically-powered capstan under the wing (arrow 1, bottom) extends and retracts the antenna. The wire is stored on a reel (arrow 2). —

**STATEMENT AND OWNERSHIP, MANAGEMENT**

**AND CIRCULATION**

(Act of October 23, 1962;

Section 4369, Title 39, United States Code)

1. Date of Filing: October 1, 1966.
  2. Title of Publication: Electronics Illustrated.
  3. Frequency of Issue: Bimonthly.
  4. Location of Known Office of Publication: Fawcett Place, Greenwich, Connecticut 06830.
  5. Location of the Headquarters or General Business Offices of the Publishers: Greenwich, Connecticut 06830.
  6. Names and Addresses of Publisher, Editor, and Managing Editor: Publisher, Fawcett Publications, Inc., Greenwich, Conn.; Editor, Robert G. Beason, Stamford, Conn.; Managing Editor, Robert D. Freed, Stony Brook, N. Y.
  7. Owner: Fawcett Publications, Inc., Greenwich, Conn.; W. H. Fawcett, Jr., Norwalk, Conn.; Marion Bugg, Kansas City, Mo.; Roger Fawcett, New York, N. Y.; V. D. Fawcett, Greenwich, Conn.; M. B. Fawcett, Norwalk, Conn.; Gordon W. Fawcett, Greenwich, Conn.; Gloria Leary, Santa Monica, Cal.; V. F. Kerr, Bakersfield, Cal.; Allan Adams & Jack Adams—Trustees, Greenwich, Conn.; John R. Fawcett, Wilton, Conn.; Thomas K. Fawcett, New York, N. Y.; Roscoe Kent Fawcett, Reno Nevada; M. F. Fawcett, Greenwich, Conn.; H. A. Fawcett, New York, N. Y.
  8. Known Bondholders, Mortgagees, and Other Security Holders Owning or Holding 1 Percent or More of Total Amount of Bonds, Mortgages or Other Securities: None.
  9. Paragraphs 7 and 8 include, in cases where the stockholder or security holder appears upon the books of the company as trustee or in any other fiduciary relation, the name of the person or corporation for whom such trustee is acting, also the statements in the two paragraphs show the affiant's full knowledge and belief as to the circumstances and conditions under which stockholders and security holders who do not appear upon the books of the company as trustees, hold stock and securities in a capacity other than that of a bona fide owner. Names and addresses of individuals who are stockholders of a corporation which itself is a stockholder or holder of bonds, mortgages or other securities of the publishing corporation have been included in paragraphs 7 and 8 when the interests of such individuals are equivalent to 1 percent or more of the total amount of the stock or securities of the publishing corporation.
  10. This item must be completed for all publications except those which do not carry advertising other than the Publisher's own and which are named in Sections 132.231, 132.232, and 132.233, Postal Manual (Sections 4355a, 4355b and 4356 of Title 39, United States Code).
- Average No. Copies Each Issue During Preceding 12 Months: A. Total No. copies printed (net press run), 385,521. B. Paid Circulation: 1. Sales through dealers and carriers, street vendors and counter sales, 109,727; 2. Mail subscriptions, 186,888. C. Total paid circulation, 296,615. D. Free distribution (including samples) by mail, carrier or other means, 2,187. E. Total distribution (sum of C and D), 298,802. F. Office use, left-over, unaccounted, spoiled after printing, 86,719. G. Total (sum of E and F—should equal net press run shown in A), 385,521.
- Single Issue Nearest to Filing Date: A. Total No. copies printed (net press run), 380,026. B. Paid circulation: 1. Sales through dealers and carriers, street vendors and counter sales, 98,880; 2. Mail subscriptions, 198,070. C. Total paid circulation, 296,950. D. Free distribution (including samples) by mail, carrier or other means, 2,259. E. Total distribution (sum of C and D), 299,209. F. Office use, left-over, unaccounted, spoiled after printing, 80,817. G. Total (sum of E and F—should equal net press run shown in A), 380,026.
- I certify that the statements made by me above are correct and complete.

(signed) GORDON W. FAWCETT

# EI Classified

Starts on

Page 140

regulator adjustments and for checking alternator and generator outputs. Accuracy of both instruments was 5 per cent.

The current function is useful for checking the generator, alternator or regulator. The ohmmeter function is handy for checking the continuity of cables, wires, coils, and fuses.

EICO shows how to use a shunt bar in the Operating Manual but doesn't mention anywhere how to assemble it. Full wiring instructions for the shunt bar are in the Knight-Kit manual.

Equal to or better than other commercial units costing up to twice as much, these analyzers are really useful instruments. The professional, as well as the Saturday mechanic will be able to use them to set dwell angle and the idle speed to the factory-recommended settings. And, as we said, they will check many other things too. But don't forget that the instruments just give you an indication. You must know how and where to make the adjustments.

## Audio Mixer

Continued from page 68

Up to four microphones can be mixed simultaneously. You can also mix a high-level signal, such as from another tape recorder or ceramic cartridge, by connecting the high-level source to either J5 or J6. Note that the high-level source kills the mike input associated with it. For example, connect a high-level source to J5 and you will disable the mike plugged in J3.

The signal level at jack J8 is more than adequate for a comfortable headphone volume. Use headphones rated at 2,000 ohms impedance or higher—crystal phones are recommended. The level at J8 is about 1 V, rms. You can connect the output at this jack to any high-level amplifier input designed to accept a 1-V signal. However, distortion and noise level at J8 are slightly higher than at J7.

With power switch S1 on, setting S2 to the bat side will cause M1 to indicate the battery condition. As long as the meter pointer indicates in the red region above the 0 VU mark, the batteries are okay. Depending on the FETs you use, the batteries may still be usable when the pointer falls below 0 VU. Don't discard the batteries if the pointer falls below 0 VU. Wait until you can just about hear or start to measure an increase in distortion or sharp loss in gain.

# HOLY HEAT SINK!

You can get  
**10**  
issues of  
**EI**  
for only  
**\$3.98!**

(How about that?)



"What we need is lightning. The batteries are running down."

ELECTRONICS ILLUSTRATED  
Circulation Department  
Fawcett Building  
Greenwich, Connecticut 06830

3-67

**ZAP!** Sure, I want to take advantage of your special money-saving offer. Enter my subscription biff! wow! right now!

- I enclose \$3.98       New order  
 Bill me later         Renewal

NAME .....

ADDRESS .....

CITY ..... STATE ..... ZIP .....

# ELECTRONICS ILLUSTRATED

# Classified Ads

Your advertisement can reach this mail-buying audience for only 50¢ per word . . . payable in advance (Check or M.O. please) . . . minimum 10 words. Closing dates are the 20th of 4th preceding month i.e. copy for the July issue must be in our office by March 20th. Mail to ELECTRONICS ILLUSTRATED, 67 West 44th St., New York 36, N. Y. Word count: Zipcode number free. Figure one word: Name of state (New Jersey), name of city (New York); sets of characters as in key (I4-D); also abbreviations as '95MM. 8x10, D.C., A.C.

## SAVE MONEY • ORDER BY MAIL

### • • • FOR SALE

**TELEPHONE RECORDER-ACTUATOR** (TW1-007). Solid state module automatically turns tape recorder, amplifier, or transmitter on when telephone is used. Connected anywhere on line. Simple installation instructions included. Prepaid \$18.95. Twilight Electronics, Box 11595-1, Saint Louis, Missouri 63105.

**NEW SUPERSENSITIVE transistor locators** detect buried gold, silver, coins. Kits, assembled models. \$19.95 up. Underwater models available. Free catalog, Ralco-A19, Box 10563, Houston, Texas 77018.

**INVESTIGATORS, FREE Brochure**, latest subminiature electronic surveillance equipment. Ace Electronics, 11500-X NW 7th Ave., Miami, Florida. 33168.

**CANADIANS: — OVER 500 Electronic Scientific and Technical Books Available** by Mail. Free Catalog. Books, Box 796B, Montreal.

**CANADIANS—GIANT Surplus Bargain Packed Catalogs**. Electronics, Hi-Fi Shortwave Amateur Citizens Radio. Rush \$1.00 (Refunded). ETCO, Dept. E1, Box 741, Montreal.

**GOVERNMENT SURPLUS**. How and Where to Buy in Your Area. Send \$1.00. E.I. Surplus Information, Headquarters Bldg., Washington 6, D. C.

**CONVERT ANY television** to sensitive, big-screen oscilloscope. Only minor changes required. No electronic experience necessary. Illustrated plans, \$2.00. Ralco-A19, Box 10563, Houston 18, Texas.

**CB & Ham goodies—New catalog free**. Tepabco, Browne St., Gallatin, Tennessee 37066.

### • • • BUSINESS OPPORTUNITIES

**INVESTIGATE ACCIDENTS**. Earn \$750 to \$1,100 monthly. Men urgently needed. Car furnished. Expenses paid. No selling. No college education necessary. Pick own job location. Investigate full time. Or earn \$8.44 hour spare time. Write for Free Literature. No obligation. Universal, CEE-3, 6801 Hillcrest, Dallas, Texas 75205.

**WANTED**. We are interested in the different models of Aviation Transceivers and accessories, new and used, in the following marks: King—Narco—A.R.C.—and Bendix. Rush Your best Quotations and Catalogues to:—Belgian Automatic Instruments,—Kortrijkstraat, 199—Wevelgem—Belgium.

**TRAIN FOR solid high paying career** in electrical repair. Practical equipment included. Free fact pack. I.T.I. Dept. 65002, 815 E. Rosecrans, Los Angeles 90059.

**VENDING MACHINES—No selling**. Operate a route of coin machines and earn high profits. 32-page catalog free! Parkway Machine Corp., 715E1 Ensor St., Baltimore 2, Md.

### • • • EMPLOYMENT OPPORTUNITIES

**PRINTING — ADVERTISING Salesmen**. Excellent moneymaking sideline selling Decalcomania Name Plates. Advertising Specialties. Sign Letters, Automobile initials. Free Samples. Ralco-EI, Box L, Boston, Mass. 02119.

### • • • AGENTS WANTED

**SELL AMERICA'S biggest value wedding line!** Big 40% profit showing wedding invitations and over 50 exciting accessory items. Sideline for printing, Christmas card salesmen. Free display album. Elmcraft, 7201 S. Cicero, Dept. EW-174, Chicago, Illinois 60629.

### • • • BUILD IT-DO IT YOURSELF

**HOBBYISTS, EXPERIMENTERS, Amateur Scientists, Students**. Construction Plans—All complete including drawings, schematics, parts lists, prices, parts sources . . . Laser—Build your own coherent-light optical laser. Operates in the pulsed mode, in the visible light range—\$6.00 . . . Diode Laser—Invisible light (infrared) can be continuously modulated—\$3.00 . . . Reverberator (Echo) Unit—Build your own. Use with your automobile radio, home radio or hifi, electric guitar, etc.—\$3.00 . . . Radar—Build your own ultrasonic doppler radar. Detect motion of people, automobiles, even falling rain drops. Transistorized, uses standard small 9-volt battery—\$4.00 . . . Long-Range "Sound Telescope"—This amazing device can enable you to hear conversations, birds and animals, other sounds hundreds of feet away. Very directional. Transistorized. Uses 9V battery—\$3.00 . . . Or send 25¢ coin or stamps for complete catalog . . . Technical Writers Group, Box 5501, State College Station, Raleigh, N. C. 27607.

**AUTOMATIC Washer repair manuals** any make, model, 13 different manuals. \$2.75 each postpaid. Dryer repair manuals for G.E., Kenmore, RCA Whirlpool. \$2.75 each postpaid. Major Appliance, 13112 Caine Ave., Cleveland, Ohio 44105.

**BUILD A Solo Organ**. Five models. Complete plans. Free folder. Solotron Company, 29641 Gilchrist, Farmington, Mich. 48024.

### • • • EDUCATION & INSTRUCTION

**GAME WARDEN**, Government Hunter, Forestry, Park and Wildlife Services announce job openings regularly. Prepare at home for outdoor work, good pay, security. Complete information Free! Write North American School of Conservation—MAW, Newport, California 92660.

**CORRESPONDENCE COURSES—B.Sc.**, Engineering, Electronics, Catalog \$1. Canadian Institute of Science & Technology, 263 F Adelaide St., W., Toronto.

**LEARN TECHNICAL Writing—qualify at home** for high paying prestige career not requiring college. Growing demand in all industries for tech writers now. Low monthly tuition. Easy to understand. Free career book, sample lesson. American Technical Writing Schools, Dept. EC-27, 5512 Hollywood Blvd., Hollywood, Calif. 90028.

**ELECTRONICS CAREER—F.C.C. License Training**. Correspondence, or resident classes. Free details. Write: Dept. 8, Grantham Schools, 1505 N. Western, Hollywood, Calif. 90027.

### • • • SHORTWAVE LISTENING

**SWL PROGRAM Guide**, Programs of all major stations listed hourly. \$2.00. All Books for SWL's. Inquiries invited. 218-E Gifford, Syracuse, N. Y. 13202.

### • • • TAPE RECORDERS

**LEARN WHILE Asleep** with your recorder, phonograph or amazing new "Electronic Educator" endless tape recorder. Details free. Sleep-Learning Research Association, Box 24-E1, Olympia, Washington.

**RENT STEREO Tapes—over 2500 different**—all major labels—free brochure. Stereo-Parti, 1616-AY Terrace Way, Santa Rosa, California.

### • • • INVENTIONS & INVENTORS

**INVENTORS! WE will develop, sell your idea** or invention, patented or unpatented. Our national manufacturer-clients are urgently seeking new items for highest outright cash sale or royalties. Financial assistance available. 10 years proven performance. For Free information write Dept. 59, Wall Street Invention Brokerage, 79 Wall Street, New York 5, N. Y.

**PATENT SEARCHES** including maximum speed, full airmail report and closest patent copies, \$6.00. Quality searches expertly administered with complete secrecy guaranteed. Free Invention Protection forms and "Patent Information." Write Washington Patent Search Bureau, Dept. 20, 711 14th St. N.W., Washington 5, D. C.

**INVENTORS! HIGHEST cash sale or royalties** for your inventions. Patented-Unpatented. Urgent demand from our client manufacturers. Financial Assistance available. Write Dept. 45, United Invention Brokerage, 78 Wall Street, New York 5, N. Y.

### • • • RADIO & TV

**SCHEMATIC DIAGRAMS** with voltages, layouts, troubleshooting information. Radio \$1.00. Television, etc. \$2.50. Add 50¢ for air mail. Send make, model: Healy Enterprises, 2436 Delafield, Houston 23, Texas



TV TUNERS rebuilt and aligned per manufacturer's specification. Only \$9.50. Any make UHF or VHF. We ship COD. Ninety day written guarantee. Ship complete with tubes or write for free mailing kit and dealer brochure. JW Electronics, Box 51K, Bloomington, Indiana.

FREE CATALOG. Electronic parts, tubes. Wholesale. Thousands of items. Unbeatable prices. Arcturus Electronics EL, 502-22 St., Union City, N. J. 07087

POLICE—AIRCRAFT—Emergency Calls on your broadcast radio with TUN-AVERTER! Economical—Practical! Tune the Band! Only \$29.95! Free catalog. Salch & Co., Dept. 5, Woodsboro, Texas 78393

DIAGRAMS—SENT Airmail—Television \$3.00. Radio 1919-1966 \$2.00. Give model. Diagrams, Box 55E1, Williamsport, Pa. 17704.

TV AND Radio Tubes. Free List. Gamma, 140 West 26th, Hamilton, Ont.

RADIO & T.V. Tubes—33¢. Free List. Cornell, 4213-15 University, San Diego, Calif. 92105.

FREE ELECTRONICS Catalog. Tremendous bargains. Send postcard. Electronics, Department C-584 AE, Hawiatt, New York 11557.

McGEE RADIO Company. Big 1966-1967 Catalog Sent Free. America's Best Values, HiFi—Amplifiers—Speakers—Electronic Parts. Send name, address and zip code number to McGee Radio Company, 1901 McGee Street, Dept. E1, Kansas City, Missouri 64108.

SUPER SNOOPER Audio Telescope printed circuit kit, \$5.95. Others. Electronix, Box 42—E2, Madison Heights, Mich. 48071.

FREE! GIANT bargain catalog on transistors, diodes, rectifiers, SCR's, zeners, parts. Poly Paks, P. O. Box 942E1, Lynnfield, Mass.

15 DISTANCE ONE Tube plans—25¢. "Radio Workbench" Handbook—50¢. Includes transistor experiments catalog. Laboratories, 12041-K Sheridan, Garden Grove, Calif. 92640.

• • • ROCKETS

ROCKETS: IDEAL for miniature transmitter tests. New illustrated catalog 25¢. Single and multistage kits, cones, engines, launchers, trackers, rocket aerial cameras, technical information, etc. Fast service. Estes Industries, Penrose 13, Colorado 81240.

• • • MISCELLANEOUS

BEERS, PEACH Brandy, Wines—Strongest Formulas, \$2.25. (complete brew supplies hydrometers catalog 10¢)—Research Enterprises, 29-85 Samoset, Woburn, Mass. 01801.

# BESTSELLING NOVEL OF OUR TIME

## NOW IN PAPERBACK

"Magnificent"  
"Fascinating...Stunning"  
"Filled with Excitement"  
"A Monumental and  
Imaginative Novel of the  
Old-New Nation Israel"

A Fawcett Crest Book • Wherever Paperbacks Are Sold

Buy this Fawcett Crest Book from your paperback bookseller. If sold out, send \$1.65 plus 10¢ for postage and handling to Fawcett Crest Books, P.O. Box 1014, Greenwich, Connecticut. Please order by number and title. No Canadian orders.



# AMERICAN BASIC SCIENCE CLUB'S ELECTRONICS LAB and RADIO COURSE

All the Equipment for 65 Exciting Projects, Including  
3 Tube Short Wave Radio, DC Power Supply,  
Microphone and Audio Amplifier, Signal Tracer—only

**\$18<sup>80</sup>**  
COMPLETE  
LAB AND  
COURSE

**Get it All in One Complete Shipment —  
or Divided into these 4 Monthly Kits**

**TROUBLE SHOOTING WITH THE SIGNAL TRACER**

## YOU GET A VALUABLE ELECTRONICS LAB

Containing parts by RCA, MALLORY, PYRAMID, GE, CENTRALAB, STACKPOLE, TRIM, CINCH and other reliable manufacturers. Retail value of parts alone is **MORE THAN 25 DOLLARS**

## PLUS A COMPLETE ELECTRONICS COURSE

You **REALLY** LEARN ELECTRONICS. The progressive "learn by doing" American Basic Science Club system is the **EASIEST, MOST THOROUGH and MOST EXCITING** way to a solid background in electronics. Basic enough for beginners... rewarding enough for experts. **NOWHERE ELSE** is a course of this scope available at this **LOW PRICE!**

### ENTHUSIASTIC MEMBERS WRITE:

"basic principles unforgettably learned" . . .

It is only after having completed the experiments in your kits that I can say I have truly and unforgettably learned the basic principles of electronics. **JOHN R. KANIA**, 2 Berkeley Ave., Yonkers 5, N. Y.

"your kits are interesting and rewarding" . . .

I am an electronics student in the Air Force and find your kits interesting and rewarding. We have not covered anything in the school that you have not covered in the kits. **JOHN G. DILL**, Keesler Air Force Base, Biloxi, Miss.

"far ahead of friend taking another course" . . .

A friend of mine is taking a correspondence course in electronics, and I have learned more from your first two kits than he has in twenty lessons. **RAY P. BILLODEAU**, 339 Exchange St., Leominster, Mass.

"the number of concepts presented is amazing" . . .

Your kits offer a range of experiments usually performed only in the better high school and college laboratories. The number of concepts presented, and the clarity and concreteness of their development is amazing. **R. M. HELM**, Professor of Physics, East Carolina College, Greenville, N. C.

### 1st KIT — DC AND AC CIRCUITS

Equipment for 26 Projects Including:

- Electroscope • Electromagnetic Relay • Galvanometer
- AC Buzzer • Magnetizer and Demagnetizer • Solenoid Coin Tossler • Safety AC Power Supply with Isolation Transformer.

Subjects Covered:

- Electron Theory
- DC and AC
- Electro-Chemistry
- Transformer Principles
- Inductance

**FREE with 1st Kit — Surprise "Mystery Box"**

### 2nd KIT — RESISTANCE, CAPACITANCE AND RECTIFICATION

Equipment for 18 Projects Including:

- Strobe Light - variable pulse Neon Lamp "freezes" the motion of vibrating or rotating objects and checks RPM
- Thermocouple • Wheatstone Bridge (measures resistance)
- Extinction Voltmeter • DC Power Supply (Transformer, Vacuum Tube Rectifier and 20-20 mfd. Capacitor Filter Circuit.)

Subjects Covered:

- Ohm's Law
- Rectification
- Resistance
- Neon Glow Tubes
- Capacitance
- Filter Circuits

**FREE with 2nd Kit — Electric Soldering Iron**

### 3rd KIT — AMPLIFIERS AND OSCILLATORS

Equipment for 14 Projects Including:

- Two Stage Amplifier • Capacitance Burglar Alarm
- Proximity Detector • Variable Frequency Ripple Tank Wave Generator (Produces standing waves, nodal lines, etc. Invaluable in understanding wave theory) • Code Practice Oscillator.

Subjects Covered:

- Vacuum Tube Amplifiers
- Frequency and Wave Length
- Wave Theory
- Oscillator Circuits

**FREE with 3rd Kit—"Steps to a Ham License" Manual**

### 4th KIT — AUDIO AMPLIFICATION AND RADIO

Equipment for 7 Projects Including:

- Short Wave and Broadcast Radios (3-tube regenerative. Uses 115V AC house current. Complete with Headset) • Carbon Microphone and Two Stage Audio Amplifier • Radio Transmitter • Signal Tracer and Continuity Tester (valuable trouble-shooting tools).

Subjects Covered:

- Audio Amplifiers
- Radio Theory
- Regen. Circuits
- Tuning Circuits
- Signal Tracing

**FREE with 4th Kit — Radio-TV Service Manual**

**ALL FOUR KITS IN ONE SHIPMENT ONLY \$18<sup>80</sup> POSTPAID**

**OR—YOU CAN GET THE FOUR KITS, ONE A MONTH**

SEND **\$200** WITH COUPON PAY **\$420** PLUS COD POSTAGE ONLY ON RECEIPT OF EACH KIT

**ALL SHIPMENTS ON 10 DAY APPROVAL.  
YOUR SATISFACTION OR YOUR MONEY BACK.**

**WE KNOW YOU WILL BE AMAZED AND DELIGHTED.**

USE THIS "NO RISK" COUPON FOR EITHER PAID IN FULL OR MONTHLY PLAN

AMERICAN BASIC SCIENCE CLUB, Inc., 104 Heimann, San Antonio, Texas 78205

- Send me ABSClub's Electronics Lab in four kits — one a month. I enclose \$2.00 and will pay \$4.20 plus COD Postage on arrival of each kit. I understand that all kits will be on 10 day approval with full refund guaranteed and also that I may cancel unshipped kits at any time without obligation.
- Send me ABSClub's Electronics Lab (all four kits) in one shipment. I enclose \$18.80 full payment, postage paid to me. I understand that this will be on a 10 day approval with full refund guaranteed.

NAME \_\_\_\_\_

ADDRESS \_\_\_\_\_

CITY and STATE \_\_\_\_\_ ZIP \_\_\_\_\_

# FREE... World's Largest Electronic Kit Catalog!

A Kit For Every Interest — Save Up To 50%



**NEW** Heathkit Electric Guitars ... 3 famous American-made Harmony models. Solid-body, 2-pickup model (shown) assembles in just one evening. Costs only \$99.95 ... save \$45!

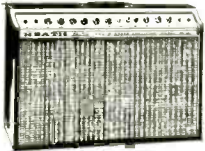

**NEW** Heathkit "Starmaker" Transistor Guitar Amplifier ... all the features guitarists want most, 60 watts peak power; tremolo & reverb; 2 channels — 4 inputs; two 12" speakers; assembles in 8-10 hours; only \$129.95



**NEW** Heath factory-assembled 2-watt Walkie-Talkie ... up to 6 mile range; rechargeable battery; all silicon transistors; super-het receiver; only \$99.95



**NEW** Heathkit Stereo Receiver ... world's best transistor stereo value! 30 watts; FM/FM stereo;  $\pm 1$  db from 15 to 50,000 Hz; 20-hour assembly; only \$99.95

**NEW** Heathkit Color TV ... 180 sq. inch picture; exclusive built-in self-servicing; choice of installation; 25-hour assembly; only \$379.95



**NEW** Heathkit Portable Phonograph ... all-transistor; 4 speeds; automatic; monophonic; superior sound; assembles in just 2 hours; only \$39.95



**NEW** Heathkit 12" Portable B&W TV ... all transistor; AC or battery powered; new integrated circuit first time ever in a kit; assembles in 10 hours; only \$119.95

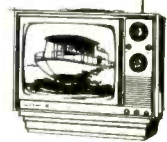

**NEW** Heathkit Solid-State FM/FM Stereo Table Radio ... same tuner & IF circuit as used in deluxe Heathkit stereo components for best performance; handsome walnut cabinet; 10-hour assembly; only \$69.95

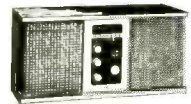

## See All 250 Kits In The New Heathkit® Catalog

- \* Portable and Table Model AM, FM, and Short-wave Radios
- \* Citizen's Band Radio ... Walkie-Talkies, Transceivers, Accessories
- \* Intercoms, Garage Door Opener, Automotive Kits, Tools
- \* Educational Kits for Home or Classroom Study
- \* Stereo/Hi-Fi Components ... Tuners, Amplifiers, Speakers, Turntables, Cartridges, Furniture
- \* World's Largest Line of Amateur Radio Gear
- \* Lab & Test Instruments for Home Workshop, Industrial & Educational use

## Why Millions Choose Heathkit® Electronics

- \* Biggest Selection ... Over 250 Kits
- \* Up to 50% Savings
- \* Easiest To Build
- \* Easy Credit Terms
- \* Free Technical Consultation
- \* Highest Quality Components
- \* Best Performance
- \* Greatest Satisfaction

39-3



Mail Now For FREE Catalog!

Please send my FREE 1967 Heathkit Catalog

Name \_\_\_\_\_

Address \_\_\_\_\_

City \_\_\_\_\_ State \_\_\_\_\_ Zip \_\_\_\_\_

Prices and specifications subject to change without notice.

CL-266

# EXPLORE

## The Space-Age World Of Electronic Kits ...

with this  
**FREE**  
1967  
**HEATHKIT®**  
Catalog

Over 250  
Home & Hobby  
Kits You  
Can Build!



PLACE  
5c  
STAMP  
HERE

**HEATH COMPANY**  
Benton Harbor, Michigan 49022

**MAIL TODAY**  
**For Your FREE**  
**Copy!**

World's largest electronic kit catalog describes and illustrates over 250 easy-to-build kits ... stereo/hi-fi, CB radio, amateur radio, color TV, electric guitars and amplifier, short-wave, test equipment, home study educational kits, marine ... all at up to 50% savings over factory-built versions. Mail this card to get your FREE copy, or write Heath Company, Benton Harbor, Michigan 49022.