

ELECTRONICS ILLUSTRATED

By the Publishers of MECHANIX ILLUSTRATED

Special Bargain Projects

Low in Cost!
High in Fun!
Easy to Build!

Build This!

TRANSISTOR TESTER

for \$2



Build This!

1-TRANSISTOR FM SIGNAL BOOSTER

ONLY 8 PARTS ALTOGETHER!



Build This!

ELECTRONIC GAME

89¢

for only

IT USES COMPUTER LOGIC!

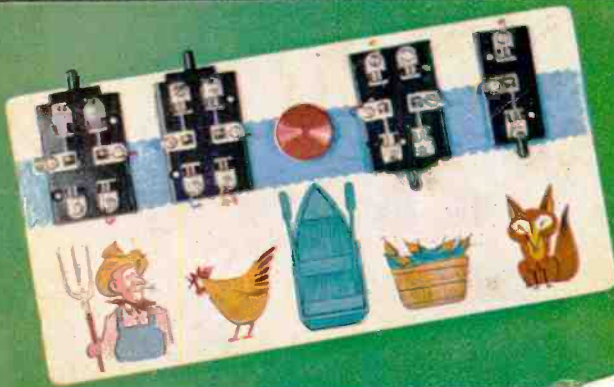

Read About EI's New Swap S
CB Converter ★ Universal

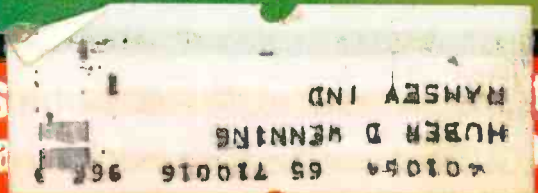

ule
ply

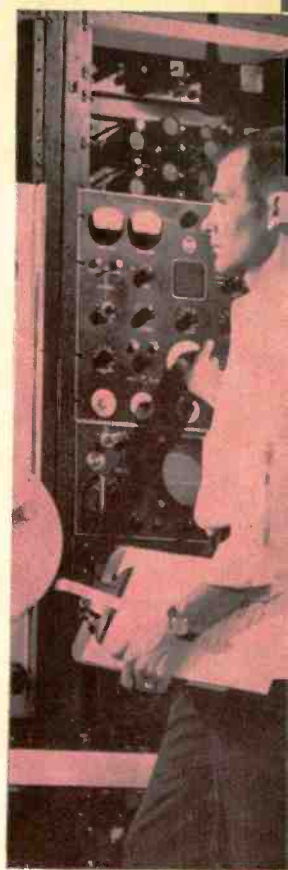

ELECTRONICS COMES ALIVE WITH CUSTOM TRAINING KITS

You get your hands on actual parts and use them to build, experiment, explore, discover. NRI pioneered and perfected the "home lab" technique of learning at home in spare time. Nothing is as effective as learning by doing. That's why NRI puts emphasis on equipment, and why it invites comparison with equipment offered by any other school. Begin now this exciting program of practical learning created by NRI's Research and Development Laboratories. It's the best way to understand fully the skills of the finest technicians—and make their techniques your own.

GET A FAST START WITH NRI'S ABSORBING, NEW ACHIEVEMENT KIT

Delivered to your door—everything you need to make a significant start in the Electronics field of your choice! This new starter kit is an outstanding, logical way to introduce you to NRI training kits . . . an unparalleled example of the value of NRI home-study training. What's in it? Your first group of lesson texts; a rich vinyl desk folder to hold your study material; the industry's most complete Radio-TV Electronics dictionary; valuable reference texts; lesson answer sheets; pre-addressed envelopes; pencils; pen; engineer's ruler, and even postage. No other school has anything like it.

"BITE-SIZE" LESSON TEXTS PROGRAM YOUR TRAINING AT HOME

Certainly, lesson texts are necessary. NRI's programmed texts are as simple, direct and well illustrated as 50 years of teaching experience can make them. They are carefully programmed with NRI training kits to make the things you read about come alive. You'll experience all the excitement of original discovery.

HOBBY? CAREER? PART-TIME EARNINGS? MAIL COUPON TO NRI

Whatever your reason for wanting to increase your knowledge of Electronics . . . whatever your education . . . there's an NRI instruction plan to fit your needs. Choose from three major training programs in Radio-TV Servicing, Industrial Electronics and Communications or select one of seven NRI courses in specialized subjects. Mail coupon for NRI catalog. Find out how you can train at home this exciting, rewarding way.

DISCOVER THE EXCITEMENT OF NRI ELECTRONICS TRAINING

Founded 50 years ago—in the days of wireless—NRI pioneered the "learn-by-doing" method of home-study. Today, NRI is the oldest, largest home-study Electronics School, offering the kind of instruction that makes learning exciting, fast. You build, test, experiment, explore. Whatever your interest, your need, your education, investigate the wide variety of NRI training plans . . . find out about the NRI Achievement Kit. Cut out and mail the postage-free card now. No salesman will call. NATIONAL RADIO INSTITUTE, Electronics Division, Washington, D.C. 20016.

50 YEARS OF LEADERSHIP IN ELECTRONICS TRAINING

Pick your field of ELECTRONICS

NOW NRI OFFERS YOU 10 WAYS TO TRAIN AT HOME IN SPARE TIME

Any training—if it is to be worth your time and money—must give you the knowledge and the skills you seek, the knowledge and the skills employers want. That's why NRI puts emphasis on providing a *choice* of carefully developed training plans in Electronics. NRI now offers you 10 ways to train at home . . . 10 ways to meet the challenge of today's job market by training with NRI for a career in Electronics, for part-time earnings, or

simply for developing a new, fascinating hobby. The proof of the quality of NRI training plans is in its record of tens of thousands of successful graduates and the reputation NRI holds throughout the Electronics industry. Move ahead now in this exciting, growing field. Select the training plans of most interest to you and mail the postage-free card today. NATIONAL RADIO INSTITUTE, Electronics Division, Washington, D. C. 20016.



TELEVISION-RADIO SERVICING

Complete training from basic fundamentals of electricity to home entertainment equipment. You learn to fix radios, hi-fi and stereo sets, black-and-white and color TV, etc. A profitable field full or part-time.



INDUSTRIAL-MILITARY ELECTRONICS

From basic principles to computers. A comprehensive training plan that teaches you the fundamentals, then takes you into such modern-day miracles as servos, telemetry, multiplexing, phase circuitry, other subjects.



COMPLETE COMMUNICATIONS*

Designed to teach and provide you with actual practice in operation, service and maintenance of AM, FM, and TV broadcasting stations. Also covers marine, aviation, mobile radio, facsimile, microwave, radar.



FCC LICENSE*

Specifically designed short course to prepare you for your First Class FCC Radiotelephone License examinations. You begin with fundamental Electronic principles, advance to required subjects covering equipment, procedures.

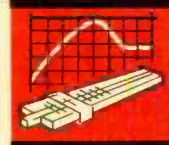

MATH FOR ELECTRONICS

A brief course for engineers and technicians who need a quick review of essential mathematics used in industry, communications, in government jobs. Basic arithmetic review, short-cut formulas, modern digital number systems, much more.



BASIC ELECTRONICS

A concise course to teach modern Electronic terminology and components. A wealth of practical, useful information to help you better understand the field, give you some technical knowledge. For anyone who wants a basic understanding of Radio-TV Electronics.



ELECTRONICS FOR AUTOMATION

Not for beginners, but for men with some fundamental knowledge of Electronics who want an understanding of Automation in present use. Covers process control, ultrasonics, telemetering and remote control, electromechanical measurements, other subjects.



AVIATION COMMUNICATIONS*

Prepares you to install, maintain, service aircraft communications equipment. Covers direction finders, ranges, markers, Loran, Shoran, Radar, landing systems. Earn your First Class FCC License with Radar Endorsement.



MARINE COMMUNICATIONS*

Covers transmitters, direction finders, depth indicators, radar, sonar, other equipment used on commercial ships and pleasure boats. Prepares you for First Class FCC License with Radar Endorsement.



MOBILE COMMUNICATIONS*

Learn to install and maintain mobile equipment and associated base stations. Covers transmitters and receivers used by police and fire departments, public utilities, construction firms, taxis, etc. Prepares for First Class FCC License.

*NOTE: You must pass your FCC License exams (any Communications course) or NRI refunds in full the tuition you have paid.

Our 50th Year of Leadership in Electronics Training



ELECTRONICS ILLUSTRATED

NOVEMBER, 1964

A Fawcett Publication

Vol. 7, No. 6

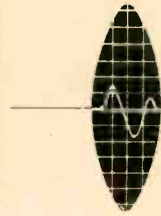

Special Bargain Projects

| | | |
|-------------------------------|-------------------------|----|
| 1-Transistor FM Booster | George Costa | 25 |
| \$2 Transistor Tester | Fred Maynard, 11Q0846 | 47 |
| Old Riddle—New Game | Len Buckwalter, KBA4480 | 58 |

General Features

| | | |
|---|-----------------------|-----|
| New Way to Keep Tabs on Tickers | Sanford Maizel | 67 |
| The ABC's of Color TV | Len Buckwalter, K1ODH | 70 |
| Britain's Floating Freebooter | Don Carter | 74 |
| The Agonies of Major Armstrong | Robert A. Harper | 84 |
| "Mr. Watson, I See You" | | 90 |
| Instant Lingos | C. Hansen | 98 |
| Electronic Swap Shop Announcement | | 108 |

Construction Projects

| | | |
|-------------------------|----------------------|----|
| Hi-I Power Supply | Walt Henry | 77 |
| Universal BFO | Fred Blechman, K6UGT | 96 |

Radio: CB • Amateur • SWL

| | | |
|---------------------------------------|-------------------------|-----|
| Notes From EI's DX Club | | 31 |
| Kit Report: Short-Wave Receiver | | 32 |
| 24-Hour Short-Wave Schedule | | 38 |
| CB's Flood of Ink | Rufus Cartwright | 55 |
| The Listener | C. M. Stanbury II | 60 |
| Ham Shack | Robert Hertzberg, W2DJJ | 69 |
| In-Line Modulation Monitor | Herb Friedman, W2ZLF | 81 |
| CB Corner: Dutch Uncle | Len Buckwalter | 89 |
| DX Boon For the Broadcast Band | Alex Bower | 93 |
| Kit Report: 6-Meter Converter | | 100 |
| All-Transistor Modulated Dipper | Herb Friedman | 101 |
| Converter For One-Way CB | Kevin Redmond, K2HTZ | 104 |

Audio & Hi-Fi

| | | |
|-----------------------------|-------------|----|
| Hi-Fi Today | John Milder | 34 |
| The Novo Two Kangaroo | Harry Kolbe | 49 |

Theory & Practice

| | | |
|-------------------------------------|------------------|-----|
| Dr. Doppler's Strange Effect | Elbert Robberson | 28 |
| How to Pinch Pennies on Parts | Bert Mann | 52 |
| Beginner's Page: R-C Timer | H. B. Morris | 114 |
| Super-Size Schematics | | 120 |

Regular Departments

| | | |
|---------------------------------|----------------|-----|
| Feedback From Our Readers | | 6 |
| Electronics In the News | | 10 |
| Subscription Blank | | 14 |
| Electronic Marketplace | | 19 |
| Broadsides | | 23 |
| Good Reading | Tim Cartwright | 76 |
| EI At Large | | 117 |
| Over and Out | Rodrigues | 122 |

Audit Bureau of Circulations



MEMBERSHIPS



Magazine Publishers Association, Inc.



COVER — Ektachromes by
Grayson Tewksbury,
EI Studios.

Profits That Lie Hidden in America's Mountain of Broken Electrical Appliances

By J. M. Smith *President, National Radio Institute*



And I mean profits for you — no matter who you are, where you live, or what you are doing now. Do you realize that there are over 400 million electrical appliances in the homes of America today? So it's no wonder that men who know how to service them properly are making \$3 to \$5 an hour — in spare time or full time! I'd like to send you a Free Book telling how you can quickly and easily get into this profitable field.

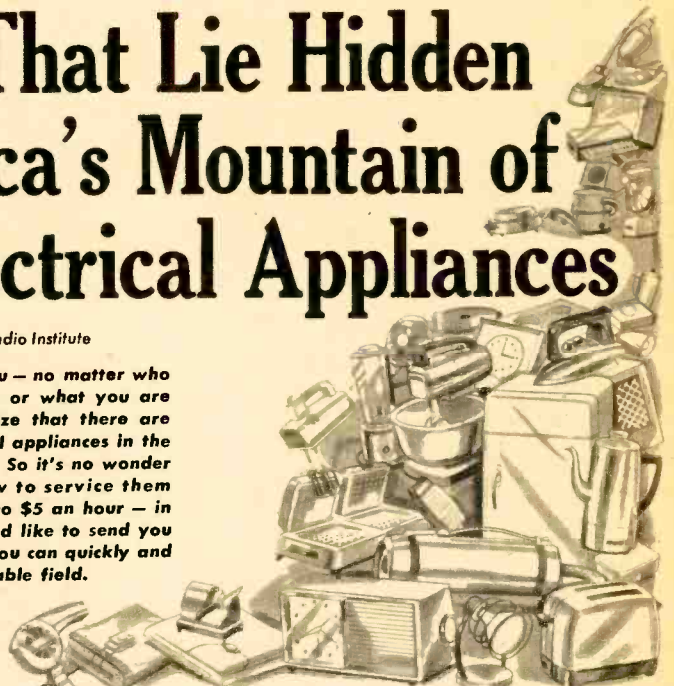

THE COMING OF THE AUTO created a multi-million dollar service industry, the auto repair business. Now the same thing is happening in the electrical appliance field. But with this important difference: anybody with a few simple tools can get started in appliance repair work. No big investment or expensive equipment is needed.

The appliance repair business is booming — because the sale of appliances is booming. One thing naturally follows the other. In addition to the 400,000,000 appliances *already* sold, this year alone will see sales of 76 million *new* appliances. For example, 4,750,000 new coffee makers, almost 2,000,000 new room air conditioners, 1,425,000 new clothes dryers. A nice steady income awaits the man who can service appliances like these. And I want to tell you why that man can be you — even if you don't know a volt from an ampere now.

A Few Examples of What I Mean

Now here's a report from Earl Reid, of Thompson, Ohio: "In one month I took in approximately \$648 of which \$510 was clear. I work only part time." And, to take a big jump out to California, here's one from

J. G. Stinson, of Long Beach: "I have opened up a small repair shop. At present I am operating the shop on a spare time basis — but the way business is growing it will be a very short time before I will devote my full time to it."

Don't worry about how little you may now know about repair work. What John D. Pettis, of Bradley, Illinois wrote to me is this: "I had practically no knowledge of any kind of repair work. Now I am busy almost all my spare time and my day off — and have more and more repair work coming in all along. I have my shop in my basement."

We Tell You Everything You Need to Know

If you'd like to get started in this fascinating, profitable, rapidly growing field — let us give you the home training you need. Here's an excellent opportunity to build up "a business of your own" without big investment — open up an appliance repair shop, become independent. Or you may prefer to keep your present job, turn your spare time into extra money.

You can handle this work anywhere — in a corner of your basement or garage, even

on your kitchen table. No technical experience, or higher education is necessary. We'll train you at home, in your spare time, using methods proven successful for over 45 years. We start from scratch — tell you in plain English, and show you in clear pictures — everything you need to know. And, you will be glad to know, your training will cost you less than 20¢ a day.

FREE BOOK and Sample Lesson

I think that our 24-page Free Book will open your eyes to a whole world of new opportunities and how you can "cash in" on America's "Electrical Appliance Boom."

I'll also send you a Free Sample Lesson. It shows how simple and clearly illustrated our instruction is — how it can quickly prepare you for a profitable future in this big field. Just mail coupon, letter, or postcard to me: Mr. J. M. Smith, President, National Radio Institute, Dept. 504-114, Washington 16, D.C. (No obligation, of course — and no salesman will call on you.)

EARN WHILE YOU LEARN with this APPLIANCE TESTER

— Yours at No Extra Charge



Your NRI Course comes complete with all the parts to assemble a sturdy, portable Appliance Tester that helps you earn while you learn. Easy-to-follow manual tells how to assemble and use the Tester right away. Locate faulty cords, short circuits, poor connections, etc. in a jiffy; find defects in house wiring, measure electricity used by appliances; many other uses.

With this Tester you save time and make money by doing jobs quicker, making sure appliances operate correctly after repairs.

MAIL THIS FOR FREE BOOK and SAMPLE LESSON

Mr. J. M. Smith, President
NATIONAL RADIO INSTITUTE
Dept. 504-114, Washington 16, D.C.

Tell me how I can "cash in" on the "Electrical Appliance Boom." Send me your illustrated FREE BOOK that outlines the whole NRI Course, tells what opportunities are open to me, answers my questions, describes success of other students, and much more. Also send me the FREE SAMPLE LESSON so I can see how clear and easy your instructions are. I am particularly interested in:

- Spare Time Earnings Business of My Own Better Job

I understand there is no obligation on my part, and no salesman will call on me.

Name

Address

City Zone State

Accredited Member National Home Study Council



Citizen Band Class "D" Crystals

CITIZEN BAND CLASS "D" CRYSTALS

3rd overtone — .005% tolerance — to meet all FCC requirements. Hermetically sealed HC6/U holders. 1/2" pin spacing. .050 pins. (Add 15c per crystal for .093 pins).

\$2.95
EACH

All 23 channels frequencies in stock: 26.965, 26.975, 26.985, 27.005, 27.015, 27.025, 27.035, 27.055, 27.065, 27.075, 27.085, 27.105, 27.115, 27.125, 27.135, 27.155, 27.165, 27.175, 27.185, 27.205, 27.215, 27.225, 27.255.

Matched crystal sets for ALL CB units (Specify equipment make and model numbers) \$5.90 per set

CRYSTALS IN HC6/U HOLDERS

SEALED OVERTONE 486 pin spacing — .050 diameter — .005% tolerance
 15 to 30 MC \$3.85 — 30 to 40 MC \$4.10 — 40 MC to 65 MC \$4.50 — 65 MC to 100 MC \$6.00 ea.

FUNDAMENTAL FREQ. SEALED From 1601 KC to 2000 KC \$5.00; from 2001 KC to 2500 KC \$4.00; 2501 KC to 5000 KC \$3.50; 5001 KC to 7000 KC \$3.90; 7001 KC to 10,000 KC \$3.25.

RADIO CONTROL Specify frequency. .05 pins spaced 1/2" (Add 15c for .093 pins). \$2.95 ea.



QUARTZ CRYSTALS FOR EVERY SERVICE

All crystals made from Grade "A" imported quartz—ground and etched to exact frequencies. Unconditionally guaranteed! Supplied in:

FT-243 holders MC-7 holders
 Pin spacing 1/2" Pin spacing 3/4"
 Pin diameter .093 Pin diameter .125

CRIA/AR holders FT-171 holders
 Pin spacing 1/2" Pin spacing 3/4"
 Pin diameter .125 Banana pins

MADE TO ORDER CRYSTALS . . . Specify holder wanted
 1001 KC to 1600 KC: .005% tolerance \$4.50 ea.
 1601 KC to 2000 KC: .005% tolerance \$3.55 ea.
 2001 KC to 2500 KC: .005% tolerance \$2.75 ea.
 2501 KC to 9000 KC: .005% tolerance \$2.50 ea.
 9001 KC to 11,000 KC: .005% tolerance \$3.00 ea.

Amateur, Novice, Technician Band Crystals

.01% Tolerance . . . \$1.50 ea. — 80 meters (3701-3749 KC)
 40 meters (7152-7198 KC), 15 meters (7034-7082 KC), 6 meters (8335-8650 KC) within 1 KC
 FT-241 Lattice Crystals in all frequencies from 370 KC to 540 KC (all except 455 KC and 500 KC) \$1.25 ea.
 Pin spacing 1/2" Pin diameter .093
 Matched pairs — 15 cycles \$2.50 per pair
 200 KC Crystals, \$2.00 ea.; 455 KC Crystals, \$1.25 ea.; 500 KC Crystals, \$1.25 ea.; 100 KC Frequency Standard Crystals in HC13/U holders \$4.50 ea.; Socket for FT-243 Crystal 15c ea.; Dual Socket for FT-243 Crystals, 15c ea.; Sockets for MC-7 and FT-171 Crystals 25c ea.; Ceramic Socket for HC6/U Crystals 20c ea.

3 PLANTS TO SERVE YOU BETTER ORDER FROM CLOSER PLANT TEXAS CRYSTALS

DEPT. E-114
 1000 Crystal Drive
 FORT MYERS, FLORIDA
 Phone 813 WE 6-2109

Division of



AND
 4117 W. Jefferson Blvd.
 LOS ANGELES, CALIF.
 Phone 213-731-2258

ELECTRONICS ILLUSTRATED

By the Publishers of MECHANIX ILLUSTRATED

editor **ROBERT G. BEASON**
 managing editor **Robert D. Freed**
 feature editor **Richard A. Flanagan**
 art editor **Lou Rubsamen**
 editorial associate **William C. Fuller**
 production editor **Rosanne Walsh**
 advertising mgr. **John F. Webster**
 eastern adv. mgr. **Don Daily**

CONTRIBUTING EDITORS

amateur radio **Robert Hertzberg, W2DJJ**
 citizens band **Len Buckwalter, KBA4480**
 swl-dx **C. M. Stanbury II**
 special projects **Herb Friedman, W2ZLF/KBI9457**
 audio **Harry Kolbe**
 audio **John Milder**
 audio **David Muirhead**

EXECUTIVE STAFF

art director **Al Allard**
 associate art director **Ralph Mattison**
 advertising director **Mortimer Berkowitz, Jr.**
 production director **George H. Carl**

ADDRESSES

Editorial and Advertising Offices: 67 West 44th St., New York, N.Y. 10036. Subscriptions: Change of address Form 3579 to Subscription Dept., Fawcett Bldg., Greenwich, Conn. 06830.

ELECTRONICS ILLUSTRATED is published bi-monthly by Fawcett Publications, Inc., Fawcett Place, Greenwich, Conn. W. H. Fawcett, Jr., President; Gordon Fawcett, Secretary and Treasurer; Roger Fawcett, General Manager; Roscoe K. Fawcett, Circulation Director; Donald P. Hanson, Assistant General Manager.

Second-class postage paid at Greenwich, Conn., and at additional mailing offices.

Subscription price \$4 for 12 issues in U.S. and possessions and Canada. All other countries \$6 for 12 issues. Foreign subscriptions and sales should be remitted by International Money Order in U.S. funds payable at Greenwich, Conn.

Printed in U.S.A. Copyright © 1964 by Fawcett Publications, Inc. Permission hereby granted to quote from this issue of this magazine on radio or television provided a total of not more than 1,000 words is quoted and credit is given to the title of the magazine and issue, as well as the statement, copyright 1964 by Fawcett Publications, Inc.

1958...the RCA Radio-Phone Series

1959...the RCA Mark VII

1963...the RCA Mark VIII

and now 1964...

THE NEW RCA MARK NINE

the latest and greatest RCA CB radio of them all

Look at some of the new features...

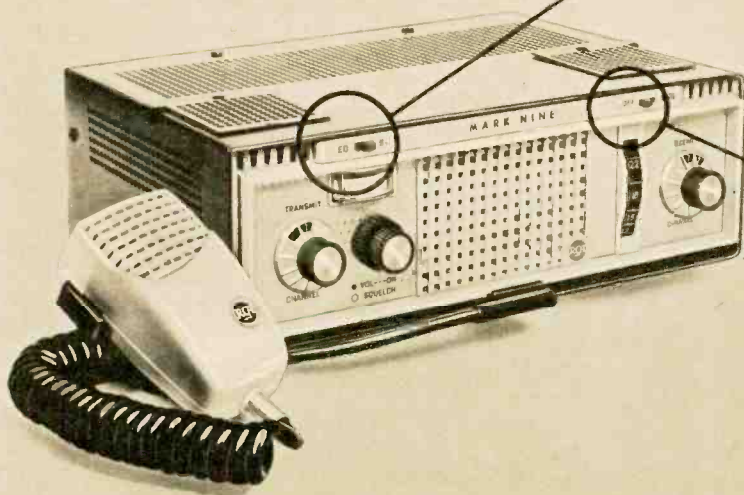

NEW! Combination "S" Meter and Relative RF Output Meter

"S" Meter indicates the relative strength of incoming signal in "S" units. RF Output Meter (EO) indicates relative strength of the signal being transmitted.

NEW! Spotting Switch

Permits precise manual tuning of receiver without use of receiver crystals. Receiver can be tuned (or "spotted") quickly to any incoming channel. This means, when you buy crystals for extra channels, you can (if you wish) omit the RECEIVE crystals and buy only TRANSMIT crystals.

NEW! External Speaker Jack

Lets you connect an external speaker to the set, so incoming calls can be heard in remote locations.

RCA, a pioneer in the development of citizens' band radio, has been providing quality equipment since the inception of the Class D Citizens' Radio Service in 1958. Now, these years of experience culminate in the great new RCA Mark Nine.

- 9 fixed crystal-controlled TRANSMIT/RECEIVE channels, separately controlled
- All-channel continuously tunable receiver
- Illuminated meter and working channel indicator
- Push-to-talk ceramic mike with coiled cord

ONLY **\$13475***

AC UNIT

*Optional User Price

Get all the Facts Before You Buy.
Mail Coupon Today. Paste on 4¢ Post-Card

RCA ELECTRONIC COMPONENTS AND DEVICES
Commercial Engineering Dept. K134R
415 South Fifth Street, Harrison, N. J.

Please send more information on the RCA Mark Nine CB Radiophone

Name _____

Address _____

City _____ Zone _____ State _____



The Most Trusted Name in Electronics

FEEDBACK

from our readers



Write to: Letters Editor, Electronics Illustrated, 67 West 44th Street,

New York, N.Y. 10036

● RARE ONE



You will never believe it, kind sirs, but this letter comes from one who is soon to be no longer. Having been found guilty of the most criminal capers, I now stand condemned to pay for my many transgressions with the supreme sacrifice. And I thank you for a most illuminating article (THE SHOCKING FACTS ON ELECTRIC SHOCK, September '64 EI) on precisely what I can expect to happen. I think you will believe me, kind sirs, when I say my debut in the chair will be shocking.

Name Withheld

Sure we believe you—about your shocking debut, anyway. Some day we just might run into one another and you can tell us all about it.

● CHECK

I plan to build your FM transmitter (LICENSE-FREE FM TRANSMITTER, July '64 EI), but I wanted to check with you first. Are you certain these rigs are AOK with the FCC?

Sam Reeves
New York, N.Y.

A note from the FCC about this transmitter reminds us that "lengthening a wire by as little as 1 inch or misplacing it by a quarter of an inch may be enough to produce exces-

sive radiation and make operation of the device illegal," and that using such a device for baby sitting is outside the intent of the rules, which see low-power FM transmitters mainly as wireless microphones where it is "difficult or inconvenient" to string wires. Furthermore: "Our rules for operation without a license in the band 88-108 mc are not intended to provide a hobby-type activity..."

● WISE INJUN

I would like to know how to get a ham ticket. I'm tired of Part 15.

Charles Veres
Miami, Fla.

We're with you, OM. Our September '63 issue will tell you what you want to know.

● POCKET SHOP

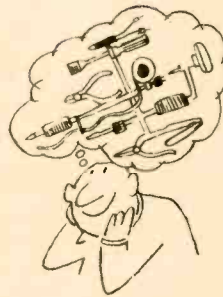

That story you had about tools (TOOLS FOR THE ELECTRONIC HOBBYIST, September '64 EI) got me thinking. What I think somebody should do is make an all-purpose tool that you could use for just about anything. Then you wouldn't need all those separate tools. You could buy just one.

Miles Joseph
Los Angeles, Calif.

Dime stores have been selling Handy Andy can openers for years, MJ. We were talking about tools.

[Continued on page 8]

Heathkit's great base station deserves

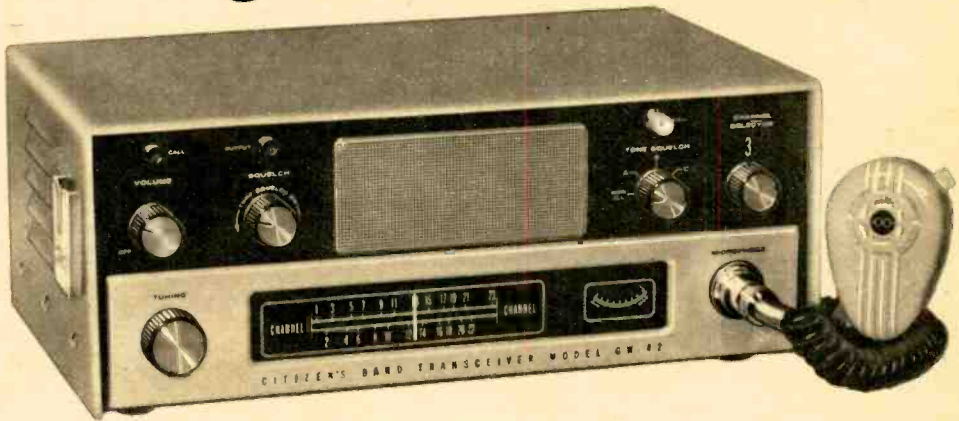

an equally fine working partner!

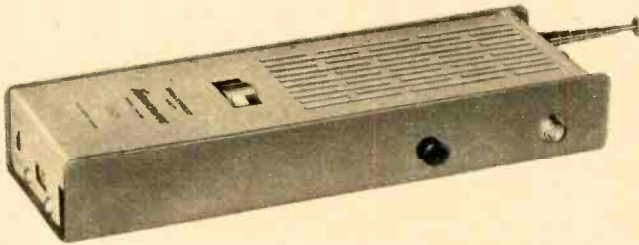

In a two-way radio communications system, overall performance is only as good as it's weakest link. The deluxe Heathkit GW-42 "Master Station" CB Transceiver teamed up with the powerful GW-52 1-watt "Walkie-Talkie" brings you Citizen's Band radio facilities of outstanding capability with complete freedom and mobility of operations. Check and compare the many features offered in Heathkit equipment with any other...see why Heathkit is your best buy in CB!

"Master Station" CB Transceiver

- 5 Crystal-controlled transmit & receive channels • Built-in 3-way power supply • Built-in 4-tone selective call circuitry • All-channel receiver tuning • Built-in tuning meter • Adjustable squelch control • Switchable automatic noise limiter • Push-to-talk microphone • Beautifully styled • Easy-to-build.

Kit GW-42... 23 lbs. \$119.95
 Assembled GWW-42... 22 lbs. \$189.95

1 Watt Walkie-Talkie

- Rugged 10-transistor, 2-diode circuit • Long-range transmitter—1-watt input • Sensitive superheterodyne receiver with RF stage • Adjustable squelch control • Automatic noise limiter • Crystal-controlled transmit & receive channels • \$20 rechargeable battery included

- Built-in 117 v. AC battery charger • Built-in battery condition meter • Easy circuit board assembly.

Kit GW-52... 4 lbs. \$ 74.95
 Assembled GWW-52... 4 lbs. \$124.95



FREE HEATHKIT CATALOG

See these and over 250 other exciting Heathkits available in easy-to-build kit form. Save 50% or more by doing the easy assembly yourself! Send for your free catalog today!



HEATH COMPANY, Dept. 39-11-1
 Dept. 10, Benton Harbor, Mich. 49023

- Enclosed is \$ _____, plus postage. Please send model (s) _____
- Please send my Free Heathkit Catalog.

Name _____

Address _____

City _____ State _____ Zip _____

GX-124R-1

BECOME A RADIO TECHNICIAN
For ONLY \$26.95

BUILD 20 RADIO CIRCUITS AT HOME

with the New
Progressive Radio "Edu-Kit"[®]
ALL Guaranteed to Work!

only
\$26.95
Reg. U.S.
Pat. Off.



A COMPLETE HOME RADIO COURSE

- BUILD**
- 12 RECEIVERS
 - 3 TRANSMITTERS
 - SIGNAL TRACER
 - SIGNAL INJECTOR
 - CODE OSCILLATOR
 - SQ. WAVE GENERATOR
 - AMPLIFIER

- No Knowledge of Radio necessary
- No Additional Parts or Tools Needed
- Excellent Background for TV

Training Electronics Technicians Since 1946

FREE Set of Tools, Pliers-Cutters, Tester, Soldering Iron, Alignment Tool, Wrench Set.

WHAT THE "EDU-KIT" OFFERS YOU

The "Edu-Kit" offers you an outstanding PRACTICAL HOME RADIO COURSE at a rock-bottom price. You will learn radio theory, construction and servicing. You will learn how to build radios, using regular schematics; how to solder and wire in a professional manner; how to service and trouble-shoot radios. You will learn how to work with punched metal chassis as well as the new Printed Circuit chassis. You will learn the principles of RF and AF amplifiers and oscillators, detectors, receivers, test equipment. You will learn and practice code, using the Progressive Code Oscillator. You will build 20 Receiver, Transmitter, Code Oscillator, Signal Tracer, Square Wave Generator, Amplifier and Signal Injector circuits, and learn how to operate them. You will receive an excellent background for TV. In brief, you will receive a basic education in Electronics and Radio, worth many times the small price you pay, only \$26.95 complete.

PROGRESSIVE TEACHING METHOD

The Progressive Radio "Edu-Kit" is the foremost educational radio kit in the world, and is universally accepted as the standard in the field of electronics training. The "Edu-Kit" uses the modern educational principle of "Learn by Doing." You begin by building a simple radio. Gradually, in a progressive manner, and at your own rate, you construct more advanced multi-tube radio circuits, learn more advanced theory and techniques, and do work like a professional radio technician. These circuits operate on your regular AC or DC house current.

THE KIT FOR EVERYONE

You do not need the slightest background in radio or science. The "Edu-Kit" is used by young and old, schools and clubs, by Armed Forces Personnel and Veterans Administration for training and rehabilitation. One of the most important aspects of the "Edu-Kit" is the Consultation Service which we provide. We welcome students to send us their problems, whether related to any of the material covered in the "Edu-Kit" course, or encountered in other experiences in the field of electronics.

THE "EDU-KIT" IS COMPLETE

You will receive all parts and instructions necessary to build 20 different radio and electronic circuits, each guaranteed to operate. Our kits contain tubes, tube sockets, variable, electrolytic, mica, ceramic and paper dielectric condensers, resistors, the strips, coils, hardware, tubing, punched metal chassis, Instruction Manuals, hookup wire, solder, selenium rectifiers, volume controls, switches, etc. In addition, you receive Printed Circuit materials, including Printed Circuit Chassis, special tube sockets, hardware (wrench set, and a self-powered, dynamic Radio and Electronics Tester. The "Edu-Kit" also includes Code Instructions and the Progressive Code Oscillator. You will also receive lessons for servicing with the Progressive Signal Tracer and the Progressive Signal Injector, a High Fidelity Guide, FCC Amateur License Training Book, and a Quiz Book.

All parts, components, etc., of the "Edu-Kit" are 100% unconditionally guaranteed, brand new, carefully selected, tested and matched. Everything is yours to keep. The complete price of this practical home Radio and Electronics course is only \$26.95.

TROUBLE-SHOOTING LESSONS

You will learn to trouble-shoot and service radios, using the professional Signal Tracer, the unique Signal Injector, and the dynamic Radio and Electronics Tester. Our Consultation Service will help you with any technical problems.

J. Sinsality, of 25 Poplar Pl., Waterbury, Ct. writes: "I have repaired several sets for my friends, and made money. The 'Edu-Kit' paid for itself. I was ready to spend \$240 for a course, but I found your ad and sent for your kit."

FREE EXTRAS

- Set of Tools • Radio Book • Radio and Electronics Tester • Electric Soldering Iron • Pliers-Cutters • Alignment Tool • Tester Instruction Book • Kit Book • TV Book • Quiz Book • Membership in Radio-TV Club; Consultation Service • FCC Amateur License Training • Printed Circuitry • Certificate of Merit • Valuable Discount Card • Wires and Solder

ORDER FROM AD—RECEIVE FREE BONUS RADIO & TV PARTS JACKPOT WORTH \$15

- "Edu-Kit" Postpaid. Enclosed full payment of \$26.95.
- "Edu-Kit" C.O.D. will pay \$26.95 plus postage.
- Send me FREE additional information describing "Edu-Kit."

Name _____
Address _____

PROGRESSIVE "EDU-KITS" INC.

(ATT: S. GOODMAN, M.S. IN ED., PRES.)

1186 Broadway Dept. 558AE Hewlett, N. Y.

FEEDBACK

Continued from page 6

● **GUN JUMPER**

In last September's EI there was some plans to build a ham station (TWO BAND HAM STATION, September '63 EI). I would like to know where I can buy the parts. Also how to make a hole in the metal chassis.

Blair W. Schultz
Monmouth, Ill.

From your letter, BWS, we'd guess that project isn't for you—just yet, anyway. We suggest you read **TOOLS FOR THE ELECTRONIC HOBBYIST** (September '64 EI) and **HOW TO PINCH PENNIES ON PARTS** (this issue), then pick some simpler project. Your ham station can come later.

● **OLD-FANGLED**

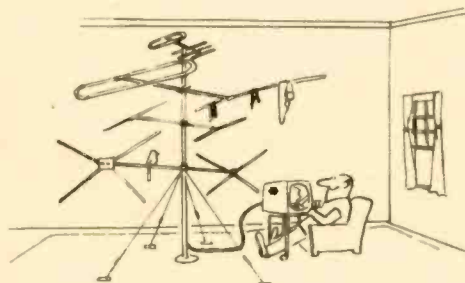

Seeing as how you folks are all worked up over indoor TV antennas (HOW GOOD ARE THE NEW INDOOR TV ANTENNAS, September '64 EI), I thought maybe you all would like to hear about mine. I figured years ago that rabbit ears are a TV set's ruination. So I outfoxed them real neat. No spindly collapsible fishpoles for this viewer, no siree. This feller's setup in the living room is the real thing. Let me tell you I don't need one of them new indoor jimcracks. Mine's the kind you just don't beat.

Joe Manbeck
St. Louis, Mo.

Good show, Joe, Now how's about telling us what you use for BCB reception—a 75-ft. long-wire from kitchen to bedroom to basement, we're thinking, with 6-in. porcelain insulators, no less.

You Can't Buy Better Color TV Performance At Any Price!

**Heathkit® Deluxe
Color TV Saves 30%
Has Exclusive Features,
& Is Easy To Build!**



GR-53A
\$399⁰⁰

(Includes chassis,
all tubes, VHF & UHF
tuners, mask, mounting
kit, & special speaker)
cabinet optional \$49.00

Here's What The Experts Say! Popular Electronics, May issue: "The GR-53A is not a skimpy receiver in which corners have been cut to keep costs down and still provide color TV. Instead, the GR-53A (on a comparison shopping basis) has the same color and sound fidelity, flexibility, and ease of handling as those manufactured receivers which sell for over \$600."

Radio-TV Experimenter, June issue: "The repair cost savings during the Heath Color TV set's life compared to commercial units may be more than \$200."

Popular Mechanics, February issue: "Mounted, pre-aligned critical circuits enable beginners to assemble. Picture quality is topnotch."

Science & Mechanics, April issue: "Built-in servicing circuits such as a dot generator are valuable aids in getting the set operating for the first time & eliminating expensive service calls & bills when realignment or part replacement is needed later on." **Anyone Can Build It!** No special skills or knowledge required . . . all critical assemblies are factory-built & tested . . . simple check-by-step instructions take you from parts to picture in just 25 hours!

Exclusive Built-In Service Center Eliminates Maintenance Costs! You adjust and maintain the GR-53A yourself with the degaussing coil, service switch, and built-in dot generator! No more costly TV service calls! No other set has these self-servicing features!

No Expensive Service Contract! Since you maintain the set, there's no need for a costly service contract. Heath warrants the picture tube for 1 year, all other parts for 90 days!

Compare These Additional Features: • 26-tube, 8-diode circuit • Deluxe Standard-Kollman VHF tuner with push-to-tune fine tuning for individual channels, 2 thru 13 • New transistor UHF tuner

for channels 14 thru 83 • High definition 70° 21" color tube with anti-glare bonded safety glass • 24,000 volt regulated picture power • Automatic color control & gated AGC for peak performance • 3-stage high gain video I.F. • Line thermistor for longer tube life • Thermal circuit breaker for component protection.

Cabinet Or Custom Installation! After assembly, just slip the complete unit into the handsome GR-53-6 walnut-finished hardboard cabinet! Or, if you prefer, mount it in a wall or custom cabinet. **Enjoy Complete TV Reception Now!** . . . by ordering the new 1964 Heathkit 21" High Fidelity Color TV!

Kit GR-53A, chassis, tubes, mask, VHF and UHF tuners, mounting kit, speaker, 121 lbs. ---\$399.00
GRA-53-6, walnut-finished cabinet, 53 lbs. ---\$49.00



FREE HEATHKIT CATALOG

See these and over 250 other exciting Heathkits available in easy-to-build kit form. Save 50% or more by doing the easy assembly yourself! Send for your free catalog today!



HEATH COMPANY Dept. 39-11-2
Benton Harbor, Michigan 49023

Enclosed is \$ _____, plus freight. Please send model(s) _____

Please send my Free Heathkit Catalog.

Name _____
(Please Print)

Address _____

City _____ State _____ Zip _____

Prices & specifications subject to change without notice. CL-185R-1

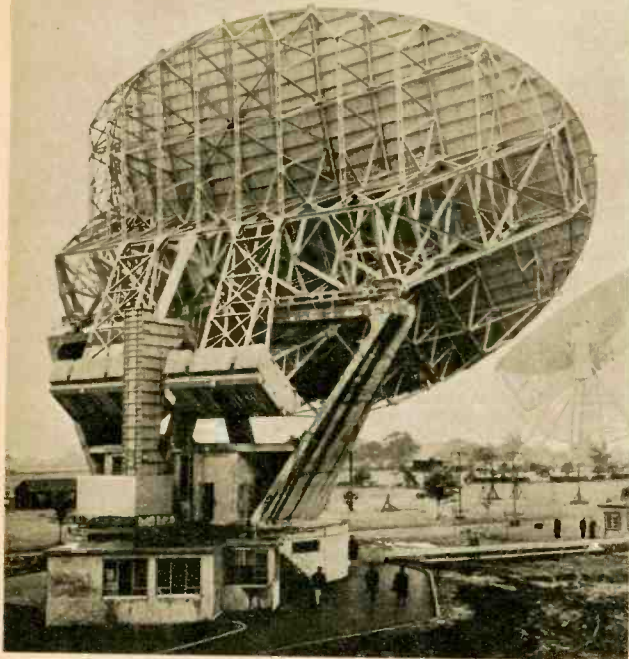

CALLING ALL STARS . . .
 Time was when bigger and better lenses in bigger and better housings were the only hope for seeing more stars. But radio telescopes put an end to that kind of nonsense years ago. Matter of fact, there's nothing quite like them when it comes to pulling in stars and galaxies that are umpteen-cubed light years away. Our photo shows the newest radio telescope in the offing, the Mark II now being erected at England's famed Jodrell Bank radio-astronomy center. Expected to cost some \$900,000, the Mark II will measure 125 ft. in diameter and be computer-controlled. It will supplement the older Mark I instrument, which also appears in our photo (right background).

...electronics in the news

Fly Food . . . Though the tiny tidbits in our photo could pass for flysize biscuits, Mr. Fly would find them none too tantalizing. Actually, what appear to be Mr. Fly's dinner are integrated circuits for use in computers and guidance systems. Sylvania, the company responsible for these inedible morsels, say the little fellows can make decisions in 5 billionths of a second. And believe it or not, each of these fly-style soda crax contains the equivalent of 28 individual components.



Quickie Crystals . . . Haste makes waste, the saying goes, but Mother Nature sometimes goes too far in the other direction. It takes her all of three million years to make a quartz crystal, for example, which engineers at ITT's Standard Telephones and Cables decided was a bit much. Result is that the ST&C people are one up on Mother Nature these days. Thanks to some mighty high temperatures and some tremendous pressures, their crystals actually beat Nature's own. And the three weeks they spend on each batch is less time than it takes Mama N. to blink an eye—let alone fire up her crystal factory.



This New Heathkit® FM Stereo Tuner At \$49.95...



Plus... This Heathkit® 16-Watt Stereo Amp At \$39.95...



Equals Complete Stereo Electronics For \$89.90!

Start With The New Heathkit AJ-13 Stereo Tuner! First you'll like the ease with which it operates... just three controls—On/Off-FM-Stereo Selector... a Tuning Control... and AFC On-Off switch. What could be simpler?

And yet, you enjoy a host of maximum performance features like the built-in stereo converter... automatic frequency control that locks-in all stations for quiet, drift-free reception... a stereo indicator light that silently signals when stereo is being broadcast... large edge-lighted slide-rule dial for easy station reading... easy flywheel tuning... external antenna terminals... plus point-to-point wiring and a pre-assembled, prealigned "front-end" for fast, simple assembly! Goes together in a couple of evenings!

You'll Like The Modern Color Styling, Too!... mocha brown & beige steel cabinet with midnight black trim accents.

Now Add The Heathkit AA-32 16-Watt Stereo Amplifier with its 4 stereo inputs... mag, phono, ceramic phono, tuner & auxiliary. Its clean, pure power response of ± 1 db from 30 to 30,000 cps at 8 watts per channel! Its full complement of controls... mono/stereo switch; a dual-concentric volume control for adjusting both channels simultaneously or individually; full-range tandem-type tone controls for simultaneous adjustment of bass or treble. Its 7-tube amplifying circuit with 2 fourstage preamps, and 2 push-pull power output stages. Its complete transformer operated full-wave silicon-diode circuit. Its simple fast point-to-point wiring

...beginners finish in just a few hours! Its attractive styling... matches the AJ-13 Tuner. Its low, low price... \$39.95!

Now Settle Back & Listen! The sound's superb... the operation simple... the styling handsome... the savings big! Discover why more people rely on Heath to take the high cost out of quality. Use the handy coupon & choose both units now!

Kit AJ-13, FM Stereo Tuner, 13 lbs. \$49.95

Kit AA-32, 16-Watt Stereo Amp, 15 lbs. \$39.95



FREE HEATHKIT CATALOG

See these and over 250 other exciting Heathkits available in easy-to-build kit form. Save 50% or more by doing the easy assembly yourself! Send for your free catalog today!



HEATH COMPANY, Dept. 39-11-3
Benton Harbor, Michigan 49023

Enclosed is \$_____, plus postage. Please send model(s)_____

Please send my Free Heathkit Catalog.

Name _____ (Please Print)

Address _____

City _____ State _____ Zip _____

Prices & specifications subject to change without notice.

HF-170R-1

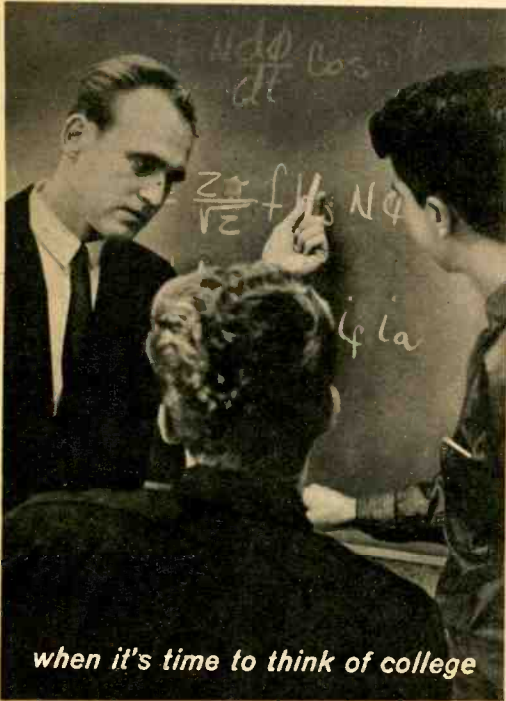

inquire about Electronics at MSOE

Planning your space age engineering education now, will enhance your career later. Find out about MSOE programs in Electronics, Computers, and Electrical Engineering.

Obtain all the facts about courses leading to 4-year Bachelor of Science and 2-year Associate in Applied Science degrees. Find out about MSOE scholarships, financial aids, job placement opportunities, and other services.

Assure yourself of a bright future in the exciting field of space age engineering and technology. Write for your Free "Career" booklet which will tell you about educational advantages at MSOE.



MSOE

MILWAUKEE MS-217
SCHOOL OF ENGINEERING
Dept. EI-1164 1025 N. Milwaukee St.
Milwaukee, Wisconsin 53201

Tell me about a career through residence study:

- Electronics field Mechanical field
 2-years or 4-years

Name..... Age.....

Address.....

City, State.....

...electronics in the news

On Cue . . . Ordinarily it takes a dexterous disc jockey to bring off spot radio announcements at the right moment. But a new magnetic disc recorder just may let DJs take life easier. Insert one of the discs in the slot in



the machine's front panel, and the recorder automatically centers and cues the disc for playback or record. Ampex, the designer, expects this new device will improve reproduction quality and lower recording costs. Reason: present discs are non-magnetic and transferred to tape before they are played.



Living Color

Time was when all the window shades had to be pulled and all the lights turned out if you wanted to watch your favorite television program. But with the advance of science and technology, those days

belong with rotating discs and postage-stamp screens. True, these same problems reappeared to some extent when color came along, but then who cared as long as it was color? Now, with new processes and techniques, you can watch color-television programs in a fully lighted room. At least that's the word from Sylvania Electric out Chicago way. The Sylvania folks claim they have a color picture tube some 40% brighter than most others. Reason, according to the firm's engineers, is use of new phosphors, notably one based on the rare earth element called europium. In addition, a unique screening method is said to help the tube achieve its remarkable color and definition.

first all-transistor stereo receiver kit!

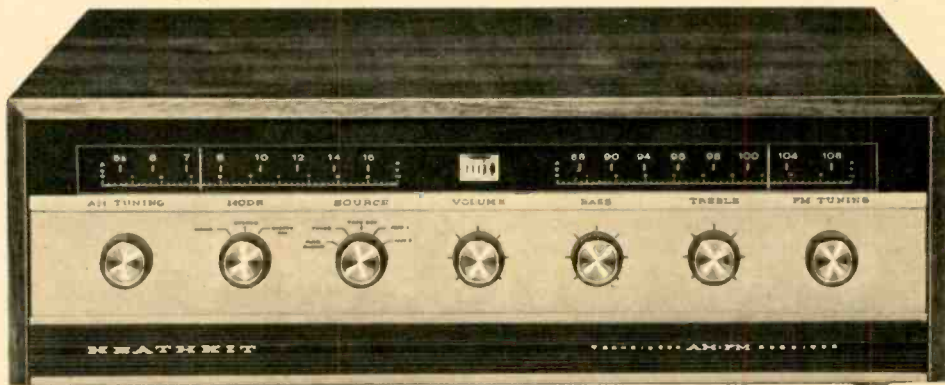

New! Cool-Operating Heathkit Receiver Combines All-Mode Tuner & 40-Watt Amplifier Into One Compact Walnut Cabinet ... Only \$195.00

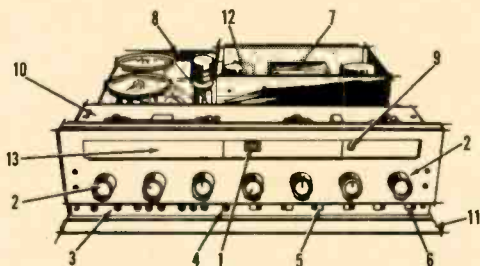

1. Tuning meter
 2. Individual AM and FM tuning
 3. Input level controls
 4. Level balance control
 5. Local-distance switch
 6. Speaker phase switch
 7. Transformer operated power supply
 8. AM rod antenna
 9. Stereo indicator light
 10. Preassembled FM "front-end"
 11. Hinged lower front panel (conceals secondary controls)
 12. Regulated and electronic filtered power supply
 13. Illuminated slide-rule dial
- 43 transistor, 16 diode circuitry • Dimensions: 17" L x 5 $\frac{3}{8}$ " H x 14 $\frac{3}{4}$ " D.

Two 20-watt power amplifiers...two separate pre-amplifiers... plus wide-band AM, FM and FM Stereo...all beautifully housed in one compact, "low-silhouette" walnut cabinet. Add to this, cooler, faster operation with no fading, no faltering, just clean, pure, unmodified sound, and you have the exciting new Heathkit Stereo Receiver. The first all-transistor receiver in kit form! And it's so easy to own... just \$195.00!

Advanced features in addition to those shown at the left include: automatic switching to stereo; inputs for magnetic phono and two other sources; filtered tape recorder outputs; high-gain RF stages; squelch control; AFC; effortless flywheel tuning; external antenna terminals; and preassembled FM "front-end" and 3-stage AM-FM I.F. strip. Just add two speakers and a phonograph or tape recorder, and you have a complete music system. "Transistor sound," designer styling, advanced features, plus big savings...more than enough good reasons to move up to the "better listening" of the New Heathkit Stereo Receiver!

Kit AR-13, 30 lbs. \$195.00

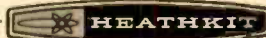

HEATH COMPANY, Dept. 39-11-4
Benton Harbor, Michigan 49023

Name _____ (Please Print)

Address _____

City _____ State _____ Zip No. _____

Prices & specifications subject to change without notice.

Enclosed is \$195.00 plus postage, please send Kit AR-13 Stereo Receiver.

Please send complete detail and specification sheet on the AR-13 Stereo Receiver.

Please send Free copy of Heathkit Catalog.

HF-165R

...electronics in the news

Bye, Bye Tootie . . . The ship's whistle just may be going the way of the Dodo bird. At least, that's a possibility in the New York/New Jersey harbor where a portable, two-way radio communications setup now is being tested. The G-E designed equipment is ex-



pected to increase navigational safety in the area, since ships now will know the location and destination of other vessels in the immediate vicinity. Radioing ahead to drawbridges is still another way the two-way radios will be put to practical use.

Multi-Monitor . . . Eyeing only part of the almost endless data collected from space flights are the 15 ceiling-mounted TV monitors in our photo. Installed directly above a battery of teletype machines, the cameras provide continuous monitoring of incoming

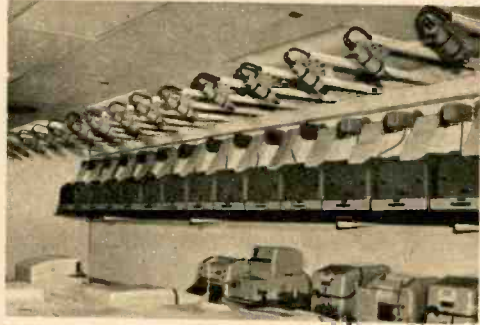

and outgoing data to and from tracking stations. In all, 100 of these miniaturized monitors are used in a closed-circuit TV system developed by Cohu Electronics for the California Institute of Technology's jet propulsion laboratory located at Pasadena. Information can be displayed instantly on a master console for evaluation.

GET ACQUAINTED OFFER!

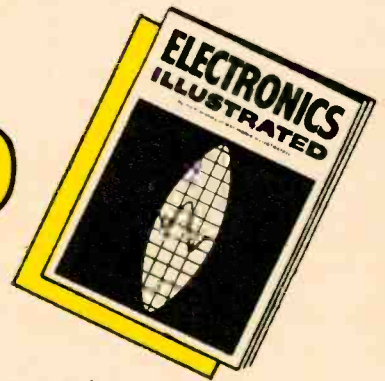

ELECTRONICS ILLUSTRATED 11-64
Circulation Department
Fawcett Building
Greenwich, Connecticut 06830

YES! I want to take advantage of your special get-acquainted offer. Please enter my subscription right away.

- I enclose \$2.98 Bill me later
 New order Re-order

NAME
ADDRESS
CITY STATE ZIP

The coupon below is your ticket to the very best in hobby electronics —issue after issue of feature articles and construction projects certain to interest every electronic hobbyist, be he ham, CBer, SWL, hi-fi buff or general experimenter. Why not take advantage of this easy way to subscribe? Just fill in the coupon and drop it in the mail.

10 issues for only \$2.98



**"\$59.95?
Must be an import"**

Not an import—not a toy—a full fledged 100 milliwatt transceiver with all the features found in units selling at \$20 to \$50 more.

Here's the tremendous value you get in the new Cadre C-60. Two crystal-controlled channels. Sensitive superhet receiver (1 microvolt). Powerful transmitter that delivers over 70 milliwatts to the antenna. Features: AGC, earphone jack, speech clipping, high impact plastic case, telescoping antenna. Includes channel 11 crystals. Uses standard penlight cells or special rechargeable nickel-cadmium batteries. **\$59.95.**

FOR GREATER RANGE—The Cadre C-75 1.5 watts, 2 crystal-controlled channels. **\$99.95.** See Cadre CB transceivers and the new Consort FM Wireless Microphone. For free catalog, write:

CADRE Industries Corp., Commercial Products Div., Endicott, N. Y.



**"It's not.
It's the Cadre C-60!"**

...electronics in the news

Number, Please . . . Your local operator now can dial any one of Japan's 8.4 million telephones as easily as she can dial one in London or Paris. Touch-tone keys provide all that's needed to bring in Japan clear as the neighbors down the block. Backbone of the U.S.—



Japan hookup is a new 6,100-mile cable between Hawaii and Japan. Since this cable connects at Hawaii with lines to California, the wire-bridge across the Pacific now is complete. The installation cost AT&T \$80 million.



Ready Readout . . .

Though it may not win the National Regatta, the platform in our photo is sea-going enough to be destined for the Gulf of Mexico. And, once there, it should be able to withstand most any gale that

happens to blow along. Purpose of the MAMOS (Marine Automatic Meteorological Observing Station) is to let you know just how rough things are out there on the Gulf. Developed by Cardion Electronics for the U.S. Weather Bureau, the platform automatically will transmit wind speed and direction, air and sea temperatures and barometric pressure. Packed with electronic gear, the floating weather station is designed to operate unattended for a full year. Windmill-type fans located on the bow will drive generators to maintain power in MAMOS' storage batteries; twelve hatches on deck house racks filled with data-processing equipment. Aft is the transmitting antenna.

master mathematics in your leisure
PROGRAMMED LEARNING
 exclusive with

Britannica Schools

a member of the Encyclopaedia Britannica Family

THESE 17 TESTED COURSES IN THE GENU-
 INE "TEACHING MACHINE" APPROACH

- 7TH GRADE MATHEMATICS • WHOLE NUMBERS AND NUMERALS
- MODERN MATHEMATICS FOR THE JUNIOR HIGH SCHOOL • BASIC MATHEMATICS • VERBAL PROBLEMS IN ALGEBRA • ALGEBRA I
- PLANE GEOMETRY • ALGEBRA II • MODERN ALGEBRA • THE LANGUAGE OF ALGEBRA • TRIGONOMETRY • SOLID GEOMETRY
- ANALYTIC TRIGONOMETRY • INTRODUCTION TO SETS • INEQUALITIES AND FUNCTIONS • INTRODUCTORY CALCULUS I & II
- DESCRIPTIVE STATISTICS • MANAGEMENT DECISION MAKING

Not a "scrambled book" or miniature gadget promising only "review" or "highlights" from a box.

Here is the full curriculum of mathematics, presented only after testing on thousands of students.

You will find not just "2,000 simple steps," but 6,000 ... 8,000, or in some areas, more than 11,000 carefully developed and researched "frames" of information.

Permits you to progress at your own rate of speed. You take periodic tests under your own Britannica tutor. This is no "do-it-yourself" short cut. Sold only through the mail.

BRITANNICA SCHOOLS

14 East Jackson Boulevard
 Chicago, Illinois 60604

Dept. E1114
 NO OBLIGATION ...
 ACT TODAY

Please send me full details on mathematics.

NAME _____
 ADDRESS _____
 CITY _____ STATE _____ ZIP CODE _____
 AGE _____ OCCUPATION _____

LEARN

ELECTRONICS

TELEVISION

ELECTRICITY

Two Year
 Electronics
 Engineering
 Technology Program



**COYNE
 ELECTRONICS
 INSTITUTE**

Founded
 1899

on a quarter of a million dollars worth of equipment for top salaries and an Exciting Career. Special finance plans. Part time employment service while in school. Also Free graduate employment service.



Use this coupon to get our FREE BOOK
"YOUR OPPORTUNITIES IN ELECTRONICS"

COYNE ELECTRONICS INSTITUTE, Dept. of Electronics 84-A
 1501 W. Congress Parkway, Chicago, Illinois 60607

Name _____ Age _____
 Address _____ Phone _____
 City _____ Zone _____ State _____

Unlike most other schools, we do not employ salesman

...electronics in the news



Electronic Lectures

Way things are moving these days, it may not be long before students who attend real-life classes are rare as morning-glory horns. Matter of fact, there's already a

hookup down Tennessee/Georgia way that lets a prof in one state lecture ten graduate students in another state at a single sitting. One contribution to such futuristic learning setups is an electronic writing machine which Georgia Tech uses for a course in nuclear engineering. A two-way telephone hookup carries the lecture from an instructor at Oak Ridge, Tenn. to students in Atlanta, Ga. But to illustrate his talks, the instructor simply jots lecture notes on an Electrowriter nearby. Relayed over 200 miles the drawings are reproduced instantly and sent via closed-circuit TV to the classroom. Victor Comptometer Corp. is the company responsible for the magic-writing system.

Dandy Decor . . . If it's true that you can't judge a book by its cover, it also follows that you can't tell a lamp by its shade. Proof is the decorative-looking lamp in our photo, which also happens to be a hi-fi speaker system. Housed in its base is a 6-in. woofer, while the shade itself serves as an electrostatic



tweeter. Acoustica Associates, the manufacturer, says the Omnisonic has a response from 40 to 25,000 cps and that the shade radiates uniformly in a 360° pattern throughout the listening area.

ELECTRONIC MARKETPLACE



TWENTY-THREE SKIDOO . . . Switching channels on a CB rig can be a job for the nimble-finger few, especially if it



comes to plugging in a crystal each time. But channel-changing is a one-control operation on Sonar's FS-23 transceiver. Thanks to

frequency synthesis, 12 crystals do the work of 23. And for low-noise operation, the double-conversion receiver incorporates a Nuvistor RF. The FS-23 works off 12 VDC or 117 VAC. \$229.95. Sonar Radio Corp., 73 Wortman Ave., Brooklyn, N. Y. 11207.

Trip Taper . . . One thing the bird-watcher, businessman and Boy Scout have in common is need for a portable tape recorder. And one possible answer is the Freeman 550 Senior. Complete with batteries, leather carrying case, remote-control microphone and telephone pickup, the 550 will play or record up to two hours on a standard 5-in. reel. \$159.50. Freeman Electronics Corp., 729 N. Highland Ave., Los Angeles, Calif. 90038.



rying case, remote-control microphone and telephone pickup, the 550 will play or record up to two hours on a standard 5-in. reel. \$159.50. Freeman Electronics Corp., 729 N. Highland Ave., Los Angeles, Calif. 90038.

YOUR NEW COPY IS WAITING



FREE! For fun and pride in assembly, for long years of pleasure and performance, for new adventures in creative electronics mail the coupon below and get Conar's brand new catalog of quality do-it-yourself and assembled kits and equipment. Read about items from TV set kits to transistor radios . . . from VTVM's to scopes . . . from tube testers to tools. And every item in the Conar catalog is backed by a no-nonsense, no-loopholes, money-back guarantee! See for yourself why Conar, a division of National Radio Institute, is about the fastest growing entry in the quality kit and equipment business.

CONAR

MAIL THIS COUPON NOW

CONAR ME4C

3939 Wisconsin Ave., Washington 16, D.C.

Please send me your new catalog.

Name _____

Address _____

City _____ State _____ Z-Code _____

11,000 DIRECT TUBE SUBS

Only all-inclusive directory of electron tube equivalents. Needed wherever vacuum tubes are used. Contains direct subs for practically every type tube including foreign and newest '64-'65 tubes.

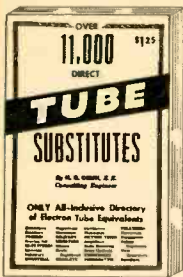

All tubes suggested for substitution have characteristics similar to those they are to replace, **FIT INTO SAME SOCKET & NEED NO WIRING CHANGE.**

Over 7000 Direct Subs for USA Tubes

2678 Substitutes for TV PICTURE Tubes

1500 Substitutes for FOREIGN Tubes

The only **COMPLETE GUIDE** featuring **ALL** electron tube substitutions. This valuable book will save you **TIME & MONEY**, will permit your set to operate even though original tubes are unobtainable. Used by G.E., Boeing, Sig. Corps Schools & many research organizations. **\$1.25** Post-paid

Guaranteed Money Back in 5 days if Not Satisfied

RUSH COUPON NOW!

M. G. CISH, Consulting Engineer, Dept. E-3
Amagansett, N. Y.
Enclosed find \$1.25. Rush "11,000 DIRECT TUBE SUBS."

Name _____
Address _____
City _____ Zone _____ State _____

FREE GIANT NEW 1965 CATALOG

BURSTEIN-APPLEBEE CO.

Dept. 34, 1012 McGee St., Kansas City 6, Mo.

Rush me FREE 1965 B-A Catalog

Name _____

Address _____

City _____ State _____

SEND FOR IT TODAY

FREE

MARKETPLACE

Twenty Tipper . . . Gone are the days of the single-tipped soldering iron. With GE's pistol-grip iron, you have nearly as many tips as a transistor has uses. A threaded shank permits



interchanging 20 different iron-clad or copper screw-on tips. What's more, a sliding contact in the shank allows the working face of any tip to be turned to the desired working position. About \$15. General Electric Co., 1 River Rd., Schenectady, N.Y. 12305.

Bandscanner . . . Thanks to a new spectrum monitor, hams no longer have to depend totally on their ears to find an opening in the bands. Called the Ham-Scan, the unit permits visual observation of band activity up to 50 kc above and below the frequency to which your receiver is tuned. The Ham-Scan also



identifies a signal as SSB, AM or CW. As a result, it's an easy matter to check carrier and sideband suppression of SSB transmitters and to identify a clear case of splatter when you see one. Kit, \$79. Heath Co., Benton Harbor, Mich. 49022.

What Job Do You Want In Electronics?

Whatever it is, Cleveland Institute can help you get it!

Yes, whatever your goal is in Electronics, there's a Cleveland Institute program to help you reach it *quickly* and *economically*. Here's how: Each CIE program concentrates on electronics theory as applied to the solution of practical, everyday problems. Result . . . as a Cleveland Institute student you will not only learn electronics but *develop the ability to*

use it! This ability makes you eligible for any of the thousands of challenging, high-paying jobs in Electronics. Before you turn this page, select a program to suit your career objective. Then, mark your selection on the coupon below and mail it to us *today*. We will send you the complete details . . . without obligation . . . if you will act NOW!

Electronics Technology



A comprehensive program covering Automation, Communications, Computers, Industrial Controls, Television, Transistors, and preparation for a 1st Class FCC License.

First Class FCC License



If you want a 1st Class FCC ticket quickly, this streamlined program will do the trick and enable you to maintain and service all types of transmitting equipment.

Industrial Electronics & Automation



This exciting program includes many important subjects as Computers, Electronic Heating and Welding, Industrial Controls, Servomechanisms, and Solid State Devices

Electronic Communications



Mobile Radio, Microwave, and 2nd Class FCC preparation are just a few of the topics covered in this "compact" program . . . Carrier Telephony too, if you so desire.

Broadcast Engineering



Here's an excellent studio engineering program which will get you a 1st Class FCC License and teach you all about Program Transmission and Broadcast Transmitters.

Mail Coupon TODAY For FREE Catalog

Cleveland Institute of Electronics

1776 E. 17th St., Dept. EI-54
Cleveland, Ohio 44114

Please send FREE Career Information prepared to help me get ahead in Electronics, without further obligation.

CHECK AREA OF MOST INTEREST—

- | | |
|---|--|
| <input type="checkbox"/> Electronics Technology | <input type="checkbox"/> First Class FCC License |
| <input type="checkbox"/> Industrial Electronics | <input type="checkbox"/> Electronic Communications |
| <input type="checkbox"/> Broadcast Engineering | <input type="checkbox"/> Advanced Engineering |



Your present occupation _____

Name _____ Age _____
(please print)

Address _____

City _____ State _____ Zip _____

Approved for Veteran's Training under Korean GI Bill. EI-54

Cleveland Institute of Electronics

1776 E. 17th St., Dept. EI-54
Cleveland, Ohio 44114



Accredited Member

MARKETPLACE



studying antenna system in Tri-State's electronics lab

B.S. degree in 36 months

Small professionally-oriented college. Four-quarter year permits completion of B. S. degree in three years. Summer attendance optional. *Engineering:* Electrical (electronics or power option), Mechanical, Civil, Chemical, Aeronautical. *Business Administration:* Accounting, General Business, Motor Transport Administration. One-year Drafting-Design Certificate program. Graduate placement outstanding. Founded 1884. Rich heritage. Excellent faculty. Small classes. Well-equipped labs. New library. Residence halls. Pleasant community. Attractive 200-acre campus. Modest costs. Enter Jan., Mar., June, Sept. For Catalog and View Book, write J. A. McCarthy, Director of Admissions.



TRI-STATE COLLEGE

48114 College Avenue • Angola, Indiana

“Use it



with any 12 volt CB transceiver”

New Cadre Selective Call encoder-decoder

Put an end to meaningless chatter at the home base and in the mobile units. Contact only the stations you want to talk to. 3-tone, fool-proof selective call system provides up to 24 different tone codes. Code can be changed in field easily with no special relay needed. Easy connection to any of the famous Cadre 5-watt CB transceivers—works with all 12 volt transceivers, regardless of make. Cadre 524, only \$69.95.

CADRE INDUSTRIES CORP.
Commercial Products Div., Endicott, N.Y.

Slim Jim . . . Put an ordinary CB transceiver under a dash, and you just might be in for some shin-banging now and again. But not so with the Mark Nine. A wafer-thin 3½ x 11¼ x 3 in., this little 9-pounder will squeeze

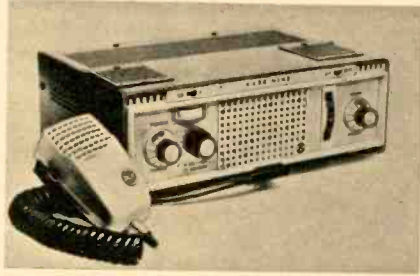

into most any tight under-the-dash spot. As supplied, the Mark Nine is all set for 117-VAC operation, but you'll need an accessory, firewall-mounted DC supply to go mobile. Other features include TVI traps, automatic noise limiting and a spotting switch. \$134.75. RCA, 415 S. 5th St., Harrison, New Jersey 07029.

Two for the Shelf . . . Just a mite bigger than a half-dozen reference books, the Mini-Flex II speaker system is right at home on most any bookshelf. Enclosed in an ebony case is a 6-in. woofer with a 3-in. mid-range cone, a separate tweeter and cross-over net-



works. The specially tuned, ducted enclosure is said to offer virtually undistorted response from 45 to 18,000 cps. \$49.50. LTV University, 9500 W. Reno, Oklahoma City, Okla. 73101.

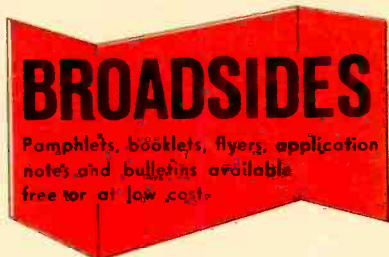

Ten different circuits for **SCR speed control** of series motors are yours in a new RCA bulletin. The booklet contains complete schematic diagrams and explains why different circuits may be required for different motors. Ask for application note SMA-34 from the Radio Corp. of America, U.S. Route 202, Somerville, N.J. 08876.

The entire line of Sonotone **audio products** is pictured and described in catalog SAH-76. For your copy, write the Sonotone Corp., Elmsford, N.Y. 10523.

First who's who in the **tape-recording industry** is a 16-page directory listing names and addresses of 40 companies along with the products they manufacture. The booklet is free from the Magnetic Recording Industry Association, 110 N. Wacker Dr., Chicago, Ill. 60606.

A pocket-size booklet, **Condensed Glossary of Electronics Terminology**, defines over 100 terms commonly used in electronics today. For your copy, write the International Resistance Co., 401 N. Broad St., Philadelphia, Pa. 19108.

Communications equipment from 1923 to the present is pictured in an Anniversary Photo Album prepared by National Radio. In all, some 52 photos depict the progression from bulky tube sets to the latest transistorized equipment. Request your copy from the National Radio Co., Inc., 37 Washington St., Melrose, Mass. 02176.

Difficulty locating a substitute for a transistor or a diode can be eliminated with a new pocket-size guide. Semitronics' 20-page reference lists **recommended equivalents** for some 3,000 transistors and diodes. The booklet is available for 25¢ from the Semitronics Corp., 265 Canal St., New York, N.Y. 10013.

Knowing where to find **servicing information** on radios and TVs is a snap with a new Master Index by Supreme. The 43-page listing includes every TV and radio set covered in the firm's Most-Often-Needed service manuals. A copy can be obtained by sending 10¢ to Supreme Publications, 1760 Balsam Rd., Highland Park, Ill. 60035.

Buying a hi-fi kit?

The first thing you need is free.



Mail coupon for your free copy of
"The Kit Builder's Manual" by Fisher.

FREE! \$1.00 VALUE! "The Kit Builder's Manual" is a comprehensive, illustrated guide to high fidelity kit construction, complete with detailed specifications of all Fisher StrataKits. It is the first thing you need before you make an investment in stereo amplifier, tuner or loudspeaker kits.

Fisher Radio Corporation 211119
21-40 44th Drive
Long Island City, N. Y. 11101

Please send me "The Kit Builder's Manual" without charge.

Name _____

Address _____

City _____ State _____

No other solid state stereo tuner/amplifier kit has EICO's \$500-\$600 quality...



and looks it. (for only \$229⁹⁵)

EICO's new all transistor 3566 has all the quality, reliability and operating conveniences of the costliest Tuner/Amplifiers.

SUPERIOR TRANSISTOR SOUND. The clarity and detail of exactly reproduced transients... plentiful reserve power for orchestral crescendos (even with inefficient speaker systems)—all against a velvet quiet background.

UNSURPASSED FM STEREO TUNER PERFORMANCE: Entirely new FM "Front End" and 4-Stage IF Strip with wideband ratio detector. **Handles even abnormally strong signals without overloading** (a strong local signal won't "blanket" the dial)... **Unsurpassed usable sensitivity** with only slightly more signal required for full 40db quieting. **Time-switching** transistor multiplex circuitry, incorporating separation and balance adjusts, achieves outstanding 38db channel separation... completely effective filtering of all types of interference. Noiseless, purely electronic **Automatic Switching** between FM Stereo and FM Mono (controlled by the pilot frequency in stereo broadcast signal), with defeat. **Stereo Indicator Light** gives instantly visible indication of stereo broadcasts... **D'Arsonval tuning meter** gives exact center-of-channel tuning indication... **Adjustable-threshold interstation noise muting** gives you silence between stations while tuning, and infallible stereo program indication. **Exactly right AFC pull-in range** permits you to tune in stereo stations accurately with ease.

UNSURPASSED STEREO AMPLIFIER/PREAMPLIFIER PERFORMANCE: Designed with the highest performance objectives. **Phenomenally low noise, low distortion RIAA phono preamplifiers** with maximum overload resistance. **Low distortion, variable inflection feedback tone controls** permit boost or cut at the extremes of the range without affecting mid-range response of the volume level. **Unique, very low distortion drive of power amplifier output stages**, plus 36db of overall feedback to reduce distortion to an inaudible level. **No output transformers**—giving unrestricted bass response and eliminating transient distortions.

SIMPLIFIED KIT ASSEMBLY: You wire only non-critical audio and power supply circuits, mostly on military-style terminal boards for easy check-out... **FM "Front End," 4-stage FM IF strip, and entire multiplex circuit pre-wired and pre-aligned**... **Transistor Sockets** eliminate risk of transistor heat damage... **This kit can be recommended to beginners!**

CONTROLS: Input Selector, Mode (incorporates FM stereo defeat), Volume, Balance, Bass, Treble, Loudness Compensation, Muting-off, AFC-off, Power on-off. **INPUTS:** Mag. Phono, tape, auxiliary, 300 Ω antenna. **OUTPUTS:** left and right speakers, tape, headphones. **INDICATORS:** Illumination tuning dial, tuning meter, stereo program indicator light. **FUSES:** Line, Left Speaker, Right Speaker. **SIZE (HWD):** 5 x 16½ x 13¼ inches.

AMPLIFIER/PREAMPLIFIER SPECIFICATIONS: POWER: 66 watts total IHF music power output. **IM DISTORTION:** 2% at 30 wpc (watts per channel); 1% at 25 wpc; 0.3% at normal listening level. **IHF POWER BANDWIDTH:** 20-20,000 at 25 wpc; 0.5% harmonic distortion. **HARMONIC DISTORTION:** 0.16% at normal listening level. **FREQUENCY RESPONSE:** ± 1 db 10-60,000 cps. **HUM & NOISE:** 70db below 10mV on mag. phono; 70db below rated power on other inputs. **SENSITIVITY:** 3mV on mag. phono, 180mV on other inputs. **SPEAKER CONNECTIONS:** 8-16 ohms.

FM MPX STEREO TUNER SPECIFICATIONS: SENSITIVITY: 2 microvolts for 30db quieting (IHF Standard) 2.7 microvolts for 40db quieting. **IHF HARMONIC DISTORTION:** 0.5%. **CHANNEL SEPARATION:** 38db. **FREQUENCY RESPONSE:** ± 1 db 20-15,000 cps. **IHF SIGNAL-TO-NOISE RATIO:** 60db. **IHF CAPTURE RATIO:** 4.5db. **IMAGE REJECTION:** 50db. **IF & SPURIOUS REJECTION:** 80db. **SCA REJECTION:** 40db. **38 KC SUPPRESSION:** 55 db. **19 KC SUPPRESSION:** 45db.

EICO 3566 also available factory wired (includes oiled walnut cabinet) \$349.95... optional oiled walnut cabinet for kit \$9.95.

Visit the EICO exhibit in the Pavilion of American Interiors at the World's Fair.

EI-11

EICO EICO Electronic Instrument Co., Inc.
131-01 39th Avenue, Flushing, N.Y. 11352

Please send 1964 Catalog

Name _____

Address _____

City _____ Zone _____ State _____



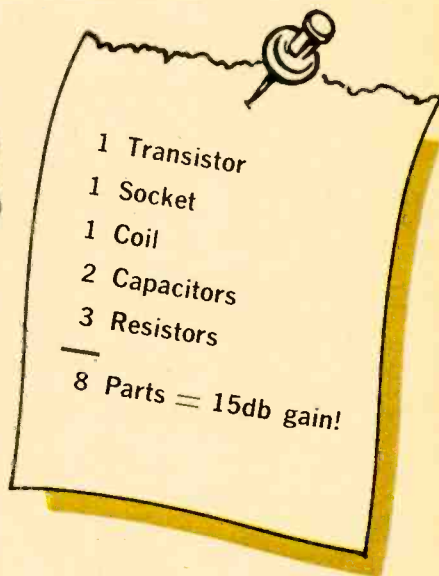
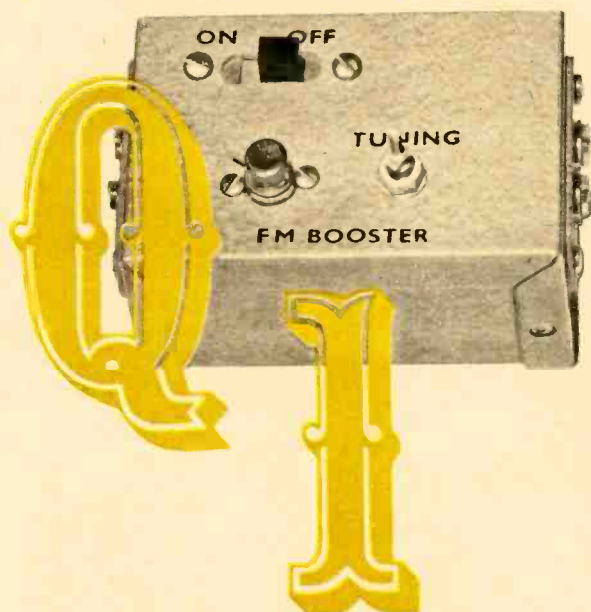

BOOSTER FOR FM

By GEORGE COSTA

THE FM listener has it made if he lives in the heart of a city or in its suburbs. But out in the boondocks reception can be an entirely different story. Even a really sensitive FM tuner or receiver may not have all the pulling power necessary to lift those weak mono or stereo stations out of the noise. A high-gain antenna is one answer but they're expensive and take a lot of work to put on the roof.

A better way to skin the cat is to use EI's FM signal booster. For about \$7 (a lot less than fringe-area antennas cost) the booster will increase the signal strength some 15db in the middle of the band (slightly less at each end). If you've been missing a lot of stations, the booster will enable you to hear clearly many that hardly show up on the dial now. After about two hours work, the booster will put you in the sit-back-and-listen class again. The project requires only one transistor and has just eight operating components in its circuit (see cover).

The booster is designed for use in fringe areas only, where all stations are of low, but usable signal strength. It cannot be used in strong-signal areas, such as the heart of a large city, to pull in weaker stations. Reason is, strong signals from nearby stations (one or two will do it) will overload the transistor and cause crossmodulation. This prevents the booster from helping the weaker stations.

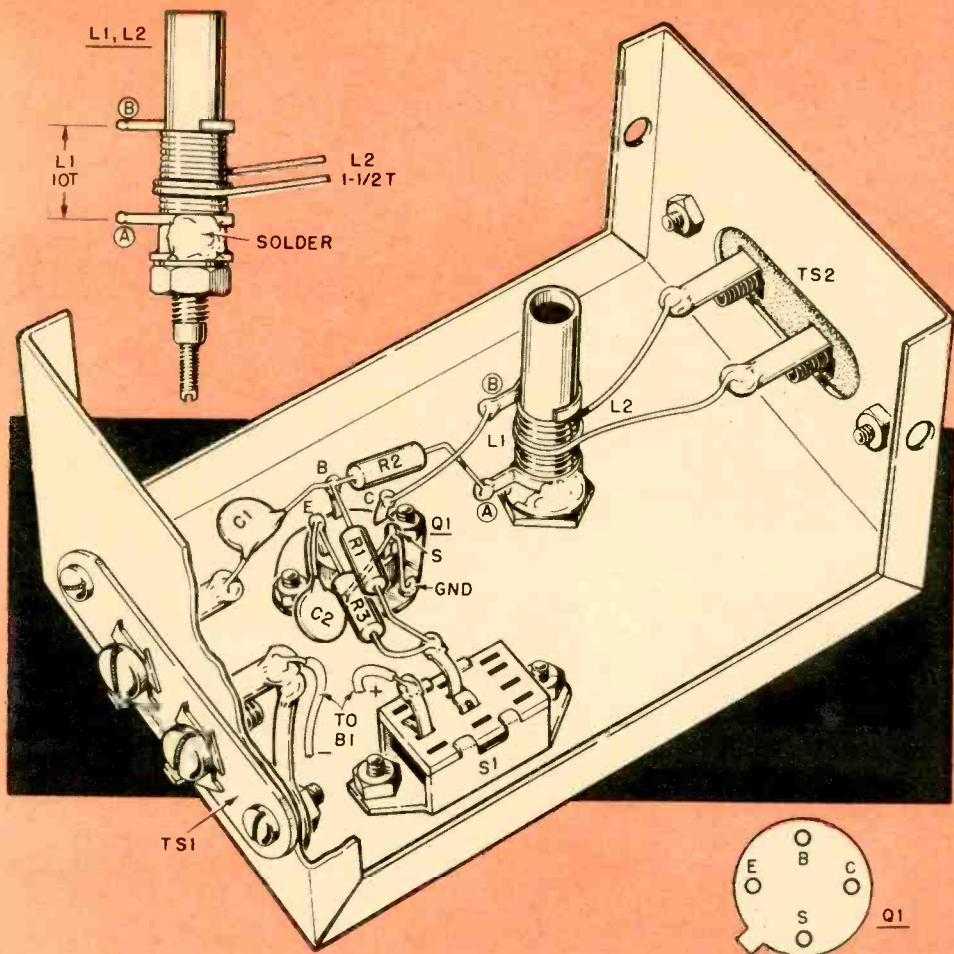

Transistor socket shown is saddle-mount type. On mounting-ring type socket, scrape metal around socket hole and force ring against underside to be assured of good ground. Solder Q1's shield lug to ring.

Q1 BOOSTER

Construction. Because the booster operates at 88-108 mc, it is extremely important that you follow the layout shown in our pictorial. And you must not make substitutions for transistor Q1 or the coil form because the circuit has been designed around the parts specified. The booster can be built in a $1\frac{5}{8} \times 2\frac{1}{8} \times 3\frac{1}{4}$ -inch Minibox. The sketch on the last page of this article shows the layout of holes required for the switch, transistor and coil form.

Keep all leads as short as possible, especially the leads to ground from C2, the antenna terminal strip and the ground lug on Q1's socket. The ground lug on Q1's socket

PARTS LIST

- B1—9 V battery (Burgess 2U6 or equiv.)
- C1—100 mmf ceramic disc capacitor
- C2—.005 mf ceramic disc capacitor
- L1—10 turns No. 24 enameled wire wound on a Cambridge Thermionic Corp. coil form No. 2022-4-1 (Newark Electronics Corp. stock No. 40F3131, 59¢ plus postage)
- L2—1½ turns No. 24 enameled wire wound over L1 near ground end.
- Q1—2N2398 transistor (Sprague; Newark Electronics price: \$3.75 plus postage)
- R1—3,300 ohm, ½ watt resistor
- R2—22,000 ohm, ½ watt resistor
- R3—1,000 ohm, ½ watt resistor
- S1—SPST slide switch
- TS1, TS2—2-lug, screw-type terminal strip
- Misc.— $1\frac{5}{8} \times 2\frac{1}{8} \times 3\frac{1}{4}$ -inch Minibox; transistor socket, 4- or 5-pin circle, mounting ring (Elco No. 3307)

A package of all parts except the coil wire, hardware and battery connector is available from Newark Electronics Corp., 223 West Madison St., Chicago, Ill. 60606 for \$6.80 plus postage. Use stock No. 100F. (Note: Newark has a \$2 minimum order requirement.)

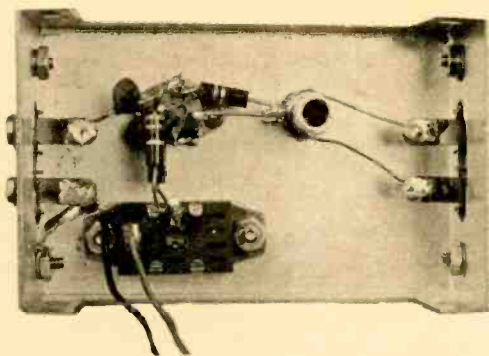

Layout is open. Box must be this size to accommodate battery and to prevent oscillation which would occur if input and output are too close.

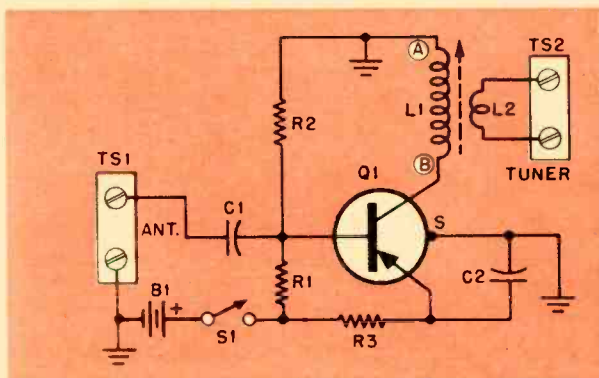

Booster's schematic. The circled letters on L1 correspond to the lugs shown on the pictorial. Emitter and base are +8 V with respect to ground.

should be soldered directly to the socket's mounting ring with a short piece of bare wire. Solder with Q1 out of the socket.

A word of caution about Q1 and its socket. The 2N2398 is a four-lead transistor (the fourth lead is a shield) and can be plugged into the socket in four different positions. Install the socket so Q1's tab is in the position shown in the cabinet drilling diagram. The shield lug then will be directly opposite S1. Paint a mark on the top of the box opposite the tab to remind you of Q1's position.

The coil form for L1 and L2 comes with two silver-plated collars, or hooks, which slide on the ceramic form. Slide one of these hooks all the way on the form and solder it to the head end. This is the ground end of L1. Slide the other hook on the form to within 1/4 to 5/16 inch from the first hook.

Solder a piece of No. 24 enameled wire to the hook at the head end and wind 10 turns. Solder the end of the wire to the other hook. The turns should be close together (no overlapping) and wound tightly. Coat the coil with coil dope to prevent the wire from moving and to form a base for L2. Secondary L2 is 1 1/2 turns of the same size wire and should be wound over L1 near the ground end after the coil is mounted in the box.

Tune-Up and Checkout. The booster is designed so that tune-up is necessary only to compensate for minor differences in layout and variations in transistor characteristics. If your FM tuner does not have a tuning indicator, turn L1's slug-adjustment screw so the slug is flush with the open end of the coil form. Then screw the slug into the form 15 complete turns. This will peak the booster near the center of the FM band.

If your tuner has a tuning indicator, tune it to a weak station near 100 mc and adjust L1's slug for strongest signal indication. Tuning is broad and it may require several turns of L1's slug before you notice a change.

To check whether the booster is operating, tune in a weak station without the booster and note the level of signal and noise. Then connect the booster and check signal and noise levels. If the booster is working correctly the difference will be quite noticeable.

If there is no difference, go over the wiring and check to see that Q1 is in its socket properly.

The booster should be mounted near the tuner and connected to its antenna terminals with a short (3 or 4 inches) piece of 300-ohm twinlead. The lead from the antenna should be kept away from the output of the booster to prevent oscillation.

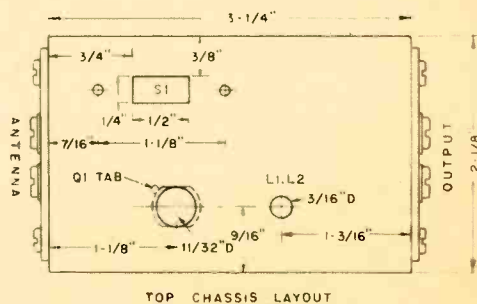

Use these dimensions when drilling the Minibox and all parts will be in the correct location.

DR. DOPPLER'S

STRANGE EFFECT

Being the story of how a pondering star-gazer got mixed up with such imponderables as speed traps and burglar alarms.

By ELBERT ROBBERSON

THE ROAD is clear and the car is eager. Our driver shoots forward, ever faster. Suddenly a uniformed man appears, seemingly out of nowhere. Our driver pulls to the curb and patiently hears what he should have realized already. He has been exceeding the speed limit. Question is, how did the trooper know? Answer: Doppler Effect.

When an Austrian named Johann Christian Doppler wrote something called, "Über das farbige Licht der Doppelsterne," back in 1842, he hardly had speed traps in mind. But today Dr. Doppler's strange Effect affects most everyone. Sometimes it's beneficial; sometimes it's a nuisance. But any person interested in electronics should know of it, how it works and something of how it is used.

Sounds and Stars. Dr. Doppler's paper actually dealt with starlight. He reasoned that just as the sound from a moving source seems to change in pitch (see our illustration below), the light from a moving source should appear to change in hue. And right he was, as a Harvard and MIT man named

E. C. Pickering proved nearly 50 years later.

But uses of the Doppler Effect aren't limited to astronomy. Matter of fact, you could write a book about applications of Dr. Doppler's discovery and still likely leave out a dozen or two.

Figuring out the basics of the Doppler Effect is no tough task. Let's take sound as an example. As you know, sound waves from any source travel at a reasonably constant speed through most any medium. But set that source in motion—or have the listener himself move toward or away from the source—and you've shaken the applecart rather badly.

To understand why, take another look at our train below. Since the train is moving, each sound wave produced by the train's whistle will be given a little extra push by the forward motion of the train. End result is a compression of the original sound wave and a rise in the sound's pitch so long as the train is moving toward the listener. Quite the opposite effect takes place when the train is



Most popular example of Doppler Effect is apparent change in pitch of passing train whistle. So long as

the train is approaching, the sound you hear will be pitched higher than the actual tone of the whistle.

moving away from the person hearing the sound.

If you have a mind to, you can call on formulas to tell you exactly what's going on. When the sound source and the listener are moving toward one another, the Doppler shift in cycles per second is

$$\frac{V}{C} \times f$$

where V = speed of moving object, C = speed of sound, and f = frequency of sound.

And when the source and the listener are moving away from one another, the new frequency in cps is

$$f - (V \times f/C)$$

where V , C and f mean the same as they do above.

At The Races. For a real down-to-earth example, let's say a Ferrari Berlinetta is approaching the stands. With our Berlinetta careening along at a 175-mph clip—more than 256 fps—its engine just might be emitting a 700-cps roar. Assuming a sound velocity in air of 1,120 feet per second, the Doppler shift will be just what our formula said it would:

$256 \times 700/1120$, or about 160 cps.

Add this to the frequency of the engine noise and the approaching snarl will be 860 cps.

With the Berlinetta going away from the stands, the frequency of the sound you hear will be

$700 - 256 \times 700/1120$,
or about 540 cps.

As you might guess, these same relationships hold for sound in water. And here's the real clincher: replace *speed of sound* with *speed of light* in the foregoing formulas,

and these relationships are true of light rays, or even radio waves!

Getting Practical. Listen to locomotives or racing cars and all you get is deaf. But use a little electronics, and the Doppler shift of sound in air really can be put to work. Suppose you have a lab, a factory, store or just a simple pile of gold in a room that you don't want intruders messing around in.

You could bar the windows, double-lock the doors, plaster the place with foil strip or wires, install invisible light projectors and photocells and have a watchman periodically check the whole kaboodle. But anyone who seriously wanted in might come through a ceiling, wall or the floor. He thus might elude your carefully placed photoelectric systems or other traps—having first slugged the watchman, of course.

Such a blueprint for burglary can be foiled by Doppler Effect equipment. Here's the way Walter Kidde & Co. does it. In an area to be protected, a small transmitter fills the room with ultrasound—a tone of 19,200 cps that's inaudible to the human ear. A companion receiver picks up this sound, along with echoes from the walls, floor, ceiling or any other motionless object in the area. So long as nothing in the space moves, all of the echoes are the same frequency as the original sound. Result is that the alarm just sits and waits.

Let some reflective object in the area move as stealthily as mere inches per second, though, and a sound reflection differing from the original frequency will be picked up by the receiver. This, in turn, causes a comparison circuit in the master-control unit to flip



But as soon as the train has passed, the sound will be pitched lower. Only for the brief moment

when you and the train are neck-and-neck will you hear the real note its whistle is emitting.

DR. DOPPLER'S

STRANGE

EFFECT



In-car components of Doppler speed-trap system are surprisingly few. Gauge directly in front of officer shows speed of car ahead.

its electronic wig. In the guard's office or maybe at police station, bells ring, lights flash and the secret is out.

The Electronic Side. If you have a hi-fi system, the Doppler Effect can be annoying. Feed your woofer some tweets and you'll get distortion you likely won't need a wave analyzer to detect. Reason is that the frequencies of high notes are shifted back and forth by excursions of the speaker cone while it is pumping out fat lows.

But speakers aren't the only victims of Dr. Doppler's discovery. Put yourself in a car zooming at 100 mph toward a radio broadcasting station and there'll be a Doppler shift in the station's frequency. In this case, of course, your own speed is so puny in comparison to the velocity of the radio waves that the shift wouldn't be noticeable. But raise the vehicle speed or the station's frequency and

the Doppler shift can become significantly large.

Take artificial satellites as an example. Broadcasting on VHF and UHF frequencies and moving at speeds of 17,000 mph or so, they Dopple markedly. Matter of fact, the Doppler shift can be detected with an ordinary receiver and a simple frequency standard. And with a somewhat more sophisticated setup, satellite altitude, distance and speed can be calculated.

Dr. Doppler's strange Effect often causes TV-signal flutter, too. Passing aircraft usually are the culprits. Picture and sound can deteriorate every few minutes as Doppler-shifted TV-signal reflections go in and out of phase with the desired straight-path signal. People who are not electronically hep blame hams, the set manufacturer or the repairman

[Continued on page 112]

Another common application of the Doppler Effect is in burglar alarms. In system shown here, transmitter (upper right) sends out tone so high in frequency it cannot be heard by human ear. Receiver (lower left) picks up steady tone from transmitter unless something or someone in the room moves. When this happens, frequency of reflected sound changes, triggering the alarm.

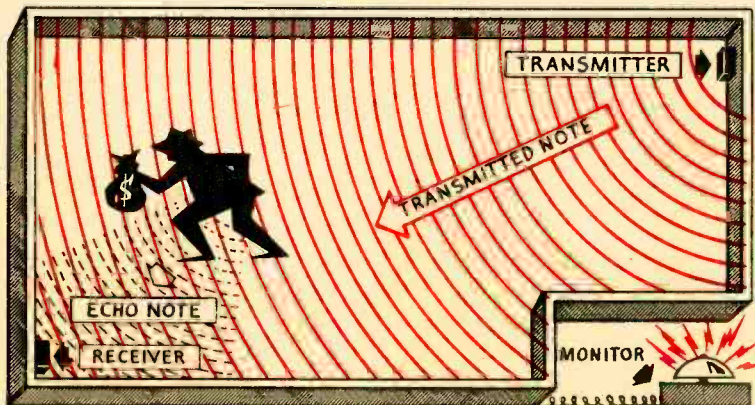

Notes from EI's DX CLUB

THREE CHEERS. We finally made it through that maze of misinformation circulated in European DX circles and came up with the straight dope on West Berlin SW operations. RIAS' own 20-kw transmitter in the divided city holds down 6005 kc at 1300-2300 EST. Rest of the day RIAS programs are carried on this same channel by a 100-kw VOA job at Munich. Advice: shoot for West Berlin midafternoons.

Antarctica hardly is rare on the ham bands anymore but EIDXer Gregory Surma, WA8GLY, of Detroit made it real DX again. He worked KC4USK down on 40 meters.

Anyone interested in exotic Pacific islands who can't quite get out of bed in the wee hours should try for R. Tahiti at 2300 EST on 11825 kc. But do it now before 25 meters goes dead at night.

Back to 40 meters, was anybody able to work those Latin American hams playing rebel last May 20? It seems they found a safe (though illegal) way to tweak Castro's beard. But this isn't the first time that broadcaster and amateur became one.

Most distant SWBC station heard in Eastern North America is that domestic relay at Perth, Western Australia. EIDXer Gerry Klinck of Buffalo, N.Y., reports excellent reception at 0500-0700 EST on 9610 kc.

Story runs that some Dominican Republic stations just can't get call letters straight. According to reliable sources, all transmitters operated by government-owned R. Santo Domingo Television are assigned letters HISD. But the DR's international service on 9505 kc still announces as HI4U at 1800 sign-on. Catch is that this type call supposedly went out with Trujillo.

DXers mourning the loss of Surinam's SWBC station should stop. The government

telephone service verifies promptly via letter.

There doesn't seem to be any question about it now. That mysterious station playing the song Honey Honey continuously around 1300 EST on 11697 and 9560 kc is a jammer aimed at the Russian-based R. Teje Iran. But the jammer also apparently has no connection with R. Tehran's new 100-kw transmitters as believed by some. Credit for this piece of detective work goes to members of the EIDXC and ASWLC as well as to a little gadget called the Fraud Finder. We wonder who really is responsible for the Honey Honey bit.

Watch for offband SWBC stations Sundays when some radioteletype interference is silent. Sample catch: R. Yerevan (Armenian S.S.R.), which has English for North America at 1520-1530 EST on 11690 kc.

If you hear jamming on 9640 kc at 0830-0845 and 1730-1745 EST, it's aimed at N.T.S. (R. Free Russia) transmissions over facilities of the Korean Broadcasting System. And speaking of N.T.S., this outfit's U.S. address is Box 7043, North Station, Arlington, Va. 22207.

Moving up 5 kc, we'll remind you that Vatican State counts as a country for EIDXC purposes. And Vatican R. easily can be logged during its North American beam at 1950 EST.

Persons interested in having a crack at BCB DX should make a try for a station called ZNS on 1540 kc. It's located in Nassau, Bahamas, and often comes through in the early evening, conditions permitting.

Latest news on the club front is that the DXRC has folded. This leaves the FCC with only one organization assisting it by issuing call letters to SWL's.



Knight-Kit Star Roamer

THE KIT: STAR ROAMER 5-band short-wave receiver
THE SOURCE: Allied Radio Corp., 100 N. Western Ave., Chicago, Ill. 60680
THE PRICE: \$39.95
THE CONSTRUCTION TIME: about 20 hours

WHAT YOU want and what you need in a receiver depend on a good many things, your pocketbook being one of them. But most anyone interested in radio needs an all-band set or two around his shack, and this is precisely where the Knight-Kit Star Roamer fits in. For \$39.95, the Star Roamer would seem to be a natural for most any short-wave listener or novice ham who wants a low-cost, general-coverage receiver.

What It Is. Basically a four-tube superhet, the Star Roamer provides most of the features the beginning SWL or ham would look for. It tunes long wave (200 to 400 kc); medium-wave, i.e., standard broadcast (550-1800 kc); and short-wave (1.8 through 30 mc in three separate bands). Automatic volume control (AVC) and automatic noise limiter (ANL) circuits are part of the works. So, too, are an illuminated slide-rule dial, an S-meter, electrical bandspread, a headphone jack and other features you'd expect to find in a communications receiver.

A quick look at the Star Roamer's schematic reveals a circuit surprisingly similar to that found in a good many AC/DC radios. To be sure, the Star Roamer does have a power transformer and therefore can be operated only on AC. But its rectifier (a selenium diode) is a half-wave affair, just as it is in the case of AC/DC sets. What's more, output from the power supply is a low 105

volts DC, a factor which has one adverse effect on the circuit's performance.

Tube lineup in the Star Roamer is a 6BE6 converter in a pretty straightforward hookup. The IF, a 6HR6, again is more or less conventional, with one exception—a potentiometer between suppressor grid and ground can be set to cause this stage to oscillate, thus equipping the set for CW reception. The three-stage audio section which follows a solid-state diode detector also is somewhat atypical, inasmuch as it contains one more stage than the usual AC/DC set would have. A 12AX7 duo-triode provides the AF amplification, while a 6AK6 power pentode drives the self-contained 4-in. speaker.

Putting It Together. Building the Star Roamer is a reasonably pleasant task. We found the assembly manual easy to follow, and we uncovered no errors of any consequence. One thing that did bother us about the manual is its failure to explain that certain leads and wires must be trimmed and stripped before they are connected. Realizing that we would end up with a rat's nest of looped and double-looped leads, we soon took it upon ourselves to strip and tin leads as we went along. But since the Allied Radio people state that "you can build a perfect Star Roamer" "even if you've never built anything before," we think the little matter of trimming leads to length is something they should have inserted in the manual.

Another failing of the manual bothered us somewhat. This is its habit of arbitrarily injecting a step at a point where it just doesn't make much sense. For example, we had the wiring nearly completed when we were in-

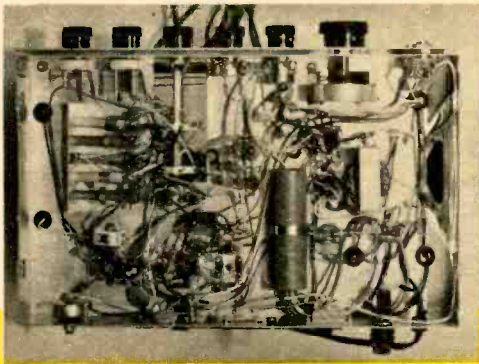

Underside of completed receiver. Unit looks neater than most others would because builder trimmed many leads. Manual did not instruct him to do so.

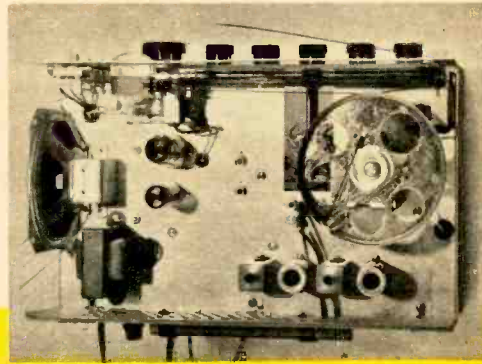

Top view of completed receiver, again with cabinet removed. Loopstick (at bottom) serves for BCB reception; other bands require external antenna.

structed to mount a two-terminal strip "on top of chassis with a 6-32 x 1/4-in. screw, lockwasher and nut." Doing so posed no particular problem, of course, but we were surprised to find this step in a section of the manual entitled "wiring the chassis top." Logically, one would have expected such a step to appear much earlier.

Other steps-out-of-order proved more troublesome. For example, with leads connected to every pin on tube V2's socket, we then were instructed to "solder the other lead (of a capacitor) to ground lug B near pin 3 of V2." In view of the leads running in and around this ground lug, this was no easy task. But this step could have been easy had Knight-Kit given it precedence over some of the other wiring on this same socket.

All things considered, though, the manual is a good one. For the beginning SWL, it even contains tips on when to listen in, and for the ham-to-be it offers the complete International Morse Code. Reason for this last extra is a feature of the Star Roamer we haven't mentioned as yet. Because of the rather unusual method this set uses to receive CW signals—the oscillating IF stage we talked about earlier—the Star Roamer also can be used as an audio oscillator for code practice. Knight-Kit provides for this by adding a Code-Normal switch on the rear panel, which cuts out the speaker, as well as a jack to accept leads from a key.

How It Performed. The Knight-Kit Star Roamer is billed as being long on economy. We found it to be somewhat less long on performance, as is the case with most low-cost SW receivers.

After extensive instrument alignment, sensitivity on the low end of its lowest short-wave band was measured as 8.5 μv for 10 db signal-to-noise ratio (S/N). On the top end of this same band, we measured a sensitivity of 14 μv for 10 db S/N. And though usable, a sensitivity of this order is rather low for a receiver of this type.

As for the audio end of things, the audio output stage is on the short side when it comes to driving the speaker. At all but extremely low listening levels, the stage overloads and produces severe distortion. We suspect that the low B+ voltage mentioned earlier is at fault here.

Another handicap of the Star Roamer is its 8-kc IF bandwidth and very-low front-end selectivity. These two weaknesses make it very difficult to pick out individual signals on a crowded band. In addition, they combine to make the 200-400-kc band almost unusable. Strong local AM broadcast stations simply punch through to the detector, in some cases causing severe cross-modulation and local oscillator pulling.

The control labeled Sensitivity, which causes oscillation in the IF amplifier to produce a beat note with the signal, turned out to be so critical in adjustment that its use produces severe motor-boating more often than not.

Summing up, we found the Star Roamer to be attractive in design and a relatively easy kit to build. Some features—such as the S-meter and automatic noise limiter—are excellent. But, in common with much low-cost equipment, the receiver has some problems when it comes to performance. 



- ✓ *Cost-cutting speakers in space-saving designs*
- ✓ *Nuvistor joins transistor for semi-solid-state*
- ✓ *Prefinished cabinets in kits you construct*

EVER STOP to think that we audio buffs have our own kind of calendar? As you probably are well aware, our audio New Year begins in the fall. And it gets under way just enough in advance of Christmas to tempt most audiophiles into giving themselves a present or three. All of this means, of course, that it's now new-product time in the hi-fi industry. And from what I've been seeing lately during visits to manufacturers, this year's new equipment is going to spell temptation.

To begin, let's take a look at speakers. Certain to create a stir is the new (and long-awaited) AR-4 from Acoustic Research. At less than \$60, the AR-4 is an economy system by anyone's standards. And it's also an amazing speaker no matter how you judge the thing. Matter of fact, it occupies about a third as much space (and sells for about a quarter of the price) as the company's now-famed AR-3.

It's no news, of course, that small speakers can produce big sound. But a lot of audiophiles are going to be stunned at the sound this system produces. The bottom end is there, all right. It doesn't begin to roll off until about 60 cps and there's *useful* response down to 40 cps—with extremely low harmonic distortion. All of this bottom issues from an 8-in. woofer in an acoustic-suspension enclosure.

The high end is there, too, thanks to a new tweeter with excellent dispersion and transient response. The highs are detailed, open and unpeaked. And you can translate this audio jargon into unqualified praise for one of the most natural-sounding speakers I've heard. It's quite an achievement.

If the above seems to indicate that other manufacturers have been standing still, let's correct that impression right off. Other low-price speakers in the offing are going to give owners of expensive rigs something to think about. One of them—the Fisher XP-5—is almost identical in low-end design to the

AR-4. It, too, sports an 8-in. woofer in an acoustic-suspension configuration, though it officially hasn't been dubbed such by Fisher. At \$50, the XP-5 sounds embarrassingly good. And though it's been on the market for a few months without causing the stir it should have, its day should come this fall. My guess is that things really will take off when the audio public begins to realize what's happening to economy speakers.

From KLH comes another new system tentatively designated the Model Seventeen. And it also seems destined to get its share of attention. This is an under-\$70 speaker, in—you guessed it—an acoustic-suspension design. In this case, the woofer is a 10-in. unit and the enclosure is a shade larger than those just mentioned.

The low end of the Seventeen is an improvement on that of the popular Model Ten (now being dropped in favor of the less expensive new system). In fact, there's excellent, low-distortion response to just under 40 cps. The tweeter employs a modification of the strange cone-design used in the Model Six (a system that is unlikely to be dropped or improved on in its price class for a long time to come).

Most all the features of the earlier speaker are present in the Seventeen, and at a far lower price. I know that KLH began to develop the unit with doubts that what they wanted could be done for the price. But they did it, and the results can't be faulted.

I can't (and won't) attempt to compare the AR-4, XP-5 and the Seventeen with each other. *You* do it. Whichever of these systems you prefer, all of them point the way toward lower-price good sound than anyone thought possible a few years ago.

Before we leave speakers, I also ought to mention that there's good news from Electro-Voice for the do-it-yourself audiophile school. For one thing, the E-V people are making their popular Models Two and Four

{Continued on page 108}

Master Electronics faster with RCA Home Training

NEW, EASY WAY TO BEGIN WITH "AUTOTEXT" PROGRAMMED INSTRUCTION
HERE'S WHAT YOU GET!

40 fascinating
THEORY LESSONS.



Here are all the basic principles of radio and electronics in easy-to-understand language, fully illustrated!

40 exciting
EXPERIMENT LESSONS.



Each contains hundreds of absorbing, experiments and construction techniques to help you learn easier!

40 complete
SERVICE PRACTICES.



Filled with practical, time-saving, money-saving servicing tips to use throughout your training!

PLUS ALL THIS AT NO EXTRA COST...

15 KITS!

to build a Multimeter, AM Receiver and Signal Generator. Kits contain new parts for experiments, integrated so as to demonstrate what you learn in the lessons and to help you develop technical skills. Each kit is fun to put together! Compare what RCA gives you with any other school!



MULTIMETER

A sensitive precision measuring instrument you build and use on the job. Big 4½" meter with 50 micro-amp meter movement. 20,000 ohms-per-volt sensitivity d-c, 6,667 a-c.



AM RECEIVER

Have the satisfaction of building your own AM radio with this high quality 6-tube superheterodyne set. Big 5" speaker, fine tone!



SIGNAL GENERATOR

A "must" for aligning and trouble-shooting receivers. Build it for your own use. 170 KC to 50 MC fundamental frequencies for all radio and TV work.

Begin your training the faster, easier way with new "Autotext" programmed instruction. You learn almost automatically—and go on to advanced training sooner than you ever thought possible! Practical work with the very first lesson. Liberal Tuition Plan. Pay only as you learn. No long term contracts to sign! No monthly installments required!

Complete selection of Home Training Courses to choose from: TV Servicing • Color TV • Transistors • Communications Electronics • FCC License Preparation • Mobile Communications • Automation Electronics • Digital Techniques • Nuclear Instrumentation • Automatic Controls • Industrial Applications • Drafting • Computer-Programming.

CLASSROOM TRAINING ALSO AVAILABLE

RCA Institutes Resident School in New York City and RCA Technical Institute in Cherry Hill (near Camden), New Jersey offer training that will prepare you to work in rewarding positions in fields such as automation, communications, television, computers, and other industrial and advanced electronic applications. You are eligible even if you haven't completed high school. Check Classroom training and information will be rushed to you.

Send postcard for free illustrated book today!
Specify home training or classroom training!

RCA INSTITUTES, INC., Dept. EI-N4
350 West 4th St., New York 14, N. Y.



THE MOST TRUSTED NAME
IN ELECTRONICS

24-HOUR SHORT-WAVE SCHEDULE

- *Updated listings! Latest times, frequencies, call letters!*
- *English-language broadcasts round the clock, round the world!*

THE 24-Hour Short-Wave Schedule EI published in the January 1962 issue long has been prized by most every short-wave listener in North America. For with this Schedule close at hand, the short-wave listener never had to search the bands for English-language broadcasts. A quick check of the Schedule told him precisely when and where to listen for English-language broadcasts any time of the day or night.

Now, EI's 24-Hour Short-Wave Schedule has been updated to incorporate the very latest information on times, frequencies, call letters, station names and locations. Though some of the stations will prove a challenge for even the ablest DXer, many can be heard throughout North America when ionospheric conditions are favorable. A detailed and accurate reception report sent to nearly any station on the Schedule will bring you an attractive QSL card for your shack.

Keep in mind that all time designations are in Eastern Standard Time, and that all frequencies are in kilocycles. Good listening!

ABBREVIATIONS USED IN THIS SCHEDULE

Br.—British
C.—Central
E.—East
N.—North

R.—Radio
Rep.—Republic
S.—South
W.—West

*—Transmissions beamed to North America
+—Best reception in Western U.S.
B.C.—Broadcasting Company (or Corporation)

All times listed are Eastern Standard Time. To convert, subtract 1 hour for Central Standard Time, 2 hours for Mountain Standard Time, and 3 hours for Pacific Standard Time. All frequencies are in kilocycles.

| TIME (EST) | FREQ. | CALL | STATION NAME | LOCATION |
|------------|-------|------|--------------|----------|
|------------|-------|------|--------------|----------|

12 MIDNIGHT

| | | | | |
|-------|---|------|----------------|---------------------|
| 4973 | — | — | R. Yaounde | Yaounde, Cameroon |
| 6040 | — | — | R. Yaounde | Yaounde, Cameroon |
| 6145+ | — | DMQ6 | Deutsche Welle | Cologne, W. Germany |
| 9575+ | — | DMQ9 | Deutsche Welle | Cologne, W. Germany |
| 9735+ | — | DMQ9 | Deutsche Welle | Cologne, W. Germany |

12:15 A.M.

| | | | | |
|-------|---|---|-----------------------|-------------------------|
| 5035 | — | — | Ici Bangui | Bangui, C. African Rep. |
| 6130* | — | — | R. Nacional de Espana | Madrid, Spain |
| 7220 | — | — | R. Bangui | Bangui, C. African Rep. |
| 9360* | — | — | R. Nacional de Espana | Madrid, Spain |

| TIME (EST) | FREQ. | CALL | STATION NAME | LOCATION |
|-------------------|-------------------|-------|-----------------------|-------------------------|
| 12:30 A.M. | | | | |
| | 6090 | — | V. Cambodia | Phnom Penh, Cambodia |
| | 6185 | — | W. Nigeria B.C. | Ibadan, Nigeria |
| | 11925 | HLK6 | Korean B.C. | Seoul, S. Korea |
| 12:45 A.M. | | | | |
| | 4885 | — | E. Nigeria B.C. | Enugu, Nigeria |
| 1 A.M. | | | | |
| | 4685 | — | Deutsche Welle | Cologne, W. Germany |
| | 5984 | — | R. Buea | Yaounde, Cameroon |
| | 6015 | — | V. America | Rhodes, Greece |
| | 6090 | LR11 | Argentina Calling | Buenos Aires, Argentina |
| | 6185 | — | V. America | Rhodes, Greece |
| | 7130 | — | V. America | Rhodes, Greece |
| | 9530 | — | V. America | Rhodes, Greece |
| | 11780+ | LR12 | Argentina Calling | Buenos Aires, Argentina |
| | 11785 | DMQ11 | Deutsche Welle | Cologne, W. Germany |
| 1:30 A.M. | | | | |
| | 11975 | ELWA | R. Village | Monrovia, Liberia |
| | 7075 | — | United Arab Rep. B.C. | Cairo, Egypt |
| | 11930 | — | United Arab Rep. B.C. | Cairo, Egypt |
| | 15335 | — | R. Ceylon | Colombo, Ceylon |
| 1:45 A.M. | | | | |
| | 6145 | — | Ici Paris | Paris, France |
| | 7280 | — | Ici Paris | Paris, France |
| | 9620 | — | Ici Paris | Paris, France |
| | 9775 | — | Ici Paris | Paris, France |
| | 11845 | — | Ici Paris | Paris, France |
| | 15245 | — | Ici Paris | Paris, France |
| 2 A.M. | | | | |
| | 3316 | — | Sierra Leone B.C. | Freetown, Sierra Leone |
| | 5980 | — | Sierra Leone B.C. | Freetown, Sierra Leone |
| | 6050 | HCJB | V. Andes | Quito, Ecuador |
| | 7035 | — | R. Peking | Peking, China |
| | 7120 | XZK4 | Burma B.C. | Rangoon, Burma |
| | 7525 | — | R. Nederland | Hilversum, Netherlands |
| | 9650 | — | R. Peking | Peking, China |
| | 11730 | — | R. Nederland | Hilversum, Netherlands |
| 2:15 A.M. | | | | |
| | 9580 | — | R. Australia | Melbourne, Australia |
| 2:30 A.M. | | | | |
| | 6105 | — | V. Malaya | Kuala Lumpur, Malaya |
| | 7110 | — | V. Malaya | Kuala Lumpur, Malaya |
| | 7220 | — | Trans World R. | Monte Carlo, Monaco |
| | 9635 | — | R. Malaya | Kuala Lumpur, Malaya |
| | 9675 | — | Warsaw Calling | Warsaw, Poland |
| | 11840 | — | Warsaw Calling | Warsaw, Poland |
| | 11900 | — | V. Malaya | Kuala Lumpur, Malaya |
| | 11925 | HLK6 | Korean B.C. | Seoul, S. Korea |
| | 11945 | DMQ11 | Deutsche Welle | Cologne, W. Germany |
| | 15275 | DMQ15 | Deutsche Welle | Cologne, W. Germany |
| 3 A.M. | | | | |
| | 6055 | OLR2G | R. Prague | Prague, Czechoslovakia |
| | 9775 ^o | — | R. Moscow | Moscow, U.S.S.R. |
| | 11945 | — | R. Prague | Prague, Czechoslovakia |
| | 15285 | — | R. Prague | Prague, Czechoslovakia |
| | 15420 | — | R. Prague | Prague, Czechoslovakia |
| | 21450 | — | R. Prague | Prague, Czechoslovakia |
| 3:30 A.M. | | | | |
| | 9675 | — | Warsaw Calling | Warsaw, Poland |
| | 11840 | — | Warsaw Calling | Warsaw, Poland |
| | 15275 | — | Warsaw Calling | Warsaw, Poland |

| TIME (EST) | FREQ. | CALL | STATION NAME | LOCATION |
|---------------|--|--|---|--|
| 3:45 A.M. | 15410 17845 | DMQ15 DMQ17 | Deutsche Welle Deutsche Welle | Cologne, W. Germany Cologne, W. Germany |
| 4 A.M. | | | | |
| | 4785 9655 15435 17720 21520 | — HED6 GWE HEU7 HER8 | R. Tanganyika Switzerland Calling BBC Switzerland Calling Switzerland Calling | Dar-es-Salaam, Tanganyika Berne, Switzerland London, England Berne, Switzerland Berne, Switzerland |
| 4:15 A.M. | 7240 17820 | — — | Kenya B.C. R. Ceylon | Nairobi, Kenya Colombo, Ceylon |
| 4:30 A.M. | 7250 11875 15235 | — — — | R. Malaysia NHK NHK | Singapore, Malaysia Tokyo, Japan Tokyo, Japan |
| 5 A.M. | | | | |
| | 9470 11690 11710 15070 15290 17790 | VUD — VUD GWC VUD GSC | All India R. R. Moscow All India R. BBC All India R. BBC | Delhi, India Moscow, U.S.S.R. Delhi, India London, England Delhi, India London, England |
| 5:15 A.M. | 6095 7130 | BED29 BED7 | V. Free China V. Free China | Taipei, Taiwan Taipei, Taiwan |
| 5:30 A.M. | 7190 9610 [°] 11850 [°] 15175 [°] 15225 21730 [°] | HLK30 LLG LLK LLM — LLQ | Korean B.C. R. Norway R. Norway R. Norway R. Kabul R. Norway | Seoul, S. Korea Oslo, Norway Oslo, Norway Oslo, Norway Kabul, Afghanistan Oslo, Norway |
| 6 A.M. | | | | |
| | 2450 4970 5900 6120 9585 9770 11715 11835 15155 17885 | 4VEH VQA52 ZNB 4VEH YDF6 4VEH YDF2 4VEH — — | Evangelistic V. R. Sabah ZNB Evangelistic V. V. Indonesia Evangelistic V. V. Indonesia Evangelistic V. Springbok R. Springbok R. | Cap Haitien, Haiti Jesselton, N. Borneo Mafeking, Bechuanaland Cap Haitien, Haiti Djakarta, Indonesia Cap Haitien, Haiti Djakarta, Indonesia Cap Haitien, Haiti Paradays, S. Africa Paradays, S. Africa |
| 6:30 A.M. | 4494 9508 9555 [°] 11805 11855 15185 | — — OIX2 OIX8 — OIX4 | Sudan B.C. Sudan B.C. Finnish B.C. Finnish B.C. Sudan B.C. Finnish B.C. | Omdurman, Sudan Omdurman, Sudan Helsinki, Finland Helsinki, Finland Omdurman, Sudan Helsinki, Finland |
| 7 A.M. | | | | |
| | 5044 7110 9505 9665 9752 11725 15165 [°] 15285 15300 [°] | — HED2 OLR3B HED6 — OLR4E OZF7 OLR5H GWR | Korean Central B.C. Switzerland Calling R. Prague Switzerland Calling Korean Central B.C. R. Prague V. Denmark R. Prague BBC | Pyongyang, N. Korea Berne, Switzerland Prague, Czechoslovakia Berne, Switzerland Pyongyang, N. Korea Prague, Czechoslovakia Copenhagen, Denmark Prague, Czechoslovakia London, England |

| TIME (EST) | FREQ. | CALL | STATION NAME | LOCATION |
|------------------|--------|-------|-----------------------|------------------------|
| 7:30 A.M. | | | | |
| | 3300 | — | British Honduras B.C. | Belize, Br. Honduras |
| | 6090 | — | V. Cambodia | Phnom Penh, Cambodia |
| | 9620 | — | R. Sweden | Stockholm, Sweden |
| 7:45 A.M. | | | | |
| | 11795 | DMQ11 | Deutsche Welle | Cologne, W. Germany |
| | 11865 | HER5 | Switzerland Calling | Berne, Switzerland |
| | 15205 | DMQ15 | Deutsche Welle | Cologne, W. Germany |
| | 15315 | HEU6 | Switzerland Calling | Berne, Switzerland |
| | 17845 | HER33 | Switzerland Calling | Berne, Switzerland |
| 8 A.M. | | | | |
| | 4885 | — | Kenya B.C. | Nairobi, Kenya |
| | 4970 | VQA52 | R. Sabah | Jesselton, N. Borneo |
| | 4973 | — | Ici Yaounde | Yaounde, Cameroon |
| | 6040 | — | Ici Yaounde | Yaounde, Cameroon |
| | 15245 | — | Ici Paris | Paris, France |
| | 21620 | — | Ici Paris | Paris, France |
| 8:15 A.M. | | | | |
| | 15125 | — | V. West | Lisbon, Portugal |
| | 17895 | — | V. West | Lisbon, Portugal |
| | 21495 | — | V. West | Lisbon, Portugal |
| 8:30 A.M. | | | | |
| | 11810 | VUD | All India R. | Delhi, India |
| | 15215 | VUD | All India R. | Delhi, India |
| 8:45 A.M. | | | | |
| | 9515 | TAT | R. Ankara | Ankara, Turkey |
| 9 A.M. | | | | |
| | 6015 | — | V. America | Rhodes, Greece |
| | 6185 | — | V. America | Rhodes, Greece |
| | 7130 | — | V. America | Rhodes, Greece |
| | 7275 | — | V. Nigeria | Lagos, Nigeria |
| | 9530 | — | V. America | Rhodes, Greece |
| | 9590 | — | R. Nederland | Hilversum, Netherlands |
| | 9690 | — | V. Nigeria | Lagos, Nigeria |
| | 11925 | HLK6 | Korean B.C. | Seoul, S. Korea |
| | 15115* | HCJB | V. Andes | Quito, Ecuador |
| | 15155 | — | R. South Africa | Paradays, S. Africa |
| | 15190 | — | R. Ghana | Accra, Ghana |
| | 15410 | ETLF | R. Voice of Gospel | Addis Ababa, Ethiopia |
| | 15445 | — | R. Nederland | Hilversum, Netherlands |
| | 17840 | — | R. Sweden | Stockholm, Sweden |
| | 17885 | — | R. South Africa | Paradays, S. Africa |
| | 17890* | HCJB | V. Andes | Quito, Ecuador |
| 9:15 A.M. | | | | |
| | 5040 | XZK9 | Burma B.C. | Rangoon, Burma |
| 9:30 A.M. | | | | |
| | 5955 | ETLF | R. Voice of Gospel | Addis Ababa, Ethiopia |
| | 5984 | — | R. Buea | Yaounde, Cameroon |
| | 9585* | YDF6 | V. Indonesia | Djakarta, Indonesia |
| | 11715* | YDF2 | V. Indonesia | Djakarta, Indonesia |
| 9:45 A.M. | | | | |
| | 6070 | — | R. Ghana | Accra, Ghana |
| | 9660 | — | R. Sweden | Stockholm, Sweden |
| | 9665 | HEU3 | Switzerland Calling | Berne, Switzerland |
| | 11865 | HER5 | Switzerland Calling | Berne, Switzerland |
| | 15315* | HEU6 | Switzerland Calling | Berne, Switzerland |
| | 17910 | — | R. Ghana | Accra, Ghana |
| | 21545 | — | R. Ghana | Accra, Ghana |

| TIME (EST) | FREQ. | CALL | STATION NAME | LOCATION |
|----------------|--------|-------|---------------------|--------------------------|
| 10 A.M. | | | | |
| | 6195 | GRN | BBC | London, England |
| | 7120 | ETLF | R. Voice of Gospel | Addis Ababa, Ethiopia |
| | 7250 | — | Vatican R. | Vatican State |
| | 9645 | — | Vatican R. | Vatican State |
| | 11740 | — | Vatican R. | Vatican State |
| | 11865 | — | Ici Leopoldville | Leopoldville, Rep. Congo |
| | 15245 | — | Ici Leopoldville | Leopoldville, Rep. Congo |
| | 15285° | OLR5H | R. Prague | Prague, Czechoslovakia |
| | 17830° | — | R. Prague | Prague, Czechoslovakia |
| 10:15 A.M. | 11795 | — | Deutsche Welle | Cologne, W. Germany |
| 10:30 A.M. | 4797 | — | R. Somali | Hargeisa, Somali |
| | 7130 | BED7 | V. Free China | Taipei, Taiwan |
| | 9505 | — | R. Belgrade | Belgrade, Yugoslavia |
| | 9675 | — | R. Somali | Hargeisa, Somali |
| | 9685 | BED73 | V. Free China | Taipei, Taiwan |
| | 11825 | BED69 | V. Free China | Taipei, Taiwan |
| | 15240 | — | R. Belgrade | Belgrade, Yugoslavia |
| 10:45 A.M. | 9705 | ETLF | R. Voice of Gospel | Addis Ababa, Ethiopia |
| 11 A.M. | | | | |
| | 6185 | — | V. America | Rhodes, Greece |
| | 7130 | — | V. America | Rhodes, Greece |
| | 9009 | — | Kol Yisrael | Tel Aviv, Israel |
| | 9410 | GRI | BBC | London, England |
| | 9530 | — | V. America | Rhodes, Greece |
| | 9555 | OIX2 | Finnish B.C. | Helsinki, Finland |
| | 11805 | OIX8 | Finnish B.C. | Helsinki, Finland |
| | 15155 | — | R. South Africa | Paradays, S. Africa |
| | 15185 | OIX4 | Finnish B.C. | Helsinki, Finland |
| | 17883 | — | R. South Africa | Paradays, S. Africa |
| 11:15 A.M. | 6065 | — | R. Sweden | Stockholm, Sweden |
| | 11705 | — | R. Sweden | Stockholm, Sweden |
| | 15275 | DMQ15 | Deutsche Welle | Cologne, W. Germany |
| | 17815 | DMQ17 | Deutsche Welle | Cologne, W. Germany |
| 11:30 A.M. | 4905 | ETLF | R. Voice of Gospel | Addis Ababa, Ethiopia |
| | 4973 | — | Ici Yaounde | Yaounde, Cameroon |
| | 6040 | — | Ici Yaounde | Yaounde, Cameroon |
| | 7150 | — | R. Moscow | Moscow, U.S.S.R. |
| | 7330 | — | R. Moscow | Moscow, U.S.S.R. |
| | 17910 | — | R. Ghana | Accra, Ghana |
| 11:45 A.M. | 6055 | HER2 | Switzerland Calling | Berne, Switzerland |
| | 9662 | HEU3 | Switzerland Calling | Berne, Switzerland |
| 12 NOON | | | | |
| | 5035 | — | R. Bangui | Bangui, C. African Rep. |
| | 5900 | ZNB | ZNB | Mafeking, Bechuanaland |
| | 6070 | — | R. Ghana | Accra, Ghana |
| | 6195° | GRN | BBC | London, England |
| | 7220 | — | R. Bangui | Bangui, C. African Rep. |
| | 9510° | GSB | BBC | London, England |
| | 9540 | ZL2 | R. New Zealand | Wellington, N.Z. |
| | 11780 | ZL3 | R. New Zealand | Wellington, N.Z. |
| 12:15 P.M. | 15115 | — | R. South Africa | Paradays, S. Africa |
| | 17883 | — | R. South Africa | Paradays, S. Africa |
| 12:30 P.M. | 9550 | OLR3A | R. Prague | Prague, Czechoslovakia |
| | 11990 | OLR4C | R. Prague | Prague, Czechoslovakia |
| | 15448 | — | R. Prague | Prague, Czechoslovakia |

| TIME (EST) | FREQ. | CALL | STATION NAME | LOCATION |
|---------------|-------|------|------------------------|--------------------------|
| 12:45 P.M. | 11705 | — | R. Sweden | Stockholm, Sweden |
| 1 P.M. | | | | |
| | 3300 | — | British Honduras B.C. | Belize, Br. Honduras |
| | 4820 | — | R. Gambia | Bathurst, Gambia |
| | 4850 | — | Ici Nouakchott | Nouakchott, Mauritania |
| | 6195 | GRN | BBC | London, England |
| 1:15 P.M. | 6025 | — | V. West | Lisbon, Portugal |
| | 6190 | — | Vatican R. | Vatican State |
| | 7250 | — | Vatican R. | Vatican State |
| | 9645 | — | Vatican R. | Vatican State |
| | 9680 | — | V. West | Lisbon, Portugal |
| | 11760 | — | R. Addis Ababa | Addis Ababa, Ethiopia |
| | 11935 | — | V. West | Lisbon, Portugal |
| | 15125 | — | Vatican R. | Vatican State |
| 1:30 P.M. | 4940 | — | Ici Abidjan | Abidjan, Ivory Coast |
| | 6100 | — | R. Belgrade | Belgrade, Yugoslavia |
| | 6135 | — | Warsaw Calling | Warsaw, Poland |
| | 7125 | — | Warsaw Calling | Warsaw, Poland |
| | 7200 | — | R. Belgrade | Belgrade, Yugoslavia |
| | 11800 | — | R. Ghana | Accra, Ghana |
| | 15270 | ETLF | R. Voice of Gospel | Addis Ababa, Ethiopia |
| 1:45 P.M. | 4973 | — | Ici Yaounde | Yaounde, Cameroon |
| | 6040 | — | Ici Yaounde | Yaounde, Cameroon |
| 2 P.M. | | | | |
| | 4960 | — | R. Moscow | Moscow, U.S.S.R. |
| | 5930 | — | R. Prague | Prague, Czechoslovakia |
| | 6025 | — | R. Prague | Prague, Czechoslovakia |
| | 6110 | GSL | BBC | London, England |
| | 9705 | ETLF | R. Voice of Gospel | Addis Ababa, Ethiopia |
| | 9865 | YDF6 | V. Indonesia | Djakarta, Indonesia |
| | 11715 | YDF2 | V. Indonesia | Djakarta, Indonesia |
| | 11850 | — | Sofia Calling | Sofia, Bulgaria |
| | 11900 | — | R. South Africa | Paradays, S. Africa |
| | 15155 | — | R. South Africa | Paradays, S. Africa |
| | 15270 | ETLF | R. Voice of Gospel | Addis Ababa, Ethiopia |
| | 15330 | — | Sofia Calling | Sofia, Bulgaria |
| 2:15 P.M. | 4815 | — | Ici Ougadougou | Ougadougou, Upper Volta |
| | 6045 | — | Ici Ougadougou | Ougadougou, Upper Volta |
| | 11705 | — | R. Sweden | Stockholm, Sweden |
| 2:30 P.M. | 6020 | — | R. Nederland | Hilversum, Netherlands |
| | 6055 | HER2 | Switzerland Calling | Berne, Switzerland |
| | 6070 | — | Sofia Calling | Sofia, Bulgaria |
| | 6135 | — | Warsaw Calling | Warsaw, Poland |
| | 6190 | — | Bucharest Calling | Bucharest, Romania |
| | 6234 | — | R. Budapest | Budapest, Hungary |
| | 7110 | HED2 | Switzerland Calling | Berne, Switzerland |
| | 7215 | — | R. Budapest | Budapest, Hungary |
| | 7225 | — | R. Bucharest | Bucharest, Romania |
| | 7290 | — | Sofia Calling | Sofia, Bulgaria |
| | 9510 | — | Bucharest Calling | Bucharest, Romania |
| | 9715 | — | R. Nederland | Hilversum, Netherlands |
| | 11865 | — | Ici Leopoldville | Leopoldville, Rep. Congo |
| | 11950 | — | R. Nederland | Hilversum, Netherlands |
| | 15245 | — | Ici Leopoldville | Leopoldville, Rep. Congo |
| 2:45 P.M. | 3240 | ELHC | R. Voice of Holy Cross | Bolahun, Liberia |
| | 4800 | ELHC | R. Voice of Holy Cross | Bolahun, Liberia |
| | 5995 | VUD | All India R. | Delhi, India |
| | 6145° | — | Vatican R. | Vatican State |
| | 7235 | VUD | All India R. | Delhi, India |
| | 7250° | — | Vatican R. | Vatican State |
| | 9520 | VUD | All India R. | Delhi, India |
| | 9645° | — | Vatican R. | Vatican State |
| | 9915 | VUD | All India R. | Delhi, India |

| TIME (EST) | FREQ. | CALL | STATION NAME | LOCATION |
|---------------|--------|-------|-----------------------|---------------------------|
| 3 P.M. | | | | |
| | 6070 | — | R. Ghana | Accra, Ghana |
| | 7090 | — | R. Tirana | Tirana, Albania |
| | 7225 | — | Korean Central B.C. | Pyongyang, N. Korea |
| | 9009 | — | Kol Yisrael | Tel Aviv, Israel |
| | 9457 | — | R. Peking | Peking, China |
| | 9545 | — | R. Ghana | Accra, Ghana |
| | 9715 | — | R. Tirana | Tirana, Albania |
| | 9725 | — | Korean Central B.C. | Pyongyang, N. Korea |
| | 15220 | — | R. Australia | Melbourne, Australia |
| | 15280 | ZL4 | R. New Zealand | Wellington, N.Z. |
| | 17840 | — | R. Australia | Melbourne, Australia |
| 3:15 P.M. | <hr/> | | | |
| | 15300 | — | R. Addis Ababa | Addis Ababa, Ethiopia |
| 3:30 P.M. | <hr/> | | | |
| | 5950 | — | Warsaw Calling | Warsaw, Poland |
| | 7285 | — | Warsaw Calling | Warsaw, Poland |
| | 9360 | — | R. Nacional de Espana | Madrid, Spain |
| | 9525 | — | Springbok R. | Paradays, S. Africa |
| | 11865 | — | R. Habana | Havana, Cuba |
| | 11900 | — | Springbok R. | Paradays, S. Africa |
| <hr/> | | | | |
| 4 P.M. | | | | |
| | 3335 | YVQC | Ecos del Orinoco | Ciudad Bolivar, Venezuela |
| | 5990 | — | Bucharest Calling | Bucharest, Romania |
| | 6030 | — | Itha'at Al-Jemhoriya | Baghdad, Iraq |
| | 6095 | — | Itha'at Al-Jemhoriya | Baghdad, Iraq |
| | 6190 | — | Bucharest Calling | Bucharest, Romania |
| | 7130 | — | V. America | Rhodes, Greece |
| | 7195 | — | Bucharest Calling | Bucharest, Romania |
| | 7255 | — | Sofia Calling | Sofia, Bulgaria |
| | 9530 | — | V. America | Rhodes, Greece |
| | 9700 | — | Sofia Calling | Sofia, Bulgaria |
| | 11800 | — | R. Ghana | Accra, Ghana |
| | 11850 | — | Sofia Calling | Sofia, Bulgaria |
| | 15340 | — | R. Habana | Havana, Cuba |
| 4:15 P.M. | <hr/> | | | |
| | 5980 | DMQ6 | Deutsche Welle | Cologne, W. Germany |
| | 7235 | DMQ7 | Deutsche Welle | Cologne, W. Germany |
| 4:30 P.M. | <hr/> | | | |
| | 6020* | — | R. Nederland | Hilversum, Netherlands |
| | 6070 | — | Sofia Calling | Sofia, Bulgaria |
| | 6085* | — | R. Nederland | Hilversum, Netherlands |
| | 7090 | — | R. Tirana | Tirana, Albania |
| | 7290 | — | Sofia Calling | Sofia, Bulgaria |
| | 9545 | — | R. Ghana | Accra, Ghana |
| | 9715* | — | R. Nederland | Hilversum, Netherlands |
| | 15295 | — | Lebanese B.C. | Beirut, Lebanon |
| <hr/> | | | | |
| 5 P.M. | | | | |
| | 5900 | — | R. Budapest | Budapest, Hungary |
| | 6095* | BED29 | V. Free China | Taipei, Taiwan |
| | 6100 | — | R. Belgrade | Belgrade, Yugoslavia |
| | 6234 | — | R. Budapest | Budapest, Hungary |
| | 7130* | BED7 | V. Free China | Taipei, Taiwan |
| | 7200 | — | R. Belgrade | Belgrade, Yugoslavia |
| | 7215 | — | R. Budapest | Budapest, Hungary |
| | 7285 | TAS | R. Ankara | Ankara, Turkey |
| | 9505 | — | R. Belgrade | Belgrade, Yugoslavia |
| | 11825* | BED69 | V. Free China | Taipei, Taiwan |
| | 15300 | DZH9 | Far East B.C. | Manila, Philippines |
| | 15345* | BED49 | V. Free China | Taipei, Taiwan |
| | 15395* | BED71 | V. Free China | Taipei, Taiwan |
| | 17810 | DZ16 | Far East B.C. | Manila, Philippines |
| | 17890* | BED40 | V. Free China | Taipei, Taiwan |
| 5:30 P.M. | <hr/> | | | |
| | 5950 | — | Warsaw Calling | Warsaw, Poland |
| | 5960 | — | Bucharest Calling | Bucharest, Romania |
| | 6190 | — | Bucharest Calling | Bucharest, Romania |
| | 7195 | — | Bucharest Calling | Bucharest, Romania |
| | 7250 | — | R. Malaysia | Singapore, Malaysia |
| | 9540 | — | Warsaw Calling | Warsaw, Poland |

| TIME (EST) | FREQ. | CALL | STATION NAME | LOCATION |
|------------------|--------|-------|-----------------------|------------------------|
| 6 P.M. | | | | |
| | 4970 | VQA52 | R. Sabah | Jesselton, N. Borneo |
| | 5970* | CKNA | R. Canada | Montreal, Canada |
| | 6000* | — | R. Americas | Swan Island |
| | 9625* | — | R. Canada | Montreal, Canada |
| | 11705* | — | R. Japan | Tokyo, Japan |
| | 11720* | CHOL | R. Canada | Montreal, Canada |
| | 11780* | — | R. Japan | Tokyo, Japan |
| | 11800* | — | R. Americas | Swan Island |
| | 15135 | — | R. Japan | Tokyo, Japan |
| 6:30 P.M. | | | | |
| | 7230 | DZ19 | Far East B.C. | Manila, Philippines |
| | 11850 | DZH8 | Far East B.C. | Manila, Philippines |
| | 15300 | DZH9 | Far East B.C. | Manila, Philippines |
| | 15385 | DZF3 | Far East B.C. | Manila, Philippines |
| | 17810 | DZ16 | Far East B.C. | Manila, Philippines |
| 7 P.M. | | | | |
| | 6105 | — | V. Malaya | Kuala Lumpur, Malaya |
| | 7110 | — | V. Malaya | Kuala Lumpur, Malaya |
| | 9635 | — | V. Malaya | Kuala Lumpur, Malaya |
| | 9700* | — | Sofia Calling | Sofia, Bulgaria |
| | 11900 | — | V. Malaya | Kuala Lumpur, Malaya |
| 7:30 P.M. | | | | |
| | 3300 | — | British Honduras B.C. | Belize, Br. Honduras |
| | 5960* | — | RAI | Rome, Italy |
| | 6234* | — | R. Budapest | Budapest, Hungary |
| | 7215* | — | R. Budapest | Budapest, Hungary |
| | 7225 | VUD | All India R. | Delhi, India |
| | 9585* | — | RAI | Rome, Italy |
| | 9765 | VUD | All India R. | Delhi, India |
| | 9833* | — | R. Budapest | Budapest, Hungary |
| | 11785 | VUD | All India R. | Delhi, India |
| | 11885 | — | R. Pakistan | Karachi, Pakistan |
| | 15335 | — | R. Pakistan | Karachi, Pakistan |
| 8 P.M. | | | | |
| | 5930* | — | R. Prague | Prague, Czechoslovakia |
| | 6005* | — | R. Prague | Prague, Czechoslovakia |
| | 6085 | ZYK2 | R. Jornal | Recife, Brazil |
| | 7275 | — | V. America | Colombo, Ceylon |
| | 7345* | — | R. Prague | Prague, Czechoslovakia |
| | 9520* | OZF5 | V. Denmark | Copenhagen, Denmark |
| | 9550* | OLR3A | R. Prague | Prague, Czechoslovakia |
| | 9700* | — | Sofia Calling | Sofia, Bulgaria |
| | 9795* | — | R. Prague | Prague, Czechoslovakia |
| | 11835 | — | V. America | Colombo, Ceylon |
| | 15220* | — | R. Australia | Melbourne, Australia |
| | 17840* | — | R. Australia | Melbourne, Australia |
| 8:30 P.M. | | | | |
| | 5985* | — | R. Nederland | Hilversum, Netherlands |
| | 6035* | — | R. Nederland | Hilversum, Netherlands |
| | 6150* | — | Bucharest Calling | Bucharest, Romania |
| | 6165* | HER3 | Switzerland Calling | Berne, Switzerland |
| | 6175* | — | Deutsche Welle | Cologne, W. Germany |
| | 6190* | — | Bucharest Calling | Bucharest, Romania |
| | 6234* | — | R. Budapest | Budapest, Hungary |
| | 7195* | — | Bucharest Calling | Bucharest, Romania |
| | 7215* | — | R. Budapest | Budapest, Hungary |
| | 7225* | — | Bucharest Calling | Bucharest, Romania |
| | 9510* | — | Bucharest Calling | Bucharest, Romania |
| | 9535* | HER4 | Switzerland Calling | Berne, Switzerland |
| | 9590* | — | Bucharest Calling | Bucharest, Romania |
| | 9640* | DMQ9 | Deutsche Welle | Cologne, W. Germany |
| | 9665* | HEU3 | Switzerland Calling | Berne, Switzerland |
| | 9833* | — | R. Budapest | Budapest, Hungary |
| 8:45 P.M. | | | | |
| | 9660* | — | R. Sweden | Stockholm, Sweden |

TIME (EST) FREQ. CALL STATION NAME LOCATION

9 P.M.

6025⁺ — V. West Lisbon, Portugal
 6035 — XZK3 Burma B.C. Rangoon, Burma
 6185⁺ — V. West Lisbon, Portugal
 9745⁺ HCJB V. Andes Quito, Ecuador
 11915⁺ HCJB V. Andes Quito, Ecuador
 15115⁺ HCJB V. Andes Quito, Ecuador

9:30 P.M.

4985 CP75 La Cruz del Sur La Paz, Bolivia

10 P.M.

4885 — Kenya B.C. Nairobi, Kenya
 5960⁺ — RAI Rome, Italy
 6090⁺ LR11 Argentina Calling Buenos Aires, Argentina
 6095 — BED29 V. Free China Taipei, Taiwan
 6135⁺ — R. Habana Havana, Cuba
 6150⁺ — Bucharest Calling Bucharest, Romania
 6234⁺ — R. Budapest Budapest, Hungary
 7130⁺ BED7 V. Free China Taipei, Taiwan
 7195⁺ — Bucharest Calling Bucharest, Romania
 7215⁺ — R. Budapest Budapest, Hungary
 7225⁺ — Bucharest Calling Bucharest, Romania
 9510⁺ — Bucharest Calling Bucharest, Romania
 9570⁺ — Bucharest Calling Bucharest, Romania
 9575⁺ — RAI Rome, Italy
 9590⁺ — Bucharest Calling Bucharest, Romania
 9690 LRA32 Argentina Calling Buenos Aires, Argentina
 9833⁺ — R. Budapest Budapest, Hungary
 11780 LR12 Argentina Calling Buenos Aires, Argentina
 11825⁺ BED69 V. Free China Taipei, Taiwan
 11860⁺ BED45 V. Free China Taipei, Taiwan
 15240 — Korean Central B.C. Pyongyang, N. Korea
 15345⁺ BED49 V. Free China Taipei, Taiwan
 17890⁺ BED40 V. Free China Taipei, Taiwan

10:15 P.M.

6130⁺ — R. Nacional de Espana Madrid, Spain
 9360⁺ — R. Nacional de Espana Madrid, Spain
 9660⁺ — R. Sweden Stockholm, Sweden

10:30 P.M.

4845 HJGF R. Bucaramanga Bucaramanga, Colombia
 5930⁺ — R. Prague Prague, Czechoslovakia
 6005 — R. Prague Prague, Czechoslovakia
 7250 — R. Malaysia Singapore, Malaysia
 7345 — R. Prague Prague, Czechoslovakia
 9550⁺ OLR3A R. Prague Prague, Czechoslovakia

10:45 P.M.

9745⁺ — R. Prague Prague, Czechoslovakia
 6025⁺ — V. West Lisbon, Portugal
 6185⁺ — V. West Lisbon, Portugal
 7275 — Springbok R. Paradays, S. Africa
 9525 — Springbok R. Paradays, S. Africa

11 P.M.

6130⁺ LKJ R. Norway Oslo, Norway
 9610⁺ LLG R. Norway Oslo, Norway
 9700⁺ — Sofia Calling Sofia, Bulgaria
 9710 — Mauritius B.C. Forest Side, Mauritius

11:15 P.M.

6136⁺ — R. Nacional de Espana Madrid, Spain
 6160⁺ — Overseas B.C. of Thailand Bangkok, Thailand
 7305⁺ — Overseas B.C. of Thailand Bangkok, Thailand
 9360⁺ — R. Nacional de Espana Madrid, Spain
 11910⁺ — Overseas B.C. of Thailand Bangkok, Thailand

11:30 P.M.

6234⁺ — R. Budapest Budapest, Hungary
 7215⁺ — R. Budapest Budapest, Hungary
 9833⁺ — R. Budapest Budapest, Hungary
 15130 VUD All India R. Delhi, India
 17855 VUD All India R. Delhi, India



TRANSISTOR TESTER

By FRED MAYNARD, 11Q0846

THINGS are shaping up on that new project. You've bought almost all the parts and by digging into an assortment of leftover transistors you can save yourself a few extra dollars. But it has been a while since you used any of those transistors—and it even may be difficult to remember which ones are PNP or NPN, what the gain is or whether they're good or bad.

For a \$2 bill (there are still a few around) you can build a tester that will tell you whether an unmarked transistor is NPN or PNP, what its approximate gain (β) is and whether it is leaky or shorted. The tester is simple to operate and also can be used to check diodes.

The tester has two bulbs, one being a reference to which you compare the brilliance of the other. Push buttons S1, S2 and S3 (see schematic), in conjunction with resistors R1, R2 and R3 respectively, inject known base currents into the transistor you're testing.

How it Works. This is how you use the tester to determine the approximate gain, or beta, of a transistor you know to be NPN or PNP. To begin with, the gain of a transistor is equal to its collector current (I_c) divided by its base current (I_b). Find these two currents and you have it made. Take a look at the schematic on the next page to see how it's done.

When S5 is pressed, the full battery voltage is applied to reference lamp P2 and approximately 70 ma flows through it, causing it to light at maximum brilliance. Now let's plug in a transistor and press S3. If P1 glows as brightly as P2, it means the current through

P1 is about the same as it was through P2. Trace your way through the schematic carefully and you'll see that the current through P1 also is the collector current (70 ma) of the test transistor.

When we pressed S3 we injected a base current of 0.48 ma. Let's see why. Pressing S3 completed a series circuit made up of R3, a 6,200-ohm resistor; B1 and B2 (3 volts); and the forward-biased emitter-base junction of the transistor. The current through this circuit can be found simply by using Ohm's Law ($I=E/R$). In this case E is 3 volts, the voltage of B1 and B2, and R is 6,200 ohms, the value of R3. Divide 3 by 6,200 and you get 0.48, which is the base current we need to know. (The base current for S2 is 3/3,000 or 1 ma. For S1 it is 3/300 or 10 ma.) Put these values in the formula for gain (beta), which we said earlier is collector current divided by base current and you get 70/0.48, which is 145.

To sum this up quickly, if pressing S3 causes P1 to light to full brilliance, the gain is at least 145. It's that simple. If P1 lights to only half brilliance, P1's and the collector current would be about half and the gain would be 35/0.48 or about 73. Therefore, you can mark switches S1, S2 and S3 as 7, 70 and 145, respectively, to correspond to the gain of the transistor when the particular push button you press causes P1 to light to full brilliance.

When testing a transistor, always press S1 first. Bulb P1 should light to full brilliance if the transistor has any life at all since it takes a gain of only 7 to light the bulb when you

TRANSISTOR TESTER

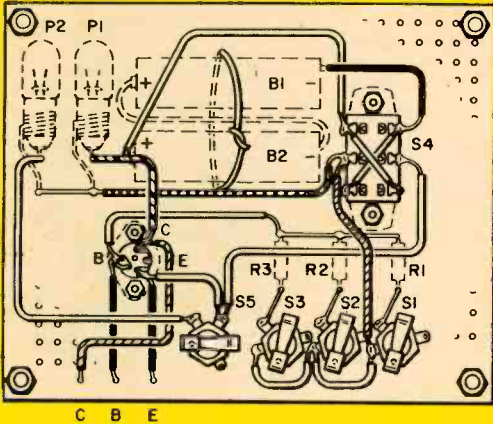

PARTS LIST

- B1, B2—1.5 V battery
- P1, P2—2 V, 60 ma pilot lamp (#48)
- R1—300 ohm, 1/2 watt, 5% resistor
- R2—3,000 ohm, 1/2 watt, 5% resistor
- R3—6,200 ohm, 1/2 watt, 5% resistor
- S1, S2, S3, S5—Single-pole miniature push-button switch (Lafayette MS-449 or equiv.)
- S4—DPDT slide switch
- Misc.—Transistor socket, miniature alligator clips

Author's model was built on a 4x5-inch perforated board with pilot lamps, batteries and resistors mounted on top. Put clips on leads marked C, B, E (lower left) to check diodes and power transistors.

Push buttons S1, S2, S3 produce base currents of 10, 1 and 0.48 ma, respectively. If when S3 is pressed P1 lights as brightly as P2, the collector current is 70 ma and the gain is approximately 145 (70/.48).

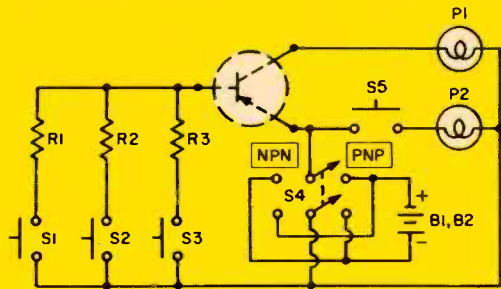

press S1 (70 ma collector divided by a 10 ma base current).

If this test does not cause P1 to light to full brilliance, the transistor may be in the socket incorrectly, NPN/PNP switch S4 may

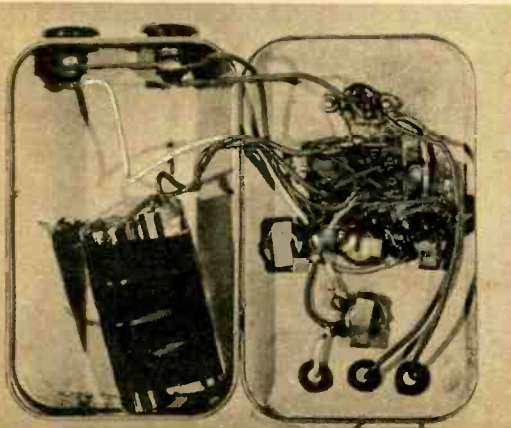

Pocket-size tester was built in a 2 1/4 x 3 3/4-inch metal candy box. If you use penlite batteries, they should be high-current alkaline energizers.

be set incorrectly or the transistor may be open. (Note: Some transistors have what is called a reverse beta. Therefore, you may find that when the transistor is plugged in backwards—the collector and emitter leads reversed—P1 will glow slightly.)

If pressing S1 caused P1 to light to full brilliance, press S2. If P1 still lights to full brilliance, the gain is at least 70/1 or 70. If P1 glows at about half brilliance, the gain may be 35 or higher. Now press S3. If P1 still lights to full brilliance, the gain is about 145.

If P1 lights to full or nearly full brilliance when none of the buttons is pressed there is a collector-to-emitter short. High leakage (common in some low-grade power transistors) can cause P1 to glow dimly. However, P1 will come up to full brilliance when S1, S2 or S3 are pressed. Such transistors may be useful for some applications.

Diode Testing. To check the polarity of an unmarked diode, connect its leads to the emitter and collector clips. If the diode is good, P1 should light (about half brilliance)

[Continued on page 113]

The NOVO TWO KANGAROO

An unusual bass-reflex system that pockets its midrange/tweeter kangaroo-fashion, this budget duo really outdoes many a more expensive design hands down!

By HARRY KOLBE



SURE that's a way-out name for a speaker system, but the Novo Two Kangaroo is way-out in performance, too. Response starts way, way down around 30 cps and goes right up to about 16 kc. Over this range there are no apparent peaks or valleys. Add a tight low end, a very clean high end with excellent dispersion and transient response, a midrange you really know is there and what do you have? Right, man! The sound of the Novo Two Kangaroo—a distributed-port, bass-reflex design whose volume is about 3.5 cubic feet.

How'd it get its name? Simple. It's built of Novoply and has two speakers. The kangaroo jumps into the picture because the 8-inch midrange/tweeter is enclosed in its own housing within the main cabinet, more or less piggy-pouch style. And now that we've let you in on that side of the story, let's shorten that handle and call it the NTK from here on out. The NTK's 28 $\frac{1}{4}$ x 15 $\frac{3}{4}$ x 18 $\frac{1}{8}$ -inch size definitely takes it out of the bookshelf class, yet it won't be obtrusive in a small room.

Much of what's outstanding about the

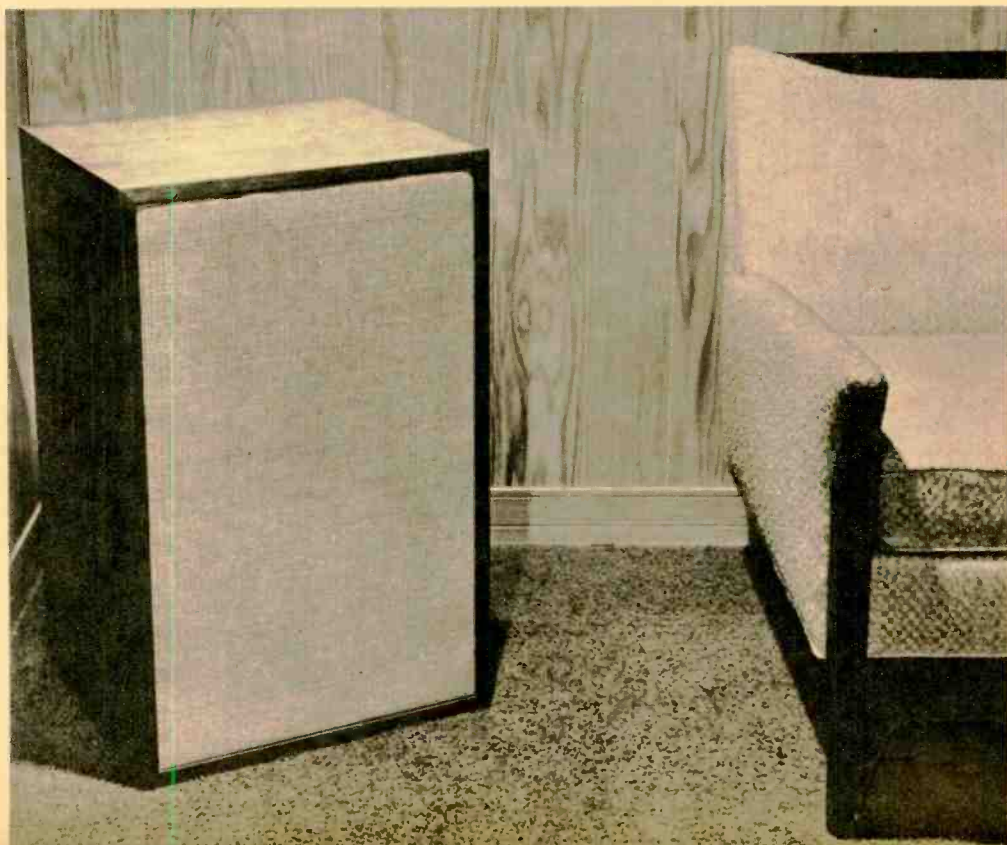

NOVO TWO KANGAROO

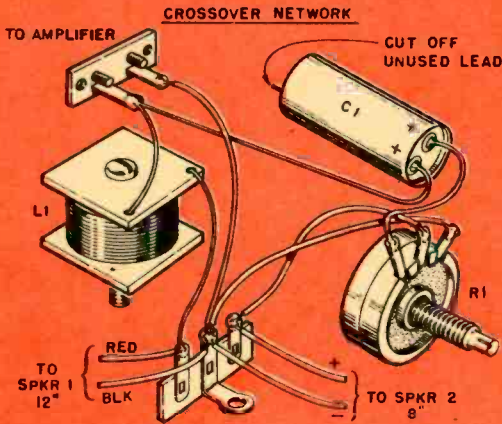

PARTS LIST

- C1—50/50 mf, 150 V electrolytic capacitor (Lafayette C-106 or equiv.)
- L1—Choke: Approx. 1 lb. No. 18 enameled wire wound on 1-inch diameter by 1½-inch long dowel (See text and diagram below)
- R1—8-ohm L-pad (Lafayette VC-49 or equiv.)
- SPKR 1—12-inch woofer speaker (Lafayette SK-182)
- SPKR 2—8-inch speaker (Lafayette SK-130)
- Lumber: Approx. 16 square feet of ¾-inch plywood or Novoply; Approx. 2 square feet of ¼-inch plywood; 1 sq. ft. ½-inch plywood; ¾ x ¾-inch pine cleats.
- Hardware: Four 1x1-inch angle brackets; 1½-inch No. 8 flat-head wood screws; 2-inch finishing nails; 1⅝-inch annular nails; ¼-20 and 10-24 tee-nuts.
- Misc: 1-inch thick Fiberglass wool; Mortite; felt strips, white glue, wood tape

Joints are shown butted, but they may be mitered (maintain overall dimensions). Do not change the location of 15 port holes at top of the rear panel.

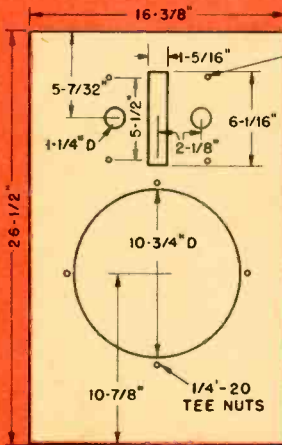

FRONT PANEL

¾" NOVOPLY PANELS (FRONT & REAR)

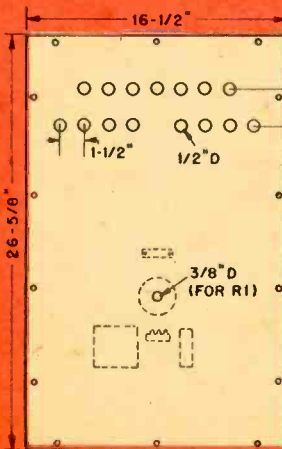

REAR PANEL

10-24 TEE NUTS FOR MOUNTING 8" SPEAKER

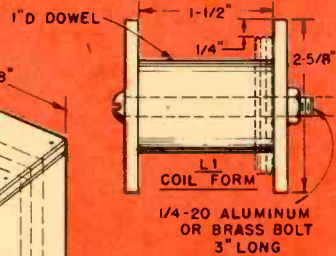
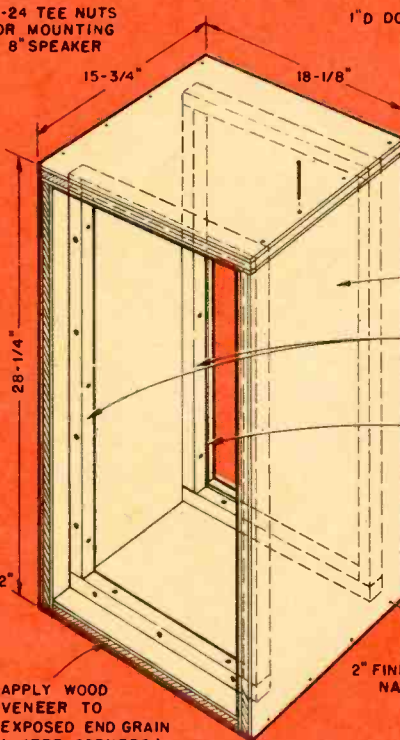

1/4-20 ALUMINUM OR BRASS BOLT 3" LONG

¾" VENEERED NOVOPLY SIDES, TOP & BOTTOM

¾" X ¾" CLEATS, FASTEN WITH GLUE & 1-3/8" LONG ANNULAR NAILS

COVER THE BACK OF REAR CLEATS WITH FELT

NOTE:

ASSEMBLE FRONT PANEL WITH MORTITE & 1-1/2" FH. WOOD SCREWS, REAR PANEL WITH WOOD SCREWS ONLY. (USE #8 SCREWS)

APPLY WOOD VENEER TO EXPOSED END GRAIN (MITRE CORNERS)

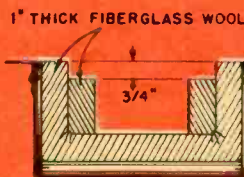

SECTION THRU COVER

2" FINISHING NAILS

1/2" PLYWOOD TOP

1" X 1" ANGLE

ASSEMBLE WITH GLUE & BRADS

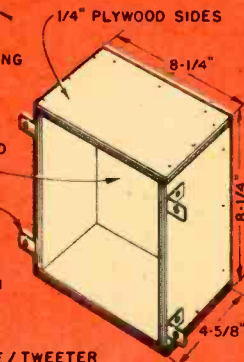

MID-RANGE / TWEETER COVER



Three-quarter-inch square cleats should be nailed (annular nails). Before mounting front panel, put double layer of Mortite on cleats.

Countersink eight tee-nuts (right) to mount speakers. Paint the front panel dull black so panel won't show through the grille cloth.

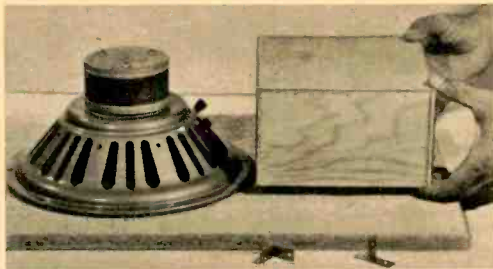
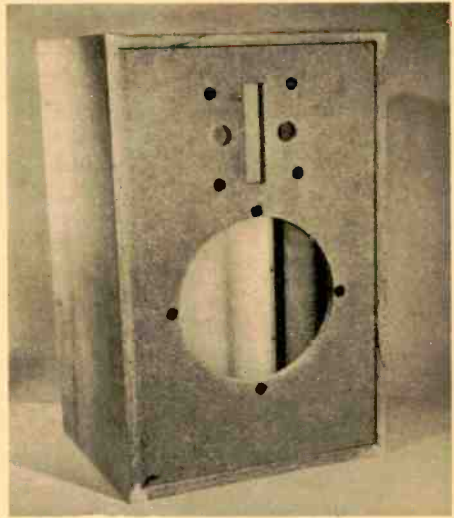

Midrange/tweeter cover is made of 1/4-inch and 1/2-inch plywood and is filled with fiberglass wool. Mount on panel with four 1 x 1-inch angle brackets.

Put light coat of glue on face of front panel, then staple tightly-stretched grille cloth. Put weights on back of front panel and let glue dry 5 hours.



NTK's performance stems from its two Lafayette speakers—the SK-182 and the SK-130. The SK-182, a hefty 12-inch woofer, is claimed to have a 30-cps free-air resonance. By feeding 6.3-V, 60-cps AC to the speaker for 12 hours, we dropped the resonant frequency to 22 cps.

The SK-130 is a high-quality 8-inch speaker with a one-pound magnet. Though it's intended for small, single-speaker systems, it does an excellent job as a midrange/tweeter. And because this is an extended range speaker, the NTK's crossover frequency can be the low 800 cps that it is. We do not recommend using other speakers.

In the top of the rear panel there are fifteen 1/2-inch diameter holes that form a highly damped port which smooths out the bass response and prevents transient overhang. Damping is so good that damping material isn't needed inside.

The 8-inch speaker faces into a vertical slot which front-loads it and improves the upper midrange and treble dispersion. A cover over the 8-inch speaker shields it from the air pressure developed by the woofer.

We used 3/4-inch Novoply (less expensive than plywood) for the main enclosure, since it is denser and more rigid than plywood.

[Continued on page 111]

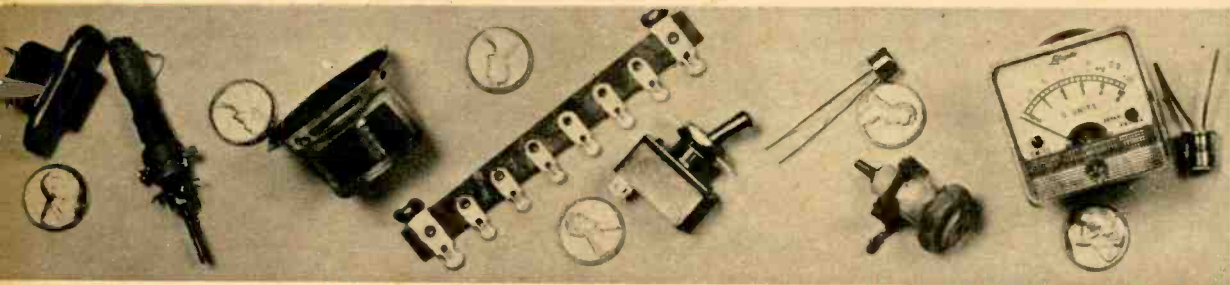

By
BERT MANN

How To PINCH

Get the pitch on how and where to buy at bargain

WORST thing about building projects is picking up the parts. And we're not talking about a thumb-and-finger act. We're referring to that something you must do before you can call a project even started—begging, buying, borrowing, scrounging or stealing every last component from power diode to load resistor—and preferably at rock-bottom prices.

Too often we hear of hobbyists who spend \$15 to \$20 to build a project that could have been brought in for a ten spot or less. When we say in EI that the parts bill for a project should run you so many dollars, we mean it. This is not a guesstimate and there's no gimmick—other than being able to buy shrewdly.

Getting the best experimenter-quality parts is more than a matter of opening a catalog and filling out an order blank. With careful planning, it is possible to save 30 to 50 percent, without sacrificing quality.

First thing to do is get hold of catalogs—loads of them. Matter of fact, the best investment you can make is in \$2 worth of post cards. Send one to each firm listed at the end of this story and ask for the latest catalog and to have your name put on their mailing list for future flyers. (The photo on the third page of this article shows only lesser-known catalogs—not such well-known ones as Allied and Lafayette.)

Go through the catalogs page by page to learn who specializes in what. When the time comes to order parts, you'll know exactly where to look. And don't limit your collection of catalogs to those of the major mail-order houses. There are many smaller outfits and local dealers who specialize in manufacturer's and military surplus. They, too, pub-

lish flyers from time to time that list job lots, special deals and discontinued inventory.

And be sure to save old catalogs. Often when a component's price is changed the stock number changes, too. If you can't locate a part in the latest catalog, look back a year or two. When you find out what the part is, you'll be able to get its price and stock number out of the current catalog. Some distributors may not list a part in the current catalog even though it still may be in stock. With the old catalogs handy, you'll be able to order the part without a lot of correspondence regarding latest price and availability.

Of course, latch onto the purchasing agent's bible—The Radio-Electronic Master catalog. While you have to pay for this one, it's well worth the money. Local distributors may sell copies or you can order one from the publisher listed at the end of this story.

Many distributors, such as Allied, Lafayette, Newark and Radio Shack, have branches in several cities. Since mail orders can take up to two weeks to arrive, it might be worth a trip to town to get a lot of parts fast. Lafayette's setup is different. They have their own stores in the Northeast and Associate Stores throughout the country. While the Associate Stores don't stock the entire Lafayette catalog, they do stock Lafayette brand names.

Sometimes you'll notice that one of our Parts Lists calls attention to an unusual part or contains special ordering information. For example, take a look at the Parts List for the Q1 BOOSTER FOR FM elsewhere in this issue. We specified Newark Electronics for the coil form and the transistor for a good reason. Your distributor might have these



PENNIES ON PARTS

basement prices and you'll save enough money to build another project free.

uncommon parts but if he doesn't you'd lose a lot of time shopping around or searching most other catalogs for them.

Another example of this is the field-effect transistor (Q1) in the FET SIGNAL TRACER (see page 67, May '64 EI).

And don't forget the greatest money saver of all—an old TV, radio, military or industrial surplus chassis. A real scrounge artist can strip an old chassis for a king's ransom in components. But be selective; stick to transformers, speakers, sockets, controls, etc. Do not salvage resistors and capacitors. After many years of service the capacitors might leak like a washerless faucet and the resistors may be nowhere near their marked value. There'll be enough lemons in new components. Why make trouble for yourself?

Before buying one part, study the project and make a list of those parts which are labeled: *do not substitute*. These are critical parts and you should not substitute. After you have extracted these items you're ready to buy.

Let's Start With Resistors. Most projects require no better than 10 per cent tolerance. Five or 1 per centers won't necessarily improve performance. Dealers often have specials on bags of resistors which enable you to obtain a large quantity of commonly used values at low unit cost. Common resistor values are multiples (10, 100, 1,000, etc.) of 1, 1.2, 2.2, 2.7, 3.3 and 4.7 ohms. Large outfits usually won't try to fool you. The resistors aren't rejects and the bags usually have good quantities of popular values. Not only will you have the resistors for the project at hand, but you'll have an inventory for the future.

But watch out for three things: obsolete values, odd values or a bag with just one value. Read the contents description (if there is one) carefully and limit purchases to ½-watt sizes. Rarely will you need 1- or 2-watters.

When it comes to capacitors it's a different story. There are a few common values (5, 25, 50, 100, 470 mmf; .001, .005, .01, .02, .05, .1 and .25 mf) but a bag of umpteen ceramic discs for a buck may have only one or two useful types. And keep your eye on voltage ratings. Fifty .01 mf capacitors for \$1 may look like a great buy but if they're rated at 100 volts they don't have the moxie for tube projects and their physical size will be too great for transistor projects.

Capacitors should be rated at 150, 250, 400, 500 or 600 volts to be a good buy. For transistor projects, you'll get the most for your money with ratings between 15 and 50 volts. Biggest capacitor savings are on house brands at both mail-order and local distributors. Tubulars often are offered in packages of five or ten pieces at half the usual price.

Compared to imports, American-made low-voltage capacitors cost an arm and a leg. The American capacitor may have less leakage and/or better tolerance but in non-critical applications the import will do the job as well. Many local dealers now sell imported capacitor kits that contain commonly used values at bargain-basement prices.

It's the big and special components on which you really can save a buck. Power transformers are a good example. They're not cheap but there is a lot of new surplus around and it isn't unusual to get the type you need for 20 to 30 per cent below catalog

How To

PINCH PENNIES ON PARTS

price. Some dealers, such as Barry, Burstein-Applebee, Fair Radio, Olson and McGee have big listings of transformer bargains. And don't overlook house-brand transformers.

You also can save money on meters. An imported meter that nominally sells for \$5 may be able to do the job just as well as a \$20 American meter. However, if you require great accuracy, stick with American meters. While imports are fine for experimenter applications (measuring the plate current in a ham transmitter, for instance), they rarely are as accurate or as rugged as American jobs. There are loads of good meters on the surplus market. They are new and the only rub may be that their case design is old fashioned. One of several sources of surplus meters is Fair Radio.

Relays, rheostats and cabinets usually are expensive but there is a lot of new surplus around. Among others, Allied Control, Barry and Herbach & Rademan are good sources. Surplus is a good place to look for wire, jacks and plugs, knobs, hardware and coaxial connectors. Some surplus printed-circuit boards are loaded with resistors, capacitors and semi-conductors. Only rub is their leads may be short.

The day will come when you need a really special, uncommon part. Rather than spend days trying to locate it or modify a standard part, latch on to *industrial* catalogs. Allied, Radio Shack and others publish these catalogs, but you'll have to have a piece of business stationery to get a copy. For ham equipment, try the Arrow Electronics, Harvey Radio, Harrison Radio and Burstein-Applebee catalogs.

The table below has the names and addresses of a good many mail-order houses. Spend 4¢ to get a catalog from each one. They're anxious to get your name on their mailing list.

| | | |
|--|--|---|
| Allied Radio Corp. 100 N. Western Ave. Chicago, Ill. 60680 | Fair Radio Sales Co. 2133 Elida Rd. Box 1105 Lima, Ohio 45802 | Newark Electronics Corp. 223 W. Madison St. Chicago, Ill. 60606 |
| Alpha Aracon Radio Electronics, Ltd. 555 Wilson Ave. Downsview P.O., Toronto, Ont. | Gem Electronic Distributors, Inc. 34 Hempstead Turnpike Farmingdale, N.Y. 11735 | Olson Electronics 260 S. Forge St. Akron, Ohio 44308 |
| American Relays, Electronics Div. 39 Lispenard St. New York, N.Y. 10013 | R. E. Goodheart, Inc. Box 1220 Beverly Hills, Calif. 92013 | Poly Paks Box 942 S. Lynnfield, Mass. 01940 |
| Arrow Electronics Inc. 900 Broad Hollow Rd. Farmingdale, N.Y. 11735 | Harvey Radio Co., Inc. 103 W. 43rd St. New York, N.Y. 10036 | Radio Shack Corp. 730 Commonwealth Ave. Boston, Mass. 02117 |
| Barry Electronics Corp. 512 Broadway New York, N.Y. 10012 | Herbach & Rademan, Inc. 1204 Arch St. Philadelphia, Pa. 19107 | Selectronics 1206 S. Napa St. Philadelphia, Pa. 19146 |
| Burstein-Applebee Co. 1012-14 McGee St. Kansas City, Mo. 64100 | Lafayette Radio Corp. 111 Jericho Turnpike Syosset, N.Y. 11791 | TAB 111 Liberty St. New York, N.Y. 10006 |
| Capitol Commodities, Inc. 4757 Ravenswood Ave. Chicago, Ill. 60640 | McGee Radio Co. 1901 McGee Street Kansas City, Mo. 64108 | United Catalog Pub- lishers (The Radio- Electronic Master) 645 Stewart Ave. Garden City, N.Y. 11530 |
| Edlie Electronics, Inc. 154 Greenwich St. New York, N.Y. 10006 | John Meshna, Jr. 19 Allerton St. Lynn, Mass. 01901 | Universal Relay Corp. 42 White St. New York, N.Y. 10013 |
| | | Walter Ashe Radio Co. 1125 Pine St. St. Louis, Mo. 63101 |

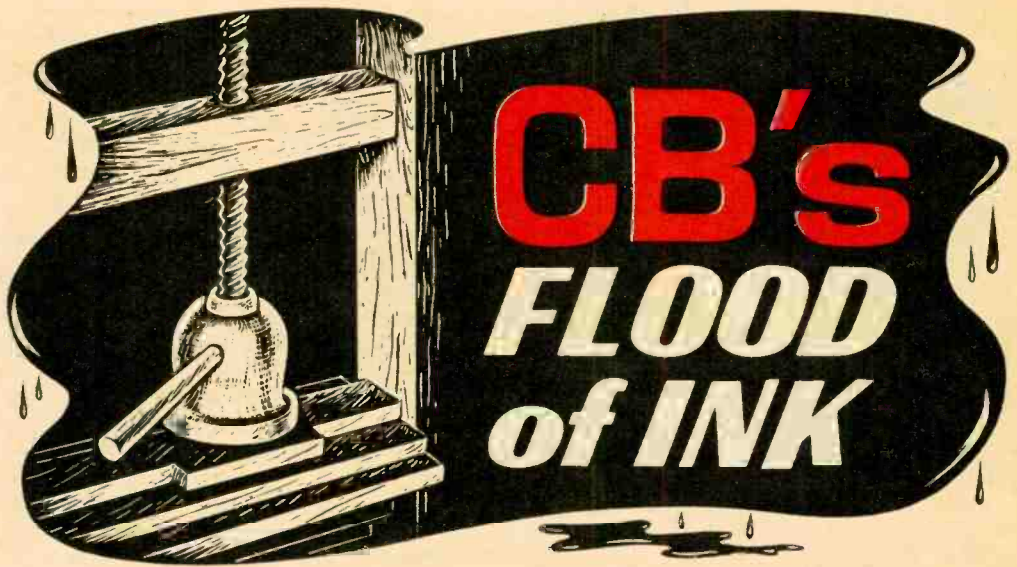

NAMES like Rebel Yell, Little Beat, Channel Chatter and Break Break have been cropping up everywhere that you find Citizens Banders—which, in view of CB's popularity these days, means clear across the nation. What are these names and what do they represent? Newspapers, that's what. CB papers, to be more precise, and the above are but a few of the scores appearing regularly in the world of CB journalism.

Truth to tell, we're in the midst of a veritable flood of ink streaming from CB printing presses. The number of CB publications has increased by leaps and bounds until there are almost twice as many today as just a couple of years ago. Some papers are newcomers to the field and have appeared only a time or two. Others are old enough to have a fair number of candles on their birthday cakes.

Those who police CB agree that nothing could be better for the service than the current profusion of papers. Not only are they helping to improve the band, but they also are helping club members to become better informed.

CB on the Scene. Things haven't always been this way, of course. Matter of fact, CB didn't exist a little over six years ago. It wasn't until 1958 that CB as we know it really began to roll with the FCC's allocation of 23 channels for Class D operation. For the first time in history every U.S. citizen over 18 was given the right to go on the airwaves without taking a rigorous exam. Canada followed suit

in 1962 when its Department of Transport (Canada's equivalent to the FCC) established the General Radio Service.

But this was only the beginning, and starts often are not too smooth. With equipment selling at reasonable prices and licenses going for the asking, applications began pouring in. And what had appeared to be one of the biggest boons in the history of radio soon threatened to dissolve into a hodgepodge on the airwaves. In many areas, attempting to switch to a clear channel was worse than trying to play Chinese checkers on a chess board.

With more and more CBers clamoring to get their voices airbound, self-regulation appeared to be the only possible answer. Obviously, the already-overburdened FCC couldn't play policeman everywhere. Was there chance that CBers might be able to pull up their own socks?

As individual CBers found others with similar interests—and similar problems—CB clubs began to appear. Clubs were instrumental in improving the service, besides aiding members with operational and technical problems. Clubs rapidly expanded their functions to include Civil Defense activities, community projects and rescue operations. And many eventually discovered that one meeting a month wasn't enough to relay all information to their members. Better, they thought, would be a club paper to pass important data along.

Good and Bad. Now, over 200 papers are

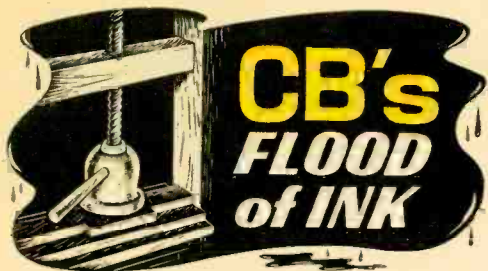

published by CB clubs. Of these, some have contributed to bringing club members closer together and thus have furthered the aims of the club. Others, like dogs without masters, seem to have no clear idea of where they are going and, therefore, are getting nowhere fast.

Why is it that some CB papers flourish while others can't keep their heads above water? Properly put together, a CB publication can be an asset. But if it's going to be an asset, it needs some full-fledged backing or it'll go no further than modulation without a carrier.

To put it another way, a paper must have cooperation and support from all club members. And one way of getting support is to ask all members to act as reporters. Surely every club member will have something to contribute in the way of news events, accidents or personal happenings.

Similarly, letting a few persons do all the writing, editing and typing for the paper is one sure way of sending it to its deathbed. It's not expected that every member can be an editor or writer, but there are other areas of work in putting a paper together that can be just as important.

Prime Principles. In any publication, certain basic principles in purpose, content and layout should be followed. The primary purpose of any club paper, of course, is to further the aims of the club. And one good way of doing this is to keep members well informed of club activities.

If a CB club publishes a paper solely for the sake of having one—or because of some

far-fetched concept of the status it might bring—then forget it. Since any publication is a reflection of the club publishing it, a poor paper only hurts the club.

To remain a paper worthy of its name, the publication should be both interesting and informative to its readers. A regular column on new FCC directives and what they mean to the man behind the gear is but one item that should come in for must coverage.

Publishing items about operating and technical problems, along with ways to solve them, is another excellent course of action. Information of this sort ordinarily can be obtained from club members who themselves have encountered these problems and successfully solved them. Then, too, such data often can be researched from magazines which feature CB articles. Other CB club papers also are an excellent source of ideas.

Though content can include a variety of topics, in many cases it will be determined by the requirements of the individual club. Many CB papers find that brief articles on basic electronic theory improve their publication and, in turn, help members know their equipment better.

The Slim Line. But a certain amount of discretion on content is in order. No Mrs. CBer wants to feel that the club she belongs to has turned into an electronic development lab. Overnight, perhaps, she discovers the little paper that once carried such imaginative news items has become an electronic textbook.

Nor is the converse better. No man worth his mettle wants to fight his way through trivia in search of the thing the paper supposedly exists to disseminate—CB news.

Personal items about members are a regular feature of most CB publications. Brief bits on who received promotions, who had birthdays or who had new additions to the family go a long way in creating a closer relationship between members.

On the other hand, care is needed to prevent the paper from becoming a gossip column. All of us like to see our names in print,



though none of us wants his name connected with some flippant remark. (If we seem to be belaboring this point, it's only because this type of material still is appearing in all too many CB publications.)

One simple rule to keep in mind about content is that readers are the only reason for any CB paper to exist. The readers are the ones who should benefit from it and their satisfaction is required to keep the publication a going concern.

Of course, what readers want well may vary from club to club. Therefore, it's entirely possible that material suitable for one paper may be of little or no value to another. If the members of a particular club are involved primarily in Civil Defense, then the club paper understandably should carry articles slanted in this direction. Similarly, a club whose members are interested in rescue operations could be expected to carry more articles on rescue procedures in its paper than another group primarily interested in some other project.

The Arty Side. In laying out the paper, the one big thing to remember is to keep it clean and simple. Photos and artwork have their place in a CB publication, of course, but artsy-craftiness does not.

You likely won't have many photos (depending on how your paper is printed, you may have none at all). But the illustrations you do have should possess news, human interest or maybe just plain humor. Otherwise, they have no place in your publication. Matter of fact, throwing in illustrations for the sake of illustrations will create more problems than it will solve.

In the majority of cases, CB papers are doing a good job in layout and printing. The photos below show just a few of the routes taken by some of the better papers. In most instances, the type of printing will dictate whether illustrations or photos are feasible. Mimeograph gives presentable copy at a reasonable price, but photos pose a problem with many mimeo machines.

If photos are a must you probably should

go to a commercial process like letterpress or offset printing. Naturally, expenses will run higher, though quality will be much improved. In any case, one of the above should fit your needs. The only process that seems objectional is Ditto. Reason is simple: papers using this process are difficult to read when produced in quantity.

The Current Crop. Looking over the CB papers now being published by CB clubs and regional organizations reveals a promising fact: the publications as a whole are good. The number of papers fulfilling their purpose of being useful to the clubs far exceeds those that seem to serve no valid purpose.

Several papers are doing a bang-up job for their members. One, for example, published by the Virginia State Citizens Band Radio Association (VSCBRA), states its role this way: "The biggest jump in service to VSCBRA members came with the establishment of the Groundplane." And it's easy to see why. The paper is well written and has good coverage of technical subjects. A typical issue contained articles on standing wave ratio (SWR) as well as FCC comments about CBers' television interference (TVI) problems.

Another paper—the Band Scanner published by the Five Watt Whips of Lowell, Mass.—recently introduced club members to a worthwhile topic in an article titled, What's the Meaning of Balanced Modulation? And this is only one of the fine technical articles appearing monthly in CB papers. Matter of fact, technical topics are becoming a regular feature in most of the CB ink-flood. This, of course, is a step upward in helping CBers gain a better understanding of their gear and what goes on inside. Generally speaking, the articles are well written and are on subjects relating directly to CB.

Along the same line is the matter of operating tips. Most papers, at one time or another, have carried a 10-code to help cut down transmission time. There is some variation in wording, of course, but the meaning

[Continued on page 112]



OLD RIDDLE-



THE FOX, THE CHICKEN & THE CORN

A farmer on his way to market with a fox, a chicken and a basket of corn comes to a river. The boat at the shore will carry only the farmer and one other object. This presents a problem. If the farmer takes the corn and leaves the fox and the chicken, the fox will eat the chicken. If he takes the fox and leaves the chicken and the corn, the chicken will eat the corn. He must plan the crossing so that these combinations are not left together on either side of the river. How does he do it?

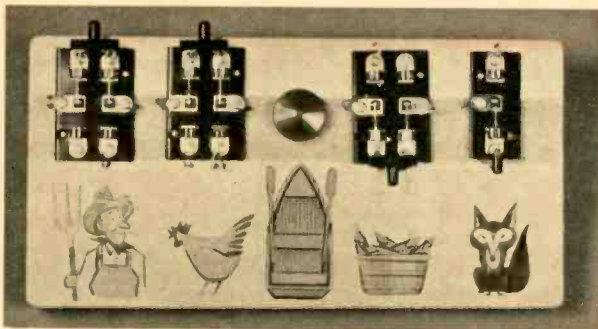

Farmer and chicken switches are up, corn and fox switches are down. This first move is permissible since fox is left with corn he won't eat.

FARMER JONES can solve this age-old riddle simply by experimenting—except it might cost him several chickens and a lot of corn. What he really needs is a computer to examine all possibilities and come up with the right combination of moves across the river. And a computer, in effect, is what we've given him here . . . a computer game for 89¢.

By turning the greying old riddle into a game, you and your friends can have hours of fun and at the same time get the farmer and his flock safely across. While you're at it, you'll be learning about computer logic and *AND* and *OR* functions, which are so basic to the world of real computers.

How to Play the Game. The object of

the game is to get all characters across the river without lighting the bulb. If the bulb lights, you must start all over again. A switch represents each character and each switch position represents a side of the river. When a switch handle is moved from its down to its up position (top of the board), it means that character has crossed the river. At the beginning of the game, place all switch handles in the down position.

Certain old-time restrictions must be observed. The boat holds no more than two characters at a time. The fox must not be left with the chicken, and the chicken must not be left with the corn. And another thing, a fox, chicken or basket of corn cannot row a boat. Whenever the boat crosses the farmer must be aboard.

To start the game—we'll tell you now—

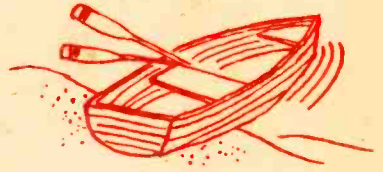

NEW GAME

By
LEN BUCKWALTER, KBA4480

the farmer takes over the chicken, returns and takes over the fox. In terms of switch positions, taking over the chicken means that S1 and S2 get pushed up while S3 and S4 remain down. Having the farmer return means you set S1 down. Taking over the fox means that switches S1 and S4 get set to up and switch S3 remains down. Remember, each switch must be closed. An object is either on one side of the river or the other—not drifting in the middle.

The game is over when all switches are up and the bulb has not lit in the process of getting them there.

Not as sophisticated as a full-size computer, the game demonstrates, in a small way, *AND* and *OR* concepts. Consider the *AND* function. In the game we have a chicken *AND* a fox; a pair that should never be left unguarded. Whenever this combination occurs, the bulb lights. Trace the wiring of the

switches for this combination and you will see that the chicken *AND* fox form a complete circuit between battery and bulb. In effect, switches in series constitute an *AND* circuit. Thus, the game will say "no" when an undesirable *AND* condition exists.

The word *OR* refers to a parallel hookup of switches. Use two parallel-connected switches to turn on one electrical device and you'll see the similarity. Either switch will close the circuit. There are combinations in the game which typify the *OR* function. One example is the farmer may be left alone with the chicken *OR* (fox *AND* corn). Put the switches in the appropriate position and the bulb will not light.

Construction. The game can be built on a thin piece of wood measuring about 5x11 inches. Before mounting any parts permanently, lay them in place on the board to determine where holes are to be drilled for screws and wires. Then paint the river, farmer, chicken, basket of corn and fox as shown in our photo. The four knife switches, which have threaded holes, are fastened to the board with 6-32 screws. After mounting the switches, drill small holes in the board near the lugs for connecting wires. The bulb is held in its hole with plastic wood and a red plastic bottle cap is glued over it.

If you never are able to solve the riddle, send a stamped, self-addressed envelope to Farmer Jones, c/o EI, and the old boy will tell you how he did it. —

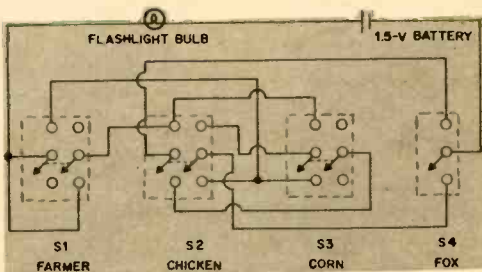

Three knife switches at left are DPDT; switch at right is SPDT (Lafayette SW-24 and SW-23, respectively). Use penlite cell and No. 222 bulb.



**SCENE SHAP-
ING . . .** A year ago EI was wondering in a DX article about what would happen if a U.S. station capable of reaching foreign

audiences started airing extreme views on race relations, politics or religion. One of the subjects discussed then was Carl McIntire's broadcasts over WINB, Red Lion, Pa., a short-wave outlet teamed with BCB station WGCB. The McIntire programs feature attacks on such targets as the U.S. State Department, the Voice of America and Radio Free Europe. It's possible they have provided Washington with a few headaches.

But, compared with another organization which recently began using WINB's international facilities, McIntire is quite moderate. World Prophetic Ministry, Inc., sponsors a half-hour broadcast every Sunday afternoon at 1530 EST on 11795 kc. In the course of these programs, letters are solicited from all over the world. End result is that an international mailing list is built up for the Prophetic News Letter and other literature turned out by WPM.

The Prophetic Letter—many of whose readers, one would assume, come from the short-wave audience—gets pretty rough at times. For example, the April 1964 issue included an attack on the Vatican Radio. Titled, *The Voice That Cannot Be Silenced?*,

the story accused Vatican R. of "religiously brainwashing multiplied millions." The article went on to describe the Catholic Church in rough-and-tumble terms not often seen in print.

World Prophetic Ministry also is opposed to the UN resolution against genocide. Apparently it feels that under the resolution "the Bible will be eventually condemned and done away with in these United States." Matter of fact, WPM seemingly looks on the anti-genocide declaration in somewhat the same terms as it sees postal zip numbers—as part of some satanic plot.

While McIntire has claimed federal harassment for some time, the FCC apparently sees no reason to stomp on what he calls his Twentieth Century Reformation Hour.

If WPM does continue successfully along the lines it now follows we soon may expect an anything-goes condition on American short wave, a state of affairs which certainly will mean plenty of excitement for SWL's. However, it also might lead to some interesting questions as regards public interest and our 1933 Communications Act, the law which created the FCC itself.

The Far East Angle. Let's look at a complication stemming from the foregoing. If a broadcast-band station carries one dubious program, will SW outlets necessarily flood the air with similar transmissions? For example, another station in the WPM-net is

[Continued on page 125]

WINB describes itself as a "commercial, international short-wave radio station" whose purpose it is "to promote the God of the Bible and Country." Station operates both on 17720 and 11785 kc and primarily relays programs of parent BCB outlet, WGCB on 1440 kc. Studios in our photo are those of WGCB.



LAFAYETTE RADIO ELECTRONICS

1965 Catalog No. 650

Over 500 Pages—Featuring
Everything in Electronics for
HOME • INDUSTRY • LABORATORY

from the
"World's Hi-Fi & Electronics Center"

- Stereo Hi-Fi—all famous brands plus Lafayette's own top-rated components
- Citizens Band—transceivers, Walkie-Talkies and accessories
- Tape Recorders • Ham Gear
- Test Equipment
- Radios, TV's, and Accessories
- P.A. Equipment; Intercoms
- Cameras; Optical Goods
- Marine Equipment; Auto Accessories
- Musical Instruments; Tools; Books and MUCH MORE

BUY ON TIME—Use Lafayette's famous Easy-Pay Credit plan
... up to 24 Months to Pay



See the Largest Selection in
Our 44 Year History.

MAIL THE ATTACHED CARD OR THE COUPON BELOW FOR YOUR FREE 1965 CATALOG

LAFAYETTE 12-TRANSISTOR
C.B. WALKIE-TALKIE Model HE-100

39⁹⁵

2-for- 78.88

- Variable Squelch Reduces Background Noise
- Separate Microphone and Speaker for Better Modulation and Increased Range
- Optional Plug-in 117 Volt AC Power Pack
- With Leather Case, Earphone, Telescoping Antenna, Batteries, Crystals for Channel 10 • Imported



99-3022

NEW! LAFAYETTE ALL-TRANSISTOR
C.B. "WALKIE-TALKIE" Model HA-70

10⁹⁵

2-for- 21.00

- Great Fun for Kids too! At a Price Everyone Can Afford
- Ideal for Picknicking, Fishing, Hunting, Camping, etc.
- Complete with Telescoping Antenna, Transmit Crystal, Battery, Plastic Carrying Case • Imported



99-3011

NEW! LAFAYETTE 6-TRANSISTOR
C.B. WALKIE-TALKIE Model HA-85

19⁹⁵

2-for-38.75

- Transmits and Receives up to 1 Mile
- Crystal-Controlled Transmit and Receive
- 6 Transistors plus 2 Diodes
- Complete with Leather Carrying Case, Earphone, Telescoping Antenna, Batteries, Pair of Crystals • Imported



99-3013

Lafayette Radio Electronics
Mail Order and L. I. Sales Center
111 Jericho Turnpike, Syosset, L. I., New York

New York, N. Y.
100 Sixth Ave.
Jamaica, N. Y.
165-08 Liberty Ave.
Brooklyn, N. Y.
2265 Bedford Ave.
Bronx, N. Y.
542 E. Fordham Rd.
Scarsdale, N. Y.
691 Central (Park) Ave.

Newark, N. J.
24 Central Ave.
Paramus, N. J.
182 Route 17
Plainfield, N. J.
139 W. 2 St.
Boston, Mass.
584 Commonwealth Ave.
Natick, Mass.
1400 Worcester St.

Lafayette Radio Electronics
Dept. EIK4-1 P. O. Box 10
Syosset, L. I., N. Y. 11791

- Send me the FREE 1965 Lafayette Catalog 650
 \$ enclosed; send me #
(Prices do not include shipping charges).

Name
Address
City State Zip

NEW! LAFAYETTE 23-CHANNEL CRYSTAL-CONTROLLED DUAL CONVERSION 5-WATT CB TRANSCEIVER

**WITH
ADVANCED "RANGE-BOOST"
CIRCUIT**

Model HB-400

Efficient, dependable 2-way communications in any fixed or mobile application is assured with this rugged, new 5-watt CB transceiver. A military-type frequency synthesizing circuit makes it possible to transmit and receive over the full range of 23 channels with crystal-controlled accuracy—no extra crystals to buy and install! Advanced Range-Boost circuit can be used to increase sideband power during transmission—lets you get through when noisy conditions make reception of your signal difficult!

Highly efficient circuit design uses 13 tubes (including two nuvistors) and 8 diodes to provide top performance under a wide range of operating conditions. Dual-conversion receiver offers high .3 μ v sensitivity and low noise, plus excellent adjacent channel rejection. Includes every needed feature for optimum reception—crystal-controlled "fine tuning" capability on all channels of ± 2.5 Kc (Delta Tuning), high-efficiency variable noise limiter, variable squelch, and Automatic Volume Control. Also included is an illuminated meter which indicates relative RF power output or received signal strength in "S" units, and plug-in facilities for the Lafayette PRIVA-COM selector call unit.

Operates in a fixed or mobile location with equal ease . . . has built-in power supply for either 117V AC or 12V DC. Specially designed "Vari-Tilt" mounting bracket simplifies mobile installation—permits fast removal of the transceiver too! And, there's nothing else to buy—you get all crystals and a built-in vibrator for 12V DC, plus 2 power cables. Measures a compact 12"Wx5"Hx10"D (including controls and plugs at rear).

Model HB-400.

99-3001WX

169⁵⁰



Double Side Band Full Carrier

- ✓ Meets All FCC Requirements
- ✓ Precision-Engineered and Ruggedly Built For Reliable 2-Way Radio Communications

- Frequency Synthesized Circuit Provides 23 Crystal-Controlled Transmit & Receive Channels—No Extra Crystals to Buy!
- Continuous One-Control Channel Tuning
- Full 5-Watt Input
- Push-To-Talk Microphone & Electronic Switching
- Dual Conversion Receiver With 3/10 μ v Sensitivity
- Delta Tuning Offers "Fine Tuning" of ± 2.5 Kc on Receive
- Variable Squelch, Variable Noise Limiter, AGC
- Built-in 117V AC & 12V DC Power Supply
- "Vari-Tilt" Mounting Bracket for Easy Mobile Installation
- Plug-in Facilities For Lafayette Selective Call Unit

ADVANCED "RANGE-BOOST" CIRCUIT

Increases Your Effective Range—Lets You Get Through When Others Fail

Want to effectively increase your range? You can—with Range-Boost! A simple turn of a switch on the HB-400 increases the average percentage of modulation and lets your voice cut through QRM and noise to reach further . . . gives you more "talk-power" when you need it—without overmodulating!

CONVENTIONAL

Average Percentage of Modulation is Lower

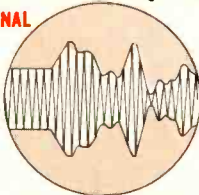

WITH RANGE-BOOST

Average Percentage of Modulation is Higher—Sideband Power is Increased

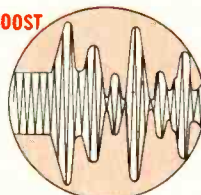

NEW! LAFAYETTE ALL-TRANSISTOR DUAL CONVERSION 5 WATT CB TRANSCEIVER

**FEATURING
AUTHENTIC MECHANICAL
FILTER**

Model HB-500



Small, Compact . . . Measures Only 11 $\frac{1}{4}$ "Wx6 $\frac{1}{2}$ "Dx3"H.
Low Current Drain . . . 350 ma on Receive, 850 ma on Transmit.

■ 12 Crystal Transmit Positions plus 12 Crystal Receive Positions ■ 23 Channel Tunable Receiver with Precise Vernier Tuning ■ Dual Conversion Super-heterodyne Receiver ■ 15 Transistors, 3 Diodes, 1 Zener Diode plus 1 Thermistor ■ Zener Diode Voltage Regulated Receive Oscillator for Superior Frequency Stability ■ Dependable Sealed Relay Switching ■ Automatic Noise Limiter ■ Variable Squelch ■ For 12 Volt DC Mobile Operation (Negative or Positive Ground) or for 117V AC Operation when used with Matching Solid State AC Power Supply (Optional) ■ Meets All FCC Regulations Part 95

If you're looking for a high-performance CB transceiver in a small, compact size, you'll want the HB-500! Using advanced solid-state circuitry, this transceiver offers full 5-watt performance, yet is small enough to fit conveniently into the most compact car. And, battery drain is so low as to be negligible—the transceiver draws no more than .35 amps on receive, .85 amps on transmit. As a result, you need neither heavy-duty battery nor generator—an important advantage in mobile applications! The transmitter features full crystal control on any 12 of the 23 CB channels. Dual conversion receiver with better than .5 μ v sensitivity offers 12 crystal-controlled channels, plus full 23 channel tuning capability. A 455 Kc mechanical filter provides ultra-sharp receiver selectivity—virtually eliminates adjacent channel interference! Other features include an efficient Automatic Noise Limiter, variable Squelch for silencing the receiver on standby, spotting switch for exact frequency location on tunable receiver, "S" meter and illuminated channel dials. This rugged transceiver offers instantaneous, cool-running operation and features printed circuit, all-transistor design. Equipped with mobile mounting bracket, push-to-talk dynamic microphone, crystals for operation on channel 12. Operates on 12V DC (neg. or pos. ground) or on 117V AC with optional solid-state power supply. Imported.

Model HB-500.

139⁵⁰ 99-3027WX

HIGHLY SELECTIVE MECHANICAL FILTER

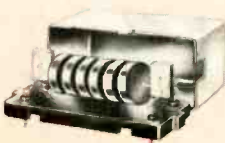
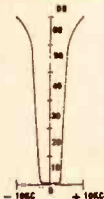

With CB channels only 10 Kc apart, selectivity is important! In the HB-500, ultra-sharp selectivity is achieved by means of a true mechanical bandpass filter in the 455 Kc IF section. At 10 Kc on either side of the center frequency, the filter provides 60 db of attenuation — an extremely high rejection ratio that assures complete adjacent channel rejection!

Model HB-501 Solid State AC Power Supply

Matching solid state AC power supply for HB-500 for fixed station operation (at home, business office). Transceiver rests on power supply to form attractive integrated unit. Size 11 $\frac{1}{4}$ "x6 $\frac{1}{4}$ "x3 $\frac{1}{2}$ ". Imported.

99-3028 Net 16.95

THE FUTURE IS FILLED WITH JOBS



IS YOURS ONE OF THEM?

Many of today's "good jobs" may not even exist in the near future. There will be plenty of jobs—but they'll be different. They'll demand different skills. *New skills.*

You can usually tell if your job is on the way out—when a machine or new method will soon replace it. Don't wait to do something about it.

You won't get tomorrow's jobs with yesterday's skills

What can you do? You can re-train—now. Learn the new skills and abilities you'll need to qualify for the opportunities of the future.

Re-training isn't the easiest way out. But it's the *only* way to be sure you'll earn a living—and a better one at that—tomorrow. Find out more about it this week at the local office of your state employment service.

Train now for tomorrow's jobs



PUBLISHED AS A PUBLIC SERVICE BY FAWCETT PUBLICATIONS



New Way To **KEEP TABS ON TICKERS**

Nurses just may be the sweetest souls around any hospital but as pulse-takers they're well nigh lowest on the list.

By SANFORD MAIZEL

THINK OF the human body as a machine and the heart becomes the all-important motor that keeps things running. See the body in your mind's eye as some kind of electronic apparatus and the heart is its power supply.

But motor, power supply or whatever you call it, the heart is perhaps the single most important component in the body's scheme of things. Let it fail for long and the marvelous mechanism that is the human body fails with it. Worse yet, no amount of fuming or fixing can undo the damage. Clearly, the motor isn't replaceable readily. And the power supply, if repairable at all, has to go right on functioning even while it's on the service bench.

Since the heart is so supreme in its role, one well might wonder just what means medical science has devised to gauge its behavior. Fortunately, there are quite a few—some little more than gadgets of a very elementary sort, others computers so able they can keep

track of the heart's every beat and murmur.

But the interesting angle here is that all these devices are electronic. This gives strength to the parallel between power supply and heart, of course. But it also poses a question. How can electronic gear keep tabs on tickers that are nothing more than big muscles—and anything but electronic in the way they work?

Answer is that the heart is a muscle, sure enough. And in the fact that it *is* a muscle lies the explanation as to why electronics can record its every action in such grand measure.

Medical science long has known that the body's nervous system has a pronounced electronic twist. The brain is hub of the nervous network and most any biology student knows what you can do with a battery and a frog's leg or two. Not so common knowledge is the fact that the muscles themselves produce electrical impulses every time they're flexed. Impulses there are and, most significant of all,

TABS ON TICKERS

the bigger the muscle the bigger the jolt.

Impulses from the heart muscle first were detected in 1858 and by 1903 a Dutchman named Einthoven had put together a galvanometer sensitive enough to plot the heart's electrical activity. So strong are the heart's impulses that they can be taken off the body most anywhere, even from the arms or legs. Hook up a device which enables you to chart the currents flowing in the heart and you have Einthoven's contribution to the cause—the electrocardiogram, or EKG.

But the old electrocardiograph is getting a new look these days, thanks to growing miniaturization in the electronics industry itself. Time was when it took a Charles Atlas of sorts to lug an EKG machine around, but a new portable by Computer Instruments Corp. weighs in at a mere 10 lbs. Completely solid-state, the unit contains some 24 transistors and six zener diodes. And though it's smaller than the instrument bag most doctors tote, the machine uses standard-size paper and presents all standard traces.

Wonder that it is, the transistorized EKG is low man on the totem pole when it comes to modern ways of keeping tabs on tickers. For one thing, EKGs are useful only when viewed in light of a patient's previous records and established norms. A time-consuming chore no doctor relishes, this task has been passed to a computer in a system devised by the National Bureau of Standards.

In this setup (see our drawing), information from the EKG is recorded on magnetic tape, compared with the patient's previous records and cross-related to general heart pathology. These data then are fed into a programmed digital computer which provides the physician with a punchcard analysis in less time than it takes to tell.

Another new and simpler electronic device is a bedside cardiac monitoring system about the size of a portable tape recorder. Made by the Sanborn Co., this unit (see our photo) actually is three instruments in one—a monitor, an electrocardiograph and a pacemaker. Colored panels on the face of the instrument give visual warning of any irregularities in the heart's actions. A separate panel lights, depending on whether the heart rate has become too rapid or too slow, no pulse is being detected or actual cardiac arrest has occurred.

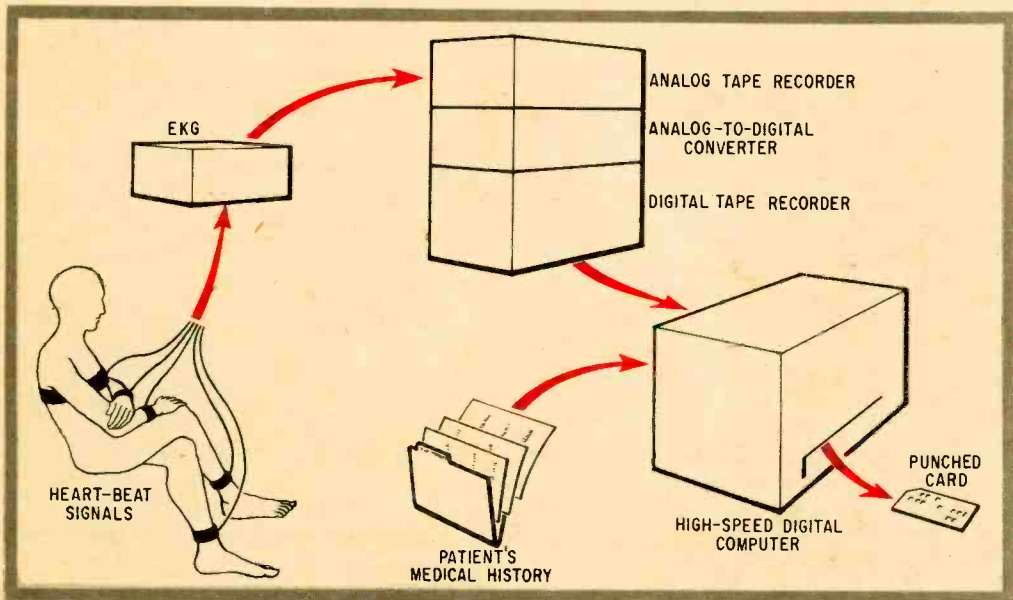

A computer gets into the ticker-tapping act in this system developed by the National Bureau of Standards. Computer compares EKG with patient's previous records and delivers a punch-card analysis in minutes.



SALTED HAMS . . . Maritime mobiles are a dime a dozen but here's betting you can't beat one we uncovered (if that's the word) a few weeks back. This ship has three separate, complete ham shacks on board. Explanation: skipper, second mate and radio operator are all hams.

Here's the full story. The 15-meter band went crazy the other afternoon and we could hear only one solitary signal. It belonged to W4WYI/M, radio operator of the Marine Skipper, then located somewhere deep in the Gulf of Mexico.

The facts W4WYI/M passed along go something like this. The ship's captain is W3WVF, with an HT-37 and a Drake 2-A in his cabin. The mate, meanwhile, is K2OOR, and he sports a KWM-1. W4WYI/M himself boasts the Collins S-line. The three of them use individual antennas—mostly wires to the rigging or verticals clamped to the side of the bridge. And they work out everywhere . . . on non-overlapping schedules, of course!

C Is for Politeness . . . though it does all right for capacitors, too. The C we're talking about here is the old wire-line telegraph C, sent as dit dit (space) dit. Many newcomers on CW are puzzled by it, mostly because it doesn't appear on any lists of operating sig-

nals. It means, "Is this frequency clear? Is it OK for me to transmit?" If no request in the form of AS ("wait") or QRX ("stand by") is heard, the operator proceeds to send—usually a CQ.

Staying on The Beam . . . We were completely baffled a while back when our hither-to well-behaved beam changed its pattern by about 120 degrees overnight. And, wonder of wonders, it was our next-door neighbor's garbage pail that gave us a clue to the trouble.

Noting that it contained some strips of aluminum, we inquired and learned that he had added to the insulation in his attic, using rock-wool batts backed with aluminum foil. This material obviously is a perfect reflector for our beam's elements, which almost overlap his roof.

With a little experimenting, we were able to make the antenna again agree with a compass and the remote-control unit in our shack. Just the same, we don't mind telling you that this one had us stumped for a while.

Which SB? . . . Just to set the record straight, this business of using upper side-band on 10, 15 and 20 meters and lower side-band on 40 and 80 is purely arbitrary. Matter of fact, there's no reason under the sun why you can't switch from one mode to the other whenever you feel like it.

On 20, which certainly is the most crowded of all ham bands, we often go from USB to

[Continued on page 113]



Though it's hard to believe, every member of Chicago's Price family is a ham—from Pop on down. OM Don (left rear) is K9PDT; wife Diane (center) is K9TRP; daughter Donita (seated) is K9TVN; Alan, the smallest boy, is WN9IAN; the other two boys are Jim, K9TVP, and Gerry, K9TVO. On strict schedules, they all share a well-equipped station, consisting of a Hallicrafters SX-117 receiver, HT-32 transmitter and Viking Thunderbolt amplifier. Don and his daughter team up in their work, too; both are employed by the Hallicrafters Co.

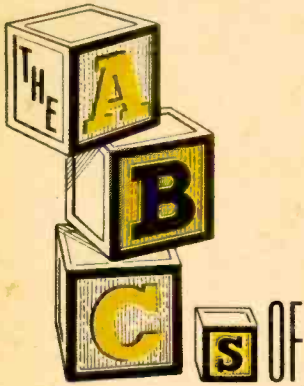

COLOR TV

By LEN BUCKWALTER, K10DH "CONVERT

Any TV Set

to Color for 75 Cents," the poster said, and we stopped short. The sign, as it happened, was in the window of a junk-'n-surplus radio store of the kind found in the downtown section of many a large city. And, sure enough, an old black-and-white set in the window was flashing a TV show in full color—blue sky, green grass and red foreground. Everything looked pretty as a pot of posies until our hero loomed large on the screen. He, too, was in full color: blue face, green shirt and red jeans.

As you've no doubt guessed, the 75-cent conversion was a piece of tinted celluloid taped over the screen. Fraud? Maybe so, but the incident does help launch our discussion of how color-TV works. Reason: the designer of that six-bit setup had selected the three colors—red, green and blue—that form the heart of today's color-TV systems.

Primary Colors. If you want to pick a pleasing pigment from the massive color charts put out by big paint companies, here's luck. The human eye can discern about 40,000 different colors. Even so, the vast visible spectrum can be decoded into three primary colors. It happens, however, that there are several sets of primaries. In school most of us learned that the three primary colors are red, blue and yellow. Those are the primaries for painting. Color TV uses another set, the fundamental primaries, which are red, blue and green. Mixed in different proportions, these three colors will produce any other hue, including white.

Figure 1 shows how the combining of primaries works, with all light coming from three sources, one for red, one for green,

one for blue. Mixing occurs where the circles overlap. For example, red and green produce yellow; red and blue create magenta (a purplish red); while blue with green equal cyan (a lightish blue). Where all three primary colors overlap (center), white appears. And though we've shown only four additional colors, varying mixture with mixture triggers a near-endless number of hues.

Color Camera. To put our three-color setup to work, let's say the Mardi Gras is on TV. As the color camera sweeps the scene, it doesn't see gaudy, rainbow-splashed objects and people. Instead, it thriftily scans each point in the scene solely for its red, green and blue content. Some clown, for example, holds a yellow umbrella. The camera, though color-blind to yellow, does respond to the red and green light that encode yellow.

How it's done is shown in Fig. 2, a simpli-

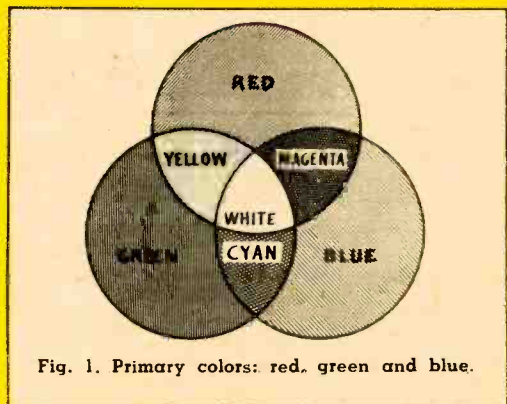

Fig. 1. Primary colors: red, green and blue.

fied diagram of the color camera. Yellow light from the umbrella enters the camera and is split into its red/green components by filters (actually special dichroic mirrors). The two shafts of light convert to electrical signals as they hit the light-sensitive pickup tubes. The two shafts of light convert to electrical signals as they hit the light-sensitive pickup tubes.

What about the umbrella handle? If that handle is pure blue, it won't penetrate the red and green filters, though it will register on the blue camera tube. In this fashion, any scene is divided into three electrical signals corresponding to red, green and blue hidden in all the colors of the original scene. And the strength of each electrical signal corresponds to the amount of red, green or blue in the televised object.

Incidentally, it's important to note that these color signals actually represent one small point of light in the original scene. This is due to scanning action in the camera tubes. Though the camera tubes see the complete scene, their electrical images build up in much the same manner as the word images you're reading on this page—from left to right and from top to bottom.

Electron beams sweep inside the tubes and sample one point of light at a time. For discussion's sake, however, it's more convenient to talk about the red/blue/green mixture of a single point. In operation, the beams scan the image 60 times each second, fast enough for the human eye to see a complete scene at the receiving end.

Transmitting Color. Creating the three-part color signal wasn't a major stumbling block, even in TV's early days. The concept

of primary colors probably dates back to the caveman who first mixed root juices to liven up his limestone walls. And the idea of converting color to electrical signals, as we have seen, is accomplished handily by filters and photo-sensitive tubes.

But what did tax the ingenuity of color-TV's developers in the 1950's was how to transmit three color channels without violating tough technical restrictions. For one, the color program must be *compatible*; in other words, it must be receivable on black-and-white sets. Second, there must be *narrow bandwidth* so that any additional signals for transmitting color information won't spill outside the channel width already assigned to TV stations—6 mc. Finally, there must be *reverse compatibility*, which means that owners of color-TV sets also should have the option of viewing black-and-white programs.

To see how color is made compatible, it's necessary to examine a black-and-white pickup. Figure 3, top, shows a conventional monochromatic TV camera. Light from the umbrella enters the camera and converts to an electrical signal. There is no color sensitivity, only a flow of current representing lights and darks as the camera scans the scene.

Since it represents more or less white light, this current flow is termed a *brightness* signal. But as we have seen already, a color camera can create the identical brightness signal. Red, green and blue mix in the Adder, which assembles the brightness signal by recombining the primary colors. This conversion of the colors to a brightness signal satisfies the

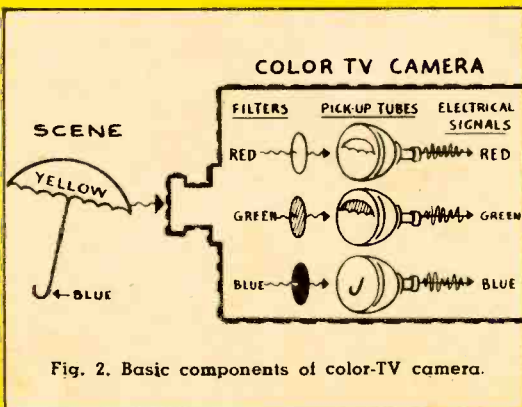

Fig. 2. Basic components of color-TV camera.

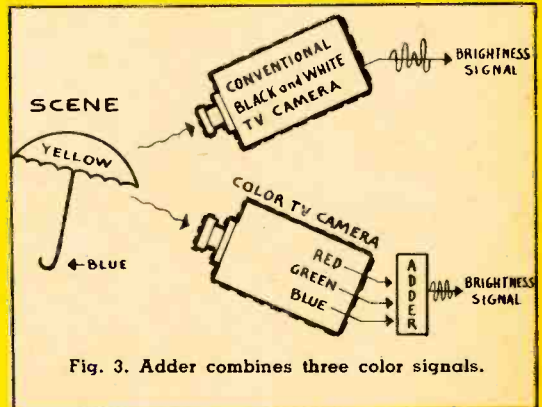

Fig. 3. Adder combines three color signals.



COLOR TV

requirements of black-and-white TV receivers.

Next major step is transmitting red, green and blue as *unmixed* signals. Though easily stated, this problem handed development engineers one of their hairiest chestnuts. Remember that all TV channels are assigned a slot 6-mc wide (channel 10, for example, extends from 192 to 198 mc). And even a lowly black-and-white program rams an incredible amount of information into this span: a brightness signal (about 4 mc wide), five pulse types to lock receiver to transmitter and a sound signal to boot. Where, then, could color signals fit without spilling beyond 6 mc and flooding adjacent channels with interference?

Close examination of the brightness signal reveals curious openings, as you'll note from our sketch of a brightness signal in Fig. 4. At the left are electrical currents of low frequency which correspond to large objects in the scene. As frequencies get higher, toward the right, smaller picture detail is represented. But it soon was discovered that picture information, regardless of frequency, doesn't spread smoothly; it clusters in evenly spaced packets.

To understand this a bit better, consider the old barbershop quartet. Though its members sang in harmony, creating an apparently smooth blend of sound, each voice had its own frequency and spacing. In similar fashion, large and small picture elements are strung out with definite gaps. Those spaces provide the needed openings for color.

Inserting red, green and blue signals into the holes can't be done directly. To keep color in its own slots, it's first placed on an electrical framework that meshes with the openings. This is the color *subcarrier*. As shown in Fig. 4, it exists on 3.58 mc. Reason for this frequency: color information superimposed on 3.58 mc interleaves perfectly with the available openings. But there's still room for improvement. Before seeing how the color signal is placed on 3.58 mc, let's examine certain steps that make the interleaving process practical.

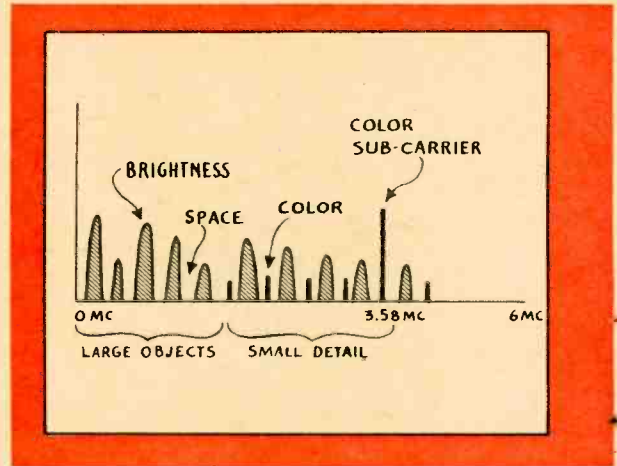

Color Cutting. The human eye possesses a peculiar quality; it sees less color as an object grows smaller. Furthermore, close combinations like red/brown and blue/green easily are confused when they appear in small detail. And really tiny picture elements—pinhead-size objects—are seen by the eye as shades of gray, no matter what their original color might be.

These limitations of the eye permit slashing the color signal to well-near half the original quantity. It's done by filtering color frequencies which carry small detail. Only color in medium-size and large objects need be applied to the 3.58-mc subcarrier. Small detail in the color picture will be rendered by the brightness signal.

Another giant step toward narrowing the color signal concerns the color green. It never reaches the subcarrier. You'll recall that the brightness signal consists of red, green and blue signals added together. But if the receiver knows the value of red and blue, it readily can subtract them from brightness to determine the green content. You might say this aspect of color-TV is much like Ohm's Law—if you know current and voltage, you have enough information to determine resistance.

Thus, the subcarrier used need be impressed only with red and blue information. Green travels along in the brightness signal. These techniques, which rid the color signal of unnecessary information, reduce required bandwidth and significantly aid the interleaving process.

How the red and blue content of the origi-

◀ Fig. 4. Openings in brightness signal explain how color information can be interleaved without increasing bandwidth. Red and blue colors are contained in 3.58-mc subcarrier, while the color green is injected in brightness signal itself.

Fig. 5. Two distinct kinds of modulation enable subcarrier successfully to convey required information. Amplitude modulation determines amount of color present; phase modulation determines whether that particular color is red or blue.

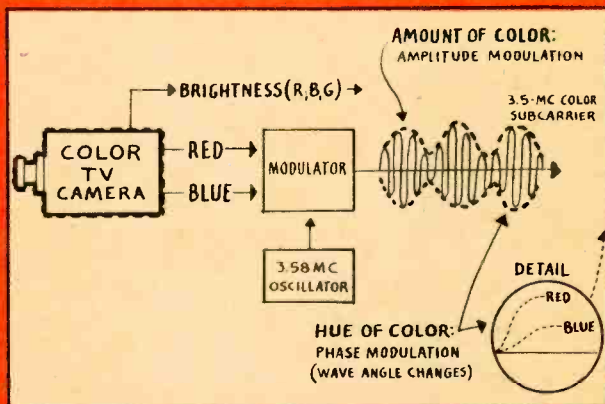

nal color is superimposed on the subcarrier is illustrated in Fig. 5. Notice that as the hue shifts between red and blue, the angle of the wave changes. This is phase modulation. The amount of color, on the other hand, shows up as variations in strength of the wave, or amplitude modulation. It is these variations of 3.58 mc, called sidebands, that actually interleave with the brightness signal.

All camera signals, including brightness and red/blue subcarrier variations, are modulated on the TV channel frequency and broadcast over the air. The subcarrier itself, on 3.58 mc, now is discarded. Reason: it has served its purpose, i.e., thrusting color into the openings as variations of 3.58 mc. Advantage of this process is that it conserves energy and also prevents possible subcarrier interference to the TV sound channel.

Receiving Color. A simplified diagram of a color receiver is shown in Fig. 6. Let's consider each block, starting at the top, left. This section, actually a black-and-white TV receiver, performs all the functions of a conventional TV set. It selects the desired channel, then removes the radio-frequency carrier that conveyed signals over the air to the receiving antenna. Emerging from the set itself is the brightness signal. And in a black-and-white set, this flow of current, varying according to the lights and darks in the original scene, is ample to create a monochrome picture.

But here the similarity with black-and-white ends; everything else shown here is part of some additional circuit for detecting and reproducing color. Note that the 3.58-mc

sidebands (containing red/blue information) feed the Demodulator. This stage precisely reverses what happened in the transmitter; red and blue signals are converted from sidebands into currents which resemble those from the red and blue pickup tubes in the color camera. (To achieve this, the receiver generates 3.58 mc and compares it with incoming color sidebands.) The result to this point consists of red, blue and brightness.

The green present in our picture is unscrambled in the Matrix. The process reverses what occurred in the transmitter Adder; red and blue subtract from brightness to recover the green signal. Signals, now identical to those from the studio cameras, are applied to the picture tube.

But what if the color set is picking up a black-and-white program? In this case, only [Continued on page 116]

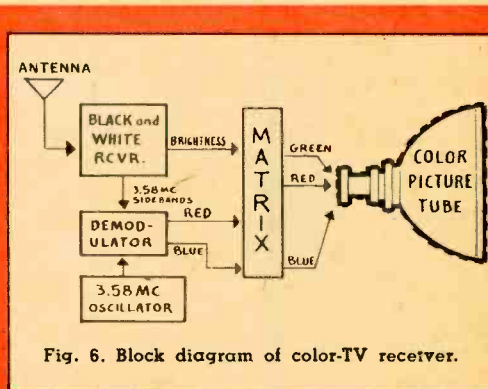

Fig. 6. Block diagram of color-TV receiver.

*A Panamanian ship
manned by an Irish crew
is giving the English
something new—
daytime radio,
American style.*

PUT TEN IRISHMEN on an old 702-ton car ferry, anchor it outside British territorial waters and you've got another buoy to guide ships through the English Channel. But place an American-style AM radio station on board that ship and you've come up with a preposterous pickle that'll bullyrag the British almost batty. And almost batty they are, what with the good ship *Caroline* rock-'n-rollin' away only five miles offshore.

The *Caroline* has proven a blight for the British simply because British-style broadcasting is a good bit different from the American kind. Though the government is in ultimate control of all broadcasting in the U.S., it has never gone far toward footing the bill. That's something advertisers do and the result is that American-style AM programs theoretically cost the listener nary a penny.

The British, in contrast, don't have any advertisers on AM radio. The government foots the bill—or, more precisely, the public does, by means of a tax levied on every radio set in operation. But comes the day when a station goes on the air with commercially sponsored programs and something's bound to happen.

In actual fact, R. *Caroline's* formula of popular music and commercials has gone over big with the culture-drowned English. Reports run that the Limeys are deserting the stuffed-shirt BBC by the hundreds of thousands. Over here, *Caroline* makes

BRITAIN'S

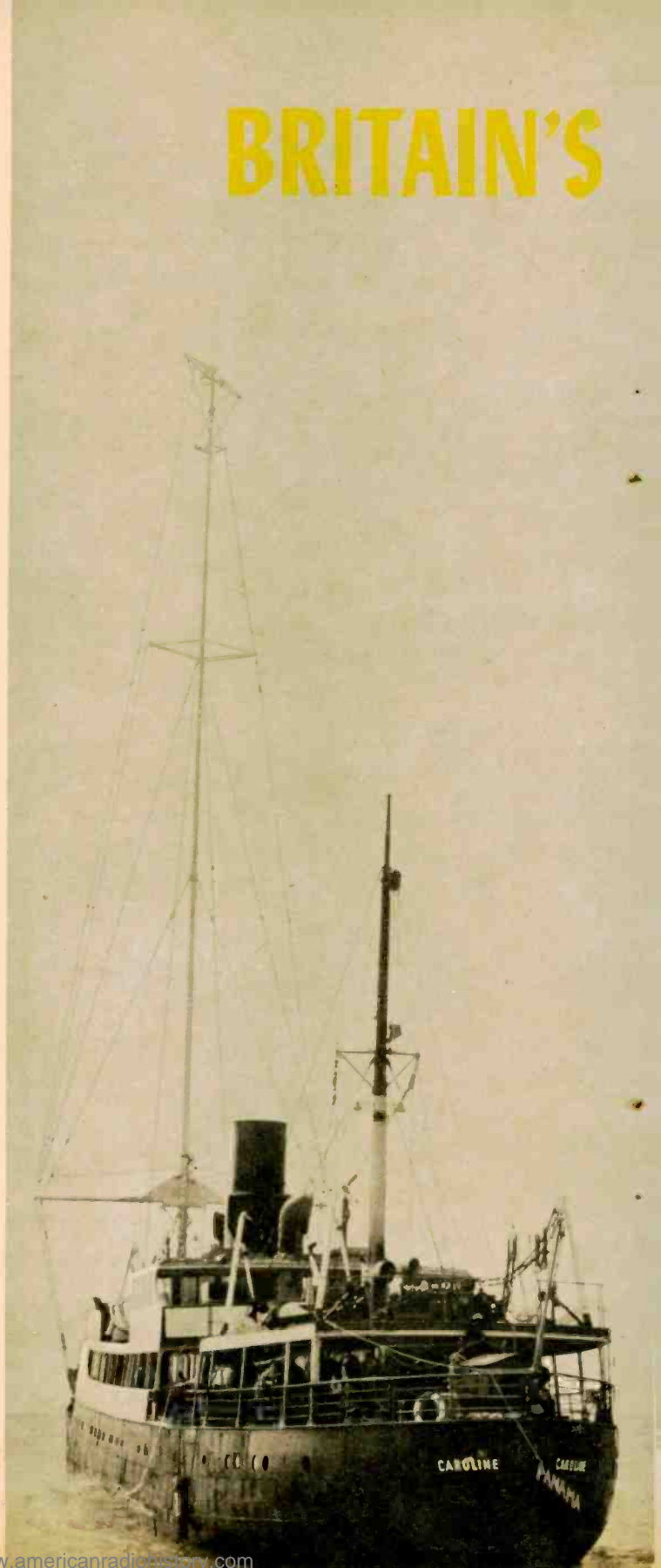

FLOATING FREEBOOTER



Anchored in international waters about five miles off the English coast, R. Caroline broadcasts from a 168-ft. mast. That's Jan Gunnarson, the 25-year-old radio technician, at left; Simon Dee, 28-year-old disc jockey, is at the right.

a top-flight challenge for North American DXers, provided the Royal Navy doesn't send a torpedo her way.

Interestingly enough, R. Caroline is only one of two such ventures conceived almost simultaneously; R. Atlanta, Caroline's only rival, actually was a \$750,000 pilot project. But it fell far behind its Irish competition, which opened up at the end of March on 1510 kc. However, this channel produced interference to boats in the Straits of Dover and the Thames Estuary, plus assorted howls from Belgium's national radio (also a user of 1510). Result was that Caroline switched to 1519 kc. At this writing, she's on the air from 6 a.m. to 10 p.m., British summer time (0000 to 1600 EST). And, during the day at least, she rolls into Britain like a Mexican powerhouse.

Though Britain is unlikely to seize either Caroline or Atlanta (aboard *Mi Amigo*, a converted freighter), she may pass laws prohibiting British firms from advertising over unlicensed radio stations. Needless to say, neither R. Caroline nor R. Atlanta have licenses. Other laws could prevent Britons from financing (this would get R. Atlanta) or servicing these vessels.

With the sunspot count at a minimum, North American DXers stand a good chance of bagging this pirate ship at midnight EST until the end of October. After that date, England returns to standard time (GMT) so you should try one hour later. And, since the British Post Office happens to be the regulatory agency in charge of British broadcasting, reports shouldn't be addressed to R. Caroline by name. Instead, send them to her managing director, Ronan O'Rahilly, 54-62 Regent St., London, W.1.—*Don Carter*



By Tim Cartwright

GOOD READING

AUDIO AND ACOUSTICS. By G. A. Briggs. *Herman Publishing Service, Inc., Stamford, Conn.* 167 pages. \$2.95

Though this is G. A. Briggs's eleventh book on audio and related subjects, it isn't his best. There's a bit too much of his famed (and un-British) sense of humor. And you might say the *bon mots* come in too quick succession.

Reservations aside, this is a valuable addition to the audiophile's Briggs shelf. In general, the various chapters (on subjects like the human ear, room acoustics, reverberation and concert halls) aren't meant to supply the last word. The real purpose of the book is to provide fill-in material on subjects that Briggs and other authors have had to gloss over in more formal treatments. And when the subjects don't serve as introductions for anecdotes, the result is just the kind of coverage that will fill in the blank spots in many an audio buff's knowledge of audio and hi-fi.

SEMICONDUCTOR ELECTRONICS. By Tugomir Surina and Clyde N. Herrick. *Holt, Rinehart and Winston, New York.* 429 pages. \$8

Probably the most interesting thing about this book is that it's the product of an unusual collaboration. Tugomir Surina is director of the Institute for Electronics and Automation in Zagreb, Yugoslavia; co-author Clyde N. Herrick is an instructor in electronics at San Jose City College in California. However these two men were brought together on this assignment, and whoever is responsible for what's within the book, the result is a remarkably complete and up-to-date coverage of semiconductor theory.

The book apparently was conceived as a text for a half-year theory course and, therefore, presupposes a reasonably solid math background. Even so, this is a volume that ought to wind up as an important part of any reference shelf on modern electronics. In fact, this unusual collaboration has to be called unusually successful by most any standard.

PRACTICAL HAM RADIO PROJECTS. By Charles Caringella. *Howard W. Sams & Bobbs-Merrill, New York & Indianapolis.* 128 pages. \$2.50

Charles Caringella, known to his fellow hams as W6NJV, seems well aware that economy isn't the only objective in ham homebrew equipment. For one thing, the dozen projects he outlines in this book are of the kind that will reinforce any ham's satisfaction in do-it-yourselfing. But the ham who takes to this book will do more than glean gear for his own construction bench. That gear also will be a bit different (and often a bit better and more flexible) than its commercial equivalents.

The projects are practical, of course, but they also are imaginative and fun to build. And it's this latter combination that puts this book in a place that other volumes only try for. A good job all round.

ELECTRICAL MOTOR CONTROLS AND CIRCUITS. By J. David Fuchs and Stephen W. Garstang. *Howard W. Sams & Bobbs-Merrill, New York & Indianapolis.* 288 pages. \$4.95

Time was when motor control referred
[Continued on page 115]

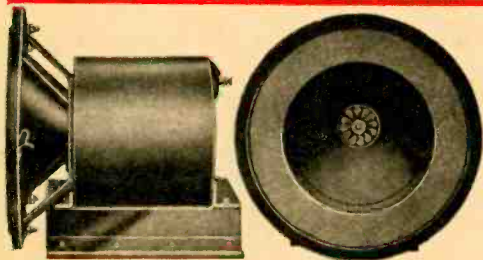

Moving-coil speakers have come a long way in the last decade or so, though all bear striking resemblance to those elderly first models. This illustration, taken from the book *Audio and Acoustics* discussed above, shows the original Rice-Kellogg moving-coil loudspeaker. Unit had a 6-in. cone which was fitted with a rubber surround.

Regulated **VARI-VOLTER**

By WALT HENRY

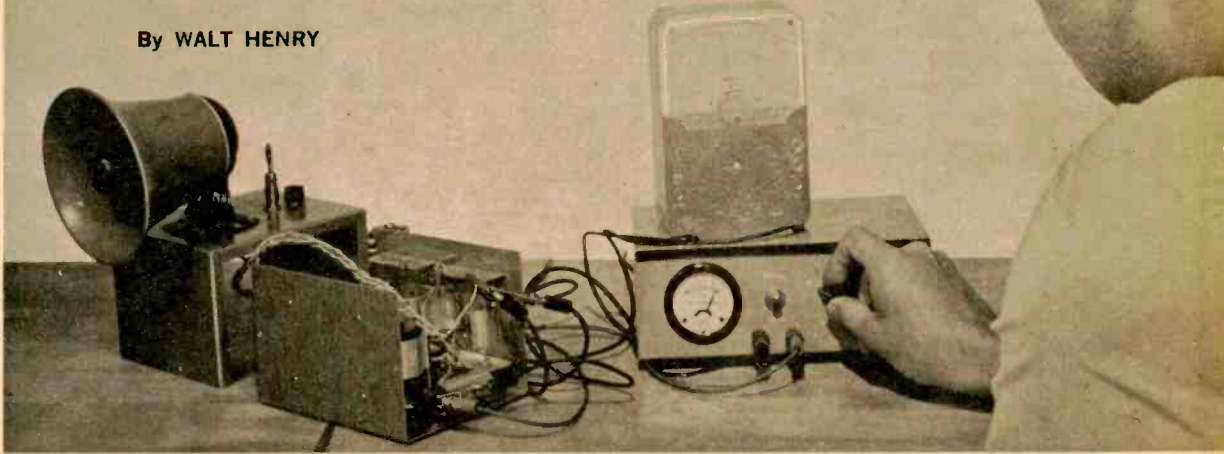

Who needs batteries when a DC supply gives you up to 30 V at 500 ma?

GETTING home-brew projects to work properly often is a cut-and-try proposition when it comes to DC power. Sure, batteries are the first thing that comes to mind; they're unbeatable when there's no other source of power around. But when it comes to experimental work they sometimes create more problems than they solve.

Not every piece of transistor equipment can operate on a 9-volt transistor-radio battery. As often as not you may find 3 volts will do the job. On the other hand, you may discover a project needs 24 volts at a whopping 200 ma. The assortment of flashlight and 9-volt batteries you'd have to have on hand for that sort of power could set you back quite a few dollars. Besides, you'd end up with a nightmarish lash-up of series-parallel connections. And it just doesn't make good sense to use batteries when there's AC power sitting around begging to be converted and put to work.

This high current (Hi-I) DC power supply is the answer. Just turn its front-panel knob to any setting up to 30 volts and you have clean DC power all the way up to 500 ma. (That's twenty 1.5-volt alkaline-energizer batteries in series.) The Vari-Volter can furnish 200 ma at low voltages and a full 500 ma from about 18 to 30 volts. AC ripple

is less than 2 millivolts up to 400 ma and about 5 millivolts at 500 ma. A curve showing the output voltage versus the load current is shown in Fig. 3. Note that up to 400 ma the output voltage does not drop.

The supply is regulated, which means when you set the output to, say, 25 volts, it will stay there whether it's called upon to deliver 4 or 400 ma. When you pull 500 ma, there is a small drop in output voltage. The supply can withstand overloads up to 750 ma, at which time a built-in fuse will blow.

There's a dual-range milliammeter on the front panel to tell you how much current is being drawn. The Vari-Volter will set you back about \$25 but this is less than what you'd pay for a large assortment of batteries that would be dead in a year.

Construction

The most compact way to build the Vari-Volter is to mount all the small parts on a 7¼x3-inch piece of perforated board as shown in the pictorial and photo on the next page. You then mount the board vertically (with angle brackets at the bottom corners) in the center of the U-section of a 8x6x3½-inch Minibox. The author's circuit board is made of glass epoxy and 2-56x¼-inch machine screws are used for tie points. How-

VARI-VOLTER

ever, standard perforated phenolic board and flea clips will work just as well.

Interconnecting wires from parts on the board to the components on the front and rear panel should come from the rear of the board and should be tied together to keep construction neat. And make the wires long

enough so that the board can be removed from the cabinet without disconnecting leads. This will simplify troubleshooting, should it ever be necessary.

Though parts layout isn't critical, certain points should be remembered in order to keep the AC ripple level low. For best performance the negative lead from C1 and the ground ends of resistors R6 and R11 should all be connected to the negative output terminal. The circuit board ground buss must be

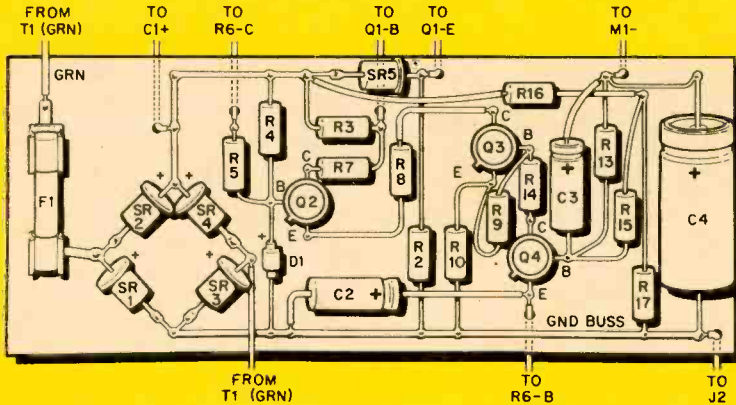
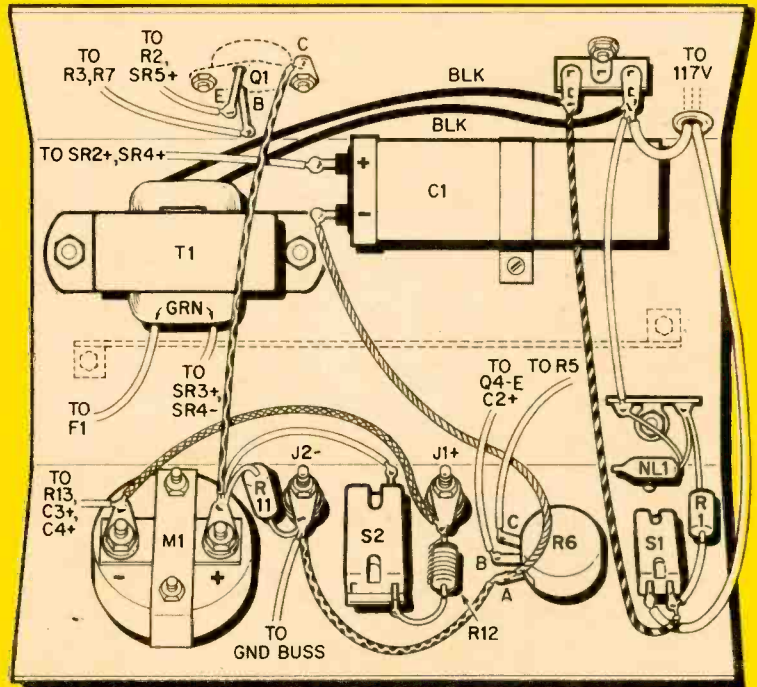

Fig. 2— Author mounted parts on 7¼x3-inch piece of epoxy board and used 2—56x¼-inch screws for solder terminals. Alternatively, perforated phenolic board and flea clips will do the job just as conveniently. Solder interconnecting wires to components on board before mounting it in the cabinet.

Fig. 1—Mount parts shown at right in the U-section of a 8x6x3½-inch Minibox before installing the circuit board (dotted lines). For cooling purposes Q1 must be mounted on the back panel. Be sure to use the mounting kit specified in the parts list to electrically insulate Q1's case (collector) from the cabinet. Lug at the right of Q1 (C) must not touch cabinet. R12 shown was wound by author but a commercially available resistor has been specified in the Parts List.



connected to the negative output terminal (J2-) with heavy wire. There must not be electrical connection to the cabinet.

Transistor Q1 must be mounted on the rear cabinet panel (which acts as a heat sink) for purposes of heat dissipation. Use the mica insulator mounting kit specified in the Parts List to insulate Q1's case electrically from the cabinet.

Although Q1 is rated at 90 watts, the heat sink required to dissipate this much power

would be quite large. If Q1 is firmly mounted on the cabinet, the safe continuous power dissipation for moderate-temperature operation is about 5 watts. This is more than adequate for the Vari-Volter. The addition of a commercial heat sink, such as the Motorola MS-10, will keep Q1 a little cooler.

Calibration

Remove transistors Q2, Q3 and Q4 and turn on AC power. The output voltage at J1 and J2 should be close to zero. If it is not, Q1 may be excessively leaky or shorted. The DC voltage from the emitter of Q1 to ground should be about 40 volts. Measure the voltage across zener diode D1. Though not critical, the voltage should be within 3 volts of 20 volts.

Set voltage control R6 to zero volts (full counterclockwise) and connect a voltmeter to the output terminals. Insert Q2, Q3 and Q4 one at a time and note if the output voltage rises after each transistor is plugged in. If the voltage rises perceptibly, that transistor may be leaky or shorted.

With all the transistors installed, slowly rotate R6 clockwise. The output voltage should rise to a maximum of about 30 volts. If it is within 2 or 3 volts of 30, try a slightly different value resistor for R13.

To check regulation, set R6 to 30 volts and load the Vari-Volter to 500 ma. (You can do this with a 75-ohm, 20-watt variable resistor, or with a series-parallel lash-up of pilot lamps.) The voltage change between no load and full load of 500 ma should not be more than 3 volts. If the change is greater, one or more transistors may have a low beta. Also, if the power transformer's secondary does not have a rating of at least 1 amp regulation will not be good.

The accuracy of the panel meter should be checked by connecting a milliammeter in series with it. If M1 does not indicate accurately on the 500 ma range, it may be necessary to change the value of shunt resistor R12 a bit. If M1 reads too high, try shunting R12 with resistors from 10 to 100 ohms. If M1 reads too low, try adding resistors from .5 to 5 ohms in series with it.

The voltage-calibration markings on the front panel surrounding voltage control R6 are Letraset dry-transfer type. Complete sets of this type are available from parts distributors, such as Allied, Lafayette and Newark.

If the Vari-Volter is to be operated con-

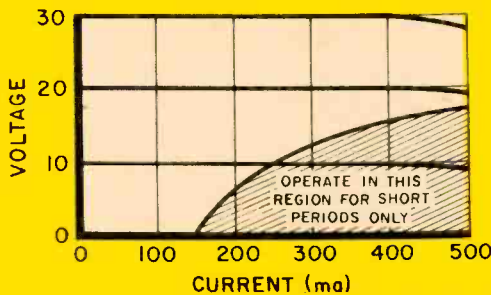
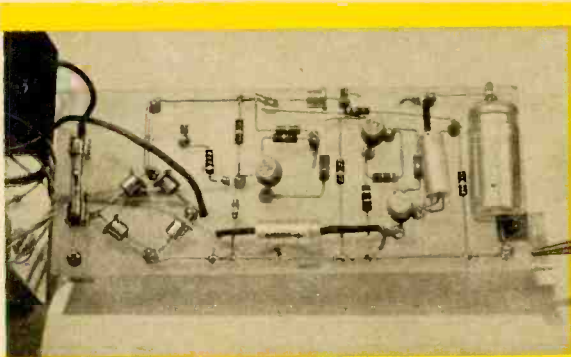
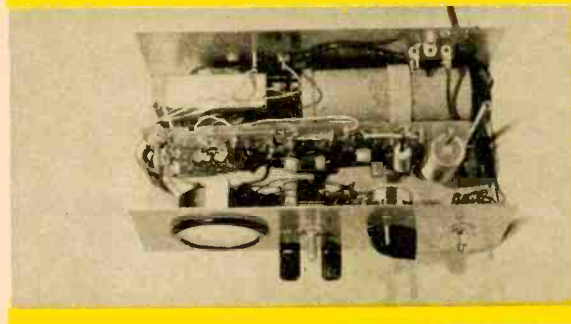

Fig. 3—Curves show supply's regulation. Note that output voltage doesn't fall until load current reaches 400 ma. Shaded area shows current/voltage combinations that are not safe. For example, don't pull 300 ma at 10 volts.



VARI-VOLTER

PARTS LIST

- C1—1.500 mf, 50 V electrolytic capacitor
 C2, C3—25 mf, 25 V electrolytic capacitor
 C4—150 mf, 50 V electrolytic capacitor
 D1—1N769 or 1N968 zener diode (20 V, $\pm 10\%$)
 F1— $\frac{3}{4}$ A, 3AG fuse and holder
 J1, J2—Five-way binding post
 M1—0.50 ma DC milliammeter (Emico NF-2C)
 NL1—NE2 neon lamp
 Q1—2N1541 transistor
 Q2, Q3—2N388 transistor
 Q4—2N1309 transistor
 Resistors: $\frac{1}{2}$ watt, 10% unless otherwise indicated
 R1—150,000 ohms R2—6,800 ohms
 R3, R17—1,000 ohms R4—5,600 ohms
 R5—2,200 ohms
 R6—10,000-ohm linear-taper potentiometer
 R7, R8—560 ohms R9—3,900 ohms
 R10—39 ohms
 R11—1,500 ohms, 2 watts
 R12—1.5 ohms, 2 watts (IRC type BWH)
 R13, R15—10,000 ohms
 R14—470 ohms R16—27,000 ohms
 S1, S2—SPST toggle switch
 SR1-SR5—750 ma, 400 PIV silicon diode (Lafayette SP-266 or equiv.)
 T1—Power transformer: primary, 117 V; secondary, 24 V @ 1 A (Olson Electronics T-290 or equiv.)
 Misc.—Transistor sockets, 8x6x3 $\frac{1}{2}$ -inch Mini-box, perforated board, flea clips, transistor mounting kit (Motorola MK-15)

tinuously at low voltages, the current drain must be kept low to keep Q1 from overheating. Unsafe operating conditions are indicated by the shaded area in the curve in Fig. 4. If you need a voltage-current combination in this area, the supply may be operated there for a short time only.

The Vari-Volter consists of a bridge rectifier (SR1-SR4), a series power transistor (Q1), a high-gain DC amplifier (Q2, Q3, Q4) and a zener-diode voltage reference (D1). Q1 acts as a variable resistance in series with the bridge rectifier and output terminal J1. Q1's resistance is determined by its base current, which causes the supply's output voltage to rise or fall. Q1's base current is controlled by the DC feedback amplifier (Q2, Q3, Q4).

The output of a voltage divider formed by R13, R15 and R17 is applied to the base of Q4. A reference voltage established by D1 is selected by potentiometer R6 and applied to the emitter of Q4. Assume that the output voltage decreases because of increased loading Q4's emitter-base voltage will increase and its collector current will increase. This current is amplified by Q3 and Q2 and increases Q1's base current. This causes the output voltage to increase to its original value. The circuit then stabilizes itself.

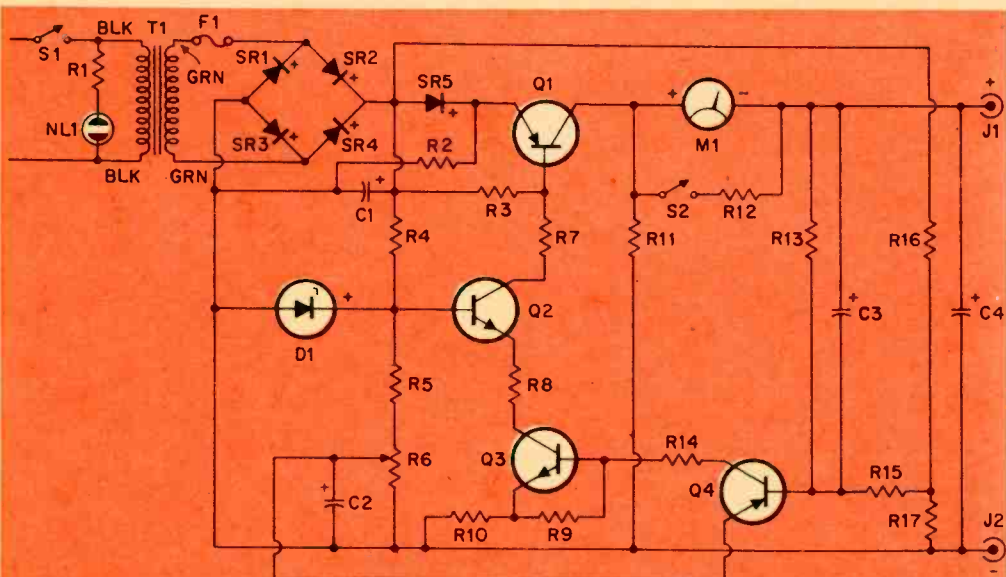

Fig. 4—Output of bridge rectifier SR1-SR4 goes through Q1, which acts as variable resistance. Q4 compares output voltage with reference voltage from R6. Difference is amplified by Q2, Q3 and fed to Q1's base. If Q1's base current increases, Q1's resistance drops and the output voltage will rise.

Ham CB **IN-LINE** Modulation Monitor



Low power means modulation's gotta be high. Put this meter in the line and without swiping RF it will help you put out a well-modulated signal instead of one that's in the mud.

By HERB FRIEDMAN, W2ZLF

THERE'S one extremely important principle that many amateurs and CBers often forget. When the transmitter's input power is low, the modulation level is extremely important in determining whether your message gets through. True, if you are a ham running a full gallon (1,000 watts) you'll be heard even if your modulation is way down in the basement. But if you're a CBer running a big three watts or a ham operating a flea-power 6- or 2-meter transmitter, you've got to fill every drop of RF with audio and keep it filled.

The best way to be certain your modulation peaks run as closely as possible to 100 per cent and your average falls somewhere over 85 per cent is to keep close watch on it with a modulation monitor—a device that indicates directly the percentage of modulation of your signal. Understandably, flea-power operators ordinarily shy away from such a device because many monitors steal an appreciable amount of RF. And you can't afford to use a meter that requires a full watt of power when you're running only three or four watts to begin with.

Regardless of whether you're working 80 or 2 meters and no matter how little or how much (up to 1 kw input power) your rig puts out, you can now own a modulation monitor that allows *all* your RF to get to the antenna.

El's Modulation Monitor is tailor-made for the low-power, all-band operator (CB, too). Being an in-line instrument, it can be connected permanently in the transmission line to give you a continuous indication of modulation percentage during transmission.

The amount of RF it takes cannot even be measured with an RF power meter. To avoid calibration problems, the Monitor has been designed to be self-calibrating; that is, you don't need an oscilloscope.

And, like many professional instruments, the Monitor uses a VU meter that is calibrated for both per cent modulation readings and in db. The db scale is particularly handy when you have to check speech clippers, compressors and other accessories classified as modulation boosters since it gives you an indication of the performance of these devices directly in db. The Monitor also has a headphone jack and volume control to allow you to listen for distortion in your signal.

Construction. All component values are critical and you should not make substitutions. For example, though the GE-2 transistor we specify is a general replacement for a 2N217, don't use a 2N217. Regardless of what replacement guides say, don't try different transistors.

The connection between J1 and J2 is a short length of coaxial cable that must be the same type as your transmission line. Make certain the shielded braid at both ends of the lead is soldered firmly to a solder lug at both J1 and J2. Also make sure you use the entire braid for the ground connection, not just a few strands.

R1's value is determined by your transmitter's input power. Use a 10,000-ohm resistor if your input power is up to 100 watts. If greater than 100 watts, R1 should be 33,000 ohms.

Take extra care that D1 is installed correctly. The lead marked with a black band

Model shown is built in the main section of a 3x5x7-inch Minibox. Layout of parts at the right side of the box is tight so be sure you follow our layout as closely as possible. The coaxial cable used to connect J1 and J2 must be the same type as the transmission line you now use.

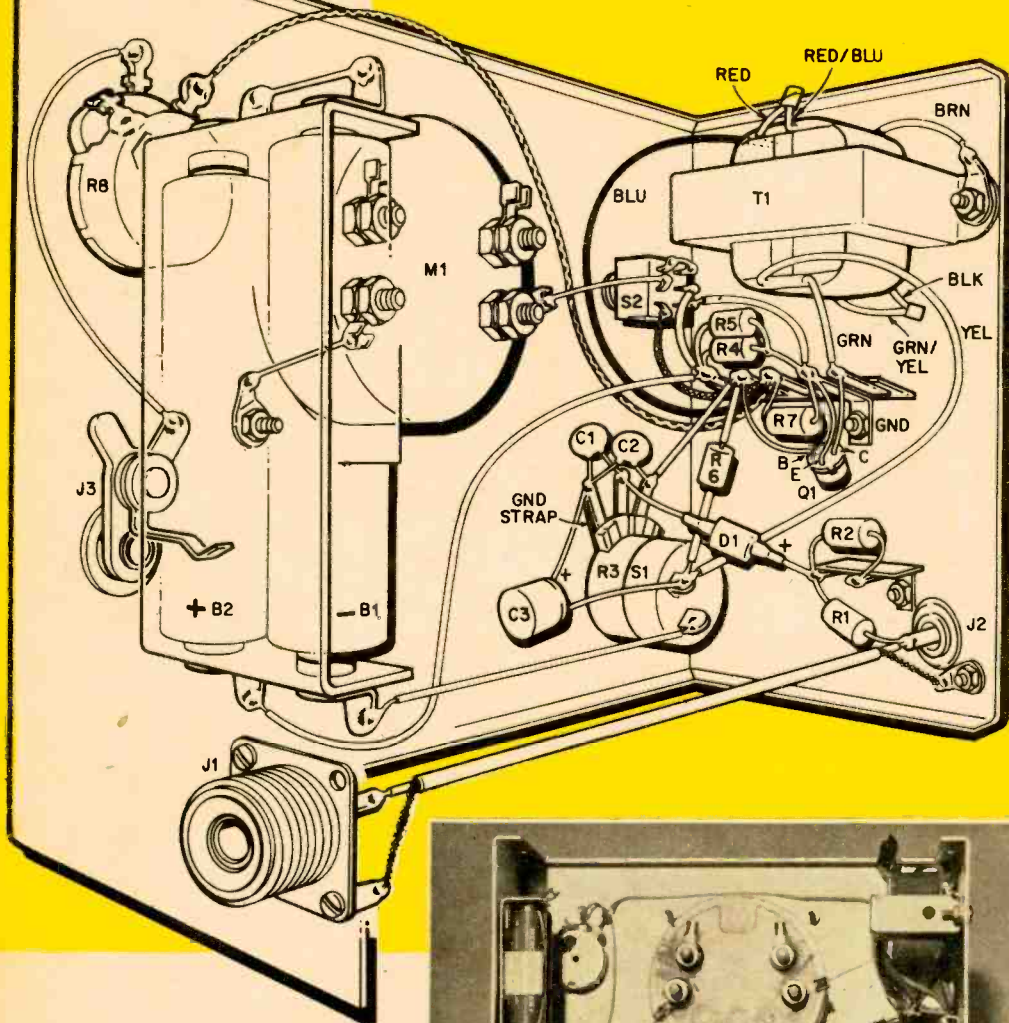

Layout is relatively uncrowded except for right side. Do not use a smaller VU meter as its characteristics may differ from the type we've specified. Top lugs on meter are for built-in pilot lamps and are not connected.

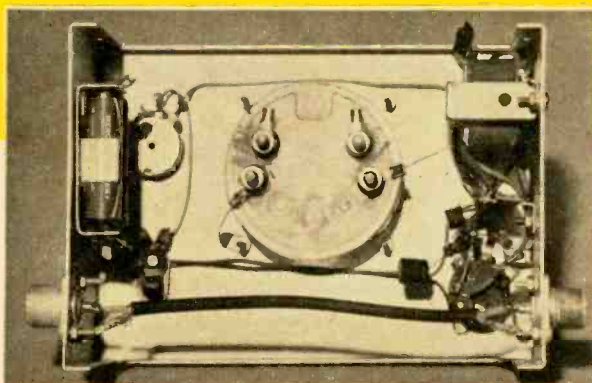

- B1, B2—1.4 V mercury battery (Mallory ZM-9 or equiv.)
- C1, C2—100 mmf, 25 V or higher ceramic disc capacitor
- C3—30 mf, 6 V or higher electrolytic capacitor
- D1—1N34A or 1N54 diode
- J1, J2—SO-239 connector
- J3—Phone jack
- M1—VU meter (Lafayette TM-80)

PARTS LIST

- Q1—GE-2 transistor (General Electric)
- Resistors: ½ watt, 10% unless otherwise indicated
- R1—See text
- R2—1,000 ohms
- R3—5,000 ohm, linear-taper potentiometer with switch
- R4, R5—3,300 ohms, 5%

- R6—82,000 ohms
- R7—560 ohms
- R8—20,000 ohm, audio-taper potentiometer
- S1—SPST switch on R3
- S2—DPDT toggle switch
- T1—Transistor interstage transformer: 500-ohm center-tapped primary; 5,000-ohm center tapped secondary (Stancor TA-4)

or a + should be connected to R1. D1's leads must be short; therefore, use a heat sink, such as an alligator clip, when soldering them.

The Monitor's accuracy is somewhat dependent on battery voltage. For this reason, and for long-term reliability, B1 and B2 should be 1.4-volt mercury batteries and mounted in battery holders. If you solder to the batteries operation may be intermittent.

Calibration and Use. Connect your transmitter's output to either J1 or J2 and connect your transmission line to the other jack. Set S2 to CAL (calibrate) and set R3 full counterclockwise so S1 is off. Turn on your transmitter and then rotate R3 just enough that S1 clicks on. Advance R3 until M1 indicates full scale—the +3db mark. Next, set S2 to MOD (modulation); M1's pointer will fall back to zero and will kick upscale when you speak.

Modulation of 100 per cent will be produced when the *average* speech peaks are between 60 and 80 per cent. If you adjust your rig so the *average* peaks hit 100 per cent, still higher peaks will cause modulation to exceed 100 per cent and your signal will be distorted and there'll be sideband splatter.

While 100 per cent is the ideal modulation level, many transmitters can't quite make it. For example, many CB transceivers—to comply with FCC regulations—have the modulation limited to 80 to 90 per cent so the absolute maximum is 100 per cent. Any attempt to push the modulation level higher results only in distortion. If shouting into the mike drives the monitor only to 85 per cent,

this is as high as you can go. Once the saturation level is reached, raising your voice simply increases distortion. And besides, someone listening to you won't be able to tell the difference between 85 and 100 per cent modulation, anyway.

Another problem may be carrier-controlled modulation. Some transmitters are designed so you will not be able to exceed 60 to 80 per cent modulation. If you find that M1 is sluggish near the bottom of the scale, your transmitter may have carrier-controlled modulation. To determine this, check it with an oscilloscope. If the modulation pattern appears predominantly negative, your rig has carrier-controlled modulation. This sometimes can be corrected by overcoupling the transmitter to the transmission line, which may raise the modulation to 80 to 90%.

Since the Monitor is transistorized it is somewhat heat sensitive and should not be placed on top of your transmitter. We suggest that after a few minutes use, the calibration be rechecked just in case it has drifted.

To use the Monitor as a tune-up meter, temporarily adjust R3 so M1 indicates mid-scale. As you increase transmitter loading the pointer will rise, indicating higher RF output.

The Monitor is designed to be used with crystal phones. If the impedance of your phones is around 2,000 ohms, indications will not be accurate. To get around this, disconnect the phones or set the monitor volume control to full off before you use the meter.

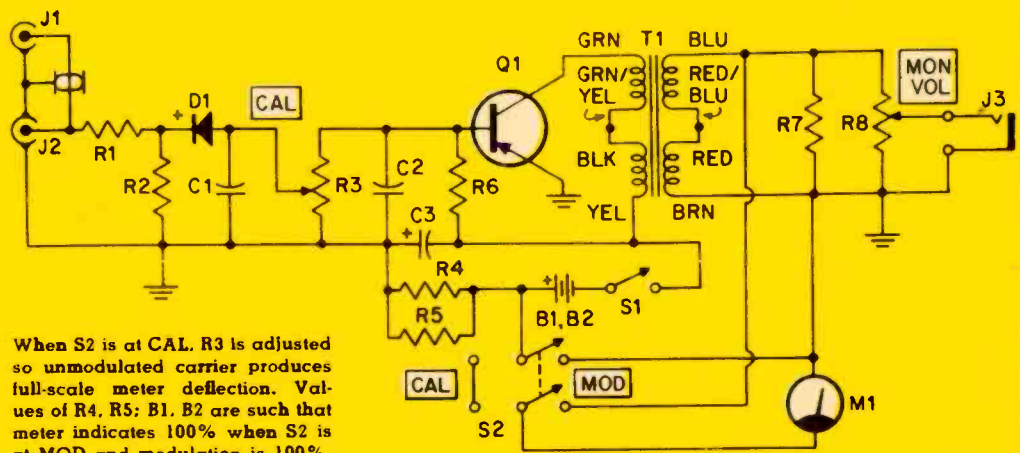

When S2 is at CAL, R3 is adjusted so unmodulated carrier produces full-scale meter deflection. Values of R4, R5; B1, B2 are such that meter indicates 100% when S2 is at MOD and modulation is 100%.



The agonies of MAJOR ARMSTRONG

By ROBERT A. HARPER

ON THE Sunday evening of January 31, 1954, a tall, imposing man put on scarf, overcoat, hat and gloves as if to go out. Go out he did, but not as any of us would have wanted.

Throwing open a window in his luxurious skyscraper apartment, he saw once more the towers of Manhattan against the wintry sky. Then Major Edwin Howard Armstrong, greatest inventor in the history of radio, jumped to his death.

Today, as then, every radio and TV set reflects the genius of an American who remains almost a stranger outside his profession. But, despite the fact that he is little known and little appreciated, Major Armstrong perhaps outstrips even Edison as the greatest technical genius America ever has produced.

Edwin H. Armstrong was known to his many friends, even to his wife, as the Major. His life was fraught with titanic battles over legal and financial rights to the contributions he made to the radio art. It also was underscored by his tremendous vitality, indomitable courage and outstanding achievements.

Though he patented 42 of his inventions, he was known best for five major contributions:

- The regenerative circuit, developed in 1912, which revolutionized the crystal-detector-and-earphone stage of radio.
- The superheterodyne receiving circuit, in 1918, which is used universally in

receivers because of its high selectivity and amplification and which knows no peer today.

- The superregenerative receiving circuit, invented in 1922, which still is unsurpassed for its simplicity and sensitivity on high-frequency short waves.
- FM (frequency modulation) radio, in 1933, which eliminated static and is in wide use today, both for hi-fi reception and for television, satellite and military communications.
- An FM multiplexing system, developed in 1953, which made possible transmission and reception of two or more separate signals over the same channel.

One easily might question how a famous, though controversial, man of such scientific stature and unbridled integrity conceivably could take his own life. Looking backward to the beginning of Armstrong's career and at the way he directed his life, multiple clues can be found. Peer into the pages of radio history, distorted though they may be, and one sees many reasons for this tragedy.

Armstrong was born in 1890. He lived a genteel life most of his boyhood in a large home in Yonkers, N.Y., deeply influenced by the traditions and thinking of the Victorian age. In classic fashion, he tinkered with a telegraph key and wireless devices in a large, comfortably furnished attic room.

At the age of 15 he first exhibited traits of daredevilness that were to stick with him

all his life. He seemed to delight in taking physical risks. He scaled the sheer rocky cliffs of the New Jersey Palisades and participated in other daring feats. Friends said that if he felt fear it was to a lesser extent than ordinary men. Later in life he was to climb a 100-ft. tower atop a 20-story building—a tower which the Radio Corporation of America had erected for one of its first broadcasting stations. He stood on top of a ball at the tip of the tower, had his photo taken and then presented the picture to his bride-to-be.

Also at the age of 15 Armstrong had decided definitely what was to be his role in life. He announced to his parents that he was going to be an inventor.

At 18 he began the four-year electrical engineering course at Columbia University's School of Engineering and Applied Science. Except for an intense interest in the engineering concepts of radio, he wasn't a particularly outstanding student. But his zeal and devotion to research earned him the title of nuisance. One of his professors even went so far as to suggest that "Armstrong should pack up his stuff and get out."

Armstrong was influenced greatly by Michael I. Pupin, a Serbian goatherd who arrived in the United States at the age of 15.

wearing a Turkish fez and carrying 5 cents in his pocket. This same Pupin became a redoubtable inventor and Armstrong knew him as professor of electro-mechanics at Columbia. Pupin, proud of his former pupil, was to be one of Armstrong's staunchest supporters in the long years of violent controversy that were to follow.

By his junior year, Armstrong had taken the early findings of three great pioneering inventors—Edison (the incandescent bulb), John Ambrose Fleming (the two-element vacuum tube) and Lee de Forest (the audion)—and developed the feedback or regenerative circuit. He found that by taking a portion of the current from the plate of a vacuum tube and feeding it back to the grid, it again would go through the process of amplification. Result was a surplus of current that could be put through the same process over and over. In fact, if feedback were increased beyond a critical point, the tube would become a generator of oscillations.

Armstrong wanted to patent his invention in 1912. His father refused to put up the money, believing an education was the most important thing at the time. When an uncle refused to lend him the money Armstrong did the next best thing. He had his notes and

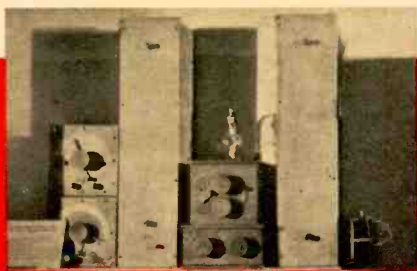

Three of Armstrong's crowning achievements are shown here in their earliest forms. Above, left: the original regenerative receiver; above, right: the first superheterodyne; below: first FM receiver set up outside Armstrong's lab.





The agonies of MAJOR ARMSTRONG

drawings notarized. But even this documented proof of prior claim to the invention of regeneration did not save Armstrong from what was to come. His revolutionary discovery was to be victim of a painful, 19-year-long litigation which was to scar him for the rest of his life.

Armstrong graduated the following year. He already had demonstrated his invention to several prominent radio engineers. One, David Sarnoff, then was chief radio inspector of the Marconi Wireless Telegraph Company of America. Soon he would rise to the top in the corporate complex of the Radio Corporation of America. Sarnoff and the other attending engineers were impressed by Armstrong's superb skill and thoroughness.

Like many an inventor, Armstrong was described as pugnacious and sometimes impulsive. He acted on hunches. He spent hours diagnosing a problem. He was a thinker as well as a doer. Most important of all, he was endowed with an unswerving devotion to principle. And in this last characteristic later

could be found an explanation for his unflinching determination to wrest public recognition and financial satisfaction from 21 corporations which he felt had infringed upon his FM patents. (As of this writing, 19 cases have been concluded on a basis favorable to the Armstrong estate. Most recent ruling of patent infringement was that against Motorola, which came this past May 14.)

Even while involved in his own litigation, costing millions in attorney's fees, lost time, periods of utter frustration and despair, Armstrong struggled for truth in its every form. His unbending integrity forced him to write hundreds of letters in an effort to button down and document facts just to "keep the record straight" concerning the history of radio.

Armstrong invented the superheterodyne circuit while a captain in the U.S. Signal Corps during World War I. He was sent overseas to Paris and assigned the problem of intercepting German front-line communications. The superheterodyne was his answer and the circuit still is unchallenged. Matter of fact, one would have to look far and wide to find a receiver that isn't a superheterodyne.

He returned home, a little more bald, still exuberant and full of the insatiable curiosity that characterized him from early youth. The truce that existed, because of the war, between Armstrong and de Forest over the claim to the regenerative circuit was over.

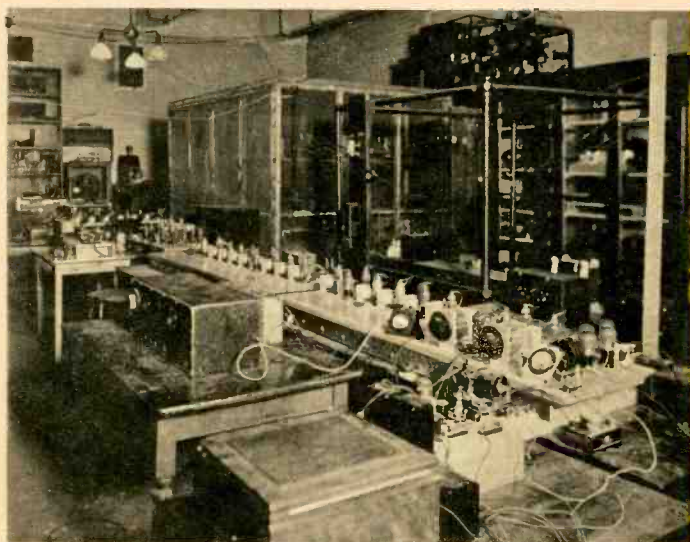

No engineer ever has devised a circuit to beat Armstrong's superheterodyne, nor has anyone equalled the method of broadcasting Armstrong dubbed FM. The Major did much of his work in his basement lab at Columbia University, and it was here that he set up this elaborate looking FM receiver. The year probably was 1935 and, considering the components of the day, Armstrong's was no mean undertaking. Later that year, Armstrong introduced FM in a demonstration that left his audience bewildered and unbelieving.

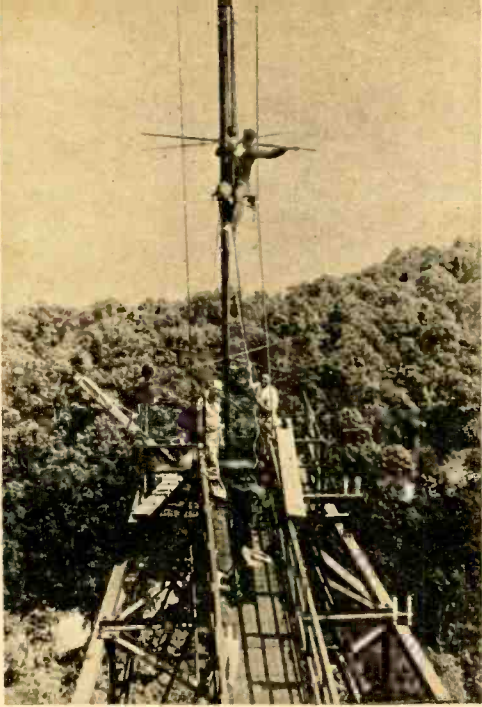

With industry cool toward FM, Armstrong set up his own station. That's the Major himself, adjusting the antenna from a swinging bosun's chair.

But the second stage of the 19-year litigation was about to begin.

Armstrong, sure of his rights, had licensed several firms to use the patents. The struggle had cost him a small fortune. To offset attorney's fees, Armstrong reluctantly sold his remaining patents, including those to the superheterodyne, to Westinghouse for nearly half a million dollars. Westinghouse then became the defender.

The battle over who really had invented the regenerative circuit continued all the way through the Supreme Court. In 1928 the court awarded its decision to de Forest on points of law rather than technology. Armstrong was infuriated. Engineering organizations supported him and insisted that the invention of the regenerative circuit was his, regardless of what the law might say.

Despite advice from friends, Armstrong's sense of pride and integrity could not be assuaged. He again undertook a multi-year court fight to prove he *had* invented the regenerative circuit. This time he was girded for the battle financially. He was the largest stockholder in the Radio Corporation of America.

Earlier in the 1920's Armstrong had developed the superregenerative circuit. This he sold to RCA for a substantial sum and 60,-

000 shares of stock. But despite its unsurpassed simplicity and sensitivity, the superregenerative circuit proved to possess serious shortcomings for the application RCA had in mind—AM broadcast-band reception. Armstrong was called in as consultant to RCA to help iron out these problems. For his efforts he accumulated an additional 30,000 shares of RCA stock.

Sarnoff, the same age as Armstrong, had become the brilliant administrator, vice-president and general manager of the corporation. He had formed the famous patent pool by the time Armstrong had decided to seek anew the legal recognition of his regenerative circuit. RCA, because of interests in the patents of both de Forest and Armstrong, withdrew support from Armstrong. Selling a large portion of his RCA shares prior to the 1929 crash, Armstrong began his futile fight to "set the record straight."

It was inevitable that the lives of Armstrong and Sarnoff should become intertwined from the beginning. Armstrong was the technical genius of radio. Sarnoff was and still is its administrative genius. They were friends—good friends. During his many visits to see Sarnoff, Armstrong fell in love with Sarnoff's secretary, Esther Marion MacInnis. They were married on December 1, 1923. In speaking of the marriage, Mrs. Armstrong has said that, though she never called "Howard a genius, nevertheless he was one and it was difficult at times to anticipate his needs and moods or to keep pace with his extremely busy life."

Following military service, Armstrong returned to Columbia and worked with Professor Pupin without salary or teaching responsibility. Even so, his home was as much a workshop as the laboratories he headed at the university. He personally handled all of his correspondence and wrote his own technical papers.

Friends and cohorts expected, and did get, telephone calls from Armstrong at odd hours of the night when he was pursuing a particularly knotty research problem. He liked a lusty drink to help him relax. He wasn't keen about playing cards, nor did he like small talk, but he was delighted to discuss radio with friends anywhere, anytime. And his own apartment was to become the bastion of his last strong-willed effort to combat encroachments upon his FM patents.

In 1933, after a decade of work and de-



The agonies of MAJOR ARMSTRONG

feat, he completed the circuitry which made FM possible. Again he called Sarnoff and demonstrated the apparatus. Subsequently, he was invited to make a field test and set up shop in the Empire State Building, following a series of tests in the basement of Philosophy Hall at Columbia. He began installing his equipment the following spring—the year he was to receive his second setback in the Supreme Court over the regenerative circuit.

Ironically, RCA attorneys were lined up against him in that case. But cordial relations still existed between him and Sarnoff and the RCA engineering staff knew and respected him. Just the same, repeated successful tests at the Empire State Building with receiving equipment some 80 miles away didn't rally RCA policymakers to the new kind of radio Armstrong called FM. Instead, Armstrong was asked to move his FM equipment out to make room for experimental work in television.

Armstrong had permitted RCA to preview his invention for two years. He made no public announcement until April 1935. Less than two weeks later RCA announced it was putting up \$1 million to develop television. No mention was made of FM.

Less than a year later the Federal Communications Commission made its annual report to Congress concerning developments in radio and communications. There again was no mention of FM as such.

The next year Armstrong came face to face with a giant new problem. At a meeting called by the FCC to elicit information from the radio industry to aid it in apportioning experimental frequency bands above 30 mc, Armstrong appeared to tell of the needs of FM. RCA also was there in full force—including President Sarnoff. RCA avoided mentioning anything about FM throughout the hearing.

The deliberate way it was done rent the

final fabric of any cordial feelings Armstrong had for Sarnoff. It also launched him into a feverish activity to build his own FM station to prove the value of FM and to gain public acceptance for the new medium. With his own funds Armstrong designed and built a station and broadcasting tower at Alpine, N.J., near the west bank of the Hudson. July 18 of this year marked the 25th anniversary of the first regularly scheduled broadcast from Alpine. Appropriately, it was observed in ceremonies sponsored by the Columbia's School of Engineering and Applied Science, which is celebrating its 100th anniversary as well.

[Continued on page 107]

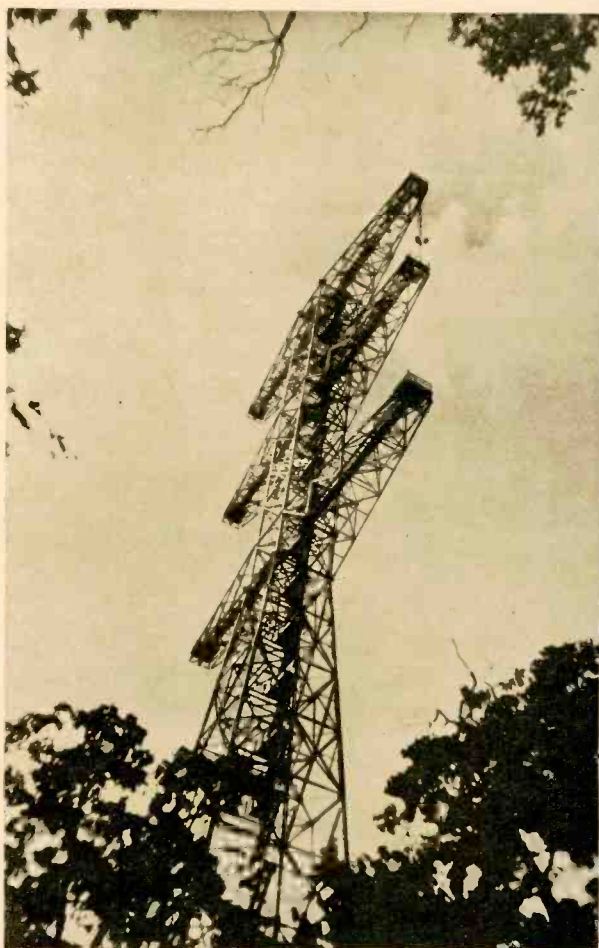

Best monument to radio's greatest inventor is one he erected himself—the 400-ft. tower near Alpine, N.J., he put up to prove FM's many merits.

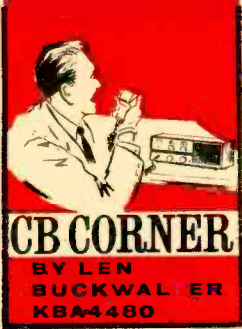

DUTCH UNCLE

LIVING-COLOR COAX . . . was only one new product at a parts show we visited recently. But this wasn't what took us traveling; we wander off to many a show simply to talk with CB manufacturers and sneak a preview of what's destined for dealer shelves.

After three days of browsing through exhibits at this fair, we reached a well-researched conclusion. Our findings: last year's fancy-chassis spree—which converted CB's black-box rig into a jazzy, slicked-up transceiver—has levelled off.

Sure, there were lots of knobs and plenty of chrome in evidence. Just the same, CB gear appears to be entering its Dutch-uncle phase (for you swinging youngsters, that's an old-timey type term meaning strict, harsh, no frills, etc.). Emphasis is on guts, not front-panel geegaws. Result is equipment that's rugged and that reveals signs of improved, often imaginative engineering.

But the CBER's appetite for the novel and flamboyant wasn't overlooked completely. A sample rib-tickler was that coaxial cable in color, produced for real by a manufacturer.



Battery dead and rig not working? Blimp-like accessory by Antenna Specialists can be hung on whip to signal help, also doubles as litter bag.

Remember the Model-T Ford? It came in any color—so long as it was black. We always thought the same applied to coax. And right we were, until this manufacturer discovered that sales shot up when he jacketed coax in gleaming white!

Somewhat unsold, we pressed him for the reason.

"White cable lasts longer, reflects the sun's rays," he said. "And it looks better running down the side of a house."

Our reaction is best summed up in two words: ho-hum. But lest those who live in multi-hued homes shouldn't see eye-to-eye, we'll mention that the coax is available in no less than 17 colors.

Coax excepted, solid and sophisticated engineering dominated the CB section of the show. Biggest circuit news had to do with crystals and frequency control. More and more manufacturers (Sonar and Regency, for example) are producing transceivers with frequency synthesis. And inflated though the term may be, its meaning is dirt-simple. In a nutshell, it means that the outputs of a few crystals are mixed to produce many operating channels.

Frequency synthesis in the past normally has meant a 23-channel unit but the new Regency set has ideas all its own. Called the Romper, it's an eight-channel rig but, since one crystal socket is brought out to the front panel, the user can go to any channel with one extra crystal. This cuts a few corners, of course, but it also cuts something else—cost.

Another intriguing frequency idea we stumbled across was at the James Knight booth. Departing from frequency-synthesis (which requires additional stages), JK sees a disarmingly simple technique to make a single crystal function on more than one channel.

Secret is that crystals can oscillate in two modes (series and parallel), and that going from one mode to another results in a 10-kc frequency drop. Since CB channels run 10

[Continued on page 119]



"Mr. Watson, I see you."

"MR. WATSON, come here, I want you," said Alexander Graham Bell into a little black box way back on March 10, 1876. Mr. Watson dutifully came as requested, we imagine, for this is what an assistant is supposed to do. And whatever his contributions to the task then at hand, Mr. Watson did go down in history. For his was the first name ever transmitted over wires by a new device called the telephone.

In time, conversations on Mr. Bell's telephone took on most of the marks of a chat between two persons in the same room. But real conversations involve both hearing and seeing the person you're talking to. And, truth to tell, the telephone has been limping along on one cylinder most of the long years

of its existence. This is not to say that video is all *that* important, of course. It isn't, and any two-way radio operator can tell you so. But it can add an important second dimension, as the TV viewer with a picture-tube-gone-bad knows only too well.

Though attempts to add sight to telephone sound go back as far as 1927, it's only in the last decade or so that talk/see really began to shape up. And, not surprisingly, it was the transistor (a Bell Labs development) that helped make for the big jump in telephone talk/see feasibility during these past few years.

Today, talk/see telephones at long last are with us, though not in the way they were foreseen some 20 or 30 years ago. In spite of modern know-how, it just isn't practical to add sight to the sound on every private phone across the country. But it now is practicable to connect city to city, which is precisely what Bell Telephone is doing. Fact is, Bell already has inaugurated its new Picturephone service between three U.S. cities — New York, Chicago and Washington, D.C.

How do you make a talk/see call? First you arrange for an appointment. Then, at the designated time, you go to the special telephone booth equipped for talk/seeing in your city. Plunk down a goodly number of shekles (three minutes, New York to Chicago, will set you back 27 bucks, plus tax), and you can talk/see a distant relative. Each Picturephone booth accommodates up to five persons, so the small fry will have no trouble squeezing in for a glimpse of a far-away grandma on a 4 $\frac{3}{8}$ x 5 $\frac{3}{4}$ -in. screen.

"Mr. Watson," Alex might say if he were still around, "I see you . . ."



Talk/see device developed by Japan's Tokyo Shibaura Electric can be attached to any telephone, sends a still picture over existing telephone lines.



DX BOON for the



BROADCAST BAND

Stations that you never even dreamed of soon will dazzle you, because we're in for the greatest BCB DX in radio history!

By ALEX BOWER

THOUGH a good many SWL's seem unaware that broadcast-band DX exists, things are due to change. The present sunspot picture (SUNSPOTS ARE COMING!, Sept. EI) has thrown *short-wave* DXing its foulest ball in many a year. But the same state of affairs promises to make this one of the best *broadcast-band* DX seasons of all time.

Despite the vast number of BCB stations currently on the air, quantity rather than quality (DX-wise) seems to remain king. But quality certainly doesn't rule out domestic (U.S. and Canadian) stations. Obviously, with a mere 50 watts, CFSE (1425 kc) at Senneterre, Que., is a considerably better catch than R. Punto Fijo's YVNN (1110 kc) with a mighty 10,000 watts.

New Worlds. Nor is BCB listening merely a DX challenge. The enterprising listener can encounter new and exciting worlds even via stations in and around the U.S. For example, many readers already will be familiar with the Mexican border stations. There presently are five of these English-speaking two-country operations, ranging in power from the 250-kw XERF at Acuna down to the 5-kw XEMO at Tijuana.

Among the five, programming ranges the gambit from John Birchers to Black Muslims. And with presidential election time rolling round again, these transmitters will bear especially careful watching.

For those with a sense of humor and a taste for the way-out, there is the all-night Long John Show on New York's WOR

(710 kc), featuring both interesting and outlandish personalities. But balanced against this wide range of listening opportunities, the modern BCBer faces certain serious obstacles.

For one thing, all-night shows like Long John's create QRM which BCB DXers simply have to learn to live with. In other words, the era of wide-open frequencies between 1 and 5 in the morning virtually is gone. Monday mornings hold about the only hope here, since many stations then leave the air for maintenance purposes.

Still another matter to consider is that many broadcast stations plainly can't be made into DX by any tugging of the thinking cap. Worse yet, most of these must be coaxed patiently into answering reports. And even with the quantity approach, there just isn't time to keep after them all.

Getting Started. Now that we've run down the action in general, let's get to specifics on how you can log DX on the broadcast band. The novice first will accomplish long-distance BCB reception via those potent clear-channel operations like KFI (640 kc) in Los Angeles and KSL (1160 kc) in Salt Lake City. Both these stations often are received in the East after 0100 EST even on the simplest receivers. In addition, there's WOR, which we mentioned previously; WCBS (880 kc), also in New York; WMAQ (670 kc), in Chicago; plus many others. Those Mexican border stations, with the exception of XEMO, also fall into this category.

These same frequencies also provide the

DX BOON for the BROADCAST BAND

beginner with his best source of foreign DX. Because there will be only one U.S. station to contend with, a Latin American transmitter on one of these frequencies often can be bagged either under or over it. Of course, it goes without saying that you likely will need a good outdoor antenna to pull off such a feat.

Once a DXer realizes that distant BCB reception, both foreign and domestic, can be a fact, he presumably will become more selective. And when it comes to QSL's, by all means verify as many countries as possible. In addition, you might try for all the states and all the Canadian provinces. This done, you could hunt for some of those special targets we have mentioned.

And speaking of veri's, you most certainly should keep EI's DX Club in mind while you're plastering the shack wall with BCB QSL's. Reason is that the Club offers a hard-to-qualify-for award which could be right up your alley. It requires that you have logged and QSLed at least 15 BCB stations in 15 different countries. Since there are but three countries on the entire North American continent, this award is no pushover. Even so, with the present BCB DX boon, now is *the* time to try for it.

With The Pros. Advanced DX ordinarily requires advanced equipment. It also takes on so many guises one best might split it into some seven categories. To begin, there are those regional full-time stations in North America with powers usually ranging from 1 to 5 kw. (This is where XEMO fits in.) Secondly, there are those daytime-only stations which often can be received up to 1,000 miles away about sunrise and sunset. Most of these stations can be logged on simple equipment, though a reasonably selective receiver will remove the co-channel interference headache.

Third category here consists of split-frequency Latin American outlets. These stations—HOU at David, Panama (1013 kc), is one example—operate *between* the regular 10-kc FCC channel spacing. But to pick up one of these you'll need a set with plenty of Q (selectivity). Surplus military receivers which cover the broadcast band are excellent buys in this respect.

Next we have transatlantic stations—those

in Africa, Europe and the Near East—which, happily, are among the world's best verifiers. And, thanks to that low sunspot count we already have made note of, TA reception now is at its peak. Matter of fact, a station such as RIAS in West Berlin probably is no more difficult to hear on 989 kc than it is on short wave, at least in Eastern North America. Thing is, you must have good equipment.

Some TA's like Bordeaux, France (1205 kc), and the VOA's Munich outlet (1196 kc) can be had simply through use of a high-Q set. But because of Europe's 9-kc channel separation (539, 548, 557 etc.), many stations are separated from U.S. stations by only a kilocycle or two. To log these, you'll need crystal selectivity. Only communications receivers have this feature and, new, they'll cost you a pretty penny. One way out, of course, is to shop around for a used model.

Transpacific stations (those in Asia and Oceania), on the other hand, usually operate on the same 10-kc channels we have in the U.S. But to hear them you must catch one of these frequencies wide-open domestically—or with a minimum of activity on it.

Our final pair of categories both are domestic. The 1230-, 1240-, 1340-, 1400-, 1450- and 1490-kc outlets all are classified as graveyard channels. On each, several dozen North American stations operate with a maximum nighttime power of 250 watts. These frequencies always are laden with QRM and reception beyond 500 miles is difficult.

In Canada, meanwhile, we find a flock of flea-power transmitters. Most of these relay the CBC networks, almost never identify themselves individually and have powers somewhere between 20 and 40 watts. With luck on a Monday morning, you might pick up CBLC/CBLK (1090 kc) at Chapleau/Kirkland Lake, Ont.; CBRF/CBUD (1080 kc) at Furnie/Castlegar, B.C.; or CBFG (1420 kc) at Gaspé, Que.

Station CFSE, mentioned earlier, also belongs in this group. But, unlike the others, it's operated by RCAF personnel and *does* identify itself regularly.

All set for a great season of BCB DXing? Our table at right contains the cream of the crop, so start pulling them in! —

EI's GUIDE TO BROADCAST-BAND DX

| KC | CALL | STATION | LOCATION |
|------|--------|--|--|
| 605 | HJKL | R. Nueva Granada | Bogota, Colombia |
| 615 | YNM | Radiodifusora Nacional | Managua, Nicaragua |
| 625 | TIRICA | R. Internacional de Costa Rica | San Jose, Costa Rica |
| 640 | TGW | R. Nacional | Guatemala City, Guatemala |
| 647 | | B.B.C. | Daventry, England |
| 650 | YVQQ | Ondas Portenas | Puerto la Cruz, Venezuela |
| | KORL | KORL | Honolulu, Hawaii |
| 655 | YSS | R. Nacional | San Salvador, El Salvador |
| 660 | KFAR | KFAR | Fairbanks, Alaska |
| 665 | | Emisora Nacional | Lisbon, Portugal |
| 670 | JOBK | N.H.K. | Osaka, Japan |
| 674 | | R.T.F. | Marseilles, France |
| 680 | WAPA | WAPA | San Juan, Puerto Rico |
| 683 | | R.N.E. | Sevilla, Spain |
| 720 | | R. Jamaica | Kingston, Jamaica |
| 730 | VP4RD | R. Trinidad | Port of Spain, Trinidad |
| 746 | | R. Nederland | Hilversum, Netherlands |
| 755 | | V. West | Lisbon, Portugal |
| 760 | ZFY | R. Demerara | Georgetown, British Guiana |
| 764 | | S.B.C. (reports go to Berne) | Sottens, Switzerland |
| 770 | 3LO | 3LO | Melbourne, Australia |
| 780 | 4YA | 4YA | Dunedin, New Zealand |
| 782 | CSB9 | R. Miramar | Miramar, Portugal |
| 795 | | R. Barbados | Black Rock, Barbados |
| 800 | IYZ | IYZ | Rotorua, New Zealand |
| 818 | | UARBS | Cairo, Egypt |
| 820 | HJED | La Voz de Rio Cauca/CaRaCol | Cali, Colombia |
| 825 | YNOL | Ondas del Luz | Managua, Nicaragua |
| 830 | | R. Caribbean | Castries, St. Lucia, Windward Islands |
| 834 | | R. Belize | Belize, British Honduras |
| 836 | | R.T.F. | Nancy, France |
| 845 | | R.A.I. | Rome, Italy |
| 854 | OAX4A | R. Nacional | Lima, Peru |
| 863 | | R.T.F. | Paris, France |
| 870 | WHOA | WHOA | San Juan, Puerto Rico |
| | KAIM | KAIM | Honolulu, Hawaii |
| 880 | TGJ | R. Nuevo Mundo | Guatemala City, Guatemala |
| 895 | OBX4Z | R. El Sol | Lima, Peru |
| 910 | YVPF | R. Aeropuerto Internacional | Caracas, Venezuela |
| 935 | | R.T.M. | Agadir, Morocco |
| 989 | | R.I.A.S. | West Berlin, Germany |
| 998 | | R. Andorra | Andorra |
| 1007 | | R. Nederland | Hilversum, Netherlands |
| 1013 | HOU | La Voz del Baru | David, Panama |
| 1020 | YVQB | R. Cumana/Cadena Rumbos | Cumana, Venezuela |
| | TGUX | La Voz Panamericana | Guatemala City, Guatemala |
| | TIAC | R. Fides | San Jose, Costa Rica |
| 1025 | | 4VEH | Cap Haitien, Haiti |
| 1035 | | Faro del Caribe | San Jose, Costa Rica |
| 1075 | TIFC | B.B.C. | Droitwich, England |
| 1088 | | R. Punto Fijo/Cadena Rumbos | Punto Fijo, Venezuela |
| 1110 | YVNN | R. Corporacion | Santiago, Chile |
| 1140 | CB114 | WITA | San Juan, Puerto Rico |
| | WITA | V. America (reports to Washington, D.C. 20025) | Poror, Philippines |
| 1165 | | R. Americas | (clandestine) |
| 1185 | HRVW | La Voz de Centro America | San Pedro Sula, Honduras |
| 1196 | | V. America/RIAS (see previous listings for address) | Munich, West Germany |
| 1205 | | R.T.F. | Bordeaux, France |
| 1214 | | B.B.C. | Brookmans Park, England |
| 1367 | | R.T.F. | Lille, France |
| 1375 | | R. St. Pierre | St. Pierre & Miquelon Islands |
| 1466 | 3AM2 | R. Monte Carlo | Monte Carlo, Monaco |
| 1575 | | R. Union | Santo Domingo, Dominican Republic |

This listing includes the most interesting of those foreign stations regularly heard in the U.S. and Canada. Unless otherwise noted, reports simply may be addressed to the station at the location listed. Many Latin American stations operate on the same frequency, so it will pay you to be sure of your identification before reporting.

Tune CW or SSB on any radio with EI's **UNIVERSAL BFO**

By FRED BLECHMAN, K6UGT

COMES the day when you want to listen to code or single-sideband signals on the short-wave bands but you don't have the right kind of radio. Maybe you're on vacation or visiting someone and your communications receiver is far away. Or perhaps you just don't own one.

What you do have access to is a broadcast radio that also covers some SW bands. Trouble is, it has no beat-frequency oscillator and without BFO Morse code comes through as so many thumps and SSB is a bunch of quacking ducks. What do you do?

Why you just put EI's \$3 Universal BFO near that radio and both CW and sideband come through with the snap you'd expect out of a \$500 rig. Only limitation of the Universal BFO is an intermediate frequency of 450 to 460 kc in your receiver. This restriction should affect few radio owners, however, because nearly all tube and transistor radios of the type in question have IF frequencies in this range.

To put the Universal BFO into operation, you merely place the accessory within a few inches of the radio and adjust L1's slug (when listening to a station) until the CW tone suits you. What you are doing is adjusting the frequency of the BFO so it is within, say 1 kc

of the receiver's IF frequency. The BFO's signal radiates into the receiver and beats with the IF frequency to produce the tone.

Construction

Use a plastic box for our BFO. A metal cabinet will prevent the signal from radiating. The wiring is not critical and any reasonable parts arrangement should work.

Don't try to mount loopstick L1 directly on the brittle plastic box. Instead, use the bracket usually supplied with it or make a right-angle bracket from scrap aluminum. The switch, output jack and battery holder can be mounted with screws or glued to the inside of the box. The pictorial's caption has additional construction details.

Operation

Tune in *any* station on *any* band of a radio with a 450- to 460-kc IF frequency. Bring the BFO near the radio and adjust L1's slug until you hear a loud whistle. The loudness of the whistle will depend on the position and distance of the BFO with respect to the radio. But be careful. If the BFO's signal is too strong it will block the radio's input and prevent other signals from getting through.

On the other hand, if you get no reaction,



connect the BFO's output at J1 directly to the receiver's antenna terminal.

Once you have found the correct position, tune the radio until you hear the thumping sound of CW or the quacking sound of an SSB signal. CW is easy to tune with L1 but SSB will take a bit of practice. With patience you'll be able to convert the quacking into understandable conversation. While the BFO's stability isn't quite up to that of sets with built-in BFO's, it is adequate for this application.

Once you get the knack of it you'll be able to take the BFO along with that all-band portable to the beach or wherever you travel and have the operating convenience of your receiver at home.

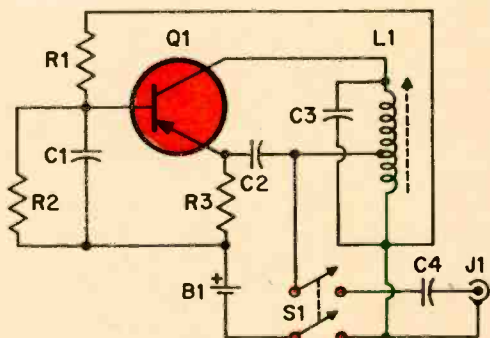

BFO is a Hartley oscillator whose operating frequency can be varied with L1's slug. If signal radiated by L1 cannot be heard in receiver, connect a lead from J1 to receiver's antenna post.

PARTS LIST

- B1—1.5-volt penlite battery (size AAA)
- C1, C2, C4—.0015 mf, 500 V ceramic disc capacitor
- C3—680 mmf, 500 V ceramic disc capacitor
- J1—Phono jack
- L1—Tapped antenna coil (Lafayette MS-299)
- Q1—2N1307 transistor
- R1—68,000-ohm, 1/2-watt resistor
- R2—10,000-ohm, 1/2-watt resistor
- R3—1,000-ohm, 1/2-watt resistor
- S1—DPST slide switch
- Misc.—Battery holder, plastic box

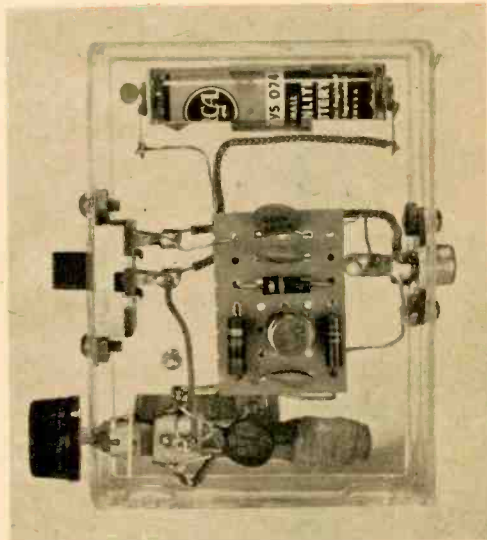

Take it easy when drilling the holes to mount the jack, switch, battery holder and the coil's mounting bracket or the plastic box will crack.

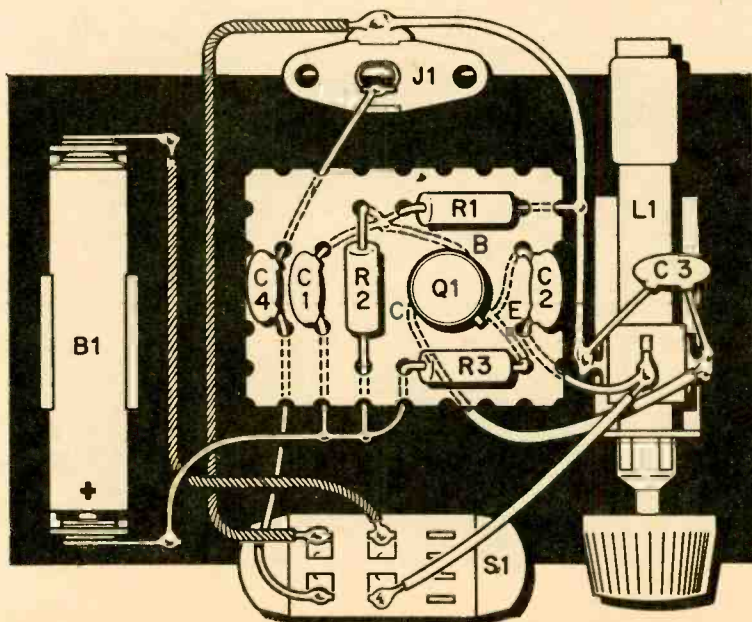

Mount the battery holder, output jack, switch and coil in the plastic box first. Then install the other parts on a 1 × 1½-inch piece of perforated board. The board is supported by the leads to and from B1, S1, J1 and L1. Use spaghetti on all wires that cross each other.

INSTANT LINGOS

WE'VE HEARD of a big department store that claims to speak 42 different languages, but rare is the American who can mouth more than one. Thing is, if you're exposed to another language enough times and in the right ways, you likely will end up speaking it like a native. But learning another lingo in a nation where English is king can be pretty rough.

Latest arrival on the lingo-learning scene is such a natural it's just bound to make things a good bit easier for the would-be foreign-language speaker. That something is the electronic language lab which, thanks to magnetic tape, comes close to being the best language instructor yet. Matter of fact, if there's ever been a revolution in lingo-learning, we're smack in the middle of one right now. And electronics is the little something that has made it possible.

How It Began. When you come right down to it, a language lab amounts to an effort by educators to get languages out of books and

into mouths and ears where nature put them in the first place. And, while this is what good teachers always have done, credit for the world's first language lab could go to a Britisher.

Some 22 years ago, an English electronics engineer named F. Paul Thomson put on his thinking cap, called on his past experience and came up with one of the forerunners of today's language lab. Thomson had learned a good deal about language instruction before World War II, when he helped teach German-Jewish refugees to speak English. Tossing this knowledge into the hat along with his electronic know-how, he eventually devised a full-fledged language lab.

Listen And Learn. Electronic language labs can take about as many forms as there are languages, but all have certain common aspects. Big thing about any language lab, according to one educator in the field, is that it enables students "to learn foreign tongues the same way they learned their

Electronic language lab at Cornell University makes lingos easy to teach, easy to learn. Machine (lower center of photo) is equipped with a special start/stop/repeat switch which places it under complete control of instructor. Students shown here are engaged in group-practice session.



native English—by hearing, imitating and speaking.” And it’s because of this need to hear, imitate and speak that most every language lab depends on the one medium that’s made to order for such activities—magnetic tape.

To see just how tape helps the lingo learner, let’s take a look at a language lab recently installed at the College of New Rochelle, a girls’ school in a New York suburb. Based on the listen, repeat and learn maxim, the lab is comprised of 30 individual student booths and an instructor’s console.

Because of the way the booths are set up, the linguists-in-training take a particularly active part in what’s going on. They can respond appropriately while hearing lesson material and instructions over earphones installed in each booth. Further, by means of microphones and dual-track record/playback equipment also installed in each booth, they can record lessons on one track and responses on another.

Once the lessons are complete, the students play back their tapes to compare their pronunciation, grammar and vocabulary with their instructor’s. And since the students’ section of the two-track tape can be erased and re-recorded at will, students can

go over lessons as many times as necessary to improve vocabulary, perfect accents or sharpen fluency.

Russian Without Tears. In another instant-lingo setup—this one at Cornell University—there’s a veritable battery of electronic language-learning equipment. Matter of fact, it’s just plain impossible for foreign-language students *not* to get plenty of conversational practice in large doses and small classes.

Using discs, tapes and even scopes—to make the spoken sound visible as well as audible—the school now is turning out the foreign-language adept at a highly accelerated rate. Lessons are piped through microphones into a bank of recorders which can prepare enough oral-study materials for 100 students at a time. And, thanks to magnetic tape, none of the foreign-language instructors is faced with the tedium of repeating words and phrases over and over. The tapes can be replayed as often as a student wishes.

Perhaps the most valuable electronic adjunct to the Cornell lab is an all-band short-wave receiver. Feed its output into a tape recorder and advanced students can have just about any modern language, straight from the mouths of real experts.

—C. Hansen

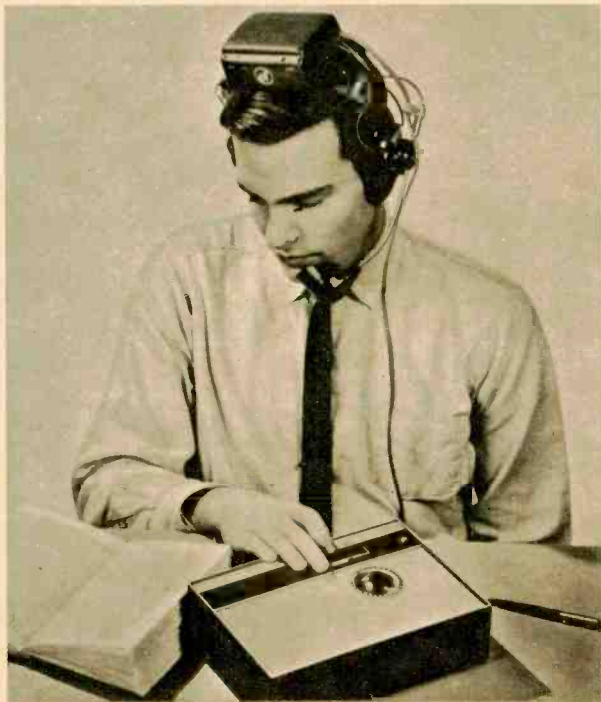

Portable language lab (left) includes book-size tape recorder and headset assembly containing earphones, miniature radio receiver and mike. But even such modern devices can't get around one of the chores of mastering Chinese (above)—learning to read and write the traditional characters.

6-Meter Converter



SOONER or later most hams get the urge to move up in the world—up to 6 meters, that is. But since many communications receivers just can't fly that high, it usually takes a converter to pull in the band. You merely connect the converter to the receiver's antenna terminals and tune the 6-meter hand on the receiver itself.

The Ameco CB-6K 6-meter converter fills the bill perfectly. Not only is it easy to build, but it performs exceedingly well. Price is \$19.95, while the optional PS-1K matching power supply kit will run you \$10.50. And for those who prefer the easy way out, factory-wired versions are also available at \$27.50 and \$11.50, respectively.

The CB-6K is a very hot unit. In fact when it was connected to a Lafayette HA-63 communications receiver (used for test purposes), sensitivity and performance on 6 meters was better than the receiver was capable of on any of its other bands.

The manufacturer claims a noise figure of better than 4db. Although we were not able to make absolute measurements, the performance of the CB-6K bore this out. The CB-6K uses a 6ES8 cascode RF amplifier.

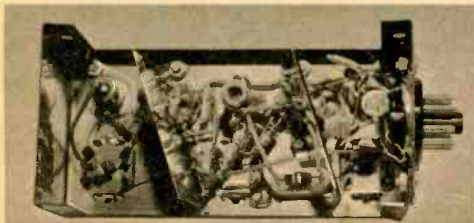

Underside of CB-6K. Note two vertically-mounted plates used to shield stages from each other.

And cascode amplifiers are highly regarded for their low noise, high gain and broad bandwidth. We found the sensitivity varied

less than 1.5db across the entire 6-meter band. Spurious response and image rejection are excellent—better than 70db. The RF amplifier is followed by a 6U8 which functions as the mixer and crystal-controlled local oscillator.

A unique feature of the CB-6K is that it can be used with virtually any receiver. By simply plugging in the proper crystal and selecting the appropriate tap on the output coil, the converter will work with any receiver that operates on any frequency from 600 kc to 35 mc. Crystals are available (choice of one is supplied with the kit) for the following outputs: .6-.16 mc, 7-11 mc, 10-14 mc, 28-30 mc and 30.5-34.5 mc.

The CB-6K is a snap to operate. You simply connect an antenna to its input and connect its output to the receiver's antenna terminals. For example, if you use a 43-mc crystal, 50 mc will come in at 7 mc on the receiver's dial, 52 mc will come in at 9 mc and 54 mc will come in at 11 mc. The CB-6K can be powered from the receiver or the PS-1K power supply into which the CB-6K plugs directly.

The CB-6K is not difficult to build. If you haven't worked with high-frequency equipment, keep in mind that leads must be kept as short as possible and follow the layout exactly. There are several steps that require that connections be soldered to the chassis. For these we recommend a heavy-duty iron. Nothing will spoil a good noise figure faster than a bad solder connection. We built the converter in about 6 hours and the power supply in about 1 hour.

Alignment is tedious but not impossible. Be very careful with it, and to be on the safe side, repeat the procedure a couple of times. And don't try any shortcuts to improve alignment. Ameco's procedure is the best way. 

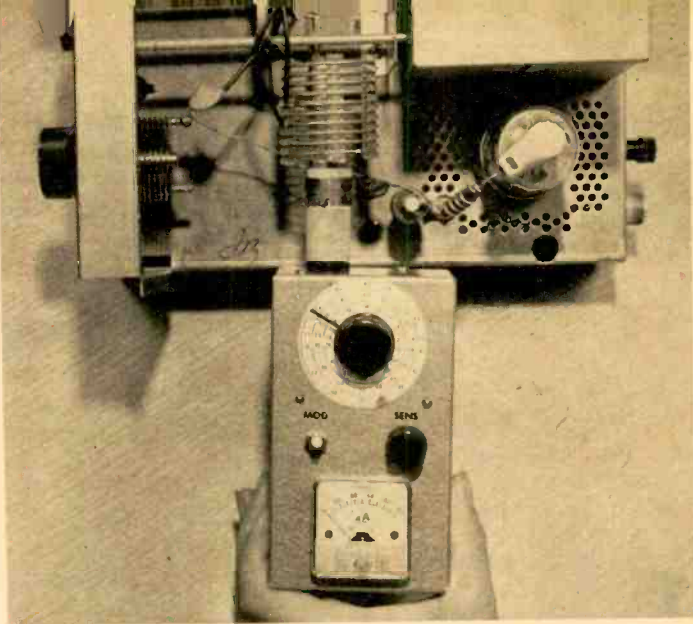

All-Transistor **MODULATED DIPPER**

A portable handful of modulated RF all the way from 3.4 to 108 mc!

By HERB FRIEDMAN, W2ZLF

THOUGH the grid-dip oscillator, a gadget most people call a GDO, is among a ham's most valuable service instruments (see USING A GDO, Sept. '63 EI), it has two built-in shortcomings. First, practically all commercial GDO's selling for less than \$100 operate on AC power. This prevents them from being used in mobile service. Secondly, most GDO's don't have built-in modulation. Use the GDO as a signal generator and you'll see quickly that locating an unmodulated signal on a receiver can be mighty frustrating.

EI's transistorized Modulated Dipper solves both these problems for less than \$25. The Dipper is neatly portable since it is powered by a 9-volt battery. The built-in modulator makes its buzz-saw-like signal easy to find. Using six plug-in coils, its range is about 3.4 to 108 mc. The accuracy depends on how carefully you wind the coils.

Construction. Component placement is critical and the pictorial must be followed exactly. Start off by drilling the holes for tuning capacitor C2 so the shaft is centered 1½ inch from the top of the cabinet. The shaft must not touch the cabinet; therefore, make certain its shaft hole is large enough

to allow for play in the mounting-screws.

Next, mount coil socket SO1 with pin 3 nearest the front panel (bottom of the main section of the Minibox shown in the pictorial). Keep Q1's leads short and be sure to use a heat sink on them when soldering. Punch M1's hole at the bottom of the cabinet with a 1½-inch chassis punch. If you plan to limit the Dipper's range to 50 mc, M1 can be a 100 µa meter. For operation above 50 mc, M1 must be a 50 µa meter.

The modulator is built on a 1 $\frac{7}{8}$ x 1¼-inch piece of perforated board; flea clips are used for tie points. Mount T1 by fitting its tabs through two holes made with a No. 30 drill and then bend the tabs flat. T1's yellow and green leads should be clipped short. If, upon use, you find the buzz-saw modulation sound too harsh, replace R3 temporarily with a 250,000-ohm potentiometer. Adjust the pot (from the maximum-resistance position) for the desired tone. Do not let Q2's collector current exceed 6 ma. Then substitute a fixed resistor for the pot.

When mounting the modulator assembly with two L brackets, make certain it doesn't prevent C2 from being rotated to minimum

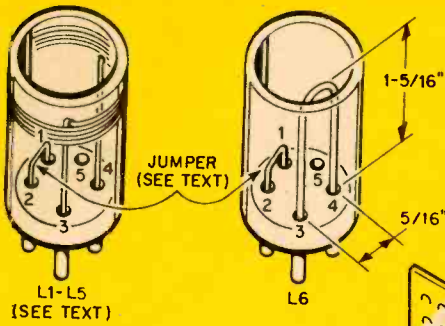

Start winding coils L1-L5 at top of form under the ridge and in line with pin 3. Coil L6 is a large loop of wire whose dimensions are critical. Copy layout at right to avoid problems.

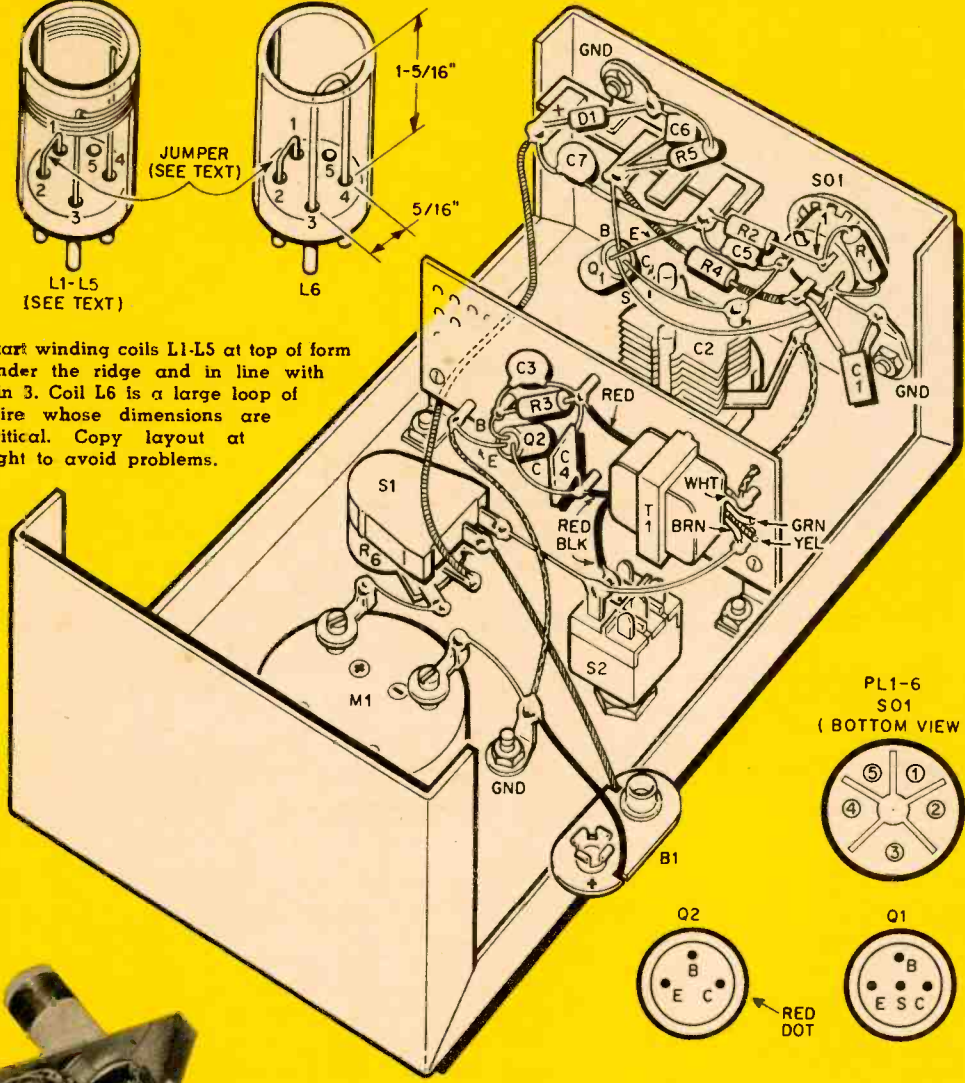

PL1-6
S01
(BOTTOM VIEW)

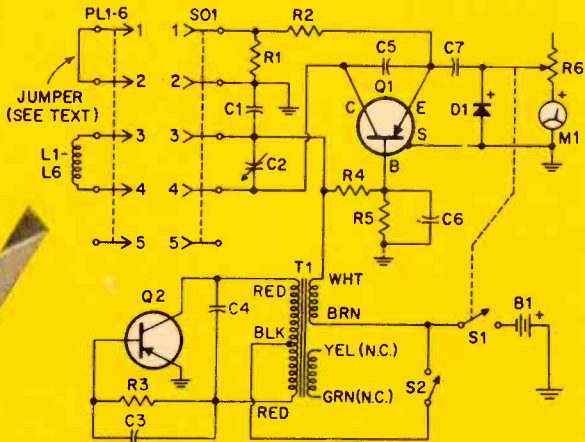
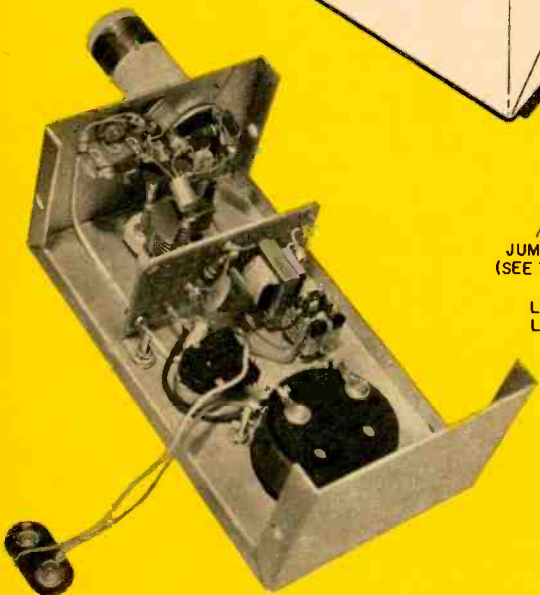
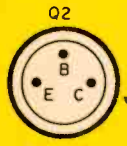
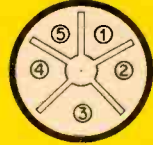

Install all parts around C2 and coil socket before mounting modulator board (center). Wire modulator before installing in 5 1/4 x 3 x 2 1/8-inch Minibox.

When C2 is adjusted so Q1 oscillates at frequency of external tuned circuit, RF is pulled from dipper. Voltage at emitter drops and M1 dips.

MODULATED DIPPER

capacity (plates fully open).

Winding the Coils. The plastic coil forms are sensitive to heat, so you must use a low-wattage iron when soldering to the pins. If you apply too much heat and the plastic starts to melt, moisten a fingertip and hold the pin in position until the plastic hardens.

Both ends of each coil except L6 should be soldered this way: scrape away 1/2 inch of the enamel insulation and tin the exposed wire. Apply a non-corrosive soldering paste to the wire and pass it through the coil-form pin so a quarter-inch of the wire is exposed. Build up a bubble of solder on the tip of the iron and dip the exposed wire in the bubble quickly. The instant you see the solder run up the wire into the pin, remove the heat.

The wire must be tensilized before the coil is wound. To do this, unwind slightly more wire than is needed for the coil and clamp the free end in a vise. Then stretch the wire until it goes slack when the tension is removed. The coil now can be wound without the wire springing back.

One-eighth of an inch from the top of the coil form is a ridge which is used to hold the coil in place. Using a No. 36 drill, make

a hole just below the ridge in line with pin 3. Put the wire through the hole from the outside and solder it to pin 3. Wind the required number of turns as tightly and as closely as possible. Drill another hole at the bottom of the coil and solder the other end of wire to pin 4. Coils 5 and 6 have a jumper connected between pins 1 and 2. If you cannot obtain sufficient meter deflection with coil No. 4, add a jumper to it.

Coil No. 6 is just a loop made from a piece of No. 16 wire *exactly* 3 1/4 inches long. Grasp the center of the wire with needle-nose pliers and bend it into a loop 5/16-inch wide. Tin and thoroughly flux the ends of the loop and fit it inside the coil form so the ends are flush with the bottom of pins 3 and 4. Dip the pins into a bubble of solder just long enough to fill them with solder. If the pins don't fill on the first try, build up a small bubble of flux on the pin ends and try again. When all the coils are wound, coat them with radio service cement or Q-Dope.

Calibration. Cut a 2 1/8-inch diameter heavy-paper disc and cement it to the cabinet around C2's shaft. Drill a small hole in a knob just large enough to give a tight fit to a short piece of wire and cement (epoxy) the wire in the hole. Place the knob on C2 so the wire points to the 3 o'clock position when C2 is open fully.

[Continued on page 116]

PARTS LIST

- B1—9 V battery
Capacitors: ceramic disc, 50 V or higher
 C1, C6—.01 mf
 C2—3.9-50 mmf miniature variable capacitor (Hammarlund APC-50B; do not substitute)
 C3—.04 mf C4—.05 mf
 C5—5 mmf C7—33 mmf
 D1—1N34A diode
 L1-L6—Coils, wound on PL1-PL6: see text and coil-winding table
 M1—0-100 μ a DC microammeter (see text)
 PL1-PL6—Amphenol 24-5H coil form (Allied Radio 46 H 693)
 Q1—2N384 transistor Q2—2N217 transistor
Resistors: 1/2 watt, 10% unless otherwise indicated
 R1—3,000 ohms, 5% R2—240 ohms, 5%
 R3—100,000 ohms R4—33,000 ohms
 R5—3,300 ohms
 R6—500,000 ohm miniature pot with SPST switch (Lafayette VC-39 or equiv.)
 S1—SPST switch on R6
 S2—Subminiature DPDT toggle switch (Lafayette SW-76) or equiv.)
 SO1—Amphenol 78-S55 5-prong socket (Allied Radio 40 H 122)
 T1—Transistor output transformer: primary, 500 ohms; secondaries, 8 ohms and 3,000 ohms (Lafayette TR-119; page 305, catalog No. 640)

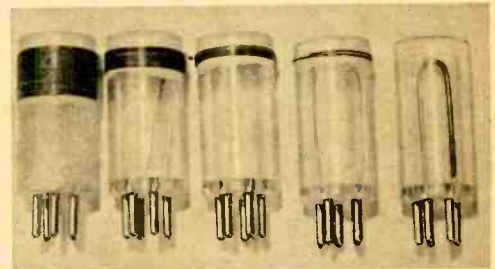

Coils are shown in order from No. 2 (left) to No. 6 (right). Coil No. 1 (3.4-6.9 mc) is not shown.

COIL DATA

| Coil No. | Frequency Range (mc) | Wire Size* | No. of Turns |
|----------|----------------------|------------|--------------|
| 1 | 3.4-6.9 | #28 | 48 1/4 |
| 2 | 6.7-13.5 | #24 | 22 |
| 3 | 13-27 | #24 | 9 1/8 |
| 4 | 25-47 | #24 | 4 1/8 |
| 5 | 46-78 | #24 | 1 1/2 |
| 6 | 78-110 | #16 | See text |

*All wire enameled

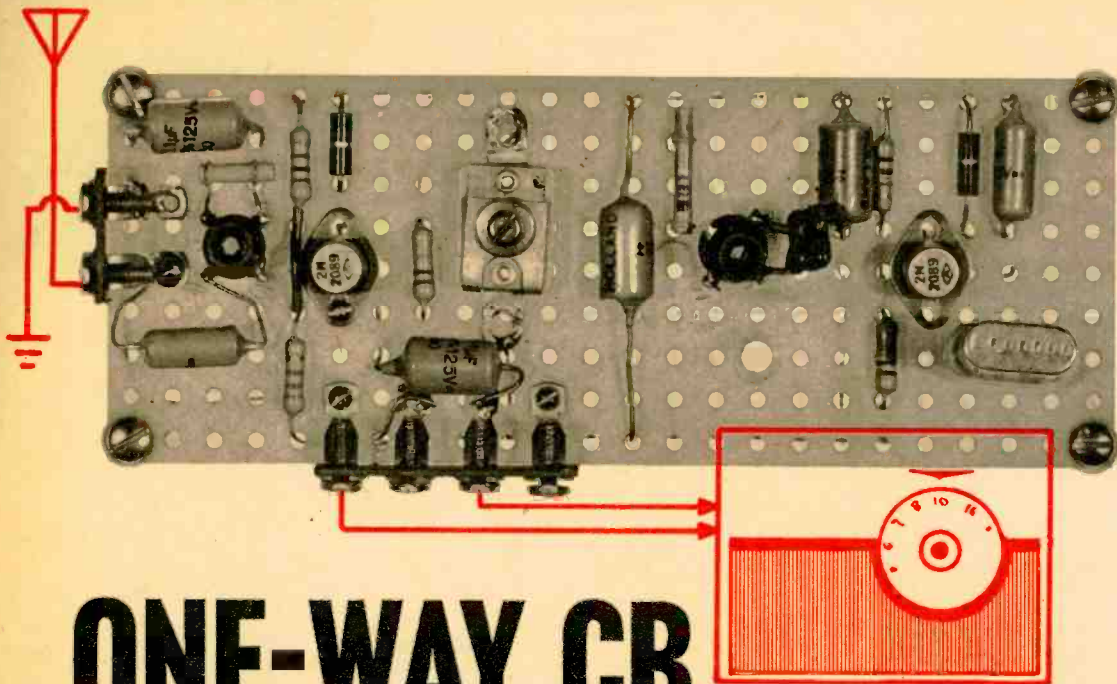

ONE-WAY CB

By KEVIN REDMOND, K2HTZ

NO ONE will deny that the Citizens Band has put two-way radio within the reach of everyone who needs it. But not everybody does. For some CBers, *one-way* radio is sufficient, essential—and economical.

For example, when you're driving home you may want to tell your wife what time you will arrive. You know your range and that your signal will get there if the channel is clear. Your wife doesn't have to come back and tell you she got the message. *And* you save the cost of one 5-watter. The transceiver in your car is the only one you buy if you have a receiver at home. You simply come on, give your call, transmit your message and go off. Nothing in the FCC's rules requires that receipt of the message be acknowledged.

That's one-way radio, and what you need at home obviously is an economical receiver, which can have many other uses in addition to the one we've just outlined. For instance, you may simply want to monitor the Citizens Band. Or, if you do have 5-watters everywhere, a second receiver will permit you to monitor one channel while you're working on another.

The answer to your need is our simple CB converter which feeds CB signals through any standard AM radio. And it doesn't require modification of the radio, either. Just connect the converter to the radio's antenna ter-

minals and tune the CB channels around 1,000 kc on the radio's dial. The converter includes a separate oscillator to reduce blocking and to prevent radiation from the antenna. A small 12-volt battery (Eveready 228 or equivalent) will power the converter for a long time because of the low current drain.

Construction

Our converter was built on a 6½x2½-inch piece of perforated board on which ceramic standoff insulators were attached at the corners. The standoffs can be used to mount the board in most any enclosure since both ends are tapped for machine screws. The converter could be mounted in the main section of a 7x5x3-inch Minibox. The terminal strips and a power switch then would be mounted in the ends of the box.

The converter has been laid out so the antenna terminals are near the mixer stage, far away from the oscillator, to reduce radiation pickup. The negative DC supply buss runs along one side of the board and the positive, or ground, buss runs along the other side. Both busses are at AC ground since there is a .1 mf capacitor (C6) connecting them. This layout permits a neat, square arrangement of all parts and provides for convenient grounding anywhere on the board.

Start winding L1 (far right) on its form at lug you call D. Wind 1 turn, pull out a loop, twist it and connect it to adjacent lug, C. Continue winding and 5 turns later pull out another loop, twist it, and connect it to adjacent lug B. Wind 20 more turns tightly and solder to remaining lug, A. L2 is wound similarly. If you can't tune L2, add a .1 mf capacitor from its lug D to gnd.

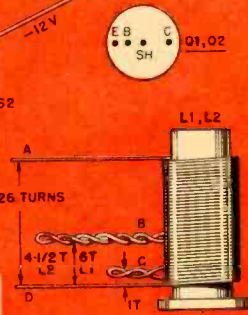
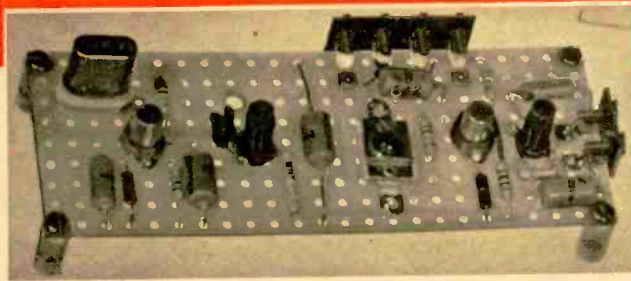
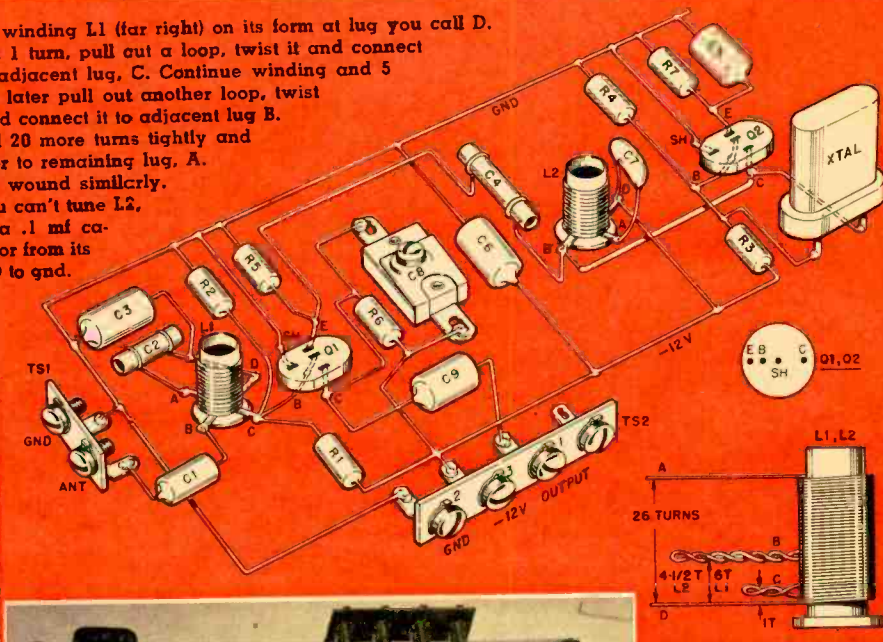

Coils L1 and L2 (above) must be evenly wound so turns don't overlap. Coat coils with coil dope. Try to follow layout shown in pictorial and photo as closely as possible to preserve performance characteristics. Converter could be built in a 7x5x3-inch Minibox.

Be sure to use spaghetti on the leads of all components that cross each other. Capacitor C8 can be left out when the converter is used with portable or AC/DC radios. More about C8 later.

The lugs on the coil forms for L1 and L2 should line up with the holes in the perforated board. If they don't, a little filing will do the trick. Additional coil-winding details are covered in the pictorial's captions. Care must be exercised when bending the lugs on the coil forms to prevent separating them from the base of the form.

Adjustment and Operation

It is important that the mixer stage's (Q1) current be .5 ma. A higher current will cause Q1 to saturate. If the current is less than .5 ma, the gain will be reduced. To check this, measure the voltage drop across R6. It will be 5 volts if the current is correct.

The oscillator stage's current should be 3 ma with the crystal removed. This will cause

a voltage drop of .6 volts across R7. The RF voltage injected at the emitter of Q1 is approximately 200 mv (.2 volt), although satisfactory mixing will take place if the voltage is from 100 to 300 mv (.1 to .3 volts).

After connecting the converter to the radio (hot end of a loop or ferrite-rod antenna) through a .1 mf capacitor and hooking an antenna to TS1, adjust C8 (if used), L1 and L2 for maximum output while listening to a CB station. The converter need not be retuned once it is peaked. You tune the AM radio to select different CB channels.

If an AC/DC or portable radio is not shielded properly it may pick up broadcast stations at the same time it receives CB stations from the converter. The loop antenna on AC/DC and portable radios, therefore, should be shielded by placing the antenna in a grounded metal enclosure which can be made of aluminum foil.

Normally, reception of broadcast stations will be minimized when the output of the

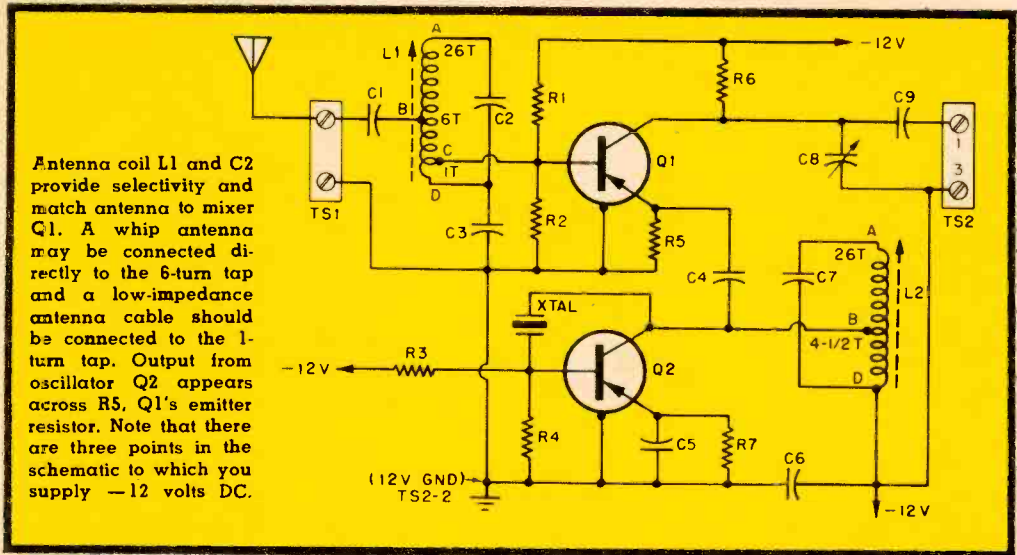

ONE-WAY CB

converter is connected to the hot end of a loop antenna. This is because of the loading effect of the converter on the loop antenna.

One-way CB is not limited to an installation in which the 5-watter is in the car and the receiver is at home. You could just as well have your 5-watter in a store or office and the converter connected to your car radio. With this setup there are a few special points to keep in mind.

Instead of using a small 12-volt battery for operating power, the converter now can be operated from the car's battery. If the car has a positive-ground electrical system, the converter can be connected directly to the car radio's antenna terminal. If the car has a negative-ground electrical system, connect a .1 mf isolating capacitor between the converter's output and the car radio's antenna input. Capacitor C8, which is not necessary when the converter is used with portable and AC/DC radios, should now be added to compensate for the car radio's antenna-cable capacitance, which is about 40 mmf.

How does the converter perform? Since the author used the converter with his car radio his measurements are based on this type of operation. The average car radio has a sensitivity of approximately 2 microvolts for a 1-watt output. (Because of such gain, the converter's circuit was greatly simplified.)

PARTS LIST

- Capacitors: All 50 v or higher
 C1—.047 mf C2—10 mmf
 C3, C5, C6, C9—.1 mf C4—100 mmf
 C7—6.8 mmf
 C8—9-180 mmf trimmer capacitor
 L1—Antenna coil: 26 turns No. 28 enameled wire tapped at 1st and 6th turn; wound on Cambridge Thermionic Corp. coil form No. 2173-4-3 (Newark Electronics Stock No. 40F3629)
 L2—Oscillator coil: 26 turns No. 28 enameled wire tapped at 4½ turns; wound on same type coil form as L1.
 Q1, Q2—2N2089 transistor (Amperex)
 Resistors: ½ watt, 10%
 R1—33,000 ohms
 R2, R4—1,000 ohms R3, R6—10,000 ohms
 R5—100 ohms R7—220 ohms
 TS1—2-lug, screw-type terminal strip
 TS2—3-lug, screw-type terminal strip
 XTAL—26 mc third-overtone crystal (Texas Crystals or International Crystal)
 All the above parts plus coil wire, perforated board and standoffs are available from PR labs., So. Hillsdale Avenue, Nesconset, N. Y., for \$12.50 postpaid.

With a 1-microvolt input signal (modulated 30 per cent) at the base of mixer-transistor Q1, the car radio will deliver the identical 1 watt of audio power.

For even better CB reception, the converter can be combined with the CB booster described in the March 1963 EI (see CB SIGNAL BOOSTER, page 32). The low-impedance output tap of the booster should be connected to the low-impedance tap (first turn) on L1 in the converter. This combination with an ordinary broadcast receiver is equivalent to a really hot CB receiver.

Major Armstrong

Continued from page 88

Armstrong ran into trouble and competition from TV in obtaining an FCC license to build his station. There also was a problem with the frequency band allotment over which he could broadcast. But even as he was enjoying the opportunity to build his station, he continued making improvements in the FM system. Twelve additional patents were issued.

Meanwhile, others had become interested and FM broadcasting was on the upswing. Armstrong's first broadcast had evaporated the backstairs claims that FM never would work. Subsequent hearings before the FCC, prompted by RCA's demand for television bands, provided additional bands for FM.

Armstrong had won. His stamina, courage and resources had placed his invention before the public. And he had done so despite the lineup of RCA, American Telephone & Telegraph and others who obviously wanted to protect their interests in AM broadcasting. But World War II was in the offing and once again Armstrong was to face radical changes in the course of his life.

World War II put all FM stations off the air. Armstrong's energies were devoted to war work, some of it still secret. The dream he had for FM was held in abeyance.

Following the war he learned quickly that the battle lines had been re-formed. Once again he was faced with the personal task of supporting and championing the infant FM industry. Some radio-equipment manufacturers were licensed under the Armstrong patents. Others, including RCA, ignored his patents but manufactured equipment using his system anyway.

Worst of all, FCC membership had changed somewhat. Political interests moved into the stream of events. And the frequency bands the FCC previously had allotted for FM were changed, making obsolete every station and every receiver then in existence.

Armstrong criss-crossed the country, giving talks about FM to arouse civic and fraternal organizations in its support. He even ran full-page ads in newspapers when radio manufacturers produced inferior FM equipment. His resources were being expended just as fast or faster than they were coming in. But he refused to heed the advice of his friends

and attorneys to end the struggle by compromising. This was not part of his nature.

RCA apparently was having some misgivings about continuing the battle. The corporation made several offers to settle the FM patent business once and for all. One offer was for a million dollars. Armstrong stuck to his guns. He refused on grounds that his interests were in royalties, not lump-sum payments.

In 1948 the last legal battle began. During the day-long, five-year period of pre-trial testimony, Armstrong was to sit in the witness stand for hours on end, answering questions put to him by batteries of attorneys. The long period of bantering and bickering preyed on his physical endurance. It took its toll in both his health and spiritual well-being. The effort to hold up under such grueling experiences would have destroyed an ordinary man much sooner.

Marion Armstrong said that during the trial he would come home exhausted. He would retire for a few hours of sleep, then get up at 4 a.m. to read the transcript of the preceding day's testimony. And he would leave early enough in the morning to be briefed by his attorneys before continuing with his testimony.

"This went on for days on end," she has said, "utterly destroying him."

His wife, like so many of his friends, wanted him to "give in, take life easier and retire to the Connecticut home" he had purchased. Armstrong's determination to stick to his principles wouldn't permit him this luxury. He was a fighter and his wish to set "the record straight" was paramount. Besides, Sarnoff had stated on the witness stand that RCA had done more for FM than anyone else. For Armstrong, this represented an invitation to battle to the end.

By 1953 his financial resources were in serious straits. He had been ill for two months. Friends and relatives claimed he was near a breakdown.

No one ever will know what passed through the mind of Major Armstrong on the night of January 31, 1954.

They found his body the next morning on the third-floor extension of the apartment building in which he had lived. He was fully dressed in overcoat, hat, gloves and scarf. Major Armstrong's agonies were over. It was the end of what his biographer has called "one of the great American tragedies."

ELECTRONIC SWAP SHOP

El's Swap Shop provides a way for readers to obtain equipment they want in exchange for items they no longer have use for. Notices must be from individuals, not commercial concerns. Entries must include your name and address as well as a description of what you now have and what you would like in exchange. Address: El's Swap Shop, ELECTRONICS ILLUSTRATED, 67 West 44th Street, New York, New York 10036



**COMING
NEXT ISSUE!!!**

**IN
THIS
VERY
SPOT!!!**

Announcing The

**GRAND
OPENING**

**!! of El's
ELECTRONIC !!**

SWAP SHOP

**HAM, CB, SWL,
HI-FI & STEREO**

Bargains Galore!

If you have some surplus electronic gear you'd like to swap, tell us about it in a letter to El's Swap Shop. See rules above.

Hi-Fi Today

Continued from page 34

in kit versions. And they're also releasing a line of cabinet kits (for speakers and equipment) in pre-finished versions. The new kits are inexpensive, relatively easy to build and beautiful to behold. So shoulder your screwdriver and get to work.

Some brief words about other products:

• From United Audio, two less-expensive variations on the amazing Dual 1009 automatic turntable. For \$25 and \$20 less than their forebear, the Models 1010 and 1011 offer the same foolproof changing mechanism and virtually the same gentle record-handling (they track and trip at 1½ grams) as the 1009. I don't know whether their rumble is as low as the 1009's (which beats even some transcription turntables). However, the basic mechanism and construction look similar.

• From KLH, the Model Sixteen transistor amplifier. KLH claims the Sixteen, at \$219, has a sound that's indistinguishable in most respects from that of the most expensive amplifiers on the market. After a month of listening, I have to agree. Equally important, I have to confirm that this *is* a foolproof transistor amplifier. Short or open the speaker terminals, and you've done nothing to lose sleep over. The amplifier just refuses to be damaged by any of the usual (or unusual) transistor perils.

• From Scott, a Nuvistor/transistor tuner, the 312, with beautiful performance. At a distance of 130 miles, I've pulled in New York stations I'd forgotten existed. And reception has been free of ignition interference (I live a couple of hundred feet off a highway) and other disturbances that no amount of antenna trickery could eliminate. The price is \$259—not cheap, but also not too much for what the 312 offers.

I've managed to run out of space, though I've plenty left to say about what's new on the hi-fi scene. For now, I'll just add (and this is not an adman's hyperbole) that this looks like the best year for audiophiles in a long, long time.

Novo Two Kangaroo

Continued from page 51

These properties make it unnecessary to brace the cabinet. For a more attractive enclosure, use veneered Novoply.

Construction. First thing to do is connect the secondary of a 6.3-volt filament transformer to the woofer and let it hum away for about 12 hours. While the woofer is being worked-in, proceed with the enclosure. The sides, top and bottom are butted together with finishing nails and glue. If veneered Novoply is used, miter the joints and glue and clamp them together.

After the glue has dried, install the $\frac{3}{4}$ x $\frac{3}{4}$ -inch cleats with $1\frac{3}{8}$ -inch long annular nails and glue. The front cleats should be set back one inch from the front edge, while the rear cleats should be set back $\frac{7}{8}$ ths of an inch from the rear edge. Cover the rear cleats with felt weatherstripping.

Cover the face of the front panel with water-diluted Elmer's glue, then place the glued surface over the grille cloth (on a flat table). Pull the grille cloth around the edges and staple it along one long and one short edge first. While stapling the other two edges, pull the cloth tight, keeping the weave as straight as possible.

Tighten the speaker bolts evenly and only finger-tight or you may bend the speaker frames. Connect leads to the terminals of the midrange/tweeter, put a layer of Mortite around the edge of its cover, and mount the cover with 1 x 1-inch angle brackets and $\frac{3}{4}$ -inch flat-head wood screws. Install the front panel's mounting screws through the cleats from the rear.

Crossover choke L1 is wound on a $1\frac{1}{2}$ -inch length of 1-inch diameter wood dowel with $2\frac{5}{8}$ in. square masonite end-pieces. It's held together with a three-inch $\frac{1}{4}$ -20 aluminum or brass (not iron) bolt. Wind the choke (about 1 lb. No. 18 enameled wire) to within $\frac{1}{4}$ -inch of the outside edges of the end pieces. Bolt the coil and glue C1 to the back panel. One of C1's + leads goes to lug 3 on R1, lug 1 on R1 is common and lug 2 goes to the 8-inch speaker. C1 is a dual 50 mf capacitor, whose sections are used as two banks to form a non-polarized capacitor.

Install the back panel with $1\frac{1}{2}$ -inch No. 8 flat-head wood screws and the Kangaroo is ready to go. Happy jumping!



LONG NOSE AND
DIAGONAL PLIERS

look to
Xcelite for
the best in
pliers & snips, too

2-PAIN NOSE ELECTRICIAN'S
PLIERS



COMBINATION
SLIP JOINT PLIERS



SIDE CUTTING PLIERS



UTILITY PLIERS



UTILITY PLIERS



ELECTRONIC SNIPS

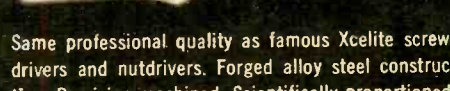

Same professional quality as famous Xcelite screwdrivers and nutdrivers. Forged alloy steel construction. Precision machined. Scientifically proportioned. Variety of sizes. All available with permanent, plastic coated Cushion Grip handles for extra working comfort (except slip joint models).

XCELITE

XCELITE INC. • 16 BANK ST., ORCHARD PARK, N. Y.
Send Catalog Sheet N664 on pliers and snips.

name _____
address _____
city _____ state & zone _____

Dr. Doppler's Strange Effect

Continued from page 30

who is "never able to get their set working right."

Traffic Control. Though various forms of Doppler radar work at a number of jobs, the one that hits us right *here* is the radar speed detector. But there's another vehicle-aimed Doppler Effect instrument that shouldn't hurt anyone's feelings. It's an overhead car detector that can be cantilevered out from a pole or hung across a highway on a wire.

Covering from one to three lanes, the detector can be used for traffic-light control to favor the busiest roads with their fair share of the green light. In addition, the device can supply figures for traffic studies. As each car passes under the radar beam it makes two Doppler blips that rack up one car for the record.

In The Air. Early airplane pilots had a sure method of navigation: they just followed railroad tracks, rivers or roads to where they wanted to go. But for high, all-weather flying and ocean-hopping, something a mite better was needed.

Airways eventually broke out in a rash of different kinds of radio beacons, ranges and other devices. But none told the man at the stick what he really wanted to know. This, of course, was what he once could learn from looking over the side—the direction he's flying and how far he has flown.

Today, Doppler navigation systems do this job, with the advantage that landmarks aren't needed any more. Fact is, such Doppler navigators work over trackless ocean as well as over land.

With a few refinements, these systems operate in somewhat the manner of the radar speed trap, but in reverse. The radar equipment is on the moving vehicle (the plane) and the target is the stationary ground or water, ahead and astern.

Under The Sea. The navigator of a ship, or even a small boat, has almost the same problem as the airplane pilot. Guided by compass and speedometer, he heads for where he would *like* to go. But where he *really* goes depends upon wind and current. Underwater Doppler navigation ties his position down to the bottom and permits accurate steering in zero visibility without need for ex-

ternal navigational aids.

Underwater Doppler navigation works by the frequency-shift of underwater ultrasonic beams bouncing back to the boat from the sea bottom. As in aircraft radar, the echoes are compared in a computer. Fore-and-aft Doppler-shift frequencies are resolved into pulses (through digital circuitry) that actuate a counter for every six feet of forward motion, adding up miles like a car's odometer. Analog circuitry converts sideways shift in frequency to a voltage that registers drift angle on a meter.

Though it's a far stretch from a speed trap on the highway to an underwater navigation aid, these devices are but a handful of the growing Doppler crowd. Further, all these items are a far cry from what Johann Doppler had in mind 120-odd years ago. But they also are good reason why anyone who wants challenge in electronics would do well to look further into Dr. Doppler's strange Effect. 

CB's Flood of Ink

Continued from page 57

of any 10-code symbol is basically the same across the country. Needless to say, this code has contributed much in the way of increasing the use of the band.

The Cenla published by the Cenla CB Radio Club down in Alexandria-Pineville, La., seems to have done something that few other papers have tried. That something was an article listing the monitoring channels of other clubs in the area. This seems a fine idea, for it's an excellent way to avoid needless use of emergency channels. In addition, it's helpful to know which channels in a particular area will be open in case of emergency.

Another Look. Clubs that have fallen by the wayside well might make a comeback by taking a good hard look at their papers. They would do well to ask themselves: "Do we need a club paper? Are we helping the club with our present publication?"

The answers well may indicate what is wrong and where improvement is in order. One of the best sources of comparison is other CB papers. Most clubs will exchange papers on a paper-for-paper basis. From these it's a simple matter to judge for yourself what is good and what is not-so-good in the CB paper business.—Rufus Cartwright 

Ham Shack

Continued from page 69

LSB. Result is that we can continue QSO's that otherwise would be hopeless. Granted, this is no 100% cure for QRM, though it does work in many cases. Only effort involved is turning the sideband selector switches on the receiver and transmitter.

Red-Face Department . . . An irate woman in New Orleans complained so often and so noisily about amateur interference with her TV and radio reception that the FCC finally sent an engineer around to investigate. But was a ham at fault? Not this time. Wanna guess what was? A sputtering thermostat in the lady's own refrigerator, no less!

Any Age Goes . . . No. 1 question asked by prospective hams and by parents anxious to get their teen-age children interested in electronics is, "How old must you be to obtain a license?" Answer is the same as it's been for more than 50 years (and the same as we've said before in this corner): there's no age limit of any kind.

\$2.00 Transistor Tester

Continued from page 48

at one of S4's positions and not at the other. If P1 lights when S4 is set to NPN, the anode is connected to the collector clip and the cathode is connected to the emitter clip. If the diode has been connected the other way, P1 will light when S4 is set to PNP.

If the bulb does not light at either setting of S4 the diode is open. If P1 lights (full brilliance) when S4 is set to either PNP or NPN, the diode is shorted. If P1 lights brightly at one setting of S4 and dimly at the other, the diode is leaky and useless.

Transistors which are open or have low gain still may have a perfectly good and useful diode junction. A transistor's PN junctions are either collector-base or emitter-base. If the transistor is a PNP type, the base lead is the cathode and both the collector and emitter leads are anodes. In NPN, it's the opposite. The good junction can be determined with the tester in the way you check a diode. Power-transistor junctions can be used as rectifier diodes in power supplies.

LATEST SAMS BOOKS FOR EVERYONE IN ELECTRONICS

Use This Handy Order Form

- Electronic Gadgets for Your Car.** Practical projects for building a tachometer, transistorized battery checker and charger, handbrake protector, and other automotive electronic devices. Easy to build from readily available parts. Order CAR-1, only \$2.95
- Tape Recorders—How They Work.** New 2nd edition. Fully explains principles of magnetic recording, various types of recorders, mechanisms and components, testing procedures. Best reference book on the subject. Order TRW-2, only \$3.95
- Two-Way Mobile Radio Handbook.** Completely revised and enlarged. Latest coverage of 2-way radio equipment; explains basic system theory and operation; describes receivers; transmitters; control systems; power; servicing. Practical, complete information on 2-way radio. Order MRS-2, only \$3.95
- TV Receiver Tube Usage Guide.** Lists tubes, fuses and semiconductor diodes used in hundreds of popular TV receivers (including color models) made by over 25 manufacturers. Shows instantly what replacements may be needed. Order TUR-1, only \$1.95
- Science Projects in Electricity/Electronics.** Demonstrates basic principles of electricity and electronics through the construction of fascinating projects that are not only instructive but useful. Ideal for self-learning or as science-class project guide.
 - Order SPN-1, only \$2.95
 - Science Projects in Electricity. SPE-1, only \$2.95
 - Science Projects in Electronics. SPJ-1, only \$2.95
- Introduction to Microelectronics & Integrated Circuits.** A clear explanation of this most important development. Tells you what microelectronics is, how these amazing miniature integrated circuits are designed, how they work, how and where they are used. Order ICL-1, only \$2.95
- Handbook of Algebraic & Trigonometric Functions.** Comprehensive reference includes basic formulas for geometry, algebra, trigonometry, and calculus; special sections present mathematical tables and conversions. Invaluable for students, technicians, and engineers. Hardbound. Order ALG-1, only . . . \$4.95
- How to Read Schematic Diagrams.** RSD-1 \$1.50
- Computer Circuit Projects You Can Build.** BOC-1 2.95
- TV Diagnosis & Repair.** TDR-1 1.50
- Radio Receiver Servicing.** RS-2 2.95
- Modern Dictionary of Electronics.** DIC-2 6.95
- TV Servicing Guide.** SGS-1 2.00
- Handbook of Electronic Tables & Formulas.** HTF-2 3.95
- Electronic Experiments & Projects.** ESE-1 2.50
- Tube Substitution Handbook.** TUB-7 1.50
- 161 Ways to Use Your VOM & VTVM.** 2.00
- Understanding Transformers & Coils.** TAC-1 1.95
- Automotive Electronics Test Equipment.** AEL-1 2.50
- How to Repair Major Appliances.** MAJ-1 3.95

Famous ABC's Books

- Computer Programming. CPL-1. \$1.95
- Electronics Drafting. DRA-1 \$1.95
- Boolean Algebra. BAB-1. 1.95
- Transistors. TRA-1. 1.25
- Electronic Test Equipment. STE-1. 1.95
- Electronic Organs. ECO-1. 1.95
- Electronics. ELW-1. 1.95
- Lasers & Masers. LAL-1. 1.95
- Short-Wave Listening. SWL-1. 1.95
- Computers 1.95

HOWARD W. SAMS & CO., INC.

Order from any Electronic Parts Distributor or mail to Howard W. Sams & Co., Inc., Dept. EI-11 4300 W. 62nd St., Indianapolis 6, Ind.

Send books checked above. \$ _____ enclosed.

Send FREE Booklist. Send Photofact Index.

Name _____

Address _____

City _____ Zone _____ State _____

IN CANADA: A. C. Simmonds & Sons, Ltd., Toronto 7



R TIMER C

TAKE a capacitor and resistor, add a drop of solder to connect them in series and what have you got? An R-C (or time-constant) circuit, which is used in almost all electronic equipment.

One function of the R-C circuit is to establish the time it takes a voltage to build up or diminish to a specific value. But it does other jobs, too, like coupling one amplifier stage to another, selecting pulses in a TV set and shaping waveforms and pulses. By building our photo timer, metronome, light flasher or a tone generator for code practice (see art) it's easy to determine how the circuit works.

When everything is connected except the earphone and capacitor C2, neon bulb NLI flashes on and off. Here's why. First thing that happens is battery B1 starts to charge C1. (If C1 were connected directly to B1, it would charge in a fraction of a second.) Since R1 and R2 are in the path of current flow, they limit the number of electrons that can reach C1's plates each second. This means it will take longer for the voltage across C1 to come up to B1's voltage.

The time depends on the values of R1, R2 and C1. Increase or decrease the value of any one and charging time changes proportionately. Multiply the resistance, in ohms, of R1 and R2 by the capacitance, in farads, of C1 and you get what's called the time-constant (in seconds) of the circuit. And time-constant is simply the name that has been given to the time that it takes for the voltage across a capacitor to equal 63 per

cent of the supply voltage. Once C1 is fully charged it cannot take on any more electrons and current flow stops.

But that isn't the end of the story since we saw NLI flash. What happens is that NLI acts as a switch that discharges C1. It does it this way: when the voltage across C1 reaches about 65 volts, NLI lights. NLI now becomes a short across C1 and discharges it. C1's voltage drops when it is discharged, and it takes NLI's voltage along with it since they're in parallel. NLI looks like an open switch now so C1 starts to charge again until NLI fires. And so it goes, NLI flashing on and off until B1 poops out.

For slow speeds, use a 10-megohm potentiometer for R1 and a 2-mf, 150-V capacitor for C1 (or two 1-mf, 150-V capacitors in parallel). Resistor R1 limits the maximum voltage that can be applied to NLI. Depending on R2's setting, NLI will flash from about once each second to once every 13 seconds.

For a light flasher, use one 1-mf capacitor. The speed will now be about three flashes per second to approximately one flash every 6 seconds.

At much higher speeds (.001-mf, 150-V capacitor for C1) the timer becomes an audio oscillator which you can key for code practice. To hear the tone, connect an earphone (1,000 ohms impedance or higher) through a .001-mf capacitor (C2) as shown. The earphone is also used for a metronome (1 mf for C1). You'll hear a click each time NLI fires.

—H. B. Morris

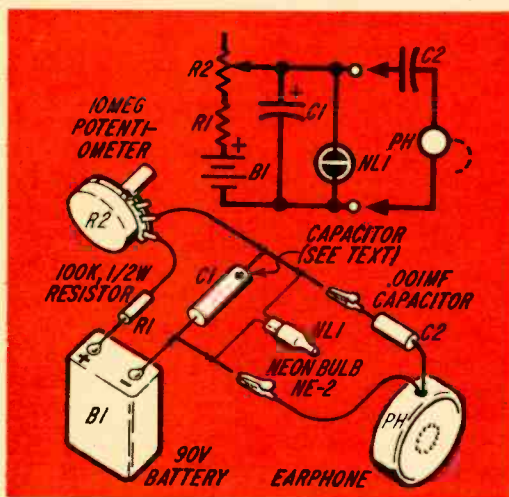

Good Reading

Continued from page 76

either to an on/off switch or a man's ability to use his arms and legs. But the arrival of automation has changed all that. Nowadays, pressing a single control button can make a few thousand diodes flip-flop into action and an entire factory roar into production.

Someone has to understand how all of this happens, of course—if only to know what to do when the motors don't start to turn. And this book, turned out by two motor-control experts at the Allen-Bradley Co., offers some of the answers. As such, it should be invaluable to electricians, contractors, maintenance men and anyone else whose job it is to keep the motors turning.

UNDERSTANDING DIGITAL COMPUTERS. By Ronald M. Benrey. John F. Rider, New York. 166 pages. \$3.75

If you haven't tackled computer theory by now, you should. For whatever your feelings about thinking machines, it's all but impossible to be a truly informed member of modern society without some knowledge of how they work. Though it keeps things simple, Mr. Benrey's book is a good, well-organized introduction to the subject of digital computers. And whether or not you decide to go on to analog theory after reading it, you should at least take advantage of this interesting primer.

DAVID SARNOFF. By John Tebbel. Encyclopaedia Britannica Press, Chicago & New York. 191 pages. \$2.95

This book, part of the Britannica's Great Lives series, obviously is aimed at young people. Its tone is one of awe and even breathlessness. The hero can do no wrong. His life is an unbroken line onward and upward.

Be this as it may, David Sarnoff is worth writing and reading about. After all, he is the man responsible for much of the accelerated progress of electronics in this century.

And make note of

THE RADIO AMATEUR'S HANDBOOK, 1964 (41st) Edition. American Radio Relay League. 592 pages. \$3.50

ELECTRONIC ENGINEERS & TECHNICIANS REFERENCE HANDBOOK. Sams. 224 pages. \$4.95

In any CB application . . .
you'll outperform 'em all with a
MESSENGER.



**Your own 2-way radio for
Business or Personal use!**



"PERSONAL MESSENGERS"—Compact, hand-held 100 milliwatt or 1½ watt units! Rugged and reliable—11 transistors, 4 diodes. Twice the sensitivity and 40% more range than similar units with conventional circuitry—more output than similar units with same rated inputs!

Cat. No. 242-101 . . . 100 Milliwatts . . . \$109.50 Net
Cat. No. 242-102 . . . 1½ Watts . . . \$129.50 Net



"MESSENGER"; "MESSENGER TWO"

For mobile, base station. High efficiency makes full use of maximum allowable legal power. Excellent receiver sensitivity and selectivity. Automatic "squelch" control. 5 crystal controlled channels on the "Messenger" and 10 crystal controlled channels plus tunable receiver on the "Messenger Two".



"MESSENGER" — \$114.95 Net
Cat. No. 242-127 115 VAC/6 VDC
Cat. No. 242-128 115 VAC/12 VDC

"MESSENGER TWO" — \$169.95 Net
Cat. No. 242-162 115 VAC/6 VDC
Cat. No. 242-163 115 VAC/12 VDC



"MESSENGER III"—Everything you want in a CB transceiver—a husky signal, extreme sensitivity, razor-sharp selectivity—and complete flexibility for base station, mobile, public address, or battery powered portable use! Double conversion receiver—set-and-forget "Volume" and "Squelch" controls—11 channel coverage—"Tone Alert" Selective Calling System available as accessory.

The nation's most popular Citizens Radio equipment line!

Rated BEST by Distributor Salesmen in National Survey!

Cat. No. 242-150
12 Volts DC Messenger III . . . \$189.95 Net
Cat. No. 250-823
117 Volt AC Power Supply . . . \$ 29.95 Net

WRITE TODAY for full color brochure, or see your Dealer/Distributor and ask for a demonstration!



E. F. JOHNSON COMPANY

2242 TENTH AVE. S.W. • WASECA, MINNESOTA

ABCs of Color TV

Continued from page 73

a brightness signal is received. The Matrix responds by splitting the brightness signal into three parts and applying them to the picture tube. How the color screen can produce this as black and white should be apparent in a moment.

Color Picture Tube. In the most common type of picture tube, the screen consists of more than a half-million phosphor dots (each about the size of a pinhead), which glow when struck with a beam of electrons. Depending on chemical makeup, the dots give off red, green or blue light. The dots form small triangular groups known as trios (for a total of 195,000 groups) distributed over the face of the screen.

Small size and close spacing of these dots cause the eye to perceive a mixture of red, green and blue light. This arrangement, therefore, provides the required primary color medium for producing all hues. And the dot trios can be considered the receiver's counterpart of the three-tube color camera televising the program.

Beams of electrons needed to excite the dots into glowing originate in the three electron guns situated in the neck of the tube. As each beam moves toward the screen, it is directed to its assigned color dot—red, green or blue. What color the eye will see from a dot trio depends on the arriving color signals. Feeding each gun, color signals control electron-beam strength and thus the amount of primary color generated at each dot.

To return to our yellow umbrella example, red and green color signals cause red and green guns to cast strong beams at red and green phosphor dots. They glow and the mixture appears to the eye as the desired yellow hue. This condition continues as the electron beams scan (in step with the camera) over the umbrella area of the scene. As the blue handle region is scanned, red and green guns are shut off, while blue becomes active. For countless other colors, varying signals regulate the guns so they produce the right amount of primary color at each dot trio.

Black and White. The ability of the color receiver to produce a black-and-white picture again relates to primary colors. As noted in

the color wheel of Fig. 1, a mixture of red, green and blue produces white. But these colors can't be mixed in equal proportions, since the human eye is more sensitive to certain colors than others. Studies have shown that to see white, the primary colors must mix in a 30% red, 59% green and 11% blue ratio. If the dot trios are made to glow in this relationship, the viewer will see the screen filled with white light.

The Matrix in Fig. 6 provides these values any time a black-and-white program is received. The brightness signal is split among the three picture-tube guns: 30% to the red, 59% to the green and 11% to the blue. Now let's say the scene is gray. Here, the brightness signal is weaker, but the Matrix still splits it into that 30-59-11 relationship. The color dots respond by emitting less white light which is, after all, gray. In this fashion, a complete scale from white to gray to black may appear on the color screen in step with the brightness signal.

Modulated Dipper

Continued from page 103

Mark off three scales on the top and bottom of the disc. Turn on the Dipper and turn on modulation. Set an accurately calibrated receiver to a desired frequency and adjust C2 until you hear the buzzing sound from the receiver. Turn off the modulation and adjust C2 for maximum S-meter indication, then mark the Dipper's dial. If your receiver doesn't have an S-meter, adjust C2 for cleanest tone.

Keep in mind that the Dipper is a simple oscillator—it is not meant for precision readings to the nearest 10 kc. Dependable calibration can be obtained with 500 kc or 1 mc markings. Do not try to use the Dipper as a frequency standard; the calibration won't hold that close.

Using the GDO. There are so many ways of using the Dipper that we suggest you refer to the previously mentioned article in EI and to the Radio Amateur's Handbook.

Plug in the coil for the frequency you need and turn on power, but leave the modulation off. Advance R6 for a convenient indication on M1. Place the coil near the parallel-tuned circuit and slowly rotate C2 until M1 dips. The dial frequency at the dip is the frequency of the tuned circuit.

EI AT LARGE

Touching Bases

THE way we talk sometimes in this corner, you might get the idea that a magazine editor keeps himself chained to his desk 18 hours a day while he squints beneath his green eyeshade and stabs passing verbs and adjectives.

Matter of fact, our opinion is that editors as a breed *do* hunch over desks too much of the time. You can tell the clan by its pasty-white complexion in the midst of a long, sunny summer. But we do try to get out and about once in a while, seeing business friends and finding out what's going on inside the firms and people in our field of electronics. This happens to be the subject at hand—a trip around a few bases, a more-or-less typical jaunt for talking and looking.



It started at 4 o'clock one morning, when we rolled out to catch an early-hour 707 jet from Newark to Detroit. We were met at the Detroit airport by Doug Galbraith, one of EI's representatives in the Motor City, and then began a cross-state car ride, with Doug at the wheel, which took us to the shore of Lake Michigan and a city called Benton Harbor.

By then it was almost lunch time and we were about to pay our first call, on Earl Broihier and Neil Turner at the Heath Company, the kit people. Lunch at the local hostelry, a tour of the plant and we came to the real point of our visit. What was going on at Heath? What were they planning?

First new item we found coming up was a service instrument, an FM multiplex generator kit tabbed at \$99 and having some nine functions. Next came discussion of the company's upcoming (at that time) extension of its de luxe sideband line for hams—a trans-

[Continued on page 118]

SOLDERING TIPS FOR HI-FI KIT BUILDERS

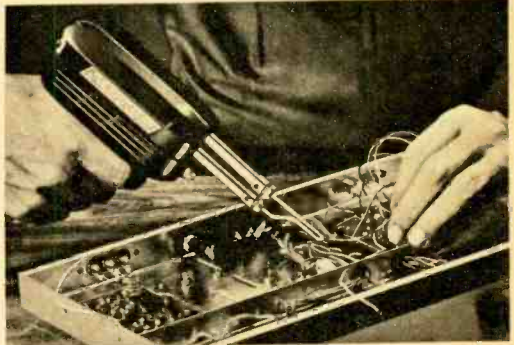

HEAT WIRES NOT THE SOLDER

Wires or leads will then become hot enough to melt the solder and it will flow into the joint. Never apply heat directly to the solder.



USE PROFESSIONAL EQUIPMENT

Virtually all radio and TV servicemen use Weller Dual Heat Soldering Guns. A Weller Expert Soldering Kit includes everything you need for strong, noise-free connections.

A Weller Dual Heat Gun is indispensable in electronic soldering. Heat and spotlight come on instantly when trigger is pulled. 2 trigger positions let you switch instantly to low 100-watt or high 140-watt heat. Low heat prevents damage to components and prolongs tip life. High heat is ready when you need it.

Kit includes gun in plastic utility case, 3 tips, tip wrench, flux brush, soldering aid and solder. Model 8200PK \$8.95. Weller Electric Corp., Easton, Pa.

Weller[®]

WORLD LEADER IN SOLDERING TECHNOLOGY

Continued from page 117

mitter and linear amp to be added to the already-out receiver. Last was a preview of a new low-cost FM tuner and a peek around a corner at what looked like a big new electronic organ.

On the road again, we drove a few miles south to Buchanan, Mich., a smallish city (pop. 5,244) where you wouldn't ordinarily expect to find a large industry. Buchanan has two, a lift-truck company and Electro-Voice, Inc., the speaker & microphone manufacturer. There we had a pleasant chat about ham radio, microphones, hi-fi and some other subjects with Larry LeKashman, Jon Kelly and Al Kahn (who was a ham way back when) but there was one piece of news we picked up in Buchanan that eclipsed everything else.

E-V for some time has been making a speaker system called the Patrician. It's huge and has, amongst other goodies, a 30-in. woofer. The Patrician sells for \$875. And here hangs the tale. E-V, we learned, was busy making up the Patrician as a *kit*, to sell for \$580. Hands down, it certainly will be one of the biggest kits on the market—and most expensive.

A few more miles, with a stop for short refreshment, and we caught an old-fashioned prop plane across the tip of Lake Michigan from South Bend to Chicago. So ended a day.

Next morning in the Windy City it was a visit to Lou Dezetel and Allied Radio's Knight Electronics plant in suburban Maywood. We found the Knight-Kit crew at work in a field quite a few electronics companies are veering toward—photography. The embryo product at hand was a little exposure meter, meant to sell for around \$15. The kit had all of a dozen parts, offered two ranges and would take about 30 minutes to put together in its plastic case.

The KG-70 all-transistor AM stereo-FM tuner kit, we discovered, was turning into a new number, the KG-765, with improved design. Also coming along was a new CB transceiver with a Nuvistor front end, and a new 54-watt transistor stereo amplifier.

Next stop, closer toward the Loop, was at Hallicrafters, where Travis Marshall reeled off half a dozen new products then in the design stage or ready for introduction. Among

them were low-cost AM/CW ham transmitters for 6 and 2 meters, made to sell for about \$180 each; an all-transistor CB 5-watter for a like price (battery pack for portable operation to be added later) and a 1-watt CB walkie-talkie that would come in at around 100 clams.

Over at Shure Brothers, where they specialize in microphones and cartridges, Howie Harwood enthused (the next day) about a new stereo cartridge they'd worked up to follow their M44 and V-15 models, which caused quite a stir not long ago. The new one, the M55, said Harwood, combines the best qualities of its predecessors and should go for \$35 to \$40. Then he sprang the big surprise with what he called "our first complete audio system, a packaged component hi-fi unit."

Shure, known as an accessory maker, was taking a giant step into a new world—components. The system (since introduced on the market) was unlike anything we'd ever seen. There are two versions, each consisting of a set of speaker systems and a third package holding a record changer and integrated amp. One outfit comes in walnut, the other as a set of luggage. Just snap it together and off you go. Unusual and attractive—yes. Cheap—no. The grips will hang you up for \$400 and the walnut takes 50 potatoes more.

Last call was on Grommes, an outfit that makes a lot of things but specializes in hi-fi components. A ten-minute chat with headman Bill Grommes is just the thing to brace you for the rest of the day. He's a sort of evangelist when it comes to his business and his products. He obviously enjoys talking about them and his enthusiasm is contagious.

His subject this day was a new line of hi-fi components he's coming out with.

"I don't know what we're going to call it yet," he said. "But right now we refer to it as the Rolls-Royce line."

With a working handle like that, you can be pretty sure what the new line will be. Good specs, attractive design (matched-grain walnut and gold)—and expensive.

That was the end of our gadding-about.

So, as the sun sank slowly in the west, we went over the hill to the East in one of Boeing's new three-jet 727's. A little over an hour later we were back at Kennedy Airport and on the way home, tired to the bone. But the chain had been broken, for a little while, at least.—R.G.B.

CB Corner

Continued from page 89

kc apart, making a crystal do double-duty becomes a matter of some simple coil switching. Matter of fact, full 23-channel coverage can be worked out with 12 crystals and a little extra circuitry.

Just before leaving the James Knight booth, we noticed that display crystals were plated in gold, apparently as a dress-up for the show.

"Can we get some of these for our rig?" we jokingly asked Jack Craven.

"Don't laugh," he replied. "People see them and place orders! We'll supply them at \$5 a pair."

Then came the inevitable punch line. Those gold-plated rocks, Jack explained, really are "for the CBer who has everything."

In its booth, Mark was showing its one-of-kind SSB rig. Two improvements already have been made in the unit since last reported in this column. Milt Mann of Mark described a much-improved noise limiter and a squelch circuit of the VOX type.

"How's the new rig working out?" we asked.

Milt's reply: "We get up to 50 miles mobile."

The man from Mark also cleared up some points about conventional rigs attempting to receive carrier-less SSB signals. CBers, it seems, are using all sorts of oddball methods to detect sideband in regular rigs. Carriers have been reinserted by transmitters in garage-door openers, by turning on another CB set, even by using the carrier of a non-SB station operating on the same channel.

[Continued on page 123]

Solve Electronics Problems Fast With Special New Slide Rule

Professional, high quality instrument . . . specifically designed for electronic engineers and technicians . . . made to our rigid specs by Pickett & Eckel. Has special scales for solving reactance and resonance frequency problems. Accurately and quickly locates decimal points. Carries widely used formulas and conversion factors not found on any other slide rule. Comes complete with top-grain leather carrying case, illustrated instruction manual, 90 day consultation service — all for just \$14.95. Carries lifetime guarantee against defects in material and workmanship.



SEND COUPON TODAY

TO: CLEVELAND INSTITUTE OF ELECTRONICS

1776 E. 17th St., Dept. EI-101, Cleveland, Ohio 44114

Please send me your electronics slide rule.

I am enclosing \$14.95. (If not fully satisfied after 10 day trial, CIE will refund payment.)

Please send additional descriptive literature.

Name _____ (Please Print)

Address _____

City _____ State _____ Zip _____

GREAT NEW SCOTT KITS AT A NEW! LOW PRICE!



LK-48B 80-Watt Stereo Amplifier Kit \$129.95



LT-110B FM Stereo Multiplex Tuner \$139.95

Save money . . . build the world's best stereo . . . with great new stereo kits from Scott. Scott's full-color instruction book and matching Part-Charts make them a breeze to put together . . . and, they'll give you and your family years of trouble-free enjoyment. The LK-48B stereo amplifier includes a switched front panel headphone output and dozens of other unique Scott features. The LT-110B FM stereo tuner incorporates famous Scott Sonic Monitor, factory-wired, silver-plated front end and Time-Switching multiplex.

FREE 24 PAGE BOOKLET

Rush me free Scott's free 24 page Custom Stereo Guide.

Name _____

Address _____

City _____ Zone _____ State _____

SCOTT

H.H. Scott, Inc., 111 Powdermill Road, Maynard, Mass.

Export: Scott International, 111 Powdermill Road, Maynard, Mass. Canada: Atlas Radio Corp., 50 Wingold Ave., Toronto. Cable HIFI

SUPER-SIZE SCHEMATICS



IN A DAY when the speaker in a little transistor portable is likely to be bigger than all the other components put together, you might get the idea that everything electronic has to be small to be good. But there's one area where the bigger the better still holds. Man-size schematics have it over ordinary squiggles any day of the week.

Making super-size schematics is a fairly simple job. Needed equipment consists of a piece of white cardboard (to be used as a backdrop), an adjustable camera, inexpensive close-up lens attachments (such as Kodak's 3+ Portra accessories) and a set of photofloods. Tape the cardboard backdrop to any flat surface and fasten the schematic directly to the backdrop (if you've taken it from a magazine, it's best to back it with black paper to keep lines and lettering from showing through). Next, set up the photofloods about 4 feet from the schematic and 3 to 4 feet from one another. Place your camera on a tripod and station the tripod so the camera covers the area you want to include in your photo.

With a 3+ Portra attachment on a 35mm camera, for instance, you can photograph an area $4\frac{1}{2}$ by $6\frac{3}{8}$ in. Put two 3+ lenses piggyback on the camera and you can cover an area $2\frac{5}{8}$ x $3\frac{15}{16}$ in. Follow the instructions furnished with the lenses and remember that a little target-shifting could be necessary to compensate for parallax if you use a viewfinder or twin-lens camera. This done, check your camera settings with a light meter or against the instructions supplied with the film and shoot. Have the film developed and printed, crop the best print with a ball-point pen and send it out to be enlarged. The result will cost you a few pennies but you'll have a schematic that any man can dope out without a magnifying glass. 

THIS TINY SPACE-BATTERY RECHARGEABLE FLASH HAS TWIN BEAMS, WEIGHS JUST 2 OZ., IS THE World's Smallest, Most Powerful Flashlight

STRONGER THAN LARGE REGULAR 2-CELL LIGHT

■ This mighty midget is right out of science fiction. fits in the palm of your hand, can be worn on your wrist, fastened to a hat, carried in pocket or purse. Gives 5 hours of continuous light, then the permanent battery can be recharged right from your house current. (Never buy batteries again.) 2 powerful beams can be used together or separately, disperse light in 4 directions. Powered by a space-age cadmium dynamo cell. Flash and recharger unit, complete \$6.95. Mail your order in now!

FLASH
& RECHARGER
\$6.95



HAMILTON HOUSE
Dept. 1L-11, Cos Cob, Conn.

- Enclosed is \$6.95 plus 45¢ for postage, insurance, and handling in check, money order or cash. No C.O.D.'s. Rush me one FLASHLIGHT AND RECHARGER SET.
- Check here to order two Flashlight and Recharger sets. SAVE! Enclose just \$14.35 complete. We pay shipping charges on one set.

NAME _____

ADDRESS _____

CITY _____ STATE _____ ZIP CODE _____

Money Back in Ten Days If Not Completely Satisfied!

OVER AND OUT

BY *Rodriguez*



"Naturally it's a little heavier than most 20-watt amplifiers. There's six pounds of solder in it."



"Yeh, I'd like to hear it, too, Al. Only I can't afford any records."

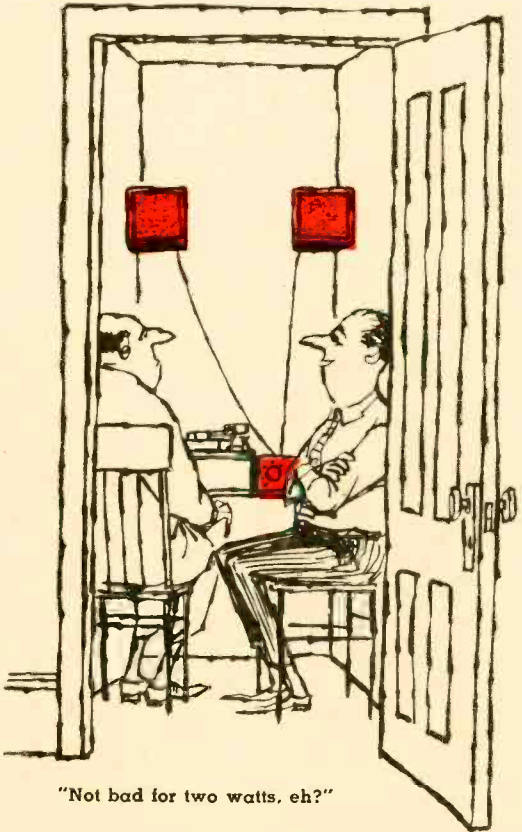

"Not bad for two watts, eh?"

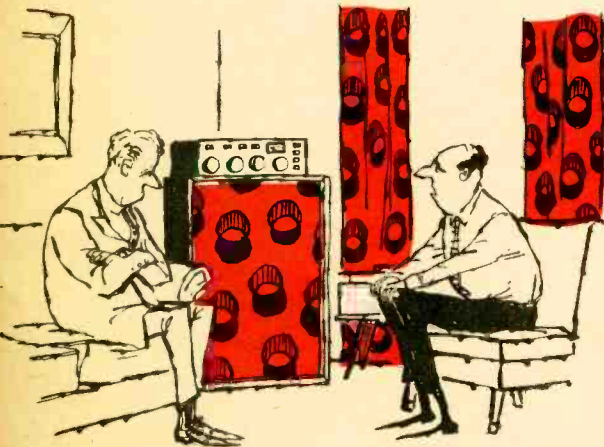

"It's the only way she'd let me keep it here."

CB Corner

Continued from page 119

But these techniques aren't needed if the regular set has a beat-frequency oscillator. And a BFO is exactly what's on the new Utica T&C III. Though the rig delivers conventional AM, it anticipates the need for side-band reception by including a BFO.

The T&C III also sports a downright practical feature—a public-address (PA) provision. This little extra is useful enough and it's appearing on more new transceivers (the Johnson Messenger III and the General Radiotelephone MC-6 are two). By adding a bullhorn or other speaker, the CBER can make the rig double as PA amplifier. Controlling a crowd is one application that comes to mind.

Cadre exhibited something new in selective calling. Angle is that their system goes one better than earlier one- and two-tone units. Push the Cadre call lever and *three* coding signals are transmitted in sequence. The number of possible tone combinations thereby is increased, which should prevent falsing in crowded areas.

Transistors still dominate the portable field, of course, but power is creeping upward. Last year saw rise of the 1-watt walkie-talkie, and power now has been upped to 2 watts. Webster displayed a 2-watt walkie-talkie of small size that boasts a range of up to three miles.

A raft of new antennas designed for the marine CBER appeared at the show. Many are designed around the half-wave vertical—a type that solves installation problems for the sea-going CBER, especially on small, non-metal boats. These antennas need no ground plates under the boat and work well over fiberglass hulls. Other antenna trends we uncovered: mobile antenna whips are leaning more toward fiberglass construction. And base-station antennas are boasting more durable construction to endure wind and weather.

Our final stop was at the booth of a steel-tower manufacturer. Towers are illegal for CB, you say? This tower maker claims some 10 per cent of his sales are to CBERs. The rest of the story: those power-bent CB operators mount a TV antenna atop the tower, the CB antenna below it. And, come to think of it, there isn't anything wrong with a CB/TV tower . . . so long as you follow the letter of the law.

QUANTITY TUBE BUYERS

GET RAD-TEL'S QUALITY BRAND NEW TUBES

1 YEAR GUARANTEE / 1 DAY SERVICE

YOUR CHOICE

1B3-1G3

1K3-1J3

FREE!

WITH THE PURCHASE OF EVERY 10 TUBES!

Send "MAIL

ORDER TUBE

CIRCULAR

WITH 600 TYPES

TERMS: 25% deposit on all orders, balance COD. Orders under \$5 add \$1 handling charge plus postage. Orders over \$5 plus postage.

UP TO 75% OFF*

*Mfrs. sug. list price

MONEY BACK GUARANTEE

Tubes branded and boxed Rad-Tel

| Type | Price | Type | Price | Type | Price |
|------|-------|------|-------|-------|-------|
| 024 | .79 | 6AV6 | .41 | 6W4 | .61 |
| 1B3 | .79 | 6AX4 | .66 | 6X8 | .80 |
| 1R5 | .77 | 6BE6 | .55 | 7AU7 | .65 |
| 1X2 | .82 | 6BG6 | 1.70 | 12AD6 | .57 |
| 2BN4 | .64 | 6BN4 | .62 | 12A77 | .76 |
| 3BZ6 | .56 | 6BN8 | .76 | 12AU7 | .61 |
| 3CB6 | .56 | 6BQ6 | 1.12 | 12AV6 | .41 |
| 3V4 | .63 | 6BQ7 | 1.00 | 12AX4 | .67 |
| 4BQ7 | 1.01 | 6BS8 | .95 | 12AX7 | .83 |
| 5AT8 | .83 | 6CB6 | .55 | 12AZ7 | .86 |
| 5C8 | .81 | 6CG7 | .61 | 12BA6 | .50 |
| 5CL8 | .76 | 6CL6 | .94 | 12BE6 | .53 |
| 5U4 | .60 | 6CY5 | .70 | 12BH7 | .77 |
| 5U8 | .84 | 6DQ6 | 1.10 | 12BL6 | .56 |
| 5Y3 | .46 | 6E8 | .79 | 12BY7 | .77 |
| 6AF4 | 1.01 | 6I6 | .71 | 12SK7 | .95 |
| 6AH6 | 1.10 | 6K6 | .63 | 12SQ7 | .91 |
| 6AK5 | .95 | 6L6 | 1.06 | 25BQ6 | 1.17 |
| 6AL5 | .47 | 6S4 | .52 | 25L6 | .57 |
| 6AM8 | .78 | 6SL7 | .84 | 35C5 | .51 |
| 6AN8 | .93 | 6SN7 | .65 | 35W4 | .42 |
| 6AQ5 | .53 | 6SQ7 | .94 | 35Z5 | .60 |
| 6AS5 | .60 | 6T8 | .85 | 50C5 | .53 |
| 6AU4 | .85 | 6U8 | .83 | 50L6 | .61 |

RAD-TEL TUBE COMPANY

Dept. EI, 55 Chambers Street, Newark, N. J. 07105

FOR SPEEDY SERVICE

1102171 647 98 24 0664

T M BROWN

5936 23rd PARKWAY

WASHINGTON, D. C. 20031

WE'RE LOST WITHOUT THIS LABEL

Well, not really lost — but we can do things faster for you if you send along the ADDRESS LABEL from your magazine any time you write to us about your subscription.

CHANGE OF ADDRESS

If you're moving, please let us know six weeks before changing your address. Better still, attach the magazine address label to this form, and print your new address here.

name

street

city

state zip

attach label here

ELECTRONICS ILLUSTRATED Sub. Dept., Greenwich, Conn. 06830

ELECTRONICS ILLUSTRATED Classified Ads

Your advertisement can reach this mail-buying audience for only 50¢ per word . . . payable in advance (Check or M.O. please) . . . minimum 10 words. Closing dates are the 20th of 4th preceding month i.e. copy for the March issue must be in our office by November 20th. Mail to ELECTRONICS ILLUSTRATED, 67 West 44th St., New York 36, N. Y. Word count: Zone number free. Figure one word: Name of state (New Jersey), name of city (New York); sets of characters as in key (14-D); also abbreviations as 35MM, 8x10, D.C., A.C.

• • • FOR SALE

EXCELLENT BUYS on Tubes and equipment all listed in the "Green Sheet." Send .25¢ for your copy today. Cash paid for unused tubes. Write, Barry Electronics Corp., 512 Broadway, Dept. El, NYC 12, NY.

INVESTIGATORS, WRITE for free brochure on latest subminiature electronic listening devices. Dept.-5X, Ace Electronics, 11500 NW 7th Ave., Miami 50, Florida.

SENSATIONAL NEW transistor treasure finders locate buried gold, silver, coins. Kits, assembled models from \$19.95. Free catalog. Relco-A19, Box 10563, Houston 18, Texas.

CANADIANS—GIANT Surplus Bargain Packed Catalogs. Electronics, Hi-Fi Shortwave Amateur Citizens Radio. Rush \$1.00 (Refunded). ETCO, Dept. El, Box 741, Montreal.

GOVERNMENT SURPLUS. How and Where to Buy in Your Area. Send \$1.00. E.I. Surplus Information, Headquarters Bldg., Washington 6, D. C.

TV CAMERAS, transmitters, converters, etc. Lowest factory prices. Catalog 10¢. Vanguard, 190-48—99th Ave., Hollis, N. Y. 11423.

CONVERT ANY television to sensitive, big-screen oscilloscope. Only minor changes required. No electronic experience necessary. Illustrated plans, \$2.00. Relco-A19, Box 10563, Houston 18, Texas.

BANSHEE TS-30 Transistor Ignition Systems And Coils. Dealers Wanted. Free Money Maker Brochure. Slep Electronics, Drawer 178E1, Ellenton, Florida.

• • • BUSINESS OPPORTUNITIES

HIGH WEEKLY Earnings! Address—mail letters featuring real merchandise. Get \$10 with every order—keep \$8 profit. Supplies furnished. Free particulars. Modern Merchandising, Box 357, Oceanside, New York.

FREE REPORT: "609 Unusual, Successful Businesses." Box 122-ELB, Wheeling, Illinois.

MAKE \$100.00 FAST sewing, assembling our products. Materials supplied! FMN, DeFuniak Springs 15, Florida.

VENDING MACHINES—No selling. Operate a route of coin machines and earn high profits. 32-page catalog free! Parkway Machine Corp., 715E1 Ensor St., Baltimore 2, Md.

• • • EMPLOYMENT OPPORTUNITIES

PRINTING - ADVERTISING SALESMEN. Excellent moneymaking sideline selling Decalcomania Name Plates. Advertising Specialties. Sign letters, Automobile initials. Free Samples. "Ralco"—El, Box L, Boston 19, Mass.

• • • EDUCATION & INSTRUCTION

HIGHLY-EFFECTIVE HOME-STUDY review for FCC Commercial phone exams. Free Literature! Cook's School of Electronics, P. O. Box 3608, Cleveland, Ohio 44119

• • • BUILD IT YOURSELF

KILL TELEVISION Commercials. Complete build yourself kit \$2. Zak Nampa, Alberta, Canada.

PROFESSIONAL ELECTRONIC Projects—Organs, Timers, Computers, etc.—\$1 up. Catalog Free. Parks, Box 1665, Seattle, Wash. 98125

• • • TAPE RECORDERS

LEARN WHILE Asleep with your recorder, phonograph or amazing new "Electronic Educator" endless tape recorder. Details free. Sleep-Learning Research Association, Box 24-El, Olympia, Washington.

TAPE RECORDERS Hi-Fi Components. Sleep Learning Equipment, tapes. Unusual values. Free Catalog. Dressner, 1523 Jericho Tpke., New Hyde Park-4, N. Y.

RENT STEREO Tapes—over 2500 different—all major labels—free brochure. Stereo-Parti, 1616-AY Terrace Way, Santa Rosa, California.

SARKES TARZIAN'S Galaxie tensitized Mylar: 1800"/1.69, 2400"/2.79, 3600"/3.89. Postpaid. Free all-components, tape catalog. Pofe, 1716-EL Northfield, Muncie, Indiana.

WINDSOR TAPE Club members Hear Before They Buy. Free "samplers" of new releases. Save on tape purchases—all major labels. Free brochure—Windsor Tape Club, Dept. B, Windsor, Calif.

• • • RADIO & TV

TV TUNERS rebuilt and aligned per manufacturers specification. Only \$9.50. Any make UHF or VHF. We ship COD. Ninety day written guarantee. Ship complete with tubes or write for free mailing kit and dealer brochure. JW Electronics, Box 51K, Bloomington, Indiana.

DIAGRAMS, SERVICE Material, Radio, Television, \$1.00. Supreme Publications, 1760 Balsam, Highland Park, Illinois 60035

7" TV TEST Tube—\$6.99. Tubes—6146—\$2.95; 6211(12AU7 equiv.) 39¢, 3 for \$1. Germanium diodes, tested, equiv. 1N34, 1N60 etc., 30 for \$1. Tophat silicon rectifiers, 750 MA—1000 pIV 75¢. Transistors, tubes, resistors, condensers, etc., bargain priced. Free catalog. Arcurus Electronics, Dept. EIL, 502-22nd St., Union City, N. J. 07087.

BEFORE YOU Buy Receiving Tubes, Test Equipment, Hi-Fi Components, Kits, Parts, etc. . . send for your Giant Free Zalytron Current Catalog, featuring Standard Brand Tubes: RCA, GE, etc.—all Brand New Premium Quality Individually Boxed, One Year Guarantee—all at Biggest Discounts in America! We serve professional servicemen, hobbyists, experimenters, engineers, technicians. Why Pay More? Zalytron Tube Corp., 469-L Jericho Turnpike, Mineola, N. Y.

DIAGRAMS FOR repairing radios \$1.00. Television \$2.50. Give make model. Diagram Service, Box 1151E1, Manchester, Conn. 06042.

FREE ELECTRONICS Catalog. Tremendous Bargains. Electrolabs, Department C-559AE, Hewlett, New York 11557.

15 DISTANCE ONE-TUBE Plans — 25¢; One-tube Handbook — 50¢. Includes Transistor experiments, catalog. Laboratories, 1131-K Valota, Redwood City, California.

75 SCHEMATICS, PROJECTS; Radios To Binary. \$1.00. Tattershall, Hamilton, Mo.

RADIO & T.V. Tubes—33¢. Free List. Cornell, 4213-15 University, San Diego, Calif. 92105.

• • • INVENTIONS & INVENTORS

INVENTORS! We will develop, sell your idea or invention, patented or unpatented. Our national manufacturer-clients are urgently seeking new items for highest outright cash sale or royalties. Financial assistance available. 10 years proven performance. For free information write Dept. 59, Wall Street Invention Brokerage, 79 Wall Street, New York 5, N. Y.

• • • DETECTIVES

DETECTIVES—EXPERIENCE Unnecessary. Detective Opportunities. Write Wagner, 8-125 West 86th, New York 24.

• • • ROCKETS

ROCKETS: IDEAL for miniature transmitter tests. New illustrated catalog 25¢. Single and multistage kits, cones, engines, launchers, trackers, technical information, etc. Fast service. Estes Industries, Penrose 13, Colorado.

• • • PERSONAL

BORROW \$1,233 AIRMAIL! Repay \$54 for twenty-nine months. State licensed. Postal Finance, Dept. 88-T, Kansas City 1, Kansas.

• • • MISCELLANEOUS

RAY GUN—Want to build a Laser? Shoots a coherent beam of light, burns anything in its path. Complete blueprints and directions, \$9.95. Dept. El, Exacto Supply Co., 109½ West 5th, Pittsburg, Kansas.

• • • PRINTING, MULTIGRAPHING,

FREE SAMPLES QSL, CB, SWL Cards, Memo Pads and other unusual personalized items. Lowest Prices. Fast Service. Brewster Printers, Dept. SW-10, 415 N. 8th, St. Louis, Mo.

• • • MUSIC

ACCORDIONS, GUITARS, Band Instruments! Save ½. Famous makes, free home trial. Easy terms. Trades. Free discount catalogs. Mention instrument. International Music Mart, Dept. EL-114, 5535 Belmont, Chicago 41.

The Listener

Continued from page 60

KSAB (1020 kc) on Okinawa, owned by the Far Eastern Broadcasting Company. While FEBC's Okinawa operation is BCB only, it has a major short-wave facility in Manila (Call of the Orient). In addition, it owns veteran San Francisco SW station KGEI (The Voice of Friendship).

At present, FEBC carries nothing more controversial on SW than editorials critical of Argentina's government and supporting Brazil's military regime. The question that comes to mind is whether the WINB type of programming now transmitted by the Okinawa broadcast-band station might not, because of the connection between outlets, end up one of these days on the distance-spanning short-wave outlets.

Since that Okinawa BCB station almost never is heard in North America, listeners will have to keep tabs via short wave. KGEI, of course, presents no reception problems and their 1730-1900 multi-language transmission (English, Spanish, Portuguese and

Russian) on 15240 kc will be of most interest. Meanwhile, given the right conditions, the Manila station is heard at 0330 EST on 11855 (DZH8) and 9715 (DZI8); 0800 on 15300 (DZH9) and 11920 (DZF2); and at 1030 again via DZH8/DZI8.

Something To Think About. Of all the stations we've discussed, only KSAB can be considered really hot DX. WGCB's merit as a logging depends entirely upon your location, while DZI8, DZH8, DZF2 and DZH9 constitute only minor challenges. KGEI and WINB aren't DX at all. Yet all eight calls are of vital interest to every "distant radio listener," for they provide him with inside information on the currents (sometimes hidden) which shape today's world.

If we define DRL as DXing plus SWling, then DX/SWL equals something more serious than a mere hobby. It's also something more important than a collection of QSL cards or a list of call letters in a log book. And maybe this extra DRL factor explains that zeal with which some DXers and SWL's pursue their hobby. The DRL factor is something to think about, and we'd like to hear your thoughts on it.

LARGE, SELECT STOCK! DEPENDABLE, FAST SERVICE!

MICRO TUBE FABULOUS LOW PRICES!

- Every tube tested in our own laboratory for mutual conductance and life test.
- We guarantee FREE replacement for one year of any tube purchased from us which fails to function efficiently under any or all operating conditions. Prompt refunds on any defective merchandise.
- Advertised tubes not necessarily new, but may be electrically perfect factory seconds or used tubes—each clearly so marked.

| | | | | | | |
|-------|--------|------|-------|---------|----------|---------|
| 0Z4 | 6AB4 | 3B27 | 6K7 | 6W6GT | 7F8 | 12BY7 |
| 1A27 | 6AC7 | 6C4 | 6K8 | 5X4 | 7H7 | 12CA5 |
| 1B3GT | 6AF4 | 6C5 | 6L7 | 6X5 | 7N7 | 12D57 |
| 1H4G | 6AG5 | 6C6 | 6N7 | 6X8 | 7Q7 | 12K7 |
| 1H5GT | 6AG7 | 6CB6 | 6Q7 | 5Y6G | 7X7/XXFM | 12L6 |
| 1L4 | 6AH6 | 6C6G | 6S4 | 7A4/XXL | 7Y4 | 12Q7 |
| 1L6 | 6AK5 | 6CF6 | 6S8GT | 7A5 | 7Z4 | 12SA7 |
| 1N5GT | 6AL5 | 6CC7 | 6SA7 | 7A6 | 12AB | 12S67 |
| 1Q5GT | 6AL7 | | | | | 12S7 |
| 1R5 | 6AM8 | | | | | 12K57 |
| 1S5 | 6AN8 | | | | | 12SN7CT |
| 1T4 | 6AQ5 | | | | | 13S07 |
| 1U4 | 6AQ6 | | | | | 12V6GT |
| 1U5 | 6AQ7CT | | | | | 2W6GT |
| 1V2 | 6AS5 | | | | | 12K4 |
| 1X2 | 6AS5 | | | | | 1223 |
| 2A3 | 6AT6 | | | | | 14A7/ |
| 2A4 | 6AT8 | | | | | 12B7 |
| 3BC5 | 6AU4CT | | | | | 14B6 |
| 3BN6 | 6AU5CT | | | | | 14Q7 |
| 3B76 | 6AUG | | | | | 19 |
| 3CB6 | 6AUB | | | | | 19AU4CT |
| 3CF6 | 6AV5CT | | | | | 19B6G6 |
| 3C56 | 6AV6 | | | | | 19C6 |
| 3LF4 | 6AW8 | | | | | 19T8 |
| 3Q4 | 6AX4CT | | | | | 24 |
| 3S4 | 6AX5CT | | | | | 25AV5 |
| 3V4 | 6BB | | | | | 25B06 |
| 4BQ7A | 6BA6 | | | | | 25DN6 |
| 4B7 | 6BK5 | | | | | 25L6GT |
| 5A58 | 6BC8 | | | | | 35W4GT |
| 5A78 | 6BD6 | | | | | 25Z5 |
| 5A8 | 6BE6 | | | | | 25Z6 |
| 5A94 | 6BF5 | | | | | 35A5 |
| 5BK7 | 6BF6 | | | | | 35B5 |
| 5J6 | 6BG6G | | | | | 35C5 |
| 5T3 | 6BH6 | | | | | 35L6GT |
| 5U4G | 6BJ6 | | | | | 35W4 |
| 5U5 | 6BK5 | | | | | 35Y4 |
| 5V4G | 6BK7 | | | | | 35Z5CT |
| 5V6GT | 6BL7CT | | | | | 37 |
| 5X8 | 6BN6 | | | | | 39/44 |
| 5Y3GT | 6BQ6 | | | | | 50A5 |
| 5Y4G | 6BQ7 | | | | | 50B5 |
| 6A7 | 5BY5G | | | | | 50C5 |
| 6A8 | 6BZ6 | | | | | 50L6GT |
| | | | | | | 50X6 |

Jan Surplus Tubes

37¢ ea.
\$35
for
ANY TUBE LISTED
PER HUNDRED ASSTD

| | | | |
|-------|-------|-----|---------|
| 6CL6 | 6SC7 | 7A7 | 12AQ5 |
| 6CM6 | 6SF5 | 7A8 | 12AT6 |
| 6CN7 | 6SF7 | 7B4 | 12AT7 |
| 6CH6 | 6S7 | 7B5 | 12AU6 |
| 6CJ6 | 6S6 | 7B6 | 12AU7 |
| 6CK6 | 6CJ6 | 7B7 | 12AV6 |
| 6DE6 | 6S7GT | 7B8 | 12AV7 |
| 6D6 | 6S7 | 7C4 | 12AX4GT |
| 6E6 | 6S7 | 7C5 | 12AX7 |
| 6H6 | 6T8 | 7C6 | 12A7 |
| 6J4 | 6T8 | 7C7 | 12B4 |
| 6J5 | 6U8 | 7E6 | 12BA6 |
| 6J7 | 6V6 | 7E7 | 12BA7 |
| 6K6GT | 6W4GT | 7F7 | 12BE6 |
| | | | 12BF6 |
| | | | 12BH7 |
| | | | 12BQ5 |
| | | | 12BQ6 |
| | | | 12B7 |

SPECIAL PURPOSE and INDUSTRIAL TUBES

AT SPECIAL SAVINGS!

| Type | Price | Type | Price |
|--------|-------|-------|--------|
| 0A2 | \$.60 | 872A | \$6.95 |
| 0A3 | .70 | 884 | .80 |
| 0A4 | .75 | 885 | .75 |
| 0B2 | .45 | 954 | .20 |
| 0B3 | .65 | 955 | .30 |
| 0C3 | .50 | 957 | .30 |
| 0D3 | .40 | 2050 | .90 |
| 2D21 | .55 | 2051 | .90 |
| 2E26 | 1.95 | 5643 | .75 |
| 4X150A | | 5654 | .75 |
| New | 18.00 | 5686 | 1.50 |
| 5R4GY | 1.95 | 5687 | .75 |
| 6J4WA | 1.15 | 5703 | 1.50 |
| 2I8 | 8.00 | 5725 | .90 |
| 304TL | 35.00 | 5726 | .90 |
| 4I6B | 18.95 | 5751 | .40 |
| 5J29 | .50 | 5751 | .90 |
| 750TL | 32.00 | 5763 | .80 |
| 807 | 1.00 | 5814A | .75 |
| 811A | New | 5879 | .90 |
| 815 | 2.50 | 5881 | 1.95 |
| 829B | 7.00 | 6146 | 2.45 |
| 832 | 3.00 | 6159 | 2.75 |
| 832A | 5.50 | 6201 | 1.00 |
| 866A | 2.95 | 6900 | 1.95 |

EXTRA SPECIALS:

- 6/12 volt VIB 89¢
- 6/12 volt New VIB \$1.49
- 50 watt 25K Sprague Resistors 30¢

MICRO

SINCE 1957

EVERY DEAL A FAIR DEAL

Not Connected With Any Other Mail Order Tube Co

ALL TUBES SENT POST-AGE PAID. Please send 35c handling for orders under \$5. Send 25% dep. on C.O.D. orders. Send approx. postage on Canadian and foreign orders.

MICRO

ELECTRON TUBE CO.

P.O. Box 55 Park Sta.
Paterson 3, N. J.

WRITE DEPT. E-11 FOR OUR FREE COMPLETE LIST OF TUBES & SPECIAL PURPOSE TUBES

You probably thought top quality electronic test instruments were too expensive...*didn't* you?

Well, they're not when you build them with money-saving RCA kits

You've known right along that you can save money on electronic test instruments by building from kits.

But you may have shied away from kits because you thought they involved complicated calibration or adjustment problems. Forget it!

RCA kits are inexpensive, of course, but they're also easy to build. Build them right and they'll give you the best performance you can buy in their price range.

What's better about RCA test instrument kits?

Ease of assembly is one thing. Parts are clearly identified. Each assembly diagram appears on the same page as the step-by-step instructions for that section of assembly. There's no need to refer back constantly to other pages, which consumes time and increases the chance of error.

Ease of alignment is another thing. Each kit contains complete instructions for accurate calibration or alignment of the instrument. Where necessary, precision calibrating resistors are provided for this purpose.

What does it mean? It means that with RCA kits you can get a professional V-O-M or VTVM for as little as \$29.95*. Or you can get a good oscilloscope (one of the most useful—but normally one of the most expensive—test instruments) for only \$79.50*

Specialized instruments such as an AC VTVM or an RF Signal Generator, are also available as kits for far less than they would cost otherwise. In every case, RCA kits, when completed, are identical with RCA factory assembled instruments.

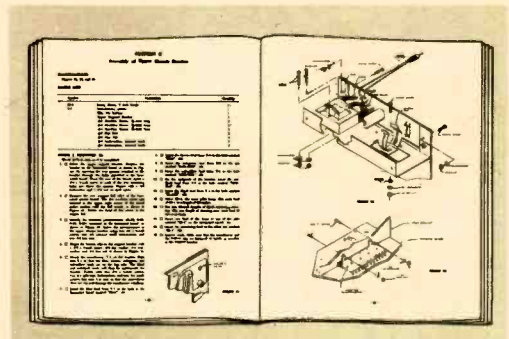

Each sub-assembly is described in a separate section with illustrations applying to that sub-assembly available at a glance. No cross referencing necessary.

LOOK WHAT'S AVAILABLE TO YOU IN KIT FORM:



RCA VOLT-OHM-MYSTO. The most popular VTVM on the market. WV-77E(K). Kit price: \$29.95*



RCA SENIOR VOLT-OHM-MYSTO. A professional VTVM. WV-98C(K). Kit price: \$57.95*



RCA VOLT-OHM-MILLIAMMETER. One of most useful instruments. WV-38A(K). Kit price: \$29.95*



RCA 3-INCH OSCILLOSCOPE. Compact, lightweight, portable. WO-33A(K). Kit price: \$79.95*



RCA HIGH-SENSITIVITY AC VTVM. Doubles as audio pre-amplifier. WV-76A(K). Kit price: \$57.95*



RCA RF SIGNAL GENERATOR. For audio and TV servicing. WR-50A(K). Kit price: \$39.95*

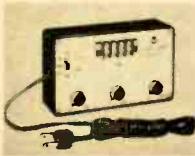

RCA TV BIAS SUPPLY. For RF, IF alignment in TV sets. WG-307B(K). Kit price: \$11.95*



RCA TRANSISTOR-RADIO DYNAMIC DEMONSTRATOR. For schools. WE-93A(K). Kit price: \$39.95*

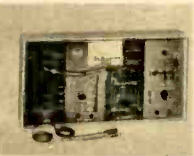

RCA V-O-M DYNAMIC DEMONSTRATOR. A working V-O-M. WE-95A(K). Kit price: \$37.95*

See them all—and get full technical specifications for each—at your local Authorized RCA Test Equipment Distributor. Or write for information to: Commercial Engineering, Section K-134-W, RCA ELECTRONIC COMPONENTS AND DEVICES, HARRISON, N. J.

* User price (optional)

RCA ELECTRONIC COMPONENTS AND DEVICES, HARRISON, N. J.



The Most Trusted Name in Electronics

NEW! DIFFERENT!

EXCITING!

Men 17-55...Prepare

**Now for a Real Job in
Space and Missile
Electronics**

**NO ADVANCED
EDUCATION
REQUIRED!**

To help you **EARN GOOD MONEY** later in industry, DeVry's modern training provides a thorough grounding in basics . . . then develops your skill. Thus, there is no need for advanced education or previous technical experience at the start. Whether you prepare in your spare time at home or in our well-equipped Laboratories, DeVry helps you become a well-trained technician, ready for a real career in Electronics.

**BUILD
AND KEEP
VALUABLE
EQUIPMENT!**



You build the 5-inch streamlined commercial type oscilloscope and the transistorized, portable meter above. This test equipment is similar in every way to the latest design used on today's jobs — with function grouped controls and meter scales color-keyed to the panel markings. And you keep this valuable equipment; you'll use it both in your training and on the job.



FROM RADIO TO ROCKET ELECTRONICS

Front Pages have been full of stories about "Men in Orbit" and "Outer Space Race." With headlines about Vanguards, count-downs, launching pads, the miracles of **ELECTRONICS IN SPACE** are exciting the Free World.

But there is **BIG NEWS** on the "Help Wanted" pages too! The Space Age has touched off another wave of opportunity for trained men in Electronics jobs ranging all the way from Radio and Television to Communications, Radar, Broadcasting, Automation, Industrial Electronics, Missile Work, etc. Yes, "Electronics" today spells **OPPORTUNITY IN CAPITAL LETTERS**.

"What does that mean to me?" you ask. Just check yourself. Are you 17-55? Are you handy with simple tools? Can you follow step-by-step instructions? Are you ambitious enough to invest a few hours of your spare time each week?

If your answer is "Yes," then when you are trained Electronics may be your path to better living, money, excitement, more security, future. Here's more good news: you don't need to leave home or quit your present job—to prepare for many of the opportunities Electronics offers. DeVry's **SPARE TIME** program is an answer!

CONTINUOUS EMPLOYMENT and COUNSELING SERVICE

DeVry's 33 years in Electronics training has won us wide and respected contact with many key placement people in the industry. Thus, when you become a DeVry graduate you are, from then on, entitled to our highly effective Counseling and Employment Service.

DRAFT AGE? If you are subject to military service, we have valuable information for you.

TURN PAGE FOR MORE FACTS . . .

MAIL POSTAGE-FREE CARD NOW!

DeVRY TECHNICAL INSTITUTE

4141 Belmont Ave., Chicago, Illinois 60641, Dept. EI-11-U

Please give me your two free booklets, "Pocket Guide to Real Earnings" and "Electronics in Space Travel"; also include details on how to prepare for a career in Electronics. I am interested in the following opportunity fields (check one or more):

- | | |
|--|---|
| <input type="checkbox"/> Space & Missile Electronics | <input type="checkbox"/> Communications |
| <input type="checkbox"/> Television and Rad o | <input type="checkbox"/> Computers |
| <input type="checkbox"/> Microwaves | <input type="checkbox"/> Broadcasting |
| <input type="checkbox"/> Radar | <input type="checkbox"/> Industrial Electronics |
| <input type="checkbox"/> Automation Electronics | <input type="checkbox"/> Electronic Control |

Name _____ Age _____

Address _____ Apt. _____

City _____ Zone _____ State _____

Check here if you are under 16 years of age.
Canadian residents: Write DeVry Tech of Canada, Ltd.
970 Lawrence Avenue West, Toronto 19, Ontario

**2 FREE
BOOKLETS**

**GIVE YOU FACTS ON HOW
YOU MAY GET STARTED!**

WHETHER IT'S RADIO-TV OR MISSILE ELECTRONICS...

Get Your Training From DeVry! PREPARE FOR A VARIETY OF GOOD JOBS

Hundreds and hundreds of companies in the vast Electronics industry are on the lookout for trained technicians. They seek men to help build, test, install and service a wide variety of Electronic devices. To men with skill in Electronics, these firms offer GOOD-PAYING JOB OPPORTUNITIES, such as those shown below . . . and others.

What's more, the trained man can start his OWN BUSINESS in Electronics, when he has all the advantages of preparing the DeVry way.

Why not see for yourself how YOU may get ready with DeVry's help to enter and prosper in Electronics . . . one of history's fastest-moving fields! Mail the coupon now.

WHAT SOME DeVRY TECH GRADUATES ARE DOING

Edward Hahn, Illinois, was a laborer. Now he is an Electronic Senior Engineer with the Martin Company, a large producer of missiles.
Dale L. Gawthorpe, Illinois, left a clerk's job to take the DeVry program. He is now enjoying his work with automatic pilot equipment at Sperry Phoenix Company.
Charles Morishita, Oregon, worked as a farmer before taking DeVry's training. Now he builds and tests equipment at Lockheed's Space and Missile Division.
Gerald R. Borner, Washington, has found his DeVry training a valuable aid on his job as Radar Technician in Boeing Airplane Company's Aero Space Division.

A FEW OF THE MANY JOB OPPORTUNITIES!

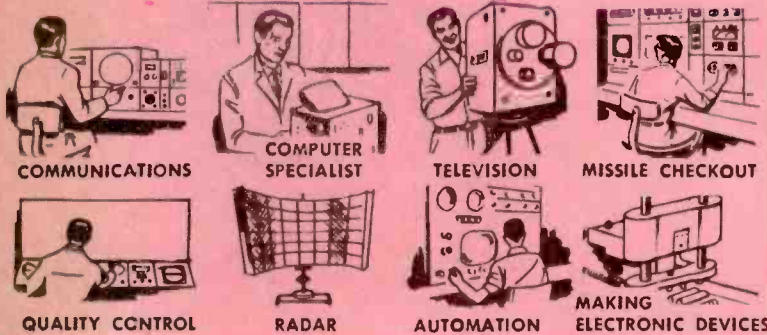

DeVry Tech President VISITS MISSILE BASE

DeVry's president, Mr. T. J. Lafabet, accorded a special invitation to inspect a famous missile facility, was deeply impressed with the role of Electronics in the national defense.

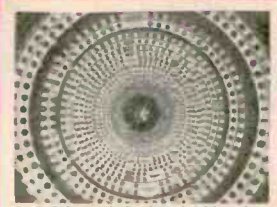

A PEARL VIEW! This inside view of a ballistic missile is seldom seen by a civilian. It's a sight that greatly impressed Mr. Lafabet.



ELECTRONICS — THE HEART OF THE MISSILE! The wiring in missile devices soon comes clear to a DeVry Tech man because he learns basic circuits by use of the "Electro-Lab", a training method that helps speed up learning.

Postage Will be Paid by Addressee

No Postage Stamp Necessary if Mailed in the United States

BUSINESS REPLY MAIL
First Class Permit No. 4148, Chicago, Ill.

DeVry Tech
4141 Belmont Avenue
Chicago, Illinois 60641

DON'T DELAY MAIL TODAY!