

BONUS
16 PAGES • The ABC's of Electronics

ELECTRONICS ILLUSTRATED

MAY • 35¢



A "Hot" 2-Way CB Radio

It's New!
TRANSISTOR
MICROPHONE

By the Publishers of **MECHANIX**
ILLUSTRATED

AN EASIER WAY TO LEARN



You train in your own home—keep your present job while learning. Well illustrated NRI lessons teach Radio-TV-Electronic principles. You build, test, experiment with Radio-TV circuits, get actual practice with kits NRI gives you. Graduate Vagnoni, at left, knew nothing about Radio when he enrolled.

TRAINING KITS GIVE EXPERIENCE



You don't have to know anything about electricity or Radio to understand and succeed with NRI courses. Many successful NRI men did not finish high school. NRI trained men have been accepted for responsible positions throughout the United States and Canada. Graduate Barnett, for instance, is Chief Engineer with station KGCU.

THOUSANDS ACHIEVED SUCCESS THIS WAY

For over 40 years, NRI has been training men for success. Multiple uses of Electronics in office machines and production machinery—plus importance of Electronics in missiles, rockets, etc.—are creating a need for more and more Electronic Technicians. Because the work is interesting and important, the pay high and the future bright, job counselors are advising men to train for a career in Electronics. National Radio Institute—America's oldest and largest home study Electronic school—is now offering complete training in Industrial Electronics as well as its courses in Radio-Television and Radio-Television Communications. Read on the next page about the special Electronic training equipment NRI furnishes at no extra cost to make training at home faster and easier.

CUT OUT AND MAIL POSTAGE-FREE CARD

FIRST CLASS
PERMIT NO. 20-R
(Sec. 319 P L & R)
WASHINGTON, D. C.

BUSINESS REPLY CARD
NO POSTAGE STAMP NECESSARY IF MAILED IN THE UNITED STATES

POSTAGE WILL BE PAID BY

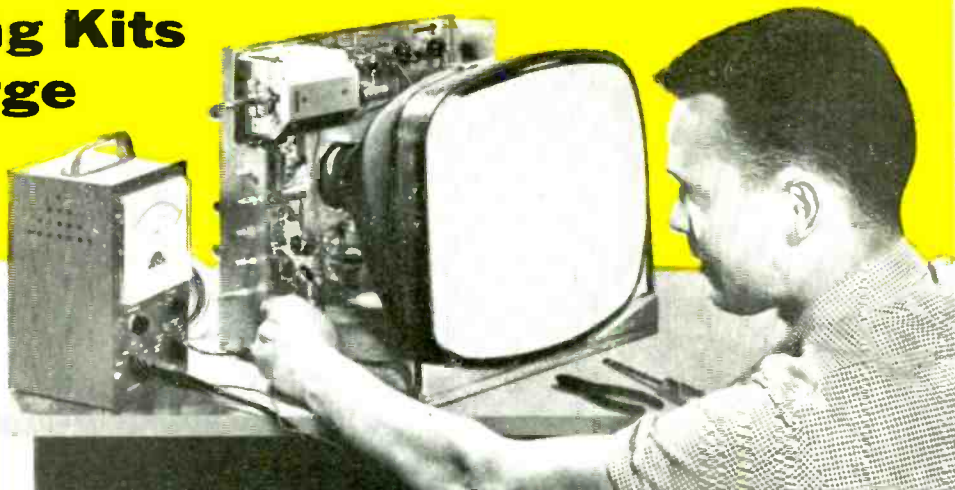
NATIONAL RADIO INSTITUTE

Washington 16, D.C.



Special Training Kits No Extra Charge

People look up to and depend on the Technician, more than ever before. New Electronic products are increasing the job opportunities for Radio-Television-Electronic Technicians. Right in your own home, in your spare time, you can gain knowledge, develop skills needed to get good jobs in this vast industry. You learn by doing. You get NRI kits developed especially to give actual practice and experience. As part of your NRI training you can get a lot including picture tube to build the 17" Television receiver and multi-use vacuum tube Voltmeter, shown at right. You use this equipment to learn Radio-TV-Electronic circuits, make tests, experiments. All equipment is yours to keep.



Good Spare Time Earnings

"I am doing very well in spare time TV and Radio. Sometimes have several TV jobs waiting and also fix car Radios for garages. I paid for instruments out of earnings." G. F. SEAMAN, New York, N. Y.

Has Own Radio-TV Business

"We have an appliance store with our Radio and TV servicing, and get TV repairs. During my Army service, NRI training helped get me a top rated job." W. M. WEIDNER, Fairfax, South Dakota.

FOR GOOD PAY TO START AND A BRIGHT FUTURE Learn ELECTRONICS Radio Television AT HOME IN YOUR SPARE TIME



CUT OUT AND MAIL
POSTAGE-FREE CARD

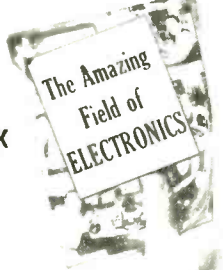
64-Page Electronic Catalog FREE

No Obligation • No Salesman Will Call

NO STAMP NEEDED
NRI PAYS POSTAGE

NATIONAL RADIO INSTITUTE
Washington 16, D. C. O.E.K.

Send me complete information
without cost or obligation.
(Please print.)



NAME

AGE

ADDRESS

CITY ZONE STATE

Accredited Member National Home Study Council

You Can Start Soon Earning Extra Money in Spare Time

Many NRI students find it easy and profitable to fix sets for friends and neighbors starting a few months after enrolling. Use the Tester built with parts NRI furnishes to locate and correct Radio-TV receiver troubles. Picking up \$10, \$15 and more a week gives substantial extra spending money. Many who start in spare time soon build full-time Radio-Television sales and service businesses, enjoy prestige, respect and satisfaction in this fast-growing industry.

Benefit by NRI Experience—Oldest, Largest Home Study Electronic Radio TV School

NRI's more than 40 years experience training men for success—the outstanding record and reputation of this school—benefits you in many ways. NRI methods are tested, proven. Successful graduates are everywhere, in small towns and big cities. Here is an investment that pays big profits soon. Each week, invest only a few hours spare time in yourself preparing to be a Radio-TV-Electronics Technician. Invest in training to get ahead. NRI can provide the training you need.

NRI Offers the Tested Way to Better Pay

Technical know-how brings better pay, fast advancement. Radio-TV-Electronic opportunities are great, and are increasing. NRI has devoted over 40 years to developing simplified, practical training methods. Mailing the card at left can be one of the most important acts of your life. Do it now. Reasonable tuition. Low monthly payments available. Let us send you 64-page Catalog FREE. Address: NATIONAL RADIO INSTITUTE, Dept. O.E.K., Washington 16, D. C.



J. E. Smith
Founder



Broadcasting offers satisfying careers. Hundreds of Radio and Television stations on the air offer interesting jobs for Operators and Technicians. Police, Aviation, Two-Way Communications are expanding. Men with Radio-TV training are in demand.



A solid, proven field of opportunity for good pay is servicing the millions of Radio and TV sets now in use. Government, military, guided missile manufacturers, industry all need Technicians. Color TV, Hi-Fi are increasing the opportunities.

National Radio Institute Washington 16, D. C. Est. 1914

YOU be the judge of *knight-kit*® value

A PRODUCT OF ALLIED RADIO



FREE examination privilege

More and more people are finding out how easy it is to build exciting Knight-Kits, how satisfying they are to own, and how much they save.

If you haven't yet enjoyed the experience and fun of building and owning a Knight-Kit, we invite you to take advantage of our free examination offer. Order any Knight-Kit. Examine it on arrival. Inspect the

quality of the components, the circuitry, the easy-assembly manual. We're so confident you'll want the kit, we can make this offer: If you're not COMPLETELY SATISFIED, just return the kit for full refund.

Order a Knight-Kit now. Know the thrill of the most satisfying build-your-own experience in electronics.



Y-731 Deluxe FM-AM Stereo Hi-Fi Tuner (Multiplex add-in) \$87.50
only \$5 down



Y-774 Deluxe 40-Watt Stereo Amplifier (with Center Channel) \$79.50
only \$5 down



Y-773 Super-Value 20-Watt Stereo Hi-Fi Amplifier... \$44.50
only \$2 down



Y-787 FM-AM Hi-Fi Tuner (with Multiplex Jack) \$49.95
only \$2 down



Y-713 Best-selling Citizens Band Transceiver, Tunable 22-channel super-regen receiver... \$39.95
only \$2 down



Y-253 4-Band "Span Master" Receiver (with cabinet) \$25.95
only \$2 down



R-100 Amateur Communications Receiver (HI-gain, with built-in Q-Multiplier) \$104.50
only \$5 down



Y-708 1000 Ohm/Volt Pocket Volt-Ohm-Milliammeter \$9.95



Y-737 "Ranger" Clock-Radio with "sleep" switch... \$24.95
only \$2 down



Y-777 5-Transistor Superhet Portable Radio (less battery) \$25.95
only \$2 down



Y-125 General-purpose VTVM (11 meg. input res.) \$25.75
only \$2 down



Y-143 Model "600" Tube Checker (checks over 700 types) \$32.95
only \$2 down

easiest to build...
satisfying to own
...money-saving

ONLY \$2 DOWN
on orders up to \$50;
\$5 down on orders
up to \$200...

see scores of
other *knight-kits*

HI-FI KITS

Stereo Preamplifier
60-W Stereo Amplifier
Monaural Amplifiers
Hi-Fi Tuners
Speaker Systems
and others

HOBBYIST KITS

"Space-Spanner" Radio
"Ranger" Radios
Transistor Radios
2-Way Intercom
Electronic Lab Kits
and many others

INSTRUMENT KITS

Lab AC VTVM
VOM's
5" Scopes
Tube Checkers
Signal Tracer
Audio Generator
Sweep Generator
plus many others

AMATEUR KITS

50-Watt Transmitter
Self-Powered VFO
100 kc Crystal Calibrator
Code Practice Oscillator
Grid Dip Oscillator

ALLIED RADIO

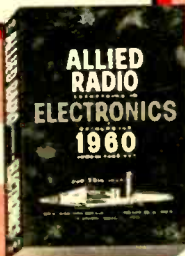
there's a money-saving *knight-kit* for every need... see them all in the

ALLIED CATALOG

Describes the complete KNIGHT-KIT line in detail. Order the kit of your choice—judge quality and value for yourself under our Free examination privilege!

FREE

send for it!



ALLIED RADIO, Dept. 26-E
100 N. Western Ave., Chicago 80, Ill.

Send FREE Catalog featuring Knight-Kits.

Name _____

Address _____

City _____ Zone _____ State _____

ELECTRONICS ILLUSTRATED

May, 1960

Vol. 3, No. 5

A Fawcett Publication

CHARLES TEPFER Editor
 Larry Klein Technical Editor
 Edward Nanas Feature Editor
 David Kipnes Assistant Editor
 Murray Cooper Art Editor
 Lou Rubsamen Art Associate
 Elaine Sapoff Editorial Assistant

CONTENTS

16 PAGE BONUS

ABC's of Electronics 65

CB 2-WAY RADIO

All About Citizens Band Range 56
 CB Modulator (Build-it Course) 36

FEATURES

Radio's Most Exciting Frontier 25
 Cash in a Flash 34
 Stereophones 40
 Spotlight on 10 Meters 44
 How FM Tuners are Made 81
 Gun Jumpers Beware 93
 Bootleg Station on High Seas 96
 EI Picturescope 100
 Before Breakfast QSO's 102
 Electronics Fights Pain 106

BUILD-IT PROJECTS

Fingertip Switching 29
 Transistorized Mike 32
 Transistor Tester 48
 Remote Reading Thermometer 51
 Electronic Brain 54
 Milt Kiver on Tube Testers—2 60
 EI's Hot Tips 64
 Hi-Fi Clinic 84
 Eliminate TV Overload 86
 Power-Transistor Intercom 87
 Heath Educational Kit 90
 DC Power Supply 98
 Try These 104

Ralph Daigh Editorial Director
 James Boynton Advertising Director
 Al Allard Art Director
 Ralph Mattison Associate Art Director
 George H. Carl Production Director

Larry Eisinger Editor-in-Chief
 Phyllis Bendremer Production Editor
 Benita Mills Assistant Production Editor
 John F. Webster Advertising Manager

ELECTRONICS ILLUSTRATED is published monthly by Fawcett Publications, Inc., Fawcett Place, Greenwich, Conn. W. H. Fawcett, Jr., President; Gordon Fawcett, Secretary and Treasurer; Roger Fawcett, General Manager; Roscoe K. Fawcett, Circulation Director; Donald P. Hanson, Assistant General Manager.

EDITORIAL AND ADVERTISING OFFICES: 67 West 44th Street, New York 36, N. Y.
 ADDRESS ALL MAIL: Subscriptions, change of address, Form 3579 to Subscription Dept., Fawcett Bldg., Greenwich, Conn.; and all editorial and advertising to Fawcett Publications, Inc., 67 W. 44th St., New York 36, N. Y.

Second-class postage paid at Greenwich, Conn., and at additional mailing offices.
 Subscription price \$4.00 per year in the U. S. and possessions and Canada. All other countries \$6.00 per year. Foreign subscriptions and sales should be remitted by International Money Order in U. S. funds payable at Greenwich, Conn.

Printed in U.S.A. Copyright 1960 by Fawcett Publications, Inc.
 Permission hereby granted to quote from this issue of this magazine on radio or television provided a total of not more than 1,000 words is quoted and credit is given to the title of the magazine and issue, as well as the statement, copyright 1960, by Fawcett Publications, Inc.

Make More Money Soon Fixing Electric Appliances



**Actual Lesson
FREE** Fast Growing
Field Offers
Good Pay, Security
Interesting Work

Learn at Home in Spare Time

Earn more money. Enjoy doing important, interesting work. Learn Electrical Appliance Servicing. This is a field of increasing opportunity. Today every wired home has many electrical appliances and millions and millions of new appliances are made and sold each year. Find out more about this great, growing field. Find out how NRI can train you, at home and in spare time to be an Appliance Service Technician. See how you can start soon to make extra money servicing appliances.

Add to Your Income Soon After Enrollment Opportunities Increasing for Service Technicians

NRI Training is practical, thorough. You get easy-to-understand lessons, and NRI supplies parts to build professional type Multi-Use Tester. Use it to get practical experience. Soon, you can add to your income by servicing appliances. Build a profitable *sideline* for your spare time—qualify for a good job—develop a business and be your own boss. As an Appliance Service Technician, your opportunities are broad—your services wanted, gladly paid for, highly regarded in your community.

Appliances are necessary to comfortable, convenient living. Owners pay well to keep them in repair. The field is amazingly big. In addition to major appliances such as electric ranges, air conditioners, refrigerators, there are over 40,000,000 electric irons, 5,000,000 electric blankets, 15,000,000 coffee makers, plus more millions of vacuum cleaners, fans, toasters, mixers, etc.

Learn and Earn With Tester Diploma When You Finish



Locate appliance troubles easily with Portable Appliance Tester you build. You use it to learn and do actual electric appliance repair jobs. For only \$3.00 with enrollment and \$6 per month, get training including Tester—a small price to pay for increased earnings. Mail coupon for Sample Lesson and Book—your first step toward more interesting work, bigger earnings. **NATIONAL RADIO INSTITUTE, Dept. KEO, Washington 16, D. C.**



Over 40 Years
Experience
Backs Up
NRI Training

Find Out What
Appliance Repair
Offers You

Mail Coupon FOR LESSON AND BOOK **FREE**

National Radio Institute
Dept. KEO, Washington 16, D. C.

Please send me Electric Appliance Servicing Lesson and Book FREE. (I understand no salesman will call.)

Name _____ Age _____

Address _____

City _____ Zone _____ State _____

ACCREDITED MEMBER NATIONAL HOME STUDY COUNCIL

A Message From the Editor

I am terrible at keeping a secret — I just can't do it! Last month I told you that we were working on a unique free gift for each reader of the June issue of **ELECTRONICS ILLUSTRATED**. Well, I know I shouldn't be telling you what it is now, but I just can't hold back any longer.



In our June issue you will get **ABSOLUTELY FREE** a special, newly-developed plastic test record for your hi-fi system. EI made this record especially for you, it is not obtainable anywhere else. We have developed an interesting new way for you to test whether your hi-fi system needs improvement or repair, and this is the program contained on the record and described in a special 8-page article which accompanies the record. The EI Test Record is simple to use, merely pull (or cut) it out of the June issue and put it on your record player or changer. It can be played many times without deterioration. You can also use the EI Test Record to demonstrate your hi-fi system to neighbors and friends because it includes some rousing good music.

Normally, such a test record will cost you about a dollar, but you

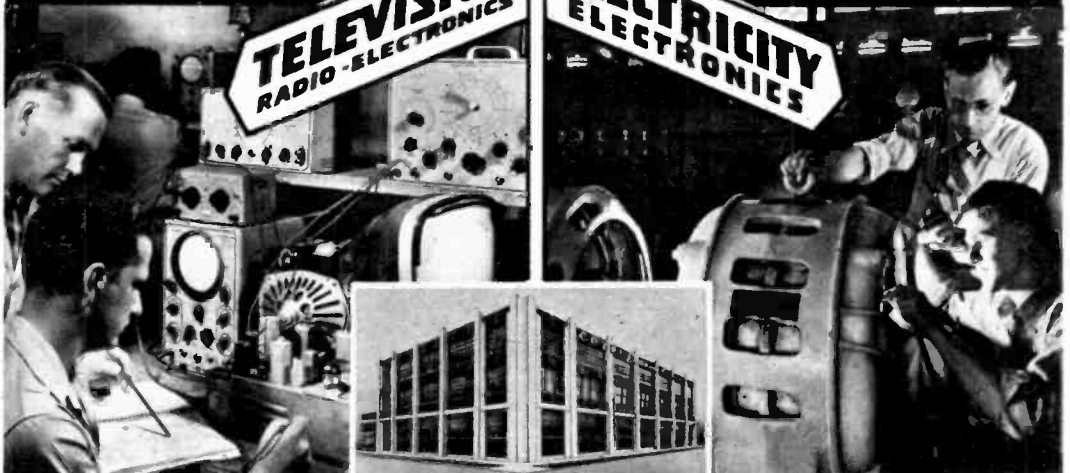
will get it absolutely free in our June issue.

Remember to look for it on the newsstands about the middle of May — and tell your friends about it too!

As you know, we constantly present unusual projects that our readers cannot get anywhere else. This is a tough thing to do for amateur radio, which has been written about and experimented with for many, many years. But we think we have come up with a new project for the ham in our June issue. This is a control unit for the ham shack that will just about do anything except identify your station. It is also an ideal suitcase unit to take with you if you like hamming in the field or during your vacation. This one was developed for us by Howard Pyle, W7OE, who is an authentic pioneer ham having been an active radio amateur since before World War I. You have seen his name on articles in our magazine before, and we plan to have lots more from him.

From time to time we like to help our project builders keep peace in the family. This is most necessary because projects do take time to build (and money) and most wives are under-

Train in New Coyne Shop-Labs for Today's Top OPPORTUNITY FIELDS!



Instructor helping students check the wiring and trace the circuits of television receivers.

This modern fire-proof building which is occupied entirely by Coyne, houses the NEW COYNE SHOP-LABS.

Instructor explaining operation and testing of a large Motor Generator.

TELEVISION-RADIO ELECTRONICS

Here at COYNE you're trained for Testing, Trouble-Shooting and Servicing on AM and FM Radio, Auto Radio, Television, Color TV, etc. Thousands of COYNE trained men in good jobs or own well paying TV-Radio businesses.

ELECTRICITY ELECTRONICS

Big opportunities everywhere—city, town and country, in Power Plant Work, Motors, Industrial Electronics, Armature Winding, Home and Factory Wiring, Appliances, Refrigeration, Maintenance, Illumination, etc.

**OLDEST AND BEST
EQUIPPED SCHOOL OF ITS
KIND IN THE U. S.**

Send Coupon or Write for

FREE BOOK

"GUIDE to CAREERS"

Whether you prefer Electricity—Television—Radio or Combined Electronics Training this book describes all training offered.

Information comes by mail and no salesman will call.



To get Free Book and information, mail this Coupon in envelope or Paste on Postal Card, or write to address below.

WE TRAIN YOU IN CHICAGO

Our famous Practical-Technical method gives you practical experience on a massive outlay of equipment—over a quarter of a million dollars worth—plus necessary technical training right here in the NEW COYNE Shop-Labs

Training in Refrigeration and Electric Appliances can be included.

Training offered to **VETERANS and NON-VETS** alike

START NOW—PAY LATER

Enroll now, pay most of tuition after Graduation. Part time employment help for students. Lifetime employment service to Graduates. Starting dates, every six weeks.

B. W. COOKE, JR., President

COYNE
ELECTRICAL SCHOOL

FOUNDED 1899

CHARTERED AS AN EDUCATIONAL INSTITUTION NOT FOR PROFIT
1501 W. Congress Parkway, CHICAGO, Dept. 50-8C
ELECTRICITY • RADIO • TELEVISION • REFRIGERATION • ELECTRONICS

COYNE ELECTRICAL SCHOOL, Dept. 50-8C
1501 W. Congress Pkwy., Chicago 7, Ill.

At no obligation to me send FREE book "Guide to Careers" and details of all the training you offer. However, I am especially interested in:

ELECTRICITY TELEVISION BOTH FIELDS

Name _____

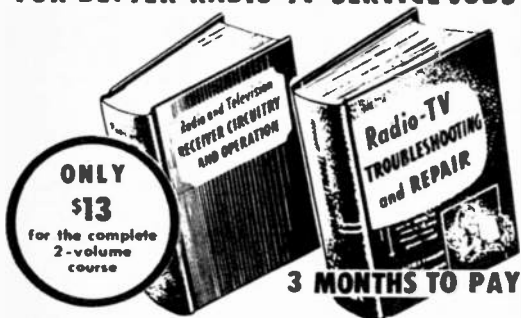
Address _____

City _____ State _____

(I understand no Salesman will call.)

Complete Training

FOR BETTER RADIO-TV SERVICE JOBS



Let these two great Ghirardi training books teach you to handle all types of AM, FM and TV service jobs by approved professional methods—and watch your efficiency and earnings soar!

Each book is a complete service training guide. Each contains complete data on modern methods and equipment—NOT a re-hash of old, out-of-date material. Each is co-authored by A. A. Ghirardi whose famous RADIO PHYSICS COURSE and MODERN RADIO SERVICING were, for 20 years, more widely used for military, school and home study training than any other books of their type!

THE NEW Ghirardi RADIO-TV SERVICE LIBRARY

Almost 1500 pages and over 800 clear illustrations show step-by-step how to handle every phase of troubleshooting and servicing.

1—Radio and Television Receiver TROUBLESHOOTING AND REPAIR

A complete guide to profitable professional methods. For the beginner, it is a comprehensive training course. For the experienced serviceman, it is a quick way to "brush up" on specific jobs, to develop improved techniques or to find fast answers to puzzling service problems. Includes invaluable "step-by-step" service charts. 420 pages, 417 illus., price \$7.50 separately.

2—Radio and Television Receiver CIRCUITRY AND OPERATION

This 669-page volume is the ideal guide for servicemen who realize it pays to know what really makes modern radio-TV receivers "tick" and why. Gives a complete understanding of basic circuits and circuit variations; how to recognize them at a glance; how to eliminate guesswork and useless testing in servicing them. 417 illus. Price separately \$6.75.

Special low price . . . you save \$1.25

If broken into lesson form and sent to you as a "course," you'd regard these two great books as a bargain at \$50 or more!

Under this new offer, you save \$1.25 on the price of the two books—and have the privilege of paying in easy installments while you use them! No lessons to wait for. You learn fast—and right!

STUDY 10 DAYS FREE

Dept. PR-50, RINEHART & CO., Inc.
232 Madison Ave., New York 16, N. Y.

Send books below for 10-day FREE EXAMINATION. In 10 days I will either remit price indicated (plus postage) or return books postpaid and owe you nothing.

Radio & TV Receiver TROUBLESHOOTING & REPAIR (Price \$7.50 separately)

Radio & TV CIRCUITRY & OPERATION (Price \$6.75)

Check here for MONEY-SAVING COMBINATION OFFER
I will . . . Save \$1.25. Send both of above big books at special price of only \$13.00 for the two. (Regular price \$14.25 . . . you save \$1.25) Payable at rate of \$4 plus postage after 10 days if you decide to keep books and \$3 a month for 3 months until the total of \$13.00 has been paid.

SAVE! Send cash with order and we pay postage. Same 10 day return privilege with money refunded.

Name _____

Address _____

City, Zone, State _____

Outside U.S.A.—\$8.00 for TROUBLESHOOTING & REPAIR; \$7.25 for CIRCUITRY & OPERATION; \$14.00 for both. Cash only, but money refunded if you return books in 10 days.

standably piqued when their husbands neglect them for an electronics project. Well, we have something that you can build for your wife in our June issue. This is an automatic oven thermometer which plays "Smoke Gets In Your Eyes" when the roast is done. It is easy to build—we've tested it and we guarantee that it will definitely keep smoke out of your wife's eyes if you build it for her.

Our 16-page bonus section in this issue is a condensation of the very popular basic electronics course which we ran in our first 14 issues. We've had many requests for such a reprint. It was difficult condensing the series to 16-pages, but we think we have preserved the original intention which was to familiarize those of you who are new to electronics with the terms and basic concepts and to refresh the veteran electronics hobbyist who may have forgotten some of the theory.

Those of you who are confused about buying hi-fi consoles should read our special report on these units starting on page 40 in this issue. This is a real roll-up-the-sleeves job in which an EI task force got right into the consoles to find out for you just how good they are and how much you do get for your money. Even if you do not want this information for yourself, I think you should read it for what help you can give to your friends and neighbors who are considering buying such packages.

Once again, remember that special free test record in our June issue.

Charles Zeffu

Men 17 to 55—GET FREE FACTS!

See How **DeVry Tech** Can
Prepare You For A Profitable Future In Many Fields

from **Communications** to
Guided Missiles, etc.



**NO PREVIOUS TECHNICAL EXPERIENCE
OR ADVANCED EDUCATION NEEDED!**

Laborers and bookkeepers, store clerks, shop men, farmers, salesmen — men of nearly every calling — have taken the DeVry Tech program and today have good jobs or service shops of their own in Electronics. You don't have to quit your present job. If you are 17 to 55, see how you may get yourself ready for a future in the fast-growing Electronics field.

Whether you prepare at home or in our well-equipped Chicago or Toronto Laboratories, you get sound, basic training in both principles and practice. At home, you use educational movies. You build actual circuits and test equipment. You read simple directions, follow clear illustrations. When you finish, you are prepared to step into a good job in this excitingly different field. You may even start a service shop of your own. Mail coupon for free facts today.

Get **FREE** Booklet!

We'll give you a free copy of an interesting booklet, "Electronics in Space Travel." See for yourself how you may take advantage of the opportunities in this fast-growing field.



Electronics in
SPACE TRAVEL

"One of North America's Foremost
Electronics Training Centers"

Accredited Member
of National
Home Study Council



Radar



**Automation
Electronics**



Television



Micro-Waves



Computers



Broadcasting



**Your Own
Service Shop**

**FREE
EMPLOYMENT
SERVICE**

Puts you in touch with job opportunities—or helps you toward a better position in the plant where you are now employed.

Draft Age?

We have valuable information for every man of draft age; so if you are subject to military service, be sure to check the coupon.



DeVry TECHNICAL INSTITUTE
CHICAGO • TORONTO

MAIL COUPON NOW!

DeVRY TECHNICAL INSTITUTE

4141 Belmont Ave., Chicago 41, Ill., Dept. EI-5-Q

Please give me your FREE booklet, "Electronics in Space Travel," and tell me how I may prepare to enter one or more branches of Electronics as listed above.

Name _____ Age _____

Street _____ Please Print _____ Apt. _____

City _____ Zone _____ State _____

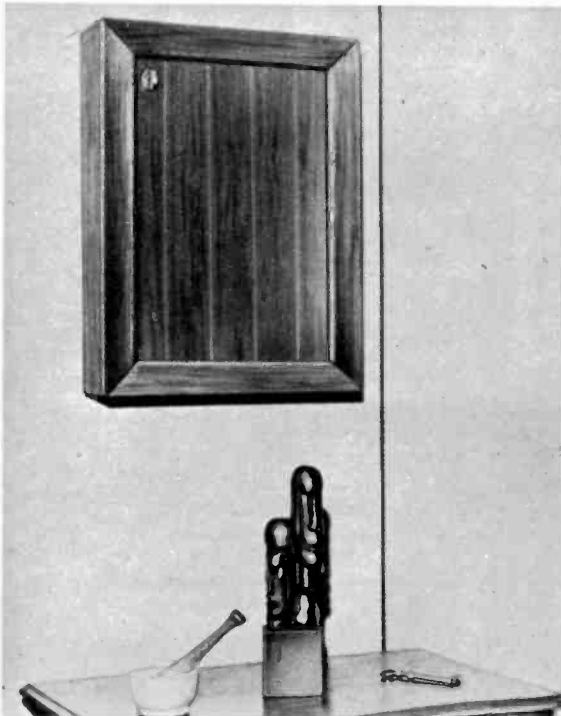
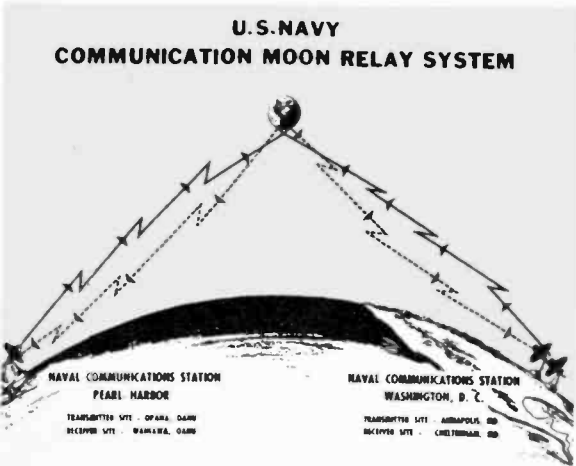
Check here if subject to Military Training.

DeVry Tech's Canadian Training Center is located
at 526 Roselawn Avenue, Toronto 12, Ontario

2640



The moon is now used as a passive reflector for relay of radio signals by the Navy. With stations in Washington, D. C. and Hawaii, the system utilizes teletype and facsimile methods of communications in the 400 mc bands which are not normally affected by ionospheric disturbances. However, transmission is limited to times when the moon is in sight of both stations. Photo right is of the USS Hancock, first transmitted by moon relay.



The newest thing about the speaker shown here is not that it can be hung on the wall but that it has no cone. Instead, the entire thin specially treated wood front panel serves as the vibrating element producing sound waves. This is a new concept developed by Abraham Cohen, president of Advanced Acoustics Corp. Called the 440 Bi-Phonic Coupler, it radiates from both front and rear. A conventional type tweeter is used for better response in the high frequencies.

"HOW A 'CRAZY RUMOR' GOT ME PROMOTED!"



What I overheard one morning shook me right out of a rut!

"Company's getting ready to cut back . . . bound to be layoffs," I heard them say. "Just another crazy rumor," I told myself.

Just the same, I took quick stock of myself that night. Came up with four good reasons why the company would keep me on:

- Three years' experience*
- Getting along with foreman*
- Turning out acceptable work*
- Prompt and dependable*

And four just-as-good reasons why they might let me go:

- Making no real headway*
- Others better qualified*
- Still rated "semi-skilled"*
- Needs special training*

I wasn't in trouble. But I sure wasn't "in solid" like I should be. That's when I made up my mind to enroll for training with I.C.S.

I picked I.C.S. because it's the oldest and largest with 257 courses. The training is quick and thorough. It's recognized by my company and accredited by the National Home Study Council. You study in your spare time and get personalized, practical instruction—know-how you can apply next day on the job.

That was a year ago. There have been two layoffs since then. While some of the others were just hanging on or being released, I was moving up. My I.C.S. training started something. Not only did it get me promoted (with a fat pay hike), but it put me in line for real advancement.

Don't wait for a "crazy rumor" to set you straight. Take out your "job insurance" right now. Mail the coupon and get full, free details on how I.C.S. has helped thousands, how it can help you. No obligation—and you get three valuable books *free!* (1) How to Succeed; (2) Catalog of opportunities in the field of your choice; (3) Sample lesson (math).

For Real Job Security—Get an I. C. S. Diploma!

I. C. S., Scranton 15, Penna.

Accredited Member,
National Home Study Council

INTERNATIONAL CORRESPONDENCE SCHOOLS



BOX 73574D, SCRANTON 15, PENNA.

(Partial list of 258 courses)

Without cost or obligation, send me "HOW TO SUCCEED" and the opportunity booklet about the field BEFORE which I have marked X (plus sample lesson):

ARCHITECTURE and BUILDING CONSTRUCTION

- Air Conditioning
- Architecture
- Arch. Drawing and Designing
- Building Contractor
- Building Estimator
- Carpenter Builder
- Carpentry and Millwork
- Carpenter Foreman
- Heating
- Painting Contractor
- Plumbing
- Reading Arch. Blueprints

ART

- Commercial Art
- Magazine Illus.
- Show Card and Sign Lettering
- Sketching and Painting

AUTOMOTIVE

- Automobile
- Auto Body Rebuilding and Refinishing
- Auto Engine Tuneup
- Auto Technician

AVIATION

- Aero-Engineering Technology
- Aircraft & Engine Mechanic

BUSINESS

- Accounting
- Advertising
- Business Administration
- Business Management
- Cost Accounting
- Creative Salesmanship
- Managing a Small Business
- Professional Secretary
- Public Accounting
- Purchasing Agent
- Salesmanship
- Salesmanship and Management
- Traffic Management

CHEMICAL

- Analytical Chemistry
- Chemical Engineering
- Chem. Lab. Technician
- Elements of Nuclear Energy
- General Chemistry
- Natural Gas Prod. and Trans.
- Petroleum Prod. and Engr.
- Professional Engineer (Chem)
- Pulp and Paper Making

CIVIL ENGINEERING

- Civil Engineering
- Construction Engineering
- Highway Engineering
- Professional Engineer (Civil)
- Reading Struc. Blueprints
- Sanitary Engineer
- Structural Engineering
- Surveying and Mapping

DRAFTING

- Aircraft Drafting
- Architectural Drafting
- Drafting & Machine Design
- Electrical Drafting
- Mechanical Drafting
- Sheet Metal Drafting
- Structural Drafting

ELECTRICAL

- Electrical Engineering
- Elec. Engr. Technician
- Elec. Light and Power
- Practical Electrician
- Practical Lineman
- Professional Engineer (Elec)

HIGH SCHOOL

- High School Diploma

- Good English
- High School Mathematics
- High School Science
- Short Story Writing

LEADERSHIP

- Industrial Foremanship
- Industrial Supervision
- Personnel-Labor Relations
- Supervision

MECHANICAL and SHOP

- Diesel Engines
- Gas-Elec. Welding
- Industrial Engineering
- Industrial Instrumentation
- Industrial Metallurgy
- Industrial Safety
- Machine Shop Practice
- Mechanical Engineering
- Professional Engineer (Mech)
- Quality Control
- Reading Shop Blueprints
- Refrigeration and Air Conditioning
- Tool Design Tool Making

RADIO, TELEVISION

- General Electronics Tech.

- Industrial Electronics
- Practical Radio-TV Eng'g
- Practical Telephony
- Radio-TV Servicing

RAILROAD

- Car Inspector and Air Brake
- Diesel Electrician
- Diesel Engr. and Fireman
- Diesel Locomotive

STEAM and DIESEL POWER

- Combustion Engineering
- Power Plant Engineer
- Stationary Diesel Engr.
- Stationary Fireman

TEXTILE

- Carding and Spinning
- Cotton Manufacture
- Cotton Warping and Weaving
- Loom Fixing Technician
- Textile Designing
- Textile Finishing & Dyeing
- Throwing
- Warping and Weaving
- Worsted Manufacturing

Name _____ Age _____ Home Address _____

City _____ Zone _____ State _____ Working Hours _____ A.M. to P.M. _____

Occupation _____ Canadian residents send coupon to International Correspondence Schools, Canadian, Ltd., Montreal, Canada. . . . Special low monthly tuition rates to members of the U. S. Armed Forces.



CITIZEN BAND CLASS "D" CRYSTALS

All 22 Frequencies in Stock

3rd overtone. .005% tolerance—to meet all F C C requirements. Hermetically sealed HC4/U holders. 1/2" pin spacing—.050 pins. (.093 pins available, add 15¢ per crystal). Add 5¢ per crystal for postage and handling.

**\$2.95
EACH**

The following Class "D" Citizen Band frequencies in stock (frequencies listed in megacycles): 26.965, 26.975, 26.985, 27.005, 27.015, 27.025, 27.035, 27.055, 27.065, 27.075, 27.085, 27.105, 27.115, 27.125, 27.135, 27.155, 27.165, 27.175, 27.185, 27.205, 27.215, 27.225.

Matched crystal sets for Globe, Gonset, Citi-Fone and Hallcrafters units . . . \$5.90 per set. Specify equip. make.

RADIO CONTROL CRYSTALS IN HC4/U HOLDERS

Specify frequency, 1/2" pin spacing . . . pin diameter .05 (.093 pin diameter, add 15¢) . . . \$2.95 ea.

FUNDAMENTAL FREQ. SEALED CRYSTALS

in HC4/U holders
From 1400 KC to 4000 KC. .005% Tolerance . . . \$4.95 ea.
From 4000 KC to 15,000 KC any frequency
.005% Tolerance . . . \$3.50 ea.

SEALED OVERTONE CRYSTALS

Supplied in metal HC4/U holders
Pin spacing .484, diameter .050
15 to 30 MC .005 Tolerance . . . \$3.85 ea.
30 to 45 MC .005 Tolerance . . . \$4.10 ea.
45 to 60 MC .005 Tolerance . . . \$4.50 ea.

QUARTZ CRYSTALS FOR EVERY SERVICE

All crystals made from Grade "A" imported quartz—ground and etched to exact frequencies. Unconditionally guaranteed! Supplied in:

FT-243 holders MC-7 holders DC-34 holders FT-171 holders
Pin spacing 1/2" Pin spacing 3/4" Pin spacing 3/4" Pin spacing 3/4"
Pin diameter Pin diameter Pin diameter Banana pins
.093 .125 .156

MADE TO ORDER CRYSTALS

1001 KC to 2600 KC:
.01% Tolerance . . . \$2.00 ea. .005% Tolerance . . . \$2.75 ea.
2601 KC to 9000 KC:
.005% Tolerance . . . \$2.50 ea.
9001 KC to 11,000 KC:
.005% Tolerance . . . \$3.00 ea.

Specify holder wanted

Amateur, Novice, Technician Band Crystals
.01% Tolerance . . . \$1.50 ea.—80 meters (3701-3749 KC),
40 meters (7152-7198 KC), 15 meters (7034-7082 KC), 6
meters (8335-8450 KC) within 1 KC
FT-241 Lattice Crystals in all frequencies from 370 KC to
540 KC (all except 455 KC and 500 KC) . . . 50¢ ea.
Pin spacing 1/2" Pin diameter .093

Matched pairs ± 15 cycles \$2.50 per pair
200 KC Crystals, \$2.00 ea.; 455 KC Crystals, \$1.50 ea.;
500 KC Crystals, \$1.50 ea.; 100 KC Frequency Standard
Crystals in HC4/U holders \$4.50 ea.; Socket for FT-243
crystal 15¢ ea.; Dual socket for FT-243 crystals, 15¢ ea.;
Sockets for MC-7 and FT-171 crystals 25¢ ea.; Ceramic
socket for HC4/U crystals 20¢ ea.

(Add 5¢ per crystal for postage and handling)

Write for free catalog complete with oscillator circuits

ASK YOUR PARTS DEALER FOR TEXAS CRYSTALS

See big red display . . . if he doesn't stock them, send us his name and order direct from nearest factory

OUR NEW FLORIDA PLANT NOW OPERATING

—Send orders to our nearest location!

TEXAS CRYSTALS

Texas Crystals, Dept. E-50 Texas Crystals, Dept. E-50
8538 W. Grand Ave. 1000 Crystal Drive
River Grove, Ill. OR Ft. Myers, Florida
Phone GL 3-3555 Phone WE 6-2100

ATTACH THIS COUPON TO YOUR ORDER FOR SHIPMENT VIA 1ST CLASS MAIL AT NO EXTRA COST
TERMS: All items subject to prior sale and change of price without notice. All crystal orders must be accompanied by check, cash or M.O. with PAYMENT IN FULL. NO COD's. Add 5¢ per crystal for postage and handling charge. E-50

. . . News



A new stereo preamplifier-amplifier kit has been introduced by Lafayette Radio. Model KT-250 includes a blend control which provides variable channel separation and may be used to reduce the channel separation found in some stereo material. Lafayette says it will also eliminate vertical rumble when playing a monophonic record with a stereo cartridge. Each channel has its own bass and treble controls. There is provision for a third channel output. Complete specs available from Lafayette, 165-08 Liberty Ave., Jamaica 33, N. Y. Kit is priced at \$64.50. Wired and factory tested model carries a \$89.50 price tag.



Globe Electronics is now offering their Deluxe Scout Amateur radio transmitter, an improved version of the Scout 680-A. The Deluxe, a 6-80 meter bandswitching transmitter for 90 watts CW and 75 watts phono input power has a built-in power supply. One feature of the \$149.95 transmitter is the pi-net output on 10-80 meters. Complete specs available from Globe, 22-30 S. 34th Street, Council Bluffs, Iowa. Mention EI for prompt service.

NOW!
at a price
you can afford!

MAKE MORE MONEY in TELEVISION RADIO-ELECTRONICS

**BETTER...MORE COMPLETE...LOWER COST...
WITH NATIONAL SCHOOLS SHOP-METHOD
HOME TRAINING!**

BETTER... Training that is proved and tested in Resident School shops and laboratories, by a School that is the **OLDEST** and **LARGEST** of its kind in the world.

MORE COMPLETE... You learn **ALL PHASES** of *Television-Radio-Electronics*.

LOWER COST... Other schools shake several courses out of the material in our **ONE MASTER COURSE** . . . and you pay more for less training than you get in our course at **ONE LOW TUITION!**



These two **FREE** books will show you how!

You get all information by mail . . . You make your own decision . . . at home! **NO SALESMAN WILL CALL**

TOP PAY... UNLIMITED OPPORTUNITIES LIFETIME SECURITY CAN BE YOURS!

You are needed in the Television, Radio, and Electronics industry! Trained technicians are in growing demand at excellent pay—in **ALL PHASES**, including Servicing, Manufacturing, Broadcasting and Communications, Automation, Radar, Government Missile Projects.

NATIONAL SCHOOLS SHOP-METHOD HOME TRAINING, with newly added lessons and equipment, trains you in your spare time at home, for these unlimited opportunities, including many technical jobs leading to supervisory positions.

YOU LEARN BY BUILDING EQUIPMENT WITH KITS AND PARTS WE SEND YOU. Your National Schools course includes thorough *Practical* training—**YOU LEARN BY DOING!** We send you complete standard equipment of professional quality for building various experimental and test units. You advance step by step, perform more than 100 experiments, and you build a complete TV set from the ground up, that is yours to keep! A big, new TV picture tube is included at no extra charge.

EARN AS YOU LEARN. We'll show you how to earn extra money right from the start. Many of our students pay for their course—and more—while studying. So can you!

LESSONS AND INSTRUCTION MATERIAL ARE UP-TO-DATE, PRACTICAL, INTERESTING. Every National Schools Shop-Method lesson is made easy to understand by numerous illustrations and diagrams. All instruction material has been developed and tested in our own Resident School Shops, Laboratories and Studios.

SEND FOR INFORMATION TODAY . . . it can mean the difference between **SUCCESS** and failure for you! Send for your **FREE BOOK** "Your Future in Television-Radio-Electronics" and **FREE** Sample Lesson. Do it **TODAY**, while you are thinking about your future. It doesn't cost you anything to investigate!

GET THE BENEFITS OF OUR OVER 50 YEARS EXPERIENCE

Approved for
GI Training



NATIONAL SCHOOLS

Los Angeles 37, Calif.

YOU GET...

- 19 Big Kits—**YOURS TO KEEP!**
- Friendly Instruction and Guidance
- Job Placement Service
- Unlimited Consultation
- Diploma—Recognized by Industry
- **EVERYTHING YOU NEED FOR SUCCESS!**

SHOP-METHOD HOME TRAINING COVERS ALL PHASES OF INDUSTRY

1. Television, including Color TV
2. Radio AM & FM
3. Electronics for Guided Missiles
4. Sound Recording and Hi-Fidelity
5. FCC License
6. Automation and Computers
7. Radar & Micro-Waves
8. Broadcasting and Communications

RESIDENT TRAINING AT LOS ANGELES

If you wish to take your training in our Resident School at Los Angeles, the world's TV capital, start **NOW** in our big, modern Shops, Labs and Radio-TV Studios. Here you work with latest Electronic equipment—professionally installed—finest, most complete facilities offered by any school. Expert, friendly instructors. Personal attention—Graduate Employment Service. Help in finding home near school—and part time job while you learn. Check box in coupon for full information.

NATIONAL TECHNICAL SCHOOLS

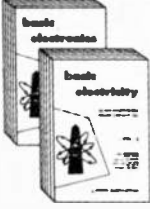
WORLD-WIDE TRAINING SINCE 1905

MAIL NOW TO
NATIONAL SCHOOLS, Dept R4Y-40
4000 S. FIGUEROA ST., LOS ANGELES 37, CALIF.
Rush free TV-Radio "Opportunity" Book and sample lesson. No salesman will call.

NAME _____ AGE _____
ADDRESS _____
CITY _____ ZONE _____ STATE _____

Check if interested **ONLY** in Resident School training at Los Angeles
VETERANS Give date of Discharge.

Now you can master
BASIC ELECTRICITY
BASIC ELECTRONICS
 The Rider 'picture-book' way



Fabulous illustrated training course now used by U. S. Navy—No Other Books Like Them!

A Complete Idea on Every Page

Here's how this easy, illustrated course works: every page covers one complete idea! There's at least one big illustration on that same page to explain it! What's more, an imaginary instructor stands figuratively at your elbow, doing "demonstrations" that make it even easier for you to understand. Then, at the end of every section, you'll find review pages that highlight the important topics you've just covered. You build a thorough, step-by-step knowledge at your own pace—as fast as you yourself want to go! Sponsored by the Navy to turn out trained technicians in record time, this modern course presents Basic Electricity and Basic Electronics in a simple way that everyone can grasp—regardless of previous education!

10 Complete Volumes

BASIC ELECTRICITY—Volumes 1 and 2 cover DC components and circuits; Volumes 3 and 4 cover AC components and circuits; Volume 5 covers AC and DC motors and machinery.

BASIC ELECTRONICS—Volume 1 covers Diodes and Power Supplies; Volumes 2 and 3 cover Amplifiers and Oscillators; Volumes 4 and 5 cover Transmitters and Receivers.

Home Study Without Correspondence

This course is so different, so complete—there's no need for the usual letter writing, question and answer correspondence! Learn at home—at your own pace!

10 Day Examination — Money Back Guarantee

Send today for these exciting new training courses — you risk nothing! When you receive the volumes, examine them in your own home for 10 full days. If, at the end of that time, you're not completely satisfied, simply return the books to us and we'll gladly refund your full purchase price! Total cost for either 5-volume course is only \$10.00! In Canada, prices approximately 5% higher.

BASIC ELECTRICITY #169, 5-vols. soft covers, \$10.00; #169H, all 5 vols. in one cloth binding, \$11.50.

BASIC ELECTRONICS #170, 5-vols. soft cover, \$10.00; #170H, all 5 vols. in one cloth binding, \$11.50.

JUST PUBLISHED

VOLUME 6 BASIC ELECTRONICS by Van Valkenburgh, Nooger & Neville Inc. We are pleased to announce the publication of Volume 6, **BASIC ELECTRONICS** by Van Valkenburgh, Nooger & Neville. Volume 6 is a companion volume to the present five volume course on Basic Electronics by the above authors. It is intended to enable you to expand into the areas of semiconductors, transistors and frequency modulation after the content of the first five volumes has been completed. Volume 6 utilizes the same famous "picture-book" technique used in the present highly successful five volume course.

The original five volume course in **BASIC ELECTRONICS** is available as heretofore as five individual volumes in paper covers and as all five volumes in one cloth binding. Vol. 6 #170-6 paper cover, \$2.90; #170-6H, cloth \$3.60.

at electronics parts jobbers or bookstores, or order direct: Dept. EI-5



JOHN F. RIDER PUBLISHER INC.
 116 West 14th Street, New York 11, N. Y.

In Canada 5% higher; add city & state taxes. All prices subject to revision.



The mock-up of the car above shows a bright band of light between the two incandescent headlights. This is Syl- vania's new fluorescent lighting system with a brightness level 338% greater than any fluorescent unit made heretofore. Called the Controlled Powerbeam System, the new unit throws a narrow band of light for a considerable distance with a minimum amount of glare. The light is distributed uniformly immediately in front of and to the sides of the car illuminating any objects in the vicinity.



A "time-of-flight" mass spectrometer made by Bendix is being used at Sweden's University of Uppsala in a research program on tobacco smoke. Because the spectrometer is so fast it can make 10,000 analyses per second, the Swedish scientists hope to discover hitherto unknown facts about the physics and chemistry of tobacco combustion.

The instrument derives its tremendous speed from its ability to instantly identify vaporized gases, liquids and solids by revealing their respective molecular masses. Ionized molecules of the elements being analyzed are pulsed like radar signals from one end of a four foot special vacuum tube to the other and their speed, or "time of flight" is measured electronically and appears as a wave pattern or spectrum on an oscilloscope.

BUILD YOUR OWN LOW COST! TOP QUALITY! PORTABLE RADIOS

SAVE
UP TO
50%

IDEAL FOR THE BEGINNER!

EASY ASSEMBLY . . . ONLY A SCREWDRIVER NEEDED!

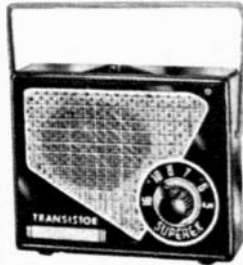


TRANSISTOR RADIO KIT

COMPLETE WITH ALL
PARTS AND SIMPLE
INSTRUCTIONS!

Model DYN
JUST \$5.75

BUILD AND LEARN with this exciting extra-sensitive Transistor and Diode kit. Highest quality parts for long life, pre-punched chassis board, variable capacitor for tuning, famous powerful "Loopstick" for loud, clear reception. Beautiful Black & Gold portable plastic case . . . complete with earphone, battery.



TWIN TRANSISTOR & DIODE RADIO KIT

COMPLETE WITH ALL
PARTS AND SIMPLE
INSTRUCTIONS!

Unnational, top quality kit! No soldering required . . . just a minimum of experience. Its latest electronic advances and quality parts assure outstanding performance and maximum enjoyment for years to come!

- Pre-punched chassis board
- Genuine Loopstick for extra power
- Precision tuning capacitor
- Advanced circuitry
- Portable gold-trimmed plastic case
- Battery and headphone

Model TNT
JUST \$7.49

WHEN YOU BUILD

FREE! ADJUSTING KNOB AND CIRCUITS you can really build, packed with either Loopstick.



NEW VARI-LOOPSTICK

Original and finest loopstick today! Permits adjustment for maximum efficiency on several stations consecutively. High "Q" to 275. Micrometer adjustment and 1-hole snap-in mount. Specified in many magazine construction articles.



List \$1.00

TRANSISTOR VARI-LOOPSTICK

List \$1.25

Specially designed and engineered for maximum transistor set performance. Micrometer adjustment . . . extremely sensitive and compact. Its impedance tap to match transistors.



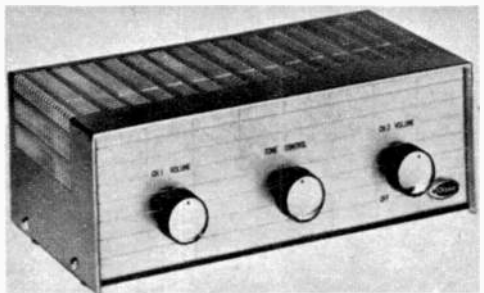
Write for free catalog and name of local radio parts distributor.

SupereX ELECTRONICS CORP. successor to Grayburne
6 Radford Pl., Yonkers, N.Y.

. . . News



Century Electronics Company, Inc. has placed their new line-operated peak-to-peak VTVM, model VT-10 on the test equipment market. The VTVM comes complete with a single probe that does the work of a DC, AC, Lo-Cap and RF probe. It has a 100 micro-ampere meter and an amplifier-rectifier circuit with frequency compensated attenuator. The VT-10 is priced at \$58.50 from Century at 111 Roosevelt Avenue, Mineola, New York.



A stereo amplifier featuring separate volume controls for each channel and designed for use with any high output crystal or ceramic stereo cartridge has been introduced by Olson Radio Corp. of 260 S. Forge St., Akron, Ohio. Price for the Model AM-150 is \$19.95.

AT LAST!

RADIO-TV and ELECTRONICS TRAINING

... AT A PRICE YOU CAN AFFORD!



***21 INCH**
Receiver Kit included

Yes, this great course costs far less than any training of its kind given by other major schools! Radio-Television Training School will train you for a good job in Television or Industrial Electronics — **AT HOME IN YOUR SPARE TIME.**

Think of it — a complete training program including over 120 lessons, Fourteen Big Radio-Television Kits, Complete Color-TV Instruction, Unlimited Consultation Service... **ALL at a really big saving to you.** How can we do this? Write to us today... and find out!

And what's more — you can (if you wish)
OPEN YOUR OWN RTS-APPROVED AND FINANCED RADIO-TV SERVICE SHOP

We Want Many More Shops This Year

This 38 year old training organization — called RTS, that's Radio-Television Training School — wants to establish a string of Radio-TV Repair Shops in principal cities throughout the U. S. So far, a great many such shops are **NOW IN BUSINESS AND PROSPERING.** We are helping and training ambitious men to become future owners and operators of these shops in all areas.

COMPLETE COLOR INSTRUCTION INCLUDED

RTS APPROVED SERVICE SHOP

Get your free book on the **FAMOUS RTS BUSINESS PLAN** find out how you can open **A REPAIR SHOP OF YOUR OWN**

We supply and finance your equipment

When you are ready and qualified to operate one of our RTS-Approved TV Repair Shops **WE WILL SUPPLY AND FINANCE EVERY BIT OF EQUIPMENT YOU NEED TO GET STARTED** plus an inventory of parts and supplies. In other words we will stake you... **AN OFFER NEVER MADE BEFORE BY ANY TRAINING ORGANIZATION.** Under the RTS Business Plan you receive:

1. An electric sign for the shop front.
2. Complete laboratory of test equipment.
3. Letterheads, calling cards, repair tickets, etc.
4. Basic inventory of tubes, parts, supplies.
5. Complete advertising and promotional material.
6. Plans for shop arrangement.
7. Instructions on how to go into business.
8. Continuous consultation and help.
9. The right to use RTS seal of Approval, and the RTS Credo.
10. The right to use the Famous Trade Mark.

you build these and other units



*tubes excluded

FOR UNSKILLED INEXPERIENCED MEN ONLY — WE TRAIN YOU OUR WAY!

We must insist that the men we sign up be trained in Radio-TV Repair, Merchandising and Sales by our training methods—because **WE KNOW** the requirements of the industry. Therefore, we will **TRAIN YOU**... we will show you how to earn **EXTRA CASH**, during the first month or two of your training period. **YOU KEEP YOUR PRESENT JOB. TRAINING TAKES PLACE IN YOUR OWN HOME, IN YOUR SPARE TIME!**

RADIO-TELEVISION TRAINING SCHOOL

5100 S. VERMONT AVENUE
LOS ANGELES 37, CALIFORNIA

Est. 1922



ACT NOW!

CUT OUT AND MAIL — TODAY!

RADIO-TELEVISION TRAINING SCHOOL

5100 S. Vermont Avenue, Dept. E1-560
Los Angeles 37, California

SEND ME FREE — all of these big opportunity books — "Good Jobs in TV-Electronics," "A Repair Shop of Your Own" and "Sample Lesson." I am interested in:

- Radio-Television Industrial Electronics (Automation)

Name _____ Age _____
please print

Address _____

City & State _____

300



RTS' Membership in The Association of Home Study Schools is your assurance of Reliability, Integrity, and Quality of Training.

ALL THESE FREE!

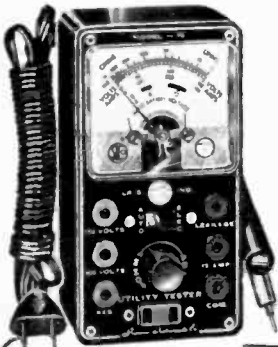


EXAMINE ANY OF THESE TESTERS *BEFORE* YOU BUY!!

Yes, we offer to ship at our risk one or more of the testers described on these pages.

Superior's New Model 70 UTILITY TESTER®

FOR REPAIRING ALL ELECTRICAL APPLIANCES and AUTOMOBILE CIRCUITS



As an electrical trouble shooter the Model 70:

- Will test Toasters, Irons, Broilers, Heating Pads, Clocks, Fans, Vacuum Cleaners, Refrigerators, Lamps, Fluorescents, Switches, Thermostats, etc.
- Measures A.C. and D.C. Voltages, A.C. and D.C. Current, Resistances, Leakages, etc.
- Will measure current consumption while the appliance under test is in operation.
- Incorporates a sensitive direct-reading resistance range which will measure all resistances commonly used in electrical appliances, motors, etc.
- Leakage detecting circuit will indicate continuity from zero ohms to 5 megohms (5,000,000 ohms).

As an Automotive Tester the Model 70 will test:

- Both 6 Volt and 12 Volt Storage Batteries • Generators • Starters • Distributors • Ignition Coils • Regulators • Relays • Circuit Breakers • Cigarette Lighters • Stop Lights • Condensers • Directional Signal Systems • All Lamps and Bulbs • Fuses • Heating Systems • Horns • Also will locate poor grounds, breaks in wiring, poor connections, etc.

Model 70—UTILITY TESTER
Total Price... \$15.85—
Terms: \$3.85 after 10 day trial,
then \$4.00 monthly for 3 months,
if satisfactory. Otherwise return, no
explanation necessary.



INCLUDED FREE This 64-page book—practically a condensed course in electricity. Learn by doing.

Just read the following partial list of contents: What is electricity? • Simplified version of Ohms Law • What is wattage? • Simplified wattage charts • How to measure voltage, current, resistance and leakage • How to test all electrical appliances and motors using a simplified trouble-shooting technique. • How to trace trouble in the electrical circuits and parts in automobiles and trucks.

Model 70 comes complete with 64 page book and test leads

\$15⁸⁵
only

Superior's New Model 82A A truly do-it-yourself type

TUBE TESTER

TEST ANY TUBE IN 10 SECONDS FLAT!



Model 82A—Tube Tester
Total Price... \$36.50
Terms: \$6.50 after 10 day trial,
then \$6.00 monthly for 3 months
if satisfactory. Otherwise re-
turn, no explanation necessary.

- 1 Turn the filament selector switch to position specified.
- 2 Insert it into a numbered socket as designated on our chart (over 600 types included).
- 3 Press down the quality button—

THAT'S ALL! Read emission quality direct on bad-good meter scale.

FEATURES:

- Tests over 600 tube types. • Tests OZ4 and other gas-filled tubes. • Employs new 4" meter with sealed air-damping chamber resulting in accurate vibrationless readings. • Use of 22 sockets permits testing all popular tube types and prevents possible obsolescence. • Dual Scale meter permits testing of low current tubes. • 7 and 9 pin straighteners mounted on panel. • All sections of multi-element tubes tested simultaneously. • Ultra-sensitive leakage test circuit will indicate leakage up to 5 megohms.

Production of this Model was delayed a full year pending careful study by Superior's engineering staff of this new method of testing tubes. Don't let the low price mislead you! We claim Model 82A will outperform similar looking units which sell for much more—and as proof, we offer to ship it on our examine before you buy policy.

Model 82A comes housed in handsome, portable Saddle-Stitched Texon case (Picture Tube Adapter available for \$5.50 additional)

Only
\$36⁵⁰

DID YOU EVER?

Order merchandise by mail, including deposit or payment in full, then wait and write . . . wait and write?

Purchase anything on time and sign a lengthy complex contract written in small difficult-to-read type?

Purchase an item by mail or in a retail store then experience frustrating delay and red tape when you applied for a refund?

Obviously prompt shipment and attention to orders is an essential requirement in our business . . . We ship at our risk!

NO

CONTRACT TO SIGN CO-MAKERS EMPLOYER NOTIFICATION

The simple order authorization included in this offer is all you sign. We ask only that you promise to pay for or return the goods we ship in good faith.

EXAMINE ANY ITEM YOU SELECT IN THE PRIVACY OF YOUR OWN HOME

Then if completely satisfied pay on the interest-free terms plainly specified. When we say interest-free we mean not one penny added for "interest" for "finance" for "credit-checking" or for "carrying charges." The net price of each tester is plainly marked in our ads—that is all you pay except for parcel post or other transportation charges we may prepay.

Superior's New Model 76

ALL PURPOSE BRIDGE

IT'S A CONDENSER BRIDGE

IT'S A SIGNAL TRACER

IT'S A RESISTANCE BRIDGE

IT'S A TV ANTENNA TESTER



Model 76 ALL PURPOSE BRIDGE
Total Price \$26.95
Terms: \$6.95 after 10 day trial, then \$5.00 per month for 4 months if satisfactory. Otherwise return, no explanation necessary.

✓ CAPACITY BRIDGE SECTION

4 Ranges: .00001 Microfarad to .005 Microfarad; .001 Microfarad to .5 Microfarad; .1 Microfarad to 50 Microfarads; 20 Microfarads to 1000 Microfarads. Will also measure the power factor of all condensers from .1 to 1000 Microfarads.

✓ RESISTANCE BRIDGE SECTION

2 Ranges: 100 ohms to 50,000 ohms; 10,000 ohms to 5 megohms.

✓ SIGNAL TRACER SECTION

With the use of the R.F. and A.F. Probes included with the Model 76, you can

make stage gain measurements, locate signal loss in R.F. and Audio stages, locate distortion and hum, etc.

✓ TV ANTENNA TESTER SECTION

Loss of sync., snow and instability are only a few of the faults which may be due to a break in the antenna, so why not check the TV antenna first? Locates a break in any TV antenna and measures the location of the break in feet from the set terminals.

Complete with R.F. and A.F. probes and test leads

\$26.95
NET

Superior's
New
Model 77

VACUUM TUBE VOLTMETER

WITH NEW 6" FULL-VIEW METER

Compare it to any peak-to-peak V. T. V. M. made by any other manufacturer at any price!

- Extra large meter scale enables us to print all calibrations in large easy-to-read type.
- Employs a 12AU7 as D. C. amplifier and two 9006's as peak-to-peak voltage rectifiers to assure maximum stability. • Meter is virtually burn-out proof. The sensitive 400

AS A DC VOLTMETER: The Model 77 is indispensable in Hi-Fi Amplifier servicing and a must for Black and White and color TV Receiver servicing where circuit loading cannot be tolerated.

AS AN ELECTRONIC OHMMETER: Because of its wide range of measurement; leaky capacitors show up glaringly. Because of its sensitivity and low loading, Intermittents are easily found, isolated and repaired.

AS AN AC VOLTMETER: Measures RMS values if sine wave, and peak-to-peak value if complex wave. Pedestal voltages that determine the "black" level in TV receivers are easily read.

micro-ampere meter is isolated from the measuring circuit by a balanced push-pull amplifier. • Uses selected 1% zero temperature coefficient resistors as multipliers. This assures unchanging accurate readings on all ranges.

SPECIFICATIONS

- DC VOLTS—0 to 3/15/75/150/300/750/1,500 volts at 11 megohms input resistance.
- AC VOLTS (RMS)—0 to 3/15/75/150/300/750/1,500 volts. • AC VOLTS (Peak to Peak)—0 to 6/40/200/400/800/2,000 volts.
- ELECTRONIC OHMMETER—0 to 1,000 ohms/10,000 ohms/100,000 ohms/1 megohm/10 megohms/100 megohms/1,000 megohms. • DECIBELS: -10 db to + 18 db, + 10 db to + 38 db, + 30 db to + 58 db. All based on 0 db = .006 watts (6 mw) into a 500 ohm line (1.72v).
- ZERO CENTER METER—For discrimination alignment with full scale range of 0 to 1.5/7.5/37.5/75/150/375/750 volts at 11 megohms input resistance.

Comes complete with operating instructions, probe leads, and streamlined carrying case. Operates on 110-120 volt 60 cycle. Only.....

\$42.50
NET



Model 77—VACUUM TUBE VOLTMETER. . . . Total Price . . . \$42.50
Terms: \$12.50 after 10 day trial, then \$6.00 monthly for 5 months if satisfactory. Otherwise return, no explanation necessary.

Try any of the instruments on this or the facing page for 10 days before you buy. If completely satisfied then send down payment and pay balance as indicated on coupon. **No interest or Finance Charges Added!** If not completely satisfied return unit to us, no explanation necessary.

MOSS ELECTRONIC, INC.

Dept. D-731, 3849 Tenth Ave., New York 34, N. Y.

Please send me the units checked on approval. If completely satisfied I will pay on the terms specified with no interest or finance charges added. Otherwise, I will return after a 10 day trial positively canceling all further obligation.

Name

Address

City Zone State

All prices net, F.O.B., N. Y. C.

- Model 77..... Total Price \$42.50 \$12.50 within 10 days. Balance \$6.00 monthly for 5 months.
- Model 76..... Total Price \$26.95 \$6.95 within 10 days. Balance \$5.00 monthly for 4 months.
- Model 70..... Total Price \$15.85 \$3.85 within 10 days. Balance \$4.00 monthly for 3 months.
- Model 82A..... Total Price \$36.50 \$6.50 within 10 days. Balance \$6.00 monthly for 5 months.
- Include Model 82A. Picture Tube Adapter at: \$5.50

Export Division: Rocke International Corp., 13 East 40th St., New York 16, N. Y.



engineering degree in only 27 months

Grasp your chance for a better life. Become a graduate Electronics Engineer. Then promotion will not pass you by. Share rewards that await college graduates. Important firms visit Tri-State campus to interview seniors. Start any quarter. Founded 1884. Bachelor of Science Degree in 27 months in Electrical Engineering with either Electronics or Power major . . . also in Mechanical, Civil, Chemical, Aeronautical Engineering. In 36 months a B.S. in Business Administration (General Business, Accounting, Motor Transport Management majors). Mature students. Enrollment limited. Small classes. More professional class hours. Campus. Well-equipped, new and modernized buildings, labs, dorms. Modest costs. Enter July, September, January, March. Mail coupon today for information.



TRI-STATE COLLEGE

McCarthy, Director of Admissions
4850 College Avenue, Angola, Indiana

Please send me Your Career Book and Catalog with full information on Electronics Engineering and other degree courses. I am especially interested in courses checked:

- Electrical (Radio, TV, Electronics Option)
 Electrical (Power option) Chemical Aeronautical
 Civil Mechanical General Business
 Accounting Motor Transport Management General Education

Name

Street Address

Postoffice Zone State

FREE!

H. H. Scott Helps You
PLAN FOR STEREO
With New Hi Fi Guide
and Catalog



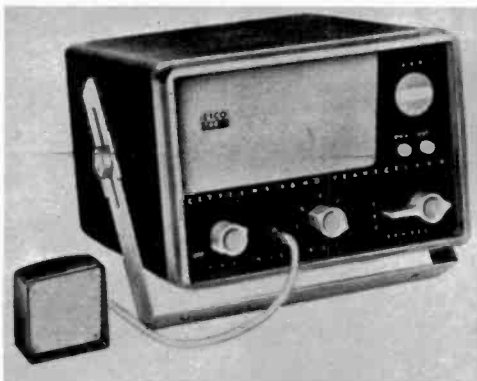
H.H. Scott Inc., 111 Powdermill Road, Dept. E1-5, Maynard, Mass.
Rush me your **FREE** Hi Fi Guide and catalog to help me plan my stereo system.

Name

Address

City State

...News



EICO has announced production of their Citizens Band transceiver kit. It has a superheterodyne receiver with RF stage and noise limiter and comes complete with a detachable ceramic microphone. Antennas are available. A range of up to 20 miles is claimed by EICO. Three models are available priced from \$59.95 to \$69.95 for the kit and \$89.95 to \$99.95 for the wired units. Further information may be procured from EICO at 33-00 Northern Blvd., Long Island City, N. Y.



This Knight Deluxe Stereo Tape Recorder records and plays both 2- and 4-track stereo tapes. It has 3 speeds and comes complete with built-in preamplifiers. Level meters on the panel aid in channel balancing. The recorder is priced at \$229.95 and is listed under Allied stock No. 92 RU 774. Specs available from Allied 100 N. Western Ave., Chicago, Ill.

IMPORTANT: For the man who wants to make big money in Radio-Television!

ONLY SPRAYBERRY TRAINING IN RADIO and TELEVISION

**OFFERS YOU ALL OF THESE VITAL NEW ADVANTAGES
TO HELP YOU EARN MORE MONEY FROM THE START!**

NEW BUSINESS BUILDERS

... through these practical proven plans and ideas we help you make plenty of extra money in spare time while training.

NEW TRAINING EQUIPMENT

... the famous Sprayberry Training kits have been newly engineered by our staff to offer you the latest in Radio-TV Service Techniques!

NEW TRANSISTOR COURSE

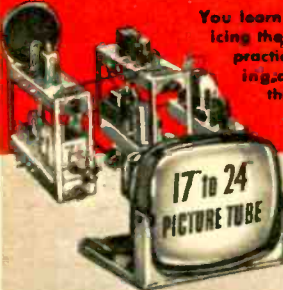
... literally millions of new transistor radios are being used. We show you how to make money fixing them!

NEW HIGH FIDELITY

... there's big money to be made installing and servicing Hi-Fi units. Your Sprayberry training now offers you this valuable and profitable preparation!

TRAIN AT HOME—SPARE TIME

WITH THESE 25 BIG COMPLETE KITS OF PARTS & EQUIPMENT



You learn Radio-TV Servicing the best way... the practical way... testing and assembling these modern kits of equipment.

▶ The new Sprayberry Training Television Receiver, built and tested in 3 sections.

Now offered... this fine modern oscilloscope.



▶ You build this powerful two-band super-heterodyne radio receiver.

You build the new Sprayberry tester → a complete 10-range Volt-Ohm-Milliammeter test meter.



FREE These two big new books are yours free! Find out what Radio-Television offers you... and let us show you how easily you can learn, even without previous experience of any kind. Rush COUPON today!

The field of Radio-Television Servicing is such a fast moving industry that the best jobs and biggest incomes always go first to the man with the most modern, complete and up-to-date training. Thanks to constant revision and improvement... Sprayberry Training helps you earn more from the start... and keeps you earning more in the months and years ahead!

Make no mistake! All radio-television training is not alike. The basic purpose behind Sprayberry Training is to prepare you as rapidly and as surely as possible... to make top money servicing Radio and Television sets and equipment. This is where the big money has been for years... and will continue to be in the years ahead.

It's important for you to know that for over 30 years... Sprayberry Training has been preparing ambitious men for success in this interesting and profitable kind of work. Our school has helped hundreds to qualify for the best jobs... or to get started in profitable businesses of their own. Today our student rolls are the largest in our school's history... because the need and demand for Radio-Television Service Technicians has never been more urgent.

Just \$6.00 Starts You

To encourage more men to enter Radio-Television at once... to help fill the great need for trained men... we're making it easier than ever before to start training. Just \$6.00 enrolls you. This liberal offer is naturally limited. Get the facts now

and consider enrollment while these favorable terms are available to you.

KEEP YOUR JOB... while learning

Under the Sprayberry Plan you train entirely at home in spare time. You combine the most modern lesson training with fascinating and invaluable practical work with 25 big kits of parts and equipment that we supply. You get the equivalent of years of shop practice... and you can train as fast or as slowly as you wish. We help you make excellent spare time money while learning... and everything you receive—lessons, books, manuals, equipment—all yours to keep!

This is the Radio-Television industry's most modern and up-to-the-minute training. Sprayberry is the one school that gives you personalized attention and takes a real interest in your progress. Remember... just \$6 starts you! Mail the coupon today. Let the facts speak for themselves. Let us send you our new catalog and sample lesson... and prove the kind of opportunity that Sprayberry training can open up for you.



MAIL COUPON—No Salesman Will Call

SPRAYBERRY ACADEMY OF RADIO-TELEVISION
DEPT. 120-K, 1512 W. JARVIS AVE., CHICAGO 26, ILL.
Please rush all information on your ALL-NEW Radio-Television Training Plan. I understand this does not obligate me and that no salesman will call upon me. Include New Catalog and Sample Lesson FREE.

NAME.....AGE.....
ADDRESS.....
CITY.....ZONE.....STATE.....

SPRAYBERRY ACADEMY OF RADIO-TELEVISION
Dept. 120-K, 1512 West Jarvis Ave., Chicago 26, Ill.

YOU NEED THIS

FREE GIANT 1960 B-A CATALOG

A Complete Buying Guide for Everything in
RADIO 1960 TV ELECTRONICS
BA
 ANNUAL CATALOG NO. 601
 SINCE 1947

204 KING-SIZED PAGES

EVERYTHING IN RADIO TV AND ELECTRONICS

100'S OF NEW ITEMS LISTED HERE FOR 1st TIME

21 PAGES OF BARGAINS NOT IN ANY OTHER CATALOG

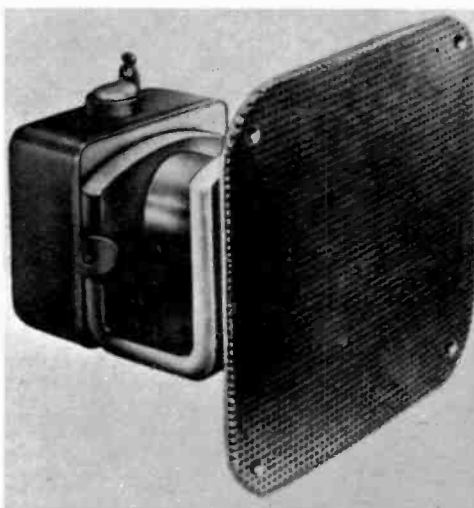
BURSTEIN-APPLEBEE CO.
 Dept. E1, 1012 McGee St., Kansas City 6, Mo.
 Send Free 1960 B-A Catalog No. 601.

Name _____
 Address _____
 City _____ State _____

SEND FOR IT TODAY

... News

Two new high compliance dual voice coil woofers with a 350 cycle crossover network have been put on the hi-fi market by Lafayette. The speakers feature two electrically separate voice coils for a single cone. Lafayette claims that when used with two satellite speakers the frequencies below 350 cycles are blended through the single woofer cone providing three channel stereo. The 8" speaker, SK-139, is priced at \$20.95 and the 12", SK-133, at \$25.50. Complete information available from Lafayette.



A new 3½" cone-type tweeter has been added to the line of loudspeakers made by Audax, Inc., a division of the Rek-O-Kut Co. The A-34T features include a 4 MFD crossover capacitor and a perforated protective screen attached to its face. It is priced at \$9.95 from the manufacturer in Corona, New York.

A superconductive gyro, expected to operate at about -452° F. (liquid helium temperatures) is being constructed at General Electric's Schenectady plant. This gyro, proposed for nuclear submarines and space vehicles, is expected to give higher accuracy and reliability than conventional gyros. It is called Project Spin.

Olson

*** FREE**

Fill in coupon for a FREE One Year Subscription to OLSON RADIO'S Fantastic Bargain Packed Catalog — Unheard of LOW, LOW, WHOLESALE PRICES on Brand Name Speakers, Changers, Tubes, Tools, Hi-Fi's, Stereo Amps, Tuners and other Bargains.

NAME _____
 ADDRESS _____
 CITY _____ ZONE _____ STATE _____

If you have a friend interested in electronics send his name and address for a FREE subscription also.

OLSON RADIO CORPORATION
 407 Forge Street Akron 8, Ohio

Learn Electronics

PREPARE FOR YOUR F. C. C. LICENSE—YOUR TICKET TO A BETTER JOB AND HIGHER PAY!



F.C.C. LICENSE—THE KEY TO BETTER JOBS

An F.C.C. *commercial* (not amateur) license is your ticket to higher pay and more interesting employment. This license is Federal Government evidence of your qualifications in electronics. Employers are eager to hire *licensed* technicians.

WHICH LICENSE FOR WHICH JOB?

The **THIRD CLASS** radiotelephone license is of value primarily in that it qualifies you to take the second class examination. The scope of authority covered by a third class license is extremely limited.

The **SECOND CLASS** radiotelephone license qualifies you to install, maintain and operate most all radiotelephone equipment except commercial broadcast station equipment.

The **FIRST CLASS** radiotelephone license qualifies you to install, maintain and operate every type of radiotelephone equipment (except amateur) including all radio and television stations in the United States, its territories and possessions. This is the highest class of radiotelephone license available.

GRANTHAM TRAINING PREPARES YOU

The Grantham Communications Electronics Course prepares you for a **FIRST CLASS F.C.C.** license, and it does this by **TEACHING** you electronics. Each point is covered simply and in detail, with emphasis on making the subject easy to understand. The organization of the subject matter is such that you progress, step-by-step, to your specific objective—a first class F.C.C. license.

CORRESPONDENCE OR RESIDENCE CLASSES

Grantham training is available by correspondence or in resident classes. Either way (residence or correspondence), we train you quickly and well—no previous training required. Even a beginner may qualify for his first class license in a relatively short time.

FOUR COMPLETE SCHOOLS: To better serve our many students throughout the entire country, Grantham School of Electronics maintains four complete Divisions—located in Hollywood, Calif., Seattle, Wash., Kansas City, Mo., and Washington, D.C. All Divisions of Grantham School of Electronics offer the same rapid courses in F.C.C. license preparation, either by home study or in resident classes.

This booklet
FREE!



This free booklet gives details of our training and explains what an F.C.C. license can do for your future.

Upgrade Your Income with a First Class F. C. C. LICENSE

In resident classes or by home study, Grantham training is the easy way to learn more quickly and to prepare more thoroughly for F.C.C. examinations. And your first class F.C.C. license is the quick, easy way to prove to your employer that you are worth more money.

If you already have practical experience in radio-electronics, the Grantham course can add a knowledge of theory and an F.C.C. license to that practical experience. This is most important in qualifying you for higher pay and greater job security.

Our free booklet gives details of how you can prepare quickly for a better job in the rapidly expanding electronics industry. Clip the coupon below and mail it to the Grantham School nearest you.

Get your First Class Commercial F.C.C. License Quickly

GRANTHAM SCHOOL OF ELECTRONICS

HOLLYWOOD
CALIF.

1505 N. Western Ave.
Hollywood, Calif. (HO 7-7727)

SEATTLE
WASH.

408 Marion Street
Seattle, Wash. (MA 2-7227)

KANSAS CITY
MO.

3123 Gillham Road
Kansas City, Mo. (ME 1-6376)

WASHINGTON
D. C.

821 - 19th Street, N. W.
Washington, D. C. (ST 3-3614)

MAIL COUPON TO SCHOOL NEAREST YOU

(Mail in envelope or paste on postal card)

To: **GRANTHAM SCHOOL OF ELECTRONICS**

1505 N. Western • 408 Marion • 3123 Gillham Rd. • 821-19th, NW
Hollywood • Seattle • Kansas City • Washington



Gentlemen:

Please send me your free booklet telling how I can get my commercial F.C.C. license quickly. I understand there is no obligation and no salesman will call.

Name _____ Age _____

Address _____

City _____ State _____

I am interested in: Home Study, Resident Classes 08-E

...News

New Bulletins and Catalogs. . .

"Amperex Frame Grid Tubes for TV" is a new booklet describing how frame grid tubes for TV applications are manufactured and lists the specifications of these tubes. Available from Amperex Electronic Corp., 320 Duffy Avenue, Hicksville, Long Island.

Electro-Voice published an interesting microphone fact sheet complete with sketches illustrating the information. It is written by L. R. Burroughs, Vice President of Electro-Voice, Buchanan, Michigan.

Jerrold Electronic Corp. is offering a TV distribution system handbook for TV servicemen. The new booklet provides 150 typical layout charts covering most of the situations a serviceman might encounter in planning TV systems. Priced at \$1.00, the handbook is available from Jerrold, at the Jerrold Building, Philadelphia 32, Pennsylvania.

"The Gyro Through the Ages," an interesting and educational booklet, has been made available by Sperry Gyroscope Company. This publication explains how the gyroscope works and how it is used in navigation and guidance systems. Sperry Gyroscope Company, Great Neck, New York.

Sun Radio and Electronics Company has published a 236 page catalog containing complete lines of radio and electronic supplies. A reference guide and index are included in the book. Free from 650 Sixth Avenue, New York 11, New York.

A tube substitution guide including substitution data for foreign tubes has been made available by Vis-U-All, 640 Eastern Avenue, S.E., Grand Rapids 6, Michigan.

A bulletin describing Channel Master's three new heavy duty chimney mounts has been made available by that company. Also included is a Specifications Chart. Write to Ellenville, New York.

Build the Best CITIZENS BAND TRANSCEIVER . . .



EICO

=760 (117 VAC) less bracket: Kit \$59.95. Wired \$69.95
 =761 (117 VAC & 6 VDC): Kit \$69.95. Wired \$99.95
 =762 (117 VAC & 12 VDC): Kit \$69.95. Wired \$99.95

Highly reliable: exemplary electronic, mechanical, industrial design. Powerful 5-watt (as defined by FCC) crystal-controlled transmitter & extremely sensitive, selective superhet receiver with RF stage & noise limiter. Built-in speaker, detachable ceramic mike. Pre-set & sealed crystal oscillator circuit elements. To change channels, just change crystals — no adjustments needed. Built-in variable "pi" network matches most popular antennas. Portable whip rear bumper & roof antennas available. No exams or special skill needed — any citizen 18 years or older may obtain station license by submitting FCC form, supplied free by EICO.



Build the Best 6-TRANSISTOR RADIO RA-6
 Kit \$29.95 Wired \$49.95
 includes FET, less 9V battery

High sensitivity & selectivity. New plug-in type transistors. Big-set volume & tone: 4" x 6" speaker; push-pull audio. Built-in Ferrite rod antenna. Pre-aligned RF & IF transformers. Planetary vernier tuning. Earphone jack for private listening. Attractive tan leatherette case, retractable handle. Compact: 8½" w, 4½" h, 2½" d. Only 3 lbs.



90-WATT CW TRANSMITTER* #720
 Kit \$79.95 Wired \$119.95

*U.S. Pat No. D-184,776

"Top quality" — ELECTRONIC KITS GUIDE. Ideal for veteran or novice. 90W CW, 65W external plate modulation. 80 through 10 meters.



New Code Practice Oscillator #706
 Kit \$8.95 Wired \$12.95

Rugged battery-operated transistor oscillator circuit, built-in speaker. Front panel has flashing light, phone jack, pitch control (500-2000 cps), external key terminals, "temporary" key. Panel switch selects Tone, Light, or both Tone & Light. 6½" h, 3¾" w, 2¾" d.



HIGH-LEVEL UNIVERSAL MODULATOR-DRIVER #730
 Kit \$49.95 Wired \$79.95

Cover E-5 \$4.50

Delivers 50W undistorted audio. Modulates transmitters having RF inputs up to 100W. Unique over-modulation indicator.

Compare — judge for yourself — at your neighborhood EICO dealer. For FREE catalog on over 70 models of easy-to-build professional test instruments, hi-fi and ham gear, fill out coupon on Page 24.



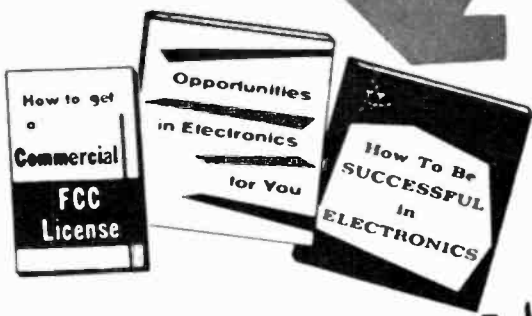
GRID DIP METER #710
 Kit \$29.95 Wired \$49.95

Includes complete set of coils for full band coverage. Continuous coverage 400 kc to 250 mc. 500 ua meter.

EICO Add 5% in the West. ©1960
 3300 N. Blvd., L. I. C. 1, N. Y.

**want to
double
your pay?**

**More Ahead
in
ELECTRONICS**



**Get All
3 Free!**

FIND OUT what the FCC license means
Your FCC license is recognized by employers as proof of your technical ability.

FIND OUT how the FCC license helps you get a better job or increase your pay on your present job

"Investment in training really pays off"

"I am now employed by the Western Electric Company as an electronic tester. My status as a student of Cleveland Institute was an important factor in my being employed. Knowledge gained through the course has proved amazingly helpful and affords me a feeling of complete confidence."

T. E. Spence, Greensboro, N. C.



MAIL COUPON TODAY

Cleveland Institute of Electronics

Cleveland Institute of Electronics
Desk EI-20, 4900 Euclid Avenue, Cleveland 3, Ohio

Please send Free Booklets prepared to help me get ahead in Electronics. I have had training or experience in Electronics as indicated below:

- | | |
|---|---|
| <input type="checkbox"/> Military | <input type="checkbox"/> Broadcasting |
| <input type="checkbox"/> Radio TV Servicing | <input type="checkbox"/> Home Experimenting |
| <input type="checkbox"/> Manufacturing | <input type="checkbox"/> Telephone Company |
| <input type="checkbox"/> Amateur Radio | <input type="checkbox"/> Other |

FIND OUT how we guarantee your FCC license

The Master Course in Electronics will provide you with the mental tools of the electronics technician and prepare you for a First Class FCC license (Commercial) with a radar endorsement. When you successfully complete the Master Course, if you fail to pass the FCC examination, you will receive a full refund of all tuition payments.

FIND OUT how employers make job offers like this to our graduates every month

RCA has positions for technicians, field engineers & instructor technicians to install, maintain, and teach military radar, communications, and fire control equipment. Company benefits.

YOU'LL BE GLAD YOU DID!

Accredited by the
National Home Study Council

In what kind of work are you now engaged? _____ In what branch of Electronics are you interested? _____

Name Age

Address

City Zone State EI-20

the experts say
your BEST BUY
 is **EICO**...

EICO, 3300 N. Blvd., L.I.C. 1, N.Y. EI-5

Show me HOW TO SAVE 50% on 70 models of top-quality: HI-FI TEST INSTRUMENTS "HAM" GEAR Send FREE Stereo HI-FI Guide. Send FREE Short Course for Novice License. Send FREE Catalog & name of neighborhood EICO dealer.

Name
 Address
 City..... Zone State

ADD 5% IN THE WEST

...in
STEREO and MONO HI-FI



STEREO Dual Amplifier-Preamplifier HF81
 Kit \$69.95.
 Wired \$109.95.
 "Excellent" — SATURDAY REVIEW: HI-FI MUSIC AT HOME.



NEW! STEREO Automatic Changer/Player 1007 (.7 mil diamond, 3 mil sapph dual styli)
 \$59.75 incl. FET.



FM Tuner HFT90 Kit \$39.95*
 Wired \$65.95*.
 Cover \$3.95.
 "One of the best buys" AUDIOCRAFT.
AM Tuner HFT94 Kit \$39.95. Wired \$65.95, incl. Cover & F.E.T.
FM/AM Tuner HFT92 Kit \$59.95. Wired \$94.95. Includes Cover & F.E.T.



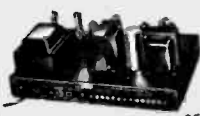
STEREO Dual Preamplifier HF85
 Kit \$39.95.
 Wired \$64.95.
 "Extreme flexibility" — a bargain! — HI-FI REVIEW



Mono Power Amplifiers (60, 50, 35, 30, 22, 14-Watt; use 2 for Stereo) from Kit \$23.50. Wired \$41.50.



2-Way Bookshelf Speaker System MFS1 complete with factory-built cabinet: \$39.95.



STEREO Dual Power Amplifiers: New 100W HF89: Kit \$99.50. Wired \$139.50.
70W HF87: Kit \$74.95. Wired \$114.95.
28W HF86: Kit \$43.95. Wired \$74.95.



Mono Integrated Amplifiers: (50, 30, 20, 12-Watt; use 2 for Stereo) from Kit \$34.95. Wired \$57.95.



TRUE HI-FI quality to drive hi efficiency speakers to concert volume.

...and in
TEST INSTRUMENTS



New Power & Bias Supply for Transistorized Expt. #1820*
 Kit \$19.95.
 Wired \$27.95
 * Patent Pending



Miniaturized Multi-Signal Tracer #145A
 Kit \$19.95.
 Wired \$28.95.



Vacuum Tube Voltmeter #221
 Kit \$25.95.
 Wired \$39.95.



Peak-to-Peak VTVM #232 & Uni-Probe (pat. pend.)
 Kit \$29.95.
 Wired \$49.95.



TUBE & CRT FIL. Tester #612
 Kit \$3.95.
 Wired \$5.95.
 Fast-checks radio/TV tubes, pilot lamps, etc.



1000 Ohms/Volt V.O.M. #536
 Kit \$12.90.
 Wired \$14.90.



5" Push-Pull Scope #425
 Kit \$44.95
 Wired \$79.95.



DC-5 MC 5" Scope #460
 Kit \$79.95.
 Wired \$129.50.



RF Signal Generator #324
 Kit \$26.95.
 Wired \$39.95.



Series/Parallel R-C Combination Box #1140
 Kit \$13.95. Wired \$19.95
 1350 Combinations!



6V & 12V Battery Eliminator & Charger #1050
 Kit \$29.95. Wired \$38.95.
 Extra-filtered for transistor equipmt. #1060
 Kit \$38.95. Wired \$47.95



R-C Bridge & R-C-I Comparator #950B
 Kit \$19.95.
 Wired \$29.95.

IN STOCK! Compare, take them home — right "off the shelf" — from 2000 neighborhood dealers. Over 2 MILLION EICO instruments in use throughout the world.

© 1960 ELECTRONIC INSTRUMENT CO., INC., 33-00 N. BLVD., L.I.C. 1, N.Y.

See Page 22 for the BEST BUYS in CITIZENS TRANSCEIVERS, "HAM" GEAR and TRANSISTOR RADIOS.

Radio's Most Exciting Frontier

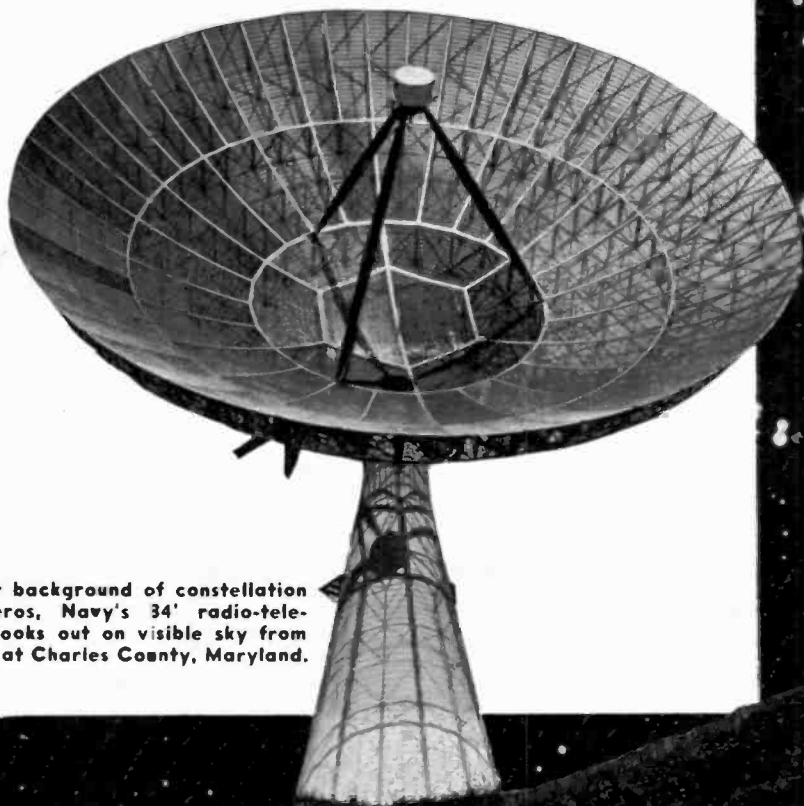
By Lloyd Mallan

The new electronic science of radio-astronomy is bringing man and his universe ever closer together.

MOST Americans have never heard of Sun Spot, New Mexico. It's hardly a town. Rather, it's the postal address of a small colony of scientists who have chosen to live and work on an isolated mountain peak two miles high. All of them work for the Air Research and Development Command of the USAF. Their task is to keep a 365-day vigil on a dwarf star 93-million miles away—our sun.

When the sky is overcast, the optical specialists leave their telescopes and play chess or watch television or go hunting. But the radio specialists have little time to relax. Few events in Nature can keep them from *listening* to the sun. Their instrument is a radio-telescope tuned to a wavelength of 21 centimeters (about 1420 mc). Their professional designation is "radio astronomer."

Other experts may be found in the deserts of California, the



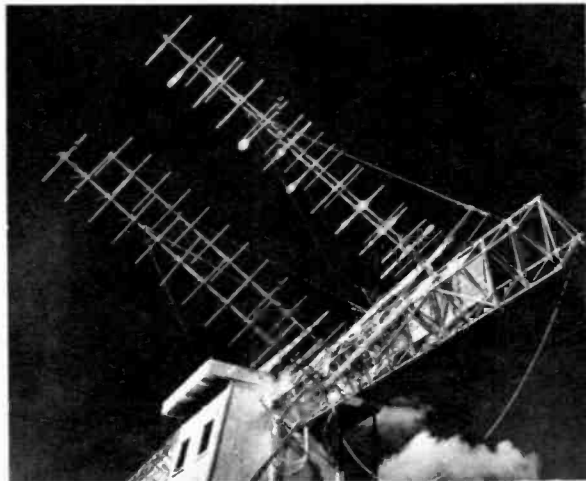
Against background of constellation Monoceros, Navy's 34' radio-telescope looks out on visible sky from its site at Charles County, Maryland.



Records taken at Gunbarrel Hill radio observatory (Bureau of Standards) are of solar noise. This information helps predict propagation disturbances.

Three parabolic antennas near Boulder, Colo., receive 50-200mc signals from radio stars.

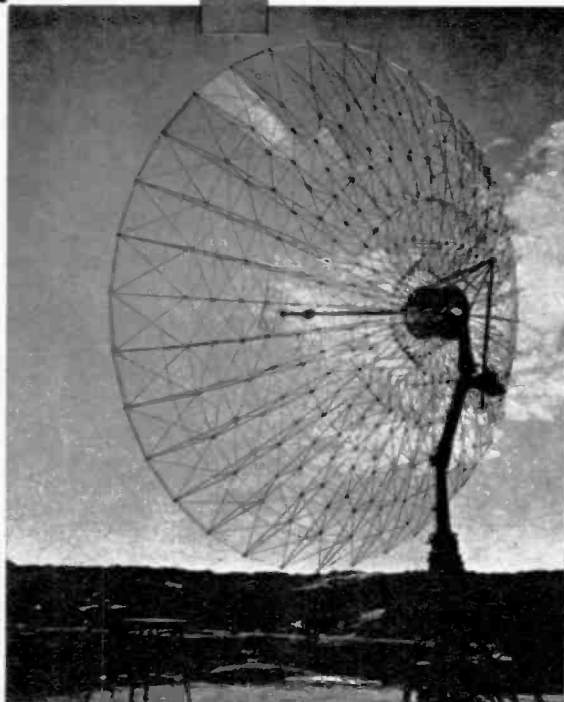
Here is an odd antenna at Sun Spot, N. M., that keeps us posted on our nearest star, the sun.

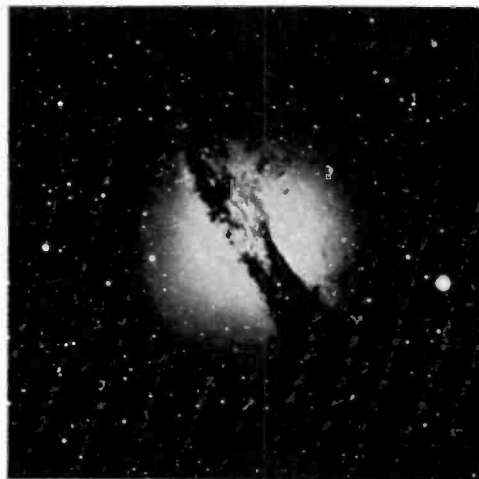
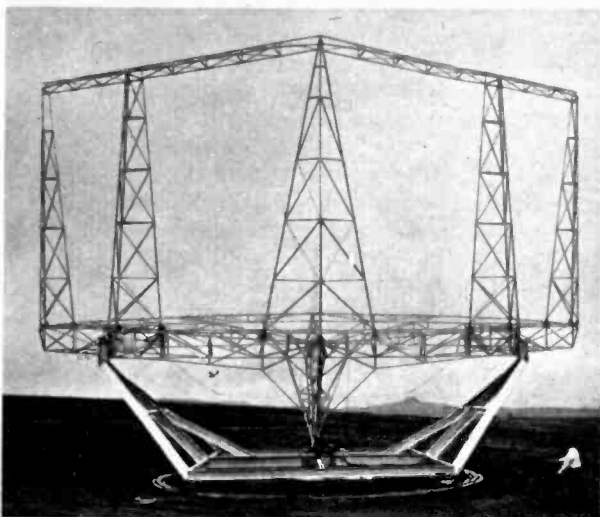


valleys of Ohio and West Virginia, on the slopes and foothills of Massachusetts and New Hampshire, on Wallops Island off the Virginia Coast, on the sandbar that is Cape Canaveral, in the Woomera Desert of Australia, in Hawaii, Japan, Alaska and England. The kinds of radio research they do are almost as diverse as their locations. Yet only 11 years ago the radio telescope was not considered a very respectable scientific instrument!

Since that time it has not only mapped the shape of our own island universe, the Milky Way, but has shown that the temperature of intergalactic space—once thought to be at absolute zero (-459.6°F)—is actually as hot as 100-million degrees. No optical telescope ever could have discovered this. Many other revolutionary discoveries were made possible by this newest frontier in radio. The men atop Sacramento Peak at Sun Spot, New Mexico, for instance, spend their days listening to the sun for an extremely practical reason. The invisible portion of the sun, which adds at least 40-million miles to the solar diameter, very seriously affects communications on earth. During the Summer of 1946, the sun's invisible envelope caused the earth's magnetic field to become so intensely distorted that all radio reception was unreliable for four days. No one in the U. S. could reliably tune his favorite program or send a radiogram. Compasses on ships and aircraft were confused in magnetic direction and this confusion amounted to a navigational error of two miles for every 100 miles flown by

Huge web-like reflector at Stanford Research Institute, Menlo Park, Calif., (left), transmits and receives signals in 100 mc range. It is used to get data about radio wave reflections from meteors and auroral ionization. At right, special low-noise amplifiers, band-pass filters and recording gear are put to work at University of Denver. Instruments are in truck, mobile.





Above is a Mt. Wilson photo of two galaxies in collision—a probable source of radio waves.

Colorado antenna, left, measures galactic radio noise with interferometer mate 916' away.

an aircraft. This is an appreciable error over intercontinental distances. On a trip to the moon in a space ship, such an error would be fatal.

By keeping a vigil on radio transmissions from the sun, the scientists in New Mexico are learning what makes our dwarf star tick. This information may one day allow them to predict far ahead what will happen to communications and navigational instruments—and thus correct for errors in advance.

Before the advent of big radio telescopes, missiles were tracked by simple radio receivers with directional antennas, and by radar that locked an optical camera onto the target. These techniques are inadequate for reporting on missiles soaring far beyond the atmosphere. Last year, an Army space-probe was sent into orbit around the sun and a radio telescope at Goldstone Dry Lake in the Mojave Desert of California, and another one near Manchester, England, followed the tiny probe until its radio transmitter gave out—at nearly a half-million miles from earth. The transmitting power was 180 milliwatts, or less than one-fifth of a watt.

Sounds simple, doesn't it? Except that the Goldstone radio-telescope has a solid-state microwave amplifier (see "Those Amazing Masers," *Electronics Illustrated*, February 1959) and a crystal-controlled receiver, the output of which is fed into a big IBM computer

for analysis. The amount of design know-how that went into the 85-foot diameter parabolic radio reflector is almost unbelievable.

Actually, radio signals coming from outer space were first noticed by Karl Jansky, of the Bell Telephone Laboratories, in 1931. He was using a conventional receiver and antenna. No one paid much serious attention to his calculations on the direction of "static"—except a radio engineer named Grote Reber. Reber built the world's first radio-telescope in his backyard—a parabolic receiving antenna 30' in diameter. Although it proved that cosmic "static" could be heard continuously on earth, it did not have sufficient resolution for the narrow bands involved. Most astronomers chose to ignore the very idea of radio astronomy. But luckily, a few were impressed. An Australian, J. G. Bolton, and an Englishman, Martin Ryle, got together and developed an interferometer antenna system—which provided much finer resolution. They found immediately that even so small a point in space as a star radiated signals. Thus radio stars were found—in 1948.

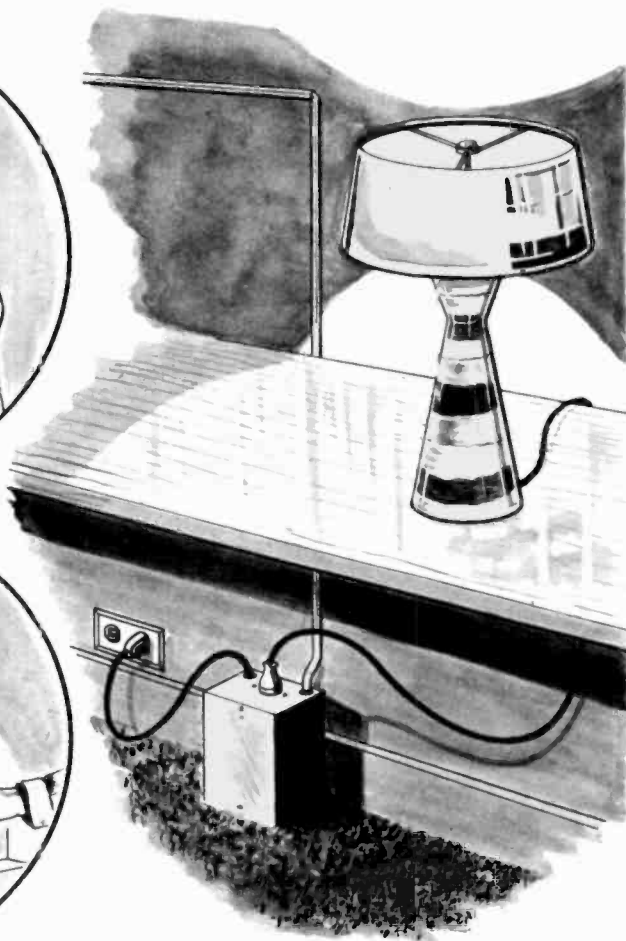
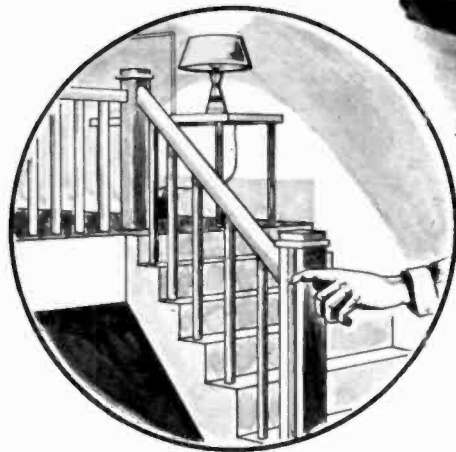
Radio-telescope interferometers are now in common use. Two identical antennas are lined up a certain distance apart—say a half-mile or a mile. They are fed into a single receiver. "Noisy" radio waves coming from space, with

[Continued on page 110]

Fingertip Switching

By Harvey Pollack

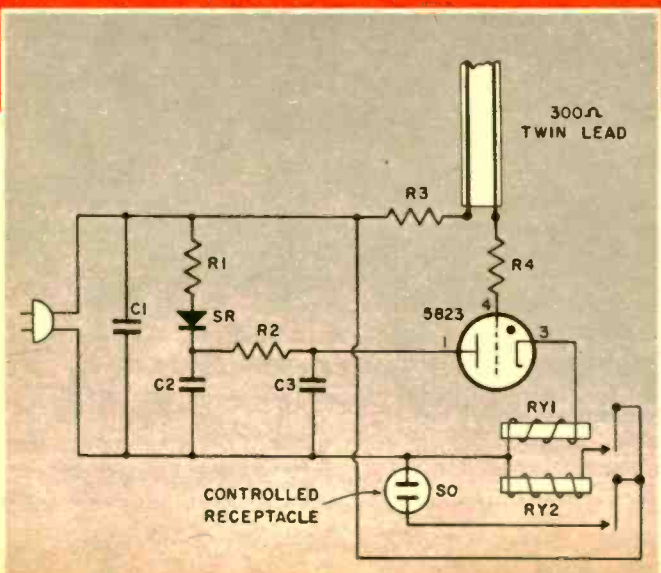
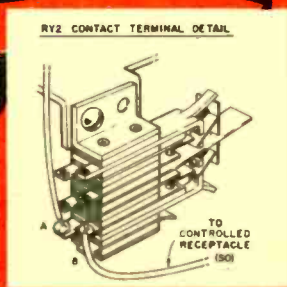
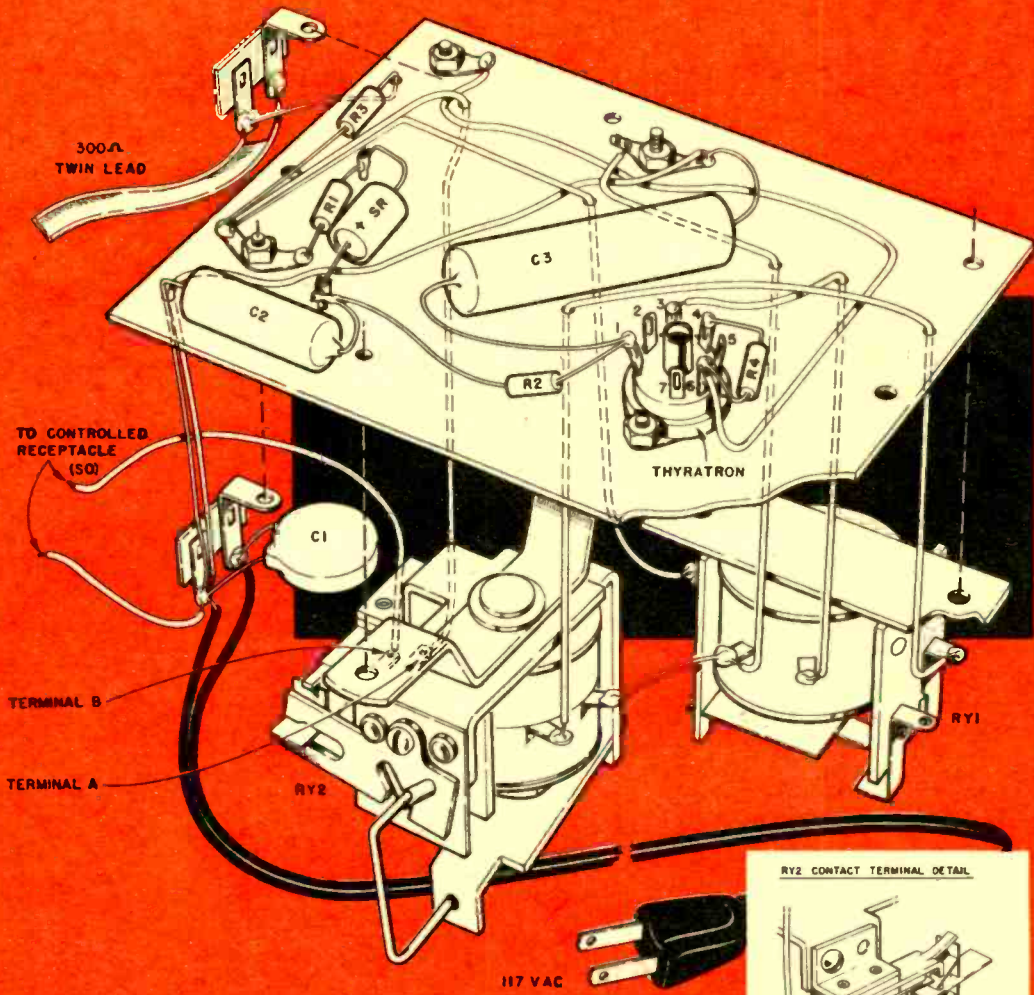
You can remote-control your appliances without the need for complicated and costly house rewiring.



MOST hobbyists have dreamed up odd little electrical tricks they would like to do if they had the "know how," if it weren't so much trouble, or if they had the necessary tools. For example, did you ever wish you could turn your garage light on or off from inside either the house or the garage? Or control a bathroom or bedroom light from any room in the house?

In most cases, the stumbling block for these projects is the problem of legal wiring. Local electrical codes may require heavy rubber-insulated cable, BX, or thin-wall conduit armor over the wires, switch wall boxes, etc.—no wonder you get discouraged!

You can circumvent all these problems by doing it with elec-



For greater clarity, phenolic board has been inverted. Pin 6 on thyatron functions as a tie point. Note contacts of RY2.

R3 and R4 isolates the twin lead from the AC line. DC power supply consists of R1, SR and C2. R2, C2, C3 controls time delay of about two seconds.

tronics. In a couple of evenings, you can build and set up a remote switching system that requires no fancy wall-cutting or cable "snaking," no armored cable, and—best of all—no switches of any kind!

Here's the way the completed system might appear: near the light or appliance to be controlled is an unobtrusive metal box into which the appliance is plugged; coming from the control box is ordinary television 300-ohm twin-lead that can be tacked to baseboards, under stairway hand-rails, or even run under rugs. Wherever you want a switch to be, you merely scrape away an inch or so of the twin-lead insulation—just enough to allow your fingertip to touch both exposed wires simultaneously. You can have any number of such independent switching points wherever you want them. Fur-

PARTS LIST

R1—22 ohm—all resistors 1/2 watt
 R2—470,000 ohm
 R3, R4—1 megohm
 C1—.003 mfd disc capacitor, 600 volts
 C2—.05 mfd capacitor, 400 volts or higher
 C3—2 mfd capacitor, 200 volts or higher
 RY1—2500 ohm relay, SPDT (Potter & Brumfield LB-5)
 RY2—115 volt AC impulse relay (Potter & Brumfield PC-11A)
 SO—AC receptacle (Cinch 2R2)
 SR—10 ma or higher, 117-volt selenium rectifier (Int'l Rect. D5410 or equiv.)
 V—5823 miniature thyatron tube
 Misc.—Line cord, terminal strips, perforated board (7" x 6"), 300-ohm twin lead, machine screws, 7-pin miniature tube socket, 3" x 4" x 5" cabinet (Bud CU-2105A), 7/8" brass spacers.

thermore, you can safely run lengths of the twin-lead of 100 feet or more.

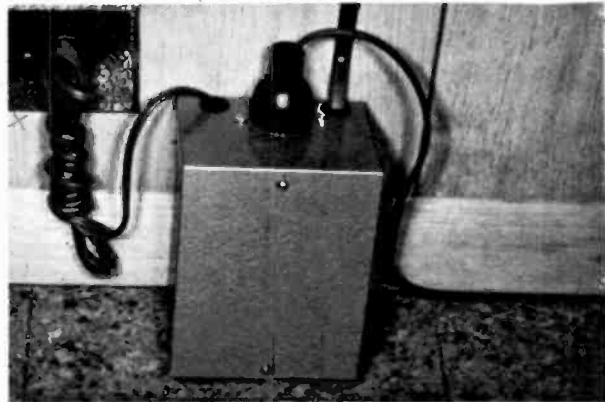
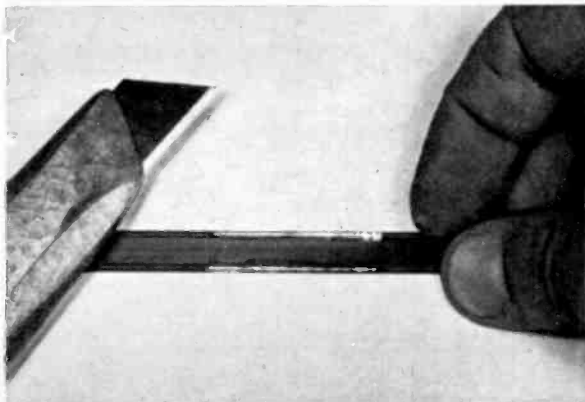
If you're thinking of safety, power consumption, or fire hazards—forget it! The twin-lead is isolated from the AC lines by more than 1,000,000 ohms, and the power consumption during idling time is less than 1/100 watt.

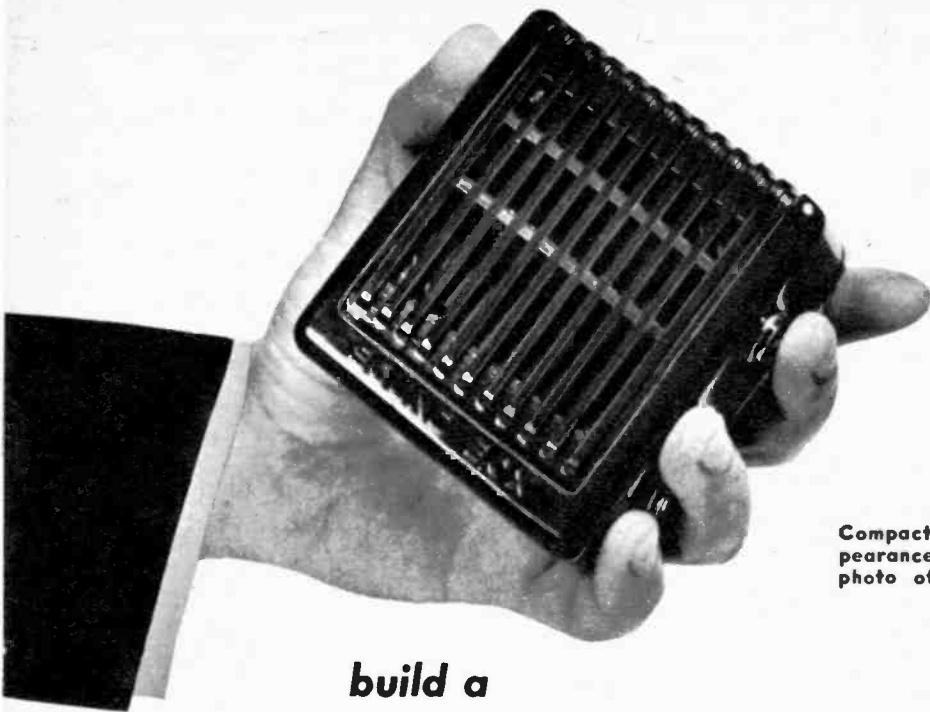
Neither the wiring nor layout of components is at all critical. A sheet of perforated phenolic secured to the inside of the metal case with two 3/4" brass spacers and 1" machine screws was made to serve as the sub-chassis. Only the two relays, the thyatron tube, and the line by-pass capacitor appear above the sub-chassis; the resistors, remaining capacitors, and small selenium rectifier are all below the perforated board, making the finished job very neat in appearance. The AC line cord for the control box and the twin lead enter through two separate grommets holes at one end of the metal box. The only part that is secured to the metal case is the chassis receptacle (SO) into which the appliance is plugged. Both the line cord and the twin lead terminate at two-lug terminal strips for rigidity and safety. The case is only what its name implies—a container. It must not be used as a common ground or terminal point for any of the connections.

It's always a good idea to test for hidden short-circuits before applying power. If you have an ohmmeter, this is [Continued on page 125]

Insulation of twin-lead is stripped about 1 1/2 inches. Several contact points may be made.

Completed set-up with twin-lead tacked along wall. Any appliance may be plugged into unit.





Compact size and neat appearance are evident in this photo of completed mike.

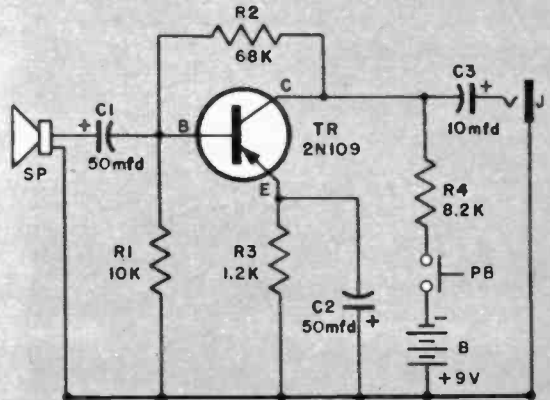
build a Transistorized Mike

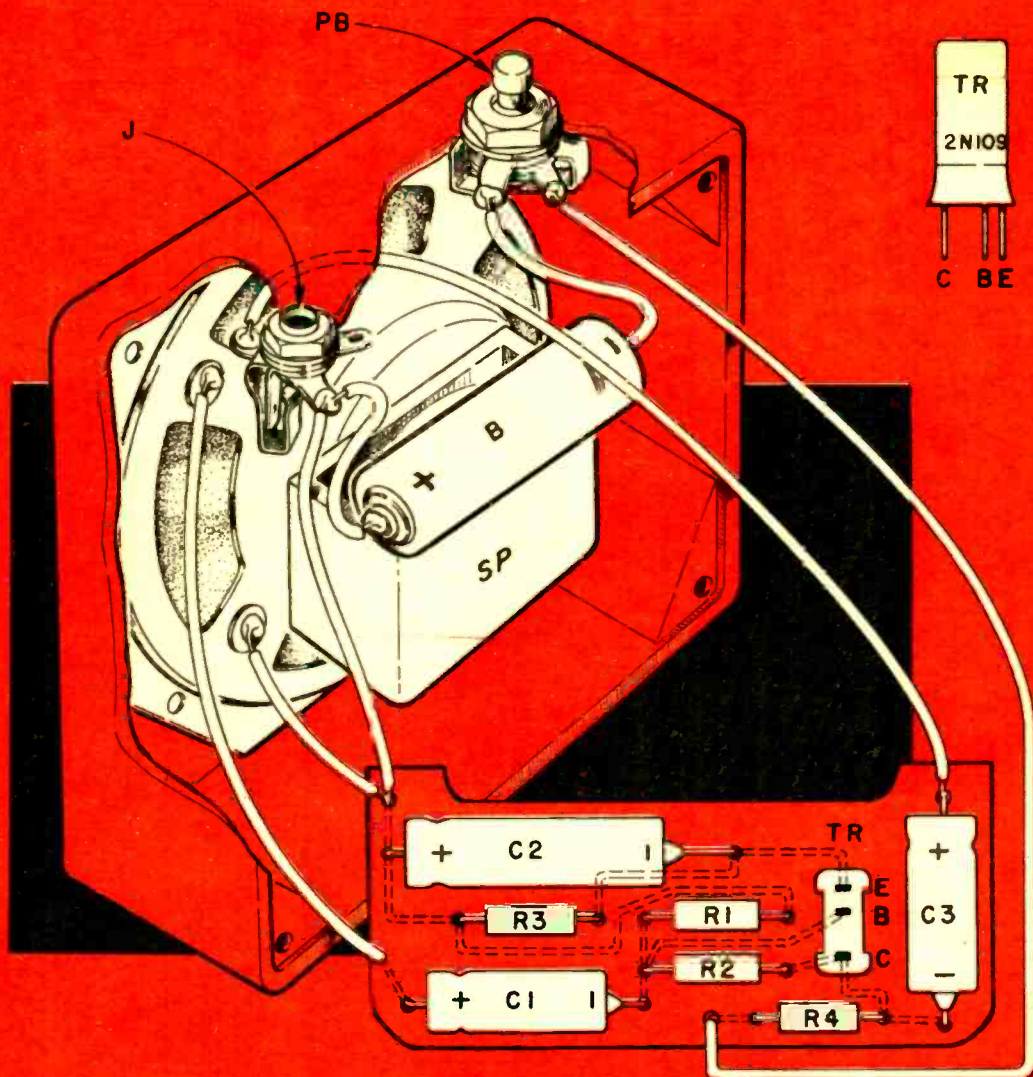
By Harry Kolbe

A good quality, high output general purpose microphone that will drive most amplifiers directly.

Small parts are mounted on a Bakelite board, which is located at the bottom of the case.

Low impedance output enables use of a long shielded cable. PB switch is normally open.





Dotted lines indicate wires beneath the board. Miniature phone jack (J) is open circuit type.

UNTIL the recent influx of low cost foreign makes, a good general purpose microphone was quite expensive. In addition to this cost factor is the need for external preamplifiers, transformers, etc. The unit described here should meet most requirements and its .4 volts output will drive any power amplifier without any additional pre-amplification.

Quality of reproduction is far better than one might expect from such simple and inexpensive components. Most striking is the extreme clarity; lacking
 [Continued on page 120]

PARTS LIST

- R1—10,000 ohm
- R2—68,000 ohm
- R3—1,200 ohm
- R4—8,200 ohm
- C1—50 mfd 6 volt electrolytic capacitor (miniature)
- C2—50 mfd 15 volt electrolytic capacitor (miniature)
- C3—10 mfd 15 volt electrolytic capacitor (miniature)
- TR—2N109 (RCA)
- PB—Pushbutton switch SPST (Lafayette MS-449 or Switchcraft Type 951)
- SP—Speaker, 2½" PM 10 ohm Voice Coil (Lafayette SK-65 or equiv.)
- B—9 volt battery (V5309A or equiv.)
- J—Miniature phone jack
- Cabinet—Plastic 3"x2½"x1½" (Lafayette MS-315)
- Misc.—Bakelite board; plastic spray

El's money making careers in electronics

Cash In A Flash

By James Joseph

Industrial cameramen with speedy cameras and speedy subjects are calling for electronics help.

YOU don't have to start in Africa to turn gunbearer for profit—and no one proves it better than 53-year-old Irving Jacobson who, safaring through U. S. industry, is the man behind the guns—electronic photo-flash guns.

As an electronic consultant to photographers—industrial, commercial and special effects—Jacobson has never fired a shot in anger, yet his fees top those of Africa's White Hunters: \$100 a day for electronic consultation, as much as \$5000 to design and build special electronic photo gear.

Jacobson's job is solving problems—electronic photo problems. Typical was a call last year from Convair space engineers. Their quandary: how to photograph the ejection of a test-dummy from a mock-up cockpit buffeted by a wind tunnel's 750 mph gale?

"It was a tough one," concedes Jacobson. "There's not a camera built that can withstand so high an airstream. Worse was the heat—up to 125°F." [Continued on page 127]

Marketable inventions often grow out of problem solving chores. Jacobson made this device which tells whether shutter and flash unit are in synchronization. He sells unit for \$300.

Here is circuitry of typical electronic camera control unit designed and built by Jacobson. It can fire three electronic flash tubes simultaneously. Cost, with three lamps, about \$900.

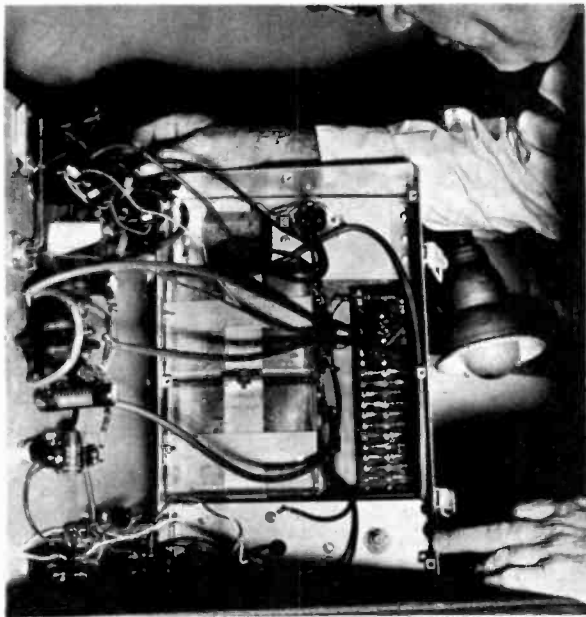
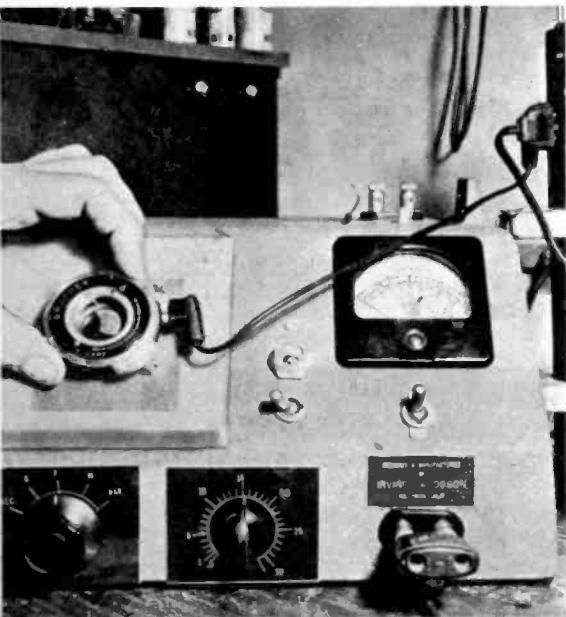


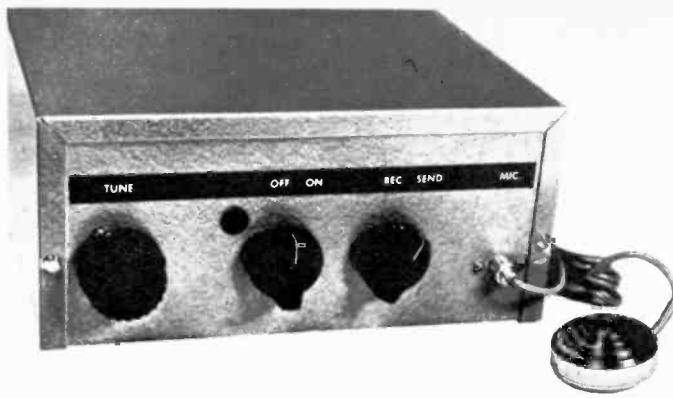


Photo-electronic consultant Irv Jacobson gets set to test lens shutter in his lab. Light passes through shutter to photocell (lower right) and is recorded on oscilloscope. This gives an accurate check on the speed of the shutter.

Consultant to cameramen often deals in light, electronic flash guns. Here are three common electronic flashbulbs and a special heavy-duty flash which Jacobson built for Cornell.

This electronic flash was designed by Jacobson to illuminate the slide of a microscope. Exact desired amount of light is sent to slide via a 10" beam-conducting lucite "nozzle".



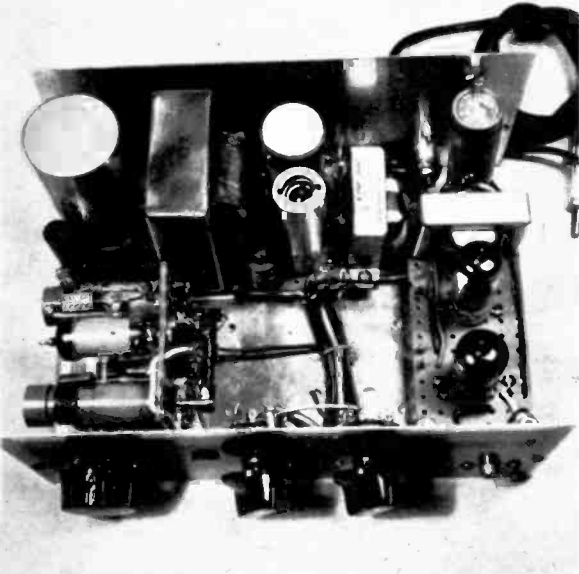


EI Build-It Course-9

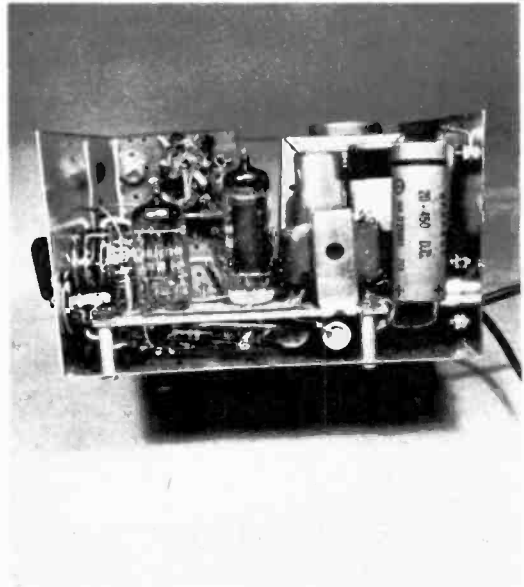
Part 9 in this series describes the modulator—the unit that superimposes voice onto the RF carrier.

LAST month's module, the RF oscillator-amplifier, served to generate a radio-frequency carrier; a sustained alternation of 27 megacycle energy. Prime purpose of the carrier, as its name implies, is to bear intelligence between transmitting and receiving antennas. The unit described here is the *modulator*; a collective name for the audio amplifiers that shape the carrier—swinging its amplitude in step with the voice frequencies.

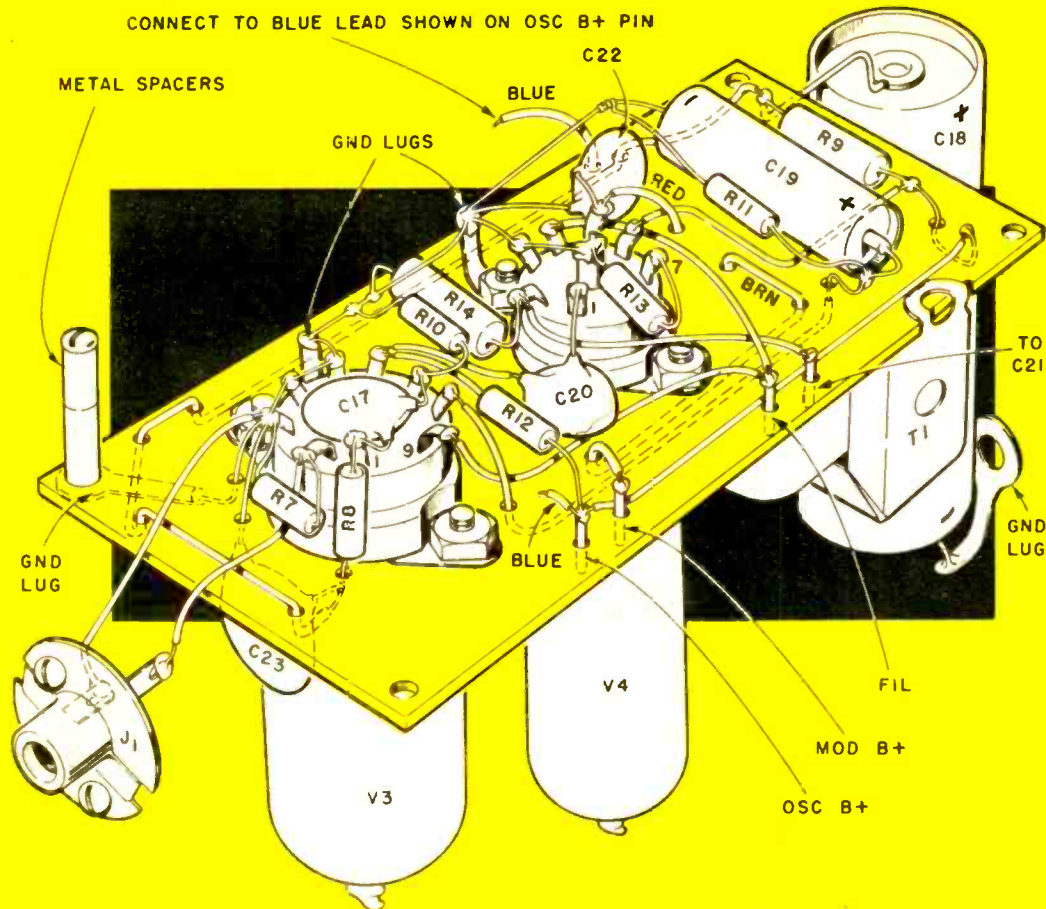
If voice frequencies were applied directly to the transmitting antenna they would set up a magnetic field that expanded and



Top view of unit, cover removed. At left is RF osc-amp module, at right is the modulator unit.

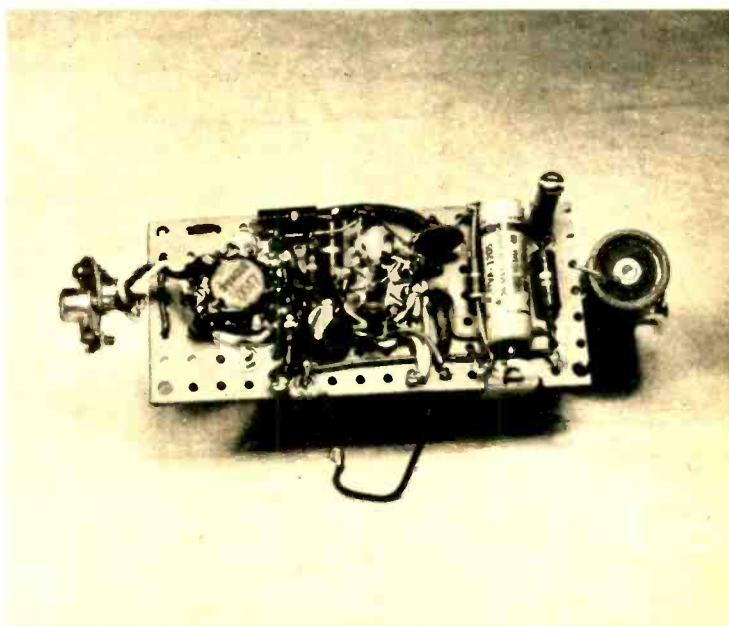


Side-view of modulator assembly shows large electrolytic capacitor suspended by top lug.



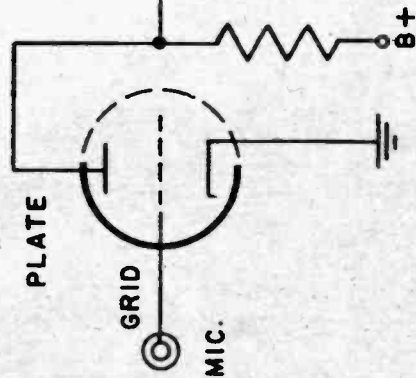
Wiring guide shows "hot" center lead of phone plug connected to pin 2 on V3. Twist leads back to tube's socket.

Bottom view reveals mounting of transformer T1. Its tabs are bent securely over the notches in the perforated board.



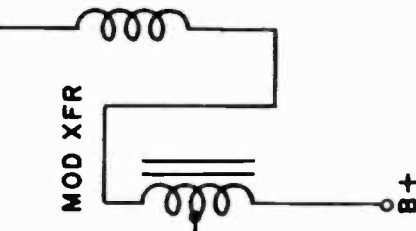
HOW THE MODULATOR WORKS

SPEECH AMP



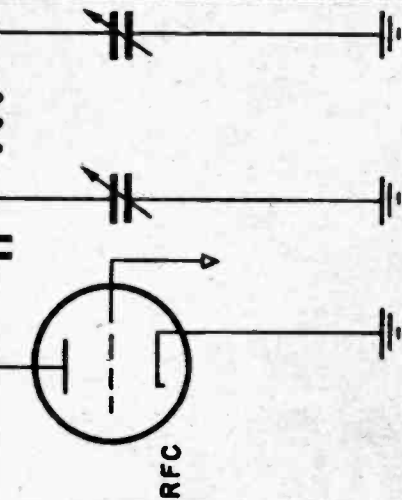
Input stage is a high-gain audio amplifier which is designed to boost the low-level signals from the microphone. A ceramic microphone is preferred because of its heat and humidity resisting qualities. However, a crystal type will also provide adequate input voltage. Audio voltages fed to the grid cause it to fluctuate in a positive and negative direction. Electrons emitted from the cathode are accelerated when the grid swings in a positive direction; slow down when the grid swings more negative. The number of electrons flowing is similarly affected. The high positive charge on the plate attracts these electrons, which now represent an amplified version of the input signal. The signal is now fed via the coupling capacitor to input grid of following stage which acts as a plate modulator.

MODULATOR



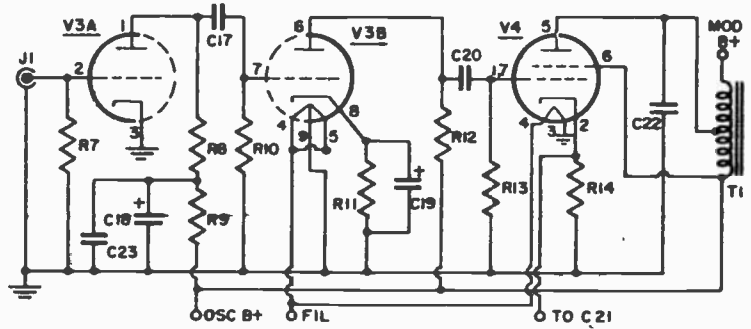
Modulator stage is basically an audio amplifier driven by the speech amplifier. Since it must develop a considerable amount of power, a beam-power type tube is often used here. As described in the text, its output in watts is designed to be about half the power of the RF amplifier tube. In actual practice about 20% more wattage is required to overcome losses in the modulation transformer. Note that the plate of the modulator taps down about half way on the transformer. This point represents the proper load for the tube; important for extracting maximum power from it. Output power is picked up from the top of the winding for delivery to the RF amplifier. Thus, the modulation transformer serves as a matching device between tubes of different load impedances.

RF AMP



Audio voltage is introduced to the RF amplifier through a radio-frequency choke. The choke's purpose is to prevent the 27 mc RF energy from flowing back into the modulation transformer and power supply. Audio flows through the choke with little opposition and is impressed on the RF amplifier tube's plate. Two voltages are now present: the high B+ (which serves as the RF amplifier tube's plate voltage) originates at bottom of modulation transformer and travels unimpeded through both the mod. xfr. (T1) and RFC, and the audio modulating voltage. When the two voltages add, the RF carrier increases in amplitude. Negative-going audio, however, bucks the B+ plate voltage and reduces it. The net effect is an RF waveform whose amplitude is a reproduction of the audio modulation.

V3 is a high- μ twin triode for greater gain. Note modulation transformer T1 doesn't use secondary connections.



contracted at a slow audio rate. Transmission would be measured in mere feet as the field collapsed and returned its energy back into the antenna. But, radiation at 27 megacycles propagates a strong *electro-static* field whose alternations are so rapid that they don't have sufficient time to contract completely back into the antenna. If it took you four seconds to read the previous sentence, the radio wave could have circled the Earth about thirty times—travelling at a constant velocity of 186,000 miles per second.

Modulation is the technique that utilizes the speed and range of radio frequencies for the transmission of intelligence. Since AM, amplitude modulation, is designated for the Citizens Band by the FCC, we'll concentrate on it here, though other forms are in service. AM requires simple equipment, is easy to adjust and highly effective.

The point at which audio power is joined to the carrier is in the plate circuit of the RF amplifier. (See the full-page theory diagram which details the signal pathways.) If the RF plate voltage is changed, the amplitude of the carrier will vary with it. The modulator tube applies audio voltage to the RF plate and swings the carrier amplitude in step with the voice frequencies. Thus, audio is "encoded" onto the carrier in the form of RF amplitude variations.

Modulation is measured in percentage (100% being the legal limit) and expresses the relationship between the carrier at rest and power increased when modulation is applied.

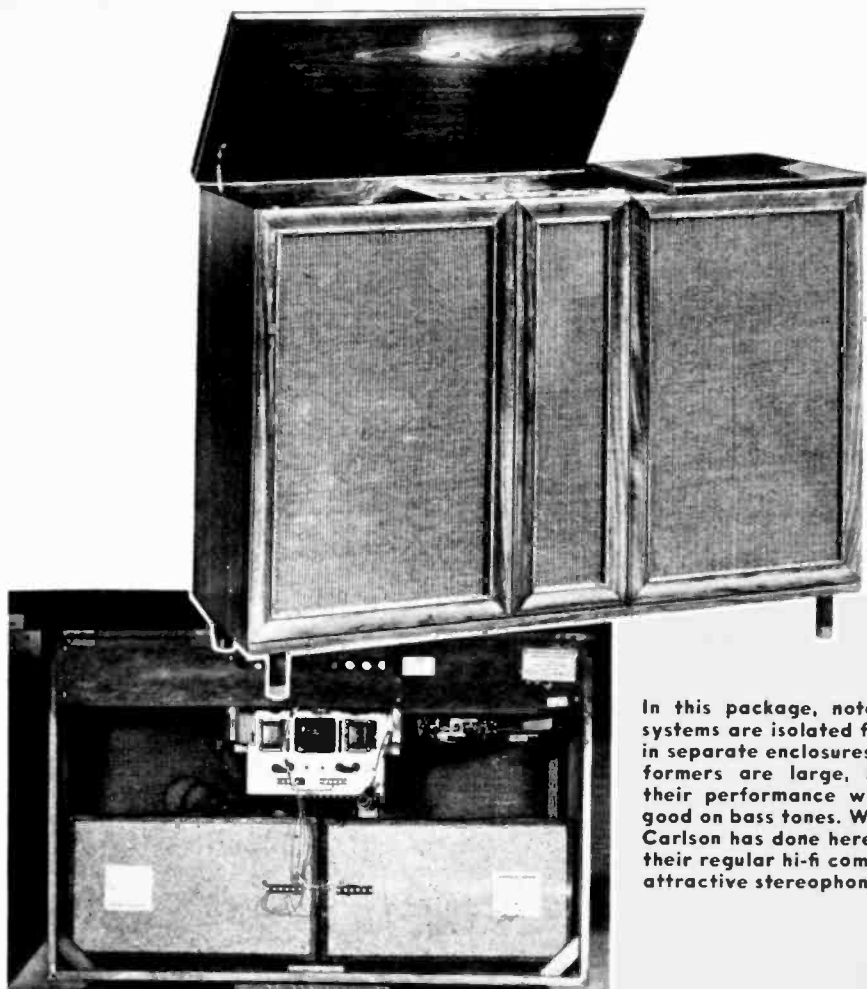
The positive half of the audio cycle increases the carrier power; the negative half decreases it. At 100% modulation the carrier is driven to the zero point. Additional audio power would keep the carrier at zero for too long a period of time during the negative half-cycle. Actually, a hole would appear; the waveforms distort, and a "splattering" interference would be heard throughout the Citizens Band. If the positive half of the audio cycle is excessively high, the limit of the RF amplifier's ability to pass current would be exceeded and a leveling off (plate saturation) would occur. This, too, is accompanied by distortion products.

In actual practice the modulator is designed to deliver a power level equal to half of the carrier power. During

[Continued on page 124]

PARTS LIST

(part numbers continue from last month's project)
 All resistors 1/2 watt unless otherwise noted
 R7—10 megohm resistor
 R8—470,000 ohm resistor
 R9—15,000 ohm resistor
 R10—1 megohm resistor
 R11—4700 ohm resistor
 R12—200,000 ohm resistor
 R13—220,000 ohm resistor
 R14—470 ohm resistor 2 watt
 C17, C22, C23—.0047 mfd disc capacitor 1000 volt
 C18—20 mfd 450 volt electrolytic capacitor
 C19—25 mfd 25 volt electrolytic capacitor
 C20—.0068 mfd disc capacitor 1000 volts
 C21—mounted in power supply: to be shown next month
 V3—12AX7 tube
 V4—6AQ5 tube
 T1—Modulation transformer secondary not used (Lafayette TR-12)
 J1—Phono jack
 Misc.—One 9-pin tube socket without centerpost, one 7-pin tube socket with centerpost, lock-washer-type solder lugs, perforated board 4-3/16"x1 1/8", ceramic microphone, flea clips, hardware, spacers



In this package, note how speaker systems are isolated from each other in separate enclosures. Output transformers are large, indicating that their performance will probably be good on bass tones. What Stromberg-Carlson has done here is to assemble their regular hi-fi components into an attractive stereophonic package unit.

how good are **Stereo Consoles**

By Norman Eisenberg

Fancy on the outside—but most one-package stereo consoles take the shortcut road to high fidelity.

STEREO has set off a new boom in consoles. To many persons who are now just ready to convert to stereo there is something eye appealing about having it all wrapped up in one big package with the connections already made. But how does the sound compare to that of component systems?

We wanted to find out if you can get hi-fi stereo from a console. Measured by the yardstick of good audio practice—or just plain common sense buying—we found that there are plenty of phonies

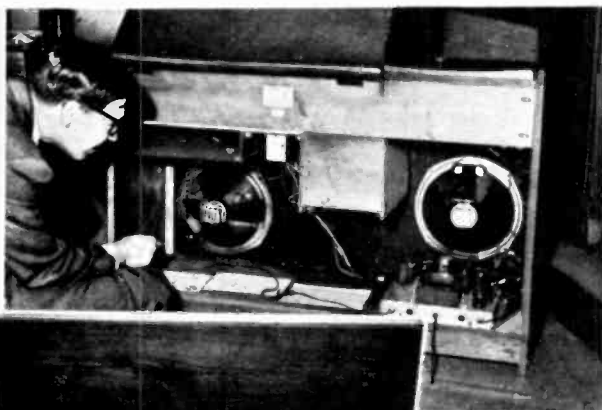
among the current crop of phonos. Fancy cabinets, sales claims and prices are no guide to quality and performance. The whole area of package sets offered by "big names" in home appliances amounts to a no-man's-land. The only technical standards seem to be "put in anything; the public won't know the difference."

There are some notable exceptions, however. "Component packages" in console cabinets offered by the known names in component high fidelity—such as Ampex, Fisher, Pilot, and Stromberg-Carlson—contain hi-fi gear and offer clean sound.

To track down the distorted sound and the distorted claims, *EI* examined and listened to several consoles ranging in price from \$88 to \$800. We checked them where you would buy them—at the dealers. A few dealers were cooperative, permitting the team to examine the sets. Many more resented the intrusion.

Of course, console dealers have their problems. Their first job is to sell in a highly competitive market. Yet, if they are not entirely responsible for what manufacturers produce and the way it is promoted, they still are in a position to take your money for merchandise they are offering. And someone spending a sizable

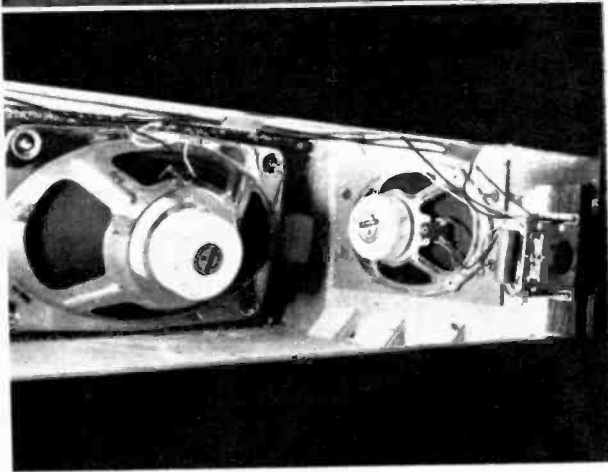
Pleasing to the eye, but how about the ear? When we took perforated back off this set we saw that no attempt had been made to damp interior of cabinet and both speakers had to operate in same hit or miss air space. We considered amplifier parts to be minimal. Price: Somewhat less than packaged components opposite.



V-M console



West German Grundig stereo consoles have elaborate tone and push-button controls and record storage space. Tuner is not adapted for multiplex, nor will it play AM-FM stereo.



Grundig's speakers looked and sounded the best of consoles in \$300 price range. There are four speakers, two facing front, two on side. At right is cross-over, extension speaker outlet.

amount of cash has a right to know what's behind the glittering facade.

In one of New York's largest chain-store discount houses, *EI's* men asked the manager if they could look at the back of a console.

"Absolutely not," he replied. "That's not how we sell merchandise."

Cooperation was the exception, not the rule. Sales persons were vague or evasive or only slightly helpful on such matters as the addition of a tuner for stereo broadcasts, or attaching a tape recorder.

What do all package sets have in common? Convenience. Buy a pre-assembled, pre-connected set and you get a working machine—or so goes the sales pitch. But these questions remain: What kind of tubes, transformers, crossover networks, cartridges, etc.? How well do they work? How will the record player treat those delicate stereo discs? How well will the amplifier and speakers reproduce what's on the record? How

This Steelman unit is under \$100. It has two small speakers for stereo (see below) that are so close together that stereo effect is very difficult to hear. There is no cabinet bottom.





Zenith stereo console above is not much lower in price than some good packaged component consoles, yet its tuner will not handle AM-FM stereocasts, and its speakers and amplifiers were not too impressive. Crossover net between woofer, tweeter is low-cost capacitor. Output transformers in amplifier seemed small.



much of a bargain is the \$100 set, and how much more do you get with the \$500 unit?

Take the claim of console convenience for a starter. Many consoles lack a tuner. If you wanted to add FM, you become involved with something like component assembly—assuming there is room in the console for the tuner, and in many consoles there is not!

Some consoles do come with FM receivers. A Zenith set in the \$500-plus class has an AM-FM receiver. It is not, however, a stereo tuner. You cannot use it to hear stereo broadcasts in which one channel is broadcast on AM and the other channel on FM. An import, the Grundig-Majestic model TC650, sells—with discount—for about \$300. It, too,

has a radio receiver; but it is not a stereo tuner.

Attaching a second tuner, or multiplex adapter, to either of these sets to hear FM broadcast stereo means changing the input wiring and switching.

Many consoles and portables *do* have provision for plugging in an external speaker. This seems to suggest an indirect confession on the producer's part that the console's speakers are not quite enough for stereo. And indeed, listening tests tended to confirm this suspicion. Aside from "assembled component" consoles, most package sets employ speakers that suggest the kind of item you can get at a surplus counter for a few dollars. There was no acoustical

[Continued on page 114]



spotlight on:

10-Meters

By C. M. Stanbury II

There's no Novice operation on these frequencies, but they provide an avenue to two fine amateur activities—mobile operations and international DX.

TWO of the most popular amateur radio activities are international DX (we've covered this subject pretty thoroughly in our last two reviews), and mobile operations, which can brighten monotonous drives and provide companionship wherever you go in your car.

Unfortunately, the two seldom mix well. Top DX generally calls for high power, if not from the transmitter then with the help of a complex antenna. And, of course much depends on propagation via the ionosphere. Mobile equipment must be light—which means low transmitter power, and the antenna has to be comparatively short and simple. The answer is 10 meters, which is not perfect, but the closest thing to it.

The upper edge of the 10 meter band is 300 kc below the dividing line between shortwave and VHF. Thus skipping is almost the problem up here that absorption is down on the 75 and 80 meter bands. And in this sense, the two areas of operation complement each other. When sunspot activity is at a minimum, there is low band activity. When the sunspot cycle reaches its peak, so does 10 meters and international mobile DX.

Because maximum useable frequency (MUF) is such a vital factor, any layer capable of reflecting 10 meter signals is important. There are two—the F2 and the "Sporadic-E" layer. This latter occurs at the same height as the normal E layer, or a little higher, but is frequently more ionized and quite difficult to predict. Many theories have been advanced to account for it, everything from meteor trails to summer heat.

However, transmissions via Sporadic-E rarely cover more than two hops (2500 miles), thus most real DX is achieved via



Vertical whip antenna extending nine feet is generally used for 10 meter mobile operations. It is nondirectional. Shakespeare "Wonderod" is shown.

Power supply, modulator are in trunk. Gonset G-66 receiver and G-77 transmitter are under dash. Each unit has meter, long tuning scale across top.



F2. As mentioned last month, MUF's lower as the transmitter gets closer to the polar regions, so on this "last of the shortwave bands," tropical stations have a real edge. Further, as the F2 MUF is highest in winter, this is the peak season for 10 meters. Despite these limiting factors, the band should not be sold short. Any distance and any rare station can at some time be worked on 10 meters. Further, when it is continuous daylight in a polar region, proximity to that pole ceases to be a handicap.

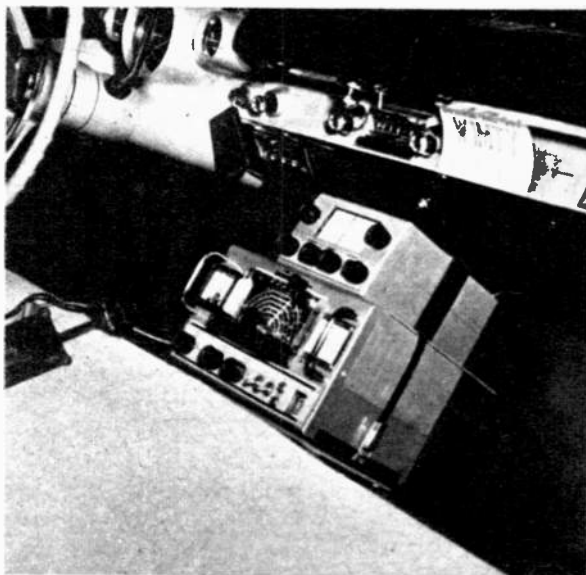
The 10 meter band's resemblance to VHF provides some real advantages for mobile and portable operations. First, required antenna lengths are short. A grounded vertical quarter wave "whip" would reach approximately 9 feet above where it is mounted on the car. While this antenna is nondirectional, skipping has so reduced QRM (man-made interference) in these frequencies as to make many clear channels available. And with a clear channel, greatly reduced power can be utilized to full advantage.

Operating on the Band

The 10 meter allocation is the widest of any shortwave ham band (2.8 to 2.97 mc), and a major portion is open for phone operations (1200 kc). Full frequency modulation may be used on the upper 700 kc of the band. FM has the advantage of reducing auto ignition noise and similar interference and requires, in one sense, less power since all of the power can be used for modulation. In contrast, the carrier power in AM voice transmissions, (with the exception of single sideband), is wasted. However, AM phone is still received more readily at a distance than the FM transmission.

Foreign phone stations often operate on the U. S. CW frequencies in the 10 meter band.

There are powerful American stations on the band using beam antennas and perhaps the full kilowatt, but they do not have the same advantage they enjoy on the lower frequencies. The United States is the easiest country of them all for an overseas ham to work. Thus when a foreign amateur hears a K or W announce as "portable mobile" or



Multi-Elmac rig of WIMTY has all controls within easy reach of operator. Transmitter is rated at 60 watts, AM crystal control or VFO.

"fixed portable," he will, if interested in DX, prefer him to a K or W powerhouse. The low power is, in effect, DX bait to the foreign ham.

Portable mobile means a portable station operated while in motion, in car, plane or boat (except in the City of New York where traffic laws forbid speaking into a microphone while a car is in motion). Fixed portable means such a station not in motion. American amateurs may carry on these activities from either the United States or Canada and the same applies to Canadians. (See chart).

Chief problem in mobile operations is the source of power for the transmitter. Batteries are a common solution, but in some cases the generator from the car itself is used. The latter procedure draws heavily on the electrical system and for that reason is seldom recommended, especially since the transmitter could not be used when the motor is not running. That vertical whip we mentioned previously is the standard 10 meter mobile antenna. It is grounded via the automobile providing the necessary half-wave tuning. ●

DX on 10 METERS				
As These Increase	Maximum Useable Frequency		Absorption	DX on 10 Meters
	F-REGION	E-LAYER		
	OVERALL			
Height of Sun in Sky	Increases	Increases	Increases	Improves
Length of Day	Decreases	Increases	Increases	Declines Slightly
Height of Reflecting Layer		Increases	Varies	Improves
Angle of Incidence		Decreases	Varies	Declines
Proximity to Earth's Poles		Decreases	Increases	Declines
Transmission in North/South or South/North Direction		Increases	Varies	Improves

On 10 meters, the tricky Sporadic-E layer also comes into play as a reflecting layer. Additionally, the more sunspot activity, the better international DX.

ANTENNAS FOR 10 METERS

As 10 Meters is the shortest wavelength of any of the short wave amateur bands, any high frequency antenna may be used.

DIPOLE—Half wavelength (approx. 16 feet) directional broadside to the antenna.

LONG WIRE ARRAYS—Usually consists of two full wavelength wires in parallel or forming a V which will be directional off each end. Four full wavelengths may be used in a rhombic arrangement.

TRAP ANTENNA—Multiband antenna tuned artificially by means of traps, not particularly directional.

BEAMS, ALL ELEMENTS DRIVEN—Consists of two or more dipole elements placed end to end or in parallel. Bidirectional.

CUBICAL QUAD—Two quarter-wave squares placed in parallel, one driven, the other acting as a reflector.

BEAMS WITH PARASITIC ELEMENTS—Consists of two or more dipole elements, one driven. Radiates in only one direction. Tops for DX.

VERTICAL QUARTER-WAVE—Just that, grounded and non-directional.

GROUND PLANE—Version of above, but ground consists of four metal radials lifted as high as possible with the vertical quarter-wave placed at the same level. Has excellent low angle radiation.

CANADIAN/AMERICAN MOBILE OPERATIONS

It has been agreed that any person holding an amateur license issued by either country may operate in the territory of the other country under the following conditions:

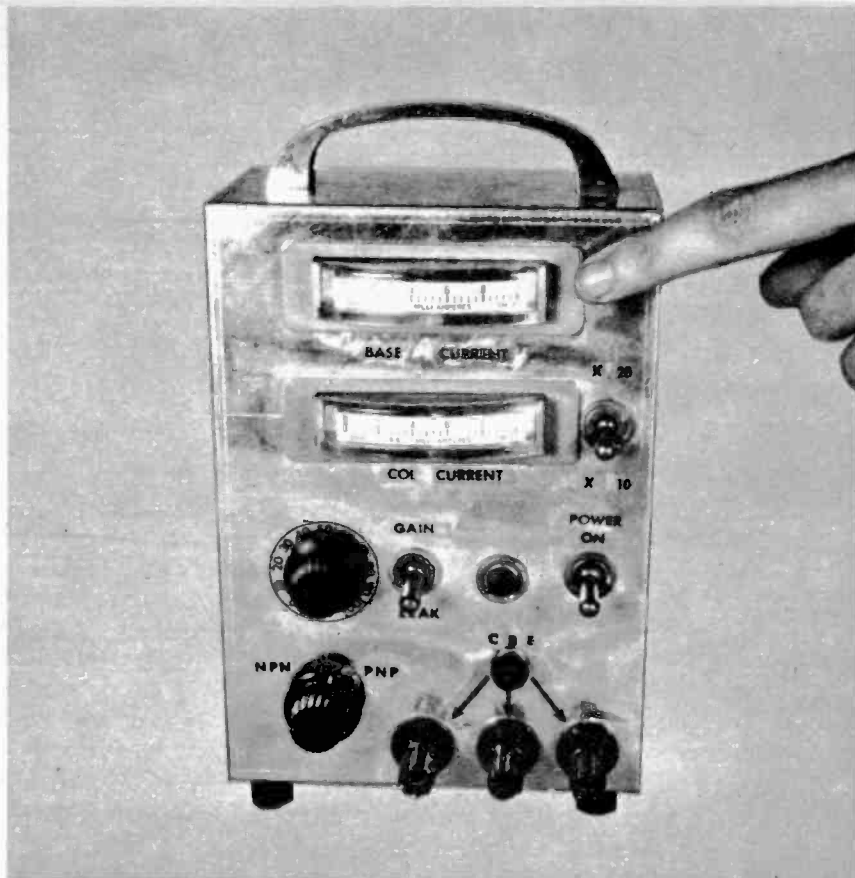
A—Each amateur may be required to register and receive a permit before operating.

B—The visiting amateur shall identify himself by (1-cw) the amateur call sign issued to him by his home country followed by a slant (/) sign and the amateur call zone prefix of the country he is visiting (for example VE3XX/W2), or (2-phone) the amateur call sign in English followed by the words "portable", "fixed", "mobile" as appropriate and the amateur zone prefix of the country he is visiting.

C—He shall indicate at least once during each contact with another station, as nearly as possible, his geographical location by city and state or city and province.

D—In all other respects the station shall operate in accordance with the rules and regulations of the country in which it is temporarily located.

For mobile 10 meter operation, a simple vertical whip using car as ground is satisfactory. Some localities prohibit ham operation while car is in motion.



Front panel features pair of edge-wise millimeters. Multiplier switch, top right, and NPN-PNP selector switch permits testing of almost any transistor.

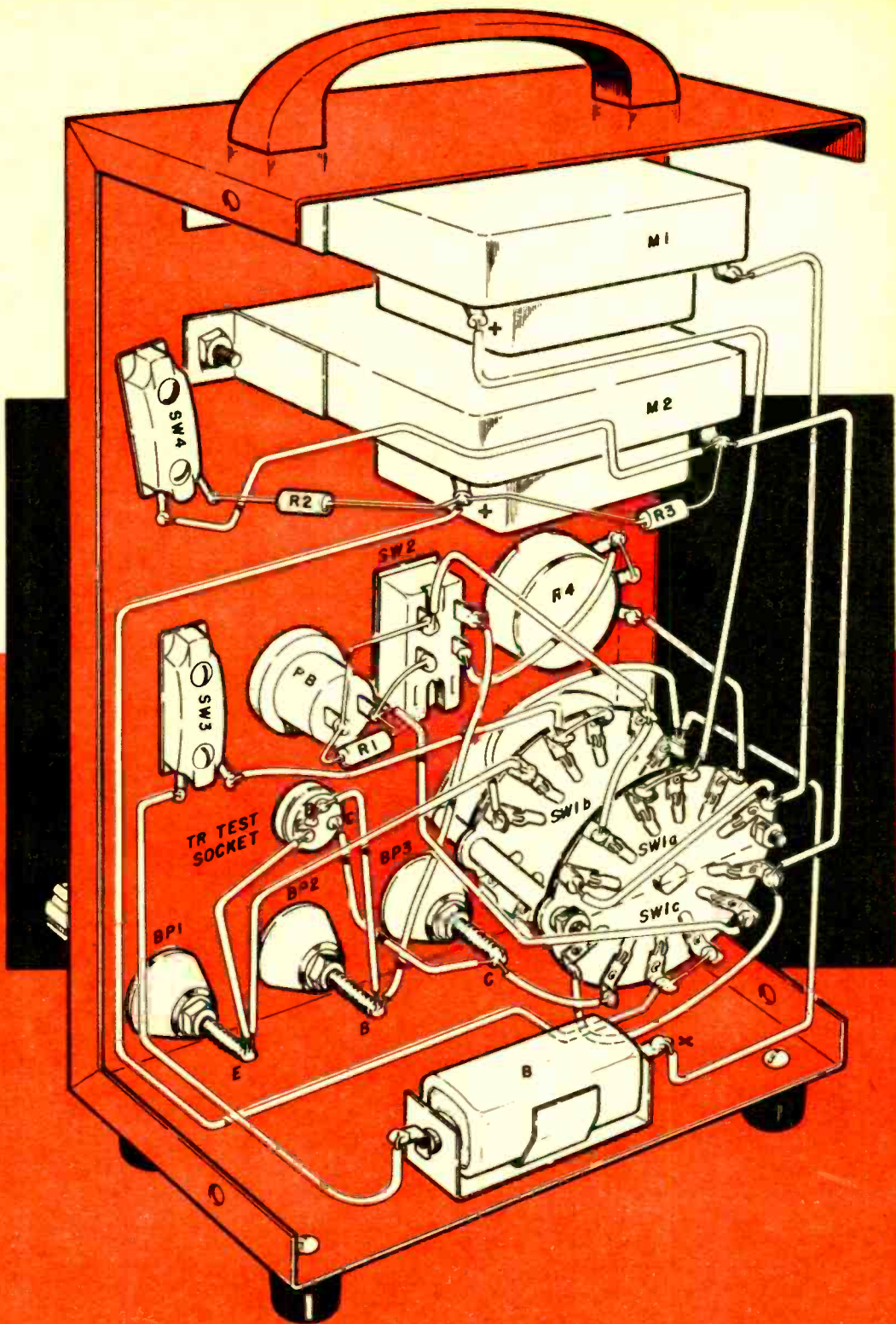
build a Transistor Tester

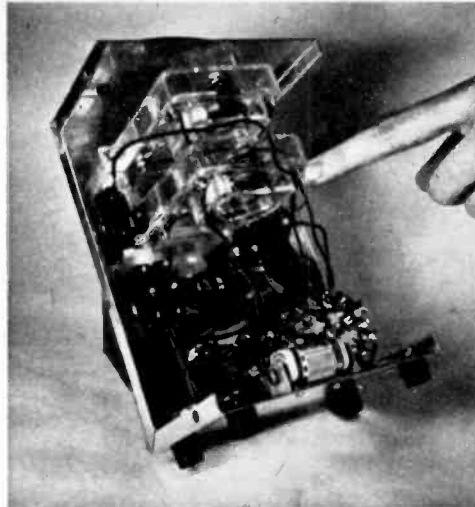
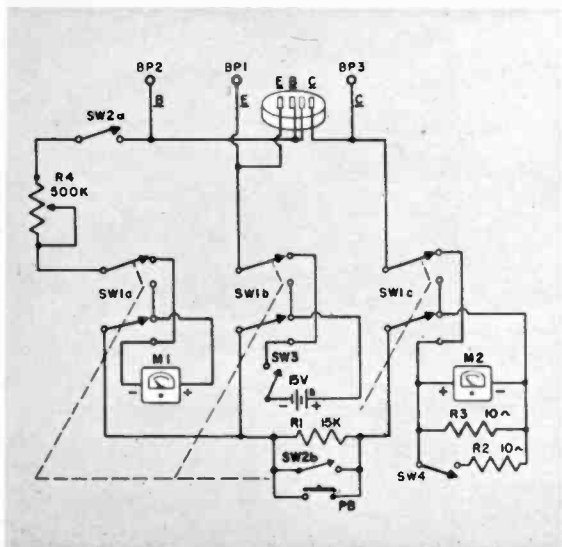
By Ronald Benray

A useful piece of test equipment for the hobbyist or technician. Will check current gain and leakage.

BEFORE any serious electronic design or experimental work can be done, the technician must have at his disposal a means of testing the components he uses. The ubiquitous VOM does a fine job of testing batteries, transformer continuity and resistance, etc., but it is less than useless, and in fact may be harmful, for testing transistors. Considering the explosive growth in popularity of transistors among home experimenters, it is unfortunate that no standard method of testing them has evolved.

The device described in this article does not create a standard criterion for testing transistors, but it will determine if a transistor is shorted or open, and it will measure two very important parameters, the current gain in a common emitter circuit con-





Negative terminal of meter M2 is used as a junction. Neat arrangement of components is evident here. Single battery fits on bottom.

Fig. 1. Dotted lines connect 6 used poles of SW1. R2, R3 are shunt resistors for X10, X20.

figuration (beta), and the collector to emitter leakage. These parameters are a measure of a transistor's quality, and besides denoting good or bad, will enable transistors to be matched for applications such as push-pull amplifiers.

To understand the action of the checker, consider a typical transistor as a "black box" with two input and two output terminals. (Fig. 2.) Since the transistor is a current amplifying device (in contrast to a vacuum tube which amplifies voltage) when a small current is fed into the input terminals of our black box, a proportionally larger current appears at the output terminals. The ratio of output to input currents, is called the current gain. As the quality of a transistor increases, gain also increases. The term "beta" is used to denote current gain in a common emitter configuration.

When the transistor tester is switched to the *gain* position, the circuit in Fig. 2 goes into operation. Input (base-emitter) current and output (collector-emitter) current are simultaneously monitored on dual meters, and the ratio between them can be easily found. The variable resistor (R4) in the base circuit provides a wide range of available base-emitter input current values and allows the current gain to be computed over a wide portion of the transistor's operating range.

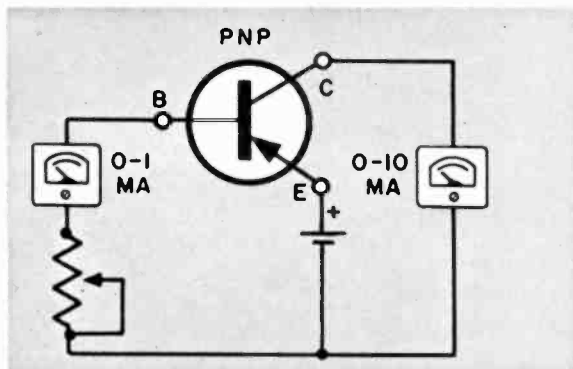


Fig. 2. Test circuit in gain position. Input (B-E) and output (C-E) current are read on meters.

The amplifying action of a transistor can be compared to the action of a water valve. A small input current (turning
[Continued on page 116]

PARTS LIST

- R1—15,000 ohm resistor, 1/2 watt, 5%
- R2, R3—10 ohm resistor, 1/2 watt, 5%
- R4—500,000 ohm potentiometer (linear taper)
- M1, M2—0-100 milliammeter (Lafayette TM-21)
- PB—pushbutton switch, normally open
- SW1—rotary switch, 8-pole, double-throw, 2 poles unused (Centralab 1418 or 1419)
- SW2—toggle switch, DPST
- SW3, SW4—toggle switch, SPST
- B—15 volt battery (Burgess Y10 or equiv.)
- BP1, 2, 3—5-way binding posts, insulated
- Misc.—transistor socket, battery holder, 7"x5"x3" aluminum Mini-box, hardware



remote reading

Electronic Thermometer

By Steve Hahn

High accuracy and wide range make this unit suitable for medical, industrial or household use.

A REMOTE reading thermometer can be put to numerous fascinating uses. For example, it is extremely handy in photographic laboratories, where close control of temperatures must be maintained.

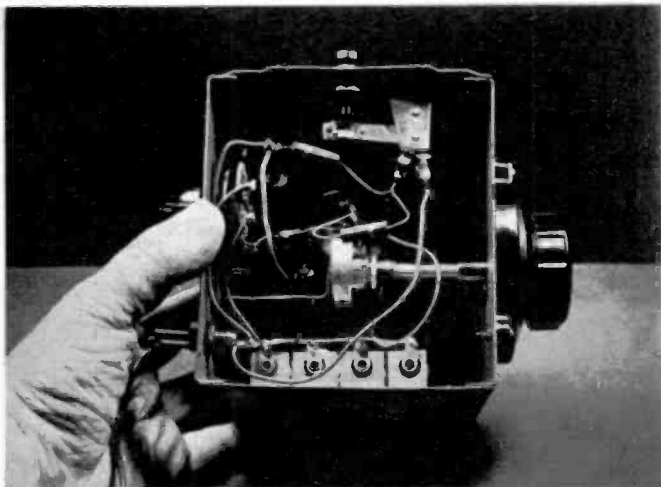
In case of illness, the device will serve as a very accurate fever thermometer when the sensing element is placed beneath the patient's armpit. It would allow constant monitoring of the patient's temperature without having to disturb his rest.

Tropical fish aquariums very often require that the water in all sections of the tank be maintained at a proper temperature. This little thermometer allows you to quickly sample the water temperatures in the aquarium to detect hot and cold spots.

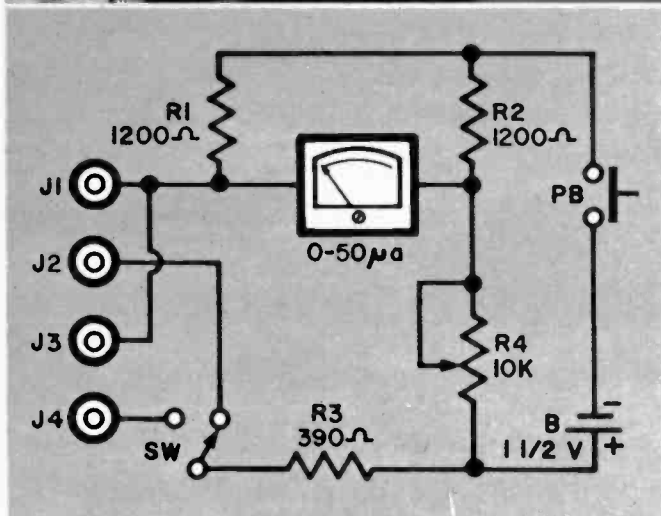
With its two-position selector switch, which, of course, can be made for as many positions as are required, instantaneous sampling of various temperatures can be made, using a separate thermistor probe for each environment such as inside-outside temperatures.

Construction

The electronic thermometer shown here costs a little over \$10 to build and yet is capable of covering a temperature range from about 0°F. to approximately 250°F. The accuracy of the unit is entirely dependent upon the care taken in calibration and it



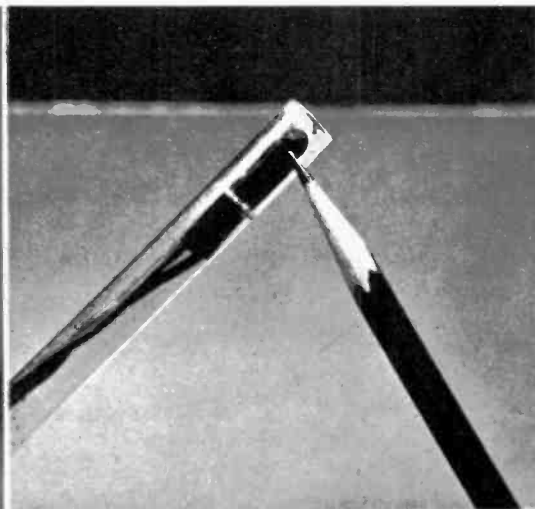
Rear view of sloping panel meter case. Pushbutton switch at top was discarded in favor of simpler model shown in the wiring guide.

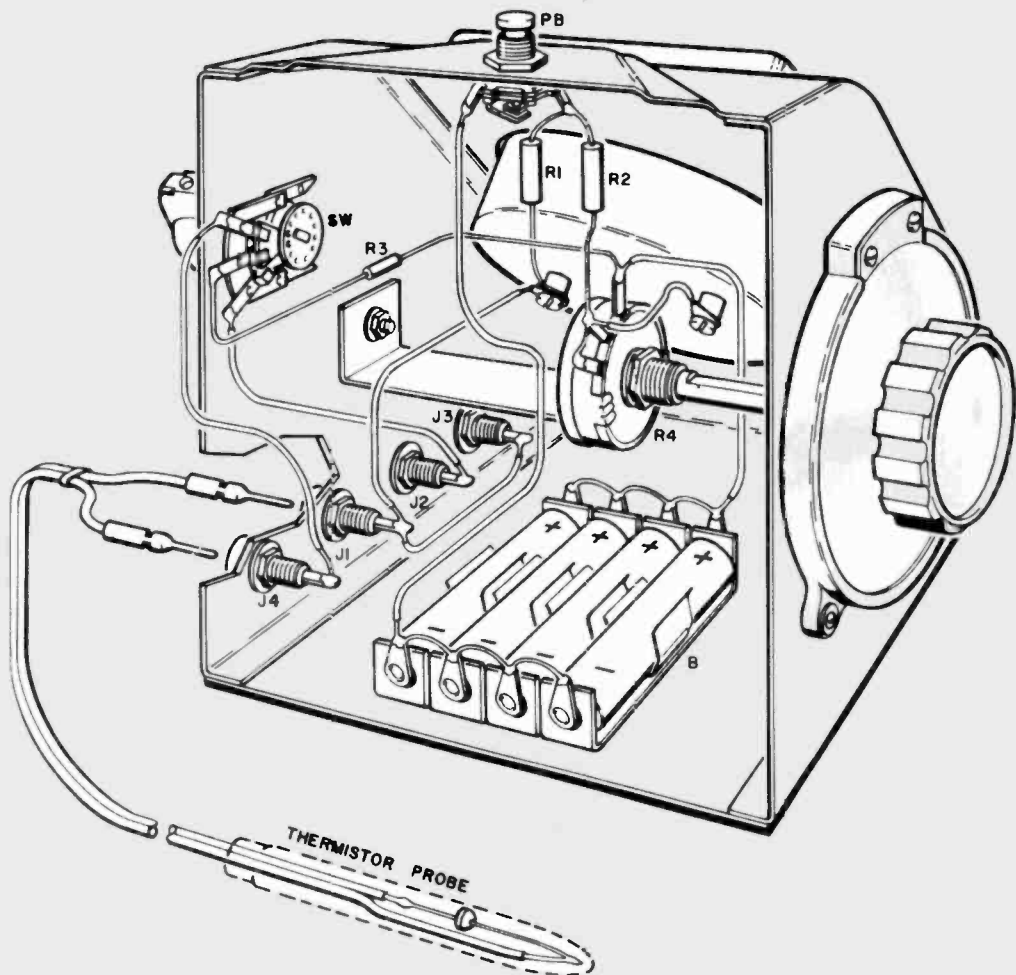


Four batteries are used in a parallel connection for longer battery life. Switch (SW) selects proper thermistor input at J1 thru J4.

R4 has one end soldered to metal bracket preventing it from turning with vernier.

Plastic case encloses thermistor bead at tip of probe. Tape insulates wires from each other.





* Shaft of potentiometer R4 is connected to vernier dial (at right) by a set screw (not visible).

is quite possible to achieve accuracies of about $\pm 0.25^\circ$ over the entire range.

A straightforward Wheatstone bridge circuit is used employing a 50 microampere meter as a null indicator. Actually, any DC meter from 50 to 500 microamps can be used, but a slight loss in sensitivity will result with the more insensitive meters.

Since the adjustment of the null control is quite critical, a standard calibrated vernier assembly was used as a control knob.

A pushbutton switch (PB) connects the batteries to the circuit. If continuous operation is desired, PB can be replaced

by a toggle or slide type. A two-position selector switch (SW) was mounted on the opposite side of the meter case with two sets of input jacks. This extra feature allows the user to check two temperatures. [Continued on page 121]

PARTS LIST

- R1, R2—1200 ohm resistors $\frac{1}{2}$ watt 5%
- R3—390 ohm resistor $\frac{1}{2}$ watt 10%
- R4—10,000 ohm linear taper potentiometer
- M—50 microamp meter (Lafayette M-70)
- PB—pushbutton, normally open
- SW—switch SPDT rotary type
- B—batteries, $\frac{1}{2}$ volt (4 in parallel)
- TH—thermistor (Veco type 34A3)
- J1-J4—insulated pin tip jacks
- Misc.—Vernier dial (F-346 Lafayette Radio), Cabinet, sloping front, $\frac{4}{2} \times \frac{4}{2} \times \frac{4}{2}$ "

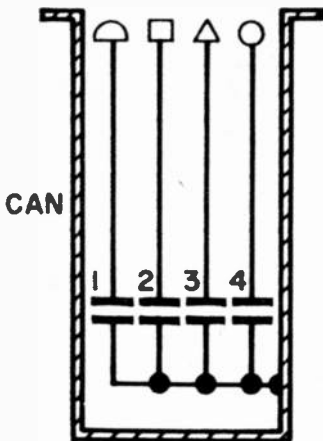
Electronic Brain

Have you any questions on electronics? Send it in and the Electronic Brain will provide the answer.

Capacitor Coding

I recently purchased a replacement filter capacitor for my radio. The old one has color coded leads, but the new one has its terminals identified by a triangle, a semi-circle, and a square. Which symbol matches what color on the old code?

John Dahlfred, Concord, N. H.



There is no correspondence between the old color-code for capacitors and the newer geometric identifying shapes. Each manufacturer merely uses the different shapes to distinguish between the specific capacitors present in the single can; these specifications are always given on the can itself and should be visible on the unit you purchased. In addition, virtually all metallic can capacitors having two or more sections utilize the case as the common terminal. (See diagram above.)

In your case, you wrote that all of the sections of the new capacitor are 10 mfd at 450 volts, making no difference which section is used to replace each of the old sections. That is, there is no harm in using a 10 mfd 450 volt capacitor to replace an 8 mfd 350 volt section, or a

10 mfd capacitor to replace a 12 mfd type since the capacitances are so close and the voltage on the new one will not be exceeded.

Zener Diodes

What is meant by the Zener voltage? How do the new Zener diodes differ from conventional silicon or germanium diodes? What are some applications of Zener diodes?

Robert M. Sechler, Bellmore, L. I.

The Zener voltage is the potential at which the back-resistance of a diode suddenly drops from several megohms to a few ohms. All diodes, standard germanium and silicon included, have such a voltage region. In most standard circuits in which diodes are used (rectifiers in power supplies, etc.), exceeding the Zener voltage would normally cause the diode to be ruined by overheating and excessive current.

A Zener diode differs from an ordinary diode in that it has been manufactured with sufficient control so that its Zener voltage can be predicted to within 5 or 10%. Silicon junction diodes are most suitable as Zener diodes and are now available with Zener voltages from 3 or 4 volts up to about 100 volts.

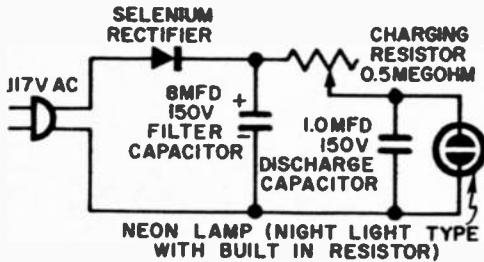
A Zener diode is most often applied as a voltage regulating device. In this application it behaves very much like a gas-tube voltage regulator; as a matter of fact, the basic Zener voltage regulator circuit is identical with that of the gas-tube type, the series limiting resistor maintaining the diode reverse current within the rating of the diode characteristics for maximum applied voltage.

A common application of Zener diodes is to provide a stable reference voltage during input voltage variations. This is made possible using a bridge-type circuit to minimize Zener impedance.

Neon Flasher

I am working on a project in which a low-wattage lamp blinking at speeds from 4 flashes per second up to 30 flashes per second is required. How can this be done?

Bernard Gotaut, Valparaiso, Indiana



The easiest way to set up a lamp that can be made to flash on and off at an adjustable rate is to utilize a relaxation neon tube oscillator. The flashing rate is controlled by the value of the capacitor (see Figure) and the value of the charging resistor. A good way to start would be to select a 1.0 mfd capacitor from the junkpile (an oil-impregnated type is best), then connect a 0.5 megohm potentiometer in as the charging resistor. By setting the pot at various values to obtain the desired flashing rate and then measuring the resistance with an ohmmeter, you can pick out $\frac{1}{2}$ watt resistor values that will give you exactly the rate you want. Or the potentiometer may be left in the circuit and calibrated for the desired frequencies.

The selenium rectifier may be the least expensive type you can buy at any of the reputable distributors of electronic components. The filter capacitor may be taken from an old radio or television set.

IF Alignment

Is it possible to use a correctly-adjusted broadcast receiver to align another superheterodyne? If so, how is this done?

Bruce Nolin, Chestertown, N. Y.

Alignment of the intermediate frequency amplifiers of superheterodyne "A" can be accomplished easily by using the IF output of superheterodyne "B" as a signal source, provided that (a)

superhet "A" is correctly aligned to begin with and (b) the intermediate frequency of the two receivers is the same.

To do this, first tune "A" to a local station that normally gives good reception; tune carefully for maximum signal. Using a coupling capacitor no larger than 10 mmfd, couple the detector plate (diode detector plate that connects to the "hot" side of the IF output transformer) of "A" to the control grid of the IF amplifier in "B." If there is instability due to the coupling lead, it may be necessary to use a shielded wire with the shield connected to the common ground of both sets. Short circuit the oscillator section of the tuning capacitor in set "B," then align the primaries and secondaries of the IF transformers in set "B" for maximum audio output from the speaker. If both sets are AC-DC, you must be sure they are plugged in so that the same leg of the AC line forms the "ground" side for each receiver.

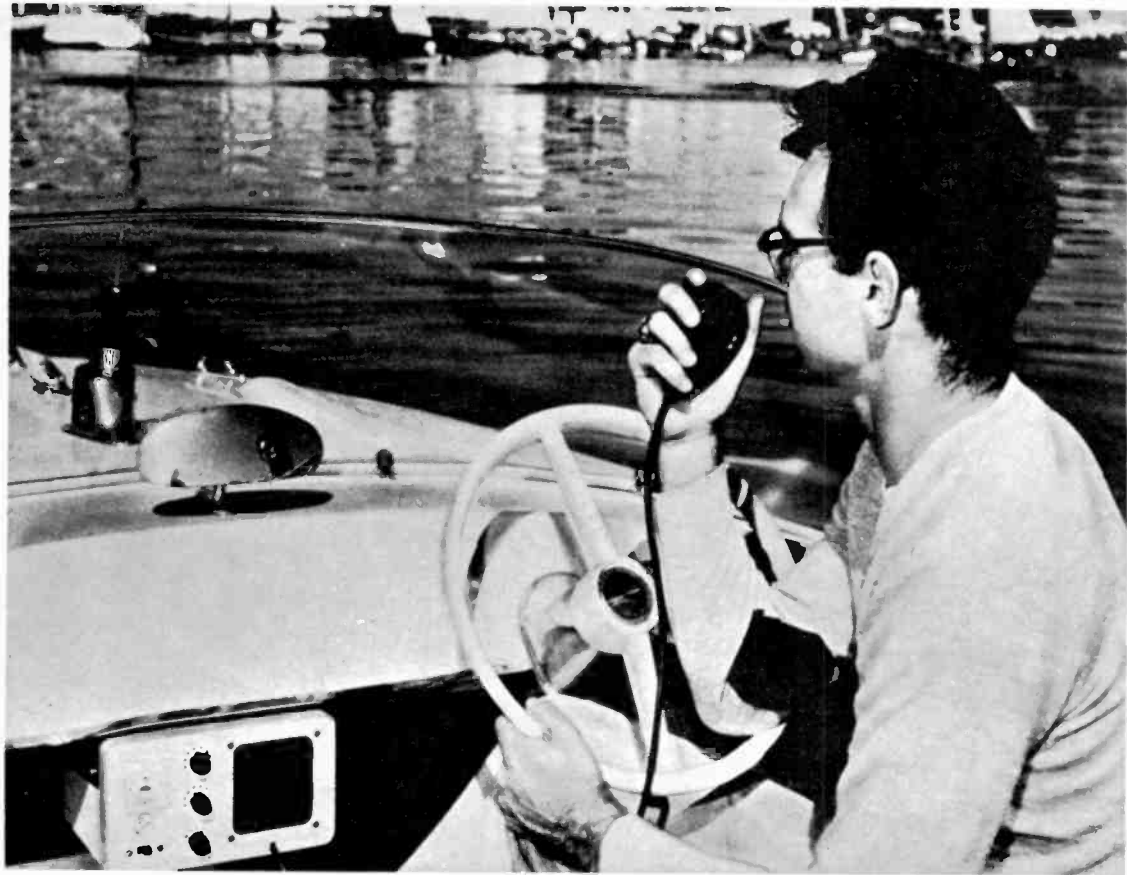
Rectifier Substitution

When a parts list calls for a selenium rectifier of a certain current rating, can I use one of larger rating? What will be the effect of this substitution?

J. G. Katzenberger, Greenville, Ohio

The current-rating specification of a selenium rectifier as given in a Parts List represents the *minimum* rating that may be used. In some cases, the smallest possible rectifier that will still meet the demands of the equipment will be stipulated by the author because of miniaturization and lack of space for larger units that might provide a more desirable safety factor.

If space permits, a rectifier of larger current rating can always be substituted for one of smaller current rating without causing any change in the performance of the circuit. This is quite analogous to the substitution of a capacitor of larger voltage rating than called for in the components list. As long as physical space allows for the exchange, there is never any harm in using a capacitor of larger voltage rating (except possibly to your pocketbook since higher voltage ratings raise the cost. This is also true of selenium rectifiers) ●



CB range is greater over water—where obstructions and man-made noise are at a minimum. Note the short antenna mounted atop the running light.

citizens band radio

All About Range

How far you can be heard with most CB rigs depends on your antenna and how it is matched to your set.

WHAT is the score on the range of Citizens Band radio? Each manufacturer seems to have his own ideas. One says "fixed station to fixed station range is 6 to 20 miles," while another estimates "3 to 10 miles," and one manufacturer apparently has thrown up his hands and says "range of transmission will vary from a few miles to several thousand miles. . ."

Actually, there are several variables which must be kept in mind when considering CB range. They are type of antenna used at each station involved in the contact, quality of the transceivers used, type of terrain over which the signal must travel, man-made noise levels at both stations, antenna heights and antenna matching into transceivers.

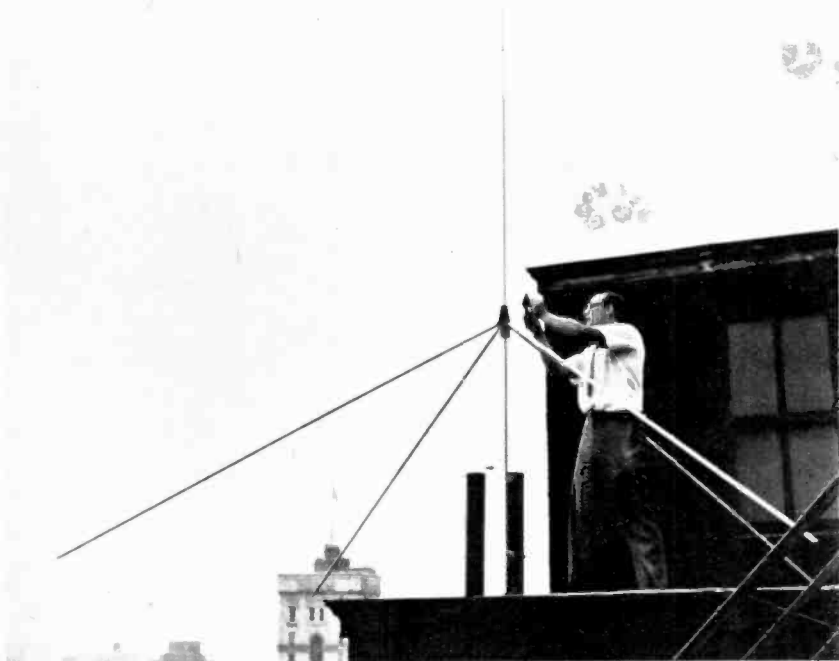
We can discount "atmospheric conditions" because this is a factor only in long distance (DX) communication for which this



To check whether CB transmitter is putting out the maximum allowable signal, make use of a field strength meter such as one shown here.

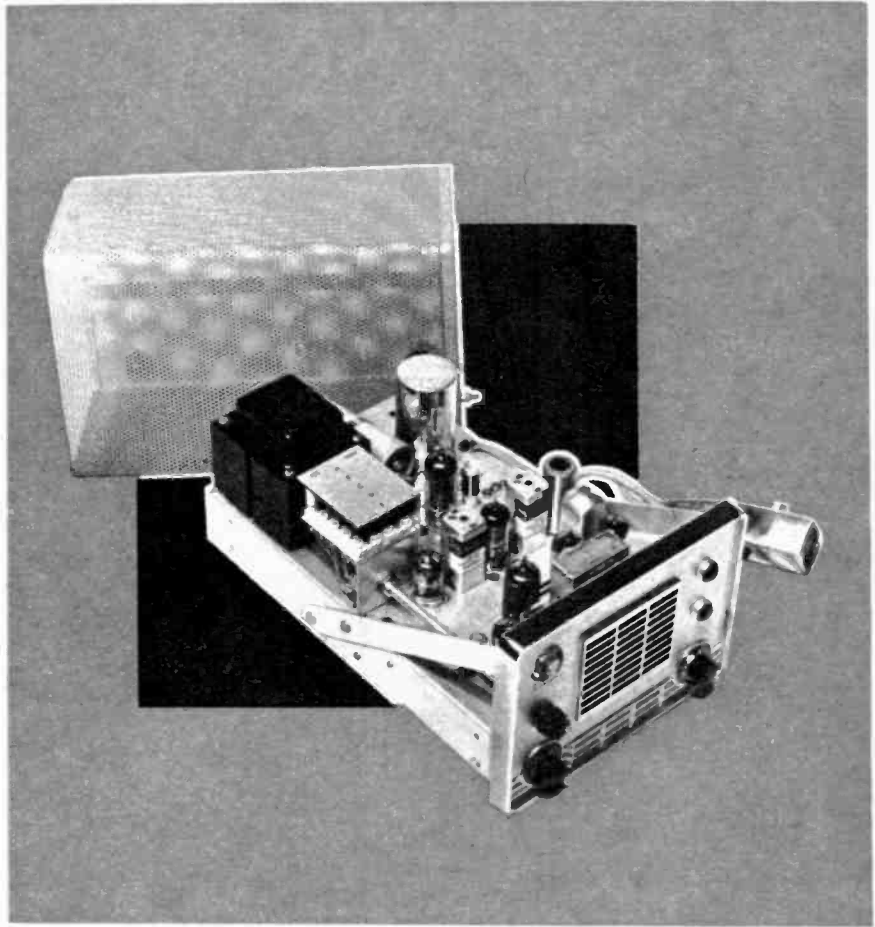


On the air adjustments of CB rigs must be made with good test equipment by a holder of a 1st or 2nd Class FCC phone or commercial license.

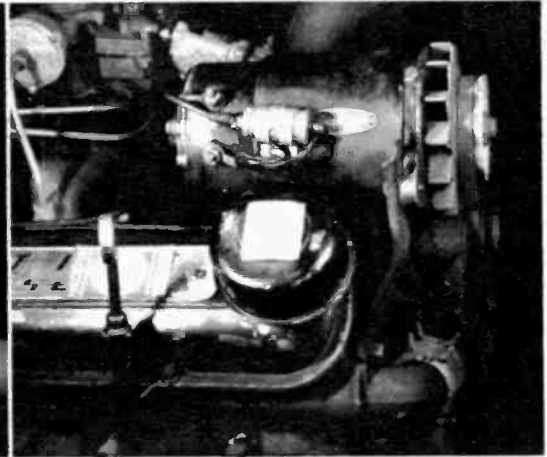


This quarter-wave ground plane antenna is ideal for CB transmission. Output of the antenna is being checked with small power indicator built from plans featured in the June 1959 *Electronics Illustrated*.

Here is the E. F. Johnson "Messenger" CB transceiver. Typical of the "hotter" rigs available. It features clean layout and oversize parts. The receiver section has an RF amplifier for greater sensitivity.



Automobile noise can play havoc with mobile reception. Use suppressors such as shown below. At left is spring for inside grease cap on wheels. At right is a capacitor or so-called "hash coil" connected to generator.



band is not to be used, according to FCC regulations. Local CB stations communicate with each other mainly via ground waves, which are radio signals that stay close to the earth and do not reach the receiving point by reflection or refraction from the region of the upper atmosphere known as the ionosphere. The intensity of these ground wave signals dies off rapidly as the distance from the transmitter increases. The higher the frequency of the radio waves used for communications, the higher the loss of signal strength in relation to the distance. Because of the relatively high frequencies used for CB (27 megacycles), the ground wave signals lose their strength quite rapidly.

The nature of these ground waves makes it desirable for the CB'er to use a vertical antenna, and there are several vertical antennas which are designed specifically for CB use. A plain vertical "whip" antenna radiates in all directions, sending some of the signal up into the ionosphere, where it is wasted. However, radio waves, like light waves, can be directed into the most desirable paths. Some of the waves which ordinarily would go off to the ionosphere can be forced into ground wave paths to

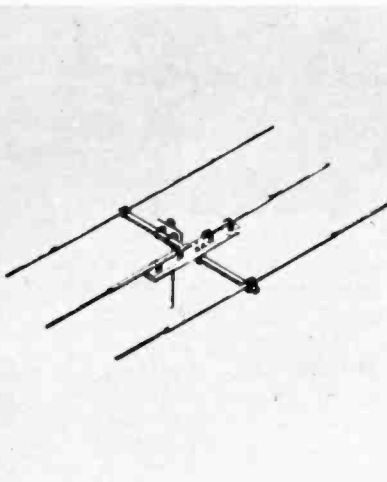
supplement the ones radiated directly along the ground. This is accomplished by the addition of three or four "radials" to the base of a vertical antenna, making the antenna a so-called "ground plane" type which has a low angle of radiation.

Vertical antennas are non-directional, that is, theoretically they will radiate an equal signal in all directions. This non-directional feature is important—in fact necessary—for communications with mobile stations, or with several fixed stations which may be located at various points surrounding the transmitting station. The word "theoretically" is included in the foregoing sentence because certain obstructions in the path of the signal can deflect, or completely absorb it.

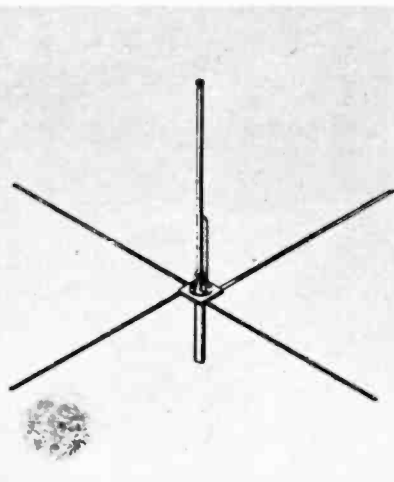
The higher the antenna, the better chance the signal will have to overshoot obstructions like buildings, trees, gas tanks, high tension lines, and the like.

Don't forget that although the higher the better, the FCC may grant approval of a proposed antenna installation only if the structure does not exceed 170 feet above sea level, or, if the antenna is to be mounted on top of an existing man-made structure (building, etc.) other

[Continued on page 111]



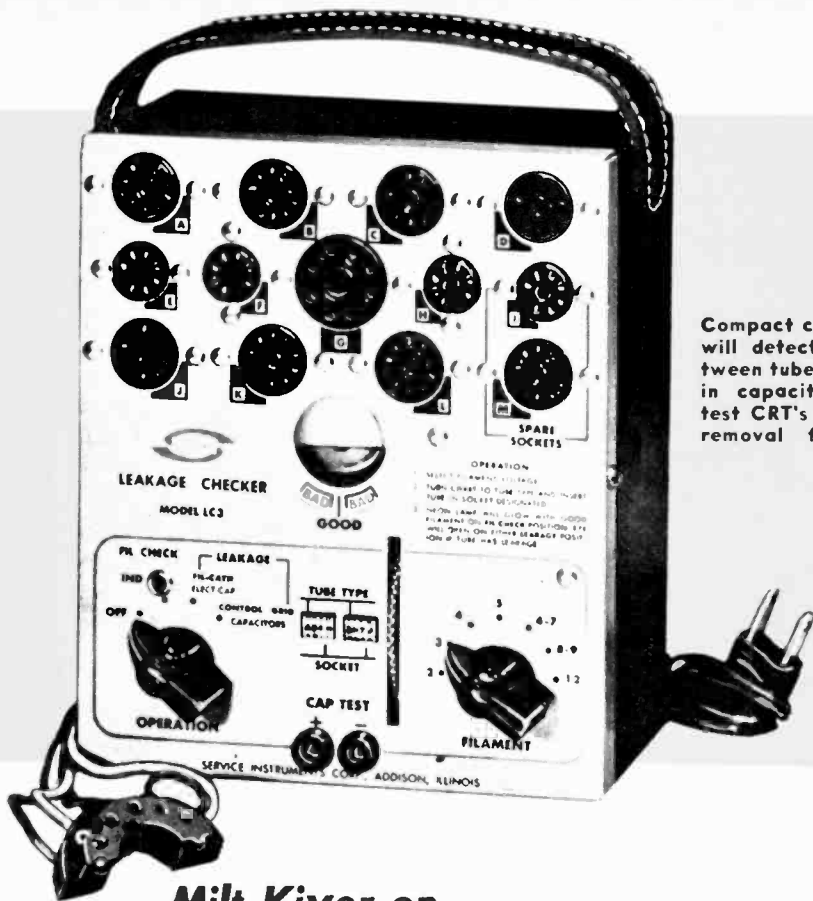
Three element beam antenna is effective for fixed station. This one is made by Mosley Company and has a broad radiation pattern.



Ground plane antenna is popular type. Radials at base decrease radiation angle for greater overall transmitting efficiency.



Various types of whip antennas are now available for mobile installations. Loading coil at base increases effective length.



Compact checker at left will detect leakage between tube elements and in capacitors and can test CRT's without their removal from chassis.

Milt Kiver on

Tube Testers-3

Here is an analysis of circuits commonly used for short, leakage and gas tests, completing this series.

MUTUAL conductance and emission testing are the established ways of determining the condition of a tube. However, anyone who has had experience with receiver servicing knows that a high percentage of tubes are defective because of leakage between the elements or because of grid contamination. A tube check is not complete, therefore, without a sensitive test for leakage or grid current and manufacturers, in increasing numbers, have been adding sensitive leakage and grid current test circuits to standard tube testers as well as making available small, individual units whose principal function is to provide such tests.

Leakage and short tests have actually been features of mutual conductance and emission testers for many years. But for the most part these tests have been fairly insensitive, and able to uncover only direct shorts or fairly low resistance leakage paths. It was found, however, that trouble could also be caused by a high resistance path between grid and cathode, by slight amounts of

gas, or by emission from the control grid. None of these conditions would be detected by the conventional methods.

It may be wondered why special recognition of these problems has just come lately, and not during the '30's and '40's. The answer, of course, is television and the fact that the eye is far more critical in viewing an image than the ear is in listening to a sound. A slight leakage current in a tube can distort a video signal enough to noticeably affect the TV picture. The ear, on the other hand, can tolerate much more distortion; less need exists for uncovering minute tube malfunctioning.

In order to gain some idea of how the above defects interfere with the normal operation of a tube, let us take a closer look at today's vacuum tubes. These tubes, for the most part, are quite small in size, requiring an exceedingly close positioning of the filament, grid, screen

grid and plate elements. During operation, the heat emitted by the filament soon causes the tube to become quite hot and it is not unusual for some of the cathode coating material to evaporate and deposit on the other nearby elements, particularly the control grid. Since this is the material that provides the electrons for the tube current, the same emitting action will occur at the grid after the tube has warmed up sufficiently. The grid, in effect, emits electrons in the same fashion as the cathode.

The electrons from the grid will travel to the plate, through the plate load resistor to the power supply, to ground, and then back to the point of origin, the grid. See Fig. 1. The latter step is completed through the grid resistor and since the latter component is quite large in value, even a minute current will produce a detectable voltage here. Furthermore, this voltage will make the top or

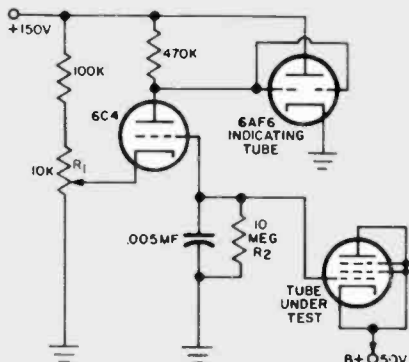
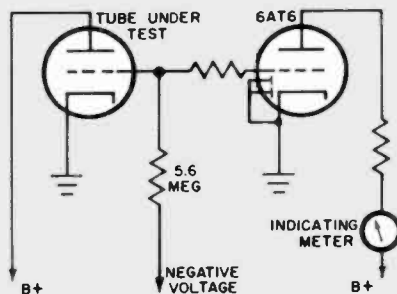
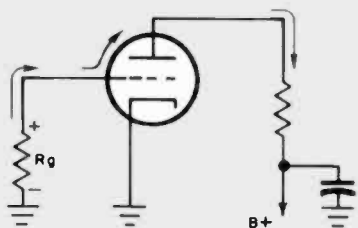


Fig. 1. (Above left). Arrows indicate direction of current through triode. Note polarity of R_g .

Fig. 2. (Above). A 5.6 megohm grid resistor lifts cut-off bias of 6AT6 to deflect test meter.

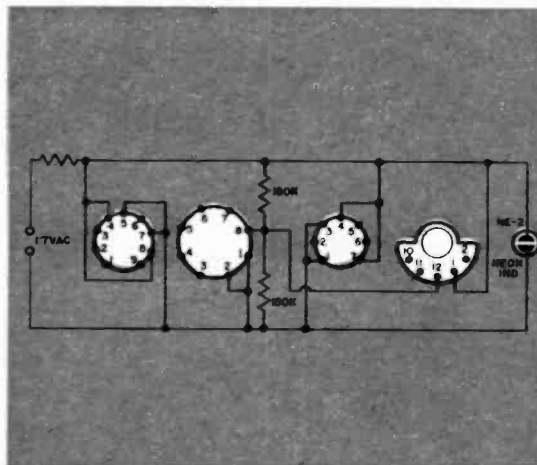
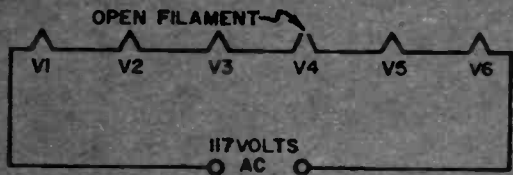
Fig. 3. (Left). Circuit of leakage tester using electron-ray tube. Bad tubes open shadow.

Fig. 4 shows another control grid emission tester. Features ten pre-wired sockets and an electron-ray tube indicators.



Fig. 5 shows an open filament in tube V4. In this series circuit, line voltage is across V4.

Fig. 6 is the circuit of a novel filament checker. Neon bulb extinguishes with good tubes.



grid end *positive* with respect to the bottom or cathode end of R_g . This, in turn, lowers the bias on the tube, leading to distortion, overloading, sync pulse clipping, and a host of other troubles.

Gas in a tube will have essentially the same effect. When gas is present, some of the electrons from the cathode collide with the gas molecules, knocking off one or more electrons and leaving positive ions. The ions will be attracted to the negative grid, taking an electron from the grid to form a complete gas molecule again. The electron flow of this "gas current" is exactly the same as it was for the previous "grid emission current." That is, to replace the electron taken from the grid by the gas molecule, another electron from the plate current returns to the grid rather than to the cathode. Again, such electrons flow up R_g to the grid, producing a positive voltage drop across the grid resistor (R_g).

Now, how do commercial tube testers reveal the existence of grid emission? First, the grid current (if present) is made to pass through a very high-valued resistor. Second, the small voltage drop produced is amplified and made to actuate a meter or an "eye" tube indicator.

A typical meter circuit is shown in Fig. 2. The tube under test has its normal voltages applied, but the grid is biased beyond cut-off so that no plate current flows. This bias is applied through the 5.6 megohm resistor. The 5.6 megohm resistor is also in the grid circuit of a 6AT6 DC amplifier and the conditions for this tube is such that it, too, is biased just beyond cut-off. Under these conditions, no plate current flows in the 6AT6 and no deflection occurs in the meter in its plate circuit.

However, if the tube under test is gaseous, or its grid is contaminated, current will flow from grid to plate and through the 5.6 megohm resistor back to the grid again. This will develop a positive voltage across the 5.6 megohm resistor, lifting the cut-off bias on the 6AT6 and producing a meter deflection. The appearance of this deflection is an indication that the tube under test is defective and a replacement is indicated.

Some leakage checkers utilize a high gain DC amplifier and an electron-ray eye tube indicator instead of a meter. Part of the circuit employed in the Sen-core LC3 leakage checker is shown in Fig. 3. The 6C4 is a DC amplifier that

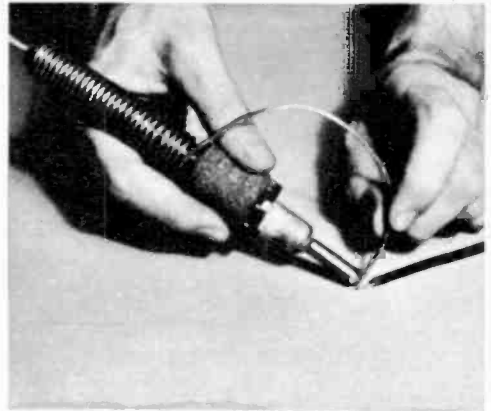
[Continued on page 118]

Fig. 7. A filament checker which can test all loctal, octal, noval and CRT's is shown at right. Continuity of other components such as fuses can also be made.

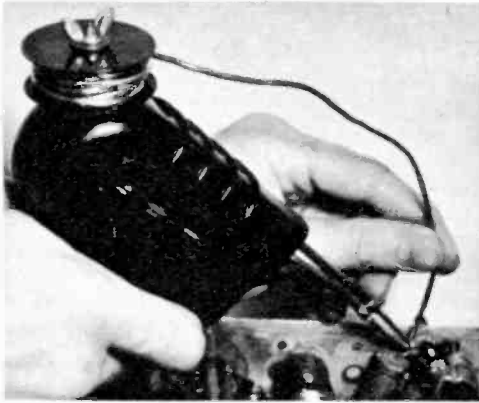




El's Hot Tips



To keep wire solder convenient for use with a pencil-type soldering iron, wrap some around the handle as shown above. This enables you to keep the solder always handy for instant use.

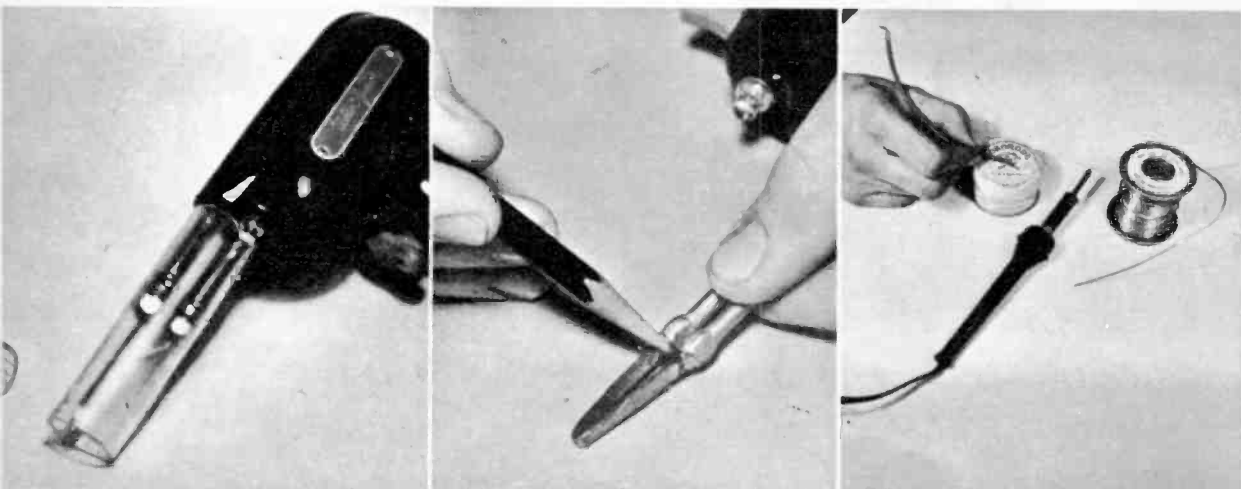


Keeping solder always at hand with your gun is no problem if you mount a small typewriter ribbon spool on the gun case. Drill a hole and put a machine screw through it from the inside.

Wire soldering gun tips have a tendency to bend or break. A 1" O.D. length of plastic tubing slipped over the tip will guard against breakage. Slit tube for fit.

Prolong the tinned life of a soldering gun's tip by tinning it as far back as shown in the photo below. Oxidation will not develop as rapidly as it does normally.

Have you ever noticed how small objects stick to an open flux can? By punching a small hole in the top of can, wires and parts can be dipped in without any mess.



Special Bonus Feature

the

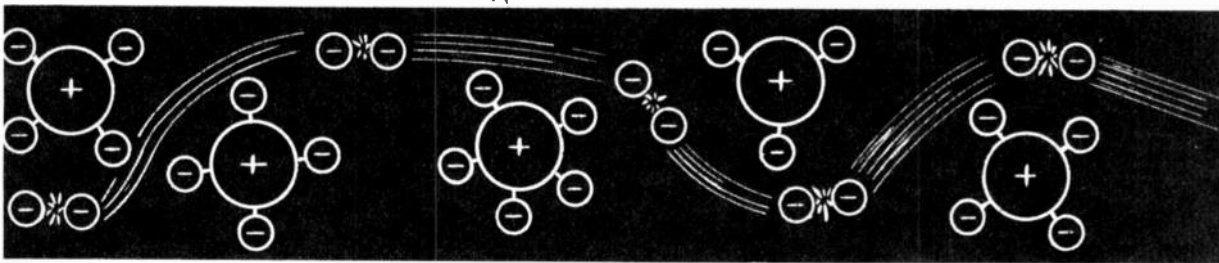
A

B

C's

of electronics

This course is a condensation of the popular series that ran in early issues of EI. It can serve you as a refresher or an introduction to basic terms and concepts of practical electronics.



Electricity flows through a conductor via the limited travel of millions of free electrons.

THE entire science of electronics is based on the behavior of that minute particle—the electron. For any understanding of the electron, what it does—and why it does it—we have to observe the electron in its home ground—the atom. Analysis has shown that the atom is constructed somewhat like our own solar system, with a central sun (the nucleus) and a number of planets (the electrons) revolving around it in their orbits. The nucleus comprises a number of positively charged particles called *protons*.

Similarly, the planets revolving around the nucleus are called *electrons*, tiny particles of negative electricity. It should be understood that this explanation is somewhat simplified, for it is now known that there are sometimes electrons in the nucleus as well, and there are some other minor types of particles within the atom. However, we will be primarily interested in the electrons.

We know that all matter is basically composed of electrons and protons each carrying an electric charge. Since all electrons and all protons are alike, the difference in characteristics of various substances, such as gold, silver, tobacco smoke or soda pop, is simply and entirely dependent on the *number* and *position* of the protons and electrons which make up each atom.

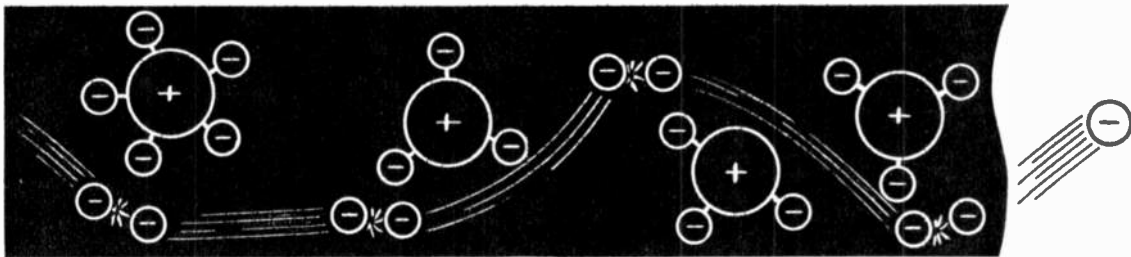
Electrons tend to repel each other with relatively enormous forces, and protons react against other protons in the same way. But electrons have a strong attraction for protons, and protons feel the same way about electrons.

This fact provides us with one of the basic electronic laws: *Like charges repel and unlike charges attract*. If this were not so, atoms and molecules would be flying apart in all directions. It is only the attractive force between the positive charge of the nucleus and the negative charges of the planetary electrons which holds them together.

However, this delicate balance between charges within the atom or molecule may be upset. The substance may lose a few electrons from the outermost orbit, or this same orbit may be constantly seeking to add a few more.

If either of these two events actually occur, the body itself is said to be *charged*. As an example, consider the old trick of running a comb briskly through the hair and then using it to pick up bits of paper by static attraction. In this case friction has caused the comb to gain or lose some electrons, and become charged.

If the comb has lost electrons, the negative charges out in orbit no longer cancel the positive ones in the nucleus, and the substance is said to be positively charged. If on the other hand the comb has added electrons, their force now exceeds that in each



nucleus, and the substance is negatively charged. This leads us to another fundamental electronic law: *A negative charge indicates an excess of electrons, while a positive charge results from an electron deficiency.*

When a body becomes charged, the condition we are discussing is actually one of static electricity. And at this point we should understand that man cannot really "make" electricity. We can cause electrons to move from place to place, yes, but whether we use friction to create the movement, or a dynamo or a solar battery, we are simply controlling electrons which are already there. A battery or generator no more creates electricity than a pump creates water.

Getting back to our hair-and-comb experiment, the charge developed between these two bodies can be easily discharged by the simple process of touching the comb to the hair without the earlier friction movement which set up the charge. But note that the bodies themselves do not actually have to touch.

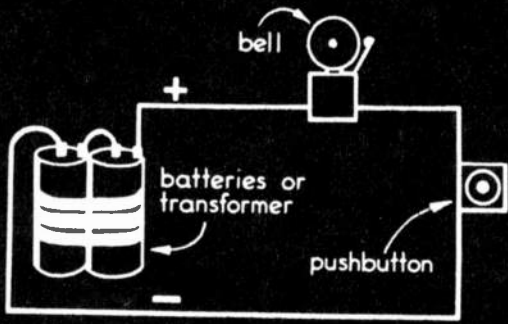
Suppose instead that one end of a copper wire touches the hair and the comb is touched to the other end. Now when we try to pick up the bits of paper with the comb, it won't work. The charge has been equalized. But how? Well, obviously electrons must have moved along that wire from the negatively-charged body to the positively-charged one. There must in fact have been a flow of *electron current*.

Anything which will cause an electron flow through a conductor is called an *electromotive force*. This flow does not mean that each excess electron flows all the way through the conductor to the point of electron deficiency. It is more like the maneuver in croquet when you try to knock your opponent's ball out.

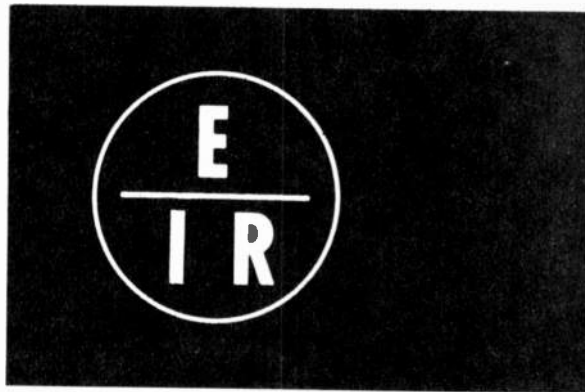
In this case you hold your foot on your own ball so it won't move. But when you smack it with the mallet, the opposing ball which was lying next to it goes flying. You could do the same thing with a whole string of croquet balls in line if you wanted to.

This same kind of chain reaction occurs in a conductor. An electron near one end strikes another, that in turn hits still another, and so on until the effect is felt all the way down the line. Thus no *one* electron moves very far, but the *effect* of the electron flow is felt at all points along the conductor.

Now if we connect the ends of a copper wire to the terminals of a battery, a fairly sizable electron current will flow. But if we connect a carbon rod across these same terminals, the current will be much less. Obviously some materials are better conductors than others.



A simple battery, a bell and a pushbutton are components of the series circuit shown above.



Ohm's Law simplified. Cover the unknown, remaining factors show the operation to be done.

It appears that the better conductors are those whose atoms will fairly readily give up an electron from its outer shell or orbit. Some materials, on the other hand, hold on to their electrons so tightly that it is difficult to free any electrons and cause them to move along in a given direction. Depending upon how strongly the atoms hold on to their outer electrons, the materials are called *resistors* or *insulators*.

When electrons go rushing through an electronic circuit, they do so because they are being pushed. Something is putting the pressure on them, a pressure known as electromotive force (e.m.f.). The greater this e.m.f., the more electrons will flow.

To get some idea of the fantastic number of electrons which are in motion when even small currents flow, just consider this: when the e.m.f. is great enough to send a current of one *ampere* through a circuit, this means that 6,280,000,000,000,000 electrons pass a given point every single second!

There are many methods known for generating an e.m.f., but the two most commonly used are chemical and electromagnetic. The first is the basis of cells and batteries, and the second is the basis of electric generators.

Whenever the e.m.f. tends to force current through a circuit, there will be some opposition to the flow because there is no such thing as a perfect conductor. Every circuit element has some resistance, but when it is specifically desired to limit the current flow to a certain value, a component known as a *resistor* is installed.

Resistors come in all sizes and shapes, and their ability to oppose current flow is expressed in a unit called the *ohm*. By international agreement, the ohm is designated as the opposition offered to a steady current by a column of mercury of specified dimensions.

The volt is described simply as *that amount of electrical pressure which will drive a current of one ampere through a resistance of one ohm*. From this definition it is obvious that there is a close interrelationship between volts, ohms and amperes.

If the voltage increases, we would expect the current to go up also. But if the resistance increases, the current will drop.

These relationships were expressed in three little mathematical formulas over 130 years ago by a French scientist, after whom they are named *Ohm's Law*. This is one of the most important of all electrical relationships.

We have adopted the letter symbol I (intensity) for the current in amperes, E for the e.m.f. in volts, and R for the resistance in ohms. In one form, Ohm's Law tells us that to find the current in amperes in any circuit, we must divide the e.m.f. in volts by the resistance in ohms. Thus the formula becomes

$$I = E/R$$

As an example of how this works, let's find out how much current a light bulb having a filament resistance of 100 ohms will pass when it is connected to a source of e.m.f. of 117 volts:

$$I = 117/100 = 1.17 \text{ amperes}$$

Now suppose we want to determine the resistance when the voltage and current are known. For example, what is the resistance of the windings of a 12-volt starter motor when the current through them is 2 amperes?

$$R = E/I = 12/2 = 6 \text{ ohms}$$

Finally, consider the case where the resistance and current are known, and the voltage must be found. Say we have a pilot lamp which has an operating resistance of 4 ohms. When lit to full brilliance it draws a current of 1.5 amperes. Can we use this lamp in a circuit where it will have an e.m.f. of 12 volts placed across it?

$$E = I \times R = 1.5 \times 4 = 6 \text{ volts}$$

Since this is a 6-volt lamp, it would quickly burn out if 12 volts were impressed across it. The answer is *no*.

The way in which the various circuit components are connected is known either as *series* or *parallel*, or some combination called *series-parallel*. In the series circuit, the components are connected so that all of the electron flow passes through all of the devices.

In the parallel circuit, all of the devices are connected directly to the source of e.m.f., so that the current has a number of paths through which it can pass. The total current flowing in and out of the source is the sum of the current through each path.

To solve Ohm's Law problems, we have to know the total resistance of any given combination of devices. In the case of

Fig. 1. This diagram shows calculation of resistance and current flow in a series circuit.

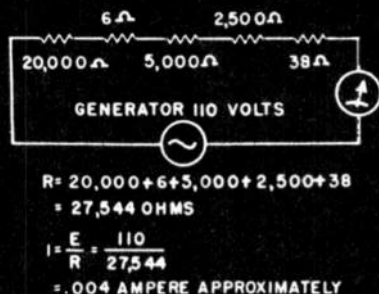
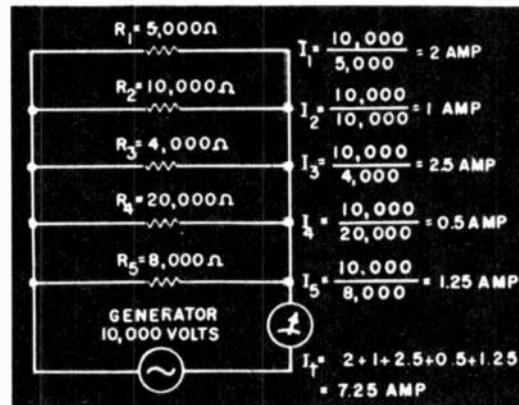


Fig. 2. Using this formula you'll be able to calculate current flow in a parallel circuit.



series circuits, it's easy. The total resistance is simply the sum of the individual resistances.

As an example, consider Fig. 1, where five resistors are connected in series. The total resistance is the sum of each unit resistance, as shown. Then the current is easily calculated in conventional Ohm's Law fashion.

Calculation of equivalent resistance in parallel circuits is a little more complex. Consider Fig. 2, in which we see five resistances connected in parallel across a source e.m.f. of 10,000 volts. If we ignore the resistance of the connecting wire, which is negligible, we see that the same voltage from the 10,000-volt supply appears across each resistor.

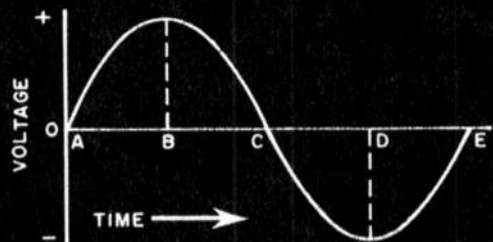
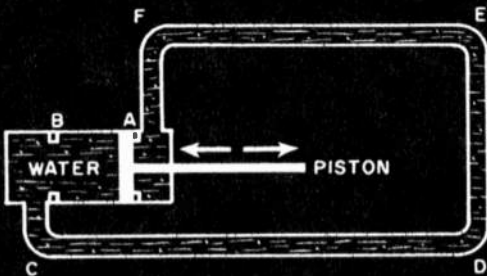
The total current from the generator I_t , which also passes through the meter, will split five ways through the resistance network, and the amount through any given resistor will depend upon its own ohmic value. Conversely, the branch currents I_1 through I_5 will add up to I_t .

Now to find each of these branch currents, we use Ohm's Law and divide the applied voltage by the individual resistance. And since the total current is the sum of the individual currents, we see that $I_t = E/R_1 + E/R_2 + E/R_3 + E/R_4 + E/R_5$. In this case $I_t = 7.25$ amperes. Then to find the total resistance of the group, $R = 10,000/7.25 = 1,380$ ohms.

The resistor is one of the most commonly encountered components in electronic circuits. Its primary use is to convert electrical energy into heat energy. This heat may serve some useful purpose, or it may be wasted when the purpose of the resistor is simply to provide a needed voltage drop.

The rate at which heat is produced when current flows through a resistor is expressed in *watts*. The formula is $W=I^2R$, where W is the power in watts, I is the current in amperes, and R is the resistance in ohms.

The watts consumed by a resistor, often called the I^2R loss, appear entirely as heat. It is obvious then, that the larger the surface area of the resistor, and the freer the circulation of air around it, the more easily the heat can be dissipated. Thus, resistors are made in a wide variety of sizes, not only in terms of resistance, but also in the amount of power they can safely handle



without danger of burn-out. These ratings, however, are based on ideal conditions, and in a crowded chassis conditions are never ideal. As a rule of thumb, always specify a resistor rated at two to four times the actual power you calculated.

Up to this point we have mentioned only direct current. However, you are undoubtedly familiar with AC which is an electron flow which periodically reverses itself. This *alternating* current appears in power lines, audio and RF oscillators.

Although this flow is in many ways unlike the flow of water, a hydraulic analogy in this case will help in understanding the basic AC concept. In Fig. 3 we see how a piston, with a back and forth movement, could cause water in a closed circuit to reverse direction.

When the piston moves from A to B, water will be pushed ahead of it and will close in behind it. The flow in the circuit will be around in the direction CDEF. When the piston reaches the end of its travel it will reverse direction. But note that momentarily, at the instant of reversal, both the piston motion and the water flow are stopped. Then the piston starts moving from B to A, and the water now flows around FEDC. And so it is with AC.

Current starts at zero rate of flow and gradually increases in amplitude until it reaches a maximum in one direction. Then it gradually decreases until it stops altogether. Next, it similarly increases to a maximum in the opposite direction, finally decreasing again back to zero.

This complete series of events is called a *cycle*, and the number of these cycles which occur in one second is said to be the *frequency* of a given AC current or voltage. Until now we have been talking only about *rate* of current flow, but we already know that any such flow must have a propelling force. This is the *voltage*.

The way in which an AC voltage changes with time is shown in Fig. 4. Beginning with that instant in time A, the voltage is zero, but begins increasing at once. By time B it has reached a maximum, and at C it has reached zero again and is ready to reverse direction. The opposite peak is reached at D, and the voltage is back to zero, ready to begin another cycle at E.

If the time from A to E is 1/60 second, then the frequency of

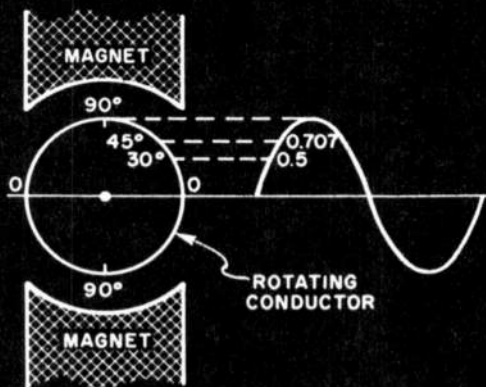


Fig. 3. In this reciprocating pump analogy the current is represented by the water. The piston's pressure may be compared to voltage.

Fig. 4. The direction of current flow is indicated by the use of plus and minus signs. A complete alternation, or cycle, is shown here.

Fig. 5. An alternating current is induced in a coil when it rotates in a magnetic field. The resulting wave form is described in text.

this particular voltage would be 60 cycles. Ordinary power lines often use a frequency of 60 cps at a voltage of 110. But just what does this mean? We have seen that the voltage is constantly varying. At points A, C and E the voltage is zero, a far cry from 110. And at points B and D, as we shall see, the voltage is actually 154. Well then, where does the 110 come in?

This 110 volt figure is called the *effective* voltage because that is the amount of DC which would be required to do the same work. That is, an AC voltage which reaches momentary peaks of 154 volts won't get your toaster any hotter in the morning than 110 volts of DC. With a little simple arithmetic you can quickly prove that the effective voltage is only 70.7 percent of the peak, and that the peak is 1.414 times as great as the effective. It is important to remember that test instrument calibrations, as well as component ratings, are normally given in terms of effective values.

An AC generator consists of a conductor moving through a magnetic field.

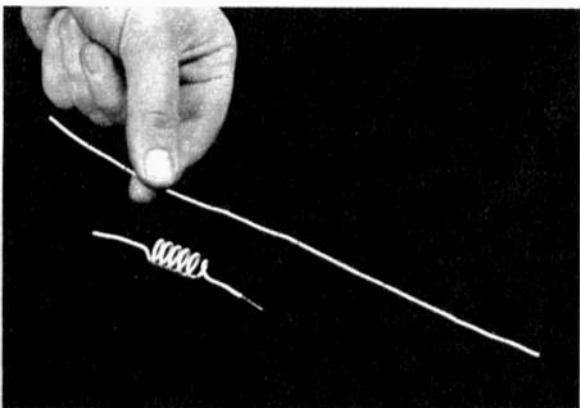
This movement causes magnetic lines of force to be cut, and a voltage is generated within the conductor. In Fig. 5 we see the circular path which would be made by a single conductor rotating between the poles of a permanent magnet. When the conductor is moving at 90 degrees with respect to the magnet poles, the maximum lines of force are cut and the induced voltage is maximum. When the conductor is moving in line between the poles, or at zero degrees, the voltage is zero because no lines of force are cut.

We have already noted that the flow of current through a DC circuit is limited by the amount of resistance in the circuit. In AC circuits resistance behavior is the same as with DC, but in addition there are other effects that retard current. One is *reactance*. There are two types; inductive and capacitive.

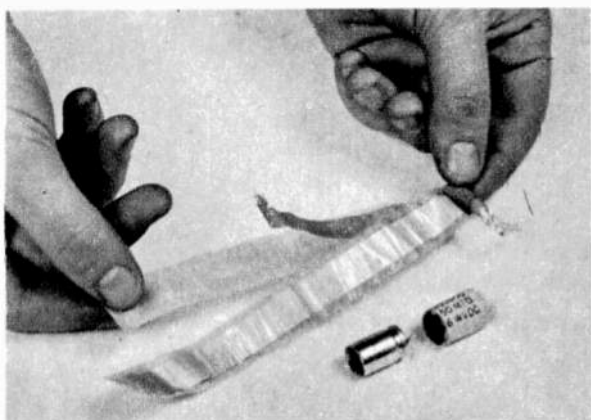
Unlike resistance, which is determined mostly by the physical composition of the conductor, reactance is determined by the changing magnetic field of AC. Inductive reactance is due to a property of coiled conductors called *inductance*. This in turn results from the fact that every current-carrying conductor has a magnetic field surrounding it.

Since AC current is constantly changing in both *intensity* and *direction*, the magnetic field around the wire similarly expands and contracts. In a straight wire this is not particularly noteworthy, but when that wire is twisted into a coil, both the inductance and reactance increase tremendously.

The magnetic field consists of "lines of force." As they expand and contract around the coil they intersect the turns of wire and induce a voltage in them. This induced voltage is called a "back e.m.f.," (voltage) because it is always opposite in polarity to the applied voltage and bucks it. Since current flow is proportional to voltage which drives it, current is therefore less when an inductance is introduced in the circuit. This voltage drop results



Straight wire leaves AC unaffected. Coil it and current is reduced by resulting magnetic field.



Opening a capacitor reveals two plates (metal foil) separated by dielectric (wax paper).

from a second opposing voltage which subtracts from the source voltage.

The inductance of an air-core coil is determined by the number of turns as well as the overall size and shape. If the turns are wound around an iron core, the inductance will increase many times, depending upon *permeability* of the core material. The permeability of air is taken as 1, while the permeability of core materials may be many thousands of times greater. It is therefore a simple matter to increase the inductance of a coil many times simply by providing it with a high-permeability core.

The unit of inductance is the *henry*, defined as the inductance of any circuit in which a current changing at the rate of one ampere per second will induce an e.m.f. of one volt. The symbol for inductance is the letter L. The values of L encountered in electronic work vary from a few microhenries (millionths) up to perhaps 50 henries.

The unit of inductive reactance is the ohm just as in the case of resistance. Its symbol is X_L and is determined by the inductance and the frequency of the current flowing through it, using this simple formula:

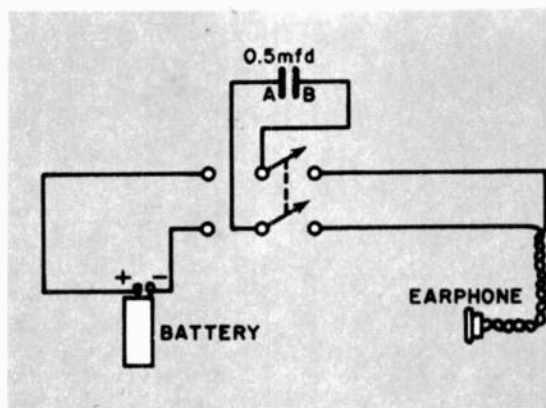
$$X_L = 6.28 \times F \times L$$

where X_L = inductive reactance in ohms
 F = frequency in cycles per second
 L = inductance in henries

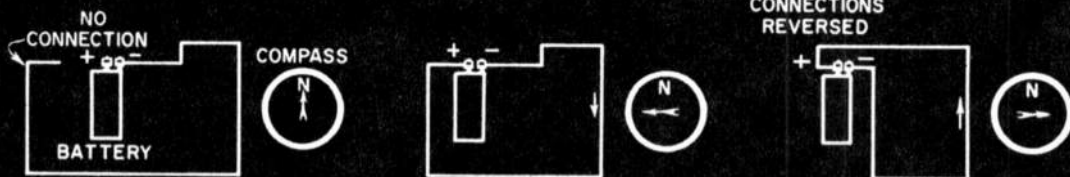
Still another reactive device often found in electronic circuits is the capacitor. This is usually an arrangement of two or more metallic plates, separated from one another by air or some other insulating material known as a *dielectric*.

When a DC voltage source is connected across the capacitor, electrons will be drawn away from one set of plates toward the positive battery terminal, and they will simultaneously be forced out of the negative terminal and into the opposite set of plates. This action will continue until the capacitor is fully *charged*. The amount of charge it can take is determined by the number, area, and spacing of its plates contributing to its *capacitance*.

Since there is no such thing as the perfect insulator there will be some leakage through the dielectric as the excess electrons try to get back to the



As described in text, this set-up demonstrates apparent flow of current through a capacitor.



A flow of current produces a magnetic field that attracts or repels the point of the compass.

opposite plates and fill up the deficiency. But for the most part the capacitor will remain charged until an external return path is provided for electrons.

This can be proved by the experiment illustrated with a single dry cell, an earphone, a .5 mfd capacitor and a double-pole double-throw switch. When the switch is thrown to the left, electrons from the negative battery terminal will pile up on plate A of the condenser while electrons from plate B will drain into the positive terminal of the cell. When the switch is thrown to the right, the charge will be equalized as the excess electrons on plate A will rush through the headphone circuit and back to plate B. At the same time, a distinct click will be heard in the phone, proving the momentary current flow.

The unit of capacitance is the *farad*, which a capacitor would have if its voltage were raised one volt by a current of one ampere for one second. Such a capacitor, however, would be physically huge so this unit is almost never encountered in practice. Electronic circuits use capacitors rated in microfarads, or even micro-microfarads.

Current doesn't actually flow *through* the capacitor but goes around the circuit, back and forth between the plates. Since the alternating current is impeded, depending on frequency, by this continuous charging and discharging, there is a *capacitive reactance* to AC, while DC is blocked altogether.

The formula for capacitive reactance is different from the one for the inductive type. Note that as the frequency of the applied signal is raised, the capacitor offers *less* opposition.

$$X_C = \frac{1}{6.28 \times F \times C}$$

where X_C = capacitive reactance in ohms

F = frequency in cps

C = capacitance in farads

There are three devices for retarding the flow of current in AC circuits: resistance, inductance and capacitance. Let's see what happens when we use them all in a single circuit.

In Fig. 6 we see combined one of each element in series with an RF generator, which is putting out 2 volts at a frequency of 2.5 megacycles. Under these conditions the inductive reactance of the coil is about 8,000 ohms, and the capacitive reactance of the capacitor is also about 8,000 ohms. With only 2 volts of signal, it would seem that the current in this case should be exceedingly small. But when we measure it, we find the current to be 0.39

milliamperes, or simply the value of E/R . It seems that the reactances in the circuit have no effect whatsoever!

The reason for this is that the two reactances are 180° out of phase and will tend to cancel each other. Complete cancellation, however, occurs only at one specific frequency known as the *resonant frequency*.

We can understand just what this means simply by shifting the frequency of our generator. Suppose we drop it down to 2.0 megacycles. The reactance of the capacitor will increase to 10,000 ohms while the inductive reactance drops to 6,400 ohms and their reactances no longer completely cancel.

To find the total impedance to current flow, we cannot simply add this net reactance to the circuit resistance. As we have noted, the effects of the two reactances are completely opposite, or 180° degrees out of phase. But more than that, the effects of each of them are at right angles, or 90° , with respect to the resistance.

This concept of *phase angle* is a little too involved for us to treat here, but its practical effect is a simple matter. It means that the effective impedance is found by adding the resistance and net reactance geometrically, rather than arithmetically, using the formula:

$$Z = \sqrt{R^2 + X^2}$$

where Z = impedance in ohms

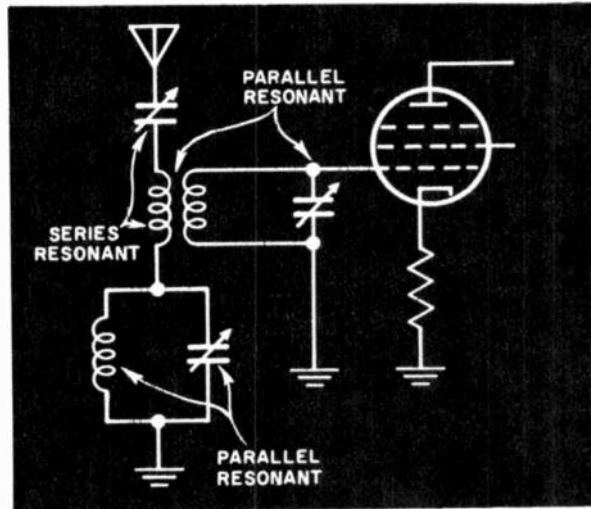
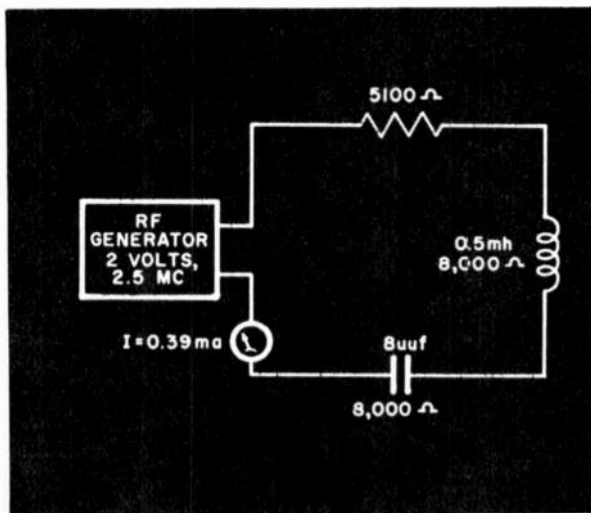
R = resistance in ohms

X = net reactance (difference between X_L and X_C , regardless of which is larger) in ohms

Resonant circuits are used in radio and TV receivers, both for the selection of the desired signal and for the rejection of unwanted signals. The relative ability of a receiver to perform these functions is called its *selectivity*. In transmitters, the entire proc-

Fig. 6. The basic elements of a resonant circuit are coil, capacitor, and resistor. Actually the resistance "lumped" here for purposes of illustration is distributed through the circuit.

Fig. 7. Parallel and series resonant circuits described in text. Considering the tube as a receiver RF amplifier, the various tuned circuits select desired signal and reject others.



ess of generation and amplification of RF energy is dependent upon tuned circuits.

Not all tuned circuits are series resonant. Another type of circuit, called parallel resonant, is encountered even more frequently. A practical application of both types is shown in Fig. 7. This shows the input to a receiver, where the primary of the antenna transformer is tuned to series resonance, while the secondary is made parallel resonant. There is also a parallel resonant trap circuit in the ground leg of the antenna circuit. Each circuit is tunable to resonance by means of a variable capacitor.

Both windings of the antenna transformer are tuned for the same purpose—to develop maximum voltage from the desired signal frequency. The primary might have been made parallel resonant as well, but in this case the series circuit will include the important inductive effect of the antenna also, while this would not have been a part of the resonant circuit if the tuning capacitor had merely been connected across the primary winding.

In the case of the secondary, the objective is to develop as much voltage as possible between the grid of the tube and ground, and this the parallel resonant circuit does very well. The other parallel resonant circuit, between the antenna and ground, is used quite differently, however. This is a *wave trap*, tuned to some strong nearby signal which might otherwise cause interference. It presents a *maximum* impedance to the undesired signal, and thus permits only a minimum of the interfering signal current to flow in the antenna coil. This is quite different from the series resonant circuit, whose impedance at resonance ideally drops to zero.

The reactive voltages appearing in any tuned circuit will be determined not only by the values of the reactances themselves, but also by the amount of resistance in the circuit. Since a minimum of resistance is usually desirable, the ratio of reactance to resistance (X_L/R or X_C/R) is called the *figure of merit* or *quality factor* of a tuned circuit. From this latter term is derived Q , its standard symbol. The Q of the tuned circuit of Fig. 6 is $8,000/5,100$, or only 1.56. This is due to the large amount of resistance, but in practice a Q of many times this figure is not uncommon.

Thomas A. Edison made a most important contribution to the modern art of electronics in 1883, only he didn't know it.

Edison's momentous experiment is illustrated in Fig. 8. He added a metal plate inside the bulb of a carbon filament lamp. When the plate was connected to the positive terminal of the filament

battery as shown, the ammeter deflected. Apparently there was a flow of current right through the empty space.

When the battery connection to the plate was removed, the current ceased. Also, when the plate circuit was connected to the

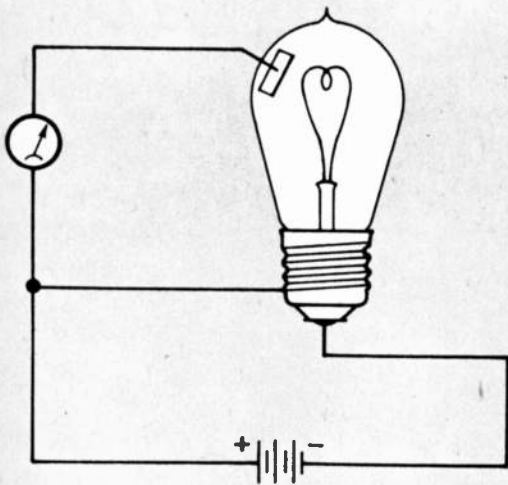


Fig. 8. A positive plate placed in a light bulb will attract electrons from the filament.

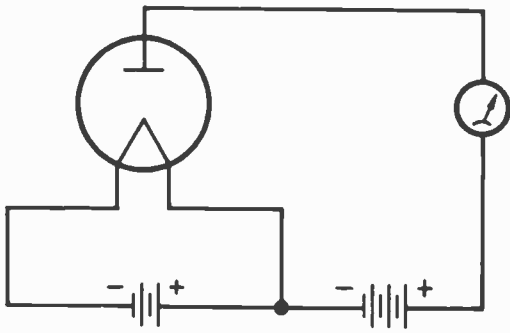


Fig. 9. Diode powered by 2 batteries; left one heats filament, right charges plate positively.

negative battery terminal, there was no current flow. Obviously, current could flow in one direction only in the bulb—from the heated filament to the positive plate it was quite feasible, but from plate to filament it was impossible.

Edison duly recorded the phenomenon, but made no effort to explain or use it, nor did anyone else at the time. And there matters stood until 1905, when Prof. J. A. Fleming of London suggested a practical application. He proposed that a two-element tube or valve, based on the "Edison Effect," might be better than the galena crystal then used for the detection of radio waves from spark transmitters.

Thus was born the "Fleming Valve," which is the basis of today's diode vacuum tube. Such a tube is shown schematically in Fig. 9, where we see it is very similar to the experimental Edison bulb in Fig. 8. The two elements are still commonly called the filament and plate, or technically, cathode and anode.

The filament may be simply a loop of tungsten wire within the evacuated tube. When a suitable voltage is impressed across the filament terminals, the wire heats up and begins to throw off electrons by a process known as *thermionic emission*.

The emitted electrons are, as we know, elements of negative electricity. Consequently they will be attracted by a positive element, but repelled by a negative one.

A very common application of the diode can be readily understood solely on the basis of principles just discussed. This is its use as a *rectifier* in power supplies, which permits the use of the AC house current for operating voltages in place of batteries. But in order to do this, the 117 volt AC must be converted to smooth DC.

If we removed the plate battery from the circuit of Fig. 9 and replaced it with an AC generator, current would flow only during the positive AC alternations.

Since the operating voltages required in electronic equipment often are greater than the 117 volt line current, a transformer is usually used to step up the voltage as in Fig. 10. Notice that we are also using AC on the filament. This is perfectly all right,

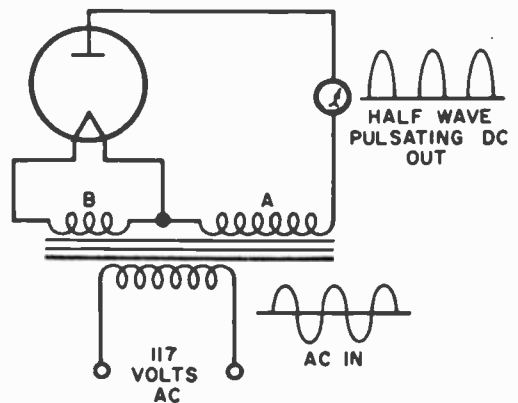


Fig. 10. When the batteries are replaced by a transformer, the 117 volts AC is rectified.

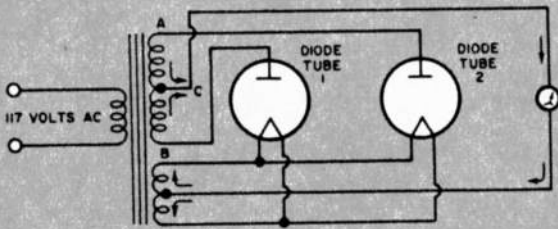


Fig. 11. Early full-wave rectifiers used two diodes, each mounted in its own glass tube.

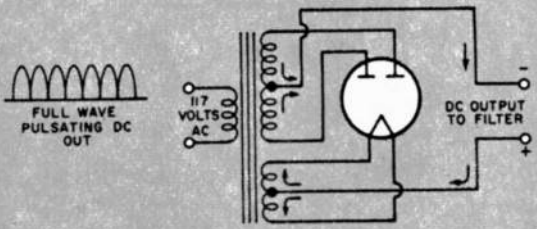


Fig. 12. Two diodes are commonly enclosed in a single tube. One filament serves both plates.

since the filament current is used solely for heat.

The voltage across plate winding A of the transformer is several times the 117 volts impressed across the primary. Whenever the plate end of winding A becomes positive, current will flow through the meter. But, when the pulse is negative there will be no current flow. The negative pulses are therefore effectively cut off, and the resulting output is pulsating DC.

It would seem, however, that this scheme could be improved upon if we could somehow avoid wasting those negative halves of each cycle. And indeed we can, simply by using two diodes in the circuit shown in Fig. 11. This provides us with a *full-wave* rectifier, as opposed to the half wave circuit in Fig. 10.

Let us begin by assuming a moment in time when the AC input tends to cause current flow from A to B in the transformer winding. This would mean that current would flow from the plate of tube 2 through the winding to the plate of tube 1. But this is impossible, for the electron flow could not continue across to the filament of tube 1.

There is another possible course for the current, however. That is from plate 2 to A to C. Continuing along, it can go through the meter and then into the center tap of the filament winding. From there it might go to the filament of tube 1, or of tube 2, or both. But the polarity of tube 1 is wrong at this time, tending to force current in just the opposite direction. And so all of the electrons go to filament 2, where they travel across to the plate and complete the circuit.

On the next alternation, all of the polarities will be reversed. Tube 2 will now be cut off, but tube 1 will begin to conduct. Then current will flow from plate 1 to B, to C, and through the plate meter return circuit and into the filament winding.

Note that although the current in the transformer windings reverses, the current through the output meter is *always in the same direction*. The negative alternations have been "flopped over" and used to fill in the gaps of the output waveform.

Even the full-wave waveform is still far from smooth and must be evened out to pure DC before it can be used for other electronic equipment. This is done by means of a *filter* comprising chokes and capacitors, or resistors and capacitors.

The circuit of Fig. 11 can be simplified and improved by placing both plates and filaments in the same envelope to make up a twin diode as shown in Fig. 12.

The diode tube is useful for detection and rectification, but the

list ends right about there. The electronic art therefore didn't really get off the ground until Dr. Lee DeForest conceived the idea of a third element for the electron tube called the *grid*.

The new applications for the triode fall into three principle types. The triode can be used as a detector of audio or video modulation, as an amplifier of audio, video, or radio signals, and as a generator of any of these frequencies. And these three fundamental applications form the basis for almost the entire electronic art.

In the triode is an electron-emitting cathode, which may be either a filament, or an indirectly heated cathode. Surrounding the cathode is the grid. This is usually a spiral winding of wire, whose turns are so spaced that the grid offers little physical obstruction to the electrons flowing from cathode to plate. Outside the grid is the plate, usually a cylindrical piece of metal.

The grid may be thought of as a gate, which can be electrically varied to control the rate of electron flow between cathode and plate. For this reason, in multi-element tubes having two or more grids, this one is known as the *control* grid. A small voltage change in the grid circuit produces a much larger change in the plate current.

The AC generated by the microphone (Fig. 13) appears across the secondary of the audio transformer, where it may either add to or subtract from the negative *bias* voltage of the grid battery. Now suppose that the grid battery delivers minus 8 volts, and that at a given instant a negative signal adds another volt. When this grid voltage changes from 8 to 9, the plate current of the tube flowing through the primary of the output transformer will also change, perhaps in this case decreasing by 4 milliamperes. The change in plate current will also cause a change in the voltage appearing across the primary of the output transformer. In this case the current change of 4 ma. might result in a voltage change of 10 volts. But this whole process was initiated by a small 1 volt change on the grid. Obviously the tube has acted as an *amplifier*, delivering a change of 10 volts at the output when it received a change of only 1 volt at the input.

To understand how it works, let's go back a little and assume the triode to have correct operating voltages on the plate and cathode, but with a small positive voltage applied to the grid. Since the electrons are negative, they will be attracted toward the positive grid. But since the grid had such an open structure, most of the electrons will fly right on through it and come under the influence of the plate.

A point will ultimately be reached where further increases in grid voltage will be ineffectual in boosting the plate current. The tube is then operating at its maximum capacity for delivering electrons under the existing conditions.

Next let's apply a *negative* voltage to the grid of the same tube. Now the electrons coming out from the cathode will tend to be repelled by the grid, which has the same polarity of charge they have themselves. Many of them will still be able to get through

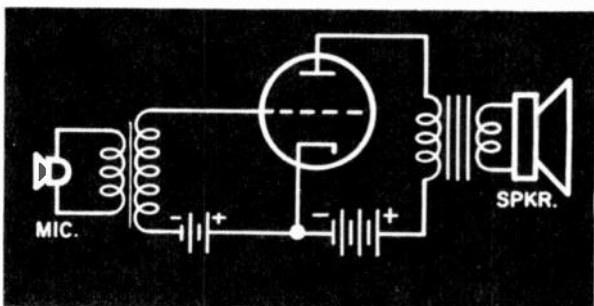


Fig. 13. In this amplifier the microphone impresses a weak voltage on the grid of the triode to control a large plate current flow.

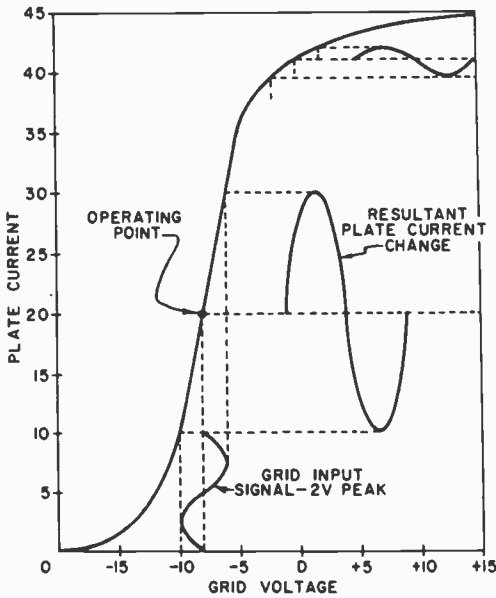


Fig. 14. As described in text, this tube characteristic curve demonstrates the purpose of using a negative grid bias for linear results.

the grid openings, but some will be repelled and turn back or hang in the space between cathode and grid.

Returning once again to our simple amplifier of Fig. 13, let's assume that the tube in this circuit has the characteristic shown in the curve of Fig. 14. As we are using the tube, the voltage on the grid is a combination of the fixed DC battery plus the AC signal on the transformer secondary. With an 8 volt bias then, and with a signal of 2 volts peak, the voltage on the grid relative to the cathode would vary from -10 to -6 volts.

Referring to our curve of Fig. 14, we see that when the grid voltage is -8 volts, the plate current is 20 milliamperes. When the negative peak of the signal swings the grid to -10 volts, the plate current will drop from 20 to 10 milliamperes.

If we were to plot these points along with a few intermediate ones on a graph, we'd come up with the grid voltage and plate current curve shown in Fig. 14, which illustrates how a small voltage

variation on the grid can effect a large variation in plate current.

Perhaps you are wondering what useful purpose is served by the fixed grid bias voltage. Why can't the signal voltage alone be applied directly to the grid? The answer to that can be seen in the small waveform at the upper right-hand corner of Fig. 14.

In this case the grid voltage is normally zero, and the signal will drive it plus-and-minus 2 volts. Then on the positive peak, the plate current will go from 41 to 42 milliamperes. And on the negative peak, it will drop from 41 to 39.5. Now we can see two distinct differences in this curve as compared with the one at the -8 volt point.

First, the amount of plate current change (or gain) is considerably less. This means that the amplification or gain is much less. Furthermore, the negative plate current peak is half again as great as the positive peak. The result is distortion. The grid is therefore biased negatively to provide an operating point in the middle of the straight-line portion of the characteristic curve, for maximum gain and minimum distortion.

The triode vacuum tube is a one-way device, in that voltages applied to the grid will cause changes in the current and voltage in the plate circuit, but changes in the plate circuit will have no effect at the grid. It is also interesting to note that while we regard a tube as an AC amplifier, these changes are all actually DC.

When the AC signal at the grid is superimposed on the fixed grid bias, the resultant voltage is pulsating DC. Similarly, the effect at the output is a fluctuation in the DC plate current, but never a change in direction. But the waveform is the same as that of the AC input signal (unless distortion has occurred), and the pulsating DC will have the same effect on the load components in the output circuit as would a similar AC signal. ●


How an FM Tuner is Made

By Len Buckwalter

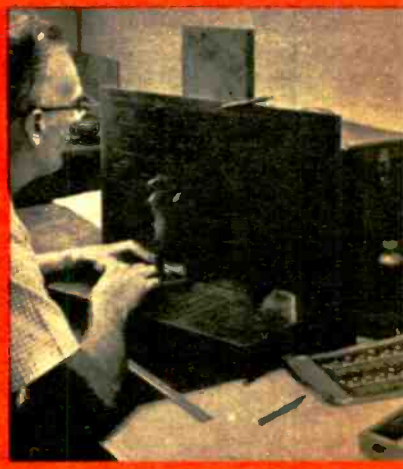

A trip through the H. H. Scott factory in Maynard, Mass. reveals careful assembly, quality control.

THESE pages trace the fabrication of an FM tuner from concept to cabinet. They are the result of a question discussed at length at *EI*; "How can a manufacturer mass produce a delicate electronic instrument and keep its quality consistently high?" Several answers emerge—some obvious, like good design, conservative components, stringent testing. But, as we learned, success with the finished product hinges to a significant degree on the end user.

The tour was headed up by Dan Von Recklinghuysen, shown seated with slide-rule below. As chief designer, he attempts to reconcile the diverging elements of good circuit design with a finished product that won't present problems on the production line. One outcome is the 310-C FM tuner, on the desk top. Sitting

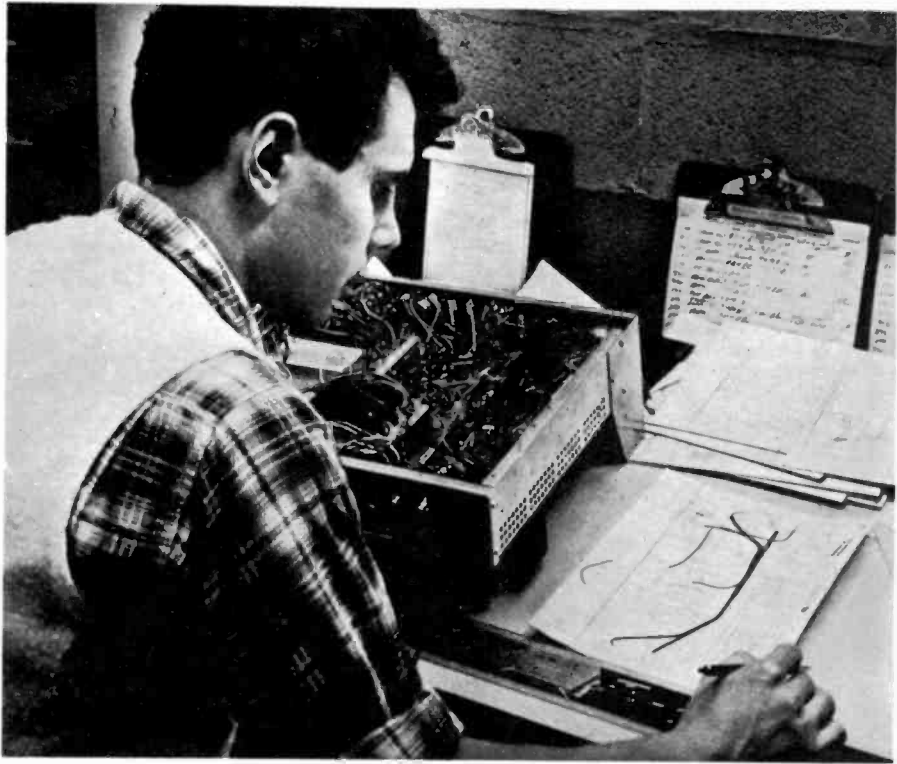


On designer's desk are tuner prototype, left, and finished product. Note close similarity.



Surface plate and height gauge are used to make chassis templates showing hole positions (far right).

Series of charts is drawn to show a group of wiring steps. Chart is color coded for reasons of clarity.



vertically next to it is the engineering prototype, the first hand-assembled unit. Close resemblance between the two is an indication of success.


As a tuner's punched chassis wends its way through the production line, the single, most important factor appeared to be "QC"—Quality Control. Each assembly is halted at eight specific check-points and subjected to mechanical and electronic testing. Alignment is accomplished in a screen room to shield out the influence of electrical disturbances.

A certain number of tuners are chosen from the production run for further testing in the Quality Control department. Operating conditions equivalent to several years of home use are simulated in the "life test," especially for newly designed units. Here, a 12-minute "On" and 3-minute "Off" cycle is used to power the tuner for six months. Voltage is stepped up to 130 to show up any component weakness.

[Continued on page 111]

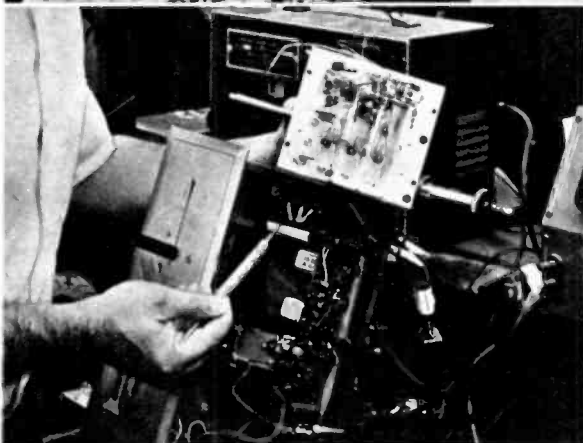


Chart serves as a step-by-step wiring guide on the assembly line. Here, a front end sub-assembly, used in the tuning section, is being wired.



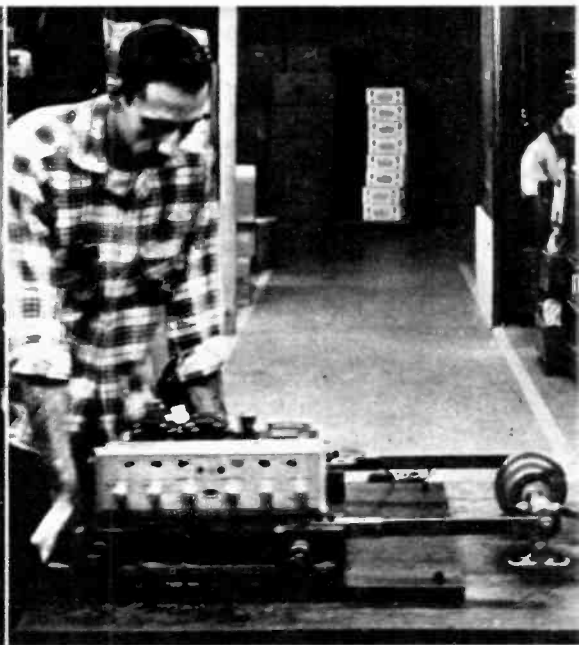
On the production line, components are successively mounted, wired and soldered to the main chassis. Inspectors check for error at points along the entire production line.

Hand holds tuning sub-assembly that will be clamped into test chassis. Pencil points to contact strips in chassis that supply power and signals to the unit under test.



Tuners are tested in screen room. The walls of copper screening are interference shields.

Twenty percent of tuners go to "shake table" to check for poor joints, loose connections.

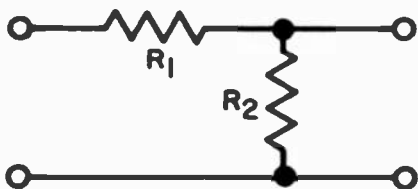


EI'S Hi-Fi Doctor

Tone Controls

Hi-fi tone control circuits look pretty complicated nowadays. But they can be as simple as any old-fashioned high frequency cut radio tone control, involving only a pot and a capacitor. Such circuits work because of reactance—which is the resistance in a capacitor. A capacitor's resistance varies with frequency; the higher the frequency the smaller the resistance. Don't calculate it—look it up on a reactance chart.*

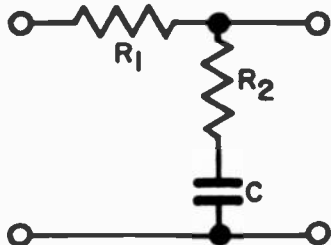
The basic circuit is a simple voltage



divider like this with R_1 and R_2 . The voltage output can be figured by using a simple equation; input $\times R_2$ divided by the sum of $R_1 + R_2$. This is constant at all frequencies, but we can make it a booster by adding a capacitor which will change the dividing ratio as frequency is changed.

Shunting a capacitor across R_1 tends to short out that resistor as the input frequency is raised and the net result is a boost in the treble frequencies.

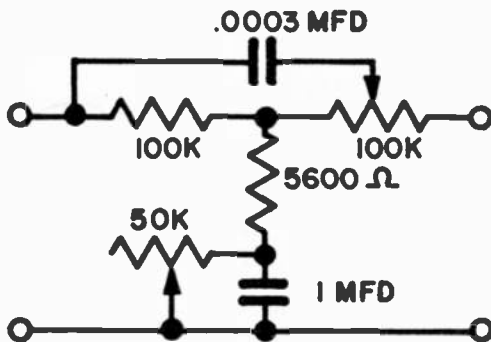
To boost the bass, add a capacitor to the other resistor (see below) now the dividing element is an impedance, ($R_2 + X_c$). The resistance adds like the sides of a right triangle add to make the



hypotenuse—like this:

$Z = \sqrt{R_2^2 + X_c^2}$ — but you don't have to figure it. Boost is so small that it's not important when X_c is small compared to R_2 . As frequency goes down however, the bass begins to come through. And where reactance and resistance are equal; the boost rate is almost 6 db per octave, then it tapers off where $X = R_1 + R_2$.

For practical values, let's pick 100,000 ohms and 5600 ohms for R_1 and R_2 for a basic division of about 20:1, a boost of almost 20 db. For C, let's pick a .1 mfd. capacitor—its reactance is about 5600 ohms at about 300 cps, gets to 100K at close to 15 cps. We can shunt a pot across the capacitor to vary the boost.



A refinement to the circuit can be a treble booster. See above. A pot and capacitor can dump the highs by a 20:1 loss or bypass them onto the following circuit.

It's easy to experiment with this circuit: increasing the capacity will slide the curve to the bass end, decreasing it slides the curve toward the treble; changing the ratio of R_1 and R_2 alters the amount of boost.

Bear in mind that the circuit has a basic loss of approximately 20:1—to get 1 volt out, you have to put 20 volts in. It "boosts" only because you cut down the loss at some frequencies.

* K & E No. 358-57 available in drafting supply houses

and Clinic

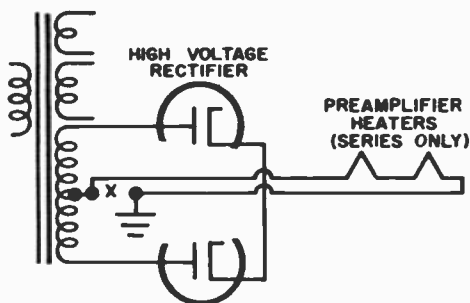
Hi-fi questions are all answered by mail. If of general interest they will appear in this column.

Humless Preamplifier

How can I eliminate all hum from my preamplifier?

H. V. Moat, Holland, Mich.

All the shielding and filtering in the world cannot cut out all the hum in a circuit involving AC heaters. This is particularly troublesome when low level signals are lacking in bass—as is the case with many pickups. One trick is to use DC heaters on the preamplifier tube or tubes. It is quite easy to work when the power amplifier has a B+ drain of 150 milliamperes and the preamplifier tube(s) heater drain is also 150 milliamperes.



Break the connection between the high voltage winding center-tap and ground, and connect the tube (s) heaters in series as shown. The whole high voltage supply current is drawn through the heaters. The voltage at the center-tap is -12 for one tube, -24 for two—you lose this amount from your B+, but get smooth filtered DC for the preamplifiers—free of 60-cps hum. If your amplifier has a drain of 300 milliamperes (as some do), then parallel your preamplifier tubes or you'll burn out the heaters.

Remember this step does not automatically get rid of other hum problems—use filtering and shielding for that.

Bass Response

Until lately I've been using a \$5.00 replacement type 12" speaker in a cheap bass reflex cabinet. Recently I switched to a highly recommended \$160.00 speaker system. To my ear, the cheap speaker has more bass. How do you account for this?

Kermit Keller, Decatur, Illinois

What you interpret as more bass in the inexpensive speaker is probably a "bump" in the bass response caused by a speaker resonance at about 80 cycles. If you've not heard a good hi-fi system in action, your standards as to what constitutes good bass and treble probably need training.

Woofers And Tweeter Controls

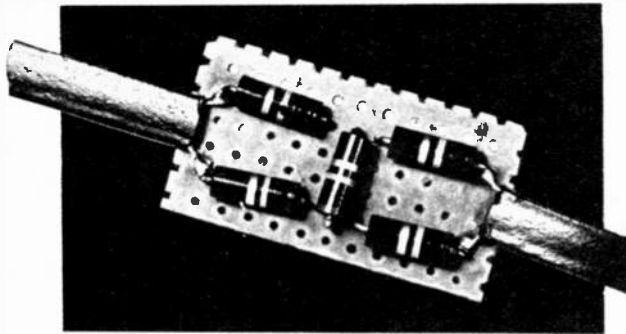
I want to be able to set the balance of my 3-way speaker system. There seems to be conflicting opinions as to the best type controls to use. Would a T-pad, an L-pad or a simple potentiometer be best?

Carl Wood, Alhambra, Calif.

If you are controlling the volume of one speaker and it is the only one connected to your amplifier, theoretically, the 3-section T-pad is preferred. The T-pad in action allows both the speaker and the amplifier to operate into their rated impedance.

The two-section L-pad is compensated to match the amplifier only. However, since both the T-pad and the L-pad will affect the damping factor of your amplifier, their use should be avoided with high quality full range speakers.

As far as two or three way speaker systems are concerned—since the amplifier's damping factor has, in effect, already been affected by the crossover network, you have an open choice between the L-pad and the less expensive potentiometer. The pad or the pot, whichever is used, should be connected between crossover and speaker. ●

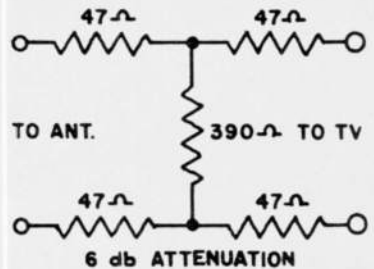
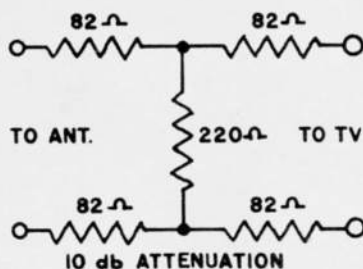
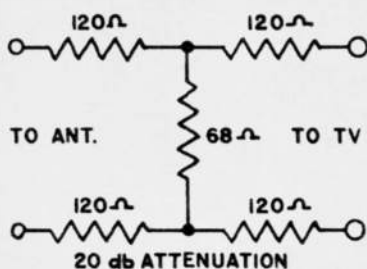


Carbon attenuator resistors are mounted on perforated board and then spliced into the TV antenna line.

how to Eliminate TV Overload

By David Gordon

Three simple circuits to improve your reception.



The 20 db pad will drop about 90% of the input signal voltage, the 10 db pad drops about 65% and the 6 db pad about 50% when installed.

NEW problems are always besetting the TV viewer. Not too long ago the big headache was how to drag enough microvolts of signal down the antenna to get a goodlooking snow-free picture. But the combination of new tubes and designs in TV receivers together with beefed-up transmitters cured that problem; and caused another one—overload.

If a new antenna (master or individual), a new set or a boost in the TV station's power causes picture jitter, smear or inadequate contrast, you may very well have an overload condition. After checking the AGC control (there may also be a *distant-local* switch), an attenuation network may be your best bet.

Three simple, but effective 300-ohm attenuator configurations are shown. There's a choice of three attenuation ratios (20 db, 10 db, and 6 db) one of which should prove best. ●

build a **Power-Transistor Intercom**



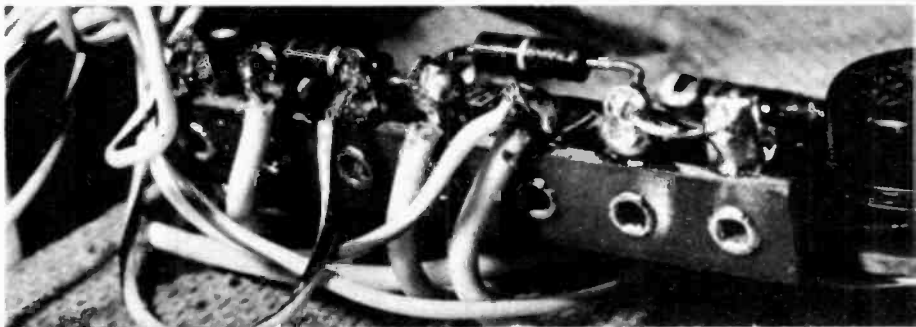
By George Gordon

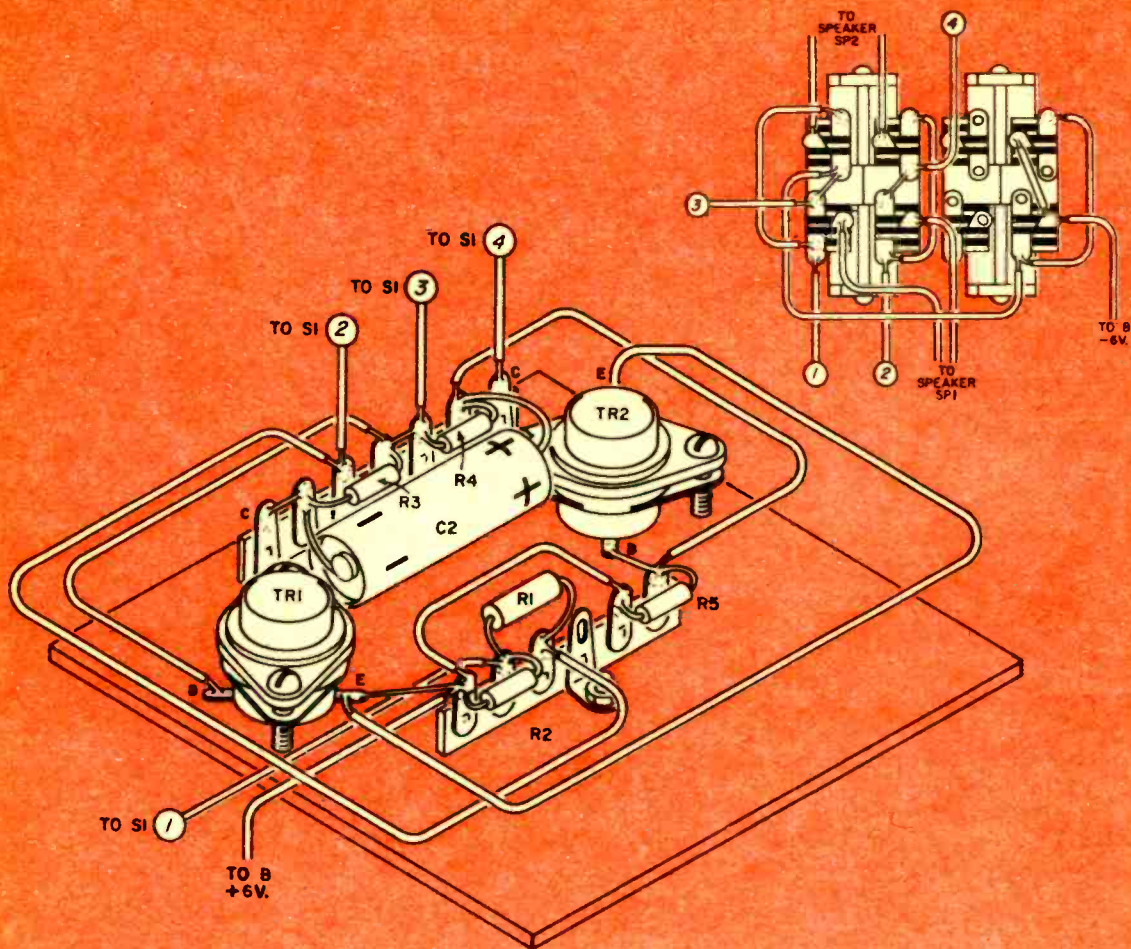
Instant warm-up and portability are only a few of the features of this battery-operated unit.

IN SOME applications, transistors have no particular advantage over tubes. But for a device such as an intercom, transistors are a natural. A good case in point is the unit described here.

The two units of this "portable" battery-operated intercom can be set up permanently or temporarily between store and basement, main house and barn, or playroom and kitchen. You can use it as a front door answerer, a call device for a sick-room or to re-position a TV roof antenna with the help of a second person.

Don't let this close-up of the terminal board frighten you. Avoid those cold solder joints and the rest is just simplicity itself.





Or use it between two kerosene-lighted cabins in the North Woods. Numerous other applications will occur to you before you even begin to build it. A three-way talk-listen control switch with a neutral "off" position serves to reduce battery drain considerably. Total power consumption is less than that of the filaments alone of some tube-type intercoms.

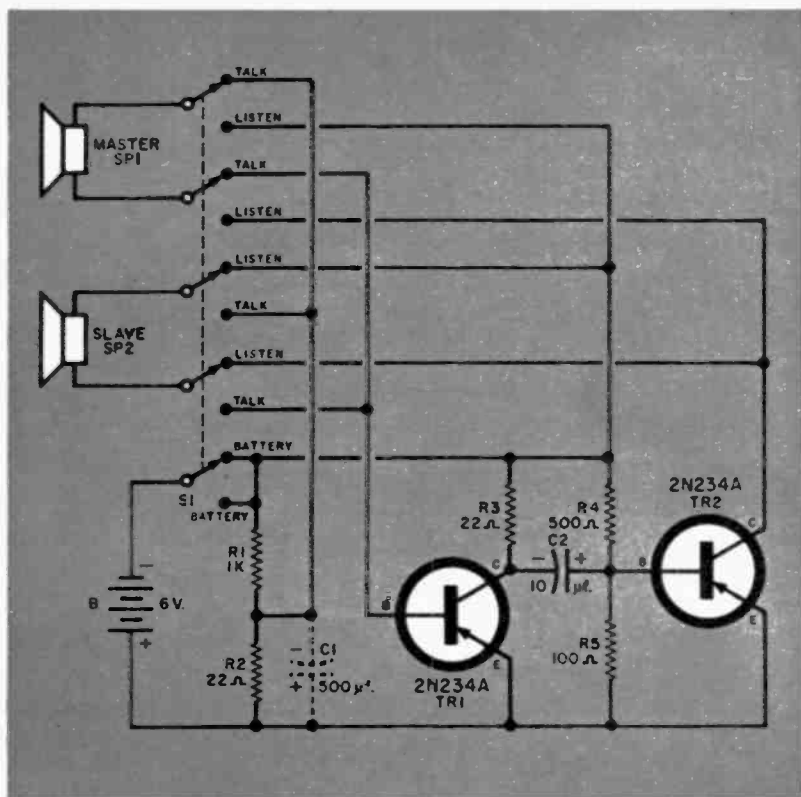
The low impedance and relatively high current delivery of the two audio power transistors make possible direct coupling to the two loudspeakers, thus doing away with input and output transformers. Since all of the circuitry is contained in the Master unit, just a single two-wire cable is all that is necessary to connect the Slave unit.

The system illustrated was assembled with an eye toward appearance and

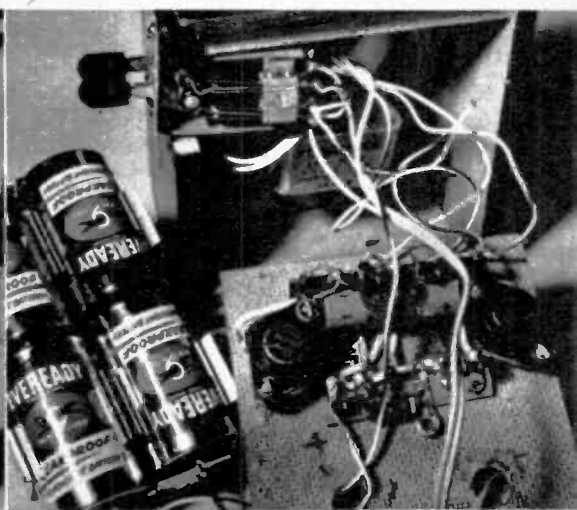
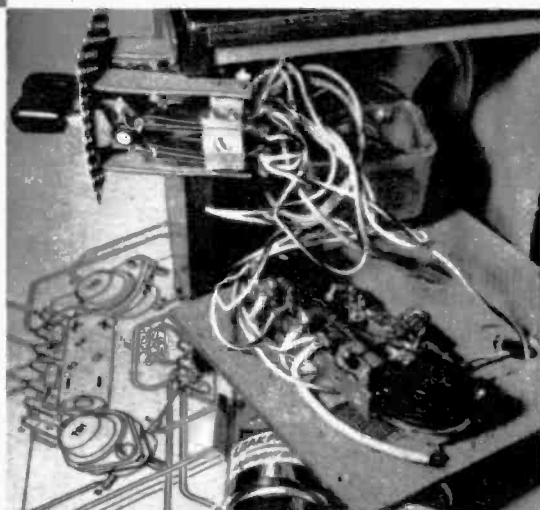
durability, and the new parts price came to about thirteen dollars. However, you need not be bound by the parts listed. A well-stocked junk bin may contain some of the standard items used in this system. The finished wood enclosures, for example, can just as well be a [Continued on page 122]

PARTS LIST

- C1—500 mfd, 3-6 volts electrolytic capacitor (See caption under schematic diagram)
- C2—10 mfd, 3-6 volts electrolytic capacitor
- R1—1000 ohms or less (see text) } all resistors
- R2, R3—22 ohm } 1/2 watt
- R4—500 ohms or less (see text)
- R5—100 ohm
- TR1, TR2—2N234A transistor, Bendix. Available at Tab, 111 Liberty St., NYC
- SP1, SP2—4" PM speaker and enclosure plus 25 ft. cable (Lafayette SK-108)
- SI—Two 4PDT lever switches (Lafayette SW-20)
- B—Four size "D" cells (connected in series) and holder



At left, wiring guide illustrates the few connections necessary on the rear speaker board. C1 (above) is installed if feedback or instability develops.



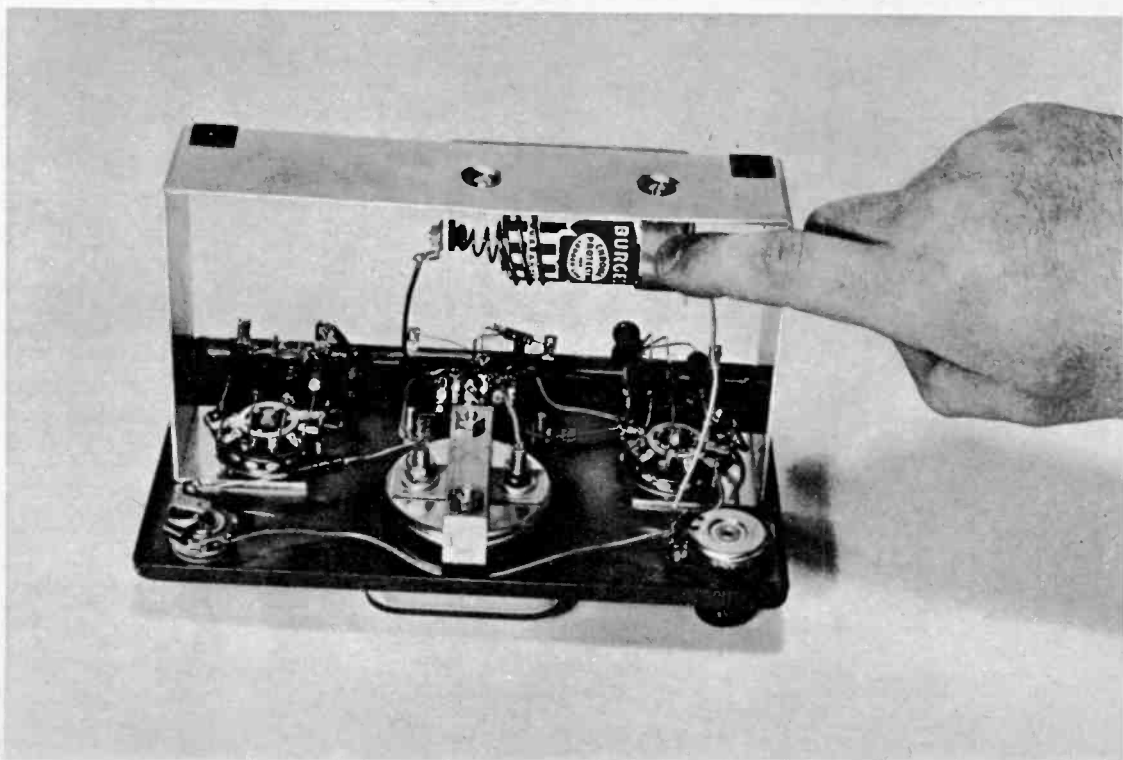
Two views of master intercom unit. Seemingly complex wiring of the two 4-pole lever switches taped together, is simplified in wiring guide.

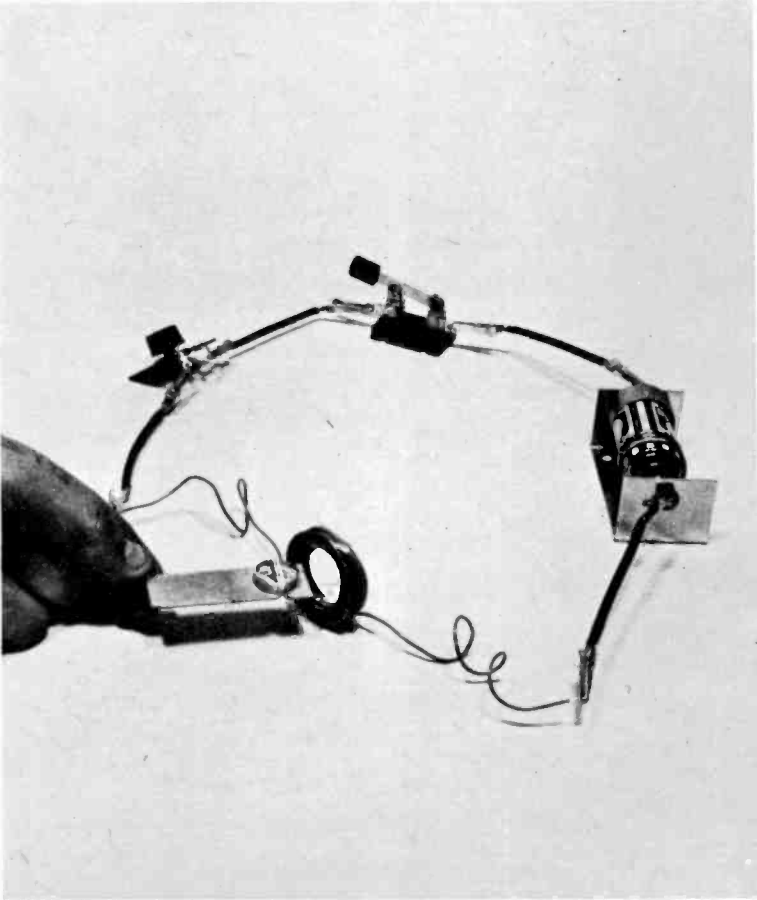


El assembles a
Heath Educational Kit

Here's a kit with a double punch—a useful test instrument coupled with a basic electronics course.

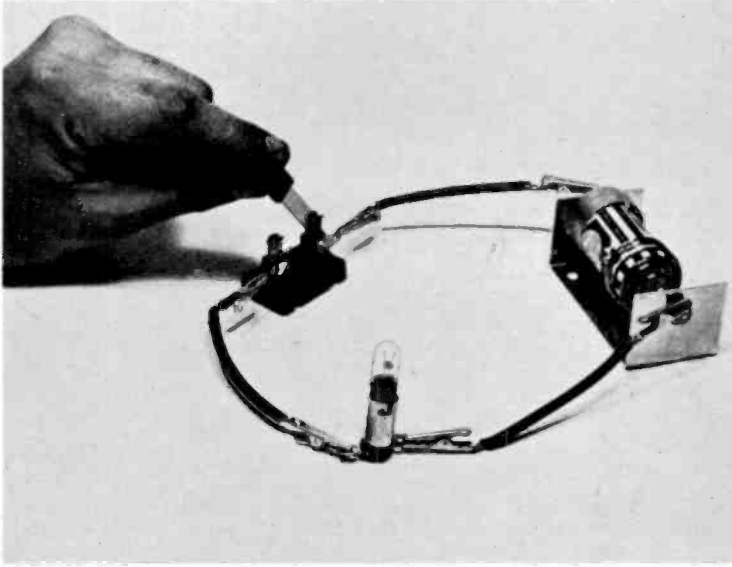
Completed wiring of the multimeter is neat. Precision resistors are used. Flashlight cell is for the ohmmeter circuits. It will last for many months.

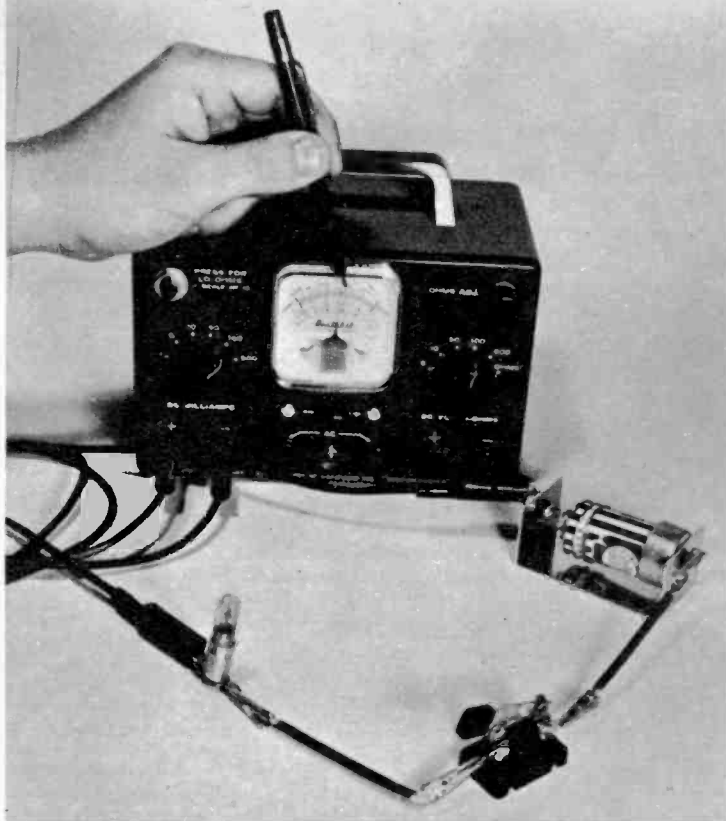




Shown on this page are two of the many basic electronics experiments that help the builder of this kit attain some understanding of electronics principles. Components shown are supplied with the kit. Circuit left develops magnetic field in coil which is indicated by compass. The experiment illustrates the magnetic effect of an electric current in a loop of wire. This effect was discovered by the Danish physicist Oersted in 1820. He also learned that the direction of the magnetic field is perpendicular to the wire and its intensity diminishes as the distance from the wire increases. Thus the magnetic field of the coil is strongest at the center, weakest at rim.

A basic direct current series circuit is demonstrated as shown with the parts supplied. Lamp lights when knife switch is closed. This is true because the current flows through each part of the circuit in an undivided, consecutive and continuous path from voltage source, i.e. the battery.





Current and voltage can be read on the big multi-meter dial face. All experiments are profusely illustrated in the manual which also contains several work problems.



Completed instrument is an attractive addition to any workbench. Test leads are made from wire and clips supplied with kit (EK-1).



Meter in use in an ohmmeter circuit checking out a wall switch for continuity. Many other household appliances can also be easily tested.

electronics on the cinders . . .

Gun-Jumpers Beware!

Keeping anxious sprinters honest at the starting block is the job of versatile electronic device.

College trackmen get ready on the starting line, depressing their little finger pads at right. In photo below they're off to a good start, thanks to electronic panel being operated by California coach, Hilmer Lodge, who got the idea for foolproof starter.

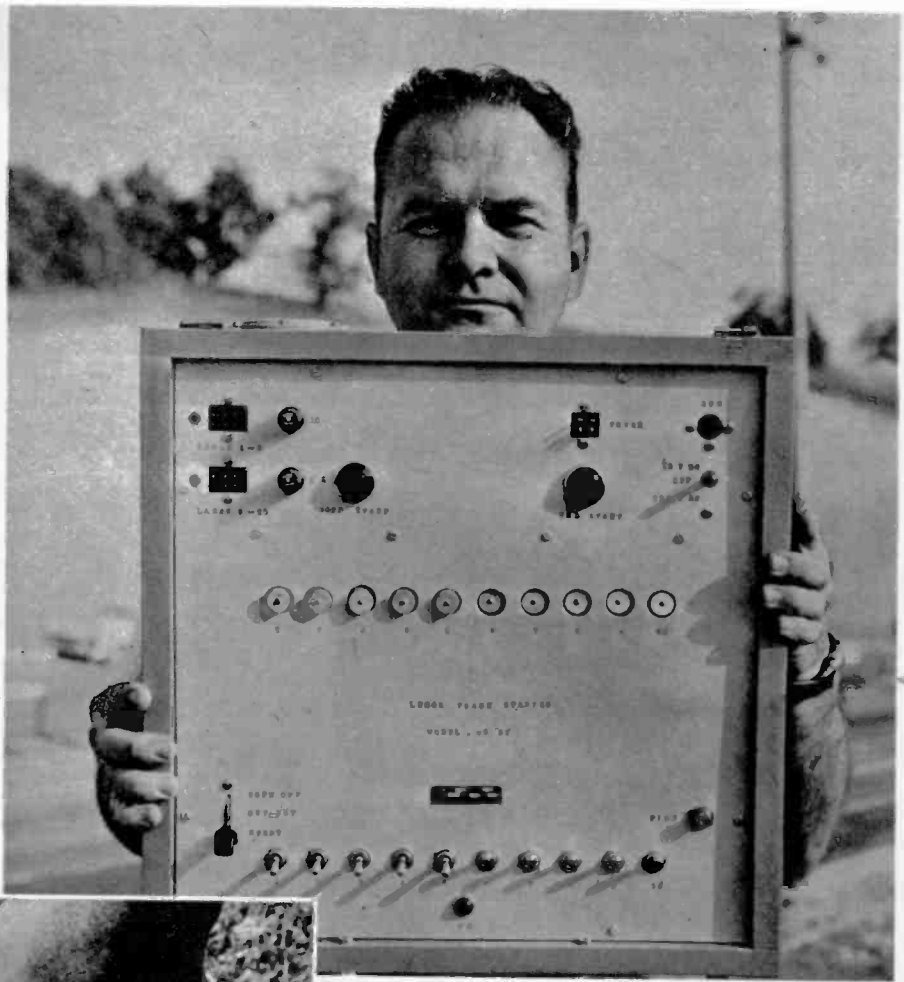
Photos by John R. Hamilton, GLOBE



MOST reliable gun west of the Pecos is one attached to an electronic race starter that not only insures fair starts, but also mousetraps gun-jumpers with its impartial "eye." The great Olympic star Jesse Owens hails the device as "the greatest improvement in track and field since starting blocks."

The starter's gun is wired into a portable, battery-operated control panel that includes a variety of knobs, switches, fog horns, etc. Also wired into the panel are some ten plastic-covered "bean bags," one for each entry in any given race.

The idea of the electronic jump-detector originated with Hilmer



Here's a close-up of the control panel. Switches at bottom activate the necessary number of pads, which depress knobs across middle of board. There are also good and bad start lights on board.

When sprinter takes his "on the mark" position, he places his thumb on pad at starting line. Position shown at left gives the runner balance for a good, fast start. Pad contains pressure switch.



At bottom left we see how by simply pressing pad, corresponding knob is depressed. When all knobs are down, all runners are ready. If knob pops up before gun goes off, gun has been jumped.


Lodge, Mt. San Antonio College track coach. Details were worked out with O. V. Riley, head of Chrondek Electronic Co., La Verne, Calif. Every possible variation of a sprint start is accounted for in the electronic unit, which now sells for about \$400.

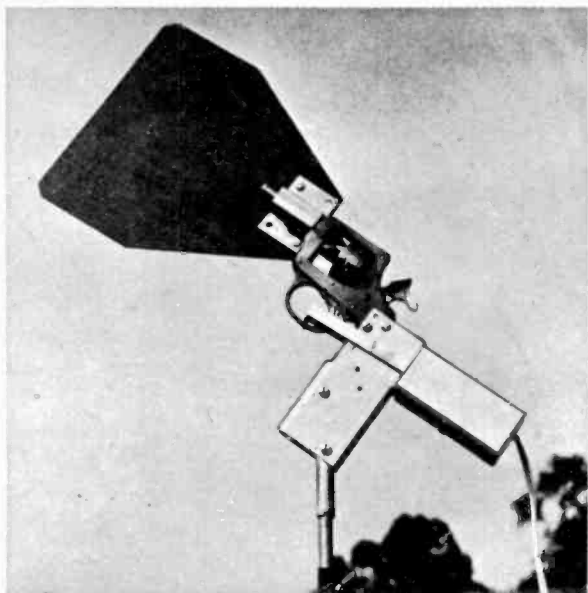
When "on your mark" is called, each athlete places his thumb or fingers on his very own plastic-covered pad. These are strung out in front of each lane on the starting line. The pad is, in reality, a pressure switch, linked electrically to a knob on the official starter's control panel. When all runners are on their marks (have their fingers on the pad), all the knobs on the panel are down.

The gun cannot fire until all the knobs are depressed, thus insuring that each man on the starting line is really ready. When "get set" is shouted, the official starter flicks a switch, setting the unit into operation. If any thumb or finger leaves the little pad before the gun fires, a corresponding knob on the control panel flies up, a raucous fog horn blasts off, and the gun won't fire. No question about who jumped the gun first. There

it is—a tell-tale raised knob on the panel. Too many gun-jumps and the guilty runner is disqualified.

The firing of the gun is automatic and it won't go off any faster than the two-second rule allows. Two seconds must elapse after "get set" before the trigger is actuated. This rule was devised to guard against "rolling" starts, where the runner may move off the blocks anywhere between a second and a second and a half after "get set." This feature indirectly protects world record holders from having their records stolen by sprinters who have mastered the technique of flying off the blocks a fraction of a second before the gun—not enough to be detected by the starter's naked eye, but enough to rewrite the record books.

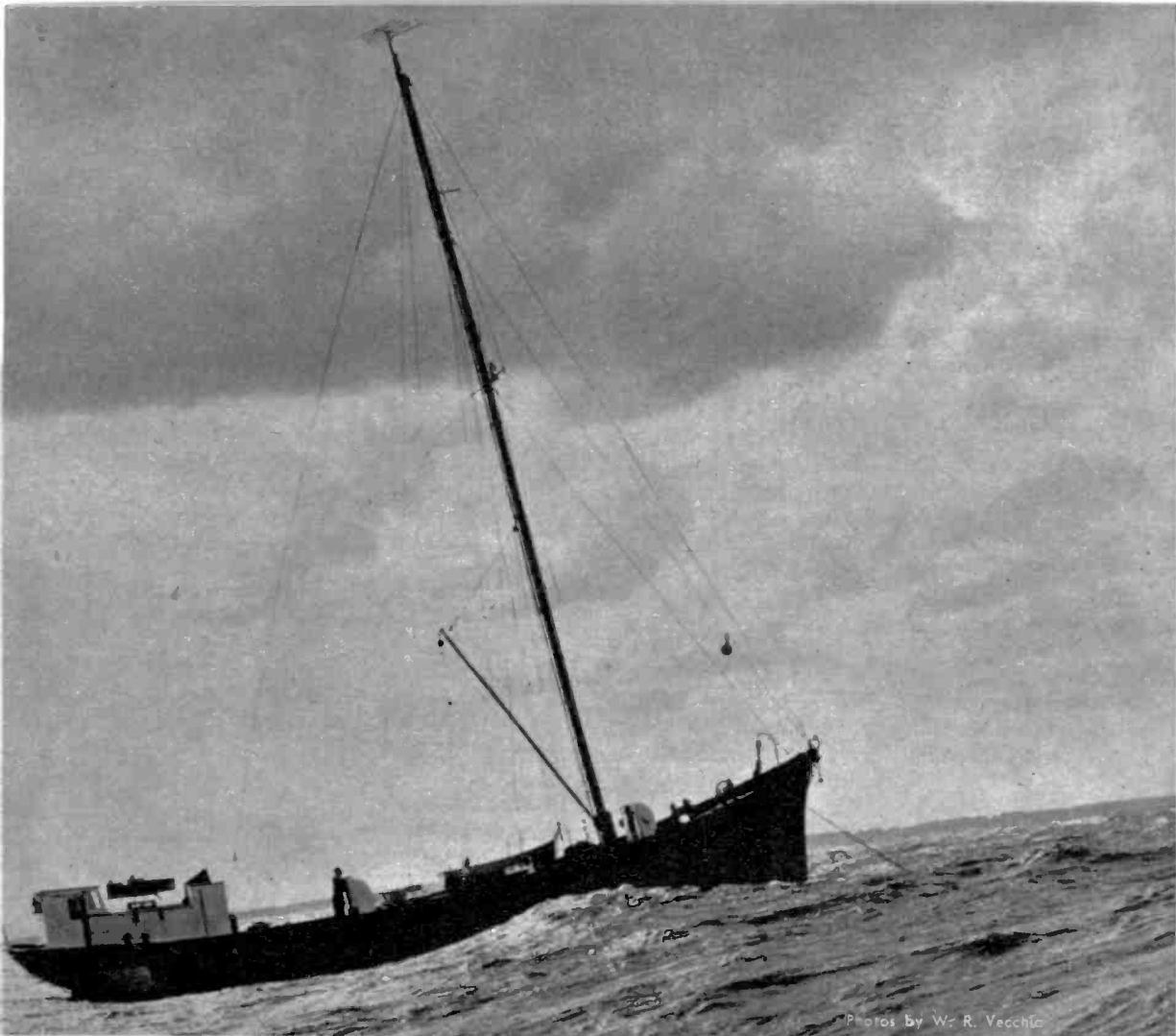
With the outdoor track season and the Olympic Games just around the corner, track officials are eyeing the Lodge race starter as the mechanism to silence once and for all the beefs of sprinters who for years have been blaming bad performances on bad starts. The new starter represents a kind of electronic justice for all who take to the cinders. 



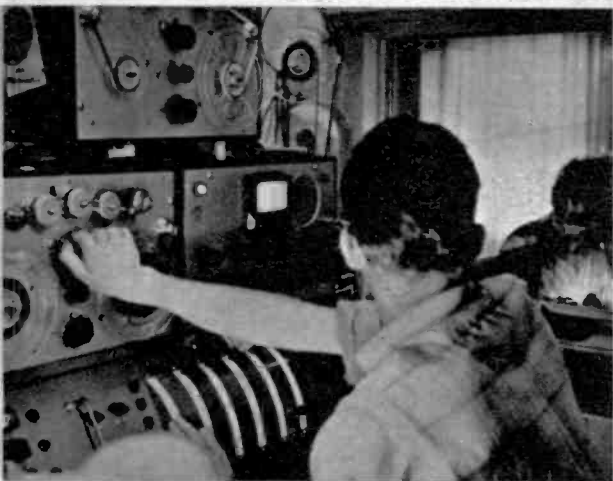
Electrically fired gun is equipped with a telescoping stand and a flash shield. There is a two second delay after "get set" is called by the official starter before the gun goes off.



The control panel can be hauled around the track to wherever it is needed. Note 12-volt auto battery at bottom of special handcart. Starting panel also operates on 117-volt AC.



Photos by W. R. Vecchie



Out of reach of authorities, Cheefa (above) rocks at anchor in Baltic Sea. Note antenna atop mast. Left, engineer tapes programs in Copenhagen studio. Only taping is done ashore. Transmitter is at sea. Right, Phil Irwin, an American, does English language show with model of transmitting ship on table.

Radio Mercur frustrates authorities . . .

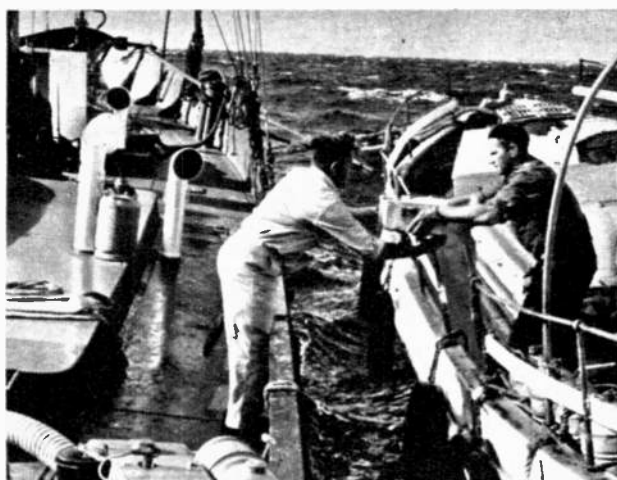
Bootleg Station on High Seas

A FEW miles off the Danish coast, in the Baltic Sea, floats a unique "illegal" radio station—the talk of all Scandinavia and the frustration of the Danish government. Like most of Europe, Denmark's radio is state-owned, hence non-commercial.

In 1958 several Danes and an American started their own commercial radio station, and so far the Danish government has been unable to silence it. Their FM transmitter is aboard a ship anchored beyond the three-mile limit in "international" waters. Called the *Cheeta*, the ship flies a Panamanian flag. The station is Radio Mercur, chartered in the tiny, independent country of Liechtenstein. It treats Scandinavians to a *potpourri* of light music, comedy and English broadcasts of news and tourist information. Phil Irwin, formerly with WOLF in Syracuse, N. Y., is station manager.

All programs are recorded in Copenhagen. A crew of four mans the 60-foot, 109-ton vessel, which has an extra heavy anchor to keep her in position. Each afternoon, regardless of weather, *Cheeta* is visited by the station's motor launch with the next day's taped programs.

The sale of FM receivers has boomed in Radio Mercur's listening area. Range is about 50 miles on 89.55 mc. *Cheeta's* mast serves as a tower for the Yagi-type 4-element antenna that can be aimed at Sweden for Swedish language broadcasts. The effective radiated power is 1500 watts. ●



Launch pilot hands box of tapes containing next day's programs to *Cheeta* crew member. Daily trip from shore takes from two to five hours, depending upon weather. Right, transmitter operator plays tapes below decks. Transmitter itself is cooled by tap from the small ship's own ventilating system.

smoother shaving with a **DC Power Supply**

By Ernest Kaye

ALTHOUGH modern electric razors have reached a point where a little improvement can be made in their design, you will find that a DC power supply will frequently provide a slight speed-up of the razor's action and a smoother shave.

The type of razor most benefitting from DC is the vibrator-driven unit. Contact-arcing is minimized and the RF noise radiating into nearby radios is cut down considerably.

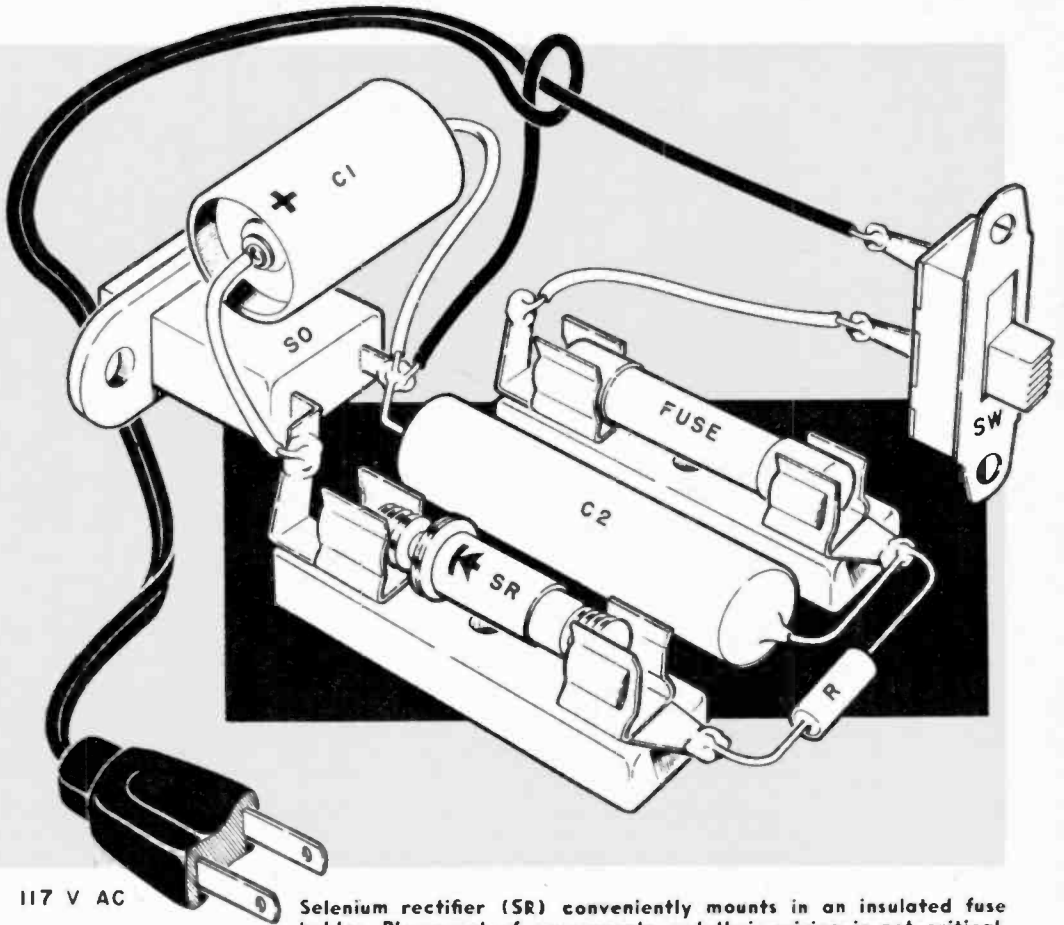
Although the author constructed his unit in a Mini-Box, almost any type of container, including an old Band-Aid box will serve. Parts layout is not important and there is practically no heat emitted by the rectifier. Just make sure that no portion of the circuit connects directly to the metal housing. The silicon rectifier diode used mounts conveniently in a fuse clip, but if a unit with leads is available, you can, of course, use it with terminal post supports.

[Continued on page 124]

PARTS LIST

R—determined by load (shaver)	SW—SPST toggle or slide switch
C1—10 mfd electrolytic capacitor, 150 volts	SO—AC chassis mounting receptacle
C2—.1 mfd capacitor, 400 volts	F—fuse, 3AG-1A, 250 volts
SR—silicon rectifier, 500 ma at 140 volts	Misc.—2 fuse holders, case, AC line cord



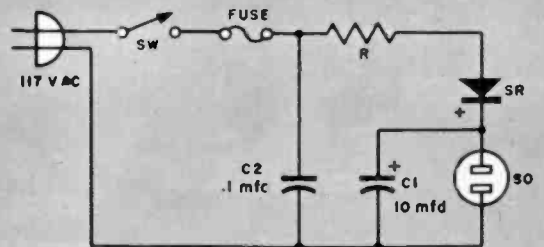
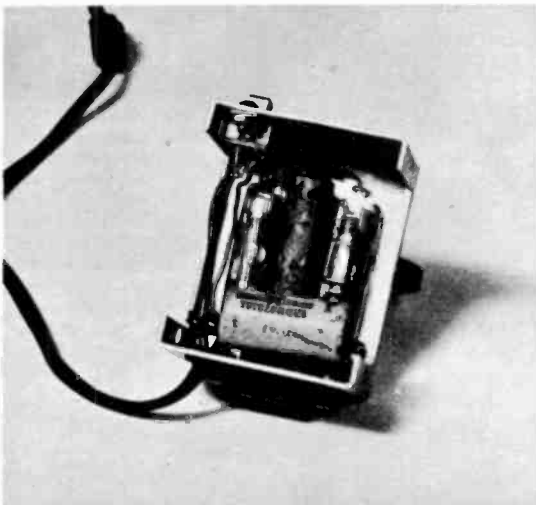


117 V AC

Selenium rectifier (SR) conveniently mounts in an insulated fuse holder. Placement of components and their wiring is not critical.

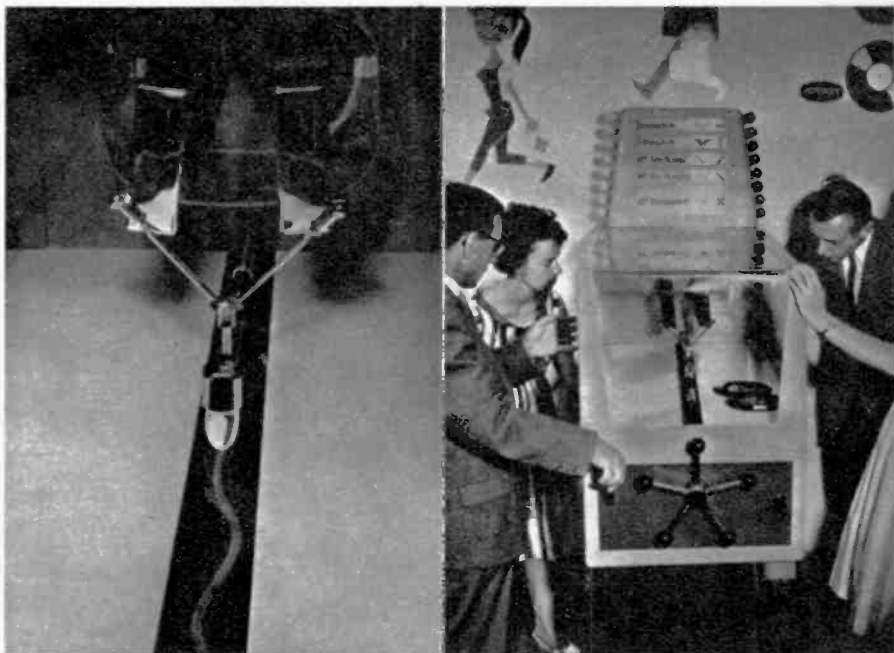
Interior view of power supply shows neat, compact design. Slide switch is at top left.

Value of resistor (R) must be chosen experimentally. Observe polarities of SR and C1.





E I Picturescope



No, these West Germans aren't examining a juke box. It's a Telefunken device which demonstrates how a stereo cartridge works. "Cartridge" (20 times normal) rides enlarged groove. As groove deflects it in various directions, corresponding bulbs light up. Bulbs' brightness depends on "violence" of movement (loudness). Wheel turns machine into monophonic demonstration.

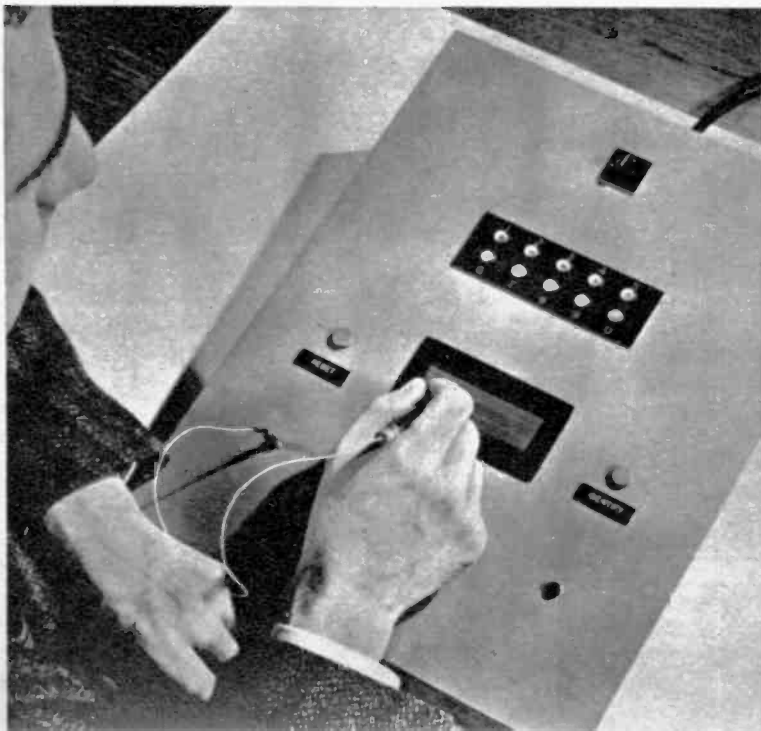
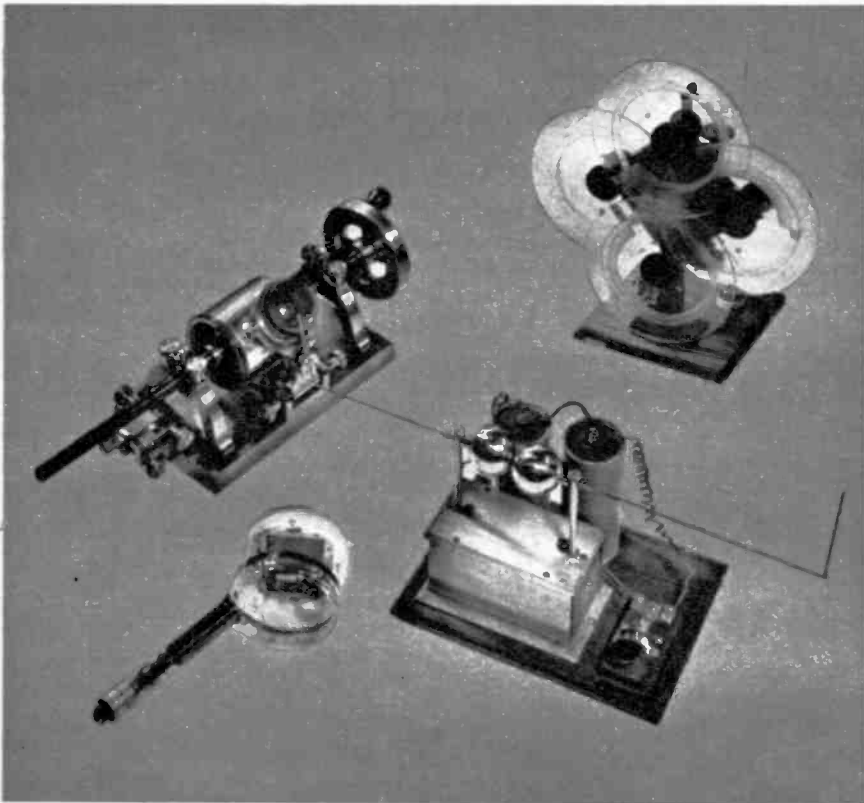


Table-top machine at Bell Labs reads handwritten, spelled-out numerals zero through nine as inscribed on special surface. By touching stylus to "identify" button, a logic circuit picks out certain tell-tale elements and lights correct bulb. Unit paves way for machines that will read any word.

A flea power wireless microphone is now on the market from Polytran Industries, San Mateo, Calif. It sells for \$9.95 and falls into the classification of an interesting electronic toy. Certified by the manufacturer to meet FCC requirements for low powered transmitters, these transistorized units allow you to talk through any radio—if you're near enough to receiver. No license needed.



Outstanding firsts in the communications field are on display in the Ford Museum, Dearborn, Mich. Top left: Edison's first phonograph, 1877. Top right: First device to transmit and receive a television image, made by C. F. Jenkins in 1925. Bottom left: Vladimir Zworykin's early iconoscope (1940), which made modern TV possible. Bottom right: Hugo Gerasback's 1905 Tellmeo wireless, the first home radio in the world.



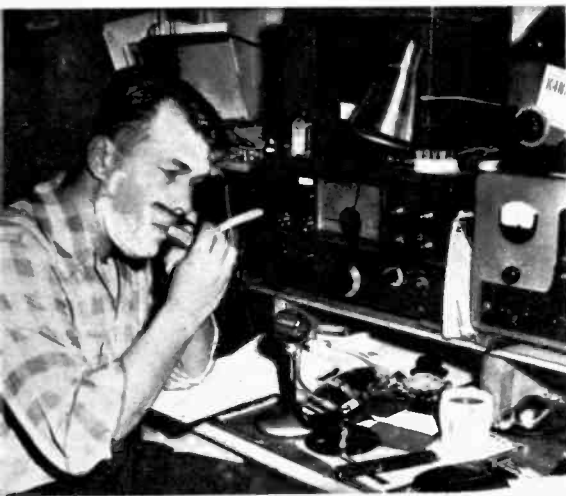
Courageous Carole, K9AMD, awoke regularly at 5:30 a.m., pointed her beam toward the Caribbean and managed to raise 20 HH stations. She became the first YL to earn Radio Club d'Haiti QSO certificate.

early birds on the ham bands

Before Breakfast QSO's

Early to bed, early to rise may not make a ham wealthy or wise, but the notion has caught on.

Dick, W9VWJ, trims whiskers while checking into Donut Dunkers' Net. He says early morning rag-chew improves his disposition. Right, Jim's W9JFG rig is just a slipper's throw from his bed. XYL Rosi, K9ESY, pours coffee.





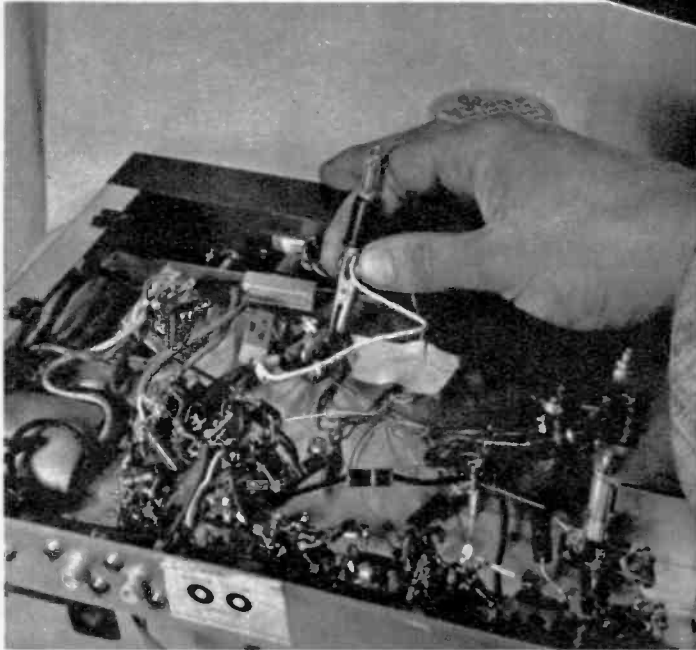
Why sleep when you can chase DX? Here Scotty, K9GSS, is joined at his ham rig by another K9 (canine, that is) whose name is Jolie, no call.

MILKMEN and disc jockeys aren't the only ones going strong before dawn. Many amateur radio operators also follow the "early-bird-gets-the-worm" theory. "I hate to get up early," admits Dick, W9LZE, "but contacts like KS6AG in Pago Pago and XZ2SY in Rangoon, Burma, are well worth climbing out of a warm bed."

"Work 20 Haitian stations and get our club certificate," said Lou Decatrel, HH2LD, President of the Radio Club d'Haiti. "But you're going to have to catch some of the boys before they go to work." (See top photo, opposite page.)

Hams with low power find the bands less crowded with kilowatts before daylight, and a pre-dawn bonus is the "long skip" condition when radio signals travel unusually far, even permitting an up-and-at-'em Novice to work all states on 80 meters. Chasing DX and certificates aren't the only reasons hams get up before the chickens. Some just prefer to start the day with a friendly rag-chew instead of push-ups. (See photo, far left.)

Try These

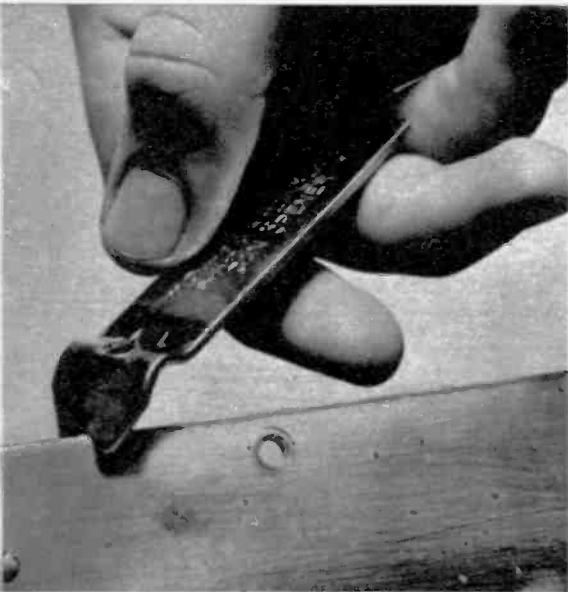


Neon Warning Light

Avoid shock while working on the under side of the chassis. A pair of miniature alligator clips, a 250 k ohm resistor and a NE-2 neon bulb. Just clip one end to chassis ground and the other to terminal of filter capacitor (hot positive lead).

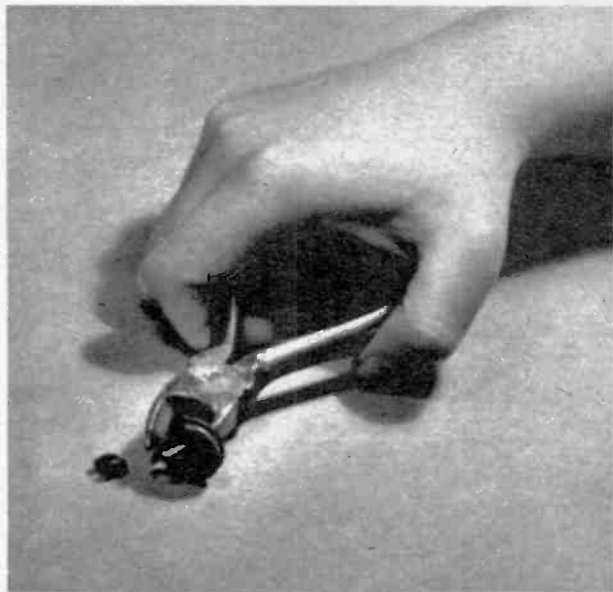
Deburring Tool

A beer-type can opener is a very good chassis deburring tool. Simply grind the end of the opener flat, then file a $\frac{1}{4}$ " deep "V" notch.



Rubber Grommet

By snipping out a wedge-shaped section from an oversize grommet, you can easily reduce its size without any impairment of its function.





The data that Launched Thousands of Careers is yours *FREE*

Tells how you can be successful in **ELECTRONICS**

Send for your Free Copy today!

This is a brand new edition of the book that has launched thousands of men on good-paying careers in electronics.

It brings you completely up to date—answers important questions on newest career developments in electronics, including Automation, Instrumentation, Industrial Electronics, Aeronautical Electronics, Guided Missiles, Radar, Servo-Mechanisms, Computers, Astronautics, Telemetry, Communications, Manufacturing.

Since its founding in 1927, CREI has provided thousands of professional electronics men with technical education. During World War II, CREI trained thousands for the Armed Services. Leading firms recommend CREI home study courses for their own personnel. Among them: All America Cables and Radio, Inc.; Canadian Broadcasting Corporation; Columbia Broadcasting System; Gates Radio Company; Federal Electric Corp.; The Martin Company; Douglas Aircraft Co.; U. S. Information Agency (Voice of America); Canadair Limited; Trans-Canada Air Lines; United Air Lines. Their choice of education for their own personnel is a good cue for your choice of a school.

You don't have to be a college graduate. You do have to be willing to study—at home. You can do it while holding down a full-time job. Thousands have. Since 1927 CREI has provided alert young men with the technical

knowledge that leads to more responsibility, more job security, more money. And CREI has constantly kept pace with the rapid expansion and progress in electronic achievement. Remember this: CREI starts with a review of the fundamentals and takes you along at your own speed. You are not held back by a class, not pushed to keep up with others. You set your own pace. CREI instructors guide you through the lesson material and grade your written work personally. You master the fundamentals, then get into more advanced phases of electronics engineering principles and practice.

Brand-New Course Added: Automation and Industrial Electronics Engineering Technology: Complete course, covers all electronic phases of automation. Special emphasis on theory, functioning and applications of servo-mechanisms and computers. Also note-worthy: Lessons on machine control, instrumentation, data processing and telemetry.

CREI ALSO OFFERS residence training in Washington, D. C. ... at the same high technical level. Day and evening classes start at regular intervals. Qualified residence school graduates earn degree as "Associate in Applied Science." You can qualify for CREI home study education if you have had electronic training, or experience in electronics—and realize the need of a high level technical knowledge to make good in the better electronic jobs. (Electronics experience is not required for admission to CREI Residence School.)
What's the next step! Certainly to get more information than we can cram into one page. Fill out and mail coupon today, or write Capitol Radio Engineering Institute, Dept. 1705-G, 3224 - 16th St., N.W., Wash. 10, D. C.

MAIL THIS COUPON . . . TODAY!

CAPITOL RADIO ENGINEERING INSTITUTE

ECPD Accredited Technical Institute Curricula—Founded 1927
Dept. 1705-G, 3224 Sixteenth St., N.W., Washington 10, D. C.

Please send me your course outline and FREE illustrated Booklet "Insurance for Your Future in the New World of Electronics" describing opportunities and CREI Home Study courses in Practical Electronic Engineering Technology.

- CHECK FIELD OF GREATEST INTEREST
- Radar, Servo and Computer Engineering Technology
 - Electronic Engineering Technology
 - Communications, Engineering Technology
 - Television Engineering Technology
 - Aeronautical Electronic Engineering Technology
 - Automation and Industrial Electronics Engineering Technology

B³

Name Age

Street

City Zone State

CHECK: Home Study Residence School Korean Veteran



To obtain fast, immediate service, and to avoid delay it is necessary that the following information be filled in:

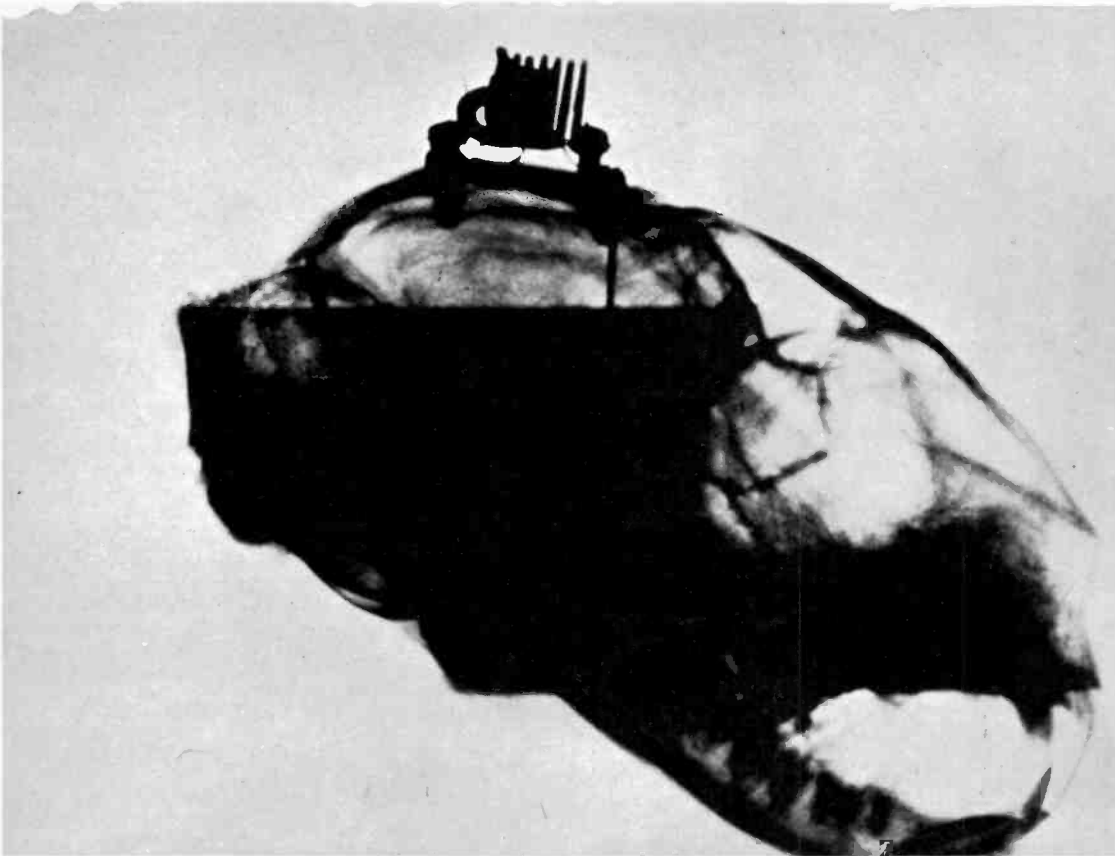
Employed
By

Type of Present Work

Education:
Years High School

Other

Electronics Experience



X-ray of cat's head shows clearly tiny electrode penetrating brain as well as subminiature tube socket. Mounting screws act as electrical ground.

Electronics Fights Pain

By James G. Busse

Do cats have 9 lives? We're not saying, but these cats may make life bearable for stricken humans.

A LONG cage, with transparent plastic sides, lines one wall of the research laboratory. The rest of the room is crowded with voltage supplies, banks of special electronic counters, test equipment of every kind—and a new transistorized electroencephalograph for recording brain waves.

A psychiatrist enters the room carrying a black cat. At first the animal appears to be just another cat, like thousands purchased yearly for medical research. Closer inspection shows that there is something different about this kitty. On the crown of its head is a small piece of dental plastic. Imbedded in the plastic is a subminiature tube socket. Below the plastic, a fine nichrome wire electrode penetrates the cat's brain.

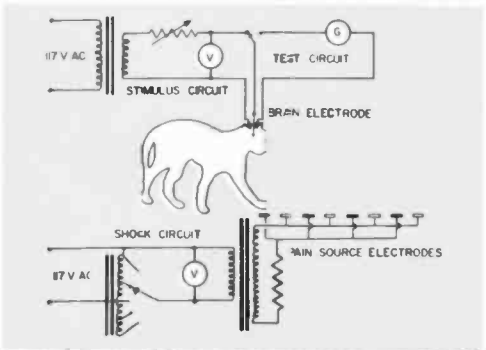
The presence of this electrode doesn't seem to bother the cat at all. It behaves very much like any normal cat, purring softly as it watches the small

[Continued on page 112]

This apparatus records reactions of animals to the electric shocks from the pain source and stimulus to the brain. Much data must be gathered prior to human experimentation.

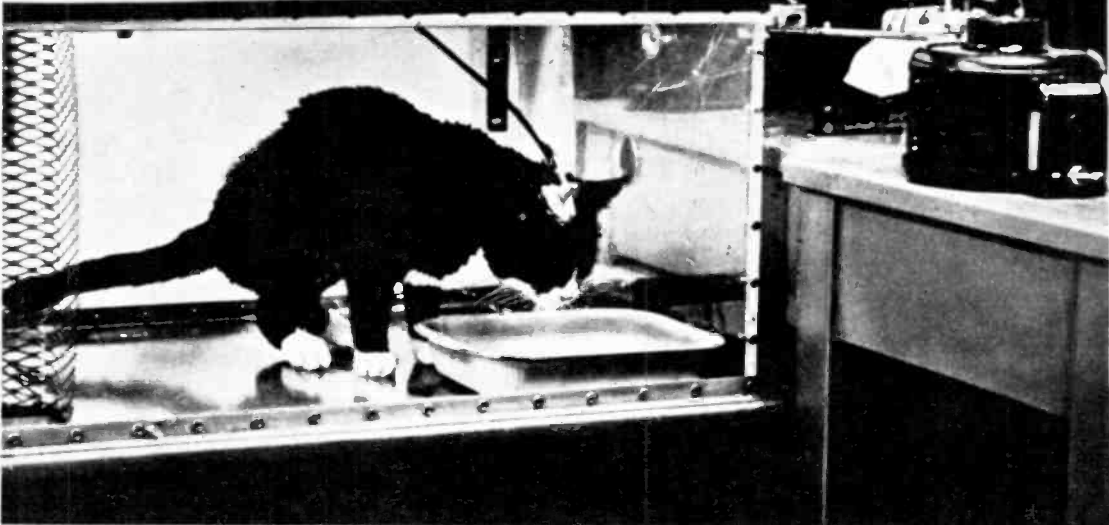
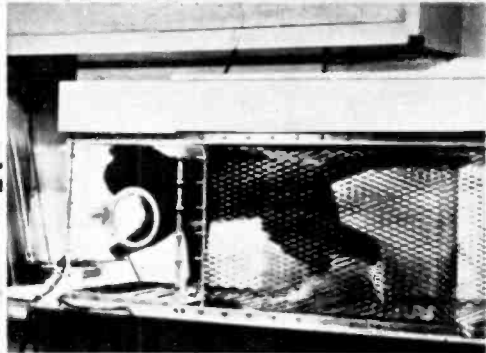


Diagram at right shows the two major elements of the research gear. Cat must cross pain source to get at food. Voltages are carefully controlled and all reactions recorded.



Cat places his paw on lever which drops a piece of meat into pan at other end of cage. A smart and hungry animal can learn this trick in less than a day. They learn while wired.

Cat below has crossed painful grid to get at meat. If pain is too great, he renegs. When stimulus is sent into brain, he will cross a much "hotter" grid than he would without stimulus.



FROM HEATH . . . MORE NEW HOBBY KITS!



AD-10 \$33.95

STEREO RECORD PLAYER KIT (AD-10)

Made by famous Garrard of England to superb specifications. "Plug-in" cartridge feature. Rubber matted heavy turntable is shock-mounted, and idler wheels retract when turned off to prevent flat spots. Powered by a line-filtered, four-pole induction motor at 16, 33 $\frac{1}{2}$, 45 and 78 rpm. Supplied with Sonotone STA4-SD ceramic stereo turnover cartridge with .7 mil diamond and 3 mil sapphire styli. Assembles in minutes; mechanism and vinyl covered mounting base pre-assembled, arm pre-wired. With 12" record on table, requires approximately 15" W. x 13" D. x 6" H. Color styled in cocoa brown and beige. 10 lbs.

Mechanism Only: Less cartridge, base and cables. Model AD-30, 8 lbs., \$22.95



AA-50 \$79.95

HI-FI RATED 25/25 WATT STEREO AMPLIFIER-PREAMPLIFIER KIT (AA-50)

A complete 25/25 watt stereo power and control center (50 watts mono) . . . 5 switch-selected inputs for each channel . . . new mixed center speaker output . . . stereo reverse and balance controls . . . special channel separation control . . . separate tone controls for each channel with ganged volume controls . . . all of these deluxe features in a single, compact and handsomely styled unit! Five inputs for each 25 watt channel are provided: stereo channel for magnetic phono cartridge (RIAA equalized); tape head input; three high level auxiliary inputs for tuners, TV, etc. There is also an input for monophonic magnetic phono cartridge, so switched that monophonic records can be played through either or both amplifiers. The automatically mixed center speaker output lets you fill in the "hole-in-the-middle" found in some stereo recordings, or add extra monophonic speakers in other locations. Nearly all of the components are mounted on two circuit boards, simplifying assembly and minimizing possibility of wiring errors. Handsome cabinet features new "visor" effect, with vinyl-clad steel cover in black leather-like texture with gold design. 30 lbs.



AA-20
\$34.95



AA-30 \$45.95

ECONOMY PREAMPLIFIER KIT (AA-20)

Although these two new Heathkit models are designed as companion pieces, either one can be used with your present stereo system. The preamplifier (AA-20) features 4 inputs in each stereo channel (RIAA "mag" phono, "xtal" phono, and two auxiliary inputs). A six-position function selector switch gives you instant selection of "Amplifier A" or "Amplifier B" for single channel monophonic; "Monophonic A" or "Monophonic B" for dual channel monophonic using both amplifiers and either preamplifier: "Stereo" and "Stereo Reverse". Self-powered. (AA-20) 8 lbs.

HI-FI RATED 14/14 WATT BASIC STEREO AMPLIFIER KIT (AA-30)

Two 14-watt high fidelity amplifiers, one for each stereo channel, are packaged in the single, compact, handsomely styled amplifier (AA-30). Suitable for use with any stereo preamplifier or with a pair of monophonic preamplifiers, it features individual channel gain controls, speaker phase reversal switch and convenient pilot light. Output accommodates 4, 8 and 16 ohm speakers. Handsome satin black expanded-metal cover, gold colored chassis. (AA-30) 21 lbs.



ORDERING INSTRUCTIONS

Fill out the order blank below, giving us your name and address in the space provided at right. Include charges for parcel post according to weights shown. Express orders are shipped delivery charges collect. All prices F.O.B. Benton Harbor, Mich. A 20% deposit is required on all C.O.D. orders. Prices subject to change without notice. Dealers and export prices slightly higher.

QUAN.	ITEM	MODEL NO.	PRICE

Ship via Parcel Post Express C.O.D. Best Way

FREE CATALOG

Describes over 150 different and exciting kits in Hi-Fi, Test, Ham Radio, Marine and Hobby fields. Send for yours today!



HEATH COMPANY Benton Harbor 39, Mich.

Please send my free copy of your complete catalog.

NAME _____

ADDRESS _____

CITY _____ ZONE _____ STATE _____



first of a series designed to teach the fundamentals of electronics . . .

EK-1
\$19.95

EDUCATIONAL KIT (EK-1)

Youngsters and oldsters alike will find this kit a priceless introduction into the wonderful world of electronics. Now, at less than the cost of several standard textbooks on the subject, Heath offers a complete basic electricity course, resulting in a finished test instrument of a thousand and one uses. The EK-1 is a combination kit and text-workbook designed to teach the principles of voltage, current, and resistance—the basic “yardsticks” of electronics to students of junior high level. Adults also will find the project beneficial as a beginning or refresher course in electronics. When finished with the project the student will have learned the theory and construction of direct current series and parallel circuits, voltmeter, ammeter and ohmmeter circuits and the application of ohms law to these circuits. The completed meter will then be used to verify ohms law and the maximum power transfer theorem, one of the most important theorems in electronics. The finished kit, a practical volt-ohm-milliammeter, may be used to make measurements of voltage, current and resistance in a wide variety of applications.

Procedures for checking home appliances and automobile circuits are included with the kit. The EK-1 will serve as a prerequisite to following Heathkit Educational Kits. Get started NOW in this new and exciting series. 4 lbs.

XR-2P
\$29.95
(6 lbs.)



XR-2L
\$34.95
(7 lbs.)

6-TRANSISTOR PORTABLE RADIO KIT (XR-2 series)

Dependable portable entertainment wherever you are—wherever you go! Choose the gleaming, two-tone molded plastic model or the handsome simulated leather-and-plastic combination—both feature a gracefully curved grille in smart beige plastic. The XR-2P complements the handsome grille with a mocha colored case of high-impact plastic, while the XR-2L encases the grille in sun tan color Sur-o-Lon simulated leather. Vernier tuning control gives you smooth, precise station selection. Six Texas Instrument transistors are used for quality performance and long life; a large 4" x 6" PM speaker provides “big set” richness of tone. Ready to play after simple assembly—transformers prealigned. Six flashlight batteries used for power (500-1000 hrs.) (batteries not included).

HW-19 (10 meter)
HW-29 (6 meter)
\$39.95



10 & 6 METER TRANSCEIVER KITS

Complete ham facilities at low cost! Ideal for beginning and veteran hams for “local” net operations. Transmitter and receiver are combined in one easy-to-use instrument. Features neat, modern styling, press-to-talk transmit/receive switch, built-in AC power supply, variable gain control and built-in amplifier metering jack. Operates mobile using vibrator power supply. Microphone and two power cables included. Styled in mocha and beige. Less crystal. 10 lbs.

Vibrator Power Supplies: VP-1-6 (6v.), VP-1-12 (12v.). 4 lbs. kit; **\$8.95** ea., Wired; **\$12.95** ea.

ORDER DIRECT BY MAIL OR SEE YOUR HEATHKIT DEALER*

*The convenience of Local Heathkit Sales and Service costs but a few dollars more.

Radio's Most Exciting Frontier

Continued from page 28

much interference superimposed on them, reach both antennas at the same time. But because the feeding systems are of different lengths, the signal from the nearer antenna reaches the receiver first. The time-lag between reception of noisy signals from the two antennas creates an interference pattern. Waves from the farthest antenna have their crests positioned slightly behind the peaks of those from the nearest antenna. This causes the two waves to cancel partially, leaving a residual signal that is much sharper—and thus more easily identifiable as coming from a specific source in space.

Dr. John Draus, director of the Ohio State Radio Observatory at Columbus, says: "There are so many terrestrial noises that can be mistaken for space-signals—and so many noises in space that can be misidentified—that we never take it for granted that we have signals from the planet Jupiter, even when our antenna is pointed at Jupiter with apparently extreme accuracy. We usually record the signals over many months. If results are consistent, we know we have Jupiter. If another radio observatory verifies this kind of signal at those frequencies and times independently, we feel a lot better."

This revolutionary electronic instrument—the radio-telescope—is simple in concept: a reflector, an antenna; and a radio receiver. Its refinements, however, are complex. In every case a reflector of one shape or another captures radiations and focuses them on an antenna system that feeds a receiver.

By 1962, the mountains of West Virginia will shelter a U.S. Navy radio-telescope whose reflector will be approximately the size of New York's Yankee Stadium—a diameter of over 600 feet. It will be steerable up-and-down, 180 degrees from horizon to horizon and 360 degrees around to cover the entire visible sky. Its field of view will be within a tiny fraction of a cubic degree of space and its gain, or sensitivity, will be about six times greater than the

present radio giant at Jodrell Bank in England. For astronomical purposes, it is expected to record radio signals from the outer absolute limit of the physical universe, and would be in a position to check on some of Einstein's famous calculations.

Before the giant Navy radio telescope is completed at Sugar Grove, West Virginia, however, an even bigger giant will already be operating in Puerto Rico. This is the 1,000-foot-diameter parabolic dish of Cornell University's new Space Research Center. Like the Navy's dish, it will be used both for transmitting (radar) and receiving. Its work will be purely analytical—defining the nature of the solar system and the universe. It will not be able to resolve frequencies much higher than 400 mc.

Sharp tuning at higher frequencies than this—in the case of big antennas—requires a driving element mounting of incredible stability and an accuracy of the shape of the antenna's parabola that must be measured in micrometers. Cornell's super-dish is designed for a tolerance of two inches. At 400 mc and lower, it will be extremely efficient. The longer the wavelength (lower the frequency), the less critical does the surface shape of a radio-telescope become.

New applications of radio telescopes are exciting and almost endless in possibilities. Using an 84-foot "dish" for transmission, the Air Force Cambridge Research Center in Massachusetts has been in constant communication with Jodrell Bank in England. This may not appear spectacular—except the transmitted signals were sent and received by way of the moon! The messages were bounced off the pockmarked, dusty surface of our natural satellite to create a reliable intercom system between the United States and England, while at the same time it provided a precise measurement of the moon's distance from earth. It's part of a series of experiments to develop radio-telescopes for navigational use on space ships. The idea is that a space crew could locate their destination—the moon or a planet—and guide themselves there with microwaves bounced off its surface. ●

All About Range

Continued from page 59

than an antenna tower, it does not increase the overall height of the man-made structure by more than 20 feet. (See Part 19, FCC Regulations, available from the Supt. of Documents, U. S. Government Printing Office, Washington 25, D. C.)

Vertical polarization of CB signals is just fine, except for a slight "catch." The chief source of radio noise at CB frequencies is that generated by the spark in the ignition system of automobiles. And guess what? It's mostly vertically polarized, and your vertical antenna will receive these noises with surprising and annoying clarity. In order to get as much distance as possible, the mobile CB'er must take steps to cut down on this interference. Ignition noise can cut the station's effective communication range down to the point where you would probably be better off shouting. A "hash coil" is a specially-designed capacitor which may be connected to the output of the auto's generator. These can be obtained from most electronic or automotive supply houses. Static eliminators, springs which go inside the car wheel's grease caps, will cut down on interference caused by static electricity pickup by the tires. Resistor spark-plugs also have proven helpful.

Now let's look at the transceiver itself. Dual conversion superhets have checked out very well on Citizens Band. The sensitivity of the receiving portion of the transceiver generally shows up on the manufacturer's specification sheets as "microvolts." The lower the number, the better the receiver. You might also look for receiver bandwidth (in kilocycles). The lower the number the less chance there is of receiving interference from strong stations on adjacent CB channels.

Since almost all CB transceivers have the same five watts input to the final amplifier of their transmitter, and all have roughly the same power output, range depends to a great extent on getting as much radio energy as possible from the unit into the antenna. When

working with CB's low power, wasting even one watt can weaken your signal to the point of making it useless. Never use 300 ohm twin-lead TV wire for a CB antenna lead-in. Use only coaxial cable of the proper impedance, that suggested by your unit's manufacturer. Even when your coaxial cable is of the proper impedance, you must be concerned with "standing wave ratio," which is the amount of mismatch between the signal and the lead-in. The standing wave ratio is equal to one when the line is perfectly matched. There are several reasonably priced meters available in kit form for checking your "swr" and you may have to trim the length of your lead-in to get a proper match. A simple antenna tuning indicator that you can build was described in the June 1959 issue of *EI*. Incidentally, you need a first or second class phone or commercial FCC license before you can make some of these adjustments. Better check the FCC regulations (Part 19, 71C).

Whether you can work one mile or 30 miles depends on all the above mentioned variables. Now you can see how difficult it is to make a definite statement of fact regarding how far you can talk on CB. In the country, with fairly level terrain, 15 mile range between mobile units is not uncommon. CB communications over water should span 15 miles or your units should receive a thorough going-over by a qualified communications man. 📡

How An FM Tuner Is Made

Continued from page 83

Last stop was the service department where the inevitable question was: "What's the major cause of tuner disservice?" Defective tubes and, to a lesser extent, bad parts were blamed. But ruling out components, the service people claimed that three factors comprised the basis for the greatest amount of returns: owner doesn't read the instruction manual; attempts to align the tuner with inferior test equipment; and improper antenna orientation by the user. 📡

Electronics Fights Pain

Continued from page 107

group of observers in the laboratory.

The psychiatrist, Dr. Glen Duncan, hopes this cat will give medical science an insight on pain and he is employing electronics in a unique manner to investigate the strange relationship between pain and awareness of pain (consciousness).

Scientists have long known that a certain part of the brain called the "septal nuclei" is concerned with consciousness. When this brain tissue is completely removed from an animal, the animal no longer has any sensation of pain. In fact, the animal acts more like a vegetable than an animal. It seems to be entirely unaware of anything that's happening. Applying alcohol or drugs to this part of the brain reduces the animal's sensitivity to pain. This is the reason why some intoxicated persons can injure themselves, yet feel no pain.

Dr. Duncan believes it may also be possible to make an animal less sensitive to pain by stimulating the septal nuclei with an electrical pulse. The effect of such a stimulus would partially conceal the pain sensation in the brain.

In practice, a delicate operation must be performed to plant a thin electrode in the cat's septal nuclei. Fine plastic tubing is used to insulate the electrode from other parts of the brain through which it passes. Four metal screws are also set into the animal's skull and wired together to form an electrical ground.

The stimulus producing circuit consists of an ordinary filament transformer connected in series with a rheostat and the electrode in the cat's brain. Unrectified low voltage current is used because it seems to be more effective than direct current and doesn't injure brain tissue. The voltage of the stimulus varies from test to test, but averages 3.5 volts. Lower voltages have little or no effect on the brain and higher voltages tend to throw animal into a convulsion.

A lever operated switch is placed at one end of the long cage. At the other end is an empty feeding pan. Mounted

above the pan is a machine that automatically drops a piece of meat when activated by the lever. A hungry cat soon learns to press the lever in order to receive his tasty tidbit.

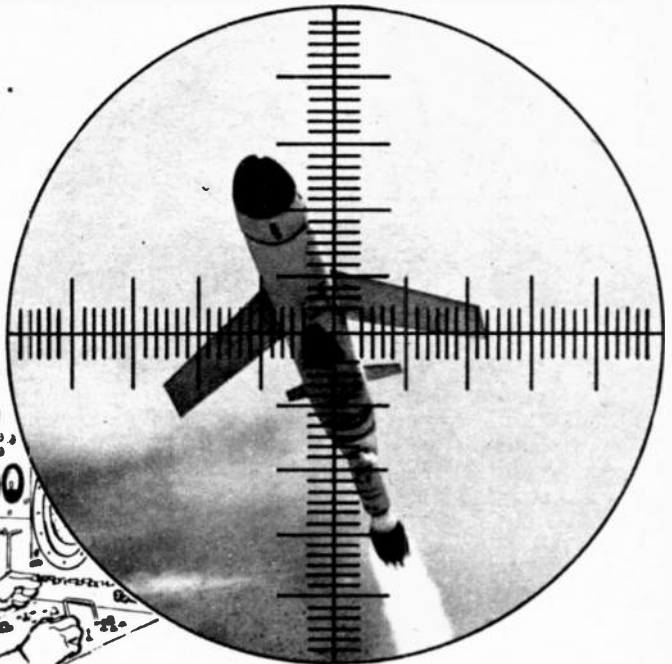
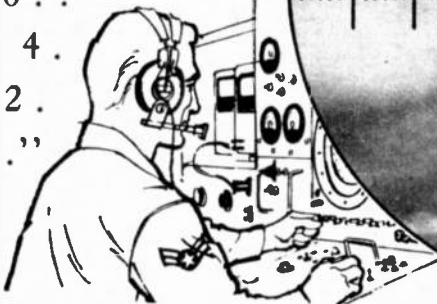
Meanwhile, an electronic source of pain in the form of a grid is placed in the center of the cage. The cat must pass it to get at the food. When the cat steps on a number of alternately charged, parallel electrodes connected to the secondary of a step-up transformer, he receives a shock. Although painful, the shock is harmless because of the high resistance of the circuit.

Once the cat is "educated," he is ready to tell us how much pain he can stand. The psychiatrist sets the grid at 100 volts. The cat feels a slight tingle and speeds up as he crosses the electrodes to get to the meat. Voltage is increased to 200 volts and the cat gets an unpleasant shock as he crosses the electrodes. Nevertheless, this doesn't stop him. With the shock voltage at 300, the cat hesitates, then attempts to jump over the pain source. That's all for him. With the possibility of receiving a 400 volt shock, the cat decides he'd rather stay hungry.

Now we will see if the cat is less sensitive to pain when his brain is being stimulated through the thin electrode. But first, we must give him a few minutes rest. The psychiatrist turns off the voltage on the pain source electrodes and convinces the cat that it is once again safe to cross the grid to the meat. Soon the cat is again crossing the grid without apprehension and once again the psychiatrist applies 100 volts to the pain source. The cat crosses. Then 200 volts. The cat runs across. Raising the potential to 300 volts, the psychiatrist simultaneously sends an electrical stimulus into the cat's brain. Instead of attempting to jump over the grid, the cat calmly walks across without the least bit of hesitation! Even a 600 volt shock has no noticeable effect on the animal.

Hundreds of similar experiments are being performed in an effort to amass evidence related to the possibility of using electrical stimulation as a safe, practical method of at least partially eliminating pain. ●

“All personnel . . .
 clear the firing area
 stand by for
 countdown
 minus 10
 . . . 9 . . . 8
 7 . . . 6 . . .
 . 5 . . . 4 . . .
 3 2 . . .
 . . . 1 . . .”



YOU MAY HANDLE A SITUATION LIKE THIS...

If you measure up to the Aerospace Team

A man in this situation requires cool judgment and an aptitude for advanced technical training. This is the kind of man who can measure up to the qualifications of the U. S. Air Force. He is the kind of man who can build a career in the Aerospace Age that will be meaningful and rewarding.

Are you that man? As a trained and experienced Air Force technical specialist, you

will have the opportunity to work with the intricate equipment of the Aerospace Age—the age of air and space travel. You will enjoy steady advancement and solid security. And you will be superbly prepared for the future.

If you would like to learn more about the many unique advantages that go with a career in Air Force blue, fill in and mail this coupon today.

U.S. AIR FORCE

There's a place for tomorrow's leaders on the Aerospace Team

PASTE COUPON ON POSTCARD AND MAIL TO:

Airman Information, Dept. ME05, Box 7608, Washington 4, D. C.

Please send me more information on my opportunities in the U.S. Air Force. I am between the ages of 17-34 and reside in U.S.A. or possessions.

Name _____

Address _____

City _____ Zone _____ County _____ State _____

Stereo Console

Continued from page 43

treatment of the speaker compartment, no scientifically designed speaker enclosure and little attempt to isolate the speakers to avoid mechanical feedback.

Amplifiers similarly made an unfavorable impression, having relatively few tubes, crowded chassis, and puny output transformers. This latter situation was found in cheap and expensive consoles alike. Good hi-fi amplifiers must of necessity use large transformers with grain-oriented laminations for clean response at low frequencies. Indeed, listening tests revealed uncomfortably booming bass responses in some consoles indicative of poor amplifier response as well as poor speaker baffling.

Tone controls, regardless of their fancy labels, provided less actual control over the sound than the *least* you would expect from any component hi-fi amplifier or preamplifier. An extreme example was a Steelman model, priced just under \$100. This unit had a single "tone control" that was supposed to handle both treble and bass for both channels.

The most elaborate looking control panels were found on the imports. The exotically-labeled knobs and switches all worked well enough, but it was hard to decide just what they did. Some seemed to duplicate or cancel the others. Some of their markings ("voice," "orchestra," etc.) seemed arbitrary. And for all the gloss and gimmickery, there was no provision for accepting external program sources such as tape, tuner, etc.

All the consoles, regardless of price, used some kind of four-speed automatic record changer fitted with a crystal or ceramic cartridge. None ran silently. Low-pitched noise was pronounced at moderately loud listening levels. Whether this was simply motor rumble, or rumble compounded with vibrations from the speakers, was hard to assess. But noise there was.

If real, deep bass was missing from the sound of most consoles, so was clean, transparent treble. Highs varied from harsh to an unnatural thickness. The

latter was characteristic of most imports.

All the consoles did provide *something* of a stereo effect, but channel separation lessened as you stepped back from the cabinet. Often the shaky stereo effect was achieved within the limits of an obviously restricted audio response band. In all fairness, the higher priced consoles had less apparent restriction, no match, however, for a component hi-fi system or one of the "component packages" in console form.

Most consoles represent a hash of technical compromises, topped with a frothy crust to appeal to the eye, not ear. An outstanding exception is a console by Stromberg-Carlson—with Garrard changer, Shure cartridge, S-C stereo tuner, dual 12-watt control amplifier and pair of full-range, correctly housed speaker systems. Its price of about \$600 compares favorably with the cost of conventional consoles that offer far less performance.

The big compromise in a console has to do with mechanical feedback. Vibrations from the speaker can be transmitted through the cabinet, sensed by the cartridge, then amplified, and returned to the speaker. A vicious cycle. The way out chosen by most companies is to limit the speaker's bass response. This, in turn, means that everything else can be limited—through the amplifier and back to the pickup. Feedback is licked at the expense of fidelity.

Here's how *EI* finally classified the consoles it examined: Top honors go to the people who put honest-to-goodness hi-fi components in console furniture. Each component carries the name of its proud manufacturer. These consoles are in the same class as a regular component system, with the added cost (average \$75) for the cabinet. They are available in hi-fi stores and some music, furniture and department stores. Lower-priced consoles, down to about \$300, are often compromised acoustically by having the speakers installed in the same cabinet with the other equipment, plus other compromises mentioned above. The foreign imports are a better buy in this category than most of those made here. Below \$300, fidelity and stereo were difficult to discern.

NEW! Lafayette 50 Watt Complete Stereo Phono System



LAFAYETTE LA-250A

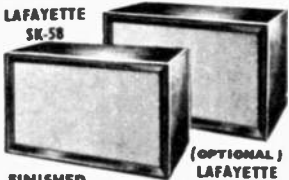
COMPLETE STEREO SYSTEM
184.50



GARRARD RC121/11
WOOD BASE



LAFAYETTE
SK-58



PINISHED
ON 4-SIDES

(OPTIONAL)
LAFAYETTE
ELITOFLEX

This superb system will add a new dimension in living to your home with all the excitement and realism of a live concert. The new Lafayette LA-250A, 50-watt stereo amplifier (25 watts each channel) forms the heart of this outstanding stereo hi fi phonograph music system—the features, versatility and advanced circuitry of this unit are second to none. Also included is the famous Garrard RC121/11 intermix 4-speed automatic record changer with full manual or automatic operation supplied with your choice of stereo cartridges—the new GE VR-22 (.7 Mil) diamond stereo cartridge, Pickering 371-7D (.7 Mil) diamond stereo cartridge, Shure M7D (.7 Mil) diamond stereo cartridge, or the new Electro-Voice 31 MD7 (.7 Mil) diamond stereo cartridge. Supplied with the Lafayette wood base cut for the RC121 in your choice of finishes. These outstanding components are coupled

COMPONENTS

LAFAYETTE LA-250A 50-WATT AMPLIFIER	99.50
NEW GE VR-22 (.7 MIL) DIAMOND STEREO CARTRIDGE ...	24.45
GARRARD RC 121/11 STEREO CHANGER	41.65
LAFAYETTE WOOD CHANGER BASE	3.95
2- LAFAYETTE SK-58 FAMOUS FREE EDGE	
12" COAXIAL SPEAKERS @ 29.50	59.00

REGULAR CATALOG PRICE ~~224.99~~

YOUR GUARANTEED BEST STEREO SYSTEM BUY!
You Save 44.05

with the 2 famous free edge Lafayette SK-58 12" Coaxial speakers with built-in crossover network and brilliance level control. System supplied with plugs, cables and simple instructions. Shpg. wt., 67 lbs.

HF-670 HI-FI STEREO PHONO SYSTEM with choice of cartridge and mahogany, walnut or blond changer base (please specify) 17.45 down 12.00 Monthly Net 184.50

HF-671 Same as HF-670, but with 2 Lafayette Elitoflex Series Bookshelf Enclosures (please specify finish). Shpg. wt., 143 lbs. 22.99 Down, 15.00 Monthly Net 247.50

HF-675 Stereo AM-FM-Phono System. Same as HF-670 but including the new Lafayette LT-50 stereo tuner. Shpg. wt., 85 lbs. 28.75 Down, 17.00 Monthly Net 299.50

LAFAYETTE'S FREE CATALOG!

308 GIANT SIZED PAGES

The Complete Catalog Featuring
"The Best Buys In The Business"



FOR THE NEWEST AND FINEST IN
STEREOPHONIC HI-FI EQUIPMENT AND SYSTEMS

- TAPE RECORDERS ● PUBLIC ADDRESS SYSTEMS
- AMATEUR EQUIPMENT ● INDUSTRIAL SUPPLIES
- MINIATURE COMPONENTS ● RADIO & TV TUBES AND PARTS
- EXCLUSIVE LAFAYETTE TRANSISTOR & HI-FI KITS

Send for Lafayette's FREE Catalog—the most complete, up-to-the-minute electronic supply catalog crammed full of everything in electronics at our customary down-to-earth money-saving prices.

Leaders in Hi-Fi

The most complete selection and largest stocks of hi-fi components and systems—available for immediate delivery at the lowest possible prices. Save even more on Lafayette endorsed "best-buy" complete systems.

NEW YORK
100 SIXTH AVENUE
NEW YORK 13, N. Y.

JAMAICA
165-08 LIBERTY AVE.
JAMAICA 33, N. Y.

BOSTON
110 FEDERAL ST.
BOSTON 10, MASS.

NEWARK
24 CENTRAL AVE.
NEWARK 2, N. J.

PLAINFIELD
139 W. 2nd ST.
PLAINFIELD, N. J.

FREE!
308 GIANT
SIZED PAGES

CUT OUT
AND PASTE
ON POST
CARD

LAFAYETTE RADIO
P.O. BOX 222
JAMAICA 31, N. Y.
DEPT. E1E-6

Name.....
Address.....
City..... Zone..... State.....



Transistor Tester

Continued from page 50

the handle) controls a large current flow (flow of water, for example). One of the measures of quality of a valve is how leaky it is, the higher the quality the less leakage. This analogy carries over directly to transistors, the current leakage being a very important measure of transistor quality. Basically, leakage current is the current that flows in the output (collector-emitter) circuit with no signal applied to the input (base-emitter).

Some leakage current is inherent in all transistors, resulting from the existence of free electrons in P-type material and holes in N-type material. However all *very* leaky transistors should be discarded. The transistor tester determines the extent of leakage by removing the input source from the transistor and by monitoring the resultant collector current on a meter. An average audio transistor should have a leakage of a few hundred (or less) *microamperes*.

If all new components are used the finished tester should cost about 15 dollars.

The new moderately priced "edge-wise" meter movements were used, but since these meters are only available in an 0-1 ma movement, a shunting system was incorporated to extend the range of the collector circuit meter M2. A toggle switch (SW4) chooses a multiplication factor of 10 or 20, thus making it possible to determine the current gain of transistors whose beta values range from 10 to approximately 150. If you desire you can dispense with this and replace the meter and shunt with a standard 0-20 or 0-25 ma meter.

A standard transistor socket was mounted on unit's front panel for common audio and "entertainment" transistors, while three binding posts provide a means of testing types with other basing arrangements.

After completing the tester, if you have used the shunted 0-1 ma meter for M2, a simple meter calibration test must be performed. With no transistor in the socket, turn the unit "on," throw the

function switch (SW2) to *leakage*, and with the selector switch S1 in either NPN or PNP position, short binding post *E* to binding post *C* with a piece of wire. With multiplier switch SW4 in the X10 position, reading on Meter M2 should be 0.1 ma.

This same procedure can be used to test the battery at periodic intervals. As long as the battery is serviceable the meter should read around 0.1 ma. ●

Testing Procedure

Now that the tester is completed, try the instrument on a spare transistor. Plug the transistor into the socket if it fits. If not, check the lead configuration in one of the many available transistor manuals, and connect to the binding posts, directly or with leads.

Set the selector switch (SW1) to the appropriate position, either NPN or PNP.

Set scale switch SW4 in the X20 position. (If, during the beta test, the meter deflection is small, switch to the X10 position.)

First flip the function switch SW2 to "Leakage," then turn the power on (SW3). There should be almost no deflection of M2. If there is a slight deflection (very much less than 1 ma) the transistor is leaky, but if the meter reads 1 ma, the transistor is "shorted" and should be discarded.

If the transistor passes the "short" test press the pushbutton switch PB and read the actual value of leakage current on M2.

Now, flip SW2 to "Gain" and vary base circuit variable resistor R4. Read the base-emitter current on M1, and the corresponding collector-emitter current on M2. The current gain can be calculated by dividing the value of the Collector current by the value of the Base current. Correct values of beta will be found in manufacturers' specifications, catalogs, and transistor manuals.

TV Booster Makes TV Sets Work Better

Improve TV reception! Our wonderful new device can improve reception for many TV sets. For the first time you can enjoy really high class viewing at really low cost. This wonderful new device called **TV BOOSTER** will cost you nothing to run. No operating expenses whatsoever. Uses no electricity. Completely safe and it never wears out. Once applied you never have to see or touch it again. For the rest reception you've ever seen at next to no cost, we guarantee greatly improved results. Stations in your viewing area can be better seen and you'll get the clearest pictures you have ever dreamed possible sold on money back guarantee!

Give Your TV Set a Boost

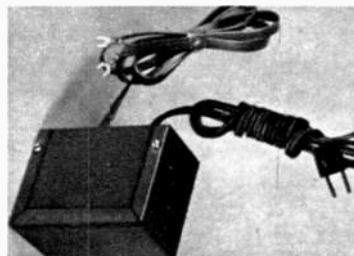
You spent a fortune on your set and are spending even more repairing it. Every single year your TV repair bill gets larger. Every single year your reception gets worse, and worse, and worse. Is this a vicious cycle? No! Too often it's the fault of your TV antenna! If it is indoors, you probably have a **cheap** three-foot long rabbit ears antenna. With the two three-foot long pieces of wiring sticking out unsightly like a rabbit's ears. If you own your own home or live in an apartment you probably have a so-called large antenna on top of your roof. And so what happens? Along comes a storm and down comes the poor antenna, after the storm you turn on your set and the whole mess with hazy pictures is back again maybe worse! It must give you the results you want or your money back! We offer a money back guarantee so you have nothing to lose—and only better TV reception to gain.

Start Getting Maximum Pulling Power From Your Present TV Antenna with **TV BOOSTER** or Your Money Back

It works on any year, make or model TV set ever made. We guarantee you must be 100% satisfied or you get every cent back! It must improve your TV reception or your money back. Works best primarily in metropolitan areas.

Amaze Your Family With Super TV Reception

To connect the **TV BOOSTER** to your set takes only about 2 minutes and a screwdriver. You don't even get your hands dirty. You simply plug it into the nearest electric socket and connect its wires to your set and it's connected **forever**—anyone can do it. Just unscrew your present antenna wires. Slip on the wires of **TV BOOSTER** and plug in its cord. Use your TV antenna and your **TV BOOSTER**. Now turn on the weakest channel, try reversing the plug and leave it in the socket in the way you get the clearest brightest picture. That's all there is to it! Other channels should show you an improvement from pictures you have seen before—you will enjoy better sound, and more living pictures than you have ever seen before. You'll begin to enjoy living TV better than you've ever dreamed possible or you get every cent back. Try it—you are the sole judge. Your money back if not thrilled with results.



From The Advancements In Electronic Research Improved TV Reception For You

Now with the latest developments of Electronic Research comes breathtaking TV reception—Living TV so wonderful you'll say you can't believe your eyes. Send today for the **TV BOOSTER** that will improve all television sets and turn them into Living TV. **TV BOOSTER** is sold only by mail and is not sold in stores. Don't delay—try it on our money back guarantee—send for it Today. Mail Coupon Now.

**TV BOOSTER CO. Dept. 207
403 Market Street
Newark, New Jersey**

Rush my **TV BOOSTER** to try at your risk. I must be 100% satisfied or I can return it after a full week's trial and get my money back—I am to be the sole judge. I enclose \$4.95 cash, check or M.O., send postage prepaid (I save up to 75c postage by sending full payment with my order.) I will also receive a written and dated guarantee with my order and I must be delighted with the reception of every single channel in my area or I get my money back.

I enclose \$5.98 send Deluxe Model.

NAME

ADDRESS

CITY..... STATE.....

Continued from page 63

is directly coupled to the control elements of a 6AF6 electron-ray tube. The amount of current flowing through the 6C4 is set initially by R1 until the shadow in the electron-ray tube just closes. If, now, the bias on the 6C4 should become slightly positive, the current flow in the tube will rise, the plate voltage will decrease, and the shadow on the screen of the 6AF6 will open.

In operation, the tube under test has all its elements, with the exception of the control grid, given a positive potential of 50 volts. The grid of the test tube is returned to ground through R2, a 10-megohm resistor. If there is any gas or grid contamination in the tube being checked, current will flow from grid to plate, through B+ to ground and back to the grid through R2. The voltage developed across R2 by this current will provide a positive potential for the 6C4. The result will be an opening of the shadow of the electron-ray tube.

The value of R2 was chosen here so that control grid leakages of 100 megohms or less will open the eye shadow.

These sensitive indicators of gas, leakage, or grid contamination may be packaged separately, as shown in Fig. 4, or they may be included as part of a regular Gm or emission type checker. Sometimes, as in the Sencore unit, the instrument will perform other useful tests (such as checks for leakage in capacitors, leakage between heater and cathode, and filament continuity).

Filament Checkers

Another useful device is a filament checker. This is a quick-test device designed to reveal in short order whether the filament in a tube is intact (i.e., continuous) or whether it is open. When tubes have their filaments wired in parallel in a receiver, an open filament is quickly detected by a dark tube or a cold one. However, when tubes are connected in series, an open filament in any tube will automatically cause all of the tubes in its string to go out. The problem now is: "Which one is bad?"

There are several ways of tackling this problem. One is to pull each tube out in turn and, with an ohmmeter check the continuity between its filament terminals.

In a filament checker designed specifically for this purpose, the test for an open filament is made by simply plugging the suspected tube into an appropriate socket. If the filament is intact, the neon bulb goes out; if the filament is open, the bulb remains lit.

The circuit for the filament checker shown in Fig. 7 is illustrated in Fig. 6. Seven, eight, and nine-pin tube sockets are available plus a socket designed for a cathode-ray picture tube.

An NE 2 neon bulb is also connected across the AC line and, in the absence of any tubes, will light up. As soon as a tube with a good filament is inserted, a short is thrown across the NE 2 and it is extinguished.

Before we close this discussion on tubes, mention might be made of another test, known as a "life test," which is found in some tube checkers. The purpose of this test is to get some indication of the probable life of a tube within the near future. That is, can we expect the tube to continue operating satisfactorily, or is its emission destined to fall off shortly?

Several different approaches are employed. One method is to reduce the filament voltage on the tube, say from 6.3 volts to 5 volts, and note whether this has any marked effect on the Gm reading. If the heater is providing a satisfactory number of electrons, so that a full space charge is being developed, then a nominal voltage decrease should have little noticeable effect. However, if the heater is just barely emitting the required number of electrons, the reduction in filament voltage will cause the Gm reading to decrease by a sizable amount. Such a tube can be expected to drop below a satisfactory operating level sometime in the next few months.

Still another approach to a life test is to suddenly open up the heater circuit. This stops the heating effect. If the meter needle seems to hang momentarily in its position and then decrease slowly to zero, enough electrons are

**FREE
HI-FI
TEST
RECORD
IN
THE
JUNE
ISSUE
OF EI***

*** ELECTRONICS ILLUSTRATED**
On Sale At Your Newsstand • 35¢

being supplied by the heater or filament. However, if the sudden opening of the heater circuit causes the meter needle to drop immediately, without the momentary hesitation, then the reserve emitting capability of the heater is poor and it may fall below a useful operating level in the foreseeable future.

It is important to note that any "life test" is, at best, a guess as to the probable remaining life of a tube.

Transistorized Mike

Continued from page 33

is the harshly distorted and noisy reproduction often encountered in the cheaper microphone. Response is fairly directional and therefore the mike is relatively insensitive to acoustical feedback.

Essentially the microphone consists of a miniature $2\frac{1}{2}$ " permanent magnet speaker followed by a one transistor amplifier. In theory, the speaker alone could be used as a microphone. Unfortunately, the audio power output of the speaker is low, but of far more serious consequence is the problem of matching the very low speaker impedance (10 ohms) to the very high input impedance (10,000 ohms or more) of most audio equipment. In such a system the mismatch is so great that for all practical purposes no signal would flow. To the rescue comes the transistor. The transistor is one of the best impedance transforming devices ever invented. In addition, it is also an amplifier. The low speaker impedance is easily matched to the low input impedance of the grounded emitter transistor. The output impedance of this configuration is very high. Also, along the way, the signal power is increased by more than a few decibels.

As mentioned previously, the mike is intended to match the high input impedance characteristic of most amplifiers, preamps, tape recorders, etc. Occasionally, however, audio devices are designed with low input impedance. This microphone may easily be modified so as to have a low output impedance. Simply remove the collector load resis-

tor 8.2K (R4) and connect in its place the primary leads of a transformer such as an Argonne AR-107 which has an output impedance of 200 ohms.

Construction

The complete unit is contained in a MS-315 Lafayette miniature speaker baffle. The MS-315 comes with a miniature phone jack which will serve as the microphone output. On the side panel occupied by the jack drill a $\frac{1}{4}$ " hole and mount the push button switch. In the center top panel of the baffle drill a $\frac{3}{16}$ " hole. This hole serves as an acoustic port which improves the low frequency response of the microphone. Before mounting the speaker it is damped to reduce peaks and flatten response. Cement pieces of felt over three of the openings in the speaker frame. Cover the fourth hole with a piece of cardboard (at least $\frac{1}{16}$ " thick) in the center of which a $\frac{1}{8}$ " hole has been made. The speaker is now mounted. Coat the rubber rim gasket with cement. Do not get any cement on the cone. Allow the cement to become slightly tacky and then press the speaker into position in the baffle. Set the baffle aside to dry.

The next step is the construction of the transistor preamp. By careful layout and use of miniature transistor circuit components the amplifier will fit on a $2\frac{3}{16}$ " by $1\frac{1}{16}$ " chassis of perforated phenolic board. The only difficult aspect of the preamp construction is the mounting of the transistor socket. Begin by enlarging two adjacent holes in the board to about $\frac{3}{16}$ ". With long nose pliers break away the board remaining between the two holes. A rectangular slot is now easily shaped with a small flat file (a nail file is fine). The slot is made just large enough for a snug force fit of the transistor socket. All leads and components must be bent down as close as possible to the surface of the board. After all preamp wiring has been completed the whole unit is thoroughly sprayed with a clear plastic spray. Make all of the necessary connections between the preamp, speaker, switch, output jack and battery. Cement the preamp to the side of the baffle, screw down the back cover and the microphone is ready for use.

Remote Reading Thermometer

Continued from page 53

peratures by selecting one or the other of two separate probes.

The thermometer operates on 1½ volts DC and draws very little current, averaging about 15 milliamperes over the temperature range covered. However, to assure long, trouble-free operation, four size "AA" cells were used wired in parallel and these should last at least a year, with moderate use.

The thermistor used for our temperature sensing unit is a plastic impregnated bead unit about the size of a match head. To this unit, we soldered the cable which should be of fairly low resistance; lamp cord will do very nicely. If the environment in which the probe is to be used is very extreme, enclose the thermistor in a plastic tube, such as is used to ship transistors. A thin-wall aluminum tube, like the ones used with high priced cigars, can also serve. In calibrating this unit, we subjected the thermistor to some mild environments directly without any protection, and found that the impregnating compound protected the device. However, the thermistor will definitely crack and give inaccurate readings if it is placed in very hot water.

Calibration

In calibrating the thermometer, it is advisable to first mark a null point on the meter scale. In the Lafayette micro-ampere meter used this is very easily done by removing four small screws on the back of the base plate of the meter and simply lifting off the meter cover. Taking care not to damage the meter needle, the numbers on the meter face are then blanked out with white paint and a permanent narrow slash is painted in the center of the scale.

The unit is calibrated in the following manner: water is boiled (preferably in a pot with a lid) and the thermistor in a protective probe is immersed. The thermistor specified is comparatively sluggish and has a response time of approximately 30 seconds. However, in the calibration procedure it is advisable

NEW-BRIAR PIPE DISCOVERY WILL YOU TEST SMOKE THIS DEMONSTRATOR AT OUR RISK?

Breaking in a new pipe is usually torture, but this "magic-cake" discovery will change all that. A nut sweet cake, specially built into the genuine imported briar bowl, makes this mellow beauty break in like a dream. You'll get dry, clean, sludge-free smoking, because the special construction of this wonderful pipe utilizes the 3 C's of Scientific Smoke Control - Combustion, Condensation and Capillary Attraction.

We've set aside a limited quantity of these imported briar beauties as Demonstrators. The bowl's are "slight seconds" taken out of the regular production line before final smoothing and polishing, but they're guaranteed to smoke exactly like our regular top quality \$2.95 model.

Because we want to make new friends for this sensational new kind of briar pipe, we've written off the cost of these Demonstrators. Send us nothing for the pipe. Please send 25¢ to cover postage and handling.

All we ask in return is your good-will and word of mouth advertising if you like the pipe. Remember, the risk is ours, you can't lose. Sorry, only 1 Demonstrator to a family on this non-profit transaction. (Good in the U. S. A. only.)

PIPE 2/3 ACTUAL SIZE



WALLY FRANK Ltd. Dept. J 117

132 Church Street, New York 7, N. Y.

I enclose 25¢. Send me the Demonstrator Pipe described above. Please Print Name and Address Below.

Landscape your home with
plans and tips from the new
LANDSCAPING AND LAWN IDEAS



Fawcett Book 441 75 cents

HOW-TO:

- Plan or improve your landscape
- Build a new lawn or repair an old
- Plant trees, flowers, hedges
- Build paths, patios and terraces

ON SALE AT YOUR NEWSSTAND

To order direct send 75 cents plus 10 cents for mailing to Fawcett Books, Dept. E1, Greenwich, Conn. Sorry, no Canadian orders.

to leave it submerged in the boiling water for at least five minutes. After this period has elapsed, the "read" push-button (PB) is depressed and the vernier dial is rotated until the meter nulls; in other words, until the needle reads on the center scale marker. The reading on the vernier scale now represents an environment of 212°F. If the null indicator moves to the right of center, temperature in the environment is going up. If the null meter moves to the left of center, the temperature is going down. The amount of temperature rise or fall as shown by the null meter must be determined experimentally. However, it is usually a very sensitive indication with a range of -1°F. to the meter zero mark, to +1°F. to the meter maximum.

The same procedure should be used with ice water, giving a calibration for 32°F. Of course, the device is not entirely linear and five or six intermediate temperature points should be taken before a calibration curve is drawn. Fairly accurate, easily come-by standards include fever thermometers, which give good readings in the 96°F. region. After the meter has been calibrated, the actual calibration chart may be kept nearby or a calibration scale can be glued directly over the vernier.

One word of caution: the read button must only be depressed when a thermistor probe is connected into the bridge circuit. If this rule is not observed, excessive currents through the sensitive meter will damage the movements.

The thermistor has a negative co-efficient of resistance; in other words, its resistance goes down as the temperature of the environment goes up. Components possessing this property have been around for quite a while but the ratio of temperature versus resistance has not been too great. In thermistors, this ratio is enormous, ranging from 1 to 1, to 10 million to 1, in a given unit. In addition, thermistors have a very wide operating range and can be used in environments from -100°C. to over 400°C. They come in various sizes from glass encapsulated beads as tiny as the head of a pin, to washers about the size of a quarter. A wide variety of internal resistances are also available from as low as 10 ohms to as high as 5 million ohms. The smallest thermistor, for example, will dissipate only a few milliwatts while the largest can easily handle more

than a watt. Depending upon the type selected, the response time can be as little as one second or as much as 30 seconds. With this wide range of impressive properties, thermistors are ideally suited for temperature indicating and control devices covering a wide range of environments with a high degree of accuracy.

For those who wish to experiment the Veco Company supplies a thermistor kit for \$5.00 (available from Lafayette Radio, part No. M 168). Among other thermistors, the kit contains a tiny bead thermistor (No. 31A1) which is extremely sensitive and not much thicker than a human hair. This little thermistor can be substituted directly for the larger one used in this thermometer. It has a very rapid response time and is actually able to detect different temperatures due to air currents in a totally enclosed room.

Power-Transistor Intercom

Continued from page 89

pair of odd-sized utility or cigar boxes. In addition, any old 3" or larger PM speaker salvaged from a radio will do—

a matched pair isn't necessary because we are interested in the transmission of voice—not Beethoven's Ninth.

Construction Tips

Mount the transistor amplifier on the back panel of the Master speaker encl-

sure. By using a wood or fiber panel, instead of a metal one, you will be able to mount all parts directly on the surface without using insulating washers.

To mount the transistors, you can use two 9-pin miniature tube sockets. Clip all terminals on the socket except two opposing ones. Plan this so that the mounting flanges of each transistor lines up with the mounting flanges on the socket. Since the shell of the transistor is the *collector*, you can bolt the transistor and socket flanges together with a nut and bolt, which can then serve as an excellent tie point. Terminal strips are used to provide tie points for the resistors and capacitors and to insure rigid mounting.

Two 4-pole, 3-way telephone type lever switches achieve the necessary 5 poles indicated in the schematic diagram. Four poles of one switch are used to connect the speakers; while the other switch is used to apply battery power. Although a 5-pole switch would have been more efficient, this type is difficult to obtain. You can achieve the same purpose by mounting two of the 4-pole types side by side and operating them jointly. You can connect the levers with a piece of tape. Be sure to make wiring connections to the switch terminals before mounting them on the Master unit, for it will be difficult to work within the cramped quarters of the enclosure. Leads from the amplifier to the switches should be at least 6" long and color coded to facilitate circuit tracing.

If you use a metal utility box or meter case for the Master unit, you can mount the switches directly on the case. However, if you use a wood enclosure, make a cutout in the wood to accommodate a square metal strip. You can then mount the switches on the metal strip, and then fasten the strip over the cutout.

CAUTION: Most transistors are extremely sensitive to improper polarity. You can damage them if you accidentally reverse your battery leads. Make certain also that you do not insert the transistors or batteries in the reverse position, for this will be tantamount to altering the polarity. Before operating the unit, R1 must be adjusted so that there will be a 3-volt drop measured

RADIO SHACK FLASH!

Send Coupon for Latest
FREE
ELECTRONICS CATALOG
plus every new issue for 1960



For the newest and best in electronics equipment—stereo, hi-fi, ham radio, tapes—mail coupon today for Radio Shack's latest FREE 312 page catalog. Also get every new edition for next 12 months, Free. Satisfaction guaranteed or your money back. Mail coupon now.

Radio Shack Corp., 730 Commonwealth Ave.,
Boston 17, Mass. Dept. 60E8

Send FREE Electronics Catalog—Also every new issue for 12 months, a full year's subscription Free.

Name _____

Address _____

Postoffice _____

or City _____ Zone _____ State _____



take your
HEADQUARTERS
with you
Regency

**MODEL CB-27 CITIZENS BAND
TRANSCIVER AT ONLY \$124.95**

No operator's examination required for license.

USES: SERVICEMEN, HUNTERS, FISHERMEN, FARMERS, DOCTORS, FREIGHT DISPATCHERS, TRUCK FLEETS, CONSTRUCTION COMPANIES, OIL COMPANIES, BOATS, TAXI OPERATORS, ETC

The REGENCY Model CB-27 is a small (4½" x 6½" x 8¾") Citizens Band Transceiver incorporating features found only in expensive communication equipment.

TRANSMITTER provides choice of two channels for interference-free transmission. Unit comes equipped with crystal for one channel operation. Hand-held microphone with push-to-talk button is included.

The RECEIVER is tunable across the band for maximum flexibility. Features: Double conversion, super-heterodyne design, adjustable squelch, noise limiter, illuminated slide rule dial, AVC, and crystal controlled first oscillator.

Available in two Models—Model CB-27 for use on 115V 60 cy AC, and Model CBM-27 for 12V DC. \$124.95

DISTRIBUTED BY MEMBER COMPANIES

Regency Division, I.D.E.A., Inc.

7900 Pendleton Pike, Indianapolis 26, Indiana

from the collector to emitter of TR1. A 1000-ohm potentiometer or decade box can be used to set R1 for the 3-volt reading and then replaced with the proper value resistor. R4 should be similarly adjusted for the proper 3-volt bias on TR2.

Theory of Operation

Although the circuit is ingenious, it is also simple. Original design honors go to Motorola Inc. Here is how it works:

When the Master's switch is flipped to the *talk* position, the Master speaker is connected to the *talk* circuit (providing a DC path for the base of TR1) and serves as a microphone; while the Slave speaker is connected to the *listen* circuit in its normal capacity as loudspeaker. When the switch is flipped to the *listen* position, the speakers exchange their places in the circuit, and their functions. In other words, each speaker is used either as a microphone or a loudspeaker, depending upon the position of the Master switch. Battery power is supplied in each position through the fifth set of switch contacts, which are strapped together.

The speakers function as microphones by a reversal of the principle under which they normally operate. When you talk into the speaker, the resulting cone movement causes the voice coil to move through the magnetic field of the speaker slug. As the lines of magnetic force are crossed, an alternating current is developed in the voice coil winding which varies with the frequency and intensity of the sound waves. This varying signal is applied to the base of transistor TR1, amplified, and then further amplified by TR2. The voice coil of the loudspeaker in the collector circuit of TR2 reproduces the original sound waves.

Build-It Course—9

Continued from page 39

100% modulation the carrier power rises to an average value equal to 1½ times its unmodulated value. A 100 watt transmitter requires 50 audio watts to achieve full modulation.

Construction

Building the modulator follows the techniques used with previous modules in this series. A perforated board supports all components—except the large electrolytic capacitor C18 and the phono receptacle J1. The illustrations reveal how C18 is suspended from a solder lug by its top lead, which provides support and a chassis ground connection.

Locate the position of T1 on the board and mark off the points (two on each side) where the tabs overlap. File notches where the marks appear. Once the tabs are bent into these notches, the transformer will seat firmly in place.

The various input and output connections on the modulator are brought out to flea clips (or simple wire loops, if desired) where shown in the pictorial wiring guide. Interconnections to other modules will be covered in a future article.

Next month, several power supplies for the Citizens Band rig will be described; in theory and practice.

DC Power Supply

Continued from page 99

Since voltage output of the rectifier-filter circuit will approach peak values when the load is light, the value of resistor R should be determined experimentally with your particular razor. Start with R at several hundred ohms and gradually lower its value until the voltage at the output socket *with the razor plugged in* is about 115 volts as measured on the DC scale of your volt meter.

The small bracket screwed to the front of the unit and the keyhole slot on the rear are optional but they are convenient for wall-mounting of the supply and of the razor itself.

Note: This supply can also be used with small AC-DC motors, drills, etc., with the same procedure used to determine the value of R.

REMEMBER!
HI-FI TEST RECORD IN JUNE E!

Fingertip Switching

Continued from page 31

easy. If not, use a flashlight bulb and battery as a continuity tester. Test across the twin-lead wires to be sure that the two isolation resistors (R3 and R4) are effectively maintaining high resistance between the two legs of the twin-lead and their terminal points. Power may now be applied.

While watching the 2500-ohm relay (RY1), touch one finger across any two adjacent bare spots in the twin-lead. The relay should pull in momentarily, then drop out at once. At the same time, RY2 should rock to a new on or off position. Remove your finger, wait about two seconds, then repeat. For each successive contact, the rocker arm of the relay should shift to its alternate position indicating on-off action.

Keeping your finger bridged across the two wires, observe the thyatron. Its blue glow should normally flash on and off slowly—possibly once or twice per second without triggering the 2500 ohm relay. This model was tested with four different 5823 thyatrons to be sure.

Resistor R1, the selenium rectifier SR, and C2 comprise a DC power supply that serves to charge capacitor C3 to about 150 volts. R1 prevents damage to the rectifier due to line surges and serves, as well, as a fuse in the event that C2 should short-circuit. Capacitor C1 is a line by-pass that stabilizes the system against random triggering by sudden surges in the line voltage.

The voltage across C3 is applied to the anode and cathode of the 5823 thyatron through the coil of relay RY1. Since its control electrode (grid) is normally floating, however, the tube does not conduct and RY1 does not pull in. When the twin-lead conductors are bridged even by the high resistance of the skin, however, the control element is driven momentarily positive by one of the positive cycles of the line voltage, causing it to fire and energize RY1. RY2 is advanced one step by this action, turning the appliance on or off. The thyatron discharges C3 very quickly and extinguishes, allowing RY1 to release.

BRAND NEW TUBES 1/2 PRICE ALL GUARANTEED!

These GENUINE RCA Tubes are all BRAND NEW, individually boxed in original manufacturer's cartons—just as they come from the factory! All are GUARANTEED for 12 full months. Here is a PARTIAL LIST: If you don't see the type you need here, order it. We will ship any RCA Tube manufactured on our sensational 1/2 price offer.

1B3GT	---\$2.90	6C6T	---\$2.45	12BE6	---\$2.15
5A0T	---2.20	8Q6A	---4.15	12BQ6GT/	---
5U4B	---2.10	6J6	---2.80	12CU6	---4.45
6AL5	---1.85	6K6GT	---2.35	12D06A	---4.20
6BD6	---2.15	6SA	---2.05	12SA7	---3.70
6AU6	---2.10	6SN7GT	---2.60	12SK7	---3.40
6AX4GT	---2.65	8U8A	---3.30	12SQ7	---3.15
6BG6	---0.50	6V6GT	---2.15	25Q6GT/	---
6BQ6GT/	---	6W4GT	---2.40	25CU6	---4.60
6CU6	---4.35	6W6GT	---2.65	35W4	---1.40
6C7A	---3.95	12AU7A	---2.45	35Z6GT	---1.85
6C86A	---2.25	12AV6	---1.65	50C5	---2.15
6C06A	---5.80	12BA6	---2.00	50L6GT	---2.40

ONE HALF OFF THESE PRICES Prices Subject to Change

12 MONTH GUARANTEE: All receiving tubes are guaranteed for 12 months from date of purchase. We replace any tube that does not give efficient performance for full 12 months. (Guarantee does not apply to burned-out or broken tubes—but we guarantee safe, intact arrival.) You buy with confidence.

NEW TYPES: EMPIRE will automatically stock all new tubes. If original type is no longer available we will ship the newer, directly interchangeable version. NOTE: When ordering tubes clearly list each tube type. Minimum tube order accepted, \$5.00. Add 50¢ P. P. and handling charge.

FREE: With each order, we send you a complete current list of all RCA Receiving Tubes. On orders of 50 or more tubes, we give an EXTRA DISCOUNT of 10%. Rush your order now to:

EMPIRE MDSG. CO., Dept. E46
140 Marbledale Rd. Tuckahoe, N. Y.

ONE CENT SALE

BUY ONE AT OUR REGULAR LOW PRICE AND GET THE SECOND FOR ONLY 1¢ MORE

CITIZENS BAND TRANSMITTER (27 MC) chassis complete with crystal. \$12.49 each, two for \$12.50.

TRANSMITTER similar to above but with 5 watt RF stage instead of 1 watt. \$14.99 each, two for \$15.00.

CITIZENS BAND RECEIVER chassis tunable through all 22 channels. Complete with audio amplifier. \$9.99 each, two for \$10.00.

AMATEUR BAND TRANSCEIVER (144-148 MC) chassis with dual VHF triodes for walkie-talkie radiophone. \$9.99 each, two for \$10.00.

TRANSCEIVER TRANSFORMER: Mike to grid input and plate to low impedance headphone output. Good for telephone handsets, \$1.99 pair, two for \$2.00.

TELEPHONE HANDSET with push-to-talk switch. \$5.99 each, two for \$6.00.

COILED CORD 4 conductor 11" telephone cord. Extends to over 4 ft. .99 each, two for \$1.00.

KIT OF PARTS for AM-FM VHF radio receiver. Tunable from 80-200 mc. which includes U. S. satellite frequencies. \$6.99 each, two for \$7.00.

TRANSISTOR AUDIO AMPLIFIER gives 50X voltage gain on low level signals. Operates on 1 1/2 volts. \$3.99 each, two for \$4.00.

CONVERTER (crystal controlled) for 27 MC Citizens Band. Adapts any standard broadcast radio to 27 MC band. Tunes all 22 channels. Complete with tubes and crystal. \$14.99 each, 2 for \$15.00.

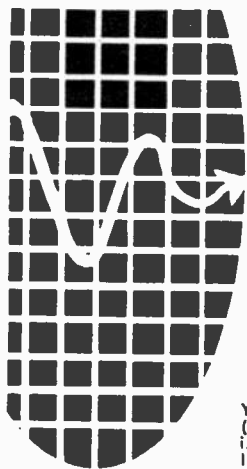
TRANSMITTER CRYSTALS in holders. Assorted frequencies for experimenters. Bag of 10 only \$1.49, two bags for \$1.50.

ALL MERCHANDISE GUARANTEED

Limited Quantity—No Literature or Catalog

Remit in full, include sufficient postage. No C.O.D.'s.

VANGUARD ELECTRONIC LABS. Box 12-EL-5
Hollis 23, N. Y.



ELECTRONICS ILLUSTRATED

Your advertisement can reach this mail-buying audience for only 35¢ per word . . . payable in advance (Check or M.O. please) . . . minimum 10 words. Closing dates are the 20th of 3rd preceding month i.e. copy for the August issue must be in our office by May 20th. Mail to **ELECTRONICS ILLUSTRATED**, 67 West 44th St., New York 36, N. Y. Word count: Zone number free. Figure one word: Name of state (New Jersey), name of city (New York); sets of characters as in key (14-D); also abbreviations as 35MM, 8x10, D.C., A.C.

SAVE MONEY • ORDER BY MAIL

• • • FOR SALE

GOVERNMENT SELLS: Surplus Electronics; Test Equipment; Oscilloscopes; Transceivers; Jeeps; Boats; Aircrafts; Misc.—Send for U. S. Depot Directory & Procedure \$1.00. "Government Surplus Sales," Box 425-EL, Nanuet, N. Y.

MONEY SAVING Prices on tubes, TV, Radio, Transmitting and Industrial Types. New, 1st quality, guaranteed. Top name brands only. Government surplus and commercial test, lab and communications equipment in stock. Sell us your excess tubes and equipment. Unused, clean tubes of all types wanted. Send specific details in first letter. Write for "Green Sheet" catalog 25¢. Barry Electronics Corp., 512 Broadway, (Dept. EI.), WA 5-7000, New York 12, N. Y.

GOVERNMENT SURPLUS—Anyone can buy electronic equipment direct from U. S. Government. Weekly letter tells When, Where and What is being offered. 3 months (13 issues) \$7.00. Government Surplus Sales, P. O. Box 6602EI, Washington 9, D. C.

• • • PRINTING, MULTIGRAPHING, MIMEOGRAPHING

QUALITY PRINTING: Economically priced: Embossed Business Cards \$3.95 per 1,000. Samples on request. Edward Printing Service, 7430 Selwick Dr., Parma 29, Ohio.

100 PERSONALIZED ENVELOPES, 150 Sheets \$2.98. Armstrong, 52724 Frances Road, South Bend 17, Indiana.

• • • EMPLOYMENT OPPORTUNITIES

PRINTING - ADVERTISING SALESMEN. Excellent moneymaking sideline selling Decalomania Name Plates, Advertising Specialties, Sign letters, Automobile initials. Free Samples. "Ralco"—El, Box L, Boston 19, Mass.

• • • BUSINESS OPPORTUNITIES

GROW MUSHROOMS. Cellar, shed and outdoors. Spare, full time, year round. We pay \$4.50 lb. dried. We have 29,000 customers. Free Book. Mushrooms, Dept. 315, 2954 Admiral Way, Seattle, Wash.

VENDING MACHINES—No selling. Operate a route of coin machines and earn high profits. 32-page catalog free! Parkway Machine Corp., Dept. 33, 715 Ensor St., Baltimore 2, Md.

EARN MONEY distributing catalogs. Details, \$1.00. Center Distributors, 149-A Continental, River Edge, N. J.

• • • HI-FI

UNUSUAL VALUES. Hi-fi components, tapes, tape recorders, catalogue; package quotations. Budget Hi-Fi, 83-06c Vietor Ave., Elmhurst, N. Y.

• • • TAPE RECORDERS

LEARN WHILE Asleep with your recorder, phonograph or amazing new "Electronic Educator" endless tape recorder. Details free. Sleep-Learning Research Association, Box 24-EI, Olympia, Washington.

TAPE RECORDERS, Hi-Fi components, Sleep Learning Equipment, tapes. Unusual values. Free catalog. Dressner 69-02 Z 174 St., Flushing 65, N. Y.

HI-FI, RECORDERS. Free Wholesale Catalogue. Carston, 125-G East 88, N. Y. C. 28.

• • • RADIO & TV

STEREO IN your car, book covers F-M converters, etc., \$2.00. Free folder of pocket F-M kits, etc. Eteradio, 650 N. Fair Oaks, Pasadena, California.

CRYSTAL SET experimenters, write Radio Workshop, 2 Village Rd., Pompton Plains, N. J.

DIAGRAMS FOR repairing radios, amplifiers, \$1.00; television \$2.00. Give make, model. Diagram Service, Box 672-EI, Hartford 1, Conn.

15 DISTANCE ONE-TUBE plans—25¢, with Transistor experiments, catalog. Laboratories, 1131-K Valota, Redwood City, California.

• • • BUILD-IT-YOURSELF

"AUTOMATIC GARAGE Door Control" book; complete, clear plans, photos, exploded view, instructions. Standard parts, radio/post control. \$2.00 (guaranteed). RL Books, 5649G Costello, Van Nuys, Calif.

• • • MISCELLANEOUS

IDENTIFY YOUR equipment. 50 decal transfers \$1.00. 3 lines. A&B Services, Box 147A Kittery, Maine.

• • • PERSONAL

LOANS BY Mail. \$50 To \$600 For Any Purpose. Employed men and women eligible. Confidential. 2 years to repay. Write for free loan application. American Loan Plan, City National Bldg., Dept. EI-4150, Omaha 2, Nebraska.

• • • STAMPS & COINS

READ AMERICAN HOBBIEST—monthly. \$1.00 per year. Box 121, Wildwood, N. J.

• • • DETECTIVES

DETECTIVES—WORK Home—Travel. Experience unnecessary. Detective Particulars free. Write, Wagner, 8-125 West 86th, New York 24.

• • • MUSIC

SONGPOEMS AND Lyrics Wanted! Mail to: Tin Pan Alley, Inc., 1650 Broadway, New York 19, N. Y.

ALL TUBES INDIVIDUALLY BOXED . . . UNCONDITIONALLY GUARANTEED ONE YEAR SEND FOR FREE COMPLETE TUBE LIST & ORDER BLANK INQUIRY PUTS YOU ON MAIL-LIST

TELTRON SMASHES PRICES on TUBES for '60!

GIFT OFFER
ONE 6BG6 tube will be shipped FREE with any \$10.00 or more order accompanying this ad.

\$7.50 list value. Bonus Box includes 3 8SN7 tubes & 25 assorted resistors & condensers with each order of \$25.00 or more of receiving tubes and special purpose tubes only.

FREE EICO TUBE TESTER



By popular demand we are repeating this fabulous **FREE GIVE-AWAY**. You get this EICO tube tester kit at \$22.95. **ABSOLUTELY FREE** when you purchase \$199.00 worth of receiving tubes from TELTRON within 60 days. Tube tester may be purchased outright for \$34.95 PREPAID. Send for FREE list of other EICO test equipment & NI FI components that we distribute.

Semiconductors for immediate delivery.

1N34	.49
1N38	.95
1N60	.34
1N65	.49
1N82A	1.00
1N253	4.25
1N256	19.95
1N295	3.50
1N460A	4.60
1N1096	9.00
2N63	3.75
2N130A	2.75
2N329A	40.00
2N484	1.75
2N622	30.00
2N633	1.35

Special-purpose, transmitting and industrial Tubes for immediate delivery.

0A2	.70	807	1.00
2A4G	.75	611A	3.25
2D21	.65	813	9.25
2E26	2.50	833A	40.00
2X2	.75	R66A	1.00
5R4GY1.00	2050	.85	
6J4	1.00	5675	12.25
12A1	.60	5879	1.10
FC27	8.50	6146	3.85
HY95	1.75	6161	34.50

HEAVY DUTY SOLDER GUN KIT, 135 w. gun. Dual spotlight illum. work when gun on. JNCL: wire soldering brush & also make tight twists, reopen old joints, lge. pkg. solder. Prepaid. \$4.99. 3 for \$14.25.

FIBER FUSE CLIPS.....15c ea.
12 for \$1.65
PREPAID
RCA CHEATER CORDS
39c ea.
6 for \$1.95
PREPAID

Complete Outdoor ALL CHANNEL CONICAL ANT. local/fringe area, & elem. ant. with crossbar, 5' seamless mast (alum.), chimney mt. or wall brkt. (state need) 8 standoffs, 50' 300 ohm wire, 3 -2.49, Imm. dl. FOB Harrison, N.J.

SWITCH-TYPE Indoor Antenna
Shipped postage paid. New & position switch for use on UHF, VHF and color sets. Attractively packaged \$2.99, lots of \$12.49.

PARALLEL PICTURE TUBE BRIGHTENER 99c
Series type.....\$1.39

AUTO VIBRATORS
6 Volt 4 Prong Universal.....\$1.59
12 Volt 3 Prong Stancard.....\$1.79
12 Volt 4 Prong Stancard.....\$1.99

NEW LIBERAL TERMS: NO MINIMUM ORDER. FREE POSTAGE ON ALL TUBE & PARTS ORDERS OVER \$5.00 IN U.S.A., APOs & TERRITORIES. 25% DEPOSIT REQUIRED ON CODs. PLEASE SEND APPROXIMATE POSTAGE ON CANADIAN AND FOREIGN SHIPMENTS. EXCESS WILL BE REFUNDED. All picture tubes and outdoor antennas shipped FOB Harrison, New Jersey.

TUBES LISTED MAY BE FACTORY SECONDS OR USED TUBES AND CLEARLY MARKED.

MOST PARTIAL LIST OFTEN USED TUBES

DZ4	.45	6BA8	.45	9UB	.45
1B3GT	.82	6BC5	.45	10DE7	.70
1B5	.51	6BE6	.50	12AB5	.45
1Y4	.43	6BE8	.50	12AF5	.44
1U4	.51	6BF5	.46	12AT6	.44
1U5	.51	6BG5	1.18	12AT7	.37
1X2	.43	6BG6	.51	12AV6	.71
2AF4	.82	6BK5	.51	12AV7	.43
2BN4	1.02	6BK7	.75	12AV7	.58
3AU6	.55	6BN4GT	.78	12AX4GT	.60
3BC5	.43	6BN6	.44	12AX7	.61
3BN6	.58	6BQ6GT	.83	12B4	.85
3BZ6	.90	6BQ7A	.83	12BE6	.46
3C6	.45	6BY6A	.83	12BH7	.46
3DT6	.51	6C7	.95	12BG6	.83
3V4	.51	6CB6	.41	12B6	.48
4BC8	.69	6CG6	.51	12C6	.85
4CB7	.75	6CG6	1.63	12C6	.43
5AM8	.51	6CH6	.44	12C6	.63
5AT8	.64	6CH7	.54	12C6	.59
5AV8	.54	6CJ6	.44	12K5	.46
5BK7	.54	6CK6	.45	12SA7	.45
5BN6	.61	6CE6	.95	12SN7GT	.56
5U4G	.59	6D6	.50	12SQ7	.43
5U4GA	.43	6D6GT	.50	12T6GT	.43
6AQ8	.45	6E6	.89	12W6GT	.43
5U8	.45	6H6	.47	12W6T	.43
5V4G	.59	6J5	.47	17DQ6	.43
5X8	.55	6K6	.61	19AU4	.60
5Y3GT	.30	6K6GT	.61	25BQ6GT	1.48
6AC7	.43	6S4	.39	25C06G	.82
6AD4	1.02	6SA7	.41	25C08	.82
6AC5	.65	6SC7	.54	25L6GT	.41
6AH6	.52	6SK7	.54	25W4GT	.36
6AL5	.47	6SL7GT	.45	25Z6GT	.48
6AM8	.43	6SN7GT	.60	25B5	.48
6AR8	.59	6SQ7	.38		

NEW AND HARD TO GET TYPES PROMPT DELIVERY

10B5	.60
1D3GT/1B3	.70
2C75	.50
3AF4	1.02
4DE6	.55
4C7	.37
5CQ8	.58
6B-8	.64
6B85	.74
6C6	.66
6C26	.64
6D35	.69
8AW8	.85
8C78	.90
11C7	.74
12K6	.58
17X4GT	.50
17D4 50 50EHS	.59

Obsolete, seldom used tubes. Irmed. delivery.

1A6	.93	7B4	.44
1C50T	.57	7B5	.41
1C7A	.39	7B8	.47
1C7B	.39	7C5	.44
1M4G	.39	7F8	.77
1LA6	.66	7M7	.51
1L8A	.69	7M7	.52
1H4	.68	7V7	.82
1LN5	.68	7Y4	.35
3LF4	.66	7Z4	.40
5T4	.59	12ABGT	.45
6A7	.59	12K7GT	.40
6B8	.40	12Q7GT	.48
6AB7/7	.60	12SR7	.57
1B53	.60	14A7	.43
6AQ7GT	.60	14B6	.36
6AS7G	1.50	14Q7	.52
6D6	.59	27	.45
6FSGT	.44	35A5	.48
6F6	.42	35Y4	.35
6E7	.89	37	.59
6E8T	.50	39/44	.39
6U5	.54	50A5	.48
6U7G	.40	50X6	.53
6U7	.47	56	.48
XXL	.47	7A	.54
7A6	.47	75	.44
7A8	.46	77	.85
7A7	.42	80	.40

RECEIVING TUBE SPECIALS

65N7GT A & B	
Lots of 50.....	\$24.50
Lots of 100.....	\$44.50
6W4GT	
Lots of 50.....	\$18.95
Lots of 100.....	\$34.95
12AU7 & A	
Lots of 50.....	\$24.95
Lots of 100.....	\$47.95
6AU6 & A	
Lots of 50.....	\$18.95
Lots of 100.....	\$34.95
6C6 & A	
Lots of 50.....	\$22.95
Lots of 100.....	\$41.95

TELTRON ELECTRIC CO.

428 Harrison Ave. Harrison, N. J. Phone HUmboldt 4-9848

Dept. EI-5



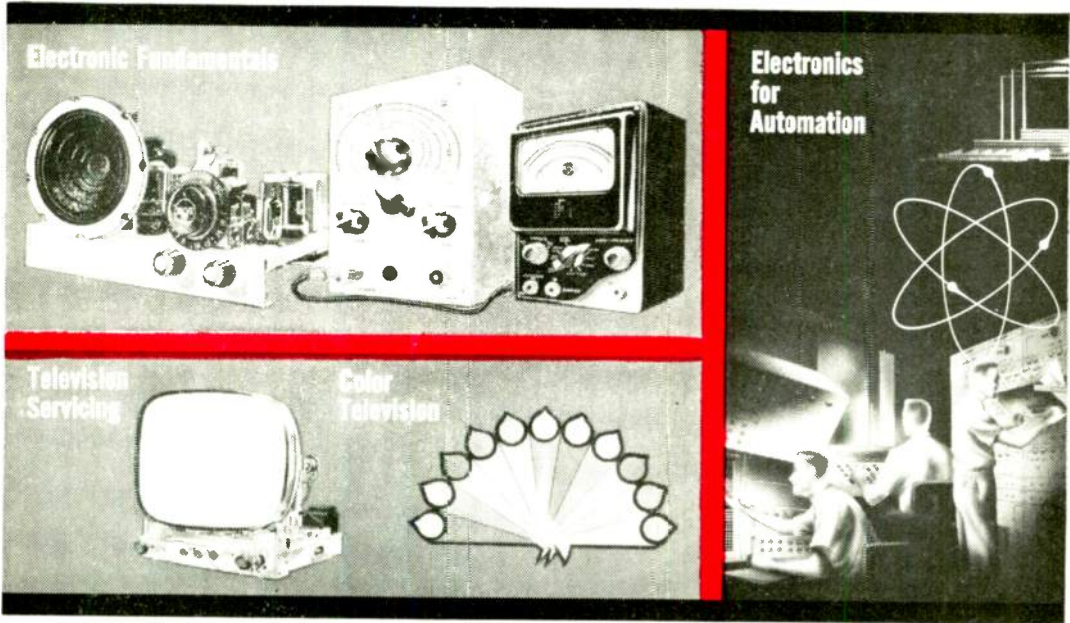
LET RCA TRAIN YOU IN ELECTRONICS

ANOTHER WAY
RCA SERVES
EDUCATION
THROUGH
ELECTRONICS

RCA Institutes, one of the leading technical institutes in the United States devoted exclusively to electronics, offers a Home Study Course in . . .

ELECTRONICS FOR AUTOMATION

. . . Now you have four comprehensive courses for your electronic training . . . from basic electronic theory to the more advanced principles of color TV and Automation.



Practical work with your very first lesson. Pay as you learn. You need pay for only one study group at a time.

CANADIANS take advantage of these same RCA Courses at no additional cost. No postage, no customs, no delay. Send coupon to:

RCA Victor Company, Ltd., 5001 Cote de Liesse Rd., Montreal 9, Quebec

SEE OTHER SIDE

CUT OUT AND MAIL THIS POSTAGE-FREE CARD TODAY!

RCA INSTITUTES, INC., DEPT. EI-50

A Service of Radio Corporation of America

Without obligation, please send me the FREE catalog checked below. No salesman will call.

Home Study Catalog

Resident School Catalog

NAME _____ (Please Print) _____ AGE _____

ADDRESS _____

CITY _____ ZONE _____ STATE _____

KOREAN VETS! ENTER DISCHARGE DATE _____



Send for our 64 page Home Study Catalog

FREE!

HOME STUDY SCHOOL

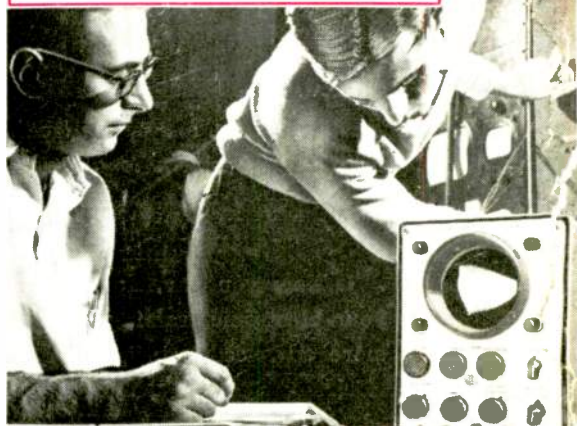
6 REASONS WHY RCA TRAINING IN ELECTRONICS

can be the smartest investment
you'll make in your *entire lifetime!*

- 1. You get the finest training-at-home** under the supervision of the RCA Institutes, experts in technical training for over 50 years. The very name "RCA" means dependability, integrity, and scientific advance.
- 2. You get comprehensive training** in your choice of four complete, up-to-date Courses . . . from basic electronics theory to color TV and Automation.
- 3. You get Theory, Experiment, and Service practice.** Starting with the very first lesson . . . a complete training package throughout the course. No special technical background is required.
- 4. You get prime quality equipment** as a regular part of your Course . . . equipment that you keep and use on the job. You never have to take apart one piece to build another.
- 5. You get each study group on a pay-as-you-go basis.** Should you wish to interrupt your training at any time, you will not owe RCA Institutes a penny more, unless and until you decide to resume the course.
- 6. You get top recognition — worldwide.** Graduates of RCA Institutes are now working for leaders in the electronics field, and many have their own businesses. This record is true tribute to the high quality of RCA Institutes training.

Fill in the other side of this postage-free card for complete information on Home Study courses.

RESIDENT SCHOOL COURSES
IN NEW YORK AND LOS ANGELES



LET RCA TRAIN YOU IN ADVANCED ELECTRONICS

Here is college-level training that will enable you to work with professional engineers on research or production projects in fields such as automation, guided missiles, radar, television, computer, and other advanced electronic applications. Other courses available include TV and General Electronics, Radio & TV Servicing, and Technical Writing. Thousands of Resident School graduates are today engaged in important government or industrial projects. Now is the time to prepare yourself for a promising new career.

Coeducational classes start 4 times each year. Applications now being accepted. Convenient locations in New York City and Los Angeles.

SEE OTHER SIDE

First Class
U.S. Postage
PAID
Permit No. 10662
New York, N. Y.

BUSINESS REPLY CARD

No Postage Stamp Necessary if Mailed in U. S.

Postage will be paid by —
RCA INSTITUTES, INC., DEPT. EI-50

350 West Fourth Street

New York 14, N. Y.



Send for this FREE catalog today! Fill in other side of postage-free card and check Resident School.



RCA INSTITUTES, INC.
SCHOOLS OF TELEVISION
AND ELECTRONIC TECHNOLOGY
A Service of Radio Corporation of America