

Special Feature Pull-Out Section

Old-Time Radio^{T.M.}

HISTORICAL EVENTS IN ELECTRONICS

Edited by
William M. Palmer, W5SFE

- BIOGRAPHICAL SKETCHES OF GREAT MEN
- HISTORY OF INVENTION
- PICTORIAL HISTORY OF ELECTRONICS
- OLD-TIME RADIO PROJECTS
- NEWS OF HISTORICAL INTEREST

*The human mind is sleepless in the pursuit of knowledge.
It is ever seeking new fields of conquest. It must advance;
with it, standing still is the precursor of defeat.*

—From History of Civilization
by E. A. Allen
Published in 1891, by Central
Publishing House, Cincinnati,
Ohio

Published by

Electronics Digest

1024 Currie Street, Fort Worth, TX 76107

Copyright 1972 by Electronics Digest Division
Tandy Corporation

Joseph Tykocinski Tykociner

October 5, 1877 — June 12, 1969

Electrical Engineer, Inventor, Educator

by William M. Palmer

Today's growing ethnic consciousness, although often billed as humanitarian in objectives, has the insidious effect of setting up tiny self-seeking nations within our nation.

When our forefathers came to America they gladly cast off the ties that bound them to their mother country, and they merged their knowledge and resources with that of settlers of many national origins to achieve the common aim . . . a new nation founded upon individual freedom . . . and the opportunity for all to climb the highest mountain of achievement. They believed in working together for the common good.

Out of this heritage came men like Alexander Graham Bell, Michael Pupin, Nikola Tesla, Charles Steinmetz, David Sarnoff, Vladimir Zworykin . . . and countless others including the subject of this biographical sketch, Joseph Tykocinski Tykociner (Joe-seff Tick-oh-shin-sky Tick-oh-shiner).

Tykociner was born in Vloclavek, Poland, on October 5, 1877. A hundred years before that, another great Polish friend of America, during the Revolution, Count Casimir Pulaski, was distinguishing himself at the battle of Brandywine as a soldier in the army of General George Washington. Count Pulaski fell mortally wounded during the siege of Savannah (Georgia) and died on October 11, 1779.

In recognition of his valor, a famous early-day fort was named for him, Fort Pulaski, on Cockspur Island at the mouth of the Savannah River, 17 miles east of Savannah, Georgia. Today, it is a part of the U. S. National Park System which is dedicated to conserving the scenic, scientific, and historic heritage of the United States.

Unfortunately, the shifting sands of destiny erased the path to recognition for another great man of Polish ancestry, the subject of our biographical sketch,

Joseph Tykociner, who has been called "a man ahead of his time."

Tykociner experienced the same skepticism faced by many other inventors when mankind examines new ideas and innovations which portend changes in his traditional environment. It was in this intellectual atmosphere that Tykociner demonstrated his dream of a quarter century, the recording of sound electrically on the same film carrying motion pictures.

Tykociner's device was built around the principle of producing sound by passing a ray of light through a sound track of the film into a special light-sensitive tube converting it into a fluctuating electric current which could drive a telephone receiver or speaker. Its outstanding feature was the recording of the sound on film photographically, instead of the less efficient mechanical method of making recordings.

Sadly, his work with sound-on-film came almost a decade too soon. One of the motion picture leaders of that era declared that the inventor's sound pictures were not practical. He went on to explain that movies were an illusion of sound and that if one were to combine the two illusions simultaneously it would produce a trauma greater than the human mind could bear. "The public won't accept it," he finalized. So Joseph Tykociner never profited from his sound-on-film invention the credit for which some years later went to other men.

Tykociner's historic demonstration of the first sound-on-film movies was made the evening of June 9, 1922, at a meeting of the Urbana (Illinois) Section of the American Institute of Electrical Engineers which was held at the University of Illinois. The demonstration included a violin player, Mrs. Tykociner,

(Continued on page 16)

*Let us honor our men of science
Who once walked upon the planet Earth
Along the uncharted trails of electronics
In search of a better way of life
For all mankind*

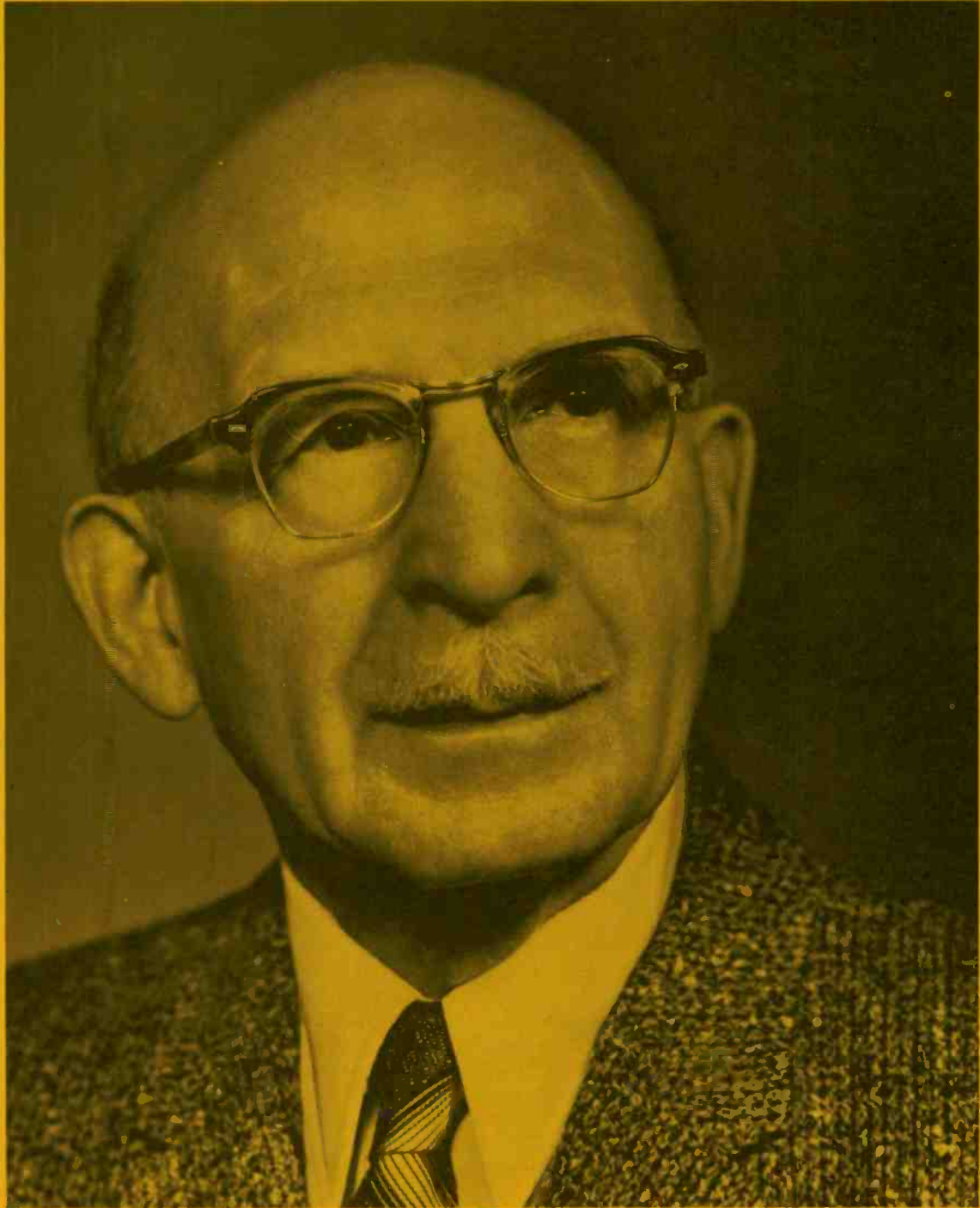

Photo Courtesy University of Illinois

Joseph Tykocinski Tykociner

October 5, 1877 — June 12, 1969

Electrical Engineer, Inventor, Educator

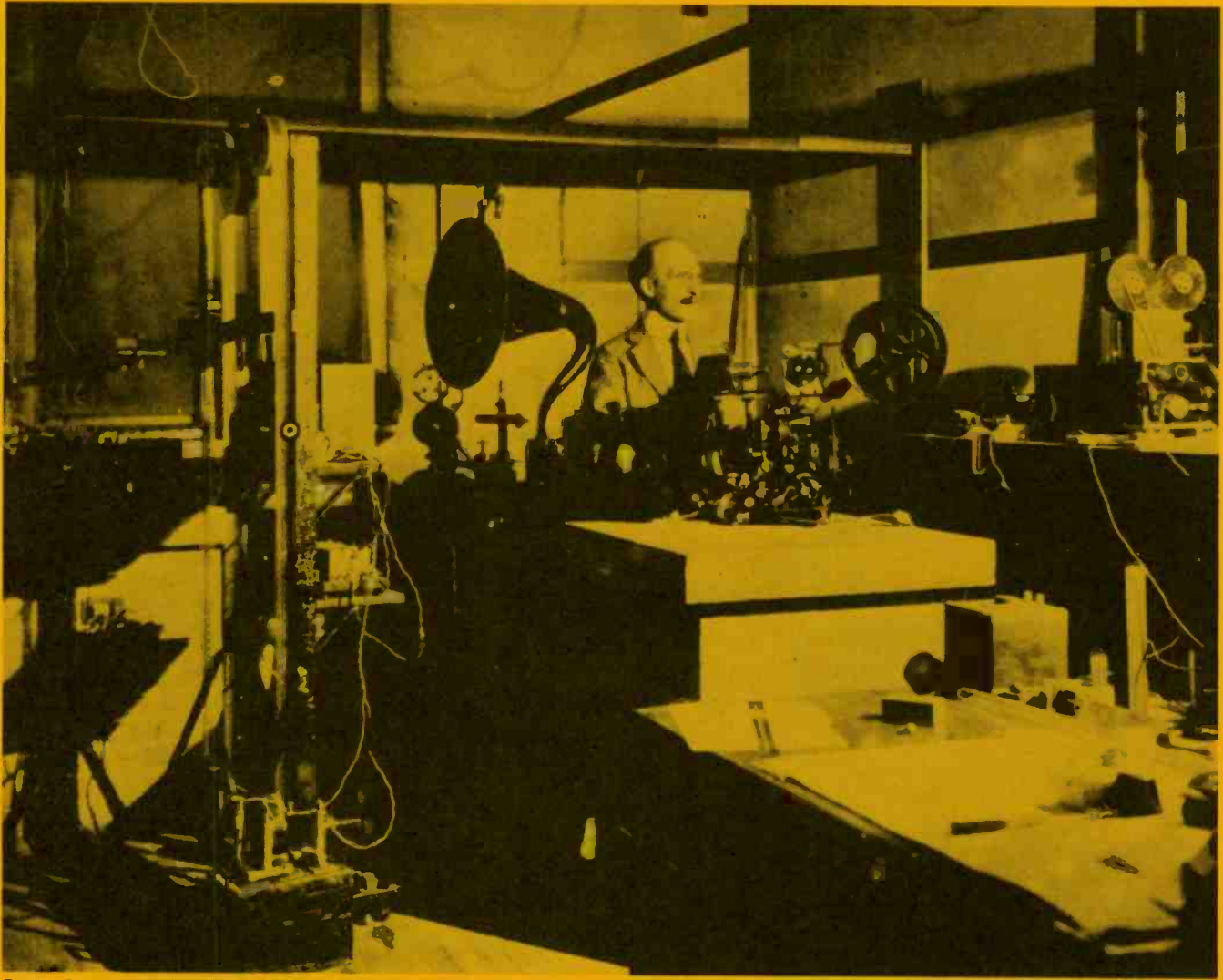

Photo Courtesy University of Illinois

This old photograph shows Joseph Tykociner at work in his laboratory at the University of Illinois at Urbana. He produced a variable-density sound track beside the picture images on the film, the principle that is used in motion pictures today. The inventor's wife was the first woman to "star" in talking pictures. With a small bell in her hand, she said, "I will ring the bell." The action plus sound amazed spectators.

JOSEPH TYKOCINER

(Continued from page 14)

who rang a hand bell, and Professor Ellery B. Paine, then head of the University's electrical engineering department, who recited Lincoln's famous Gettysburg Address. It was the crowning achievement of Tykociner, who had come to the faculty in 1921 after a brilliant career in Europe in the new field of wireless communications.

On July 30, 1922, the *New York World* devoted a half-page to Tykociner's futuristic invention. He forecast a revolution in the movies. "Many noted plays, comedies, and farces that are not now adapted to the screen, because of the wit, humor of the dialogue, and personality of the actors, may be revived and find new favor," he predicted. "I have

great hopes that it will cause a revival of the masterpieces of dramatic art," he said. Today, we know just how accurate was the prediction of this great man of vision . . . who saw beyond the horizon a world several decades away.

Tykociner, who conceived the idea of sound-on-film recording during a voyage from Antwerp to America in 1896, was graduated from Higher Technical Institute at Coethen in 1901, and studied in Berlin and Goettingen, Germany. He joined the Marconi Wireless Telegraph Company in England as a junior engineer. Two years later he joined the staff of the Telefunken Company in Berlin as a research engineer. In 1904, Tykociner was offered a responsible position in Russia, and during the ensuing fourteen years made the Russian navy the first fleet completely equipped with wireless. After World

War I when Poland was reborn, Tykociner set up the nation's first wireless communications system.

In 1920, Tykociner came to America to stay. After a year's work at the Westinghouse Electric and Manufacturing Company's research laboratory, he accepted a position with the experiment station of the University of Illinois. At the U. of I. he pioneered in both radio and other electronic fields.

In 1929, he became a professor in the Graduate College. He retired with the rank of professor emeritus in 1949. His scientific investigations included, besides sound-on-film motion pictures, high-frequency measurements, dielectrics, piezoelectricity, photo-electric tubes, and microwaves. He was a fellow of the American Physical Society and the American Society for the Advancement

(Continued on next page)



Licensed under Armstrong U. S. Patent No. 1,113,149.

MacMillan Listens to Honolulu and New Zealand "Tunes In" California

From a little ice-bound schooner—eleven degrees from the North Pole—comes this message:

"Am very thankful that Arctic Exploring Ship Bowdoin is equipped with complete Zenith radio apparatus. Here at top of world, in darkness of great Arctic night, we have already listened to stations practically all over United States, from Europe, and even from far away Honolulu. Zenith has united the ends of the earth."

—"MacMillan"

Again, from far-off New Zealand comes a report of radio reception even more startling:

"It may interest you to know that the writer last evening landed KGO, Oakland, California, between 6:45 and 7:30 P. M. Heard his call four or five times distinctly, and jazz music. The music was not as clear as the voice, but one could pick up the tune all right. As San Francisco is 6,300 miles from New Plymouth, and only one tube was used, we think this is a very fair performance."

—(signed) H. Charles Collier.

The sets used by Captain MacMillan and Mr. Collier are earlier models—since improved by the addition of a **third stage of audio frequency**. These new models, described at the right, represent an achievement in radio construction not duplicated in any other set on the market. A demonstration will convince you.

Write today for full particulars and name of nearest dealer.

Zenith Radio Corporation
McCORMICK BUILDING, CHICAGO

Using



Model 3R The new Zenith 3R "Long-Distance" Receiver-Amplifier combines a specially designed distortionless three-stage amplifier with the new and different Zenith three-circuit regenerative tuner.

Fine vernier adjustments—in connection with the unique Zenith aperiodic or non-resonant "selector" primary circuit—make possible extreme selectivity.

The new Zenith 3R has broken all records, even those set by its famous predecessors of the Zenith line. Under favorable conditions, satisfactory reception over distances of 2,000 to 3,000 miles, and over, is often accomplished in full volume, using any ordinary loud-speaker. The Model 3R is compact, graceful in

\$160

line, and built in a highly finished mahogany cabinet....

Model 4R The new Zenith 4R "Long-Distance" Receiver-Amplifier comprises a complete three-circuit regenerative receiver of the feed-back type. It employs the new Zenith regenerative circuit in combination with an *audion detector* and *three-stage* audio-frequency amplifier, all in one cabinet.

Because of the unique Zenith "selector," unusual selectivity is accomplished without complication of adjustment.

The Zenith 4R may be connected directly to any loud-speaker without the use of other amplification for full phonograph volume, and reception may be accomplished over distances of more than 2,000 miles.....

\$85

ZENITH RADIO CORPORATION,
Dept. 1-O 328 South Michigan Avenue, Chicago, Illinois

Gentlemen:
Please send me illustrated literature on Zenith Radio.

Name.....

Address.....

Courtesy Zenith Radio Corporation

This is an old Zenith radio advertisement which ran in several publications in 1924, nearly five decades ago. It was an exciting era of long-distance wireless communication and Arctic exploration. Note the line under the radio: Licensed under Armstrong U. S. Patent. That was radio pioneer Edwin Howard Armstrong, inventor of the regenerative feed-back principle of amplification (Electronics Digest, January/February 1971).

History of the Vacuum Tube

Some of the more important historical types of gas tubes are discussed in this article. It serves as a useful foundation for treatment of other basic electron tubes

Part IV

by Robert G. Middleton

We have noted that the earliest vacuum tubes were "soft"; that is, these tubes contained sufficient residual gas so that their characteristics were dominated by ionic conduction. Actually, there is no perfect vacuum condition in tubes, although "hard" tubes were evacuated to so great an extent that ionic conduction could be disregarded for practical purposes. At about the turn of the century, it was known that certain types of "soft" tubes operated as rectifiers. The groundwork had been laid in 1850 by Geissler, who discovered that colored lights could be produced by means of a high-voltage discharge through a tube containing gas at a low pressure.

Cooper Hewitt Mercury-Arc Rectifier

Soft tubes containing mercury vapor were extensively developed by Peter Cooper Hewitt, including the Cooper Hewitt mercury-vapor lamp (Figs. 1 and 2). Iron electrodes are located at *a* and *b*. Electrode *b* contacts a small pool of mercury. A metallic coating *d* is placed around the mercury pool, to provide capacitor action for easy starting. However, this type of tube requires a high starting voltage, usually provided by an induction coil or step-up transformer. The starting voltage was applied momentarily between *a* and *b*. Although several thousand volts were required to fire the tube, the arc drop fell to



Fig. 1 A Cooper Hewitt mercury-vapor lamp.



Fig. 3 A Cooper Hewitt mercury-arc rectifier tube.

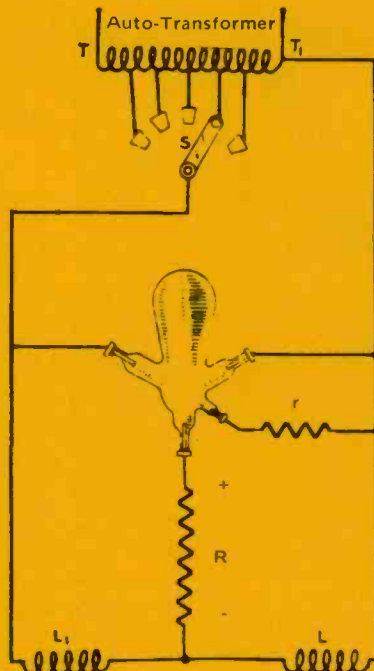

Fig. 4 Plan of the Cooper Hewitt mercury-arc rectifier tube.

approximately 50 volts thereafter.

Discovery of the fact that the mercury-vapor lamp operated as a rectifier was based on the observation that operation was possible only on dc, with the mercury pool employed as the negative electrode. Later, the mercury-vapor tube was operated on ac by means of a circuit expedient. A large inductor was connected in series with the tube. In turn, the flywheel action of the inductor sustained current flow through the tube during the inoperative half cycle, so that the arc was not extinguished during this period. Because the lamp developed peak output on alternate half cycles, it exhibited an objectionable stroboscopic effect.

Hewitt was intrigued by the rectifier action of the mercury-vapor lamp, and soon developed the mercury-arc rectifier tube (Figs. 3 and 4). This tube was extensively used to change ac to pulsating dc in most applications which demanded substantial current and good efficiency. Operating voltage is applied by the transformer to the iron electrodes. The mercury pool is connected through load *R* to a pair of inductors and thence to the iron electrodes. An auxiliary starting electrode is also connected via resistor *r* to one of the iron electrodes.

To start the mercury-arc rectifier tube, the mounting is momentarily tilted or turned clockwise, so that the mercury pool contacts the starting electrode. In turn, mercury is vaporized and the tube starts operation. The mercury pool serves as the cathode, and electrons flow on alternate half cycles into one or the other of the iron anodes. Inductors *L* and *L*₁ are used for their flywheel effect. Otherwise, the rectifier tube would become extinguished or deionized when

(Continued on next page)



Fig. 2 Construction of the Cooper Hewitt mercury-vapor lamp.



Fig. 5 A filamentary type of mercury-vapor lamp.

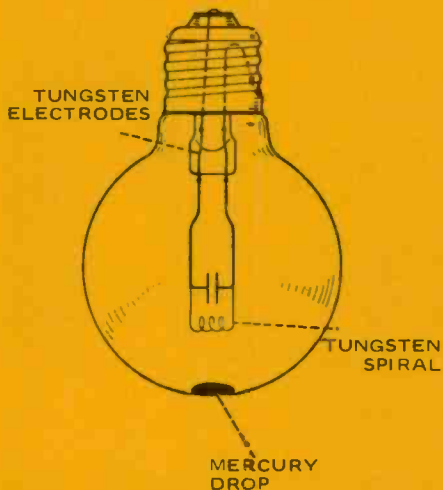

Fig. 6 Plan of a filamentary mercury-vapor lamp.

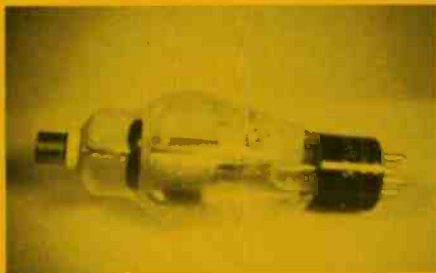

Fig. 7 A hot-cathode mercury-vapor rectifier tube.

HISTORY OF THE VACUUM TUBE (Continued from preceding page)

the current path changes from one anode to the other. A mercury-vapor tube radiates a bright purple light.

Hot-Cathode Mercury-Vapor Tubes

Although the Cooper Hewitt tube operates with an intensely hot spot on the surface of the mercury pool, it is fundamentally a cold-cathode design in that no filament or heater is provided for electron emission. In contrast, there is the hot-cathode (incandescent filament) mercury-vapor lamp (Figs. 5 and 6). When current flows through the filament, the vapor pressure of the mercury rises, and the mercury vapor is ionized by electron emission from the

filament. Thereupon, a mercury-arc discharge takes place between the tungsten electrodes. This arrangement is often used as a source of ultraviolet radiation.

A mercury-arc discharge is easily started (and sustained) by electron emission from a hot cathode, a feature exploited during the 1930's by rectifier tube engineers. One example is the hot-cathode mercury-vapor rectifier tube (Fig. 7). It employs a coated type of filament, which must be operated for at least 15 seconds before anode voltage is applied. Thereupon, the mercury vapor ionizes and radiates a purple glow. The tube drop is only 15 volts when 7,000 volts are applied at 0.25 ampere current demand. Thus, the tube operates at high efficiency.

A cathode in a mercury-vapor tube emits electrons, and also heats the surrounding space to vaporize the mercury. Therefore, specialized cathode constructions were found necessary (Fig. 8). Heat from the inner turns of the spiral filament is absorbed by the outer turns. Thermal radiation from the outer surface is reduced by means of a polished shield surrounding the filament. The plate, or anode, is a metal cup fitting over the top end of the cathode. To avoid tube damage in operation, the cathode must be able to emit more electrons than are demanded at peak anode current flow. Thus, a mercury-vapor tube has no advantage over a high-vacuum tube in this regard; its advantage is its high efficiency, due to the low tube drop.

Argon Gas Rectifier Tubes

Another classical type of hot-cathode gas tube utilizes argon, and was called a Tungsar or Rectigon tube. One variety of tube contained a mixture of argon and mercury vapor. Mercury-vapor tubes of all types were termed phanotrons. Typical phanotrons are the Tungsar bulbs (Figs. 9 and 10). A spiral tungsten filament was employed, with a graphite anode. The gas pressure was approximately 5 centimeters of mercury. To obtain ample electron emission, the tungsten filament was operated at a much higher temperature than that in a high-vacuum tube. Because of the argon gas, the tungsten was inhibited from excessive evaporation, and the tube was fairly long-lived.

Thyratron Tubes

A thyratron tube is basically a three-electrode gas tube or phanotron. That is, a thyratron contains a control grid in addition to the cathode and anode

(Continued on next page)

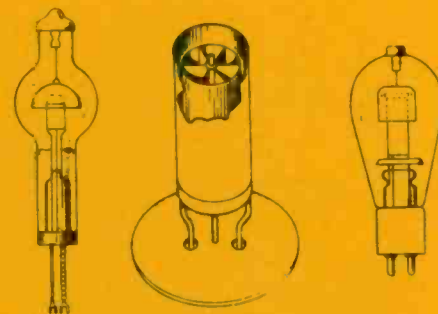

MERCURY-VAPOR TUBES WITH HEATER DETAILS

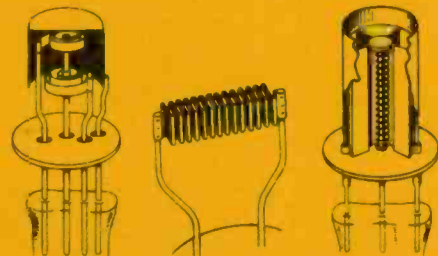

HOT-CATHODE EMITTING STRUCTURES

Fig. 8 Hot-cathode construction for mercury-vapor rectifier tubes.



Fig. 9 Representative Tungsar bulbs.

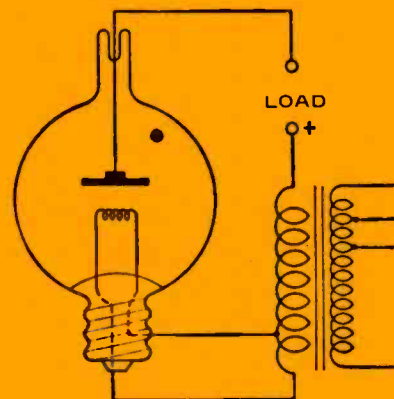

Fig. 10 Plan of a Tungar rectifier bulb.



Fig. 11 Appearance of a small thyratron.

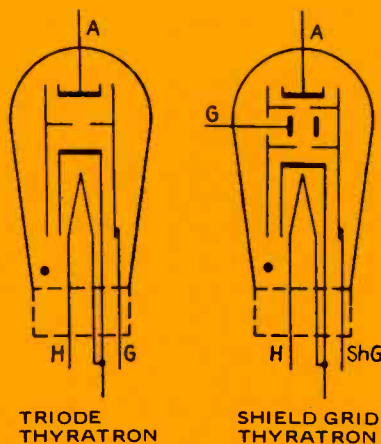

Fig. 12 Internal construction of triode and tetrode thyratrons.



Fig. 13 A larger type of thyratron.

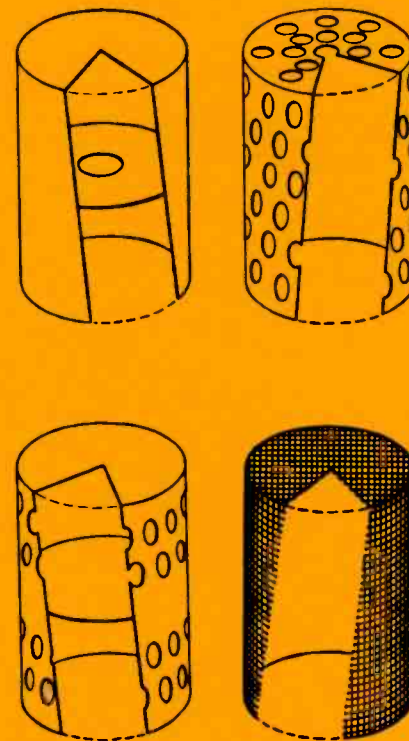

Fig. 14 Conventional thyratron grid constructions.

HISTORY OF THE VACUUM TUBE (Continued from preceding page)

(Figs. 11 through 13). The control grid in a thyratron does not have an operational function at all times, as in a high-vacuum tube. Instead, a thyratron grid can only inhibit anode current flow (ionization) up to a certain critical grid voltage. Thereupon, the tube "fires" and the grid loses control. Anode current can then be stopped only by bringing the anode voltage to zero. Then, the grid resumes control.

Note in Fig. 12 that the grid in a thyratron is designed differently from a grid in a high-vacuum tube. A thyratron grid shields the cathode both from the anode and from the walls of the glass envelope. Thereby, the effect of stray fields is minimized and operation is stabilized. In typical thyratron grid constructions (Fig. 14), control action takes place through a hole, pattern of holes, or screening. A double-grid or tetrode type of thyratron provides shielding for the control grid, in addition to the cathode and anode. In turn, maximum operating stability is realized. This type of tube

was extensively developed during the 1940's.

Neon Gas Tubes

Many types of gas tubes containing neon or mixtures of neon and other gases have been developed. It was noted previously that work in this field was started by Geissler in 1850. There are various ornamental forms of Geissler tubes (Fig. 15). Present-day tubes used in so-called neon signs are a direct outgrowth of this line of development. During the 1930's neon tubes were utilized in television receivers (Fig. 16). These consisted of a cold-cathode type of gas diode, with a cathode 1 1/2 inches square, and a wire electrode serving as the anode. The tube contained neon gas at low pressure, and the cathode surface glowed a reddish-orange when approximately 75 volts were applied between the electrodes. A brighter glow was produced by higher operating voltages.

In this era, television pictures were reproduced on a "screen" 1 1/2 inches square, but a magnifying glass was often provided to increase the apparent size of the image. The image was developed by means of a scanning disk (Fig. 17). Since a scanning disk was limited in the number of scanning lines which could be

(Continued on next page)

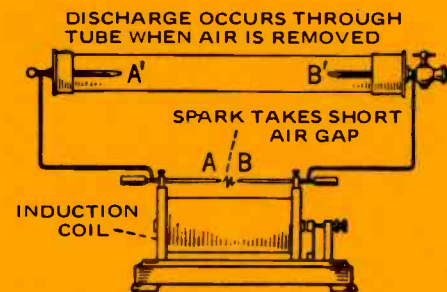

Fig. 15 Geissler tube arrangement, and various ornamental forms.

HISTORY OF THE VACUUM TUBE (Continued from preceding page)

employed, the reproduced images were necessarily quite crude. To anticipate subsequent discussion, neon tubes were eventually supplanted by cathode-ray tubes in order to provide large and well-detailed images.

There are many other forms of neon bulbs (Figs. 18 and 19). One of their important characteristics is the comparative constancy of voltage drop between electrodes as the current flow changes. The interval from *A* to *B* is called the dark-current region. Breakdown occurs at *B*. Little voltage-drop variation takes place from *C* to *D*; this is the normal operating interval. Arc breakdown ultimately occurs at *E*, accompanied by a very large decrease in

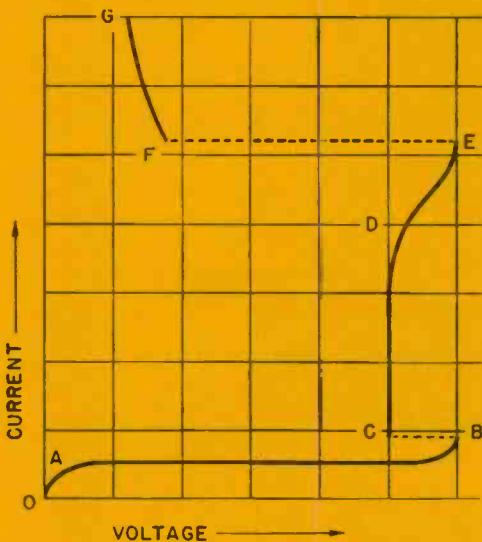

Fig. 19 Voltage-current characteristic of a neon tube.

voltage drop, increase in current, and often destruction of the tube. The constancy of tube drop provided over its operating interval makes the device useful as a voltage regulator.

However, whenever substantial current must be accommodated and optimum regulating characteristics are desired, larger gas diodes are utilized (Figs. 20 and 21). These were developed during the 1930's. Various inert gases are employed in voltage-regulator tubes, other than neon gas. Note that in the basic voltage-regulator circuit arrange-

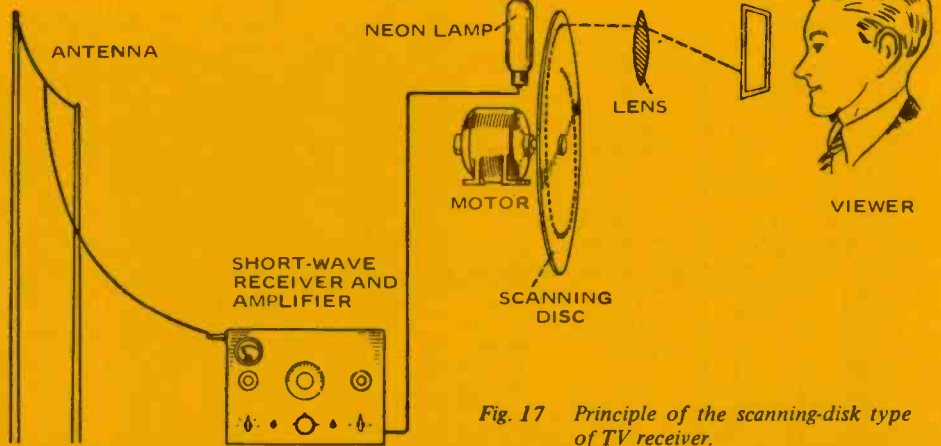

Fig. 17 Principle of the scanning-disk type of TV receiver.



Fig. 16 A neon tube used in a 1930-vintage television receiver.



Fig. 18 Some varieties of neon bulbs.



Fig. 20 A voltage-regulator tube.

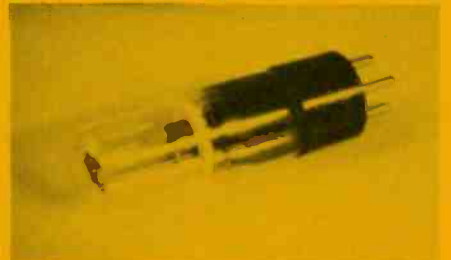

Fig. 22 A strobtron tube.

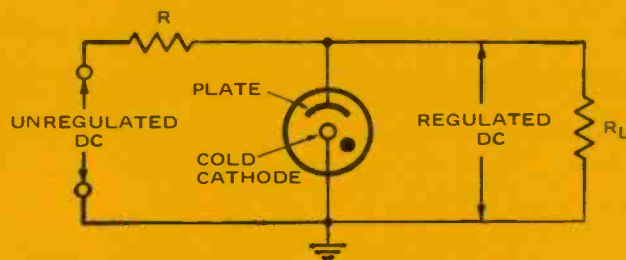
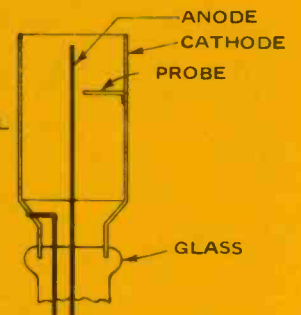

Fig. 21 Plan of a voltage-regulator tube and basic voltage-regulator circuit.



ment a probe is mounted on the cathode and extends into the vicinity of the anode. This structure provides an intensified electrostatic field which facilitates the onset of ionization and thereby increases the dynamic range of the tube.

Strobtron Tube

Although a neon bulb is a stroboscopic light source, it does not have a high-intensity output. Therefore, a specialized glow-tube light source was developed in the 1930's for use in strobe applications, known as the strobtron

tube (Figs. 22 and 23). The strobtron tube was designed to maximize the light output from the neon gas content. The cathode is cesium coated, and the two grids are used to start ionization at the firing voltage. As soon as the tube ionizes, the grids lose control, and current flows until the anode is brought to zero potential. Although the strobtron is basically a cold-cathode tube, it is comparable to a hot-cathode thyratron after ionization starts.

(Continued on next page)

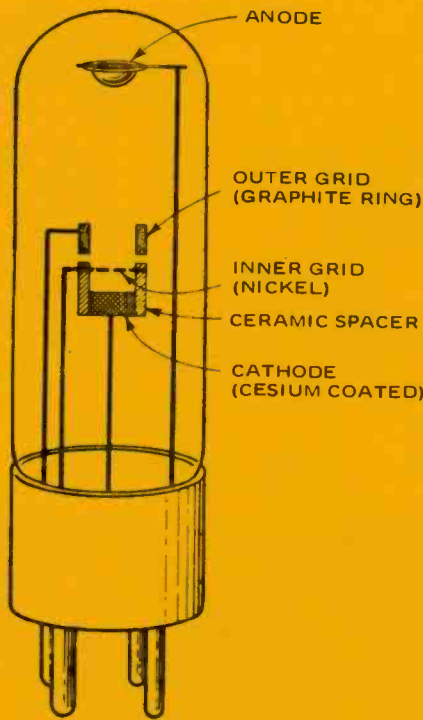

Fig. 23 Structure of the strobotron tube.



Fig. 24 A small T-R tube.

HISTORY OF THE VACUUM TUBE
(Continued from preceding page)

T-R Tubes

During the 1940's various other forms of gas tubes were developed. One important type was called the T-R (transmit-receive) tube (Fig. 24). Used in radar systems, it is basically a spark-gap two-electrode arrangement in water vapor at a pressure of 1 millimeter of mercury. A simple gap at atmospheric pressure has a resistance during conduction of 30 to 50 ohms. The time for deioni-

zation is about 10 microseconds. On the other hand, a T-R tube may have a recovery time of 3 microseconds, with a resistance of only a few ohms during conduction. A water-vapor type of T-R tube has a recovery time of 0.5 microsecond.

T-R tubes are usually designed to fit into and to be a part of a resonant cavity (Fig. 25). To facilitate ionization at a low signal voltage, another electrode, called a keep-alive, is often included. This electrode has a potential of about -1,000 volts with respect to the main gap. A low discharge is maintained by the keep-alive and one electrode of the main gap. Thereby, a small signal voltage applied to the main gap easily triggers the T-R tube into conduction.

Conclusion

Some of the more important historical types of gas tubes have been discussed. However, it should not be supposed that other than a preliminary sampling has been presented. The data which have been provided serve as a useful foundation for treatment of other basic electron tubes, such as phototubes, image dissectors, iconoscopes, image orthicons, kinescopes, and specialized tubes utilized in radiation technology.

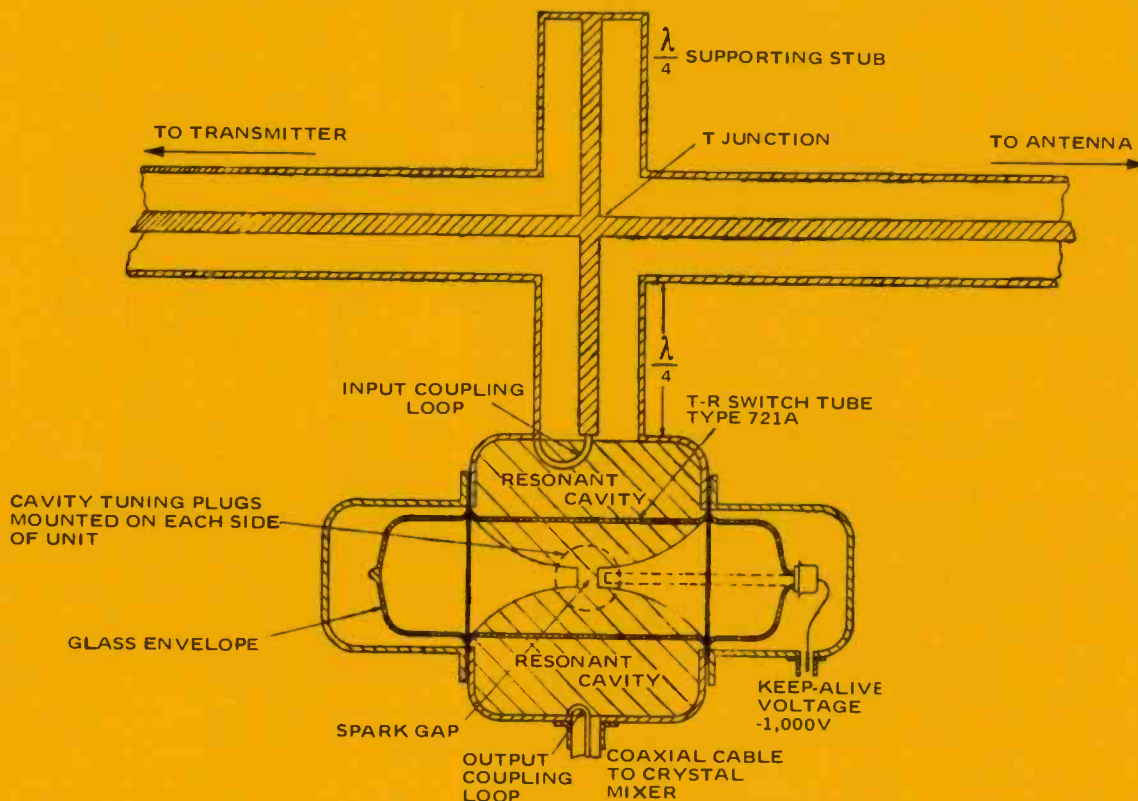

Fig. 25 A T-R tube arrangement.

Prize-Winning Crystal Radio of the 1920s

This simple, easy to construct, crystal radio receiver was a big hit in the early 1920s. It was billed in advertisements as "the simplest radio outfit made – yet as practical as the most expensive"

By Arthur Trauffer

In the early 1920's, Hugo Gernsback, editor and publisher of "Science and Invention" and "Radio News" magazines, offered a first prize of \$100 in gold to the reader who could construct the simplest practical "radiophone receiver" that would give good results.

Out of about 800 contestants, the editorial staff of "Science and Invention" awarded the first prize to young James Leo McLaughlin of New York City for a simple crystal radio he built in about a half hour from easily-obtainable materials; at a cost (at that time) of about 40¢ – not including the earphone and antenna, and which worked as well as many crystal radios on the market at that time. Instructions for building McLaughlin's radio were published in "Science and Invention," sometime later in "Literary Digest," and finally appeared in the book "Practical Radio" by Henry Smith Williams (1922). Radiogem Corporation of New York City put McLaughlin's simple radio on the market in kit form, as shown in the advertisement from "Radio News."

Construction Details

As shown in the illustrations, the simple radio consists of a pint-size paper ice cream container about 3½" in diameter; 13 small and 2 large paper fasteners; 3 small paper clips; a coil of No. 26 enameled copper wire; a common pin; and a piece of galena crystal. Pictorial details of construction are shown in Figs. 1, 2, and 3, and are easy to follow.

To make the "switch points" for the coil, take the container and punch nine holes in it about 1" down from the top and about ½" apart, using a small nail or an ice pick. Into each hole push a small paper fastener. Using pen and ink, number each fastener from right to left from 1 to 9. Alongside hole No. 1 push two small paper fasteners with a small paper clip underneath, and mark it GND for the ground connection.

½" down from GND punch a small hole for the starting point of the coil,

which is wound with No. 26 enameled copper wire. Scrape the enamel off the end of the wire, push it through the hole, and wrap it around one of the paper fasteners (GND) on the inside of the container. Pull the wire tight and start winding the coil. The total number of turns on the coil is about 80, and a tap is taken off at each of the following turns: 15th, 23rd, 31st, 39th, 47th, 55th, 63rd, 71st and 80th. In other words, the 15th turn is contact No. 1, and the

remaining eight taps are made at every 8th turn. Be sure the enamel is scraped off clean before wrapping the wire around the paper fasteners on the inside of the container.

Figures 1, 2 & 3 show how to make the switch lever from a large paper fastener which slides over the contacts. Push the ends of the fastener through the side of the cover, close to the lid. Bend one end down flush with the side and
(Continued on next page)



Photo by Art Trauffer

Fig. 1 Again, Arthur Trauffer, of Council Bluffs, Iowa, demonstrates his ingenuity in rounding up parts to build a realistic replica of an early-day crystal radio receiver. These are great projects for a home or school museum. Not only that, they demonstrate principles of electronics as applied in the embryonic stage of radio.

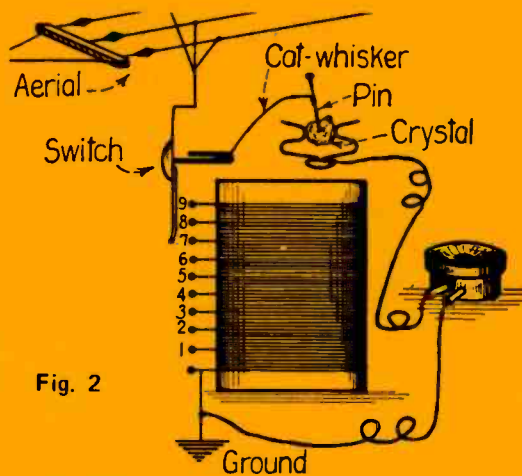

Fig. 2

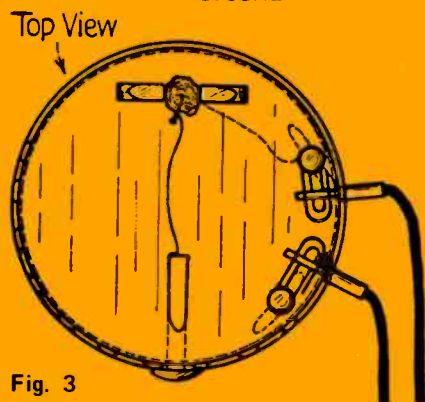

Fig. 3

PRIZE-WINNING CRYSTAL RADIO (Continued from preceding page)

push the other end through the top and bend over. Place the cover on the container and bend the fastener so it rides over the contacts easily when the cover is turned, being sure it touches each of them. Cut off the surplus end.

The other large fastener is pushed through the lid opposite the switch and is bent, as shown in the illustrations, so it holds the crystal. The catwhisker for the crystal is made from a short length of No. 24 wire and a common pin and fastened as shown in the illustrations.

Figure 3 shows the simple hookup.

The earphone should be high-impedance magnetic, and the more sensitive the better. Crystal earphones can also be used, since they are high-impedance.

Use an antenna from 25 to 100 feet long, and a cold water pipe ground.

Figure 1 shows the replica built by the writer.

It goes without saying that this crystal radio was designed and used in the early days of broadcasting when there were fewer stations and they were operating on lower power, so do not be surprised if you hear several stations at the same time when tuning this set. The nearest and most powerful stations will of course be heard the loudest.

RADIOGEM

The Dollar Radio Receiving Set The Simplest Radio Outfit Made —Yet as Practical as the Most Expensive!

You need know absolutely nothing about wireless to operate and enjoy the RADIOGEM. It is so sturdy, so simply constructed that it is small wonder radio engineers who have tested it have pronounced the RADIOGEM a brilliant achievement. The RADIOGEM is a crystal radio receiving set for everyone at a price anyone can afford.

Why The RADIOGEM Can Be Sold For Only \$1

Here's the secret: The RADIOGEM Construction eliminates all unnecessary trimmings, cabinets and the like, which do not play any part in the operation of a set. You receive the RADIOGEM unassembled, together with a clearly written instruction book, which shows you how to quickly and easily construct the set, using only your hands and a scissor. The outfit comprises all the necessary wire, contact points, detector mineral, tube on which to wind the coil, etc., etc. The instruction book explains simply and completely the principles of radio and its graphic illustrations make the assembling of the RADIOGEM real fun. Remember the RADIOGEM is a proven, practical radio receiving set and will do anything the most expensive crystal set will do.

The RADIOGEM is the Prize Winner of the Age

Out of hundreds of radio models submitted recently in a great nation-wide contest, radio engineers, the judges, unanimously chose the RADIOGEM as the winner—the simplest radio-receiving set made! And the RADIOGEM costs you nothing to operate; no form of local electricity is required.

Sent Postage Prepaid on receipt of \$1
—stamps, money-order or check.

Order Your Radiogem To-day—
or send for Free Descriptive
Circular

DEALERS

The RADIOGEM is the wonder item of the radio age. It is storming the country, for the RADIOGEM'S price is so low everyone is able to buy one. Write immediately for full particulars before that shop across the street beats you to it.



This is a copy of an advertisement of the Radiogem Corporation, circa 1922. It uses the magic of early-day radio, the reception of signals through the air, to sell its little receiver, "The wonder item of the radio age."

PARTS LIST

- 1 paper ice cream container (about 3 1/2" x 3 1/2").
- 13 paper fasteners (small size).
- 2 paper fasteners (large size).
- 3 paper clips (small size).
- 1/4 lb. No. 26 enameled copper wire (Radio Shack).
- 1 galena or silicon crystal (mounted or unmounted).
- 1 common pin.
- 1 (or pair) high-impedance magnetic ear-

Hear the programs of the Broadcasting
Stations on the RADIOGEM



\$1 without
PHONE or
AERIAL
(Patent Pending)

What They Say About RADIOGEM

I am enclosing herewith \$1.00 to pay for the Radiogem. I had it carefully wound by our wireless operator and find that it works beautifully—fully as good as any crystal set we know of.

Radiogem received, which we assembled and were very much astonished at results obtained and the clearness and volume of tone produced.

The greatest distances I heard on one of your sets is 1000 miles, having heard WGY at Schenectady, N. Y. I think your set is the best I have ever sold at any price.

On an aerial 150 feet long and 20 high one of my customers has heard WOC and WTR, KSD, WMC on one of your sets using a Peerless headset.

Herewith P.O.M.O. amt. \$1.00 for another "RADIOGEM." The one received is O.K. Placed about 15 ft. of picture cord under front porch and grounded to a gas meter, and heard the Sacramento Bee and Sacramento Broadcasting Union much better than with my large crystal set.

Your RADIOGEM RECEIVER is a wonder. I have received every station in Philadelphia with it much louder than with a high-priced crystal set.

Your two Radiogem sets received last night, and one was wired up for testing. WOC is about 40 miles away, and their signals could be heard with headphones on table. After they quit KYW at Chicago about 170 miles east was heard. Every word could be plainly heard here. WMC at Memphis, Tenn., could also be easily heard and understood.

We find that this set does a great deal more than you claim for it. We took WEAR on our audion set last night; this being the Baltimore American Broadcasting station, and then cut in the Radiogem and got excellent results. After the Baltimore concert was over, we continued to use the audion set and about ten o'clock were listening to WEAP—New York—and a little later we disconnected the audion set entirely and hooked up the Radiogem, very clearly hearing both piano music and announcement of name of station and its location.

You claim a radius of 20 miles over your "Radiogem" is sometimes a possibility. You should adhere to the truth. I constructed one for my mother, installed it with an aerial, and she listens not once in a while, but at her will, to Schenectady, Newark, New York, or Providence, R. I., and her home is Attleboro, Mass. I can't give your set too much praise.

(Names and Addresses on Request)

Early-Day Radio Sets

Commercial radio began fifty-one years ago this November...when radio station KDKA went on the air in Pittsburgh, Pennsylvania—the year was 1920. The photographs on this page show several types of radio sets from the collection of West Virginia University's Department of Physics that tuned in programs during radio's "golden age."

The first known radio program in the U.S. was broadcast by R.A. Fessenden from his experimental station at Brant Rock, Mass., on Christmas Eve, 1906. Two musical selections, the reading of a poem, and a short talk apparently constituted the program, which was heard by ship wireless operators within a radius of several hundred miles of Brant Rock. In the experiment a water-cooled microphone was used to modulate an Alexanderson alternator and 1 kw. of power was radiated at the frequency of 50 kc.

Radio station KDKA at the plant of the Westinghouse Electric and Manufacturing company in East Pittsburgh, Pa., began broadcasting regularly scheduled programs, operating on 833 kc. with 50 w. of power. KDKA first went on the air in the evening of Nov. 2, 1920, with a broadcast of the returns of the Harding-Cox presidential election. This occasion was generally conceded as marking the beginning of commercial broadcasting in its modern form. The success of the KDKA motivated others to install similar stations.

(Continued on page 18)

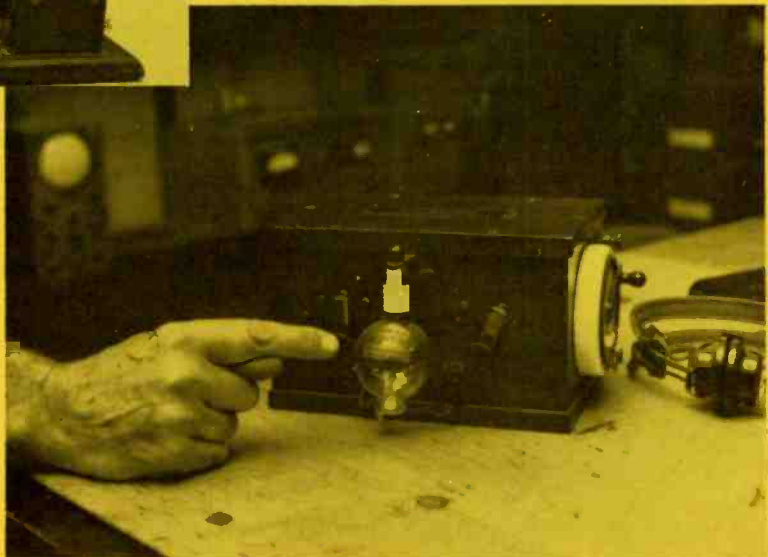

Photo West Virginia University

Okey M. Cogar, research technician in West Virginia University's Department of Physics, tunes one of the oldest sets in the department's collection. This battery-powered model was made by the Signal Radio Company of Menominee, Mich., in about 1907 and was known as a loose-coupled receiver. Each listener had to have a set of headphones. Tuning these sets was a tedious affair and required the continued attention of the operator.

Photo West Virginia University

This is the triode tube of a De Forest Audion. This induction set was built about 1907, and was powered by batteries. The set required use of headphones. The triode, which enabled early experimenters to control a large current with a small signal, was invented by Dr. Lee De Forest. It consists of a bulb with a plate, a grid, and a filament. The entire development of modern electronics is based on the triode. Ownership of its patent was fought over in the courts for many years. The patent originally was granted to De Forest in 1908, and, after 2,863 court cases, it was reaffirmed by the U. S. Supreme Court in the early 1920's. The final decision, again in De Forest's favor, was made in the 1930's. The label on the bulb says, "This bulb is licensed for experimental purposes only."





Bell Telephone Labs

Lloyd Espenshied

Born 1889

Electrical Engineer-Inventor,

Wire and Radio Communications Pioneer

Lloyd Espenshied

Born 1889

Electrical Engineer-Inventor,

Wire and Radio Communications Pioneer

By William M. Palmer

America, a relative of all the nations of the earth, has made many noteworthy contributions toward a better way of life for mankind — many of these contributions have come from our men of science.

One of the tragic frailties of human nature is the tendency to forget, out of the complacency of an affluent life, the accomplishments of these men as environmental "problem solvers." As we go about our daily lives, enjoying the many conveniences made possible by modern technology, we often take for granted the countless hours of research which preceded the great inventions that lifted our country, the United States, to the highest standard of living in man's history . . . in less than 200 years. How, otherwise, could our country have given assistance — food, money, and equipment — to more needy people of the world than any nation since man's beginning in the dim past?

One of the many brilliant American scientists was a pioneer in the development of both wire and radio communications. He was co-inventor, with Herman A. Affel, of the system for using a coaxial conductor (coaxial cable) as a wide-band, long-distance, transmitting medium. The application for the patent mentioned its possible use for television transmission — the forerunner of today's television coaxial cable system which makes possible nation-wide network television programs.

In 1915, teams of engineers from the old West Street Laboratories of the American Telephone & Telegraph Company, under the direction of John J. Carty, began establishing radiophone test sites at a number of points along the Atlantic seaboard. In October of the same year, from a site leased from the U.S. Navy at Arlington, Virginia, speech was successfully transmitted and simultaneously received in both Paris, France, and Honolulu, Hawaii. He was the receiving engineer in Honolulu during the historic test.

It was the same year that another "first" took place, when the transcontinental telephone line was opened with conversations between President Woodrow Wilson at Washington, D. C., Alexander Graham Bell at New York City, Thomas A. Watson at San Francisco, California, and the founder and first president of AT&T, Theodore N. Vail, at

Jekyll Island, just off the coast of Georgia.

Another important invention by the subject of this biographical sketch was the radio altimeter, which demonstrated its practicality as an air navigation instrument in 1938.

In addition to these noteworthy accomplishments, he helped to develop single sideband (SSB) which has found wide use in modern communications — both commercial and amateur radio. He holds more than 130 patents in the field of electricity/electronics.

In spite of his brilliant work in science, few Americans of today's generation would recognize the name of this distinguished engineer-inventor, Lloyd Espenshied.

Mr. Espenshied was born in St. Louis, Missouri, in 1889. By age 14, he had already developed a keen interest in amateur radio, which may have influenced his choice of a career. He attended Manual Training High School in Brooklyn, New York, and later attended the famous Pratt Institute, where he received a degree in applied electricity in 1909. It was while attending Pratt Institute that Espenshied worked part-time as a radio operator for the United Wireless Telegraph Company of America.

Upon graduation from Pratt Institute, Mr. Espenshied joined Telefunken Wireless Telegraph Company, as an assistant engineer. After a brief work span there, he joined the engineering staff of the American Telephone & Telegraph Company, and later the world-renowned Bell Telephone Laboratories. He retired in 1954.

Many honors have been bestowed upon this distinguished American. He is a Fellow of the Institute of Electrical and Electronics Engineers, a member of the American Association for the Advancement of Science, and a member of the American Geographical Society.

Mr. Espenshied was awarded the Medal of Honor of the Institute of Radio Engineers in 1940, and in 1967 was co-recipient of the Pioneer Award of the Institute of Electrical and Electronics Engineer's Aerospace Electronics Systems Group.

Yes, we in America owe much to our men of science . . . whose research work began in the past, when today was still a dream; whose subsequent discoveries have made tomorrow a vision of hope.

FROM AN ALBUM

(Continued from page 15)



Photo West Virginia University

The Atwater Kent was a household favorite during the late 1920's and the 1930's. This model was built about 1925. Note that earphones had been replaced by a horn-shaped speaker. The Atwater Kent had lots of batteries – 6-volt storage batteries for the filament, a large dry cell for the B+ voltage, and several dry cells for the C voltage.



Photo West Virginia University

Cogar is tuning the loud speaker that was used with the Atwater Kent receiver. Adjusting the tension on the diaphragm changes the pitch of the sound. The idea was to eliminate some of the "tinniness" of the early receivers.



Photo West Virginia University

This Grebe Synchronphase Radio Receiver was made by A. H. Grebe and Co. Inc. of Richmond Hill, N. Y., in about 1928. The fine workmanship exemplified by this model is not exceeded in sets made today. Batteries were used for power. Sets that could use house current didn't become practical until about 1930 because of the great variety of power supplies available to home owners in different sections of the country.



Photo West Virginia University

This Crosley two-step amplifier was made by the Crosley Manufacturing Company of Cincinnati, Ohio, in about 1920. It was used with a crystal detector set and headphones. All of these early sets required very long outside antennas, some of which were tunable.