

electronic service dealer

Vol. 7, No. 1

May, 1967

the official publication of the california state electronics association



CSEA CONVENTION-JUNE 9,10,11-FRESNO

STORY PAGE 21

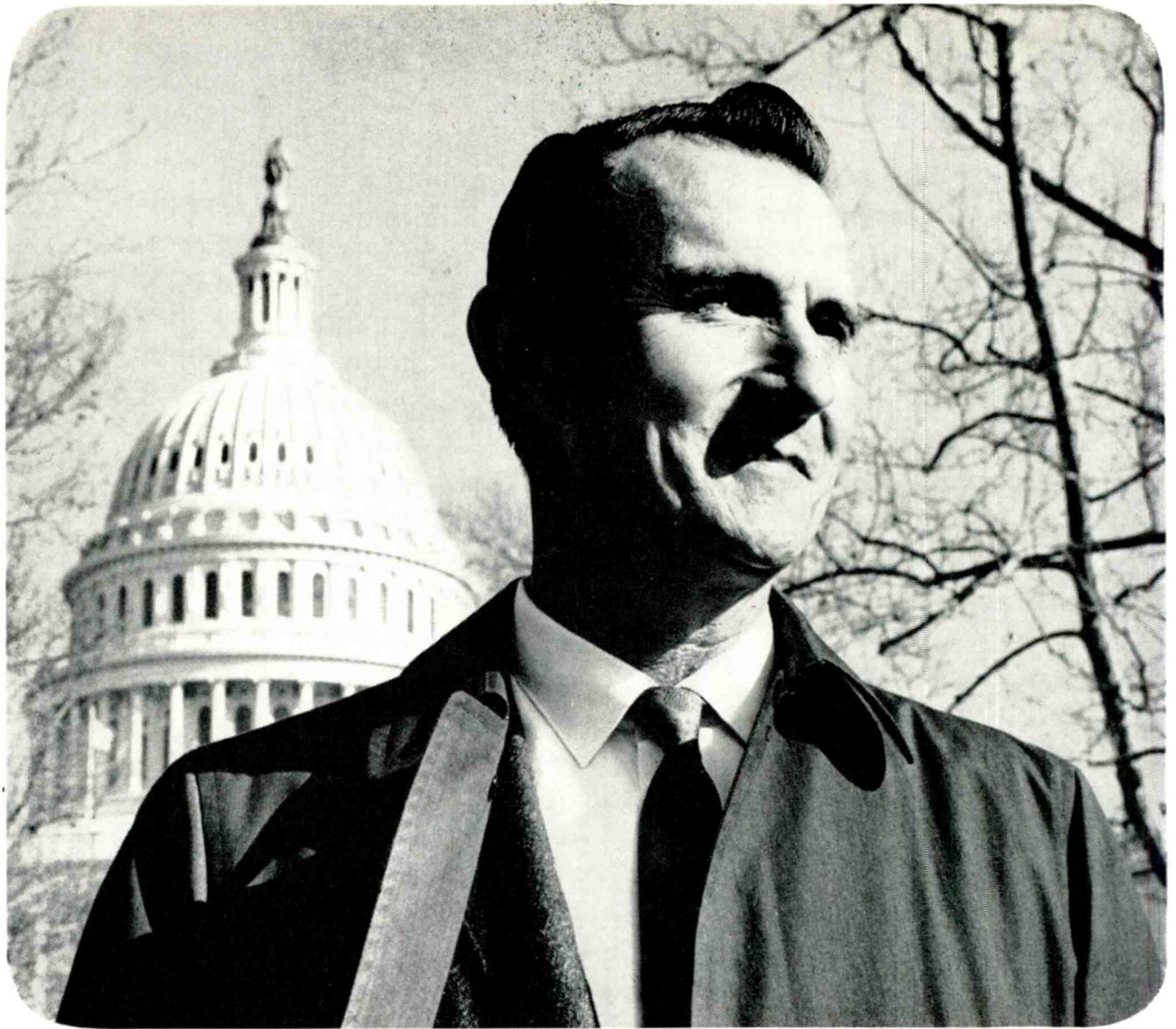

"When you're commissioned to do antenna installations for the Capitol

... Blair House, the Pentagon, Washington National Airport, Department of Justice, Federal Trade Commission, Federal Communications Commission, and the National Space and Aeronautics Administration Buildings, you can't take chances. That's why we install JFD television antennas exclusively," says JERRY PEAKE, of Jerry Peake Co., Inc., Washington, D.C.

"As the biggest professional antenna installing company around these parts, we can't afford to be No. 2. We've got to deliver top picture—VHF and UHF — for the dealers, retailers and department stores who rely on us to keep their sets sold and customers satisfied. Color, especially, must be natural and ghost-free. Only

JFD LPV antennas come across with this kind of reception."

Jerry Peake Co., Inc., Washington, D.C., has installed over 185,000 antennas in the last 18 years in the Washington, D.C. area. He relies on both JFD LPV-CL Color Lasers and LPV-TV Log Periodics — like other professionals — to get performance people expect from a professional.

Here's why:

W-I-D-E BAND LPV LOG PERIODIC DESIGN delivers *more gain, higher signal-to-noise ratios, pinpoint directivity that kills ghosts—VHF and UHF.*

SHOWROOM QUALITY COLOR — *flat response across each channel. No "suck-outs" or "roll-off." Out-performs any other antenna in color or*

black and white — keeps customers sold.

CAPACITOR-COUPLED ELEMENTS work on *both* fundamental and harmonic modes. *Entire antenna (not just part of it as in other antennas) responds to every channel.*

RUGGED NEW "FLIP-LOK" ASSEMBLY snaps out elements — keeps them *tight* and right on target.

JFD® LPV®

JFD ELECTRONICS CO. 15. Avenue at 62 Street, Brooklyn, N.Y. 11219

JFD International, 64-14 Woodside Ave., Woodside, N.Y. 11377 JFD Canada, Ltd., Ontario, Canada
JFD de Venezuela, S.A., Avenida Los Haticos 125-97, Maracaibo, Venezuela

ORVAC ELECTRONICS

112-B E. Orangethorpe
Anaheim, California

MAR VAC

2080 Placentia
Costa Mesa, California

CASS ALTSCHULER

801 Seventh Avenue
Oakland, California

DUNLAP ELECTRONICS

1800 - 18th Street
Sacramento, California 95809

Also in: Chico, Vallejo, Modesto, Fresno, Walnut Creek, Bakersfield, Marysville, Stockton, Merced, Redding and Reno, Nevada

QUEMENT ELECTRONICS

1000 South Bascom Avenue
San Jose, California

REDWOOD ELECTRONICS SUPPLY COMPANY

711 Summer Street
Eureka, California

WHOLESALE RADIO & ELECTRIC SUPPLY COMPANY

1348 El Camino Real
San Carlos, California

WHOLESALE RADIO & ELECTRIC SUPPLY COMPANY

1116 Folsom Street
San Francisco, California 94103
Also in Petaluma

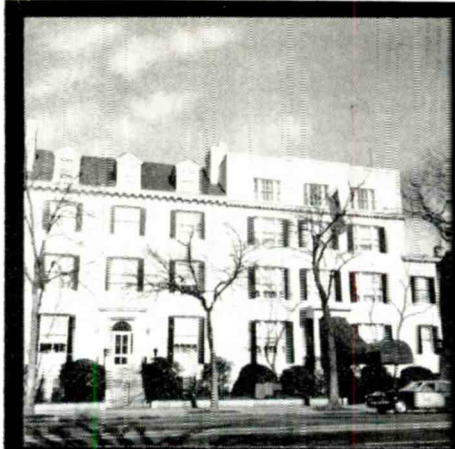

1.

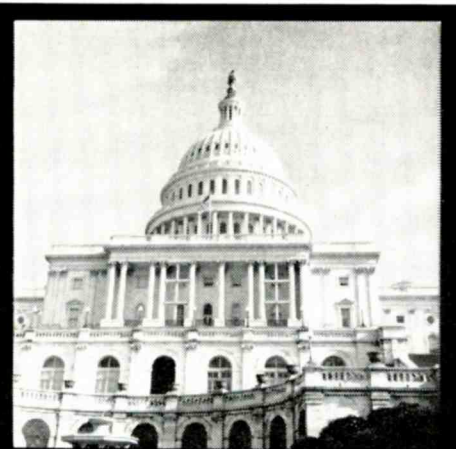

2.



3.



4.



5.



6.



7.

1. Blair House
 2. The Capitol
 3. The Pentagon
 4. Washington National Airport
 5. Department of Justice
 6. Federal Trade Commission
 7. National Space and Aeronautics Administration
 8. Federal Communications Commission
 9. Model LPV-CL430—one of eight new JFD LPV-CL Color Lasers (with FREE signal splitter) for best VHF/UHF/FM performance
 10. Model LPV-TV100—one of eight JFD LPV-TV Log Periodics for most powerful VHF/FM reception
 11. Model LPV-UCL22—one of four JFD LPV-UCL Color Lasers for ghost-free UHF pictures

Licensee subject to patent and pending cover the unique JFD log periodic design. CONTACT JFD FOR MORE INFORMATION. JFD LOG PERIODIC ANTENNAS ARE AVAILABLE IN A VARIETY OF SIZES AND CONFIGURATIONS. CONTACT JFD FOR MORE INFORMATION. JFD LOG PERIODIC ANTENNAS ARE AVAILABLE IN A VARIETY OF SIZES AND CONFIGURATIONS. CONTACT JFD FOR MORE INFORMATION.

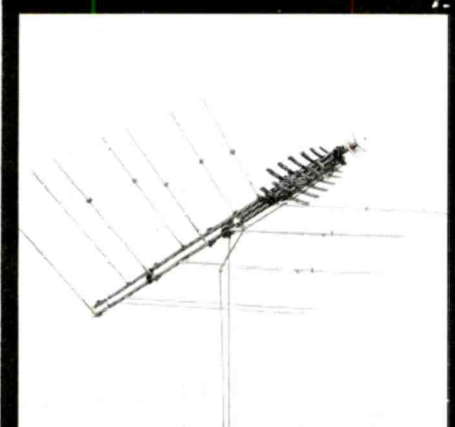

9.

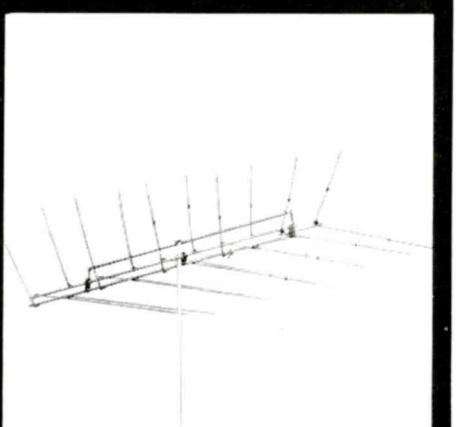

10.

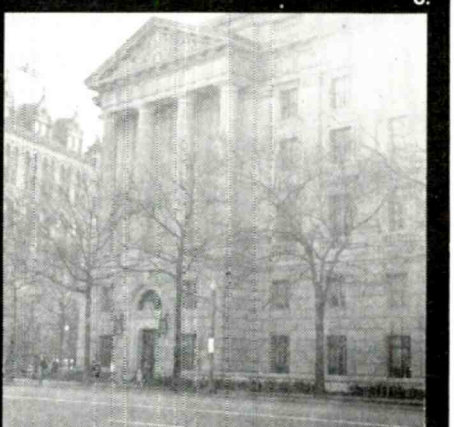

8.

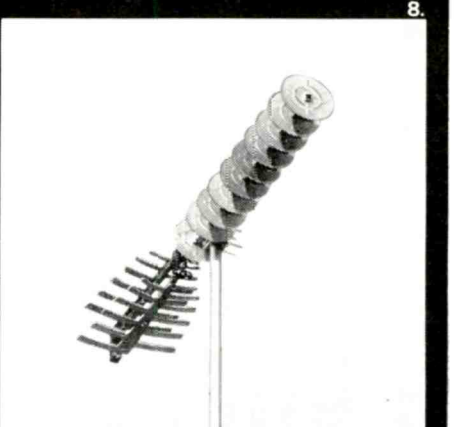

11.

SWITCH TO THE JFD LPV—THE **PROFESSIONAL'S** ANTENNA. YOUR JFD LPV DISTRIBUTOR CAN PROVE IT TO YOU!

ANDREWS ELECTRONICS
 1590 W. Burbank Boulevard
 Burbank, California
DEAN'S ELECTRONICS
 2310 Long Beach Boulevard
 Long Beach, California
GROSSMAN & REYNOLDS
 1800 West Valley Boulevard
 Alhambra, California
MARCUS ELECTRONICS
 5751 W. Pico Boulevard
 Los Angeles, California

MARTIN DISTRIBUTING COMPANY
 2509 East Florence Avenue
 Huntington Park, California
HURLEY ELECTRONICS
 2101 N. Fairview, Santa Ana, 638-7220
 In: Inglewood, 679-2276 Ontario, YU
 6-6638; San Bernardino, TU 5-0721; Long
 Beach, HE 6-8268; Oxnard, HU 3-0133;
 Oceanside, SA 2-7694.
PAPEL BROTHERS
 4652 E. Third Street
 Los Angeles, California

RABER WHOLESALE ELECTRONICS
 265 So. Laurel St., Ventura
 116 No. Nopal St., Santa Barbara
RADIO PRODUCTS SALES
 1501 So. Hill Street
 Los Angeles, California
WESTERN RADIO & T.V.
 1415 India Street
 San Diego, California
VALLEY RADIO SUPPLY
 1134 33rd Street
 Bakersfield, California

LETTERS

Dear Mr. Martin:

I have recently had occasion to read your excellent editorial and article concerning the Electronic Repair Bureau in the March issue of the Electronic Service Dealer.

It is our objective that by the implementation of this law that the public can save renewed confidence in the electronic repair industry in general and the independent repair dealer in particular. As the public confidence increases, their reliance on the skills and

services offered by this profession should proportionately increase. The enforcement of this law also protects the honest and conscientious service dealers from the unfair business practices by those who attempt to gain competitive advantage by fraud and misrepresentation. I also trust that as the public becomes more aware of our law enforcement activities for their protection that they will pay their repair bills with less reservation and misgiving.

We value your support and comments and also the support and suggestions we have received from the industry toward making this law work for the benefit of all.

Sincerely,
Henry M. Shine, Jr.
Director
Dept. of Professional &
Vocational Standards
Sacramento, Calif.

Dear Don,

Several days ago, O. W. Donald wrote you and asked that you add his and the name of Charles Erwin to your mailing list. At that time, he was of the opinion that I was already receiving your publication and didn't mention that I would also like to receive your fine publication.

I mentioned to Jack Betz when he was in Ft. Smith last month that I was not receiving the publication and he said that he would contact you and ask you to add us to the mailing list, so, if he has then you can disregard this letter, but if he hasn't then we will appreciate it if you will forward us a copy of your latest issue.

I'm enclosing a copy of our latest local bulletin.

Sincerely,
LeRoy Ragsdale
Modern Electronics
Ft. Smith Arkansas

You and O.W. should now be getting both editions of ESD.

Dear Don:

Once again the time has come for all of us to band together in combat against the unwarranted adverse publicity about our friend, the radio/TV service dealer.

Enclosed with this letter are copies of posters we have used through the years to help fight the battle. These posters are available to your TV service dealers at no charge, through local Sprague distributors across the country, and we will be happy to supply as many as are needed. Each poster carries an "RP" number in the bottom left-hand corner for ordering.

If the service dealer prefers to write directly to us individually, we ask that he enclose a dime with his request to cover the cost of packaging and mailing.

Sincerely yours,
Bill Woodury
Assistant to President
Sprague Products Co.

In our "One Voice" editorial I had forgotten the continued dealer support over the years by Sprague. No doubt a fine example of manufacture's interest and help. Dealers should take advantage of Bill's offer.

Tarzian offers
**FAST, DEPENDABLE
TUNER REPAIR
SERVICE (ALL
MAKES)**

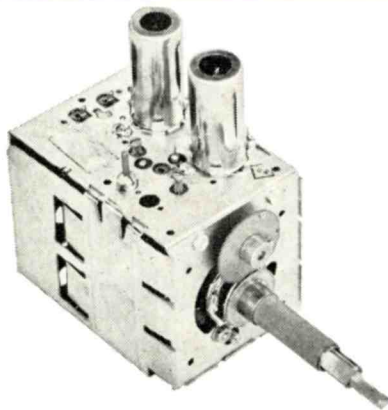

It just makes sense that a manufacturer of tuners should be better-qualified, better-equipped to offer the most dependable tuner repair and overhaul service.

Sarkes Tarzian, Inc. pioneer in the tuner business, maintains two complete, well-equipped Factory Service Centers—assisted by Engineering personnel—and staffed by specialized technicians who handle ONLY tuner repairs on ALL makes and models.

Tarzian-made tuners received one day will be repaired and shipped out the next. Allow a little more time for service on other than Tarzian-made tuners.

Tarzian offers a 12-month guarantee against defective workmanship and parts failure due to normal usage. And, compare our cost of \$9.50 and \$15 for UV combinations. There is absolutely no additional, hidden charge, for ANY parts except tubes. You pay shipping costs. Replacements on tuners beyond practical repair are available at low cost.

Ⓢ Tarzian-made tuners are identified by this stamping. When inquiring about service on other tuners, always give TV make, chassis and Model number. All tuners repaired on approved, open accounts. Check with your local distributor for Sarkes Tarzian replacement tuners, replacement parts, or repair service.

 **SARKES TARZIAN, INC.**
Bloomington, Indiana

MANUFACTURERS OF TUNERS . . . SEMICONDUCTORS . . . AIR TRIMMERS . . . FM RADIOS . . . AM/FM RADIOS . . . AUDIO TAPE . . . BROADCAST EQUIPMENT

ONLY
\$9.50
INCLUDING

**ALL PARTS
(except tubes)
and LABOR**

**24-HOUR SERVICE
1-YEAR WARRANTY**

**TWO SERVICE CENTERS
TO SERVE YOU BETTER**

See your distributor, or use the address nearest you for fast factory repair service

10654 Magnolia Blvd.
North Hollywood, Calif.
Tel: 769-2720

electronic service dealer

STAFF:

DONALD J. MARTIN
Publisher and Managing Editor
CSEA Press Secretary

A. DIANE POWELL
Associate Editor

FRANK BURNS
Business Manager

JIM KIRBY
Art & Cover Director

Vol. 7, No. 1

May, 1967

CSEA EDITORIAL ADVISORY BOARD AND OFFICERS

President
PAUL E. FORT, JR.
Vice President
HUGH WILKINS
Secretary
OAKLEY DEXTER
Treasurer
CAPP LOUGHBORO
Immediate Past President
DARRELL PETSVAL

BOARD OF DIRECTORS

Zone A
AL FOX
ZONE B
NORMAN JAMES
LARRY SCHMITT
OAKLEY DEXTER
ZONE C
AL CHESSER
ZONE D
MEL HAURY
ZONE E
LLOYD KAUN
ZONE F
CAPP LOUGHBORO
VIRGIL GAITHER
HUGH WILKINS
ZONE G
PAUL E. FORT, JR.

BOARD OF DELEGATES

Chairman
VIRGIL GAITHER
Vice-Chairman
OAKLEY DEXTER
Secretary
RAY MERREL



CALIFORNIA STATE
ELECTRONICS ASSOCIATION, INC.

RALPH JOHNNOT
Executive Director
13543 S. Hawthorne Blvd.
Hawthorne, California 90250
(213) 644-4636

Electronic Service Dealer is published monthly at 13543
So. Hawthorne Blvd., Hawthorne, Calif. 90250. Phone:
(213) 675-8070 by Associated Publications.

FEATURES

- 16 CSEA STATE BOARD OFFICE MOVED TO HAWTHORNE TO PROVIDE BETTER SERVICE
- 21 CSEA CONVENTION SLATED FOR FRESNO JUNE 9, 10, 11
- 29 FINDING FLAWS IN INSURANCE PROGRAMS
By Ralph Betz, Special Feature Editor

DEPARTMENTS

- 4 LETTERS
- 7 EDITORIAL
Owner Responsibility for Drivers
Unregistered Dealers Should Be Reported
License Laws Beginning To Be Passed
- 13 CSEA NEWSWIRE
- 25 TRADE/TALK
- 22 CLASSIFIED ADS

Entered as Controlled Circulation
at Los Angeles, California.

Help stamp out blue people

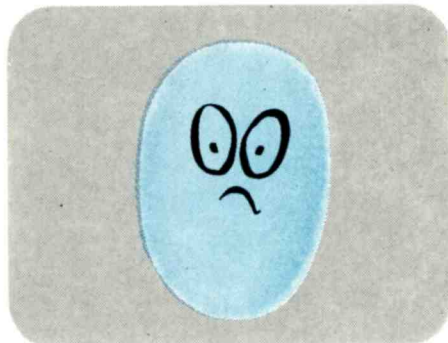

Focus on Jerrold Paralog Plus™ Coloraxial Antennas for true color



Jerrold Paralog Plus Antennas show a definite improvement in the sharpness, fidelity and color stability of the image on any TV set. Sharp directivity, uniform response and perfect matching see to that! Rugged construction insures that the quality stays high—not just for weeks or months

—but for years and years. It's the high-gain Coloraxial antenna for people who insist on VHF and FM reception—without compromise. And there are seven models to choose from.

The Paralog Plus is one of a complete spectrum of problem-solving Jerrold TV reception

aids—Pathfinder, VUfinder and Colorpeak antennas...Powermate pre-amplifiers, amplified-couplers and splitters . . . Coloraxial cable, wall outlets and wall plates. All with an appeal that can set sales rolling. For more details, see your Jerrold representative. Catalog available on request.

JERROLD®

Focusing on one thing—
better reception



Owner Responsibility For Drivers

I received a call a few days ago from a local dealer who suggested that we publish a warning to dealers regarding their responsibility and liability concerning outside technicians.

He had had the experience of hiring an outside man who reported that he had a valid driver's license when, in fact, he did not. Since it has always been his policy to do a complete check on all men he hires, a later search revealed the man had had his driver's license revoked for violations. A check with his attorney later revealed that if this man had had an accident the incident would have been compounded by the lack of a valid driver's license and the shop owner would have been liable.

With technicians in such shortage, most dealers will hire just about anyone that can plug in a tube and with very little investigation. I think that this dealer's experience may act as a warning to all dealers to make sure of the people they hire regardless of the time and effort it takes. In the long run it could mean a lot of money to you and save a lot of headaches.

Unlicensed Dealers Should Be Reported

From what we understand, the industry itself is falling down on its obligation to report to the BERDER the dealers operating without a registration certificate. When the law was first passed the complete list of registered dealers was sent out to key people in every area in the state and they reported all dealers they knew about who were not listed as registered. In the past year or so, very few reports have been received by the BERDR and it is important that registered dealers report this unfair competition to the Bureau for investigation. It's your industry and only you can keep it clean.

License Laws Beginning To Be Passed

It so happens that in my opinion the registration law is a far superior method of cleaning up the service industry than licensing with its grandfather clause and qualification standards. Now, there is probably nothing as controversial in this industry as that statement and I will try to qualify my beliefs.

First of all, when we first began publishing magazines in this industry in 1958, licensing of television service dealers was, and had been, a hot item in the California State Legislature for several years. The advocates of licensing were individuals who were, and still are, interested in eliminating the crooks from the profession and building the image of the service industry. Those opposed to licensing included many who felt that it was a method to limit competition. A means to legally say everyone now in the industry is automatically a professional technician but all of those to come must take X number of hours of instruction, apprenticeship, etc. in order to qualify to take a test to achieve the same status as those prior to the law being passed. Many felt

the industry was over populated with dealers and this would tend to limit new people from coming in and further cutting up the business. Others opposed to a license law included organized labor who felt the industry was ripe for a labor movement plus, of course, the crooks who wanted no part of a program that could put them out of business through license revocation.

The registration law has achieved, and will continue to achieve, the most important part of any license law and that is a method of determining fraud, of acquiring evidence, of winning court cases, and of revoking registrations to do business. Isn't this the major part of any license law?

With the extreme shortage of technicians the one thing this industry does not need is a license that sets standards and qualifications. These laws that are now taking effect in Indiana, Connecticut, New York, and Illinois will only cut down the number of people able to do some form of service work. It am not saying that in the future these may or may not be good or effective but right now I can only see these States coming up with more help problems.

For example, in New York you must be at least 18 years of age, pay a fee of \$25, and pass a prescribed examination presented by a Board of five examiners. In order to take the test you must have 4,000 hours of practical experience or at least 2,000 hours of experience plus having successfully completed a course of study in the service field that was approved by the Board. Anyone having these qualifications prior to the passing of the law would be exempt from the examination.

What caused the rash of license laws being passed in 1967? If you want it straight from the shoulder...it was the series of industry attacks by major newspapers and magazines. In all due respect to the service industry people who worked on these bills, who wrote them and who helped particular legislators make headlines by introducing these laws to protect the consumer...the fact remains that these articles did the trick. Any advocate of legislative action will tell you that a law will never become a law unless it is the popular thing to do. Maybe...just maybe...instead of letters of indignation the advocates of licensing should have written letters of thanks to these publications. It was no different in California. While the registration law was in the legislature for final adoption, a big article broke in the metropolitan newspapers indicating that 9 out of every 10 dealers were crooks. The article was badly written, in that these 10 dealers had received about 80% of all the consumer complaints and were ripe for catching, but the fact remains that the registration law was re-adopted almost without opposition just a few weeks later. The article gave the legislature something to hang its hat on just as the current rage on the service industry nationally is doing its job in States that had fought for licensing for 10 or 15 years prior to 1967.

(More Page 30)

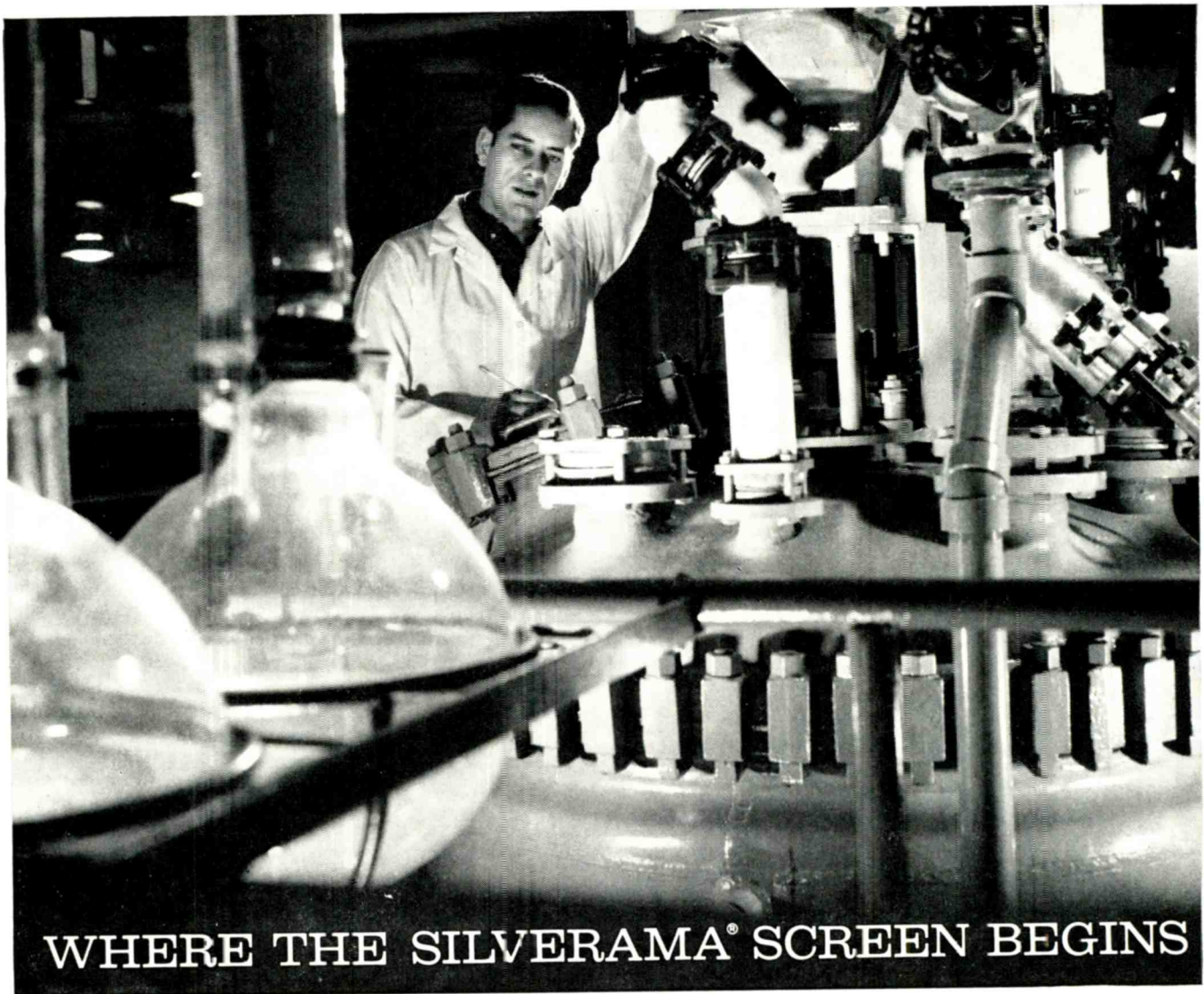

WHERE THE SILVERAMA® SCREEN BEGINS

TV picture quality depends on precise control of phosphors

Television picture quality depends on the quality of the phosphor screen inside the faceplate. That's why every RCA Silverama replacement picture tube is completely rescreened—in the same painstaking manner and with the same precision—as RCA picture tubes produced for use in original equipment. Before receiving their new Silverama screens, reused glass envelopes are scrubbed completely clean and given a series of chemical baths internally to restore them to the peak of their optical capabilities.

RCA produces and develops its own screen phosphors. These are

formed by reacting solutions of zinc sulfate and zinc and cadmium sulfates with hydrogen-sulfide gas in this complex precipitator, (above). The resulting zinc sulfide and zinc-cadmium sulfide are then activated, fluxed, fired, washed, dried, and screened to form phosphors which emit blue and yellow light, respectively. These are carefully blended to produce phosphors that possess the pleasing "white", high light output, and uniform smoothness, which characterize RCA Silverama picture tube screens.

Make RCA Silverama your first choice in picture tubes.



Drying ovens remove moisture from phosphor

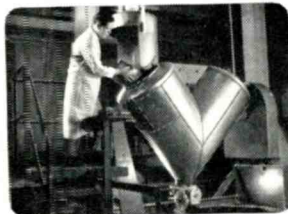

Phosphors are blended for best screen quality



Base materials are fired to form the phosphors

RCA ELECTRONIC COMPONENTS AND DEVICES, HARRISON, N. J.



The Most Trusted Name in Electronics



Guide to

COMPLETE RECEPTION

with

RCA ANTENNAS

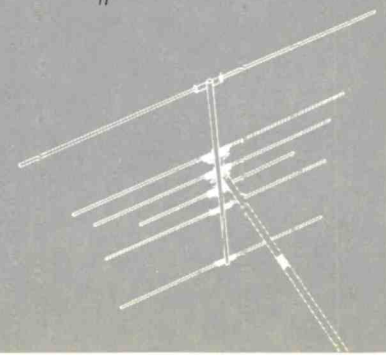
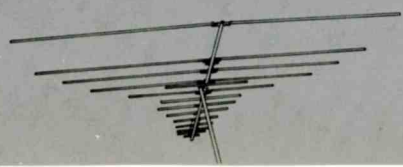
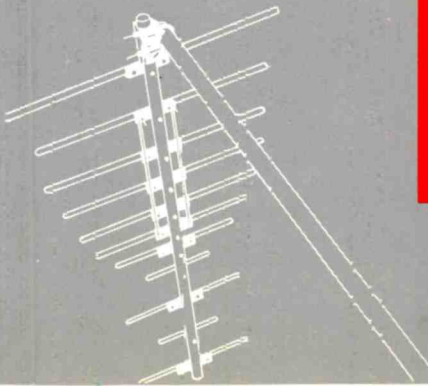
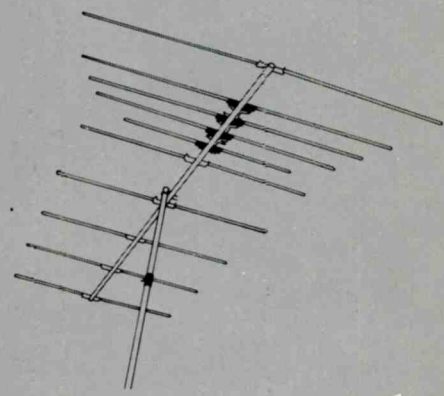
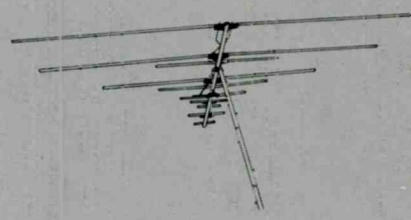
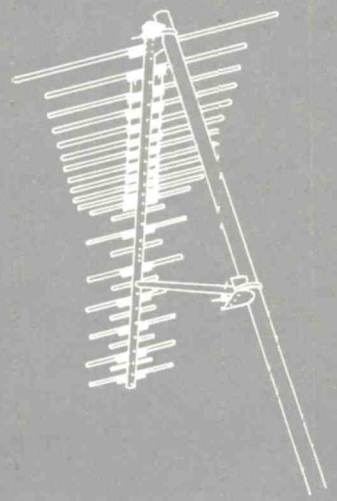
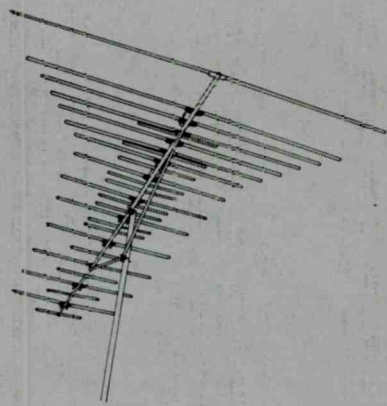
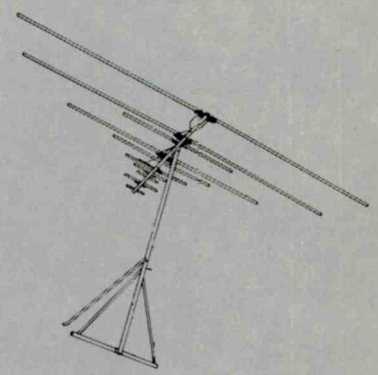
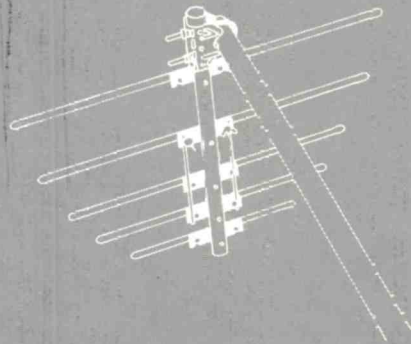
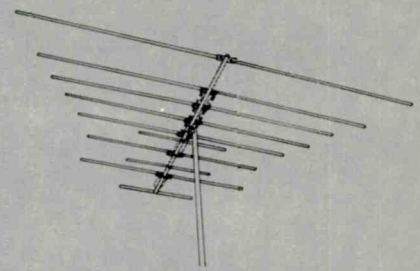
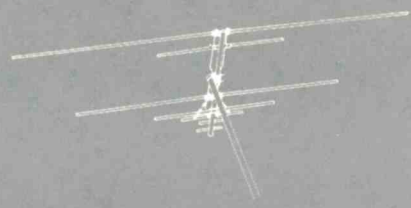
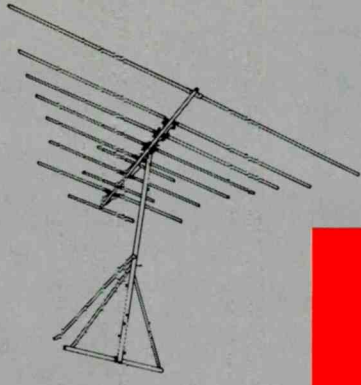

RCA

OUTDOOR ANTENNA

FACT SHEET

The engineering developments that have gone into the design of these antennas add a new dimension in TV reception quality and enjoyment. This full line of "top performance" antennas enables the entire market to be covered with the selection of the appropriate antennas.

The following features apply to some or all of RCA's Outdoor Antenna line:

- Excellent weather resistance obtained by employing the latest techniques in gold color finishes.
- Ultra-compact design.
- Highly efficient due to extremely low VSWR.

† Larger antennas have special FM feature that enables reception to be tailored to the area's needs.

- The 150 series UHF antennas have an "add on" feature allowing them to be attached to an existing VHF antenna lead in without use of a separate coupler.
- Most combination UHF/VHF antennas include a model 10A135 splitter to separate the UHF signal from the VHF at the receiver.

Their superior performance assures customer satisfaction on VHF, UHF, and FM, Color or Black & White TV. RCA Tops Them All in Presenting The Complete Picture.

VHF/FM OUTDOOR ANTENNAS

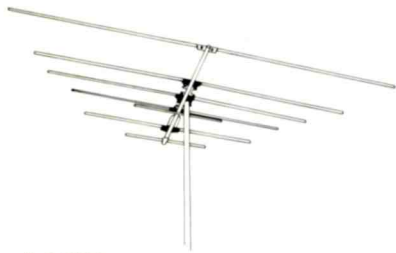

Elements	7
Double Elements	0
Total Active Elements	7
Longest Element	110"
Boom Length	43"

LIST*
\$14.95

10B1010

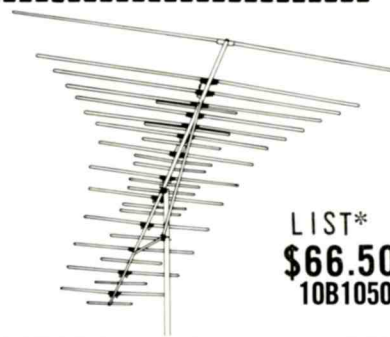

LIST*
\$66.50
10B1050

† Special FM Feature

Elements	27
Double Elements	6
Total Active Elements	33
Longest Element	110"
Boom Length	192"
Boom Support	Yes

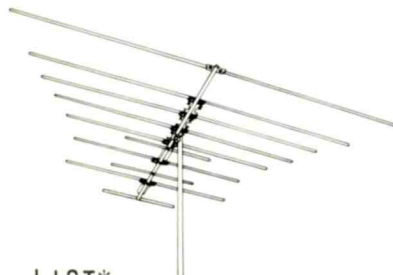

† Special FM Feature

Elements	10
Double Elements	1
Total Active Elements	11
Longest Element	110"
Boom Length	62½"

LIST*
\$20.95

10B1020

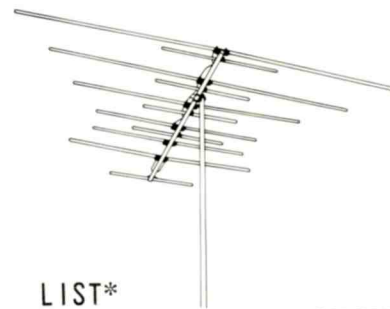

LIST*
\$23.50

10B200

Elements	10
Double Elements	1
Total Active Elements	11
Longest Element	97½"
Boom Length	62½"



† Special FM Feature

Elements	14
Double Elements	1
Total Active Elements	15
Longest Element	110"
Boom Length	82¼"

LIST*
\$33.95

10B1030



LIST*
\$29.95

10B300

Elements	12
Double Elements	1
Total Active Elements	13
Longest Element	110"
Boom Length	79¾"



† Special FM Feature

Elements	19
Double Elements	3
Total Active Elements	22
Longest Element	110"
Boom Length	112"

LIST*



LIST*

Elements	15
Double Elements	4
Total Active Elements	19
Longest Element	110"
Boom Length	131¾"

VHF/UHF/FM OUTDOOR ANTENNAS

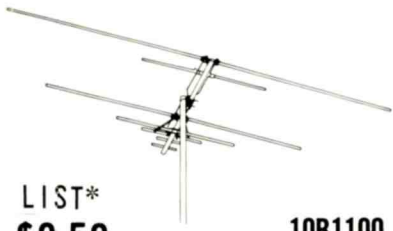

LIST*
\$9.50 10B1100

Elements	7
V&U Elements	V = 4 U = 3
Double Elements	V = 0 U = 1
V&U Active Elements	V = 4 U = 4
Total Active Elements	8
Longest Element	81½"
Boom Length	29¾"

UHF OUTDOOR ANTENNAS

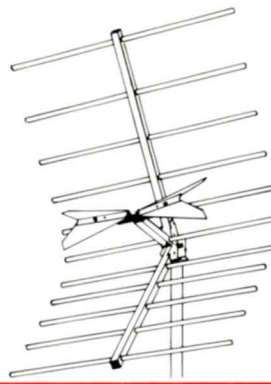

LIST*
\$8.25
7B140

Elements	12 *
Double Elements	*
Total Active Elements	*
Width	22"
Height	30"



LIST*
\$15.95 10B1110
(Coupler—U/V Splitter Included)

Elements	10
V&U Elements	V = 5 U = 5
Double Elements	V = 0 U = 3
V&U Active Elements	V = 5 U = 8
Total Active Elements	13
Longest Element	93"
Boom Length	41"

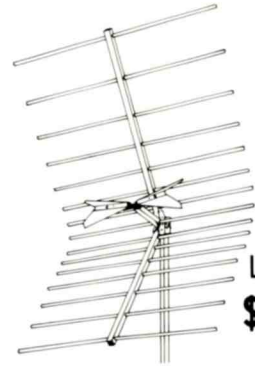

LIST*
\$10.95
7B141

Elements	16 *
Double Elements	*
Total Active Elements	*
Width	28"
Height	38"

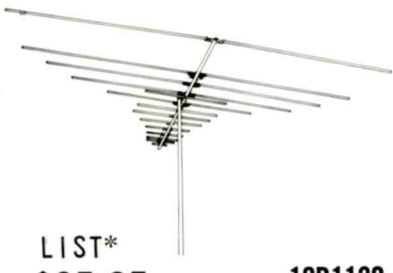

LIST*
\$25.95 10B1120
(Coupler—U/V Splitter Included)

Elements	14
V&U Elements	V = 8 U = 6
Double Elements	V = 0 U = 5
V&U Active Elements	V = 8 U = 11
Total Active Elements	19
Longest Element	110"
Boom Length	72½"

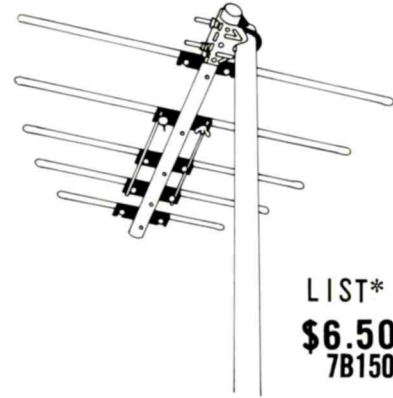

LIST*
\$6.50
7B150

Elements	5
Double Elements	5
Total Active Elements	10
Longest Element	21"
Boom Length	18¼"



LIST*
\$40.50 10B1130
(Coupler—U/V Splitter Included)

† Special FM Feature	
Elements	21
V&U Elements	V = 11 U = 10
Double Elements	V = 1 U = 9
V&U Active Elements	V = 12 U = 19
Total Active Elements	31
Longest Element	110"
Boom Length	94"

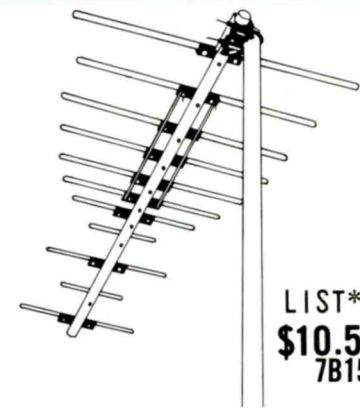

LIST*
\$10.50
7B151

Elements	11
Double Elements	9
Total Active Elements	20
Longest Element	21"
Boom Length	39¼"

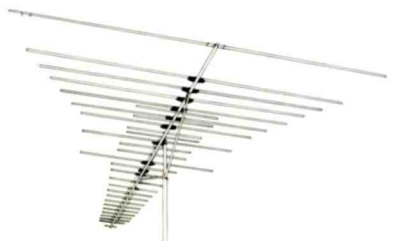

LIST*
\$57.30 10B1140

† Special FM Feature	
Elements	29
V&U Elements	V = 16 U = 13
Double Elements	V = 2 U = 12
V&U Active Elements	V = 18 U = 25
Total Active Elements	43
Longest Element	110"
Boom Length	138½"

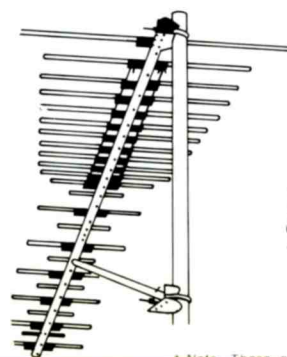

LIST*
\$21.50
7B152

Elements	24
Double Elements	18
Total Active Elements	42
Longest Element	22¼"
Boom Length	82"
Boom Support	Yes

* Note: These are aperture reflector type antennas in which the performance

FM OUTDOOR ANTENNAS



LIST*
\$18.95

10C450

Elements	6
Double Elements	0
Total Active Elements	6
Longest Element	66"
Boom Length	60¼"



LIST*
\$30.95
10C550

Elements	10
Double Elements	0
Total Active Elements	10
Longest Element	66"
Boom Length	129½"
Boom Support	Yes

OUTDOOR ANTENNA KITS



LIST*
\$22.95

10B1011
(Kit version of 10B1010)

Elements	7
Double Elements	—
Total Active Elements	7
Longest Element	110"
Boom Length	43"



10B1111
(Kit version of 10B1110)
LIST*
\$23.95

Elements	10
V&U Elements	V = 5 U = 5
Double Elements	V = 0 U = 0
V&U Active Elements	V = 5 U = 5
Total Active Elements	13
Longest Element	93"
Boom Length	41"



10B1021
(Kit version of 10B1020)
LIST*
\$29.50

† Special FM Feature

Elements	10
Double Elements	1
Total Active Elements	11
Longest Element	110"
Boom Length	62½"



10B1121
(Kit version of 10B1120)
LIST*
\$34.50

Elements	14
V&U Elements	V = 6 U = 8
Double Elements	V = 0 U = 0
V&U Active Elements	V = 6 U = 8
Total Active Elements	19
Longest Element	110"
Boom Length	72½"

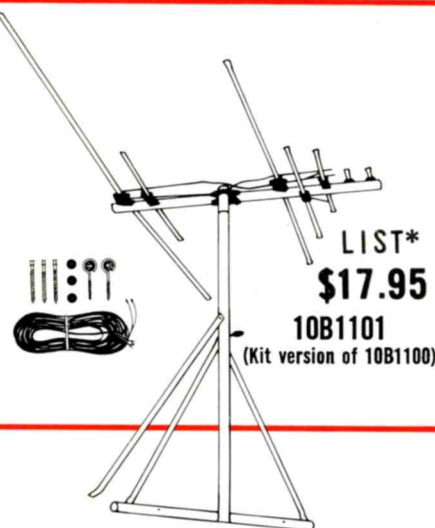

LIST*
\$17.95
10B1101
(Kit version of 10B1100)

Elements	7
V&U Elements	V = 4 U = 3
Double Elements	V = 0 U = 1
V&U Active Elements	V = 4 U = 4
Total Active Elements	8
Longest Element	81½"
Boom Length	29¾"

Available only from. . .

RCA VICTOR DISTRIBUTING CORP.
6051 TELEGRAPH ROAD
LOS ANGELES, CALIFORNIA 90022



- | | |
|----------------------|------------|
| LOS ANGELES | • 723-6661 |
| SAN FERNANDO VALLEY | • 781-6501 |
| PASADENA/BURBANK | • 246-8373 |
| SAN GABRIEL VALLEY | • 443-6907 |
| WHITTIER/ALAMBRA | • 728-7295 |
| LONG BEACH/DOWNEY | • 639-6950 |
| INGLEWOOD/REDONDO | • 675-4401 |
| ORANGE COUNTY (714) | • 521-6700 |
| SAN BERNARDINO (714) | • 889-1518 |



THE MOST TRUSTED NAME IN ELECTRONICS

* DISTRIBUTOR SUGGESTED, OPTIONAL WITH DEALER.



CSEA NEWS WIRE

A ROUND-UP OF STATE AND LOCAL NEWS OF
THE CALIFORNIA STATE ELECTRONICS ASSOCIATION

WARRANTY PRICING COMMITTEE OF NEA DISCUSSED

NEA's survey and creation of a warranty pricing committee came under discussion at the last board meeting of CSEA. Under the plan, NEA will survey and report the warranty prices being paid by manufacturers in different parts of the country.

ESD ESD ESD

YUBA SUTTER AND BUTTE CHAPTERS MERGE

The Yuba Sutter and Butte Chapters of CSEA have merged into one chapter and will now be called the Superior Chapter.

ESD ESD ESD

MONTHLY BILLING FOR ALL MEMBERS STARTING JULY 1

All members of CSEA will be receiving monthly dues billing starting on July 1, 1967. In some instances the state office will bill state dues, zone dues, chapter dues and NEA dues with one total billing and remit to the various activities as a service to these chapters. The state will bill the state dues monthly regardless but each chapter or zone will determine whether or not they desire this service of the state office. Monthly billing of insurance will continue as before but any dealer with insurance who lets his policy lapse after the grace period will have it cancelled. A similar grace period will be set on dues as well. The board felt that by changing the billing to monthly it would be easier for members to pay a smaller monthly figure for dues than to pay the larger quarterly dues. In all instances, State dues will be paid directly to the State office so that an up-to-date roster may be maintained.

ESD ESD ESD

RAY DOYLE AND WALTER AVRIL INSTALLED AT JOINT MEETING

Ray Doyle of the Pasadena Chapter and Walter Avril of the Glendale chapter were installed last month as presidents of their respective chapters. The installation dinner was a joint affair between the two chapters and Ralph Johonnot acted as installing officer.

ESD ESD ESD

SPECIAL THANKS TO BILL LAWLER AND HIS WIFE

A special thanks was given last month by the CSEA Board of Directors to Bill Lawler and his wife of Los Angeles for their help in moving the State office materials from Fresno to Hawthorne. In spite of wind and snow and rain...the move went through late into the night and was truly above and beyond a call of duty.

ESD ESD ESD

RED CARPET PLAN

CSEA Board of Directors has adopted, tentatively, a red carpet plan for all members. The red carpet is made of special material and will be used as a drop cloth for all tube cadies. It will be red in color, will carry the CSEA bug as well as a message, and will be used to identify CSEA "Red Carpet Service". Full details and production of the drop cloth have not been completed as yet but members will be notified when they are available.

ESD ESD ESD

CSEA CONVENTION PLANNED FOR JUNE 9, 10, 11 IN FRESNO

The annual CSEA Convention will be held June 9, 10 and 11 in Fresno, California at the Hacienda Hotel. The three-day affair will highlight one of the most outstanding programs in the history of the Association. At the present time, plans are being made to have major manufacturers sponsor meals and to provide special top notch speakers and panels. A full report can be found in this issue of ESC.

ESD ESD ESD

NEW INCOME PROTECTION INSURANCE PLAN BEING CONSIDERED

A new plan for income protection is being considered by the insurance committee of CSEA for possible offering to members. The new plan seems to provide greater coverage at less cost and is offered by American Life and Casualty Company.

ESD ESD ESD

ZONE B NOT TO SOLICIT MANUFACTURERS OR DISTRIBUTORS

Zone B, again last month, went on record as being against the solicitation of prizes, gifts or donations for its chapter members from any manufacturer or distributor. This move does not mean that these firms may not participate in social or other such functions but rather that no pressure of any kind will be placed or implied. The service industry has come a long way and a great deal of the help has come from the many manufacturers and distributors. The Zone delegates agreed that the time has come to thank these people.

ESD ESD ESD

ANDY SMITH NAMED PRESIDENT OF SACRAMENTO CHAPTER

Andrew Smith of C and S Television Co. was recently elected as the new President of the Sacramento Chapter of CSEA. The election was held during the chapter's annual meeting and also included the election of Richard Curtis of Handy Andy as vice-president, Joe Rodriguez as Treasurer and Directors included George Rogers, Diamond Lum, Walter Kinney and Aloph Gower who automatically reverts to the Board. The chapter also reported much action in regards to special classes and plans for this year. John Grote was re-elected as Executive Secretary for the group.

1



2



3

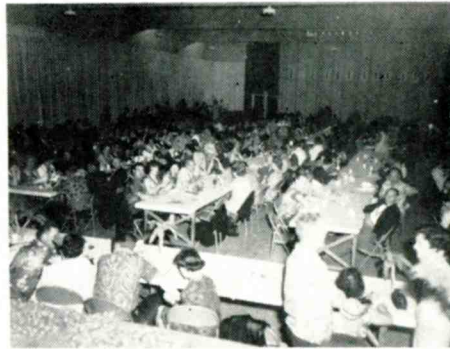

4

5

6

487 PEOPLE ATTEND SANTA CLARA CHAPTER LUAU

Thanks to Larry Schmitt, we have the above 6 pictures of the fantastically successful Santa Clara Chapter Luau.

(1.) ZONE B OFFICERS are installed by past president Darrel Petswal. Standing 1. to r. are Vern Hasset, secretary treasurer, Ken Deedler, vice president; and Lee Hoy who was re-elected president.

(2.) OUTGOING PRESIDENT T. C. Marshburn of the Santa Clara Chapter is shown here installing the new Chapter officers. 1. to r. are Jim Ballard, President; Marshburn, Barner Tinger, Vice President and Woodrow Yoder the new Secretary/Treasurer.

(3. 4. 6.) THE HEAD TABLE and a view of the huge crowd that enjoyed the largest and finest installation of officers for any chapter or organization anywhere. A truly remarkable turnout. MUSIC FOR THE AFFAIR was naturally Hawaiian and enjoyed by all.

(5.) EVEN SOME OF THE DISTRIBUTORS got into the act as Bill Wallace (left) talks over business with Bob Harris of Calectron. Wallace is with the H. R. Basford Company distributors of Zenith while Calectron distributes RCA products.

ESD ESD ESD

SONOMA DEALERS REPORT SET BREAKDOWN INCREASING

The Sonoma County dealers reported that they are having more and more trouble with new sets with seriously increasing problems of in-warranty TV breakdown. Many sets are reported to need circuit repair when they come out of the box and many feel the manufacturers are trying to take advantage of the retailers 90-day free service. Some dealers have actually reported that they had to repair a customer's set prior to that customer ever using it. The Chapter also reported more and more use of the rate schedule price guides originally printed in ESD.

ESD ESD ESD

ACTRA and Zone B delegates will meet this month with officials of the Pleasanton Job Corp Center in order to learn more about the operation and training now being conducted in TV servicing. The program there includes 450 hours of training over a period of 36 weeks initially and it is hoped that these representatives of CSEA will be able to help place the graduates of this program.

ESD ESD ESD

AMENDMENT TO BERDR PROPOSED

The Sacramento Chapter reported that amendments to the BERDR are to be introduced at this legislature. They would include, a dealer going into business on May 31st would not have to renew his registration until the following June 30th a year later . . . a grace period of 30 days without penalty or renewal fee payments . . . and the reduction of the fee for late renewal from double to one half times the renewal fee . . . a 50% penalty.

NATIONAL ELECTRONICS ASSOCIATION'S CERTIFICATION PROGRAM OUTLINED

PURPOSE:

To provide a level of technical competence for practicing Electronic Service Technicians to attain — comparable to that required by the NEA *United States Department of Labor* 4-year apprenticeship program completion requirements for *Journeyman Electronic Technician* (Radio and Television Repair).

To provide service dealers — manufacturers — educational facilities and others with a guide in employment judgement.

To provide the consumer with a means of judging minimum technical ability of their home electronic service agency.

To provide the *Journeyman Technician* with a national reference attesting to his educational background and technical experience.

TESTING:

The National Electronic Associations, Inc., through its Apprenticeship and Training Committee, will provide tests covering theory and practical problems, the solution of which normally would be expected and needed for those engaged in Electronic Service of home entertainment and associated equipment, including antenna theory. A grade of 80% correct is considered passing. Tests grading will be by the National Committee and/or public educational facility.

CERTIFICATE:

A 9" x 11" framed certificate on parchment, signed by the National President, National Apprenticeship Committee Chairman, and representative of the State Electronic Service organization. Each certificate will contain the date of certification attainment and the registration number assigned to that individual and recorded permanently in the certification file of the National Electronic Associations, Inc. Also a billfold size card with similar information will be supplied.

FEES:

Each certification applicant, before completing the personal information page of the test will pay a \$5.00 fee to the testing officer. This fee covers cost of materials, testing and grading expenses, registration and record keeping.

Retesting fees: In the event that applicant fails the first test attempt, he may engage in second and succeeding attempts at later dates for an additional \$5.00 fee.

ELIGIBILITY & REQUIREMENTS:

Applicant must have had four full years of Radio & Television service experience, or equivalent part time work. Federal law requires the exam be open to all qualified persons regardless of Race, Creed, Color, Sex, or National Origin.

Slight changes in fees, testing procedure and definitions are contemplated for future phases of the program as technical changes occur and the program becomes widespread. The basic program will remain the same.

ADDITIONAL INFORMATION:

Other details not covered here, or information on dates of testing examinations, may be obtained from: The California State Electronics Association.

NEW STATE OFFICES



Board of Directors meeting in new offices stop for a moment for this picture—new CSEA drop cloth is shown in second picture.

- DELCO AUTO RADIOS
- RCA
- ZENITH
- GENERAL ELECTRIC

PLUS—THE BEST LINES
OF GENERAL
REPLACEMENT PARTS



ANDREWS

ELECTRONICS

1500 W. BURBANK BLVD.
BURBANK, CALIF.

TH 5-3536 ST 1-3120
VI 9-6014

CSEA State Office Moved To Hawthorne to Provide Better Service

The California State Electronics Association's Board of Directors has moved the state wide Association's office to 13543 So. Hawthorne Blvd., in Hawthorne, California as of the first of April.

The move from Fresno was made in order to provide greater services for the members and to take advantage of the Electronic Service Dealer's offices.

Heading the new office is former CSEA State President Ralph Johannot and he will be assisted by Mrs. Betty Nickolson.

Immediate plans call for the establishment of better communications with members with a monthly newsletter from the Executive Secretary, special CSEA member promotions, a complete insurance package, preparation for an outstanding three day convention in Fresno June 9, 10 and 11th and the immediate attention towards providing greater services to the chapters, zones and individual members.

Future plans include such items as legislation and industry regulations, possible employment direction service for those seeking new positions and those being offered, an industry image building campaign, etc.

The new offices consists of fully carpeted and paneled executive office, reception area and work room for printing and duplicating materials.

All future correspondance should be directed to this office and it will receive immediate attention.



RALPH JOHANNOT

CSEA State Offices

13543 S. Hawthorne Blvd.
Hawthorne, Calif. 90250

Area Code
213

Phone
644-4636

Ralph Johannot
Executive Director
Betty Nicholson
Secretary



RECEPTIONIST AND SECRETARY BETTY NICHOLSON is shown here as she conveys information to a phone caller. Executive Director Ralph Johannot goes over some of the details of Association work as the new executive offices are opened for business.

DISTRIBUTED IN CALIFORNIA BY:

CHANNEL MASTER ANDREWS ELECTRONICS

1500 W. Burbank Blvd.
TH 5-3536

ASSOCIATED RADIO DIST.

1583 Howard St.
San Francisco, HE 1-0212
IN

Palo Alto: DA 3-3173
San Mateo: FI 5-3575
Vallejo: MI 3-4531

HURLEY ELECTRONICS

2101 N. Fairview, Santa Ana, 638-7220
IN

Inglewood: 679-2276
Ontario: YU 6-6538
San Bernardino: TU 5-0721
Long Beach: HE 6-8268
Oxnard: HU 3-0133
Oceanside: SA 2-7694

KIESUB CORP.

311 W. Pacific Coast Hwy.
Long Beach 591-1335 & SP 5-1428
IN

Anaheim: KI 7-3527 & 865-0688
Bakersfield: FA 7-5535
Oxnard: HU 3-9541
San Bernardino: TU 5-6807
Van Nuys: ST 1-3930

MILLER'S ELECTRONICS

530 East 8th Street (94606)
Oakland, 834-9185
IN

Santa Rosa, 542-5423
2076 Armory Drive (95401)
Walnut Creek, 934-3000
1263 Arroyo Way (94596)
San Rafael, 453-1130
134 Jacoby Street (94901)
Hayward, 537-5833
21726 Meekland Avenue (94541)
San Jose, 295-6818
522 So. Bascom Ave. (95128)

NORCAL ELECTRONICS

1115 "R" Street
Sacramento, 442-9041

WESTERN RADIO & TELEVISION SUPPLY CO.

1415 India St., San Diego
BE 9-0361

WESTERN ELECTRONICS

4580 East Belmont Ave.
Fresno, California
Fresno, 251-5531

CHANNEL MASTER

UHF/VHF

COLOR-DUCT

PAT. PENDING

82

the direct line to Color

First major improvement in
75 ohm coaxial cable since the
introduction of braided shielding.

CHANNEL MASTER

COLOR-DUCT 82

is the successor to
ordinary coaxial cable...

**100% shielding and
lowest UHF/VHF loss
are the reasons why:**

- Color-Duct 82 is the lowest loss RG-59 type cable ever made for color TV reception.
- Color-Duct 82 is more electrically stable, even in high moisture.
- Color-Duct 82 is the most economical coax available.

Color-Duct 82 is your most DIRECT and ECONOMICAL line to color on all channels. In addition to all its other advantages and superior performance, new Channel Master Coaxial Shielded Color-Duct 82 is the most economical coaxial cable you can buy. Now a professional coaxial installation can be made at low cost for any owner of an 82-channel, color or black and white set.

STANDARD RG-59/U TYPE CABLE

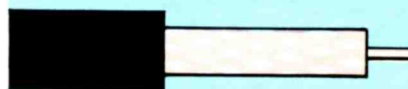

For many years, RG-59/U type cable has been the standard coax for use in home and commercial television installations where coaxial transmission lines are required. Its braided shield serves three functions: to prevent interference pick-up, to prevent radiation, and to serve as one of the conductors. The effectiveness with which these functions are carried out by the shielding depends upon the quality of the braid and the size and number of wires making up the "picks", or strands of wire woven to form the braid.

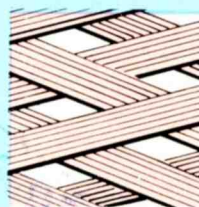

In any braided shielding, air spaces are formed between the picks which have the effect of reducing both the conductivity and the shielding of the braid from 80 percent in the best quality coax to as low as 50 percent in lower grade cable where fewer picks have been used in the braid.

These air spaces in ordinary shielding create a resistance to current traveling from antenna to set and are largely responsible for the high db loss traditional in coaxial cable. In addition, more serious problems occur in the presence of water and high humidity conditions. Additional db losses under these conditions can be a serious problem in color and at high UHF frequencies.



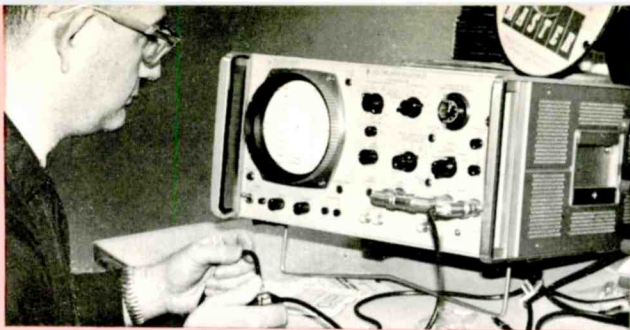

QUALITY-CHECKED... ELECTRONICALLY.

Channel Master Color-Duct 82 is electronically checked on the production line by an advanced device known as a Time Domain Reflectometer. The "TDR" checks for maintained impedance, continuity of shielding, insulation quality and quality of dielectric by sending a radar signal through the cable. Any defects are displayed on a CRT screen.



model 9537

"100% SHIELDING" literally creates a direct line to color.

Until now, solid shielding has been used *only* on transmission cables in commercial and military communications, radar, and in professional audio and broadcasting installations. Here, where complete shielding from radiation and interference pick-up are critical, the solid tube type of shield has always proven most effective.

NOW, Channel Master has applied this proven 100% shielded construction... for the first time in TV history... to 75-ohm coaxial cable designed for home television installation.

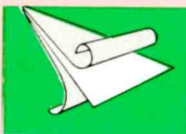

Channel Master's solid shield is created by laminating aluminum foil to both sides of high tensile strength mylar.

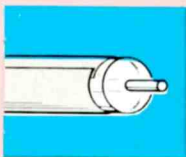

This shield is then totally wrapped and over-lapped around the virgin polyethylene dielectric core containing the copper clad center conductor.

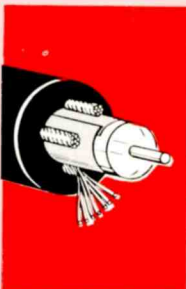

Before the black outer jacket is applied, four equally-spaced, parallel drain wires are positioned around the circumference of the shield. In addition to providing extra strength to the cable, these wires maintain electrical conductivity even if a break should occur in the shielding.

100% shielding not only eliminates the moisture problems of braid but creates the most electrically-efficient RG-59 type coaxial cable ever developed.

Here, diagrammatically, is how Channel Master Color-Duct achieves amazing low-loss superiority over RG-59 type cable.

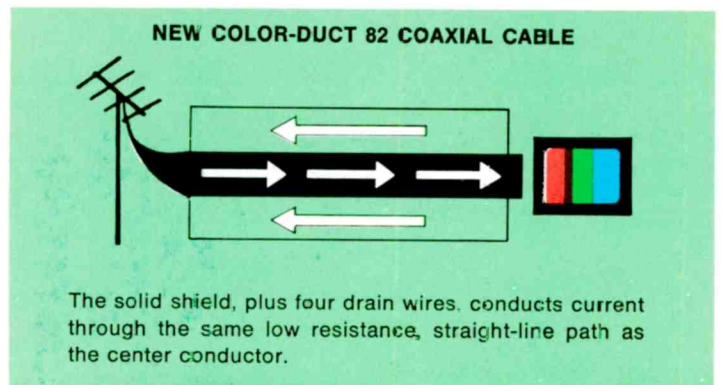
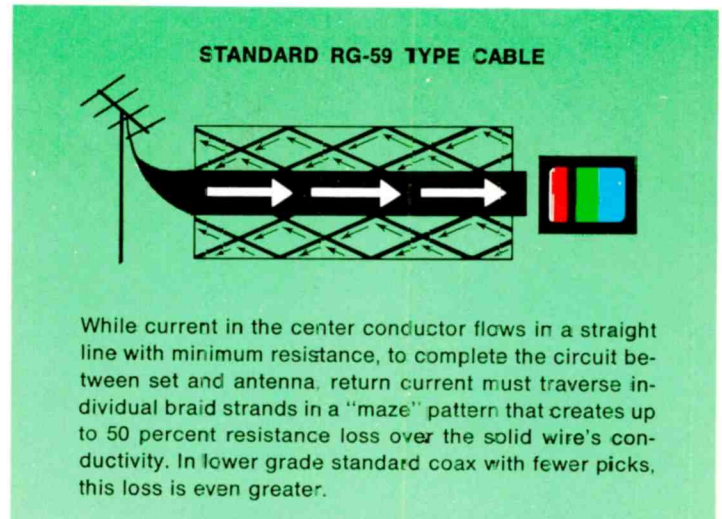

Exclusive Color-Duct 82 design proves its superiority in actual installations... VHF and UHF.

DB LOSS PER 100 FEET RG-59/U VS CHANNEL MASTER COLOR DUCT-82

VHF	RG-59/U	COLOR DUCT-82
55 MC	2.8	2.0
200 MC	5.6	3.8
UHF		
500 MC	9.0	6.3
650 MC	10.1	6.9
800 MC	11.8	8.3

At higher UHF frequencies, use of Color-Duct 82, instead of ordinary coax, is actually the equivalent of adding a 3 db amplifier to the installation! This is a tremendous boom for UHF color and VHF fringe area coaxial installations.

CHANNEL MASTER

75 OHM ACCESSORIES

For professional UHF/VHF/FM home installations of single and multiple set systems. Ideal companion equipment for New Coaxial Shielded Color-Duct 82 Cable.

2 AND 4 SET COUPLERS

Indoor or outdoor mounting ... can also be used as MATV line splitters.

UHF, VHF and FM



2 Set Coupler
Model 0047

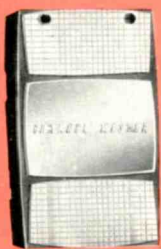

4 Set Coupler
Model 0045

Commercial Grade MATV VHF/FM



2 Set Coupler
Model 7042



4 Set Coupler
Model 7044

BAND SEPARATOR/ANTENNA JOINER

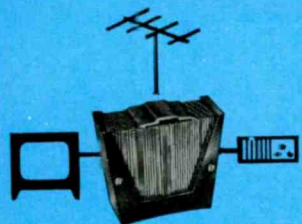

Band Separator
and 75 to 300 ohm
Matching Transformer
Model 0048

Used at the set to separate the combined U and V signals from 75 ohm transmission line into separate 300 ohm VHF and UHF outputs. Also may be used as

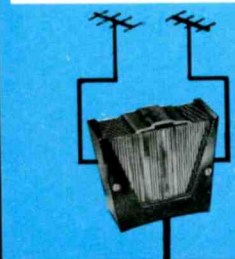

UHF/VHF plus FM
Antenna Joiner
and
300 to 75 ohm Balun

BALUNS

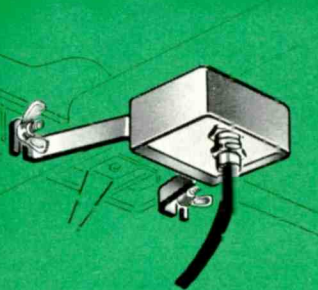

UHF/VHF/FM
Antenna-Mounted Balun
Model 0035A

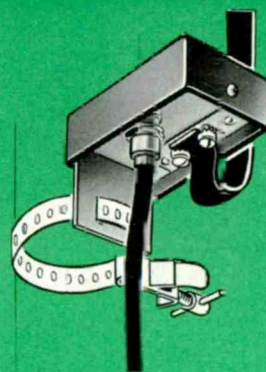

VHF/FM
Mast-Mounted Balun
Model 7000

available at:

MATCHING TRANSFORMERS

82 CHANNEL

Industry's best price and performance value for home cc-ax or MATV application.

UHF/VHF/FM Matching Transformer.

For indoor mounting only. 75 ohm input—300 ohm output. Model 7-80.

... thousands used in MATV installations.

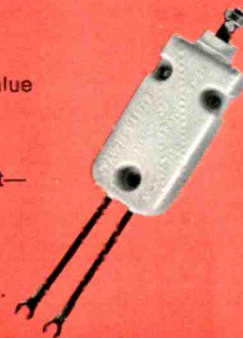



A VERY FAMILIAR SCENE for past CSEA Convention goers is this one at the large Olympic size pool at the Hacienda Hotel in Fresno. The hotel features two pools and excellent convention facilities

CSEA CONVENTION SLATED FOR FRESNO JUNE 9, 10 & 11

THREE DAY EVENT TO FEATURE TOP SPEAKERS

SPONSORED EVENTS AND ASSOCIATED BUSINESS

The 12th annual convention of the California State Electronics Association will be held on June 9, 10 and 11th at the Hacienda Hotel in Fresno California with an outstanding program planned for all members, guests and delegates.

Initial plans call for all meal meetings to be sponsored by top manufacturers such as General Electric, RCA, Sylvania, Jerrold, Winegard, Channel Master, JFD, Finney, Zenith and others asked to participate. Local distributors have also been asked to join with these delegates and to add their support to the three day convention program. (A complete program and sponsor list will be included in the June Convention Issue of ESD.)

The idea behind sponsored meal functions is to make it possible for any delegate or member of CSEA to join in the convention programs at the least amount of cost. Through this program of sponsored events, a dealer will be

able to attend the convention for a total cost of his room (\$9 for a single per night and \$11 for a double) plus a \$10 registration fee. In other words, a delegate may bring his family and register for two nights for a total cost of \$32 including all meals.

Every chapter of CSEA is asked to sponsor his chapter's delegate to the convention and to register in advance so that all voting credentials can be checked out and varified. A special mailing to chapter Presidents will be in the mail within the very near future along with a complete finalized program.

Agenda Highlights

The three days of programs will be void of formal board type meetings with the old CSEA Board of Directors meeting at 9:00 a.m. on Friday morning June 9th just prior to the opening of the convention at 12:30.

Mr. Jack Betz, President of the National Electronic Associations, will be

the keynote speaker at the kick-off luncheon and will explain the many programs of NEA to the delegates. M. C. for the event will be Emmett Melford of Riverside and Darrel Petzwal of Sacramento will introduce Jack Betz.

That afternoon, Lee Hoy of Marin County, will act as MC and will introduce Gerry Barkoukus, NEA/OJT coordinator who will explain the nationwide apprenticeship program of NEA and the Federal Government, He will be followed by Mr. Dick Glass, former President of NEA who is now in charge of the NEA self certification program. At 3:00 p.m. that afternoon, there will be a report of the nominating committee for officers of CSEA for 1967-68 and open nominations from the floor. All voting delegates will participate and will then carry on any other business of the Association.

The evening, there will be a get-acquainted cocktail party followed by dinner. The dinner will be MC'd by

(Continued on Page 24)



Are you eligible for the Bright Guy Awards?

It's easy to get them—and to get all the business they'll bring you. New customers. More sales. More money.

The Bright Guy Awards is the big program Sylvania's running this year to boost your sales.

Your Sylvania distributor can put your name and address in up to four TV Guide ads in your area. The ads call you "the brightest serviceman in town"—and tell people in your town why they should call you.



You'll get into the Yellow Pages, too, under the heading "TV Service and Repairs."

Once again this year you'll be eligible for over



one hundred valuable, interesting SMB-Bright Guy gifts, just for buying the Sylvania TV replacement parts you normally buy anyway.

And you'll get window displays proclaiming you "the brightest"—the TV serviceman everyone's reading about.

You're eligible for the Bright Guy Awards just by buying Sylvania's famous *color bright 85*[®] color picture tube. And our other picture tubes, and our receiving tubes. So see your Sylvania distributor.



Sylvania Electronic Tube Division, Electronic Components Group, Seneca Falls, New York 13148.

SYLVANIA
SUBSIDIARY OF
GENERAL TELEPHONE & ELECTRONICS **GTE**

THE HUGH NEW CONVENTION CENTER
AT THE HACIENDA HOTEL WILL BE
THE SCENE OF MANY ACTIVITIES.

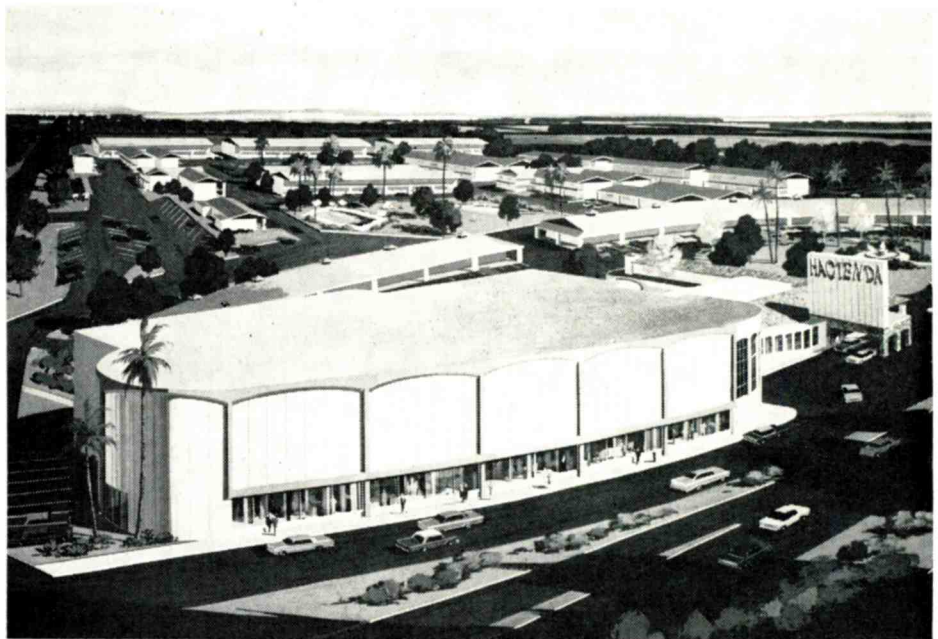

(Continued from Page 21)

Art Blumenthal of San Mateo and the guest speaker will be introduced by Everett Pershing of the Glendale Burbank chapter. The guest speaker will be Mr. Walter Burns whose topic will be "How To Double Your Income."

Saturday

Saturday morning's breakfast will be MC'd by Ray Merrill of San Diego and the guest speaker will be introduced by Oliver Hartwig of Berkeley.

The morning session will include three panel discussions. The first one will be moderated by Mike Fuzario of San Francisco and the tentative panel includes: Darrell Petswal of Sacramento, Jim Scarrborough of Glendale/Burbank, Ralph Singleton of Los Angeles and Vern Hassett of Sabastapool. The topic will be Serviceability.

The second panel discussion will be MC'd by Ken Deedler of San Mateo and his panel will include: Harry Bornstein of Santa Monica, Abe Bowers of Los Angeles, Don Cheeseman of Glendale/Burbank and Oliver Hartwig of Berkeley. The topic is on extended warranties.

The third panel discussion of the morning session will be MC'd by Bob Whitmore of Long Beach and will include a panel of Art Blumenthal of San

Mateo and Lloyd Brown of Redondo Beach representing the dealer trade and Don Coogan of RCA representing the manufacturers and Irv Tjomsland of Hurley Electronics in Inglewood representing the distributor.

The luncheon program will be MC'd by Allan Crawford of El Cerrito and the guest speaker will be introduced by Ben Leff of Pasadena.

That afternoon will be a CSEA business session with a report of the nominating committee and the election of new officers, committee reports and resolutions to be adopted by the convention delegates.

The evening program will feature a special presentation by Mr. M. L. Finneburgh, Chairman of the Board of the Finney Company. MC for the evening will be Bob Whitmore and the guest speaker will be introduced by Jim Ballard of Sonoma Valley. This event will be preceded by a special cocktail party.

Sunday

Sunday morning breakfast will feature Vern Hassett of Sabastapool as MC and the guest speaker will be introduced by Al Chesser of Fresno.

The morning session will be another CSEA business session with the adop-

tion of resolutions, formal appointment of committees and all other CSEA general business.

The annual President's luncheon will be MC'd by publisher Don Martin and the featured speaker will be a representative of the BERDR. This will be followed by the President's address and the formal adjournment of the convention. A special meeting of the new Board of Directors will follow and anyone wishing to stay may do so.

This is a pre-convention tentative list of events and people. A full report will appear in the next convention issue of ESD.

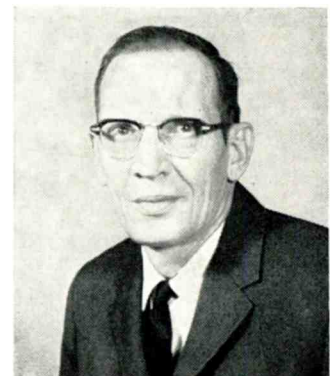

JACK BETZ
NEA NATIONAL PRESIDENT
OF WATERLOO, IOWA

ELECTRONIC SERVICE DEALER

electronic service dealer

TRADE / TALK

TEN "MOST WANTED" TUBES DESCRIBED BY G.E.

Owensboro, Ky.—A list of the "ten most wanted" entertainment receiving tubes in the electronic parts distributor market has been compiled by the General Electric Tube Department.

These "ten top tubes" statistics are based on industry sales to the distributors. The most popular types are:

1. 5U4GB/5AS4A
2. 50C5
3. 6CB6A/6CF6
4. 6DW4B
5. 6JE6A
6. 6AQ5A/6HG5
7. 6DQ6B/6DM4A
8. 35W4
9. 6AX4GTB
10. 6BQ7A/6B27

RCA ANNOUNCES SIX NEW RECEIVING TUBES FOR COLOR TV RECEIVERS

New York, N.Y.—Introduction of six new receiving tubes for color television receivers, providing color TV circuit designers with further opportunity for improving receiver performance was announced by RCA.

The 6CM3, 25CM3, and 34CM3 are intended for damper-diode service; the 6KY6 and 7KY6 for video-output applications; and the 6ME8 for color-TV demodulator service, according to C. H. Lane, Manager, Marketing Department, RCA Solid-State and Receiving Tube Division.

RCA-6CM3, 25CM3, and 34CM3 are high-perveance half-wave vacuum rectifier tubes of the novar type having a T9 envelope. They are especially useful as damper diodes in horizontal-deflection circuits of color-television receivers.

These tubes feature a maximum peak-inverse-plate-voltage rating of 5,500 volts, a maximum peak-plate-current rating of 1,700 milliamperes and a maximum average-plate-current rating of 400 milliamperes. In addition, heater and cathode are insulated to of as much as 5500 volts with average values up to 900 volts.

STEVENS NEW RAYTHEON ADVERTISING MANAGER

Van M. Stevens, Jr. has been appointed corporate advertising manager

for Raytheon Company. He will plan and implement advertising and promotional programs as an integral part of the company's overall public relations activities. In addition, he will coordinate the advertising activities of the various operating divisions of the company and serve as advertising manager for the government divisions and certain other segments of the firm.

MARSHANK REP FIRM ADDS BIELSKY

Los Angeles, Calif.—Marshank Sales Company, manufacturers' representative, have announced the addition of Jerome D. Bielsky as a field sales engineer.

Jerry brings 14 years of experience in the sound contracting industry to the company. For the past nine years he has operated Fidelity Sound Systems in Hollywood, California.

This pioneer Los Angeles, California firm is celebrating its 48th year in business.

JERROLD ANNOUNCES CHANGES IN ADMINISTRATION STAFF

Philadelphia, Pa.—Jerrold Electronics Corporation has announced several divisional changes designed to strengthen marketing operations and customer service in the fields of educational and instructional television, master antenna television systems, and consumer TV-FM reception products, according to Robert H. Beisswenger, president of the parent Jerrold Corporation.

The Distributor Sales Division has been restructured and a new Educational and Communication Systems Division has been formed. Distributor Sales will concentrate on Jerrold's consumer antennas and accessories, to keep pace with the growing reception aids market. Systems products for ETV, ITV, MATV and microwave markets will be handled by the Educational and Communication Systems Division.

The newly appointed Manager of the Distributor Sales Division is Joseph Kerner. Mr. Kerner has twenty years of sales, marketing and management experience in the consumer electronics industry.

In commenting in the reorganiza-

tion, Mr. Kerner added, "The popularity of color television, with its special requirements for high performance antennas and accessories, plus the growing demand by all TV set owners for improved reception, has created a greater emphasis by Jerrold in the reception aids market. By devoting ourselves exclusively to consumer products, we expect to expand our operations and increase our entire product line."

Serving with Mr. Kerner is Milt Dienes, the Division's new Sales Manager. Previously, Mr. Dienes was Sales Manager for The Jerrold Corporation's high fidelity products, and he has had continuing experience with the firm's network of distributors since 1957. Other key personnel include Craig Stevenson, Consumer Products Manager, and Russ Gimellaro, Technical Director.

RCA OPENS NEW COLOR TUBE PLANT

Scranton, Pa.—RCA's new \$26 million color television picture tube facility here was dedicated recently by President Robert W. Sarnoff who predicted that electronics would become as important to the City's future as coal was to its past.

The 350,000 square-foot plant is producing a 22-inch color tube which employs a new RCA-developed red-emitting phosphor, making it the brightest in the color television industry. According to John B. Farese, Vice President, RCA Electronic Components and Devices, the addition of the Scranton output to that of RCA's color tube plant at Lancaster makes Pennsylvania the world's leading producer of color television picture tubes.

INTERNATIONAL RECTIFIER HAS RECORD SALES & PROFITS

El Segundo, California — International Rectifier achieved the best nine months and third quarter earnings in its 20-year history, as nine-month net income rose 37 percent on a 23 percent increase in sales, Eric Lidow — president of the worldwide manufacturer of semiconductors, ethical drugs, medical electronics and exotic alloys—announced.

(More Next Page)

TRADE/TALK

(Continued)

Net income for the nine months ending March 31, 1967 rose to a record high of \$1,952,161, or 77 cents a share, vs. \$1,422,677, or 56 cents a share in the comparable year-earlier period. Nine-month sales advanced to \$26,091,895 from \$21,168,998 a year ago.

RCA TO OPEN SERIES OF TRAINING CENTERS

New York, N.Y.—Permanent training centers to help cope with the serious shortage of experienced television technicians are being established by the RCA Service Company in six key metropolitan areas, A. L. Conrad, Presi-

dent, announced.

Mr. Conrad said the project, first of its kind in the television industry, will enable the RCA Service Company to train some 2,500 technicians in the coming year, twice as many as it trained in 1966.

He estimated that 25,000 additional color TV service technicians will be required by the industry in each of the next five years because of the tremendous growth of color television. There are more than 10 million color television sets now in use in the United States and this number is expected to jump to more than 16 million by the end of 1967.

The training centers are expected to be operating by mid-Summer in New York, Philadelphia, Miami, Chicago, Detroit and Los Angeles. Both

present and newly hired employees will take part in the program.

SELF-TEACHING TRANSISTOR COURSE AVAILABLE FROM G.E.

Owensboro, Ky.—There is an easy, inexpensive method for electronic technicians to learn the sophisticated skills and techniques needed for transistor-circuit troubleshooting, and they need not lose a single minute of valuable "shop" time.

The method?

Completing the programmed instruction (self-teaching) course offered by the General Electric Company, "Transistors & Circuit Troubleshooting."

This attractively bound, three-volume course is designed to instruct electronic service technicians in troubleshooting the transistorized circuits in radios, stereos and the new TV receivers.

Programmed instruction, a relatively new, scientific method of self-teaching, has gained wide popularity throughout American industry and educational institutions. It is based on learning bits of information at a time instead of large chunks, and learning these bits in a logical, carefully planned sequence.

In "Transistors & Circuit Troubleshooting," for example, the student begins with transistor fundamentals in Volume I and ends in Volume III with an analysis of troubleshooting vertical sweep circuits in solid state television sets.

In progressing through the course, the student masters one step (called a frame) at a time and does not move to the next step until the preceding step is understood fully. Each frame also has a planned study sequence: The student first studies the question, answers it in a few words or checkmarks and only then looks at the correct answer—all on one page.

To discourage looking at the answer before completing the question, the answers are "semi-exposed" on the same page as the questions; i.e., they are printed in black type on a dark gray background, purposely making it hard to see when reading the question. However, if the student is tempted by "straying-eyes," he can use a mask-bookmark provided with the course, sliding it down the answer column after completing each frame.

Included with the course are three final examinations, required schematic diagrams and three combination mask/bookmark/training logs. The examinations were designed to be taken at the completion of each volume.



RCA Hi-Lite color picture tubes bring OEM quality to your replacement tube customers

Odds are that when a dealer is called to replace a customer's color picture tube and he replaces it with an RCA Hi-Lite, he's giving the set owner a better product than he had when his set was new.

That's because RCA Hi-Lite picture tubes are RCA's best... the same quality... the same tubes... that go into today's original equipment sets. RCA Hi-Lites are all-new... glass, gun, the works! And incorporate the continued advancements in picture tube technology achieved by the world's leading color picture tube manufacturer. So your dealer literally "up-dates" his customer's color set when he installs one.

Here's picture brightness and color fidelity at its finest, available for the service trade in 19-inch and 25-inch rectangular and 21-inch round tube types.

How about you? Are you offering your customers today's color?



RCA Electronic Components and Devices, Harrison, N.J.

The Most Trusted Name in Electronics

CALECTRON

San Francisco: 33 Gough Street, MA 1-3400
Fresno: 2930 Butler Avenue, 268-8411
No. Sacramento: 330 Commerce Circle, 922-5885

PRODUCT NEWS

Conducted by **A. Diane Powell**, Associate Editor



JFD LPV

NEW UHF COLOR LASER ANTENNA SERIES ANNOUNCED BY JFD ELECTRONICS

A new series of UHF antennas in the JFD Color Laser group—the LPV-UCL series—have been announced by JFD Electronics Co., Brooklyn, N.Y.

Because UHF signals are more susceptible to buildings, trees and other obstructions, signal loss on this spectrum can become significant. UHF is more limited to line-of-sight distances than VHF, and its signals attenuate more swiftly. With these factors in mind, the scientists at the JFD antenna research laboratories, Champaign, Ill., delved into the new space-age telemetry and developed two advanced features for the new LPV-UCL series.

The first is the new disc-on-rod director system. Adapted from the high gain antennas used for NASA, Apollo and military radar, the radical new disc shape increases the capture area to bring in much higher gain than the conventional thin-linear director elements. It also broadens the bandwidth and pulls in sharper color reception on all UHF channels. Its narrow beamwidth rejects ghosts, interference and other undesirable signals. The disc-on-rod system is omni-polarized to intercept UHF signals that often depart from horizontal polarization.

The other advanced development of the LPV-UCL series is the new, wide-band "zoned" trapezoid driver. This section of the antenna features wide log periodic dipoles and delivers unprecedented gain and flat frequency response. It reinforces the performance of the disc-on-rod directors on the low end of the UHF spectrum where most 14 to 83 stations are located.

EICO INTRODUCES NEW GENERAL-PURPOSE TUBE/BATTERY/CONTINUITY TESTER

For quick-testing 800 types of radio/TV vacuum tubes (octals, loctals, 7- and 9-inch miniatures, novars, nuvisors, compactrons), load-testing of commonly used batteries (1.5 to 90 volts), and go/no-go continuity testing EICO Electronic Instrument Co., Inc., 131-01 39th Avenue, Flushing, N.Y. 11352, has announced Model 636 Tube Tester. Complete with bakelite case, handle, and tube data manual covering 800 types of tubes, Model 636 is \$34.95. (wired only).

Professional features include: transformer isolation, 3-color meter, neon lamp short-indicator. 8-5/8"H. 7-1/2" W, 3-1/8"D; 117 VAC; 60 Hz; 4 lbs.

justs the monitor controls for each powered color comparator senses the being displayed on the monitor. Using a preset color temperature. During set-balanced by one standardized instrument, and therefore, display the same color temperature.

United States and Canadian distributors for Gardner Laboratory's TV Colorgard is the Television Zoomar Company. Further information concerning TV Colorgard may be obtained from Television Zoomar Company, 500 Fifth Avenue, Room 5520, New York, N.Y. 10036, Telephone: Bill Pegler (212) 279-5835.

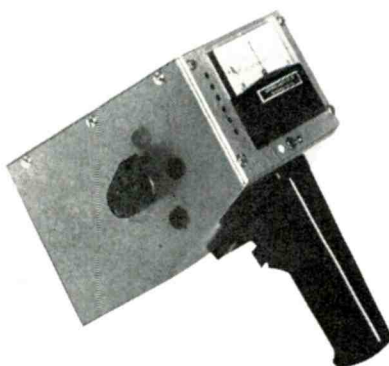

Gardner Laboratory's TV COLORGARD

COLOR MONITOR SET UP TIME CUT TO MINUTES BY TV COLORGARD

TV Colorgard, a new instrument which cuts color television monitor set up time (color balance) from hours to minutes, has been developed by Gardner Laboratory. The hand-held, self-TV Colorgard, all color monitors are red, green and blue colors displayed on the monitor screen. The color balance on a television screen is determined by color until the TV Colorgard meter indicates that the correct color balance is up, the broadcast engineer simply ad-

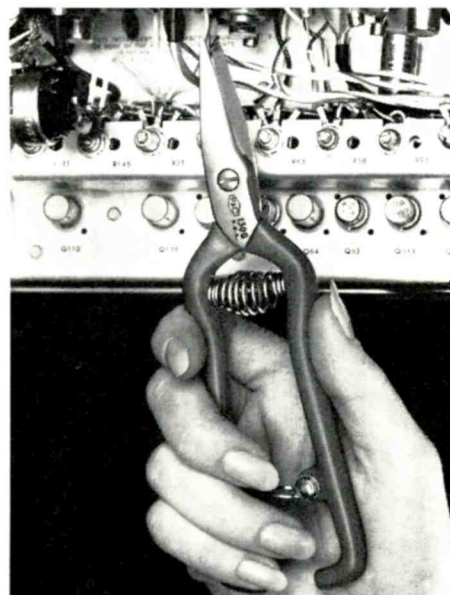

MINIATURE METAL SHEARS NOW AVAILABLE FROM P&C

P & C Tool Company, Portland, Oregon, has just introduced new miniature metal shears especially designed for light electronic assembly work, repairs and engineering construction.

These lightweight shears have a long nose for working in tight spots, plus hot-forged, heat-treated, hollow ground blades for wire snipping, accurate cutting of any thin-gauge material up to .025" thickness.

The special contour of the vinyl plastic coated handles permits a positive, comfortable grip. A self-opening spring greatly reduces fatigue, increases production.

Write to P & C Tool Company, Box 22066, Portland, Oregon 97222, for complete ordering information on No. 1306 Metal Shears.

FIGART'S SELECTS

JERROLD

BEST BUYS IN ALL CHANNEL ANTENNAS

- ✓ **VU-831 List \$17.95**
14 element 300 ohm
including splitter
- ✓ **PXB-48 List \$26.50**
15 element 300/75 ohm
less splitter
- ✓ **PXB-65 List \$46.50**
36 element 300/75 ohm
less splitter

Area tested for
finest performance!

FIGARTS RADIO SUPPLY

6320 Commodore Sloat Dr.
Los Angeles, Calif. 936-6218

A NEW "PROFIT CENTER MERCHANDISER" BY MALLORY BATTERY

Mallory Battery Company has launched an aggressive merchandising program designed to help dealers obtain a larger share of the growing market for batteries needed to power portable electrical equipment.

"Right now the market for batteries is about \$250 million a year, and is still growing as more and more new battery-powered products come into use," explained Herbert R. Roberts, marketing director. This is in addition to such familiar items as flashlights, transistor cameras, tape recorders, and other devices.

"Our aim will be to help dealers boost the sale of Duracell longlasting batteries which are especially intended for modern portable powered equipment."

To carry out the program, Mallory has designed a new "profit center merchandiser"—an eye-catching display containing an assortment of all popular transistor radio and flashlight types, plus those for photo needs, he said. The specially designed merchandiser is being offered to dealers and provides a compact and well-equipped battery department in only 18" of wall space.

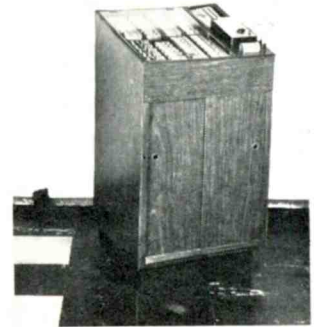

NEW COIL CATALOG AVAILABLE FROM WORKMAN

Workman Electronic Products, Inc., Sarasota, Florida, has just completed a new coil catalog that lists general and exact replacements for radio and TV. Schematic drawings and illustrations of all coils are contained in this catalog. It is available, without cost, to qualified servicemen. Ask for catalog #100.

Why not sell the best

NEW ZENITH LOG-PERIODIC ANTENNAS built to the quality standards of Zenith original parts

Advanced designs . . . developed by the Antenna Research Laboratories of the University of Illinois. Model 973-49 (right) works like a powerful, multi-element Yagi. It offers superior Color or B&W reception on *all* channels. And it delivers better FM/Stereo FM performance in metropolitan areas.

Other Zenith quality periodic antennas are specially designed for UHF, VHF, FM and FM stereo, or planar helical UHF reception.

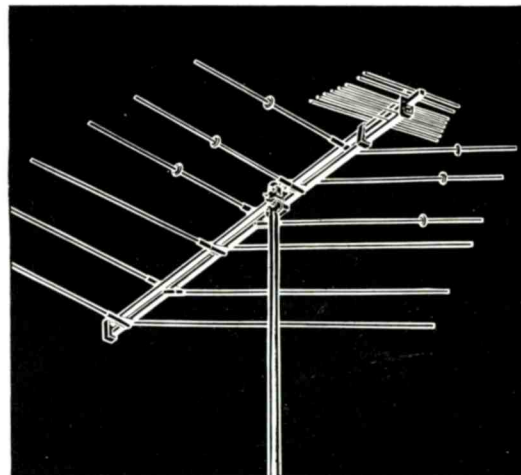

Order Zenith antennas and all genuine Zenith replacement parts and accessories from your Zenith distributor.

ZENITH®

The quality goes in before the name goes on

FINDING FLAWS IN INSURANCE PROGRAMS

By RALPH BETZ

Special Feature Editor

When a businessman purchases a building lot for a few thousand dollars he wants to be sure about title to the property. He doesn't hesitate to pay an attorney a fee to examine an abstract. That same businessman may toss insurance policies into a desk or safe with no more than a casual glance, and those policies may cover values a hundred times greater than the building lot.

A businessman may have faith in insurance companies and their agents, but faith alone will not compensate for errors and omissions that affect the coverage in policies. It is better to know and examine insurance coverage before rather than after a loss. Some of the items that often escape attention are listed below.

Fire Insurance — Most fire insurance policies on business property contain a coinsurance clause, a feature that frequently is misunderstood.

Tipton had a fire policy for \$40,000 on a building with an appraised value of \$100,000. The policy contained the 30% coinsurance clause. When a fire damaged the building to the extent of \$10,000 Tipton said the insurance company owed him \$8,000 or 30% of his loss.

"We owe you only \$5,000" the insurance adjuster reported. "Under the 30% coinsurance clause you agreed to insure the building for at least 80% of its fair value. You insured only one-half of the amount required to comply with the coinsurance clause therefore we can pay only one-half of the loss. You became a self-insurer for one-half of the risk by neglecting to comply with the terms of the agreement."

Replacement Cost—Many businessmen renew fire insurance policies year after year without checking policies for needed changes in coverage. They seldom think of the replacement cost option which may be had for an additional premium. During an inflationary period this option is of more than usual importance. A machine that was purchased for \$5,000 a few years ago might cost much more to replace in case of fire. Without the option the insured collects only the original cost of the machine, less depreciation.

Fidelity Bonds—It is common practice among executives buying blanket fidelity bonds for their firms to exclude company executives without listing their names.

The Jones Company, a firm in which a father and his two sons were the only company executives, purchased a blanket fidelity bond with the usual exclusion of company executives, none of which were named. When the father died the sons promoted a bookkeeper to an executive position as secretary of the company. After the secretary had embezzled \$10,000 of company funds the Jones Company asked the fidelity insurer for reimbursement of its loss. The insurer denied liability, citing the endorsement that excluded coverage for all executives of the company.

When an employee has been guilty of dishonest acts and the employer is aware of his dishonesty, that employee is automatically excluded from coverage under most blanket fidelity policies.

In a recent case evidence was introduced that Horton was reprimanded by his employer and threatened with discharge because of petty thefts. Later on the employer discovered that Horton had stolen quantities of material which he sold to another party. The employer was denied recovery because he had been aware of Horton's dishonesty prior to his arrest.

Holdup and Burglary—Bergman's policy limited the insurance company's liability to \$1,000 for holdup or burglary. He thought this was adequate protection because he deposited each day's receipts in a night depository at the bank. The only money in the office at night was the petty cash fund.

When burglars ruined a safe and other office equipment his loss amounted to \$3,000, but he could not collect more than \$1,000 from the insurance company. On trips to the night depository he frequently carried cash deposits far in excess of the \$1,000 for which he was covered in case of holdup.

Unfortunately, there are insurance solicitors who misrepresent the terms of a contract in their eagerness to make a sale. When agent Jolson called on Borden to solicit burglary insurance, Borden explained that his place of business had been burglarized within the month.

"Don't take another chance," Jolson advised. "Our burglary policy will protect you in the event of another burglary." Jolson produced a printed application form which Borden signed, relying upon the agent's warranty.

A few months later Borden's place was again burglarized. He reported his loss to the insurance carrier, who made an investigation and denied liability, stating that on the application he signed he verified a printed statement that there had been no burglary of his premises within a specified time.

The court held the insurance company not liable because of a material concealment of fact. Borden then sued the agent and recovered.

The supreme court held that the agent or broker in negotiating for a policy . . . owes a duty to exercise reasonable skill, care and diligence, and that the agent failed to do so.

The agent argued that the insured should have read the policy, but the court held that the agent's misleading statements and lack of care relieved the owner of the consequences of not having read the policy.

Public Liability—Some businessmen cannot visualize the need for insurance to cover injury and damage claims made by customers and others.

Jensen's clerk placed a parcel on the sales floor near a customer who was making a purchase at the counter. The customer walked away from the counter with a large package in his arms, failed to see the parcel placed in his path, fell and broke an arm. Jensen was compelled to pay the hospital and medical expenses, plus lost wages until the injured customer returned to work.

Vehicle Liability—The inadequacy of low limits insurance for bodily injury coverage on automobiles and trucks may result in catastrophic losses.

Vogel carried \$10,000/20,000 bodily injury liability insurance on a small delivery truck. This was the minimum coverage required under the financial responsibility law of his state. His employee, Armand, hit a pedestrian while speeding and caused partial disability of the victim. Vogel was sued for \$100,000. The case was taken to court and the jury returned a verdict of \$65,000 against Vogel. The insurance company paid \$10,000, and Vogel paid \$55,000.

CSEA Office Moves to Hawthorne

Last month the California State Electronics Association accepted the offer of our firm to move their executive offices from Fresno to Hawthorne.

Over the years, the State office has never been in Southern California or in direct communication with this publication and I have always felt that CSEA was missing a great opportunity. The location, of course, was not the important thing but rather the direct communication with ESD was missing. We seemed to be in two different worlds with key information never being available for reporting.

Even in the very first few weeks the advantage of being in close contact with each other has produced good results. Items that we have missed editorially, Ralph has picked up from some other source. At the same time, items that he might have missed we have picked up. What it has produced is a well advised, up-to-date communication of material and information of benefit to, not only CSEA people, but the industry as a whole.

In my seven years association with CSEA I have had complete editorial liberty and have never checked out an item with anyone before publishing. Needless to say, this has produced some real fireworks at times but we have all lived through them and the industry, I believe, is better off for this type of stand. This policy will continue without change.

We have also taken the policy of producing a general dealer publication and not a house organ for CSEA. As you know, ESD is different from any other association magazine anywhere in the United States and our success, I believe, stems from this policy of publishing integrity and format. This will not change.

All of this is a lead in to my first hand impression of CSEA's operation as of the past three or four weeks.

To say that the Association has no problems would be an understatement of fact. There are many problems but most of them arising from the fact that most of the industry's ills have been cured over the past few years. CSEA is not involved in the pitfalls of license failures as it was in 1958, 1960, 1962, etc. It has a different roll to play. Its new roll is that of providing services to its members, information in regards to building a better business, communication of mutual problems, etc.

With new people and new aims and objects there are going to be a lot of changes made in the CSEA structure. Ralph Johannot is a dedicated individual who has lived Association work for 20 years and has contributed greatly to the advancement of the industry. He is well respected by all who know him and there is no doubt that he will do a fine job of directing the State office. Many new ideas and programs are already underway and I feel the Fresno Convention will be a major step in the revitalizing of this outstanding State Association.

CLASSIFIED ADVERTISING

FOR SALE

Sams photofact in binders and files. 265 folders complete and in perfect condition covering all popular television. Make offer. Guarantee Television Service, 733 Laurel St., San Carlos, Calif. 5933246.

RCA WR64 COLOR BAR GEN. \$85.

Appliance Dolly \$25.

**C&S TV
665-3831**

FOR SALE

Sams PHOTOFACTS sets 1 thru 656 complete and in good condition. Most like new. Also Sam's Transistor Manuals 1 thru 75 like new. Photofacts in used but usable file cabinets. Reasonable. Make offer. Al Poage, 927 Colorado Ave., Palo Alto, Calif. Phone 321-2965.

HEALTH PLAN OFFERED

SAVE more than 40% on your Hospitalization Plan. Call J. Wartels—Insurance Counselor to Electric League.

JACK M. WARTELS
CR 8-0543 TR 8-0161

USE OUR WANT ADS

**HUNDREDS OF WORKING
USED LATE MODEL
THIN LINE—PORTABLES**

Low shipping costs anywhere

TV brokers WE 1-6622

4920 W. Pico, L.A. 19, California

WINEGARD

California

Participating

DISTRIBUTORS

DUNLAP ELECTRONICS

1800 18th St., Sacramento
452-3171

EDISCO, INC.

5901 Mission St.
San Francisco, Calif.
866-7087

HURLEY ELECTRONICS

210 East Hardy, Ingewood
678-7644

HURLEY ELECTRONICS

925 W. Esther St.
Long Beach, Calif.
436-8268 or 638-3389

MILO OF CALIF., INC.

2060 India Street
San Diego, California
232-8951

PENINSULA ELECTRONIC SUPPLY

980 So. First St., San Jose
294-8781

QUEMENT ELECTRONICS

100 S. Bascom Ave.
San Jose
294-0464

SCHAD ELECTRONIC SUPPLY, INC.

499 S. Market St., San Jose
297-5858

AT LAST! THE PERFECT 82-CHANNEL
(VHF-UHF-FM) HOME COLOR TV SYSTEM

Winegard's New BC-782 82 Channel Booster Coupler Only \$44.95

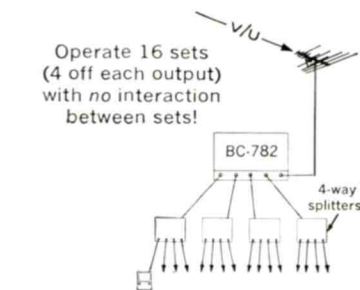
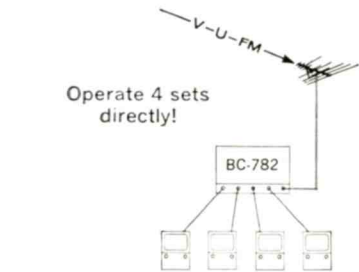
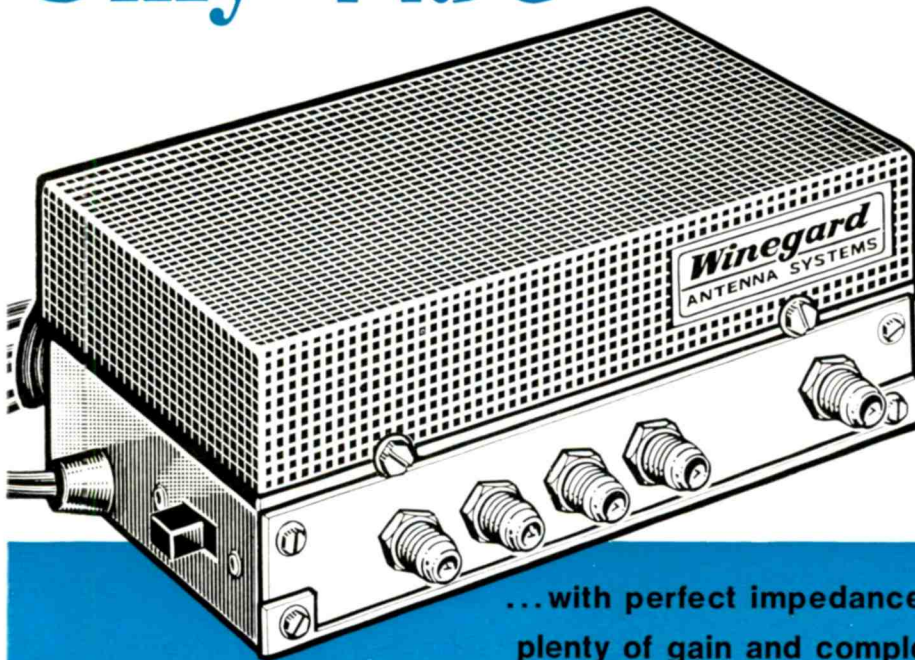

...with perfect impedance match on all 82-channels,
plenty of gain and complete isolation between sets!

Here's the greatest thing ever to happen to your booster coupler business... Winegard's sensational 75 ohm BC-782.

What makes the BC-782 so great? First off, it's an 82-channel booster coupler, the only truly operational and efficient TV signal amplifier that delivers *uniform gain* on *all* 82 channels.

It has solid state circuitry, incorporating 3 of the newest overlay silicon type transistors (temperature tested from -60° to 200° C.) for long life... low noise figures to cut snow... and *full* gain on *all* 82 channels.

The BC-782 has extra power, too—enough gain to operate 1, 2, 3 or 4 sets directly—or as many as 16 sets (4 off each output) with *no* interaction between sets.

Even the housing is something special—with steel construction throughout (not plastic) comparable to the most expensive commercial units, for positive electrical shielding.

And that's not all. The BC-782 has plenty of other

exclusive performance and construction features, including:

- Extremely high isolation between sets—no interaction—no need to terminate unused output terminals.
- Responds to the very weakest fringe area signals.
- Perfect for COLOR TV reception because of flat gain response on all channels 2 to 83, plus FM.
- Ultra-low noise figures effectively eliminate snow even in deep fringe areas.
- F-type 75 ohm jacks with connectors provided.
- On-off switch.
- Complete with mounting brackets and screws.

That's Winegard's new BC-782, the greatest thing ever to happen to your booster coupler sales. And with a great price to match—only \$44.95. Call your Winegard distributor today, or write for Fact-Finder #250 for all the facts, plus information about Winegard's new COLOR TV Booster/Coupler/Amplifiers.

Model BC-382

300 ohm twin lead Booster Coupler with same exclusive features as BC-782. \$39.95



© Copyright 1967, Winegard Company, Burlington, Iowa

WINEGARD COMPANY • 3000 KIRKWOOD STREET • BURLINGTON, IOWA 52601

Finally somebody is helping...
helping you prepare for

The growing crisis in service

Motorola takes the bull by the horns . . . introduces
“on-the-job” technical training
for your men—with a greatly expanded
staff of technical personnel.

Home entertainment products are changing—fast. There’s more transistorization . . . and of course more color every year. This means great opportunity for service organizations that keep abreast. Well-informed technicians will be in even greater demand than they are now.

Motorola can help your service department be well prepared.

We have recently increased our staff of field technical personnel. It is their job to help provide you with Technical information for your men and to give some of the training your men will need to cope with this rapidly changing industry.



Each of our technicians has had extensive, practical consumer experience. They know their business—from your side of the fence. The training will be done *right in your place of business*. It will provide a valuable adjunct to the large-scale training meetings held by Motorola Regional Managers & Distributors.

Two hours will be spent in formal training. The remainder of the day will be spent working with your men *on your work* to give information—and to help find ways to make more profitable and productive use of service time. Get full information on availability of this training for your shop. Just call your Motorola Distributor.



MOTOROLA®