

Electronic Design[®] 12

VOL. 26 NO.

FOR ENGINEERS AND ENGINEERING MANAGERS — WORLDWIDE

JUNE 7, 1978

Are your batteries languishing on a shelf, while you pin down specs? Little wonder. Common wisdoms about battery properties aren't always true. You have to

evaluate each candidate on its own merits, and heavily derate nominal amp-hr ratings. Primary batteries or secondaries? For a full charge of info, reach to p. 88.



A New Dawn In Trimmer/Resistor Technology...

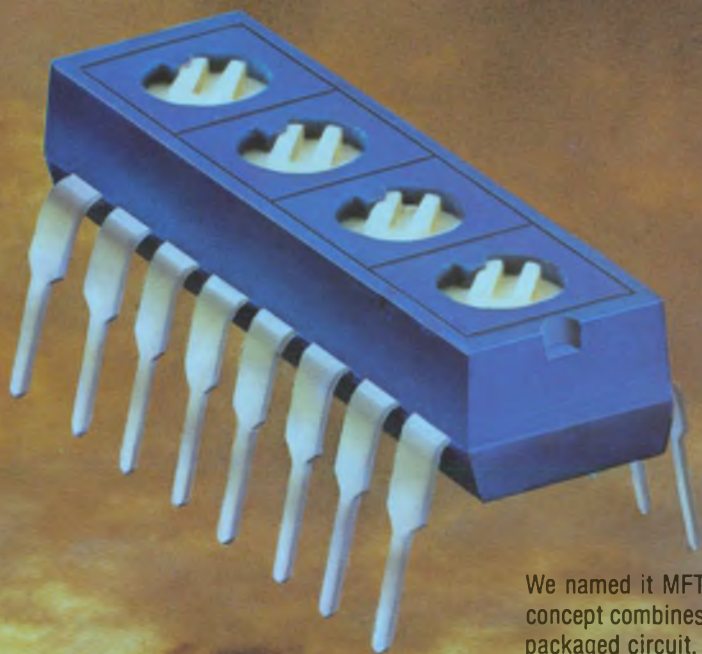

**We've put it
all together in
one space/cost
saving package.**

We named it MFT™ . . . our multi function trimmer. This revolutionary concept combines cermet trimmers and fixed resistors into a single pre-packaged circuit. A consolidation of functions has been designed into a new product line of cost-effective DIP components.

All trimmer applications require a fixed resistor to either divide a voltage or limit a current. The nine MFT trimmer models will functionally satisfy almost any trimmer application.

SAVES SPACE — MFT trimmers drastically reduce PC board space required for the peripheral components of a linear IC.



SAVES TIME — MFT trimmers reduce the time and cost of designing circuits. It also saves production time as MFT trimmers are compatible with DIP automatic insertion equipment. And, there are less components to purchase and handle.

SAVES MONEY — MFT trimmers lower total "on-board" component costs. In addition, MFT trimmer DIPs are compatible with automatic test equipment, reducing inspection costs.

INCREASES PERFORMANCE — Temperature tracking is better than discrete components . . . 50 ppm/°C. Trimmers/Resistors are manufactured simultaneously on a common substrate. MFT trimmers are more reliable as a result of pre-tested circuitry and reduction of connections.

The sealed multi function trimmers are available in nine configurations of the multiple trimmer and network combinations. Call or write today for your MFT trimmer catalog.

TRIMPOT PRODUCTS DIVISION, BOURNS, INC., 1200 Columbia Avenue, Riverside, CA 92507. Phone: 714 781-5204. TWX: 910 332-1252.



BOURNS®

For Immediate Application — Circle 130 For Future Application — Circle 230

The only other professional quality sweepers in our price range that we know about make a loud noise and are constantly needing their bags emptied.

So if you're more interested in clean sweeps than clean floors, we recommend our Model 1061. It sweeps from 1MHz to 400MHz at

line frequency, with excellent signal quality. Output flatness is $\pm 0.25\text{dB}$, sweep linearity 2%. The calibrated output is +10 to -60 dBm and you have a choice of either 50-ohm or 75-ohm output impedance.

All for \$675.

But if anyone else tries to sell

you a sweeper with a three-digit price tag, watch out. You may be getting sucked in.

Wavetek Indiana, Inc. 66 N. First Ave., P.O. Box 190, Beech Grove, Indiana 46107. Telephone (317) 783-3221, TWX 810-341-3226.

WAVETEK®



**Without Wavetek's
Model 1061,
the under \$700
sweeper market
would be a vacuum.**

The only Double-Balanced Mixers with a 2-YEAR GUARANTEE*

featuring Hi-Rel tested diodes -

Introduced in 1971 at \$7.95 . . .

still only

\$7.95

(500 pieces)

\$9.95 (1-49)

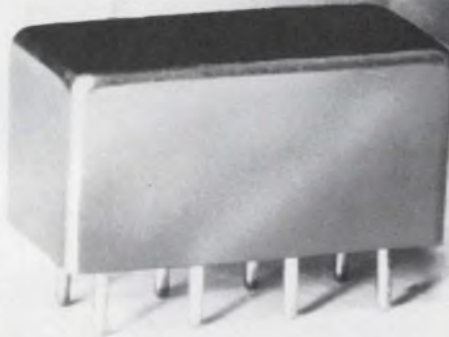

*including diodes!

Yes, a two-year guarantee for hermetically sealed DBM's is now a reality . . . made possible by an accelerated-life diode screening program adopted at Mini-Circuits.

Each Schottky diode used in Mini-Circuits' SRA-1 mixers is now preconditioned by the HTRB (High Temperature Reverse Bias) technique, previously reserved almost exclusively for semiconductors assigned to space applications. With HTRB testing, each diode is operated for 168 hours at 150°C with one volt reverse bias applied.

To screen out "infant mortality", the diodes are deliberately stressed to accelerate aging and to force time-related failure modes to take their toll. In conventional testing or "baking", the diode does not experience anywhere near the stress encountered with the HTRB program. Hence, the ability at Mini-Circuits' to locate the potentially-unreliable diodes before they are assembled into SRA-1 units. And, with double-balanced mixers, the overall reliability hinges almost entirely on the diodes used.

Yes, the HTRB procedure costs us more and screens out more devices. But our goal is to improve reliability to a level unmatched for off-the-shelf DBM's at no increase in cost to our customers. You — our customers by your overwhelming confidence in our product line have made us the number one supplier of DBM's in the world.

To earn your continuing support, we are now employing HTRB Hi-Rel testing for every diode used in the SRA-1, at no increase in cost to you. So, for the same low price of \$7.95, you can purchase our SRA-1, with a two-year guarantee, including diodes.

To ensure highest system reliability demand highest quality diodes on your source-control drawings and purchase orders. Specify SRA-1 mixers, with HTRB tested diodes from Mini-Circuits! . . . where low price now goes hand-in-hand with unmatched quality.

MODEL SRA-1

Freq. range (MHz) LO: 0.5-500 RF: 0.5-500 IF: dc-500

Conversion loss (dB)	Typ	Max.	
One octave from band edge	5.5	7.0	
Total range	6.5	8.5	
Isolation (dB)	Typ	Min.	
Lower band edge to	LO RF	50	45
one decade higher	LO RF	45	35
Mid range	LO RF	45	30
	LO IF	40	25
Upper band edge to	LO RF	35	25
one octave lower	LO IF	30	20

Min. Electronic attenuation: 20 mA: 3 dB

Signal, 1 dB compression level: +1 dBm

Impedance all ports: 50 ohms



World's largest manufacturer of Double-Balanced Mixers

Mini-Circuits
MINI-CIRCUITS LABORATORY
A Division of Scientific Components Corp.

2625 East 14th Street Brooklyn, New York 11235 (212) 769-0200
Domestic and International Telex 125460 International Telex 620156

International Representatives: AFRICA: Afrifa (PTY) Ltd, P.O. Box 9813, Johannesburg 2000, S. Africa AUSTRALIA: General Electronic Services, 99 Alexander Street, New South Wales, Australia 2065 ENGLAND: Dale Electronics, Dale House, Wharf Road, Frimley Green, Camberley Surrey EASTERN CANADA: B.D. Hummel, 2224 Maynard Avenue, Utica, NY 13502 (315) 736-7821 FRANCE: S.C.I.E. - DIMES, 31 Rue George, Sand 91120 Palaiseau, France GERMANY, AUSTRIA, SWITZERLAND, DENMARK: Industrial Electronics GmbH, 6000 Frankfurt/Main, Klüberstrasse 14, West Germany INDIA: Gaikwar Enterprise, Kama Manal, M.L. Dananjkar Marg, Bombay 400 026, India ISRAEL: Vectronics Ltd., 69 Gordon Street, Tel-Aviv, Israel NETHERLANDS, BELGIUM, LUXEMBOURG: Coimex, Veldweg 11, Hattem, Holland

NORWAY: Datamatik AS, Ostensjoveien 62, Oslo 6, Norway SINGAPORE & MALAYSIA: Electronics Trading Co. (PTE) Ltd., 87 Bukit Timah Road, Singapore 9, Malay Peninsula SWEDEN: Integerad Elektronik AB, Box 43, S-18251, Djursholm, Sweden

U.S. Distributors: NORTHERN CALIFORNIA: PENNSTOCK Co., Foothill Office Center, 105 Fremont Avenue, Los Altos, CA 94022 (415) 948-6533 SOUTHERN CALIFORNIA, ARIZONA: Crown Electronics, 11440 Collins Street, Nu Hollywood, CA 91601 (213) 877-3550 **NEW YORK, MICROWAVE DISTRIBUTORS COMPANY:** 61 Mall Drive, Commack, N.Y. 11725 516 543-4771

NEWS

- 49 **News Scope**
- 54 **Z 8000 16-bit μ C family** will challenge minis.
- 60 **In-circuit tests** find more faults on PC boards.
- 64 **Faster, denser static RAMs** push into new designs.
- 76 **Lower-cost fixed discs** will fill in the gaps.
- 81 **Washington Report**

TECHNOLOGY

- 88 **Focus on batteries:** Battery specs are expressed in a special jargon: Understand the jargon, derate heavily and you'll avoid trouble.
- 104 **Pick the right dc/dc converter** for your switch-mode power supply. Different circuit types determine the characteristics of the magnetic components.
- 112 **Protect your rechargeable battery.** Put hysteresis into the discharge-sensing circuit so that the load stays removed—even as battery-voltage rebounds.
- 116 **Develop cooperative μ P subroutines** that exchange information without hogging memory. The clue: a routine based on register-controlled stacking.
- 122 **Reduce your μ C system's overhead.** With a system-monitor analysis of the system's operations, you can spot possible bottlenecks in program execution.
- 128 **Put testability into PC boards** during the design stage. You'll make it easier to diagnose and isolate faults automatically, and you'll cut the cost of repair.
- 134 **Test your charge-pump phase detectors.** Pinpoint the nonlinearities so you can operate your detectors in the good part of their characteristics.
- 140 **George Bugliarello of Polytechnic Institute of New York** speaks on expanding your research capabilities.
- 144 **Ideas for Design:**
Sample-and-holds and a summing amplifier form an analog memory unit. Quad comparator provides two functions—level shifting and time delays. Turn a car's side marker lamps into 'turn' signals with a CMOS gate.
- 152 **International Technology**

PRODUCTS

- 155 **ICs & Semiconductors:** PROM family is fastest and densest—and plugs right into expandability.
- 162 **Micro/Mini Computing:** Alphanumeric and graphic boards include microprocessor software.
- 188 **Data Processing:** Computers family get high speed from hardware arithmetic unit.
- 190 **Data Processing:** Bell-compatible high-speed modem comes as single board.
- 178 Packaging & Materials
- 195 Modules & Subassemblies
- 202 Components
- 208 Instrumentation
- 210 Power Sources

DEPARTMENTS

- 85 **Editorial:** Sharing vital information
- 7 Across the Desk
- 212 Evaluation Samples
- 212 Vendors Report
- 213 New Literature
- 221 Employment Opportunities
- 230 Advertisers' Index
- 230 Information Retrieval Card

Cover: Photo by Art Director, Bill Kelly. Batteries courtesy of Eagle Picher, Gates, GE, Globe, Gould, Mallory, Marathon, Ray-O-Vac, and Union Carbide. And spec sheets are from Elpower, Gates, Honeywell, Panasonic, Power Conversion and Ray-O-Vac.

ELECTRONIC DESIGN is published biweekly except 3 issues in July by Hayden Publishing Company, Inc., 50 Essex St., Rochelle Park, NJ 07662. James S. Mulholland Jr., President. Printed at Brown Printing Co., Waseca, MN. Controlled circulation postage paid at Waseca, MN and New York, NY, postage pending Rochelle Park, NJ. Copyright© 1978. Hayden Publishing Company, Inc. All rights reserved. POSTMASTER: Please send form 3579 to ELECTRONIC DESIGN, P.O. Box 13803, Philadelphia, PA 19101.

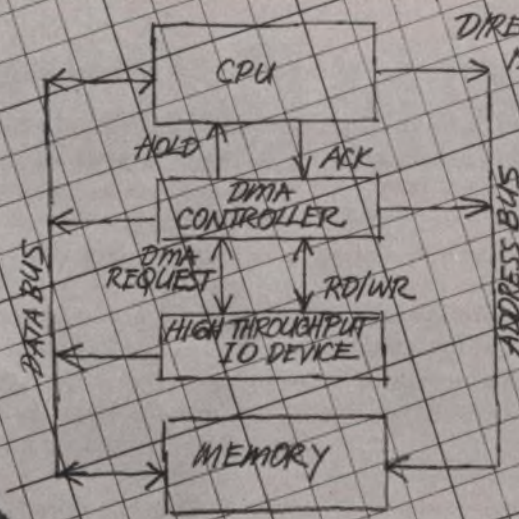

DIRECT MEMORY ACCESS (DMA) IS A TECHNIQUE FOR MOVING DATA WITHIN A COMPUTER SYSTEM AT VERY HIGH SPEED. THIS IS ACHIEVED BY MEANS OF A SUBSYSTEM CAPABLE OF TAKING CONTROL OF THE SYSTEM BUSES FROM THE CPU AND CREATING ADDRESSES AND READ/WRITE COMMANDS. IN THIS WAY, DATA CAN BE TRANSFERRED DIRECTLY BETWEEN PERIPHERAL CONTROLLERS AND SYSTEM MEMORY WITHOUT CPU INTERVENTION.

Watch this space for a whole new family of microprocessor components designed by Advanced Micro Devices.

They're built from your side of the board. They're microprocessor-based solutions from a system viewpoint.

For example:

DMA WITH EVERYTHING ON IT.

Advanced Micro Devices' new Am9517. It's a multimode DMA controller that lets you transfer information directly

MOS MICROPROCESSING: WE'RE ON YOUR SIDE.

from your peripheral controller to your system memory at blinding speeds of up to 2 million words per second. And that's just the beginning.

The Am9517 is a 40-pin, 5V only, N-channel, silicon-gate device that implements four fully independent DMA channels and includes provision for unlimited expansion.

Software control provides automatic reinitialization of all channels upon completion or external termination of a DMA transfer.

It's got everything: Memory-to-memory transfer, address increment or decrement and software DMA request capability offer powerful data manipulation options. Software control of the polarity of DMA request and acknowledge signals—plus

a simple interface—provide easy interfacing with a great variety of microprocessor systems. And, as always, MIL-STD-883 for free.

(For those designs that don't need everything, we supply the Am8257, a plug-in replacement for the Intel 8257.)

If you're looking for a DMA controller that looks at microprocessing the way you do, call us.

Advanced Micro Devices



Multiple technologies. One product: excellence.
901 Thompson Place, Sunnyvale, California 94086
Telephone (408) 732-2400

dependability

Our customers just plug in our power supplies and forget about them. Fortunately, these same customers don't forget about us. Which helps to explain why we are now the world's largest manufacturer of SCR supplies.

In a word: dependability. In another word: reliability.



One- and three-phase rack-mounted power supplies from 500 to 10,000 watts. Call TOLL FREE 800-631-4298 for complete information and prices, or write for our catalog.



ELECTRONIC MEASUREMENTS INC.
405 Essex Road, Neptune, N.J. 07753
Phone: (New Jersey) 201-922-9300. TOLL FREE 800-631-4298
Specialists in Power Conversion Equipment

Publisher

William Maass

Associate Publisher

George Rostky

Editor

Laurence Altman

Managing Editors

Ralph Dobriner

Michael Elphick

Senior Editors

Stanley Runyon

Stephen E. Scrupski

Associate Editors

Sid Adlerstein

Nicholas Bodley

Dave Bursky

Morris Grossman

Gene Heftman

Andy Santoni

Max Schindler

Contributing Editors:

Jules H. Gilder, Alfred D. Gronner,
Sidney Moskowitz, Nathan Sussman

Editorial Offices

Headquarters

50 Essex St.

Rochelle Park, NJ 07662

(201) 843-0550

TWX: 710-990-5071

(HAYDENPUB ROPK)

Cable: Haydenpubs Rochellepark

East

Jim McDermott, Eastern Editor

P.O. Box 272

Easthampton, MA 01027

(413) 527-3632

West

8939 S. Sepulveda Blvd., Suite 414

Los Angeles, CA 90045

(213) 641-6544

TWX-1-910-328-7240

Dave Barnes, Western Editor

465 S. Mathilda, Suite 302

Sunnyvale, CA 94086

(408) 736-6667

Editorial Production

Marjorie A. Duffy, Production Editor

James Keane, Copy Editor

Art

Art Director, William Kelly

Richard Luce, Anthony J. Fischetto

Business Manager

Thomas E. Vachon

Production

Manager, Dollie S. Viebig

Edward J. Grimm, Paul InCalcaterra

Circulation

Director, Barbara Freundlich

Senior Assistant, Gail Stone

Information Retrieval

Paula Greenleaf

Advertising Promotion

Director, William Hussey

Assistant, Judith Nappo

Reprints

Maxine Sassano

Across the desk

Magic circuit

Texas Instruments seems to have performed some magic if it can "Put BIFETs into your Linear Circuits" (Dale Pippenger and Dave May, ED No. 1, Jan. 4, 1978, p. 104). The instrumentation amplifier of Fig. 2 (p. 106) could care less whether a 741 or a TL081 is in the circuit, as far as input impedance is concerned. The 100-k Ω resistors determine the input impedance in either case. Also, the 100-k Ω resistors may look nice in Figs. 1 and 2 at room temperature, but look out for that bias current doubling every 8 to 10 C at elevated temperatures. Here a good bipolar amplifier may well produce less error!

Burry Baril
Design Engineer

Burr-Brown
International Airport Industrial Park
P.O. Box 11400
Tucson, AZ 85734

Dale Pippenger replies

In response to Mr. Baril of Burr-Brown:

Obviously, the purpose of having 100-k Ω input resistors on the circuits shown in Figs. 2 and 3 was merely to demonstrate that you can operate from very large source impedances with BIFET inputs and their low-input-bias currents.

Moreover, a typical bipolar amplifier may be very stable on input bias current compared to BIFETs, but only on a percentage value. For example, a 741 input-bias current changes only about 60% from 0 C to 70 C, while a TL071 would change 100% (or double) every 10°. But look at the actual numbers. The typical ΔI_B for the 741 going from 0 to 70° is 75 nanoamps. The ΔI_B for a TL071 would be less than 7 μ A under the same conditions.

Mr. Baril is correct, though, in that there are some good bipolar amplifiers that will produce less error—for a price.

Lots of snow

While sitting out "The Blizzard of 78," I came across an even bigger snow job in the January 4 issue of ELECTRONIC DESIGN.

"Put BIFETs into your Linear Circuits" includes a section ("BIFETs hold down the noise," p. 106) that doesn't belong between the covers of ELECTRONIC DESIGN. For starters, the authors categorize noise as "burst, broadband and root hertz." Burst and broadband noise are indeed well recognized, but "root-hertz noise" can only be a corruption of the unit volts (or more typically nanovolts) per root hertz. This unit is not a category for noise but rather the dimension of noise spectral density. Noise spectral density is, in turn, the usual form of measurement for broadband noise, one of the authors' other two categories for noise.

In the second paragraph, burst noise is described in terms of "rail-to-rail jolts." Now perhaps this is a metaphor referring to the choo-choos of old. But, if it refers to power rails, the rails at TI must be a lot closer together than they are at other places, or TI must have record popcorn noise in its bipolar amplifiers.

In the next paragraph, the authors equate broadband and 1/f noise, which are generally categorized as two different regions in the noise spectrum. At low frequencies, 1/f noise dominates, but the spectral density falls with increasing frequency (hence, the term 1/f noise) until it approaches, asymptotically, the wide-band noise.

(continued on page 44)

Electronic Design welcomes the opinions of its readers on the issues raised in the magazine's editorial columns. Address letters to Managing Editor, Electronic Design, 50 Essex St., Rochelle Park, NJ 07662. Try to keep letters under 200 words. Letters must be signed. Names will be withheld upon request.

JANCO ROTARY SWITCHES

offer **SIMPLE**
solutions to complex
switching problems!



P-C Rotary Switches

"THE MIGHTY MINIATURE"

Optimum simplicity! Features the sophisticated circuitry of a coded switch plus all the advantages of a sealed rotary... and it's only .6" in diameter and .5" deep (from mounting face to the base of the pin terminals). Mounting is simpler! Wiring is simpler! Available in 8, 10, 12 positions. 1" diameter is available in up to 24 positions.

PUSH-BUTTON Rotary Switches

Unique in design by virtue of their simplicity, these Janco rotary switches also function accurately and quickly in the most adverse environmental conditions. Can be "ganged" together for high density packaging. Available in bi-directional and uni-directional in 8, 10, 12, 16 positions with codes galore!



**MIL SPEC
QPL**
Mil-S-3786 &
Mil-S-22710

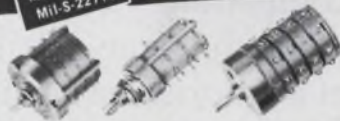

Rotary Selector Switches

Standard rotary selector switches, power, miniature, micro-miniature, solenoid operated, keylock, momentary, etc. ... Janco has the rotary switch for your application. Proof is in the usage! Almost every military and commercial craft that flies has been using Janco rotary switches for over 30 years!

Janco
CORPORATION

3111 Winona Ave., Burbank, CA. 91504
Phone 213-845-7473 • TWX 910-498-2701

Intel delivers the 8-bit microcomputer,

Our newest 8085A selection is, quite simply, the world's fastest 8-bit microcomputer. It's the 8085A-2, with a 5 MHz clock rate—66% faster than a standard 3 MHz 8085A. Now you can achieve a new level of system performance using the world's best selling and best supported microcomputer family.

5MHz

There's a surprising measure of economy that goes along with the 8085A-2's startling performance. Its superior bus architecture enables you to use relatively slow, low cost standard memories.

You don't need the costly, high speed memories that other high performance microcomputers demand. In fact, at any clock rate, MCS-85™ CPUs operate with 25% slower memories than even the most efficient competitive microcomputers.

The 8085A-2's faster clock rate sets a performance trend all MCS-85 components will follow. That gives you the design option of 5 MHz or 3 MHz operation within the same family. Of course the 8085A is fully compatible with the 8085, and offers the same growing selection of memories, programmable peripheral interfaces and support circuitry.

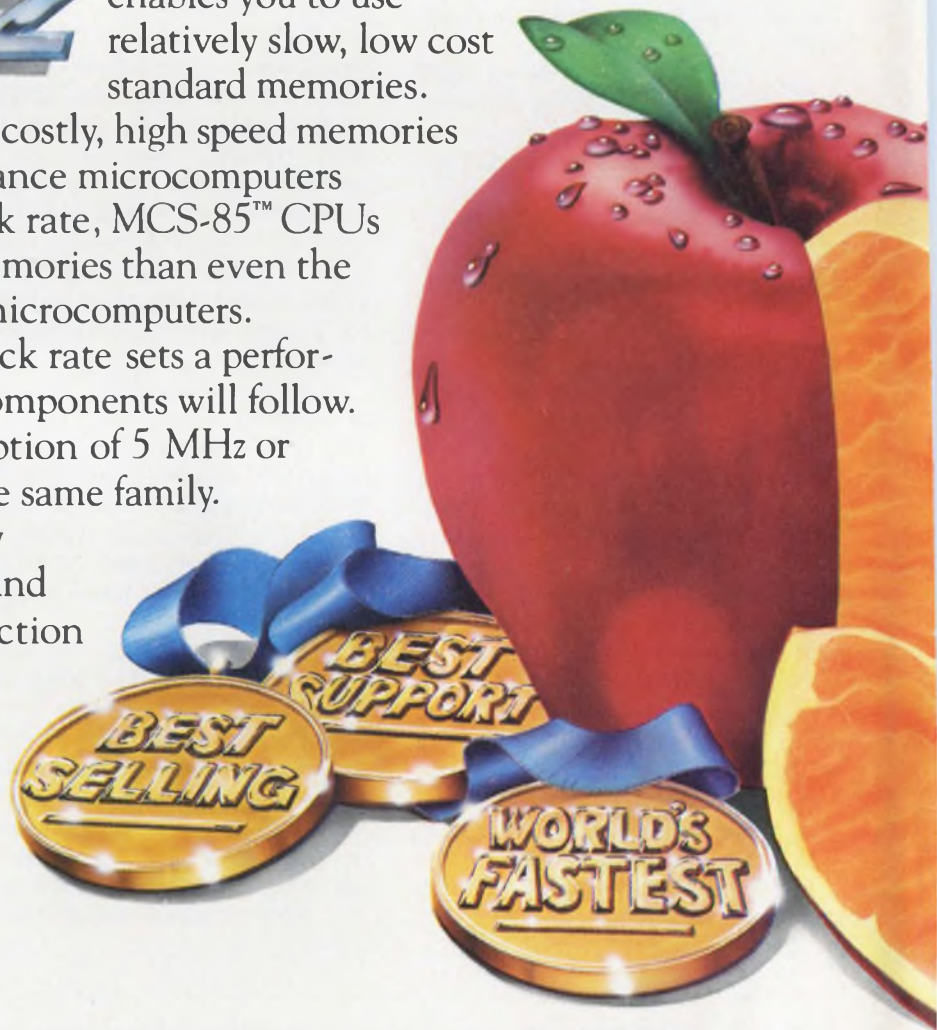

world's fastest the newest 8085A.

Join the Majority. Since its introduction, more major companies have chosen the 8085A than all other microcomputers combined. Almost overnight, the 8085A became the new industry standard.

Full software and bus compatibility with the familiar 8080 is one reason why. Designers have found they have a head start in implementing new MCS-85-based designs. And, the 8085A is your bridge to compatibility with upcoming Intel microcomputer advances.

#1 in Support. Choosing the right microcomputer means more than evaluating CPU performance. When you choose MCS-85, you get the highest performance CPU, plus a full family of compatible memories and peripherals, and access to our fast growing software library. Making Intel your microcomputer supplier unlocks the door to the industry's most comprehensive development support, too.

Our Intellec[®], and new Intellec[®] Series II, Microcomputer Development System speeds your product to market. It's the only development system with two high level languages, PL/M and FORTRAN. It's the only development system that gives you symbolic debugging, using ICE-85[™] in-circuit emulation. And it's the only development system you'll need for today's leading microcomputers, and tomorrow's, too.

Intel further supports our microcomputers worldwide with on-site FAE applications assistance, training classes and design seminars.

The quickest way to get started is to order MCS-85 components from your nearest Intel distributor. Or, for a new 8085A-2 data sheet, contact your local Intel sales office or write: Intel Corporation, 3065 Bowers Avenue, Santa Clara, CA 95051.
Telephone: (408) 987-8080.

intel[®] delivers.

Europe: Intel International, Rue du Moulin a Papier, 51-Boite 1, B-1160, Brussels, Belgium. Telex 24814.
Japan: Intel Japan, K.K., Flower Hill-Shinmachi East Bldg. 1-23-9, Shinmachi, Setagaya-ku, Tokyo 154.
Telex 791-28426.

Distributors: Almac/Stroum, Component Specialties, Cramer, Hamilton/Avnet, Harvey, Industrial Components, Pioneer, Sheridan, Wyle/Elmar, Wyle/Liberty, L.A. Varah or Zentronics.

The smallest member of this emergency team does 15 jobs.

It's Mostek's single-chip
microcomputer—industry's choice for
electrocardiographs,
fish finders, and more.

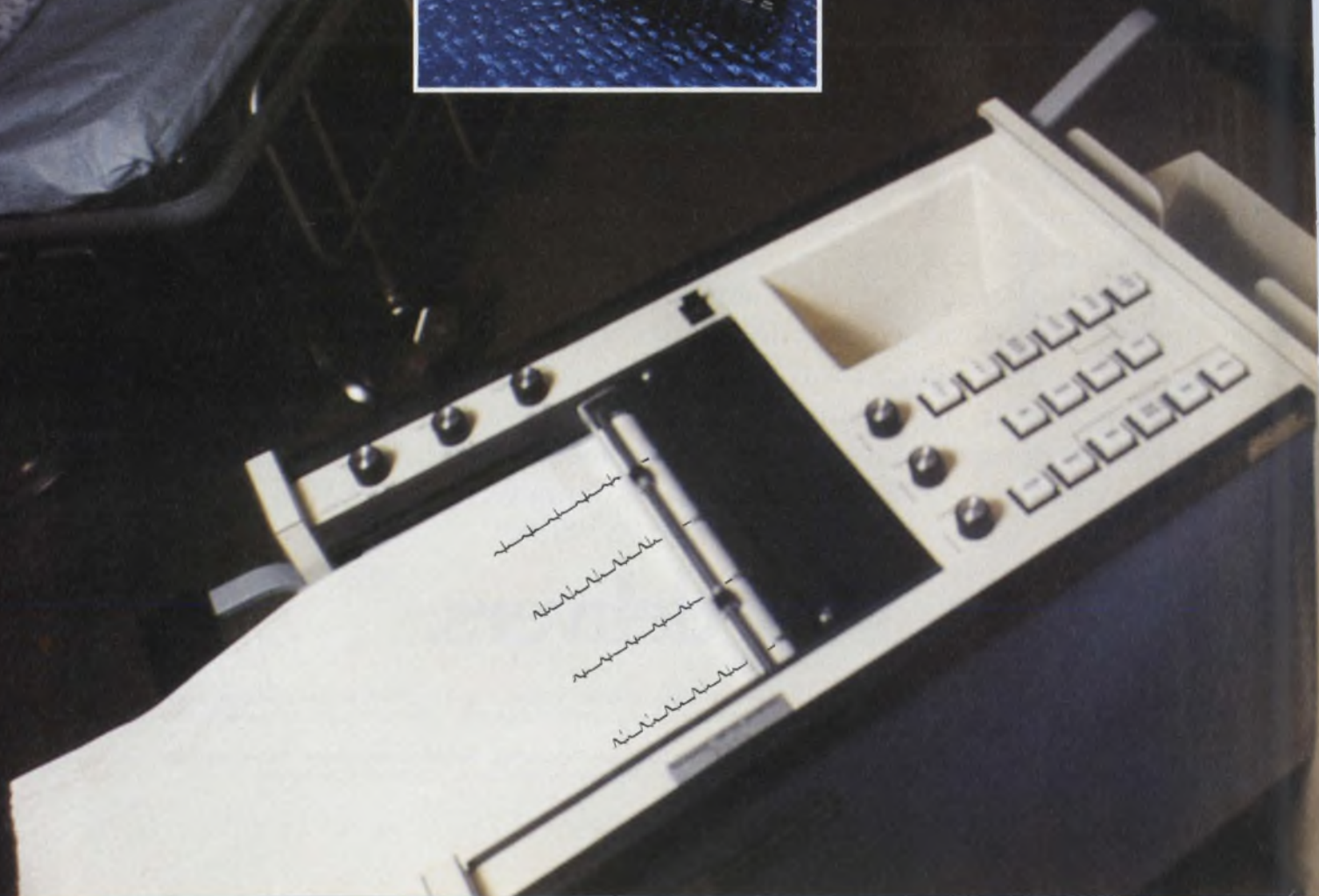

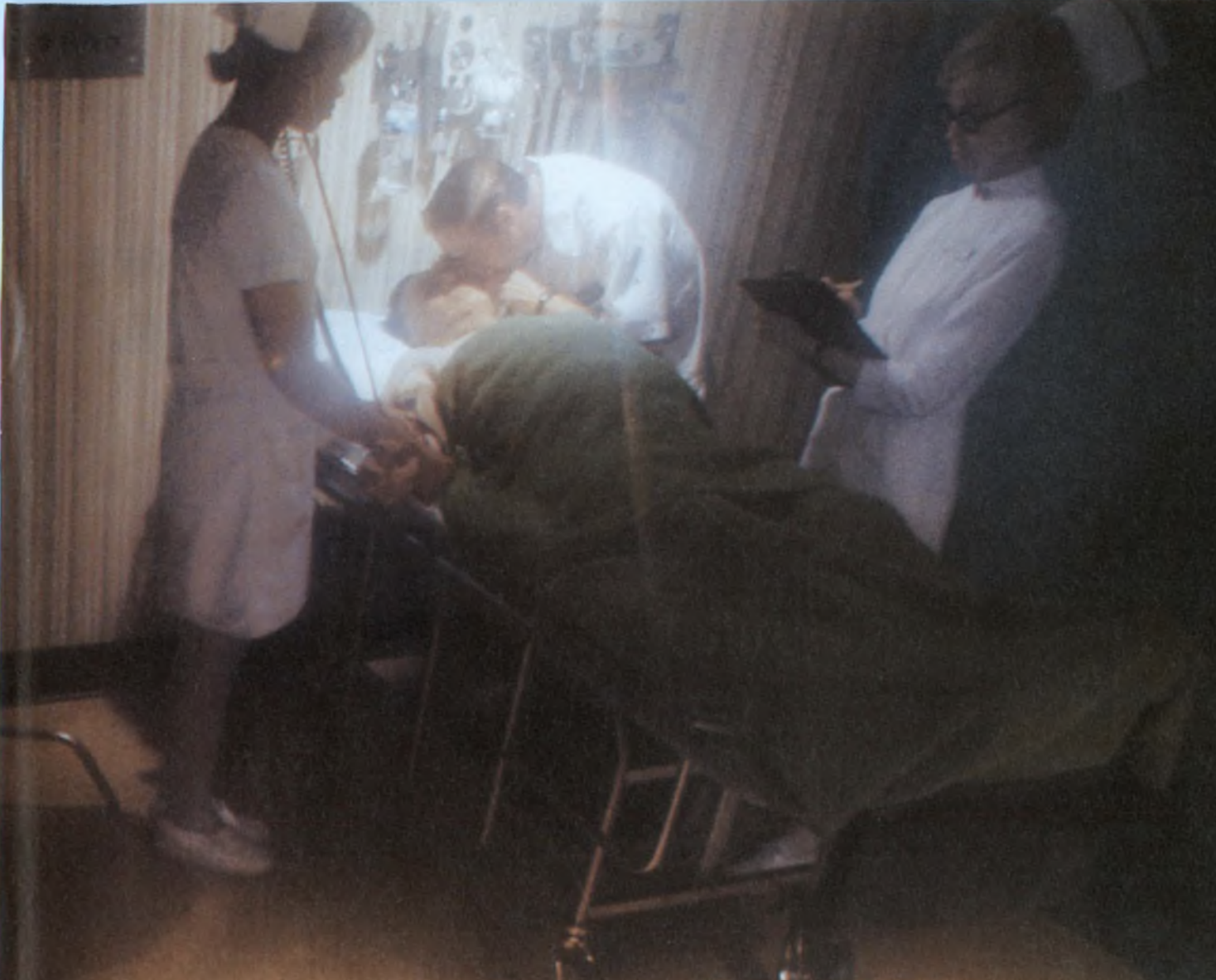

Mostek's 3870 gives you industry's highest performance in a single-chip microcomputer. With its 2K bytes of ROM, 32 I/O lines, and single +5 Volt power supply, the 3870 simplifies system design and lowers cost.

That's why it was chosen for use in Cambridge Instruments' Model 3038/2 Electrocardiograph. The 3870 receives 12 different electrode inputs, monitors the keyboard input, and controls the chart recorder pens and driver.

Shakespeare Marine Electronics designed the 3870 into their chart printing depth finder, the Ultimate 1™. It reads and charts the number and size of fish at depths from 6 inches to 400 feet. With the 3870 as a control center, the Ultimate 1 offers more features than its competitors.

Oehler Research developed a bullet speedometer called the Chronotach 33™. Using a Mostek 3870, it computes bullet velocity,

stores and summarizes this information, then displays five ballistic parameters. With the 3870's low power requirements, the unit runs on flashlight batteries making it ideal for outdoor use.

Computer Automation used Mostek's 3870 in a low cost programmer's console for their Naked Mini 4 computer. The result:

a control and display panel that facilitates initial start-up, program debugging, and troubleshooting.

Bell and Howell designed a microfilm recorder, the ABR System 100™, with a 3870. They

chose single-chip technology for its design simplicity, low cost, and enhanced serviceability. The 3870 met those requirements while allowing additional features.

These are just some of the proven

design capabilities of Mostek's 3870. And designers are already using Mostek's 3872, a single-chip microcomputer with 4K bytes of ROM and *In-Socket Expandability* (ISE-1)™ for easy system upgrade.

For more information

about Mostek's 3870 family, contact Mostek, 1215 West Crosby Road, Carrollton, Texas 75006; phone (214) 242-0444.

In Europe: Mostek GmbH, West Germany; phone (49) (0711) 701045.



MOSTEK®

© 1978 Mostek Corporation
Photo courtesy of Pleasant Grove Hospital, Pleasant Grove, Texas

The power audio leaders are sounding off again.

Fairchild didn't get to be the largest manufacturer of power audio amplifiers in the United States by resting on its laurels. So here we go again.

The low-down on low.

Our new μ A7307 is, modesty aside, simply the best low-cost amp for battery operation available today. Particularly at low voltage.

It's constructed on a single silicon chip using Fairchild's patented Planar process. And to save space, it's packaged in a plastic 8-pin mini-DIP with copper frame.

Power supply voltages range from 3.5 to 12 V. Power output from 0.22 to 1.6 W. Speaker impedance is 4Ω . And minimum working voltage is 3 V.

The low-down on high.

Our new μ A783 is a high voltage monolithic integrated circuit in a 12-pin power package.

It's designed for use as an audio frequency Class B power amplifier and for 8 and 16Ω applications.

With 24 V of power supply voltage, you get 9 W of power output using an 8Ω speaker.

The μ A783 also has a wide supply voltage range from 4-30 V.

Applications are primarily line operated TV and audio.

A powerful performer.

Our new TDA2002/2002A's are 10 W audio power amps in 5-pin TO-220 power type packages.

The specs are powerful, too:

Power supply voltage 16 V. Power output 10 W. Speaker impedance 2Ω .

Features include thermal shutdown, overvoltage protection (on the TDA2002 only) and short-circuit protection.

TDA2002/2002A's are perfect for auto and mobile radios and CB's.

All-purpose, all-American amp.

Our new TBA820 is an integrated monolithic audio amplifier in a 14-pin plastic power package. It's constructed on a single silicon chip, using Fairchild's Planar process.

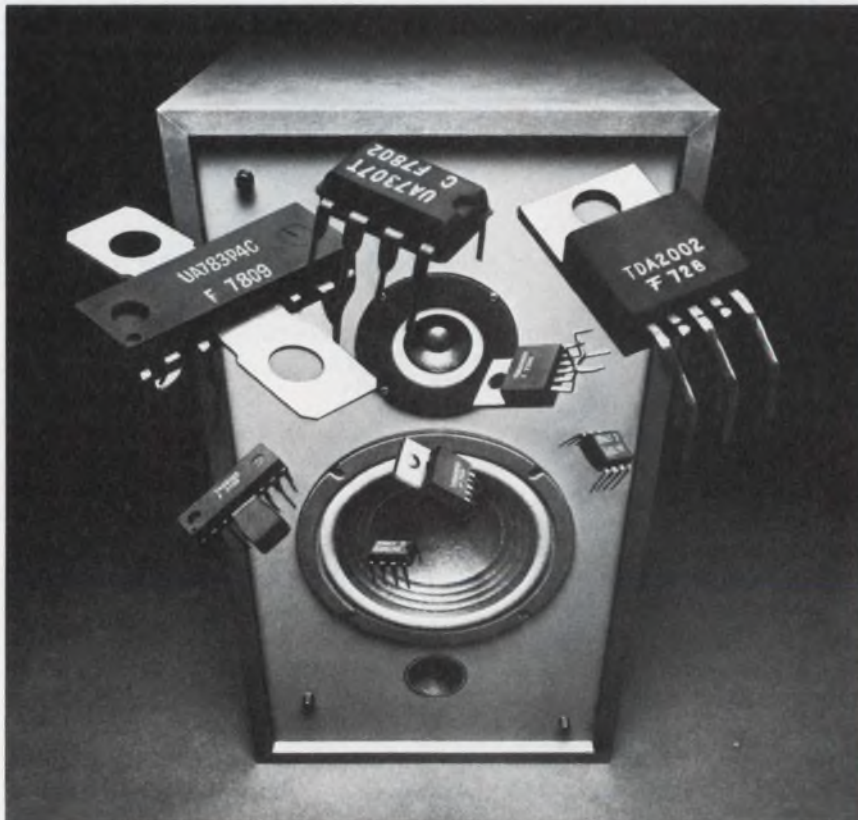

AUDIO POWER AMPLIFIERS

Device	Power Supply Voltage Speaker Impedance Power Output	Package	Features/Mkt. Area
TDA2002 TDA2002A	16 V, 2 Ω , 10 W 14.4 V, 2 Ω , 8 W 14.4 V, 4 Ω , 5 W	5-pin TO-220 type Power package	2-4 Ω loads Thermal shutdown Overvoltage protection Short-circuit protection Auto radio, CB, Mobile Radio
μ A783P3 μ A783P4	24 V, 8 Ω , 9 W	12-pin Batwing	Thermal shutdown Operation 4-30 V Line operated TV & Audio
TBA810DS TBA810DAS	14.4 V, 4 Ω , 6 W	12-pin Batwing	Thermal shutdown Overvoltage protection Auto radio, CB, Mobile Radio
TBA810S TBA810AS	14.4 V, 4 Ω , 6 W	12-pin Batwing	Thermal shutdown General purpose audio
μ A706BPC	14 V, 4 Ω , 5.5 W	14-pin dual in-line power pkg. w/bracket	Not recommended for new designs
TBA800 TBA800A	24 V, 16 Ω , 5 W	12-pin Batwing	Suitable for 24 V supply operation, e.g., TV and line operated radio
TBA641B11	14 V, 4 Ω , 4.5 W	14-pin quad in-line power pkg. w/bracket	Not recommended for new designs
μ A706APC	9 V, 4 Ω , 2.2 W	14-pin dual in-line power package	Not recommended for new designs
TBA641A12	9 V, 4 Ω , 2.2 W	14-pin dual in-line power package	Not recommended for new designs
TBA820 TBA820L	12 V, 8 Ω , 2 W 9 V, 8 Ω , 1.2 W 6 V, 4 Ω , 0.75 W 3.5 V, 4 Ω , 0.22 W	14-pin DIP	Low power supply operation Suitable for battery operation
μ A7307TC	9 V, 4 Ω , 1.6 W 9 V, 8 Ω , 1.2 W 6 V, 4 Ω , 0.75 W 3.5 V, 4 Ω , 0.22 W	8-pin mini-DIP	Low cost low voltage-battery operation

The TBA820 is an inexpensive, all-purpose amplifier used primarily as a low frequency Class B amp.

It operates over a wide supply voltage range of 3-16 V. And it's capable of providing up to 2 W of output power.

The low quiescent current in TBA820's make them extremely useful in battery operated portable applications.

Say hello to some old favorites.

Fairchild has the broadest and most complete power audio line in the U.S. for use in TV, radio, hi-fi, CB and industrial applications.

It covers the entire range from 3.0 to 30 V of power supply. And from less than 1 to 10 W of power output.

In short, we've got your amp.

For details on our power audio products, or for your own power audio line card, just contact your Fairchild sales office, distributor or representative today. Or use the direct line at the bottom of this ad to reach our Linear Division. Fairchild Camera and Instrument Corporation, 464 Ellis Street, Mountain View, California 94042. Telephone: (415) 962-4903. TWX: 910-379-6435.

FAIRCHILD

**Call us on it.
(415) 962-4903**

When the
chips are down,
GE's DataSentry[®] keeps
the memory up!

nickel-cadmium battery

DataSentry[®]
nickel-cadmium battery
Standby
power

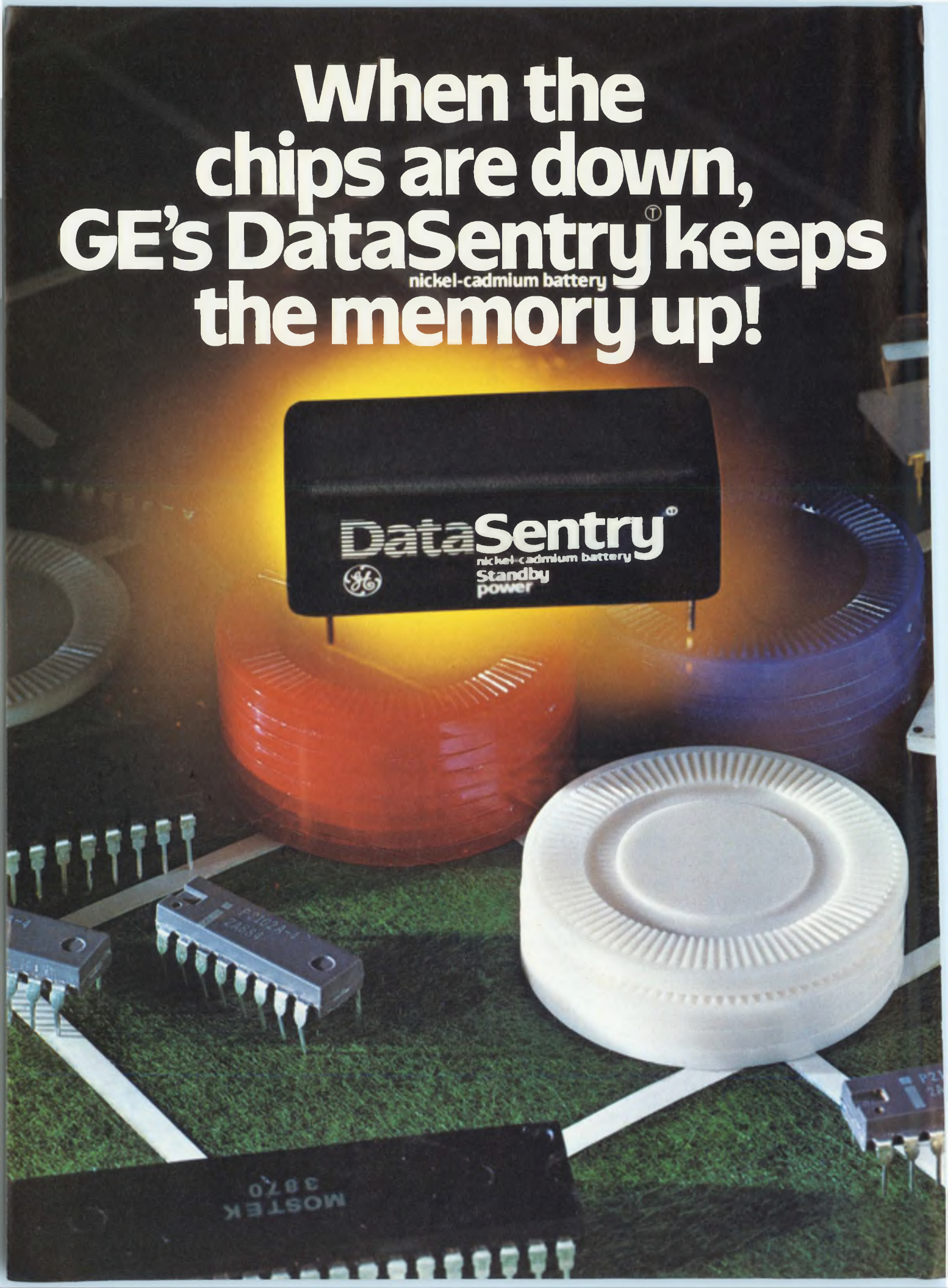

GE's exclusive winning combination: rechargeable standby power in a DIP.

GE's new DataSentry[®] nickel-cadmium batteries are Dual Inline Packaged—they mount right on the card in standard pin sockets. There's no costly auxiliary mounting hardware or interconnecting wiring. And, the multi-pin design and rugged plastic case insure mechanical integrity. Keep in mind too that the compact size and DIP configuration make the DataSentry[®] standby power modules highly compatible with microelectronic P.C. board design.

Two of a kind, and any combination wins.

DataSentry[®] modules are available in two voltages: 2.4 and 3.6 volts. Multiples of these two sizes give you the versatility to custom match standby power to the design requirements of your system. For example, if you need 6.0v, simply combine one 2.4v module and one 3.6v module. A 4.8v design means two 2.4v modules. And so on. Now you can match system requirements by simply combining inexpensive standard components.

The backing you need to cover your bits.

With DataSentry[®] modules, not only can you "build-up" the right voltage for your system, but you can also "back-up" a wide range of memory requirements. For example, these versatile modules will typically support a small memory drawing 10 microamps for almost three months, or a larger memory drawing one half amp for more than five minutes.

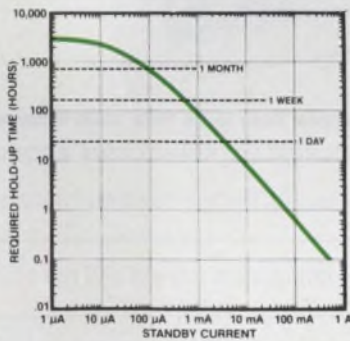

GE's standby power lowers your ante ... again.

You already know you can create a non-volatile RAM through the addition of standby power. And you also know the cost savings are considerable. Now with DataSentry[®] modules, you can save even more. The DIP configuration means you can take full advantage of standardized board manufacturing techniques as well as high volume soldering and cleaning processes. And that means less production time. And cost.

You can bet your bits it's a consistent winner.

DataSentry[®] modules provide proven application reliability, backed up by GE's reputation as a world leader in rechargeable battery technology. Take a look at the hand DataSentry[®] modules hold:

- no maintenance
- continuous overcharge capability
- the versatility of both high and low discharge rate capability
- flat discharge voltage profile
- resealable safety vent



Now it's your deal.

You can always deal yourself winning cards when you back your chips with DataSentry[®] standby power modules. For a first hand look at your ace on the board, simply fill out the reply card below and mail to:

DataSentry[®]
General Electric Battery Department
P.O. Box 922/Gainesville, FL 32601

GENERAL  ELECTRIC

A world leader in rechargeable battery technology.

REPLY CARD

Name: _____

Title: _____

Company: _____

Address: _____

City: _____ State: _____

Phone Number: _____

Application: _____

Requirements: _____

Please have a Sales Engineer contact me immediately.

[®] Trademark of the General Electric Company

Here's your latest edition of the GI Microelectronics 1978 Product Guide... Quick...Tear it out!



If you want more information please use this coupon.

AMERICA
General Instrument Corporation
Microelectronics
600 West John Street
Hicksville, New York, U.S.A. 11802

EUROPE
General Instrument
Microelectronics, Ltd.
Regency House, 1/4 Warwick Street,
London, W1R 5WB

ASIA
General Instrument
International Corp.
Fukide Bldg., 8th Floor
1-3 Toranomom 4-Chome
Minato-ku, Tokyo 105

GI MICROELECTRONICS 1978 PRODUCT GUIDE:

I'm impressed. Please send me more information re:

I'm very impressed. Please call me re:

I'd like to be impressed, but your guide has been removed. Please send me a copy.

NAME: _____ TITLE: _____

COMPANY: _____

ADDRESS: _____

CITY: _____ STATE/COUNTRY: _____

ZIP: _____ TELEPHONE: _____

**GENERAL INSTRUMENT CORPORATION
MICROELECTRONICS**



NEW from **H** Hayden! in personal computing books!

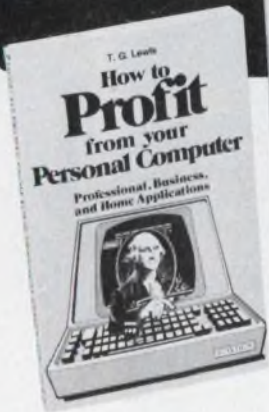

HOW TO PROFIT FROM YOUR PERSONAL COMPUTER:
Professional, Business, and Home Applications
By T. G. Lewis. Describes how to put the computer to work for you.
#5761-X, paper, 256 pp., \$7.95

HOME COMPUTER SYSTEMS HANDBOOK
By Sol Libes. A technical look at personal computers.
#5678-8, paper, \$8.45

THE FIRST BOOK OF KIM
By Jim Butterfield, Stan Ockers, and Eric Rehnke. How to write KIM programs, with illustrations.
#5119-0, paper, 176 pp., \$8.95

FORTAN WITH STYLE: Programming Proverbs
By Henry F. Ledgard and Louis J. Chmura. Programming style guide that conforms to the new definition of standard FORTRAN.
#5682-6, paper, 176 pp., Available May, 1978

BASIC BASIC, Second Edition
By James S. Coan. Fundamentals of BASIC programming.
#5106-9, paper, \$8.95; #5107-7, cloth, 288 pp., \$9.95

HOW TO BUILD A COMPUTER-CONTROLLED ROBOT
By Tod Loofbourrow. Provides an application of a microprocessor and hands-on experience with robotics. #5681-8, paper, \$7.95

ORDER FORM		15-DAY FREE EXAMINATION!	
Catalog No.	Title		Price
_____	_____	_____	_____
_____	_____	_____	_____
_____	_____	_____	_____
_____	_____	_____	_____
Name _____			
Title _____			
Company _____			
Address _____			
City _____	State _____	Zip _____	
Send to: HAYDEN BOOK COMPANY, INC. 50 Essex Street, Rochelle Park, N.J. 07662			

Rush me the book(s) listed on 15-day FREE examination. At the end of that time, I will send payment, plus postage, or return the book(s) and owe nothing.

Payment enclosed. Publisher pays postage. Same return guarantee.

Prices are subject to change without notice. Offer good in U.S.A. and Canada only.

Payment must accompany orders from P.O. Box numbers. Name of individual ordering must be filled in.

\$725.*

2K bytes RAM.

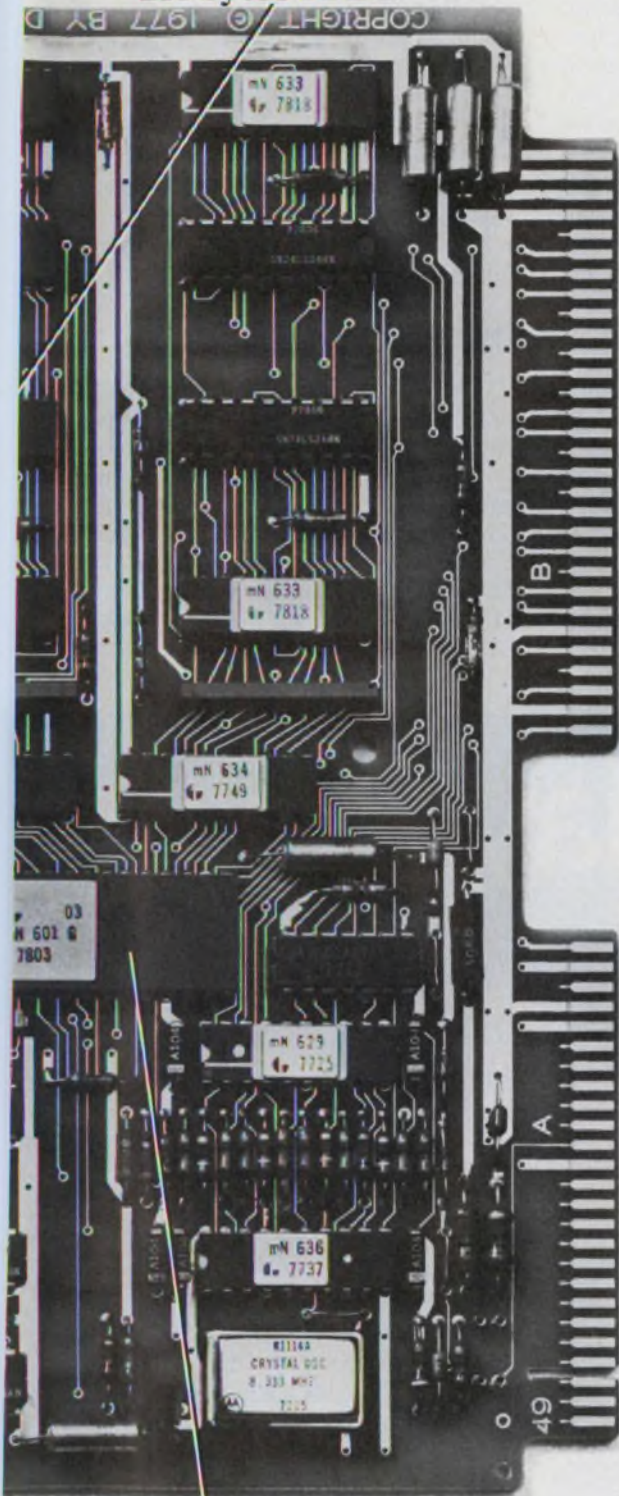

16-bit microNOVA.

Introducing the Data General microNOVA Board Computer, MBC/1. The smallest, most functional 16-bit single board micro-computer you can buy. More power and capability in less space than any other. It's a full 16-bit processing unit. And it has multiply/divide, stack architecture, data channel (DMA) and 16-level priority interrupt, 2K bytes static RAM, sockets for up to 4K bytes of PROM. It also has async interface, 32-line digital I/O, optional console debug software and self-test diagnostics. All in a space of 7.5 x 9.5 inches.

It's all supported by our MBC/M real-time multi-tasking monitor and monitor emulator that lets you develop software under Data General's AOS, RDOS and DOS operating systems for execution on MBC/1.

To go along with all of this, there's a full array of compatible interfaces, design interface support, compatible software and excellent program development tools. If you want more board in less room, reserve a Data General MBC/1 microNOVA Board Computer. For more information, mail the coupon, call Data General or your nearest full service industrial distributor: Schweber or Wyle (Elmar/Liberty). Or call your local dealer.

*Single unit price. Quantity discounts available.

Mail to: microNOVA PRODUCT INFORMATION
DATA GENERAL CORPORATION,
WESTBORO, MA 01581

Name	Title	
Company	Tel. No.	
Address		
City	State	Zip

Data General Corporation, Westboro, MA 01581. (617) 366-8911. Data General (Canada) Ltd., Ontario. Data General Europe, 61 rue de Courcelles, Paris, France, 766.51.78. Data General Australia, (03) 89-0633. Data General Ltda., Sao Paulo, Brazil, 543-0138. Data General Middle East, Athens, Greece, 952-0657. © Data General Corporation, 1978. microNOVA is a registered trademark of Data General Corporation.

ED67

 **Data General**
We make computers that make sense.

Across the desk

(continued from page 7)

Next, we are given an expression for "broadband-noise spectral density," which is related to reciprocal frequency. I don't know where the authors dug up this expression, which they purport to relate to equivalent input noise. It looks suspiciously like the equation that describes excess noise (above Johnson or thermal noise) for a resistor under bias. In any case, it could hardly be the expression for spectral density, since it is dimensionally incorrect. Remember that spectral density should be $V/\sqrt{\text{Hz}}$.

The last paragraph in the section, a discussion of "root-hertz noise," appears to be a garbled description of $1/f$ noise.

A. Paul Brokaw

Director of Product Planning

Analog Devices Inc.

Semiconductor Div.

829 Woburn St.

Wilmington, MA 01887

Dale Pippenger replies

A few comments relative to "The Blizzard of '78," the January BIFET article and Paul Brokaw's comments:

1. Although the term of "nanovolt per root hertz" is a narrow-bandwidth measurement of noise density, it is often referred to as root-hertz noise and is used as a meaningful test for noise. Even the popular Analog low-noise device AD504 specifies noise at 100 Hz and 1 kHz in nanovolts per root hertz. It's not exactly broadband noise—it's the noise density over a 1-Hz bandwidth at the frequencies tested.

2. The rail-to-rail jolt at the output of an op amp during burst noise is well known when used as transducer amplifiers operating at high gain. This burst of noise, or jolt, could swing the output from rail to rail even with 1-mV input burst, if the amplifier were operating at a gain of, say, 10,000. The resulting 10-V burst on the output is what is referred to as "popcorn noise" due to its high energy level. Though 1 mV of input burst noise is a lot, it is not uncommon in older general-purpose bipolar amplifiers.

3. The $1/f$ noise and broadband-

noise measurements are definitely separate techniques. While broadband noise is an average level of the total noise over some bandwidth (frequently 10 Hz to 10 kHz for op amps), $1/f$ noise is, as stated, spot noise—over a narrow 1-Hz bandwidth measured at frequencies of typically 10 Hz, 100 Hz, 1 kHz, 10 kHz and 100 kHz.

4. Regarding amplifier input impedances, we did not intend the values mentioned to be the result of external circuit techniques that yield high values. The 741 4-M Ω input impedance mentioned is actually higher than the data-sheet specification for a typical value.

I do hope the snow storms are over for this winter.

Incredible

The TI BIFET article in your January 4 issue raises several questions of credibility:

1. The chip photos, claimed to be the same scale, are stated to show that the TI chip is "about the same size" as the 741 chip, but the National LF355 is "twice as large." Simple measurement of the photos reveals that the TL081

Time Delay Relays

More design options with delays of .01 seconds to a year... and more.

Widest choice of timing modes, voltages, mountings, enclosures and contact arrangements. Save design time by selecting a standard P&B time delay relay. Or, we'll make a special for you if your application demands it. All built to P&B's high standards of quality and performance. Potter & Brumfield Division AMF Incorporated, 200 Richland Creek Dr., Princeton, IN 47671. 812/386-1000.



CIRCLE NUMBER 98

Potter & Brumfield

is 1.97 times the 741 area, and the LF355 is 1.90 times the TL081 area.

It appears to me that TI has shown what we have been claiming all along: Even the most simple BIFET op amp chip is larger than a 741 and has an extra two ion-implant steps. Therefore, it must cost more to produce than a 741. If priced below a 741, the only valid reason is to buy market share.

2. Comparing the TL081 with the LF355 isn't cricket anyway. Comparison should have been made with the LF351, National's equivalent to the TL081. The LF355 (now LFT355), like the PMI OP15, is a precision op amp, against which neither the TL081 nor LF351 can compete in performance.

3. Although the virtues of BIFETs are considerably extolled, I believe that one must evaluate the advantages on a sound engineering basis:

a) Noise in a BIFET circuit is a function of a lot more than just the ion-implant process characteristics. In an LF355 circuit it comes primarily from the current noise in the second stage reflected by the gm of the first-stage FETs to the inputs. In fact, evaluating units from several sources have even shown popcorn noise. The best BIFET

amplifiers have yet to meet the noise performance of the best bipolar amplifiers.

b) Warm-up drift of IB and its change over even the 0 to 70-C range was not discussed. Since the input bias current is junction leakage current on the FETs, this will approximately double every 10 C. Therefore, warmed up at 70 C, the input current is equal to or greater than a number of bipolar amplifier families.

*Daniel J. Dooley
VP, Engineering*

Precision Monolithics Inc.
1500 Space Park Dr.
Santa Clara, CA 95050.

Ooops!

Those of you who read our special report on data converters (ED No. 12, April 12, 1978, p. 38) and who know Russell Apfel, manager of LIC systems at Advanced Micro Devices, may get the idea that he changed his last name to Aptel. He hasn't. We did it for him, accidentally. For that we apologize to Russell and promise to write 1000 times: "f not t, f not t, f not t . . ."

Misplaced Caption Dept.



So that's what an overloaded power transformer smells like.

Sorry. That Franz Xavier Messerschmidt's "A Rascal," a sculpture in the Osterreichische Galerie in Vienna.

...and other solutions to your tough design problems are found in P&B's growing product line.

AMF

Potter & Brumfield



NEW low-cost S87R industrial relay. UL recognized. Contacts rated to 20 amps, 277V AC, 50,000 operations at rated load. Contact forms to 2C. Ideal for vending machines, HVAC, home appliances and machine tool controls.
CIRCLE NUMBER 156



NEW T10 PC Board Relay. Now sealed for flow soldering and immersion cleaning. Only .425" high allowing 0.6" center-to-center spacing. Ideal for high density applications. Choice of 2, 4 and 6 Form C contacts for 0.1 to 3 amp switching @ 28V DC.
CIRCLE NUMBER 157



W58 thermal circuit breaker. Positive snap action switching up to 35 amps for under \$1.00 in quantity. Exclusive blade design. Pressure actually increases until contacts open... with "snap." Trip times at 200% of rated load—1 to 4 amp models 10 to 45 seconds, 5 to 35 amp models, 6 to 30 seconds.
CIRCLE NUMBER 158



NEW EAX solid state AC relay. Thyristor controlled and isolated by pulse transformer circuit. Can be driven directly by logic circuits such as TTL, MOS and HTL. Terminals for 0.1" grid printed circuit board mounting. Rated 1.2 amps, 120V AC.
CIRCLE NUMBER 159

ROLM has it all together



or apart

with the new Micro-Modular Concept

Anyway you want it. In any configuration you need.

For any small Mil-Spec computer system with large performance requirements, you can start with the ROLM® Model 5605 microprocessor. This high speed, single module processor can address 64K of memory and as many as 61 devices.

It uses our semi-conductor or core memory modules. Like the CPU, they're Mil-Spec components ready for severe environments.

Select from a full line of ROLM interfaces ranging from standard I/O buffers to NTDS and communications interfaces.

Tie the whole system together with a custom, or standard, motherboard ready for an enclosure of your design or the ROLM Mil-Spec Half ATR chassis.

While your system is in design & development, your software can be developed on one of the ROLM standard AN/UYK-19 processors. Since all ROLM modules are interchangeable and compatible, processors such as the ROLM 1602A can be used for programming, test and maintenance—without modification!

And your flexibility of selection doesn't stop with hardware. At no added cost you have your pick of extensive, updated, upward compatible software with your programming station.

We call this the "micro-modular" approach to designing a Mil-Spec computer system. It puts it all together in a way that makes sense; just the way you want it.

That's Why We're #1 in Mil-Spec Computer Systems

ROLM

MIL-SPEC
Computers

4900 Old Ironsides Drive, Santa Clara, CA 95050. (408) 988-2900. TWX 910-338-7350.

In Europe: 645 Hanau, Muehlstrasse 19, Germany, 06181 15011, TWX 418-4170.

CIRCLE NUMBER 13

You can use our complete NRZI Magnetic Tape System with your PDP-II or Nova for under \$5250.*

or, you can pay 20-100% more to other independent peripheral suppliers like Pertec Wangco, Kennedy... and even to DEC and Data General.

Then try to justify it.

Unless your firm likes giving money away, Digi-Data is the only recommendation that makes sense.

And whether you need compatibility with PDP-11 or NOVA, Eclipse or even HP21MX, it's not just our price advantage that gives you the edge.

- It's the product reliability that results from our ultra-simplistic design. Thousands of field installations have verified that reliability.
- It's the confidence that our 16-year record of corporate stability assures.
- It's our 30-day ARO delivery for most standard configurations.
- It's our long-term record of responsible service.
- And it's the performance, serviceability and economy realized by using common designs for the many different configurations available in our Minidek, Mididek and Maxidek tape transport models.

And after all what really counts is the overall value that Digi-Data provides. Whether you need stand-alone tape drives, formatted systems or minicomputer mag tape systems, Digi-Data is First in Value. Call or write today for details.

*Single quantity price.
Substantial volume discounts available.



**DIGI-DATA
CORPORATION**

8580 Dorsey Run Road, Jessup, MD 20794
(301) 498-0200

® ... **First In Value**

MEPCO/ELECTRA

SPR 5000 Y

**RESISTOR...
ONE SIZE
ONE STYLE**

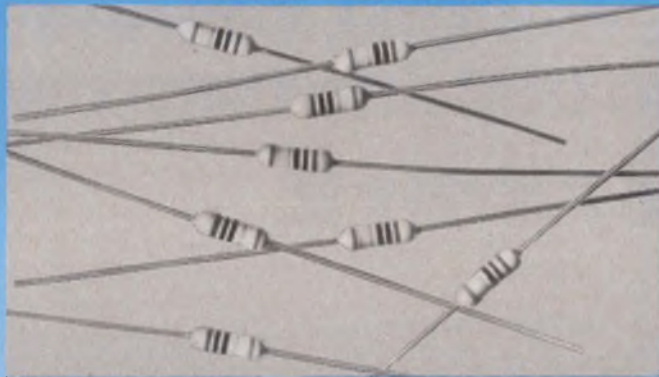

For all standard precision applications

You're looking at the state-of-the-art in discrete film resistor technology. **MEPCO/ELECTRA S** SPR 5000 Y—the only resistor that gives you everything you need for all your 1%, 100 PPM applications ... in one size, one style.

Whether you're building automotive, instrumentation or communications equipment, with all the tight space requirements high power handling capabilities, and broad range of values these applications require, you'll find what you need in SPR 5000 Y ... with this big plus—reduced resistor inventory.

**MEPCO/ELECTRA SPR 5000 Y:
DUAL RATED—1/4W & 1/2W.**

One resistor can be used in both 1/4 and 1/2W applications, which means dual power handling capability in the smallest possible size.

BROADER RESISTANCE RANGE—10 Ω to 22.1M Ω

Widest resistance range for any resistor with comparable tolerance and T.C.'s.

REPLACES RN55, RN60 and RN65—

Perfect replacement for these MIL styles with the added plus of a broader resistance range, dual rated ... and at a better price.

CWV—350V Max.

STANDARD TOLERANCE—1%

STANDARD T.C.— \pm 100 PPM (\pm 50PPM available)

In the market for a standard precision resistor that offers better than standard specs? Find out about SPR 5000 Y. For more information ... "Call M/E" at (817) 325-7871. Or write **MEPCO/ELECTRA Inc.**, P. O. Box 760, Mineral Wells, Texas 76067.



CIRCLE NUMBER 15

June 7, 1978

Computer model improves fiber-optic communications

Working from a new computer modeling program to predict performance of a fiber-optics communications system, engineers at Harris Corp. (Melbourne, FL) have developed a 7.8-kilometer link for a cable-television system in London, Ontario, Canada. The system transmits at 322 megabits per second, and has two repeaters spaced 2.6 km apart.

Rather than set up rise-time budgets and add up the rise times of each system element to see if the over-all system goals are met, the Harris group uses computer models for each of the system elements—transmitter, optical waveguide, receiver, noise filter and equalizer—and, with the computer, applies a pseudorandom word to the cascaded models. The output is an "eye" diagram which shows the resulting distortion and jitter.

In comparing the computed and measured results, a Harris spokesman says, "If you lay one on top of the other, you can't tell the difference. Most people have been too scientific," he adds, "and not approached the problem in a practical way."

The system is described in a paper at this week's International Com-

munications Conference in Toronto, Canada. Author C. Richard Patispaul notes that a number of approaches have been taken for calculating error rates in avalanche photodetector receivers, including an exact solution, Monte Carlo Simulation, Chernoff bounding, and Gaussian approximations. The Gaussian approach is the most convenient, says Patispaul, although it cannot accurately predict optimum avalanche gain and the decision threshold. Patispaul notes that such factors are rarely encountered in practical receivers. Optimum gain cannot be achieved because it generally exceeds the maximum rating of the device, while decision thresholds are unimportant since the data waveform must be symmetrically limited prior to retransmission to prevent excessive pulse-width distortion.

Thus, with the Gaussian approach, he can compute noise effects and then calculate the intersymbol interference and the jitter.

Jitter comes in two forms: random and systematic. Random jitter is estimated using an approximation based on signal slope and signal-to-noise ratio, whereas systematic jitter is taken

from the waveform simulations. With nonregenerative receivers, the random jitter grows as the square root of the number of receivers, while systematic jitter increases linearly with the number of receivers. All taken, the degradation due to jitter was found to be about 2 dB.

The signals are transmitted over the 7.8-km link using injection-laser diode transmitters, low-loss, graded-index optical fibers and avalanche photodiode receivers (see photo).

The response time of the diode transmitter is minimized by biasing the diode above the lasing threshold and modulating the drive current around the bias point in binary fashion, with operation always in the lasing region. Average optical power output coupled from the laser to an integral fiber pigtail is more than 1 milliwatt.

The fiber pigtail is coupled to the trunk cable with a single-fiber optical connector with a maximum insertion loss of 2 dB, and the cable fibers have attenuations less than 8.5 dB/km at the operating wavelength of 850 nm. A total of eight fibers are incorporated in the cable; six are used for two-way video signals and two are reserved for spares and future expansion.

The receiver comprises the avalanche photodiode and a wideband amplifier, providing a modulation bandwidth greater than 500 megahertz.

MSI beats μ Ps and custom LSI—sometimes

Off-the-shelf Schottky TTL can make a better computer CPU than can custom logic or bit-slice microprocessors, says Carlton G. Amdahl, executive vice-president of Magnuson Systems Corp. (Santa Clara, CA). That's why Amdahl chose MSI over LSI for Magnuson's M80 Series of IBM-compatible central processors.

"Bit-slice microprocessors are too restrictive to provide the performance levels we want," says Amdahl, who claims the Magnuson processor is 1.2 to 2 times faster than the equivalent IBM 360 and 370 units. The greatest advantage is in business data processing applications using Cobol, and the smallest advantage in scientific applications using Fortran.

There are microprocessors in the \$200,000-and-up computer's control console, though, and the CPU architecture is designed so that higher technology devices, when they become eco-

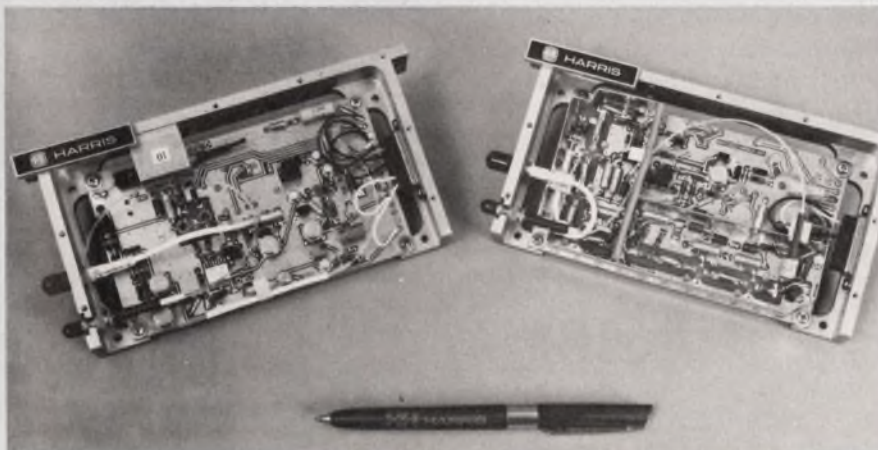

Fiber-optic transmitter (left) and receiver (right) developed by Harris Corp. handles 322 megabits per second. First installation will be in a cable TV system in Canada.

nomical, can replace TTL boards easily.

The modular approach to computer architecture allows changes and upgrades in software and hardware to follow any new developments from IBM, as well as allow compatibility with Honeywell, Burroughs, and other manufacturers' machines. Emulating IBM CPUs is becoming a favorite pastime: Two Pi Company Inc. (Sunnyvale, CA) with its V32 (ED 10, May 10, p. 36) and National Semiconductor Corp. (Santa Clara, CA) with its System/400 (ED 11, May 24, p. 37).

DMM responds to rms, average and peak ac

Digital-multimeter users no longer have to be concerned if their meters respond to ac signals with average, rms, or peak readings—or carry around three different instruments to cover all needs. The Model 3030A from Ballantine Laboratories Inc. (Boonton, NJ) has switch-selectable ac response, as well as a decibel range with an adjustable reference and high sensitivity on ac and dc ranges.

In audio-equipment testing, for example, average response can check sinusoidal signals, rms response can check distorted signals, and peak response can check sound waveforms and power-supply noise. In addition, the 3030A can make a gross check for distortion in sinusoidal signals: a clean sinusoid has a peak value 1.414 times its rms value.

In the decibel mode, the 3030A has rms response from 20 Hz to 50 kHz, with a reference adjustable from over 1000 Ω to less than 50 Ω at 1 mW. Range is more than 60 dB.

In voltage and current modes, full-scale ranges are from 20 mV to 1200 V and from 20 μ A to 2 A in both ac and dc modes—unlike some DMMs, which are less sensitive on ac signals. Resistance ranges are 20 Ω to 2 M Ω .

The 3030A responds from 20 Hz to 50 kHz in the rms mode, to 110 kHz in the average mode, and to 20 kHz in the peak mode. In rms, crest factor is 10 at 650 counts and 3 at full scale of 1999 counts.

The tradeoff is cost. At \$365, the 3030A is twice the price of some average or rms-only 3½-digit instruments. And the instrument's 90-day delivery is rather long for a DMM.

CIRCLE NO. 315

Sensing thermal gradients raises peak IC currents

Peak currents twice as large as any previously allowed can now be handled safely in linear power devices. A temperature-gradient sensing system built into National Semiconductor's LM-138 three-terminal 5-A voltage regulator permits the chip to pass 10-A pulses as often as every 2 ms.

Even with the sensitive system, the LM-138's die size is no larger than a conventional 5-A voltage regulator whose internal-protection circuits would cause the output to collapse instantly at such a transient. Of the three protection modes usually built into voltage regulators—current limiting, safe-area protection, and thermal shutdown—the new method affects only the current-limit mechanism.

"Such a sophisticated thermal control technique will be widely used, both for protection and for optimizing performance," predicts Bob Dobkin, director of advanced circuit development at National Semiconductor (Santa Clara, CA).

The gradient-sensing system makes the LM-138 adjustable-voltage regulator very useful for driving switched loads with high start-up or surge-current demands.

But the spike could come from the power line as well as the load, Dobkin points out. No matter. The new technique uses thermal time-constants within the chip to "time" the overload and permit high transients, but safely shuts the regulator down if the over-current persists for more than a few milliseconds.

In high-power outputs for audio or motor-control amplifiers, shutdown can be delayed without external components. The amount of delay can be controlled by deciding how close the gradient-sensing devices will be to the chip's primary heat sources, the power transistors.

Two flexible disc drives introduced at NCC

Both single and double-density recording are possible with two new intelligent flexible disc drives shown at the National Computer Conference.

Both machines, the RFS 1200 and RFS 2400 from Ex-Cell-O's Remex Div. (Irvine, CA), contain integral formatters and Motorola 6800 micro-processor controllers.

The RFS 2400 double-density ma-

chine is one of the first floppy discs to be directly compatible with IBM's double-density format, introduced last November.

The single-density Remex unit, the RFS 1200, can record 256-kbytes while the RFS 2400 holds 512 k. The 1200 uses FM recording, while the 2400 employs a modified FM system that doubles the information capacity without doubling the number of flux reversals in the disc.

Both the 1200 and 2400 machines respond to a macrocommand, as opposed to the standard single-command structures. The macrocommand is an 8-bit word that tells the disc systems to perform the complete recording operation while the controlling central processing unit attends to other computing tasks.

Self-correcting memory can cut service costs

The error-correcting features built into a new 65 kbyte μ C memory board not only eliminates most data errors, but also speeds repair by pinpointing the faulty IC among the 52 dynamic RAM chips on the board.

The board's error-correction logic corrects all single-bit errors and detects all double-bit errors in each 8-bit word.

Board-edge LEDs show which IC produced the error. And the service technician can judge the frequency and severity of the fault by manually resetting the error-status LEDs and watching for the occurrence of another fault.

The fault-locating design, the MBC-064C from Mupro of Sunnyvale, CA, may cut field service costs by reducing the costly field inventory of complete replacement boards.

Raster-matrix printer charts new speeds

At 600 lines per minute, the P600 matrix printer is invading the speed territory held by full-font band and drum machines.

Introduced at the National Computer Conference in Anaheim, CA, the Printronix (Irvine, CA) printer uses a raster-matrix technique that is faster than the conventional dot-matrix. The P600 lays down a line of overlapping dots one row at a time rather than form characters serially and one at a time in, say, a 5 \times 9 or 7 \times 9 format.

The raster technique is also found in printers from Tally (Kent, WA) and Okidata (Mt. Laurel, NJ).

DP Dialogue

Notes and observations from IBM that may prove of interest to the engineering community



To increase the power available to customers in Fridley, Minn., a Northern States Power Co. construction crew is converting a single-phase 13,800-volt line to three-phase service.

Northern States Builds with 'Compatible Units'

Northern States Power Company is saving about \$1 million a year in construction costs with computer management of standardized equipment assemblies and construction procedures, called "compatible units." The Minneapolis-based utility spends about \$35 million a year to expand and maintain the distribution network that carries electric power from substations out to its residential and commercial customers.

"Power distribution is a huge, permanent construction program," says G. A. Breyer, superintendent of distribution performance. "We dispatch crews on more than 15,000 separate projects a year, to meet growing customer needs and repair storm damage. Just planning the materials needs of 700 people in 250 crews is a

massive job. Work can be held up while material is assembled or because a vital part is lacking. To avoid this, we occasionally sent excessive material out with a crew—a costly solution."

"A typical compatible unit," explains Les Drager, manager of business systems, "is a pole crossarm assembly, with its attaching hardware. The unit also includes standard labor hours and materials."

To specify a project, the designer selects the compatible units to be installed at each point along the construction site. The computer then explodes this input into a complete list of parts, which are drawn from stock and assembled for the crew.

"On 70 percent of our projects," Breyer points out, "the system can now

automatically 'classify' — that is, allocate — the costs of the work.

"Compatible units are entered directly into the System/370 Model 165. We have measured time savings for designers of 26 percent.

"A major basis for allowing us our rate of return is the investment in our physical system. With more than a million poles in place, just maintaining an accurate field inventory has been expensive; our last count took six years. In the future, we expect the computer to keep a perpetual inventory.

"The system created a discipline for us, standardizing parts to cut down on inventory. And it has refocused our designers' attention away from bookkeeping and onto the integrity of the distribution system."



Marine Biologist Chick Gaddy on Caper's Island, east of Charleston, South Carolina.

Preserving the Heritage of the Palmetto State

In a program to preserve its irreplaceable natural resources, the state of South Carolina has collected data on more than 400 sites, ranging from the breeding grounds of the rare loggerhead sea turtle to stands of timber more than 400 years old.

"In South Carolina, we are very proud of the beauty and heritage of our state," says Dr. Wayne Beam of the Wildlife and Marine Resources Department, "and we want to preserve it for future generations. Now we can make recom-

mendations on land use permitting development compatible with conservation of natural resources.

"The value of the program is in rapid pinpointing of needed information," Beam continues. "We generate hundreds of thousands of characters of new data each month in our field survey work. There is no way to handle a state-wide assessment like this and have it do anything but sit in the files unless it is automated."

Areas surveyed contain rare or

endangered species of plants or wildlife, unique and outstanding natural features, historical sites and buildings. Complete information for each location is entered into an IBM System/370 at the University of South Carolina. The goal is to provide the data that planners need to assess the impact of future development.

Accumulated details on animals of special ecological significance include all their feeding and habitat requirements, their geographical distribution, the environmental limits they tolerate and their breeding and nursery areas.

The program is called Heritage Trust and was developed in collaboration with The Nature Conservancy, a privately funded organization based in Arlington, Virginia, which is working with other states on similar programs.

Beam adds: "By doing keyword searches we can quickly compile a list of all locations where the gopher tortoise has been sighted, or other such extracts. And using the computer we can do analytical work—correlating such factors as size and fecundity, to help improve commercial fish harvests.

"We recognize that we are a growing and developing state and must make the most effective use of our land from an economic as well as an ecological standpoint. The computer will give us the capability to compare sites, assess their relative importance and decide which areas contain unique values that should be preserved."

What is Computing Worth?

Computer services available today offer a range of interaction and responsiveness. Which is the right choice for an engineering or scientific group? How much should the service cost? How can it be justified and evaluated? Even though many vital contributions of the computer are intangible (who can put a dollar value on a computer simulation that reveals a weakness in a structural design?), an approach to potential cost-benefit analysis has evolved that is applicable across most industries and disciplines.

One emerging technique sets intangible benefits aside, and defines a concept of *relative value*, based on cost avoidance. The costs of completing each task by alternate methods are determined and compared, including different levels of service from the computer. One cost that can be quantified is man-

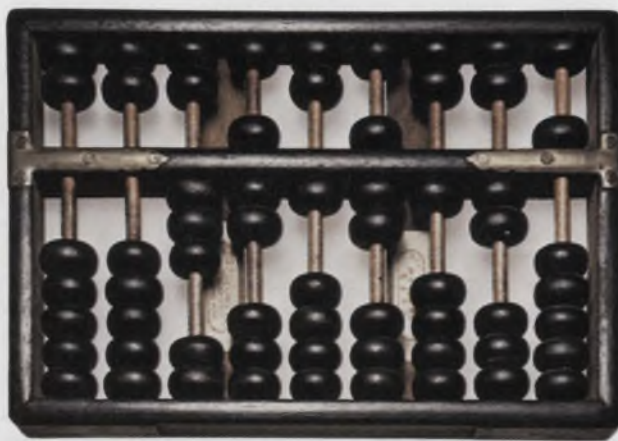

The abacus, perhaps the first computing instrument, has been relatively unchanged for over 5,000 years.

By contrast, a wide range of operating modes and services have been developed for modern computers. The concept of relative value helps users select the service best suited to their needs.

hours lost waiting for "turn-around." Where workers can do other things while waiting for results, this cost is low. If the next step depends on completion of the previous one by the computer, the cost may be substantial. And productivity may be closely correlated to the response time of the system.

Studies of engineering productivity led one major aerospace company to create a dual scheduling system for batch work: This offers standard service or rapid turnaround (less than two hours) at a slightly higher internal charge. For engineers whose work is closely tied to the computer, the company found, the added productivity justifies the higher charges to the project.

Another quantifiable cost is the time spent formulating a problem for the computer and writing a program. Today this time can be greatly shortened with

Weber Products are Tested Before They're Built



Before building a prototype, engineers at Weber Aircraft use an IBM System/370 to test the structural design of airliner seats like these. One result is a seat that is both stronger and lighter.

"To determine the structural capabilities of a new design for an airliner seat, we could build a prototype, attach instruments, and physically apply loads in a test fixture," says Gordon P. Cress of Weber Aircraft. "Then, if it didn't pass muster, we'd have to repeat the entire cycle of construction and test, which can

take many weeks. Now we can get better and much faster results by analyzing a model of the seat using the computer."

Cress is chief of structures and test for the Burbank, California, maker of interior equipment — such as galleys and passenger seats — for commercial aircraft. "We face stringent FAA requirements on the *g* forces our products must withstand," he adds. "At the same time, it is vital to save every possible ounce of weight. Without the computer, we would face the alternatives of putting excess structure — and hence weight — into the product, or of building and structurally testing an entire series of prototypes to produce a single design."

Weber, a division of Walter Kidde & Company, uses an IBM System/370 to analyze a tentative design. For each section of a structure, a stress program using input data such as cross-sectional area, moment of inertia, and fixity, calculates the forces and moments on all three axes.

"With this program," Cress notes, "we can arrive at the most structurally efficient design. It tells us which component is critical under each load. It gives us the data we need to select materials, decide the thickness or gauge required, and then determine the number and sizes of attachments. If one of a pair of units — say, two galleys back to back — will lean on the other under *g* forces, the analysis shows us this and indicates the force it will exert.

"I can instruct the computer to apply 9*g* forward, 4½*g* upward and 3*g* to one side and print out the load imparted by the acceleration on every element in the

design. The printout tells me what the stresses are at all attachment points."

Since the simulation answers questions overnight instead of taking several weeks, the design cycle is greatly shortened. When a structure must be revised, Weber engineers discover it early in product development.

Customers often ask for modifications — changing the location of the coffee unit or tray section in a galley, for example — which shift some weight or change the gross weight. When this happens, a computer analysis reveals immediately the impact of the change; for example, whether structural modifications are required.

"We end up with a product that meets strength and safety factor standards without adding unnecessary material," Cress adds. "As a demonstration of compliance with its standards, the FAA now accepts a structural analysis using computer-generated loads and stresses in lieu of a physical test of a prototype."

the aid of such options as interactive computing.

A third cost is the losses when a project is delayed. The scheduled time of many "downstream" events, such as tooling and the availability of manufacturing facilities, are tightly linked to the schedule of R&D. Often, delivery commitments have been made. And delays in R&D tend to be magnified later.

To make a comparison, the cost of computation is calculated as a function of a service parameter, such as turnaround time. Then the relative productivity of specific professional groups is plotted against that cost variable.

Finally, the intangible factors can be brought back into the analysis: the new approaches to problems, the further alternatives explored, the improved professional environment that attracts better people and encourages more effective research. These make relative value a very conservative approach that promises to become extremely useful in data processing resource management.

DP Engineering Dialogue is designed to provide you with useful information about data processing applications, concepts and techniques. For more information about IBM products or services, contact your local IBM branch office, or write Editor, DP Dialogue, IBM Data Processing Division, White Plains, N.Y. 10604.

The IBM logo, consisting of the letters "IBM" in a bold, blue, sans-serif font.

Data Processing Division

Minis, look out: Here comes a powerful family of 16-bit μ C chips

A new family of 16-bit micro-computer chips can outperform many minicomputers. That's what Zilog Corp. (Cupertino, CA) is claiming about its Z8000 series of MOS devices.

The Z8000 family members add up to quite a range of capabilities:

- A 16-bit general-purpose CPU, which runs at a 4-MHz clock rate and can directly address up to 8 Mbytes of main memory.

- A programmable, interrupt-driven parallel I/O interface and counter-timer circuit (CIO), which provides a TTL-compatible interface with the CPU. The CIO also can operate under DMA control and can be used in a polling operation.

- A programmable serial I/O (SIO) interface with two independent full-duplex channels.

- A memory manager unit (MMU) provides segment relocatability and memory protection.

- A three-channel, dual-address direct-memory-access (DMA) controller.

- Four memory chips—a 4-k \times 8 quasistatic RAM with self-refresh and 200-ns access time, a 16-k \times 1 dynamic RAM with 150 to 250-ns access time, a 4-k \times 1 static RAM with 100-ns access, and a 256 \times 8 bidirectional buffer chip.

Built with standard n-channel, silicon-gate depletion-load technology, most chips require just a single 5-V power supply and a single-phase TTL-level clock.

The CPU, organized around sixteen 16-bit general-purpose registers, has several other 16-bit registers serving such special functions as flag control, program counter, memory-segment number and refresh control. In addition, eight of the 16 general-purpose registers may be halved into 8-bit blocks to handle single-byte operations.

Stephen E. Scrupski
Senior Editor

Z8000 functions

The segmented version of the Z8000 CPU is housed in a 48-pin package. Pin functions are as follows:

AD₁₅-AD₀—Address/Data (inputs/outputs, active high, three-state); multiplexed address/data lines used both for I/O and to address memory.

\overline{AS} —Address Strobe (output, active low, three-state) indicated addresses are valid.

\overline{BUSAK} —Bus Acknowledge (output, active low). A low on this line indicates the CPU has relinquished the bus.

\overline{BUSRQ} —Bus Request (input, active low). This line must be driven low to request the bus from the CPU.

\overline{DS} —Data Strobe (output, active low, three-state). This line times the data in and out of the CPU.

\overline{MREQ} —Memory Request (output, active low, three-state, a timing signal that eases the interface to dynamic memories.

$\overline{\mu I}$ —Multi-micro In (input, active low) tests for the state of the multi-microprocessor request.

$\overline{\mu O}$ —Multi-micro Out (output, active low).

\overline{NMI} —Nonmaskable Interrupt (input, active low).

\overline{NVI} —Nonvectored Interrupt (input, active low).

Φ —System clock, a TTL-level clock input.

RESET—Reset (input, active low) resets the CPU.

R/ \overline{W} —Read/Write (output, low-Write, three-state) provides early status information for a read or write cycle.

SA₆-SA₀—Segment Number (out-

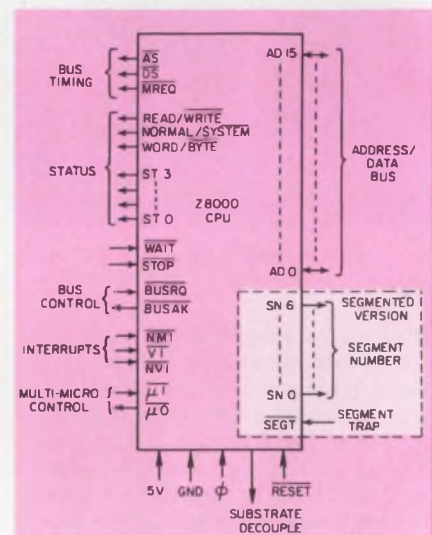

puts, active high, three-state).

\overline{SEGT} —Segmentation Trap (input, negative-edge triggered).

ST₃-ST—Status (outputs, active high). These lines specify the following statuses: memory request, stack pointer request, instruction fetch first word, instruction fetch subsequent words, internal operation or halt, VI acknowledge, NVI acknowledge, NMI acknowledge, I/O reference, refresh, segmentation I/O, set bootstrap, reset bootstrap.

\overline{STOP} —Stop (input, active low) single-steps instruction execution.

\overline{VI} —Vector Interrupt (input, active low).

\overline{WAIT} —Wait (input, active low) indicates to the CPU that the memory or I/O device is not ready for data transfer.

W/ \overline{B} —Word/Byte reference (output).

N/ \overline{S} —Normal/System Mode (output).

Good news:

up to 2/3 smaller.

Surprise:

and generally less expensive*.

New Metallized Polyester Capacitors

TRW Thin Gauge X659F
.022 MFD. 400V DC



TRW

ACTUAL SIZE

We call the X659F "the new dimension capacitor". It's the smallest possible size—at the smallest possible price. The advanced design of the new TRW X659F utilizes very thin gauges of metallized polyester with design highlights such as capacitance values to 20.0 MFD, dissipation factors less than 1.0%. Electrically, the new X659F is interchangeable with our X663F. Same rugged durability and long stable life.

The new X659F can help you solve many packaging problems. Oval shape allows either vertical or flat, horizontal board-hugging mounting. Where minimum space and weight are required, X659F is the answer. It's ideally suited to small portable equipment for commercial and instrument grade products.

For complete specifications and applications information, send for our new X659F Capacitor spec sheet. Call or write: TRW Capacitors, 301 West "O" St., Ogallala, Nebraska 69153. Tel: (308) 284-3611.

*100V DC, 200V DC, 400V DC are priced lower; 50V DC higher.

TRW CAPACITORS

ANOTHER PRODUCT OF A COMPANY CALLED TRW
CIRCLE NUMBER 119

Three types of interrupts—maskable, nonvectored, and vectored—can be handled by the CPU, which reduces interrupt-response times by automatically saving the program status.

Although the Z8000 CPU is similar to the Z80 processor, it is also architecturally advanced. The Z8000 provides more instructions, more data element types and addressing modes, greater power per instruction, and a larger addressing space. Moreover, programs written for the Z80 can be easily translated into Z8000 code.

The Z8000 CPU is five to 10 times faster than any 8-bit microprocessor, says Zilog, including its own Z80A, and two to five times faster than modern 16-bit minicomputers such as the PDP 11/45.

Citing some benchmark comparisons between the Z8000 and the PDP-11/45, Zilog notes that, for example, the Z8000 performs its five main addressing modes—register, indirect register, direct address, indexed and immediate—faster than the 11/45 performs similar operations. The Z8000 ranges from 0.75 to 2.50 μ s, while the 11/45 ranges from 0.90 to 2.78 μ s. In addition, the Z8000 performs an add operation in about 2.25 to 3.75 μ s for various word lengths, while the 11/45 ranges from 3.68 to 6.46 μ s.

Interfacing the CPU

The CPU interfaces to such peripherals as line printers, paper-tape readers and punches, card readers and keyboards via the CIO chip, which also serves as a counter-timer circuit for real-time operations. Built to work with the μ C system's daisy-chain interrupt structure, the chip provides automatic interrupt vectoring without extra hardware.

The CIO has three independently programmable channels for counting and timing, each of which can be individually nested for priority-interrupt control. The chip also can generate system clocks and baud rates as well as count external events for realtime controls.

Handshake and pattern-recognition logic comes from two independent, 8-bit bidirectional ports on the CIO; moreover, the two ports can be linked to form one 16-bit I/O port. The chip also has a special-purpose 4-bit port.

The counter-timer section consists of a 16-bit down counter, a 16-bit time-constant register and a 16-bit current-count register, each of which can be

The 8086's growing family

Already available for 16-bit designs is the 8086 family centered on the 16-bit, 5-MHz MOS device (or 8-MHz with selected parts). It can address 1 Mbyte of memory with its 20 address bits. What's more, the 8086's throughput is 10 times that of the Santa Clara company's 8-bit 8080A.

At the same time, Intel is providing a family of bipolar peripheral chips to work with the 8086. All the peripheral devices operate from a single 5-V supply and are housed in 20-pin packages:

- The 8284 clock generator uses a crystal or TTL signal as a frequency source and provides, along with the 8086 system clock, three extra TTL clocks for the 8288 bus controller.

- The 8282/8283 octal latch delivers three-state outputs, either noninverting (8282) or inverting (8283). So does the 8286/8287 octal transceiver, with the noninverting 8286 or inverting 8287.

- The 8288 bus controller provides decoded command signals for the 8086 and generates command signals for Intel's Multibus.

The 8086 CPU is built with Intel's HMOS scaled n-channel, depletion-load silicon-gate process and consists of about 20,000 transistors. Also requiring only a single 5-V supply, it has four 16-bit registers, which can be addressed also as eight 8-bit registers; two 16-bit pointer and two 16-bit index registers; and four 16-bit segment registers to allow extended addressing.

The 8086 actually comes in two pin configurations, each in a 40-pin package—one for small systems (minimum-mode device) and for large systems using the 8288 bus controller (maximum-mode). The change is made by connecting one pin either to V_{cc} or ground, which

causes seven of the other pins to change functions.

Typical instruction execution times for the 8086 include two clock cycles, or 0.4 μ s at 5 MHz for a register increment or decrement; three clock cycles or 0.6 μ s for register-to-register operations; and nine clock cycles plus the effective-address calculation time, or a total of about 3.4 μ s, for a memory-to-register transfer.

The internal functions of the 8086 are partitioned logically into two processing units—the Bus Interface Unit (BIU) and the Execution and Control Unit (ECU).

Both the BIU and the ECU can interact, but will usually perform as separate, asynchronous operational processors. The BIU provides functions related to instruction fetching and queuing, operand fetch and store, and address relocation, as well as basic bus control. The ECU receives prefetched instructions from the BIU queue and provides nonrelocated operand addresses to the BIU. Memory operands are passed through the BIU for processing by the ECU, which returns results to the BIU for storage.

Another key feature is the 8086's interrupt-handling capability. Interrupt operations are software or hardware-initiated. Software-initiated interrupts are, of course, controlled by the specific program. Hardware interrupts, on the other hand, are either nonmaskable or maskable.

The 8086 processor provides a single nonmaskable interrupt pin, which has higher priority than the maskable interrupt-request pin. The interrupt input is edge-triggered on a low-to-high transition. In addition, the 8086 provides a single interrupt-request input, which can be masked internally by software.

programmed to serve as either counter or timer. The section also includes two 8-bit control and status registers.

To handle serial data communications, the SIO chip supports all common protocols—Bi-Sync, SDLC, and HDLC—with cyclic-redundancy character generation and checking. Data rates range up to 880 kbits/s at the 4-MHz system clock rate.

In asynchronous operation, the SIO's character length can be programmed from 5 to 8 bits. Its stop bits are also programmable.

Meanwhile, unaided by the CPU, the DMA chip controls block transfers for

high-speed direct data transfer between memory and I/O. The chip can transfer and/or byte-search at up to 1.25 Mbytes/s. What's more, with dual-address, three-channel operation, the DMA features programmable starting addresses, block lengths and port timings.

To address up to 8 Mbytes of memory directly, the 48-pin CPU has 16 address lines plus seven memory-segment lines to work with. In addition, it can use its status lines to designate separate address spaces for code, data, and stack information for both the system and normal modes.

TONES FOR PHONES.



**Low distortion.
Lower voltage.
Lowest cost.**

INTERSIL'S ICM7206 CMOS TOUCH TONE® ENCODER.

This device generates pairs of sine wave tones suitable for use in a telephone handset or portable tone generator. The tone pairs are selected from a total of 8 frequencies, making this monolithic solid-state circuit suitable for use with a 4 x 3 or 4 x 4 matrix single-contact keyboard. ICM7206A and ICM7206B are standard options for use with keyboards having two contacts per key. The ICM7206A is used where the common line is connected to a positive supply and the ICM7206B where the common line is connected to a negative supply.

Distortion of output tones is only 2 to 3%, with simple filtering, decreasing in value at ascending harmonic frequencies.

LOWEST SYSTEM COST, MINIMUM PARTS COUNT.

The ICM7206 operates at supply voltages down to 3V, and dissipates less than 5.5mW at 5.5V. Packaged in a 16-pin plastic DIP, it uses a 3.57MHz standard color TV crystal and requires only nine additional components for a minimum-parts, low cost tone generator.

Since it contains an on-chip zener diode, a single external resistor makes the circuit "latch-up" proof, and therefore resistant to high voltage transients, etc. The device is guaranteed to operate from -40 to +85°C. It is available in quantity from Intersil stocking distributors, priced at \$3.41 in 100 piece lots. For larger-quantity prices, consult the local sales office. Send for complete data.

CUSTOM CIRCUITS ALSO AVAILABLE.

We also develop custom CMOS LSI circuits for your special telephone and telecommunications applications. Call your local sales office for information, or, return the coupon below.

INTERSIL FRANCHISED DISTRIBUTORS: Advent/Indiana • Alliance Electronics • Arrow Electronics • CESCO Century Electronics • Component Specialties • Components Plus • Diplomat/IPC • Diplomat/Southland • Elmar Electronics Harvey/Binghamton • Intermark Electronics • Kierulff Electronics • LCOMP • Liberty Electronics • R.A.E. Ind. Elect. Ltd. • RESCO • Schweber Electronics • Sheridan • Zentronics.

INTERSIL SALES OFFICES: CALIFORNIA: Sunnyvale (408) 744-0618, Carson (213) 532-3544 • COLORADO: Denver (303) 750-7004 • FLORIDA: Fort Lauderdale (305) 772-4122 ILLINOIS: Hinsdale (312) 986-5303 • MASSACHUSETTS: Lexington (617) 861-6220 • MINNESOTA: Minneapolis (612) 925-1844 • NEW JERSEY: Englewood Cliffs (201) 567-5585 OHIO: Dayton (513) 866-7328 • TEXAS: Dallas (214) 387-0539 CANADA: Brampton, Ontario (416) 457-1014.

*Registered trademark of A.T.T.

INTERSIL

ED060778

Analog Products — Low Power
10710 N. Tantau Avenue, Cupertino, CA 95014
Tel: (408) 996-5000 TWX: 910-338-0171

____ Please send me your product literature on your ICM7206.

Please send me a free sample* of your ____ ICM7206JPE
____ ICM7206AJPE ____ ICM7206BJPE

____ Please send me your new Mark Twain Poster.

Name _____

Company _____

Address _____

City _____ State _____ Zip _____

*To qualify for a free sample, attach this coupon to your company letterhead. Sample offer valid for the first 1000 industry requests received within 60 days of publication. One per person.

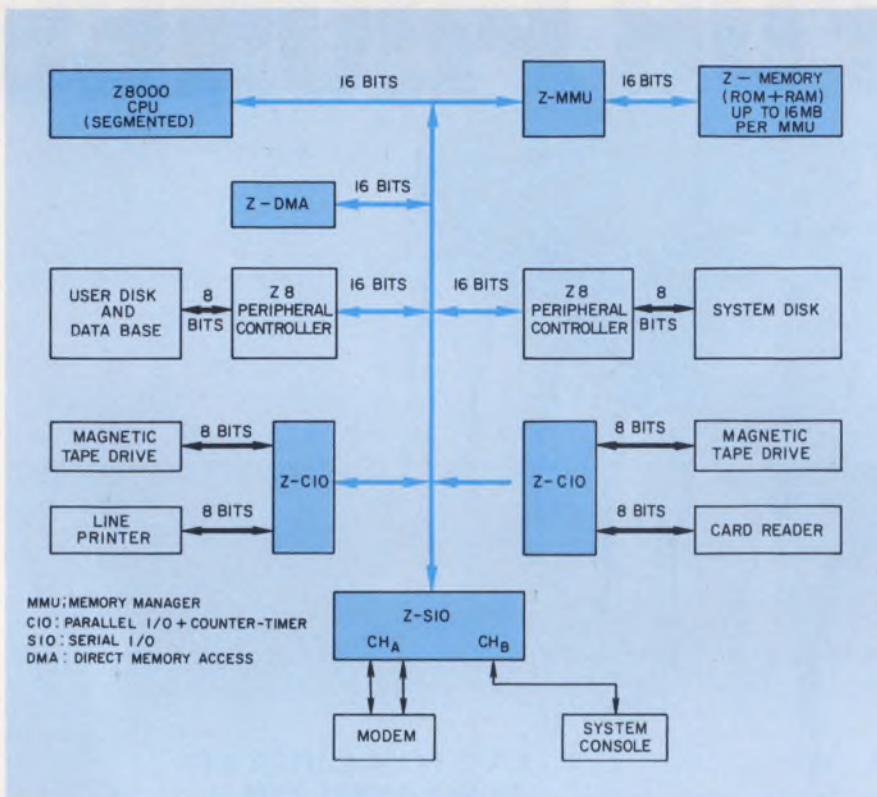

The Z8000 family of MOS microcomputer chips can be built into a powerful 16-bit processing unit that can control conventional computer-peripheral devices as well as access up to 48 Mbytes of main memory.

But since each address space can hold 8 Mbytes, a single Z8000 can actually address up to 48 Mbytes. A 40-pin version of the Z8000 is also available (it lacks the seven segment pins and segment-control pin) for directly addressing up to the conventional 64 kbytes or, with the status lines, up to 384 kbytes.

The key to the CPU's extended memory addressing is the MMU chip. Housed in a 48-pin package, it takes inputs from the CPU, the segment lines, the upper eight bits of the address, and the status information via four status bits. (The lower eight address bits go directly to the memory.) The MMU transforms its inputs into 16 bits that, when combined with the lower-order eight bits, form a 24-bit address.

With the help of another memory chip, the buffer unit, one Z8000 can interface with another or to any other Zilog Z-Bus-compatible device acting as a slave processor—for example, a peripheral controller. The 256 × 8-bit, bidirectional buffer unit has simultaneous read and write, programmable block length, and 12 programmable operating modes. The device is particularly useful for interfacing to fast peripheral devices. Or, a direct-memory

access chip can be used to control a fast data transfer to the buffer unit, where a second processor will draw the data out.

Dynamic-RAM refresh cycles are automatically controlled at a programmable rate by a CPU refresh row counter. Sequential RAM rows may be refreshed at intervals from 1 to 64 μs (with a 4-MHz clock). Moreover, the refresh row counter is nine bits wide to allow for future high-density memories (present 16-k dynamic RAMs have 128 rows). And, with a clock rate of 4 MHz, the counter can use slower, lower-cost, dynamic RAMs.

Interrupts and traps are handled by the CPU in similar ways. Typical interrupts are triggered asynchronously by peripherals that need attention from the CPU. Traps—synchronous events that result from executing specific instructions—occur each time an instruction is executed with the same set of data.

Changing status

When either an interrupt or a trap occurs, the old program status is pushed onto the system stack, along with an extra word that indicates why. A new program status is then fetched

from an area in the main memory pointed to by the new-program-status area pointer, a register consisting of a 7-bit segment number and an 8-bit offset value.

Not surprisingly, the Z8000 CPU has a formidable instruction set—about 110 different instructions, each of which can use the device's five main addressing modes. In addition, signed-multiply and signed-divide instructions can be implemented in hardware for both 16-bit and 32-bit data.

The instructions can operate on several types of data: bits, binary-coded decimal digits (4-bits), bytes (8-bits), words (16-bits), long words (32 bits), byte strings and word strings. Bits can be set, reset and tested. Digits are used in BCD arithmetic operations, bytes for character or small-integer values. Words are used for larger-integer values, instructions and nonsegmented addresses, and long words for long-integer values and segmented addresses.

For bits and digits, the memory address of a data type designates the byte that contains it. For data types 16 bits or longer, the address designates the left-most (high-order) byte.

A byte-data type is addressed by specifying a byte address that can range between 0 and 8,388,607 (or 65,535 for the nonsegmented version).

A bit-data type can be addressed by specifying a byte address and the bit number within the designated byte, or by specifying a word address and bit number within the designated word. The bits in a byte or word are numbered consecutively from right to left (least to most significant), 0 to 7 or 0 to 15. A word-data type can be addressed by specifying the byte address of its left-most, or high-order, byte.

In memory as well as word registers, the high-order byte is the most significant byte of the word, which allows a mixture of numeric and character data to be sorted together correctly. A double-word data element can be addressed by specifying the left-most byte of its left-most word. Quadruple words are only addressed in registers as quadruple-register groups.

As capable as the Z8000 is, it requires development support from such aids as translators for PLZ (assembly and systems languages), Basic, Cobol and Fortran. In addition, an automatic translator will help Z80 users to convert to the Z8000. Since both processors are register-oriented, the addressing modes of the Z80 are now a subset of the Z8000. ■■

5 thru 120 Volt lamps, all in a single socket. Now that's a system!

Sylvania Mix 'n March. The only system that offers you the universal parts flexibility built around two series of T-2 slide base lamps. The first is our Pilot Lamp series spanning 5 to 120 volts. The second is our Indicator Lamp series from 4 to 48 volts.

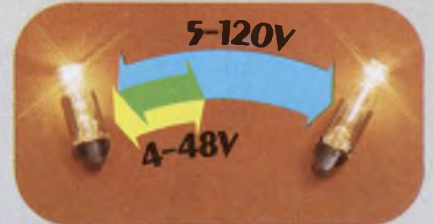

All the lamps in each series are physically identical. So sockets and lenses are fully compatible. And in a number of instances, lenses and caps are even interchangeable between series.

As you can see, our system is calculated to make life a lot easier for everyone.

From the guy who builds the prototypes, to the guy who does the purchasing, to the guy who controls production inventory. To find out just how easy, clip the coupon and send for our handsome 17" x 22" wall chart that graphically highlights the universal parts compatibility of the Sylvania Mix 'n March System.

SYLVANIA
Mix 'n Match
SYSTEM

GTE Sylvania
 Miniature Lighting Products
 West Main Street
 Hillsboro, N.H. 03244
 Tel: 603-464-5533

Why should I have to change the socket and the lens whenever I change the lamp voltage? Send me your FREE wall chart on the system that's calculated to make life easier for everyone.

NAME

COMPANY

STREET

CITY

STATE ZIP

GTE SYLVANIA

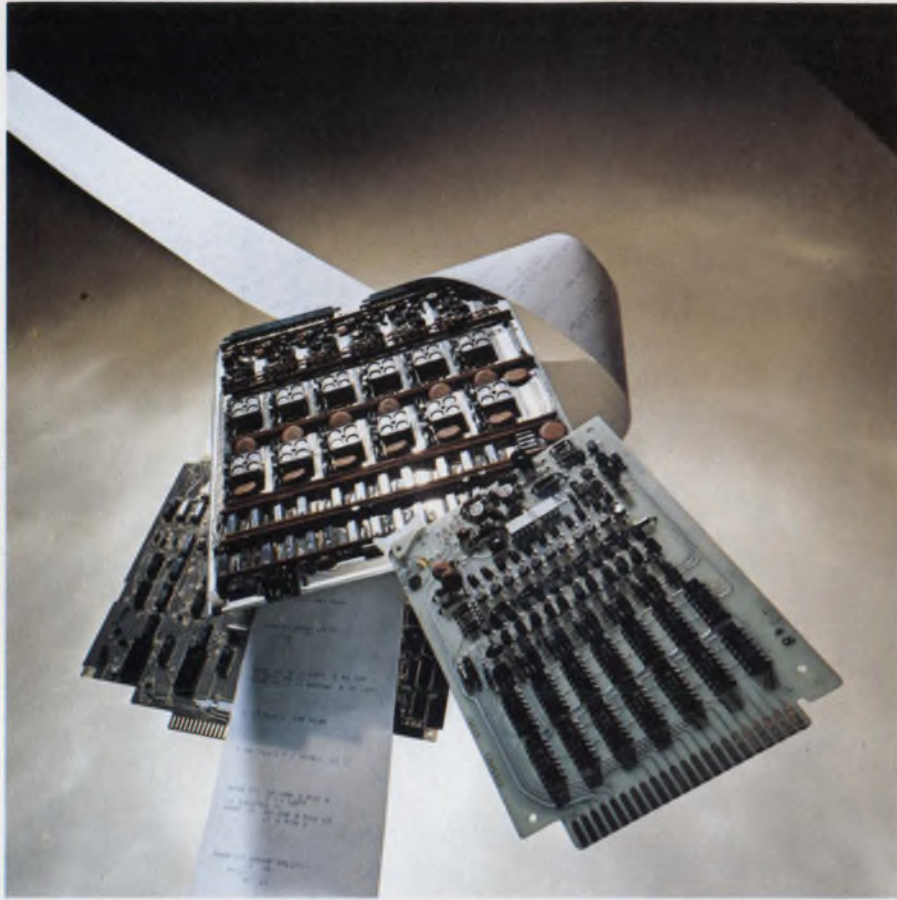

In-circuit tests find more faults on PC boards

In-circuit testing is losing its label as a lower-cost but weaker alternative to functionally testing printed-circuit boards for final checkout. Instead, in-circuit testing has become an important part of the production process—after all, it screens out the workmanship errors that account for 90% of the board failures at functional test.

In-circuit testing—which checks individual components on a PC board to determine if the proper components are mounted in the correct locations, and which checks for short and open

circuits on the board—is becoming so popular that the two “old timers” in the business, Faultfinders and Zehntel, are expanding their product offerings. And in just the past six months, three of the largest makers of functional test systems, Computer Automation, GenRad, and Teradyne, have introduced in-circuit systems. What’s more, Hewlett-Packard Co. (Palo Alto, CA), by far the largest test-equipment supplier, is said to be planning to introduce an in-circuit tester this summer.

Test each node

An in-circuit tester generally has a “bed-of-nails” fixture with a large

number of test pins—one for each node on the board. Unlike functional testers, which usually rely on the board’s edge connector for input and output, the in-circuit tester does not require that power be applied to the board during the test. This allows a board to be checked quickly, and without the common “smoke test.” The bed-of-nails fixture, which can cost as much as \$1000, is much more expensive than the \$100-or-so card-edge interface of the functional tester, but the tester itself is usually much less expensive—\$30,000 to \$100,000 for an in-circuit tester compared to \$150,000 or more for a functional unit.

The functional unit, though, offers

Andy Santoni
Associate Editor

a higher level of confidence that the board has no faults and works as designed—95% or better compared to 70% to 90% at best for in-circuit systems. In-circuit test-system vendors agree, then, that in-circuit testers are best used together with functional testers.

With just a functional tester, it may take minutes to test and isolate failures on a very complex board. But since the workmanship errors uncovered by in-circuit testers can account for as many as 90% of the faults found on PC boards, prescreening with an in-circuit tester can remove many boards with these faults from the time-consuming task of fault isolation on the functional tester. So mostly good boards or boards with difficult-to-diagnose problems would have to go through fault isolation.

Indeed, the latest in-circuit tester has some functional-test capability of its own. Using signature analysis, the Troubleshooter 800 from Zehntel Inc. (Concord, CA) can inspect medium and large-scale integrated circuits, as well as discrete components. The tester generates stimuli and learns the output signatures of such devices as memories, synchronous and asynchronous receiver/transmitters, and microprocessors, and sets acceptance criteria for individual ICs. The cyclic-redundancy-check signature analysis technique is licensed from Hewlett-Packard.

Controlled by an SBC 80/20 single-board computer, the Troubleshooter 800 has full on-line editing so that programs can be changed during the test procedure. Programs are stored on a dual floppy-disc drive. The standard tester can handle as many as 1024 points, and is priced from \$50,000 to \$100,000 depending on the number of test points and other options.

Costs cut even lower

Less expensive, but no less capable, is Computer Automation Inc.'s Mica in-circuit tester. The \$30,000 to \$70,000 price tag results from the Irvine, CA, firm's vertical integration, explains Doug Cutsforth, who heads the Industrial Products Division's in-circuit-tester operation. The Mica uses Computer Automation's own peripherals, as well as its Naked Mini computer and the same operating system as the company's Capable series of functional testers.

The advantage of the in-circuit tester and the functional tester using similar

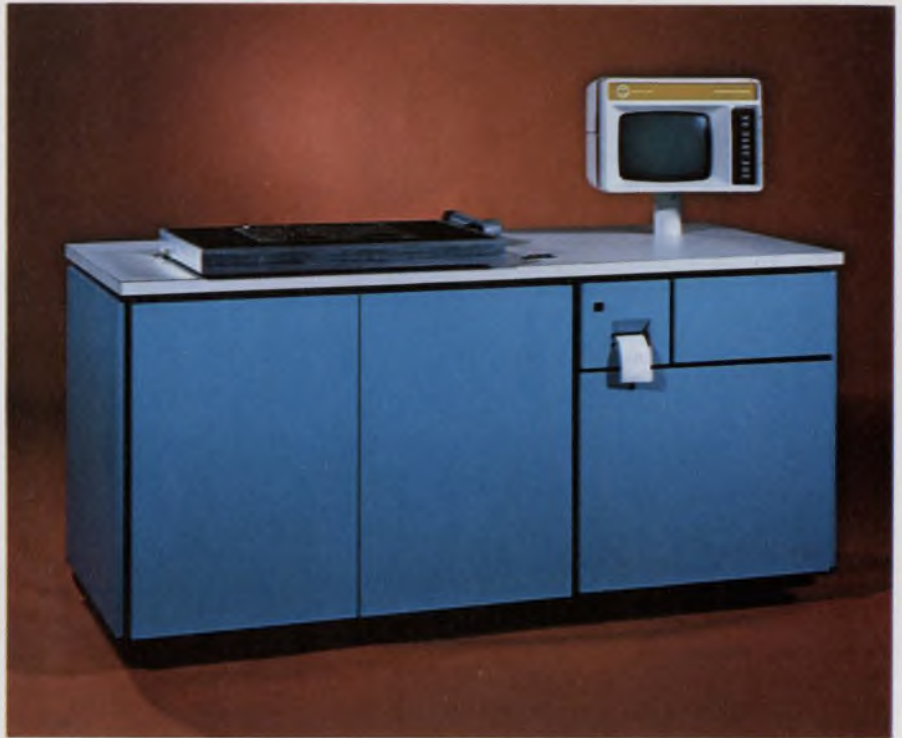

Medium and large-scale integrated circuits can be tested using signature analysis on Zehntel's Troubleshooter 800 in-circuit tester.



Four-line scanning increases the accuracy of GenRad's 2270 in-circuit tester. Bar-graph displays on the CRT ease potentiometer presetting and trimming.

operating systems is that all the functional tests possible with the Capable series are also possible on the Mica tester, within the frequency limits of the fixture, says Cutsforth. The Capable series includes an IEEE-488 instrument bus driver to simplify adding instruments to the basic system—and this extra is extended to the Mica system. In addition, programming is simplified—the user only enters a

parts list, and the computer handles the conversion to specific test procedures.

Software is a problem

Writing software for an in-circuit tester is easier than writing software for a functional tester, but still isn't as easy as it could be, says Al Morford, Eastern marketing coordinator for



Rubber-tipped pressure rods hold PC boards in place on Teradyne's L529 tester. The system screens out workmanship errors before functional testing.

Faultfinders Inc. (Latham, NY). By simply entering a parts list and nodal points, then using a known good board to check out the program and fixture, "we can generate a good program to about 85% or 90% effectiveness," says Morford, whose company is working on ways to simplify programming further, as well as on new hardware to lower testing costs. Within the next quarter, Faultfinders expects to introduce a universal test fixture with pins on 0.1-in. centers and low-cost personality cards that select the right pins for each board type to be tested.

Other changes are already taking place in in-circuit tester fixtures. In earlier designs, the spring-loaded pins that make contact with the board under test are wired to a multi-pin connector on the edge of the fixture via a patch panel, called a Virginia panel, that is similar to the patch panels that used to be common on analog computers. The patch panel made it easier to install and change pins on the fixture by eliminating the need to solder directly to the interface connector, but Virginia panels aren't very dense—a major consideration in systems with hundreds of pins.

Instead, tester makers and independent fixture suppliers such as Everett/Charles Inc. (Pomona, CA) are wiring from the test probes to interface receptacles. The receptacles are permanently wired to the test-system interface connector.

There is a unique fixture on Teradyne Inc.'s L529 in-circuit tester.



The lowest-cost in-circuit tester using a bed-of-nails fixture is Computer Automation's Mica 5000 system. Its price, as low as \$30,000, is less than half that of some competitors.



An IEEE-488 interface and 19 programming and control card slots help expand the Faultfinders FF303 in-circuit tester into a functional test system as well.

Instead of holding the board in place with a vacuum during testing, as all the other manufacturers' systems do, the Boston, MA, firm employs a special fixture that includes an array of pressure rods to hold the board down. There's no air pump—and no need for connecting to a vacuum or air supply.

But there might not be enough pressure to assure good contact, competitors say, pointing out that the fixture also does not allow access to the top of the board during testing. Access might be needed for setting calibration controls during checkout, for example. But this function is beyond the focus of in-circuit testing anyway, says Jeff Hotchkiss, product manager at Teradyne. He points out that the L529 will most commonly be used for prescreening in conjunction with a functional board test system used for calibration.

That's also one of the reasons that Teradyne tester can use a "self-learning" technique not only for determining the values of components on the board, but also for setting tolerance limits on those values. To generate a program for a particular board type, the operator keys in a list of all components connected to each node on the board. The tester then makes resistance and impedance measurements at each node on a known-good board and stores the results. Additional known-good boards are run through the tester. Whenever a new measurement is different from previous data, the tester alters its program to adjust the median value and the tolerance band for each measurement.

At first, the test system assumes a "default" tolerance of 5% for each measurement. But the wider the variation a functionally-acceptable board can have, the wider the tolerance the tester will place on that measurement. The tolerance can reach 40% or more.

In prescreening applications, high-accuracy measurements are unnecessary. Teradyne's tester permits a wide latitude in measuring circuit parameters as long as the boards check out as working in subsequent functional checks.

Improved measurement accuracy

In some applications, though, in-circuit testers have to have higher accuracies, says Michael Salter, product manager at GenRad Inc. (Concord, MA). GenRad's Test Systems Division, the leader in selling functional board testers, introduced its first in-circuit tester in February. The Model 2270, which starts at \$65,000, includes a four-line scanner to switch up to four circuit-board points at a time to various measuring instruments. Compared with the three-line scanning of most other in-circuit testers, says Salter, four-line scanning permits higher accuracies. ■■

Now, everything you loved about the 2114 plus 125mW power down.

Memory retention at 2.5 volts V_{cc} — the 2114LV. 125mW stand-by vs. 350mW operating. Think of the power you save. And think of the complete 2114 family from Synertek. All fully static. No clocks or triggers using valuable system time. 200, 300 and 450nsec versions. The low power 2114L series — plus power down.

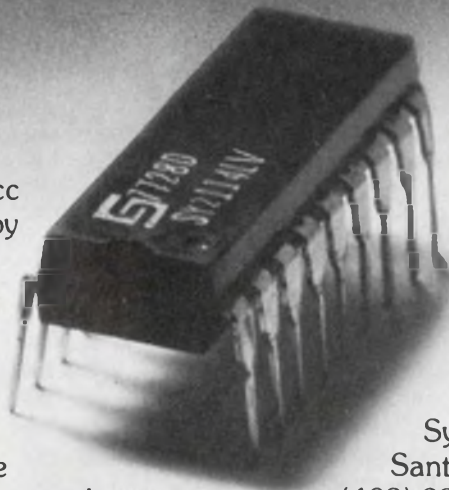

And Mil versions soon-to-come. The broadest family of 4K static RAMs available. From Synertek, now. For specs, samples and complete information, contact Larry Hester, Synertek, 3001 Stender Way, Santa Clara, California 95051. (408) 988-5600. TWX: 910-338-0135.

Synertek

Fast 4-k, and byte-wide static RAMs are pushing into new designs

New 4-k and 8-k static MOS RAMs are competing for socket territory with older static designs, especially in high-speed cache and microcomputer system designs. The battle is being joined on several fronts:

- **Speed:** Superfast, 4096-bit MOS RAMs are challenging bipolars in the 50-ns cache race. Meanwhile, 100 to 500-ns, 8-k and 16-k devices, organized in 1-k and 2-k \times 8-bit configurations, offer micro designers convenient cost-saving configurations while maintaining fast access time.

- **Improved 1 k and 4-k bipolar statics** with 30 to 50-ns speeds nevertheless still are the choice for the fastest TTL and ECL cache and buffer systems.

- **Power:** Automatic, on-chip, power-down switching in new MOS statics can cut power drastically whenever a chip is unselected.

- **Unlocked vs clocked RAMs:** You can now get truly static storage coupled with either static or clocked (dynamic) access circuits on the periphery of a chip. Main differences are in addressing flexibility and average power consumed.

- **Organization:** Right now, 4-k \times 1 and 1-k \times 4 RAMs dominate but byte-wide "by-8s" may yet take over, as they ease power drain and simplify chip-selection logic. With clocked or power-down RAMs, the wider words tend to save power, since fewer chips are on at a time.

- **Pinouts:** A wide choice is already on the market, and JEDEC standards are still not approved. This means designers must make prudent choices on their own.

- **Capacity:** The number of bits per chip is growing, but 1-k statics still dominate shipments. The consensus is 4-k statics will grow to be a volume commodity by the first half of next

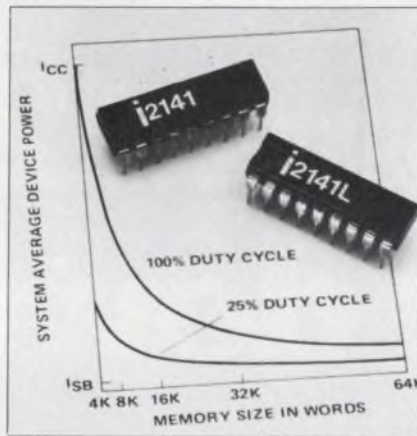

These 4-k \times 1 static RAMs from Intel go on low-power standby automatically. The 2141L low-power versions require only 40-mA supply current (I_{cc}) in active operation and 5 mA on standby, which saves over 90% of the power consumed by conventional, fully static RAMs.

year—but by then, several firms will be sampling or shipping 8-k and 16-k statics. And one firm will sample a 32-k quasistatic before the end of this year.

Speed: which nanoseconds?

Most of the new statics are in the 200 to 500-ns access-time range, which makes them suitable for MOS μ Ps. Meanwhile, many manufacturers are on the brink of producing 150 and 120-ns NMOS 4-k RAMs. But remember clocked parts have cycle times slower than their access times. And it's the cycle time that determines how often you can read or write in a chip. The chart on p. 66 gives specifications on some of the leading static RAMs.

On the other hand, the HMOS 2147 from Intel (Santa Clara, CA) and the VMOS 4017 from AMI (Santa Clara, CA), both with 55 ns access times, are leading an attack on bipolar RAMs,

those ultrafast units that serve bipolar bit-slice μ Ps and other fast processors as cache memories, writable control stores and scratchpads. Clocking doesn't apply here (yet), so cycle time is the same as access time. But there are two specs on access time to watch out for.

Address access time (t_{AA}) is familiar—the number of nanoseconds you wait to get data, after address bits stabilize on the RAM inputs. But there's also **chip-select access time (t_{ACS})**—the number of ns after chip-select occurs and before you get data. Chips are known by their address access times, because T_{ACS} is usually no problem. But when power-down and fast access time are combined in the same RAM, an important tradeoff exists.

Actually, the latter of the two events (chip select and address settling after the respective access times are added) governs how fast your RAM can read. And to figure out write speed, you have to add two access times again: address-write (t_{AW}) and chip-write (t_{CW}).

But chip-select pulses often arrive a few nanoseconds after addresses settle, because they're often decoded from the address lines themselves. So most RAMs have a t_{ACS} shorter than t_{AA} to allow time for the decode gates to derive the chip-select term.

The 4017 has a t_{AA} of 55 ns and a t_{ACS} of 30 ns, while the Fairchild bipolar 93471 RAM has a t_{AA} of 30 ns and a t_{ACS} of 25 ns. As long as the address decoding takes less than 25 or 5 ns, respectively, the RAMs will perform just as fast in a memory system as a glance at their t_{AA} specs implies.

But Intel's 2147 may not. Its t_{AA} is 55 ns, but its t_{ACS} is 55 ns if the chip has been deselected for more than 55 ns, and 65 ns if deselected for less. This is because deselection starts the chip's powering down process, and some time is lost in powering back up.

Avoid short turnoffs, then, and the

2147 will recycle at 55 ns—provided you can get the chip select decoded that soon. The AMI 4017 and the 93471 don't have this problem, because they don't have the valuable power-down feature. But Motorola's MCM 2147 claims to have the power-down feature without short turnoff time problems.

One other caveat on speed: The 2147 and the 4017 are specified with min/max ns values, but the Fairchild 93471 data sheet has only typicals. And the best production testing has about ± 2 ns accuracy.

A hot issue

As the trends of more memory per system and more memory per chip continue, the problem of too much heat per board becomes inevitable. RAM manufacturers are reducing chip power, not only to cut heat, but to cut power-supply and cooling costs for the OEM.

Though the single +5-V supply has become the rule for virtually all static RAMs, the approaches to cutting power consumption vary.

As the chart indicates, one major way to cut average power per chip is to clock dynamic MOS peripheral circuits. Another is automatic on-chip power-down, which is controlled by the chip-enable (chip-select) pin. Indeed, one static RAM, the 8-k 8108 from EMM Semi (Phoenix, AZ) features both clocking and power-down, for impressive savings in the standby mode (see chart).

With either power-down or clocking, power buses on the PC board should have lower inductance than buses used for full-power statics. And there should be more decoupling capacitors because current transients in the 5-V lines are large and rapid.

Second-sources for the Intel 2114 static RAM abound. The SY 2114 from Synertek (Santa Clara, CA), the 7114 from Intersil (Santa Clara, CA) and the 9114 from AMD (Sunnyvale, CA) have minimum output drives of 3.2 mA, compared with Intel's 2.1 mA. AMD's 9124, available in sample quantities now, is also 2114-compatible, but adds the power-down feature. AMI's 2114H under development will draw about 800 mW to achieve a breakthrough speed of 70 ns.

While most RAMs are still spec'd for 5 V $\pm 5\%$, Texas Instruments (Dallas, TX), National Semiconductor (Santa Clara, CA) and Motorola (Austin, TX) among others, have begun designing commercial statics to stand $\pm 10\%$, as

the military has long required.

"If a manufacturer cannot meet $\pm 10\%$ on a consistent basis, he doesn't have enough margin in his design as it relates to his process," argues Ron Livingston, National Semiconductor's memory marketing manager for MOS statics.

The lowest-power 4-ks come in CMOS—standby power is at the micro-watt level. But CMOS RAMs still feature premium costs. However, as more CMOS equivalents of NMOS static RAMs appear, the price gap is narrowing. Acknowledging that today's CMOS:NMOS price ratios range around 3:1 or 4:1, Intersil's memory marketing manager Ron Hammer sees the ratio "heading for only about 1.6:1, but with a nine-to-18 month lag behind NMOS."

Since RAMs are volatile, battery backup is often used in systems where data must not be lost when power goes down. Most static RAM types reliably retain stored data when their +5-V power is lowered to +2.5, so batteries need not supply full operating power. Various manufacturers spec 2.0 V for data retention, and AMD's 9130/9140 are okay down to 1.5 V.

Another battery approach is pin separation. Some RAMs have a 5-V pin for the array and another to power the peripheral circuits that complete the chip. Only the array needs power when the system is inactive.

Meanwhile, unlocked RAMs are getting the business from clocked statics. Since the fully static (unlocked) RAMs have static peripheral circuits as well as static flip-flop circuits in their storage arrays (see box), they draw relatively constant current, whether or not they are reading or writing data. Being direct-coupled, fully static RAMs pay relatively constant attention to their address inputs, too.

Not so with cooler-operating clocked statics, also known as edge-triggered, synchronous or edge-activated. The leading edge of the chip-enable (CE) pulse sets off the dynamic peripheral circuits in a clocked static, and triggers the various internal clocks that get the read/write jobs done. Then the peripheral circuits revert to ultralow power drain. The static array is the only significant load until the chip is accessed again.

The state of the address inputs is ignored by a clocked RAM, except at the CE-fall instant and for a few nanoseconds after. The advocates of fully static RAMs argue that their

Static RAMs are easier to use

Static RAMs are usually easier to use than dynamic RAMs because they require no refresh logic. They use a complete flip-flop to store each bit, instead of a capacitor. Since capacitor charges tend to leak away, dynamics must be refreshed, usually about every 2 ms, either by data accesses to all rows, or more typically by external refresh circuitry. Refresh usually uses about 3% of the chip's time, but often can be done when the CPU doesn't need memory access.

Dynamic cells do have fewer parts than static cells, so dynamic die sizes are smaller for the same capacity, and prices are lower. But statics are making inroads—especially in small systems, where the elimination of refresh logic saves a significant amount of power, space and/or cost.

Some new statics use only four transistors per cell instead of six, by replacing the two depletion-load transistors connected to V_{DD} with two smaller polysilicon resistors. Proponents of the four-transistor design report better margins, lower power, and smaller cell size.

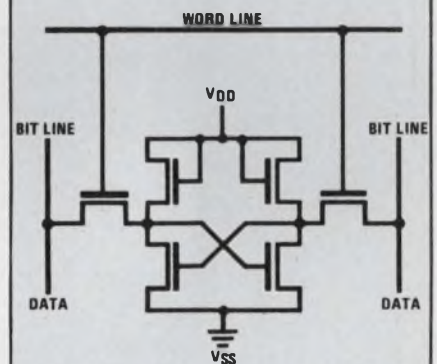

Static RAM Cell

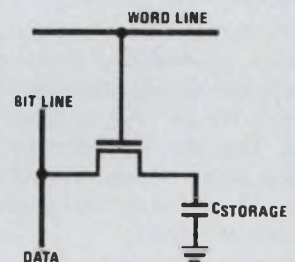

Dynamic RAM Cell

4k and 8k static RAM types

	Device type	Process	Organization, words × bits	Power (mW) on/standby (max)	Access/cycle times (ns)	No. of pins	Original developer
Fully static RAMS without power-down	2114	HMOS	1k × 4	525/525 to 370/370	200/200 to 450/450	18	INTEL
	4044/4046	NMOS	4k × 1	649/649 to 370/370	150/150 to 450/450	18/20	TI
	4045/4047	NMOS	1k × 4	550/550 to 400/400	150/150 to 450/450	18/20	TI
	AM9114	NMOS	1k × 4	525/525 to 370/370	200/200 to 450/450	18	AMD
Fully static RAMS with chip select power down	2147	HMOS	4k × 1	945/160 to 735/53	55/55 to 70/70	18	INTEL
	4244 4245	NMOS	4k × 1 1k × 4	~300/50	150/150 to 450/450	18	TI
	2141	HMOS	4k × 1	385/110 to 200/28	120/120 to 250/250	18	INTEL
Clocked static RAMS	8108	NMOS	1k × 8	270/60	300/450	22	EM & M SEMI
	4801	NMOS	1k × 8	250/50	90/150 to 250/350		MOSTEK
	26104	NMOS	4k × 1	320/242 to 165/127	150/240 to 350/510	18	ZILOG
	4104	NMOS	4k × 1	116/28	200/310 to 300/460	18	MOSTEK
CMOS static RAMS	IM6507	CMOS	512 × 8	33/005 (at 25°C)	400/670 (at 25°C)	24	INTERSIL
	HM6504	CMOS	4k × 1	35/005	170/240 to 300/420	18	HARRIS
	HM6514	CMOS	1k × 4	35/005	170/240 to 300/420	18	HARRIS
	MWS5114	CMOS/SOS	1k × 4	250 μW	450	18	RCA
	CDP1825	CMOS/SOS	1k × 4	5.0 mW	300	18	RCA

(continued from page 65)

RAMs are easier to understand and use as well as accessible all the time, while the clocked RAMs have cycle times about twice as long as their access times. But the clocked-static proponents point to the considerable power saved and relaxed timing requirements for address validity.

"Of course, clocked approaches are borrowed from dynamic RAMs, and tend to be more complex and less reliable, and dynamic circuits take more

space," notes Intel's Rick Pashley, who led the design of the 50-ns 1-k 2125 and the 55-ns 4-k 2147. "Some clocked designs have to give over 60% of the chip to the peripheral circuits," he says.

But Roger Badertscher, responsible for component development at Zilog, says, "Clocked approaches are certainly reliable. We use clocked logic on everything we make. In our 6104 clocked RAM, the peripheral portion is large percentagewise because our dynamic peripheral circuits can toler-

ate a much smaller, high-impedance array. In a fully static design, the cell has to drive the sense amp in both polarities; in ours, only one."

The Zilog (Cupertino, CA) 6104 RAM and the Mostek 4104 are similar clocked static RAMs. Neither has power-down. But Mostek specifies much lower power, while Zilog offers higher speed. Both are compatible with the pinouts of the Intel 2147 and 2141, but socket compatibility, of course, requires that the chip-select line be strobed for each access.

Going straight to 16k

The future for static RAMs is at best a mixed bag. While AMI, Intersil, RCA and Synertek may introduce 16-k statics next, in the belief that the industry won't really stop off at 8 k, Intel is working on a clocked 1-k × 8 for microprocessors. National expects to have an 8-k next year, and TI is planning to introduce two fully static RAMs late this year, a 1-k × 8 and a 2-k × 8 that will have the 2716 EPROM pinout. And Fairchild is considering both MOS and I²L statics in 4-k × 4 and 2-k × 8.

Intersil's 16-k, scheduled for introduction in the first quarter of 1979, will be a 24-pin RAM with better than 200-ns access time. And EMM Semi, while sampling the 8108 1-k × 8, is working on a 16-k static.

RCA says it intends to skip the 8-k static RAM derby and plunge directly into 16-k's. The company feels that the price-per-bit of its 16-k will simply be much more attractive than any 8-k's. RCA's 16-k will be CMOS/SOS, of course, and first cut samples should be available late this year, with production quantities by the middle of 1979.

A sub-100-ns MK4801 1k × 8 static from Mostek, the MK4801—scheduled for sampling in August and volume shipments in the fourth quarter of 1978—will feature both clocking and power-down as options. This byte-wide 300-mW RAM has 24 pins, with a pinout similar to the EMM 8108 and the Intel 2716 EPROM.

So far, getting 16-k on a static chip is challenging enough. But Zilog reports that samples of a clocked 32-k quasistatic RAM will be available late this year (see ED No. 11, May 24, 1978, p. 54). Access time is estimated at 200 to 250 ns, cycle time 300 to 450 ns. The clocked 32-k will have a dynamic storage array, but with a totally hidden on-chip refresh circuit, it will look just like a static in any μP environment. ■



MEASUREMENT COMPUTATION **NEWS**

product advances from Hewlett-Packard

JUNE, 1978

Capture state, timing, and glitch information simultaneously

Now you can approach digital system design and troubleshooting from a timing or state point of view with HP's 1615A Logic Analyzer. The analyzer can be used as a 24-bit state analyzer for real-time monitoring of program execution, or as an 8-bit timing analyzer for locating problems on control lines or other asynchronous system elements. With its cross triggering and arming capability between timing and state modes, the 1615A allows you to debug interaction problems between asynchronous and synchronous system elements.

Evaluation of system performance at the time of a glitch, verification of I/O stability prior to reading a port, monitoring of asynchronous handshake sequences at specific problem points in a program, and many other measurements are easily accomplished with this analyzer.

Keyboard entries save you both development and debugging time. In addition, powerful triggering capabilities, six clock qualifiers, and sophisticated delay and occurrence capabilities assure that the necessary timing and state information is captured for analysis.

Glitches greater than 5ns are detected and separated from data which allows them to be used as part of a trigger specification. A trace specification can include both pattern and/or glitch requirements on any combination of lines—glitches can even be captured during data transitions.

A menu input system reduces the number and complexity of front panel controls while retaining the necessary measurement parameters.



Simultaneous state, timing, and interactive measurements, plus glitch triggering make this logic analyzer a powerful tool for both hardware and software designers. Simple keyboard entries to pin-point areas of interest in system activity also save development and debugging time of synchronous and asynchronous digital systems.

For complete details on this new logic analyzer, check C on the HP Reply Card.

IN THIS ISSUE

Introducing Series E calculators • Signature analysis starts paying off • New hi-rel GaAs FETs

HP's computing controller line newly expanded. Now choose the right controller for your job



Whatever your interfacing needs may be, chances are HP has a computing controller that's right for you. With a full line of controllers, interface cards, and new user guides, HP offers you an easy-to-use system that will save you time and money.

Make Your Instruments Smart at a Price you Can Afford—HP's 97S, 9815A, 9875A

The new 97S is the inexpensive solution to automating data acquisition operations for low-cost, low-speed instrumentation. It combines the HP-97A fully programmable, printing calculator with a powerful BCD interface.

For applications dedicated solely to data logging, HP offers an economical solution with the new 9875A Tape Cartridge Unit. In addition to acting as a peripheral mass storage device for data exchange between the HP Series 9800 desktop computers, the 9875A is a stand-alone data logger. With a built-in microprocessor, it can log data on a DC-100 tape cartridge without a controller.

Where enhanced small system performance, varied interfacing capability, and a moderate price are needed, HP's 9815A computing controller can serve as a data logger or controller for a small instrumentation system. The 9815A's Auto-Start

feature cuts operator instruction by automatically loading and executing a program when the power is switched on. The controller also features a 16-character, alphanumeric thermal printer, two optional I/O channels, and a tape cartridge for quick storage and retrieval of 12,000 12-digit numbers. HP's four optional interface cards enable the 9815A to interface to a variety of HP peripherals.

For Greater Speed and Power—HP's 9825A, System 45

Consider the powerful and versatile HP 9825A controller with vectored priority interrupt for control of multi-device systems. You can increase data throughput by programming software buffers between the program and your instrument. For real-time communication with high-speed instruments, the 9825A has direct memory access (up to 400k transfers per second) and a built-in 250K byte tape cartridge. A memory load/record feature allows you to suspend processing anytime, store the complete contents of memory on tape, and continue later. A live keyboard also permits you to do calculations, call subroutines, list programs, etc., while the program is running.

If you have high-performance computational needs, HP's System 45 could be the

answer. Similar to the 9825A in its data acquisition and control features, System 45 also offers 15 levels of priority interrupt and a CRT. Its dual processors allow I/O and computation operations to be handled simultaneously. On the CRT, you can plot your data, create drawings, histograms, pie charts, and contour plots and circuit diagrams. To make programming faster and easier, System 45 has a typewriter keyboard and enhanced BASIC language.

Five Interface Cards and User Guides

To get your system up and running fast, plug in one of HP's standard interface cards and attach the cable to your instrument. Choose from five cards:

- HP-IB—implements IEEE standard 488-1975
- Bit-Parallel-general purpose interface
- Bit-Serial-RS-232-C communications interface
- BCD-instrument/measurement interface and
- Real Time Clock

To help you put things like interrupt and direct memory access into perspective, HP recently published an **I/O Guide**, a conceptual explanation of interfacing and **HP-IB Programming Hints for Selected Instruments (9825A)**.

Obtain full details by checking D on the HP Reply Card.

Troubleshoot data telephone lines quickly and accurately with new analyzer

New from Hewlett-Packard comes the 3771A/B Data Line Analyzer for making troubleshooting measurements on telephone lines used for carrying high speed data. Two versions are available—the 3771A is compatible with CCITT standards, the 3771B with Bell Publication 41009. Both measure two basic types of parameters affecting data lines—steady state and transient. The steady state parameters measured are: level, phase jitter, weighted noise, noise-with-tone, and frequency shift. The transients measured are: 3-level impulse noise, phase hits, gain hits, and dropouts.

Because of the nature of the transients, they are normally measured over 15-minute intervals and by measuring all of them simultaneously, the 3771A/B saves considerable operator time. Also, any comparison of results is statistically valid.

Though usable as a stand alone test instrument, the 3771A/B also functions as part of an automatic test system. The 3771B can be used with the HP 4943A/4A Transmission Impairment Measuring Set for complete data line characterization and testing. In addition, an option, available starting next August, will allow the 3771A/B to be controlled externally via the HP-IB.

Obtain more information on other optional features and multi-language instructions by checking E on the HP Reply Card.

HP-IB



Hewlett-Packard's new 3771A performs troubleshooting measurements to CCITT standards on high speed data transmission lines. When used with the existing HP 3770B Telephone Line Analyzer, shown in background, they provide a complete, portable data line test system.

New OEM switching power supply for computers and peripherals



If you're an OEM manufacturer of computers and peripherals, consider this 550 watt switching regulated power supply for your products.

Designed for use in electronic data processing equipment, HP's new 63312F multiple-output, switching regulated DC power supply provides three adjustable output voltages of +4.75 to 5.25V, -12 to -15V, and +12 to +15V. An optional fourth output can be specified by the customer to drive a CRT terminal, a motor, or control circuitry.

Featuring brownout protection, the 550W modular supply allows full output power with input voltages ranging from 87 to 127V AC for a 120V input, or 174 to 250V AC for a 240V input.

The unit's three main outputs are regulated to 0.1% for full line and load variations with ripple and noise of 0.05V p-p at the main 5V output and 0.075V p-p at the ± 12 to ± 15 V outputs. To delay loss of DC output voltage following AC input interruptions, the supply maintains the terminal voltage for minimum carryover of 20ms under full load.

Available with barrier block or edge connector interface, the supply has over-voltage crowbar circuits for each of the three main outputs to help protect sensitive loads. Other protective features include output current limiting and overtemperature shutdown. Easy access to components also allows the 63312F to be readily serviced.

For full details about this product, check F on the HP Reply Card.

Two mobile reference standards calibrate remote measurement stations

A new measurement assurance concept is emerging in metrology to supplement the usual hierarchy of NBS, to company primary lab, to secondary lab. Critical to such a Measurement Assurance Program (MAP), is a stable portable reference which can carry a reference parameter right out to a production line, a flight line, or a communication tower.

HP now offers two such packages for verifying microwave power meters and frequency counters. The 435A-K05 Dual Power Reference features two totally redundant high-stability oscillators, each of which supplies 1 mW, 50 MHz reference power from a 50 Ω source to calibrate thermistor, thermocouple, and crystal detector power sensors. Each output is factory-set to 1 mW, $\pm 0.7\%$, traceable to the NBS.

The 435A-K06 Frequency Power Reference verifies frequency counters and power meters with a 10 MHz, 0.5 V standard frequency source and a separate 1 mW, 50 MHz power reference (identical to source of 435A-K05). The frequency reference oscillator exhibits an aging rate of $< 5 \times 10^{-10}$ /day.

Complete specifications can be obtained by checking item G on the HP Reply Card.



435A - K05



435A - K06

Extremely fast, convenient time and frequency measurements for a broad range of applications

The new 5391A Data Acquisition System makes over 50,000 frequency and time measurements per second. Its 8K byte memory stores up to 2,000 four-digit measurements, all under convenient control of a computing controller. The 5391A also measures successive pulse widths or periods with 2 ns resolution, characterizes signals with rapidly varying frequencies up to 500 MHz, compares the varying frequency of two input signals, or totalizes a group of serially occurring pulses. Its many applications include:

Electronics - VCO testing, radar rang-

ing, data communications, measuring pulse jitter and frequency stability, studying effects of high energy radiation upon electronic devices.

Mechanical Engineering - studies of: rotating machinery, turbine blade flexure, timing in fuel injection systems, high-speed mechanisms.

Physics Research - studies of: time of flight (including velocity and acceleration), nuclear fuel burning rates, and shock waves.

Check H on the IIP Reply Card.

HP-IB

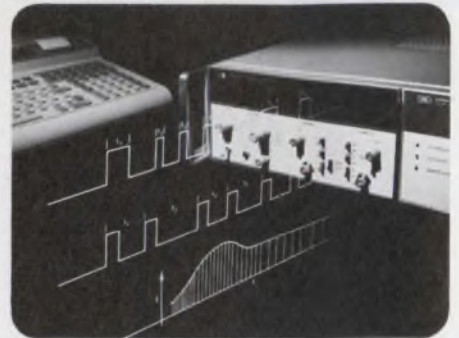

HP's 5391A Data Acquisition System is capable of over 50,000 measurements per second in frequency, period, time interval, ratio, or totalize mode.

Signature analysis starts paying off in digital field service



Signature analysis users report increased efficiency troubleshooting microprocessor-based products—in the field and on the line.

Signature analysis is the new digital troubleshooting technique for microprocessor based products. You troubleshoot quickly and confidently—right down to the component level in production or the field. Over 200 companies have designed signature analysis into their products so they can use the low-cost, portable HP 5004A Signature Analyzer for efficient field service. For example:

On-site service. A designer of controls for long-range pipe systems foresaw the difficulties of a board exchange program in remote locations. They designed their product for signature analysis and are forecasting lower downtime and reduced spares.

Field office repair. A cash register manufacturer with a new microprocessor-based product avoided retraining of a large, mechanically-oriented field service

force by redesigning their product for signature analysis. Now existing dealer personnel service the product locally.

Service center savings. The board turnaround point for a minicomputer company's board-exchange program had a high rate of "no trouble found" for bad returned boards. By retrofitting some boards for signature analysis, they can troubleshoot most of those boards.

Production line troubleshooting. A maker of computerized games used the HP 5004A Signature Analyzer to cut troubleshooting time on the production line for a very cost-sensitive product.

Check out the benefits of signature analysis and HP's 5004A for your products and send for a copy of *A Designer's Guide to Signature Analysis*. Item 1 on the HP Reply Card.

Economical, high-accuracy automatic network analyzer for RF/microwave measurements

You can make error-corrected vector measurements of RF/microwave networks rapidly and with results formatted in the form you want with the HP 8409A semi-automatic network analyzer. This system consists of programmable signal sources covering 110 MHz to 18 GHz, network analyzer with test sets, computing controller and digital plotter, plus the applications software to operate the system and perform the error-corrected measurements. The Hewlett-Packard Interface Bus is used to connect and control the system elements.

The system's ease of operation and the straightforward nature of the software make the 8409A an outstanding system for production applications requiring high-accuracy measurements.

Check J on the HP Reply Card for more information.

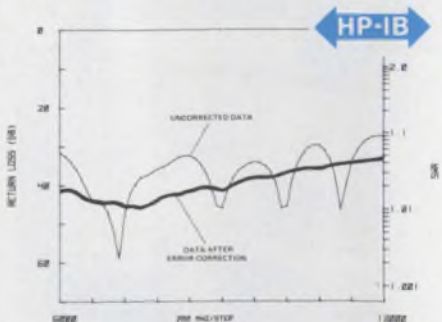

The dramatic effects of error correction are shown in this plot generated by HP's semi-automatic network analyzer system. It offers major advantages in speed, accuracy and convenience, yet costs only 50% more than a manual network analyzer.

New, high-rel GaAs FET available off-the-shelf

Hewlett-Packard has developed a cost-effective standard test program for high-reliability Gallium Arsenide FETs that enables us to provide these devices off-the-shelf. This means that component and reliability engineers can now easily and more economically obtain stabilized GaAs FETs which meet rigid specifications for applications requiring high reliability performance.

Products available under this program are based on the recently introduced

standard HFET-1101 and HFET-1102 GaAs FET transistors.

A unique pricing policy distributes the cost of lot acceptance testing over the devices purchased by the various customers obtaining parts from each lot.

If you would like more information on the preconditioning and screening programs, designated TXVBF-1101/2, check K on the HP Reply Card.

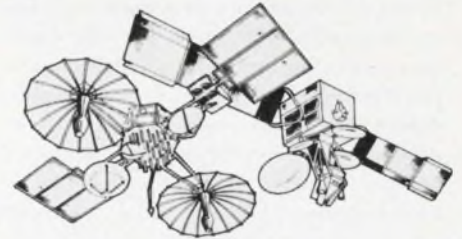

Standard hi-rel programs will now give confidence to engineers considering the use of GaAs FETs in applications with demanding performance requirements.

Lowest guaranteed noise figure in new FET

The new HFET-1102 is a packaged microwave GaAs FET with superior gain characteristics and the lowest *guaranteed* noise figure at 4 GHz in the industry—1.7 dB maximum.

This low noise performance and a useful range from 1 to 12 GHz, makes the HFET-1102 excellent for use in critical first stage microwave receiver/amplifier applications in land and satellite communications, radar, avionics, and ECM.

In addition, the HFET-1102 has a high minimum small-signal associated gain of 11.0 dB at 4 GHz and should minimize distortion even at the moderate power levels at which the device can be operated. The HFET-1102 is packaged in the hermetically sealed HPAC-100A (100 mils square).

Check L on the HP Reply Card for more information.



This new rugged GaAs FET, with a 1.7 dB *guaranteed* noise figure, is intended for first stages of amplifier design.

New optoelectronic catalog now available from HP



The 1978 Optoelectronic Designer's Catalog is here. Included in this 228-page volume are complete, up-to-date, detailed specifications on HP's entire optoelectronic product line.

This catalog is divided into five major product sections: solid state lamps, solid state displays, optocouplers, emitters, and PIN photodiodes. Included is also a new section on fiber optic technology. Each section contains a selection guide, product photographs, package dimensions, complete specifications, and performance graphs.

Order your free copy of the catalog by checking M on the HP Reply Card.

New bipolar transistor offers superior linearity

The linearity of HP's new HXTR-5102 microwave transistor at 4 GHz is unmatched by any other one-half watt bipolar transistor on the market and assures the user of minimal distortion.

The new transistor has typical power output figures at 1 dB gain compression of 29 dBm at 2 GHz and 27.5 dBm at 4 GHz. Typical associated gain is 11.5 dB at 2 GHz and 7 dB at 4 GHz. Class A power-added efficiency is 37% at 2 GHz and 23% at 4 GHz. Featuring superior power, gain and efficiency up to 5 GHz, this NPN device is a very reliable, cost-effective microwave transistor for applications requiring power and linearity.

For more information, check N on the HP Reply Card.



Internal matching at input enables broad bandwidth designs with this 34-finger ballasted transistor.

HP introduces a new line of calculators that, logically, have no equal

With HP's new line of scientific, engineering, and business calculators—the Series E—excellence becomes available at a more affordable price. Like their predecessors, the Series E calculators have the “feel” and reliability, born of quality design and construction. And like their predecessors, the Series E calculators have no “equal”. That is, they have HP's user-heralded RPN logic for fast, efficient

problem solving that has no equal, literally and figuratively. When you add to those traditional HP qualities a number of new convenience features and a lower price, it all adds up to value.

The new conveniences include larger LED displays for improved readability, commas inserted between thousands, a new level of accuracy, and a built-in diagnostic system that tells you 1) when you've

performed an incorrect operation; 2) why it was incorrect; and 3) if the calculator isn't working.

In addition, each calculator is accompanied by a complete, modular documentation system.

For a closer look, visit your nearest HP dealer, or send for detailed literature by checking A or B on the HP Reply Card.



HP-31E. Scientific. Trigonometric, exponential, and math functions. Metric conversions. Fixed and scientific display modes, 10-digit display, and 4 separate user memories.



HP-32E. Advanced Scientific with Statistics. More math and metric capabilities than HP-31E, plus 15 user memories, hyperbolics, comprehensive statistics. Engineering, scientific, and fixed display modes. Decimal degree conversions.

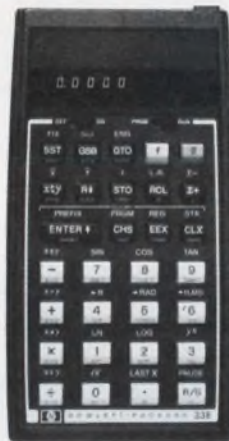

HP-33E. Programmable Scientific. 49 program lines of fully merged key codes. Editing, control, and full range conditional keys, plus 8 user memories.



HP-37E. Business Management. Features for intuitive problem solving. Simultaneous PV, PMT, and FV. Amortization schedules, statistics with trendline forecasting, plus 5 financial and 7 user memories.



HP-38E. Advanced Financial Programmability. No previous programming experience necessary. IRR and NPV for up to 1980 cash flows in 20 groups. 2,000-year calendar, 5 financial and 20 user memories, plus up to 99 program lines.

East-1 Choke Cherry Road, Rockville, MD 20850.

Ph. (301) 948-6370.

South-P.O. Box 10505, Atlanta, GA 30348.

Ph. (404) 434-4000.

Midwest-5201 Tollview Dr., Rolling Meadows, IL 60008.

Ph. (312) 255-9800.

West-3939 Lankershim Blvd, North Hollywood, CA 91604.

Ph. (213) 877-1282.

Europe-Central Mailing Depot, P.O. Box 529,

Amstelveen-1134, Netherlands.

Ph. (020) 47 20 21

Japan-Yokogawa-Hewlett-Packard Ltd., Ohashi

Bldg., 59-1 Yoyogi 1-Chome

Shibuya-ku, Tokyo 151. Ph. 03-370-2281/92.

HEWLETT  PACKARD

 **MEASUREMENT** **COMPUTATION** **news**
product advances from Hewlett-Packard

May/June 1978

New product information from
HEWLETT-PACKARD

Editor: **Bojana Fazarinc-Bitencourt**

Editorial Offices:

1507 Page Mill Road
Palo Alto, California, 94304 U.S.A.

Take a chance on a power supply and win an airline trip.



Red Eye Flights to Customer Sites

A chancy power supply's bottom-line cost doesn't show up on a price list. It shows up in increased emergency service calls, total aggravation, and catastrophic downtime costs to the customer. Our Switching Regulated Power Supplies - the Dependables - can minimize such worries.

Time-Proven Winners: the Dependables

For over 19 years, the Dependables have proved their reliability in OEM digital applications where superior line and dynamic load regulation are needed. And their low RFI/EMI and low output ripple (less than 3 mV peak-to-peak at line frequencies) make them ideal for sensitive analog applications.

Brownoutproof: These Days, a Must

The Dependables can supply their specified regulated outputs **at full load** over input variations from 92 to 138 or 184 to 250 VAC. And they'll keep it up for several minutes even if the input drops to 70 or 140 VAC. If AC fails completely, the supplies will hold up for at least 30 mSec., allowing orderly shutdown or shift to optional DC back-up. **Catalog DP-77** gives details on our single output supplies and brownoutproof features.

DC to DC Units Too

DC input versions, using 48, 120 or 220 VDC as standard input voltages, are available. We can also provide units that operate from both AC and DC sources allowing easy transfer to battery back-up for UPS applications. Ask for **Data Sheet PM-27** for our DC/DC Converter specifications.

Supplies to Fit Your Application

A complete family of standard models provide output voltages from 2 to 48 VDC with output power up to 2000 watts. Single and four-channel multiple outputs with options such as logic inhibit, power-fail signal, remote margin check or programming, and sequencing allow tailoring the supplies to your needs. **Data Sheet PM-26** gives details on the multiple units.

To find out how the Dependables can keep your system on the air and your maintenance people out of it, call or write Pioneer Magnetics, Department A, today.



**Pioneer
Magnetics**

1745 Berkeley Street • Santa Monica, CA 90404
Telephone (213) 829-6751 • TWX 910-343-6249

Lower-cost hard-disc memory systems fill gaps in price and performance

Less-expensive hard-disc memory systems are filling the price and performance gaps between larger capacity, more expensive hard discs and floppy-disc systems, in much the same way that minifloppies fit between floppies and cassette-tape memories.

While the new fixed disc systems don't offer the lowest cost per bit, they do serve applications such as small-business systems for the lowest cost per function, according to George Sollman, director of product management at Shugart Associates (Sunnyvale, CA). Larger discs, with up to hundreds of megabytes, offer a lower cost per bit, but the system price is too high, says Sollman. A 25-Mbyte disc, which has more storage than is usually necessary in a small-business system, is also priced too high—\$2500 to \$3000. And a floppy disc drive, which costs as little as \$500 to \$600, can store no more than 2 Mbytes. The new 10 to 30-Mbyte fixed discs are more reasonably priced at \$1300 to \$2900.

The new drives come not only from Shugart, but also from California Computer Products Inc. (Anaheim, CA) and International Memories Inc. (Cupertino, CA). They all use the same technology as the Winchester disc drives from IBM. A nonremovable disc and a lightweight read/write head assembly are enclosed in a sealed housing. But while the Shugart and CalComp drives use standard 14-in. discs, the IMI drive uses a novel 8-in. platter. Prices and capacities vary, too. Shugart offers 14.5 and 29-Mbyte drives for \$1325 and \$1800 in quantities of 250. CalComp has a 17-Mbyte drive at \$1300, and IMI has 11 and 25-Mbyte versions at \$1500 and \$2900 in large quantities.

The Shugart Model SA4000 operates from the same supply voltages as the firm's floppy-disc memories, so the

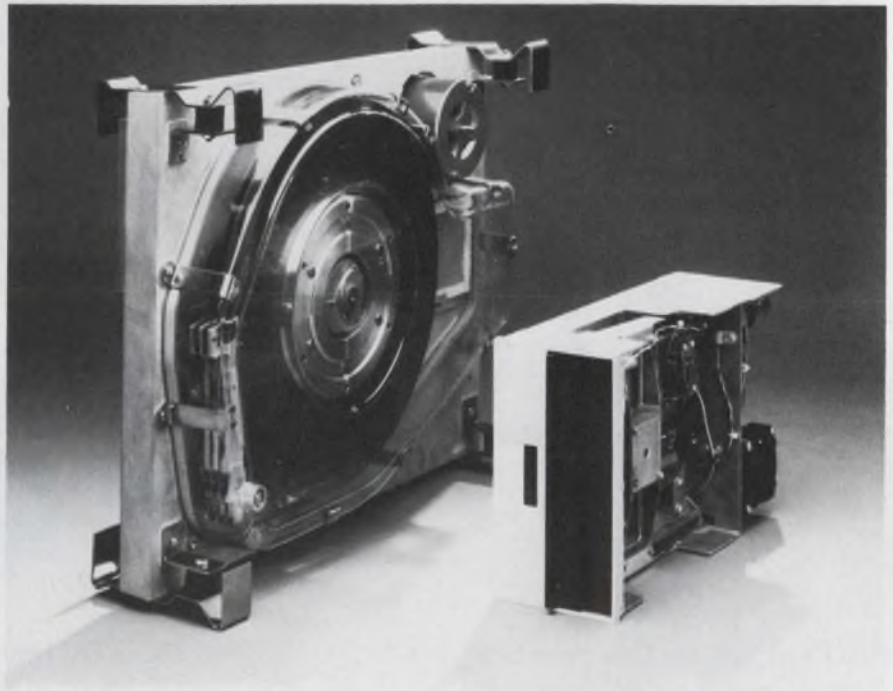

Low-cost disc drives, like the Shugart SA4000 on the left, store 10 times the data of an 8-in. floppy (shown on the right), yet cost only about three or four times as much.

same power supply can operate with both in a system. The drive itself has no power supply, which helps cut the weight. So do a ribbed-aluminum baseplate, instead of a solid-cast one, a smaller motor than is common in disc drives, and a band actuator instead of a standard voice-coil actuator. As a result, the Shugart drive weighs all of 35 lb—80% less than some disc drives, says Sollman.

Using floppy techniques

In addition, the Shugart drive borrows some low-cost technology from the firm's floppy-disc drives. Instead of a closed-loop servo system that—Sollman claims—costs the OEM \$200 to \$300 and decreases system reliability, the SA4000 uses a stepper motor to position the read/write heads. The tradeoff is seek time, which is 87 ms

average, 220 ms maximum.

"We think that's a poor tradeoff," says David L. Britton, president of International Memories. The IMI drive has a seek time of 50 ms average, 105 ms maximum and a higher track density—300 per inch to 172 for the Shugart. And the technology already exists, says Britton, to develop higher-density versions of the IMI drive; 40 and 75-Mbyte versions are already in the works.

Britton prefers to lower drive costs by using smaller components—new designs, not just scaled-down versions of existing parts—and cost and weight savers like a fiberglass-reinforced polyester baseplate.

On the other hand, CalComp's 14-in. drive, like Shugart's, uses a band positioner and stepper motor. But unlike the Shugart, the CalComp keeps its seek time to 130 ms, maximum, by employing a 6800-type microprocessor.

the 3½ that thinks it's a 4½



3028B DMM

THE COMPETITIVE DIFFERENCE

Let's put competitive comparisons in it's proper perspective. The difference between the highest-priced and lowest-priced 3½-digit DMM's over an average life span, works out to be about 10 cents per working day...about 1.5 seconds of a development engineer's time! What is the difference worth compared with *orders of magnitude* greater sensitivity, and resolution...or the cost of a single incorrect reading? How long does it take to improvise a test you can't make on a less versatile instrument—or to find another instrument that *can* give you the data you want?

A bench instrument is the *means*, not the end. *Your* job is to use its measurements to test...to develop...to analyze. Why be distracted from the problem at hand while you search for some way around the limitations of your instrumentation? Why blunt the meaning of your measurements with doubts about their validity? It just doesn't make sense to compromise on the quality and utility of one of the less expensive instruments on your bench.

The Ballantine 3028B gives *uncompromised performance* ...for about 10 cents more a day.

Available on GSA Contract GS-00S-04619

From \$265 US Sales Price

Ballantine Laboratories, Inc. Boonton, New Jersey 07005 USA

Ballantine



variable capacitors

... made by Johanson. Quality without compromise is our target in the design and manufacture of capacitors in sizes, mounting configurations and capacitance values to meet every application. Perhaps that's why—for more than three decades—superior variable capacitors have been synonymous with the name Johanson, where standards of excellence always come first.

The heart of this trimmer consists of a one piece integral contact drive mechanism press fitted to concentric rotor tubes (U.S. Patent No. 3,469,160).



The standard of excellence!



MANUFACTURING CORPORATION
Rockaway Valley Road
Boonton, N.J. 07005
(201) 334-2676, TWX 710-987-8367

CIRCLE NUMBER 21

The microprocessor allows the stepper motor to slew at high speed with controlled acceleration, explains Don Friedman, product marketing manager at CalComp. As the head moves across the disc, it does not have to determine at each track whether or not to continue. Instead, it accelerates and decelerates directly from one track to the next track it needs to access.

The Marksman also includes a brake to halt the disc within a couple of seconds when the speed, about 3000 rpm in operation, drops below 600 rpm, as when the drive is turned off. At that point, the heads come in contact with the disc; at operating speed they ride on a cushion of air.

But braking doesn't really matter, says Shugart's Sollman. Unlike drives

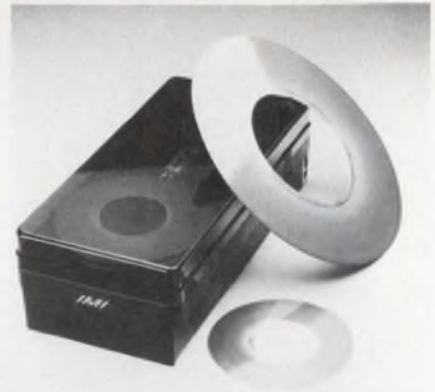

The smallest hard-disc drive, from International Memories Inc., uses an 8-in. platter. It is otherwise similar to standard drives like IBM's Winchester, which use the 14-in. platter also shown here.

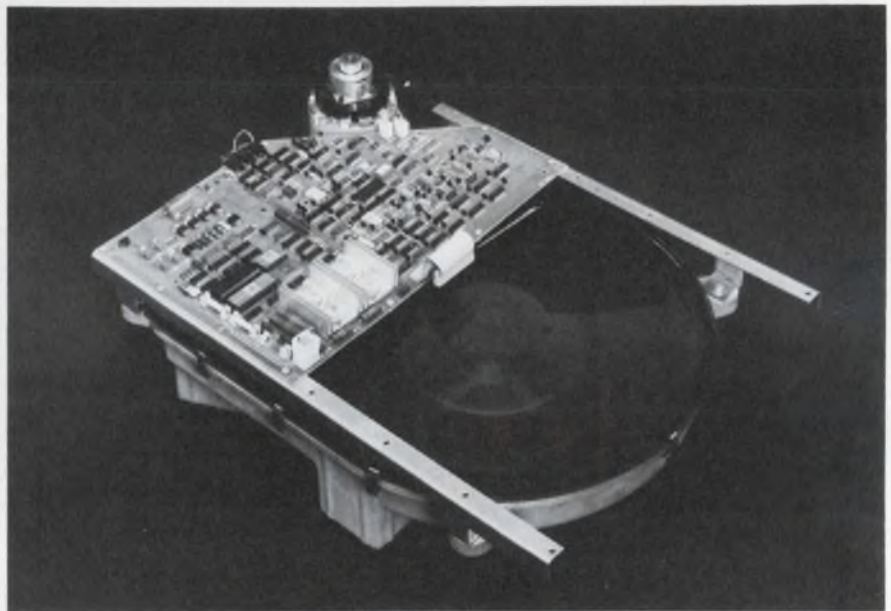

Access time is kept low in CalComp's Marksman drive with a 6800 μ P that slews a band-positioner stepper motor at high speed with controlled acceleration.

with removable media, fixed-media drives are rarely stopped or started more than once or twice a day. Moreover, with loading of only 10 to 15 grams and improved lubrication on the disc and heads, the head can land on the disc without scoring it, he says, claiming that after 30,000 start/stop cycles "we see no degradation."

More 8-in. drives?

Shugart is also looking into 8-in. disc drives, says Sollman, adding there is "significant interest" in a drive that would be the same size as a floppy and store 5 Mbytes.

All these developments may become moot depending on IBM's moves in disc

technology, since any drive that is incompatible with IBM's is unlikely to attain great popularity. While IBM won't comment on product plans, there are industry reports that a new 8-in. IBM drive, called the Piccolo, will soon be introduced. Using thin-film discs and heads, the Piccolo could pack up to 1200 tracks per inch on a disc. The head includes diode selection and amplification circuitry as well as a small gap.

IBM or no IBM, Lee Walther, a Cupertino based consultant, says, "Magnetic oxide-coated technology has been approaching its limits." He looks forward to another generation of discs, possibly thin-film designs and possibly within the next few weeks. ■■

NOW YOU CAN GET BOTH PACKAGE DENSITY AND CIRCUIT DESIGN FLEXIBILITY.

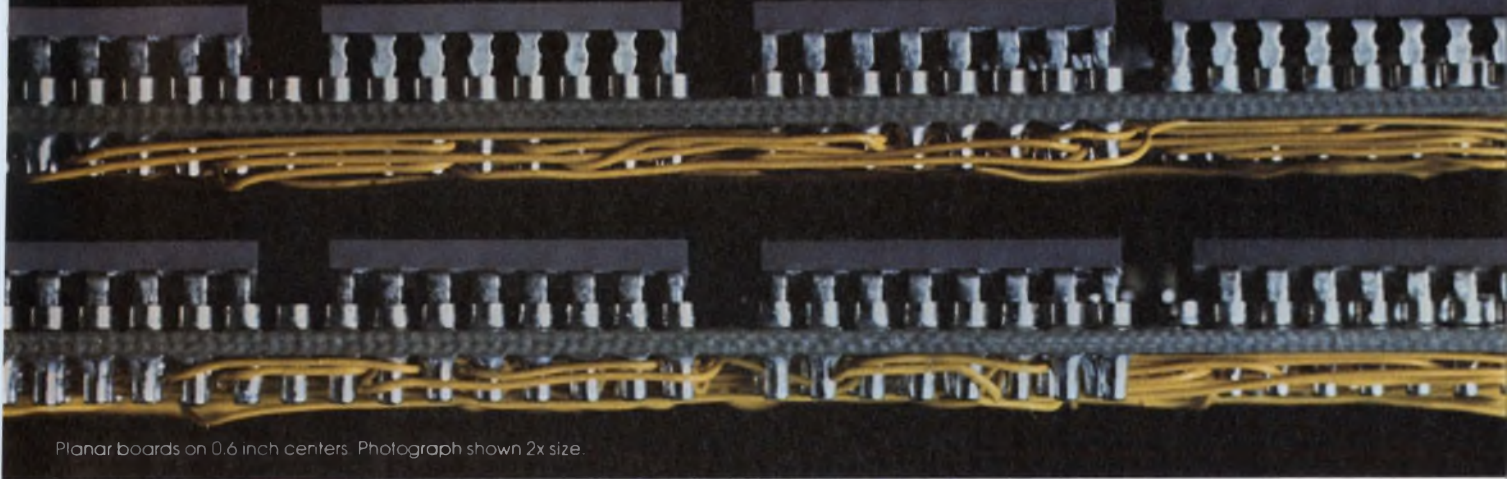

Planar boards on 0.6 inch centers. Photograph shown 2x size.

Introducing Augat's patented Planar stitch-wire. A high speed, low cost system that eliminates the high engineering cost of breadboarding, complete circuit card prototyping and extensive debugging. As a result, turn around time can be cut by one-half to one-third.



Augat's stitch-wire system works like this. After components are mounted on Planar boards, a stitch-wire machine welds insulated wire to stainless steel pads.

Wiring instructions can be furnished using punched tape programs or wire lists. You can also do special wiring configurations including twisted pairs or wiring on the compo-

nent side. Changes can also be made simply, either by stitch-wire machines or by hand soldering.

Adopting stitch-wire is easy, because Augat stocks the wiring machines and a wide range of general purpose Planar boards. Including boards compatible with most mini and micro-computers. These boards feature

large etched power and ground planes. The combina-

tion of large planes and low profile wiring makes them ideal for high speed logic. What's more, we can design and produce stitch-wire boards to your specifications. Or we can provide the

boards and equipment you need to do the job.

Augat stitch-wire offers density and flexibility advantages you can't get anywhere else. To find out how you can get started with stitch-wire, write Augat, Inc., 33 Perry Avenue, P.O. Box 779, Attleboro, Mass. 02703. Tel. (617) 222-2202.

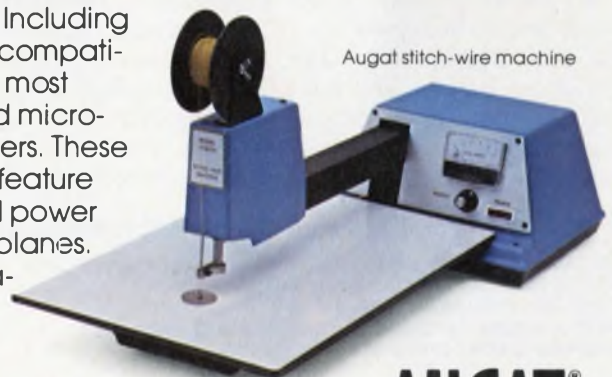

AUGAT®

Augat interconnection products, Isotronics microcircuit packaging, and Alco subminiature switches.

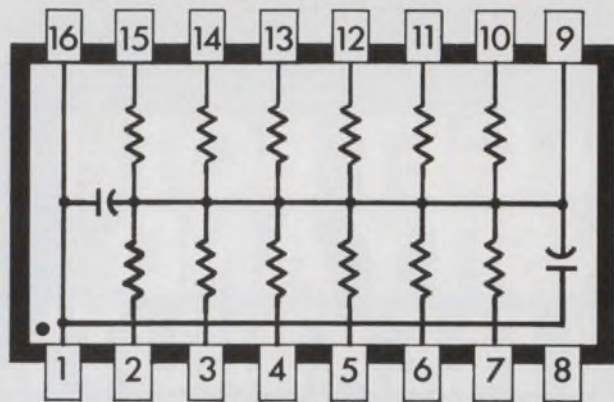

(1 of 3 standard circuits)



TYPE 906C DUAL IN-LINE

Low profile, for applications with height limitation. Molded plastic package stands up against severe environmental conditions. Excellent for use with automatic insertion equipment. Compatible with other standard DIP components. Standard resistance values from 50 to 100Ω, capacitor is .01 μF @ 50 WVDC. Other ratings available on special order.

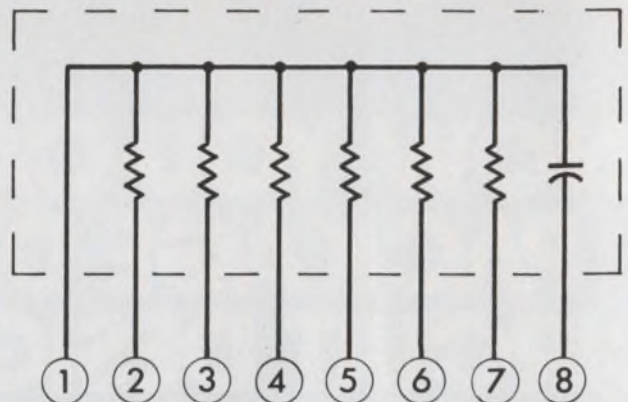

TYPE 201C SINGLE IN-LINE

For use where utilization of board space is important. Conformal resin coating for mechanical and environmental protection. Bosses on plastic base give positive seating on board surface and eliminate entrapment of moisture. Standard resistance values from 50 to 100Ω, capacitor is .01 μF @ 50 WVDC. Other ratings can also be supplied.

Cut component count...simplify board layout...reduce equipment size...with Sprague ECL terminating resistor-capacitor networks.

(Metanet® Metal-Film Resistors, Monolythic® Ceramic Capacitors)

This series of Multi-Comp® precision r-c networks is specifically designed for ECL terminator applications (V_{TT} Series Terminator, -2V) where repetitive component values and circuits are required, as in signal and data processing equipment. With up to 14 resistors and capacitors per network, their use will usually result in considerable cost reductions as

compared with discrete components. Unlike some manufacturers, Sprague makes its own resistor and capacitor chips, ensuring that performance characteristics are carefully matched for mechanical and electrical compatibility. Other Sprague Multi-Comp resistor-capacitor networks include bypassed pull-up, speed-up, and active terminator networks.

Sprague puts more passive component families into DIP and SIP packages than any other manufacturer:

- RESISTOR-CAPACITOR NETWORKS (ask for Bulletins 6611, 6611.1, 6612)
- MULTIPLE TANTALUM CAPACITORS (ask for Bulletin 3542)
- 4-TERMINAL TANTALUM CAPACITORS (ask for Bulletin 3542.3)
- MULTIPLE CERAMIC CAPACITORS (ask for Bulletins 6242B, 6243)
- 4-TERMINAL CERAMIC CAPACITORS (ask for Bulletin 6242.3)

- TANTALUM-CERAMIC CAPACITORS (ask for Bulletin 6642)
- MULTIPLE METAL-FILM RESISTORS (ask for Bulletin 7042A)
- PRECISION RESISTOR NETWORKS (ask for Bulletins 7041A, 7041.1, 7042A)
- MULTIPLE PULSE TRANSFORMERS (ask for Bulletin 40400)
- TAPPED DELAY LINES (ask for Bulletin 45004)

For complete technical data on the component type(s) in which you are interested, write for appropriate engineering bulletin(s), as listed above, to: Technical Literature Service, Sprague Electric Company, 347 Marshall Street, North Adams, Mass. 01247.

THE BROAD-LINE PRODUCER OF ELECTRONIC PARTS



a
General Cable
subsidiary

Industry group pushes multibillion \$ solar satellites

A campaign is being mounted to persuade Congress to launch a multibillion-dollar program of solar-energy-collecting satellites. The persuaders are an industry group known as the Sunsat Energy Council, headed by Dr. Peter E. Glaser, vice president of Arthur D. Little Inc. (Cambridge, MA), who first proposed the idea 10 years ago. The group has a substantial electronics representation, including such firms as Arco, GE, RCA and Westinghouse.

Sunsat is proposing 10,000-MW solar satellites, whose generating capacity is estimated at \$1700 per kilowatt—comparable to the \$1400 average cost of nuclear power generators. The satellites would require no fuel and only periodic maintenance, however, so the cost gap would narrow over time. The initial thrust of the campaign is to get Congress to add initial development funds to the \$15.6-million planned by President Carter to be spent jointly on predevelopment studies by the Department of Energy and the National Aeronautics and Space Administration over the next four years. Under a bill co-sponsored by Rep. Ronnie Flippo (D-AL) and Sen. John Melcher (D-MT), that figure would be increased to \$25-million in the next fiscal year.

These funds would be only a small down payment, however, since the satellites proposed by Sunsat could cost as much as \$10-billion each in production quantities, according to Econ-Inc., a Princeton, NJ, economic analysis firm.

A 10,000-MW solar-power satellite, which could supply all the electricity needs of New York City, would weigh about 100,000 tons and would have to be assembled in orbit, according to one preliminary study conducted for NASA by the Boeing Co. (Seattle). And 45 of these satellites would be able to match the present total electrical generating power of the United States.

Both photovoltaic (solar-cell) and Brayton heat-engine models have been studied. The photovoltaic satellite would be 15 miles long and 3 miles wide and be covered by about 14-billion solar cells, which would transform sunlight directly into electrical energy to be beamed down to earth via a microwave link. The Brayton heat engine satellite would use a series of four parabolic-dish antennas, each about 3.5 miles in diameter and similar to conventional radar antennas. These dishes would collect the sun's energy and direct it to a solar furnace that would drive a series of turbo-generators. The electricity produced would then be beamed to earth.

On the ground, the microwave energy would be collected by rectifying antennas (known as rectennas) measuring about 5 miles by 7.5 miles and resembling a chain-link fence mounted in strips high enough off the ground to allow farming or animal grazing underneath. Backers of the concept maintain the energy levels would be low enough to allow birds to pass through the beams without harm. Nor would the energy have any effect on aircraft or their passengers.

Pilot solar-power plant nears construction

A pilot solar-power plant is due to begin operating in September, 1981, under an agreement just signed by the Department of Energy and Southern California Edison Co. (Los Angeles). And construction of this 10-MW plant is due to begin this fall 12 miles southeast of Barstow, CA, in the Mojave Desert.

DOE will fund the solar portion of the plant at an estimated \$108-million while Southern California Edison and its associates, the Los Angeles Department of Water and Power and the California Energy Commission, will provide \$15-million for the nonsolar portions such as the turbines, and another \$5-million for operation and maintenance.

Southern California Edison will operate the pilot plant for at least five years and will distribute power to the existing electric grid. The plant will obtain steam to drive its turbine generator from sunlight reflected from a field of mirrors (heliostats) onto a boiler atop a 100-meter tower.

Even in relatively cloud-free desert regions, however, earth-based solar collectors receive about a tenth of the solar energy a satellite collects above the earth's atmosphere, which filters out the sun's rays.

Navy to buy more Phalanx ship-defense systems

The Navy plans to step up procurement of the automated Phalanx close-in weapons system, which will defend ships against low-flying, anti-ship missiles penetrating area fleet defenses.

Low-rate production began in late 1977 at General Dynamics Corp.'s Pomona (CA) division. Now the Navy is requesting \$95.5-million to procure 45 systems in the next fiscal year (1979) and \$88.6-million to procure another 49 systems the following year.

Phalanx uses a computer-controlled Gatling gun to knock down incoming attackers. During operational evaluation tests conducted last year, targets ranging from a Navy 5-in. shell to a B-52 bomber were automatically detected, acquired and traced but not fired upon, according to Rear Adm. Justin Langille III, the Navy's assistant deputy chief of naval operations for surface warfare. Reliability exceeded the requirement by a factor of four, according to Langille, adding that maintainability was also better than required.

'Revolutionary' aircraft avionics to be tested

Air Force Avionics Laboratory engineers have begun demonstrating the Digital Avionics Information System (DAIS), which may "revolutionize aircraft avionics and cockpit displays." The initial demonstration, called mission alpha, is the first of four close-air-support demonstrations scheduled for Wright-Patterson (Ohio) Air Force base between now and 1980. The tests will feature take-off, climb, cruise, navigation, management of aircraft weapon systems, weapon delivery and precision approach and landing.

Capital Capsules: A radar originally developed for the canceled B-1 bomber is now being considered for the B-52 and FB-111 bombers, according to William J. Perry, under secretary of defense for research and engineering. Known as the Electronically Agile Radar (EAR) and originally developed by Westinghouse, the radar is said to be less susceptible to enemy jamming and more accurate than radars of the current B-52 and FB-111...NASA has begun experimenting with a **transmitting system small enough to be packed into an ordinary briefcase** to determine if it can relay medical data via the agency's own ATS-6 communications satellite and the Communications Technology Satellite, which is a joint U.S.-Canadian project. The first test was conducted May 12 at Baltimore-Washington International Airport. Data on "victims" of a simulated airplane crash were sent to medical specialists in Boston, Chicago and Brooke Army Medical Center (San Antonio, TX).

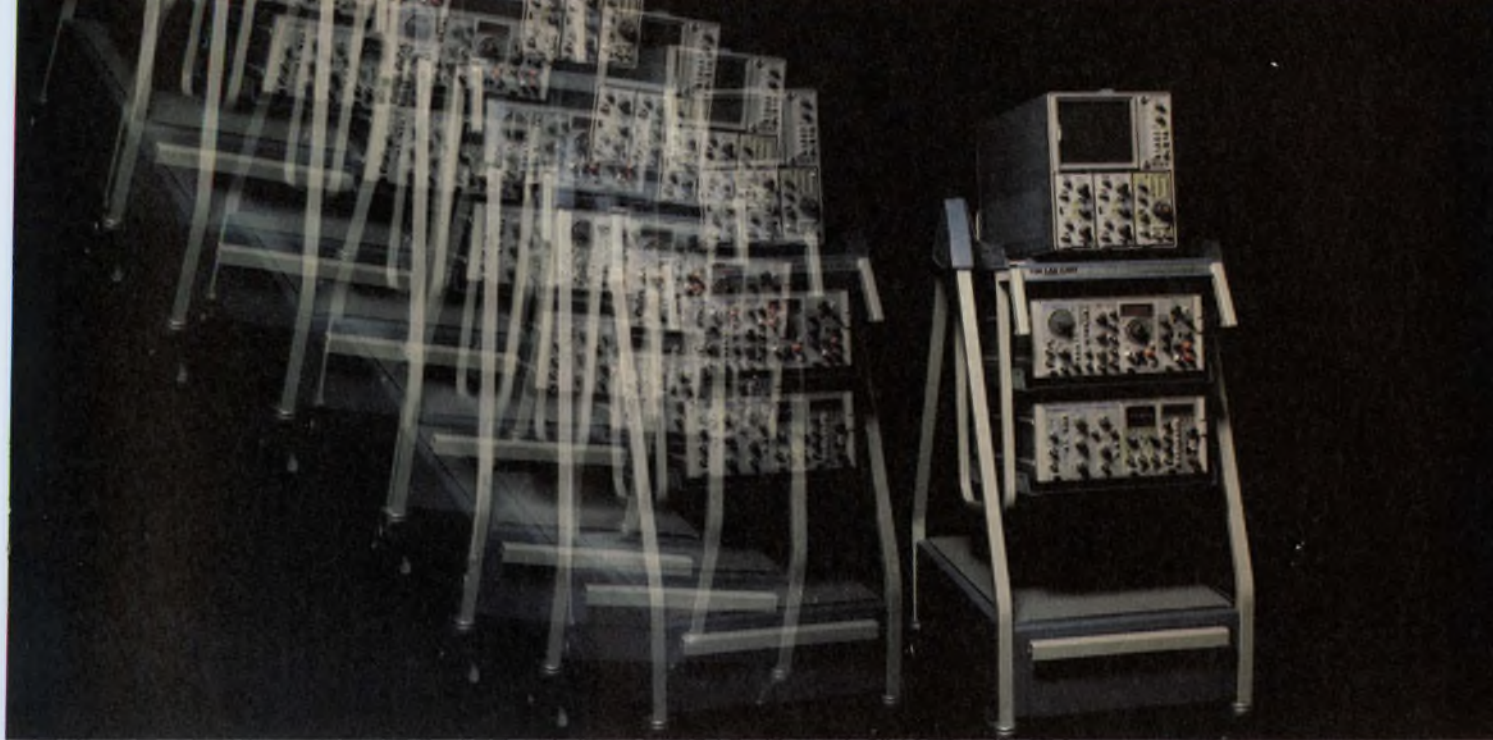

Get Rolling.

If you need test and measurement instrumentation that really moves, get behind the wheels of cart-mounted instrumentation from Tektronix.

You can load the upper tier of a Tek Model 3 Lab Cart with your Tektronix Oscilloscope, put one or two TM 500 Mainframes on the lower decks and fill them with your own configuration of TM 500 modular plug-ins:

- DMMs
- Counters
- Generators
- Amplifiers
- Power Supplies
- Plug-in Scopes
- Logic Analyzers
- Word Recognizers
- Custom Plug-ins

There are over 30 TM 500 instruments to choose from, so you can assemble a configuration that handles several specialized applications or use each individual instrument for general purposes.

Your entire instrumentation system plugs into a power distribution unit requiring a single line cord.



Your probes, accessories, additional plug-ins and documentation tuck away neatly in the bottom drawer. Now you're all set to go places.

You can travel to immovable machines and probe their inner workings . . . in one trip, not several. Or slip your mobile lab down a narrow laboratory aisle to give your bench more elbow room.

Or, zip across the production floor for a scope calibration. Tek instruments, Scopemobiles™ and Lab Carts have an internal common ground, an important feature if you get into sensitive digital circuitry.

And, if you need table top working space along with cart portability choose the TEK Rack Cart Model 7.

Like a moveable desk, the Rack Cart leaves a flat surface on top for charts, files and record keeping. And, 28" of



depth inside allows room to rackmount Tektronix instrumentation to the front or rear of the cart. A special option lets you rackmount a TM 500 six wide mainframe at an upward angle for easier usage.

With a rollabout test and measurement laboratory of Tektronix instruments, you've got a lot going for you. Flexibility. Accuracy. Configurability.

So, get rolling.

Call your Tektronix Field Engineer and ask him about taking a test stroll with the TM 500 family of modular instruments. They really go together.

TM 500 Designed for Configurability

For configurable, accurate, reliable test and measurement instrumentation, contact: Tektronix, Inc., P.O. Box 500, Beaverton, Oregon 97077, (503) 644-0161, Ext. 5283. In Europe: Tektronix Limited, P.O. Box 36, St. Peter Port, Guernsey, Channel Islands.

Tektronix[®]
COMMITTED TO EXCELLENCE

When you need illuminated switches, or more than illuminated switches...



Dialight is the first place to look. We make just about any kind of illuminated push button switch that anyone could want . . . Single lamp, dual lamp, neon, incandescent, LED lighted, you name it.

Perhaps you're looking for snap action switches with silver or gold contacts, or wiping action switches with gold contacts for low level application.

And if you're looking for rear panel or front bezel mounting switches, switches with momentary or alternate actions, or high quality switches for computer applications, we have them.

You'll find that Dialight switches are not only available at a reasonable price, they're also available with some very attractive features. Lamp removal is from the front so you don't have to remove

an entire switch just to change a lamp. And you never have to use anything more complicated than your fingers for replacement or installation.

Along with outstanding variety and design, you get superior Dialight quality. Most Dialight switches are Underwriter's Laboratory listed and CSA approved.

And Dialight distributors are widely located throughout the United States, Canada and worldwide.

Call or write Dialight today. We'll send you our free switch catalogs so you can select a quality switch that's American made and Dialight guaranteed.

DIALIGHT

A North American Philips Company

Dialight meets your needs.

Dialight, 203 Harrison Place, Brooklyn, N.Y. 11237 (212) 497-7600

CIRCLE NUMBER 26

Sharing vital information

Recently, two semiconductor-device specialists from Intel Corporation delivered a paper to a packed audience at the IEEE Reliability Physics Symposium in San Diego. They described a new way to explain those intermittent wrong readings (soft errors) that are plaguing very dense semiconductor-memory chips. Apparently, high-energy alpha particles penetrate the silicon substrate of a semiconductor memory and cause charge concentrations that can change ONE readings to ZERO readings. For a better description, see "Alpha Particles May Be Cause of Soft Errors in Memory" (News Scope, ED No. 11, May 24, 1978, p. 37).

The point is, Intel management decided to share, with the general design community, information that is vital to next-generation dynamic-memory designs. It was a gutsy decision, since the next six to 12 months are crucial for establishing these memory designs. Intel must have felt tempted to keep the information private and use it for competitive advantage.

We applaud Intel's decision to go public, and we urge other manufacturers that have important data like Intel's to follow suit. Too often, basic reliability information must be developed independently by U.S. manufacturers—a waste of their time that is also expensive. And too often the result has been premature, unreliable devices that tend to stigmatize subsequent devices, and retard new memory markets and system design.

Such setbacks would really hurt U.S. manufacturers today, for they must compete fiercely with foreign-built memory parts developed in government-sponsored, cooperative efforts—where reliability information is freely shared. And while eliminating the effects of alpha particles may not be the entire answer, clearly Intel's contribution will increase understanding of the phenomena among U.S. device designers and memory users alike. The resulting synergism will not only help define the problem but also point to solutions—or at least alert memory-chip users to incorporate ways to correct for soft errors.

The greatest result, however, is that, armed with information they may not have found on their own, U.S. memory manufacturers can help—not hurt—themselves in the world marketplace.

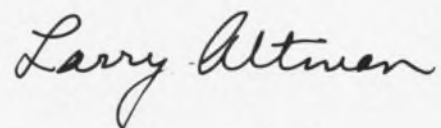

LAURENCE ALTMAN
Editor

The dawn of high performance,
low cost counter timers.

Now you can have more capability and more flexibility for less money.

Racal-Dana 9900 Counter Timers offer you the most advanced technology in low cost universal counter timers. LSI construction permits precision measurement capability to 50MHz for as little as \$675, to 200MHz for \$795 and an optionally portable unit for under \$1000 complete.

Time interval averaging with 100psec. resolution, AC and DC channels, and bounce protection are standard on all units.

Proven reliability enables us to offer a full 2-year warranty.

Don't settle for yesterday's performance. A brand new day has begun. Call or write today.

Racal-Dana Instruments Inc., 18912 Von Karman Avenue, Irvine, CA 92715. Telephone: 714/833-1234.



Model	Frequency (MHz)		Sensitivity	Period, T.I.A., Ratio & Totalize	Trigger Level		Base Price (U.S. List)
	Direct	Prescaled			Var.	Fixed	
9901	50		10mV	*		*	\$ 675.00
9903†	50		10mV	*	*		\$ 850.00
9905	50	200	10mV	*		*	\$ 795.00

†Battery Option

RACAL-DANA
RACAL

NEW! 3-VOLT POWER SOURCE



LITHIUM BATTERIES

The miniature power source that packs in 10 times the energy density... double the voltage!

Despite their tiny size, Sanyo Lithium Batteries offer as much as 10 times the energy density of carbon-zinc cells—and an amazing 3 volts, practically twice the cell voltage of mercury, silver oxide or carbon-zinc batteries!

Using low-cost manganese dioxide in the cathode, these new cells are remarkably stable and are unaffected by wide temperature variations. Available in a wide range of mini sizes, for every type of electronic application.



Model No.	Nominal Voltage	Dimensions				Nominal Capacity (mAh)
		Diameter		Height		
		Inch	mm	Inch	mm	
LF-1/2V	3V	0.787	20.0	0.126	3.2	170
LF-1/2W	3V	0.965	24.5	0.110	2.8	200
LF-1/3W	3V	0.965	24.5	0.079	2.0	120
LR-bH	3V	0.311	7.9	0.283	7.2	30



SANYO

SANYO ELECTRIC, INC.

51 Joseph St., Moonachie, N.J. 07074 (201) 641-2333
1200 W. Artesia Blvd., Compton, Cal. 90220 (213) 537-5830

OSAKA, JAPAN: Sanyo Electric Trading Co., Ltd. 33, Hiyoshi-cho, 2-chrome, Moriguchi. (06) 992-1521

BASEL, SWITZERLAND: Sanyo Electric Trading Co., Ltd. Steinengraben 48, CH-4051. (061) 22 85 85

NURNBERG, GERMANY: Perfect Electronic GMBH, Oberer Bergauer Platz 1, 8500. (0911) 596758

FOCUS

on
Batteries

"That X#%-*%&? battery is dead again!" This despairing cry is heard—more and more as electronic devices depend more and more on battery power. The major problem is that it's difficult to pin down exactly how much power a battery can deliver—and for how long.

The design criterion for battery voltage is simple enough: Circuit-voltage needs determine the number of cells in a battery pack—nominal values of 2 V/cell

for lead-acid systems, 1.2 V/cell for nickel-cadmium, 1.5 V/cell for carbon-zinc, etc. Also, for a given power requirement, a low-voltage, high-current battery pack is more economical and takes less room than one with higher voltage and less current. For example, a 6-V, 0.15-A nickel-cadmium battery costs about \$3.50 against only \$1.20 for a 1.2-V, 0.75-A unit (in quantities of 5000), although both have the same 0.9 watt-hour capacity.

But determining run time, which depends on your

Morris Grossman
Associate Editor



Sealed lead-acid batteries from Gates, Globe, Gould and Elpower are all suitable for electronic applications. In all of them, the electrolyte is in the form of a gel, which is reflected in the registered trademarks some bear. Going counterclockwise from the top right, Elpower's batteries are designated Solid-Gel, Gould's carry the name Gelyte and Globe's goes by gel/cell. Gates doesn't bother with a special identifier.



Both lead-acid and nickel-cadmium rechargeable batteries are made by GE. Each has its advantages and

problems. And GE supplies in-depth handbooks to help you figure them out and make the correct choice.

circuit's current drain, is very complicated. Which brings you to the most important battery spec—its capacity (C), usually stated in ampere-hours, not watt-hours. How many ampere-hours (A-h) can the battery give you? A simple question with a very involved answer.

Some manufacturers call battery capacity "service capacity" and others, "average capacity." But unless the manufacturer provides a minimum value for the initial A-h rating, it's no better than a nominal value or model number. Don't use it without derating. Unfortunately, few companies clearly characterize battery-capacity values with any kind of descriptive—minimum, average or even typical.

Although Sanyo and GE both claim that their nickel-cadmium batteries are rated for minimum values, their catalogs, along with almost all others, don't clearly say so. Furthermore, an A-h rating—even a minimum guaranteed value—is almost useless without, at least,

- A specified discharge rate.
- An allowable voltage swing from full charge to a low cut-off voltage (usually circuit determined).
- An operating ambient temperature.

- A knowledge of the duty cycle.
- A designated capacity cut-off point with age.

Battery capacity? It depends. . .

For example, a battery with a nominal 9-A-h capacity rating, when discharged over 20 hours (designated C/20) might give you only a 7 A-h usable capacity at a 2-h "rate" (C/2), and 4 A-h at 0.2 h (5C). Such C/h rate designations have the dimension of amperes; therefore, C/20 means a 0.045-A, C/2 a 3.5-A, and 5C a 20-A discharge rate. So when comparing battery capacities, you must know also the discharge rates.

But not all manufacturers use the C/h designation. Sanyo defines discharge rate (for which it unfortunately also uses the letter C) as equal to discharge current (A) divided by nominal capacity (A-h). Most confusing. In Sanyo's designation, 2C has the dimension 2/h, and in the more widely used discharge-rate notation, 2C is 2 A—both quite different animals. Moreover, Sanyo's "C" is based on the nominal A-h capacity: the other "C" is the actual capacity.

And Globe-Union, in its gel/cell catalog, uses multiples of a 20-h discharge "rate," designated J_{20} . Thus,

A battery primer

A battery is an electrochemical system that converts chemical energy into electrical energy. When the chemical reactions are essentially irreversible, a battery unit is called a primary cell. When they are reversible, the cell's known as a secondary, or rechargeable, cell.

Primary and secondary cells, although differently constructed, possess the same basic components: two electrodes and an electrolyte. One electrode chemically "reduces" when current flows and becomes the positive (cathode) terminal, while the other "oxidizes" and becomes the negative (anode) terminal. The process continues until either the circuit is broken or the cell constituents are used up.

The anodic material used for the negative terminal is usually a metal such as lead, cadmium, magnesium or zinc. Each is characterized by the ease with which it gives up electrons and becomes positively charged ions (cations) in the electrolyte.

Cathodic materials, on the other hand, are usually chemical compounds such as PbO_2 , MnO_2 , HgO and Ag_2O or AgO . Known as depolarizing materials, these are also characterized by the ease with which they accept electrons. They reduce to a lower state of oxidation by electrolyte activity, and in so doing, from negatively charged ions (anions) in the electrolyte.

The electrolyte in a battery, as can be seen in the illustration, completes the electric circuit between the two electrodes with its ionic conduction path. And since it reacts chemically with both electrodes, the electrolyte must match the properties of the cathodic and anodic materials. The rate of chemical reactions occurring in the cell depends on the rate of ionic diffusion, the temperature, the effective surface area of electrodes and the load connected across the cell. As the battery reaches the end of usefulness, the electrolyte grows progressively "weaker" and the electrodes are partially consumed.

A battery system consists of a particular combina-

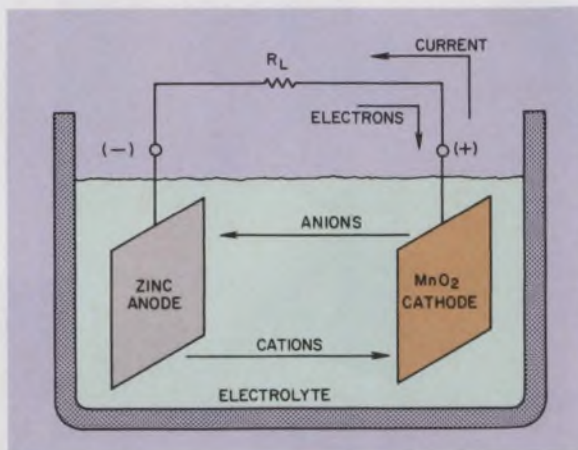

In the flow of charges in a basic cell and its external circuit, notice that current "flows" from the positive to the negative terminal in the external load. Actually, the carriers of "electric current" in most wires are electrons, which flow in the opposite direction. Plus-to-minus flow has been accepted for over a hundred years—since Faraday. Since electrons carry negative charge, however, the effect is the same as positive charges flowing from positive to negative.

tion of anode, cathode, and electrolyte. Some common primary systems include carbon-zinc, alkaline-manganese, mercuric-oxide and silver-oxide. All these systems happen to use zinc as the anodic material, but different electrolyte and cathodic materials. These four systems provide primary-battery power for 90% of the portable devices manufactured today.

The lowest voltage a device can tolerate and still be functional is called the "end-point voltage." As a rule, the higher the end-point voltage specified by a device, the lower the battery-service life. Because silver and mercury batteries are usually lightly

a 0.9-A-h battery discharged at a J_{20} rate would deliver 0.9/20, or 0.045 A. And at $4 \times J_{20}$ rate, 0.18 A would flow. Clearly, the J_{20} designator has the same meaning as $C/20$, and is more compatible with most manufacturers than Sanyo's A/A-h.

Another major influence on how much of a battery's rated capacity actually is usable is the voltage swing your circuit can tolerate. Say a fully charged lead-acid cell can reach 2.4 V, and discharge to about 1.75 V when exhausted. But if your circuit must operate above 2.3 V (1.91 V per cell) with a 2.4-V nominal (12-cell) supply, then you can use only 60 to 75% of the battery's rated capacity. Ditto for nickel-cadmium cells, which usually operate from about 1.35 V fully charged to 1.0 V discharged, and are rated 1.2-V nominally. Discharge to only 1.1 V, and you can use only part of the cell's capability.

Here, a voltage regulator can help you extract a battery's full capability. At the low of 1.75 V/cell, a 15-cell lead-acid battery (nominal 30 V) has 26.25 V. You can easily regulate the swing of such a "30-V" battery, which goes from over 30 to 26.25 V, to a needed value above 23 V—somewhere between 23 and 24 V; thereby, you use such a battery to its full capacity.

A 30-V battery, operating at full capacity, is more efficient and economical than a 24-V unit used only to 65% of its capacity. Furthermore, you would require a larger 24-V unit to give you the same delivered capacity as the 30-V battery.

Voltage regulation enters also into how so-called 9-V transistor-radio batteries (ANSI-F22) are built. Six 1.5-V carbon-zinc cells are used in series to make up such a unit. But a carbon-zinc cell's output voltage droops seriously with use, and averages only about

loaded, have flat voltage characteristics over 95% of their life, then die rather abruptly, they pose little problem in signaling the proper end-point. But if the battery-operated device draws a relatively heavy current and the battery has a drooping voltage (such with zinc-carbon units), the end point becomes critical, since the voltage drop-off is steep. Too high an end point, because the circuit can't tolerate the poor regulation, can make you throw away batteries with lots of life left in them.

Another concept important to battery performance is "voltage recuperation." If a device is operated intermittently, its cells tend to recuperate during the off time. A flashlight, for example, may give about four continuous hours of usable light. However, if it is used only a half hour a day for 16 days, it may give as many as eight hours of usable light.

Zinc-carbons have appreciable voltage-recuperative powers, so they show double the service life on an intermittent load. Alkaline batteries, however, improve only 20% with rest. Mercury and silver batteries have even less voltage recuperation. Thus their discharge curves are virtually identical for continuous and intermittent conditions.

What's a dry battery?

Although the electrolyte for almost all batteries is basically a liquid, when absorbed in a gelatinous or semi-solid composition, you get an effectively "dry" battery. Development with this type of construction in primary cells have led also to dry batteries that can be recharged, or so-called secondary cells.

Nevertheless, some types of secondary batteries, which still use a liquid electrolyte, are also classified as "dry." They are completely sealed to prevent leakage and can be operated in any position. What's more, the need for venting has been overcome in some types by controlling gas generation.

1.2 V at mid-life. On average, then, only 7.2 V is obtained from the six cells.

Nickel-cadmium cells, on the other hand, don't droop as much with use, and though they may start lower—at about 1.4 V—they also average 1.2 V at mid-life. To attain the same average output, then, you still need only six nickel-cadmium cells to get 7.2 V average.

Sounds good, right? It's not as good as you think. When some vendors print on their ANSI-F22 nickel-cadmium battery cases, "For use with 9-V equipment," be careful. You're getting a battery with better voltage regulation than a carbon-zinc, but you're still not getting a truly 9-V battery. You actually would need seven nickel-cadmium cells to get closer to a carbon-zinc's starting-fresh voltage, which would cost more. Fortunately, the full 9 V isn't really needed for most

Dry cells contain a measured amount of water (except lithium systems, which contain *nonaqueous* solvents). Moisture in the cell slowly evaporates during long-term storage, which reduces capability.

Dry cells also contain active ingredients in contact with each other, which on a limited basis enter chemical reactions during storage. These reactions produce permanent loss of energy. In secondary batteries, you merely recharge; with primaries, you eventually throw them away.

Chemical reactions within a battery speed up under high temperature, but low temperature retards the reactions. For example, a flashlight on a winter's night glows dimly when first switched on, but recovers its normal brightness as it gets warmed.

Shelf life is limited

Lowering the temperature, therefore, can help slow down the detrimental reactions during storage. A well constructed D-sized dry cell stored at 20 C experiences a capacity loss of, say, 5 to 10% during the first year of storage and possibly a 5% loss during the second year, according to Ray-O-Vac. But smaller cells have greater percent loss during storage.

Storage at 10 C may cut the storage loss in half. But before that, the batteries should be sealed in a polyethylene bag, preferably with a desiccant. When the batteries are again ready to be used, they should be allowed to warm to room temperature for approximately 24 hours before being removed from the polyethylene bag. In this way, condensation that can damage the batteries is minimized. Most important, however, avoid elevated temperatures, since deterioration may be four to six times as great at 45 C as it is at 20 C.

Many manufacturers warn that battery life is reduced 50% for every 10-C increase above room temperature (20 C).

so-called 9-V applications.

In addition to voltage regulation, which involves the low-voltage cut-off point and discharge rate, ambient operating temperature determines a battery's ultimate capacity.

Temperature is seldom ideal

Unless your battery operates in an ideal 20-C ambient, at which most batteries are rated, you may not get all the capacity the battery can give.

Although most data sheets provide capacity-vs-discharge rate and voltage-swing data, precise data on the temperature effects on capacity are often hard to establish. For instance, one vendor's gelled-electrolyte sealed lead-acid spec sheets dispose of temperature effects as follows: "The battery is rated at

20 C; below this temperature its capacity decreases, above this temperature it increases."

However, an engineering bulletin from the same vendor does provide a plot of the effect of temperature and discharge rate on capacity. But the graph's temperature range is rather limited, and capacity-vs-temperature data aren't provided directly as a percentage of rated capacity. The graph spans only -29 to 20 C. If the nominal 100% capacity is taken at 20 C, the graph can be interpreted to give 65% capacity at -18 C, which corresponds to the value provided



Sealed nickel-cadmium batteries come from Gould (top), Marathon (middle), Sanyo (bottom) and many others. Nickel-cadmiums are generally longer-lived and lighter, but also more expensive than lead-acid units. And like lead-acids, they can be safely mounted in any position and arranged in a large variety of configurations with a wide choice of terminals.

by another vendor's catalog.

Indeed, that second vendor's curve is easy to read. It can be read directly as percentage capacity vs temperature, and covers the total lead-acid range of -60 to 60 C, providing values of about 108% at 40 C to 40% at -40 C.

A third vendor's lead-acid-battery catalog provides both an easy-to-read short capacity-vs-temperature table and a graph. Unfortunately, if you plot the table's points on the graph, the curve you get doesn't correspond to the curves already there. The table's -12 and -40 C points appear to be inaccurate. Not only that, but the graph's curves seem to be displaced about 2% up from where they should be.

For its sealed nickel-cadmium (NiCd) batteries, the third vendor provides a small graph and limited-range bar chart, both barely useful. Although most other specs and curves put peak (100%) capacity at 20 C, these NiCds are shown to have it at roughly 25 C, with capacity falling off gradually above and below this temperature. At 40 C, the capacity appears to be about 75%, and at 0 C about 50%.

By contrast, a competitor's data seem to show 80% capacity at 40 C and no change, or 100% from 20 to 0 C. And still another contender's NiCd data go from 102% to 95% over the same range of 40 to 0 C.

As a matter of fact, most temperature data found in catalogs seem both incomplete and inconsistent—and probably not too precise. (Note: Temperature properties in Table 3 shown in the lithium side box aren't consistent with the main text's table comparing D-sized cells.) Nickel-cadmium battery catalogs, in general, are stingy with data for operation below 0 C, but GE says that its sealed cells deliver usable capacity down to -40 C, and provides curves in its \$5 *Nickel-Cadmium Application Engineering Handbook* to back up the claim.

Lead-acid types, for some reason, have better data for operation down to -60 C, where about 10% rated capacity remains. And most lead-acid batteries are rated to operate (discharge), at least from -40 to 60 C. But don't accept any sweeping claims about the temperature superiority of any class of batteries. The information you get is inconclusive. You must check the ratings of specific units.

On one point, however, all manufacturers agree: Whether capacity goes up or down, with increasing temperature battery life decreases.

Use a large safety margin

Clearly, to make sure your circuit gets the ampere-hours it needs, and that (expletive deleted) is no longer heard when your design is turned on, don't select a battery without allowing substantially for the current load and voltage droop as the battery discharges, the ambient temperature and age. Even if you can tolerate the full voltage droop (because you use a regulator or the circuit is tolerant), and you derate just for discharge rate, temperature and age, with each con-

Can you charge primary batteries?

Battery chargers that attempt to rejuvenate primary batteries are widely distributed and advertised. Also, some electronic devices have ac adapters that allow currents to pass through batteries in the charging direction. Advertisements often claim that all types of batteries can be at least rejuvenated, including primary batteries, which aren't designed to be recharged. But seldom are the hazards spelled out.

Leclanche-system (carbon-zinc) cells are rechargeable to some degree (sometimes 10 to 20 times), if the discharge and charge cycles are controlled with precision. The National Bureau of Standards, in circular LC965, makes the following comments:

"From time to time, attention has been turned to the problem of recharging dry cells. Although the dry cell is nominally considered a primary battery, it may be recharged for a limited number of cycles under certain conditions:

1. The battery open-circuit voltage shouldn't be below 1 V/cell.
2. The battery should be placed on charge very soon after removal from service.
3. The ampere-hours of recharge should be 120 to 180% of the discharge.
4. Charging rate should be low enough to distribute recharge over 12 to 16 hours.
5. Cells must be put into service soon after charging, since recharged cells have poor shelf life.

Dry-cell recharging becomes economical only when quantities of dry cells are used under controlled

conditions with a system of exchange of used cells for new ones—not very practical for home use."

When carbon-zinc cells are in use, zinc dissolves in the electrolyte and often forms products with the manganese dioxide. Upon recharging, the zinc ion must ravel from the electrolyte and redeposit on the anode. To produce a smooth plating, a good portion of the original zinc shell of the battery must remain intact, and the current must be distributed very uniformly. Conditions existing in the ordinary dry cell quickly lead to unevenness in the plating. Zinc dendrites (tree-like growths) soon penetrate the separator, touch the cathode and cause an internal short.

While the cathode is discharging, the manganese dioxide is reduced to one of the lower valent oxides. The reoxidation of the manganese dioxide during recharge may not proceed smoothly, if substantial insoluble reaction products prevent current from being distributed evenly within the cell.

It can be dangerous

But recharging any cell not specifically designed for charging may be dangerous. Most primary cells are so-called dry, sealed units. Excessive gassing, which may result from a too-high charging current, may occasionally cause such a tightly sealed "dry" cell to rupture, and result in personal injury or equipment damage. Even without rupturing, the cell might leak and corrode equipment.

tributing a derating of, say 70%, the initial nominal battery-capacity rating you choose should be easily close to three times the actual circuit use.

Caution: Battery-selection graphs provided by some manufacturers often recommend only 1.5-to 2-times actual, and don't explain why. The same manufacturer might, in fact, consider 50% capacity its battery's end of life, which leaves no room for the other factors. But if such derating results in a large expensive unit, a short duty cycle can often save the day and allow you to use a smaller battery.

Say you have a 250-mA load that operates about eight hours every 24-hour period. Of course, if the battery must deliver the 250 mA during a single 8-h stretch, then your only recourse is to provide a 250-mA \times 8 h, or *actual* 2 A-h capability. (Naturally, the battery you choose will have a larger, say, 6-A-h initial rating.)

However, if the 8-h operation can be split into, say, eight 1-h intervals, with one or more hours between on-periods, you can decrease the needed battery size dramatically. For 1-h discharge intervals, only 250-mA-h capacity (plus, of course, all the safety margins) is needed, almost 1/10 of the original example. But the battery must then be capable of fast charging (such

as with some NiCd units). And the battery charger must be a bit more sophisticated and expensive than one for a slow-charge system as in the first case. The charger must now more precisely control the charging current and perhaps also sense the battery's temperature.

Manufacturers often recommend that standard nickel-cadmium sealed batteries be charged at C/10; therefore, with the full 8-h operation example, such standard cells can be used and charged at a 2/10, or a 200-mA rate. At this charging rate, about 150% more energy must go into the battery than is recovered, so the battery should be fully charged after 15 hours. The remaining one hour—or even longer—over the required charging time can easily be withstood by standard NiCd's.

"Fast-charging cells," however, are normally charged at 1-C to 4-C rates, but the charger must automatically switch to an acceptable topping-charge rate, when the battery approaches full charge. A temperature-safety interlock also is recommended to cut charging off, say, when the battery-case gives over 45-C temperature. At these high charging rates, charging efficiency is higher than at the slow 0.1 C, so only about 120% more charge is needed than is discharged.

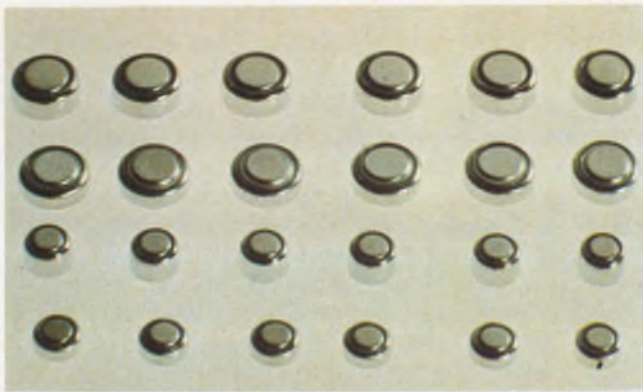

Tiny disc batteries for electronic watches, hearing aids and cameras use mercuric-oxide and silver-oxide electrochemical systems. Starting clockwise from the caption, Mallory, Panasonic, Union Carbide, and many others compete in this expanding market. And Catalyst Research makes disc and rectangular-shaped small lithium-iodine units suitable for direct mounting inside pacemakers, as well as on PC boards for volatile-memory standby power. Mallory also supplies pacemaker batteries.

Thus, with an eight hour operation split into the 1-h intervals described, the charge rate would have to be about 300 mA for 1 h.

So called quick-charge nickel-cadmium cells, charged at about 0.3 C—not slow, not fast—don't usually require the more elaborate chargers that fast-charger types must use. Quick-charge batteries are built to handle this intermediate overcharge rate for extended periods.

Don't fast-charge lead-acid cells?

But general battery wisdom holds that lead-acid cells shouldn't be fast or even quick-charged, and definitely not heavily overcharged. Even *over-discharging* below 1.6 V should be avoided. For standby operation, where main-power outages are infrequent and short, straight constant-current charging can be used. But the current should be set low—usually between C/1000 and C/400—which makes a full recharge time very long.

Even with such a low charge rate, the battery can

be overcharged. At C/167 (or 15 mA in a particular lead-acid battery), GE's *User's Guide to Rechargeable Lead-Acid Batteries* says that "exposure of the SLA (sealed lead-acid) battery to even this low level of overcharge in a standby application will not allow full life potential."

Not true, says Ron Hammel, battery expert at Gates in his Application Note GAN-002. "The evolutionary design improvement of the Gates sealed lead-acid system produces a cell capable of very long float life. Essentially 100% recombination of oxygen is achieved during charging, resulting in a system that is not limited by water loss. Expected float life at room temperature is greater than eight years."

"Furthermore," says Hammel in another Application Note, GAN-003, "Tests on the standard 6-V, 2.5 A-h and 5 A-h sealed lead-acid batteries show that they can in fact take fast charging at 2.5 to 2.55 V, which produces a 3 to 4-C charge rate. And 100% of rated capacity is recovered. *But further testing is being conducted to determine the effects of fast charging on cycle life.*"

So be on guard: Conventional wisdom is subject to change with little notice.

Nevertheless, all manufacturers agree that a multistep charge cycle is best for lead-acid batteries. In this mode, the battery is charged at not more than 20% of its rated capacity until a specified voltage is reached (the average is 2.5 V/cell). Thereafter, the charger should automatically switch to a lower output voltage (about 2.3 V/cell). More-complex systems have a third step, and even temperature sensing and compensation. After full charge, such constant-voltage charging should be removed.

A single-level, constant-voltage charge is cheaper, but takes longer than the multistep charger to safely recharge a battery. And, as previously mentioned, constant-current trickle chargers at low rates also can be used.

Cycling determines life

Of course, the charge/discharge cycle, to a great extent, determines a battery's life. For example, with Gates lead-acid batteries you can readily expect about 200 deep *discharge-recharge* cycles. Deep discharge means that the lead-acid battery's total A-h capacity is drained off to at least the cut-off voltage, or just below 1.6 V in lead-acid systems.

Deep-discharge service is considered the most severe on standard lead-acid cells—and the most life-shortening. At only 60% discharge—less than a deep discharge—500 to 600 cycles can be expected from the Gates' lead-acid batteries.

Gould's cylindrical NiCad batteries, however, can take up to 1000 cycles, or five or more years of standby-power use. And GE says its nickel-cadmium units can last from 500 to 30,000 cycles, depending upon the operating conditions, but doesn't commit itself to a definite figure for life under standby conditions. However, Nife reports that its NiCd's can last 20 years in float-standby service.

But remember that charge/discharge cycling isn't the only battery "killer."

How long is life?

To save space and initial cost, you can use a small battery that will need frequent recharging. But not only will this battery live a short life, it won't even live as long as you would expect. Don't forget that battery-capacity ratings are initial values for new units. And any battery will deteriorate with use, but a small one, because of its heavier use, will fade faster.

Some batteries deteriorate merely with time, although manufacturers say that nickel-cadmium units can be stored indefinitely in a charged or uncharged condition. But lead-acids tend to sulfate, if stored in a discharged state. And not only does their capacity fade with age, but in some lead-acid units, initial capacity may be no more than 80% of rated, according to Globe. In long-life lead-acid designs, the battery



Lithium batteries are the newest and hottest items on the battery scene. Honeywell (top), Mallory (middle) Matsushita/Panasonic (bottom) and almost every other primary-battery maker offer them, or will soon. High-energy density and long shelf life are two important advantages.

plates are thick and electrolyte paste is dense. So it takes time for the electrolyte to permeate the cells fully.

Nickel-cadmium batteries can last up to 10-times longer than an equivalent lead-acid type, and have somewhat better energy densities, but don't forget that NiCd's also can cost three times as much, initially.

However, until lithium rechargeable secondary batteries are perfected, silver-zinc and silver-cadmium batteries provide substantially more electrical energy for their size and weight than any other rechargeable

Lithium comes of age

Although lithium became important in battery development only in the last 10 years, Thomas Edison used lithium compounds in developing the alkaline storage battery way back in 1909. And the element lithium, discovered in 1817, was first prepared as a free metal in 1855.

On the Periodic Chart of Elements, lithium (Li) has atomic number 3 and an atomic weight of 6.94. It is the first element in the alkali metal group, which includes sodium, potassium, rubidium and cesium. It is a silvery-white metal, slightly harder than sodium but softer than lead, and the lightest of all solids with a density of only 0.54 g/cm³. (Alkali metals are so chemically active that they never occur in nature as pure elements; rather, they are always bound into stable compounds.)

Important properties that set lithium apart from other metals, which makes lithium's use as battery anodes advantageous, include

1. The highest electrode potential—3.045 V.
2. The highest ampere-hour/lb capacity density—theoretically 1751 A-h/lb.
3. The hardest of the alkali metals.
4. The highest melting point of all the alkali metals.

Different cathode systems, of course, develop different open-circuit voltages, but even the lowest lithium-cell voltage is higher than any other primary-cell system (Table 1). Also, note that lithium cells have greater energy density than other primary units. Not only lithium's high electrode potential, but also its light weight contributes to the high-energy density of lithium batteries (Table 2).

In addition to high-energy density, lithium systems perform very well at low temperatures. Because the electrolyte is nonaqueous, conductivity at cold temperatures is far superior to that of other primary cells. Even at -55 C, some lithium systems will provide about 50% capacity (Table 3).

And to some applications, the long shelf life of lithiums makes a big difference. In many uses, a device is "on the shelf" longer than it is in use. Unless carbon-zinc primary batteries are routinely changed, chances are good that when you most need them, they're dead. Alkaline systems are better, but lithiums far exceed any other primary—10 years at 20 C is projected. And even at elevated temperatures, lithium units have a substantial advantage (Table 4).

According to Mallory engineers, the degradation of cell performance during storage is primarily associated with the lithium anode for all except the Li/SO₂ system. For example, in the case of the Li/CuS and Li/CF_x systems, the lithium anode reacts slowly with the organic solvents (tetrahydrofuran, dimethoxyethane, propylene carbonate) and with trace amounts of impurities in the solvents (water, propylene glycol) to form a passive film on the lithium electrode. This film helps increase cell impedance during storage.

In the case of Li/V₂O₅ and Li/Ag₂CrO₄ systems, lithium is further passivated by soluble reaction products deposited on the anode. These are formed

Table 1. Lithium-cell systems

Soluble reactants	Open circuit volts
*Thionyl chloride (SOCl ₂)	3.6
Vanadium pentoxide (V ₂ O ₅)	3.4
Sulfur dioxide (SO ₂)	2.9
Molybdenum trioxide (MoO ₃)	2.9
*Inorganic solvent, all others organic	
Solid reactants	Open circuit volts
Copper fluoride (CuF ₂)	3.4
Silver chromate (Ag ₂ CrO ₄)	3.0
Copper sulfide (CuS)	2.2

Table 2. Primary-cell energy densities

Primary-cell systems	Nominal voltage	D-cell weight oz	Energy density	
			W-h/lb	W-h/in ³
Lithium/inorganic electrolyte	3.4	3.5	190	13
Lithium/organic electrolyte	2.8	3.3	140	8
Silver oxide	1.5	—	60	8
Magnesium	1.8	3.5	55	4
Mercury	1.35	5.9	45	6
Manganese alkaline	1.5	4.5	35	3
Carbon zinc	1.5	3.3	25	1.5

Table 3. Low-temperature performance

Temp C	Percent of capacity at 20 C					
	Lithium		Mercury	Magnesium	Alkaline	Carbon zinc
	V ₂ O ₅	SO ₂				
-7	88	96	0	58	15	5
-30	78	85	0	23	3	0
-40	73	60	0	0	0	0

Table 4. Storage life

Storage temp C	Lithium	Mercury	Magnesium	Alkaline	Carbon zinc
20	10 yrs +	3-4 yrs	5-7 yrs	2-3 yrs	1-2 yrs
65	12 mo +	4 mo.	7 mo	2 mo	1.5 mo

Note: All table data supplied by Honeywell

between the strongly oxidizing depolarizers and the organic solvents. In the case of the Li/SO₂ system, however, the depolarizer (liquid SO₂) remains in contact with the lithium anode at all times, and the lithium anode reacts with SO₂ to form a protective film that prevents any further rapid chemical reaction with SO₂. The protective film causes a slight voltage delay after the Li/SO₂ cells are stored, but the film is nonpassivating.

Lithium batteries readily available

Many battery manufacturers now offer lithium batteries as standard, off-the-shelf items, or make them to order. But different companies have concentrated on particular cathode systems. Here's a partial

list of battery makers active in lithium, and their systems:

Company	System
Mallory	Li/SO ₂ Li/PbI ₂
Matsushita (Panasonic/National)	Li/CF _x
Ray-O-Vac	Li/CuS
Saft	Li/Ag ₂ CrO ₄ Li/CuO
Sanyo	Li/MnO ₂
Eagle Picher	Li/CF _x
Honeywell	Li/V ₂ O ₅ Li/SOC ₂
Power Conversion	Li/SO ₂
GT&E	Li/SOC ₁₂
Altus	Li/SOC ₁₂
Tadiran	Li/SOC ₁₂
Catalyst Research	Li/I ₂
Union Carbide	Li/SOC ₁₂ Li/SO ₂ Cl ₂

The Li/SO₂ system is versatile and relatively inexpensive to produce, and it is the first lithium system produced in large quantities in standard ANSI sizes. It employs a lithium anode, and a gaseous SO₂ cathode dissolved in acetonitrile, which is reduced on a carbon conductor. It has an open-circuit voltage of 2.92 V and a typical voltage under rated load of 2.7 V. It is a relatively high-pressure system, and the cells must have safety vents to prevent an explosion should the system accidentally be incinerated.

Lithium cells have safety problems

According to Mallory, the Li/SO₂ system, under extreme high-temperature abuse, is no more hazardous than sealed alkaline, mercury or magnesium cells. These cells invariably generate some hydrogen gas, particularly when stored at high temperatures, and do not usually have a safety-vent feature.

The probability of well-made lithium cells venting in a battery under regular-use conditions of temperature, pressure and acceleration/deceleration is extremely low. But if this should happen in a user's equipment, beware of SO₂ release, which can be

inhaled and whose reaction product is corrosive.

In the unlikely dual event of a short and a safety fuse failing to open, a lithium battery's vent should yield to pressures less than those considered "safe." Should an internal short develop within the cell, because of excessive shock or vibration, the vent mechanism should operate well before pressure builds up to an unsafe level.

Disposing of discharged Li/SO₂ batteries, according to Mallory, is relatively safer than disposing of discharged mercury batteries. Although the typical discharged battery could have around 30% of the SO₂ and lithium still unreacted, the pressure inside the discharged lithium cells will have fallen to about 1-1/2 atmospheres. Thus, much less current can be maintained under short-circuit conditions than can be maintained in an undischarged cell.

Before disposing of a used battery, you should short it (with 0.1 to 0.25 Ω). Then, since there will be little unreacted lithium and SO₂ left, you can get rid of the battery without worrying about explosions or poisoned breathing.

But the most popular lithium system appears to be Li/SOC₁₂ (lithium/thionyl chloride), which uses a lithium anode and gaseous cathode dissolved in an inorganic electrolyte. It has a 3.63-V open-circuit voltage and a typical voltage under rated load of 3.2 to 3.4 V. Like an Li/SO₂ system, the Li/SOC₁₂ has a very flat discharge profile during 90% of its life. It's built somewhat like an Li/SO₂ cell, except that it must be hermetically sealed. The Li/SOC₁₂ system is a very low-pressure system, and because of that, it is potentially superior to Li/SO₂ in high-temperature and unusual form-factor applications.

The system appears to be safe in low-rate cell designs (Tadiran). It may even be safe, if properly vented, in high-rate cell designs, but there's not enough data on high-rate configurations to make that claim with a high degree of confidence, according to Honeywell.

The Li/V₂O₅ system, under development by Honeywell since the late 1960s, uses a lithium anode, a carbon/V₂O₅ cathode, and a double-salt MF electrolyte. It has a two-plateau discharge profile of approximately 3.4 V for the first 50% of life and 2.4 V for the last 50%. If both plateaus are used, the Li/V₂O₅ offers the highest energy density of lithium-organic electrolyte systems: 11 W-h/in.³ and 120 W-h/lb. It is a relatively low-pressure system, and thus, low-rate batteries need not be vented. Consequently, it may be a good choice for applications where safety is a big concern.

All high-energy-density battery systems have a common safety hazard—they can short. Therefore, they all should have a fuse, preferably of the "slow-blow" type, in series with the cells. The fuse should open at approximately twice the maximum current required by the equipment. To increase safety, diodes also should be fitted into a battery assembly, where parallel stacks of cells are linked together, to prevent reverse current flow in low-voltage units.

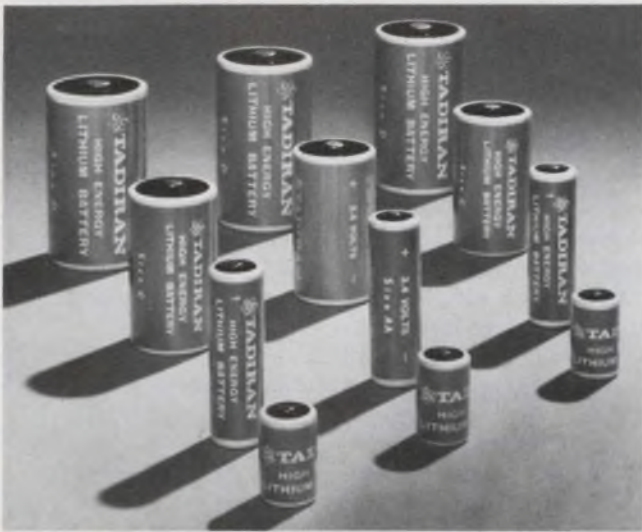

Not all lithium batteries are alike. Power Conversion's lithium cells (bottom) are Li/SO₂ systems with an organic electrolyte that deliver a nominal 2.8 V. Tadiran's units (top) are Li/SOCl₂ (thionyl-chloride) systems with a non-aqueous, inorganic electrolyte, and deliver 3.4 V.

battery on the market, according to Yardney. Its standard Silvercel and Silcad batteries are available with 0.1 to over 300 A-h capacities. And special cells can be designed for the most complex shapes.

The silver-zinc Silvercel rechargeable battery can provide as much as six times more energy per unit of weight or volume than other secondary battery types (see bar charts). Its extremely low internal resistance permits discharges at rates as high as 30

times the ampere-hour capacity rating. And a flat-voltage characteristic alleviates voltage-regulation problems. Custom cells have been built with capacity ranging from 0.1 to 20,000 A-h.

The silver-cadmium (Silcad) battery combines the high-energy and space-and-weight-saving characteristics of the silver-zinc battery with the long-life, low-rate characteristics and better resistance to overcharge of the nickel-cadmium battery. The silver-cadmium battery also lives long on the shelf in charged or uncharged conditions, has a level voltage output, and is mechanically rugged. Watt-hour capacity per unit of weight and volume is two-to-three-times greater than a comparable nickel-cadmium battery—and it retains charge better, according to Yardney.

Furthermore, silver is recoverable from such silver-system batteries, which helps reduce their rather high cost. And it's cost that keeps these silver-system cells from more widespread use outside of missile, satellite and submarine systems.

But you can avoid the generally high initial cost of secondary batteries by using low-cost primary types.

Lowest initial cost isn't always best

If it's economy you seek—at least an initial low cost—then consider throw-away primary batteries (see "Battery Primer" box for distinction between primary and secondary batteries). You've got plenty of types to choose from (see primary-cell table).

Over the life of most electronic equipments, rechargeable secondary batteries usually work out to cost less than throw-aways. But then some battery-operated devices are one-shot affairs, while others have short lives. And stiff competition in the consumer market often prohibits supplying expensive rechargeables, and the rechargers for them.

If you decide to go with primary batteries, the most common choices include Leclanche (carbon-zinc and improved zinc-chloride), alkaline and mercury or silver-oxide types. Special applications may require magnesium, lithium, zinc-air (Gould) or solid-state batteries.

Leclanche batteries are low-cost and very easy to get anywhere. They are only good, however, in light, preferably intermittent-duty, applications. In addition, their shelf life is limited and their output voltage is variable.

For heavy-duty, continuous, high-current applications, a better choice is the alkaline-manganese battery. It has better shelf life, contains 50 to 100% more energy and lasts three to seven-times longer. But although alkaline cells are superior for most uses, only for continuous duty and high-current drains (above 300-mA) will you achieve significant economic advantage over carbon-zinc, according to Union Carbide (who makes both types).

Alkaline-manganese batteries are mostly manufactured to be primaries, but now they have a spin-off rechargeable type, available in combinations of D or

Standard primary cells

Name	Type	Volts/Cell	Features
Carbon-zinc	Primary	1.5	Low cost, discharge characteristic falls gradually, variety of shapes and sizes.
Carbon-zinc (zinc chloride)	Primary	1.5	Good low temperature performance, discharge characteristic falls gradually, service capacity at moderate to high current drains greater than carbon-zinc.
Alkaline-manganese dioxide	Primary and rechargeable	1.5	Good low temperature performance, discharge characteristic falls gradually, high efficiency under continuous or heavy-duty high-drain conditions. Under some conditions, will provide up to seven times service life of carbon zinc cells. More expensive than carbon-zinc batteries, low impedance, several standard sizes.
Mercuric oxide	Primary	1.35 and 1.4	Excellent high-temperature performance, relatively flat discharge characteristic.
Silver oxide	Primary	1.5	Flat discharge characteristics, fair low-temperature performance.

Courtesy of Union Carbide

G cell sizes. The number of charge/discharge cycles they can sustain—about 40 cycles—is much less than that of nickel-cadmiums, but their initial cost is a fraction of the nickel-cadmiums'.

For a high energy-to-volume ratio and a flat discharge curve, the traditional primary choice is the mercury battery. Its flat-discharge characteristic makes it ideal for reference-voltage applications.

Like mercury cells, silver-oxide cells provide a flat discharge curve. But while they have a higher voltage than mercury cells—1.55 V for silver vs 1.35 V for mercury—they have a lower A-h capacity.

Like secondary cells, however, primary-cell capacity depends on more than can be stated in a single A-h rating number. According to Union-Carbide, "There is no relation between continuous-duty service and intermittent service. It is, therefore, impossible to rate the merits of different batteries on intermittent service by comparing results of continuous-duty tests."

Long rest periods between use can really help attain maximum capacity from primary cells. And temperature, cut-off voltage and age must be considered for primaries just as they are for secondaries.

Now for the big difference. There's a serious problem you'll encounter with primary batteries that you won't with secondaries: How to determine the amount of charge left after shelf life and use. You can't simply recharge a primary battery as you can a secondary.

So Union Carbide warns: "The remaining capacity or quality, of a primary cell can't be determined by taking a short-circuit amperage reading—a popular, but misleading testing approach."

Size D cells for flashlight and photoflash use have the same size and shape. However, a photo-finish-type cell will deliver over twice as much current on a short-circuit test, but have less service (A-h) capacity than a typical flashlight cell in normal use. Short-circuit amperage can be adjusted over a wide range by varying the carbon and electrolyte content of the

depolarizing mixture. More carbon reduces internal resistance, but then less depolarizer can be included. So service capacity suffers.

D cells differ

Thus, not all D-sized cells are alike. Union Carbide makes at least eight different types of carbon-zinc and zinc-chloride D cells. Moreover, Ds are made with different battery systems and have widely differing characteristics (see table, "Comparison of D-sized Cells"). A carbon-zinc D nominally delivers 1.5 V; a lead-acid, 2 V; and a lithium D, 2.95 V. So none of those can be interchanged directly.

Another possible confusion is reported by Howard P. Barry, a battery engineering expert at Gould. "Nickel-cadmium D cells (and C cells) come in two versions: D units usually supplied by OEMs in electronic equipment, which have about 4 A-h capacities, and consumer-outlet units for replacement purposes, which have only 2 A-h capacities. "Don't compare the two products," he warns.

Lithium systems tops in energy density

While you're comparing primary batteries, note that lithium systems top the list in energy density, temperature range and, often most important, shelf life—10 years to 75% capacity at 21 C is projected by Power Conversion Inc., for its Eternacells.

But like D cells, all lithium systems are not alike (see box entitled "Lithium Comes of Age"). The term "lithium battery" loosely identifies a host of electrode combinations and electrolytes—whose voltage can range from 1 to 4 V—that have lithium as the negative (anode) electrode. And unlike other cells, *all lithium systems contain no water.*

However, the cathode and electrolyte you choose will have a major influence on operating character-

Comparative energy densities of secondary cells

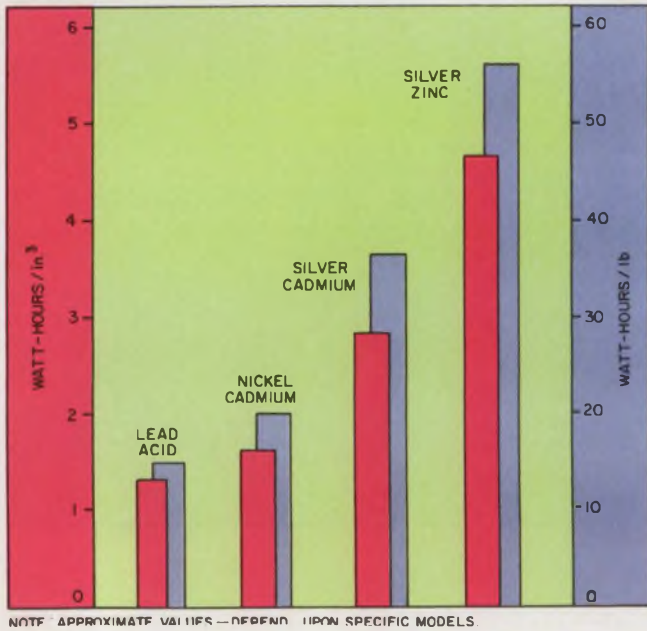

istics. You can pick from solid or liquid cathodes. Electrolytes for solid cathodes are lithium salts in an organic solvent, while those with liquid cathodes can have organic or inorganic solvents.

Also, Mallory offers a lithium battery with a solid electrolyte in addition to a more "conventional" Li/SO₂ system with an organic solvent. The absence of any liquid in this solid-state battery eliminates gassing and corrosion. And a shelf life of over 15 years at 21 C is projected. Energy density is 5 to 10 W/in.³, but current output is measured in microamperes at a nominal output voltage of 1.85 V.

All lithium-type batteries have higher impedances

Typical discharge characteristics of secondary cells

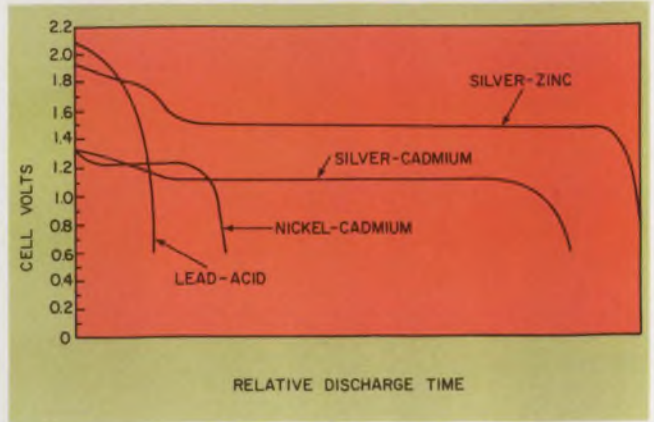

than aqueous-electrolyte cells such as silver or mercury oxide; therefore, their current-output capability is generally lower. In fact, solid-cathode types—metal halides, sulfides or oxides of vanadium, manganese, chromium, silver, and carbon monofluorides, etc.—are 100 times poorer. And liquid-cathode types—thionyl chloride (SOCl₂), sulfuril chloride (SO₂Cl₂), and sulfur dioxide (SO₂)—are still 10 times poorer than aqueous batteries in current-output capability.

The materials for many lithium systems cost less than, say, silver-oxide systems. However, low material cost tends to be offset by higher manufacturing costs, because lithium is hard to handle. Lithium batteries can be hazardous because of their high energy content, the high reactivity of lithium and the use of other rather uncommon materials.

Until very recently, lithium batteries were considered strictly primary-cell types. But this "conventional notion," like many others, was shot down when

Comparison of D-sized cells

Characteristics	Primary Cells*				Secondary** cells	
	Zinc carbon	Alkaline manganese	Mercury	Lithium	Lead acid	Nickel cadmium
Nominal open-circuit volts	1.5 V	1.5 V	1.35-1.4 V	2.95 V	2.0 V	1.2 V
End volts	0.8 V	0.8 V	0.9 V	2.0 V	1.4 V	0.9 V
Capacity-50-h rate (C/50)	6 A-h	10 A-h	18 A-h	10 A-h	5.0 A-h C/10	5.3 A-h C/10
% of 50-h rate-0 C	80%	80%	80%	95%	90%	100%
% of 50-h rate-29 C	20%	40%	40%	80%	60%	80%
W-h/lb	35	42	56	150	11.8	15.7
W-h/in ³	2.3	3.6	6.4	8.7	1.4	1.7
Weight-oz	3.3	4.5	5.9	3.5	6.4	5.2

* Data from Mallory's technical data sheets.

** Data derived from GE's "Lead-Acid Sealed Cell User's Guide" and "Nickel-cadmium Battery Applications Engineering Handbook."

Bell Telephone Laboratories (Murray Hill, NJ) recently announced a 2.5-V lithium battery with a vanadium-disulfide cathode that was rechargeable. The cathode material is in the form of a layered compound, like mica or graphite, so that sheets of the material can easily be separated, according to Bell. But few details are available on this still experimental battery.

It should be clear that all the items listed as necessary specifications for secondary batteries—minimum rated capacity, discharge rate, temperature, etc.—except for charging also apply to primary batteries, and that you must check all the

separate properties of each type and model. A battery's superiority in one property is often offset by a deficiency in another property. And because one model of a particular battery class has some desirable capability doesn't mean that all the other models in the class have the same desirable capability. Blanket assumptions and so called common-wisdom are dangerous to depend on. For instance, primary batteries are supposed to be nonrechargeable. But even that, albeit with severe limitations, can often be done on primary cells (see box entitled "Can You Charge Primary Batteries?").■

Need more information?

For further information on batteries, readers may consult the manufacturers listed here by circling the appropriate numbers on the reader service card. But all the manufacturers don't make every battery type. More information on specific vendor lines may be found in ELECTRONIC DESIGN'S GOLD BOOK.

- Accudyne Corp., 340 N. Franklin St., Janesville, WI 53545. (608) 752-9081.
Circle No. 451
- Acme Battery Corp., 700 Canal St., Stamford, CT 06902. (203) 324-4125.
Circle No. 452
- ACR Electronics Inc., 3901 N. 29 Ave., Hollywood, FL 33020. (305) 921-6262.
Circle No. 453
- Alexander Mfg. Co., Box 1645, Mason City, IA 50401. (515) 423-8955.
Circle No. 454
- Aristo-craft Miniatures, 314 5 Ave., New York, NY 10001. (212) 279-9034.
Circle No. 455
- Artech Corp., 2816 Fairfax Dr., Falls Church, VA 22042. (703) 560-3292.
Circle No. 456
- Bayshore Systems Corp., 5404 Port Royal Rd., Springfield, VA 22151. (703) 321-9625.
Circle No. 457
- Carbone Lorraine Inds. Corp., 400 Myrtle Ave., Boonton, NJ 07005. (201) 334-0700.
Circle No. 458
- Catalyst Research Corp., 1421 Clarkview Rd., Baltimore, MD 21209. (301) 296-7000.
Circle No. 459
- Chloride Standby Systems Ltd., William St., Southampton SO1 1QH, England, Southampton 30611.
Circle No. 460
- Cole Co., 3 Inwood Rd., Upper Montclair, NJ 07043. (201) 783-6999.
Circle No. 461
- Daini Seikosha Co., Ltd., 31-1 Kameido 6-Chome, Koto-ku, Tokyo, Japan (682) 1111.
Circle No. 462
- Dual-Lite Inc., Simm Ln., Newtown, CT 06470. (203) 426-2585.
Circle No. 463
- Eagle-Picher Industries Inc., P.O. Box 130, Seneca, MO 64865. (417) 776-2258.
Circle No. 464
- Eica Battery Co., 2485 Charleston Rd., Mountain View, CA 94040. (415) 961-7530.
Circle No. 465
- Electrochimica Corp., 2485 Charleston Rd., Mountain View, CA 94040. (415) 961-7400.
Circle No. 466
- Electronic Batteries Inc., P.O. Box 525, Lindenhurst, NY 11757. (516) 226-2200.
Circle No. 467
- Electroplan Ltd., P.O. Box 19, Orchard Rd., Royston, Herts SG8 5HH, England. Royston (0763) 41171.
Circle No. 468
- Elpower Corp., 2117 S. Anne St., Santa Ana, CA 92704. (714) 540-6155.
Circle No. 469
- Eltra Corp., C & D Batteries Div., 3043 Walton Rd., Plymouth Meeting, PA 19462. (215) 828-9000.
Circle No. 470
- Eltra Corp., Prestolite Battery Div., 511 Hamilton St., Toledo, OH 43694. (419) 244-2811.
Circle No. 471
- Ever-Ready (Holdings) Ltd., Ever Ready House, 1255 High Rd., Whetstone, London N200EJ, England. 01 446-1313.
Circle No. 472
- Exide Power Systems, Rising Sun & Adams Ave., Philadelphia, PA 19120. (215) 342-8000.
Circle No. 473
- Fuji Electrochemical Co. Ltd., Hamagomu Bldg 5-36-11 Shinbashi, Minato-ku Tokyo, Japan (03) 434-1271.
Circle No. 474
- Garrett Mfg. Ltd., 255 Attwell Dr., Rexdale, Ont., Canada M9W5B8. (416) 677-1410.
Circle No. 475
- Gates Energy Products Inc., 1050 S. Broadway, Denver, CO 80217. (303) 744-4806.
Circle No. 476
- General Electric Co., Battery Business Div., P.O. Box 861, Gainesville, FL 32602. (904) 377-0326.
Circle No. 477
- Globe-Union Inc., Battery Div., 5757 N. Green Bay Ave., Milwaukee, WI 53201. (414) 228-1200.
Circle No. 478
- Gould Inc., Portable Battery Div., 931 Vandavia St., St. Paul, MN 55114. (612) 645-8531.
Circle No. 479
- A/S Hellelens Ltd., 6 Telefonvej, DK-2860 Scborg, Denmark. 01 563011.
Circle No. 480
- Honeywell Power Sources Center, 104 Rock Rd., Horsham, PA 19044. (215) 674-3800.
Circle No. 481
- ITT Components Group Europe, Av Louise 480, B-1050 Brussels, Belgium. 649 96 20.
Circle No. 482
- Leclanche SA, 48 Ave de Grandson, CH-1400 Yverdon, Switzerland. 024-25-81-21.
Circle No. 483
- J. Lucas Inds. Ltd., Great King St., Birmingham, B192XF, England. 021-554-5252.
Circle No. 484
- Luxtron Inc., 25 Locust St., Haverhill, MA 01830. (617) 372-5211.
Circle No. 485
- Mallory Battery Co., S. Broadway & Sunnyside Ln., Tarrytown, NY 10591. (914) 591-7000.
Circle No. 486
- Marathon Battery Co., 8301 Imperial Dr., Waco, TX 76710. (817) 776-0650.
Circle No. 487
- Mauratron Inc., 1115 S. Broadway, Carrollton, TX 75006. (214) 242-0512.
Circle No. 488
- Mouser Corp., 11511 Woodside Ave., Lakeside, CA 92040. (714) 449-2220.
Circle No. 489
- MXE Engineering, Vondellaan 75, P.O. Box 116, Harderwijk, Holland. 03410-12486.
Circle No. 490
- Nife Inc., 21 Dixon Ave., Copiague, NY 11726. (516) 842-5240.
Circle No. 491
- Panasonic, Matsushita Industries Div., OEM Battery Dept., One Panasonic Way, Secaucus, NJ 07094. (201) 348-7000.
Circle No. 492
- Pathcom Inc., Pace Two-Way Radio Products, 24049 S. Frampton, Harbor City, CA 90710. (213) 325-1290.
Circle No. 493
- Plainview Electronics Corp., 8 Manetto Hill Rd., Plainview, NY 11803. (516) 822-5357.
Circle No. 494
- Power Conversion Inc., 70 MacQuesten Pkwy S., Mount Vernon, NY 10550. (914) 699-7333.
Circle No. 495
- Power Inc., 12809 Eagle Ridge Dr., Burnsville, MN 55337. (612) 890-1360.
Circle No. 496
- Power-Sonic Corp., P.O. Box 5246, 3106 Spring St., Redwood City, CA 94063. (415) 364-5001.
Circle No. 497
- Racal Communications Inc., 5 Research Pl., Rockville, MD 20850. (301) 948-4420.
Circle No. 498
- Ray-O-Vac Div., ESB Inc., 101 E. Washington Ave., Madison, WI 53703. (608) 252-7400.
Circle No. 499
- Recco Inc., P.O. Box 7065, Orlando, FL 32804. (305) 843-8484.
Circle No. 500
- Saft UK Ltd., Castle Works Station Rd., Hampton Middlesex, England. 01979-7755.
Circle No. 501
- Sanyo Electric Inc., Battery Div., 51 Joseph St., Moonachie, NJ 07074. (201) 641-2333.
Circle No. 502
- Seatech Corp., 985 NW 95 St., Miami, FL 33150. (305) 693-1431.
Circle No. 503
- SGL Inds., SGL Batteries Mfg. Co., 14650 Dequindre, Detroit, MI 48212. (313) 868-6410.
Circle No. 504
- Shigoto Industries Ltd., 350 Fifth Ave., New York, NY 10001. (212) 695-0200.
Circle No. 505
- Sparton Corp., Sparton Electronics, 2400 E. Ganson St., Jackson, MI 49202. (517) 784-9131.
Circle No. 506
- Stored Energy Systems, 2271 Mora Dr., Mountain View, CA 94040. (415) 961-7500.
Circle No. 507
- Sturdee Systems, 260 MacLaren St., Lake Bluff, IL 60044. (312) 234-5037.
Circle No. 508
- Tadiran Israel Electronics Inds. Ltd., 3 Derech Hashalom, P.O. Box 648, Tel Aviv 61000, Israel. 972-326-7272.
Circle No. 509
- Tauber-Dreyer Corp., 17074 Dearborn St., Northridge, CA 91325. (213) 993-0048.
Circle No. 510
- Teledyne Big Beam, 290 E. Prairie St., Crystal Lake, IL 60014. (815) 459-6100.
Circle No. 511
- Terado Corp., 1068 Raymond Ave., St. Paul, MN 55108. (612) 646-2868.
Circle No. 512
- Ultra Electronics Components Ltd., Fassetts Rd., Loudwater, Bucks, England. 0494 26233.
Circle No. 513
- Union Carbide Corp., Battery Products Div., 270 Park Ave., New York, NY 10017. (212) 551-3763.
Circle No. 514
- Varta Batteries Inc., Cross Westchester Exec Pk., 85 Exec. Blvd., Elmsford, NY 10523. (914) 592-2500.
Circle No. 515
- Weingart Inc., DBA, Fort Wayne Electrical Center, 1800 Broadway, Fort Wayne, IN 46804. (219) 743-0689.
Circle No. 516
- Westinghouse Electric Corp., KW Battery Co., 3555 W. Howard St., Skokie, IL 60067. (312) 297-8210.
Circle No. 517
- Whittaker Corp., 10880 Wilshire Blvd., Los Angeles, CA 90024. (213) 475-9411.
Circle No. 518
- Yardney Electric Div., 82 Mechanic St., Pawcatuck, CT 02891. (203) 599-1100.
Circle No. 519
- Yuasa Battery Co. Ltd., No. 12-11 2-chome Higashi-Shinbashi, Minato-ku, Tokyo 105, Japan. 03-437-2411.
Circle No. 520
- Zygo Inds. Inc., P.O. Box 1008, Portland, OR 97207. (503) 292-4695.
Circle No. 521

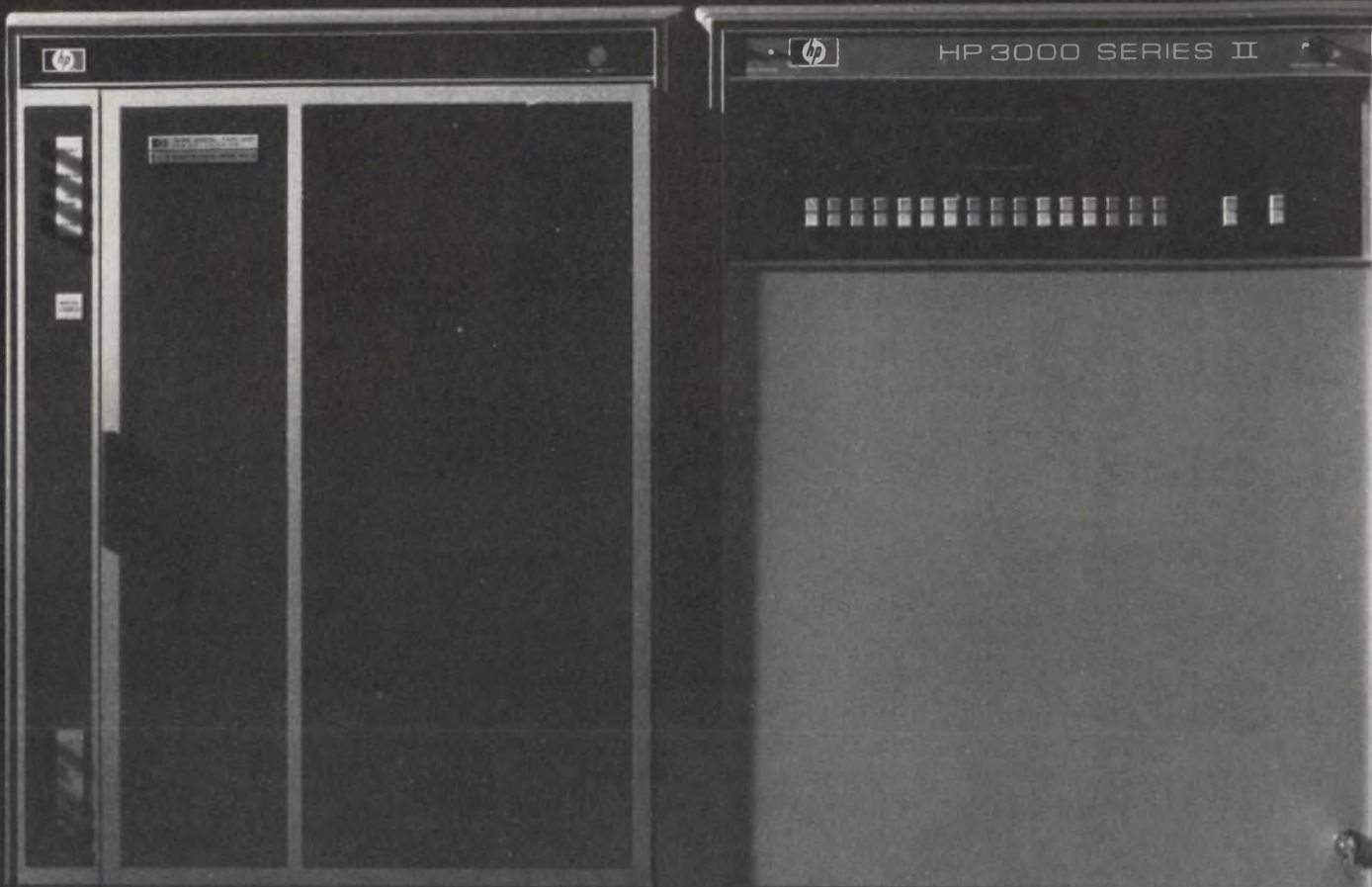

WHEN HEWLETT-PACKARD WANTED TO PROTECT THEIR MEMORIES, THEY REMEMBERED US.

When a computer loses power, its volatile memory goes blank. Plain, simple, and costly.

It doesn't have to happen.

Because Gates Energy cells and batteries provide dependable standby power. They furnish the energy when the local power company can't.

That's why more and more major computer manufacturers are making Gates an integral part of their products.

Our energy cells have outstanding capability for float



charging. So, they're always at peak power for emergency situations.

And, for portable instrumentation, Gates Energy cells offer safe, reliable sealed lead-acid construction and extended discharge service.

Learn more about Gates Energy. Send for our comprehensive information packet full of design data, spec sheets and application notes. Circle our Reader

Service Number, or write us directly.

Gates Energy Products, Inc., 1050 South Broadway, Denver, CO 80217. Phone (303) 744-4806.

GATES ENERGY

CIRCLE NUMBER 29

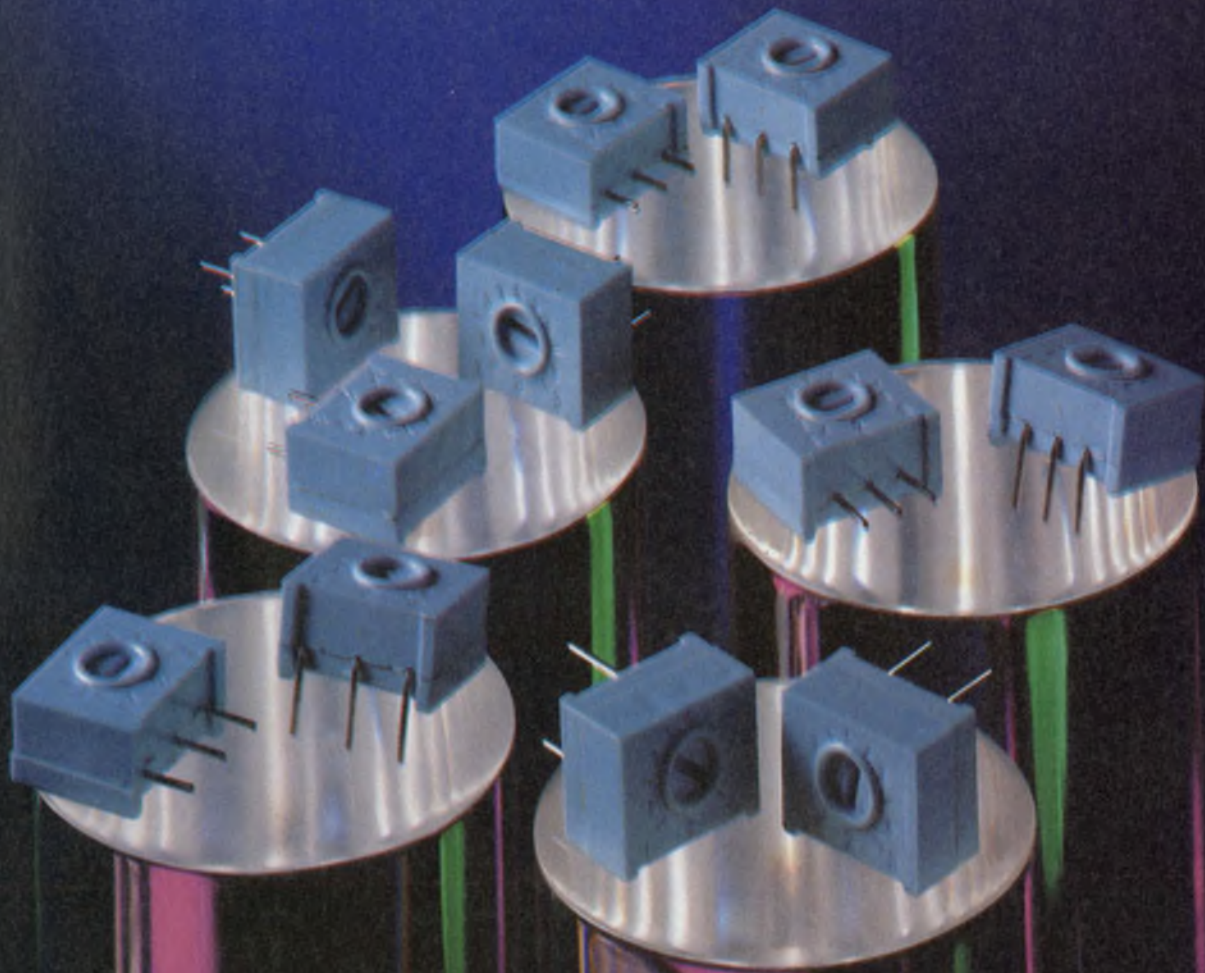

Go the full 360 with CTS...

Series 360 single turn cermet trimmers. You couldn't travel in better trimmer circles than CTS. With the CTS Series 360 family, 1 of the 11 pin styles is sure to satisfy your trimmer needs. And that's especially true if you're designing for digital voltmeter-ammeter-ohmmeter applications, TWX equipment, sweep generators, oscilloscopes, aircraft radio and navigation equipment, computer peripheral equipment, automotive braking equipment, calculators, engine and emission control analyzers or fire detection equipment. Plus our latest application, the speaker phone.

How's that for a full circle of satisfied needs!

You get all-around performance from the CTS 360 cermet trimmers. Eleven popular grid spacings in-

cluding top and side adjust on .100", .125", .150" and T0-5 centers. Power rating 1 watt @ 25°C, ½ watt @ 85°C. Standard TC ± 150 ppm/°C throughout the resistance range. Settability .03%. New gold plated multicontact wiper for lowest possible noise level. Mini dimensions: .360" x .434" x .298".

The price of each 360 style is low; your CTS distributor's inventory is high—call him today; get it promptly.

For nonstandards—and for complete information—write directly to the company that has put millions into electronics for industry. **CTS of West Liberty, Inc., 6800 County Road 189, P.O. Box 266, West Liberty, Ohio 43357. Phone (513) 465-3030.**

CTS CORPORATION
ELKHART, INDIANA



A world leader in cermet and variable resistor technology

Pick the right dc/dc converter for your switch-mode power supply. Different circuit types determine the characteristics of the magnetic components you need.

When you're designing switched-mode power supplies, pick the dc/dc converter type first. The type you pick largely determines the magnetic-component characteristics you'll need.

From the magnetics viewpoint, dc/dc converters fall into three categories:

- Flyback.
- Forward.
- Push-pull.

Both flyback and the forward converters store energy in an inductor, and only while their switches are conducting. But a flyback, or "parallel," converter's load is in parallel with the inductor, so its stored energy passes to the load during the off (flyback) period. On the other hand, a forward, or "series," converter's inductor is in series with the load, so its energy goes into load and inductor simultaneously during the on-period as well as into the load from the inductor during the off-period.

Flyback—it's simple

When a flyback converter's switch (S) conducts, it impresses the input voltage across the inductor (Fig. 1a). This voltage cuts off the output diode. Inductor current rises linearly, storing energy, until the switch opens. Then the inductor voltage reverses, and its stored energy goes into the output capacitor and the load. Varying the transistor-switch's conducting time, while holding the switching frequency constant, controls the amount of energy stored in the inductor.

Note that in a flyback converter, the inductor stores all the energy that ultimately goes to the output capacitor and load. So, by adding a second winding to the inductor, you can easily isolate the supply from the line. Fig. 1b shows a circuit, based on Fig. 1a, that uses a two-winding inductor.

Flyback converters offer another advantage: The output circuit doesn't need smoothing by a filter choke. This is an important advantage in both high-voltage and multiple-output supplies.

Flyback converters also have two drawbacks, high output ripple and the need for large-core inductors.

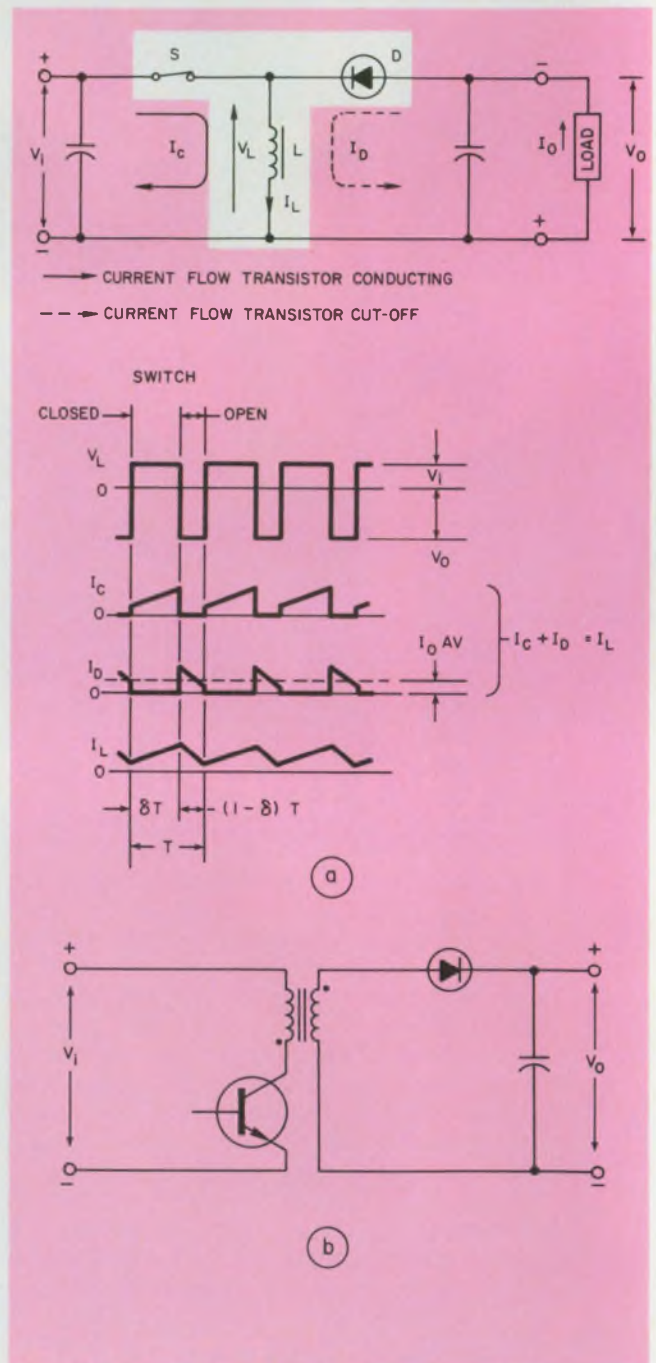

1. Flyback converters are simple but prone to ripple. The energy stored in the inductor (a) passes to the output when the power-transistor switch stops conducting. Actual circuits (b) often use a two-winding inductor.

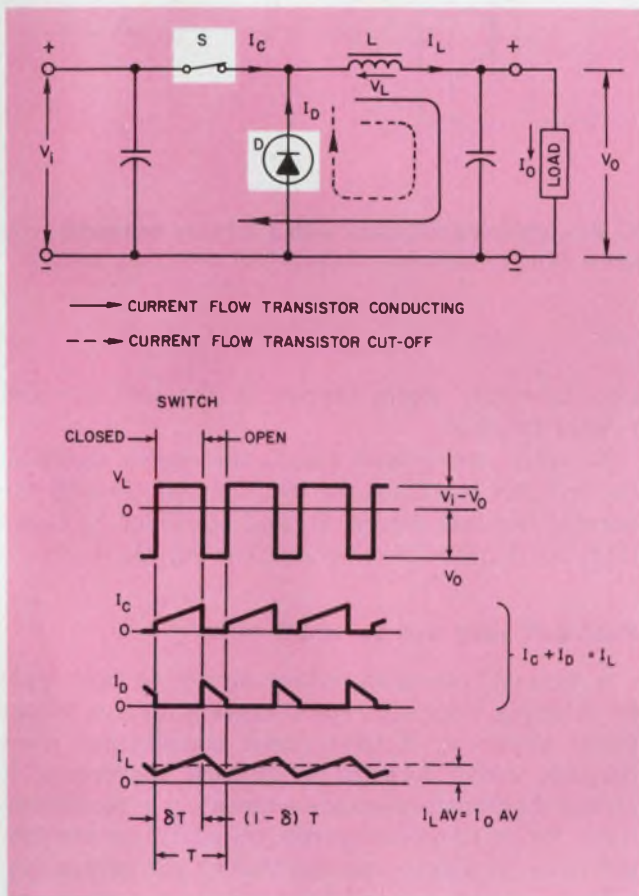

2. Forward converters suppress output-voltage ripple by delivering current to the output with the switch either closed or open. When the switch opens, the "flywheel" diode keeps inductor current flowing to the output.

In fact, because its output capacitor charges only with the transistor off, you get the highest output ripples in a flyback converter. And because it drives its inductor in only one direction, you need the largest cores in a flyback converter.

As with a flyback converter, you can control a forward converter's inductor energy, and so its output voltage, by varying the on/off times.

Fig. 2 shows the basic scheme and associated voltage and current waveforms of a forward converter. When the switch conducts, the inductor current rises linearly and flows into the capacitor and load. During this on-cycle, energy both transfers to the output and stores

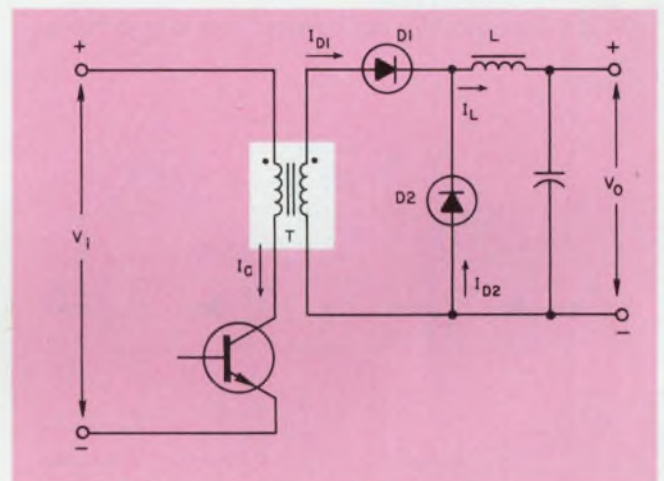

3. Line isolation is a problem with a forward converter. The solution, a transformer, adds cost and weight.

in the inductor. When the switch opens, the inductor energy keeps current flowing into the load by means of the flywheel diode.

But to be practical, forward converters should include a transformer for line isolation, as in Fig. 3. This addition, while improving a forward converter's performance, does add to its cost and weight.

Forward to low ripple

The forward converters, however, do have a major plus: low output-voltage ripple. A forward converter's inductor hinders high-frequency ripple current from going into the smoothing capacitor better than the inductor in a flyback converter. This ripple smoothing is important to low-voltage supplies.

Still, forward converters bring mixed blessings. Though you can get multiple outputs by adding secondary windings, each winding takes an additional two diodes, an inductor and a capacitor. But on the positive side, forward converters for most applications need only a single switching power transistor.

Sometimes, a combination of forward and flyback converters works best. Fig. 4 shows a dual-output supply that uses both converter types. Here, some of the inductor's stored energy powers an auxiliary output via a secondary winding. When the transistor

Switched-mode power-supply map

First, a switched-mode supply rectifies and filters its power, input A. Next, it chops, most often at approximately 25 kHz, the resulting dc voltage, B, with a switch, S. The chopped voltage then powers a transformer, C, whose rectified and filtered output is the required dc, D. Take a left turn at D, and go to the control circuit, E, which senses and compares the output to a reference. As the output tends to deviate from the required voltage, the control circuit adjusts the drive-circuit output, F. This, in turn, varies the switch's on-to-off time.

A system like this can operate from ac or dc input.

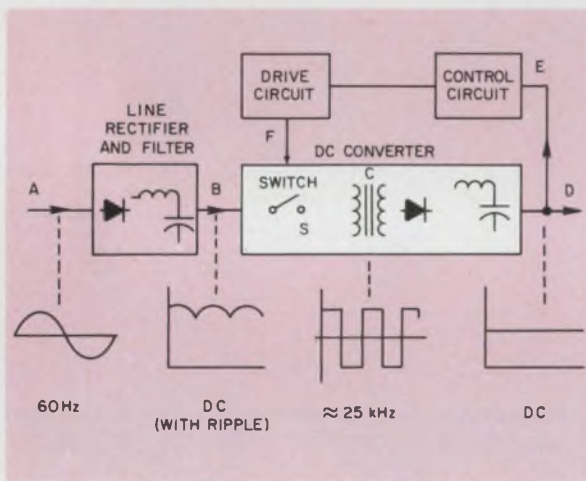

stops conducting, the output voltage V_{01} is the same as the voltage across inductor L. So, when you stabilize V_{01} , you automatically stabilize V_{02} .

Clearly, the inductor can store only limited energy. Therefore, the circuit is only practical for a constant-load second output of up to 30% of the main output.

The transformer in Fig. 4 has a third winding, plus a series diode, for demagnetizing the core. While the transistor conducts, the magnetizing current increases linearly to a final value. When the transistor turns off, the third winding and its diode transfer the magnetizing energy back to the dc supply. This demagnetizing winding should be tightly coupled (bifilar) with the primary winding to avoid voltage spikes when the transistor switches. The demagnetizing winding and diode limit the transistor's collector-to-emitter voltage to twice the dc input.

There's another converter, which you can think of as a combination of two forward converters, phased 180° apart. It's called a push-pull converter, and it offers low output-voltage ripple, and good regulation while using small cores.

Look at Fig. 5. With switch S_1 closed and S_2 open, as in Fig. 5a, diode D_2 conducts. This diode current

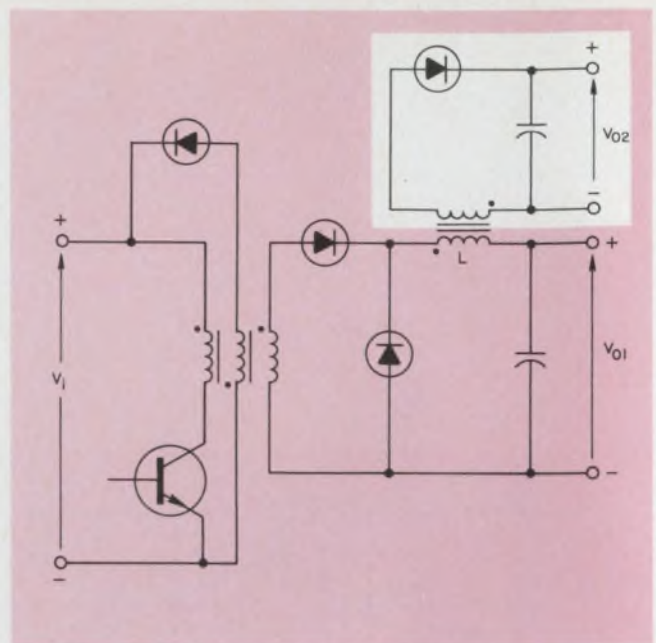

4. By combining a flyback with a forward converter, you get a simple regulated, dual-output switching supply.

simultaneously stores energy in the inductor and powers the load.

When S_1 opens, as in Fig. 5, the energy stored in the inductor continues the load current through the parallel flywheel diodes, D_1 and D_2 . When S_2 closes (Fig. 5c), D_1 continues conducting but D_2 stops.

Push-pull your way to small cores

A push-pull converter reduces output-voltage ripple by doubling ripple-current frequency to the output filter. Moreover, it uses small transformer cores because, unlike forward or flyback converters, it excites the transformer core alternately in both directions. But push-pull converter transformers are subject to dc imbalance that can lead to core saturation.

You can get multiple outputs from a push-pull converter by adding secondary windings or by using the energy stored in the output choke, as in the forward converter of Fig. 4. But with added secondaries, each winding needs its own output diodes, inductor and smoothing capacitor.

Each basic converter design leads to several possible circuits. Flyback and forward converters can accommodate both one and two-transistor designs.

Your power transistor's collector-to-emitter voltage and collector-current capabilities often determine the actual flyback or forward-converter you can use.

In push-pull converters, you can connect the transformer primary in several ways, the most popular of which are shown in Fig. 6. Depending on how you drive the transformer, you get a single-ended (a), push-pull (b) or full-wave bridge (c) circuit. Here again, transistor capabilities determine the circuit details.

(continued on page 108)

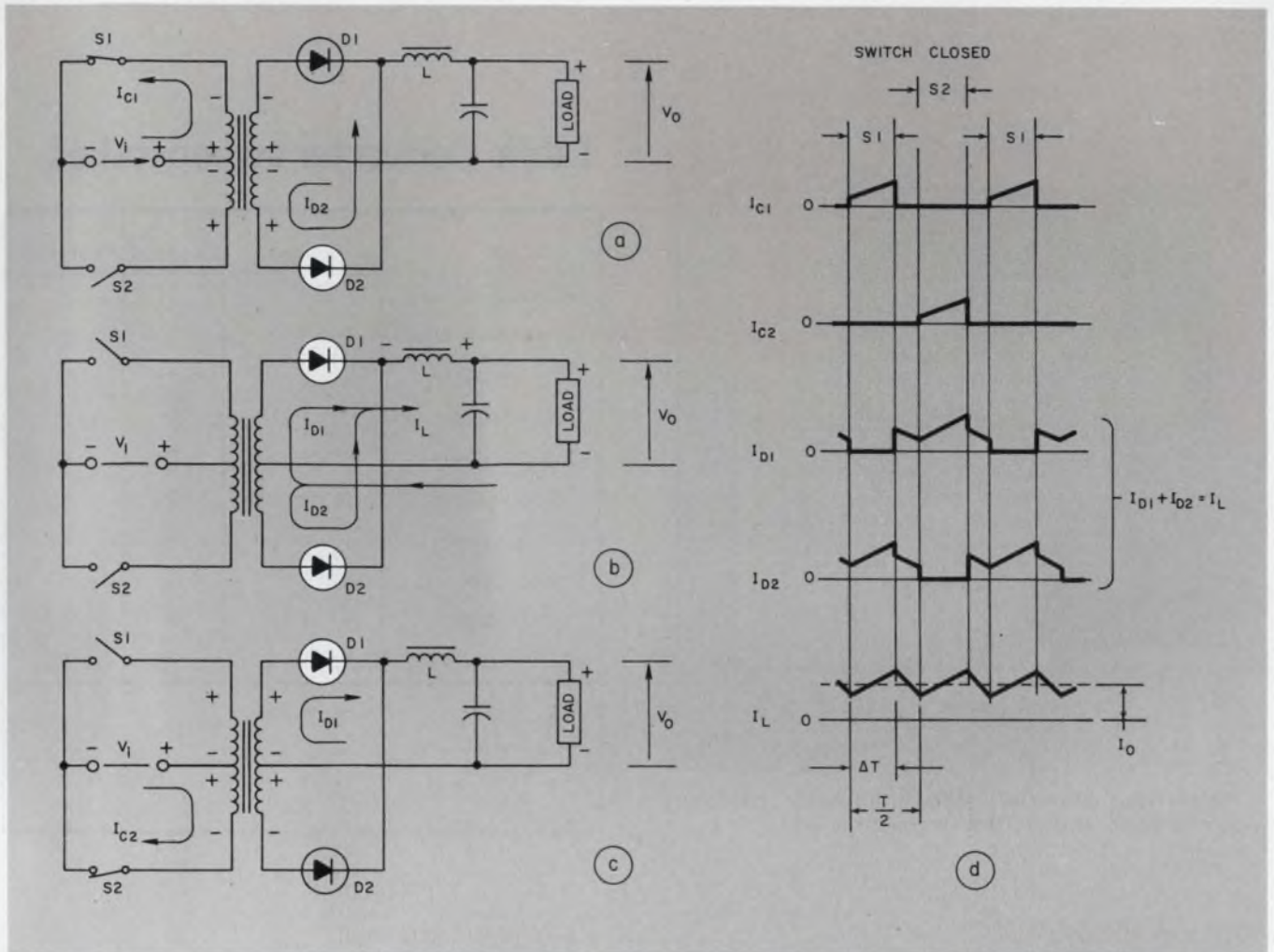

5. Push-pull converters use parallel "flywheel" diodes, D_1 and D_2 . When S_1 closes (a), D_2 conducts. When S_1 opens

(b), both diodes conduct. When S_2 closes (c), D_1 conducts, and the transformer is used efficiently (d).

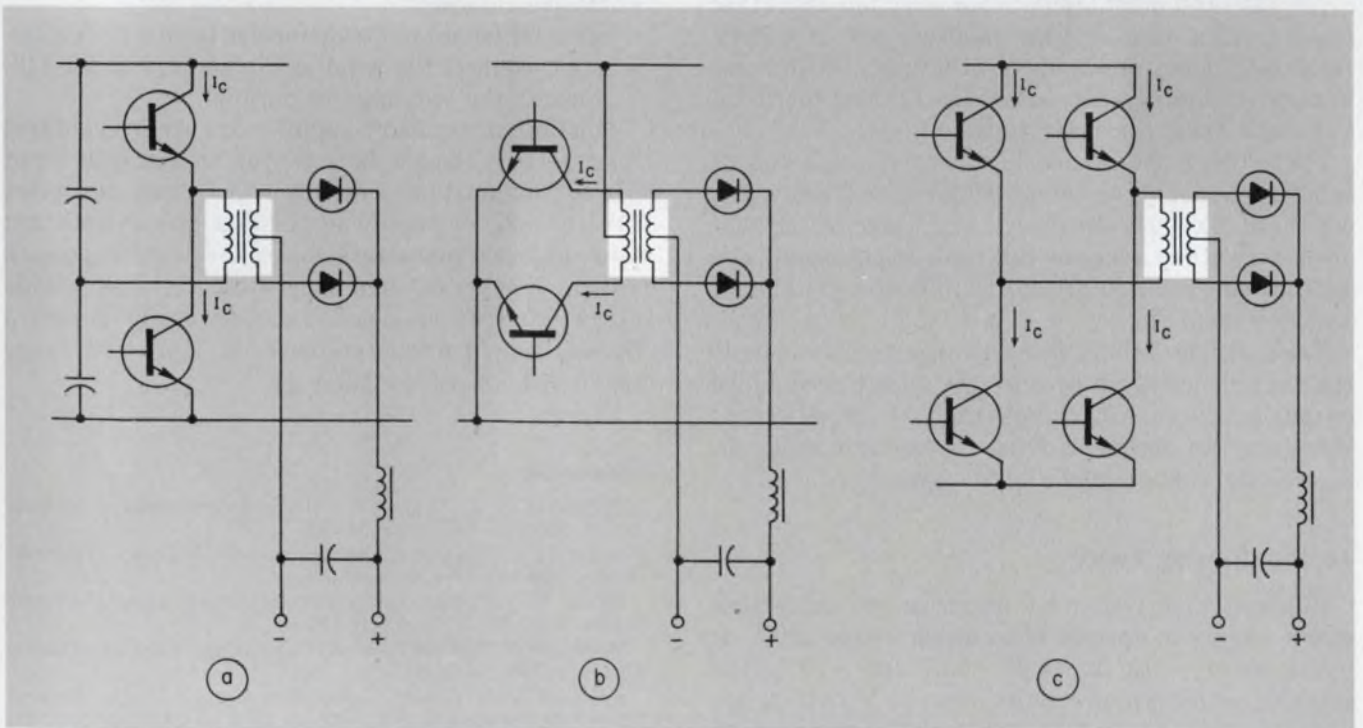

6. Push-pull converter transformers can be single-ended (a), push-pull (b) and full-wave-bridge (c).

Table. Converter sweepstakes

	Flyback	Forward	Push-Pull
Circuit simplicity	+	0	-
Component count	+	0	-
Drive circuitry	+	+	-
Output ripple	-	0	+
Choke volume	-	0	+
X fmr volume	Not Required	0	+
Line isolation	+	-	+
Power level	-	0	+
Voltage level	+	0	0
Multiple outputs	+	0	0

+ Favorable
0 Average
- Unfavorable

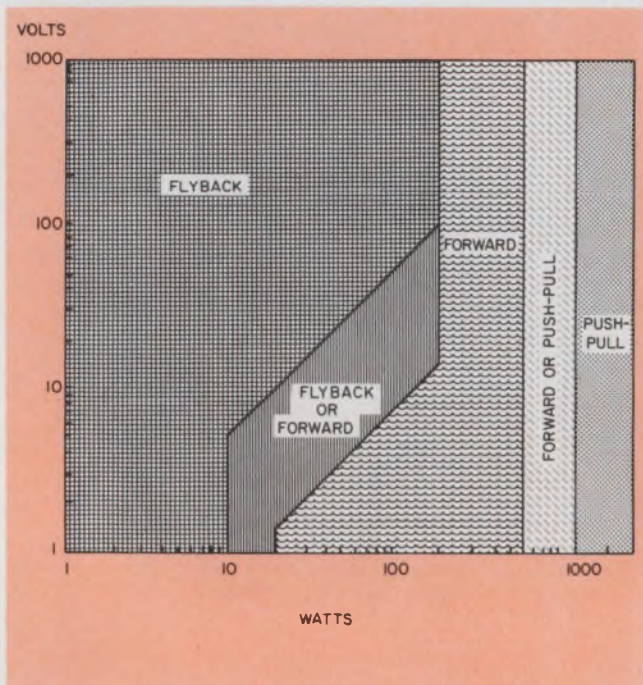

7. **Select your converter**—flyback, forward or push-pull —by the power and voltage it must deliver.

(continued from page 106)

To select the converter for your switching supply, start by looking at the rough guide in Fig. 7. Here, converters are typed by their two most distinguishing performance differences—output voltage and power capability. You must temper your selection with other requirements such as line isolation, output-voltage ripple, efficiency and number of outputs. With these in mind, the table summarizes the relative merits of the three basic converter types.

For a high-performance, high-power, single-output supply, whose output-voltage ripple is well below 1%, push-pull is clearly the choice. For lower-power supplies, forward converters can replace push-pull. For high voltage, flybacks are most suitable, so you should consider them first.

For multiple outputs, flyback converters are usually the first choice again because they don't need added output inductors. You can get each additional output by adding an output winding to the main inductor, as well as a single diode and a capacitor.

To the drawing board

Suppose that you must design a switched-mode power supply to operate from either 110 or 220-V dc input power, with limits of +15% and -20%. The supply's output requirements are +24 V at 10 A (for a total of 240 W). You'll need an auxiliary supply to provide ± 5 V and +16 V outputs at approximately

a 5-W continuous total.

The main-supply requirements of 24 V and 240 W suggest a forward converter (Fig. 7). At a 240-W output level, a forward converter performs as well as a push-pull converter but it is simpler and uses less-expensive circuitry.

Use a bifilar-wound transformer primary. For 220-V input, connect the windings in series and for 110-V, connect the windings in parallel.

Most often, auxiliary supplies are series-regulated linears. Here, though, because you have only dc input power, you must use a switcher. A flyback converter fills the bill for supplying this low-power, constant load. Flyback converters make the least expensive switching supplies—and they work well over a wide range of input voltages. You can easily design a flyback supply to operate over the full input range required here—88 to 253 V.■

Bibliography

- Distefano, M. I., "Adjust Ferrite-Core Constants," *Electronic Design*, Nov. 22, 1977, pp. 154-156.
- Gross, T. B., "Multilayer Coil Design is Made Easy," *Electronic Design*, Mar. 15, 1978, pp. 102-106.
- Manka, W. V., "Design Power Inductors Step by Step," *Electronic Design*, Dec. 20, 1977, pp. 148-154.
- Martin, W. A., "Simplify Air-gap Calculating," *Electronic Design*, April 12, 1978, pp. 94-96.
- Switched Mode Power Supply Transformer Design Manual*, Ferroxcube, Saugerties, NY, May 15, 1978. **CIRCLE NO. 319**
- van der Poel, J. M., "Improve Inductor Design Accuracy," *Electronic Design*, Feb. 2, 1976, pp. 58-62.

UNITRODE JUST CUT YOUR POWER TRANSISTOR COSTS IN HALF.

Introducing Unitrode's new transistors and Darlington's for pulse power applications. Rated up to 5A peak and up to 500 V. And priced as low as 18¢—in quantities of 25,000—half the cost of the competition.

But what you pay is just the beginning of what you save. Because we make our new transistors and Darlington's in TO-92 packages, they take up a lot less space on your circuit board. And because we can deliver them taped and reeled, you can use them with your automated insertion equipment.

It's time you heard the specs.

For our HV transistors: UPTA510-530,
1A peak to 300V; UPTB520-550,
.5A peak to 500V.

For the Darlington's:
U2TA506-510, 5A peak
to 100V.

The low cost, the current ratings and the convenient packaging make Unitrode's new power transistors and Darlington's perfect for high volume manufacturing applications such as: power supplies, hammer drivers, thermal printers, lamp drivers, relay replacements and chargers.

Best of all, Unitrode's new series are available right now, in the quantities you need.

The Unitrode TO-92 power transistors and Darlington's.

They save you money now and they'll save you money later.

For more information, call or write: Unitrode Corporation, 580 Pleasant Street, Watertown, MA 02172. 617-926-0404.



UNITRODE

IN SEMICONDUCTORS, UNITRODE MEANS POWER.



New Developments from Systems...

The SEL 32/30



Until now, you've either had to forego 16-bit pricing to get 32-bit performance, or you've had to give up 32-bit performance just to keep the budget in line.

No longer. Now you can invest in a full-blown 32-bit computer and pay no more than you would for a 16-bit computer. And not have to worry about insufficient power for future needs.

The SEL 32/30 is the smallest of the SYSTEMS hierarchy

of 32-bit computers. But don't let its small size fool you. This Maxibox is big in performance and throughput, ideally suited for scientific or process control applications such as telemetry, simulation, industrial or laboratory automation. And it costs you no more than a 16-bit computer.

The SEL 32/30 is value-engineered for the OEM. It is a single chassis, fully integrated system that is upward compatible with the entire SEL family of 32-bit computers. So even if you start with a minimal investment,

it will continue to pay off as your customers' applications expand.

If power and performance is what you need, and budget is a definite consideration, talk to us. We'll make sure that when you invest in a SEL 32/30 Maxibox, more dollars will flow to your bottom line.

Call us. We're easy to talk to (305) 587-2900
6901 West Sunrise Boulevard
Ft. Lauderdale, Florida 33313.

MOS Maxibox.

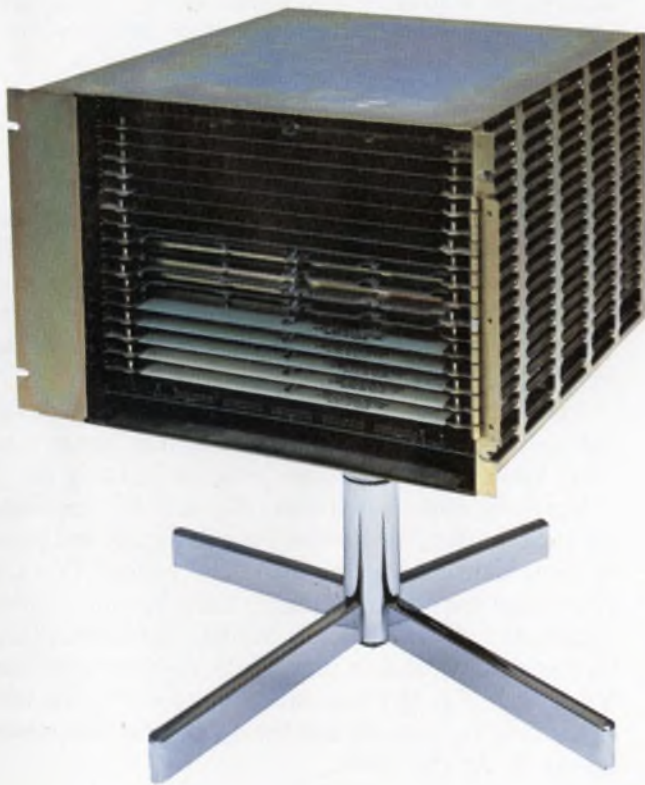

SYSTEMS
ENGINEERING LABORATORIES

Protect your rechargeable battery.

Put hysteresis into the discharge-sensing circuit so that the load stays removed—even as battery-voltage rebounds.

Don't let a battery of rechargeable nickel-cadmium cells discharge too fast or you'll run the risk of reverse-charging some of the cells. Should even one cell reverse-charge, normal recharging won't restore the battery to its rated capacity. Not only that, but you can expect to vent gas through the seals or even do permanent damage to the cells.

To protect your battery, particularly if it's in a portable instrument, use a load remover that discharges the battery continuously but slowly, after it disconnects the load.

At first glance, you might expect to solve the problem with just a simple load-remover circuit. But most load cutouts let the battery discharge only partially and then remove its load completely. And cutting off all current in a partially-discharged nickel-cadmium unit leads to yet another source of degraded performance, "memory effect." Then your battery loses energy-storage capacity—permanently.

With just the slightly more complex circuit, you get discharge protection while lessening "memory effect." For slightly more money, you prolong the battery's useful life and can easily monitor its state of charge.

The problem with simplicity

One commonly-used load-cutout circuit (Fig. 1) simply compares the battery voltage (V_b) to a fixed reference (V_r) and disconnects the load when the battery voltage becomes too low. But this straightforward approach runs straight into trouble when cell voltages "rebound" (output voltages rise upon load removal). Then you get a slow oscillation of the output, caused by the control circuit. This oscillation is similar to chattering in relays and hunting in servos. The frequency and duration of this oscillation varies with the battery-charge state and can cause unacceptable on/off load cycling. Clearly, then, hysteresis (direction dependence of the voltage-detection level) is needed to prevent load reconnection due to the temporarily

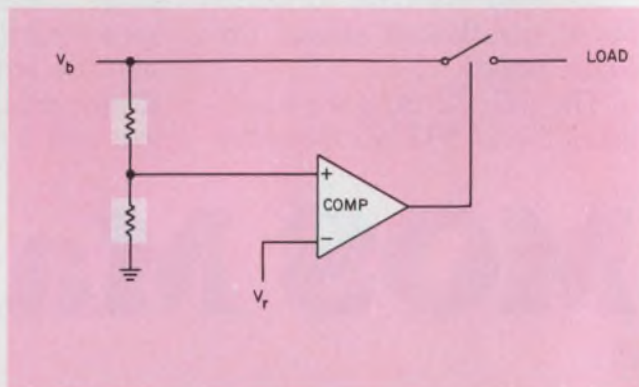

1. Popular load-cutoff circuits compare the battery voltage (V_b) to a fixed reference voltage (V_r). The load is disconnected when the battery voltage gets too low.

higher "rebound" voltage level.

The circuit in Fig. 2 provides the necessary continuous discharging as well as needed hysteresis. The hysteresis is generated independently of the comparator and battery characteristics. The required hysteresis is produced by the simple resistive voltage divider composed of R_4 , R_5 , and R_7 .

Another resistor combination, R_2 and R_3 , divides the voltage from the basic reference source, zener diode CR_1 . You set the reference level by varying R_2 .

Normally, the switch poles S_{1A} and S_{1B} are closed while S_{1C} is open, the battery isn't charging, and power is being delivered to the load. The voltage (V_1) that represents the output is higher than V_r and so forces comparator A low. The low comparator output turns on transistor Q_1 and, in turn, Q_2 . So the output voltage, V_4 , is V_b minus Q_2 's saturation voltage, V_{ces} . In most cases, this V_{ces} is much less than V_b , so for the present ignore it. At this point,

$$V_1 \approx \left[\frac{R_7}{\frac{R_4 R_6}{R_4 + R_6} + R_7} \right] V_b$$

As the battery discharges, V_b drops. Eventually, then, V_1 gets to equal V_r and A goes high. The high comparator output turns off Q_1 and Q_2 . This makes

Steven D. Swift, Design Engineer, and David A. Gunderson, Design Engineer, John Fluke Manufacturing, Mountlake Terrace, WA 98043.

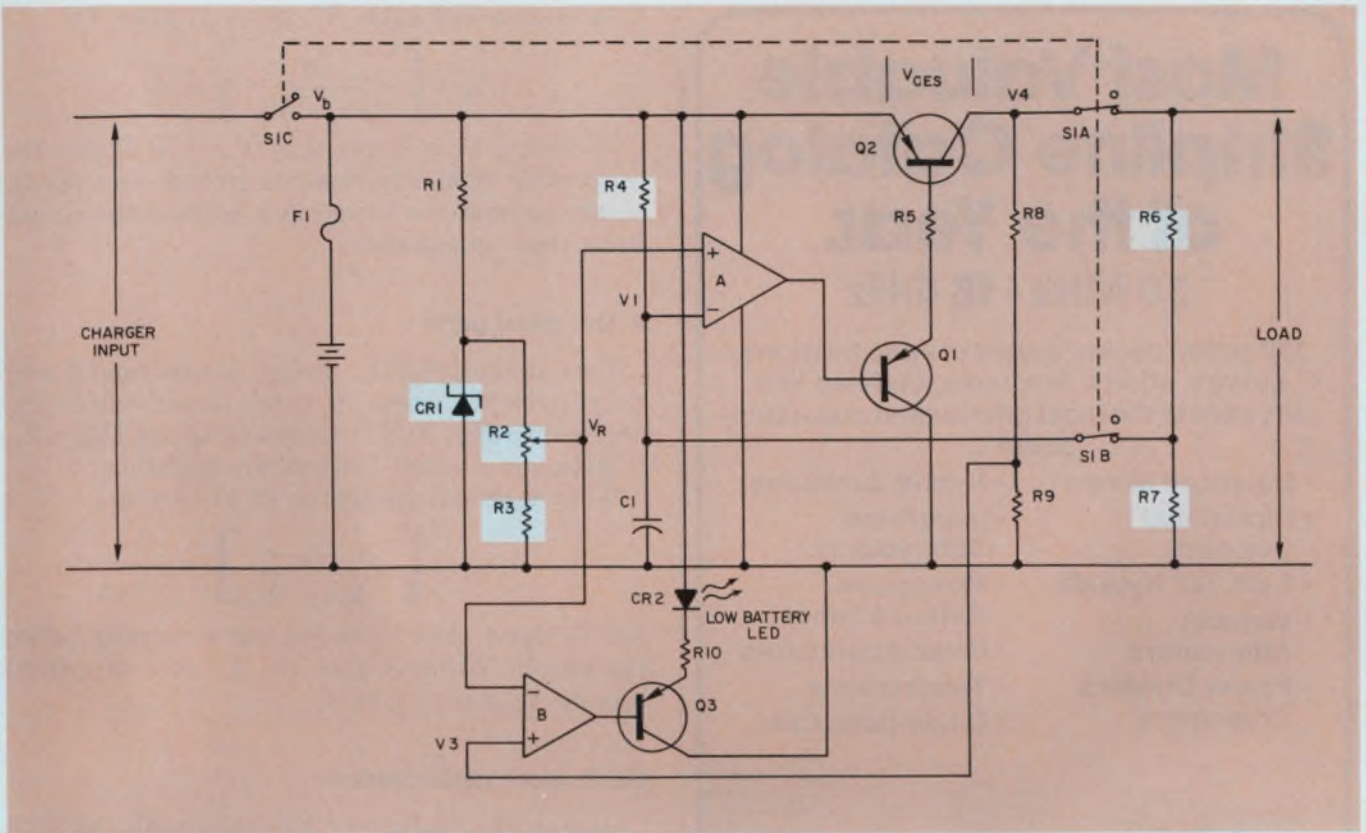

2. Putting hysteresis into the load remover protects the battery from being reconnected due to rebounding when

the load is removed. Cutting R₆ into or out of the divider provides the needed hysteresis in the circuit.

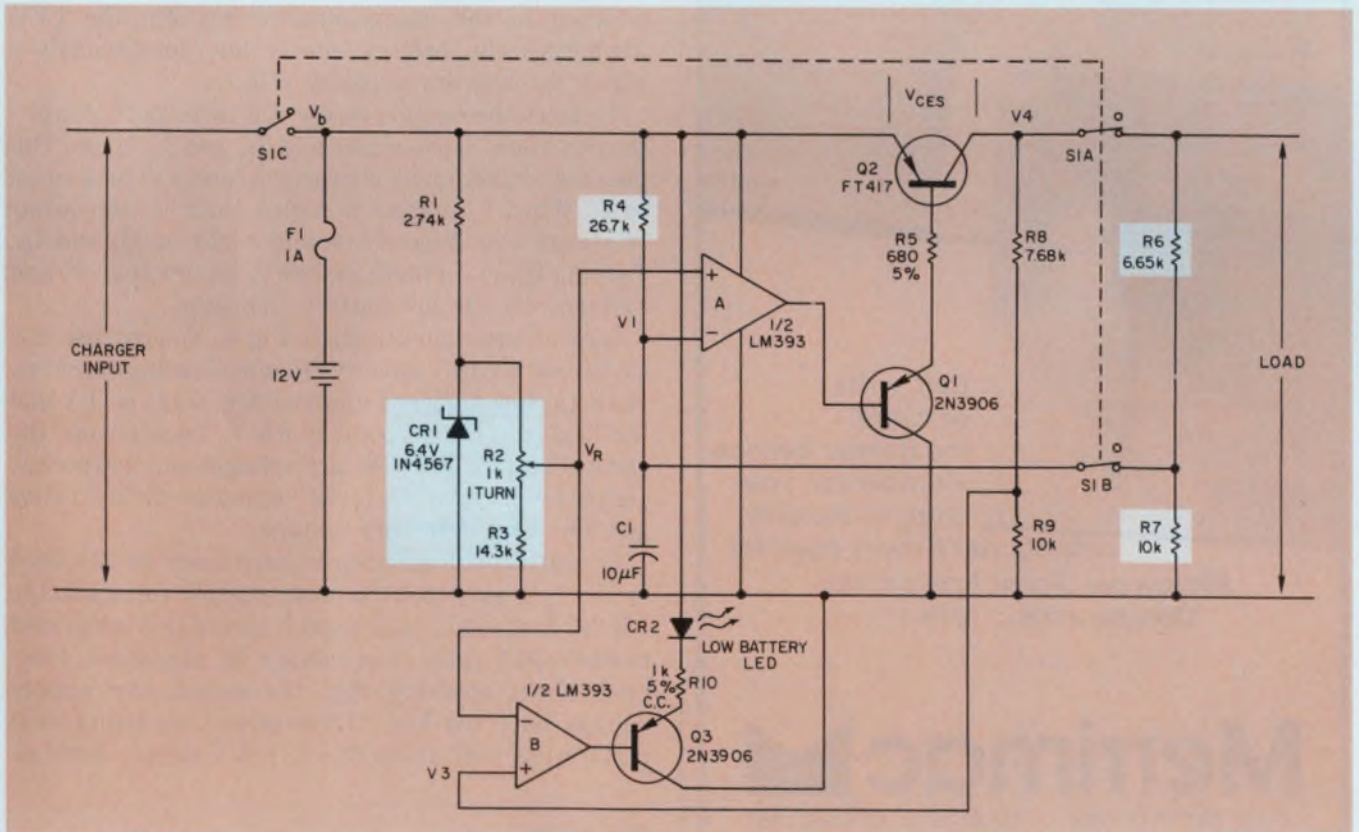

3. This cut-off circuit works with a 12-V nickel-cadmium battery. The low-battery-indication signal trips at 11 V while the load cuts off at 9.5 V. This same circuit can

handle most other battery voltages and trip points—simply change the divider ratios and the zener voltage. After load removal, a low current inhibits memory effect.

Most Valuable Stripline Catalog of the Year.

30 MHz - 18 GHz

128 action packed pages of specifications, curves, charts, diagrams, outlines and answers to the most often asked questions about...

- Balanced Mixers
- Directional Couplers
- 3 dB, 90° Hybrids
- Variable Attenuators
- Power Dividers/Combiners
- Hybrid Junctions
- Integrated Subsystems
- Monopulse Antenna Feeds
- Fixed Attenuators
- Terminations
- Diode Detectors

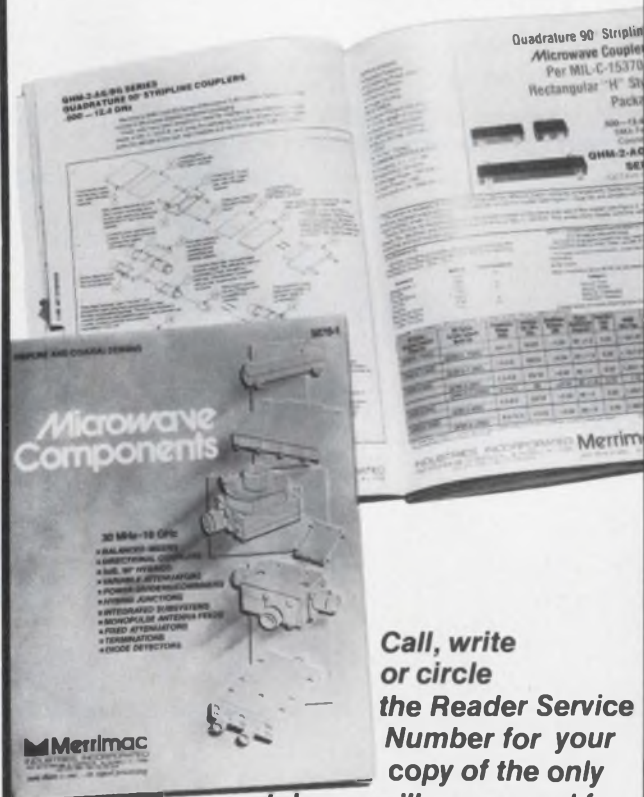

Call, write or circle the Reader Service Number for your copy of the only catalog you'll every need for Microwave Signal Processing Components... M78-1.

Merrimac

now there is one... in signal processing

INDUSTRIES, INCORPORATED

41 FAIRFIELD PL., W. CALDWELL, N. J. 07006 • 201 575-1300 • TWX 710-734-4314

CIRCLE NUMBER 33

V_1 take on a new value V'_1 , which is given by

$$V'_1 = \left[\frac{R_7}{R_4 + R_7} \right] V_b.$$

Obviously, V'_1 is lower than V_1 , so it forces the comparator input even closer to ground. As a result, V_b can increase due to rebound, without the circuit being reset unnecessarily.

A few more parts

The additional resistive divider, consisting of R_8 and R_9 , provides the drive, V_3 , to the second half of the dual comparator, B. With transistor Q_3 and LED CR_2 , B gives you a visual low-battery indication.

When Q_2 is on, divider R_8 , R_9 gives you

$$V_3 = \left[\frac{R_9}{R_8 + R_9} \right] V_4.$$

Set V_3 higher than V_1 so you get a warning before the cut-off. When Q_2 goes off, V_3 goes to ground because V_4 goes to ground.

Much more performance

Once on, the low-battery indicator remains on until the battery voltage falls even lower—to below the comparator operating voltage or below the LED forward drop. LED brightness decreases as the battery discharges but the low-battery indicator works, even with the battery disconnected from the load. In addition to the charge-state indication, the LED discharges the battery slowly but continuously—which thwarts any memory effect.

To reset the circuit, throw the three-pole, double-throw switch, S_1 (S_{1C} closes and S_{1A} and S_{1B} open). This puts the battery under charge and forces V_1 to be equal to V_b . When V_b charges to higher than V_r , the output of comparator A goes low and turns on Q_1 and Q_2 . Turning Q_2 on, in turn, makes V_3 higher than V_1 and so turns off the low-battery indicator.

Look at an actual design, in Fig. 3. You can use this circuit with a 12-V battery (10 nickel-cadmium cells). Here, the low-battery-indication trip point is 11 V and the load-cut-off trip point is 9.5 V. You can use the same circuit for other battery voltages and trip points, simply by changing the resistive voltage-divider ratios and the zener-reference voltage.

For battery voltages much higher than the 12 V used in Fig. 3, be sure that the power-supply voltage to the LM 393 dual comparator doesn't exceed this integrated circuit's 36-V limit. You needn't be concerned, however, about ensuring that the comparator supply voltage isn't too low. Other circuit elements stop performing well above the IC's 2-V supply limit.■

Bibliography

Nickel-cadmium Battery Application Engineering Handbook, Second Edition, General Electric Co., Gainesville, FL. Publication GET-3148A, 1975.

Introducing the King of the Static RAM Family

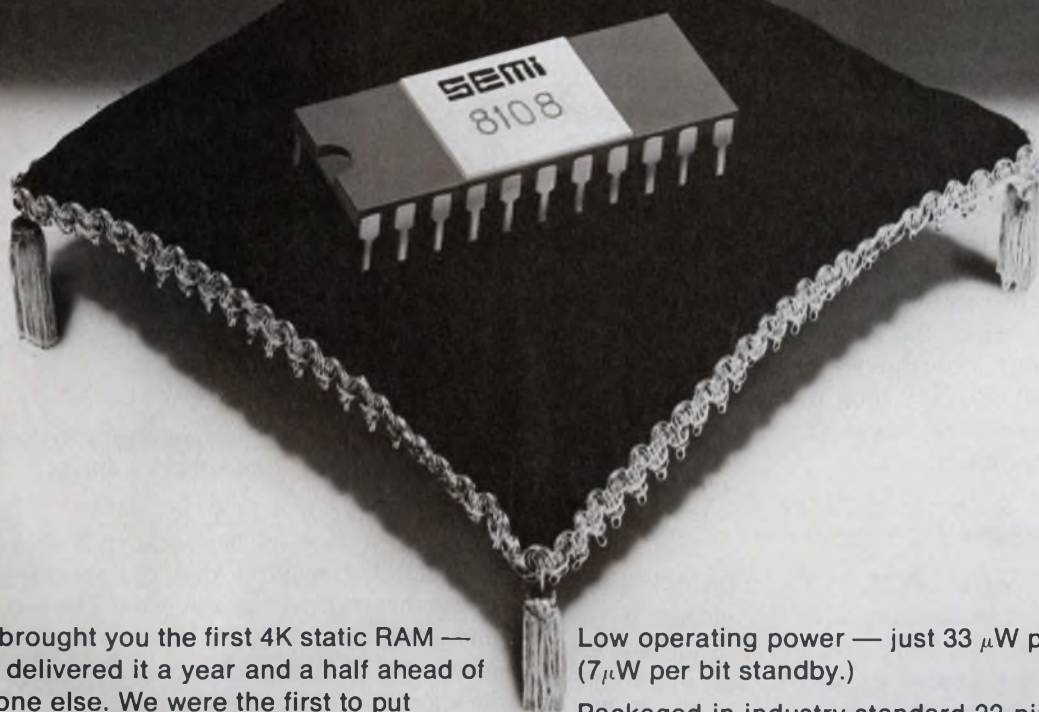

We brought you the first 4K static RAM — and delivered it a year and a half ahead of anyone else. We were the first to put it and its many descendents into volume production.

Now we'd like you to meet the new King of the Static RAMs . . . the 1K x 8, 300 nsec SEMI 8108. Look at his credentials!

A 1K Byte memory system in a single package.

300 nsec access time. The speed you'll need for microprocessor systems.

Low operating power — just 33 μ W per bit. (7 μ W per bit standby.)

Packaged in industry standard 22-pin DIP, for a 30% saving in board space over 18-pin 4K devices.

The new King will soon mount his throne to lead you to new design conquests. Call or write us for advance technical information.

Memory at Work

EMM SEMI, INC.

A subsidiary of Electronic Memories & Magnetics Corp., 3883 N. 28th Ave., Phoenix, Arizona 85107 (602) 263-0202

ALABAMA: Gentry Associates, Huntsville 205/534-9771 • **ARIZONA:** EMM, Phoenix 602/263-0202 • **CALIFORNIA:** EMM, Hawthorne 213/644-9881; EMM, Los Alamitos 213/598-8705; EMM, Burlingame 415/692-4251; Varigon, El Segundo 213/322-1120 • **FLORIDA:** Gentry Assoc., Orlando 305/894-4401 • **GEORGIA:** Gentry Assoc., Atlanta 404/455-1206 • **ILLINOIS:** EMM, Des Plaines 312/297-7090 • **MASSACHUSETTS:** EMM, Lexington 617/861-9650 • **MINNESOTA:** EMM, Hopkins 612/933-7115 • **NEW JERSEY:** EMM, Cherry Hill 609/779-7911 • **NEW YORK:** EMM, Melville 516/423-5800 • **TEXAS:** EMM, Dallas 214/231-2539; Young Sales, Dallas 214/341-2900 • **WASHINGTON:** The Thorson Co., Bellevue 206/455-9180 • **CANADA:** Cantec, Ottawa 613/255-0363

See us at booth 1327 at the NCC Show, Anaheim, CA, June 5-8

CIRCLE NUMBER 34

Develop cooperative μ P subroutines

that exchange information without hogging memory.

The clue: a routine based on register-controlled stacking.

Subroutines often reduce the amount of memory space required for complex microcomputer programs, by dividing a program into nonredundant modules. And passing data, or parameters, from one module to another can be done with a minimum of interaction with each module. To see how parameters can be passed easily and quickly by subroutine, look at several 8080 assembly-language coding techniques used by an output routine that drives a serial printer.

Say a printer-drive program, subroutine PCC, receives a character to be output from the main program in the 8080's C register (Fig. 1). When control is received, the subroutine tests the printer's status register until the printer is ready. Then the C register byte is output. Since the accumulator and flags are modified in this subroutine, the program-status word (PSW) is saved (PUSH), then restored (POP) to the stack. This procedure leaves the calling program's registers unmodified.

Address in register

The output routine, PCM, in Fig. 2 prints a single character stored in memory with the address passed as a parameter. Since the parameter is an address, two registers are needed to pass it, and in an 8080, the HL register-pair is best suited to do it. This subroutine makes use of the PCC routine; it saves the BC register pair on the stack and fetches the character to be printed from memory with HL as an address. Then it puts the byte into the C register and calls PCC.

What you have is a hierarchy of subroutines, each with a single, clearly defined purpose—a call to PCM, which in turn calls PCC, and finally execution returns to the original caller (main program).

Now use subroutines PCC and PCM to print an asterisk (*). Load the character into the C register, then pass control to PCC. The following code sequence will do:

```
MVI C, '*' 2; move literal to reg C
CALL PCC 3; transfer control
Total: 5 bytes
```

If the character resides in memory location 500, use PCM. Pass the address parameter via HL as follows:

```
; PRINT CHAR IN C REG
PCC: PUSH PSW ; SAVE CALLER STATUS
TEST: IN STATUS ; TEST PRTR RDY
ANI 4 ; STATUS BIT
JZ TEST ; BUSY, TRY AGAIN
MOV A,C ; A ← C
OUT DEVICE ; OUTPUT CHAR FROM A
POP PSW ; RESTORE CALLER STATUS
RET → ; RETURN TO CALLER
```

1. The character in register C is printed as soon as the status bit indicates that the printer is free.

```
LXI H,500 3; load address to Reg HL
CALL PCM 3; transfer control
6 bytes
```

The first method uses one byte less of program memory, but requires that the parameter character be an integral part of the code. The second requires one extra byte of code, but allows you to pass the address of a variable character stored in any memory location.

But for a more sophisticated way to pass the character to be printed—and one that takes less main program space—check the PCML routine in Fig. 3. This program simply adds another level to the hierarchy. The calling sequence to this subroutine can be as follows:

```
CALL PCML 3; invoke PCML
DB '*' 1; define literal byte
(not an instruction)
4 bytes
```

Visualize the memory layout that contains the calling sequence and subsequent instructions. Assume the CALL instruction to be in location 40.

Instruction:	CALL	PCML	*	next
Memory Contents:	CD	XX	XX	2A XX
Location:	40	41	42	43 44

After the CALL instruction is executed in locations 40-42, the program counter is pushed onto the stack. The value pushed is the address of the next byte after CALL: location 43, which contains the asterisk character to be printed. So when PCML is entered, the top of the stack contains address 43, a pointer to the

```
; PRINT CHAR IN MEMORY AT (H,L)
```

```
PCM:  PUSH B      ; SAVE B-C PAIR

      MOV  C,M     ; CHAR MOVED TO REG C
                        FROM LOC = H,L

      CALL PCC     ; USE PCC TO PRINT

      POP  B      ; RESTORE 8-C PAIR
                        AND SAVE

      RET
```

Note: M must be coded to use H,L as the address.

2. Add another level with a module that fetches a character from any memory location.

character to be printed.

The first instruction in PCML—XTHL—exchanges the address on the top of the stack with the HL register. This action places the character location, address 43, in HL and pushes the old HL contents onto the stack. The character in memory is printed by calling PCM, then passing address 43 into HL as before.

After the character is printed in PCM, control returns to the next instruction following the call in PCML. But now the INX H instruction increments HL to 44. The μP executes another XTHL, so the 44 in HL is put onto the stack, and the old contents of HL are restored. Finally, execution of a RET loads the program counter with the number 44 from the stack, and main-program execution resumes normally from location 44.

In short, the character is embedded within the program code, but PCML ensures that the return occurs at the next μP instruction, not at the location of the character.

This way of passing literal arguments in the instruction stream will require some extra code for stack manipulation in the subroutine, but less code in the calling sequence. And if the subroutine is used several times, you can expect a net reduction in code space. Furthermore, you save a register pair and don't have to put your characters in any specific storage locations.

The PSML routine extends these advantages: It prints a string of characters literally embedded in the instruction stream (Fig. 4). A special code, FFH,

```
; PRINT CHAR FROM MEMORY LITERAL
```

```
;
PCML: XTHL        ; SET UP WITH CHAR ADDRESS

      CALL  PCM   ;

      INX  H     ; ADVANCE MEMORY POINT TO 1

      XTHL        ; PAST CHAR & PUT ON STACK

      RET         ; RETURN TO 1 PAST CHAR
```

3. Single characters embedded anywhere in the instruction stream are printed by three levels of nesting.

placed at the end of the string, marks the end of data.

Use the following calling sequence:

```
CALL PSML ; Print command
DB 'HELLO'; Message (Literal allocation)
DB OFFH ; String End (Literal allocation)
NOP ; Next command
```

This program is very similar to PCML except that each character is tested first to see if it is the end-of-string code. The subroutine calls PSM to print the string from memory, where the starting address is passed in HL as a parameter. Note that PSM can be used by itself as a subroutine with an address to branch around noninstructions such as tables and literals. It has one significant return parameter; the string address in HL points to the location that follows the user-designated end code.

Passing data on the stack

When several parameters are to be passed to a subroutine, they can be pushed onto the stack one after the other, then accessed from the stack by the called subroutines. For example, to pass three explicit addresses, X, Y, and Z, to a subroutine, use this code:

```
LXI H,X 3 ; Load first address
PUSH H 1 ; Put on stack
LXI H,Y 3 ; Load second
PUSH H 1 ; Put on stack
LXI H,Z 3 ; Load third
PUSH H 1 ; Put on stack
CALL SUBR 3 ; Issue Call
15 bytes
```



```

; PRINT STRING FROM MEMORY LITERALLY
PSML: XTHL      ; ENTER HERE
      CALL PSM  ; PRINT STRING FROM MEMORY
      XTHL
      RET       ; RETURN TO CALLER
; PRINT STRING FROM MEMORY (HL)

```

```

PSM:  PUSH PSW
PSM1: MVI A, OFFH ; MOVE END-CODE TO REG A
      CMP M       ; (HL): A
      CNZ PCM     ; CALL PRINT CHAR IF ≠ FF
      INX HL      ; HL + 1 (INCREMENT)
      JNZ PSM1    ; GET NEXT CHAR IF ≠ FF
      POP PSW     ; OTHERWISE EXIT
      RET        ; TO PSML

```

4. To print an embedded string, use the PCM program repeatedly—one byte at a time—by utilizing the internal loop of the PSML subroutine.

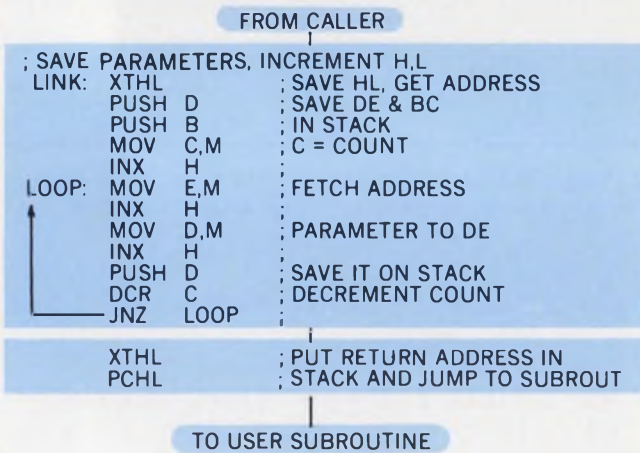

5. When called, LINK saves in-stream parameters up to and including the pointer to a specified subroutine (top). As control passes to the lower block the HL registers point to the next instruction in the main program. A stack-exchange command provides LINK with a subroutine address and puts caller-return at the top of the stack.

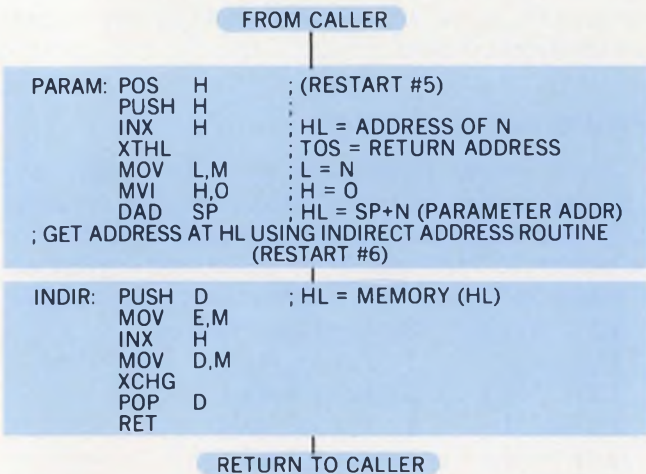

6. PARAM retrieves selected data from the stack by addition of index number N (the positional indicator) to the current stack-pointer value.

Of course, the subroutine must “pop” the stack three times to retrieve those addresses.

Rather than code parameters one after the other with an explicit push-pop system, you can design a LINK routine, which accesses parameters from the instruction stream, then automatically places a call to the designated routine. LINK accesses a list of parameters, which are preceded by a count and ended with the targeted subroutine address. You can use LINK as follows:

```

RST LINK      1 ;
DB 4          1 ; Count Incl Subnam
DW X          2 ; Parameter X
DW Y          2 ; Y
DW Z          2 ; Z
DW Subnam    2 ; Subroutine address

```

10 bytes

Already you have saved five bytes over a simple calling sequence.

Since LINK will be used many times, you may want to call it with the restart (RST) instruction, which, because of its limited addressing, requires two fewer bytes per instance than a call instruction (Fig. 5). The RST is a 1-byte call to one of eight specific locations in memory. In this example, LINK uses RST #7 and is located in memory at location 56 (=8 × 7).

LINK includes status saving for six of the 8080 registers and may even include an option to save the PSW. The subroutine loads the parameter count into the C register. Looping and fetching double-byte parameters it then pushes them onto the stack as it counts C down to zero.

The last parameter placed in the stack is the actual subroutine starting address (SUBNAM). The last two instructions place the incremented memory address from HL onto the stack for the return address via an exchange instruction, and load the program counter directly with the subroutine starting address (Fig. 5b). Therefore, any subsequent RET instruction references the next usable instruction of the calling program.

Once the subroutine is entered, it can access any of the parameters, including the prior contents of all registers from the stack, and can use any of the six registers for temporary storage. However, you must decide what to reload and delete from the stack before returning control to the caller.

To access the actual parameters from the stack, use PARAM (Fig. 6), which is called with positional designator N:

```

RST PARAM    1
DB N         1

```

2 bytes

Configured as restart #5, the program increments HL to point to N, sets HL to N, then extracts the address from the stack. PARAM places the addressed parameter into the HL register pair, but does not alter the stack contents.

There's another subroutine you may want to use. INDIR—an indirect-address procedure—will place a word based on the address contained in HL into HL. ■

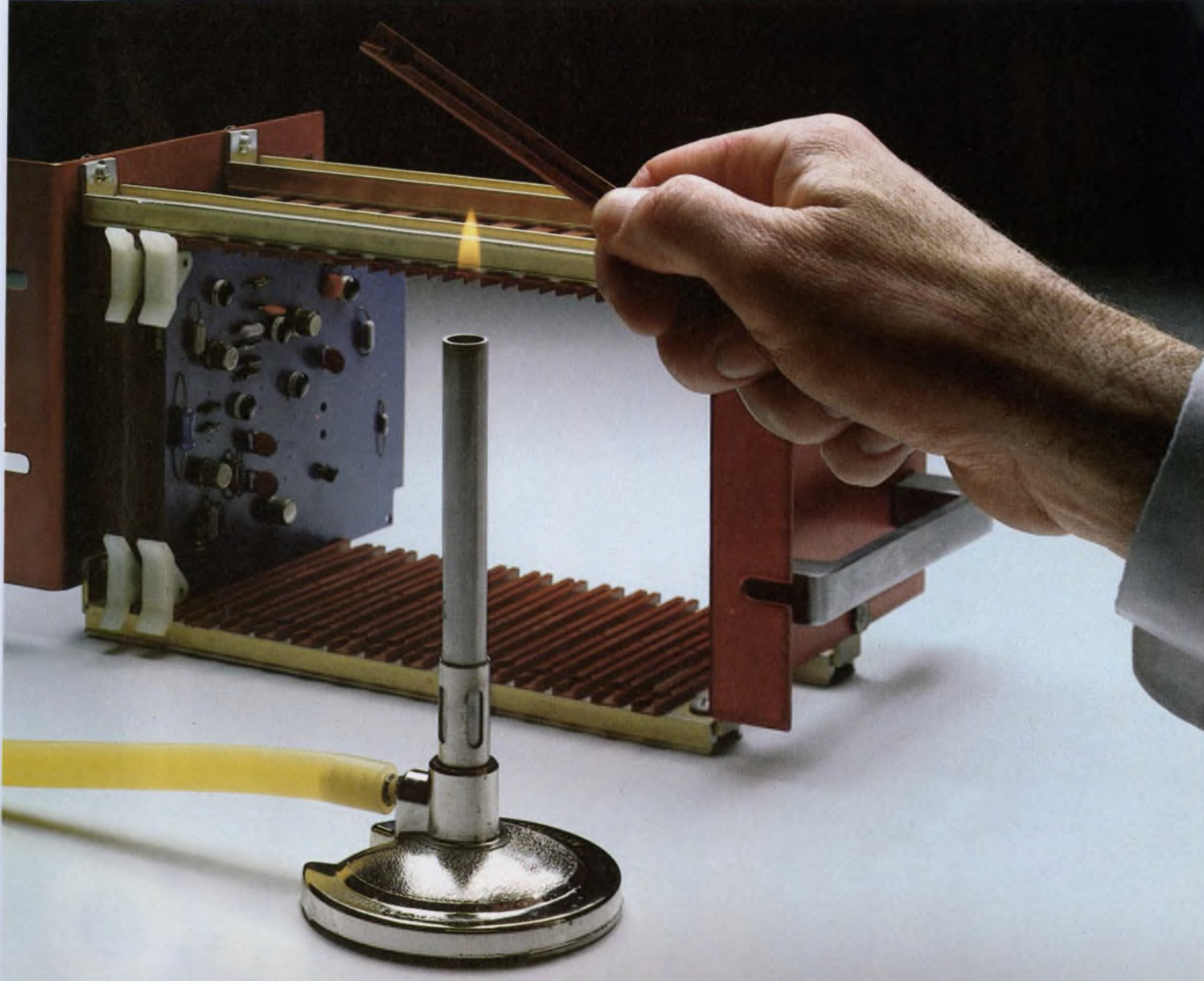

Vydine[®] M-340 nylon. It meets UL standards for fire-retardancy.* And Bivar's standards for performance.

When Bivar, Inc., of Santa Ana, California, wanted to introduce a new line of PC board card guides, they looked into Monsanto's line of Vydine[®] nylon resins. They required a material with good fire-retardant characteristics for the computer and instrumentation fields. Good enough to meet UL standards. Rigid enough for the application. Yet flexible enough for the required snap-in insertion feature.

Vydine M-340 by Monsanto was the answer. It has a UL rating of 94V-0 down to 1/64 of an

inch, 94-5V down to 1/32 of an inch. Vydine M-340 also offers natural lubricity for easy card insertion and a distinct color for easy identification as a fire-retardant.

The fact is, Monsanto standards for Vydine M-340 are high enough to meet UL standards, and high enough to meet yours.

For information, write: Monsanto Plastics & Resins Co., an operating unit of Monsanto Co., Dept. 804, 800 N. Lindbergh Blvd., St. Louis, Mo. 63166.

VYDYNE[®]
NYLON RESIN BY MONSANTO

CIRCLE NUMBER 35

Monsanto

*These UL numerical flame spread ratings are not intended to reflect hazards presented by this or any other material under actual fire conditions.



MICRO

The microprocessor that thinks it's a minicomputer can now evaluate itself.

Not too long ago, Fairchild introduced 9440 μ FLAME™ — the world's first 16-bit bipolar microprocessor that executes a minicomputer instruction set with minicomputer performance.

Now we're introducing SPARK-16 — a double-sided pc board designed to evaluate the 9440 μ FLAME CPU. The newest addition to our μ FLAME family can also be used as a stand-alone microcomputer for applications requiring small amounts of memory.

Before we give you the details on SPARK-16, let us bring you up-to-date on μ FLAME: The 9440 μ FLAME microprocessor is a

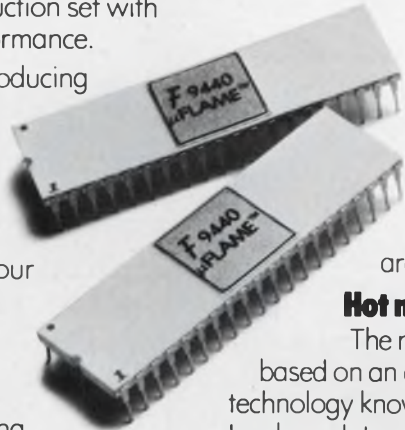

bootstrap and binary loader (FIRELOAD), and an interactive entry and debugging program (FIREBUG).

In addition, the μ FLAME microprocessor can execute the Data General NOVA 1200 instruction set. FIRE software such as text editor, symbolic debugger and business BASIC are also available now.

Hot new technology.

The new microprocessor is based on an advanced form of I²L technology known as I³L® (Fairchild's Isoplanar Integrated Injection Logic). It provides the combined advantages of bipolar high-speed and MOS packing density and power dissipation. In addition to the I³L circuitry on the 9440 chip, there is conventional

a TTY or CRT terminal. The single board price is \$995.00. If you would rather do it all yourself, we can also supply you with a 9440 + FIRE I software for \$550 (single unit price).

Only the beginning.

More sophisticated FIRE software, board level hardware and LSI support circuits will become available throughout the year. The software will include a floppy disk operating system, disk operating system and a FORTRAN compiler. New LSI circuits will include a 16K TTL dynamic RAM; a memory control with control, refresh and DMA capabilities; and an I/O bus controller.

For 9440 parts and SPARK-16 boards, contact your Fairchild representative or sales office. For a MICROFLAME brochure and data sheets, write Fairchild Camera and Instrument Corporation, MICROFLAME, P.O. Box 880A, Mountain View, California 94042.

FLAME™

MICROPROCESSOR

complete minicomputer CPU on one chip, packaged in a 40-pin DIP.

Major applications for this device include OEM data processing in a variety of computing control and instrumentation environments; telecommunications PBX and PABX switching installations; and distributed intelligence, distributed multiprocessing and front-end (terminal) processing.

Where there's flame there's fire.

Fairchild is also introducing its FIRE™ (Fairchild Integrated Real-time Executive) software. FIRE I is an initial software package for the 9440 that includes the required development aids: diagnostics, a

TTL circuitry which allows TTL interface with other logic, PROMs and RAMs.

A spark of genius.

The new SPARK-16 pc board is loaded with features including a 16-bit 9440 μ FLAME CPU, 4K words of RAM, 2K words of Autoload PROM, Memory control with DMA capability, interface logic for a Teletype or RS232C, 100-pin connector with 9440 Bus, connector for TTY/RS232C, control switches (Autoload, Continue, Halt and Reset) and display. SPARK-16 requires only a single 5 V, 4.0 A power supply and



SPARK-16

FAIRCHILD

**Call us on it.
(415) 962-4626**

Reduce your μC system's overhead.

With a system-monitor analysis of the system's operations, you can spot possible bottlenecks in program execution.

To make the best use of your microcomputer's processor, memory and I/O, you should know the performance limitations of your system software. An easy, effective way to evaluate software performance is to monitor the system to identify the limiting factors and then try to optimize the possibly troublesome routines. In this way, you increase system performance.

You can get reliable information about your system from the memory addresses generated by the processor. Most systems generate 16-bit addresses at more than 1 Mbit/s, but few, if any, instruments can collect enough data at this rate. That's where a system monitor can come in. However, you can get satisfactory information to analyze by sampling the address bus periodically. And, a system monitor can be a relatively inexpensive way to do the job. A single-board, microprocessor-based system can do the job quite nicely.

With a monitor, data can be accumulated to produce a map of memory addresses with their corresponding frequency of reference—without disturbing the overall system operation.

Memory addresses indicate activity

In most computer and microprocessor systems, the memory space includes regions that store both program instructions and data. Address samples in the program-storage region can correlate processor activity with specific program segments and identify software bottlenecks. The samples can also provide quantitative information about system performance limits by identifying program segments that take too long or run inefficiently. Tallies of access collected by a system monitor can help you paint a picture of memory usage or bus usage and thus let you optimize program segments to shorten run time or reduce bus accesses.

Besides address data, a system monitor can collect information about processor utilization that can be

Wes Patterson, Manager of Engineering, Motorola Microsystems, 3102 N. 56 St., Phoenix, AZ 85018, and **Kurt Frisbie**, President, Microcosym, Inc., 7342 W. Bluefield, Peoria, AZ 85345.

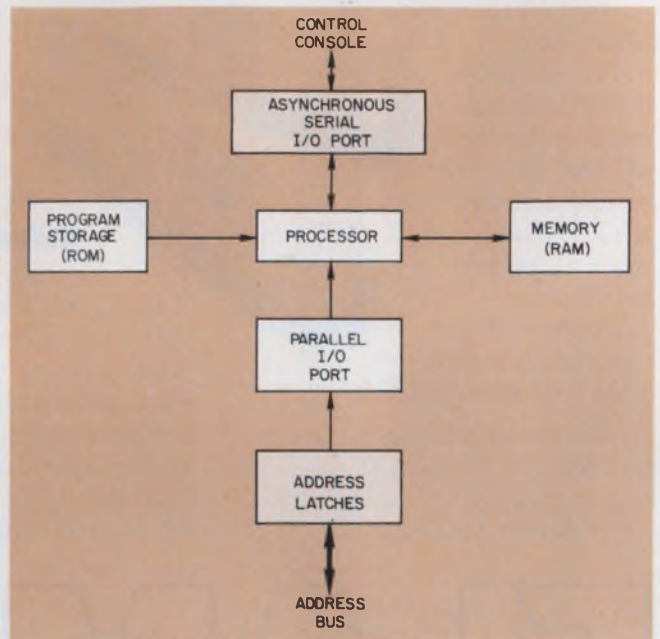

1. The system monitor, a dedicated microcomputer, uses a μP , memories and I/O circuits to observe and record activity on the address bus. The 12 most-significant bits of the address bus are monitored.

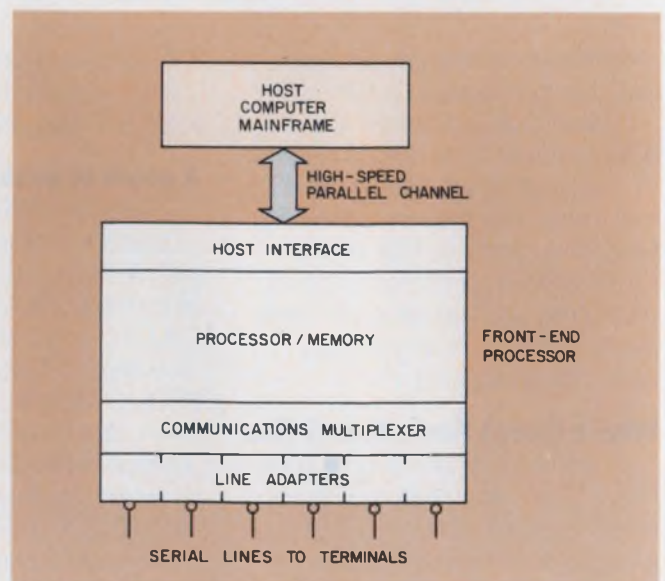

2. A typical front-end processor multiplexes a number of terminal channels that operate at identical or different baud rates, and in turn, feeds them to a host computer for further processing.

used to project maximum system capacity and quantify design improvements.

The system-performance monitor diagramed in Fig. 1 consists of an M6800 microprocessor, a ROM or PROM for program storage and a RAM for scratch-pad storage and data accumulation. Address samples are read as parallel inputs. A serial RS-232 interface to a control console provides inputs for initialization and output for data retrieval.

In its monitor mode, the microprocessor periodically samples the system by latching the 12 most significant

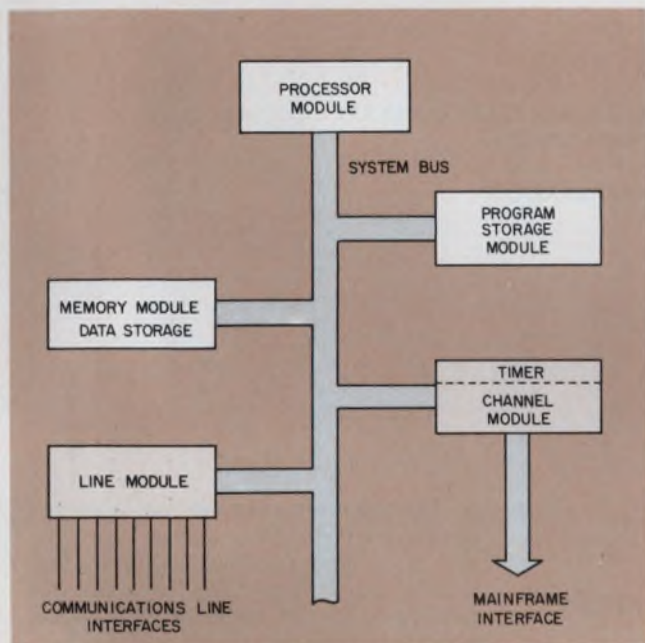

3. Six boards make up a front-end processor. The brain is an M6800-based CPU aided by memories and I/O circuits. Serial-communication lines are multiplexed for rapid multiple-channel data entry into a high-speed CPU.

0000	Data storage
1000	
2000	(Data storage expansion)
3000	
4000	
5000	
6000	Serial I/O devices
7000	
8000	Channel I/O devices
9000	(Program storage expansion)
A000	
B000	
C000	Program storage
D000	
E000	
F000	

4. A map of the front-end processor memory shows how 64 kbytes are allocated to the various system functions. The addresses are in hexadecimal.

bits from the address bus. Under program control, this information is decoded according to initialization parameters to select one of 256 4-byte counters maintained in the RAM. Each sample is recorded by incrementing the selected counter. Then the next sample is taken. After the desired number of samples are captured, fraction and histogram forms of all the counter samples are printed on the control console.

To see how the monitoring system works, analyze a typical microcomputer system: Microcosym's MCS30 front-end processor for Honeywell computers. This special-purpose system controls remote access via telephone or other communications lines to a host mainframe computer system. The front-end manages the telecommunications network so that the high-speed mainframe needn't deal with relatively low-speed communication lines.

Although there are architectural differences among front-end processors, a typical programmable front-end unit such as Microcosym's can be represented by the diagram of Fig. 2. Major system elements include the processor, memory, a communications multiplexer with line adapters and an interface to the host computer.

Estimates of the MCS30's processing requirements and system capacity can be made while it is being designed. However, because of the real-time nature of the system, a rigorous paper-and-pencil analysis is possible only for worst-case situations that aren't even feasible. But monitoring system performance during actual operation not only can produce a realistic assessment of the system capacity but also uncover system bottlenecks.

The basic front-end processor, shown in Fig. 3, consists of six circuit boards. The processor module contains an M6800 microprocessor, bus control logic and 1-MHz system clock. The channel interface module's two boards provide the mainframe interface. A PROM storage module holds program instructions, while another memory module provides storage for data buffers, system tables and variables. The line module provides eight serial asynchronous interfaces, but this basic front-end processor may be expanded with additional line and memory modules.

Operating system software for the MCS30 not only performs front-end data processing tasks but provides most of the control for hardware interfaces as well.

The memory map of Fig. 4 shows how data storage, program instruction storage and I/O-device addresses are allocated in the MCS30.

Measure system loading

To observe the monitor at work, experiments were conducted on an MCS30 system configured for 24 communication lines—eight dial-up and 16 direct connect—operating at data rates of up to 1200 baud. Experiments were designed and conducted to measure processor and memory use under known system loads. The results were used to determine the capacity of

Address	Samples	%	
0000	199961	12.6	XXXXXXXXXXXXXX
0100	49201	3.1	XXX
0200	7530	0.5	X
0300	437	0.0	
0400	234	0.0	
0500	882	0.1	
0600	4351	0.3	
0700	11769	0.7	X
0800	9829	0.6	X
0900	8865	0.6	X
0A00	5362	0.3	
0B00	242	0.0	
0C00	299	0.0	
0D00	1762	0.1	
0E00	260	0.0	
0F00	155	0.0	
1000	1413	0.1	
1100	273	0.0	
1200	292	0.0	
1300	164	0.0	
*			
8000	23559	1.5	XX
*			
8800	12191	0.8	X
*			
B800	710367	44.9	XX
B900	75446	4.8	XXXXX
BA00	276476	17.5	XXXXXXXXXXXXXXXXXXXXXX
BB00	17830	1.1	X
BC00	14	0.0	
BD00	5	0.0	
BE00	1	0.0	
BF00	11	0.0	
C000	156	0.0	
C100	755	0.0	
C200	267	0.0	
C300	232	0.0	
C400	5	0.0	
C500	3	0.0	
*			
C800	2105	0.1	
C900	1525	0.1	
CA00	214	0.0	
CB00	301	0.0	
CC00	807	0.1	
CD00	2122	0.1	
CE00	482	0.0	
CF00	1136	0.1	
*			
D100	2383	0.2	
D200	15008	0.9	X
D300	45966	2.9	XXX
D400	7336	0.5	X
D500	5869	0.4	
D600	20035	1.3	X
D700	23301	1.5	XX
D800	4691	0.3	
D900	2538	0.2	
DA00	2031	0.1	
*			
DC00	22322	1.4	X
FF00	1080	0.1	
TL	1581851		
EX	0		
IL	2154890		
M%	42.3	Bus utilization for six lines	
*		in continuous operation	

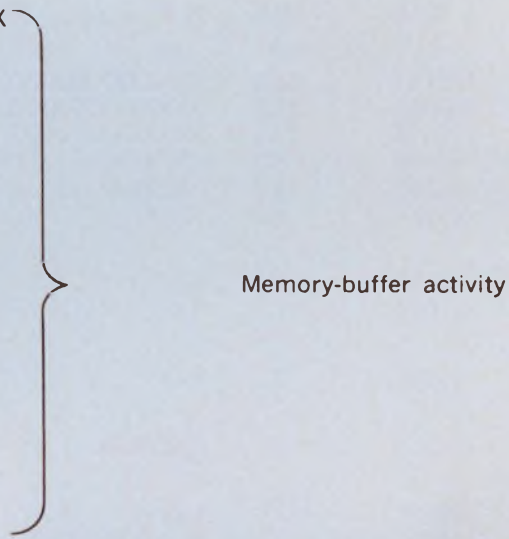

6. When six lines operate continuously, the bus-utilization factor is 42.3%. Each operating line contributes 1.1% more utilization than the 35.5% bus utilization factor obtained for an idle system.

lines in continuous operation is 2304_{10} bytes, or approximately 400 bytes/line. At this rate, a 32-line system, at 100% utilization, would require $2816 + 32(400) = 15,616$ bytes.

An MCS30 with 16 kbytes of memory can handle at least 32 lines, even with all lines in continuous operation. Thus, under worst-case conditions the total available read/write memory space, 50,000 bytes, would provide enough data storage for 125 lines. With reasonable line utilization, many more lines could be supported by the front-end processor.

Determine limiting resources

From these analyses, it is clear that the MCS30's capacity is limited by the processor. Doubling the processing power by upgrading to a 2-MHz version, the M68B00, would provide a better balance between processor and memory limitations, but wouldn't com-

Address	Sample	%	
B800	5518	0.6	X
*			
B820	128757	13.3	XXXXXXXXXXXXXX
B830	209866	21.7	XXXXXXXXXXXXXXXXXXXXXXXXXXXX
B840	128462	13.3	XXXXXXXXXXXXXX
B850	56446	5.8	XXXXXX
B860	64159	6.6	XXXXXX
B870	40507	4.2	XXXX
*			
BA10	80430	8.3	XXXXXXXX
BA20	15979	1.7	XX
*			
BA50	31928	3.3	XXX
*			
BA70	64936	6.7	XXXXXX
*			
BAA0	47128	4.9	XXXXX
BAB0	93709	9.7	XXXXXXXXXXXX
*			
TL	967825		
EX	343157		
IL	2384407		
M%	26.2		
*			

} Processor activity in scan program segment which scans line interfaces.

7. A more detailed histogram of the critical program segment in the B800 to B8FF area of memory shows a concentration of activity in the segment that scans the line interfaces.

pletely offset the processor as a limiting factor. A multiprocessor design could possibly be a more effective alternative.

Also, according to the analysis of processor utilization, the overhead in an idle system consumes almost half the available processing power. A closer examination of Fig. 5 indicates that almost half the overhead stems from processor activity in memory area B800_H to B8FF_H.

The results in Fig. 7 show a concentration of processor activity in the 48-byte area B820_H to B84F_H. System performance could be upgraded significantly by reducing the execution time of this code segment.

The program section in question is the time-driver scan of the line devices for activity. Operations are shown in the flow chart of Fig. 8. The line scan occurs every 7.5 ms and examines all 32 line devices for activity. Each active line requires 51 machine cycles in this segment, while each idle line requires 57 cycles.

Since the initial scanner treated all line devices equally, each device was checked at a rate determined by the character-transfer rate on the fastest line. The maximum line speed of the MCS30, 1200 baud, meant that 300-baud lines were being scanned four times as often as required, and 110-baud lines, 12 times. Also, idle lines were being scanned at a much higher rate than necessary to detect ring-ins.

The solution is to employ different scan chains for each line speed, so that each is scanned at a rate consistent with the line speed. Idle line devices are placed in a linked chain that is scanned only once per second. A line is linked to the appropriate chain after the speed has been determined, and is deleted from the chain when it has been disconnected. Furthermore, in implementing this chain scheme the 51 machine cycles formerly required were reduced to just 29 cycles. ■■

Reference

Nutt, Gary J. "Tutorial: Computer System Monitors," *Computer*, IEEE, November, 1975, pp. 41-50.

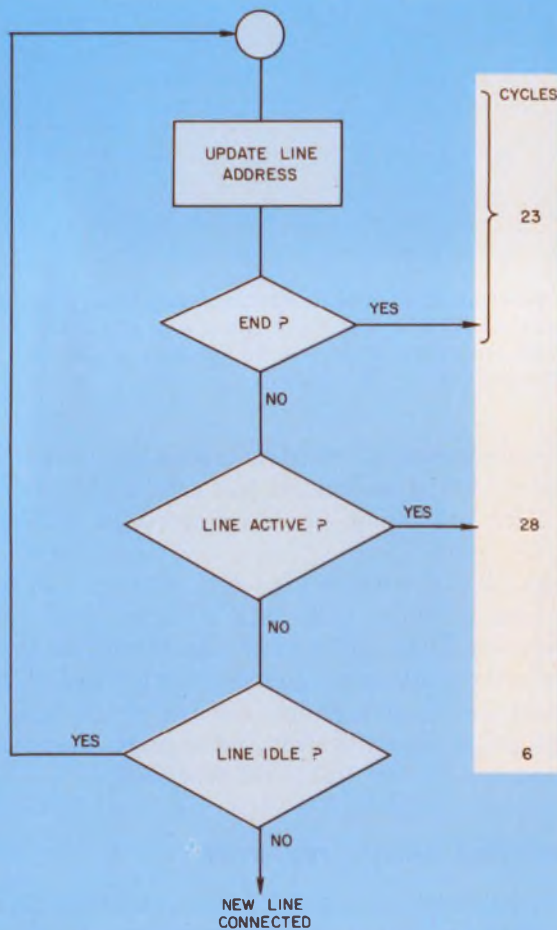

8. A flow chart helps to pinpoint program sections that need to be optimized, one of which is the subroutine that scans lines for activity.

Upgrade your system with Mostek's 64K ROM.

Mostek's newest ROM, the MK 36000 offers 24-pin compatibility with our complete family of 8K and 16K ROMs, as well as existing EPROMs. That means you can achieve higher system density at a much lower cost.

Mostek's 64K ROM can be accessed in 250ns max; it requires no more than 220 mW active power, and automatic standby power is just 25 mW typical.

Mostek's widely copied Edge-Activated™ design concept provides many other features including +5V only power with ±10% tolerance, on-chip address latches, totally

	NUMBER OF BITS	PIN-COMPATIBLE	ACCESS TIME	ACTIVE POWER (MAX)	STANDBY POWER (MAX)
MK 30000	8,192	Yes	350ns	330 mW	330 mW
MK 34000	16,384		250ns	220 mW	40 mW
MK 36000	65,536				

static operation, and direct TTL compatibility with common I/O.

Not only do you get all that in the standard 24-pin package, but you can get it now. There's no better way to upgrade your system than

with Mostek's 64K ROM.

For more information on Mostek ROMs, call a Mostek distributor or sales representative now. Or contact Mostek at 1215 West Crosby Road, Carrollton, Texas 75006; telephone (214) 242-0444. In Europe, contact Mostek GmbH, West Germany; telephone (49) (0711) 701045.

MOSTEK.

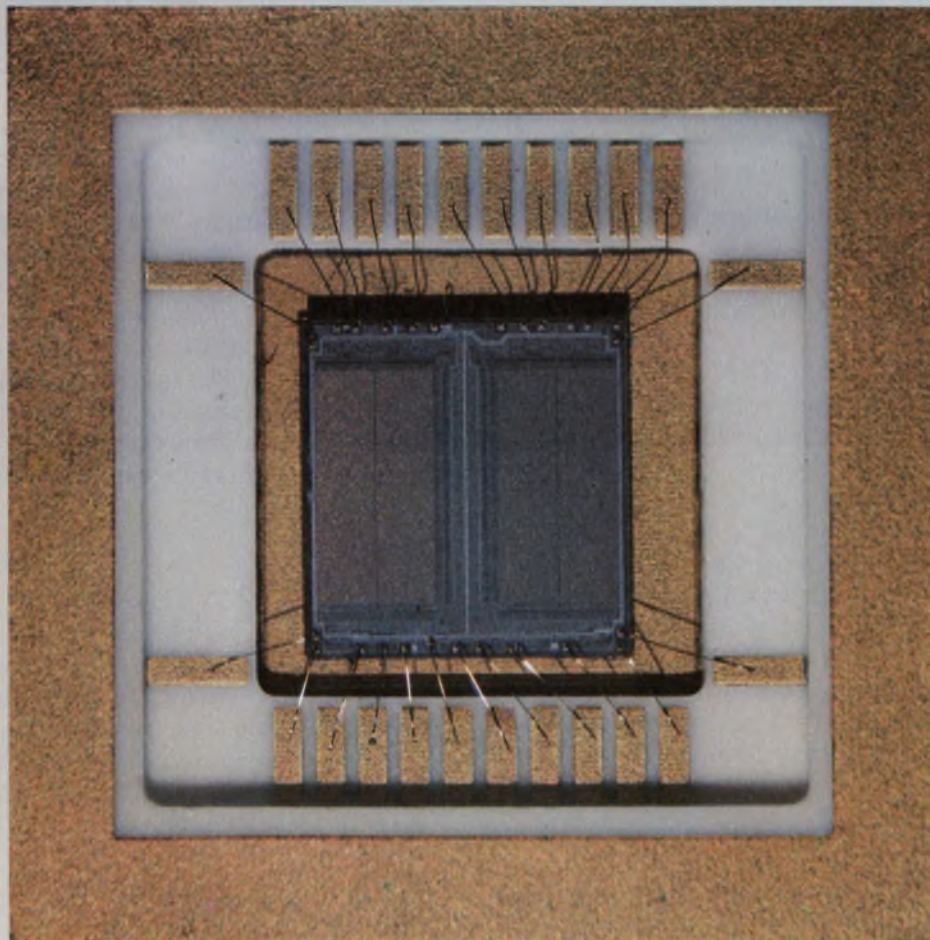

Put testability into PC boards during the design stage. You'll make it easier to diagnose and isolate faults automatically, and you'll cut the cost of repair.

You must design today's PC boards with testability in mind. If you don't, automatic fault diagnosis and isolation can become a nightmare. But if you do, you'll enjoy higher reliability, lower testing complexity, less testing-setup time and throughput time, and lower over-all manufacturing costs.

How do you do it? In dozens of ways.

For instance, the more test and control points on a PC board and the better they are sited, the more thorough, accurate and swift the testing, the better the resolution in fault diagnosis and the higher the throughput rate.

Test points monitor logic values of certain circuit lines, whereas control points are driven to produce a failure mode by establishing known states. Control points can also serve as test points.

Test points should be attached to

- Points of large fan-in/out.
- Outputs of memory elements.
- Internal points in feedback loops.
- Internal branches of statistically redundant logic.
- Data inputs of registers.
- Bottleneck inputs.
- Buried logic.

Control points should be attached to

- Memory-address lines.
- Parallel-load lines of counter chains.
- Unused set/reset lines of memory elements.
- Buried logic.

As a general rule, the ratio of I/O pins and test/control points to the number of integrated circuits should be 2:1. Avoid 1:1 or less. If the master edge connector doesn't have enough pins for test/control points, put an additional connector at the opposite end of the PC board.

Flip-flops, counters, shift-registers and other memory elements usually start at unknown states when power is applied, which makes it difficult to detect a failure. To alleviate the problem, you should initialize these elements to a known condition at the start of testing. With complex circuitry, you may want to place logic in several known states. This not only

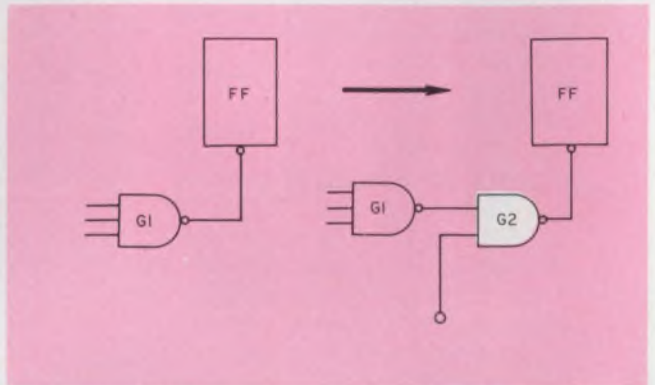

1. Getting circuits started can be a problem unless you add logic for external initialization.

allows for independent initialization of various functions, but also cuts the need to sequence logic to a known state. This, in turn, simplifies the generation of certain internal states and cuts down the number of test steps you'll need for the board.

Ideally, you should reset logic elements from the external pins of your board where, in some cases, additional logic may be required (Fig. 1). If you haven't any external pins on your board, you must add a power-up reset (Fig. 2).

For DTL and standard low-power TTL circuits, you can safely wire-OR a line so that it can be driven low from the tester. But caution: Schottky TTL and high-power circuits cannot be driven low safely for greater than one second.¹ However, you can use the same pull-up for several sets and resets on a number of different flip-flops (Fig. 3).

Getting started

To simplify initialization, segment long counter chains and registers into smaller ones with control points between stages. Your best bet is to initialize the whole chain with an additional line.

For logic that feeds back into itself—a flip-flop, shift register, or counter—drive the output low with the wire-OR technique. Example: The "slave" stage of a master-slave flip-flop is initialized by driving the Q or \bar{Q} output low, with the "master" stage remaining unchanged (Fig. 4).

Other helpful suggestions for initialization design:

John Mittelbach, Product Marketing Specialist, Computer Automation, Industrial Products Div., 2181 DuPont Dr., Irvine, CA 92713.

- Bring out set/reset lines from all sequential logic elements to provide control points—ideally, one control point per element. However, you can bring out a common line for groups of similar logic elements.
- Parallel-load long counters to reduce the need for external clocking.
- Break internally connected set/reset lines on the PC board by running the lines to external points that later can be reconnected on the backplane.
- Design memory-address logic so an address can be held fixed by an external pin. This permits the

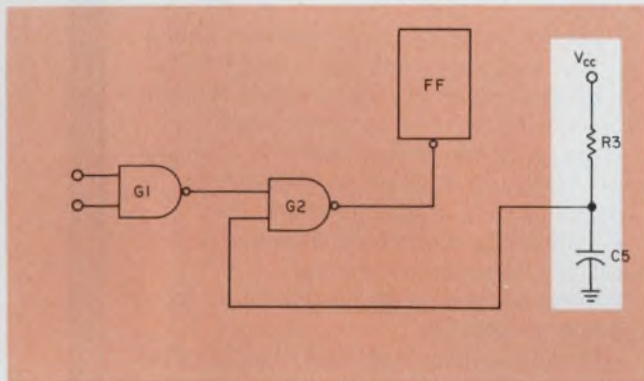

2. **No external pins?** Add a power-up reset to provide internal initialization.

memory to be treated as a register during complex-card testing.

Testing timing circuits is a separate problem. Free-running clocks, oscillators and other synchronous circuits must be externally inhibited. To do so, you can either add extra logic or interrupt the clock signal from an external pin functioning as a control point.

Handling timing circuits

In Fig. 5, an oscillator can be overridden at A and an external clock signal input at B. In Fig. 6, with A and B jumpered via the back wiring, an external oscillator can be used for a synchronization stimulus.

Locate oscillators near the edge connector to provide simple override control and to minimize signal crosstalk. Connect the outputs of fast timing circuits, such as pulse generators, to test points for troubleshooting with pulse-catching techniques.

Avoid one-shots whenever possible. They are difficult to test and noise-prone. When they're cascaded, problems snowball and there's no way to slow down the over-all logic sequence to assist fault diagnosis. If you must use one-shots,

- Place the slow ones ($> 1/2$ ms) in IC sockets so they can be removed whenever they brake testing speed.
- Use one-shots with an external dc reset capability.
- Either provide external override control or wire so that the one-shot can be disabled during testing.
- Bring out the sense lines of fast one-shots ($< 1/2$

ms) so that you can use a latch in the tester interface to observe operation.

A feedback loop is also difficult to test since the loop hides the source of the fault. But if the loop can be broken or overridden, you can locate the source. You can break feedback loops by

- Adding test points to each memory element in the loop, thus increasing loop visibility.
- Adding control points to inhibit the clock of each memory element, which will also serve a dual purpose as points of reference.

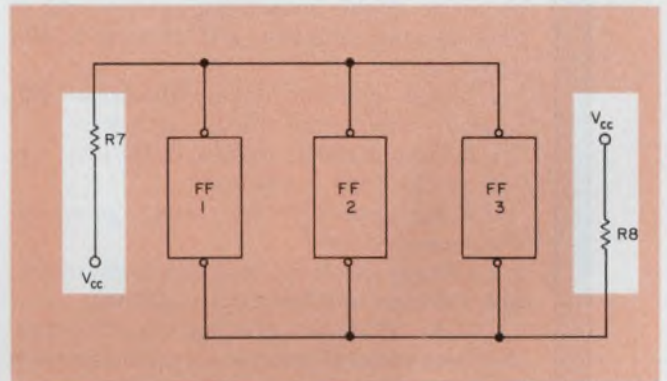

3. **One pull-up resistor** serves several sets and resets on a number of flip-flops.

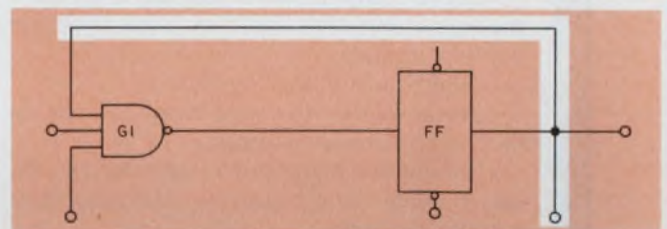

4. **Wire-OR a flip-flop back to itself** to provide initialization.

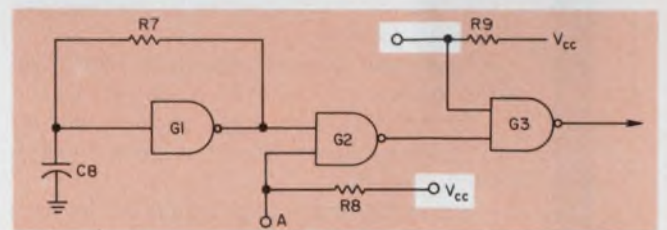

5. **When handling timing circuits**, you may have to override synchronous elements externally.

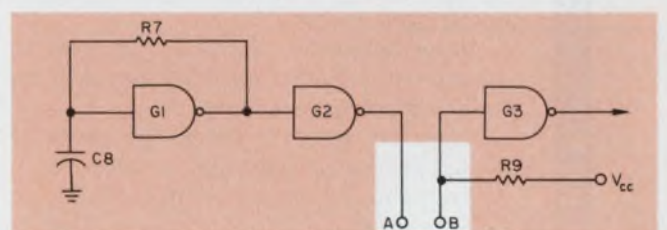

6. **An external oscillator** provides a synchronization stimulus via jumpers.



Testability design checklist

- Route test/control points to the edge connector to enable monitoring and driving of internal board functions and to assist in fault diagnosis.

- Divide complex logic functions into smaller, combinational logic sections.

- Avoid one-shots; if used, route their signals to the edge connector.

- Avoid potentiometers and "select-on-test" components.

- Use a single, large-edge connector to provide I/O pins and test/control points.

- Make PC-board I/O signals TTL-compatible to keep ATE interface costs low and give flexibility.

- Provide adequate decoupling at the board edge and locally at each IC.

- Provide signals leaving the board with maximum fan-out drive, or buffer them.

- Buffer edge-sensitive components from the edge connector—such as clock lines and flip-flop outputs.

- Don't tie outputs together.

- Never exceed the logic rated fan-out; in fact, keep it to a minimum.

- Do not use high-fan-out logic devices. Do use multiple fan-out devices, and keep their outputs separate.

- Keep logic depth on any board to a low level by using edge-terminated test/control points.

- Single-load each signal entering the board whenever possible.

- Terminate unused logic pins with a resistive pull-up to minimize noise pick-up.

- Do not terminate logic outputs directly into transistor bases. Do use a series current-limiting resistor.

- Buffer flip-flop output signals before they leave the board.

- Use open-collector devices with pull-up resistors to enable external override control.

- Avoid using redundant logic to minimize undetectable faults.

- Bring outputs of cascaded counters to higher-order counters so that they can be tested without large counts.

- Construct trees to check the parity of selected groups of eight bits or fewer.

- Avoid wire-OR and wire-AND connections.

If you can't, use gates from the same IC package.

- Provide some way to bypass level-changing diodes in series with logic outputs.

- Break paths when a logic element fans out to several places that converge later.

- Use elements in the same IC package when designing a series of inverters or inverters following a gate function.

- Standardize power-on and ground pins to avoid test-harness multiplicity.

- Bring out test points as near to d/a conversions as possible.

- Provide a means of disabling on-board clocks so that the tester clock may be substituted.

- Provide mounted switches and RC networks with override lines to the edge connector.

- Route logic drives of lamps and displays to the edge connector so that the tester can check for correct operation.

- Divide large PC boards into subsections whenever possible.

- Separate analog circuits from digital logic, except for timing circuits.

- Uniformly mount ICs and clearly identify them to make it easier to locate them.

- Provide sufficient clearance around IC sockets and direct-soldered ICs so that IC clips can be attached whenever necessary.

- Add top-hat connector pins or mount extra IC sockets when there aren't enough edge-connector pins for test/control points.

- Use sockets with complex ICs—CPUs, UARTs, and long, dynamic shift registers.

- Wire feedback lines and other complex circuit lines to an IC socket with a jumper plug so that they can be interrupted at test.

- Use jumpers that can be cut during debugging. The jumpers can be located near the board-edge connector.

- Fix locations of power and ground lines for uniformity among several board types.

- Make the ground trace large enough to avoid noise problems.

- Group together signal lines of particular families.

- Clearly label all parts, pins, and connectors.

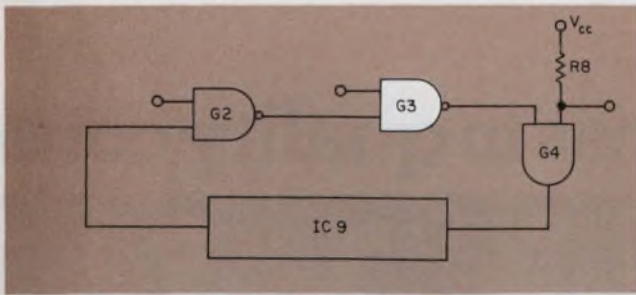

7. **Break feedback loops** to locate trouble spots. One way to do it is add an extra gate.

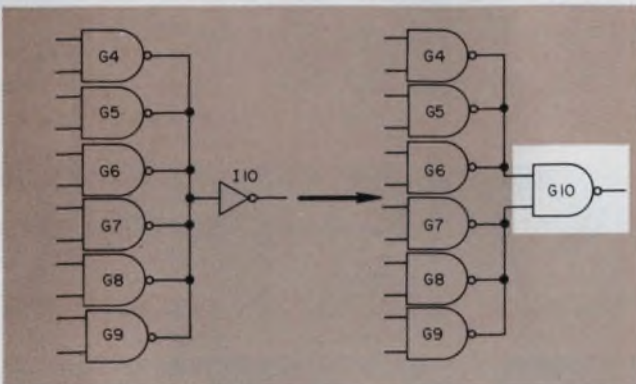

8. **You can spot faults on strung elements** by adding summing gates to the logic.

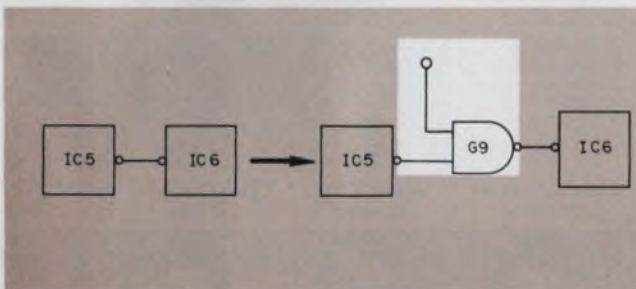

9. **Troubleshoot long counter chains** better by adding logic to independently clocked carryouts.

- Breaking the loop physically by bringing both sides to external pins that can be shorted for normal operation. When not jumpered, the separated lines provide a driving point and a sensing point.

- Driving control points low with the wire-OR technique or using them as sensing points when not driven.

- Adding to the feedback path a gate than can be interrupted by a signal from the tester (Fig. 7).

Elements in some logic families allow you to string common outputs to make up wired-AND or OR gates. This practice is economical in terms of logic usage but creates problems for fault diagnosis: The fault source can be any one of several logic elements in the chain. For effective diagnosis, use an additional summing gate in the wired-AND/OR configuration (Fig. 8).

Use as many gates as possible in the same IC package to keep the number of IC placements down. And remember that you can break the wired connec-

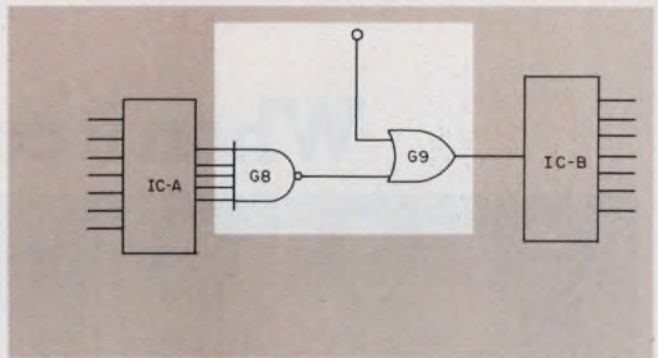

10. **You can add logic to sequential circuits** and control a multiple-enabled point externally.

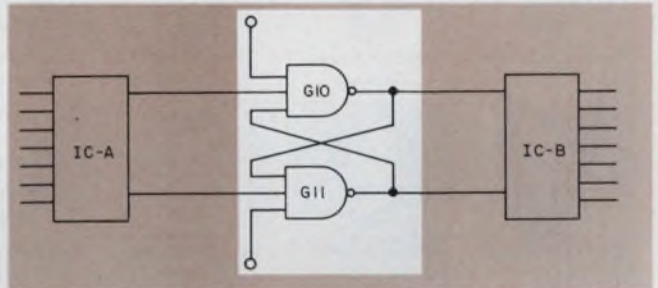

11. **Another means of external control:** Add gate inputs to circuits with latches.

tions into smaller parts, each going to a separate pin that can be jumpered after test.

Long counter chains usually require many test patterns, which makes for a long test period. But to make things easier for yourself, you can

- Break up long chains into smaller ones by means of the PC-board edge connector and jumpering later.

- Add control points to the direct lines where the counters can be loaded directly.

- Attach a control point to pull down the cascading line, while being careful to avoid internal damage of the counter.

- Add logic that can be independently clocked by the carry-out from earlier stages. If the carry-out is active in the low state, as in Fig. 9, an extra logic gate will allow the next stage to be clocked independently.























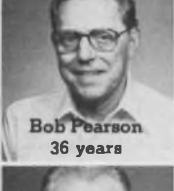

Don't forget sequential circuits, which are often complex and, if not initially considered, difficult to test. Usually, a long string of inputs is required to place the circuit into a state suitable for test. You might have to repeat the process several times to test all elements enabled by this state.

To improve the situation, you can add extra circuitry or inputs to force certain states on the PC board. For example, when a point is enabled by many conditions, it can also be enabled externally with an extra gate and input (Fig. 10). Or if your board circuit has a latch, you can control the point externally with extra points (Fig. 11).■

Reference

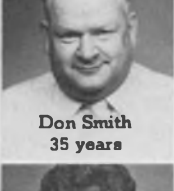
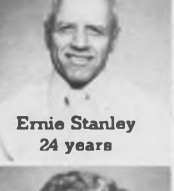
1. *The TTL Data Book*, First Edition, Texas Instruments Inc., Dallas, TX p. 86.

When it comes to quality control

 Sam Abate 25 years	 Marilyn Adams 20 years	 Mary E. Adams 25 years	 Virginia Alberts 25 years	 Russ Auer 22 years	 Alice Bartell 25 years	 Frank Bartos 26 years	 Wes Bessert 27 years
 Irene Brinkmeier 24 years	 Bernice Brown 24 years	 Bob Brown 24 years	 Maym Brown 24 years	 Gerald Brubaker 24 years	 Leon Burgener 37 years	 Carlo Christensen 36 years	 Becky Coomes 22 years
 Betty Donmeyer 26 years	 Russ Dorsey 24 years	 Leo Dougherty 26 years	 Flora Downing 24 years	 Ruth Dreibelbis 26 years	 Virginia Dubey 23 years	 Ruth Eisenbise 25 years	 Don Epping 26 years
 Ellen Greene 22 years	 Irene Hadju 23 years	 Bob Hamon 39 years	 John Harris 24 years	 Catherine Hartman 23 years	 Floyd Haynie 25 years	 Bob Heisler 28 years	 Dawn Henke 22 years
 Gerdy Johnson 24 years	 Bob Johnston 24 years	 Gene Kampmeier 24 years	 Marie Kirchberg 28 years	 Mary Kirkpatrick 23 years	 Alfred Knoll 21 years	 Violet Knowles 27 years	 Karl Koch 24 years
 Caryl Lorenz 24 years	 Charlene Magee 23 years	 Carole Mani 22 years	 Joyce Mater 23 years	 Eleanor McKenzie 28 years	 John McKenzie 24 years	 Phyllis McLain 26 years	 Homer Meiers 25 years
 Mary Jane Myers 27 years	 Gerald Osborne 27 years	 Bob Pearson 36 years	 Marie Piper 22 years	 Genevieve Potter 22 years	 Donald Prinkey 24 years	 Karl Roberts 23 years	 Millie Roenneburg 25 years
 Virginia Schlamp 22 years	 Milly Seefeldt 22 years	 Don Smith 35 years	 Jim Spangler 26 years	 Vi Springer 27 years	 Mary Stamm 23 years	 Ernie Stanley 24 years	 Elva Stouffer 30 years
 Alice Tretter 28 years	 Irene Undieme 22 years	 Ruby Valk 27 years	 Everett Voss 36 years	 Vernenna Wachlin 27 years	 Gen Watson 24 years	 Ruth Weckerly 22 years	 Helene Wegner 22 years

we're years ahead of the competition.

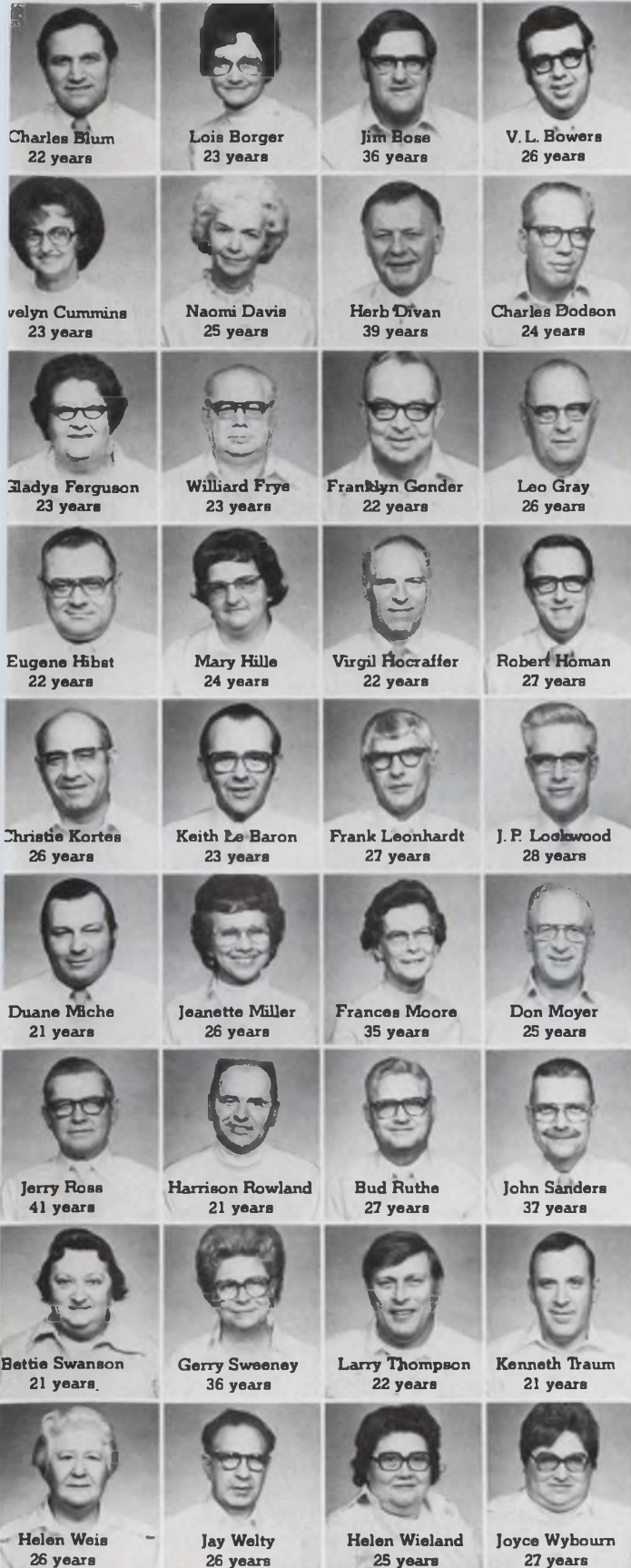

2775.

That's the total number of years these Quality Assurance employees have been on the job. And it's a figure that speaks for itself.

Because they use that experience to help make sure every MICRO SWITCH product meets the toughest performance standards in the business. Ours.

That's the MICRO SWITCH commitment to quality. A commitment made by every department. Every day. It adds up to the kind of products your money can't buy anywhere else.

We team our fine people with the very latest equipment. They use everything from simple, hand-held ring gauges to ultra-sophisticated electronic devices. Plus an evaluation lab that duplicates almost any environmental condition.

And it's all used with the same thought in mind. To see to it every MICRO SWITCH product is exactly what our designers intended it to be.

You see, when you buy a MICRO SWITCH product, whether it's a keyboard, a position sensor or a manual control, you're buying more than just a component. You're buying a company.

A company with capabilities to help solve your problems. Whether through research and development. Innovation. Availability. Reliability. Or Quality Assurance.

MICRO SWITCH. Consider what it would cost to have anything less.

For more information, write for our Quality Assurance booklet. MICRO SWITCH, Freeport, Illinois 61032. Or call 815/235-6600.

MICRO SWITCH products are available worldwide through Honeywell International.

MICRO SWITCH
Can you afford anything less?

Test your charge-pump phase detectors.

Pinpoint the nonlinearities so you can operate your detectors in the good part of their characteristics.

Even when you must measure their transfer characteristics, it's often worth the trouble to use charge-pump phase detectors. For phase and frequency detection in phase-locked synthesizers, charge-pump circuits:

- Offer linear ranges of almost 720° .
- Include their own acquisition circuitry.
- Come as ICs: the MC 4044¹ and 12040² from Motorola and the 11C44³ from Fairchild are examples. (You do need to add some parts, though.)
- Add relatively high rejection of the input frequen-

cy and its harmonics when used in a type-2 loop.

But you can't just drop one of these potent ICs into your circuit and expect great performance. Charge-pump detectors suffer from gain distortion—especially in the crucial zero-phase-error region of their gain characteristics, where they often operate. These nonlinearities, though not peculiar to one manufacturer's components, may be more severe in one product than another. And parts may vary—even from the same manufacturer. So, sometimes you may want to test the charge-pump transfer characteristics.

Dr. William Egan, Senior Engineering Specialist, and **Eugene Clark**, Senior Engineer, GTE Sylvania, P.O. Box 188, Mountain View, CA 94042.

Pain in the gain

The gain distorts in both directions—high and low. Increased gain reduces loop-stability margin, leading

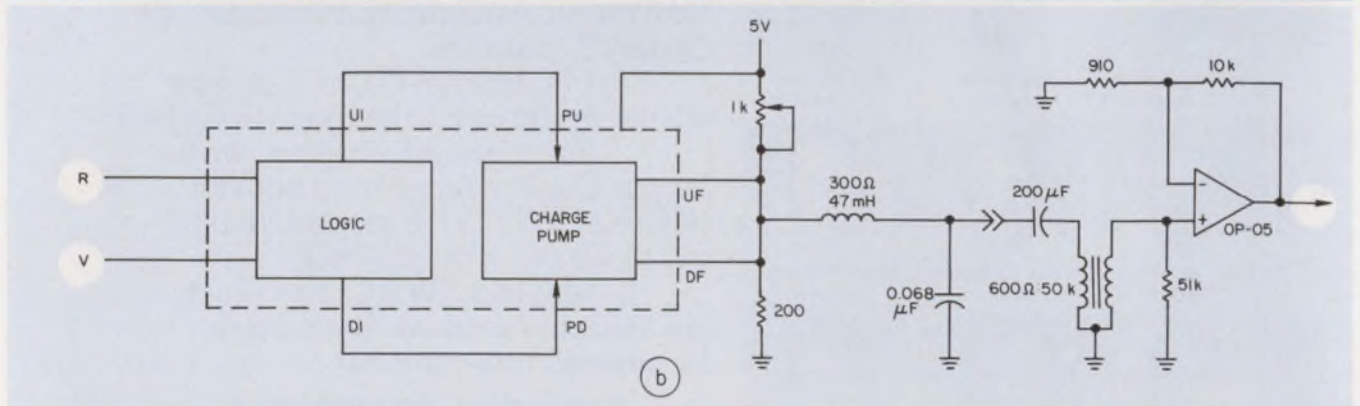
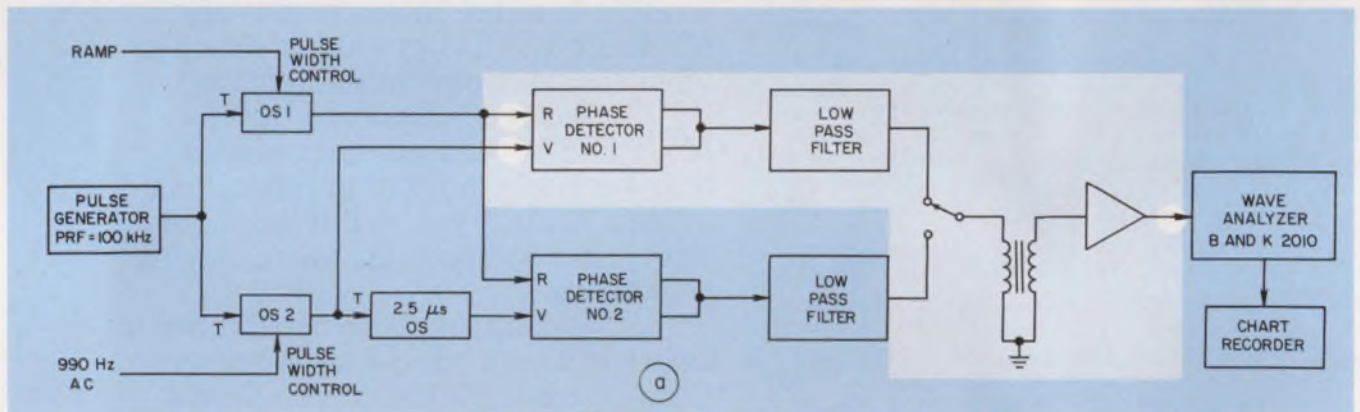

1. **A gain-nonlinearity instrument** for charge-pump phase detectors (a) detects the small-distortion regions about the zero-phase-difference zone and monitors drive sig-

nals. One channel (b) contains a detector/filter combination with a transformer working into the high-impedance, low-noise operational amplifier.

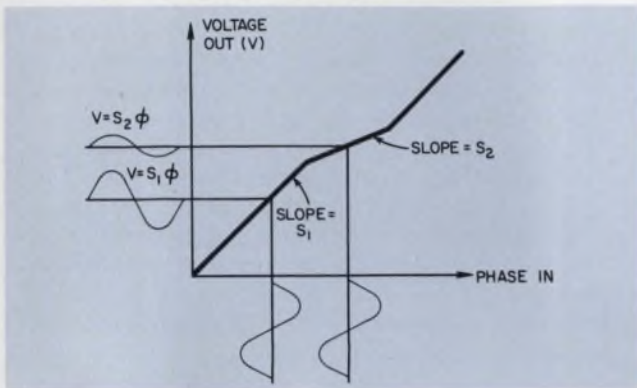

2. A phase-to-voltage transfer-function slope represents the ratio of the charge-pump detector's output voltage to its phase modulation. This slope, then, provides a way of measuring transfer functions.

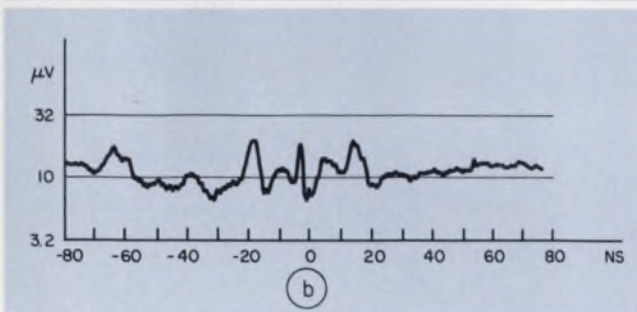
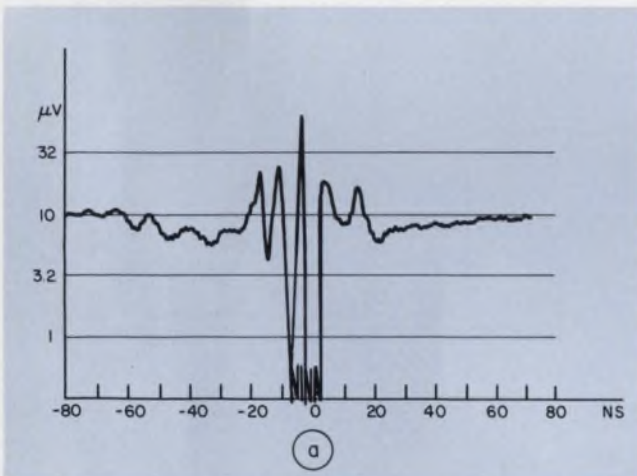

3. Response changes severely in an MC 4044 detector (a) within its zero-phase-error region and over a 150-ns range of delays between the inputs. With 90° offset inputs, response (b) shows interaction.

to oscillation; decreased gain reduces loop bandwidth, which usually increases FM noise at the synthesizer output. So, test for both too-high and too-low gain.

When the detector has a zero-gain region, or "dead zone," be careful. Its phase-locked loop can wander from end to end in this zone, and in so doing stay effectively open. As a result, your PLL may be no improvement over an open-loop oscillator.

You can avoid trouble due to small regions of distortion in the transfer function of the charge-pump phase detector, but first you must locate them. Since the regions of distortion can be narrow, you need high resolution from the testing apparatus.

Haze at zero phase

A system for measuring phase-detector gain non-linearity must detect small regions of distortion near the zero-phase-difference zone. Such an instrument should also monitor the drive signals to ensure that input perturbations aren't mistaken for transfer-characteristic distortion. The scheme shown in Fig. 1a performs both functions.

Here, a pulse triggers two monostable multivibrators, OS_1 and OS_2 . Second inputs control the width of both outputs. A voltage-ramp input widens the output of OS_1 . A 990-Hz ac signal time-modulates the output trailing edge of OS_2 . This time modulation is converted to voltage by the phase detectors and the low-pass filters following them. As Fig. 2 shows, the ratio of the output voltage to the phase modulation represents the slope of the phase-to-voltage function.

The combination of the transformer and amplifier, boosts the low-pass-filter output and feeds it to a true-rms detector in the wave analyzer. The detected voltage is recorded while the ramp input to OS_1 causes the average phase difference to sweep through the region of interest near zero.

Using a low-noise op amp with a transformer to capitalize on its high input impedance, plus filtering from the wave analyzer, you can make the measurements with only a small amount of ac modulation. More modulation would average the transfer-function slope over a larger region and mask small-region effects. You can get the details of the phase detector, filter and amplifier channel from Fig. 1b.

Another phase-detector and low-pass-filter com-

bination operates similarly, except one input to the detector is delayed about 90°. This detector monitors the input-phase difference between OS₁ and OS₂ near the zero-phase-error region. Here, both output pulses end at almost the same time. Because the two phase detectors do not operate in the zero-phase region

simultaneously, only one will be nonlinear at a time.

Fig. 3 shows the results of testing two MC 4044¹ phase detectors. Fig. 3a shows the response of the first detector in the region of zero phase error over a 150-ns range of delays between the inputs. Fig. 3b shows the corresponding output for the second phase detec-

Pumping charge

A charge-pump phase detector either drives charge to, or removes it from, a capacitor, depending on the phase-error polarity. The simplified schematic (a) illustrates this concept. Here, current flows in the loop filter with either switch, S_U or S_D, closed. Its direction depends on which is closed.

The average charge-pump current is proportional to the time difference between the two inputs, the reference and divider signals. The timing diagram (b) shows signal transitions that represent the phases being compared. The average current, then, is proportional to the phase differences.

In the timing diagram, the divider frequency is lower than the reference frequency, as during a transient condition. So, initially, S_U closes between divider and reference pulses, which causes the pump to source a current, i_p. But later, the reference comes up first, and S_D closes between the reference and divider pulses. Then the pump sinks i_p between the pulses. In this region of the phase detector character-

istics, the divider output always causes i_p to increase while the reference always makes i_p decrease.

The type-2 loop filter integrates i_p and thus phase. The filter resistance, R_f, produces a zero in the response, for loop stability. In the steady state, net current into C_F is zero. Therefore, the current pulses are only wide enough to compensate for leakage.

The amplitude of undesirable output at the reference frequency and its harmonics is proportional to the current-pulse width. These extraneous signals frequency modulate the output of synthesizers that use charge-pump phase detectors.

As the phase difference nears and then passes through zero, the current pulse of one polarity narrows and ultimately disappears while an opposite-polarity pulse appears and widens. For a constant phase-to-current transfer function, the rise, fall and delay times of both pulses must be correctly related. The plot of capacitor current vs time (c) shows a positive pulse, like one that would occur when the

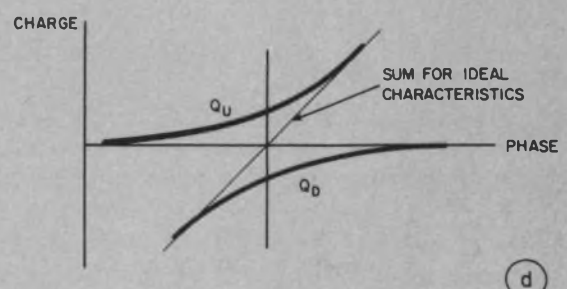
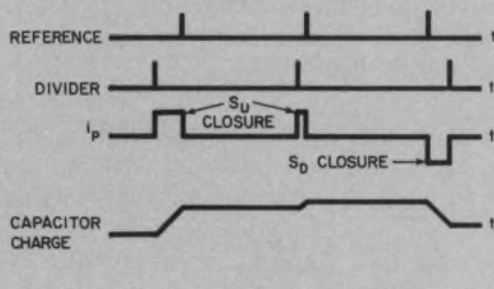
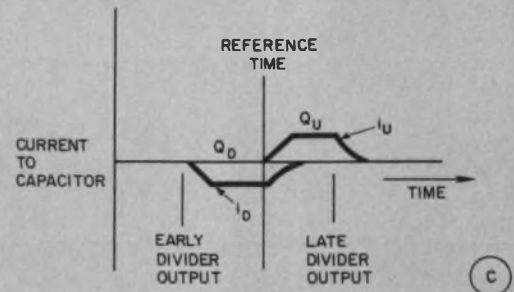
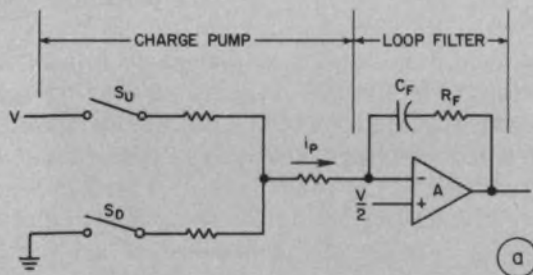

tor, whose input is offset 90° . As you can see, there is interaction but not much compared to the gain change. (The observed interaction may be due to coupling between the monostables.) For more detail, expand the region of interest by increasing the chart-recorder speed. The average-output levels indicate

divider output comes after the reference (late). The negative-current pulse occurs when the divider output is early. As the divider output goes from early to late, the charge transferred to the capacitor might change as in curves Q_D and Q_U , for the ideal case (d).

Finite rise and fall times translate into reduced amplitudes when you're dealing with narrow pulses. So the characteristics bend near zero phase difference. However, the ideal characteristic in (d) shows that the net-transfer characteristics are linear through the zero phase-shift region.

In reality, you can expect gain distortion. Gain increases in the crossover region (e) if there is excessive overlap between the opposite-polarity pulses. With insufficient overlap, gain decreases—even to zero (f). Other distortions occur if the individual charge-vs-phase curves are improperly related. Delays, races, and instability in the charge-pump-driving logic can cause similar distortions, including greater transfer-function variations than those described.

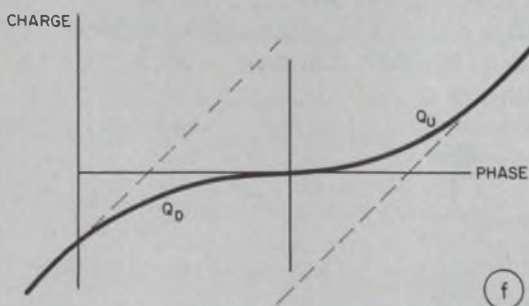
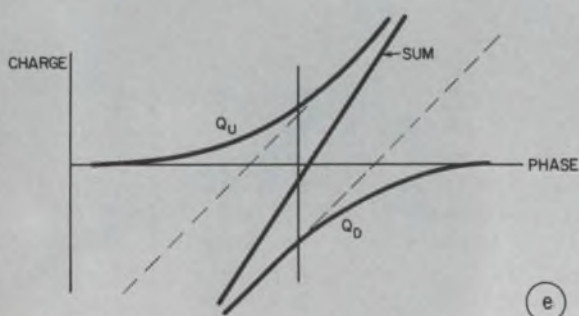

that the input phase modulation has an rms value of about 0.16 ns—about the order of resolution that you can expect using this circuit and the MC 4044.

Range of change

Obviously, from Fig. 3a, the gain changes severely—it drops more than 20 dB (into the noise) in about a 3-ns interval. A second, narrower, low-gain region is also evident, as is a region where the gain increases nearly 20 dB. And there are other regions, where the gain goes either high or low. The charge-pump-control pulses show that there is indeed a dead zone—where one pulse ends before the other begins.

Testing the second detector, near zero phase error, gives similar results. And the results of testing both detectors are consistent with a published plot for the MC 4044³ of output voltage versus phase. Further, that plot suggests that the gain may reverse sign, perhaps in the low-gain, -7 ns region of Fig. 3b. ■

References

1. "Phase-Frequency Detector, MC 4344, MC 4044," *Data Sheet*, Motorola Semiconductor Products, Inc., Phoenix, AZ 85036, 1973.
2. "Phase-Frequency Detector, MC 12040," *Semiconductor Data Library*, Series A, Vol. 4, Motorola, Inc., 1974, pp. 6-38 to 6-41.
3. "11C44 Phase/Frequency Detector," *Data Sheet*, Fairchild Semiconductor, 464 Ellis St., Mountain View, CA 94042, 1975.

Living with the distortion

Say you've located the distorting regions of a charge-pump phase detector. How can you avoid them? In a type-2 loop, the simplest way to avoid steady-state operation in the nonlinear region near zero phase error is to inject enough constant current into the loop's filter capacitor. Unfortunately, the resulting current pulse from the charge pump generates unwanted sidebands about the reference.

For better results, inject a pulse of current at the zero-phase-difference time. Choose the magnitude and polarity so the pulse gets canceled by the compensating pulse from the charge pump. This way, you get the required phase offset without net-current injection to produce unwanted sidebands. Even if the pulses don't match exactly, the magnitudes of the troublesome lower frequencies are reduced, as Eric G. Breeze shows in "High Frequency Digital PLL Synthesizers," in the *Fairchild Journal of Semiconductor Progress*, Vol. 5 No. 6, November/December, 1977, pp. 11-13.

By designing out trouble we ended up with the IMP* - the world's smallest controller.

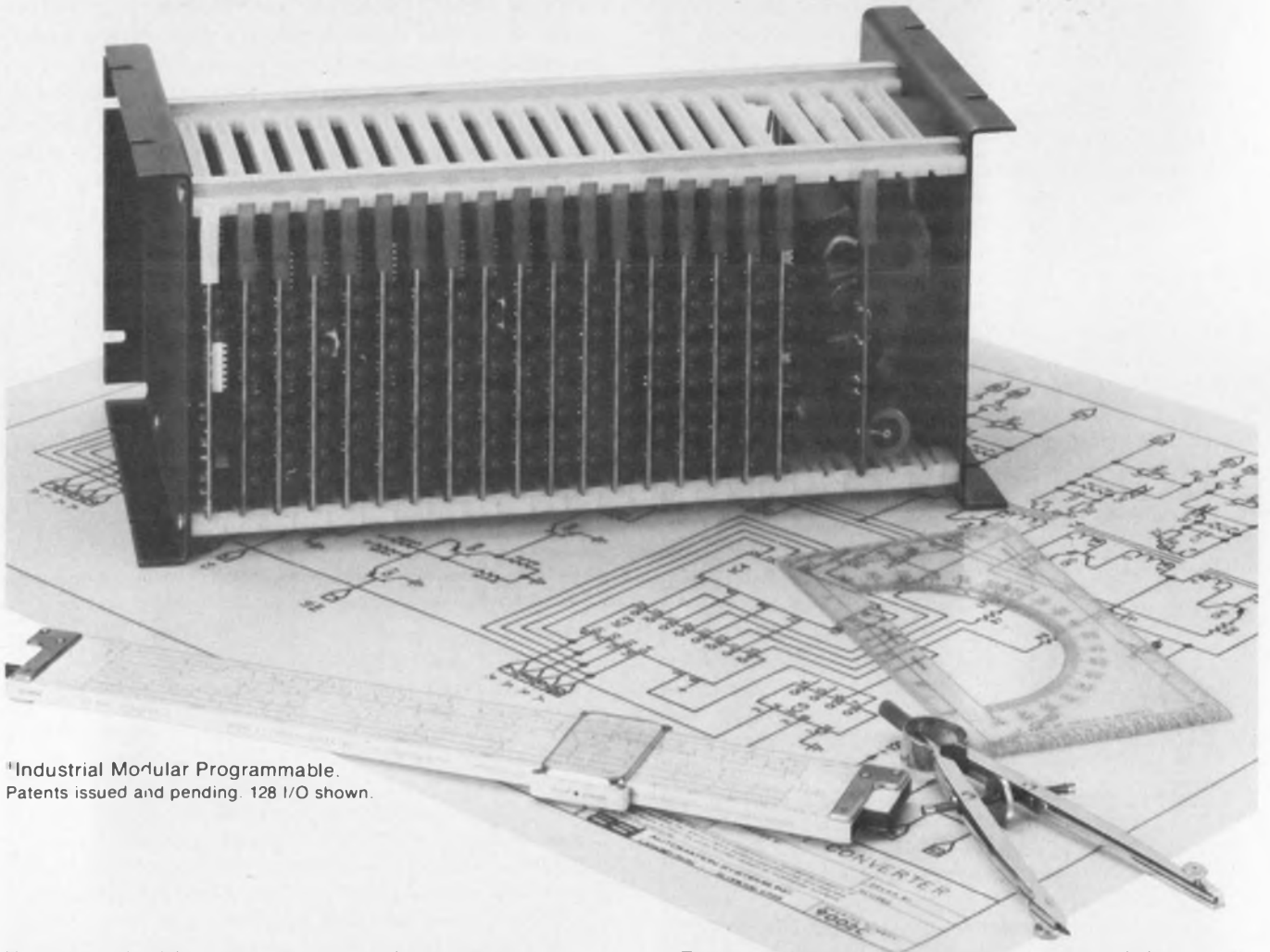

*Industrial Modular Programmable.
Patents issued and pending. 128 I/O shown.

We started with a clear picture of the control functions necessary to make a highly versatile controller — better than anything already on the market. To give it super-reliability, we then set about designing it with the highest quality components and connections.

Finally, we made the whole thing modular so you only buy what you need. And when we put it all together we found we had by far the most compact controller on the market. For the facts on the IMP, just give us a call. It's no trouble at all.

asi

AUTOMATION SYSTEMS, INC

LANCER PARK • ELDRIDGE, IOWA 52748 • 319/285-8171

CIRCLE NUMBER 39

DESIGN BECKMAN TRIMMERS IN. DESIGN PROBLEMS OUT.



Presenting the 93P. Our new half-inch trimmer with its built-in dial is a turn for the better.

For the first time, you can have a cermet half-inch single-turn, with dial setting capabilities. A variable resistor that's somewhere between trimmer and precision pot, designed to save labor costs with screwdriver position adjustability, and high-resistance capabilities.

Now you can write your manuals, and specify fast setting instructions. Using the 93P means reduced labor. It'll take less time to make that initial setting, less time to check the board. Calibration time is minimized. And the 93P has custom dial setting capabilities, too.

Cermet technology has many advantages over wire wound. With 10% tolerance, and 100 ohms to 2 meg

ohms resistance range, it wins hands-down at high resistances. Inductive problems are eliminated. And the 93P is sealed for environmental stability.

Why a larger cermet part? The longer the element, the more the power dissipation. And it stands to reason, you can get more marking and more adjustability.

Design in a trimmer that's not a trimmer as you've known it until now. The 93P.

Call your local Beckman Helipot distributor for free evaluation samples. To get his number, or immediate technical literature, call (714) 871-4848, ext. 1776. Start designing problems out today.

BECKMAN®

CIRCLE NUMBER 253

The big switch

...is to energy saving switchers.

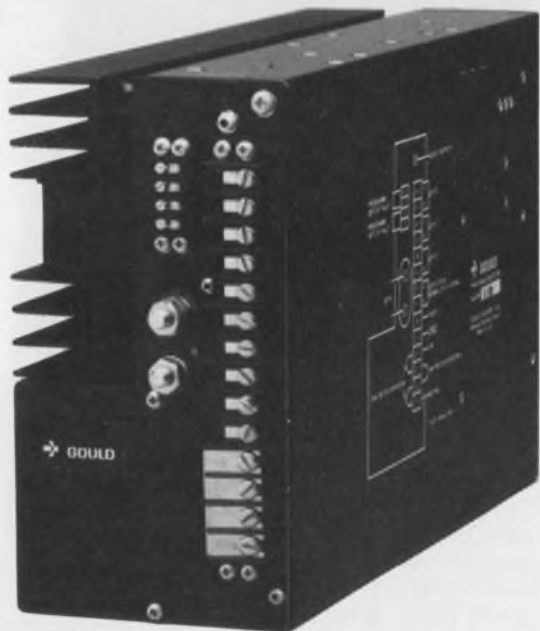

300 watt, quad output MGQ 300: 75% energy efficient.

Switching power supplies are more efficient than linears.

To produce a 200 watt output, a linear supply needs 400 watts coming in. A Gould switcher needs only 270. The switcher saves the 130 watts that the linear throws off in the form of heat.

Since the switcher dissipates less heat, your system operates at a lower temperature. This improves overall reliability and can reduce the need for external cooling.

But energy efficiency isn't the only advantage switchers offer. They're 1/3 the size and 1/4 the weight of linears. And they offer far better holdup and brownout protection.

Gould offers single and multiple output switchers with power levels from 8 to 2,250 watts. And custom designs can be provided to meet your exact specifications. You'll be backed by a high volume production capability and worldwide service network that only a \$1.5 billion company like Gould could offer.

For more information contact Gould Inc., Electronic Components Division, 4601 North Arden Dr., El Monte, CA 91731. Phone (213) 442-7755.

Gould.
The power in switching power supplies.



Illuminated single-pole rockers come in red, green, amber, white or clear. Hot-stamped legends available.



Flush-mounted switches snap in and stay in. Available in a wide range of designer colors and styles. Choose from bright nickel-plated metal or all-plastic bezel. 1 or 2 pole.



Locking rocker switches. Supplied with a unique removable "key" to prevent inadvertent or unauthorized operation.

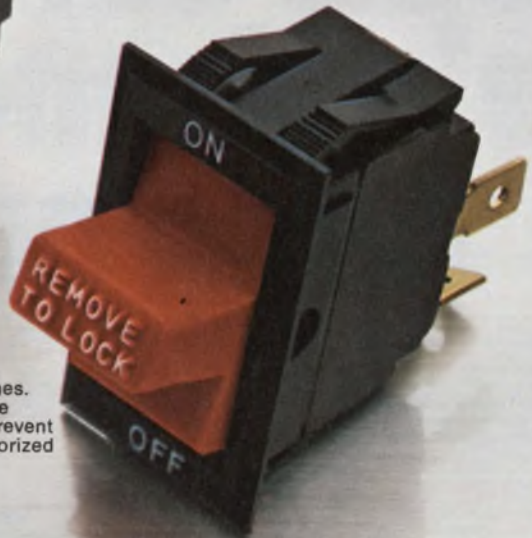

We've added a new look to our rocker line—"see thru"

One of the industry's biggest selections of reliable snap-ins just got bigger. We've added new mechanical indicator switches to our already broad Rockette® line. Look over our full lineup. It includes sub-panel mounting, as well as a wide variety of termination types and circuit configurations. Then look up your Cutler-Hammer Sales Office or Switch Distributor.



NEW rockers with mechanical indicators show functions thru a "window" on the actuator. Available non-illuminated or illuminated and can be customized with words or colors. Choose from bright nickel-plated metal or all-plastic bezel.

CUTLER-HAMMER
SPECIALTY PRODUCTS GROUP, Milwaukee, WI 53201



CIRCLE NUMBER 255

**Dow Corning[®] silicone
elastomers perform
from one extreme
to another.**



When you're designing a component that has to go to extremes — especially temperature extremes — it's nice to know that Dow Corning silicone elastomers will get you there. And help reduce total design costs at the same time. They perform consistently and stay flexible from -55 to +200 C. Or better.

Take a look at some of Dow Corning's electrical/electronic design problem solvers.

Flame-retardant potting compound. For general potting and deep section encapsulation, try our two-part Sylgard® 170 A and B encapsulant. It has excellent flame retardancy and provides outstanding electrical insulation on modules, relays, power supplies, transformers, ferrite cores and other devices. Sylgard 170 encapsulant is recognized under the Component Program of U.S. Labs, Inc. up to 170 C. Its cost is very competitive with less effective organics.

Durable, flexible conformal coating. For a tough, clear, shock-insulating conformal coating on circuit boards, you can't beat Dow Corning® 3140 RTV silicone coating. This flowable, one-part silicone coating is the only conformal coating that has UL component recognition to 180 C and also meets the requirements of Mil Spec MIL-I-46058-C and MIL-A-46146.

Tough adhesive sealant. For those critical bonding and sealing jobs, high-tear-strength Dow Corning® 3145 RTV adhesive sealant is a must. It stands up to the toughest jobs and virtually never needs maintenance. As with all of these products, it's noncorrosive to sensitive electronics. Two colors are available. The gray-colored sealant has UL component recognition to 200 C; clear has UL component recognition to 180 C.

If you're looking for reliability and reduced design costs, specify the products that go to extremes for you — Dow Corning silicone elastomers. Our technical support group will also go to extremes to help. For more information, write Dow Corning Corporation, Dept. A-8554, Midland, Michigan 48640.

Cost-cutting silicone elastomers.



DOW CORNING

DOW CORNING Cost-cutting
silicone
elastomers.

CIRCLE NUMBER 256



Sure, Littelfuse makes fuses. But that's just one side of our story.

We're Fuses.

Small dimension fuses. Normal-blo, slo-blo or fast-acting. Glass or ceramic. Indicating, rectifier, pigtail and subminiature types for specialized applications. Plus a full range of mating fuseholders, blocks and clips.

We're Switches.

Single and double pole snap-action rocker types in wide range of switching and color combinations. Plus a full line of momentary action plunger and rocker switches.



We're Relays.

Miniature and heavy-duty power relays for low-voltage (12VDC) electronic and automotive applications.



We're Circuit Breakers.

24VDC and 125VAC breakers featuring automatic or manual resetting for use in a variety of electronic and automotive applications.



We're Indicator Lights.

Cartridge lamps and lampholders, subminiature lampholders, miniature lampholders and snap-mount plastic lights. Wide choice of lens styles, colors, finishes and terminations.

And We're Ready to Help Solve Your Design Problems!

LITTELFUSE SUBSIDIARY OF **Tracor**

800 East Northwest Highway / Des Plaines, Illinois 60016 / (312) 824-1188

For the full story, write on company letterhead for a copy of our Catalog 19. For indicator lights only, request our Littelite Product Guide.

FOR RENT...NOW...

the truly universal PROM Programmers
from Data I/O that enable you to program
any of the more than 200 PROMs now available.

A single Data I/O programmer — the Model V or Model IX — can be used to program every single commercially available PROM.

Data I/O programmers are universal. You can use them to program any PROM, and more than 200 PROMs are currently available. This means you don't have to get a separate programmer to accommodate different PROMs. With either the Model V or Model IX and the appropriate personality card, you can program any PROM or its second source equivalent. Moreover, one personality module can be used to program all PROMs within a generic family and keep your yield at the maximum.

ROM emulation and editing capabilities are built-in, making software development a breeze and virtually eliminating PROM waste.

All the Data I/O programmers save lab time and slash your development expense. These are

portable, rugged, human-engineered and easy to use units. They're ideal for field service. Both the Model V and Model IX offer a direct display readout of PROM or RAM data at any address and offer unlimited data editing capabilities.

Operation is totally automatic, and you can enter data manually through the keyboard or load it automatically from a preprogrammed master PROM. There are built-in error checking routines to insure accurate and correct data transfers, and serial or parallel I/O are standard. These unique PROM programmers and their personality cards are available now.

Rental Electronics, Inc.

Another of the AMERICAL companies

More than 12,871
state-of-the-art instruments . . .
off-the-shelf, throughout North America.

Tell me more about the Data I/O PROM Programmers now!
Call me at _____

Send me your Equipment Sales Catalog — I might be interested in buying some of your great "previously owned" equipment on a money-back guarantee.

I have a pressing need right now for the following: _____

Please phone me immediately at _____

Send me a copy of your free illustrated Rental Catalog.

Name _____
Title _____
Company _____
Address _____
City _____
State _____ Zip _____
Phone No. _____ Ext. _____

GSA #GS-045-21963 Neg
© 1978 Rental Electronics, Inc.

Complete this coupon and return it today to the world's oldest and largest electronic equipment rental firm, REI, 19347 Londelius St., Northridge, California 91324

Anaheim, CA (714) 879-0561
Mountain View, CA (415) 968-8845
Fort Lauderdale, FL (305) 771-3500
Des Plaines, IL (312) 827-6670
Burlington, MA (617) 273-2770
Gaithersburg, MD (301) 948-0620 • Oakland, NJ (201) 337-3757
Cleveland, OH (216) 442-8080 • Dallas, TX (214) 661-8082
Houston, TX (713) 780-7218 • Seattle, WA (206) 641-6444
Northridge, CA (213) 993-RENT (7368)
Rexdale (Toronto), Ontario (416) 675-7513
Montreal, Quebec (514) 681-9246 • Vancouver, B.C. (604) 684-6623

CIRCLE NUMBER 257

Two multi-turn trimmers that will set well with you.

Both our Type RT and MT cermet trimmers combine 20-turns and multi-fingered wipers to give you unexcelled adjustability. Both types: 10 ohms to 2.5 megs $\pm 10\%$. Typical TCR is less than ± 35 PPM/ $^{\circ}\text{C}$. True quality trimmers at very competitive prices. We have what you need. Our distributors have them when your need is now. Ask for Publication 5237 (RT) or 5241 (MT).

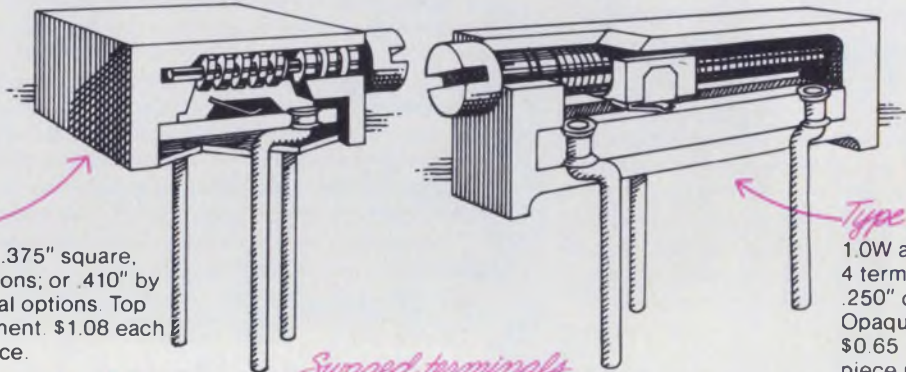

Type MT

0.5W at 70°C; .375" square, 3 terminal options; or .410" by .375", 4 terminal options. Top or side adjustment. \$1.08 each 1000 piece price.

Immersion sealed
... tested in 85°C water.

Swaged terminals

for extra strength and reliable bonding.

Type RT

1.0W at 40°C; .750" long, 4 terminal options; choice of .250" or .340" case heights. Opaque or translucent case. \$0.65 or 0.93 each 1000 piece price.

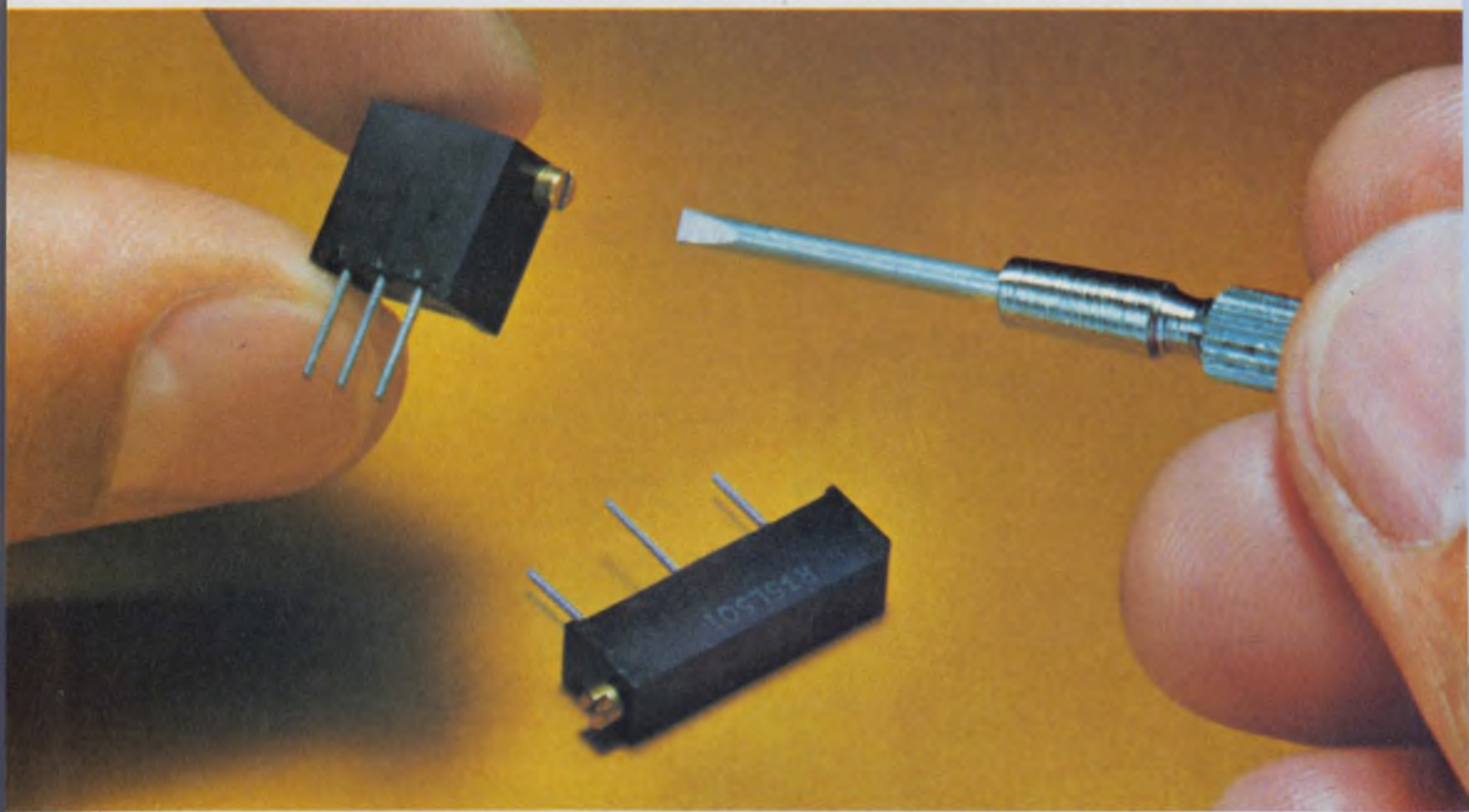

Quality in the best tradition.



ALLEN-BRADLEY
Milwaukee, Wisconsin 53204

CIRCLE NUMBER 258

SIEMENS

Introducing the small digital IC tester that acts like a large test system.

No other digital bench-top IC tester in the same price range offers the advantages of the Siemens 725. The 725, a 24-pin, MPU based digital IC tester, was designed and built to test virtually all SSI and MSI devices. It offers both functional and parametric test capabilities as well as other features usually associated with larger, costlier test systems. And at a functional test rate of 1 MHz, the 725 is faster than any other bench-top.

The 725 is a highly flexible piece of equipment. It can handle high-volume end user/manufacturing situations, as well as low to medium end user situations. The standard

configuration operates with a single manual test site, IC handler or wafer prober.

A multiplexed system is also available for dual test site operation—again emphasizing the flexibility of Siemens 725 IC Tester.

Both systems are utilized in conjunction with a Siemens library of cassette test programs. A prompted English language programming system facilitates customer program development or modification via an optional I/O device. Find out how the many advantages and flexibility of Siemens 725 can work for you.

Siemens Corporation

Measurement Systems Division
3 Computer Drive
Cherry Hill, N.J. 08034
(609) 424-2400



The 1 MHz, MPU based, multiplexed Siemens 725.

The "INTELLIGENT" DVM's from Guildline

from \$

27995

G GUILDLINE

100.7065

MODELS 9575 / 9576

MEASUREMENT

dc voltage • ac voltage
resistance • 1 μ V sensitivity
auto and manual ranging
scale length 3½ digits to 6½ digits
hidden decodes
396 readings/s at 3½ digits
51 readings/s at 5½ digits

PLUS

offset • multiplication • ratio
limits • percentage deviation
max, min, peak-to-peak
temperature • statistics
all under time control

with 4 systems (bcd, binary)
interfaces: (RS 232, IEEE/IEC)

G Guildline Instruments, Inc.
2 Westchester Plaza, Elmsford, NY 10523, (914) 592-9101
Available on GSA contract

Need 24 or 40-pin DIP's off the shelf?

We're your source.

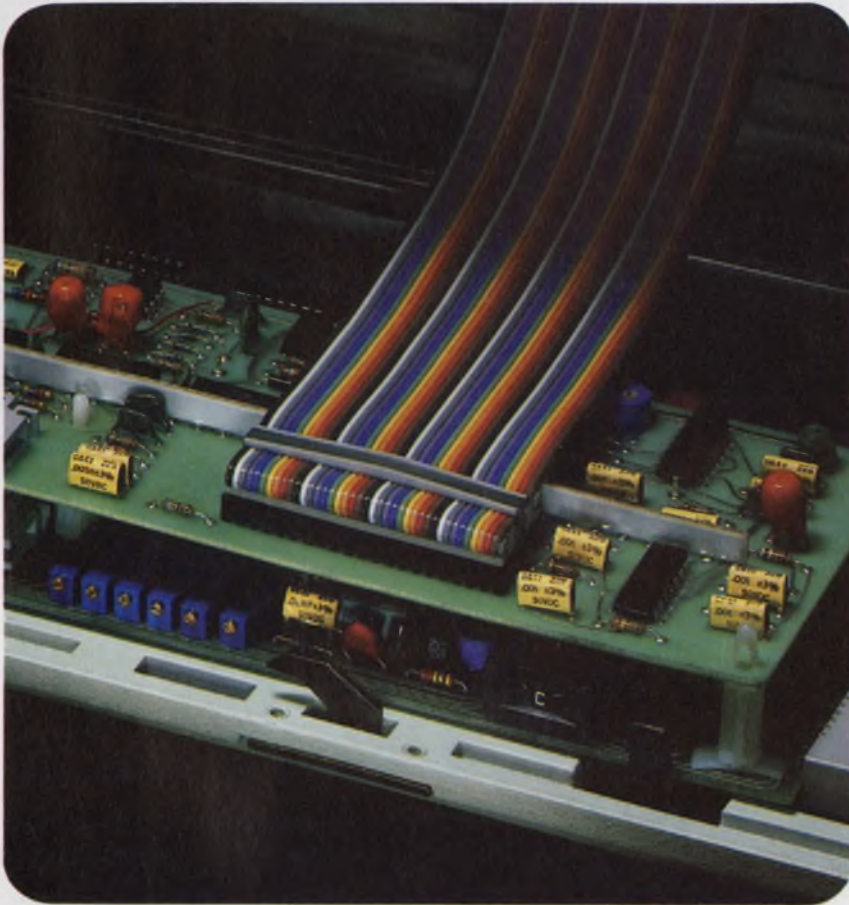

Want the speed, savings and reliability of mass termination with larger size D.I.P. connectors? Come to 3M. Our Scotchflex brand D.I.P. connectors in 24 and 40-contact sizes let you design quick, easy interboard jumpering with readily available parts. Their space-saving low-profile design makes them ideal for microprocessor applications. They also speed and simplify test jumpering or checkout of I.C. sockets.

Both connectors have .100" x .600" grid spacing and are available with either rectangular legs for use with standard I.C. sockets or round legs for use with high density packaging panels. They may be used with Scotchflex shielded, non-shielded or color-coded flat cable or with twisted pair or parallel lay woven cable.

Where frequent plugging and unplugging is necessary, strain relief bars and pull tabs are available for all Scotchflex D.I.P. connectors including 14 and 16-pin sizes.

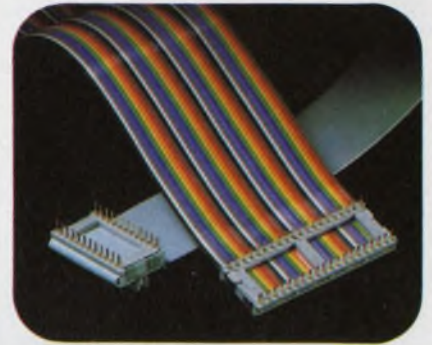

Need some more ways to simplify wiring and increase circuit density? 3M's Scotchflex line offers you the widest choice of mass terminating cable, connectors and system components to accommodate your design packages. Plus proven reliability. Off-the-shelf availability. And the unmatched experience of the people who pioneered the concept of electronic mass termination.

Scotchflex connectors are recognized under the component program of Underwriter's Laboratories, Inc. 
"Scotchflex" is a registered trademark of 3M Co.

Scotchflex[®] systems from 3M. The source.



Licon has more economical ways to light and control switch action.

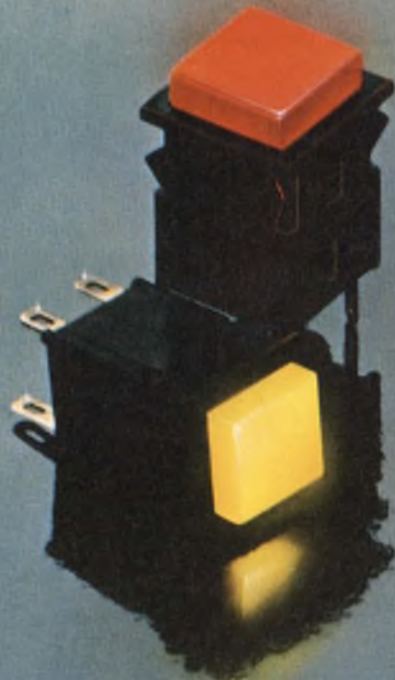

If you sat down . . . took the best features of all low cost, low energy lighted pushbutton switches . . . you'd come up with the same thing we did . . . the LICON® Series 05 Lighted Pushbutton Switches. These are the switches you asked for.

Here are the ideal LPB switches for office machines, computers, appliances, home entertainment, etc. wherever requirements dictate low level switching, economy and high reliability. The Licon Series 05 Switch is available in momentary and maintained action plus lighted, non-lighted versions. The maintained action style offers "dual indication", light and lens position. Available in both double and single pole styles—single pole N.O., double pole N.O. and SPDT styles. Exclusive design offers smooth, pleasing "feel" plus snap-in bezel mounting that assures rigid retention. These amazing little switches also feature bifurcated, silver plated contacts, .110 quick disconnect or PC board terminals, a rainbow of colored lens cap choices and U.L. Listing.

05 Series Switches fit .625 square panel hole size; accept low cost T 1 $\frac{3}{4}$ wedge base lamp. Relamp from front panel. .25 Amp., 125 VAC rating. In addition, all these features are available in a compatible L.E.D. version complete with L.E.D. display lens.

05-6 Series Switches mount in a .750 square panel cutout. Use versatile front panel replaceable T 1 $\frac{3}{4}$ flange base lamp. Offered in .25 or 3 Amp versions, 125 VAC rating. Lens barriers are available.

We've got more to talk about too. Ask for full details, contact your local Licon Distributor, or call or write for our Switch Catalog: LICON, 6615 West Irving Park Road, Chicago, Illinois 60634. Phone (312) 282-4040 TWX: 910-221-0275.

For Full Details CIRCLE NUMBER 262
To Have Salesman Call CIRCLE NUMBER 263



LICON

A DIVISION OF ILLINOIS TOOL WORKS INC.

32K ROM

**It's fully-static NMOS.
It's fast (300 ns max. cycle time).
It's available in volume now.**

If you're ready for a 32K ROM, make the move up to a Rockwell R2332 fully-static N-Channel ROM, (4096 x 8-bits).

The R2332 is universally compatible with N-Channel microprocessors, and supports Rockwell's growing R6500 microprocessor family.

The fast R2332-3 features maximum access and cycle time of 300 ns. Both the R2332-3 and the standard 450 ns R2332 use 400 mW power and one 5V power supply.

R2332 and R2332-3 inputs are TTL compatible with a 400 mV minimum noise immunity on both the HIGH and LOW inputs. All eight outputs are tri-state drivers capable of driving 100 pf and a TTL gate.

The R2332 from Rockwell operates totally asynchronously and requires no clock input, so it's compatible with both static and clocked-static versions. Two mask-programmable chip select

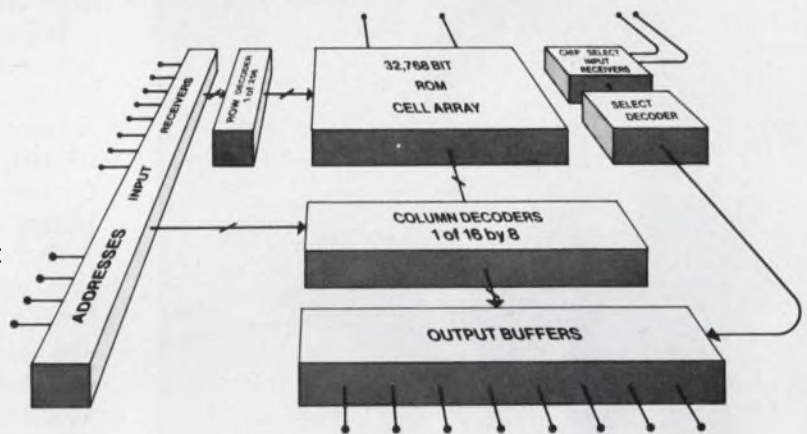

inputs allow four 32K ROMs to be OR-tied without external decoding. Programming allows selection when the input is HIGH or LOW or in a don't care mode. Both chip select and chip deselect delays are 100 ns.

Get started today by getting more information on R2332 and the R6500 family. Contact a local Hamilton/Avnet distributor or write: D-727-C, Microelectronic Devices, Rockwell International; P.O. Box 3669, Anaheim, CA. 92803 or phone (714) 632-3729. Telex (via TWX) 910-591-1698.



Rockwell International

...where science gets down to business

George Bugliarello of New York Poly Speaks On Expanding Your Research Capabilities

Lots of companies don't have the research capabilities they'd like. They can often get help from universities, but they don't know they need the help or they don't know how to get it.

The federal government, on the other hand, uses universities to great advantage. It has a relatively small research establishment of its own. It has the National Bureau of Standards, the David Taylor

Model Basin, NASA's laboratories and a few others, but in the aggregate, the federal in-house research establishment is relatively small. It is certainly small in comparison, say, with what's available in the USSR, which does its research primarily through its government research institutes—not through universities. In fact, there's an almost impervious barrier between the institute and the universities.

But here, the federal government has a wonderful system. Using the universities for research, it pays only an incremental cost when it decides to shift priorities from one program to another. It isn't committed forever to a large number of permanent researchers. So the system is flexible and cost-effective.

Industry doesn't take similar advantage of the universities. In part, that's because industry doesn't adequately understand the schools, but in larger measure it's because the schools don't understand industry. Sure, faculty members frequently consult for industrial companies, but they see only a narrow picture of what's involved.

There's an historical reason, too. After the Soviets sent up Sputnik in 1957, our universities became heavily involved in government research programs and they learned how to work with the government or, at least, with the relatively small number of federal agencies involved.

The universities learned the road to Washington. But they forgot the path to hundreds of industrial companies. Consequently, many companies forgot—or never learned—how to take advantage of what's available in the universities.

Of course, there can be large difficulties in plugging an academic institution into interaction with an industrial organization. Faculty scheduling and faculty reward structures can pose problems. Despite the problems, the payoff for industry can be significant.

Look at the usual procedure. If a company wants to go into a new area, it normally scrounges around for experts in the field. It tries to buy the right people, then the right equipment, but it really doesn't know how to evaluate the people or the equipment. A

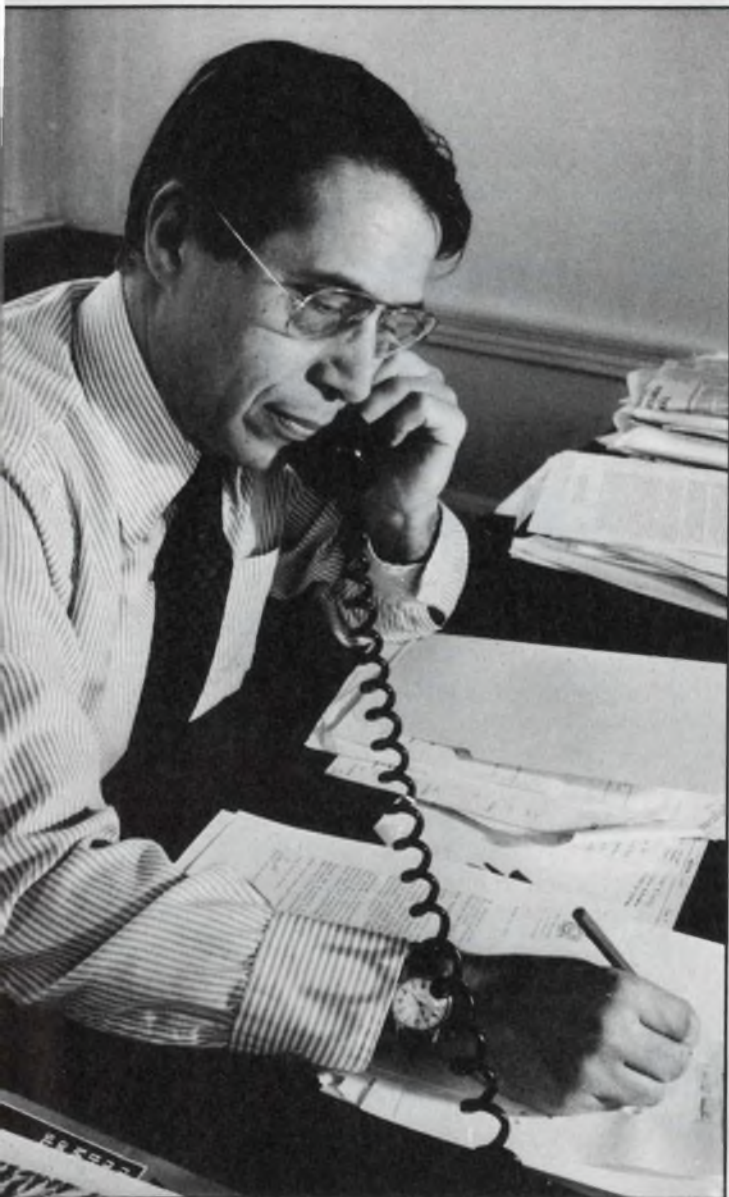



mistake here can be costly.

A university can offer various levels of help. It can provide the research until the company feels strong enough to do its own. Or it can help the company select the right people and point the company in the right direction. That's important.

But the company may have to adjust to the special schedule requirements of a university. There are vacations and sabbaticals—often long ones. And students often drop everything else when they are preparing for examinations. But schedules can be negotiated.

The company may also have to negotiate special incentives for university people. In general, faculty members are judged and recognized by what they publish. The old dictum, "Publish or perish," still prevails in academia. An industrial company has different needs. It may want nothing published about some contracted research. Here, too, is something that must be negotiated.

There's a further problem. Many companies aren't equipped to evaluate university researchers. They really don't know how to assess the capability of engineering faculty members. There are basic questions they tend to ask candidates for engineering positions: "What have you designed? What have you brought to commercial success?"

Such questions may not be appropriate for a university researcher. It's even difficult to judge him on the basis of his patents, for it can take many years to evaluate a patent's commercial value. You can sometimes evaluate an engineer on the basis of something he has developed to commercial success, but that's not the usual university researcher's role.

In most cases, but not always, the university's assumed role is basic research, rather than applied research, which is more easily carried out in an industrial company. And this brings up another point.

Many people feel that most companies, perhaps all but the very large ones, need applied research—not basic research. So they think they have no use for what universities can offer.

I think there are several things wrong with this feeling. Our decreasing fund of knowledge derived from basic research should be of major concern to all of us. We are living too much on capital, rather than generating new capital from basic research. So I think we need lots more basic research. Small companies need it as much as large ones, perhaps more if they are going to make it in a highly competitive environment where know-how is more important than squeezing the last penny out of a run-of-the-mill product.

If small companies cannot do basic research individually, then they can do it as a group. A number of companies can band together to develop an organic program of basic research. They can assess the basic things they'd like to see studied, then go to a university, or a group of universities, and ask for a research program aimed at those things.

Before we go any further: What is basic research? And what's applied research? Some people feel that universities are fine for developing the fundamentals of microwaves (basic research), but not for developing a better tape recorder (applied research).

I don't believe that's quite true. I don't believe there's a dichotomy between basic and applied research when it comes to a person. I have personally done both and feel both are intellectually invigorating.

The important point, though, is that there is no such thing as THE university. Each school is different from the others.

Some schools do only basic research while others do only applied research. Still others do some of each. So it's unwise to think in stereotypes. There are some 4000 universities in this country. Fewer than 200 have engineering schools, and each of these has its own physiognomy, its own personality, its own attitudes.

In a research-oriented university, most faculty members are heavily involved in keeping abreast of what's going on in their fields. In another type of university, the emphasis might be on teaching at the undergraduate level, the postgraduate level or both. Clearly, the university that spends all its effort in teaching can't be used in the same way as a research university. It's not likely to do the same kind of job. Even within one type, different universities may do different jobs, depending on their personalities.

So the wise company executive should occasionally

Who is George Bugliarello?

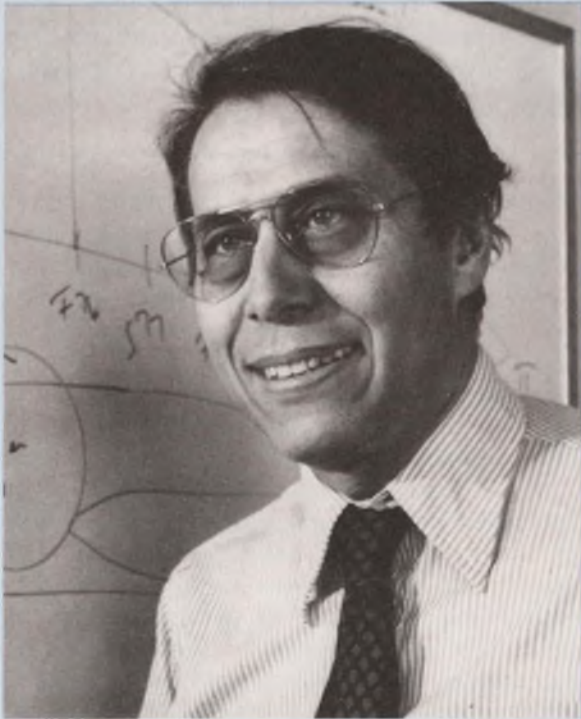

There's scarcely a field of human endeavor that's beyond the scope of George Bugliarello's searching mind. He started in engineering, taking his doctor of engineering degree (*summa cum laude*) in 1951 from the University of Padua, less than a hundred miles from his birthplace in Trieste. Then a Fulbright scholarship took him to the University of Minnesota, where he took a master's in civil engineering before returning to teach at the University of Padua for a year. Then on to MIT where, in 1959, he took his doctor of science degree with a minor in industrial management.

From MIT he went to Carnegie-Mellon and stayed for 10 years. There he taught fluid mechanics and developed a biotechnology program. Then on to the University of Illinois at Chicago Circle, where 42-year-old Bugliarello took the post of dean of engineering.

And in September 1973, a month after 119-year-old New York University's School of Engineering and Science merged with 119-year-old Polytechnic Institute of Brooklyn, Bugliarello became the first president of the newly formed Polytechnic Institute of New York.

By this time, he had been married 11 years to the former Virginia Upton Harding, an art historian with whom he shares a love of history and philosophy. Though his reading centers in those fields, he reads almost anything, especially when he's traveling. He does a lot of that. He has visited Venezuela and Zaire for the State Department as part of his heavy involvement in the problems of developing countries. And he's currently chairman of a committee of the National Research Council that deals with technological

innovation in these countries.

When he's not traveling, reading or just relaxing with his wife and teen-age sons, Nicholas Luigi and Frederico David, Bugliarello is editing or writing works in a broad range of disciplines. He's written a book on noise pollution, one on computer systems in water resources, and one on the regional role of engineering colleges. He's now writing a book on what he calls the biosoma—the intimate combination of biological organisms and machines. The book will study the biosoma's role in the earth's evolution.

Man started as a biological organism that originated in matter that came from space and formed the earth, Bugliarello says. "And we're entering a period in which we are going back into space—our fatherland."

go to lunch with the dean of engineering or various department heads. He should get to know the people running the universities and the professors. He's already paying for these academic resources through taxes, and perhaps through corporate contributions. He should take further advantage of them.

He should know that faculty members are important nodes of information. In their fields, they travel a lot, read a lot and write a lot. So they tend to know a lot. In a good university, the faculty members aren't the fellows who study an assignment the day before the students do. They are highly competent individuals who can make important contributions to industrial companies.

Let me show you an example outside our electronics industry. Japan, we all know, is the undisputed leader in naval architecture. Many people assume Japan's lead comes from lower labor costs. That's not really the total picture. The bulbous bow, that most significant innovation in naval architecture, came from Japan's university research.

In general, there are two areas where universities tend to be far more effective than industrial companies: where the creation is very complex, and where many disciplines are involved.

If relatively few steps are needed between an idea and its implementation—say it's merely necessary to improve a process—then the best environment for this type of research is usually the company itself. But if the number of steps is large between the initial idea and what's required to make the idea practical, there's no substitute for the involvement of a university.

Or say a project requires a knowledge, not only of electronics, but also of materials, biology and psychology—say we're trying to develop an electronic device that must function in a patient. For such a project, there's no substitute for a university-like environment because the university has the people in all these disciplines and can bring them together easily. Or universities can work together when one doesn't have all the needed expertise. We at

Polytechnic, for example, have worked with the New York University School of Dentistry on a materials problem.

It would be far more expensive for a company to assemble such talent, keep them happy and provide them with enough research to keep them busy in their fields. It's a rare company that can keep a group of medical doctors, biologists and psychologists busy.

But there's something that disturbs many managers in industry—the university's pace.

There's a widespread feeling that the atmosphere in a university makes for a leisurely pace, while industry is in a hurry. In industry, a time advantage over a competitor can be very important. So industry seems always to be working against time, while universities seem not to be.

I don't think this is true. The universities have their own time pressure, which can be just as severe as what you find in industry. Research-oriented universities live by contracts or research grants, which are generally fixed-fee. The universities want to get renewal contracts for following years and they don't get renewals till they write a report.

But aren't all these reports the same? Don't they all conclude with "more study is needed"? Of course, they do. That's reality. The more you know about any subject, the more you need to know. The more you learn, the more you find other things you'd like to know. But there's much more in a report than the final line. The report also provides a wealth of useful information. And, of course, it can tell which factors are important and which are trivial. And it can point to fruitful directions.

Of course, the universities are not like industry. They are different—which is their value. The universities can go to infinite lengths to learn more and more about a subject. They want to acquire knowledge for its own sake while industry wants to acquire knowledge so it can go to the marketplace. Industry knows that at some point it must cut off study and go into production.

The university is not geared to production of things, but rather, to the production of knowledge. And this, in part, is the essential difference between applied and basic research.

Say your company wants to develop a more efficient, less costly solar cell. If you expect a university to spend the next eight months developing a commercial, low-cost solar cell with double the efficiency previously available, you probably won't succeed. But if you work closely with the university, you can tap a group of experts, learn what the important parameters are, learn what's already been learned by other researchers, and learn which of several approaches is likely to be most rewarding. That would be using the university intelligently.■

A CRT Yoke for all reasons

Military

Airborne (HUD, HDD, VSD, HSD), shipboard, ground systems, missile systems.

Compact, lightweight, encapsulated to withstand physical stress. Special ferrite core designs.



Commercial

Computer terminals, monitors, medical applications, hard-copy machines, etc.

Engineered and tooled for volume production. Cost-effective and geometry corrected.



Special Designs

Phototypesetting, random graphics, flying spot scanners, mappers, vidicons.

Designed for low residual and superior resolution using special assembly techniques.



Send us your reasons for needing a better yoke. We'll supply technical data sheets, recommendations, engineering assistance.



syntronic

Syntronic Instruments, Inc.
100 Industrial Road, Addison IL 60101
Phone (312) 543-6444

Sample-and-holds and a summing amplifier form an analog memory unit

You can make a summing amplifier and two sample-and-holds perform like an analog accumulator, or long-term integrator. The circuit in Fig. 1a gives you dc stability without the use of costly chopper-stabilized amplifiers, and low frequency response is better than from conventional amplifiers.

Input voltage v_i in Fig. 1a is added to output voltage V_0 and sampled in S/H₁. And the output level of S/H₁ is sampled and held in S/H₂, which forces V_0 to increase either positively or negatively depending on the preceding sampled value of $v_i + V_0$. The final voltage level at the end of a time interval is the sum of all voltage increments sampled during that interval.

The system waveforms in Fig. 1b result from sampling signals V for S/H₁ and W for S/H₂—the leading edge of W controls S/H₂. At $t = t_0$, $V_0 = 0$, and at t_1 , S/H₁ samples and holds the input waveform v_i after it first passes through the summing amplifier. Sampling signal W transfers the output of S/H₁ to S/H₂ at t_1' and the output of S/H₂ is fed back to the summing amplifier's input. At t_2 , S/H₁ samples signal voltage $v_1 + v_2$, which is then transferred to S/H₂ at t_2' . The process repeats until signal Q resets both sample-and-holds to zero. In equation form, the final amplitude of the output staircase, V, looks like this:

$$V_p = \sum_{r=1}^4 v_r = v_1 + v_2 - v_3 + v_4.$$

If you hold v_i constant ($v_i = K$) for several sampling pulses, output V_0 is a staircase with constant (K) amplitude steps. And the slope of the staircase is positive or negative according to the sign of K.

References

1. Tobey, G.E. and Graeme, J.G., *Operational Amplifiers, Design and Application*, McGraw-Hill Book Co., New York, 1971.
2. Lopez, R.A., Asquerino, J.C.M., and Rodriguez-Izquierdo, G., "Reactive Power Meter for Nonsinusoidal Systems," *IEEE Transactions on Instrumentation and Measurement*, Vol. IM-26, No. 3, Sept. 1977, pp. 258-260.

R.A. Lopez, PhD, J.C.M. Asquerino, PhD, Consejo Superior de Investigaciones Cientificas, Spain, and G. Rodriguez-Izquierdo, Professor, University of Santiago de Compostela, Spain.

CIRCLE NO. 311

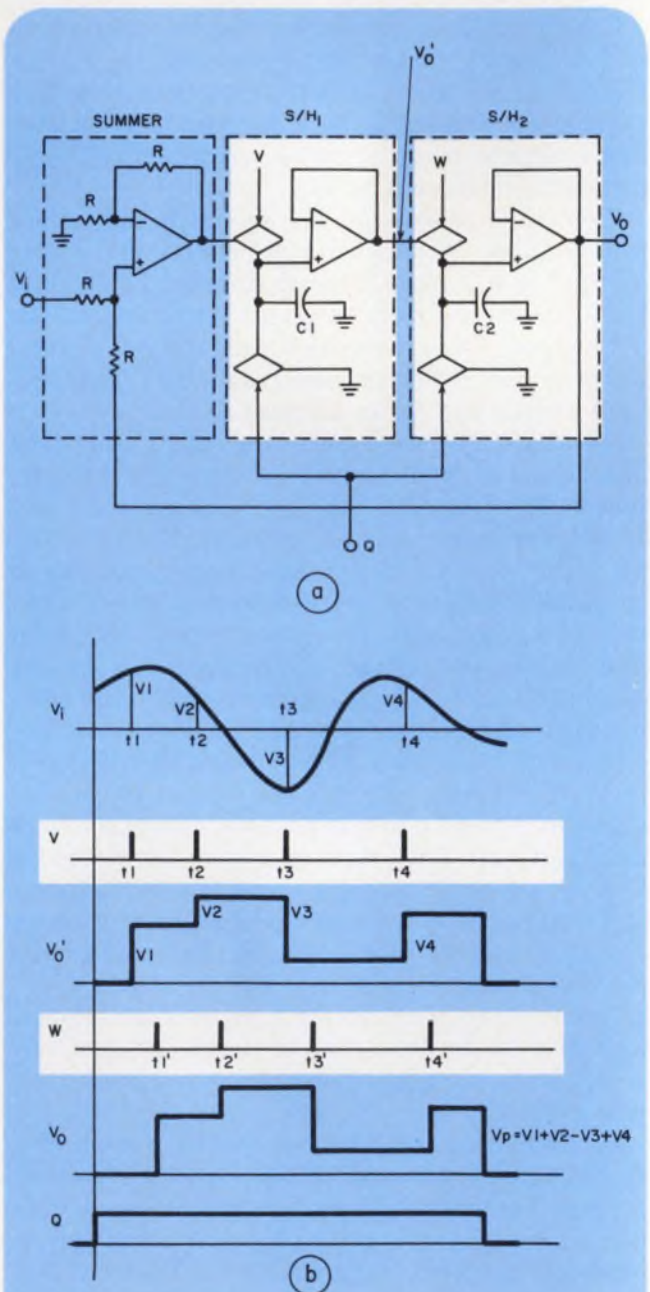

1. An analog accumulator (a) adds all its input voltage levels in a given time interval and produces the algebraic sum at the output. System waveforms (b) depend on sampling signals V and W, which allow the output of the summing amplifier to be sampled and held by S/H₁ and S/H₂.

Motorola presents the Gap-Filler. A 55 Amp SCR for 40% less.

That big hole between 35 A and 60 A SCRs that's long been open because of a technology gap is now filled—to overflowing—with Motorola's new 55 A SCR giving you the opportunity to select the right device for the job . . . and save a few bucks besides.

The MCR63/65 family's a direct spinoff of our tried-and-true, high-volume, hermetic pressfit package that's literally filled millions of failure-free hours of operation in everything from autos to welders.

The technology's super, too. Large, center-fired die geometry for uniform current distribution. Glass-passivated junctions for long-term reliability. Pressfit, isolated or non-isolated stud options for design flexibility.

But the best part's price. Just \$5.87 for a 200 V unit in 1-99 quantities . . . about 40% less than you were forced to pay for a 63 A device that you may not have wanted or represented design overkill.

Use it in industrial and consumer designs for power supplies, battery chargers, temperature, motor, light and welder controls.

Contact Motorola Semiconductors, Inc., P.O. Box 20912, Phoenix, AZ or your authorized distributor for this or any other from Motorola's broad thyristor line.

Gap-Filler SCR	VDRM V	Surge A†	Trigger/ Hold mA	Price 1-99			
				MCR63	MCR64	MCR65	
MCR63 Pressfit	-1	25	550	10/15 (typ)	4.78	5.16	5.78
	-2	50			5.05	5.42	6.05
	-3	100			5.32	5.70	6.33
MCR64 Stud	-4	200			5.50	5.87	6.50
	-5	300			5.68	6.06	6.69
	-6	400			6.21	6.85	7.21
MCR65 Isolated Stud	-7	500			6.92	7.30	7.93
	-8	600			7.91	8.53	9.16
	-9	700			9.25	9.87	10.50
	-10	800			10.83	11.21	11.83

†(One cycle, 60 Hz)

Fill a gap. Save a bundle.



MOTOROLA

Semiconductor Group



Ideas for design

Quad comparator provides two functions—logic-level shifting and time delays

A quad comparator ($\mu\text{A}3302$, Fairchild) makes a versatile level shifter that converts parallel BCD data from TTL outputs into the voltage levels required to drive PMOS, NMOS or CMOS. Not only that, you can add an RC network to each comparator to provide time delays in the data paths. Most available level-shifter ICs are designed for specific voltage levels and are relatively expensive.

The circuit in Fig. 1 is a low-cost level shifter for converting TTL outputs into +5 and -8-V levels to drive PMOS logic. For time delay, select values of R_1 and C_1 that give a time constant less than the time between data transitions. The minimum delay through the circuit is the $\mu\text{A}3302$'s response time—typically 300 ns. For drive purposes, each comparator has an open-collector output capable of sinking a minimum of 2 mA. And the value of output resistor R_6 determines the rise time of the output signal.

Delay times of the positive and negative signal transitions won't be equal unless the threshold level set by R_1 and R_2 is midway between the two levels of the input signal (but not for TTL signals). You can set the delay more accurately if the gate driving a comparator has well defined and consistent output levels, such as open-collector TTL or CMOS provide. If your input data have fast rise and fall time edges, you can omit resistors R_4 and R_5 , which give the circuit Schmitt-trigger action.

Each comparator can have its own delay time: Assign different values to the RC combinations. Of course, you can create variable delays by using a potentiometer instead of a fixed resistor. The circuit

shown in Fig. 1 inverts the TTL output data, but for noninversion, apply the input to the $\mu\text{A}3302$'s noninverting input.

In Fig. 2a, the $\mu\text{A}3302$ is used to convert TTL to MOS levels of -20 V and ground, while Fig. 2b shows a MOS to CMOS level shifter.

Steve Barton, Staff Engineer, Fairchild Semiconductor, 464 Ellis St., Mountain View, CA 94040.
CIRCLE NO. 312

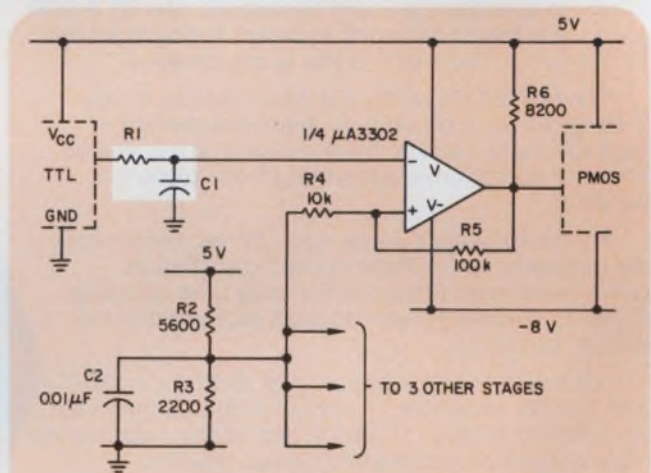

1. TTL outputs can be converted to PMOS logic levels by a $\mu\text{A}3302$ comparator. The quad device lets you convert four parallel TTL outputs. You can insert time delays in the data paths by selecting appropriate values for the R_1C_1 combinations.

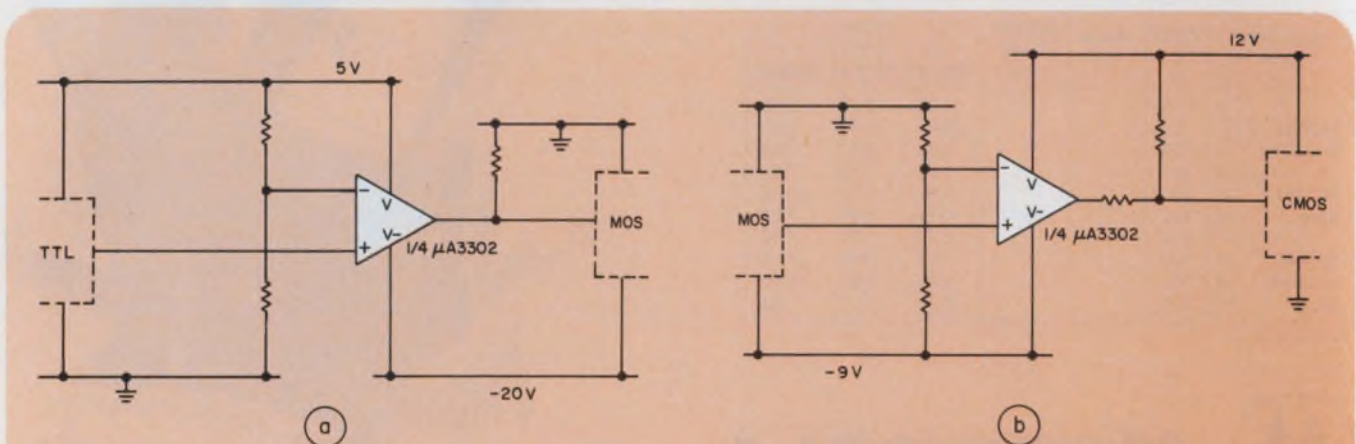

2. The versatility of a quad comparator allows you to use it for TTL to MOS-level shifting for MOS levels

of -20 V and ground (a) or MOS to CMOS shifting for CMOS +12 V and ground levels (b).

Way above average edgeboards for way below average prices.

THERE are two major differences between TI's gold contact edgeboard connectors and everybody else's.

One, they cost less. And two, they're clad.

Basically, a clad metal is two or more metals bonded together into a composite. The bond is molecular and thus permanent and inseparable.

In the case of our edgeboard connectors, a *50 to 75 microinch gold inlay* is bonded at the contact mating surface—the only surface critical to contact reliability.

This inlay is much thicker than ordinary plating, far less porous, and much more reliable. Yet it costs considerably less than lesser connectors:

As low as 1.5¢ per contact for our soldertail versions in quantities of 50,000. And 1.8¢ per contact for our wirewrap configurations in the same quantities.

For a copy of our way-above-average edgeboard catalog, write Texas Instruments Incorporated, Mail Station 2-16, Attleboro, Massachusetts 02703. Or call (617) 222-2800,  Extension 268 or 269.

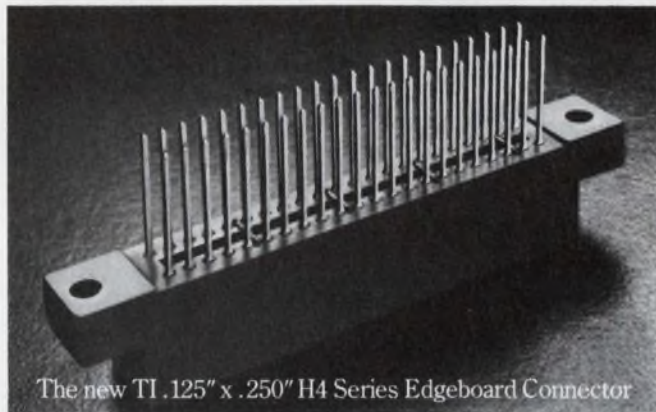

The new TI .125" x .250" H4 Series Edgeboard Connector

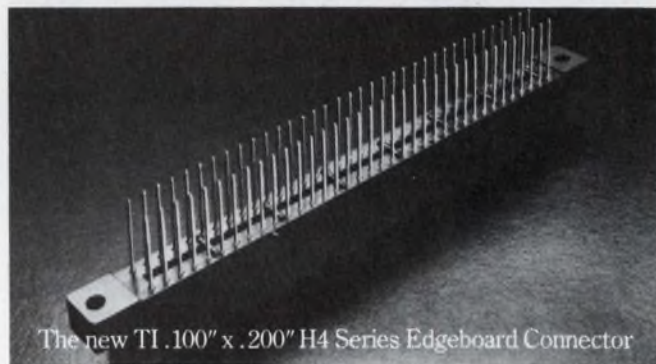

The new TI .100" x .200" H4 Series Edgeboard Connector

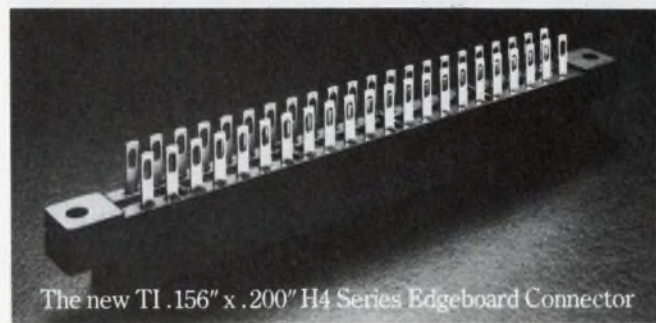

The new TI .156" x .200" H4 Series Edgeboard Connector

TEXAS INSTRUMENTS
INCORPORATED

CIRCLE NUMBER 43

© 1978 Texas Instruments Incorporated

Turn a car's side marker lamps into 'turn' signals with a CMOS gate

If your car has single-filament side marker lamps (most do), you can convert them into turn signals with one Exclusive-OR CMOS gate and a couple of MJ1000 Darlington's (Motorola). What's more, the flashing of the side-marker turn signals will be even more dramatic than use of signal lamps with two filaments, which are specifically designed to operate as both side markers and turn indicators.

Both the front and rear side markers are controlled by the circuit in the figure. When the driver turns off the headlight switch, the side markers flash right along with the car's regular turn indicators. With the headlights on, the Exclusive-OR gate allows the side markers to operate normally. But when the driver hits the turn signal, the gate reverses the drive to the side markers and flashes them off—just the reverse of the regular turn-signal lights. The flashing goes from full-on to full-off, but to a driver approaching from the side, it looks like a flash from a turn signal.

The on-off flash feature gives a car an added safety factor not present with two-filament lamps. Since one filament of a two-filament lamp is always lit during night driving, the turn-signal flash of this type lamp

is not nearly as distinct as the on-off flash of a single-filament lamp.

Before installing the system in a car, you should be aware of the following precautions:

1. Both CMOS ICs (MM74C86 and MC14507) are rated at 15 V maximum. This is very close to the charging voltage of a car's electrical system (14.7 V). Although no problems have been reported with the system, cars with mechanical regulators can cause excessive spiking, which could cause problems. In this case you would need a separate power supply for the CMOS, decoupling it from the car's electrical system.

2. The circuit requires no heat sink for the Darlington with the lamps shown. But lamps drawing more current may require a heat sink or a higher power Darlington.

3. If you're towing a trailer, don't parallel the sidemarkers with the trailer's lamps or you can overload the Darlington.

John Okolowicz, Senior Development Engineer, Honeywell Process Control Div., 1100 Virginia Dr., Fort Washington, PA 19034.

CIRCLE NO. 313

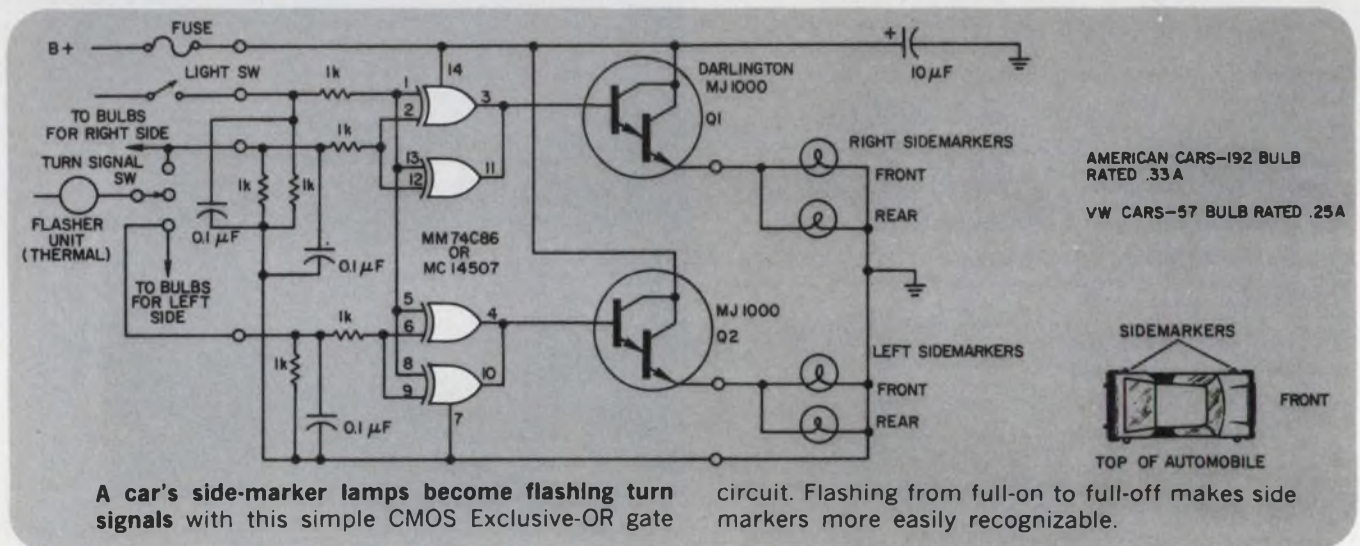

IFD Winner of February 1, 1978

Floyd S. Griffin, Vice President, Ordnance Research Inc., P.O. Box 1426, Fort Walton Beach, FL 32548. His idea "Add Foldback Protection to your Supply and Stop Pass-transistor Failures" has been voted the Most Valuable of Issue Award.

Vote for the Best Idea in this issue by circling the number for your selection on the Reader Service Card at the back of this issue.

SEND US YOUR IDEAS FOR DESIGN. You may win a grand total of \$1050 (cash)! Here's how. Submit your IFD describing a new and important circuit or design technique, the clever use of a new component or test equipment, packaging tips, cost-saving ideas to our Ideas for Design editor. Ideas can only be considered for publication if they are submitted exclusively to ELECTRONIC DESIGN. You will receive \$20 for each published idea. \$30 more if it is voted best of issue by our readers. The best-of-issue winners become eligible for the Idea of the Year award of \$1000.

AT LAST! EXACT REPLACEMENTS IN .43" LED DIGITS.



Bright. Tough. Competitive.
They're the new Litronix DL-7000
Series .43" digits — available
now in a complete range of green,
yellow, red and hi-brite red.

Digits are encapsulated in a solid
plastic DIP with a standard

0.3" pin-out for IC sockets and PCBs.

This is The End to sole-
source .43" digits. The replacements
are available now.

Litronix, 19000 Homestead
Road, Cupertino, California 95014.
Phone (408) 257-7910.

CIRCLE NUMBER 44

litronix

AN AFFILIATE OF SIEMENS

THE LIGHTS FANTASTIC





BANUELOS

How Fairchild Takes the Thorns out of LSI Testing.

Choosing the right LSI test system is tough. There are many things to consider, and one of the most important is customer support. Here's how Fairchild makes the difference. Whether you buy our Sentry general purpose LSI tester or our Xincom memory test system, we'll back you with the largest and most professional service and support team in the industry.

Applications Engineering. Our team of applications specialists will program our systems to give you all the information you need about how to test your device. Whether you buy a system or not. If you do buy, all that information and programming are yours.

A world of training. Even the best system is only as good as the people who run it. To make sure your people know everything they have to about LSI testing, we've built the largest and most comprehensive training center in the world. With every Sentry or Xincom system, you're covered with course credits. Even before your system is installed, your people will learn operation and maintenance, basic programming and assembly language. They can also take special courses in programming and advanced LSI testing techniques. And they'll get all the hands-on training they'll need in our test lab.

On-site preparation. While your people are training at one of our centers in the U.S., Europe or Asia, our engineers are at your plant helping you get ready for delivery. Our product specialists help you find the best locations for your system. They make sure all your device programs have been checked out. And they make sure your system gets up and running fast.

Service is our specialty. No matter where you are, we've got you covered. More than 100 field engineers around the world assure fast response whenever you need help. You can choose from a variety of service con-

tracts. One gives you complete calibration and servicing, free parts replacement and a guarantee to be there within 24 hours. Another provides a spare parts kit that offers even faster turnaround. And if your operation needs it, we can provide a resident service or applications engineer.

We won't let you forget. If you need additional or special training, we can help. Our programmed learning center offers video tapes, audio cassettes and special workbooks. On-site courses can also be arranged. Nearly a hundred application notes are available to help you solve almost any LSI testing problem. There's even a User's Club, which gives you a chance to exchange programs and experiences with others in your field.

There's more. Whether you choose Sentry or Xincom, we'll make sure you don't get stuck. We'll help get rid of the thorns all along the way. Before, during and after your system arrives.

Find out more about Fairchild's total support program. Mail the coupon today. Or contact: Fairchild Test Systems Group, 1725 Technology Drive, San Jose, CA. 95110 (408) 998-0123

Fairchild: First in LSI testing

- Please have a representative call.
- Send your Total Support brochure.

My test needs include _____



Name _____
Title _____
Company _____
Address _____
City/State/Zip _____
Area Code () Phone _____

FAIRCHILD

Magnetic device shows it's a lifter and a turner

An intriguing device that exhibits both magnetic levitation and axial rotation has recently been demonstrated by the University of Technology in Loughborough, England.

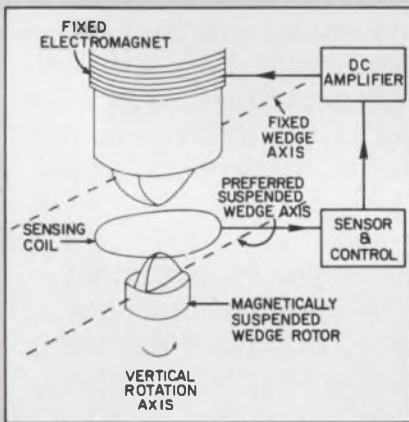

In the basic system (see diagram), a fixed electromagnet is excited by a dc supply controlled by a parallel transis-

tor pair. The height of the levitated object is sensed by a circular coil. Changes in height, which produce changes in coil inductance, are fed back via the amplifier and used to regulate the field current. This feedback loop maintains the levitated object at a constant height.

Unlike other dc levitators, this unit has wedge-shaped pole pieces. For this reason, there is a preferred alignment parallel to the axes of the wedges.

If the suspended piece is disturbed by an angular rotation, it will return to its previous position through a series of slowly decaying axial oscillations. However, if it is spun with enough initial angular velocity, it will assume a steady rotation that can be sustained indefinitely.

If the "rotor" is braked slightly while spinning steadily, it will automatically restore itself to its previous speed. Hence power may be drawn from it.

Paralyzed persons need an arm they can use

Most artificial arms haven't been much help to severely paralyzed persons because they require some degree of shoulder or arm movement. So a computer-controlled "arm" has been developed to be operated remotely by the muscle actions of the mouth. It can be operated by a variety of controls such as chin switches or head and mouth levers.

The arm mechanism, developed at Queen Mary College in London, can be fitted to a wheelchair or to a bed. A person simply aims the arm in the general direction of an object, and the computer works out the sequence that causes the arm to locate, grasp and retrieve it.

The arm has a "shoulder," which has two-axis motion (azimuth and elevation), an "elbow," and a "wrist," which also has two-axis motion (azimuth and rotation), and a "hand."

The hand's fingers are equipped with external micro-switch touch sensors, internal pressure sensors and a light beam to detect an object between them. With these "senses" the arm can search in a set pattern for an object and pick it up. Eventually, a TV camera will be added to the hand so that objects can be found via pattern recognition.

The arm reaches 1.2 m and can lift objects as heavy as 1 kg and as wide as 10 cm. Books and cups, among other things, are handled with ease and with the finger sensors, fragile objects cause no problems.

The shoulder and elbow joints are cable and pulley-driven by 110-V ac motors and the wrist by 6-V dc motors. Analog angle signals fed back from potentiometers, are converted to digital form and multiplexed to the computer. Limit switches are used to prevent overdrive.

Sinusoid laser modulation nearly constant to 2.5 GHz

Direct sinusoidal modulation of an InGaAsP/InP heterostructure laser diode has been achieved up to an unusually high 2.5 GHz and with almost constant modulation efficiency. The laser, which is a promising source for fiber-optic systems operating between 1.1 and 1.6 μm , was developed by Japanese researchers at KKD Research and Development in Tokyo.

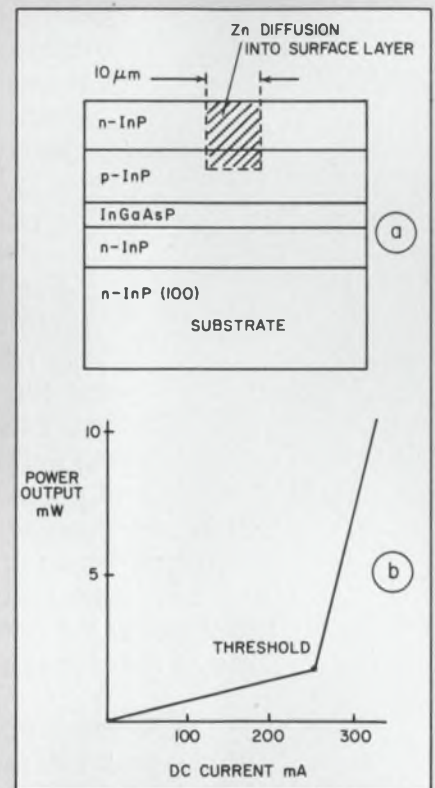

Shown in cross-section in the figure, the laser emits at 1.31 μm . The linear region of the output begins above a threshold current of 236 mA. Modulation current is applied through a series resistance of 47 Ω . If the bias current is high enough, the modulation is linear over a broad modulation range. For example, with a ratio of bias current to threshold current of 1.3, the modulation is flat between 0.05 to 2.5 GHz.

With pulsed, rather than sinusoidal modulation, the output is substantially undistorted, again provided the bias is high enough.

abbott

POWER SUPPLIES

Come to the specialist.

We started out pretty small back in '61. But we were big on product quality and reliability. Had to be. Uncle Sam was our only customer. Over the years we stuck with our own technology. We grew. Became specialists. And we kept on improving our power supplies.

It all paid off. Just look at Abbott today.



Militarized Power Supplies — Our early bread-and-butter line has grown to over 1500 versions. Some we stock. Yet we're equipped to provide fast delivery on any number of high efficiency, hermetically sealed, single or dual output power supplies and switcher modules. That includes our popular 60 and 400Hz and DC versions with outputs from 3VDC to 740VDC, 1 to 250 Watts. And prices go as low as \$174 for 2-4 units.

For Catalog Circle Card Number 90



Industrial Power Supplies — Ours isn't a big line yet — only 279 models. But you won't find a better quality of OEM power modules anywhere. (It's just our hi-rel way of thinking.) We provide covered/open frame, AC to DC single, dual and triple output versions, with outputs of 5 to 36VDC, 0.5 to 320 Watts. Plus DC to AC converters with 50 to 60Hz outputs. Competitively priced? You bet. As low as \$35 for up to 24 units.

For Catalog Circle Card Number 91



Transformers — For the do-it-yourself power supply designer who wants our kind of quality for his own military, industrial and pcb application. If you're one of them, we offer over 800 standard transformers, with instructions on how to specify for your custom units. Included are 60 and 400Hz, single phase input versions. Prices start as low as \$5.10 for up to 9 pieces.

For Catalog Circle Card Number 92

See Power Supply Section 4000, and Transformer Section 5600, Vol. 2, of your EEM catalog; or Power Supply Section 4500, and Transformer Section 0400, Vol. 2, of your GOLD BOOK for complete information on Abbott products.

abbott

transistor

LABORATORIES, INCORPORATED

General Offices
5200 W. Jefferson Blvd., Los Angeles 90016
(213) 936-8185 Telex: 69-1398

Eastern Office
1224 Anderson Ave., Fort Lee, N.J. 07024
(201) 224-6900 Telex: 13-5332



Your Open-Frame Supplies Are Waiting For You Now!

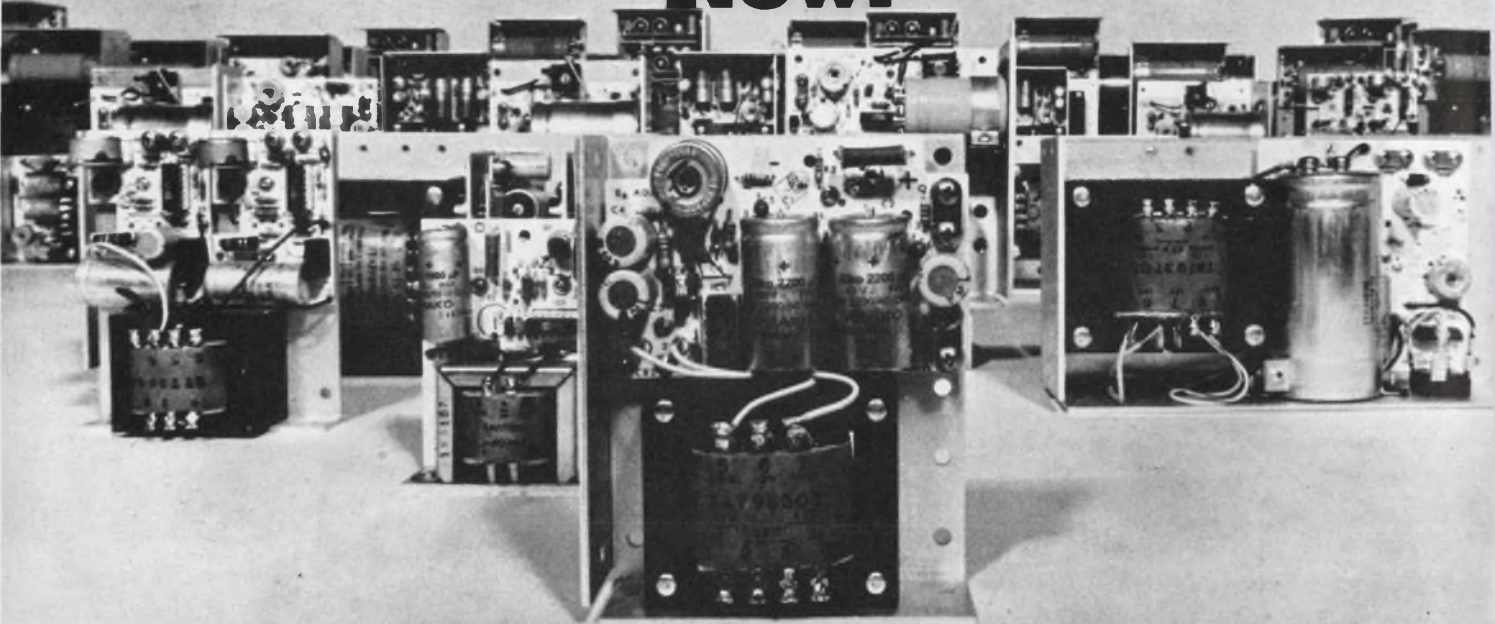

(call us today . . . have them tomorrow)

EM II SERIES SPECIFICATIONS

That's right! Power/Mate stocks over 6,000 open-frame power supplies in our East Coast and West Coast stocking locations . . . and they are just waiting for your order. Every model shown on this page is stocked in depth and ready to be shipped the same day your order is received.

So, if you're looking for an economically priced power supply . . . with a reputation for quality (almost 500,000 in the field and still going strong) . . . just give us a call.

Your supplies are waiting . . . so you won't have to.

Input
105-125/210-250 VAC at 47-63 Hz, except EMA-A case and ETA-B case models which are 105-125 VAC at 47-63 Hz. Derate output current 10% for 50Hz operation.

Output Ratings
See Voltage/Current Rating Chart.

Regulation
Line regulation is rated at 0.05% for a 10% input voltage change and load regulation rated at $\pm 0.1\%$ for a zero to full load change.

Output Ripple
Better than 1mV RMS; 3mV peak to peak typical.

Remote Sense
All except EMA-A, ETA-B.

Transient Response
Occurs within 50 microseconds for a 50 to 100% load change.

Overload Protection
Self-restoring current limiting (foldback type).

Temperature Coefficient
 $\pm 0.005\%/^{\circ}\text{C}$ typical. $\pm 0.02\%/^{\circ}\text{C}$ maximum.

Overvoltage Protection
Optional on all models except EMA-A, ETA-B.

Cooling
Convection cooled.

Mounting
EMA-A, ETA-B
EMA-B, ETA-C
EMA-D, ETA-C, D, ETR-E

2 Surfaces
4 Surfaces

EMA "A" CASE \$27.00 1.7" X 3.03" X 3.78"		EMA "B" CASE \$35.00 2.07" X 4.00" X 4.87"		EMA "C" CASE \$59.00 2.95" X 4.87" X 5.82"		EMA "CC" CASE \$74.00 3.23" X 4.90" X 7.03"		EMA "D" CASE \$94.00 3.23" X 4.87" X 9.00"	
Model	Voltage/Current Rating Chart	Model	Voltage/Current Rating Chart	Model	Voltage/Current Rating Chart	Model	Voltage/Current Rating Chart	Model	Voltage/Current Rating Chart
EMA-5/6A	5V @ 1.2A 6V @ 1.0A	EMA-5/6B	5V @ 3.0A 6V @ 2.5A	EMA-5/6C	5V @ 6.0A 6V @ 5.0A	EMA-5/6CC	5V @ 11.0A 6V @ 10.0A	EMA-5/6D	5V @ 15.0A 6V @ 12.5A
EMA-9/10A	9V @ .75A 10V @ .75A	EMA-9/10B	9V @ 1.8A 10V @ 1.8A	EMA-9/10C	9V @ 3.8A 10V @ 3.6A	EMA-9/10CC	9V @ 8.0A 10V @ 7.5A	EMA-9/10D	9V @ 10.5A 10V @ 10.0A
EMA-12/15A	12V @ 0.5A 15V @ 0.5A	EMA-12/15B	12V @ 1.5A 15V @ 1.3A	EMA-12/15C	12V @ 3.0A 15V @ 2.8A	EMA-12/15CC	12V @ 6.0A 15V @ 5.0A	EMA-12/15D	12V @ 8.8A 15V @ 8.0A
EMA-18/20A	18V @ 0.4A 20V @ 0.4A	EMA-18/24B	18V @ 1.2A 20V @ 1.0A 24V @ 1.0A	EMA-18/20C	18V @ 2.5A 20V @ 2.3A	EMA-18/24CC	18V @ 4.5A 20V @ 4.0A 24V @ 3.8A	EMA-18/24D	18V @ 7.1A 20V @ 7.0A 24V @ 6.5A
EMA-24A	24V @ 0.4A			EMA-24C	24V @ 2.3A				

ETA "B" CASE \$48.00 2.25" X 4.03" X 4.90"		ETA "C" CASE \$68.00 2.98" X 4.03" X 7.90"		ETA "D" CASE \$96.00 3.23" X 4.90" X 9.40"		ETR "E" CASE \$115.00 2.20" X 4.88" X 11.00"	
Model	Voltage/Current Rating Chart	Model	Voltage/Current Rating Chart	Model	Voltage/Current Rating Chart	Model	Voltage/Current Rating Chart
ETA-12/15B	12V-0.5A 12V-0.5A or 15V-0.5A or 15V-0.5A	ETA-12/15C	12V-1.5A 12V-1.5A or 15V-1.3A or 15V-1.3A	ETA-12/15D	12V-3.0A 12V-3.0A or 15V-2.8A or 15V-2.8A	ETR-122E	5V,6A + 12V,1.5A — 12V,1.5A or 6V,5A or + 15V,1.3A or — 15V,1.3A
ETA-5B	5V-1.2A .5V-1.2A or 6V-1.0A or 6V-1.0A	ETA-5C	5V-3.0A 5V-3.0A or 6V-2.5A or 6V-2.5A	ETA-5D	5V-6.0A 5V-6.0A or 6V-5.0A or 6V-5.0A	ETR-142E	5V,6A 12V,1.5A or 6V,5A or 9V,1.2A or 5V,0.8A
ETA-515B	5V-1.2A 15V-0.5A or 6V-1.0A or 12V-0.5A	ETA-515C	6V-3.0A 15V-1.3A or 6V-2.5A or 12V-1.5A	ETA-515D	5V-6.0A 15V-2.8A or 6V-5.0A or 12V-3.0A	ETR-113E	5V,6A 5V,3A or 6V,5A or 6V,2.5A
ETA-524B	5V-1.2A 24V-0.4A or 6V-1.0A	ETA-524C	5V-3.0A 24V-1.0A or 6V-2.5A	ETA-524D	5V-6.0A 24V-2.3A or 6V-5.0A	ETR-132E	5V,6A 18V,1.0A or 6V,5A or 20V,1.0A or 24V,1A



POWER/MATE CORP.

514 S. River St./Hackensack, New Jersey 07601/(201) 343-6294/TWX (710) 990-5023
17942 Skypark Circle/Irvine, California 92714/(714) 957-1606/TWX (910) 595-1766

When you can't afford failure . . . you can't afford less!

New products

PROM family is fastest and densest —and plugs right into expandability

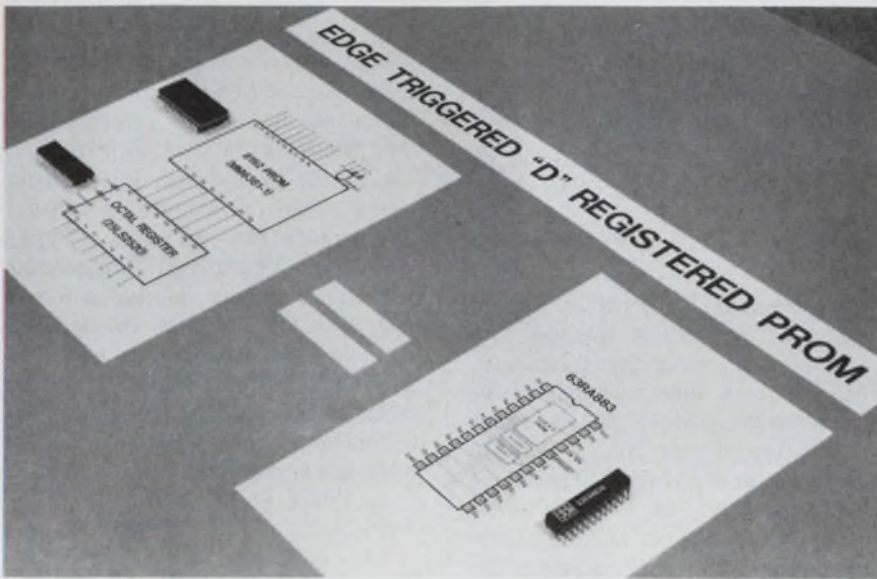

Monolithic Memories, Inc., 1165 E. Arques Ave., Sunnyvale, CA 94086. Paul Franklin (408) 739-3535, Ext. 124. P&A: See text.

Worst-case access times are better than ever and densities are 50 to 100% higher with Monolithic Memories' new family of bipolar titanium-tungsten-fuse PROMs.

Until now, Fairchild and AMD offered the fastest PROMs. Their $1\text{ k} \times 4$, 512×4 , and 256×4 units have access

times of 55, 50, and 45 ns. MMI's times are 15, 15 and 10-ns faster. What's more, the family's pinouts meet the new JEDEC standards. And the family's pin compatibility allows you to plug a variety of sizes into one socket.

For example, if you use a 20-pin socket—say, to accommodate $4\text{ k} \times 4$ or (when announced) $8\text{ k} \times 4$ PROMs—you can insert either 18-pin units ($2\text{ k} \times 4$ or $1\text{ k} \times 4$) or 16-pin units

(512×4 or 256×4), starting at pin 1. All you have to move is the ground connection.

Both ROMs and RAMs with pinouts compatible with these PROMs are planned by Monolithic. The JEDEC pinouts cover up to 1-Mbit ($128\text{ k} \times 8$) compatibility.

But the really special feature of this PROM family is that most of the members are offered in four versions: high-speed Schottky (S); low-power Schottky (LS); power-switched Schottky (PS); and registered Schottky PROMs with either asynchronous (RA) or synchronous (RS) enables for the three-state outputs.

PS versions cut power consumption 70 to 80% until the chip gets enabled, but there is no performance penalty for saving power: The access time for the first word (byte or nibble) after the chip is enabled is the same as if the PROM had been powered up and enabled all the time.

The registered PROMs are particularly useful for microstores with pipeline architecture. Using MMI's ic's 24-pin, 300-mil-wide "skinny-DIP" instead of a conventional PROM and a separate octal register package (see photo) will mean a 4:1 savings of PC-

(continued on page 156)

Memory size		Access times (ns) by type (see text)				
Bits	Organization	High-speed Schottky (S)	Low-power Schottky (LS)	Power-switched Schottky (PS)	Synchronous (RA)	Asynchronous (RS)
256	32×8	25	35	—	—	—
1 k	256×4	45	55	35	—	—
2 k	512×4	45	55	35	—	—
2 k	256×8	45	—	45	45	—
4 k	$1\text{ k} \times 4$	50	65	40	50	50
4 k	512×8	45	—	45	45	—
8 k	$2\text{ k} \times 4$	60	75	50	60	60
8 k	$1\text{ k} \times 8$	50	—	50	50	—
16 k	$4\text{ k} \times 4$	70	—	70	70	70
16 k	$2\text{ k} \times 8$	70	120	70	60	—

ICs & SEMICONDUCTORS

(continued from page 155)

board area, the company claims.

Power-switched PROMs are also available from Raytheon, and registered PROMs from AMD.

Worst-case access times over 0 to 75 C and $\pm 5\%$ voltage are shown in the table for all announced configurations. Monolithic will make military versions of all its new PROMs, with access times about 10 ns longer and "instant-on" operation with the chip at -55 C.

Several other options are being offered with the Monolithic family, such as the choice of 4-wide or 8-wide outputs and open-collector or three-state outputs in the 2, 4, 8 and 16-kbit sizes. The 256-bit comes only in 8-wide (32×8), and the 1 k in 4-wide. Both come in open-collector and three-state.

Representative prices for 100-up quantities in plastic are \$2.98 for the 63S140 (256×4 in S), \$5.86 for the 63S240 (512×4 in S), \$9.78 for the 63S440 ($1 \text{ k} \times 4$ in S), and \$12.78 for the 63RA441 ($1 \text{ k} \times 4$ in RA).

Availability is from stock for the 256×4 , 512×4 , and $1 \text{ k} \times 4$ in S and LS and the $1 \text{ k} \times 4$ in RA and RS. Other types will follow throughout the year.

MMI	CIRCLE NO. 301
AMD	CIRCLE NO. 302
Fairchild	CIRCLE NO. 303
Raytheon	CIRCLE NO. 304

Plastic power transistors handle up to 500 V

Panasonic, 1 Panasonic Way, Secaucus, NJ 07094. Bill Bottari (201) 348-7276.

A family of power and high-voltage plastic-cased silicon transistors has power ratings from 30 to 65 W and collector-to-emitter voltages from 40 to 500 V. TIP29 npn units offer 1-A collector current at up to 100 V and are complemented with TIP30 pnp transistors with the same ratings. TIP41 npn units offer 6-A collector current at up to 100 V and are complemented with TIP42 pnp transistors. TIP47 through TIP50 npn transistors have collector currents of 1 A at up to 500 V. TIP120 through TIP122 units are npn Darlington with 5-A collector current at 100 V and are complemented with TIP125 through TIP127 pnp Darlington. All units are in TO-66 packages.

CIRCLE NO. 320

Current source doubles as temperature sensor



National Semiconductor, 2900 Semiconductor Dr., Santa Clara, CA 95051. Dave Whetstone (408) 737-5856. \$0.90 to \$3.50 (100 qty).

A programmable constant current source IC, the LM134, operates as a current-mode temperature transducer. The chip is a three-terminal device programmable over a 10,000-to-1 range in operating current, from $1 \mu\text{A}$ to 10 mA, by means of a resistor between the trim terminal and the negative terminal. Current range can be extended by the addition of a pnp transistor to the circuit. The device operates on any voltage from 800 mV up to 40 V with a typical current change of 0.01%/V. The sense voltage used to establish operating current is 64 mV at 25 C and is directly proportional to absolute temperature. At a junction temp of 25 C, the set current increases at 0.33%/°C.

CIRCLE NO. 321

Programmable chip has 3 down counters

NEC Microcomputers, 5 Militia Dr., Lexington, MA 02173. (617) 862-6410.

A programmable interval timer that operates with the 8080A bus structure, the uPD8253, contains three 16-bit down counters. The chip can be programmed in any one of six operation modes: to interrupt the processor on a terminal count; as a programmable one-shot pulse-width generator; as a rate generator; as a square-wave generator; as a hardware-triggered strobe; and as a software-triggered strobe. The chip can be programmed to count in binary or BCD and is enabled by a select line or by memory-mapped I/O.

CIRCLE NO. 322

Low-cost tuning diodes provide high swing

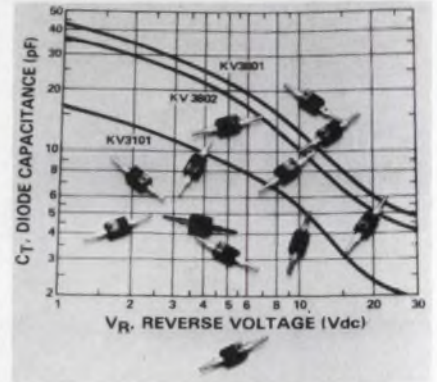

KSW Electronics, S. Bedford St., Burlington, MA 01803. Jerry Hartke (617) 273-1730. \$0.58 to \$0.63 (100 qty); 8 wks.

A family of low-cost, hyperabrupt tuning diodes is for use in vhf-uhf communication circuits. Types KV3101, KV3801 and KV3802 provide capacitance swings as high as 6 to 1 from 3 to 25 V and allow the designer to select capacitance values at 3 V of 11, 25 or 29 pF from the high-Q, plastic-packaged series. These low-inductance devices have typical Q values in the 300 to 400 range at 50 MHz and can be used up to 1 GHz in VCOs and filters.

CIRCLE NO. 323

Schottky rectifiers are in full-wave bridge

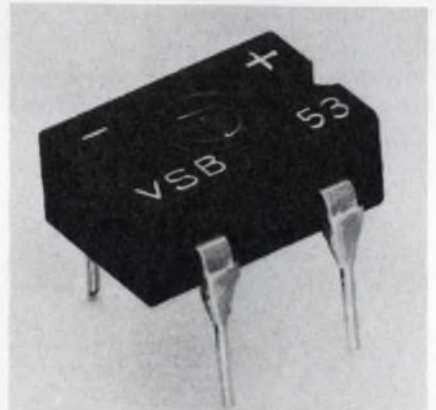

Varo Semiconductor, P.O. Box 676, Garland, TX 75040. Mary Ann May (214) 271-7511. \$2.70 (1000 qty).

More cost-effective than using separate Schottky discrete devices, the VSB full-wave Schottky bridge rectifier is available in ratings of 10 to 40 V with a 0.65-V drop at 750 mA (40 C). The peak surge current rating for a non-repetitive 100- μs pulse width is 75 A and the maximum operating junction temperature is 150 C. The size of the encapsulated bridge is $0.38 \times 0.25 \times 0.15$ in.

CIRCLE NO. 324

TRI-COLOR

WIRE CUTTING AND STRIPPING DISPENSER



- 3 Rolls of wire in one convenient dispenser
- 3 Colors, Blue/White/Red, 50 ft. (15m) of each color
- AWG 30 (0,25mm) KYNAR® insulated wire
- Built-in cutting plunger cuts wire to desired length
- Built-in stripper strips 1" of insulation
- Easily refillable
- For wire-wrapping and other applications.

Model No. **WD-30-TRI**
Patent Pending

WD-30-TRI	DISPENSER WITH WIRE	\$5.95
R-30-TRI	TRI-COLOR REPLACEMENT SPOOLS	\$3.95

Kynar® Pennwalt

MINIMUM BILLING \$25.00 / ADD SHIPPING CHARGE \$1.00 / NEW YORK STATE RESIDENT ADD APPLICABLE TAX



MACHINE & TOOL CORPORATION 3455 CONNER ST. BRONX, N.Y. 10475 (212) 994-6600/Telex 125091

Free 1978 Engineering



Data from Datel...

Update your files now!

Circle Reader Service Card Number Listed Below

• MICROCIRCUITS FOR DATA CONVERSION—	CIRCLE 241
• HIGH PERFORMANCE A/D-D/A CONVERTERS—	CIRCLE 242
• ENGINEERING POWER SUPPLY HANDBOOK—	CIRCLE 243
• MINIATURE DIGITAL PANEL METERS—	CIRCLE 244
• MINIATURE DIGITAL PANEL PRINTERS—	CIRCLE 245
• 40-COLUMN ALPHANUMERIC PRINTER—	CIRCLE 246
• A/D-D/A I/O FOR INTEL'S MICROCOMPUTERS—	CIRCLE 247
• A/D-D/A I/O FOR M6800 EXORCISER—	CIRCLE 248
• A/D-D/A I/O FOR DEC PDP-11—	CIRCLE 249
• A/D-D/A I/O FOR NOVA, MICRO NOVA—	CIRCLE 250
• PORTABLE PRINTING DATA LOGGER—	CIRCLE 251
• DIGITAL CASSETTE RECORDERS—	CIRCLE 252



1020 TURNPIKE STREET, CANTON, MASS. 02021 / TEL. (617) 828-8000 / TWX: 710-348-0135 / TELEX: 924461

Santa Ana, CA (714) 835-2751, (L.A.) (213) 933-7256 • Sunnyvale, CA (408) 733-2424 • Gaithersburg, MD (301) 840-9490
Houston, TX (713) 932-1130 • Irving, TX (214) 256-4444

OVERSEAS: DATEL (UK) LTD—TEL: ANDOVER (0264) 51055 • DATEL SYSTEMS SARL 620-06-74 • DATELEK SYSTEMS GmbH (089) 776095

32-k static MOS ROM features standard pinout

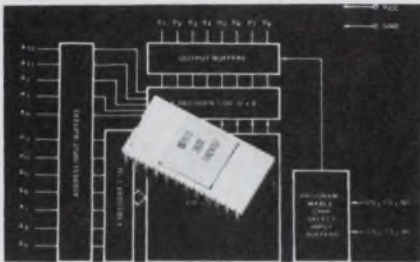

Signetics, P.O. Box 9052, Sunnyvale, CA 94086. Rick Eklund (408) 739-7700. \$11.50.

The 2632, a 32-k MOS mask ROM, is fully static and in an industry-standard 24-pin package. The memory is completely TTL-compatible, operates from a single +5-V supply and has a maximum access time of 450 ns. The ROM is organized as 4096 by 8 bits, is pin-compatible with the 2607 1 k × 8 static ROM, the 2616 2 k × 8 static ROM and both the 2708 and 2716 EPROMs. Maximum supply current for the 2632 is 80 mA.

CIRCLE NO. 325

Tape audio system packed into linear bipolar IC

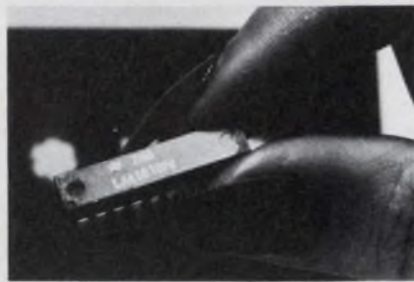

National Semiconductor, 2900 Semiconductor Dr., Santa Clara, CA 95051. Charlie Smaltz (408) 737-5719. \$2.85 (100 qty).

The LM1818, a linear bipolar IC, contains all the active electronics for building a tape audio system. The chip features electronic switching between the record and playback modes according to the position of an spdt record/playback switch. There are two preamplifiers with one common output. One amplifies inputs and the other amplifies the signal from the playback head. ALC circuitry provides a constant output level for a wide range of record source input levels.

CIRCLE NO. 326

BiFET op amp features low input offset voltage

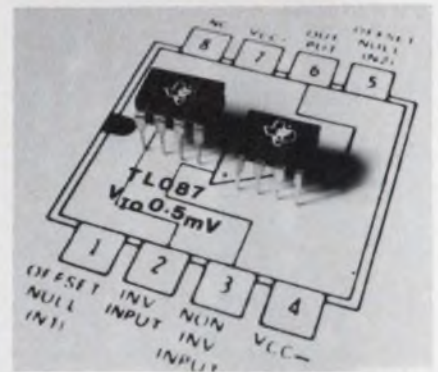

Texas Instruments, P.O. Box 5012, M/S 308 (Attn: TL087C), Dallas, TX 75222. Dale Pippenger (214) 238-5908. \$8.52 to \$9.50 (100 qty); stock.

The TL087C op amp features a low 0.5-mV maximum input offset voltage. Other features include internal frequency compensation and high slew rate of 13 V/μs typically. The device has an input bias current of 0.2 nA, input offset current of 3 nA and offset voltage tempco of 10 μV/°C. The IC is offered in an 8-pin plastic or ceramic DIP and operates from 0 to 70 C.

CIRCLE NO. 327

we did it again!

**18% MORE
STAND-BY POWER
in the same space**

we introduced the world's smallest, maintenance free battery . . . now, we present a big battery with greater power in conventional space.

- Needs no memory conditioning
- No cell reversal
- Better float life
- Spill-proof
- Rechargeable
- Maintenance free

WITH IMMOBILIZED ELECTROLYTE

EAGLE ^{EP} PICHER

Carefree magnum

RECHARGEABLE BATTERY

CFM 6V33 6 VOLT 33 AMPERE HOURS

EAGLE-PICHER INDUSTRIES, INC.
SENECA, MISSOURI 64865

6.25" length, 3.35" width, 6.5" width, 12.2 pounds

New, 16 Bit Microcircuit D/A Converter

Datel has it...



Two versions to choose from:

DAC-HP16BMC

- ▶ 16 Bit Binary Resolution
- ▶ 15 ppm/°C Max. Tempco
- ▶ ±0.003% Linearity
- ▶ 0 to +10V, ±5V Output
- ▶ 35 μsec. Settling Time

DAC-HP16DMC

- ▶ 4 Digit BCD Resolution
- ▶ 15 ppm/°C Max. Tempco
- ▶ ±0.005% Linearity
- ▶ 0 to +10V Output
- ▶ 15 μsec. Settling Time

When high resolution and stability are demanded, Datel's DAC-HP series provides the performance — applications such as precision signal reconstruction, automatic test systems, and ultra-linear ramp generation. DAC-HP's excellent performance results from special low tempco nichrome thin-film resistors, laser trimmed for optimum linearity, and a low tempco zener reference circuit. Operating temperature range is 0 to 70C, with models available for -25 to +85 and -55 to +125C operation.

\$7750*
(100's)

Price, both versions: \$119.00* (1-24)

*U.S.A. domestic prices only

DATEL
SYSTEMS, INC.

1020 Turnpike Street, Canton, MA 02021
TEL: (617) 828-8000 TWX: 710-348-0135

Santa Ana, (714) 835-2751, (L.A.) (213) 933-7256 • Sunnyvale, CA (408) 733-2424 • Gaithersburg, MD (301) 840-9490 • Houston, (713) 932-1130 • Irving, TX (214) 256-4444
OVERSEAS: DATEL (UK) LTD - TEL: ANDOVER (0264) 51055 • DATEL SYSTEMS SARL 620-06-74 • DATELEK SYSTEMS GmbH (089) 77 60 95

Alphanumeric and graphic boards include μ P software

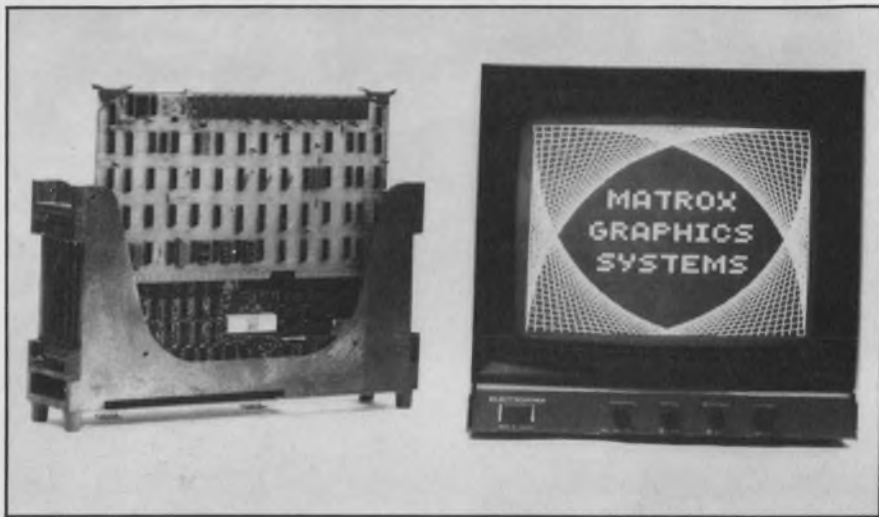

Matrox Electronic Systems, P.O. Box 56, Ahuntsic Station, Montreal, Que, H3L 3N5. Lorne Trottier (514) 481-6838. P&A: See text.

Not only do they provide alphanumeric or full graphics on a single SBC-80-compatible board, but the MSBC-2480 and MSBC-512 are the only boards that come with complete software packages so that they can just be plugged in and turned on.

Although there are several sources for alphanumeric-display boards—EDAC (Alameda, CA), Datacube (Chelmsford, MA), HAL Communications (Urbana, IL), among others—none of them comes with the software necessary to make them work. And most don't offer both U.S. and European video standards; the Matrox duo does. And unlike the Matrox boards, most don't have either external-sync capability or limited graphics. For graphic displays, Matrox has the field pretty much to itself, aside from one EDAC 256 × 256 board for the SBC-80 bus.

For alphanumeric, the MSBC-2480 produces a 24-line × 80-character display with either a 6 × 10 or 8 × 10 character cell. The MSBC-512 provides variable resolution graphics ranging from 256 × 256 to 512 × 512 points.

Supporting the alphanumeric card is MTX-ALPHA, software written for 8080-based systems. The 3-kbyte package emulates the ADM-3A or the DECSCOPE VT-52 terminals. Line-at-a-time and text-block input modes are also available.

The graphics card is supported by MTX-GRAPH, which consists of: a variable-resolution subroutine to permit 64 × 64, 128 × 128 or 256 × 256 point displays under software command; a point-plot routine that plots a point when its X-Y coordinate is specified; a line-vector routine that draws a line when the end points are specified; an alphanumeric-display section for full ASCII-character generation; a synchronization subroutine that allows generation of animation synchronization; and a color option that permits color and grey-scale generation.

On the 2480 all code combinations for character generation are housed in a 2716 EPROM. Reprogram the EPROM, and you can create a new character font. Besides upper and lower-case ASCII characters, some limited graphics is available on the 2480. The display is memory mapped, so individual characters can be controlled. Access time is 450 ns, and all memory-reference

instructions can be executed in display memory. A wait line is available if the processor is too fast for the display memory.

For graphics applications, the MSBC-512 provides variable resolution with an on-board 262,144 × 1-bit display memory. Depending on the RAMs inserted on the board, display resolution can be 256 × 256, 256 × 512, 512 × 512, or 256 × 1024 points. (4-k, 8-k or 16-k dynamic RAMs can be used.) Each point can be individually addressed, and has a read/write access time of 2.1 μ s. Erasing takes 48 ms for the entire screen.

Both the MSBC-2480 and 512 cards are form compatible with the SBC-80 family of cards. The 2480 requires a 5-V, 1.5-A supply while the 512 needs both a 5-V, 850-mA and a 12-V, 250-mA supply. External sync signals can be fed into both boards to permit mixing the MSBC video outputs with other video sources (such as a TV camera).

Prices for the Matrox boards are \$450 for the MSBC-2480 and from \$695 to \$1395 (depending on resolution) for the MSBC-512, both in unit quantities. Delivery takes two to four weeks.

Matrox	CIRCLE NO. 307
Datacube	CIRCLE NO. 308
EDAC	CIRCLE NO. 309
HAL Communications	CIRCLE NO. 310

Add-in memory mates with LSI-11s

Mostek, 1215 W. Crosby Rd., Carrollton, TX 75006. Bill Smith (214) 242-0444. \$1690 (32-k).

In addition to being totally hardware and software compatible with DEC's LSI-11/2, the MK 8005 add-in memory is compatible with the LSI-11 and the PDP-11/03. The memory uses dynamic RAMs to offer capacities of 8, 16, 24 or 32 × 16 bits on a single memory card measuring 9 × 5.2 in. The cards also have internal distributed refresh, a battery back-up provision and address DIP switch for assigning starting addresses. Write access time is 140 ns, with read access time 375 ns and cycle time 425 ns. Power requirements are +5 V dc, 1.5 A and +12 V dc, 0.1 A.

CIRCLE NO. 328

Make Motorola your Custom CMOS Source

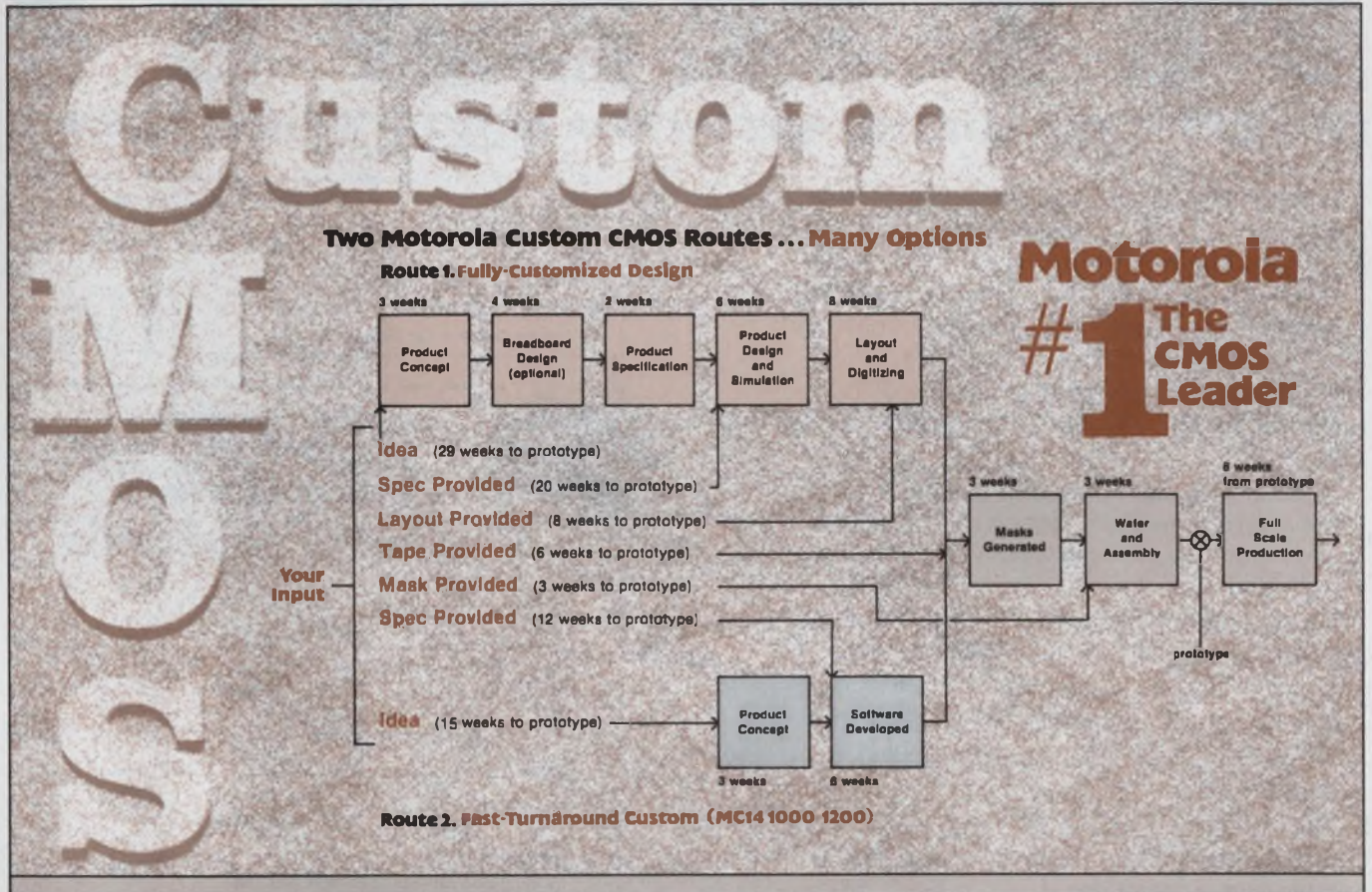

For options you can't get anywhere else.

Flexibility and customer-orientation are the intangible differences in Motorola's Custom CMOS program. You choose either the fully-customized design or the fast-turnaround route which utilizes the MC141000/1200 CMOS single-chip programmable microcomputer. From there, we do business your way. If you prefer, we'll even help you make the choice. Just what you expect from the CMOS leader.

Start at any point, with your idea, logic, breadboard, tape, punched cards, or mask set. We'll take it from there to high-volume chip production with either method. It's Custom CMOS done the way you want it.

In the fully-customized approach, our circuit complement includes all the usual counters, flip-flops, and gates, plus op amps, comparators, and oscillators. We combine linear and digital on your CMOS chip wherever it does the job better. Our diverse technologies and broad CMOS experience give us the design capability and versatility to do your whole job.

Add to all this our human and production resources. Our large design team is experienced in CMOS, and our Austin, Texas, CMOS Center is the most modern CMOS facility. Our record of over 100 million CMOS units shipped in 1977 indicates we can produce whatever volume you want. Our combination of human, technological, and physical resources offers the highest level of confidence for a successful custom program. Just what you expect from the CMOS leader.

Give us the chance to discuss your Custom CMOS requirements. Make Motorola your CMOS source by contacting your Motorola sales office, or by sending the coupon to Motorola Semiconductor Group, Mail Drop M370, P.O. Box 20912, Phoenix, AZ 85036.



MOTOROLA
Semiconductor Group

CIRCLE NUMBER 51

Motorola Semiconductor Group
P.O. Box 20912, Phoenix, AZ 85036
Mail Drop M370

Motorola CMOS sounds like the answer for my custom requirement. I'm working on _____

Please contact me for:
 immediate need future design

Name _____

Title _____

Company _____

Dept. _____

Address _____

Phone _____

City _____ State _____ Zip _____

A FIRST!

THE SAME SCHEMATIC, BUT WITH A SCHOTTKY DIFFERENCE

Varo is now manufacturing full-wave, dual in-line bridges incorporating Schottky Barrier Rectifiers: an industry first.

The VSB (Varo Schottky Bridge) is available in a four-series family: from 10 to 40 volts, with a .65 volt drop at 750 milliamps (40°C). The VSB package design (Industry Standard) is compatible with automatic or manual testing and inserting.

Varo's VSB can be used in computer power supply, bubble memory, telecommunication system applications, and wherever power-savings, low V_f and fast recovery times are desirable. From an applications standpoint, the possibilities are limited only by your imagination.

Cost? Varo's VSB costs less than the same circuit design using discrete Schottky devices.

Reliability? Varo tests every VSB device before shipping.

For complete specifications and a sample part, contact the people who have the VSB in stock right now: Varo. First.

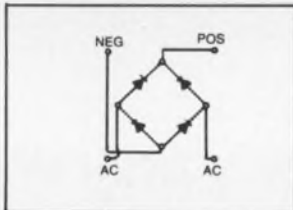

Call Special Customer Service phone: (214) 271-1314

SERIES	V_{RMS}	Surge I	25 A @ ½ cycle, 60 Hz 75 A @ 100 μ sec pulse width
VSB 51	10 V		
VSB 52	20 V		
VSB 53	30 V		
VSB 54	40 V		
OpTemp	-65°C to 150°C	V_f	.41 V @ 0.1 A .56 V @ 0.5 A .65 V @ 0.75 A
DC Forward Current = 750 milliamps @ 40°C			



VARO INTRODUCES FULL-WAVE, DUAL IN-LINE BRIDGES WITH SCHOTTKY BARRIER RECTIFIERS.

For specifications and sample part, mail this coupon to Varo Semiconductor, Inc.; Box 676 Garland, Texas 75040 or call Special Customer Service phone: (214) 271-1314.

NAME _____

COMPANY _____

ADDRESS _____

CITY _____

STATE _____ ZIP _____

PHONE _____

Send me:

Information package sample part; the

VSB Series I want is (see table) _____

My application is: _____

RFQ qty _____ delivery _____

VARO SEMICONDUCTOR, INC. BOX 676 • 1000 NORTH SHILOH • GARLAND, TEXAS 75040 • (214) 271-1314 EUROPEAN OFFICE: UK VARO SEMICONDUCTOR INTERNATIONAL, INC. DEEPDENE HOUSE, BELLEGROVE ROAD, WELLING KENT, ENGLAND DA163PY TELE: 01-304-6519-0



VARO

THE WORLD'S LEADING RECTIFIER COMPANY

CIRCLE NUMBER 52

MICRO/MINI COMPUTING

16-bit μ C module expands TI 990 memories

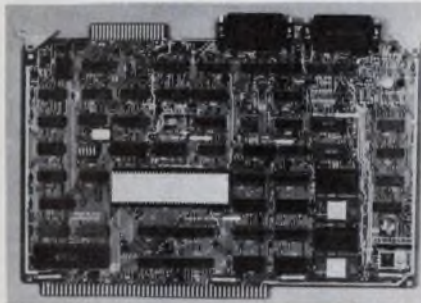

Texas Instruments, P.O. Box 1443, M/S 653 (Attn: TM990), Houston, TX 77001. Alan Lofthus (713) 776-6511. \$625.

The TM990/101M module expands TI's 990 family and offers up to 4 kwords by 16 bits of EPROM and up to 2 kwords by 16 bits of static RAM. The board also contains two serial I/O ports, one intended for remote use with a terminal or modem, and the other for local usage with TI's 301 Microterminal, an EIA terminal or a teletypewriter. The board provides three programmable interval timers, up to 17 interrupts and 16 lines of programmable parallel I/O.

CIRCLE NO. 329

Single-board computer provides 4 serial ports

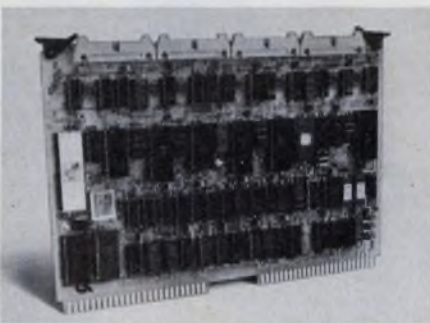

Control Logic, 9 Tech Circle, Natick, MA 01760. Hiram French (617) 665-1170. \$950; 4 wks.

A single-board computer on a 10 x 7-in. card, the MM1-MSC has four serial I/O ports that communicate asynchronously at rates in excess of 50 kbaud. Processing is provided by a Z80 CPU with 1 kbyte of 2708 EPROM or 2 kbytes of 2716 EPROM and 1280 bytes of RAM. A priority interrupt controller provides interrupt capability upon receipt of data from all four ports as well as three external interrupt states.

CIRCLE NO. 330

Interface board mates IEEE 488 to S-100 bus

Pickles & Trout, P.O. Box 1206, Goleta, CA 93017. (805) 967-9563. \$250 (kit), \$325 (assembled); stock to 3 wks.

The P&T-488 board provides S-100 computers with an interface to the IEEE 488-1975 standard digital interface for programmable instrumentation. Using the board, the computer can function as a talker, listener or

controller on the interface bus, allowing intricate instrumentation systems to be configured with S-100 equipment supplying the intelligence. Software package 1.0 is supplied with the board on a cassette tape that can be read with the built-in tape interface and a standard audio cassette player. The software is source code in Intel standard mnemonics, allowing the user to locate the software in the region of memory most suitable to his system.

CIRCLE NO. 331

Your best salesman never says a word.

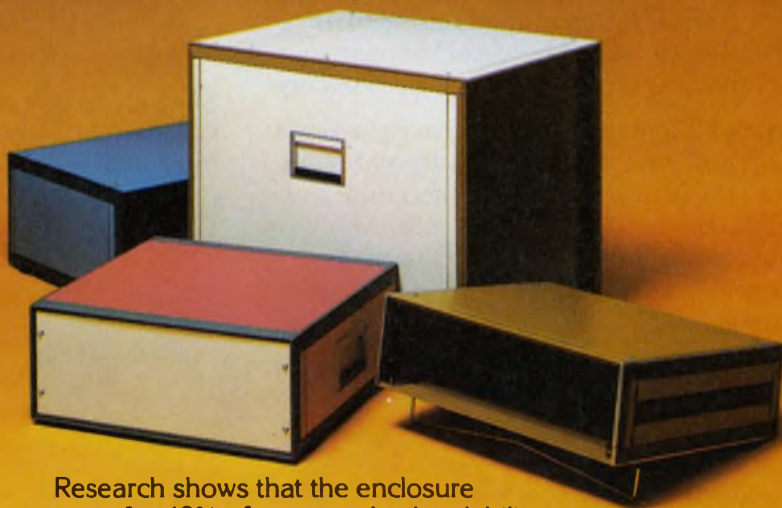

Research shows that the enclosure accounts for 48% of your product's salability. People buy looks. And they buy quality.

The VIP Series 19 is the perfect combination of functional design and precision engineering. It gives your product a custom quality appearance. And the rugged strength that lets you know the quality doesn't stop at appearances.

There is complete accessibility from top, bottom, front and rear. All 10 sizes accept standard EIA panels in heights from 5 1/4" to 28". You can choose from a variety of decorator colors, or we'll paint to match yours.

Despite the versatility and custom look, standardized components mean two-week delivery and off-the-shelf prices.

Hire the best salesman you can get for your product. VIP Series 19. It says the nicest things about you.

ZERO

We make you look good.

Zero Corporation • Burbank, CA 213/846-4191 • Monson, MA 413/267-5561

CIRCLE NUMBER 53 CALL ME I'M INTERESTED
CIRCLE NUMBER 54 MAIL CATALOGUE

“We needed a sealed connector without all the problems of sealed connectors.

The innovators at AMP provided the solution.”

Soft, rubber sealed connectors seem satisfactory until you really put them to the test in rugged applications like industrial controls, recreation vehicles, and off-highway equipment. Then you need AMP's new, low cost Econoseal connector. It's really rugged and eliminates “soft” problems like electrical failure due to flexing, difficulties in assembly, uncertain mating and unmating, and ultimately—poor sealing.

AMP's Econoseal connector avoids them all—and still costs no more than the old types. It's made of tough, durable thermoplastic that's immune to practically everything from road salt and brake fluid to 50 G shock and temperatures from -55°C to $+105^{\circ}\text{C}$.

And there are more advantages with the AMP Econoseal connector:

- **It is polarized** and assures positive latching.
- **It's easy to assemble.** Seals are preloaded into the housing to minimize production time.
- **Installation is easy.** No mating hardware is required and its D-shaped design assures firm panel mounting using ordinary spring washers.

- **It's repairable.** Unique design allows easy contact extraction without damage to seal integrity.
- **Quick disconnect.** Just squeeze the integral locking ring.
- **You get AMP technical support.** And we'll supply it as early as you want. Because we believe early involvement means better service for you.

So don't go soft on sealed connectors. Choose AMP Econoseal types. For more information, just call Customer Service at (717) 564-0100. Or write AMP Incorporated, Harrisburg, PA 17105.

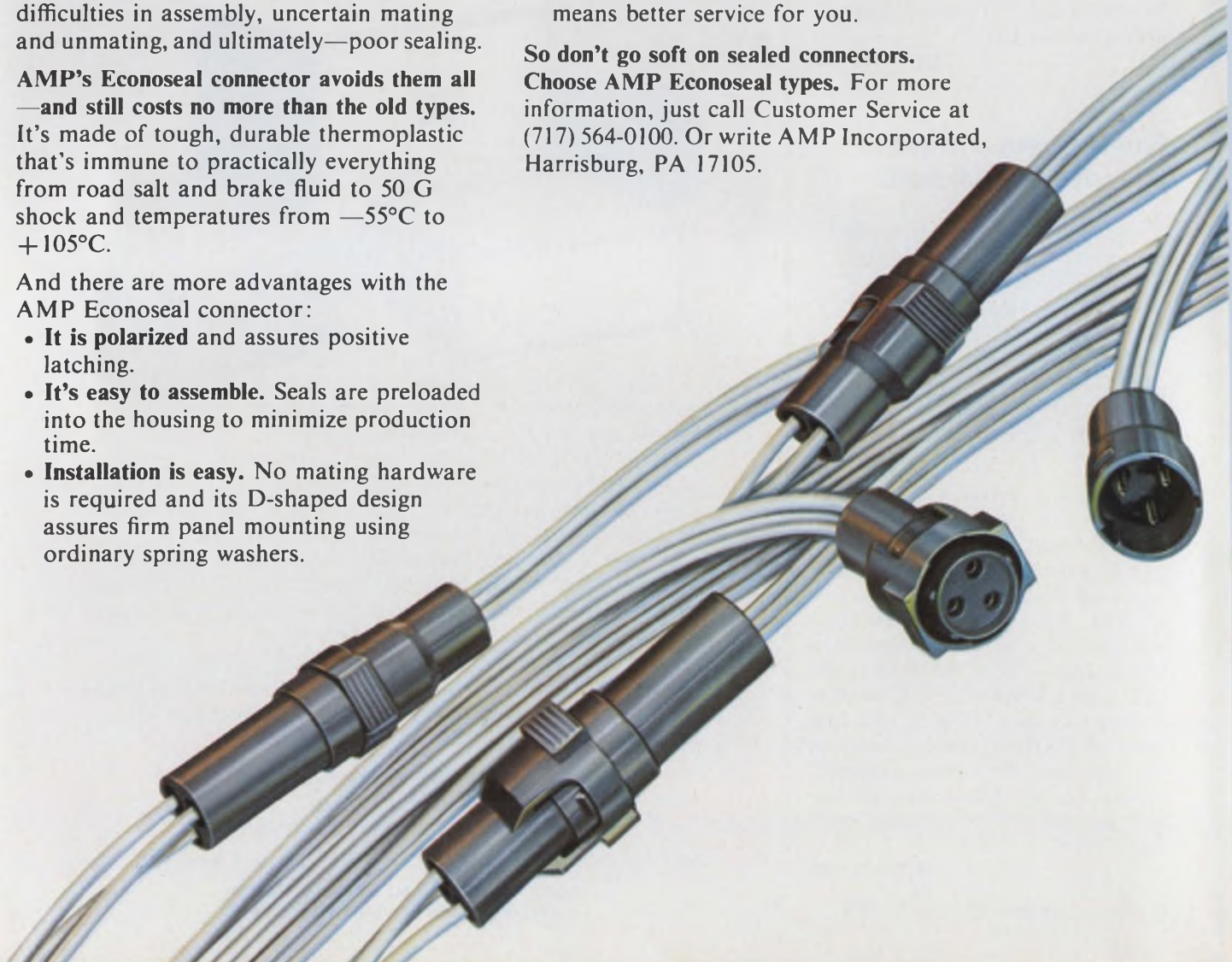

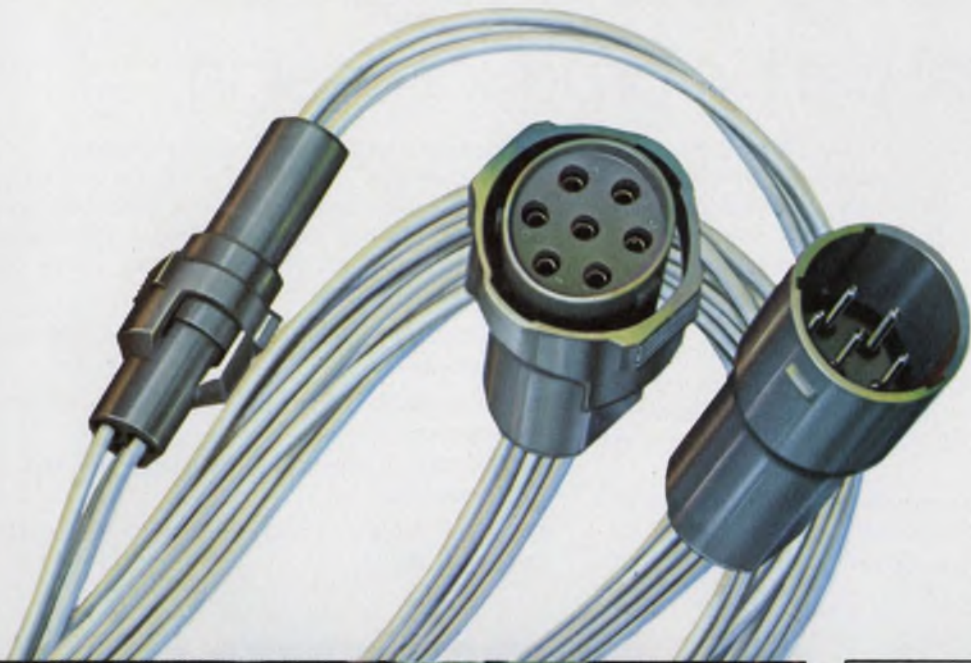

**AMP has a better way...
The Multimate System**



It means that the wide range of Multimate connector families can accommodate a variety of common contacts to handle signal, power, coax, and even fiber optics. And you save on both inventory and tooling. In addition to Econoseal connectors, other families that are part of Multimate include: Metrimate Series connectors . . . Circular Plastic connectors . . . "M" Series connectors . . . and several more. For additional information on these Multimate products, just call Customer Service at (717) 564-0100.

AMP is a trademark of AMP Incorporated.

CIRCLE NUMBER 55

AMP
INCORPORATED

Coming through...

with a vital part in product design

It's what's up front that counts. That's why it pays off to involve Belden in the early stages of a project.

We know the codes, specs and electrical/environmental parameters you're faced with. We've come through with answers to some extraordinary new applications.

As much as any component, wire, cable and cord, can make a critical difference in your product's performance. And your costs. By drawing on thousands of high-quality standards—and a wealth of custom engineering knowhow—we can tailor an answer to fit your needs. Exactly.

We can even help you cope with the economics of wire processing, assembly and installation. Our problem solving experience ranges from innovative

packaging to total manufacturing analysis.

Whether you need cord sets, special harnesses, shielded cable construction, flat cable—or help putting it all together, involve a Belden Wire Specialist. He'll come through with everything we've got. For answers right now, phone:

317-966-6661 Electronic Division or mark 400 on reader service card.

312-986-1600 Electrical Division or mark 401 on reader service card.

312-887-1800 Transportation Division or mark 402 on reader service card.

Or write Belden Corporation, 2000 S. Batavia Ave., Geneva, IL 60134

BELDEN



Coming through...
with new ideas for moving electrical energy

MICRO/MINI COMPUTING

SBC-compatible memory provides error correction

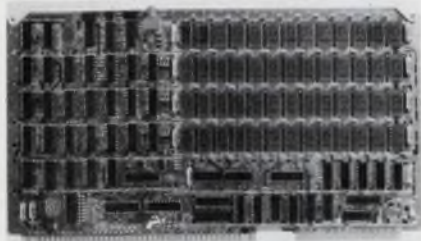

Mupro, 424 Oakmead Pkwy., Sunnyvale, CA 94086. Don Pantle (408) 737-0500. \$455 to \$2750; 4 wks.

A line of Intel Multibus compatible memory boards mates with SBC-80 systems and provides error correcting logic. The line includes seven memory sizes of 4 to 64 kbytes. The 4 to 16-k boards are available with 4-k dynamic RAMs; 16-k and larger boards have 16-k RAMs. All sizes are available without error detection, with single-bit parity or with single-bit error correction and double-bit error detection. All error correcting configurations are equipped with diagnostic indicators to pinpoint the memory chip in which any correctable error occurred. On-board refresh of the dynamic RAM is provided along with battery backup capability.

CIRCLE NO. 332

Buffered cassette unit holds 350,000 characters



MFE, Keewaydin Dr., Salem, NH 03079. (603) 893-1921. \$1190.

The Model 2500 buffered data cassette terminal uses a tape drive that allows recording on both sides of the tape for a 350,000-character capacity. ANSI compatible, the unit is available with TI or NCR compatibility, selectable rates up to 2400 baud and a binary mode. Also standard are TTY and RS-232C interfaces.

CIRCLE NO. 333

ELECTRONIC DESIGN 12, June 7, 1978

DMA diskette controller mates to SBC 80 Multibus

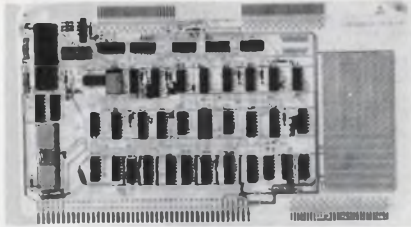

Micro/Tel, 11691 Lackland, St. Louis, MO 63141. Ron Flowers (314) 569-3450. \$995.

The diskette controller circuit board can be used in SBC 80 Multibus computer systems. The board has IBM 3740 compatible format (single density), uses a single-card cage slot, has capacity for multiple drives, works in DMA or programmed I/O modes and is compatible with Shugart 801 and similar drives. PLM-compatible software drivers are also provided. Options are a dual-density configuration and an ISIS-II operating system emulator.

CIRCLE NO. 334

Bipolar minicomputer emulates any mini or μ C



Dynamic Sciences, 7660 Gloria Ave., Van Nuys, CA 91406. Jerry Reznick (213) 782-0820. From \$1000 (100 qty); 13 wks.

When software is already available for a mini or microcomputer, but a new level of performance is required for system expansion or new product development, the T-1000 eliminates the cost and bother of new software and new interface design. This minicomputer can be microprogrammed to run the instruction set of known mini or microcomputers. Its bipolar construction and architecture give it a 300,000 operations/s range and it emulates computers with 8 to 32-bit word lengths. The CPU contains 16 full-word hardware registers. Up to 65,536 words of memory can be directly addressed with 262,000 words of extended addressing available.

CIRCLE NO. 335

true μ P DC/DC CONVERTERS

SAVE
YOUR
CHIPS...



...AND
YOUR
INPUT
SOURCE

The U, CU Series

- INPUT PROTECTION:
Over/Under Voltage
Shutdown-Standard
- CHIP PROTECTION:
Clamped Logic Outputs
- INPUT RANGE TO 4:1:
9-36V...18-72V...28-90V
- UP TO 25 WATTS OUT:
Singles-Triples-Quads

See Us in EEM and Gold Book

Get The Facts Fast, Circle the number for Free Catalog. We'll also include the new issue of our power supply journal,

WATTS UP AT SCI



**SEMICONDUCTOR
CIRCUITS, INC.**

218 RIVER ST., HAVERHILL, MA 01830
Tel. (617) 373-9104, TWX. 710-347-0269

CIRCLE NUMBER 56

Highest energy ...
lightest weight ...
most compact ...
rechargeable battery
on the market!



4.5 volts per module
3-5-10 amp/hr sizes
5.7-9.2-18.6 ounces

Yardney silvercel®

If you have to carry batteries ...
depend on batteries ... or design
with them ... you'll appreciate
Yardney!

Our Silvercel rechargeable batteries pack the most useable power into the smallest and lightest weight modular package now commercially available. In fact, per unit of weight Silvercel delivers 3 to 4 times the energy of common rechargeable batteries and does it with flat, non-tapering discharge voltage characteristics.

Whether you are an OEM development engineer, a supplier or a battery user, we invite your inquiry. Our technical assistance and advice are yours for the asking.

Write or phone
for complete information.

COMMERCIAL/INDUSTRIAL SALES

Yardney
ELECTRIC CORPORATION

82 MECHANIC STREET,
PAWCATUCK, CONNECTICUT 02891
(203) 599-1100

CIRCLE NUMBER 57

MICRO/MINI COMPUTING

RAM board plugs into NCR computers

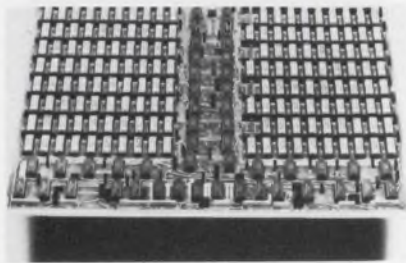

Computer Enhancement, 3189-E Airway Ave., Costa Mesa, CA 92626. (714) 754-0521.

RAM-Stor 8000 is a single PC board that is totally interchangeable with the NCR memory modules used in Criterion computers. The board plugs into existing memory-card slots in the processor and may be used to add to or replace the NCR memory modules. The board accepts 4-k chips for compatibility with the Criterion Models 8450 through 8570 and 16-k chips for the larger 8580 and 8590 models. Prices are approximately 20 to 30% lower than NCR prices.

CIRCLE NO. 336

Serial line controller plugs into PDP-8 bus



Computer Extension Systems, 17311 El Camino Real, Houston, TX 77058. (713) 488-8830. \$495.

The SLC8 serial line controller plugs directly into the PDP-8 Omnibus. The module offers switch-selectable rates of 50 to 9600 baud in 13 increments; 5, 6, 7 or 8 data bits; 1, 1.5 or 2 stop bits and parity selection. Device codes for transmit and receive are independently switch selectable. RS-232 and 20-mA loops are provided along with reader control for a teletypewriter.

CIRCLE NO. 337

Solid-state store is alternative to disc

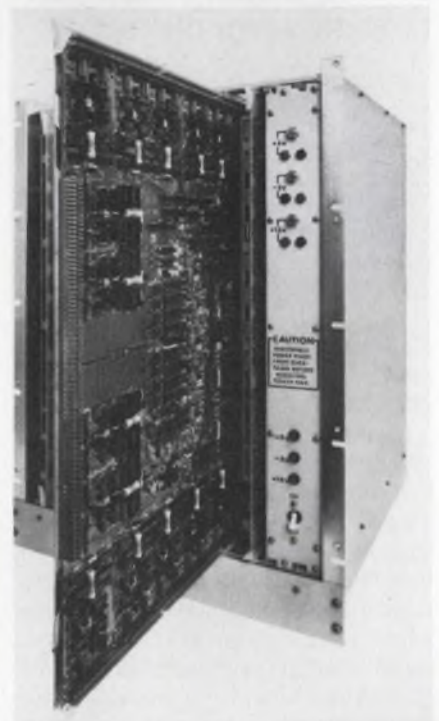

Imperial Technology, 831 S. Douglas St., El Segundo, CA 90245. Roy Norman (213) 679-9501.

Of solid-state construction, the MaxiRAM storage system looks like a hard-disc but provides maximum throughput with random-access capability. It also provides a maximum access time of 1.5 μ s with a transfer rate of 625 kwords/s. It has zero latency, and with a built-in controller, it has total transparency to the host computer. System capacity ranges from 0.524 to 8.388 Mbytes. Each 19-in. chassis accepts up to eight pluggable modules of 524 kbytes each. A second chassis may be interconnected to provide up to 8.388 Mbytes through one controller.

CIRCLE NO. 338

F8 CPU board plugs into S-100 bus

Comptronics, 19824 Ventura Blvd., Woodland Hills, CA 91364. Don Swanke (213) 340-8843. \$275.

An F8 CPU board, Model F-8S100, is compatible with the S-100 bus and comes complete with 3850 CPU and 3853 SMI. The unit provides sockets for 2 k of EPROM monitor, two PIO sockets and connections for six I/O ports. The board has 64 bytes of scratchpad RAM and a fully buffered data bus.

CIRCLE NO. 339

FASCO

Engine $E/E/R^*$ s them better!
*ENERGY/EFFICIENCY/RATIO

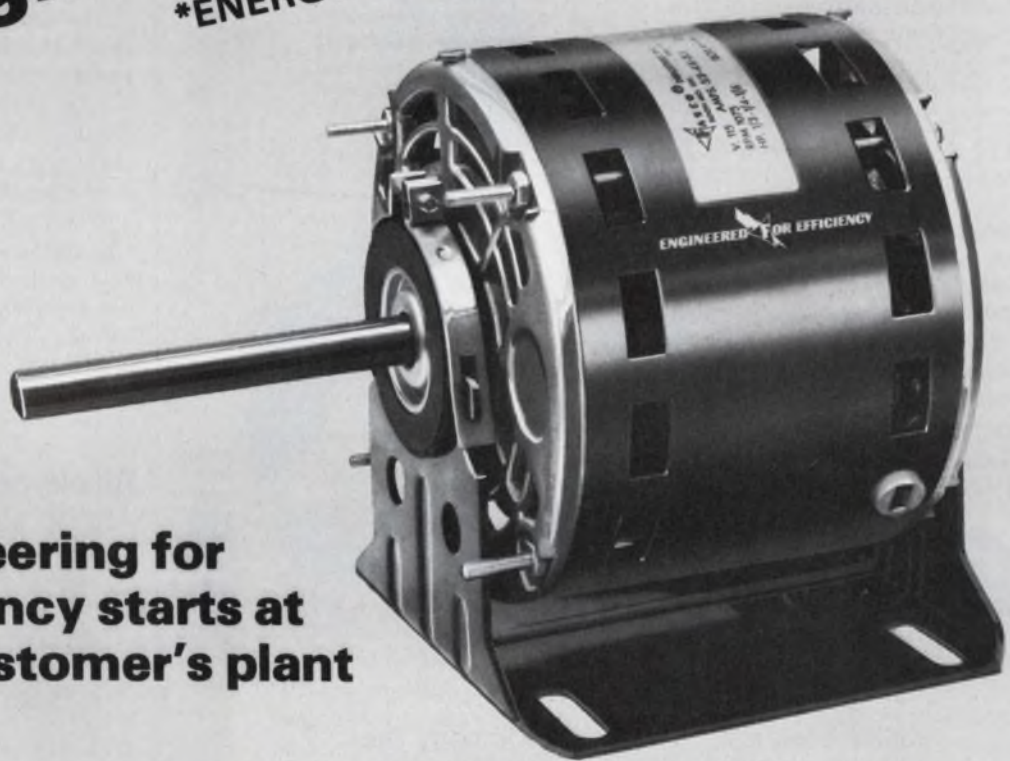

Engineering for efficiency starts at the customer's plant

FASCO believes that the marriage of a low-cost, efficient motor to your product . . . should be one of compatibility. You want your motor to be right for trouble-free operation . . . you also want it to be efficient and available at a reasonable price.

FASCO will accomplish this by sending a qualified sales engineer to your plant. Fasco's engineers are trained to gain a thorough understanding of your specifications and design goals.

Our sales engineers located in offices in major cities stand ready to assist you in making the honeymoon between our motor and your product a memorable and long-lasting success!

For more information about the proven advantages of FASCO motors and blowers write Fasco Motor Group Headquarters, 1600 W. Jackson Street, Ozark, Mo. 65721 . . . or call (417) 485-2311.



FASCO[®] INDUSTRIES, INC.

Motivated people . . . make better products.

I can show you how to find faulty intermittents fast!



Few things waste more time than locating an intermittent circuit component. Isolate off-again, on-again electronic components by quick-freezing them during testing. Remember: MS-240 Quik-Freeze® is not only a circuit cooler, but also a full-fledged freezer. It can drop surface temperature to -45°C in seconds. A handy extension nozzle confines the chilling spray to the suspected components. Use MS-240 also to prevent undesirable heat transfer to delicate circuit elements during soldering or welding.

For further information, call or write Miller-Stephenson Chemical Co., Danbury, CT 06810 (203) 743-4447

**ms miller-stephenson
chemical co., inc.**

Danbury, Connecticut 06810 (203) 743-4447

miller-stephenson chemical company, inc.
Danbury, Connecticut 06810 (203) 743-4447

ED-6W



- Ask our Technical Director for application information
- Enclosed is \$2 for trial pack
- Send for literature and prices

I intend to use MS-240 on _____

Name _____ Title/Dept. _____

Company _____

Address _____

City _____ State _____ Zip _____

Registered trademark

For industrial use only. Trial Unit must be sent to Company address
LOS ANGELES • CHICAGO • DANBURY, CONN. • TORONTO

CIRCLE NUMBER 59

MICRO/MINI COMPUTING

Full operating computer
packed into single unit



Computer Data Systems, 5460 Fairmount Dr., Wilmington, DE 19808. (302) 738-0933.

The disc-based computer system, Versatile 3B, and its expanded version, Versatile 4, combine a 9-in. video screen with 24×80 display, built-in mini-floppy disc drive with 143 kbytes of storage, upper/lower case alphanumeric keyboard, separate numeric keypad and all electronics within a single plastic enclosure. The mainframe uses the 8085 CPU, has 24-kbytes of static RAM and a serial I/O port with RS-232 connector. The Versatile 4 provides 32-k of static RAM and 315 kbytes of disc storage. Operating software includes a 20-k Extended Basic by Micropolis, a disc operating system and a complete software library of demonstration programs.

CIRCLE NO. 340

All elements of μC
are on single chip

Intel, 3065 Bowers Ave., Santa Clara, CA 95051. Rob Walker (408) 249-8027. \$10 (lg qty).

The 11-MHz 8049 and 8039 single-chip microcomputers contain all elements of a computer, including memory. The devices are fully programmable systems that perform I/O control and processing tasks at rates to 720,000 operations/s. Each chip contains an 8-bit general-purpose central processor, 128-byte read/write memory, three programmable 8-bit I/O ports and eight other control and timing lines, programmable interval timer/event counter, priority interrupt controls, system clock generator and a full set of generally required system controls and utilities. Within the 8049 is an 8-bit CPU with a $1.36 \mu\text{s}$ instruction cycle time. The μP executes over 90 different instructions.

CIRCLE NO. 341

If you need a DAC for low-power applications, you probably spend a lot of time looking at power specs.



Our price deserves a second look, too.

Our new MP-7523 is an 8-bit multiplying CMOS D-to-A Converter featuring very low power dissipation — only 12 mW in normal environments. In production quantities, you can get the 7523 for just \$2.00 per part.

If you're looking for a low-cost DAC for battery-powered equipment or other low-power systems, the 7523 is hard to beat for price/performance. It uses an advanced thin-film-on-CMOS technology to provide 8-bit resolution with accuracy to 10-bits.

The excellent multiplying characteristics of the MP-7523 make it ideal for a lot of other applications, too. Like ratiometric A/D converters, CRT character generation, low-noise audio gain control, motor speed control and digitally controlled attenuators.

The MP-7523 is presently available only in a 16-pin plastic DIP, rated for 0-70°C. If your application falls within this range, you'll find it offers much better perfor-

mance than bipolar DACs that cost more than \$2.00.

Check the key specs shown below. If they fit your needs, send us the coupon today for a detailed data sheet. If you have an immediate application, contact Standard Products Marketing at (408) 247-5350.



3100 Alfred Street, Santa Clara, CA 95050 • (408) 247-5350

MP-7523 Key Specifications

Linearity*	$\pm 1/2$ LSB ($\pm 0.2\%$)
Settling Time	100 nsec
Power Dissipation	12 mW
Feed Through	$1/2$ LSB@200 kHz
Multiplying	Full Four Quadrant

*7523 Devices with linearities of $\pm 1/4$ ($\pm 0.1\%$) and $\pm 1/8$ LSB ($\pm 0.05\%$) are available at higher prices.

To: Micro Power Systems, Standard Products Division
3100 Alfred Street, Santa Clara, CA 95050

- Please send me technical data for the MP-7523 D/A Converter.
- I have an urgent requirement. Please have a converter applications specialist phone : () _____

Name _____

Title _____

Company _____

Address _____

City/State/Zip _____

- Please also send data on your linear CMOS switches, multiplexers and other converters.

ED67

**INTRODUCING
EVERYTHING OEMs WANT
IN A 5Mb DISK.**

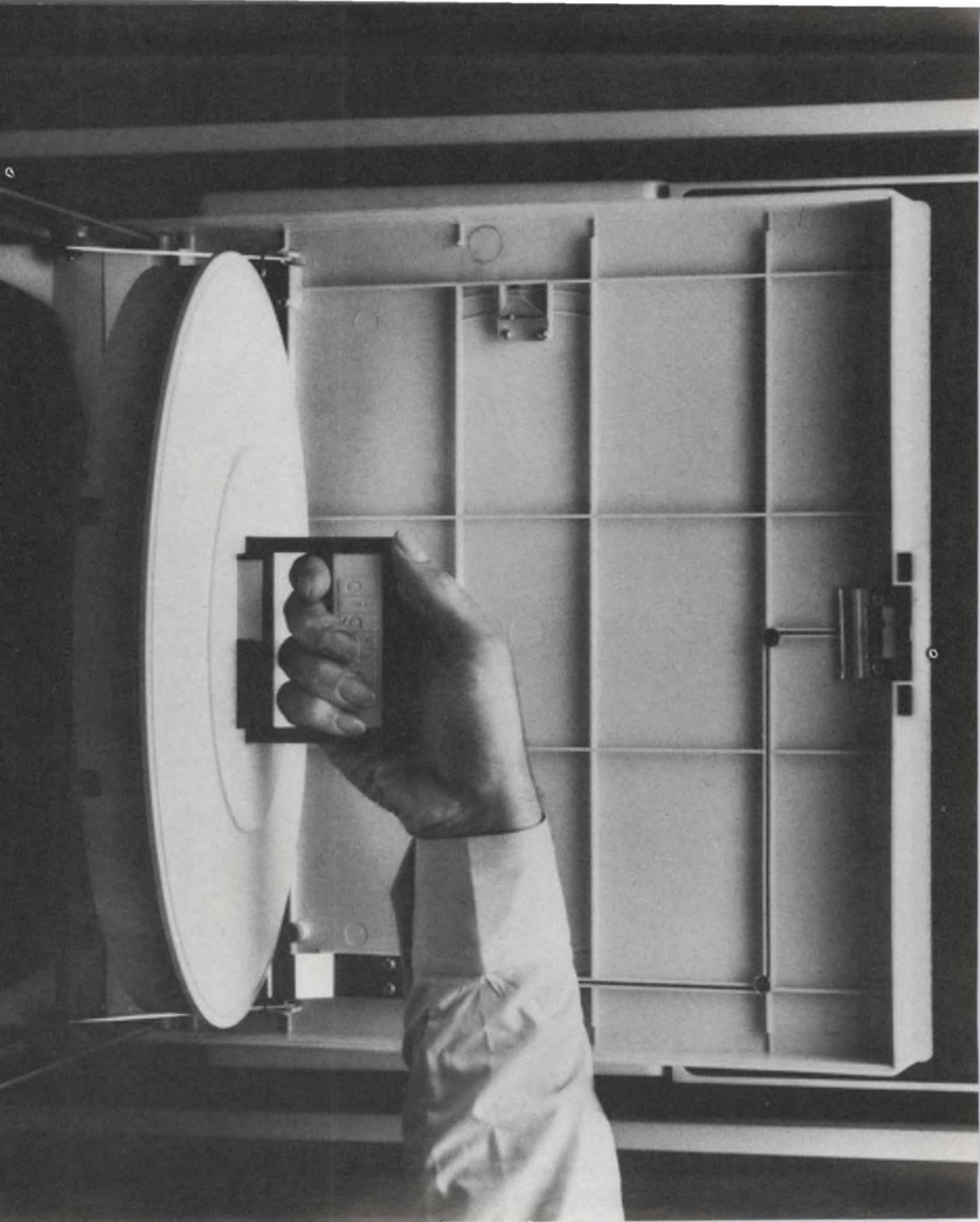

PLUS EVERYTHING THEY WANT IT IN.

The new RL01 5Mb disk.

Introducing a top-load, rack mountable, low priced 5.2Mb disk with state-of-the-art performance and solid OEM reliability.

The RL01 features 512Kb per second transfer rate.

Plus an incredibly simple design. There's no back plane. And just 5 electronic modules. So it's super reliable and easy to spare.

The RL01 is simple to service, too. All maintenance is done from the top of the unit. The heads can be changed in minutes, not hours. There's even a universal power supply with a frequency range of 47.5-63 Hz that can be quickly (but not accidentally) switched between 100-127V and 200-254V. And it can be replaced with just four screws without disturbing heads or logic.

The RL01 is also easy to configure. Our one board controller can power four drives for up to 20.8Mb.

Our RL01 is so good, you probably won't want a system without one. So we're offering those, too.

Incredibly priced new packaged systems, starting at just \$18,000.

Here's what you get: a PDP-11 CPU with 64 Kb of main memory, clock, serial line interface, cabinet, 10Mb of RL01 capacity with controller, an LA-36 terminal, and our RT-11 operating system.

You can get a PDP-11/03 based system for just \$18,000, PDP-11/04 based for just \$21,000, and the PDP-11/34 based one in the picture for just \$25,500. And prices go even lower with our OEM discounts.

The new RL01 disk and new PDP-11/RL01 packaged systems.

They're the systems you've always wanted.

Which is just what you'd expect from the OEM Group at Digital.

Call or write: Digital Equipment Corporation, PK3/M-86, Maynard, MA 01754. (617) 493-4237. In Europe: 12 av. des Morgines, 1213 Petit-Lancy/Geneva. Tel. 93 33 11. In Canada: Digital Equipment of Canada, Ltd.



digital
OEM PRODUCTS
GROUP

Half the price of other mercury relays — and



it works in all positions

Our DB relays offer exceptional reliability at extremely low cost (\$1.35 in 10,000 quantities). Self-healing contacts in welded steel package give more than 2 billion bounce-free operations between failures. Contact resistance is stable to 0.015 ohm with loads from nanowatts to 20 watts.

Operation is unaffected by mounting position.

Terminal pin options are available to match most dry reed and mercury wetted relay foot prints.

DB relays are well suited to applications in telephone, modem, data acquisition, and industrial control circuits.

The DB relay offers lower price than mercury relays, and superior performance to dry reeds.

For further information, write or call Fifth Dimension, Inc., 707 Alexander Road, Princeton, NJ 08540; phone (609) 452-1200; TWX 510-685-2387.



Fifth Dimension Inc.

Princeton, New Jersey

CIRCLE NUMBER 62

MICRO/MINI COMPUTING

Complete system develops software

Space Byte, 1720 Pontius Ave., Los Angeles, CA 90025. (213) 468-8080. \$5995.

A complete system for developing software consists of an 8085 CPU, modular terminal-mounted mainframe, 16-k fully static RAM and a 2708/2716 EPROM programmer. All PROM programming routines are intrinsic to the on-board 3-k system monitor. Included with the system is a Hazeltine 1500 video display terminal, iCOM 3712 dual flexible-disc drive and a floor stand. System software includes iCOM FDOS III 8080, 8085 and Z80 macro assembler, utilities and operating system and a 3870/F8 cross assembler.

CIRCLE NO. 342

Memory adds 4-bit resolution to CRTs



Intel Memory Systems, 1302 N. Mathilda Ave., Sunnyvale, CA 94086. Connie Magne (408) 745-7120. \$2400/\$3400; 4 wks.

A refresh memory system, in-5770, provides 4-bit resolution to the picture elements (pixels) of video images projected onto raster-scan CRT display terminals. The system is mounted on one 11.25 x 16-in. PC board and uses 16-k MOS dynamic RAMs. It has a total capacity of 256-k 4-bit words organized into four image planes each 256 k x 1-bit wide. Use of a 256-kword memory enables the in-5770 to maintain a one-to-one relationship to each picture element making up the 512 x 512 graphic matrix common to most terminal CRTs. When required, the in-5770 continuously recreates the stored graphic images by projecting a 512 x 512 matrix of shaded elements onto the screen, reproducing the image in a manner similar to that used to print photos in a newspaper.

CIRCLE NO. 343

Memory-intensive boards aimed at μ C OEMs



Mostek, 1215 W. Crosby Rd., Carrollton, TX 75006. Jim Vittera (214) 242-0444. \$364 to \$573 (100 qty); stock.

High-performance, memory-intensive μ C boards and peripherals in the SD Series use the Z80 μ C and industry-standard dynamic RAMs to offer versatility to the OEM. The series includes two versions of the Z80-based single-board μ C, the OEM-80/4 and 80/16. Both boards have four 8-bit I/O ports, serial ASCII interface (110-9600 baud), TTL-buffered I/O lines and four counter/timer channels. The difference between the boards is that the OEM-80/4 has 4 kbytes of RAM while the 80/16 has 16 kbytes. The RAM-80 expansion board adds 16 kbytes of RAM to the OEM-80. The RAM-80B is a combination memory and I/O expansion board. It has 32 TTL-buffered I/O lines in addition to 16 kbytes of RAM. The RAM-80B is expandable to 32, 48 or 65 kbytes of RAM using the SRAM-80 expansion kit. The FLP-80 flexible diskette controller interfaces the OEM-80 to up to four single or double-sided drives for large systems. With asynchronous or real-time operation, the FLP-80 accommodates data base expansion to 2 Mbytes of storage.

CIRCLE NO. 344

Floppy-disc system mates with S-100 bus

Quay, P.O. Box 386, Freehold, NJ 07728. John Lacatel (201) 681-8700. \$695; 4 to 8 wks.

A floppy-disc system for use in S-100 bus computers, the Model 80 F1 system includes the Q/80 FDC floppy-disc controller board, QDOS disc-based operating system, the Q/FDI 5.25-in. band-driven disc drive with power regulator, interface cable and the Q/80 FC floppy-disc cabinet. In addition to the floppy-disc support, the system provides a programmable 8-bit, TTL compatible, parallel I/O port capable of supporting standard peripheral devices.

CIRCLE NO. 345

Circular connectors.

Work through shock, vibration, or salt spray long after others crumble.

Both front and rear release models.

SAE cylindrical, threaded-coupling, crimp contact connectors come in shell sizes 10 to 48 and with up to 121 contacts. Thousands are now in service in Naval fire control, communications, and computer applications.

MIL-C-5015G testing proves the value of fused cadmium on nickel finish.

Proprietary fused cadmium finish holds up to 5% salt spray testing for 1000 hours and more. Tests performed in July 1976 by an independent test laboratory indicated the SAE MS connectors meet the requirements stated by the strenuous MIL-C-5015G specifications. (Copy of test report available upon request.)

Why you should look to SAE for environmental connectors.

SAE builds in high quality from the initial precision engineering, through meticulous assembly, to rigorous environmental testing under strict white room conditions.

Do you have a connector problem to challenge us with? Do you want more details on our fast growing line of environmental connectors? Call or write: SAE, Stanford Applied Engineering, 340 Martin Avenue, Santa Clara, CA 95050, (408) 243-9200.



Silicon insulator. Silicon material good for 20 years.

Retention system. High strength plastic epoxy retention fingers (for rear release models); rugged beryllium/copper clips for positive contact retention (for front release).

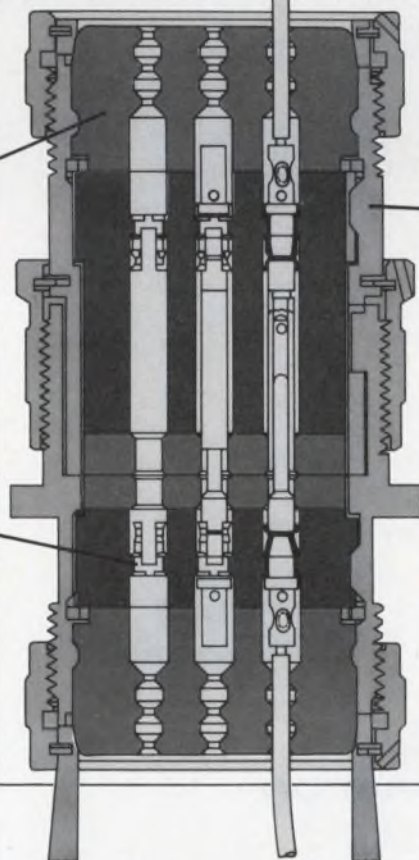

Proprietary finish. Fused cadmium plate over nickel finish offers long life and superior corrosion protection.

Your quality alternative
for PC connectors • sockets
• switches • flat cable systems.

Introducing the Incredible DATALOGGER 2000

... an easy-to-operate ... simple to understand ...



DATA INFORMATION CENTER that speaks your language!

It's incredible but ... the Datalogger 2000 can measure 4 parameters that you've chosen ... offer 1200 internal alarms ... manage your data collection and report it in your language ... and still remain 'pushbutton-simple' to operate.

The DigiTec DATA INFORMATION CENTER features:

- **Multi-Parameter capability**
Combine up to 4 of the 38 field interchangeable signal conditioning modules for measuring:
 - Temperature (Thermocouple, Thermistor, RTD)
 - DC Voltage, DC Auto-ranging
 - AC Voltage, True RMS
 - Transmitter output
- Up to 20 channels internal—expandable to 1000.
- $\pm 25,000$ count display (4% digits) of measured data.
- Alphanumeric printout.
- Exclusive skip-channel capability.
- 24-hour crystal controlled clock and Julian date.
- Internal microprocessor.
- Pushbutton programming.

And these options can make your DATA INFORMATION CENTER even more versatile!

- **Internal alarms**
Up to 1200 individual set-points.
4-level limits assignable per channel.
- **English messages**
6-character message assignable to each limit which eliminates the need for translation codes and look-up tables.
- **Data outputs**
Isolated BCD.
Isolated RS-232-C, TTY compatible, with selectable baud rates from 110 to 9600.

For a free brochure that explains how your measuring and collecting of data can be made simple, write or call:
Don Gerdeman, our Datalogger Specialist.

UNDER
\$3000
...it's incredible

DigiTec: Precision measurements to count on.

DigiTec

**UNITED
SYSTEMS
CORPORATION**

918 Woodley Road, Dayton, Ohio 45403
(513) 254-6251, TWX (810) 459-1728

CIRCLE NUMBER 64 FOR INFORMATION
178

CIRCLE NUMBER 65 FOR DEMONSTRATION

PACKAGING & MATERIALS

Low-price IC sockets have low profile

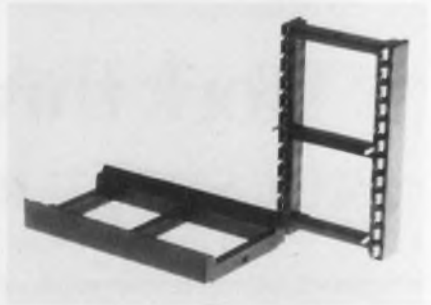

Stanford Applied Engineering, 340
Martin Ave., Santa Clara, CA 95050.
Tim McGarvey (408) 243-9200.
\$0.006/line; 8 wks.

The low-profile Type 3600 IC sockets are 0.15 in. high above the circuit board and maintain their 0.1-in. contact centers when butted end-to-end to provide continuous rows of contacts. Sockets are available with 14 to 40 contacts. The springs accept leads as large as 0.027×0.017 in. The close-entry insulator design protects spring members and guides component leads. Solder wicking is eliminated by an antiwicking contact design.

CIRCLE NO. 346

Ionizing air guns neutralize static charge

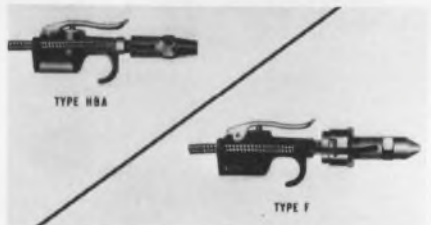

Simco, 920 Walnut St., Lansdale, PA
19446. Allen Schwingler (215)
368-2220. \$215; stock.

When standard compressed-air guns blow dust and other foreign matter off parts, static electricity attracts the dust right back. Ionizing air guns neutralize static charges as they clean, keeping the dust from re-attracting. The ionizers are inside the nozzle tips and are energized from small power supplies that plug into a 110-V line and connect to the nozzles through flexible shielded cables. Type HBA is a general purpose antistatic cleaning gun. Type F includes a replaceable filter cartridge that provides clean gas or air. Type FX, the filtered gun without ionizer, is also available.

CIRCLE NO. 347

ELECTRONIC DESIGN 12, June 7, 1978

LET'S PUT OUR HEADS TOGETHER.

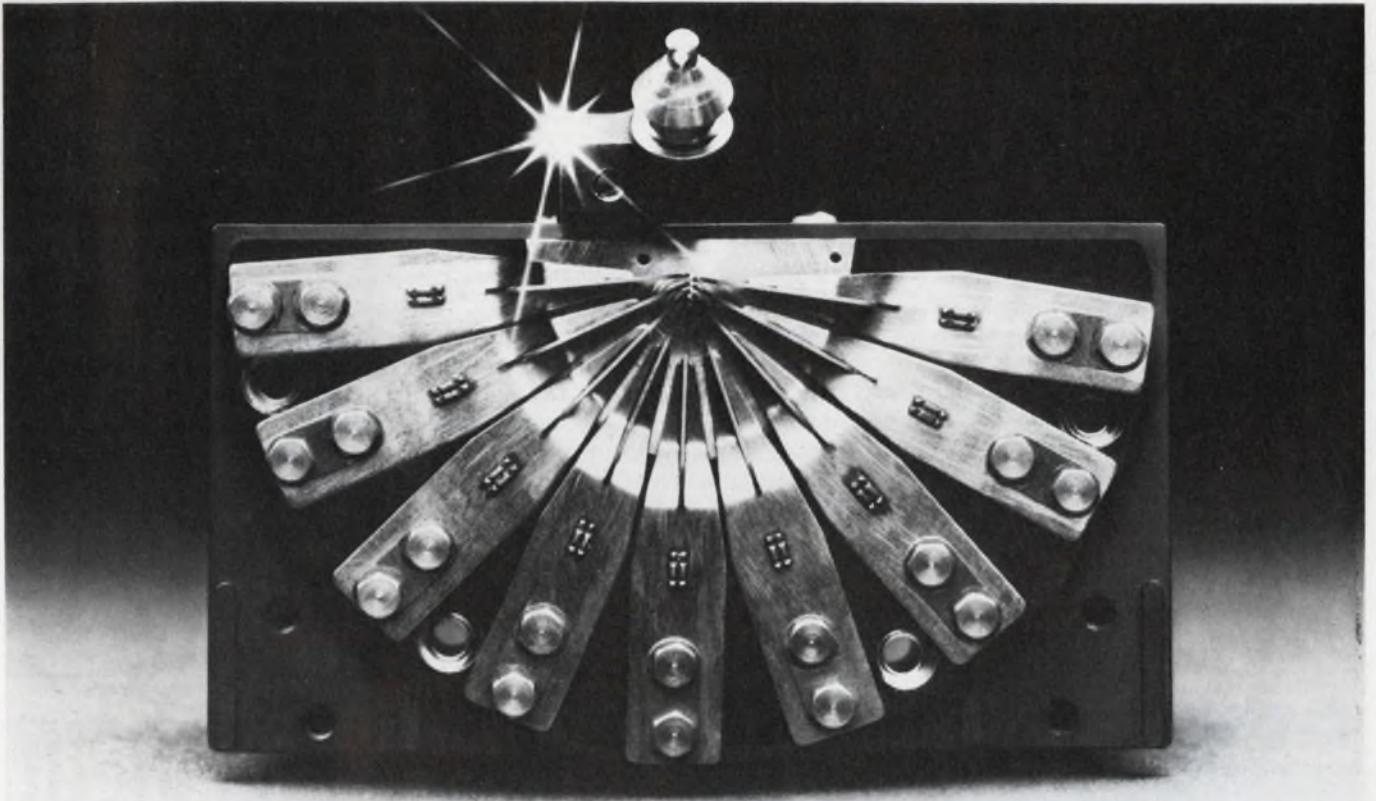

The Facit 4540 Serial Matrix Printer has already made a name for itself with its standard 250 characters a second - all crisp, fullbodied and perfect throughout the 500 million characterservice life of the printhead. Versatility comes from the rare 9x9 dot matrix, and the Facit 4540 offers a genuine 100% duty cycle and entire elimination of adjustment and lubrication.

The whole secret is in the unique print-head and its microprocessor controlled impact printing mechanism.

Integration of mechanics and electronics has made Facit peripheral data products world famous.

Facit 4540 extends this tradition. So let's put our heads together. To make your systems more efficient, more competitive and more in demand.

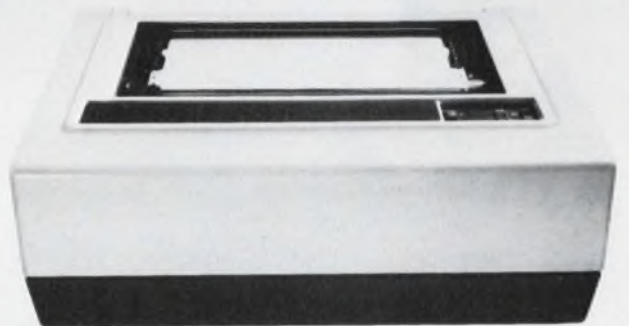

Facit 4540 Serial Matrix Printer with the unique printhead.



FACIT
DATA
PRODUCTS

FACIT-ADDO INC., 66 FIELD POINT RD. GREENWICH, CONN. 06830. (203) 622-9150. TELEX 96-5998.

PACKAGING & MATERIALS

Display mounts hold any combo of digits

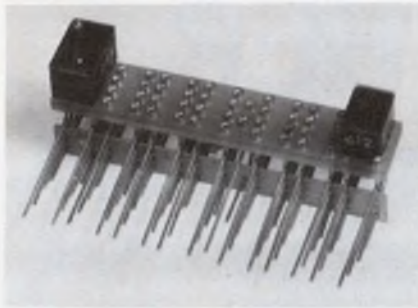

Aries Electronics, P.O. Box 231, Frenchtown, NJ 08825. (201) 996-4096.

Display mounts can be tooled for any number of displays in any combination of digits, decimal points or other designators. Staggered pins allow easy entry into PC boards. Collet sockets have gold-plated beryllium-copper contacts, tin-plated pins and glass-epoxy bases. The sockets can be supplied for vertical, horizontal or elevator applications.

CIRCLE NO. 348

Magnet-wire connectors pierce tough insulation



Thomas & Betts, 36 Butler St., Elizabeth, NJ 07207. (201) 354-4321.

Dragon Tooth connectors are made of tough tin-plated copper alloy and have multiple sharp ridges on the inner barrel surface for penetrating tough magnet-wire insulations. The connector line accommodates a range of wire sizes from 20 to 12 AWG in a variety of combinations, including the combining of magnet wire with stripped lead wire. The ring tongues take bolt sizes #6, #8, #10 and 1/4 in.

CIRCLE NO. 349

PC board holders have conductive-foam pad

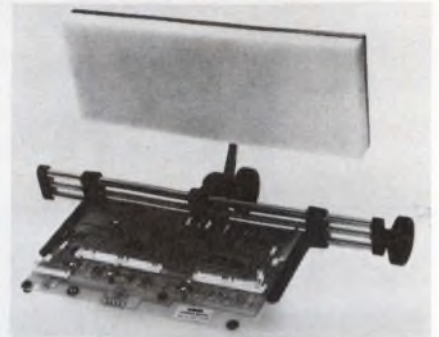

Micro Electronic Systems, 8 Kevin Dr., Danbury, CT 06810. (203) 746-2525. \$75 to \$102; stock.

Four sizes of PC-board holders, PCS 1 through PCS 4, have a conductive-foam pad that rests on top of the components, while the frame is flipped over for hand soldering. When inserting components, the boards rest at a 30° angle. The units come with a divider for assembly of two boards at a time. Sizes range from 5.5-in. deep × 10-in. wide to 7.5 × 14 in.

CIRCLE NO. 350

odds • on choice



in ceramic resonators

We've taken the gamble out of low frequency, frequency control from 195 KHz to 600 KHz for such applications as TV remote controls, telephone tone generators and digital clock generators to name a few. Our new ceramic resonators provide stability and reliability without circuit complexity, far beyond that possible with LC networks and at costs far below quartz. Standard tolerance is ± 2 KHz.

muRata
CORPORATION
OF AMERICA

Write for complete technical information to: Murata Corporation of America, 1148 Franklin Road, S.E., Marietta, Georgia 30067. Phone: 404-952-9777.
first in ceramics

CIRCLE NUMBER 67

Just Published!

A "how-to-design" book written from a power supply designer's point of view!



Covers all the circuits, systems, magnetics, and thermal design skills essential to modern power supply design.
#5847-0, cloth, 384 pages, \$19.95

switching and linear power supply, power converter Design

Abraham I. Pressman
Raytheon Company

ORDER YOUR 15-DAY EXAM COPY NOW! When billed, remit or return book.
HAYDEN BOOK COMPANY INC.

50 Essex Street,
Rochelle Park, N.J. 07662

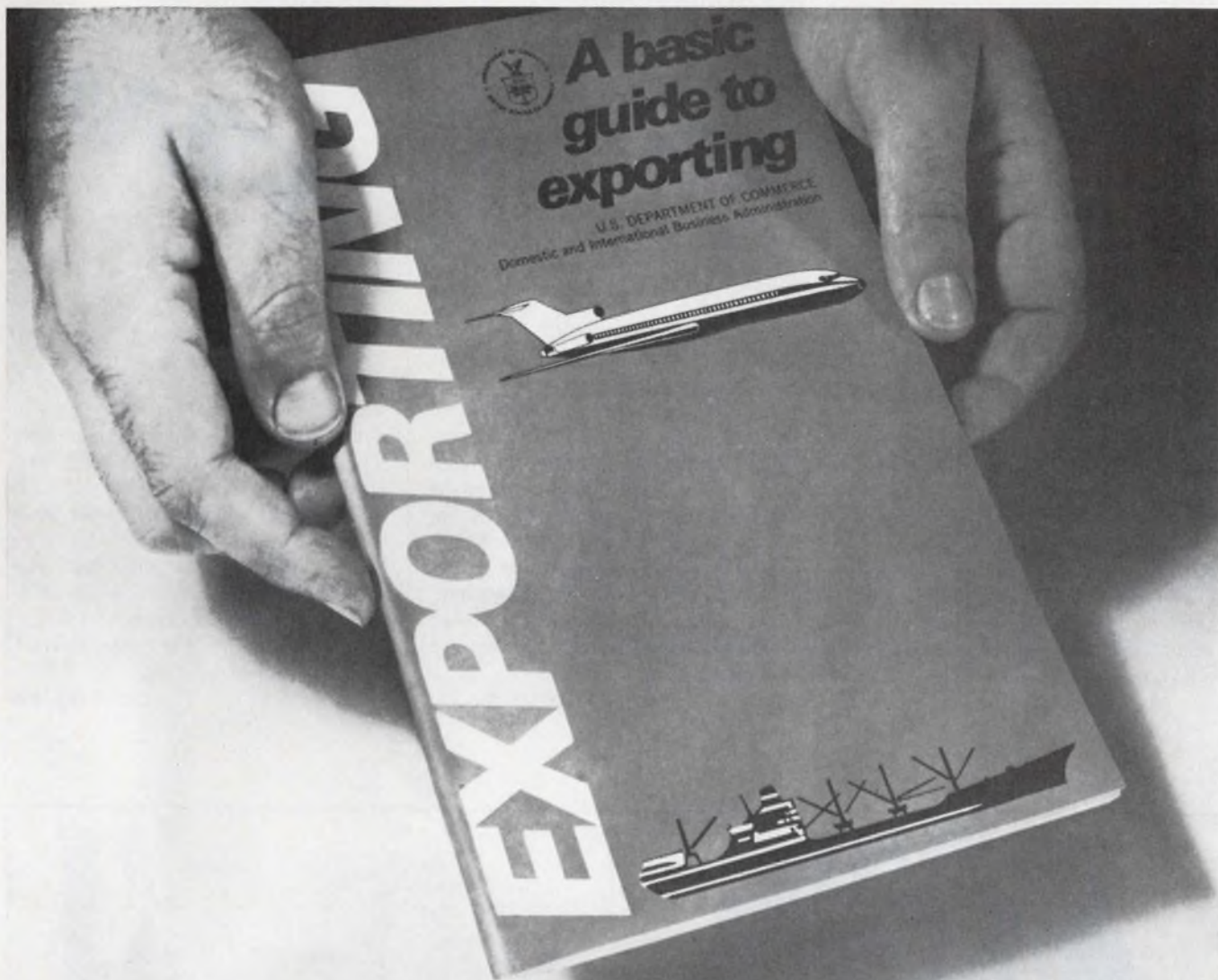

The book that turns businessmen into best sellers.

Many who've read it are now reaping the rewards. Because they've found that U.S. exports are a more than \$100 billion a year business, that exporting creates both company profits and company growth, that U.S. goods have never been more competitive in international markets. Above all, they've found that, with the help available from the U.S. Commerce Department, selling overseas is no more difficult than selling at home. And this fact-filled book can prove the same to you. Send us the coupon today and start sending your products where the money is.

U.S. Department of Commerce

The Secretary of Commerce
U.S. Department of Commerce, BIC 8A
Washington, D.C. 20230

Please send me a copy of "A Basic Guide to Exporting."

Name

Title

Company

Address

City State Zip

A Public Service of This Magazine
& The Advertising Council



Connector backshell includes strain relief

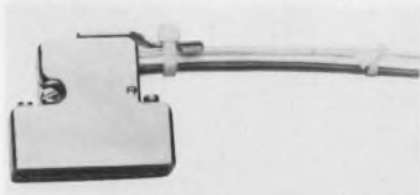

Glenair, 1211 Air Way, Glendale, CA 91201. John Merrell (213) 247-6000. \$6.50 (100 qty).

The 90-degree-cable-entry backshell mates with RS-232 interface D-sub-miniature connectors (MIL-C-24308). The low-profile backshell provides maximum cable strain relief by securing the strain relief to the cable by a plastic tie strip. Cable plug entrapment, complete enclosure of plug and receptacle and captive-male-screw locks are also provided.

CIRCLE NO. 356

Flat cables are accurately centered

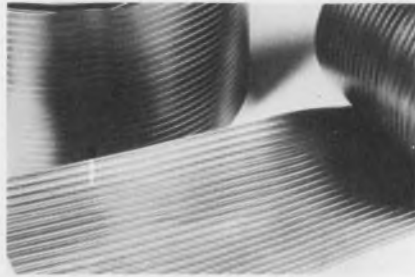

Molex, 222 Wellington Ct., Lisle, IL 60532. Kerry Krafthefer (312) 969-4550. Stock.

Jet-Flecs flat cable is manufactured under controlled conditions that produces a precision center-to-center controlled cable of predictable and consistent electrical characteristics. The ribbon cables, with 0.156-in. centers, are available with 22 AWG stranded conductors. The cable design allows individual or groups of conductors to be separated from the cable through a zipping process.

CIRCLE NO. 357

Edge connector lets you wrap wire

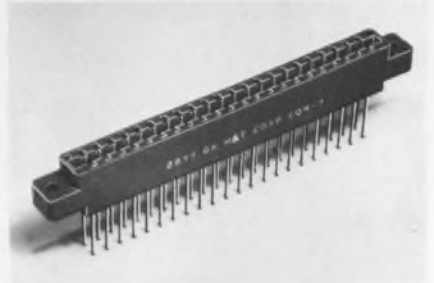

OK Machine & Tool, 3455 Conner St., Bronx, NY 10475. Judy Camen (212) 994-6600. \$3.49; stock.

The Model CON-1 edge connector is a 22/22-contact connector for single or double-sided PC boards. The connector has 0.025-in.-square, three-level wire-wrapping contacts on centers of 0.156 in. Contacts are nickel-silver over beryllium-copper and have a bifurcated-bellows design that provides constant pressure while minimizing contact distortion and stress. The connector body is molded of UL and MIL approved Valox.

CIRCLE NO. 358

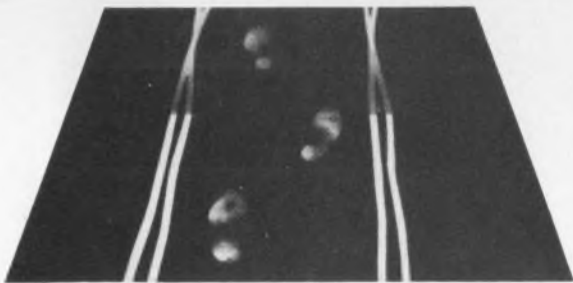

Kager Trapdust Mats

Clean Rooms • Chemical Labs • R & D Labs
Product Assembly Area
Hospital Operating Rooms

Literally pulls dust, dirt and bacteria off the bottoms of workers' shoes, and off the wheels of equipment vehicles. Place in the hallways and entrances leading up to any area where dirt and dust are critical factors. Unique plastic material does not have to be bonded to floors. Fully washable and reusable. No expensive wastage caused by having to dispose of soiled surface layers. Single surface has long life. Available in variety of sizes.

KAGER INTERNATIONAL 1180 South Beverly Drive, Suite 710
Los Angeles, California 90035
Telephone: (213) 879-1575
TWX: 910-490-2121

U.S. Headquarters for the Kager Group of Companies
known worldwide as manufacturers of unique tools and production equipment.

CIRCLE NUMBER 70



ANTI-SLIDE

Rolls can be cut down to any desired size

Stops everything from slipping and sliding around—in- dispensable in assembly work. Tools and components are playful little devils. They love to dance or play hide and seek on and around the work surface. ANTI-SLIDE puts an end to this time consuming and wasteful mischief. This unique fully washable and reusable plastic material holds objects placed on it as if they were glued. Components do not move even if they are pushed. In addition, ANTI-SLIDE acts as a noise and vibration dampener. No other even remotely similar product exists. Available in five attractive colors. Send inquiries to:

KAGER INTERNATIONAL 1180 South Beverly Drive, Suite 710
Los Angeles, California 90035
Telephone: (213) 879-1575
TWX: 910-490-2121

U.S. Headquarters for the Kager Group of Companies
known worldwide as manufacturers of unique tools and production equipment.

CIRCLE NUMBER 71

ELECTRONIC DESIGN 12, June 7, 1978

RELIABLE. The Megabyte Memory contains one megabyte of reliable, non-volatile core memory on each pluggable pc module. Two versions are available, 1024K x 8 & 1088K x 8.

COST EFFECTIVE. The Megabyte Memory is priced at less than 0.1¢ per bit in OEM quantities.

LOW POWER. While operating at a 2 microsecond cycle time the Megabyte Memory consumes only 12.00 microwatts per bit; standby

power is 3.4 microwatts per bit. The system chassis can accommodate up to four Megabyte modules, two logic cards and a power supply. General purpose I/O cards or custom interfaces are available to meet most OEM applications.

Call or write us today for complete technical information.



Now a million bytes of memory on one card!

Reliable

Cost effective

Low power

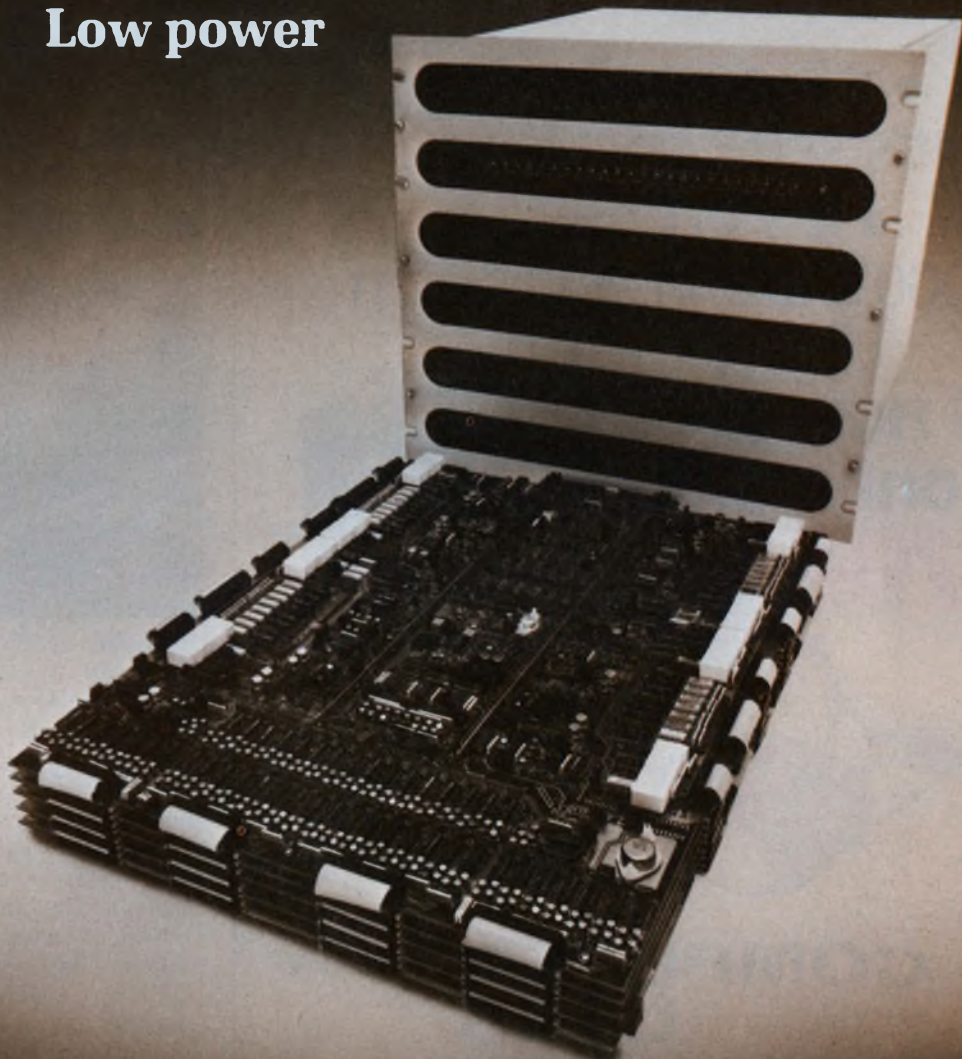

Commercial Memory Products, a Division of Electronic Memories & Magnetics Corporation
12621 Chadron Avenue • Hawthorne, California 90250 • Phone (213) 644-9881

SEE US AT BOOTH 1327 AT THE NCC SHOW ANAHEIM CA. JUNE 5-8

PACKAGING & MATERIALS

Prototyping board fits DEC and Heath computers

Vector Electronic, 12460 Gladstone Ave., Sylmar, CA 91342. Floyd Hill (213) 365-9661. \$15.95; stock.

A general-purpose prototyping circuit board permits convenient construction of custom interface circuits for Heath H-11 microcomputers and DEC LSI-11, PDP-8 and PDP-11 mini-

computers. Form, size and connector-compatible with the DEC double-height, extended-length module, the Model 4607 plugboard is 8.43 × 5.187 in. It has etched contacts spaced to fit the dual 36-pin connectors used in the computers. To allow unrestricted component placement, the plugboard is bare with an array of 0.042-in. diameter holes on centers of 0.1 in. DIP sockets or discrete components may be placed anywhere on the board.

CIRCLE NO. 359

The world's cheapest 8-Bit, 16-MHz VIDEO A/D

- It's complete...
- It's self-contained...
- It's proven...
- 1000's are in operation

and now
it's only
\$479!*



COMPUTER LABS

COMPUTER LABS, INCORPORATED
505 EDWARDIA DR. ● GREENSBORO, N. C. 27409
919/292-6427 ● TWX 510-922-7954

*In quantity of 100.

CIRCLE NUMBER 73

Mini uhf connectors are half standard size



Amphenol, 33 E. Franklin St., Danbury, CT 06810. (203) 743-9272. \$0.52 (plug), \$0.65 (jack), (500 qty); stock.

Type 81 miniature uhf plugs and jacks, for use with RG58/U coax cable, have five times greater frequency range and are half the size of standard-sized connectors. The plug is 0.125 in. long and 0.438-in. diameter. The jack is 1.188 × 0.375 in. You assemble by stripping the coax cable, soldering the center contact and sliding the parts together.

CIRCLE NO. 360

Molded D-type cables provide strain relief

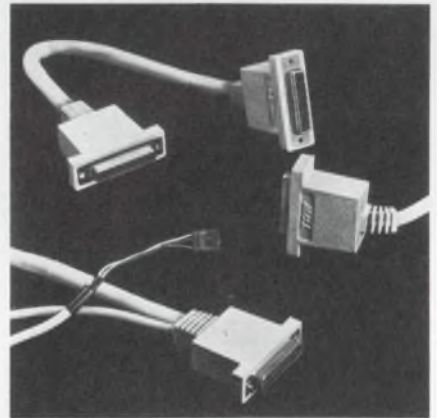

TRW Holyoke Wire & Cable, 775 New Ludlow Rd., South Hadley, MA 01075. Roger Brickley (413) 533-3961. \$12 to \$15 (12 ft); 4 to 6 wks.

A line of molded cable assemblies with a choice of 9-to-50 position D-subminiature connectors is available in any length, shielded or unshielded. The cables feature a fully functional strain relief and an external covering that withstands substantial abuse. All 25-position cable assemblies in the line fulfill the requirements of RS-232, while 9 and 37-position assemblies meet RS-449. The cables are usually furnished in EIA color-coded 22-gauge wire, but other sizes and types can be provided.

CIRCLE NO. 361

CIRCLE NUMBER 74 ►



Is there life on Germanium?

Plenty.

The demand for our Germanium semiconductors continues to grow.

Germanium has advantages over Silicon for many applications; low saturation voltage, low battery drain for example. And we've just announced the world's first single-chip 100A power transistor, based of course on Germanium technology.

At GPD we make devices to all the well-known specs: JAN, EIA, and PRO-ELECTRON AD, ADY, ADZ, ASZ, AU, AUY and ASY.

And we can now replace practically all the Germanium products you used to buy from Motorola (MP500-506, 2N4276-4283, 4048-4053), Delco (DTG110, 2N1100, DTG2000-2400A), GE (2N319-324, 524-526, 1370-1381, 1413-1415, 1924-1926), Siemens, Mullard, SGS-ATES, and Thomson.

Our range goes from 150mW small signal to 100A power, in packages of all shapes and sizes.

Germanium is here to stay.

We'll be making Germanium devices as long as you, the customer want them.

Send for our latest catalogue or let us know your specific problem.

GPD, Box 65, Shawsheen Village Station, Andover, Mass, 01810.

Tel: (617) 475-5982.

Telex: 94-7150 GPD Andr.

Germanium Power Devices Corporation

The Germanium Manufacturers

UK Representative Wintronics PO Box 24 E. Grinstead, Sussex. 034287-277 **UK Agents** Jermyn Industries Sevenoaks, Kent. Sevenoaks (0732) 50144 Tlx 851-95142/Consort Electronics Ltd Rosebank Parade, Reading Road, Yately, Camberley, Surrey, Yately (0252) 871717 Tlx 851-858809 **Norway** Nordisk Elektronik (Norge) A/S Mustadsvei 1 Postboks 91-Lilleaker, Oslo 2 0752-13800 Tlx 856-16963 **Italy** Syscom Elettronica Spa, Via Gran Sasso 35, 20092 Cinesello Balsamo, Milano 92 89 251/2/3 and 92 89 159 Tlx 843-36118 (Syscom)/Euroelettronica S.r.L. Sede: 20145 Milano, Via Mascheroni, 19, 4981851/2/3/4/5 Tlx 39102 Thomelec/Uff. Regionale: 00197 Roma, Via B. Oriani, 32, 895394 Tlx 61358 Thomelec/Uff. Regionale: 40138 Bologna, Via Massarenti, 410/3 534062 **Belgium, Holland, Luxembourg** B.V. Laboratorium Voor Electronentechniek Diode, Hollantlaan 22 Utrecht. 030-884214 Tlx 844-47388/ Rue Picard 202 Picardstraat 1020 Bruxelles (02) 4285105 Tlx 846-25903 **Austria, Hungary, Czechoslovakia, Yugoslavia** Rieger GmbH Marxergasse 10 A-1030 Wien 3 (0222) 734684-0 Tlx 847-1-1087 **Union of South Africa** L'Electron Enterprises (Pty) Ltd P.O. Box 19544 Johannesburg 2000. 22-3363/4/5 Tlx 960-80671 **Denmark** E. V. Johansen Elektronik A/S Svanevej 12 DK-2400 Copenhagen NV 451839022 Tlx 855-16522/GDS-Henckel Elektronik ApS Fyrevangen 4 DK-4622 Havdrup. (03) 38-5716 Tlx 855-43168 **Portugal** Diltram Componentes Electronica, Lda Av. Miguel Bombarda 133, L.D Lisboa 1 45313 **France** TMC 125 Rue Anatole-France 93121 La Courneuve, 833-33-74 ext. 189 Tlx 842-210311F (Publi) **Sweden** Integrerad Elektronik P.O. Box 43 S-182 51 Djursholm. (08) 753-03-30 Tlx 854-10282 **Switzerland** GDC Muller S.A. 8 rue de l'Aubepine C. P. 77 1211 Geneva 9. 215977 Tlx 845-59434/Omni Ray AG 8008 Zurich Dufourstrasse 56 (01) 478200 Tlx 845-53239 **West Germany** Solicom GmbH Wargauer Str. 46. 8000 Munchen 90 089-69 65 66 Tlx 841-05-22870

Now all in one package – a complete RF Analyzer for swept measurements

- transmission (gain/loss)
- reflection (return loss/SWR)
- absolute power
- absolute frequency

COMPLETE SYSTEM INCLUDING 1-1500 MHz SWEEPER

It's simple to get scalar swept-measurement information with Wiltron's new all-in-one RF Analyzer.

Just connect the input and/or output of the device to be measured to the Analyzer. No need to hunt for an array of couplers, amplifiers, cables and other equipment.

Besides being simple to use, this first-of-its-kind Analyzer gives you better accuracy than put-together setups.

The new Model 640 is small and convenient, yet it is a *complete measuring system*. It contains all of the needed test circuitry—sweeper, directional signal separator, calibrated amplifiers, detectors, and display system.

It's ready to measure the device under test.

WIDE PLUG-IN CHOICE

The sweeper and amplifiers are plug-ins, so you have maximum flexibility. Both log and linear amplifiers are available. A variety of external directional bridges, detectors, and RF fittings is also available so that you can measure in almost any setup, 50 or 75 ohms.

Small as it is, the sweeper is the equal of much larger sweepers. And it has the most complete frequency marker system known to be available in any-sized sweeper.

The amplifiers are gems. Low noise, wide range, stable, fast, complete with positionable reference traces and a ± 90 dB calibrated offset arrangement.

All of this adds up to:

- precise sweeps as wide as 1500 MHz or as narrow as 1 MHz.
- a 70 dB dynamic measuring range from +10 to -60 dBm.
- return loss measurable to below 54 dB (1.004 SWR).
- outstanding convenience.

PROMPT DELIVERY — CALL FOR DEMO

The 640 is discussed in our *Wiltron Technical Review No. 7*. Copy on request.

Call now for a demo of the 640.

Wiltron reps have demo units so you can see one right away.

There's no waiting for delivery either.

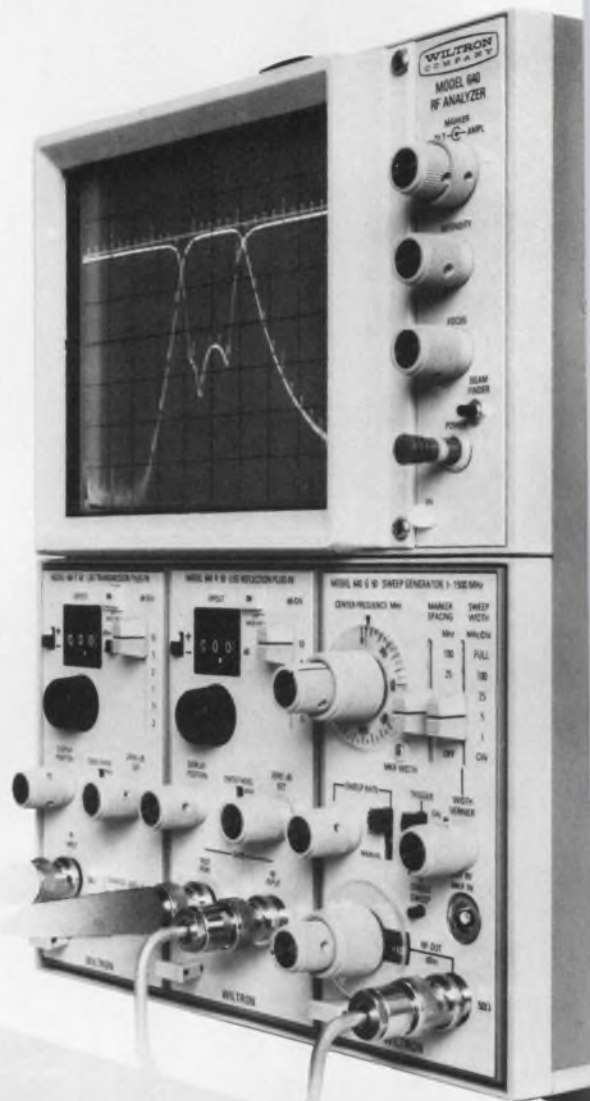

(Five plug-ins to meet your requirements)



Swept Signal Source



Log Amplifier with internal detector



Log Amplifier with internal SWR bridge and detector



Log Amplifier



Linear Amplifier



825 East Middlefield Road • Mountain View, CA 94043 • (415) 969-6500 • TWX 910-379-6578

CIRCLE NUMBER 75

PACKAGING & MATERIALS

Press-on heat sink saves PC-board space

Aavid Engineering, 30 Cook Ct., Laconia, NH 03246. (603) 534-4443.

For TO-5 transistors, a heat sink for press-on applications is available in black-anodized or gold-chromate finish. The types 2115B and 2115C are simply pressed on to the transistor without any special tooling. In addition, the heat sink can be applied after PC-board assembly and no additional board space is required.

CIRCLE NO. 362

Card-edge connector adds strain relief

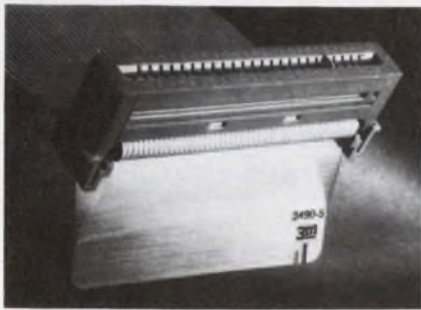

3M, Dept. EP8-7, P.O. Box 33600, St. Paul, MN 55133. (612) 733-3350.

The addition of strain-relief capability makes the 50-position Scotchflex card-edge connector more reliable and rugged. The 3415-0002 connector has flanges into which the strain-relief clip firmly snaps. An optional pull-tab allows easier disconnection and reconnection with minimal flexion and wear. The strain relief and optional tab permit flat cable to be guided straight out from the back of the connectors, so PC boards can be stacked tighter, improving the density of packaging.

CIRCLE NO. 363

Insulated wire meets MIL and UL specs

Haveg Industries, P.O. Box 7, Winowski, VT 05404. (802) 655-2121.

PTFE/polyimide-insulated wire is covered by MIL-W-22759/28-31 and rated to 260 C with nickel-plated conductors. The wire is also available in UL Style 1394 with a temperature rating of 200 C, for use where its flexibility, space-saving properties and resistance to cut-through are required.

CIRCLE NO. 364

ELECTRONIC DESIGN 12, June 7, 1978

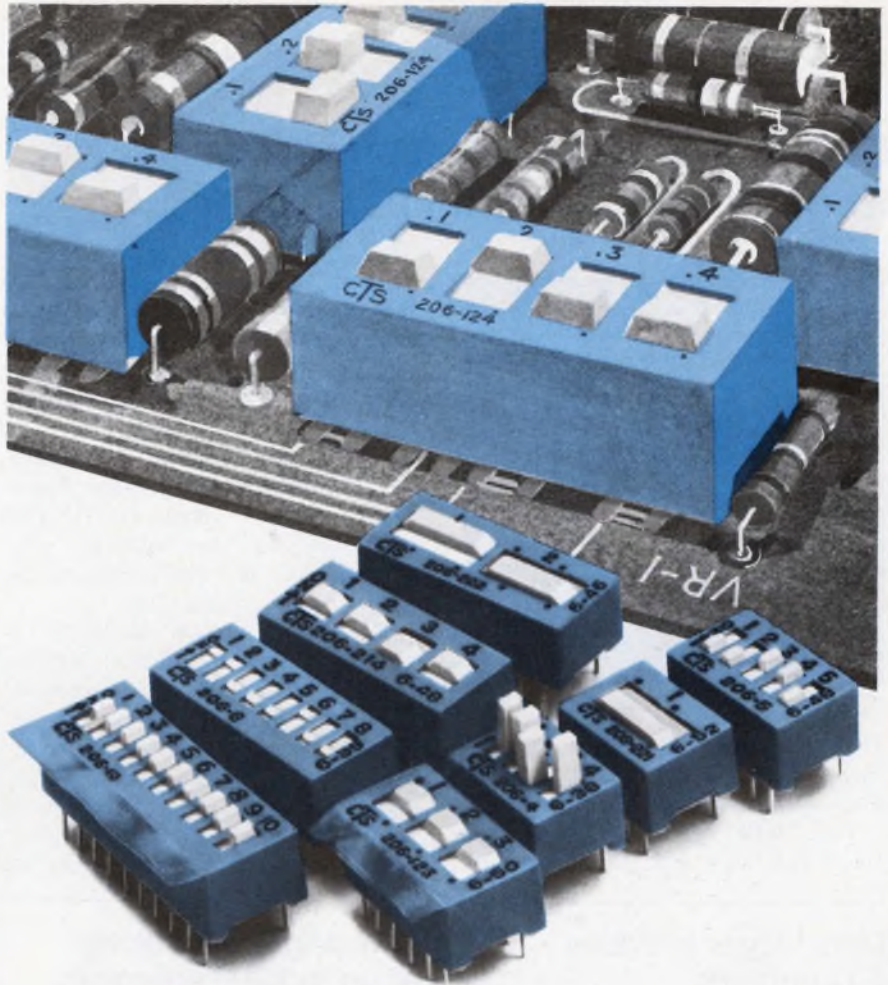

CTS Offers You the DIP Switches You Need!

Choose from the finest line of DIP switches and options available. The CTS family of quality Series 206 DIP switches provides every imaginable electrical and mechanical configuration.

New configurations include 2 DPDT's... 2 SPST's including a 2 and a 3 circuit package... and 1 each 2 circuit SPDT and DPST switch, all in addition to the 15 standard DIP switches previously available... high (extended) or low (flush) switch actuators... and sealed versions for contaminant-free operation after flow soldering and cleaning.

All are designed for standard DIP socket insertion; feature crisp, positive *slide detent actuation*; reliable gold plated contacts and are economically priced.

CTS DIP switches are used in all areas of the electronics industry including communication, data processing, instrumentation and consumer applications. For prompt, efficient assistance for your DIP switch requirements, contact **CTS KEENE, INC.**, 3230 Riverside Avenue, Paso Robles, California 93446. Phone: (805) 238-0350.

CTS CORPORATION
ELKHART, INDIANA



CIRCLE NUMBER 76

Computer family gets high speed from hardware arithmetic unit



Hewlett-Packard, 1507 Page Mill Rd., Palo Alto, CA 94304. (415) 856-1501. From \$27,500; 16 wks.

The 1000F-Series computers are speed demons thanks to a newly de-

veloped hardware-executed scientific instruction set that performs technical calculations with unmatched speed. A fast floating-point processor and new 350-ns 16-k RAMs help boost throughput.

All HP 1000 Systems offer multi-terminal and multilanguage operations. Fortran IV, Basic, and HP 1000 assembler are the languages supported, as is microprogramming through a microassembler.

The memory-based Model 25 is aimed mainly at dedicated applications, the Model 45 at more-generalized engineering and scientific use. The latter also offers a new disc-based operating system that handles main-memory data arrays as large as 2 Mbytes in Fortran. Model 45 starts at \$46,500.

CIRCLE NO. 305

Data logger provides 64 channels



Kaye Instruments, 15 DeAngelo Dr., Bedford, MA 01730. Dick Eastman (617) 275-0300.

Standard features of the RAMP/Processor data logger include linearization for thermocouples in C or F and 65 channels of programmable integration. Also included are 35 individually programmable offset and scaling functions, independent alarm settings and relay closures on every channel along with rate-of-change alarming, and alphanumeric display and print-out. Signals are scanned, converted into engineering units and checked for alarms at a maximum rate of 160 channels/s. The system can be used as a stand-alone data logger or as a computer front end with distributed remote scanning.

CIRCLE NO. 365

Line printers zip along at up to 1200 lines/min



Documation, P.O. Box 1240, Melbourne, FL 32901. (305) 724-1111.

The DOC1000 and 2000 printers are rated at 1000 and 1200 lines/min using a 48-character set. The band printers, with a fully buffered print line of 132 characters, handle up to 6-part forms, ranging from 3 to 24 in. in length and in width from 4 to 18.75 in. Vertical line spacing is at 6 or 8 lines/in., at slew rates up to 50 in/s. Other features include interchangeable character arrays and a universal character set buffer that handles all character sets, including OCR fonts.

CIRCLE NO. 366

Desktop workstation features dual- μ P DMA

Digi-Log Systems, Babylon Rd., Horsham, PA 19044. (214) 672-0800.

Microterm II is an integrated desktop workstation that features a dual-microprocessor DMA architecture and a multitasking operating system. Hardware includes single or dual mini-diskettes, a 24 \times 80-character CRT, keyboard with keypad, communications interfaces, internal printer, external line-printer interface and up to 80-k RAM. The hardware package is only slightly larger than a standard office typewriter. The software package includes indexed sequential access method (ISAM) file controls, database control, English command language, sort capability, utilities, IBM 2780 RJE emulation, TTY emulation and an interactive software development system.

CIRCLE NO. 367

Graphic display employs 32-bit multi-chip μ P

Megatek, 1055 Shafter St., San Diego, CA 92106. (714) 224-2721. \$20,000 to \$25,000; 8 to 13 wks.

The Megraphic 7000 series of intelligent refresh graphic systems and terminals features longer graphic word length, a 32-bit bipolar bit-sliced μ P, self-contained refresh memory, a versatile interface and advanced expandable hardware. An interface enables the display to be connected to DEC's PDP-11 and Data General's Nova and Eclipse computers. The basic system includes a rack-mountable chassis with a 12-slot motherboard, high-speed graphics processor and vector generator, 2 k \times 32 RAM and a DMA interface to the host computer.

CIRCLE NO. 368

Impact printer spews out 600 lines/min

Printronix, 17421 Derian Ave., Irvine, CA 92714. Mel Posin (714) 549-8272.

A 600-line/min printer, the Model 600 offers the advantages of raster-matrix impact printing. The mechanism has 50% fewer parts than drum, chain, belt or band printers. The 96 ASCII character set is expandable to 160 characters without degrading the speed. The printer also has computer graphics and plotting capability.

CIRCLE NO. 369

Low Cost* Monolithic, AM IF Amplifier/Detector.

The Ferranti ZN414 — for use in battery operated broadcast receivers, model radio control, CB, RDF, etc. Can also be used as a 1 chip TRF receiver.

- On-chip AGC with 20db range
 - On-chip transistor detector
 - VCC 1.2V to 1.6V
 - I_c 300μA
 - 72db power gain
 - Input frequency range 150KHZ to 3MHZ
 - Threshold sensitivity better than 50μV
 - Audio output voltage greater than 30MV RMS
 - Can drive hi-impedance earphone direct
 - Excellent audio quality
 - No on-chip alignment necessary
- *\$.49 ea. in 1000 piece quantities

FERRANTI
better by design

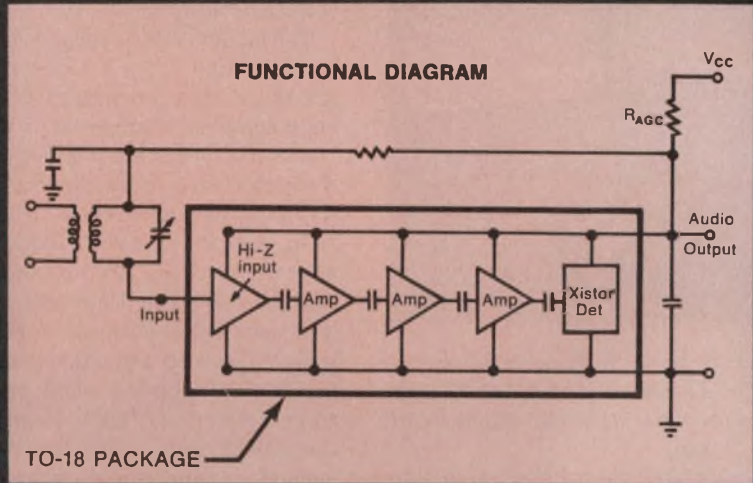

FOR COMPLETE SPECIFICATIONS, CONTACT: FERRANTI ELECTRIC, INC. / SEMICONDUCTOR PRODUCTS
EAST BETHPAGE ROAD, PLAINVIEW, NEW YORK 11803 PHONE: (516) 293-8383 / TWX: 510-224-6483

CIRCLE NUMBER 77

VARIETY

ESSEX/SUFLEX has a wide selection of Astratite[®] heat shrinkable tubing to insulate and protect circuits, wiring harnesses, fuses, diodes, capacitors, terminals and junctions.

Polyolefin very flexible, flexible or semi-rigid . . . lower cost Polyvinyl Chloride tubings (cross-linked and non cross-linked) standard wall or thin wall . . . greater or lesser than 2:1 recovery ratio. All from one source — Essex/Suflex. And most of these Astratite versions are UL listed.

Samples, property data and prices available from 29 Essex/IWI Warehouse/Sales Centers and many independent distributors — or contact: Essex Magnet Wire & Insulation Division, Essex/Suflex, Newmarket, N.H. 03857, Phone: 603/659-5555.

**ESSEX
GROUP**



Subsidiary of
**UNITED
TECHNOLOGIES**

Essex/Suflex, Newmarket, N.H. 03857, Phone: 603/659-5555.

Bell-compatible high-speed modem comes as single board or small box

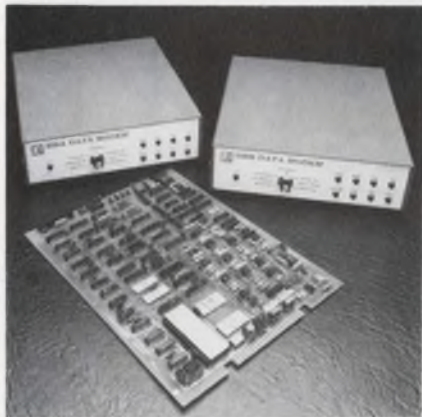

Universal Data Systems, 4900 Bradford Dr., Huntsville, AL 35805. George Grumbles (205) 837-8100. \$2200 (unit qty.); 8 wks.

A single-board, Bell-compatible 4800-bit/s data modem, the Model 208,

is about one-third the size of the Bell system equivalent. It is available for either four-wire (208A) or two-wire (208B) networks.

The modem can be supplied as a free-standing unit or in a rack-mountable enclosure that accommodates up to eight complete channels at 4800 bits/s. Data communications OEMs may specify the 208 as a single card for integration into their products. In a standard 19 in. rack the enclosure requires only a space of 7 in. In the single-card configuration the UDS 208 occupies less than 100 square in. of PC board space. The size reduction was made possible by applying a high-speed microprocessor, drastically reducing the component count, which also improves modem reliability and reduces power consumption.

CIRCLE NO. 306

Intelligent terminal carries low price tag



Ontel, 250 Crossways Park Dr., Woodbury, NY 11797. Ed Heinze (516) 364-2121. From \$1500; 8 to 13 wks.

The OP-1/R low-cost intelligent terminal is configured to be used in clustered or on-line systems. It can execute its own software programs while sharing the data base of a cluster or host computer. Multiple μ Ps share memory in the form of 4, 8, 16 or 32-k RAMs, plus up to 8 k of ROM or PROM. The display has upper and lower case, a set of 128 displayable characters, 7 \times 9 dot matrix and line drawing capabilities. Communications are asynchronous from 110 to 19,200 baud.

CIRCLE NO. 370

CRT module displays over 6300 characters



Motorola Data Products, 455 E. North Ave., Carol Stream, IL 60187. Francey Freeman (312) 690-1400.

The M4408 is a 15-in. raster-scan CRT display module for systems that require a high character density. It is capable of displaying over 6300 upper and lower-case characters based on a 7 \times 9 dot matrix, with three line descenders, in a 9 \times 15 character block. The M4408 mounts either vertically to display a fully typewritten page of 96 characters \times 48 rows, or horizontally to simulate a wide-page printer format of 132 characters \times 48 rows. The module has dual 50-MHz amplifiers and a 10-mil spot size to provide the bandwidth and resolution necessary for high character density use. The size is 13.6 \times 11.6 \times 14.1 in.

CIRCLE NO. 371

Software package for lab analytical tasks

Digital Equipment, Maynard, MA 01754. Dave Simler (617) 481-9511. \$300.

A packaged set of Fortran-callable subroutines performs a variety of the most commonly required laboratory analytical tasks. Called LSP-11, the package runs under Fortran on all PDP-11 computers. All subroutines are involved with processing data acquired by other laboratory system software. The package is composed of subroutines for peak processing, interval histogramming (with or without reference points), fast Fourier transforms, phase angle and amplitude spectra, power spectrum and correlation function. The software works with RT-11, supporting Fortran IV/RT-11 and RSX-11M, supporting either Fortran IV/IAS-RSX or Fortran IV-Plus.

CIRCLE NO. 372

Module feeds S-100 bus with sync or async data

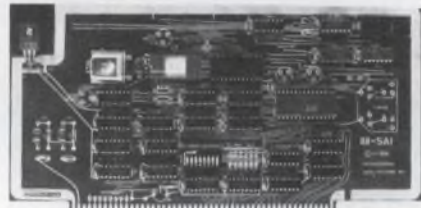

International Data Systems, 400 N. Washington St., Falls Church, VA 22046. (703) 536-7373. \$299; stock.

The 88-SAI interface board provides a synchronous or asynchronous port for any S-100 bus processor. The device allows baud rate, synchronous or asynchronous mode, word size, parity and number of stop bits to be selected under software control. The board is compatible with RS-232C interfaces and MIL-STD-188-level devices.

CIRCLE NO. 373

Digital plotter serves personal computing

Houston Instrument, 1 Houston Sq., Austin, TX 78753. Gabrielle Ryan (512) 837-2820. \$1085; 4 wks.

Microplotter 2 is a true digital plotter with an 8.5 \times 11-in. page size. The plotter provides 0.005 or 0.01-in. resolution and has an RS-232C interface.

CIRCLE NO. 374

Add a Burroughs Microprocessor Display



...it's as easy as B.C.D.

Now Burroughs makes it easier than ever to add an alphanumeric display to your product. Microprocessor control has been built into our popular SELF-SCAN® panels, so all you do is plug them in and input BCD signals for display of a full 64-character ASCII subset. The microprocessor eliminates 95% of the input circuit design normally required and minimizes the load on your system's microprocessor.

You get all the brightness, legibility and sales appeal of the popular SELF-SCAN display (more than a quarter-million in operation worldwide). SELF-SCAN displays are rugged yet lightweight and have a thin cross section. All this is yours at a very affordable price — as little as \$315 in 100 quantities.

Our new brochure contains all the information you need to start saving design time, weight, space, and big dollars as well. Get your copy today; call or write Burroughs Corporation, Electronic Components Division, P.O. Box 1226, Plainfield, NJ 07061. (201) 757-5000. Overseas, contact Burroughs ECD International, Langwood House, High Street, Rickmansworth, Hertfordshire, England. Telephone Rickmansworth-70545.

the first name in displays
the last word in displays

Burroughs



FOR GENERAL INFORMATION CIRCLE NUMBER 79
FOR DETAILED SPECIFICATIONS CIRCLE NUMBER 80

Line driver eliminates short-haul modems



Avanti Communications, P.O. Box 205, Broadway Station, Newport, RI 02840. Diona Walter (401) 849-4660. \$350; stock.

The Model 300 data-line driver provides switchable data rates up to 19.2 kbaud with drive capability of more than 400 ft. A single unit eliminates the need for two synchronous modems. All the important features of modems have been included, such as crystal-controlled data-rate selections of 2.4, 4.8, 9.6 and 19.2 kbaud. Switchable RTS to CTS delays are also provided.

CIRCLE NO. 375

Digital data collector includes built-in clock



Precision Digital, 368 Hillside Ave., Needham, MA 02194. Jack Peters (617) 449-2265. \$395; stock.

Digital data collector, Model 1010, has its own built-in clock and -formatting logic. The device connects with a DPM or a/d converter and the data source. The integral clock generates a print command at whatever time intervals are selected from 1 s to 1 day. Print data are broken down by the printer into numbered blocks that provide numerical records that can be searched for key events. The block numbers actually indicate the elapsed time.

CIRCLE NO. 376

Color display system scans 1000 lines

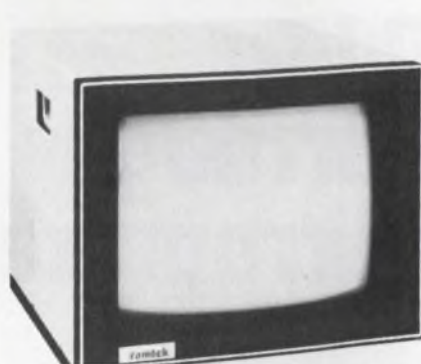

Ramtek, 585 N. Mary Ave., Sunnyvale, CA 94086. Beverly Toms (408) 735-8400. From \$9900; 13 wks.

The 1000-line color monitors are for use with graphic and imagery systems and have 1280 × 1024-pixel addressability on a 19-in. diagonal CRT. The video bandwidth is 40 MHz and the horizontal line frequency can be adapted to operate between 28 and 36 kHz. The system is available in rack mount, tabletop cabinet or stylized case. The size is 19 × 18 × 20 in.

CIRCLE NO. 377

optoelectronics

The first truly 'sunlight-visible' displays

The high legibility of the latest Plessey range of standard hermetic displays makes them suitable for all ambient light conditions—displays in aircraft, road vehicles and measuring equipment.

- High brightness—easily visible in direct sunlight
- Designed for military applications
- Competitive pricing
- Supported by a specialist custom design service

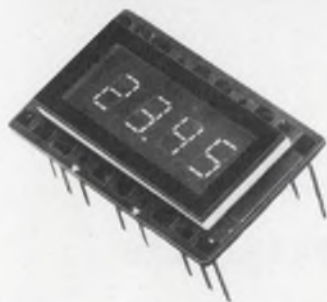

Ask for a set of data sheets on the latest GPD 420 and 620 displays or call us to discuss your requirements.



PLESSEY



Plessey Optoelectronics & Microwave Ltd
1641 Kaiser Avenue
Irvine, California 92714 U.S.A.
Tel: 714-540-9934 Telex: 910-595-1930

Plessey Optoelectronics & Microwave
Wood Burcote Way, Towcester,
Northamptonshire, NN12 7JN
Tel: Towcester (0327) 51871 Telex: 31628

TDK makes tapes, too.

TDK's magnetic materials open up the world of sound.

TDK's long tradition in coming up with new and improved magnetic materials for ferrites is the rock-hard foundation for our magnetic tape technology. All those long years spent with materials have now given us a head start in the research and development of materials for audio recording tapes — the key to a fresh and vibrant sound. The results we have achieved for our tapes speak for themselves. All you have to do is listen.

Our latest coup was the creation of a new material called 'Avilyn' and this goes into our SA top-of-the-line cassette tape series. The same strict adherence to quality and originality produces astonishing results in our AD and ED cassette tape series, too.



We're rather proud of our magnetic recording tapes. After all, we have customers for them in over a hundred countries around the world. But we don't devote all our attention to tapes.

TDK is also busy making and supplying electronic materials and parts to the world's assemblers and end-product manufacturers. TDK is a big name in ferrite cores which no radio or television receiver can do

without, ferrite magnets for speakers and motors, coils, transformers, noise filters, PTC thermistors, electro-magnetic wave absorbers, ultrasonic elements and parts made of piezo-electric materials.

We simply can't afford to spend all our time with tapes. For a start, we'd get angry complaints from manufacturers of communications equipment scattered all over the world who rely

on us for ferrite cores because of their winning low-loss and high-permeability characteristics.

The common denominator of all these products is the magnetic material expertise we've been busy refining for over 40 years. We first hit it big with ferrites and now we've branched out to become a broad-line manufacturer of electronic materials and parts — and tapes, too.



TDK ELECTRONICS CO., LTD. 14-6 Uchikanda 2-chome, Chiyoda-ku, Tokyo 100, Japan Phone: Tokyo 031-257-2525

TDK CORPORATION OF AMERICA 2041 Rosecrans Avenue, Suite 365, El Segundo, California 90245 U.S.A. Phone: (213) 644-8625 CHICAGO BRANCH 2906 West Peterson Avenue, Chicago, Illinois 60659 U.S.A. Phone: (312) 973-1222

NEW YORK BRANCH 755 Eastgate Blvd., Garden City, N.Y. 11530 U.S.A. Phone: (516) 248-5230

TDK ELECTRONICS CORP. (Handles recording tapes only) 755 Eastgate Blvd., Garden City, N.Y. 11530 U.S.A. Phone: (516) 746-0880

TDK DE MEXICO S.A. de C.V. (Handles ferrite magnets only) Carr. Juárez-Porvenir Parque Ind. A. J. Bermúdez, Cd. Juárez, Chih. Mexico Phone: 3-88-27

MH&W INTERNATIONAL CORP. (Handles professional ferrites only) 14 Leighton Place, Mahwah, New Jersey 07430 U.S.A. Phone: (201) 891-8800 Telex: 134 484

MH&W INTERNATIONAL (CANADA) LTD. (Handles professional ferrites only) 6358 Viscount Road, Mississauga, Ontario, L4V 1H4 Phone: (416) 245-3606

MONTREAL 7575 Trans Canada Highway, Suite 305, St. Laurent, Quebec, H4T 1V6 Phone: (514) 331-2827

CIRCLE NUMBER 81

Due to popular demand
**MICROPROCESSOR
 DATA MANUAL**
 is now in book form!

**ALL THE INFORMATION
 ON MICROPROCESSOR
 SELECTION AND
 SOFTWARE IN ONE
 CONVENIENT SOURCE!**

- First appeared in **Electronic Design Magazine!**
- Over 30 manufacturers represented!

**MICROPROCESSOR
 DATA MANUAL**
 Edited by Dave Bursky

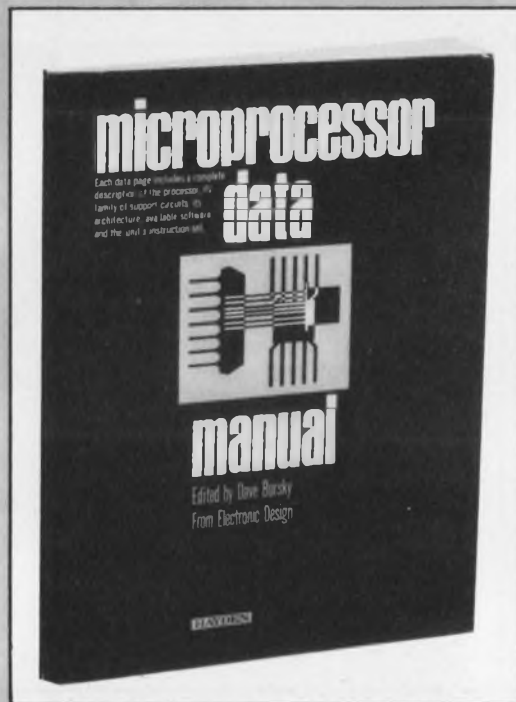

The manual includes a complete data page for each microprocessor or family of processors, with a complete description of the processor, its family of support circuits, architecture, available software, and the unit's instruction set.

Other sections include:

- the pitfalls to avoid when choosing a specific model;
- micro fundamentals and a glossary of terms;
- a report on floppy-disc drives;
- background information on micro selection and software.

Send to: **HAYDEN BOOK COMPANY, INC.**

50 Essex Street, Rochelle Park, N.J. 07662

Please send me MICROPROCESSOR DATA MANUAL (#5114-X, \$7.95) on 15-day examination. At the end of that time, I will send payment, plus postage and handling, or return the book and owe nothing.

Name _____

Firm _____

Address _____

City/State/Zip _____

78-009

SAVE MONEY! If you send cash with order, publisher pays postage and handling. Same return guarantee. Price subject to change without notice. Offer good in U.S.A. and Canada only.

**Make your micro
 decisions easier! Order
 your copy today!**



MODULES & SUBASSEMBLIES

Flash a/d converts at 50-MHz rate

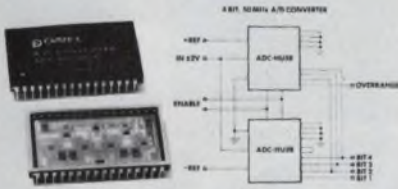

Datel Systems, 1020 Turnpike St., Canton, MA 02021. Eugene Murphy (617) 828-8000. \$179 to \$289; 4 wks.

ADC-HU3B is a 3-bit flash converter in hybrid form. In flash, or parallel-type a/d converters, all bits are converted simultaneously resulting in this unit's conversion rate of 50 MHz min. The device is expandable—two or more units can be directly connected for higher resolution. Two connected units give 4-bit resolution and four units can be connected for 5-bit resolution, both at 50 MHz. Maximum linearity is 0.1%. The tempo is ± 25 ppm/ $^{\circ}$ C, of full-scale range, ± 15 μ V/ $^{\circ}$ C. 32-pin ceramic case, 1.7 \times 1.1 \times 0.16 in.

CIRCLE NO. 378

Servo amp also serves as conventional amp



McFadden Electronics, 8953 Atlantic Blvd., South Gate, CA 90280. Sandra Barton (213) 564-5958. \$890; 8 wks.

Provisions are made in the 130 PAS dc power amplifier so that the unit functions as a conventional or servo-control amplifier. Both the gain of the summing amplifier and servo-loop equalization are set by selecting components in two accessible plug-in boxes. Output is 125 W at ± 25 V max. Current limit is 0.75 to 5 A and 1-min. short-circuit-current protection is 0 to 2.5 A. Gain for the power amplifier is 5 and for the summing amplifier it is 1 to 100. Frequency response is -3 dB at 1.5 kHz min. Noise is 100 μ V rms and drift is 20 μ V/ $^{\circ}$ C referenced to input. The size is 19 \times 5.5 \times 7 in.

CIRCLE NO. 379

Thumbwheel switches set digital time-delay relay

International Microtronics, 4016 E. Tennessee St., Tucson, AZ 85714. Dr. Otto Fest (602) 748-7900. \$59; stock to 4 wks.

A compact solid-state time-delay relay, Model 280, is set by direct-reading thumbwheel switches. Operating from a 12-V input, the unit is capable of timing, in either on or off-delay modes, from 1 ms to 9999 s. Accuracy and repeatability are $\pm 0.5\%$. Maximum power-turn-on time is 30 ms and minimum power-recycle time is 10 ms. External frequency modulation permits fine tuning the oscillator's base frequency or, with an external waveform, actual modulation of the time delay. Two switch options, spdt relay and spdt reed relay are offered and provide switching times from 10 μ s to 1 ms.

CIRCLE NO. 380

Mini-DIP op amp subs for 741 types

Precision Monolithics, 1500 Space Park Dr., Santa Clara, CA 95050. Donn Soderquist (408) 246-9222. \$1.50 (100 qty).

By mounting the Model OP-02P in a mini-DIP, a high performance op amp is provided that is pin-for-pin compatible with the 741 types. Untrimmed input-offset voltage is 3 mV over a 0 to 70- $^{\circ}$ C ambient range and input-offset current is 10 nA max. Input drift is 10 μ V/ $^{\circ}$ C max over the ambient range and noise is typically 0.65 μ V pk-pk.

CIRCLE NO. 381

Touch-Tone decoder responds to 12 digits

Palomar Engineers, P.O. Box 455, Escondido, CA 92025. Jack Althouse (714) 747-3343. \$125.

A Touch-Tone decoder that responds to the 12 standard digits has 12 output terminals and a dc voltage appears on the line corresponding to the digit being received. A signal of 0.1 to 1 V rms is required to activate the decoder. A response time of 200 ms reduces the possibility of false outputs from voice or music signals on the input line. The output impedance is 150 Ω , suitable to drive TTL logic or relays. The decoder requires +12 V dc at 100 mA and the case size is 2.25 \times 4.75 \times 7 in.

CIRCLE NO. 382

Move Air... Not Components!



There's an Etri Fan

(Just say ee-tree)

for virtually
every application

Etri fans move more air... no matter how crowded it is behind the panel. You don't have to burn up hours juggling components and making trade-offs just to get the airflow you need. We're not a bit hard to fit into your panel. Sizes on our flat axials range from a skinny 1" profile on up... all on standard mounting centers. Air deliveries from 20 to over 2000 CFM will help you keep your cool.

Etri fans are plenty rugged, too. Vibration-resistant housing; precision-molded, reinforced impellers; lifetime bearings... that's just part of the story.

Want to see more?

Send for our free catalog!

Etri, Inc.

8002 S. Madison Street
Burr Ridge, IL 60521
(312) 325-9380

CIRCLE NUMBER 83

Fail-Proof Miniature BITE Indicators

BUILT-IN TEST
EQUIPMENT

- Complete selection from one source!
- Mil-spec or commercial quality
- Ball or Flag Indicators and Annunciators
- Magnetic Latching, Self-Restoring and Manual-Reset models
- Micro-miniature sizes
- Positive indication
- Excellent visibility
- Fast reliable response
- Negligible power drain
- Standard voltages 1.5, 3, 6, 12, 24, 28 VDC
- Off-shelf delivery
- Write or phone for catalog



Sudden
Service
on Small
Quantities!

PROTOTYPES

available on phone or letterhead request

MINELCO

a TALLEY INDUSTRIES Company
135 South Main Street
Thomaston, Conn. 06787 203-283-8261

CIRCLE NUMBER 84

MODULES & SUBASSEMBLIES

LED display module is cost effective

National Semiconductor, 2900 Semiconductor Dr., Santa Clara, CA 95051. (408) 737-5000. \$2.20 (100 qty); stock.

This 3-digit, monolithic, GaAsP LED display, NSA0038, uses cost-effective PC-board mounting instead of dual in-line packaging. The thinner PC-board mounting also saves space. The common-cathode multiplexed display has a minimum peak current of 2.5 mA/segment and a typical-digit light intensity of 2.96 mcd at peak current.

CIRCLE NO. 383

Photodetectors match response of human eye

Centronic, 1101 Bristol Rd., Mountainside, NJ 07092. Tony Green (201) 233-7200. \$10 to \$90; 2 to 4 wks.

The spectral response of the human eye has been closely matched in a series of photodetectors for light-intensity measurement and control applications monitored by a person. No correction factors are required to obtain an output indication in lumens, regardless of the light source measured. The devices are hermetically sealed for full environmental protection. Six different active areas from 1 to 300 mm² range in responsivity from 0.03 to 90 nA/lux. Noise decreases in the larger sizes from 1.5×10^{-4} to 1.2×10^{-5} lux Hz^{-1/2}.

CIRCLE NO. 384

Biphase modulator gives fast phase reversal

Olektron, 6 Chase Ave., Dudley, MA 01570. Joe Oleksiak (617) 943-7440. \$85; 4 wks.

A compact rf biphase modulator, the Model P4-BPM-90TTL provides fast phase-reversal operation. The unit has a transition time of less than 10 ns and a frequency range of 5 to 500 MHz. The modulator has a control-logic level of zero degrees relative phase for TTL low and 180° phase for TTL high. Other characteristics include an rf-power level of +5 dBm max, rf loss of 3 dB max at 100 MHz, a carrier suppression of 40 dB min and a VSWR of 1.3 to 1 at 100 MHz. The modulator has a balance phase of ±2°, an amplitude of 0.5 dB and a temperature range of -50 to 100 C.

CIRCLE NO. 385

Display generator is packed into keyboard

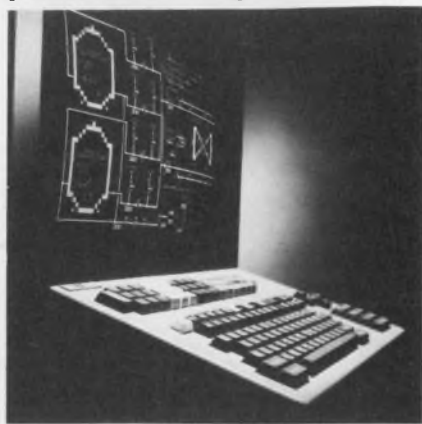

Aydin Controls, 414 Commerce Dr., Fort Washington, PA 19034. J.E. Bauer (215) 542-7800.

The Model 5217 display generator is an interactive color-limited graphics-display system. The total display generator, including dual RS-232 interfaces and power supply, is contained within the operator's keyboard. Any RS-170 compatible monochrome or color-CRT monitor may be used with this keyboard generator. The unit provides eight colors, 256 characters and symbols, individual control by character of color, blink, intensity, size, normal or reverse video and protect. It has full edit capability and interactive operator controls. The display format is 80 char/line by 48 lines/page.

CIRCLE NO. 386

Chopper amp generates low noise



Energy Electronic Products, 6060 Manchester Ave., Los Angeles, CA 90045. Tom Nixon (213) 670-7880. \$51 (100 qty).

The MP221 chopper amplifier generates less than 0.1 μV pk-pk of noise from dc to 1 Hz, 0.3 μV from dc to 10 Hz and 1 μV from dc to 100 Hz. Noise current is less than 3 pA from dc to 1 Hz. These specs include flicker-noise and Johnson-noise components. The amplifier has a maximum voltage drift of 0.05 μV/°C, a maximum current drift of 2 pA/°C and a long-term drift of 1 μV/mo or 2 μV/yr.

CIRCLE NO. 387

The new Sinclair DM235 is yet another example of outstanding Sinclair value-engineering. Developed from the Sinclair DM2 and world-beating PDM35 (already outselling all other digital multimeters), the DM235 provides full facilities for every application, including field servicing, testing and laboratory work. At a price no comparable digital meter can approach.

A new dimension in styling

Up till now, choosing a meter suitable for use on the bench and in the field hasn't been easy. Either you bought a bulky bench instrument (awkward to carry around) or a hand-held portable (difficult to use on the bench). The Sinclair concept is different. By keeping the thickness down to only a fraction over 1 1/2 inches, and the weight down to under 1 1/2 lbs., we've produced an instrument that has all the advantages of conventional bench meters, but that packs neatly into any tool kit or brief case.

The new Sinclair DM 235 digital multimeter.

3 1/3 digits...6 functions... fully portable. Under \$80!

A rugged construction giving total portability

Very rugged mechanical construction using all solid-state components. Protected against accidental overload. Size only 10 inches x 5.8 inches x 1.6 inches, weight less than 1 1/2 lbs.

Like every other Sinclair product, the DM235 comes to you with a 12 month repair-or-replacement warranty.

Find out more!

If you'd like full details of the DM235, its operation and its performance, and a complete distributor list, just send the coupon below. We'll send you all the facts by return mail.

The DM235 has all the performance you need—at around half the price of what you'd expect to pay. Send the coupon for the full story.



Sinclair Radionics
115 East 57th Street
Galleria
New York, N.Y. 10022

CIRCLE NUMBER 85

sinclair
Smaller, better.

A big, bright, unambiguous display

The DM235 has a full 3 1/2 digit display reading to ±1999. Large, high-brightness 0.3 inches LEDs give clear, unambiguous readings with an ultra-wide angle of view. And an LED display means proven lifetime reliability.

ambiguous reading of function and range selected from a single input terminal pair.

Basic operation from four standard C size disposable cells, providing complete independence of AC supply.

Line operation available via optional AC adaptor/charger.

Six functions in 26 ranges

- DC Volts 1 mV to 1000V
- AC Volts 1 mV to 750V
- DC Current 1µA to 1A
- AC Current 1µA to 1A
- Resistance 1Ω to 20 MΩ
- Diode test 0.1µ A to 1 mA
- 10 MΩ input impedance

A full range of optional accessories

- DM235 meter complete with test leads and probe \$79.95
 - Eveready carrying case with lead storage compartment \$19.95
 - Rechargeable battery units \$14.95
 - AC adaptor/charger 117V 60Hz . . \$ 6.95
 - 30KV high voltage probe \$29.95
- (All prices subject to Sales Tax)

High accuracy

Basic accuracy of 0.5% (2 V DC range), other DC ranges and Resistance 1.0%, AC ranges 1.5% 30 Hz-10kHz. Temperature coefficient < 0.05 of applicable accuracy per °C.

Easy to use by anyone, anywhere

Automatic polarity operation, automatic placement of decimal point, and automatic out-of-range indication. Un-

The Sinclair credentials

Sinclair has pioneered a whole range of electronic world-firsts from programmable pocket calculators to miniature TVs—holding a world lead in innovative electronics. The DM235 embodies six years' experience in digital multimeter design, in which time Sinclair has become one of the world's largest producers.

To: Sinclair Radionics
115 East 57th St. — Galleria
New York, N. Y. 10022
Please send me full illustrated details of the new Sinclair DM235

Name _____

Position _____

Company _____

Address _____

Phone _____

See the DM235 at: Star-Tronic Dist. Co., Farmington, Mich. 313-477-7700; Crane & Egert Corp., Elmont, N.Y. 516-488-2100; Dytec Central, Arlington Heights, Ill. 312-394-3380; F.L.W. Inc., Costa Mesa, California. 714-751-7512; International Standard Components, Mountainview, CA. 415-964-4171; Ossmann Instruments Inc., E. Syracuse, N.Y. 315-437-6666; Par Associates, Denver, Colorado. 303-355-2363; Par Associates South, Sandia Park, N.M. 505-281-5602; Scientific Associates, Falls Church, VA. 703-573-8787; Southern Peripherals, Atlanta, Georgia. 404-455-3518 and Greenville, S.C. 803-233-1469. Available in Canada from Gladstone Electronics, Toronto, Ont. 416-787-1448.

PTS 160 SYNTHESIZER

DIRECT, LOW-NOISE, FAST SWITCHING

any way you look at it . . .



INSIDE
(modular)

OUTSIDE
(functional)

PERFORMANCE: State-of-the-art direct design, 0.1 - 160 MHz, +3 to +13 dBm output, metered and flat to ± 0.5 dB. Low distortion, typ. more than 40 dB down. Excellent spectral purity: Residual phase noise -70dB. Low spurious outputs: -75dB (incl. power-line spurs). Fully programmable: Frequency in TTL-BCD with storage for 8-bit serial setting. Amplitude by voltage. Fast switching: 5 - 20 μ sec.

ADAPTABILITY: Optional resolution, 0.1Hz to 100 KHz. (steps can be field-installed any time). Your frequency-standard or ours, 5 or 10 MHz oven or TCXO. Manual controls or remote-only. All in a package smaller and lighter than others.

RELIABILITY: A cool 35-45W; MTBF > 10,000h, demonstrated by two years' production.

PRICES: from \$3,050 to \$4,700 (0.1Hz res. oven std.)



You'll find the PTS 160 gives you more performance per dollar. We invite you to check it.

PROGRAMMED TEST SOURCES, INC.

LITTLETON, MA 01460 617-486-3731

Circle No. 221

PTS
FREQUENCY SYNTHESIZERS

MODULES & SUBASSEMBLIES

Micro module performs four functions

Wintek, 902 N. 9th St., Lafayette, IN 47904. (317) 742-6802. \$149.

The Counter/Timer module performs any of four functions of frequency counting, period measurement, event counting and free-running timing. The module measures frequencies up to 30 MHz, periods from 1^{-16} to 2^{24} s and elapsed time to 100 days, all with an accuracy of 0.001%. Automatic battery back-up is an option. The module is on a 22/44-pin 4.5 x 6.5 card.

CIRCLE NO. 388

Modulator converts dc signals to ac

Computer Conversions, 6 Dunton Ct., E. Northport, NY 11731. Steve Renard (516) 261-3300. \$100; stock to 4 wks.

A modulator, Model MOD503, with up to $\pm 0.1\%$ FS linearity converts dc-input signals to linearly proportional ac-output signals. The device accepts bipolar 10 or 100-V-dc inputs and provides an ac output of 0 to 7 V rms. The output impedance is 1 Ω max and input impedance is 100 k Ω . Any ac-output voltage can be provided by internal or external transformers and the output is short-circuit protected. Gain and zero adjustments are provided. The required reference is 26 V, 400 Hz.

CIRCLE NO. 389

8-bit video a/d samples at 20-MHz rate

ILC Data Device, Airport International Plaza, Bohemia, NY 11716. (516) 567-5600. \$1595; stock to 12 wks.

An 8-bit video a/d converter, VADC-820, samples at a 20-MHz rate. Compatible with both NTSC and PAL standards, the converter digitizes TV and radar signals for storage, measurement and transmission. Flexibility is provided by four pin-programmable input-voltage ranges whose end points can be screwdriver adjusted as much as $\pm 10\%$ by internal gain trim. Binary-coded ranges are 0 to +1 and 0 to +2 V; offset-binary ranges are ± 0.5 and ± 1 V. The video track-and-hold input amplifier has a 100-MHz small-signal bandwidth.

CIRCLE NO. 390

ELECTRONIC DESIGN 12, June 7, 1978



VECKNIT®

The Conductive People

1958-1978

Celebrating our 20th year

**CONDUCTIVE
WINDOWS AND
VENT PANELS**

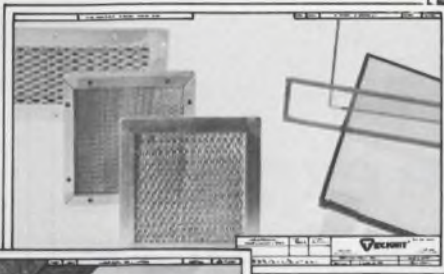

KNITTED WIRE MESH

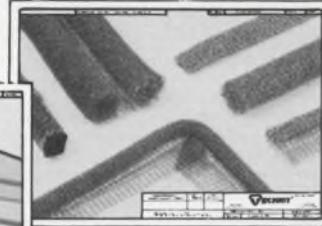

1958

1961

**CONDUCTIVE
ELASTOMERS**

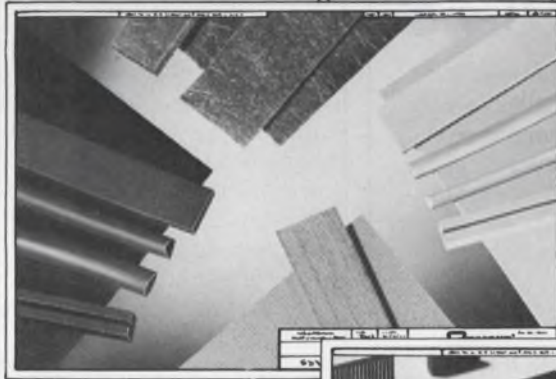

1968

1973

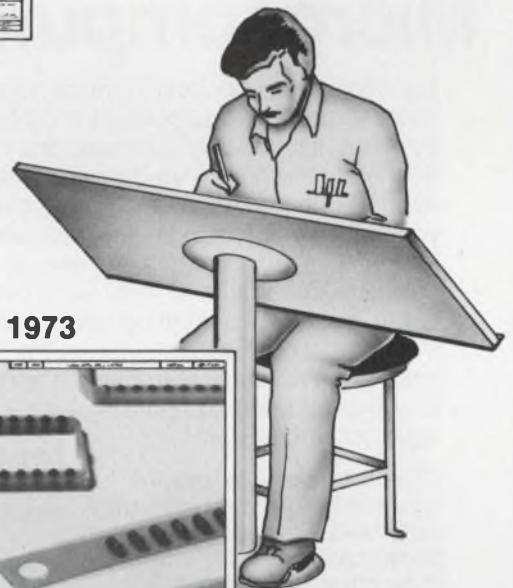

ZEBRA & CELCI

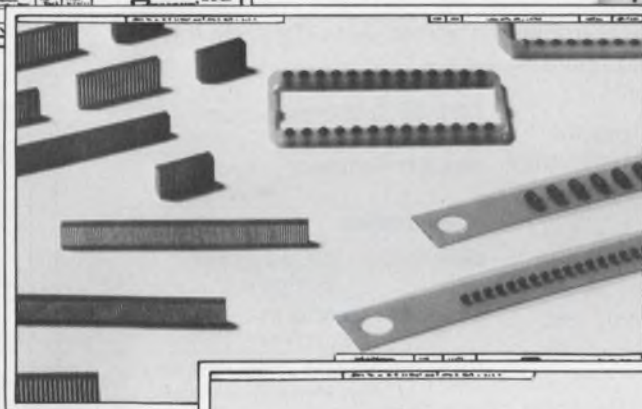

1978

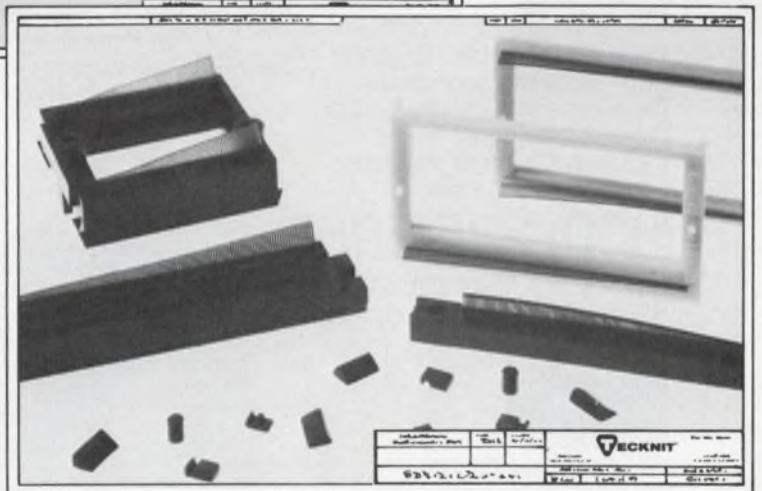

ELECTRONIC CONNECTORS

EASTERN-DIVISION—
129 DERMODY ST., CRANFORD, NJ 07016 (201) 272-5500

WESTERN-DIVISION—
320 N. NOPAL ST., SANTA BARBARA, CA 93103 (805) 963-5811

ELECTRONIC DESIGN 12, June 7, 1978

CIRCLE NUMBER 86

199

MODULES & SUBASSEMBLIES

Tiny DPM sports liquid-crystal display

Datel Systems, 1020 Turnpike St., Canton, MA 02021. Eugene Murphy (617) 828-8000. \$49 (100 qty); stock to 4 wks.

Said to be the world's smallest ac-powered digital panel meter, the DM-3100U2 uses a half-inch high LCD

in a case size of 2.53 × 3.25 × 0.94 in. The 3 1/2-digit meter operates on 115-V, 60-Hz power and 9 to 15-V dc external sources (at 3 mA). Autozeroing corrects for zero error. Autopolarity is featured with a ±1.999-V-dc input range. The internal reference is ratiometric for scaling engineering units. The LCD includes pin-selected descriptor labels for units identification and decimal points are also pin selected for range multipliers.

CIRCLE NO. 391

Ticket printer subsystem is aimed at OEMs

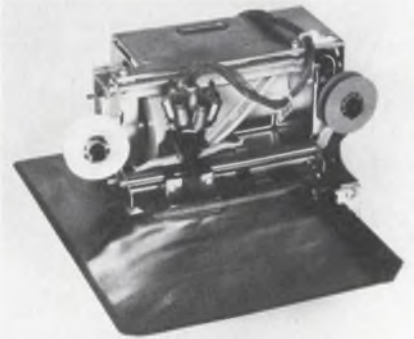

Syntest, 169 Millham St., Marlboro, MA 01752. (617) 481-7827. \$485 (100 qty); 4 to 6 wks.

The SP-308 ticket printer subsystem is for OEM use. The 40-column 5 × 7 dot matrix impact printer accepts multicopy forms up to 11 × 17 in. A maximum of 22 lines may be printed at 50 char/s. The microprocessor controller accepts ASCII data in either RS-232C or 20-mA current-loop formats. Standard data rates to 9600 baud are available. Parity and number of stop bits is programmable. The printer provides 40-character buffering, double-width print capability, tab function and pressure-roll release control. The size is 7 × 8 × 8.5 in.

CIRCLE NO. 392

Rent from the experts: Microcomputer Rentals

For microcomputer development hardware, check with the rental experts. We specialize in renting all major development systems. It's our only business. So, we're able to devote more time and attention to your design needs. Giving you technical support not always available from a rental firm. Like helping you select which system best fits your needs. Because we handle all major systems, we give you balanced objectivity in our recommendations. And, we're available to help you with setup and trouble-shooting diagnostics. When you rent from Microcomputer Rentals, you get the latest documentation and software. We keep up-to-date so you're up-to-date. On the full range of microcomputer development systems.

Check our prices before you rent: You'll be pleasantly surprised. Our prices, in some cases, are 20% lower than other rental firms. For example, an Intel MDS 230 rents for only \$1395 on a monthly basis. Weekly and longer term rates are available.

Free rental guide: Write for our FREE Microcomputer Development System Rental Guide covering all major systems. Or, for immediate action, Call Toll Free

(800) 235-5955

Call toll free (800) 235-5955 (Within California, call collect (213) 991-1704)



Microcomputer Rentals
705A Lakefield
Westlake Village, CA 91361

AMI: 6800 Microcomputer Development Center

Hewlett Packard: Logic Analyzers

Intel: Intellec

Millennium: Microsystem Analyzer

Motorola: Exorterm Exorciser

Pro-Log: PROM Programmers Systems Analyzers

Tektronix: Microprocessor Labs Logic Analyzer

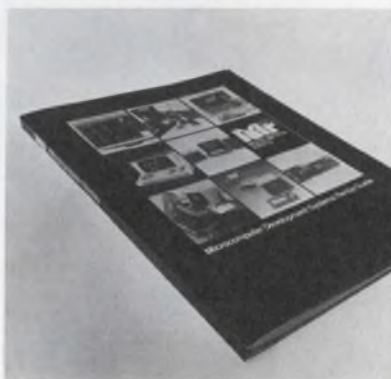

CIRCLE NUMBER 149

LED readouts include drive circuitry

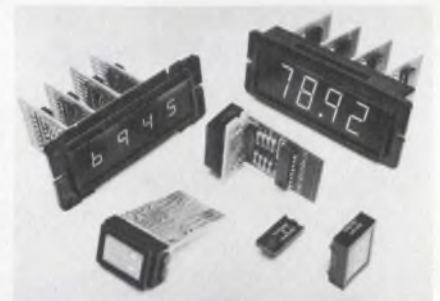

Dialight, 203 Harrison Pl., Brooklyn, NY 11237. (212) 497-7600. \$1.10 to \$4.58 (1000 qty); stock.

A variety of LED readout-display options is provided by individual modules available with complete-drive circuitry. The line includes 0.3 or 0.6-in. character-height seven-segment modules, alphanumeric dot-matrix and caption-display modules. The line also includes discrete modules for individual panel mounting. You can assemble displays by simply sliding selected modules into a bezel that snaps together without the use of tools.

CIRCLE NO. 393

The world's only precision low-power op amps: PMI's OP-08 and OP-12.

How did we come up with the OP-08 and OP-12?

How did we do it? By being fussier. By using our proprietary ion-implantation and zener-zap trimming processes. By careful design: completely balanced input stage and second stage, and proprietary output design to drive a 2Kohm load. By careful fabrication. And by QA like nobody else in the industry.

When you have to go quality and performance all the way, it's good to know that PMI's OP-08 and OP-12 are available—on your distributor's shelf—right now.

Hybrid Designers: You can order the OP-12 in chip form.

If you'd like to get your hands on an OP-08 or an OP-12, just write us (on your company's letterhead) and we'll send a sample and a data sheet. Be glad to, in fact. After all, when you make the only chip of its kind, it pays to advertise.

When you have one of those demanding applications—like a piece of precision portable or space-bound equipment—you've probably hankered for an op amp that would give you lower offset voltage and lower offset voltage drift than the 108A. And, while we're at it, better overall specs.

By George, we've got it.

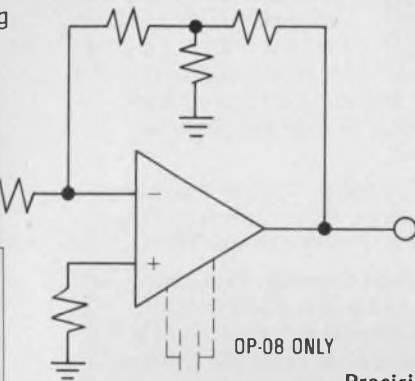
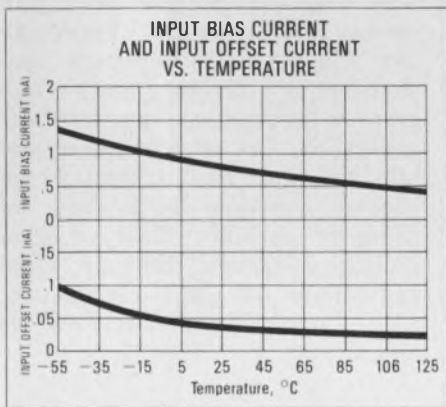

Precision Monolithics Incorporated
1500 Space Park Drive
Santa Clara, California 95050
Telephone: (408) 246-9222
TWX: 910-338-0528
Cable: MONO



PMI's new OP-08's and OP-12's are the **only** precision, low-power, low-input-current op amps on the market. They are pin-for-pin replacements for 108A's and 308A's in all applications to give you even better performance. Here are the key specs:

Offset voltage of the OP-08 and OP-12 is three times lower than the LM108A. Voltage drift is two times lower. CMRR and PSRR are at precision levels.

And for battery and solar-powered systems, the OP-08 and its internally-compensated twin, the OP-12, each drive a 2kohm load—five times the output current capability of the 108A and 308A.

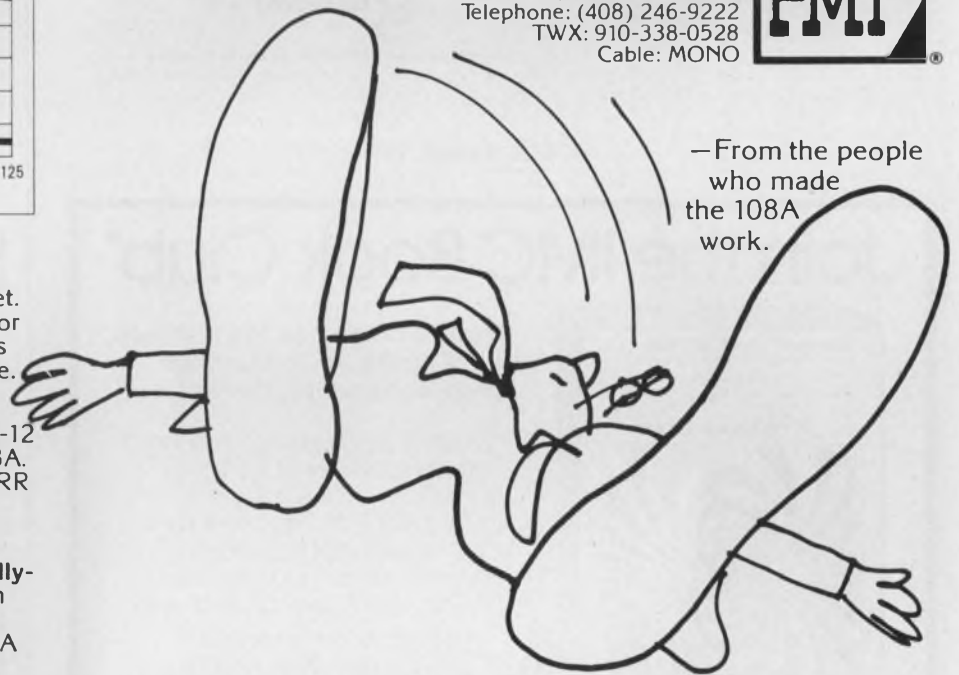

Electrical Characteristics $V_S = \pm 15V$	OP-08A/OP-12A OP-08E/OP-12E			OP-08B/OP-12B OP-08F/OP-12F			OP-08C/OP-12C OP-08G/OP-12G			Units
	Min	Typ	Max	Min	Typ	Max	Min	Typ	Max	
Input Offset Voltage	—	0.07	0.15	—	0.18	0.30	—	0.25	1.0	mV
Offset Voltage Drift	—	0.5	2.5	—	1.0	3.5	—	1.5	10	$\mu V/^\circ C$
Input Offset Current	—	0.05	0.20	—	0.05	0.20*	—	0.08	0.50	nA
Input Bias Current	—	0.80	2.0	—	0.80	2.0*	—	1.0	5.0	nA
Output Voltage Swing $R_L = 2K$	± 10	± 12	—	± 10	± 12	—	± 10	± 12	—	V
Common Mode Rejection Ratio	104	120	—	104*	120	—	84	116	—	dB
Power Supply Rejection Ratio	104	120	—	104*	120	—	84	116	—	dB
Power Consumption	—	9	18	—	9	18	—	12	24	mW

*For OP-08B/08-12B

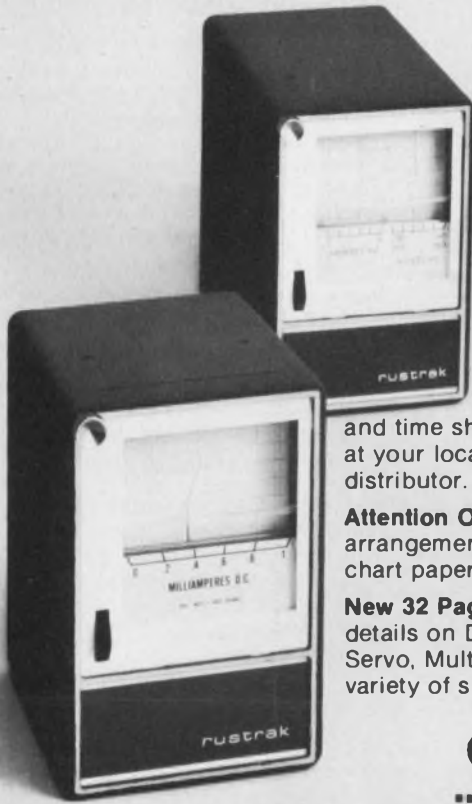

Rustrak miniature DC & AC recorders

The Widest Selection of Models and Ranges. DC ranges from 10 μ V. AC up to 600V, 1000A. Choose from single, dual channel

and time sharing models. In stock at your local authorized Rustrak distributor.

Attention OEM's. Custom mounting arrangements, colors, nameplates, chart paper and scales available.

New 32 Page Catalog. Provides details on DC, AC, Temperature, Servo, Multichannel, Event and a variety of special recorder types.

gulton®

Measurement & Control Systems Division
Gulton Industries Inc., East Greenwich, Rhode Island 02818
401-884-6800 • TWX 710-387-1500

CIRCLE NUMBER 88

Join the IMC Book Club*

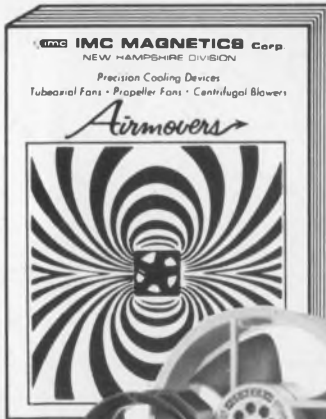

Free 24 page catalog contains facts on IMC's Off-The-Shelf precision cooling devices.

This airmover catalog is devoted to technical information and illustrations on the full line of Tubaxial Fans, Propeller Fans and Centrifugal Blowers. IMC Boxer®, Fulmar®, Condor®, and IMCair® airmovers are featured.

For immediate service please call Stan Barbas, Sales Mgr. 603/332-5300

*Product Literature Broadside and request card will be sent to you along with this catalog.

SERVING INDUSTRY OVER 27 YEARS

imc

27
Motors
Fans
Blowers

IMC MAGNETICS CORP.
NEW HAMPSHIRE DIVISION
ROUTE 168, ROCHESTER, NEW HAMPSHIRE 03867

CIRCLE NUMBER 89

COMPONENTS

Intelligent keyboard uses capacitive switches



C.P. Clare, 3101 W. Pratt Ave., Chicago, IL 60645. (312) 262-7700.

A solid-state keyboard uses a microprocessor and low-profile capacitive keyswitches. The keyboard employs an 8-bit single-chip microprocessor with on-chip ROM, RAM and EPROM. All key functions are software controllable, so a keyboard quickly programs to the exact requirements of any application. The microprocessor permits automatic repeats, multiple application programs in a single intelligent encoder, field program changes using new firmware, serial and parallel I/O and N-key rollover.

CIRCLE NO. 394

LED displays come in variety of colors

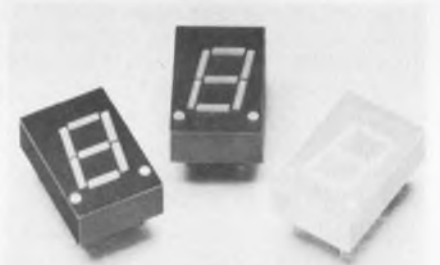

Industrial Electronic Engineers, 7740 Lemona Ave., Van Nuys, CA 91405. Helen Sands (213) 787-0311. \$1.52 to \$2.20 (500 qty); stock.

Series 7650, 0.43-in. LED displays are available in high-efficiency red, yellow, green and normal-intensity red with a choice of a common anode, a common cathode, left and right-hand decimal points or an overflow ± 1 . Evenly illuminated segments and wide-angle viewing are provided. The minimum package width allows digits on centers of 0.5 in. The LEDs are suitable for multiplex operation and can be driven directly from MOS circuits.

CIRCLE NO. 395

Magnetic breakers are OK with UL and CSA



Heinemann Electric, Magnetic Dr.,
Trenton, NJ 08648. (800) 257-9590.

GH3 magnetic circuit breakers, available in a variety of standard ratings, are UL-listed and CSA approved for 14,000-A interrupting capacity at 480 V. Available with a choice of three time delays, the breakers have ratings from 15 to 100 A at 480 V, 60 Hz. Because they are of hydraulic-magnetic design, ambient temperature has no effect on the current rating, on the calibrated must-trip point or on the instantaneous-trip point. The breakers always carry 100% of the rated load, making derating unnecessary.

CIRCLE NO. 396

Multiposition switches have low, flat profile

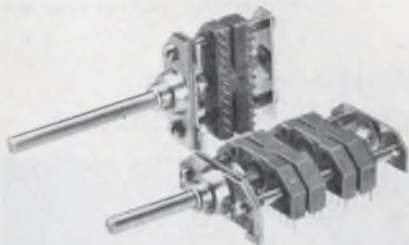

ITT Schadow, 8081 Wallace Rd., Eden
Prairie, MN 55344. (612) 944-1820.

Low-profile approaches to switching are well served by a flat switch, Model SBL 11, that has a height of less than 0.43 in. The switch is multiposition with a maximum of five decks in a six-pole version and is suitable for direct soldering into PC boards. Its sections are movable to provide flexibility in circuit layouts and to allow for PC tolerances. Shorting and nonshorting versions are available, and the switch is compatible with ICs in pin configuration.

CIRCLE NO. 397

Reticon announces the tunable filter on a chip

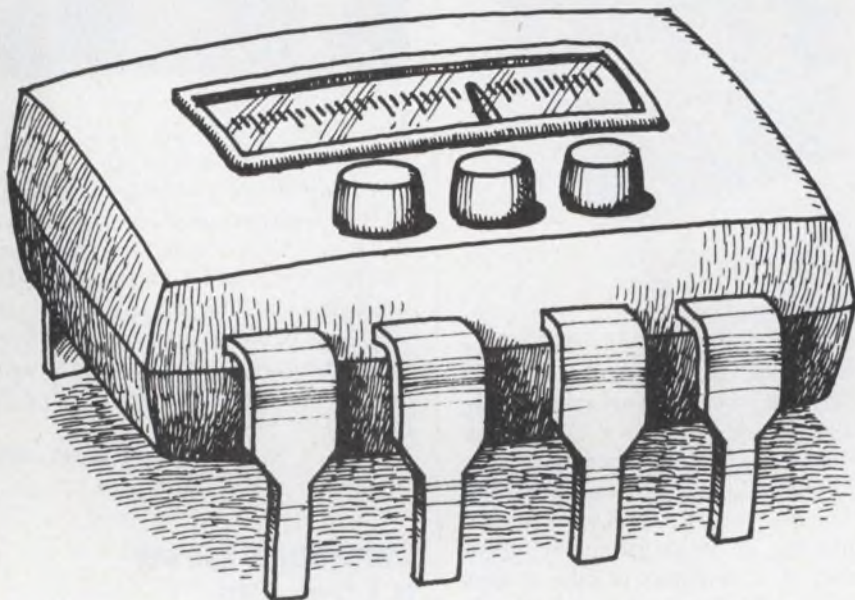

Now from Reticon the first commercially available CTD transversal filters. These devices offer electronic tunability over a 1000 to 1 range, have linear phase response so the shape of your signals wouldn't be distorted and provide attenuation of more than 50dB for unwanted signals even if they are only 3 percent away from your desired frequency. All of these features are available in a single 16-lead DIP package requiring only a single positive supply.

This family of R5602 devices are sampled data filters, each consisting of 64-stage split electrode structure. The specific frequency response required is simply obtained by programming the device with the correct tap weights. A single mask layer used in its fabrication contains all necessary response information. Currently available as standard filters are two low pass and two band pass configurations. The exact performance of each of these filters depends on the particular filter function. As an example, the R5602-3 band pass filter tunes from a center frequency of 250Hz to 250KHz with a bandwidth that is 5½ percent of the sample clock frequency and has a dynamic range greater than 60dB. Your particular frequency response can now also be easily and inexpensively realized in a custom device.

Everybody needs a filter, so get our data sheet and see what our filters can do for you. Contact one of our 70 salesmen or 20 distributors in our worldwide network or write directly to us.

Discover the IC's that do it all!

RETICON®

AN  COMPANY

910 Benicia Ave • Sunnyvale, California 94086
(408) 738-4266 • TWX: 910-339-9343

CIRCLE NUMBER 118

COMPONENTS

13-A, 4PDT relay does big job in small space

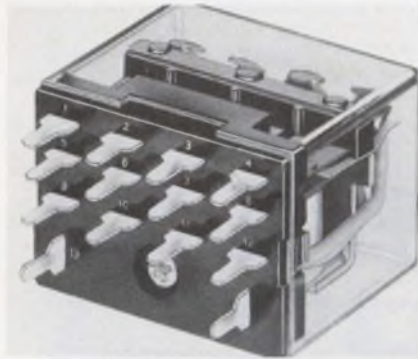

Guardian Electric, 1550 W. Carrol Ave., Chicago, IL 60607. E. T. Lorge (312) 243-1100.

A 13-A, 4PDT relay, 1380AC or 1385DC does a big switching job in about half the space of competitive relays. Size is 1.6 × 1.1 × 1.38 in. and mechanical life is 10⁸ operations. The relay has a Lexan dust enclosure and a choice of three mating sockets with solder lug, PC or screw-mount termination. It is available in coil voltages from 6 to 120 V ac and 6 to 110 V dc.

CIRCLE NO. 398

Standard line of LCDs fits small instruments

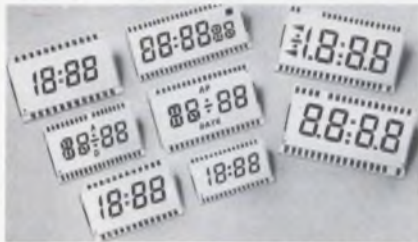

Beckman Helipot, P.O. Box 3100, Fullerton, CA 92634. Jo Rickard (714) 871-4848.

A standard line of multifunction LCDs provides numeric and alphanumeric readouts consisting of 3 1/2 to 6 characters with digit heights of 0.13 to 0.25 in. The Model 734 has four digits plus colon and decimal points. Model 735 has 3 1/2 digits, two annunciator arrows and plus/minus signs. The arrows accommodate two functions per display. The displays are 0.95 × 0.54 in. These displays can be ordered with variations in font, numeric style, symbols, colored polarizers, reflectors, glass thickness and terminal assignments.

CIRCLE NO. 399

Rectangular CRT is midget size



AEG-Telefunken, 570 Sylvan Ave., Englewood Cliffs, NJ 07632. (201) 568-8570. \$48 (1000 qty); stock.

A miniature cathode-ray tube, D5-100, measures only 2-in. diagonally. It has a 1.77 × 1.4-in. face plate and 1.6 × 1.2-in. useful screen size. Its length is 4.5 in. This mini CRT requires only 35-mW of header power and features instant-on operation. Deflection is electrostatic and the resolution is 625 lines.

CIRCLE NO. 403

Centrifugal blower is 1.5-in. thin



Howard Industries, 1 N. Dixie Hwy., Milford, IL 60953. (815) 889-4105. \$12.

Designed to fit where other blowers won't, the Slim-line centrifugal blower, Model 3-15-2804, delivers 26 cfm of cooling air at 0-in. static pressure. Over-all size is 1.5 × 5 × 5 in. A rugged cast-zinc housing and frame serves as an excellent heat sink. A sealed lube system requires no service and delivers an estimated 10 years of continuous duty without lubrication.

CIRCLE NO. 404

Glass-sealed capacitors insert automatically



Arco Electronics, 400 Moreland Rd., Commack, NY 11725. (516) 864-7000.

A line of axial-lead glass-sealed multilayer capacitors is rugged, reliable and ideal for automatic insertion. These miniature hermetically sealed devices have a variety of tempco and physical sizes. Capacitance values of 10 to 47,000 pF and working voltages of 50, 100 and 200 V are offered.

CIRCLE NO. 405

Cermet trimmers provide high temp stability

Allen-Bradley, 1201 S. Second St., Milwaukee, WI 53204. (414) 671-2000.

A resistance tempco of less than ±35 ppm/°C for values above 250 Ω is offered on six different types of cermet trimmers over the range of -55 to 125 C. Styles of the trimmers are single-turn Type E, Type D, Type S and Type A and the 20-turn Type MT and Type RT. All are rated at 0.5 W except the Type RT, rated at 1 W. All but the Type S provide standard resistance values with a range of 10 Ω to 2.5 MΩ; the Type S, 50 Ω to 1 MΩ. Type D provides ±20% tolerance, the other, 10%.

CIRCLE NO. 406

Mini power switch offers 11 toggle options



C & K Components, 103 Morse St., Watertown, MA 02172. Jim Martinec (617) 926-0800.

Handling 10 A at 125 V ac, the 9221 switch has a body size of 0.75 × 0.75 in. The switch, with bushing mount, accepts 11 different toggle actuator handles that include short, tall, thick, thin, round, flat and plastic.

CIRCLE NO. 407

From TEC Your Complete Source For Switches and Indicating Devices.

NEW MONEY SAVING TOGGLES



TEC NOW HAS EXPANDED ITS MINIATURE TOGGLE SWITCH LINE TO INCLUDE ROCKER AND LEVER ACTUATED STYLES.

TEC'S UNIQUE UNITIZED CENTER TERMINAL/CONTACT PIVOT DESIGN ON ALL ITS TOGGLES SIGNIFICANTLY SHORTENS ASSEMBLY TIME AND AIDS RELIABILITY.

OTHER DEVICES AVAILABLE FROM TEC

SUBMINIATURE LIGHTED SWITCHES



THE INCANDESCENT AND LED SUBMINIATURE SERIES OF SWITCHES AND SWITCH/INDICATORS ARE IDEAL FOR USE ON DISPLAY AND CONTROL PANELS WHERE SPACE IS LIMITED.



TACTILE FEEL CRICKET SWITCHES

TEC'S CRICKET SWITCH PROVIDES YOU WITH A LOW-COST PCB MOUNTING, TACTILE FEEL MOMENTARY SWITCH.

SUBMINIATURE ROTARY SWITCH



THESE LOW PROFILE NONSHORTING ROTARY SWITCHES ARE IDEAL FOR ANY APPLICATION WHERE A COMPACT, HIGHLY RELIABLE WATERTIGHT SWITCH IS NEEDED TO CHANGE CIRCUITS.

JUMPER BAR SWITCH



THE JUMPER BAR SWITCH PROVIDES THE USER LOW COST SWITCHING AND FLOW SOLDERABILITY.

TEC ALSO MANUFACTURES A COMPLETE LINE OF INDICATORS, READOUTS AND OTHER TYPE SWITCHES. SOME OF THESE TYPES ARE INCANDESCENT AND LED TRI-LIGHTS, HIGH INTENSITY LED INDICATORS, CARTRIDGE LIGHTS, LED FAULT INDICATORS, TRANSISTOR CONTROLLED INDICATORS AND 7 SEGMENT LED DISPLAY READOUTS.

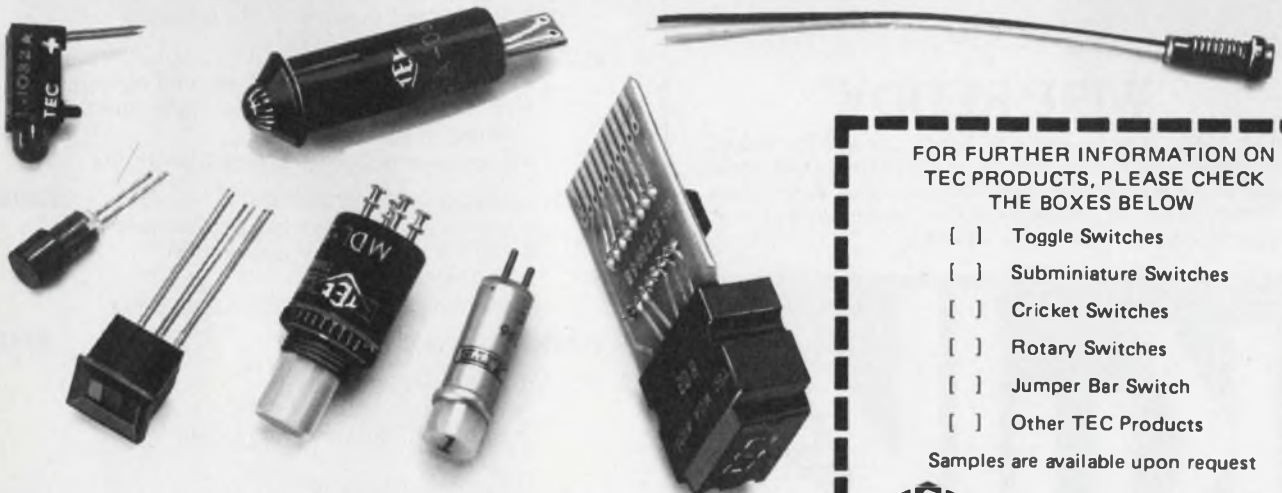

FOR FURTHER INFORMATION ON TEC PRODUCTS, PLEASE CHECK THE BOXES BELOW

- Toggle Switches
- Subminiature Switches
- Cricket Switches
- Rotary Switches
- Jumper Bar Switch
- Other TEC Products

Samples are available upon request



TEC, Incorporated
2727 N. FAIRVIEW AVENUE
TUCSON, ARIZONA USA 85705
(602) 792-2230 TWX 910-952-1377

TEC TEC, Incorporated

2727 N. FAIRVIEW AVENUE • TUCSON, ARIZONA USA 85705 • (602) 792-2230 TWX 910-952-1377
AN EQUAL OPPORTUNITY EMPLOYER M/F. COMMITTED TO AFFIRMATIVE ACTION - A TEC, INCORPORATED CORPORATE POLICY

CIRCLE NUMBER 82

COMPONENTS

Polystyrene capacitors reduced to 1/4 size

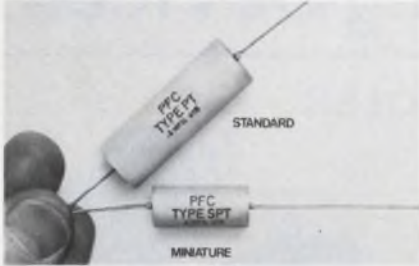

PFC, 100 Community Dr., Great Neck, NY 11022. (516) 487-9320. 8 wks.

Ultra-miniature polystyrene capacitors having values from 0.1 to 5 μF at 100-V rating are less than 1/4 the size of comparable units. Offered as hermetically sealed tubular metal-enclosed units, these capacitors operate from -55 to 85 C with a tempo of $-120\text{ ppm}/^\circ\text{C}$. The dissipation factor is 0.0002 and the dielectric absorption is 0.05% max. Insulation resistance is $10^{12}\ \Omega$ below 1 μF .

CIRCLE NO. 408

Incandescent display fits small space

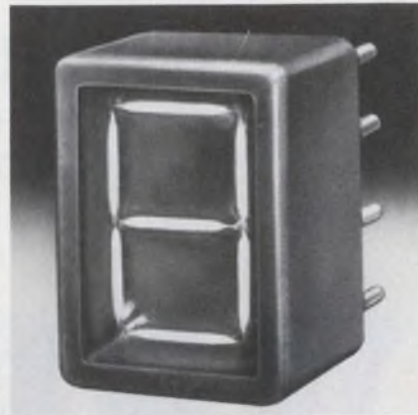

Day-Light Display, P.O. Box 1231, West Caldwell, NJ 07006. Phil Schneider (201) 575-1045. \$8.20 (100 qty); 2 wks.

The Day-140 7-segment incandescent display is in a package that measures only $0.274 \times 0.275 \times 0.31$ in. The 1/4-in.-high character is housed in an 8-pin DIP. Three models are available for operation at 3 to 5 V at 8 to 12 mA.

CIRCLE NO. 409

Meter relays provide both alarm and control



Weston Instruments, 614 Frelinghuysen Ave., Newark, NJ 07114. (201) 242-2600.

Series 7600 and 7700 meter relays employ an analog-meter mechanism integrated into a control configuration that also provides an alarm indication. Both optical and solid-state systems are available in sizes of 3.5 and 4.5 in. The 7600 optical meter relays provide superior rejection of signal noise, and they use a long-life incandescent lamp and a light-sensitive phototransistor for alarm and control. The 7700 solid-state meter relays provide better immunity against shock and vibration.

CIRCLE NO. 410

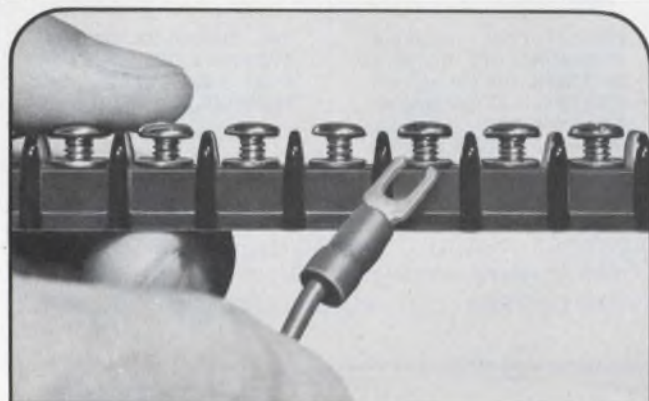

WIRE REDDY™

Cut wiring time in half with Kulka's new Wire Reddy™ terminal boards. Either brass or cost-saving steel screws are in place and ready to receive wire ends or terminals. Other time-saving hardware in the line are Kliptites™ and wire wraps. All are in Kulka's catalog.

Kulka®

A NORTH AMERICAN PHILIPS COMPANY

520 S. Fulton Ave., Mt. Vernon, NY 10551 Tel: 914 664 4024

CIRCLE NUMBER 93

H-P 2100/21MX USERS

Let Analytical Systems apply its expertise with H-P minicomputer hardware and software to your interface applications

INTERFACE SUBSYSTEMS NOW AVAILABLE

- 21101 - Asynchronous Serial Communications . . . \$550**
 - support of H-P and non H-P devices
 - signals conform to EIA-232C standards
 - attachment directly or via modems
- 21201 - Parallel Interface . . . \$975**
 - DMA/DCPC driven 8-bit parallel output
 - controller configurable for many line printer interfaces
 - one driver supports all configurations
- 21301 - Analog Data Acquisition . . . \$3675**
 - controller implemented data acquisition
 - control memory for acquisition parameters
 - spooling of data directly to disc file
- 21XXX - Custom Subsystems . . . RPQ**
 - Product Support**
 - RTE driver(s), diagnostic
 - printed circuit assembly, interface cables
 - full documentation

Analytical Systems Corporation
P.O. Box 533 • Elgin, IL 60120 • (312) 888-4040

CIRCLE NUMBER 69

PowerTech, Inc.

"BIG IDEAS IN
BIG POWER"

Why parallel devices for high current capability when a single module combines design flexibility with savings in space and circuit assembly costs. Using PowerTech's standard 200 amp or 500 amp single-chip silicon transistors as basic building blocks (we call them powerblocks), PowerTech has put together high-current Powerblock Power Systems with virtually no limitation on maximum current. Each internal powerblock is factory-matched. Our building block approach provides optimum design flexibility with voltages of up to 600 volts and currents up to 1200 amps or higher. Powerblock Systems exhibit the ultra-low V_{BE} and V_{CE}

(sat) that yield the lowest system losses of any darlington... with ultra-high current gains of 100 minimum at rated current. And, they're super-rugged. Inherently so, because we SOAR-test each individual powerblock before incorporating it into the "black box" system. The high current gain of the system reduces the drive requirements making it suitable for high VA inverters, pulse width modulated motor controls, and other high-current switching and linear circuits. For information, application assistance, and free design guide call Sales Engineering, PowerTech, Inc., 0-02 Fair Lawn Avenue, Fair Lawn, N.J. 07410; Tel. (201) 791-5050.

Type =	V_{ce}	h_{FE} @ I_c	P_D	Size
MT-5001	80	100 @ 250A	0.3 KW	5.7 cu. in.
MT-5003	80	100 @ 500A	0.7 KW	11.0 cu. in.
MT-5005	80	100 @ 800A	1.4 KW	18.7 cu. in.
MT-5007	80	100 @ 1200A	2.1 KW	18.7 cu. in.

*Voltage ratings to 400 V available.

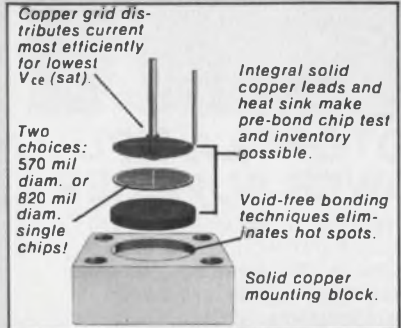

1200 AMP 80v POWERBLOCK

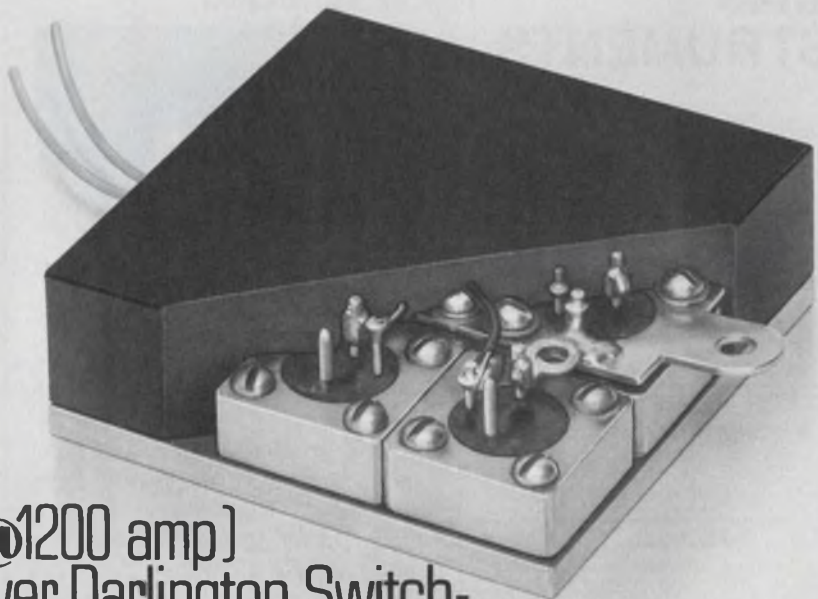

(h_{FE} 100 min. @ 1200 amp)
NPN Silicon Power Darlington Switch-
Highest KVA at lower cost,
weight and space

Internationally represented by: FRANCE, International Semiconductor Corporation, Boulogne 604.52.75 • GERMANY, Infratron, Hamburg 040/81 75 78; Munchen 524181 • ENGLAND, Scelectron Limited, London 01-328-5571 • SWEDEN, AB Elektrofex, Sundryberg 08-28 92 90 • ISRAEL, Professional Electronics Ltd., Ramat Hasharon 03-471240 • NETHERLANDS, Manudax-Nederland B.V., Heeswijk 04139-1252 • BELGIUM, Manudax B.V., Brussels 2-152518

CIRCLE NUMBER 94



MOTOROLA MPU POWER SUPPLIES

... the cooler-running, longer-lasting, lower-cost, triple-output power supply:

- 50% to 100% more heat sink area
- 25% lower transistor junction temperatures
- standard, state-of-the-art OVP
- lowest-cost of any national manufacturer**

*Trademark Motorola Inc. **Based on latest published data

Contact Motorola Subsystem Products, P.O. Box 20912, Phoenix, AZ 85036 or call (602) 244-3103.



MOTOROLA INC.

CIRCLE NUMBER 95

Save on Calculators

TEXAS INSTRUMENTS

Model	Your Cost	Model	Your Cost
TI 59	\$214.95	TI 1680	25.95
PC-100A	146.95	TI 25 LCD	26.95
TI 58	96.95	Money Manager	19.95
TI 57	62.95	TI 1700 Data Clip	29.95
Programmer	48.95	Data Man	22.95
SR 51-2	49.95	Little Professor	12.95
TI 55	49.95	TI 30 SP	18.95
TI 1790 Datachron	43.95	TI 25 LCD	26.95
MBA	63.95	TI 5040 P/D	98.95
SR 40	23.95	TI 5050 M	83.95
TI 2550-3	25.95	TI 5015	64.95
TI 1050	11.95	TI 5100	43.95
TI 58/59 Libraries	28.95	TI 1025	10.95



TI Accessories at discount prices

One free TI 503-1 digital watch with single purchase order of \$650+ from this ad.

All TI units come complete, fully guaranteed by TI.

HEWLETT-PACKARD

Model	Your Cost	HP 67	354.95
HP 97	594.95	HP 91	259.95
HP 92	399.95	HP 10	137.95
HP 80	233.95	HP 19C	273.95
HP 29C	154.95	HP 25C	125.95

HP accessories at discount prices. One year guarantee by H.P. All units come complete. We will beat any deal. Try us at anytime.

SPECIALS

Model	Your Cost	Model	Your Cost
Norelco #185	99.95	Price order All models & speeds	from 129.95
Norelco Philips 95	149.95	RCA Selectavision	199.95
Norelco #88	242.95	Sony Betamax 8600	Call us
Norelco #11	164.95	Zenith Video Recorder	\$29.95
Norelco #91 Dict/Transc	298.95	Sony 1979 TVs	Best deal
Norelco #98 Dict/Transc	409.95	RCA TVs all models	from 75.95
Norelco Mini Cassettes	2.95	Zenith TVs all models	from 87.95
Cong 2705A 2625-2629	199.95	Call	77.95
Samp TRC 800CA	159.95	Atari Video Game	159.95
Samp TRC 8010A	159.95	Victor printer 305	99.95

No one can beat Olympic Sales Co. prices and fast service. Try us. Prices are F.O.B. (LA). Goods subject to availability. Ask for our famous catalog. We will beat any price if the competitor has the goods on hand. Add \$3.00 for shipping hand held calculators. CA residents add 6% sales tax.

OLYMPIC SALES COMPANY, INC.
216 South Oxford Ave. • P.O. Box 74545
Los Angeles, CA 90004 • (213) 381-3911 • Telex 67-3477

CIRCLE NUMBER 96

INSTRUMENTATION

100-MHz scope views trigger signals



Philips Test & Measuring Instruments, 85 McKee Dr., Mahwah, NJ 07430. Stuart Rauch (800) 631-7172.

A 100-MHz oscilloscope, PM3262, features an alternate display that shows the main and delayed time-base together over the entire screen width. In addition, it has a third channel for simultaneous viewing of trigger signals. Trigger facilities include composite triggering to permit stable display of asynchronous signals. Also, because of the 50-mV-to-24-V dynamic range, the unit accepts most trigger inputs and triggers to 250 MHz. Extended X-Y display is possible using the X-external input or Ya or Yb inputs. Weighing 21.1 lb, the scope is 12.5 × 6.1 × 16.2 in. Power draw is 45 W.

CIRCLE NO. 411

Temperature programmer is μ P controlled



Victory Engineering, Victory Rd., Springfield, NJ 07081. (201) 379-5900. \$925; 6 to 8 wks.

The Model 8000 μ P-controlled temperature programmer is for use with environmental test chambers. The device is programmable, nonvolatile and has two constant displays of 4 digits and 3 digits. Each uses 0.43-in., 7-segment LEDs. In addition, programming is guided with six individual LED status indicators. Integral proportional controllers and a second channel for temperature or humidity are optional. A cycle can be repeated up to 255 times while 4 to 50 segments/cycle can be used. Soak time is 1 to 4096 min and retention time is 10 h, if and when a power loss occurs.

CIRCLE NO. 412

DMM offers LCD with 40-h battery operation



Data Precision, Audubon Rd., Wakefield, MA 01880. Bob Scheinfein (617) 246-1600. \$295.

The digital multimeter, Model 258, combines 10- μ V sensitivity and true-rms measurement of ac volts and current with an LCD display and 40-h continuous battery operation, provided by rechargeable NiCd batteries. The meter's functions include V dc and ac, I dc and ac and ohms with 4½ digits on all parameters. The basic one-year accuracy is $\pm 0.05\%$ of input without need for recalibration. Other specs include V dc measurement from 10 μ V to 1 kV with 0.005% resolution in five ranges, V ac from 10 μ V to 500 V true rms from 30 Hz to 20 kHz, I ac from 10 nA to 2 A, R from 100 m Ω to 20 M Ω .

CIRCLE NO. 413

Digital multimeter selects own ranges, or you do it

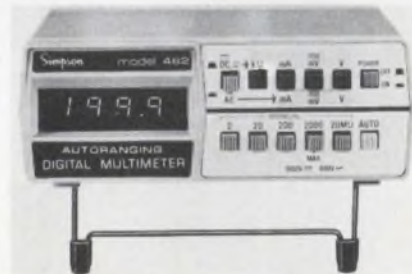

Simpson Electric, 853 Dundee Ave., Elgin, IL 60120. (312) 697-2260. \$185.

The Model 462 3-1/2-digit multimeter gives the user the option of automatic or manual range selection of ac and dc voltage ranges between 2 and 1000 V, as well as resistance ranges between 2 k Ω and 20 M Ω . In addition, manual selection adds ac and dc voltage ranges of 200 mV and four current measurement levels, both ac and dc, between 2 and 2000 mA. The total number of ranges is 23. All functions and ranges are pushbutton selected. Basic dc voltage accuracy is $\pm 0.25\%$ of reading +1 digit. Rechargeable NiCd batteries, line-cord recharger, test leads and manual are included.

CIRCLE NO. 414

5 DAY DELIVERY

Microcomputer Analog I/O Systems
with extensive software diagnostics

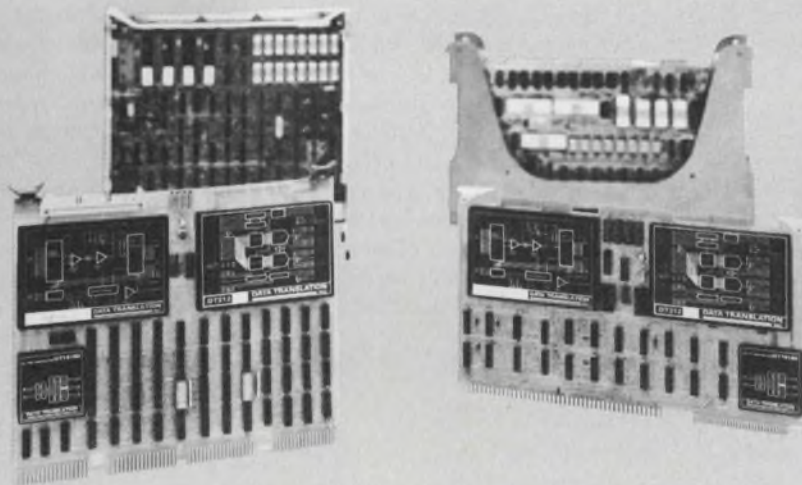

For:

INTEL SBC-80 Series (8080A)

ZILOG MCB Series (Z-80)

DEC LSI-11 & LSI-11/2

Computer Automation LSI 2,3 & 4 Series

National Semi IMP/PACE & BLC-80 Series

PLUS the widest selection of Data Acquisition Modules
anywhere. Concentrate on the Software and other key
system Requirements... and let us take care of Your
Analog Problems.

SEND for Full Technical Data or Call us.

GSA Contract No. GS-00S-64219

DATA TRANSLATION

INC

4 Strathmore Rd., Natick MA 01760

(617) 655-5300 Telex 94-8474

SALES OFFICES: AZ 602-994-5400; AR 405-364-8320; CA 408-248-9616; 714-540-3245; CO 303-837-1247; CT 516-488-2100; DC 703-527-3262; DE 703-527-3262; ID 801-466-6522; LA 713-780-2511; MD 703-527-3262; MA 617-655-5300; MN 612-488-1129; NJ 516-488-2100; NM 505-292-1212; 505-523-0601; NY 516-488-2100; OK 405-364-8320; TX 512-451-5174, 214-661-0300, 505-523-0601, 713-780-2511, 512-828-2251; UT 801-466-6522; VA 703-527-3262; WI 715-294-3128 CANADA 416/625-1907.

CIRCLE NUMBER 97

POWER SOURCES

Tiny module puts out 5 V at 300 mA



Calex, 3305 Vincent Rd., Pleasant Hill, CA 94523. R.C. Kreps (415) 932-3911. \$19 (100 qty); stock.

The miniature modular Model 21-30 encapsulated power supply is 1.75 × 2.25 × 1 in. It weighs 5.3 oz. The output voltage is 5 V ±1% at 300 mA. Line and load regulation is ±0.1% and noise and ripple is less than 2 mV rms. Input power is 115 V ac at 50 to 400 Hz. The module mounts on PC boards.

CIRCLE NO. 415

Switcher supply provides 25-W quad output



Boschert, 384 Santa Trinita Ave., Sunnyvale, CA 94086. Scot Warner (408) 732-2440. \$80 (100 qty).

The OL-25 switching-regulated power supply provides +5 V at 3.5 A, -5 V at 0.5 A and ±12 V at 0.5 A in a size of 2.5 × 4 × 6 in. Input-line regulation is ±0.2% max, input-frequency range is 47 to 440 Hz and efficiency is typically 65%. Ripple and noise is 2% pk-pk. Load regulation on the +5-V output is ±1% and for all other outputs, ±5%. Should a blackout occur, the outputs remain within specified limits for 16 ms minimum.

CIRCLE NO. 416

Switching supplies sport digital meters



Lambda Electronics, 515 Broad Hollow Rd., Melville, NY 11746. (516) 694-4200. \$1300; stock.

A current or voltage-selectable digital meter is provided in the LGS-G series of switching power supplies. Seven models are available with output voltages from 5 to 28 V and currents up to 200 A. All models are convection cooled. The supplies contain 20-kHz switching circuitry and have efficiency ratings over 65%. Standard built-in overvoltage protection shuts down the inverter and crowbars the output voltage. Overtemperature and current limiting are also provided.

CIRCLE NO. 417

ALCOSWITCH®

MULTI-POSITION SLIDE SWITCHES FOR INDUSTRIAL APPLICATIONS

A most versatile switch family designed specifically for printed circuit applications featuring a unique wiping action to assume a low contact resistance—This is called our MSSA Series.

- 1, 2, 3, or 4 POLE OPTION
- CHOICE OF 3 or 4 POSITIONS
- VERTICAL PC OR RIGHT ANGLE MOUNTING
- GOLD OR SILVER PLATED CONTACTS AND TERMINALS
- PC LEVELLING TABS FOR ADDED STABILITY
- EPOXY SEALED TERMINALS
- QUALITY AT ECONOMY PRICING

Ask Customer Service for a sample and copy of our new 100-page switch catalog.

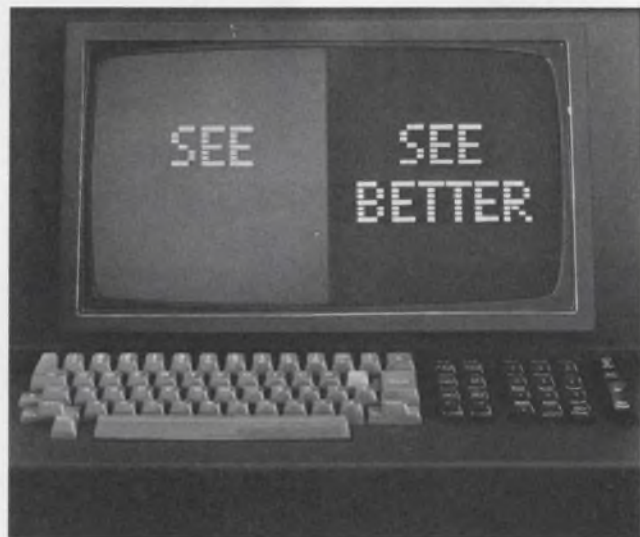
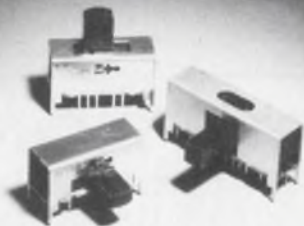

3M Brand Light Control Film Improves Readout Readability.

Microlouvers within the film enhance contrast, screen out ambient light. Works equally well on LED and CRT displays. For information on how you can use 3M Light Control Film in your product write: Visual Products Division, Industrial Optics, 3M Center, St. Paul, MN 55101.

ALCO ELECTRONIC PRODUCTS, INC.
1561 OSGOOD STREET, NORTH ANDOVER, MA 01865 U.S.A.
TEL: (617) 885-4371 FAX: (617) 882-5552
A SUBSIDIARY OF **AUGAT** INC.

CIRCLE NUMBER 99

3M
COMPANY

CIRCLE NUMBER 112

ELECTRONIC DESIGN 12, June 7, 1978

Designing in optical switches?

Call us for your broadest choice of high-technology optoelectronic components — off the shelf!

Spectronics optoelectronic switches and other components are designed to meet growing needs in such areas as industrial controls, copiers, card readers, computers, solid state relays, motion sensors, switching supplies and object sensors. Even if your application is different, it's likely we've got a component to do your job.

Infrared Emitters and Detectors

Spectronics IR emitters and detectors are available either as stand-alone components or in pre-aligned optical switch (interrupter module) configurations. They interface directly with digital logic circuits.

Here's How They Work

Spectronics high-efficiency infrared light emitting diodes and light sensitive phototransistors are specially matched for peak efficiency. Design our components into your circuits just like diodes and transistors.

What's your application? Do you need to sense falling quarters or moving parts? Or perhaps the leading edge of paper or the speed of a shaft? Spectronics infrared LEDs and phototransistors will do these jobs for you . . . and a lot more. In pulsed applications, the emitter and detector can be placed a dozen feet apart. Or we've got standard modules with gaps from .1 to .375 inches.

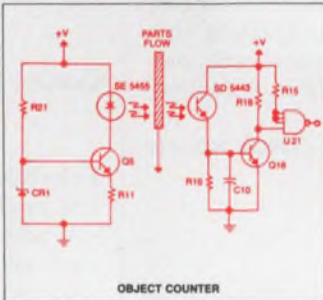

Need to detect a moving train of objects or count passing water drops? Or sense a credit card or other document? Then consider our reflective object sensors. We can supply the discrete components or make custom arrays for just about any application.

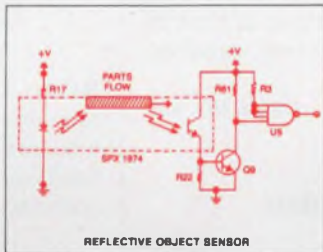

Designing a Microprocessor Interface?

You can isolate your μP from power line and switching transients with our optocouplers. Our patented epoxy inner mold assures reliable isolation from surges to 5000 VDC. Drive currents can be as low as 1 mA.

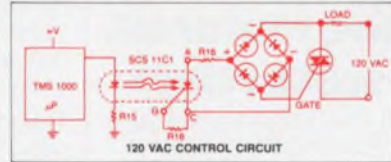

Gating an SCR or TRIAC?

Level shifting from control circuits to power line levels is readily accomplished. Our SCR coupler can gate a 40 amp TRIAC. The complete Spectronics line also includes standard transistor and darlington outputs.

Replace Mechanical Switches

By specifying Spectronics opto switches you eliminate such common problems as corrosion, contact bounce and mechanical fatigue. Lifetime measured in decades — not number of switching cycles! Products are directly microprocessor compatible from -55°C to $+100^{\circ}\text{C}$.

High-Technology Leader

Last year, Spectronics devoted over \$1 million to optoelectronic research and development. That's one of the reasons you'll be hearing more about us. And we want to hear from you. Call us now for assistance with your non-standard design problem, or write for our free opto catalog. Spectronics Commercial Components Division, 830 East Arapaho Road, Richardson, Texas 75081, telephone (214) 234-4271.

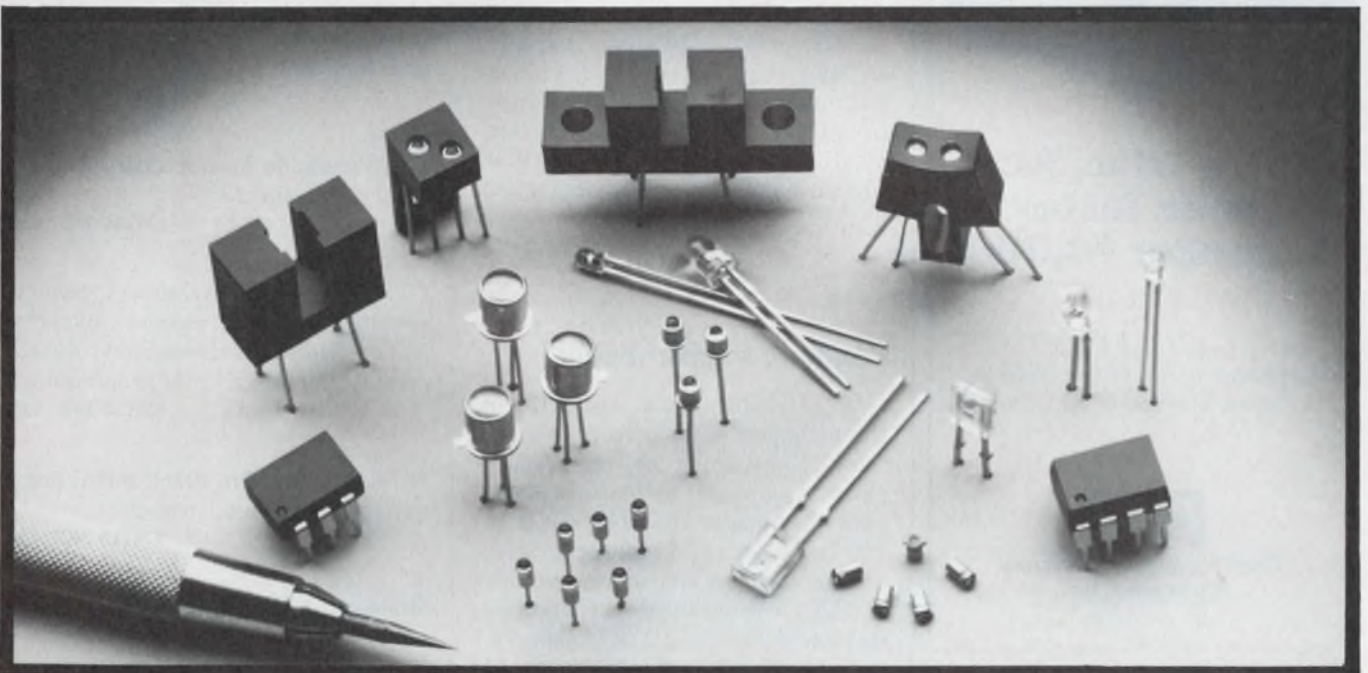

The EMR is dead.



Long live Motorola solid-state relays!

For logic level designs where you need solid-state reliability, convenience, versatility, standard packages, multiple sourcing and low-cost, solid-state relays are the only way to go!

Motorola presents a new broad line of SSRs and I/O modules which is vastly superior to EMRs for power designs, PC boards and I/O systems . . . and with performance/reliability advantages over similar contemporaries.

Contact Motorola Subsystem Products, P.O. Box 20912, Phoenix, AZ 85036, (602) 244-3103 or circle the reader number.



MOTOROLA INC.
CIRCLE NUMBER 101



Now a Triac, SCR & Diode Tester for under \$4,000!

Get the facts TOLL FREE
Call Bruce Rahm 800-527-4634
(In Texas, 214-234-4173 Collect)



**Control & Information
Systems, Inc.**

10 Spring Valley Village • Richardson, Texas 75080

CIRCLE NUMBER 102

Evaluation samples

Indicator lights

Solid-state neon and incandescent indicator lights are described in a 24-page catalog. Bound into the new catalog is a self-mailer sample-request form that makes it easy for designers to obtain free samples of any of the company's indicator lights for prototypes and new designs. Industrial Devices.

CIRCLE NO. 418

PC board stand-offs

Over 100 stand-offs and spacers for PC boards are shown in a catalog, each with multiple specification variations. Free samples are available. RSM Products.

CIRCLE NO. 419

Adhesives

Acrylic and rubber-based adhesives range from an economical, general-purpose adhesive to those applied to textured and low-friction surfaces. W.H. Brady.

CIRCLE NO. 420

Miniature sync motors

One-watt unidirectional or 2-W reversible miniature synchronous motors are only 1-1/16 in. dia and 2-1/2 oz. Start, stop, and reversing is almost instantaneous. Speeds of 1 to 360 rpm from integral gear trains. Up to 5 oz-in. UL listed. Free samples to OEMs who outline their application. Haydon Switch & Instrument.

CIRCLE NO. 421

Miniature stepper motors

Only 1-1/16 in. dia. and 2-1/2 oz, these steppers will operate from simple "on-off" switching or from single-phase, two-phase, or four-phase supplies. Step angles available from 0.9 to 36°. Torque up to 2.7 oz-in. at 1.5° step; 0 to 400 steps per second. Free samples to OEMs who outline their application. Haydon Switch and Instrument.

CIRCLE NO. 422

Vendors report

Annual and interim reports can provide much more than financial position information. They often include the first public disclosure of new products, new techniques and new directions of our vendors and customers. Further, they often contain superb analyses of segments of industry that a company serves.

Selected companies with recent reports are listed here with their main electronic products or services. For a copy, circle the indicated number.

Micro Mask. Integrated circuits and electronic components.

CIRCLE NO. 423

Control Data Corp. Computers.

CIRCLE NO. 424

Fairchild Camera and Instrument. LSI products; ICs; discrete products; instrumentation and systems; government and industrial products; digital watches and clocks; video entertainment systems.

CIRCLE NO. 425

RCA. Electronics—consumer and commercial products and services; broadcasting; vehicle renting and related services; communications; government systems and services.

CIRCLE NO. 426

Dow Jones. Financial publications and services.

CIRCLE NO. 427

San Fernando Manufacturing. Electronic components.

CIRCLE NO. 428

CTS Corp. Variable resistors; cermet-resistor networks; cermet microcircuits; switches; loudspeakers; quartz crystals; metal and plastic specialties.

CIRCLE NO. 429

Bliss & Laughlin. Steel, metal products and construction tools.

CIRCLE NO. 430

Honeywell. Information systems; control systems.

CIRCLE NO. 431

New literature



PDP-11 enhancements

A literature packet includes an informative folder, 10 data sheets, and a full deck of Able cards describing PDP-11 enhancements. The deck of Able cards is pocket-sized and designed for easy filing as well as quick reference. Each card contains a photograph on one side and a technical summary of a single model on the other. Able Computer Technology, Irvine, CA

CIRCLE NO. 432

LEDs

"The End of the Incandescents," a 14-page catalog, describes LED panel lights, discrete-packaged LEDs and LED accessories. Data Display Products, Inglewood, CA

CIRCLE NO. 433

Semi test system

Information and specifications on the 203 semiconductor-memory-test system is included in an eight-page brochure. Siemens, Measurement Systems Div., Cherry Hill NJ

CIRCLE NO. 434

Leasing equipment

"Lease Program," a 4-page brochure, details the leasing programs for any of the company's equipment. Computer Power Systems, Long Beach, CA

CIRCLE NO. 435

Connectors

A 40-page catalog lists almost 2200 types of connectors and interconnection devices. TRW Cinch Connectors, Elk Grove Village, IL

CIRCLE NO. 436

Electronic counters

An 80-page catalog features electronic counters, controls, special-purpose instruments, rate indicators, time indicators, sensors and data-acquisition systems for both in-plant and OEM design engineers. Applications, specifications, model variations, options and accessories are included. Veeder-Root, Hartford, CT

CIRCLE NO. 437

Plotters

Functions, specifications and design features of the DT series plotters are contained in a brochure. DATA TECHNOLOGY, Woburn, MA

CIRCLE NO. 438

OEM computers

A 64-page technical book covers OEM minicomputers. The first 50-pages of the book detail hardware. Information on the processors includes details on processor architecture, register and instruction sets. The second section covers software, operating systems and executives, utilities, diagnostics. Computer Automation, Berkhamsted, Herts HP4 3AP, England

CIRCLE NO. 439

Keyboards

A four-page brochure describes a keyboard incorporating a micro-processor and low-profile, reed key-switches. The brochure contains complete electrical and mechanical data. C.P. Clare, Chicago, IL

CIRCLE NO. 440

Breadboarding systems

Descriptions and specifications of four circuit-design test instruments are contained in a 12-page brochure. E&L Instruments, Derby CT

CIRCLE NO. 441

Power supplies

A four-page catalog summarizes the submodular line of miniaturized, rugged power supplies. The catalog outlines the parameters of the standard modules and their key operating specifications. Arnold Magnetics, Culver City, CA

CIRCLE NO. 442

MORE POWER MORE BANDWIDTH LESS COST



Our Model 601L is an ultra-wideband RF Power Amplifier whose wide range of frequency coverage and power output provides the user with the ultimate in flexibility and versatility in a laboratory instrument. Easily mated with any signal generator, this completely solid state unit amplifies AM, FM, SSB, TV pulse and other complex modulations with minimum distortion.

With a flat frequency response from 0.8 to 1000MHz the Model 601L will provide a linear class A output of 1.2 watts and a maximum saturated power output of 2 watts.

Constant forward power is continuously available regardless of the output load impedance match, making the 601L ideal for driving reactive as well as resistive loads.

Unconditional stability and instantaneous failsafe provisions in the unit provide absolute protection from damage due to transients and overloads.

Priced at \$1195 U.S.A.

APPLICATIONS INCLUDE:

- Laboratory Instrumentation
- RFI/EMI Testing
- NMR Spectroscopy
- TV Signal Distribution
- Communication Systems

For further information or a demonstration, contact:

ENI
3000 Winton Road South
Rochester, New York 14623
Call 716-473-6900, or
Telex 97-8283 ENI ROC

ENI

The world's leader in power amplifiers

CIRCLE NUMBER 103

NEW LITERATURE



Electronic components

"Electric Components," 208-pages, covers the full line of A-B attenuators, fixed resistors, potentiometers, resistor networks and trimmers. Photos, dimensional drawings and tables supplement the text to provide comprehensive data on each product. Allen-Bradley, Milwaukee, WI

CIRCLE NO. 443

A/d-d/a peripherals

Electrical and mechanical parameters and programming considerations on the SineTrac PDP series of data-acquisition systems are detailed in a 12-page brochure. Datel Systems, Canton, MA

CIRCLE NO. 444

Electronic hardware

Detailed drawings, material and performance specifications, photos and all necessary ordering and specifying information for electronic hardware are given in a 28-page catalog. Samtec, New Albany, NY

CIRCLE NO. 445

PM motors

A 20-page catalog of dc, permanent-magnet motors for heavy-duty applications contains motor-selection information, electrical specifications, schematics, performance curves, dimensional drawings and photographs. Clifton Precision, Clifton Heights, PA

CIRCLE NO. 446

Switches

Prices, part numbers, and options for thumbwheel, PCB, and DIP switches are listed in a 12-page catalog. EECO, Santa Ana, CA

CIRCLE NO. 447

Terminals

Detailed information on Teflon-insulated terminals is given in a 36-page catalog. A cross-reference of MIL-T-55155A part numbers is also featured. Sealectro, Circuit Component Div., Mamaroneck, NY

CIRCLE NO. 448

Power supplies

The pros and cons of designing with switching power supplies are contained in a brochure. The brochure describes typical applications of switching power supplies in CRT systems, electromechanical systems, microprocessor-based systems, and large multiple-supply systems. Boschert Associates, Sunnyvale, CA

CIRCLE NO. 449

FIVE DAY DELIVERY!

WRITE
or
CALL
for
FREE BROCHURE
#5DD-78

STANTRON

MODULAR
ELECTRONIC
CABINETS

DIVISION OF
WYCO METAL PRODUCTS

6914-6918 BECK AVENUE, NORTH HOLLYWOOD, CALIFORNIA 91605
(213) 875-0800 TWX 910-499-2177

CIRCLE NUMBER 104

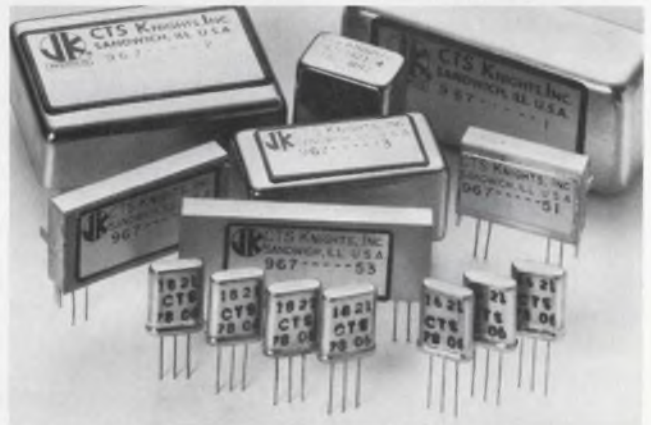

100 standard crystal filters to choose from—and then some.

Delivery is virtually off-the-shelf. Choose from 10.7 MHz and 21.4 MHz configurations, with 3 dB Bandwidths from 13 to 240 KHz. Filters in standard packages (supplied for natural or 50 ohm impedances) offer plug-in convenience and speedy delivery. For extra space and cost savings, in standard filters, order sets of loose H3W3 2-pole Monolithic crystals.

Prices from \$3 to \$35 (25 pieces).

For more facts, circle Reader Service Number, see EEM, or write: CTS Knights, Inc., 400 Reimann Avenue, Sandwich, IL 60548 or call (815) 786-8411.

CTS KNIGHTS, INC.



CIRCLE NUMBER 105

ELECTRONIC DESIGN 12, June 7, 1978

simply superior

The IM 1000 Universal PROM Programmer

Simply stated, our goal was to design one PROM programmer suitable for engineers, manufacturers and field service personnel

And that's what we did. With a design that's simplicity itself. Incorporating standard features not standard on any other single universal programmer. But using about 1/3 the usual parts. Which means 2/3 of what can usually go wrong, won't. Then we burn—in our equipment for 72 hours at 50°C to make certain of trouble free performance for you. And we back that up with a full 2 year warranty



The IM 1000 is simple to operate, too. Thanks to its 14 digit alpha-numeric display which shows selected modes, addresses, PROM and RAM data and error messages. And our 4K X 8 RAM memory is by far the most powerful editing system available.

It's simply the greatest advance in PROM programming yet. Superior in performance and dependability to any PROM programmer you've ever used. For more information, circle our number or give us a call. It's that simple

**Programmer base price \$1695.
Personality modules \$330.**

IM International Microsystems, Inc.
638 Lofstrand Lane, Rockville, Maryland 20850
or call: (301) 340-7505

CIRCLE NUMBER 106

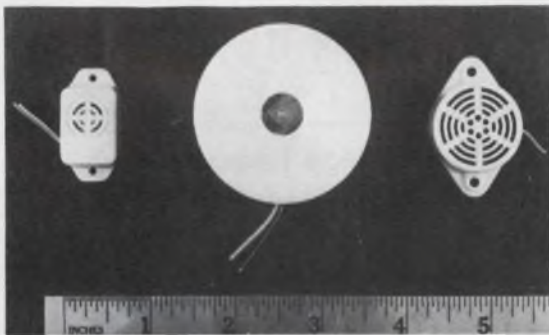

NEW ELECTRONIC BUZZERS

Star Micronics offers a choice of low cost U.L. Component Recognized electronic alarms. Model SDB (center) generates an output of 85 decibels at 10 feet. It's only two inches in diameter and one inch in height. U.L. Yellow Card S2015.

Star's electronic buzzers are radically different from conventional electromechanical alarms. There are no mechanical points to ignite hazardous vapors and cause explosions. RF noise, arcing, and electrical contact maintenance are eliminated.

Wide choice of voltage ranges and high reliability makes these units ideal for gas or smoke detectors and thousands of other applications.

star micronics, inc 
subsidiary of star mfg. co., ltd.
Pan Am Building
200 Park Avenue, New York, New York 10017
Tel. (212) 986-6770 TWX: 710-581-4082

CIRCLE NUMBER 107

ELECTRONIC DESIGN 12, June 7, 1978

Meet the new 32-W parallel shaft gearmotor. With gear-head featuring new spherical self-aligning bearing design* This compact (4.08 in. sq.) PM powerpack delivers torques up to 175 Lb-in. Speeds from 8 to 660 Rpm. You can get it with DPM controls to match, too. Find out more about it.

*Bodine has
a new 32!*



*Patent Pending

**BODINE
ELECTRIC
COMPANY**

ADE (After Delivery Economies)
make Bodine a better fhp buy

Bodine Electric Co., 2500 W. Bradley Place, Chicago, IL 60618

CIRCLE NUMBER 108



CIRCLE NUMBER 109

There's a Hoffman enclosure for almost every electronic application you can think of.

One company uses our NEMA 12 enclosures to house water-testing instrumentation. Whatever *your* electronic application, Hoffman probably offers an enclosure to match it, whether it's for servo controls or sensitive instruments.

Hoffman electronic rack enclosures, consoles, instrument boxes, and a full range of NEMA types are just some of the components in a broad-spectrum 1700-product line. All are quality-built in the materials, finishes, and sizes your application requires.

There's a Hoffman enclosure for almost every electronic application you can think of. Check with your Hoffman distributor, or write directly for specifications — we'll match our enclosures with your thinking any time you like.

For complete data write:
HOFFMAN ENGINEERING COMPANY
 Division of Federal Cartridge Corporation
 DEPT. ED676, ANOKA, MN 55303

Hoffman[®]
 ELECTRICAL ENCLOSURES

PROM ERASER

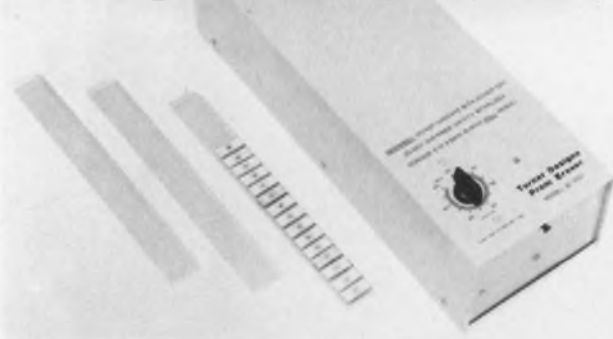

Designed specifically to deliver a calibrated dose of ultraviolet at the correct wavelength and intensity to assure long-term data retention. Tested by leading manufacturers of EPROMs, it meets data-sheet requirements of Intel, National, AMD, AMI, Mostek and others.

- SAFE - Operator protected against uv and ozone
- SMALL - 7 in. wide, front loading
- AUTOMATIC lamp start and timer
- CONVENIENT - Metal-tray loading
- FLEXIBLE - One to 60 PROMs per cycle
- AVAILABLE from current stock

Write or call for further data, or to order

TURNER  **DESIGNS**
 2247A Old Middlefield Telephone Mountain View, CA 94043
 415/965-9800

CIRCLE NUMBER 110

Test With Confidence

High-voltage Leakage Tester

audibly signals excess leakage

... GROUNDS
 ... ARCING

MODEL

103

Measures Leakage
 ... not capacity current



TEST VOLTAGE CONTINUOUSLY VARIABLE ADJUSTABLE LEAKAGE LIMIT ... CAPACITY COMPENSATION ON AC TESTS ... RATINGS TO 10,000 VOLTS AC & DC ... LIMITED ENERGY ... NON-DESTRUCTIVE ... FOR LAB AND PRODUCTION LINE SERVICE ...

MANUFACTURERS OF INSULATION TESTERS
 CABLE & HARNESS TESTERS ... MEGOHMMETERS
 STROBOSCOPES ... COIL & WINDING TESTERS
 & BATTERY TESTERS

SLAUGHTER COMPANY

MOORE & HAILEY STS
 Tele: 405-223-4773

ARDMORE, OKLAHOMA 73401
 TWX: 910-830-6972

CIRCLE NUMBER 111
 ELECTRONIC DESIGN 12, June 7, 1978

Two lightweight contenders for your triple power needs

In this corner, the AED101, a highly efficient power supply designed specifically to provide the DC power range required by floppy disk subsystems operating one to four drives. Extremely lightweight and compact, the 101 provides triple-output power (+5V @ 12 amps;

-12V @ 7 amps; +24V @ 3.5 amps) for up to 4 drives plus drive electronics, formatter and interface circuitry.

It also offers OVP, foldback current limiting, 5V switching regulator, and is UL recognized.

In the other corner, the AED201, 4½ lbs. lighter and designed to meet the special DC power requirements for one to two floppy disk drives (+5V @ 5 amps;

-5V @ 7 amps; +24V @ 2.8 amps). The 201 provides foldback limiting on +5V, superior power efficiency, and is designed to meet UL478 Standards. Both models are field proven, and they are available right now.

*Prices shown are for 100-249 per year

IDEAL POWER FOR SHUGART PERTEC, MEMOREX AND OTHER FLOPPY DRIVES



**Power Systems Division, 440 Potrero Avenue
Sunnyvale, California 94086. Phone 408-733-3555**



CIRCLE NUMBER 113

FREE Washer Catalog and Sample Pack

Catalog lists 3000 sizes of non-standard washers and spacers available without die charge

All metal washers are flat and tumble de-burred. They are made immediately to your order from existing dies. Materials certified if needed.

Boker's complete stamping capability includes tooling, welding, metallurgical lab, assembly, and quality control. Let us give you a quick quote.

For your convenience our complete catalog is reprinted in ThomCat. Look under BOKER'S in Volume 9.

Satisfied customers from coast to coast.

BOKER'S, INC.

3104 Snelling Ave. So., Mpls., MN 55406 Phone 612-729-9365

CIRCLE NUMBER 114

ELECTRONIC DESIGN 12, June 7, 1978



OD's from .086" to 1.936"
ID's from .027" to 1.637"
Thicknesses: .005" to .125"
Any stampable material

Stamping Specialists Since 1919.

Buzzzzz.

(Write for new catalog.)

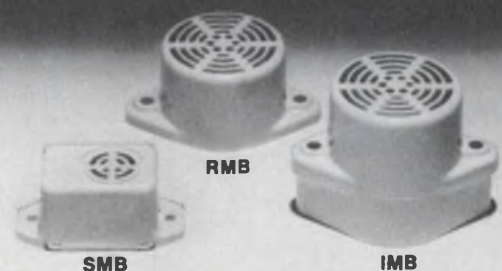

Solid state electronic MICRO-BUZZER from CITIZEN: High reliability, competitively priced with immediate delivery.

A complete range: SMB 1.5, 6, 12, 24, VDC
RMB 3, 6, 12, 24, VDC
IMB (Intermittent) 6, 12, VDC

CITIZEN

CITIZEN AMERICA CORPORATION
1710 - 22nd St.
Santa Monica,
CA 90404

Toll Free (800) 421-6516
In Calif. (213) 829-3541
TWX: (910) 343-6450

Name	_____
Company	_____
Address	_____
City	_____
State	_____
Zip	_____
Phone	_____

CIRCLE NUMBER 115

Just
Published!



Switching and Linear power supply, power converter Design

Abraham I. Pressman
Raytheon Company

A "how-to-design" book
written from a power
supply designer's
point of view!

Covers all the circuits, systems,
magnetics, and thermal design
skills essential to modern power
supply design.

#5847-0, cloth, 384 pages, \$19.95

**ORDER YOUR 15-DAY
EXAMINATION COPY
NOW!** When billed,
remit or return book.

**HAYDEN BOOK
COMPANY INC.**
50 Essex Street,
Rochelle Park, N.J.
07662



Electronic Design

Advertising Sales Staff

Susan G. Apolant
Sales Coordinator

Rochelle Park, NJ 07662

Robert W. Gascoigne
Thomas P. Barth
Stan Tessier
Constance McKinley
50 Essex St.
(201) 843-0550
TWX: 710-990-5071
(HAYDENPUB ROPK)

Philadelphia

Thomas P. Barth
(201) 843-0550

Boston 02178

Gene Pritchard
P.O. Box 379
Belmont, MA 02178
(617) 489-2340

Chicago 60611

Thomas P. Kavooras
Berry Conner, Jr.
200 East Ontario
(312) 337-0588

Cleveland

Thomas P. Kavooras
(312) 337-0588

Los Angeles 90045

Stanley I. Ehrenclou
Burt Underwood
8939 Sepulveda Blvd.
(213) 641-6544

Texas

Burt Underwood
(213) 641-6544

San Francisco

Robert A. Lukas
465 S. Mathilda, Suite 302
Sunnyvale, CA 94086
(408) 736-6667

United Kingdom-Scandinavia

Constance McKinley
50 Essex St.
Rochelle Park, NJ 07662
Phone: (201) 843-0550

Europe

W. J. M. Sanders
S.I.P.A.S.
Raadhuisstraat 24 - P.O. Box 25
1484 EN Graft-de-Ryp, Holland
Tel: 02997-1303 and 3660
Telex: 13039 SIPAS NL
Telegrams: SIPAS-Amsterdam

G. Nebut
Promotion Presse Internationale
7 ter Cour des Petites Ecuries
75010 Paris, France
Telephone: 5231917. 1918. 1919

Dieter Wollenberg
Erikastrasse 8
D-8011 Baldham/Muenchen
Germany
Telephone: 0 8106/4541

Robert M. Saidel
Technimedia International
Via G. Fara, 30
20124 Milan, Italy
Tel: 65.72.765
Telex: 25897 Utidioma

Tokyo

Haruki Hirayama
EMS, Inc.
5th Floor, Lila Bldg.,
4-9-8 Roppongi
Minato-ku, Tokyo, Japan
Phone: 402-4556
Cable: EMSINCPERIOD, Tokyo



Electronic Design

ELECTRONIC DESIGN's function is:

- To aid progress in the electronics manufacturing industry by promoting good design.
- To give the electronic design engineer concepts and ideas that make his job easier and more productive.
- To provide a central source of timely electronics information.
- To promote communication among members of the electronics engineering community.

Want a subscription? ELECTRONIC DESIGN is circulated free of charge to those individuals in the United States and Western Europe who function in design and development engineering in companies that incorporate electronics in their end product and government or military agencies involved in electronics activities. For a free subscription, use the application form bound in the magazine or write for an application form.

If you do not qualify, paid subscription rates are as follows: \$30.00 per year (26 issues) U.S./Canada/Mexico, \$40.00 per year (26 issues) all other countries. Single copies are \$2.50 U.S. and all other countries. The Gold Book (27th issue) may be purchased for \$30.00 U.S./Canada/Mexico, and \$40.00 all other countries.

If you change your address, send us an old mailing label and your new address; there is generally a postcard for this in the magazine. You will have to requalify to continue receiving ELECTRONIC DESIGN free.

The accuracy policy of ELECTRONIC DESIGN is:

- To make diligent efforts to ensure the accuracy of editorial matter.
- To publish prompt corrections whenever inaccuracies are brought to our attention. Corrections appear in "Across the Desk."
- To encourage our readers as responsible members of our business community to report to us misleading or fraudulent advertising.
- To refuse any advertisement deemed to be misleading or fraudulent.

Individual article reprints and microfilm copies of complete annual volumes are available. Reprints cost \$6.00 each, prepaid (\$5.50 for each additional copy of the same article), no matter how long the article. Microfilmed volumes cost \$23 for 1976 (Vol. 24); \$30 for 1973-75 (Vols. 21-23), varied prices for 1952-72 (Vols. 1-20). Prices may change. For further details and to place orders, contact Customer Services Dept. University Microfilms, 300 N. Zeeb Rd., Ann Arbor, MI 48106. (313) 761-4700.

Want to contact us? If you have any comments or wish to submit a manuscript or article outline, address your correspondence to:

Editor
ELECTRONIC DESIGN
50 Essex St.
Rochelle Park, NJ 07662

If you're into exporting, or about to take the plunge, this could be your market research department.

It's your guide to one of the most useful libraries in the world. And it's issued by the U.S. Commerce Department on a monthly basis. Inside, you'll find a list of reports containing a wealth of information for the overseas marketer. Spot news; timely surveys of industrial, commodity, commercial and economic conditions in more than 100 countries; in-depth market research performed by the Commerce Department or private research firms overseas; as well as reports sent to Washington by U.S. Foreign Service Officers. For a free sample, just send us the coupon. And start doing your market research the easy way.

Secretary of Commerce
U.S. Department of Commerce, BIC-10A
Washington, D.C. 20230
Please send me my free copy of your Index to
Foreign Market Reports.

Name _____

Title _____

Company _____

Address _____

City _____

State _____

Zip _____



A Public Service of This Magazine & The Advertising Council

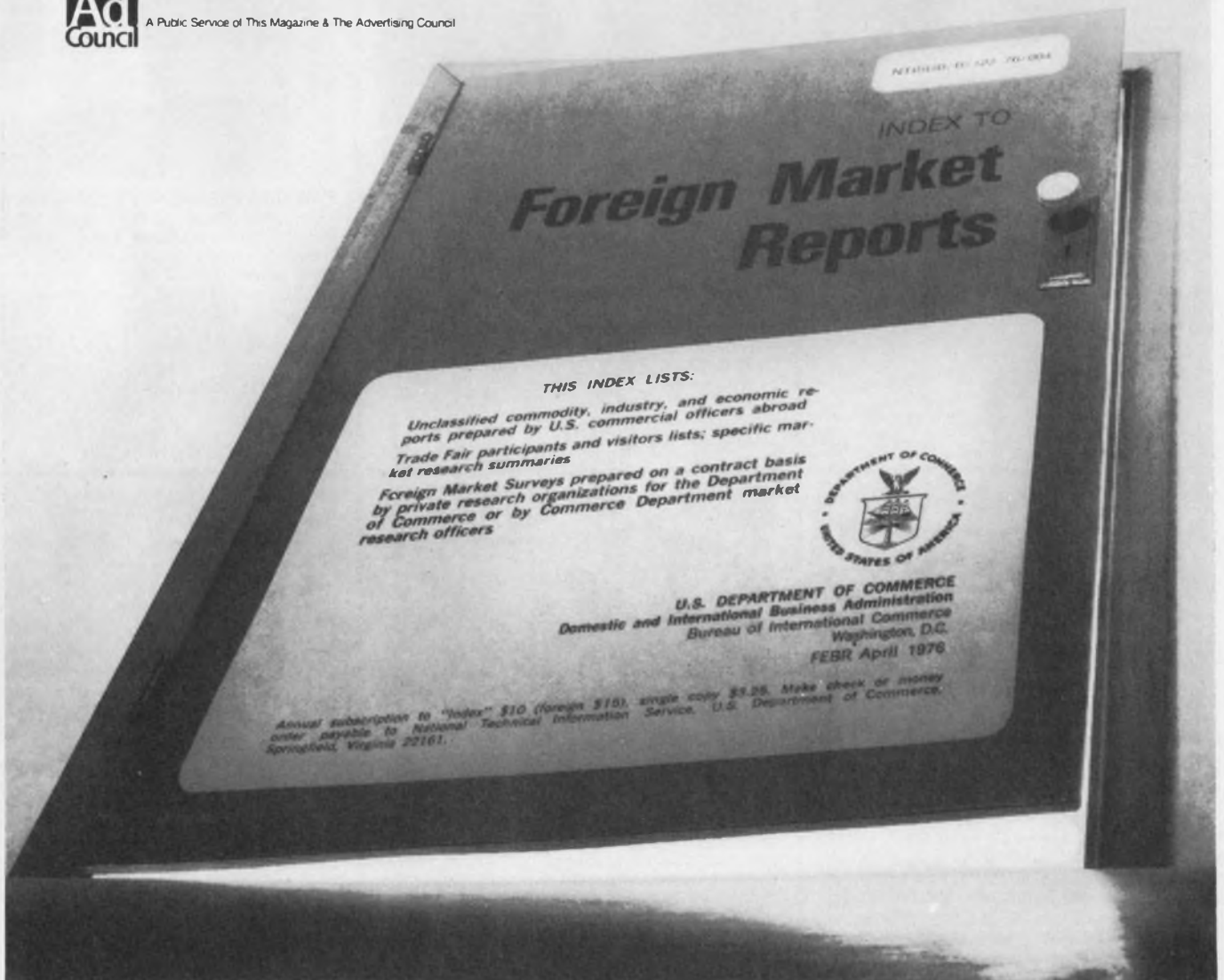

THIS INDEX LISTS:

Unclassified commodity, industry, and economic reports prepared by U.S. commercial officers abroad
Trade Fair participants and visitors lists; specific market research summaries

Foreign Market Surveys prepared on a contract basis by private research organizations for the Department of Commerce or by Commerce Department market research officers



U.S. DEPARTMENT OF COMMERCE
Domestic and International Business Administration
Bureau of International Commerce
Washington, D.C.
FEBR April 1976

Annual subscription to "Index" \$10 (foreign \$15), single copy \$3.25. Make check or money order payable to National Technical Information Service, U.S. Department of Commerce, Springfield, Virginia 22161.

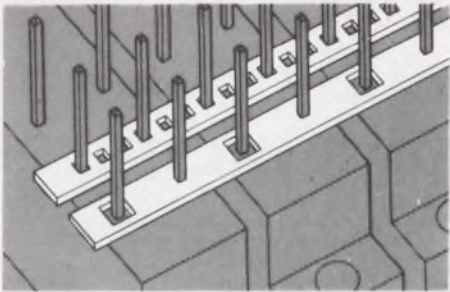

STRIP/BUS BY ROGERS. Low Cost Bussing Systems; easy installation, reliable solder joints; greater pin exposure. Write or call for details. Rogers Corporation, Chandler, AZ 85224. Phone (602) 963-4584. (EUROPE: Mektron NV, Ghent, Belgium; JAPAN: Nippon Mektron, Tokyo)

STRIP/BUS

181

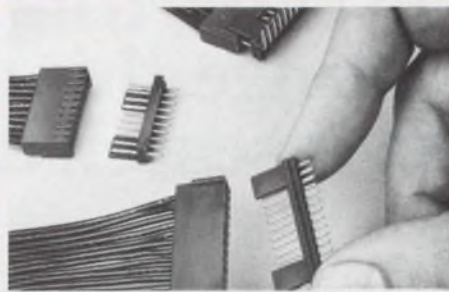

NEW "POL-R-LOK" MINIATURE CONNECTORS FEATURE POLARIZED LOCKING INTERCONNECTS ON .100 CENTERS for consumer electronic applications. Locking polarizing header and mating crimp receptacle available with 2-28 positions. Straight or right angle .025" square pins. Receptacle bellow contacts accommodate 22-30 AWG leads. Flame retardant 94V-0 thermoplastic molded connector bodies. 3.5 amp nominal at 250VAC. METHODE ELECTRONICS, INC 1700 Hicks Road, Rolling Meadows, ILL 60008. (312) 392-3500.

MINIATURE CONNECTORS

184



GAME PLAYING WITH COMPUTERS, Revised Second Edition, by Donald D. Spencer. The volume presents over 70 games, puzzles, and mathematical recreations for a digital computer. The reader will also find brand-new "how to" information for applying mathematical concepts to game playing with a computer. #5103-4, 320 pp., \$16.95. Circle the Info Retrieval Number to order your 15-day exam copy. When billed, remit or return book with no obligation. **Hayden Book Co., 5 Essex St., Rochelle Park, N.J. 07662.**

GAMES-PLAYING GUIDE

18



HANDSOME, RUGGED ENCLOSURES Custom-crafted laminated Formica®-Mahogany-Formica® construction, internally reinforced corners, rich wood grain or solid color exteriors. Superb workmanship, competitive prices, any quantity. W. A. Miller Co., Inc., 307 Mingo Loop, Oquossoc, Maine 04964. Phone: 207/ 864-3344

ENCLOSURES

182

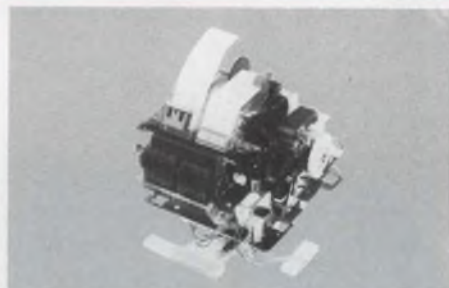

Low Cost Numeric Dual Printer. Prints 3 lines per second and has 11 character locations per column with a dual capacity of 6-10 columns, up to 22 columns as a single. Large library of characters. Small print mechanism, self-inking ribbon and variable space control. Tape re-wind (1 or both sides) available. Quantity price as low as \$66. Addmaster Corporation, 416 Junipero Serra Drive, San Gabriel, CA 91776. (213) 285-1121 Telex 6744770

LOW COST PRINTER

185



PRD 7838 FREQUENCY SYNTHESIZER • Wide Frequency Range: 1 KHz to 80 MHz • High Resolution: 1 Hz steps • Fully Programmable frequency and output level • Output Options sine wave, TTL, ECL available • Leveling ± 0.25 dB • Modular Construction: ease of servicing • Economical: \$3,795 complete with frequency standard. HARRIS CORPORATION/PRD Electronics Division 6801 Jericho Turnpike, Syosset, New York 11791 516/364-0400

FREQUENCY SYNTHESIZER

188

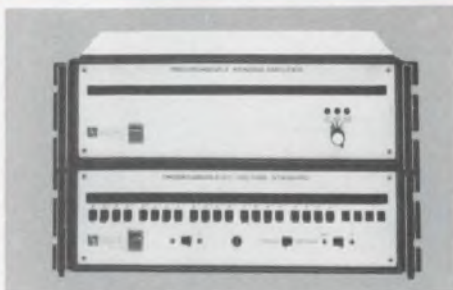

PROGRAMMABLE DC STANDARD. A new auxiliary option, MODEL RA-4, extends the range of the main frame instrument. Combined RA-4/501 specs are:
4 Ranges: ± 100 mV, ± 10 V, ± 100 V, ± 1000 Vdc. Resolution (1ppm): 0.1 μ V, 1 μ V, 10 μ V, 100 μ V Accuracy: $\pm(0.01\%$ of setting + 0.0005 of Range) Stability: 0.0001% 24 hrs; 0.0025%/90 days; 0.005%/year
Price \$1350 (export higher). Electronic Development Corp., 11 Hamlin St., So. Boston, MA 02127. Phone Bob Ross at (617) 268-9696

PROGRAMMABLE DC STANDARD

183



STANDARD & CUSTOM DESIGNED HARDWARE. When you need dimensionally accurate, burr-free, chip-free electronic hardware . . . shipped on time . . . at competitive prices . . . order from R.A.F. You will always get high-quality, standard parts from stock. Custom designed parts from your blueprints manufactured and delivered promptly. Send for our 110 page, fully-illustrated catalog today. RAF Electronic Hardware, Inc., 260 Hathaway Drive, Stratford, CT 06497 (203) 377-6393, TWX 710-453-2073.

FREE 110-PAGE CATALOG

186



PROGRAMMING PROVERBS FOR FORTRAN PROGRAMMERS, H. F. Ledgard. These 26 unique "proverbs," or rules and guidelines, are specially designed to help FORTRAN programmers upgrade the quality of their work. Comes with many sample programs. #5820-9, 144 pages. \$6.95. Circle the Info Retrieval Number to order 15-day exam copy. When billed, remit or return book with no obligation. Hayden Book Co., 50 Essex Street, Rochelle Park, N.J. 07662.

PROGRAMMING PROVERBS

189



35- and 75-Ohm Coaxial Connectors Add new confidence to your application with field-proven GR874® General Purpose and GR900® Precision Coaxial Components. You'll find lower SWR and higher repeatability. A broad component selection. Easy interconnection among a wide variety of connector types with minimum number of GenRad adaptors. GenRad, 300 Baker Ave., Concord, MA 01742, (617) 369-8770.

COAXIAL CONNECTORS

190

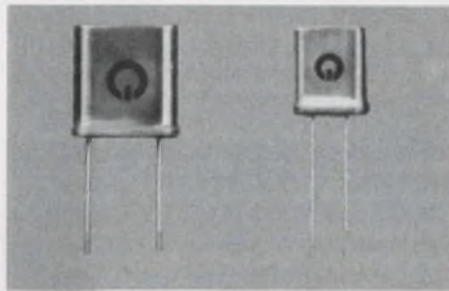

HIGH STABILITY LOW COST QUARTZ CRYSTAL for μ -processor and clock oscillator. Accuracy is $\pm 0.002\%$ at 25°C. Frequency change over -10 to $+55^\circ\text{C}$ is within ± 20 ppm. 1,000, 1,8432, 2,000, 2,097152, 2,4576, 3,2768, 4,0000, 5,0000, 5,0688, 5,1850, 5,7143, 6,5536, 10,0000, 18,0000, 18,4320, 20,0000, 22,1184 Immed. Div. \$1.85 ea. 10 MHz up in HC-18/u; (Min. 100 pcs.) Q-MATIC CORP., 3194-D Airport Loop Dr., Costa Mesa, CA 92626, (714) 545-8233, Telex 678389

CRYSTAL

193



BASICS OF AC & DC LINEAR SOLENOIDS BROCHURE 16-Page "Dormeyer Coach's" treatise on fundamentals of applying AC and DC linear solenoids for commercial and consumer equipment. "Solenoids . . . What They Are, How To Use Them" covers essentials of construction, operation, standard types, typical usage, effect of duty cycles and ambient temperature, plus provides a handy troubleshooting chart. FREE. Dormeyer Industries, 3418 N. Milwaukee Ave., Dept. ED, Chicago, IL 60641. Phone: (312) 283-4000.

BASIC BROCHURE ON SOLENOIDS

196

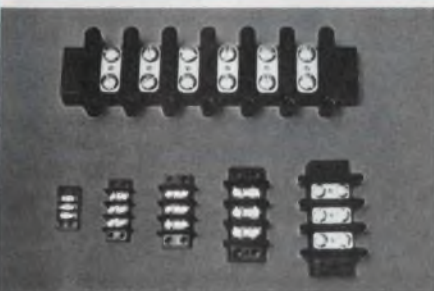

CARRIER TERMINAL BLOCKS, UL recognized. From TRW Cinch Connectors. 14 series covering current ratings from 10A to 70A, voltage ratings from 1100VRMS to 4000VRMS. Wide range of wire sizes accommodated. Up to 25 crew terminals and a variety of terminal hardware. Immediate delivery from distributor stock. Write for free catalog. TRW Cinch Connectors, 1501 Morse, Elk Grove Village, IL 60007. 312-439-8800.

CINCH CONNECTORS

191

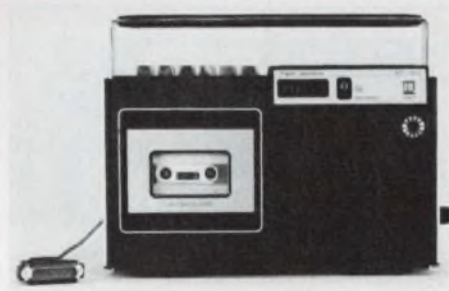

PROGRAM LOADER . . . uses computer's existing RS232 terminal port.

. . . A complete storage system . . . up to 109 8-bit characters/sec . . . any line speed 110 to 9600.

. . . Everything including RS232 plug and 48 inch cable in one ultra-compact rugged 5.5 lb. package . . . over 1.5 megabits/cassette. . . . \$975.00 (USA-only) from DIGITAL LABORATORIES, 600 Pleasant St., Watertown, MA 02172 (617) 924-1680

PROGRAM RECORDER/LOADER

194

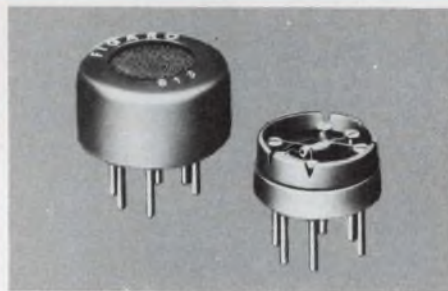

FIGARO GAS SENSOR TGS is a gas sensitive semiconductor. When combustible gas is absorbed on the sensor surface, a marked decrease of electrical resistance occurs. Major features of the sensor include high sensitivity, long term reliability and low cost. The applications are: GAS-LEAK ALARM, AUTOMATIC FAN CONTROL, FIRE ALARM, ALCOHOL DETECTOR, etc. Figaro Engineering Inc., North America Office-3303 Harbor Boulevard, Suite D-8, Costa Mesa, Calif. 92626 Tel: (714) 751-4103 Telex: 678396

GAS SENSOR

197

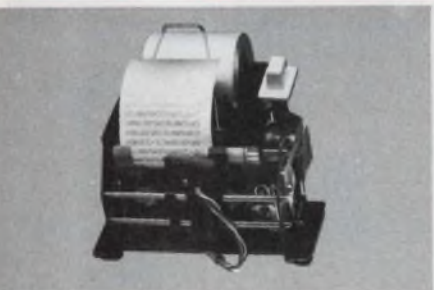

FAST, LOW COST DISCHARGE PRINTER DC-4004A prints 48 columns at 144ccps. Printing alphanumerics in 5 x 7 matrix format on 4.72" paper, its MTBF is 144 million characters. Just 2.6" H x 6.7" W x 5.9"D. it's only \$127 in 100 quantity. Interface electronics, other printers available. HYCOM 16841 Armstrong Ave., Irvine, CA 92714 (714) 557-5252.

DISCHARGE PRINTER

192



For Sale ... Now ...

this "like new" Brush Mark "260" Pressurized Ink Recorder, for only \$5,400.00 . . . with Money Back Guarantee and immediate worldwide delivery. Features include 4 standard event and 6 analog channels; Range: 1mV to 400 VDC; Response: DC to 40 Hz at 50 Div.; DC to 100 Hz at 10 Div; Speeds: 1, 5, 15, 125 mm/min.; Sensitivity: 1 mV/Div. This Brush "260" is only one of thousands of used electronic instruments for sale. Call (617) 273-2777 or (213) 993-7368 - or write for a free catalog to **REI SALES COMPANY 19347 Londelius Street Northridge, CA 91324 195**

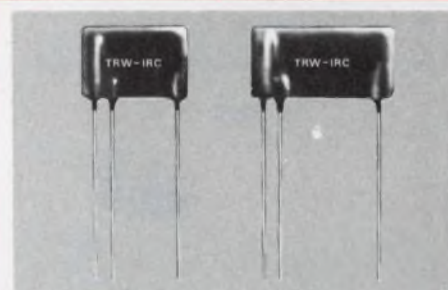

Thick-Film High Voltage Dividers are the latest line of high-voltage resistors from TRW. Each device consists of a high-voltage thick-film resistor circuit deposited on a high alumina ceramic substrate. The circuit can be encapsulated in a high-temperature epoxy coating with printed circuit leads or it can be made as a substrate for customer assembly into an integral high-voltage function. Available in various sizes and configurations. TRW/IRC Resistors, 401 N. Broad St., Phila, Pa. 19108, (215) 922-8900.

HIGH VOLTAGE RESISTORS

198



Compact and Stable, Low Frequency Mechanical Filters ranging from 280Hz to 200kHz. Their main applications are Telephone signaling system, Data transmission system, Loran C receiver, Omega receiver, Fishing sonar, Automatic answering phone, Pocket pager, Alarming system, Remote control system. SEIKO INSTRUMENTS, INC., 2990 West Lomita Blvd., Torrance, Ca. 90505 (213) 530-3400 Telex: 25-910-347-7307 SEIKOINST TRNC

FILTERS 199

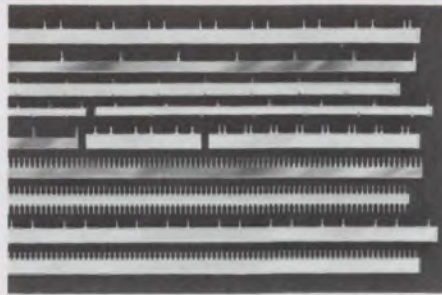

MINI/BUS® BY ROGERS, low-cost, low-inductance, high capacitance printed circuit board bus bars for noise reducing voltage distribution, are available in a variety of ready-to-ship designs. Prototype kits are also available from stock. Call or write Mini/Bus product specialist for a complete list. Rogers Corporation, Chandler, AZ 85224. Phone: (602) 963-4584. (EUROPE: Mektron NV, Gent, Belgium; JAPAN: Nippon Mektron, Tokyo.)

BUS BARS 202



Our M-Series plug-in ultrasonic instruments are designed to operate with the Tektron TM500 system. The modularized function together with the wide range of available accessories make the M-Series exceptional versatile. Available plug-ins include high energy pulse generators, low-noise receiver amplifiers, stepless RF gates, 3D isometric displays. Applications include flaw detection, materials characterization, thickness gauging, ultrasonic imaging. MetroTek, 80 Wellsia Way Richland, WA (509) 946-0684

ULTRASONIC SYSTEM 200



Free New catalog contains over 34,500 quality power supplies from the world's largest manufacturer, Power/Mate Corp. Power Supplies for every application including submodulars, open frame, variorated, encapsulated, laboratory & system. All units UL approved and meet most military and commercial specs for industrial and computer uses. Power/Mate Corp., 514 S. River St., Hackensack, NJ 07601 (201) 343-6294

POWER SUPPLIES 200

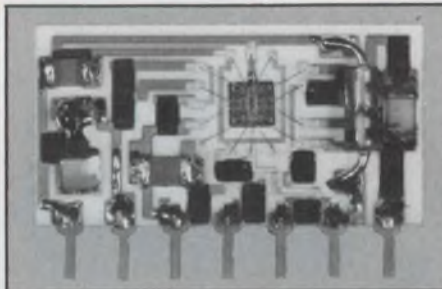

ULTRA SMALL ACTIVE BAND PASS FILTER fabricated using OP Amp incorporated Hybrids Circuit. Operating Voltage 1-2.5V/4-15V, Frequency Range 288.5-2800Hz, Q 180+20, 35+5 and etc. .788" x .138" x .433". By adding Feed Back Circuit of extra Diode and Capacitor, it does the job of small but reliable Oscillator. Active Filters can be tailor-made to customer's specifications. IWATA ELECTRIC CO., LTD. Mansei Bldg., 1-1-16 Sotokanda, Chiyodaku, Tokyo, Japan.

ACTIVE FILTER 203



EXTREMELY SHOCK-ABSORBENT CASES These polyethylene cases protect your delicate product better than metal or fiberglass cases (and far cheaper). Shock-damping outer shell first absorbs some impact energy then foam absorbs even more. Result: your product suffers fewer g's. Airtight and water proof. Meet military/airline/ASTM specs. Unbelievable prices. 64 sizes. Also custom — send dwgs. Thermodyne International Ltd 12600 Yukon Ave, Hawthorne, CA 90250 (213) 679-0411.

SHOCK-ABSORBENT CASES 206



MULTI-TURN ABSOLUTE ENCODER ± 1 part in 100,000 system accuracy — Electro-Magnetic Transducer +5 digit LED Display + BCD, Binary, and DC output — 10, 64 or 100 turns — adjustable scale factor (0 to 999,999) — Hi noise immunity — zero offset — unambiguous crossovers. Units less than \$995.00/axis. Send for Free Catalog & Application Notes. Computer Conversions Corporation, East Northport, N.Y. 11731 — (516) 261-3300

MULTI-TURN ABSOLUTE ENCODERS 201



VARIAC® AUTOTRANSFORMERS There are hundreds of Variac continuously adjustable autotransformer models for smooth control of ac voltage to regulate light, heat, power, current, motion and speed. Metered, ganged, motor-driven, remote-controlled, high frequency single and three-phase models with optional overload protection, ball-bearings and microswitches. Ask us about your special application requirements. GenRad, 300 Baker Ave., Concord, MA 01742, 617-369-8770.

GENRAD 204



NEW '78-'79 GOLD BOOK OFFERED AT 25% PRE-PUBLICATION DISCOUNT. Upcoming set will contain more than 2,500 pages of information for quickly locating and specifying products used by the electronics industry. Complete with Product, Trade Name, Manufacturers, Distributors Directories and Catalog Compendium. Published in July. Reserve your copy NOW at Pre-Publication Rate of \$22.50 US, Canada and Mexico (Regularly \$30) or \$30 in all other countries (Regularly \$40).

THE GOLD BOOK 207

Electronic Design

recruitment and classified ads

PLACE YOUR AD AT ONLY \$55 PER COLUMN INCH IN

Electronic Design

YOU REACH ENGINEERS WITH TITLES LIKE THESE:

- Chief Engineer • Development Engineer • Design Engineer • Project Engineer • Electronic Engineer • Engineer-Supervisor • Section Leader • Staff Engineer • Systems Engineer • Test Engineer • Standards Engineer • Master Engineer

Total Qualified and Paid 98,260

Electronic Design RECRUITMENT ADVERTISING RATES

15% commission to recognized agencies supplying offset film negatives. 2% 10 days, net 30 days. Four column makeup. Column width 1-3/4" x 10"

SPACE	DIMENSIONS		COST
	Wide	Deep	
One column inch	1-3/4" x 1"		\$55.
2 col. in	1-3/4" x 2"		\$110.
1/16 page (1/4 col.)	1-3/4" x 2-1/2"		\$137.
1/8 page (1/2 col.)	1-3/4" x 5"		\$275.
1/4 page (1 col.)	1-3/4" x 10" Vert.		\$550.
	3-1/2" x 5" Hor.		
1/2 page (2 cols.)	3-1/2" x 10" Vert.		\$1100.
	7" x 5" Hor.		
3/4 page (3 cols.)	5-1/4" x 10"		\$1650.
1 page	7" x 10"		\$2200.

LATE CLOSING DATES

Electronic Design is mailed every two weeks. Because of its timeliness, personnel recruitment advertising closes only two weeks before each issue's mailing date.

Issue Date	Recruitment Closing Date	Mailing Date
June 21	May 26	June 9
July 5	June 9	June 23
July 19	June 23	July 7
Aug. 2	July 7	July 21
Aug. 16	July 21	Aug. 4



HOW TO PLACE YOUR AD

CALL THE RECRUITMENT HOT LINE 201-843-0550 TELECOPIER EXT. 212

Camera-ready film (right reading negatives, emulsion side down) or camera-ready mechanicals must be received by deadline. Or, if you wish us to set your ad (typesetting is free) simply pick up the phone and call our RECRUITMENT HOT LINE — (201) 843-0550. Ask for:

Constance McKinley
RECRUITMENT ADVERTISING MANAGER
ELECTRONIC DESIGN

50 Essex Street, Rochelle Park, New Jersey 07662

Engineer

ELECTRICAL ENGINEERS

At CRAY RESEARCH INC., we design, build, market and support Super Scale Computers used in scientific applications.

We currently have an outstanding opportunity for Electrical Engineers with a computer background. We are seeking one candidate with MOS experience and a BSEE or equivalent experience. His responsibilities will be for test of MOS Memory System from component level to system level. Other candidates we are seeking will have primary responsibility for check out of Cray 1 and related equipment.

Preferred candidates have a BSEE or equivalent experience. These positions offer excellent growth opportunities, salary and company benefits. Send a resume and salary history in complete confidence to:

Don Hable
CRAY RESEARCH INC.
Highway 178 North
Chippewa Falls, WI 54729

An Equal Opportunity Employer

CRAY
RESEARCH, INC.

ELECTRONIC ENGINEERS

Join our talented group of special test engineers in ENSCO's Engineering Test and Analysis Division. ETA is a rapidly expanding division currently involved in designing, conducting and analyzing tests for the Rail Transportation Industry. New emphasis on Energy Efficient Rail Transportation has greatly increased the demand for our testing services. As a result we have immediate openings for Electrical Engineers with 2-5 years experience in the following areas:

- Interface Design for Analog and Digital Transducers
- Real-time Digital Data Acquisition and Field Testing
- Data Multiplexing
- Environmental Packaging

BSEE desirable but not essential. Salary is highly competitive and commensurate with experience, with a benefit package that is one of the best in the industry. We are a people oriented company and we strive to promote from within.

Please send resume in confidence or call the Personnel Dept. at (703) 321-9000 for further details.

ENSCO, INC.

5408-A Port Royal Road
Springfield, Virginia 22151

An Equal Opportunity Employer M F



Come join me at Hughes and be part of the new world of electronics.

It's a good feeling to be in the vanguard of technology with employment stability through dynamic growth and diversification!

For Immediate Openings In:

Circuit Design Engineers

Experienced in RF, IF, Video, and A/D circuit design for use in Signal Processing in both airborne and space applications.

Digital Logic Design Engineers

Experienced in design and development of digital circuits using TTL, STTL, ECL and CMOS technologies.

Software Development Engineers

Experienced in the development of software for special purpose digital processors. Digital hardware background experience desired.

Product Design Engineers

Experienced in extremely high density physical and thermal designs for airborne and spaceborne signal processing.

Project Engineers

Experienced in the management of all aspects of a project including management of subcontracts and remote manufacturing facilities.

Digital Module Test Engineer

Experienced in developing software for automatically testing digital modules.

Digital Associate Engineer (Non MTS)

Having good rapport with digital logic design, logic schematics and the conversion of these to a computerized interconnect data base.

Call now—*call collect*: Richard Fachtmann, Assistant Manager, Signal Processing Laboratory, (213) 391-0711, Ext. 3904. Or send resume (referencing this ad) to: Professional Employment C, Aerospace Groups, 11940 W. Jefferson Blvd., Culver City, Ca 90230.

HUGHES

HUGHES AIRCRAFT COMPANY
AEROSPACE GROUPS

U.S. citizenship required. Equal opportunity M/F/H/C employer

Actual Hughes Scientific and Engineering Manpower Growth Curve
This chart indicates the Company's extraordinary record of growth with stability in the dynamic electronic technology industry.

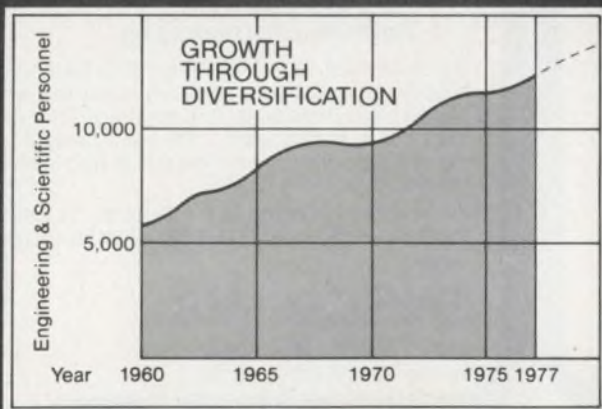

ENGINEERS

RCA Consumer Electronics

... is interviewing for Engineering positions requiring experience in one or more of the disciplines listed below. Successful candidates will work on TV and other products or related systems planned for the consumer market.

- TV SYSTEMS
- POWER & DEFLECTION
- SIGNAL PROCESSING
- TUNER DESIGN
- REMOTE CONTROL
- DIGITAL SYSTEMS
- MICROPROCESSOR APPLICATIONS
- IC DESIGN — LINEAR AND DIGITAL
(Consumer Products)
- AUTOMATION TECHNIQUES
- MECHANICAL DESIGN —
Electronic Products
- MANUFACTURING SYSTEMS
& PROCESSES

Openings are all degree levels. Competitive salaries and benefits.

Send resume to: Professional Employment,
M.S. 6-207, RCA Corporation, 600 N. Sherman
Drive, Indianapolis, IN 46201

RCA

We are an equal opportunity employer F/M

Big ads equal big savings

The regular or ROP rate for Electronic Design's full page black and white unit is 23% greater than the special rate for recruitment advertising. By using a full page, advertisers get important positioning, frequent domination of the spread —and significant cash savings. Small-space classified display ads are a bargain, too, but nothing can match full pages for full impact.

CSC ENGINEERING PROFESSIONALS

Outstanding Career Opportunities At Kennedy Space Center

The Applied Technology Division of Computer Sciences Corporation is expanding its staff at the Kennedy Space Center to create additional engineering opportunities for the following individuals (BSEE preferred for all positions):

OPERATIONS OR SYSTEMS ENGINEERS LAUNCH OPERATIONS PERSONNEL

DIGITAL AND COMPUTER SYSTEMS ENGINEERS

Entry-level and intermediate positions are also available in the above areas

FIELD ENGINEERS

Career opportunities also exist for field engineers experienced in hands-on preventive and corrective maintenance of Prime 300 computer systems

Applicants must have recent hardware maintenance experience and a working knowledge of Prime 300 architecture and systems software.

Computer Sciences Corporation offers competitive salaries and benefit packages to the above qualified professionals. For further information, please call or send resume to:

Dennis Foldesi
(305) 867-7334

Applied Technology Division
P.O. Box 21127
Kennedy Space Center, Fla. 32815
Major Offices and Facilities
Throughout the World

COMPUTER SCIENCES CORPORATION

An Equal Opportunity Employer

At MOTOROLA, your ability to design for the future is dependent upon the collaboration of talented, innovative professionals. We have positions available for experienced engineers in the following areas:

- MECHANICAL ENGINEERS**
To design/develop tools, fixtures and machines used in the manual and automatic assembly of radios. Requires a BSME with experience in automation and mechanization of small parts assembly.
- QUALITY CONTROL ENGINEERS**
Must be vendor oriented; have knowledge of mechanical measurements and have experience with a wide variety of materials including molded plastics, cast and sheet metals.

MFG. ENGINEERS

ELECTRICAL ENGINEERS
To design and fabricate test fixtures and procedures including development of automatic test programs. BSEE with experience in RF circuits preferred; with successful track record in documentation and test cost reduction.

We've moved into our new Major Mobile Communications Facility here in Ft. Worth. Maximize your potential with a company that values your experience and can offer unparalleled opportunities for professional recognition and career mobility. Reference your resume with salary considerations, or call (COLLECT)

(817) 232-1980
Professional Recruiting Department 132

MOTOROLA INC.
COMMUNICATIONS GROUP
5555 Beach Street, Ft. Worth, Texas 76118



equal employment
opportunity/
affirmative action
employer

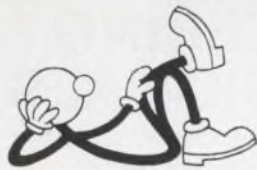

EFFORTLESS ...

If you're ready to move on with your career, it can be a lot easier than you expect.

We are the members of



who work extensively with electronics industry leaders. The companies we service have many openings and pay for us to search you out.

Send your resume to the office nearest you. Then sit back and relax while we do the work.

UNITED PERSONNEL SERVICES, INC.
13612 Midway Road, Suite 100
Dallas, Texas 75240
(214) 387-3750

PETER A. KECHIK & ASSOCIATES, INC.
1420 Renaissance Drive
Park Ridge, Illinois 60068
(312) 298-1148

ANDERSON-TAYLOR
P.O. Box 21
Exton, Pennsylvania 19341
(215) 363-1600

CAREER SPECIALISTS, INC.
4600 El Camino Real, Suite 206
Los Altos, California 94022
(415) 941-3200

BRENTWOOD PERSONNEL ASSOCIATES
Electronics Division
1280 Route 46
Parsippany, New Jersey 07054
(201) 335-8700

RIKER PERSONNEL
834 Circle Tower
Indianapolis, Indiana 46204
(317) 632-5422

190 associates internationally

ENGINEERS

The Boeing Company in Seattle, Washington, has a variety of challenging career opportunities for experienced engineers on a wide-range of programs.

Enjoy the relaxed life-styles and unspoiled beauty of the Pacific Northwest in the "Nation's Most Liveable City." You won't find a better opportunity to combine career growth with a pleasing environment. We'd like to hear from you if you have a BS degree or higher in engineering or computer science and experience in any of the following areas:

- AUTOMATED TEST INSTRUMENTATION DEVELOPMENT
- COMPUTER AIDED DESIGN
- COMPUTERS AND DISPLAYS DESIGN
- DIGITAL CIRCUIT DESIGN
- ELECTRICAL/ELECTRONIC TEST
- ELECTRONIC MATERIALS AND PROCESSES
- ELECTRONIC PACKAGING DESIGN
- ELECTRONIC PARTS EVALUATION
- FLIGHT/MISSION/SYSTEMS TEST
- GUIDANCE AND CONTROL ANALYSIS
- NONDESTRUCTIVE EVALUATION
- OPERATIONAL SOFTWARE DEVELOPMENT
- SOFTWARE/COMPUTING SYSTEM DESIGN AND ANALYSIS
- SOFTWARE/COMPUTING SYSTEM TEST AND EVALUATION
- SOFTWARE QUALITY ASSURANCE
- TEST SYSTEMS SOFTWARE DEVELOPMENT
- TEST PROGRAM PLANNING
- SYSTEMS DESIGN ANALYSIS
- SYSTEMS REQUIREMENTS DEFINITION
- WIRING AND CONTROL DESIGN

Candidates must be U.S. citizens. Selected candidates will be offered an attractive salary, comprehensive fringe benefits package, and relocation allowances.

Send your résumé to The Boeing Company, P.O. Box 3707-LML, Seattle, WA 98124.

An equal opportunity employer.

BOEING
Getting people together

Engineers

WE ARE SEEKING ENGINEERS WHO ARE SPECIAL

HUTCHINSON INDUSTRIAL CORP., a well established manufacturer of peripheral equipment components, located in a clean air setting just an hour from Minneapolis, is currently seeking to build for the future with:

MECHANICAL DESIGN ENGINEER: This highly visible position offers an excellent opportunity for advancement. The successful candidate will hold responsibilities for the development and improvement of mechanisms and light machinery. In addition, must be able to work as an independent project engineer. An appropriate education includes a MSME degree.

ELECTRICAL ENGINEER: BSEE with educational background or experience in electromechanical interfacing instrumentation, control systems and automatic test equipment. Wide variety of challenging project responsibilities.

For immediate consideration submit comprehensive resume including salary history in confidence to:

Verne Meyer
HUTCHINSON INDUSTRIAL CORP.
40 West Highland Park
Hutchinson, MN 55350
An Equal Opportunity Employer



We already know your next employer.

May we introduce you?

Wallach Associates, Inc., specializes in bringing together talented, experienced professionals and the nation's leading research, service and technical corporations.

Just one call to Wallach puts you in touch with a wide range of exceptional companies. Companies that offer top salaries, top benefits . . . as well as interview and relocation expenses. All at NO COST TO YOU.

- Minicomputers
- Microprocessors
- Software development
- Signal processing
- Digital systems
- Command & Control
- Radar Systems
- Communication Systems
- EW/SIGINT/ELINT
- Microwave Systems
- Electromagnetics
- Fire Control Systems

If you find your area of expertise listed above, call TODAY! And even if you don't see your technical specialty here, contact us anyway. Chances are we're also looking for people with your qualifications.

Contact Robert Beach, V.P. We'll put you in touch with your next employer . . . fast! Representing equal opportunity employers nationwide (agency).

WALLACH
Your career connection

WALLACH
associates, inc.

1010 Rockville Pike
P.O. Box 2148
Rockville, Maryland 20852
(301) 762-1100

CAREER OPPORTUNITIES AT RANCO

Microprocessor Applications Engineer.

Our advanced product design group is now offering an exciting and challenging opportunity to pioneer new product applications for the controls industry. BSCIS/BSEE (MS preferred) with three plus years experience in microprocessor systems design required. Prefer background in the controls or related industry with intimate knowledge of semi-conductor manufacturers.

Project Engineer-Electronics.

BSEE/BSME with five to seven years experience in monolithic power semi-conductor packaging and high volume hybrid micro-applications. Knowledge of current state-of-the-art and technology trends required.

Send resume and salary history to:

Mr. R. E. Goolsby
Ranco Controls Division
601 West Fifth Avenue
Columbus, OH 43201



An equal opportunity employer

Mesur-Matic Electronics Corp., a problem solver in the field of incremental motion and a manufacturer of digital stepping motors and control systems is expanding its staff. We have an outstanding position available.

ELECTRONIC ENGINEER

We require that rare combination of outstanding technical and managerial competence. Initially you will be responsible for design and documentation, follow-through to successful production, and interface with marketing.

If you are:

Experienced as an engineer in current electro-mechanical and electronic technologies, particularly in micro-processors, especially as related to control.

Innovative in engineering concepts--proven in a "hands on" engineering/management environment.

A well organized professional, profit orientated, with potential for advanced management responsibilities in the near future.

We are:

Prepared to create the position; offer the challenge; and provide a financial package, [including equity participation], commensurate with the abilities of the right person.

Please send resume including salary and work history in the strictest confidence:

MESUR-MATIC ELECTRONICS CORP.

50 Grove St.
Salem, MA 01970

(617) 745-7000

ELECTRONIC TECHNICIAN (in St. Louis)

Growing electronic manufacturer has immediate opening for Senior Electronic Technician with at least 5 years bench experience for prototype development, service and repair of audio and linear circuitry, and qualification and testing of electronic products. Drafting and PC layout experience also preferred.

**Box 11JMC
c/o Hayden Publishing Co.
50 Essex Street
Rochelle Park, NJ 07662**

OPTICAL/MECHANICAL DESIGNER

Senior Engineer capable of optical instrument design with emphasis on packaging design and testing of flight instrument. Experience in I.R. spectrometers and operation at temperatures of 100°K desirable.

SENIOR SYSTEM AND DESIGN ENGINEER

Senior Engineer capable of electronic system design, analysis, and detailed circuit design. Must have experience in digital circuits and micro processors. Experience in design of circuits in temperatures of 100°K desirable.

Send resume to:
**Professional Employment
DEPT. 754**

JET PROPULSION LABORATORY

California Institute
of Technology
4800 Oak Grove Drive
Pasadena, CA 91103

An Equal Opportunity Employer

SUPERVISOR ELECTRONICS MANUFACTURING (in St. Louis)

Old established company has super growth position in a new division. Responsibilities include hiring, training, supervising, troubleshooting and a multitude of hands-on types of activities. If you have 3 or more years experience in this field including supervision then send resume and salary history to:

**Box 11MAC
c/o Hayden Publishing Co.
50 Essex Street
Rochelle Park, NJ 07662**

ENGINEERS

Advanced Technological Opportunities In Large-Scale Digital Computer Systems

Control Data Corporation's Computer Development Division is now in the process of forming a design team for the development of new, large-scale digital computer systems. These teams will be utilizing advanced technologies such as sub-nanosecond custom LSI arrays and state-of-the-art packaging techniques and fourth generation architecture.

Positions require a minimum of a BSEE and at least 3 years of experience in large CPU design such as logic design, custom LSI array design, block level simulation, gate level simulation, array placement and interconnect, and/or, detailed timing simulation.

These positions offer excellent incomes commensurate with experience, a generous benefits program and outstanding opportunities for both professional achievement and personal growth. In addition, we can also provide you and your family with an excellent lifestyle in the Minneapolis Area.

FOR FURTHER INFORMATION CALL ONE OF OUR ENGINEERING MANAGERS — COLLECT:

Terry Kirsch
(612) 482-2296

Jim Stockard
(612) 482-3088

Or send resume to:

Sue A. Summerfield

CONTROL DATA CORPORATION

4201 Lexington Avenue North
St. Paul, Minnesota 55112

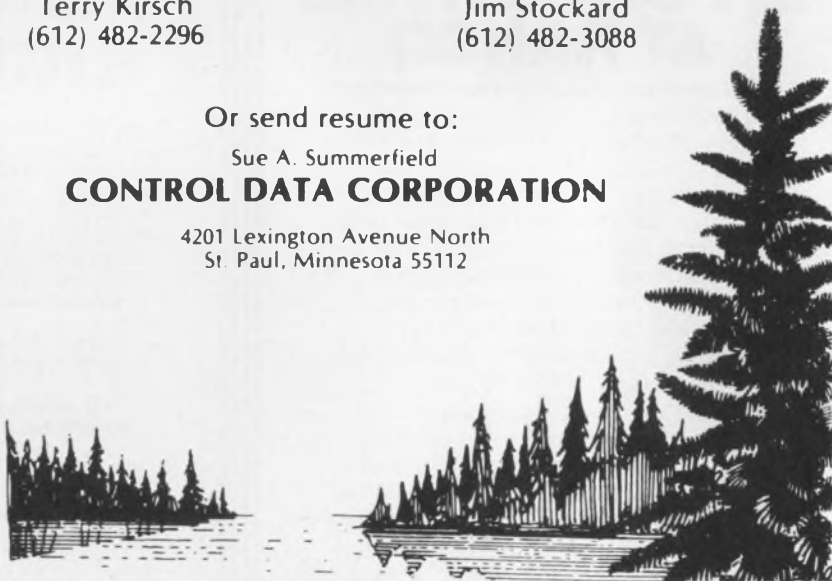

**GD CONTROL DATA
CORPORATION**

An Affirmative Action Employer M/F

**KEEP ELECTRONIC DESIGN'S
GOLD BOOK HANDY
WHEN YOU CALL**

SEMICONDUCTOR ENGINEERS

Everybody knows that NCR means Computers and Terminals. But, everybody doesn't know that NCR has a Microelectronics Division. Our division of NCR is responsible for designing and developing the unique custom devices used in most NCR systems. We do this because we can do it. We know what LSI is all about; we know how to achieve reliability, and we know what "yield" means.

We developed our own microcomputer chip set that contains electrically alterable ROM's, non-volatile RAM's, SDLC Communications, and direct memory access. And, it operates in a multi-processor environment.

We do all this because we have a competent technical staff, advanced equipment in a modern facility and the backing of a \$2-billion-a-year corporation.

Now we are growing—to do even more. To do this, though, we must add to our staff. We need

- **Design Engineers:** BSEE (MSEE preferred) with 2-3 years experience in digital circuit design including computer aided design.
- **Test Engineers:** BSEE (MSEE preferred) experienced with microprocessors and computer based test systems.
- **MOS Process Engineer:** BS (MS preferred) in Engineering Physics or EE, plus experience in P and N channel. A sound understanding of solid state semiconductor physics for process and device analysis is required for this manufacturing position.
- **QA Engineer:** BSEE plus experience in MOS/LSI technology, innovative and thoroughly grounded in advanced QA techniques and digital circuit design. This is not an ordinary QA responsibility; it requires development skills and experience.

Take the time to explore your career. And spread the word—NCR means complete systems ... and Microelectronics.

Reply in confidence to:

**T. F. Wade, Manager
Personnel Resources
Microelectronics Division
NCR Corporation
8181 Byers Road
Miamisburg, Ohio 45342**



An Equal Opportunity Employer

Electrical Engineer

Experienced in system design, closed loop servo systems and stabilized multi-axis gimbals. Applications will be in TV, IR and Laser. Must be capable of assuming complete design responsibility and work with a minimum of supervision.

We offer a full benefit program that includes a unique incentive program. Please send resume, in confidence, to Susan Maguire.



Electro-Optical Division

**KOLLMORGEN
CORPORATION**

347 King Street, Northampton, MA 01060

An Equal Opportunity Employer

MINI/MICRO SOFTWARE/FIRMWARE

Outstanding positions available for software and firmware engineers with mini/micro applications and design experience. To participate in development of unique turnkey databased systems. High potential individuals needed for profitable rapidly expanding organization.

Bruck's Personnel, Inc., 2541 Monroe Ave.
Rochester, N.Y. 14610 • 716-442-5400

Southern Openings

PICK YOUR STATE AND POSITION. Critical needs exist in FL, GA, AL, MS, LA, TX, NC, SC, KY, & TN. We have 192 affiliates in the U.S. to help. Confidential and no fees.

LANDRUM PERSONNEL ASSOCIATES
P.O. Box 1373, Pensacola, FL 32596, 904/434-2321

Recruitment Ads Pull

DIGITAL DESIGN ENGINEERS

Two or more years experience in performing design, development, implementation, testing, and modification for digital and Communications System and related equipment. B.S. or the equivalent in Engineering, Physics, Mathematics or related sciences.

RELIABILITY ENGINEER

Candidate must have a BS degree or equivalent experience in electrical engineering or math/physics with extensive course work in digital electronics. Graduate work in systems analysis, math statistics, or operations research desirable. Also desired is 3 to 5 years work experience involving reliability maintainability analysis of large scale ground support electronic systems. This challenging position will involve support to a creative and cooperative engineering department in developing ground based command and control systems for the Shuttle Program. Work will include failure mode effects analysis, maintenance analysis, system modeling, and reliability prediction all leading to the optimization of equipment and system design. Ample opportunity for creative contribution to design in the areas of redundancy, fault detection and isolation, error correction, and maintainability.

ELECTRONIC TECHNICIANS

We have immediate openings for Electronic Technicians to work in the NASA JSC Mission Control Center for the upcoming Space Shuttle Orbital Flight Testing. Applicants must have at least 1 of the following qualifications:

- Maintenance experience on inside plant communications equipment, instrumentation recorders, or pneumatic delivery systems
- Maintenance experience on minicomputers and associated peripherals
- An Associate Degree in electronic technology or military service electronics school graduate with some practical maintenance experience.

These are excellent opportunities to work in the beautiful Clear Lake area. Ford Aerospace provides excellent benefits such as medical and dental insurance, stock investment plan, etc. Interested applicants should send resume in confidence to Mr. John C. Brown at:



**Ford Aerospace &
Communications Corporation
Space Information Systems Operation
Post Office Box 58487 Houston, Texas 77058
equal opportunity employer m/f**

Advertiser's index

Advertiser	page	Advertiser	page	Advertiser	page
AMP, Incorporated.....	166,167	General Electric Company.....	14,15	Rucal Danna.....	86
Abbott Transistor Laboratories, Inc.....	153	General Instrument Corporation, Microelectronics Division.....	16,17-40	Rental Electronics, Inc.....	138G
Addmaster Corporation.....	220	Germanium Power Devices Corp.....	185	Reticon.....	203
Advertising Council.....	181,219	Gould, Inc., Electronic Components Div.....	138B	Rockwell International.....	139
Advanced Electronic Design.....	217	Guildline Instruments, Inc.....	138J	Rogers Corporation.....	220,222
Advanced Micro Devices.....	4,5	Gulton Industries, Inc.....	202	Rolm Corporation.....	46
Alco Electronic Products, Inc.....	210				
Allen Bradley Co.....	138H	Hayden Publishing Company, Inc.....	41,180,189*,193*,218	Sanyo.....	87
Analytical Systems.....	206	Hewlett-Packard.....	67-74	*Schoeller & Co.....	192
Augat, Inc.....	79	Hoffman Engineering Company.....	216	Seiko Instruments.....	222
Automation Systems Inc.....	138	Hycom.....	220	Semiconductor Circuits, Inc.....	169
				*Sfermice.....	188
Ballantine Laboratories, Inc.....	77	IBM General Systems Division... 51,52,53		Siemens Corporation.....	138I
Beckman Instruments, Inc. Helipot Division.....	138A	IMC Magnetics Corporation.....	202	Sinclair Radionics, Inc.....	197
Belden Corporation.....	168	Intel Corporation.....	8,9	Slaughter Co.....	216
Bodine Electric Company.....	215	International Microsystems.....	215	Spectronics, Incorporated.....	211
Boker's Inc.....	217	Intersil.....	57	Sprague Electric Company.....	80
Bourns, Inc., Trimpot Products Division.....	Cover II	Iwata Electric Co., Ltd.....	222	Stanton, Division Wyco Metal Products.....	214
*Burr-Brown Research Corporation.....	15			Stanford Applied Engineering, Inc.....	177
Burroughs Corporation.....	191	Janco Corporation.....	7	Star Micronics.....	215
		Johanson Manufacturing Corp.....	78	Sylvania Miniature Lighting Products, Inc.....	59
CTS Corporation.....	103,187	Kager.....	182	Synertek.....	63
CTS Knights, Inc.....	214	Kulka Electric Corp.....	206	Syntronic Instruments, Inc.....	143
California Eastern Laboratories, Inc.....	170A-170V			Systems Engineering.....	110,111
Citizen America Corporation.....	217	Licon, Division of Illinois Tool Works, Inc.....	138L	TDK Electronics.....	193
Computer Conversions Corp.....	222	Litronix, Inc.....	149	TEC, Incorporated.....	205
Computer Labs, Inc.....	184	Littelfuse.....	138F	TRW Capacitors, an Electronic Components Division of TRW, Inc.....	55
Control & Information Systems.....				TRW Cinch Connectors, an Electronic Components Division of TRW, Inc.....	221
Cutler-Hammer, Specialty Products Division.....	138C	3M Company.....	138K,210	TRW/IRC Capability.....	221
		Merrimac Industries, Incorporated.....	114	Tecknit.....	199
Data General Corporation.....	42,43	Meppco/Electra, Inc.....	48	Tektronix, Inc.....	83
Data Translation, Inc.....	209	Metrotex.....	222	Texas Instruments, Incorporated.....	147
Datel Systems, Inc.....	158,159,161	Methode Electronics, Inc.....	220	Thermodyne International, Ltd.....	222
Dialight, A North American Philips Company.....	84	Micro Computer Rentals.....	200	Turner Division, Conrac Corporation.....	216
Digi-Data Corporation.....	47	Micro Power Systems.....	173		
Digital Equipment Corporation.....	174,175	Microswitch, A Division of Honeywell.....	132,133	United Systems Corporation.....	178
Digital Laboratories.....	221	Miller Co., Inc., W.A.....	220	Unitrode Corporation.....	109
Dormeyer Industries, Inc.....	221	Miller-Stephenson Chemical Co., The.....	172		
Dow Corning Corporation.....	138D, 138E	Minelco Division/General Time Corp.....	196	Varo, Semiconductor, Inc.....	164
		Mini-Circuits Laboratory, A Division of Scientific Components Corp.....	2		
*EMI Technology, Inc.....	14,15	Monsanto Company.....	119	Wavetek Indiana Incorporated.....	1
EMM Electronic Memories, Commercial Memory Products.....	183	Mostek Corporation.....	10,11,127	Wiltron Company.....	186
EMM Semi, A Division of Electronic Memories & Magnetics Corporation.....	115	Motorola Semiconductor Products, Inc.....	145,163,208,212		
Eagle-Picher Industries, Inc.....	160	MuRata Corporation of America.....	180		
Electronic Development Corp.....	220			Yardney Electric Corporation.....	170
Electronic Measurements, Inc.....	6	OK Machine and Tool.....	157		
Electronic Navigation Industries.....	213	Olympic Sales Company, Inc.....	208	Zero Manufacturing Co.....	165
Energy Electronic Products.....	220				
Essex Group Magnetics.....	189	PRD Electronics, Inc.....	221		
Etri Inc.....	195	P.T.S. Communications.....	198		
		Panasonic Electronic Components.....	Cover III		
Facit-Addo, Inc.....	179	Pioneer Magnetic Corporation.....	75	Boeing.....	226
Fairchild Semiconductor, A Division of Fairchild Camera and Instrument Corporation.....	12,13	Plessey Optoelectronics.....	192	Computer Sciences Corp.....	225
Fairchild Semiconductor, Components Group.....	120,121	Potter & Blumfield, Division of AMF, Incorporated.....	44,45	Control Data Corp.....	228
Fairchild Systems Technology, A Division of Fairchild Camera and Instrument Corporation.....	150,151	Power/Mate Corp.....	154,222	Cray Research, Inc.....	223
FASCO Industries.....	171	Power Tech, Inc.....	207	Enso, Inc.....	223
Ferranti Electric, Inc.....	189	Precision Monolithics, Incorporated... 201		Ford Aerospace & Communications Corp.....	229
Fifth Dimension, Inc.....	176	Q-Matic.....	221	Hughes.....	224
Figaro Engineering, Inc.....	221			Hutchinson Industrial Corp.....	227
		RAF Electronic Hardware.....	220	Mesur-Matic Electronics Corp.....	227
Gates Energy Products, Inc.....	102	RCA Solid State Division.....	Cover IV	Motorola, Inc.....	225
GenRad.....	221,222	REI.....	221	NCR Corp.....	229
				RCA.....	225
				Ransco Controls Division.....	227
				Wallach Associates, Inc.....	227

RECRUITMENT

Boeing.....	226
Computer Sciences Corp.....	225
Control Data Corp.....	228
Cray Research, Inc.....	223
Enso, Inc.....	223
Ford Aerospace & Communications Corp.....	229
Hughes.....	224
Hutchinson Industrial Corp.....	227
Mesur-Matic Electronics Corp.....	227
Motorola, Inc.....	225
NCR Corp.....	229
RCA.....	225
Ransco Controls Division.....	227
Wallach Associates, Inc.....	227

*Advertisers in International Edition

Tighter and Tougher.

Tighter tolerances at tough-to-beat prices.

Now you can have metallized polyester capacitors with tighter tolerances, *without* paying higher prices. At Panasonic, we offer you $\pm 10\%$ tolerances for what you'd expect to pay for metallized polyester capacitors with $\pm 20\%$ tolerances. And that's just another example of the Panasonic Plus.

Tougher leads.

Our specs call for our leads to withstand 2.2 lbs. of steady pull applied radially to the lead wire for 5 seconds. That's really tough. And we back up our specs with a special offer: send back any Panasonic Type ECQ-E (Z) metallized polyester capacitor that loses a lead in normal manufacturing, and we'll replace it with two units free of charge.

Tighter lead times.

Our popular 250VDC capacitors are available for immediate, off-the-shelf shipment in OEM quantities. And our 100, 400, 630, and 1,000VDC units are available almost as quickly, with normal factory lead time.

For free samples and a catalog of Panasonic metallized polyester capacitors, write: Panasonic Electronic Components, One Panasonic Way, Secaucus, N.J. 07094. Or call (201) 348-7268.

Electrical Specifications

Rated Voltage: 100V.D.C., 250V.D.C., 400V.D.C., 630V.D.C., 1,000V.D.C. **Capacitance Tolerance:** $\pm 10\%$ (K), $\pm 20\%$ (M). **Insulation Resistance:** Less than $0.33\mu\text{F} \geq 9,000\text{M}\Omega$; $0.33\mu\text{F}$, or more $\geq 3,000\text{M}\Omega/\mu\text{F}$. **Dissipation Factor:** $\leq 1.0\%$ at 1kHz. **Withstanding Voltage:** Rated Voltage X1.5 (1 min.) **Operating Temperature:** $-25^\circ\text{C} \sim +85^\circ\text{C}$.

The
Panasonic Plus—
metallized polyester
capacitors...
 $\pm 10\%$ tolerances at
 $\pm 20\%$ prices.

Part No.	Capacitance $\pm 10\%$ (K) Rated (μF)	Part No.	Capacitance $\pm 10\%$ (K) Rated (μF)
ECQ-E2473(K)ZS	0.047	ECQ-E2394(K)ZS	0.39
ECQ-E2563(K)ZS	0.056	ECQ-E2474(K)ZS	0.47
ECQ-E2683(K)ZS	0.068	ECQ-E2564(K)ZS	0.56
ECQ-E2823(K)ZS	0.082	ECQ-E2684(K)ZS	0.68
ECQ-E2104(K)ZS	0.10	ECQ-E2824(K)ZS	0.82
ECQ-E2124(K)ZS	0.12	ECQ-E2105(K)ZS	1.0
ECQ-E2154(K)ZS	0.15	ECQ-E2125(K)ZS	1.2
ECQ-E2184(K)ZS	0.18	ECQ-E2155(K)ZS	1.5
ECQ-E2224(K)ZS	0.22	ECQ-E2185(K)ZS	1.8
ECQ-E2274(K)ZS	0.27	ECQ-E2225(K)ZS	2.2
ECQ-E2334(K)ZS	0.33		

Panasonic
just slightly ahead of our time

RCA first in CMOS.

The go-everywhere μ P now has a do-everything design aid.

Now you can quickly and economically prove out the RCA 1800...our cost-effective, environmentally rugged, CMOS microprocessor.

Our new COSMAC Micromonitor CDP18S030 is a complete portable μ P system diagnostic tool. The best tool, in fact, to perform breadboard debugging and factory checkouts and field tests without additional diagnostic equipment.

The Micromonitor can take instructions electronically, supply hardcopy or CRT display through your terminal, and

become more powerful via our COSMAC Development system with floppy disk.

Prototype debugging. Simply plug the CPU of your system under test into the Micromonitor. You now have control of both hardware interfaces and program execution. You can plug memory into the Micromonitor to emulate ROM. Using the keyboard and display, you can start/stop, examine any portion of the system, and make changes.

Unique automated testing. The Micromonitor can be used with any of its configurations to provide the factory test system you require.

Field service. Its self-contained package is designed to be carried easily to any place RCA 1800 microprocessor systems are in operation.

Operation software. An optional Micromonitor Operating System (MOPS) CDP18S831 gives you an extended set of commands. MOPS, on the COSMAC Development System with floppy disk option, helps the Micromonitor do everything from simple terminal-Micromonitor dialog to fully automated system testing.

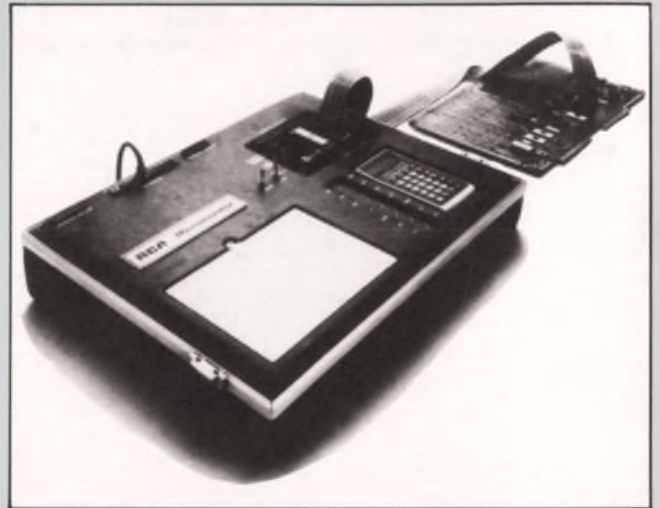

RCA Solid State, Box 3200
Somerville, NJ 08876

Tell me more about why the Micromonitor is one more reason to go RCA 1800. My microprocessor application is:

Name _____

Title _____

Company _____

Address _____

CIRCLE NUMBER 117

RCA 1800. Our systems are go.

RCA