

# Electronic Design 23

VOL. 24 NO.

FOR ENGINEERS AND ENGINEERING MANAGERS

NOV. 8, 1976

**The fastest storage scope** opens new doors in combined real-time and stored measurements. Writing speed soars to 2500 cm/ $\mu$ s, with a bandwidth of 400 MHz.

With four independent plug-ins, you can capture a fast pulse, then perform a spectral analysis. Work in variable persistence or bistable modes, too. See p. 79.

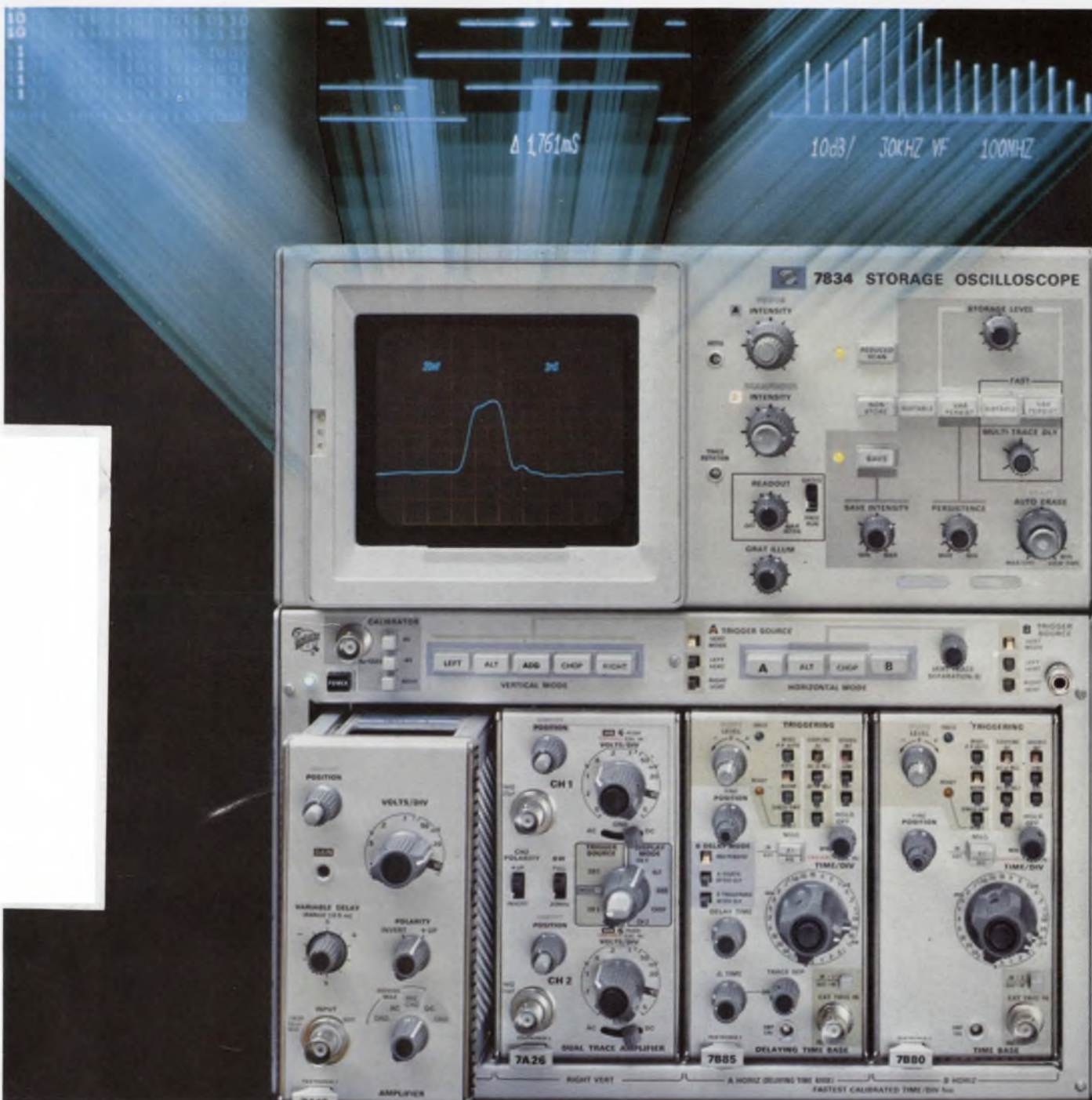



**FEEL**  
the pot . . .

**CLICK**  
the switch . . .

**GANG**  
the modules . . .

and add "quality-touch" appeal to your product.

**FEEL THE POT . . .** a smooth, quality feel, only from Bourns® 81/82 Model Potentiometers. Rotational torque range, only .3 to 2.0 oz. inch, is consistent for one, two, three or four cup assemblies.

Independent linearity of  $\pm 5\%$  and low 1% CRV provide exceptional setability in both cermet and conductive plastic element types.

**CLICK THE SWITCH\*** . . . one that really clicks, with positive action detent at either CW or CCW end. The Bourns Model 85/86 potentiometer/switch combination is rated at 2 amps in DPST style and 1 amp in DPDT. Contacts are constructed of fine silver with gold overlay. This provides exceptionally low contact resistance, for reliable operation at low level analog or logic signal levels — or any application requiring an "on-off" function.

**GANG THE MODULES . . .** potentiometers and switches. Up to 4 modules can be ganged on the same single or dual concentric shaft, without sacrifice to the satin-smooth feel or the sure-fire click. Other options include a wide choice of bushing and shaft styles, P.C. pins or solder lugs. Think of the possibilities! Now you can specify custom pots and switches assembled from "off-the-shelf" modules — at standard cost and leadtime.

Add "quality-touch" appeal to your equipment with BOURNS Model 80 Family of Modular Potentiometer/Switches. Write or call today for complete technical information, direct or through your Bourns distributor.

**FEEL, CLICK, GANG . . . BEAUTIFUL!**

**TRIMPOT PRODUCTS DIVISION, BOURNS, INC.,** 1200 Columbia Avenue, Riverside, California 92507, Telephone (714) 781-5122 — TWX 910 332-1252.

\*Patent pending



Int'l Sales Offices: European Hdqtrs. — Switzerland, 042/23 22 42 • Belgium 02/218 2005 • France 01/2039633 • Germany 0711/24 29 36  
• Italy 02/32 56 88 • Netherlands 070/88 93 18 • United Kingdom 01/572 6531 • Japan 075 92 1121 • Australia 86 9410 • Brazil 257-3535

# SURPRISE!



## The World's First Rectangular LED Lamps

For the first time LEDs are offered in a rectangular epoxy package. Available in high-efficiency red, yellow and green, they feature a flat, high intensity, light emitting surface.

And, since they're end or side stackable, they're ideal for flush mounted panel indicators, backlighting legends, and linear arrays. Plus you get long life and solid state reliability. And they're in stock right now. Choose our 5082-4570 for yellow, the 5082-4670 for high efficiency red, or the 5082-4970 for green. Priced at \$1.00\* in quantities of 1000. \*U.S. Domestic prices only

In the U.S., contact Hall-Mark, Schweber, Wilshire or the Wyle Distribution Group (Liberty-Elmar) for immediate delivery.  
In Canada, contact Schweber Electronics or Zentronics, Ltd.

**HEWLETT**  **PACKARD**

Sales and service from 172 offices in 65 countries.  
1507 Page Mill Road Palo Alto, California 94304

# TO-5 RELAY UPDATE:

## Solve your energy crisis with TO-5 relays

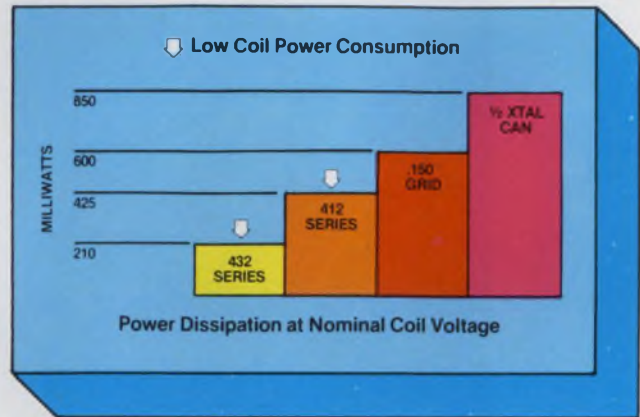

Subminiaturization and pc board compatibility — two obvious advantages of Teledyne TO-5 relays. But there's another outstanding advantage: low coil power consumption. This feature is best illustrated in the above graph which shows our TO-5 relay power savings compared to other miniature relays. The Teledyne 412 Series dissipates about 30% less power than the .150" grid relay, and 50% less than the 1/2 crystal can. Our sensitive 432 Series is 65% less than the .150" grid. And 75% less than the 1/2 crystal can.

This means you can save over 6 watts in a typical system using, let's say, ten TO-5 relays. In the end, you gain significant advantages in terms of thermal and power supply considerations that can help prevent an "energy crisis" in your system.

Our complete line of TO-5 relays includes military and commercial/industrial types, with virtually all military versions qualified to established reliability MIL specs. For complete data, contact Teledyne Relays — the people who pioneered the TO-5 relay.

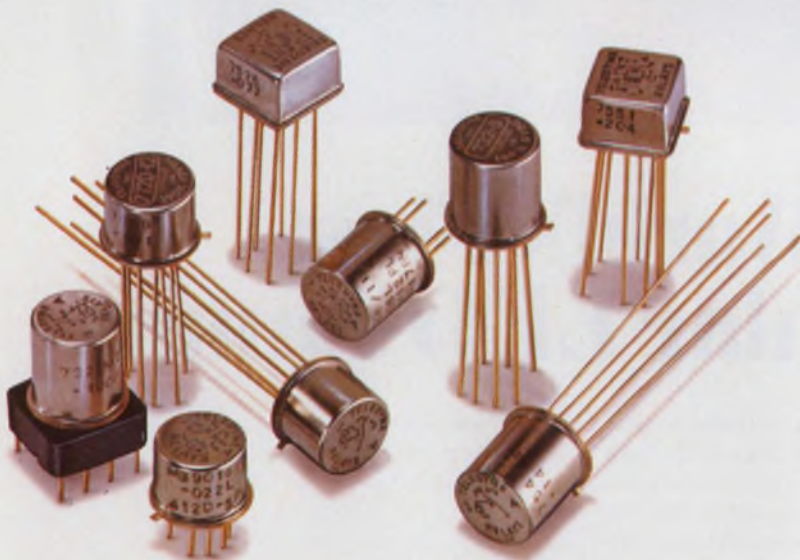

- **Hybrid "T" Series**  
SPDT & DPDT types with internal transistor driver and suppression diode
- **"D" and "DD" Series**  
Military and commercial/industrial versions with internal suppression and steering diodes
- **Maglatch Series**  
SPDT, DPDT, and 4PST magnetic latching types
- **Centigrad® Series**  
World's smallest relay — only .225" (5.72mm) high x .370" (9.40mm) square
- **Hi-Rel Series**  
Screened versions for space flight applications (NASA qualified)
- **High Environment Series**  
Hi-temperature, Hi-shock, and Hi-vibration types

 **TELEDYNE RELAYS**

3155 West El Segundo Boulevard, Hawthorne, California 90250  
Telephone (213) 973-4545

CIRCLE NUMBER 3

ELECTRONIC DESIGN 23, November 8, 1976

## NEWS

- 15 **News Scope**
  - 20 **Electron-beam IC technology** goes commercial in 1977.
  - 22 **Microcomputer control** of a pinball machine makes troubleshooting simple.
  - 24 **A two-chip MOS calculator** and clock-timer reduce pilot's in-flight workload.
  - 26 **Round one** goes to Control Data in airborne-computer competition.
  - 31 **Washington Report**
- 

## TECHNOLOGY

- 35 **MICROPROCESSOR DESIGN**
  - 40 **Focus on adhesives and coatings:** Specifying these materials is tougher than for most components. Read these tips on the best way to cut through the hazy spec data.
  - 50 **Consider the 6100 CMOS microprocessor** when an 8-bit  $\mu$ P can't deliver desired performance. The 12-bit word length and available software can ease system design.
  - 60 **Use conductive elastomers** to simplify switch design and to make high-density connections from PC boards to LED displays, ICs and to other boards.
  - 68 **A 'simplified' notch-filter design?** When you see a published application circuit that looks useful, beware! It might not work as well as you wish.
  - 72 **Ideas for Design:**
    - Inexpensive triggered-sweep generator updates recurring-sweep scopes.
    - Interface CMOS to TTL with diodes and save the cost of expensive buffers.
    - Remotely control a pocket calculator with a simple CMOS interface circuit.
- 

## PRODUCTS

- 78 **Instrumentation:** Scope combines fast storage and real-time operation.
  - 82 Power Sources
  - 84 Components
  - 87 Packaging & Materials
  - 90 Integrated Circuits
  - 93 Data Processing
  - 98 Discrete Semiconductors
  - 100 Modules & Subassemblies
- 

## DEPARTMENTS

- 39 **Editorial:** The general and the lady
- 7 Across the Desk
- 104 New Literature
- 110 Advertisers' Index
- 112 Product Index
- 112 Information Retrieval Card

**Cover:** Photo by Kolsky-Rose Studios, courtesy of Tektronix, Beaverton, OR.

---

# Our Complementary While Everyone

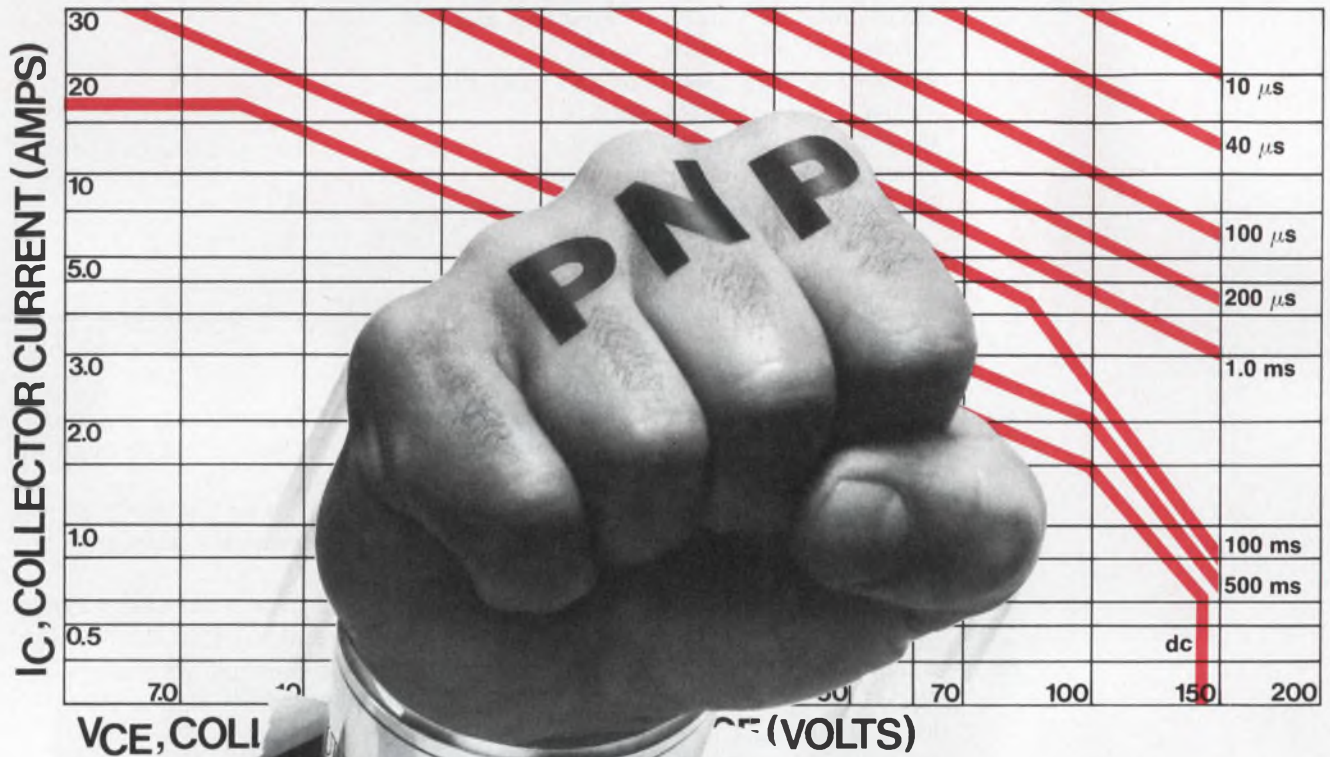

## 2N6609 \$2.59

The '6609 is the first **TRULY IDENTICAL** performance/price complement to the industry-standard '3773

2N6609  
\$2.59

2N3773  
\$2.59

MJ15002  
\$2.45  
MJ15004  
\$3.20

The first new product family specifically designed for high power audio... I<sub>c</sub> of 1 A (MJ15003/4) or 0.5 A (MJ15001/2) at 100 V.

MJ15001  
\$2.45  
MJ15003  
\$3.20

2N6594  
65¢

A complementary pairing for cost-effective, 2N3055 replacement.

2N6569  
65¢

MJ11011  
\$4.10  
MJ11013  
\$4.60  
MJ11015  
\$5.25

The first Darlington complements with... 1,000 min gain at 20 A... 60 to 120 V V<sub>CEO</sub>... 30 A!

MJ11012  
\$4.10  
MJ11014  
\$4.60  
MJ11016  
\$5.25

All prices 250-999

## Big Power-From Big Power People

# Power Went Big SOA Else's Went Nowhere

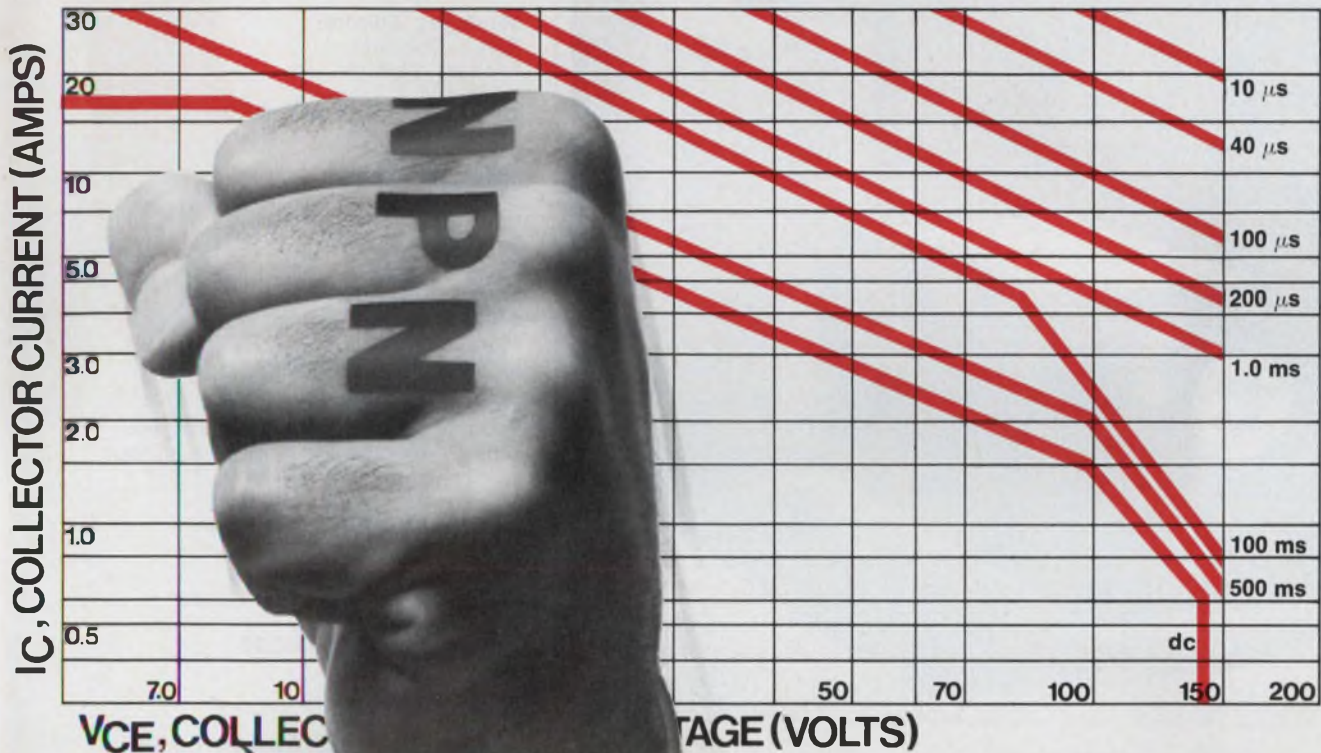

**2N3773 \$2<sup>59</sup>**

Nothing in the world does it better than linear silicon power in making small signals bigger and better.

And nothing in the world does that better than new Motorola linear complements for 50 W and bigger jobs in motor controls, disc drives, audio amps and regulators.

Because nobody in the world expands state-of-the-silicon power art like us.

Do things better than ever — simplify circuits with direct-coupled complementary symmetry... realize higher frequency stability... accomplish low-distortion design... achieve high efficiency and reliable performance economically.

Do it with the ruggedest complementary SOA's around.

Do it with your choice of the finest NPN or PNP devices in the business... **discretes** or **Darlington's**.

Do it with equal performance at equal price!

Do it with Motorola linear silicon power. Because we're bigger in it than anyone else.

Socket!



**MOTOROLA Semiconductors**

Motorola Semiconductor Products, Inc., Box 20912, Phoenix, AZ 85036

CIRCLE NUMBER 4



# A SMART WAY TO BEAT YOUR POWER SUPPLY SIZE PROBLEM

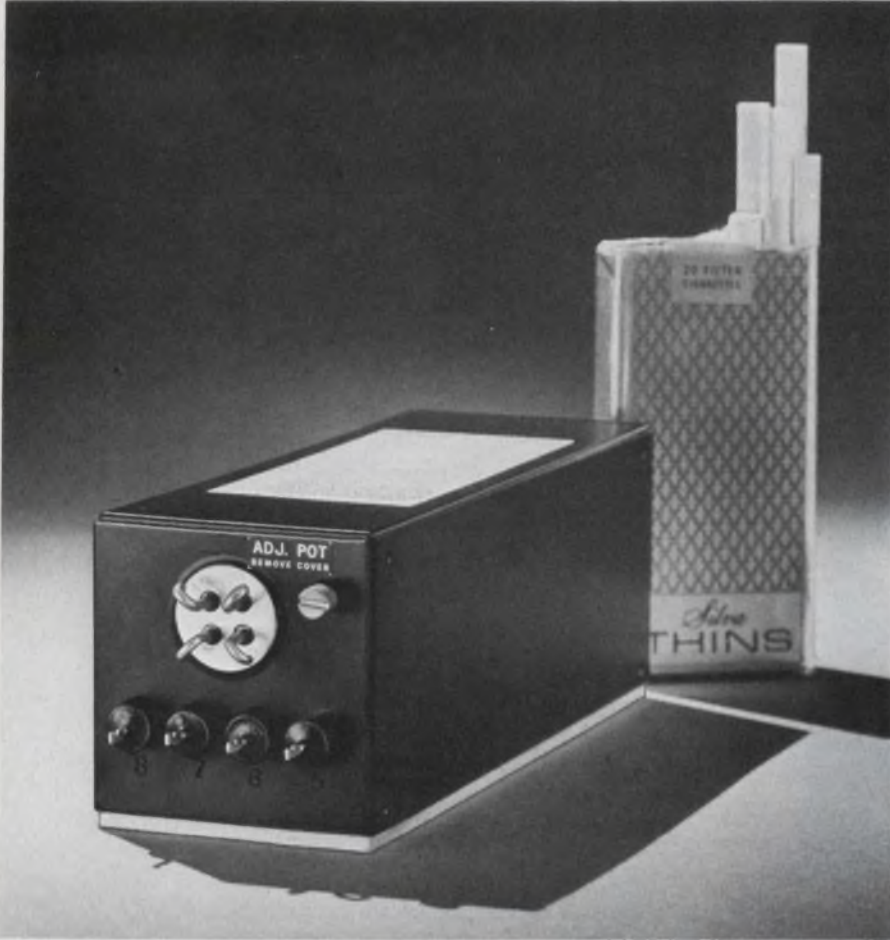

**2 1/2" thin, 2 3/8" narrow, 6 1/4" short**

yet this converter produces 50 watts of regulated DC power from an input of 20-32 VDC! It weighs less than 2 pounds. This is only one of our wide variety of many small lightweight converters, inverters and power supplies—there are over 3500 models listed in our newest catalog, including size, weight, and prices. If you have a size problem, why not send for an Abbott catalog?

**MIL SPEC ENVIRONMENT** — All of the hermetically sealed power modules listed in our new catalog have been designed to meet the severe environmental conditions required by modern aerospace and military systems, including MIL-STD-810C. They are hermetically sealed and encapsulated in heavy steel containers. New high performance units meet MIL-

STD-461A for conducted and radiated electromagnetic interference.

**RELIABLE** — Highest quality components are used in Abbott power modules to yield high MTBF's (mean time between failure) as calculated in MIL-HDBK-217. Typical power modules have over 100,000 hours MTBF — proving that the quality was built in from the beginning.

**WIDE RANGE OF OUTPUTS** — Any voltage from 5 volts DC to 740 VDC is available by selecting the correct model you need from our catalog with any of a variety of inputs including:

60  $\sim$  to DC  
400  $\sim$  to DC  
DC to DC  
DC to 400  $\sim$   
DC to 60  $\sim$

Please see pages 1836-1848 of your 1976-77 EEM (ELECTRONIC ENGINEERS MASTER Catalog) or pages 676-682 Volume 2 of your 1976-77 GOLD BOOK for information on Abbott Modules.

**Send for our new 60 page FREE catalog.**

**abbott transistor**  
LABORATORIES, INCORPORATED

GENERAL OFFICES  
5200 W. Jefferson Blvd.  
Los Angeles, CA 90016  
(213) 936-8185  
Telex 69-1398

EASTERN OFFICES  
1224 Anderson Ave.  
Fort Lee, NJ 07024  
(201) 224-6900  
Telex 13-5332

CIRCLE NUMBER 5

**Sr. Vice President, Publisher**  
Peter Coley

## Editors

Editorial Offices  
50 Essex St.  
Rochelle Park, NJ 07662  
(201) 843-0550  
TWX: 710-990-5071  
Cable: Haydenpubs Rochellepark

**Editor-in-Chief** George Rostky

**Managing Editors:**  
Ralph Dobriner  
Michael Elphick

**Senior Associate Editor**  
Stanley Runyon

**Associate Editors:**  
Sid Adlerstein  
Dave Bursky  
Samuel Derman  
Jules H. Gilder  
Morris Grossman  
John F. Mason  
Max Schindler  
Michael Shunfenthal

**Contributing Editors:**  
Peter N. Budzilovich, John Kessler  
Alberto Socolovsky, Nathan Sussman

## Editorial Field Offices

### East

Jim McDermott, Eastern Editor  
P.O. Box 272  
Easthampton, MA 01027  
(413) 527-3632

### West

Dick Hackmeister, Western Editor  
8939 S. Sepulveda Blvd., Suite 510  
Los Angeles, CA 90045  
(213) 641-6544  
TWX: 1-910-328-7240

## Editorial Production

Marjorie A. Duffy, Production Editor  
James Keane, Copy Editor

## Art

**Art Director,** William Kelly  
Richard Luce, Anthony J. Fischetto

## Production

**Manager,** Dollie S. Viebig  
Helen De Polo, Anne Molfetas

## Circulation

**Director,** Barbara Freundlich  
Trish Edelmann

## Information Retrieval

Paula Greenleaf

## Advertising Promotion

Susan G. Apolant



# Across the Desk

## Yes, gallant reader, there is a TI library

Allyn T. Gallant (Across the Desk, ED No. 18, September 1, 1976) may have misunderstood Texas Instruments regarding its plans for a library service for users of the SR-52 programmable calculator. Until recently, information regarding PPX-52 was not available for public release.

The Professional Program Exchange for the SR-52 (PPX-52) is now operating and accepting members and programs. With hundreds of programs in dozens of professional categories available, chances are PPX-52 members will find many of their problems already solved. And more programs are being received each day.

For an annual fee of \$15, a PPX-52 member will receive the first PPX-52 Program Catalog and frequent updates, three *free* programs of his choice, and a subscription to the PPX-52 EXCHANGE (a bimonthly newsletter). Members can order additional programs from the catalog for only \$3.00, and will also be able to order optional SR-52 libraries (including the three new ones: Aviation, Navigation, Surveying) as well as accessories and supplies through PPX-52.

*Stav Prodromou  
Manager-Applications*

Texas Instruments Inc.  
P.O. Box 5012  
Dallas, TX 75222

## Contributors live on

Inventors, like great painters or musicians, it seems, are seldom appreciated during their life spans. But when "the chips are down,"

few are forgotten.

Those who *would* forget the great contributions to society by outstanding individuals like Anthony Lamb (see ED No. 15, July 19, 1976, p. 7) pass on like grains of sand, whereas the contributors stand out boldly like gold dust—if not today, then tomorrow or some time thereafter.

I for one salute Mr. Lamb for his contribution to a society who "can't see the forest for the trees."

*Gill Hammond*

Gates Learjet, Inc.  
Mid-continent Airport  
P.O. Box 1280  
Wichita, KS 67201

## Misplaced Caption Dept.



Does a 7474 have 14 pins or 16?

Sorry. That's Jan Vermeer van Delft's "The Artist in his Studio," which hangs in the Kunsthistorisches Museum in Vienna.

*(continued on page 10)*

Electronic Design welcomes the opinions of its readers on the issues raised in the magazine's editorial columns. Address letters to Managing Editor, Electronic Design, 50 Essex St. Rochelle Park, N.J. 07662. Try to keep letters under 200 words. Letters must be signed. Names will be withheld on request.



## OPTRON REFLECTIVE TRANSDUCERS

NEW OPB 704 OFFERS  
MAXIMUM RELIABILITY  
IN A SINGLE  
HERMETIC PACKAGE

OPTRON's new, low cost OPB 704 reflective transducer assures maximum reliability by combining a high efficiency solution grown LED with a silicon phototransistor in a single miniature hermetic package.

The hermetically sealed glass-metal-ceramic package offers extremely high reliability and stable performance at a cost competitive with that of plastic encapsulated devices. And, the OPB 704 has a usable continuous operating life of more than five years when operated at an average LED device current of 20 mA.

The OPB 704's phototransistor senses radiation from the LED only when a reflective object is within its field of view. With an LED input current of 50 mA, the output of the phototransistor is typically 0.5 mA when the unit is positioned 0.100 inch from a 90% reflective surface. With no reflective surface within the phototransistor's field of view, maximum output is 10  $\mu$ A with a LED input of 50 mA and  $V_{CE}$  of 5 volts.

Ideal applications for the OPB 704 reflective transducer include EOT/BOT sensing, mark sensing, detection of edge of paper or cards and proximity detection.

The OPB 704 and other low cost, high reliability OPTRON reflective transducers are immediately available. Custom designed versions for special applications are available on request.

*Detailed information on the OPB 704 reflective transducer and other OPTRON optoelectronic products... chips, discrete components, limit switches, isolators and interrupter assemblies... is available from your nearest OPTRON sales representative or the factory direct.*



OPTRON, INC.

1201 Tappan Circle  
Carrollton, Texas 75006, USA  
TWX-910-860-5958  
214/242-6571

**Finally.**

**A self-locking connector that's  
classified UL 94V-0 for flame resistance  
and UL 498 for 600 volts.**

**And recognizes that people aren't.**

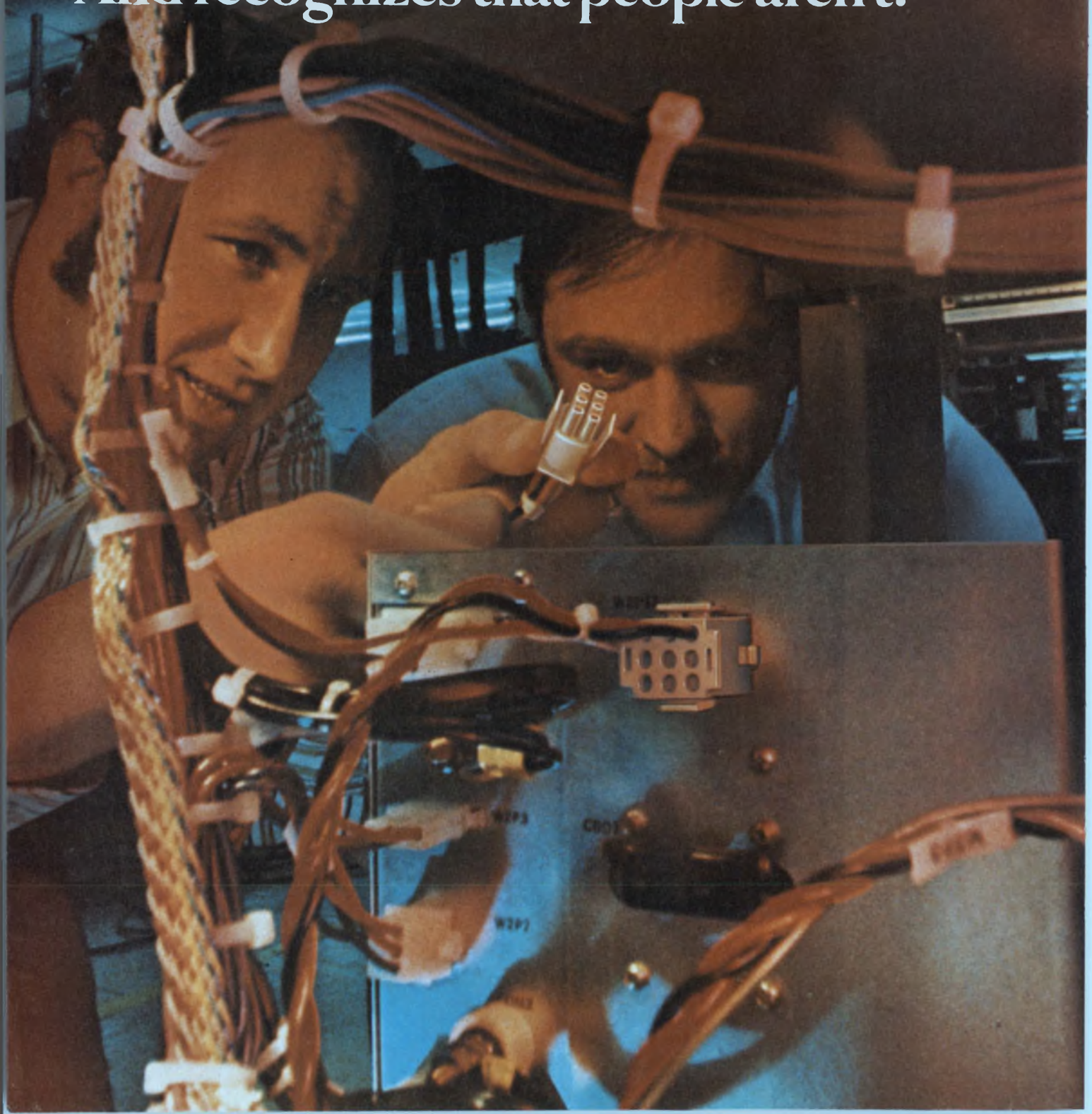



Our flame retardant Universal MATE-N-LOK series can take up to 600 volts with ease.

But people can't.

That's why, along with all the UL, CSA, and VDE/CEE credentials you need for worldwide and flame-retardant use, Universal MATE-N-LOK connectors offer you an exclusive safety feature:

A unique silo-design housing that makes it virtually impossible for you, or anybody else, to touch or mismatch the pins and sockets.

So, in addition to reducing the potential of a fire, you're eliminating the chance of a short—or a shock.

With Universal MATE-N-LOK connectors, you get versatility too. Wire-to-pc board or wire-to-wire. Panel mount or free hanging. Mix pins and sockets in either half, for all types of keying combinations. And no matter how you apply them, Universal MATE-N-LOK connectors are greedy for power—with dual-wire capabilities and other features that let you pack more action into less space.

Of course, Universal MATE-N-LOK connectors, for sophisticated through non-critical applications, are backed by AMP technical service. Not just ordinary service, but the kind that says we'll help you with design problems. Application tooling. Training for your people. And troubleshooting. Just call us.

Find out more about how Universal MATE-N-LOK connectors—and AMP—can help you get more power to your products.

Without getting power to the people who use them.

Call Customer Service at (717) 564-0100, or write:  
AMP Incorporated, Harrisburg, Pa. 17105.

**AMP**  
INCORPORATED

CIRCLE NUMBER 7

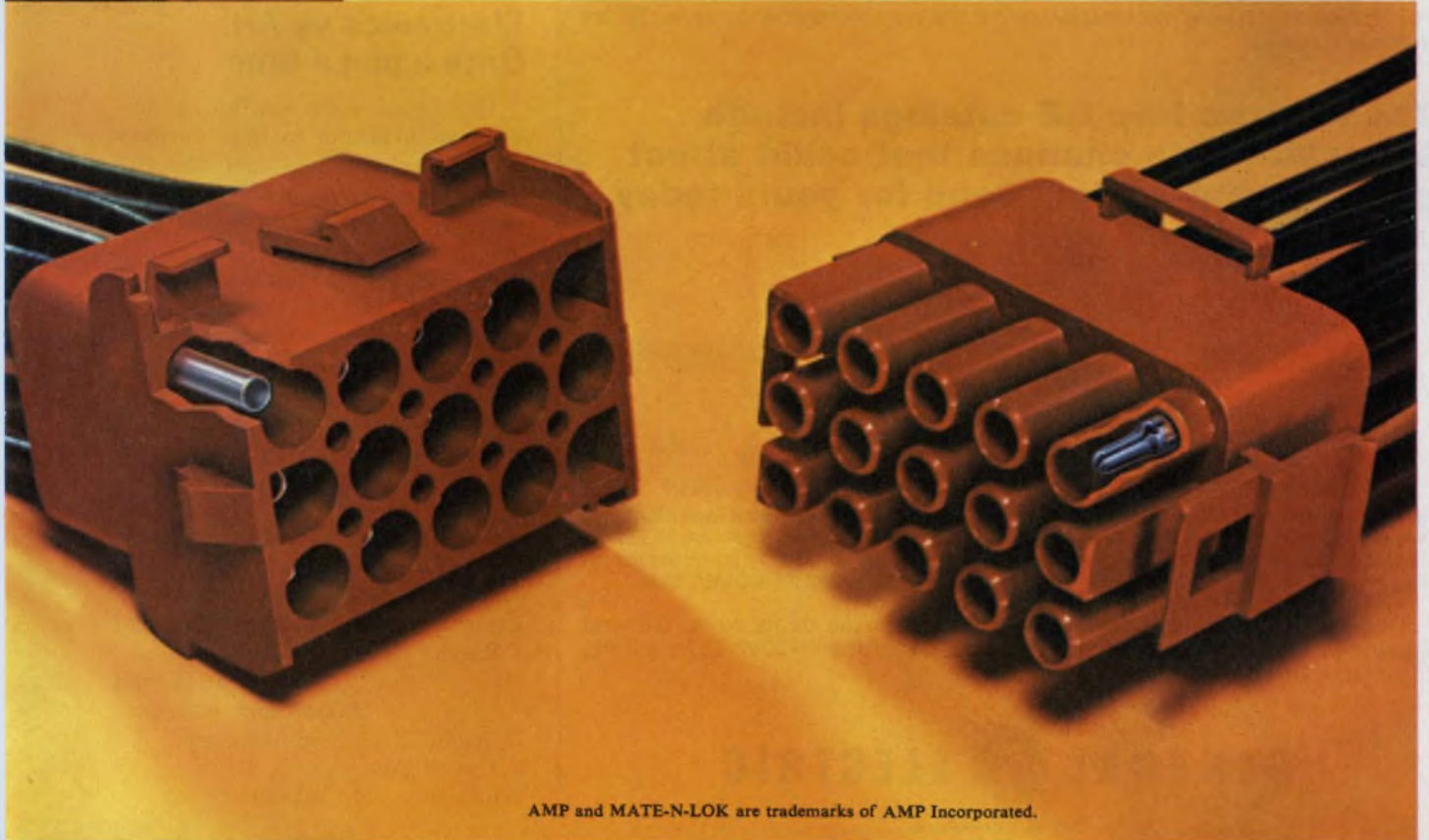

AMP and MATE-N-LOK are trademarks of AMP Incorporated.

# General Electric wedge base lamps can save time, space, money.

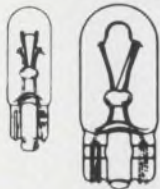

These lamps are ideal for applications such as indicators, markers and general illumination where space is at a premium. Their wedge-based construction makes them easy to insert and remove. They don't require bulky, complicated sockets. And because the filament is always positioned the same in relation to the base, you get consistent illumination from lamp to lamp.

You can choose from over 25 types of GE wedge base lamps. Voltages range from 6.3 V to 28 V. Candlepower from 0.03 to 12 cd. Bulb sizes range from subminiature at 6mm to a heavy-duty bulb at 15mm.

To send for updated wedge base lamp technical information, circle number below or write GE for Bulletin #3-5259.

## Check these 6 halogen cycle lamps GE has added to its low-voltage line.

General Electric now offers over 27 halogen cycle lamps that pack high light output in small packages. (In addition, GE offers 8 sealed beam halogen lamps primarily for aircraft applications.) Bulb diameters range from  $\frac{3}{8}$ " to  $\frac{1}{2}$ ". Lengths from .520" to 2.25". Voltages from 3.5 to 28. O.V. And candlepower from 2.15 cd up to 250 cd.

They're ideal for you if you're designing applications such as optical systems, instrumentation, illuminators, fiber optics, card readers, displays and aircraft navigation. A variety of terminals are offered.

For updated technical information circle the number below or write GE for Bulletin #3-5357.



## These three free GE catalogs include important data changes that could affect your present design. Send for yours today.



#3-5169

June '75 Miniature lamp catalog features 40 pages and 500 data changes for complete 500-lamp line.



#3-6252R1

Feb. '75 Sub-miniature lamp catalog features 24 pages and 91 changes for more than 210 lamps.



#3-6254R

Dec. '74 Glow Lamp catalog features 8 pages and 50 changes for 83 Glow Lamp Indicator and Circuit Component lamps.

For up-to-date technical information on any of these items write: General Electric Company, Miniature Lamp Products Department #3382-L, Nela Park, Cleveland, Ohio 44112.

GENERAL  ELECTRIC

CIRCLE NUMBER 8

## ACROSS THE DESK

### Military or otherwise— look for a PC standard

Bill Walkup's statement (ED No. 16, August 2, 1976, p. 43) that there is no preferred-card (PC) standard—military or otherwise—or any progress toward a standard is wrong. MIL-STD-454E, "General Requirements for Electronic Equipment," calls out a matrix of 20 preferred card sizes, under requirement 17.

To develop a standard of PC board sizes, I suggest that anyone so inclined begin with a metric format for two reasons. First, the rise in popularity of the Euro-card has made equipment manufactured around this board size more attractive in recent years to the European market, and this should not be ignored by U.S. exporters. Second, since we will be converting to the metric system in this country, we should develop a standard which won't have to be changed within the next several years.

*Bryan West  
Sales Manager*

Electronics Inc.  
171 Bridge Rd.  
Hauppauge, NY 11787

### Electronics vs Art: Once a pun a time . . .

I've found your continuing program of bringing to light formerly obscure art depicting the life of the engineering profession to be very enlightening. It's occurred to me that the lost subtitle for the "Last Supper" probably reads something like, "On the occasion of your fortieth birthday, I would like to present you with this gold watch."

Painting isn't the only art that's concerned itself with electronics. As far back as 1741, the great chorus, "Let Us Break Their Bonds Asunder," was written to honor the untiring efforts of the semiconductor-reliability specialists. Even in the 18th century, they had a Handel on the problem.

*John A. Carroll  
Electronics Engineer*

Dynamic Measurements Corp.  
5 Lowell Ave.  
Winchester, MA 01890

# NATIONAL ANTHEM



A Review of New Products and Literature from

National Semiconductor • No. 4

## A drove of (peripheral) drivers

National's interface products include a variety of circuits to solve peripheral drive problems of all kinds. For example, if you need a high voltage (30 V), high current (300 mA), high speed (25 ns) driver with TTL inputs, then try our DS75450 series. These dual peripheral drivers have AND, NAND, OR, and NOR input configurations, and work nicely as power drivers, relay and lamp drivers, bus and memory drivers, etc.

Or, if you can sacrifice high speed for low cost, look into our DS75460 series of dual peripheral drivers. These circuits are functionally interchangeable with the DS75450 described above, but are rated at 65 ns, and are designed for



applications that require a higher breakdown voltage (35 V).

If you've had latch-up problems and would like to broaden your system's operating margins, then our DS3611 series is for you: 300-mA sink capability; 80-V breakdown; and no latch-up even at 55 V. The circuits are functionally interchangeable with the DS75451 through DS75454.

## Low-Cost Development System for SC/MP Microprocessor

The SC/MP Low-Cost Development System (LCDS) is a simple-to-use controller that provides a maximum of flexibility at a minimum—and very affordable—cost. It has everything needed to develop and test SC/MP hardware and software designs for your applications.

LCDS features easy interfacing and expansion. Four prewired edge connectors, for example, provide a plug-in interface for SC/MP family cards, and also let you interconnect additional SC/MP applications hardware. (There's room for a fifth connector, too, if you wish to add it.) You can also add a flat cable connector for coupling the LCDS to an external card cage.

Built-in control and monitor functions permit transfer of control between the LCDS resident firmware—subroutines that let you enter software debug commands via the control and

display panel, or an optional Teletype®—and your own application programs.

Expansion is easy, too, because of the cards offered for use with the LCDS. The 2K × 8 read/write memory and 4K × 8 ROM/PROM cards, for example, provide additional memory: just plug them into the card bus.

The minimum LCDS comprises a SC/MP CPU card, scratchpad memory, ROM-based firmware, and control logic. Also included are a 16-key dual-function hexadecimal keyboard, all necessary function keys and control switches, and a six-digit hexadecimal display.

With the basic LCDS configuration alone, you can examine and alter the SC/MP registers and memory locations, run SC/MP programs in continuous or single instruction mode, and even operate with an optional Teletype using SC/MP DEBUG. 

## N8080 family rounds out National's microprocessor line

National's line of microprocessors is now the broadest in the industry: to the ranks of our bit-slice IMP, 16-bit PACE, 8-bit SC/MP and 4-bit FIPS, we have added our new N8080 family. Well suited to the broad spectrum of general purpose microprocessor applications, the 8-bit INS8080A CPU fits neatly between our cost-effective 8-bit SC/MP and the versatile 16-bit PACE CPUs.

The INS8080A CPU, with its full line of support circuitry, offers you a family

approach to system design, multiple source availability, and total product support from National—RAMS, ROMS, PROMS, I/O components, and a wide variety of linear and digital interface circuits.

In addition, we are backing our N8080 family with a full range of development tools, both hardware and software, for quick and easy assembly of basic design kits and implementation of development systems. 

How about driving power from CMOS? Our DS3631 family of dual peripheral drivers does it, sinking 300 mA and withstanding 56 V at the outputs. Other features include CMOS-compatible pnp inputs; low  $V_{CC}$  dissipation; output circuit protection against  $V_{CC}$  loss; and operation between 4.75 V and 15 V. Pin-outs are identical to those of the DS75451, DS75461, and DS3611 series.

Finally, there are our telephone relay drivers—the DS3686 and DS3687. Both are duals rated at 65 V and 300 mA. The DS3686 is a positive-voltage driver; the DS3687, negative. (See *National Anthem* No. 2, March 1976.)

You'll find complete information and specifications for these and many other products in our 464-page *Interface Data Book* (\$4.00). 

## Bi-FET™ 741 Op Amp:

low input-bias current,  
low input-noise current,  
high input impedance

The LF13741 op amp is a Bi-FET™ version of the popular 741 circuit. But the use of our Bi-FET technology lets us place JFET input followers ahead of the bipolar stages, which results in very low input bias and noise currents—50 pA and 0.01 pA/√Hz, respectively (typ.)—and a very high input impedance of  $5 \times 10^{11} \Omega$ . The slew rate is 0.5 V/μs, and GBW is 1 MHz.

This drop-in replacement for the 741 gives you that circuit's general operating characteristics, but you'll find that the LF13741 is easier to apply and will save you money if you've been using external, discrete JFETs with a 741 to get better input characteristics.

The LF13741 excels in those applications that require a low input-current moderate-speed amplifier or comparator such as transducer amplifiers, photocell circuitry, buffers in sample-and-hold systems, long-interval timers, and low-drift peak detectors. 

## Durawatt™ RF line for CB rigs



Specifically designed for a citizens band transmitter line-up, these eight Durawatt™ and Durawatt 92-Plus™ power transistors offer a unique combination of special processing, power capability, and package types.

For example, the complete family of pre-drivers, drivers, and output types is interrelated through tuned roll-off processing, which rejects spurious responses and provides for optimum performance.

In addition, all family members have dissipation ratings that meet worst-

The accompanying tables present a summary of National's wide range of semiconductor memory products. They show at a glance whether or not we supply a given memory type, its organization(s), and its production status.

The letters in the tables represent memory organizations, as shown in the legend below the tables. Letters without asterisks show memories that are in volume production. The asterisks indicate products yet to enter production, although some of these are already in the sampling phase.

A letter with an asterisk preceded by the same letter without an asterisk indicates that another version of the same device is to be put into production. The second version may differ from the first in speed, pin-out, number of leads, etc. Keep in mind, too, that a single letter entry in the tables may represent a number of product types differing, again, in speed, pin-out, number of leads, etc.

In addition to the memory products shown in the tables, National supplies shift registers, PLAS, character generators, code converters, etc. Full information and specifications for our complete line of memory products will be found in our *Memory Data Book* (\$3.00); for information on asterisked products, contact your local National representative. 

case conditions: infinite vswr at rated output power. Under worst-case conditions, when a 4-W a-m rig loses its antenna the output stage must withstand 30-W dissipation; the driver, 4 W; and the pre-driver, 0.8 W. Our transistors are designed to take such punishment and are rated at such levels; the output devices, in particular, are the strongest you can buy.

Finally, the family members are available in a variety of package types to meet your performance needs in an economic way. Our two pre-driver types, for instance, are a TO-92 NCBT13 and a Durawatt 92-Plus NCBX14; the three drivers include a TO-126 NCBJ14, a TO-39 NCBS14, and a TO-202 NCBV14; and the three output types are the TO-126 NCBJ35, the TO-39 NCBS35, and the TO-39 NCBW35. 

# Memories at a glance

TOTAL BITS	RAMS			
	MOS (static)	MOS (dynamic)	CMOS	BIPOLAR
64			C	B, C
256	D		D, E	D
1024	G, I, I*		G, G*, I	G*
4096	P*, O*	O, O*		

TOTAL BITS	ROMS	
	MOS	BIPOLAR
256		F
1024	I, J	I
2048	M, N	M, N*
4096	P, P*, Q, Q*	Q
8192	R*, S	S
16,384	U*, V*	V, W

TOTAL BITS	PROMS/EPROMS	
	MOS	BIPOLAR
256		F
1024		I
2048	M, N	M, M*, N
4096	P, Q, Q*	P*, Q, Q*

### Organization Codes

64 bits  
A = 64 x 1  
B = 32 x 2  
C = 16 x 4

256 bits  
D = 256 x 1  
E = 64 x 4  
F = 32 x 8

1024 bits  
G = 1024 x 1  
H = 512 x 2  
I = 256 x 4  
J = 128 x 8

2048 bits  
K = 2048 x 1  
L = 1024 x 2  
M = 512 x 4  
N = 256 x 8

4096 bits  
O = 4096 x 1  
P = 1024 x 4  
Q = 512 x 8

8192 bits  
R = 2048 x 4  
S = 1024 x 8

### 16,384 bits

T = 16,384 x 1  
U = 4096 x 4  
V = 2048 x 8  
W = 1024 x 16

## Control Mode Entry Via Keyboard

Pushbutton entry of control mode is a popular feature of modern instrumentation because it is a convenience to the instrument user and its designer as well. In the application shown here, we use our MM74C922 keyboard encoder to scan and debounce the push-buttons for a mutually exclusive (one mode at a time) control group.

### Keyboard encoders broaden CMOS line

Our MM54C922/MM74C922 (16 key) and MM54C923/MM74C923 (20 key) encoders provide all the logic you need to encode an array of SPST switches. An external capacitor or clock implements the scan, and diodes in the switch array are not needed to eliminate ghost switches.

Features of the new encoders include on-chip row pull-up devices, which allow the use of switches with up to 50-k $\Omega$  ON resistance; two-key rollover between any two switches; internal debounce circuitry that needs only a single external capacitor; on- or off-chip clocking; LPTTL-compatible Tri-State<sup>®</sup> outputs (for easy expansion and bus operation) with a last-key register; and +3 V to +15 V operation.

One feature of the MM74C922 is that it permits the use of inexpensive, form-A contact (N.O. SPST), push-button switches. But in addition, the MM74C922 eliminates the need for a mode storage register because its output retains the last mode entered. If the instrument's mode controller uses a ROM or PLA sequencer, then the MM74C922's output is directly usable as a part of the ROM address, and points to the start address of the selected mode routine.

The MM74C922's data output strobe can reset or initialize the controller to enter the control mode from the top. And if a microprocessor controls the system, then the MM74C922 can scan,

debounce, and encode the mode keys, and also provide an interrupt to the processor to indicate a mode change.

If you wish to display the instrument's mode, connect the MM74C922's output directly to a 1-of-n decoder such as our MM74C42 or MM74C154, which can directly drive LED lamps. But if the mode is to be displayed in a seven-segment format, connect the MM74C922's output to some appropriate driver such as our MM74C48. (Remember to add current-limiting resistors between the MM74C48's output and the seven-segment display.) Both techniques are cost effective approaches to push-button mode entry.

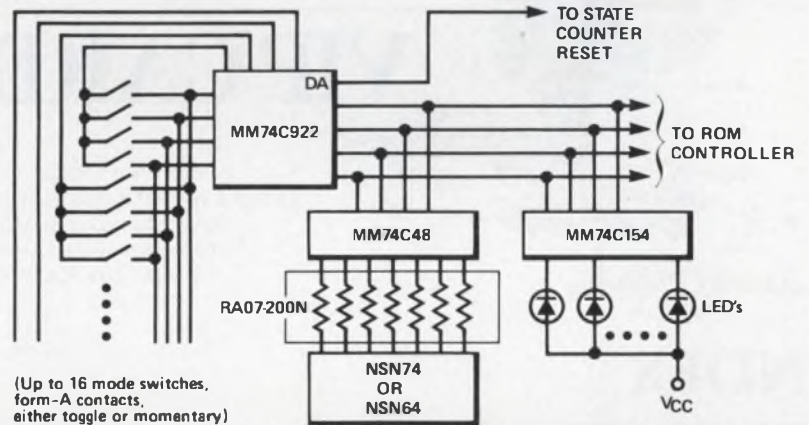

### Dual and Quad Numeric Displays

National's new NSN (dual digit) and NSB (quad digit) series of displays are third-generation designs: the dice are mounted on a PC board and topped with a reflective cavity. Available in 0.3-, 0.5-, and 0.7-inch heights, each end-stackable module mounts the digits with their decimal points, and with or without polarity indication.

Four drive modes are available for the NSN series—common anode or common cathode, either multiplexed or direct. For the NSB series, the drive is common anode or cathode, multiplexed.

You will find the NSN and NSB multi-digit displays cost-effective in a wide variety of applications that includes CB and TV channel indicators, data terminal displays, and instrumentation in general.

### Termination networks for data lines

Our RA24 and RA28 thin-film resistor arrays are designed for use as digital transmission line terminators. The RA24 is a 24-resistor network in a 14-lead, molded Epoxy B DIP; the RA28 is a 28-resistor network in a 16-lead DIP. Other than the resistor count and the number of leads, the two types are identical.

Both feature low inductance (5-ns risetime, typical), excellent tracking (2 ppm/ $^{\circ}$ C typical,  $-55^{\circ}$  to  $+125^{\circ}$ C), and low cost. Resistor matching is to 0.2% typical, and package dissipation is 2 W at  $25^{\circ}$ C.

Two versions—the RA24-3k/6.2kN and RA28-3k/6.2kN—are tailored for programmable instrumentation terminations per IEEE specification 488-1975 for bus-organized peripheral control.

### Single-chip quad analog switches

National's LF13331 and LF13201 series of SPST analog switches are the industry's first single-chip, quad, JFET switches. Our Bi-FET<sup>™</sup> technology makes them possible, and yields performance generally superior to that of CMOS (particularly the ON-resistance and leakage parameters) at lower-than-CMOS prices. In addition, these parts do not exhibit the latch-up problems common to CMOS switches.

Available in various combinations of normally closed and normally open configurations, the switches maintain a constant ON resistance (150  $\Omega$ ) over their analog input range of  $\pm 10$  V, and to 100 kHz. The inputs operate from minimum TTL levels, and feature a break-before-make action. The LF13201 series is pin-compatible with DG201 types.

## New Pressure Transducer Housings are Second Generation Designs

Our new housings for the LX1700 series pressure transducers create small and lightweight, yet rugged, alternatives in pressure transducer packaging. Designated the PX7-1 (a zinc casting) and PX7N-1 (in nylon), these new packages, in combination with the LX1700 transducers, are well suited to applications such as air conditioning and refrigeration compressor control, compressed-air tank monitoring and control, gasoline and diesel

engine diagnostics, 3-15 psig pneumatic measurement and control, etc.

The housings are available in absolute, gauge, and differential (PX7D-1, nylon) configurations for pressure ranges from  $\pm 5$  psi to 0-300 psi. Mechanical features include an internal, captive O-ring seal, and a  $\frac{1}{8}$ " NPT male pressure connector. A 13-inch cable for electrical connection makes testing

easy; the 5-pin connector at the cable end is keyed, locked, and strain relieved. Z



ED-118



## VIP CARD

Complete card and mail to  
**NATIONAL SEMICONDUCTOR**  
 Attn: Marketing Services  
 2900 Semiconductor Drive  
 Santa Clara, CA 95051

## INDEX

Please send me the information that I have checked:

- |                                                               |                                                                |
|---------------------------------------------------------------|----------------------------------------------------------------|
| <input type="checkbox"/> SC/MP LCDS, Pg. A, Col. 2            | <input type="checkbox"/> Durawatt CB RF Line, Pg. B, Col. 1    |
| <input type="checkbox"/> N8080 MPU, Pg. A, Col. 2             | <input type="checkbox"/> MM74C922/923 Encoders, Pg. C, Col. 1  |
| <input type="checkbox"/> DS75450 Perph. Drvrs., Pg. A, Col. 1 | <input type="checkbox"/> Dual/Quad Displays, Pg. C, Col. 1     |
| <input type="checkbox"/> DS75460 Perph. Drvrs., Pg. A, Col. 1 | <input type="checkbox"/> RA24/28 Term. Nets., Pg. C, Col. 2    |
| <input type="checkbox"/> DS3611 Perph. Drvrs., Pg. A, Col. 1  | <input type="checkbox"/> LF13201/331 Switches, Pg. C, Col. 3   |
| <input type="checkbox"/> DS3631 Perph. Drvrs., Pg. A, Col. 1  | <input type="checkbox"/> LX1700/PX7 Transducers, Pg. D, Col. 1 |
| <input type="checkbox"/> DS3686/87 Rly. Drvrs., Pg. A, Col. 1 | <input type="checkbox"/> MM5382/83 Calen. Clks., Pg. D, Col. 3 |
| <input type="checkbox"/> LF13741 Op Amp, Pg. B, Col. 1        |                                                                |

Please send me the literature that I have checked:

- |                                                          |                                                                                      |
|----------------------------------------------------------|--------------------------------------------------------------------------------------|
| <input type="checkbox"/> AN-146 FM Remote Speaker System | <input type="checkbox"/> AN-159 Data Acquisition System Interface to Computers       |
| <input type="checkbox"/> AN-158 CMOS Line Drivers        | <input type="checkbox"/> AN-160 Increasing Throughput for IMP-16 Serial Input/Output |

Your End Product or Application: \_\_\_\_\_

Have Salesman Call  YES  NO

Please print clearly; this information will be used for our mailing list.

NAME \_\_\_\_\_ TITLE \_\_\_\_\_

COMPANY \_\_\_\_\_

ADDRESS \_\_\_\_\_

CITY \_\_\_\_\_ STATE \_\_\_\_\_ ZIP \_\_\_\_\_

## Digital calendar-clock circuits

The MM5382 and MM5383 digital calendar clock circuits provide the timing, control, and interface circuitry for a minimum-cost, solid state, digital clock radio.

The circuits have four display modes: time; alarm; date; and sleep—as well as a four-year calendar display. The timekeeping function operates in either a 12-hour or a 24-hour mode. The MM5382 is the 12-hour version, and has a month-date format; the MM5383 is the 24-hour version, and has a date-month format.

Outputs consist of a presettable 59-minute sleep timer (e.g., a timed radio turn-off) and an alarm tone. A power failure indication warns the user that the time displayed may be in error.

Other features include: alarm display; brightness control; 24-hour alarm set; PM indication; fast and slow set controls; and a nine-minute snooze alarm. (The MM5383 has an alarm on indicator.) Both circuits provide open drain outputs for the direct drive of LED displays to 15 mA. Z



NOVEMBER 8, 1976

## Japan's 2-way CATV uses fiber optic cables

An interactive CATV network using fiber-optic cables will begin demonstration runs in Tokyo on Nov. 15. The network will provide two-way services ranging from request entertainment through computer-assisted instruction, cashless shopping, medical assistance, police and fire protection and remote telemetering.

By 1978 a full-fledged, 300-subscriber system will be installed in the Higashi Ikoma area in a model city near Osaka. Tests will be carried out through 1979. Later, it is hoped, operational systems will be built throughout Japan.

The system is being developed by the Japanese Ministry of International Trade and Industry, with consulting assistance on fiber-optic technology supplied by Arthur D. Little of Cambridge, MA.

With a Panafacom U-400 computer providing the controls, the test subscribers will use a keyboard installed in their homes to obtain a variety of two-way services.

- Special TV programs by request. Via the home keyboard, the subscriber can trigger the computer to activate the video information storage and transmission unit, switching the designated program for automatic transmission.

- Request special data. A variety of specialized information, including news, is transmitted to the subscriber in still-picture form.

- Computer-assisted instruction. Questions and assignments appear on the screen of a multichannel home TV receiver with a built-in memory.

- Cashless transactions. Store and restaurant bills, rent and utility charges are among those that can be paid through the system; deductions are made automatically from the bank account of the subscriber.

- TV shopping and reservations.
- Burglar and fire arms. Detec-

tors installed in each home trigger the computer, which advises the police.

The Panafacom U-400 can address 256,000 bytes of memory; has a data transfer rate of 2 megabits/s; can do single or double precision arithmetic, and has a 16-bit word length.

The 300-subscriber network will consist of three main optical trunk cables, each containing 36 fibers and connecting the head-end to a subcenter. From each subcenter containing a video switch and associated control equipment, there will be up to 14 distribution cables radiating out, each of which can serve 12 subscribers (with 24 fibers per distribution cable). The final subscriber drop will be comprised of a two-fiber cable (one fiber each for upstream and downstream transmission) brought to an optical junction box where it is connected to the distribution cable.

In addition, independent optical fiber cable lines will be laid to local points such as a school, hospital, or town hall, so that service programs may be originated at these points and then transmitted via optical fiber to the head-end for distribution to subscribers, using a "mobile" TV camera.

## SAW devices go into commercial production

The first commercial quantity production of a surface acoustic wave (SAW) device is in progress at Crystal Technology Inc., Mountain View, CA. The device is a SAW output modulation filter which is to be used in color-and-sound video games.

The Model CTI55B filter reduces all intermodulation products of a video signal outside the channel boundaries to less than the 30 dB

required by the FCC.

Another SAW device produced by Crystal Technology is a low insertion loss i-f filter—the CTI 43B—for color TV receivers. This is produced in the laboratory and only prototypes are currently available.

CIRCLE NO. 319

## UV PROM doubles size and adds I/O ports

By introducing an ultraviolet-erasable PROM with twice the storage capacity of anything previously available Intel has leap-frogged the rest of the industry.

In addition to its high density, the new 16-k UV PROM, designated the 8755, also offers several I/O ports on the same chip, a feature not found in any other PROM.

The 8755 is designed for use with the company's third generation microprocessor, the 8085. It provides a 2 k × 8 erasable storage capability and accesses any word in less than 450 ns.

The 8755 is pin-compatible with the company's 8355 mask-programmed ROM and I/O circuit. It runs from a single +5-V supply and is housed in a 40-pin DIP. There are two 8-bit wide I/O ports built into the PROM and ROM chips and those ports are totally programmable—each bit, under software control, can act as an input or output. Also contained on the 8755 are a set of address latches, which are designed specifically to interface to the multiplexed bus structure of the 8085  $\mu$ P.

With the introduction of the 8755, a 2708-compatible UV PROM won't be far behind, said a company spokesman. The 2708 was the largest UV PROM available until now, with a capacity of 1 k × 8 bits.

## Conversion efficiency $\mu$ P for CdS-CuS solar cell

The goal of low-cost solar electricity was brought one step closer to reality last month with the announcement by scientists at the University of Delaware (in Newark) that they had achieved a conversion efficiency (sunlight to electricity) of 7.8% using a thin-film solar cell made of cadmium sulfide-copper sulfide (CdS-CuS).

This figure is higher than any reproducible efficiency attained so far with this type of cell, and is reported to be the first significant improvement in cadmium-sulfide photovoltaic efficiency since the early 1960s. (See "Major Solar-Cell Programs Strive to Lower Cost, Improve Efficiency," ED No. 6, Mar. 15, 1976, p. 24).

Scientists have plugged away all these years on CdS-CuS cells—despite the fact that single-crystal silicon delivers higher efficiency—because of the advantages it offers. One of these is low cost.

The cost of the basic material (the largest single cost factor in solar cells) is lower for CdS-CuS than it is for silicon—single crystal silicon currently costs over \$150/m<sup>2</sup> while the raw material used in the experimental work at the University of Delaware costs \$1.12/m<sup>2</sup>. In addition, thin-film cells are amenable to mass production techniques, a vital requirement if photovoltaic energy is ever to supplant conventional sources on a large scale.

The increased efficiency of the cadmium-sulfide cell was achieved at the University of Delaware by reducing the cell's reflection characteristics, which results in more sunlight being absorbed in the photovoltaic material. This was done by shrinking the area covered by the fine wire grid fixed to the upper (sun-facing) surface of the cell. The grid plays an essential role in making electrical contact to the cell's upper surface.

## Ultrasonics shows flaws in solids in 3-D

An ultrasonic device that provides a 3-D display of flaws deep inside solid materials, such as ship hulls and aircraft wings, has been developed at the Naval Research Laboratory in Washington, DC, by two scientists, Robert J. Sanford and Henry H. Chaskelis.

The technique uses a standard ultrasonic focused transducer—either lead zirconate or lead titanate. Sound waves, a quarter of an inch in diameter, are beamed into the solid object from first one direction and then another—perhaps 6 to 12 degrees apart, a distance that corresponds to the angular

separation between the observer's eyes at the object distance.

The returned signals, from each of the two positions, are displayed on a CRT, and a photograph is made from each position. The two photographs are then put into a stereoscope, and the merged, three-dimensional image, showing all the flaws in relation to each other, is displayed.

## New laser rods better than neodymium YAG

A laser rod that may replace neodymium YAG in solid-state lasers has been successfully fabricated on a product for the first time. The new rod is composed of yttrium aluminate doped with neodymium.

In contrast to the YAG rods, the aluminate has lower thermal losses, does not require an external polarizer, and can store higher energy when operated in the Q-switched mode.

While the aluminate material has been known for some time, fabrication on an experimental laboratory basis has been too costly. But under an Air Force con-

tract with Lambda-Airtron in Morris Plains, NJ, production-line technology has been developed that has brought the cost down. The first production run turned out 40 rods of b and c-type material.

Dr. Roger Belt, Airtron's research director, explains that the yttrium aluminate material has several orientations and the b and c types are of principal interest for lasers. The neodymium YAG rod, on the other hand, is a cubic material and is cut along one direction.

The yttrium aluminate does not require a polarizer because the material is anisotropic, which produces polarizing effects.

The aluminate rods have been operated at much higher power outputs than the YAG rods for single mode operation, Belt notes. This is important in applications where a Gaussian type of beam output is needed.

Cost of a four-inch aluminate rod is about \$4000, Belt says, but in large production quantities this could be lowered substantially.

The Air Force Materials Laboratory, Wright-Patterson Air Force Base, OH, has the yttrium aluminate rods available for loan to qualified requesters.

## News Briefs

**To get better speed and density** from circuits built with NMOS technology, a number of companies, including Motorola and Intel are looking toward depletion-load MOS transistors, which permit speed improvements and size reductions of 30%. Smaller size means better wafer yield, the manufacturers say. And better yields mean lower prices. . . . **Integrated-injection logic (I<sup>2</sup>L) is starting to appear** in many complex digital and linear ICs. The technology permits higher densities than MOS—and better speeds. Texas Instrument claims top honors for circuit complexity with its SBP9900 16-bit I<sup>2</sup>L microprocessor. The 100,000 square-mil chip offers twice the speed of its NMOS counterpart and dissipates less than half the power. New I<sup>2</sup>L products coming from TI and other vendors include 4-k RAMs, specialized control circuits and telecommunications ICs. . . . **The logic workhorse of the industry—the 54/7400 TTL series—is losing its**

**place** to a combination of two other bipolar technologies—low-power and Schottky TTL. Called 54/74LS00, the new family provides higher speed than the standard TTL without any increase in power drain. Among the major IC manufacturers developing LS logic circuits—either proprietary or second source—are American Micro Devices, Motorola, National Semiconductor, Signetics, Texas Instruments and Teledyne Semiconductor. . . . **An all solid-state telephone is being developed** by American Micro Devices that will consist of two or three MOS chips, a speaker and keyboard. The price will be lower than electromechanical telephones, the company says, due to a reduction of hand-assembly steps. One chip will be used for the number entry and dialling, another to detect an incoming ring signal and to stimulate electronically, through a speaker, the sound of a ringing bell. A third circuit will store telephone numbers.

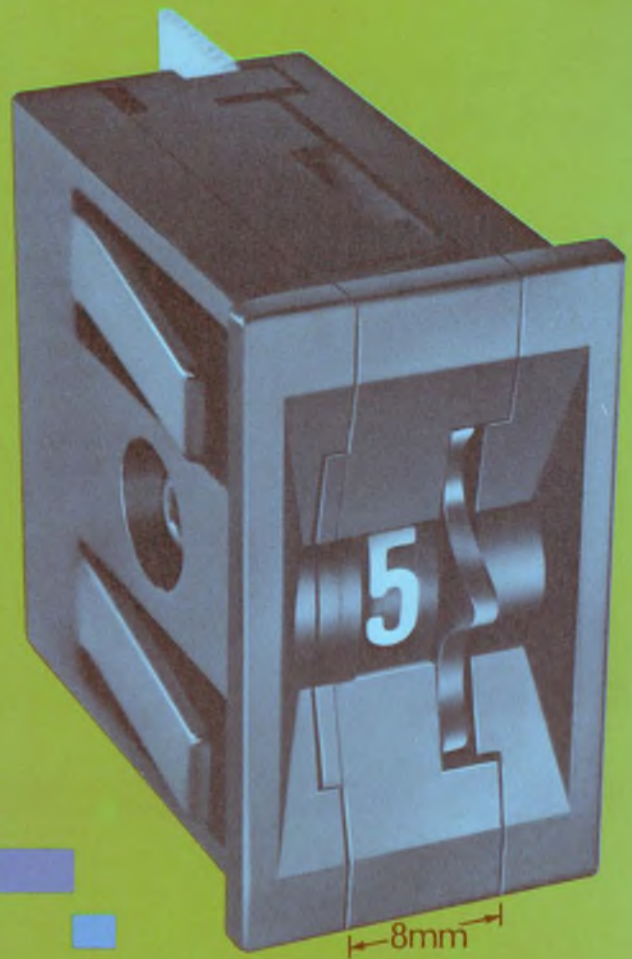

# Intro- ducing our new thumbwheel switch

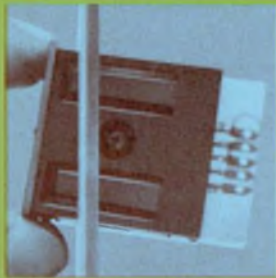

for 8-mm thumbs. It's a skinny switch that we call the 1800 Series. It has many of the features of our notorious 1776 Series —but simpler, more standardized, and cheaper. For example, just \$2.50 for one, less for more, with a choice of five codes, gloss or matte finish, with or without stops, and readable by 20/20 eyes from 10 feet away.

It's got PC board terminations for plug-in or solder connections, and it snaps into a panel for mounting (no tools needed). It mounts singly or ganged (up to 20 stations), and will give at least 500,000 detent operations before it tires.

So now we've left you with no excuse for not choosing EECO when you need a thumbwheel switch. We've got more versions for more applications than any other switch maker in the country. And more offices to buy from (87 in the U.S. and Canada). For any thumbwheel switch, see us first.

WE'VE GOT YOUR SWITCH.

**EECO**  
SWITCHES/PACKAGING/READERS

1441 East Chestnut Avenue, Santa Ana, California 92701 Phone 714/835-6000  
Distributed in the U.S. by Hall-Mark, G.S. Marshall, and Schweber In Canada by R.A.E.

# Compare Multiwire:<sup>TM</sup>



**costs less than wirewrapping...**



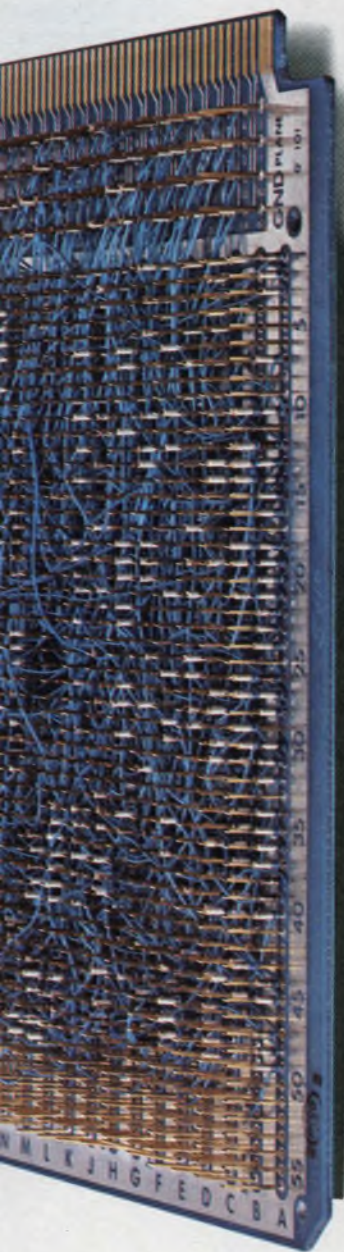

**works better than multilayering.**



Two major systems — wirewrapping and multilayering — have been used for complex electronic interconnection in the last 15 years. Despite improvements and refinements, each still has inherent disadvantages. That's why Multiwire was created by Photocircuits. It overcomes the disadvantages of wirewrapping and multilayering.

A Multiwire board is basically a customized pattern of insulated wires laid down on an adhesive-coated substrate by a machine operating under numerical control.

### Multiwire vs. wirewrapping.

Today, interconnection costs are more important than ever. So take a long, hard look at a key advantage of Multiwire panels. They cost much less than wirewrapping in small or production quantities.

Here's an example of how much less: a Multiwire replacement of a 60 DIP wrapped-wire panel. Total tooling costs were just \$750. In order quantities of 1000 pieces, the Multiwire boards at \$45 each were more than \$30 less than the wrapped-wire panel. (A 40% cost savings.) Multiwire prices also include a 100% continuity check.

But cost is not the only reason for the superiority of Multiwire over wirewrapping. There are also design advantages. For example, Multiwire offers two-dimensional packaging density equal to wirewrapping. But with Multiwire panels, you reduce board-to-board spacing. And Multiwire weighs much less too. So it can contribute substantially toward improving the envelope or three-dimensional package of your product.

Electrically, Multiwire is also superior. The extreme repeatability of the manufacturing process provides much higher electrical reliability as received — this is an important cost-saving factor. In addition, you get the controlled impedance characteristics required without variations.

### Multiwire vs. multilayering

With Multiwire, reliability goes up and inspection cost goes down. Multiwire doesn't need extensive inspection — like multilayering does — for nicks, pinholes, hairline cracks, spacing violations and bridging. Yet Multiwire regularly yields better than 99% reliability at incoming inspection.

Compared to multilayering, designing a new Multiwire board is a far simpler operation. Component locations and a wiring list are all we need. Our computer-aided system does the rest.

Since the computer also takes care of deletions and/or additions, engineering changes are simplified. What's more, Multiwire makes it easier to find paths for interconnections, because the insulated wires can cross one another. For these reasons we can deliver finished Multiwire boards to your door in weeks rather than months.

The advantages of Multiwire over wirewrapping and multilayering vary from case to case. We'd like to help you evaluate possible time, cost, design and reliability benefits. For information and price estimates, call the Multiwire Marketing Department at 516-448-1111.

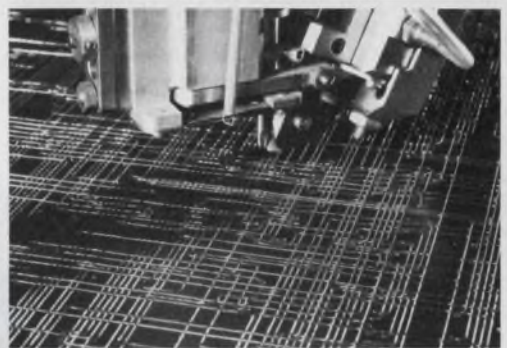
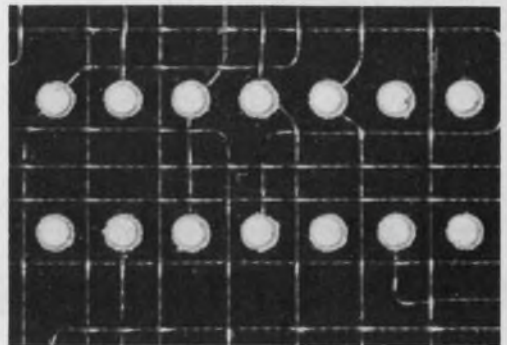

	Wrapped panels	Multi-layers	Multi-wire
Design & tooling cost	Low	Very High	Low
Design & tooling time	Short	Very Long	Short
1st piece delivery	Short to Very Short	Long	Short
Board cost in small quantities	High	High	Medium
Board cost in production quantities	High	Medium	Medium
2 dimensional packaging density	High	High	High
3 dimensional packaging density	Medium	High	High
Weight	High	Low	Low
Ease of changes	Excellent	Poor	Good
High speed electrical characteristics	Fair to Poor	Excellent	Excellent
Interchangeability with other techniques	Fair	Excellent	Excellent
Repairability	Excellent	Poor	Good
Controlled impedance	Poor	Good	Good
Electrical reliability as received	Fair	Good	Excellent

# Multiwire from Photocircuits

Division of Kollmorgen Corporation, Glen Cove, New York 11542

CIRCLE NUMBER 10

# Electron-beam IC technology goes commercial in 1977

The name of the game in integrated circuit (IC) technology these days is increasing the density of circuitry packed onto the surface of semiconductor chips only a few square millimeters in area. Such results are generally achieved by using optical photographic techniques for generating a photo-etched master mask. These masks are then used to control the diffusion and etching processes required to produce ICs.

During the past few years, a number of IC research and development laboratories have been experimenting with electron beam techniques for mask etching. Electron beams can cut these masks to greater resolution and with higher quality than optical techniques, thus making possible chips with greater circuit density at greater production efficiency.

The increased production efficiency results from the ability to draw the mask pattern in final size directly onto a coated resist substrate.

Under a licensing agreement with Bell Laboratories, Murray Hill, NJ, the first of these electron-beam machines will soon enter the commercial market. Etec Corp. of Hayward, CA, and the Extrion Division of Varian Associates of Gloucester, MA, both plan to market a Bell Labs invention, the computer-controlled EBES (electron-beam exposure system).

EBES eliminates a complex series of steps necessary in current methods, including preparing large-sized artwork, photographically reducing this pattern, and repeatedly exposing the pattern at actual size upon a photosensitive plate. Etec expects to have its units available first; Extrion, about six months later in November, 1977.



**EBES electron beam exposure system** from Bell Labs increases accuracy and efficiency of IC production.

In addition to generating masks, the 1/2-micron ( $10^{-4}$  cm)-wide electron beam can be used to etch circuit patterns directly onto the semiconductor wafer. This process promises to reduce device-development time by eliminating the need for masks.

## Software gets on the beam

A computer-aided design system by Calma Co., Sunnyvale, CA, can interface with the electron-beam lithographic equipment. This software development unit can also generate, as well as store on magnetic tape, the programs needed to support the Bell Labs EBES system or another analogous system manufactured by Cambridge Instruments, Melbourn, England.

The leading feature of the Calma software is a capability that permits the creation of all geometric shapes directly, removing the restrictions and laborious digitizing

procedures generally required to produce nonorthogonal shapes," says Dr. Arthur Collmeyer, vice president for research and development at Calma.

This process is a "fracturing" technique, according to Collmeyer. A complex geometric shape is broken down into a collection of simpler shapes. Each of these simpler shapes is coded into digital format.

Besides generating digital data the Calma system allows the designer a choice in the width of the interconnecting lines. The computer's taped algorithms serve to translate the designer's circuit layout into actual mask patterns.

Even though a somewhat different algorithm is used by the British-made electron-beam system, observes Collmeyer, the Calma software can accommodate, it, too.

## Scanning the surface

The Bell Labs EBES is reportedly the only commercial electron-beam system to use a raster-scan technique. All other systems use a method known as vector scan. These two methods of beam control differ only in the procedure used in translating the beam of electrons across the face of the chip. In the TV-like raster scan, the beam must cover the entire chip surface whether or not the beam is writing. The vector-scan method, on the other hand, scans only those areas to be etched.

EBES writes its intricate pattern on a chromium-coated glass substrate covered with a film of chemical "resist" that is sensitive to the electron beam. The unexposed portions of the resist and the underlying chromium are then etched out by chemicals, leaving a negative mask pattern of chromium on the glass. ■■

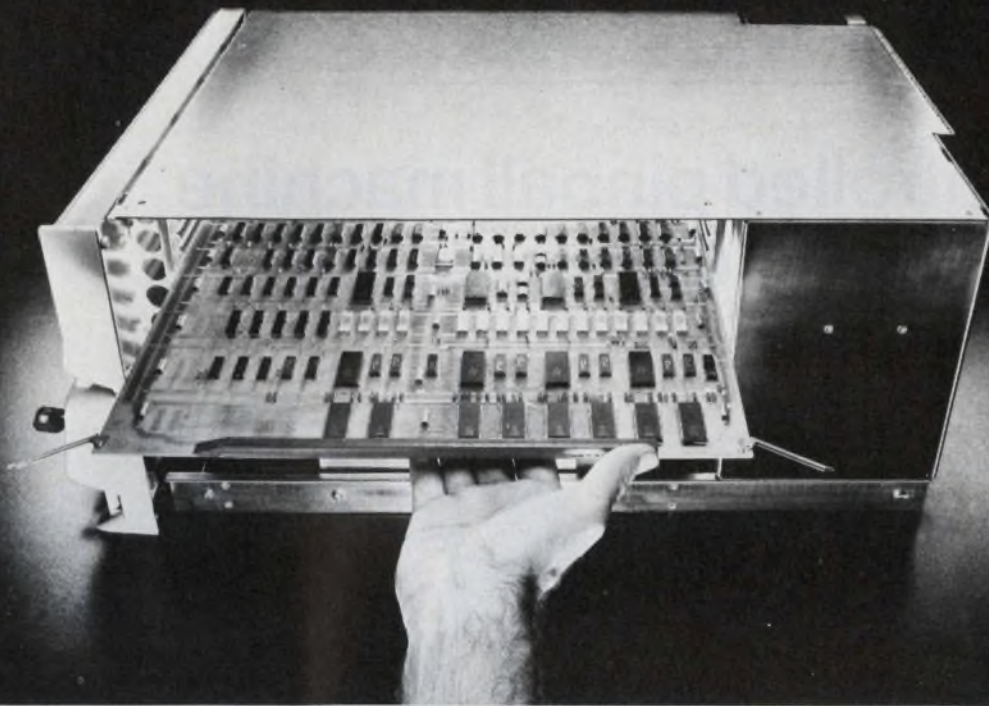

# Give your data communications system a little goose and it'll put out ten times as much.

Open up the back of any Data General communications system, pop in our single-board DCU/50 Data Control Unit, run through a little step called COMGEN and stand back. Because that system can start pumping out ten times as much data. And possibly a good deal more.

What makes this all possible is a rather clever piece of engineering.

We've designed the DCU/50 as an intelligent programmable controller. So it takes over jobs the CPU used to do. Things like character handling and code conversion. Which frees up the CPU processing power and speeds up total systems throughput.

On the other hand, you may not need more throughput. Instead, you may need more lines or different types of lines. Both of which are just as easy to get. You just plug in some different boards.

We make modular synchronous and asynchronous multiplexors you can mix

in any proportion. They can handle anything from one to sixteen lines, are fully software supported and work equally well with or without the DCU/50.

Which brings up a rather significant point.

When you buy your communications equipment from Data General, you can get exactly what you need right now. And later, if you need more throughput, more lines or different types of lines, you won't have to throw out anything. All Data General communications hardware and software are completely compatible. So you can add on to what you already have.

Write for our free brochure, "The Sensible Way to Use Computers in Data Communications" and detailed information about the DCU/50 Data Control Unit.

And if that isn't enough information, we'll send a sales engineer who can also put out ten times as much.

## DataGeneral

• Data General, Route 9, Southboro, Mass. 01772, (617) 485-9100. Data General (Canada) Ltd., Ontario. Data General Europe, 15 Rue Le Sueur, Paris 75116, France. Data General Australia, Melbourne (03) 82-1361

CIRCLE NUMBER 11



# $\mu$ C-controlled pinball machine diagnoses its own troubles

A unique new microcomputer-controlled pinball machine by Mirco Games, Phoenix, incorporates new solid-state design and circuit features that give it a number of substantial advantages over its electromechanical, relay-operated counterparts. Called the "Spirit of '76," the pinball machine uses a 6800 microprocessor, a Motorola peripheral interface adapter, 8-k of basic memory, and includes these advantages:

- Maintenance is substantially simplified by incorporated diagnostic-program routines that identify trouble by coded numbers that appear on the same LED displays used for keeping game scores.

- Reliability is increased by the elimination of the usual "rat's nest" of wires and by the use of low-current, solid-state control of the lights, bells and solenoids that operate the flippers—arms that strike and move the ball during play.

- Operating costs are reduced by lowering the current requirements for the game to 3.5 A at 5 V—about one-tenth that used by the electromechanical machines.

- Weight is some 60 lb lighter than a comparable electromechanical machine, thanks to the elimination of stepping switches and relays and their wiring, and by the use of a smaller power supply. (Reduced weight saves considerable shipping costs.)

- Electromagnetic interference to radio and TV sets is lowered by using low-level microcomputer peripheral interface signals, in place of stepping switches and relays, to control the Darlington transistors that energize the 30-V machine solenoids.

Three diagnostic routines stored in the microcomputer program not only minimize the machine's downtime, but also check every working component in the machine.



Microcomputer control of a pinball machine makes troubleshooting simple. The Mirco Games unit uses only 1/10 the power of regular machines.

The routines are entered using a special combination of diagnostic settings on switches located on the PC board holding the microcomputer, its interface ICs, and power transistors. The board is located behind the scoring panel.

## Routine checks all bulbs

One diagnostic routine checks out all the bulbs in the machine simultaneously and rapidly detects any burned-out lamps. Another routine can determine if trouble is present in any one of the switches. In this case, coded numbers appear in the LED scoring displays. These numbers are referenced to a checklist that reveals both good and defective switches.

Another diagnostic routine briefly turns on all the solenoids in the

machine in sequence to make sure they are all working. It also checks the LED digits by cycling the scoring digits from 0-to-9 and back to zero.

The microcomputer provides the machine owner, or operator, with readily controllable back-panel features.

Free-game scoring levels ranging from 40,000 to 104,000 points can be adjusted by resetting the proper back-panel switches. Other switches provide a range of one to four games per coin as well as a free-play mode for those locations that play without coins.

The  $\mu$ P can vary the levels of required playing skill. The flippers can be made to work faster or slower through microprocessor control of the energy applied to the flipper solenoids. ■■

# “As the first interactive small plotter, it was the only intelligent choice.”

## Problem: Until now, no small plotter could carry on an intelligent conversation.

Because most B-sized plotters have been pretty much the same: slow, unreliable, and dumb. Even with large off-line plotters you can wait hours, even days, for results... and if there's a mistake—start over.

**Solution: Tektronix' new microprocessor-based 4662. For interactive plotting, page scaling, digitizing, and camera-ready output. Just \$3995.†**

The 4662 is the first smart buy among 11"x17" flatbed plotters. Its digital design and vector generation offer exceptional accuracy and repeatability without drift or slidewire dirt build-up. Its 1600-byte buffer lets the host work while the 4662 plots... at speeds up to 22 ips.

**It's the first B-sized plotter with graphic input.** Digitizing capability and built-in joystick mean you can input corrections in seconds, experiment with designs, and run off camera-ready copies practically as fast as you load paper.

**It's plug-to-plug compatible with virtually any RS-232 system... from minis to mainframes.** You can plot circles around any other B-sized plotter, for about the same price as the competition. For a demonstration, call your local Tektronix Sales Engineer, or write:



The 4662 contains its own character generator, alpha rotation, and page scaling, thus minimizing support software. Proven graphic and plotter software is provided by Tektronix.

**Tektronix, Inc.**  
Information Display Group  
P.O. Box 500  
Beaverton, Oregon 97077  
**Tektronix Datatek NV**  
P.O. Box 159  
Badhoevedorp, The Netherlands



## The 4662. Plug it in. It speaks for itself.

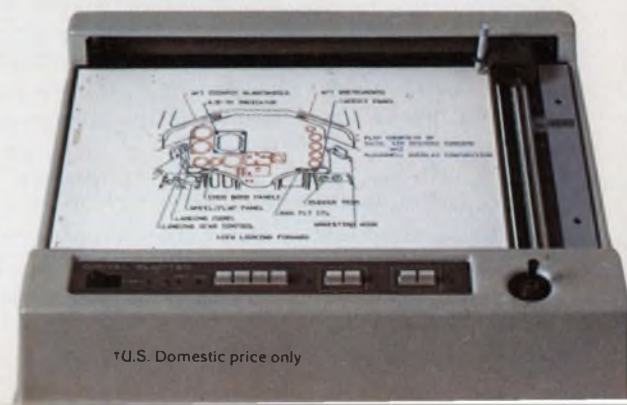

# Calculator-timer makes life easier for light-aircraft pilots

Four principal design problems have been solved in the development of the TMS-1000, a combined calculator-timer from Martin Avionics Corp., Grapevine, TX, that decreases the light-aircraft pilot's workload during instrument flight. The problems were: packaging, design of a special keyboard, production of a highly visible LED display and electromagnetic interference from the calculator-timer's power supply that can disturb the aircraft's navigation and communication equipment.

"The most difficult problem we faced," says Bruce Martin, president of Martin Avionics, "was packaging a two-chip MOS calculator-timer system in a space sufficiently small to fit into the control yoke of a Beechcraft. Because the space available in the control yoke could not be modified, it was necessary to achieve high packaging density with a double-sided PC board.

"The converter that powered the system—it worked off an input voltage from 8 to 30 V—was packaged separately and mounted behind the aircraft panel."

Because a light aircraft's yoke vibrates considerably, the keyboard's calculation and timing keys had to have sufficient travel for the pilot to feel certain he had made a positive input to the system.

## Long-travel keys needed

The conventional, quick-action keyboard, with a key travel on the order of 0.008 in., proved unsatisfactory during field tests. So special long-travel momentary key-switches with a movement of 0.050 in. were incorporated. They were housed in a TO-5 transistor can.

The normally poor contrast, or



**A two-chip MOS calculator and clock-timer reduces pilot's in-flight workload.** The TMS-1000 by Martin Avionics, requires tight packaging, enhancement of the LED display, and elimination of EMI.

"washout," of the LED display in sunlight proved a stumbling block, at first. But installing two optical devices in the display assembly obtained satisfactory performance. One device, a circular polarizer, prevents light entering the display from re-emerging and reducing the LED display's contrast. The other optical device, an injection-molded prismatic lens, bends the light from the LED display upwards into the pilot's eyes from its chest-high location in the control yoke.

A major problem, the electromagnetic interference from the dc-to-dc-converter power supply, was finally solved with brute-force filtering—putting the power-supply components inside a sealed can and bringing out the supply leads through feedthrough capacitors.

Both visual and audio alarms are incorporated into the TMS 1000 system. The two-chip, 28 and 40-pin system includes:

- A digital clock that can be set to any desired time down to the second.
- A four-function, reverse Polish notation calculator.
- Two scratch-pad memories for entering communication frequencies, navigational bearings or other data.
- An elapsed-time, or down-counting, timer.

The digital clock is used for such straightforward timing functions. A highly audible alarm mounted behind the panel can be set to sound off at the end of a period of time set into the clock.

The down-counting timer principally keeps track of the elapsed time during a precision-timed instrument approach. At the end of the elapsed period, the audible alarm and a flashing LED in one corner of the display signal the pilot it is time to decide to either complete his landing or take off again. ■■

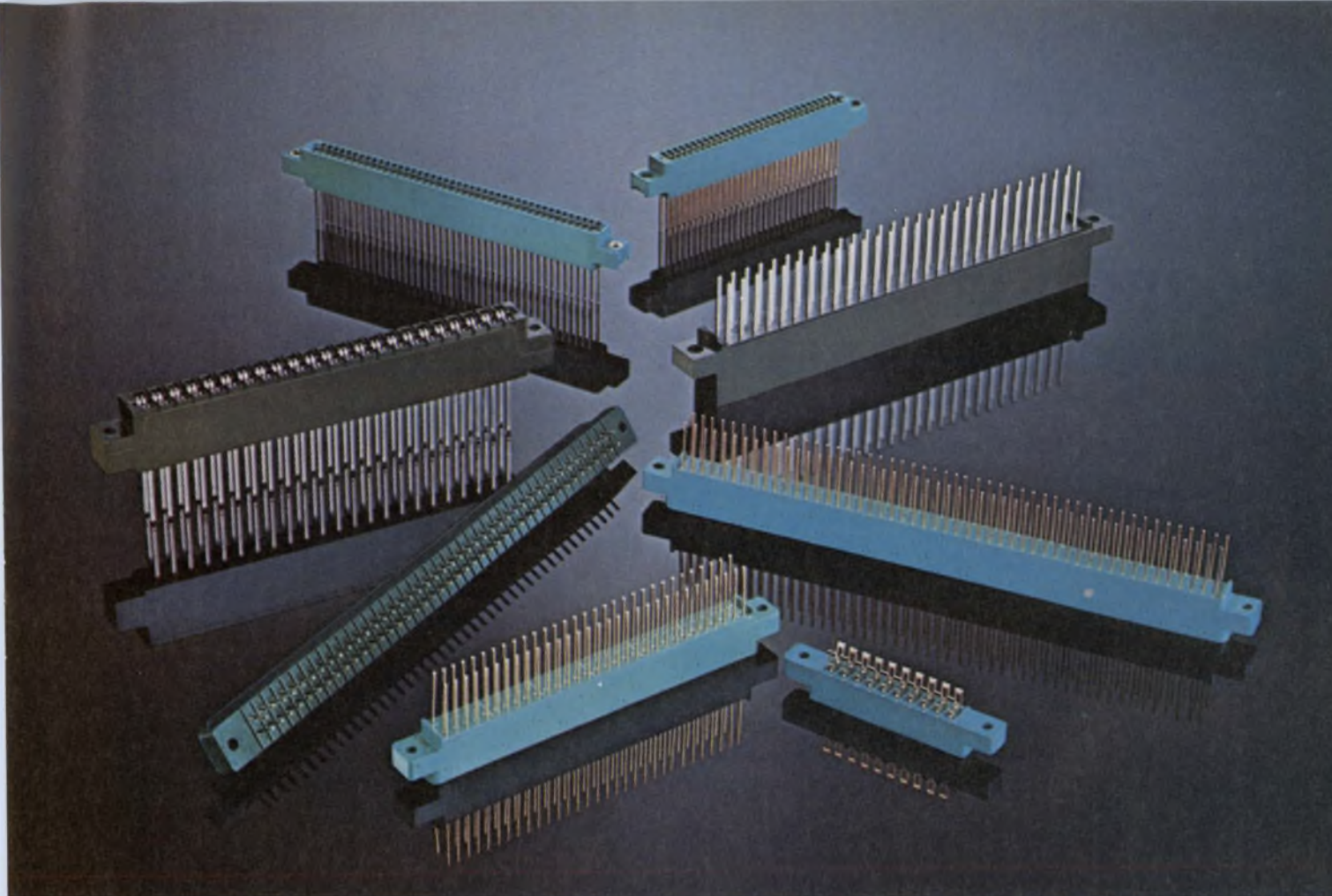

## PC Connectors give our family the edge.

We can give you the edge with fast delivery and wide variety in off-the-shelf PC connectors.

In .100, .125, .156 and .200 inch spacing you can take your choice for motherboard or automatic wiring applications.

You can also pick the contact you want — gold-dot or gold-plated. These include bifurcated bellows, cantilever beam and bifurcated cantilever beam designs.

Connector housings are available in glass-reinforced phenolic, diallyl phthalate and glass-reinforced polyester thermoplastic. A variety of mounting configurations are also readily available.

All have been designed to meet the applicable performance requirements of MIL-C-21097, and they're all available now.

So be sure to have a shipping date in mind when you contact GTE Sylvania, CPO, Box 29, Titusville, Pa. 16354 Phone 814-589-7071.

Remember, good connections run in our family.

**GTE SYLVANIA**

# Round 1 goes to Control Data in airborne-computer competition

The winning model in the Navy's standard airborne computer competition is a high-speed, bipolar,  $\mu$ P-based machine with an AMD 2901 controller and low-power Schottky bipolar logic in both MSI and LSI. The winning manufacturer, Control Data Corp., will base the computer on its in-house CDC-480, and the Navy will designate it the AN/AYK-14.

Taking the first round over IBM, Lear Siegler and Sperry Univac also gives CDC the edge in supplying airborne computers for at least eight future Navy airborne weapons systems, beginning with the F-18 fighter (two each in 800 aircraft) and the Light Airborne Multi-Purpose System (LAMPS) Mark 3 helicopters (one each in 204 helicopters). The entire AYK-14 program will be open to competition again in 1980.

CDC's AYK-14 is organized into 16-bit words (plus two parity bits), but can be made into a 32-bit machine for high-performance systems. AMD 2901 high-speed bipolar microprocessors are the heart of the system. Four of them, each representing a 4-bit slice of the 16-bit words, are used for each computer.

## Navy knows what it wants

Since the Navy is specifying core memory in the initial systems, CDC will use 14-mil cores that provide a cycle time of 900 ns and access time of 350 ns. N-MOS semiconductor memory would double these speeds, but the Navy is worried about its volatility. MNOS does not have a volatility problem, but isn't far enough along in the development cycle.

The LAMPS will use the basic XN-1 version of the computer,



An airborne computer, dubbed the AN/AYK-14, has been developed for the Navy by CDC. The heart of the unit is the AMD 2901 microprocessor.

which measures  $7.62 \times 10.125 \times 19$  inches, weighs 45 pounds, and contains 65-k words of core memory, with growth provisions to 96 k. The XN-2 for the F-18 fighter is slightly smaller,  $7.62 \times 10.125 \times 14$  inches, 32 pounds, and contains 32 k of core, expandable to 65 k.

All computers must be compatible with the 1553A multiplexed data bus specified for new Air Force and Navy aircraft. The AYK-14 is also software-compatible with Univac's UYK-20 Navy shipboard computer.

During benchmark testing, the Navy required at least 375,000 operations per second (OPS) for transferring data from registers to memory. The CDC version reportedly achieved 411,000 OPS in that mode and 670,000 OPS in register-to-register transfer.

As part of the Navy's reliability-assurance warranty (RAW) program, the manufactured computers will be subjected to probably

the most stringent reliability requirements ever imposed on military avionics equipment—2200 flight hours meantime between failure (MTBF), or five years of operation, whichever comes first. This is part of the Navy's RAW program and is required for all AYK-14 computers used in operational aircraft, although not those used in test and evaluation aircraft.

RAWs are also required in any future alternate sourcing. All computers must be identical on a form, fit and function basis, right down to the shop-replaceable assembly (SRA) level—essentially the card on which the electronic components are mounted.

Beyond the F-18 and LAMPS, the AYK-14 is being specified principally for P-3 anti-submarine warfare (ASW) patrol aircraft, which will require computers with up to 128 k of core. The AYK-14 architecture does permit the computer eventually to address 512 k of core, if needed. ■■

RIGHT ON TARGET AGAIN



Bearing it well!



**NEW  
FROM  
SGS-ATES**

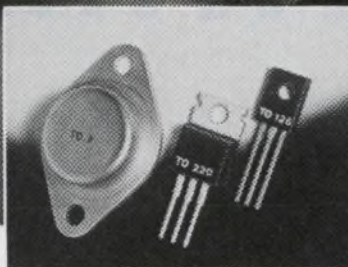

## Complementary power Darlington pairs

### 4 Amperes - TO 126 package

NPN	PNP
2N 6037	2N 6034
2N 6038	2N 6035
2N 6039	2N 6036
SJE 800	SJE 700
SJE 801	SJE 701
SJE 802	SJE 702
SJE 803	SJE 703

### 8 Amperes - TO 220 package

BDX 53/A/B/C	BDX 54/A/B/C
--------------	--------------

### 8 Amperes - TO 3 package

NPN	PNP
SJ 1000	SJ 900
SJ 1001	SJ 901
2N 6055	2N 6053
2N 6056	2N 6054

### 10 Amperes - TO 3 package

SJ 3000	SJ 2500
SJ 3001	SJ 2501

### 12 Amperes - TO 3 package

2N 6057	2N 6050
2N 6058	2N 6051
2N 6059	2N 6052

SGS-ATES Semiconductor Corporation · Newtonville, MA, 02160 · 435 Newtonville Avenue · Tel: 617-9691610 · Telex: 922482  
Stocking Distributors: Edmar Electronics Co., Des Plaines, IL, (312) 298-8580 · Energy Electronic Products, Los Angeles, CA, (213) 670-7880 · Esco Inc., Dayton, OH, (513) 226-1133 · KA Electronics Sales, Dallas, TX, (214) 634-7870 · Radar Electric Co., Seattle, WA, (206) 282-2511 · Re-Coil Electronics Inc., Santa Clara, CA, (408) 984-0400 · Rical Electronic, Santa Ana, CA, (714) 557-6543 · Semtex, Wakefield, MA, (617) 245-9050 · Wilshire Electronics, Burlington, MA, (617) 272-8200 · Zeus Components Inc., Elmsford, NY, (914) 592-4120 · Burlington, MA, (617) 273-0750 · Pompano Beach, FL, (305) 942-4312 · Zeus/West Inc., San Dimas, CA, (714) 599-8374 · Mexel, Mexico 12, DF, (905) 575-7868 · Preico Electronics Ltd., Montreal 357, Quebec, (514) 389-8051

CIRCLE NUMBER 14

**The  
microprogrammed  
state machine:**

**Get an Am 29811  
and you've  
got it made.**

If you make state machines — and you're tired of gates and flops and hassles and headaches — we've just made your life a lot easier.

Get an Am29811, add some Am2911's and you get an amazingly powerful, efficient microprogram controller. Throw in a couple other 16- and 20-pin packages, and throw away your state machine problems. For good.

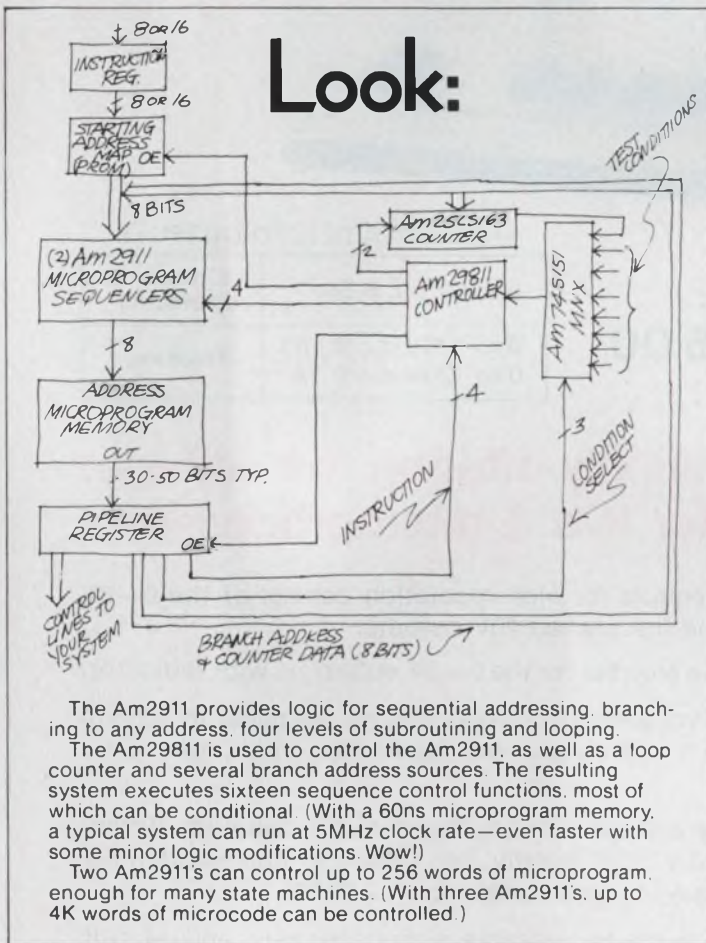

## Look again:

### Sequence Control Instructions

Jump to Zero

\*Jump to Branch Address

Load Counter

\*Repeat Jump if Counter  $\neq$  0

\*Push PC or Push PC and Load Counter

Jump to Map Address

\*Loop

\*Repeat Loop if Counter  $\neq$  0

\*Jump to Subroutine

\*Return

\*Jump to One-of-Two Subroutines

\*Jump and Pop Stack

Jump to External Address

Jump to Branch Address

\*Jump to One-of-Two Branch Addresses

Continue

\*Conditional Instructions

Terrific. But how much?  
Am2911, \$2.95 in volume.  
Am29811, \$2.60 in volume.  
 The entire controller shown, including 8-bits of loop counter and 8-input multiplexer is only \$11.64. That's right. \$11.64 total price.

If you want to know more about the Am2911 or the Am29811, just wire, write or phone. We'll send you a whole book about microprogrammed controllers. For free, of course.

Boy. Some guys really have it made.

# Advanced Microprocessors



Advanced Micro Devices, Inc. • 901 Thompson Place, Sunnyvale, California 94086 • Telephone (408) 732-2400 •

Distributed nationally by Hamilton / Avnet, Cramer and Schweber Electronics and regionally by Arrow, Bell and Century Electronics

CIRCLE NUMBER 15



introducing:

# A MULTI-OUTPUT POWER SUPPLY

## KEPCO MPS 620M



Price:  
**\$475.00**

### THREE STABILIZED OUTPUTS

0 to 6V d-c @ 5A	Crowbar Protected
0 to +20V d-c @ 1A 0 to -20V d-c @ 1A	Tracking

**a convenient bench top power supply offering the voltage/current combination required for IC's & microprocessors**

- FEATURES:**
- 10-turn controls for high resolution control of the 0—6V output and the tracked 20V outputs.
  - Adjustable crowbar for the 0—6V output ... with indicator.
  - Remote error sensing connections on the panel to accommodate a 1 volt drop in the load wires from the 0—6V output.
  - Full range adjustment of voltages and rectangular current limits (not a "slot" supply, no "foldback" current limiting, and no derating to an ambient of +50°C).
  - All three outputs available simultaneously and at full rating.
  - Convection cooled.
  - Two large recessed meters with switch, to monitor voltage and current.
  - Rack mountable in a 5¼" rack space (¾ width).

**KEPCO**® For complete specifications, write Dept. FM-05

KEPCO, INC. • 131-38 SANFORD AVENUE • FLUSHING, N.Y. 11352 U.S.A. • (212) 461-7000 • TWX #710-582-2631 • Cable: KEPCOPOWER NEWYORK

CIRCLE NUMBER 16

# Washington Report

## Army eyes new integrated aircraft control

Controls for increasingly complex avionics functions in modern military aircraft are beginning to saturate the already crowded cockpit. All the services have been worrying about the problem, but the Army is doing something about it. It's sponsoring a new integrated control panel that will be multiplexed to as many as 10 avionics subsystems.

Grumman Aerospace and Collins Avionics Division of Rockwell International have been selected from the list of 14 bidders to begin the development of the system known as the Integrated Avionics Control System, or AN/ASQ-( ) (V). Each company has \$1.6 million from the Army Electronics Command for the development phase. One of them will be selected to do the production.

While the new system is being considered primarily for helicopters in the development stage, such as the advanced Attack Helicopter and Advanced Scout Helicopter, the Army also expects to retrofit it into such existing helicopters as the CH-47 Chinook and AH-1 Cobra.

## ILLIAC IV super computer begins real-time operations

ILLIAC IV, the world's most powerful computer, has begun processing data relayed by communications satellites in real time and executing instructions interactively.

The experiment, supported by the Defense Advanced Research Projects Agency (DARPA), is part of anti-submarine warfare studies aimed at identifying and monitoring the acoustic signatures of enemy submarines. The data are collected from the ocean depths and relayed via commercial communications satellites to DARPA's Acoustic Research Center at the NASA Ames Research Center, Mountain View, CA.

The ILLIAC IV then processes the data at rates estimated at 150-million instructions per second. Although the computer has been operating since late 1975, it has been limited to batch processing until this new experiment, which uses its parallel-processing capability.

## IR seekers compete with lasers for new weapons

Infrared seekers that home on the heat generated by enemy aircraft, tanks and other targets are being considered by the new Army weapons search and Development Command for at least two new Army weapons that are now scheduled to use laser target designators—the Copperhead artillery projectile and the Hellfire missile to be used on the Advanced Attack Helicopter (AAH).

The trouble with lasers is that the troops or aircraft doing the illumi-

nating are vulnerable to enemy fire. To eliminate this hazard the Army may decide to put all the target acquisition capability in the warhead itself—letting it home on the target's own heat.

Raytheon and General Dynamics, Pomona Division have been selected to conduct parallel studies of an advanced passive IR seeker for Copperhead. The same seeker may also be used on the Army's proposed General Support Rocket System.

## **Raytheon OKed for 2nd Pave Paws radar**

Raytheon has been funded by the Air Force to build a second Pave Paws phased-array radar following a General Accounting Office ruling on a protest by General Electric, the losing bidder.

GE claimed that it had submitted the lowest bid, but GAO ruled that the firm's costs were not realistic. Under the best and final-offer ceiling prices (130% of target costs), GE bid \$79.3 million for a two-site system, while Raytheon bid \$83.6 million. The Air Force estimated that although "most probable" costs were \$75.6 million for GE and \$77 million for Raytheon, GE had not considered all known technical risks.

GAO upheld the Air Force action, permitting the service to award a \$28-million contract for the West Coast radar site at Peale Air Force Base, CA. Raytheon beat GE for the initial \$46.6-million contract to build a radar array on the East Coast, at the Otis Air Force Base, MA, but the second site was held up pending resolution of GE's protest.

## **Proposed Naval aircraft to use ECM, Elint**

A new land-based patrol aircraft with state-of-the-art electronic countermeasures (ECM) and electronic intelligence (Elint) equipment is being studied by the Defense Dept. as an alternative to the Navy's plans to convert its carrier-based aircraft to vertical and short-take-off-and-landing (V/STOL) versions.

The Land-based Multipurpose Naval Aircraft (LMNA) should be about the size of a Boeing 707 and equipped with air-to-air and air-to-surface missiles to repel anyone attempting to cut off sea lanes.

Approximately 180 of them can be built for \$75-million each (before anticipated inflation), estimates William D. O'Neil of the Pentagon's Directorate of Defense Research & Engineering. This cost makes them competitive with carrier-based aircraft designed to do the same job.

For a radar that would permit the LMNA to detect and elude enemy fighters, O'Neil suggested a version of the radar used in the Airborne Warning and Control System (AWACS) or the E-2C.

**Capital Capsules:** The Air Force is studying a deep-space surveillance system with long-wavelength infrared (LWIR) sensors to supplement its existing Spacetrack network. The sensors may be placed in space to extend the range of the ground-based radars. . . . The State Dept.'s Passport Office, which is planning to encode data magnetically on future passports, is launching a study of how the data can be "frozen" to be tamper-proof. . . . The European Space Agency has voted to participate in NASA's Space Telescope program during which a 2.4-meter telescope will be orbited for deep space studies. ESA would provide an estimated 15% of the \$400-million development and launch costs as well as some operating funds.

# Now 1% time measurements are this easy...

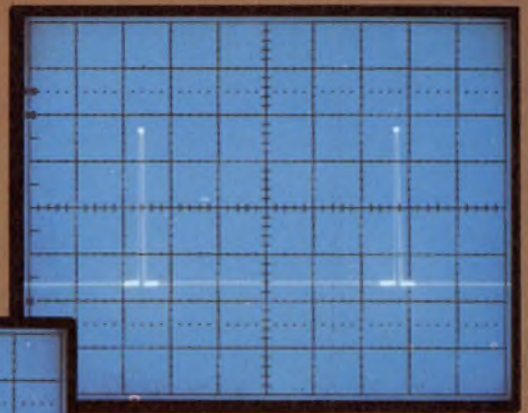
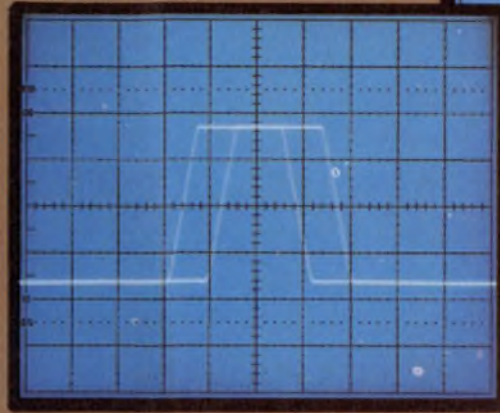

1 Position intensified spots at beginning and end of time interval.

2 Switch to delayed sweep mode and use  $\Delta$  Time dial to superimpose beginning and end of interval.



3 Read time interval directly.

## Faster Timing Measurement

Differential time measurements are made faster when the new DM 44 with *Delta Delayed Sweep\** and direct numerical readout is included on a TEKTRONIX Portable Oscilloscope. At the same time, measurement repeatability is improved, the chance for computational errors is eliminated, and 1% accuracy is consistently achieved. Frequency measurement (on periodic waveforms) with 2% accuracy is obtained by simply pushing the 1/Time button.

## Built-in DMM as a Bonus

There's no need to carry a separate multimeter. DM 44-equipped TEKTRONIX Portables also measure dc voltage with 0.1% accuracy and temperature from  $-55^{\circ}\text{C}$  to  $+150^{\circ}\text{C}$  simultaneously with oscilloscope display of related waveforms. And you get ohms measurement with 0.25% accuracy as well.

## Your Choice of Oscilloscope Performance

The DM 44 is available on five high-performance portable oscilloscopes to best match your performance and price needs. Choose bandwidth of 100, 200, or 250 MHz. Or select from two fast storage models. One actually stores single-shot signals at its full 100 MHz bandwidth.

Due to highly cost-effective design, the outstanding DM 44 option adds only \$410 to the price of the basic portable oscilloscope chosen. All DM 44-equipped TEKTRONIX Portable Oscilloscopes, and seven more models as well, perform analysis on up to 16 channels in the digital domain by simply adding the

LA 501W Logic Analyzer. Capabilities of the DM 44 are also available in the TEKTRONIX 7000 Series of plug-in oscilloscopes.

## Let Us Show You

To see how the DM 44 makes faster, more accurate measurements in your application, contact your Tektronix Field Engineer. Or write to Tektronix, Inc., P.O. Box 500, Beaverton, Oregon 97077 for complete information. In Europe, write to Tektronix, Limited, P.O. Box 36, St. Peter Port, Guernsey, Channel Islands.

\* Two independently adjustable delayed sweeps.

U.S. Sales Price FOB Beaverton, Oregon



# TEKTRONIX®

committed to  
technical excellence

FOR TECHNICAL DATA CIRCLE NUMBER 212  
FOR DEMONSTRATION CIRCLE NUMBER 213

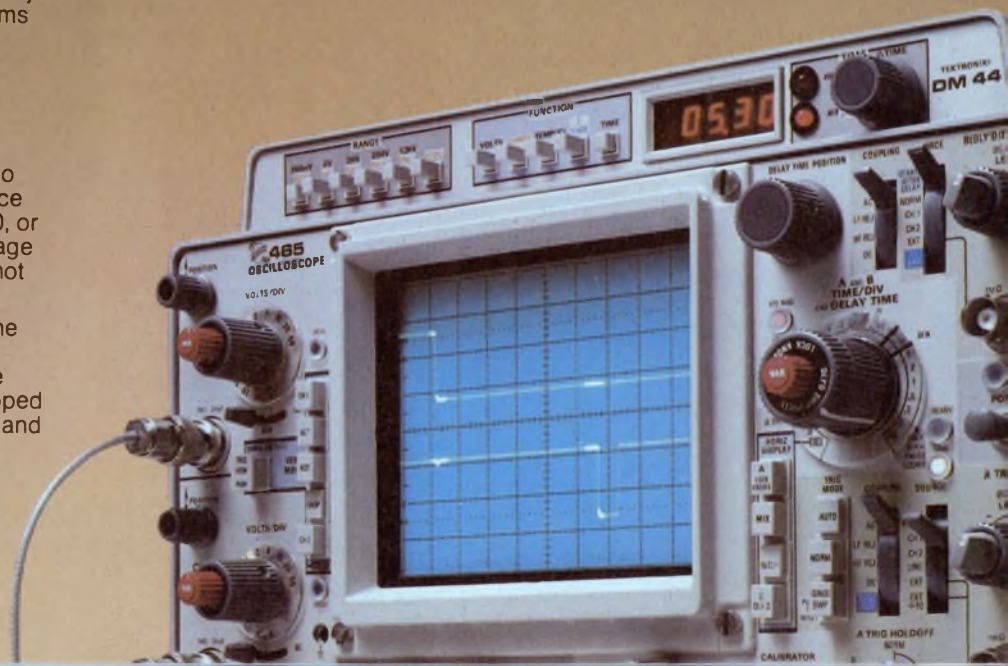

*Our FIRE-PLUG<sup>™</sup>  
connectors already  
meet UL 94V-0  
flammability tests.*

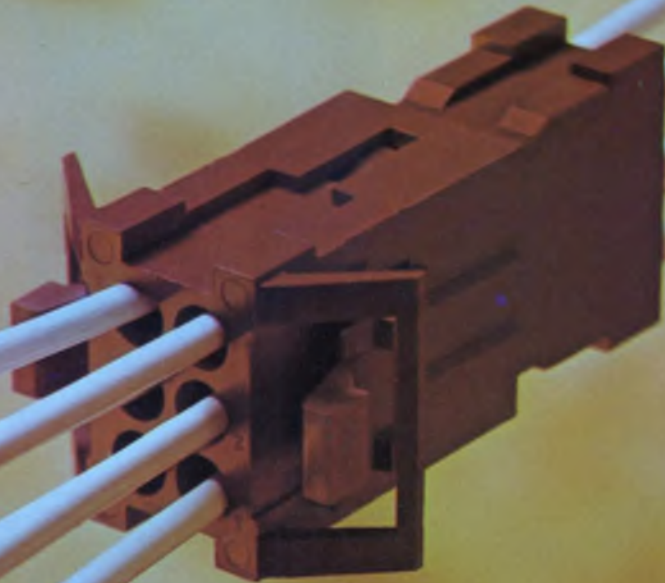

*And you can't beat our price.*

**These new Amphenol<sup>®</sup> connectors** are classified 94V-0 for flame resistance by Underwriters Laboratories. That's the most stringent test of plastic material flammability conducted by UL. And these connectors are also listed by CSA.

What's more, FIRE-PLUG connectors exceed UL's upgraded standards for thermoplastic materials scheduled to go into effect July 1, 1977. So you can upgrade your products now.

**They cost no more than what you're buying now.** FIRE-PLUG connectors are priced no higher than commercial connectors sold under the less stringent UL 94V-2 rating.

**Interchangeable, too.** FIRE-PLUG connectors are interchangeable, intermatable, and intermountable with the most popular types of commercial connectors.

**Save time and labor with faster panel mounting.** The FIRE-PLUG has mounting latches that flex easily. Only fingertip pressure is needed to push and lock the housing into a panel. Cable-to-cable styles are also available.

**You can get them now—in quantity.** Just call your Amphenol Industrial Distributor for fast delivery. Or write or call: Ray Hayer, Amphenol Connector Systems, Bunker Ramo Corporation, 900 Commerce Drive, Oak Brook, Illinois 60521. (312) 986-3749.



*Semi-automatic crimping machine.  
Hand tools also available.*

*The right idea  
at the right time.*

**AMPHENOL** Connector Systems

**BUNKER  
RAMO**<sup>®</sup>

CIRCLE NUMBER 18

# Microprocessor Design

## Separate I/O instructions for $\mu$ P's will disappear in future systems

*Chuck Peddle, microprocessor manager at MOS Technology, Norristown, PA, speaks on evolving  $\mu$ P I/O architectures and peripheral chips.*

I believe that future  $\mu$ P systems will use memory-managed I/O instructions rather than hardware-controlled I/O. In fact, Intel and TI have, in effect, conceded that a memory-managed I/O is better. Their recently introduced peripheral chips for the 8080 use memory-managed I/O.

Hardware-controlled and memory-managed I/Os are the two major methods of program-controlled communication between a  $\mu$ P and a peripheral device. Hardware-controlled I/O is used in the 8080  $\mu$ P system and the 8080's original peripheral chips use that method. The 6800  $\mu$ P and our version, the 6502, use memory-managed I/O instructions.

In a hardware-controlled I/O system, the  $\mu$ P has a particular instruction, called an I/O

command. During the execution of that instruction, the  $\mu$ P outputs an operand designating a particular peripheral device, along with a control signal that indicates which kind of I/O instruction will be performed.

The control signal tells the system either that data will transfer from one of the  $\mu$ P's registers to the peripheral device (a data-output instruction) or that data will transfer from the peripheral device into one of the  $\mu$ P's registers (a data-input instruction). The control signal must be separate from normal memory-data-transfer paths to be recognized by the I/O devices.

### Memory-managed I/O uses less logic

A memory-managed I/O system needs none of the circuitry employed in a hardware-controlled I/O system to generate the control signals and

*(continued on page 36)*

## Logic state analyzer presents loads of $\mu$ P data

A logic-state analyzer called the Logicorder-32 crams address and data from 32 successive memory accesses, plus a triggering address and delay, onto a standard oscilloscope screen. All of this in hexadecimal notation for 16-bit words. Since the Logicorder really stores 64 accesses, you may choose which group of 32 you are looking at. Also the unit uses five toggle switches instead of 16, or the harder-to-use thumbwheel switches, to set 16-bit address and delay functions.

To enter a desired trigger address or delay, put its associated toggle switch in "slew." This resets an internal counter for that function. Four other toggle switches increment one hexadecimal digit of the counter at a time, until the desired number is reached.

The Logicorder's memory can be manually reset to enter new data or automatically reloaded two times a second to periodically update the display. The analyzer occupies one compartment in the Tektronix TM-500 series of modular instruments.

The Logicorder-32 sells for \$895 and is available in 90 days. Scanoptik, Inc., P.O. Box 1745, Rockville, MD 20850. (301) 977-9660.

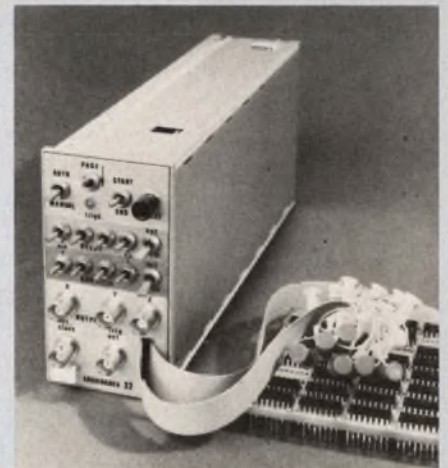

CIRCLE NO. 508

## MICROPROCESSOR DESIGN

(continued from page 35)

I/O data. Instead the programmer treats peripheral devices in the same manner as locations in memory. When data transfer from the  $\mu$ P registers to a peripheral device, the  $\mu$ P simply writes data into a "location in memory." Only, in this case, the memory location is the peripheral device, and the operation can be called a data output. Similarly, when the programmer wants to transfer data from the external device to the  $\mu$ P, it simply reads data from a "location in memory," in the peripheral device.

A memory-managed I/O system uses simpler circuitry than the hardware I/O in the 8080 because there is no need to generate an I/O control signal either from an I/O pin or by time-multiplexing the information during the status readout.

Likewise, additional circuitry on peripheral devices is not needed to interpret a control signal.

Instead, a memory-managed I/O uses the same control signals as the  $\mu$ P's memory since every  $\mu$ P must have the logic to address and control memory.

Memory is differentiated from I/O by decoding addresses rather than by separate control signals. A unique address line is assigned to indicate I/O operation because in many systems there is no need to use all of the  $\mu$ P's 16 address lines from memory.

If more than half of the addressing capability is needed for memory, then the advantages of memory-managed I/O start to disappear. This

rarely happens in  $\mu$ P systems.

In our 6502, we assign the most-significant address line to ROM and the next most-significant line to I/O. So the I/O device has to decode only three address lines; one telling it that ROM has not been selected another to indicate that I/O is being performed and a third to indicate a particular I/O block. Additional address lines can be decoded to select I/O devices within a block, but much fewer than all 16 addresses need to be decoded.

### Peripheral chips can be very useful

Peripheral chips designed for use in memory-managed I/O systems use fewer pins than those built for hardware-controlled I/O systems and are much more versatile. Registers that are  $\mu$ P-addressable are incorporated into these chips and, depending on the software program, configure the device to perform different functions.

One device, the asynchronous communications interface adaptor (ACIA), has been designed especially for memory-managed I/O systems to transfer data between a  $\mu$ P system and a serial communications line. The  $\mu$ P can write data into the ACIA's control register that specify transmission rate, word length, parity, and number of stop bits. Other ACIA registers indicate the status of the transmit and receive data registers. All this logic fits into a 24-pin package.

The equivalent device for a hardware controlled I/O, the universal asynchronous receiver-transmitter (UART), requires a 40-pin package because dedicated external pins must be driven by the  $\mu$ P system to control operations.

---

## $\mu$ Ps interface process controllers to a minicomputer.

Retrofitting already existing Beckman Instruments series 8800 process controllers so that they can be supervised by a mini is now possible. With a minicomputer supervising the controllers, data may be manipulated or stored in memory, and any gross deviations from normal will automatically alert the operator.

Simply plug in a  $\mu$ P-based interface card, the Model 8000 computer interface, into each process controller.

The interface card converts the analog outputs from the process controller into a digital ASCII format and drives a 5-wire data bus. The bus, in turn, connects to a switching box that drives either an optional display panel or a standard RS-232 line running to a minicomputer and peripherals.

The bus uses time-sharing, bidirectional multiplexing, and up to 36 process controllers can sit on it.

For data-transfer reliability, all data sent from the minicomputer to controller, or vice versa, are echoed back to the originator. If there is a transmission error, the data are repeated. If the minicomputer system fails, control is transferred by the switching box to the optional display panel, for manual control.

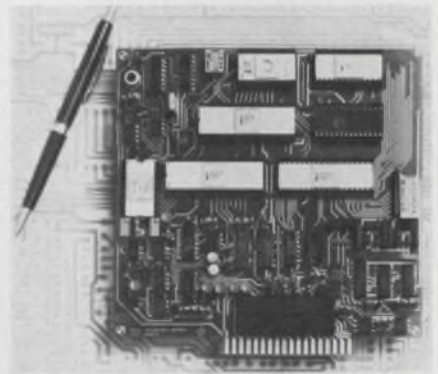

For normal operations, the plant operator sits at an interactive CRT terminal controlling the minicomputer and accesses each process controller. The plant operator monitors the three signals sent by the process controller: the deviation around a setpoint, the integral of the deviation, and the derivative of the deviation. An alarm alerts the operator when a control point exceeds deviation limits. The CRT display indicates the process-variable setpoint, the controller output and the amount of deviation. With this information, the operator can make necessary corrections.

*Beckman Instruments, Inc., 2500 Harbor Blvd., Fullerton, CA 92634. (714) 871-4848.*

---

## Build a 6800-based system with four boards and a backplane

An integrated set of cards, based on the 6800  $\mu$ P, makes a computer having several advantages over competing types. The cards consist of CPU, ROM, RAM and support modules.

The 101CPU module contains the  $\mu$ P, and has parallel keyboard inputs and a dot matrix-printer output, rather than serial I/O lines that are common on other PC boards. Parallel I/O is more desirable if you need high speed operation because data are transferred 8 bits at a time, instead of one bit at a time in the serial mode.

You also get a total of 48 parallel-I/O lines plus 16 software-pollled interrupt lines. The board also comes with 1 k of EPROM (2708) and 4 k of RAM. The 101CPU also has fully buffered lines to drive external circuits. It costs \$595, complete.

The 101ROM module has sockets for 14 k of PROM, and additionally has two kinds of serial asynchronous ports. One type uses EIA or current loop levels, with selectable transmission rates from 110 to 9600 baud. The second port has modem circuitry, including isolation transformers, for direct connection to a leased telephone line.

The 101RAM module comes with 16 k of static RAM memory, for \$1095. The nearest equivalent, a Motorola product, uses dynamic RAMs and sells for \$1495. Dynamic RAMs produce more noise on power-supply lines because they must be periodically refreshed. They are thus less desirable in this application.

The 101UNB program development module provides address traps and switch-selectable interrupt and restart vectors. The module contains additional communications ports, RAM and I/O.

The 101REG module contains power-supply regulators that work with rectifiers and filters on the motherboard to supply the required dc voltages. It costs \$195, and the motherboard runs \$445. A separate transformer must also be used, \$88.

*Revenue Control Sciences, 137 Richmond St., El Segundo, CA 90245. (213) 322-1893.*

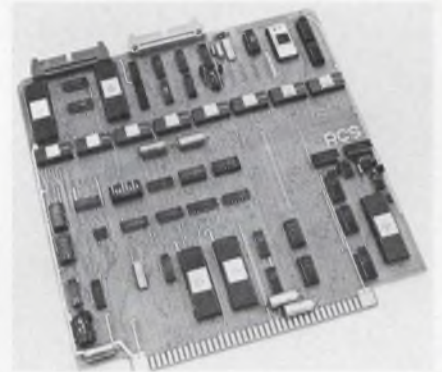

CIRCLE NO. 510

---

### Micro Capsules

Motorola is second sourcing the **2900 four-bit slice family**. The company initially will offer the bit slice chip (MC2901), the microprogram sequencer (MC2909), and the one-by-two-port register (MC2918). . . . **Raytheon is introducing four new 2900 components:** a 4-bit bus transceiver (2905), a transceiver plus parity (2906), a transceiver in a 20-pin DIP (2907), and a 4-bit register with TTL and three-state outputs (2918). Raytheon is also making the 93415, a 1-k  $\times$  1 high speed RAM. . . . **A  $\mu$ P-compatible, direct-memory-access or interrupt-driven-data transfer controller** is on the market from Standard Microsystems Corp., Hauppauge, NY. The chip uses the 8080 bus structure. Control and status registers within the chip are set by software to enable single-character, multicharacter, or multiblock data-transfers between the chip and peripheral devices.



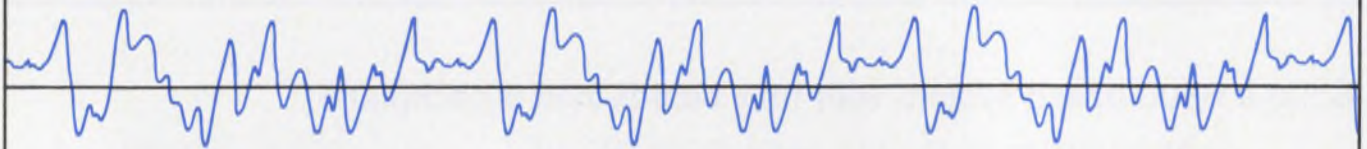

# Stop noise problems with **High Noise Immunity** Logic.

Noisy environments simply cease to be a problem when you design with High Noise Immunity Logic from Teledyne. HiNIL provides high immunity to any and all types of electrical noise, without the cost and inconvenience of special filtering or shielding.

Use HiNIL in place of your conventional I/O logic. It interfaces easily with TTL, DTL, MOS and CMOS. It will protect your CMOS inputs against static charge damage and SCR latchup. And it gives you a guaranteed dc noise margin of 3.5 V (as compared to 1.0 V for CMOS



and 0.4 V for TTL) without added filter circuits or tight supply regulation.

Or design entirely with HiNIL. You will get even better noise protection and a simpler design, and you can use a low cost, loosely regulated power supply. The complete HiNIL family includes more than 40 devices, with more being added all the time. They're available in ceramic or molded plastic DIPs.

Get complete details on the full family of HiNIL logic circuits from your local Teledyne Rep or Distributor. Or contact us at the address below.

## **TELEDYNE SEMICONDUCTOR**

1300 Terra Bella Avenue, Mountain View, California 94043 Tel: (415) 968-9241 TWX: 910-379-6494 Telex: 34-8416

**SALES OFFICES:**

DOMESTIC: Salem, N.H. (603) 893-9551; Stony Brook, N.Y. (516) 751-5640; Des Plaines, IL (312) 299-6196; Los Angeles, CA (213) 826-6639; Mountain View, CA (415) 968-9241 • INTERNATIONAL: Hounslow, Middlesex, England (44) 01-897-2503; Triengen, West Germany 7741-5066; Kowloon, Hong Kong 3-240122; Tokyo, Japan 03-405-5738.

CIRCLE NUMBER 19

## The general and the lady

Once upon a time, during a state visit to Spain, Argentina's Eva Peron was honored by Generalissimo Francisco Franco with a splendid parade, complete with marching bands, drumworks and all sorts of fanfare. That evening, at the end of a Lucullan feast, Franco proudly turned to Madame Peron and said: "Well, Eva, how did you like the parade?"

"Oh, it was lovely," she answered, "really lovely. But I was just wondering. Why, when they marched under my balcony, did they keep shouting 'Whore! Whore!?'\*"

"Oh that!" said Franco, with a wave of his hand. "Don't let that bother you. They still call me 'General,' and I haven't been in the army for 20 years."

Well, as we know, Eva and Francisco didn't seem to suffer from their reputations. But many of us suffer from ours. Sometimes, we even suffer from the reputations of others. For events leave reputations that live too long.

We remember too well the successes and failures of our colleagues. Joe is a fantastic engineer because we remember that he once designed a sensationally successful product. (But everything he's done since has been ho-hum.) Frank is a bum, because we cannot forget that we could never trigger that scope he designed in 1956. (But he *has* designed a whole series of successful instruments since then.) We remember to give Joe handsome salary hikes, while we remember to forget about Frank.

With companies too—vendors and customers—we act as if their present were their past. And we both suffer for it. A vendor who once supplied bad parts and gave lousy delivery might, today, deliver excellent components rapidly. And the customer who paid his invoice in 180 days, and then only after a series of dunning letters, might today be taking discounts for cash payments.

Of course, we can't ignore history. If a vendor keeps shipping us bad parts, we ought to find a better vendor. If a manager has a long record of failures, it probably isn't wise to hire him to teach us how to run our engineering departments. By the same token, if he has a fine track record, we might want to learn from him.

But history should not be our only guide. The present must be a factor.



RECOGNIZED BY  
AMERICAN REVOLUTION  
BICENTENNIAL  
ADMINISTRATION

ELECTRONIC DESIGN is deeply honored to have received official recognition as a participant in the American Revolution Bicentennial Celebration, with authority to display the Bicentennial Symbol.

GEORGE ROSTKY  
Editor-in-Chief

\*Most authoritative rumors hold that the lady was not a whore, but rather, a friendly waitress, renowned for her great service, in one of the less fashionable cabarets in Rosario.

# FOCUS

## on Adhesives and Coatings

The use of insulating and conductive adhesives and coatings in electronics is increasing.

But specifying them can be a complicated and frustrating business. To begin with, an adhesive or coating suited for a specific application must meet requirements in at least six areas: mechanical, electrical, thermal, environmental, chemical and application compatibility. A fully defined spec is expected to list some 30 or 40 parameters, but very few do. The reason? The manufacture of adhesives, and to a lesser extent of coatings, is a highly proprietary business, with suppliers turning out what seem to be endless variations of the same basic formulas.

For any given adhesive application, a supplier might have 5 to 10 combinations of the same basic compound that are suitable in one or more respects. But these variations are seldom specified completely enough to be directly compared with another supplier's product.

One supplier points out that he cannot afford to turn out test data for the many possibilities inherent in a given adhesive type. Moreover, generalities are not easy to make, for the same reason.

The best approach, recommended by both suppliers and a number of experienced adhesive users, is to provide the supplier with sufficient information for him to settle on a recommendation within a range of two or three formulations.

Information that suppliers consider helpful answers the following questions:

- What is the electronic component or device to be used for?
- What is the material or substrate of the parts to be bonded?
- Is a flexible, semiflexible or rigid adhesive needed?
- How does the designer intend to apply the

adhesives? Will he use a dip, spray, paint, or fluid bed?

- What equipment does the user have? Can he oven-cure parts? Can he afford to invest in new equipment?

- What are the continuous operating temperatures of the finished product, transient elevated temperatures, if any, and the temperature during storage?

- In what ambient will the product be used: benign, solvent, chemical, or humid?

- Are there any required specs, such as MIL standards?

Adhesive specs tend to include only the key properties of the cured material, and, surprisingly enough, some specs don't even include the bond strength.

But the material is only a part of specifying an adhesive. There are two other important facets: the preparation of the surfaces to be bonded and the choice of an adhesive-application system that is affordable and compatible with the surfaces to be bonded.

Failure to properly clean the surface to be bonded is the most frequent cause of poor joint performance; close behind is the failure to keep the surface clean until the bond is made.

### Bond specs are often vague

Yet much of this preparation information is available only by contacting the adhesive manufacturer personally. And, while the cleaning is important, it is frequently not specified in detail.

The manner of applying the adhesive—brushing, spraying, dipping—can result in considerable variations not only in labor cost, but also in equipment requirements that can run into thousands of dollars. Yet these details are neglected

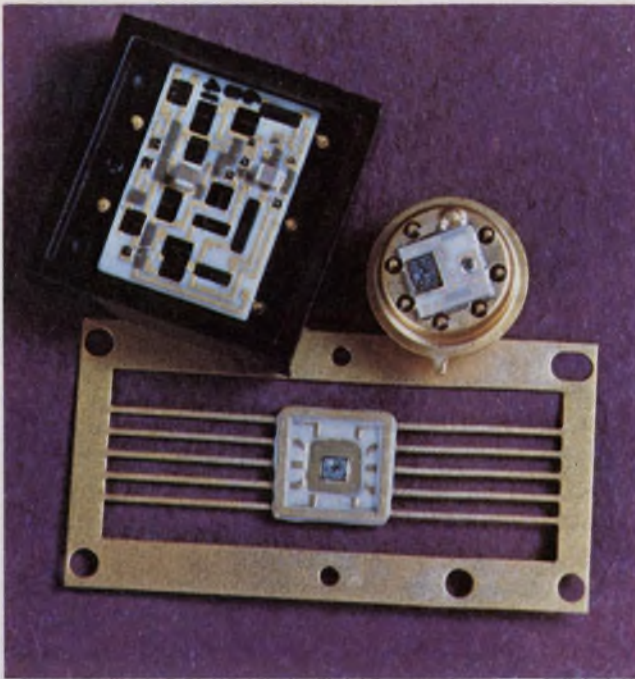

Die bonding using conducting epoxy adhesives is supplanting eutectic bonding in hybrids and microcircuits. Chips on these devices were bonded with Epoxy Technology adhesives.

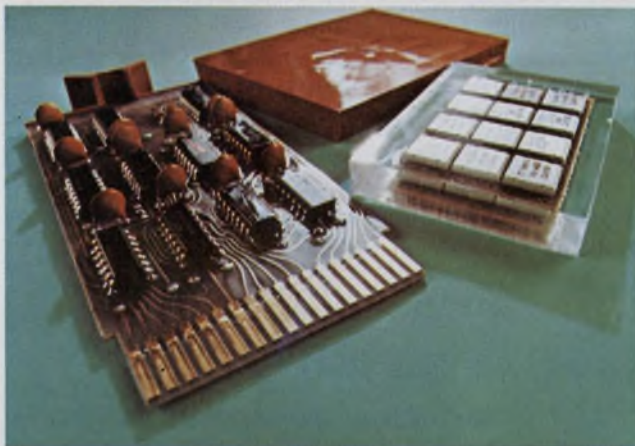

Microprocessor and other logic circuits are protected against adverse environments of industrial or commercial applications by these conformal coatings and encapsulants of Dow Corning silicone materials.

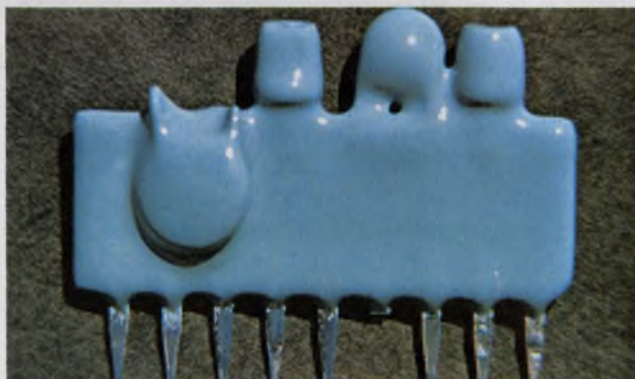

Components like this AM radio receiver assembly are protected by a hard, fused coating of epoxy powder by Hysol. The powder is applied in a fluid-bed process.

by many adhesive and coating suppliers.

The bond strengths specified pertain to specific kinds of mating surfaces, prepared in a specific manner, and can vary widely with different surface preparation and cure conditions. But the suppliers don't always let the designer know. The designer is frequently misled by "testmanship"—the specs don't fully describe the test methods used to obtain the values. Or, in some instances, extensive tests are developed that produce impressive, but insignificant, numbers.

When using adhesives, the designers must make many tradeoffs. But these are generally passed on by word of mouth, not the literature.

Usually these tradeoffs are compromises involving adhesive performance, physical performance, applications cost and processing ease. Since the designer often ignores the latter two, a cheaper material can end up costing more than the more expensive material: Factors such as application time, equipment use, scrap and training time must be included in the picture.

With coatings, the tradeoffs are similar. The designer must juggle environmental protection, temperature cycling resistance, processing ease and material costs. Or he might trade good chemical resistance for coating flexibility, or water-absorption for flexibility.

With adhesives, compromises must also be made between a bond's high tensile strength and high peel strength.

The retention of bond strength over a certain time is often quoted for unstressed specimens in the technical literature. But this quoted strength can be substantially reduced if the bond is aged under cyclic loads at various temperatures.

Specs for such adhesives as epoxies and other polymers indicate production of heat—an exotherm—during the curing cycle, but not how much.

The designer should also carefully check the specs for the elevated temperatures required for a heat-cured adhesive. This type of adhesive can only be used if the temperature tolerance of the components or semiconductors is satisfactory above the cure point.

### Dielectric and conducting adhesives

At least four basic kinds of adhesives are used in the electronics industry: acrylics, cyanoacrylates, epoxies and silicones. When used in their basic formulated state, these adhesives are all dielectrics with good insulating qualities.

But now many adhesive manufacturers fill these adhesives with conductive particles, such as silver, copper, gold, platinum, graphite and carbon. This permits them to be used as conductive bonds in applications ranging from bonding EMI

shielding to assembling components like waveguide systems.

The acrylics can be obtained as thermosetting systems or as solvent-dispersed modified systems to be used primarily for coatings.

The cyanoacrylates set instantly and are widely advertised as "a drop that holds a ton." But they are highly specialized in application, and once the adhesive sets it cannot be reversed. They have poor high-temperature and moisture resistance and don't satisfactorily fill gaps between mating parts.

The silicones are generally used as sealants and gaskets. They have good high-temperature and low-temperature characteristics. For example, one-part, room-temperature-vulcanizing (RTV) adhesive/sealants have a useful temperature range of  $-65$  to  $260$  C.

RTVs are used for bonding and sealing wires, terminals and other electronic equipment components. Most RTVs are cured by exposure to air



**Conductive silver coatings**, sprayed inside the plastic cases of a sensitive digital meter (left) and analog meter (right), protect meter circuits from EMI. Coatings on distributor cap (top center) and circuit-breaker bushing (bottom center) reduce radiated EMI.



**This waveguide and flange** is assembled by using a two-component Emerson & Cuming conductive silver "epoxy solder." It forms a rigid connection.

moisture. But when sealed in a container, they have an exceptionally long pot life.

Two-component silicones are also available, but their principal electronics use is in encapsulation. They have a higher upper temperature rating of  $300$  C.

Epoxies are the strongest of all the adhesives and provide the best metal-to-metal bonds. One-part epoxies must be kept refrigerated to obtain a good "pot" life. But they must be cured at elevated temperatures.

Two-part epoxies are room-temperature cured, but require careful mixing of the two components before curing begins. These epoxies can also be heated for improved bonding and other characteristics.

Electrically conducting epoxies are used principally as "epoxy solder" that is frequently applied to bond materials not normally compatible with regular solders—usually because of heat-sensitivity.

Epoxy solders are supplied as one or two-component systems. The two-component systems, which can be cured at room temperature, are used for temperature-sensitive devices.

The conductive filler most used for epoxies and other adhesives is a silver powder. Other powdered materials, such as copper or aluminum, tend to oxidize after curing and reduce joint conductivity.

The silver epoxy's conductivity is good. For example, typical volume resistance for Emerson and Cuming's Eccobond Solder 56C is about  $2 \times 10^{-4}$   $\Omega$ -cm.

### Silver-epoxy is widely used

Applications include the assembling of waveguide plumbing (see photo), bonding a tantalum slug to the can of a tantalum capacitor and making connections to heat-sensitive semiconductors.

Adhesives experts caution that the conductivity of such a joint is substantially affected by the cleanliness or other preparation required of the parts to be joined.

For nonmetallic surfaces, the pretreatment usually consists of a solvent wash or a good vapor degreasing to remove undesirable films or materials from a PC board. When bonding metallic surfaces together, in particular aluminum, note that a more complex treatment is needed for maximum conductivity and strength.

In this case, chemical pretreatment as well as abrasive cleaning might be necessary. It may also be necessary to provide chromate conversion or an anodized surface on the mating metals. But this varies with adhesives, so ask the manufacturer.

Until about three years ago, the bonding of semiconductor chips in hybrid and other micro-electronic devices was usually performed by eutectic or solder-type operations. These operations raise the chip temperature to almost 400 C for extended periods of time and often degrade semiconductor characteristics.

As a result, conductive-epoxy die bonding, with its substantially lower temperatures, is now used for such electronic products as hybrid devices, LEDs and digital watch assemblies.

At present, there are two schools of thought regarding adhesive die bonding. Herbert S. Kraus, president of Ablestik Laboratories, Gardena, CA, believes that the adhesive should be a single-component system even though it requires elevated curing temperatures.

Kraus cites the advantages of such a system: the adhesive can be dispensed without being weighed and mixed; and waste adhesive material that results from two component, mixed systems

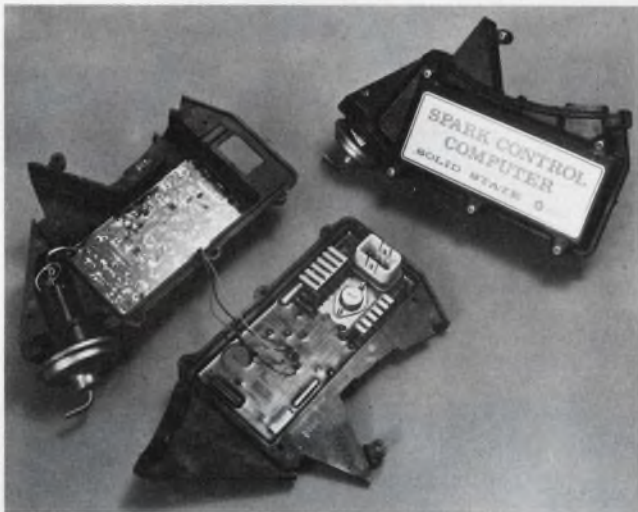

The two PC boards of this advanced Spark Control Computer from Chrysler are protected by transparent General Electric silicone coatings from the shock, vibration and high ambient temperatures under the car hood.

is eliminated.

DuPont apparently agrees with Kraus. The company makes a series of single-component epoxy-based compositions that are used for bonding semiconductor chips to substrates and for attaching wire leads and discrete components. Thermal stability of the DuPont materials bonds is good up to 250 C.

The DuPont silver compositions 5504, 5815, 6838, 8072 and gold 9294 are all electrically conductive with sheet resistivities of less than 0.1  $\Omega$  per square mil thickness.

Where a device to be bonded must be insulated

from the substrate, an 8762 adhesive containing powdered alumina serves to maximize heat transfer.

All of these single-component types require typical cures ranging from about 45 minutes at 200 C to 24 hours at 100 C.

Some military and space applications don't permit the use of silver die bonding because of silver migration. In these cases, gold and occasionally palladium or platinum are used as the conductive filler. However, all three are more expensive than silver and are poorer electrical and thermal conductors.

Over on the side of two-component, conductive epoxy adhesives for bonding is Frank Kuleza, president of Epoxy Technology, Watertown, MA.

Except for convenience, the one-component systems have limitations, Kuleza insists, and points out that one-component systems require refrigeration and in addition have relatively high curing temperatures and times.

To support his argument, Kuleza points to Epoxy Tech's H20E, a two-component silver epoxy widely used for assembly in the digital watch field. Although the two components must be mixed, the ratio is one-to-one by weight or volume and is not critical. And the two-component material can be cured in 45 seconds at 175 C or in 12 hours at 50 C.

The epoxy bonds with both single and two-component systems can be adversely affected by the thermal-compression techniques used for bonding wires to the chips. With thermal compression, the chip adhesive might reach 400 C and soften. One answer here is to specify an epoxy that is formulated with sufficient viscosity at that temperature to remain in place. Another answer often used by hybrid fabricators is ultrasonic wire bonding.

### Conductive coatings fight EMI

Conductive coatings for electronic applications, with a few exceptions, have the same dielectric materials as adhesives. These include the epoxies, acrylics and latex resins that also have a conductive filler.

But these coatings are supplied with a low or even watery viscosity, so that they can be sprayed, brushed, dipped, or silk-screened to provide a conductive surface on plastics, ceramics, glass and other nonconductive materials.

Conductive coatings are becoming more important in the prevention of electromagnetic and radio-frequency interference (see ED No. 20, Sept. 27, 1976, p. 24) particularly for electronic products with plastic housing or cabinets. These plastics are transparent to EMI.

To prevent EMI from being radiated from a

plastic-housed device like an electric drill or shaver, or from reaching the sensitive circuitry of electronic measuring instruments, the interior of the plastic housing is coated with a conductive film. This is the most cost-effective method of EMI-proofing complex shapes or large areas.

These anti-EMI coatings consist of particles of silver, copper, metal alloys, graphite or carbon dispersed in a liquid binder resin. The effectiveness of representative coatings, from Acheson Colloids, is shown in the comparison chart.

Ballpark figures for coating costs per square foot are: silver, \$2; copper, 75¢; graphite, 50¢; carbon, 25¢. Approximate relative costs per square foot for competing methods of EMI shielding include: metal spray, \$2.75; vacuum metallizing, \$1.25; plating, \$1.00.

The most stable of these coatings uses silver as the conductive element and is generally the easiest to apply or repair.

Some conductive coatings might require complex mixing equipment to ensure uniformity during application. This can be an overlooked pitfall in large production runs.

Also, some coatings have a tendency to cause the plasticizer to leak from the plastic substrate into the coating, reducing the effectiveness of the shielding.

Durability of most anti-EMI coatings is good. Tests by Acheson Colloids, Port Huron, MI, on silver coatings have shown no degradation after 96 hours of salt spray, water immersion and exposure to ozone.

### Conformal coatings protect circuit boards

Conformal dielectric coatings protect PC boards and their components from such hostile environments as moisture, chemical fumes, fungus, abrasion, salt, and even skin oils deposited in handling.

Circuit boards that formerly needed no coatings might require them today for other reasons. For example, Underwriters' Laboratories requires coatings on any 110-V board with conductors not separated by at least 0.25 inch.

Ideally, conformal coatings should provide many good electrical properties, high humidity resistance, ease of application, low temperature cure, suitable physical properties, transparency, removability or repairability, fungus resistance, hydrolytic stability and thermal-shock resistance.

Five principal types of coatings are MIL-spec approved: acrylics, polyurethanes, epoxies, silicones, and Parylene, a proprietary product of Union Carbide. Polyimide and diallyl phthalate coatings are also available.

Many designers experienced in the use of conformal coatings agree that although the MIL

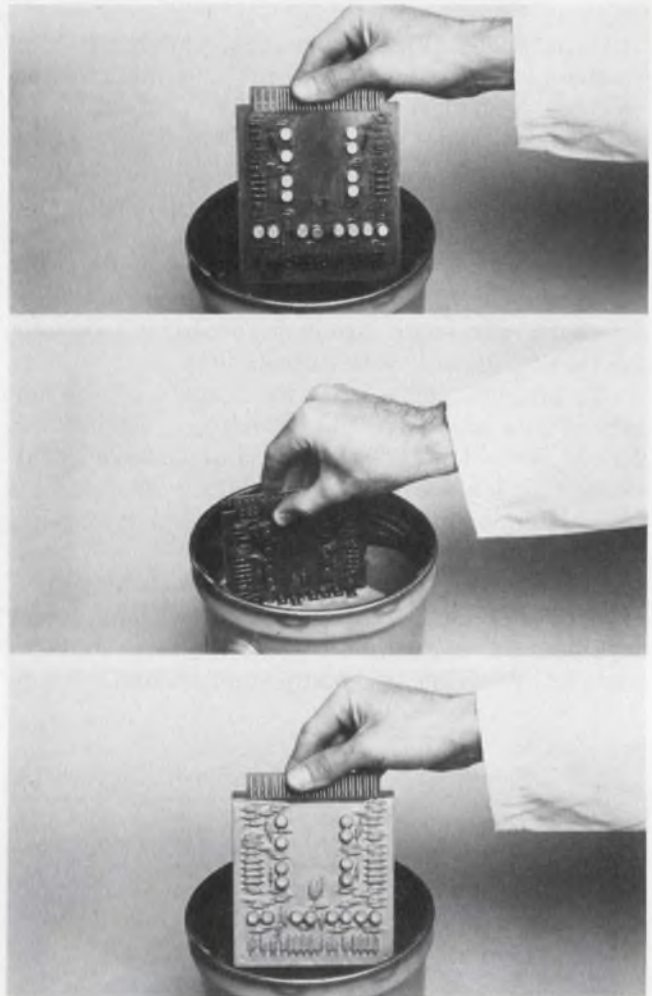

Conformal dielectric coatings protect PC boards and their components against moisture, abrasion and contamination. This Silgan elastomer coating holds components securely.



Special, highly stable ceramic-like adhesive can perform satisfactorily up to 2200 C. Here a Sauereisen inorganic cement is used for stable alignment of lamps operating up to 330 C. From left to right: a film projector lamp, a flash bulb and an aircraft warning light. At far right, external leads of mercury switch are sealed.

types cost more initially, they offer desirable features like high reliability.

What the specs don't mention is that while these coatings are good at sealing out moisture, they are excellent at sealing it in. As a result, PC boards must be carefully cleaned and baked. Also, if the boards are to be handled after cleaning, they should be stored untouched in a desiccant cabinet or sealed in polyethylene bags.

Acrylic coatings are good from a production standpoint because they can be applied easily. They are solvent-based. An acrylic film forms when the solvent evaporates, and curing is rapid. Thus, several coats can be given fairly quickly.

If the PC board needs to be repaired, the cured acrylic film can be softened by soaking the board in a solvent like trichlorene or methylene chloride. However, be careful of the environment in which acrylic-coated boards are to be used because low solvent resistance is a drawback of these films.

Because of their good electrical properties and resistance to temperature and humidity extremes, silicone materials are suited for PC-board conformal coatings and are useful in harsh environments. For example, a General Electric silicone rubber gel was chosen to protect the PC boards for Chrysler's electronic Spark Control Computer located under the auto's hood.

To provide a conformal coating that combines a good moisture barrier with the shock resistance of silicone rubber, Dow Corning has developed the R-4-3117 coating, the first in a new family of "elastoplastic" silicone resins.

Dow's R-4-3117 is a tough but flexible coating for electronic parts, components and assemblies that provides environmental protection from -65 to 200 C.

Supplied as 75% solid in a solvent of xylene,

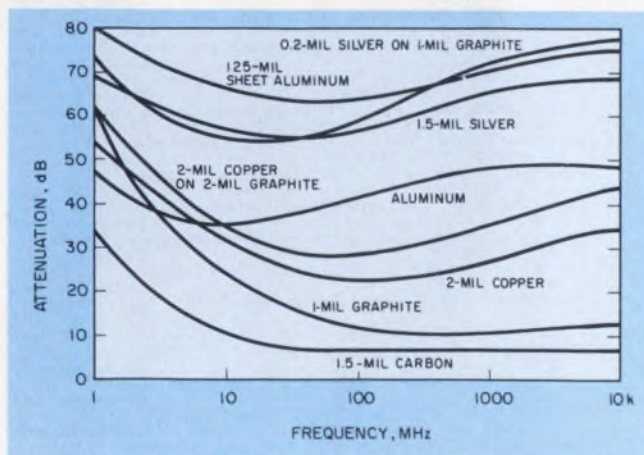

Shielding effectiveness of conductive coatings varies with material type and coating thickness. Typical attenuations of Acheson Colloids' formulation on a 0.125-in.-thick polycarbonate sheet are shown.

the coating gives greater protection against damage and abrasion than regular silicone rubber coatings. It can be applied with standard brushing, dipping, spraying or flow-coating. A dip coat gives a typical thickness of 2 to 4 mils.

The coating is cured at room temperature, with 40% relative humidity, and has a tack-free surface within one hour. Optimum room temperature cure is 24 hours, but tack-free curing can be obtained in 10 minutes with a catalyst and oven curing.

Circuits coated with R-4-3117 can be repaired by soaking the faulty area in the solvent. To replace a single component, a pin-type soldering iron can be applied directly through the coating, which is then cleaned and recoated.

### Silicones have disadvantages, though

While silicones have many advantages, including ease of handling, they are not as strong as the organic polymers like the epoxies and polyurethanes. To combine the best of the silicone and organic polymer worlds, a new family of high-strength composites has been developed by the SWS Silicones Corp., Adrian, MI.

Known as Silgan elastomers, the new materials combine low viscosity and ease of handling with the high tensile and tear strengths associated with organic polymers.

The Silgan elastomers cure at room temperature without exotherm and with low shrinkage, and are available as one and two-part compounds. Their maximum service temperature is 125 C, lower than the 200 C for Dow's elastoplastic silicone resin. But the Silgan tensile strength is three times as great. These elastomers achieve their unusually high strength because they contain rod-like organic particles dispersed in a liquid silicone matrix.

A major problem with PC-board conformal coatings is obtaining a complete and uniform coating over, around and under all the components. For this reason, a fairly slow speed of immersion in dipping is usually required so that the coating can adequately displace the air surrounding the components. Immersing the board too quickly will trap air and leave bubbles in the coating.

### Epoxy coatings are tough

Epoxy coatings are available as two-component systems or as one-part epoxy powders that have been developed especially for application to electronic components with an automatic, fluidized bed-dipping equipment. The epoxy powders require that the compound be preheated to 145 C. Cure times range from 2 minutes at 170 C to



20 minutes at 110 C.

Epoxy coatings have high abrasion resistance, high chemical resistance and good humidity resistance. But they are difficult to repair. Also, when applied to components on a PC board, the epoxy shrinks slightly during the curing period. Therefore, if fragile components are present, they must be protected with a softer buffer material like silicone to prevent breakage.

Polyurethane coating materials are available either as a single or two-component system. Their resistance to chemical activity and humidity is high, and their dielectric properties are stable.

But their good chemical resistance is a drawback. If a PC board must be repaired the highly active stripping compound can easily corrode the PC conductors and other metals with which it comes in contact.

Another limitation is that the boards must be carefully prepared for polyurethanes because traces of moisture can cause blistering in humid environments.

The single-component urethanes have production limitations in that they can require up to 9 or 10 days at room temperature to fully cure. The two-component urethanes can be cured in up to three hours, but only at elevated temperatures.

### Voids create problems

Problems with voids are not unusual for either spray or dip conformal coatings. But this problem has been solved by one of the newest coatings, a proprietary product of Union Carbide called Parylene—generically poly-para-xylylene.

Parylene, in contrast to the competitive materials, is applied with a vacuum deposition technique at room temperature. A number of PC boards can be put into the chamber at one time, and the Parylene is vaporized and deposited out as a solid coating. No curing is required.

Because the Parylene has a low viscosity, it penetrates and covers all portions of the board—in the corners and underneath the components.

The general coating thickness used for PC boards is 0.5 mil, but the thickness can vary from a few angstroms to as high as 3 mils, although seldom over 1 mil.

While the cost of the Parylene is some \$250 per pound—more than 10 times that of other materials—less of it is used. However, expensive deposition equipment is required.

Tensile strength is good: 9000 psi for Parylene N and 13,000 psi for Parylene C. Both require a 200% elongation to break. And the dielectric and moisture-barrier properties are very good.

Because the coating is applied at room temperature, thermal stress is negligible. However, the coating does not strip easily, so repair work can get complicated. ■■

## Need more information?

The companies and products cited in this report have, of necessity, received only brief coverage. They have been selected for their illustrative qualities. Many companies not mentioned might offer similar products. Readers may consult manufacturers from this partial listing and from ELECTRONIC DESIGN's GOLD BOOK for further details:

- Ablestik Laboratories, 833 W. 182 St., Gardena, CA 90248. (213) 321-6252. **Circle No. 407**  
Acme Chemicals & Insulation Co., Div. of Allied Products, 166 Chapel St., New Haven, CT 06513. (203) 562-2171. **Circle No. 408**  
Adhesive Products Corp., 1660 Boone Ave., Bronx, NY 10460. (212) 542-4600. **Circle No. 409**  
Allaco Products Div., Bacon Industries Inc., 192 Pleasant St., Watertown, MA 02172. (617) 926-2550. **Circle No. 410**  
LB Allen Co., 9329 Bernice, Schiller Park, IL 60176. (312) 678-3097. **Circle No. 411**  
Ambroid Co. Inc., 612 Montello St., Brockton, MA 01853. (617) 583-6165. **Circle No. 412**  
American Cyanamid Co., Industrial Chemicals & Plastics Div., Wayne, NJ 07470. (201) 831-1234. **Circle No. 413**  
Applied Plastics, 612 E. Franklin Ave., El Segundo, CA 90245. (213) 322-8050. **Circle No. 414**  
Armstrong Cork, W. Liberty & Charlot, Lancaster, PA 17604. (717) 397-0611. **Circle No. 415**  
Astrodyne Inc., 350 Middlesex Ave., Wilmington, MA 01887. (617) 272-3850. **Circle No. 416**  
Atlantic India Rubber, 571 W. Polk St., Chicago, IL 60607. (312) 427-8290. **Circle No. 417**  
Atlantic Research Corp., 5390 Cherokee Ave., Alexandria, VA 22314. (703) 354-3400. **Circle No. 418**  
Automatic Coil Co., 55 S. Denton Ave., New Hyde Park, NY 11040. (516) 328-3300. **Circle No. 419**  
Avdel Corp., 50 Lackawanna Ave., Parsippany, NJ 07054. (201) 263-8100. **Circle No. 420**  
Bacon Industries, 192 Pleasant, Watertown, MA 02172. (617) 926-2550. **Circle No. 421**  
Cadillac Plastic/Chemicals, 15841 2nd Ave., Detroit, MI 48203. (313) 869-9500. **Circle No. 422**  
Carboline Co., 350 Hanley Indl. Ct., St. Louis, MO 63144. (314) 644-1000. **Circle No. 423**  
RH Carlson Co., Inc., P.O. Box 191, Greenwich, CT 06830. (203) 661-9288. **Circle No. 424**  
Castall Inc., Weymouth Indl. Park, E., Weymouth, MA 02189. (617) 337-6075. **Circle No. 425**  
Chase & Sons Inc., 19 Highland, Randolph, MA 02368. (617) 963-2600. **Circle No. 426**  
Chemtronics Inc., 45 Hoffman Ave., Hauppauge, NY 11787. (516) 582-3322. **Circle No. 427**  
Chomerics Inc., 77 Dragon Ct., Woburn, MA 01801. (617) 935-4850. **Circle No. 428**  
Conap Inc., 1405 Buffalo St., Olean, NY 14706. (716) 372-9650. **Circle No. 430**  
Corkpak Co., Inc., 70 Argyle Ave., New Rochelle, NY 10804. (914) 632-1713. **Circle No. 431**  
Cotronics Corp., 37 W. 39th St., New York, NY 10018. (212) 531-9376. **Circle No. 432**  
Cox & Co. Inc., 215 Park Ave. S., New York, NY 10003. (212) 674-4727. **Circle No. 433**  
Crown Industrial Products Co., State Line Rd., Hebron, IL 60034. (815) 648-2424. **Circle No. 434**  
JC Dolph Co., New Rd., Monmouth Junction, NJ 08852. (201) 329-2333. **Circle No. 435**  
Dow Chemical Co., 2020 Dow Center, Midland, MI 48640. (517) 636-1000. **Circle No. 436**  
Dow Corning Corp., S. Saginaw Rd., Midland, MI 48640. (517) 636-8000. **Circle No. 437**  
DuPont, 1007 Market St., Wilmington, DE 19898. (302) 774-2421. **Circle No. 438**  
Dynaloy Inc., 7 Great Meadow Lane, Hanover, NJ 07936. (201) 887-9270. **Circle No. 439**  
Electro-Kinetic Systems Inc., 2500 E. Redley Ave., Chester, PA 19013. (215) 439-0889. **Circle No. 440**  
Electro Materials Corp. of America, 605 Center Ave., Mamaroneck, NY 10543. (914) 698-8434. **Circle No. 441**  
Electronics Micro Systems Inc., 1672 Kaiser Ave., Santa Ana, CA 92714. (714) 549-2295. **Circle No. 442**  
Emerson & Cuming Inc., 60 Walpole St., Canton MA 02021. (617) 828-3300. **Circle No. 443**  
Epoxylyte Corp., 1901 Via Burton, Anaheim, CA 92806. (714) 956-9300. **Circle No. 444**  
Epoxy Technology, Inc., 65 Grove St., Watertown, MA 02172. (617) 926-0136. **Circle No. 445**  
Fel-Pro Inc., 7450 N. McCormick Blvd., Skokie, IL 60076. (312) 674-7700. **Circle No. 446**  
Fenwal Inc., Main St., Ashland, MA 01721. (617) 881-2000. **Circle No. 447**  
Furane Plastics Inc., Sub. M&T Chemicals Inc., 5121 San Fernando Rd., West Los Angeles, CA 90039. (213) 247-6210. **Circle No. 448**  
GC Electronics, 400 S. Wyman St., Rockford, IL 61101. (815) 968-9661. **Circle No. 449**  
General Electric Silicone Prod., Waterford, NY 12118. (518) 237-3330. **Circle No. 450**  
Geos Corp., 420 Fairfield Ave., Stamford, CT 06902. (203) 357-0400. **Circle No. 451**  
Hardman Inc., Belleville, NJ 07109. (201) 751-3000. **Circle No. 452**

# Dialight LEDs

The widest choice for your every application.

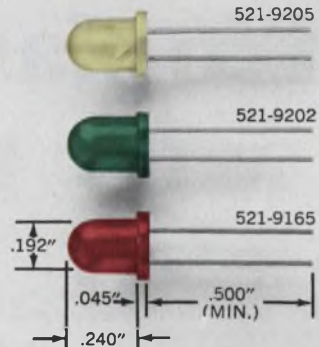

Now available in green, yellow and red. Mini-sized for maximum front panel density and easy panel mounting. High luminous intensity, low cost. Vibration/shock resistant. Solid state for long life. Wide viewing angles. Ideal for applications like panel lighting, film annotation and alpha-numeric displays.

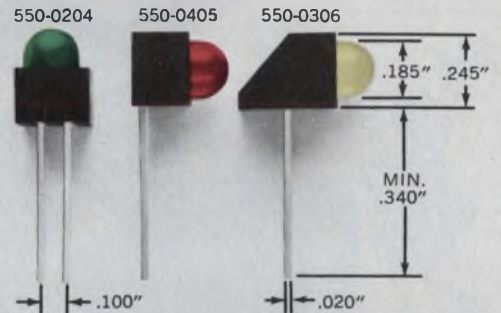

Mix 'em or match 'em. LED logic state fault indicators are available in red, yellow and green, in a variety of shapes, some with a built-in integral resistor. Can be driven from DTL and TTL logic. Designed for easy alignment on PC boards so that multiple functions can be displayed.



Dialight, the company with the widest choice in switches, LEDs, indicator lights and readouts, looks for needs . . . your needs . . . and then they develop solutions for your every application. No other company offers you one-stop shopping in all these product areas. And no other company has more experience in the visual display field. Dialight helps you do more

with these products than any other company in the business, because we are specialists that have done more with them. Talk to the specialists at Dialight first. You won't have to talk to anyone else. Send for your free new copy of Dialight's current catalog.

## **DIALIGHT**

Dialight, A North American Philips Company  
203 Harrison Place, Brooklyn, N. Y. 11237  
(212) 497-7600

# See Dialight.

- Hecht Rubber Corp., 6161 Phillips Hwy., Jacksonville, FL 32216. (904) 355-3401. **Circle No. 453**
- Heeger Inc., 725 Ceres St., Los Angeles, CA 90021. (213) 627-9319. **Circle No. 454**
- Highside Chemicals, Inc., 10 Colfax Ave., Clifton, NJ 07013. (201) 777-0626. **Circle No. 455**
- High Temp Resins Inc., 225 Greenwich Ave., Stamford, CT 06902. (203) 357-7401. **Circle No. 456**
- Hysol Div., Dexter Corp., 15051 E. Don Julian, City of Industry, CA 91744. (213) 968-6511. **Circle No. 457**
- Isochem Resins Co., Cook St., Lincoln, RI 02865. (401) 723-2100. **Circle No. 458**
- Leffingwell Chemicals Co., Box 188, 111 S. Berry St., Brea, CA 92621. (714) 529-3973. **Circle No. 459**
- Loctite Corp., 705 N. Mountain Rd., Newington, CT 06111. (203) 278-1280. **Circle No. 460**
- Lu-Sol Products, 10774 Weaver St., Box 1033, El Monte, CA 91731. (213) 443-7983. **Circle No. 461**
- MacLean-Fogg Lock Nut, 1000 Allanson, Mundelein, IL 60060. (312) 566-0010. **Circle No. 506**
- Henry Mann Inc., 3983 Mann Rd., Huntingdon Valley, PA 19006. (215) 355-7200. **Circle No. 463**
- Maroni Associates, P.O. Box 99, Sudbury, MA 01776. (617) 443-2170. **Circle No. 464**
- Mereco Products, Div. Metachem Resins Corp., 530 Wellington Ave., Cranston, RI 02910. (401) 781-4070. **Circle No. 465**
- Metex Corp., 970M New Durham Rd., Edison, NJ 08817. (201) 287-0800. **Circle No. 466**
- Micro Circuits, 10782 Maudlin Rd., New Buffalo, MI 49117. (616) 469-2727. **Circle No. 467**
- Miller-Stephenson Chemicals Co., Inc., P.O. Box 628, Danbury, CT 06810. (203) 743-4447. **Circle No. 468**
- 3M Co., Headquarters Product Information Center, 3M Center, St. Paul, MN 55101. (612) 733-1110. **Circle No. 469**
- M & T Chemicals Inc., Rahway, NJ 07065. (201) 499-0200. **Circle No. 470**
- National Adhesives Div., National Starch & Chem Corp., P.O. Box 4800, Bridgewater, NJ 08807. (201) 526-6300. **Circle No. 471**
- NL Industries Inc., Industrial Chemicals Div., P.O. Box 700, Hightstown, NJ 08520. (609) 448-3200. **Circle No. 472**
- Oneida Electronics Manufacturing Co., Inc., P.O. Box 678, Meadville, PA 16335. (814) 336-2125. **Circle No. 473**
- Opticon Chemical Div., Dynalysis Inc., P.O. Box 2445, Palos Verdes, CA 90274. (213) 830-8304. **Circle No. 474**
- Opticon Inc., 1366 Coil Ave., Wilmington, CA 90744. (213) 830-8304. **Circle No. 475**
- Owens-Corning Fiberglas Corp., Supply Div., Fiberglas Tower, Toledo, OH 43659. (419) 259-3730. **Circle No. 476**
- Permabond, P.O. Box 1033, El Monte, CA 91731. (213) 443-7983. **Circle No. 477**
- Permabond International Corp., 45 W. 45 St., New York, NY 10036. (212) 869-9494. **Circle No. 478**
- Phoenix Materials Corp., 10 Butler Rd., Kittanning, PA 16201. (412) 548-1531. **Circle No. 479**
- Plastics Consulting & Manufacturing Co., 1431 Ferry Ave., Camden, NJ 08104. (609) 963-7700. **Circle No. 480**
- Polysciences, Paul Valley Industrial Park, Warrington, PA 18976. (215) 343-6484. **Circle No. 481**
- Randolph Products, 12 St., Carlstadt, NJ 07072. (201) 438-3700. **Circle No. 482**
- Rawn Co. Inc., P.O. Box 9, Spooner, WI 54801. (715) 635-8711. **Circle No. 483**
- Sauerisen Cements Co., 160A Gamma Dr., Pittsburgh, PA 15238. (412) 781-2323. **Circle No. 484**
- SGL Homalite, 11 Brookside Dr., Wilmington, DE 19804. (302) 652-3686. **Circle No. 485**
- Sheldahl Inc., N. Highway 3, Northfield, MN 55057. (507) 645-5633. **Circle No. 486**
- Sigma Plastronics Div., 14531-33 Tireman Ave., Dearborn, MI 48126. (313) 846-4410. **Circle No. 487**
- Smooth-On Inc., 1000 Valley Rd., Gillette, NJ 07933. (201) 647-5800. **Circle No. 488**
- Spectra Strip Corp., 7100 Lampson, Garden Grove, CA 92642. (714) 892-3361. **Circle No. 489**
- Sprayway Inc., 484 Vista Ave., Addison, IL 60101. (312) 628-0998. **Circle No. 490**
- Sumitomo Bakelite Co. Ltd., 345 Park Ave., New York, NY 10022. (212) 935-8880. **Circle No. 491**
- SWS Silicones Corp., Box 428, Adrian, MI 49221. (517) 263-5711. **Circle No. 492**
- Symplastics Inc., 3718 Clifton Pl., Montrose, CA 91020. (213) 249-7810. **Circle No. 493**
- Techform Labs Inc., 215 W. 121 St., Los Angeles, CA 90061. (213) 532-1254. **Circle No. 494**
- Techkits, Inc., P. O. Box 105, Demarest, NJ 07627. (201) 768-4457. **Circle No. 495**
- Techni-Tool Inc., 5 Apollo Rd., Plymouth Meeting, PA 19462. (215) 825-4990. **Circle No. 496**
- Technical Wire Products, 129 Dermody St., Cranford, NJ 07016. (201) 272-5500. **Circle No. 497**
- Tra-Con Inc., 55 N. St., Medford, MA 02155. (617) 391-5550. **Circle No. 498**
- Transene Co. Inc., Route 1, Rowley, MA 01969. (617) 948-2501. **Circle No. 499**
- Union Carbide Corp., 270 Park Ave., Dept. RB 36, New York, NY 10017. (212) 551-6071. **Circle No. 505**
- U.S. Steel Corp., 600 Grant St., Pittsburgh PA 15230. (412) 433-1121. **Circle No. 500**
- Vigor Co., Div. B., Jadow & Sons Inc., 53 W. 23 St., New York, NY 10010. (212) 741-9500. **Circle No. 501**
- Vitta Corp., 332 Danbury Rd., Wilton, CT 06897. (203) 762-8366. **Circle No. 502**
- Waldom Electronics Inc., 4637 W. 53 St., Chicago, IL 60632. (312) 585-1212. **Circle No. 503**
- Workman Electronics Products Inc., P.O. Box 3828, Sarasota, FL 33578. (813) 371-4242. **Circle No. 504**

# If reliability's giving you a devil of a time, TO-126 plastic power will keep the gremlins out

## THERMAL EXPANSION SPOOK

An uncoordinated, disoriented monster who makes things come apart at the seams when the heat's on, and off, particularly above 75°C. Thwarted by closely matched coefficients of expansion in dice, solder, leads, headers and encapsulant.

## UNSAFE OPERATING OGRE

Laughing, elusive fiend who strikes terror, and holes, in the best-armored calculations of designers. Never totally vanquished but best defined and held at bay through 100% testing of SOA capabilities under actual operating conditions.

## HERMETICITY HOOLIGAN

Dirty, ragged contaminator whose instant touch condemns exposed collector-base junctions to fates worse than death; excessive leakages, weak knees, jitters and snapbacks. Stopped before he starts by instant application of super-reliable Motorola glass.

## SOFT SOLDER DICKENS

A lazy, lead-footed hypocrite who promises stress relief between die and header but invariably hardens his heart against it causing total thermal characteristic decay. Banished forever by proprietary gold eutectic hard solder bonding.



## HOT-TEMPERATURED TROLL

#1 rabble rouser, incites other imps to riot, normally preys on individuals with no internal fortitude, stressing them beyond limits of endurance. Stopped cold by total engineering behind TO-126 package construction and testing.

## FICKLE WIREBOND FURY

Likes to team with the Dickens to strain wires or drive wedges between base-emitter lead connections during power cycling. Creates discontinuity and doubt in performance. Exorcised by fatigue-resistant Mg-Al wires.

## FOGGY-HEADED HARPY

Creeps in on little cat feet through unnoticed cracks and crevices splashing open disorder all over the place. Hung out to dry by proprietary 5021 compound and high-pressure mold equipment.

Motorola's got a lot more reliability going for you in plastic power than any other manufacturer. Find out in a new engineering bulletin from your authorized distributor, your nearest field sales rep, or Box 20912, Phoenix 85036. We won't fail you.

Hallelujah.

**SUPERPOWER**  
unlimited



**MOTOROLA Semiconductors**

# World Travelers

Kennedy tape recording equipment—it's the finest in the world, and that's why it's in use around the world. Kennedy recorders are monitoring and recording airport traffic and arrivals in Holland; solar activity to determine the Earth's weather, in Switzerland; gasoline usage at stations in Sweden; banking systems for up-dating payments and billing in Japan; computerized feed lots in India; utility power distribution to industry in England and telephone usage analysis, toll ticketing, message switching control and automatic program load for virtually every country with a telephone service.

These are only a few of the countries and applications where Kennedy products are solving problems.

Asynchronous tape drives, vacuum column tape drives and a complete line of cartridge recorders are available for any application.

To service Kennedy products, there is a European service center and parts depot to handle factory warranties, repairs and parts stocking. If you're an OEM doing business in Europe, that's something to think about.

Kennedy tape products—they're the finest in the world. If you're thinking international, think

**KENNEDY CO.**

540 W. WOODBURY RD., ALTADENA, CALIF. 91001  
(213) 798-0953

**KENNEDY · QUALITY · COUNT ON IT**



## Consider the 6100 CMOS microprocessor when an 8-bit $\mu$ P can't deliver desired performance. The 12-bit word length and available software can ease system design.

When the 6100 microprocessor was introduced about a year ago, it offered the user three advantages over most existing  $\mu$ P circuits: static CMOS circuitry, 12-bit word lengths and the use of an already existing and popular instruction set. It was and still is the only  $\mu$ P that can emulate the software operation of a full minicomputer—Digital Equipment Corporation's PDP-8/E.

The microprocessor is a single-chip CMOS circuit built with a self-aligned, silicon-gate process. Internal circuitry is completely static, and the  $\mu$ P can operate at any speed between dc and the maximum operating frequency (8 MHz). Only one supply, from 4 to 11 V, is required for operation, and the on-chip oscillator needs only an external crystal. While low power consumption (less than 10 mW with a 4 MHz clock and +5 V supply) is a standard feature of the CMOS processor, full MIL temperature range performance is an added bonus. All on-chip input and output buffers permit simple interfaces to all TTL logic families.

### 12-bit words add flexibility

Because the 6100 has a 12-bit data word, several advantages in data-acquisition applications are readily apparent. In many systems, 10 or 12-bit analog-to-digital converters are used to prepare signals for digital storage. However, most available  $\mu$ Ps have 8-bit word lengths, and you must use at least two data words and some extra control circuitry and instructions to get the data. The 6100, however, requires only one instruction and only one memory location to store the data.

To keep the  $\mu$ P pin count to a reasonable 40, the address and data paths are multiplexed on the same 12-line bus (Fig. 1a). The 6100's timing and state control lines provide all external signals needed to communicate with memory and peripheral devices (Fig. 1b).

Many other available circuits are intended as direct support for the  $\mu$ P (Table 1): the 6402/3,

a CMOS universal, asynchronous receiver/transmitter (UART); the 6101, a parallel interface element (PIE); the 6610, 6611 and 6612,  $256 \times 4$  field-programmable CMOS PROMs; and the 6312, a  $1024 \times 12$  mask-programmable ROM for program storage. Of course, you can choose from a wide selection of CMOS RAMs, including  $256 \times 4$  and  $1024 \times 1$  models.

Building a microcomputer based on the 6100 is straightforward. All the CMOS parts are static and require only a single supply. A complete system can be built with the  $\mu$ P, a ROM, a RAM and a PIE (Fig. 2). The ROM should be located in the higher part of memory, including 7777, to define the restart location after a reset. An output on the ROM, RSEL, defines the area in the 4-k memory field dedicated to RAM.

The ROMs and RAMs designed for the 6100 have address latches built onto their chips, so external parts won't be needed. The PIE has two read, two write and four sense lines to control inputs and outputs, as well as four programmable flag outputs. Only one sense line and two flag lines are used in the system shown in Fig. 2, which leaves two read, two write and three sense lines for external I/O control.

If a UART is added, the amount of programming for the serial I/O can be reduced. And since the UART has its own crystal for synchronization, it can operate independently of the system clock. To control the UART, the PIE needs one read, one write, and two sense lines, which leaves all the others for external control.

The PIE can also handle priority-vector interrupts. To add either two or more vector interrupts or more I/O control, additional PIEs can be connected to the system bus. Each PIE must have a different address, but up to 31 units can be connected in a system.

### Software simplifies the control panel

One special feature of the 6100 is the provision for a dedicated control panel. The limited number of pins on the single-chip  $\mu$ P prevents the contents of internal registers from being read by displays without help from the software. Since a control-panel memory can be included the 6100

can display the registers without relying on the main memory. A  $256 \times 12$  ROM and  $16 \times 12$  RAM, separate from the main memory, are all that's needed to duplicate the full PDP-8/E control panel (Fig. 3).

The control panel communicates with the processor via the Control-Panel Request (CPREQ) line. This line functions somewhat like the Interrupt-Request (INTREQ) signal, but with some important differences: The CPREQ bypasses the interrupt-enable system and forces the processor

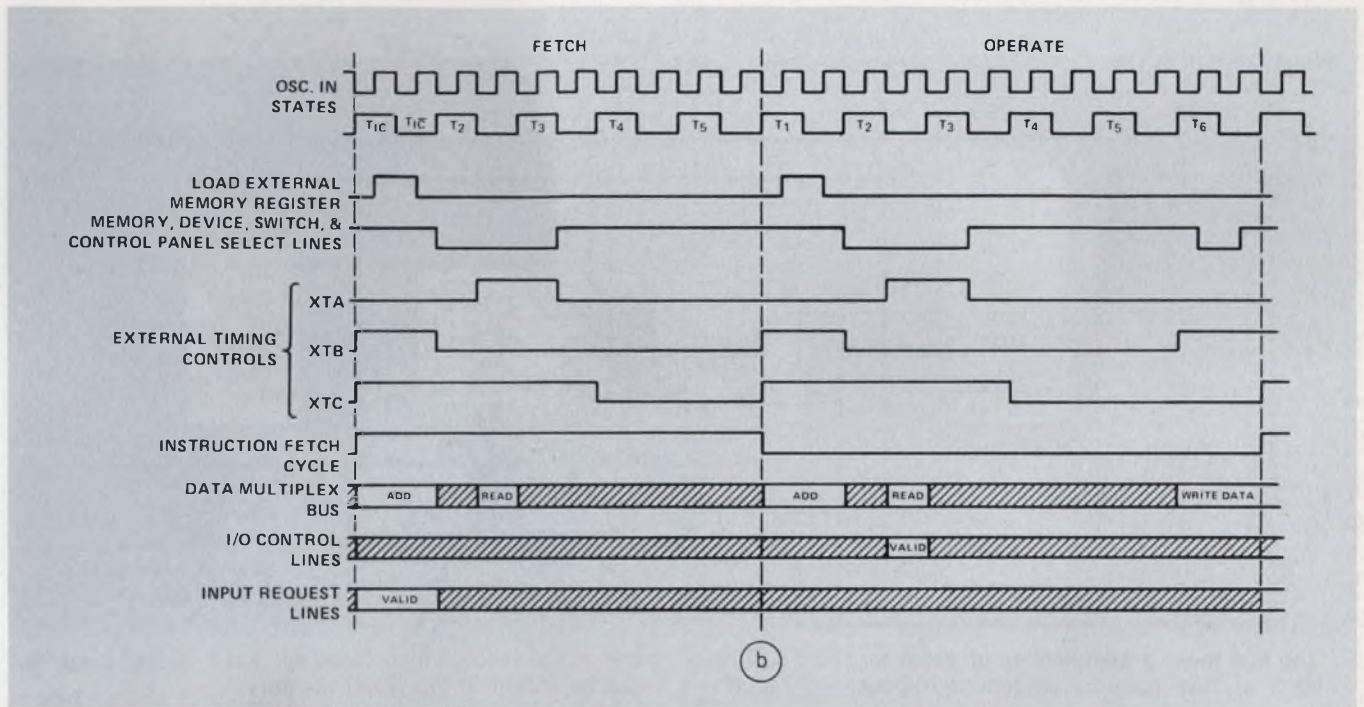
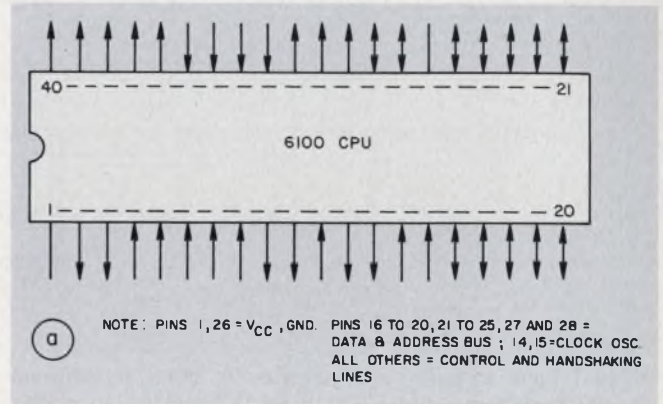

1. By using a shared address and data bus, the pin count of the 6100  $\mu$ P can be kept to 40 (a). Timing

waveforms are more complex than for many of the static  $\mu$ Ps since the multiplexed bus must be controlled.

**Table 1. System components for the 6100**

Part number	Description	100-up price
HM-6100	12-Bit CMOS microprocessor (single chip)	\$25.20
HD-6101	CMOS parallel interface element	\$8.85
HD-6402/03	CMOS universal asynchronous receiver/transmitter	\$6.95
HM-6312	$1024 \times 12$ CMOS read-only memory	Consult factory
HM-6508	16-pin $1024 \times 1$ CMOS random-access memory	\$6.80
HM-6518	18-pin $1024 \times 1$ " " " "	\$6.80
HM-6501/51	22-pin $256 \times 4$ " " " "	\$8.40
HM-6561	18-pin $256 \times 4$ " " " "	\$6.80
HM-6562	16-pin $256 \times 4$ " " " "	\$6.80
HM-6610/11	16-pin $256 \times 4$ CMOS field programmable read only memory	In development
HM-6612	18-pin $256 \times 4$ CMOS field programmable read only memory	In development

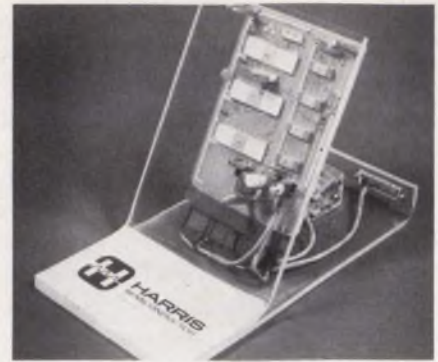
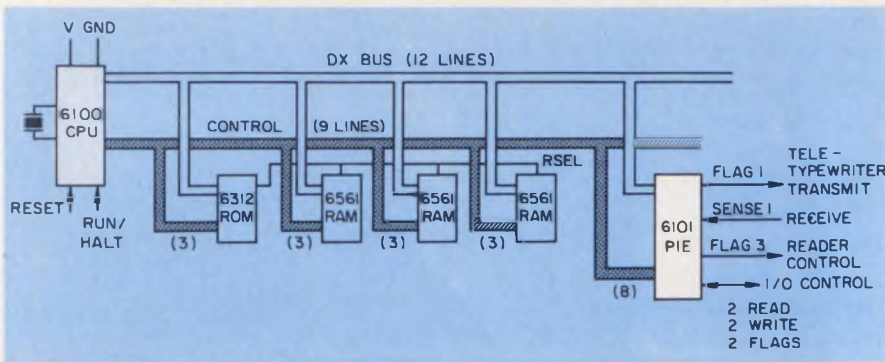

2. Just four circuits are needed to build a minimal operating system—the 6100, a ROM, a RAM and a PIE.

A bare-bones system can operate for a week on a set of flashlight batteries.

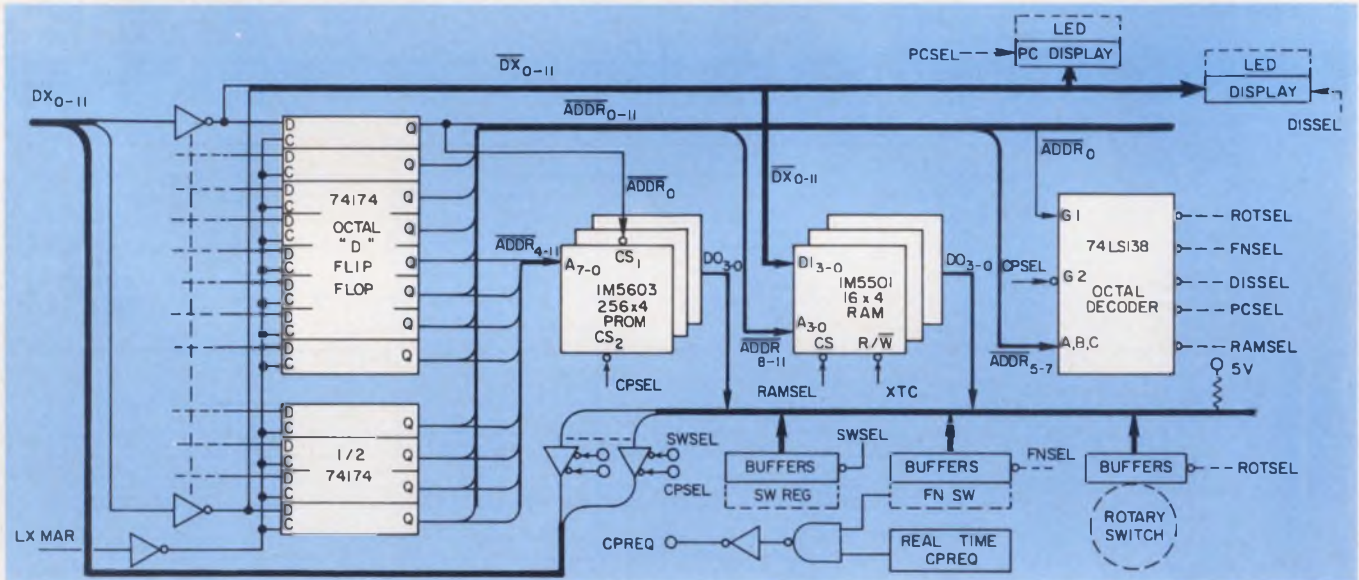

3. You can make a complete front panel for the 6100 by using a second memory system that does not require

any space in the main memory. Even debug programs can be stored in the panel memory.

to ignore the IOT, ION and IOF instructions. Once a CPREQ is granted, the DMAREQ (direct-memory-access request) or INTREQ commands will not be recognized until the CPREQ instruction has been fully serviced.

When a CPREQ is granted, the value of the program counter is stored in location 0000<sub>n</sub> of the panel memory and resumes operation at location 7777<sub>n</sub> of the panel memory. The panel memory is a second RAM/ROM bank (4-k words, maximum) organized with RAMs in the lower pages and ROMs or PROMs in the higher pages. The service routine then can be easily stored in memory locations, starting with 7777<sub>n</sub>.

While the CPU is in the panel mode, the control-panel memory select (CPSEL) line—not the main memory select (MEMSEL) line—is active. However, during the execute phase of indirectly addressed AND, TAD, ISZ or DCA instructions, the MEMSEL line activates, thus permitting access to the main memory. Therefore, the CPSEL line should be used as an indicator to distinguish between main and control-panel usage.

To exit from the control panel routine, simply have the 6100 execute the following sequence:

ION

JMP I 0000<sub>n</sub> (Loc 0000<sub>n</sub> in CPMEM).

The ION command resets the internal CPREQ, and the indirectly addressed location 0000<sub>n</sub> holds the count of the PC just before the CPREQ signal is acknowledged. The value in location 0000<sub>n</sub> returns to the 6100's PC, and the original program flow continues.

Several options, such as test, maintenance and diagnostic routines, can be added to the control panel program. The panel can also be considered a portable device that can be plugged into a socket on the processor board either to help troubleshoot a down system or simply to observe system operation.

### Memory organization permits easy expansion

The 6100 has a basic addressing capacity of 4-k, 12-bit words. Each location has a unique four-digit octal address (from 0000<sub>n</sub> to 7777<sub>n</sub>).

## A look inside the 6100 microprocessor

Since the 6100 microprocessor was designed to emulate the PDP-8/E minicomputer made by Digital Equipment Corp., it should come as no surprise that the  $\mu$ P is also architecturally identical. The 6100 has six 12-bit registers, an arithmetic-and-logic unit (ALU), all the gating and timing logic, and the instruction-decode and control ROM.

The accumulator register (one of the six just mentioned) is the central focus point of the 6100. All the arithmetic and logic operations are performed in it. For any ALU operation, the data held in the accumulator and the data fetched from memory are combined and stored (temporarily) back in the accumulator. Under software control, the accumulator can be cleared, set, complemented, tested, incremented or rotated. The accumulator also serves as an input/output register since all I/O transfers must pass through it.

A one-bit extension called the link is built into the accumulator. It can be complemented with a carry out of the ALU or cleared, set, complemented, tested and rotated along with the rest of the accumulator—all under program control. The link also serves as the carry output for two's complement arithmetic.

The other 12-bit registers include the MQ, a programmable register that can be used as a temporary storage location. The TEMP register can be used for microprogram control and helps to avoid race conditions. The MAR register holds the current address of the memory location selected for reading or writing. And, of course, both arithmetic and logic operations are done in the 12-bit ALU, as well as shifting left or right.

The PC (program counter) register holds the address of the memory location from which the next instruction will be fetched. During normal operation (an instruction fetch), the contents of the PC are transferred to the MAR, and the PC gets incremented by one. Of course, a jump or skip instruction modifies the procedure. Also included on the chip is a 12-bit instruction register (IR) that holds the instruction to be executed.

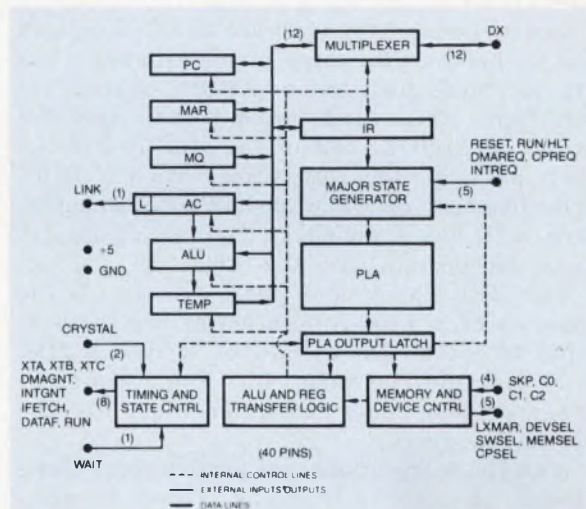

Data and addresses share a common 12-line bus that feeds directly into a 12-bit multiplexer. The multiplexer, in turn, is controlled by the major-state generator and control ROM. All timing and state signals needed by the 6100 are generated by an on-chip clock (only a 4-MHz crystal is required). An internal dividing circuit reduces the clock so that the internal states are 500 ns long.

Programmed data transfers, the easiest means of controlling data I/O, require the least hardware support. However, to use this form of I/O, the 6100 must remain in an idle state (wait loop), while the I/O device completes its last transfer and prepares for the next. Interrupts can reduce or totally eliminate the time waiting for device status signals.

Whenever the INTREQ input is driven LOW, the interrupt system permits external signals to divert the program to a preselected subroutine. If no higher priority requests for an interrupt exist, the current request is granted when the 6100 completes its current instruction. After reacting to an interrupt request, the Interrupt-Enable flip-flop in the 6100 gets reset so that no other interrupts can be acknowledged until the current interrupt is serviced and the system goes back to program control.

However, to make the memory space easier to operate, the locations are split into  $37_8$  pages, each with  $177_8$  addresses (in decimal notation, 32 pages of 128 locations each). The memory size can be extended to 32 k by using a memory-controller circuit to organize the memory as eight 4-k blocks called memory fields,  $0_8$  to  $7_8$ . Defining a memory location then requires three bits from the controller to specify the field, the five most significant bits of the word for the page number, and the lower-order seven bits for the

relative page address.

The 6100 is compatible with several ROMs and RAMs developed by both Harris and Intersil. The 6312 is a 12-k, mask-programmable ROM with an access time of 500 ns. Both the address and data lines are multiplexed on the same pins. Included on the ROM is a RAM-select output that defines an area in the memory-field dedicated to RAM. The ROM can operate over the full military temperature range with a supply of 4 to 11 V.

(text continued on p. 55)



# Instruction set and addressing schemes

Instructions of the 6100 are 12 bits long and can be broken into three major groups: memory reference instructions (MRI), operate instructions (OI) and input/output transfer instructions (IOT). All of the over 70 instructions are software compatible with the PDP-8/E command set. The basic PDP-8/E paper-tape soft. are supplied by Digital Equipment Corp. can operate with the 6100.

The MRI instructions either operate on the contents of a memory location or use the contents to operate on the AC or PC. Each MRI is broken into two parts: Bits 0 to 2 represent the operation code, the other nine bits the operand address.

Operate instructions are broken into three groups of microinstructions. Group 1 commands perform logic operations on the contents of the accumulator and link registers and are identified by a 0 in the bit-3 position. Group 2 microinstructions primarily test the contents of the accumulator or link and then conditionally skip the next sequential instruction. They require a 1 in the bit-3 position and a 0 in the bit-11 position. The Group 3 microinstructions perform logic operations on the contents of the AC and MQ registers and have a 1 in the bit-3 and bit-11 positions.

Operate microinstructions from a certain group can be microprogrammed with other microinstructions from that same group, thus reducing the number of lines of code. The actual code for a microprogrammed combination of two or more microinstructions is a logic OR of the octal codes for the individual commands.

IOT instructions initiate the operation of peripheral devices and transfer data between peripherals and the 6100. The instruction word is broken into three parts: Bits 0 to 2 are set to 110, bits 3 to 8 indicate the device selection code to control the desired peripheral (up to 64), and bits 9 through 11 contain the specific operation code that determines the actual I/O operation.

Direct memory accesses (DMAs), sometimes called data breaks, can also be implemented in the 6100 system. Data can be sent directly to a high speed peripheral, such as a magnetic disc or tape unit. Since the 6100 only sets up the transfer, transfers occur on a "cycle stealing" basis with no  $\mu P$  intervention.

The 6100 has a direct addressing capability of 4 k words of memory. However, to permit combining operations and data, the memory is broken into 32 pages of 128 words each.

Only three addressing modes are possible:

- *Direct addressing.* In this mode, bit 4 of the instruction word can be checked. If the bit is 1, the page address is interpreted as the current page; if 0, the address is defined on page 0. By this method 256 memory locations can be

directly addressed (128 on page 0 and 128 on the current page).

- *Indirect addressing.* With this mode, all 4 k of memory can be addressed. When bit 3 is 0 the operand address is obtained by first referencing a "pointer" address that is located either on the current page or page 0 of the memory. The address of the data or instruction to be handled is in the location specified by the pointer.

- *Auto-indexed addressing.* Within the 6100, provisions have been made for an external stack of eight registers (memory locations 0010 to 0017, octal) that can be used for indexing applications. Whenever these locations are indexed indirectly, the contents are incremented by 1 and restored before they are used as an operand address.

## Memory reference instructions

Mnemonic	Octal code	Operation
AND	0000	Logic AND
TAD	1000	Binary ADD
ISZ	2000	Increment, and skip if zero
DCA	3000	Deposit and clear AC
JMS	4000	Jump to subroutine
JMP	5000	Jump
IOT	6000	In/out transfer
OPR	7000	Operate

## Operate instructions

NOP	7000	No operation
IAC	7001	Increment accum.
RAL	7004	Rotate accum. left
RTL	7006	Rotate two left
RAR	7010	Rotate accum. right
RTR	7012	Rotate two right
BSW	7002	Byte swap
CML	7020	Complement link
CMA	7040	Complement accum.
CIA	7041	Complement and increment accum.
CLL	7100	Clear link
CLL RAL	7104	Clear link - rotate accum. left
CLL RTL	7106	Clear link - rotate two left
CLL RAR	7110	Clear link - rotate accum. right
CLL RTR	7112	Clear link - rotate two right
STL	7120	Set the link
CLA	7200	Clear accum.
CLA IAC	7201	Clear accum. - Increment accum.
GLT	7204	Get the link
GLA CLL	7300	Clear accum. - clear link
STA	7240	Set the accum.
NOP	7400	No operation
HLT	7402	Halt
OSR	7404	OR with switch register
SKP	7410	Skip
SNL	7420	Skip on nonzero link
SZL	7430	Skip on zero link
SZA	7440	Skip on zero accum.
SNA	7450	Skip on nonzero accum.
SZA SNL	7460	Skip on zero accum. or skip on nonzero link or both
SNA SZL	7470	Skip on nonzero accum. and skip on zero link

SMA	7500	Skip on minus accum.
SPA	7510	Skip on positive accum.
SMA SNL	7520	Skip on minus accum. or skip on nonzero link or both
SPA SZL	7530	Skip on positive accum. and skip on zero link
SMA SZA	7540	Skip on minus accum. or skip on zero accum. or both
SPA SNA	7550	Skip on positive accum. and skip on nonzero accum.
SMA SZA SNL	7560	Skip on minus accum. or skip on zero accum. or skip on nonzero link or all
SPA SNA SZL	7570	Skip on positive accum. and skip on nonzero accum. skip on zero link
CLA	7600	Clear accum.
LAS	7604	Load accum. with switch register
SZA CLA	7640	Skip on zero accum. then clear accum.
SNA CLA	7650	Skip on nonzero accum. then clear accum.
SMA CLA	7700	Skip on minus accum. then clear accum.
SPA CLA	7710	Skip on positive accum. then clear accum.
NOP	7401	No operation
MQL	7421	MQ register load
MQA	7501	MQ register into accum.
SWP	7521	Swap accum. and MQ register
CLA	7601	Clear accum.
CAM	7621	Clear accum. and MQ register
ACL	7701	Clear accum. and load MQ register into accum.
CLA SWP	7721	Clear accum. and swap accum. and MQ register
SKON	6000	Skip if interruption on
ION	6001	Interrupt turn on
IOF	6002	Interrupt turn off
SRQ	6003	Skip if INT request
GTF	6004	Get flags
RTF	6005	Return flags
SGT	6006	Operation is determined by external devices, if any
CAF	6007	Clear all flags

### Input/output instructions

#### Teletypewriter keyboard/reader

KCF	6030	Clear keyboard/reader flag, do not start reader
KSF	6031	Skip if keyboard/reader flag = 1
KCC	6032	Clear AC and keyboard/reader flag, set reader run static
KRS	6034	Read keyboard/reader buffer
KIE	6035	AC 11 to keyboard/reader interrupt enable FF
KRB	6036	Clear AC, read keyboard buffer, clear keyboard flags

#### Teletypewriter teleprinter/punch

SPF	6040	Set teleprinter/punch flag
TSF	6041	Skip if teleprinter/punch flag = 1
TCF	6042	Clear teleprinter/punch flag
TPC	6044	Load teleprinter/punch buffer select and print
SPI	6045	Skip if teletypewriter interrupt
TLS	6046	Load teleprinter/punch buffer, select and print and clear teleprinter/punch flag

Two available CMOS RAMs are the 6508 and 6518—1-k × 1-bit units. The 6508 comes in a 16-pin DIP, the 6518 in an 18-pin DIP. Both have maximum access times of 450 ns and their data retention is guaranteed for supply voltages as low as 2 V. Several 256 × 4 static RAMs in 16, 18 or 22-pin DIPs are also available. All these static RAMs have a maximum access time of 450 ns and, like the 6508 and 6518, are guaranteed to retain data with voltage supplies as low as 2 V.

Coming soon in a 16-pin DIP is a 256 × 4 fusible-link PROM built with CMOS devices. It consumes only 50 mW and will be pin compatible with the 16-pin RAMs (except for its  $\overline{PE}$  input). The three-state output version, the 6611, and the open-drain version, the 6610, will both feature an access time of 450 ns.

### System communication is easy

The 6402 and 6403 UARTs can interface the 6100 with an asynchronous-serial data channel (Fig. 4a). The receiver section converts serial start, data, parity and stop bits to parallel data and verifies proper code transmission, parity and stop bits. Conversely, the transmitter puts parallel data into serial form and automatically inserts start, parity and stop bits. The data word length can be 5, 6, 7 or 8 bits, and parity can be even or odd. Both the parity checking and generation can be inhibited and you can have 1.5 stop bits when transmitting a 5-bit code or 1 or 2 stop bits when handling 6, 7 or 8-bit codes.

Power requirements for either the 6402 or 6403 are a low 10 mW at clock frequencies up to 2 MHz (125 kbaud). Although there are some slight control differences between the 6402 and 6403, they function identically.

The 6101 PIE (Fig. 4b) provides addressing, interrupt and control for a variety of peripheral functions. Data transfers are controlled by the 6101's IOT instructions, control lines and 12-bit bus. The PIE consumes less than 5  $\mu$ W in standby and about 5 mW when fully active. It is housed in a 40-pin DIP.

The basic timing of the 6100 is controlled either by the on-chip crystal oscillator or by an external frequency source. Several input lines control the  $\mu$ P's operation. The Reset input clears the AC, loads 7777<sub>r</sub> in the PC and halts the processor. The Run/Halt can start and stop the  $\mu$ P operation, while the Wait line can pause the unit in 250-ns steps so that slower memory circuits or peripherals can be connected to the  $\mu$ P.

The DMAREQ input signals the processor to transfer control of the busses to the external device on a cycle-steal basis with no processor intervention. The 6100 acknowledges that the request has been granted by generating a DMAGNT signal at the end of the current instruction. All fur-

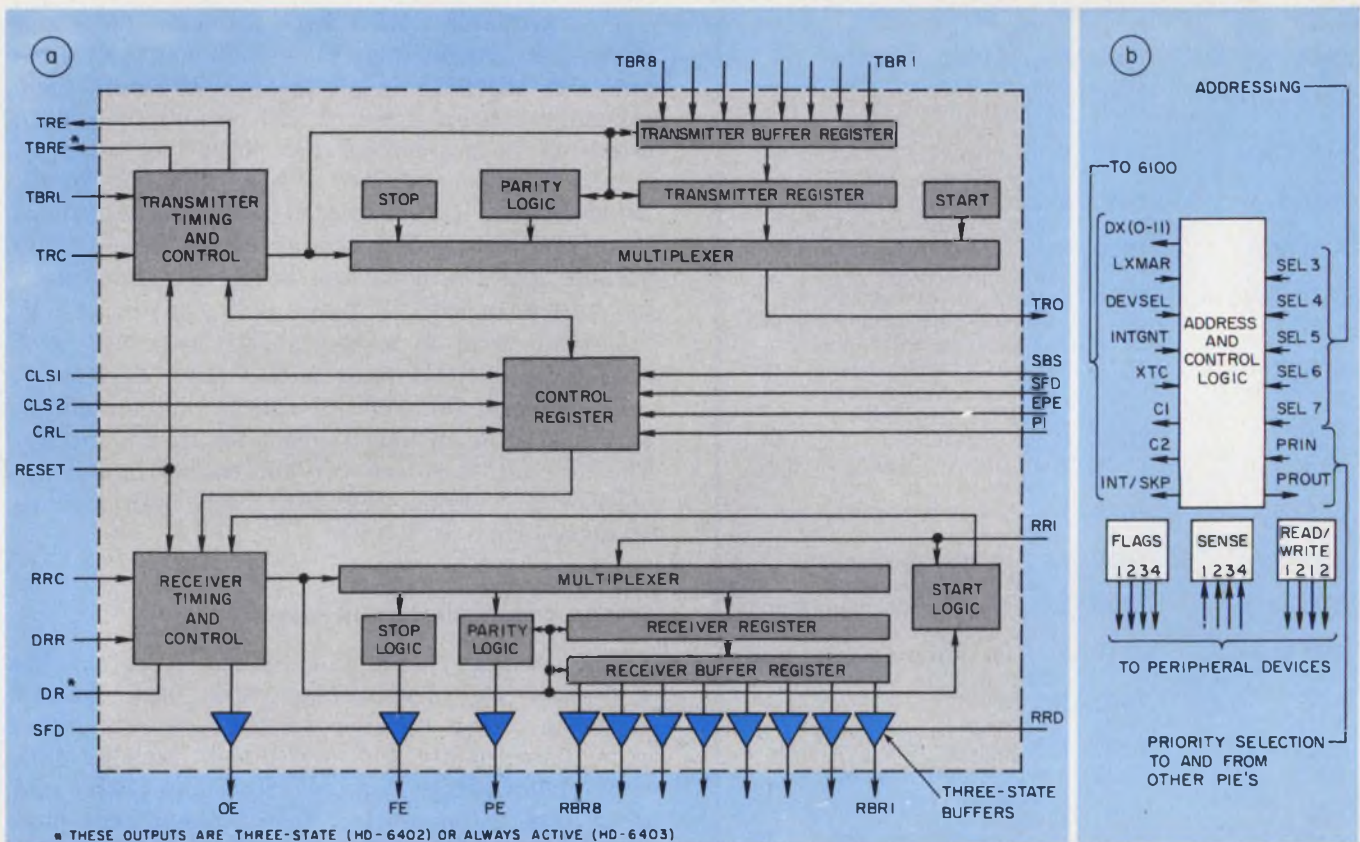

4. Connecting the CMOS UART (a) or the PIE (b) is very straightforward. The UART can operate at clock frequen-

cies from dc to 2 MHz (up to 125-k baud) and the PIE can handle both vectored and nonvectored interrupts.

ther instruction fetches are suspended until the DMAREQ line is released.

An interrupt from an external device activates the 6100's INTREQ input, and the 6100 responds with a INTGNT signal at the end of the current instruction to acknowledge the interrupt. The current contents of the PC are dumped into location 0000<sub>h</sub>, and the program fetches instructions, starting with location 0001<sub>h</sub>. To return to the original program, the PC value must be retrieved from 0000<sub>h</sub>. If nested interrupts are required, the addresses for the PC dumps must be stored in a software stack. Any IOT instruction will reset the INTGNT signal.

Peripherals are controlled and timed by the  $\mu$ P output (see the example of a teletypewriter interface in Fig. 5). The load-external-memory-address register (LXMAR) command latches the address appearing on the system bus. Four select lines distinguish which peripheral the  $\mu$ P has selected for a data transfer: one for memory (MEMSEL), one for the control panel (CPSEL), one for the switch register (SWSEL) and one for external devices used during IOT (DEVSEL).

Three other control lines designate data being transferred to the  $\mu$ P (XTA), data being transferred from the  $\mu$ P (XTB) and data ready for writing or reading (XTC). Other outputs signify the internal state of the  $\mu$ P.

After each instruction is completed, the  $\mu$ P

internally scans its internal priority network to determine the next operation. The request lines, RESET, CPREQ, RW/HCT, DMAREQ and INTREQ, are sampled in the last cycle of an instruction execution. The worst response time to an external request can be calculated as the time required to execute the longest instruction, preceded by any six-state execution cycle (14  $\mu$ s at 4 MHz).

If no external requests are pending, the next instruction in the normal program flow is executed. All indirect and auto-index, memory-reference instructions go through a common state sequence to generate the effective address of the operand. The subsequent sequence, known as the execute phase, is controlled by the functional class of the instruction. Internal and external IOT instructions have identical state sequences. Device addresses and the control bit are available in the external address register for internal IOT instructions.

#### Prototyping is simple, says Simon

The Simon prototyping microcomputer system is a 6100-based computer that has a buffered bus structure with three-state TTL-compatible I/O lines. It provides a simple way to evaluate 6100-family systems and components.

The basic system, described in Table 2, comes

	6341	WUART = 6341	
	6342	SKPDR = 6342	
	6340	RUART = 6340	
	6343	SKPTBR = 6343	
	0105	*105	
00105	7300	START,	CLA CLL
00106	1130		TAD BUFF
00107	3131		DCA BPTR
00110	6342	LISN,	SKPDR
00111	5110		JMP .- 1
00112	7300		CLA CLL
00113	6340		RUART
00114	0133		AND K0377
00115	6341		WUART
00116	3531		DCA I BPTR
00117	1531		TAD I BPTR
00120	1132		TAD MDOLAR
00121	7450		SNA
00122	5125		JMP DONE
00123	2131		ISZ BPTR
00124	5110		JMP LISN
00125	7300	DONE,	CLA CLL
00126	3531		DCA I BPTR
00127	5134		JMP STARTW
00130	0155	BUFF,	0155
00131	0000	BPTR,	0000
00132	7534	MDOLAR,	7534
00133	0377	K0377,	0377
00134	7300	STARTW,	CLA CLL
00135	7000		NOP
00136	1130		TAD BUFF
00137	3131		DCA BPTR
00140	1531	CHRTY,	TAD I BPTR
00141	7450		SNA
00142	5134		JMP STARTW
00143	4146		JMS TYPE
00144	2131		ISZ BPTR
00145	5140		JMP CHRTY
00146	0000	TYPE,	0
00147	6343		SKPTBR
00150	5147		JMP .- 1
00151	6341		WUART
00152	7300		CLA CLL
00153	5546		JMP I TYPE

5. This short program helps to interface the 6100 with a serial ASCII device such as a teletypewriter. When information is entered via the keyboard, the 6100 echos the characters back on the printer.

with a control panel (similar to DEC's PDP-8/E), 4 k words of CMOS memory (with battery back-up for nonvolatility) and a PDP-8/E compatible teletypewriter interface designed for a 20-mA current loop.

All these functions fit on three boards. A fourth board slot inside the Simon cabinet can accommodate user-designed circuits. A built-in 5-V power supply can handle the three boards, the front panel and almost any built-in user circuit.

Simon executes the basic PDP-8/E paper-tape software supplied by DEC. However, to write a program using the Simon system, the symbolic editor can be used to generate the ASCII symbolic program by interactive entering and editing. Next, the symbolic program gets assembled by the PAL-III program—a two-pass assembler.

On the first pass of the assembler, all user symbols are defined and stored in an assembler symbol table. During the second pass, the binary

Table 2. Software support

Part number	Description	Price
0656-SW PDP-8/E	Extended software kit: Binary loader PAL III assembler Symbolic editor DDT—dynamic debugger ODT (low)—octal debugger ODT (high)—octal debugger RIM and binary punch Octal memory dump PDP-8 23-bit floating-point package.	\$212.50
1656-SW FOCAL-8:	An interactive algebraic language. It is similar to Basic & Fortran in many respects.	\$152.50
2656-SW PDP-8/E	Diagnostic software: This software package consists of programs to perform extensive tests on the processor, memory and the teletypewriter.	\$400.00
3656-SW FOPAL-III:	This is a cross assembler written in standard Fortran.	\$125.00
6900-S SIMON:	Prototyping system used for software and hardware development. (Includes 0656-SW)	\$3300.00
SIMON with dual floppy system.		In development
DECUS: Digital Equipment Computer Users Society—This is a library of users programs. Listed are some of the categories available to any users:		
Programming language, monitor, programming system		
Text editing, text manipulation		
Debugging, disassembly, simulation, trace, dump		
Binary loading, binary punching		
Duplication, verification		
Numerical function, numerical input-output		
Utility		
Display		
Data management, symbol manipulation, sorting		
Probability, statics, curve-fitting		
Scientific application, engineering application		
Hardware control		
Games, demonstration		
Plotting		
Desk calculator, business applications		
Maintenance		

equivalent of the input source language is generated and, if desired, punched.

Two service programs, ODT and DDT, can be used to run the user program and to use the teletypewriter keyboard to control program execution, examine registers, change register contents and make alterations to the user program. With DDT, you can debug the programs by using the symbolic language of the source program, whereas the ODT gives you the octal representation.

A cross-assembler, FOPAL-III, is identical to PAL-III but can run on any computer that supports Fortran. ■■

Previous articles in this series covered the 8080, F-8, 6800, 2650 and the 1802 microprocessors. The next article will discuss the PACE.

# Who provides the industry's broadest line of electronic packaging hardware ... including A New High-Density Lever Switch?

SAE does! We're proud to announce the development of a completely new and patented switching concept called the SAE switch (which stands for *Side And Edge*™). The switch consists of multiple positions; each actuated by a lever that interconnects opposite sides of a PCB with a horseshoe-shaped terminal.

Based upon the layout of the circuit board, the switch allows for SPST, SPDT, SPST-DB and DPDT contact closures.

Mounting in either a horizontal or vertical position, the SAE switch reduces overall front panel area; eliminates the need for interconnecting cables or connectors, as well as knobs or dials. Levers are on .140" or .156" centers for easy actuation.

Available in an unlimited number of switching positions in length and in up to three board widths, the switch can accommodate 150 switching positions in only 34 square inches! Our new brochure gives the complete details ... send for it now!

™-Stanford Applied Engineering, Inc.

For an immediate reply, call the following toll-free "ZIP QUOTE" number at the factory ... 800-538-6843.

CIRCLE NUMBER 23

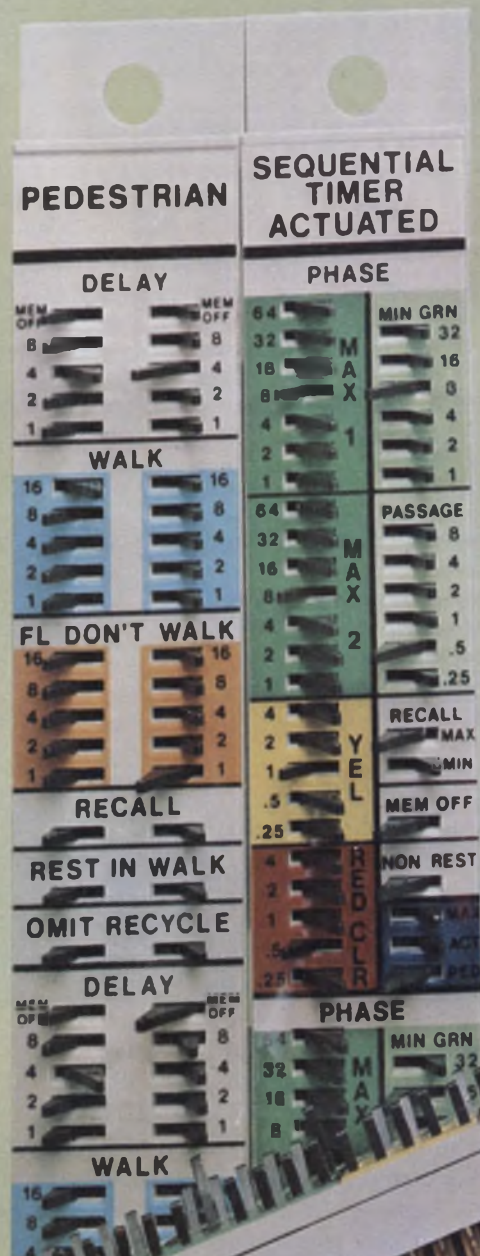

**Stanford Applied Engineering, Inc.**

340 Martin Ave., Santa Clara, CA 95050  
(408) 243-9200 TWX 910-338-0132

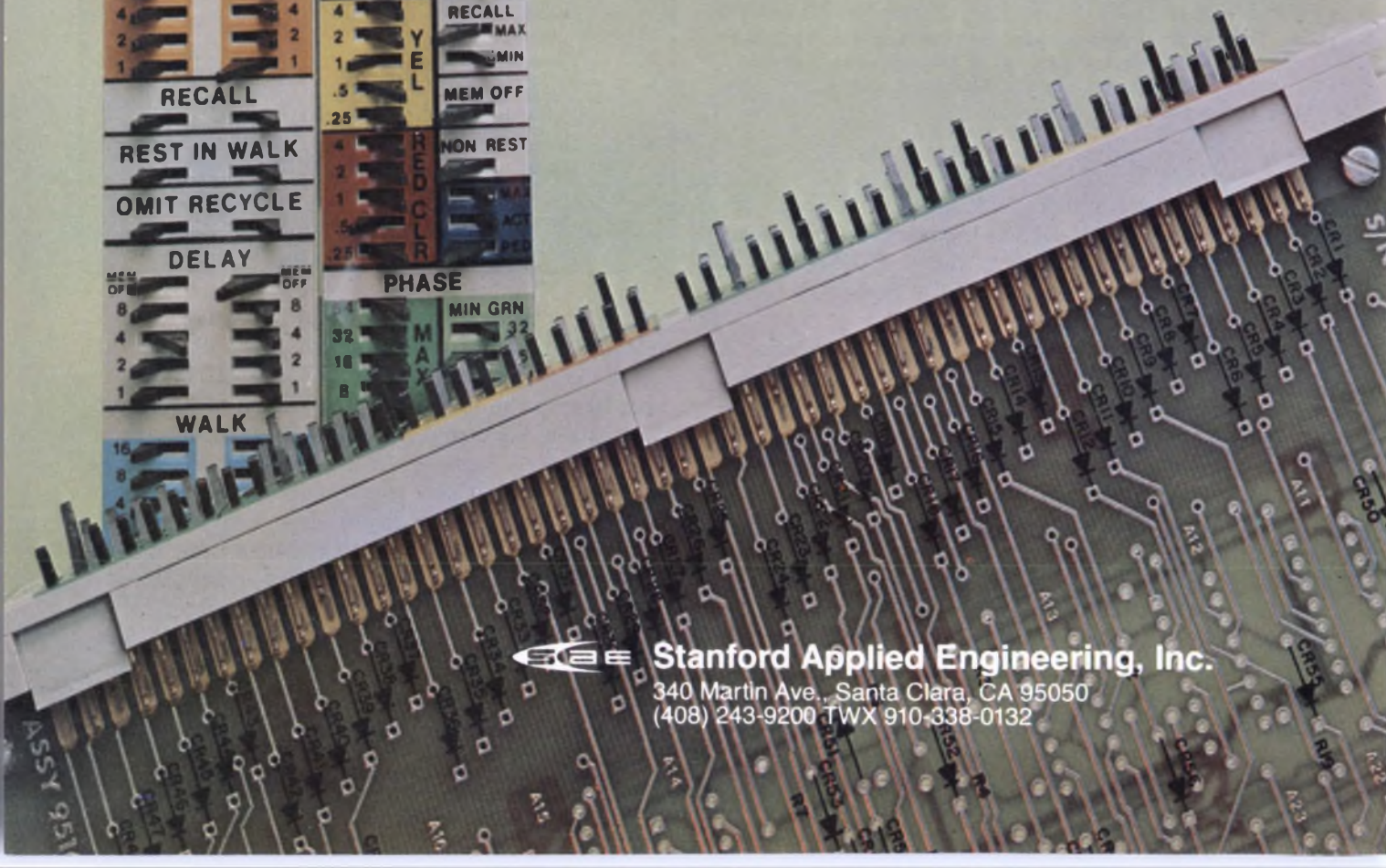

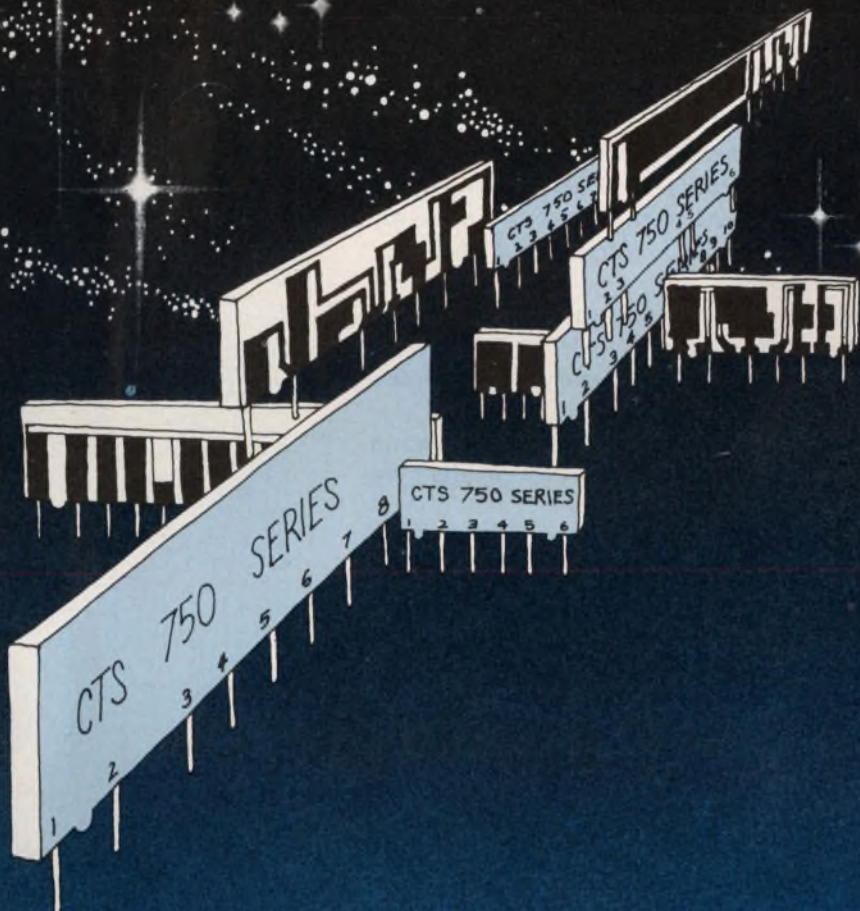

# CTS conquers space.

And has for *well over a decade* with space saving Series 750 SIP cermet resistor networks. And with space a very important commodity in modern systems, you'll want to make CTS a very special source for your network needs.

You conserve valuable PCB space, enjoy greater system reliability, use fewer components, install easier—automatically, cut handling costs and derive faster inspection. CTS experience, technology and production capacity insure the highest quality, fastest delivery available.

Where one of our more than 130 *standard* off-the-shelf SIP's won't meet your circuit require-

ments, we'll custom design the resistor network you need in either conventional or low profile package configurations.

Be assured of ultra-high stability and reliability. Over 900 million hours of test data prove CTS reliability with an established failure rate of only 0.00051% per 1000 hours @ 95% confidence level—considerably superior to military failure level S of established reliability specs.

For your copy of our reliability report or complete resistor network data, write: **CTS OF BERNE, INC.**, 406 Parr Road, Berne, Indiana 46711. Phone (219) 589-3111.

**CTS CORPORATION**

Elkhart, Indiana

A world leader in cermet variable resistor technology.



## Use conductive elastomers to simplify switch design and to make high-density connections from PC boards to LED displays, ICs and other boards.

Conductive elastomers have had a strong influence on the design of electronic circuits and devices in the last few years. Their unique mechanical and electrical properties have already facilitated their use as signal-measurement and transmission probes, RFI shields and static arrestors.

More recently, conductive elastomers have been used to connect PC boards to LEDs flat packs, leadless ICs, other PC boards, and replace switches.

They significantly reduce materials and manufacturing costs as well as improve product reliability.

Because of the amorphous nature of these materials, they can be shaped many ways. It is not necessary, for instance, to arrange connectors in a linear pattern or bring sets of printed-circuit connectors to an edge tab.

In addition, fabrication techniques produce elastomers having characteristics that permit 7000, or more, interconnections per square inch.

### These materials are made in many shapes

Conductive elastomers are easily formed into sheets, films, rods and foams. Various sizes, thicknesses, densities and even precision-molded dimensions can be specified. The material makes a better electrical connector than a metal-to-metal connector because it conforms to the contacting surfaces; consequently, a wider area carries current at the point of contact. The material flexes indefinitely without changing its mechanical or electrical properties, yet is soft enough to dampen shock and vibration.

Moreover, these elastomers won't corrode, and many of them are self-sealing—tears and punctures close up tightly enough to keep out adverse elements. Also the conductivity is not affected by particles of dirt or other contaminants.

Yet with all of these desirable properties, the material is made from only two substances.

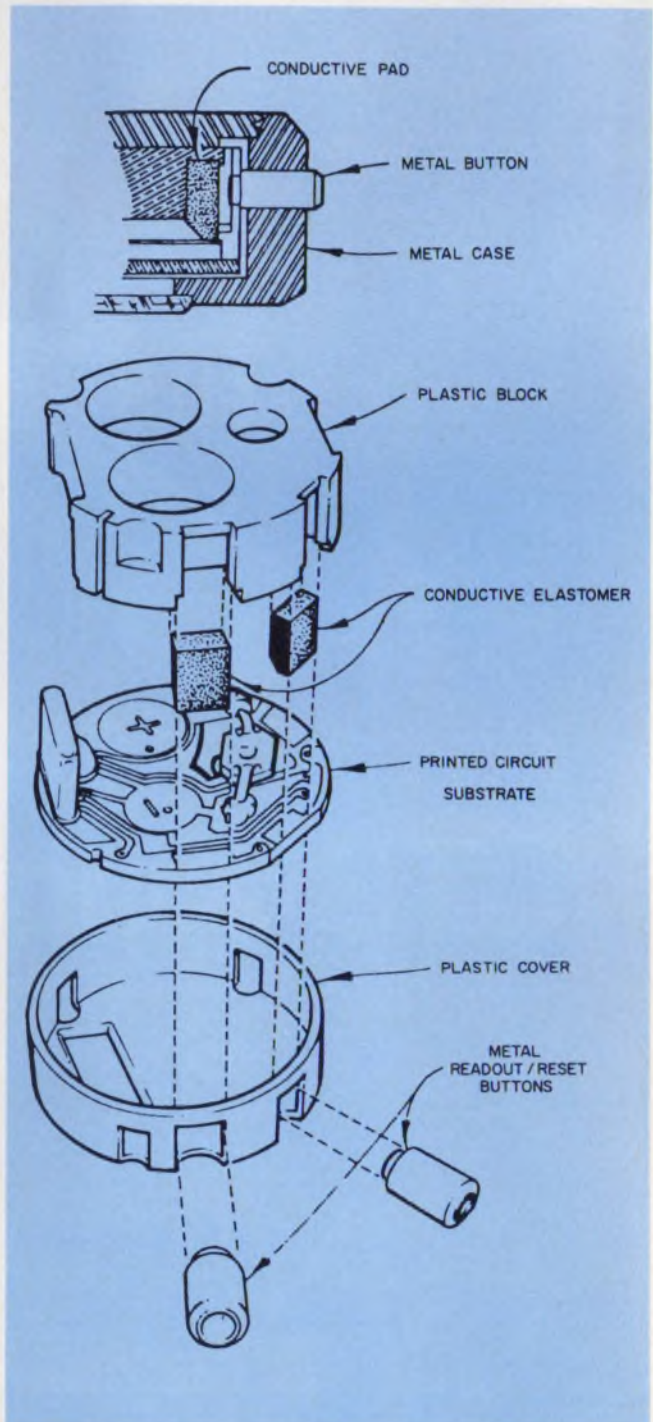

1. Conductive elastomers used as switch elements replace mechanical switches in a digital watch.

Charles H. Kuist, Vice President, R&D, Chomerics, Inc., 77 Dragon Court, Woburn, MA 01801.

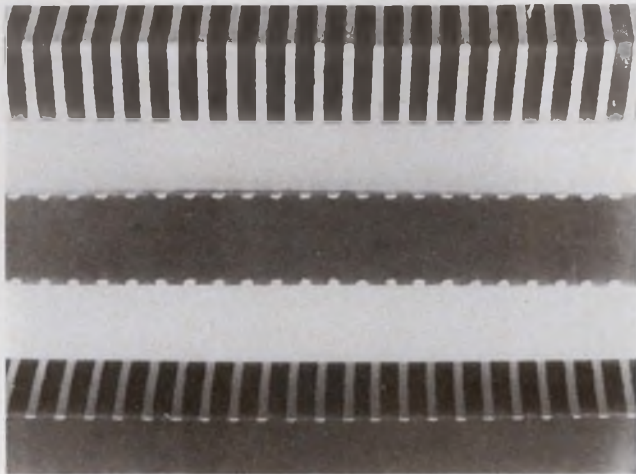

2. Alternate layers of conducting and nonconducting elastomers produce a material that connects PC board contacts to external components.

Conductive elastomers are blends of normally insulating elastomers, called matrix materials, and minute particles of conductive materials called fillers. The filler density is high enough that the particles are in constant contact and form discrete, low-resistance paths from one surface of the material to the other.

The most popular matrix material for electrical-contact applications is silicone rubber, which

remains stable at temperatures ranging from  $-100$  to  $400$  F, and resists moisture, oxygen, ozone, and ultraviolet light. Other matrix materials are polyurethane, ethylene-propylene-diene (EPDM) rubber, butyl rubber, neoprene, and vinyl. All offer specific advantages for specific applications.

The fillers are selected for their required resistivities and include carbon—the most widely used and the least expensive—silver or silver compounds, gold and nickel. Tin, zinc, and conductive oxides have been tried but have proved much less effective. The filler can account for up to 85% of the weight of a conductive elastomer and usually has a thermal conductivity 5 to 10 times that of the matrix material alone.

#### Reduce mechanical assembly costs

A conductive elastomer can be used as a switch element in a digital watch (Fig. 1). In this application, the elastomer is formed into pads made of a mixture of silicone rubber and metal powder (Table 1, Material A). The material replaces beryllium-copper spring fingers used in an earlier version.

Although the elastomer pads are more expensive than metal connectors, they eliminate so much soldering labor that they considerably re-

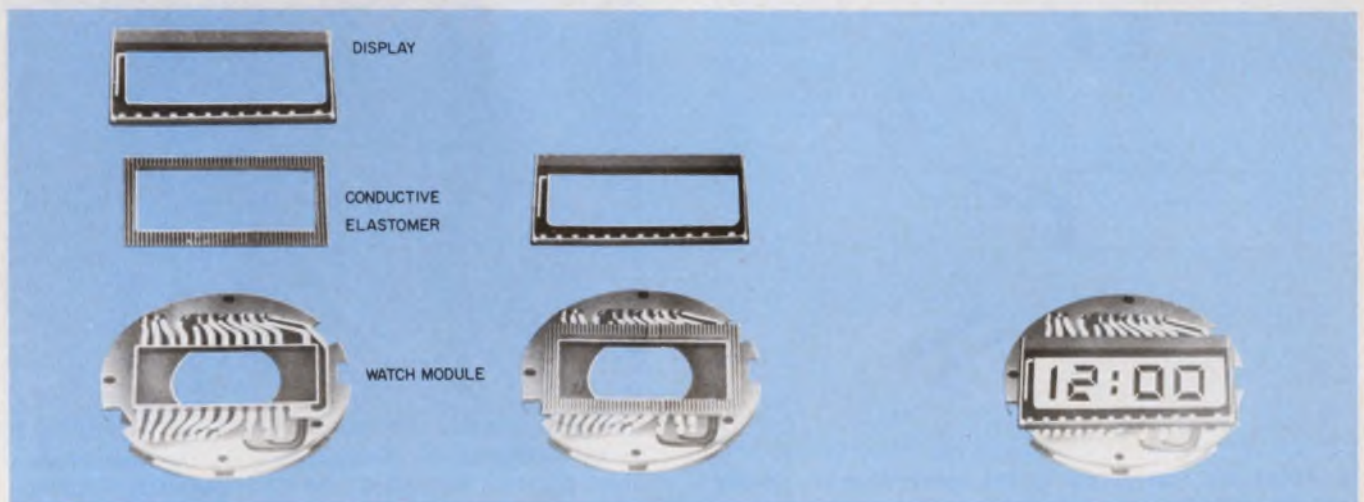

3. A tiny assembly such as a watch module can use the material to provide shock mounting and electrical connection.



# Table 1. Properties of conductive elastomers

Property	Switch Elements Material A carbon, silicone	Display Mounting Material B silver-plated-copper spheres, silicone	High-Density Interconnectors, Material C		
			Type A	Type B	Type C
Thickness, in.	0.020 min	0.030 min Note 2	0.005 nom	0.010 nom	0.030 nom
Density, gm/cc	3.65	—	—	—	—
Tensile strength, lb/in. <sup>2</sup>	200	—	—	—	—
Tear strength, lb/in.	20	—	—	—	—
Elongation, %	120	—	—	—	—
Hardness, Shore A	60-70	42	45	45	45
Deflection at 100 lb/in. <sup>2</sup> , % of thickness	30-50	25 to 40	10 to 15	10 to 15	10 to 15
Recommended pressure, lb/in. <sup>2</sup> (max)	200	—	—	—	—
Compression set, % Note 3	14	10	10	10	10
Continuous use temperature, C	-55 to 125	-55 to 125	-55 to 125	-55 to 125	-55 to 125
Shock resistance, G (max)	30	30	30	30	30
Contact size, in. <sup>2</sup> (min)	—	—	0.006	0.012	0.024
Contact spacing, in. (min)	—	—	0.006	0.012	0.024
Conductive path width, in. (min)	—	0.010	—	—	—
Spacing between path centers, in. (min)	—	0.020	—	—	—
Recommended compression, % (max)	—	25	—	—	—
Current carrying capacity per sq. in. of conducting surface, A	50	—	—	—	—
Dc voltage resistivity, ohm-cm (max)	0.010	—	—	—	—
VA for minimum pad size (max)	—	—	0.05	1	1
Breakdown voltage between adjacent contacts, V	—	—	200	500	700
Current carrying capacity per path, mA Note 1	—	>50	—	—	—
Resistance along path, ohm/in. Note 1	—	10	—	—	—
Breakdown voltage between adjacent paths, V Note 1	—	600	—	—	—
Capacitance between adjacent paths, pF/in. Note 1	—	1	—	—	—

Note 1: For 0.010-in. conductive paths on 0.020-in. centers.

Note 2: Maximum thickness depends on geometry.

Note 3: % of original height loss after 25% deflection for 72 h at 125 C.

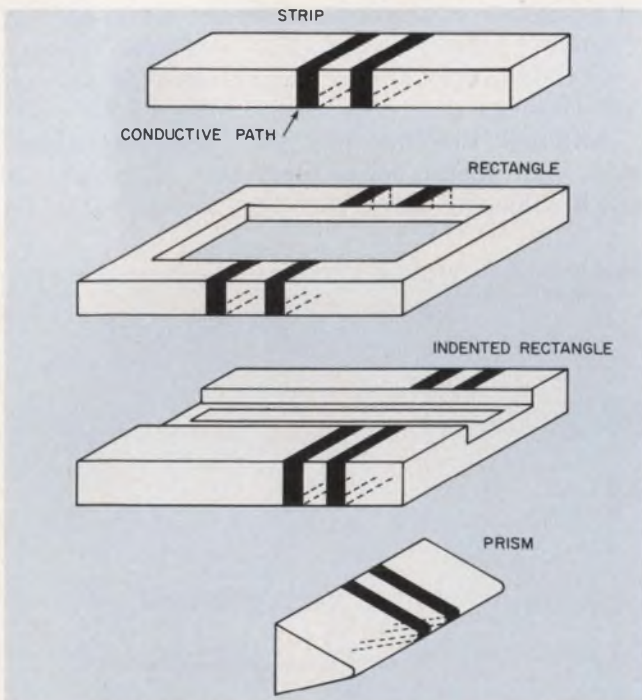

4. These are just a few of the many unusual shapes that are possible with conductive rubber paths vulcanized into a nonconductive rubber base.

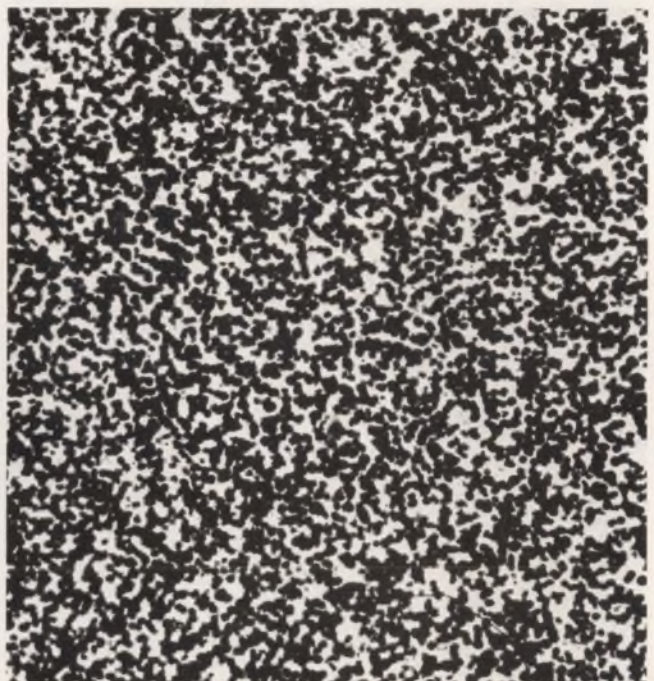

5. An elastomer can conduct only in the direction to which pressure is applied. The filler consists of spherical metal balls that only come in contact with each other under pressure.

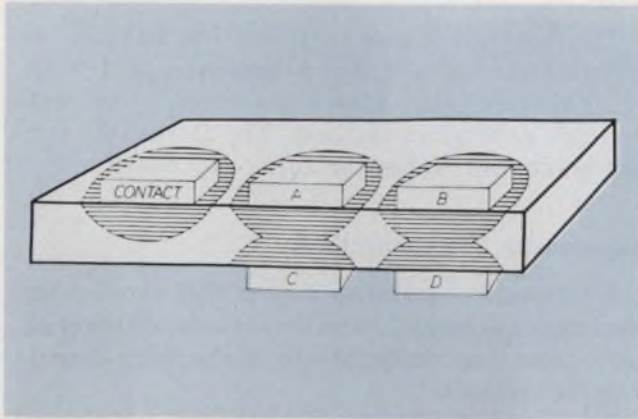

6. The resistance between opposing contacts is less than  $1 \Omega$ . And resistance between adjacent contacts is greater than  $1000 M\Omega$  with this material.

## Table 2. Manufacturers of conductive elastomers

Chomerics  
77 Dragon Ct.  
Woburn, MA 01801  
(617) 935-4850

Metex Corp.  
970 New Durham Rd.  
Edison, NJ 08817  
(201) 287-0800

Emerson & Cuming, Inc.  
869 Washington St.  
Canton, MA 02021  
(617) 828-3300

Spectrum Control, Inc.  
152 E. Main St.  
Fairview, PA 16415  
(814) 474-5593

Instrument  
Specialties Co., Inc.  
244 Bergen Blvd.  
Little Falls, NJ 07424  
(201) 256-3500

Tecknit  
129 Dermody St.  
Cranford, NJ 07016  
(201) 272-5500

duce over-all package costs.

The pads are retained in slots in the watch's plastic housing, but for other applications the elastomer can be laminated to metal surfaces or bonded with adhesives.

Another elastomer material, called Cho-strel, has conductive-rubber paths vulcanized into a nonconductive rubber base (Table 1, Material B). The material is only 0.030 in. thick, can be easily compressed, but will not separate even under severe pressure. As shown in Fig. 2, the material can be die cut into any desired shape.

This one-dimensional discrete-path conductive elastomer is used for mounting displays close to

an outside surface to enhance the appearance of digital-panel meters and other products (Fig. 3). Such up-front mounting is difficult to achieve with conventional spring-clip connectors.

Because it is produced in a variety of shapes and sizes (Fig. 4), this elastomer can be used in place of metal-edge connectors for such applications as interconnecting linear arrays, flexible circuits, PC boards, LCD and gas-discharge displays, and calculator keyboards. For these applications, designers have a choice of conductive-path widths and path spacing and can design their contact configurations accordingly. The typical path width is 0.01 inch and spacing is on

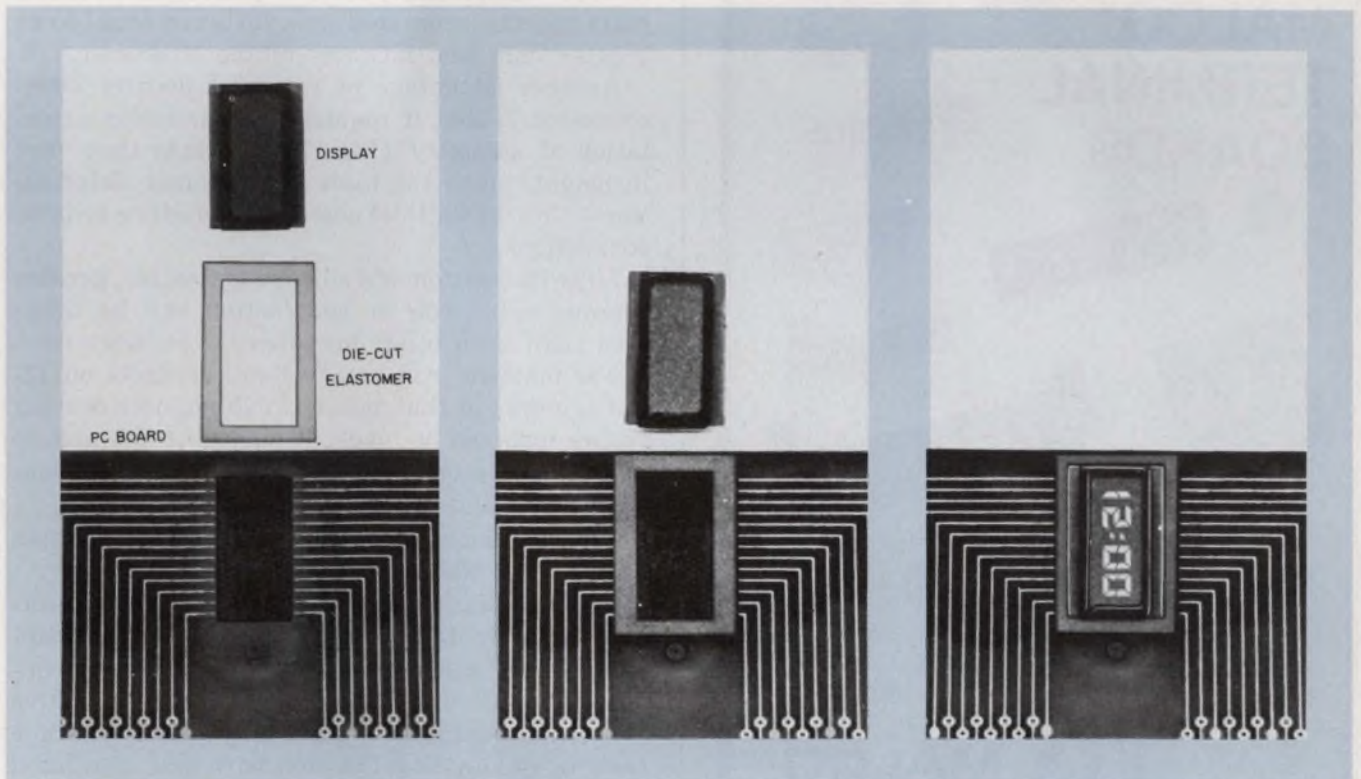

7. An elastomer for high density connections requires no orientation during assembly. Since it flexes up to

15% of its thickness under pressure, variations in connector flatness up to this limit may be accommodated.

## WP Embedded Controllers for your Tape and Disc drives are best on all your PDP-11 & NOVA computers

Because  
they  
are



- Available for all PDP-11, NOVA and NOVA-emulating computers
- Usable with virtually all tape and disc drives
- PE and NRZ compatible up to eight drives (tape)
- Usable with four single, dual or ten-high drives (disc)
- Lowest in cost

SEND FOR COMPLETE INFORMATION

 **western peripherals™**

(714) 991-8700 • TWX: 910-591-1687 • Cable: WESPER  
1100 Claudina Place, Anaheim, CA 92805

CIRCLE NUMBER 25

## MALCO TERMINAL BOARDS



Made to your specs.  
Manufactured to meet your time schedule.  
**CALL MALCO-MANDEX (312) 254-4200**  
or write for our free catalog:  
Malco National Headquarters,  
12 Fross Drive,  
Montgomeryville, Pennsylvania 18936.

 **MALCO**  
A Microdot Company  
Helping industry put things together™

CIRCLE NUMBER 26

0.02-inch centers.

The material is able to flex up to 40% of the material thickness under a pressure of 100 lb/in<sup>2</sup>. This flexibility allows the material to mate surfaces varying in flatness. The flatter the contact plane, the higher the connector density.

### High-density interconnections

A conductive elastomer can exhibit short-range conduction—conductive paths are created through, not across the material—to make high-density interconnections.

The material consists of a silicone matrix and a filler of spherical metal particles with carefully controlled diameters, which are dispersed to form small clusters (Fig. 5).

Since there is no continuous contact across the face of the elastomer, the contacting area must be wide enough to touch enough clusters so that a conduction path can be made through the elastomer. When the contacting area for this material exceeds 85 square mils, enough clusters carry current through the elastomer. The connection reliability is above 99.9% for a contact area above the minimum square mils.

When the die-cut sheet is sandwiched between opposing contacts, the resistance through the sheet will be less than 1  $\Omega$ , and the resistance between adjacent contacts greater than 1000 M $\Omega$  (Table 1, Material C).

As shown in Fig. 6, this construction allows the electrical interconnection of any configuration of independent contact pairs. The contact pairs must be separated by a distance equal to or greater than the thickness of the elastomer.

Another advantage of this high-density interconnector is that it requires no particular orientation at assembly (Fig. 7). Contacts that vary in height, up to the limit of elastomer deformation—15% of its thickness—still produce reliable connections.

Since the elastomer's silicone is flexible, greater thermal expansion or contraction can be tolerated than with other high-density connectors.

The material will handle 6-mil contacts on 12-mil centers, so that nearly 7000 connections per square inch can be made. It should be possible to make an elastomer that will handle 4-mil contacts on 8-mil centers.

For such interconnections the cost per contact decreases as the number of contacts increases.

While typical applications involve interconnecting electronic devices and substrates, the elastomer is being considered as an alternative to conventional IC-wire bonding. If this alternative proves successful, it will not only reduce package costs by eliminating the gold wire and associated labor but will also permit salvaging an IC package in the event of defective assembly. ■■

# "I'll tell you why this OEM picked PDP-8. It's good engineering and it's good business."



The man in the picture is Dr. David Kemper, biochemist and product manager in charge of development, production, installation and field support for an amazing analytical device called Rotochem IIa, from American Instrument Co.

The computer inside his product is a PDP-8A from Digital. Dr. Kemper is buying scores of them. Why?

"They're inexpensive in a market that's cost sensitive. They're incredibly reliable in a

market that's reliability oriented. And our customers can get service anywhere in the world. The PDP-8A gives us the performance we need at a price we can't beat. We can offer the capability to run 50 tests on each of 250 patients."

Sensitive but tough. High in performance, low in cost. "Good engineering. Good business." It's the same story you hear from OEMs around the world. And that's why PDP-8's the most

successful minicomputer ever.

Digital Equipment Corporation, Parker Street, Maynard, MA 01754. (617) 897-5111.

European headquarters: 81 route de l'Aire, 1211 Geneva 26.

Tel: 42 79 50. In Canada: Digital Equipment of Canada, Ltd.

**PDP-8  
The Most  
Successful  
Minicomputer  
Ever!**

**digital**

**50,000 computers saving  
managers millions.**

# It pays to look into Metal Glaze™ from all angles.

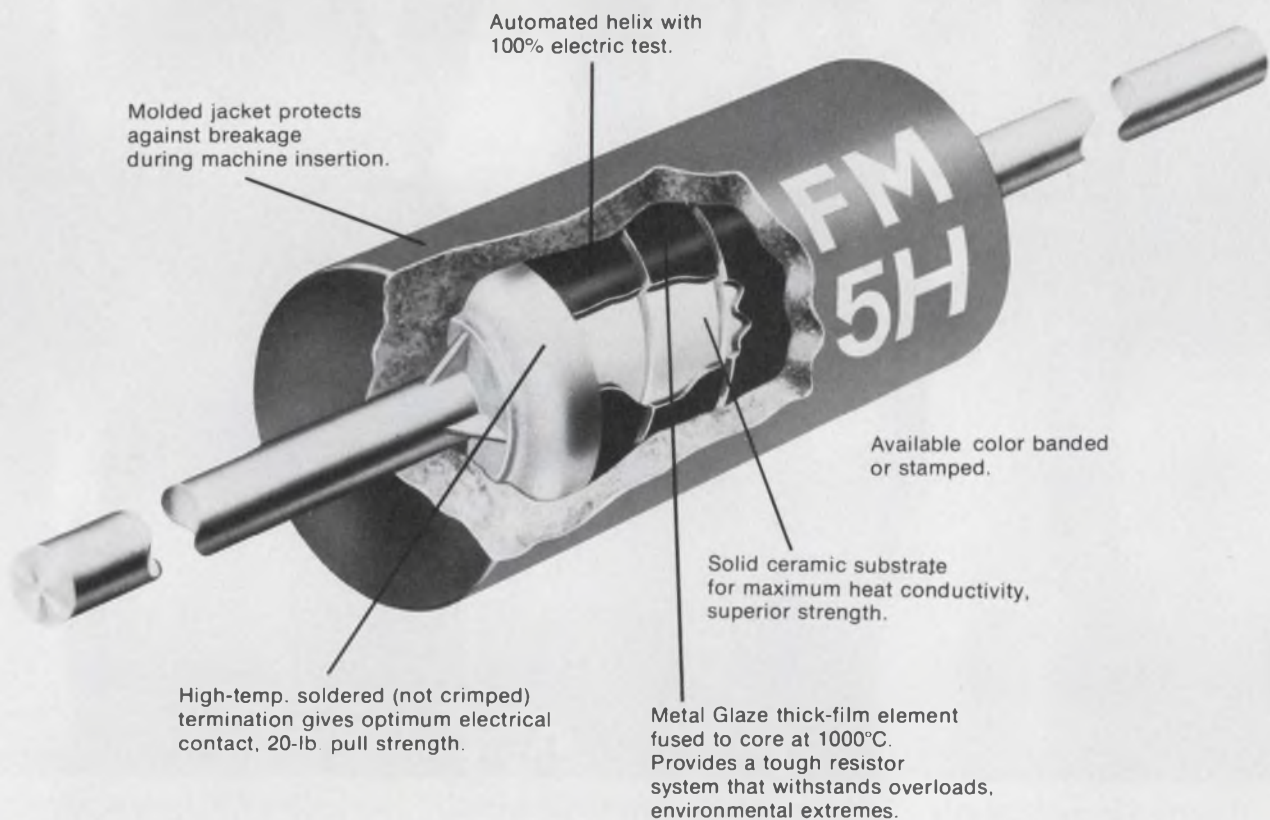

\*™Metal Glaze is TRW trademark for its thick-film resistors.

We have designs on you. Especially if you're designing any type of low-power circuitry and need resistors with excellent load life stability and cost effectiveness.

TRW/IRC Metal Glaze resistors can take the heat. For instance, their thermal characteristics are outstanding, resulting in lower operating temperatures, greater reliability.

Another advantage, you can often double-rate our Metal Glaze resistors so you can use smaller resistors, saving board space.

The ability and toughness of Metal Glaze to withstand heat with minimum drift has been proven billions of times in all types of electronic equipment, worldwide. And they're available in ratings  $\leq 3$  watts,  $\geq 1\%$  tolerance, with ranges as low as 1 ohm.

For complete resistor choice including Metal Glaze, carbon comp., thin-film, wirewound and networks, contact your local TRW authorized distributor or sales representative. Or TRW/IRC Resistors, an Electronic Components Division of TRW, Inc., 410 N. Broad St., Philadelphia, Pa. 19108, (215) 922-8900.

**RG PULSE OR SURGE POWER RATING:  
MAXIMUM APPLIED POWER/PULSE ON TIME**

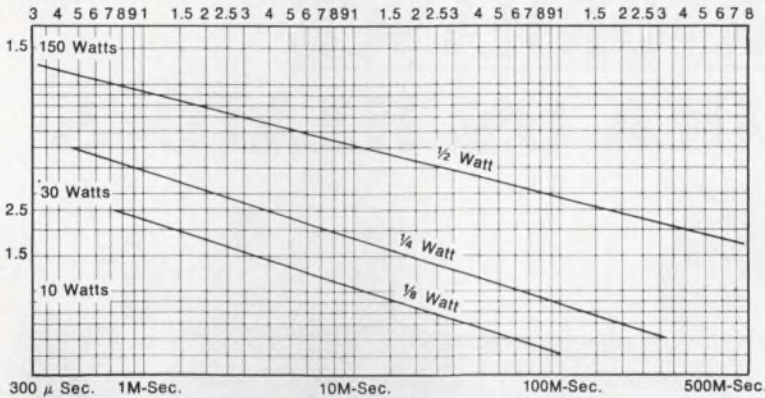

Note: Average power dissipation not to exceed component rating.

**Overload Protection**

Rugged Metal Glaze construction provides excellent power surge capability. A 1/4w unit will conservatively operate within specifications when exposed to 18w, 10msec pulses, provided average power, and max voltage ratings are not exceeded. Ask us about your applications, including those requiring steady state conditions exceeding mil rated power.

**TYPICAL TO-55 DESIGN TOLERANCE**

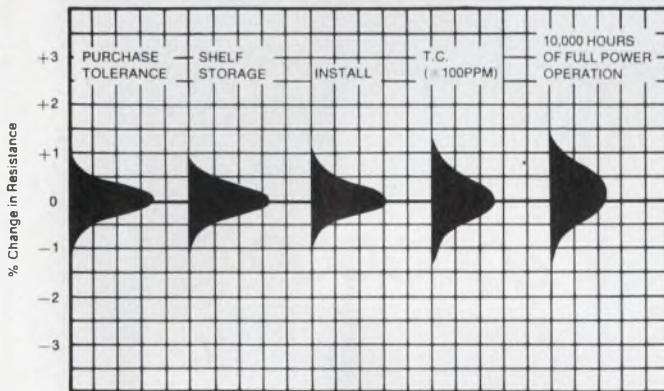

**Minimum Design Tolerance**

(Design tolerance = a statistical summation of various parameters including load life, TCR, installation, and moisture resistance) All the features of Metal Glaze Resistors result in tight, predictable design tolerances which can be as low as  $\pm 1.5\%$ , depending upon your application.

**TYPICAL DISTRIBUTION OF TEMPERATURE COEFFICIENT OF RESISTANCE**

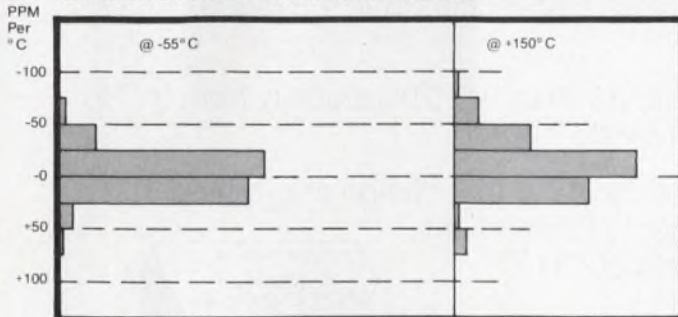

**Absolute, Linear TCR**

T.C.'s of 50, 100, or 200ppm are specified across the entire resistance range from 1 $\Omega$  to 1M $\Omega$ . Our TC characteristic is essentially linear with temperature, and is a normal distribution centered near zero.

**AVERAGE RESISTOR TEMPERATURE RISE VS. APPLIED POWER**

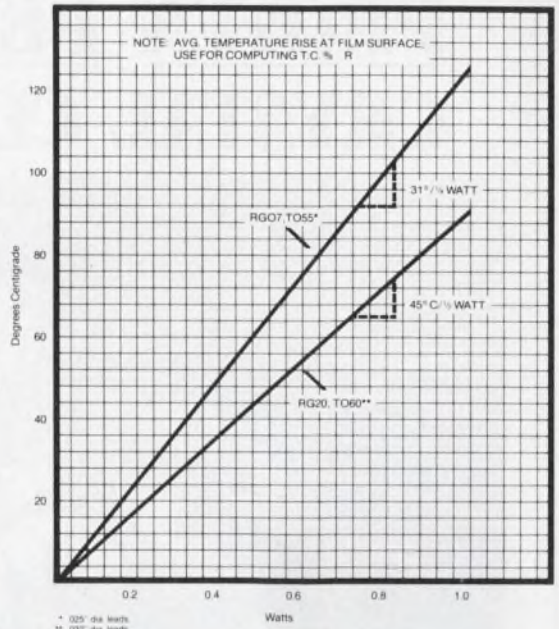

**High Thermal Conductivity**

A solid alumina substrate and other design features efficiently transfer heat from the resistor element. As an example, a 1/4w unit at full load has a hot spot temp rise of only 30°C, half the rise experienced in some other types. Cooler operation means stability and reliability are optimized.

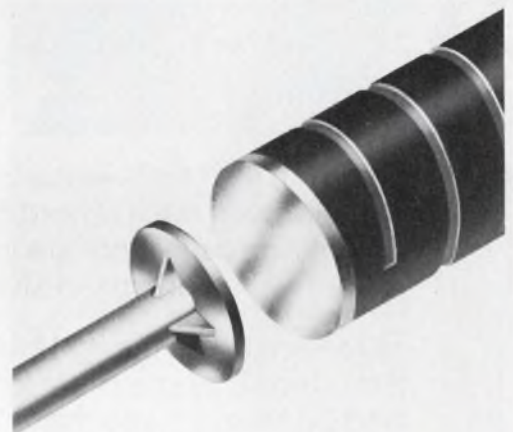

**Capless Terminations**

All Metal Glaze resistors have our exclusive high temperature soldered terminations. This capless construction means excellent pull strength and prevents substrate damage during assembly. With the additional protection of a molded jacket, 1/4w Metal Glaze resistors withstand a 20lb pull test.

**TRW IRC RESISTORS**

ANOTHER PRODUCT OF A COMPANY CALLED TRW

CIRCLE NUMBER 122

# PROVEN PERFORMANCE CRYSTAL CLOCK OSCILLATORS



Motorola's K1100A leads the industry with a crystal clock oscillator that has a proven track record of more than one million units. That's right . . . over one million oscillators are in use by satisfied, repeat customers. That's not all . . . we feature fast deliveries.

How versatile is the K1100A? With over 1200 frequencies already designed, and same day shipment for standard stock frequencies of 4, 4.9152, 5, 10, and 20 MHz . . . you make the decision.

Oscillators are available from 250 kHz to 32 MHz, +0.01% stability from 0°C to 70°C, TTL compatible, and standard +5V dc input.

For full specifications and prices on the oscillator that design engineers trust, write Motorola, Component Products Department, 2553 N. Edgington, Franklin Park, Illinois 60131. Or call (312) 451-1000, ext. 4183.



**MOTOROLA**  
Communications and Electronics Inc.

"SEE US AT ELECTRONICA — HALL #7 — BOOTH #7325-7-9"

CIRCLE NUMBER 123

# THAT BUG IN YOUR EQUIPMENT: YOU MAY NEED VISHAY RESISTORS.

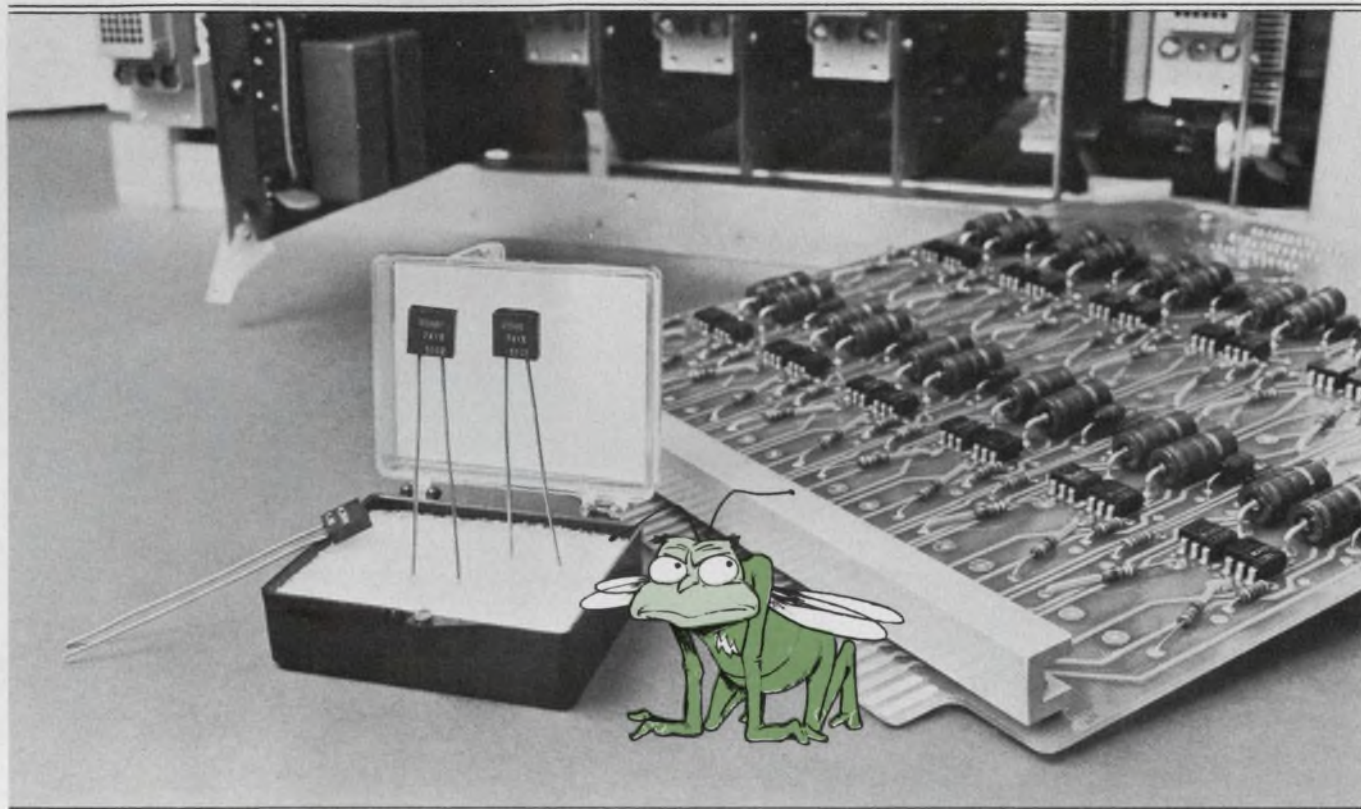

Here is some news that may shock you:

Many manufacturers and users of precision electronic equipment suffer unnecessarily with unexplained instabilities and drifts. They resign themselves to the need for constant adjustments and troubleshooting which could, in fact, be avoided.

Often, the instability is traceable to a few "fixed" resistors which aren't fixed at all. If these resistors would only retain their original values, there would be no need for costly controls and other compensating circuitry.

The answer? A *real* precision resistor.

Some precision resistors offer you tight tolerance at the expense of high inductance. Others offer low inductance and fast rise time at the expense of loose tolerance. But only Vishay Bulk Metal® resistors offer you the complete set of top performance characteristics, including  $0 \pm 1$  ppm TCR, that will most often get that frustrating bug out of your equipment. Only Vishay offers you the consistent matching and tracking so necessary in A/D conversion networks and bridge circuits.

And now Vishay offers you the chance to *make your own* custom Bulk Metal resistors for breadboard and prototype use. Call or write for information on our popular one-day training seminar in calibrating and encapsulating Vishay resistors in your own plant. Vishay Resistive Systems Group, 63 Lincoln Highway, Malvern, PA 19355; phone (215) 644-1300; TWX 510-688-8944.



**Only Vishay resistors give you all six top performance specs.**

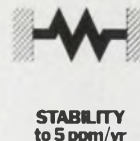
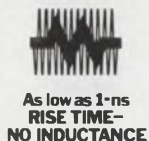
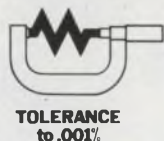





# Introducing The Most Advanced Line Of Quad OP Amps Ever Made. Nothing Performs Quite Like Them.

The HA 4602/4622 high performance quad operational amplifiers are keys to a whole new concept in amplifier design. They're unique in that they have bipolar, CMOS, and dielectric isolation all in one chip. So they give you a full measure of confidence like you've never known before in general purpose amplifiers. For example:

- Eight times the slew rate and bandwidth of the 741 at only three-fifths quiescent power.
- High accuracy and stability, even at high gains, over the specified temperature ranges.
- Monolithic construction to provide optimum parameter matching and temperature tracking.
- High performance and a quad structure which is ideal for active filter applications.

**STANDARD FEATURES.** Both Harris high performance quad amps have standard features you won't find in any other quad amps. The 4602 typically offers a slew rate of  $4V/\mu\text{sec}$ , unity gain bandwidth of 8MHz, input noise voltage of  $8\text{NV}/\sqrt{\text{Hz}}$  and input offset voltage of 0.3mV. The 4622 is uncompensated and provides stability at  $A_v = 10V/V$ , gain bandwidth of 70MHz and a slew rate of  $25V/\mu\text{sec}$ .

## PERFORMANCE/PRICE.

Impressed with this high performance? You'll be just as impressed by the price. For military use the HA 4622-2 and HA 4602-2 cost \$9.90. For commercial, the HA 4625-5 and the HA 4605-5 cost \$4.95 (100 up prices).

**ECONOMY TOO.** For those of you more inclined to go the economy route, there's our very popular HA 4741 quad op amp. With its superior typical bandwidth of 3.5 MHz, slew rate of  $1.6V/\mu\text{sec}$  and input voltage noise of

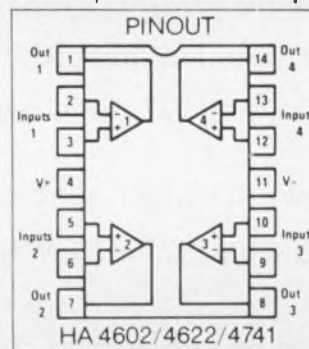

$9\text{NV}/\sqrt{\text{Hz}}$ , it offers you a lot of amp for not a lot of money. For instance, the HA 4741 for military usage costs just \$4.60, while the HA 4741-5 for commercial is just \$2.48.

**AND FAST DELIVERY...** Right now we have a full inventory of our new quad op amps. So whether you prefer high performance, or economy, rest assured your order can be honored immediately.



**HARRIS**  
SEMICONDUCTOR  
A DIVISION OF HARRIS CORPORATION

P.O. Box 883, Melbourne, Florida 32901 (305) 724-7412

**OEM SALES OFFICES:** CALIFORNIA: Long Beach (213) 426-7687, Palo Alto (415) 964-6443, FLORIDA: Fort Lauderdale (305) 971-3200, Melbourne (305) 724-7430, ILLINOIS: Hinsdale (312) 325-4242, MASSACHUSETTS: Wellesley Hills (617) 237-5430, MINNESOTA: Minneapolis (612) 835-2505, NEW YORK: Endwell (607) 754-5464, Melville (L.I.) (615) 249-4500, OHIO: Dayton (513) 226-0636, PENNSYLVANIA: Wayne (215) 687-6680, TEXAS: Richardson (214) 231-9031

**SALES REPRESENTATIVES:** ALABAMA: Huntsville (205) 533-6640, ARIZONA: Scottsdale (602) 948-5590, CALIFORNIA: Los Angeles (213) 870-9191, Mountain View (415) 961-8121, San Diego (714) 565-9444, COLORADO: Denver (303) 773-0666, CONNECTICUT: East Norwalk (203) 838-1493, FLORIDA: Boca Raton (305) 395-6108, Oviedo (305) 365-3283, Tampa (813) 933-1759, ILLINOIS: Elk Grove Village (312) 640-1850, INDIANA: Indianapolis (317) 849-6454, IOWA: Cedar Rapids (319) 377-8275, KANSAS: Wichita (316) 943-6221, MARYLAND: Lanham (301) 459-1556, MASSACHUSETTS: Burlington (617) 273-1313, MICHIGAN: Farmington (313) 476-2446, MISSOURI: Hazelwood (314) 731-5799, Independence (816) 737-1100, NEW JERSEY: Keasbey (516) 567-5900, West Caldwell (516) 567-5900, NEW MEXICO: Albuquerque (505) 265-5655, NEW YORK: Albany (518) 489-7408 or 4777, Huntington Station (516) 567-5900, NORTH CAROLINA: Winston Salem (919) 722-5151, OHIO: Cleveland (216) 831-8292, Dayton (513) 890-2150, OREGON: Beaverton (503) 643-1644, PENNSYLVANIA: Allison Park (412) 487-4300, King of Prussia (215) 265-0634, SOUTH CAROLINA: Greenville (803) 268-1125, TEXAS: Dallas (214) 691-4592, Houston (713) 661-3007, VIRGINIA: Charlottesville (804) 973-6672, WASHINGTON: Bellevue (206) 454-0300, CANADA: Mississauga (Toronto) (416) 676-1042, Montreal (514) 626-6723, Ottawa (613) 749-0740

**NATIONAL DISTRIBUTORS:** Hamilton Avnet, The Harvey Group, Inc., Schweber Electronics, R.V. Weatherford Company

# TWO-MINUTE QUIZ.

There are two major electronics directories to assist engineer/specifiers in doing their jobs. How do they rate in a head-to-head editorial comparison?

1. "Which provides the greater number of product headings in its Product Category?"  
GOLD BOOK has 5182. EEM has 3335.
2. "Which furnishes the greater number of pages in its Product Directory?"  
GOLD BOOK has 542. EEM has 255.
3. "Which provides more pages in the Trade Name Directory?"  
GOLD BOOK has 33. EEM has 24.
4. "Which supplies the greater number of pages in the Manufacturers Directory?"  
GOLD BOOK has 397. EEM has 338.
5. "Which furnishes the larger number of manufacturers?"  
GOLD BOOK has 6771. EEM has 3300.

What more need be said, except to ask one additional question:

6. "Which leads in circulation in the increasingly important foreign market?"  
GOLD BOOK has 13,000. EEM has zero.

On top of all this, GOLD BOOK rates are lower than EEM rates by far!

**ELECTRONIC DESIGN'S GOLD BOOK  
WORKS WORLDWIDE!**



# Introducing SpinGuard.<sup>®</sup>

## A new case for AVX quality.

SpinGuard is AVX's new multi-layer ceramic capacitor in an economical epoxy case. Axial leaded to make it perfect for automatic insertion.

Because it comes from AVX, you can be sure of its quality. Quality designed in, built in and demonstrated by exhaustive testing. To guarantee you greater reliability, exact

adherence to temperature and tolerance specifications.

And because it's axial leaded, you can order SpinGuards taped and reeled to run trouble free on your automatic insertion equipment. Cutting your assembly time. Reducing your assembly costs.

AVX quality in a low-cost component, designed for low-cost assembly. That's quite a case for switching to SpinGuard.

### Free sample

Mail this coupon today. We'll send you a SpinGuard sample, plus information on how to get more samples in your specific applications ratings. Mail coupon to AVX Ceramics, P.O. Box 867, Myrtle Beach, SC 29577

Name \_\_\_\_\_  
Title \_\_\_\_\_  
Company \_\_\_\_\_  
Address \_\_\_\_\_  
Tel. \_\_\_\_\_ Zip \_\_\_\_\_

## AVX: The Insiders

AVX Ceramics, P.O. Box 867, Myrtle Beach, SC 29577 (803) 448-3191 TWX: 810-661-2252  
Olean, NY 14760 (716) 372-6611 TWX: 510-245-2815

AVX Limited, Aldershot, Hampshire, GU12 4RG England, Tel: Aldershot (0252) 312131 Telex: 858473

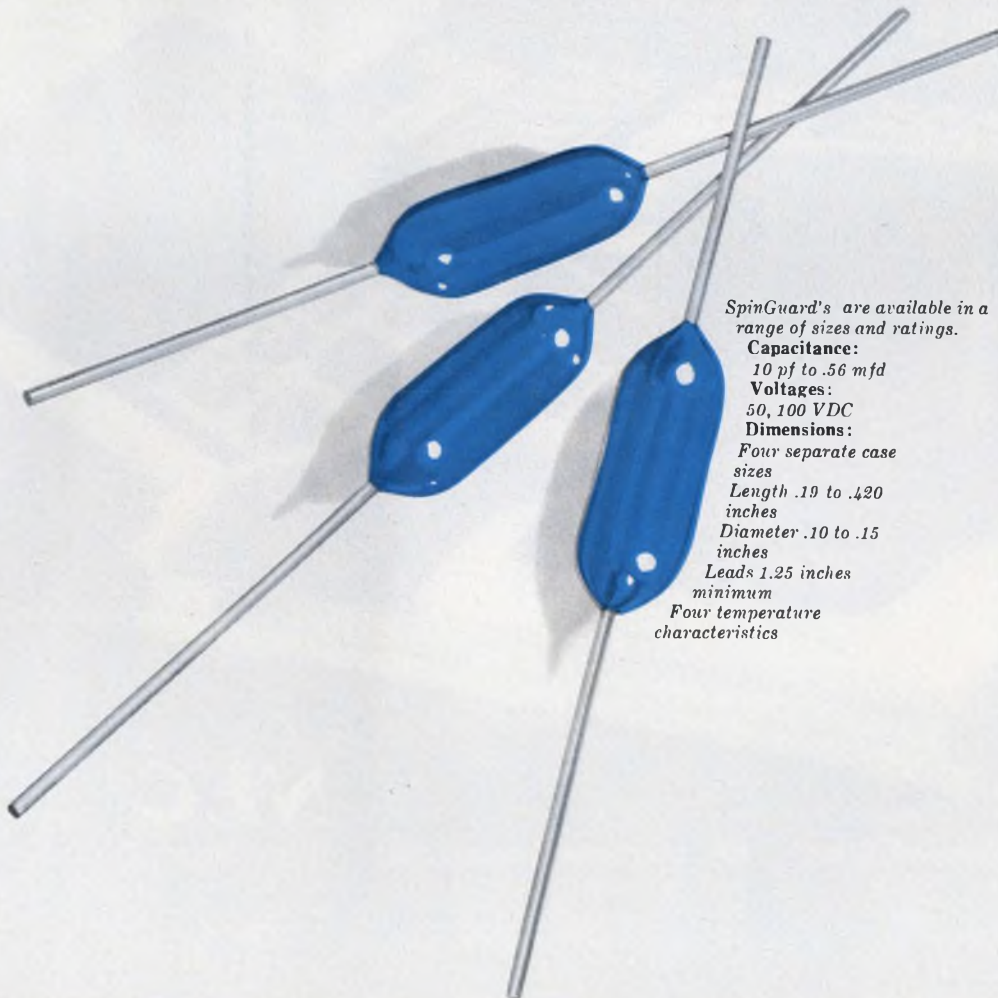

*SpinGuard's are available in a range of sizes and ratings.*

**Capacitance:**

*10 pf to .56 mfd*

**Voltages:**

*50, 100 VDC*

**Dimensions:**

*Four separate case sizes*

*Length .19 to .420*

*inches*

*Diameter .10 to .15*

*inches*

*Leads 1.25 inches*

*minimum*

*Four temperature*

*characteristics*

CIRCLE NUMBER 27

# Eye-Pleasing GREEN.

**NEC is the world's largest vacuum fluorescent display producer.**



Last year, NEC produced 15 million displays for calculators. We expect a 30% increase this year. Reliability/price advantages are optimum. Another decisively attractive feature is the color—green. The human eye is most sensitive to green which opens up wide new applications—POS terminals, clocks, car dashboards, microwave ovens and instruments. A wide range of other OEMs are also turning to us.

Choosing the right display can decide how well your product sells. Contact NEC, the world's largest "green" display producer.



**NEC America, Inc., Sunnyvale Office**  
505 West, Olive Ave., Suite 310, Sunnyvale,  
Calif. 94086, U.S.A. Tel: 409 738 2181,  
Telex: NECAM SUVL 35-7475

**NEC Electronics (Europe) GmbH**  
4000 Düsseldorf, Immermannstrasse  
22, West Germany Tel: Düsseldorf  
357088, 357089, 357080  
Telex: NECD 8587419

## NEC

**Nippon Electric Co., Ltd.**  
NEC Building, 33-1, Shiba-Gochome,  
Minato-ku, Tokyo 108, Japan  
Tel: 03-454-1111  
Cable: MICROPHONE TOKYO  
Telex: NECTOK J22686

# The GOULD/Brush 2000 Series.

## The most significant advance in direct writing recorders in the past decade.

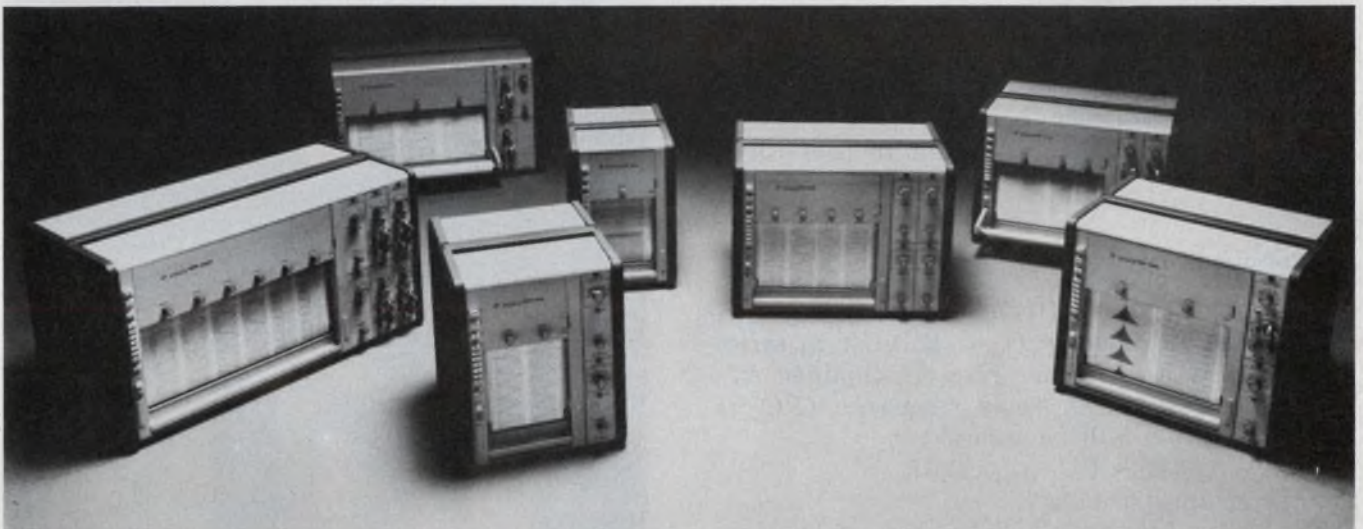

The new GOULD/Brush 2000. We can modestly say it's the best in performance, versatility and reliability. And if you take a look at all it has to offer, we know you'll agree.

Let's start with frequency response that's unexcelled in performance. An exceptional 30 Hz at 100mm, 50 Hz at 50mm, and up to 125 Hz at reduced amplitude.

Superior resolution is assured through a high-stiffness servo penmotor that enforces 99.65% linearity over the entire channel width.

Traces are uniform in width at all writing speeds. And

they're clear and crisp, with no smudges, smears or puddles. The pressurized fluid writing system is completely closed, allowing the recorder to be operated in any position—even upside down.

Then take flexibility. Our plug-in signal conditioners fit every model in the 2000 Series, and record virtually any function you could possibly want.

Thanks to its modular design, it's as versatile as your needs. Channel choices range from 1 to 8. In combinations of 100mm or 50mm channels.

There's a lot more the GOULD/Brush 2000 Series can

give you ranging from easy use and easy servicing to a cost that's downright economical. For details on the oscillographic recorders you should be using, write Gould Inc., Instrument Systems Division, 3631 Perkins Ave., Cleveland, Ohio 44114. Or Gould Allco S.A., 57 rue St. Sauveur, 91160 Ballainvilliers, France. Or call the number below.

**FOR BROCHURE CALL  
TOLL FREE AT (800) 325-6400.  
EXTENSION 77.**

In Missouri: (800) 342-6600.

**The GOULD/Brush 2000 Series,  
Winner of 1976 1-R 100 Competition.**

 **GOULD**  
The product development company

# A 'simplified' notch-filter design?

When you see a published application circuit that looks useful, beware! It might not work as well as you wish.

Anyone who has searched through the literature for notch filters has probably run across a gyrator circuit (Fig. 1a).<sup>1,2,3</sup> The circuit appears straightforward enough and looks better than the twin-tee filter (Fig. 1b). The twin tee requires you to match capacitors for best performance. The gyrator circuit has no capacitor-matching requirements, and it uses op amps that are widely available at low cost.

But getting the gyrator circuit to perform is not as easy as it looks.

## Gyrator-circuit operation

The circuit gyrates (transforms) capacitor  $C_2$  to look like an inductor ( $L = R_4 R_5 C_2$ ) in series with  $R_4$  and  $R_5$  (assume gyrator amplifier  $A_2$ 's gain  $K$ , equals 1). At series resonance ( $XC_1 = XL$ ), the output will be zero if

$$(R_4 + R_5) / R_3 = R_2 / R_1,$$

and the op amps are ideal.

The center frequency may be changed by varying the ratio of  $R_4$  and  $R_5$  with a pot.

One such gyrator with a  $Q$  of 10 and a center frequency of 1 kHz was constructed with a dual op amp. But the notch attenuation was only 6 to 10 dB. What was wrong? Let's look again at our previous assumptions:

- a)  $K = 1$ , and
- b) the op amps are ideal, or:
  - $A_{OL} = \infty$ , open-loop gain.
  - $BW_{OL} = \infty$ , open-loop bandwidth.
  - Distortion = 0%.

## Where did we go wrong?

First, let's look at the problem of poor attenuation at the center frequency. The gain of the circuit can be simplified to:

$$A = \left| \frac{E_o}{E_i} \right| \approx \frac{4Q^2 (1 - K)}{1 + 4Q^2 (1 - K)}$$

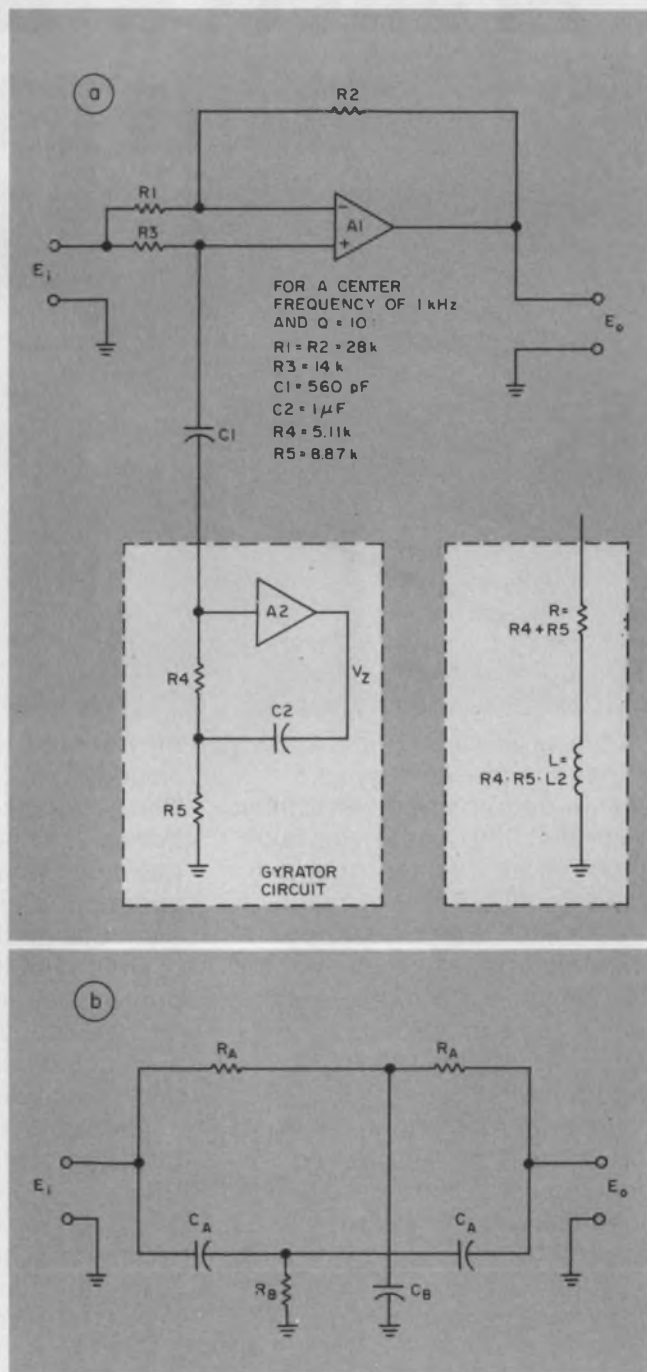

1. The notch filter (a) as it appears in application notes for op amps seems quite simple. The classical twin-tee notch filter (b) requires that the capacitors and resistors be matched for maximum notch attenuation.

Robert E. Williams, Research Instructor, Dept. of Ophthalmology, Baylor College of Medicine, 1200 Mour-sund, Houston, TX 77054.

The circuit gain at the center frequency is very sensitive to small changes in  $K$ . If, for example,  $K = 0.999$ , instead of 1, circuit gain will be  $4/14$ , with a  $Q$  of 10, instead of zero.

The closed-loop gain of  $A_2$  can easily be lower than 0.999 since a 741-type op amp can have an open-loop gain of only 1000 at 1 kHz, the spec-sheet typical. The gain of the gyrator circuit must be boosted to compensate for this possibility. However, the gyrator gain must not be boosted too far. As  $K$  approaches the value  $1 + 1/4Q^2$ , then  $E_o/E_i$  approaches infinity.

Next, look at the voltage gain from the circuit input to the gyrator output when the input frequency equals the notch-center frequency:

$$\left| \frac{V_2}{E_1} \right| = \frac{R_2}{R_1 + R_2} \sqrt{1 + \left[ \frac{(R_1 + R_2) Q}{R_2} \right]^2} \approx Q$$

An input signal at the notch frequency can be within the amplitude range of the over-all circuit, yet may overdrive  $A_2$ 's output when high notch  $Q$  is specified. With increasing  $Q$ , the input-to-output voltage gain,  $A$ , approaches unity, but the  $V_2/E_1$  gain increases linearly. Of course, this reduces the attainable attenuation in the notch and produces a distorted waveform at the filter's output.

### Here is a workable solution

The circuit of Fig. 2 illustrates a workable solution to both problems. The input circuit of  $A_3$  divides by  $Q$  so that the gyrator amplifier will operate linearly. The output circuit of  $A_1$  amplifies by  $Q$  so that the total circuit will have unity gain in the pass band.

You must adjust three pots in this circuit for best performance. First, adjust  $R_1$  for the desired notch frequency. Next, alternately vary  $R_2$  and  $R_3$  for maximum attenuation at the notch frequency.

Pot  $R_3$  is added to set  $A_2$ 's gain exactly equal to unity. Pot  $R_2$  adjusts the resistor ratio around  $A_1$ , so that the notch-frequency attenuation is maximum.

So the simple becomes complicated. A two-op-

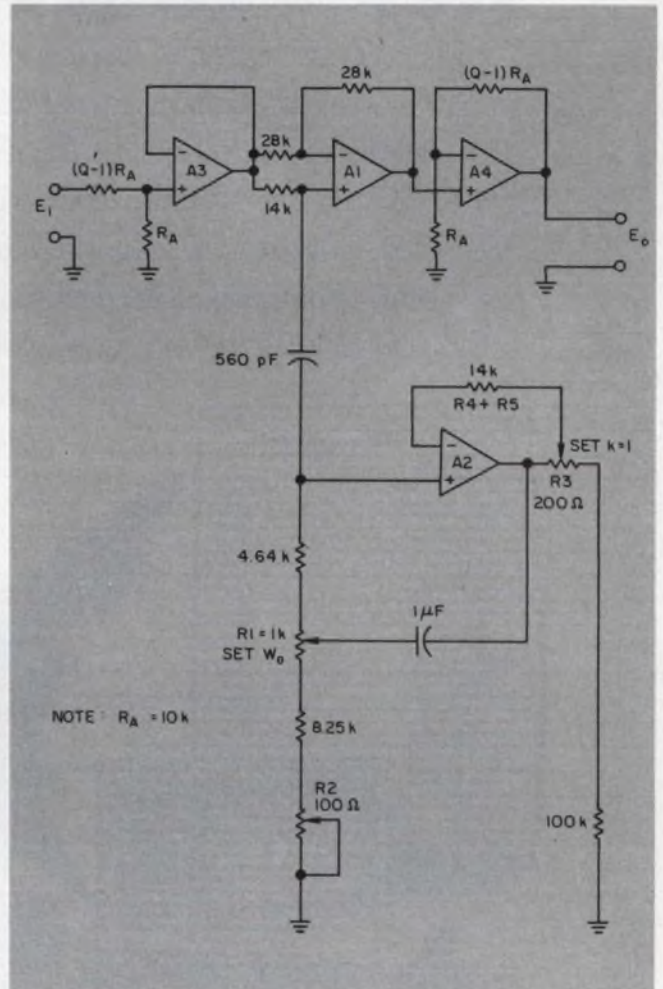

2. The final notch filter, as it looks after the designer takes into account all of the variations from the ideal.

amp notch filter expands into a four-op-amp notch having, possibly, three potentiometers.

Oh well, you can always use a twin tee. ■■

### References

1. *Op Amp Circuit Collection*, AN31-14, National Semiconductor Corp., Santa Clara, CA, February, 1970.
2. *The Linear Integrated Circuits Data Catalog*, Fairchild Semiconductor, Mountain View, CA, UA747 Data Sheet, 1976, pp. 12-102.
3. *Linear Quads and Duals*, Raytheon Semiconductor, Mountain View, CA, December, 1975, p. 21.



# MEMORY AT WORK

## Replacing four 2102s

If you're designing the 2102 into any application, stop. Look at our new SEMI 4804A.

It will quadruple your density, cut your power per bit in half. One SEMI 4804A static 1K x 4 RAM replaces four 2102s (or 2112s). It operates on 5V (but will protect data down to 1.5  $V_{DD}$ ), reads and cycles in 450 nsec., and is packaged in an 18-pin DIP.

The SEMI 4804A is second-sourced, and is available now from your local EMM SEMI distributor. (If you need 4K x 1 organization, ask about our new SEMI 4801. That's available immediately, too.)

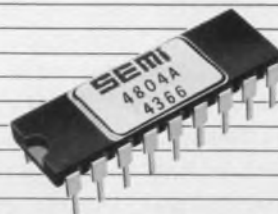

Write or call today  
for full details.



**EMM SEMI**

A subsidiary of

Electronic Memories & Magnetics Corp.

3883 N. 28th Ave., Phoenix, Ariz. 85017

(602) 263-0202



# Reliability test results:

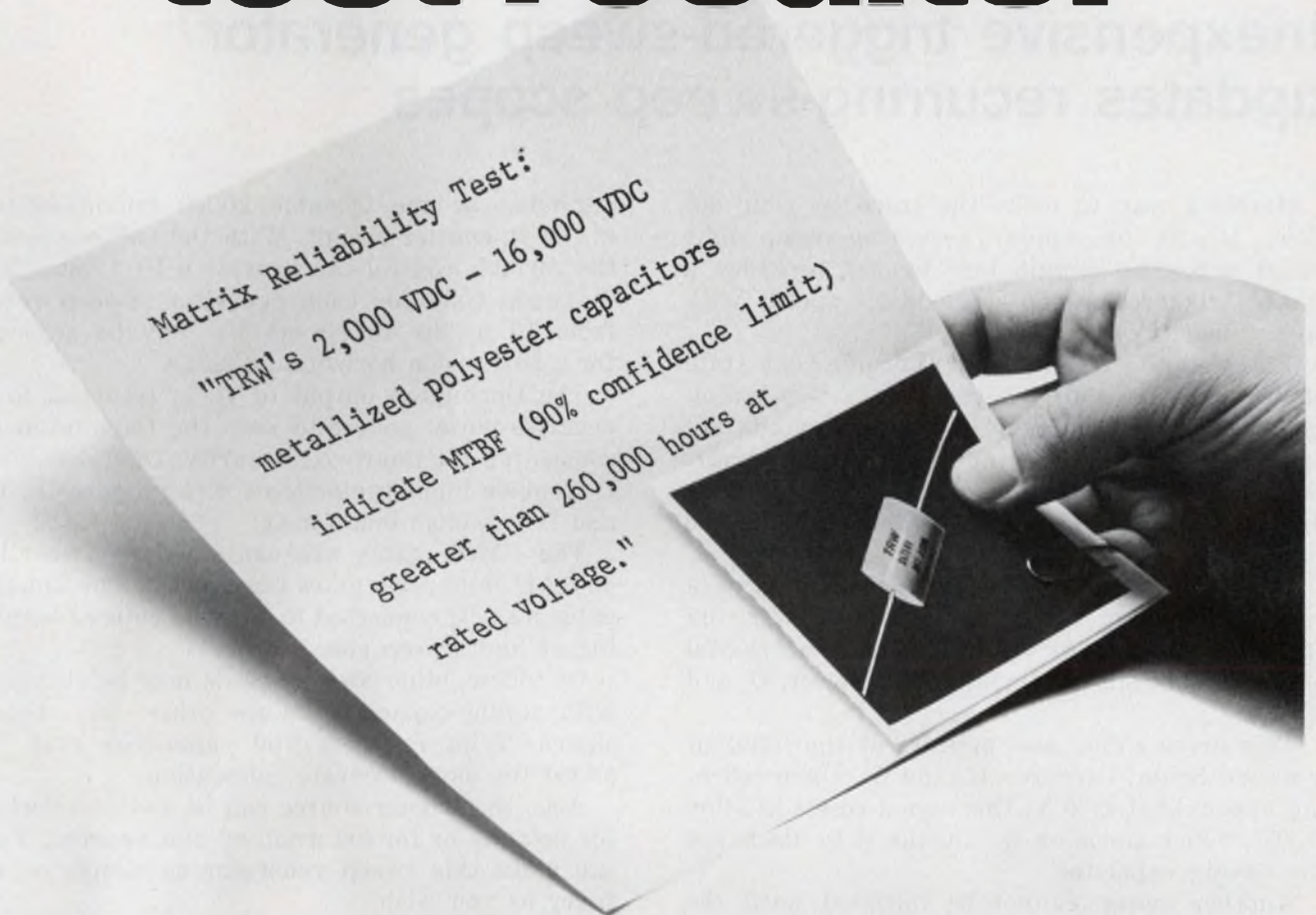

TRW's X675HV series is designed to meet the requirements of voltage multipliers and high voltage filters in high density, high voltage power supplies, instrumentation, data displays, pulse modulators and copiers.

They're smaller, lighter, self-healing and eliminate wet components which can bleed, crack and wreck a board.

The standard design is metallized polyester with axial leads, tape wrap and epoxy endfill case. Insulation resistance is 30,000 megohms x MFD and the dissipation factor is less than 1% at 1000 Hz.

The X675HV series can replace traditional dielectrics in many applications with substantial savings in size at comparable lower costs. *On quantity orders, modifications can be made to your specifications.*

Want to know more? Use the coupon for complete specs on the X675HV series — or information on any dielectric you require.

#### TRW Capacitors

An Electronic Components Division of TRW, Inc.  
301 West "O" Street,  
Ogallala, Nebraska 69153.

- Please send me specs on your new X675HV capacitors.
- I'd also like a copy of the matrix test results.
- Please have someone contact me.

\_\_\_\_\_  
Name

\_\_\_\_\_  
Firm Name

\_\_\_\_\_  
Address

\_\_\_\_\_  
City

\_\_\_\_\_  
State

\_\_\_\_\_  
Zip

## TRW CAPACITORS

ANOTHER PRODUCT OF A COMPANY CALLED TRW

CIRCLE NUMBER 31

## Inexpensive triggered-sweep generator updates recurring-sweep scopes

Here's a way to make the trace on your old Eico, Heath, or similar recurring-sweep unit stand still. The circuit (see figure) provides a stable, triggered sweep at moderate speeds with good linearity.

Transistor  $Q_1$  conducts in the quiescent state of the circuit and "shorts" the sweep-timing capacitor. When a triggering signal exceeds approximately 6 V at the input of  $G_1$ , the Schmitt trigger (made of  $G_1$  and  $G_2$ ) switches, causing flip-flop  $G_3/G_4$  to change state. This state change turns off and holds off  $Q_1$ .

Constant-current source  $Q_2$  then can charge a selected timing capacitor,  $C_1$ ,  $C_2$  or  $C_3$ . The rising capacitor voltage drives the scope's horizontal amplifier through the Darlington follower,  $Q_3$  and  $Q_4$ .

This drive signal also appears at the input of a second Schmitt trigger,  $G_5$  and  $G_6$ . Upon reaching approximately 6 V, this signal resets flip-flop  $G_3/G_4$ , which turns on  $Q_1$  causing it to discharge the timing capacitor.

Another sweep cannot be initiated until the first one is completed, because one of the  $G_2$  inputs inhibits triggering, when the flip-flop's  $G_4$  output is HIGH.

The charging rate for the timing capacitor is

regulated by the variable 20-k $\Omega$  potentiometer in the  $Q_2$ -emitter circuit. With the values shown, the variable control can provide a 10:1 variation in sweep time for each capacitor. Sweep rates from 10  $\mu$ s/div to 10 ms/div may be selected for a 10-division horizontal display.

The Darlington output of  $Q_3$  is returned to a negative power source to keep the Darlington in conduction for improved linearity. Diodes  $D_1$  and  $D_2$  provide input protection for  $G_1$ ; diodes  $D_3$ ,  $D_4$  and  $D_5$  establish bias for  $Q_2$ .

The CMOS gates are contained in two CD-4001AE chips; two gates are unused. The unused gates may be connected to provide retrace blanking at high sweep speeds.

Of course, other sweep speeds may be obtained with timing-capacitor values other than those shown. Trim resistors and capacitors may be added for more accurate calibration.

Also, the trigger source can be switch-selected for polarity or for external, or line, sources. You can make this sweep generator as simple or as fancy as you wish.

*W. J. Woodward, Senior Engineer, Savannah River Laboratory, E. I. du Pont de Nemours & Co., Aiken, SC 29801.*

CIRCLE No. 311

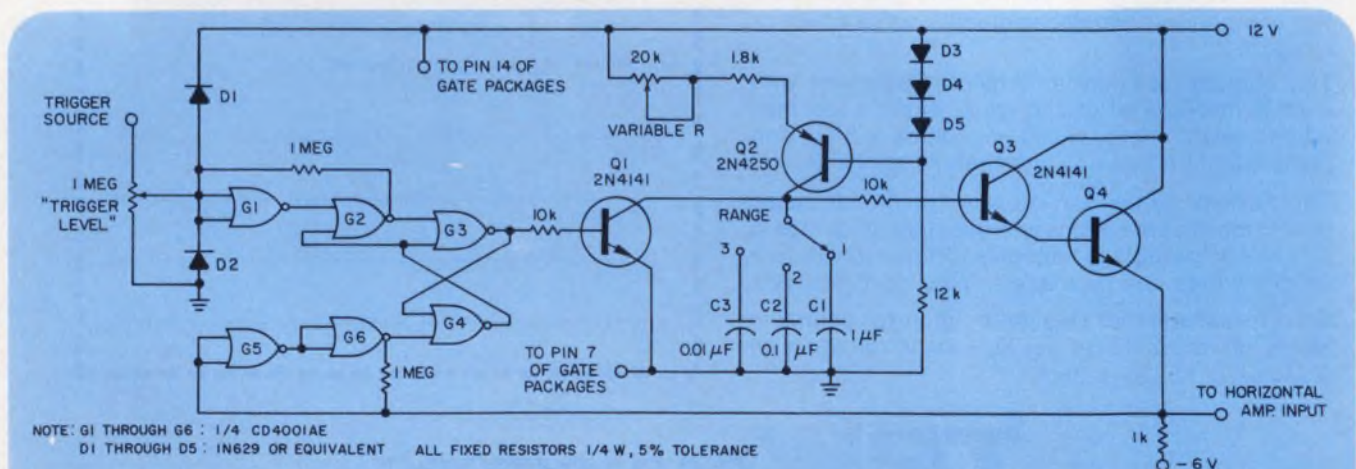

A triggered-sweep capability can be added to old recurring-sweep scopes with this simple trigger-

generator circuit. Variable resistor R provides a 10:1 sweep for ranges selected with  $C_1$ ,  $C_2$  or  $C_3$ .

# Sprague puts more passive component families into dual in-line packages than any other manufacturer.

## Call Sprague First!



**HIGHER PACKAGING DENSITY**

**LOWER PRODUCTION COSTS**

plus improved performance and compatibility with DIP microcircuits

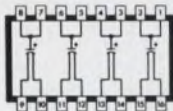

**DIP  
MULTIPLE  
TANTALUM CAPACITORS**



Solid-electrolyte tantalum capacitors with 2 or 4 sections per package. 8- or 16-pin configurations. Standard ratings are  $6.8 \mu\text{F} @ 35\text{V}$ ,  $15 \mu\text{F} @ 20\text{V}$ ,  $22 \mu\text{F} @ 15\text{V}$ ,  $33 \mu\text{F} @ 10\text{V}$ . Capacitance tolerance,  $\pm 20\%$ . Operating temperature range,  $-55\text{C}$  to  $+85\text{C}$ . Write for Bulletin 3542 or circle 151 on reader service card.

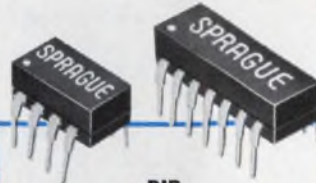

**DIP  
MULTIPLE  
CERAMIC CAPACITORS**



Monolithic<sup>®</sup> construction . . . alternate layers of ceramic dielectric material and metallic electrodes are fired into a solid homogenous block. 2, 4, 7, or 8 capacitor sections per package. Standard ratings,  $18 \text{pF}$  to  $0.1 \mu\text{F} @ 100\text{V}$ . Capacitance tolerance,  $\pm 20\%$ . Write for Bulletin 6242 or circle 152 on reader service card.



**DIP  
TANTALUM/CERAMIC  
CAPACITOR ASSEMBLIES**



Solid tantalum and Monolythic<sup>®</sup> ceramic alternating isolated sections. Choice of 4 or 8 sections per package. Standard tantalum ratings,  $6.8 \mu\text{F} @ 35\text{V}$ ,  $15 \mu\text{F} @ 20\text{V}$ ,  $22 \mu\text{F} @ 15\text{V}$ ,  $33 \mu\text{F} @ 10\text{V}$ . Ceramic ratings .01, .047, .1  $\mu\text{F} @ 100\text{V}$ . Cap. tol.,  $\pm 20\%$ . Write for Engineering Bulletin 6642 or circle 153 on reader service card.



**DIP  
RESISTOR/CAPACITOR  
NETWORKS**

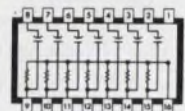

(1 of 3 designs)

Metanet<sup>®</sup> metal-film resistors and Monolythic<sup>®</sup> ceramic capacitors in bypassed pull-up, R-C coupling, speed-up, and active terminator networks. Resistor ratings, 100 to  $6800\Omega$  with 125mW power dissipation. Capacitor ratings,  $100 \text{pF}$  to  $.01 \mu\text{F} @ 100\text{V}$ . Write for Engineering Bulletin 6612 or circle 154 on reader service card.

**DIP  
MULTIPLE  
METAL-FILM RESISTORS**



Noble metal film resistors encased in protective glass. Choice of 7 or 8 resistors per 14- or 16-pin package. Resistance values, 50 $\Omega$  to  $100,000\Omega$ . Power dissipation, 125mW. Standard resistance tolerance,  $\pm 5\%$ . Operating temperature range,  $-55\text{C}$  to  $+70\text{C}$ . Write for Bulletin 7042 or circle 155 on reader service card.

**DIP  
PRECISION RESISTOR  
NETWORKS**

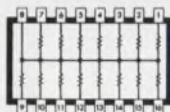

(1 of 5 designs)

Noble metal film resistors in pull-up, pull-down, interfacing, and terminating configurations, for applications requiring repetitive resistance patterns. 14- or 16-pins. Up to 28 resistors per package. Individual resistors from 50 to  $100,000\Omega$ . Dissipation, 125 mW. Write for Bulletin 7042 or circle 156 on reader service card.

**DIP  
MULTIPLE  
PULSE TRANSFORMERS**

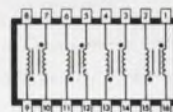

(1 of 2 designs)

Four transformers in 16-pin package. All cores have exclusive protective coating. Inductance values from 10 to  $1000\mu\text{H}$ . ET product values of 5 volt- $\mu\text{sec}$ . Choice of four turns ratios . . . 1:1, 2:1, 3:1, 4:1. Operating temperature range,  $0\text{C}$  to  $+70\text{C}$ . Write for Engineering Bulletin 40400 or circle 157 on reader service card.

**DIP  
TAPPED  
DELAY LINES**

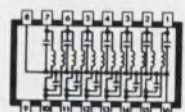

Lumped constant delay lines . . . ideal for timing and pulse synchronization circuits. 14- or 16-pin packages with delays of 50, 100, or 150 nanoseconds at a characteristic impedance of  $100\Omega$ . Working voltage, 50VDC. Operating temp. range,  $0\text{C}$  to  $+70\text{C}$ . Write for Bulletin 45004 or circle 158 on reader service card.

**Popular Types Now Available OFF-THE-SHELF From Your Sprague Industrial Distributor.**

For complete technical data, write for any of the above-mentioned Engineering Bulletins to: Technical Literature Service, Sprague Electric Company, 347 Marshall Street, North Adams, Mass. 01247.

**THE BROAD-LINE PRODUCER OF ELECTRONIC PARTS**



# Interface CMOS to TTL with diodes and save the cost of expensive buffers

The next time you have to interface CMOS ICs to TTL, don't search for a buffer chip or a discrete-transistor level changer. Put some inexpensive junction diodes to work and save a bundle. Connect almost any signal diode between the CMOS output and the TTL input (Fig. 1). A diode array, such as Fairchild's monolithic CA3039, works very well.

When the CMOS output is HIGH, the diode is reverse biased, and the TTL input assumes a HIGH level. When the CMOS output goes LOW, the diode conducts, and the current is provided by the TTL input.

The CMOS output has good current-sinking characteristics, so that the small forward current of the diode is easily handled. The 0.6-V drop across the diode is well below the specified LOW level for TTL. The diodes must be able to handle the highest reverse bias: The CMOS,  $V_{cc}$ , can be as high as 15 V.

*Sudarshan Sarpangal, Electronic Engineer, Power Group and Puttaiah, Electrical Engineer, Telemetry Group, Isro Satellite Systems Project, Peenya Industrial Estate, Peenya 562140, Bangalore, India.*

CIRCLE NO. 312

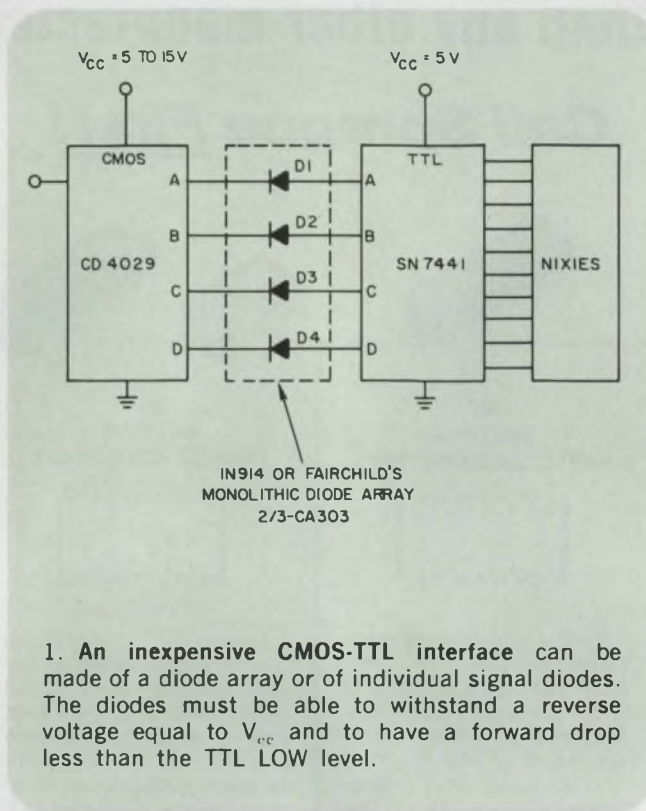

1. An inexpensive CMOS-TTL interface can be made of a diode array or of individual signal diodes. The diodes must be able to withstand a reverse voltage equal to  $V_{cc}$  and to have a forward drop less than the TTL LOW level.

## Remotely control a pocket calculator with a simple CMOS interface circuit

Pocket calculators, when properly interfaced, can accept inputs from a digital multimeter or frequency counter and process the data. One frequent requirement is the calculation of mean value. This is especially useful to obtain a "smoothed" value,  $\bar{E}$ , of a noisy signal,  $E_n$ , as expressed by

$$\bar{E} = \frac{1}{N} \sum_{1}^N E_n$$

The basic instructions to the calculator to perform this averaging is as follows:

C / CE—clear calculator

$E_1$  —data entry

+

$E_2$  "

+

.

.

.

.

$E_N$  " —sum of entries  
 $\div$  —divide  
 $N$  —number samples entry  
 $=$  —display of mean value

In the figure, a standard arrangement of 9-V-operated calculator-chip, keyboard matrix, LED-display and segment driver are supplemented with additional CMOS hardware to achieve the remote-control operation. The digit outputs,  $D_1$  through  $D_{11}$ , of the calculator chip are sequential nonoverlapping pulses. Pulse  $D_{11}$  appears first. The pulses multiplex the display digits and also provide control signals for the calculator-chip input, KO, which enters the functions, and KN, which enters the numbers.

Entry of the number 6, for example, requires a contact closure at the corresponding keyboard cross point and pulse  $D_{11}$  to cause the entry of a



# The most important part of every Honeywell tape system.

Common sense is basic to the Honeywell tape engineering philosophy. When we innovate for one tape product, we believe it's only common sense to apply that technology to other tape products in our broad line . . . lab, portables, high environmental and airborne recorders. The result is almost always a solution exactly right for your recording needs.

But if it's not, common sense dictates that we provide you with a custom tape system. Our consistent success with custom tape applications is common knowledge in the industry.

For more information and a catalog of our high-performance common-sense tape solutions, write or call Chuck Miller at Honeywell Test Instruments Division, P. O. Box 5227, Denver, Colorado 80217. (303) 771-4700.

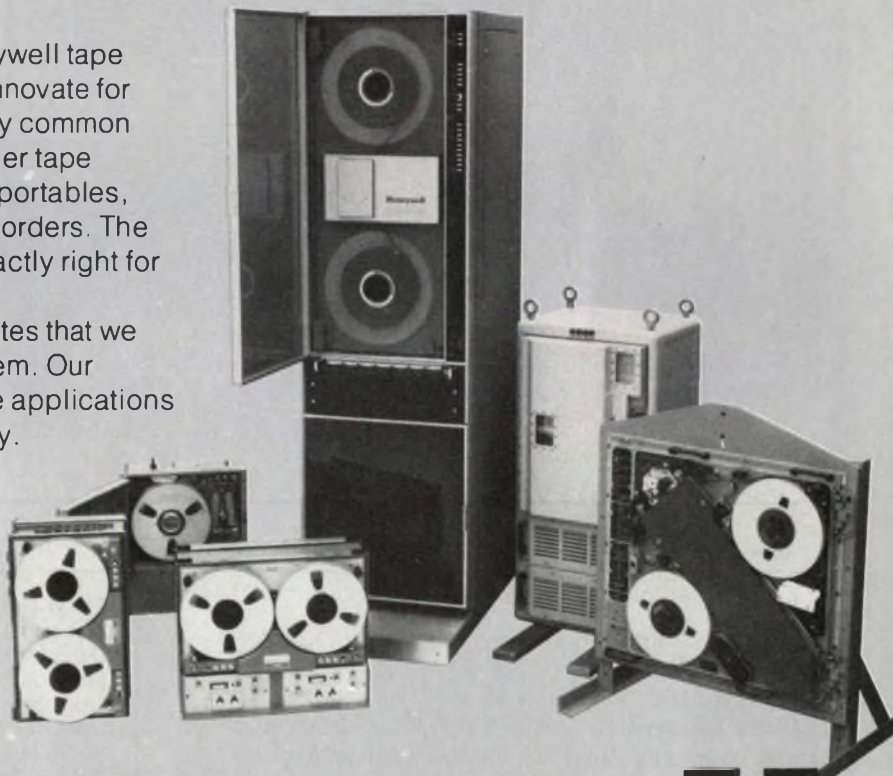

CIRCLE NUMBER 33

# Honeywell

## IDEAS FOR DESIGN (CONTINUED)

number 6 via the calculator chip's KN input. The contact must remain closed for the keyboard debounce time (about 25 ms).

In remote-control operation,  $D_{11}$  resets the 74C93 CMOS counter. Pulses  $D_1$  to  $D_{10}$  are ORed with diodes and provide a pulse train, DS, which is counted by the 74C93. The counter output is a binary-code equivalent of the 1-out-of-N output code of the calculator chip.

The output of the counter is compared via a 74C85 with an external input, ABCD. When equal, the 74C85's output, labeled  $A = B$ , goes high. A program-initiate pulse, PP, directed by input E, allows entry of numbers or functions into KN or KO, respectively. The width of PP must at least equal the keyboard debounce time. Signal E, when LOW, interprets signals ABCD

as functions, and when HIGH, as numbers, as follows:

$E = 0$	$E = 1$	DCBA
%	0	0000
MS	1	1001
C/CE	2	1000
MR	3	0111
÷	4	0110
×	5	0101
.	6	0100
=	7	0011
+	8	0010
-	9	0001

Peter A. Ernst, Institut für Regelungstechnik,  
Universität Erlangen-Nürnberg, Cauerstrasse 7,  
8520 Erlangen, Germany. CIRCLE No. 313

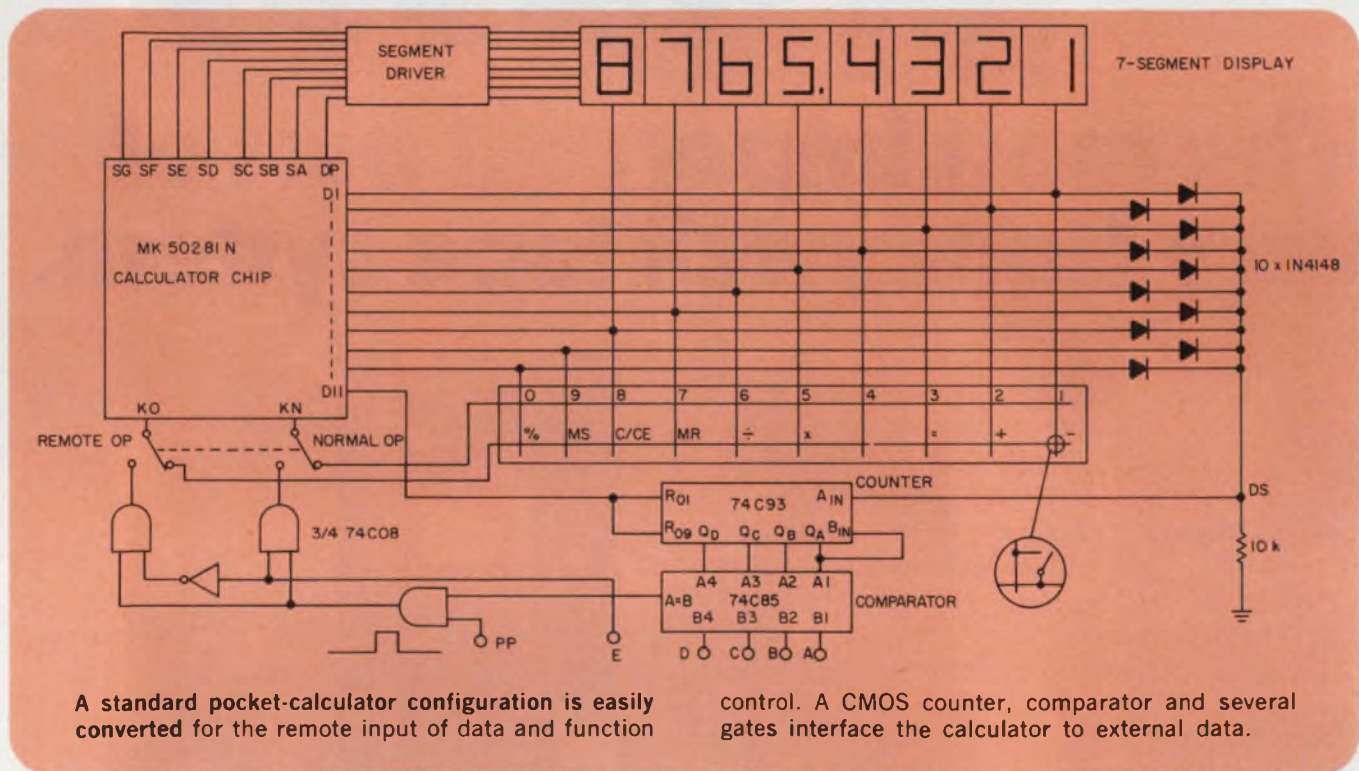

A standard pocket-calculator configuration is easily converted for the remote input of data and function

control. A CMOS counter, comparator and several gates interface the calculator to external data.

### IFD Winner of July 5, 1976

Michael S. McNatt, Senior Engineer, LaBarge Inc., Electronics Div., 6540 E. Apache, P.O. Box 36, Tulsa, OK 74101. His idea "Computer Sound Effects Generated with Only Four ICs" has been voted the Most Valuable of Issue Award.

Vote for the Best Idea in this issue by circling the number of your selection on the Reader Service Card at the back of this issue.

**SEND US YOUR IDEAS FOR DESIGN.** You may win a grand total of \$1050 (cash)! Here's how. Submit your IFD describing a new or important circuit or design technique, the clever use of a new component or test equipment, packaging tips, cost-saving ideas to our Ideas for Design editor. Ideas can only be considered for publication if they are submitted exclusively to ELECTRONIC DESIGN. You will receive \$20 for each published idea, \$30 more if it is voted best of issue by our readers. The best-of-issue winners become eligible for the Idea of the Year award of \$1000.

# SORENSEN IS THE SOURCE.

## FOR MODULAR SWITCHING POWER SUPPLIES.

### Check our standard features:

- 10 models, 1.8V to 56V with power levels ranging up to 225 watts.
- 115/220 Vac input by external barrier strip change.
- 50/60-Hz operation with no derating.
- Logic shutdown for system applications.
- Extra long hold-up time.
- Low ripple and noise through use of double-stage filtering.
- Wide-range output voltage adjustment.
- Built-in adjustable overvoltage protection.
- Superior line and load regulation.
- Internal adjustable current limiting.
- UL component recognition.
- High power-to-weight ratio.
- 20-kHz switching.
- Rack adaptors available.
- Immediate delivery.
- Made in U.S.A. of quality components.
- Five-year warranty, backed by worldwide service organization.



5V 30 Amps.

**\$295.**

### Check our specifications:

- AC Input Power:** 98 Vac-132 Vac, 187 Vac-250 Vac.  
Frequency: 47-63 Hz single phase. 360-440 Hz (double rms Ripple spec.) *No derating.* Voltage selectable by a single link on the front panel.
- Voltage Regulations:** Line: 0.03% over full AC input range. Load: 0.03% for zero to full load.
- Voltage Ripple:** Typical 2m V rms, 20mV pk-pk (20Hz to 20 MHz).  
Max. 5mV rms, 50mV pk-pk (20Hz to 20MHz).
- Temperature Coefficient:** 0.01% max. per °C.
- Stability:** 0.05% max. for 24 hours after warm-up.
- Transient Response Time:** Output voltage returns to within 1% in less than 1.2 ms following a step-load change from either 50% to 100% or 100% to 50% of full load.
- Overshoot:** No overshoot at turn-on, turn-off or power failure.
- Hold-Up Time:** Full regulated voltage holds up for 40ms after removal of power at full load, and nominal input and output voltages (80ms for half load).
- Overvoltage Protection:** Built-in adjustable overvoltage protection standard on all models.
- Efficiency:** Up to 78%.
- Remote Sensing:** Voltage drops can be compensated for up to the max. specified terminal voltage.
- Paralleling:** May be directly paralleled without derating.
- Soft-Start:** In-rush current is limited by soft start circuit.

Model No.	Nominal Voltage	Output Voltage Adjustment Range		Output Current				Price
		min.	max.	@40°C	@50°C	@60°C	@71°C	
SSD2-30	2	1.8	3.0	30.0	27.0	22.5	15.0	\$295
SSD5-30	5	4.7	6.5	30.0	27.0	22.5	15.0	295
SSD9-20	9	6.5	9.5	20.0	18.0	15.0	10.0	295
SSD12-15	12	9.5	13.0	15.0	13.5	11.2	7.5	295
SSD15-12	15	13.0	17.0	12.0	10.8	9.0	6.0	295
SSD18-10.5	18	16.0	21.0	10.5	9.4	7.8	5.2	295
SSD24-8.5	24	20.0	26.0	8.5	7.6	6.3	4.2	295
SSD28-7	28	25.0	33.0	7.0	6.3	5.2	3.5	295
SSD36-5	36	32.0	43.0	5.0	4.5	3.7	2.5	295
SSD48-4	48	42.0	56.0	4.0	3.6	3.0	2.0	295

For OEM discounts call:  
Sorensen, (603) 668-4500.  
676 Island Pond Road,  
Manchester, NH 03103.

**SORENSEN**  
POWER SUPPLIES

A Raytheon Company

CIRCLE NUMBER 34



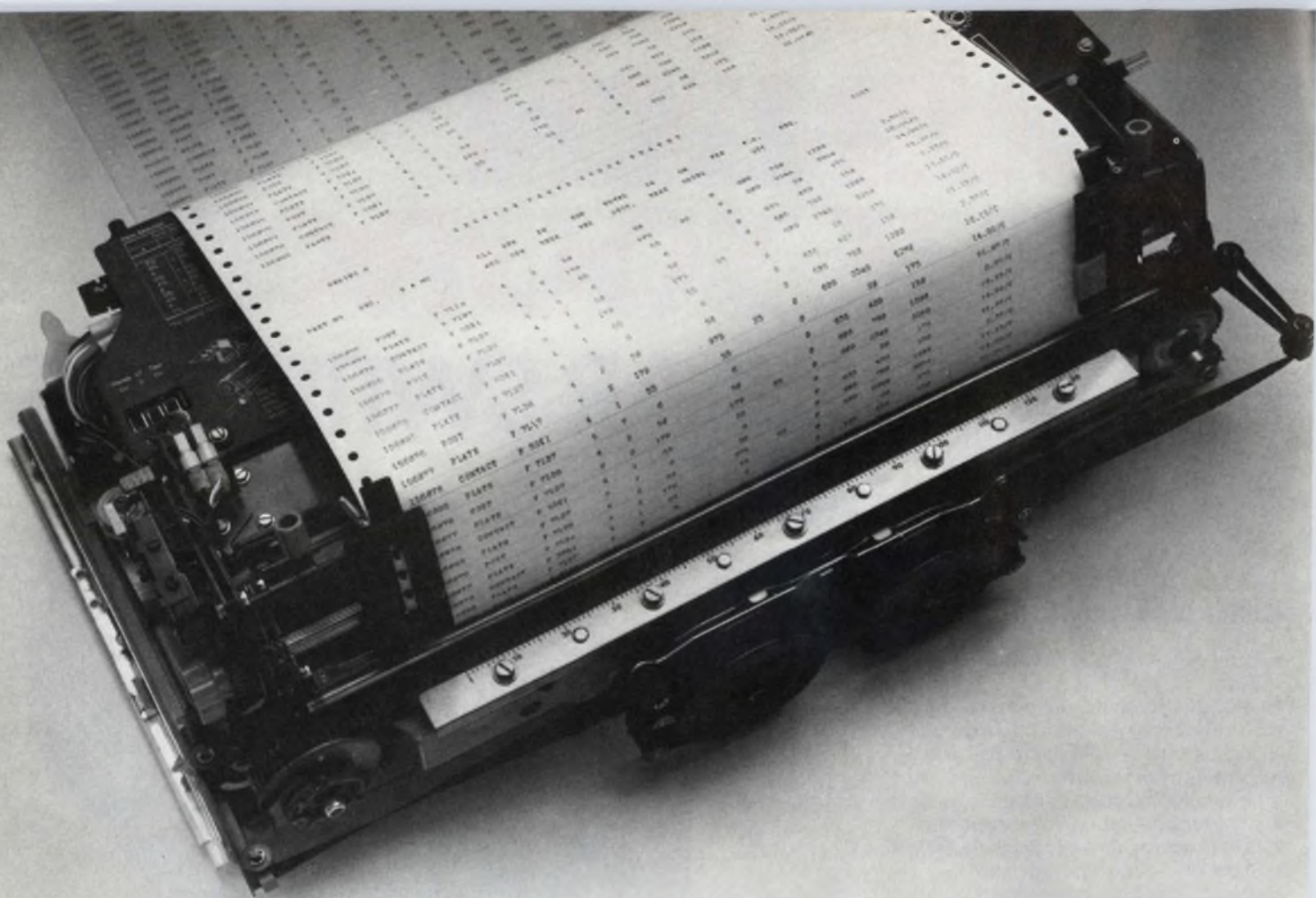

**The Teletype model 40 OEM printer.  
When you look at it from price and performance,  
you'll find it difficult to look at anything else.**

The fact of the matter is simply this:  
We don't think any other printer can even come close to the model 40.

And that's no idle boast. Not when you consider the facts.

Consider: Where else can you get a 132-column, heavy-duty impact printer that delivers over 300 lines per minute for less than \$2000, or an 80-column printer for under \$1400?

The big reason behind the model 40's price/performance advantage is our unique design.

Even though it operates at speeds of more than 300 lpm, wear and tear is less than you'd find in a conventional printer operating at considerably slower speed. Fewer moving parts and solid-state components add up to greater reliability and reduced maintenance.

Here's something else to consider: Where else can you get a printer that delivers the kind of flexibility and reliability the model 40 offers?

For complete information, please contact our Sales Headquarters at: 5555 Touhy Ave., Skokie, Ill. 60076. Or call Terminal Central at: (312) 982-2000.



**The Teletype model 40 OEM printer.  
Nothing even comes close.**

## Scope combines fast storage and real-time operation

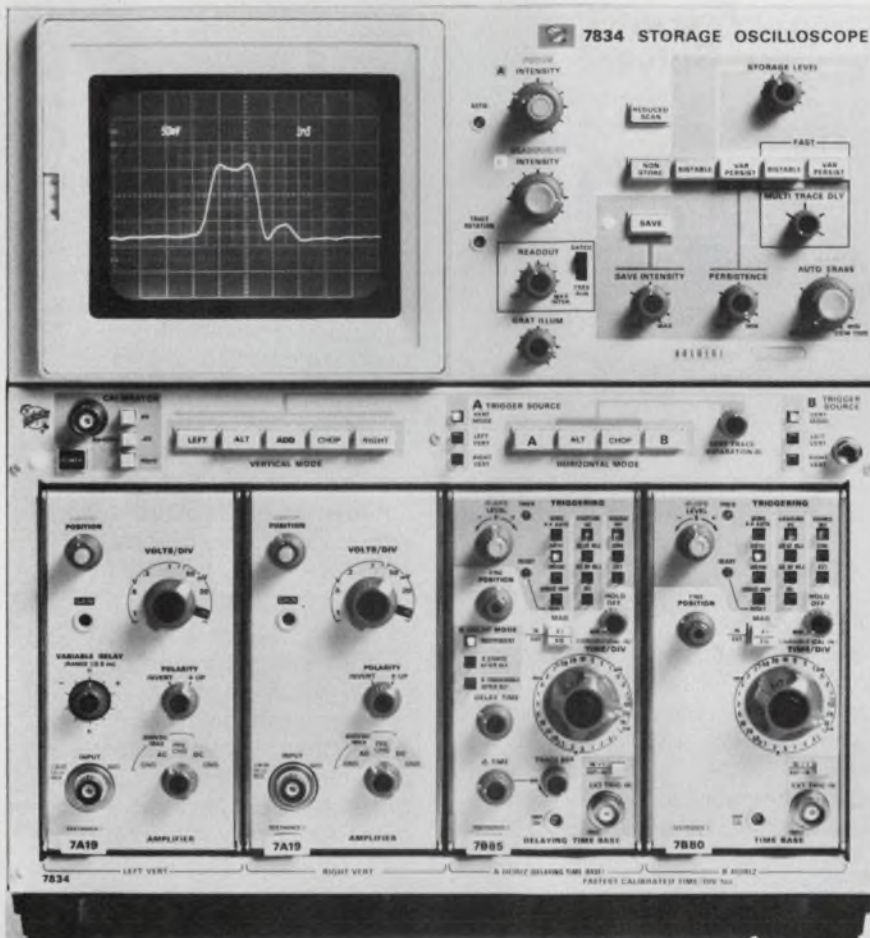

Tektronix, P.O. Box 500, Beaverton, OR 97077. (503) 644-0161. See text.

With a stored writing rate of 2500 cm/ $\mu$ s, the Tektronix 7834 easily outstrips the present title holder to become the world's fastest storage oscilloscope. The lead was formerly held by a teammate, the Tektronix 466, which writes at a much slower 1350 cm/ $\mu$ s.

With this new top speed—that is, the rate at which a clearly visible trace can be recorded on a CRT as a signal sweeps across—you can capture a single-shot signal with a rise time of 1.4 ns and a peak-to-peak amplitude of seven divisions.

The only catch to using the speed (if it is a catch) is that the 7834's operation is limited to the central  $8 \times 10$ -division graticule of the CRT (0.45 cm/div in reduced-scan mode).

Perhaps more significant than the 7834's storage speed is its ability to function also as a real-time scope with a 400-MHz bandwidth, coupled with its ability to house up to four 7000-Series plug-ins.

In terms of performance, here are some benefits these capabilities bring:

- You can look at rise times up to 0.9 ns over the full-screen amplitude of eight graticule divisions

(0.9 cm/div).

- You can use real-time and spectrum analyzer plug-ins together to "step" simultaneously into the frequency and time domains of high-speed phenomena.

- You can zero in on a digital problem with a logic-analyzer plug in, then pinpoint the electrical cause—be it noise or whatever—in the real-time mode.

- Or you can choose plug-ins for sampling, TDR, counting, multi-meter functions, and more. Parameters associated with the displayed waveforms can be read out alongside the waveforms.

Want a detailed look at what you've captured? Go into the 7834's bistable storage mode, which retains images for long periods, and analyze at your leisure. Got a slowly moving waveform? Use the variable-persistence mode and watch, without flicker, while your signal's rise time creeps to new values, or the spectral content of the signal gently changes.

Take advantage of other 7834 features, and get even more flexibility. You can plug in two time bases and set up the scope to switch between the two bases. The result: a simultaneous display of nontime-related waveforms, actually a quasi-dual-beam mode.

By using the 7834's remote-control features (erase, save and transfer), you open up more possibilities. You can either control the storage operation remotely in hazardous areas or control the image externally to display consecutive pulses (in pulsed laser work, for example).

Other features of the Tek unit—like a programmable readout that can be used to display identifiers such as test numbers or conditions—bring even more benefits. Buy your own for \$6900 and learn all the details. Delivery takes 8 weeks.

CIRCLE NO. 301

# All aerosols are not alike.

The constant progression of sophistication in electronics has demanded a parallel progression in standards of purity. Industrial cleaning is one very vital link in maintaining component and system purity and reliability.

Let's look at eight important criteria and compare Miller-Stephenson products to the general aerosol industrial cleaner industry.

## SOLVENTS:

Miller-Stephenson — Most of our aerosols contain 80% Active Ingredient, 20% Propellant.  
 Other Aerosol Cleaners — Active Ingredient averages 70-75%.  
 Miller-Stephenson — Uses only Certified Virgin Solvent.  
 Other Aerosol Cleaners — Some utilize reclaimed solvents. Though lower in cost, reclaimed solvents usually contain foreign substances.

## PROPELLANTS:

Miller-Stephenson — Uses only the highest purity, safest propellants. They are nonflammable - TWA 1000 ppm.  
 Other Aerosol Cleaners — Many use cheap, sometimes flammable, sometimes higher order of toxicity propellants.



## FILTERING:

Miller-Stephenson — We double filter "Freon" solvent and propellant — first with a 0.5 micron filter, then with a Millipore 0.2 absolute filter.  
 Other Aerosol Cleaners — Some use no filters; others only a 0.5 micron filter.

## LOADING LINES:

Miller-Stephenson — All loading lines are dedicated to the individual ingredients used.  
 Other Aerosol Cleaners — Loading lines are often used for multiple products and if not thoroughly flushed, contamination will occur.

## LOADING ENVIRONMENT:

Miller-Stephenson — Class 100 Clean Room conditions.  
 Other Aerosol Cleaners — Normally uncontrolled — environmental contamination can occur.

## VOLUME PRODUCTION:

Miller-Stephenson — Our principal raw materials come direct from Du Pont tankers into our 5500 gallon storage tanks through a closed system direct to container.  
 Other Aerosol Cleaners — Low volume suppliers often load from open 55-gallon drums thereby introducing possibility of contamination.

## CONTAINER:

Miller-Stephenson — Our new seamless cans further reduce the possibility of contamination.  
 Other Aerosol Cleaners — Cans with soldered seams may introduce residual contaminants.

## SAFETY IN SHIPPING:

Miller-Stephenson — Most of our "Freon" aerosol solvents are non-regulated items, exempt from all Federal Regulations "Restricted Articles". May be Shipped Air Transport.  
 Other Aerosol Cleaners — Do not meet Air Transport Regulations.

**MS aerosol solvents have the lowest residual contamination in the industry — some approaching 5-7 ppm. The general range for the industry is 50-130 ppm.**

\*Freon™ is Du Pont's registered trademark for its fluorocarbon compounds.

## miller-stephenson

Danbury, Connecticut 06810 (203) 743-4447

- Enclosed is \$2.00, please send my "Trial Unit" of MS-180.
- Enclosed is \$5.00, please send my "Trial Units" of MS-180 & Cobra Brush.
- Please send FREE literature and prices.

Intended Use \_\_\_\_\_  
 Name \_\_\_\_\_ Dept./Title \_\_\_\_\_  
 Company \_\_\_\_\_  
 Address \_\_\_\_\_

LOS ANGELES • CHICAGO • DANBURY, CT • TORONTO

CIRCLE NUMBER 36

ED-11U



**MS-226 "COBRA"™**  
Solvent Spray Brush

Scrubbing action dislodges hard-to-remove residue. Fits all Miller-Stephenson aerosol solvents and cleaners.

## INSTRUMENTATION

### Amp improves rf instruments



Wavetek Indiana, 66 N. First Ave., Beech Grove, IN 46107. (317) 783-3221. \$725; 60 days.

Model 2101 is a wideband amplifier that can improve the sensitivity of rf measurement instruments and upgrade the power capability of signal sources such as sweep and signal generators. The company claims that this amplifier covers twice the frequency range of other commercially priced units. Typical 3-dB bandwidth is 0.5 to 2500 MHz. Output power for a 1-dB gain compression is +17 dBm. The gain is 30 dB and gain flatness is  $\pm 1$  dB to 1000 MHz and  $\pm 1.5$  dB to 2400 MHz. The noise figure is less than 10 dB and max VSWR (input and output) is 2 up to 1000 MHz and 3 up to 2400 MHz.

CIRCLE NO. 302

### Automatic $\mu$ P bridge costs just \$995



GenRad, 300 Baker Ave., Concord, MA 01742. (617) 369-4400. \$995.

The GR 1657 Digibridge™ measures the R, L, C, D and Q of resistors, capacitors, coils and other components at a selectable frequency of 1 kHz or 120 Hz. Basic accuracy is 0.2%. A 5-digit LED readout displays R, L and C and four full digits for D and Q. The broad visual display capability is augmented with  $\mu$ P-directed ranging and automatic decimal positioning. Measurement time is less than 1/3 s for any type of component.

CIRCLE NO. 303

# A NEW GENERATION OF IMAGE SENSORS

## SIMPLICITY OF USE

Requiring less than a dollars worth of circuitry to drive—and barely more than that for video processing—is just one of the key features of our new “G” series image sensors. Compare the non-critical single TTL clock needed for the “G” device to the complex multi-phase clocks prescribed by others.



You need only this for Reticon

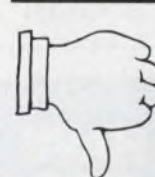
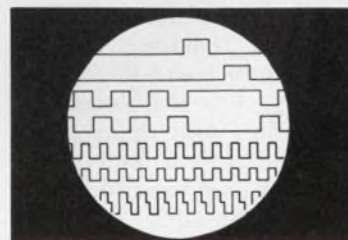

You need all these for others

## HALF THE PRICE

Or even less will bring you 256, 512, 768, or 1024 sensor elements on 25 $\mu$  centers or up to 1728 elements on 15 $\mu$  centers in our “H” series.

## SUPERIOR PERFORMANCE

Low dark current allowing low light level operation, on-chip noise cancellation, and smooth spectral response from visible through infrared makes this new generation the unquestionable choice.

## APPLICATIONS

Page readers, facsimile, OCR, point of sale readers, non-contact measurements and inspection and many others.

# RETICON®

910 Benicia Avenue, Sunnyvale, California 94086  
PHONE: (408) 738-4266 TWX: 910-339-9343

CIRCLE NUMBER 37

## POWER SOURCES

### Power supply added to single board $\mu$ P line

Intel, 3065 Bowers Ave., Santa Clara, CA 95051. (408) 246-7501. \$270, \$460; stock

The SBC630 and 635 are power supplies for Intel's SBC-80 single-board computer systems. They convert 115 V or 230 V ac to regulated  $\pm 12$  and  $\pm 5$  V dc and include system protective features. The SBC-630 is a supply for the basic system. It powers a fully loaded SBC-80/10 single-board computer and has residual capability for external logic functions. The SBC-630 also has an extra power output at +26.5 V to power relays and displays. The SBC-635 is a high current power supply for expanded systems. It powers a fully loaded SBC-80/10 board and up to three memory, I/O and combination boards. This unit connects to the modular backplane and card-cage assemblies used to package expanded SBC-80 systems.

CIRCLE NO. 304

### Mini switcher packs 250 W of wallop

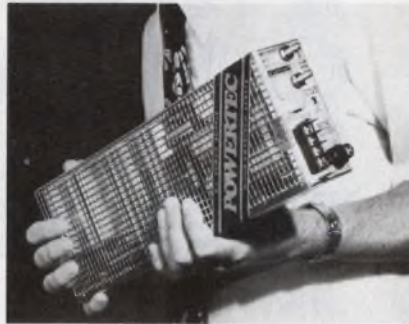

Powertec, 9168 DeSoto Ave., Chatsworth, CA 91311. (213) 882-0004. \$395.

Model 9E5-50C-17 delivers 5 V  $\pm 10\%$ , 50 A of switching-regulated power in a  $2.25 \times 4.94 \times 15.88$ -in. 6-lb, 3-oz package. Input voltage is 115/230 V ac  $+10/-20\%$  with a 20-ms hold-up. Ripple and noise is 50 mV pk-pk, regulation is 2 mV for a 30% line change and 0.2% for a full-load change. Transient response is  $\leq 400 \mu$ s for recovery to 0.1% with a maximum deviation of 250 mV for a 50% load change. Over-all efficiency is 80% min.

CIRCLE NO. 305

### Power CA3130 amps from on-board supply

Semiconductor Circuits, 306 River St., Haverhill, MA 01830. (617) 373-9104. \$19.50 to \$50.50 (qty 10); stock to 2 wk.

The 3130 series of encapsulated dc supplies can power up to 30 type CA3130 op amps. Of the five models now available, four are for board mounting and one is for bench work. Three of the board units provide dual 7.5-V outputs at 60, 150 and 300 mA. They range from  $2 \times 2 \times 0.875$  to  $2.5 \times 3.5 \times 1.25$  in. The other board-supply gives you three outputs:  $\pm 7.5$  V at 200 mA and 5 V at 500 mA. It is  $2.5 \times 3.5 \times 1.25$  in. The bench supply delivers  $\pm 7.5$  V at 300 mA. All models feature 0.1% line and load regulation, more than 150-kh MTBF, 1-mV rms typical PARD, less than 15-C case temp rise for high line and full load, short-circuit protected outputs and  $-25$  to  $+71$  C operation without derating. They operate from 105 to 125 V, 50 to 440 Hz inputs and their dual outputs can be connected for 15 V.

CIRCLE NO. 306

THE TOTAL MEMORY SUPPLIER

**WE HAVE  
DYNAMIC MOS RAMS.  
THINK ABOUT IT.**



The most complete line of Dynamic MOS RAMs available. From 1024 x 1 to 4096 x 1, 16, 18 and 22 pin. 4096 x 1, 16K x 1 available 1st quarter '77.

Clip to letterhead. Rush complete list of total memories in stock.

Name	Title
Tel.	M.S.

811 E. ARQUES, SUNNYVALE, CA. 94086

**THINK  
Signetics**

a subsidiary of U.S. Philips Corporation

© 1976.

CIRCLE NUMBER 38

tiny trimmers...  
**tiny price!**

MuRata's new line of subminiature trimmers has established a standard of performance in the economical trimmer field second to none . . . Alumina-base, non-combustible design, extreme resistance to solvents, and a wide 100 ohm to 2 megohm range of resistances. What's more, they are backed by MuRata's world-wide reputation for quality you can count on. Find out how these new pots can be put to work for you. Send for complete technical information today.



**muRata**  
CORPORATION OF AMERICA

Rockmart Industrial Park, Rockmart, Georgia 30153  
Phone: 404-684-7821/Telex: 54-2999/TWX: 810-766-1340

CIRCLE NUMBER 39

## Unit tests grounding and insulation

*Associated Research, 6125 W. Howard St., Chicago, IL 60648. (312) 647-7850. \$375; stock.*

The Model-4027 ac Hypot and continuity tester is designed for factory testing of line-powered electrical equipment in accordance with UL specifications. Continuity is indicated by a lamp. If continuity is passed, the unit's high-voltage test circuit is energized to a pre-set value, or may be applied gradually. Both a visual and an audible signal indicate a high-voltage-stress failure and the high-voltage test circuit immediately de-energizes. Leakage current is also monitored. The leakage current detector can be adjusted over a range of 0.5 to 5 mA. You can bypass leakage testing. The unit is housed in a 12.5 x 9.75 x 9.5-in. grounded steel cabinet with a removable hinged cover. Max output test voltage is 3 kV at 5 mA. Output is continuously variable from zero to maximum and is monitored on a 4.5-in. kV meter.

CIRCLE NO. 307

## Fast efficient units stabilize your lines



*Topaz Electronics, 3855 Ruffin Rd., San Diego, CA 92123. (714) 279-0111. Starts at \$265.*

The 75-series regulators provide protection against line voltages as low as 20% below normal, while regulating output voltage to within  $\pm 5\%$  of nominal. They are 98% efficient. These solid-state units sense and correct for voltage variations in less than one cycle. The regulator's output has less than 0.1% total harmonic distortion. Models are available in power ratings from 600 VA to 20 kVA for single-phase, and 6 to 100 kVA for three-phase.

CIRCLE NO. 308

## Get $\pm 15$ V dc from any of four inputs

*Stevens Arnold, 7 Elkins St., South Boston, MA 02127. (617) 268-1170. \$165 (1-9); stock to 6 wks.*

Standard input ratings of R-series dc/dc converters are 12-2, +2.5; 24-3, +4; 28  $\pm 4$ ; and 48  $\pm 6$  V dc. These 25-W low-noise, isolated units deliver regulated  $\pm 15$  V dc at up to  $\pm 830$  mA. The units feature 1-mV true-rms, or 40 mV pk-pk, wideband noise measured over a 5-Hz to 20-MHz system noise bandwidth. EMI/RFI is minimized by a multiple shielded transformer, continuous six-sided case shield, and a pi-type input filter. The switching frequency is over 20 kHz. Min isolation is  $1 \times 10^4 \Omega$  and 500 V dc. The device boasts 65% power-transfer efficiency that is said to be at least 10% above the usual. Fault protection includes reverse input voltage, thermal output shutdown and nonlatching current limiting. You can balance the  $\pm 15$ -V outputs to within  $\pm 0.5\%$ . Regulation is  $\pm 0.1\%$  max.

CIRCLE NO. 309

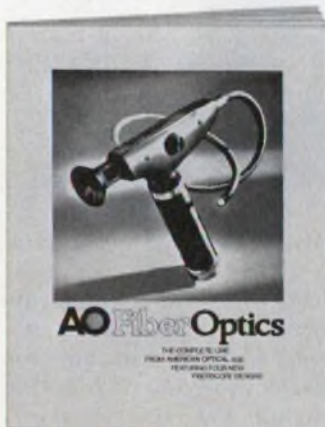

## FREE Fiber Optics Catalog

Features the complete AO line of fiber optics products—from Inspection Fiberscopes and Light Guides to Illuminators, Image Conduits, Faceplates and Custom Components. Includes the four newest remote inspection fiberscopes now available.

Describes the principle, technology and techniques used to make flexible light and image transmissions a proven, practical fact. Write today for your FREE copy of the AO Fiber Optics catalog to American Optical Corporation, Fiber Optics Division, Southbridge, Mass. 01550.

**AO**  
American  
Optical

CIRCLE NUMBER 40

ELECTRONIC DESIGN 23, November 8, 1976

THE TOTAL MEMORY SUPPLIER

## WE HAVE BIPOLAR & STATIC MOS RAMS. REMEMBER THAT.



Total line in stock 24  
Bipolars—from 8 to 1024 bits.  
14 MOS  
Statics—from 256 x 4 to 1024 x 1 with 1K x 4 and 4K x 1 available 1st quarter '77.

Clip to letterhead. Send me complete list of total memories in stock.

Name  Title

Tel.  M.S.

811 E. ARQUES, SUNNYVALE, CA. 94086

THINK  
Signetics

a subsidiary of U.S. Philips Corporation

© 1976

CIRCLE NUMBER 41

# It's new It's flexible



## It could be the answer to your complex switching needs.

It's the Series 1800 from Ledex Inc. Mix both **high** and **low** current switch modules in one ganged assembly!

Wiping contacts in the low current modules keep the switching surfaces clean so they can handle from 10mA/5 volts to as much as 1A/60 volts.

Rugged bridging contacts, in the high current modules, let you switch from 10mA/20 volts to 6A/250 VAC.

There's circuit flexibility too! Select 2p2t or 4p2t circuits with self-cleaning contacts. Bridging contacts provide 2NO, 2NC or 1 NO + 1NC circuits.

Program up to 20 modules per assembly with interrelated switching action.

Momentary, push/push, interlock, reciprocal, master and reciprocal + master release functions are available.

For front panel flexibility, choose either unlighted, single or dual bulb illumination; square or rectangle caps with full or split lens. Horizontal or vertical mounting plus a wide range of legends and cap colors lets you design that "just right" look for your new product.

Ask for catalog B-5508 and see if the Series 1800 is the answer to **your** complex switching needs.

## LEDEX INC.

123 Webster Street  
Dayton, Ohio 45401  
(513) 224-9891

License rights by RAFI of West Germany

CIRCLE NUMBER 43

## COMPONENTS

### Linear-motion pots offer 0.25% linearity



*New England Instrument Co., Kendall Lane, Natick, MA 01760. (617) 873-9711. \$55.50: 1-in. stroke, 1% ind. lin. (100 up); 6-8 wks.*

A line of standard 1/2-in. cylindrical linear-motion potentiometers features elements made of Resisto-film—a conductive-plastic film. Resistance ranges to 50 k $\Omega$ /in. are standard with a 10% tolerance. Independent-linearity tolerances are 1, 0.5 and 0.25%. Electrical strokes as long as 6 in. are standard, and maximum shaft drive force is 1 oz. Resolution is essentially infinite, and operational life expectancy is 10-million strokes.

CIRCLE NO. 320

### Ground-fault detectors plug into outlets



*KABO Electronics, 123 Bacon St., Natick, MA 01760. (617) 653-0015. Stock.*

The KABO RCO 39 leakage-current monitor will immediately disconnect power upon sensing current leakages in excess of 5 mA or upon sensing low line voltages. This unit is designed to plug directly into duplex wall receptacles, as when used with portable equipment. The KABO RCO 40 is physically modified to allow use at the end of an extension cord. It also disconnects power immediately upon sensing leakages in excess of 5 mA. Both units are fail safe and must be manually reset for further operation. Rated 120 V, 15 A, 60 Hz and 1800 W, all units are factory calibrated and carry a one-year factory warranty.

CIRCLE NO. 321

## Toggle switches designed for GHz range

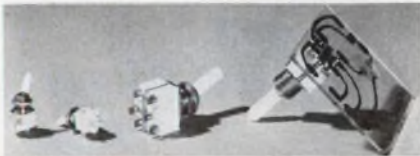

Instru-Meck Inc., 1275 Bloomfield Ave., Fairfield, NJ 07006. (201) 575-1860. \$3: Giga, \$2: Att; (OEM qty).

A family of low-cost toggle switches is specifically designed for high-frequency low-energy applications. Offered in two sizes, subminiature and miniature, the switches have low internal resistance, low inductance and low capacitance. The subminiature Giga-switch is capable of operating at frequencies to 2 GHz, while the miniature Att-switch is effective to 1 GHz. The switches are available in a standard DPDT style, or with a shorting strap across two terminals for use in attenuators. Both types can be mounted in single holes, but the Att-switch can be soldered into a PC board.

CIRCLE NO. 322

## LC display for clocks allows portable use

UCE Inc., 20 N. Main, Norwalk, CT 06854. (203) 838-7509. \$12 (1000 up).

A 3-1/2 digit liquid-crystal display for portable digital clocks is available with either light or dark digits on contrasting backgrounds. It reads to 11:59. Referred to as Series 3603, the display is designed for single-edge mounting either with PC connectors or conductive elastomers. Alternately, the leads may be directly solderable. The over-all size is 2.75 x 1.35 in. Individual characters are approximately 0.5-in. high by 0.34-in. wide. Normal room readability is 15 to 20 ft. Units are available for reflective or transmissive and semi-transmissive or semireflective displays. This allows application both in high ambient daylight, as well as backlighting for dark bedroom visibility. Reduced power consumption allows battery life of more than one year for portable clocks.

CIRCLE NO. 323

## Position sensor detects verticality



Fifth Dimension, Inc., 707 Alexander Rd., Princeton, NJ 08540. (609) 452-1200. \$0.75 to \$2 (1000 up); stock.

The TS3 is an omnidirectional position sensor. It is designed to be size and functionally compatible with TTL, DTL or CMOS circuitry. A SPST contact is closed only when the switch is in an upright position. Canting the switch from the vertical in any direction causes the contact to open. A proprietary design feature provides positive on-off operation. Repeatability is said to be within  $\pm 3$  degrees. Mercury contacts contribute to reliable operation. Results of testing to date indicate a life in excess of 50-million cycles, when switching low-level loads. Contact resistance is below 2  $\Omega$ .

CIRCLE NO. 324

# shigoto cables and cord sets

... we go to any lengths.  
... we go to any ends.

That's why Shigoto can help make your ends meet. From hundreds of standard combinations to unusual characteristics that meet your own requirements. Even U.L. and C.S.A. approved. Our volume production for O.E.M.'s in electronics, communications, automotive, appliances, and practically every other industry, takes all the variables out of performance differences. Shigoto's ability to consistently produce top quality assemblies, when combined with large quantities, always brings in the prices you need. Unmatched quality has become our standard, our reliability and delivery schedules will become yours. Call, write, or wire your specs. At Shigoto, you'll find we'll go to any ends, to any lengths, to satisfy you.

**Shigoto Industries Ltd.**  
350 Fifth Ave., N.Y., N.Y. 10001/(212) 695-0200/Telex 224219  
One of the World's Largest Manufacturing Importers

CIRCLE NUMBER 44

ELECTRONIC DESIGN 23, November 8, 1976

THE TOTAL MEMORY SUPPLIER

## WE HAVE BIPOLAR & MOS PROMS. THINK OF THAT.

Long list in stock. 17 Bipolars—from 256 to 8K bits—with 16K available soon. 4K and 8K MOS EPROMS available 1st quarter '77.

Clip to letterhead. Send list of total memories in stock.

Name	Title
Tel.	M.S.

811 E. ARQUES, SUNNYVALE, CA. 94086

THINK **Signetics**  
a subsidiary of U.S. Philips Corporation

©1976

CIRCLE NUMBER 45



## COMPONENTS

### Gas-discharge display claimed to be largest

Cherry Electrical Products, 3600 Sunset Ave., Waukegan, IL 60085. (312) 689-7702. \$7.71 (2000-up).

A new 1-in.-high gas-discharge display added to the Plasma-Lux line of Cherry has five digits in one planer-edge connectable pack-

age. This orange seven-segment display, W05-0001, is the largest display currently on the market, according to Cherry, and can be read at distances to 50 ft. The W05-0001 design is not multiplexed, which allows it to be easily driven from a BCD-output thumb-wheel switch or a BCD-to-7-segment decoder/driver. Decimal points between digits are an optional item in volume applications.

CIRCLE NO. 325

### Resistor networks track to 5 ppm

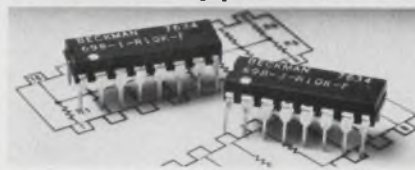

Beckman, 2500 Harbor Blvd., Fullerton, CA 92634. (714) 871-4848. \$0.81: 698-1, \$0.65: 698-3 (100 up); stock.

Series 698 precision film-resistor networks are economic alternatives to individual, precision, thin-film discretes. Their performance equals that of matched precision discretes, but at the price of unmatched precision discretes, according to Beckman. The molded DIP networks offer 5-ppm tracking accuracy, 1% resistance tolerance, 0.5% resistor-ratio tolerance and a 50 ppm/°C temperature coefficient. Series 698-1 consists of 15 resistors with a common terminal; Series 698-3 has eight isolated, straight-through resistors. Both series also allow you to connect resistors within the network in series or parallel to vary resistance values. The networks meet all MIL-R-83401 requirements except power. Total package power dissipation at 25 C is 1.25 W for both models. Individual resistor power rating at 25 C is 0.125 W for the Series 698-1 and 0.2 W for Series 698-3. Operating and storage temperature range is -65 to 125 C.

CIRCLE NO. 326

### Current-ladder networks now second sourced

Hycomp Inc., 146 Main St., Box 250, Maynard, MA 01754. (617) 897-4578. \$21: HC 130L/LA, \$38: HC 20L/4306 (100 up).

A line of nichrome thin-film current ladder networks that are electrically and mechanically interchangeable with the Analog Devices' AD 850 series is now offered by Hycomp. The HC 130 and the HC 130A (replacements for the AD 850 and AD 8510) are 12-bit binary and 3-decade BCD-weighted current ladders. The HC 420 and HC 430 (replacements for the AD 852 and AD 853) are 8-bit and 4-bit binary weighted current ladders. All units are available in DIP or flatpack versions.

CIRCLE NO. 327

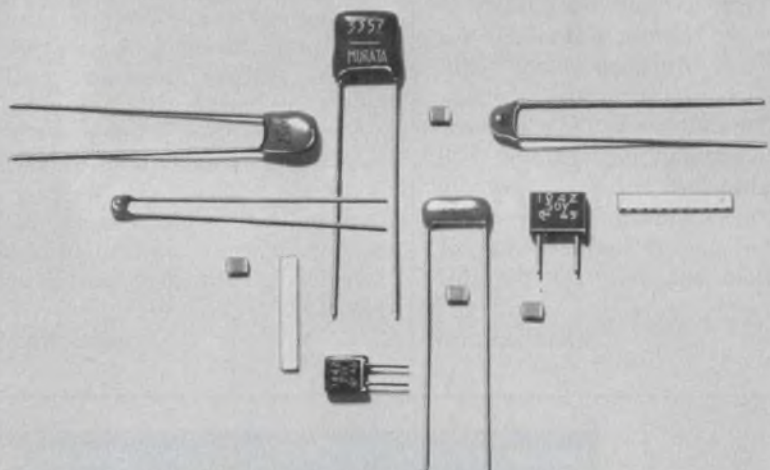

## muRata M-caps™

a little more quality—  
a little less cost—  
a little faster delivery.

We aren't the only ceramic capacitor manufacturer to make exceptional monolithic capacitors. That's for sure. Our's are just a little bit better in the places that count . . . quality, cost and delivery.

Check our complete line of monolithic M-Caps — epoxy coated rectangulars, chips, molded rectangulars and CK types — we offer everything that they offer plus that little bit extra. What's more, MuRata is the world's largest manufacturer of ceramic capacitors with a reputation for quality that's over 30 years old.

Write for complete details or better yet, give us a call. We'll demonstrate how we're just a bit better.



1148 Franklin Road, S.E., Marietta, Georgia 30067  
Tel: 404-422-9777 Telex: 54-2329 TWX: 810-763-4723

CIRCLE NUMBER 46

### Blower delivers air in a wide stream



McLean Engineering Labs, Princeton Junction, NJ 08550. (609) 799-0100. \$69.30 (1-4).

An air blower dubbed Slot Formation delivers air in one 12.5-in.-wide continuous stream. It is rated at 150 cu ft/m at zero back pressure. Most other units must have two smaller separated airstreams to deliver the same amount of air, because they use squirrel-cage fans. The Slot Formation, in contrast, uses a tangential fan. In addition, this unit is shorter than equivalent units. The Slot Formation is 3.5 in. high, compared to others 5.25 in. high. The motor draws 80 W at 3150 rev/min.

CIRCLE NO. 328

### Tool cuts and strips BX armored cable



Seatek Co., Inc., 1156 E. Putnam Ave., Riverside, CT 06878. (203) 637-3700. \$14.95.

The Roto-Split cuts and strips BX armored cable. The cable may be from 14 to 10 AWG, and have two or three conductors. The tool also cuts shielded flexible tubing. A built-in automatic stop enables the BX cable casing to be cut without damaging the insulated wires. The Roto-Split's open channel construction also allows cable to be cut in the middle of a roll. The tool clamps the cable so no vise is required. The Roto-Split weighs 14 oz. The circular cutter is replaceable.

CIRCLE NO. 329

### DIP-IC burn-in sockets operate at 200 C

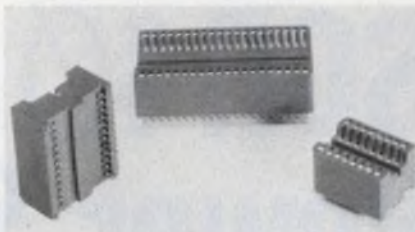

Stanford Applied Engineering, Inc., 340 Martin Ave., Santa Clara, CA 95050. (408) 243-9200. 14 pin: \$1.14 (1000-up).

A line of DIP burn-in sockets operates at 200 C. Dubbed the IS3900 series, they are available with 14, 16, 18, 20, 22, 24, 28, or 40 contacts. The glass-filled insulator houses contacts with large double-beam contact surfaces. The self-aligning beryllium-copper contacts take 5000 insertions and are plated with 50  $\mu$ in. of gold. Contact resistance is 15 m $\Omega$  at 1 A. Insulation resistance is 5000 M $\Omega$  at 500 V dc, and dielectric withstanding voltage is 1200 V rms at 60 Hz.

CIRCLE NO. 330

## reliable OEM X-Y

When your OEM product needs an X-Y recorder, get the unique newly designed Spartan. You can't beat these refined features that improve performance, durability, and your product's reputation:

- Point plotter pen drop speeds—over 45 up-down cps.
- Rapid pen response—45 in/sec slew rates in both axes.
- High common mode capability—200 VDC. Floating, guarded input.
- Automatic power-down upon overrange. Motor and clutch protection assured.
- Throwaway pen-and-ink cartridge. No ink mess or clogs.

For more information on the reliable XY-575 (OEM) recorder, request Bulletin E500. Esterline Angus Instrument Corporation, Box 24000, Indianapolis, IN 46224. Tel. 317-244-7611.

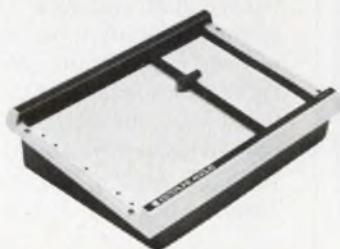
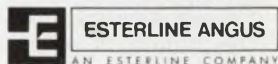

CIRCLE NUMBER 47

ELECTRONIC DESIGN 23, November 8, 1976

THE TOTAL MEMORY SUPPLIER

## WE HAVE BIPOLAR & MOS ROMS. DON'T FORGET IT.

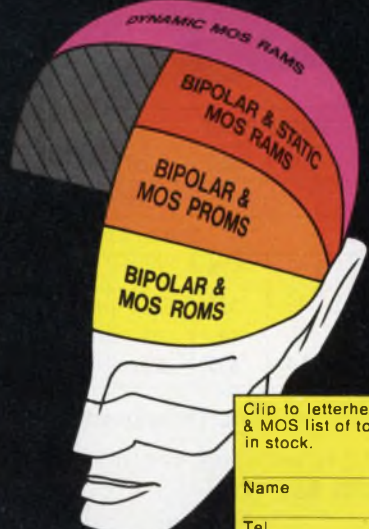

Wide variety in stock 13 Bipolars—from 256 to 16K bits Plus 7 Static MOS including 8K and 16K. Plus 4 character generators including 8K. Both TS & OC.

Clip to letterhead. Send Bipolar & MOS list of total memories in stock.

Name \_\_\_\_\_ Title \_\_\_\_\_

Tel. \_\_\_\_\_ M.S. \_\_\_\_\_

811 E. ARQUES, SUNNYVALE, CA. 94086

THINK signetics

a subsidiary of U.S. Philips Corporation

© 1976

CIRCLE NUMBER 48

from *Electronic Measurements* . . .

# SCR 1 $\emptyset$ & 3 $\emptyset$ DC Power Supplies

We are pleased to report that we now produce the industry's largest selection of SCR phase-controlled power supplies.

How did we do it?

Slowly.

We didn't acquire the largest selection without selling a lot of power supplies along the way. Our way, for 35 years, has been giving the user what he wants; and in a watts/dollar ratio that gives him no choice but E/M.

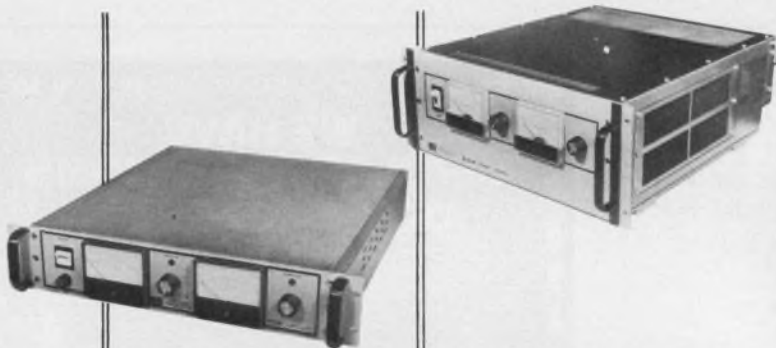

Type	SINGLE PHASE				THREE PHASE			
Watts	500	800	1600	2400	2500	5000	10 KW	To 60 KW
Volts	0 to 7.5 V up to 600 V DC							
Amperes	0 to 0.75 A up to 3000 A DC							
Height (in.)	3.50	3.50	5.25	7.00	7.00	8.75	12.25	To 4'
Price (\$)	450	575	800	1000	1200	1500	2300	To
	to	to	to	to	to	to	to	9500
	500	650	895	1100	1600	2300	2900	

Over 100 standard models. Thousands of optional combinations.

To order, or for any technical information, call  
TOLL FREE (800) 631-4298



**ELECTRONIC MEASUREMENTS INC.**

405 Essex Road, Neptune, N.J. 07753  
Phone (New Jersey) 201-922-9300 (Toll free) 800-631-4298

Specialists in Power Conversion Equipment

CIRCLE NUMBER 49

## PACKAGING & MATERIALS

Socket pivots 30° on a PC board

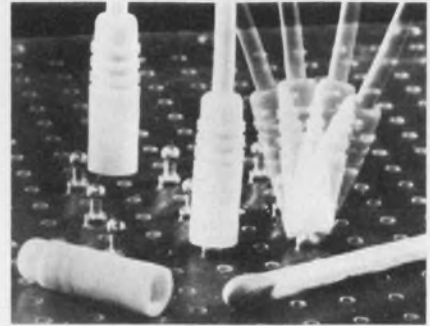

*Oxley Developments Co., Ltd.,  
Priory Park, Ulverston, Cumbria,  
LA12 90G, England.*

A single-wire connector, called SNAPLOX, consists of a socket that fits over a ball-ended plug. The connector can pivot 30° from the vertical in any direction. Sockets are made of a grooved PTFE sleeve that completely surrounds a silver-plated cavity with a solder pot at one end to make a connection with the wire. Plugs are serrated and splined for insertion into loosely toleranced holes in PC boards. They are palladium or gold-plated. Another version of the plug, for insertion into conductive metal chassis, is surrounded by an insulating PTFE bussing. Socket sleeves and bushings for chassis-mounted plugs can be coded in a range of 11 colors.

CIRCLE NO. 331

Sealing gaskets shield against EMI and RFI

*Compac, 222 Middle Century Rd.,  
Smithtown, NY 11787. (516) 360-3837. \$4.08-\$10.44 per pair (100-up).*

A line of EMI/RFI shields and fluid-seal gasket pairs are made of woven aluminum wire screen impregnated with a rubber sealing material. The Compac gasket shields against interference when the aluminum screen contacts both mating assembled surfaces. The rubber material fills the gaps between the individual wires of the screen, making the joint pressure tight. The gasket thickness runs 0.020 + 0.004 in. The wide diameter measures 0.015 in. The gasket is usable over a temperature range from -40 F to 212 F.

CIRCLE NO. 332

## PC card guide acts as a heat sink

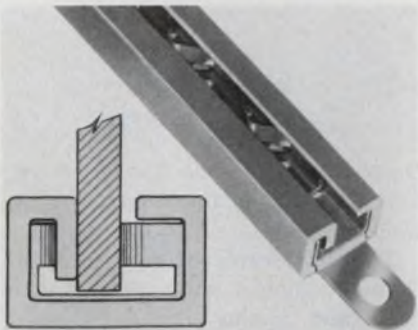

Unitrak Div., Calabro Plastics, Inc., 8738 West Chester Pike, Upper Darby, PA 19082. (215) 789-3820. 6.5¢/in. (high qty).

The Series 1000 metal PC card guide, when assembled into an aluminum-heat-sink guide bar, dissipates board heat. The card guides come in copper, stainless-steel, phosphor bronze, or beryllium. The spring-finger grip of the guide presses the edge of the PC card into contact with the guide bar. The guide bar's large contact area and mass, when mounted to a chassis, provides good test sinking for the board.

CIRCLE NO. 333

## PC-board bus strip takes high temperatures

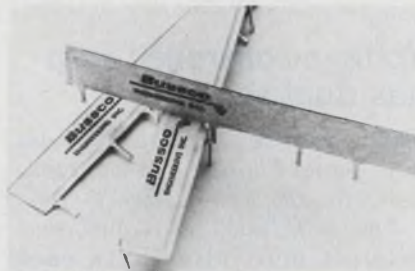

Bussco Engineering Inc., 119 Standard St., El Segundo, CA 90245. (213) 322-6580. See text; 3-4 wk.

A line of PC-board bus strips withstands temperatures up to 520 F for 30 s without delaminating or deteriorating. The E-series Models B10200/B10300 use high-temperature plastics and a thermosetting adhesive. They are available in vertical and flat-DIP styles with one or several conducting layers. Multilayer configurations provide distributed capacitance and reduce propagation delay time. A two-layer model that is 6 in. long and has per-layer pin spacing of 1 in. costs 70¢ in 1000-up quantities.

CIRCLE NO. 334

## Cable clamps adjust to different bundle sizes



Thomas & Betts, 36 Butler St., Elizabeth, NJ 07207. (201) 354-4321. 46¢ (5000 up).

The ANC series cable clamps have an adjustable locking tab that accommodates a range of wire-bundle sizes. Their design allows removal and installation of additional wires without unscrewing or disassembling the clamp. The new clamps come in four sizes. They accommodate wire-bundle diameters from 3/16 through 1-1/8 in. The ANC series is made of nylon. They have a toothed locking device contained in a narrow channel which locks the hoop securely. To add a wire, the installer unsnaps the locking tab, lays in the wire, and pushes the locking tab back into the channel. The clamps are available in both screw-mounting and adhesive-backed styles.

CIRCLE NO. 335

# PHOTO ETCH<sup>TM</sup> PRINTED CIRCUIT KIT

## Makes circuits THREE WAYS

- 1 FULL SCALE ARTWORK MASTER
- 2 MAGAZINE ART ILLUSTRATION → FILM POSITIVE → NEGATIVE → DEVELOPED PHOTO RESIST IMAGE ON COPPER CLAD CIRCUIT BOARD → ETCHED CIRCUIT BOARD
- 3 DIRECT ETCH DRY TRANSFERS APPLIED TO COPPER CLAD BOARD

**NO** CAMERA DARKROOM FILM CUTTING TRACING

**USES DATAK'S POS-NEG PROCESS**  
The revolutionary photographic way that makes PERFECT printed circuits from original art or a printed page.

KIT CONTAINS: 5" x 6" steel printing frame; 4 sheets 5" x 6" photocopy film; yellow filter; chemicals for 1 pint film developer and 1 pint film fixer; 5" x 6" copper clad board; 3" x 4" copper clad board; spray can of photo etch resist; 1 pint resist developer; 2 sheets 8 1/2" x 11" layout film; 1 roll 1/16" printed circuit tape; 1 roll 1/32" printed circuit tape; 8 sheets dry transfer direct etch PC patterns including pads, transistors, round can and flat pack ICs, DIP ICs, edge card connectors, lines, circles, logs, etc. % to anhydrous ferric chloride to make 1 pint etchant; instructions.

ER-4 COMPLETE PHOTO ETCH SET	\$26.95
ER-2 PC patterns and tapes—refill	3.95
ER-3 1/4 pound dry etchant—refill	1.49
ER-5 6 sheets photocopy film—refill	3.95
ER-6 Film process chemicals—refill	1.95
ER-7 Photo resist spray, 2.5 oz.—refill	2.95
ER-8 Resist developer, 16 oz. can—refill	2.95

AT YOUR DISTRIBUTOR OR DIRECT

the **DATAK** corp.  
65 71st St. • Guttenberg, N. J. 07093

CIRCLE NUMBER 50

ELECTRONIC DESIGN 23, November 8, 1976

## THE TOTAL MEMORY SUPPLIER

# WE HAVE BIPOLAR PLAS/FPLAS. SOMETHING TO REMEMBER.

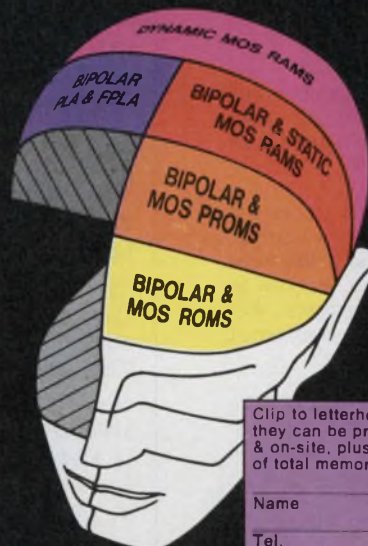

Variety of Bipolars in stock. Field programmable input/output connections in the package for greatest flexibility. Both TS & OC available and second sourced.

Clip to letterhead. Show me how they can be programmed in-house & on-site, plus send complete list of total memories in stock.

Name \_\_\_\_\_ Title \_\_\_\_\_  
Tel. \_\_\_\_\_ M.S. \_\_\_\_\_  
811 E. ARQUES, SUNNYVALE, CA. 94086

THINK

# Signetics

a subsidiary of U.S. Philips Corporation

© 1976

CIRCLE NUMBER 51

# Are you buying wire and cable from memory?



**Call Blake for a new concept in quality, service and delivery.**

Just tell us what you need.

A single conductor hook-up wire? A special UL-approved computer cable? A complex multi-conductor molded cable assembly?

Blake manufactures and stocks the broadest possible line of electronic wire and cable products. We have the facilities and the know-how to meet your exact requirements. With consistent quality. And prompt delivery.

So don't buy wire and cable from memory. Contact a Blake sales engineer now for a new concept in quality, service and delivery.

Call us at (213) 776-3303. Or write:

**BLAKE**  
WIRE & CABLE  
5740 ARBOR VITAE STREET  
LOS ANGELES, CALIFORNIA 90045

CIRCLE NUMBER 52

## INTEGRATED CIRCUITS

### Voltage-controlled amp has dual sections

*Solid State Music, 2102A Walsh Ave., Santa Clara, CA 95050. (408) 246-2707. \$6 (1-24); stock.*

The SSM 2000 is a dual two-quadrant multiplier with each channel having separate control and differential signal inputs and current outputs. It can be used directly in voltage-controlled filters, two and four-quadrant multipliers, audio mixdown panels, agc circuits and many other applications. The circuit has a control accuracy of 1% or better over its 80 dB control range and its dual design allows complete independent selection of the control characteristics of the two channels.

CIRCLE NO. 336

### ECL line grows to 74 choices

*Philips, P.O. Box 523, Eindhoven, the Netherlands. (040) 784616.*

The addition of a number of Signetics' types to its ECL 10,000 series now lets Philips offer 74 different types of integrated circuits in this series of emitter-coupled logic. ECL circuits feature speeds much faster than Schottky TTL, independent of loading. Typical operating frequencies are greater than 150 MHz. The ECL 10,000 series provides a complete family of SSI, interface elements, high performance MSI, and memories. The company now offers 13 memories. With the exception of some of the memories, which are available in ceramic encapsulation only, all types can be supplied in either plastic or ceramic encapsulation. The 16-pin DIP package is the standard for the series, with the exception of the GXB10155 which is 18-pin, and the GXB10181 which is 24-pin. Features of this line are its speed  $\times$  power product, propagation-delay/rise-time ratio, noise immunity and immunity from power-supply variations. ECL 10,000 gives you complementary outputs and can directly drive twisted-pairs and transmission lines.

CIRCLE NO. 337

### 4, 8 & 16-channel muxes withstand $\pm 20$ -V inputs

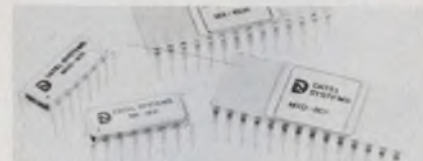

*Datel Systems, 1020 Turnpike St., Canton, MA 02021. (617) 828-8000. From \$14 (1 to 9); stock.*

The MX series of 4, 8 and 16-channel analog multiplexers can withstand analog input overvoltages of  $\pm 20$  V, a logic input overvoltage of  $\pm 4$  V or a loss of multiplexer power with control and signal inputs applied. The units feature break-before-make switching to ensure that no two channels are ever momentarily shorted together. All models contain DTL/TTL and CMOS-compatible channel address decoding. Binary-coded logic inputs of 2, 3 and 4-bit words perform channel selection in the 4, 8 and 16-channel models, respectively. Each model has an inhibit input, which enables or disables the entire device. All models have transfer accuracies of 0.01% at channel sampling rates up to 200 kHz. The multiplexers handle input signals ranging between  $\pm 10$  V. The dielectric isolation between channels holds crosstalk down by 86 dB. The MX series units have a typical channel ON resistance of 1.5 k $\Omega$  at 25 C, and remains less than 2 k $\Omega$  over the full 0-to-70-C range. Each MX series unit consumes 7.5 mW at standby and only 15 mW at a 100-kHz channel sampling rate. The power supply is nominally  $\pm 15$  V, but can range between  $\pm 5$  to  $\pm 20$  V.

CIRCLE NO. 338

### TO-99 op amps offer high GBW, slew rate

*Hybrid Systems, Crosby Dr., Bedford, MA 01730. (617) 275-1570. \$9.25, \$11.25; stock to 3 wk.*

Both of these amplifiers are wideband and have high slew rates. Each is housed in a TO-99 package. The A975 features a slew rate of 80 V/ $\mu$ s; the A970 has a gain bandwidth of 100 MHz and an open loop gain of 95 dB. Input impedance for both devices is greater than 100 M $\Omega$ . They operate over the range from 0 to 70 C.

CIRCLE NO. 339

### 3-terminal regulators have topnotch specs

National Semiconductor, 2900 Semiconductor Dr., Santa Clara, CA 95051. (408) 737-5000. \$2.10 (100-up); stock.

The LM140LA series of three-terminal positive regulators reportedly has performance far superior to LM78L specifications. All units have an output voltage tolerance of 2%, a ripple rejection of 41 to 55 dB minimum, a line regulation of 0.04%/V, and a load regulation of 0.01%/mA. The available output voltages range from 5 to 24 V and with adequate heat sinking, the units can deliver up to 100 mA. Current limiting ensures the peak output current will remain at a safe level. Safe area protection for the output transistor also helps to prevent the IC from overheating. The LM140LA, LM240LA and LM340LA are all available in the low profile metal TO-39 package, and the LM240LA and LM340LA are also available in plastic TO-92 packages.

CIRCLE NO. 340

### Universal game ICs create many variations

Texas Instruments, P.O. Box 5012, Dallas, TX 75222. (214) 238-2011. See text; stock.

A family of universal game circuits for video game applications offers users a wide range of games with easily changeable features and game rules. The first six circuits include the SN76423, a game logic chip with automatic random English; the SN76425, a horizontal and vertical sync generator; the SN76426, a character generator; the SN76427, a wall and ball generator; the SN76428, a game logic circuit with manual English; and the SN76460, a 0 to W (Win) at 20 digital scoring circuit. Combinations of these circuits allow games with multiple balls, multiple walls, multiple players, and obstacles. All devices are supplied in 300-mil-wide plastic DIPs. Prices in 100-unit quantities are: \$1.25 for the 76423 and 428, \$1.53 for the 76426 and 427, \$1.89 for the 76425 and \$4.54 for the 76460.

CIRCLE NO. 341

### Hybrid regulator passes 5 A at 5 V

Fairchild Analog Products, 464 Ellis St., Mountain View, CA 94042. (415) 962-3816. \$7.95 (100 qty); stock.

A new hybrid IC voltage-regulator module packs the capacity to regulate up to 5 A at 5 V, with built-in short-circuit and safe-area protection into a TO-3 can. The unit is pin-compatible with Fairchild's line of 7800-series monolithic voltage-regulators. The 78-H05KC offers all the advantages of a monolithic regulator at higher current levels. For automatic thermal-overload protection, a hybrid circuit limits the max junction-temperature of the power-output transistor. If the safe operating area is exceeded, the device shuts down, rather than failing or damaging other system components. This feature eliminates the need for costly output circuitry and overly conservative heat-sinking arrangements typical of high-current regulators.

CIRCLE NO. 342

## SEIKO'S MECHANICAL FILTERS AND OSCILLATORS

- Utilizes the precision machining technology of SEIKO, manufacturer of fine timepieces.
- A wide assortment of types from miniature filters ideal for pagers to high performance filters used in communications equipment are available.
- Frequency range from 280Hz to 100kHz.
- See the 1976 edition of the "GOLD BOOK" for details.

**Sales Office:**  
**SEIKO INSTRUMENTS, INC.**  
 2990. West Lomita Blvd., Torrance, Calif. 90505 U.S.A.  
 Phone: (213) 530-3400  
 Telex: 259103477307 SEIKOINST TRNC

**Manufacturer & Exporter**  
**DAINI SEIKOSHA CO. LTD.**  
**Industrial Electronics Div.**  
 31-1, 6-chome, Kameido, Koto-ku, Tokyo 136, Japan.  
 Phone: (03) 682-1111  
 Telex: 2622410 DSEIKO J

*SEIKO mechanical filters have been developed and commercialized through the precision machining technology of SEIKO*

CIRCLE NUMBER 53

ELECTRONIC DESIGN 23, November 8, 1976

THE TOTAL MEMORY SUPPLIER

## WE HAVE 8K OR 16K N-CANNEL ROMS. KEEP THAT IN MIND.

Easy to buy. one time mask charge per code. Easy to order 300 piece minimum. Easy to get One hundred piece minimum delivered as fast as four weeks after receipt of order.

Clip to letterhead. Send details on 8K and 16K ROMS plus full list of total memories in stock

Name	Title
Tel.	M.S.
811 E. ARQUES, SUNNYVALE, CA. 94086	

## THINK Signetics

a subsidiary of U.S. Philips Corporation

© 1976

CIRCLE NUMBER 54

# IMC FAN FACTS

## Our standard Boxer Fan is rugged and reliable

Here's a compact\* whose whirlwind delivers 70 to 115 cubic feet of air per minute. The Boxer can convert to a variety of uses — has long life and saves time and money. Literature on request! For immediate service please call Fred Taylor, Sales Manager—603/332-5300 or write.



\*4-11/16" square  
by 1-1/2" deep.



Our 25th Anniversary

**IMC MAGNETICS CORP.**

NEW HAMPSHIRE DIVISION

ROUTE 168, ROCHESTER, NEW HAMPSHIRE 03867

CIRCLE NUMBER 55

60/50 HZ AIRMOVER

## INTEGRATED CIRCUITS

### FPLAs now span mil temp range

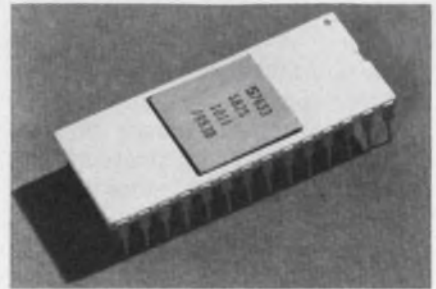

Signetics, 811 E. Arques Ave., Sunnyvale, CA 94086. (408) 739-7700. \$48, \$54.25; stock.

Two full military range versions of standard Field Programmable Logic Arrays (FPLAs) are now available. The Schottky-TTL devices, which employ nichrome-fuse technology, are said to offer the best performance now available over the  $-55$  to  $+125$  C range. Key specifications include 600-mW typical power dissipation and 80-ms max access time. The S82S100, is a three-state output version and the S82S101 is an open-collector FPLA. The TTL-compatible arrays are basically collections of AND and OR gates whose internal and external input connections can be arbitrarily programmed by the user. They feature single +5-V supply operation, and differ in organization from other FPLAs now on the market in ways that improve their flexibility. They are organized with 16 inputs and 8 outputs, whereas other devices typically have 14 inputs. The  $16 \times 8$  I/O configuration allows direct manipulations of two data-bytes and provides the capability to scan an address field 65,536 words deep. The organization also includes 48 product terms. The number of product terms used or shared among the FPLA outputs does not affect speed or power dissipation. By contrast, other FPLAs typically dissipate 4 mW more power for each product term used. Another feature is a chip-enable input, with which you can expand inputs and product terms and apply the three-state device to bus-organized systems. Both FPLAs are full-military-temperature and Mil-Std 883B-processed units in 28-pin, dual-in-line, ceramic packages.

CIRCLE NO. 343

# MAGNETIC SHIELDING

## MATERIAL

- CO-NETIC AA Alloy  
High Permeability  
.002" to .100" thick

### EXCLUSIVE

Perfection Annealed — No further anneal required if severe forming is avoided.

- NETIC S3-6 Alloy — High Saturation Induction.  
.004" to .095" thick

- Immediate Shipment from Stock

SEND FOR NEW MG-3

Material, Application & Fabrication Guide

MAGNETIC SHIELD DIV.



PERFECTION MICA CO.

740 N. Thomas Dr.  
Bensenville, Ill. 60106

Ph. (312) 766-7800

TWX (910) 256-4815

*The Preferred Source  
for Magnetic Shielding*

CIRCLE NUMBER 56

DATA PROCESSING

**Unit duplicates and programs PROMs**

*Pro-Log Corp., 2411 Garden Rd., Monterey, CA 93940. (408) 372-4593. See text.*

A PROM programmer, the series 92, will duplicate MOS or bipolar PROMs when used alone. Through a 20-mA current loop driven by a teletypewriter or  $\mu$ P development system, the Series 92 can additionally program, list or verify PROMs. The unit consists of the M920 master-control unit and a plug-in personality module. The Series 92's PROM duplicating function is controlled by a single pushbutton. Run and fail lights automatically indicate machine status and whether or not a PROM has been successfully programmed. The unit comes packaged in an attache case and weighs less than 15 lb. An M920 master-control unit costs \$995. Personality modules range from \$350 to \$550.

CIRCLE NO. 344

**Printer has a MTBF of five-million lines**

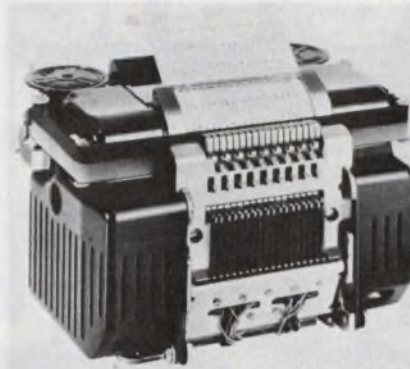

*C. Itoh Electronics, Inc., 280 Park Ave., New York, NY 10017. (212) 573-9466. \$120; 1 wk.*

The Model 102 impact printer is said to have an MTBF of 5-million lines. The unit prints 18 columns in 13-character font, at a speed of 2.7 line/s. The Model 102 prints in black and red, on 2.5-in.-wide paper. A transistorized, brushless, constant-speed dc motor that requires 15 V dc at 490 mA drives the unit. Printer dimensions are 3.375 x 5.75 x 4.875 in.

CIRCLE NO. 345

**Disc controller takes up one slot in a mini**

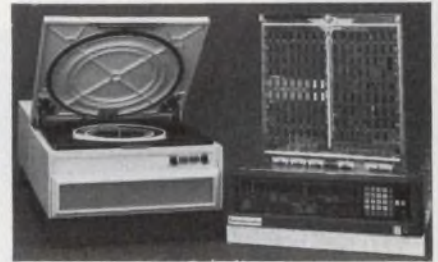

*Minicomputer Technology, 1901 Old Middlefield Way, Mountain View, CA 94043. (415) 965-4567. \$1900 (single qty).*

The TDC803 disc controller enables Interdata minicomputers to handle four CalComp Trident disc drives. The TDC803 controller occupies one slot in the chassis of an Interdata computer. It generates cyclic redundancy check characters, senses the disc's rotational position and has dual-access capability and an onboard logic probe. The manufacturer will integrate the disc drive and controller at additional cost.

CIRCLE NO. 346

**OEM DESIGNERS**  
**Get this FREE Design File**  
on CDC's new modular switching power supplies

These compact, modular power supply switchers simplify design in 300-600 watt applications and keep costs down too. (They're priced at less than 90¢ per watt!) Benefits to the end user include **low EMI noise levels** (we are designed to meet VDE STD 0875) and **highly reliable operation** plus convenient maintenance and easy add-on capability up to 1200 watts in a single, 19 in. rack. Get specs, prices and feature details today from:

**Magnetic Components Group**  
**CONTROL DATA CORPORATION**

7801 Computer Avenue South, Minneapolis, MN 55435  
(612) 830-5800 TWX 910 576 2978

CIRCLE NUMBER 57

THE TOTAL MEMORY SUPPLIER

**WE HAVE BIPOLAR MIL-SPEC MEMORIES. STORE THAT AWAY.**

Total lineup manufactured in fully military approved plants. RAMs, ROMs, PROMs, FPLAs to 883 processing. Dual in-lines & flat packs ready to take on toughest assignments.

Clip to letterhead. Send entire list of total memories in stock.

Name	Title
Tel.	M.S.

811 E. ARQUES, SUNNYVALE, CA. 94086

**THINK signetics**

a subsidiary of U.S. Philips Corporation

© 1976.

CIRCLE NUMBER 58



# We're the only total memory supplier.

## Remember it.

### Only Signetics has a complete line of Bipolar & MOS memories.

There are definite advantages in doing business with a total supplier. Most obvious, you get everything you need from one source without shopping all over the country. So you save time and all the hassle.

In addition, you get increased buying power. Because when you buy in volume, you naturally get the lowest price. So you save money. It all sounds simple because it is.

Signetics has made a positive commitment to stay ahead in technological leadership in Bipolar & MOS memories. No brag, just fact. With years of experience in supplying the needs of major customers and being a subsidiary of U.S. Philips Corporation, Signetics has the resources to make it happen.

Signetics has a total product line of memories — RAMs, ROMs, PROMs, FPLAs/PLAs and a long list

of Shift Registers including 12 Static and 8 Dynamic from 100 to 1024 bits.

#### **Signetics Bipolar & Static MOS RAMs.**

Signetics' total line of Bipolar & MOS devices includes all the hard-to-find and in-demand devices. 24 Bipolars — 8 to 1024 bits. 14 MOS Statics — 256 x 4 to 1024 x 1. 1K x 4 and 4K x 1 available 1st quarter '77.

**Signetics Dynamic MOS RAMs.** The most complete line of dynamic MOS RAMs from 1024 x 1 to 4096 x 1 (16, 18 and 22 pin). 1024 x 1 to 4096 x 1 organization. 16K x 1 available 1st quarter '77.

**Signetics Bipolar & MOS ROMs.** These mask-programmable chips offer easy word expansion. 13 Bipolars in stock — 256 to 16K bits. 7 MOS Statics in stock — up to 16K bits. Plus 4 character generators including 8K's. Both TS and OC available.

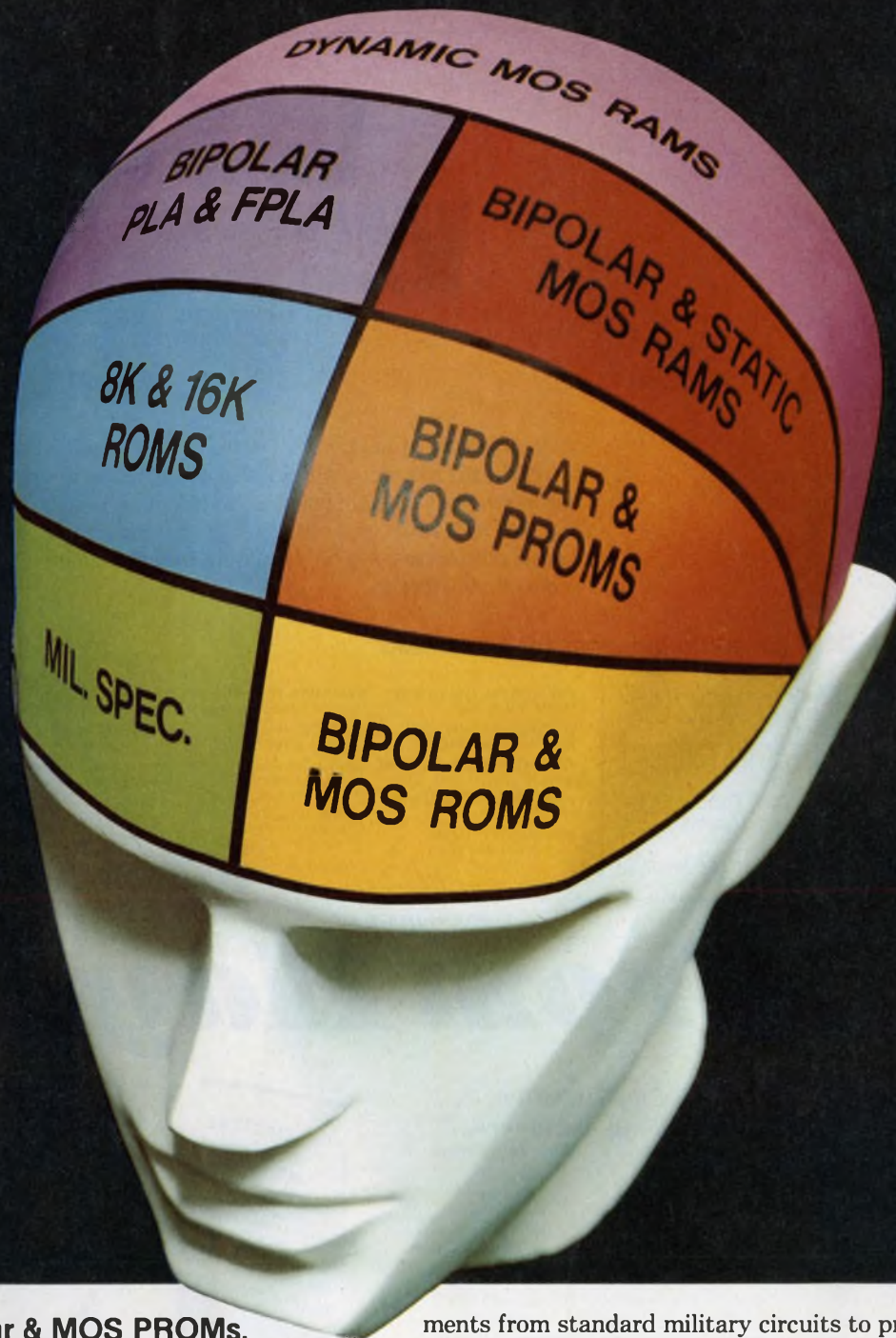

### Signetics Bipolar & MOS PROMS.

All readily available through a vast Signetics distributor programming network. The new 18-pin devices offer small size, high PC board packing density, low complexity, very low power, and low component and system cost. 17 Bipolars in stock from 256 to 8K bits, with 16K available 1st quarter '77. 4K and 8K MOS EROMS available 1st quarter '77.

**Signetics Bipolar FPLAs/PLAs.** All devices deliver increased do-it-yourself flexibility and greatest system reliability with fewer parts and connections. It's easiest, fastest and simplest to modify and correct logic functions by limited editing of input/output connections within the package, and it's second sourced. Both TS and OC are available and in stock.

**Signetics Bipolar MIL-SPEC Memories.** Total line manufactured to 883 military standards and available in dual in-line and flat pack configurations. In addition, Signetics supplies logic and analog require-

ments from standard military circuits to proprietary high performance series—making Signetics the total military supplier, too.

#### Clip to letterhead for fast response.

- Send me a full list of total Bipolar & MOS memory line.
- Please have a Field Applications Engineer call me for an appointment.

My application is \_\_\_\_\_

Name \_\_\_\_\_ Title \_\_\_\_\_

Telephone \_\_\_\_\_ Mail Stop \_\_\_\_\_

**THINK Signetics**

811 E. Arques Ave., Sunnyvale, Ca. 94086

© 1976.

A subsidiary of U.S. Philips Corporation

Model  
AI-400



Actual Size

# WE'RE WARNING YOU...<sup>SM</sup>

... this is a lot of buzzer in a little package! Designed with two pins ... for PC board mounting and wave soldering. Easy to use for computer terminals, medical equipment, point-of-sale terminals. Rated to 90 dbA at 2.9 kHz; 5 to 30 vdc; draws just 10 mA maximum current. Sturdy yellow plastic case; 1.625" (41.3mm) overall diameter. Ask for free catalog and a demonstration.

Where to buy an audio indicator for every need:



projects<sup>®</sup>  
unlimited

3680 Wyse Road, Dayton, Ohio 45414  
Tel. (513) 890-1918, TWX 810-450-2523

Distributors throughout the world.

CALIFORNIA, COSTA MESA  
MarVac Electronics

COLORADO, DENVER  
Waco Electronics Inc.

MASSACHUSETTS, SHARON  
Adcour

MICHIGAN, FARMINGTON  
CMP Distributor Co.

MISSOURI, ST. LOUIS  
Olive Industrial Elec.

NEW YORK, ROCHESTER  
Ossmann Component Sales

OHIO, CLEVELAND  
CMP Distributor Co.

OHIO, CINCINNATI  
COLUMBUS  
Hughes Peters, Inc.

TEXAS, DALLAS  
K. A. Electronic Sales

UTAH, SALT LAKE  
Newark Electronics

WASHINGTON, SEATTLE  
Frank Jackson & Associates

WISCONSIN, MILWAUKEE  
Taylor Electric Co.

B. C., VANCOUVER  
Deskin Sales Corp.

ONTARIO, TORONTO  
Deskin Sales Corp.

ONTARIO, WILLOWDALE  
Electro Sonic, Inc.

QUEBEC, MONTREAL  
Deskin Sales Corp.

CIRCLE NUMBER 60

# new from Hayden!

"... well-organized, extremely well written ...  
highly recommended for practicing engineers..."

IEEE Transactions

## DIGITAL SIGNAL ANALYSIS

Samuel D. Stearns

This is an ideal master handbook on today's signal processing procedures and systems, containing recent advances, new design material, and a comparison between continual and digital systems that's extremely helpful to newcomers to the field. Featuring a foreword by Richard Hamming, the book contains a review of linear analysis; sample-data systems; analog-to-digital and digital-to-analog conversion; the discrete Fourier transform and the fast Fourier transform algorithm; spectral computations; non-recursive and recursive digital systems; computer simulation of continual systems; analog and digital filter designs, and more 288 pages

"Jacobi's book is great ... a new, original, readable, usable book on writing for business and professional people. ..."

Jim Lufkin, Mgr. Professional Publications, Honeywell.

## WRITING AT WORK:

Dos, Dont's, and How Tos

Ernst Jacobi, Xerox Corporation.

This guide to better writing follows its own principles by being lively, informative, and easy to read. More than a collection of pat rules and formulas, the book is a storehouse of practical advice for business and professional people to make their writing sharper, more interesting, and more informative. It shows you how to overcome procrastination and change your entire attitude toward writing, making it easier and more enjoyable for you! 208 pages.



## HAYDEN BOOK COMPANY, INC.

50 Essex Street, Rochelle Park, New Jersey 07662

### Order today—15-day examination!

Please send me the following book(s) to read and use FREE for 15 days. At the end of that time, I'll either send the amount indicated, plus postage and handling, or return the book(s) with no obligation.

- DIGITAL SIGNAL ANALYSIS, #5828-4, \$19.95  
 WRITING AT WORK, #5730-X, \$10.95

Name \_\_\_\_\_

Company/Institution \_\_\_\_\_

Address \_\_\_\_\_

City/State/Zip \_\_\_\_\_

**SAVE MONEY! Payment Enclosed.** Publisher will pay all shipping and handling charges. Same 15-day return privilege and full refund if not satisfied.

## DATA PROCESSING

### Paper-tape reader hardly makes a sound

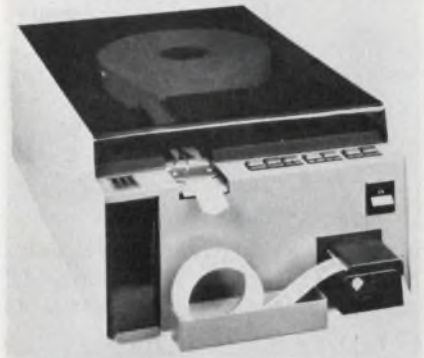

*Data Specialties, Inc., 3455 Commercial, Northbrook, IL 60062. (312) 564-1800. \$1995; 45 days.*

The SRP-300 paper-tape reader and punch reportedly has a sound intensity of only 58 dB. The unit connects to a terminal through an RS-232 or current-loop interface. It features full or half duplex, and line or local operation. It also has a search or edit control, back space, tape feed, and selectable baud rates. The tape-punch mechanism cuts paper, Mylar and rolled or folded tapes.

CIRCLE NO. 351

### Mag-tape system runs with DEC's LSI-11

*Computer Operations, Inc., 9700-B George Palmer Hwy., Lanham, MD 20801. (301) 459-2100. See text; 30 days.*

A magnetic tape system is compatible with DEC's LSI-11 and PDP-11/03. The CO-3000 LSI system has a capacity of 148-k 16-bit words, in blocks of 256 words each. The system supports such DEC software as the RT-11 operating system and Macro, Edit, Linker, Fortran IV and Basic programs. The CO-3000 LSI consists of a tape controller and drive. The tape controller occupies a quad slot in the LSI-11. The transfer rate is 4-k, 16-bit word/s. A search for pre-numbered word blocks is done at 60 in./s. The controller will support a total of four drives. The first drive and controller cost \$1995 and additional drives are \$1395 (both one-up).

CIRCLE NO. 352

# Premier Electronic Cabinets and Cases

- ESTHETICS KEYED TO MODERN SYSTEMS
- RUGGED-FUNCTIONAL CONSTRUCTION
- ECONOMICAL PRICING
- PROMPT SERVICE & AVAILABILITY



INSTRUMENT CASES - TIC SERIES

TVA Series Vertical Assembly—  
Construction Details  
(1 Frame, 2 End Panels, Rear Door)

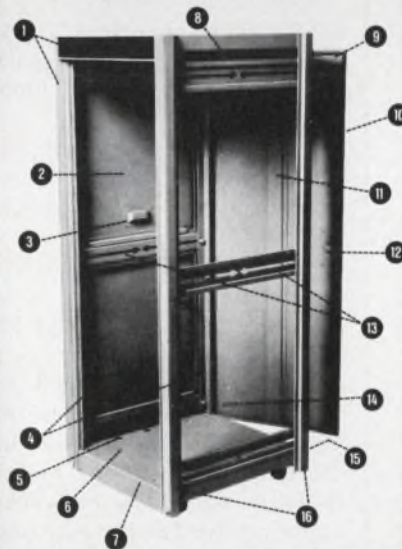

1. Trim: extruded anodized aluminum with textured vinyl inlays
2. Outside removable flush end panels (16 ga.)
3. Recessed hand grip for panel removal
4. 2 pr. panel mounting angles, fully adjustable front to rear with tapped 10-32 holes on EIA & WE Standards spacing (12 ga.)
5. 1" dia. holes for cable entry beneath base
6. Recessed caster mounting holes
7. 1 piece formed steel base provides for heavy equipment mounting area and concealed caster mounting (14 ga.)
8. 1 piece solid top for extra rigidity and squareness (14 ga.)
9. Foam gasketing (3 sides)
10. Magnetic closure gasket
11. Door stiffener channel
12. Keyed latch and brushed aluminum pull handle
13. Horizontal cross-brace and panel mounting angle supports
14. Quick release, spring loaded door hinges (top and bottom)
15. 1 1/8" dia. knock-outs for rear cable entry underneath rear door
16. Formed steel uprights (14 ga.) provide 1/2" recess to panel mounting angles

All features shown are standard in the Trimline TVA Series  
Welded, formed steel construction

Complete catalog and prices on request



**PREMIER METAL PRODUCTS COMPANY**

381 Canal Place, Bronx, N.Y. 10451/(212) 993-9200

# OPEN FRAME POWER SUPPLY ELECTION

## ★ DELTRON PLATFORM ★

- ★ Competitive Prices.
- ★ Stock Delivery.
- ★ 1 yr. Warranty.
- ★ "Real" Specs.
- ★ User Designed.
- ★ Lowest Temp. Derating.



FROM THE "PRIMARY" ON ...  
IT'S "Q" SERIES  
ALL THE WAY!

U. L.  
Recognition.  
Interchange-  
able with  
competitive  
units.



Size A Model No.	Size B Model No.	Size C Model No.	Size D Model No.	Size E Model No.
volts—amps	volts—amps	volts—amps	volts—amps	volts—amps
Q 5—3.0	Q 5—6.0	Q 5—9.0	Q 5—12.0	Q 5—18.0
Q 6—3.0	Q 6—6.0	Q 6—9.0	Q 6—12.0	Q 6—18.0
Q 12—1.7	Q 12—3.4	Q 12—5.7	Q 12—7.0	Q 12—10.8
Q 15—1.5	Q 15—3.0	Q 15—4.8	Q 15—6.3	Q 15—9.5
Q 18—1.3	Q 18—2.6	Q 18—4.0	Q 18—5.2	Q 18—7.8
Q 20—1.2	Q 20—2.4	Q 20—3.6	Q 20—4.8	Q 20—7.2
Q 24—1.2	Q 24—2.4	Q 24—3.6	Q 24—4.8	Q 24—7.2
Q 28—1.0	Q 28—2.0	Q 28—3.0	Q 28—4.2	Q 28—6.0
Dimen 4 1/2 x 4 1/2	Dimen 5 3/4 x 4 1/2	Dimen 7 x 4 1/2	Dimen 9 1/4 x 4 1/2	Dimen 14 x 4 1/2
Price: 1—\$32 100—\$26 250—\$24	Price: 1—\$54 100—\$44 250—\$41	Price: 1—\$67 100—\$54 250—\$51	Price: 1—\$87 100—\$70 250—\$66	Price: 1—\$113 100—\$ 91 250—\$ 85

**Deltron inc.**

Wissahickon Avenue  
North Wales, PA 19454

Tel: 215/699-9261 Twx: 510/661-8061

AC 13

CIRCLE NUMBER 63

## DISCRETE SEMICONDUCTORS

### Zener diodes offered in a choice of tolerances



Schauer Manufacturing Corp., 4500  
Alpine Ave., Cincinnati, OH 45242.  
(513) 791-3030. \$0.73: 1%, \$0.25:  
10% (1000 up); stock.

A new line of 1-W zener diodes is available in any voltage from 2.6 to 34 in 1, 2, 5 and 10% tolerances at any test current. The diodes are packaged in a DO-41 epoxy-molded case with tin-coated leads. They feature good avalanche characteristics at low voltages.

CIRCLE NO. 353

### Silicon photocells respond to green light

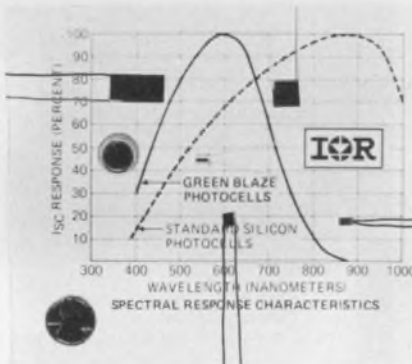

International Rectifier Corp., 233  
Kansas St., El Segundo, CA 90245.  
(213) 678-6281. \$3.25 (1000 up);  
stock.

A series of green-response silicon photocells added to the Spectra-Band series of photovoltaic devices are called Green Blaze photocells. With a broadened photopic curve having a maximum response in the vicinity of 556 nm, applications are chiefly in photographic, photometer and visible-band measurement equipment. Temperature coefficient in the short-circuit current-operating mode is 0.2%/°C, and operating temperatures for the new units are between -40 and 125 C. Long-term stability ensures less than ±2% drift in current response over a period of two years.

CIRCLE NO. 354

### Plastic thyristors save 1/3 the cost

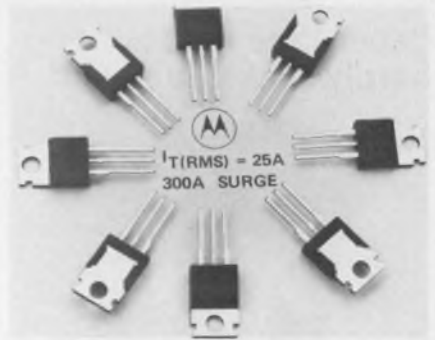

Motorola Semiconductor Products  
Inc., P.O. Box 20912, Phoenix, AZ  
85036. (602) 244-6900. \$1.49 to  
\$4.95 (100 to 999); stock.

A series of plastic-packaged thyristors, the 2N6504 through 2N6509, has ratings at 25 A with peak reverse blocking voltages ranging from 50 to 800 V. All the devices have a peak nonrepetitive surge current rating of 300 A. Housed in TO-220 packages, they feature glass-passivated junctions and a center-gate-fire design for maximum parameter uniformity and stability. Designed for half-wave ac applications, such as motor and heating controls, these devices offer savings of up to 1/3 when compared with the existing metal-cased equivalents.

CIRCLE NO. 355

### Mark-sensing arrays fit your applications



Ultra Sensors, Inc., 2400 W. 102nd  
St., Suite 313, Minneapolis, MN  
55431. (612) 881-2041. See text.

Custom, solid-state mark-sensing arrays at under \$1.00 per-channel (in OEM quantities) are believed to be the lowest price available in the industry. A standard package is the Cyclops, a single-channel device. And custom six-channel arrays on 0.125-in. centers, or 22-channel arrays on 0.1-in. centers are typical examples. Each channel is a microminiature GaS emitter and Si detector in one integral package. The field of vision is zero and there is no focal point or blind spot as with conventional configurations. A \$4.90 kit includes application notes and complete specification sheets.

CIRCLE NO. 356

**LSI**

## Dumb Terminal

**NOW FORTIFIED WITH DCA!**

A single Dumb Terminal currently provides all of the following key ingredients:

- DIRECT CURSOR ADDRESSING
- 12 ..... Diagonal Screen
- 960 ..... Upper Case Character Display
- 59 ..... Data Entry Keys
- 32 ..... Positive Action Switches
- 11 ..... Selectable Baud Rates\* (from 75 to 19,200)
- 1 ..... RS232S Interface
- 1 ..... 20mA Current-loop
- 1 ..... Hatchback Bonnet

\*No official minimum requirements have yet been established.

NET WEIGHT: 25 lbs.  
The Dumb Terminal (ADM-3A) is a product of Lear Siegler Inc. Anaheim, California

# NOW FORTIFIED WITH DCA\*!

\*DCA means Direct Cursor Addressing. And that's exactly what you'll find added to each and every ADM-3A Dumb Terminal from Lear Siegler. As a basic, standard ingredient.

Now our Dumb Terminal's even more of a snap to use. Because direct addressing lets the operator tell the cursor—quite literally—where to go. Up. Down. Right. Left. Any X and Y location you choose. Even where to home.

Your operators will tell you it's "GRRRRREAT!" Not to mention fast and simple. For tracking down typos. Typing in additions. Even for retyping entire passages. Because if the problem's still on the screen, it's open to instant improvement.

What's more, the Dumb Terminal still provides a balanced diet of your favorite standard features. Like a bright 12" diagonal screen. Fifty-nine data entry keys. A 960 character display. Plus 32 positive action switches that let you activate goodies like 1 of 11 different baud rates, an RS232S interface, or a 20mA current-loop. And more. All handsomely packaged in a handy hatchback bonnet.

And if you want to sweeten up the deal by adding switch-selectable options, you've got your pick of plenty. Like a complete upper and lower case USASCII character set, a 1920 character display, or even an "answer-back" capability.

So forget the flaky imitations with their puffed-up, premium prices. (And join the thousands who already start their day, in an LSI kind of way.)

Because what the Dumb Terminal—now fortified with DCA—really delivers, you won't find anywhere else.

Not even in Battle Creek.



## DUMB TERMINAL. SMARTER BUY.

Forget the box tops, for more information contact:  
Lear Siegler, Inc./E.I.D., Data Products

714 N. Brookhurst St., Anaheim, CA 92803  
Tel. (714) 774-1010

# designed by Grayhill as the world's smallest rotary switch



**10 positions, 1 or 2 poles,  
diameter less than .300"**

- Non-shorting...wiping contacts  
...rated to make or break 15,000  
cycles minimum at logic loads.
- Now available with integral knob  
...as well as screwdriver or  
shaft operated.
- For communications circuits,  
electronic stopwatches, and  
other low voltage applications  
where size is critical

As the pioneer in switch microminiaturization, we present our Series 75, designed as the smallest the state of the art permits. If you think that small switch means big price...guess again. Here's a lot of switch in a tiny package at a cost that's surprisingly low. Write for Bulletin #237 describing these miniature switches...and consult EEM for more information on Grayhill products.



561 Hillgrove Avenue • LaGrange, Illinois 60525  
(312) 354-1040

CIRCLE NUMBER 65

## MODULES & SUBASSEMBLIES

### Log amp handles positive and negative inputs



*Teledyne Philbrick, Allied Dr. at  
Rte. 128, Dedham, MA 02028.  
(617) 329-1600. \$60 (1 to 9);  
stock.*

The 4356 log amplifier can act as a compression or expansion circuit. It can handle both positive or negative voltage or current inputs and provides an output voltage that is the log of the input. The output signal follows the log function over a dynamic range of greater than  $\pm 1000$  to 1 from dc to 10 kHz. As a noise eliminator, the 4356 provides better than 40 dB of improvement in the signal-to-noise ratio when small dynamic range signals are measured in the presence of large-dynamic-range impulse noise. The modules have a log conformity of  $\pm 20$  mV for input current of  $\pm 10 \mu\text{A}$  to  $\pm 10$  mA. The  $1.145 \times 2.02 \times 0.62$  in. module requires  $\pm 15$  V at  $\pm 8$  mA, and functions over a 0-to-70-C range.

CIRCLE NO. 357

### Keep temp to 0.1 C with small unit

*RFL Industries, Inc., Boonton, NJ  
07005. (201) 334-3100. \$150; stock.*

Model 76, a solid-state, time-proportioning temperature controller, offers  $\pm 0.1$ -C accuracy, in a package measuring  $7.8 \times 3.4 \times 1.6$  in. The unit controls temperatures of electrical-resistance heating by passing up to 15 A, either 115 or 230 V ac, to the heaters. By using one-of-five selected thermocouples or RTD sensors, the unit controls temperatures from  $-150$  F ( $-100$  C) to 2000 F (1000 C). Both coarse and fine setpoint-controls are provided. Options include a calibrated setpoint-dial with indicator and offset-adjustment, a remote power-level indicator and a direct-reading temperature indicator.

CIRCLE NO. 358

### Synchro driver delivers up to 25 VA

*Magnetics, 182 Morris Ave., Holtsville, NY 11742. (516) 654-1166.  
\$29 (500-up); stock to 4 wks.*

A 25 VA synchro driver, part number 12961, takes 9-V, rms, sine and cosine information, 60 Hz, and converts it to 90 V, line-to-line, synchro information. Special construction techniques provide 2-arc-minute accuracies instead of the usual 5 or 10. The units, in  $3 \times 4.75 \times 2.25$  in. hermetic cases, meet all rugged environment specs of MIL-T-27 and operate from  $-55$  to  $+125$  C. The input impedance is four times the reflected load impedance. In the same size case a 90-V, line-to-line, 100-VA, 400-Hz unit can be supplied.

CIRCLE NO. 359

### 8-bit a/d converter comes already trimmed

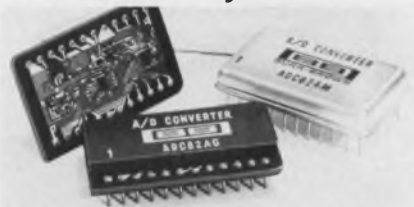

*Burr-Brown, International Airport,  
Industrial Park, Tucson, AZ 85734.  
(602) 294-1431. From \$36 (100-  
up); stock.*

The ADC82, an 8-bit a/d converter offers a conversion speed of  $2.8 \mu\text{s}$ , maximum. The converter is totally self-contained and has its own internal clock, comparator and reference circuits. It operates by successive approximation and has an initial accuracy of better than  $\pm 1$  LSB with no external gain or offset adjustments. The ADC82 operates with input signal ranges of 0 to 10 or  $\pm 10$  V and both parallel and serial outputs are provided. Maximum nonlinearity error is  $\pm 1/2$  LSB, and monotonicity is guaranteed over a temperature range of  $-25$  to  $+85$  C. Operation at derated specifications is permitted over a temperature range of  $-55$  to  $+100$  C. Any of six input ranges are available:  $\pm 2.5$ ,  $\pm 5$ ,  $\pm 10$ , 0 to 5, 0 to 10 or 0 to 20 V. The converters are available in either a metal (ADC82AM) or ceramic (ADC82AG) 24-pin DIP that measures  $1.4 \times 0.8 \times 0.25$  in.

CIRCLE NO. 360

# OK, you Power Schottkys, the heat's on. Talk!

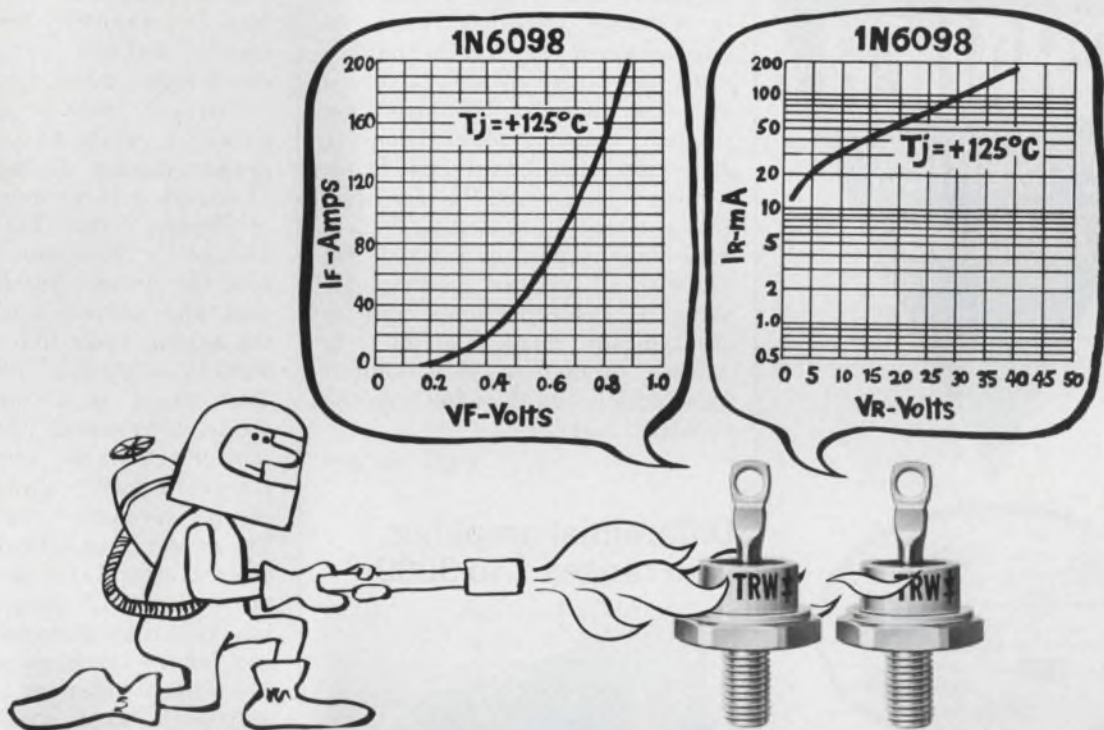

These new TRW Power Schottkys have quite a story to tell and it starts with the fact that they're JEDEC registered. Then they'll tell you that they let you maintain 50 Amps—typically 0.55 Volt forward drop at a  $T_j$  of 125° C. The highest operating junction temperatures, lowest reverse leakage typically less than 200mA @ 40V, 125° C, and highest voltages on the market today. (Yet, for all that, they're competitively priced.)

Yes, TRW's Schottky Diodes are now 1N registered. And they're about to be JAN and JANTX qualified.

Let these new Power Schottkys take your heat, try one in your present circuit or in the circuit you're working on, you'll find out they're not just talk.

1N6095	25 AMP	30V	DO-4
1N6096	25 AMP	40V	DO-4
1N6097	50 AMP	30V	DO-5
1N6098	50 AMP	40V	DO-5

If you'd like to hear more about how TRW's Power Schottkys can help you in the design of low-voltage, high-current power supplies, call John Power at (213) 679-4561. Or use the coupon. (These components are available from stock from our distributors.)

#### TRW Power Semiconductors

An Electronic Components Division of TRW, Inc.,  
14520 Aviation Boulevard, Lawndale, California 90260

- Please send me data sheets on TRW's Power Schottky Diodes
- Have a salesman get in touch with me

Name \_\_\_\_\_

Company Name \_\_\_\_\_

Position \_\_\_\_\_

Address \_\_\_\_\_

City \_\_\_\_\_

State \_\_\_\_\_

Zip \_\_\_\_\_

ED

## TRW POWER SEMICONDUCTORS

ANOTHER PRODUCT OF A COMPANY CALLED TRW

CIRCLE NUMBER 66



**ALONE  
AGAIN**

in low cost 1-watt  
Zener Diodes

**SCHAUER**

"Z" SERIES  
ZENERS

DO-41 epoxy  
molded case

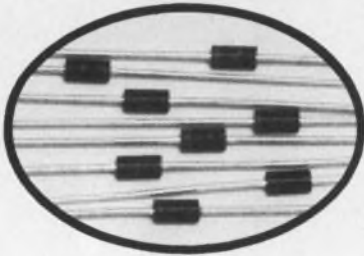

**ANY VOLTAGE**  
2.6 to 34.0

**ANY TOLERANCE**  
1% 2% 5% 10%

**At Any Test Current**

**Compare These Prices  
On 1% Tolerance Diodes**

Quantity	Price each
1-99	91¢
100-499	83¢
500-999	77¢
1000 up	73¢

**LARGE STOCK  
GOOD DELIVERIES**

Send for complete rating data  
and other tolerance prices.

Semiconductor Division

**SCHAUER**  
MANUFACTURING CORP.

4511 Alpine Ave., Cincinnati, OH 45242  
Telephone 513-791-3030 Telex 21-4576

CIRCLE NUMBER 67

**MODULES & SUBASSEMBLIES**

**Thermocouple reference  
is battery powered**

*Litek Corp., 71 Cornehlisen Dr.,  
Huntington Station, NY 11746.  
(516) 427-4743. \$76 (1-9); stock to  
4 wks.*

Model NC340 self-powered thermocouple reference-junction compensators eliminates the need for ice baths and ovens. The circuit is instantly energized from its self-contained replaceable battery when the power switch is turned on. The output terminals are standard banana plugs, allowing direct insertion into readout or recording instruments. Standard reference temperature setting is 0 C with other references available for use with all types of thermocouple materials. Compensation accuracies are typically  $\pm 1/4$  C at 25 C to  $\pm 3/4$  C from 0 to 50 C. Output impedance is less than 250  $\Omega$  on the standard models.

CIRCLE NO. 361

**Differential-amplifier  
gain ranges 1 to 3000**

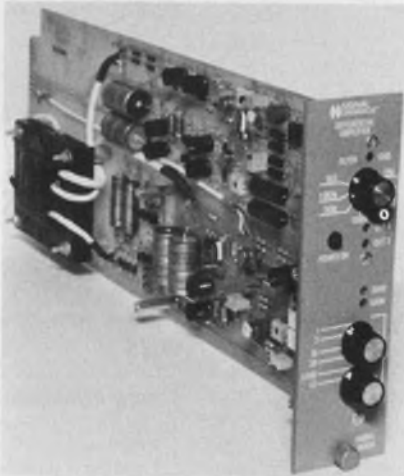

*Signal Laboratories, Inc., 202 N.  
State College Blvd., Orange, CA  
92668. (714) 634-1533. \$395 (unit  
qty); 30 days.*

Precision differential amplifier, Model IA 104, features a guarded input with 25-M $\Omega$  impedance, 0.01% accuracy, gain selection ranging from 1 to 3000 and selectable low-pass filtering. Two isolated  $\pm 10$ -V,  $\pm 100$ -mA outputs are provided. A triple-box shielded transformer is used to achieve isolation from the 115-V, 60-Hz power line.

CIRCLE NO. 362

**Put your  $\mu$ P on TV  
with a display system**

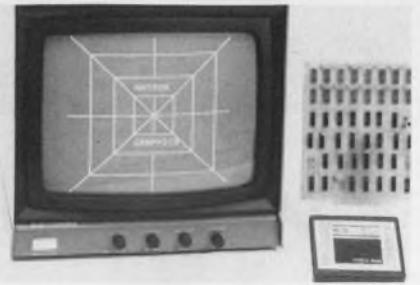

*Matrox Electronic Systems, P.O.  
Box 56, Ahuntsic Stn., Montreal,  
Quebec H3L2S0. (514) 481-6838.  
From \$598; 2-to-8 wk.*

You can mate a  $\mu$ P to a TV monitor with the MTX256-2 graphic display. It displays a total of 65,536 dots arranged in a 256  $\times$  256-dot raster. Each dot is addressed in less than 3.4  $\mu$ s. Connect the system directly to a  $\mu$ P's data and address bus. To a  $\mu$ P, the system looks like a write-only memory, with four 8-bit locations. The output is a standard composite-video signal (75  $\Omega$ , crystal-controlled). Both American (60-Hz-field rate) and European (50-Hz versions) are available. The system consists of two modules: A central-timing unit (CTU) provides all TV sync signals and interface-timing signals for a  $\mu$ P and for the image-memory module. The image memory (IM) is a 65,536-bit RAM that stores one TV-field (256  $\times$  256) at one level of intensity; no external refresh is required. The IM is continuously scanned producing a video signal that drives any standard monochrome or color TV monitor directly. The system provides separate horizontal-and-vertical-sync outputs to drive a slave MTX1632-SL video RAM for alphanumeric and graphic capability. The simplest graphic system (MTX256-2-1) consists of one CTU module and one IM module, and is also available as a PC board, using +5 V at 400 mA, and +12 V at 120 mA. This unit will provide a 256  $\times$  256 dot raster with one level of intensity. The monitor must be purchased separately. A graphic system with one CTU can give you gray scale, color, image motion, light pen, cursor plot, vector plot, point plot, bar-graph plot, alphanumeric and ROM screen patterns.

CIRCLE NO. 363

# New Sangamo Type 101 Aluminum Electrolytic Capacitors for up to 100 kHz filtering in Switching Power Supplies: **COOLER PERFORMANCE.**



When you need longer-life capacitors for your higher-frequency (10 to 100 kHz) switching regulator power supply — play it cool.

Look into new, cooler-operating Sangamo Type 101 Computer-Grade Aluminum Electrolytic Capacitors.

Their unique Thermal Pack™ case mechanically secures the internal wound section. And compresses the extended conducting cathode foil into metal-to-metal contact with the aluminum case bottom.

Results: Rugged construction. No need for potting compound. Less weight. More volume for gas expansion. And vastly improved heat transfer and dissipation, for cooler performance.

Get high capacitance, low impedance, high ripple current capability — and economy —

## Type 101 Capacitors Electrical/Mechanical Specifications

Capacitance Range	450 uF to 465,000 uF
ESR Values at 20 kHz	.0048 ohms to .040 ohms
Max. Ripple Current Capability at 20 kHz	40 amps at 65°C; 31.4 amps at 85°C
Operating Temperature Range	-55°C to +85°C
Voltages Available	5 to 100 VDC
Nominal Case Sizes	1.375" x 1.625" (34.93 mm x 41.28 mm) to 3.000" x 5.625" (76.2 mm x 142.88 mm)
Terminal Connections	Standard threaded insert type
External Insulation	Uniform polypropylene coating

in a great new case. Specify Sangamo Type 101 Computer-Grade Capacitors.

Write for complete specs and engineering samples.

Sangamo Capacitor Division, Box 128,  
Pickens, SC 29671; phone: (803) 878-6311;  
TWX: 810-397-2496; Telex: 57-0441.

# SANGAMO CAPACITORS

A DIVISION OF SANGAMO WESTON, INC.



# BEND!

Thermoplastic  
2-row  
barriers—  
priced  
like fragile  
phenolics.

The interconnection company that  
innovates to serve you better.

# BEAU

 Beau Products Division  
Vernitron  
Electrical Components

P.O. Box 10, Laconia, N.H. 03246 / N.H. tel.: 524-5101  
CALL TOLL FREE: (800)258-0370

CIRCLE NUMBER 70

# CLIP!

Panel-mount Beau  
connectors  
in 1/4 the  
time with  
exclusive  
C-clips.



The interconnection company that  
innovates to serve you better.

# BEAU

 Beau Products Division  
Vernitron  
Electrical Components

P.O. Box 10, Laconia, N.H. 03246 / N.H. tel.: 524-5101  
CALL TOLL FREE: (800)258-0370

CIRCLE NUMBER 71

## New Literature



card-edge  
connectors

 Elco  
Corporation

### Card-edge connectors

Card-edge connectors, available in numerous sizes and configurations with both single and dual readout contacts, are described in a 24-page catalog. Elco Corp., El Segundo, CA

CIRCLE NO. 364

### Ceramic capacitors

A 56-page technical reference catalog contains data on product performance and testing, photographs, sketches and graphs. Centre Engineering, State College, PA

CIRCLE NO. 365

### Crimping tool

Hand, air, electric, hydraulic and air-tape crimping tools and machines are featured in a 16-page catalog. ITT Cannon Electric, ETC Terminal Products Unit, Solon, OH

CIRCLE NO. 366

### Test instruments

Photos, descriptions and specifications on a wide range of industrial, commercial and educational instruments can be found in a 42-page catalog. B&K Precision, Chicago, IL

CIRCLE NO. 367

### Rf capacitors

The RF Capacitor Handbook, a 256-page manual, covers basic circuit design considerations and uses for rf capacitors, including high frequency circuit design, characteristics of different designs, test methods, actual data characterizing rf capacitors and ways of maximizing gain, bandwidth and power. American Technical Ceramics, Huntington Station, NY

CIRCLE NO. 368

### Semiconductors

Updated with the latest product listings and specifications, a 40-page catalog describes more than 2000 semiconductor products. ITT Semiconductors, Woburn, MA

CIRCLE NO. 369

### Microwave instrumentation

A 170-page catalog features the latest state-of-the-art multiple-band microwave devices and instrumentation, which span the 1-to-18-GHz frequency range. Narda Microwave, Plainview, NY

CIRCLE NO. 370

### Electronic kits

A 96-page catalog describes nearly 400 electronic kits for virtually every do-it-yourself interest. Heath, Benton Harbor, MI

CIRCLE NO. 371

### Resistor networks

Schematic diagrams, dimensional drawings and standard resistance values for the company's 14-pin thin-film DIPs; 6, 8 and 10-pin SIPs; 14 and 16-pin thick-film DIPs; 14-lead flatpacks and custom networks are presented in a 10-page catalog. Beckman Instruments, Fullerton, CA

CIRCLE NO. 372

### Ferrite products

Soft magnetic ferrite (SIFERRIT) materials are described in a 450-page handbook. The book offers illustrations, performance curves and specifications. Copies of the book are available upon request on company letterhead only. Siemens, Components Group, 186 Wood Ave. S, Iselin, NJ 08830

INQUIRE DIRECT

NEW!

# The TROMPETER Connection!



### FEATURES:

- ① Enclosed hardened Beryllium Copper outer conductor spring.
- ② Positive shield integrity — metal to metal.
- ③ Positive jacket retention. Meets Mil C 39012 Cat. A. Patent Pending.

**WRENCH  
CRIMP™  
CONNECTORS**  
BNC - TNC - N

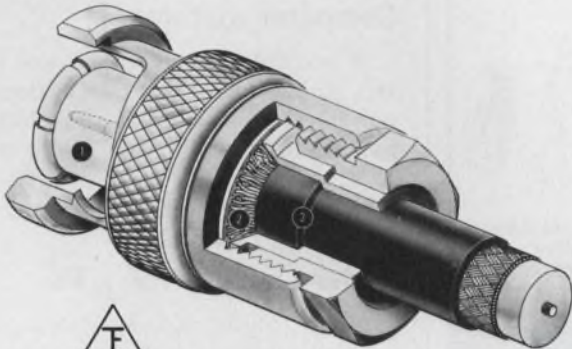

**TROMPETER  
ELECTRONICS, INC.**

8936 Comanche Avenue, Chatsworth, CA. 91311 • (213) 882-1020/TWX: 910-494-1210

CIRCLE NUMBER 72

## WHO MAKES WHAT & WHERE TO FIND IT

Volume 1 of **Electronic Design's GOLD BOOK** tells all. And, when you look up an item in its **PRODUCT DIRECTORY** you'll find each manufacturer listed **COMPLETE WITH STREET ADDRESS, CITY, STATE, ZIP AND PHONE.** Save time. There's no need to refer elsewhere to find missing information.

**IT'S ALL THERE  
in  
Electronic Design  
GOLD BOOK**

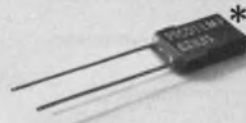

### Small Wonder

\* It's **PICOTEMP®** thermal cutoff  
New from **Micro Devices**  
(Actual Size)

PICOTEMP® thermal cutoffs. Fit tight spaces — and limited budgets. Same accuracy and similar capabilities as the widely used MICROTEMP® safety thermal cutoffs... but smaller in size. Weighs just 1/48th of an ounce. Installed costs are less, too.

Use PICOTEMP thermal cutoffs when installation or space restrictions rule out MICROTEMP. At present, motors and transformers are two leading applications.

But, wherever you use PICOTEMP thermal cutoffs, you're assured of positive, low cost protection against overheating caused by malfunctions in electrical circuits and components.

The PICOTEMP thermal cutoff is completely sealed

against atmosphere. Because of its unique design and construction, it won't derate. And it is unaffected by age or extended use.

Here are some other things you'll want to know:

- current capacity—to 5 amps. at 120 VAC. Will hold this rating up to and including 240 VAC.
- temperature tolerance +0° C.—3.3° C.
- temperature ratings—63 °C.—150° C. (146° to 300° F.)
- leads are 26 gauge silver plated wire.

Recognized under the Component Program of Underwriters' Laboratories, Inc. UL File #E40667A. MITI approved.



**MICRO DEVICES**



DIVISION OF EMERSON ELECTRIC CO.  
1881 SOUTHTOWN BLVD.  
DAYTON OH 45439 513-294-0581

CIRCLE NUMBER 73

# MAGNETIC SHIELDING FOR ANY CONFIGURATION

Ad-Vance reduces your shield costs because it already owns tooling for most standard shields. Or, our Magnetic Shielding Specialists will custom fabricate shields to your exact specifications.

- Magnetic Shields for 332 Types of Photomultiplier Tubes.
- AD-MU Sheet Stock.
- AD-MU Tape Data Protectors assure full fidelity of valuable tapes.
- Unequaled engineering & design service.
- In-house quality control.
- Fast delivery, competitive pricing.



AD-MU Foils Cut, Wrap Easily & Quickly



Typical Custom Fabricated Shields For Components & Systems

Ask For NEW 48-PAGE Time-Saving Reference Data/Catalog on Magnetic Shielding Techniques & Problem Solving



## AD-VANCE MAGNETICS, INC.

226 E. SEVENTH ST., ROCHESTER, IND. 46975  
(219) 223-3158 TWX 810 290 0294

The Magnetic Shielding Specialists



CIRCLE NUMBER 75

# Quartz Crystals

1 to 200 MHz — AT CUT

Quality, stability, accuracy ... and delivery on precision made crystals. Produced to exact specifications in our own U.S. plant. Fast, dependable shipment for short orders or full production quantity runs.

COMMERCIAL  
O E M  
&  
MILITARY



UNITED STATES  
CRYSTAL CORP.

3605 McCart  
Fort Worth, Texas 76110  
(817) 921-3014  
TWX 910-893-4084

CIRCLE NUMBER 76

## KEEP

Electronic Design's

## GOLD BOOK

## HANDY

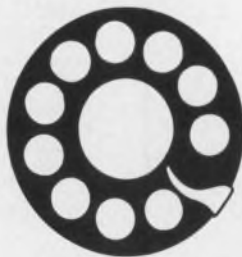

## When You Call

Save time when you contact suppliers. Check their catalog pages first in *Electronic Design's* GOLD BOOK. Maybe the information you need is right at your fingertips.

## NEW LITERATURE

### Microprocessors

A functional description of the EA 9002 8-bit  $\mu$ P, the  $\mu$ P's architecture including control flags, timing diagrams, I/O definitions, typical applications, an op-code map, the complete instruction set, and a list of available support items are included in a brochure. Electronic Arrays, Mountain View, CA

CIRCLE NO. 373

### Computer systems

A booklet describes the use of HP Model 3000 Series II systems in small-to-medium sized businesses. Hewlett-Packard, Palo Alto, CA

CIRCLE NO. 374

### Power supplies for $\mu$ Ps

Single, dual and triple-output power supplies suitable for powering logic circuitry, op amps and microprocessors are described in a 28-page catalog. Acopian, Easton, PA

CIRCLE NO. 375

### Semiconductor materials

Semiconductor materials and capabilities are described in a literature packet. Dow Corning, Midland, MI

CIRCLE NO. 376

### Batteries

A "Gel/Cell" catalog lists specifications for 30 battery types. A current vs time selection chart and discharge curves are included. Globe-Union, Milwaukee, WI

CIRCLE NO. 377

### Cascadable amplifiers

Thin-film cascadable amplifiers are described in a 20-page catalog. In addition to specifications and performance data on the TO-8 amplifier, attenuator and limiter models offered, the catalog includes mounting instructions, cascading rules and sections on reliability, screening and applications. Watkins-Johnson, Palo Alto, CA

CIRCLE NO. 378

# Electronic Design

ELECTRONIC DESIGN's function is:

- To aid progress in the electronics manufacturing industry by promoting good design.
- To give the electronic design engineer concepts and ideas that make his job easier and more productive.
- To provide a central source of timely electronics information.
- To promote communication among members of the electronics engineering community.

**Want a subscription?** ELECTRONIC DESIGN is sent free to qualified engineers and engineering managers doing design work, supervising design or setting standards in the United States and Western Europe. For a free subscription, use the application form bound in the magazine. If none is included, write to us direct for an application form.

If you do not qualify, paid subscription rates are as follows: \$30.00 per year (26 issues) U.S., \$40.00 per year (26 issues) all other countries. Single copies are \$2.00 U.S., \$3.00 all other countries. The Gold Book (27th issue) may be purchased for \$30.00 U.S. and \$40.00 all other countries.

If you change your address, send us an old mailing label and your new address; there is generally a postcard for this bound in the magazine. You will have to requalify to continue receiving ELECTRONIC DESIGN free.

**The accuracy policy of ELECTRONIC DESIGN is:**

- To make diligent efforts to ensure the accuracy of editorial matter.
- To publish prompt corrections whenever inaccuracies are brought to our attention. Corrections appear in "Across the Desk."
- To encourage our readers as responsible members of our business community to report to us misleading or fraudulent advertising.
- To refuse any advertisement deemed to be misleading or fraudulent.

Microfilm copies are available of complete volumes of ELECTRONIC DESIGN at \$19 per volume, beginning with Volume 1, 1952 through Volume 20. Reprints of individual articles may be obtained for \$3.00 each, prepaid (\$.50 for each additional copy of the same article) no matter how long the article. For further details and to place orders, contact the Customer Services Department, University Microfilms, 300 North Zeeb Road, Ann Arbor, Michigan 48106 telephone (313) 761-4700.

**Want to contact us?** If you have any comments or wish to submit a manuscript or article outline, address your correspondence to:

Editor  
ELECTRONIC DESIGN  
50 Essex Street  
Rochelle Park, N.J. 07662

# Better... ...across the board.



Our PLP-550 logic probe is internally programmed to select C-MOS, HTL, TTL/DTL logic. Stretch memory catches single, short pulses you can't see. Unique three lamp system gives you duty cycle information you'd otherwise need a scope to see. Next time out, take the Kurz-Kasch PLP-550 with you... and leave your scope back at the shop. Soon to be available are single and dual family probes in the same rugged, functionally designed package. Call or write.....



**Kurz-Kasch, Inc.**  
Electronics Division.

1501 Webster Street, P.O. Box 1246, Dayton, Ohio 45401 (513) 223-8161

CIRCLE NUMBER 77

## CUSTOM MICA CAPACITORS for Specialized Form Factors and Extremes of Environmental Resistance



CEM type mica capacitors are epoxy molded, using pour-mold under high vacuum to produce a void free assembly capable of operation in most severe environments.

The pour-mold technique also allows incorporation of curved surfaces, special mounting arrangements, and non-uniform shapes, for greater utilization of available system space, and usually, lighter weight assemblies.

Designers... Look:

- Moisture proof
- Shock proof
- High Corona resistance
- Unbreakable

To see how Custom Electronics can fill your requirements, write for FREE descriptive CEM Techni Tip, and general Techni Tip including sample of mica dielectric.

Send for FREE Product Brochures



**CUSTOM ELECTRONICS, Inc.**

4 Browne Street, Oneonta, N.Y. 13820  
PH: (607) 432-3880 TWX: 510-241-8292

CIRCLE NUMBER 78



**MINIATURE CERAMIC TRIMMER CAPACITORS** 9371 series of ceramic trimmer capacitors are compact, economical and rugged. They are 50% smaller than other trimmers of this type yet provide high capacitance values. Available in 4 capacitance ranges, 1.5 to 4, 3.0 to 10, 3.5 to 18 and 5.0 to 25 pf with Q's > 300 at 10 MHz. They have an overall diameter of .225" with .215" above board height. JOHANSON MANUFACTURING CORPORATION, Rockaway Valley Road, Boonton, N.J. 07005 201-334-2676

TRIMMER CAPACITORS

181

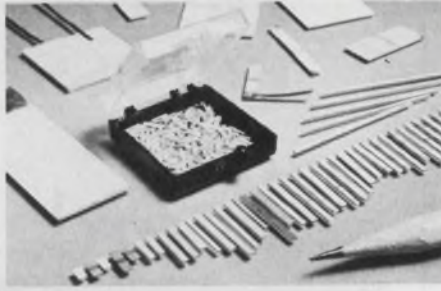

**Low Power Electromechanical And Acoustic Transducers** convert mechanical or acoustic to or from electrical energy. Applications include phono cartridges; microphones; head phones; delay lines; micropositioning and relays. E. Hanson, Gulton Industries Inc., Electronic Components Div., 212 Durham Ave., Metuchen, NJ 08804 (201) 548-2800

TRANSDUCERS

184

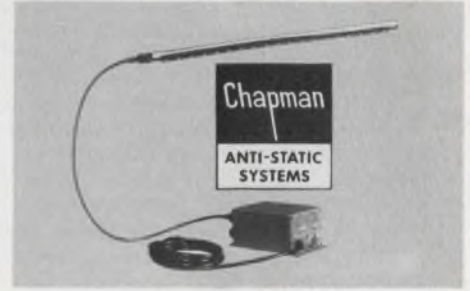

**ANTI-STATIC SYSTEMS FOR PRINTERS, OCR COM and other machines.** Static causes rapidly moving paper and film to jam. . . cause arc tracks on undeveloped film. . . attract and hold dust to photographic negatives causing imperfections on printed circuit boards. Numerous products, of interest to both OEM and user, are detailed in new 32 page catalog to solve these problems quickly, reliably and economically. Chapman Anti-Static Div., Portland Co., 58 Fore St., Bx 427, Portland, ME 04112. (207) 773-4726

ANTI-STATIC SYSTEMS

187



**Free New '76 catalog** contains over 34,500 quality power supplies from the world's largest manufacturer, Power/Mate Corp. Power Supplies for every application including submodulars, open frame, variorated, encapsulated, laboratory & system. All units UL approved and meet most military and commercial specs for industrial and computer uses. Power/Mate Corp., 514 S. River St., Hackensack, NJ 07601 (201) 343-6294

POWER SUPPLIES

182



**Basic Electricity & Basic Electronics** by Van Valkenburgh, Nooger & Neville, Inc. Derived from the COMMON-CORE Training Program initially developed for the U.S. Navy. Thorough, comprehensive coverage. Available in separate paperbacks or cloth volume. Write for FREE brochure. Hayden Book Co., Inc., 50 Essex St., Rochelle Pk, N.J. 07662 (201) 843-0550.

TRAINING TEXT

185



**HOW FAST IS SUPERFAST?** Not quite like a speeding bullet, but three working days is typical turnaround for hundreds of parts and kits that assemble into thousands of configurations to enclose your circuitry in style. Rack-mounting chassis units, card cages, portable instrument cabinets, subassembly housings, mini-consoles. For free literature, circle number below or phone TECHMAR OMNI-CLOSURE, 2232 So. Cotner Ave., Los Angeles, CA 90064. (213) 478-0046.

FREE CATALOG

188



**A high-reliability first.** The "2972" Card Reader is fully qualified for Airborne or Ground Support Equipment. Eliminates human error. Saves space. Competitive with other reliable programming methods. AMP Incorporated, Capiton Division, Elizabethtown, PA 17022. (717) 367-1105.

MIL SPEC STATIC CARD READER

183



**CMOS DIGITAL TIMERS** by General Time. Low prices enable their use in lieu of both low and high accuracy analog timers and many electromechanical timers.  $\pm 0.5\%$  typical repeat accuracy. On-delay, off-delay, and interval modes available in four different packages; AC and DC. Short reset, recycle and abort times; fast startup. From the industrial control specialists at Industrial Controls Division, General Time, Main Street, Thomaston, CT. 06787. Tel. (203) 283-5881. Telex 96-2445. Helpful literature available on request.

CMOS DIGITAL TIMERS

186

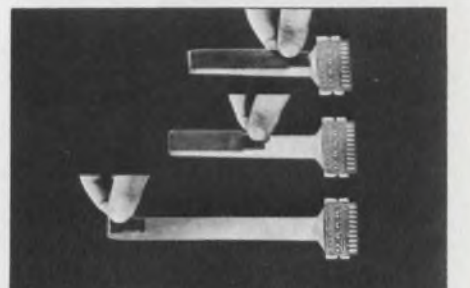

**When you want a flexible circuit** that doesn't just sit there, but really flexes—millions of times with complete reliability—then you want an R/flex flexible circuit from Rogers. Rogers has the know-how to make *flexible* flexible circuits to do your job. For help, write or call Rogers Corporation, Chandler, AZ 85224. Telephone: (602) 963-4584. (EUROPE: Mektron NV, Ghent, Belgium; JAPAN: Nippon Mektron, Tokyo)

FLEXIBLE FLEXIBLE CIRCUITS

189

# Electronic Design

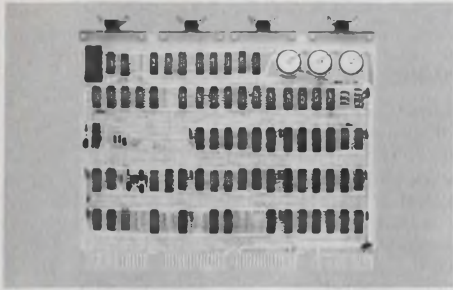

**The TCU-100**, a self-supporting timekeeper for a PDP-11, can give you the time as follows: month and day, hours and minutes, seconds. It can be initialized by simple commands from the computer and features rechargeable battery power for uninterrupted use when the computer is off, plus extensive interrupt capability. Price: \$495. For literature, write or call Digital Pathways, 4151 Middlefield Road, Palo Alto, CA 94306. (415) 493-5544.

SELF-SUPPORTING TIMEKEEPER 190



**MAGNETIC SHIELDING** Take advantage of Eagle's 23-year background in shield design and production. Custom and standard models. Full service includes design, engineering, fabrication, heat treating, finishing, testing. Also wide selection of sheet and foil so you can form your own shields. For helpful design and cost data, request Bulletin E-77. Eagle Magnetic Co., Inc., Box 24283, Indianapolis, IN 46224, 317-297-1030.

MAGNETIC SHIELDING 193



Why not try  
**SILVER?**  
FREE facts

**Solve some of your toughest production and research problems** with our highly conductive silver paints and glues. Just Ohm's Law and common sense. Thousands of users. Proven dependable for 26 years. Make wires, rf shields. Dependable contacts on plastic, skin, iron. Detect cracks, count, change pc boards and pots. Simplify, shrink, put one component on another. FREE 8-page crash course in saving with silver. Circle number below. Micro-Circuits, R1 Box 518, New Buffalo, Mi. 49117.

SILVER PAINT 191

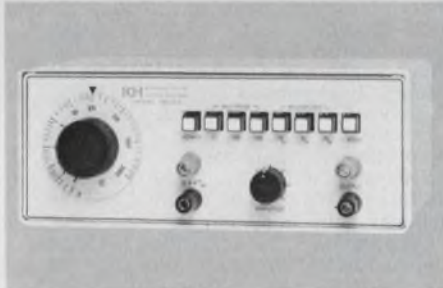

**Krohn-Hite Model 5800A** function generator, budget priced at \$245, offers sine, square and triangle waveforms over a range of 0.2 Hz to 2 MHz. Distortion is typically less than 0.3%. Simple 1000:1 frequency tuning dial. Pushbutton controls. 50-ohm output adjustable from 5 mv pk-to-pk to 15 volts. Auxiliary 1-volt pk-to-pk square wave output. Stock delivery. KROHN-HITE, AVON INDUST. PARK, AVON, MA 02322

FUNCTION GENERATOR 194



**HIGH RESOLUTION FREQUENCY SOURCE:** 0.5Hz to 50MHz, 50 ohm, TTL square wave output with high spectral purity and excellent short term stability (standard deviation typically better than 2 parts in 10<sup>7</sup> when measured over a 2 msec interval). Divided output may be set up to 7 decades lower than the output-to-counter allowing easy adjustment of frequencies to 6 places. Other features allow ext. control of freq. (1%) and freq. div. of an ext. source. MATEC, INC., 60 Montebello RD., Warwick, R.I. 02886. (401) 739-9030

FREQUENCY SOURCE 192



**Overcurrent Protector**, manual reset eliminates fuse replacement. Convenient panel mounting. 19 fractional ratings from 0.1 to 5 amp. Other models up to 400 amp. Trip-free and fool-proof, UL and CSA approved. High quality, low cost \$1.33 ea. in 1000 lots. E-T-A Products Co. of America, 7400 N. Croname Rd., Chicago, Ill. 60648. Tel: (312) 647-8303. Telex: 253780.

CIRCUIT BREAKER 195

## Advertising Sales Staff

Tom W. Carr, Sales Director  
Jean Bunfield, Sales Coordinator

## Rochelle Park, NJ 07662

Robert W. Gascoigne  
Daniel J. Rowland  
Thomas P. Barth  
50 Essex St.  
(201) 843-0550  
TWX: 710-990-5071

## Philadelphia

Thomas P. Barth  
(201) 843-0550

## Boston 02178

Gene Pritchard  
P.O. Box 379  
Belmont, MA 02178  
(617) 489-2340

## Chicago 60611

Thomas P. Kavooras  
Berry Conner, Jr.  
200 East Ontario  
(312) 337-0588

## Cleveland

Thomas P. Kavooras  
(312) 337-0588

## Los Angeles 90045

Stanley I. Ehrenclou  
Burt Underwood  
8939 Sepulveda Blvd.  
(213) 641-6544

## Texas

Burt Underwood  
(213) 641-6544

## San Francisco

Robert A. Lukas  
3579 Cambridge Lane  
Mountain View, CA 94040  
(415) 965-2636

## London

Constance McKinley  
50 Essex St.  
Rochelle Park, N.J. 07662  
Phone: (201) 843-0550

## Amsterdam, Tokyo, Seoul

Sanders, W. J. M.  
Raadhuisstraat 24  
Graft-De Ryp, Holland  
Phone: 02997-1303  
Telegrams: Euradteam-Amsterdam

Haruki Hirayama  
Electronic Media Service  
5th Floor, Lila Bldg.,  
4-9-8 Roppongi  
Minato-ku, Tokyo, Japan  
Phone: 402-4556  
Cable: Electronicmedia, Tokyo

Mr. O-kyu Park, President  
Dongbo Intl Corp.—  
World Marketing  
C.P.O. Box 4010  
Seoul, Korea  
Tel. 76-3910/3911  
Cable: DONGBO SEOUL  
Telex: EBKOREA K27286



# Advertiser's Index

Advertiser	Page	Advertiser	Page	Advertiser	Page
AMP, Incorporated	8, 9, 108	Grayhill, Inc.	100	Portland Co., Inc.	108
AVX Ceramics Corporation	65	Gulton Industries, Inc., Electronic Components	108	Power/Mate Corp.	108
Abbott Transistor Laboratories, Inc.	6	Harris Semiconductor	64F-G	Premier Metal Products Company	97
Ad-Vance Magnetics, Inc.	106	Hayden Book Company, The	*84, 96, *96F, 108	Projects Unlimited	96
Advanced Micro Devices	28, 29	Hewlett-Packard	1	RCA Solid State	Cover IV
American Optical Corporation	83	Honeywell Test Instruments Division	75	Ransco Industries Inc.	96A
Blake Wire & Cable Corp.	90	IMC Magnetics Corporation	92	Reader Service Card	112A-B
Bourns, Inc., Trimpot Products Division	Cover II	Industrial Controls Division, General Time	108	Reticon	81
Bunker Ramo, Amphenol Connector Division	34	Johannes Manufacturing Corp.	108	Rogers Corporation	108
CTS Corporation	59	Kennedy Co.	49	SGS Ates Semiconductor Corporation	27
Custom Electronics, Inc.	107	Kepeco, Inc.	30	Sangamo Capacitors, a Division of Sangamo Weston, Inc.	103
Cutler-Hammer, Specialty Products Division	Cover III	Krohn-Hite Corporation	109	Schauer Manufacturing Corp.	102
Daini Seikosa Co., Ltd.	91	Kurz-Kasch, Inc.	107	Shigoto Industries, Ltd.	85
Data General Corporation	21	Lear Siegler, Inc., E.I.D. Data Products Group	99	Signetics Corporation	82, 83, 85, 87, 89, 91, 93, 94, 95
Datak Corporation, The	89	Ledex, Inc.	84	Sorenson, A Raytheon Company	77
Deltron, Inc.	98	Magnetic Components Division, Control Data Corporation	93	Sprague Electric Company	73
Dialight, A North American Philips Company	47	Magnetic Shield Division, Perfection Mica Company	92	Stanford Applied Engineering Inc.	58
Digital Equipment Corporation	64A	Malco, A Microdot Company	64	TRW Capacitors, an Electronic Components Division of TRW, Inc.	71
Digital Pathways	109	Matec, Inc.	109	TRW/IRC Resistors, an Electronic Components Division of TRW, Inc.	64B-C
EECO	17	Micro-Circuits	109	TRW Power Semiconductors, an Electronic Components Division of TRW, Inc.	101
EMM Semi, A subsidiary of Electronic Memories & Magnetics Corp.	70	Micro Devices Corp.	105	Techmar Omniclosure	108
E-T-A Products Co. of America	109	Miller-Stephenson Chemical Co.	80	Tektronix, Inc.	23, 33
Eagle Magnetic Co., Inc.	109	*Molex, Incorporated	96B,C	Teledyne Relays, A Teledyne Company	2
Edmund Scientific Company	110	Motorola Communications & Electronics, Inc.	64D	Teledyne Semiconductor	38
Electronic Design	*96F, 111	Motorola Semiconductor Products, Inc.	4, 5, 48	Teletype Corporation	78
Electronic Measurements, Inc.	88	MuRata Corporation of America	82, 86	Trompeter Electronics, Inc.	105
Esterline Angus Instrument Corporation	87	National Semiconductor Corporation	11, 12, 13, 14	United States Crystal Corp.	106
GTE Sylvania, Parts Division	25	Nippon Electric Company, Ltd.	66	Valhalla Scientific	112
Gates Energy Products, Inc.	111	O.K. Machine & Tool Corporation	111	Vernitron Electrical Components	104
General Electric Company, Miniature Lamp Products Department	10	Optron, Inc.	7	Vishay Resistive Systems Group	64E
Gold Book, The	*96H, 105, 106	Philips Electronic Components	96G	Western Peripherals	64
Gold Inc., Instrument Systems Division	67	Photocircuits, Division of Kollmorgen Corporation	18, 19		
		*Plessey Semiconductors	96D-E		

\*Advertisers in non-U.S. edition

## Design Data from Manufacturers

Advertisements of booklets, brochures, catalogs and data sheets. To order use Reader-Service Card (Advertisement)



### GIANT FREE CATALOG

New 164-page catalog! Packed with 1,000's of hard-to-find buys in Optics, Science, Electronics. Loaded with optical, scientific, electronic equipment available from stock. Rare surplus buys. Many "one-of-a-kinds". Ingenious scientific tools. Components galore: lenses, prisms, wedges, mirrors, mounts, accessories. 100's of instruments: pollution test equipment, lasers, comparators, magnifiers, microscopes, projectors, telescopes, binoculars, photo attachments, alternate energy sources. Shop, save by mail! Request free Catalog "DA".

CIRCLE NUMBER 171

### Edmund Scientific Co.

America's Largest Science-Optics-Electronics Mart  
300 Edscorp Bldg., Barrington, New Jersey 08007 (609) 547-3488

## classified ads

### CASH FOR YOUR SCRAP

We buy scrap P.C. boards, connectors, modules, fingers, cutoffs and all other material containing gold, silver and platinum. No waiting for your money. We pay the freight. Send sample for quote and indicate number of pounds for sale.

ZONE INDUSTRIES  
719 North 12th St. — P.O. Box 371  
St. Charles, Illinois 60174

### MICROCOMPUTER RENTALS DEVELOPMENT HARDWARE SPECIALISTS

PROM Programmers  
Intellec 8's and 4's  
EXORcisers  
Pro-Log Analyzers

1562 Devonshire Ave.  
Westlake Village, CA. 91361  
Phone (213) 991-1704

**ok** wire-wrapping center



**ok**®

# wire wrapping center

your one stop shopping for quality electronic parts and tools.

50ft. wire roll



dip socket

Hobby-wrap tool



pre-stripped wire

**OK MACHINE & TOOL CORPORATION**  
3455 Conner St., Bronx, N.Y. 10475 / (212) 994-6600 / Telex 125091

CIRCLE NUMBER 81

# AUTHOR'S GUIDE

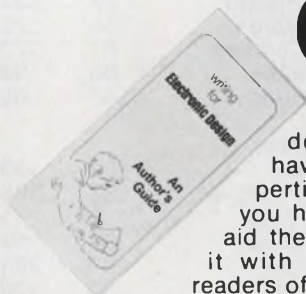

If you've solved a tricky design problem, if you have developed special expertise in a specific area, if you have information that will aid the design process... share it with your fellow engineer-readers of *Electronic Design*.

Articles you have authored not only raise your own professional status, but help build your company image as well. The readers benefit, your company benefits.

To help you prepare material that meets *Electronic Design's* high editorial standards, our editors have prepared a special author's guide entitled "Writing for *Electronic Design*." It covers criteria for acceptability, form, length, writing tips, illustrations, and payment for articles published. It's available without cost.

It's easy to write for *Electronic Design*, but it's often hard to get started. Send for your copy of our Author's Guide today.

**Circle No.**  
**250**

# Free!

Power advantage . . . economic advantage. Get full details on the energy future . . . new Gates rechargeable, sealed lead-acid batteries. Send today for our free, informative brochure containing exclusive battery features, application information, ratings and specifications. Find out what this new third-generation energy cell could mean to your design work.



**Energy Cells**  
EXCLUSIVE FEATURES  
APPLICATION INFORMATION  
RATINGS & SPECIFICATIONS

Yes! I would like to know more about these new energy cells. Please send free information.

Name \_\_\_\_\_

Title \_\_\_\_\_

Company \_\_\_\_\_

Address \_\_\_\_\_

City, State, Zip \_\_\_\_\_

Mail to: George Sahl,  
Gates Energy Products, Inc.  
1050 S. Broadway, Denver CO 80217



ED-116

**Where the energy future is now**

CIRCLE NUMBER 82

# Product Index

Information Retrieval Service. New Products, Evaluation Samples (ES), Design Aids (DA), Application Notes (AN), and New Literature (NL) in this issue are listed here with page and Information Retrieval numbers. Reader requests will be promptly processed by computer and mailed to the manufacturer within three days.

Category	Page	IRN	Category	Page	IRN
<b>Components</b>			multiplexers, IC 90 <b>338</b>		
audio indicators	96	<b>60</b>	op amps 90 <b>339</b>		
capacitors 71 <b>31</b>			regulator, TO-3 91 <b>342</b>		
capacitors, ceramic 65 <b>27</b>			regulators, voltage 91 <b>340</b>		
capacitors, ceramic 86 <b>46</b>			<b>Microprocessor Design</b>		
capacitors, electrolytic 58 <b>23</b>			analyzer, logic state 35 <b>508</b>		
capacitors, mica 107 <b>78</b>			$\mu$ C system 37 <b>510</b>		
display, LC 85 <b>323</b>			<b>Modules &amp; Subassemblies</b>		
display, numerical 86 <b>325</b>			amplifier, differential 102 <b>362</b>		
fans 92 <b>55</b>			amplifier, log 100 <b>357</b>		
filters, oscillators 91 <b>53</b>			converter, a/d 100 <b>360</b>		
fluorescent displays 66 <b>28</b>			driver, synchro 100 <b>359</b>		
ground-fault detectors 84 <b>321</b>			graphics module, $\mu$ P 102 <b>363</b>		
ladder networks 86 <b>327</b>			temp controller 100 <b>358</b>		
lamps 10 <b>8</b>			thermocouple reference 102 <b>361</b>		
passive components 73 <b>151</b>			<b>Packaging &amp; Materials</b>		
position sensor 85 <b>324</b>			aerosols 80 <b>36</b>		
potentiometers II <b>252</b>			barriers, thermoplastic 104 <b>69</b>		
potentiometers, linear 84 <b>320</b>			blower, air 87 <b>328</b>		
quartz crystals 106 <b>76</b>			bus strip 89 <b>334</b>		
reflective transducers 7 <b>6</b>			cabinets and cases 97 <b>62</b>		
relays 2 <b>3</b>			cable clamps 89 <b>335</b>		
resistor networks 59 <b>24</b>			connectors 9 <b>7</b>		
resistor networks 85 <b>326</b>			connectors 104 <b>71</b>		
switch modules 84 <b>43</b>			connectors, PC 25 <b>13</b>		
switch, rotary 100 <b>65</b>			DIP sockets, hi temp 87 <b>330</b>		
switches, subminiature III <b>253</b>			electronic kits (NL) 87 <b>330</b>		
switches, toggle 85 <b>322</b>			fiber optics catalog 83 <b>40</b>		
trimmers 82 <b>39</b>			gaskets, shielding 88 <b>332</b>		
<b>Data Processing</b>			guides, PC card 89 <b>33</b>		
communication system 21 <b>11</b>			interconnections 19 <b>10</b>		
controllers 64 <b>25</b>			magnetic shielding 92 <b>56</b>		
disc controller 93 <b>346</b>			socket, PC board 88 <b>331</b>		
mag tape system 97 <b>352</b>			terminal boards 64 <b>26</b>		
PROM programmer 93 <b>344</b>			tool, cable cutting 87 <b>329</b>		
paper tape punch 97 <b>351</b>			wire and cable 90 <b>52</b>		
printer, impact 93 <b>345</b>			wrapped wiring 103 <b>68</b>		
tape system 75 <b>33</b>			<b>Power Sources</b>		
teleprinter 78 <b>35</b>			energy cells 103 <b>69</b>		
<b>Discrete Semiconductors</b>			power stabilizer, ac 83 <b>308</b>		
LEDs 47 <b>20</b>			power supplies 6 <b>5</b>		
npn, pnp devices 5 <b>4</b>			power supplies 93 <b>57</b>		
photocells 98 <b>354</b>			power supply 82 <b>304</b>		
photoemitter/detector 98 <b>356</b>			power supply 82 <b>306</b>		
power Darlingtons 27 <b>14</b>			power supply 83 <b>307</b>		
power Schottkys 101 <b>66</b>			power supply 83 <b>309</b>		
thyristors 98 <b>355</b>			power supply 98 <b>63</b>		
zener diodes 98 <b>353</b>			switcher 82 <b>305</b>		
<b>Instrumentation</b>			<b>new literature</b>		
amplifier 81 <b>302</b>			computer systems 106 <b>374</b>		
bridge 81 <b>303</b>			crimping tool 104 <b>366</b>		
DMM 33 <b>212</b>			electronic kits 104 <b>371</b>		
DMM, 4-1/2 digit 112 <b>80</b>			microprocessors 106 <b>373</b>		
logic probe 107 <b>77</b>			power supplies for $\mu$ Ps 106 <b>375</b>		
oscilloscope 79 <b>301</b>			resistor networks 104 <b>372</b>		
<b>Integrated Circuits</b>			semiconductors 104 <b>369</b>		
amplifier, voltage-cont. 90 <b>336</b>			test instruments 104 <b>367</b>		
HiNiL 38 <b>19</b>					
IC 92 <b>343</b>					
ICs 90 <b>337</b>					
ICs, video game 91 <b>341</b>					
image sensors 81 <b>37</b>					
memories 70 <b>30</b>					

**A PORTABLE  
4 1/2 DIGIT  
MULTIMETER  
FOR \$299.  
A 10 MHZ  
COUNTER OPTION  
FOR \$50.**



**VALHALLA  
SCIENTIFIC**  
7707  
CONVOY COURT  
SAN DIEGO,  
CALIF. 92111  
714-277-2732  
**WHAT MORE  
CAN WE SAY?**

CIRCLE NUMBER 80

# New "Cricket" sub-miniatures: Interchangeability plus full 6 amp rating.

Cutler-Hammer introduces a broad new line of quality sub-miniature switches whose specifications meet industry standards for size, terminal spacing and bushing height. They're rated 6 amps. They're fully interchangeable. They feature high torque bushings. They're competitively priced. And they're available right now. For more information on new, interchangeable sub-miniature switches, call your Cutler-Hammer sales office or Stocking Distributor. Just ask for "Cricket."

**Flat Lever.** Designed for comfortable, finger-tip control. Keyed bushing prevents switch rotation.



**Lever Lock.** Locks in position to assure precise control of vital or sensitive functions and equipment. No accidental operation.

**Watertight.** Toggle or pushbutton. "O" ring seal shuts out dirt and moisture. Keeps switch mechanism dry in adverse environments.



**Mod Cap.** White, red and black color-tipped caps let you choose and vary your operational coding.

**Rockers.** Sub-panel or snap-in. Variety of paddle or low-profile styles. With decorative bezels. Also with L.E.D. for illuminated functions.



**Wirewrap.** Gold plated terminals in .750 and .964" lengths to satisfy power or dry circuit requirements.



**Printed Circuit.** Toggle or pushbutton. Fits standard printed circuit board mounting dimensions. Right angle and vertical mounting.



**Standard.** Toggle or pushbutton. One to four poles. Eight circuits. Two decorator cap styles in a variety of colors. Dry circuit capability, too.



 **Switch to No.1**

**CUTLER-HAMMER**  
SPECIALTY PRODUCTS DIVISION, Milwaukee, Wis. 53201



23 Part I approvals in 13 months ...

# Acceptance of High Rel COS/MOS is climbing fast.

In rapid succession, 23 RCA COS/MOS circuits have become the first CMOS devices to pass the rigorous environmental and life-test requirements for QPL-38510, Part I Qualification. That's just more evidence of the inherent reliability of COS/MOS.

It means you can buy with even greater confidence. And if you buy for military or other high-reliability applications, you have a wide range of options. The approved list includes gates, multi-vibrators, binary ripple and synchronous counters, and multiplexers/demultiplexers.

It also means you have the assurance of a dependable High Rel source. With a disciplined organization. Tightly controlled environments and processes. And a wholehearted commitment to High Rel COS/MOS.

You'll see the results of this commitment in our latest High Rel data book (SSD-230), just off the press. Contact your local RCA Solid State distributor. Or RCA.



RCA No.	MIL-M-38510/	RCA No.	MIL-M-38510/
CD4000A	05201	CD4017A	05601
CD4001A	05202	CD4018A	05602
CD4002A	05203	CD4019A	05303
CD4007A	05301	CD4020A	05603
CD4009A	05501	CD4021A	05704
CD4010A	05502	CD4022A	05604
CD4011A	05001	CD4023A	05003
CD4012A	05002	CD4024A	05605
CD4013A	05101	CD4025A	05204
CD4014A	05702	CD4027A	05102
CD4015A	05703	CD4049A	05503
		CD4050A	05504

Write: RCA Solid State, Box 3200, Somerville, N.J. 08876; Sunbury-on-Thames, Middlesex TW16 7HW, England; Ste. Anne de Bellevue H9X 3L3, Canada; Fuji Building, Tokyo, Japan.

# RCA

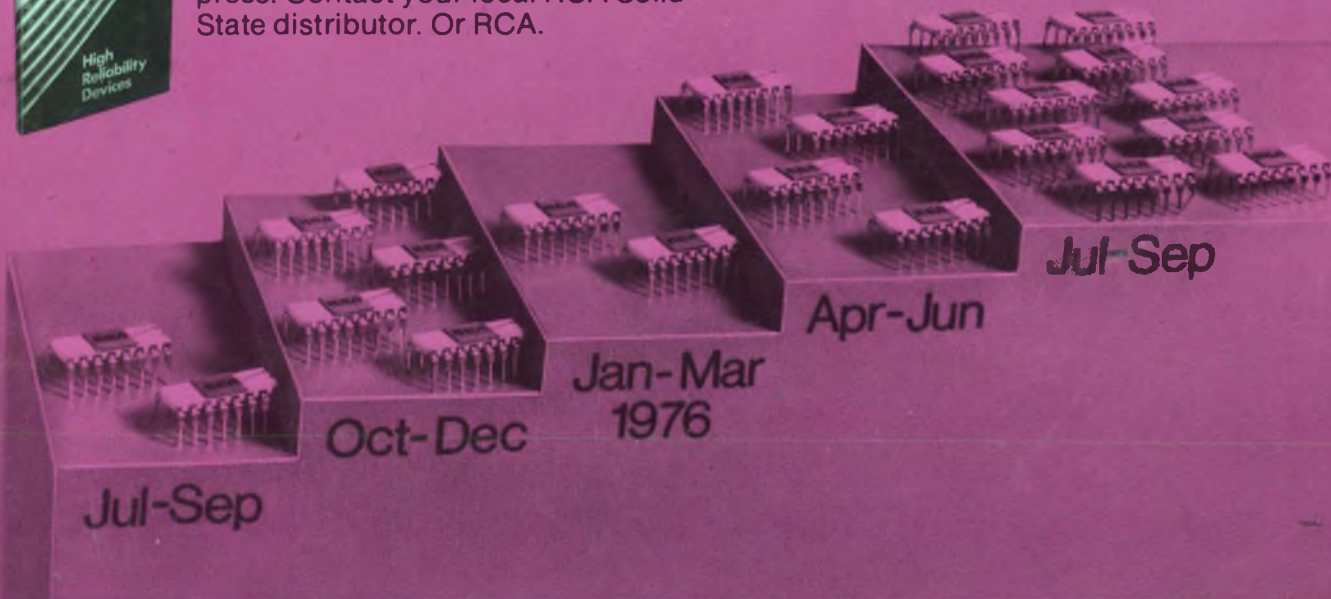

RCA. First house in CMOS.