

Electronic Design 21

VOL. 24 NO.

FOR ENGINEERS AND ENGINEERING MANAGERS

OCT. 11, 1976

Lasers are lighting the way to applications once thought of as science fiction. Memories, fusion, wide band communications, and laser radar are some examples of

the newer applications. Laser technology is making strides in diode, ion, chemical and other laser types. To be enlightened, beam coherently over to p. 24.

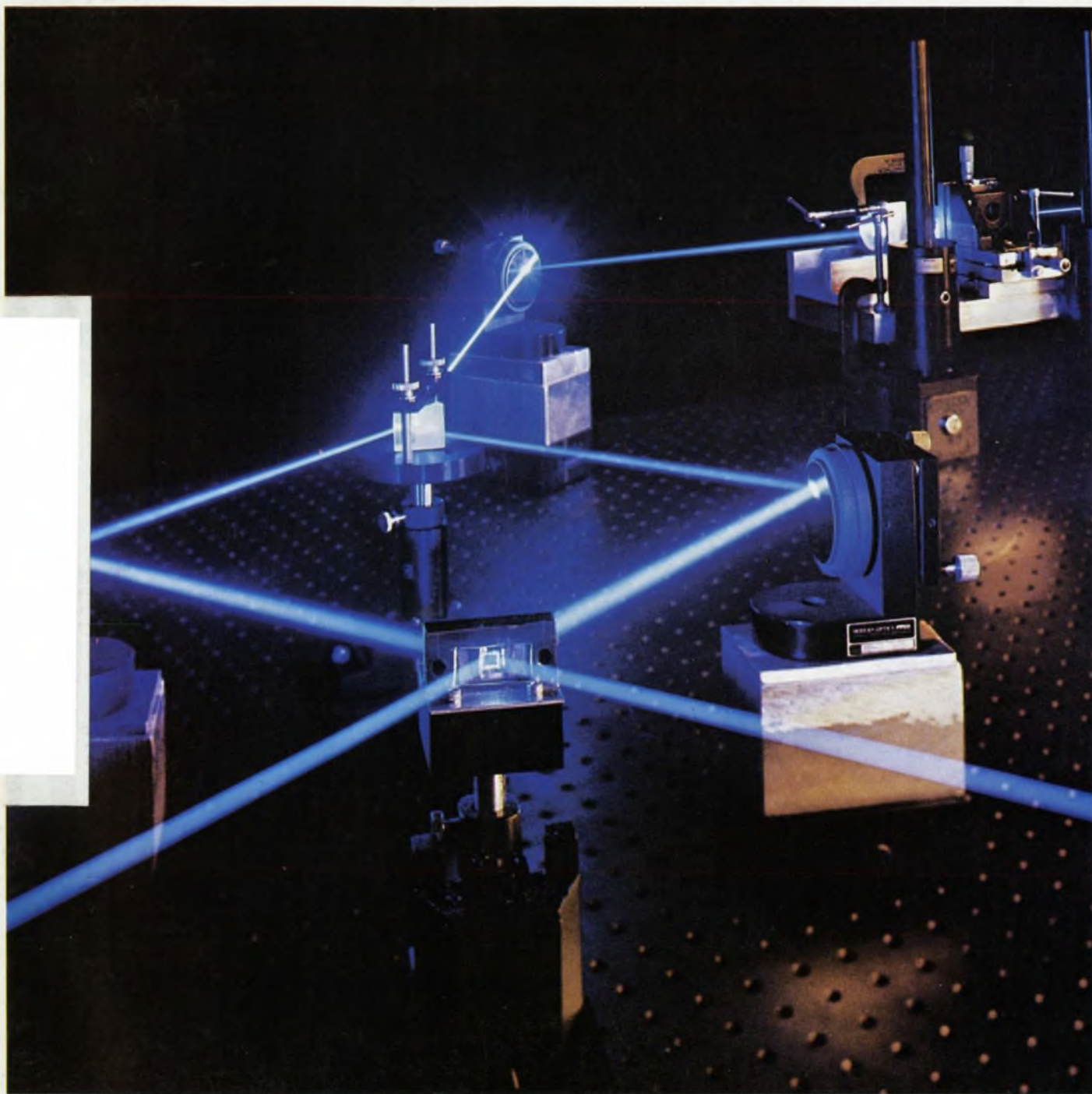

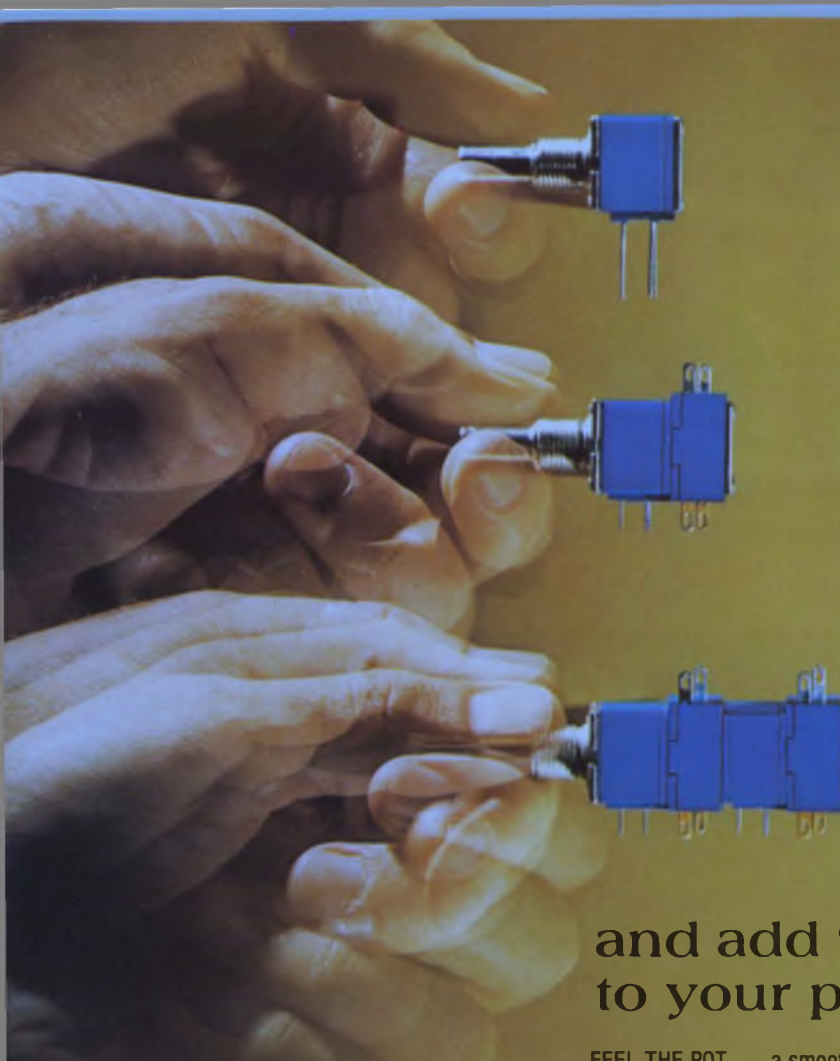

FEEL
the pot ...

CLICK
the switch ...

GANG
the modules ...

and add "quality-touch" appeal to your product.

FEEL THE POT . . . a smooth, quality feel, only from Bourns® 81/82 Model Potentiometers. Rotational torque range, only .3 to 2.0 oz. inch, is consistent for one, two, three or four cup assemblies.

Independent linearity of $\pm 5\%$ and low 1% CRV provide exceptional setability in both cermet and conductive plastic element types.

CLICK THE SWITCH* . . . one that really clicks, with positive action detent at either CW or CCW end. The Bourns Model 85/86 potentiometer/switch combination is rated at 2 amps in DPST style and 1 amp in DPDT. Contacts are constructed of fine silver with gold overlay. This provides exceptionally low contact resistance, for reliable operation at low level analog or logic signal levels — or any application requiring an "on-off" function.

GANG THE MODULES . . . potentiometers and switches. Up to 4 modules can be ganged on the same single or dual concentric shaft, without sacrifice to the satin-smooth feel or the sure-fire click. Other options include a wide choice of bushing and shaft styles, P.C. pins or solder lugs. Think of the possibilities! Now you can specify custom pots and switches assembled from "off-the-shelf" modules — at standard cost and leadtime.

Add "quality-touch" appeal to your equipment with BOURNS Model 80 Family of Modular Potentiometer/Switches. Write or call today for complete technical information, direct or through your Bourns distributor.

FEEL, CLICK, GANG . . . BEAUTIFUL!

TRIMPOT PRODUCTS DIVISION, BOURNS, INC., 1200 Columbia Avenue, Riverside, California 92507, Telephone (714) 781-5122 — TWX 910 332-1252.

*Patent pending

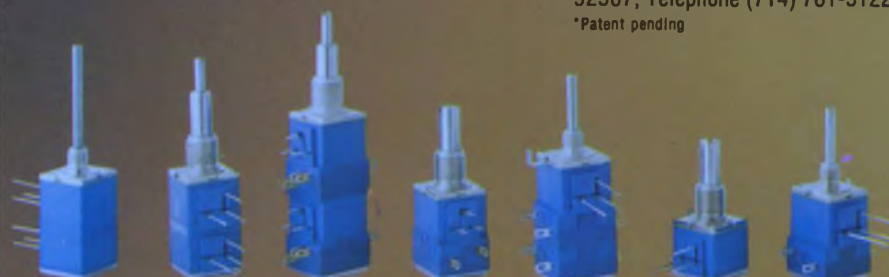

Int'l Sales Offices: European Hdqtrs. — Switzerland, 042/23 22 42 • Belgium 02/218 2005 • France 01/2039633 • Germany 0711/24 29 36
• Italy 02/32 56 88 • Netherlands 070/88 93 18 • United Kingdom 01/572 6531 • Japan 075 92 1121 • Australia 86 9410 • Brazil 257-3535

CIRCLE NUMBER 262

New Sangamo Type 101 Aluminum Electrolytic Capacitors for up to 100 kHz filtering in Switching Power Supplies: **COOLER PERFORMANCE.**

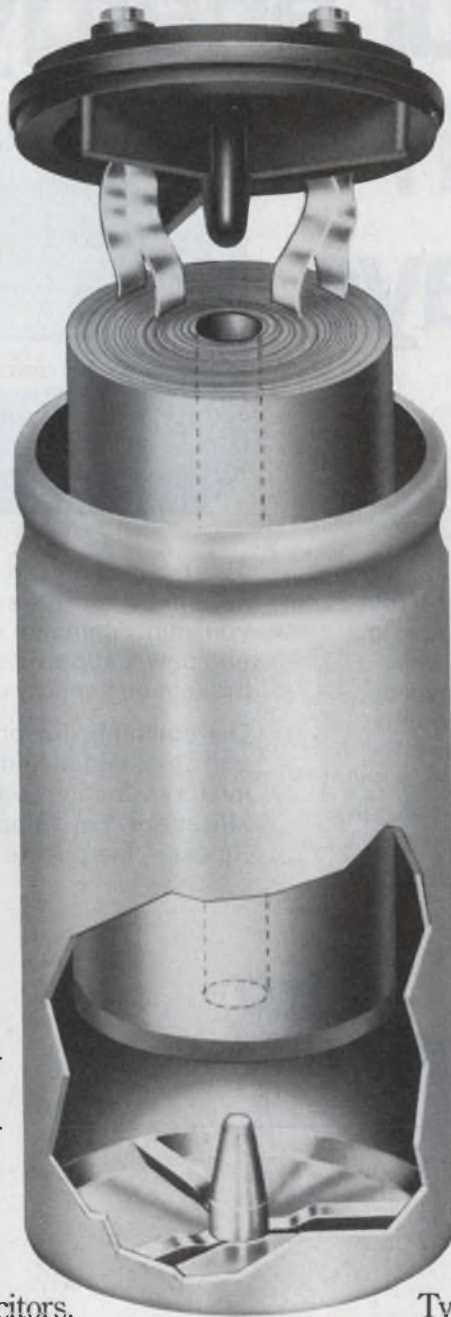

When you need longer-life capacitors for your higher-frequency (10 to 100 kHz) switching regulator power supply — play it cool.

Look into new, cooler-operating Sangamo Type 101 Computer-Grade Aluminum Electrolytic Capacitors.

Their unique Thermal Pack™ case mechanically secures the internal wound section. And compresses the extended conducting cathode foil into metal-to-metal contact with the aluminum case bottom.

Results: Rugged construction. No need for potting compound. Less weight. More volume for gas expansion. And vastly improved heat transfer and dissipation, for cooler performance.

Get high capacitance, low impedance, high ripple current capability — and economy —

Type 101 Capacitors Electrical/Mechanical Specifications

| | |
|--|---|
| Capacitance Range | 450 uF to 465,000 uF |
| ESR Values at 20 kHz | .0048 ohms to .040 ohms |
| Max. Ripple Current Capability at 20 kHz | 40 amps at 65°C; 31.4 amps at 85°C |
| Operating Temperature Range | -55°C to +85°C |
| Voltages Available | 5 to 100 VDC |
| Nominal Case Sizes | 1.375" x 1.625" (34.93 mm x 41.28 mm) to 3.000" x 5.625" (76.2 mm x 142.88 mm) |
| Terminal Connections | Standard threaded insert type |
| External Insulation | Uniform polypropylene coating |

in a great new case. Specify Sangamo Type 101 Computer-Grade Capacitors.

Write for complete specs and engineering samples.

Sangamo Capacitor Division, Box 128, Pickens, SC 29671; phone: (803) 878-6311; TWX: 810-397-2496; Telex: 57-0441.

SANGAMO CAPACITORS

A DIVISION OF SANGAMO WESTON, INC.



TO-5 RELAY UPDATE:

Solve your energy crisis with TO-5 relays

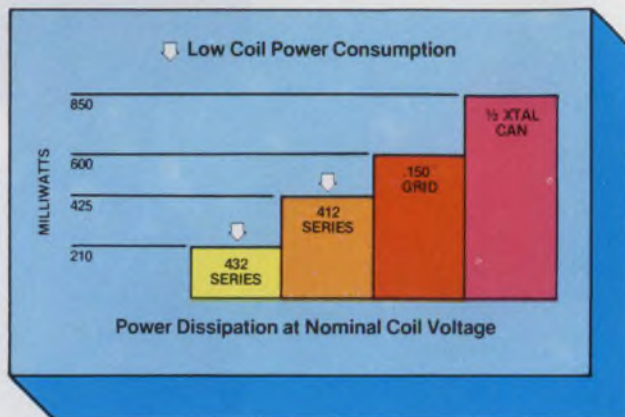

Subminiaturization and pc board compatibility — two obvious advantages of Teledyne TO-5 relays. But there's another outstanding advantage: low coil power consumption. This feature is best illustrated in the above graph which shows our TO-5 relay power savings compared to other miniature relays. The Teledyne 412 Series dissipates about 30% less power than the .150" grid relay, and 50% less than the 1/2 crystal can. Our sensitive 432 Series is 65% less than the .150" grid. And 75% less than the 1/2 crystal can.

This means you can save over 6 watts in a typical system using, let's say, ten TO-5 relays. In the end, you gain significant advantages in terms of thermal and power supply considerations that can help prevent an "energy crisis" in your system.

Our complete line of TO-5 relays includes military and commercial/industrial types, with virtually all military versions qualified to established reliability MIL specs. For complete data, contact Teledyne Relays — the people who pioneered the TO-5 relay.

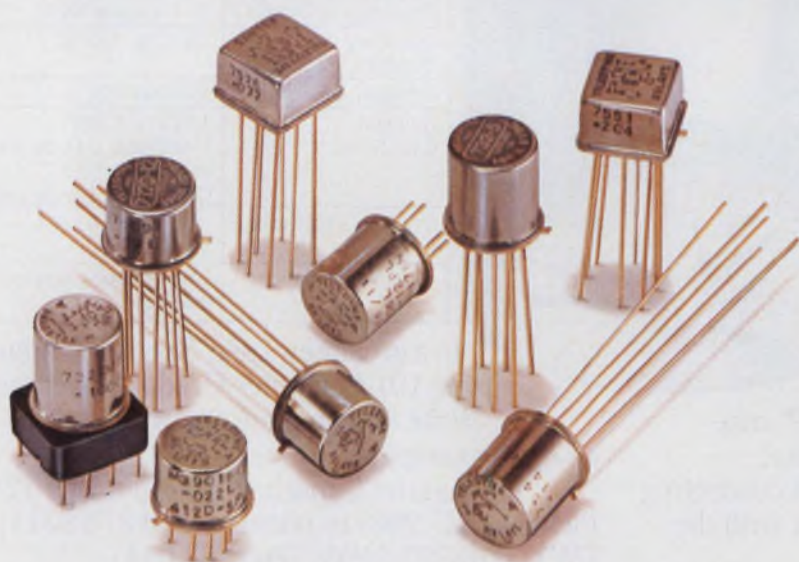

- **Hybrid "T" Series**
SPDT & DPDT types with internal transistor driver and suppression diode
- **"D" and "DD" Series**
Military and commercial/industrial versions with internal suppression and steering diodes
- **Maglatch Series**
SPDT, DPDT, and 4PST magnetic latching types
- **Centigrad® Series**
World's smallest relay — only .225" (5.72mm) high x .370" (9.40mm) square
- **Hi-Rel Series**
Screened versions for space flight applications (NASA qualified)
- **High Environment Series**
Hi-temperature, Hi-shock, and Hi-vibration types

 **TELEDYNE RELAYS**

3155 West El Segundo Boulevard, Hawthorne, California 90250
Telephone (213) 973-4545

CIRCLE NUMBER 3

NEWS

- 19 **News Scope**
- 24 **Lasers are being used in a host of new applications**, including communications systems, nuclear fusion, video discs, supermarket scanners and pollution monitors. An Electronic Design special report.
- 35 **Washington Report**

TECHNOLOGY

- 41 **MICROPROCESSOR DESIGN**
- 52 **Consider solid-state photodetectors** for your next sensing application. But check these pointers on how they work and how best to apply them.
- 62 **Control an LP-filter's cutoff frequency** electronically. Cover a 20:1 range with a digital control that can be linearized and set with a thumbwheel switch.
- 68 **Avoid failure of PC board components** by limiting the circuit board's vibration under stress. Make the board stiffer, if necessary, to cut down movement.
- 72 **Orion Hoch of AMS** speaks on making your engineers responsible.
- 78 **Ideas for Design:**
Control logic for μ P enables single-cycle operation.
Get precise voltage division without precision parts.
Precision voltage-to-frequency converter uses only single supply voltage.
- 84 **International Technology**

PRODUCTS

- 87 **Instrumentation:** Wideband rf amplifier offers best gain flatness.
- | | |
|----------------------------|-------------------------|
| 90 Packaging & Materials | 102 Data Processing |
| 94 Power Sources | 108 Integrated Circuits |
| 93 Modules & Subassemblies | 111 Components |

DEPARTMENTS

- 49 **Editorial:** Teaching the horse not to eat
- | | |
|--------------------|--------------------------------|
| 7 Across the Desk | 118 Advertisers' Index |
| 112 New Literature | 120 Product Index |
| 114 Bulletin Board | 120 Information Retrieval Card |
| 114 Vendors Report | |

Cover: Photo by Bob Bachus, courtesy of Aerospace Corp., El Segundo, CA.

Now AMP's most versatile interconnection system is even more so.

We've added a whole family of pin headers.



Top performance in a tiny space. AMPMODU posts, receptacles and headers make your packaging designs as tight as necessary.

We've also made it easier to place pins on a board. Forget about positioning pins one at a time. Forget costly front-end insertion equipment. Because AMP engineering ability shows up in our recently introduced AMPMODU pin headers.

Pins are fully protected. Headers are polarized and have self-retention locking latches. Headers fit everywhere on a board, including board center.

Ten basic header styles offer several thousand possible variations. You can approach mass termination with AMPMODU headers. Up to 80 positions.

These headers now complement the AMPMODU interconnection system, which features dual cantilever spring beams in the receptacle, five basic contact types and board to board or board to wire versatility. The forgiving nature of the receptacle design also ensures a uniform, positive electrical contact with the mating posts, everytime.

At AMP our application, service and sales engineers are located throughout the world, and are ready to help you with prototyping as well as providing a complete after-sale service.

For more facts about AMPMODU headers, write or call Customer Service. (717) 564-0100. AMP Incorporated, Harrisburg, PA 17105.

SEE US AT
MILAN BIAS SHOW

AMP
INCORPORATED

CIRCLE NUMBER 4

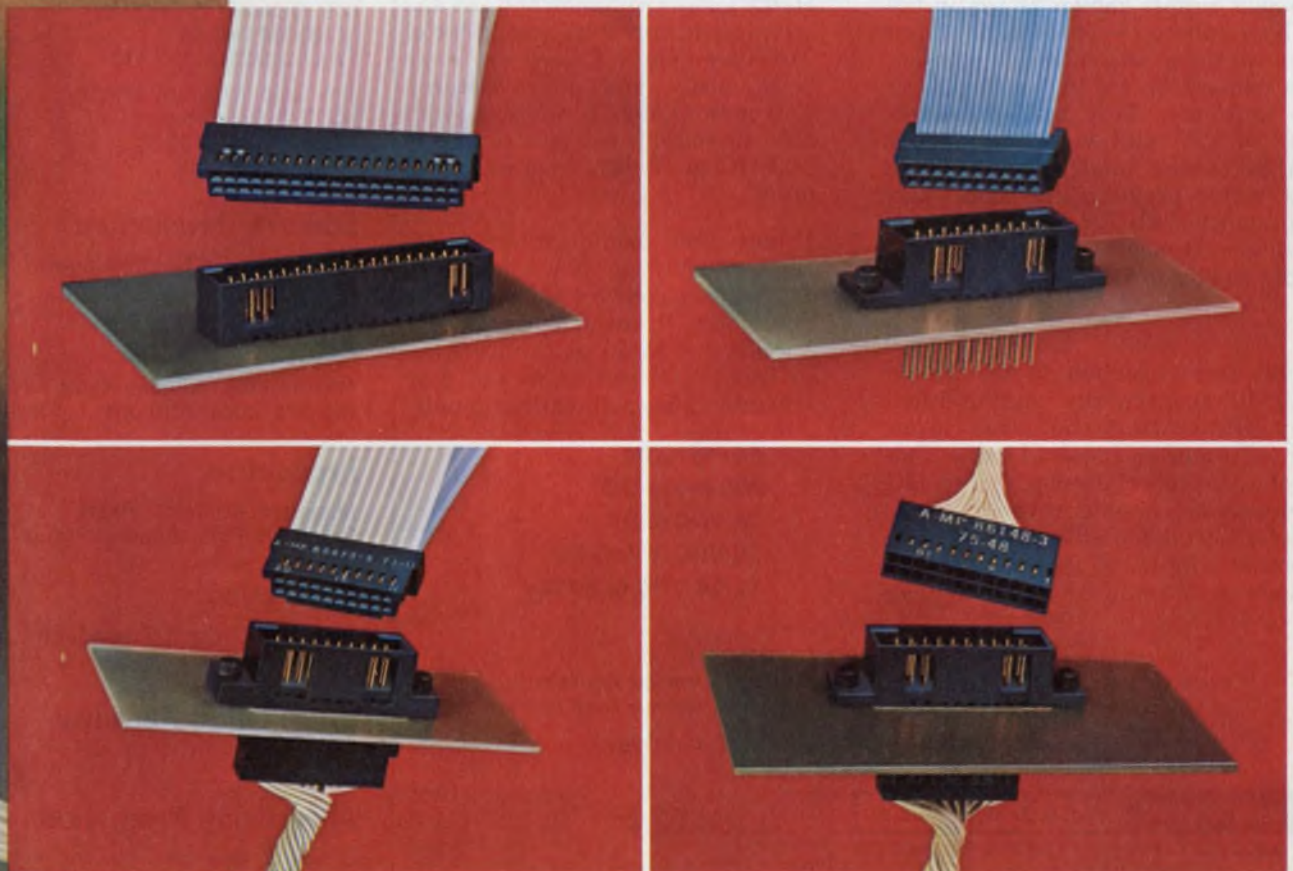

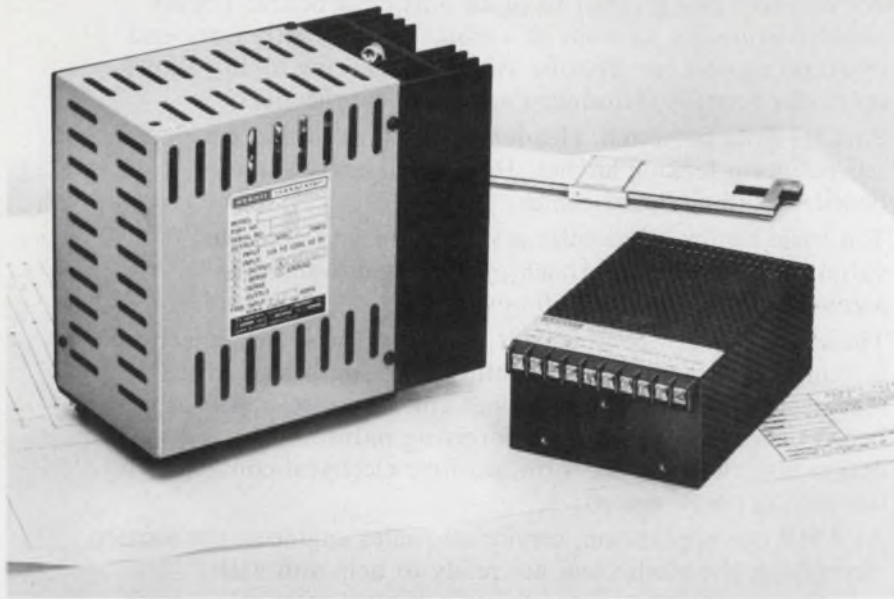

Reduce Your Power Supply Size and Weight By 70%

A new way has been found to substantially reduce power supply size and weight. Consider the large power supply shown at left in the above photo — it uses an input transformer, into a bridge rectifier, to convert 60 Hz to 5 volts DC at 5 amperes. This unit measures 6½" x 4" x 7½" and weighs 13 pounds. Abbott's new model Z5T10, shown at right, provides the same performance with 70% less weight and volume. It measures only 2¼" x 4" x 6" and weighs just 3 pounds.

This size reduction in the Model Z5T10 is primarily accomplished by eliminating the large input transformer and instead using high voltage, high efficiency, DC to DC conversion circuits. Abbott engineers have been able to control the output ripple to less than 0.02% RMS or 50 millivolts peak-to-peak

maximum. This design approach also allows the unit to operate from 100 to 132 Volts RMS and 47 to 440 Hertz. Close regulation of 0.15% and a typical temperature coefficient of 0.01% per degree Celsius are some of its many outstanding features. This new Model "Z" series is available in output voltages of 2.7 to 31 VDC in 12 days from receipt of order.

Abbott also manufactures 3,000 other models of power supplies with output voltages from 5 to 740 VDC and with output currents from 2 milliamps to 20 amps. They are all listed with prices in the new Abbott catalog with various inputs:

60 A to DC
 400 A to DC
 28 VDC to DC
 28 VDC to 400 A
 12-28 VDC to 60 A

Please see pages 1836-1848 of your 1976-77 EEM (ELECTRONIC ENGINEERS MASTER Catalog) or pages 676-682 Volume 2 of your 1976-77 GOLD BOOK for information on Abbott Modules.

Send for our new 60 page FREE catalog.

abbott transistor
 LABORATORIES, INCORPORATED

GENERAL OFFICES
 5200 W. Jefferson Blvd.
 Los Angeles, CA 90016
 (213) 936-8185
 Telex 69-1398

EASTERN OFFICES
 1224 Anderson Ave.
 Fort Lee, NJ 07024
 (201) 224-6900
 Telex 13-5332

CIRCLE NUMBER 5

Sr. Vice President, Publisher
 Peter Coley

Editors

Editorial Offices
 50 Essex St.
 Rochelle Park, NJ 07662
 (201) 843-0550
 TWX: 710-990-5071
 Cable: Haydenpubs Rochellepark

Editor-in-Chief George Rostky

Managing Editors:

Ralph Dobriner
 Michael Elphick

Senior Associate Editor

Stanley Runyon

Associate Editors:

Sid Adlerstein
 Dave Bursky
 Samuel Derman
 Jules H. Gilder
 Morris Grossman
 John F. Mason
 Michael Shunfenthal

Contributing Editors:

Peter N. Budzilovich, John Kessler
 Alberto Socolovsky, Nathan Sussman

Editorial Field Offices

East

Jim McDermott, Eastern Editor
 P.O. Box 272
 Easthampton, MA 01027
 (413) 527-3632

West

David N. Kaye, Senior Western Editor
 8939 S. Sepulveda Blvd., Suite 510
 Los Angeles, CA 90045
 (213) 641-6544
 TWX: 1-910-328-7240

Jim Gold, Western Editor
 1537 Shasta Ave.
 San Jose, CA 95128
 (408) 279-8588

Editorial Production

Marjorie A. Duffy, Production Editor
 James Keane, Copy Editor

Art

Art Director, William Kelly
 Richard Luce, Anthony J. Fischetto

Production

Manager, Dollie S. Viebig
 Helen De Polo, Anne Molfetas

Circulation

Director, Barbara Freundlich
 Trish Edelmann

Information Retrieval

Peggy Long

Advertising Promotion

Susan G. Apolant

Across the Desk

Converter series includes several useful features

On p. 172 of the June 7 issue of *ELECTRONIC DESIGN*, you featured an 8-channel R/D converter. Since *ELECTRONIC DESIGN* has a reputation and policy of comparing competitive units, I was surprised you did not mention DDC's hybrid synchro or resolver converters in the story.

We at DDC have a similar product, the Model HMSDC series, that has been available for over three years. It is far superior to the MN7200 in that it features simultaneous sampling, 150 μ s conversion time, single-line-per-channel addressing, a temperature range of -55 to +105 C. It also can accommodate multiple references with mixed frequencies and different line-to-line voltage levels.

For full data Circle No. 319

Steve Muth

Marketing Product Manager

ILC Data Device Corp.

Airport International Plaza
Bohemia, LI, NY 11716

ED issue may inspire youth to greater glories

Your "200 Years of Progress" issue of Feb. 16, 1976, merits sincere congratulations for a job well done. This year, when "Bicentennial" has too often become distorted to "Buy-centennial," your issue provides a refreshing assurance that our past can be portrayed with the justifiable pride it deserves without displaying Old Glory on a beer can or bumper sticker.

I hope copies of this issue will find their way to reference shelves where future young scientists may receive inspiration to say "But, folks, you ain't seen nothin' yet!"

In the interests of accuracy, and without being too critical, I'd like

to call attention to the statement on page 121 that "Telstar settled into a nearly perfect orbit, in which the satellite appeared to hover over the same spot." Unfortunately, that is inaccurate, since a synchronous orbit of about 22,000 miles is implied. Telstar had an apogee of 3503 miles, a perigee of 593 miles, and a period of 157.8 minutes.

Syncom, by Hughes, in February, 1963 became the first to achieve synchronous orbit, but without operating. Syncom 2, in July, 1963, followed by Syncom 3 in August, 1964, both achieved synchronous orbits and operated. Many have followed since then to this most useful position in space.

As one of a team of General Electric engineers working in 1960 to develop a synchronous satellite called Advent, I remember the arguments between recognized experts of orbital mechanics as to whether a stable, synchronous orbit was possible or whether it was a theoretical "knife edge" condition that could neither be attained nor sustained.

Name Withheld

Inaccuracies disputed in exchange on hybrid amp

In your June 7 issue (ED No. 12, p. 32) Fred Pouliot of Analog Devices generated inaccuracies of his own in attempting to correct the "inaccuracies" that appeared in the new product story "Hybrid Isolation Amplifiers Avoid Transformers but Maintain Isolation" (ED No. 2, Jan. 19, 1976, p. 91).

He stated that the Model 275 requires a board area of 8.75 in.² and has a volume of 7.79 in.³. The combined figures for the Burr-Brown 3650 isolation amplifier and

(continued on page 10)

Electronic Design welcomes the opinions of its readers on the issues raised in the magazine's editorial columns. Address letters to Managing Editor, Electronic Design, 50 Essex St. Rochelle Park, N.J. 07662. Try to keep letters under 200 words. Letters must be signed. Names will be withheld on request.



OPTRON OPTICALLY COUPLED ISOLATORS

NEW HIGH ISOLATION VOLTAGE
"DIP" SERIES OFFERS
HIGH TRANSFER RATIO

Now, OPTRON provides a 5 kV isolation voltage capability for its standard six pin plastic dual-in-line isolators. A new, unique internal design allows high voltage isolation while still maintaining a high current transfer ratio. The 5 kV DC or 3750 rms AC feature is available for all devices in OPTRON's popular OPI 2100 and OPI 3100 series.

OPTRON's extended "DIP" series includes JEDEC types 4N25 through 4N38A, features complete interchangeability with popular industry types and provides an inexpensive coupler for every application. Devices are available with isolation voltages of 1500, 2500 or 5000 volts with minimum current transfer ratios ranging from 2.0 to 500%.

OPTRON's "DIP" and a full line of other isolator packages with isolation voltages to 50 kV provide the versatility required for maximum electrical and mechanical design flexibility.

1.5 kV isolation with 60% current transfer ratio. Phototransistor base lead available. Hermetic TO-5 package.



OPI 102

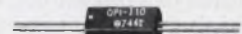

OPI 110

10 kV isolation and 40% current transfer ratio. 4 μ sec switching time in low cost miniature plastic package.

Detailed technical information on "DIP" and other isolators as well as all OPTRON optoelectronic products... chips, discrete components, assemblies, and PC board arrays... is available from your nearest OPTRON sales representative or the factory direct.



OPTRON, INC.

1201 Tappan Circle
Carrollton, Texas 75006, U.S.A.
214/242-6571 • TELEX-73-0701
TWX-910-860-5958

Draw one of these:

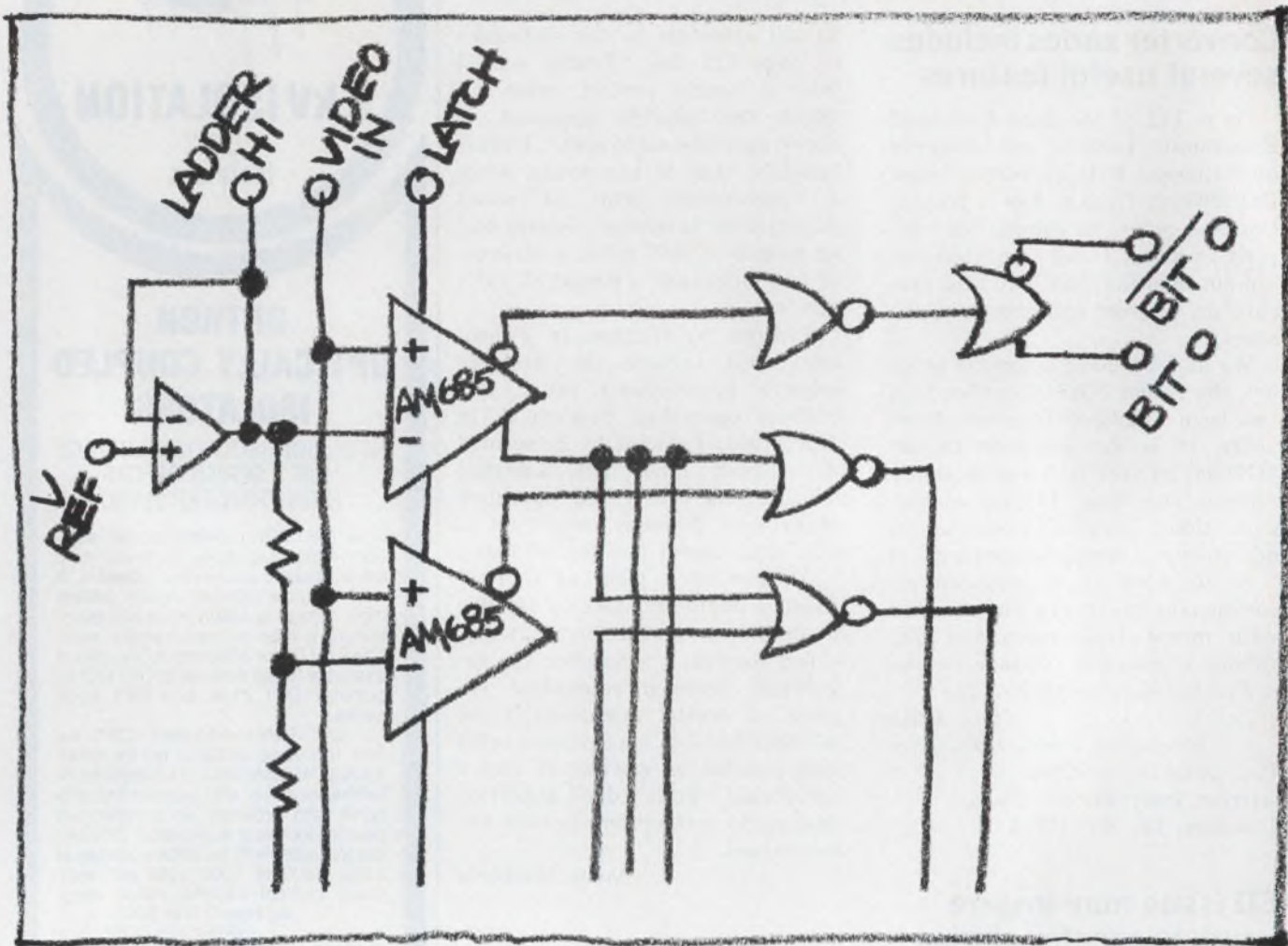

Never thought you'd own a Porsche, did you? Well, there's only one way to find out: fill out the coupon.

Advanced Micro Devices will send you a contest kit that includes two samples of your choice of three terrific high-speed comparators—the Am685, Am686 or Am687—applications materials, data sheets and contest entry form.

Then you design an original application using the high-speed comparator you've chosen. That

shouldn't be too hard to do because Advanced Micro Devices' comparators are the fastest, most accurate parts you can get. Anywhere.

If you're the winner, you'll own a brand new, shiny, speedy Porsche 924. Which is one of the fastest, most accurate cars you can get. If your design comes in second or third you'll win a Porsche Chronometer. The next six winners win Porsche Racing Team Jackets.

You must have your entries in by January 15th. A panel of impar-

tial experts will pick the top 10 designs. A drawing will be held to determine the winners. And we'll announce the names of the winners by March 1, 1977.

In the meantime, you've got some very important things to think about. Like what color you want. Do you want a silver body with black interior? Red with saddle? Blue with tan? How about a gold racing stripe along the side?

And you thought linear comparators were boring.

Advanced Linear



Advanced Micro Devices • 901 Thompson Place, Sunnyvale, California 94086 • Telephone (408) 732-2400 • Distributed nationally by Hamilton/Avnet, Cramer and Schweber Electronics.

Drive one of these:



First, the kit. Then, the car.

Don't wait around! Only the first 3,000 entries will be eligible. Send us the coupon, attached to your company's letterhead. No letterhead, no kit.

Advanced Micro Devices, 901 Thompson Place
Sunnyvale, California 94086

I'm a player. Here's my coupon and letterhead. Send me the kit and the parts.

NAME _____

COMPANY _____

ADDRESS _____

PART TYPE Am685 Am686 Am687

(Check Box)

Premier Electronic Cabinets and Cases

- ESTHETICS KEYED TO MODERN SYSTEMS
- RUGGED-FUNCTIONAL CONSTRUCTION
- ECONOMICAL PRICING
- PROMPT SERVICE & AVAILABILITY

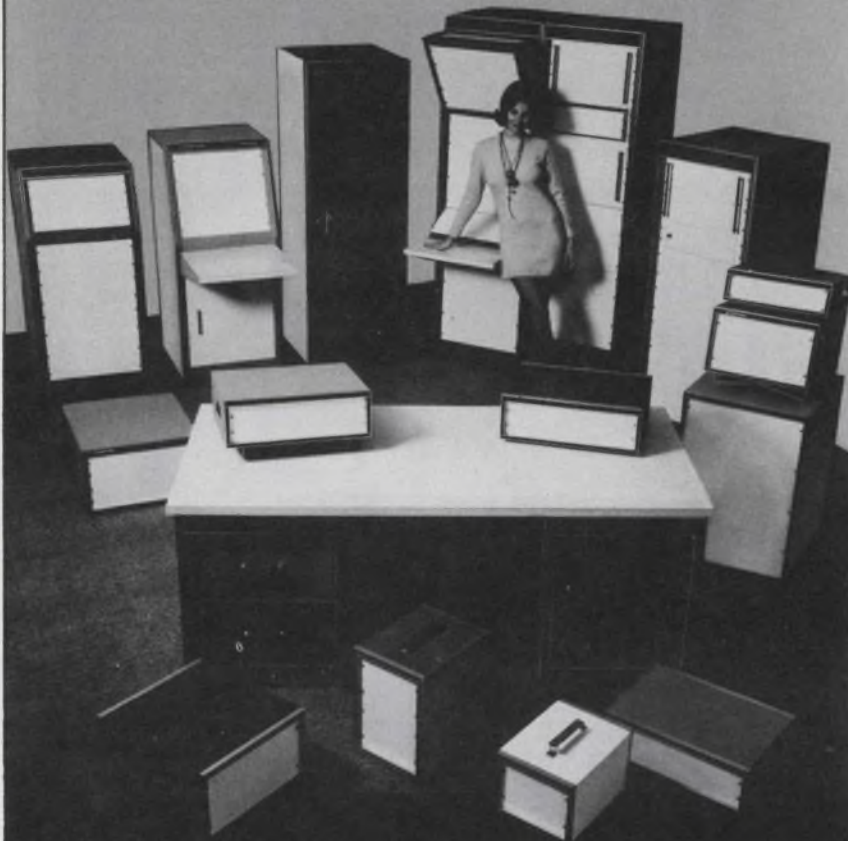

INSTRUMENT CASES - TIC SERIES

TVA Series Vertical Assembly— Construction Details (1 Frame, 2 End Panels, Rear Door)

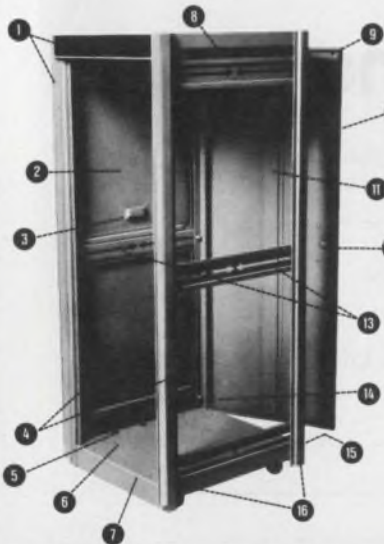

1. Trim: extruded anodized aluminum with textured vinyl inlays
2. Outside removable flush end panels (16 ga.)
3. Recessed hand grip for panel removal
4. 2 pr. panel mounting angles, fully adjustable front to rear with tapped 10-32 holes on EIA & WE Standards spacing (12 ga.)
5. 1" dia. holes for cable entry beneath base
6. Recessed caster mounting holes
7. 1 piece formed steel base provides for heavy equipment mounting area and concealed caster mounting (14 ga.)
8. 1 piece solid top for extra rigidity and squareness (14 ga.)
9. Foam gasketing (3 sides)
10. Magnetic closure gasket
11. Door stiffener channel
12. Keyed latch and brushed aluminum pull handle
13. Horizontal cross-brace and panel mounting angle supports
14. Quick release, spring loaded door hinges (top and bottom)
15. 1 1/8" dia. knock-outs for rear cable entry underneath rear door
16. Formed steel uprights (14 ga.) provide 1/2" recess to panel mounting angles

All features shown are standard in the Trimline TVA Series
Welded, formed steel construction

Complete catalog and prices on request



PREMIER METAL PRODUCTS COMPANY
381 Canal Place, Bronx, N.Y. 10451/(212) 993-9200

CIRCLE NUMBER 8

ACROSS THE DESK

(continued from page 7)

the Model 700 isolated supply are 3.29 in.² and 0.95 in.³, respectively.

In addition, he stated that "The Analog Devices Model 275 includes in its specifications, errors created by the power supply. The external supply required for the Burr-Brown unit has additional error terms that must be considered."

Leakage current is one of the most important isolation specifications. The AD275 is specified at 8 μ A max (115-V ac, 60 Hz); the Burr-Brown 3650 plus the Model 700 have a total of 1.5 μ A max at a higher voltage (240-V ac, 60 Hz).

Marketing people (me included) tend to be biased towards their own products. But, in matters concerning one product vs. another it is the customer who ultimately decides which product best serves his needs. So, we'll see Fred, we'll see.

Dennis Haynes
Product Manager

Burr-Brown Research Corp.
International Airport
Industrial Park
Tucson, AZ 85734

Misplaced Caption Dept.



Let's see. We'll say it uses three microprocessors, consumes 800 milliwatts, delivers 45 watts rms, has a sensitivity of 2 microvolts, and never breaks down.

Sorry. That's Gerard Dou's "Self-Portrait," which hangs in the Rijksmuseum in Amsterdam.

SORENSEN IS THE SOURCE:

FOR RELIABLE OPEN-FRAME POWER SUPPLIES.

SOC, our new line of open-frame power supplies:

- Standard voltage and package sizes
- 115/208/230 Vac input standard
- Made in U.S.A. with quality components
- No overshoot with turn-on, turn-off or power failure
- Stocked for immediate delivery
- Conservatively designed and rated
- Low heat dissipation, high temperature stability
- One-year warranty, worldwide service organization
- UL recognized

| Model No. | Series | Voltage** | Output Current (A dc)* | | | Price |
|------------|--------|-----------|------------------------|--------|--------|-------|
| | | | @ 40°C | @ 50°C | @ 60°C | |
| SOC 2-3 | A | 2V | 3.0 | 2.4 | 1.8 | \$32 |
| SOC 2-6 | B | 2V | 6.0 | 4.9 | 3.8 | 54 |
| SOC 2-10 | C | 2V | 10.0 | 8.0 | 6.5 | 67 |
| SOC 5-3 | A | 5V | 3.0 | 2.4 | 1.8 | 32 |
| SOC 5-6 | B | 5V | 6.0 | 4.9 | 3.8 | 54 |
| SOC 5-10 | C | 5V | 10.0 | 8.0 | 6.5 | 67 |
| SOC 12-1.6 | A | 12V | 1.6 | 1.3 | 1.0 | 32 |
| SOC 12-4.0 | B | 12V | 4.0 | 3.0 | 2.5 | 54 |
| SOC 12-6.0 | C | 12V | 6.0 | 5.0 | 4.2 | 67 |
| SOC 15-1.5 | A | 15V | 1.5 | 1.2 | 1.0 | 32 |
| SOC 15-3.0 | B | 15V | 3.0 | 2.6 | 2.2 | 54 |
| SOC 15-5.0 | C | 15V | 5.0 | 4.2 | 3.5 | 67 |
| SOC 24-1.0 | A | 24V | 1.0 | .75 | .55 | 32 |
| SOC 24-2.2 | B | 24V | 2.2 | 1.9 | 1.6 | 54 |
| SOC 24-3.5 | C | 24V | 3.5 | 2.9 | 2.4 | 67 |
| SOC 28-0.8 | A | 28V | 0.8 | .64 | .45 | 32 |
| SOC 28-2.0 | B | 28V | 2.0 | 1.7 | 1.4 | 54 |
| SOC 28-3.1 | C | 28V | 3.1 | 2.6 | 2.0 | 67 |

* Free-air rating — no external heatsink.

** ±5% adjustable.

Common Specifications:

AC Input Power: Vac 105-125, 190-226, 210 to 250 available by using taps on transformer.

Frequency 50 to 63Hz. (Derate 10% at 50Hz.)

Voltage Regulation (comb. line and load): ±0.15% + 6mV for 105 to 125 Vac and 100% load change.

Voltage Ripple and Noise: 1.5mVrms, 5mVpp.

Temperature Coefficient: 0.03%/°C.

Drift (24 hours): 0.2% after 1-hour warm-up.

Remote Sensing: 100mV maximum drop in each leg.

Operating Temperature: 0°C to 60°C.

Storage Temperature: -20°C to +85°C.

Overvoltage Protection: Available on all models except 2 volt. Specify by adding "VP" suffix to model number and add \$8 to unit price.

Current Foldback: Automatic, factory-set to 140% of rated (40°C) output current.

Cooling: Convection.

Finish: Black anodize.

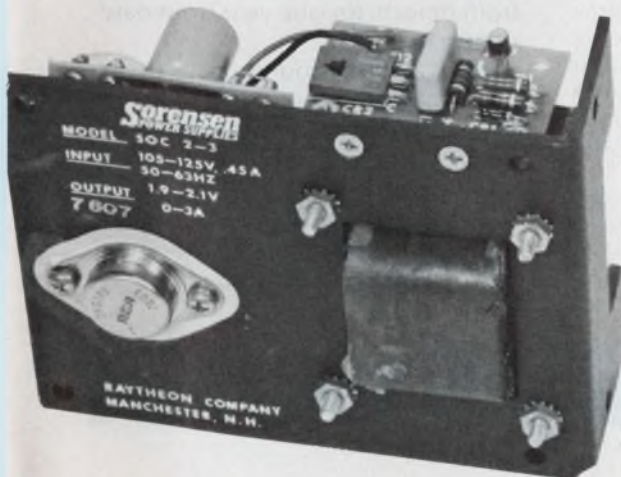

Call us for OEM discounts:

(603) 668-4500.

Sorensen

676 Island Pond Rd.,

Manchester, N.H. 03103.

SORENSEN
POWER SUPPLIES

A Raytheon Company

CIRCLE NUMBER 9

How can you guarantee your product for ninety days if the parts that go into it aren't guaranteed for ninety seconds?

When you're in the business of marketing information systems and modems that sell from \$500 to \$50,000 it doesn't help to have your customers think of you as anything less than a really solid operation.

Of course, you're only as solid as the products you sell.

The best way to get your customers believing in you and your product is to make that product better than anyone else—and to guarantee it.

But how can you be sure nothing will go wrong with the machines you make if you can't be sure of the parts you put into them?

The answer is you can't, unless you're using guaranteed parts.

At MF Electronics, we make molded crystal oscillators the best way anyone knows how to make them. Since we feel they're the best, we're able to guarantee them for one full year.

The difference between oscillators.

What separates good oscillators from bad is space. Space is one thing there shouldn't be any of inside an oscillator. But the way most oscillators are made, space is one thing you can count on.



The hollow truth about crystal oscillators.

Look at this oscillator. The fact that we can lift the cap to show you what's wrong with it shows you what's wrong with it.



After the crystal and other parts are attached to the base, the cap is glued on, creating a bond that's tenuous at best.

Air seeps through this bond, allowing dirt and moisture to collect. You've got a leaky oscillator, one that's prone to loose parts and electrical shorting. That's how deadly a breath of fresh air can be to the inside of an oscillator.

The un-hole-y oscillator: It's molded. What a blessing.

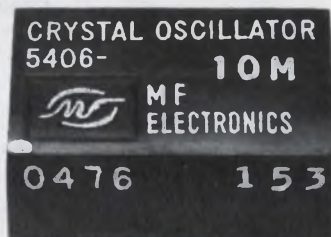

A molded oscillator, on the other hand, has no holes, no open spaces, nothing to hide and nowhere to hide it. Its crystal is hermetically sealed and set in a monolithic block of solid black plastic. There are no spaces for air to penetrate, no room for dirt or moisture to accumulate. Wave soldering can't even deteriorate the unit, so there's no danger of loose pins or joints.

A test that rings true.

One of our customers, who is also one of the country's largest users of crystal clock oscillators, tested the performance of

various oscillators. He found that MF's molded oscillator lasted 3000 hours in an 85°C/85% relative humidity test. If you've ever done any oscillator testing yourself you know how remarkable that is.

Two more solid reasons to use MF Crystal Oscillators.

3rd overtone crystals are used in MF's molded oscillators to provide greater electrical and mechanical stability in frequencies exceeding and including 20 MHz.

And an MF molded oscillator is the only one made that meets the UL oxygen index guideline of 28%.

Because we're solid, your product is more solid.

So when you use MF molded crystal oscillators, you're giving your product a more efficient component, a heart that will beat longer. And your customers will be giving you fewer complaints and service calls.

MF Electronics is the only company that makes molded crystal oscillators. We invented them.

We make what we think are the best crystal oscillators you can buy. And we guarantee them, so your product can be "the best you can buy."

Guaranteed!

THE MF GUARANTEE

MF Electronics warrants this molded crystal oscillator to be free from defects for one year from date of purchase.

Any oscillator found to be defective during this period may be returned to the factory, postage paid, for repair or, at our option, replacement without charge.

MF Electronics limits its liability to the repair and/or replacement of the returned MF oscillator.

MF ELECTRONICS CORP.

118 E. 25th St., New York, N.Y. 10010 (212) 674-5360 TWX: 710-581-4109

CIRCLE NUMBER 10

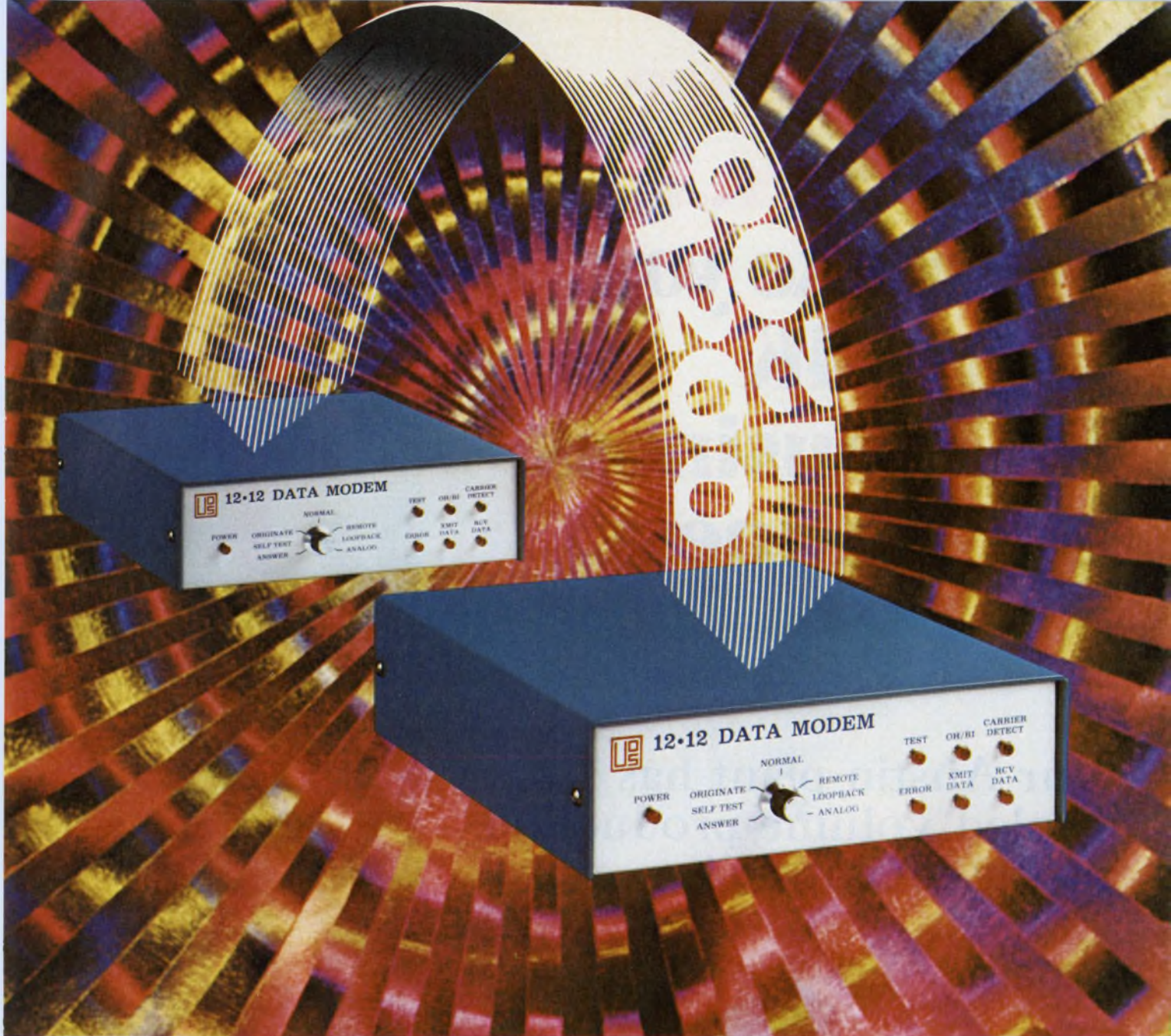

UNIVERSAL'S NEWEST MODEM

For two-wire, full-duplex operation at 1200 BPS, Universal Data Systems proudly announces the Model 12-12, the newest addition to the UDS family of data modems. The unit operates synchronously or asynchronously over unconditioned dial-up or private telephone lines.

Terminal interface discipline with the 12-12 is identical to that commonly used for 103/113 modems. Using experience-proved phase shift modulation techniques, the UDS-12-12 transmits at 1200 BPS or any integral sub-multiple rate, without restrapping or adjustments.

The 12-12 is insensitive to word length, and it includes integral provision for automatic remote and local loopback testing. Delivery: 45 days ARO. For technical details contact UDS today.

\$600 Single Unit Price.



universal data systems

member of
IDCMA

4900 Bradford Drive • Huntsville, Alabama 35805 • Telephone (205) 837-8100 • TWX 810-726-2100

Created by Hill & McKenzie Advertising, Winter Park, Florida

CIRCLE NUMBER 11

Today more than ever...

We make your 16-pin 4K RAM business our business.

Our Austin plant has tripled volume production of the MCM6604.

Again.

and again last quarter!

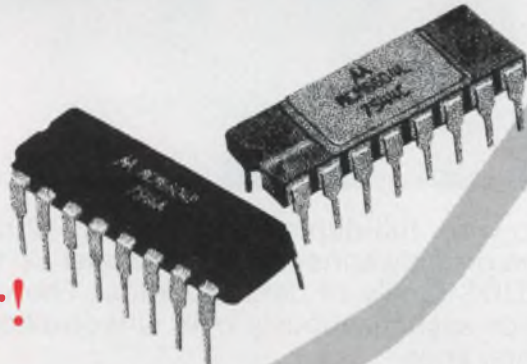

MOTOROLA Semiconductors

MOTOROLA SEMICONDUCTOR PRODUCTS INC. • P.O. BOX 20912 • PHOENIX, AZ 85036

-still the production house

For hundreds, or for hundreds of thousands to meet volume production 4K RAM needs, call your authorized Motorola distributor or Motorola sales office.

| | | | |
|---|---|---|----------------|
| ALABAMA | Huntsville | Hall-Mark Electronics | (205) 837-8700 |
| ALABAMA | Huntsville | Hamilton/Avnet Electronics | (205) 533-1170 |
| ARIZONA | Phoenix | Liberty Electronics Corp. | (602) 275-7851 |
| ARIZONA | Phoenix | Liberty Electronics Corp. | (602) 251-272 |
| CALIFORNIA | Culver City | Hamilton Electro Sales Ltd. | (213) 558-2000 |
| CALIFORNIA | El Segundo | Liberty Electronics Corp. | (213) 552-8100 |
| CALIFORNIA | Irving | Cramer/Los Angeles | (214) 771-8000 |
| CALIFORNIA | Mountain View | Elmar Electronics, Inc. | (415) 961-3811 |
| CALIFORNIA | Mountain View | Hamilton/Avnet Electronics | (415) 961-7000 |
| CALIFORNIA | San Diego | Hamilton/Avnet Electronics | (714) 275-2421 |
| CALIFORNIA | San Diego | Liberty Electronics/San Diego | (714) 565-9171 |
| CALIFORNIA | Sunnyvale | Cramer/San Francisco | (408) 738-3011 |
| COLORADO | Commerce City | Elmar Electronics, Inc. | (303) 291-9811 |
| COLORADO | Denver | Hamilton/Avnet Electronics | (303) 534-1212 |
| CONNECTICUT | Danbury | Schwaber Electronics | (203) 792-3500 |
| CONNECTICUT | Canaan | Hamilton/Avnet Electronics | (203) 785-0381 |
| CONNECTICUT | North Haven | Cramer/Connecticut | (203) 235-5841 |
| FLORIDA | Ft. Lauderdale | Hamilton/Avnet Electronics | (305) 925-5401 |
| FLORIDA | Hollywood | Schwabe Electronics | (305) 972-7511 |
| FLORIDA | Orlando | Cramer/Orlando | (305) 854-1511 |
| FLORIDA | Orlando | Hall-Mark Electronics | (305) 855-0020 |
| GEORGIA | Atlanta | Cramer/Atlanta | (404) 448-5050 |
| GEORGIA | Norcross | Hamilton/Avnet Electronics | (404) 448-0800 |
| ILLINOIS | Chicago | Newark Electronics Corp. | (312) 638-4411 |
| ILLINOIS | Elmhurst Industrial Park | Semiconductor Products, Inc. Chicago | (312) 218-1000 |
| ILLINOIS | Elk Grove Village | Schwaber Electronics | (312) 583-2740 |
| ILLINOIS | Mt. Prospect | Cramer/Chicago | (312) 593-9430 |
| ILLINOIS | Schiller Park | Hamilton/Avnet Electronics | (312) 678-6310 |
| INDIANA | Indianapolis | Graham Electronics Supply, Inc. | (317) 834-8202 |
| INDIANA | Indianapolis | Pioneer Electronics Co. | (317) 874-6000 |
| KANSAS | Lenexa | Hall-Mark Electronics | (913) 886-4747 |
| KANSAS | Lenexa | Hamilton/Avnet Electronics | (913) 886-8900 |
| MARYLAND | Gaithersburg | Pioneer Electronics | (301) 948-0710 |
| MARYLAND | Handover | Hamilton/Avnet Electronics | (301) 796-5000 |
| MARYLAND | Romney | Schwaber Electronics | (301) 872-5200 |
| MARYLAND | Savage | Pyltron Electronics, Inc. | (202) 792-7000 |
| MASSACHUSETTS | Lexington | Harvey Electronics | (617) 861-9200 |
| MASSACHUSETTS | Waltham | Cramer/Waltham | (617) 885-7700 |
| MASSACHUSETTS | Waltham | Schwabe Electronics | (617) 890-4848 |
| MASSACHUSETTS | Woburn | Hamilton/Avnet Electronics | (617) 833-8000 |
| MICHIGAN | Detroit | Hall-Mark Electronics | (313) 481-1012 |
| MICHIGAN | Livonia | Hamilton/Avnet Electronics | (313) 528-4700 |
| MICHIGAN | Livonia | Pioneer/MI | (313) 525-1800 |
| MINNESOTA | Edina | Hamilton/Avnet Electronics | (612) 941-3801 |
| MINNESOTA | Edina | Hamilton/Avnet Electronics | (612) 941-3801 |
| MISSOURI | Earth City | Hamilton/Avnet Electronics | (314) 231-1444 |
| MISSOURI | St. Louis | Pioneer Electronics Co. St. Louis | (314) 201-5350 |
| NEW JERSEY | Cedar Grove | Hamilton/Avnet Electronics | (201) 236-0800 |
| NEW JERSEY | Cherry Hill | Cramer/Maryland | (609) 424-5893 |
| NEW JERSEY | Mt. Laurel | Hamilton/Avnet Electronics | (609) 234-2133 |
| NEW JERSEY | Moorestown | Avnet Electronics | (608) 235-1800 |
| NEW JERSEY | Pennsauken | Avnet Electronics | (609) 882-4000 |
| NEW JERSEY | Saddle Brook | Avnet Electronics | (201) 797-5800 |
| NEW JERSEY | Somerset | Schwaber Electronics | (201) 468-6008 |
| NEW MEXICO | Albuquerque | Hamilton/Avnet Electronics | (505) 785-1500 |
| NEW MEXICO | Albuquerque | Schwaber Electronics | (505) 884-6800 |
| NEW YORK | Farmingdale | Hamilton/Avnet Electronics | (516) 231-5600 |
| NEW YORK | Hempstead | Cramer/Long Island | (718) 275-0300 |
| NEW YORK | Hempstead | Cramer/Rochester | (718) 275-0300 |
| NEW YORK | Rochester | Schwaber Electronics | (718) 481-4000 |
| NEW YORK | Rochester | Schwaber Electronics | (718) 481-4000 |
| NEW YORK | Syracuse | Cramer/Syracuse | (315) 437-8671 |
| NEW YORK | Syracuse | Hamilton/Avnet Electronics | (315) 437-2682 |
| NEW YORK | Westbury, LI | Hamilton/Avnet Electronics | (516) 333-5800 |
| NEW YORK | Westbury, LI | Schwaber Electronics | (516) 334-7474 |
| NEW YORK | Woodbury, LI | Harvey Electronics | (516) 333-5800 |
| NORTH CAROLINA | Greensboro | Pioneer Electronics | (919) 273-4441 |
| NORTH CAROLINA | Winston-Salem | Cramer/Winston-Salem | (919) 725-8711 |
| OHIO | Cincinnati | Schwaber Electronics | (513) 481-2510 |
| OHIO | Cleveland | Hamilton/Avnet Electronics | (216) 481-1400 |
| OHIO | Cleveland | Pioneer-Standards Electronics, Inc. | (216) 587-3800 |
| OHIO | Dayton | Hamilton/Avnet Electronics | (513) 236-9900 |
| OHIO | Dayton | Pioneer/Dayton | (513) 236-9900 |
| OHIO | Dayton | Cramer/Cleveland | (513) 248-8400 |
| OKLAHOMA | Tulsa | Hall-Mark Electronics | (918) 835-8418 |
| PENNSYLVANIA | Horseshoe | Pioneer/Philadelphia | (215) 674-5710 |
| PENNSYLVANIA | Pittsburgh | Pioneer/Pittsburgh | (412) 782-2300 |
| SOUTH CAROLINA | Charleston | Ohio Radio Supply Company, Inc. | (803) 775-5333 |
| TEXAS | Austin | Sterling Electronics | (512) 838-1341 |
| TEXAS | Dallas | Hall-Mark Electronics | (714) 231-5101 |
| TEXAS | Dallas | Hamilton/Avnet Electronics | (214) 861-6866 |
| TEXAS | Dallas | Schwaber Electronics | (214) 661-5010 |
| TEXAS | Dallas | Sterling Electronics | (214) 861-5131 |
| TEXAS | Irving | Midland Specialty Corp. | (918) 827-9000 |
| TEXAS | Houston | Hall-Mark Electronics | (713) 781-8100 |
| TEXAS | Houston | Hamilton/Avnet Electronics | (713) 526-4861 |
| TEXAS | Houston | Sterling Electronics, Inc. | (713) 827-9000 |
| UTAH | Salt Lake City | Hamilton/Avnet Electronics | (801) 262-8451 |
| WASHINGTON | Bellevue | Hamilton/Avnet Electronics | (206) 746-8750 |
| WASHINGTON | Bellevue | Rimac/Stream Electronics | (206) 783-2300 |
| WASHINGTON | Seattle | Liberty Electronics Corp. | (206) 783-8200 |
| CANADA | | | |
| CALGARY | T2E 8L7 Alta | Varah's | (403) 276-8819 |
| LONDON | Ont | CM Paterson Co. Ltd. | (416) 434-3204 |
| MISSISSAUGA | Ont | Hamilton/Avnet | (416) 677-7432 |
| OTTAWA | Ont | Zenitronics Ltd. | (613) 238-6411 |
| OTTAWA | K2P 3B4 Ont | Hamilton/Avnet | (613) 236-1700 |
| ST. LAURENT | P.Q. H4S 1G2 | Hamilton/Avnet | (514) 331-6443 |
| TORONTO | Ont | Zenitronics Ltd. | (416) 788-5111 |
| TOWN OF MOUNT ROYAL | P.Q. | Zenitronics, Ltd. | (514) 735-5381 |
| VANCOUVER | B.C. | Varah's | (604) 873-3211 |
| WINNIPEG | Man | Varah's | (204) 633-8190 |
| MOTOROLA AMERICAS DISTRICT OFFICES | | | |
| ALABAMA | Huntsville 35805, 2608 Arlie St., Suite 3 | (205) 533-1650 | |
| ARIZONA | Phoenix 85018, 4350 E. Camelback Road, Suite 250F | (602) 994-6328 | |
| ARIZONA | Scottsdale 85141, 8201 E. McDowell Road, E. Suite 2195 | (602) 948-3811 | |
| CALIFORNIA | Encino 91316, 15720 Ventura Blvd., Suite 504 | (213) 986-8850 | |
| CALIFORNIA | Orange 92668, One City Blvd., West Bank of America Tower Bldg., Suite 722 | (714) 634-2644 | |
| CALIFORNIA | San Jose 95117, 10711 Conroy Court, Suite 210 | (415) 580-4664 | |
| CALIFORNIA | San Jose 95117, 4020 Moorpark Ave., Suite 118 | (408) 885-0150 | |
| CANADA | Ontario, Downsview, M3N 1Y4 | Motorola Semiconductor Products, Canada | |
| CANADA | Ontario, Ottawa 6 | Motorola Semiconductor Products, Canada | |
| CANADA | Suite 106, 1007 Merivale Rd | (613) 729-4381 | |
| CANADA | Quebec, Montreal 8 | Motorola Semiconductor Products, Canada | |
| CANADA | 7800 Cole de Liesse Road | (514) 731-6681 | |
| CANADA | Vancouver, B.C. | Motorola Semiconductor Products, Canada | |
| CANADA | 708 E. 7th Street | (604) 885-3141 | |
| COLORADO | Denver 80237, 3515 S. Tamarac, Suite 330 | (303) 773-6800 | |
| CONNECTICUT | New Haven, Hamden 06518, 3074 Whitney Avenue, Building C, Room | (203) 281-0771 | |
| FLORIDA | Ft. Lauderdale 33313, 8000 West Sunrise Blvd. | (305) 584-8000 | |
| FLORIDA | Pompano Beach, Ft. Lauderdale 33309, 1001 N.W. 62nd Street | (305) 281-4333 | |
| FLORIDA | Orlando/Maitland 32751, 520 S. Mainland Ave. | (305) 644-3422 | |
| FLORIDA | St. Petersburg 33702, 9720 Executive Center Drive North, Suite 108 | (813) 576-6030 | |
| ILLINOIS | Chicago/Schiller Park 60178, 4825 North Scott Street | (312) 878-7205 | |
| ILLINOIS | Chicago/Schaumburg/Consumer 60198, 1228 E. Algonquin Road, Room 2024 | (312) 576-2788 | |
| ILLINOIS | Schaumburg/Industrial 60172, 1301 East Algonquin Road | (312) 576-5518 | |
| INDIANA | Fort Wayne 48025, 2777 Maplecrest Road, Room 31 | (219) 485-1611 | |
| INDIANA | Indianapolis 46250, 8525 East 86th Street, Suite 108 | (317) 848-7880 | |
| IOWA | Cedar Rapids 52403, 4403 First Avenue, S.E. Suite 304 | (319) 393-8832 | |
| KANSAS | Kansas City/Mission 66202, 8700 West Squarb Road, Suite 104 | (813) 284-3050 | |
| MASSACHUSETTS | Boston/Lexington 02172, 2 Millis | (617) 861-1350 | |
| MICHIGAN | Benon Harbor/Douglas 49068, 36 South Center | (616) 857-2159 | |
| MICHIGAN | Detroit/Garden City 48135, 1812 Middlebelt Rd. | (313) 281-8200 | |
| MICHIGAN | Detroit/Garden City 48135, 1812 Middlebelt Rd. | (313) 281-8200 | |
| MINNESOTA | Minneapolis 55426, 8950 Wayzata Blvd., Suite 224 | (612) 545-0251 | |
| MISSOURI | St. Louis 63141, 760 Office Parkway | (314) 872-7681 | |
| NEW JERSEY | River Edge 07661, 337 Johnson Avenue | (201) 468-1200 | |
| NEW YORK | Poughkeepsie/Fishkill 12524, Route 9 | (914) 898-8970 | |
| NEW YORK | Long Beach/Neppauge 11987, 350 Vanderbilt Motor Parkway | (516) 438-0000 | |
| NEW YORK | Rochester, 14818, 3380 Monroe Avenue | (716) 281-7220 | |
| NEW YORK | Syracuse 13211, 123 Pickard Bldg., E. Mollay Road | (315) 454-8373 | |
| NORTH CAROLINA | Raleigh 27612, 4505 Creedmoor Road, Suite 118 | (919) 872-7804 | |
| OHIO | Cleveland 44143, 840 Brainard Road | (216) 461-3180 | |
| OHIO | Dayton 45340, 3480 South Dixie Drive, Room 130 | (513) 284-2231 | |
| OHIO | Columbus 43085, 633 High Street, Suite 116 | (614) 468-5833 | |
| OKLAHOMA | Tulsa 74145, 4833 South Sheridan, Suite 408 | (918) 864-5227 | |
| OREGON | Portland 97221, 1730 S.W. Skyline Blvd., Suite 203 | (503) 287-2925 | |
| PENNSYLVANIA | Philadelphia/Ft. Washington 19334, 501 Office Center Drive, Suite 128 | (215) 843-4500 | |
| SOUTH CAROLINA | Columbia 29204, U.S. No. 1 North at I-20 | (803) 788-0585 | |
| TENNESSEE | Knoxville 37919, 9041 Executive Park Drive, Building 400, Suite 403 | (615) 890-5592 | |
| TEXAS | Dallas 75240, 4825 LBJ Freeway, Suite 140 | (214) 661-9929 | |
| TEXAS | Houston 77050, 1010 North Loop West, Suite 111 | (713) 488-4583 | |
| WASHINGTON | Seattle/Bellevue 98005, 300 120th Avenue, N.E. Suite 202 | (206) 455-3700 | |
| WASHINGTON | D.C./MARYLAND, Lanham 20801, 5000 Princeps Garden Parkway, Suite 804 | (301) 571-2600 | |
| WISCONSIN | Milwaukee/Wauwatosa 53228, 908 North Mayfair Road | (414) 478-5554 | |

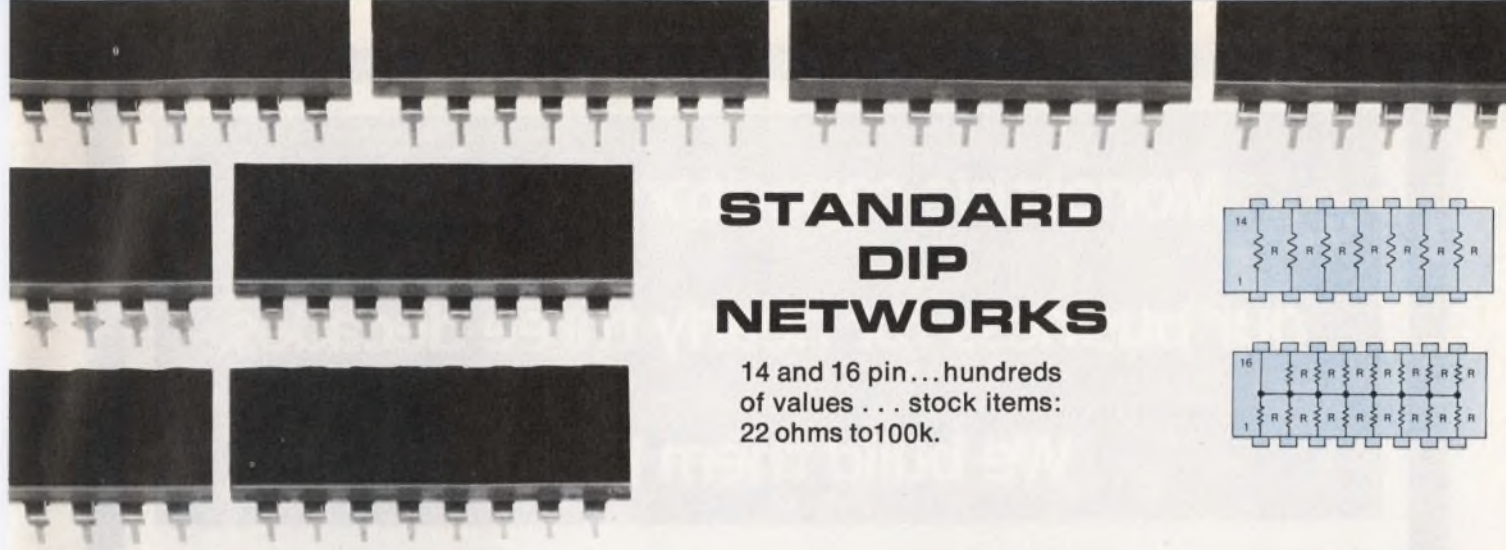

STANDARD DIP NETWORKS

14 and 16 pin... hundreds
of values... stock items:
22 ohms to 100k.

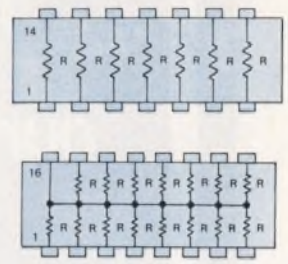

THICK FILM RESISTOR

DIP'S

CUSTOM DIP NETWORKS

Our computer controlled laser has solved thou-
sands of custom designed dip and sip networks
... use it to solve your's!

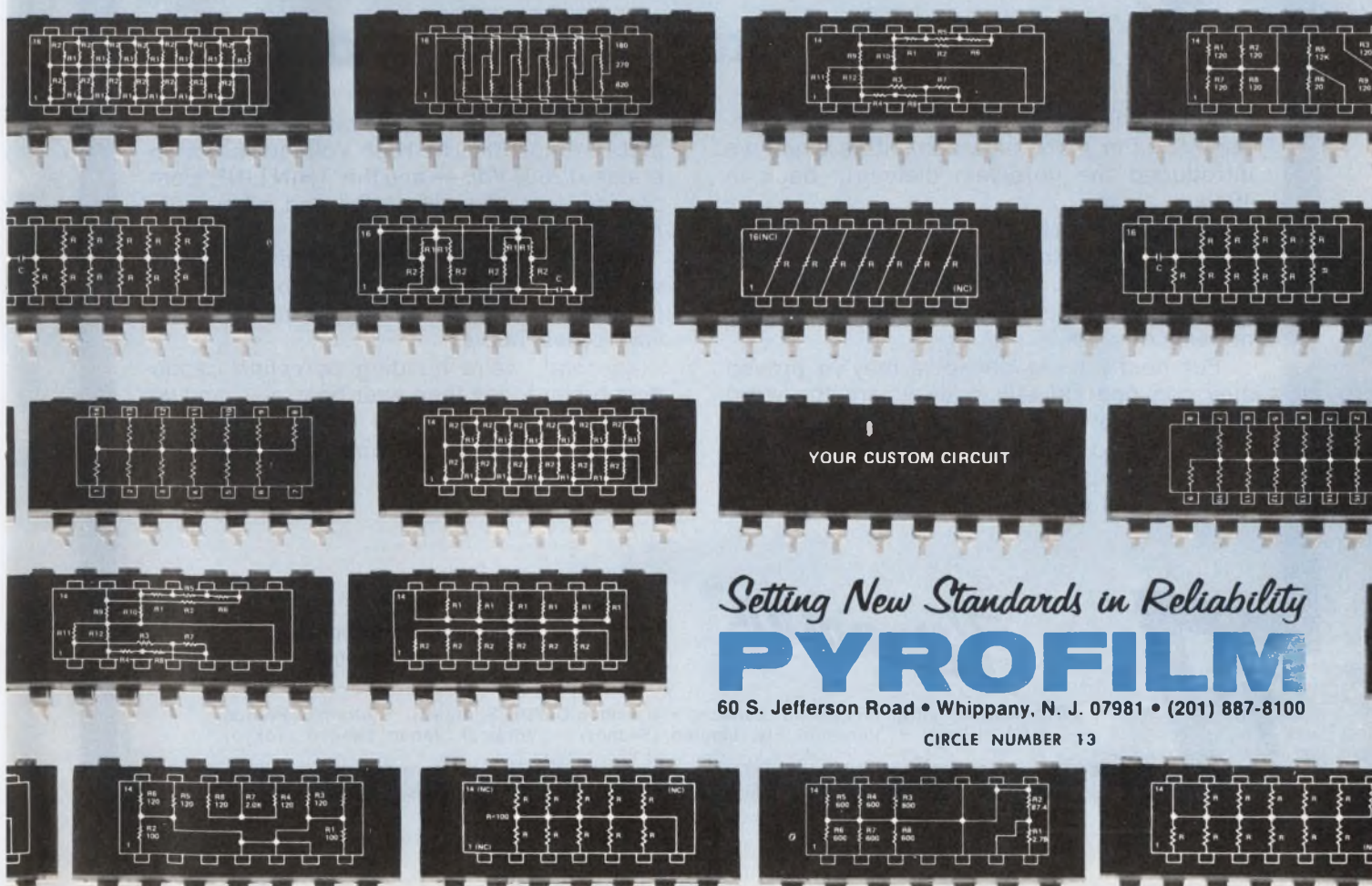

YOUR CUSTOM CIRCUIT

Setting New Standards in Reliability

PYROFILM

60 S. Jefferson Road • Whippany, N. J. 07981 • (201) 887-8100

CIRCLE NUMBER 13

Monolithic capacitors have been
our business for nearly three decades.

We build them better.

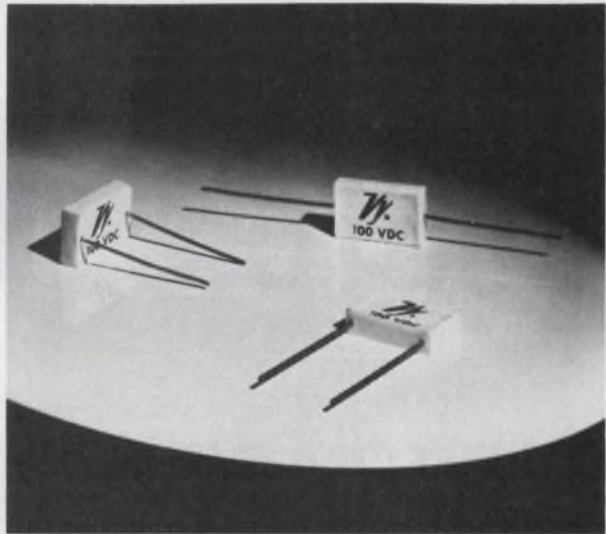
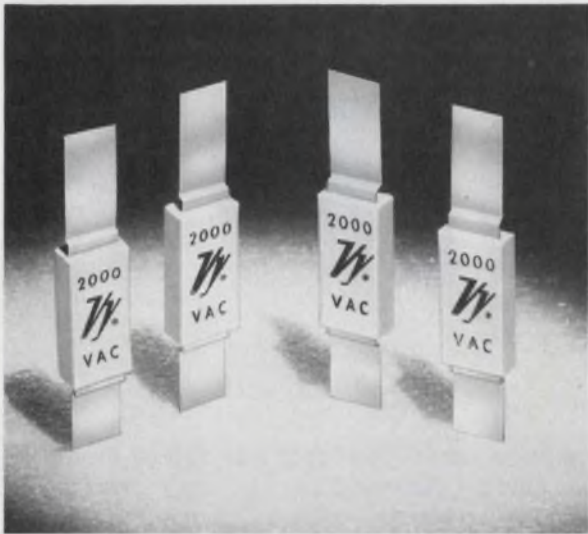

VY[®] Porcelain Capacitors: first then and now.

Vitramon, Incorporated was the first company to offer monolithic capacitors when we introduced the porcelain dielectric back in 1948.

In those days, 'VY' Porcelain Capacitors were the most stable available. Today — 28 years later — our 29 styles of porcelain capacitors are still among the most stable components offered.

For nearly three decades, they've proven they can operate efficiently where the word critical is routine: in spacecraft, missiles and high-frequency microwave equipment.

'VY' Porcelain Capacitors are available for many special purposes. For example, our VY

87 High Current parts have ratings of 2000 Vac and 10 Amps RF. The High Voltage series operates at 2500 Vdc — and the 'THIN LINE' components feature axial, radial and edge-radial configurations.

If you're looking for established reliability, we offer CYR and CY parts approved to MIL-C-23269 and MIL-C-11272 — backed by millions of test hours.

In short, we're building porcelain capacitors better today than ever before — and we deliver what we offer.

Please call us for more details: (203) 268-6261.

Vitramon North America
Division of Vitramon, Incorporated
Box 544, Bridgeport, Conn. 06601

Subsidiaries: Vitramon Limited (London) • Vitramon GmbH (Stuttgart) • Vitramon France S.A.R.L. (Paris) • Vitramon Pty. Limited (Sydney) • Vitramon Japan Limited (Tokyo)

The one variable the world can standardize on.

Our new Type M conductive plastic variable resistor is hard metric. A 10 mm cube that's tiny, flexible and rugged. The MINI-METRIC is the smallest dual pot available today. Manufactured in the United States, it's dimensioned the way the rest of the world thinks. Allen-Bradley has what you need; or, it can be ordered through our distributors. Ask for Publication 5239.

Choices

single or dual pot or pot/switch combinations

100 ohms to 1 megohm

conductive plastic resistance elements, $\pm 20\%$ tolerance, standard resistance values conform to IEC.

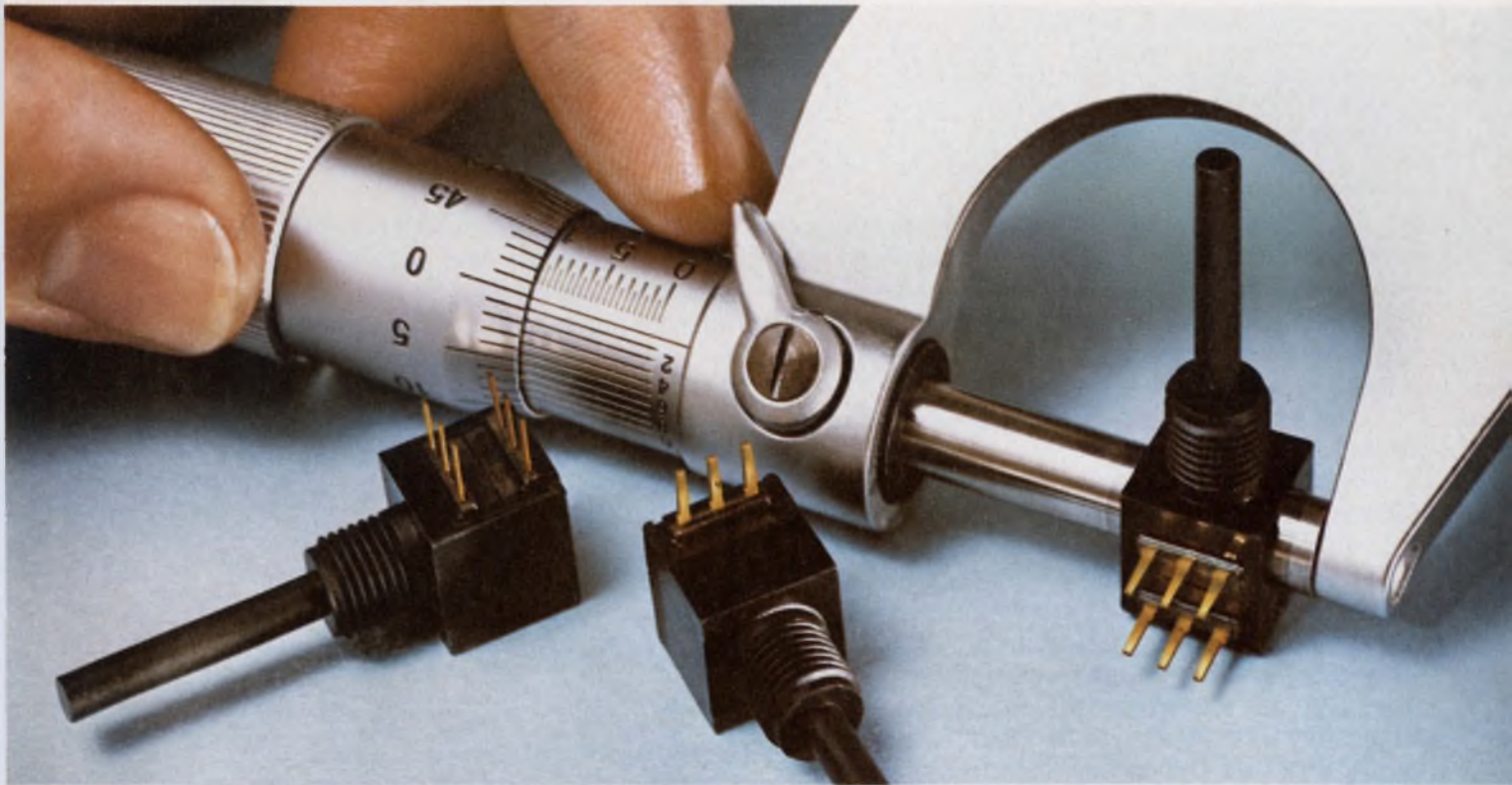
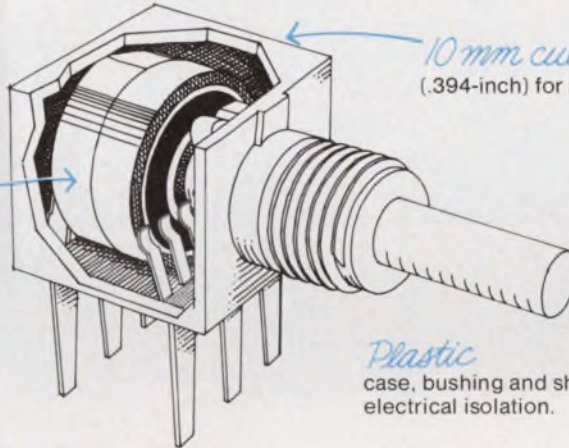

Quality in the best tradition.



ALLEN-BRADLEY

Milwaukee, Wisconsin 53204

CIRCLE NUMBER 15

EC131

**You can buy
this signal generator
for a 3-month job,
and then let it
gather dust.**

**You can rent
this signal generator
for a 3-month job,
and return it
when you're done.**



When you buy electronic test equipment for a short-term project, you're stuck with the equipment after the project is completed. Maybe it'll sit around gathering dust and costing you money. Or maybe you could sell it at a loss.

Or maybe, you should have rented it from REI.

When you rent equipment from us, you keep it only as long as you need it. When you're through with it, you send it back. Since you pay only for the time you have your instruments, you never have to spend your money on idle equipment. Short-term needs are just one reason for renting. Immediate delivery is another. Because we maintain over \$10 million in inventory in fully stocked instant inventory centers around the country, you can get delivery within hours.

REI stocks over 8,000 fully checked-out test instruments. And they're ready whenever you are. For the full story on renting as well as our low prices, send in the coupon for prompt delivery of our free illustrated catalog. Or call us now for your immediate requirements.

Rental Electronics, Inc.,
99 Hartwell Avenue, Lexington, Mass. 02173.
Please send me your free instrument rental catalog:

Name _____ Title _____

Company _____

Address _____

City _____ State _____ Zip _____

Tel. Number _____

Rental Electronics, Inc. 

A PEPSICO LEASING COMPANY

Burlington, MA (617) 273-2770 • Gaithersburg, MD (301) 948-0620 • Oakland, NJ (201) 337-3757 • Ft. Lauderdale, FL (305) 771-3500
Des Plaines, IL (312) 827-6670 • Dallas, TX (214) 661-8082 • Mountain View, CA (415) 968-8845 • Anaheim, CA (714) 879-0561
Rexdale, Ontario (PLC Leasing Ltd.) (416) 677-7513

CIRCLE NUMBER 16

OCTOBER 11, 1976

Electron Devices Meeting to discuss VMOS progress

Recent advances in VMOS technology have produced microwave power transistors with double the power output and upper-frequency limit. In addition, parasitic capacitances that had limited the speed of first-generation VMOS arrays developed for memory applications have been reduced substantially.

All these improvements will be reported and discussed at the International Electron Devices Meeting in Washington, DC, Dec. 6-8.

A microwave, vertical-channel MOS transistor (VMOST) that uses 1- μm gates to reduce capacitance and increase the upper operating frequency to around theoretical limits will be described at the Dec. 8 session by Dr. Terry Heng, manager of microwave devices at the Westinghouse Research Laboratories in Pittsburgh.

"Previously, we reported obtaining about 3 W at 1 GHz," says Heng, "but with our latest devices, we're up to 6 W at close to 2 GHz, which is the state of the art."

The Westinghouse device is a uniquely fabricated silicon MOSFET "with the gate deposited by angle evaporation rather than vertical evaporation," Heng adds. "As a result, we can reduce gate length to only 1 μm , thus minimizing parasitics."

Heng continues: "Our process is unlike others used for VMOS. No chemical etch is required. We have the transistor fingers very close to one another, and each finger has an oxide overhang. The metal is evaporated and deposited through the overhang."

But since the evaporation occurs at an angle, a photoresist opening of 3 μm is used to obtain a 1- μm gate. This 3-to-1 dimensional advantage makes the process substantially less critical than using a vertical deposition and a 1-to-1 ra-

tio between gate and photomask opening.

"Because we're using the 3- μm mask to get the 1- μm gate, our yield is almost 100%," says Heng.

The VMOST is highly linear. The third-order intermodulation product power compared to carrier power, a standard industry comparison, is down, typically, 24 to 26 dB, compared to 17 to 19 dB for bipolar transistors.

"We're also working on a gallium-arsenide version of this device," Heng says, "because with silicon we probably can't get up beyond 4 GHz. Cutoff frequency on our devices is now about 5 GHz. To get a factor of 3-to-5 increase in frequency response, we'll have to go to a new material like the gallium arsenide."

The original VMOS-array process—the early work was done at Stanford University by Dr. J. J. Rogers and Dr. James Meindahl—deposits the gate metallization and then, unlike the Westinghouse approach, requires a chemical etch. A principal drawback to the original process is the relatively high overlap capacitance associated with the way the gate is incorporated into the structure. As a result, gate speed is limited and unsuitable for high-speed memory arrays.

This capacitance problem has been reduced roughly one half with new processing techniques developed by American Microsystems, Santa Clara, CA. Dr. I. S. Bhatti, senior R&D engineer at AMI and J. J. Rogers will describe the process in their joint paper, "Minimization of Parasitic Capacitances in VMOS structures."

"We've done two things," says Bhatti. "We've changed from phosphorus to arsenic junctions. And we're now using a structure like self-aligned thick oxide. Under the gate there's a thick oxide layer on

the edge of the V groove.

"For a typical N-MOS device with phosphorous junctions," Bhatti continues, "the average gate-drain overlap capacity is about 0.54 femtofarad (fF) per micron overlap. With the arsenic junctions, the overlap capacity is reduced to 0.29 fF/micron."

As a result, Bhatti points out, American Microsystems is looking at fast, 1-k static VMOS RAMs with access time in the range of 40 to 50 ns. The higher speed is possible, thanks to effective short-channel lengths of 1 to 2 μm .

LSI reference voltage source is introduced

The need for a reference-voltage source that can be deposited on MOS LSI chips in controllers and microprocessors for analog controls has been satisfied by a temperature-stable MOSFET reference source developed by General Electric Research Laboratories, Schenectady, NY. The device will be described by GE researchers Dr. W. J. Butler and Dr. C. W. Eichelberger at Session 23 of the International Electron Devices Meeting.

Operated in the punch-through mode, the MOSFET device has demonstrated a temperature stability of 1 ppm/ $^{\circ}\text{C}$ over a range of 0 to 100 C—in the laboratory. Nevertheless, Butler feels that in a production environment, deviations in the reference voltage would be less than 10 ppm/ $^{\circ}\text{C}$, for a 100-C temperature spread from 200 to 300 K (-73 C to 27 C).

The MOSFET is operated as a two-terminal device supplied by a constant current source. By adjusting the value of current through the MOSFET, the temperature coefficient can be changed from negative to positive.

CCDs beware: Here come the bubbles

Magnetic bubble memories, which have been talked about for so long, are about to enter the marketplace. And that could spell trouble for charge-coupled devices (CCDs).

A 100-kbit, bubble-memory chip, 345-by-365 mil in area, is now be-

ing sampled by Texas Instruments. It will be in production by the middle of next year, and a 500-kbyte chip will be in production by 1978.

The bubble-memory chip will sell for about 0.05¢/bit. Although CCD memories sell for about 0.03¢/bit, the density offered by bubbles is much larger.

The CCD chips that are now available contain only 16 kbits. 65-k chips are in the works, but these are still significantly smaller than the TI bubble device.

The most important difference, however, is that bubble memories, unlike CCDs, are nonvolatile.

The bubble chip has a major/minor-loop memory construction, with 144 working minor loops of 641 bits each and one major loop. An additional 13 minor loops can be used only as spares and not to increase the capacity of the memory. Thus, of the 100 kbits on the chip, 92 are actually usable.

The inclusion of spares on the chip is unusual to semiconductor technology and helps TI overcome yield problems on such a dense device.

After fabrication, the chip is tested to see which loops are not functioning properly. This information is then fed into a special section of memory. In an application, the controller first looks at this section of memory to determine which loops are operational, so the spare/replacement operation is transparent to the user.

The chip will come in a 14-pin, 1-in. wide, dual-inline package with coils and magnets.

New technique controls atomic layers of crystal

The synthesis of a new crystal-line material by scientists at Bell Laboratories, Murray Hill, NJ, could lead not only to tailor-making materials with built-in electronic and mechanical properties but also to the development of an entirely new class of optical semiconductors.

The construction of the material, called a monolayer crystal, demonstrates the ability to accurately control the periodicity and substance of actual atomic layers of the crystal, according to the scientists. This type of control distinctly contrasts with existing

crystal-growing capabilities in which the microstructure of the crystal is determined by natural thermodynamic and chemical processes.

The monolayer crystal's growing process is called molecular-beam epitaxy. Alternate layers of arsenic, aluminum and gallium—each one atom thick—are deposited on a gallium arsenide base. This layer-by-layer growth process produces a crystal that has a mirror-smooth surface and exhibits anisotropic electrical and optical properties.

The resultant crystal has the same average composition as crystals used in fabricating light-emitting diodes and solid-state lasers.

X-ray-laser development put back on the beam

The development of practical X-ray lasers heretofore has been stymied because, unlike the optical energy in regular lasers, the X-rays tended to pass through any reflecting surfaces without being reflected.

But now Amnon Yariv, a researcher at the California Institute of Technology in Pasadena, CA, has solved this problem by applying what he calls an "internal Bragg scattering" of X-rays to gallium phosphide crystals.

The X-rays are directed at an angle at the long, thin crystals. Once inside, the X-rays are reflected by the crystals' atomic planes and made to bounce back and forth, explains Yariv.

As the X-rays bounce back and forth, their energy builds up until coherent X-rays are given off by the crystals.

Because the crystals act like waveguides, adds Yariv, laser efficiency is high while the need for input pumping power is small.

Compact storage battery operates for 10,000 hrs

The electric-powered automobile has moved one step closer to reality with GM's successful test of a compact lithium/iron sulfide battery cell.

The experimental cell not only operates for more than 10,000 hours—believed to be a world's

record—but also reportedly packs the energy of a conventional lead-acid battery into 1/5 to 1/10 the space (as measured in watt-hours per unit volume). If successfully developed, such a battery might increase the 20-to-30-mile range of current, lead-acid-battery-powered urban vehicles to 200 miles before recharging is needed (see News Scope, ED No. 20, Sept. 27, 1976, p. 21).

The compact cell has been tested through more than 700 cycles of heavy discharge and recharge—also believed to be a record—during 14 months of continuous operation. The cell operates at temperatures in the range of 650 to 900 F—high enough to keep its inorganic salt electrolyte in a molten state.

During the test, the cell was operated in a laboratory furnace under a controlled helium atmosphere. In actual operation in a vehicle, the lithium/iron sulfide battery would be hermetically sealed and housed in an insulating jacket. This insulation might add a 10% to 15% weight penalty, says GM researcher Dr. John Dunning.

Although "little degradation in either specific energy or in current efficiency" was seen during early cycles of test, Dunning notes, "a short circuit gradually developed in the cell, so that the current efficiencies fell from nearly 100% to 20% at the end."

And although the record lifetime and cycles of the cell indicate that progress is being made in the laboratory, problems of high cost, durability, and performance improvement still remain.

A consumer revolution: 'basement' computers

The increasingly popular hobby of building computers in the basement promises to be "nothing less than the leading edge of a consumer-computer revolution," according to a study by the Venture Development Corp., Wellesley, MA.

The hobbyist ranges from the "home brew" experimenter to the sophisticated engineer, the researchers warn, adding that the manufacturers who fail to appreciate the differences in the consumer's needs will probably not succeed.

We saw your microprocessor

coming. So we designed an entire family of socket homes for it. Socket cards for card file mounting, and we've even got the card files. Socket boards for LSI mounting in frames, drawers, and racks,

and we've even got the frames, drawers, and racks. Our socket cards, the 3D Series, come with built-in test points, a ceramic monolithic bypass capacitor

at each socket, and solder tab connection to pins on LSI chips. Our socket boards, the 2D Series,

offer a good selection of socket complements, and are compatible with other boards for hybrid installations. We also offer automated wiring service. We're ready for you.

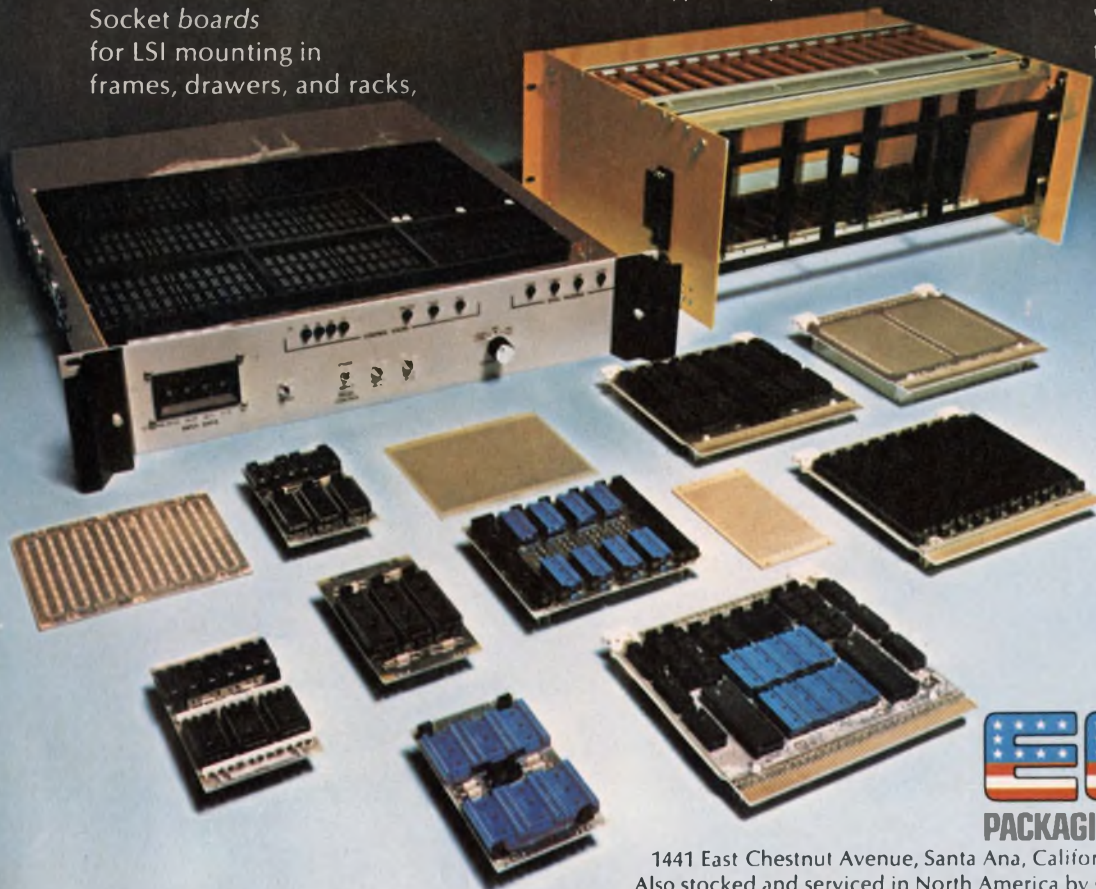

EECO

PACKAGING/SWITCHES/READERS

1441 East Chestnut Avenue, Santa Ana, California 92701 Phone 714/835-6000
Also stocked and serviced in North America by G. S. Marshall, R-A-E, Zentronics.

Designers'

Toggle Switches
Bat, lever lock, Designer
Line, sealed. Big, broad
choice.



Rocker Switches
Singles and multiples.
Wide, colorful selection
range. Legends, too.



Cutler-Hammer, of course! The broadest
line. Styled to meet today's and tomorrow's
requirements. They're solid quality, look
great, work long and hard. Carried in stock
for local availability by Switch Distributors.

Backed by Cutler-Hammer sales engineers
who can deliver innovative design help for

Pushbutton Switches
Choice of sizes, colors,
circuits, ratings. Styled
to "turn you on".



**Tool Handle &
Slide Switches**
Variable speed, reversing.
Double insulated.



 **Switch to No.1**

Choice.

the exact switch or relay you need—
when you need it.

It's no wonder so many designers specify
Cutler-Hammer. For quality, reliability,
availability, and style. For commercial,
industrial, and military applications.

We simply offer more—of everything!

Snap Switches

Lever, roller, leaf, and
pushbutton actuators.
Four terminal styles.



Switch Accessories

Guards. Boots. Seals.
Caps. Decorator
facenuts. And much
more to protect, code
or customize.



Rotary Switches

Precision and general
purpose. Single and
multiple wafer.



Illuminated Switches

Rockers, paddles,
pushbuttons, indicators.
Snap-in and bushing.



Relays

Hermetics, non-sealed,
potted. Power, latching,
and timing functions.



CUTLER-HAMMER

SPECIALTY PRODUCTS DIVISION, Milwaukee, Wis. 53201



The pace of new laser developments quickens, both in and out of the lab

Lasers are coming out of the lab and into the real world in more and more applications, ranging in diversity from pollution detection to welding.

Helium-neon (He-Ne) lasers can be found in video discs, supermarket scanners and a host of other useful equipment. Argon-ion lasers are helping the medical and dental professions. And military as well as nonmilitary applications are steadily increasing.

Meanwhile, in the laboratories, room-temperature diode lasers and sun-pumped YAG lasers are being developed to improve communications here and in space. And, thanks to current research on excimer lasers, fusion is well on its way to becoming a power source.

He-Ne laser proliferating

Helium-neon lasers, due to their low cost and high reliability, figure in hundreds of different applications.

Almost anywhere that precision alignment is necessary, He-Ne lasers have found and are finding a home. The construction industry employs them to dig straight tunnels and measure distances. The machine-tool industry uses them for positioning on milling machines.

A potentially large market for these lasers is the home video-disc player. The MCA-Philips joint venture in the video-disc field uses a laser to read the markings on the disc.

Holofile of Woodland Hills, CA,

David N. Kaye
Senior Western Editor



Like radar, lasers can be used to track aircraft and missiles. However, the lack of ground clutter with systems like this Nd:YAG laser tracker from GTE Sylvania allows low-flying vehicles to be tracked with great accuracy.

has just announced a holographic data-recorder and playback system that was jointly developed with TRW Systems. Up to 200 Mb of data can be stored in a series of 2×2 -mm holograms on a 4×6 -in. piece of microfiche.

The holographic data recorder and playback system is used mainly as a credit card verifier. All the numbers of bad credit cards can be stored on a single piece of fiche. The card can be read by an embossed card reader and compared automatically to the data stored on the fiche. Any bad cards can be readily identified. A He-Ne laser is used to illuminate the holograms on the fiche.

Holograms illuminated by He-Ne lasers are also being used for non-destructive tire testing.

The largest future market most probably will be supermarket scanning. Now that most products sold in the supermarket have the universal product code printed on them, markets are considering installing point-of-sale terminals with laser scanners that can read the code. Once the code is read, the terminal automatically records the price and prints a tape that includes an alphanumeric description of the item as well as the price.

Many medical applications

Argon-ion lasers figure in most medical laser applications. One of the pioneer uses of lasers in medicine was in retinal coagulation. Now argon lasers make reconnect-

ing detached retinas routine.

But the primary focus is bleeding in the gastrointestinal system. An endoscope containing three sets of fiber optics has been developed by Michael Bass of the University of Southern California.

One bundle of fibers is run coherently and terminates in a viewing plate. Another bundle allows an intense light to be transmitted down to the area of interest so that it can be viewed through the viewing plate. Finally, a single fiber is connected to the laser, so that when the area of interest is spotted, the laser can be fired to cauterize the area and stop the bleeding. Thus, bleeding ulcers can be cured without the need for surgery.

Research is currently underway to investigate the possibility of destroying cancerous cells in the skin by dyeing them and hitting them with laser light. The darker cancerous cells should absorb more light and be damaged more readily than unstained normal cells.

Work is also underway to perfect the laser scalpel. Ideally, this scalpel will allow for bloodless surgery, since the laser will cauterize as it cuts. The problem so far has been that the laser, while burning, creates smoke that impairs the surgeon's vision. Developing a device that sucks away the smoke should solve this problem.

Dentists look at lasers

Dentists are becoming increasingly interested in lasers. At the Cincinnati Children's Hospital Research Foundation, researchers have focused a ruby laser beam on tooth cavities and have been able to obliterate the decay. Laser energy is absorbed by the dark, decayed parts of the tooth, but not by the healthy areas. Due to its speed and lack of excessive heat, laser drilling most likely can be carried out without anesthetics, according to the researchers.

Researchers at UCLA, among other institutions, are investigating the use of lasers in sealing tooth enamel to prevent cavities or fuse cracks in teeth. By focusing laser light through a fiber-optic strand, lasers might be used to seal and clean the inside of root canals as well.

A great deal of attention is

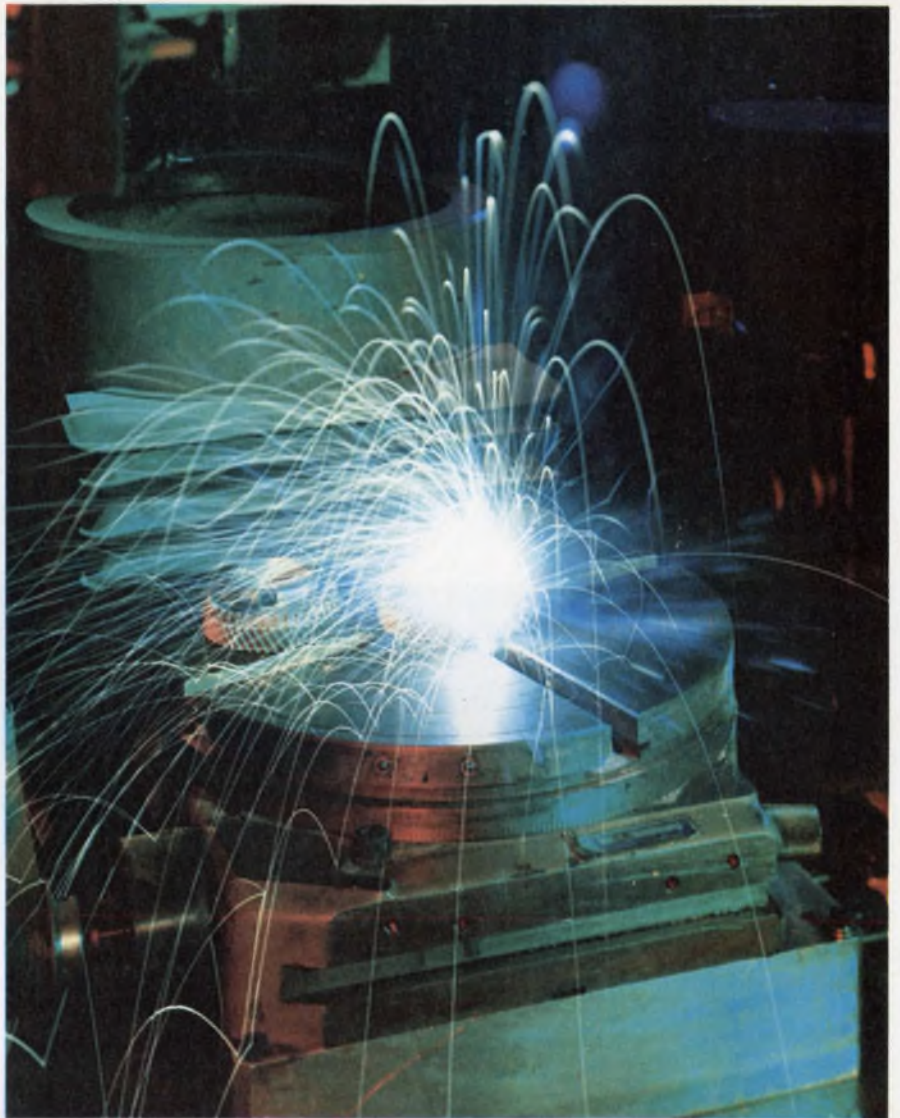

Two gears of an automobile transmission component are welded together by a high-power CO₂ industrial laser from Avco Everett Research Laboratory.



Machine-tool positioning is easy with the Hewlett-Packard 5501A Laser Transducer System. The system uses a two-frequency laser head and interferometric optics for precise linear displacement measurements.

centering on improving tunable dye lasers. Dye lasers are primarily used by physicists in absorption spectroscopy.

An argon-ion laser pumps a dye, such as Rhodamine 6G. The dye fluoresces and relaxes by giving off a broadband of wavelengths. By tuning the optical cavity, it is possible to tune an argon-ion dye laser from about 400 to 800 μ . This tuning requires more than one dye, however.

Two of the major commercial fabricators of dye lasers are Spectra-Physics, Mountain View, CA, and Coherent Radiation, Palo Alto, CA. The most significant difference between the dye lasers produced by the two companies is the tuning technique used.

Spectra-Physics inserts a wedged interference filter in the cavity.

The filter is a glass plate with a three-layer coating. The bottom coating is a layer of reflective coating. On top of that is a wedge of silicon dioxide of linearly varying thickness. The third coating is another layer of reflective coating.

The cavity is tuned by moving the wedge up and down and exposing the laser beam to differing thicknesses of silicon oxide.

Coherent Radiation uses a variation of the Leo filter, which is a birefringent plate tilted at Brewster's angle and simply rotated in the cavity. As the plate rotates the effective-transmission length

through, the plate changes, and the cavity is tuned.

Chemical lasers for DOD

The Department of Defense is very interested in chemical lasers for its weapons systems. These lasers depend on a chemical reaction rather than electrical energy for pumping. Much of this work is classified, but two known companies pushing the state-of-the-art of chemical lasers are Aerospace Corp., El Segundo, CA, and TRW Systems, Redondo Beach, CA.

Aerospace is working on nitro-

gen fluoride (NF) lasers with a wavelength of about 0.9μ . NF should be more efficient than the long-worked-on HF (Hydrogen Fluoride) lasers, according to Steven Suchard of Aerospace. Due to their huge potential powers, Suchard also foresees these lasers being applied to fusion work. The NF laser, however, is not working in the laboratory yet. TRW is working on carbon nitrogen radical compounds for chemical lasers. This work is also very early.

Military applications abound

The military's interest in laser applications does not stop with high-powered laser weaponry. Interest includes many other applications: laser range finders, laser target designators, laser fiber-optic battlefield communications, and missile and ring-laser guidance systems for aircraft.

A 4-laser-assembly engagement system by Menet Corp., Santa Monica, CA, is now used to record rifle hits in war games. The package of four injection-diode lasers is mounted on each rifle. Each target carries a retroreflector. When the target is hit, a pulse of laser energy reflected from the target is detected and scored electronically.

The new technology

It wasn't too long ago that room-temperature diode lasers lasted only a few minutes in the laboratory. Recently, however, their lifetimes have been extended to about 10,000 hours. And although commercially available diode lasers are only quoted at a couple of thousand hours, laboratories are reporting lifetimes as high as 100,000 hours.

"We can now confidently make GaAs diode lasers that will last at least 100,000 hours. They have an efficiency of about 50% with about 10 mW of output," says Bernard DeLoach, head of the GaAs Laser Dept. at Bell Laboratories, Murray Hill, NJ.

These lasers operate at about 0.9μ . By adding aluminum to the active layer, the wavelength can be shifted down to around 0.8μ .

"Our AlGaAs diode-laser's real-time data are up nearly 20,000 hours already, and we feel that 100,000 hours are not unrealistic,"



This Q-switched YAG laser, from Korad, is cutting through 1/4-in. thick titanium. YAG lasers are also being tested for communications.

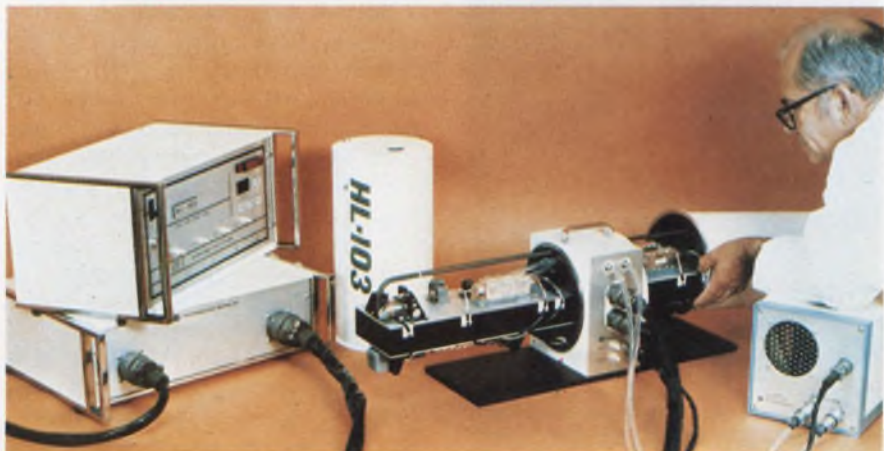

Nd:YAG pulsed laser systems, such as the HL-103 from International Laser Systems, are used in such applications as nondestructive testing and ballistics research.

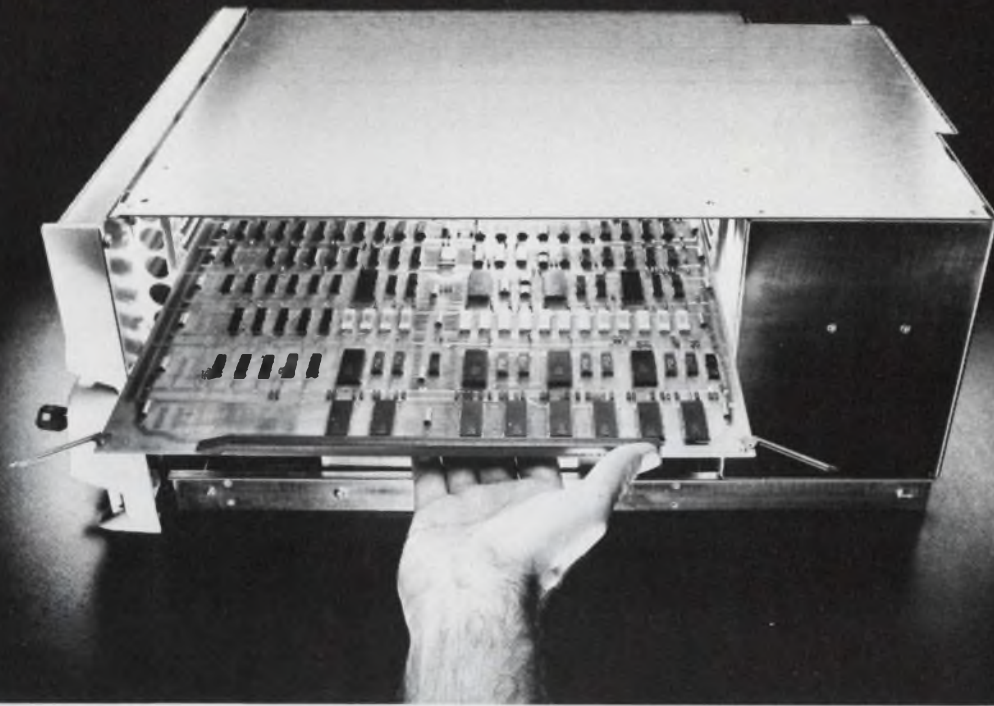

Give your data communications system a little goose and it'll put out ten times as much.

Open up the back of any Data General communications system, pop in our single-board DCU/50 Data Control Unit, run through a little step called COMGEN and stand back. Because that system can start pumping out ten times as much data. And possibly a good deal more.

What makes this all possible is a rather clever piece of engineering.

We've designed the DCU/50 as an intelligent programmable controller. So it takes over jobs the CPU used to do. Things like character handling and code conversion. Which frees up the CPU processing power and speeds up total systems throughput.

On the other hand, you may not need more throughput. Instead, you may need more lines or different types of lines. Both of which are just as easy to get. You just plug in some different boards.

We make modular synchronous and asynchronous multiplexors you can mix

in any proportion. They can handle anything from one to sixteen lines, are fully software supported and work equally well with or without the DCU/50.

Which brings up a rather significant point.

When you buy your communications equipment from Data General, you can get exactly what you need right now. And later, if you need more throughput, more lines or different types of lines, you won't have to throw out anything. All Data General communications hardware and software are completely compatible. So you can add on to what you already have.

Write for our free brochure, "The Sensible Way to Use Computers in Data Communications" and detailed information about the DCU/50 Data Control Unit.

And if that isn't enough information, we'll send a sales engineer who can also put out ten times as much.

DataGeneral

• Data General, Route 9, Southboro, Mass. 01772, (617) 485-9100. Data General (Canada) Ltd., Ontario. Data General Europe, 15 Rue Le Sueur, Paris 75116, France. Data General Australia, Melbourne (03) 82-1361

CIRCLE NUMBER 20

reports Harold Lockwood of RCA Laboratories in Princeton, NJ, another hotbed of diode-laser activity. "Although current diodes have lasing thresholds in the 200-mA region, we are looking to lowering them to between 50 and 100 mA." Lockwood also envisions an increase in the output power to about 50 mW.

These laser diodes will be used in high data-rate (more than 30 MHz) communications through fiber optics. Bell Laboratories, Atlanta, GA, is already testing this potential application by driving a pair of 2100-foot bundles of low-loss (about 6 dB/km) fibers 44.7 Mb/s with a diode laser. Each bundle contains 144 fibers. Silicon-avalanche, photodiode detectors are used on the receive end.

This sort of technology would enable a 1/2-in. diameter bundle to carry about 50,000 telephone calls. In contrast, a copper-cable system requires about 6 cables, each with a 3-in. diameter, to carry the same load. Bell expects to install fiber links between central offices by the early 1980s.

YAG lasers also figure prominently in the future of communications. A sun-pumped YAG laser of the type demonstrated by GTE Sylvania last year will be used in 1980 by the Air Force on a communications satellite to test Gb/s, data-rate, space-to-space laser communications.

Excimers for fusion

One of the most interesting laser developments of late is the excimer laser. An excimer is an unstable molecular bond that forms between a pair of electrically excited elements. As the bond breaks, energy is given off in the form of laser light.

The most actively pursued excimers are combinations of inert gases and halides, such as fluorides, bromides and chlorides. The exci-

(continued on page 30)

The principle of dye laser action is shown as a blue argon-ion laser beam from a Spectra-Physics laser is passed through a dye solution. The greenish light is a fluorescent effect in the dye that has a broader spectral band than the original laser beam. Spectral lines from that broad band can be selected by cavity tuning.

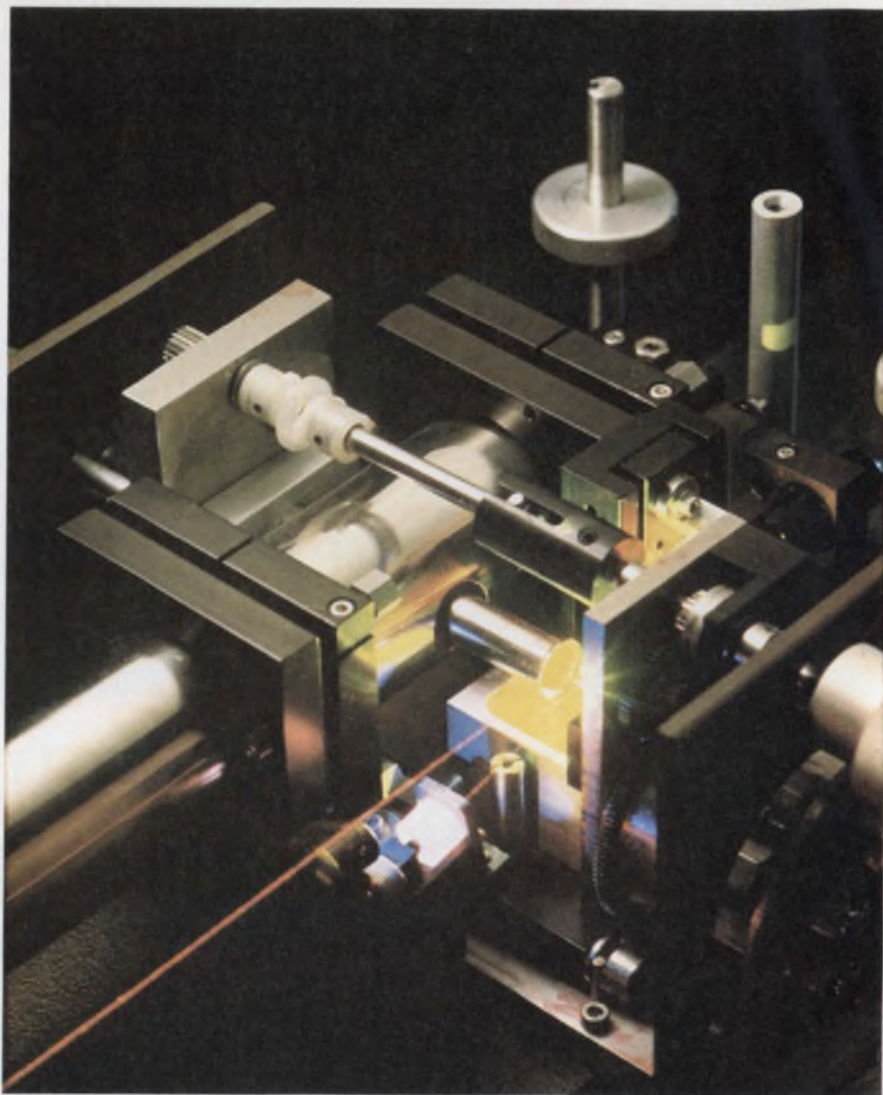

A jet stream of Rhodamine 6G dye is hit with light from a Coherent Radiation argon-ion laser. The result is a dye laser that can be tuned from about 480 to 520 nm.



LINEAR INNOVATIONS
FROM TI

BIFET



LINEAR IC'S

First quad BIFET op amp. Super Beta performance at low cost.

An innovation from Texas Instruments. The new TL084. The industry's first four-in-one BIFET operational amplifier.

Joining Bipolar and JFET technologies on the same TL084 chip gives you the outstanding qualities of Super Beta plus excellent AC characteristics: Extremely low input current, high speed, and less noise.

All at down-to-earth economy. Only \$4.35 (\$1.09 per function) in 100-piece quantities. Plastic or ceramic 14-pin and 16-pin dual-in-line packages. Same pin-outs as the LM124/2902.

| | # of Op Amps per Package | Input Bias Current (pA) | Input Offset Voltage (mV) | Unity Gain Bandwidth V/μs | Slew Rate V/μs |
|---------------------------------|--------------------------|-------------------------|---------------------------|---------------------------|----------------|
| μA741C (Single General Purpose) | 1 | 80,000 | 2 | 1.0 | 0.5 |
| LM324 (Quad General Purpose) | 4 | 45,000 | 2 | 0.7 | 0.5 |
| LM308 (Super Beta) | 1 | 1,500 | 2 | 1.0 | 0.2 |
| LF355 (Single BIFET) | 1 | 30 | 3 | 2.5 | 5 |
| LF356 (Single BIFET) | 1 | 30 | 3 | 5.0 | 12 |
| TL084C (Quad BIFET) | 4 | 30 | 4 | 2.5 | 7 |

Typical data at 25°C

New source for LF155 op amps.

If your LF155 op amps are coming too slow or costing too much, check out TI. Immediate delivery from TI

distributors. In a choice of packages: 8-pin plastic or ceramic DIP, TO-99 metal can. Electrically and mechanically equivalent to their counterparts. Only \$1.60 for LF355P (100 pieces).

Also consider subbing TI's LF155 for certain Super Betas. Same pin-out. And you'll get 'em faster at a savings.

For more details on TI's innovative TL084 quad or the LF155 op amps, call your TI Distributor for data sheets. Or, write Texas Instruments, P.O. Box 5012, M/S 308, Dallas, Texas 75222.



TEXAS INSTRUMENTS
INCORPORATED

(continued from page 28)

mer laser's big selling point is its high efficiency, coupled with short pulses, high peak powers and wavelengths in the UV.

The goal in fusion work is to develop what the Energy Research and Development Administration (ERDA) calls the "Brand X" laser. It will have a wavelength of between 0.3 and 0.5 μ , 10^{12} W of peak power, 100 ps to 1- μ s pulse width and at least 5-to-10% efficiency. All of these characteristics are theoretically within reach of excimers. Peak powers are already in megawatts, and efficiencies in the 1% range for such excimers as xenon fluoride, krypton fluoride and argon fluoride.

"We should soon be seeing efficiencies in the 10-to-15% range,"

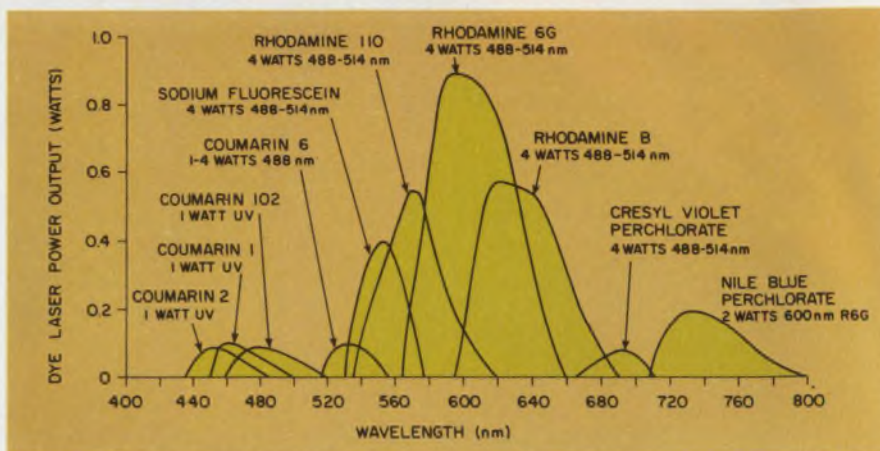

Various dyes can be used to tune the dye laser all the way from 400 to 800 nm. These are some of the typical dyes used. The performance data are for the Spectra-Physics Model 375 high-performance CW dye laser.

says Mani Bhaumik, manager of the Advanced Research Laboratory at the Northrop Research and Technology Center in Haw-

thorne, CA. Excimers also look promising for applications in military weapons systems and isotope separation. ■■

Photodiode preamp available in small package

A photodiode/preamplifier module, which comes in a small package and whose characteristics can be "tailored" to a specific application, has been developed by General Electric Co.'s Space Technology Products Div. in Philadelphia.

Using a highly sensitive silicon avalanche photodiode, the hermetically sealed "Laser Eye" is designed for applications like laser range finders or laser scanners. In typical scanning systems, a laser beam scans a region of the earth's surface. The reflected signal carrying information about the "target" area is detected and amplified by the photodiode/preamplifier.

The GE unit can be modified (by the manufacturer) to conform to a variety of customer needs. Characteristics that can be altered include such properties as preamplifier bandwidth, sensitivity (to protect the detector in situations of high signal strength), and coupling (ac or dc).

Sensitivity is specified at 3.3×10^5 -V output per watt of illumination, under conditions of a 15-ns pulse at 0.9- μ m wavelength. RMS dark noise at the output is quoted as 10^{-4} V.

"Laser Eye" weighs 40 gms and



Photodiode/preamplifier weighs a scant 40 gms, yet provides high sensitivity. Its characteristics can be modified for specific applications.

is 1.8 cm \times 1.4 cm \times 3.6 cm in size. Its power supply leads are filtered internally to permit operation in noisy environments.

The unit currently comes in two models, the LE-303 and LE-304, which differ only in their operating bandwidth. ■■

From the leader in power device technology and innovator in plastic packaging . . .

POWER TRANSISTORS

The Designer's Choice from General Electric

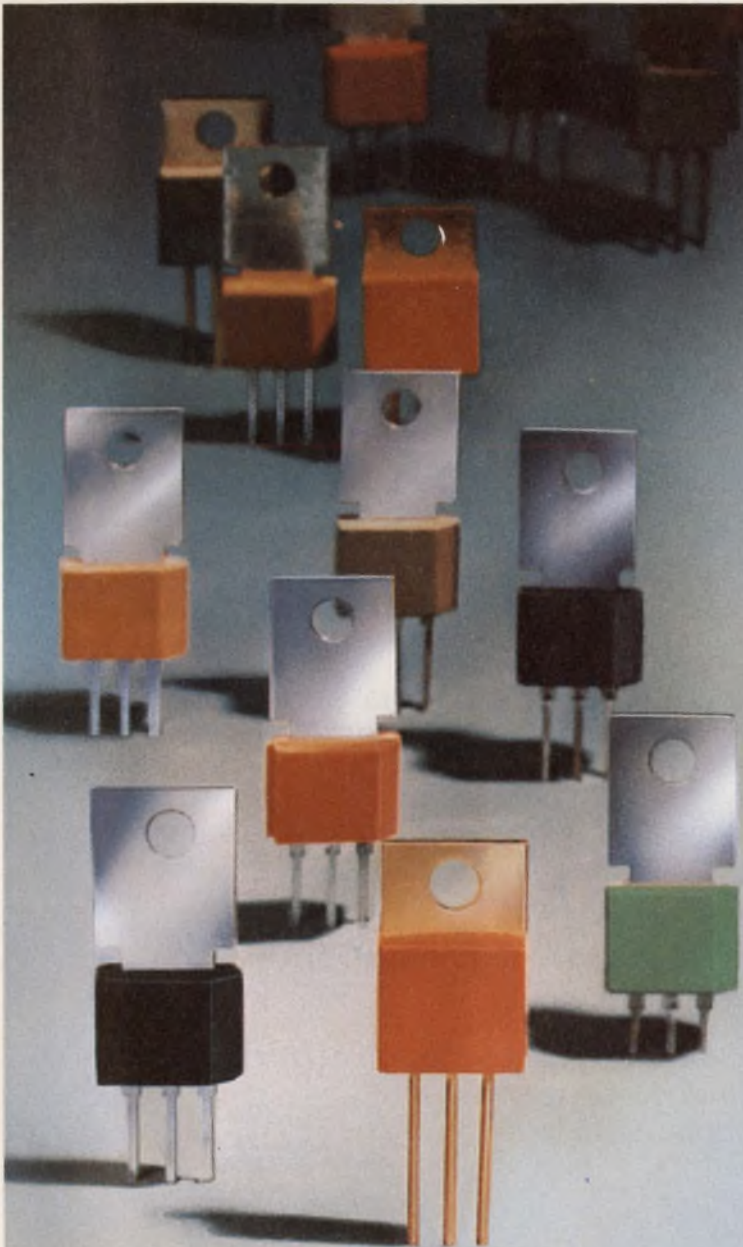

- Excellent free air power dissipation
- Silicone resin plastic encapsulated TO-202 and TO-220A^B packages
- Hard solder chip attachment for superior power and temperature cycling capability
- Good current gain
- Fast switching speeds
- Color coded for polarity (NPN or PNP) and lead configuration

General Electric's technology, experience and quality products can serve your industrial application needs. Our Power Transistor Selector Guide and factory personnel are available for your inquiries. Contact your local GE distributor or write to General Electric Co., Electronics Park, Bldg. 7, Box 49, Syracuse, NY 13201.

GENERAL  **ELECTRIC**

PROVEN PERFORMANCE CRYSTAL CLOCK OSCILLATORS



Motorola's K1100A leads the industry with a crystal clock oscillator that has a proven track record of more than one million units. That's right . . . over one million oscillators are in use by satisfied, repeat customers. That's not all . . . we feature fast deliveries.

How versatile is the K1100A? With over 1200 frequencies already designed, and same day shipment for standard stock frequencies of 4, 4.9152, 5, 10, and 20 MHz . . . you make the decision.

Oscillators are available from 250 kHz to 32 MHz, +0.01% stability from 0°C to 70°C, TTL compatible, and standard +5V dc input.

For full specifications and prices on the oscillator that design engineers trust, write Motorola, Component Products Department, 2553 N. Edgington, Franklin Park, Illinois 60131. Or call (312) 451-1000, ext. 4183.



MOTOROLA
Communications and Electronics Inc.

Not New...Just the Best



ERIE RED CAP

Miniature Ceramic Capacitors

WIDEST SELECTION OF MINIATURIZED CERAMIC CAPACITORS IN THE INDUSTRY!

Erie is in the Red Cap winner's circle because of a well engineered component that's backed by a unique process control system. Combine this with talented, motivated people and you have Erie as the leader in its field. These tiny high quality capacitors are not new... but they are the best. Our customers attest to it. Our test laboratories prove it.

Red Cap dielectrics are manufactured by Erie's exclusive Monobloc Process®... a modern, time-proven ceramic film technology. And tough environmental extremes routinely are endured by our own Jet-Seal, a hard, bright red polymeric protective coating. (The superior aesthetic appearance of Jet-Seal comes to you at no charge.)

Erie Red Caps have it all. 21 temperature characteristics. 1pF to 10uF capacitance range. Ratings from 25 to 500 Vdc. You name the application... we've got a Red Cap for the job. All this is due to Erie's total in-house capability... from exclusive ceramic formulations to unique packaging. So on your very next buy of ceramic capacitors, do it the easy way... specify Erie Red Caps.

Write TODAY for Red Cap brochure 8000... or call our nearby factory representative.

CAPACITANCE
RANGE
1pF to 10uF

21
TEMPERATURE
Characteristics

Voltage Range
25 to 500 Vdc

Encapsulated
by
"JET-SEAL"

Meet or Exceed
Requirements
of MIL-C-20
MIL-C-11015
As applicable

ERIE TECHNOLOGICAL PRODUCTS, INC.
Erie, Pennsylvania 16512

ON NOV. 22 Electronic Design

Presents:

INSTRUMENTS '76



**DRAMATIC CHANGES ARE TAKING PLACE
IN THE WORLD OF INSTRUMENTS . . .**

DON'T MISS THIS MAJOR EDITORIAL WRAP-UP

- **PROGRAMMABLE INSTRUMENTS**

Exactly what "programmable" means. Discussion of the IEEE-488 and CAMAC interface busses.

- **SMART INSTRUMENTS**

Instruments that include μ Ps, memories or other advanced circuits for calculations, self diagnosis, automatic operation, etc.

- **COMBINED INSTRUMENTS**

Instruments that combine several functions — e.g. scope, DVM and counter — with special emphasis on synergistic results.

- **BATTERY-POWERED INSTRUMENTS**

Circuit and packaging techniques used to achieve power efficiency, portability, ruggedness, small size and other desirable features.

- **SAFE INSTRUMENTS**

Design techniques to avoid hurting operator or damaging external equipment. Discussion of safety codes.

- **STANDARDS AND CALIBRATION**

A look at primary and secondary standards and stable transfer instruments for calibration. Questions the meaning of "traceable to NBS."

- **MEDICAL ELECTRONIC INSTRUMENTS**

Update on diagnostic and clinical instruments with emphasis on design problems rather than applications.

INSTRUMENTS '76

A full-scale, full-staff report with emphasis on the incorporation of microprocessors in instruments and the new sophistication that is sweeping the instrument field. Watch for it November 22.

***IT'S ANOTHER REASON WHY ELECTRONIC DESIGN IS THE
BEST READ ELECTRONICS PUBLICATION IN THE WORLD!***

From the first connector to the last termination, we can put connector back panel assemblies together to your exact specifications.

We make our own connectors, stamp our own metal, make our own circuit boards and program our own automatic wiring machines. Since we control every step of the process, we can promise you

zero electrical defects on delivery.

You can minimize your capital investment by letting us do the complete job. But, if you have your own assembly or semiautomatic wiring capability we'll stop at any point you want. We'll even sell you just the connectors, on 0.100, 0.125, 0.156 or 0.200-in. centerline spacing, if that's your need.

So, if you're wrapping up the details of a new product design, it's time to start rapping with us. For complete details, contact GTE Sylvania, Connector Products Operation, Titusville, Pa. 16354. Phone 814-589-7071 TWX 510-692-6763.

GTE SYLVANIA

CIRCLE NUMBER 24

**Our package deal:
with
or without wrapping.**



KEPCO

digital power supplies

your
choice
of:

- resolution: 2 or 3-digit BCD; 8-, 10- or 12-bit binary.
- grounding: fully isolated optically.
- volts and amperes: to 1000V, to 90A.
- unipolar and bipolar outputs.
- high speed or conventionally filtered output.

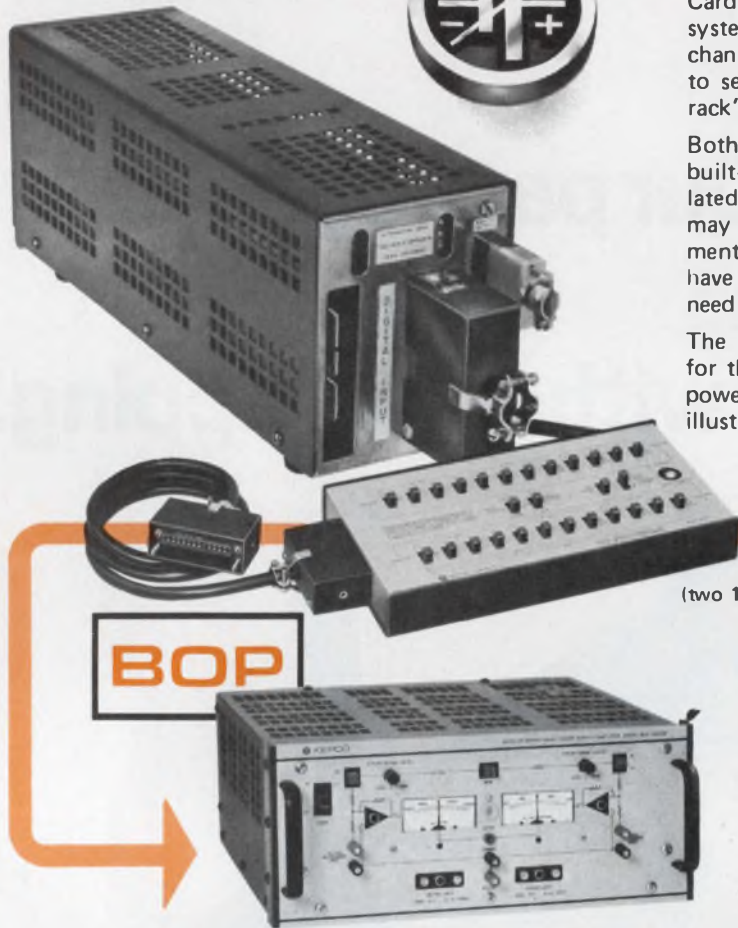

Kepeco's Digital Programmers are composed of individual PC Cards that may be combined as you require to form a control system. The combination to the left provides a 12-bit, 2-range channel for voltage setting, plus an independent 8-bit channel to set a current limit. It is housed in a convenient "quarter-rack" assembly, seen here from the rear.

Both channels are strobe-accessed for noise immunity, have a built-in delay (10 μ sec) for deglitching and are optically isolated so that either side of your power supply (up to 1000V) may be grounded. Data inputs are TTL compatible, complementary-logic with built-in storage registers. The programmers have isolated on-card a-c operated power supplies— all you need to do is plug 'em in.

The SN Programmer's outputs are d-c analog signals, suitable for the control of any of Kepeco's *Operationally Programmable* power supplies, either the high speed kind (whose response is illustrated below) or conventionally-filtered models.

Manual Program Generator
(two 12-bit words) for system test.

BOP

OPS

Response character of the BOP 1000M, programmed from -250V to +250V, showing strobe and delay.

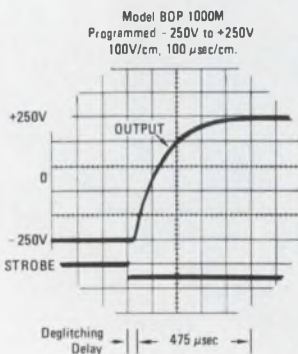

BIPOLAR VOLTAGE

The SN Programmer mates perfectly with one of the new Kepeco high voltage, bipolar units, Model BOP 1000M with an SN-12R (12-bit) Card controlling voltage, and an SN-8R (8-bit) card controlling current. Your *Bipolar* output is:

| RANGE | RESOLUTION |
|------------------|------------|
| -1000V to +1000V | 244 mV |
| -100V to +100V | 24.4 mV |
| -40 mA to +40 mA | 0.16 mA |

For complete specifications and applications notes on our full line of voltage and current regulators and digital programming interfaces, write Department FJ-05

UNIPOLAR VOLTAGE

The SN Programmer also mates beautifully with Kepeco's many high speed unipolar power supplies, for example, a Model OPS 55-5M. With the SN-12R Card for voltage control and the SN-8R Card for current control, you get a *Unipolar* output of:

| RANGE | RESOLUTION |
|--------|------------|
| 0-55V | 13.2 mV |
| 0-5.5V | 1.3 mV |
| 0-5 A | 20 mA |

Response character of the OPS 55-5M, programmed from 40V down to 5V, showing strobe and delay.

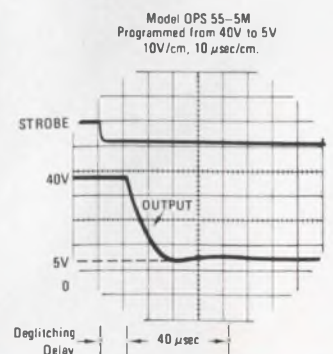

KEPCO®

KEPCO, INC. • 131-38 SANFORD AVENUE • FLUSHING, N.Y. 11352 U.S.A.
(212) 461-7000 • TWX #710-582-2631 • Cable: KEPCOPOWER NEWYORK

CIRCLE NUMBER 25

Washington Report

Foreign military sales resume growth trend

Foreign military sales, which had been declining steadily for the past three years, have suddenly spurred upward.

On a single day this past September, the Pentagon submitted to Congress proposed letters of offer to foreign customers that totalled \$6-billion worth of military hardware and services. Orders for the entire previous fiscal year amounted to \$8.3 billion, down from \$9.5 billion the year before.

The big ticket item in U.S. military sales abroad is fighter aircraft, particularly the General Dynamics F-16. An order for 160 F-16s from Iran, at an estimated cost of \$3.8 billion, was the major factor in the \$6 billion package sent to Congress. Four NATO countries earlier ordered 348 F-16s.

Electronic systems are expected to be dominant in the coming year. Saudi Arabia is planning a \$1 billion command and control system for its domestic police force, and Iran has Rockwell International under contract for systems integration of its proposed \$500 million IbeX electronic surveillance system.

Technology studies due for October release

Two ad hoc study groups commissioned by the President's Office of Science and Technology Policy have completed their review of technology and its impact on the economy and their findings are due to be released this October.

One group, led by Dr. Simon Ramo, vice chairman of the board at TRW, examined the contribution of technology to the economy. The other, led by Dr. William Baker, president of Bell Laboratories, considered anticipated advances in science and technology. More than 60 issues covering the spectrum of the physical and biological sciences are involved.

The purpose of the studies is to identify the areas in which the recently reactivated Office of Science and Technology Policy can oversee federal activities for the President. That office had been dormant for the past three years until Dr. H. Guyford Stever, former director of the National Science Foundation, was appointed presidential science advisor.

Defense business booms in California

California, which already has the lion's share of the defense business and is considered a critical state in next month's presidential election, increased its share of military business from 21.2% last year to 23% for the fiscal year ended June 30.

A recent Pentagon analysis of how military prime contracts were distributed by state during the past fiscal year shows that California received nearly \$9-billion from the previous fiscal year.

New York was a distant second with \$3.3-billion in military prime contracts, down from \$3.7 billion from the year before.

Pentagon officials maintain that their figures are not a true picture of how much money winds up in the individual states because the figures do not take subcontracts into account. California, however, does lead the nation among electronics and other subcontractors as well as the big air-frame prime contractors.

DOD to charge for use of production facilities

For years, the Defense Department has encouraged its contractors to woo overseas markets for their military equipment by permitting them to use government-owned facilities rent-free if potential foreign sales are involved.

No more. The Army has advised its contractors they will have to pay to use its facilities. The other services are following suit. The new policy is contained in a revision to the Armed Service Procurement Regulations.

The policy applies to both prime and subcontractors involved in commercial transactions with foreign governments. Permission to use the facilities must be obtained in advance. Exact charges will be determined by the Pentagon's Office of the Assistant Secretary of Defense for Installations and Logistics.

NASA to test fly-by-wire flight controls

Electronic digital "fly-by-wire" flight control systems might cut aircraft production costs by 10% and permit weight savings of up to 20% over aircraft with conventional mechanical control systems, the Air Force estimates. Nevertheless, both military and commercial users are leery of the new technology because adequate test data are scarce.

So the National Aeronautics and Space Administration (NASA) has begun a test program at its Dryden Flight Research Center, Edwards, CA. Three IBM AP-101 digital computers, similar to those used in the Space Shuttle, are hooked into the pilot's control stick in an F-8 Crusader fighter plane. The goal is to determine if lightweight wires can translate the digitized signals to the aircraft control surfaces.

Capital Capsules: The National Oceanic and Atmospheric Administration (NOAA) is pulling together its technology-related activities into a **new Office of Ocean Engineering**, headed by Steven N. Anastasion of NOAA's Office of Marine Resources. The new office will consolidate the agency's work in data buoys, undersea vehicles and ocean instrumentation. . . . **The Navy has installed the first of two visual simulators for its new LAMPS helicopter** at Norfolk, VA. The second one will be installed later this year at San Diego. . . . The recent congressional **compromise on production funds for the B-1 bomber** has permitted the defensive electronic countermeasures program to remain on schedule. Subcontractor AIL will deliver ground-test hardware in mid-1977 and first-flight-test hardware in early 1978. Defensive ECM will not be installed on the first 34 of the 240-aircraft program, however.

TEKTRONIX now has 5 ways to look at logic.

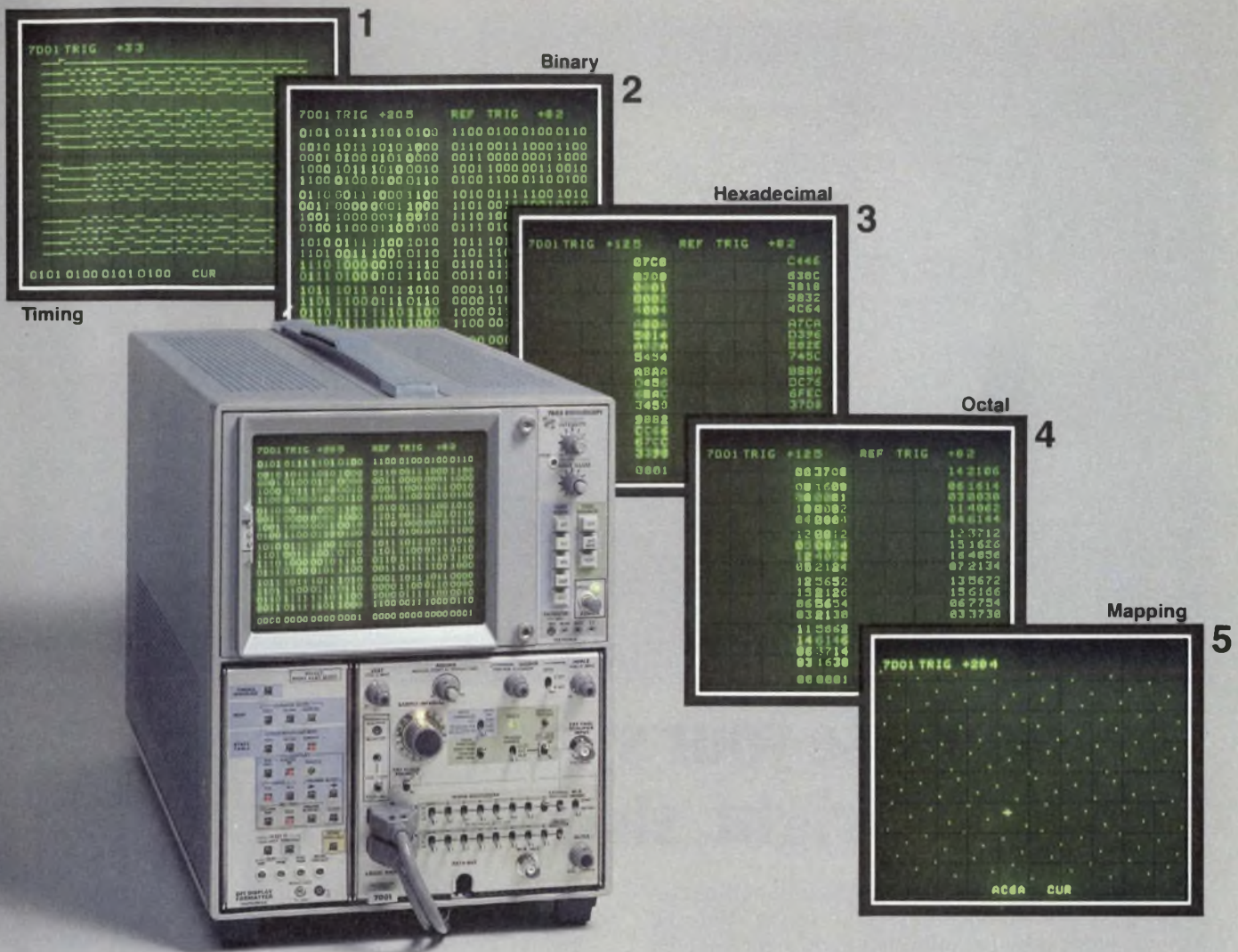

The New DF1 Formatter

First, we gave you the timing display and binary readout with our 7D01 Logic Analyzer. Now, with the DF1 Display Formatter, which is dedicated to the 7D01, you have five display formats to operate from, all in a 7000-Series mainframe. Now you can convert a timing display into tables of words in Binary, Hexadecimal, Octal ... or a mapping configuration ... whatever your application requires.

A STATE TABLE mode of operation produces standard tables of up to 16 lines of 16-bit words. Using the 7D01's cursor, you can step through these tables word-by-word in Binary, Hex, or Octal. A 17th word is added to each table emerging from the 7D01's memory, to serve as a "key" and indicate you are indeed scrolling correctly through the long memory. The 7D01's fine cursor

control steps the display line-by-line, while the coarse control advances it table-by-table.

One of the most powerful analytical capabilities provided by the STATE TABLE mode is that you can display two tables—a reference table of "proved" data plus a "new" data table drawn from a system under test—on the same crt for side-by-side comparison. New data that is different from the reference data is automatically intensified ... you immediately know faulty data exists, and you know its location.

With the DF1 you can map, not just one, but three ways. The ability to map FAST, SLOW, or MANUAL lets you quickly recognize a word of interest, track it, isolate it, then pinpoint it for detailed analysis. The importance of mapping is derived from the speed with which you can isolate problems.

The logic analyzer package shown (7603 Option 1, 7D01, DF1) starts as low as \$5790. If you already own a 7000-

Series mainframe, add the 7D01-1 (7D01/DF1 combination) for only \$4390. Also consider that your money buys you these important 7D01 features: 1) Word recognition, 2) 16 channel timing resolution, 3) 15-ns asynchronous timing resolution, 4) 4k formattable memory (4, 8 or 16 channels), and 5) High Z probes.

For more information or a demonstration of the DF1, contact a Tektronix Field Engineer near you. Or write Tektronix, Inc., P.O. Box 500, Beaverton, OR 97077.

United States sales prices are F.O.B. Beaverton, OR. For price and availability outside the United States, please contact the nearest Tektronix Field Office, Distributor, or Representative.



FOR TECHNICAL DATA CIRCLE # 241
FOR DEMONSTRATION CIRCLE # 242

HP displays.

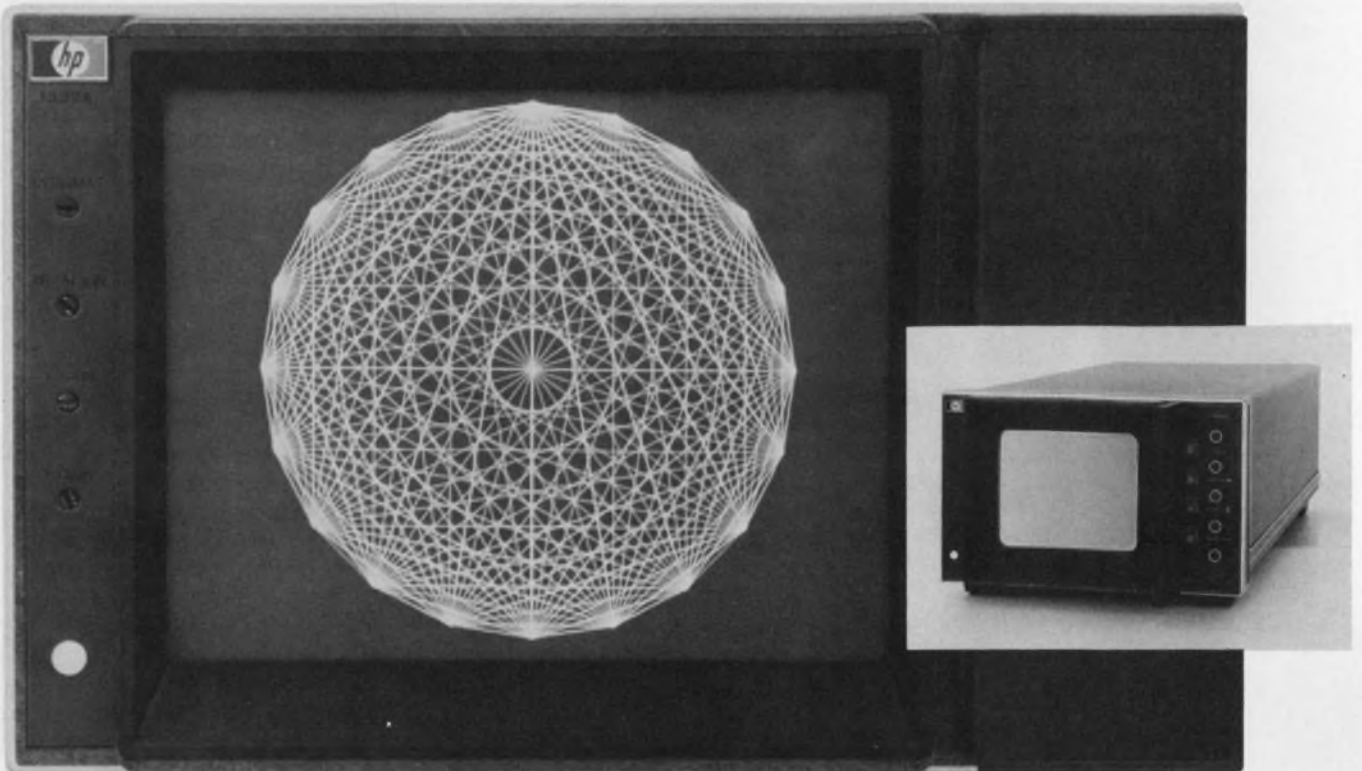

Because your system deserves a bright, sharp image.

You put a lot into each OEM system: good circuit design, quality components, careful testing. But end users will judge it by the information they get from the display. They expect bright, sharp images. That's why HP's 1332A, 1333A, and 1335A CRT displays make excellent choices for all types of systems—from spectrum, network, and chemical analyzers, to automatic test systems.

Each display has a very small spot size that focuses uniformly over the complete viewing area, regardless of writing speeds or intensity level. This eliminates the need to refocus at each intensity setting and assures crisp images, even around the outer edges of the screen. Fine image detail with excellent contrast and uniformity make them particularly well suited for applications involving complex graphics, especially those with alphanumeric data.

The 1335A, a variable-persistence, storage, and non-storage display, introduces a totally new CRT design optimized exclusively for information display. It offers exceptionally good resolution over the entire 8 x 10 cm screen. And the 1335A is versatile too. Any operating mode—erase, store, write, conventional, or variable persistence—can be selected with manual front-panel controls, remote program inputs, or a combination of both. Manual controls can be inhibited entirely during remote operations. The 1335A is a welcome

addition to medical and instrumentation systems.

OEMs who need a larger viewing area and a brighter image at faster scan rates like the 1332A. They appreciate its 9.6 x 11.9 cm viewing area, its superior performance, and the ease with which the 1332A, like the others, integrates into a variety of racks and cabinets.

For photographic recording of displayed data, the new 1333A offers new performance levels. Its extremely small spot size of 0.20 mm (0.008 in.) provides the exceptional quality necessary for easy and accurate photo evaluation. And its 8 x 10 cm screen allows reproduction on Polaroid film with very little optic reduction. For convenience, all frequently used controls on all of these displays have been placed on the front panel for maximum accessibility.

Which display best fits your requirements? Let your local HP field engineer help you decide. Or write for specific details. We'll help you pick a display that makes your system look as good as it actually is.

085-9 A

HEWLETT  PACKARD

Sales and service from 172 offices in 65 countries.
1507 Page Mill Road, Palo Alto, California 94304

NEW

PRICE/PERFORMANCE BREAKTHROUGH



Now! 0.1% Accuracy On All 5 DC Voltage Ranges

SIMPSON

MODEL 464

Digital Multimeter

USE IT EVERYWHERE:
In Field or Factory
Production Line Testing,
Laboratory, R & D, and for
General Electronic Servicing.

- 3 1/2 Digit, 0.43" LED Readout
- Highly Reliable LSI Circuitry
- Bi-Polar Operation and Automatic Zero
- Full Pushbutton Selection of Ranges and Functions
- 28 Ranges: 6 AC current ranges to 10 amps
6 DC current ranges to 10 amps
6 resistance ranges to 20 megohms
5 AC voltage ranges to 600 volts
5 DC voltage ranges to 1000 volts

- High Accuracy: \pm (0.1% of reading + 1 digit) on all 5 DC V Ranges (+15 to 35°C)
- Choice of Battery/AC Line Combination or AC Line Operation Only
- High Impact Shock-Resistant Case with Tilt-View, Adjustable Handle
- Conforms to Applicable ANSI C39.5 Requirements

Model 464A line operation **\$210.00**
Model 464D line and battery operation **\$247.00**

ORDER FROM YOUR ELECTRONICS DISTRIBUTOR

SIMPSON ELECTRIC COMPANY

853 Dundee Avenue, Elgin, Illinois 60120 • (312) 697-2260

CABLE: SIMELCO • Telex: 72-2416

IN CANADA: Bach-Simpson, Ltd., London, Ontario

IN ENGLAND: Bach-Simpson (U.K.) Ltd., Wadebridge, Cornwall

IN INDIA: Ruttonsha-Simpson Private, Ltd., Vikhroli, Bombay

CIRCLE NUMBER 28



KATY INDUSTRIES



INDUSTRIAL EQUIPMENT GROUP

WHO MAKES THESE CUSTOM ICs?

We don't make commodity ICs. Our 15 years of intensive experience in ICs is devoted to the development and manufacture of **innovative** circuits . . . circuits making special contribution to industry technology . . . circuits manufactured under the most exacting QAR program ever implemented . . . **creative** circuits such as the types shown here. **If you can't quite do the job with standard products, we can design integrated circuits tailored to your needs.**

- Printer Controllers
- Ground Fault Interrupters
- Smoke Detectors
- Voltage Regulators
- Photographic Shutter Controls
- Camera Flash Controls
- Stroboscopic Controls
- Auto Ignition Circuits
- Hall-Effect Switches
- Anti-Theft Controls
- Lamp Monitors
- Low Coolant Monitors
- Brake Fluid Monitors
- Seat Belt Interlocks
- Clock Circuits
- Photo Diodes
- Quad FM Decoders
- Electronic Timers
- Electronic Games
- AM/FM/TV Circuits
- Communications Circuits
- CB/Scanner Circuits
- MOS Custom Circuits

For the full story on digital bipolar and MOS circuits, write or call George Tully; for consumer entertainment and other linear circuits, write or call Bob Milewski; for automotive and photographic circuits, write or call Brad Marshall.

*Sprague Electric Company, 115 Northeast Cutoff,
Worcester, Mass. 01606 (Tel. 617/853-5000).*

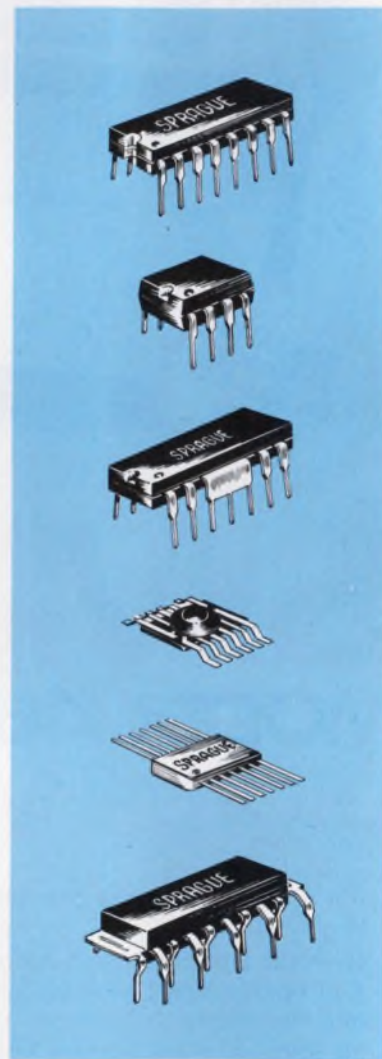

ICs for IMAGINATIVE DESIGNERS



**... and you thought we
only make great capacitors.**

Microprocessor Design

μ P development systems need more power to speed up software debugging

Microprocessor development systems help the engineer generate and debug software for his application. But even with the recent flood of new μ Ps, development systems have been slow to evolve. Bruce Gladstone, vice president of Microkit, Santa Monica, CA has some views on future trends.

I look for three important features to appear in future development systems: in-circuit emulation and analysis, ability to use one development system with more than one μ P, and more efficient generation of application software.

In-circuit emulation was introduced by Intel some time ago. It replaced the 8080 in the user's system with a plug that connects to a development system. Now the user is able to debug hardware and software in a real environment.

With in-circuit analysis, the programmer



hooks into an existing μ P in a system and runs tests on that system. He can set breakpoints and see if the test program ever reaches that breakpoint. He can examine user memory. In effect, he can find out whether his μ P is working properly in the environment that it must run in.

You should not have to spend many thousands

(continued on page 42)

Restructured 8080 assembly language eases programming



Bsal-80, a restructured assembly language, replaces 8080 assembly language statements so that programming becomes easier. The language is used with the company's text editor, loader and relocatable assembler. The software package, on paper tape, is supplied as part of a development system continuing a keyboard/display unit, along with the requisite 8080 processor and associated circuitry. A user-supplied teletypewriter is also necessary to feed data into the system.

Bsal-80 provides a non-mnemonic, replacement statement language structure which is as efficient as assembly language but much easier to compose. If . . . Then, Begin . . . End, Else Begin . . . End commands, parametric macros, and equate identifiers, make structuring documentation of Bsal-80 programs easier than normal assembly language programs. Relocatability and automatic memory allocation are provided through Local and Global data declarations and Entry and External program declarations via the linking loader.

For example, a normal 8080 assembly-language statement might read INRA. This instruction means "increment the register or memory location called A". The equivalent Bsal-80 statement is: "A = A + 1". Some other Bsal-80 statements might be translated into two assembly language statements by the assembler.

The development system, called Model 80-BDS, sells for \$3950. muPro, Inc., 10340 Bubb Rd., Cupertino, CA 95014. (408) 996-1137.

CIRCLE NO. 507

MICROPROCESSOR DESIGN

(continued from page 41)

of dollars for a particular development system for each different μ P. Whether it be through personality cards or some other technique, I believe that the development system of the future must be able to work with a wide variety of μ Ps.

Almost every μ P and development-system manufacturer has made similar development systems. They have used a teleprinter as the console and the sole I/O device in their systems.

I feel that a CRT terminal, with a system designed specifically for it, is a better way to go.

Unfortunately, a teleprinter ties you down to a very slow device. Because of the speed limitation, only a small amount of the information that should be displayed for easy program debugging ever gets to you, and you're forced into elaborate command strings to do even the simplest job. For example, most teleprinter-oriented systems have a debug-

monitor program with 15 or 20 commands, when only four basic commands are really necessary. You must be able to store data, display data, and set and reset breakpoints.

If I merely add a CRT terminal to a teleprinter-oriented system, my task is only eased slightly. If I want to execute my program, display the change in memory location, display the contents of the registers and display the flags, I'm still going to have to type in commands to do each one of them. On the other hand, if I design my system for the CRT to begin with, I can display all of that information with a single command.

Debugging becomes easy because we can write our entire CRT display (960 characters) in half the time it takes to print one character on a teleprinter. You can look at the contents of the registers at the same time you are looking at the contents of memory. Then, as you make a change in the program, you can execute and look immediately at all of the pertinent data once again.

Program larger EPROMs on an Intellec 8/Mod 80



If you have Intel's Intellec 8/Mod 80 development system and you're looking around for a software-controlled EPROM programmer that will work on 2704/2708 devices, the Model 2730 programmer is for you.

The Intellec 8/Mod 80 already programs 1702s. But the 2704 and 2708 store more bits, don't slow down an 8080 system like the 1702s do, and cost less per bit.

The programmer plugs into the system via a ribbon connector and consists of two PC boards. First, the software, which is supplied on paper tape, is loaded into

two 1702 EPROMs. These are then plugged into the Intellec; this is the control program. To program either a 2704 (512×8) or a 2708 ($1\text{ k} \times 8$), the IC is plugged into the 2730's programming socket. The starting and ending locations in RAM that are to be duplicated into the EPROM are then entered, and the programmer is activated.

The programmer also transfers data from an EPROM back into any specified location in a RAM. In addition, it verifies (compares the contents of a programmed EPROM with RAM data) and prints out any differences.

The Model 2730 costs \$365 for the complete system.

Texas Microsystems, Inc., 3320 Bering Dr., Houston, TX 77057. (713) 789-9820.

CIRCLE NO. 508

Simplified 16-bit microprocessor is easier to use

In its effort to make microprocessors simpler and easier to use, Texas Instruments of Dallas, TX, has come up with a new 16-bit unit that is in a smaller package than its predecessor and contains an internal clock.

Dubbed the TMS 9980, the new micro is a low-performance version of the currently

(continued on page 44)

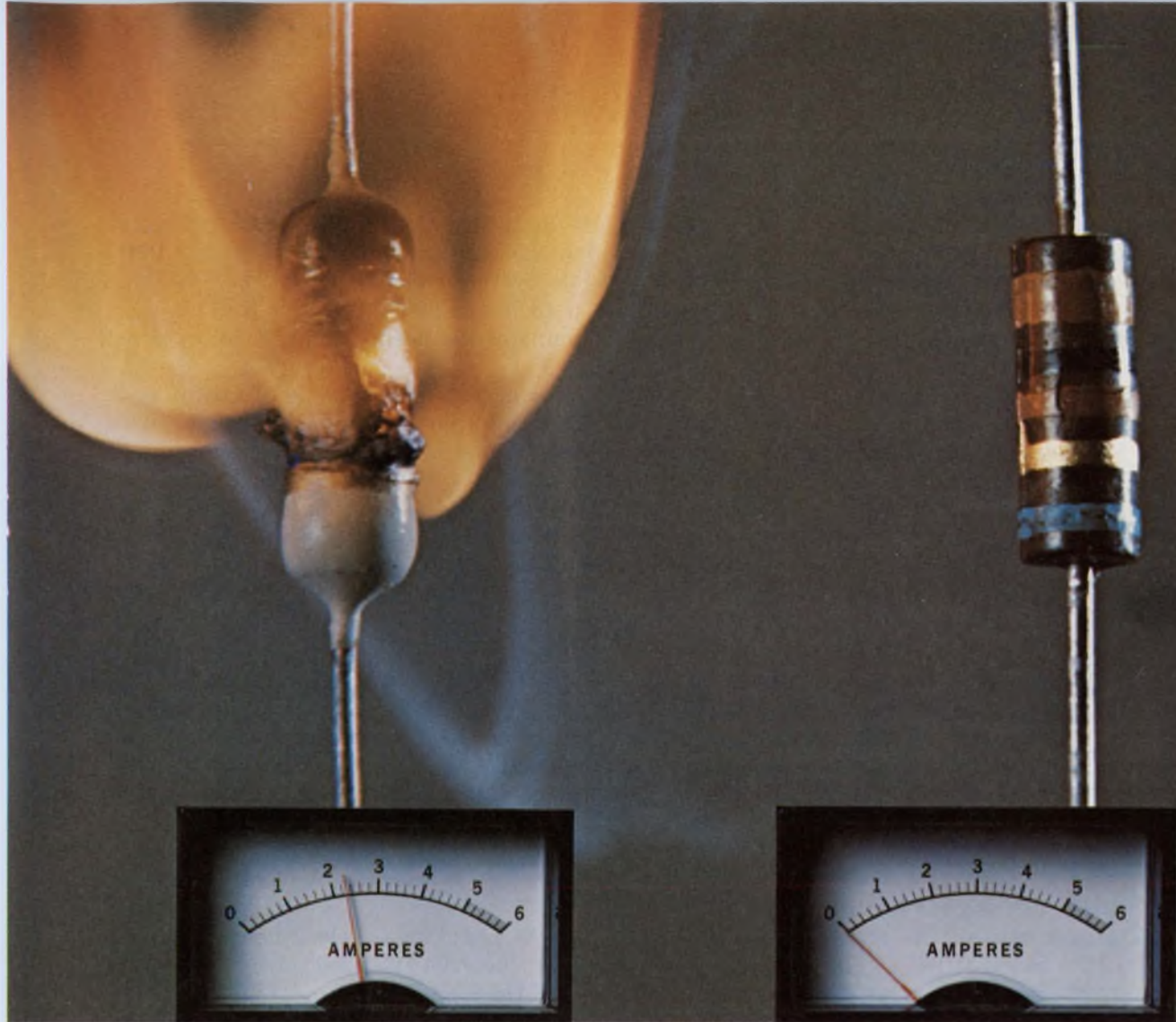

The failure. A 16 W overload causes this 1/2 W carbon film resistor to burst into flame. The initial failure mode is a short circuit, causing even more current to be drawn as shown on the meter.

The successful failure. The TRW 1 W rated BW-20F (1/2 W size) stays cool and fuses quickly and safely under identical power surge conditions. The failure mode, as shown, is an open circuit.

A failure your circuit can live with.

Failsafe, Fusible, Wirewounds Offer Built-In Circuit Protection.

Cool wirewounds like our BW failsafe series have a dual personality.

They provide stable resistance to normal operating current. But at specific overloads, they open circuit like a good fuse. So, as shown above, they'll protect your circuit from excess heat and fire in places where severe fault conditions are encountered.

The BW failsafe series, UL listed per Document 492.2, can save cost by eliminating the need for both resistor

and fuse. Save space, too, because they're about half the size of standard 1 and 2 W devices.

Depending on your specific circuit parameters, other TRW film and wirewound resistors can be engineered to meet your requirements.

For more information on resistors your circuit can live with, contact TRW/IRC Resistors, an Electronic Components Division of TRW, Inc., 401 N. Broad St., Phila., Pa. 19108. Tel. 215-922-8900. Telex: 710-670-2286.

TRW IRC RESISTORS
ANOTHER PRODUCT OF A COMPANY CALLED TRW
CIRCLE NUMBER 30

(continued from page 42)

available TMS 9900. Unlike the 9900, which comes in a 64-pin DIP, TI's semiconductor designers have performed some microsurgery and squeezed the 9980 into a 40-pin DIP. The reduction in the number of pins is made possible by the multiplexing of the 16-bit data words onto only 8 pins instead of the 16 pins used in the 9900. The new micro's internal clock makes the chip easier to use and eliminates the need to connect an external 4-phase clock to the chip, saving still more pins.

While the 9980 is slower than its predecessor, it is nevertheless capable of executing the entire 9900 instruction set, including the hardware multiply and divide. And, as with the 9900, direct accessing (DMA), memory mapped I/O and serial I/O are possible. It also features six interrupts.

Along with the new micro, TI has also introduced four peripheral circuits that are compatible with the 9980, as well as the rest of the 9900 series of components. The first of these is the TMS 9901. This is a programmable-systems-interface chip that provides interrupt prioritization, I/O control and interval timing. Under program control, the chip can provide up to 15 individually maskable interrupt-request lines or up to 16 programmable I/O ports.

The next chip in the newly introduced series is the TMS 9902, which is a universal asynchronous receiver transmitter (UART). The data rate of the UART is programmable and ranges from 5 to 76,800 bits/s. Additional programmable features of the 9902 include selection of even parity or no parity and character lengths of from 5 to 8 bits.

Synchronous communication control is provided by the TMS 9903. In addition to handling various synchronous data transmission protocols—such as IBM's new synchronous data link control (SDLC) and Bi-Sync—the 9903 can handle data rates that range up to 250-k bit/s. Character length and sync register are programmable and an interval timer is provided.

The last chip of the series is the TIM 9904. This is a four-phase clock generator driver. While the other chips in this series are NMOS devices, the 9904 is a low power Schottky semiconductor. Schottky technology is used because of the high speed required. The output of the 9904 however, is MOS compatible.

Sample quantities of the new chips will be available during the fourth quarter of this year and the first quarter of next year.

Texas Instruments, Inc., P.O. Box 5012, MS/84, Dallas, TX 75222. (214) 238-2481.

CIRCLE NO. 509

A MODEL TO TAKE HOME TO MOTHER.

HIGH-RELIABILITY, SUPERIOR EFFICIENCY AND A 5 YEAR WARRANTY AT \$145. (1-99)

ETATECH's patented "UNIVERTER"™ pulse width modulated power conversion circuit is combined with practical packaging techniques to provide a low cost line of fully regulated Series "B" power modules. Compactly designed with fewer component parts, these units are ideally suited for microprocessor systems, digital instrumentation, portable test equipment and military or high quality commercial electronics. Call or write for our complete technical data file.



LOW COST 50-60 WATT DC-DC CONVERTERS

- 70% min. efficiency @ 5V, 10A (Model BSD10, \$165., 1-99 pcs.)
- Std. inputs 28 and 48 VDC; specials from 20-180 VDC avail.
- 70K hrs. MTBF (@80°C, baseplate) in compact size (4 1/8" x 7" x 1 1/4").

50-60 Watt AC-DC Series "B" Modules

Features 75% min. efficiency @ 5V, 10A (Model B5S10, \$145., 1-99 pcs.). Std. outputs 12, 15, 28 and 48 VDC. Specials 2-48 VDC avail.



ETATECH, INC.
187-M W. Orangethorpe
Placentia, CA 92670
(714) 996-0981

ETATECH

... HIGH DENSITY POWER MODULES

CIRCLE NUMBER 101

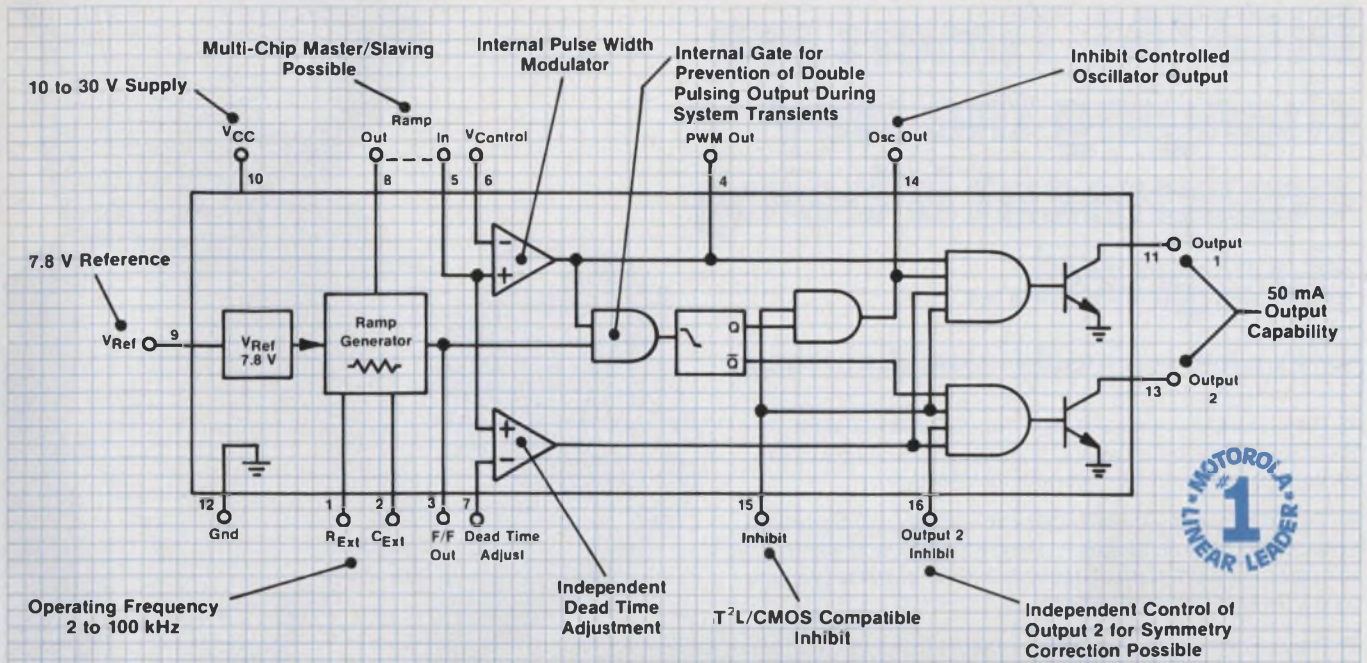

If switching regulator control is all work and no play, boy, do we have news for you.



MC3420 Switchmode* Regulator Control

It used to be a dull, tedious job putting together reference, oscillator, PWM, phase-splitter and dual alternating outputs from numerous components to form a regulator control circuit. Not to mention hours of design time.

The MC3420 Switchmode regulator control circuit has changed all that.

Now all you do is plug it in and you've got all the functions needed to regulate the simplest to the most complex constant frequency

switching power supply.

It's virtually all things to all designs.

- It has a power supply voltage range of 10V to 30V.
- It's capable of 2 to 100 kHz operation and can be slaved to others like itself for synchronization.
- Its 0 to 100% dead-time comparator is unique.
- Its outputs are open-collector type with a saturation voltage of 0.5V @ 40mA and can block 40V.
- It features an inhibit input and has options for

independent control of one output for implementing a symmetry correction control loop.

Best of all, it's priced at just \$5.75 (100 up), a pittance compared to what it cost in parts and time before.

Now it's so easy and simple to control single and double-ended supplies, transformer-coupled dc-to-dc converters, transformerless voltage doublers and polarity converters et al you'll wonder what happened to all the hard work. We did it for you.



*Trademark Motorola Inc.

Motorola Semiconductor Products Inc., Box 20912, Phoenix, Arizona 85036

MOTOROLA Semiconductors
—and you thought we were just a production house

CIRCLE NUMBER 31

General Time's new DIGITAL Timers are changing the way equipment is being designed...

here's what you should know about them.

- Their low, low prices and high dependability enable them to replace both low and high accuracy analog timers as well as most electro-mechanical timers.
- Their digital circuitry provides exceptional $\pm 0.5\%$ repeat accuracy in all time ranges — even those as long as 60 minutes. Their short reset, recycle and abort times give you a new level of design flexibility.
- They're now *in stock* at all Distributors listed below. For complete information about General Time Q-20 Digital Timers use the reader service number provided.



AUTHORIZED STOCKING DISTRIBUTORS

ALABAMA

CRAMER
Huntsville (205) 539-5722

ARIZONA

CRAMER
Phoenix (602) 263-1112

METERMASTER
Phoenix (602) 273-7331

CALIFORNIA

CRAMER
Irvine (213) 771-8300
(714) 979-3000
San Diego (714) 565-1881
Sunnyvale (408) 739-3011

METERMASTER
Los Angeles (213) 685-4340
Palto Alto (415) 968-6292

NEWARK ELECTRONICS CO.
Inglewood (213) 678-0441

COLORADO

CRAMER
Denver (303) 758-2100

NEWARK ELECTRONICS
Denver (303) 757-3351

CONNECTICUT

ARROW ELECTRONICS, INC.
Hamden (203) 248-3801

CRAMER
No Haven (203) 239-5641

HARTFORD, ELECTRIC SUPPLY
Hartford, CT (203) 233-3694

NEWARK ELECTRONICS
Westport (203) 226-6921

DISTRICT OF COLUMBIA

CRAMER
Gaithersburg (301) 948-0110

FLORIDA

ARROW ELECTRONICS, INC.
Ft. Lauderdale (305) 776-7790

CRAMER
Orlando (305) 894-1511
Hollywood (305) 923-8181

NEWARK ELECTRONICS
Ft. Lauderdale (305) 587-2372

GEORGIA

CRAMER
Atlanta (404) 448-9050

ILLINOIS

ALLIED ELECTRONICS
Elgin (312) 697-8200

CRAMER
Mt. Prospect (312) 593-8230

METERMASTER
Elk Grove Village (312) 593-8650

NEWARK ELECTRONICS
Chicago (312) 638-4411
Hickory Hills (312) 599-2300

INDIANA

GRAHAM ELECTRONIC SUPPLY
Indianapolis (317) 634-8486

IOWA

NEWARK ELECTRONICS
Cedar Rapids (319) 362-1171

MARYLAND

ARROW ELECTRONICS, INC.
Baltimore (202) 737-1700
(301) 247-5200

CRAMER
Hanover (301) 796-5790

NEWARK ELECTRONICS
Beltsville (301) 937-5085

MASSACHUSETTS

ALLIED ELECTRONICS
Braintree (617) 848-4150
(800) 225-1890

ARROW ELECTRONICS, INC.
Burlington (617) 273-0100

CRAMER
Newton Centre (617) 969-7700

GRAYBAR ELECTRIC CO., INC.
Boston (617) 482-9320

NEWARK ELECTRONICS
Woburn (617) 935-8350

MICHIGAN

CRAMER
Livonia (313) 425-7000

NEWARK ELECTRONICS
Oak Park (313) 548-0250
Wyoming (616) 241-6681

MINNESOTA

ARROW ELECTRONICS, INC.
Bloomington (612) 888-5522

CRAMER
Edina (612) 835-7811

NEWARK ELECTRONICS
Minneapolis (612) 331-6350

MISSOURI

OLIVE INDUSTRIAL ELECTRONICS
St. Louis (314) 863-7800

NEW JERSEY

ARROW ELECTRONICS, INC.
Moorestown (609) 235-1900
Saddlebrook (201) 797-5800

BROWNELL ELECTRO INC.
South Plainfield, (201) 753-4600

CRAMER
Moonachie (201) 935-5600
Cherry Hill (609) 424-5993
(215) 923-5950

NEWARK ELECTRONICS
Kenilworth (201) 272-8410

NEW MEXICO

CRAMER
Albuquerque (505) 265-5767

NEW YORK

ARROW ELECTRONICS, INC.
Farmingdale (516) 694-6800
Fishkill (914) 896-7530

CRAMER
Endwell (607) 754-6661
Hauppauge (516) 231-5600
Rochester (716) 275-0300
E. Syracuse (315) 437-6671

NEWARK ELECTRONICS
Rochester (716) 473-6600
Plainview (516) 822-5000

NORTH CAROLINA

CRAMER
Raleigh (919) 876-2371
Winston-Salem (919) 725-8711

OHIO

ARROW ELECTRONICS, INC.
Cleveland (216) 464-2000
Kettering (513) 253-9176

CRAMER
Cleveland (216) 248-8400
Cincinnati (513) 771-6441

HUGHES-PETERS, INC.
Cincinnati (513) 351-2000
Columbus (614) 294-5351

NEWARK ELECTRONICS
Cleveland (216) 361-4700
Cincinnati (513) 874-5115

PIONEER
Cleveland (216) 587-3600

STOTTS-FRIEDMAN
Dayton (513) 224-1111

CLEVELAND TIME CLOCK
AND SERVICE CO.
Cleveland (216) 861-2496

OKLAHOMA

CRAMER
Tulsa (918) 836-3371

PENNSYLVANIA

WEST CHESTER ELECTRIC SUPPLY
West Chester (215) 696-7500

RHODE ISLAND

W H EDWARDS, INC.
Warwick (401) 781-8000

TEXAS

CRAMER
Dallas (214) 666-9300

NEWARK ELECTRONICS
Garland (214) 271-2511
Houston (713) 782-4800

UTAH

CRAMER
Salt Lake City (801) 487-4131

NEWARK ELECTRONICS
Salt Lake City (801) 486-1048

WASHINGTON

CRAMER
Seattle (206) 762-5755

WISCONSIN

ARROW ELECTRONICS, INC.
New Berlin (414) 782-2801

CRAMER
Oak Creek (414) 764-1700

NEWARK ELECTRONICS, INC.
Brookfield (414) 781-2450

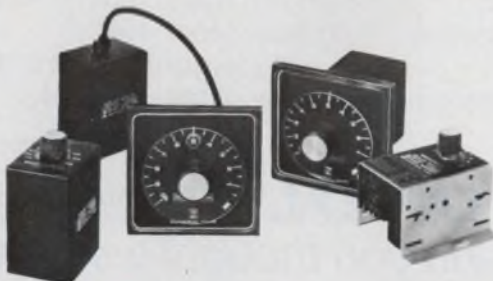

CIRCLE NUMBER 32

 **GENERAL TIME**
A TALLEY INDUSTRIES COMPANY
INDUSTRIAL CONTROLS DIVISION
THAMSTON, CONNECTICUT 06787



Rickey's tackling the SDK-80 microcomputer kit for his next science project.

Rickey likes soccer, lizards, hot fudge sundaes, skateboards and microscopes. He can't decide if he'd rather be Franco Harris, Bobby Fischer or Jonas Salk.

When his Dad brought home the Intel SDK-80 microcomputer systems kit, Rickey helped him put it together. It took only four hours. Everything was there. The 8080 CPU, RAM, PROM, programmable, I/O, a printed circuit board with all those capacitors and resistors and the other things that go with it. The

best part was the instruction manuals. Every step was clearly explained. It was easy. The programming part looked especially interesting. So simple. Just imagine talking to a computer.

The big thrill came on Saturday when they went to his Dad's office to use a terminal. When they connected the SDK-80 to the teletypewriter they got a printout. That was exciting. Within an hour they were talking to the computer, then inventing games. They stayed all day.

Now Rickey is building a micro-

computer of his own. He may be the first kid on his block with his own computer. Thanks to a \$350 low interest loan from his Dad.

If you're interested in being the first on your block to have a microcomputer, contact your Intel distributor: Almac/Stroum, Component Specialties, Components Plus, Cramer, Elmar, Hamilton/Avnet, Industrial Components, Liberty, Pioneer, Sheridan, or L. A. Varah.

Microcomputers. First from the beginning. **intel**[®]

3065 Bowers Ave., Santa Clara, California 95051.

CIRCLE NUMBER 33



There is no more accurate 12-bit A/D converter on the market ... and it's monolithic.

Differential and overall linearity within $\frac{1}{2}$ LSB. Inherently monotonic operation (and no missing codes). Immunity to noise transients. They all add up to unusually high accuracy for our 8702, a single chip, 12-bit CMOS A/D converter.

The 8702 has some other important advantages, too. CMOS technology means very low power dissipation — typically less than 20 mW. It is easy to use; no active auxiliary components are needed. And its latched parallel outputs are



ideal for inputting to microprocessors.

Compared to modules, the 8702 offers immediate significant cost savings plus the prospect of even greater future economies due to its monolithic construction. And the savings in PCB real estate go without saying.

The 8702 comes in a 24-pin ceramic DIP. Other versions include 8 and 10 bit devices in ceramic, and an 8 bit unit in plastic for commercial environments. Call or write for full details.

TELEDYNE SEMICONDUCTOR

1300 Terra Bella Avenue, Mountain View, California 94043 Tel: (415) 968-9241 TWX: 910-379-6494 Telex: 34-8416

SALES OFFICES:

DOMESTIC: Salem, N.H. (603) 893-9551; Stony Brook, N.Y. (516) 751-5640; Des Plaines, IL (312) 299-6196; Los Angeles, CA (213) 826-6639; Mountain View, CA (415) 968-9241 • INTERNATIONAL: Hounslow, Middlesex, England (44) 01-897-2503; Tiengen, West Germany 7741-5066; Wiesbaden, West Germany 06121-39171; Kowloon, Hong Kong 3-240122; Tokyo, Japan 03-405-5738.

CIRCLE NUMBER 34

Teaching the horse not to eat

Farmer Jack taught his horse to quit eating. This made for fantastic efficiency since the horse's output-to-input ratio was almost infinite. Jack was delighted. He didn't need to master business math to know that profit margins soar if you maintain finite income and reduce expenses to zero. And it worked. Briefly.

Unfortunately, the horse quit working. In fact, it quit breathing.

Charlie was another farmer, except that he ran an engineering department in an electronics company. Charlie decided to impress the president with dramatic improvements in his department's efficiency. So he fired a couple of his engineers and urged the others to work harder. Why shouldn't 20 guys design as well as 22 guys? And they did. Or so it seemed, but some things didn't get done—things Charlie never noticed.

When Charlie saw his department functioning with fewer engineers, he realized that the remaining engineers didn't need so many secretaries. Or technicians. Or draftsmen. So he fired more people. In time he noticed that some of the engineers were typing. And wiring. And drafting. He knew *that* was inefficient, so he fired them.

Eventually the president noticed that the company was surviving and, in fact, growing more profitable, as engineering expenditures shrank. So he decided to impress *his* boss, the board of directors, with dramatic improvements in the company's efficiency. He wiped out the entire engineering department, including Charlie—the ultimate efficiency. And it worked. Briefly.

Then competition started turning out newer, better and less expensive products. And the company started losing money—slowly at first, then rapidly. And the terrified board ordered the company to design new products in a hurry.

But there were no more engineers.



RECOGNIZED BY
AMERICAN REVOLUTION
BICENTENNIAL
ADMINISTRATION

ELECTRONIC DESIGN is deeply honored to have received official recognition as a participant in the American Revolution Bicentennial Celebration, with authority to display the Bicentennial Symbol.

GEORGE ROSTKY
Editor-in-Chief

Nothing—not even a scope or a voltmeter or even another logic tester. Because CSC's Logic Monitor™ 2 is the most convenient, efficient way ever developed to monitor circuit activity in digital IC's: it provides instant and continuous display of static and dynamic states of DIP IC's up to 16 pins.

Its built-in power supply, high input impedance and selectable logic thresholds provide the most accurate monitoring of counters, shift registers, gating networks, etc., on big, bright LED's. And because there is no loading of the circuit under test, logic level shifts, false triggering and power sup-

ply loading (that can occur with some equipment) are problems of the past.

LM-2 is a second-generation IC test instrument consisting of two units—a connector/display and a switchable precision voltage reference power supply. In operation, the threshold switch on the power supply is set to the proper logic family (RTL, DTL, TTL, HTL or CMOS). A clip lead is connected to the ground (plus VCC lead, in the case of CMOS), and the connector/display unit simply clipped over the IC under test. That's it.

Each of the 16 pins on the connector/display unit automatically

connects to the corresponding IC pin without any possibility of shorting, and feeds one input of a voltage comparator circuit. The other input is fed from a precision selectable voltage source. When the voltage on a particular pin is more positive than the reference (logic "1"), the corresponding LED lights—at any pulse frequency from DC to 30KHz (50% duty cycle).

If you're looking for an easy way to monitor digital circuits, LM-2 with its 16 channels of automatically-in-sync information and fast, instinctive operation, can't be beat. You won't find anything like it, anywhere near the price.

CSC'S LOGIC MONITOR 2. AT \$124.95, NOTHING ELSE LETS YOU DO SO MUCH SO FAST AND SO WELL FOR SO LITTLE.

Fully isolated power supply module—Constant, bright LED readings without drawing power from circuits under test

Sturdy, high impact construction throughout—At CSC, part of making a good thing means making it to last

Clip module slips easily over IC—Now, checking static and dynamic states of dual in-line IC's of up to 16 pins is literally a snap

Selectable threshold level—Matches characteristics of logic family under test—RTL, DTL, TTL, HTL or CMOS

Non-corrosive nickel-silver contacts—For maximum reliability and minimum contact resistance

Precision plastic guides and flexible web*—For short-free positive contact with IC under test

Big, bright 16-LED display—More information and no more eyestrain—get a picture of everything that's happening *simultaneously*

High input impedance—100K impedance for minimum circuit loading



For more information, see your distributor or write for our catalog and distributor list.
44 Kendall St., Box 1942 New Haven, CT 06509 • 203-624-3103 TWX: 710-465-1227 West Coast office:
Box 7809, San Francisco, CA 94119 • 415-421-8872 TWX: 910-372-7992

CIRCLE NUMBER 35

U.S. PAT. NO. 3,914,007 © 1976 Continental Specialties Corp

"I'll tell you why this OEM picked PDP-8. It's good engineering and it's good business."

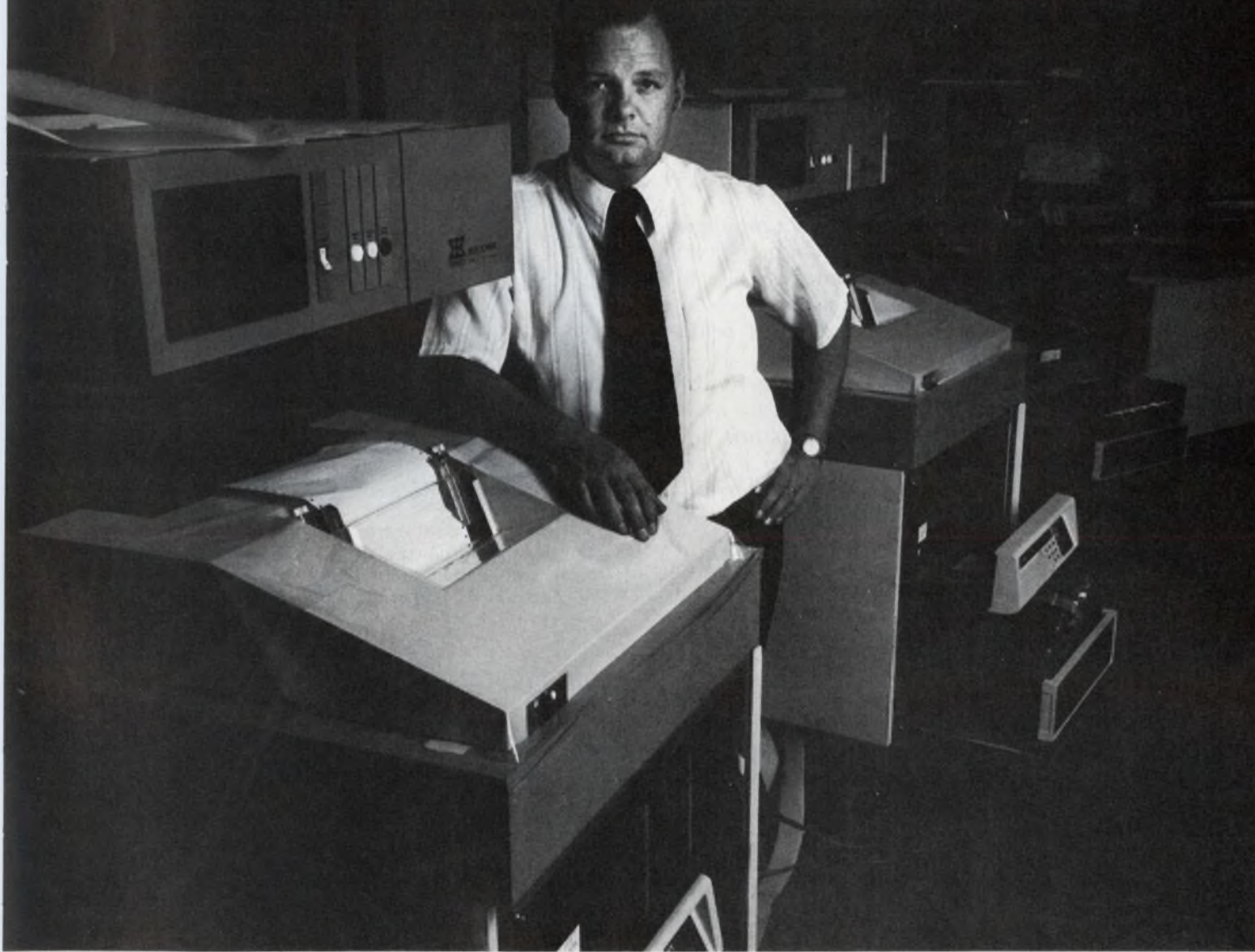

The man in the picture is Dr. David Kemper, biochemist and product manager in charge of development, production, installation and field support for an amazing analytical device called Rotochem IIa, from American Instrument Co.

The computer inside his product is a PDP-8A from Digital. Dr. Kemper is buying scores of them. Why?

"They're inexpensive in a market that's cost sensitive. They're incredibly reliable in a

market that's reliability oriented. And our customers can get service anywhere in the world. The PDP-8A gives us the performance we need at a price we can't beat. We can offer the capability to run 50 tests on each of 250 patients."

Sensitive but tough. High in performance, low in cost. "Good engineering. Good business." It's the same story you hear from OEMs around the world. And that's why PDP-8's the most

successful minicomputer ever.

Digital Equipment Corporation, Parker Street, Maynard, MA 01754. (617) 897-5111.

European headquarters: 81 route de l'Aire, 1211 Geneva 26.

Tel: 42 79 50. In Canada: Digital Equipment of Canada, Ltd.

**PDP-8
The Most
Successful
Minicomputer
Ever!**

digital

**50,000 computers saving
managers millions.**

Consider solid-state photodetectors for your next sensing application. But before you design with them, check these pointers on how they work and how best to apply them.

Use solid-state photodetectors to sense, measure or digitize your data. But before you design them into your system, make sure to check not only the electrical specs, but the optical and mechanical ones as well.

Optoelectronic detectors are beginning to appear in many new applications—from data reception in high-speed optical-fiber data links to all-solid-state television cameras and headsets for the wireless reception of stereo from a nearby receiver.

There are many different types of active detectors to choose from, including pn, p-i-n and avalanche photodiodes, phototransistors and multidevice arrays.

Most of these devices, when kept dark, operate as normal diodes or transistors. However, when ultraviolet, visible or infrared light shines on an intentionally overlarge, reverse-biased junction it generates free charge carriers in the material.^{1,2,3} The electron-hole pairs increase the minority current (reverse leakage) and thus the general current flow in the detector.

Avalanche photodiodes are operated at high levels of reverse bias to get amplification. They are, though, similar in construction to the regular pn devices. Unfortunately, the avalanche multiplication of free carriers creates a lot of noise which can be detrimental for very low level sensing—especially at low frequencies. The noise increases as the gain goes up.

In general, p-i-n photodiodes are also similar to the pn devices, except that between the p and n materials is an intrinsic layer. This extra layer decreases the capacitance that exists between the p and n regions which, in turn, results in faster photodiode response times.

Phototransistors employ the same basic principles as photodiodes, but they deliver larger currents that can perform some control functions. In a phototransistor, the base-collector junction absorbs the radiant energy and electron-

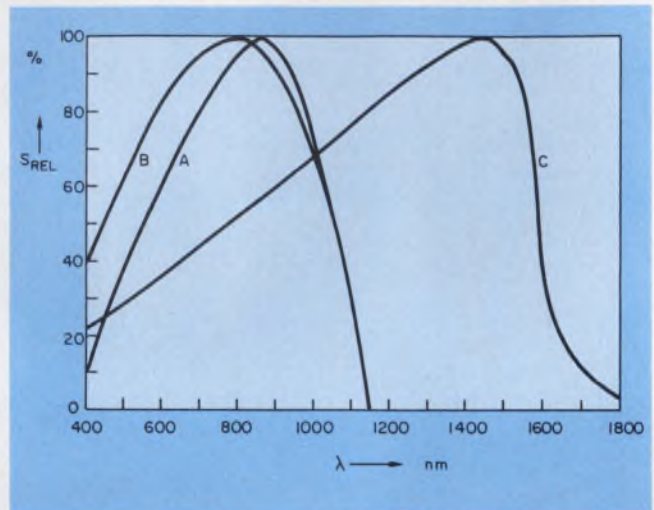

1. Relative spectral response curves for photodiodes compare the responses of normal silicon devices (a), silicon with enhanced response in the blue portion of the spectrum (b) and germanium photodiodes (c).

hole pairs are generated to form the collector current. The holes diffuse their way into the base, which, in turn, injects electrons into the base, and thus amplifies the light energy. However, unlike normal transistors, many phototransistors don't have external base connections. Some phototransistors do have a third lead, this lead can be used for gating purposes.

Multidevice arrays, such as used in the all-solid-state television cameras, can contain as many as 10,000 devices on a single silicon chip. Many of the arrays also include decoding and scanning circuitry on the same chip.

Check the specs before buying

Whether you decide to use a photodiode, phototransistor or array, there are many electrical specs that should be considered since even within one device family there are many variations. Photodiodes, for instance, come in just about all shapes, sizes and ratings, as illustrated in Table 1. The wide differences make selection difficult.

Photodetectors made from the same basic material tend to have substantially the same photosensitivity per unit area, but minor differences

Gerhard Krause, Director of Research and Development, and Fritz Keiner, Design Engineer, Optoelectronic Elements, Siemens AG, D8000 Munchen 1, Postfach 103, West Germany.

Table 1. Comparison of common photodiodes

| | Manu- facturer | Device | Dark current (nA) bias | Capaci- tance pF | Rise time t_r (μ s) | Active area mm^2 | NEP $\text{W}/\sqrt{\text{HZ}}$ | Case |
|---|------------------------|---------------|------------------------------|------------------------|----------------------------------|---------------------------------|------------------------------------|--|
| Standard photo- diodes | Texas In- struments | TIXL 98 | 2 (25 V) | 2 (12 V) | 0.045 | 1 | — | TO 5 |
| | Telefun- ken | BPX 34 | — | 25 (0 V) | 1 | 0.035 per photo- diode | — | Ceramic/ plastic 50-element array |
| | Siemens | BPX 90 | 5 (10 V) | 170 (10 V) | 0.8 | 5 | — | Plastic/ as array also |
| | RCA | C30814 | 600 | 5 (200 V) | 0.025 | 20 | — | TO 8 |
| | RCA | C30803 | 300 | 3 (200 V) | 0.025 | 5 | — | TO 5 |
| Photo- diodes with low dark current | Siemens | BPW 32 | 0.003 (1 V) | 80 (1 V) | 1 | 1 | 2.1×10^{-15} | Plastic |
| | Philips | BPX 94 | 0.1 (1 V) | 70 (5 V) | — | 1.44 | 2×10^{-14} | TO 18 |
| | Fairchild | FPT 102 | 0.1 (10 V) | 20 (10 V) | — | 0.775 | 1×10^{-14} | Miniature |
| | UDT | PIN 020A | 0.05 (5 V) | 5 (5 V) | 0.005 | 0.2 | 6×10^{-15} | TO 18 |
| | Siemens | BPW 33 | 0.02 (1 V) | 500 (1 V) | 1 | 7.5 | 5.3×10^{-15} | Plastic |
| Fast photo- diodes | Hewlett- Packard | 5082-4205 | 0.15 (10 V) | 0.7 (10 V) | 0.001 | 0.3 | 1.4×10^{-14} | Micro- ceramic |
| | UDT | PIN 12 ULC | 2×10^3 (10 V) | 100 (10 V) | 0.014 | 200 | 1×10^{-12} | Special- case |
| | Siemens | BPW 34 | 2 (10 V) | 15 (10 V) | 0.01 | 7.6 | 4.2×10^{-14} | Plastic |
| | RCA | C30807 | 40 (45 V) | 2.5 (45 V) | 0.003 | 0.8 | — | TO 18 |
| | Siemens | BPX 65 | 1 (20 V) | 3.5 (20 V) | 0.0005 | 1 | 3.3×10^{-14} | TO 18 |
| | Motorola | MRD 500 | 2 (20 V) | — | 0.001 | — | — | TO 18 |
| Schottky barrier photo- diodes | UDT | PIN 5 | 200 (10 V) | 5 (5 V) | 0.007 | 4 | 2.2×10^{-13} | Special- case |
| Germanium photo- diodes | Philips | OAP 12 | 15×10^3 (10 V) | — | — | 1 | — | Miniature |

in the spectral response curves are always present. The material resistivity has different values, depending upon where the chip was located in the wafer. Diffusion depth and the quality of the antireflection coating commonly applied to the chips can also affect the response.

For a standard illuminant (the unfiltered radiant flux of a tungsten-oxide incandescent tube

with a color temperature of 2856 K), silicon photodiode sensitivity is about 10 nA/(lux \times mm²). The radiation at the optimum wavelength (Fig. 1) gives the detectors a peak sensitivity of about 0.55 A/W. Photodiodes typically have a photosensitivity tempo of 0.1 to 0.2%/°K.

The linearity of the diode response can be a major problem for illuminations higher than 10⁵

lux, but otherwise nonlinearities are negligible. When photodiodes are operated in a photovoltaic mode, the generated emf is approximately proportional to the log of the incident flux (assuming the detector has a forward bias of at least 70 mV).

Watch out for dark current

Photodiode dark current is perhaps the most critical diode parameter for direct-coupled applications as well as in applications where the detection threshold is determined by noise. And, as with all semiconductors, temperature increases swell the reverse current. For instance, a temperature rise of 25 C increases the diode dark current by an order of magnitude. Dark current is also partly determined by the diode's reverse voltage—it is proportional to the square root of the reverse voltage.

Photodiode frequency response is often determined by the load resistance used and the diode's junction capacitance. The capacitance, at least for broadband amplifiers, limits the detectors capability to sense weak signals in the presence of noise (noise-determined threshold). The smaller the capacitance per unit area the better the diode's performance.

Capacitance is proportional to the junction area divided by the square-root of the reverse voltage. Unfortunately, photodiodes with low reverse currents have large reverse capacitances; so be careful when you select a diode. Sometimes you might be able to compensate for the capacitance by using negative feedback or some compensation networks.

As the diode load resistance approaches zero, the operating frequency limit is reached. This limit is determined by the diffusion time of the carriers in the heavily doped semiconductor region and by the transit times of the carriers in the space-charge region. The spreading resist-

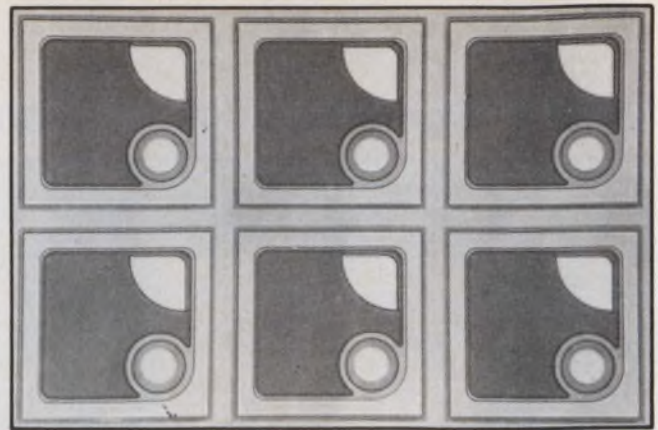

2. These phototransistor chips are Siemens type BP 102. The bright circular spot is the emitter contact, the triangular spot the base and the dark square the photo-sensitive area, which measures 0.6 mm².

ance of the semiconductor material also acts, together with the load resistance, to lower the operating frequency limit of the detector.

If noise limits the threshold, operation of a photodiode in the photovoltaic mode will always be inferior to that of a reverse-biased diode. The optimum reverse bias for many diodes is about 0.1 V at low frequencies.

Photovoltaic operation may be necessary if the dc components of the dark current cause problems. For well-defined linear operation, the voltage generated by the diode should not exceed a few millivolts at low-incident-flux intensities. This voltage is often generated by the offset voltage of the op amp via its feedback path. Error-compensation circuitry can often eliminate the offset problem of the op amp. Usually, for low-incident-flux intensities, photodiodes with the lowest values of dark current can deliver the largest photovoltaic outputs.

Photomultipliers or diodes? A tough choice

At optical wavelengths above 900 nm the photodiode offers performance superior to that of the photomultiplier. If the noise generated by the incident background radiation cannot be neglected, photodiodes are preferable for weak signals because they have greater quantum efficiencies than photomultipliers.

The photodiode also has better stability and linearity than a photomultiplier. However, when weak digital signals (signal to noise ratio << 100) must be detected, the best photomultipliers do top diodes in performance.

Avalanche photodiodes offer internal gain and thus don't require the ultra-low-noise amplifiers normally needed. Unfortunately, the high operating voltages of 100 to 400 V, and the high stabilities necessary for operation, are drawbacks.^{5,6,7,8} The quantum yield is usually smaller than that of normal photodiodes, and the signal-

Table 2. Avalanche diode characteristics

| Manufacturer | Device* | Photo-current gain | Operating voltage V | Active area mm ² | NEP W/√Hz |
|-------------------|---------|--------------------|---------------------|-----------------------------|-----------------------|
| EMI | S 30500 | 100 | 140 to 200 | 0.2 | — |
| Texas Instruments | TIXL 59 | 200 | 170 | 0.45 | 2 × 10 ⁻¹³ |
| Texas Instruments | TIXL 69 | >600 | 170 | 1.8 | 2 × 10 ⁻¹³ |
| RCA | C30811 | 50 | 350 | 0.5 | — |

*All diodes listed are silicon and are housed in TO-5 cases.

to-noise ratio is lower at low frequencies because of the multiplication noise generated by the avalanche. Gain-bandwidth products of avalanche photodiodes, however, can reach 80 GHz. Some typical devices are shown in Table 2.

The p-i-n diodes offer a faster response than normal pn junction diodes. And, they avoid the high voltages, needed by avalanche diodes, for operation. P-i-n's are also smaller, lighter, more rugged, more stable and less expensive than most photomultipliers. For most standard applications the external bias voltage needed by the p-i-n's is about 20 V, maximum and is typically between 10 and 20 V.

Phototransistors compete with diodes

Phototransistors have response curves similar to those of photodiodes.² However, due to variations in current gain caused by processing, phototransistors have considerable linearity error. Table 3 shows many commonly available phototransistors and their characteristics; a typical chip is shown in Fig. 2.

Phototransistor linearity can be improved by the use of appropriate circuitry so that the linearity matches that of photodiodes.^{9,10} The signal-voltage-gain of a simple phototransistor is typically between 100 and 1000, and for Darlington-connected transistor-phototransistor pairs it can reach values higher than 10,000. When you select a phototransistor, be careful. Many manufacturers sort the transistor batches into different photosensitivities for a given type.

The cutoff frequency of circuits using phototransistors is far lower than that of circuits that use photodiodes. This is partly due to undesired feedback from within the phototransistor (caused by the collector-base capacitance) and partly due to the finite-current gain-bandwidth product, f_T . Small-signal rise and fall times for a load resist-

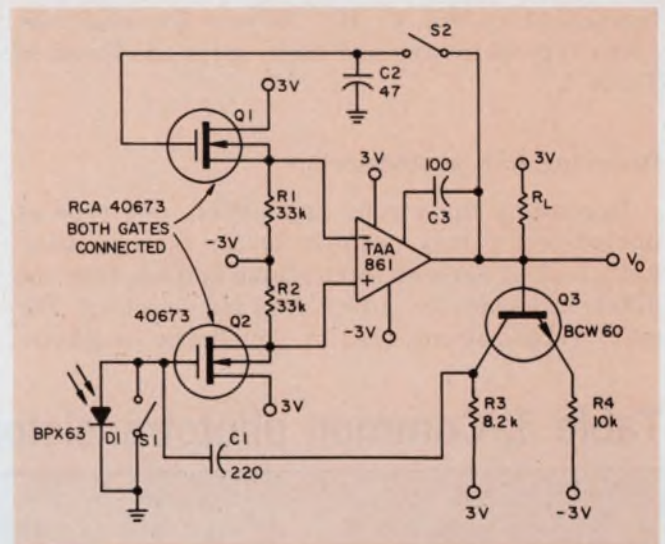

3. This automatic-exposure timer circuit can measure light intensities to 10^{-2} lux and has an automatic adjustment of op amp offset before each measurement.

ance, R_L ; a current gain, β ; and a capacitance, C_{CB} ; are governed by

$$t_r = t_f = \beta / (4 f_T^2 + 4.8 \beta^2 \times C_{CB}^2 \times R_L^2)^{1/2}$$

Switching times can be reduced by keeping the load resistance as small as possible. Darlington's are, of course, even slower than ordinary phototransistors because their gains are so much higher. Darlington response times can be kept low by using active-load resistances and capacitance compensation.^{11,12}

Photodetector arrays—composed of diodes or transistors in linear, circular or two-dimensional patterns—can serve many applications even when their resolution is far below that of television cameras. Spectral responses of arrays are similar to those shown for discrete devices in Fig. 1, and sensors for the near-infrared spectrum are also available. Good sensitivity in video applications can be obtained by extending integration times up to 40 ms for the picture signal. Detection

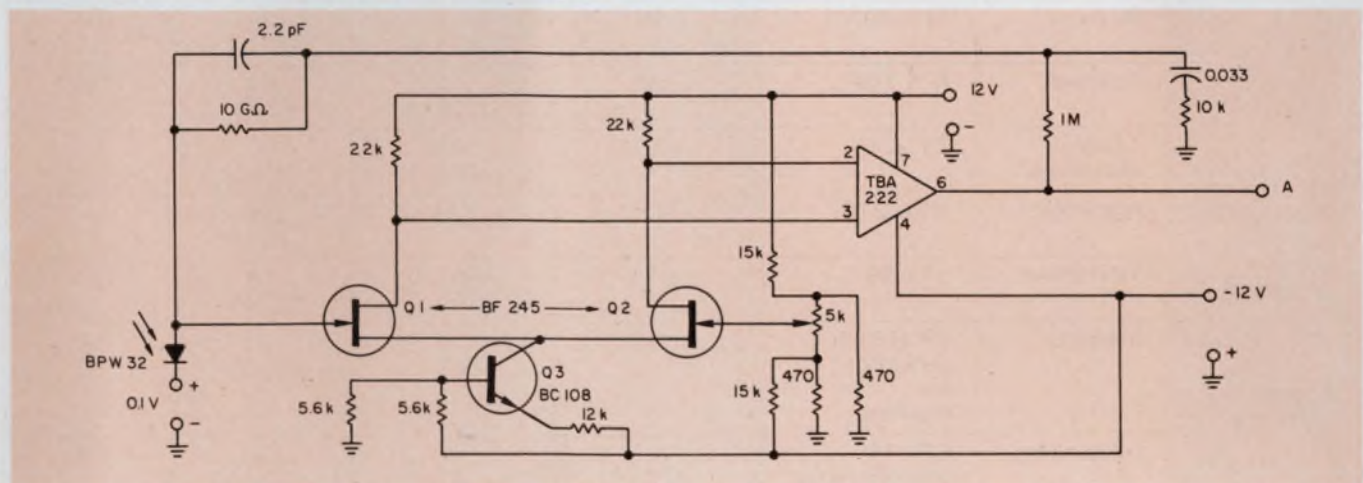

4. With a bandwidth of 1 kHz, this photodetector circuit performs better than many photomultiplier circuits with

signal-to-noise ratios of more than 10. The JFET input prevents diode loading.

thresholds as low as 10^{-9} W/cm² are available. Some typical arrays and their specs are listed in Table 4.

Designing with photodetectors

Depending upon your application, one type of photodetector may perform better than another. Let's look at several applications and see how the different conditions affect detector selection. For many applications, as in automatic exposure

timers, light meters and some instruments, there is usually a three-step process to select a detector:

1. Select a photodetector with a chip area necessary to do the job.

2. Use a device that has, in the spectral range of interest, the smallest ratio of dark current to the product of (active area) \times [area-independent spectral sensitivity (A/W)].

3a. Work with the smallest possible reverse voltages. (For many applications, less than 1 V

Table 3. Common phototransistor types

| | Manu- facturer | Device | Photo- sensitivity (*) mA/[mW/cm ²] | Rise time/ fall time t _r /t _f , μ s (R _i) | Dark current nA | Half aperture angle (deg) |
|---|------------------------|---|---|--|-----------------------|------------------------------------|
| Plane window | Siemens | BPX 38/III | 0.34 | 8 (1 k Ω) | 12 (25 V) | 40 |
| | Texas In- struments | TIL 99 | 0.25 | 8/6 (100 Ω) | <100 (10 V) | — |
| | Fairchild | FPT 136 | 0.18 | 2.8 (100 Ω) | 10 (5 V) | 50 |
| Lens | Philips | BPX 25 | 2.6 | 1.5/1.5 (50 Ω) | 100 (24 V) | 7 |
| | Texas In- struments | TIL 81 | 4.4 | 8/6 (100 Ω) | <100 (10 V) | 12 |
| | Motorola | MRD 300 | 1.5 | 6.5 | <25 (20 V) | — |
| | Siemens | BPX 43/III | 1.67 | 8 (1 k Ω) | 12 (25 V) | 18 |
| | Monsanto | M T 2 | 0.13 | 2/2 (100 Ω) | 1 (5 V) | 10 |
| Micro- ceramic package | Texas In- struments | TIL 604 | 0.35 | 8/6 (1 k Ω) | 25 (30 V) | 22 |
| | Motorola | MRD 604 | 0.425 | 4.8/4.8 | <25 (30 V) | — |
| | Philips | BPX 71-204 | 0.55 | 3/2.5 (1 k Ω) | <25 (30 V) | 20 |
| | Telefunken | BPW 15 | 0.2 | 1.6/1.7 (100 Ω) | 10 (20 V) | 15 |
| Linear array | Siemens | BPX 80/III | 0.53 | 5 (1 k Ω) | 25 (25 V) | 16 |
| | Fairchild | FPA 700 | 0.175 | 4 (100 Ω) | 4.0 (5 V) | 50 |
| | Texas In- struments | TIL 630 | >0.075 | 8/6 (1 k Ω) | 50 (30 V) | — |
| Darling- ton photo- transistor | Motorola | MRD 370 | 20 | 50 | 100 (10 V) | — |
| | Telefunken | BPX 99 | 60 | 80/60 (100 Ω) | 10 (20 V) | 12.5 |
| Special versions | Siemens | BP 103/III generator for rf pulses | 0.135 | 5 (1 k Ω) | 5 (30 V) | 58 |
| | Telefunken | BPY 78 photothyristor | — | — | 100 (40 V) | 7.5 |

* For a tungsten lamp at color temperature of 2856 K, 1000 lux corresponds under normal test conditions to approx. 5 mW/cm².

is sufficient.) Or,

3b. Use the detector as a photovoltaic cell. In this case, only a small forward voltage is permissible (less than 1 mV/pA-mm²). Be careful, though, because undesired op-amp offset voltages can feed back to the photodiode via the feedback path. And, of course, devices with the lowest dark currents are the most desirable.

A typical circuit for an exposure timer with a sensitivity of 0.01 lux is shown in Fig. 3. The circuit automatically adjusts the offset each time an exposure reading is taken.

Incident light can cause problems

In many applications, such as in security installations, remote controls, sound transmission and parts handling, daylight or artificial light cannot be prevented from falling on the detector. This extra light causes a background current in the detector and thus additional noise. This extra light must be minimized.

To help screen the light, you can place in front of the detector an optical filter that passes only the desired portion of the spectrum. The transparency within the passband should be as high as possible, preferably better than 90%.

Try to use a device with the largest possible active area, or intensify the received optical power with a lens. Select a detector with the best response in the critical portion of the spectrum. The use of a tuned circuit as the load resistance can also help eliminate the effects of unwanted incident light.

No stringent demands are made upon the amplifier. For the preceding applications, the photodiode, because of its high quantum efficiency, offers performance superior to that of the photomultiplier. An avalanche photodiode would not improve performance any further.

Photodetection systems that use a light beam modulated at frequencies of less than 3 kHz or so and have noise generated by unmodulated radiation that can be considered negligible, find many applications in industrial environments. Here are some guidelines for selecting these detectors:

1. Use a photodiode with the largest possible ratio of active area divided by noise equivalent power (NEP). (The NEP is equivalent to the incident radiation in W/√Hz necessary to produce an output signal equal to the detector noise.) If possible, intensify the optical power with a lens to get best efficiency.

2. If no NEP value is specified, select a device that has, in the spectral range of interest, the largest ratio of active area × area-independent spectral sensitivity, divided by the square-root of dark current.

3. Use a very small reverse voltage (approximately 0.1 V) to power the device. Using the

Table 4. Comparison of photodetector arrays

| Manufacturer | Device | Number of photodiodes | Maximum scanning frequency (Hz) | Spacing of photodiodes (μm) | Notes |
|--------------------------------|-----------|-----------------------|---------------------------------|-----------------------------|-------------------|
| Fairchild | CCD 101 | 500 | 10 ⁶ | 30 | Linear array |
| International Photomatrix Ltd. | M 1024 | 1024 | 4 × 10 ⁶ | 25 | Linear array |
| Reticon | RL 1872 F | 1872 | 10 ⁷ | 15 | Linear array |
| Reticon | RO - 64 | 64 | 2.5 × 10 ⁶ | 100 | Circular array |
| International Photomatrix Ltd. | 2 D 1 | 64 × 64 | 3 × 10 ⁶ | — | Square array |
| Fairchild | CCD 201 | 100 × 100 | 4 × 10 ⁶ | 31/41 | Rectangular array |

detector in a photovoltaic mode degrades the results.

With a bandwidth of 3 kHz the photodiode surpasses the photomultiplier for a specified signal-to-noise ratio greater than 10. The photomultiplier offers advantages only over very narrow bandwidths. Fig. 4 illustrates a photodetector circuit with a signal bandwidth of 1 kHz. The only critical requirement is that the gate current of FET Q₁ must be held to less than 1 pA.

Photodetectors work at high frequencies

Operation of photodetectors finds much use in video scanning and data transmission applications, at frequencies reaching 30 MHz if unmodulated background noise is negligible. Again, there are many different considerations before picking a detector:

1. Use the largest possible beam cross-section, provided that the active area of the detector is fully illuminated. If possible, intensify the received optical power.

2. Select a device with the largest ratio of active area × area-independent spectral sensitivity, to the square-root of the device capacitance.

3. Take the highest reverse-voltage for the selected photodiode.

4. Select a compatible amplifier with a small value of input capacitance.

5. Choose the load resistance for the detector as close as possible to the permissible maximum to obtain the maximum bandwidth needed. If necessary, allow for a decrease in frequency response at the input and compensate for it in the amplifier.

(continued on page 58)

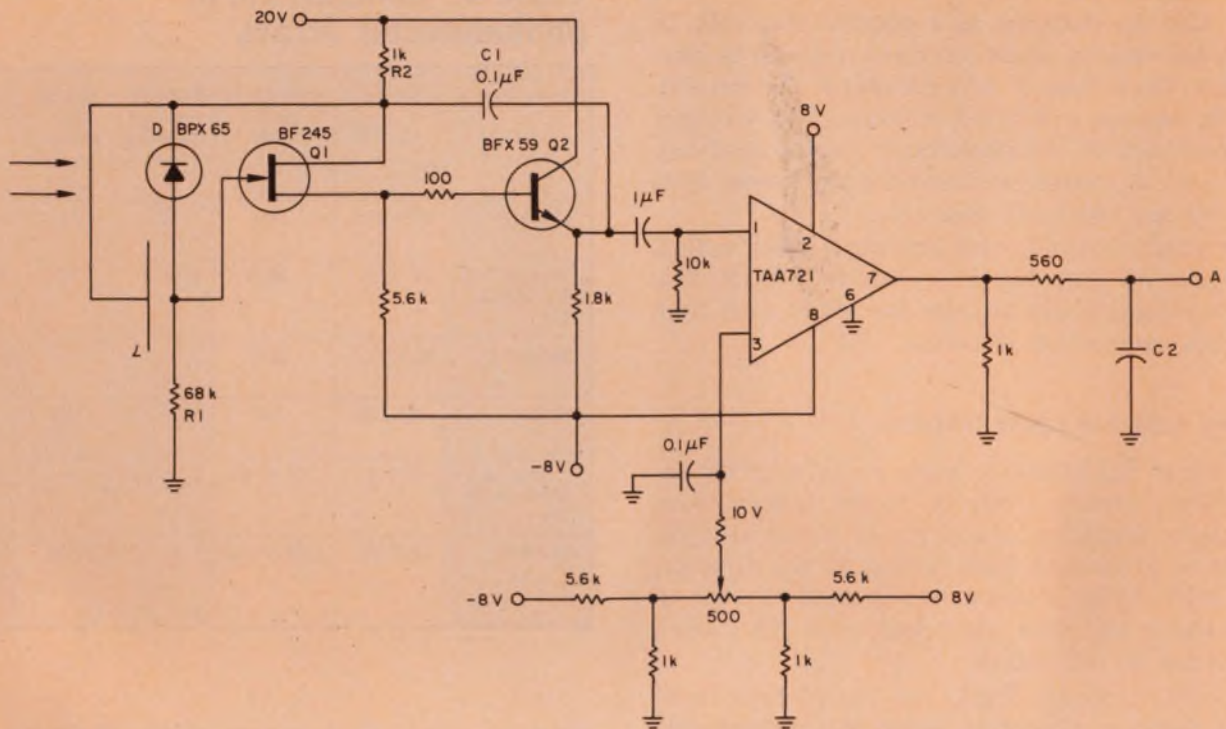

5. For operation at frequencies exceeding 5 MHz, this photodetector circuit uses compensation that is fed back

through C_1 to balance the photodiode capacitance. The JFET amplifier prevents diode loading.

6a. Apply a feedback signal to the low end of the load resistor so that its load resistance is effectively reduced. Or better still,

6b. Compensate for the capacitance of the photodetector and amplifier.⁵

At bandwidths of 5 MHz, p-i-n photodiodes can detect signals as weak as 10^{-12} W/Hz^{1/2} with a signal-to-noise ratio of 1 (Fig. 5). This value is approximately proportional to the square-root of the frequency. With avalanche photodiodes you can obtain a ratio of 2×10^{-13} W/Hz^{1/2} and with the best but relatively expensive photomultipliers a ratio of 10^{-16} W/Hz^{1/2}. However, for signal-to-noise ratios greater than 100, the p-i-n photodiode has performance superior to the best photomultiplier.

At frequencies above about 30 MHz photodetectors are found mostly in fiber-optic data links and optical measuring equipment—and don't forget, the background noise caused by unmodulated incident radiation must be negligible. Many of the same selection rules apply, but just to reinforce them here are the two most important that should be included for selecting the optimum device:

1. Pick an avalanche photodiode with the largest ratio of active area to NEP, but make sure the active area is fully illuminated.

2. Don't select a gain larger than is necessary to overcome the noise of the subsequent amplifier; You might have to use a diode with a slight-

ly larger than necessary active area.

Avalanche photodiodes perform better than multipliers as long as the signal-to-noise ratio is kept to more than 5 throughout the spectrum of interest. P-i-n's have a worse signal-to-noise ratio than avalanche diodes, but are usually used because they use lower voltages.

Photodetectors work with high intensities, too

One other large group of applications with high light intensities that require photodetectors include the paper-tape readers, photoflash units and short-distance photoelectric controls. For applications like these, there are some additional selection guidelines:

1a. Use phototransistors only if the irradiant intensity approximately agrees with the values printed on the device data sheet. Lenses might be needed to concentrate the light. Or,

1b. Choose circuit configurations in which the current gain of the phototransistors has no direct influence on the output (Fig. 6). Or,

1c. Use photodiodes or photovoltaic cells.

2. If necessary, select the phototransistor or photodiode with the smallest ratio of dark current divided by the product of active area \times area-independent spectral sensitivity.

3. Remember that the limiting frequency of phototransistors is inversely proportional to the load resistance and current gain.

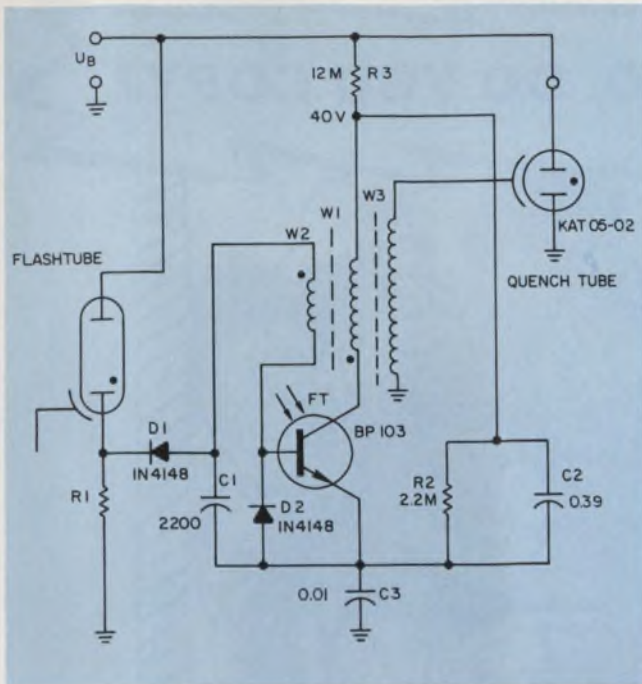

6. This computer-controlled photoflash circuit integrates the photocurrent with C_1 . Only when the base-emitter junction is turned on does the oscillator start to trigger the quench tube.

4. If small signals are to be detected use a photodiode, instead of a phototransistor since phototransistors have an undefined amplification factor. (See 1a).

5. Phototransistor collector voltage is not critical. Voltages ranging from 5 to 12 V are typically used. ■■

References

1. Sze, S.M., *Physics of Semiconductor Devices*, London, 1969, John Wiley Ltd.
2. Hunter, L.P., *Handbook of Semiconductor Electronics*, Third Edition, 1970, McGraw-Hill Book Co., New York.
3. Moss, T.S., Burrell, G.J. and Ellis, B., *Semiconductor Opto-Electronics*, Butterworths, London, 1973.
4. Krause, G. and Keiner, F., *Neue Belichtungsautomaten mit Fotodioden*, Fernseh und Kinotechnik, 1974, H.2, pp. 47-51.
5. Kuliczky, W.K. and Davis, G.K., "The Avalanche Photodiode as an Electronic Mixer in an Optical Receiver," *IEEE Trans. Electron. Devices*, Vol. 19, No. 11, 1972, pp. 1181-1190.
6. Barelli, A.E., "Improve Avalanche-Photodiode Design," *Electronic Design*, Vol. 21, No. 15, July 19, 1973, pp. 68-74.
7. Nishida, K. and Nakajima, M., "Temperature Dependence and Stabilization of Avalanche Photodiodes," *Review of Scientific Instruments*, Vol. 43, No. 9, pp. 1345-1350.
8. Kordes, R., "Optimize Photodiode Detector Design," *Electronic Design*, Vol. 20, No. 23, Nov. 9, 1972, pp. 84-86.
9. Krause, G. and Keiner, F., "Linearisierungsschaltung für Fototransistoren in Blitzgeräten," *Elektronik 3* (1975), pp. 92-93.
10. Krause, G. and Keiner, F., "Computer-Blitzgeräte Stark Vereinfacht," *Elektronik 4* (1975), p. 107.
11. Krause, G., "Reducing the Time Constant of Phototransistors," *Siemens Electronic Components Bulletin VIII* (1973) 1, pp. 8-9.
12. Geiger, D.F., "Increase Phototransistor Bandwidth," *Electronic Design*, Vol. 21, No. 8, April 12, 1973, pp. 102-104.

4 volt thru 120 volt interchangeability

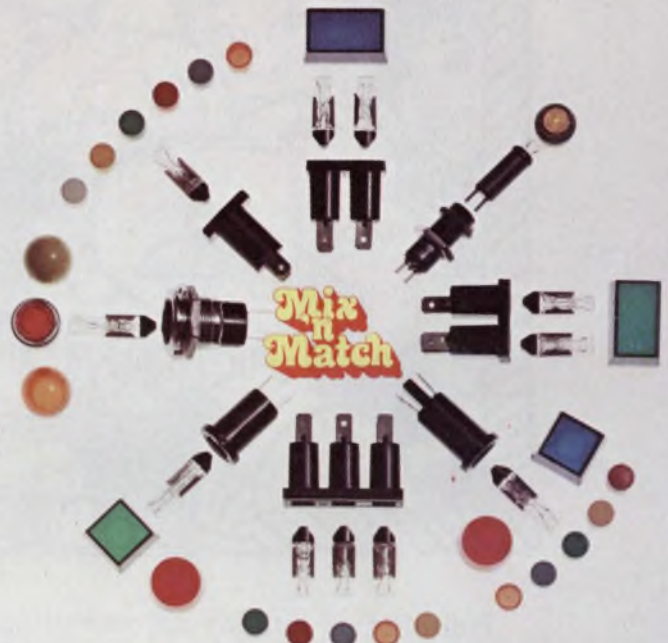

For the widest selection without overspecifying or overstocking, Sylvania offers you the universal parts flexibility of its "Mix 'n Match" lamp, socket, and lens system built around two series of T-2 slide base lamps. One is the *Pilot Lamp* series (5 to 120 volts), the other the *Indicator Lamp* series (4 to 48 volts). All of the lamps in each series are physically identical—hence sockets and lenses in each series are fully compatible with all of the lamps in its series. Use coupon below to order free 17"x22" Product Selector.

Try out your bright idea for \$5

Get the money-saving Experimenter's Kit packed with twelve T-2 slide base lamps of assorted or specific voltages, a complete range of sockets, lenses and color caps, and the unlimited inspiration of a 56-page Design Data Handbook.

Enclosed is our check for \$5 for Experimenter's Kit & Design Data Handbook.
(If you prefer lamps of a specific voltage, please indicate preference below.)

4V 6V 10V 12V
 24V 48V 60V 120V

Please send free "Mix 'n Match" Product Selector

NAME _____

COMPANY _____

STREET _____

CITY _____

STATE _____

ZIP _____

Please make checks payable to: GTE Sylvania Incorporated
Mail To: W. Main St., Hillsboro, N. H. 03244

We're helping you make it.
GTE SYLVANIA

CIRCLE NUMBER 37

TEN-FOUR, CB-LAND, DO YOU COPY?



... Hammer up and lay an eyeball on this copy for a minute. We don't want to overmodulate, but we've got four handbooks that, for not much lettuce, can have you doing your thing in the left lane in no time.

How to get your license from Uncle Charley. How to select and set up a rig. How it works. How to fix your set when something's dusting your ears. Do you copy ... it's all here!

Whether you're a green apple or a trucking guy, even if you drive a pregnant roller skate and want help the next time you get bubble trouble, here's the information, tips and techniques you need.

Use the coupon and put down your handle (name) and 10-20 (address) to order the book(s) you want. They come with a 15-day money back guarantee. And keep the wheels spinning and the beavers grinning.



HAYDEN BOOK COMPANY, INC., 50 Essex St., Rochelle Park, N. J. 07662

MOST OFTEN ASKED QUESTIONS AND ANSWERS ABOUT CB RADIO
CB Magazine Staff

Everything from "WHAT DOES CB MEAN?" to "HOW DO RG-58 and RG-59 CABLE DIFFER?" Over 160 questions sent in to *CB Magazine* cover all you need to know to really enjoy your rig. 5747-4, \$3.95.

CITIZENS BAND RADIO Revised 2nd Edition
Allan Lytel

Compares different types of equipment ... how they work ... maintenance and repair ... the FCC and you. 5737-7, \$4.90.

PRACTICAL CB RADIO SERVICING Revised 2nd Edition
R. R. Freeland

How to handle just about every problem you'll ever face. Step-by-step instructions, including spot-testing and troubleshooting. Filled with charts, diagrams, illustrations. 0869-4, \$6.95.

CBers' HOW-TO BOOK
Leo G. Sands

How to select and install equipment, including mobile and base stations ... codes and channels ... how to modify your rig for greater convenience and performance. 0718-3, \$4.95.

Please send the books checked on 15-day examination. Enclosed is my check for \$_____—Include your state sales tax (NJ-5%, CA-6%, FLA-4%) and 65¢ per book for postage & handling. I understand that I may return the book(s) within 15 days for a complete refund if not satisfied.

Name _____

Address _____

City _____

State/Zip _____

76-47

Clairex optical switches

Order any of our standard designs of optical switches and we'll give you the most reliable units and the best delivery in the industry.

Custom designs take a

little longer. Tell us your needs and we'll design to your specifications. We may even suggest an alternate, more economical solution.

Clairex optical switches

are made with hermetically sealed emitters and detectors for maximum reliability. Glass lenses align the light beam to improve target detection, to minimize false triggering from

stray light, and to reduce dust pickup.

Call (914) 664-6602 or write Clairex®, 560 South Third Avenue, Mount Vernon, New York 10550.

Form 1976
Product Data

CLI200 CLI200D



Optical Switches

GENERAL DESCRIPTION — The CLI200 and CLI200D are optical switches, consisting of an infrared light emitting diode on the emitter, a phototransistor output for the CLI200 and a darlington photo-transistor output for the CLI200D. The emitters and sensors are hermetically sealed to provide maximum reliability. They also have glass lenses to align the light beam for accurate target detection, minimize false triggering from stray light and reduce dust pickup as compared to flat window or plastic lenses. The switches have short leads that plug into printed circuit boards for soldering. All units are pretested to insure operation.

ABSOLUTE MAXIMUM RATINGS

Maximum Temperatures
Storage Temperature -55°C to +150°C
Operating Junction Temperature +100°C

EMITTER (GaAs Diode)

Power Dissipation
At 25°C ambient $P_t = 100$ mw, derate linearly 1.33mw/°C

Maximum Voltage
 V_R Reverse Voltage = 3.0 volts

Maximum Current
 I_F DC Forward Current = 60ma (continuous)

DETECTOR (NPN Silicon)

Maximum Power Dissipation
Total Dissipation
at 25°C Ambient Temperature $P_t = 50$ mW derate 0.5mW/°C
at 100°C Ambient Temperature $P_t = 12.5$ mW

Maximum Voltages,
 V_{CO} Collector to Emitter Voltage
 V_{EO} Emitter to Collector Voltage
Maximum Current $I_C = 200$ ma (Pulsed)

40 volts
5 volts

All dimensions = .005"

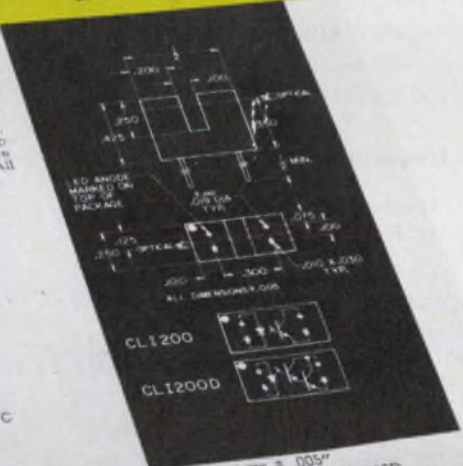

CLI200
CLI200D

ELECTRICAL CHARACTERISTICS (25° Free Air unless otherwise designated)

| Symbol | Characteristics | Test Conditions | | CLI200 | | CLI200D | | Units |
|---------------------|---|-----------------|------|--------|------|---------|--|-------|
| | | Min. | Max. | Min. | Max. | | | |
| Led V_R | Reverse Voltage | | | | | | | Volts |
| V_F | Forward Voltage | | | | | | | Volts |
| Sensor BV_{CO} | Collector to Emitter Breakdown Voltage | | | | | | | ma |
| I_D | Dark Current | | | | | | | Volts |
| Coupled I_C | Sensor Current | | | | | | | mSEC |
| V_{CE} (SAT) | Collector to Emitter Saturation Voltage | | | | | | | mSEC |
| t_r , t_f | Rise or Fall Time | | | | | | | |
| t_r , t_f | Rise or Fall Time | | | | | | | |

CLAIREX ELECTRONICS
A DIVISION OF CLAIREX CORPORATION
560 South Third Avenue, Mount Vernon, N. Y. 10550 • (914) 664-6602
A.D., 5/76-104

CLAIREX ELECTRONICS
A Division of Clairex Corporation

Control an LP-filter's cutoff frequency

electronically. Cover a 20:1 range with a digital control that can be linearized and set with a thumbwheel switch.

Few active low-pass filter configurations allow electronic control of cutoff frequency over a wide range. Fewer still provide both a given shape factor and a near-zero dc offset voltage. However, the two-pole low-pass filter arrangement in Fig. 1 exhibits all these properties. It allows control over at least a 20:1 control range; the range can be extended to over 50:1 before the filter's shape factor is appreciably changed. Further, it is an easy matter to cascade as many filter sections as is necessary to satisfy a particular need.

Controlling the cutoff frequency

The filter's cutoff frequency can be varied by controlling the gain of both A and B (Fig. 1a). Theoretically, they can each have any value less than +1, but as a practical matter, they should be kept below about +0.75.

Changes in cutoff frequency occur too rapidly for good control with values much greater than +0.75. Also, the filter's shape factor changes significantly for gains close to +0.9. However, gain in the negative direction is limited only by amplifier saturation. For the maximum control range, A and B may take on both positive and negative values.

A convenient way of controlling A and B is with a multiplying d/a converter. This device accepts an analog input voltage and provides an output current proportional to both the analog input and a digitally applied word.

Fig. 2 shows such a variable-gain circuit, using an AD7520 multiplying DAC. An R2R-ladder network with CMOS current switches provides digital inputs. The two LM747 op amps convert the current output of the converter into a voltage output. The circuit can provide a bipolar output voltage. Resistors R_1 , R_2 and R_3 define the relationship between most-positive and negative gains, and the input variable resistor, R_x , adjusts the gain limits.

In the AD7520, almost all the input currents

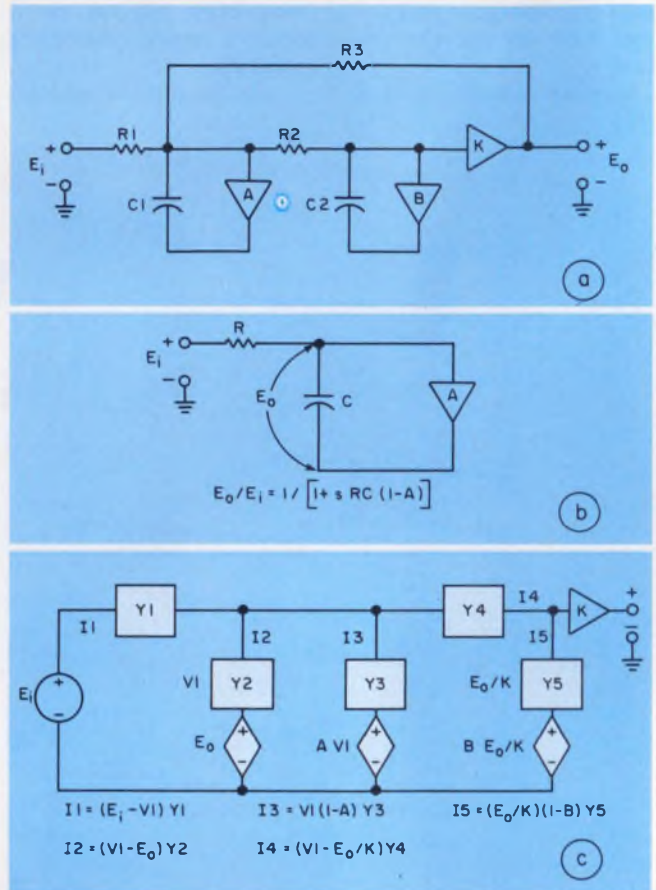

1. A two-pole Butterworth low-pass filter can be built from two capacitor-multiplier circuits in tandem (a), made up of two basic circuits (b) with an over-all feedback resistor, R_3 . A generalized equivalent circuit (c) helps in deriving performance equations for the filter.

are directed to output I_{01} , when all the digital inputs are at a logic ONE; the currents go to I_{02} with all digital inputs at ZERO. The I_{01} output signal current to op-amp A_1 provides the negative-gain value, and I_{02} to op-amp A_2 provides the positive-gain values. Fig. 3 shows the relationship between gain A and the digital control.

N is the most negative gain required. It occurs when all inputs are at logic ONE, and

$$N = R_1/R_x, \text{ or } R_x = R_1/N,$$

where R_x is the output resistance of the I_{01} port. Resistance R_x is about 10 k Ω . But because R_x

Olyn G. Boyle, Consultant, 9802 Edison St., Alliance, OH 44601.

varies significantly from device to device, the circuit includes input pot R_1 to trim the negative gain, N .

The most positive gain, P , when all inputs are at logic ZERO, is

$$P = (R_1/R_2) (R_x/R_x).$$

And since

$$R_x = R_1/N,$$

then

$$P = (R_3/R_2) N.$$

With P thus related to N , the single trimmer

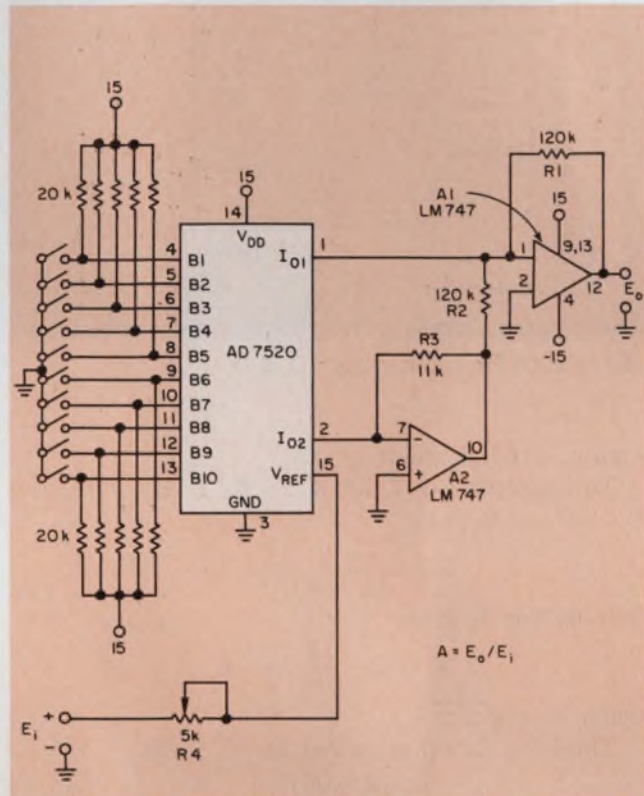

2. The variable-gain amplifiers, A and B in Fig. 1, can be implemented with multiplying a/d converters.

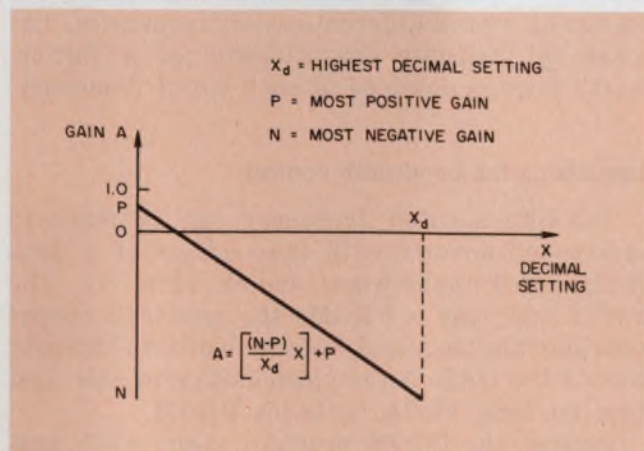

3. The cutoff frequency of the filter can be linearly related to decimal settings of a thumbwheel switch that controls the gain of the filter-system amplifiers.

adjustment establishes both limit values. In Fig. 2, maximum gain, N , is set at -7 and P at approximately 0.65 . The cutoff frequency range is greater than $20:1$.

Putting the filter circuit together

Fig. 4 is a schematic of the low-pass filter using the variable-gain amplifiers of Fig. 2. The two LM310s serve as low-bias-current voltage buffers with unity gain, and the LM308 is a low-bias-current op amp whose gain determines the amplifier term, K , in the simplified filter circuit (Fig. 1a). These low-bias-current amplifiers minimize dc-offset voltages caused by bias currents. The LM-747 op amps in the DAC aren't low-bias-current devices; the final outputs of both variable-gain circuits drive capacitors that block any dc offset.

The dc path through the filter is fixed and independent of the gains of the multiplying DAC; thus, the low-bias-current devices can hold the dc offset of the filter to less than 3 mV over the entire cutoff-frequency range.

Switches S_1 and S_2 provide a convenient way to adjust the gain of the two variable-gain circuits. With the two switches open and an all logic-ONE digital input, the gain of each variable-gain circuit is adjusted to its most negative value (-7). Switches S_1 and S_2 are closed for normal filter use.

For a filter cutoff-frequency range of 50 to 1000 Hz—a $20:1$ range—and a Butterworth filter response, the circuit is designed with a damping factor, $\delta = \sqrt{2/2}$.

Examining the basic filter configuration

It's apparent that the two-pole filter in Fig. 1a uses two sections of the simple capacitor-multiplier (Miller-effect) circuit shown in Fig. 1b. The capacitor-multiplier circuit has a transfer function,

$$E_o/E_i = 1/[1 + sRC(1 - A)], \quad (1)$$

where A is the gain of an ideal voltage amplifier. The cutoff frequency of this circuit is therefore

$$f_c = 1/[2\pi RC(1 - A)]. \quad (2)$$

Clearly, the cutoff frequency can be adjusted by varying the gain A .

Not so obvious is that two of these circuits can be employed in tandem to provide a second-order transfer function whose natural frequency also can be adjusted by the amplifier gain, A . At the same time the tandem circuit can maintain a constant damping factor independent of A .

Fig. 1c is a generalized equivalent circuit, where Y_3 and Y_5 are capacitor susceptances, Y_1 , Y_2 and Y_4 are conductances, and A and B are amplifier gains.

An analysis of the node equations of Fig. 1c

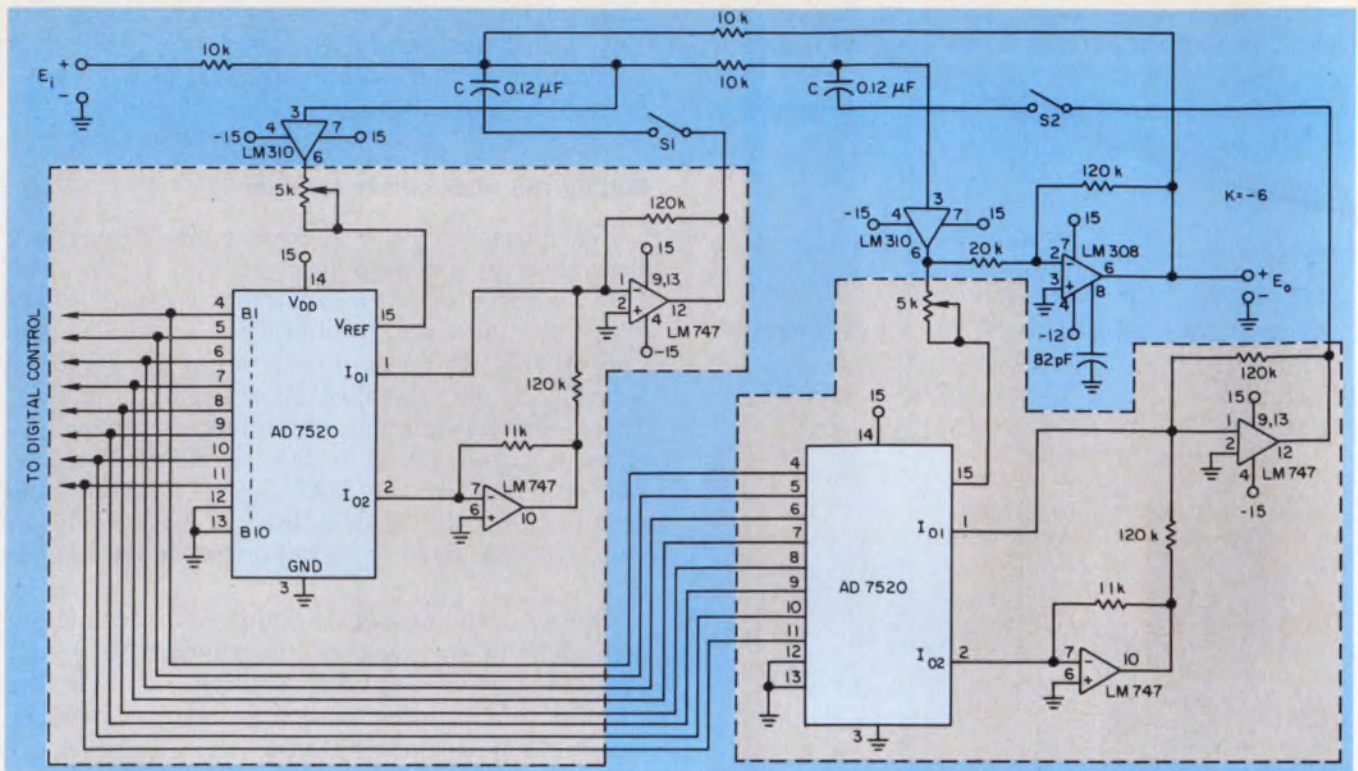

4. The complete filter uses two variable-gain circuits. For a 50-to-1000-Hz cutoff range, C is 0.12 μ F.

yields the transfer function as follows:

$$\frac{E_o}{E_i} = KY_1 Y_1 / [Y_3(1-B)[Y_1 + Y_2 + Y_3(1-A) + Y_1] + [Y_1 + (1-K)Y_2 + Y_3(1-A)] Y_1 \quad (3)$$

By setting $A = B = 0$, both the circuit and transfer function reduce to a form given by Burr-Brown,¹ though Burr-Brown's equation is incorrect— Y_1 in the denominator is missing.

The standard form of a transfer function for a second-order system is

$$\frac{E_o}{E_i} = \frac{\omega_n^2}{s^2 + 2\delta\omega_n s + \omega_n^2}, \quad (4)$$

where ω_n is the natural radian frequency, and where δ is the damping factor. Eq. 3 is converted to this standard form by substituting

$$\begin{aligned} Y_1 &= 1/R_1 & Y_2 &= sC_1 & Y_3 &= sC_2 \\ Y_2 &= 1/R_2 & Y_1 &= 1/R_2 \end{aligned} \quad (5)$$

and simplified by setting $A = B$; thus,

$$f_n = \frac{1}{2\pi(1-A)} \left[\frac{1 + (1-K)(R_1/R_2)}{R_1 R_2 C_1 C_2} \right]^{1/2} \quad (6)$$

$$\delta = \frac{1}{2[1 + (1-K)(R_1/R_2)]^{1/2}} \left[\left(\frac{R_2 C_2}{R_1 C_1} \right)^{1/2} + \left(\frac{R_1 C_2}{R_2 C_1} \right)^{1/2} + \left(\frac{R_1 R_2 C_2}{R_2^2 C_1} \right)^{1/2} + \left(\frac{R_1 C_1}{R_2 C_2} \right)^{1/2} \right] \quad (7)$$

where

$$G_o \text{ (dc gain of the filter)} = \frac{K}{1 + (1-K)(R_1/R_2)} \quad (8)$$

Eq. 6 indicates that the circuit's natural, or cutoff frequency, can be adjusted by varying A, and Eq. 7 doesn't contain A, therefore the damping

factor is independent of A.

To simplify Eq. 7, let $R_1 = R_2 = R_3 = R$, and $C_1 = C_2 = C$, then

$$\delta = \frac{2}{(2-K)^{1/2}}$$

Solving for K gives

$$K = 2 - \frac{4}{\delta^2} = -6,$$

when $\delta = \sqrt{2/2}$.

Then Eq. 7, when solved for C, yields

$$C = \frac{(2-K)^{1/2}}{2\pi f_n R(1-A)}$$

With $f_n = 50$ Hz, $A = -7$, $R = 10$ k Ω and $K = -6$, C is 0.12 μ F. The dc gain of the filter from Eq. 8 is $-3/4$. Fig. 5 is the filter's frequency response at several different cutoff frequencies. The same flat response characteristic of a Butterworth filter is obtained at each cutoff frequency.

Linearizing the bandwidth control

The filter's cutoff frequency can be made to correspond directly with the settings of a decimally coded thumbwheel switch (Fig. 6). The switch addresses a PROM; the memory's output provides the required binary word to linearly control the DAC. An implementation of this idea uses an Intel 1702A, 2048-bit PROM.

Because the PROM provides about +5-V output for logic ONE and -4 V for a logic ZERO, 1N914 diodes are used in the PROM's output. The AD7520 can't accept a negative digital input

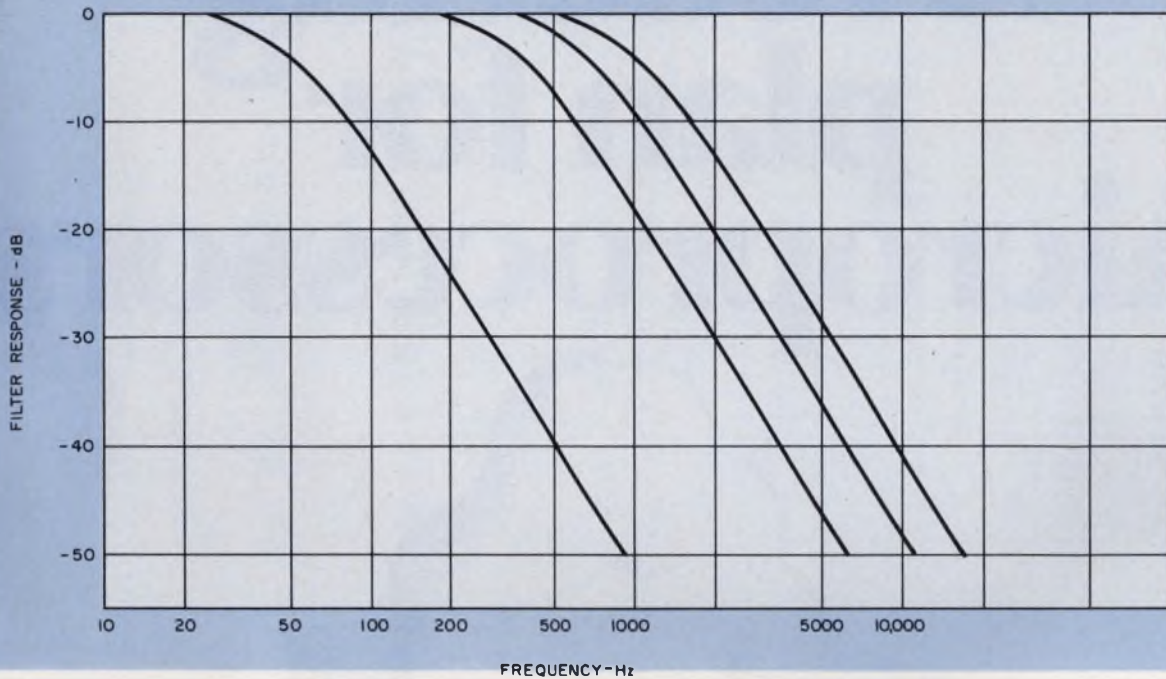

5. The filter's response at several different cutoff frequencies has the same shape and roll-off characteristics.

voltage. Thus the digital inputs are kept between approximately +4 V and ground.

Programming of the 1702A PROM can be done on the Intellec 8, which uses an 8080 microprocessor. The PROM contents are easily determined.

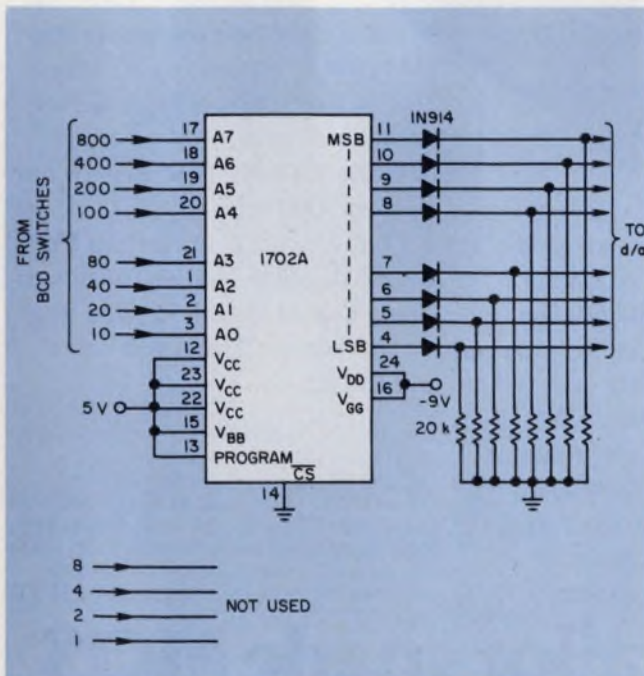

6. A PROM can be used to linearize control of the filter's cutoff frequency and allow the use of a thumb-wheel-switch to set the cutoff value.

Using Eq. 6, let

$$f_o = \frac{1}{2\pi} \left[\frac{1 + (1 - K)(R_1/R_3)}{R_1 R_2 C_1 C_2} \right]^{1/2}$$

be the cutoff frequency of the filter, when gain A is zero. Then,

$$f_c = f_o / (1 - A)$$

and

$$A = 1 - (f_o/f_c) \quad (9)$$

Since from Fig. 3,

$$A = \left[\frac{(N - P)}{X_d} X \right] + P, \quad (10)$$

then from Eqs. 9 and 10,

$$X = X_d [1 - P - (f_o/f_c)] / (N - P).$$

Decimal setting, X, is then converted to the desired binary values for each different cutoff frequency, f_c , before coding the PROM.

For the filter in Fig. 5, the cutoff-frequency resolution is approximately 10 Hz for the narrowest bandwidth, and it decreases to about 50 Hz for the widest bandwidth.

Additional even numbers of filter poles are easily obtained by cascading several stages of the circuit. An odd real pole can be obtained by adding a single capacitor-multiplier stage on the end of the filter. The Burr-Brown reference is an excellent source for obtaining the needed damping factor for each of the filter stages that may be cascaded. ■■

Reference

1. Huelsman, L.P., Graeme, J.G., Tobey, G.E., *Operational Amplifiers; Design and Applications*, Burr-Brown, McGraw-Hill, New York, NY, 1971, p. 296.

A reducing plan for microprocessors.

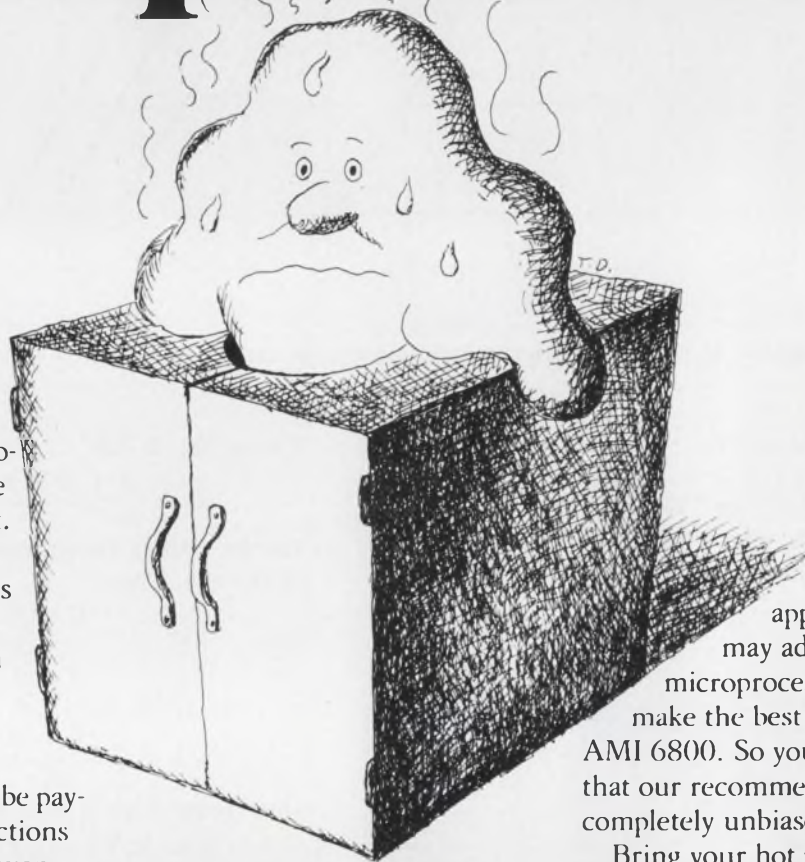

Here's a way to get a micro-computer that's *exactly* the right size for your product.

It's a custom microprocessor. We've made millions of them since 1966. And we're selling more of them today than ever.

The reason is simple. When you buy a standard microprocessor, you could be paying for a lot of built-in functions that you don't need. And, even though the standard part is cheaper going in, you can tell by the chart that custom comes out ahead in high volume runs.

If you're not sure which way to

go, come to us. Nobody can match our experience in custom MOS, with our full-time staff of engineers, technicians and marketing specialists. We've recently developed a totally new method of design that cuts about 25 percent off the development cycle time. And our production lines in Santa Clara and Pocatello are geared to produce all the CMOS, N-Channel or P-Channel circuits you want.

After we've assessed your

application, we may advise a standard microprocessor—ours! We make the best one going, the AMI 6800. So you can be sure that our recommendation will be completely unbiased.

Bring your hot new idea to your nearest AMI sales office. Or write for our brochure on Custom MOS to: AMI, 3800 Homestead Road, Santa Clara CA 95051. One way or another, we'll help you cut out the fat.

Long Beach CA (213) 595-4768 • San Jose CA (408) 249-4550 • Altamonte Springs FL (305) 830-8889 • Elk Grove Village IL (312) 437-6496 • Norwood MA (617) 762-0726
Livonia MI (313) 478-9339 • Minneapolis MN (612) 559-9004 • Monsey NY (914) 352-5333 • Cleveland OH (216) 292-6850 • Ampler PA (215) 643-0217 • Richardson TX (214) 231-5721

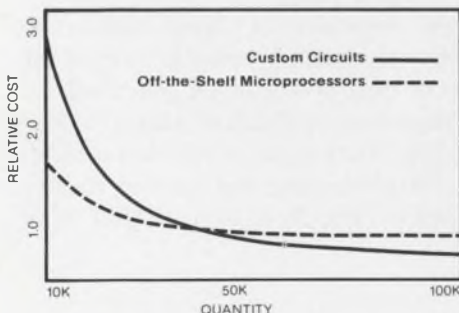

After we've assessed your **tailor-made MOS from AMI**

AMERICAN MICROSYSTEMS, INC.

CIRCLE NUMBER 40

ELECTRONIC DESIGN 21, October 11, 1976

SURPRISE!

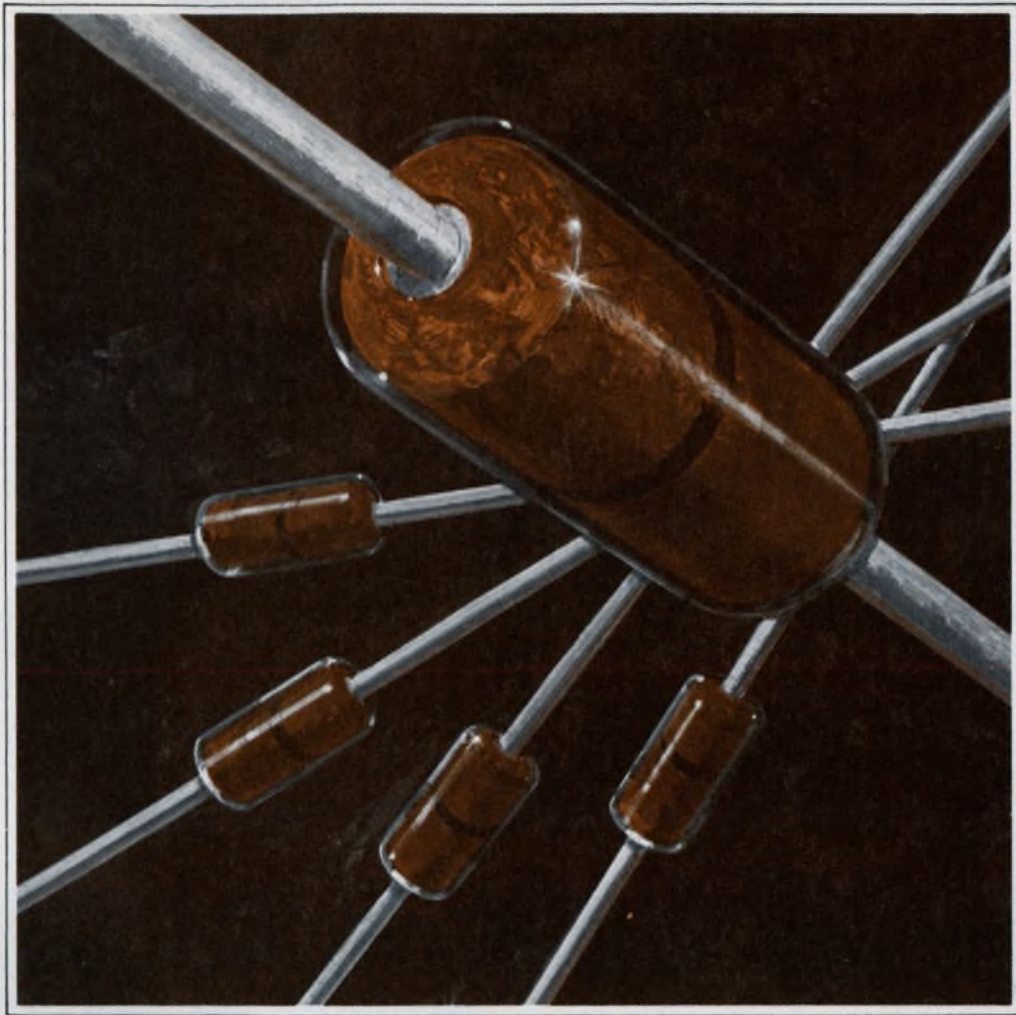

An Engineering Masterpiece: A Schottky Diode in a D035 Package

HP's HSCH-1001 (1N6263) Schottky gives you lower forward voltage than other silicon semiconductors in your circuit: 410 mV max at 1 mA. So it turns on sooner and with less loss. It's highly efficient, with only 200 nA reverse leakage current at 50 V, 15 mA forward current at 1 V, and picosecond switching speed. With an operating temperature range of -65°C to $+200^{\circ}\text{C}$ it is ideal for harsh environments. And we offer it in a hermetically sealed package rugged enough for automatic insertion.

It's ideal for waveform clipping, clamping and sampling, transistor speed-up, and rf signal detection and power monitoring, or anywhere else you might use germanium or silicon general purpose diodes.

Price in 1000 quantities is 45¢* This engineering masterpiece is in stock now. *Domestic U.S. price only.

In the U.S. contact Hall-Mark, Schweber, Wilshire or the Wyle Distribution Group (Liberty/Elmar) for immediate delivery.

In Canada, contact Schweber Electronics or Zentronics, Ltd.

HEWLETT  **PACKARD**

Sales and service from 172 offices in 65 countries.
1507 Page Mill Road Palo Alto California 94304

For assistance call: Washington (301) 948-6370, Chicago (312) 677-0400, Atlanta (404) 434-4000, Los Angeles (213) 877-1282

01613

CIRCLE NUMBER 41

Avoid failure of PC board components

by limiting the circuit board's vibration under stress.

Make the board stiffer, if necessary, to cut down movement.

Electrical engineers often allow poor mechanical design of PC boards because mechanical factors are the last thing on their minds during the electrical design phase. Therefore, it is important to consider some of these factors before the design is frozen.

PC boards suffer under vibration

Circuit boards that operate for extended periods under severe vibration will often suffer from fatigue failure. It can occur in the form of broken solder joints, broken wires on electronic components, cracked printed-circuit runs or broken pins on electrical connectors.

Extensive testing and analysis with sinusoidal and random vibration has shown that fatigue failures on plug-in circuit boards are related to the dynamic displacements at the center of the board.

The board is assumed to be mechanically hinged on all four sides—the connector forming one hinge, and the card supports on the other three edges forming the rest. The hinges allow the board to bend but not to move. Also, all components are evenly distributed over the circuit board. For mechanical conditions that differ drastically from these the solution will also vary.^{1,2}

For rectangular boards, a simple equation relates the maximum allowable displacement (from rest position) to the length of the shorter side.¹

$$\delta_{\max} = 0.003 \times b, \quad (1)$$

where b is the shorter linear dimension of the board.

When the dynamic displacement at the center of the circuit board is less than this value, the circuit board, the components and the connections won't fail.

Equation 1 provides an adequate margin of safety for stresses that are developed in the electrical lead wires of circuit components such as resistors, capacitors, diodes, flat-pack integrated circuits and hybrid circuits. These components

are supported by their wires, which extend from the opposite sides of the component body and are soldered to the circuit board. As the board bends back and forth under vibration, the component wires bend also and eventually break (Fig. 1).

Components located at the center of the board will get the greatest stress, particularly if their wires are parallel to the shorter side of the board.

Dynamic displacement at the center of a typical plug-in circuit board can be determined for both sinusoidal and random-vibration environments:

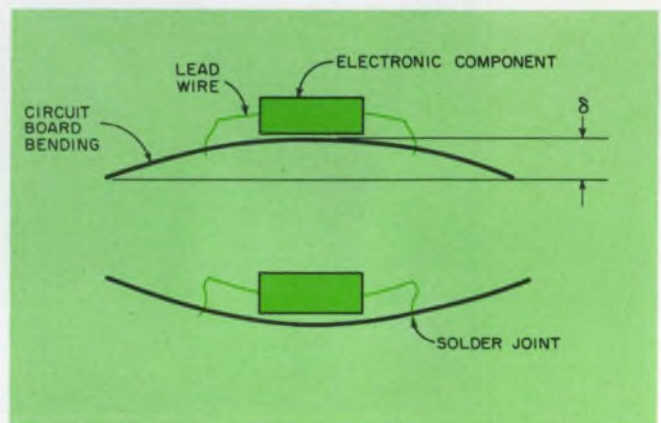

1. Circuit boards bend during vibration, with the most severe stresses on the lead wires of the components in the center of the board.

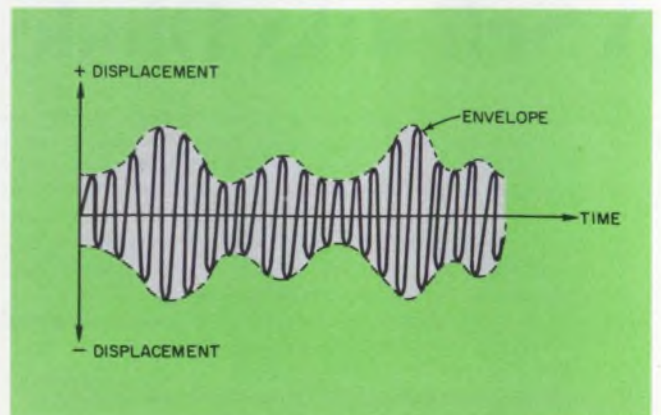

2. When random vibration is applied to a system having a single degree of freedom, the system responds by oscillating at its resonant frequency.

$$\delta_d = \frac{9.8 G_{out}}{f_n^2} \quad (2)$$

The symbols in this equation have a slightly different meaning for the two kinds of vibration. For sinusoidal vibration the peak single-amplitude displacement occurs at the center of the board. So, the natural frequency of the board (f_n) must be determined. The output-acceleration force acting at the center of the board must also be calculated in gravity units, G_{out} .

For sinusoidal vibration, get f_n , then G_{out}

The natural frequency can be calculated as follows:

$$f_n = \frac{\pi}{2} \sqrt{\frac{D}{\rho}} \left[\frac{1}{a^2} + \frac{1}{b^2} \right] \quad (3)$$

$$D = \frac{E h^3}{12 (1 - \mu^2)} \quad \text{board-stiffness (lb-in.)}$$

$$\rho = \frac{\text{mass}}{\text{area}} = \frac{W}{gab}, \quad (\text{lb s}^2/\text{in.}^3)$$

where:

$$E = \text{board modulus of elasticity,} \quad (\text{lb/in.}^2)$$

$$h = \text{board thickness,} \quad (\text{in.})$$

$$\mu = \text{Poisson's ratio,}$$

$$W = \text{total weight of circuit board and components,} \quad (\text{lb})$$

$$g = \text{acceleration of gravity,} \quad (386 \text{ in./s}^2)$$

$$a = \text{board length,} \quad (\text{in.})$$

$$b = \text{board width.} \quad (\text{in.})$$

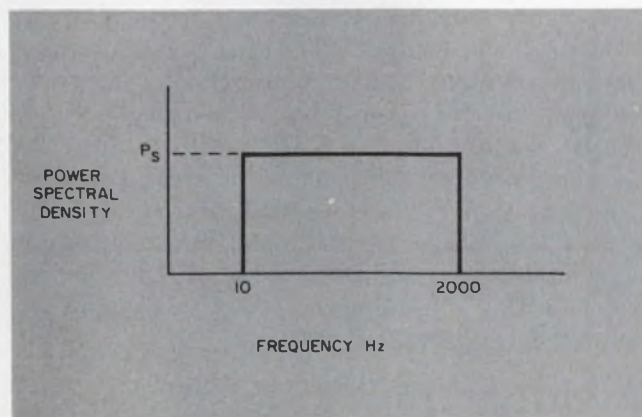

3. A white-noise power spectrum contains a uniform power spectral density over a given frequency range. It is a commonly specified environment for boards.

The output acceleration force, G_{out} , can be determined from the input acceleration and the circuit-board transmissibility, Q , at its resonance, as shown:

$$G_{out} = G_{in} Q \quad (4)$$

If there are no sinusoidal-vibration test data available for the circuit board, its Q can be approximated from the natural frequency:

$$Q = \sqrt{f_n} \quad (5)$$

For random vibration, calculate G_{out}

For random vibration Eq. 2 will give the single-amplitude displacement at the center of the board. The maximum value is determined from the maximum output acceleration force, G_{out} , Eq. 6.

Equation 3 is still used to calculate the circuit board's natural frequency—actually the number of positive zero crossings, N_n , because it is really the number of times the displacement-amplitude curve crosses the zero axis with a positive slope.

A plug-in circuit board is not really a single-degree-of-freedom system. When it is subjected to a wideband random-vibration environment, usually up to 2000 Hz, the fundamental and several higher harmonic resonances will be excited at the same time. Since most of the component stress will occur at the fundamental resonant frequency, the higher harmonic modes can usually be ignored with very little error (Fig. 2).

When a plug-in circuit board is approximated as a single-degree-of-freedom system, the output acceleration force, G_{out} , can be determined:

$$G_{out} = 3 \sqrt{\frac{\pi}{2} P_s f_n Q} \quad (6)$$

where,

$$f_n = \text{natural frequency of board (Hz),}$$

$$Q = \text{transmissibility of board at its resonant frequency,}$$

$$P_s = \text{power spectral density (G}^2/\text{Hz).}$$

The equation represents the three-sigma (3σ) acceleration force, which is three-times greater than the root-mean-square (RMS) force. For a Gaussian distribution, the 3σ value represents the maximum acceleration level that will be likely to occur.

The white-noise spectrum is the most common type of random vibration specified for board testing. This has a constant-power spectral density over a wide bandwidth (Fig. 3).

Use of the equations for sinusoidal-vibration

and random-vibration environments can be demonstrated with a sample problem.

Solving an actual problem is simple

The epoxy-fiberglass plug-in circuit board (Fig. 4) is proposed for two different programs. The first program specifies a sinusoidal vibration environment with an input-acceleration force of 5 G peak from 72 Hz to 2000 Hz. The second program specifies a white-noise, random-vibration environment, with a power spectral-density input of 0.10 G²/Hz. The problem: determine if the circuit board and its components will have an infinite fatigue life in both environments.

First solve Eq. 1 to determine the maximum allowable circuit-board displacement for both environments, based upon the length of the shortest side, b, which is 4 in.

$$\delta_{\max} = 0.003(4.0) = 0.012 \text{ in.} \quad (7)$$

The natural frequency of the circuit board is also required for both environments. The physical properties of the epoxy fiberglass board are:

E = 2 × 10⁶ lb/in.² for G-10 epoxy fiberglass; the modulus of elasticity

h = 0.062-in., board thickness

μ = 0.12, Poisson's ratio

$$D = \frac{(2 \times 10^6)(0.062)^3}{12 [1 - (0.12)^2]}$$

$$= 40.30 \text{ lb in., stiffness}$$

W = 0.35 lb, total weight

g = 386 in./s², gravity

a = 6.0 in., board length

b = 4.0 in., board width

$$\rho = \frac{0.35}{(386)(6.0)(4.0)}$$

$$= 0.3778 \times 10^{-4} \text{ lb s}^2/\text{in.}^3$$

Substitute into Eq. 3 for the natural frequency:

$$f_n = \frac{\pi}{2} \sqrt{\frac{40.30}{0.3778 \times 10^{-4} \left[\frac{1}{36} + \frac{1}{16} \right]}}$$

$$= 146.46 \text{ Hz} \quad (8)$$

Now, evaluate the individual environments. Con-

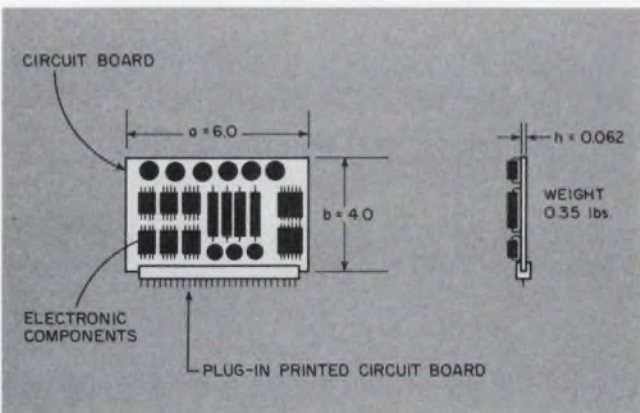

4. The plug-in printed circuit board used in the example is 0.062-in. thick and made of G-10 epoxy-fiberglass, a very common construction.

sidering the sinusoidal vibration environment first, Eqs. 4 and 5 can be combined as shown:

$$G_{out} = G_{in} \sqrt{f_n} \quad (9)$$

where $G_{in} = 5$ G sinusoidal peak input

$f_n = 146.46$ Hz, from Eq. 8

$$G_{out} = (5.0) \sqrt{146.46} = 60.51 \quad (10)$$

Substitute Eqs. 8 and 10 into Eq. 2 to find the amount of circuit board displacement that results from sinusoidal vibration

$$\delta_n = \frac{(9.8)(60.51)}{(146.46)^2} = 0.0276 \text{ in.} \quad (11)$$

Since this displacement exceeds the maximum of 0.012 in., Eq. 7, the design is not acceptable for the sinusoidal-vibration environment.

Well, maybe it will work in random vibration

Next, consider the random-vibration environment. The output acceleration force—the response—of the circuit board, G_{out} , can be determined from the following data:

$P_s = 0.10$ G²/Hz; power spectral density

$f_n = 146.46$ Hz, see Eq. 8

$Q = \sqrt{146.46} = 12.1$, transmissibility

Substitute these values into Eq. 6; for the 3 σ force

$$G_{out} = 3 \sqrt{\frac{\pi}{2} (.10)(146.46)(12.1)} = 50.05 \quad (12)$$

Substitute Eqs. 8 and 12 into Eq. 2 for the displacement of the circuit board due to the random-vibration environment

$$\delta_n = \frac{(9.8)(50.05)}{(146.46)^2} = 0.0231 \text{ in.} \quad (13)$$

Since this displacement exceeds the maximum allowable displacement of 0.012 in., as shown in Eq. 7, the design is not acceptable for the random-vibration environment either.

If the natural frequency of the circuit board is increased, the dynamic displacements will decrease very rapidly, as shown by Eq. 2. Use stiffening ribs or increase the thickness of the circuit board to accomplish this.

In our example, if the circuit board thickness is increased to 0.093 in., the natural frequency will be increased to 269 Hz. For the sinusoidal-vibration environment, the dynamic displacement at the center of the circuit board will then be decreased to 0.011 in.

For the random vibration environment, the displacement will now be decreased to 0.0107 in. Since these values are both less than the maximum allowable displacement of 0.012 in., as shown in Eq. 7, the design is now acceptable for both kinds of vibration. ■■

References

1. Steinberg, Dave S., *Vibration Analysis For Electronic Equipment*, John Wiley & Sons, New York, 1973.
2. Crandall, Stephen H., *Random Vibration*, Technology Press, MIT and John Wiley & Sons, New York, 1958.

ANNOUNCING FAIRCHILD'S 30 PICOAMP FET INPUT OP AMPS IN METAL CAN AND **PLASTIC!**

**The μ AF156 Family.
The second source you've
been waiting for.**

Fairchild's entry on the scene makes FET Input Op Amps totally viable — with two major manufacturers now providing pin-for-pin alternate sources. Now you can confidently design-in the most advanced operational amplifiers in the world.

The Fairchild μ AF156 Family:

Typical Specifications

- I_B 30 pA
- I_{OS} 3 pA
- V_{OS} 2 mV
- V_{OS} Drift 5 μ V/ $^{\circ}$ C
- Slew Rate 15 V/ μ sec
- Settling Time 1.5 μ sec (to 0.1%)
- Noise 15 nV/ \sqrt{Hz}
- Bandwidth 5 MHz



There is no doubt that these new linears represent the next major generation in Op Amps technology. And there is no doubt about Fairchild's linear reliability.

**Plus the logical next step.
Your first source
for plastic mini dip.**

Plastic Mini DIP:

This is the next development and —

Fairchild is first.

Low Cost. Low profile. Easier handling. And not just any plastic —

Fairchild's unique DM-6.

We're already in plastic Mini DIP production. Samples are available immediately.



AVAILABLE IN METAL CAN

μ AF155/155A, μ AF355/355A
 μ AF156/156A, μ AF356/356A
 μ AF157/157A, μ AF357/357A

AVAILABLE IN PLASTIC MINI DIP

μ AF355, μ AF356, μ AF357

For complete information, contact your Fairchild Distributor, Rep or local Sales Office.

FAIRCHILD
WHO ELSE?

The way to make your engineers responsible is to give them responsibility. Real responsibility. This means, for example, that an individual engineer is responsible for the cost of his project and for completing his project on time. He knows, too, that he's going to live with his project forever. He's not going to take it to production and forget about it.

Our engineers know they are responsible for getting a product to manufacturing, and then through field performance. So they design for easiest and most efficient production and minimum need for field maintenance. That's important because it changes the entire attitude of the engineering organization. It gets rid of the idea, "Well, I'll get the first unit through manufacturing and then I'll be finished with it and I'll be able to move on to something else."

It changes a whole series of things that engineers worry about on a day-to-day basis. It affects the way they work, the way they plan their projects, and the way they plan their time. And that's just part of it.

Our engineers know that top managers are deeply involved in their projects, too. And they're knowledgeable; not just desk-pilots or chart presenters. They get out on the floor and get involved.

Other managers get involved, too. The manufacturing managers, the marketing managers, the field-service people—they all get involved and interact with the design engineer right from the beginning. They sometimes put pressure on him and they give their help, too. So the engineer feels responsible to them, as well as to top management.

These are some of the positive things we do to make the engineer feel responsible. What's equally important are the things we don't do. One thing, we don't waste money. Right from the start we teach the engineer that we want to spend our money wisely. Now that's not as simple as it sounds.

We've had problems in the past, as any engineering organization has had, of making sure that happens. We've all seen organizations where you start 20 projects, spend half-a-million dollars, complete two of them and have one result in sales. That can be thoroughly demoralizing to a good engineer. He can't get worked up about spending money wisely if he sees management blowing money carelessly.

Even if you have money to spend—as we did for the last couple of years—you don't spend it unless you have the right people and the right resources to work on the right project. You mustn't spend money just because it's there. And that means that sometimes you have to let your

money sit. Managers don't like that. They know they can get a higher return if they invest it in good projects than if they put it in a bank.

How do you pick the right project? That's the hardest part. Picking the right project and the right people are key decisions and extremely difficult.

These decisions are a function of many things. The right project for TI may not be right for us, or for you. You won't be right in 100 percent of your choices, but you had better be right a high percentage of the time.

There were times when we knew which projects we wanted to do, but we had to wait until we had the right talent. You often have to look for a long time for the right people.

It's easy to hire somebody to spend money. It's not so easy to find somebody who will spend it wisely. Selecting people is very tricky. Sometimes you find somebody who's golden in one company but a lemon for you. He may not work out for you because the situation is different.

Similarly, you may find somebody who's not working out too well elsewhere. But he can flourish in the environment you provide. So

Orion Hoch of AMS Speaks On

there's no simple answer to how to find the right project or the right person.

Once you make decisions on people or projects, you start worrying about them, day in and day out. The first thing you do after you've made a plan is to wonder what changes are necessary. That's the essence of the business world. You just have to keep testing the assumptions you've made, and it's not always easy to test.

You have to keep examining your choice against the alternatives. Something very dramatic may happen in the marketplace to force you to re-evaluate your thinking quickly. You have to determine how fast technology is changing. You may have to raise the question, for example, of how long to stay with one technology before switching to another.

We're still strong on metal gate, for example,



Making Your Engineers Responsible

but I think we stayed with it too long as our dominant technology at AMS. Our philosophy was that you could stay with a simple, conservative process like metal gate and make up for its limitations in the circuit design. And that was true for a long time.

But then the progress in circuit design with silicon-gate technology started to move very fast. And that's the very thing I mean when I say you have to reexamine your plan. It may have been fine last month; but is it still good this month? And will it still be good tomorrow?

You can't lock yourself in a room and say: "Well, I've made my decision." You must be constantly ready to modify it. Or even scrap it.

That's a process all managers go through. I don't know how to get away from it. You must try to get your engineers to think that way, too. That's hard because they get involved in their own technology. They become advocates, and tend to justify everything they do.

It's difficult to know when to junk your own idea. We did that when we had to change some of our approaches. Had we been smarter, we would have made the right decision at first. But nobody guesses right every time. We goofed on projecting the rate of change of technology. Luckily, we had other products to replace the ones we had to scrap.

Nobody likes to drop a project. But it's important for the engineer to see that we abandon a project sometimes. Projects don't just die. We kill them—when we have good reason to. And

we don't conceal it from our engineers. We show a man that we must sometimes swallow our pride and alter course. That's another way of showing the engineer that management is responsible. When he sees that management is responsible, he wants to be responsible, too.

There's another element of responsibility. Just as we don't want to waste money, we don't want to waste the engineer's time.

Paper work and budgeting can be the most elaborate and time-consuming operations an engineering manager performs. We try to simplify them as much as possible.

Instead of developing an elaborate budgetary system, we simply establish resources for the director of engineering. We give him the people and money he needs; we establish his budget. But we don't track every individual project down to the *n*th dollar.

We tell him to manage within his budget, within the confines of the dollars and people we provide. But he's free to move people and money from one project to another if he wants to make up for time he's lost or gained on one project or another. We don't get into the nit-picking, project-by-project analysis of things like incremental dollars every week. That takes too much effort.

If we wanted to, we could get into the most elaborate system in the world for charting dollars and cents, and manpower and hours and all that. But I feel it's a waste of time. Do we plan? Of course we do.

At the beginning of our fiscal year we develop a financial plan and we update it at mid-year. Throughout the year we continue to compare our performance with Plan 1—the one we prepared at the beginning of the year—and with the mid-year plan.

If ever a guy wants to put all this project information on a computer, we take the computer away from him.

That's tough because we're in the computer business. Every engineer here can program a computer. So it's awfully tempting to put things on a computer. We fight that.

Computers are wonderful and they're a very important part of our business. We sell computer memories, so we want people to use computers. But that doesn't mean everything should go on a computer.

We want to simplify paper work. We make a manager responsible for a set of resources. We find we can keep track of his success with just three sheets of paper. Yes, three.

On one page a manager describes a project exactly and shows its salient features. On another page he provides a milestone chart that he keeps all year long, though he can update it at mid-year. (He can quickly see how much he has slipped if he's missed any deadlines. Or he can see if he's ahead.) On the third page he describes the market we're after and what we expect to sell in it.

For me and the senior officers, it's extremely useful to have all that information on just three pages. For the engineering managers it's a tremendous discipline and a tremendous timesaver.

Who is Orion Hoch?

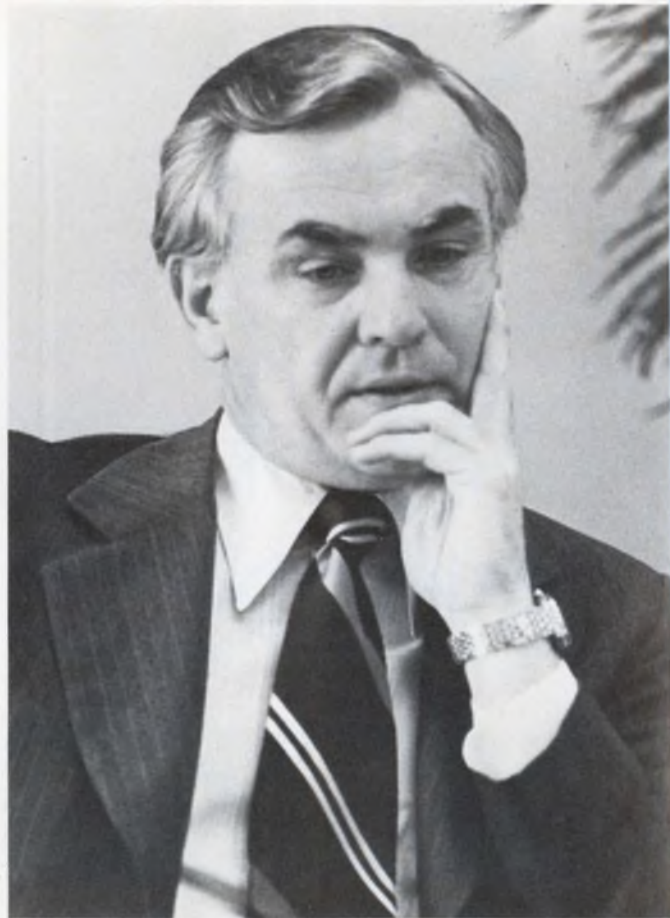

Less than 2-1/2 years after he joined Advanced Memory Systems as president, Dr. Orion Hoch was appointed president of Intersil, the company that is to result from the merger of AMS and "the old" Intersil.

It's no wonder that Hoch was selected for this position, as he was selected, in February 1974, for the AMS presidency. He came, he says, from a great school—Litton Industries—

For all the engineers, it's a demonstration that we're interested in real, worthwhile accomplishments—not just mountains of paper. And it shows that we respect the engineer's time.

There's a final element that helps maximize the engineer's responsibility. The engineer can see the results of his efforts in the growth of the company. He can see the company's progress in every quarterly report. And since we have a profit-sharing plan and stock options, he can see his own financial growth as the company grows. This real involvement makes people responsible. ■■

"an excellent place where you get six years of experience when you spend three years on a job."

At 28, he started as an engineer in Litton's Components Group and eventually became president of the Electron Tube Division, the successor to Charlie Litton's original company.

He soon took charge of a group of divisions in the Components Group before moving to the corporate staff in Beverly Hills, where his responsibilities included diverse functions like public relations, financial relations, labor relations and industrial relations. He even had responsibility at one time for a fleet of ore boats on the Great Lakes.

Finally he moved to the Business Systems and Equipment Group—with 45,000 employees, 25,000 of them overseas. This group, with about \$1-billion in annual sales, included companies like Sweda, Monroe and Royal Typewriter. Here, serving as senior corporate vice president, Hoch decided to join AMS.

"As you go along year after year you frequently tell yourself you want to go out and do it yourself," he says. "That's an opportunity a large company can't give you." When the AMS offer came along, he says, "I felt that if I didn't do it then, I would be with a large company for the rest of my life. So I packed up and left for half the salary and twice the stock."

Hoch got his bachelor's in physics at Carnegie Tech (now Carnegie-Mellon University), his master's at UCLA and his doctorate in electrical engineering at Stanford.

He and his wife, Jane, have three teen-agers—Andrea, Brenda and John. His principal entertainment, tennis, is virtually his sole form of exercise. He's an avid reader and, thanks to a rapid-reading course that tripled his reading speed, he's able to read just about all the business magazines. He also likes to play bridge. "If only," he muses, "I could play bridge and tennis and read at the same time. That would really be efficient."

High Voltage Diffused Silicon Rectifiers

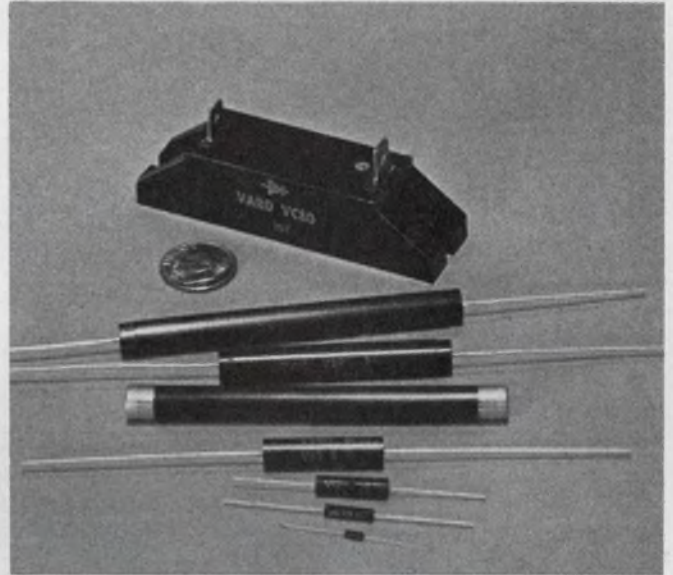

Varo Semiconductor, Inc. offers you the industry's most complete line of high voltage rectifiers for commercial and industrial applications that require high reliability at an economical cost.

Choose from one of these series:

VA, VB SERIES

- 1kV to 6kV (V_{RRM})
- 20 to 100 mA (I_o)
- 3A 1/2 cycle surge
- Fast recovery series (250ns, t_{rr})
- Minimum size

VG SERIES

- 1kV to 20kV (V_{RRM})
- 5 to 100 mA (I_o)
- 3A 1/2 cycle surge
- Fast recovery series (250ns, t_{rr})

VC SERIES

- 2kV to 8kV (V_{RRM})
- 1A to 2A (I_o)
- 50A 1/2 cycle surge
- Fast recovery series (300ns, t_{rr})

VF SERIES

- 5kV to 40kV (V_{RRM})
- 5 to 25 mA (I_o)
- 3A 1/2 cycle surge
- Fast recovery series (250ns, t_{rr})
- Axial lead or ferrule end caps

For more information
call Ms. Pat Brisendine
214/272-4551



Design us in . . . we'll stay there
VARO SEMICONDUCTOR, INC.

P.O. BOX 676, 1000 N. SHILOH, GARLAND, TEX. 75040
(214) 272-4551 TWX 910-860-5178

EUROPEAN OFFICE: UK: VARO SEMICONDUCTOR INTERNATIONAL, INC.
Deerpene House, Bellegrave Road, Welling, Kent, England DA163PY. 01-304-6519/0

CIRCLE NUMBER 43

MEMORY AT WORK

Retail Sales

The point of sale terminal is just one application where data integrity and ease of maintenance are vital. The SEMI 4104A static 4K RAM answers both problems perfectly. It is static; that means simpler, faster field maintenance. And just 15 mw will protect data. The 1K x 4 organization is ideal for small capacity systems, and the 200 nsec access (350 nsec cycle) time makes it fast enough for any 8080A class

microprocessor on the market. Get full details from your local EMM SEMI distributor, or call us today.



EMM SEMI

A subsidiary of

Electronic Memories & Magnetics Corp.
3883 N. 28th Ave., Phoenix, Ariz. 85017

(602) 263-0202



Eye-Pleasing GREEN.

NEC is the world's largest vacuum fluorescent display producer.



Last year, NEC produced 15 million displays for calculators. We expect a 30% increase this year. Reliability/price advantages are optimum. Another decisively attractive feature is the color—green. The human eye is most sensitive to green which opens up wide new applications—POS terminals, clocks, car dashboards, microwave ovens and instruments. A wide range of other OEMs are also turning to us.

Choosing the right display can decide how well your product sells. Contact NEC, the world's largest "green" display producer.



NEC America, Inc., Sunnyvale Office
505 West, Olive Ave., Suite 310, Sunnyvale,
Calif. 94086, U.S.A. Tel: 408-738-2181.
Telex: NECAM SUVL 35-7475

NEC Electronics (Europe) GmbH
4000 Düsseldorf, Immermannstrasse
22, West Germany Tel: Düsseldorf
357088, 357089, 357080
Telex: NECD 8587419

NEC

Nippon Electric Co., Ltd.
NEC Building, 33-1, Shiba-Gochome,
Minato-ku, Tokyo 108, Japan
Tel: 03-454-1111
Cable: MICROPHONE TOKYO
Telex: NECTOK J22686

Control logic for μP enables single-cycle operation

To use the single-cycle and single-instruction modes offered in the 6502 microprocessor, the control logic given for this purpose in the manufacturer's Hardware Manual (MOS Technology, 1st edition, p. 125) performed unsatisfactorily. A later circuit supplied by the manufacturer (February, 1976) is complicated, requiring no fewer than ten ICs. The circuit in Fig. 1 performs all functions and uses only six ICs.

The control lines that make the single-cycle and single-instruction modes possible are the SYNC and the RDY lines. The SYNC line goes HIGH at the beginning of each machine cycle in which an op-code fetch takes place, and stays HIGH for the remainder of this cycle. If the RDY line is pulled LOW during ϕ_1 of such a cycle, the processor stops with the address lines displaying the address.

A gated latch, consisting of gates G₁ through G₅, stops the processor by pulling RDY LOW at the proper time after switch S₁ has been moved from Run to Halt. When the Single-Cycle pushbutton, S₂, is pressed, JK flip-flops FF₁ and FF₂ cause the RDY line to go HIGH with the next ϕ_1 clock pulse and LOW again on the following pulse. Thus the processor executes one cycle.

A LED indicates the cycles in which an op-code fetch takes place.

Similarly, pressing the Single-Instruction button, S₃, causes the RDY line to go HIGH on the next ϕ_1 clock pulse. But in this case the ready line stays HIGH until the beginning of the next op-code fetch cycle and the processor executes all cycles of the instruction.

Note: The single-instruction mode can be started only when the processor is in a fetch cycle and the Fetch LED is lit.

During execution of single cycles, if the processor encounters a cycle in which a write operation takes place, it executes this cycle—and any subsequent write cycles that immediately follow. The processor stops on the next cycle that is not a write cycle. A flip-flop consisting of gates G₉ and G₁₀ is set, and the Write LED indicates that write cycles have been encountered.

One of the outputs of this flip-flop can be used to activate a data trap to display the data written during this cycle. The flip-flop is cleared automatically, the next time a single cycle or single instruction is executed.

The circuit is implemented with CMOS ICs of the 4000 series. The propagation times of these devices are sufficiently small to allow operation with a processor clock rate of at least 1 MHz.

Erich A. Pfeiffer, PhD, Chief, Biomedical Engineering Section, Veterans Administration Biomedical Engineering and Computing Center, Veterans Administration Hospital, Sepulveda, CA 91343.

CIRCLE No. 311

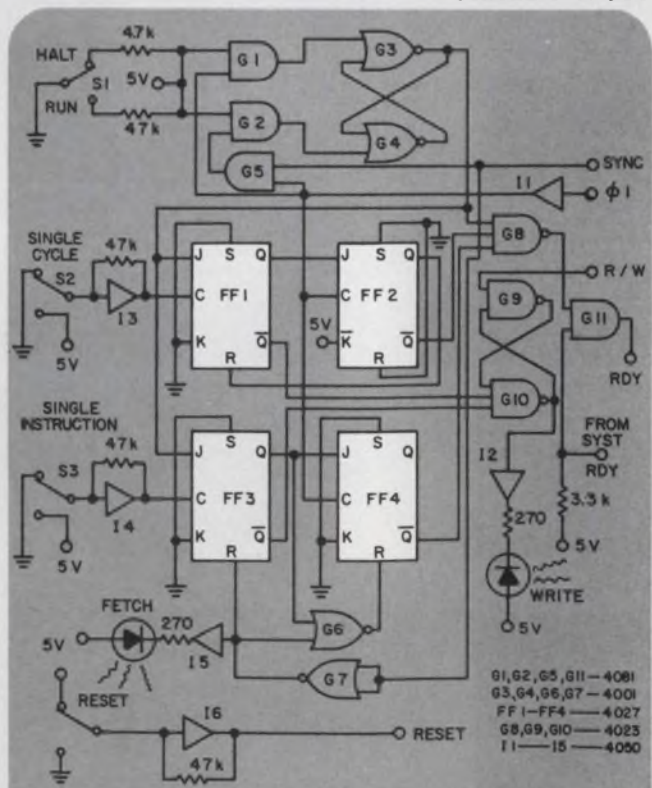

1. To operate a 6502 μP in the single-cycle or single-instruction mode, set S₁ to Halt. The μP will then stop at the proper time to allow you to initiate either mode by momentarily pressing either S₂ or S₃.

The only **FET-VOLT-OHMMETER** that is drop-proof...burnout proof...the new **Super Safe Triplet Model 64.**

The Triplet Model 64 FET-Volt-Ohmmeter is brand new and ready for safe fast in-circuit resistance and continuity testing of diodes, IC's or transistors. Six LP Ω ™ ranges have only 90mV open circuit voltage that won't bias or destroy sensitive circuitry. And, no other FET can match these exclusive features:

1. **Drop-Proof...Burnout-proof...Super Safe** solid state Volt-Ohmmeter.
2. **Low-Power Ohms—LP Ω ™**—6 ranges with 90mV power source for in-circuit measurements plus junction test circuit.
3. **Exclusive Triplet MicroPower—TMP™** permits continuous operation with carbon battery life in excess of one year.

Designed for tough use in labs, QC or inspection departments, field servicing and vocational or trade schools, the new Model 64 easily withstands 90% of costly misuses of VOM's.

Call your Triplet distributor for a demonstration.

only **\$130**

TTT® **TRIPLET**
BLUFFTON, OHIO 45817

RANGES

8 DC Volts

0-0.3-1-3-10-30-
100-300-1000 11.12
Megohm input
resistance

8 AC VOLTS

0-0.3-1-3-10-30-100-300-
1000 10 Megohm input
impedance.

7 OHMS

Low Power (LP Ω ™)

0-1k-10k-100k-1M Ω -10M Ω -
100 M Ω , Conventional
(HP Ω) 0-1000M Ω

JUNCTION TEST

Short-germanium-silicon-open



super-safe
Triplet. The easy readers.

Get precise voltage division without precision parts

Pulse-width modulation can be advantageously applied to building a voltage divider that is accurate enough to serve as a calibration standard even with parts that only have a 10% tolerance (Fig. 1).

To produce precision voltage division, the circuit uses a pulse signal that has its duty cycle proportional to the desired voltage. The signal's amplitude is stabilized, and integration of the resulting waveform provides the desired output.

An SN74L73 operates as a two-stage ripple counter driven by a clock signal generated by part of an SN74L00 gate package. Two of the 74L00 gates decode the counter output to produce waveforms of 0%, 25%, 50%, 75% and 100% duty cycle. Two FETs operated as switches driven by these controlled waveforms fix the amplitude at a reference voltage, V_R , which in this case is equal to 4.0000 V. The resulting signal output from the FET circuit is averaged by

an RC low-pass filter and then buffered with an LM 208.

The 1-V output steps are accurate to well within 1-mV; output noise level is under 0.3-mV peak to peak; and stabilization time is about 10 s. For equivalent results with a conventional divider network, expensive resistors with better than $\pm 0.05\%$ accuracy and long-term stability would be needed. Such resistors alone cost more than this entire circuit.

Logic to provide any number of output steps can be added easily. Stabilization time can be cut by reducing the averaging filter's time constant, but that would increase output ripple unless a higher clock rate is used requiring higher-speed FETs.

Maxwell G. Strange, Lead Electronics Engineer, National Aeronautics & Space Administration, Washington, DC 20546.

CIRCLE NO. 312

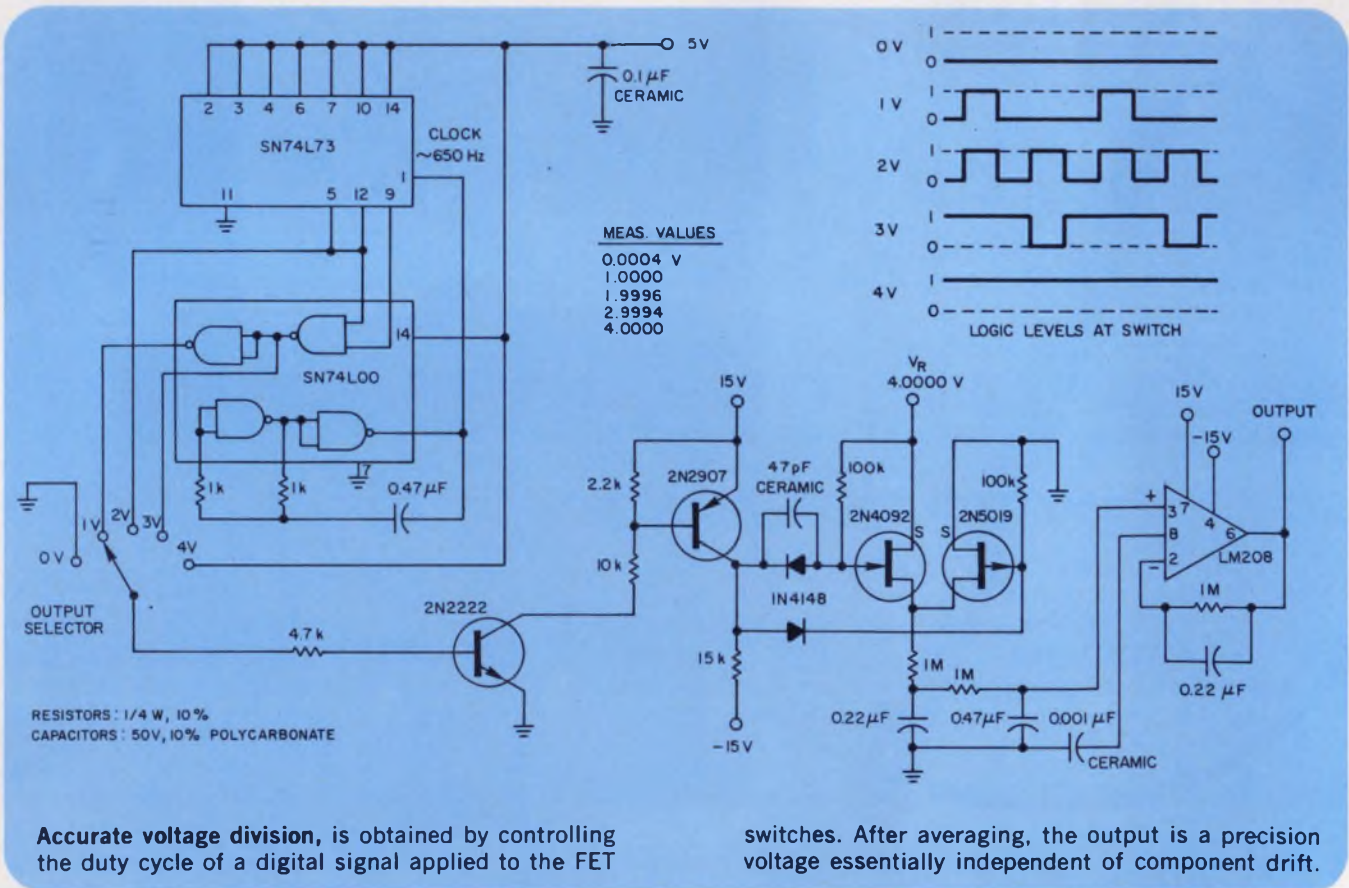

All aerosols are not alike.

The constant progression of sophistication in electronics has demanded a parallel progression in standards of purity. Industrial cleaning is one very vital link in maintaining component and system purity and reliability.

Let's look at eight important criteria and compare Miller-Stephenson products to the general aerosol industrial cleaner industry.

SOLVENTS:

Miller-Stephenson — Most of our aerosols contain 80% Active Ingredient, 20% Propellant.

Other Aerosol Cleaners — Active Ingredient averages 70-75%.

Miller-Stephenson — Uses only Certified Virgin Solvent.

Other Aerosol Cleaners — Some utilize reclaimed solvents. Though lower in cost, reclaimed solvents usually contain foreign substances.

PROPELLANTS:

Miller-Stephenson — Uses only the highest purity, safest propellants. They are nonflammable - TWA 1000 ppm.

Other Aerosol Cleaners — Many use cheap, sometimes flammable, sometimes higher order of toxicity propellants.



FILTERING:

Miller-Stephenson — We double filter "Freon" solvent and propellant — first with a 0.5 micron filter, then with a Millipore 0.2 absolute filter.

Other Aerosol Cleaners — Some use no filters; others only a 0.5 micron filter.

LOADING LINES:

Miller-Stephenson — All loading lines are dedicated to the individual ingredients used.

Other Aerosol Cleaners — Loading lines are often used for multiple products and if not thoroughly flushed, contamination will occur.

LOADING ENVIRONMENT:

Miller-Stephenson — Class 100 Clean Room conditions.
Other Aerosol Cleaners — Normally uncontrolled — environmental contamination can occur.

VOLUME PRODUCTION:

Miller-Stephenson — Our principal raw materials come direct from Du Pont tankers into our 5500 gallon storage tanks through a closed system direct to container.
Other Aerosol Cleaners — Low volume suppliers often load from open 55-gallon drums thereby introducing possibility of contamination.

CONTAINER:

Miller-Stephenson — Our new seamless cans further reduce the possibility of contamination.
Other Aerosol Cleaners — Cans with soldered seams may introduce residual contaminants.

SAFETY IN SHIPPING:

Miller-Stephenson — Most of our "Freon" aerosol solvents are non-regulated items, exempt from all Federal Regulations "Restricted Articles". May be Shipped Air Transport.
Other Aerosol Cleaners — Do not meet Air Transport Regulations.

MS aerosol solvents have the lowest residual contamination in the industry — some approaching 5-7 ppm. The general range for the industry is 50-130 ppm.

"Freon" is Du Pont's registered trademark for its fluorocarbon compounds.

miller-stephenson

Danbury, Connecticut 06810 (203) 743-4447

- Enclosed is \$2.00, please send my "Trial Unit" of MS-180.
 Enclosed is \$5.00, please send my "Trial Units" of MS-180 & Cobra Brush.
 Please send FREE literature and prices.

Intended Use _____

Name _____ Dept./Title _____

Company _____

Address _____

LOS ANGELES • CHICAGO • DANBURY, CT. • TORONTO

CIRCLE NUMBER 47

ED-10U



MS-226 "COBRA"
Solvent Spray
Brush

Scrubbing action dislodges hard-to-remove residue. Fits all Miller-Stephenson aerosol solvents and cleaners.

Precision voltage-to-frequency converter uses only single supply voltage

Low-cost ICs can provide precision (linear within 0.05%), yet economical voltage-to-frequency (v/f) conversion and need only a single power source. The 4151, a recently introduced v/f IC chip, is the heart of the circuit (Fig. 1). A 3130 MOSFET-input op amp, which operates on a single supply, is used as a low input-current integrator.

The circuit, based on the well-known charge-balancing principle, can be mathematically described as

$$f_o \text{ (output frequency)} = \frac{I_1}{I_2 \times t_1},$$

where I_2 is derived from a constant-current source within the 4151, and t_1 is the 4151's output pulse width. Current I_1 is the current in resistor R_{in} . Since I_1 is proportional to V_{in} , then clearly output frequency varies linearly with V_{in} .

The 3130 requires ultra-low input current (only 50 pA max), which virtually eliminates errors caused by bias current. The main limit to this v/f converter's dynamic range is the circuit's input-offset voltage. Without nulling, the 3130 allows operation over nearly three decades of frequency. With nulling by the LF calibration control (Fig. 1), the dynamic range can be extended to four decades or more. Nonlinearity is better than 0.05% over this range. The ultimate accuracy limit is determined by the device's offset-voltage stability and TC of the timing components.

The full-scale calibration control, R_s , adjusts I_2 to about 200 μ A. Resistor R_o and capacitor C_o determine the output pulse width, t_1 , where

$$t_1 = 1.1 R_o C_o.$$

Components R_s , R_o and C_o should be stable, and C_o should be a low dielectric-absorption capacitor for best over-all performance.

The input impedance, as well as the conversion

sensitivity is set by R_{in} . Resistor R_{in} may be raised to increase the full-scale voltage above 10 V.

The circuit provides a TTL-compatible, 5-V output, as determined by R_3 and R_1 . The pin-3 output of the 4151 is an open-collector stage.

Walter G. Jung, Pleasantville Labs, 1946 Pleasantville Rd., Forest Hill, MD 21050.

CIRCLE NO. 313

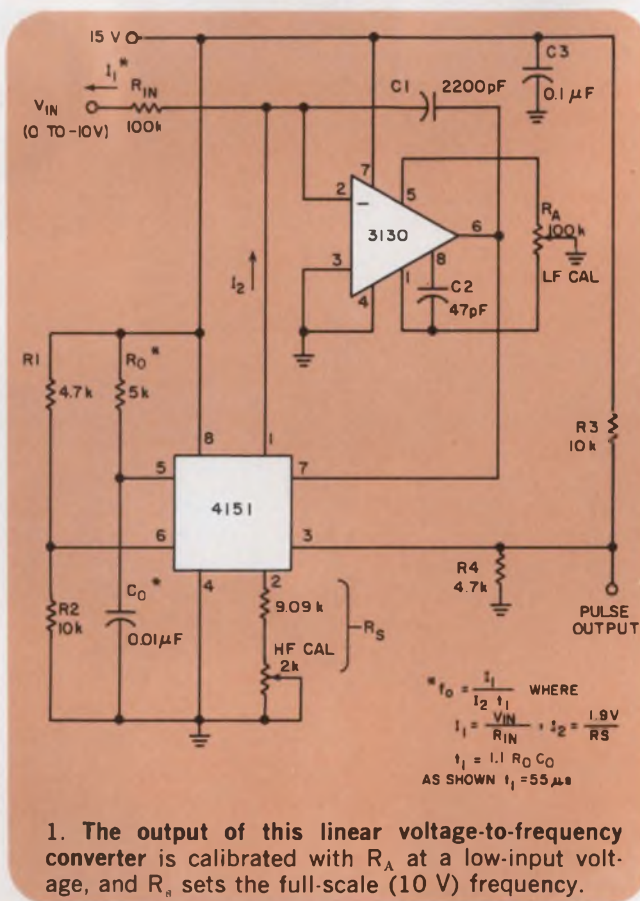

IFD Winner of June 7, 1976

Arthur R. Klinger, S/Sgt. USAF, Biomedical Equipment Repair Center, Sheppard AFB, TX 76311. His idea "Logic Probe Built from IC Timer Is Compatible with TTL, HTL and CMOS" has been voted the Most Valuable of Issue Award.

Vote for the best idea in this issue by circling the number for your selection on the Reader Service Card at the back of this issue.

SEND US YOUR IDEAS FOR DESIGN. You may win a grand total of \$1050 (cash)! Here's how. Submit your IFD describing a new or important circuit or design technique, the clever use of a new component or test equipment, packaging tips, cost-saving ideas to our Ideas for Design editor. Ideas can only be considered for publication if they are submitted exclusively to ELECTRONIC DESIGN. You will receive \$20 for each published idea, \$30 more if it is voted best of issue by our readers. The best-of-issue winners become eligible for the Idea of the Year award of \$1000.

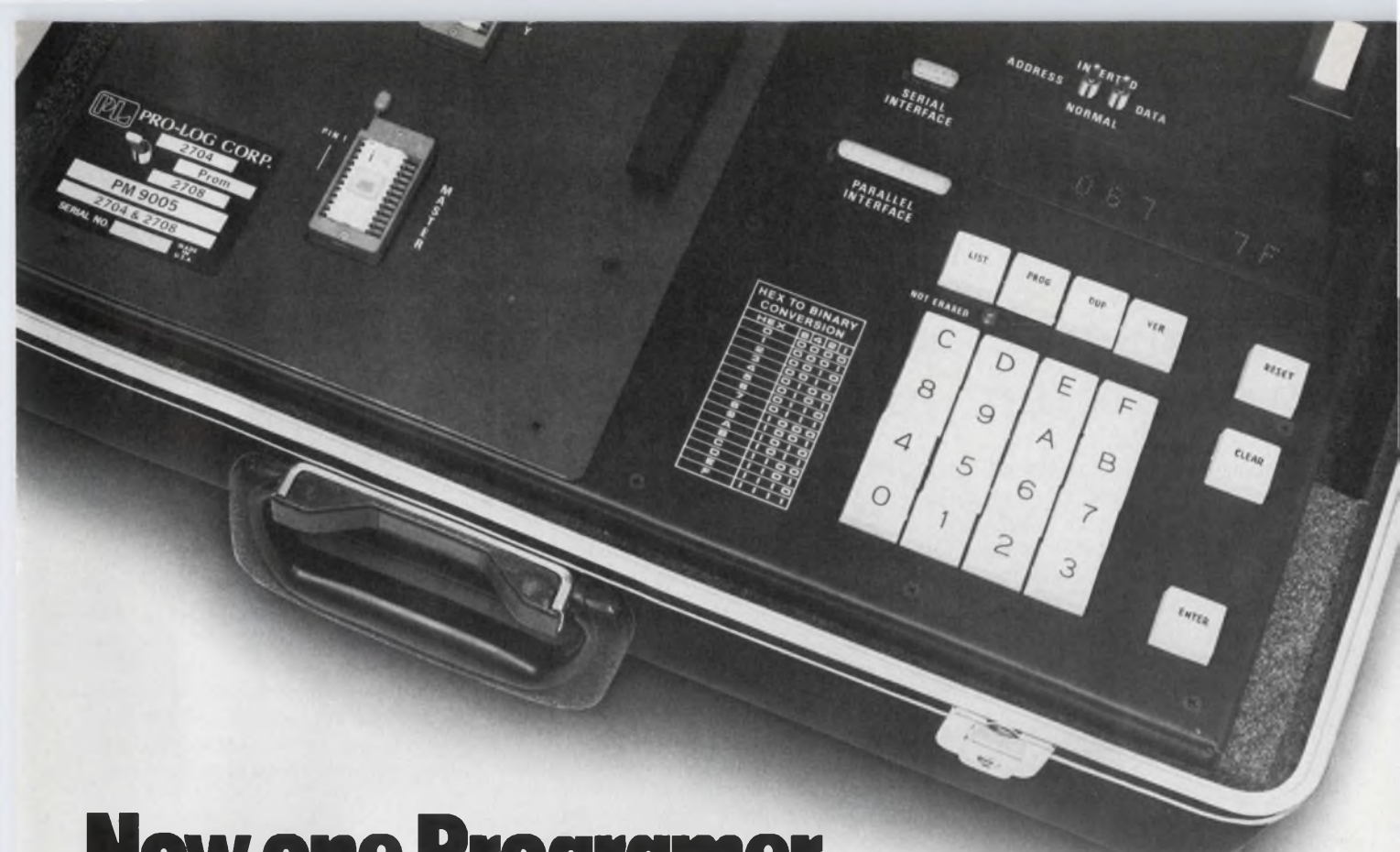

Now one Programmer handles 80 different PROMs. With more on the way.

New personality modules make Series 90 PROM Programmer more versatile than ever.

The Series 90—a simple, straightforward method of programming, duplicating or verifying MOS or bipolar PROMs. Plug-in personality modules are currently available for all the PROMs shown below.

Gives engineers design flexibility. Makes prototyping a snap.

You program from a hexadecimal keyboard. Addresses and data appear on a hexadecimal display which you can use to verify your entry prior to programming.

Wide range of interface options available for use with the Series 90

Teletype Control
Paper Tape Reader
Parallel Input/Output
RS232

Field-proven reliability.

We've been producing PROM programmers since 1973. We have more than 1,000 currently in the field.

Rugged and fully portable for field use.

It weighs less than 18 pounds and comes in an attache case. An optional bench-top model is available.

Low-priced.

The M-900 Master Control Unit costs \$1,800. Personality modules range from \$360 to \$550.

New Series 92 Peripheral Programmer and Duplicator comes with teletype interface standard.

It gives you low cost peripheral programming and off-line duplicating capability. The Series 92 uses the same personality modules as the Series 90. An RS232 interface is optional. The M-920 Master Control Unit costs only \$995.

We have other instruments, microprocessor subsystems, and education, too.

4- and 8-bit microprocessor system analyzers; 4- and 8-bit microprocessor subsystems; a half-day economics seminar for decision makers; and a three-day hands-on design course for engineers.

Call or write for data sheets, a free copy of the PROM User's Guide, or course and seminar schedules.

| AMD | Fairchild | Harris | Intel | Intersil | MMI | NSC | SIG | TI |
|-------|-----------|--------|-------|----------|-----------|-------|---------|---------|
| 1702A | 93416/ | 1024 | 1702A | 5600/ | 5300/5301 | 1702A | 82S114 | 74S188/ |
| 1702/ | 93426 | 7602/ | 1702 | 5610 | 5305/5306 | 4204 | 82S115 | 74S288 |
| 9702 | 93417/ | 7603 | 2704 | 5603A/ | 5330/5331 | 5202/ | 8223 | 74S287/ |
| | 93427 | 7610/ | 2708 | 5623A | 5335 | 5203 | 82S23/ | 74S387 |
| | 93436/ | 7611 | 3601/ | 5604/ | 5340 | 5203A | 82S123 | 74S470/ |
| | 93446 | 7620/ | 3621 | 5624 | 6335/6301 | 5204 | 82S126/ | 74S471 |
| | 93438/ | 7621 | 3602/ | 5605/ | 6305/6306 | | 82S129 | 74S472/ |
| | 93448 | 7640/ | 3622 | 5625 | 6330/6331 | | 82S130/ | 74S473 |
| | | 7641 | 3604/ | | 6335 | | 82S131 | 74S474/ |
| | | | 3624 | | 6340 | | | 74S473 |
| | | | | | | | | 74188A |

If you don't see the PROM you want here, give us a call. We're probably working on it right now.

CIRCLE NUMBER 48



PRO-LOG CORPORATION
2411 Garden Road
Monterey, CA 93940
Telephone (408) 372-4593
TWX 910-360-7082

New microprocessor has two different functions

A novel microprocessor that can be used either as a stand-alone microcomputer or as an intelligent peripheral for the powerful GI 16-bit CP1600 has been developed at General Instrument's European Center in Glenrothes, Scotland. The μP chip can be adapted by simple mask changes to function either way.

As a single-chip microcomputer, the device contains a 512-by-12-bit microprogram ROM, a two-level pushdown stack, an 8-bit ALU, a 32-by-8-bit register file and three sets of eight I/O lines. Other features include a single 5-V supply, an on-chip clock oscillator, TTL-compatible I/O lines and a real-time clock counter.

A TTL, prototype emulator board will soon be available for the user to verify his microprogram in PROM before committing it to mask tooling. For added flexibility, the board can also fit into the GIMINI development system for CP1600 systems so that a microprogram can be stored in the GIMINI's RAM to permit on-line changes of code without having to

reburn the PROMs.

As an intelligent CP1600 peripheral, the microcomputer can be programmed to scan keyboards and drive multiplexed displays, among other things. To adapt the chip to this mode of operation, one set of 8 I/O lines is dedicated to communicating with the CP1600, and a smaller program ROM is used.

For both functions, the architecture and instruction set uses bit, byte and register-transfer operations, rather than arithmetic sophistication. For example, any single bit in any of the 32 registers can be set or cleared by a single instruction. Similarly, any bit in any register can be tested for "1" or "0," with the next instruction skipped if the test is true.

The instruction execution takes 1 μs , and the real-time clock counter can keep track of pulses occurring at up to 1 MHz. A bit in the status register is cleared whenever the real-time clock counter is loaded with an initial value and is set when the count reaches zero.

English TV cable uses two Corning glass fibers

Cable-TV subscribers in the Hastings area of England now watch programs sent over an optical cable. Some 4700 ft of cable have been installed to replace the paired-wire cable in a network operated by Rediffusion Ltd. of London.

Manufactured by BICC Telecommunication Cables Ltd., the optical cable uses two glass fibers made by Corning in the U.S. The cable has a flat, 7-by-4-mm poly-

ethylene sheath that incorporates two 1-mm steel-strengthening members. The cable's two glass optical waveguides fit loosely inside a rectangular cavity.

At the transmitting end of the fiber cable, the electrical signals are converted to optical energy that uses a Plessey gallium-arsenide light-emitting diode. At the receiving end, a photodiode changes the optical signals back to electrical signals. A BICC-designed con-

ductor is used at the joint.

The optical cable was installed in 3 or 3-1/2 in. ducts in two 2625-ft sections. The ducts were extensively silted and wet, but the cable was installed without damage in two days, according to Rediffusion engineers.

Rediffusion's TV systems, which serve a total of one million subscribers, differ from conventional coaxial cable TV systems in that the final distribution of the signals is done by multi-pair cable. Each television program is carried on a separate pair of wires. The new optical cable, therefore, fits easily into the Hastings system.

Low-loss optical fiber has half the attenuation

A low-loss optical fiber with less than half the attenuation previously achieved anywhere has been revealed by the Nippon Telegraph and Telephone Public Corporation of Japan.

The Nippon fiber's loss is 0.47 dB/km at a wavelength of 1.2 μm . The loss remains below 1 dB/km over a range of 0.95 μm to 1.37 μm . The company says the best fibers until now had a loss of at least 1.1 dB/km at 1.02 μm .

Manufacture of the fiber involves chemical-vapor deposition techniques previously used by the University of Southampton, England, coupled with rigorous purification of the materials used. The fiber consists of a core of phosphosilicate glass, which is vapor-deposited inside a borosilicate cladding. The materials are carefully purified with special emphasis placed on the removal of hydroxyl-ion impurities that would otherwise contribute heavily to the fiber's absorption.

If the fiber is used in an optical-communication system with a 1.2 μm light source, the repeaters would be at least 30 km apart.

Greater RFI/EMI shielding in new, narrow-width contact strips from Instrument Specialties

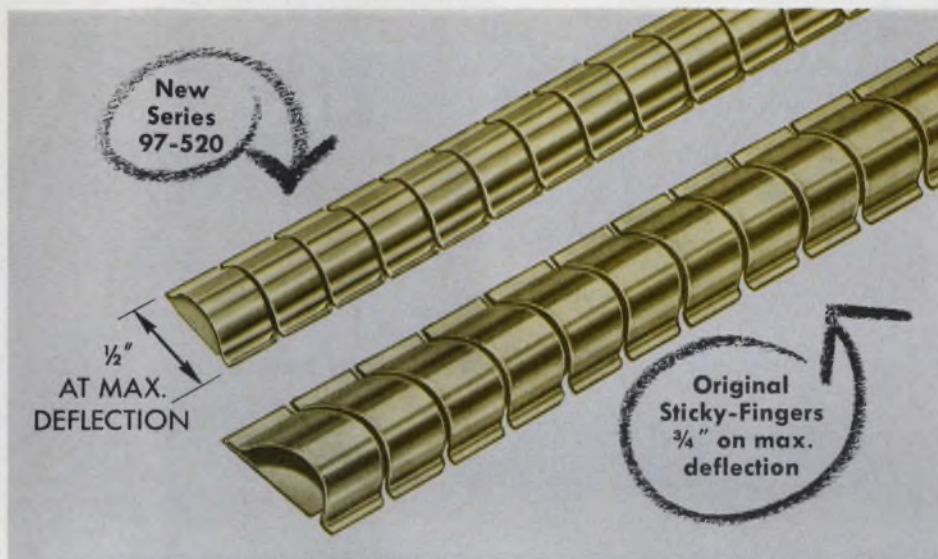

Latest addition to **sticky fingers**® line!

Instrument Specialties now offers Sticky-Fingers self-adhesive, beryllium copper contact strips in three variations to solve your most critical RFI/EMI problems.

Comparable to the shielding effectiveness of the original Sticky-Fingers, our newest series 97-520* offers shielding effectiveness of 92 dB at 10 GHz plane wave or greater than 92 dB at 1 MHz magnetic, and has a dynamic range of 0.10". Yet, it measures a scant $\frac{3}{8}$ " wide, and $\frac{1}{2}$ " at maximum deflection.

Supplied in standard 16" lengths, series 97-520 is ideal for metal cabinets and electronic enclosures where variations exist in the space to be shielded, and where high shielding effectiveness must be maintained in narrow spaces, even with frequent opening and closing of the cabinet.

Select the exact series that fits your application best. Write today for a complete catalog, list of finishes available, and our latest Independent Shielding Evaluation Report. Address: Dept. ED-68.

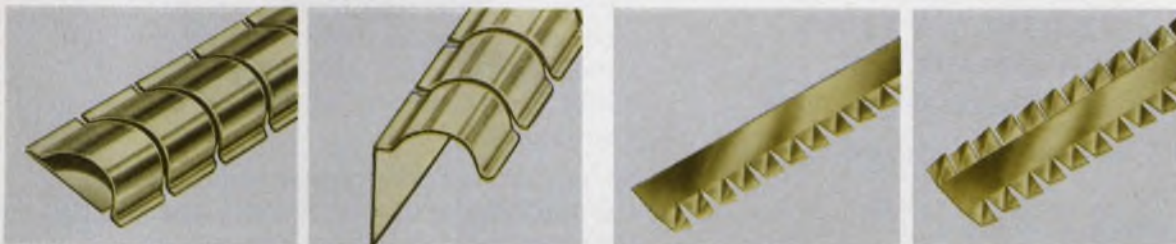

Series 97-500*—the original $\frac{3}{4}$ " wide Sticky Fingers. For greatest possible shielding and where space permits. Also available: Series 97-505—90° configuration of Series 97-500; same shielding effectiveness.

For those all-purpose applications where economy and space are both factors, specify the $\frac{3}{8}$ " wide single-twist series 97-555, or $\frac{1}{2}$ " wide double-twist series 97-560 Sticky-Fingers.

Specialists in beryllium copper springs since 1938

*Patented

CIRCLE NUMBER 49

ELECTRONIC DESIGN 21, October 11, 1976



INSTRUMENT SPECIALTIES CO., INC.
Little Falls, New Jersey
Phone 201-256-3500

For high performance receiver testing, you need high performance signals.

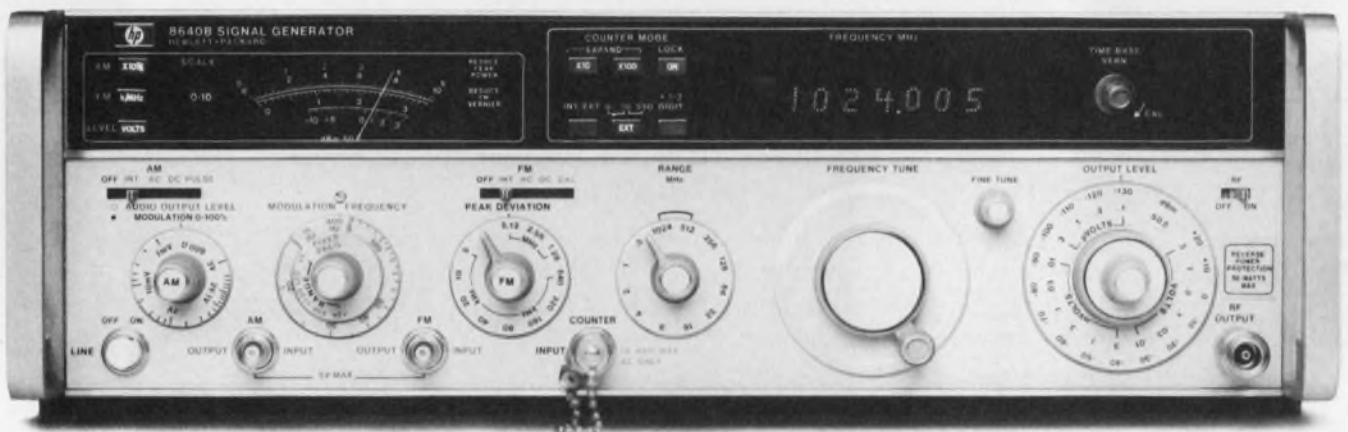

HP 8640B w/Opt. 001, 002, 003 — 0.5 to 1024 MHz.

When HP introduced the 8640B, its product concept brought together the superior characteristics needed for high performance receiver testing:

- Spectral purity <130 dB/Hz, 20 kHz offset
- Wide dynamic range; +19 to -145 dBm
- Phase lock stability/external count capability

Since then we've continued to add to the original capabilities:

- Opt. 001 — Variable modulation
- Opt. 002 — Extended frequency, 0.5 to 1024 MHz
- Opt. 003 — Reverse power protection to 50 watts
- Opt. 004 — Avionics version for NAV/COM tests
- 8640M — Ruggedized/military version

Now with the 8640B you get 1/2 digit phase-lock resolution (500 Hz, 100 to 1000 MHz), improved modulation and power settability. You can also use the new Model 11710A Down Converter to extend output frequency down to 5 kHz and test standard IF amplifiers at 262 kHz and 455 kHz. 8640B Signal Generator \$6,400*, 11710A Down Converter \$930*

So for your high performance receiver testing, you'll still choose the performance leader in RF signal generators. For more information, call your nearby HP field sales office, or write.

*Domestic U.S. prices only.

HEWLETT  PACKARD

Sales and service from 172 offices in 65 countries
1501 Page Mill Road, Palo Alto, California 94304

New Products

Wideband rf amplifier offers best gain flatness

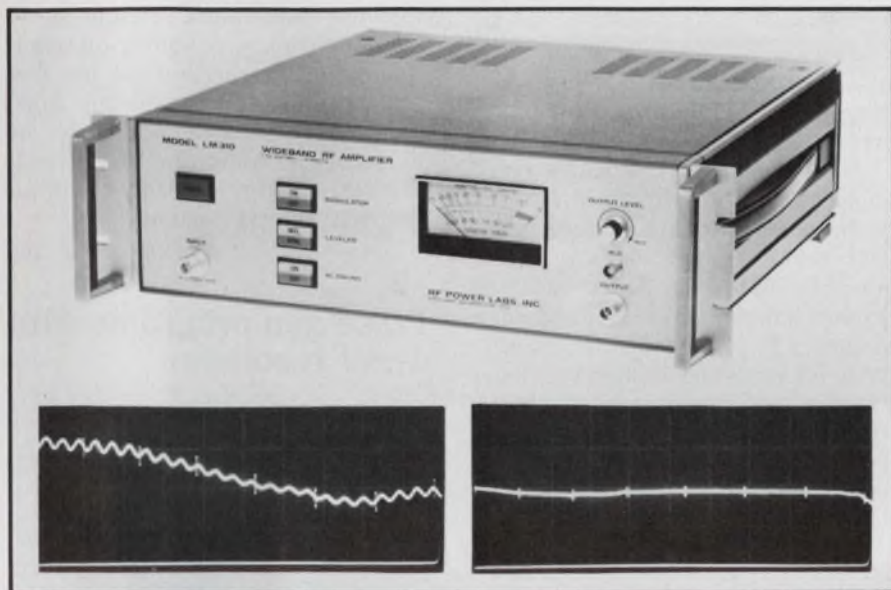

An input with 10-dB variations over 300 MHz (left photo) is flattened to ± 0.3 dB at the output (right photo). Pips are 50-MHz markers.

RF Power Labs, 11013-118th Place, NE, Kirkland, WA 98033. (206) 822-1251. See text.

With a gain variation of only ± 0.3 dB over a 300-MHz bandwidth, the RF Power Labs LM310 power amplifier is probably the flattest around.

Most rf amplifiers do well to stay flat within ± 1 dB over 6 to 10 octaves. The solid-state LM310 covers more than eight octaves (1 to 300 MHz), boosts input signals by 55 dB and delivers 10 W of output.

If that isn't enough, the 310 can also level a changing input signal to the same tolerance. For example, an input with ± 10 dB of ripple will be leveled to ± 0.3 dB over 1 to 300 MHz.

You can also select output power with a front-panel level control. Just set the control to the needed power, as read off the unit's built-in wattmeter/voltmeter, and that power will stay constant as the input changes.

The performance of the LM310 calls for a purely resistive, 50- Ω load located right at the amplifier's output terminals. For remote or mismatched loads, a sensing unit (the RS-1) is available to get the best leveling.

If you'd like to program your power levels, you can do so with the RF Power Labs unit. A 0-to-18-V-dc level at a rear-panel connector controls the output from about 0.1 to 10 W.

The 310 can do even more. It can square-wave modulate an incoming signal at 400 Hz or provide 50% duty-cycle pulse bursts at any frequency within its range. And the unit can detect standing waves at the load and make corrections to keep the load voltage constant—so you needn't worry about output levels when your load changes with frequency.

Price of the 310, which fits into a 19-in. rack is just \$1925. Delivery takes two weeks.

CIRCLE NO. 301

Memory tester mixes core and semi programs

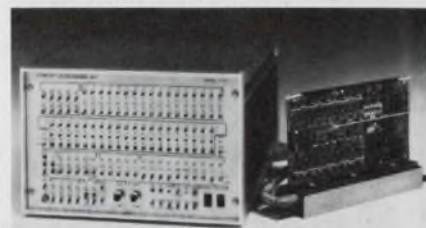

Concept Development Inc., 3198 G Airport Loop Dr., Costa Mesa, CA 92626. (714) 557-1811. \$15,900; 6-8 wks.

Model T-115 RAM tester handles configurations up to 512-k words by 20 bits. It is a stand-alone, self-contained system including a performance board, test fixture and power supplies. Various memories require different optional plug-in performance boards. The basic unit sequences programs automatically at an 8-MHz rate without data breaks or cycle stealing, and includes six standard core and four semiconductor memory programs.

CIRCLE NO. 302

DMM slips into pocket



IET Labs Inc., 335 Bear Hill Rd., Waltham, MA 02154. (617) 890-5105. \$195.

A hand-held, pocket-sized digital multimeter offers extended battery life with a push-to-read probe. Model 50 measures ac and dc V and currents as well as resistance. It provides autopolarity and basic autozero plus a 3000-count LED display. The 10-oz instrument measures less than $1.4 \times 3.0 \times 5.6$ in. Basic accuracy is $0.1\% \pm 1$ digit.

CIRCLE NO. 303

Now there are 3
circuitry configurations!

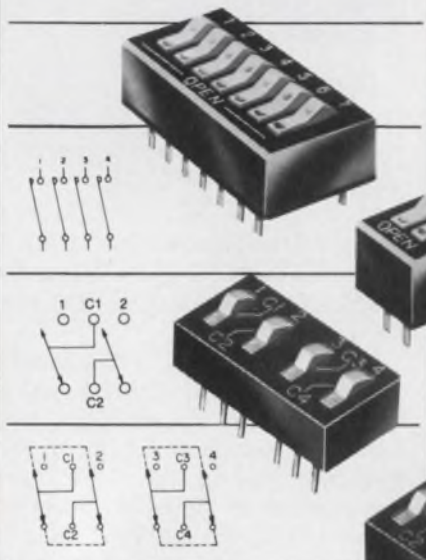

Grayhill Rocker DIP Switches - SPST, SPDT, DPDT

All with exclusive spring loaded, sliding ball contact system... life rated at 50,000 operations.

- Positive wiping action and immunity to normal shock and vibration
- SPST in 9 sizes, from 2 to 10 rockers; SPDT and DPDT in 1, 2, 3, and 4 rocker versions
- Double throw versions provide simpler, more positive actuation than bridging rockers, satisfy logic '0' and logic '1' input requirements with a single rocker.

Now Grayhill's DOUBLE-DIP™ Rocker DIP Switch (DPDT) joins the DIP-C™ (SPDT) and the plain vanilla SPST, in the industry's most comprehensive line for cost-effective on-board switching. Grayhill's Series 76 Rocker DIP Switches offer the important advantages of IC compatibility, compact high-density design, and ease of mounting by direct wave soldering or insertion into standard DIP sockets. Positive positioning through the exclusive spring-loaded sliding ball contact system provides immunity to shock and vibration and life with 50,000 operations. Detailed specifications and pricing are available from Grayhill, 561 Hillgrove, La Grange, Illinois 60525 or phone (312) 354-1040 for your free Rocker DIP family literature packet.



CIRCLE NUMBER 51

INSTRUMENTATION

Synthesized source is programmable



Wavetek Indiana, 66 N. First Ave., Beech Grove, IN 46107. (307) 783-3221. \$2600; 30 days.

Model 3001 programmable signal generator is a 1-to-520-MHz synthesized source that features CW, AM and FM operation with internal 400 and 1000 Hz or external modulation capabilities. Frequency accuracy is 0.001% and the stability is 0.2 parts per million per hour. Output power, adjustable from 13 to -137 dBm, is monitored by a front-panel meter calibrated in volts rms and dBm. Programmability is standard.

CIRCLE NO. 304

Three units form new counter line



Systron-Donner, 10 Systron Dr., Concord, CA 94518. (415) 676-5000. 6241A, \$595; 6242A, \$795; 6243A, \$994; 60 days.

Model 6241A communications counter measures frequencies from 20 Hz to 100 MHz, Model 6242A measures from 20 Hz to 512 MHz, and Model 6243A covers the range from 20 Hz to 1250 MHz. Features common to all three units include 10-mV sensitivity, ability to withstand exceptionally high input signal levels, overload fuse protected rf input (Models 6242A and 6243A) and an 8-digit LED display. Resolution is selectable in decade steps from 10 kHz to 0.1 Hz, and stability is ± 2 parts in 10^6 /year.

CIRCLE NO. 305

Unit analyzes amplitude distributions

B & K Instruments, 5111 W. 164th St., Cleveland, OH 44142. (216) 267-4800. \$4950; 2 mo.

Model 4426 amplitude-distribution analyzer is battery-operated and is designed for investigating static phenomena whose amplitude may vary unpredictably with time. The unit uses a microprocessor to compute equivalent steady level and amplitude probability distribution. Time-varying signals are distributed into 256 amplitude bins. Other features include a choice of linear logarithmic amplitude analysis, direct digital readout and an optional printer readout.

CIRCLE NO. 306

Pulse gen programs with 1-mV resolution



Berkeley Nucleonics Corp., 1198 Tenth St., Berkeley, CA 94710. (415) 527-1121. \$1520; 12 weeks.

Model 9010 precision pulse generator offers remote programming of the pulse amplitude from 0 to ± 9.999 V with 1-mV resolution, and a pulse/dc mode which allows direct measurement of the pulse top with a digital voltmeter. Additional features include: variable rep rates from dc to 1 MHz; independently variable rise and fall times; adjustable pulse delay and width; single or double-pulse mode; 50- Ω output impedance; and tail or flat top pulses with 0.01%/°C tempo.

CIRCLE NO. 307

If you're working RF linear: **GET THIS!**



New TRW RF catalog tells all!

This valuable booklet covers hybrids and discretes for RF linear applications from microwatts to kilowatts of output from 1MHz to 4GHz.

You'll find complete product specs, application block diagrams, reliability criteria and a good measure of advanced theory.

And it's yours, FREE. To get your personal copy, use the coupon or bingo number below — or call Warren Gould at (213) 679-4561.

TRW RF Semiconductors
An Electronic Components Division of TRW, Inc.
14520 Aviation Boulevard, Lawndale, California 90260
Please send me your new RF Linear catalog.

Name _____

Company Name _____

Address _____

City _____

State _____

Zip _____

EO

TRW RF SEMICONDUCTORS

ANOTHER PRODUCT OF A COMPANY CALLED TRW
CIRCLE NUMBER 52

RF power

We've made the most of it... You can, too!!

All wrapped up in a neat little package, our Model 510L is an ultra-wideband RF power amplifier whose wide range of frequency coverage and power output provide the user with the ultimate in flexibility and versatility in a laboratory instrument. Easily mated with any signal generator, this completely solid state unit amplifies AM, FM, SSB, TV, pulse and other complex modulations with a minimum of distortion.

Constant forward power is continuously available regardless of the output load impedance match making the 510L ideal for driving highly reactive loads.

Unconditional stability and instantaneous fail-safe provisions in the unit provide absolute protection from damage due to transients and overloads.

This outstanding unit covers the frequency range of 1.7 to 500 MHz with a linear power output of more than 9.5 watts and there is no tuning.

For further information or a demonstration, contact ENI, 3000 Winton Road South, Rochester, New York 14623. Call 716-473-6900 or TELEX 97-8283 ENI ROC



ENI

The world's leader in solid state power amplifiers

SEE Electronic Design's GOLD BOOK FOR COMPLETE PURCHASING INFORMATION

CIRCLE NUMBER 53

PACKAGING & MATERIALS

Zero-insertion-force sockets take any device

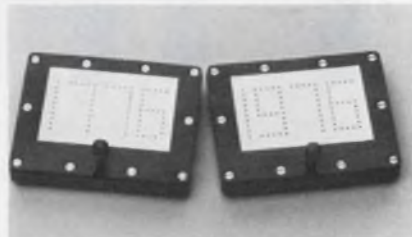

Textool Products, Inc., 1410 W. Pioneer Dr., Irving, TX 75061. (214) 259-2676. From \$7.46 (100-up).

Zero-insertion-force sockets come in any lead configuration. Called Grid Zip sockets, they allow you to specify any desired contact positions on a 14 × 21 position grid. Spacing between positions is 0.1 × 0.1 in. Zero-insertion-force sockets accept plug-in devices with no pressure on the device when it is inserted. A socket-mounted lever opens the contacts, and the device drops in. Electrical contact is made when the lever is flipped down. To remove the device, the lever is flipped to the open position.

CIRCLE NO. 308

Mini vibrator eases small parts handling



Sensonics, Inc., 25 Louis St., Hicksville, NY 11801. (516) 938-7520. \$37.10 (1-9); stock.

The Model 330 Vibratap miniature vibrator mounts on hoppers, trays or chutes to facilitate feeding small parts. The unit has a size of 0.656 × 1.25 × 0.84-in., and weighs 1.25 oz. The Model 330 taps on the surface to which it is mounted 600 times per second. It is powered from 110 to 120 V ac via a two-wire line cord.

CIRCLE NO. 309

Environmental chamber has hot and cold areas

Cincinnati Sub-Zero Products, Inc., 2612 Gilbert Ave., Cincinnati, OH 45206. (513) 751-8810. \$7200; 8-10 wks.

A series of dual—separate high and low-temperature—chambers in one unit, Model 02-65-3HC for environmental laboratories meets requirements normally served with separate units. The bottom chamber maintains a temperature range from 10 to -73 C. The top chamber has a temperature range from 27 to 204 C. The bottom zone is capable of reaching -54 C in about 45 min, and the top zone will reach 149 C in 15 min. Both zones provide working dimensions of 18 × 20 × 14 in. and are fabricated of stainless steel. The chambers include multipane observation windows with interior lighting for viewing the items undergoing test. Indicating temperature controllers are an integral part of the unit.

CIRCLE NO. 310

Cordless soldering iron recharges in four hours



Ungar, Div. of Eldon Industries, 233 E. Manville St., Compton, CA 90220. (213) 774-5950. \$24.95; stock.

The model 200 soldering station consists of a pencil iron with a quick-charge nickel-cadmium battery. The charging holder, which includes a tip-cleaning sponge, completely recharges the battery in four hours. The pencil iron has an indicator light and a trigger control with an interlock "off" switch. A built-in lamp illuminates the tip and work area. Two interchangeable element tips come pretinned: either a chisel and a micro spade. The holder is molded in high impact plastic, and takes 120-V ac input or 3.2 V dc at 285 mA.

CIRCLE NO. 320



From the originators of the photo-isolated solid-state power relays that have become the industry standard...

**A QUANTUM STEP
IN SIZE
AND PRICE
REDUCTION!**

**8 AMP SERIES 2
FOR HEATSINK OR PANEL MOUNT**

Two models, S218 (120 Vac) and S228 (240 Vac) feature standard 0.187" terminals for push-on connectors or bare-wire solder connection, positioned to provide maximum isolation between signal and power circuits. Offset positioning of the terminals permits side-by-side gang mounting for high packaging density. Occupying less than 1.0 cubic inch, they provide a full 8 ampere (rms) current rating and a high surge current capacity suitable for control of the toughest loads. The S218 units are \$5.90 in 1,000-piece lots.



**TWO NEW CRYDOM
CHALLENGER
SOLID-STATE RELAYS!**



2 AMP SERIES 3 FOR PC BOARD MOUNT

Two models, S312 (120 Vac) and S322 (240 Vac), provide a higher power handling capability than any SSR of equal size. Occupying less than 0.4 cubic inch, Series 3 SSRs achieve a full 2 ampere free-air rating in a 40° ambient. A low 3/8" profile allows 1/2" spacing of rack mounted printed-circuit boards. The S312 units are \$4.90 in 1000-piece lots.

The new Crydom Series 2 and 3 SSRs combine small size and low price, challenging all comparably rated SSRs, hybrid relays, and in-house designs on a size/cost/performance basis. They provide photo isolation, zero voltage switching, high current rating and rugged packaging — first established by the original Crydom Series 1, now the world's leading SSR design. Designed for UL/CSA approval, they offer the advantages of long life, RFI-free switching, logic level control, and excellent electrical and mechanical isolation of signal and power circuits.

The application of SSRs is no longer limited by size and cost. Crydom Challengers have knocked down these barriers. SSR control of motors, heaters, lamps, transformers, solenoids, valves and contactors now becomes practical in many new applications.

Think about it for your product... and join the Challengers!

INTERNATIONAL RECTIFIER



1521 Grand Avenue, El Segundo, CA 90245 (213) 322-4987

...the pacesetters!

Keystone THERMISTOR TASK MINDERS

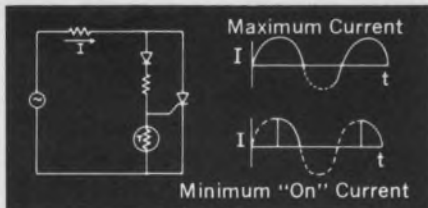
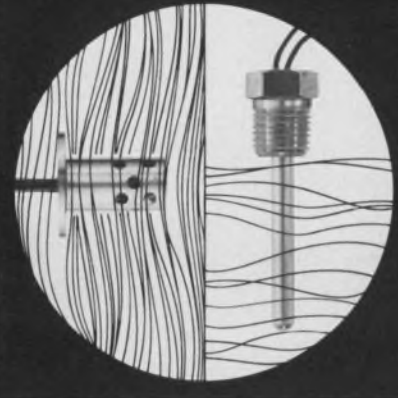

LOW-COST TEMPERATURE CONTROL

As the resistance of the thermistor decreases, a larger voltage is required to fire the SCR. In this circuit, conduction angles from 90° to 180° can be achieved. Thus, the minimum "on" current will be 50% of the maximum "on" current.

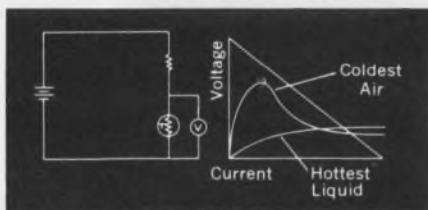

LIQUID LEVEL DETECTION

Taking advantage of the difference in dissipation constant between a liquid and a gas enables thermistors to serve as liquid level sensors over a wide range of temperatures.

Send for 12-page thermistor probe catalog detailing 23 styles and 6 applications.



Keystone
CARBON COMPANY
Thermistor Division
St. Marys, PA 15857
814/781-1591 • Telex 91-4517

CIRCLE NUMBER 56

PACKAGING & MATERIALS

Heat sink for TO-5s costs half of others



Wakefield Engineering, Inc., 77 Audubon Rd., Wakefield, MA 01880. (617) 245-5900. 5¢ (5000-up).

Heat sinks for TO-5 cases, Model 298 Press-Top Coolers, cost 5¢ each in 5000 quantities. The price is said to be half that of competing units: IERC Fan Tops or Thermalloy 2226B. The 298 coolers do not occupy any additional board area. They are installed on a TO-5 case by press fitting. The 298 is made from silver-bearing copper.

CIRCLE NO. 321

Kit makes user-designed electrical connectors



Wiring Analyzers, Inc., 9015 Wilshire Blvd., Beverly Hills, CA 90211. (213) 657-0122. \$98.

A kit allows a user to make injection-molded connectors. The model WA3DOOR contains 25 polyethylene cartridges, connector contacts and a gun that has 3 interchangeable nozzles. To make a connector, insert contacts with wire leads into the mating connector. Wrap heat-resistant tape around the mating connector. Fill the area with heated polyethylene fed from the gun. When the plastic cools, you have a connector. The polyethylene has a dielectric constant, at 60 Hz, of 2.28. The heat gun has replaceable nozzles of 1/8, 3/16 and 1/4 in. dia. Sufficient material for up to 20 connectors come in the kit.

CIRCLE NO. 322

The Accuracy Policy of Electronic Design Is:

- To make diligent efforts to ensure the accuracy of editorial matter.
- To publish prompt corrections whenever inaccuracies are brought to our attention. Corrections appear in "Across the Desk."
- To encourage our readers as responsible members of our business community to report to us misleading or fraudulent advertising.
- To refuse any advertisement deemed to be misleading or fraudulent.

This statement of accuracy has appeared in every issue of *Electronic Design*, from the very first one. Staff members are imbued with it, from their very first day.

Electronic Design

50 Essex Street
Rochelle Park, New Jersey 07662
(201) 843-0550

A panel socket takes LEDs with short leads

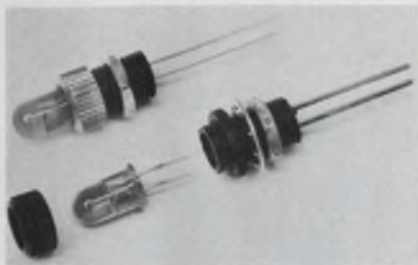

Data Display Products, Box 91072, Los Angeles, CA 90009. (213) 641-1232. 36¢ (1000-up).

Two panel sockets, series PS200, accept T1-3/4 LEDs. The LEDs plug in after their leads have been trimmed to 0.350 in. The sockets have either a black bezel (Model PS200-B) or a silver bezel (Model PS200-S). The socket is secured to a panel thickness of up to 0.125 in.

CIRCLE NO. 323

Conductive elastomer suppresses EMI and RFI



Tecknit, 129 Dermody St., Cranford, NJ 07016. (201) 272-5500. P&A: See text.

A conductive elastomer, Consil-II, suppresses EMI and RFI. The elastomer is made of silicone with embedded silver coated particles, which provide electrical and environmental sealing. Consil-II remains conductive indefinitely when mating surfaces are properly aligned and when required pressure is maintained. It is manufactured in sheets, molded parts, die-cut flat gaskets and cross-sectional strips. Cross-sections include rectangular, round, D and U shapes. Consil-II comes in two degrees of hardness. Type 470 has a durometer of 47 ± 7 ; type 700: 70 ± 7 . Both types have an operating temperature range from -60 to $+350$ F and a volume resistivity of $0.01 \Omega\text{-cm}$. Sheets with $12 \times 12 \times 0.020$ -in. dimensions cost \$18 each (15-up). Prices for strip material start at \$0.65 per ft (100 to 249 ft).

CIRCLE NO. 324

Lasers can read.

It is easy and economical to use low-power lasers to read, sort, count, and analyze in all kinds of materials — handling and quality-control situations.

A laser beam can be focussed to an extremely small spot size, insuring high resolution and accuracy. The beam is bounced off the work surface, read by a photodetector, and processed by an electronics package. Fast, error-free results unmatched by any manual or semi-manual system.

Lasers are being used by the thousands in industry today, on hundreds of production floors.

Applications include:

Non-contact surface testing where the use of a laser to detect pits, scratches or roughness can let you test 100% on-line for less cost than visual sampling.

Pattern recognition of fabricated parts, where patterns such as threads on machine parts can be detected through 100% on-line inspection.

Bar code reading for counting, identifying, or sorting materials where codes can be read reliably in any orientation, anywhere on the package.

The best source for lasers that can read is Coherent Radiation. The only laser supplier with LaserWare™: the laser-reading package containing laser and related components that was designed specifically for OEM applications. Like to know more? Return the coupon.

Please send me more information on lasers that can read.

NAME _____

COMPANY _____

ADDRESS _____

CITY _____ STATE _____ ZIP _____

PHONE _____

My application is: _____

LaserWare™ for OEM. Only from Coherent Radiation.

 **COHERENT**
Laser Division

3210 Porter Drive • Palo Alto, California 94304

CIRCLE NUMBER 57

What's the right price for this 1 Form A dry reed relay?



If we told you it has a premium quality switch and precision pins (not bent switch leads) would that help? Or that it's magnetically shielded, U/L listed and meets NARM/EIA proposed standards?

Would it help if we told you it's available in both Form 1A and 2A with .1" and .15" pin spacing, is the most automatically manufactured dry reed relay in the whole world and is available from stock ...from Wabash? The right price? All the prices are right. They're the under 25, 100 or MORE and 25,000 prices respectively.

Hard to believe, but true. And we have many other types available, handsomely priced, to fit your needs and budget. So if you'd like to know more, write us (on your letterhead) for a free sample, or call us for a high volume price quote and let us show you how, at Wabash, the price is always right.

Relays
wabash
of
Wabash, Indiana

Wabash, Inc., 810 N. Cass St., Wabash, Ind. 46922
TEL (219) 563-2191 TWX 810-290-2722

CIRCLE NUMBER 58

POWER SOURCES

Choose your input, get 50-to-200-W output

Abbott Transistor Labs, 5200 W. Jefferson Blvd., Los Angeles, CA 90016. (213) 936-8185. From \$325; 10 wk.

You can use a 115-or-220-V single-phase, 208-V three-phase or 48-V-dc input to get outputs of +5, ± 12 or ± 15 V dc, at power levels of 50, 100 and 200 W with the D line series modules. High-frequency pulse-width modulation permits these units to yield up to 75% efficiency, while delivering their full-load output at up to 55 C. They will operate, derated, at up to 71 C. Overtemperature shutdown, short-circuit protection and remote error-sensing are standard features. Overvoltage protection is optional.

CIRCLE NO. 325

Encapsulated HV supply mounts on PC board



Wall Industries, Inc., 175 Middlesex Tpk., Bedford, MA 01730. (617) 275-0708. \$164 (1-10), \$103 (250); 3-4 wks.

The HR series of high-voltage dc to dc supplies are encapsulated, have PC-pin connectors and mounting-screw inserts. They measure $3.5 \times 2.5 \times 0.1875$ in. and weigh 150 gm. The series consists of 24 standard models whose outputs range from 500 V at 5 mA to 2 kV at 1.5 mA. Standard inputs are 12, 24 and 28 V. Up to 20% trimming of the output voltage is accomplished by analog means. These non-isolated units offer a regulation of 0.1% for line and 0.2% for zero to full load. Max pk-pk ripple is 0.2%.

CIRCLE NO. 326

Low-cost supplies range from 150 to 250-V



Adtech Power, Inc., 1621 S. Sinclair St., Anaheim, CA 92806. (714) 634-9211. From \$34.95; stock.

The Golden Eagle HAPS series of power supplies offers four models with outputs of: 150 V at 0.15 A, 180 V at 0.15 A, 200 V at 0.125 A or 250 V at 0.1 A. These regulated dc power supplies use hermetically sealed ICs instead of the less reliable plastic devices. As with the EAPS line of supplies Adtech claims to have achieved significant design improvements while lowering their cost.

CIRCLE NO. 327

Line corrector 'cleans' 400-Hz power lines

California Instruments Div. of Aiken Industries, 5150 Convoy St., San Diego, CA 92111. (714) 279-8620. \$1745: 1 kVA, \$3520: 3 kVA (unit qty); 60 days.

Distortion and transient-free 400-Hz sine-wave power from solid-state ac-line correctors, the 1000-VA Invertron 1040 and 3000-VA 1340, offer a solution to power sources containing a conglomeration of parasitic EMFs, rf-induced noise, distortion and other detrimental conditions. Both models accept an input-voltage range of 95 to 115 V rms at a frequency of from 380 to 420 Hz. With an output of 115 V rms $\pm 0.25\%$ at 400 Hz, the regulation against a 10-V line change is 0.05%, and for full load, the change is 0.10%. A harmonic distortion of 10% at the input is reduced to 0.5% at the output.

CIRCLE NO. 328

New Transducer modules

measure electric power

NEW!



These new power transducers compute instantaneous ac electrical power. Simple design and high quality yield excellent reliability at an unprecedented price. New capabilities meet the needs of hundreds of previously difficult or uneconomical applications. These include, $\pm 0.50\%$ accuracy, 50 Hz to 10 kHz frequency range, one and three phase operation, accurate operation with non-sinusoidal waveforms, better than $\pm 0.25\%$ power factor influence and a 100 μ s response time.

Each transducer is encased in a small, tough nylon case for easy installation. Use the inquiry card to get complete technical data.

4949 Freeway Drive E.
Columbus, Oh 43229
614/888-7501
TWX: 810-337-2851



A subsidiary of The Arnold Engineering Company
CIRCLE NUMBER 59

PHOTO ETCH

PRINTED CIRCUIT KIT

Makes circuits **THREE WAYS**

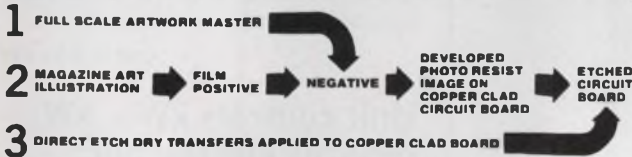

NO CAMERA DARKROOM FILM CUTTING TRACING USES DATAK'S POS-NEG PROCESS
The revolutionary photographic way that makes PERFECT printed circuits from original art or a printed page.

KIT CONTAINS: 5" x 6" steel grating frame, 4 sheets 5" x 6" photocopy film, yellow filter, chemicals for 1 gpi film developer and 1 gpi film fixer, 5" x 6" copper clad board, 2" x 4" copper clad board, spray can of photo etch resist, 1 gpi resist developer, 2 sheets 8 1/2" x 11" layout film, 1 roll 1/16" printed circuit tape, 1 roll 1/32" printed circuit tape, 8 sheets dry transfer direct etch PC patterns including pads, transistors, round can and flat pack ICs, DIP ICs, edge card connectors, lines, circles, jogs, etc. 1 lb anhydrous ferric chloride to make 1 gpi etchant. INSTRUCTIONS.

- ER-4 COMPLETE PHOTO ETCH SET \$26.95
- ER-2 PC patterns and tapes — refill 3.95
- ER-3 1/4 pound dry etchant — refill 1.49
- ER-5 6 sheets photocopy film — refill 3.95
- ER-6 Film process chemicals — refill 1.95
- ER-7 Photo resist spray, 2.5 oz. — refill 2.95
- ER-8 Resist developer, 16 oz. can — refill 2.95

AT YOUR DISTRIBUTOR OR DIRECT

the **DATAK** corp.
65 71st St. • Guttenberg, N. J. 07093

CIRCLE NUMBER 60

ELECTRONIC DESIGN 21, October 11, 1976

Dialight LEDs

The widest choice for your every application.

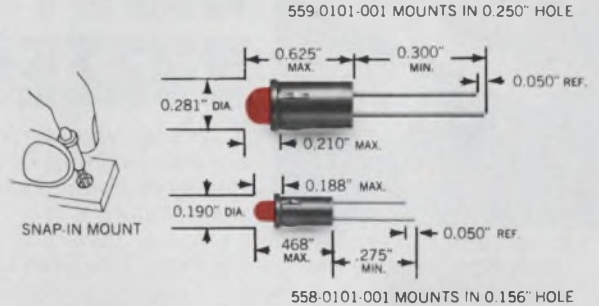

558 and 559 SERIES Available in red, green or yellow LEDs, with and without integral current limiting resistors. Snap-in mounting requires no additional hardware. Straight terminals suited for wire-wrapping and/or soldering. Low power requirements—15 to 20mA. In 1000-lot quantities each
558-0101-001 . . \$.33. 559-0101-001 . . \$.33.

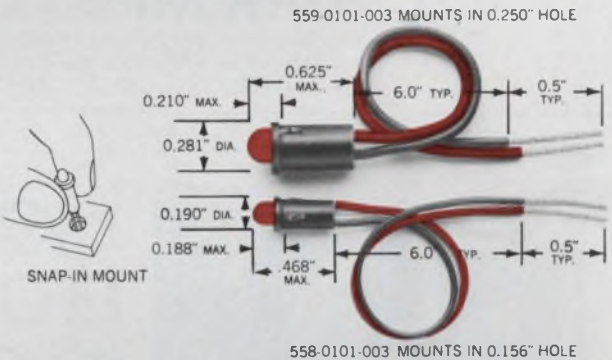

558 and 559 SERIES Available with 6" wire leads, these red, green or yellow LEDs are designed for quick positive insertion in 0.031" to 0.062" panels. Compact design allows high density packaging. In 1000-lot quantities each
558-0101-003 . . \$.75. 559-0101-003 . . \$.71.



Dialight, the company with the widest choice in switches, LEDs, indicator lights and readouts, looks for needs . . . your needs . . . and then they develop solutions for your every application. No other company offers you one-stop shopping in all these product areas. And no other company has more experience in the visual display field. Dialight helps you do more

with these products than any other company in the business, because we are specialists that have done more with them. Talk to the specialists at Dialight first. You won't have to talk to anyone else. Send for your free new copy of Dialight's current catalog.

DIALIGHT

Dialight, A North American Philips Company
203 Harrison Place, Brooklyn, N. Y. 11237
(212) 497-7600

See Dialight.

CIRCLE NUMBER 61



SERIES MINIATURE ELECTRONIC BUZZERS

• All solid state for high reliability, long life and maximum efficiency. These high quality components meet rigorous quality control standards.

- No arcing and no RF noise, because there are no moving contacts. Much more reliable than conventional "make and break" acoustic warning devices.
- Intermittent or continuous sound models.
- Available in voltage ranges from 1.1 to 16 volts, DC.
- Temperature ranges from -40°C to $+80^{\circ}\text{C}$.
- Useful in any application requiring small size, light weight and high reliability. These include automotive warning and monitoring indicators, portable and battery-operated equipment, test apparatus, timers, intercom and telephone sets, alarm devices, etc.



U.S. patent 3,887,914. Other patents pending.

STAR MFG.CO.,LTD.

U.S. Sales Office: Pan Am Building, 303 East
200 Park Avenue • New York, New York 10017
Tel. (212) 986-6770 TWX: 710-581-4082

CIRCLE NUMBER 62

POWER SOURCES

Fan lets small switchers put out up to 750 W



ACDC Electronics, Inc., 401 Jones Rd., Oceanside, CA 92054. (714) 757-1880. \$620, \$695; stock to 4 w.k.

Two fan-cooled switching power supplies, delivering almost two watts per cubic inch, comprise the JF5N series. The JF5N120 is rated at 5 V at 120 A, while the JF5N150 is rated at 5 V at 150 A. Both measure $5 \times 8 \times 10.5$ in. and weigh less than 20 lb. The replaceable fan permits full-rated output at 50 C, derating linearly to 70% at 71 C. Designed to meet UL478, these supplies operate from an input of 90-132/180-264 V ac, 47-63 Hz. Standard features include: regulation of 0.1%; ripple of 10-mV rms; overvoltage, thermal and reverse-voltage protection; provision for remote-sensing, remote-shutdown and remote-control; and parallel operation.

CIRCLE NO. 329

Unit controls kWh, kW, reduces electric bill

ITE-Datametrics, 340 Fordham Rd., Wilmington, MD 01887. (617) 658-5410. \$2000

The Mini-16 Watt-Watcher reduces electrical energy bills by monitoring and controlling energy consumption (kWh) and peak demand load (kW). It has a solid-state input converter, which eliminates the need for connection to the utility's demand meter. Offered as options are: automatic load cycling, automatic setpoint demand control, time-of-day rate-control and various remote controls.

CIRCLE NO. 330



Here is a case in point!

You need a good looking tool case that will be at home anywhere in the field or office. The new SPC 88 MD tool kit comes in an ABS heavy duty case molded with fiberglass reinforced corners for durability. It's stocked with 100 carefully selected quality tools in an easy to find arrangement.

The SPC 88 MD tool kit is designed for the field service engineer but we also make kits for the medical technician or any other professional.

Individual tools or a complete kit — we can deliver! A case in point for calling Specialized Products Company. (214) 358-4663.

Send for free brochure and product information.

2324 Shorecrest Drive/Dallas, Texas 75235

**SPECIALIZED
PRODUCTS
COMPANY**

CIRCLE NUMBER 63

Open-frame supplies come in 50 versions

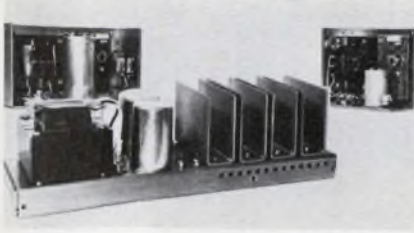

Power Pac, Inc., 18 Marshall St., S. Norwalk, CT 06854. (203) 866-4484. \$26 and up.

The Econopac series of OEM open-frame dc power supplies are available in single, dual and triple output units. The single-output units come in seven series (seven power levels), with five models in each series. Dual and triple-output units are each available in eight models. The standard outputs for the units include: 5, 6, 12, 15 and 24 V for single-output units; ± 5 , ± 6 , ± 12 , and ± 15 V for dual units; and $\pm 12/5$ and $\pm 15/5$ V for triple units. Output current capability ranges from 1 to 50 A. Regulation is $\pm 0.15\%$ for line and load combined; ripple and noise is 2-mV rms and 10-mV pk-pk maximum. Short-circuit protection with automatic-recovery is standard; over-voltage protection is optional. The units are convection-cooled.

CIRCLE NO. 331

Open-frame supplies have 1, 2 or 3 outputs

Abbott Transistor Labs, 5200 W. Jefferson Blvd., Los Angeles, CA 90016. (213) 936-8185. \$31 to \$139; stock to 10 wk.

Both the NL and ENL series of power modules offer single, dual and triple dc outputs in open-frame units. NLs convert 115 V ac, at 47 to 440 Hz, to 5, 12, 15, 24, 28, ± 12 , ± 15 , 5 and ± 12 , or 5 and ± 15 V dc. The ENL series provides the same outputs, but from 210-to-250-V-ac input. Both series operate at power levels of from 15 to 160 W. Regulation for line or load is tighter than 0.1% and ripple is 1-mV rms and 5-mV pk-pk. These supplies operate at full-rated load up to 50 C. Standard features include: short-circuit protection, remote error-sensing and input-transient protection. Overvoltage protection is optional.

CIRCLE NO. 332

Small UPS keeps phone switchboard going

Topaz Electronics, 3855 Ruffin Rd., San Diego, CA 92123. (714) 279-0111. Starts at \$280; stock.

Three small uninterruptible power systems (UPS) maintain ac power, up to 300 VA, to telephone switchboards during a commercial power outage. These UPS automatically restore ac power to the switchboard console via a built-in automatic transfer relay. Models

2645-1 and 2645-2 provide one and two internal, maintenance-free batteries, respectively. Minimum back-up time is 10 min at rated load for the 2645-1 and 27 min for the 2645-2. The Model 9234 is used with external 12-V batteries and multiple batteries can be connected in parallel for longer backup periods. A typical telephone system with 30 phones can be maintained in full operation for 30 min with one 20-Ah battery.

CIRCLE NO. 333



CTS matches crystal specs to your microprocessor.

And no waiting. CTS Industrial Distributors supply a perfectly matched crystal at the same time you buy the microprocessor, because CTS carefully checks the crystal requirements with each semiconductor manufacturer before writing crystal specs.

CTS now has a full line of standard crystals for microprocessors and clock IC's. CTS Knights crystals feature low start-up resistance, reliable CTS mil-approved manufacturing processes and gold frequency calibration for long term stability. Available in 17 standard frequencies, 1.0 to 22.1184 MHz. Other frequencies available on special order.

CTS Knights crystals are available **off the shelf** at these typical 100-piece prices: from \$5.50 each (1.0 MHz) to \$2.75 each (18.432 MHz).

See your nearest CTS distributor for full information, or write **CTS Knights, Inc.**, 400 Reimann Ave., Sandwich, IL 60548, phone: (815) 786-8411.

CTS Knights.
The frequency specialists.

CTS CORPORATION

Eikharl, Indiana



CIRCLE NUMBER 64

ALONE AGAIN

in low cost 1-watt
Zener Diodes

SCHAUER

"Z" SERIES ZENERS

DO-41 epoxy
molded case

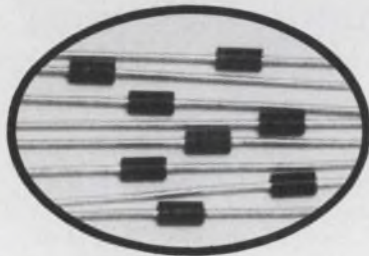

ANY VOLTAGE

2.6 to 34.0

ANY TOLERANCE

1% 2% 5% 10%

At Any Test Current

**Compare These Prices
On 1% Tolerance Diodes**

| Quantity | Price each |
|----------|------------|
| 1-99 | 91¢ |
| 100-499 | 83¢ |
| 500-999 | 77¢ |
| 1000 up | 73¢ |

**LARGE STOCK
GOOD DELIVERIES**

Send for complete rating data
and other tolerance prices.

Semiconductor Division

SCHAUER

MANUFACTURING CORP.

4511 Alpine Ave., Cincinnati, OH 45242
Telephone 513-791-3030 Telex 21-4576

CIRCLE NUMBER 65

MODULES & SUBASSEMBLIES

Compact oscillators deliver 180 to 550 kHz

Connor-Winfield, P.O. Box L, West Chicago, IL 60185. (312) 231-5270. From \$16; stock.

The C119A flat-pack oscillators measure only $1.6 \times 1.2 \times 0.5$ in. They are available at any fixed frequency from 180 to 550 kHz, with a frequency stability of $\pm 0.1\%$. The CMOS/TTL-compatible oscillators operate over 0 to 50 C and have frequency accuracy ± 1 kHz, $\pm 0.1\%$ or have an internal frequency adjust of $\pm 2\%$. They run from any fixed supply voltage from +5 to 15 V dc $\pm 5\%$ and draw a supply current of 1 to 5 mA.

CIRCLE NO. 334

Shift-register module offers selectable stages

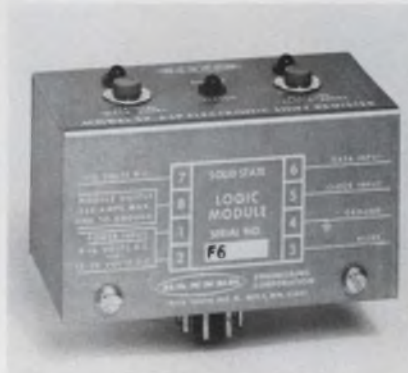

Banner Engineering, 9714 10th Ave. North, Minneapolis, MN 55441. (612) 544-3164. Under \$200; stock.

The SR-64P industrial logic module is a 64-bit shift register. It is designed for use with indexing conveyors and rotary indexing tables. Inputs may be limit switches, three-wire proximity sensors, photoelectric sensors or outputs from other logic modules. The modules use an octal base and have three indicators. A "stage selector" on the back of the module allows the operator to select up to 64 increments in the indexing system between the input and output functions of the module. Modules may be cascaded for additional stages. Power requirements of the module is 9 to 16 V ac or 12 to 20 V dc. The output can sink 0.25 A to ground.

CIRCLE NO. 335

Broadband thin-film amps span 30 to 890 MHz



California Eastern Laboratories One Edwards Ct., Burlingame, CA 94010. (415) 342-7744. 1000-up prices: from \$6.25 (5120) to \$35 (5108); stock.

Thin-film hybrid circuits, the MC5107 and 5108, are designed for vhf-CATV applications in the 30-to-250-MHz band. Both units have a bandwidth of 30 to 300 MHz with a slope of +1 dB. Pass-band ripple is typically ± 0.1 dB and the noise figure is 8.5 dB. The MC5107 has a gain of 21 dB and a third order intermodulation distortion of -67 dB when operated at an output signal level of 50 dBmV. The MC5108 has a gain of 20 dB with an intermodulation distortion of -80 dB when the output signal level is 50 dBmV. Both amplifiers have 75 Ω input and output impedances and are sealed in 10-pin plastic DIPs that have integral aluminum heat sinks. Also available are the MC5120 and MC5121 broadband hybrid amplifiers housed in 11-pin single-in-line plastic packages. They have a bandwidth from 30 to 890 MHz. The MC5120 has a gain of 21 dB and the MC5121 delivers 27 dB. Input and output impedances are 75 Ω .

CIRCLE NO. 336

Speedy a/d converter includes s/h amplifier

Datel Systems, 1020 Turnpike St., Canton, MA 02021. (617) 828-8000. \$79 (1 to 9); stock to 4 wks.

A speedy, 4-bit a/d converter, the ADC-SH4B, has a self-contained sample/hold circuit. The overall circuit has a 2 MHz throughput rate. The analog input range is 0 to +1 V. Nonlinearity is $\pm 2\%$ maximum and the input impedance is 50 Ω . The a/d converter has a temperature coefficient of ± 200 ppm/ $^{\circ}$ C. The ADC-SH4B is housed in a $2 \times 2 \times 0.375$ in. module and operates over 0 to 70 C. It requires ± 15 and +5 V dc supplies.

CIRCLE NO. 337

UP TIGHT **50%**
SHRINKDOWN AT ONLY 160°F
 with **PENNTUBE† VII-B**
Neoprene*
SHRINKABLE
TUBING

Tough! Flexible! Protective!
 Inexpensive! Shrinks down in hot water above 140°F. Good electrical and mechanical strength. Resists corrosion and chemicals and will not support a flame. Used for electrical insulation on wires, mechanical protection for pipes and fittings. Effective as scuff resistant jacketing for electrical cables and harness . . . and much more. Sizes 1/4" to 4". Black only.

PENNTUBE Plastics Co., Inc.

P | **D** SUBSIDIARY OF
 DIXON INDUSTRIES

Madison Ave. & Holley St.
 Clifton Heights, Pa. 19018
 (215) 622-2300

Export Div. • 5710 Empire State Bldg., N.Y. 10001
 *Du Pont Reg. TM †Penntube Plastics Co. Reg. TM

**SEND FOR
 FREE SAMPLE
 and Bulletin #71SN-B**

CIRCLE NUMBER 68

NO TUNING REQUIRED ever!

Murata ceramic I.F. Filters for AM, FM, FM-Stereo, TV, CB.

Murata has a piezoelectric ceramic I.F. filter in 455 KHz, 10.7 MHz or 4.5 MHz frequency ranges that can provide the solid long-term performance demanded by today's sophisticated "entertainment" applications. I.F.'s, Discriminators, Traps, Series Resonators . . . there's a Murata unit that can meet your application requirements while providing that extra bit of performance that makes the difference. Write for technical details.



muRata
 CORPORATION OF AMERICA
 2 WESTCHESTER PLAZA, ELMSFORD, NEW YORK 10523
 Phone: 914-592-9180 Telex: 13-7332

CIRCLE NUMBER 69

new from Hayden!

*"... well-organized, extremely well written . . .
 highly recommended for practicing engineers..."*
 IEEE Transactions

DIGITAL SIGNAL ANALYSIS

Samuel D. Stearns

This is an ideal master handbook on today's signal processing procedures and systems, containing recent advances, new design material, and a comparison between continual and digital systems that's extremely helpful to newcomers to the field. Featuring a foreword by Richard Hamming, the book contains a review of linear analysis; sample-data systems; analog-to-digital and digital-to-analog conversion; the discrete Fourier transform and the fast Fourier transform algorithm; spectral computations; non-recursive and recursive digital systems; computer simulation of continual systems; analog and digital filter designs, and more. 288 pages

FORTRAN served up just right for the engineer...

FORTRAN FUNDAMENTALS

Jack Steingraber

You'll find this a fast and efficient guide to the fundamentals of FORTRAN. The main objective here, in fact, is to provide an abbreviated means of learning the language and of becoming familiar with language manuals — so it's just right for the engineer whose main interest may lie elsewhere. You'll find lots of sample problems along with complete solutions, although you're constantly encouraged to try various routines and analyze your own success or failure. The step-by-step format is perfect for self-study. 96 pages

HAYDEN BOOK COMPANY, INC.
 50 Essex Street, Rochelle Park, New Jersey 07662



Order today—15-day examination!

Please send me the following book(s) to read and use FREE for 15 days. At the end of that time, I'll either send the amount indicated, plus postage and handling, or return the book(s) with no obligation.

- DIGITAL SIGNAL ANALYSIS, #5828-4, \$19.95
 FORTRAN FUNDAMENTALS, #5860-8, \$4.95

Name _____
 Company/Institution _____
 Address _____
 City/State/Zip _____

SAVE MONEY! Payment Enclosed. Publisher will pay all shipping and handling charges. Same 15-day return privilege and full refund if not satisfied.

\$10.00 minimum for free exam orders. Because of higher billing and collection costs, we must ask for payment in full with any order for less than \$10.00. Books will be shipped postpaid. Same 15-day return privilege for full refund if not satisfied.

76-28



Invertron® AC POWER SOURCES ARE FIRST IN AVIONICS TESTING

For your 400 Hz/800 Hz power requirements you can rely on Invertron® single or three phase fully isolated power output with variable voltage and frequency to meet all Avionics Power Specifications. Invertron® features reliability and flexibility which is unsurpassed for today's use or tomorrow. For other frequencies and power to 30 KVA, 21 models of Plug-in oscillators and 16 models of amplifiers are available. Learn more about the oldest and most respected name in AC Power

FOR FREE AVIONICS BROCHURE WRITE:
California Instruments
5150 Convoy Street, San Diego, California 92111
Phone: (714) 279-8620 Telex: 695047
See EEM Pgs. 1.1164, 1.1165

Aiken Industries
California Instruments
Division

CIRCLE NUMBER 70

**PROFESSIONAL
DISCOUNT
PRICES
AVAILABLE ON**

HEWLETT  PACKARD

Engineering Calculators

**PHONE TOLL FREE
800-638-8906**

FOR THE CURRENT LOW DISCOUNT
PRICE OF THE LATEST MODEL
CALCULATOR OF YOUR CHOICE

THE GUARANTEE

10 day money back trial. If you are not completely satisfied you may return the Hewlett-Packard calculator you order within 10 days for a cash refund or charge cancellation. In addition Hewlett-Packard and Capital Calculator Co., Inc. warrant each calculator for a period of one year against defective parts and workmanship.

Capital Calculator Company

Maryland residents phone:
(301) 340-7200

**701 East Gude Drive
Rockville, Maryland 20850**

CIRCLE NUMBER 71

KEEP

Electronic Design's

GOLD BOOK

HANDY



When You Call

Save time when you contact suppliers. Check their catalog pages first in *Electronic Design's* GOLD BOOK. Maybe the information you need is right at your fingertips.

MODULES & SUBASSEMBLIES

Digital angle translator resolves to 0.0014°

Interface Engineering, 386 Lindelof Ave., Staughton, MA 02072. (617) 344-7383.

The Model DD208 digital angle translator has a resolution of 0.0014 degrees. The circuit converts a binary angle input to a binary sine output. It has an execution time of 500 ns and has an accuracy of $\pm 0.0015\%$ for magnitude and $\pm 0.01^\circ$ for arctan ratio. The translators convert a natural binary angle input to corresponding sine of the angle over 90° range, or, when operated with an external controller (DD209), provide four-quadrant operation with both sine and cosine outputs.

CIRCLE NO. 338

Synchro control Xformer available in many models

Computer Conversions, 6 Dunton Ct., East Northport, NY 11731. (516) 261-3300. \$350 (prod. qty.); 4 wks.

The SCT series of electronic synchro control-transformer modules can directly replace conventional electromechanical control transformers. The modules measure $2.6 \times 3.1 \times 0.82$ in. and have standard accuracies of ± 6 , ± 15 or ± 30 minutes of arc. They simultaneously accept synchro or resolver inputs of 11.8 or 90 V, 400 Hz, or 90 V, 60 Hz, and 14, 12, or 10-bit binary digital data. The output voltage is the sine of the difference between the two input angles. Gradients are 0.4 V rms/degree or 1 V rms/degree. Output range is $\pm 7^\circ$ or $\pm 12.5^\circ$. The converters are insensitive to $\pm 10\%$ amplitude and frequency variations and $\pm 5\%$ power supply variations. The converters have transformer-isolated reference and synchro inputs, require no adjustments and have short-circuit protected outputs. Part No. SCT 40 requires a 26 or 115 V, 400 Hz, ac reference input and +15 V at 60 mA, -15 V at 25 mA and +5 V at 75 mA. Available operating temperature ranges are 0 to 70 or -55 to +85 C.

CIRCLE NO. 339

**D/s driver circuits
are blowout proof**



ILC Data Device Corp., Airport International Plaza, 105 Wilbur Pl., Bohemia, NY 11716. (516) 567-5600. From \$395; stock.

The TD-100 CM series of digital-to-synchro, torque-receiver drivers accepts 12-bit inputs. The drivers are almost blowout proof and offer a worst-case accuracy of ± 21 minutes into a torque receiver load. If a passive balanced load of a control transformer is used, the accuracy error reduces to ± 10 minutes. All models include a heat-sink-mounted thermal sensor that provides a power driver shutdown for any over-temperature condition. An override, though, is available for operation in spite of overtemperature conditions. Additional features of the drivers include an input register and fail-safe shutdown under power-supply-loss conditions. Also, the synchro output and reference input are transient-protected against inductive kick-back at turnoff of the torque receiver.

CIRCLE NO. 340

**Low-profile s/d module
delivers up to 16 bits**

Natel Engineering, 8954 Mason Ave., Canoga Park, CA 91306. (213) 882-9620. From \$525; 30 to 45 days.

The SD552 tracking synchro (resolver)-to-digital converter is available with a 14 or 16-bit output. It comes in a low profile module that measures only $0.42 \times 2.6 \times 3.1$ in. The converter has accuracies to within 0.03° at tracking rates of $3600^\circ/\text{s}$ with transformer isolation. CMOS circuitry reduces the power requirements to ± 15 V at 30 mA and +5 V at 10 mA. A 0-to-70-C operating range is standard and you can optionally order a -55 to +105 C version.

CIRCLE NO. 341

Buy One. Get Five Free.

New for 8080 users.

Buy a μ Pro-80 and you get-

- 8080 microcomputer
- High level language
- Software development system
- In-circuit emulator
- Field test system.

All five in one modular, portable package!

What a value. The μ Pro-80 Control/Display Module provides all the functions found in a minicomputer front panel—and more. Like breakpoint and program trace functions. And a push button keyboard and hexadecimal displays so you can examine or modify memory and CPU down to the status bit and register level. This tiny module also eliminates bulky terminals in test and field service environments.

Want more value? Add up your software development costs and see how much you can save with our BSAL-80 programming language. Developed especially for the 8080, this unique language can save programming hours because it uses a non-mnemonic syntax that reads the way programmers and engineers think. Also relocatability, parametric macros and automatic memory allocation save coding time. And assembly language efficiency minimizes execution time and program memory size.

You don't have to buy a μ Pro-80 to get a free brochure. Why not send for one today?



**μ Pro
muPro Inc.**

10340 Bubb Road ■ Cupertino, California 95014 ■ (408) 996-1137

CIRCLE NUMBER 72



hot stuff

or cold, CHR's family of TEMP-R-TAPE of Kapton provides outstanding endurance. They retain their excellent mechanical and electrical properties over a wide temperature range, -100 to +500F.

Available in thicknesses from .001" to .0045" with a choice of several adhesive systems including two sides.

Find your CHR distributor in the Yellow Pages under "Tapes, Industrial" or in industrial directories. Or write for complete specification kit and sample. The Connecticut Hard Rubber Company, New Haven, Conn. 06509.

CHR

an ARMCO company

CIRCLE NUMBER 73

DATA PROCESSING

Dual floppy discs mate with Nova computers

Ball Computer Products, Inc., 860 E. Arques Ave., Sunnyvale, CA 94086. (408) 733-6700. \$4700 (unit qty); stock.

A floppy disc interfaces with Data General's microNova and Monolithic Memory Inc.'s Nova emulator. The package consists of two floppy-disc drives and a single-board controller, called the Model 3190G. It connects to the computer's I/O bus. The entire 3190G is compact; the system occupies 7 in. vertically in a standard 19-in. rack. The floppy-disc drives feature a total storage capacity of 3.2 Mbit with IBM compatibility. Each drive has a seek time of 10 ms, track-to-track, and a transfer rate of 250-k bit/s. The controller board is usable with up to eight disc drives, and can also accommodate a real-time clock and teletypewriter interface.

CIRCLE NO. 342

Light pen features high sensitivity at low cost



Information Control Corp., 9610 Vellanca Ave., Los Angeles, CA 90045. (213) 641-8520. \$995.

A light pen, the LP-400, features a sensitivity of 2 footlamberts, with a response time under 300 ns. All pen circuitry is contained in the body and the pen output is TTL compatible. Touch actuated switching, optional at no additional cost, provides fingertip control with no switch bounce. The finder light beam ensures focusing of the photodetector on a 0.130-in. acceptance circle.

CIRCLE NO. 343

Calculator features simple programming



Casio, Inc., 15 Gardner Rd., Fairfield, N.J. 07006. (201) 575-7400. \$199.50.

The PRO-101 is a hand-held, programmable calculator. Programming is done by following the steps of the formula; there is no necessity for a special program language. The PRO-101 can remember 256 program steps that can be divided among up to 15 programs. Programs are retained even when the unit is shut off. Additionally, the unit has a total of 15 data memories. Programming features of the calculator include subroutine calls, indirect addressing, and a program error light.

CIRCLE NO. 344

Controller programs set up easily

Struthers-Dunn, Inc., Systems Div., Box J, Bettendorf, IA 52722. (319) 359-7501. \$1000.

The Model 1001 programmable logic controller features simple programming and low cost. Some features not available in any other programmable-logic controller are: entry of relay-ladder diagrams into the controller without converting to a computer language; and programming and editing features of a CRT. The Model 1001 also has an extra programming card for additional functions and an optional test panel that enables testing of both program and processor on an individual "go/no-go" basis.

CIRCLE NO. 345

**1/10TH
THE LIGHT
REQUIREMENT OF
ORDINARY VIDICONS**

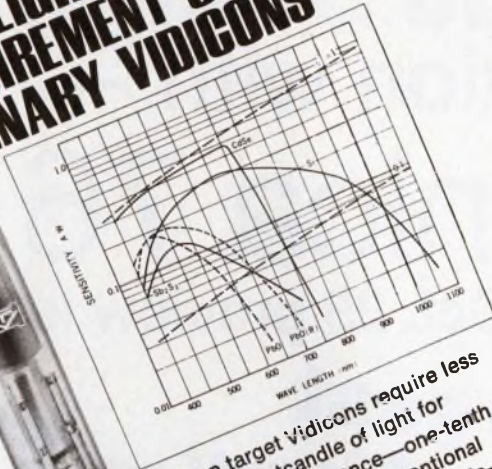

Silicon target vidicons require less than .01 footcandle of light for effective performance—one-tenth the requirement of conventional antimony trisulfide vidicons. Unsurpassed resolution is another reason for switching to the N747T or N736T Vidicon for surveillance, industrial and educational TV cameras. When you compare the performance, you'll be amazed at the price.

Call or write
for Data
Sheet

**HAMAMATSU
CORP.**

120 Wood Avenue
Middlesex, New Jersey 08846
(201) 469-6640

CIRCLE NUMBER 74

TOUCH-TONE*

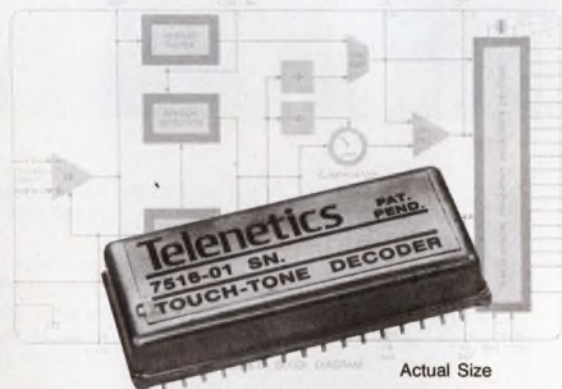

Actual Size

Telenetics' 7516-01 is a complete Touch-Tone Decoder in a 1/2 cubic inch, 32 pin DIP. Telephone Standard 2-of-8 tones are received, processed and decoded into discrete 1-of-16 or BCD (plus strobe) outputs. Input signal ranges -22 to +4 dBm with a balanced, capacitively coupled, 50 KΩ impedance. Operating voltage range is 8 to 28V dc (single supply); temperature range -30 to 70°C. Telenetics 7516-01 gives you one-tenth the size at one-third the cost of comparable Touch-Tone Receivers. Telenetics also offers these other devices:

- 7603 Touch-Tone Encoders
- 7511 Address Selector
- 7507 A complete line of Multiplexers and Analog Switches
- 7635 Touch-Tone Keyboards

Write or call today for a catalog—and pricing information:

Telenetics

Telenetics, Inc., 4120 Birch Street,
Newport Beach, California 92660
Phone: (714) 752-6363

*R-Registered trademark of AT&T

CIRCLE NUMBER 75

ELECTRONIC DESIGN 21, October 11, 1976

YEW's POWERFUL FAMILY!



AC WATTS

And, that's a lot of accuracy, even with low power factors and distorted waveforms. The YEW 2885 is renown throughout the world as the AC power measuring instrument. YEW's APR-2, on the right is used as a standard by many countries in the world.

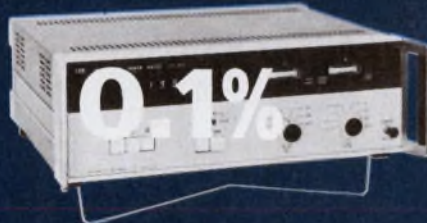

TRUE RMS V-A-W

Accuracy and versatility have generated a reputation for the YEW 2503 True RMS V-A-W instrument that's hard to beat. Distorted waveforms and low power factor hardly phase it at all.



TRUE RMS V-A-W

If 0.25% accuracy with 0.01% resolution fills your True RMS requirements, YEW's new 2504 can't be beat for pure dollar efficiency. It takes low power factors and distorted waveforms in stride, too.

PORTABLE WATTMETERS

YEW has made more precision analog portables than anyone else in the world . . . and they're usable to 2 KHz and not expensive.

Write for our technical information package.

YEW

**YOKOGAWA
CORPORATION
OF AMERICA**

5 Westchester Plaza, Elmsford, N.Y. 10523
Tel. 914/592-6767 TWX: 710-567-1256

"Visit us at ISA Booth 547"

CIRCLE NUMBER 76

Electronic Design in cooperation with ~ electronica 76

announces a special Oct. 25 preview issue of

**the World's Largest
Electronics Show — EVER!**



MUNICH
GERMANY. NOV. 25 — DEC. 1, 1976
20 EXHIBITION HALLS PACKED
WITH 1,600 EXHIBITS AND STANDS
FROM OVER 2,500 ELECTRONICS
FIRMS FROM 23 NATIONS.

This year's ELECTRONICA is going to be a stellar event. It's the "show of shows," largest in the world.

Our editors are already deeply involved to bring you a special preview of ELECTRONICA from the design engineer's point of view...the news and products to be unveiled (including those at the 7th International Congress on Microelectronics).

If you're planning to attend, take advantage of our special low-cost package tours to MUNICH — see right. If you're staying home, watch for ELECTRONICA 76 PREVIEW — October 25 in *Electronic Design*.



Note: Alert your Sales & Marketing People

October 25 can be your company's opportunity to sell at ELECTRONICA, in Europe, to the U.S. and the world! It's going to have the largest circulation in our history — 10,000 bonus distribution at Munich, 24,000 international, 103,500 in all. Tell them about the low cost tours to Munich, too. They can save a bundle!



Electronic Design in cooperation with

electronica 76 announces 1976

Travel Tours to Munich

departing from New York, Boston or Chicago



A FULL WEEK OR TWO-WEEK STAY FOR ONLY SLIGHTLY MORE THAN REGULAR AIR FARE ALONE

8 DAYS/7 NIGHTS

Included: **Air travel**, economy class via Swissair regularly scheduled flights with complimentary meal service aloft.

Transfer by deluxe motor coach from airport to hotel, and return, including baggage handling.

First class hotel accommodations (double occupancy) at Eden Hotel Wolf — one of Munich's finest — within walking distance of the fair grounds; all rooms with bath, breakfast and service.

Champagne reception co-sponsored by *Electronic Design* and ELECTRONICA 76 management.

Admission to the ELECTRONICA Exhibition.

Tour accompanied by U.S. representative of the Munich Fair Authority.

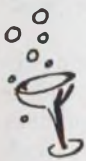

14 DAYS/13 NIGHTS

Included: All features of shorter tour except accompaniment by U.S. rep. Half-day sightseeing tour of Munich.

All tours are predicated on 10 or more participants; air fares are subject to change. All participants must depart and return with the group to qualify for this low group airfare. Regular airfare for less than 14 days is \$748.00!

8-DAY PACKAGE

\$698⁰⁰

From N.Y.
or Boston
(\$819 from Chicago.)
Subject to change.

DEPART: NOV. 24, 1976
RETURN: DEC. 2, 1976
Rates based on double occupancy.
Single supplement: \$40.

14-DAY PACKAGE

\$938⁰⁰

From N.Y.
or Boston
(\$1059 from Chicago.)
Subject to change.

DEPART: NOV. 19, 1976
RETURN: DEC. 3, 1976
Rates based on double occupancy.
Single supplement: \$90.

RESERVE NOW DEPOSIT REQUIRED

\$100⁰⁰

Returnable before
October 1, if cancelled.

DEADLINE FOR FINAL
PAYMENT:

OCT. 30
(for both tours)

NAME _____
TITLE _____
COMPANY _____
ADDRESS _____
CITY, STATE, ZIP _____
PHONE _____ DEPART FROM: NEW YORK BOSTON CHICAGO

Specify ELECTRONIC DESIGN/ELECTRONICA 1976 TOUR TO MUNICH. Make checks payable to "Kallman Associates" (U.S. Electronica representatives). Tel: 201-653-3304. Mail to: Kallman Associates, 30 Journal Square, Jersey City, New Jersey 07306.



If your jumpers aren't pink, you're paying too much for them.

Meet Great Jumpers™ and Great Daisy Jumpers™ from A P Products, the new fully pre-assembled and fully pre-tested flat cable/connector system that can cost about half as much as what you're using now.

Take your choice of the three most popular connectors, the five most popular flat cable widths, solid or stranded Electric Pink or rainbow cable, single ended, double ended or daisy chained. And Great Jumpers are directly-interchangeable replacements for the jumpers you're using now.

Our connectors are molded on. They provide both an integral cable strain relief and complete line-by-line probeability. And because they come to you factory assembled and tested, they're faster and easier to use.

Connect with the A P rep nearest you.

| | | | | |
|----------------|----------------|----------------|----------------|----------------|
| (203) 868-7748 | (219) 447-9623 | (314) 434-6242 | (512) 443-9687 | (617) 272-8163 |
| (206) 822-8223 | (301) 484-5400 | (315) 437-8343 | (513) 433-0966 | (713) 691-3961 |
| (212) 682-5844 | (303) 420-4646 | (414) 421-2300 | (602) 946-4437 | (714) 560-6266 |
| (214) 238-0408 | (305) 894-3351 | (415) 328-3232 | (602) 949-8424 | (714) 833-1802 |
| (215) 923-5195 | (312) 298-4830 | (416) 638-1322 | (609) 429-4013 | (816) 765-2998 |
| (216) 333-4120 | (313) 356-2161 | (503) 223-3374 | (612) 922-7011 | |

Faster and easier is what we're all about.



A P PRODUCTS INCORPORATED

Box 110-F Painesville, OH 44077 (216) 354-2101 TWX: 810-425-2250

CIRCLE NUMBER 77

Waters Conductive Plastic Elements Can Cure Your Servo Feedback Problems

When it comes to the application of conductive plastic potentiometers or elements in servo feedback systems for recorders, controllers, and actuators, Waters wrote the book.

Waters makes rotary servo potentiometers from 1/2" to 2" diameter, and custom elements from 1/2" to 40" in length. All Waters' CP units provide infinite resolution, multi-million cycle life, and low output smoothness (.03%). Linearities can be specified to 0.1% using Waters own automated linearization technology.

Bring your servo feedback requirements to Waters for the professional solution to your individual application.

Call Waters at 617-358-2777 or circle reader service card.

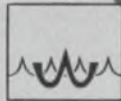

**WATERS
MANUFACTURING INC.**

LONGFELLOW CENTER
WAYLAND, MA 01778
(617) 358-2777

CIRCLE NUMBER 78

DATA PROCESSING

Data terminal can print all codes



Computer Transceiver Systems, Inc., E. 66 Midland Ave., Paramus, NJ 07652. (201) 261-6800. \$2895 (1-up); 6-8 wks.

The Model 380 Troubleshooter functions either as a standard data terminal or as a printer. In the printer mode, it will print symbols for device-control codes, vertical and horizontal tabs, a carriage return, and a line feed, instead of executing those instructions. The standard models operate in ASCII code, but units can be supplied for other codes such as APL or Baudot.

CIRCLE NO. 346

Mil tape drive stores 16.8 Mbit per cartridge

EM&M, Severe Environment Products Div., 20630 Plummer St., Chatsworth, CA 91311. (213) 998-9090. Transport, \$5000; tape module, \$595.

A tape-transport unit and removable 1/4-in.-wide tape module will work in severe-environment applications. Designated the bulk data storage unit (BDSU), the sealed tape module contains 300 ft of 1/4-in. magnetic tape and stores 16.8 Mbit of data. Performance specifications include an operating temperature range of -54 C to +95 C for MIL-E-5400, Class-2 applications. The module has a four-track sealed head, electro-optical tape-position sensing to detect tape ends and center, and an electromechanical elapsed-time indicator for a running time record. Operating power is 30 W; standby is 5 W. The tape module size is 1 x 4 x 6 in. and the transport has dimensions of 1.4 x 4 x 6 in.

CIRCLE NO. 347

Fast-Fourier-Transform modules work quickly

Plessey Microsystems, 1674 McGaw Ave., Irvine, CA 92714. (714) 540-9945. SPM-01: \$5000; SPM-02: \$6000 (unit qty).

Two Fast-Fourier-Transform modules transform 1024 points. The SPM-01 works in 600 ms and the SPM-02, in 250 ms. The modules are based on the 16-bit Miproc-16 microcomputer. Data inputs may be either analog or digital at rates up to 50 kHz. The FFT modules will perform either forward or inverse FFT and deliver the transformed data in analog or digital form as either real, imaginary, alternate real and real imaginary, or as a computer power spectrum. The SPM-01 and 02 require only a +5-V power supply and are controlled by a TTL interface from minicomputers.

CIRCLE NO. 348

Disc drive is shrunk to cassette's dimensions



Shugart Associates, 435 Indio Way, Sunnyvale, CA 94086. (408) 733-0100. \$390 (1-up); 60 days.

The SA400 Minifloppy disc drive comes in a package the size of most cassette tape units. It has front dimensions of 3.25 x 5.75 in. It is 8 in. deep and weighs 3 lb. It provides error rates of one in 10⁶ soft, and one in 10¹¹ hard errors. The Minifloppy drive stores 109.4-k bytes unformatted and 89.6-k bytes formatted on its 5.25 in. square diskette. The SA400 features a direct-drive stepping-motor actuator, with a spiral cam having a V-groove positive detent. The unit has a power consumption of 15 W under continuous duty.

CIRCLE NO. 349

Time to think small for LCD watches



Hamai. The micro-mini lamps people. The time of day in LCD watches. The big names in LCD watches in Japan find that Hamai matches the quality of their brand. More important, they benefit from the unrivalled reliability of Hamai micro-miniature lamps. You can also.

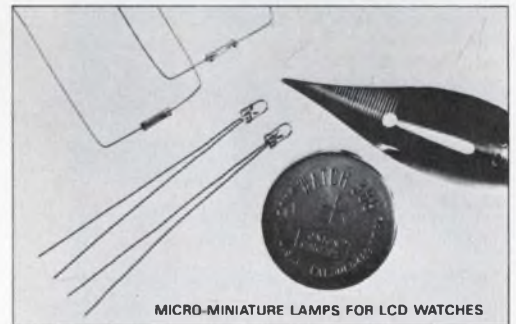

MICRO-MINIATURE LAMPS FOR LCD WATCHES

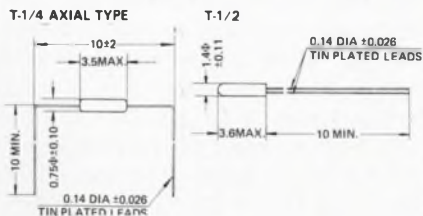

Specifications

| ITEM TYPE | LAMP NO. | DESIGN | | LUMENS (MSCP) MIN. | LIFE (HOURS) MIN. |
|------------------|----------|--------|------------|--------------------|-------------------|
| | | VOLTS | AMPS. MAX. | | |
| T-1/4 AXIAL TYPE | AXL-1 | 1.55 | 0.013 | 0.035 (0.0027) | 40 |
| | AXL-7 | 1.55 | 0.018 | 0.063 (0.005) | 40 |
| T-1/2 | H-0133 | 1.55 | 0.013 | 0.035 (0.0027) | 40 |
| | H-0135 | 1.55 | 0.015 | 0.03 (0.0024) | 20 |

Quality that shines

ROYAL

HAMAI ELECTRIC LAMP CO., LTD.

9-26, Kasuga, 1-chome, Bunkyo-ku, Tokyo 112 Japan.

Phone: Tokyo (03) 813-8811 Cable: HAMAI/ELEC Telex: 272-2408

Specialist of Micro-Miniature Lamps, Sub-Miniature Lamps & Lens-End Lamps.

INTEGRATED CIRCUITS

Monolithic DACs have internal references

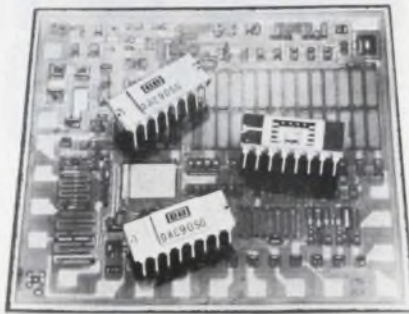

Burr-Brown, International Airport Industrial Park, Tucson, AZ 85734. (602) 294-1431. From \$8.50 (100-up); stock.

The DAC90 8-bit d/a converter is a complete monolithic unit with internal voltage reference. It settles to 0.2% in 200 ns and has a stability to within $\pm 0.2\%$ over the specified ranges of -25 to $+85$ C or -55 to $+125$ C. The converters have a gain drift of ± 50 ppm/ $^{\circ}$ C, typically, over the entire operating range. The DAC90s are housed in hermetic 16-pin ceramic DIPs.

CIRCLE NO. 350

Voltage sensors can be set with two resistors

Intersil, 10900 N. Tantau Ave., Cupertino, CA 95014. (408) 996-5000. From \$1.50 (100-up); stock.

Two settable, micropower voltage-detector circuits, the ICL8211 and ICL8212, can measure between 2 and 30 V. The ICL8211 output turns on when the voltage detected falls below a preset value, and the ICL8212 output turns on when the voltage detected rises above a preset value. The exact voltage to be detected is determined by connecting two resistors to the detector circuit. Both devices maintain virtually constant power supply currents, typically 20 μ A, over the input voltage range during their off or "sensing" state. The output of the ICL8211 in its on-state is current limited to 7 mA, and the output of the ICL8212 is not restricted. Units with ratings over 0 to 70 or -55 to $+125$ C are available in either miniDIPs or TO-99 packages.

CIRCLE NO. 351

Precision voltage ref delivers +10-V signal



Beckman Instruments, Helipot Div., 2500 Harbor Blvd., Fullerton, CA 92634. (714) 871-4848. From \$12.35 (100-up); stock.

The series 840 precision voltage reference is laser trimmed to deliver +10-V-dc output at $\pm 0.1\%$ max. absolute accuracy. It has a temperature coefficient of only ± 5 ppm/ $^{\circ}$ C. The circuit is hermetically sealed in a standard eight-pin metal TO-5 package. Two temperature range/performance levels are available: Model 840-T1 is designed for operation over -55 to $+125$ C, and the Model 840-T2 is specified over -25 to $+85$ C.

CIRCLE NO. 352

Isoplanar CMOS circuits grow with two additions

Fairchild Digital Products Div., 464 Ellis St., Mountain View, CA 94042. (415) 962-3816. 100-up prices: \$1.64 (4511); \$1.28 (4528); stock.

Two additions to the Isoplanar family of CMOS circuits include the 4528 dual, retriggerable, re-settable monostable multivibrator and the 4511 BCD-to-7-segment latch decoder/driver. The 4528 monostable offers typical device-to-device output pulse width variation of $\pm 3\%$ at $V_{DD} = 15$ V; and $\pm 1\%$ typical output pulse width variation over the commercial temperature range with $V_{DD} = 15$ V. Propagation delays are independent of the timing capacitor. The 4511 latch/decoder offers improved ac performance and improved output drive capabilities over earlier models. Both units meet or exceed all limits of the new industry standard "B" Series CMOS specifications. They are available in plastic or ceramic packages in both military and commercial temperature ranges.

CIRCLE NO. 353



seastrom wants you!

... to join the thousands of companies relying on Seastrom quality products.

Washers—all types
Spring Clips
Military Standards
Electronic Hardware

FREE ... Illustrated Catalog.
250 pages with complete description by part number.
All stocked for immediate delivery.

Seastrom Manufacturing Co., Inc.
701 Sonora Avenue Dept. E4
Glendale, California 91201
Phone: (213) 245-9121

CIRCLE NUMBER 80

Price & Performance that can't be matched!

DigiTec's full-function Universal Counter/Timers and Frequency Counters supply extended frequency ranges at a ratio of price to performance that can't be matched.

Outstanding features include dual input channels with independent controls, high input sensitivity, oven controlled crystal, and full 9 digit LED display with autoranging.



| | | |
|-----------------------------------|-----------|-------|
| 50 MHz ... Universal Counter ... | 8510A ... | \$725 |
| 150 MHz ... Frequency Counter ... | 8720A ... | 625 |
| 150 MHz ... Universal Counter ... | 8520A ... | 850 |
| 500 MHz ... Universal Counter ... | 8530A ... | 995 |
| 600 MHz ... Frequency Counter ... | 8730A ... | 795 |
| 1 GHz ... Frequency Counter ... | 8740A ... | 995 |
| 1 GHz ... Universal Counter ... | 8540A ... | 1295 |

DigiTec UNITED SYSTEMS CORPORATION

918 Woodley Road, Dayton, Ohio 45403
(513) 254-6251, TWX (810) 459-1728

DigiTec: precision measurements to count on.

*These instruments available under
GSA contract GS-00S-27741.*

FOR INFORMATION ONLY CIRCLE 271

FOR DEMONSTRATION ONLY CIRCLE 281

UNIVERSAL TWO CHANNEL SWEEP FREQUENCY RESPONSE ANALYZER



MODEL 916

- DISPLAYS & PLOTS AMP. RATIO (db) & PHASE SHIFT VS. LOG FREQUENCY
- OPEN LOOP RESULTS FROM CLOSED LOOP TESTS
- AUTOMATIC GAIN CONTROL - 80 db DYNAMIC RANGE IN EACH CHANNEL
- CONTINUOUS SWEEP OVER ANY PORTION OF 6% DECADE FREQUENCY RANGE

FREQUENCY RANGE
MODEL 916 - .005 Hz to 10,000 Hz.
MODEL 916H - .025 Hz to 50,000 Hz.

BAFCO, INC.

717 MEARNS ROAD • WARMINSTER, PA. 18974
TEL: (215) 674-1700 • TWX No. 510-665-6860

CIRCLE NUMBER 81

ELECTRONIC DESIGN 21, October 11, 1976

A touch of class

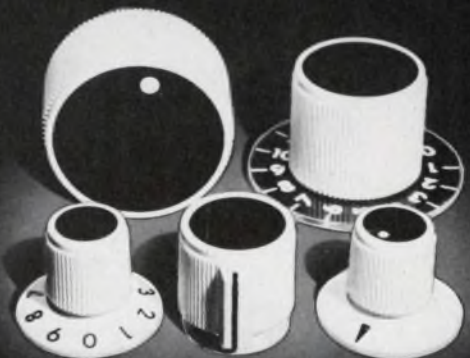

Rogan knobs and custom dials.

Our catalog and samples
of particular items will
be sent upon request.

ROGAN
CORPORATION
3455 Woodhead Drive
Northbrook, IL 60062
Phone (312) 498-2300

CIRCLE NUMBER 82

Q

WHICH OF THE
ANNUALS DO
ELECTRONICS ENGINEERS
CONSULT MOST?

A

■ **Electronic Design's**
■ **GOLD BOOK**

83%

OF THE ENGINEERS WHO RESPONDED TO
A TECHNICAL TRENDS ANALYSTS SURVEY SAY
THEY CONSULTED THE GOLD BOOK
WITHIN THE PAST MONTH

(Survey date: February, 1976)

IF IT'S ELECTRONIC...IT'S IN THE
GOLD BOOK

(91,000 copies of the 1976/77 edition are now off the presses
and are being used throughout the U.S.A. and overseas!)

COMPONENTS

PC slide switches are difficult to tease

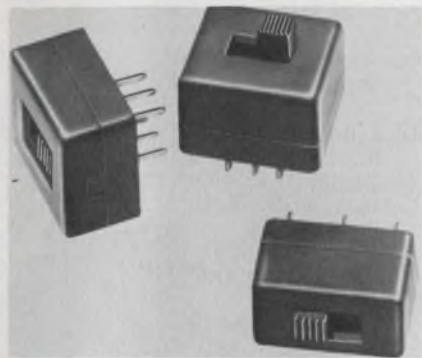

Alco Electronic Products Inc., 1551 Osgood St., North Andover, MA 01845. (617) 685-4371. \$0.67: SPDT (1000 up); stock.

PC-mounted miniature slide switches, MSS-104/204, use a proven-switch mechanism that is difficult to tease. This design provides a 4-A, 125-V-ac rating in a very small package. The fully insulated, blue, diallyl-phthalate low-profile case occupies minimal space. PC terminals are spaced 0.1-in. centers and are epoxy sealed to prevent solder-flux wicking. Contacts and terminals are normally supplied in silver with gold flash; also, optionally available with gold plate for dry circuit applications. A choice of top or side actuator lever is available. All models are available with SPDT or DPDT action. Periods of inactivity have no operational effect on switch performance. Life expectancy is minimum 30,000 operations.

CIRCLE NO. 354

Filters pass rated load, no performance loss

Corcom, Inc., 2635 N. Kildare Ave., Chicago, IL 60639. (312) 384-7400. \$25 to \$87 (unit qty); stock.

Corcom's L and T series three-phase RFI power-line filters handle full rated current without degradation of performance. The loads can be balanced or unbalanced. The L series case size is 8.40 L x 5.50 W x 2.25 H in., and the T series is 11.40 L x 5.50 W x 2.25 H in. The units are fully shielded. They are terminated with a molded screw terminal block. Both the L and T series are available in 20, 30 to 60-A versions, 250 V rms.

CIRCLE NO. 355

Liquid-crystal displays are speed enhanced

Hamlin Inc., Lake and Grove Sts., Lake Mills, WI 53551. (414) 648-2361. \$7.70: 3927, \$8.75: 3918 (2500 up); stock to 3 wks.

DIP multipurpose liquid crystal displays, Series 3900, serve as a readout units for instruments and clocks. Their terminals insert directly into sockets or PC-board, eliminating the need for separate connectors. A proprietary "speed

enhancer" substantially reduces operating time—particularly in colder temperatures. Series 3927 is a 3-1/2-digit clock display, with 0.7-in. high characters; Series 3918 is a six-digit display with 0.5-in. high characters. Both units can be read easily without distortion through a wide viewing cone. Digits may be black or clear with a choice of transmissive or reflection backgrounds. Entire display is protected from humidity.

CIRCLE NO. 356

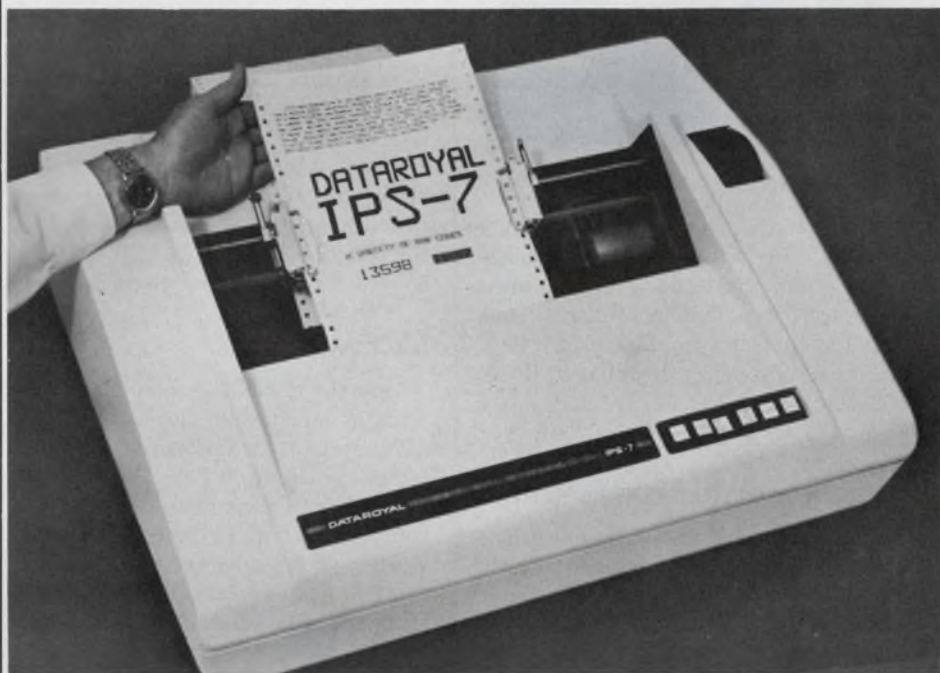

the alternative to printers that break down in the middle of the night!



OEM's now have a super-reliable 24-hour-a-day medium speed printer—designed by request. Clean, straightforward design makes IPS-7 flexible, mechanically reliable—electronically sound. Prices and capabilities are competitive

OEM's want as few brands as possible. IPS-7 is all the printer you'll need for years to come. You don't have to put tinkertoys together to assemble your custom configuration. The functional structure is built in. Just plug in your options. Compatible? Yes, interchangeable with the printer you designed in.

How does the "7" pack in so much? Start with a big healthy micro-processor that gives the flexibility—programmable forms control, diagnostic package, character size and serial or parallel interface. This takes the burden off the computer. Use rapid, super-reliable servo and stepping motors to get rid of troublesome gears, clutches, brakes, bearings and shafts—at least 75% fewer parts (consider the MTBF of those!)—and ruggedize the rest. Provide

positive filtered air flow for operation in heat, cold and dirt without a clean room. Include sensible ideas like three head-speeds—to print, to move and to give double density without double printing time. IPS-7 has low parts cost, and low downtime which is quickly back to uptime.

Only DATAROYAL says, "our printer will run and run and run."

Ask for proof of the performance you're waiting for.

DATAROYAL INCORPORATED
235 MAIN DUNSTABLE ROAD,
NASHUA, NEW HAMPSHIRE 03060 (603) 883-4157

CIRCLE NUMBER 85

New Literature



Timing equipment

Specifications on the company's timing line, including time-code generators, translator/generators, readers, tape-control units and battery power supplies, are given in an eight-page brochure. Trak Systems, Tampa, FL

CIRCLE NO. 357

Synchro/digital conversion

A 46-page handbook includes five pages of basic terminology, eight pages of s/d and d/s conversion theory and more than 30 illustrated applications. Analog Devices, Norwood, MA

CIRCLE NO. 358

TV chroma circuits

Four engineering bulletins describe TV chroma circuits. Sprague Electric, North Adams, MA

CIRCLE NO. 359

Light-sensitive FET

A design discussion on the advantages of FOTOFET over conventional bipolar light-sensitive devices and over photomultipliers, plus extensive data on the use of the FOTOFET in optical coupling, detection, isolation, counting, triggering, switching, modulation and scanning applications are given in a 24-page catalog. Teledyne Crystalonics, Cambridge, MA

CIRCLE NO. 360

Precision instruments

More than 65 precision instruments and accessories are summarized in an eight-section catalog. Photos, options and prices are included. Princeton Applied Research, Princeton, NJ

CIRCLE NO. 361

Computer equipment

A detailed discussion of HP's role as a complete computer equipment supplier to Original Equipment Manufacturer (OEM) customers is available in an eight-page brochure. Hewlett-Packard, Palo Alto, CA

CIRCLE NO. 362

Solders

A 12-page catalog covers solders, anodes, tapes, solder analysis, fluxes, cleaning solvents, surface conditioners, solder preforms, precision stamping, solder creams and copper brazing pastes. Alpha Metals, Jersey City, NJ

CIRCLE NO. 363

Microwaves

One-third of the new 226-page Anaren microwave catalog consists of application information and technical data. The catalog is divided into four sections: passive couplers, dividers and feed networks; rf frequency conversion; rf control and switching; and phase and frequency discrimination. Anaren Microwave, Syracuse, NY

CIRCLE NO. 364

Photosensitive devices

Operating principles and applications of photosensitive devices are described in a 24-page catalog. The catalog contains outline drawings, specifications, performance characteristics, figures and nomographs. ITT Electro-Optical Products, Fort Wayne, IN

CIRCLE NO. 365

Supervisory system

The philosophy of supervisory control and data acquisition and details of the makeup and specifications of the Honeywell system—SCADA—are explained in a 12-page brochure. Honeywell Process Control Div., Phoenix, AZ

CIRCLE NO. 366

Electronic Design

Advertising Sales Staff

Tom W. Carr, Sales Director
Jean Bunfield, Sales Coordinator

Rochelle Park, NJ 07662

Robert W. Gascoigne
Daniel J. Rowland
Thomas P. Barth
50 Essex St.
(201) 843-0550
TWX: 710-990-5071

Philadelphia

Thomas P. Barth
(201) 843-0550

Boston 02178

Gene Pritchard
P.O. Box 379
Belmont, MA 02178
(617) 489-2340

Chicago 60611

Thomas P. Kavooras
Berry Conner, Jr.
200 East Ontario
(312) 337-0588

Cleveland

Thomas P. Kavooras
(312) 337-0588

Los Angeles 90045

Stanley I. Ehrenclou
Burt Underwood
8939 Sepulveda Blvd.
(213) 641-6544

Texas

Burt Underwood
(213) 641-6544

San Francisco

Robert A. Lukas
3579 Cambridge Lane
Mountain View, CA 94040
(415) 965-2636

London

Constance McKinley
50 Essex St.
Rochelle Park, N.J. 07662
Phone: (201) 843-0550

Amsterdam, Tokyo, Seoul

Sanders, W. J. M.
Raadhuisstraat 24
Graft-De Ryp, Holland
Phone: 02997-1303
Telegrams: Euradteam-Amsterdam

Haruki Hirayama

Electronic Media Service
5th Floor, Lila Bldg.,
4-9-8 Roppongi
Minato-ku, Tokyo, Japan
Phone: 402-4556
Cable: Electronicmedia, Tokyo

Mr. O-kyu Park, President

Dongbo Intl Corp.—
World Marketing
C.P.O. Box 4010
Seoul, Korea
Tel. 76-3910/3911
Cable: DONGBO SEOUL
Telex: EBKOREA K27286

ABP

BPA



Series X-20
Actual Size

WE'RE WARNING YOU...SM

... panel mounting is made very easy with these new piezo crystal audio indicators. They fit a 1.125" (28.6mm) diameter opening in panels as much as 0.125" (3.2mm) thick. Behind panel depth only .500" (12.7mm)! Can be used for computer terminals ... or remote control warning, fault detection and alarm devices ... or to replace other, larger alarms. Continuous tone 35mm diameter sounding element really gets attention. Rated to 85 dbA at 3.3 kHz; 6 to 16 vdc; current drain just 10 mA. Terminals accept 0.187" (4.76mm) disconnects, screws or solder. Ask for free catalog and a demonstration.

Where to buy an audio indicator for every need:



projects[®]
unlimited

3680 Wyse Road, Dayton, Ohio 45414
Tel. (513) 890-1918, TWX 810-450-2523

Distributors throughout the world.

CALIFORNIA, COSTA MESA
MarVac Electronics

COLORADO, DENVER
Waco Electronics Inc.

MASSACHUSETTS, SHARON
Adcour

MICHIGAN, FARMINGTON
CMP Distributor Co.

MISSOURI, ST. LOUIS
Olive Industrial Elec.

NEW YORK, ROCHESTER
Ossmann Component Sales

OHIO, CLEVELAND
CMP Distributor Co.

OHIO, CINCINNATI
COLUMBUS
Hughes Peters, Inc.

TEXAS, DALLAS
K. A. Electronic Sales

UTAH, SALT LAKE
Newark Electronics

WASHINGTON, SEATTLE
Frank Jackson & Associates

WISCONSIN, MILWAUKEE
Taylor Electric Co.

B. C., VANCOUVER
Deskin Sales Corp.

ONTARIO, TORONTO
Deskin Sales Corp.

ONTARIO, WILLOWDALE
Electro Sonic, Inc.

QUEBEC, MONTREAL
Deskin Sales Corp.

CIRCLE NUMBER 86



**7th International Trade Fair
for Components and
Production Facilities
Munich - Fair Grounds
25 November - 1 December
1976**

electronica 76

**7th International
Congress
on Microelectronics
29 November -
1 December 1976**

electronica 76 - Coupon
Please submit further information

Name

Address

Münchener Messe- und Ausstellungsgesellschaft mbH, Postfach 12 10 09,
D-8000 München 12, Tel. (089) 51 07-1

CIRCLE NUMBER 87

Bulletin Board

Hewlett-Packard has announced a full-service equipment lease plan for programmable desktop calculator systems and their peripherals.

CIRCLE NO. 367

Stackpole's resistor networks come in 64 standard resistance values, ranging from 33 Ω to 270 k Ω , and are being offered in 4, 6, 8, 10 and 12-pin single-in-line packages and 14 and 16-pin DIPs.

CIRCLE NO. 368

Economical data communications at up to 4800 baud between a headquarters general-purpose system and a network of Condon intelligent terminals is a feature of the DATAFLOW communications software package from Codon Corp.

CIRCLE NO. 369

Gnostic Concepts has announced the first data base of computer installations available on an on-line basis. The census of computer sites covers 39 criteria for the United States EDP marketplace.

CIRCLE NO. 370

Diversified Data Systems has several new software products for both the 16-bit and 32-bit computer series of Interdata minis. The firm's standard IBOLS-16 package has been modified to operate under the new OS16/MT-II standard Interdata operating system. There is also a new file manager for the 32-bit computers.

CIRCLE NO. 371

Kollmorgen Corp.'s Photocircuits Div. has announced a new production group to manufacture CC-4® Additive Multilayer boards, which offer high-density packaging capabilities. Three and four-layer additive multilayer boards fill the gap between two-sided PCBs and multiwire boards, in high-density applications.

CIRCLE NO. 372

Vendors Report

Annual and interim reports can provide much more than financial position information. They often include the first public disclosure of new products, new techniques and new directions of our vendors and customers. Further, they often contain superb analyses of segments of industry that a company serves.

Selected companies with recent reports are listed here with their main electronic products or services. For a copy, circle the indicated number.

Harris Corp. Communications and information-handling products.

CIRCLE NO. 373

Scientific Atlanta. Communications, electronic test instruments and electromechanical products and enclosures.

CIRCLE NO. 374

System Development Corp. Automated systems.

CIRCLE NO. 375

Sparton Corp. Electronic products, automotive products and oil and gas exploration.

CIRCLE NO. 376

Methode Electronics. Printed circuits, connectors, switches, busbars and backplanes.

CIRCLE NO. 377

National CSS. Time-sharing services.

CIRCLE NO. 378

Rapidata. Remote access computer services.

CIRCLE NO. 379

Comsat. Communications satellite services.

CIRCLE NO. 380

AMP. Electrical and electronic connection, switching and programming devices; application tooling and power units.

CIRCLE NO. 381

Eastman Kodak. Photographic films, papers, chemicals and equipment; man-made fibers, chemicals and plastics, and R&D.

CIRCLE NO. 382

Electronic Design

ELECTRONIC DESIGN's function is:

- To aid progress in the electronics manufacturing industry by promoting good design.
- To give the electronic design engineer concepts and ideas that make his job easier and more productive.
- To provide a central source of timely electronics information.
- To promote communication among members of the electronics engineering community.

Want a subscription? ELECTRONIC DESIGN is sent free to qualified engineers and engineering managers doing design work, supervising design or setting standards in the United States and Western Europe. For a free subscription, use the application form bound in the magazine. If none is included, write to us direct for an application form.

If you do not qualify, paid subscription rates are as follows: \$30.00 per year (26 issues) U.S., \$40.00 per year (26 issues) all other countries. Single copies are \$2.00 U.S., \$3.00 all other countries. The Gold Book (27th issue) may be purchased for \$30.00 U.S. and \$40.00 all other countries.

If you change your address, send us an old mailing label and your new address; there is generally a postcard for this bound in the magazine. You will have to requalify to continue receiving ELECTRONIC DESIGN free.

The accuracy policy of ELECTRONIC DESIGN is:

- To make diligent efforts to ensure the accuracy of editorial matter.
- To publish prompt corrections whenever inaccuracies are brought to our attention. Corrections appear in "Across the Desk."
- To encourage our readers as responsible members of our business community to report to us misleading or fraudulent advertising.
- To refuse any advertisement deemed to be misleading or fraudulent.

Microfilm copies are available of complete volumes of ELECTRONIC DESIGN at \$19 per volume, beginning with Volume 1, 1952 through Volume 20. Reprints of individual articles may be obtained for \$3.00 each, prepaid (\$5.00 for each additional copy of the same article) no matter how long the article. For further details and to place orders, contact the Customer Services Department, University Microfilms, 300 North Zeeb Road, Ann Arbor, Michigan 48106 telephone (313) 761-4700.

Want to contact us? If you have any comments or wish to submit a manuscript or article outline, address your correspondence to:

Editor
ELECTRONIC DESIGN
50 Essex Street
Rochelle Park, N.J. 07662



Electronic Design BEATS Electronics IN BRITAIN!

INDEPENDENT READERSHIP STUDY IN BRITAIN SHOWS ELECTRONIC DESIGN BEST READ AMONG ALL U.S. AND INTERNATIONAL PUBLICATIONS

A recent series of face-to-face, in-plant, interviews with 613 chief design engineers and design engineers in 188 geographical locations throughout England, Scotland and Wales shows that your magazine, *Electronic Design*, leads all U.S. and international electronics publications in every readership measurement tested.

- ELECTRONIC DESIGN LEADS IN "AVERAGE ISSUE" READERSHIP
- ELECTRONIC DESIGN LEADS IN "ANY ISSUE" READERSHIP
- ELECTRONIC DESIGN LEADS IN ALL INDUSTRY SECTORS MEASURED
- ELECTRONIC DESIGN LEADS IN BOTH SMALL AND LARGE PLANTS

The study was commissioned by Morgan-Grampian (Publishers) Ltd. and was conducted by NOP Market Research Ltd. It's the first study ever to be carried out on such a scale for Britain's electronics industry.

If your company markets in Europe, you need make no more assumptions. There's no more guessing. Despite claims, *Electronic Design* leads McGraw-Hill's *Electronics* by 38/26, 32/26 and 40/25 on average issue readership, average issue readership in small plants, and average issue readership in large plants. Among those design engineers in Britain who read any publication at all, *Electronic Design* won 62/53 over *Electronics*.

So pass the word to your sales and marketing people. If your company wants to reach engineers, like you, in Europe, *Electronic Design* is the way to travel. Copies of the complete study available on request.

Electronic Design

BEST READ ELECTRONICS MAGAZINE IN THE WORLD



MINIATURE CERAMIC TRIMMER CAPACITORS 9371 series of ceramic trimmer capacitors are compact, economical and rugged. They are 50% smaller than other trimmers of this type yet provide high capacitance values. Available in 4 capacitance ranges, 1.5 to 4, 3.0 to 10, 3.5 to 18 and 5.0 to 25 pf with Q's > 300 at 10 MHz. They have an overall diameter of .225" with .215" above board height. **JOHANSON MANUFACTURING CORPORATION**, Rockaway Valley Road, Boonton, N.J. 07005 201-334-2676

TRIMMER CAPACITORS

181

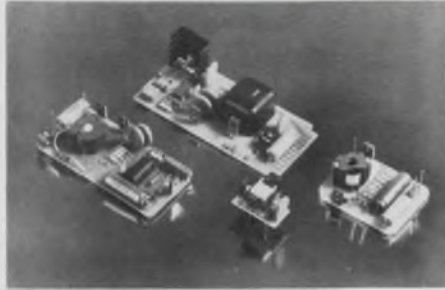

Activate gas discharge readouts! Custom designed and produced DC-to-DC power supplies to activate gas discharge displays, or for other applications. Regulation I/O options, packaging (encapsulated, aluminum shell or open frame), size and configuration, heat dissipation, mounting (PC board pins, edge connectors), etc., can be tailored to meet individual specifications. Price and delivery discussed after specifications are submitted. **Endicott Coil Co., Inc.**, 31 Charlotte Street, Binghamton, N.Y. 13905 (607) 797-1263.

CUSTOM DESIGNED POWER SUPPLIES 184



Free New '76 catalog contains over 34,500 quality power supplies from the world's largest manufacturer, Power/Mate Corp. Power Supplies for every application including submodulars, open frame, variorated, encapsulated, laboratory & system. All units UL approved and meet most military and commercial specs for industrial and computer uses. **Power/Mate Corp.**, 514 S. River St., Hackensack, N.J. 07601 (201) 343-6294

POWER SUPPLIES

187



SIGNALITE APPLICATION NEWS is used to communicate new and proven techniques and applications of Signalite's Neon Lamps and Gas Discharge Tubes. **GLOW LAMPS—DESIGN OPERATION AND APPLICATION** covers neon lamp construction, operational characteristics and applications. **SIGNALITE NEON GLOW LAMPS** literature details specifications on the full line of circuit components, voltage regulators and indicators. Signalite, Neptune, New Jersey 07753 (201) 775-2490

NEON GLOW LAMPS

182



The **TELCON TM-1200** is a quality FSK data Modem designed for asynchronous operation up to 1800 PBS. The Modem is available as a low profile desk top unit, in rack mount or in basic card configuration for OEM applications. All units comply with EIA standard RS-232 and are compatible with existing WE-202D models. Active integrated filter networks are used with excellent long term stability. All units are 100% burned-in. Price 1-9 \$365.00. **Telcon Industries**, Fort Lauderdale, Florida 305-971-2250.

MODEM

185

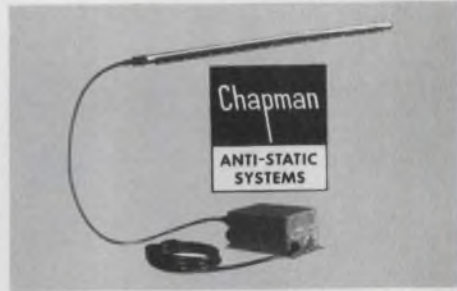

ANTI-STATIC SYSTEMS FOR PRINTERS OCR COM and other machines. Static causes rapidly moving paper and film to jam. . . cause arc tracks on undeveloped film. . . attract and hold dust to photographic negatives causing imperfections on printed circuit boards. Numerous products, of interest to both OEM and user are detailed in new 32 page catalog to solve these problems quickly, reliably and economically. **Chapman Anti-Static Div.** Portland Co., 58 Fore St., Bx 427, Portland, ME 04112. (207) 773-4726

ANTI-STATIC SYSTEMS

188



FREE HIGH VOLTAGE CAPACITOR CATALOG. Complete source listings for over 1000 power, pulse, high voltage, and special purpose capacitors and high voltage power supplies in glass, plastic and CP72 styles. Special low inductance types for laser and high energy applications. Many "custom" designs are standard with us. High reliability, long life, moderate cost, and fast delivery assured. To get your catalog, just drop us a line. **Condenser Products Corporation**, P.O. Box 997, Brooksville, FL 33512.

HIGH VOLTAGE CAPACITOR CATALOG 183

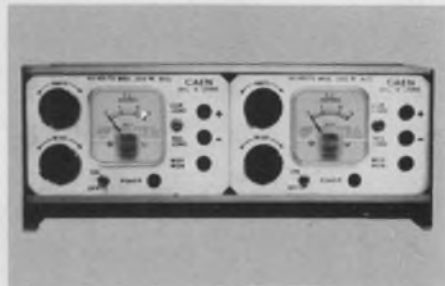

ELECTRONIC LOADS. Five different units available to test power supplies. Up to 25 amps in the single units and 50 amps in the dual by paralleling. Built in modulator for dynamic testing. Single units to 200 watts, dual units to 400 watts. Constant current or resistance selectable from front panel. "Quick," single turn controls for static and dynamic loading. Tests power supplies from 2-40 volts. Prices range from \$99.50-\$350. 30/60 days. **CAEN ENGINEERING**, 722B W. CHAPMAN, ORANGE, CA 92668 (714) 997-2751.

POWER SUPPLY TESTERS

186



Free 32 Page Catalog

WINDOWS - PLATES DISCS - OPTICS

Fused quartz, optical glasses, pyrex Ultra low expansion materials, highly resistant to thermal shock. High UV and IR transmission. Chemically inert to most corrosive materials. Stocking center for lenses, prisms and laser accessories.

Complete fabricating facilities

ESCO PRODUCTS

181 Oak Ridge Rd., Oak Ridge, N.J. 07438

(201)697-3700

LENSE, PRISM CATALOG

189



MAGNETIC SHIELDING Take advantage of Eagle's 23-year background in shield design and production. Custom and standard models. Full service includes design, engineering, fabrication, heat treating, finishing, testing. Also wide selection of sheet and foil so you can form your own shields. For helpful design and cost data, request Bulletin E-77. Eagle Magnetic Co., Inc., Box 24283, Indianapolis, IN 46224, 317-297-1030.

MAGNETIC SHIELDING 190



Krohn-Hite Model 5800A function generator, budget priced at \$245, offers sine, square and triangle waveforms over a range of 0.2 Hz to 2 MHz. Distortion is typically less than 0.3%. Simple 1000:1 frequency tuning dial. Pushbutton controls. 50-ohm output adjustable from 5 mv pk-to-pk to 15 volts. Auxiliary 1-volt pk-to-pk square wave output. Stock delivery. KROHN-HITE, AVON INDUST. PARK, AVON, MA 02322

FUNCTION GENERATOR 193



Overcurrent Protector, manual reset eliminates fuse replacement. Convenient panel mounting. 19 fractional ratings from 0.1 to 5 amp. Other models up to 400 amp. Trip-free and fool-proof, UL and CSA approved. High quality, low cost \$1.33 ea. in 1000 lots. E-T-A Products Co. of America, 7400 N. Crounse Rd., Chicago, Ill. 60648. Tel: (312) 647-8303. Telex: 253780.

CIRCUIT BREAKER 196



Rugged and low-cost 36-pin connector. Superbly designed and produced with simplified construction. Cut your costs up to 50%. Moisture-resistant glass-filled nylon insulator. Recessed contacts in both male and female housings. Hood provides positive cable strain relief. Interchangeable. E. F. Johnson Co., Waseca, MN. (507) 835-2050.

CONNECTOR 191

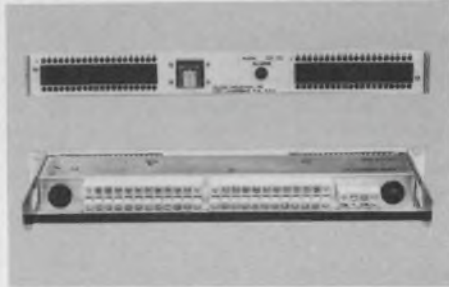

The CDF-90 offers 40 fused lines. It is designed for mounting in a standard 19 inch rack and takes only 1-3/4 inches of vertical space. Mounting flanges adjustable. If a fuse blows, a front panel alarm lights and external alarm output is energized. The fuse panels are compatible with all commonly used battery-supply voltages 24, 48, 60 and 130 volts. Available with 2 alarm indicators and 2 relays for split voltage applications. From stock—two weeks \$275. Telcon Industries, Inc., Fort Lauderdale, Florida 305-971-2250.

FUSE PANELS 194

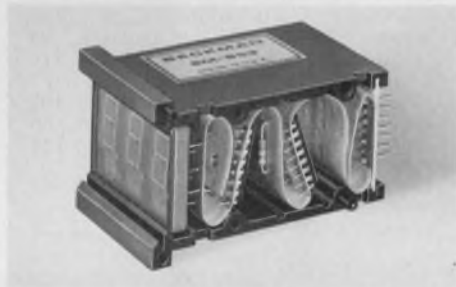

New way to pack added security into your design. R/flex circuits do several jobs at once and accordion fold to fit. Eliminate multiple circuit boards and jumpers; mount components directly on circuit. Made in 1 to 6 layers, various sizes and shapes, with or without plated-through holes. Rogers Corp., Chandler, AZ 85224 (602) 963-4584. (EUROPE: Mektron NV, Ghent, Belgium; JAPAN: Nippon Mektron, Tokyo)

FLEXIBLE CIRCUITS 197

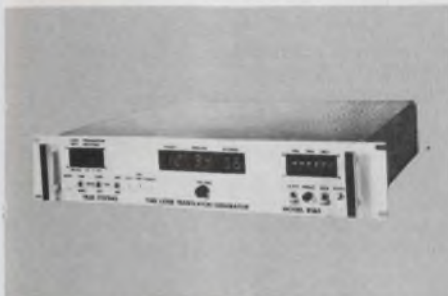

MODEL 8363 TIME CODE TRANSLATOR/GENERATOR operates on external 1 MHz standard or optional 1 MHz internal standard. Automatic WWV synchronization included. Time of day on six 0.6-inch planar displays. Code input formats include IRIG A, B, G, NASA 36, XR3, and 2137. Time generation continues with loss of input code. Numerous options and formats available. TRAK Systems, 4722 Eisenhower Blvd., Tampa, FL 33614. 813-884-1411. Telex 52-827.

TRANSLATOR/GENERATOR 192



THERMOCOUPLE REFERENCE JUNCTION Miniature electronic unit maintains reference over wide ambient range with high accuracy. Microwatt power consumption and light weight make it ideal for designing into instrument equipment. Available for all thermocouple materials and power sources. Any reference temperature setting required can be supplied. Thermocouple system calibrators and signal conditioning amplifiers also available. Send for lit. or call 516-249-4244. Hades Mfg. Corp., 151A Verdi St., Farmingdale, NY 11735.

THERMOCOUPLE JUNCTION 195



THE NEW CATCH-A-PULSE LOGIC PROBE compatible with RTL, DTL, TTL, CMOS, MOS & microprocessor using a 3.5V to 15V power supply. Automatic thresholds & auto reset memory. No adjustments. Visual indication of logic levels showing HI, LO, pulses (60 NSec) or open circuits. \$24.95. AVR Electronics, P.O. Box 45167, San Diego, CA 92145. (714) 566-1570

LOGIC PROBE 198

Advertiser's Index

| Advertiser | Page | Advertiser | Page | Advertiser | Page |
|--|----------|--|------------|---|-----------|
| AP Products Incorporated..... | 106 | Digital Equipment Corporation..... | 51 | Penntube Plastics Co., Inc..... | 99 |
| AMP, Incorporated | 4, 5 | EECO | 21 | *Philips Electronic Components and Materials | 18 |
| AVR Electronics | 117 | E-T-A Products Co. of America..... | 117 | Portland Co., Inc..... | 116 |
| Abbott Transistor Laboratories, Inc.... | 6 | Eagle Magnetic Co. Inc..... | 117 | Power/Mate Corp. | 116 |
| Advanced Micro Devices..... | 8, 9 | Electronic Design..32B, 92, 104, 105, 115 | | Premier Metal Products Company.... | 10 |
| Aiken Industries, California Instruments Division | 100 | Electronic Memories & Magnetics Corporation | 76 | Projects Unlimited | 113 |
| Allen Bradley Co..... | 17 | Electronic Navigation Industries..... | 90 | Pro-Log Corporation | 83 |
| American Microsystems, Inc..... | 66 | Electronica 76 | 113 | Pyrofilm Corporation | 15 |
| American Optical Corporation..... | 119 | Endicott Coil Co., Inc..... | 116 | | |
| | | Erie Technological Products, Inc..... | 32A | RCA Solid State..... | Cover IV |
| Bafco, Inc. | 109 | Esco Products | 116 | Rental Electronics, Inc..... | 18 |
| Bell, Inc., F. W..... | 95 | Etatech, Inc. | 44 | Rogan Corporation | 109 |
| Bourns, Inc., Trimpot Products Division | Cover II | | | Rogers Corporation | 117 |
| | | Fairchild Semiconductor, A Division of Fairchild Camera and Instrument Corporation | 71 | | |
| CTS Corporation | 97 | GTE Sylvania, Miniature Lighting Products Div..... | 59 | Sangamo Capacitors, A Division of Sangamo Weston, Inc..... | 1 |
| Caen Engineering | 116 | GTE Sylvania, Parts Division..... | 33 | Schauer Manufacturing Corp..... | 98 |
| Capital Calculator Company..... | 100 | General Electric Company, Semiconductor Products Department | 31 | Seastrom Manufacturing Co., Inc..... | 108 |
| Clairex Electronics, A Division of Clairex Corporation..... | 61 | Gold Book, The..... | 100, 110 | Signalite | 116 |
| Coherent Radiation, Laser Division.. | 93 | Grayhill, Inc. | 88 | Simpson Electric Company..... | 39 |
| Condenser Products Corporation..... | 116 | | | Sorensen, A Raytheon Company..... | 11 |
| Connecticut Hard Rubber Company, The | 102 | Hades Manufacturing Corporation..... | 117 | Specialized Products Company..... | 96 |
| Continental Specialties Corporation.. | 50 | Hamai Electric Lamp Co. Ltd..... | 107 | Sprague Electric Company..... | 40 |
| Control Data Corporation..... | 119 | Hamamatsu Corp. | 103 | Star Mfg. Co., Ltd..... | 96 |
| Crydom Division, International Rectifier Corporation | 91 | Hayden Book Company, Inc. | 60, 120 | Stanford Applied Engineering, Inc. | Cover III |
| Cutler-Hammer, Specialty Products Division | 22, 23 | Hewlett-Packard | 38, 67, 86 | | |
| | | Industrial Controls Division, General Time | 46 | TRW/IRC Resistors, an Electronic Components Division of TRW, Inc. | 43 |
| Data General Corporation..... | 27 | Intel Corporation | 16A-F, 47 | TRW RF Semiconductors, an Electronic Components Division of TRW, Inc..... | 89 |
| Datak Corporation, The..... | 95 | Instrument Specialties Company..... | 85 | Tektronix, Inc. | 37 |
| Dataroyal, Incorporated | 111 | | | Telcon Industries | 116, 117 |
| Dialight, A North American Philips Company | 95 | Janco Corporation | 113 | Teledyne Relays, A Teledyne Company | 2 |
| | | Johanson Manufacturing Corp..... | 116 | Teledyne Semiconductor | 48 |
| | | Johnson Company, E. F..... | 117 | Telenetics, Inc. | 103 |
| | | | | Texas Instruments, Incorporated..... | 29 |
| | | Kepeco, Inc. | 34 | Trak Systems | 117 |
| | | Keystone Carbon Company..... | 92 | Triple I, A Division of the Economy Co. | 119 |
| | | Krohn-Hite | 117 | Triplet Corporation | 79 |
| | | | | | |
| | | MF Electronics Corporation..... | 12 | United Systems Corporation..... | 109 |
| | | McDonnell Douglas | 119 | Universal Data Systems..... | 13 |
| | | Miller-Stephenson Chemical Co., The | 81 | *U.S. Department of Commerce..... | 17 |
| | | Motorola Communications & Electronics Inc. | 32 | | |
| | | Motorola Semiconductor Products, Inc. | 14, 45 | Varo Semiconductor, Inc..... | 75 |
| | | Mu Pro, Inc. | 101 | Vitramon North America Division of Vitramon Incorporation | 16 |
| | | MuRata Corporation of America..... | 99 | | |
| | | | | Wabash, Inc. | 94 |
| | | Nippon Electric Company, Ltd..... | 77 | Waters Manufacturing, Inc..... | 106 |
| | | | | | |
| | | Optron, Inc. | 7 | | |

classified ads

ELECTRONIC DESIGN ENGINEERS

Challenging work on state of the art television and related equipment, including color, black and white, low light level and video processing. Strong analog and math required.
Circuit Design - BS/MS - EE/Physics
2-5 years experience
Sr. Design - BS/MS
3-10 years experience

Send resume to:
D. O'Connell, Personnel Manager
Cohu Inc.
Electronics Division
P. O. Box 623
San Diego, CA 92112
Equal Opportunity Employer (M/F)

MICROCOMPUTER RENTALS DEVELOPMENT HARDWARE SPECIALISTS

PROM Programmers
Intellex 8's and 4's
EXORcisers
Pro-Log Analyzers
1562 Devonshire Ave.
Westlake Village, CA. 91361
Phone (213) 991-1704

*Advertisers in non-U.S. edition

ELECTRONIC ENGINEERS

McDonnell Douglas Corporation, St. Louis, Missouri, has immediate career opportunities to support programs on F-18, F-15, F-4, AV-8B Harrier V/STOL, Future Tactical Strike, Air Combat and Reconnaissance, Harpoon Tomahawk and Space Shuttle.

AVIONICS

FIRE CONTROL
DIGITAL FLIGHT
CONTROL
COCKPIT DISPLAY
COMPUTER SOFTWARE
INERTIAL GUIDANCE
DIGITAL COMPUTERS
ELECTRO MAGNETICS

TECHNOLOGY

GUIDANCE & CONTROL

AGE

FLIGHT SIMULATOR
SOFTWARE
SYSTEMS

FLIGHT SIMULATION

REAL-TIME,
PILOT-IN-THE-LOOP
SOFTWARE
COMPUTER SOFTWARE
DESIGN
VIDEO SYSTEMS

If you meet the above qualifications, please send your resume in confidence to:

J. H. Diller
Section Manager-Professional Employment
Department ED-11
P. O. Box 516
St. Louis, Missouri 63166

MCDONNELL DOUGLAS
CORPORATION

An Equal Opportunity Employer m/f

CIRCLE NUMBER 95

LOW NOISE MODULAR DESIGN

Switching Power Supplies!

A new line of compact, modular-design switchers that simplify design for 300-600 watt applications and sell for less than 90¢ per watt! End users benefit from low EMI noise levels and highly reliable operation plus easy add-on and maintenance features. Get everything you need to know to evaluate this high quality, money-saving line from:

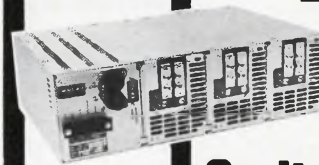

Magnetic Components Group

**CONTROL DATA
CORPORATION**

7801 Computer Avenue South, Minneapolis, MN 55435
(612) 830-5800 TWX 910 576 2978

CIRCLE NUMBER 97



FREE Fiber Optics Catalog

Features the complete AO line of fiber optics products—from Inspection Fiberscopes and Light Guides to Illuminators, Image Conduits, Faceplates and Custom Components. Includes the four newest remote inspection fiberscopes now available.

Describes the principle, technology and techniques used to make flexible light and image transmissions a proven, practical fact. Write today for your FREE copy of the AO Fiber Optics catalog to American Optical Corporation, Fiber Optics Division, Southbridge, Mass. 01550.

AO
American
Optical

CIRCLE NUMBER 96

ELECTRONIC DESIGN 21, October 11, 1976

All-new Phi-Deck,[®] precision remote controlled cassette transports starting at under \$100!

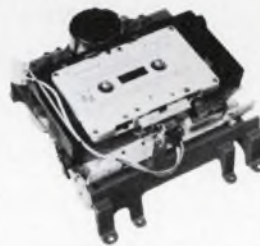

Featuring:

- Re-engineered precision parts
- New cast frames
- 4 motor reliability
- Remotely controlled
- Precise, fast head engage/disengage
- Quick braking
- Various speed ranges

Electronic packages for control or read/write

For application in:

- | | |
|-----------------------------------|---------------------------------------|
| 1. Micro processing | 6. Data duplicating |
| 2. Data recording/logging/storage | 7. Security/automatic warning systems |
| 3. Programming | 8. Test applications |
| 4. Instrumentation | 9. Audio visual/education |
| 5. Industrial Control | 10. Hi-Fi |
| | 11. Others |



Triple I A Division of The Economy Co.

1901 North Walnut P.O. Box 25308
Oklahoma City, Oklahoma 73125 (405) 521-9000

- I am interested in application no. _____
 Have Representative call Send application notes

Name _____ Title _____
Company Name _____
Address _____
City _____ State _____ Zip _____
Phone Number _____

CIRCLE NUMBER 98

Step-by-step coverage of defense radar system design . . .

INTRODUCTION TO DEFENSE RADAR SYSTEMS ENGINEERING

James N. Constant

This all-inclusive handbook covers virtually every facet of radar technology that must be mastered in order to design a complete defense radar system. In fact, it concludes with a step-by-step procedure for specifying and designing a complete radar system for a given application. Separate chapters cover target characteristics; radar detection; radar receivers; radar system error model; flight of a ballistic missile; ballistic reentry trajectories; trajectory prediction; radar data processing; reflector antennas; and array antennas. Order your 15-day examination copy today! #9194, 344 pages, cloth, illustrated, \$22.95



15-DAY FREE EXAMINATION!



Hayden Book Company, Inc.
50 Essex Street
Rochelle Park, N.J. 07662

Please send me my copy of INTRODUCTION TO DEFENSE RADAR SYSTEMS ENGINEERING to read and use for 15 days. At the end of that time, I'll send a check or money order for \$22.95, plus postage and handling, or return the book and owe absolutely nothing.

I want to save money! I have enclosed full amount. Publisher pays postage and handling. I get a complete 15-day money-back guarantee.

Name _____

Firm _____

Address _____

City/State/Zip _____

76-15

Product Index

Information Retrieval Service. New Products, Evaluation Samples (ES), Design Aids (DA), Application Notes (AN), and New Literature (NL) in this issue are listed here with page and Information Retrieval numbers. Reader requests will be promptly processed by computer and mailed to the manufacturer within three days.

| Category | Page | IRN | Category | Page | IRN |
|--------------------------------|------|-----|------------------------------------|------|-----|
| Components | | | Microwaves & Lasers | | |
| buzzers | 96 | 62 | lasers | 93 | 57 |
| capacitors, electrolytic | 60 | 38 | Modules & Subassemblies | | |
| cassette transports | 113 | 88 | control/display module | 101 | 72 |
| conductive plastic elements | 106 | 78 | control transformer, sync | 100 | 339 |
| crystals | 97 | 64 | converter, a/d | 98 | 337 |
| displays, liquid crystal | 111 | 356 | converter, s/d | 101 | 341 |
| isolators, optically-coupled | 7 | 6 | converters, d/s | 99 | 67 |
| lamps, micro-mini | 107 | 79 | driver, d/s | 101 | 340 |
| optoelectronic products | 1 | 2 | oscillator, low-profile | 98 | 334 |
| relays, TO-5 | 2 | 3 | oscillators, crystal-clock | 32 | 23 |
| resistor, DIPs | 15 | 13 | rf linear products | 89 | 52 |
| resistor, variable | 17 | 21 | rf power amplifier | 88 | 51 |
| resistors, film & wirewound | 43 | 22 | regulator control circuit | 45 | 31 |
| switches, DIP | 90 | 53 | Packaging & Materials | | |
| switches, PB | 113 | 87 | aerosols | 81 | 47 |
| switches and relays | 23 | 19 | air conditioners | 103 | 75 |
| switches, optical | 61 | 39 | cabinets and cases | 10 | 8 |
| switches, slide | 111 | 354 | chamber, environmental | 90 | 310 |
| thermistors | 92 | 56 | connectors | 33 | 24 |
| timers, digital | 46 | 32 | elastomer, conductive | 93 | 324 |
| transducers | 95 | 59 | electronic hardware | 108 | 80 |
| T-2 slide-base lamps | 59 | 37 | electronic pack, hardware | III | 263 |
| Data Processing | | | interconnection system | 5 | 4 |
| CRT displays | 38 | 27 | kit, PC | 95 | 60 |
| calculator programmable | 102 | 344 | knobs | 109 | 82 |
| calculators | 100 | 71 | socket, cards & boards | 21 | 17 |
| data modems | 13 | 11 | socket, LED-panel | 93 | 323 |
| floppy-disc drive | 107 | 349 | sockets, zero force | 90 | 308 |
| floppy-disc system | 102 | 342 | tapes, industrial | 102 | 73 |
| modules, FFT | 107 | 348 | tubing, shrinkable | 99 | 68 |
| programmable controller | 102 | 345 | vibrator, miniature | 90 | 309 |
| tape drive, ruggedized | 106 | 347 | Power Sources | | |
| Discrete Semiconductors | | | line corrector, 400 Hz | 94 | 328 |
| LEDs | 95 | 61 | power demand control | 96 | 330 |
| rectifiers, silicon | 75 | 43 | power sources, ac | 100 | 70 |
| Instrumentation | | | power supplies | 6 | 5 |
| analyzer | 88 | 306 | power supplies | 94 | 327 |
| audio indicators | 91 | 54 | power supplies | 97 | 331 |
| counter | 88 | 305 | power supplies | 113 | 86 |
| counters/timers | 109 | 271 | power supplies, digital | 34 | 25 |
| DMM | 87 | 303 | power supply | 94 | 325 |
| digital multimeters | 39 | 28 | power supply | 94 | 326 |
| freq-response analyzer | 109 | 81 | power supply | 96 | 329 |
| logic analyzer | 37 | 241 | power supply | 97 | 332 |
| memory tester | 87 | 302 | power supply, μ Ps | 97 | 333 |
| PROM programmer | 83 | 48 | new literature | | |
| pulse generator | 88 | 307 | computer equipment | 112 | 362 |
| rf amplifier | 87 | 301 | light-sensitive FET | 112 | 360 |
| rental instruments | 18 | 16 | microwaves | 112 | 364 |
| signal generator | 88 | 304 | photosensitive devices | 112 | 365 |
| Integrated Circuits | | | precision instruments | 112 | 361 |
| converter, d/a | 108 | 350 | solders | 112 | 363 |
| detectors, voltage | 108 | 351 | supervisory system | 112 | 366 |
| ICs, CMOS | 108 | 353 | synchro/digital conversion | 112 | 358 |
| reference, precision | 108 | 342 | TV chroma circuits | 112 | 359 |
| Microprocessor Design | | | timing equipment | 112 | 357 |
| development system, μ P | 41 | 507 | | | |
| EPROM programmer | 42 | 508 | | | |
| μ P and support chips | 42 | 509 | | | |

Who provides the industry's broadest line of electronic packaging hardware ... including Back Panels?

SAE does! And we offer several styles for your greater design flexibility. You now have the option of discrete connector or pin-in-board assemblies, with either open, closed or universal entries; or metal back planes on .100" or .200" grid, conforming to NAFI MIL specs.

Our PDQ™ pin-in-board back panels feature pairs of pins pressed automatically into a circuit board on .100" x .100" thru .156" x .200" centers, allowing any connector configuration or length desirable. This technique lets you choose the exact number of pins desired with no need for concern as to the availability of standard, off-the-shelf connectors.

Wave-soldering is completely eliminated and all required connections to voltage, ground and signal traces can be accomplished by the gas-tight joint. Available in both short tail and 3-level wrap versions, other features include an extra-large throat opening, polarizing keys, and easy pin replacement. Incidentally, this PDQ concept is particularly well-suited to multilayer panel applications.

Our new 128 page packaging handbook gives complete details, and also describes our entire line of electronic packaging and interconnection hardware.

™ -Stanford Applied Engineering, Inc.

For an immediate reply, call the following toll-free "ZIP QUOTE" number at the factory ... 800-538-6843.

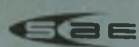

Stanford Applied Engineering, Inc.

340 Martin Ave., Santa Clara, CA 95050
(408) 243-9200 TWX 910-338-0132

What's new in solid state ...

RCA BiMOS op amps. They mix technologies to match circuit needs.



BiMOS was born with our CA3100. On a single chip we combined Bipolar with PMOS—for a more cost-effective wide-bandwidth op amp.

Next, the versatile 3130. With FET, Bipolar and

CMOS, it can do a tremendous variety of jobs well.

Latest arrival: our 3140. The most useful op amp since the 741. Able to fill the great mass of op amp sockets, thanks to MOS/FET input and Bipolar output.

Low-cost, no-compromise circuits

BiMOS gives you the best from each technology without the drawbacks. So you can select op amps with exactly the characteristics you need. A single op amp can often do jobs that ordinarily require many more parts. And that ability opens up new cost-saving ways to meet circuit needs.

Why pay more than you have to for your circuit? Check into BiMOS. Contact your RCA Solid State distributor. Or RCA.

Write: RCA Solid State, Box 3200, Somerville, N.J. 08876; Sunbury-on-Thames, Middlesex TW16 7HW, England; Ste. Anne de Bellevue H9X 3L3, Canada; Fuji Bldg., Tokyo, Japan.

| Op amp category | What BiMOS contributes | RCA device |
|------------------------------|--|----------------------------|
| General Purpose | Wide applicability Low cost. | CA3140 CA3130 |
| FET Input | Lower device cost. Reduced circuit cost. Large input voltage range: capability of swinging to 0.5V below rail. | CA3140 CA3130 |
| Wideband 4.5 to 70 MHz | High slew rate with low ringing. | CA3140 CA3130 CA3100 |
| Micropower down to 1.5 mW | Strobability. | CA3130 |
| High Current up to 22mA | Eliminates driver stage Low device cost. Rail-to-rail output swing | CA3130 |

RCA



RCA. Full house in Linear ICs.