

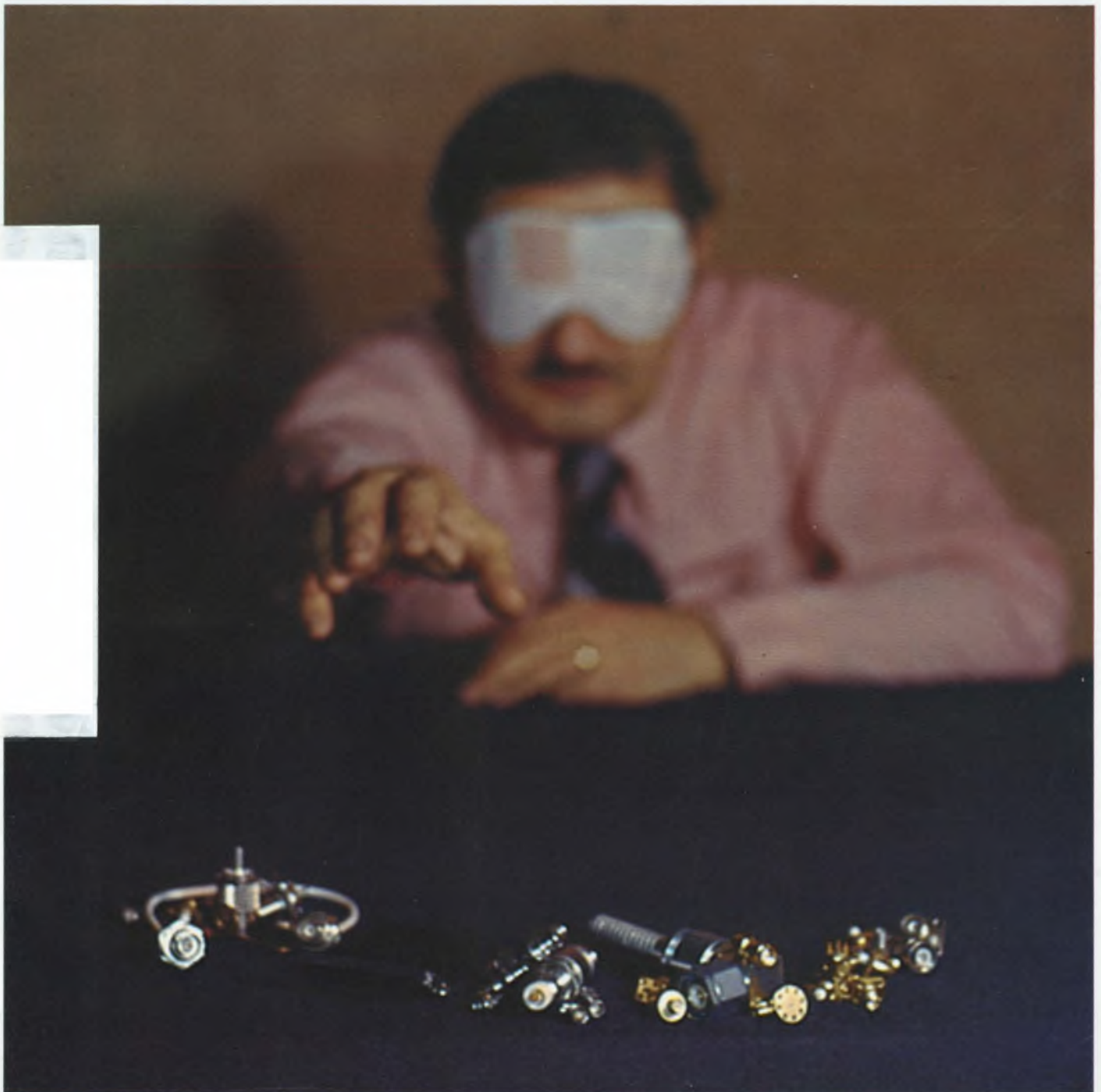

Choosing rf connectors blindly can cost you dearly. Not all jobs need impedance matching. And connectors have less loss and rf leakage than most cables.

But when needed, precision units abound. Solder, clamp or crimp? Bayonet, threaded or self-locking? Choices must be made. Make them without blindfolds. P. 60.



Unique wrap-around wiper offers superior setting stability...



Wrap-around, multi-finger wiper reduces contact resistance variation and open circuit problems. Micro-photograph shows trimmer wiper magnified 28X.

... here today at no extra cost in every Trimpot® Potentiometer

Bourns multi-fingered, wrap-around wiper design delivers more consistent, more reliable performance. More stable during setting ... more stable in your circuit.

The unique wrap-around design significantly reduces CRV fluctuations and open circuit problems due to thermal and mechanical shock ... by maintaining a constant wiper pressure on the element. As you can see in the enlarged photograph of a sectioned single-turn trimmer, the wiper is shaped so that its upper section works somewhat like a lever arm, keeping the contact fingers under constant tension.

Bourns wrap-around wiper design is essentially self-aligning and self-retaining. Therefore, more reliable ... because there is very little chance of error during manufacture. Designs that do not "wrap-around" usually require very critical heat-staking procedures to lock the wiper into a plastic slot in the rotor (slider). Our tests indicate that such designs are much less resistant to thermal and mechanical shock, and are often mis-assembled.

HERE'S PROOF:

Send for a copy of our new engineering report on TRIMMER PERFORMANCE. Tell us about your application, and we'll provide qualification samples that best suit your needs.

Bourns reliability is available at ordinary prices ... off-the-shelf from nearly 100 local distributor inventories ... plus our largest-ever factory stock. TRIMMER PRODUCTS, TRIMPOT PRODUCTS DIVISION, BOURNS, INC., 1200 Columbia Avenue, Riverside, California 92507. Telephone 714 781-5320 — TWX 910 332-1252.

Swage-Bond™ ... a revolution in trimmer reliability



Bourns exclusive Swage-Bond process virtually eliminates pin termination failure ... and provides a marked improvement in temperature coefficient consistency. In the Swage-Bond process, the P.C. pins are secured through the trimmer substrate, with a high-pressure compression swage on both the top and bottom sides. The pressure locks the pins solidly into the element, and thoroughly bonds them to the termination material. Compare Swage-Bond™ to less reliable clip-on termination designs.

The seal that seals ... without springback



Bourns trimmers stay sealed when others fail. We know. We've tested them all. Bourns uses a chevron-type sealing technique, that seals without O-rings ... eliminating the windup and springback that frequently occurs with such seals. The result is faster and more precise adjustability ... with a seal that really works.



International: HQ Switzerland, 042/23 22 42 • Belgium 02/218 2005 • France 01/2039633 • Germany 0711/24 29 36 • Italy 02/32 56 88 • Netherlands 070/88 93 18 • United Kingdom 01/572 6531 • Japan 075 92 1121 • Australia 86 9410 • Brazil 257-3535 • India 373 544

SURPRISE!

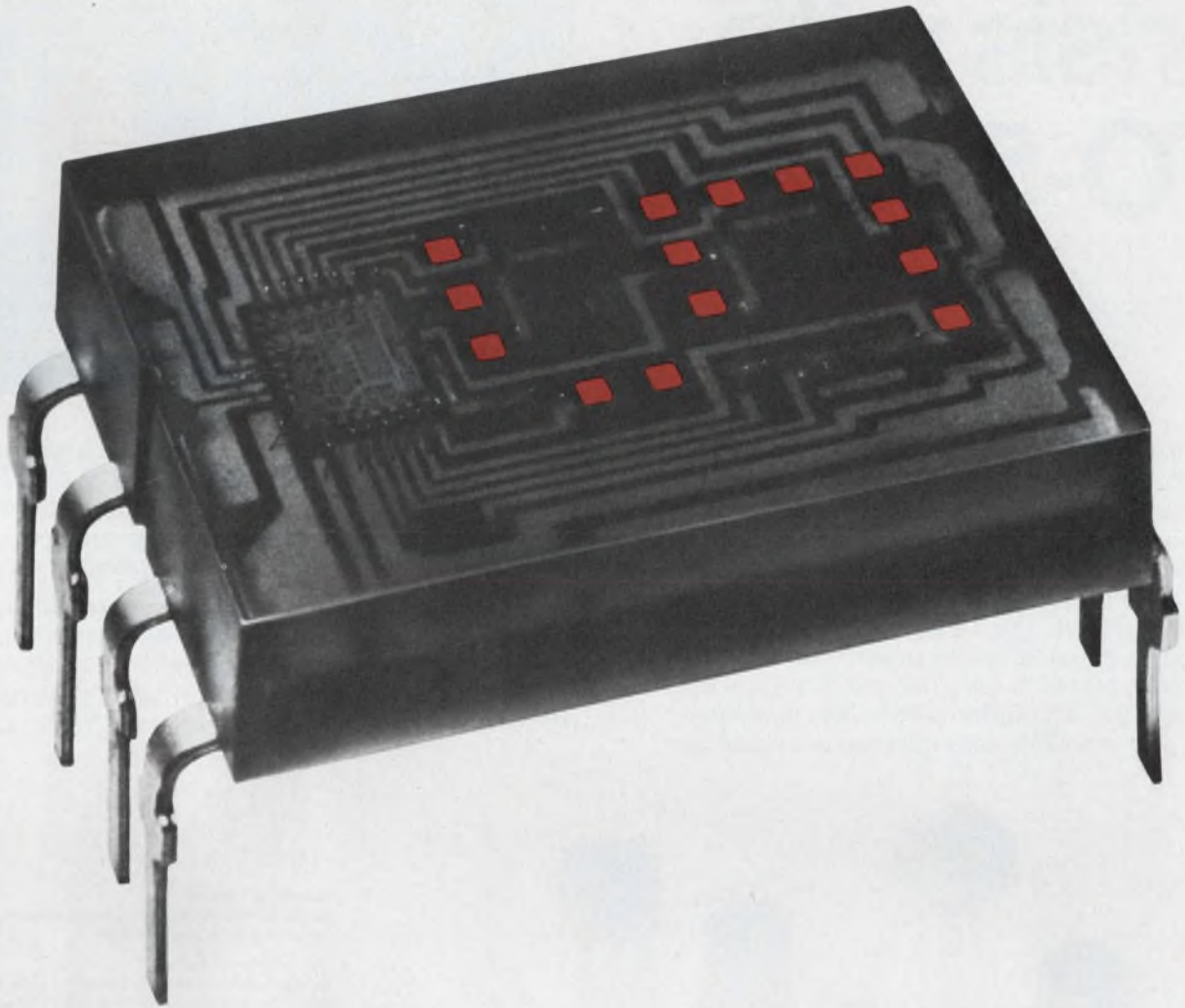

We built in the decoder/driver so you don't have to.

Not only the decoder driver but memory too!

HP's family of integrated displays was designed with an on-board IC to save you time and up to 50% of the space required by conventional LED display systems. These bright 0.29 inch high, shaped character displays are completely TTL compatible. All you do is address them directly with four-line BCD input.

HP's 5082-7300 series displays include numeric displays with right- or left-hand decimal points, a hexadecimal display (0-9, A-F), and a "±1" polarity/overflow indicator.

For immediate delivery of any quantities you need, call Hall-Mark, Schweber, Wilshire, or the Wyle Distribution Group (Liberty/Elmar) today.

01329A

HEWLETT  PACKARD

Sales, service and support in 172 centers in 65 countries
Palo Alto, California 94304 Offices in principal cities throughout the U.S.

CIRCLE NUMBER 2

TO-5 RELAY UPDATE:

Solve your energy crisis with TO-5 relays

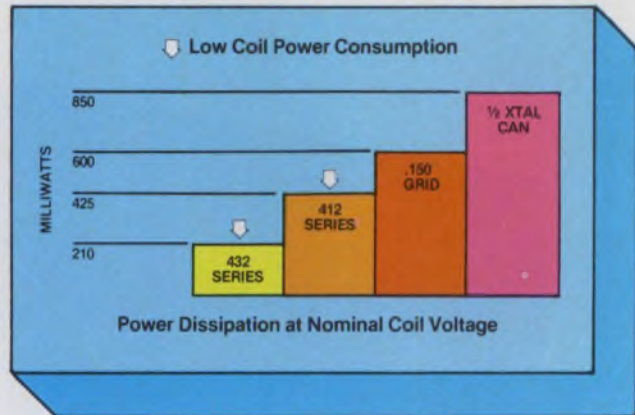

Subminiaturization and pc board compatibility — two obvious advantages of Teledyne TO-5 relays. But there's another outstanding advantage: low coil power consumption. This feature is best illustrated in the above graph which shows our TO-5 relay power savings compared to other miniature relays. The Teledyne 412 Series dissipates about 30% less power than the .150" grid relay, and 50% less than the 1/2 crystal can. Our sensitive 432 Series is 65% less than the .150" grid. And 75% less than the 1/2 crystal can.

This means you can save over 6 watts in a typical system using, let's say, ten TO-5 relays. In the end, you gain significant advantages in terms of thermal and power supply considerations that can help prevent an "energy crisis" in your system.

Our complete line of TO-5 relays includes military and commercial/industrial types, with virtually all military versions qualified to established reliability MIL specs. For complete data, contact Teledyne Relays — the people who pioneered the TO-5 relay.

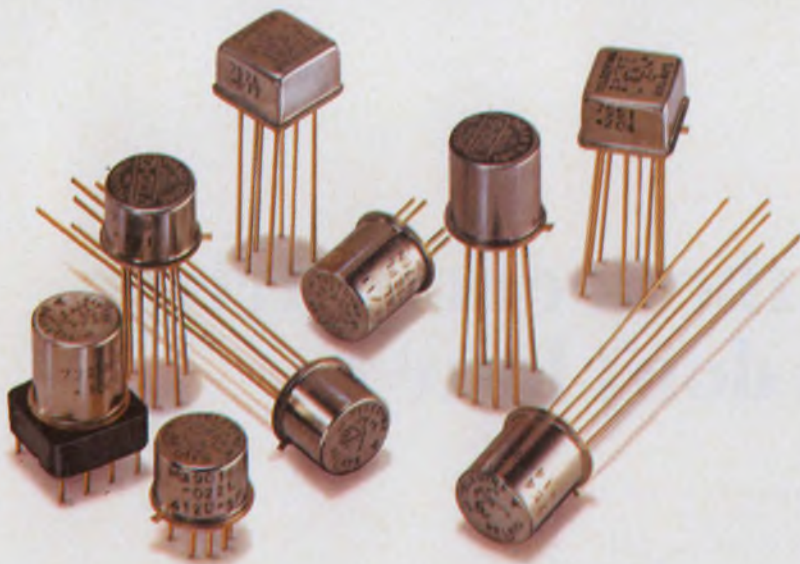

- **Hybrid "T" Series**
SPDT & DPDT types with internal transistor driver and suppression diode
- **"D" and "DD" Series**
Military and commercial/industrial versions with internal suppression and steering diodes
- **Maglatch Series**
SPDT, DPDT, and 4PST magnetic latching types
- **Centlgrid® Series**
World's smallest relay — only .225" (5.72mm) high x .370" (9.40mm) square
- **Hi-Rel Series**
Screened versions for space flight applications (NASA qualified)
- **High Environment Series**
Hi-temperature, Hi-shock, and Hi-vibration types

 **TELEDYNE RELAYS**

3155 West El Segundo Boulevard, Hawthorne, California 90250
Telephone (213) 973-4545

CIRCLE NUMBER 3

NEWS

- 21 **News Scope**
- 26 **The latest computerized X-ray scanning systems** are providing 3-D views of the whole body.
- 30 **Analog servo system** 'puts' live actors into miniature sets.
- 32 **Thermal printer plus μ P** equals simplified circuitry.
- 39 **Washington Report**

TECHNOLOGY

- 47 **MICROPROCESSOR DESIGN**
- 60 **FOCUS of rf connectors:** A breed apart from low-frequency connectors, rf types can introduce problems such as leakage and poor VSWR, especially in the GHz range. Thus, blind selection can be an expensive mistake.
- 72 **To compare electrical insulators** you must look at specs like dielectric strength, dielectric constant, dissipation factor and arc resistance.
- 78 **Parallel-coupled-microstrip-line geometry** is easy to determine with nomograms. Specialized charts for alumina substrates make the work even easier.
- 84 **Wiring for high-speed circuits** needs special treatment. Otherwise signal reflections and delays can distort signals and impair performance.
- 88 **Taro Kuninobu of Matsushita** speaks on managing by the managed.
- 94 **Ideas for Design:**
 - Phase-locked-loop circuit multiplies frequencies by 2 to 256.
 - Current-controlled bandpass filter can be built with only one IC.
 - Photoresistor provides automatic dimming of electronic display systems.
 - Accumulate and trap data in counters while their outputs remain constant.
- 104 **International Technology**

PRODUCTS

- | | |
|-----------------------------|-----------------------------|
| 107 Components | 128 Power Sources |
| 110 Integrated Circuits | 131 Data Processing |
| 114 Packaging & Materials | 134 Modules & Subassemblies |
| 122 Microwaves & Lasers | 137 Instrumentation |
| 125 Discrete Semiconductors | |

DEPARTMENTS

- | | |
|---|--------------------------------|
| 57 Editorial: Shooting at the wrong target | |
| 7 Across the Desk | 146 Advertisers' Index |
| 138 New Literature | 148 Product Index |
| 141 Evaluation Samples | 148 Information Retrieval Card |
| 141 Vendors Report | |

Cover: Photo by Art Director, Bill Kelly. Rf connectors courtesy of Amp Inc., Bunker Ramo RF Div., Lemo USA, Inc., Omni Spectra, Inc., Sealectro Corp., and Solitron/Microwave.

Performance For All Your Portable

Tektronix offers an unmatched selection of performance and value leading portable oscilloscopes. Wherever and whatever your portable oscilloscope application, you can choose the best cost/performance/weight combination for your needs from our comprehensive line of 16 models. These include the industry standard 465 (line 6 of the table) and such unique products as the 350 MHz 485, the 466 fast transfer storage oscilloscope with a 1350 cm/ μ s stored writing rate, the 3.5 pound 213 which combines a full function DMM with an oscilloscope, and 7 other extremely lightweight 200 and 300 series models.

Maximum Portability

The wide bandwidth (up to 350 MHz), dual-trace, delayed sweep 400 Series offers seven high performance models for complex measurements on such systems as computers, communications gear, and radar. At 21 to 26 pounds, this series provides excellent performance and weight characteristics.

Tektronix offers the most compact, lightweight line of oscilloscopes anywhere with the 200 Series at 3.5 pounds and the 300 Series at 7 to 10.5 pounds.



Storage Leadership

The world's fastest direct view storage is provided by the 466 which stores even single-shot events at its full 100 MHz bandwidth. Tektronix also offers the lightest weight storage by a wide margin with the 500 kHz 214 Portable Storage Oscilloscope at 3.5 pounds and the 10 MHz model 314 at 10.5 pounds.

A Choice of Numerical Readout Models

Only Tektronix gives you a choice of four portable oscilloscopes with direct numerical readout of displayed time intervals (464 DM43, 465 DM43, 466 DM43, 475 DM43). In addition to providing faster, more repeatable, easier timing measurements, these models also measure dc volts, ohms, and temperature.

Ruggedness for Field Use

To insure reliable operation under the rough handling and hostile environment encountered in the field or in production areas, TEKTRONIX Portable Oscilloscopes must pass stringent shock and vibration tests as well as subjection to extremes of temperature (-15° to $+55^{\circ}$ C) and humidity. They are also designed for minimum temperature rise to insure maximum component life.

All TEKTRONIX Portables offer battery power internally or as an option.

Highest Bandwidth of Any Portable

Portable oscilloscope bandwidth is extended to 350 MHz at 5 mV/div by the 485. The highest gain-bandwidth of any portable is achieved by the 475 with 200 MHz at 2 mV/div. Both are excellent choices for measurements on fast logic signals.



485



335



465

Leadership Oscilloscope Needs

Widest Selection of Portable Oscilloscopes

	Product	BW	Dual Trace	Delayed Sweep	Fastest Sweep Rate	Other Special Features	Price
Storage Models	466 & 464	100 MHz @ 5 mV/div	yes	yes	5 ns/div	Stored writing speed to 1350 cm μ s	\$4600/ \$3850
	434	25 MHz @ 10 mV/div	yes		20 ns/div	Split screen storage	\$3000
	314 (NEW)	10 MHz @ 1 mV/div	yes		10 ns/div	Only 10.5 lbs.	\$2235
	214	500 kHz @ 10 mV/div	yes		1 μ s/div	Only 3.5 lbs.	\$1350
Nonstorage Models	485	350 MHz @ 5 mV/div	yes	yes	1 ns/div	Widest BW in a portable	\$4900
	475	200 MHz @ 2 mV/div	yes	yes	1 ns/div	Highest gain-BW in a portable	\$3200
	465	100 MHz @ 5 mV/div	yes	yes	5 ns/div	Cost effective for 100 MHz BW	\$2145
	455 (NEW)	50 MHz @ 5 mV/div	yes	yes	5 ns/div	Cost effective for 50 MHz BW	\$1745
	335 (NEW)	35 MHz @ 10 mV/div	yes	yes	20 ns/div	Only 10.5 lbs.	\$1875
	326	10 MHz @ 10 mV/div	yes		100 ns/div	Only 10 lbs.	\$1875
	323	4 MHz @ 10 mV/div			500 ns/div	Only 7 lbs.	\$1300
	221	5 MHz @ 5 mV/div			100 ns/div	Only 3.5 lbs.	\$900
	213 (NEW)	1 MHz @ 20 mV/div			400 ns/div	DMM/Oscilloscope @ 3.7 lbs.	\$1350
	212	500 kHz @ 10 mV/div	yes		1 μ s/div	Only 3.5 lbs.	\$950
	D32 (NEW)	10 MHz @ 10 mV/div	yes		100 ns/div	Low cost for 10 MHz dual-trace & battery	\$750
	Time Interval Readout	DM43	Optional direct numerical readout of time intervals and DMM functions for 464, 465, 466, and 475 models.				

Let Us Show You

For a demonstration of how one of the above Portable Oscilloscopes can achieve results in your application, contact your Tektronix Field Engineer. Or for our latest Portable Oscilloscope brochure write: Tek-

tronix, Inc., P.O. Box 500, Beaverton, Oregon 97077. In Europe write: Tektronix Limited, P.O. Box 36, St. Peter Port, Guernsey, Channel Islands.

U.S. Sales Price FOB Beaverton, Oregon



FOR TECHNICAL DATA CIRCLE #261
FOR DEMONSTRATION CIRCLE #262



A Smart Way to Beat Your Power Supply Size Problem

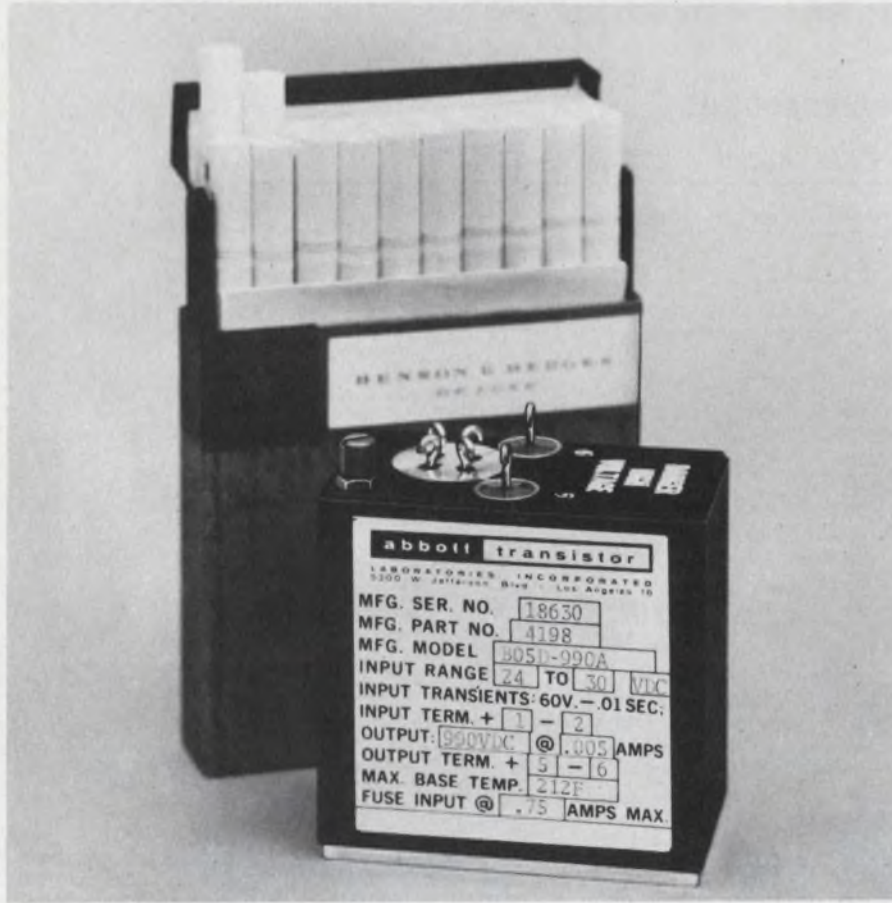

1½" thin, 2¾" narrow, 2¾" short

yet this converter produces 1000 volts DC, regulated, from a battery input of 28 VDC! It weighs less than 15 ounces. This is only one of our wide variety of many small light weight converters, inverters and power supplies — there are over 3000 models listed in our newest catalog, including size, weight and prices. If you have a size problem, why not send for an Abbott catalog?

MIL SPEC ENVIRONMENT — All of the hermetically sealed power modules listed in our new catalog have been designed to meet the severe environmental conditions required by modern aerospace systems, including MIL-STD-810B. They are hermetically sealed and encapsulated in heavy steel containers. New high performance units can meet MIL-STD-461A.

Please see pages 1037-1056 Volume 1 of your 1975-76 EEM (ELECTRONIC ENGINEERS MASTER Catalog) or pages 612-620 Volume 2 of your 1975-76 GOLD BOOK for complete information on Abbott Modules.

Send for our new 60 page FREE catalog.

RELIABLE — Highest quality components are used in Abbott power modules to yield the high MTBF (mean time between failure) as calculated in the MIL-HDBK-217 handbook. Typical power modules have over 100,000 hours MTBF — proving that the quality was built in from the beginning.

WIDE RANGE OF OUTPUTS — Any voltage from 5 volts DC to 740 VDC is available by selecting the correct model you need from our catalog with any of a variety of inputs including:

- 60 \sim to DC
- 400 \sim to DC
- 28 VDC to DC
- 28 VDC to 400 \sim
- 12-38 VDC to 60 \sim

Sr. Vice President, Publisher
Peter Coley

Editors

Editorial Offices
50 Essex St.
Rochelle Park, NJ 07662
(201) 843-0550
TWX: 710-990-5071
Cable: Haydenpubs Rochellepark

Editor-in-Chief George Rostky

Managing Editors:

Ralph Dobriner
Michael Elphick

Associate Editors:

Dave Bursky
Samuel Derman
Morris Grossman
John F. Mason
Stanley Runyon
Michael Shunfenthal
Edward A. Torrero

Contributing Editors:

Peter N. Budzilovich, John Kessler
Alberto Socolovsky, Nathan Sussman

Editorial Field Offices

East

Jim McDermott, Eastern Editor
P.O. Box 272
Easthampton, MA 01027
(413) 527-3632

West

David N. Kaye, Senior Western Editor
8939 S. Sepulveda Blvd., Suite 510
Los Angeles, CA 90045
(213) 641-6544
TWX: 1-910-328-7240

Jim Gold, Western Editor

1537 Shasta Ave.
San Jose, CA 95128
(408) 279-8588

Editorial Production

Marjorie A. Duffy, Production Editor
Tom Collins, Copy Editor

Art

Art Director, William Kelly
Richard Luce, Anthony J. Fischetto

Production

Manager, Dollie S. Viebig
Helen De Polo, Anne Molfetas

Circulation

Manager, Barbara Freundlich
Trish Edelmann, Gene M. Corrado

Information Retrieval

Peggy Long

Advertising Promotion

Paul K. Hogue

Promotion, Creative Layouts

Manager, Albert B. Stempel
Maxine Correal, Nancy Gordon

abbott transistor

LABORATORIES, INCORPORATED

general offices

eastern office

5200 W. Jefferson Blvd./Los Angeles 90016
(213) 936-8185

1224 Anderson Ave./Fort Lee, N.J. 07024
(201) 224-6900

Telex: 69-1398

Telex: 13-5332

CIRCLE NUMBER 5

Historical issue draws raves

Meucci's teletrphone

I want to congratulate you and your editors for the outstanding presentation of the most revolutionary 200 years of technological progress. I have always felt that it is very important for an engineer to know the history and price of progress. It is important to know the social and technical difficulties that our ancestors have encountered along the way.

Knowledge of history should be very strong among managers as well; it will enable them to make more rational and knowledgeable decisions.

I can imagine how hard and frustrating your research has been, I felt the same way during the presentation of my volume on television history. There are cases, however, in which an editor can't report the true facts simply because he consulted material supported by the beneficiary institution.

This is and has been the case with the telephone.

The telephone is 126 years old and it was invented by Antonio Meucci. Meucci was born near Florence, Italy on April 13, 1808. He studied mechanical engineering at the Florence Academy and worked as an engineer until 1835. At that time he went to Havana, Cuba working as a mechanical director and "scenographer" for the Tacon Theater.

In Cuba, in 1849, Meucci filed for the patent on the device that we now call telephone. It was an elaboration of a concept he had de-

veloped in 1841. (At that time A. G. Bell was not yet born.) In 1871 Meucci called his device "Teletrphone." At that time he was residing in the U.S. at 420 Tompkin Ave. in Rosebank, Staten Island, where he died in 1899.

Alexander Graham Bell was born in Edinburgh, Scotland in 1847 and he was educated at the University of Edinburgh, London and in Germany. He emigrated to the U.S. in 1871 and worked as professor at Boston University. In 1876 he filed for the patent on the Meucci device, vice.

For more information on the history of the telephone, you can consult: "Antonio Meucci, Inventor of the Telephone" by John Schiavo, published in 1958 by Vigo Press of NY.

Domenico Serafini
U.S. Correspondent

JCE Publications
L.I., NY 11951

Landmark issue

Your "200 Years of Progress" issue is itself a landmark, and all who worked on it deserve much credit. Congratulations!

Frederick T. Van Veen
Teradyne, Inc.
183 Essex St.
Boston, MA 02111

Majority ignored

In reference to your editorial "The Great Men" (ED No. 4, Feb.

(continued on page 11)

Electronic Design welcomes the opinions of its readers on the issues raised in the magazine's editorial columns. Address letters to Managing Editor, Electronic Design, 50 Essex St. Rochelle Park, N.J. 07662. Try to keep letters under 200 words. Letters must be signed. Names will be withheld on request.



OPTICALLY COUPLED INTERRUPTER MODULES

OPTRON OFFERS IMMEDIATE DELIVERY OF NEW, LOW COST SERIES

OPTRON's new, low cost optically coupled interrupter module series combines non-contact switching and solid state reliability for applications requiring sensing of position or motion of an opaque object such as motion limit, paper edge or shaft encoding.

The new OPB 813, OPB 814 and OPB 815 consist of a gallium arsenide infrared LED coupled with a silicon phototransistor in an economical molded plastic housing. With a LED input of 20 mA, the OPB 813 and OPB 815 have typical unblocked current outputs of 2.0 mA and 3.0 mA, respectively. Typical output of the OPB 814 is 3.0 mA with a 10 mA input. The entire series is available from stock.

Background illumination noise is eliminated by a built-in infrared transmitting filter and dust cover in each device type. The OPB 813 also is available with a 0.010 inch aperture for high resolution applications.

New OPTRON optically coupled interrupter modules are interchangeable with similar products as follows:

OPTRON	GE
OPB 813	H13A1
OPB 813	H13A2
OPB 814	H13B1
OPB 814	H13B2

Detailed technical information on these and other OPTRON standard interrupter and reflective modules, as well as versions for specific applications is available on request.



OPTRON, INC.

1201 Tappan Circle
Carrollton, Texas 75006, U.S.A.
214/242-6571 • TELEX-73-0701
© TWX-910-860-5958

**35 years of crimp pioneering.
More approved versions.
Worldwide engineering backup.
International standardization.
That's just the beginning of the
solderless terminal story by AMP.**



Featured is Boeing's light rail vehicle being built for Boston and San Francisco.

It's also many thousands of terminals of all shapes and sizes, each engineered to fill a specific need.

It's a range of customer application tools—from simple hand models to fully automated termination equipment—to match your production levels.

It's AMP-engineered dies that produce void-free, contaminant-free crimps that resist shock and critical environments.

It's nearly 2,000 scientists, engineers, and technical support people around the world ready to help you on production lines, in quality control, in prototype sampling.

It's all the things we do to assist you on higher performance products and lower installed costs.

Our story never ends—growth and progress never do. Let us show you how your products can benefit from using AMP solderless terminals and the other services that go with them. Call us (717) 564-0100 for a Sales Engineer visit. Or write AMP Incorporated, Harrisburg, PA 17105.

AMP
INCORPORATED
CIRCLE NUMBER 7

SEE US AT
NEPCON EAST, NEW YORK

HUGHES

HUGHES AIRCRAFT COMPANY
CONNECTING DEVICES DIV.

Today we
supply the spark
for America's
defense.

Connections were much simpler 200 years ago. Torch the fuse and the cannon fired.

Supplying the vital spark that makes a modern weapon system do its job is a lot more complicated.

That's where we come in. For many years, primes and OEMs for military and aerospace products have depended on us to provide the vital links in their electronic systems—flat cable, etched circuitry, connectors, and total interconnection systems.

Our high-rel connections have to be the best. They're used in systems like Phoenix, Maverick, Lance, Minuteman, AWACS, F-14, F-15, Space Shuttle, Viking, Sonobuoy, F-4, A-7, Condor, Standard Missile, F-18, AAH, Cruise Missile, F-8, Trident, Hobo, Sprint and many more.

To learn how we can serve your interconnection needs, contact Jack Maranto or Dave Cianciulli: Hughes Connecting Devices, 17150 Von Karman Ave., Irvine, CA 92714.

Or call (714) 549-5701.



**Hughes
Connecting Devices**

ACROSS THE DESK

(continued from page 7)

16, 1976), your readers undoubtedly join with you in deploring the lack of recognition of "the great men among us."

I am far more deeply saddened that you totally ignore and exclude the achievements and the potential of the majority of the world's inhabitants: women.

Carol E. Lyons
Chemical Engineer

Plessey Central Development
Laboratories
3860 Centinela Ave.
Los Angeles, CA 90066

Ripe nits harvested

I want to compliment you and your staff on the Bicentennial Tribute of your Bicentennial issue, but I also want to pick a few nits from your coverage of the vacuum tube era (1905-1948).

Chronology, p. 98: Edwin Howard (not Albert) Armstrong invented the superheterodyne circuit in 1917-1918, while serving in the Signal Corps, not in 1920.

P. 102: Although Professor Hazeltine's full name was Louis Alan Hazeltine, he usually preferred to drop Louis whenever possible. His invention was the neutrodyne circuit, not tuned-radio frequency.

The first sound film was Lee De Forest's Phonofilm, shown at the Rivoli Theatre, New York, in April, 1923, four years before "The Jazz Singer." Phonofilm was not a commercial success until later, due to equipment and distribution problems.

P. 105: About FM: E. H. Armstrong erected the first FM station in Alpine, NJ during 1938. It was KE2XCC and operated until March 6, 1954. John V. L. Hogan built and operated W2XR, the parent of the present-day WQXR.

Harry E. Fairman
Consultant

Fairman Associates
68 Pondview Dr.
Suffern, NY 10901

A collector's item

Your Bicentennial issue is one of the finest you have put out to date. "200 Years of Progress" was

something to see in a trade magazine. It was well laid out, and a lot of thought went into it. Am going to keep it in my library; it will be a collector's item in the future.

Thanks again for the fine job done.

Donald W. LieVan
President

LieVan Scientific Research Corp.
Route 3, Box 4
Marble Falls, TX 78654

Spectrum analyzers

What a blockbuster your 200 year issue was! And an interesting book, too.

It was fun to read and marvel at the march of progress in the recent years.

The picture of Art Fong and Harley Halverson and their first HP Microwave Spectrum Analyzer was particularly interesting. It did launch HP into spectrum analyzers in a way most of us couldn't comprehend. I did the original market forecast for that product and it was soon outselling the forecast by a factor of 3.5:1. A remarkable blend of old principles and new ideas.

John Minck

Hewlett-Packard Co.
1501 Page Mill Rd.
Palo Alto, CA 94304

Misplaced Caption Dept.



What do you mean it's too big?
It's brighter and cheaper than LEDs.

Sorry. That's Honore Daumier's lithograph, "And that, they have turned down, the ignorant fools!" ridiculing the pretensions of the new "realistic" school.

For microelectronic circuits and systems

Call Hughes (714) 548-0671

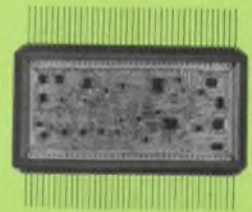

Hybrid Microcircuits—both thick film and thin film



Communications Products: crystal filters and crystal oscillators



Bipolar LSI Cell Arrays—interconnection of MSI functions



Microelectronic Systems for remote communications/control

We've been solving tough problems in microelectronic circuits and systems for years. Designing, manufacturing, testing, all within one organization specializing in microelectronics technology. That's why you can call on us for answers you need in a hurry—on specs, specials, prices and delivery. For product literature, write 500 Superior Ave., Newport Beach, CA 92663.

HUGHES

HUGHES AIRCRAFT COMPANY

Microelectronic Products Division

**DO YOU REALIZE ALL
THAT CAN HAPPEN
INSIDE A CABLE?**



THE HORRIBLE THINGS TO YOUR SIGNAL

Cable can distort a signal to the point of uselessness. And because so many variables can affect cable performance, signal distortion is more common than you think.

If, for example, a manufacturer uses poor grade PVC for the dielectric, you've got capacitance problems! And no matter how good the materials are, they can't function properly if the manufacturing tolerances aren't closely held. And no matter how closely held the tolerances are, you can't rely on a cable until you've tested it. It may be beautiful on the outside, but the inner conductor might look like rigatoni and vary impedance anywhere from 50 to 175 Ohms.

But Don't Panic, there's no need to become a cable specialist overnight. That's why we're here. We make the best cable in the business...and it doesn't cost a penny more than the stuff that can get you in trouble.

Ask anybody about our reputation for quality. It's one we've earned...in MATV; Security; RF Microwave Transmission; Data Transmission; and Instrumentation.

If you have a question about the selection of the right cable, give us a call or send for our Transmission Line Handbook and Catalog (TL-6). It combines a full product line with a wealth of engineering and applications data. Even if you've got a special problem—no sweat. We've got an engineering development capability second to none.

So don't just specify cable by type. Specify by Times Part number...for the sake of your signal.

Specify the performers. The Standard Products Group, Times Wire and Cable, 358 Hall Avenue, Wallingford, CT. 06492, Phone (203) 265-2361, TWX 710-476-0763. Ready when you are.

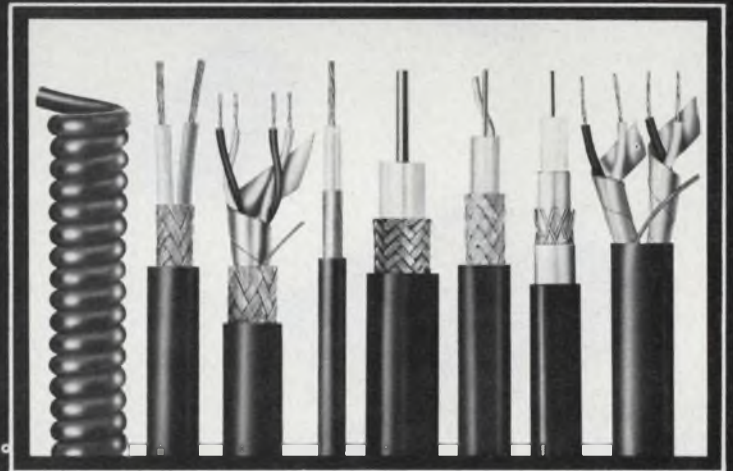

TIMES Wire & Cable

SUBSIDIARY OF

Insilco
Home Products

CIRCLE NUMBER 10

Checkmated by
high pushbutton
switch cost?



Check These Centralab Distributors For Three New Ways To Cut Switch Costs

The three new Centralab Pushbutton Switch products shown below are now available from Centralab Pushbutton Switch Distributors. They're low-cost money savers, and yet they offer the same high-quality features of all Centralab switches.

You can get these new products,

custom assembled to your specifications, from our factory trained Distributor Switch Specialists.

Contact your Centralab Distributor, listed at the right, for complete details. Ask for a copy of Centralab's New Pushbutton Switch Catalog, Series No. 301.

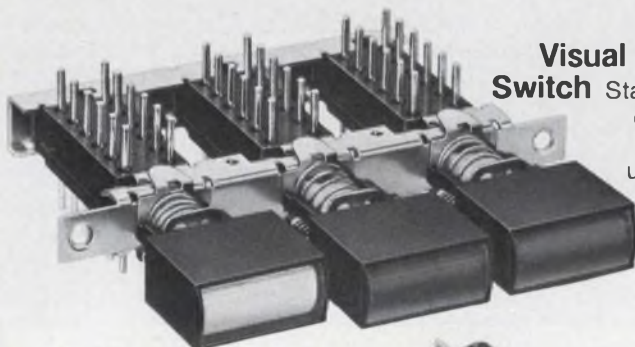

Visual Display in a Non-Lighted Switch

Status indicator button adds visual display to non-lighted Centralab switches. The button, with a unique fluorescent display, uses reflected ambient light to indicate switch status. 6 display colors. Black or chrome plated buttons. 140° peripheral viewing angle.

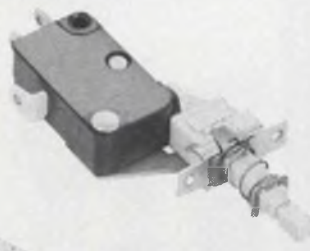

5-amp Pushbutton Line Switch

UL listed for TV-5 rating: 120V, 5A, 78A

peak inrush current. Accepts all Centralab button options.

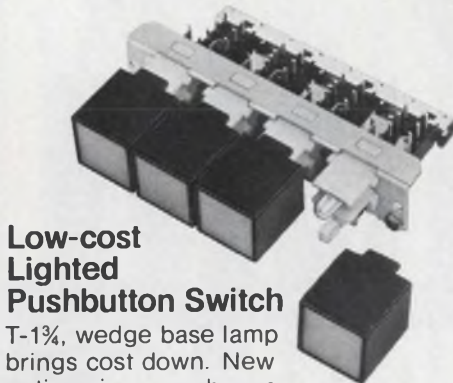

Low-cost Lighted Pushbutton Switch

T-1½, wedge base lamp brings cost down. New options increase harmonized panel aesthetics. Flat or recessed lenses. 8 lens colors. 15mm or 20mm spacing. Switch assemblies to 13 stations.

DISTRIBUTOR PRODUCTS



CENTRALAB

Electronics Division
GLOBE-UNION INC.

5757 NORTH GREEN BAY AVENUE
MILWAUKEE, WISCONSIN 53201

**FOR LOW-COST
PUSHBUTTON SWITCHES
CHECK YOUR CENTRALAB
DISTRIBUTOR.**

CALIFORNIA

Kierulff Electronics, Inc.
Los Angeles
213/685-5511

Kierulff Electronics, Inc.
Palo Alto
415/968-6292

Kierulff Electronics, Inc.
San Diego
714/278-2112

COLORADO

Kierulff Electronics, Inc.
Denver
303/371-6500

FLORIDA

Hammond Electronics
Orlando
305/849-6060

INDIANA

Radio Distributing
Co., Inc.
South Bend
219/287-2911

MASSACHUSETTS

Sterling Electronics
Watertown
617/926-9720

MINNESOTA

Gopher Electronics Co.
St. Paul
612/645-0241

NEBRASKA

Radio Equipment Co.
Omaha
402/341-7700

NEW YORK

Electronic Equipment
Co., Inc.
Hempstead
516/538-5510

Peerless Radio Corp.
Lynbrook, L.I.
516/593-2121

Summit Distributors, Inc.
Buffalo
716/884-3450

NORTH CAROLINA

Kirkman Electronics, Inc.
Winston-Salem
919/724-0541

OHIO

ESCO Incorporated
Dayton
513/226-1133

Pioneer-Standard
Electronics, Inc.
Cleveland
216/587-3600

PENNSYLVANIA

Cam/RPC Industrial
Electronics
Pittsburgh
412/288-2600

Herbach & Rademan, Inc.
Philadelphia
215/426-1700

Pyitronic Industries, Inc.
Montgomeryville
215/643-2850

TEXAS

Southwest Electronics Inc.
Stafford
713/494-6021

WASHINGTON

Almac/Stroom Electronics
Seattle
206/763-2300

ISOSTAT LICENSED

Coming through...



with wire, cable and cord
that delivers quality,
performance, economy...

Belden has it: a total service capability. Extensive design and application know-how. What it takes to deliver complex cable configurations, special harnesses, cords, lead wires, and even special packages to fit your requirements.

Our specialists and engineers will meet with your people at your plant to discuss problems in processing, assembly, installation, ordering, human engineering, color coordination, physical and electrical parameters, opportunities for cost reduction. And when we can't help you using standard products, we'll innovate a solution to your problem.

Talk to a Belden specialist about your new applications, product ideas, processing problems—all your wire, cable and cord needs. He has thousands of standard items to draw from. And standard or special, he'll come through with the best wire buy around. For answers right now, phone:

317-966-6661 Electronic Div. or mark No. 400 on reader service card
312-986-1600 Electrical Div. or mark No. 401 on reader service card
312-887-1800 Transportation Div. or mark No. 402 on reader service card,
or write Belden Corporation, 2000 S. Batavia Ave., Geneva, IL 60134.

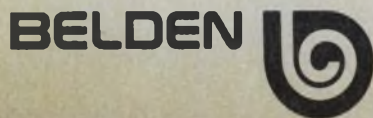

Coming through...

with new ideas for moving electrical energy

great connections...



RACK AND PANEL CONNECTORS

Our high-density rack and panel connectors have an identical contact in both the plug and the receptacle. This mutually embracing contact, Varicon™, is hermaphroditic, interlocking and spring loaded. Mating surfaces are gas-tight assuring corrosion resistance. And low contact resistance is inherent in Varicon's contact design. Get Elco rack and panel connectors in sizes ranging from 20 to 165 contacts.



FLAT CABLE ASSEMBLIES

We customize flat conductor cable assemblies to meet your needs. So you don't have to buy cable or machinery. Our complete Flattac™ cable assemblies require no preliminary stripping, welding or soldering. Their multi-contact high-pressure connections assure low contact resistance and mechanical stability.

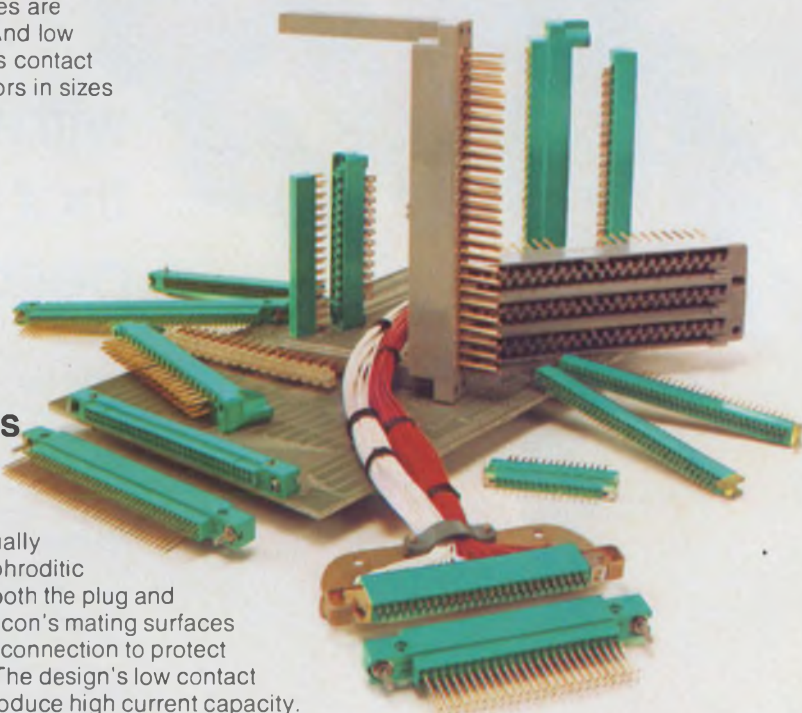

2-PIECE P.C. CONNECTORS

These connectors use just 1 contact—the unique, spring-action, mutually embracing, hermaphroditic Varicon™. Used in both the plug and the receptacle, Varicon's mating surfaces provide a gas-tight connection to protect against corrosion. The design's low contact resistance helps produce high current capacity. And Varicon's interlocking design adds resistance to shock and vibration.

whatever the occasion.



P.C. CARD ENCLOSURES

Versatile Varipak® II card enclosures, available in 32 standard models, are ideal for packaging rows of cards and connectors using almost any card spacing. Varipak allows air flow for long component life. And its modular design makes it adaptable to your special packaging techniques at minimal cost.



BACK PANEL SYSTEMS

Select our Press-Fit back panel system. It gives you the economy and reliability of printed circuitry plus the versatility of solderless wire wrapping. Or, choose Variplate™, a metal system made to your specifications for automatic wire-wrapping. Its high density makes Variplate extremely popular in the computer equipment field.



CARD EDGE CONNECTORS

Our card edge connectors are available in single and dual-readout designs. And we've designed our solderless wrap and solder contacts for virtually every termination technique in the electronics industry. Many of our connectors are included on the Military Qualified Products List (QPL) and meet MIL-C-21097. Several of these connectors have extended card guides to give you easy P.C. card insertion and protection against vibration. They're available in sizes from 4 to 100 contacts or more.

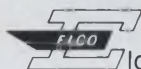

Elco Corporation's leadership in the connector field is recognized throughout the world. This preeminence has been achieved through Elco's policy of setting — and meeting — the highest standards of product performance. Today, we have offices in Belgium, Denmark, England, France, Germany, Japan and the United States. Our representatives and distributors are in many other countries, proving that Elco truly stands for

"GREAT CONNECTIONS ... WORLDWIDE"

Elco Corporation
2250 Park Place, El Segundo, Ca. 90245
213-675-3311 / TWX 910-325-6602

G+W Elco Corporation
A GULF + WESTERN MANUFACTURING COMPANY

Design with the complete flat cable/connector system.

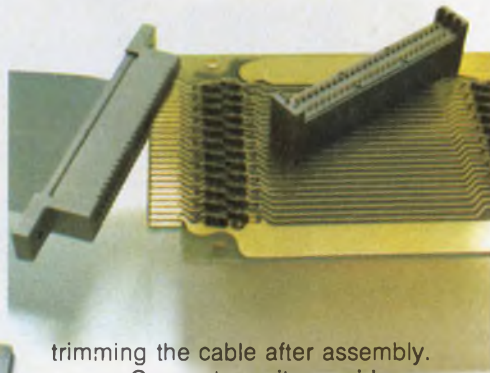

trimming the cable after assembly.

Connector units provide positive alignment with precisely spaced conductors in 3M's flat, flexible PVC cable. The connector contacts strip through the insulation, capture the conductor, and provide a gas-tight pressure connection.

With cable, connectors and assembly tools from one design and manufacturing source, you have added assurance the connection will be made surely, with no shorts or "opens."

And "Scotchflex" now offers you more design freedom than ever. From stock you can choose shielded and non-shielded 24-30 AWG cable with 10 to 50 conductors, and an ever-increasing variety of more than

The 3M DELTA pin and socket connector.



Assembly-cost savings are built in when you design a package with "Scotchflex" flat cable and connectors. But more important, 3M Company offers you the full reliability of a one-source system: cable *plus* connectors *plus* the inexpensive assembly aids that crimp the connections quickly and securely (with no special operator training required).

The fast, simple "Scotchflex" assembly sequence makes as many as 50 simultaneous multiple connections in seconds, without stripping, soldering or

100 connectors to interface with standard DIP sockets, wrap posts on standard grid patterns, printed circuit boards, or headers for de-pluggable applications. 3M's DELTA "D" type pin and socket connectors are now also available. For full information, write Dept. EAH-1, 3M Center, St. Paul, MN 55101.



3M
COMPANY

3M's "Scotchflex" line.

See our catalog in EEM 2-1034.

"Scotchflex" is a registered trademark of 3M Co.

**Custom IC's cost
\$50,000 and take a
year to develop.**

BALDERDASH!

With Interdesign's simple yet elegant approach, you can get your circuit integrated for \$1,800 in three weeks. No headaches.

Reduce production costs. Shrink size. Increase reliability. Protect your design from nosey competitors.

Production quantities from 1,000 to 100,000 or more in eight weeks.

Do you want to know more?

**Call 800/538-1730 toll-free
for our brochure.**

interdesign
THE REAL CUSTOM IC HOUSE

1255 REAMWOOD AVENUE
SUNNYVALE, CALIFORNIA 94086
408/734-8666

**You can buy
this Spectrum Analyzer
and take a big chunk
out of your budget.**

**You can rent
this Spectrum Analyzer
and get more
equipment out of
your budget.**



Even the best equipment budget can only go so far. And at the price you pay for electronic test equipment nowadays, that's not very far at all.

Unless you rent your equipment from REI.

When you rent from us, there's no large cash outlay. You pay only for the time you have your instruments, and you return them when you're through. So you never have to spend your money on idle equipment.

Getting more for your money is just one reason for renting from REI. Immediate delivery is another. We have over \$10 million in inventory in fully stocked centers around the country. And, when you have short-term needs, you can rent equipment for just as long as you need it, and make it pay for itself.

REI stocks over 8,000 fully checked-out test instruments, and they're ready whenever you are. For the full story on renting, as well as our low prices, send in the coupon for prompt delivery of our free illustrated catalog... or call us now for your immediate requirements.

Rental Electronics, Inc.
99 Hartwell Avenue, Lexington, Mass. 02173
Please send me your free instrument rental catalog:

Name _____ Title _____

Company _____

Address _____

City _____ State _____ Zip _____

Tel. Number _____

Rental Electronics, Inc.

A PEPSICO LEASING COMPANY

Burlington, MA (617) 273-2770 • Gaithersburg, MD (301) 948-0620 • Oakland, NJ (201) 337-3757 • Ft. Lauderdale, FL (305) 771-3500
• Des Plaines, IL (312) 827-6670 • Dallas, TX (214) 661-8082 • Mountain View, CA (415) 968-8845 • Anaheim, CA (714) 879-0561
• Rexdale, Ontario (PLC Leasing Ltd.) (416) 677-7513

MAY 24, 1976

F-16 radar system to contain high-level digital processing

The radar for the Air Force F-16 fighter aircraft breaks a number of frontiers, according to its developer, Westinghouse Defense and Electronic Systems Center, Baltimore, MD.

It uses a higher level of digital processing than any existing fighter aircraft radar; it contains more LSI (off-the-shelf, not custom-made); it offers more performance for its weight; it provides more operational modes than any air-to-air/air-to-ground radar; it's more reliable; and it costs less to buy and maintain.

And there are other differences:

- The conventional radar-receiver guard channel and associated circuitry have been replaced by software-controlled processing. The guard channel is normally used to subtract unwanted ground returns in the antenna sidelobes from the radar's return signal.

Eliminating the guard channel results in a major cost reduction, less complexity, lower weight, and an increase in system reliability.

- Computer software takes the place of conventional radar-track loops, which use rate gyros in the antenna. As a result, tracking accuracy and reliability are increased, and system cost is lowered.

- Software keeps clutter off the scope by continually adapting the target-detection threshold to the varying clutter conditions.

- Fully coherent signal-processing uses digital doppler filters for predetection integration; this results in a highly selective signal-detection sensitivity.

- Digital Fast-Fourier-Transform (FFT) filters are used to measure target doppler.

The basic performance parameters of the radar are continuously monitored by the radar-control computer. It uses a digital bus to monitor and test each line-replace-

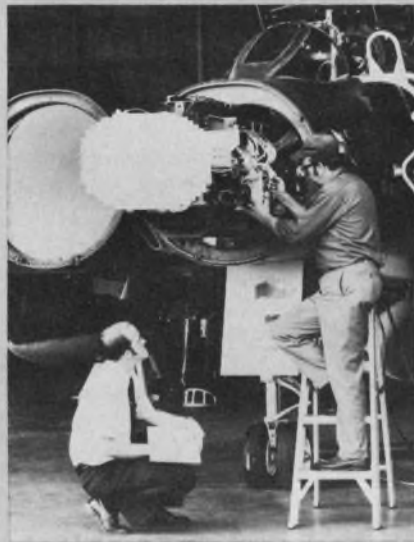

All of the radar units will be mounted in the nose of the F-16 fighter except the control panels in the cockpit.

able unit. Faults are reported to the avionic system for display upon command, and a built-in test routine, which interrupts normal radar functions, is initiated. The radar computer automatically executes a sequence of radar tests that isolate 95% of all detected failures to a particular line-replaceable unit.

A planar-array antenna, mechanically gimballed in two axes, was selected "for its good gain and low sidelobes over all scan angles." Westinghouse engineers say the balanced electric-drive system for the antenna is "lightweight, highly reliable and easily maintained."

Built-in test circuitry continuously monitors stable local-oscillator signal levels. The first mixer and the first intermediate frequency (i-f) stage of the receiver will be fabricated with micro-strip microwave-integrated-circuit (MIC) techniques. "This will lower cost, improve reliability, reduce weight

and size, and reduce the number of interconnections."

The transmitter contains an air-cooled traveling-wave-tube, a solid-state grid pulser, high-voltage power supplies and regulators, and protection and control circuitry. Air cooling instead of liquid cooling, was selected because of its size and weight advantages and improved reliability and maintainability.

Clutter rejection and other radar signal processing is performed by the digital signal processor, which uses standard ICs mounted in dual in-line packages. Off-the-shelf LSI devices are used. Custom LSI devices were avoided for cost and availability reasons.

The F-16 radar computer is a variant of the Westinghouse millicomputer family. During the full-scale development phase, a semiconductor, ultraviolet-erasable, read-only memory (UVROM) will be used to operate program storage.

Final, production radar systems will use programmable read-only memories (PROMs), which can only be programmed once, but offers lower cost for mature production systems. Temporary scratchpad memory requirements will be met using volatile, semiconductor random-access memories (RAMs).

Mini-Pak: A successor to the conventional DIP?

A new package for microcircuits that is said to be smaller and easier to mount than the conventional dual-in-line package has been developed by General Instrument Corp., Hicksville, N.Y.

Called Mini-Pak, the package is about 1/2 in. on a side and 1/8 in. thick—about one-third the size of a DIP.

The chip is mounted on top of the Mini-Pak substrate and wire-bonded to conductors that carry the signals from the chip to an array of solder bumps formed on the underside of the package. The chip and bonding wires are protected by a special coating.

The Mini-Pak is attached to a PC board by heating the perimeter of the package and allowing the solder bumps to reflow onto the connections of the PC board.

James Teeple, director of Gener-

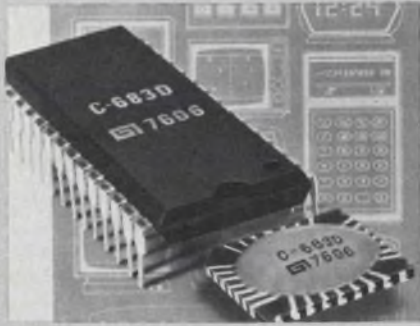

General Instrument's Mini-Pak (lower right) is one-third the size of a conventional DIP.

al Instrument's Microelectronics Group points out the following advantages of the new packaging configuration:

- Attaches and replaces easily, with simple tooling.
- Eliminates cost of drilling DIP pin holes in printed circuit boards.
- Carries its own solder for fast assembly and is virtually self-aligning because of the reflux action of the solder.
- Allows easy inspection of solder joints from the top of the board.
- Adapts easily to automated testing on board applications.

General Instrument initially plans to use Mini-Pak in its calculator, clock and TV-game product lines. Later on, according to Teeple, the company's entire product line of over 100 standard parts will be available in the new configuration.

Floppy-disc recorder has more storage capacity

A floppy-disc recording unit that has achieved four times the storage capacity of an IBM-format disc drive has been introduced by Burroughs Corp.

The unit is part of the company's new B80 "very small general purpose" computer system.

The floppy-disc unit records data at higher density, and on both sides of a flexible disc, to achieve a one-million byte capacity per diskette. The average random-access time for data stored on the disc is 266 ms. As many as six minidisks may be used on a B80 system, providing a total of six million bytes of on-line disc capacity.

The B80 system contains a processor, memory, alphanumeric display, keyboard, cassette drive and 60 or 180 char/s matrix printer integrated into a single console. The system uses software modeled after the firm's line of larger computers, with an operating system and several programming languages for a wide range of applications. "The entire processor, including nanomemory, microstack, I/O logic and system registers, is presently contained on nine large scale integrated circuit chips," says Ray MacDonald, chairman of Burroughs.

The 180 char/s printer in the console types on a 25.6-in. dual-pinned forms handler, and positions at a rate of 450 char/s.

The B80 may be configured in several different modes. Data entry and output devices may be connected to it, or the B80 may itself be a peripheral to a large system computer. It may also operate in conjunction with another B80 system in a distributed processing arrangement.

Some of the data entry and output devices that may be connected to the B80 include up to two line printers operating at 160 or 250 lines/min, and up to four keyboard input and display terminals. As many as four data-communications channels allow flexibility in transferring data to and from the system.

Data communications may be synchronous or asynchronous at speeds ranging from 75 to 9600 bits/s. Available software compilers allow configuration of a data-transfer network and interfacing to the user's program.

New IC tester offers 1000 programs by phone

Software is as close as the nearest telephone with a new computer-controlled IC tester, from Datatron. Its 400 Series features instant retrieval of more than 1000 device programs through a built-in acoustic coupler.

Called Instant Program Access (IPA), the feature eliminates extensive programming and thereby can significantly cut the cost of IC testing. All a user need do is dial a local Tymeshare access number.

At a starting price of \$49,000, the Datatron unit falls somewhere between low-end bench-top testers selling for \$5000 to \$10,000, and top-of-the line units that carry price tags of up to \$500,000.

Sun, water combination seen as energy source

Sunlight and water may be valuable sources of electricity and fuel according to recent experiments conducted by the Massachusetts Institute of Technology.

Sunlight conversion efficiencies of up to 2% have been obtained by using electrodes of cadmium sulfide or cadmium selenide in a solution of polysulfide and water. The experiments were conducted by Mark Wrighton, assistant professor of chemistry.

New and more efficient combinations of electrodes and electrode catalysts that will produce hydrogen as well as electricity are expected by Wrighton and his co-workers—research assistant Steven Kaiser, and Arthur Ellis, a graduate student.

The first system the researchers studied used a water cell containing two electrodes—one of platinum and one of titanium-dioxide crystal—connected by a wire.

When ultraviolet light was shone on the crystal electrode and assisted by a small battery, electrons were stripped from hydroxyl ions in the water and reacted with positive hydrogen ions in the water to form hydrogen molecules.

That system worked only with ultraviolet light, but researchers gained substantially higher efficiency using sunlight and replacing the electrodes with cadmium sulfide or cadmium selenide. By adding polysulfide to the water, decomposition of the electrodes—which occurred within minutes—was halted.

At one electrode the polysulfide loses electrons, becoming oxidized. The electrons travel over the wire to the other electrode where they recombine with the polysulfide to regenerate it. No polysulfide is lost, the electrodes don't decompose and the current can be used as a source of power.

The work has been funded in part by the National Aeronautics and Space Administration.

We saw your microprocessor

coming. So we designed an entire family of socket homes for it. Socket cards for card file mounting, and we've even got the card files. Socket boards for LSI mounting in frames, drawers, and racks,

and we've even got the frames, drawers, and racks. Our socket cards, the 3D Series, come with built-in test points, a ceramic monolithic bypass capacitor

at each socket, and solder tab connection to pins on LSI chips. Our socket boards, the 2D Series,

offer a good selection of socket complements, and are compatible with other boards for hybrid installations. We also offer automated wiring service. We're ready for you.

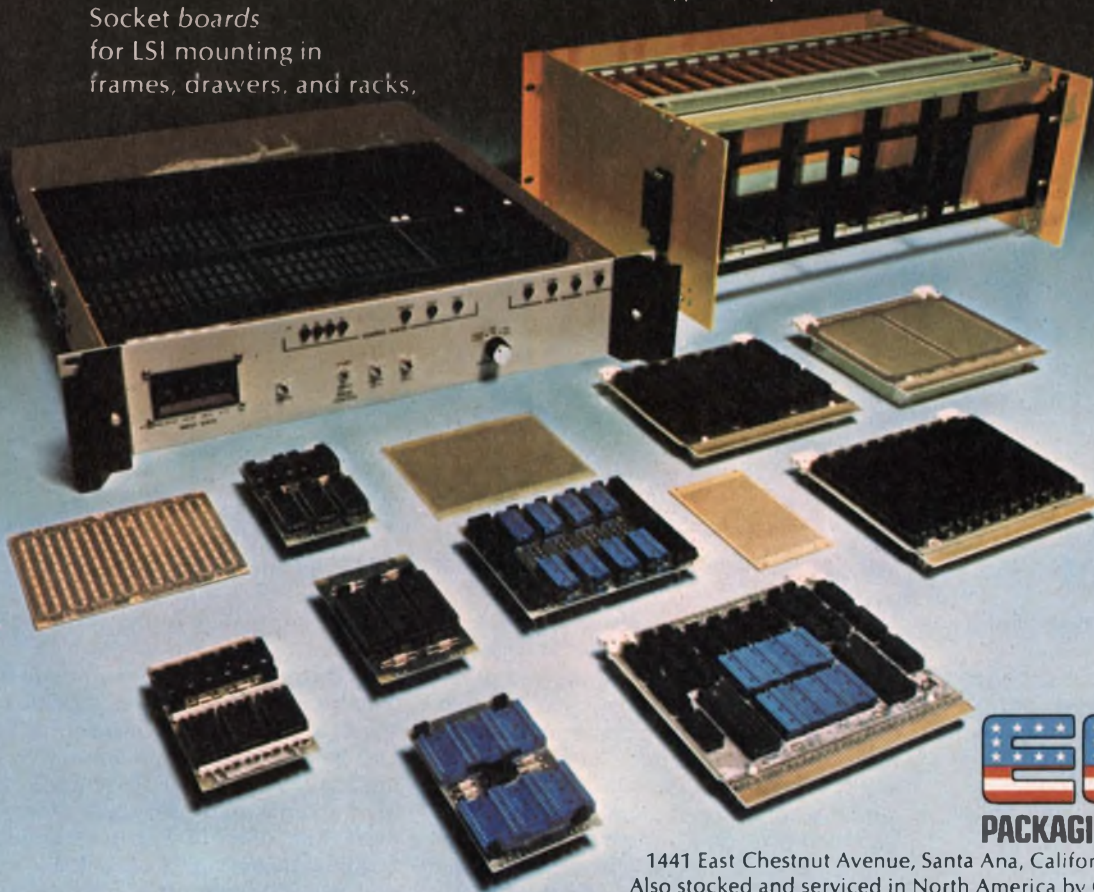

EBCO
PACKAGING/SWITCHES/READERS

1441 East Chestnut Avenue, Santa Ana, California 92701 Phone 714/835-6000
Also stocked and serviced in North America by G. S. Marshall, R-A-E, Zentronics.

Dale makes your basics better.



More muscle in your resistors

Wirewound, metal film, carbon film, tin oxide... Dale's resistor line is stronger than ever. To match expanded capacity, we've installed a network of computer terminals to speed shipments and aid you in production planning. In addition, we've upgraded our quality assurance programs so that one out of every 10 Dale employees is directly involved with quality control. As a result, the Dale resistors you order are the best we've ever made... and the most efficient for you to buy.

CIRCLE NUMBER 351

More stretch in your connectors

Don't let the costs of tooling a special connector scrap your design. Dale's innovative ED line gives you dual readout .050" and .100" edgeboards that expand in length and number of contacts without tooling charges. This "stretchability" is also available in a line of digital display connectors. In addition, Dale can provide a variety of .156" edgeboards plus dip solder and rack and panel models. To find out more about the advantages of Dale connectors, circle the reply number or call 605-665-9301 today.

CIRCLE NUMBER 352

More punch in your trimmers

A trimmer's power rating should give you leeway to derate for assured long-term stability. Dale trimmers do. Our low profile 700 Series provides 1 watt at 70°C in both wirewound and cermet models and cermet models give you 1% CRV in the bargain. In single-turn square trimmers Dale's 3/8" 100 Series gives you a half watt clear up to 85°C in a choice of 5 top adjust and 3 side adjust models. Compare. We're the new source you've been looking for.

CIRCLE NUMBER 353



Higher Q in your inductors

Dale is steadily growing as a source for a wide range of inductors including: Flame retardant coated chokes with performance and durability comparable to molded models at a much lower price; filter inductors with a wide selection of Q vs frequency; trigger transformers interchangeable with 11Z types. In addition, we offer a versatile line of transformers including low power, converter and pulse models. Get complete price and delivery information by calling 605-665-9301 today.

CIRCLE NUMBER 354

More versatility in your networks

Dual-in-line, single-in-line standard or special circuits... Dale has what you need in thick film resistor networks. For custom circuits our SDP and SSP Series offer two ceramics with space for up to 28 resistors. New low profile SIP models and machine insertable DIP's solve packaging problems. We were the first to qualify to MIL-R-83401 and now offer 10 models meeting this spec. For network help, call 402-371-0080 today.

CIRCLE NUMBER 355



Your man from Dale has a lot of ways to help you ... call him today.

DALE ELECTRONICS, INC.
1300 28th Avenue,
Columbus, Nebraska 68601
A subsidiary of The Lionel Corporation
In Canada: Dale Electronics Canada Ltd.
In Europe: Dale Electronics GmbH,
8 Munchen 60, Falkweg 51, West Germany

New computerized X-ray systems provide 3-D view of whole body

Two years ago a revolution began to take place in the way brain disease was diagnosed. Using computerized tomography (CT) scanners unbelievably clear X-ray pictures of the brain were obtained easily and safely. It took only 20 min. to get pictures far better than the poor ones that previously took three to seven days of difficult and dangerous tests to acquire.

Now, CT scanners are available for examining the whole body. Soft organs, such as the pancreas, that have never been seen before in a living human being, show up with unprecedented clarity and resolution from any angle desired. If the organ is the host for a tumor, that growth, too, is clearly displayed, as well as the condition of the tissue that surrounds it.

Pioneered by EMI Medical, Northbrook, IL, CT scanners are now being produced by General Electric, Milwaukee, WI; Syntex Medical Systems, Cupertino, CA; Ohio-Nuclear, Solon, OH; Varian Radiation, Palo Alto, CA; Pfizer Medical System, Columbia, MD; Artronix, St. Louis, MO; and others. Companies known to be developing systems include Siemens in Munich, Germany; Philips in Eindhoven, Holland; CGR in Paris, and Picker in Cleveland, OH.

A variety of scanners offered

The CT equipment now offered or being developed includes scanners for the whole body, for the brain, and for the breast.

The cost for a full system



Computerized tomograph scanners, like this whole-body scanner built by General Electric, will be bought by an estimated 625 hospitals.



This CT scanner X-ray image, showing the vascular patterns of a human lung, was taken in less than 5 s by GE's new whole-body scanner.

ranges anywhere from \$350,000 to \$700,000, depending on how much equipment is included in the package.

The market is big: General Electric estimates that each of the 377 hospitals with 500 beds or more in the United States will need a CT scanner, and 90% of the 275 hospitals that have from 400 to 499 beds will buy one.

Computerized tomography differs from conventional X-ray machines in that CT uses X-rays and a computer to reconstruct a three-dimensional picture of a single slice ("tomos" is Greek for "slice") or small cross-section of the human body as seen from a large number of positions.

Conventional X-ray machines, on the other hand, produce two-dimensional pictures of three-dimensional objects, superimposing bones,

fluids, air cavities, tissues and tumors on top of one another, making the radiologist's job as much an art as a science.

CT scanners are made up of four major components: an X-ray source, an array of detectors, a high-speed minicomputer and a display console. As in conventional X-ray techniques, the patient is placed between the X-ray source and the detector. In the new method, however, the X-ray source and detectors are mounted on a gantry so they can rotate as a single unit.

With Syntex Corp.'s System 60 tomograph, for example, the patient lies still as low-dose X-rays are passed through the body from 15 different angles within a single plane. The source and detector gantry rotate 12° after each X-ray exposure, eventually completing a half-circle around the patient. The

John F. Mason
Associate Editor

result is a tomogram, or picture of a slice of the patient's body. The slice, 1-cm thick, is viewed from above, as if one were looking along a line from the patient's head down to his feet.

X-ray absorption is the key to CT scanning. As each X-ray passes through the patient's body it is absorbed to a greater or lesser extent by the material through which it passes. Bone tends to absorb more radiation, the liver somewhat less, and air spaces or lightweight tissues, still less.

Detectors measure absorption

The detectors measure exactly how much radiation is absorbed by the tissues along many paths during one such X-ray probe or scan.

The amount of radiation absorbed is assigned a number, or value, corresponding to gradations between black and white. In EMI's system these ratings run from +1000 to -1000. Dense bone, for example, might be given a rating of 1000. Then water would be 0 and air is -1000; blood is 12, tissue 22 to 46, and fat is -100. With such a system, high resolution is possible, as well as digitalization for storing.

In the Syntex System 60, absorption is measured along 750 paths through the body by each of 12 detectors for each traverse. Since there are 15 linear passes for each full scan, each tomogram is a composite of 135,000 data points ($750 \times 12 \times 15$).

First the detectors convert the information from X-ray signals into electrical analog signals. The analog signal is translated into a digital signal that can be manipulated by the computer.

The computer then takes all the information for the amount of absorption for all these paths and puts them together rapidly to create the cross-sectional picture. That picture is displayed on a TV screen for the doctor to examine, giving a two-dimensional "slice" of the patient's anatomy. By studying a series of scans, a picture of the three-dimensional anatomy can be obtained.

The Syntex System 60 uses a constant source of narrow beam X-rays, whose quality does not vary by more than 0.1%. The system also uses sensitive detectors

composed of scintillating crystals of sodium iodide. Fine resolution is obtained by displaying the picture on a display matrix, a grid composed of 65,536 tiny squares, 256 units high and 256 units wide.

As each scan is made the data are recorded on magnetic tape. Later, information indicating the X-ray density of each small square of the picture is transferred to a floppy disc. Each disc records 12 slices, or tomograms, the patient's name, and other pertinent infor-

GE's head scanner has a 120-s scan time but produces the finished picture without further delay.

"Our approach to reducing scan times was simply to make more efficient use of the X-ray beam," explains Arthur M. Bueche, GE vice president for research and development, Schenectady, NY. "But we had to come up with an entirely new concept to do it." Bueche says the concept involved "the development of a new type of X-ray detector, arranging it in a curvilinear

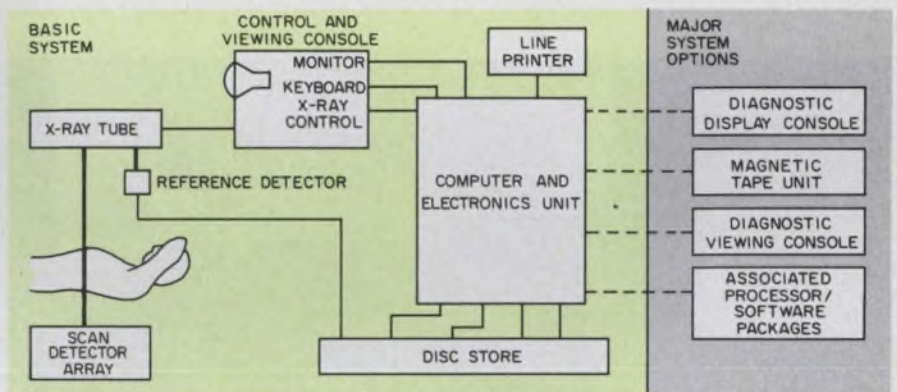

EMI's CT 5005 scanner houses an X-ray tube and an array of 30 sodium iodide crystal detectors and photomultipliers, a control and viewing console (visual and print-out), a computer cabinet and an electronics unit.

mation. When the physician wants to review a scan, he places the disc in the viewing console and uses a keyboard to retrieve the desired scan. A Polaroid camera mounted near the viewing screen can photograph a scan for later reference.

Both scan speed and the time required for processing are important: scan speed should be kept to a minimum so a patient won't have to hold his breath too long. He may even be unconscious and unable to cooperate at all. Besides, in some cases, such as photographing the colon or intestinal tract, movement is not under the patient's control.

A brief processing time is desirable not only to know a patient's results quickly, but to permit the most economical use of the machine.

General Electric's whole-body system scans in 4.8 s and gives a quick preliminary picture of the display screen in 30 s. A fully processed presentation is available in 240 s—a time GE hopes eventually to reduce to 200.

array along with many others, quickly rotating it completely around the patient, and then creating the mathematical processing procedures necessary to convert the absorption values to a visual image."

The choice of detectors

GE chose xenon detectors instead of sodium iodide, despite the latter's superior efficiency in detecting X-rays, because it is more efficient in an array.

The individual xenon detector cell requires about 1.7 times as many X-rays before reaching the same signal-to-noise ratio as the best NaI detector design, Bueche says. But to keep scan speed down to a breath-holding period of 5 s, a large array of detectors is needed, and large arrays of NaI detectors are not practical.

"The cost would be high," says Bueche, "and a number of technical problems would be insurmountable: photomultiplier-tube gain drift, the

detector's temperature coefficient, the NaI scintillator afterglow, maintaining good optical contact, and minimizing the 'dead space' between cells without adversely affecting the resolution."

The three main attributes required by a detector array—uniformity, rapid response, and high linear dynamic range—were best met by the detector array using high-pressure xenon. The Xe gas is maintained at the same pressure throughout the entire detector array, a pressure so high that there is no appreciable contamination from impurities, and uniformity is bet-

readings into cross-sectional images of body tissues and organs. The pulsed fan-beam approach in the GE system results in less X-ray exposure than the continuous, multiple narrow beams of X-rays employed by other body scanners, Bueche says.

The GE system's minicomputer is Data General's Eclipse S 200, designed to run with an 80-k core, and with an 80-megabyte disc.

An Intel 8080 microcomputer controls the firing of the X-ray tube and starts the a-to-d conversion and the motor drive. A 300-channel a-to-d conversion must be

tube and detectors moves around the patient 10° and another linear traverse is made. This process of traversing and 10° indexing continues until 18 linear traverses, spanning 180°, have been completed.

During this 20-s scanning procedure, the readings taken by the detectors are digitized and fed to the minicomputer. Over 300,000 absorption readings are taken during a single scan.

Storing the data

The large volume of data accumulated during each scan is processed and stored on the magnetic disc.

EMI's CT 1010 unit for examining the head and neck allows two ranges of total scanning angle to be selected: the standard scan angle of 180°, or the increased scan angle of 240°. Two scanning speeds are also available: 1 min or 4 min. The longer scan increases the sensitivity of the system by 2-1/2 times, thus allowing a very substantial increase in the diagnostic information amassed during the scan. The basic EMI-scanner CT 1010 costs approximately \$370,000.

A number of scanners offer color presentations by incorporating a color monitor and alternative circuit boards in the diagnostic display console, which retains all its standard controls and functions.

Varian's CT scanner makes a full 360° scan in only 6 s, using a fan-shaped X-ray beam transmitted through the patient's body to 300 xenon gas detectors. Reconstruction time is 120 s.

An advantage Varian claims is the scanner's ability to take high-resolution 6-s scans with a section width of less than 8 mm, thus permitting better definition of anatomical detail.

Special components needed

In general, today's CT scanners rely on the best available components, including MOS, CMOS and μ Ps. The heart of the system is a standard, general-purpose minicomputer, but the future will have less dependence on the minicomputer and more on μ Ps and other special components as they are developed. ■■

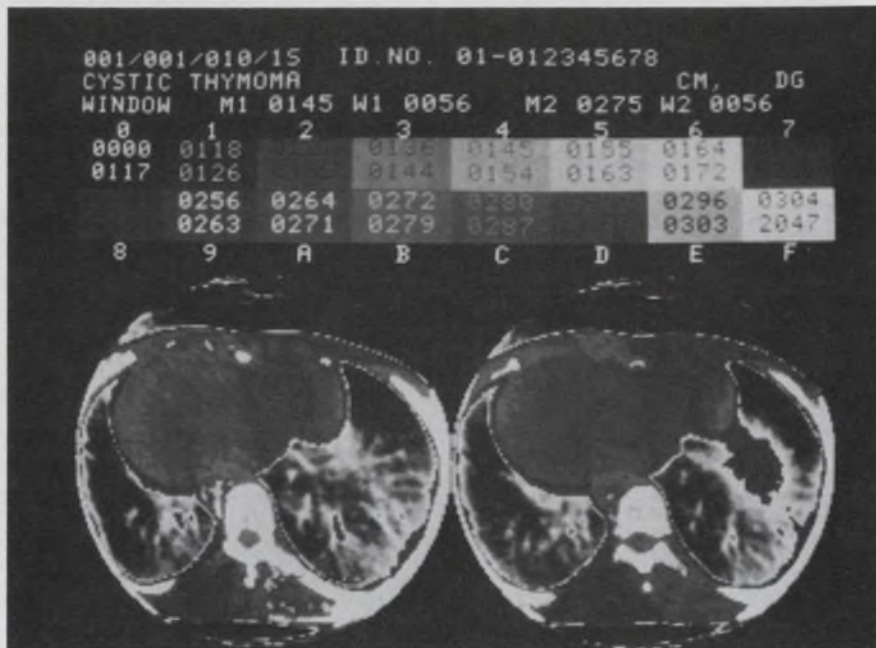

A tumor of the thymus gland to the right of heart shows up in this chest scan made in color by Pfizer's ACTA scanner.

ter than for a solid-state detector.

Xenon does not have the "afterglow" problem of some scintillator crystals such as NaI, so that it can give a complete response to the X-ray input rapidly.

The response is linear over the range of digitation of the information-handling system. The varying amounts of radiation that penetrate through the body are collected by an array of 320 detector elements in a single high-pressure xenon chamber.

Some 90,000 detector readings per scan are collected and fed to a high-speed minicomputer. More than 54-million computing operations are performed within minutes to reconstruct the detector

accomplished in less than 10 ms, including transmission.

EMI's CT5005 whole body system uses an array of 30 sodium iodide crystal detectors and photomultipliers to study sections of the head or body that are 13-mm thick. If even smaller portions need to be examined, additional collimators narrow the slice down to 8 mm.

When the patient has been positioned, the scanning frame traverses linearly across the patient, taking just over 1 s; during this time the detectors record more than 18,000 readings on the X-rays emerging from the tissue.

At the end of the linear traverse, the scanning frame with the X-ray

OK, you Power Schottkys, the heat's on. Talk!

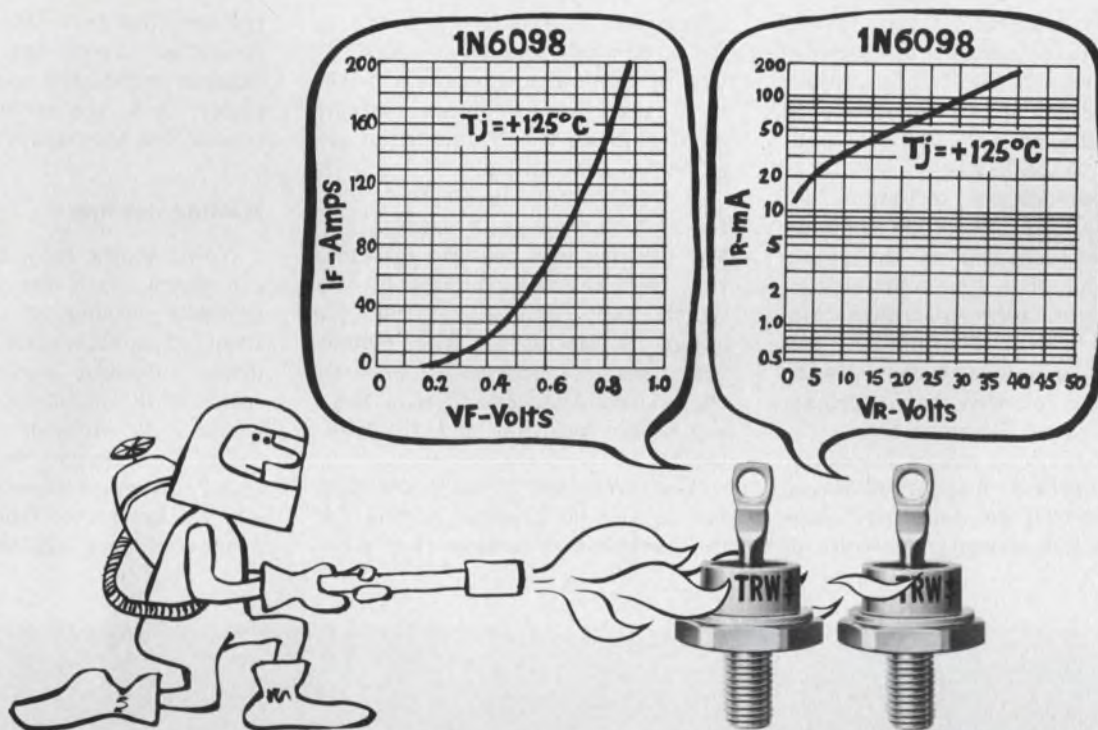

These new TRW Power Schottkys have quite a story to tell and it starts with the fact that they're JEDEC registered. Then they'll tell you that they let you maintain 50 Amps—typically 0.55 Volt forward drop at a T_j of 125°C . The highest operating junction temperatures, lowest reverse leakage typically less than 200mA @ 40V, 125°C , and highest voltages on the market today. (Yet, for all that, they're competitively priced.)

Yes, TRW's Schottky Diodes are now 1N registered. And they're about to be JAN and JANTX qualified.

Let these new Power Schottkys take your heat, try one in your present circuit or in the circuit you're working on, you'll find out they're not just talk.

1N6095	25 AMP	30V	DO-4
1N6096	25 AMP	40V	DO-4
1N6097	50 AMP	30V	DO-5
1N6098	50 AMP	40V	DO-5

If you'd like to hear more about how TRW's Power Schottkys can help you in the design of low-voltage, high-current power supplies, call John Power at (213) 679-4561. Or use the coupon. (These components are available from stock from our distributors.)

TRW Power Semiconductors

An Electronic Components Division of TRW, Inc.,
14520 Aviation Boulevard, Lawndale, California 90260

- Please send me data sheets on TRW's Power Schottky Diodes
- Have a salesman get in touch with me

Name _____

Company Name _____

Position _____

Address _____

City _____

State _____

Zip _____

TRW POWER SEMICONDUCTORS

ANOTHER PRODUCT OF A COMPANY CALLED TRW

Analog servo system puts live actors in mini sets

A very accurate servo system that allows live actors to seemingly perform "inside" of complex miniature sets has been developed by the Magicam Div. of Paramount Pictures in Los Angeles.

The two-camera technique for either film or videotape employs one camera trained on the actors performing on a blue-matte stage, and a second servo-controlled camera that views a miniature set. When a proportional mixer puts the two images together, the actors appear to be on the mini set.

"The technique allows for better than an order of magnitude saving in the cost of set building," says Joseph Matza, executive director of

Magicam. "We're the first group to accomplish real-time coordination of camera movements to within 3 s of arc. Previous systems handled about 2 to 5 minutes of arc at best," says Matza.

A sensor array involving 12 different transducers is used to collect velocity and position information from the foreground dolly (on which the camera viewing the actors is mounted). The signals from these transducers are processed to derive X and Y-axis positions, pan position and tilt position.

The processed signals are then fed to the positioning system for the background camera (for view-

ing the miniature set). Position information from the background camera is fed back to an error amplifier and the resulting signal repositions the background camera.

Matting not new

News shows have used matting for years, with the commentator typically sitting at his desk in front of a blue screen. The foreground camera would view this scene, while the background camera would view slides or news film.

The two images would be combined into one composite picture in which the video from the background camera replaces the fore-

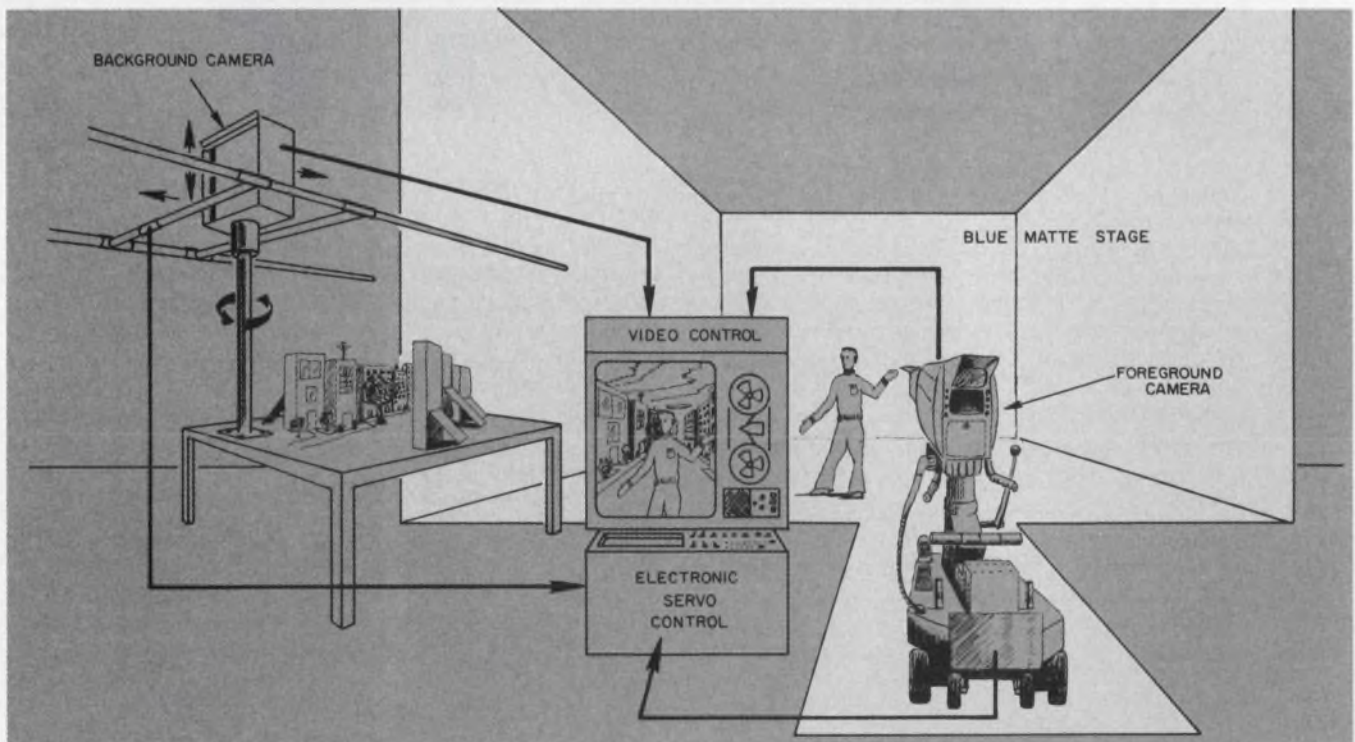

The foreground camera, which may be either a film or video camera, is trained on the blue cyclorama stage. The electronic servo control installation permits the slaving, by means of electronic servo devices, of the two video film cameras. The background camera reaches into the

miniature set with a periscope lens, and instantaneously reproduces all movements of the foreground camera in the scale of the miniature. The video control installation allows the composite image to be monitored and recorded live.

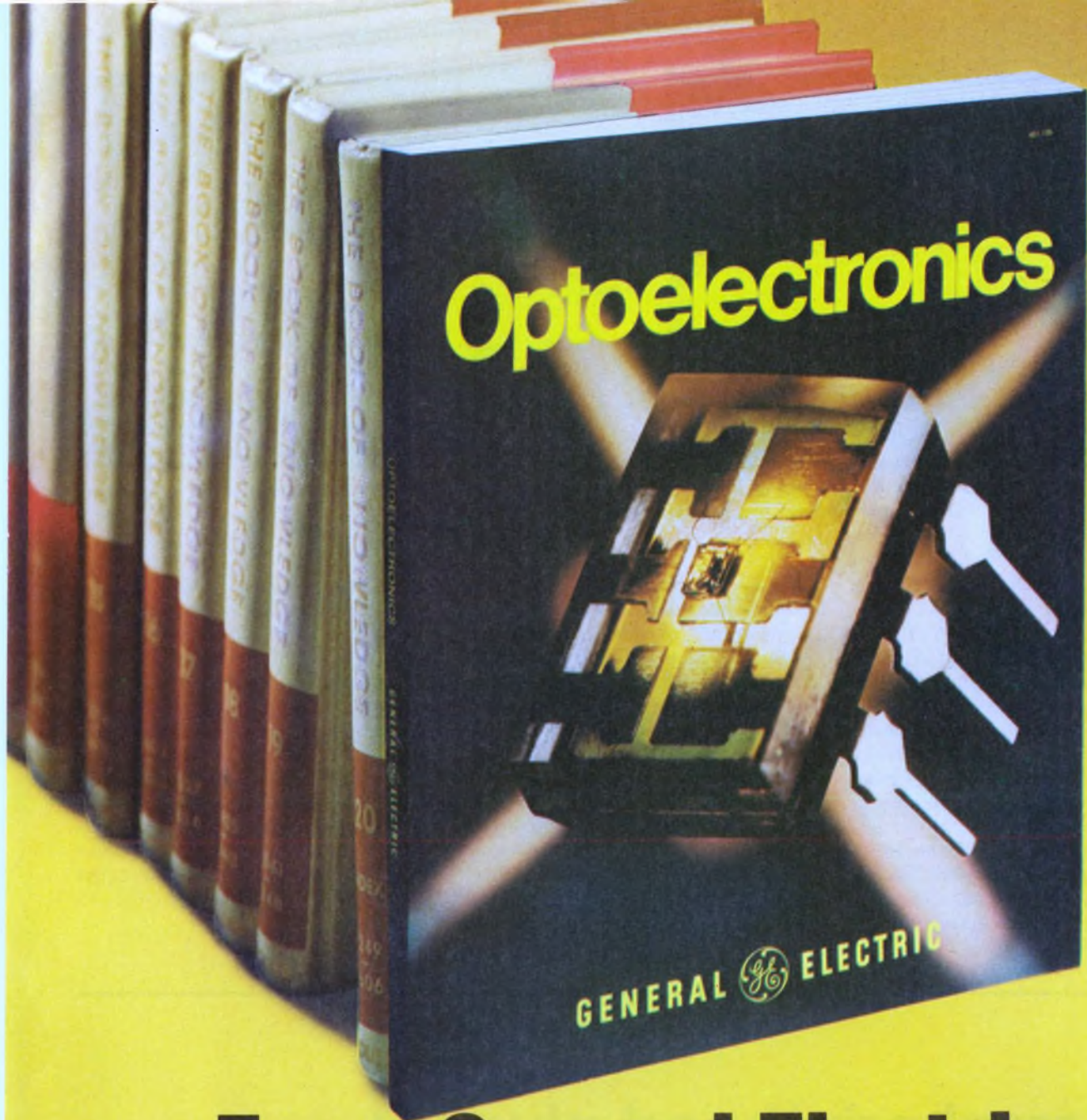

From General Electric New Optoelectronics Manual

NEW 192 page Manual written by General Electric Application Engineers contains 7 basic sections of practical user oriented information relating to Emitters, Detectors & Couplers—

- Theory
- System Design
- Reliability
- Measurements
- Circuits
- Symbols & Terms
- Specifications

Copies are available from any authorized GE distributor, GE OEM Electronic Components Sales Office, or by sending \$3.00 plus applicable tax to General Electric, Semiconductor Products Department, Electronics Park, Bldg. 7-49, Syracuse, New York 13201.

In Europe send £1.50 to ETC, County Louth, Dundalk, Republic of Ireland.

GENERAL  ELECTRIC



One camera in the Magicam system is trained on the Holy Bible (left), while other camera is trained on live actors.



The two images, combined into one picture, are shown on the monitor.

ground areas in which blue exceeds a pre-set level.

Chroma-key is a video switch that acts on the input of a comparator. Color cameras typically have three sensing tubes that are sensitive to red, green and blue. The chroma-key system subtracts half of the red-plus-green signal from the blue and uses the result to drive the comparator.

Matza points out that the foreground image always looks pasted into the background image because of the edge that is generated by

the switch. Also, areas of indecision—like shadows on the blue, translucent objects, out-of-focus edges and blue reflections—tear or are noisy as the comparator switches in and out of its threshold area.

Magicam solves this problem with a proportional process that uses differential amplifiers to perform blue-subtraction and fast dissolves (mixing of foreground and background signals). Thus, a shadow area on the blue floor, where there is reduced luminance but the

same blue chroma value, will be reproduced in the composite scene as an area of reduced luminance in the background scene.

A transparent object in the foreground, such as a glass of beer, will be reproduced as a transparent object with the amber cast of the beer (minus the blue) subtracted from the background scene.

The electronics in the Magicam system allow the foreground and the background scenes to be scaled to virtually any size relative to each other. ■■

Thermal printhead plus μ P equals greatly simplified circuitry

How do you drastically reduce the amount of drive circuitry and cabling in a thermal printhead structure? You let a microprocessor take over some of the functions.

A new thermal printhead designed to interface with a μ P is in volume production at Texas Instruments, Houston, TX. The printhead is used for generating hard-copy readout in a portable data terminal, the Model 743/745 also being manufactured by TI.

The printhead uses the same physical structure and semiconductor-implantation process as in TI's

earlier thermal printhead, Model EPN 2200. However, the number of conductors in the flexible connecting cable that links the printhead to the electronic-drive circuitry has been reduced.

In the new data terminal, the dot pattern for each alphanumeric character generated by the printhead is stored in the μ P's read-only memory (ROM). The ROM also contains the μ P program that controls such other data-terminal functions as keyboard encoding and motor control. The μ P, TI's 8080, uses part of its memory for storing character-generating information,

and thus allows a reduction in the amount of required buffer circuitry that leads to the printhead.

A unique feature of the μ P-compatible printhead is that latching (switching on, and holding) is accomplished in the head itself, through an npn and pnp-integrated structure (see Fig. 1) that operates in a manner similar to the latching action of a silicon-controlled rectifier.

Thermal printheads are not new. Earlier models, however, required that individual print elements (usually a single mesa—a raised surface formed on an inte-

THE INTEGRATED CIRCUIT BREAKER

THREE TECHNOLOGIES— ELECTROMECHANICAL, HYBRID, AND SOLID-STATE—TO MATCH YOUR GROWING PROTECTION REQUIREMENTS

You'll always need overcurrent and short-circuit protection. But with the vulnerability of solid-state circuits and the increasing threat of brownout, that alone may not be enough.

For example, if you're designing with integrated circuits and other semiconductor components, you've got to guard against overvoltage as well as overcurrent. Transient overvoltage protection requires nanosecond response; overcurrent for semiconductors may require microseconds. Sometimes conventional circuit breakers simply aren't fast enough.

And if you're designing equipment to be used on a typical ac line—motors that can burn up, instruments that can become inaccurate, and computers that can garble—you've got to watch out for brownout. But undervoltage protection is something else you can't get with conventional breakers.

These are tough problems. But Heinemann can solve them all—often with a single device combining several protection functions. We have three kinds of breakers—electromechanical, hybrid electromechanical/solid-state, and all solid-state—so we're not committed to selling you any one technology that may have limitations.

Our highly experienced field representatives and factory application engineers can apply any or all of these technologies to solving your protection problem. Whether you make computers or coffee machines. Whether you make them in South Bend or Singapore. Heinemann has representatives in all major industrial areas. And factories in the U.S., Canada, West Germany, South Africa, and Australia.

Send for our electronic protection literature package. It'll tell you what you're up against. And what kind of protection you need to safeguard your circuits and your company's reliability reputation. Heinemann Electric Company, Trenton, NJ 08602. Phone (609) 882-4800.



HEINEMANN

We keep you out of trouble.

CIRCLE NUMBER 21

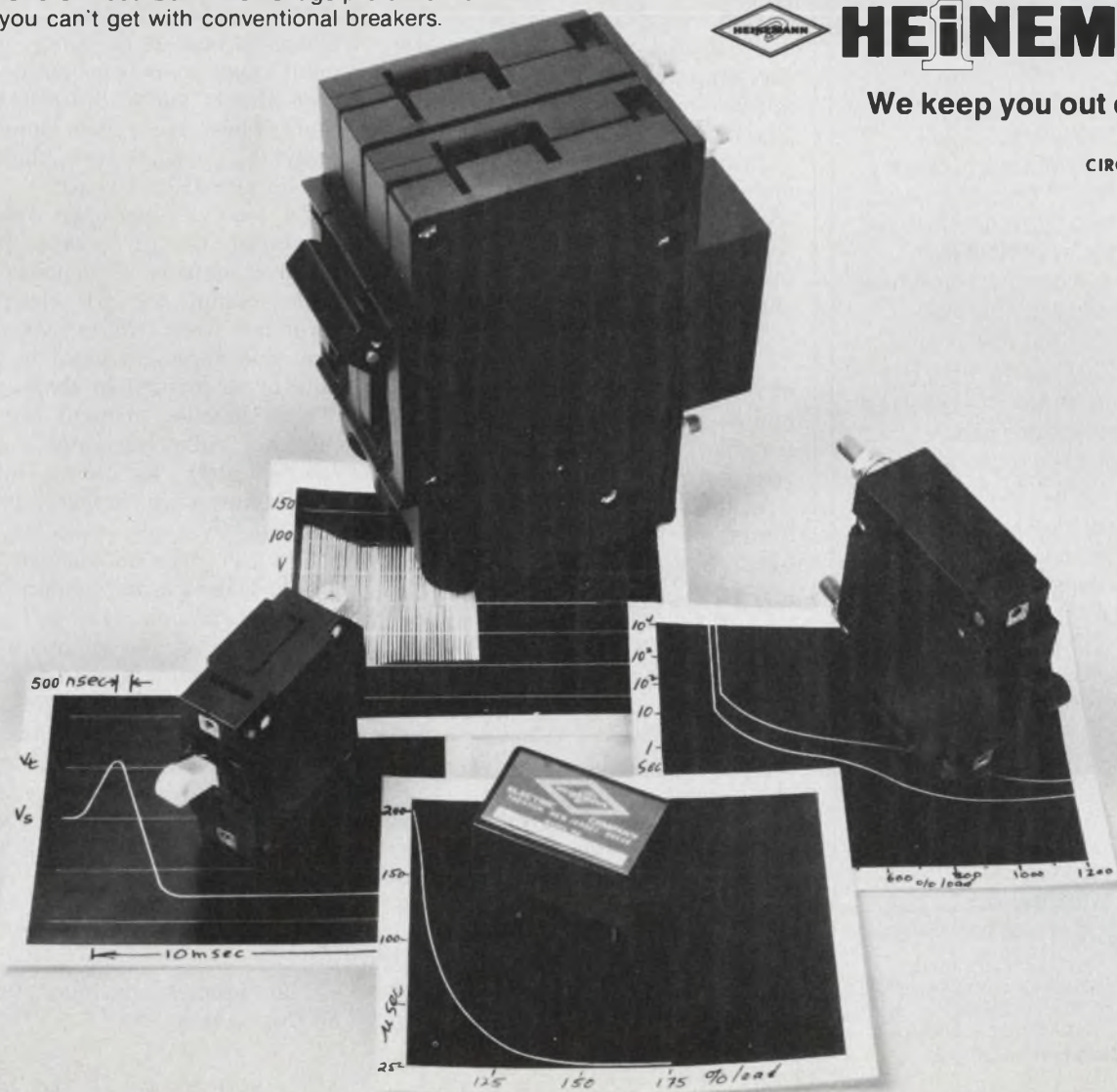

Blind coaxial mating made easy.

Blind coaxial mating used to pose a real problem. Now, standard connectors in Omni Spectra's OMQ[®] miniature and OSQ[®] subminiature series make it easy. Units in both series allow you to construct a virtually endless variety of multiple coupling configurations.

And electrical performance is outstanding. Pulse rise times of 30 picoseconds are passed without discernible degradation. Typical VSWR is 1.15 at 5 GHz.

OMQ and OSQ series also offer units for optional access to bulkhead connectors via flexible or semi-rigid cable. This includes quick connect/disconnect units that can be used with or without positive locking.

Send for complete catalog.



21 Continental Boulevard, Merrimack, N.H. 03054
Tel. (603) 424-4111, TWX 710-366-0674

CIRCLE NUMBER 22

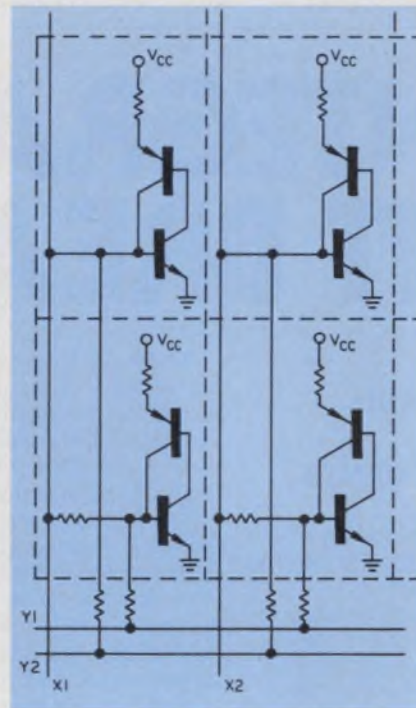

1. An npn and pnp-integrated structure achieves latching directly at the thermal printhead.

grated circuit) be driven to the "on" condition and held there for the time necessary for a mark to appear on the thermally sensitive paper.

Each mark usually consisted of a single dot, and by controlling just which mesas were to be turned on, the printer's control element determined the pattern or alphanumeric character to appear.

The drive electronics for an early TI system of this type consisted of a character generator, 35 latches and 35 printhead drivers. Approximately 10 integrated circuits were required.

In the new system, the transistor driver of each mesa is replaced with a latching circuit located on the printhead. What this does, is to turn on an individual mesa and hold it until an instruction from the μP turns it off.

By means of a matrix-addressing system, a group of mesas in a row or column can be addressed by a single machine instruction. They can also be addressed individually, as in the old system.

This printhead architecture reduces the cable from 40 to 17 leads, according to Widge Henrion, manager of technical development at Texas Instruments. The number of support ICs is reduced from 10 to

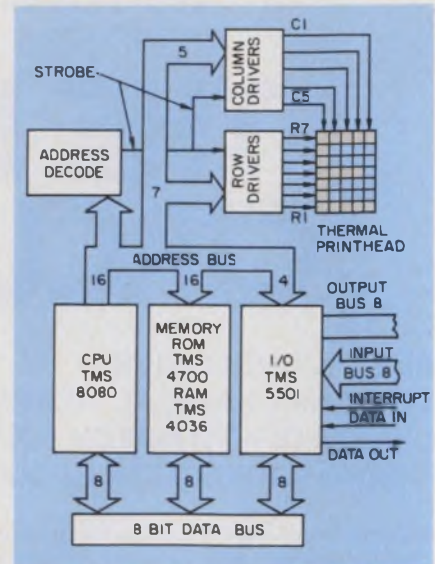

2. The 8080 microprocessor controls TI's thermal printhead while also handling other data-terminal functions.

2. The diagram of Fig. 2 shows the μP system that is used to interface with the printhead.

Fig. 2 also shows the letter E being formed. Each square of the print matrix is energized when both the R and C lines reaching that square are driven simultaneously. At the same time, the strobe line is pulsed by the μP .

To load a character into the printhead, the μP selects each of the five columns in sequence. Into each column the μP delivers a seven-bit word whose pattern of ones and zeros corresponds to the dots to be printed in that column.

For example, to print the letter "E," the following steps are executed (refer to the printhead-matrix drawing, upper right of Fig. 2):

The μP turns on the print voltage and then loads column 5 (the first column on the left) with 111111. That is, column C5 and rows R1 through R7 are all set to 1. Next, the μP sends an enabling signal to the strobe line, and the vertical line of the figure "E" is printed.

To form the next part of figure "E," the μP sets column C4 to 1 and sets R1 through R7 to 1001001. The μP next strobes the circuit, and a segment of the upper, middle, and lower bar of the "E" gets printed.

This process continues through all five columns. ■■

Problem

Interacting low-frequency filter adjustments.

Solution

HP's 3580A Spectrum Analyzer.

Benefit

Time saved, tuning simplified.

It's a typical problem. Your finished prototype usually contains multiple adjustments — which means you use a lot of time tuning your filter for top performance.

If you're designing filters to operate in the 5Hz to 50kHz range, you now can stop using so much time, stop being bothered by interactive adjustments. Our 3580A combines a built-in tracking oscillator, wide dynamic range, and digital storage to help speed and simplify every step of your next filter design. Follow this typical example and learn how the 3580A can help.

Step 1 With the 3580A, observe your spectrum and determine which frequency components to pass, which to attenuate. Decide the best type of filter to get the performance you need. Design your filter.

Step 2 Once you've selected your components and breadboarded a prototype, you can analyze your filter's performance with the 3580A. Its 80 db dynamic range gives you a clear view of everything taking place so you know exactly how your prototype is per-

forming. Now with the tracking oscillator driving your filter, you can trim component values to optimize filter performance. Note how the tracking oscillator lets you observe the influence of each adjustment on filter performance — how it reduces the frustration you experienced before with interactive adjustments.

Step 3 Package and build your first production filter. Use the 3580A's digital storage to superimpose both waveforms for simultaneous viewing — a big advantage of the 3580A. Now set up and store the response of a good production filter and simply compare other production units against the good one, making adjustments as needed.

All of the capabilities in one instrument gives you extra value in your filter design and production. It's priced at \$4485*. Your local HP field engineer can give you all the details. Or write for our 8-page technical data sheet.

*Domestic U.S.A. price only.

Step 1.

Analyze your spectrum.

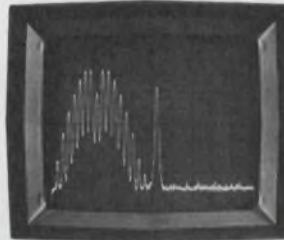

Step 2.

Adjust your prototype's response.



Step 3.

Compare all production filters with the stored standard. Note the analog look that you get with HP's digital display.

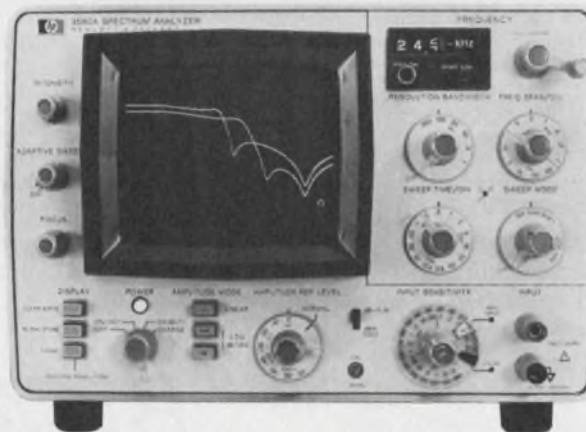

HEWLETT  PACKARD

Sales and service from 172 offices in 65 countries
1501 Page Mill Road, Palo Alto, California 94304

CIRCLE NUMBER 23

NEW 3½ Digit Multimeter from B&K-PRECISION



B&K PRECISION MODEL 283—\$170

**...you'll want it for its features
...but it's the price that will sell you!**

- High intensity LED display is easily read from at least 6 feet in the brightest room
- 0.5% DC accuracy
- 100% overrange (1000 scale reads to 1999)
- Automatic polarity
- Automatic decimal point
- Flashing overrange indication on display
- Four ranges each for voltage and current
- Six resistance ranges to 10 meg.
- Reliable In-circuit resistance measurements
- Overload protection on all ranges

Complete new circuitry makes the Model 283 the most dependable and versatile 3½ digit multimeter you can buy. The extra-bright display allows you to use it where other units would cause reading problems. The selectable "low ohms" function permits accurate measurement of semiconductor shunted resistors.

An optional, internal battery pack (BP-83, \$50.00) provides 8 hours of continuous use on one overnight charging and charges when the Model 283 is in use on 115/230VAC.

Thoughtful, convenience features like a side carrying handle, tilt stand and detachable line cord add to its usefulness.

Your B&K-PRECISION distributor has them in stock and will be glad to demonstrate its features to you. Call him, or write for additional information.

B&K PRECISION
PRODUCTS OF DYNASCAN

1801 West Belle Plaine Avenue
Chicago, Illinois 60613 312/525-3990

In Canada: Atlas Electronics, Toronto

FOR PRODUCT INFORMATION CIRCLE # 241
FOR PRODUCT DEMONSTRATION CIRCLE # 242

**Who provides the
industry's broadest
line of electronic
packaging hardware
... including
Edgeboard Connectors?**

SAE does! Our injection molding equipment produces an almost endless variety of connector configurations.

You can choose between .100", .125", .150" or .156" contact spacings. Single or dual readouts. Pierced eyelet, dip solder or wire-wound terminations in one, two or three levels. Even right-angle terminals if that's what you need. You can pick either 10, 30 or 50 mils gold over nickel plating; thru-hole or tapped insert mounting styles; in-contact or between contact polarizing keys; and phenolic or thermoplastic housings.

And if we haven't described one you like, we'd be pleased to quote a custom connector to your specification! Our new 128 page packaging handbook gives complete details, and also describes our entire line of electronic packaging and interconnection hardware.

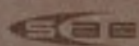
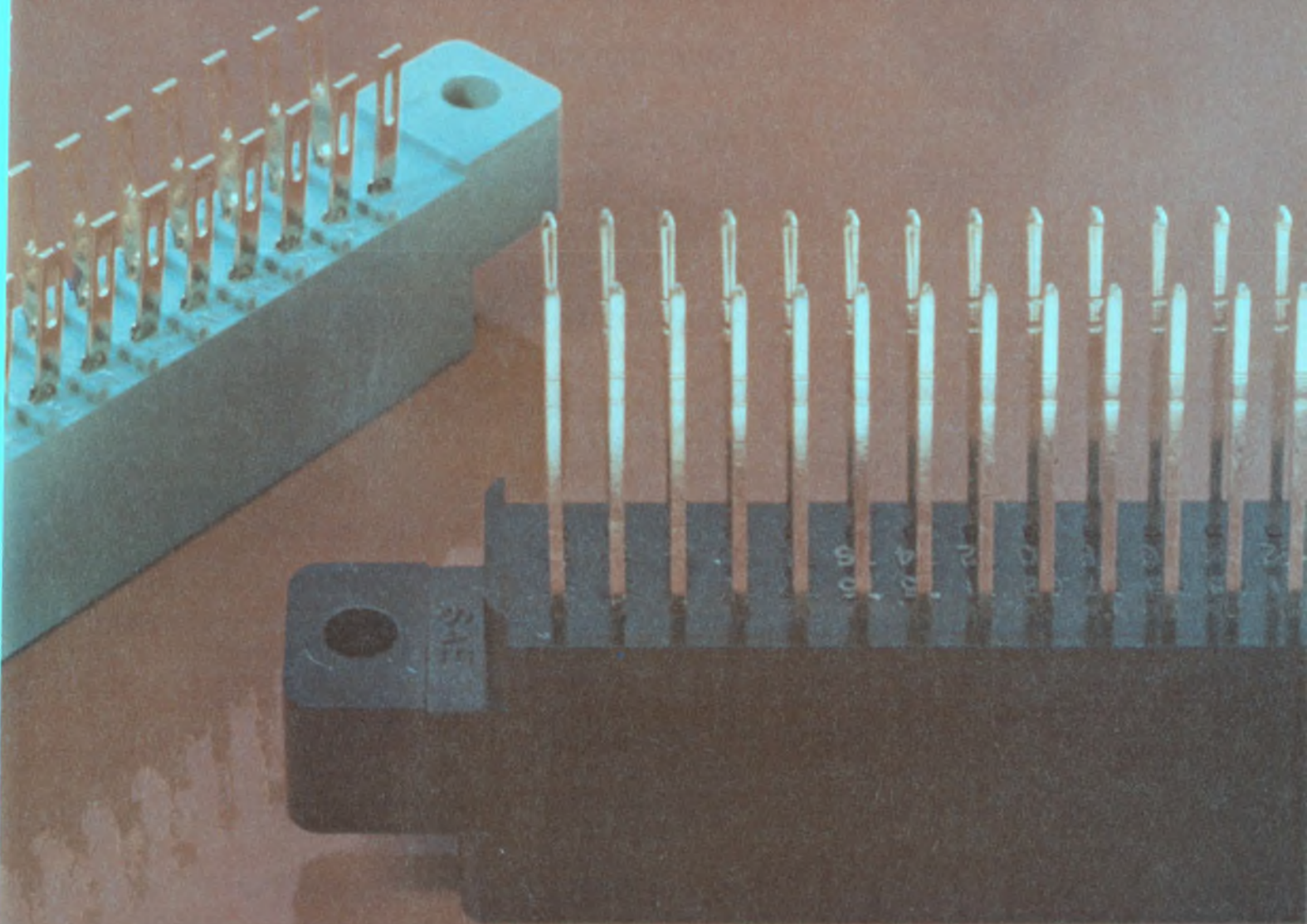

Stanford Applied Engineering, Inc.

340 Martin Ave., Santa Clara, CA 95050
(408) 243-9200 TWX 910-338-0132

CIRCLE NUMBER 25

five important reasons to specify the **KEPCO JQE** power supply

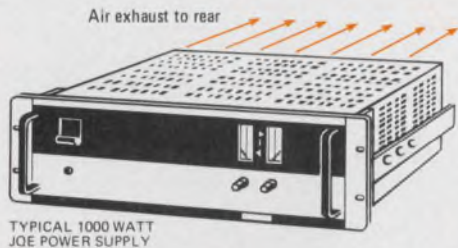

- **JQE deliver their rated output right up to +71°C** without any derating whatever. Moreover, they run cool! Internal blowers actually help circulate the air in your system to keep hot spots from developing.
YOUR MECHANICAL PEOPLE WILL APPRECIATE THIS.

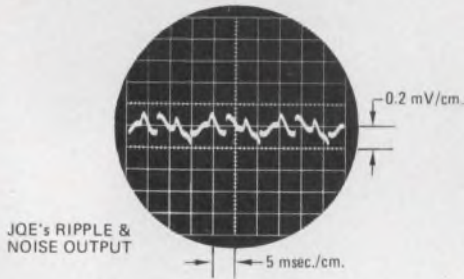

- **JQE produce clean d-c**, less than 0.2 mV rms ripple and noise (1.0 mV p-p including spikes up to 10 MHz). The output varies less than 0.0005% for the worst sort of line variation, and long-term drift is less than 0.01%.
YOUR LOAD WILL APPRECIATE THIS.

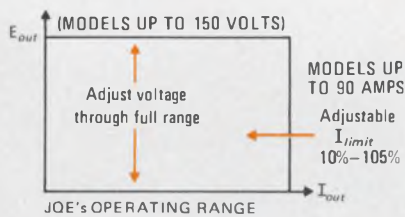

- **JQE are wide-range instruments.** Every JQE can be set from zero to its rated output. What's more, they all have one *additional* volt capacity so that wire drops do not subtract from the voltage available to your load. Buy a 0-15V model to cover the 5V, 6V, 8V, 10V, 12V and 15V loads. A 0-36V model to take care of 18, 24, 28, 32 and 36V jobs.
YOUR BUDGET WILL APPRECIATE THIS.

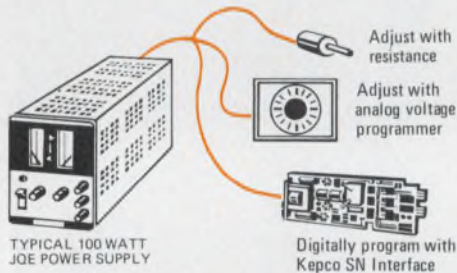

- **JQE are fully programmable**—by resistance (1000Ω/volt) or by voltage (any gain ratio you choose) or by parallel binary or BCD logic. That means you can easily interface your JQE with a computer control bus. (Use the Kepco SN Programmer)
YOUR SYSTEM WILL APPRECIATE THIS.

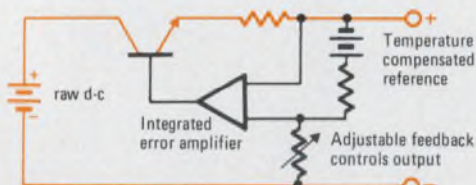

JQE IS AN OPERATIONAL POWER SUPPLY THAT BEHAVES LIKE A LARGE LINEAR AMPLIFIER

- **JQE are linear voltage stabilizers**—which means that JQE are a lot simpler and more reliable than switching machines. (You get a 5-year warranty.) A linear JQE will respond in micro-seconds to a load shift; will maintain its low output impedance into high frequency pulsed loads; produces no RFI/EMI and doesn't hack up the power line like SCR types.
YOUR NEIGHBORS WILL APPRECIATE THAT.

JQE

is a premium quality voltage stabilizer for the no-compromise job

Write Dept. V-05 for the new Kepco Catalog and Handbook.

KEPCO®

131-38 SANFORD AVENUE • FLUSHING, N.Y. 11352
(212) 461-7000 • TWX #710-582-2631

Washington Report

GAO to eliminate some disaster warning systems

In case of national disaster, man-made or natural, present plans call for the American people to be warned into a state of paralysis by five general-purpose systems and seven specialized systems. The General Accounting Office thinks that two systems would be enough, and that elimination of the other 10 would save a lot of money—\$310 million to be exact.

The two favored systems are the National Oceanic and Atmospheric Administration's Weather Radio System and the Defense Civil Preparedness Agency's national warning system. NOAA already has 77 of the planned 331 transmitters in operation for its system and expects to have them all going by 1978. Each one covers a 40-mile radius, the entire system would reach 90% of the population.

The DCPA system operates through telephone linkups of national warning centers with state and local civil defense units. The GAO estimates that these two programs will cost \$42 million through 1980.

Among the 10 systems that GAO doesn't feel are needed are NOAA's Satellite Disaster Warning System, slated to cost \$81 million through 1980, and the Defense Dept.'s Decision Information Distribution System, which has a price tag of \$73 million.

An overland Loran is in the works

The Loran C radio navigation system, which covers most of the world's oceans, may be extended to cover the continental United States.

The go-ahead depends on the findings of a special-project office set up by the Dept. of Transportation to investigate the benefits and costs of such a service.

The department says its preliminary investigations show that many government agencies and private companies could use to advantage the positioning data provided by an overland Loran system. Contributing to the attractiveness of the proposal: developments in receiver technology are continuing to bring down size and power requirements, thus making the system cheaper to use.

ILS units to get 'lightning rods'

The Air Force is installing special devices to protect instrument landing systems from the disruptive effects of lightning strikes at 58 of its bases and 72 Federal Aviation Administration units.

Developed by the Air Force's Electronic Systems Division and Rome Air Development Center, the modification kit consists of a series of diodes and

tubes that ESD says act as a self-restoring circuit breaker. The device grounds the power surges that now account for many outages and equipment failures on the solid-state AN/GRN-27 ILS units now in use.

Grissom AFB, IN, was the first to receive the lightning fix. The rest of the Air Force and FAA installations will be modified this spring, with those that have the most severe thunderstorms having priority.

FCC opens a consumer office

The Federal Communications Commission has opened a Consumer Assistance Office to handle queries from the public. The move is part of the Ford administration's campaign to convince Congress that a consumer protection agency is not needed.

According to the FCC, any person or group seeking information about rules, applications, hearings or matters pending, or FCC policies or regulations, may now contact this office, which is on the second floor of the agency's headquarters building in Washington. The telephone number is (202) 632-7001.

The office will also provide assistance to anyone who wants to participate in the Commission's processes, such as hearings, or wants to know how to file a license application.

Capital Capsules: The White House's Office of Telecommunications Policy expects to have a study by mid-1977 on the impact of optical-fiber technology on future communications systems, particularly in urban areas. The study will be conducted through the Dept. of Commerce's Office of Telecommunications Policy Research in Boulder, CO. . . . Betty Ford may well become the patron saint of citizens-band-radio retailers. **The granting of a temporary license to the First Lady prompted the FCC to allow distributors to issue temporary tickets, good for two months, to new buyers.** It's likely, however, to remain a permanent procedure because the FCC now gets about 500,000 applications per month and its Gettysburg, PA, office is saturated when it gets 300,000. . . . **The Air Force has awarded Raytheon a contract to build the first operational phased-array missile warning system (PAVE PAWS) at Otis AFB, MA.** Under the \$46.5-million contract, Raytheon will build and test the unit to watch things from the East Coast. Later, a companion unit will be built at Beale AFB, CA to detect sea-launched ballistic missiles. . . . **You have until June 30 to send in nominations for membership on the United States Metric Board,** which is to lead the nation toward voluntary adoption of the metric system. One member is to be selected from lists of qualified individuals recommended by engineers and organizations representing engineering interests. . . . **The Naval Air Development Center is seeking firms to design, develop, fabricate, and test bi-level solid-state switches for airborne multiplex applications, and solid-state load controllers.** . . . **Wireless communications for trackless haulage vehicles in coal mines is getting high priority from the U.S. Bureau of Mines.** Under a new study program, the agency plans to determine the necessary vehicular and way-side repeaters needed in a coal mine to interface a radio system, developed by the Bureau of Mines, to an existing cable or telephone line in a mine.

116 reasons why *only* Buchanan[®] PC Board Connectors provide **Lowest Total Applied Cost!**

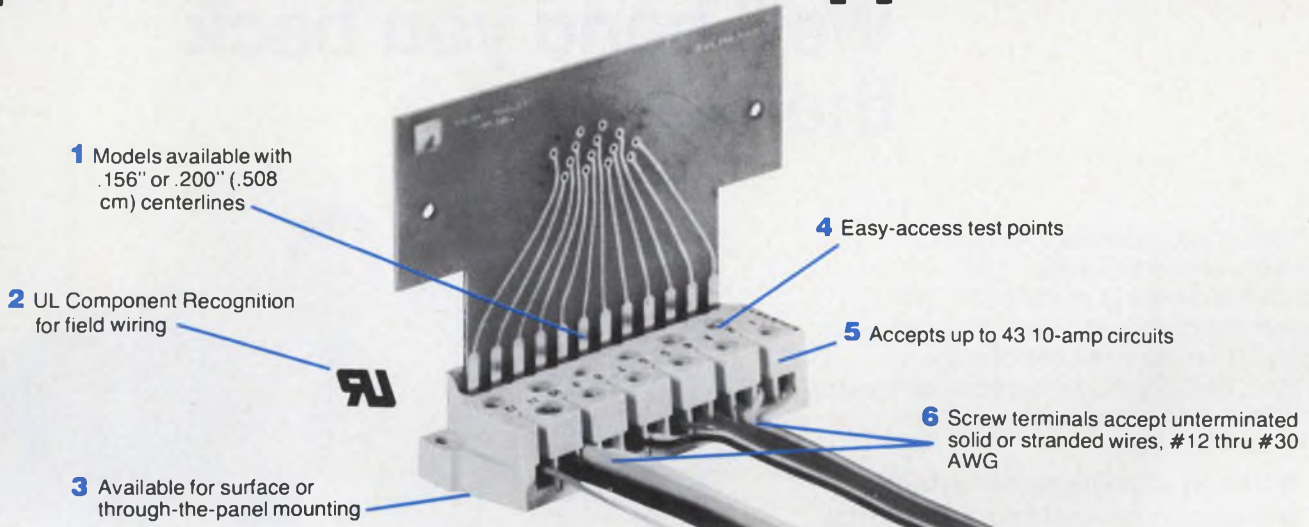

And here are 110 more—the 110 connections you eliminate!

Here's how to achieve significant Lower Total Applied Cost when building control panels or other equipment using printed circuit boards.

Simply specify the new Buchanan Connector that eliminates hybrid interfaces between electronic circuitry and electrical connections. It replaces multiple terminal strips and costly interwiring; actually saves up to 5 separate connection points—potential trouble spots—per circuit!

Models are available for just about every standard requirement. For complete engineering and ordering information, use the Reader Service Card. Or, call one of our Factory Regional Offices shown below. They'll also be happy to talk to you about special configurations.

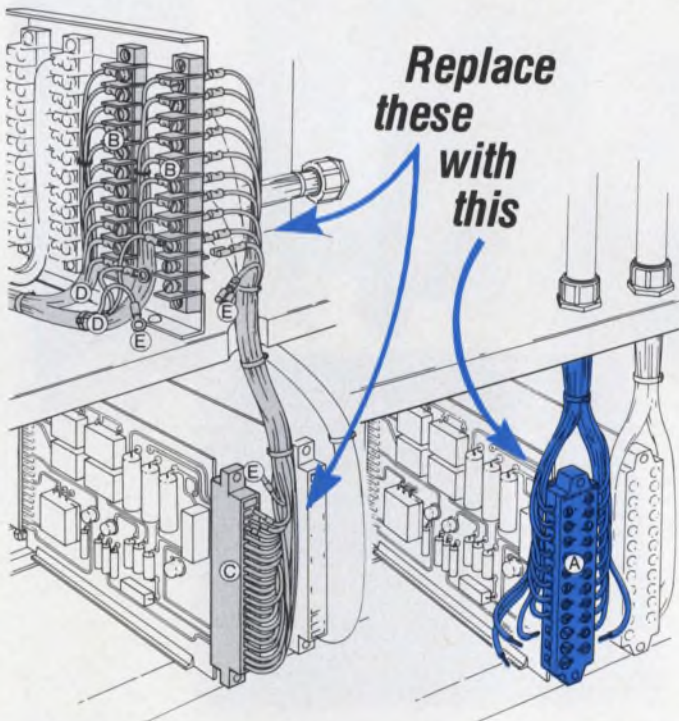

Just one Buchanan Printed Circuit Board Connector (A) replaces the two terminal strips (B), the edge card connector (C), the double wiring (D), and the 110 costly terminations (E) shown at left. Result: LTAC (Lower Total Applied Cost)!



Models available for surface or through-the-panel mounting, with or without card guides and keys.



**CONTROL PRODUCTS
DIVISION**

Amerace Corporation
Control Products Division
2330 Vauxhall Road
Union, N. J. 07083, U.S.A.
Telex 138-978

21

Atlanta—(404) 261-1224 • Cleveland—(216) 333-8540 • Chicago—(312) 437-8354 • New York Metro.—(201) 355-7770 • Los Angeles—(213) 863-5753

CIRCLE NUMBER 27

Hand us your interconnection design problem.

We'll hand you back the solution.

At Fabri-Tek's National Connector Division, we do more than just sell connectors out of the book. We'll custom-tailor a complete interconnection system from our wide line of plate, molded, backpanel, and special connector products. And we'll handle your job from start to finish:

- Design engineering and artwork
- Stamping and molding, numerically controlled drilling, selective plating, automatic subassembly, quality assurance
- Field service, applications engineering

Many "blue chip" companies rely on us to solve their special interconnection problems. Give us a chance to solve yours. Call Peter Van Wyngaeren at (612) 533-3533.

- Integrated backpanel systems
- Metal backplanes and plate connectors
- Special molded connectors
- Standard card edge connectors
- Card cages
- I/O connectors
- Telephone and military connectors

Single and Multilayer P.C. Backpanels #201
Aluminum Backpanels #202
Edge Card Connectors #203
Special Molded Connectors #204
Commercial #205
Military #206

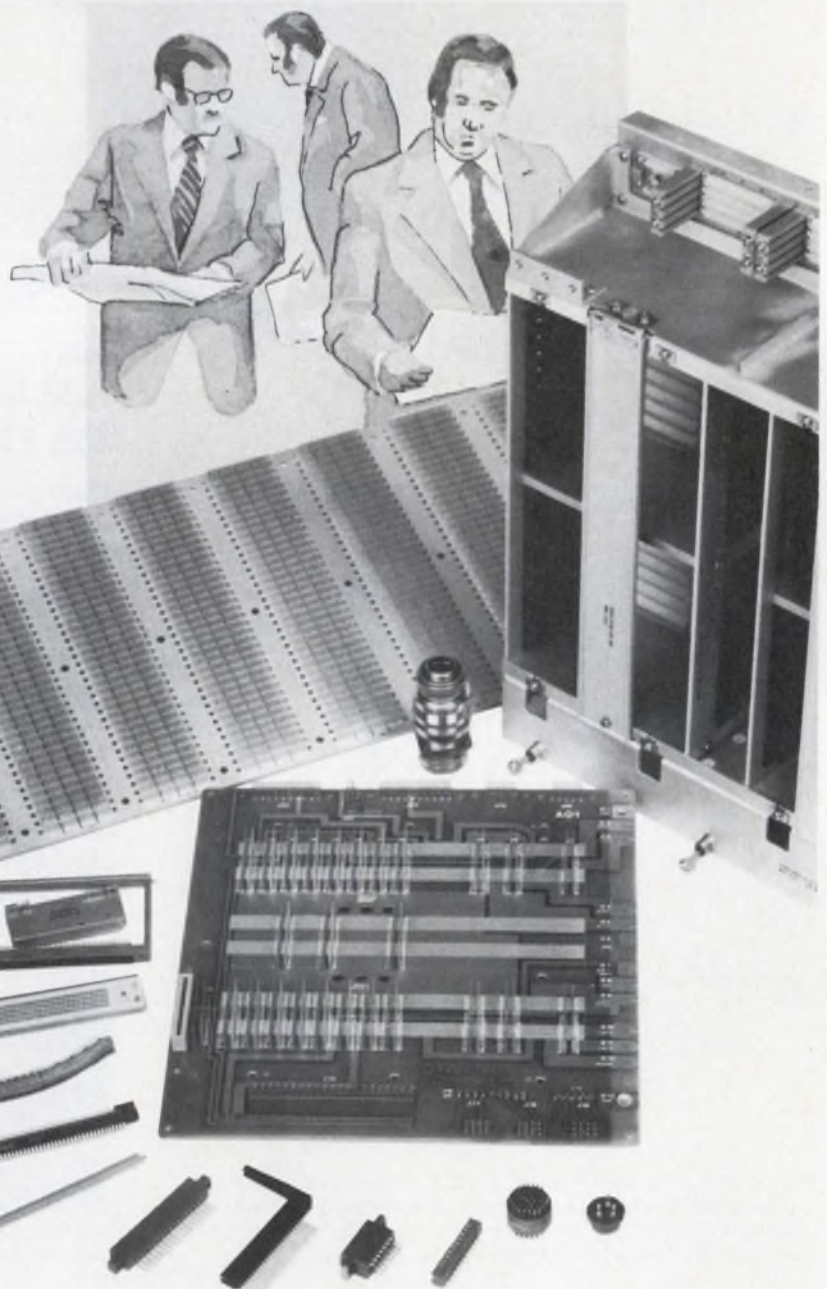

FT **FABRI-TEK**
NATIONAL CONNECTOR DIVISION
9210 Science Ctr. Drive Minneapolis, MN 55428 (612) 533-3533

We were going to second source Intel, but we couldn't wait.

Advanced Micro Devices' 4K Static RAM Family: The Am9130 and Am9140.

Fully Static—no refresh required.
No dynamic nodes.

Single 5V power supply.

High speed: Access times to 200
nanoseconds.

Two organizations: Am9140-4Kx1,
Am9130-1Kx4.

**All input and output logic levels
identical to TTL**—full 400 mV noise
immunity.

Low power dissipation: 250 mW typ.

High output drive: 3.2mA @ 0.4V.

Full military range available:

—55C° to +125C° ambient.

DC standby mode. Reduces power
dissipation by 80%.

Memory status signal. Indicates when
data are valid, allows improved overall
performance, and simplifies timing.
(And if you don't want to use it, just
ignore it. It won't affect conventional
memory operation.)

MIL-STD-883, of course.

Advanced MOS/LSI



Advanced Micro Devices • 901 Thompson Place, Sunnyvale, California 94086 • Telephone (408) 732-2400
Distributed nationally by Hamilton/Avnet, Cramer and Schweber Electronics.

CIRCLE NUMBER 29

International Rectifier.

New 10 Amp device makes one-stop shopping easy for fast-switching power transistors.

Now, IR is your source for a wide variety of 3, 5 and 10 Amp JEDEC fast-switching power transistors, to simplify your buying. These hard-glass passivated devices are the ones to use for better reliability and lower costs in line operated power supplies, whether you're chopping line voltages at 20 KHz or inverting and stepping down at high frequency.

Fast Switching Speed—Cooler Operation . . . the oscillographs show typical fall times in the one-micro-second and lower range. Gives extremely low switching losses for cooler operation and higher reliability.

Lower Leakage — High Temperature Stability . . . with ICEO in the micro-amp range, IR devices are about one-tenth the accepted leakage rates of others. Provides the higher stability important for high performance at elevated temperatures.

High Second Breakdown — High Reliability . . . high second breakdown helps provide a broad safe-operating area for an extra margin of safety.

Glass Passivation — Long Term Reliability . . . high reliability and long term stability is achieved by hard glass passivation. Also, if you're using chips to make your own circuits, IR's glass passivation gives you the most stable, easy to assemble chips you can start with, making your yields higher.

If you are paralleling devices, the tight gain, switching time and saturation voltage control of these transistors make the job easier. And through 100% testing of key parameters we can provide even closer matching if necessary.

JEDEC types listed are immediately available, so contact your local IR salesman, rep or distributor today. International Rectifier, 233 Kansas Street, El Segundo, California 90245. (213) 678-8261.

New International Rectifier Fast Switching Power Transistors

IR Part No.	V _{CEO} (sus) (Max V)	I _C Peak (A)	h _{FE} (min/max)	β @ I _C (A)	V _{CE} (sat) (Max V)	β @ I _C (A)	P _d (W)	t _r /t _f (μs)
2N6306	250	16	15/75	3.0	0.8	3.0	125	6/4
2N6307	300	16	15/75	3.0	1.0	3.0	125	6/4
2N6308	350	16	12/60	3.0	1.5	3.0	125	6/4
2N6542	300	10	7/35	3.0	1.0	3.0	100	.7/8
2N6543	400	10	7/35	3.0	1.0	3.0	100	.7/8
2N6544	300	16	7/35	5.0	1.5	5.0	125	1/1
2N6545	400	16	7/35	5.0	1.5	5.0	125	1/1
2N6249	200	30	10/50	10.0	1.5	10.0	175	2/1
2N6250	275	30	8/50	10.0	1.5	10.0	175	2/1
2N6251	350	30	6/50	10.0	1.5	10.0	175	2/1

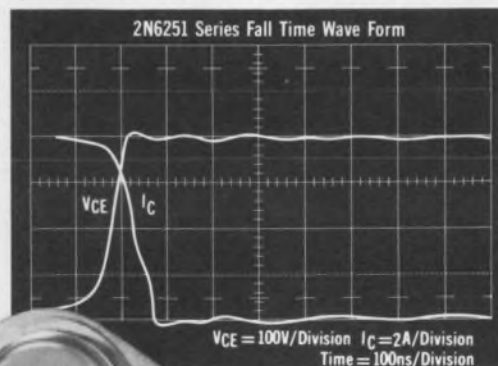
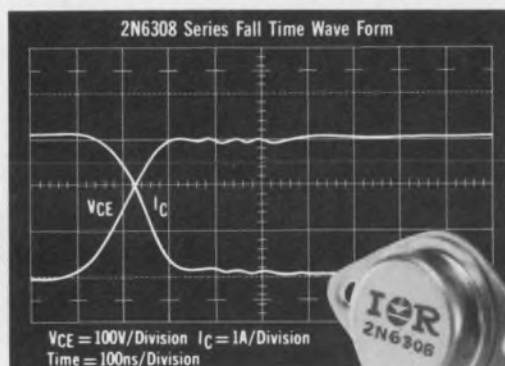

INTERNATIONAL RECTIFIER
the innovative power people



SEMICONDUCTOR DIVISION, 233 KANSAS STREET, EL SEGUNDO, CALIFORNIA 90245, PHONE (213) 678-6281

CIRCLE NUMBER 30

The right DMM decision means
 1 μ V sensitivity, 0.03% accuracy,
 and a \$425* price.

Introducing HP's 3465A DMM.

Now you have a five-function DMM with the needed accuracy, sensitivity, and low cost to solve your bench or field service requirements. See how HP's 3465A Digital Multimeter combines capability, convenience, and confidence with low cost to bring you to the right decision.

Capability: Take a look at the front panel. It has all the functions and ranges you'd expect, and more. You get ohms, ac/dc volts, and ac/dc current. Extra resolution is obtained with a full-scale readout of 19999. Accuracy is $\pm 0.02\%$ of reading $\pm 0.01\%$ of range on dc, meeting the needs for most field or bench applications. The 10 mV dc range and 100 mV ac range provide performance typically found only in more expensive 5½-digit multimeters.

Convenience: The 3465A's functional design means easy rack and stack with other instruments in the lab, while its compactness and low power consumption result in a handy field-service instrument. It will operate from four different sources of power: 1) Four standard D-cell** batteries. 2) The ac line using an HP hand-held calculator charger. 3) The ac line using its own internal power supply. 4) Rechargeable Nickel Cadmium batteries.

Confidence: Fewer components and higher reliability are achieved through the use of a newly developed Tantalum-Nitride on Sapphire thin-film resistor. Easy calibration and improved performance are obtained with a new dual-slope integrator that uses a single reference supply. All these design features, plus input protection, give you the performance you'd expect from HP.

Cost: The standard 3465A costs \$500* and is equipped with an internal power supply, a battery recharging circuit, and Nickel-Cadmium batteries. If you don't need the rechargeable batteries, order Option 001 for \$480* and save \$20* Order Option 002 for \$425* and save \$75* by powering the HP 3465A from dry-cell batteries. Also, Option 002 can operate from the ac line when using one of HP's Model 82002A chargers (supplied with most HP pocket calculators).

When you consider its capability, convenience, and cost, you can be confident that the 3465A is the right decision. Contact your local HP field sales engineer, or, write for more information.

*Domestic U.S.A. Price Only **U-2 Batteries in Europe

**HP DVM's...
 the right decision**



HEWLETT  PACKARD

Sales and service from 172 offices in 65 countries
 1501 Page Mill Road, Palo Alto, California 94304

CIRCLE NUMBER 31

Words cannot describe how good our SRL supplies are.



So let's look at some numbers.

- 14 models for laboratory/systems
- 0-10 to 0-60 volts
- 4 to 100 amps
- 250 to 2000 watts
- 0.1% regulation (constant voltage mode)
- 0.2% regulation (constant current mode)
- 350 μ V (rms) typical ripple
- 10 μ sec overvoltage protection
- 5-year guarantee

And one important word—Programmable.

All SRLs are remotely programmable in both constant current and voltage modes. And if your programming source happens to be digital, our DAP Series high-speed digital-to-analog programmer is what you need. It accepts inputs from all forms of digital sources and converts them into analog signals to program SRLs (or any other Sorensen power supply). DAPs are fully addressable, accept parallel inputs, are fully

buffered. Perfect for automatic test systems and process control.

We have lots more helpful numbers. Just circle the inquiry number to receive our new catalog of over 200 power supply products, including SRLs and DAPs. Sorensen, a Raytheon Company, 676 Island Pond Road, Manchester, N.H. 03103. (603) 668-4500.



SORENSEN
POWER SUPPLIES

A Raytheon Company

Development system simplifies designs based on COSMAC

The COSMAC Development System (CDS) comes fully assembled and can do system prototyping and software development. The CDP18S004 system is based on RCA's CDP1802 single-chip microprocessor.

The development system is supplied in a 19-in. rack-mountable chassis that has a power supply, a front panel with basic controls, a printed-circuit backplane, a basic set of small PC boards that make up an expandable COSMAC microcomputer and 22 empty card slots.

The basic set of cards provides buffering and address latching to support memory systems up to 65,536 bytes. Additional RAM, ROM and PROM cards can be bought from RCA (Route 202, Somerville, NJ 08876. 201-722-3200).

A monitor card contains an interactive utility program that performs such functions as program loading, memory dump, memory examination and modification, examination and modification of all CPU registers, specification of program "breakpoints," single

or multiple-step instruction execution and start of program execution at a given location, with automatic speed adjustment for 110 to 1200 baud terminals.

The CDP18S004 system supports many different terminals, depending on the interface option selected. The system comes with 4-k bytes of RAM, which is sufficient to run the COSMAC resident assembler or the resident editor, both of which are included in the purchase price.

A total of nine spare PC-card positions for memory are prebussed for expansion, and a total of 13 spare I/O positions (one prewired) are made available for the control electronics of user devices. Small, 44-pin PC cards (4.5 × 3-in.) are used in the basic card set and larger cards (4.5 × 6.5 in.) are used for the RAM and monitor boards. The basic COSMAC development system costs \$2250 and is available from stock.

CIRCLE NO. 570

Wire-wrapped board accommodates 6800 emulation kit

A socket board for Motorola's M-6800 chip set can save many man hours devoted to chip interconnection and evaluation. Offered by Cambion (445 Concord Ave., Cambridge, MA 02138. 617-491-5400) and designated the 787-2000-03-03, the board comes completely wire-wrapped for the 6800 evaluation kit, which can be obtained from Cambion. Pre-wired sockets on the board are available for the inclusion of additional memory. Cambion sells the board for \$197.50.

CIRCLE NO. 571

Memory expander for 2650 μ P adds 4-k bytes of RAM

A static MOS memory board, designed for use in the development of 2650 μ P-based systems, has been introduced by Signetics (811 E. Arques Ave., Sunnyvale, CA 94086. 408-739-7700). The board (called the 2650PC2000) contains 32, 21L02 MOS RAMs, organized as 4096 words × 8 bits.

(continued on page 48)

MICROPROCESSOR DESIGN

(continued from page 47)

The PC2000 can be used to extend the memory capacity of the company's PC1001 μ P-prototyping card. The PC1001 card contains 1-k byte of ROM, 1-k byte of RAM and comes completely assembled. The ROM contains a loader and debugger program (Pipbug) plus the necessary software to interface the processor with a serial data input, such as an RS-232 device.

As a stand-alone prototyping card, the PC1001 can store over 900 bytes of user program. In conjunction with the PC2000, the user program can be extended to approximately 5-k bytes.

The 2650PC2000 costs \$550 and the PC1001 costs \$495. Both cards, purchased as a set, cost \$900. Either card is available within four weeks.

CIRCLE NO. 572

F8-based evaluation board sells for \$185



The key elements of an F8-based system come fully assembled and wired on a circuit board from Fairchild (Microsystems Div., 1725 Technology Dr., San Jose, CA 95110. 415-962-8816). The new F8 kit includes a connecting cable for power supply and teletypewriter hookup, and it costs just \$185.

The board contains a 3853 CPU, 3851 program-storage unit, 3853 static memory-interface circuit and eight 2102 static RAMs (1-kilobyte memories). Other features include 32 I/O bits, two levels of interrupts and all necessary control circuits. The kit comes with programming manual and data book.

A Fairbug program is stored in the 1-kilobyte ROM of the program-storage unit. The program contains a bootstrap loader for easily entering a program into RAM memory from the terminal, at speeds from 110 to 2400 baud. It also can dump memory from RAM for future loading or to create a PROM program tape, and can read from a high-speed paper-tape reader.

Delivery is from stock.

CIRCLE NO. 573

μ P-controlled printer combines high throughput and diagnostics

A series of microprocessor-controlled, intelligent matrix printers are designed for use on the Sycor 440 clustered-terminal processing system. The Model 4600 series printers made by Sycor (100 Phoenix Dr., Ann Arbor, MI 48104. 313-971-0900) operate at 60, 120 and 180 characters per second. They use a microprocessor and 5-k bytes of memory for real time control of all system dynamics.

The throughput of the printers is greater than that of conventional printers, claims the company, because of several developments. 1. The unit can print in both directions, thereby eliminating the "dead time" of the carriage return. 2. The μ P can move the head to the beginning or end of the next print line, whichever is closer, and print that line from either left to right or right to left, thereby minimizing the time between the completion of one print line and the beginning of the next. 3. There is automatic vertical slewing whenever two or more line feeds are encountered.

In most print applications, the company claims, its 60 cps printer can equal the throughput of conventional 165 cps printers. The Sycor printers have a 12-key function pad that permits the user to set margin widths, form length and vertical and horizontal tab positions. The printers execute commands such as "top of form," and have dynamic form alignment for pre-printed forms.

The μ P-driven system also generates two diagnostic test patterns that can be initiated

(continued on page 50)



Select from this family of aluminum electrolytic capacitors designed for output filtering in switching power supplies

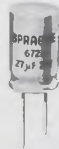

TYPE 672D

- Suitable for parallel stacking
- Plug-in PWB mounting
- Low to medium ripple current capability



TYPE 604D

- True 4-terminal isolation
- Low profile PWB mounting
- Medium ripple current capability

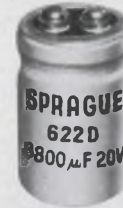

TYPE 622D

- Symmetrical ESR and capacitance tolerance
- Conventional stud mounting
- High ripple current capability



TYPE 432D

- Lowest available ESR and impedance
- Bus-bar mounting
- Maximum ripple current capability

Construction	Rolled-Section		Rolled-Section		Rolled-Section		Stacked-foil	
Terminal Configuration	2 terminals, wire pins		4 terminals, wire leads		2 terminals, low or high female threaded		2 terminals, strip-line, female threaded	
Case Size Range (D. x L.)	.326" x .505" to 1.000" x 1.625"		.750" x 1.625" to 1.000" x 3.625"		1.375" x 2.125" to 1.375" x 5.625"		1.375" x 2.125" to 3.000" x 5.625"	
Operating Temperature Range	-55°C to +105°C		-55°C to +105°C		-55°C to +85°C		-40°C to +85°C	
WVDC Range	6.3 to 100		5 to 200		5 to 55		6 to 50	
Capacitance (Range (μF))	4.7 to 6800		50 to 16,000		2,800 to 67,000		470 to 100,000	
Capacitance Tolerance	-10, +100%		thru 50 V: -10, +75% over 50 V: -10, +50%		±20%		-0, +100%	
Max. Inductance (@ 1 MHz & within .125" of capacitor)	20 nH		2 nH		20 nH		2 nH	
Max. ESR (@ 25°C and 120 Hz)	1200 μF @ 6.3 WVDC	.11 ohm	16,000 μF @ 5 WVDC	.022 ohm	67,000 μF @ 5 WVDC	.004 ohm	100,000 μF @ 6 WVDC	.0015 ohm
RMS Ripple Current (@ 85°C)		2.61 A @ 100 kHz		7.00 A @ 10 kHz		19.5 A @ 20 kHz		54.6 A @ 1 kHz
Max. Impedance (@ 25°C)		.06Ω @ 100 kHz		.017Ω @ 10 kHz		.010Ω @ 10-40 kHz		.001 Ω @ 10 kHz
Engineering Bulletin	3452		3458A		3459		3443A	
	Check 161 on Reader Service Card		Check 162 on Reader Service Card		Check 163 on Reader Service Card		Check 164 on Reader Service Card	

For complete technical data, write for Engineering Bulletin(s) (see table for bulletin numbers) on the capacitor(s) in which you are interested to: Technical Literature Service, Sprague Electric Company, 347 Marshall St., North Adams, Mass. 01247.



THE BROAD-LINE PRODUCER OF ELECTRONIC PARTS

(continued from page 48)

from the function keys. Page format is set at 10 characters to the inch and six lines to the inch, or is optionally condensed to 16-1/2 characters to the inch and/or eight lines to the inch. The increased density, in effect, doubles the storage of a page and can cut paper costs in half.

The 60 cps Model 4606 printer costs \$155/month on a one-year lease and \$133/month on a three-year lease. The 120 cps Model 4612 costs \$218/month on a one-year lease and \$190/month on a three-year lease. The 180 cps Model 4618 costs \$276/month on a one-year lease and \$242/month on a three-year lease. Purchase prices for the printers are \$5600, \$6600 and \$8620, respectively. All lease prices include maintenance. Delivery is within 8 weeks or from stock.

CIRCLE NO. 574

Enhanced macro cross-assembler arrives for 6500

An advanced macro cross-assembler for the MOS Technology 6500 microprocessor operates on both IBM S360/370 and DEC PDP-10 computers. Offered by Zeno Systems (2210 Third St., Suite 110, Santa Monica, CA 90405. 213-396-6020), the software package is written in assembly language in both cases, and is said to be more cost effective than competing packages written in Fortran.

Functionally equivalent to the software provided by the μ P manufacturer, the new ZSI assembler has normal arithmetic expressions and a macro and conditional assembly capability. Other enhancements include the following: extensive error diagnostics within the assembly listing and summarized in a separate file or at the user's terminal; optional variable cross-reference listing; and improved assembly-listing format.

CIRCLE NO. 575

Compact μ P-based data terminal weighs only 13 lb

A lightweight portable data terminal uses a μ P to reduce component count and improve performance. The Model 745 terminal, introduced by Texas Instruments (P.O. Box 1444, M/S 784, Houston, TX 77001. 713-494-5115), weighs 13 lb and costs only \$1995 in single quantities.

The unit includes an ANSI-standard keyboard with calculator-style numeric keypad and has half-duplex and full-duplex operating modes, standard parity options, automatic paper loading and 30 cps thermal printing. Also included in the 745 is a built-in acoustic coupler and optional auxiliary EIA interface capability.

In addition to the 745 TI has introduced the Model 743 KSR terminal. It is intended for time-sharing and I/O console applications and costs \$1395 in singles. The 743 offers all the features of the 745 except that it does not contain the acoustic coupler. Both units are available from stock for purchase or lease.

CIRCLE NO. 576

Macro-assembler and simulator available in Fortran IV

A set of macro-assemblers and simulators for microprocessors is available in standard Fortran IV. The programs are intended for support of the 6800, F8 and 2650 μ P systems and will run on any computer that has a word length of 16-bits or more and at least 16-k words of main memory.

The assemblers provide all the standard features, including symbolic addressing, relative addressing and constant generation. In addition to the standard features, Microtec (P.O. Box 337, Sunnyvale, CA 94088. 408-733-2919) has added features, including a macrofacility,

(continued on page 52)

Point by point,
line by line:

See why our lowest-cost Graphics package has no competition.

Our 1024 X by 780 Y viewable points separate Graphics from mere graphing. The price has never been lower. But Tektronix' new 4006-1 provides the same superior information capacity that has made us the company for all your graphics needs.

We'll throw you a curve. Tektronix will graph circles around the competition. Now, thanks to our new low priced 4006-1, we're in the same ballgame with mere alphanumeric terminals.

Graphics to gain. Nothing to lose. Add the graphics extra at an everyday price: \$2995 or \$150 a month on a two year lease. Alphanumerics? Up to 2590 on screen characters. Plus a spectacular package that includes confirmed compatibility with most mainframes through proven interfaces and time-tested software packages. And expert maintenance that follows you all over the world.

Plug-in peripherals standing by. Like our 4631 Hard Copy Unit for up to four 4006-1's with 8½"x11" copies, or

4923 Digital Cartridge Tape Recorder for low-cost, off-line storage.

Why wait for graphics? Let graphics wait on you. See what our fine-line, full-line graphics can mean for your applications. Check out the whole story and all the prices right now with your local Tektronix Sales Engineer. Or write:

Tektronix, Inc.
Information Display Group
P.O. Box 500
Beaverton, Oregon 97077



CIRCLE NUMBER 34



Graphics
\$2995

MICROPROCESSOR DESIGN

(continued from page 50)

conditional-assembly statements, a set of listing and punch-control pseudo-ops and many diagnostic error messages.

The simulators have a set of commands that permit you to set breakpoints, trace program flow, display and patch memory locations, display and modify simulated processor registers, simulate I/O routines and interrupts, and keep track of timing information. The programs cost \$800 and can be supplied on several different media. A detailed manual, source listing and test program are included.

CIRCLE NO. 577

Single chip holds complete microcomputer

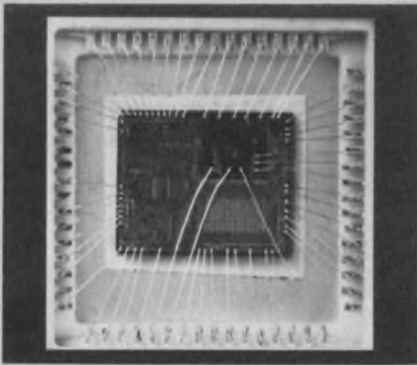

A complete microcomputer with 31 I/O channels and interrupt capability is available on a single chip. Developed by Rockwell International (3310 Miraloma Ave., P.O. Box 3669, Anaheim, CA 92803. 714-632-2321), the chip costs less than \$10 in 10,000-unit orders.

The microcomputer chip contains a 1344 × 8-bit program ROM, a 96 × 4-bit RAM, and a processor. The chip is designated the PPS-4/1 and has an instruction set of 50 commands. I/O options include two 4-bit input channels that can be simultaneously used for testing or comparing data; two 4-bit I/O channels, and 10 discrete I/O lines. Two interrupt-request input lines, one of

which can be used to automatically trigger an echo signal, provide priority input and status capabilities.

The μ C also permits clocked, simultaneous serial I/O. This feature allows "infinitely" expandable I/O options. Pulsed or complex digital waveforms may be easily generated as a variety of serial or parallel outputs. The I/O options also permit the cascading of PPS-4/1 chips to create multiprocessor systems.

Other features of the device include: TTL and CMOS compatibility, an arithmetic logic unit with five working registers, an on-chip resistor-controlled clock generator that can be externally synchronized, and a single-power-supply (15-V) requirement. Power dissipation is 70 mW.

To facilitate production testing of the programmed μ C, an on-chip scheme enables complete testing of every function, including the customer's unique ROM patterns.

The instruction set of the PPS-4/1 μ C is very similar to that used for the company's PPS-4/2 and PPS-4 μ P systems. Full software support, including assembly and simulation programs is available on the G.E. time-share network.

An evaluation model (P/N A6799) has address and memory lines bonded to external pins. A program can be stored in an external PROM or RAM for real-time development and testing, or even as a low-cost, low-quantity system.

CIRCLE NO. 578

Memory and interface support cards fit both 8080 and 6800

Common support cards for microprocessor-based systems are available for either 8080 or 6800-based systems. The cards include a ROM/RAM and a ROM or RAM, and were developed by Pro-Log Corp. (2411 Garden Rd., Monterey, CA 93940. 408-372-4593). Any combination of 64-k 8-bit words for either μ P.

Also available are common input/output cards, TTL-input gate cards, a TTL-output latch card, driver cards, isolation cards and serial I/O cards. Prices for the cards start at \$55 and go up to \$280 and delivery is four weeks.

CIRCLE NO. 579

Is our new HP-27 an engineering work of art? Or simply the most powerful preprogrammed calculator we've ever built?

It depends whether you consider versatility artistic.

The HP-27 offers you all the log, trig and exponential functions we've preprogrammed into all our scientifics. Plus new stat and financial functions, new storage capacity, new clearing operations and engineering notation.

That's why we've dubbed it our "Scientific/Plus."

It lets you forecast, allocate resources, analyze costs.

The combination of stat functions, storage registers, selective clearing and RPN logic system with 4-register stack takes the time and trouble out of sophisticated stat calculations.

It performs valuable time-value-of-money calculations.

Whether you're looking to figure your mortgage or build a capital budget, the HP-27 makes the task easy. You might even be able to do both at the same time, thanks to its exceptional storage capacity.

19 memories simplify complex calculations.

You can store constants in 10 addressable storage registers, financial data in five financial registers. And you have four operational registers in the stack for easy data manipulation.

Six clearing operations let you do multiple calculations without destroying data.

You can clear all 10 addressable registers, or just the six used for stat calculations. You can clear the entire stack, or just the "X" register. Or you can clear the prefix keys only, or you can clear the status of the financial registers.

You get uncompromising design, assembly, support.

Three things that have made believers of the million + people who own personal-sized HP calculators. Three prerequisites for a potential engineering work of art.

800-538-7922

(in Calif. 800-662-9862).

The toll-free numbers to call for

complete specs on our new \$200.00* HP-27 Scientific/Plus and a nearby dealer. Or send the coupon.

















Sales and service from 172 offices in 65 countries.
Dept. 232S 19310 Pruneridge Avenue, Cupertino, CA 95014

Hewlett-Packard
Dept. 232S
19310 Pruneridge Avenue
Cupertino, CA 95014
Please send me HP-27 specs

Name _____
Company _____
Street _____
City _____
State/Zip _____

*Suggested retail price, excluding applicable state and local taxes - Continental U.S., Alaska & Hawaii. 616/06

Financial functions

- Number of periods  
- Interest/period  
- Payment amount/period  
- Present value  
- Future value  
- Net present value NEW  
- Internal rate of return for up to 10 different uneven cash flows NEW  



Statistical functions

-   Factorial
-   Accumulates/deletes stat data (n, Σx, Σy, Σx², Σy², Σxy)
-   Linear regression
-   Standard deviation
-   Correlation coefficient NEW
-   Variance NEW
-   Normal distribution NEW
-   Linear estimate
-   Mean

RAM

IT.

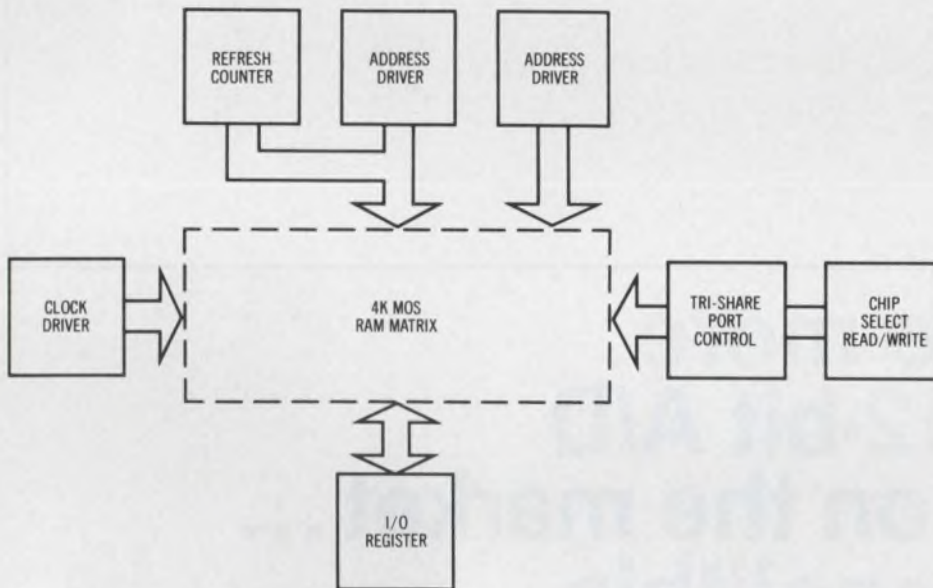

Look no further. Our RAM Interface Circuits solve memory design problems. And when we say solve, we mean solve.

Our Interface Circuits offer Schottky technology, PNP inputs, TTL/DTL compatibility, fall-through latch design, and more.

You can use them with 16, 18 or 22 pin RAMS and they're designed specifically to satisfy memory circuit drive requirements.

This diagram says it better than

any words can. And if the diagram turns you on then you'll love our 12-page booklet. Yours merely for the asking or the writing.

..... DD 5
National Semiconductor Corporation
2900 Semiconductor Dr., Santa Clara, CA 95051

Gentlemen:
Send me your book on RAM Interface Circuits.

NAME _____ TITLE _____

COMPANY _____

ADDRESS _____

CITY _____ STATE _____ ZIP _____

See us at NCC Booth 3220.

National Semiconductor



There is no more accurate 12-bit A/D converter on the market ... and it's monolithic.

Differential and overall linearity within $\frac{1}{2}$ LSB. Inherently monotonic operation (and no missing codes). Immunity to noise transients. They all add up to unusually high accuracy for our 8702, a single chip, 12-bit CMOS A/D converter.

The 8702 has some other important advantages, too. CMOS technology means very low power dissipation — typically less than 20 mW. It is easy to use; no active auxiliary components are needed. And its latched parallel outputs are



ideal for inputting to microprocessors or other digital logic.

Compared to modules, the 8702 offers immediate significant cost savings plus the prospect of even

greater future economies due to its monolithic construction. And the savings in PCB real estate go without saying.

The 8702 comes in a 24-pin ceramic DIP. 8 and 10 bit versions are also available. Call or write for the full details today.

TELEDYNE SEMICONDUCTOR

1300 Terra Bella Avenue, Mountain View, California 94043 Tel: (415) 968-9241 1WX 910-379-6494 Telex: 34-8416

SALES OFFICES:

DOMESTIC: Salem, N.H. (603) 893-9551; Stony Brook, N.Y. (516) 751-5640; Des Plaines, IL (312) 299-6196; Los Angeles, CA (213) 826-6639; Mountain View, CA (415) 968-9241 • INTERNATIONAL: Hounslow Middlesex, England (44) 01-897-2503; Tiengen, West Germany 7741-5066; Wiesbaden, West Germany 06121-39171; Kowloon, Hong Kong 3-240122; Tokyo, Japan 03-405-5738.

CIRCLE NUMBER 37

Shooting at the wrong target

Ken was a fine manager. He read (and quoted from) almost any management text you could name. And he followed all the time-honored principles of management—except when they conflicted with his feelings of the moment.

He would frequently assemble his engineers and give them lectures on the importance of disciplining themselves to direct their efforts most effectively towards achieving set objectives.

Ken's lectures were largely successful. They made sense, so his engineers automatically followed most of the basic management tenets. When a competitor offered a better counter at a better price, they quickly saw that they had to do something because counters were one of their principal products. Without neglecting their other lines, they concentrated on developing a better counter.

Unfortunately, it was at this time that Ken had the bright idea that what the country really needed was a new DVM. "Sure," his engineers agreed, "a DVM would be nice and we'll spend some time on that, too. But right now, we're tops in DVMs. Nobody comes close to us. Our real problem is counters. If we don't develop a better counter pretty damn quick, our competitors will slaughter us. They'll hit us where we hurt."

Ken knew that it would be easier to improve a voltmeter or to tell the world that his voltmeters were best. But he didn't want to face the fact that counters were his problem. This was easy for Ken because he was the boss and management principles didn't affect him. They are simply tools used to instruct underlings. Ken won the argument, of course. His engineers spent their time improving an already fine DVM line.

As one might have predicted, Ken's company took a beating. It's no longer the vibrant, prosperous company it once was. It's now struggling to stay alive. But Ken feels vindicated, nevertheless. It wasn't his bad policy that sent the company into a tailspin but, rather, poor execution on the part of his engineers.

Ken's blindness is obvious to everybody except Ken. But he may not be alone. He may not be the only engineer to solve a problem he had an easy solution for, instead of attacking a problem that needed a solution.



A handwritten signature in dark ink, appearing to read "George Rostky". The signature is fluid and cursive.

GEORGE ROSTKY
Editor-in-Chief

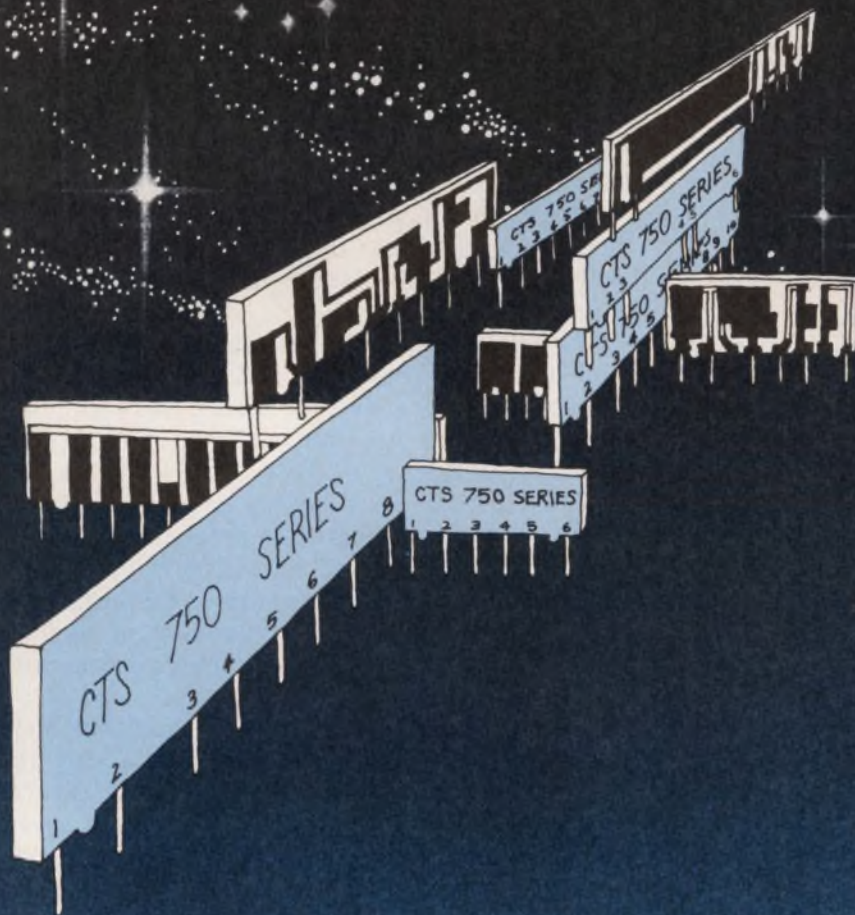

CTS conquers space.

And has for *well over a decade* with space saving Series 750 SIP cermet resistor networks. And with space a very important commodity in modern systems, you'll want to make CTS a very special source for your network needs.

You conserve valuable PCB space, enjoy greater system reliability, use fewer components, install easier—automatically, cut handling costs and derive faster inspection. CTS experience, technology and production capacity insure the highest quality, fastest delivery available.

Where one of our more than 130 *standard* off-the-shelf SIP's won't meet your circuit require-

ments, we'll custom design the resistor network you need in either conventional or low profile package configurations.

Be assured of ultra-high stability and reliability. Over 900 million hours of test data prove CTS reliability with an established failure rate of only 0.00051% per 1000 hours @ 95% confidence level—considerably superior to military failure level S of established reliability specs.

For your copy of our reliability report or complete resistor network data, write: **CTS OF BERNE, INC.**, 406 Parr Road, Berne, Indiana 46711. Phone (219) 589-3111.

CTS CORPORATION
Elkhart, Indiana

A world leader in cermet variable resistor technology.



You asked for an IC socket that
 installs easily, maximizes "real estate,"
 and delivers highest contact reliability.
 Yet costs less than 1¢* a line.

Well, you're looking at it.

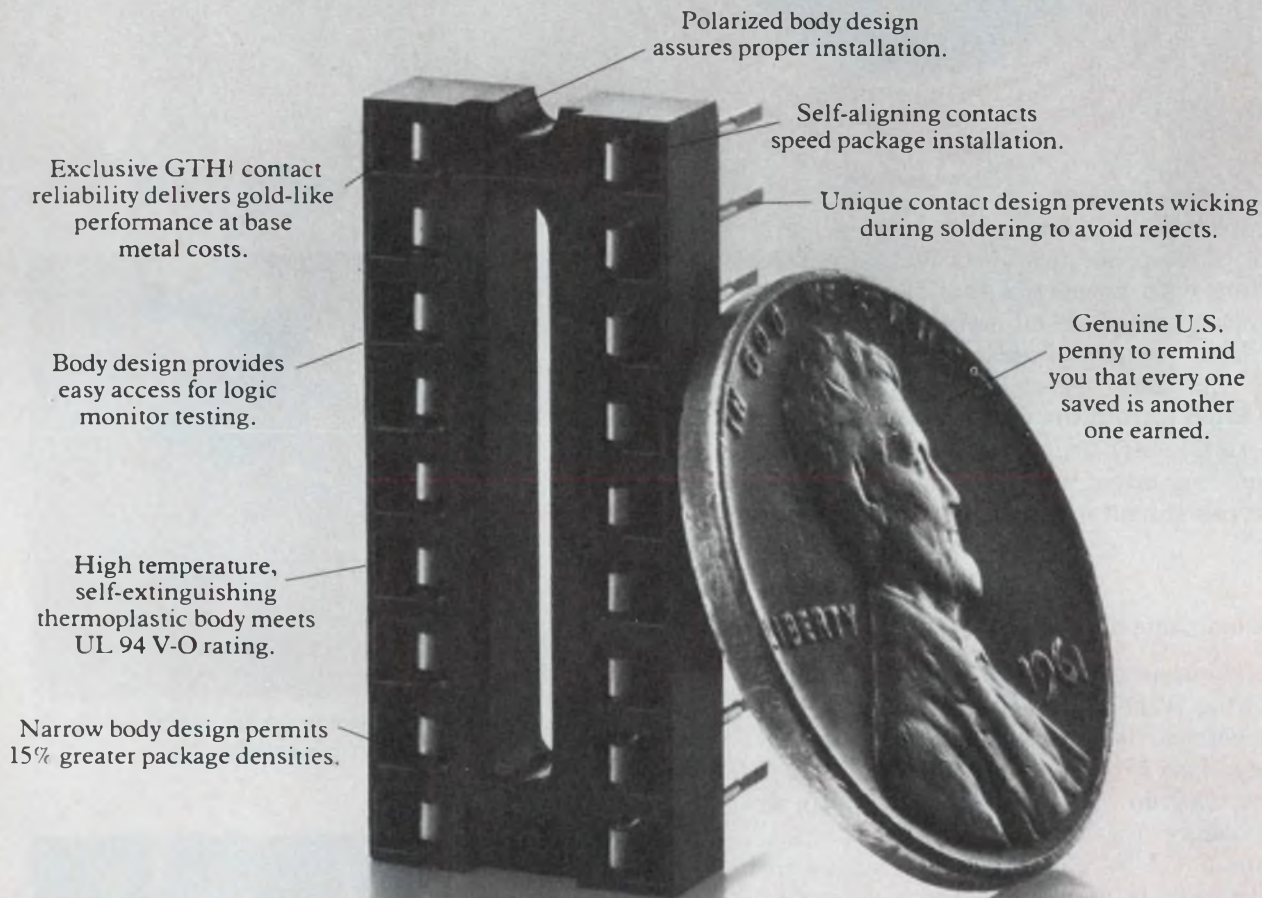

Polarized body design
 assures proper installation.

Self-aligning contacts
 speed package installation.

Exclusive GTH¹ contact
 reliability delivers gold-like
 performance at base
 metal costs.

Unique contact design prevents wicking
 during soldering to avoid rejects.

Body design provides
 easy access for logic
 monitor testing.

Genuine U.S.
 penny to remind
 you that every one
 saved is another
 one earned.

High temperature,
 self-extinguishing
 thermoplastic body meets
 UL 94 V-O rating.

Narrow body design permits
 15% greater package densities.

Burndy's all new DILB-P8.

In short, it's the most reliable, most economical IC socket on the market today.
 And it's available only from Burndy — in sizes from 8 to 40 positions
 on .100" centers. For complete details, contact Burndy or your local authorized
 Burndy Distributor. We'll also supply fully-loaded PC boards
 to your specifications. Call or write W. R. Matthias, Burndy Corporation,
 Norwalk, Connecticut 06856. Telephone 203-838-4444.

*In volume
 1)Patented

RF on DCUS RF Connectors

Mention rf connectors, and many engineers immediately think of problems with leakage, loss and impedance matching.

The result: widespread overspecification and use of connectors with properties that far exceed the average system's needs. And manufacturers don't go out of their way to discourage this practice.

"Highly matched, precision connectors will work well from dc into the GHz range," says Tore N. Anderson, staff consultant for Solitron/Microwave, "so many engineers simply specify matched types for all applications—an expensive approach."

Impedance matching isn't always needed

Not all rf-connector applications need impedance matching. Where the signal frequencies are low and electrical lengths spanned by a connector are, say, 1 to 5 percent of the signal's wavelength, you can do the job quite well with so-called uhf connectors, like the "RCA phono plug" or the Type-F CATV connector. Uhf connectors are the oldest and least-expensive class of coaxial-connector designs.

But take care: Uhf connectors are uhf in name only. Use them only up through the vhf band (see chart). Their usefulness ends where the uhf range begins.

Uhf connectors, because they are not designed for impedance matching, usually have nonuniform impedances within their structures. With different impedances in their cable-junction, internal-support and mating-contact regions, the resulting poor voltage-standing-wave ratio (VSWR) can seriously distort signals above the vhf band.



The popular BNC rf connector finds rivals in Omni Spectra's smaller OMQ and OSQ series.



TNC connectors—threaded versions of the BNC—and SMA types are Solitron/Microwave specialties. Both types, widely used for microwave work, come in numerous versions and from many vendors.

Morris Grossman
Associate Editor

Somewhere between 100 and 1000 MHz impedance-matched connectors become important. At 100 MHz, 1 percent of a wavelength is 1.18 in., which is about the same order of magnitude as the length of rf connectors; at 300 MHz, the electrical length of a typical uhf connector is about 5 percent of a wavelength.

The practice since uhf types were developed has been to consider 300 MHz as about the upper limit for uhf connectors. Below 300 MHz, a uhf connector acts merely as a lumped small shunting capacitor across the circuit with perhaps a very small amount of inductance in series with the signal. Any impedance mismatch that occurs can be neglected. Fortunately, many video and pulse-circuit applications lie below 300 MHz.

Leakage is usually negligible

To insist on impedance matching is not the only way you can overspecify rf connectors. Unless you are familiar with coaxial-cable performance capabilities, you may not realize that rf leakage in rf connectors is usually negligible in comparison with cables. A coaxial cable such as RG-59/U can easily have leakage that's only 30-dB down from the signal level. Ordinary BNC and TNC connectors, which can fit the RG-59/U, are specified to have -55 to -66-dB leakage at 3 GHz. The N series, which is somewhat superior, has as little as -90 dB—six orders of magnitude less leakage than a typical cable.

Obviously, the rf leakage you specify for connectors should be related to the quality of the cable. If you have a critical application that demands a double-shielded triaxial or a solid-sheathed cable with, say, only -90-dB leakage, you should use a precision connector specified with about -120-dB leakage. Units in Amphenol's APC-7 Series, for example, are so specified to 18 GHz, but you'll pay a good price for them.

For general purposes, BNC connectors are much cheaper. They fit small-diameter cables with ODs to about 3/8 in. The BNCs can be used to 4 GHz with low reflection losses at a nominal impedance of 50 Ω ; they're still useful to 11 GHz in some applications.

However, the BNC's two-eared bayonet locking device allows the connector to "rock" when coupled, thus producing noise in the system. This problem can be avoided by use of a TNC connector. This type has a threaded coupling that holds more securely, and allows somewhat better VSWR characteristics and a slightly lower insertion loss.

As in the case of leakage, a cable's signal losses also can outweigh the effects of even the cheapest connector. For example, losses in the popular, 0.4-in.-OD, RG-8/U cable can run as high as 1 dB/ft at 10 GHz. However, a compatible connec-

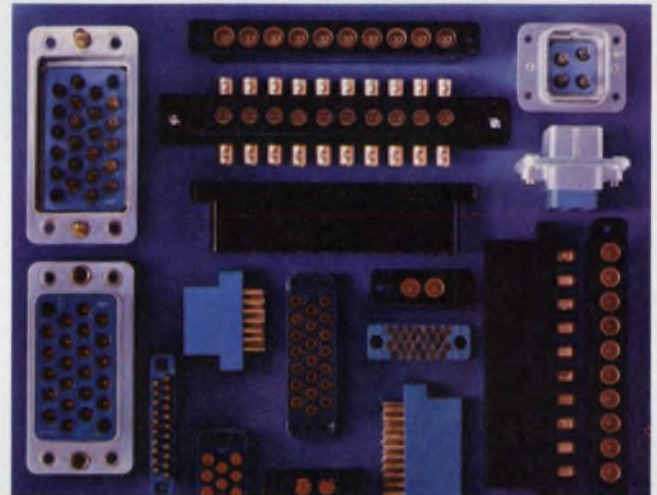
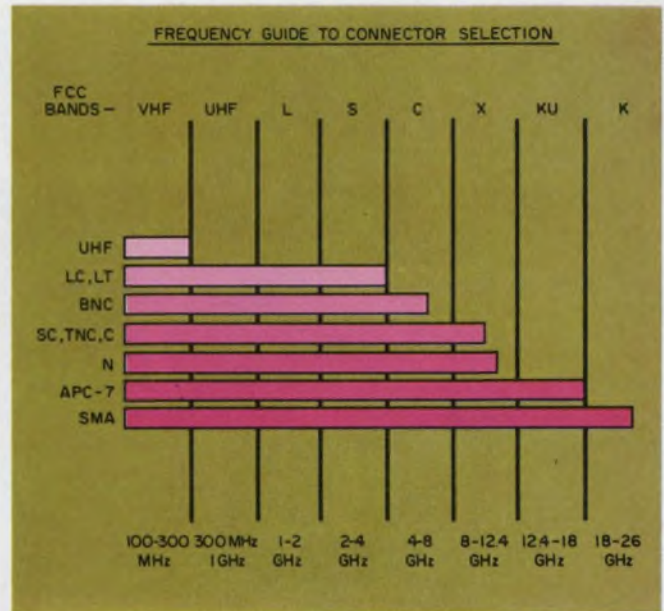

Multiple rf connectors and ribbon coaxial cables are only a small part of a complete line of other proprietary and standard rf connectors made by AMP.



Subminiature SMA connectors come in many configurations for bulkheads, striplines, semi-rigid and flexible

cables. OSM is Omni Spectra's designation for these military SMA connectors.

tor, such as the N series, has a measured insertion loss of only about 0.005 dB.

High voltages force a compromise

Long insulation paths needed in high-voltage connectors make uniform impedance-matching characteristics difficult to maintain. Hence VSWR performance suffers. For example, the

MHV series—a high-voltage version of the BNC—can withstand 5 kV peak, versus only 500 V peak for the BNC. But, the MHV units lack the BNC's broadband performance. In fact, the MHV's VSWR rating usually isn't given in manufacturer's data. The connectors are recommended for use only to 50 MHz, compared with 4 GHz for the BNC.

Look carefully at connector voltage ratings. Spec-sheet data are generally inadequate. Worse still, they can be confusing and misleading. One large manufacturer lists a widely used connector at a 500-V-peak working voltage and another lists exactly the same type as 500 V rms. Is this significant, or merely sloppy editing of the spec sheet? And different rf connectors made by the same manufacturer can be specified differently. For example, one reputable manufacturer lists its BNC's working voltage as 500 V rms, but specs its high-voltage SHV units at 5000 V dc or 3500 V ac.

Another pitfall: Don't confuse a connector's dielectric withstanding voltage with its working voltage. Spec sheets never explain the difference. The working voltage is what you're most often interested in: It's much lower in value than the dielectric withstanding voltage. Working voltage is the voltage the connector can handle internally; dielectric withstanding is the flashover voltage to ground a connector can tolerate. The flashover spec is intended to apply to cases where the connector body is above ground—not a good safety practice under most circumstances.

Furthermore, you usually aren't told the frequency of the specified voltage. What you'd really like to know is the performance of rf connectors at the microwave frequencies at which the con-



To install push-on connectors such as these Lemo self-locking types, you don't require all-around finger space to twist or turn; thus, many can be closely spaced in-line to save panel room.

Some popular rf-connector types

Connector types	Coupling method	*Size classification	Cable OD dimensions	*Maximum frequency	*Working voltage	Relative cost
QL QM LC LT	thread thread thread thread	large	0.87-1.195 in. 0.545-0.870 0.600-0.870 0.730	3 GHz	5000 V rms (at sea level)	high
N C SC	thread bayonet thread	medium	3/8-7/8	11	1000 1500 1500	med-low medium medium
BNC TNC	bayonet thread	miniature	1/8-3/8	4 11	500 500	low medium
SMB SMC SMA	snap-on thread thread	subminiature	1/16-1/8	3 10 18	500 500 350	low low medium
SSMA	thread	ultraminature	< 1/16	40	250	medium

*Some manufacturers may have different values for these specs or may express them differently.

nectors actually work. The vendor seldom warns you in the specs that voltage breakdown decreases with increasing frequency—an important factor to keep in mind when both high-frequency and high-voltage signals are involved. To be safe, unless you're given specific data, assume the voltage ratings are for 60-Hz or dc.

Also, a connector's power-carrying capability drops with increasing frequency. The rating is inversely proportional to the square-root of frequency above about 1 MHz. Almost nobody tells you about this.

And some, but not all manufacturers supply a corona-voltage rating. This is especially important when the connector operates at high altitudes, such as at 70,000 ft. In addition, at high altitudes all voltage ratings are reduced—another fact the catalogs rarely mention.

To handle large amounts of power and the high-voltages that go with it, you need large-diameter cables, and connectors to fit them. The LC series, for example, fits a 0.870-in. cable and it can handle 5 kW at and 5 kV rms up to 1 GHz.

Watch out for intermodulation

A recent Naval Research Laboratory "Alert" (C. E. Young, Code 5433, Washington, DC) points out that stainless steel connectors, which have become very popular, can introduce troublesome intermodulation noise into your sensitive communications systems. Other potential sources of this problem include nickel plating and Kovar glass-to-metal seals.

When high-power rf passes through an rf connector, nonlinearities because of ferrous materials, semiconducting junctions or dissimilar metals in contacts can contribute to the generation of these unwanted intermodulation frequencies.

Rf connectors, not specifically designed for low intermodulation, easily generate signals of -80 dBm, when carrying transmitter power levels of only 50 to 100 W. Such "noise" could swamp the many sensitive receivers that operate at -120 -dBm signal levels.

Of course, rf connectors aren't the only culprits. Other trouble sources include cables with copperweld-steel cores, braided rf cables, silicon-carbide resistors, carbon-based resistors, gold plating on a nickel undercoat, ferrite devices and rusty bolts.

Fortunately, most rf-connector applications aren't sensitive to intermodulation; hence, to require that all MIL-spec connectors be intermod-free is an undue expense and restriction. Stainless-steel connectors generally wear very well, and nickel-plated units maintain their bright fin-

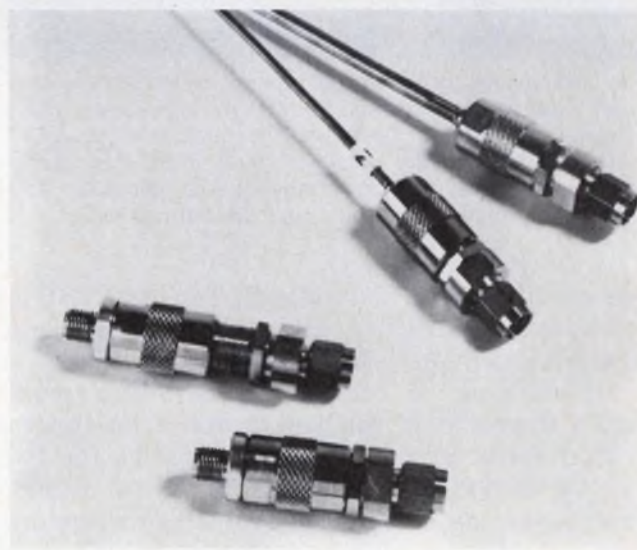

Phase-adjustable SMA connectors, made by the Bunker Ramo RF Div., provide a simple and effective way of phase matching in such applications as phased-array radar and test equipment.

ish far better than silver-plated ones.

But if the problem is likely to occur, connectors such as offered by Solitron Microwave and other manufacturers, having gold-plated beryllium-copper structures free of ferrous and other potentially troublesome materials, can keep intermodulation down to -190 dB.

When impedances must be matched

Don't forget: Above 300 MHz, a uniform characteristic impedance within a connector becomes increasingly necessary; above 1 GHz it's essential. The impedances of all the cross sections within a precision rf connector should be substantially equal to each other. You judge the connector's degree of impedance uniformity by the voltage standing-wave ratio (VSWR), which is determined by the ratios of the impedances of abutting

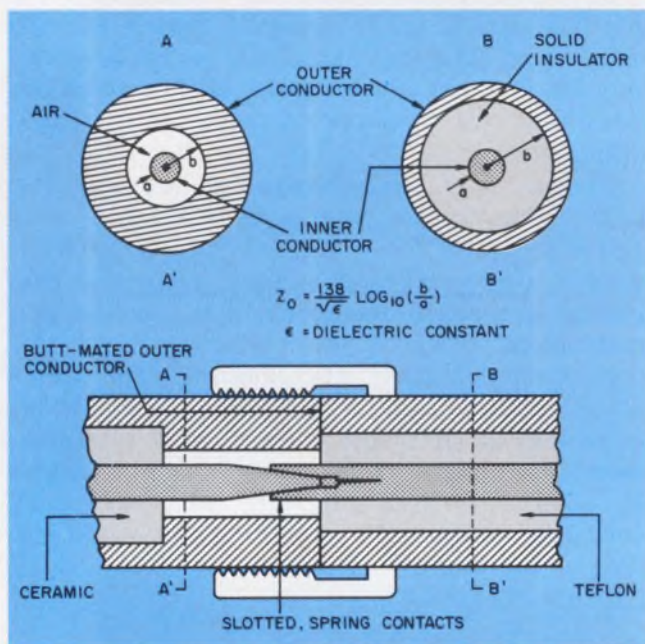

The dimensions of a coaxial connector's cross-section must change to maintain a uniform impedance when materials of different dielectric constants are used. And mating conductor and insulator parts must meet accurately to avoid distortion of the coaxial geometry and creation of undesirable voids and discontinuities.

cross sections (see illustration). The ideal VSWR of one is never reached, only approached in a few high-precision laboratory-standard connectors.

In addition, of course, the connector must match the cable. If you join a 50- Ω connector to a 75- Ω cable, at microwave frequencies the resulting VSWR of 1.5 and the 20-percent reflection factor can cause considerable signal distortion.

But what is the best impedance to use? Calculations and measurements show that an impedance of approximately 30- Ω maximizes a

cable's power-handling capability; about 77- Ω impedance provides minimum attenuation. Most manufacturers have selected a 50- Ω value as a compromise; thus many standard rf test instruments come equipped with 50- Ω circuits and couplings.

However, at the relatively low frequencies of video (CATV) and data-communication circuits, you can profitably use 75 Ω . Since communication circuits generally carry low-power signals, you lose nothing but have much to gain by minimizing attenuation. This consideration is especially important in long-line communications. And where low circuit capacitance, as in pulse circuits, is your aim, you might use 93- Ω cables. But few connectors are designed for 93 Ω , and even 75- Ω units aren't always available.

You can sometimes find impedance adapters for coupling 75 or 93- Ω systems to 50- Ω test instruments; however, for uhf application, you can usually get away with a 50- Ω connector for a 75- Ω cable. Or if your system can work with only a low-cost uhf connector, don't worry about impedance matching; most uhf connectors don't have impedance ratings.

But many test and measurement set ups can tolerate nothing but the highest precision connectors. Although precision connectors don't command a large portion of the total rf-connector market, they are a must in rf laboratories and other applications to ensure accurate, reproducible measurements. Their most important electrical characteristic—a low VSWR—should be less than 1.04; only about 1.25 is available with the standard type N. The precision APC-7, however, operates to 18 GHz with a VSWR of less than 1.039.

Precision-connector specifications are governed by IEEE Standard 287. Most precision types have been standardized in 14 and 7-mm sizes. These dimensions refer to the inside diameter of the connector's outside conductor. The cutoff frequency in a coax assembly is inversely proportional to this diameter.

For example, the theoretical limit for the 14-mm size is about 9 GHz, but this limit increases to over 18 GHz for the 7-mm size. Smaller 3.5-mm units designed by the Alford Mfg. Co. are said to operate to 30 GHz with a VSWR of less than $1.005 + 0.03 \cdot f_{\text{GHz}}$. And 1.75-mm connectors can operate past 40 GHz with a VSWR in the neighborhood of 1.2.

The problem with sex

For extreme uniformity in a connector pair's impedance, mating connectors should be as alike as possible. Thus, for high-precision laboratory applications, "sexless" connectors are the logical approach. With the standard "sexy" type N, though

Rf-connector military standards set the pace

World War II spurred the development of rf connectors. Radar systems were a principal application of the first Type N, which was followed in quick succession by the BNC, HN, and LT; others dropped by the wayside. After the hot war ended, the cold-war era that followed spawned several more series. Type C and its threaded version, SC; and type TNC, a threaded BNC, soon followed. With miniaturization, the SMC and SMB types came into existence, followed by the SMA.

However, a firm basis for standardization was not established until 1965, when Committee C83.2 of the American National Standards Institute (ANSI) produced MIL-C-39012—the bible of rf-connector standards.

Of course, many revisions and corrections have been made since then. The latest version can be obtained from the Naval Publications and Forms Center, 5801 Tabor Ave., Philadelphia, PA 19120. All engineers who specify or use rf connectors should become familiar with this spec—even if the work they do is strictly nonmilitary.

The spec has strong influences on commercial versions of rf connectors. Spec terminology and test methods are used throughout the rf-connector field. The spec carefully defines these terms and methods, and manufacturers assume you are familiar with them. In fact, manufacturers use this as an excuse for failure to define the ratings of the connectors in their catalogs.

The 39012 format includes two classes of rf connectors: Class I, a high-performance laboratory connector; and Class II, the basic connector in general field use. Class II is divided into several subclasses: (A) field-serviceable units, (B) nonfield-replaceable units, (C) field-replaceable crimp units, etc.

Slash sheets are issued for specific connectors—BNC, TNC, N, C, etc. Over 100 types are available. And also a qualified parts list (QPL) can be provided. Be sure to specify which slash sheets you want when ordering the spec, or the clerk won't be able to fill your order. Also specifically ask for the QPL.

But a word of caution: Connectors made to a MIL spec, such as the UG/U series, are not necessarily approved by the military nor are they of superior design. The UG/U numbers simply provide mechanical interface standardization and help simplify procurement and stocking. They are merely a convenient way to list particular units that may have been used only once in a military application.

International standards move slowly

The International Electrotechnical Commission (IEC) started work on rf-connector and cable standards in 1959. Today, ANSI C83.2 provides the basis for U.S. representation. The BNC and type C were adopted immediately, because no screw threads were involved: An international screw-thread scheme did not exist before 1963! Some of the U.S. inch-threaded types are being adopted, but slowly.

The agreement to standardize the type N was made in 1968, yet in 1976 the type-N standard is still only in secretariat-draft form. A revised type C to agree with MIL-C-39012 has been published, and a new BNC standard is in progress.

Meanwhile, several metric-threaded connectors based on German World War II designs have been standardized, such as the 13-mm (inner-conductor), 30-mm (outer-conductor), 50- Ω and the 8/28, 75- Ω designs.

The IEEE Precision RF Connector Standards, which have made possible great improvement in coaxial instrumentation, have been adopted as IEC Publication 457, covering 7-mm, 14-mm and 21-mm sizes.

Tore Anderson, chief U.S. delegate to the September, 1974 IEC Standards meeting in Bucharest reports an interesting highlight: The N, SMA and U.S. uhf connectors are the principle rf connectors used in Poland, despite the German claim that metric connectors are widely used behind the iron curtain. Also, understandably, most NATO countries follow U.S. practice.

it's useful over a large portion of the microwave spectrum, you still run into VSWR problems because of mechanical distortion. When its male pin section enters the fingers of its mating contact, the pin presses the fingers sideways or otherwise distorts the over-all contact configuration. Furthermore, different pins, even though they all are within a connector's acceptable tolerance range, can act in entirely different ways and produce drastic changes in the VSWR.

For laboratory applications with 14-mm coax cables, GenRad's (formerly General Radio, Elec-

tronic Instrument Div.) type 874 has remained for many years a prime example of a hermaphroditic connector. It is especially useful for high-frequency measuring instruments to about 9 GHz in a 50- Ω version, and to 2 GHz in a 75- Ω version. Its VSWR at 9 GHz is about 1.04. A clever combination of spring fingers and slots allows the inner and outer conductors to mate with each other in a rapid, "sexless" way.

The newer 14-mm GR900 series also mates hermaphroditically. It's an improvement over the GR874. The 900 eliminates the long insertion

length and the slightly out-of-round conditions that result from spring action in the 874.

The hermaphroditic APC-7 for 7-mm rigid cables achieves its coupling via a spring-action collet mechanism and threaded surfaces that mate with the opposite connector in a "truly sexless union," according to a Bunker Ramo RF Div. spokesman.

Beware of screw-machine shops

Obviously, manufacturers must make the mechanical parts of precision rf connectors dimensionally precise and keep close control of material uniformity. But that is not enough, according to Bruno O. Weinschel, president and chief engineer of Weinschel Engineering, a company engaged in rf-connector designing.

"Many connector manufacturers are basically screw-machine shops with insufficient microwave-engineering support," he says. "Too few connector manufacturers are set up to employ rf-performance tests as part of their quality control. They rely mainly upon mechanical tolerances.

The technical capability of most connector manufacturers in the U.S. is very low."

Other rf-connector experts, who highly respect Weinschel's opinions, say he probably had mostly high-precision, high-frequency applications in mind when he spoke. Fortunately, most production low-cost rf connectors for use to about 1 GHz don't require such demanding standards.

And the so-called screw-machine shop shouldn't be crossed off your list completely. A knowledgeable engineer-user, with his own company's test facilities to back him, could buy from such a vendor, and perhaps do so at a considerable cost saving.

Whenever a given spec is really critical the designer needs to know how the manufacturer's stated values were derived, advises Allen Kasiewicz, product manager of the Bunker Ramo RF Div.

"Differences in measuring equipment or test methods significantly affect the test results, especially in the GHz range. To properly interpret VSWR values—especially if a low VSWR is essential—the designer must know what test equipment was used, whether the connector was assembled to a cable and whether the connector was tested as a mated pair or as a single unit with a compensating adapter.

"It's the manufacturer's responsibility to make this information readily available."

Rf-connector MIL specs are successful

Military specifications for rf connectors achieve a degree of success that far exceeds the many overlapping attempts at the standardiza-

tion of other types of connectors, such as in the multipin, circular-connector field. MIL-C-39012—the first tri-service coordinated coax-connector spec—replaces most of its predecessors (see box).

Many experts attribute its success to the stress placed upon performance, testing and qualification procedures rather than upon detailed dimensional drawings, material callouts and protective-coating requirements. Prior to the advent of MIL-C-39012, military rf-connector specifications carried fully detailed dimensions with little in the way of performance requirements.

The dimensions called out in MIL-C-39012 are mating-surface dimensions to ensure interconnectability. The manufacturer is free to use its ingenuity in all other areas. Ed Forney, project manager at AMP's Coaxicon RF Div., believes "this is the reason connectors are now better than ever.

"But," he warns, "a change has been proposed that also would require the standardization of the dimensions of the cable end of the connector." The proposal is that a new category-D connector be included in MIL-C-39012—a connector that would "require only standard military crimp tools... and have standard stripping dimensions."

Forney believes this trend is ominous, and if encouraged would eventually leave little room for the manufacturer to improve connector performance.

"For example," he points out, "several non-standard impedance-matching crimps for the center conductors of coaxial cables and for braided-shield connections can provide better performance than the MIL spec'd types.

"The user should be allowed to determine how much of a toll he is willing to pay, and when to stifle design improvements in favor of standardization," Forney insists.

On the other hand, Weinschel thinks, "the time has come to talk about complete cable-connector assemblies, not just about the separate mating front-and-rear ends of the connector.

"The cable interface has never been standardized or optimized. Tremendous variations exist among manufacturers, and that makes it difficult to switch suppliers."

And Weinschel doesn't think MIL-C-39012 goes far enough. In addition to cable-interface standards, he would like to see eccentricity tolerances spelled out.

"While MIL-C-39012 has come to grips with critical mating and interface dimensions and tolerances of a linear nature, no portion of the spec addresses itself to eccentricities, which have a great influence upon the life and repeatability of a connector."

In fact, he believes one of the biggest mistakes designers make in specifying rf connectors is

that they disregard their repeatability characteristics and life. This applies especially to small connectors (such as the SMA family) that are rather fragile.

Holding the cable to the connector

In some crimped cable-retention methods, the cable's center contact is not held captive in the connector. Many experts prefer fully captive center-contact types for both commercial and military applications.

"The connector industry has resisted this trend for a long time and used all kinds of excuses," Weinschel observes, "but the technical

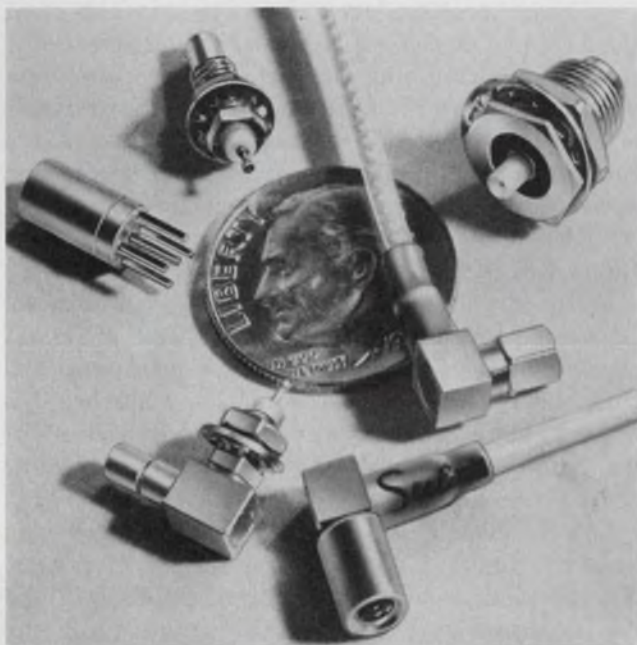

Subminiature rf connectors, designated the Nanohex series by Sealectro, are said to meet or exceed the requirements of MIL-C-39012 for SMB and SMC types. They come in snap-on, slide-on and screw-on versions.

problems of captive center contacts have been satisfactorily solved by several connector manufacturers. They furnish both the inner contact and bead, and use injection-molding techniques.

"A captive center contact ensures correct mechanical alignment, so the connector can meet the VSWR performance standards in MIL-C-23329A and MIL-C-39012 for crimped coax connectors."

Different crimp-retention methods applied to the outer coax conductor won't materially change a connector's performance, but the center conductor is much more critical. Thus Fred Pak, spokesman for King Electronics, questions the desirability of mandating a particular technique to crimp the center contacts.

"The requirements vary with each cable-connector combination," he explains. "And there is no simple way to reduce this to a common method for the whole spectrum of rf connectors. Not

enough work has been done to specify each one for its optimum performance."

Consummating the connection

After you have considered cable size and impedance matching, you must examine connector-pair coupling methods when making an rf-connector selection. The bayonet type allows a rapid push-on and twist-to-lock action. The screw-on type takes more time to attach and disconnect, but it produces less leakage and provides a more noise-free connection. Also, you are assured of greater mechanical security, especially in applications subjected to vibrations and extensive cable movement.

A third type, the push-on self-locking coupling, is ideal for test equipment and other applications that require frequent and rapid coupling and uncoupling. You simply push to mate. To disengage, you pull on the shell of the connector. Perhaps equally important as the ease and speed of coupling is that the push-on coupling also can save valuable space when many receptacles must be clustered on a panel.

Robert Wersen, national manager of Lemo U.S.A., points out that many engineers erroneously think of small-sized connectors only as a means of saving panel space. This is only one factor.

More important is the clearance you need for your fingers—approximately 0.6 in. all around the connector—to lock and remove a plug from its receptacle. A screw or bayonet mechanism with, say, a 0.5-in. OD then must allow a finger clearance completely around the connector shell of at least 1.7 in. Small size doesn't help; a 0.25-in. connector still requires almost the same clearance—1.5 in. But push-on types need only 0.6 in. on two sides of the connectors so they can be very close to each other in a single line. "As much as 40-percent less space is needed than with bayonet or screw-on types," Wersen concludes.

Of course, where frequencies are high (to about 18 GHz) and cable diameters are small (to about 0.14 in.), the use of subminiature rf connectors can save space and weight. The subminiature types SMA, SMB and SMC are included in MIL-C-39012 and have become very popular in recent years. Many manufacturers, including Bunker Ramo, AMP, Sealectro and Omni Spectra, make these or proprietary substitutes.

Omni Spectra says that it pioneered subminiatures with its OSM series, which is the equivalent of the military designation SMA. And Sealectro's Conhex and smaller Nanohex connectors are said to meet SMB and SMC requirements, while its SMR series also is said to be an SMA equivalent.

In addition to its subminiature OSM line,



Sexless connector mating used in the design of GenRad's precision 874 (top) and 900 (bottom) lines helps ensure a low VSWR.

Omni Spectra also manufactures a comparable ultraminiature OSSM line, and quick-connect disconnect OMQ and OSQ lines.

Also available in quick-connect/disconnect types is Sealectro's Nanohex series with snap-on, screw-on and slide-on versions for both braided and semi-rigid cables.

William M. Schumacher, manager of development engineering at AMP's Coaxicon RF Div., reports a very positive uptrend in the use of small rf connectors "with the present growth rate for the 3-mm (SMA, etc.) types about double that of BNCs and about 10 times that of the old type-N standby."

He attributes the trend to increased operating

speeds for digital equipment and the attendant increased use of small coaxial cables. "The rapid acceptance of the ribbon coax-cable for multicable assemblies AMP introduced last year is a result of and aids in the trend to use of small connectors," he concludes.

Assembly must be carefully done

Even small variations in mechanical dimensions or material properties of coaxial connectors can be critically significant. Despite efforts by manufacturers to simplify procedures, poor field assembly is still a major problem. Poor assembly techniques can easily destroy the advantages of even the best connector.

A major problem area is in the attachment of the braid of a coaxial cable to a connector. For a long time, clamping the braid between the conducting body and a retainer was the most popular method. But this technique requires extra connector parts, skill and more labor than such newer alternatives as crimping, according to Lee A. Eichenseer, a vice president of the Bunker Ramo RF Div.

With crimping, the braid is positioned between the connector body on the inside and a crimp-sleeve cylinder on the outside. A crimping tool then secures the connector to the cable braid—a quick, simple, strong and low-cost process. But you can't repair the assembly; the connector must be replaced; and you need special tools.

The problems with soldering braid are well known; you'll find few redeeming features. Nevertheless, some military applications still call for field-serviceable solder connectors. But the military has recognized crimping, and MIL-C-39012 includes a few standard crimp-type connectors and tools for field use.

One problem that often occurs because of poor assembly techniques is loose butt joints and air pockets where the cable's dielectric presses against the connector's dielectric. You should make every effort to ensure a tight fit.

Another problem is rounded dielectric corners. Both rounded corners and loose butt joints result in a nonuniform impedance (mismatch) and poor VSWR performance. Also, in high-voltage cables, air pockets reduce the assembly's peak-voltage capability.

Often problems result from stresses inadvertently set up during assembly that later cause physical misalignments. For example, if you assemble connectors to a long cable while the cable is coiled, the ends of the center conductor can assume a different position relative to the outer braid when uncoiled. An electrical mismatch is the result. For similar reasons, you should never assemble a cable and connectors when they are

excessively hot or cold.

Also, keep in mind that off-centered or pinched cables can cause poor performance.

Would you believe that connector center pins attached with too much or too little solder change the connector's impedance characteristics? Too little solder tends to lengthen the current path in the center conductor, which increases the path's inductance; too much can enlarge the diameter of the center pin and increase the value

of the shunt capacitance.

Small-sized connectors are most sensitive to this solder problem; solder films can produce proportionately larger dimensional changes on the smaller dimensions.

Poor assembly techniques can spoil the performance of even the best and most expensive connector. But properly assembled, even a low-cost connector when suited to the system's needs, can outlast the life of the equipment it serves. ■■

Need more information?

The manufacturers and connector types mentioned in this report are only a small sample of many more available. For further information, readers may wish to consult manufacturers listed here by circling the appropriate number on the reader service card. More vendors and information may be found in ELECTRONIC DESIGN'S GOLD BOOK.

AEL Communications Corp., Richardson Rd., Colmar, PA 18915. (215) 822-2929. **Circle No. 501**
Alford Mfg. Co., 120 Cross St., Winchester, MA 01890. (617) 729-8050. **Circle No. 502**
American Microwave Inc., 140 Fourth Ave., Waltham, MA 02154. (617) 890-4750. **Circle No. 503**
Amp Inc., 449 Eisenhower Blvd., Harrisburg, PA 17105. (717) 564-0100. **Circle No. 504**
Amtronics Inc., 247-27 St., Brooklyn, NY 11232. (212) 259-6633. **Circle No. 505**
Anzac Elecs. Div., Adams-Russell, 39 Green St., Waltham, MA 02154. (617) 899-1900. **Circle No. 506**
Astrolab Inc., 1600 Essex St., Rahway, NJ 07065. (201) 382-8204. **Circle No. 507**
AVA Elec. Corp., 242 Pembroke Ave., P.O. Box 338, Lansdowne, PA 19050. (215) 284-2500. **Circle No. 508**
Bendix Microwave Devices Plant, Hurricane Rd., Franklin, IN 46131. (317) 736-6136. **Circle No. 509**
Breeze-Illinois Inc., Main & Agard St., Wyoming, IL 61491. (309) 695-2511. **Circle No. 510**
Budwig Mfg. Co., P.O. Box 97, Ramona, CA 92065. (714) 789-0900. **Circle No. 511**
Bunker-Ramo, RF Div. (formerly Amphenol RF Div.), 33 E. Franklin St., Danbury, CT 06810. (203) 743-9272. **Circle No. 512**
Burdny Corp., Richards Ave., Norwalk, CT 06856. (203) 838-4444. **Circle No. 513**
B&W Assoc., 21 B St., Burlington, MA 01803. (617) 272-4420. **Circle No. 514**
Cablewave System Inc., 60 Dodge Ave., North Haven, CT 06473. (203) 239-3311. **Circle No. 515**
Cambridge Products Corp., 101A Foley St., Somerville, MA 02145. (617) 666-3343. **Circle No. 516**
Cambridge Thermionic, 445 Concord Ave., Cambridge, MA 02138. (617) 491-5400. **Circle No. 517**
Cerameal Inc., Box 25, North Lebanon Ctr., NY 12126. (518) 794-7800. **Circle No. 518**
Connecting Devices Inc., 567 E. El Segundo, El Segundo, CA 90245. (213) 322-6885. **Circle No. 519**
Connector Corp., 6025 N. Keystone, Chicago, IL 60646. (312) 539-3108. **Circle No. 520**
Dale Electronics, Inc., 1300 28th Ave., Columbus, NE 68601. (492) 564-3131. **Circle No. 521**
Decibel Prods Inc., 3184 Quebec St., Dallas, TX 75247. (214) 631-0310. **Circle No. 522**
Detoronics Corp., 10660 E. Rush St., South El Monte, CA 91733. (213) 579-7130. **Circle No. 523**
Deutsch Co., Municipal Airport, Banning, CA 92220. (714) 849-6701. **Circle No. 524**
EG&G, Inc., Electro Mechanical Div., Georgetown, MA 01833. (617) 352-6200. **Circle No. 525**
Elecpac Inc., Main 1 St., Cary, IL 60013. (312) 639-2307. **Circle No. 526**
Electro Audio Dynamics Wintronics, 98 Cutter Mill Rd., Great Neck, NY 11101. (814) 724-6440. **Circle No. 527**
Elec Essentials Inc., 210 Elizabeth St., New York, NY 10012. (212) 226-5080. **Circle No. 528**
Ercona Corp., 2492 Merrick Rd., Bellmore, NY 11710. (516) 781-2770. **Circle No. 529**

Gavin Elecs., 1450 U.S. Rt. 22, Somerville, NJ 08876. (201) 356-3500. **Circle No. 530**
GenRad (formerly General Radio Co.), 300 Baker Ave., Concord, MA 01742. (617) 369-8770. **Circle No. 531**
Herley Ind. Inc., 160 Eileen Way, Syosset, NY 11791. (516) 364-0100. **Circle No. 532**
Hi-G Inc., 580 Spring St., Windsor Locks, CT 06096. (203) 623-2481. **Circle No. 533**
ITT Cannon Electric, 666 E. Dyer Rd., Santa Ana, CA 92702. (714) 557-4700. **Circle No. 534**
Jerrold Elec Corp., 200 Witmer Rd., Horsham, PA 19044. (215) 674-4800. **Circle No. 535**
E.F. Johnson Co., 299 10th Ave., S.W., Waseca, MN 56093. (507) 835-2050. **Circle No. 536**
Kings Elecs Co., Inc., 40 Marbledale Rd., Tuckahoe, NY 10707. (914) 793-5000. **Circle No. 537**
L-Coil Research, 409 W. Main, Brighton, MI 48116. (313) 229-6804. **Circle No. 538**
Lemo USA Inc., 2015 Second St., Berkeley, CA 94710. (415) 548-1966. **Circle No. 539**
Malco Microdot Co., 12 Progress Dr., Montgomeryville, PA 18936. (215) 628-9800. **Circle No. 540**
Micro Coms Inc., Grenier Field-RFD 3, Manchester, NH 03103. (603) 624-4351. **Circle No. 541**
Micro Mode Prods Inc., 8400 N. Magnolia Ave., Santee, CA 92071. (714) 449-3844. **Circle No. 542**
Modpak, 31 Green St., Waltham, MA 02154. (617) 891-7048. **Circle No. 543**
3M Co., Elec. Prods. Div., 3M Center, St. Paul, MN 55101. (313) 651-9531. **Circle No. 544**
Narda Microwave Corp., 75 Commercial, Plainville, NY 11803. (516) 433-9000. **Circle No. 545**
National Tel-Tronics Div., EAD State Rd Hill, Meadville, PA 16335. (814) 724-6440. **Circle No. 546**
Omni Spectra Inc., 21 Continental Blvd., Merrimack, NH 03054. (603) 424-4111. **Circle No. 547**
Primus Electronics Corp., 790 F Hampshire Rd., Westlake Village, CA 91361. (805) 495-3931. **Circle No. 555**
Richey Elecs. Inc., 10871 La Tuna Cyn. Rd., Sun Valley, CA 91352. (213) 768-3800. **Circle No. 548**
Rowe Ind. Div., 6225 Benore Rd., Toledo, OH 43612. (419) 729-9761. **Circle No. 549**
S&A Elec. Div., Scott & Fetzer Co., 202 W. Florence Ave., Toledo, OH 43605. (419) 693-0528. **Circle No. 550**
Seaelectro Corp., 225 Hoyt St., Mamaroneck, NY 10543. (914) 698-5600. **Circle No. 551**
Sitco Antennas, P.O. Box 20456, Portland, OR 97220. (503) 253-2000. **Circle No. 552**
Herman H. Smith Inc., 812 Snediker Ave., Brooklyn, NY 11207. (212) 272-9400. **Circle No. 553**
Solitron/Microwave, P.O. Box 278, Port Salerno, FL 33492. (305) 287-5000. **Circle No. 554**
Startronics, Moulton St., Georgetown, MA 01833. (617) 352-6200. **Circle No. 556**
Tech Matl Corp., 700 Fenimore Rd., Mamaroneck, NY 10543. (914) 698-4800. **Circle No. 557**
Ted Mfg. Corp., 11415 Johnson Dr., Shawnee Mission, KS 66203. (913) 631-6211. **Circle No. 558**
Times Wires & Cable Co., 358 Hall Ave., Wallingford, CT 06492. (203) 265-2361. **Circle No. 559**
Triangle Elec. Mfg. Co., Inc., 182 N. Hamilton St., Poughkeepsie, NY 12602. (914) 471-5020. **Circle No. 560**
Tri-Point Ind. Div., Oak Mtls Group, 1 Trilon Way, Hoosick Falls, NY 11725. (516) 543-1600. **Circle No. 561**
Trompeter Electronics, Inc., 8936 Comanche Ave., Chatsworth, CA 91311. (213) 882-1020. **Circle No. 562**
Tru-Connector Corp., 245 Lynnfield St., Peabody, MA 01960. (617) 532-0775. **Circle No. 563**
TRW Cinch Connectors, 1501 Morse Ave., Elk Grove Village, IL 60007. (312) 439-8800. **Circle No. 564**
Wallace Stanley K. Suite 216, 13902 N. Date Mabry Hwy., Tampa, FL 33624. (813) 961-1037. **Circle No. 565**
Weinschel Engrg., 1 Weinschel Lane, Gaithersburg, MD 20760. (301) 948-3434. **Circle No. 566**

Not much, is it?

Log IF strips have never been easier or less expensive.

Thanks to the Plessey SL1521 Wideband Amplifier.

Complete in a single 8-lead TO-5 can, the SL1521 has a mid-band voltage gain of 12 dB, a video output of 1.0 mA and operates over the full MIL-temp range from -55°C to $+125^{\circ}\text{C}$.

For up to 60 dB compression from 60-240 MHz, just cascade up to five devices and you're done. No transistors, no discrete components, no interstage filters. And none of the costs and problems that go with them.

Or add another two SL1521's and a single interstage filter for more than 85 dB compression and a ± 20 MHz bandwidth at 240 MHz. It's still the simplest, least expensive way to go, so get all the details now.

At our prices, never has so little done so much.

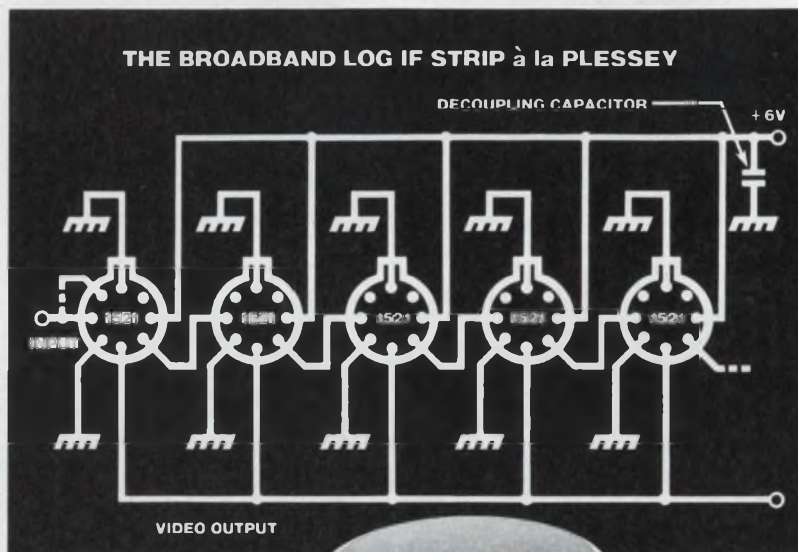

PLESSEY SEMICONDUCTORS

1674 McGaw Avenue, Irvine, CA 92714
Tel: (714) 540-9945 TWX: 910-595-1930
Represented world-wide.

State-of-the-art brought down to earth

Limiting wideband amplifiers □ TV, radio & telephone communications circuits □ High-speed dividers

NEW MICROELECTRONIC PACKAGING SYSTEMS AND ACCESSORIES.



A new series of microelectronic packaging panels are now available from Garry Manufacturing Co., of New Brunswick, N.J. Developed to provide lower system packaging costs, these panels are designed for the support and interconnection of dual in-line integrated

circuits and other electronic components. Input-output capability up to 108 terminals on 4.5 inch width panel. Also available with 72 or 36 position I/O connector or without connector. The new panels can come with multiple pattern combinations 14, 16, 24 and universal patterns.

The panels afford greater than 3.1 ratio of input-output terminals to IC locations and improve electrical and mechanical sub-division of system.

A full range of analog panels and extender to complement the PS 108 series panels are also available.

For complete information, use the Reader Service Card or contact Garry Manufacturing Co. directly.

Garry Manufacturing Co., 1010 Jersey Avenue, New Brunswick, NJ 08902. (201) 545-2424.

I.C. PLUGGABLE PACKAGING ASSEMBLIES NOW AVAILABLE IN METRIC SIZES.

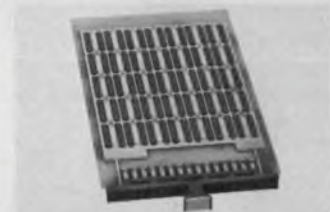

Metric series of I.C. pluggable packaging assemblies are now available from Garry Manufacturing Company, of New Brunswick, N.J. These have been put into production especially to meet the needs of European electronic manufacturers.

The new assemblies can be obtained in many metric sizes, including: 100 mm. x 160 mm. board with an I/O area that accepts the European right angle wire wrappable connector with up to 96 pins.

Other features include a pull type handle which allows for a test probe without removal of the card.

This metric series also offers a double card which measures 160 mm. x 233 mm. with a dual I/O area containing provisions for the mounting of 2-96 pin connectors.

Like all Garry I.C. pluggable packaging assemblies, this metric series offer large solder-plated ground and voltage plane area. They are available either wire-wrapped, ready for assembly, or unwrapped.

For complete information, use the Reader Service Card, or contact Garry Manufacturing Company directly.

Garry Manufacturing Company, 1010 Jersey Avenue, New Brunswick, NJ 08902. (201) 545-2424.

CUSTOM I.C. PACKAGING ASSEMBLIES.

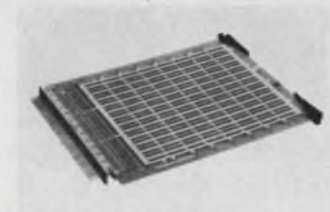

PNS 120 Series board assemblies are now available from Garry Manufacturing Company of New Brunswick. These special boards are available with 120 position NAFI type I/O connector, and as either a 64 or a 96 I.C. position board with 14 socket/terminals

plus two dummies in each position.

Garry's quick turnaround prototype facilities can go from Electrical Schematic to Hardware Prototype in less than 2 weeks.

For complete information, use the Reader Service Card or contact Garry Manufacturing Company directly.

Garry Manufacturing Company, 1010 Jersey Avenue, New Brunswick, NJ 08902. (201) 545-2424.

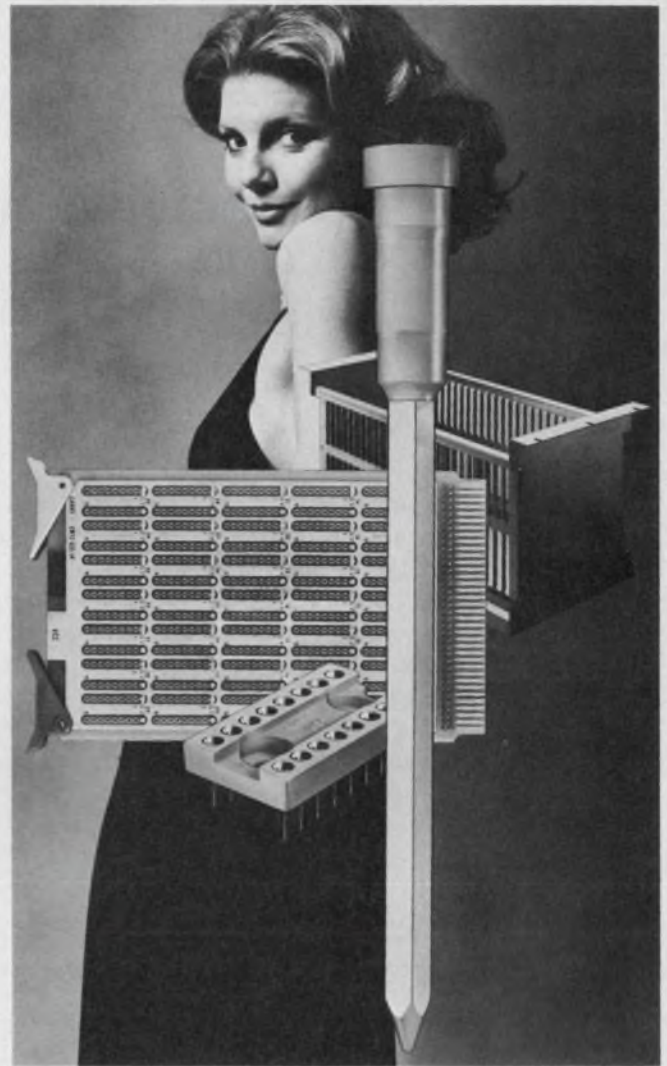

A great wrap is just the beginning of our package.

Garry offers a complete line of services and products for wire wrap* buyers.

You can buy our wire wrapping* (the best in the industry). You can buy our boards, our headers, our racks. Or you can buy the complete package. From LSI adaptor boards through microprocessors to ECL logic boards; from 8 pin header sockets to LED display sockets.

Garry is the largest privately owned swiss screw machine house and manufacturer of IC socket headers and pluggable wire wrap boards in America. We sell not only coast to coast but throughout Europe and the Far East.

Get all the details. Write for our new 48 page catalog. Garry Manufacturing, P.O. Box 94, New Brunswick, N.J. 08902

*Registered trademark of Gardner-Denver Co.

We won't pin a bum wrap on you.

Garry
Manufacturing Co

To compare electrical insulators

you must look at characteristics such as dielectric strength, dielectric constant, dissipation factor and arc resistance.

Insulating materials have been serving the electronics industry since its infancy, in applications ranging from heat sinking to structural support and encapsulation. Improvements in materials and processing have led to a wide choice of available insulations including numerous plastics, elastomers, ceramics and glasses.

If you know the key characteristics of each type of insulator and their significance for your specific application, you'll find it a simple task to identify the materials best suited for your needs. But a good understanding of insulator characteristics and their measurement is essential.

Insulation factors and their significance

The primary insulating characteristics are dielectric strength, dielectric constant, dissipation factor, resistivity, loss factor and arc resistance.

Dielectric strength is the voltage gradient at which electric failure results. The failure is characterized by an excessive flow of current and by partial destruction of the material. Dielectric strength is measured through the thickness of the material, as shown in Fig. 1, and is expressed in volts per unit of thickness.

There are two principal methods for measuring this: (1) short-time and (2) step-by-step. The short-time test is performed by increasing the voltage at a predetermined rate (100 to 3000 volts/sec) from zero to breakdown. The rate is specified by the investigator. In the step-by-step test an initial voltage of 50 percent of the short-time voltage is applied to the material, then increased in equal increments and held for lengths of time determined by the investigator.

Dielectric strength is influenced by temperature, humidity, electrode configuration, frequency, specimen geometry and voids or foreign materials in the specimen. It is often difficult to compare

Charles A. Harper, Systems Development Div., Westinghouse Electric Corp., Baltimore, MD 21203. (This article includes material from the Handbook of Electronic Packaging and the Handbook of Plastics and Elastomers, edited by Charles A. Harper and published by McGraw-Hill Book Co.)

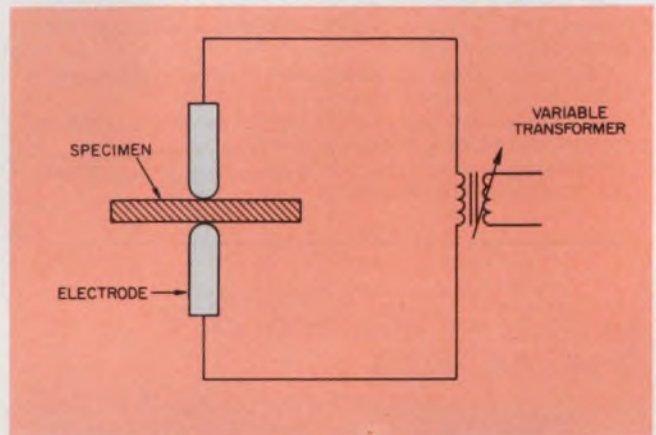

1. Dielectric strength is measured by increasing the voltage across the material under test until breakdown occurs and the current rapidly increases.

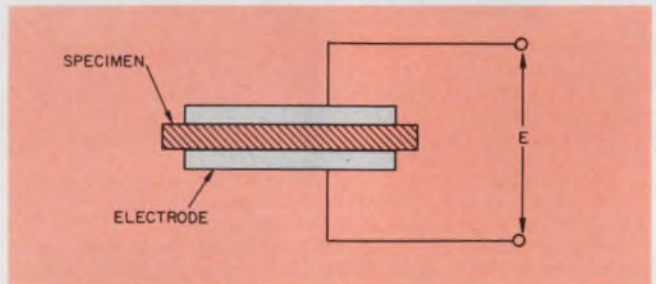

2. Dielectric constant is found by measuring the capacitance between two plates with the material between them, and then with only a vacuum between them.

breakdown data from different sources unless all test conditions are known.

The higher the value of dielectric strength, the better the insulating material. Material suppliers can provide curves that show the variation of dielectric strength with thickness.

Dielectric constant is the ratio of the capacitance formed by the two plates with a material between them, and the capacitance of those same plates with a vacuum between them (Fig. 2). This value is of particular interest to designers of microwave equipment. In radar, for example, the thickness of the part is dictated by the frequency, physical loads and the dielectric constant. For most plastics, this value is between 2 and 10. For many plastics, dielectric constant decreases

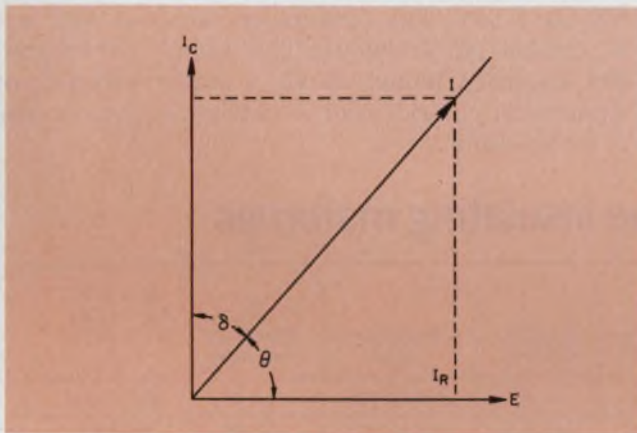

3. **Dissipation factor is the ratio** of parallel reactance to parallel resistance. Thus it is the tangent of the loss angle, δ , or the cotangent of the phase angle, θ .

with frequency and increases with temperature.

To minimize electrical power losses for high-frequency or power applications, low values are best. Higher values are best for capacitor applications.

Dissipation factor is the ratio between the parallel reactance, and the parallel resistance. The parallel resistance is the tangent of the loss angle or the cotangent of the phase angle (Fig. 3). It should be noted that dissipation factor ($\tan \delta$) is not identical to power factor ($\cos \theta$). However, at low values of $\tan \delta$ (less than 0.10) the values are nearly identical to those for power factor. The dissipation factor is related to the energy dissipated and hence to the efficiency of the insulation material.

Loss factor is another term used by some designers. This is the product of the dielectric constant and the dissipation factor. It is related to the total loss of power (in watts) occurring in the insulation material.

Dissipation factors for most plastics tend to decrease as the frequency goes up and to increase as the temperature goes up. Since this property may vary widely through any temperature or frequency range, care should be taken when reported values do not include the test conditions.

Power factor is the ratio between the power dissipated (watts) in an insulating material and

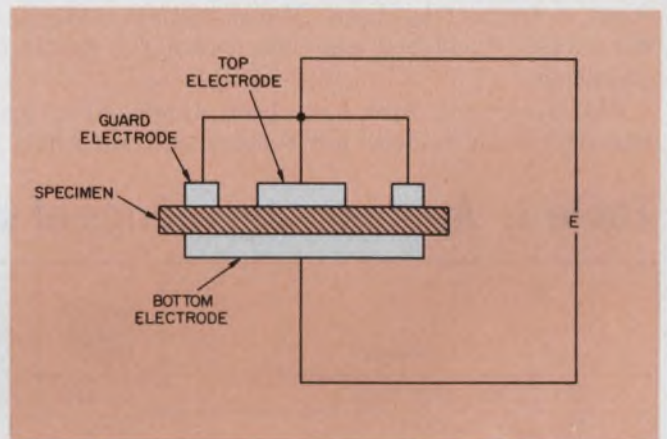

4. **Surface and volume resistivities** are measured using three electrodes, with the guard electrode at the same voltage as the top electrode.

the product of the effective voltage and current (volt-amps).

Some measures of resistance

Insulation resistance is the ratio between voltage applied to a sample and the current flowing in the sample. It has two components: surface resistance and volume resistance. Measurement of surface and volume resistivities (the specific resistances) involves separating these two components from the insulation resistance. Separation is accomplished by using three electrodes (Fig. 4), with the outermost (guard) electrode at the same voltage as the top electrode.

Surface resistivity is the resistance between two opposite edges of a surface film 1-cm square. Since the length and width are identical, their units cancel and the true unit for surface resistivity becomes ohms; however, to avoid confusion with usual resistance values, surface resistivity is normally given in "ohms per square." Surface resistivity is very sensitive to humidity, surface cleanliness, and surface contour.

Volume resistivity is the electrical resistance between opposite faces of a unit cube for a given material at a given temperature. The units of measurement are ohm-cm. Volume resistivity is related to the temperature, the moisture in the

material and the nature of the insulator.

Since dry-out and resistance increase occur rapidly, tests on a section of material that has been subjected to moist or humid conditions must be made at controlled time intervals during or after application of the test condition. Comparison or interpretation of data is difficult unless the test period is controlled and defined.

Tests for arc resistance

Arc resistance is a measure of the insulator surface breakdown caused by an arc that tends to form a conducting path. Many testing methods have been developed and are useful for specific problems.

However, only four have been agreed upon by the American Society for Testing and Materials.

The earliest of these is ASTM D49561 which is a high-voltage low-current test under clean conditions (Fig. 5).

Other tests are specified to relate more closely to contamination and surface conditions found in practice, and all rely on introducing some contaminant into the arcing area.

The dust-fog test specified by ASTM D2132-66T is performed at 1.5 kV on a sample in a fog chamber, and with a standardized dust applied to the sample surfaces. Failure is characterized by erosion of the sample or by tracking.

ASTM D2302-65T describes the differential wet-track test. This test makes use of a 3-kV arc at several power levels. The sample is inclined and partially immersed in a water solution of ammonium chloride and a wetting agent. Failure is by tracking.

Table 1. Approximate ratings of some insulating materials

Material	Dielectric Strength (V/mil)	Volume Resistivity (Ω -cm)	Dielectric Constant	Dissipation Factor	Arc Resistance (seconds)	Max. Continuous Use Temperature ($^{\circ}$ F)
ABS (20-40% glass filler)	350-500	7.16×10^{14}	—	0.007-0.015	25-40	200-230
ABS (heat resistant)	350-500	1.5×10^{16}	2.40-3.80	0.007-0.015	50-85	190-230
ABS (high impact)	350-500	1.5×10^{16}	2.40-3.80	0.007-0.015	50-85	140-210
ABS polycarbonate alloy	350-500	1.5×10^{16}	2.40-3.80	0.006-0.013	70-120	220-250
ABS (self-extinguishing)	350-500	3×10^{16}	2.40-3.80	0.007-0.015	25-70	130-180
Acetal homopolymer	380	10^{15}	3.70	0.0048	125-150	195
Acetal (20% glass filler)	580	1.2×10^{14}	3.90	0.0062	125-150	185-220
Acrylics (impact)	400-500	2×10^{16}	2.20-3.20	0.004-0.02	(no tracking)	140-200
Acrylics multipolymer	493	2×10^{16}	2.80-2.90	0.02	(no tracking)	165-175
Cellulose acetate	250-600	10^{10} - 10^{14}	3.20-7.00	0.01-0.1	50-300	140-220
Cellulose nitrate	300-600	10 - 15×10^{18}	6.40	0.06-0.09	25-75	140
Epoxy (glass filler)	300-400	10^{14}	3.50-5.00	0.01	120-180	300-500
Epoxy (low density)	380-420	10^{12} - 10^{14}	2.00-3.00	0.005-0.012	120-150	300-450
Epoxy (mineral filler)	300-400	$> 10^{14}$	3.50-5.00	0.01	150-190	300-500
Epoxy encapsulation (glass filler)	250-400	$> 10^{14}$	3.50-5.00	0.01	120-180	300-450
Fluorocarbon (FEP)	500-600	$> 2 \times 10^{18}$	2.10	0.0002	> 165	400
Ionomers	900-1000	$> 10^{16}$	—	0.0019	> 90	160-200
Melamine (alpha cellulose filler)	270-300	1.2×10^{12}	7.20-8.40	0.027-0.045	110-140	210
Melamine (asbestos filler)	410-430	1.2×10^{13}	6.10-6.70	0.041-0.05	120-180	250
Melamine (fabric filler)	250-350	10^9 to 10^{10}	6.50-6.90	0.036-0.041	100-200	250
Nylon (polyamide) type 6	400-580	10^{12} - 10^{15}	3.50-4.70	0.019-0.021	125-150	175-250
Nylon (polyamide) type 6/6	365-480	10^{14} - 10^{15}	3.40-3.60	0.017-0.018	130-140	180-300
Nylon (polyamide) type 6/10	500	10^{12} - 10^{15}	3.50	0.016-0.022	90-150	180-250
Nylon (polyamide) type 11	425	2×10^{11}	3.20	0.015-0.02	125-150	180-300
Phenolic (mica filler)	350-400	10^{12} to 10^{14}	4.20-5.20	0.005-0.013	100-200	250-300
Phenolic (glass filler)	140-400	10^{12} to 10^{13}	4.50-7.00	0.01-0.026	25-200	350-550
Polycarbonate (10% glass filler)	450	3×10^{16}	3.05	0.0075	5-120	280-295
Polycarbonate (10 to 40% glass filler)	450	4.5×10^{16}	3.00-3.48	0.0067-0.0075	5-120	280-295
Polystyrene (general purpose)	500-700	$> 10^{16}$	2.40-2.65	0.0001-0.0004	60-85	150-170
Polystyrene (high impact)	300-600	$> 10^{16}$	2.40-3.80	0.0004-0.002	20-100	140-175
Polystyrene (heat and chemical resistant)	400-600	$> 10^{16}$	2.40-3.10	0.0005-0.005	20-100	150-170
Polystyrene (glass filler)	350-425	3×10^{16}	2.38	0.001-0.003	25-40	180-200
PVC (flexible, filled)	250-800	10^{11} to 10^{14}	3.50-4.50	0.09-0.1	—	130-150
Silicones (glass filler)	200-400	—	3.20-4.70	0.002-0.02	150-250	700-750
Silicones (mineral filler)	200-400	10^{14}	3.40-6.30	0.002-0.005	250-420	500-750

The inclined-plane test is defined by ASTM D2303-64T. In this test a specimen is inclined at 45 degrees and electrodes are placed on the underside. An electrolyte is fed onto the surface at a controlled rate, and the applied voltage is increased simultaneously. Failure is by erosion and tracking.

Ratings of insulating materials

Approximate ratings of a variety of insulation materials are listed in Table 1. The figures for short-term dielectric strength are based on tests per ASTM D149 for a thickness of 1/8 in. Volume resistivities were measured at a relative humidity of 50% and temperature of 73 F. Dielectric constant and dissipation factor were both tested per ASTM D150 at a frequency of 1 MHz. Arc resistance was measured per ASTM D495.

The table provides a convenient general guide for comparing insulating materials. But it should be used only as a guide; refer to specific ratings from suppliers for detailed design specs. Also be aware that properties shown in the table vary as a function of such key parameters as frequency, temperature and thickness.

Consider the thermal properties

Thermal classifications of electrical insulating materials are particularly important in modern electronic systems, which often have to operate at elevated temperatures. Most electrical proper-

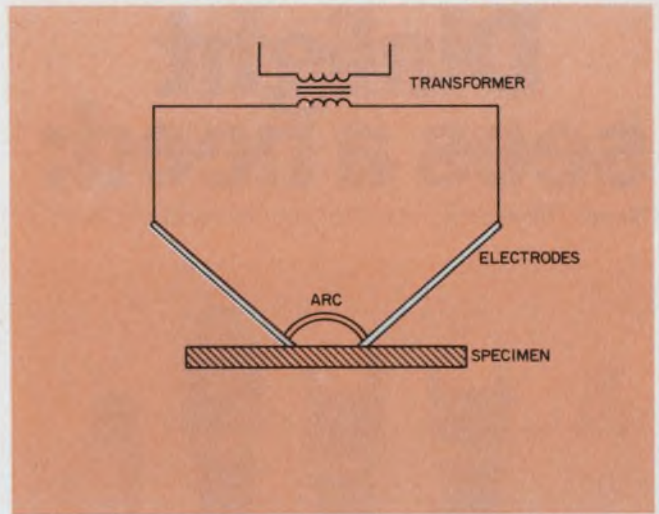

5. An arc-resistance test measures the time for the formation of a carbon path on the surface of a material after a voltage is applied to the electrodes.

ties of insulators are a function of temperature. Depending on the material, properties may vary gradually in a given direction with temperature, may alternate over a temperature range, or may change drastically beyond a critical temperature region.

For example, resistance and resistivity values generally decrease as temperature increases. Dissipation factor and dielectric constant, on the other hand, generally increase with temperature. For many plastics, they increase quite rapidly beyond a critical temperature region.

In addition to the stability of electrical properties with temperature variation, physical stability as a function of temperature is also an important

Table 2. Definitions of insulating-material classes

Class	Definition
90 C (class 0)	Materials or combinations of materials such as cotton, silk, and paper without impregnation. Other materials or combinations of materials may be included in this class if, by experience or accepted tests, they can be shown to be capable of operation at 90 C.
105 C (class A)	Materials or combinations of materials such as cotton, silk, and paper when suitably impregnated or coated or when immersed in a dielectric liquid such as oil. Other materials or combinations of materials may be included in this class if, by experience or accepted tests, they can be shown to be capable of operation at 105 C.
130 C (class B)	Materials or combinations of materials such as mica, glass fiber, and asbestos with suitable bonding substances. Other materials or combinations of materials, not necessarily inorganic, may be included in this class if, by experience or accepted tests, they can be shown to be capable of operation at 130 C.
155 C (class F)	Materials or combinations of materials such as mica, glass fiber, and asbestos with suitable bonding substances. Other materials or combinations of materials, not necessarily inorganic, may be included in this class if, by experience or accepted tests, they can be shown to be capable of operation at 155 C.
180 C (class H)	Materials or combinations of materials such as silicone elastomer, mica, glass fiber, and asbestos with suitable bonding substances such as appropriate silicone resins. Other materials or combinations of materials may be included in this class if, by experience or accepted tests, they can be shown to be capable of operation at 180 C.
220 C	Materials or combinations of materials which, by experience or by accepted tests, can be shown to be capable of operation at 220 C.
Over 220 C (class C)	Insulation which consists entirely of mica, porcelain, glass, quartz, and similar inorganic materials. Other materials or combinations of materials may be included in this class if, by experience or accepted tests, they can be shown to be capable of operation at temperatures over 220 C.

Dialight sees a need:

(Need: The widest choice for your every application.)



LED, INCANDESCENT OR NEON ULTRA-MINIATURE DATALITES®—Meet or exceed MIL-L-3661. Replaceable plug-in cartridges for 1.35-125V operation. Indicators mount as close as 1/2" centers; available with red, green, amber, blue, white translucent, light yellow or colorless lenses in wide range of lens shapes, legends and finishes. Stocked by local distributors.



INCANDESCENT OR NEON SUB-MINIATURE INDICATORS—Meet or exceed MIL-L-3661. Mounts in 15/32", 1/2" or 17/32" clearance holes. Incandescent for 1.35-28V; neon has patented built-in current limiting resistor. Choice of cylindrical, faceted, convex, flat, square and round lens shapes, finishes, legends. Stocked by local distributors.



Dialight, the company with the widest choice in switches, LEDs, indicator lights and readouts, looks for needs . . . your needs . . . and then they develop solutions for your every application. No other company offers you one-stop shopping in all these product areas. And no other company has more experience in the visual display field. Dialight helps you do more

with these products than any other company in the business, because we are specialists that have done more with them. Talk to the specialists at Dialight first. You won't have to talk to anyone else. Send for your free new copy of Dialight's current catalog.

DIALIGHT

Dialight, A North American Philips Company
203 Harrison Place, Brooklyn, N. Y. 11237
(212) 497-7600

See Dialight.

CIRCLE NUMBER 42

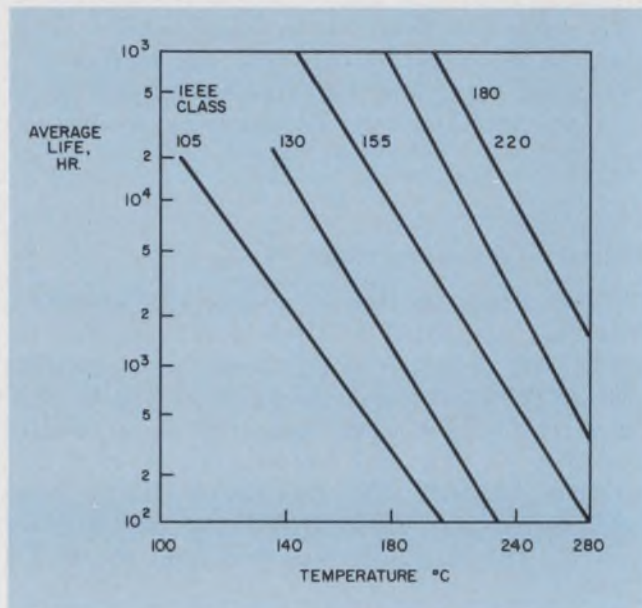

6. Typical life curves for IEEE thermal classes of insulated magnet wire.

factor in analyzing the performance of insulating materials. Physical stability and electrical stability often are indicated by the continuous-use temperature. Although this rated value implies no specific property at the stated temperature, it is generally accepted that a material will perform without major physical or electrical instability at the specified continuous-use temperature.

One widely accepted temperature classification system is the IEEE thermal classification of electrical insulating materials (Table 2). A material properly rated into one of these classifications can be expected to operate continuously and reliably up to the maximum operating temperature of its classification for a predetermined period (usually 20,000 hours but sometimes up to 100,000 hours).

It should be noted that this system implies performance only as electrical insulation and does not necessarily cover satisfactory mechanical performance. The IEEE classification system has especially wide use in rating wire insulation as a function of temperature as shown by the typical curves of Fig. 6. ■■

References

1. Harper, C. A., *Handbook of Plastics and Elastomers*, McGraw-Hill Book Co., New York, NY, 1975.
2. Harper, C. A., *Handbook of Electronic Packaging*, McGraw-Hill Book Co., New York, NY, 1972.
3. Harper, C. A., *Handbook of Wiring, Cabling and Interconnecting for Electronics*, McGraw-Hill Book Co., New York, NY, 1974.
4. Harper, C. A., *Handbook of Materials and Processes for Electronics*, McGraw-Hill Book Co., New York, NY, 1973.
5. Grafton, P., *Commonly Used Plastics*, Boonton Molding Co., Inc., Boonton, NJ, 1973.

You might pay a little more for our flexible circuits...

Less rejects.
Less customer complaints.
Less headaches.

We know you want a flexible circuit that you can depend on. A circuit that won't come back to haunt you in the form of rejects, complaints and lost business.

If it's a routine job, BMC can turn it out as inexpensively as the next guy. And probably with greater reliability.

But, you need us even more when your application calls for ultra close tolerances, exotic

materials or special adhesives.

We cut our teeth on tough jobs like that. So, we know what it takes. Like hand cleaning raw materials. Five meticulous in-process inspections. A final comprehensive quality control check. And more.

That kind of care and attention simply costs a little more. But, shouldn't all of your flexible circuit requirements be getting it?

It can save you a lot in the end.

For more information, contact Ed Dugan, Circuits Division, (612) 228-6371.

245 EAST 6TH STREET
ST. PAUL, MN 55101
612 - 228-6371

BUCKBEE-MEARS COMPANY
bmc

but, you'll get a lot less.



Circuit shown is flash firing assembly circuit for the Polaroid SX-70 Land Camera®.

CIRCLE NUMBER 43

Parallel-coupled microstrip-line geometry is easy to determine with nomograms. Specialized charts for alumina substrates make the work even easier.

Here's an accurate and quick way to determine the geometry of parallel-coupled microstrip lines (Fig. 1). Microstrip lines are used as components in high-frequency couplers, filters and other microwave-frequency circuits.

The data available in the literature¹⁻⁶ are not designed for easy use, and curves are difficult to generate for specific requirements. Simultaneous solutions for the strips' dimensional ratios, W/H and S/H , are not easily obtained. And though some of the equations appear simple,⁶ direct use would require either a digital computer or tedious calculations by hand.

Nevertheless, without substantially affecting accuracy, the equations were approximated to a form required for the construction of the nomograms (Fig. 1). The nomograms provide simultaneous solution for W/H and S/H , and relate to both the even-mode, Z_{0e} , and odd-mode, Z_{0o} , impedances of the microstrip (Figs. 3 and 4).

But first, the $(W/H)_{s,x}$ ratios for both odd and even modes must be obtained from a set of curves (Fig. 2) drawn for a range of dielectric constants, ϵ_r , between 1 and 10. The curves are plotted from Wheeler's synthesis formula.⁴

A separate pair of nomograms (Figs. 5 and 6) provide solutions for the most commonly used substrate—alumina with a dielectric constant of 9.6. With these alumina nomograms, the designer bypasses use of the curves in Fig. 2 and directly determines W/H and S/H for both the even and odd-mode impedances.

Using the nomograms

To learn how to use the nomograms, consider the example where

$$\begin{aligned} Z_{0e} &= 60 \Omega \\ Z_{0o} &= 40 \Omega \\ \epsilon_r &= 10 \end{aligned}$$

1. On Fig. 2, $(W/H)_{so} = 2.3$ for $Z_{0o} = 60 \Omega$,

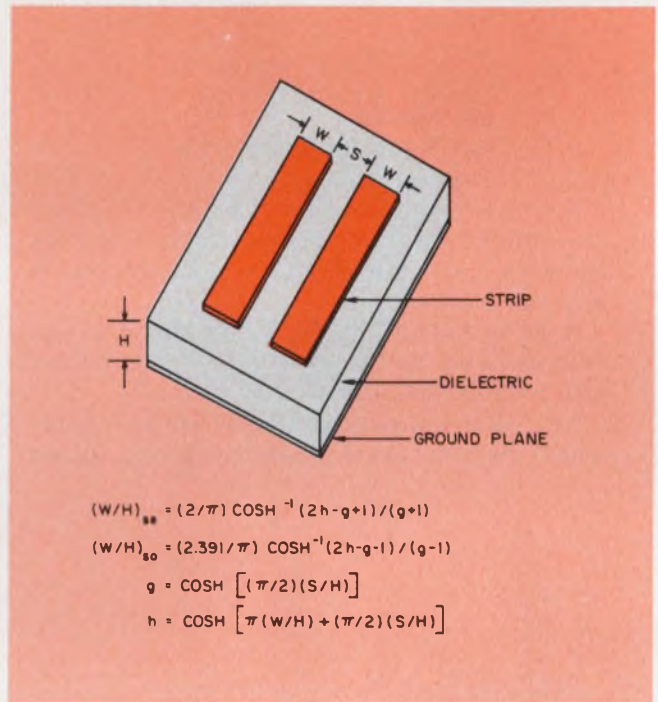

1. The geometry of parallel-coupled microstrip lines is most conveniently expressed by the two dimensional ratios W/H and S/H .

and $(W/H)_{so} = 4.2$ for $Z_{0o} = 40 \Omega$.

2. A straightedge on Fig. 3 between $(W/H)_{oe} = 2.3$ and $(W/H)_{so} = 4.2$ shows that $(S/H) = 0.5$.

3. A straightedge on Fig. 4 between $(S/H) = 0.5$ and $(W/H)_{so} = 4.2$ shows that $(W/H) + (1/2)(S/H) = 1.18$.

4. Solving $(W/H) + (1/2)(S/H) = 1.18$ by substituting $S/H = 0.5$ yields $W/H = 0.93$.

Use of the nomograms in Figs. 5 and 6 for $\epsilon_r = 9.6$ is simpler; step 1 is not needed. The value for S/H is obtained from Z_{0e} and Z_{0o} directly on the nomogram, Fig. 5. ■■

References

1. Bryant, T. G.; Weiss, J. A., "Parameters of Microstrip Transmission Lines and Coupled Pairs of Microstrip Lines," *IEEE Trans Microwave Theory Tech* (1958 Symposium Issue), Vol. MTT-15, December, 1968, pp. 1021-1027.

K. N. Shamanna, V. S. Rao, S. P. Kosta, Indian Scientific Satellite Project, A 1-6, Peenya Industrial Estate, Bangalore 562140, India.

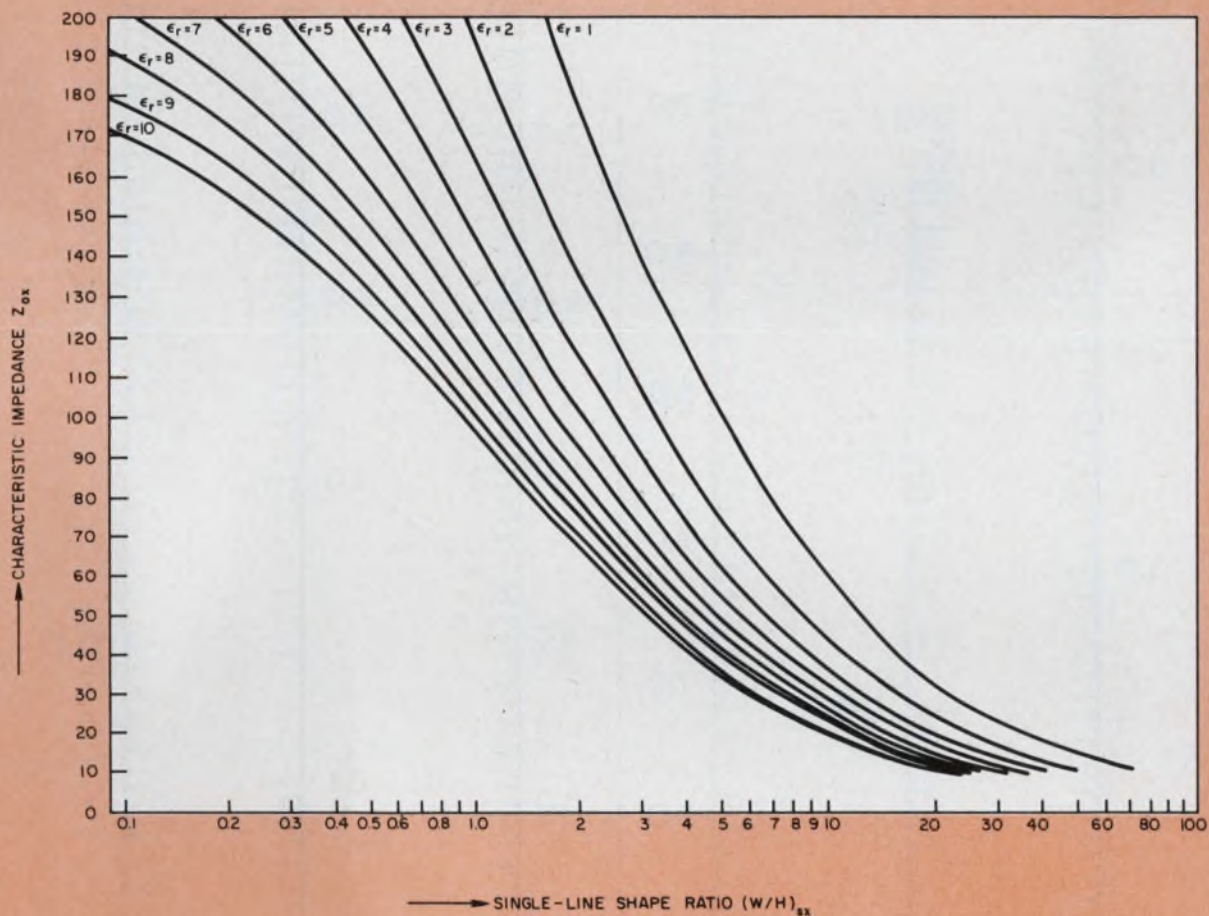

2. For a given impedance of either mode, Z_{0o} or Z_{0e} , and dielectric constant, ϵ_r , the corresponding ratio,

$(W/H)_{so}$ or $(W/H)_{se}$ can be readily obtained from this set of curves.

2. Judd, S. V.; Whitley, I.; Clowes, R. J.; Richard, D. C., "An Analytical Method for Calculating Microstrip Transmission Line Parameters," *IEEE Trans Microwave Theory Tech*, Vol. MTT-18, February, 1970, pp. 78-87.

3. Ramadan, M.; Westgate, W. F., "Impedance of Coupled Microstrip Transmission Lines," *Microwave J.*, Vol. 14, July, 1971, pp. 30-35.

4. Wheeler, H. A., "Transmission Line Properties of Parallel Strips Separated by Dielectric Sheet," *IEEE Trans Microwave Theory Tech*, Vol. MTT-13, March, 1965, pp. 172-185.

5. Napoli, L. S.; Hughes, J. J., "Characteristics of

Coupled Microstrip Lines," *RCA Review*, Vol. 31, September, 1970.

6. Akhtarzad, S.; Rowbotham, T. R.; Johns, P. B., "The Design of Coupled Microstrip Lines," *IEEE Trans Microwave Theory Tech*, Vol. MTT-23, June, 1975, pp. 486-492.

7. Levens, *Nomography*, 2nd edition, 1959, John Wiley & Sons, Inc., New York.

Acknowledgement

The authors are grateful to Prof. U. R. Rao, Director, ISSP, for his encouragement. Thanks are also due to the Antenna & Microwave Group for its help and suggestions.

(continued on page 80)

FIG. 3

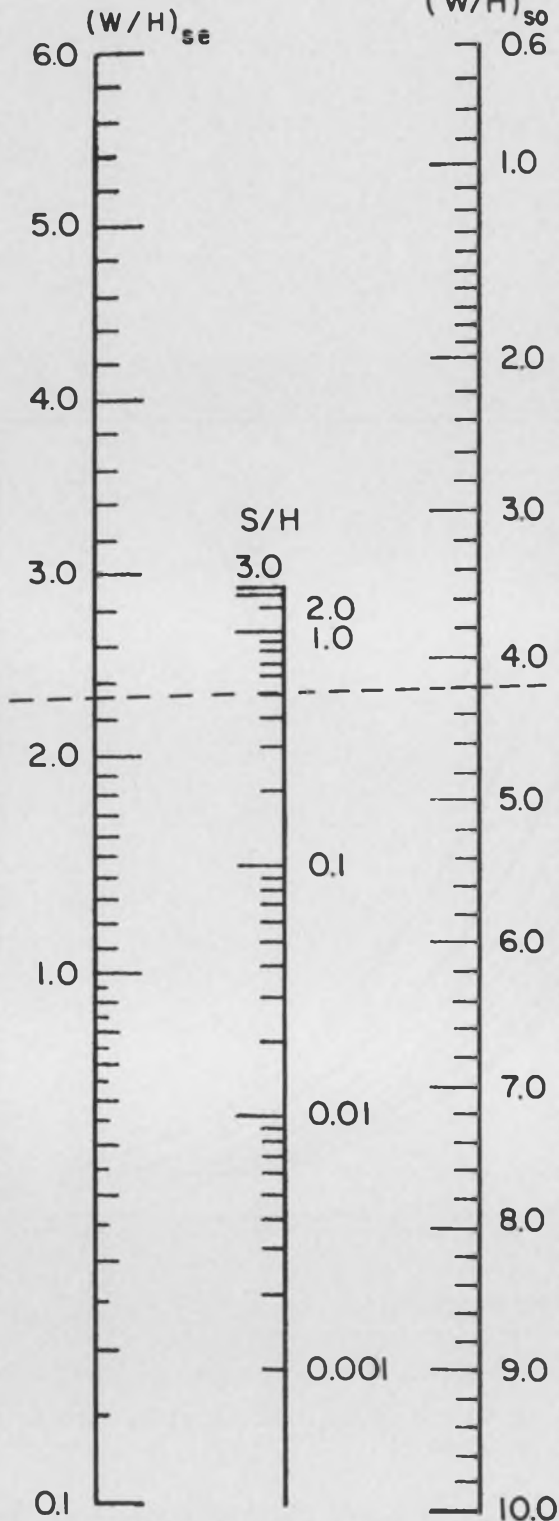

NOMOGRAM FOR OBTAINING
S/H FROM
 $(W/H)_{se}$ AND $(W/H)_{so}$

FIG. 4

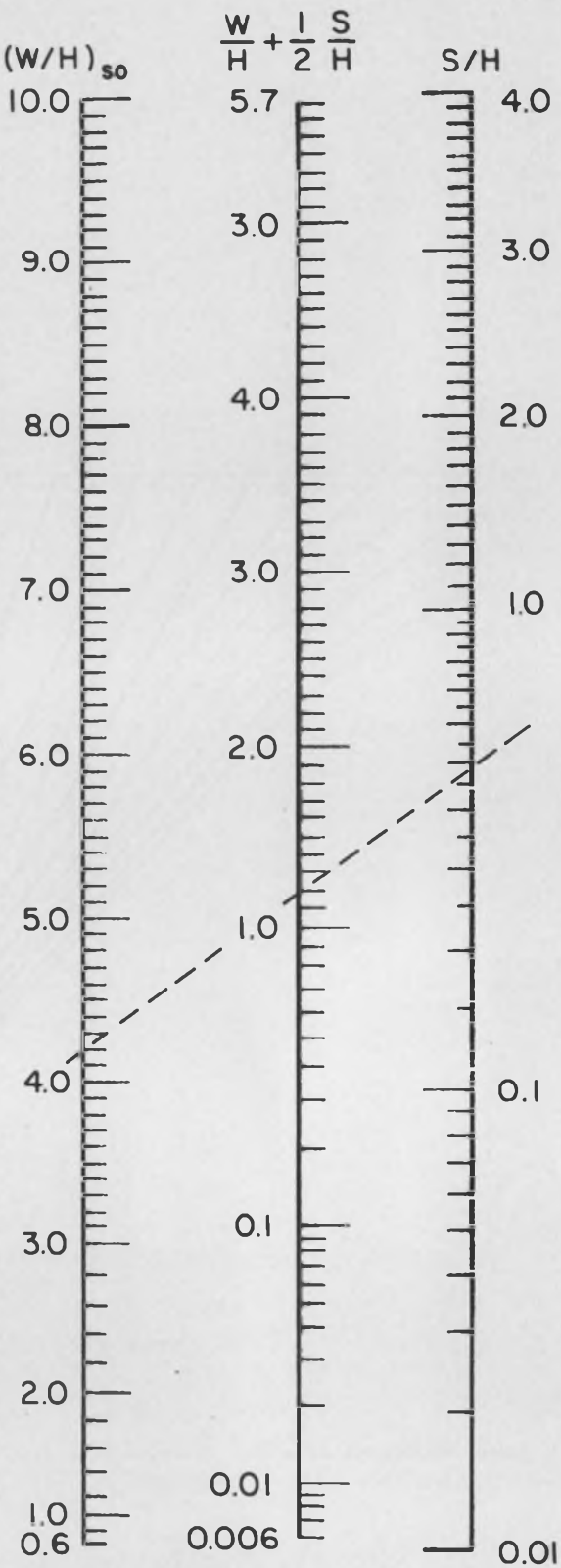

NOMOGRAM FOR OBTAINING
 $(\frac{W}{H} + \frac{1}{2} \frac{S}{H})$
FROM $(W/H)_{so}$ AND S/H

FIG. 5

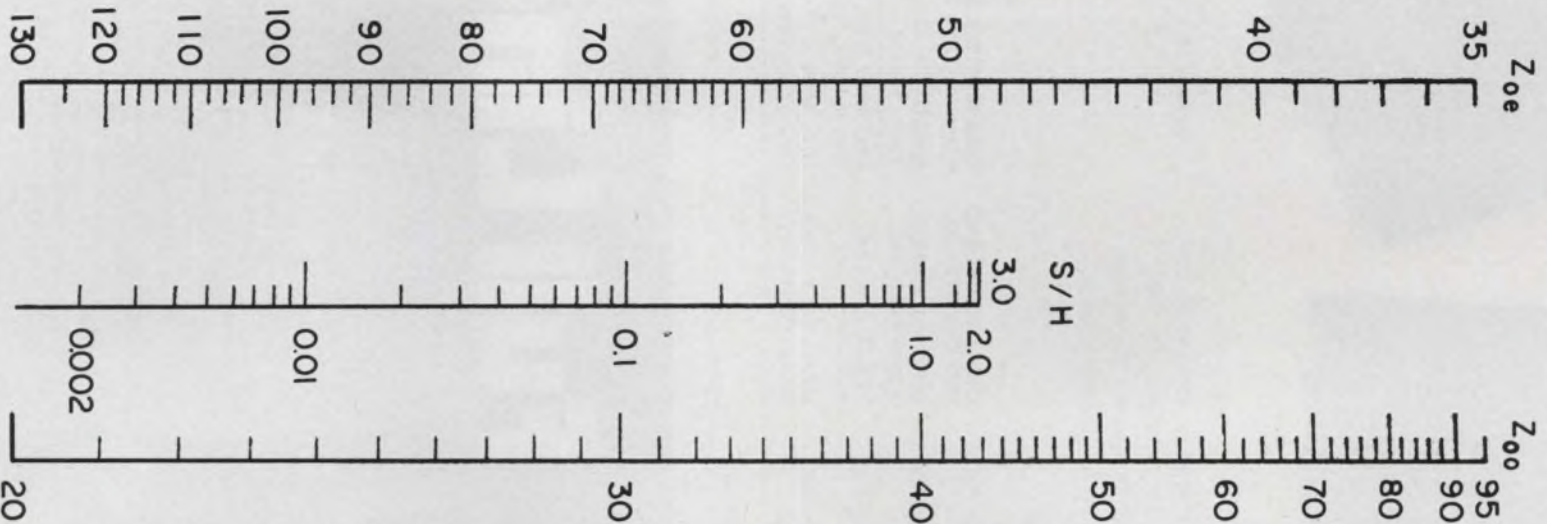

NOMOGRAM FOR OBTAINING
S/H FROM
 Z_{oe} AND Z_{00} , $\epsilon_r = 9.6$

FIG. 6

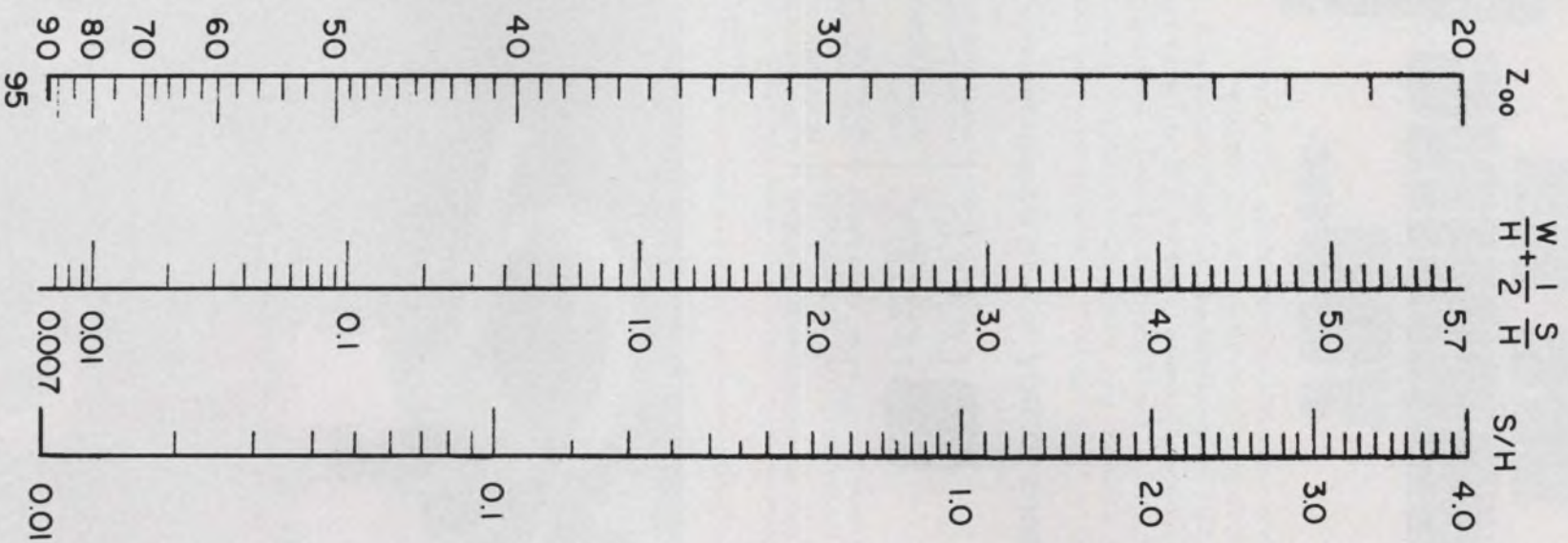

NOMOGRAM FOR OBTAINING
 $\frac{W}{H} + \frac{1}{2} \frac{S}{H}$ FROM
 Z_{00} AND S/H, $\epsilon_r = 9.6$

WE'RE WARNING YOU...

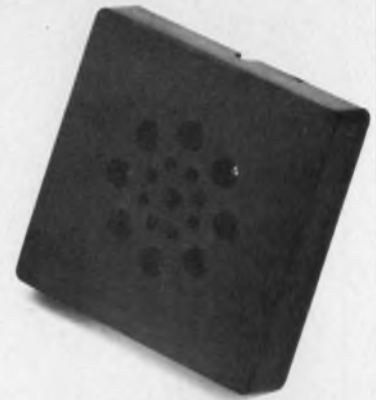

... these new audio indicators are just right for letting you know something's wrong. Ideal for computer terminals, remote control warning, fault detection and alarm devices. Six models ... featuring 35mm diameter piezo crystal ... rated to 85 dbA at 3.3 kHz ... 3 to 16 vdc, drawing just 10 mA maximum current. Supplied with .187 quick disconnect tabs, wires or PC mounting pins. Black ... 40mm square x 10mm high (X-10), or 15mm high (X-11). Life-tested for at least 1000 hours. Ask for free catalog.

Actual Size
Series X-10 Continuous
Series X-11 Pulsing

Where to buy an audio indicator for every need



3680 Wyse Road, Dayton, Ohio 45414
Tel. (513) 890-1918, TWX 810-450-2523

Selected distributorships available.

CALIFORNIA, COSTA MESA
MarVac Electronics

MASSACHUSETTS, SHARON
Adcour

MICHIGAN, FARMINGTON
CMP Distributor Co.

NEW YORK, ROCHESTER
Ossmann Components

OHIO, CLEVELAND
CMP Distributor Co.

OHIO, COLUMBUS
Hughes Peters, Inc.

TEXAS, DALLAS
K. A. Electronics

UTAH, SALT LAKE
Newark Electronics

WASHINGTON, SEATTLE
Frank Jackson & Associates

WISCONSIN, MILWAUKEE
Taylor Electric

ONTARIO, WILLOWDALE
Electro Sonic, Inc.

B. C., VANCOUVER
Deskin Sales Corp.

CIRCLE NUMBER 54



Full Line

Coil Forms and Bobbins

Check our huge volume of stock bobbins first. And, if this selection isn't enough, we can design to your specific needs.

You have a great deal of latitude in design because ITT Thermotech has its own internal tool making department and offers a full variety of highly automated injection molding machines ranging in size from 1/2 ounce to 16 ounce capacity. We also mold non-burning U.L. approved materials.

At ITT Thermotech we have been perfecting our service to you, each year, for over a quarter of a century.

Phone or write us. We'll happily send you our updated catalog. We also would appreciate the opportunity to give you an estimate.

ITT THERMOTECH

1202 South Fifth Street, Hopkins, Minnesota 55343, (612) 938-7871

CIRCLE NUMBER 55

sticks sticks sticks!



Preassembled LED displays cut price per digit and save labor

Big Sticks are what's new in LED packaging. And naturally Litronix is coming on first and strongest with eight different preassembled displays of 1" and 1/2" digits.

Price per digit is 20% to 25% less than earlier single-digit mounts. Add to that the saving in assembly and inventory costs and you've found the best LED display bargain of the year.

Inch-high displays come in modules of 2, 3, and 4 digits—the last with a colon for clocks and indicator lamps for AM, PM and alarm.

Half-inch displays are available with 2, 3½, 4 and 6 digits per stick. The 3½ digit module has plus and minus signs, and can be combined with the other modules to create instrument displays of almost any length. There are two half-inch 4-digit modules, one for general use with closely spaced digits, and one for clocks with a colon, built-in multiplexing, and indicator lamps for AM, PM and alarm.

If you need big digits, you'll prefer Big Sticks. Can we throw some your way?

Litronix, 19000 Homestead Road, Cupertino, California 95014. Phone (408) 257-7910.

No wonder
we're No.1
in LEDs

litronix

Wiring for high-speed circuits

needs special treatment. Otherwise signal reflections and delays can distort signals and impair performance.

Connections between high-speed switching circuits that operate in the nanosecond range need special treatment. Ordinary wiring can adversely stretch out and delay pulse rise and fall times, and uncontrolled reflections from improperly impedance-matched components at wiring-run terminations can badly distort pulse shapes. Such circuit wiring should be treated with the same considerations given any transmission lines: Connection runs must be impedance-matched at either the input or load ends, and the delay time between input and load must be taken into account in the circuit's behavior.

Wiring with transmission lines

Wiring for nanosecond circuits behaves like a lossless transmission line—a line with negligible series-resistance and shunt-resistance losses.

The characteristic impedance of a lossless transmission line is

$$Z_0 = \sqrt{L_0/C_0},$$

and the delay per unit length of line is

$$d_0 = \sqrt{L_0 C_0}$$

where L_0 and C_0 are the inductance and capacitance of the line per unit of its length.

When impedances are not matched, the reflections that occur at the interface terminals can cause transition signals to overshoot or undershoot. The degree of mismatch can be expressed by a reflection coefficient,

$$\rho = \frac{R_l - Z_0}{R_l + Z_0},$$

where R_l is the resistance of a device attached to a line with characteristic impedance Z_0 .

Repeated reflections bouncing between unmatched terminations on a line can continue for periods that are many times longer than the delay of a single pass of the signal "down" a line. An extreme example, where a driver circuit of low, or zero, internal resistance drives a line with

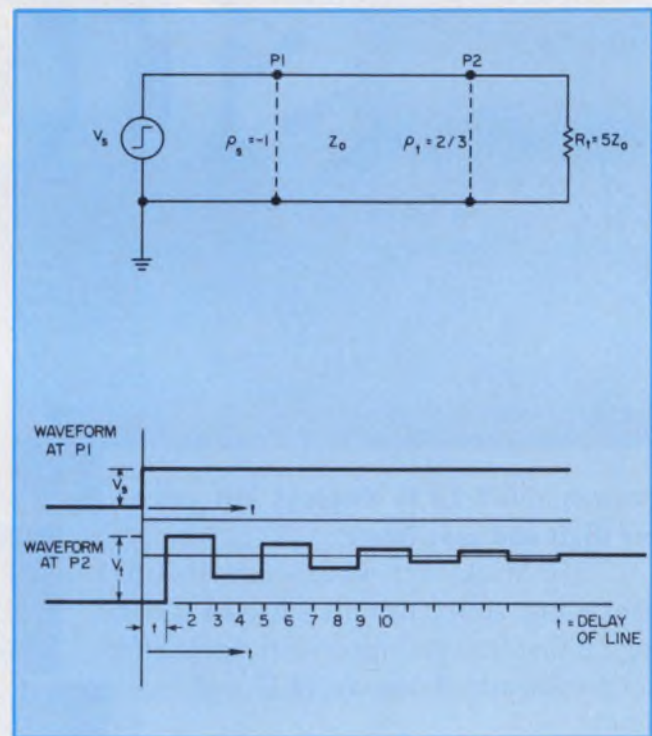

1. A negative reflection coefficient reverses the polarity of a reflected signal, which can cause overshoot or undershoot problems on pulse or step signals.

a step waveform and the line is terminated with a load equal to $5Z_0$, as shown in Fig. 1.

The reflection coefficient at the source end is

$$\rho_s = \frac{R_l - Z_0}{R_l + Z_0} = \frac{0 - Z_0}{0 + Z_0} = -1,$$

and at the receive end,

$$\rho_l = \frac{5Z_0 - Z_0}{5Z_0 + Z_0} = \frac{2}{3}.$$

Note that the input step signal at terminals P_1 does not appear at the receive end, P_2 , until a delay time, t , later. After two more such delay times, a portion of this received step waveform which was reflected back to the source, returns with its polarity inverted, since $\rho_s = -1$. This reflected wave therefore subtracts from the original transition at P_2 during the period $3t$ to $5t$. Subsequently the signal at P_2 is re-enforced by a new reflection, with its amplitude now re-inverted

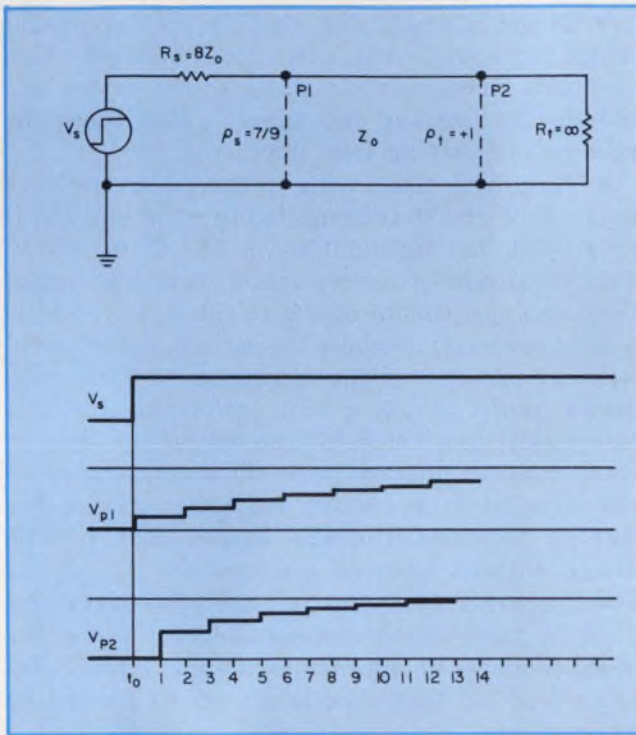

2. An improperly matched, high-resistance load can result in a very long signal rise time—several times greater than the delay of the transmission line.

to its original polarity. And so on, until the repeated reflections damp out.

In Fig. 2, the source has an internal impedance, $R_s = 8Z_0$, and the receive end is open-circuited—that is $R_T = \infty$. Thus $P_s = 7/9$ and $P_l = +1$, and all reflected signals are additive.

Although the waveforms in Figs. 1 and 2 are theoretical and may appear exaggerated, such conditions of mismatch are not unusual in practical cases. The example in Fig. 1 closely approximates a totem pole circuit that drives a lightly loaded line. The second example, Fig. 2, approximates an open-collector driver with a 1000- Ω pull-up resistor driving a single high-impedance load. In the first example, undershoots during $3t$ to $5t$ can drop below the logic-ONE threshold level of the circuit and cause errors. In the second example, a delay several times greater than the delay of the line occurs before the signal reaches the

circuit's switching threshold.

In practice, the idealized waveforms of Figs. 1 and 2 are distorted. Noise in the power and ground-distribution system helps to mask the clean, sharp lines of the waveforms. And infinite-step waveforms are not possible. The appearance of rise and fall times are modified.

However, when speed is not important, a signal's slow rise and fall times can be used to mask reflection effects. When the rise time or fall time is equal to or greater than two delay times of the transmission line, the overshoot-undershoot conditions of Fig. 1 won't occur. And in Fig. 2, the waveforms would closely resemble the classic exponential equation

$$V (1 - e^{-t/\tau}),$$

which represents the waveform of a simple RC network. Then the connection wiring can be represented as a lumped capacitor,

$$C = C_0 \cdot (\text{length of line}).$$

Each method of connection—open-wire, twisted pair or PC board—has different transmission characteristics. For example, glass-epoxy boards have a dielectric constant about three times greater than that of air. The resulting higher capacity per unit length produces a lower Z_0 , and greater delay per unit length. The approximate characteristics of the three most common wiring techniques are as follows:

	Z_0	d_0	C_0
Open wire	150 Ω	1.2 ns/ft	1.0 pF/in.
Twisted pair	115	1.4	1.2
Etched wiring (micro-strip)	100	1.7	1.46

Some loads are distributed

Not all loads are attached at the end of a wiring run. It is necessary also to consider the effects of loading at various points along a line. All load inputs include some capacity, and the best way to handle this capacitance is to consider it distributed along the line length.

This capacitance, C_0 , of course, modifies the transmission-line characteristics. The characteristic impedance Z is lowered to

The M-600 amp works harder at 2.5 ohms

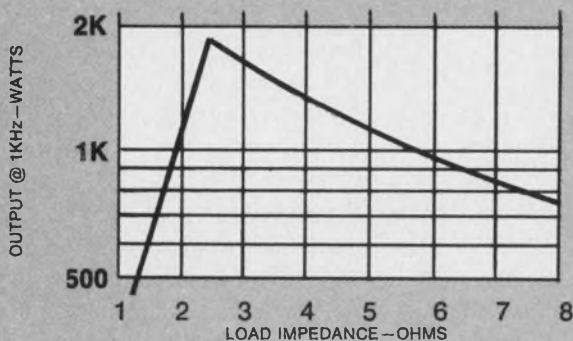

So each watt costs less

You get more watts per dollar from the Crown M-600 power amp if your circuit design lets it look at a 2.5Ω load.

The M-600 provides power from DC to 20KHz with complete protection against shorts, open circuits, mismatch, RF burnout and thermal overload. The M-600 will even drive a purely reactive load without overheating. Designed for continuous operation at full rated power, at any rated frequency.

One M-600 will cost you \$1,795. A copy of the spec sheet is free. Write today.

We'd also like to hear from you if you have any special amplification problems in the DC-20KHz range. We've already solved some tough, unique problems. We'd like to consider yours.



CROWN INDUSTRIAL

1718 W. Mishawaka Road, Elkhart, Indiana 46514
219/294-5571

CIRCLE NUMBER 45

$$Z_0 = \sqrt{L_0 / (C_0 + C_r)}$$

and the delay per unit length is increased to

$$d_0 = \sqrt{L_0 (C_0 + C_r)}$$

In addition the cutoff frequency, f_c , of the line is reduced. This has the effect of smoothing the waveforms.

Of course, when low-speed circuit components are used, long connecting paths, reflections and mismatches cause few problems. Nevertheless lines should be as short as possible. Some additional steps you can take to overcome wiring problems in high-speed circuits' include the following:

- Divide a single line that drives two loads: make the source drive two lines instead. This approach increases the loading on the driver and thereby its rise and fall times, which eases the problems of driving long lines.

- Terminate lines with a 220/330-Ω resistor network. With 220 Ω connected to +5 V and 330 Ω to ground, the termination is 132 Ω to +3 V. This arrangement covers many practical cases. Only an approximate match to the Z_0 of a line is usually necessary, because the reflected component is about one-half of the mismatch—a 20% mismatch results in only a 10% reflection. And this terminator need not be at the end of the line. In some cases termination near the source improves rise time while increasing fall time, and in this way, it increases the line length that can be driven without harmful reflections.

- Use Schottky diodes to clamp the overshoot. This, in turn, eliminates undershoot. When the diode conducts, it appears as a short-circuit giving a ρ of -1 that cancels a ρ of +1 caused by an open line.

- Use twisted pairs. Twisted-pair lines help eliminate noise caused by poor power distribution and filtering, and they also tend to reduce radiation and coupling. However, the penalty is a low impedance line that will likely need special terminators. Twisted-pair wiring may involve also the penalties of high cost and high power consumption.

And, finally, don't overlook the need for a well-filtered, low-impedance power distribution wiring system for your high-speed circuits. Switching currents, especially with TTL circuitry, generally present far greater loads than expected. High-current load pulses can generate noise signals on the V_{cc} and ground lines, which when added to reflection effects, greatly increase the potential for errors. ■■

Reference

1. Pagani, A. J., "AC Analysis," UAI App. Note, Vol. 1, No. 1; DeClue, J. L., "Wiring and Interconnection Considerations," UAI App. Note Vol. 1, No. 2, Universal Automation, Inc., 1310 E. Edinger Ave., Santa Ana, CA 92705.

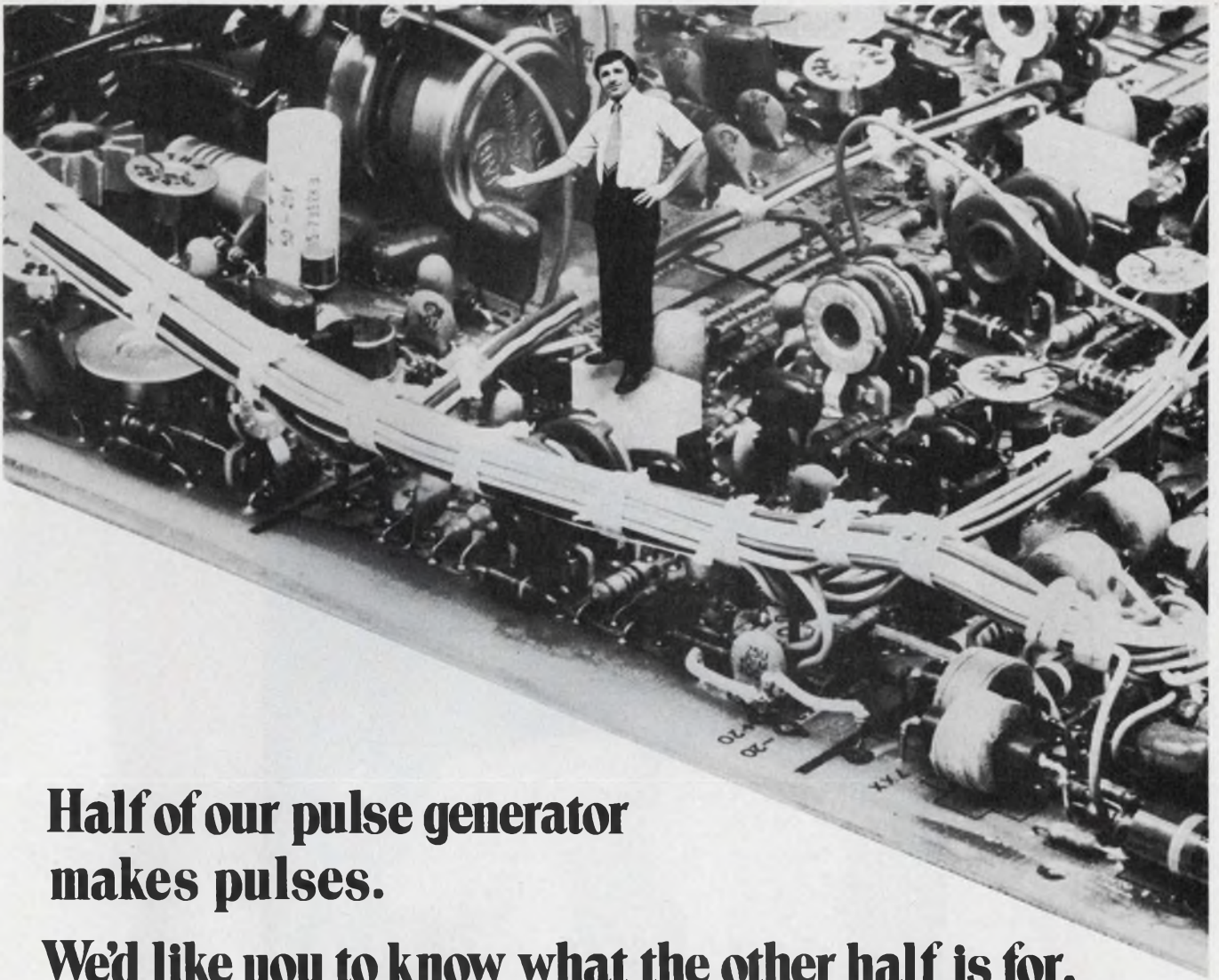

**Half of our pulse generator
makes pulses.**

We'd like you to know what the other half is for.



Pulse generators make pulses — everybody knows that. The half everybody **doesn't** know about is that today's general-purpose pulse generators (like Interstate's SERIES 20) can:

- 1) **Make your life easier.** With Interstate's constant duty cycle mode, for example, you don't have to reset width and pulse period every time you change the frequency when testing a differential amplifier or an analog computing circuit over a wide range of frequencies. The width-to-period ratio remains constant as you change the frequency. Much easier.
- 2) **Give you an infinitely more versatile pulse.** Clock and sync outputs on Interstate's SERIES 20 Pulse Generators are squarewaves, instead of those other skinny, 10-nanosecond trigger pulses. So when you're testing low-speed stuff, like electromechanical machines or reed relays, or even some of the new microprocessors, you won't have to keep switching the scope over to high speed to make sure the trigger is there. Interstate's sync pulse is readily visible — and immediately usable.
- 3) **Allow you to use the pulse generator for other jobs.** SERIES 20's pulse amplifier mode can restore levels and transition times in MECL testing, for instance, so you can avoid having to jerry-rig some complex kluge of equipment.

Put the other half of your pulse generator to work. Interstate has just produced "Today's General-Purpose Pulse Generator Report" in which our SERIES 20 Pulse Generators, at 50 MHz, 3.5 ns rise/fall time, 10 V output (into 50 ohms), are detailed and cross-compared, and application notes reveal methods and techniques for practical pulse problem-solving. For your free copy, write to:





INTERSTATE
 ELECTRONICS CORPORATION
Subsidiary of A-T-O Inc.

P.O. Box 3117, Anaheim, California 92803 • (714) 549-8282 • TWX U.S.A. 910-591-1197 TELEX 655443 & 655419

CIRCLE NUMBER 46

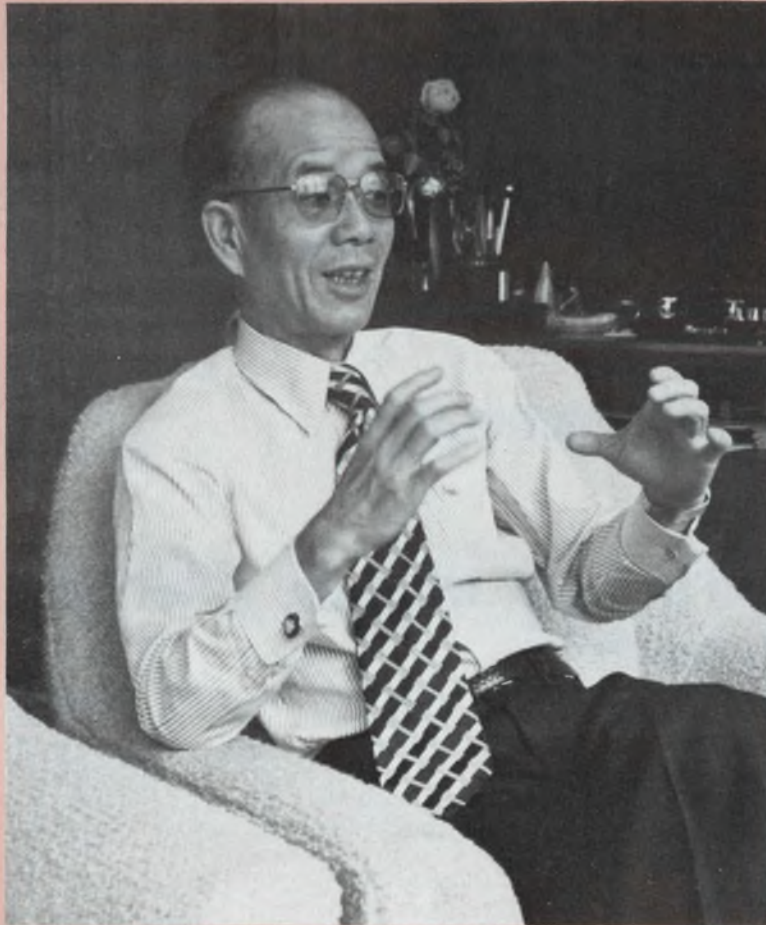
Taro Kuninobu of Matsushita Speaks On Managing by the Managed



To get the best performance from your engineers—or from anybody else—you must provide them with the best management. To provide the best management you need the best managers. And the best engineering managers, in my opinion, are most likely the engineers themselves.

The function of the people who are assigned engineering-management responsibilities should be to draw out and develop the ideas and opinions of their engineers.

In a sense, good management is like ideal gov-

ernment, which is run by the people. The people are basically groups of individuals. So the ultimate benefit should go to the individual. We must not regard the people as a mass, but rather, as a group of individuals. Similarly, we must not regard our engineers as a mass, but rather, as individuals.

Our whole philosophy at Matsushita, since the company was founded 58 years ago by Konusuke Matsushita, has always stemmed from the concept of management from below, from the ranks,

from the individual. We don't want to impose management; we want management to rise from the ranks.

We try to structure things so that all individuals will contribute. So the role of our manager is to draw ideas out of the ranks—not only in engineering—but throughout the company.

We do, in fact, have great participation. We have suggestion boxes around the plant and we get some 800,000 suggestions a month from our 80,000 employees. It's not important how many of these suggestions we use. What's important is that we create the environment in which employees know that management welcomes their participation.

Let me show you how the concept of management from below pays off. Koichi Yoshida, here, is responsible for setting up new factories in our Electronic Components Group. Well, he uses a system based on our philosophy and called 3-3-3. What we mean here is that three managers can work with 300 people in an area of 3000 tsubo—that's about 10,000 square meters. Right here you can see one advantage of our 3-3-3 system; we need only a very small number of managers. One manager to 300 people is a very small ratio.

We don't need so many "higher level" people because all our people act with a higher level philosophy and eagerness.

The objective of any system I install is to develop good managers. So everything comes down to developing people. We don't worry much about immediate financial success. We're more concerned with having people grow. If the people are developed, the financial achievement will follow.

Our attempt to get away from the traditional management pyramid structure is not new. We've been working at this since the earliest days of our company. But it's a continuing process; it is not something that is ever completed. So we are always restructuring the company to approach this ideal more closely.

As our company grows we keep reexamining the traditional system that includes section managers, general managers, division managers, and so on. And as we grow we become more concerned with some of the bad aspects of such structures. We have noticed a similar development, by the way, in the General Electric Company in the United States. From what we can see, General Electric's structure is the traditional pyramid in theory, but, in practice, the company seems to be moving away from that. GE seems to be attempting management at lower levels.

Our whole orientation is toward people rather than things. We feel people will take care of things if we take care of people.

Let me show you how this works in the engineering world. In a typical Japanese company, the research and development engineers are off by themselves. They are in their own little world. Typically, the research laboratory develops a product, then brings it to the marketing department with all the basics completed for further development of the product in any particular direction. But the product is not yet tied down, not yet tailored to the needs of a particular market.

How do we respond to this problem? First, we take the short-term projects out of the research laboratory and give them to separate development groups. We get these development groups involved in all aspects of getting a product to the customer. They are given a total responsibility for the success of their products, so they can no longer develop a product in a vacuum and ignore what happens to it when they're finished. They have great interplay directly with the marketplace. As a result, they, themselves develop more in very practical directions.

Of course some people don't succeed. But we believe a great deal in the inner strength of an individual. So if a person is not doing too well in one particular function, he might do far better in another.

For example, we quantify the success of our various divisions. If one division is not doing well for a long time, we assume that the manager of that division is not well placed. So we'll rotate him into another division. Or we'll rotate him into another function where he is likely to have greater success.

Sometimes, too, the success or failure of an individual may not be his fault but may be the result of outside economic or technological circumstances. For example, if semiconductor memories are replacing cores, we cannot expect core memories to show continued growth. But we would expect the core man to alert us to what's going on in the market. We would not have to tell him that his technology is receding. He's more likely to tell us. In fact, he would probably be the first to alert us to the importance of semiconductor memories and it's likely that he would be placed in charge of semiconductor memory development.

This is one way some of our people grow. Look at another example. We have frequent meetings with a great deal of participation by rank-and-

Who is Taro Kuninobu?

Like Konosuke Matsushita, founder of Japan's most profitable company, Taro Kuninobu did not get a great deal of formal education. Still, he became Managing Director of the Electronic Components Group of the Matsushita Electric Industrial Co., Ltd.

And recently, when the group was segregated from the rest of the firm to form the independent Matsushita Electronic Components Co., Ltd., he was named its first president. Nor is Kuninobu sorry he did not spend more years in school. He feels that formal education can be more of a hindrance than a help.

Without it, one can get a great education by listening to other people. Formal education, he says, can actually limit you because it makes you think you know, so you don't have to listen. It makes you feel you can stop listening when you leave school. There are too many people today who think a man isn't educated if he didn't go to Tokyo University.

But graduating from a fine university is no guarantee of success, Kuninobu says. The university education is often too limiting. It breeds business men, or government men, or education men—but not necessarily educated men. The

greatest vehicle for education, Kuninobu feels, is the wide open ear.

That's been his principal source of education since he joined Matsushita Electric Industrial Co., Ltd. in 1933 after graduating from a commercial high school in Yamaguchi at the age of 16. (Konosuke Matsushita didn't get that far: economics forced him to abandon formal education during his fourth year in primary school.)

Kuninobu concentrated on the financial and administrative field, was appointed a Director in 1970, then Managing Director in 1972. His group, Japan's largest components manufacturer, had sales of about 96-billion yen (\$320 million), a significant part of Matsushita's sales (in 1974) of 1.45-trillion yen (\$4.8 billion).

In his spare time he enjoys construction of electronic equipment and cameras, photography and building high-fidelity sound equipment, almost as much as he enjoys golf, a game in which he tends to go two rounds.

He's also an admirer of fine chinaware. Every year he has a fine plate inscribed with some expression of his personal philosophy. A recent plate bears the bitter commentary: "One general's great success can mean that 10,000 soldiers will die."



file engineers. In a situation like this, one would expect that there would be stronger, more outgoing people, and weaker, more introverted individuals. And one would expect stronger individuals to dominate our meetings and weaker ones to remain quiet. How then do we get contributions from those who might be more retiring and quiet? That's one of the problems of the managers.

It's a manager's job to make certain that he is not being subjected only to the views of the more aggressive engineers. It's his job to bring out the views of all the engineers. But it's not that difficult.

You see, we have close personal contact with all our people, including our engineers. Even before going into a meeting, a manager will already have a feeling for the ideas of the individual with the quiet personality. He would already know the contribution he has to make. He would have drawn out the quiet person's ideas before the meeting.

We try to encourage all individuals to grow,

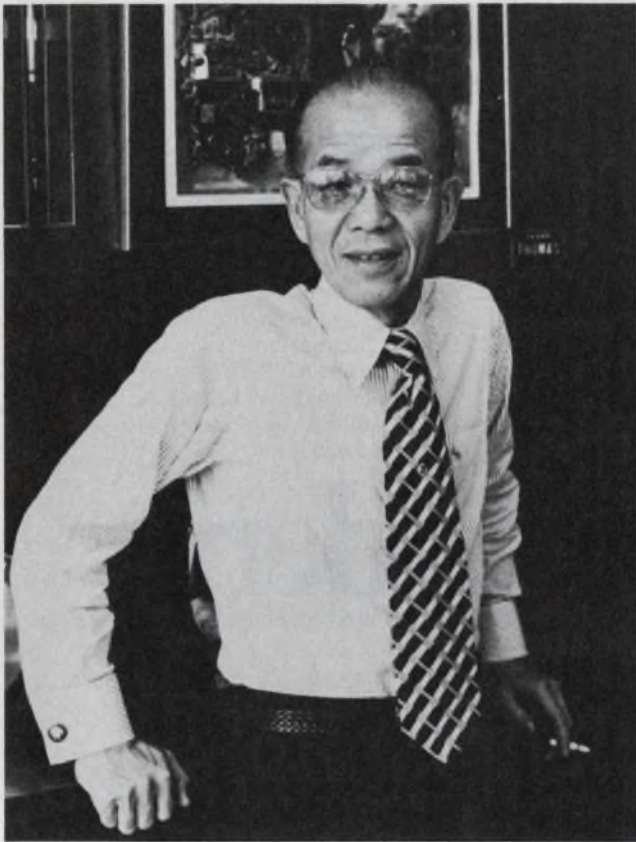

so we get a great deal of cooperation because we're all growing together. Our problem is in coordinating the growth so that we have all people working toward a common goal.

This spirit, this feeling that everybody is important, permeates our entire company, and it helps the entire company. I can give you an example right from the production line. On each production line we have a small group of volunteers, maybe four to seven individuals, called the Quality Control Circle. These people talk among themselves about production-quality problems. They discuss what they have done, what worked out well, and what's not so good. They are constantly evaluating their own efforts and the efforts of their colleagues on the production line.

These people are not quality-control functionaries, they are line operators. So, in evaluating their own performance they stimulate themselves and their colleagues continually to improve performance and thus improve the product they're producing.

Does the system work? It certainly does. I have a letter from Dr. J. M. Juran of New York City. He's an outstanding authority on quality control and he's been teaching Japanese companies how to set up effective quality-control systems. He has been using our system as a model of good quality-control management. Where does this management come from? From the operators on the production line. That's just like engineering management. That comes mostly from our engineers. ■■

Want A Safer Product And Lower Manufacturing Costs Too?

On the one hand choose the **MICROTEMP®** thermal cutoff



A reliable, accurate easy to install, "one shot" thermal limiter.

- temperature tolerance— $\pm 1.7^\circ$
- temperature ratings—58 to 242°C. (136 to 468°F.)
- current capacity—up to 30 amps at 240 VAC.
- compact—diameter, .157"; length, .457" (exclusive of leads).
- economical
- easy to install—assorted terminations, mounting packages and insulations available.
- Recognized under the Component Program of Underwriters' Laboratories, Inc. UL File #E40667A. CSA approved. BSI Certificate #5041 approved. Recognized by MITI and VDE. Military approval.

On the other hand, don't overlook the new **PICOTEMP** thermal cutoff



Used where installation or space restrictions rule out MICROTEMP® thermal cutoffs.

- temperature tolerance— $+0^\circ\text{C.} - -3.3^\circ\text{C.}$
- temperature ratings—63 to 150°C. (146 to 300°F.)
- current capacity—to 5 amps. at 120 VAC. Will hold this rating up to and including 240 VAC.
- compact—236 x 389 x .087.104 (exclusive of leads).
- economical
- Package is completely insulated, leads are 26 gauge silver plated wire.
- Recognized under the Component Program of Underwriters' Laboratories, Inc. UL File #40667A. MITI approved. CSA approved.

Both devices are completely sealed against the atmosphere. Because of their unique design and construction, they won't derate. And they're unaffected by age or extended use. You not only get positive, yet low cost protection against malfunctions in circuits and components caused by equipment failure or user abuse, but you eliminate costly and unnecessary service calls caused by nuisance tripping.

PICOTEMP or MICROTEMP? Which is best? Depends on your needs. Tell us about them.

For more information, check the reader service card or call or write:



MICRO DEVICES CORP.

1881 Southtown Blvd., Dayton, Ohio 45439
Ph: (513) 294-0581 Telex: 28 8087

CIRCLE NUMBER 47

Why SkyCaps[®] are blue on the outside.

So you'll know it's AVX on the inside. A quality monolithic capacitor that delivers the exact capacitance and temperature characteristics specified. Consistently over large quantity orders.

AVX is the quality leader in multi-layer capacitors. Leadership based on innovative design, careful manufacturing, exhaustive testing. And AVX is the technology leader. With more experience in ceramic formulation and precision metallization

than any other capacitor manufacturer.

Sky Caps[®] are immediately available, in volume, from your service-oriented AVX distributor. They're an easy and economical way to build AVX quality inside your products.

AVX: The Insiders

AVX Ceramics, P.O. Box 867, Myrtle Beach, SC 29577 (803) 448-3191 TWX: 810-661-2252
Olean, NY (716) 372-6611 TWX: 510-245-2815



SkyCap[®] dipped monolithics are available in the broadest range of sizes and ratings.

Dimensions

Body: 0.1 square to 0.5 square

Leads: Length 1.25 standard (others available)

Space 0.1 to 0.4 standard (others available)

Capacitance: 1.8pf to 4.7mfd

Voltages: 50, 100VDC
Three temperature characteristics

AVX Distributors:
Cramer Electronics, Inc.
Elmar-Liberty Electronics
Jaco Electronics, Inc.
Newark Electronics
Texas Instrument Supply

One of the most overworked words in the printed circuit board business is "quality." At Kalmus & Associates, we don't talk much about quality, we just build it into every one of our precision printed circuit boards. ■ If you're a user of PCB's, give us a try. We'll produce circuit boards that meet your specifications to the letter; that are delivered on schedule; that will reduce your production problems to a minimum. ■ For more information on the "quality house" in PCB's, send for our new catalog.

The House That Quality Built

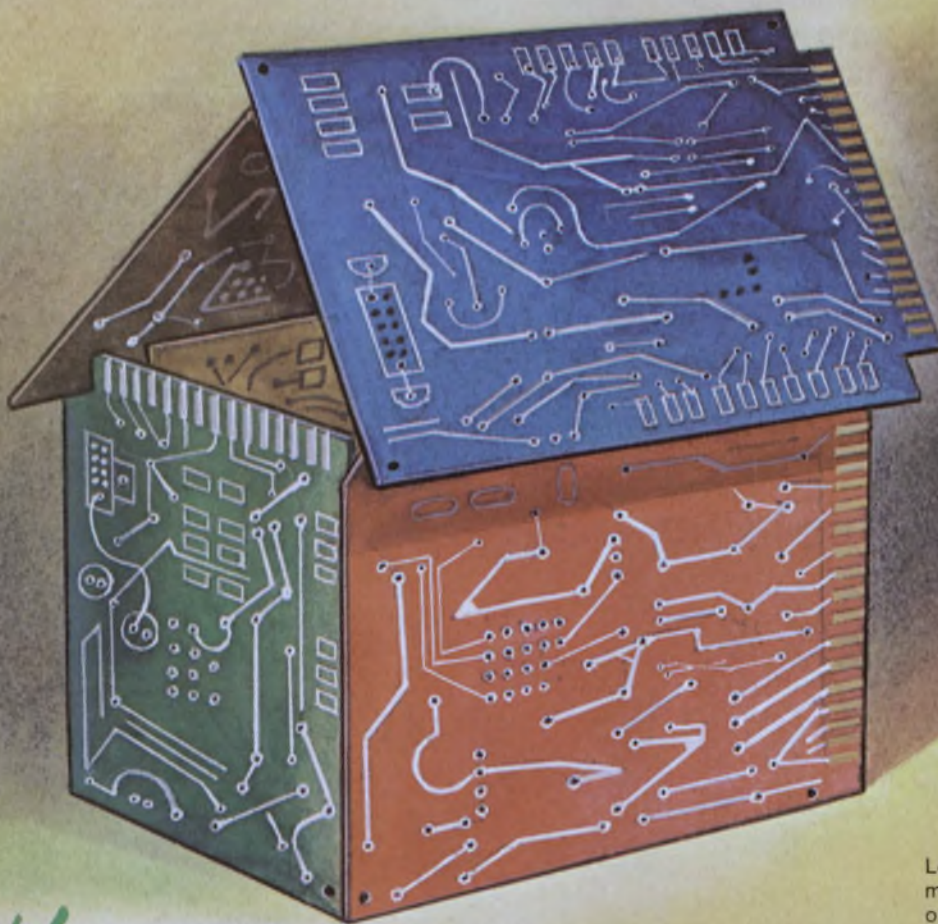

Look for this
mark of quality
on Kalmus circuitry



KALMUS & ASSOCIATES, INC.

2424 South 25th Avenue, Broadview, Illinois 60153 ■ Phone: 312-343-7004

Phase-locked-loop circuit multiplies frequencies by 2 to 256

A phase-locked-loop (PLL) circuit (Fig. 1) can multiply an input frequency, f_s , by any number between 2 and 256 and provide an output up to 130 kHz.

An XR-2208 serves as the phase detector. The flip-flops in a 4013 CMOS IC are used to divide by two to ensure that the input to the phase-detector from the frequency divider has a 50-percent duty-cycle.

The voltage-controlled oscillator in an XR-2240 programmable timer serves as the local oscillator. The open-collector outputs of the 2240's binary counter are wired-OR connected to allow division by any number from 2 to 256. The multiplication index, N , is determined by the equation

$$1 + \sum_{n=1}^{n=8} 2^{n-1} = N,$$

where n is the pin number on the XR-2240 from 1 to 8.

The figure shows the lock-range ratio, $\Delta F/f_o$, as a function of R_f , where ΔF is the frequency deviation and f_o is the circuit's free-running frequency. Frequency f_o is determined by the time constant $R_o C_o$ with R_f open circuited.

For most applications, the time constant $R_f C_f$ should be set to provide a cutoff frequency of from 0.1 to 2 percent of the input frequency, f_s . The impedance at pin 12 of the XR-2240 is about 7080 Ω . This impedance is in parallel with R_f . Thus the time constant generated with C_f is

$$t = R_f \parallel 7080 C_f.$$

If only powers of 2 are required for N , the 4013 flip-flops can be eliminated along with the RC network to pins 10 and 11 of the XR-2240. Then pin 10 should be grounded and pin 11 connected to +V. The 33-k Ω resistor connected to pin 5 of the XR-2208 should now be connected to any one of pins 1 through 8 of the XR-2240. Also, a 6.8-k Ω pull-up resistor should go from the pin to +V. Output can be taken from the 2N3904 collector.

For $N \leq 128$, the output can be taken from pin 1 with the help of a pull-up resistor. Then the 2N3904 and its two resistors also can be eliminated.

Robert M. Zwicker, Applications Engineer, Exar Integrated Systems, Inc., 750 Palomar Ave., Sunnyvale, CA 94086.

CIRCLE No. 311

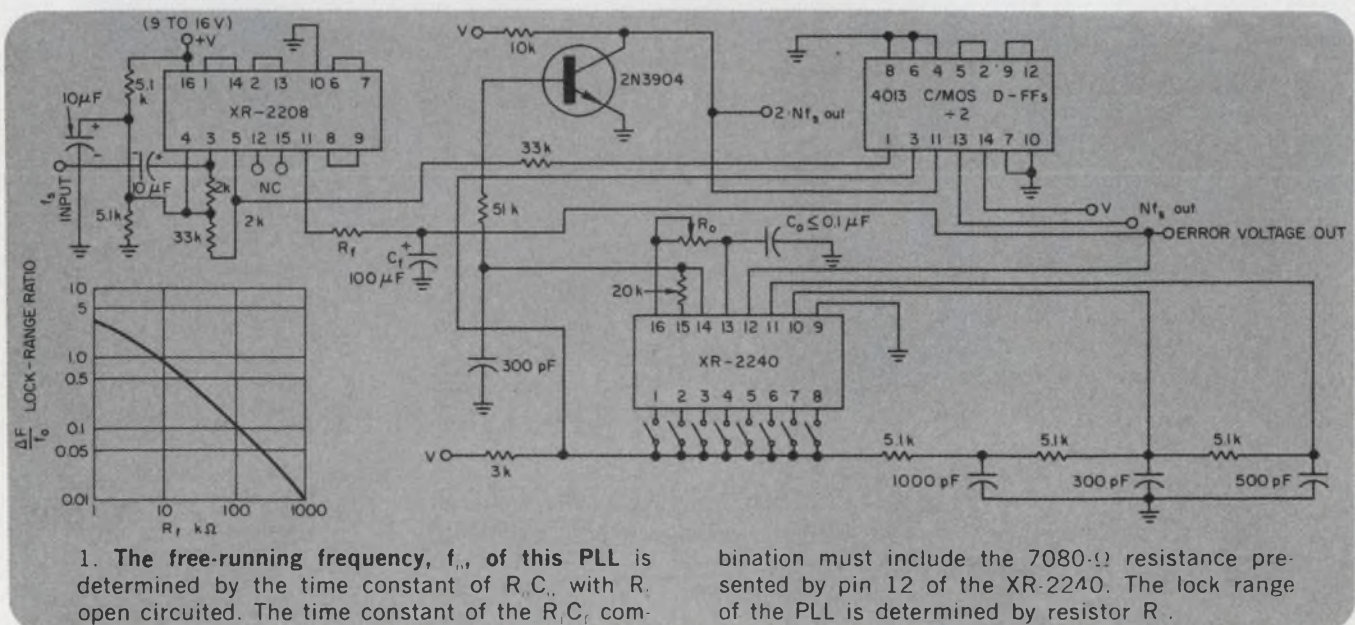

If you need panel instruments with **custom** dials, cases, accuracy, tracking, resistance, response time, or practically any combination of unusual specs...

Buy
Triplett's
designed-for-you
Panel
Instruments

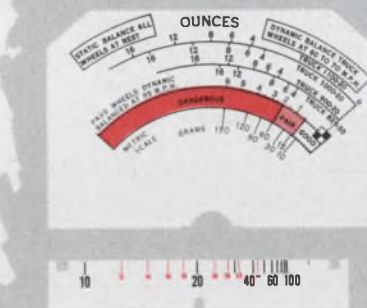
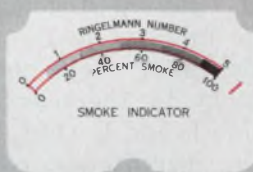
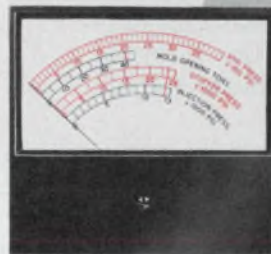
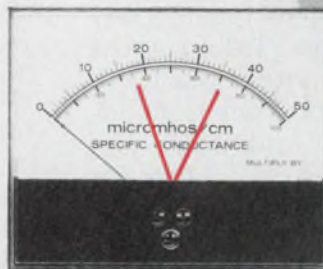
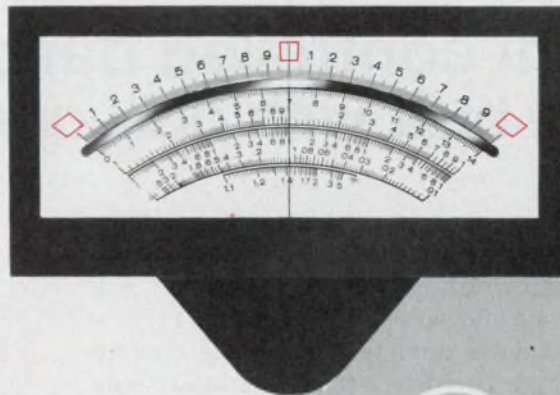

Although we stock some 1369 different styles, sizes and types of standard panel instruments, a very large proportion of our customers buy custom instruments.

Because they need:

custom dials

reading in such units as pH, roentgens, mm Hg, rpm, %, inches.

custom cases

square, round, rectangular, edge-wise (horizontal and vertical), wide, narrow, shallow.

custom accuracy

to within 1/2% with mirror scales and knife-edge pointers.

custom tracking

to match the specific needs of existing or new instrument designs.

custom resistance

for low circuit loading with tolerances as low as $\pm 1\%$.

custom damping

to meet stringent electrical and vibration requirements.

For instance, one of our customers had us design and manufacture a custom instrument to replace—in every detail of physical and electrical specifications—one which he was using on a delicate piece of medical instrumentation. Rejects from his previous source had risen to over 20%. He rejected only 3 of the first hundred we shipped—with almost negligible rejections from the many hundreds we've shipped since.

What custom panel instrument specifications do you need to make your

product more reliable, more accurate, more rugged and—in the long run—less expensive? For quick, dependable delivery of small quantities of Triplett's "designed-for-you" panel instruments, contact your Triplett Sales/Service/Modification Center. For prototypes or production quantities, contact your Triplett representative. He'll put you in touch with our Instrument Designers/Engineers who'll help you analyze the problem and suggest the optimum cost/result solution.

TRIPLETT
BLUFFTON, OHIO 45817
Manufacturers of the World's
most complete line of V-O-M's

CIRCLE NUMBER 50

Current-controlled bandpass filter can be built with only one IC

Electronic tuning of an active bandpass filter with independent control over both center frequency and bandwidth can be done with only one IC, five resistors and no capacitors (Fig. 1).

The circuit uses a dual programmable op-amp IC in which there is a direct relationship between current inputs at programming pins 1 and 13 and the amplifiers' open-loop responses. These current inputs control current sources within the IC to make the amplifiers behave as programmable integrators that need no external capacitors.

Frequency can be programmed over a four-decade range to cover audio as well as video-frequency applications. The cut-off frequencies can be set simply, by the selection of two resistors to determine I_0 and I_1 (Fig. 2). To help calculate the current magnitudes, consider the terminal voltage at pins 1 and 13 to be one diode voltage drop below the positive supply rail.

A dynamic bandpass can be realized by modulating these control currents with active sources such as transistors or FETs.

Here's how the circuit works: op-amps A_0 and A_1 are, respectively, low and high-frequency integrators that independently control the lower and upper cut-off frequencies of the filter's bandpass. To understand this action, consider the transfer functions of the circuit. For A_0 , we have

$$\frac{e_1}{e_i} = \frac{(R_1 + R_2)/R_2}{1 + sT_0} \quad (1)$$

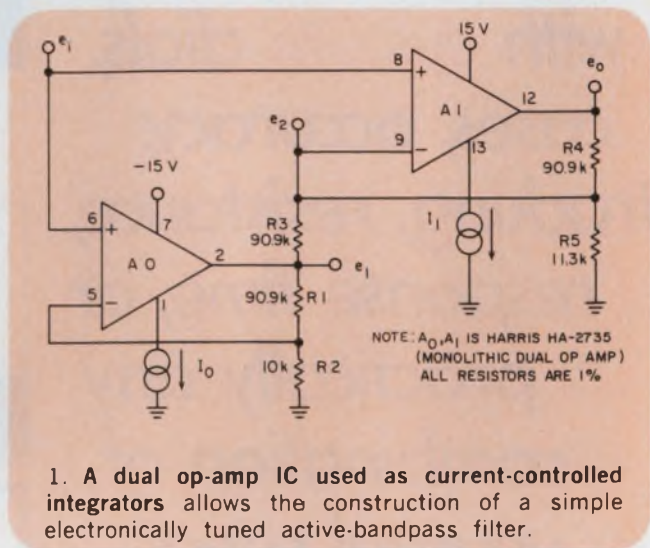

1. A dual op-amp IC used as current-controlled integrators allows the construction of a simple electronically tuned active-bandpass filter.

Assume A_1 's output impedance is small. Then e_2 is given by

$$e_2 = (R_1 \parallel R_5) / (R_3 + R_1 \parallel R_5) e_1 \quad (2)$$

Similarly if A_0 's output impedance is small the output voltage, e_0 , is given by

$$e_0 = \frac{(e_1 - e_2) (R_4 + R_5 \parallel R_3) / R_5 \parallel R_3}{1 + sT_1} \quad (3)$$

For convenience let

$$A_0 = (R_1 + R_2) / R_2, \quad (4)$$

$$A_1 = (R_1 + R_5 \parallel R_3) / R_5 \parallel R_3, \quad (5)$$

$$H_0 = R_1 \parallel R_5 / (R_1 \parallel R_5 + R_3). \quad (6)$$

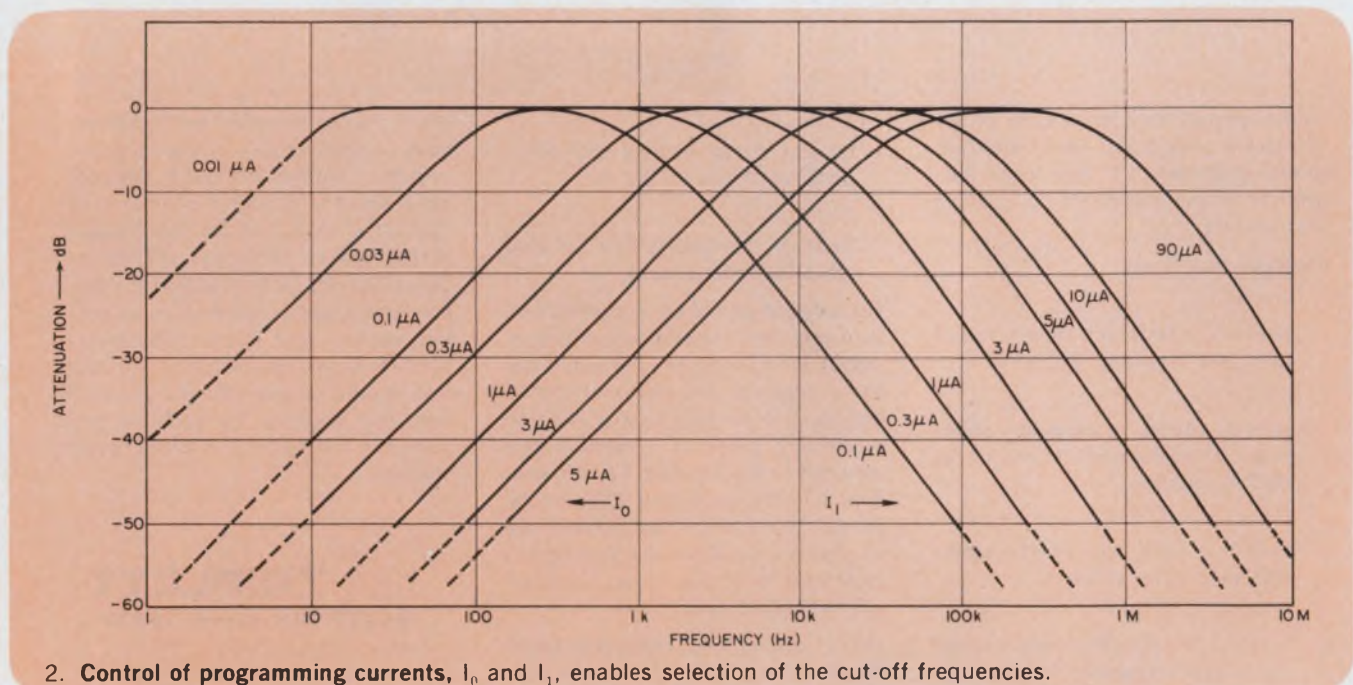

2. Control of programming currents, I_0 and I_1 , enables selection of the cut-off frequencies.



A chip off the old block.

As you can see, this chip is housed in ceramic and mounted in a forty pin, dual in-line package.

As you can't see, it's a NOVA[®] computer.

Inside that packaging sits a full 16-bit, silicon gate, NMOS microNOVA CPU. The mN601.

The mN601 is the first microprocessor designed and manufactured by a minicomputer company. And it's the highest performance NMOS microprocessor on the market. With our 160 nanosecond RAM, it has a memory cycle time of 960 nanoseconds and the fastest instruction times going. Like an Add of 2.4 microseconds. And a Load of 2.9 microseconds.

The mN601 has the 16-bit NOVA instruction set including hardware stack for easy programming. And 16-bit data for efficient memory use.

It also has hardware multiply/divide for fast program execution. Integral data channel logic for easy interfacing to high performance peripherals. Control and timing for high density RAM memories. Integral hidden refresh logic that overlaps instruction execution timing. Plus a unique I/O encoding scheme for efficient easy interface design. Even the real-time clock is included. All of which reduces the chip count.

And all that computer is in a single chip.

And because the mN601 is a NOVA, it uses the most mature, field-proven software you can get with any micro. So you can cut back on development time and cost by using compatible software like our diskette-based Disc Operating System and our Real-Time Operating System.

Also, the mN601 comes with the full documentation support you'd expect from a minicomputer company like Data General.

If you want more than a chip, you can get it. There's a whole chip set, a 4K computer-on-board and a fully-packaged 9-slot microNOVA MOS mini. And there's more.

Don't stop here.

Sign up for a technical seminar on the microNOVA. They'll be held in major cities around the country from New York to Los Angeles. They'll last a half-day. And they're free.

For more information call our toll free number, 800-225-9497 (Unless you're in Massachusetts. In which case, call 1-617-485-9100 Ext. 2509.)

microNOVA:

A giant reduction in the NOVA line.

DataGeneral

• Data General, Route 9, Southboro, Mass. 01772 (617) 485-9100. Data General (Canada) Ltd., Ontario. Data General Europe, 15 Rue Le Sueur, Paris 75116, France. Data General Australia, Melbourne (03) 82-1361

NOVA is a registered trademark of Data General Corp.

Ask CONTROL DATA for the Floppy Disk Drive more major OEM's specify.

We have it.

One major OEM after another tested our Floppy Disk Drives. Ran them through rigorous evaluations. Compared them with competition. And chose ours. Either our Model 9400; or our Model 9404 with **double-density capability.**

Both have true IBM compatibility, with the write-current switched at track 43. Both offer ceramic heads; and hard and soft-sector capability. The 9400 has a star interface; the 9404 a daisy chain interface plus power reduction, write-protect option, and double-density capability.

Whether large OEM or small, we invite you to make your own tests and comparisons. Let us demonstrate our Floppy Disk Drives, right in your facility. Evaluate them, just as many major OEM's did. We know you'll make the same choice.

Two configurations available. Choose Model 9400 for single; Model 9404 for multiple drive applications. Model 9404 also offers double-density capability.

Call (405) 946-5421 or return coupon to: Terry J. Hardie, Control Data Corporation, 4000 NW 39th Street, Oklahoma City, OK 73112.

Please have your salesman bring me a Floppy Disk Drive for evaluation.

Tell me more about your OEM Floppy Disk Drives.

NAME _____ TITLE _____

COMPANY _____ ADDRESS _____

CITY _____ STATE _____ ZIP _____ AREA CODE _____ PHONE _____

Ask the CDC OEM people

GD CONTROL DATA CORPORATION



Any scope in this family gets you started in the data domain.

Pick any one of these HP scopes. With the optional Logic State Switch, and the 1607A Logic State Analyzer, you have an economical and convenient way to time-share the display between traditional time-domain measurements and the new data domain. Select the data domain and your scope's CRT displays the results of your measurements in 1's and 0's. Select time domain and you have a display of electrical waveforms. It gives you a digital test setup that lets you perform both functional and electrical measurements with the same instrument. You'll have:

Data Domain PLUS third-channel trigger view in the 100 MHz 1740A. This scope lets you see the trigger signal along with the other two channels so you can make accurate timing measurements from the trigger signal to events on either or both channels and see the trigger point. Large display, 1 mV



sensitivity to 40 MHz on both channels...and it's only \$1,995* (plus \$105* for the Logic State Switch).

Data Domain PLUS Dual-Delayed Sweep, microprocessor and digital readout in the 275 MHz 1722A. Put this scope in your lab and you have a partner that takes care of dial settings and calculations. It gives you a direct digital readout of time, frequency, voltage, and percent. This plus Dual-Delayed Sweep for rapid, accurate timing

measurements. Price is \$4,750* (plus \$150* for the Logic State Switch).

Data Domain PLUS Dual-Delayed Sweep and 200 MHz in the 1712A. This low-cost high-frequency scope gives you the measurement convenience and accuracy of Dual-Delayed Sweep, and scaled voltage output for direct readout of time intervals on your DVM. And it's priced at just \$2,950* (plus \$150* for the Logic State Switch).

Data Domain PLUS 275 MHz in the 1720A. Here's real bandwidth value in a dual-channel scope. It has exceptionally stable triggering and it's priced at just \$3,500* (plus \$150* for the Logic State Switch).

Data Domain PLUS general purpose in the 200 MHz 1710B. Here's another scope with real bandwidth value. It gives 200 MHz bandwidth at \$2,900* (plus \$150* for the Logic State Switch).

Pick the scope with the Logic State Switch (option 101) that best fits your needs and your budget. Then add the 1607A (priced at \$2,750*) and you're ready to begin tackling problems in both the time and data domain. Contact your local HP field engineer for all the details.

*Domestic U.S.A. prices only

Data/Time Domain Oscilloscopes

HEWLETT  PACKARD

Sales and service from 172 offices in 65 countries
1501 Page Mill Road, Palo Alto, California 94304

CIRCLE NUMBER 51

IDEAS FOR DESIGN CONT.

Combine the above equations and the result is the circuit transfer function

$$\frac{e_o}{e_i} = \frac{A_1 (sT_o + 1 - H_o A_o)}{(1 + sT_o)(1 + sT_1)} \quad (7)$$

Now, if the circuit components are chosen such that

$$H_o A_o = 1, \quad (8)$$

then Eq. 7 becomes

$$\frac{e_o}{e_i} = \frac{A_1 (sT_o)}{(1 + sT_o)(1 + sT_1)} \quad (9)$$

This equation represents a classic bandpass filter. The time constants, T_o and T_1 , in conventional circuits are dependent upon external resistor-capacitor combinations, but here they are directly controlled by the currents out of pins 1 and 13, respectively. In addition, the over-all circuit gain is controlled by A_1 and can be adjusted independently. The bandpass response of

the circuit at several current settings is shown in Fig. 2 for $A_1 = 10$.

The circuit's low and high-frequency skirts closely approximate a single-pole response having maximum slopes of -20 dB/decade and -25 dB/decade, respectively. The response is accurate to within ± 1 percent within the passband. The maximum out-of-band attenuation at the lower frequencies is a function of the residue of Eq. 7. The residue, given by $(1 - A_o H_o)$, was measured to be -58 -dB down from the passband reference. If more low-frequency attenuation is desired the residue can be minimized by the selection of resistors that more closely satisfy Eq. 8.

Ernie Thibodeaux, Senior Applications Engineer, Harris Semiconductor, P.O. Box 883, Melbourne, FL 32901. CIRCLE NO. 312

Photoresistor provides automatic dimming of electronic display systems

To automatically adjust the illumination intensity of electronic readout displays a photoresistor can be used. The photoresistor controls the RC time constant of a monostable multivibrator triggered at a fixed frequency. The output of the mono can then drive the blanking input of such typical lamp drivers as SN7446 ICs.

In Fig. 1, transistor Q_1 controls the charging current to capacitor C_2 , and thus the transistor varies the duty cycle of the mono—one-half of an MC 14528.

As the ambient light changes from near total darkness to bright sunlight, photoresistor R_1 changes its resistance from a very high impedance to a very low resistance compared with R_2 .

In darkness the $100\text{-k}\Omega$ resistor, R_2 , controls the current into the base of Q_1 , producing a low duty cycle in the mono and blanking the controlled display most of the time. In bright light R_1 is much lower than $100\text{ k}\Omega$, the duty cycle is high and the controlled display is at its brightest.

Diode CR_1 helps offset the effects of temperature changes on the transistor's V_{be} ; capacitor C_1 slows the response time of the circuit and prevents sudden changes in illumination intensity; the mono is triggered continuously from a 500-Hz source.

Michael A. Molack, Senior Engineer, Dynell Electronics Corp., Melville, NY 11746.

CIRCLE NO. 313

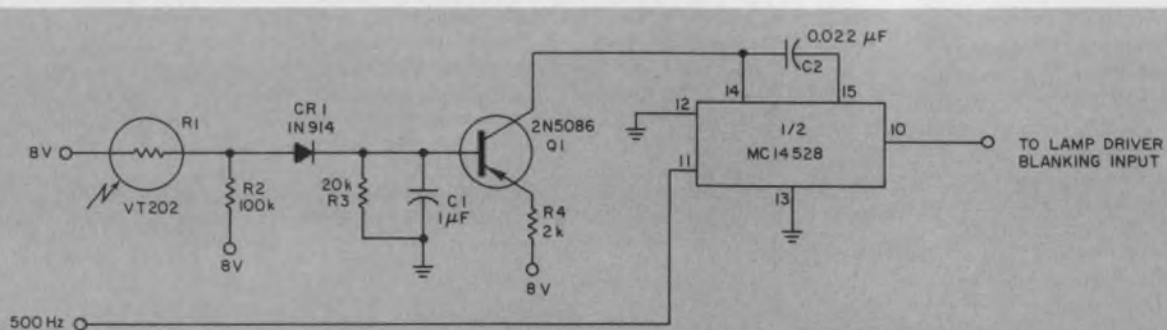

Automatic illumination control of electronic displays is provided by photoresistor control of the

duty cycle of a monostable-multivibrator circuit, to vary the display's on/off ratio.

INTERDATA 8/32 MEGAMINI LIFE SUPPORT



Risk-free computer buying—with power to spare.

You're looking for a computer system so powerful, it takes you over any snags that could cost you extra.

That's why Interdata builds the powerful 8/32 Megamini with 32-bit hardware performance and direct addressing capability of up to one million bytes. With unique software packages that are powerful, flexible and easy-to-use. With Megamini Life Support that means you'll never have to take a risk with:

On-time Delivery. Interdata guarantees on-time delivery of your Megamini. In fact, we've already shipped hundreds of 32-bit computers from production that are completely operational.

Hardware Back-up. Interdata hardware means 32 registers, each 32 bits wide. Fast single- and double-precision arithmetic. Optional, writable control store. And big computer peripherals. It also means that we support you long after your system is operational.

Software To Do the Job. Megamini's software optimizes its hardware and gives you a solid systems environment. It includes program development tools like BASIC II, FORTRAN, MACRO CAL and COBOL. And the versatile real-time OS/32 MT (Multi-Tasking) operating system. Megamini software helps you build simple solutions to your toughest applications problems.

No Surprises. Our customer requirement analysis insures that you never have to add more people than you planned on. Or more hardware than you scheduled.

Megamini Life Support. From the moment you decide on Interdata, until you are completely operational, Megamini's capabilities are carefully spelled out. The Interdata/Perkin-Elmer name stands squarely behind every promise with the viability of a \$300 million corporation. With Interdata and the Megamini, you're guaranteed power to spare.

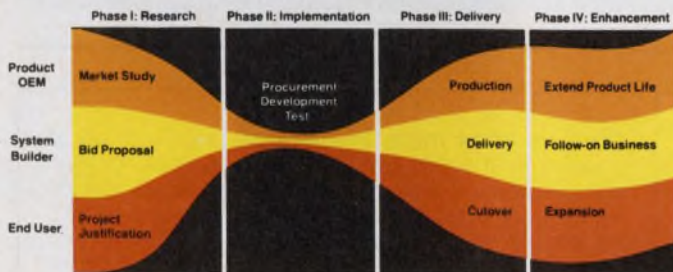

Interdata's computer products and services exist for one reason — to satisfy our customers. The Product OEM, the System Builder and the End User. Each of these computer buyers has a Computer Life Cycle with four specific Phases — Research, Implementation, Delivery and Enhancement. Interdata responds to customer needs during each Phase with Computer Life Support.

Gentlemen:

Send me more about Megamini power.

My needs are:

___ Immediate ___ 6 Months ___ 1 Year ___ For Reference Only

Name _____ Title _____

Company _____

Address _____

City _____ State _____ Zip _____

Telephone (____) _____



INTERDATA®

Interdata, Inc.
Subsidiary of Perkin-Elmer
Oceanport, N.J. 07757 201-229-4040

Come see us at booth 1429 at the N.C.C.

CIRCLE NUMBER 52

Accumulate and trap data in counters while their outputs remain constant

A little-known feature of synchronous counters such as the 9310/9316, 74160/74161 and 74162/74163 allows them to be used as four-bit data traps.

In many digital systems, especially in computer peripherals, a storage device must accept and trap new input data, while the device maintains its previous outputs. The trapped data are then transferred to the outputs at a later time. Thus, a long output word can be assembled in the storage without any limit to the time needed. When fully assembled, the bits in the device's outputs can all be changed simultaneously.

The data-trap capability is possible only in counters where the mode-control inputs (CET, CEP, and PE) are not edge triggered; Schottky and LS versions are fully edge triggered and can't be used. When the CET and CEP inputs are permanently disabled with a LOW connection, the four master latches of data-trap counters can receive

information from their P inputs as long as the clock and PE inputs are LOW (Fig. 1).

When PE goes HIGH, the four data bits are trapped in the counter's four master latches. But the counter's four outputs remain in their previous state until the clock input also goes HIGH. Between the rising edge of PE and the rising edge of the clock input, each of the four master-slave flip-flop circuits can store two bits of data statically for any length of time.

The set-up time of the data inputs, after the PE input goes HIGH, is less than 30 ns. The output delay from the time the clock input goes HIGH to the appearance of the output is less than 23 ns; the clock HIGH time must be 17 ns or longer.

Peter H. Alfke, Manager, Digital Systems Application, Fairchild Semiconductor, 464 Ellis St., Mountain View, CA 94042. CIRCLE NO. 314

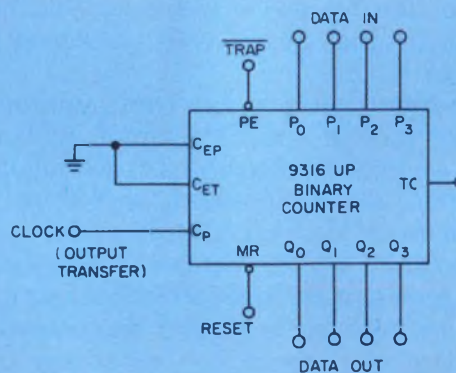
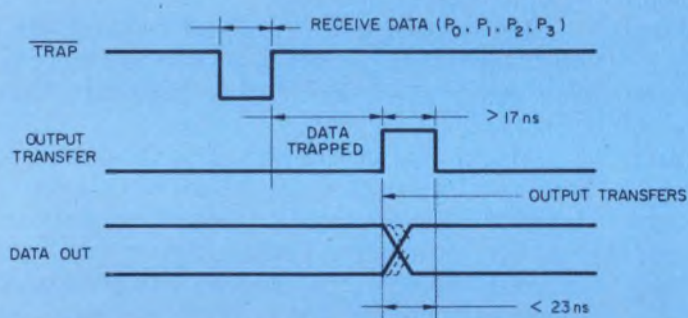

Data can be accumulated in some synchronous counters, while the counters' outputs remain constant.

IFD Winner for January 19, 1976

M. V. Subba Rao, Scientist, Central Electronics Engineering Research Institute, P.O. Pilani-Rajasthan 333031, India. His idea "Programmable Divide-by-n Counter Provides Symmetrical Outputs for all Divisors" has been voted the most valuable of Issue Award.

Vote for the Best Idea in this issue by circling the number of your selection on the Reader Service Card at the back of this issue.

SEND US YOUR IDEAS FOR DESIGN. You may win a grand total of \$1050 (cash)! Here's how. Submit your IFD describing a new or important circuit or design technique, the clever use of a new component or test equipment, packaging tips, cost-saving ideas to our Ideas for Design editor. Ideas can only be considered for publication if they are submitted exclusively to ELECTRONIC DESIGN. You will receive \$20 for each published idea, \$30 more if it is voted best of issue by our readers. The best-of-issue winners become eligible for the Idea of the Year award of \$1000.

ELECTRONIC DESIGN cannot assume responsibility for circuits shown nor represent freedom from patent infringement.

We want to break up your marriage.



You and your
SMA supplier —
maybe you've
been a twosome
long enough.

Now there's an alternative—Amphenol SMA's. You can't get better SMA connectors than Amphenol SMA's. They operate at all microwave frequencies up to 25 GHz. RF performance and mechanical integrity comply with MIL-C-39012. They're easy to assemble with either crimp or solder connections. And our quality will give you a change of heart: all shell and body parts are gold-plated stainless steel. The center contact is gold-plated beryllium-copper. The dielectric is solid TFE, making Amphenol SMA's completely interchangeable with your present source.

Our price will make you want to change partners. When you hear our price, you'll know Amphenol SMA's are the best value around. So ask for a quote.

There's a big selection of popular types. Including styles for cable mounting, flange and bulkhead mounting, and stripline mounting. We also offer between-series adapters.

And Amphenol SMA's are available. Wherever you are. Your Amphenol Industrial Distributor can fix you up with the SMA connectors you need, by giving you fast off-the-shelf service. He's close to you (there are over sixty Amphenol Industrial Distributors—nationwide). Give him a ring (on the phone, not the finger). Or for more information, write or call us: Bunker Ramo RF Division, 33 East Franklin Street, Danbury, Connecticut 06810. (203) 743-9272.



*When you can connect it
and forget it...that's quality.*

AMPHENOL CONNECTORS FROM

CIRCLE NUMBER 53

**BUNKER
RAMO**

THIS OEM ASKED US FOR A HEAD START.

Management Systems Technology in Chicago was in the market for a minicomputer and a disc. We said, "There's a better way."

Then, we introduced them to the Hewlett-Packard DISComputer concept.

Some vendors offer systems in which a disc, controller and mini-computer have been *put* together. In contrast, the elements of the HP DISComputer were *designed* together.

This means you don't get bogged down trying to optimize the performance of our hardware. Instead, you can jump ahead and put your efforts into developing your own systems.



Management Systems Technology, Inc., builds a system that provides druggists real-time data on patient profiles and drug interactions, prints labels, handles billing and taxes. At its heart is a Hewlett-Packard DISComputer.

You can also benefit from advanced HP software. RTE-III, the newest member of the RTE family, gives access to 64 partitions, up to 128K words of main memory, plus multiple languages and multi-programming.

At \$17,655*, the MX/65 DISComputer price/performance ratio is exceptional.

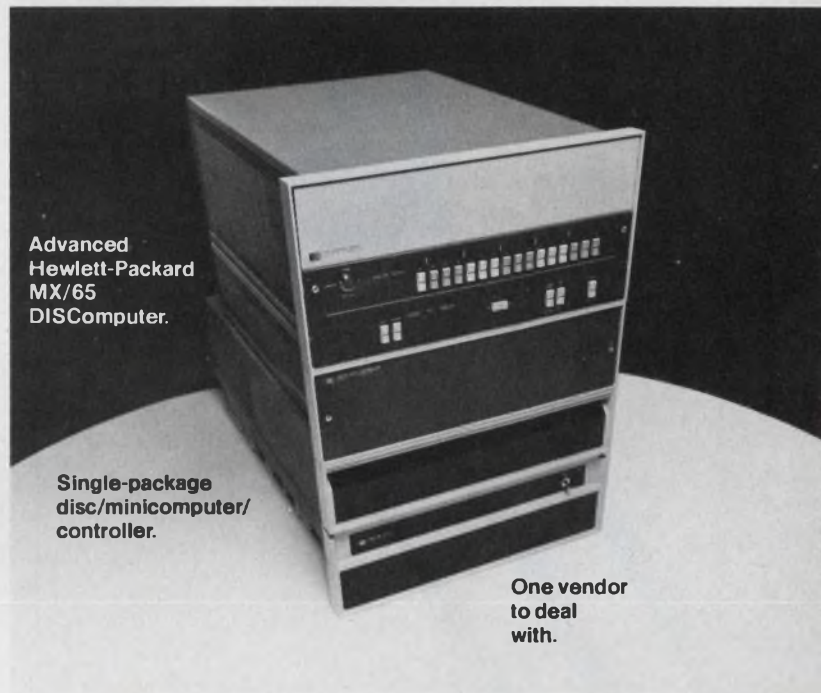

Advanced Hewlett-Packard MX/65 DISComputer.

Single-package disc/minicomputer/controller.

One vendor to deal with.

The further economies of dealing with a single vendor could help turn a head start into a winning performance any day of the week.

Just ask Management Systems Technology in Chicago.

THE HEWLETT-PACKARD MX/65 DISCOMPUTER AT A GLANCE

Minicomputer:	Controller:	Disc:
8K to 128K words Solid state 4K RAM memory Microprogrammable. Parity, EAU, floating point standard. Brownout-proof power supply Optional Dynamic Mapping System.	Links to multiple CPU's Combined seek/data transfer. Built-in error detection and correction Automatic track switching Data protect and recovery features.	25 msec average seek time 15 Mbytes of storage, expandable to 120 Mbytes Exceptional 937 Kbyte transfer rate Operates over wide power and environment range.

*DOMESTIC USA OEM PRICES QUANTITY 50 WITH 32K MEMORY, 15 MBYTE DISC.

NOW WHAT CAN WE DO FOR YOU?



Sales and service from 172 offices in 65 countries.

1501 Page Mill Road, Palo Alto, California 94304

CIRCLE NUMBER 123

Solar 'eyeball' arrays can follow the sun

Plastic "eyeballs" that follow the sun's movements to convert sunlight into electricity are being developed by Standard Telecommunication Laboratories, Harlow, Essex, England. These bowling-ball-sized spheres use a new type of self-contained magnetic drive to follow automatically the sun's movement.

Each of the eyes can produce up to 1 V. Higher voltages are obtained by connecting several of the units in series.

To allow the eyeballs to move freely, they are floated on water in a tank. The sunlight shines through the eyeball's lens and is focused onto the solar cell. As the sun moves, its light tends to wander off the solar cell, which is surrounded by four gas reservoirs like four large petals on a flower. When the sunlight falls on one of these cells the gas expands, moving a small magnet inside the eyeball. This reacts with the earth's magnetic field (or an artificial one) and the eyeball is rotated to look again directly at the sun.

A gallium-arsenide solar cell is used, and a Fresnel-lens radiation collector/concentrator. Because the gallium-arsenide cell withstands high temperatures and does not saturate at high solar radiation intensities, it is used at the focus of the lens system.

The design has several advantages. Motive power and motion direction are provided by the sun. All moving components are wear-free and sealed within the sphere. The modules can be assembled into arrays to give high output powers. Hot water is a convenient by-product and there are no environmental problems.

The area of each cell is typically 2 cm². Experimental cells have an efficiency of 16% without anti-reflection coatings. A 20% efficiency is predicted when all parameters are optimized.

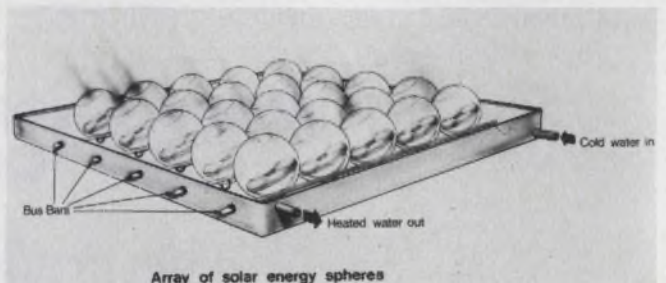

Sun-seeking "solar eyeballs" convert solar energy to electrical power. The 12-in. diameter units are floated on water so they can move freely.

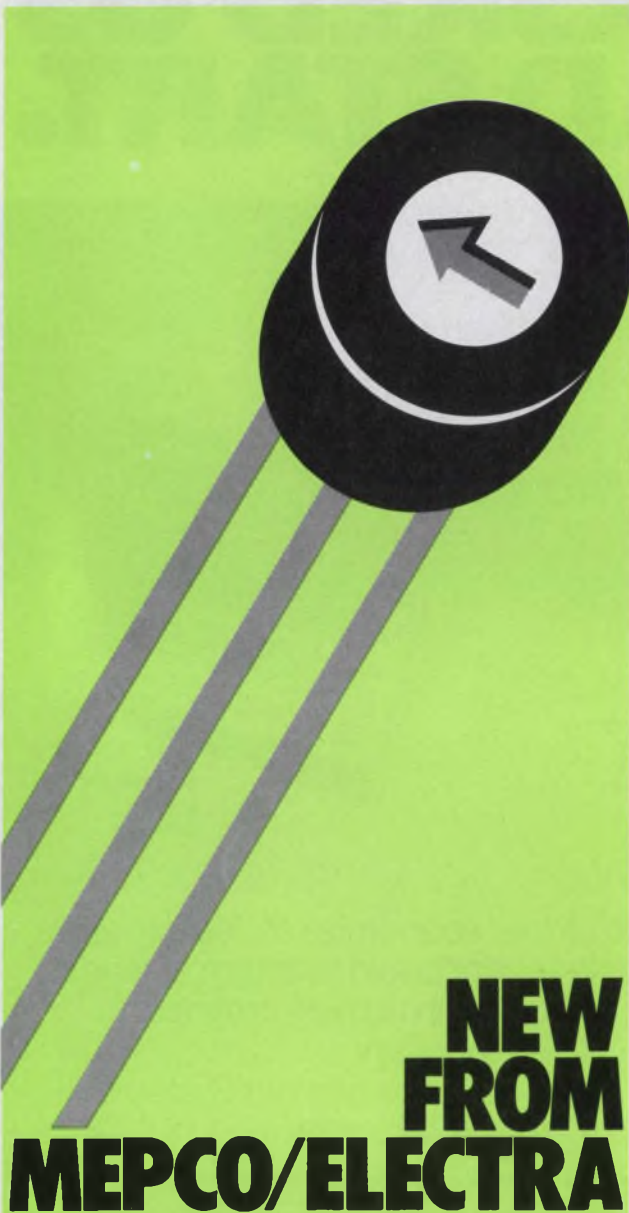

**NEW
FROM
MEPCO/ELECTRA**

MINIATURE
CERMET
TRIMMERS
49¢ EACH

(1,000 piece price)

High performance...low profile...low price. That's the story of MEPCO/ELECTRA's new ET 14 series single turn trimmer. It's the smallest size professional trimmer of its type available today. The 1/4" ET 14W has a maximum height of .150" and features a unique slider design and a CRV of 1% max., 0.25% average, regardless of direction of rotation. Want more information? Call or write MEPCO/ELECTRA, INC., San Diego, CA. 92121 (714) 453-0353

Actual Size



**NEW
IDEAS IN
ELECTRONICS**

ME
MEPCO/ELECTRA, INC.
A MEMBER OF THE MEPCO GROUP

FET array controls linear LED circuits

A novel FET array that can be used to control linear LED circuits displaying analog voltages has been developed at the Philips Research Laboratories, Eindhoven, the Netherlands. The key to the new process is the replacement of the low-resistance metal gate in the standard IGFET by a polycrystalline-silicon gate. The resistance between the ends of the gate is typically 10 k Ω , which results in a relatively large voltage gradient along the length of the gate when a small current passes through it.

With a linear voltage gradient along the gate, the depth of the inversion layer under the gate decreases linearly, reaching zero at the point where the gate voltage equals the threshold voltage. Varying the gate-to-threshold voltage shifts this point along the length of the gate, turning on the IGFETs arranged in a row underneath the gate. To avoid a gradual turn-on or turn-off, a meander gate with a width-to-length rate of 1000 is used. Experimental devices have been made with a row of 12 IGFETs, a gate resistance of 10-k Ω and a threshold voltage of 0.3 V.

Versatile OCR system tested by British

The first optical character recognition system capable of reading and converting intermixed alphabetic and numeric characters from hand-print to computer-compatible form has been tested by the British Dept. of Health and Social Security at Newcastle-Upon-Tyne, England.

Built by Information International, Los Angeles, the Grafix I system is also the first to recognize the full alphabet, special characters and numbers as they are written by a variety of people; the system was designed to recognize more than one shape for most characters.

"If Grafix I fails to recognize the character automatically, it stores a picture of the unrecognized shape—maintaining an index of the character's position and the file from which it came," explains A. L. Fenaughty, Information International's president.

In a second operation, the unrecognized image is presented to an operator on a CRT who enters the letter into the system through a keyboard terminal.

During factory tests the system achieved sustained recognition rates exceeding 150-characters-a-second reading mixed hand-print and computer-print. Less than 2% of the characters were unread by the machine requiring human interpretation later. The error rate was under 0.05%.



MEPCAPS[®] FOR THE LITTLE "EXTRAS"

THAT WIN BIG FRIENDS ON THE PRODUCTION FLOOR

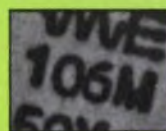

Mepcap[®] radial leaded ceramic capacitors are designed for the guys in the board room—the PC Board Assembly Room. Where helpful product features, no matter how small, can save time and money. Such as the higher range of values—1 pf to 10 μ f—available in just six Mepcap sizes. Then there's the controlled meniscus; a big help in getting good electrical contacts the first time, every time.

Easy part identification is appreciated, too. Mepcaps are light gray, against which part markings really pop out. And the unique Mepcap part numbering is the clearest, easiest to understand system going.

Mepcap ceramic capacitors. With the meaningful little "extras" that measure up where it counts the most!

Mepco/Electra, Inc.

A North American Philips Company

111 North Street Canandaigua, N.Y. 14424 (315) 394-1900

MEPCO/ELECTRA, INC.
A NORTH AMERICAN PHILIPS COMPANY

CIRCLE NUMBER 57

Our New DAC90 Costs Less Than Modular DAC's And Outperforms the IC's

Any way you compare, DAC90 offers value. Our new DAC90 gives you lower drift and better linearity than other 8-bit IC's with a lower price and a smaller package than 8-bit modules. Price? From just \$8.50.*

Performance? Settling time to $\pm 0.2\%$ is less than 200 nanoseconds! Non-linearities are guaranteed less than $\pm 0.2\%$ for all models, over their entire temperature range. And of course, monotonicity is guaranteed, too. And all versions of the DAC90 are fully TTL compatible.

Package? All of that performance comes in a hermetic 16-pin ceramic DIP.

Reference and feedback resistors are built-in so it's easy to use.

We have solutions for your other conversion problems, too.

We make A/D's, sample/holds, multiplexers, V/F's, comparators and peak detectors.

Contact Burr-Brown, International Airport Industrial Park, Tucson, Arizona 85734. Telephone (602) 294-1431.

**Unit price, model DAC90BG (-25 to +85 C) in orders of 100 or more.*



BURR-BROWN
BB

**Fifty-three
conversion
choices**

CIRCLE NUMBER 58

New Products

More alarm power output with less energy input



C. A. Briggs Co., P.O. Box 151, Glenside, PA 19038. (215) 885-2244.

The new MK2 Cybertone provides the flexibility of the original multifrequency design, but with an increased sound-power output at a reduced energy input and at lower cost. When used with a "snap-in" horn, the unit can produce a sound-pressure level of 95 dBA at 1 m average (relative to 2×10^{-4} dyne/cm² in free-field conditions). The MK2 provides selectable and programmable combinations of sweeping and continuous sounds of compelling characteristics. It is designed to operate on 12 V dc $\pm 25\%$ with a typical current drain of less than 25 mA. Ten different sounds are available from the same device.

CIRCLE NO. 301

Thermal sensor flakes only 40 to 50 Ω

Victory Engineering Corp., Victory Rd., Springfield, NJ 07081. (201) 379-5900. \$6: free standing, \$9: substrate (100 up); stock to 4 wks.

Low-resistance (40 to 50 Ω at 25 C) thermal sensor flakes are dimensioned 0.080 \times 0.080 \times 0.0015 in. as free-standing flakes. Also, they come mounted on substrates of such materials as BeO or Al₂O₃. Standard wire termination is 0.001-in. gold-plated Pt-Ir, 1-in. minimum length with opposite or adjacent configurations. Protective coatings for substrate-backed devices, and optional wire diameters, lengths and tabs are available upon request.

CIRCLE NO. 302

Ceramic bandpass filter comes in seven widths

Vernitron Piezoelectric Div., 232 Forbes Rd., Bedford, OH 44146. (216) 232-8600. \$0.25 (OEM qty); 4 wks.

A new miniature 10.7-MHz ceramic bandpass filter for high-fidelity FMs, the FM4, features customized bandwidths for different industry segments. Segmented 3-dB bandwidths, ranging from 170 kHz to 330 kHz for seven center frequencies around a nominal 10.7 MHz, are available. The filter is fully compatible with conventional and integrated circuitry, and it allows the design of straightforward filtering circuits.

CIRCLE NO. 303

Nonindicating controller offers 1% accuracy

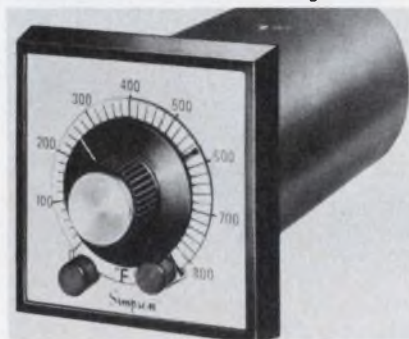

Simpson Electric Co., 835 Dundee Ave., Elgin, IL 60120. (312) 697-2260. Start \$90 (unit qty).

Panel-mounted Model 5850 non-indicating limit controllers cover a wide range of voltage, current and temperature inputs. All units offer $\pm 1\%$ of full-scale typical accuracy, a sealed all-metal housing, solid-state circuitry with a 10-A relay output and on/off control with a manual reset. Both single and double-setpoint models are available. Double setpoints overlap and are adjustable over 100% of the scale. Options include time proportioning and special ranges, non-standard hysteresis, low-limit setpoint and down-scale thermocouple break protection.

CIRCLE NO. 304

Single-turn pot incorporates knob

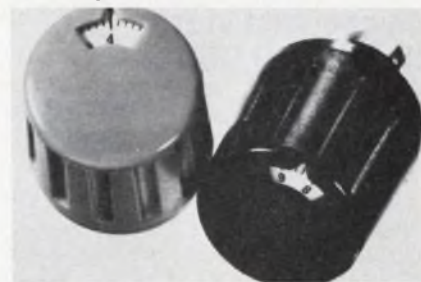

Panel Components Corp., 2015 Second St., Berkeley, CA 94710. (415) 548-1966. Typical \$4.23 (1000-up); 3 to 4 weeks.

A new single-turn pot, Model K200, incorporates a knob, dial and wire-wound pot in a single package. It offers a power rating of 1 W at 40 C and a minimum life expectancy of 10,000 turns. Nominal linearity is 0.7%, total maximum temperature coefficient is ± 70 ppm/ $^{\circ}$ C and CRV is 0.1% or 100 Ω max. Standard colors are black, grey and red. It requires only one hole and one mounting nut for the entire assembly. Wires can be soldered or attached with crimpable slip-on terminals.

CIRCLE NO. 305

Transformers couple to phone lines

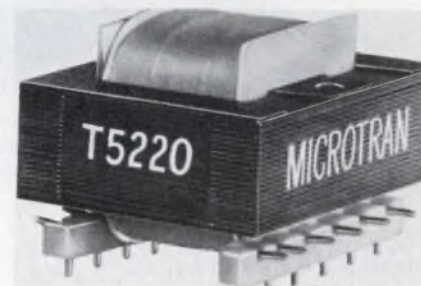

Microtran Co., Inc., 145 E. Mineola Ave., Valley Stream, NY 11582. (516) 561-6050. Stock.

New Microtran telephone-type coupling transformers, F234-4/76, are designed for interconnect to the nationwide telephone network under the new FCC Part 68 Registration Program. These transformers permit use of voice-grade telephone lines for both voice and data telecommunications. The units are open-frame PC-construction types and weigh from 0.4 to 9.5 oz. Sizes range from approximately 5/8 to 1-1/2-in. cubed.

CIRCLE NO. 306

COMPONENTS

Surge arresters handle 10,000 A

TII Corp., 100 N. Strong Ave., Lindenhurst, NY 11757. (516) 842-5000. \$2.50 (OEM qty).

A series of gas-tube lightning and surge arresters protects circuits and transmission lines from power or lightning-induced surges. Called Model 21, each arrester con-

tains three electrodes—one for each leg of a balanced transmission line plus one center electrode for ground. The envelope is hermetically sealed and color coded to indicate any of three dc firing voltages. The arrester handles repeated surges of 10,000 A and is guaranteed to dissipate to ground 15 such surges in a period of 3 min. The surge waveform must reach its peak in 8 μ s and falls to half the peak value in 20 μ s.

CIRCLE NO. 308

Hermetic resistor nets meet military specs



American Components Inc., 8th Avenue at Harry St., Conshohocken, PA 19428. (215) 825-6200. \$4.10 to \$12.20; stock of 10 wks.

A family of 14 and 16-pin hermetically sealed DIP resistor networks conforms to the requirements of MIL-R-83401. Standard in-out and pull-up circuits are offered. Information on nonstandard networks is factory available. Resistors are capable of handling 0.1 to 0.2 W at 70 C. The resistor networks are rated at 1.3 to 1.6 W at 70 C and derated linearly to 0 at 125 C. Temperature coefficients of 100, 50 or 25 ppm/ $^{\circ}$ C and tolerances of 1.0, 0.5 and 0.1 percent are available.

CIRCLE NO. 309

Flat tachometer operates to 6000 rpm

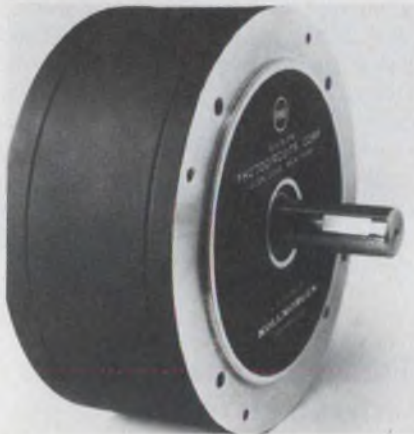

Kollmorgen Corp., Printed Motors Div., 31 Sea Cliff Ave., Glen Cove, NY 11542. (516) 448-1000.

A compact dc tachometer for industrial applications is less than 2-in. thick and operates over the range from 0 to 6000 rpm. Brush life is up to 5000 h. Other features include a low ripple of 1% at 100 rpm, a low output impedance of 0.85- Ω resistive, and a linearity of 1%. The unit's 117-bar commutators provide a high ripple frequency. Output-shaft diameters of 1/2 in. or greater help control torsional resonance. Ball-bearing shaft support ensures a high radial-load capacity.

CIRCLE NO. 310

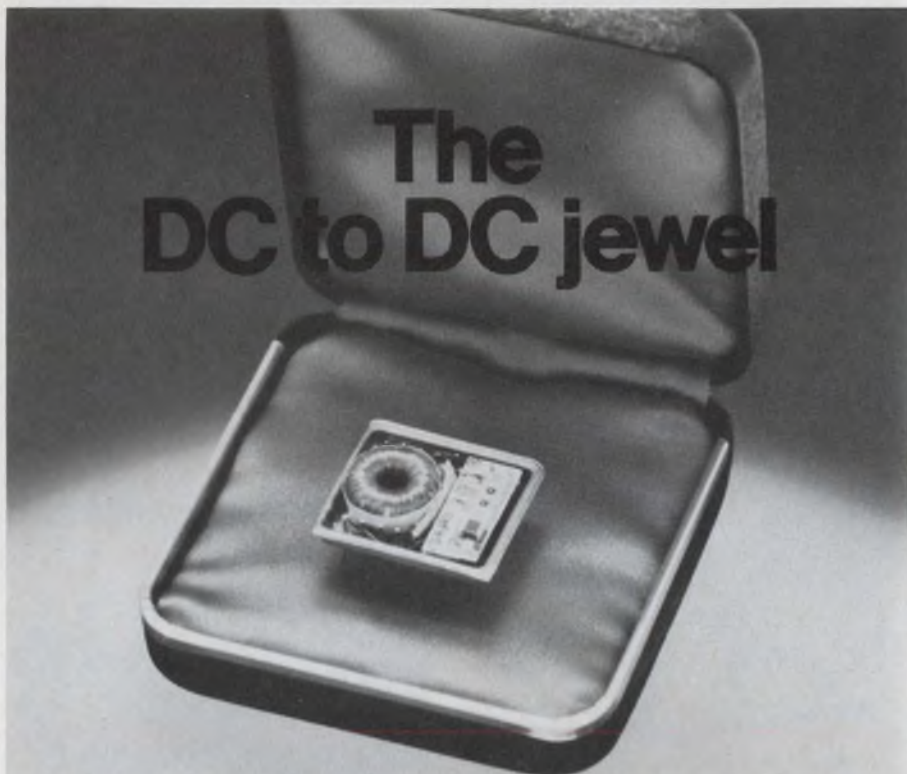

Now with a narrower input range.

The Tecnetics HC Series unregulated DC to DC power supplies are more of a jewel than ever. We've optimized performance by adding a more efficient core and narrowing the input range. And it still weighs only 0.3 ounces.

Choose from a wide variety of input voltages and single or dual outputs. HC Series power supplies are available in a non-hermetic package for industrial and commercial applications, a her-

metic package for military, space and industrial applications that require protection from severe environmental conditions, and a fully encapsulated package for use where extreme shock and vibration are expected.

Write for our 26-page catalog that gives full specs and prices on the HC Series and over three hundred other power supplies.

HC SERIES UNREGULATED ISOLATED DC-DC CONVERTER

INPUT VOLTAGES	5VDC \pm 1V to 28VDC \pm 4V
OUTPUT VOLTAGES	5VDC @ 2 watts to 300VDC @ 3 watts
OPERATING TEMP.	-55 $^{\circ}$ C ambient to 125 $^{\circ}$ C case, without derating
DIMENSIONS	1.05 x 0.94 x 0.32 Inches
EFFICIENCY	65% to 75% typically at full load 55% to 60% typically at half load
PACKAGE OPTIONS AND PRICES	HCH (Non-hermetic) 49.00 HCH (Hermetic) 59.00 HCE (Encapsulated) 69.00

tecnetics[®]

The Power Conversion Specialists

P.O. Box 910, 1625 Range Street, Boulder, Colorado 80302 (303) 442-3837 TWX 910-940-3246

CIRCLE NUMBER 59

Thick Film Dual-In-Line Resistor Networks

- Resistor Values: 100 ohm to 10K ohm
- Tolerance: $\pm 2\%$
- TCR: ± 200 ppm/ $^{\circ}\text{C}$
- Package Power Rating: 2.5 watt
- Four popular series:
 MEC1, 13 resistor, 14 pin MEC3, 8 resistor, 16 pin
 MEC2, 7 resistor, 14 pin MEC4, 15 resistor, 16 pin

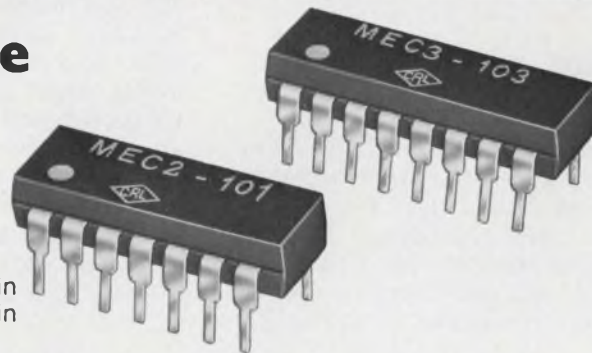

Now Available For Off-The-Shelf Delivery From Centralab Distributors

Not just another resistor network, these are backed by Centralab's 31 years in thick film microcircuitry. They're proven in use . . . reliable . . . for such typical applications as pull-up and pull-down networks or line terminators. Best of all you can get them fast . . . through our network of over 200 Centralab Distributors. When you think of networks—think of Centralab. Call your Distributor for complete details, prices and delivery.

DISTRIBUTOR PRODUCTS



CENTRALAB

Electronics Division

GLOBE-UNION INC.

5757 NORTH GREEN BAY AVENUE

MILWAUKEE, WISCONSIN 53201

CIRCLE NUMBER 60

Programmable Calibrators

DigiTec's precision, programmable Voltage/Current Calibrators provide the **extra power** required by today's systems. Keyboard, parallel TTL, IEEE Standard, or other code programming is available to simplify interface.

Standard models provide $\pm 1\mu\text{V}$ to $\pm 200\text{V}$ and $\pm 1\mu\text{A}$ to $\pm 200\text{mA}$ at 0.01% accuracy and 0.005% repeatability. Integral safety features include short circuit protection on all ranges, compliance voltage limiting, and transient-free outputs, even during start-up and switching. Prices start at \$1595.



DigiTec

**UNITED
SYSTEMS
CORPORATION**

918 Woodley Road, Dayton, Ohio 45403
(513) 254-6251, TWX (810) 459-1728

DigiTec: precision measurements to count on.

*These instruments available under
GSA Contract GS-00S-27741*

FOR INFORMATION ONLY CIRCLE #131

FOR DEMONSTRATION ONLY CIRCLE #132

INTEGRATED CIRCUITS

Driver, receiver meet tight specs

Fairchild, 464 Ellis St., Mountain View, CA 94042. (415) 962-3816. \$1.79 to \$2.43 (100); stock.

The 9636 line driver and the 9637 line receiver meet EIA standards RS-422 and RS-423, as well as the requirements of CCITT stand-

ards X.26 and X.27. The circuits also can withstand EIA standard RS-232C fault conditions. The 9636 is a dual single-ended line driver that provides TTL and CMOS-compatible inputs and operates over the military and industrial temperature ranges. The 9637 is a Schottky dual differential line receiver that has a threshold accuracy of ± 200 mV over a ± 7 -V common-mode range.

CIRCLE NO. 322

Adjustable regulators output 1.5 A



Lambda Electronics, 515 Broad Hollow Rd., Melville, NY 11746. (516) 694-4200. \$2.85 to \$4.05 (500 up).

Adjustable IC regulators provide load currents up to 1.5 A. The LAS 15U is adjustable from 4 to 30 V; the LAS 18U, from -2.6 to -30 V. The new circuits have a maximum line regulation of 2% of V_{out} and load regulation of 0.6% of V_{out} , with a guaranteed maximum tempco for the output voltage of 0.03% of $V_{out}/^{\circ}C$. Other guaranteed specs are: minimum input-output differential of 2.4 V (positive) and 2.1 V (negative); and maximum output noise voltage of 10 μ V rms per volt. Built-in functions include thermal shutdown, current limiting and safe operating-area compensation.

CIRCLE NO. 323

Reliable AC line filters

Advanced engineering of inductors combined with the unique ceramic capacitor technology acquired from Allen-Bradley offers the reliability your equipment demands. Spectrum power line filters are designed for:

- 125 240VAC @ 125°C 0-400 HERTZ
- Proven Reliability
- Controlled thermal characteristics
- Limited AC voltage rise
- Volumetric efficiency
- Available in C, Pi, L, T
- Mil-F-15733

TYPICAL PARTS	I Amps	Volts AC	Insertion Loss—Db		
			150KHz	10MHz	1GHz
54-367-006	15	125	12	53	65
51-353-112	3	125	13	70	70
51-320-023	1	240	24	70	70

For other ratings—see EEM 1-576 to 1-583

AVAILABLE from stocking distributors

HALL-Mark ELECTRONICS 215-355-7300 MOITRONICS 213-773-6521
METUCHEN CAPACITOR 201-442-0500 ROSE ELECTRONICS 415-697-0224

ELECTRO 76 Boston Booths 2624, 2626
IEEE-EMC Symposium Wash. D.C. Booths 31, 32

Chip controls switching supplies

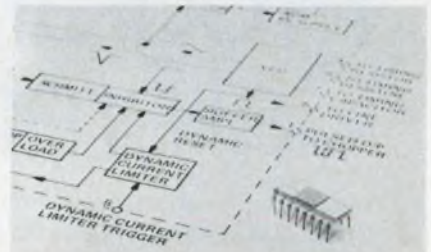

Plessey Semiconductors, 1674 McGaw Ave., Santa Ana, CA 92705. (714) 540-9979. \$6.60 (100).

A control circuit for the switching of power supplies and inverters—the SL442—operates at frequencies up to 40 kHz, withstands short circuits between adjacent pins or ground, and includes internal regulation of the chip supply rail. The SL442 has an internal oscillator that may be phase-locked for use with external synchronization; variable ratio space/mark pulses for controlling an active series or parallel element; and “soft” starting, with the output voltage increasing at a predetermined rate to the required level.

CIRCLE NO. 324



SPECTRUM CONTROL INC.
152 EAST MAIN ST · FAIRVIEW, PENNSYLVANIA 16415



SPECIALISTS IN ELECTRO-MAGNETIC COMPATABILITY

For a complete EMC solution let us test and analyze your equipment.

CIRCLE NUMBER 61

5 S-TTL interfaces aid μ P systems

Texas Instruments, P.O. Box 5012, M/S-84, Dallas, TX 75222. (713) 494-2621. \$2.25 to \$7.34 (100); stock to 12 wks.

Three registers and two bus-buffers/line drivers provide byte-size μ P-interface functions. Each octal unit has three-state outputs to facilitate direct interface with system bus, full parallel access for data inputs and outputs, and MOS-compatible inputs. The SN54S/74S373 and SN54S/74S374 registers offer a transparent latch and clocked D-type flip-flop bus interface, respectively. The SN54S/74S-412 transparent-latch register features a high-level output of 3.65 V minimum. The two drivers offer a choice between inverting or non-inverting logic elements and are designated the SN54S/74S240 and SN54S/74S241, respectively.

CIRCLE NO. 325

CMOS analog switches offer full protection

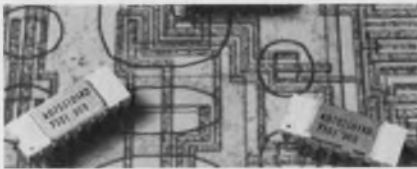

Analog Devices, Route 1 Industrial Park, P.O. Box 280, Norwood, MA 02062. (617) 329-4700. \$14 to \$30 (100); stock.

A family of CMOS analog switches eliminates SCR-latching problems and provides full over-voltage protection for analog-input voltages up to ± 25 V greater than the power supplies. The AD7510DI and AD7511DI (with inverted logic inputs) quad SPST, and AD7512DI dual SPDT switches exhibit 75- Ω ON resistance, 400-pA leakage current, 350-ns switching speeds, 3-mW power dissipation, and TTL/CMOS interfacing. The new dielectrically isolated units switch a 1-k Ω resistor in series with the power-supply line whenever the analog-input voltage exceeds the power-supply voltage. The resistor limits the current and is automatically removed when an overvoltage disappears, allowing the switch to operate normally and exhibit the low ON resistance.

CIRCLE NO. 326

Your product information file cannot possibly be complete without Clare-Pendar's new distributor catalog!

It includes complete specifications, engineering data and sources of supply of CP's entire quality line of switches, lens caps, adapters, gang assemblies and keyboard components—all immediately available from distributor inventories.



CLARE-PENDAR



Post Falls, Idaho 83854

Available from the distributor nearest you:

Powell Electronics
Richey Electronics
Texas Instruments Supply Co.

Treeko Sales, Inc.
Wilshire Electronics
M. Leff Radio Parts, Inc.

Distributors and Sales Offices Located in Major Cities, Worldwide

MEET OUR family of ELECTRONIC TEST ACCESSORIES

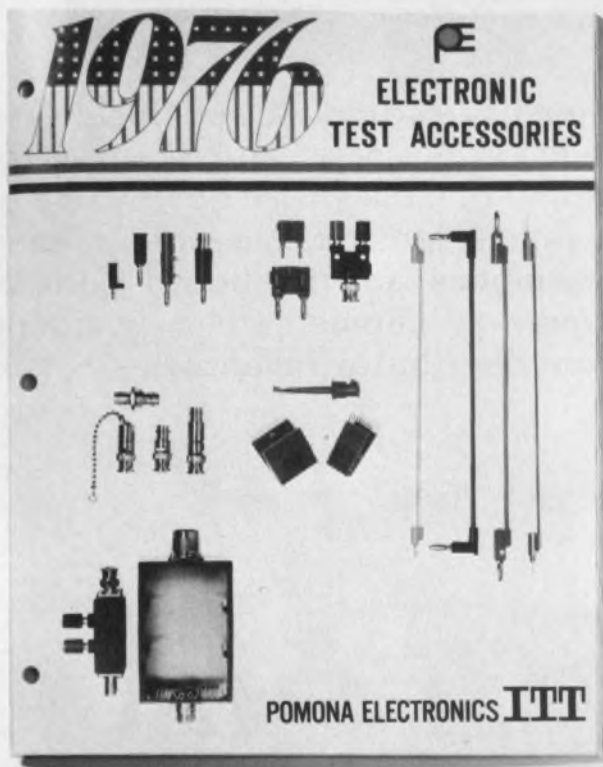

This new General Catalog is our latest family portrait. In the past twenty-five years (1976 is our Silver Anniversary year) it has grown from a handful of items to almost 500 products for the electronics industry.

Our catalog has grown to 76 pages for 1976, and we are introducing 65 new items this year. It describes and illustrates every member of our family. You're bound to find the solution to your testing problem with one or more of these quality products.

For your free copy, circle the reader service number listed below, or write:

ITT POMONA ELECTRONICS

1500 East Ninth St., Pomona, Calif. 91766
Telephone (714) 623-3463, TWX: 910-581-3822



CIRCLE NUMBER 63

INTEGRATED CIRCUITS

Darlington drivers ease interfacing

Fairchild, 464 Ellis St., Mountain View, CA 94042. (415) 962-3816. \$1.55 to \$2.46 (100); stock.

Six new high-voltage, high-current Darlington-array drivers interface TTL and MOS logic circuits with devices such as solenoids, relays, lamps, small motors and LED displays. The devices provide output voltages of 50 or 80 V and output currents up to 350 mA. The basic circuits are the 9665, 9666 and 9667, all of which spec 50-V maximum. The three devices are available in 80-V versions, designated with A suffixes. The 9665 can be used with any kind of logic. Input current limiting is set by connecting a discrete resistor to each input. The 9666 eliminates the need for external resistors, and is specifically designed for direct interfacing of PMOS logic to solenoids. It operates from supplies of 14 to 25 V. The 9667 has a series base resistor connected to each Darlington pair for direct operation with TTL or CMOS logic operating from 5-V supplies.

CIRCLE NO. 327

ICs trigger thyristors

Plessey Semiconductors, 1674 McGaw Ave., Santa Ana, CA 92705. (714) 540-9979. SL449: \$2.96 (100).

Three ICs can be used to control thyristors. The SL447 through 449 (second-sources for the RCA CA-3058, 3059 and 3079) generate thyristor trigger pulses only at zero-voltage points in the supply voltage cycle. All three ICs feature direct connection to thyristor gates, supply voltage range of 20 to 300 V, frequency range of 10 to 1000 Hz, stabilized internal supply and a gate pulse driver. The SL447 and SL448 also include a dc-gate drive capability, and may be programmed to shut down system power in case of sensor malfunction. The SL447 and SL449 operate over the temperature range of -20 to 85 C, while the SL448 operates over the MIL temperature range of -55 to 125 C.

CIRCLE NO. 328

NOTICE!
Electronic Design
SPECIALS
PREVIEW

JUNE 7
COMPUTER '76
TESTING
MICROPROCESSORS

JUNE 21
FOCUS:
POWER SUPPLIES

JULY 5
FOCUS:
CRYSTALS

JULY 19
MICROPROCESSORS

AUGUST 2
FOCUS:
NETWORK ANALYZERS

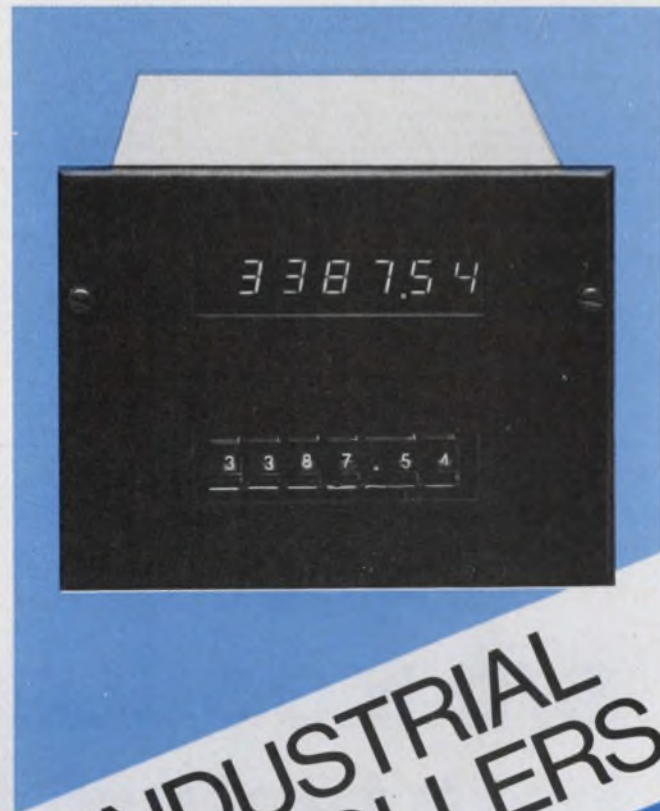

INDUSTRIAL CONTROLLERS

**Six
Decade
Bidirectional
Operation...High Noise
Immunity...BCD
Output**

Here's a six decade bidirectional counter-controller especially designed to give long, uninterrupted service in industrial environments. C/MOS circuits and special internal filters allow it to be used in high electrical noise environments. LED displays, 10 amp relay output, six decade presets are standard. A six decade set point control is available. Let a Theta Application Engineer help you team an industrial controller with a decitrak[®] shaft encoder or other transducer.

LITERATURE:

Write for descriptive literature and your free copy of Digital Solutions to Automatic Control



Theta

3002

INSTRUMENT CORPORATION

Fairfield, New Jersey 07006 • Phone: 201-227-1700

CIRCLE NUMBER 64

13-mil diameter cores are temp independent

Ampex Corp., P.O. Box 33, Marina del Rey, CA 90291. (213) 821-8933. About \$0.50/1000; stock.

The Model 1370 Unibit computer memory cores have diameters of 13

mils. Typical operating parameters for the cores include: drive current of 780 mA; disturbed ONE output of 34 mV; disturbed ZERO output of 4.5 mV; switching time of 125 ns and peaking time of 65 ns. Performance is uniform over any 75-C temperature range without compensation of the drive current and with a drive current compensation of 0.4 mA/°C the performance is uniform over a -55 to +110 C.

CIRCLE NO. 329

Connector withstands environmental hazards

ITT Cannon Electric, 666 E. Dyer Rd., Santa Ana, CA 92702. (714) 557-4700. Retail: \$4.95.

The Sure Seal connector has been tested to depths of 3 ft in a 5% salt and detergent-filled water solution. It resists exposure to dusty roads, salt-covered highways, various fluids and chemicals, as well as temperatures from 40 to 220 F. And despite these environmental hazards, the connector reliably will transmit low-level electrical signals. Sure Seal water-resistant car/trailer harness kits contain all wiring and interconnection hardware required for simple hookup.

CIRCLE NO. 330

OUR S/D MODULES both feature LSI

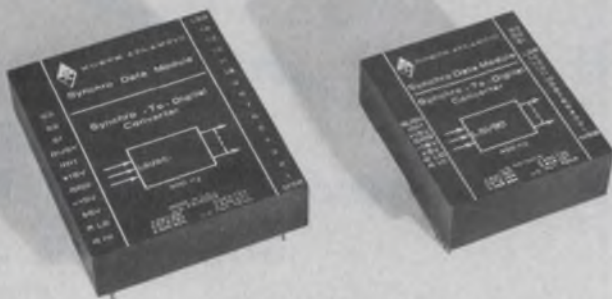

**PICK...LSI & LOWEST COST
...OR LSI & SMALLEST SIZE**

That's right! Industry-first LSI comes in two configurations; LSI/85, the industry-standard pin-compatible series...and LSI/90, the 33% smaller "matchbox" series. Both series mean better performance and better reliability.

The LSI/85 and LSI/90 feature 3-minute accuracy at speeds to 5 rps. And, operation to +70°C...optional temperature range -55° to +105°C. Plus, a companion D/S in the industry-standard pin-compatible Series 785. Both S/D and D/S meet MIL-STD-202D and come in a full range of models; 11.8V to 90V, synchro or resolver, 60Hz or 400Hz, and a choice of 10-, 12- or 14-bit data plus optional screening to MIL-STD-883. Call today for more good news on cost-effective solutions starting at \$310...and for just one piece too!



NORTH ATLANTIC
industries, inc.

200 TERMINAL DRIVE, PLAINVIEW, NEW YORK 11803
phone: (516) 681-8600

CIRCLE NUMBER 67

Adhesive backed plastic film holds wafers

Aremco Products, Inc., P.O. Box 429, Ossining, NY 10562. (914) 762-0685. 3 in. wafer carrier: \$0.55 (10,000); 2 wks.

Called Wafer-Mount 559 this semi-rigid, adhesive-backed plastic film holds silicon wafers, alumina or glass substrates for dicing and scribing. In use, paper backing is peeled from the plastic, and wafers are firmly pressed against the exposed adhesive, with no heating required. The wafer can then be held against a vacuum manifold for dicing and scribing. The parts are separated from the plastic by washing in acetone.

CIRCLE NO. 331

Aluminum handles come with choice of 6 colors

Des Tek, P.O. Box 24163, Los Angeles, CA 90024. (213) 474-5093. From \$2.04 (100-up); stock.

A line of equipment handles is available in clear or black anodized aluminum, and comes with a choice of six trim colors. Three heights of handles are available. The M-10 and M-40 series measure 1.63 in.; the M-20 series, 1.13 in.; and the M-30 series, 1.38 in. Seven lengths, from 3.5 to 14 in., in increments of 1.75 in. are also available. The 10-24 mounting-screw posts are completely adjustable, so these handles will mount at any center distance.

CIRCLE NO. 332

The one variable the world can standardize on.

Our new Type M conductive plastic variable resistor is hard metric. A 10 mm cube that's tiny, flexible and rugged. The MINI-METRIC is the smallest dual pot available today. Manufactured in the United States, it's dimensioned the way the rest of the world thinks. Allen-Bradley has what you need; or, it can be ordered through our distributors. Ask for Publication 5239.

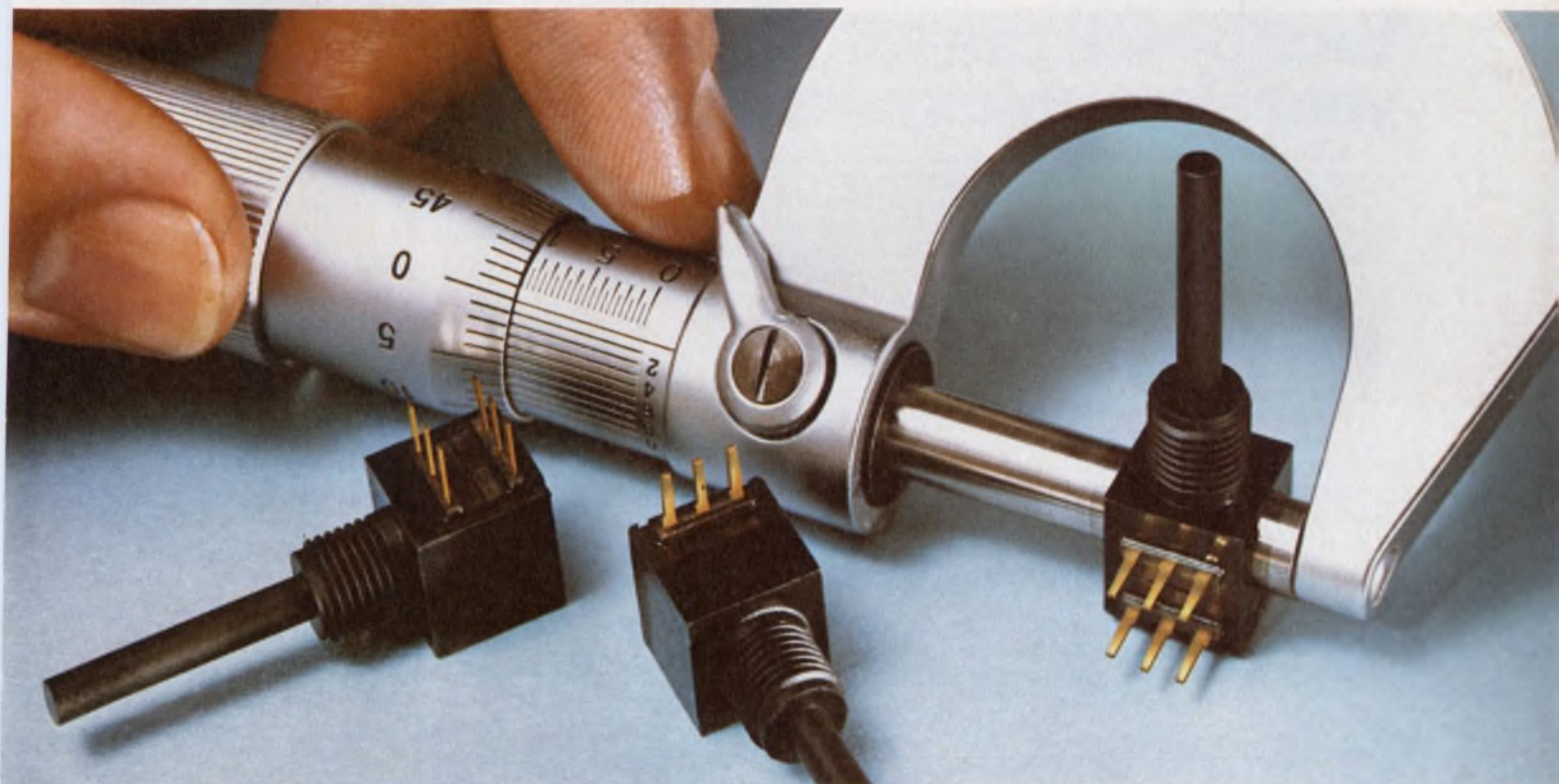
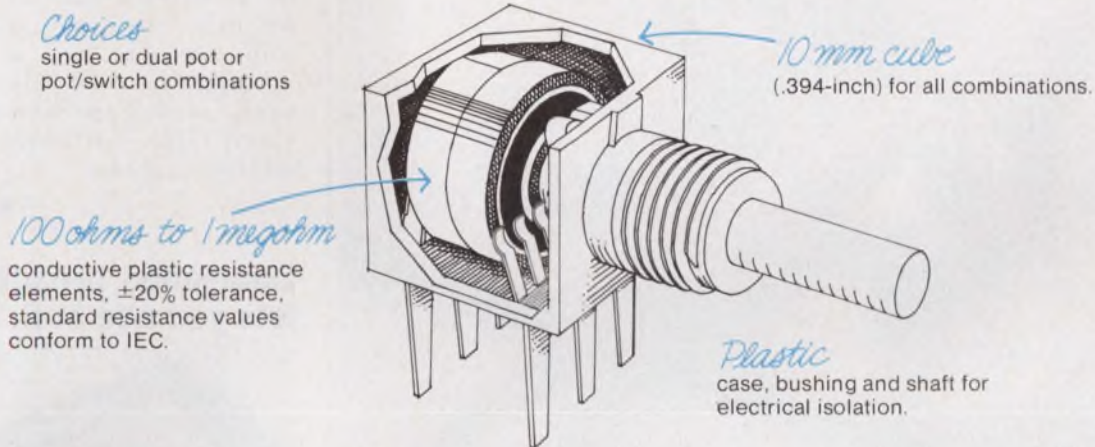

Quality in the best tradition.



ALLEN-BRADLEY
Milwaukee, Wisconsin 53204

EC131

CIRCLE NUMBER 68



Your pencil can tell you what your electronic system can't.

With some quick figuring your pencil can tell you that our SMA interface JCM Coaxial Connectors cost about half as much as MIL Spec. types.

Yet, for many applications, there's virtually no difference in performance. Our JCM's provide excellent electrical performance from DC well into the gigahertz microwave range.

Johnson JCM connectors are available with gold finish that resists wear and abrasion. Or you can save additional money by ordering JCM's with a nickel

finish. Either way, you'll get features like a brass body, Teflon® insulator and beryllium copper center contact.

Our JCM series includes both clamp-type and crimp-type connectors. All have five parts or less. And you can assemble them in three to five minutes without special tools.

Why pay for full SMA MIL spec. performance if you don't need it? Let your pencil tell you which connectors to buy. Fill out the coupon and mail it to us for more information.

E. F. Johnson Company/3005 Tenth Ave. S.W., Waseca, MN 56093

Please send me technical information on miniature JCM coaxial connectors.

Please send me samples. You can call me at _____

Name _____
 Firm _____
 Address _____
 City _____
 State _____
 Zip _____



JOHNSON

For fast service, contact your local Johnson Distributor.

CIRCLE NUMBER 69

PACKAGING & MATERIALS

Bar instrument handle for portable equipment

Buckeye Stamping Co., 555 Marion Rd., Columbus, OH 43207. (614) 445-8433. \$2.90: 4-1/2-in. size; \$3.25: 10 in. (OEM qty).

Econo-Handle is a new instrument-case handle designed especially for small to medium-sized instruments. The black vinyl-covered bar is accented with chrome-plated end caps. The handle folds flat in both directions, and is available in lengths from 4-1/2 to 10 in. The handle is ideal for converting individual bench instruments to portable instruments.

CIRCLE NO. 333

Dual-sided breadboard lets you use both sides

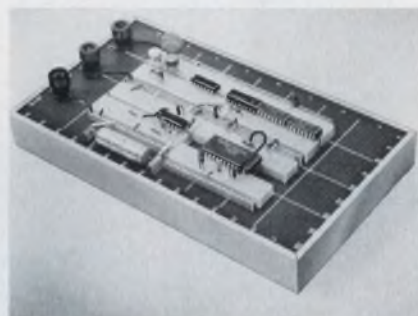

Vector Electronic Co., 12460 Gladstone Ave., Sylmar, CA 91342. (213) 365-9661. From \$25.50; stock.

The Model 51X Klip-Blok breadboard, mounted on an aluminum chassis, allows components to be attached and interconnections to be made from both sides to increase wiring convenience and reduce clutter. Interconnections can be made with 22 gauge wire. Eight Klip-Bloks accommodate a maximum of twelve 14 or 16-pin DIPs, or four 24 or 40-pin devices. The 51X accommodates packages with 0.6-in. lead spacing as well as devices with conventional 0.3-in. spaced leads. The glass-epoxy mounting board measures 4.5 x 8 in., and has a 0.1-in. grid hole pattern. The 51X board is unclad, however, a Model 51X-GP may be ordered with an etched ground plane on the bottom side for breadboarding high-frequency circuits.

CIRCLE NO. 334

Wrap and unwrap tools come three to a kit



Jonard Industries, 134 Marbledale Rd., Tuckahoe, NY 10707. (914) 793-0700. \$42 (KW-350), \$48 (KU-360); stock.

Three piece wrapping and three piece unwrapping tool kits for wire connections handle the most popular wrapped-wire sizes. Contents of the wrap kit, Model KW-350, include: the WDI-2426 tool with standard, insulated, 0.073 in. diameter \times 0.75 in. deep hole, WD-2225 single-ended tool with a 0.075 \times 0.8 in. hole; and the WD-2000 single-ended tool with a 0.071 \times 0.625-in. hole. The contents of the unwrap kit, Model KU-360, include: the UDL-2027 double-ended, left-hand tool with 0.052/0.07 \times 1.25-in.-deep holes; the UDLR-2026 double-ended, left-and-right-hand tool with a 0.07 \times 0.75-in. hole; and the UDR-2426 double-ended, right-hand tool with 0.066/0.073 \times 1-in. holes.

CIRCLE NO. 335

Insert/extract 0.6-in. DIPs with safety

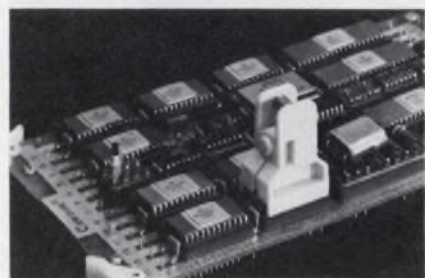

Cambridge Thermionic Corp., 445 Concord Ave., Cambridge, MA 02138. (617) 491-5400. \$1.05 (100 up); stock.

A new DIP insertion/extraction tool for 0.6-in.-wide IC packages uses a spring-loaded clothespin-type action. The tool securely grips the IC between the leads and under the body, so fragile leads are not damaged.

CIRCLE NO. 336

new SCR's

1.5 AMP IN A MINIATURE DIP

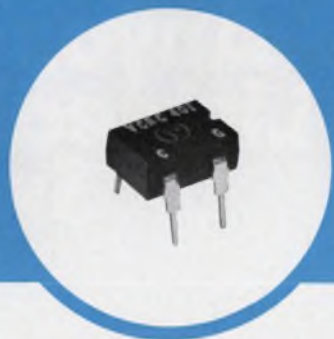

FEATURES:

HIGH di/dt AND dv/dt CAPABILITY

SHORTED-EMITTER, CENTER GATE GEOMETRY

DENSE GLASS PASSIVATION

2 DEVICES WILL FIT INTO A STANDARD 14 PIN SOCKET

COMPATIBLE WITH AUTOMATIC HANDLING

The new VCRC series of low-current SCR's are ideally suited for lighting, heating and cooling controls and ignition applications. The 4 pin, low-profile DIP is compatible with automatic testing, handling and inserting.

The VCRC series is available in 200V, 300V, 400V and 600V (V_{DRM} and V_{RRM}) ratings with 1.5 Amps [$I_{T(RMS)}$] and a peak surge current (I_{TSM}) of 100 Amps at 60 Hz.

DC gate-trigger current (I_{GT}) is 15 mA maximum at $T_c=25^\circ\text{C}$. Critical dv/dt is 200 V/ μsec (Typ.) and di/dt is 200 A/ μsec . Holding current (I_{HO}) is 20 mA max.

**FOR COMPLETE INFORMATION CALL
MIKE HAWKINS, 214/272-4551**



Design us in . . . we'll stay there **VARO**

VARO SEMICONDUCTOR, INC.

P.O. BOX 676, 1000 N. SHILOH, GARLAND, TEX 75040 (214) 272-4551 TWX 910-860-5178

EUROPEAN OFFICE: UK: VARO SEMICONDUCTOR INTERNATIONAL, INC.

Deepdene House, Bellegrave Road, Welling, Kent, England DA163PY, 01-304-6519/0

CIRCLE NUMBER 70

Card guides use flame retardant materials

Bivar, Inc., 1617 E. Edinger Ave., Santa Ana, CA 92705. (714) 547-5832. For 1000-up lots: \$0.18 (FR-650); stock.

A line of PC card guides is

manufactured from 94V-0 U.L. rated material that has fire-retardant additives. Called Temp-O-Gides, they are brownish-red in color, rigid and strong. They snap easily, but firmly, into 11/64-in. holes in plates or channels that measure 0.47 in. wide x 0.09 in. deep. The guides are designed for 1/16-in. thick boards and are stocked in 24 standard lengths from 2.5 through 14 in.

CIRCLE NO. 337

Heat sinks installed before/after assembly

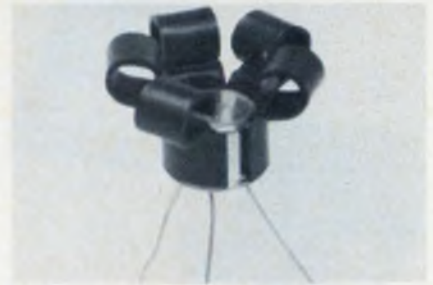

Aham, 968 W. Foothill Blvd., P.O. Box 909, Azusa, CA 91702. (213) 334-5135. \$0.07 (5000).

Aham Model 135 heat sinks fit TO-5 cases. They are stamped and formed from aluminum 0.025-in. thick, 0.75-in. diameter and 0.480-in. high and require very little board space. These low-profile coolers can be installed before or after assembly and dissipate 1 W with a case temperature rise of 55 C above ambient.

CIRCLE NO. 338

Instrument cases hold up to 2000 cm³ of circuits

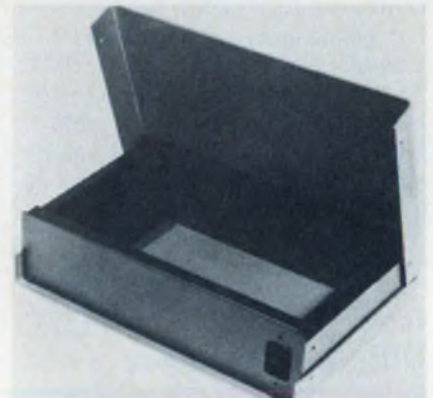

Boss Industrial Mouldings Ltd., Higgs Industrial Estate, 2 Herne Hill Rd., London SE24 OAU, England.

Instrument cases, suitable for amplifiers, test equipment and similar applications have internal capacity of up to 2000 cm³ (135 in.³). The BIM 3000 Bimcase is available with either red, grey or orange 14 gauge aluminum top and bottom covers. The covers are attached by four self-tapping screws to the matte black 18 gauge steel chassis, the rear of which is pre-punched to accept an I.E.C. power connector. The chassis has rigid upper and lower internal brackets onto which PC boards can be mounted.

CIRCLE NO. 339

Anyone can make Lighted Pushbutton Switches



Unimax makes them Status Symbols.

Single lamp, dual lamp or 4-lamp lighting. Momentary or alternate switching. Ratings from dry circuit to 10 amps. Unsealed or oil-tight. Each one is a Status Symbol. To see which one is right for you, call or write: Unimax Switch Corp., Ives Rd., Wallingford, Conn. 06492. Phone (203) 269-8701.



CIRCLE NUMBER 71

CANNON[®] SMA CONNECTORS MEET MIL-C-39012

This broad line of SMAs meets or exceeds MIL-C-39012. Cannon gives you engineering expertise—designs to fit your needs—large production capability, widespread distributor support, and extreme variety of configurations. There's a lot of savings inherent in each of those factors.

For instance, in variety, our SMA series, QPL approved under MIL-C-39012, offers more than 120 part numbers to choose from Designed for high-performance applications, the units are rugged, 50-ohm, miniature, RF connectors They have excellent electrical characteristics from dc to 18 GHz and may be used in some applications at frequencies up to 26 GHz Available in gold plating



or in comparably performing but more economical passivated stainless steel versions Both finishes meet MIL-C-39012 Small size and superior electrical properties make these units especially adaptable to microwave-component applications such as couplers, dividers, and mixers.

We are fully prepared to meet any RF connector requirement. Our manufacturing facilities are in the production of Coaxial connectors and interconnection systems. Our quality testing department can perform in-house every test required by MIL-C-39012. Our capability is your assurance of maximum performance and lower total installed cost. Send for our "RF Coaxial Connectors" brochure today. ITT Cannon Electric, 666 East Dyer Road, Santa Ana, CA 92702. **Toll-free, 24-hr (800) 854-3573; in Calif., (800) 432-7063.**

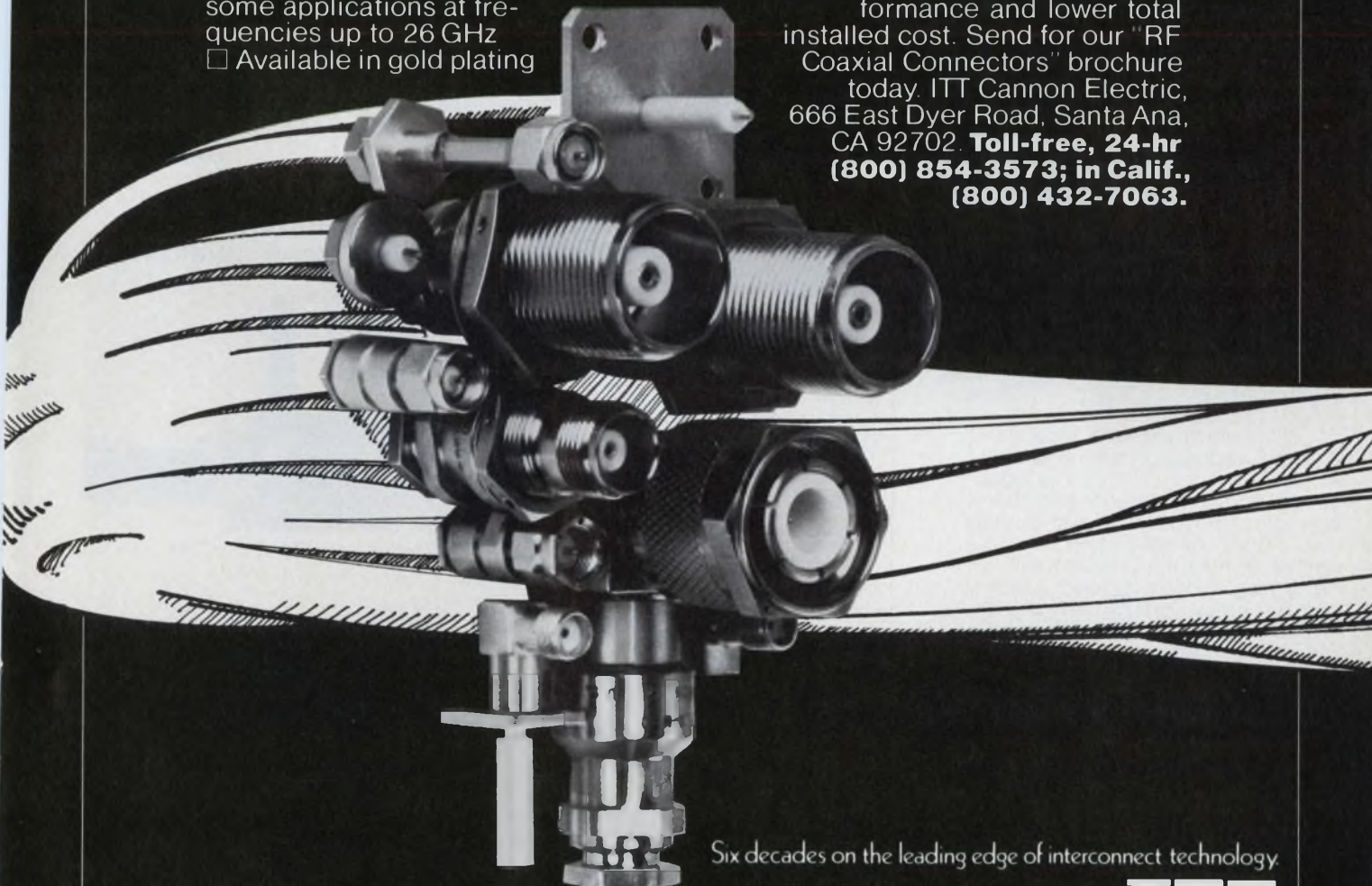

Six decades on the leading edge of interconnect technology.

CANNON ITT

EMR Model 1510
Digital Real-Time
Spectrum Analyzer

Q When is 256
equal
to 500?

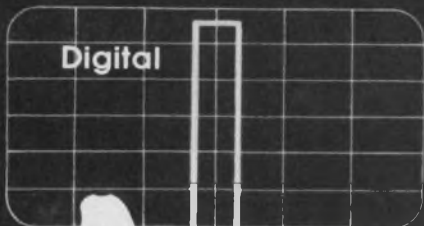
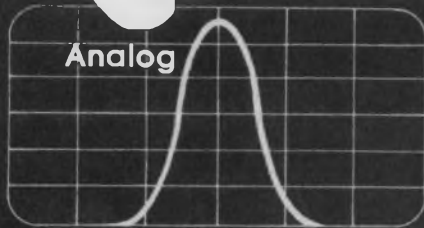

A In the digital
real-time
spectrum analyzer
with a 1024 block
size and a
theoretically
perfect
filter
shape.



It's a question of effective noise bandwidth—2.0 with the analog filters of conventional 500-line time compression analyzers, and 1.0 with the Model 1510 Digital Real-Time Spectrum Analyzer. The result: 256 digital lines are equivalent to 500 analog lines, ideal for extracting periodic signals buried in random noise or separating closely-spaced spectral components. You get extra convenience features, too. Like a built-in CRT display with all control settings indicated on the CRT. A 60+ dB dynamic range. An intensified spot cursor with LED display of amplitude in dB, frequency and integration time remaining. And, a capability for changing weighting function by simply changing a PROM. For more details, write or call: EMR-Telemetry, Weston Instruments, Inc., Box 3041, Sarasota, Fla., 33578; (813) 371-0811.

EMR Schlumberger

PACKAGING & MATERIALS

Contactors adaptable to irregular surfaces

Tecknit, 129 Dermody St., Cranford, NJ 07016. (201) 272-5500. \$0.30: copper, 0.125 × 0.187 in. (1000-up); 3-4 wks.

A fuzz button is a resilient, low impedance contactor formed by die compressing fine knitted wire mesh to a desired shape and density. It is applicable when the contacting surface is irregular and otherwise might require a special connector. It is also usable for EMI shielding and grounding, or as a shock mounting for equipment, or as a temporary contactor for device leads and printed-circuit boards. The wire material can be gold-plated copper, monel or copper of various thicknesses. The cross-section and height may be cylindrical or formed to any desired shape.

CIRCLE NO. 340

Cable Intra-Connector permits easy line tests



AP Products Inc., Box 110, 72 Corwin Dr., Painsville, OH 44077. (216) 354-2101. From \$7; stock to 4 wks.

The Intra-Connector permits quick diagnostic testing of individual lines in flat ribbon cable systems. The unit is manually installed between any mating dual-row connectors and sockets that have contacts on standard 0.1-in. centers. An extra set of dual-row contact pins extending from the Intra-Connector may then be probed individually or connected to another cable assembly. Five models are available to fit the most common flat cable connector/socket sizes: 20, 26, 34, 40 and 50 contacts or lines. The Intra-Connector is molded of glass-reinforced polyester; contacts are noncorrosive alloy 770.

CIRCLE NO. 341

Alignment crosshairs increase accuracy



Amtek, 23011 Moulton Parkway, Laguna Hills, CA 92653. (714) 581-9210. \$185.

A micro-alignment device (MAD) that attaches to the end of a microscope enables more accurate positioning of ICs during manufacturing processes, according to Amtek. MAD projects a target, or crosshair, for aligning miniature ICs or any other small part under the scope. Unlike a reticle, which is a target that fits into the eyepiece, the crosshair for MAD fits onto the field view of the microscope and greatly increases the positioning accuracy. The MAD target is a replaceable photographically generated image, which can be positioned in the X and Y planes, and contains its own light source. Custom targets and target colors are optional.

CIRCLE NO. 500

Cast-aluminum boxes provide good shielding



Andar Corp., 2230 S. Cotner Ave., Los Angeles, CA 90064. (213) 477-2111. \$25 to \$32 (unit qty); stock.

Boxes for off-the-shelf packaging are cast in A-356 aluminum alloy and black-anodize finished. Covers, made of 0.080-in. 6061-T6 aluminum plate, are grained and coated with a clear chemical film and tightly secured with closely spaced, flush screws in pretapped holes. Four sizes range in size from 1.96 × 3.39 × 1.16 to 5.76 × 3.14 × 1.40 in.

CIRCLE NO. 567

Board for μ Ps allows easy system expansion

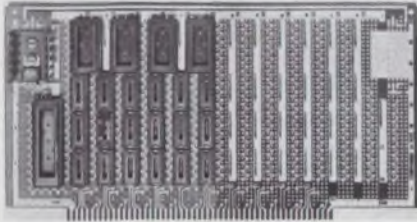

Vector Electronics Co., Inc., 12460 Gladstone Ave., Sylmar, CA 91342. (213) 365-9661. \$19.95 (1-4); stock.

A universal board for microprocessors, Model 8800 V, allows Altair, IMSAI and other micro-computer users to add circuits in a convenient and inexpensive manner. Identical in size to those used in the Altair, it serves for RAM, ROM, or PROM memory expansion, for peripheral interface hardware requirements or for I/O circuits such as a/d, d/a converters, multiplexers and relays. The board's 53.13 in.² area and 100 I/O terminals allow its use with any microprocessor-based system. The board is prepunched with 0.042-in.-diameter holes on 0.1-in. centers, so that the user can place DIPs in almost any location. Typically, the board holds two 40-pin DIPs, eight 24-pin DIPs and 36, 14 or 16-pin DIPs.

CIRCLE NO. 599

Splices for magnet wire pierce tough insulation

T&B/Thomas & Betts, 36 Butler St., Elizabeth, NJ 07207. (201) 354-4321.

Insulation-piercing fork terminals and splices for connection to aluminum or copper magnet wires have multiple sharp ridges on the inner barrel surface for penetrating tough magnet-wire insulation; thus the need for stripping, brazing and soldering is eliminated. These additions to the Dragon Tooth line accommodate a range of wire sizes from 20 to 14 AWG in a variety of combinations. Magnet wire can be combined with stripped-lead wire. The open barrel design permits easy mid-span splicing and tapping. The connectors can be installed with either the T&B Shure-Stake hand tool, or bench-mounted air/hydraulic tool when production speeds are desired.

CIRCLE NO. 600

CIRCLE NUMBER 75 ►

BergPin™ .025" square terminals... supplied in over 35 standard sizes for design flexibility above and below the board.

BergPin terminals and the machines which stake them in circuit boards comprise a fast and reliable interconnection system. These machines stake pins—to within .015" diameter of true position from nominal—at rates from 1,500 to 12,000 per hour. With BergPin, you can stake boards ranging from .062" to .125" thick.

These features distinguish the BergPin terminal from ordinary wire-wrapping and connector-mate pins.

Pin tip is designed to facilitate wire-wrapping or disconnect lead-in.

Uniform cross-section. Made from drawn, not stamped, material. Result: smooth, flat contact surfaces.

Sharp corners held to .003" maximum radius.

Star-wedge shape provides 8 lbs. retention (at nominal hole size) before soldering; up to 50 lbs. retention after soldering.

Tapered lead-in will not damage plated through hole or multi-layer construction.

Pin tip is designed to facilitate lead-in when staking.

Berg-built machines stake pins to within .015" diameter of true position from nominal. Machine rates from 1,500 to 12,000 per hour.

Supplied in over 35 standard sizes for design flexibility above or below the board. Will stake in P.C. boards ranging from .062 to .125 thick.

Available in six types of surface platings.

Pins are 3/4-hard phosphor bronze.

.100" center minimum spacing allows for traces between holes.

Board Thickness	Hole Size
1/16	.032 ± .002
3/32	.034 ± .002
1/8	.034 ± .002

BergPin terminals are a key component in the BergCon™ line . . . the most complete interconnection system available today. You can use BergCon products to package .025" square mated pairs on .100", .125", or .150" grid. Complete details on the BergPin terminal and the complete BergCon line are yours for the asking. Write or call:



BERG ELECTRONICS

Division E I du Pont de Nemours & Co. (Inc.)

New Cumberland, Pa. 17070 Phone: (717) 938-6711

Pulsers drive injection lasers

Simulation Physics, 41 B St., Burlington, MA 01803. (617) 272-5202. \$1595; 60 days.

Two pulsers for injection-laser

diodes have output voltages of 0 to 600 V, peak current of 75 A and output power of 50 kW. Pulse widths are 50 to 200 ns. Rise times (10 to 90%) are 50 ns with fall times variable—50 ns maximum. Polarities are positive and rep rate is 10 kHz. The Pulse 10 is intended for single laser diodes, and the Pulse 12 works with diode arrays.

CIRCLE NO. 342

VCOs specify $\pm 0.075\%$ stability

Microwave Technology, 840 W. Church Rd., Mechanicsburg, PA 17055. (717) 697-4681. \$745 (1 to 3).

Voltage-controlled oscillators, with center frequencies in the 800-MHz-to-6-GHz band, have a frequency stability of $\pm 0.075\%$ or better over the temperature range of 0 to 50 C. The Model EPH-134 tunes ± 100 -MHz bands, with center frequencies from 800 MHz to 1500 MHz. The Models EPH-135 and 136 tune ± 30 -MHz bands, with center frequencies in the range of 1.5 to 3.0 GHz and 3.0 to 6.0 GHz, respectively. Output power is 20-mW minimum with harmonics of -24 dBc or better, and spurious signals of -40 dBc or better. The tuning voltage required is in the range of 0 to +24 V dc. Frequency vs tuning voltage linearity is $\pm 10\%$ or better.

CIRCLE NO. 343

DANA INTRODUCES THE SMART COUNTER.

Series 9000: World's First Microprocessing Timer/Counter.

The Dana Series 9000 is smart enough to make your work a lot easier. Microprocessing controls provide all the features of a premium timer/counter, a reciprocating counter and a calculator. Plus interfacing options and operating capabilities never before available in one instrument.

The Dana Series 9000 Microprocessing Timer/Counter goes so far beyond all other counters it takes a whole brochure just to explain its capabilities. Ask for it. It's the smart thing to do.

Dana Laboratories, Inc., 2401 Campus Drive, Irvine, California 92664, 714/833-1234.



FOR PRODUCT DEMONSTRATION CIRCLE #290 FOR LITERATURE ONLY CIRCLE #289

Gunn oscillators have high stability

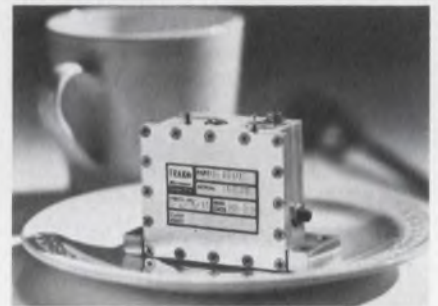

Trak Microwave, 4726 Eisenhower Blvd., Tampa, FL 33614. (813) 884-1411. \$795 to \$895; 60 to 90 days.

The Series 6901-1200 Gunn oscillators, with center frequencies between 8 and 16 GHz, are said to be virtually impervious to voltage, VSWR, or temperature shifts. The oscillators have a stability of $\pm 0.05\%$ from -54 to $+71$ C. They are mechanically tunable over $\pm 0.5\%$ of center frequency. Rf output is +13 dBm minimum to +19 dBm maximum. Also, the new units have a pushing factor of less than $\pm 0.002\%$ V from dc to 3 kHz, and a pulling factor of $\pm 0.01\%$ for 3:1 load VSWR. Harmonics are less than -50 dBc with nonharmonic spurs measured at greater than -90 dBc.

CIRCLE NO. 344

Announcing the 1740A... a new 100MHz scope with fresh measurement ideas.

In the time domain—Push the third channel trigger display button, release, and you have a simultaneous display of the trigger waveform *plus* channel A and B traces. Now you can make accurate timing measurements from the trigger signal to events on either or both channels.

A X5 vertical magnifier provides 1 mV/div sensitivity on both channels to 40 MHz, without cascading, so you can monitor low-level signals directly. Signals such as the output of read/write heads of disc or mag tape units, low-level ripple on power supplies, or medical sensor and electro-mechanical transducer outputs.

In the data domain—You can combine the 1740A with HP's 1607A Logic State Analyzer and use the analyzer's pattern trigger or delayed trigger output for external scope triggering. Add the "Gold Button" (an optional logic-state push-button in lieu of A versus B) for just \$105* and (with the 1607A) you have the convenience of logic-flow display or real-time display at the push of a button.

That means you can view the logic states of operational circuitry directly for pinpointing a program problem. Then—with a push of a button—take a look at the waveforms you've selected at that specific point in time.

Add to all this, features such as selectable input impedance (1 megohm or 50 ohms) and the time-tested 8 x 10 cm CRT used in our 180 System lab scopes for bright, easy-to-read displays. Priced at just \$1,995*, the 1740A with its new ideas, simplifies both real-time and data-domain measurements. When you get your hands on this scope—you'll know you're working with a quality instrument. Give your local HP field engineer a call today.

*Domestic U.S.A. price only.

**Data/Time Domain
Oscilloscopes**

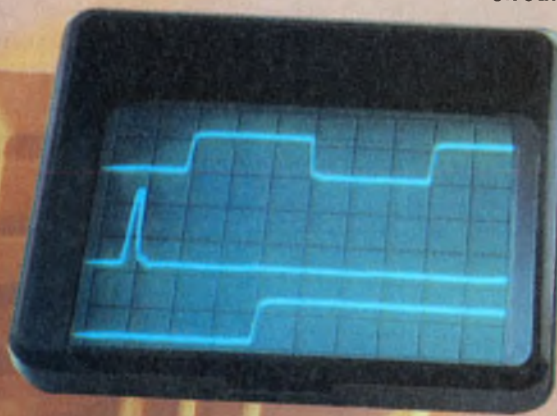
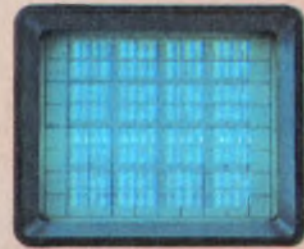

STATE
DSPL



FOR TECHNICAL INFORMATION CIRCLE #275
FOR IMMEDIATE APPLICATIONS ASSISTANCE CIRCLE #276

HEWLETT  PACKARD

Sales and service from 172 offices in 65 countries.
1501 Page Mill Road, Palo Alto, California 94304

085111

MICROWAVES & LASERS

**Detector offers
0.1-18-GHz coverage**



Weinschel Engineering, Gaithersburg, MD 20760. (301) 948-3434. \$180; stock to 30 days.

The Model 1113 coaxial crystal detector, for use in 50-Ω systems, offers a flatness of better than ±1.0 dB over the entire 0.1-to-18-GHz frequency range. Sensitivity is 0.4 mV/μW minimum at low levels and 100 mV/0.4 mW at high level. The detector has a maximum VSWR of 2.0:1 and a maximum power handling capability of 100 mW.

CIRCLE NO. 345

**Comb generators
output -2 dBm**

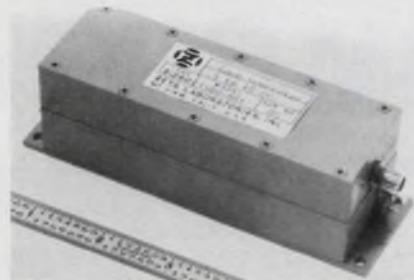

Zeta Laboratories, 616 National Ave., Mountain View, CA 94043. (415) 961-9050. \$600 to \$1200; 45 to 60 days.

The CI Series of comb generators, operating in the frequency range of 25 to 18,000 MHz, features picket spacings from 25 to 500 MHz. The spacing is generated from an internal crystal-controlled oscillator. Power outputs up to -2 dBm are available from some models, though the output is nominally -20 to -30 dBm. The CI series, housed in a 4.4 × 1.5 × 1.47-in. package, needs only a 28-V input.

CIRCLE NO. 346

**SWR bridge has
35-dB directivity**



Wiltron, 930 E. Meadow Dr., Palo Alto, CA 94303. (415) 494-6666. \$1400; 6 wks.

The Model 87A50 SWR bridge covers the 2-to-18-GHz frequency range with greater than 35-dB directivity. The reference termination is included internally. A precision APC-7 connector is used on the Test Port with stainless-steel Type N connectors on the input and output ports.

CIRCLE NO. 347

**ANOTHER
GLENNAIR**

**CONNECTOR
SOLUTION**

Have a connector, plug in a Glenair SAV-CON. Available for all popular cylindrical connectors, SAV-CON interfaces between your test cable and unit connectors. Saves contact fatigue during test and check-out phase. Give your connector a rest. Plug in a SAV-CON.

GLENNAIR 1211 Air Way, Glendale, California 91201
(213) 247-6000 TWX 910-497-2066 TELEX 67-3485

CIRCLE NUMBER 76

**ANOTHER
GLENNAIR**

**UNDERWATER
SOLUTION**

Available in hermetic and non-hermetic types, Glenair's new High Density Geo-Marine Connectors are supplied in a choice of 24 insert arrangements, up to 100 contacts (#16, 20 & 22 contact sizes). Complete molded cable assemblies can be provided in any cable length.

GLENNAIR 1211 Air Way, Glendale, California 91201
(213) 247-6000 TWX 910-497-2066 TELEX 67-3485

CIRCLE NUMBER 77

**Germanium detector
has 40 cm² active area**

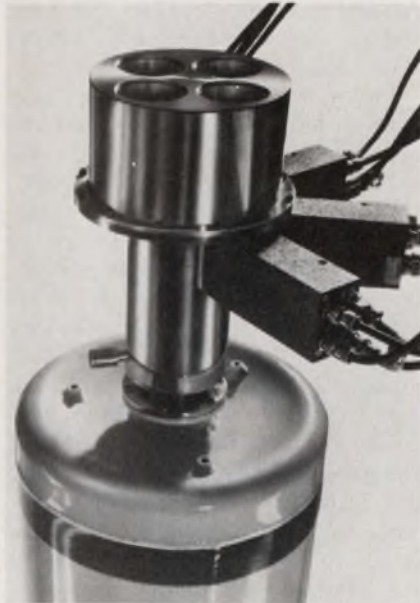

Ortec, Inc., 302 Midland Rd., Oak Ridge, TN 37830. (615) 482-4411. See text.

A germanium detector system—made by Ortec—is designed for in-vivo counting of heavy elements, whole body counting and environmental radiation monitoring. It consists of four, planar-germanium low-energy photon spectrometers that share a common vacuum cryostat. The active area of the array is 40 cm²—claimed to be the largest ever made. System resolution is better than 800 eV full width, half max at 122 keV, and 650 eV at 60 keV. Cost of a typical system is about \$50,000 per array, depending on resolution and active area.

CIRCLE NO. 348

**Power transistors handle
600 V at 40 A**

PowerTech, 9 Baker Ct., Clifton, NJ 07011. (201) 478-6205. From \$123.50; stock.

The PT-3516 and PT-3526 silicon power transistors offer collector breakdown voltages, $V_{CE0(SUS)}$, of 600 V. They have their gain, h_{FE} , specified at a collector current of 40 A. Devices have rise and fall times of less than 1.5 μ s and are rated for a power dissipation of 325 W in a JEDEC TO-63 package.

CIRCLE NO. 349

It's new It's flexible



**It could be the answer
to your complex
switching needs.**

It's the Series 1800 from Ledex Inc. Mix both **high** and **low** current switch modules in one ganged assembly!

Wiping contacts in the low current modules keep the switching surfaces clean so they can handle from 10mA/5 volts to as much as 1A/60 volts.

Rugged bridging contacts, in the high current modules, let you switch from 10mA/20 volts to 6A/250 VAC.

There's circuit flexibility too! Select 2p2t or 4p2t circuits with self-cleaning contacts. Bridging contacts provide 2NO, 2NC or 1 NO + 1NC circuits.

Program up to 20 modules per assembly with interrelated switching action.

Momentary, push/push, interlock, reciprocal, master and reciprocal + master release functions are available.

For front panel flexibility, choose either unlighted, single or dual bulb illumination; square or rectangle caps with full or split lens. Horizontal or vertical mounting plus a wide range of legends and cap colors lets you design that "just right" look for your new product.

Ask for catalog B-5508 and see if the Series 1800 is the answer to **your** complex switching needs.

LEDEX INC.

123 Webster Street
Dayton, Ohio 45401
(513) 224-9891

CIRCLE NUMBER 78



Scanbe-gram



RE: STANDARD SOCKET CARDS AND PANELS

SCANBE'S STANDARD 40 AND 60 POSITION SOCKET CARDS MOUNT A WIDE VARIETY OF DIPS....INCLUDES FIELD PROVEN ME-2 SOCKETS AND PIN STRIPS.... ALSO KIT CARDS AND UNIVERSAL MODELS FOR COMPLETE FLEXIBILITY.

SOCKET PANELS AVAILABLE....OFFERS 30 TO 180 ME-2 SOCKETS IN ZONES OF 30....PLUS UNIVERSAL PANELS....ALL CARDS AND SOCKETS PROVIDE FOR DECOUPLING CAPACITORS....STANDARD CARD FILES AND DRAWERS ALSO AVAILABLE.

SPECIFY SCANBE....
SAVE WITHOUT SACRIFICING QUALITY.

SEND FOR NEW I.C. PACKAGING CATALOG.

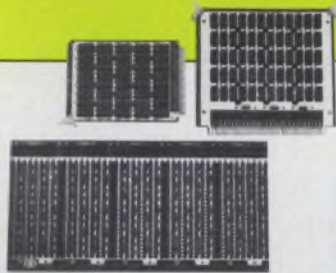

"Imitated... never duplicated."

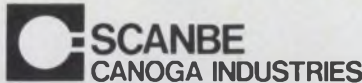

Scanbe Manufacturing Corp.
3445 Fletcher Ave., El Monte, CA 91731
Tel: (213) 579-2300 • TWX: 910-587-3437

CIRCLE NUMBER 79

DISCRETE SEMICONDUCTORS

Power transistors made for MIL requirements

Solid Power Corp., 440 Eastern Pkwy., Farmingdale, NY 11735. (516) 694-2883. See text.

Two series of silicon power transistors have been developed to meet military requirements. The JAN, JANTX and JANTXV 2N-3716 series of transistors have current capabilities to 10 A at collector voltages of up to 100 V. The devices are housed in TO-3 cases. Prices for the transistors start at \$9.12 to \$17 for the JAN version and \$13.65 to \$25.65 for the JANTX and JANTXV versions, depending on quantity. The other series, the JAN2N1722 and JANTX version, handles currents to 7 A at collector voltages of up to 80 V. These transistors are available in TO-53 packages. Price in 100-up quantities for the JAN devices is \$14.25 and is \$24.25 for the JANTX version. Delivery for all units is from two to eight weeks.

CIRCLE NO. 356

CRYDOM'S NEW LOW COST TRIAC SSR



New from Crydom. The TL Series of 10 amp triac solid state relays. Superior breakdown voltage ratings — 300V for 140VAC units & 500V for the 280VAC series. Input filter on control side prevents false triggering. Built-in snubber protects against false turn-on. Crydom quality throughout. Designed for resistive lamp loads or light inductive loads. Save 20% with our new triac output SSR.

Call or write today for details.

Features:

- Filtered control input
- Built-in snubber
- Optically coupled
- 20% lower in cost
- Standard Crydom package
- Zero voltage switching

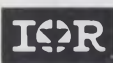
INTERNATIONAL RECTIFIER  CRYDOM DIVISION

1521 Grand Avenue, El Segundo, California 90245 • (213) 322-4987

CIRCLE NUMBER 80

IR LEDs offer response times of 50 ns, typical

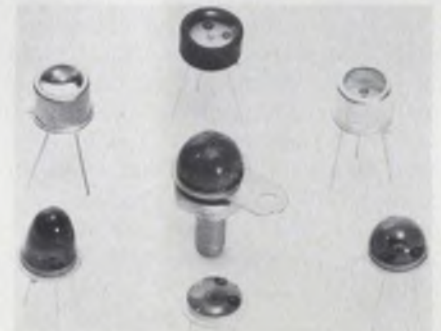

International Audio Visual, Inc., 15818 Arminta St., Van Nuys, CA 91406. (213) 787-4400. From \$7.95 (1000-up); stock.

A family of fast, infrared LEDs is designed for data transmission and general optical communications. They have a figure of merit of $F \geq 10^6$ W/s in pulsed operation and a response time of typically 50 ns. Power output in the continuous mode is over 10 mW. Several mounting arrangements are available, including the TO-5 and power stud cases, with different lens types for wide-angle and beamed-power applications.

CIRCLE NO. 357

1 Relay Miss every 2-Billion Cycles



We tested 129 of our new Series E Relays at loads from dry circuits to 3 Amps. After 35-billion operations, only 10 single-cycle misses were monitored.

Series E Relays offer:

- Indefinite life
- No contact bounce
- Operation in all positions
- Contacts stable to ± 0.015 ohms over life
- Reliability at dry circuit or power loads
- Self-healing contacts
- Hermetically sealed contacts
- 1250V rms contact breakdown
- Low cost

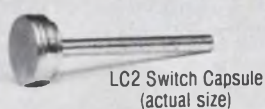

Series E Relay uses a rugged LC2 welded capsule rather than a fragile glass reed switch. This patented design holds a film of mercury securely to the metal walls of the capsule. With every operation, the mercury film renews the switch contacts. You get the reliability of mercury relays, but with complete freedom of mounting orientation. LC2 welded capsule reliability is proven by hundreds-of-thousands of units in the field, as well as billions of cycles under stringent laboratory conditions.

Send for a FREE SAMPLE of the LC2 welded capsule on your letterhead. Circle the reader service card number for Series E Relay information.



Fifth Dimension, Inc.

P.O. Box 483
Princeton, N.J. 08540
Tel: (609) 452-1200

Fast-switching power transistors handle 3 A

Kertron, 7516 Central Industrial Dr., Riviera Beach, FL 33404. (305) 848-9606. See text; stock.

The 2N6306, 7 and 8 fast-switching power transistors are designed for use in off-line switching power supplies. The devices have a V_{CB} of up to 700 V, a dc current gain of 15 to 75 at 3 A and a collector-to-emitter voltage of 5 V. They have a guaranteed E_s/b rating of 180 mJ at a 3-A collector current. The transistors have a maximum rise time of 0.6 μs and a maximum fall time of 0.4 μs , also at a collector current of 3 A. Prices for the transistors (in 100-up quantities) are as follows: 2N6306, \$3.02; 2N6307, \$3.42; and the 2N6308, \$4.43. All devices are housed in TO-3 cases.

CIRCLE NO. 360

Power Darlington's have 0.4- μs fall times

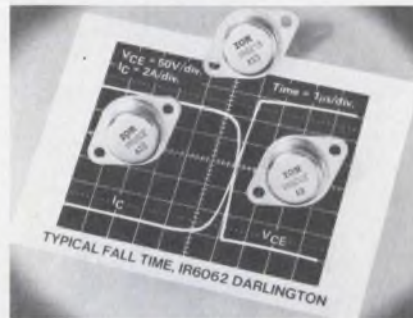

International Rectifier, 233 Kansas St., El Segundo, CA 90245. (213) 678-6281. From \$4.65 (100-up); stock.

A series of monolithic power-Darlington transistors has fall times as fast as 0.4 μs . The transistors are rated for operation to 25 A at 500 V. Designated the IR 6000, 6060 and 6250, the Darlington's are rated for 15, 20 and 25 A, respectively. They have an internal diode that helps reduce turn-off time. The glass passivated transistors have a maximum power dissipation of 100 W for the 15-A units, 125 watts for 20 and 25-A units, at a case temperature of 25 C. Minimum dc current gain is 100 at 10 A for the 25-A Darlington's, 140 at 3 A for the 15-A units and 150 at 5 A for the 20-A units. All transistors are housed in TO-3 cases.

CIRCLE NO. 361

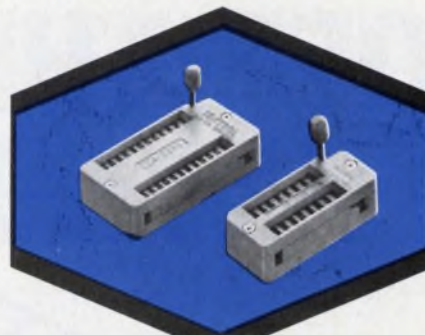

NEW ZIP DIP® II SOCKET/RECEPTACLE SERIES

IMPROVED TEXTOL SERIES
INCREASES VERSATILITY
AT COMPETITIVE PRICES

The new ZIP DIP II socket/receptacle series offers all the advantages of TEXTOL's original zero insertion dual-in-line package models plus increased socket versatility and reduced receptacle pricing.

The ZIP DIP II socket features an enlarged entry for use with an even wider range of devices and a flat top plate for easier entry and extraction. Contacts are on even 100 mil spacing (300-400-600 mil) for more convenient mounting on standard hardware.

A built-in "stop" insures that the ZIP DIP II handle can't be easily over-stressed. Top mounted assembly screws facilitate the replacement of damaged or worn internal parts. TEXTOL has strengthened both hardware and plastic for increased reliability and screw mounting of the socket to the ZIP DIP II receptacle makes possible a more positive locking system.

The ZIP DIP II receptacle (left) has all the features of previous ZIP DIP receptacles, yet at a lower price. It virtually eliminates mechanical rejects, is a disposable plug-in unit requiring no soldering and has a typical life of 25,000-50,000 insertions. The receptacle is ideal for high volume hand testing and, since replacement time is eliminated, a test station can process literally millions of devices before it must be replaced.

Detailed information on these and other products from TEXTOL . . . IC, MSI and LSI sockets and carriers, power semiconductor test sockets, and custom versions . . . is available from your nearest TEXTOL sales representative or the factory direct.

NEW TEXTOL CONDENSED CATALOG AVAILABLE!

NEW TEXTOL CONDENSED CATALOG AVAILABLE!



1410 W. Pioneer Drive • Irving, Texas 75061
214/259-2676

CIRCLE NUMBER 81

OFF-THE-SHELF KEYBOARDS?



This telephone keyboard *is*, and the others might as well be.

The key legend that makes one



keyboard different from another costs next to nothing. Prototyping?



The Chomerics approach makes small quantities of custom keyboards practical.

Special encoding? No problem.
Tight schedule? You've come to the right place. Application: Communications? Lab instruments? Computers? whatever

— Key in to the leader.

CHOMERICS

77 Dragon Court
Woburn, Ma. 01801
(617) 935-4850



POWER SOURCES

It may be ugly, but it isn't a duckling



Elexon Power Systems, 3131 S. Standard Ave., Santa Ana, CA 92705. (714) 979-4440. \$18.50 (1000).

Solv-15, 15-W open-frame supply offers outputs from 5 to 24 V, 3 to 0.75 A. Operating temperature range is 0 to 55 C full rating, de-rated linearly to 40% at 70 C. Load regulation is $\pm 0.1\%$ NL to FL and line regulation is $\pm 0.05\%$ for a 10% input change. Output ripple is $\pm 0.1\%$ pk-pk dc to 10 MHz and temperature coefficient is $\pm 0.02\%/^{\circ}\text{C}$ max.

CIRCLE NO. 362

Modules work over full MIL temp range

Abbott Transistor Labs, 5200 W. Jefferson Blvd., Los Angeles, CA 90016. (213) 936-8185. 25 W, \$358; 10 wks.

BBN-12A series of dual output power modules converts 28-V-dc input power to 25, 50, or 100 W of regulated $\pm 12\text{-V-dc}$ power. The series is switching regulated and can operate over the full military temperature range of -55 to $+100$ C. Regulation of dc input voltages is to 0.5% over the full input range of 20 to 32 V dc. Load regulation is 0.5% for no load to full load at constant input voltage. PARD (ripple and noise) has been reduced to 25 mV rms, 100 mV pk-pk over the temperature range of 25 to 100 C.

CIRCLE NO. 363

Supply takes aim at floppy discs



Power-One, 531 Dawson Dr., Camarillo, CA 93010. (805) 484-2806. \$120; stock-2 wks.

This new series is designed specifically for powering floppy-disc drive systems, including controller/formatter circuitry, from manufacturers such as Pertec, Diablo, CDC, Shugart, etc. First to be offered in this series is Model CP-162, a triple-output unit capable of powering two individual floppy-disc systems simultaneously. Outputs are +24 V at 5 A, +5 V at 3 A, and -5 V at 0.6 A, all with overvoltage protection. Of special interest is the 24-V regulator, capable of delivering up to 6-A output current for 500 ms upon initial system power-up.

CIRCLE NO. 366

Power modules provide 2.5 W/in³

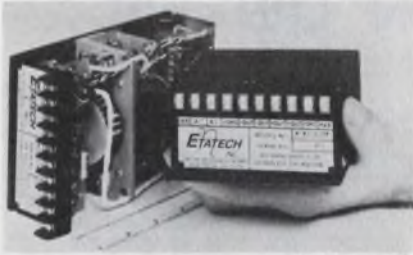

Etatech, Inc., 187-MW Orange-thorpe, Placentia, CA 92670. (714) 996-0981. \$295 (5 V, 20 A); stock.

Output power capability of "A" series of 5-to-60-V power modules has been increased from 120 W max to 135 W max. This makes possible a power density of 2.5 W/in³ for output voltages in the 47-to-60-V range. Minimum efficiencies of the series range from 75% at 5 V, 20 A to 82% at 60 V, 2.25 A. Ripple is 100 mV pk-pk maximum from all sources. The fully regulated (0.4% line/load), off-line modules provide short circuit/overload, input overvoltage and remote sensing as standard features.

CIRCLE NO. 367

If you've got a complicated problem with EMI we've got a simple solution

Electromagnetic Interference. It shows up as static on radio and snow on TV. It can make computer terminals register input error. Make a pacemaker or an EKG malfunction. And interfere with sensitive navigation equipment.

Obviously, you've got to shield your equipment against EMI. You can use sheet metal. Or foil. Or a plating process. These are fine for small enclosures with flat surfaces. But when it comes to large cases and complex shapes, you need a better solution.

And here it is. Electrodag® coatings. We've engineered a whole range of them. To give you from 10-70 dB attenuation, from 1 MHz to 10 GHz. With varied physical properties that let you apply them to almost any material.

This means that you can build your enclosures out of light plastic, coat them with Electrodag, and still get perfect skintight shielding. Even on honeycomb structures and flexible parts made from foamed resins.

And you can forget about expensive techniques like plating, metallizing and vacuum deposition. With Electrodag, all you need is a spray gun, a simple dipping technique, or a paintbrush.

You can use these new coatings for everything from CB radios and EKG units to data terminals and microphones.

This is a new field, but we're the oldest company in it. With the greatest experience, the biggest R&D staff and the most EMI coatings. For technical advice on specific applications, write: Acheson Colloids Company, Electrical Products, Port Huron, Michigan 48060. Or call (313) 984-5581.

 **Acheson**
high technology coatings

© AC Co., 1976

CIRCLE NUMBER 83

Battery Miniservo[®] recorder only \$795

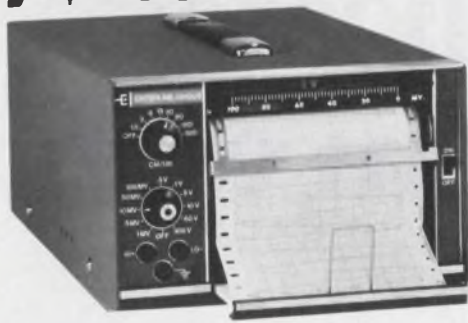

72-hour delivery

For field or remote applications. Input spans are 1, 5, 10, 50, 100, and 500 mVDC and 1, 5, 10, 50, and 100 VDC, with $\pm 100\%$ zero adjust. Eight chart speeds from 6 cm/hr to 20 cm/min. 10 cm wide, Z-fold chart. The rugged Miniservo recorder is powered by internal 12V 8-hour rechargeable battery, or from external battery, or plugged into line power. Replaceable throwaway pen/ink cartridge. For fast delivery, order stock number S22243-1A. Call Larna, 317/244-7611. For more information, write Esterline Angus instrument Corporation, Box 24000, Indianapolis, Indiana 46224.



CIRCLE NUMBER 84

Low cost dc motors with a Pancake difference.

Longer life. Higher torque. Flat profile.



This motor combines excellent performance and higher reliability in a flat-profile package. All because of its Pancake armature.

The flat lightweight copper-disc armature not only gives our low-cost motor a thin profile, but low inertia and high-pulse torque capability as well. With no iron in the Pancake armature, low-speed cogging and armature inductance are negligible and field demagnetization is zero.

Features include: variable speeds from 0 to over 3000 rpm, low mechanical time constant, brush life up to 10,000 hours, available with integral tachometers, 10 models from 1/115 to 1/8 h.p., priced for volume O.E.M. applications.

PMI offers a complete line of dc motors with a Pancake difference—prime movers, gearmotors and high performance servos up to 4 h.p. For more information call PMI Customer Service at (516) 448-1234. Or write

PMI Division

Kollmorgen Corporation, Glen Cove, New York 11542

CIRCLE NUMBER 86

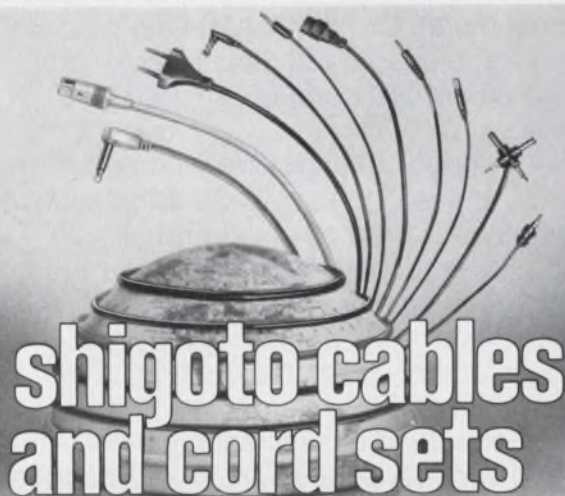

shigoto cables and cord sets

... we go to any lengths.
... we go to any ends.

That's why Shigoto can help make your ends meet. From hundreds of standard combinations to unusual characteristics that meet your own requirements. Even U.L. and C.S.A. approved. Our volume production for O.E.M.'s in electronics, communications, automotive, appliances, and practically every other industry, takes all the variables out of price-performance differences. Shigoto's ability to consistently produce top quality assemblies, when combined with large quantities, always brings in the prices you need. Unmatched quality has become our standard, our reliability and delivery schedules will become yours. Call, write, or wire your specs. At Shigoto, you'll find we'll go to any ends, to any lengths, to satisfy you.

Shigoto Industries Ltd.

350 Fifth Ave., N.Y., N.Y. 10001/(212) 695-0200/Telex 224219
One of the World's Largest Manufacturing Importers

CIRCLE NUMBER 85

SWITCH TO THE LICON[®] LPB LINE

... a spur to your imagination!

Design ideas track better with Licon LPB's! Our vast array of lighted and unlighted model choices give you more options to find the switch you need quickly and save design time, too. Here are just two bright ideas to consider: Our economical **Series 05 LPB** now has a centrally-located LED display. Bifurcated contacts with long wipe. Good tactile feedback. U.L. listed. Ideal for low energy digital electronics switching. **Series 06 LPB's** feature Licon's Ultra-reliable double-break Butterfly switches. Over 200 display options. U.L. listed, C.S.A. certified and meets 3 mm terminal spacing requirements. Wide application range. Both have standard PC or .110 quick-connect terminals. See our brilliant broad line for yourself. Call or write for our Licon Switch Catalog. Licon, 6615 W. Irving Park Rd., Chicago, Illinois 60634. Phone (312) 282-4040. TWX 910-221-0275



LICON

A DIVISION OF ILLINOIS TOOL WORKS INC.



© Illinois Tool Works Inc. 1976

CIRCLE NUMBER 87

ELECTRONIC DESIGN 11, May 24, 1976

DATA PROCESSING

Unit controls PDP-8 over phone line

Digital Communications Associates, Inc., 135 Technology Park, Atlanta, GA 30092. (404) 448-1400. \$1000 (single qty).

The AFP-8 allows control and maintenance of a PDP-8 over a telephone line. It plugs into any OMNIBUS slot of the DEC computer, replacing both the usual teletypewriter controller and front panel. It duplicates all the functions of the DEC KL8 console teletypewriter controller and is compatible with all ASCII terminals. The AFP-8 also emulates the DEC KC8 programmer's panel to give complete front-panel remote control. A user can load any program, start it, observe its detailed operation, and even execute maintenance diagnostics without physical access to the remote PDP-8. No software changes are required.

CIRCLE NO. 368

Time-sharing computer sells for under \$400



Digital Equipment Corp., Maynard, MA 01754. (617) 481-9511. \$250,000 to \$400,000.

Said to be the industry's lowest-priced general-purpose time-sharing computer system with full large-scale capabilities, the DEC-SYSTEM-20 features a new 36-bit word-length system. Other features include a full complement of high-level languages, a new field-proven operating system, and a newly designed systems architecture, with the central processing unit, core memory, controllers and a front-end PDP-11 processor integrated into a single functional unit. The system offers concurrent time-sharing, batch and transaction processing capabilities.

CIRCLE NO. 369

Naked floppy controller takes over mini's job

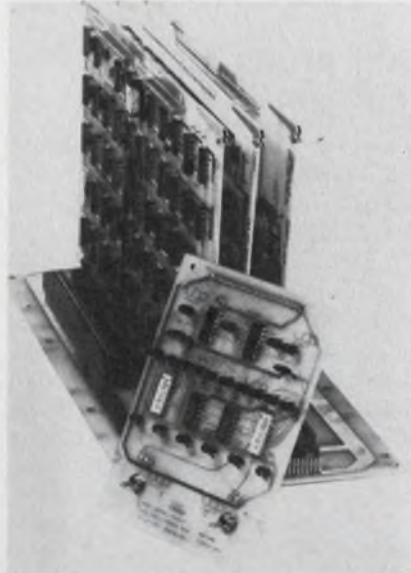

Dicom Industries, 715 Pastoria Ave., Sunnyvale, CA 94086. (408) 762-1060. \$772 (OEM); stock to 90 days.

Model 121 "Naked" floppy-disc controller is functionally a complete, multipurpose, multidrive floppy-disc memory device. It is optimized for both μ P and mini-computer applications and is compatible with DMA and programmed I/O channels. Since the 121 contains all formatter and controller logic, the mini or μ P is freed from performing the time consuming tasks of issuing track stepping commands to the floppy, generating and checking CRC codes on the data, or keeping track of sector and track positioning on each connected floppy.

CIRCLE NO. 370

Floppy disc is DEC compatible

Data Systems Design, 1122 University Ave., Berkeley, CA 94702. (415) 849-1102. \$2995, 2 drive assembly; 30 days.

The DSD-210 floppy-disc drive uses a μ P-based controller with PDP-11, LSI-11 or PDP-8 instruction set and plug-in compatibility. It's interchangeable with DEC's RX8 and RX11. IBM format (256-k bytes per diskette) is available with either two or four diskette drives. Data transfer at 10-k bytes/s. The controller is also available separately.

CIRCLE NO. 371

Bypass the middleman!

Save more than 55% with unsurpassed quality and performance!

Delivery from stock!



Deltron Slashes the Price of μ Processor Power Supplies

MPS-1: \$77

MPS-2: \$88

In any quantity!

Full one year guarantee. Designed for U.S.



MPS-1

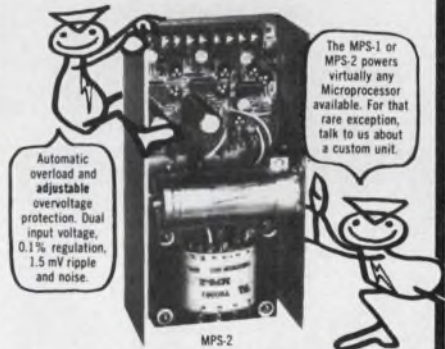

The MPS-1 or MPS-2 powers virtually any Microprocessor available. For that rare exception, talk to us about a custom unit.

Automatic overload and adjustable overvoltage protection. Dual input voltage, 0.1% regulation, 1.5 mV ripple and noise.

MPS-2

MODEL	VOLTS	AMPS			PRICE ANY QUANTITY
		40°C	50°C	60°C	
MPS-1 7 x 4% x 2%	5 \pm 5% Adj	3.0	2.5	2.0	\$77
	12 \pm 5% Adj.	0.6	0.5	0.4	
	9 to 12V Adj.	0.6	0.5	0.4	
	or 5V	0.38	0.38	0.38	
MPS-2 9 x 4% x 2%	5 \pm 5% Adj	7.0	6.0	5.0	\$88
	12 \pm 5% Adj	1.0	0.9	0.8	
	9V	1.2	1.1	1.0	
	or 5V	0.75	0.65	0.55	

Why buy brand A? Deltron's got them spec for spec at half the price.

Next time get the best for a lot less... write or call collect to:

Deltron inc.

Wissahickon Avenue, North Wales, Pa. 19454
215-699-9261, TWX 510-661-8061



CIRCLE NUMBER 88

**NEW CONVENIENCE
IN RESIN SYSTEMS**



Emerson & Cuming, Inc. one-part systems — epoxies, silicones, thermoplastics, solvent containing compounds, and others — eliminate weighing, metering, mixing, bring new convenience, speed, and accuracy to production processes involving coating, bonding, casting, molding, sealing, etc.

CIRCLE NUMBER 271

**FLAME-RETARDANT
EPOXIES & URETHANES**

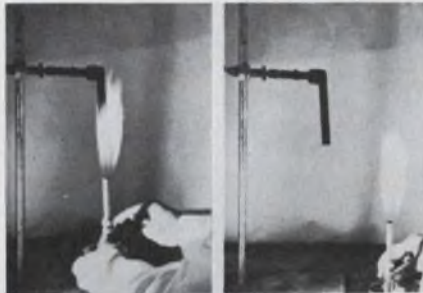

Stycast® Casting Resins and Eccocoat® Coatings, already spec'd in thousands of electrical/electronic applications, now offer an extra feature: **Flame Retardancy!** New E&C products, with the designation "FR", pass UL, Federal, and ASTM tests, including stringent UL 94 VE-O.

CIRCLE NUMBER 272

**NEW THICK SECTION CURE
SILICONES OFFER A WIDE
RANGE OF PROPERTIES**



Three new ECCOSIL® silicone rubber casting resins can be cured in thick sections and offer a range of special properties. One has low, low viscosity; another has ultra-high thermal conductivity; the third has specific gravity only 0.75.

CIRCLE NUMBER 273

Emerson & Cuming, Inc.



CANTON, MASS.
GARDENA, CALIF.
NORTHBROOK, ILL.
Sales Offices
in Principal Cities

EMERSON & CUMING EUROPE N.V., Devel, Belgium

DATA PROCESSING

**Unit prints labels
with 2-in. characters**

Diamond Engineering, 1635-150th NE, Redmond, WA 98052. (206) 883-1071. \$14,000 to \$20,000; 120 days.

The Label Printer is designed to print alphanumeric characters up to 2 in. high. The unit receives data via an EIA RS-232 serial line. It can print a line of one inch high characters on an 11 x 14.875 in. label in 1.8 seconds. The printer is designed to operate in an industrial environment, and has a heavy duty blower and filter for reliable ventilation.

CIRCLE NO. 372

**PDP-11 configured
for Fortran IV**



Digital Equipment Corp., Maynard, MA 01754. (617) 897-5111. From \$61,000; May, '76 delivery.

The PDP-11T55 is configured for data-processing "number crunching" operations, where maximum Fortran execution speed is required, in addition to traditional EDP-related problems. The system incorporates a new PDP-11/55 processor, a new floating-point processor, and 16-k or 32-k words of high-speed bipolar memory. It operates under Digital's RSX-11M operating system in a twin disc-pack configuration. The system employs Fortran IV plus an extended version of ANSI Fortran IV for high-speed systems throughput applications.

CIRCLE NO. 373

**Reader for mag cards
expands card uses**



Tycom Systems Corp., 26 Just Rd., Fairfield, NJ 07006. (201) 227-4141. \$3995 (unit qty); 30 to 60 days.

A new magnetic-card reader allows the use of IBM magnetic-card libraries with the Tycom MCR automatic send-and-receive terminal and other ASCII-compatible terminals. In this way users of the mag-card libraries can use the cards with a variety of other non-IBM equipment. The Tycom Model 38 KSR, for example, incorporates a standard IBM Selectric I or II with Tycom baseplate, an electronics control unit and a variety of optional equipment. The optionals can include ASCII-compatible CRT displays, Philips tape-cassette units, paper-tape punch and read attachments, acoustic couplers for direct telephone transmissions, minicomputers and calculators.

CIRCLE NO. 374

**Unit transforms analog
data for tape storage**

Western Laboratories, 110 S. Rosemead Rd., Pasadena, CA 91107. (213) 793-0148. \$169.

Models SMT-12 and SMT-13 Memory Translators convert low frequency analog signals of up to ±1.5 V pk into wide-deviation FM and vice versa. The FM signals can then be stored on a standard tape recorder or transmitted over a phone line. The SMT-12 has a bandwidth of 300 Hz and the SMT-13 a bandwidth of 150 Hz. Linearity when using a tape recorder is 0.08% for ±1-V peak inputs, plus tape-recorder error. When used over a phone line linearity for a ±1-V peak range is 1% typ.

CIRCLE NO. 375

E-Z-PROBES XP AND XPL ■ TEST LEADS AND JUMPERS ■ ADAPTORS

OUR NEW MICRO TROUBLE SHOOTER SOLVES YOUR IC TESTING PROBLEMS

The XM Micro Hook is designed for difficult IC test connections. Light weight (less than 1 gram) and Finger-eze Hypo Action permit direct hookup to delicate wires where weight and leverage may damage component. Fully insulated to a single contact point for true readings.

Construction: One-Piece Beryllium Copper, Gold-Plated Conductor and Hook, made for connections over leads up to .025" diameter. Durable Heat and Chemical Resistant Nylon Body. Stainless Steel Spring. Available preconnected to a wide variety of interface connectors.

Colors Red, Black, Blue, Green, Orange, Yellow, White, Brown, Violet and Gray.

EXCLUSIVE FIELD SERVICING FEATURE

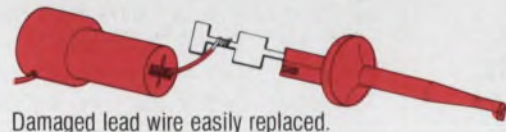

Damaged lead wire easily replaced.

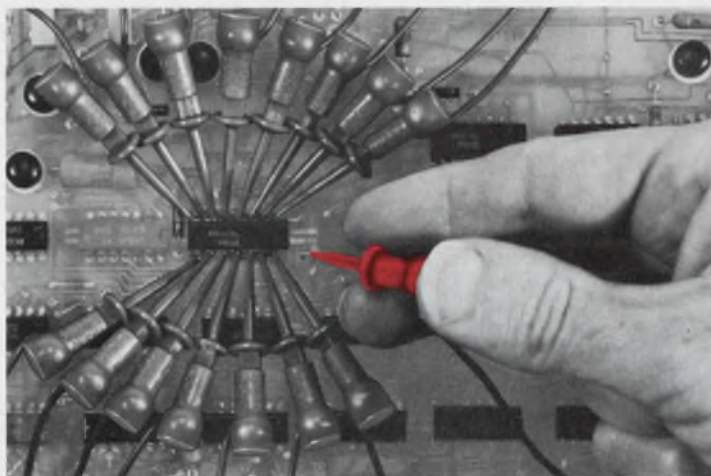

MODEL XM SHOWN ACTUAL SIZE WITH HOOK EXTENDED.

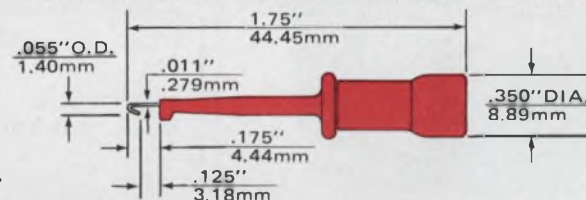

SEND FOR COMPLETE NEW CATALOG AND PRICE LIST

E-Z-HOOK
A DIVISION OF TEKTEST, INC.

114 EAST SAINT JOSEPH STREET
ARCADIA, CALIFORNIA 91006
(213) 446-6175 / TWX 910 582 1614

PATCH CORDS ■ COAXIAL JUMPERS ■ E-Z-HOOK CLIP 61-1 AND 61-2

CIRCLE NUMBER 90

selectivity you can count on!

Murata Piezoelectric I.F. Filters for Communication Systems.

Marine, Amateur, Public Service, Citizens Band . . . Murata has a miniature piezoelectric ceramic I.F. filter that can provide the long-term selectivity, stability and performance you need, even under the most adverse environmental conditions. Ladder filters, series resonators, interstage coupling filters in a variety of I.F. frequencies and with dozens of selectivity curves are included in the line. Write for our complete technical information package, today.



muRata

CORPORATION OF AMERICA
2 WESTCHESTER PLAZA, ELMSFORD, NEW YORK 10523
Phone: 914-592-9180 Telex: 13-7332

CIRCLE NUMBER 91

A PRIME STANDARD AT YOUR FINGERTIPS



\$348

FOR COMPLETE MEASURING CONFIDENCE

A NEW STANDARD IS BORN

High accuracy you can trust
Versatile measuring capabilities
An efficient, easy to operate meter
All at an affordable price
That's the DVM38. The complete DVM that sets new performance standards in 4 key areas.

A NEW ACCURACY STANDARD

The 3 1/2 digit, 1% accuracy is backed by a 15 meg Ω input impedance, compared to 10 meg Ω input of conventional DVM's, which guarantees up to 50% greater accuracy with 1/3 less circuit loading on every measurement for high accuracy you can trust.

A STANDARD IN CAPABILITIES

The DVM38 is more accurate in MORE circuits with these versatile ranges: 100 μ V to 2000V DC, 1KV AC, .01 Ω to 20 meg Ω ; 0.1 μ A to 2 A. Plus

HI and LO ohms and a 50KVDC range with accessory Hv probe.

A NEW STANDARD IN SPEED AND EASE OF OPERATION

Large pushbuttons and callouts - no need to hunt and peck. Large 4" L.E.D.'s with direct readout, down to V and mV indicators. SINGLE STEP AUTO-RANGING for maximum resolution and efficiency. 2KV DC protection minimizes downtime.

THE AFFORDABLE STANDARD

There are few 1% DVM's less expensive - there are none as complete in this price range, plus backed by a LIFETIME guarantee against factory workmanship errors.

THE DVM38 A NEW STANDARD IN DVM'S FOR SPEED, VERSATILITY AND ACCURACY.

DVM38 BACKED BY SENCORE'S 100% MADE RIGHT LIFETIME GUARANTEE

SENCORE 3200 Sencore Drive, Sioux Falls, S.D. 57107
Phone: 1.605.339.0100 TWX: 910.660.0300

CIRCLE NUMBER 92

How to Remain Un-obsolete:



101 circuit designs employing the most modern technology. Not just application notes of some new IC somebody is trying to sell you. Practical, tested functional blocks with all component values worked out, with performance data and descriptions.

You can obtain it painlessly for \$3.00. And remain an up-to-date designer.

interdesign

1255 REAMWOOD AVENUE
SUNNYVALE, CA 94086

Send me your book "101 Analog IC Designs." I have enclosed my check for \$3.00 (prepaid only).

Name _____
Title _____
Company _____
Address _____
City _____
State _____ Zip _____

Send to: **INTERDESIGN, INC.**
1255 REAMWOOD AVENUE
SUNNYVALE, CA 94086

03

MODULES & SUBASSEMBLIES

SCR/diode modules handle up to 200 A

Semikron, 542 Columbian St., P.O. Box 59, South Weymouth, MA 02190. (617) 337-7220. See text.

The Semipak power semiconductor modules can handle up to 200 A. The high-power plastic-encapsulated SCR/diode modules are available with two SCRs, two diodes, one SCR/diode and free-wheeling diode. PIV ratings of up to 1400 V (3-phase bridge) are available and 2.5-kV dielectric isolated heat-sink bases are easily connected with supplied bus-bar hardware. The cost of a 40-A, 600-V PIV (2 SCR) module is \$32 when purchased in 100-unit quantities. Delivery is from stock.

CIRCLE NO. 376

Low-pass active filter has choice of 7 cutoffs

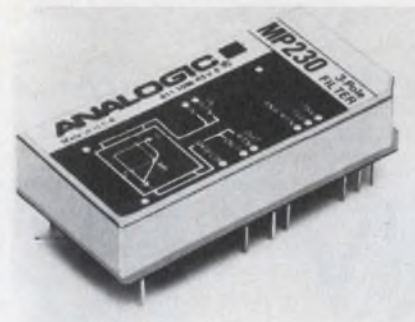

Analogic, Audubon Rd., Wakefield, MA 01880. (617) 246-0300. \$50 unit qty.; stock.

The MP230 low-pass three-pole active filter has a Butterworth response characteristic. It exhibits a maximally flat passband from zero out to the -3-dB cutoff frequency of 2 Hz. A rapid rolloff of 60 dB/decade beyond the -3-dB point filters out unwanted higher frequency components. Seven fixed cutoff frequencies (0.5, 1, 2, 3.3, 10, 33 and 100 Hz) are available. The filter has a low offset voltage of 2 μ V, maximum, and an output noise of only 1.4 μ V pk-pk. The MP230 passes an input voltage range of ± 10 V with unity gain, $\pm 0.01\%$ at dc. Depending on the selected cutoff frequency, the filter output impedance ranges from 16 to 42 k Ω . The MP230 draws ± 2 mA from ± 15 -V-dc supplies and operates over 0 to +70 C.

CIRCLE NO. 377

Log-ratio modules keep conformity for 6 decades

Analog Devices, Route 1 Industrial Park, P.O. Box 280, Norwood, MA 02062. (617) 329-4700. \$69 (1 to 9); stock.

A complete temperature-compensated, dc-coupled log ratio module, the Model 757, has six decade dynamic range. It also maintains log conformity to within $\pm 0.5\%$ maximum from 10 nA to 100 μ A. Log conformity error over the entire six-decade range (1 nA to 1 mA) on both inputs is less than 1%. The symmetrical FET input stages, with bias currents of less than 10 pA, allow either input to operate within the specified dynamic range regardless of the other channel's signal level. Both input amplifier summing junctions, each with only ± 1 -mV maximum input offset voltage are available. The module has a $\pm 0.04\%/^{\circ}\text{C}$ maximum scale factor drift and a ± 0.3 mV/ $^{\circ}\text{C}$ output offset-voltage drift. The scale factor may be adjusted for values over 1 V/decade, and the ± 10 -mV maximum output offset voltage can be externally trimmed to zero. The Model 757 is available in two versions, one for negative and one for positive input currents. Each version comes in a 1.5 \times 1.5 \times 0.4 in. (38.1 \times 38.1 \times 10.2 mm) encapsulated module, specified for operation over 0 to 70 C.

CIRCLE NO. 378

Three-phase monitor has 4 phase-to-phase ranges

Time Mark Corp., P.O. Box 15127, Tulsa, OK 74115. (918) 939-5811. \$68.50 (1 to 9); stock.

The Model 263 three-phase power monitor can protect three-phase motors and other types of three-phase loads. The unit continuously monitors each of the three phases for low voltage, loss of phase, or phase reversal. Sensitivity of the trip point can be adjusted from the front panel with a small screwdriver. A trip indicator is also provided to show when the output relay is de-energized. The units are available from stock in four phase-to-phase voltage ranges: 85 to 130, 160 to 250, 340 to 500 and 420 to 600 V. Output relay contacts are rated at 4 A.

CIRCLE NO. 379

Rf amplifier spans 2 to 200 MHz with 12-dB gain

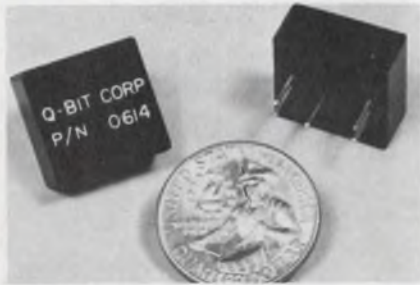

Q-Bit Corp., P.O. Box 2208, Melbourne, FL 32901. (305) 727-1838. \$29 (1 to 99); 2 to 4 wks.

The QB-614 rf amplifier offers a 12-dB gain that is flat over a 2-to-300-MHz bandwidth. The noise is only 3 dB and the input/output VSWR is less than 1.2:1. When operated at 15 V and 15 mA, the amplifier has a typical +22 dBm, 3rd order intercept point. Operation is specified for a supply as low as 9 V. The amplifier is housed in a 0.7 × 0.7 × 0.34-in. module.

CIRCLE NO. 380

Data-acquisition systems reduce measurement \$

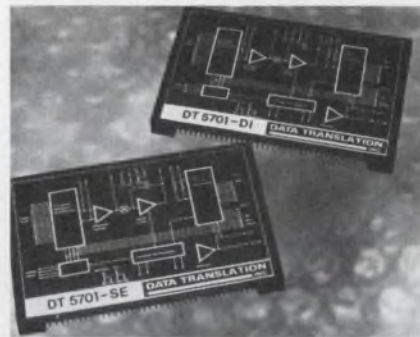

Data Translation, 109 Concord St., Framingham, MA 01701. (617) 879-3595. See text; stock.

A complete 12-bit, 16-channel, data-acquisition module, the DT-5701, is claimed to cut costs to the bone. It contains a 16-channel multiplexer, buffer amplifier, high-speed sample/hold amplifier, 12-bit a/d and all control and programming logic. The DT5701 costs only \$175 (100-pc lots). All outputs are three-state TTL buffered for direct connection to microcomputer busses. Additional features include: 35-kHz throughput rate, random or sequential multiplexer addressing and multiple shielding against EMI/RFI noise. Pin strapable input ranges of ±5, ±10, 0 to +10, 0 to +5 V are available.

CIRCLE NO. 381

F-16
CUSTOM HYBRIDS
 by **CTT**
 will be aboard!

Circuit Technology, Inc.
 160 Smith St. Farmingdale, N.Y. 11735
 (516) 293-8686 • (213) 374-7446

CIRCLE NUMBER 96

Need an RF amplifier?



DON'T BUY ENI....

until you consider the wide selection of quality amplifiers available from Amplifier Research. We offer the world's largest selection of standard high-power RF broadband amplifiers. So, if you're considering an ENI unit, simply tell us the model number and we'll send you specifications on our competitive unit.

Amplifier Research. Not a second source. Your best source for RF power amplifiers.

AR **AMPLIFIER RESEARCH**

Amplifier Research
 160 School House Road
 Souderton, Pa. 18964

YOUR BEST SOURCE FOR RF POWER AMPLIFIERS

CIRCLE NUMBER 97



**RELIABLE
HIGH-VOLTAGE
INTERCONNECTIONS
FROM
ROWE
INDUSTRIES**

**WORLD'S LEADER IN
HIGH-VOLTAGE, CORONA-
FREE CONNECTORS**

We design, develop and manufacture the hard ones. Over 600 Rowe designs are tooled. **PHONE US TODAY.**

**ROWE SUBMINIATURE
COAXIAL CONNECTORS
& CABLE ASSEMBLIES**
Ideally suited for use where space is at a premium.

APPLICATIONS:

- Airborne
- Radar
- Laser
- ECM
- X-Ray
- Displays
- Power Supplies

15 KVDC. Silicone rubber insulation.
Temp. — 55°C to 200°C.

CALL OR WRITE ROWE INDUSTRIES TODAY
(419) 729-9761 • 6233 BENDORE ROAD • TOLEDO, OHIO 43612

CIRCLE NUMBER 98

What every IC system designer needs is easy to get.

Cambion's Integrated Packaging catalog 119A has 70 pages full of products for the designer. Breadboards, Wire-Wrap* cards, card files and hardware, logic assemblies, power supplies, sockets. These are only a few of the quality Cambion products featured. Write today for your **FREE** copy, Cambridge Thermionic Corporation, ED-1, 445 Concord Avenue, Cambridge, MA 02138.



Standardize on

CAMBION®

The Guaranteed Electronic Components

*Reg. TM Gardner Denver Co.

CIRCLE NUMBER 100

Bodine's PM drive family grows—

New 32D permanent magnet Control Motors and 32D-5F right angle gearmotors, perfectly matched with Bodine speed/torque controls. Continuous duty ratings of 1/12, 1/10 and 1/8 Hp at 2500 Rpm. See your Bodine Distributor or write for Cat. CDC-PM.

New 32-frame PM motors and gearmotors!



**BODINE
ELECTRIC
COMPANY**

ADE (After Delivery Economies) make Bodine a better fhp buy

Bodine Electric Company, 2500 W. Bradley Place, Chicago, IL 60618.

CIRCLE NUMBER 99

The GOULD/Brush 2600. Versatility unlimited in a direct writing recorder.



Announcing the new, high performance Gould 2600—undoubtedly the most versatile recorder available today. The 2600 features an unequalled frequency response of 30 Hz at 100 mm and 50 Hz at 50 mm with 99.65% linearity. A servo-controlled penmotor assures precise response, while the famous Gould pressurized inking system produces the highest quality rectilinear traces.

You can order the 2600 with three 100 mm channels. Or with one 100 mm channel and four 50 mm channels. Or with six 50 mm channels.

Call your nearest Gould Sales Engineer or write Gould Inc., Instrument Systems Division, 3631 Perkins Avenue, Cleveland, Ohio 44114. Or Gould Allco SA, 57 rue St. Sauveur, 91160 Ballainvilliers, France.

**TOLL FREE NUMBER
(800) 325-6400
(In Missouri (800) 342-6600)**



GOULD

CIRCLE NUMBER 101

INSTRUMENTATION

Graphics system offers storage tube & refresh



Tektronix, P.O. Box 500, Beaverton, OR 97077. (503) 638-3411. \$27,000; 16 wks.

The 4081 graphics system is the first of a series of computer-based systems combining both refresh and storage graphics. The new product is designed to serve as an intelligent graphics terminal, which performs scaling transformations, translation, zooming, clipping, rotation and character generation. Users can now combine dynamic picture manipulation with a highly detailed picture display having up to 20,000 in. of total image. The 4081's price includes two processors, a 19-in. display, a tape cartridge drive, an ASCII keyboard, 12 function keys, a joystick and an RS-232-C communications interface.

CIRCLE NO. 382

Guided-probe unit joins board testers

Teradyne, 183 Essex St., Boston, MA 02111. (617) 482-2700. About \$35,000; 90 days.

The M150 automatic prober is intended for use on the company's L100-series circuit board test systems and is expected to increase fault-diagnosis throughput up to tenfold over manual probing techniques. It is said to significantly reduce the time needed for job-plan preparation, ECO updating, and test-plan debugging. Only three plug-ins are required to connect the prober to the test system. Each prober is supplied with a new software package that adds automatic probing capability to the control program.

CIRCLE NO. 383

DMM measures true rms and also temperature



Philips Test & Measuring Instruments, 400 Crossways Park Dr., Woodbury, NY 11797. (516) 921-8880. \$1395.

Model PM 2527 DMM includes true rms and temperature in its measurement repertoire. Ranges are: dc voltage from 10- μ V resolution to 1000-V fs deflection, with an accuracy of 0.02%; ac voltages cover the same range with bandwidth of 30 Hz to 100 kHz; resistance up to 2000 M Ω ; current with 1000-pA resolution for dc and 1-nA for ac. Surface temperature measurements range between -60 and +200 C. The instrument measures surface temperatures to 99% of final value within 10 s.

CIRCLE NO. 384

1.5-MHz analyzer gives $\pm 0.01\%$ accuracy



Quan-Tech, Randolph Park W., Randolph, NJ 07801. (201) 361-3100. \$3750; 10-12 weeks.

Wave and spectrum analyzer. Model 2525, provides frequency measurement over a range of 1 kHz to 10.5 MHz with selectable bandwidth of 200, 1000 and 3000 Hz. Accuracy is $\pm 0.01\%$, with a resolution of 100 Hz. Outstanding features include electronic tuning with a stable VCO that can be manually tuned or automatically scanned. Electronic sweep time is selectable at 5, 50, and 500 s and covers analysis windows of 15 kHz, 150 kHz and 1.5 MHz. Frequency readout is provided by a 5-digit LED display.

CIRCLE NO. 385

CIRCLE NUMBER 102 ►

Got a crash project?



If it calls for power supplies, amplifiers or bridges — call the "Instrument Professionals" whatever the task, they can help you match your equipment needs to your budget, insuring on-time delivery to keep your project on schedule!

Write or call for data on our other specialties: Instrument Leasing • Computer Peripherals • Equipment Sales • Instrument Service.

Call  Get our FREE Catalog

Continental Rentals

Div. Continental Leasing Co., Inc.
175 Middlesex Turnpike, Bedford, MA. 01730 (617) 275-0850

Metuchen NJ, (201) 549-8500; Gaithersburg, MD (301) 948-4310; Dallas, TX (214) 357-1779; Elk Grove, IL (312) 439-4700; Costa Mesa, CA (714) 540-6566; Santa Clara, CA (408) 735-8300; Los Angeles, CA (213) 477-7521

INPUT/ OUTPUT

Connection Systems

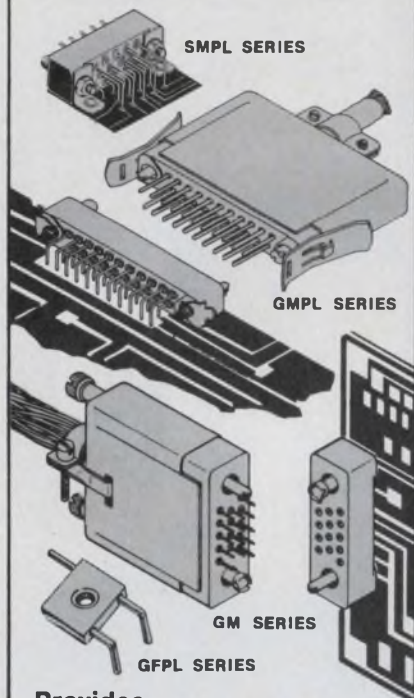

Provides

1. Reduction of Assembly Time
2. Reliability
3. High Density
4. Stock Availability

Specifications

- **Sizes** — Miniature and subminiature
- **Contacts** — .150 and .094 spacing, #20-#30 wire size
- **Contact Arrangements** — 2 through 50
- **P.C. Board Mountable Connector** — Pin or socket contacts, straight or 90° angled
- **Cable Connector** — Pin or socket contacts — crimp removable, solder, or wrap post
- **Accessories** — Polarized guides or threadlocks, metal shells, hoods, and strain reliefs



**POSITRONIC
INDUSTRIES INC.**

208 West Center
Rogersville, Missouri 65742
CONNECTOR DIVISION 417-753-2851 Telex 436445

Representatives and distributors located throughout United States, Canada, and Europe.

Send for catalogs. Samples available for specific applications.

CIRCLE NUMBER 103

New Literature



Interconnections

The 64-page M400 printed-circuit interconnection catalog includes drawings and specifications of sockets, connectors and interconnection systems. Molex, Lisle, IL

CIRCLE NO. 386

50-A triacs

The 50AC series of triacs is described in a four-page data sheet. The data sheet presents device ratings and electrical and mechanical specifications. International Rectifier, Semiconductor Div., El Segundo, CA

CIRCLE NO. 387

Digital panel meters

A 20-page guide to selecting and applying a digital panel meter contains discussions of digital vs analog displays, definitions of DPM specifications, circuit and system applications and general DPM configurations. Analog Devices, Norwood, MA

CIRCLE NO. 388

Terminal & data station

Three data sheets describe plug-in options for the HP Model 2640A CRT terminal and 2644A mini data station. Hewlett-Packard, Palo Alto, CA

CIRCLE NO. 389

Dc parametric tester

Specifications and application information on the Model IT-200 dc parametric tester are given in a 12-page catalog. Siemens, Cherry Hill, NJ

CIRCLE NO. 390

Semi screening report

An "Annual Screening Summary Report" on electronic components for 1975 contains information gathered on over 5-million parts. It includes type of part, industry part number, total quantity screened and the number failing in each test to which the lot was subjected. Continental Testing Laboratories, Fern Park, FL

CIRCLE NO. 391

1-k RAM

Detailed dynamic and static electrical characteristics, temperature characteristics, test circuits, waveforms and typical driving and sensing circuits for the MW-7001ID NMOS RAM are given in a data bulletin. RCA Solid State Div., Somerville, NJ

CIRCLE NO. 392

PROMBiTS newsletter

PROMBiTS, a bi-monthly newsletter, is designed to inform readers about programmable logic, which encompasses PROMs and FPLAs. Data I/O, Issaquah, WA

CIRCLE NO. 393

Custom hybrids

Design advantages of custom hybrid circuit packaging are covered in an eight-page brochure. Tips for the designer, an ordering guide and quality and reliability notes make this brochure a handy tool. Teledyne Crystalonics, Cambridge, MA

CIRCLE NO. 580

Data logger

A detailed description, specifications and prices of the Digi-trend 200 digital multipoint data logger and/or alarm scanner are provided in a 16-page brochure. Doric Scientific, San Diego, CA

CIRCLE NO. 581

Thick-film products

A short-form catalog describes almost 100 products used in the manufacture of thick-film, micro-circuit and optoelectronic products. Methode Development, Chicago, IL

CIRCLE NO. 582

Rental instruments

Within a 60-page catalog are detailed descriptions on more than 5000 test instruments available from the country's leading manufacturers that GE offers on either short or long-term rental. Equipment is cross-referenced alphabetically and by manufacturer. General Electric, Instrumentation & Communications Equipment Service, Schenectady, NY

CIRCLE NO. 583

Audio indicators

Solid-state audio indicators, in a wide range of shapes and sizes, plus two models of plastic panel mounts and a solid-state circuit test set are pictured in a 16-page catalog. The catalog shows dimensions and lists specifications and characteristics for all models. Projects Unlimited, Dayton, OH

CIRCLE NO. 584

Synchronous motors

Dual-speed unidirectional and single-speed reversible synchronous motors are highlighted in a 4-page catalog. Provided are dimensional drawings, performance specifications, wiring diagrams and parts selection information. North American Philips Controls, Cheshire, CT

CIRCLE NO. 585

Transformers & filters

Over 3000 standard transformers and filters are covered in a 40-page catalog. Decco, Dallas, TX

CIRCLE NO. 586

Electronic connectors

Commercial electronic connectors are described in a 16-page brochure. Competitive cross-references and ordering information are furnished. Bunker Ramo, Industrial Div., Chicago, IL

CIRCLE NO. 587

TMI CLADS CLICK WITH POLAROID

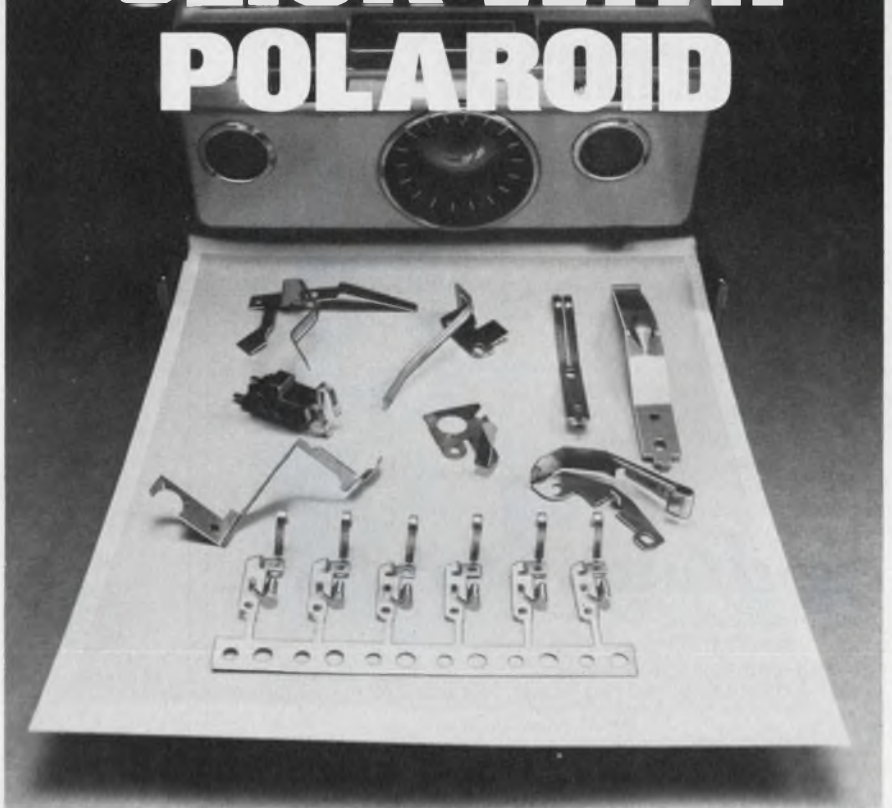

Polaroid uses TMI clad contact springs in both their Square Shooter and their SX 70 cameras for the best of reasons. Economy. Ease of Manufacturing. Reliability.

ECONOMY. Where sliding friction makes the use of silver alloy possible (such as the battery clip). TMI provides Polaroid with a coin silver contact. And where gold contacts are required (low voltage passing through the electronic shutter), Polaroid has found that TMI's 14 karat gold alloy inlay meets their performance requirements at a 50% gold savings over 24 karat gold.

EASE OF MANUFACTURING. When Polaroid selected clad contacts, a prime consideration was that cladding would allow the stamper to provide a one-step, completed assembly rather than having to rely on multiple sources inherent with either plating or welded contacts. A second consideration was the different stresses each of the springs would be subjected to. Here, Polaroid engineers were able to utilize base spring metals that included stainless steel, nickel silver, phosphor bronze, and beryllium copper.

RELIABILITY. Polaroid cameras are in use from the tropics to the Antarctic and continue to function time after time with exceptional reliability. If you're beginning to get the picture, why not write to TMI and see what we can develop for you.



TECHNICAL MATERIALS, INC.

5 Wellington Road, Lincoln, Rhode Island 02865
Telephone 401-728-7200

CIRCLE NUMBER 104

now— microwave filters with ceramic performance!

Murata's new line of Gigafil-C[®] filters with ceramic dielectric resonators bring a new standard of performance to the microwave frequency spectrum. They are available for frequencies from 760 MHz to 14 GHz, with Q's over 5,000, and in a variety of bandwidths. Outstanding features also include diminutive size and amazing temperature stability. Put ceramic to work in your microwave system. Write for details.

actual size

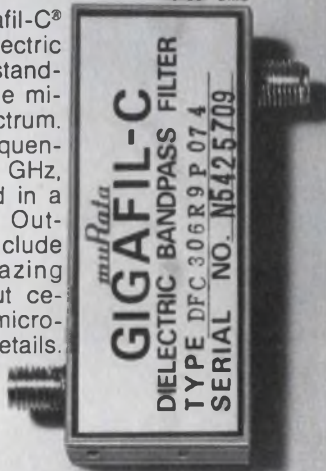

muRata
CORPORATION OF AMERICA
2 WESTCHESTER PLAZA, ELMSFORD, NEW YORK 10523
Phone: 914-592-9180 Telex: 13-7332

CIRCLE NUMBER 106

BASIC DESIGN — CUSTOM BUILT

Model 90



ROTARY CERAMIC SWITCHES

for RF and Power Applications

R.S.C. switches are available in various models that can be customized to meet your particular requirements.

Model 88

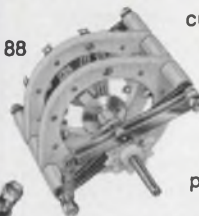

Model 86



All switches have heavily silver plated current carrying components for long life and minimum maintenance.

Model 80



Types include shorting and non-shorting, single and multi-deck, 10 to 100 amp capacity, 20° - 90° detents, and 2,000 to 24,000 volt peak flashover.

Write for catalog No. 960



RADIO SWITCH CORPORATION

RT. 79, MARLBORO, N.J. 07746
PHONE: 201-462-6100

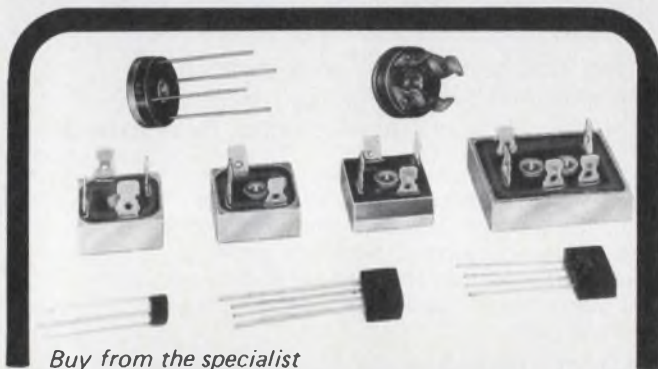

Buy from the specialist

Rectifier Bridges

Peak Reverse Voltages from 50 to 1,200 • Currents from 1 to 30 Amp • For P.C. and power terminal mounting • For Heat Sink and Chassis Mounting • Single and 3-phase. Center Tapped and Doubler • Standard and U.L. Component Recognition Types
Standard and Fast Recovery • Many unique features
Attractive Prices

edi[®] Free Samples
Write for catalog. Describe application and we will provide free samples and our best low prices.

electronic devices inc.

21 GRAY OAKS AVE., YONKERS, N.Y. 10710
(914) 965-4400 TWX (710) 560-0021 TELEX 13-1580

CIRCLE NUMBER 107

Rose enclosures. New. Beautiful. Quality. Standards.



Rose Enclosures, made specifically for electronic use, culminate years of design, engineering and production experience. Extra high quality, precision-finished units provide functional protection, easy access, excellent esthetics. Available materials: Lexan, Aluminum, Polyester and ABS. Clear plastic covers with Lexan and ABS. A competitively-priced stock of Rose Enclosures is maintained in Belding, Mich. for immediate shipment. Contact us at (616) 794-0700.

STAHLIN
BROTHERS, INC.
Belding, Michigan 48809

CIRCLE NUMBER 109

ELECTRONIC DESIGN 11, May 24, 1976

Evaluation Samples

Temperature decals

Self-contained, self-adhesive temperature decals give a "verbal" reading at a calibrated temperature. Temperatures can be selected from 100 to 160 F (40 to 70 C). The size of the decals is 3/4 x 3/4 in. William Wahl, Temp-Alert Div.

CIRCLE NO. 588

DPDT toggle switch

Model 9201 miniature DPDT toggle switch is designed to meet international electrical specifications. Specs include an electrical life of 25,000 make-and-break cycles at full load; contact rating of 6 A with resistive load at 120 V ac or 28 V dc, 3 A with resistive load at 250 V ac; insulation resistance of 20,000 M Ω (min) and dielectric strength of 1500 V rms at sea level. C&K Components.

CIRCLE NO. 589

Nylon bolts

Molded nylon bolts are made of tough, durable lightweight nylon. They are nonmagnetic, have a high dielectric strength and are solvent resistant. Sizes range from 5/16-18 to 5/8-11 thread diameters in 1/2 to 3-in. lengths. Weckesser Co.

CIRCLE NO. 590

Potentiometers

A low-cost, 10-turn, 3/4-in. short wirewound Scot Pot offers a resistance range of 100 Ω to 100 k Ω , independent linearity of $\pm 0.25\%$ standard ($\pm 0.05\%$ available), more than 1-million revolution life and resistance wire tempco of ± 20 ppm/ $^{\circ}$ C max. Power rating is 2 W at 70 C, derated to zero at 125 C; over-all operating temperature ranges from -55 to 125 C. Standard resistance values are 100, 200, 500, 1000, 2000, 5000, 10,000, 20,000, 50,000 and 100,000 Ω . For a free sample, specify desired resistance value and send your request on company letterhead to Bunker Ramo Connector Div., 2801 S. 25th Ave., Broadview, IL 60153

INQUIRE DIRECT

Vendors Report

Annual and interim reports can provide much more than financial position information. They often include the first public disclosure of new products, new techniques and new directions of our vendors and customers. Further, they often contain superb analyses of segments of industry that a company serves.

Selected companies with recent reports are listed here with their main electronic products or services. For a copy, circle the indicated number.

MSI Data. Data entry products and systems.

CIRCLE NO. 591

Astrosystems. Industrial controls and automatic test equipment, automatic drafting systems and plug-compatible memories.

CIRCLE NO. 592

Zero Manufacturing. Electronic enclosures.

CIRCLE NO. 593

Portescap. Components for watches, industrial horology, dc micromotors and stepping motors. Report published in French, German and English.

CIRCLE NO. 594

Intelsat. Telecommunications satellites.

CIRCLE NO. 595

Park Electrochemical. Adhesive bonding films, printed-circuit materials, metal nameplates and decorative trim.

CIRCLE NO. 596

Electronic Arrays. MOS/LSI products, semiconductor masks, microprocessors and memories.

CIRCLE NO. 597

Sperry Rand. Computers; fluid power equipment; gyroscopic, radar, microwave and avionics instruments; navigation, guidance and control system instruments for aviation, and consumer products.

CIRCLE NO. 598

NEW MICRO- PROCESSOR POWER SUPPLIES

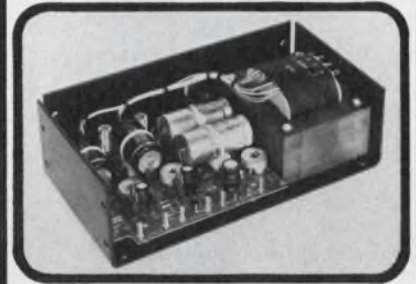

MICRO PRO SERIES

BROADEST LINE AVAILABLE —

4 INDUSTRY STANDARD CASE SIZES; 7 MODELS

LOWEST PRICES —

8080 RATED **\$31⁹⁶**
MODEL ICMP *

FEATURES:

- Ability to power any microprocessor and its associated RAM'S, ROM'S, PROM'S, FEPROM'S, clock and IO chips
- 4 case sizes and 7 models covering microprocessor as well as standard triple output 5V, $\pm 12/15$ V applications
- Overvoltage protection standard on all models
- Black anodized chassis, Blue G10 epoxy circuit board and teflon wiring used on all units
- Quality components and workmanship, one-year warranty parts and labor
- Custom designs available at cost savings you won't believe

* 100 pc pricing (for 1 pc. add 25%)

FOR INFORMATION CONTACT

ALPHA
POWER

9020 Eton Avenue
Canoga Park, Calif. 91304
Phone (213) 998-9873

CIRCLE NUMBER 110

Smallest 2A Reed Relay!



COTO'S NEW MICRO-MINIATURE Reed Relays

- Wide variety contacts 1A, 2A, 1C, or 1A (Hg. wet)
- Uses only .17 sq. in. pc board space. Package dimen. .210" x .225" x .810"
- Choice of coil resistances at 5 or 12 VDC
- Encapsulated in epoxy-coated metal can
- Electrostatic or coaxial shielding for R.F. switching

Write or Call for Bulletin 14.1



**COTO-COIL
COMPANY, INC.**
59 Pavilion Avenue
Providence, R. I. 02905
Phone (401) 467-4777

CIRCLE NUMBER 111

Maxipower Pulse Generator puts outs over 30Kw!

Cober's maxipower Model 606, 31Kw pulse generator lets you select positive, negative or bipolar pulses. Drives grids of power tubes, electron guns, sparkgaps or use it for field emission, gas discharge and plasma studies as well as for component testing, spectroscopy, laser applications and more. 2500V @ 12.5A (or other voltage/current combinations) with 50ns-10ms pulse widths. Rep rates from 1 shot-1MHz. Only 20ns rise time. Need 5000V or 25 Amps or alternating polarity pulses? Put two 606's together. Off-the-shelf and 20 years hi-power experience too. Write or phone today for all facts and prices on Cober Model 606 and our other pulse generators and modulators.

Cober
electronics, inc.

"THE HIGH POWER PEOPLE"

7 Gleason Avenue, Stamford, CT 06902
Phone: 203/327-0003 TWX: 710/474-3371



CIRCLE NUMBER 112

Electronic Design

Advertising Sales Staff

Tom W. Carr, Sales Director
Jean Bunfield, Sales Coordinator

Rochelle Park, NJ 07662

Robert W. Gascoigne
Daniel J. Rowland
Thomas P. Barth
George Mortimer
Stan Tessler
50 Essex St.
(201) 843-0550
TWX: 710-990-5071

Philadelphia

Thomas P. Barth
(201) 843-0550

Boston 02178

Gene Pritchard
P.O. Box 379
Belmont, MA 02178
(617) 489-2340

Chicago 60611

Thomas P. Kavooras
Berry Connor, Jr.
200 East Ontario
(312) 337-0588

Cleveland

Thomas P. Kavooras
(312) 337-0588

Los Angeles 90045

Stanley I. Ehrenclou
Burt Underwood
Neil Canavin
8939 Sepulveda Blvd.
(213) 641-6544

Texas

Burt Underwood
(213) 641-6544

San Francisco

Robert A. Lukas
3579 Cambridge Lane
Mountain View, CA 94040
(415) 965-2636

London

Constance McKinley
50 Essex St.
Rochelle Park, N.J. 07662
Phone: (201) 843-0550

Amsterdam, Tokyo, Seoul

Sanders, B. V.
Raadhuisstraat 24
Graft-De Ryp, Holland
Phone: 02997-1303
Telegrams: Euradteam-Amsterdam

Haruki Hirayama

Electronic Media Service
5th Floor, Lila Bldg.,
4-9-8 Roppongi
Minato-ku, Tokyo, Japan
Phone: 402-4556
Cable: Electronicmedia, Tokyo
Mr. O-kyu Park, President
Dongbo Intl Corp.—
World Marketing
C.P.O. Box 4010
Seoul, Korea
Tel. 76-3910/3911
Cable: DONGBO SEOUL
Telex: EBKOREA K27286



Electronic Design

ELECTRONIC DESIGN's function is:

- To aid progress in the electronics manufacturing industry by promoting good design.
- To give the electronic design engineer concepts and ideas that make his job easier and more productive.
- To provide a central source of timely electronics information.
- To promote communication among members of the electronics engineering community.

Want a subscription? ELECTRONIC DESIGN is sent free to qualified engineers and engineering managers doing design work, supervising design or setting standards in the United States and Western Europe. For a free subscription, use the application form bound in the magazine. If none is included, write to us direct for an application form.

If you do not qualify, you may take out a paid subscription for \$30 a year in the U.S.A., \$40 a year elsewhere. Single copies are \$1.50 each.

If you change your address, send us an old mailing label and your new address; there is generally a postcard for this bound in the magazine. You will have to requalify to continue receiving ELECTRONIC DESIGN free.

The accuracy policy of ELECTRONIC DESIGN is:

- To make diligent efforts to ensure the accuracy of editorial matter.
- To publish prompt corrections whenever inaccuracies are brought to our attention. Corrections appear in "Across the Desk."
- To encourage our readers as responsible members of our business community to report to us misleading or fraudulent advertising.
- To refuse any advertisement deemed to be misleading or fraudulent.

Microfilm copies are available of complete volumes of ELECTRONIC DESIGN at \$19 per volume, beginning with Volume 1, 1952 through Volume 20. Reprints of individual articles may be obtained for \$3.00 each, prepaid (\$5.00 for each additional copy of the same article) no matter how long the article. For further details and to place orders, contact the Customer Services Department, University Microfilms, 300 North Zeeb Road, Ann Arbor, Michigan 48106 telephone (313) 761-4700.

Want to contact us? If you have any comments or wish to submit a manuscript or article outline, address your correspondence to:

Editor
ELECTRONIC DESIGN
50 Essex Street
Rochelle Park, N.J. 07662

classified ad

DATAPRODUCTS

Dataproducts is the recognized leading manufacturer of line printer products. Planned growth to penetrate new markets offer outstanding professional opportunities in California. Our facilities are located in Woodland Hills (10 miles northeast of Malibu Beach) and in Sunnyvale (San Francisco Bay Area).

We have immediate openings in both locations for junior, senior level engineers and Sr. Project Engineers in Advanced Development, Product Development and Product Support Programs involving next generation computer peripheral equipment. This will involve the development of new impact and non-impact printing technologies.

★ ELECTRICAL ENGINEERS ★

•Analog Circuit Design •Logic Design •Firmware •Microprocessors •Servo Design •Motor Design •Power Supplies

★ MECHANICAL ENGINEERS ★

•Electro-mechanical design •Mechanisms •Servo Design

★ COMPONENTS/STANDARDS ENGINEERS ★

•Electronic components •Electro-mechanical components •Circuit Design

Positions available require BS with MS preferred. Individual should have 2 plus years experience in related field.

Get the details today. Send complete resume including salary history and requirements to Guy Carter, Employment Manager, Dept. CC, 6219 DeSoto Ave., Woodland Hills, California 91365.

Equal Opportunity Employer



Dataproducts

Bicentennial Issue

Electronic Design 4

\$4
JUST

SUPPLY
LIMITED



We've saved a limited number of copies of the unique 254-page February 16th Bicentennial issue of *Electronic Design*. It traces the historic and technological developments of the electronics industry from the Colonial period to today.

In a message from the White House published in the Bicentennial issue, President Ford commends the issue as "a special part" of our nation's 200th anniversary.

If you'd like an extra copy as a memento of this historic event, we'll be happy to provide it at \$4.

Hurry! When the supply runs out you'll have to wait another hundred years for anything like it!

Bicentennial Issue Electronic Design

Hayden Publishing Company, Inc.
50 Essex St., Rochelle Park, N.J. 07662

Please send me _____ copy (copies) of *Electronic Design's* February 16 Bicentennial issue at \$4 each. I enclose my check for _____.

Name _____

Title _____

Company _____

Address _____

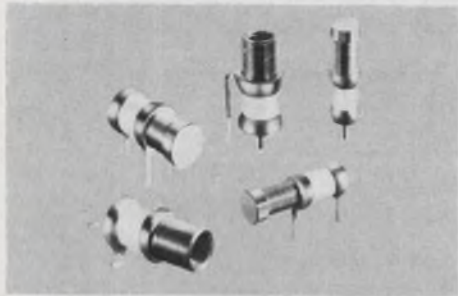

MINIATURE LOW INDUCTANCE CAPACITORS, 50% more capacity in the same size is now available in these Johanson extended range capacitors. Beautiful for microwave, VHF and UHF applications, they offer fine tuning, ultra high Q, low temperature coefficients and "sizes" for hybrid and microcircuit as well as standard applications. Featured are capacitance range .5 to 5.0 pf, $Q > 10,000 @ 100 \text{ MHz}$, and extra fine tuning. Johanson Manufacturing Corporation, Rockaway Valley Road, Boonton, NJ 07005 (201) 334-2676.

MINIATURE CAPACITORS

181



Free New '76 catalog contains over 34,500 quality power supplies from the world's largest manufacturer, Power/Mate Corp. Power Supplies for every application including submodulars, open frame, variorated, encapsulated, laboratory & system. All units UL approved and meet most military and commercial specs for industrial and computer uses. Power/Mate Corp., 514 S. River St., Hackensack, NJ 07601 (201) 343-6294

POWER SUPPLIES

184

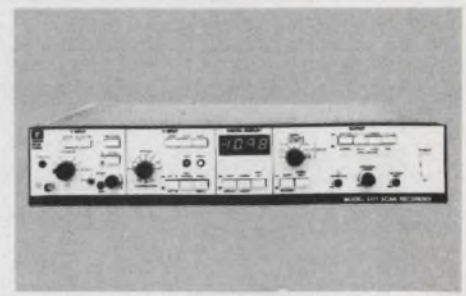

NEW MODEL 4101 SCAN RECORDER. Interfaces with analog measurement or analytical instruments. Digitizes, stores, displays spectra as waveforms, or can calculate and display two curves' sum, difference, or ratio. Baseline-compensates data, normalizes spectra, accelerates or slows data; useful as digital memory for a scope, transient recording, computer interfacing, timebase conversion. Princeton Applied Research Corp., P.O. Box 2565, Princeton, NJ 08540

SCAN RECORDER #341

187

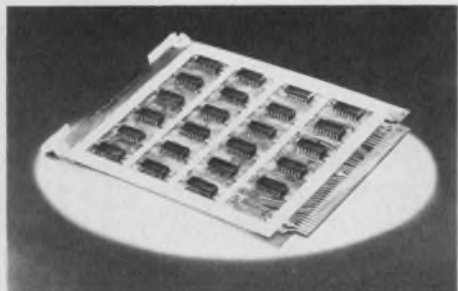

T2L Power Distribution—Noise attenuation and highest packaging density for P.C. boards with T2L logic are yours with Mini/Bus®, the Rogers way to eliminate the cost of multilayer boards by off-board power distribution. Rogers Corporation, Chandler, AZ 85224. Phone (602) 963-4584.

PC POWER DISTRIBUTION

182



NEW LOW COST SERIES 20 TEMPERATURE MONITORS tell you positively when a specified temperature is reached. Designed for volume use in production quality control, warranty protection and shelf-life or transit monitoring. In use on circuit boards, motors, electronic components. The peel-off, self-stick monitors are packaged 20 to a card. Temperature is printed on each monitor. Sample offer: 20 monitors-\$2. Specify rating. Avail. 100°-400°F. Tempil Div., Big Three Industries, Inc., So. Plainfield, NJ 07080. (201) 757-8300

TEMPIL TEMPERATURE MONITORS

185



ANTI-STATIC SYSTEMS FOR PRINTERS, OCR COM and other machines. Static causes rapidly moving paper and film to jam. . . cause arc tracks on undeveloped film. . . attract and hold dust to photographic negatives causing imperfections on printed circuit boards. Numerous products, of interest to both OEM and user, are detailed in new 32 page catalog to solve these problems quickly, reliably and economically. Chapman Anti-Static Div., Portland Co., 58 Fore St., Bx 427, Portland, ME 04112. (207) 773-4726

ANTI-STATIC SYSTEMS

188

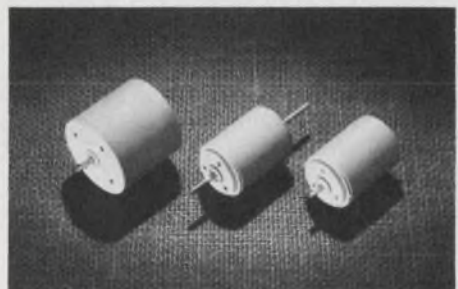

MINIATURE IRONLESS ROTOR DC MOTORS offer efficiencies to 80%, low inertia, rapid response and high starting torque. 24 and 12 VDC models available. Motor time constants are 17 and 23 MS respectively. Rotor torque is 100 and 50 gcm and starting torque 600 and 230 gcm, respectively. 12 VDC units can be ordered with either a single or extended double shaft. Tach versions also available. For reel and capstan drives, chart and pen drives, etc. North American Philips Controls Corp., Cheshire, Conn. 06410. (203) 272-0301.

IRONLESS ROTOR

183

COLUMN PRINTER KIT
in easy to evaluate form.

\$399.

HYCOM
16841 Armstrong Ave.,
Irvine, Ca. 92714,
(714) 557-5252

High speed, non-impact PRINTER
+
Alphanumeric DRIVER PRINTER
+
Permanent metallic surface PAPER
+
High impact CABINET
+
Compact regulated POWER SUPPLY
= Complete COLUMN PRINTER

PRINTER KIT

186



This hands-on, laboratory-based conference, July 12-16, 1976 will enable participants to design microprocessor based systems. Limit of 24. Will use class mini-computer systems and 8 microcomputer based setups with individual teletypes. One session reserved for student problems. Fee is \$295. ELECTRICAL ENGINEERING, IOWA STATE UNIVERSITY, Ames, Iowa 50011. (515) 294-3016 or 2663.

MICROCOMPUTER COURSE

189



LOW COST MAGNETIC FLUX DETECTOR Model FD01 series provides continuous north reference when used with directional gyro or servo compass. TSO'd for autopilots and ideal for guidance and control systems for RPV's, drones, marine vehicles, buoys. Sensing element uses flux gate windings suspended in pendulous position. Freedom to $\pm 45^\circ$ pitch and roll. Operates on 14 mA, frequency 400-Hz. 2.28" dia. x 1.91" high. Humphrey, Inc., 9212 Balboa Ave., San Diego, CA 92123. (714) 565-6631.

FLUX DETECTOR

190

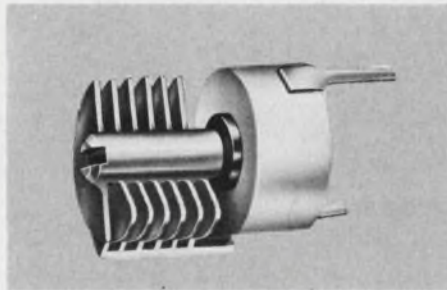

High performance Type "T" sub-miniature machined-plate capacitors. Rotors and stators machined from solid brass extrusions provide excellent stability and uniformity. High Q, low temp. coefficient (plus $30 \pm \text{ppm}/^\circ\text{C}$). Available in horizontal and vertical tuning for PC and stripline mounts. E. F. Johnson Co., Waseca, MN., (507) 835-5222.

TYPE "T" CAPACITOR

193

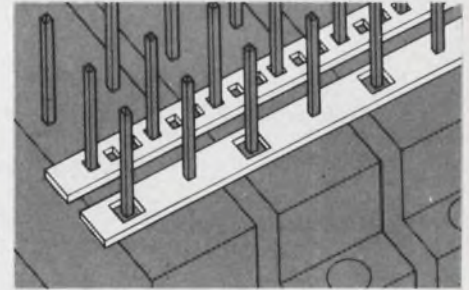

STRIP/BUS BY ROGERS. Low Cost Bussing Systems; easy installation, reliable solder joints; greater pin exposure. Write or call for details. Rogers Corporation, Rogers, CT 06263. Phone (203) 774-9605.

STRIP/BUS

196



RCA FLAMEPROOF FILM RESISTORS. Design engineers prefer them because they won't flame or short under the most severe conditions. These resistors have a 2% tolerance, and are available in 1/4 watt, 1/2 watt, 1 watt, and 2 watt ratings. Resistance values range from 10 Ohms to 1.5 Megohms, depending on wattage rating. 475 film resistors to choose from. RCA Distributor & Special Products Division, Sales Promotion Services, Cherry Hill, N. J. 08101.

FILM RESISTORS

191

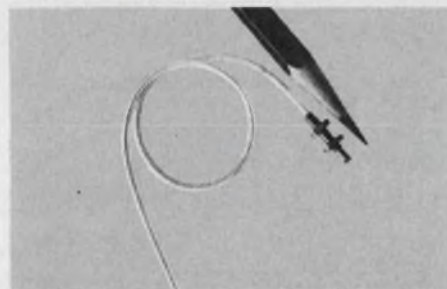

World's Smallest Displacement Transducer. Make precision, noncontacting displacement measurements at points never before possible. This new transducer, 0.080" OD, gives accuracy of $< 100 \mu\text{in.}$ in a range up to 0.020". Temperature stable. Repeatability and resolution is better than $10 \mu\text{in.}$ Price \$485, including associated electronics. Kaman Sciences Corporation, P. O. Box 7463, Colorado Springs, CO 80933. (303) 599-1892.

TRANSDUCER

194



Low-cost tape reader is fast—up to 300 cps—and quality-built. Dual sprocket drive, a state-of-the-art fiber optic light source and photo transistor read head. Simplicity of design makes it easy to adapt to specific OEM requirements. Decitek, 250 Chandler Street, Worcester, MA 01602 (617) 798-8731

SAM® TAPE READER

197

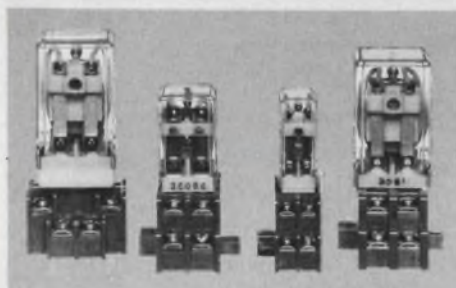

Design Engineer's favorite relays are now available with three major features: •Extremely simple construction •Only one screw fixing and far less soldering than any other relays of this type •Well integrated without wiring connections. For Relay catalog and information, please contact: Idec S & C Corp., 3553 Ryder St., Santa Clara, CA 95051 Tel: (408) 738-4332

RELAYS

192

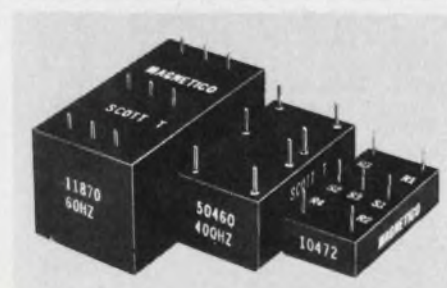

Scott T Transformer. 11870: 60HZ, 90v, L-L in. 1.1x2.1x1.1. 50460: 400 HZ, 90v, L-L in. 7/8x1-5/8x11/16. 50642: 400HZ, 11.8v, L-L in. 7/8x5/8-11/16. 10472: 400-HZ, 11.8v, L-L in. 3/4x1-1/2x3/8. All with 6v RMS sine & cosine output. MAGNETICO, INC., 182 Morris Ave., Holtsville, N.Y. 11742 516-654-1166.

TRANSFORMER

195



Overcurrent Protector, manual reset eliminates fuse replacement. Convenient panel mounting. 19 fractional ratings from 0.1 to 5 amp. Other models up to 400 amp. Trip-free and fool-proof, UL and CSA approved. High quality, low cost \$1.33 ea. in 1000 lots. E-T-A Products Co. of America, 7400 N. Croname Rd., Chicago, Ill. 60648. Tel: (312) 647-8303. Telex: 253780.

CIRCUIT BREAKER

198

Advertiser's Index

Advertiser	Page	Advertiser	Page	Advertiser	Page
AMP, Incorporated	8, 9	Fifth Dimension Inc.	127	Omni Spectra, Inc.	34
AVX Ceramics	92	Garry Manufacturing Co.	71	Optron, Inc.	7
Abbott Transistor Laboratories, Inc.	6	General Electric Company, Semi-conductor Products Department	31	PMI Division, Kollmorgen Corporation	130
Acheson Colloids Company	129	Glenair Inc.	124	*Philips Electronic Components and Materials	19
Advanced Micro Devices	43	*Gold Book, The	20, 59	Plessey Semiconductors	70
Allen Bradley Co.	115	Gold Book, The	147	Portland Co., The	144
Alpha Power, Inc.	141	Gould Inc., Instrument Systems Division	136	Positronic Industries Inc.	138
Amerace Corporation Control Products Division	41	*Hayden Book Company, Inc.	115	Power/Mate Corp.	144
Amplifier Research Corporation	135	Heinemann Electric Company	33	Princeton Applied Research Corp.	144
B & K Precision Products of Dynascan	36	Hewlett-Packard 1, 35, 45, 53, 97, 103, 123		Projects Unlimited	82
Belden Corporation	15	Hughes Aircraft Company, Connecting Devices	10	RCA Distributor & Special Products Division, Sales Promotion Services	145
Berg Electronics, Inc.	121	Hughes Aircraft Company, Microelectronic Products Division	11	RCA Solid State	Cover IV
Bodine Electric Company	136	Humphrey, Inc.	145	Radio Switch Corporation	140
Bourns, Inc., Trimpot Products Division	Cover II	Hycom	144	Reader Service Card	148A-B
Buckbee-Mears Company	77	ITT Cannon, A Division of International Telephone and Telegraph Corporation	119	Rental Electronics, Inc.	20
Bunker-Ramo, RF Division	101	ITT Pomona Electronics	112	Rogers Corporation	144, 145
Burdny Corporation	59	ITT Thermotech	82	Rowe Industries	136
Burr-Brown	106	Idec S & C Corp.	145	Scanbe Manufacturing Corp.	126
CTS Corporation	58	Interdata, Inc.	99	Semiconductor Circuits, Inc.	128 A-B-C-D
Cambridge Thermionic Corporation	136	Interdesign, Inc.	19, 134	Sencore	133
Centralab Distributor Products, Globe-Union, Inc.	14, 109	International Rectifier	44	Shigoto Industries Ltd.	130
Chomerics, Inc.	128	Interstate Electronics Corporation	87	Sorensen, A Raytheon Company	46
Circuit Technology, Inc.	135	Johanson Manufacturing Corporation	144	Spectrum Control, Inc.	110
Clare-Pendar	111	Johnson Company, E. F.	116, 145	Sprague Electric Company	49
Cober Electronics Inc.	142	Kalmus & Associates, Inc.	93	Stahl Bros. Inc.	140
Continental Rentals Div. Continental Leasing Co., Inc.	137	Kaman Sciences Corp.	145	Stanford Applied Engineering, Inc.	37
Coto Coil Company, Inc.	142	Kepeco, Inc.	38	TRW Power Semiconductors, an Electronic Components Division of TRW, Inc.	29
Control Data Corporation	96B	Ledex, Inc.	125	Technical Materials, Inc.	139
Crown Industrial	86	Licon, Division of Illinois Tool Works, Inc.	130	Tecnetics	108
Crydom Controls, Division of International Rectifier	126	Litronix, Inc.	83	Tektronix, Inc.	4, 5, 51
Dale Electronics, Inc.	24, 25	Magnetic, Inc.	145	Teledyne Relays, A Teledyne Company	2
Dana Laboratories, Inc.	122	Mepco/Electra, Inc.	104, 105	Teledyne Semiconductor	56
Data General Corporation	96A	Micro Devices Corp.	91	Tempil Division, Big Three Industries, Inc.	144
Decitek	145	Molex, Incorporated	Cover III	Textool	127
Deltron, Inc.	131	MuRata Corporation of America	133, 140	Theta Instrument Corp.	113
Dialight, A North American Philips Company	76	National Semiconductor Corporation	54, 55	Times Wire & Cable Company	12, 13
E-T-A Products Co. of America	145	North American Philips Controls Corp.	144	Triplett Corporation	95
E-Z Hook, A Division of Tektest Inc.	133	North Atlantic Industries, Inc.	114	Unimax Switch Corporation	118
EECO	23			*United States Department of Commerce	125
EMR Telemetry, Weston Instruments Inc.	120			United Systems Corporation	109
Elco Corporation	16, 17			Varo Semiconductor, Inc.	117
Electrical Engineering, Iowa State University	144				
*Electronic Design	14				
Electronic Design	102, 113, 143				
Electronic Devices, Inc.	140				
Emerson & Cuming, Inc.	132				
Esterline Angus Instrument Corporation	130				
Fabri-Tek, National Connector Division	42				

*Advertisers in non-U.S. edition

“Our catalog in the GOLD BOOK paid for itself on the very FIRST DAY!”



Len Kornfeld
Executive Vice President

Len Kornfeld is Executive Vice President of U.S. Box Crafts, Inc., Brooklyn, NY manufacturer of paper, plastic and cardboard boxes and containers. Mr. Kornfeld writes:

“The very first day the GOLD BOOK came out we received inquiries which are converting to orders that will more than pay for our advertising costs. These inquiries are still coming in steadily.

“This was our first try in the electronics industry. The results are extremely gratifying.”

The company normally directs its advertising to the general manufacturing industry. When GOLD BOOK representatives prepared a mock-up, U.S. Box Crafts decided to give it a try.

Mr. Kornfeld adds: **“We wouldn't have gone into the GOLD BOOK at all if you hadn't shown us what we could do. Now we're glad we did.”**

Because the GOLD BOOK goes primarily to *Electronic Design's* audience of specifiers, U.S. Box Crafts gets the benefit of 78,000 engineers, engineering managers and purchasing agents throughout the U.S.A., not to mention 13,000 overseas. These are the men who are ready to talk packaging—the men who have the authority to *buy*.

**THE ELECTRONIC DESIGN AUDIENCE IS WORKING
FOR U.S. BOX CRAFTS, INC. ...IT CAN
WORK FOR YOU**

Electronic Design / GOLD BOOK

HAYDEN PUBLISHING COMPANY, INC.

50 Essex Street, Rochelle Park, New Jersey 07662. Tel: 201-843-0550

Product Index

Information Retrieval Service. New Products, Evaluation Samples (ES), Design Aids (DA), Application Notes (AN), and New Literature (NL) in this issue are listed here with page and Information Retrieval numbers. Reader requests will be promptly processed by computer and mailed to the manufacturer within three days.

Category	Page	IRN	Category	Page	IRN	Category	Page	IRN
Components			transistors, Darlington	127	361	custom hybrid circuits	135	96
audible alarm	107	301	transistors, power	125	349	d/a converters	106	58
audio indicators	103	54	transistors, power	126	356	filter, active	134	377
bar-graph display	108	320	transistors, power	127	360	module, power	134	376
capacitors, electrolytic	49	161				modules, data-acq.	135	381
circuit breaker	33	21	Instrumentation			modules, log ratio	134	378
controller	107	304	amplifiers, rf	135	97	monitor, 3-phase	134	379
display, numerical	108	321	analyzer	137	385			
electronic test access.	112	63	DMM	45	31			
filter, ceramic	107	303	DMM	137	384	Packaging & Materials		
filters, i-f	133	91	DVMs	133	92	board, μ P	121	599
keyboards	116	69	graphics terminal	137	382	boxes, aluminum	120	567
line filters, ac	110	61	oscilloscope, data domain	97	51	breadboard, IC	116	334
motors, dc	130	86	PC-board tester	137	383	cable & cord sets	130	85
motors, gearmotors	136	99	panel instruments	95	50	cable/connector system	18	14
potentiometer	107	305	power amp	86	45	cases, instrument	118	339
reed relays	142	112	pulse generator	87	46	circuits, flexible	77	43
relays, TO-5	2	3	pulse generator	142	111	clad contact springs	139	104
resistor networks	58	38	recorder	130	84	coil forms & bobbins	103	55
resistor networks	108	309	recorder	136	101	connection systems	138	103
resistor networks	109	59	rental instruments	20	16	connector	114	330
resistor, variable	115	68	rental instruments	137	102	connector, cable	120	341
resistors	25	351	scope, 100 MHz	123	275	connectors	10	9
sensors, thermal	107	302	spectrum analyzer	35	23	connectors	34	22
surge arresters, gas tube	108	308	timer/counter	122	289	connectors	101	53
switch catalog	111	62				connectors	124	76
switch, lighted PB	III	253	Integrated Circuits			connectors, edgeboard	37	25
switches, LPB	130	87	a/d converter, 12-bit	56	37	connectors, marine	124	77
switches, PB	125	78	analog switches	111	326	contactor	120	340
tachometer, flat	108	310	control circuit	110	324	cores, memory	114	329
thermal cutoffs	91	47	Darlington	112	327	EMI coatings	129	83
transformer, phone	107	306	driver/receiver, line	110	322	enclosures	140	109
trimmer, carbon	108	307	ICs, custom	19	15	epoxies	132	271
trimmers, miniature	104	56	interfaces	111	325	guides, card	118	337
trimmers, single-turn	105	57	regulators	110	323	handle, instrument	116	333
			thyristor triggers	112	328	handles, equipment	114	332
			wideband amplifier	70	40	heat sinks	118	338
Data Processing						integrated packaging cat.	136	100
analog/FM translator	132	375	Microprocessor Design			interconnections	42	201
calculator,			board	47	571	interconnections	136	98
preprogrammed	53	35	cards, μ P support	52	579	micro hook	133	90
computer	99	52	cross assembler	50	575	PC board connectors	41	27
computer	131	369	evaluation module	48	573	PC circuit boards	93	49
disc controller	131	370	memory, μ P	47	572	packaging	71	41
graphics package	51	34	printer, μ P controlled	48	574	socket, IC	59	39
memory, floppy disc	131	371	program, μ P			socket/receptacles	127	81
minicomputer	132	373	macro-assembler	50	577	substrate mount	114	331
printer, label	132	372	system, development	47	570	target, microscope	120	500
reader, IBM mag-cards	132	374	terminal, data	50	576	terminal pins	121	75
remote controller	131	368	μ C, one chip	52	578	terminals, magnet-wire	121	600
						tool, DIP insert/extract	117	336
						tools, wrap & unwrap	117	335
						wire, cable & cord	15	400
Discrete Semiconductors			Microwaves & Lasers					
arrays, Darlington	127	358	comb generators	124	346	Power Sources		
detectors, germanium	125	348	detector	124	345	ac source	128	364
diodes, Impatt	127	359	filters, microwave	140	106	floppy disc supply	129	336
displays	83	44	Gunn oscillators	122	344	modular supply	129	367
indicators	76	42	laser pulsers	122	342	module	128	363
LEDs, infrared	126	357	SWR bridge	124	347	open-frame supply	128	362
modules, interrupter	7	6	VCO	122	343	power supplies	6	7
power transistor, 10-A	44	30				power supplies	46	32
rectifier bridges	140	107	Modules & Subassemblies			switchers	128	365
SCRs	117	70	amplifier, rf	135	380			

This is what the designer sees.

A REPLACEABLE LAMP LIGHTED PUSH BUTTON SWITCH

10400/10410
10420 Series

DESCRIPTION

Molex has introduced a new U.L. listed replaceable bulb/lens lighted push button switch family. The buttons may be molded in an assortment of colors and shapes to enhance the appearance of your assembled unit. Switch actions include SPST, SPDT, DPST, and DPDT with momentary or alternate action. Applications include office machines, appliances, computers and the home entertainment field.

FEATURES

50,000 minimum life cycle. In addition to the 10.1 AMP rating, the entire series offers reliable switching action at low levels (100 milli-amps at 30 volts), and a replaceable T 1 3/4 bulb in all but the 125 Neon version.

Molex offers a wide variety of button colors, bezels, and legends as

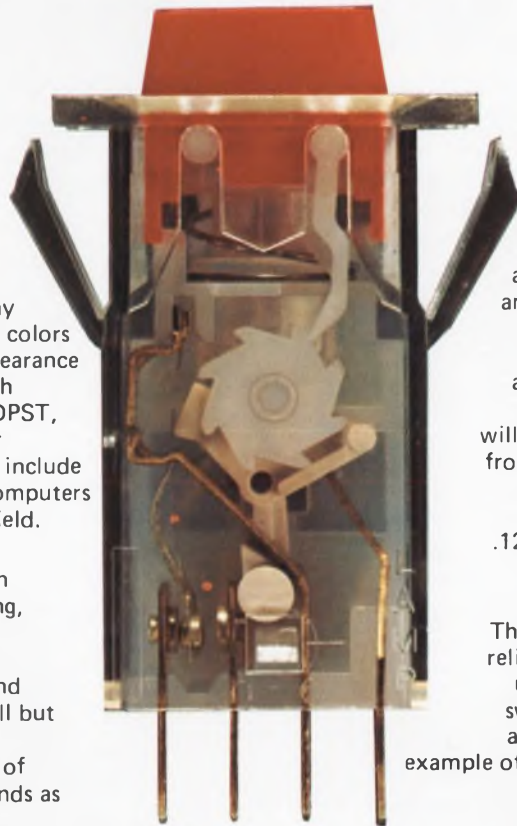

well as a square or pyramidal shaped lens. Recommended panel cutout dimensions include an .875 x .875 (10410 and 10420) and .875 x 1.050 (10400 versions) which are compatible with most comparable switches presently available today. The 10400 with integrally molded mounting ears will accommodate a panel thickness from .030 to .093, while the 10410 and 10420 versions offer a front removable feature from .030 to .125 thick panels. Spade terminals are .02 x .19 x .30 length.

FOR "UNDER A BUCK"

The Molex product is designed as a reliable, low cost unit with features usually found only on expensive switches. In 5M quantities SPST are 99¢ each (including bulb). An example of Molex "affordable technology".

10400 Rectangular bezel w/molded mounting ears

10410 Rectangular bezel w/spring clip mounting

10420 Square bezel w/spring clip mounting

Patent Pending

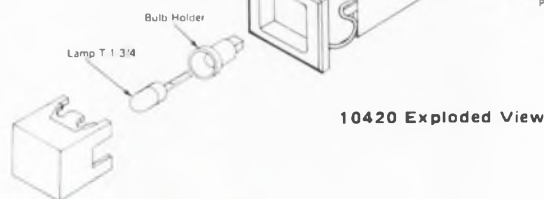

10400

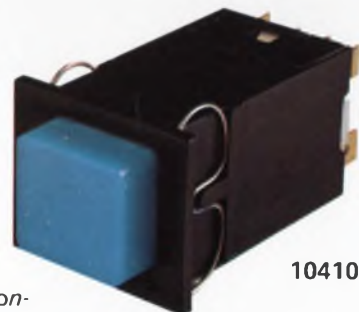

10410

MOLEX SERVICE

Molex has a nationwide network of representatives and authorized distributors to handle your off-the-shelf and large quantity orders. Field engineers are at your service to solve your tooling problems.

LITERATURE

For your FREE 16-page Switch Catalog including photos, line drawings and specifications of the Molex line, call (312) 969-4550; or write Molex Incorporated, 2222 Wellington Court, Lisle, IL 60532.



... Affordable Technology

What's new in solid state ...

Gold CHIP LICs pile up 18 million hours with near-zero failure rate.

Test results from 18.2 million unit-hours and 1.5 million unit-cycles are in—and the verdict is unanimous. RCA Gold CHIP LICs are *significantly* more reliable than their counterparts with aluminum metalization. Here is a summarized report based on testing by three different kinds of users, plus—perhaps our severest critic—ourselves.

U.S. Army jungle/salt air tests

In Panama, the Electronics Technology and Devices Laboratory of the U.S. Army Electronics Command tested 63 Gold CHIP LICs to 1,479,000 unit-hours. The tests were done under conditions designed to reveal potential electromigrative shorts and metal corrosion: 27°C, 90-98% R.H., 4.5 V reverse bias. Result: zero failures. Or a failure rate of 0.062%/1000 hrs. at 60% confidence level.

OEM reliability tests

A major OEM systems manufacturer has completed extensive testing of Gold CHIP bipolar ICs. These were operated at high power and high junction temperature. After 15,000,000 unit-hours: 2 degradational rejects not related to metalization. That's a 0.02% failure rate.

U.S. Navy plastic IC program

The Naval Electronic Systems Command has awarded RCA Solid State Division a \$1.44 million contract to apply Gold CHIP technology to plastic packaged ICs for military use. MIL-M-38510 specifications will be used.

RCA reliability tests

In a continuing program, RCA has run the following tests under industry accepted testing conditions.

- Operating Life: 332 units, 376,500 unit-hours.
- Temperature/Humidity Bias: 314 units, 1,244,000 unit-hours.
- Thermal Fatigue: 30 units, 750,000 unit-cycles.
- Pressure Cooker: 510 units, 92,460 unit-hours.
- Thermal Shock: 673 units, 214,760 unit-cycles.
- Temperature Cycle: 1,630 units, 510,000 unit-cycles.

Results: 1 failure in the pressure cooker test. It was caused by a bond wire break at the frame and was not chip related.

You can buy these Gold CHIP LICs from your local RCA Solid State distributor and evaluate them yourself: CA101AG, CA107G, CA124G, CA139AG, CA139G, CA201AG, CA207G, CA224G, CA239AG, CA239G, CA301AG, CA307G, CA324G, CA339AG, CA339G, CA741CG, CA741G, CA747CG, CA747G, CA748CG, CA748G, CA1458G, CA1558G, CA3401G, CA3724G, CA3725G.

RCA

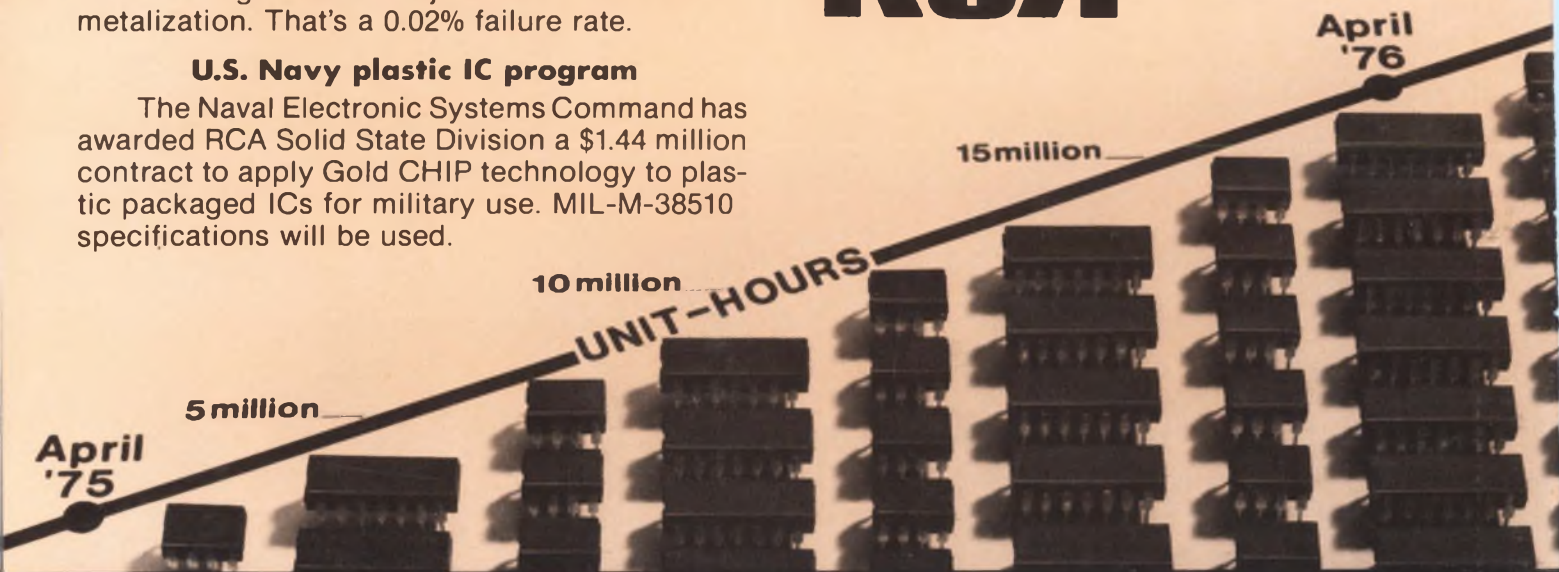

RCA. Full house in Linear ICs.