

Electronic Design. 9

VOL. 23 NO.

FOR ENGINEERS AND ENGINEERING MANAGERS

APRIL 26, 1975

Hermetic performance in plastic DIPs is achieved by elimination of many IC-chip failure modes. While past approaches sought the elusive perfect seal, silicon-

nitride passivation and corrosion-resistant metalization have raised reliability a hundredfold at no added cost to the user. Check these high-rel circuits on p. 97.

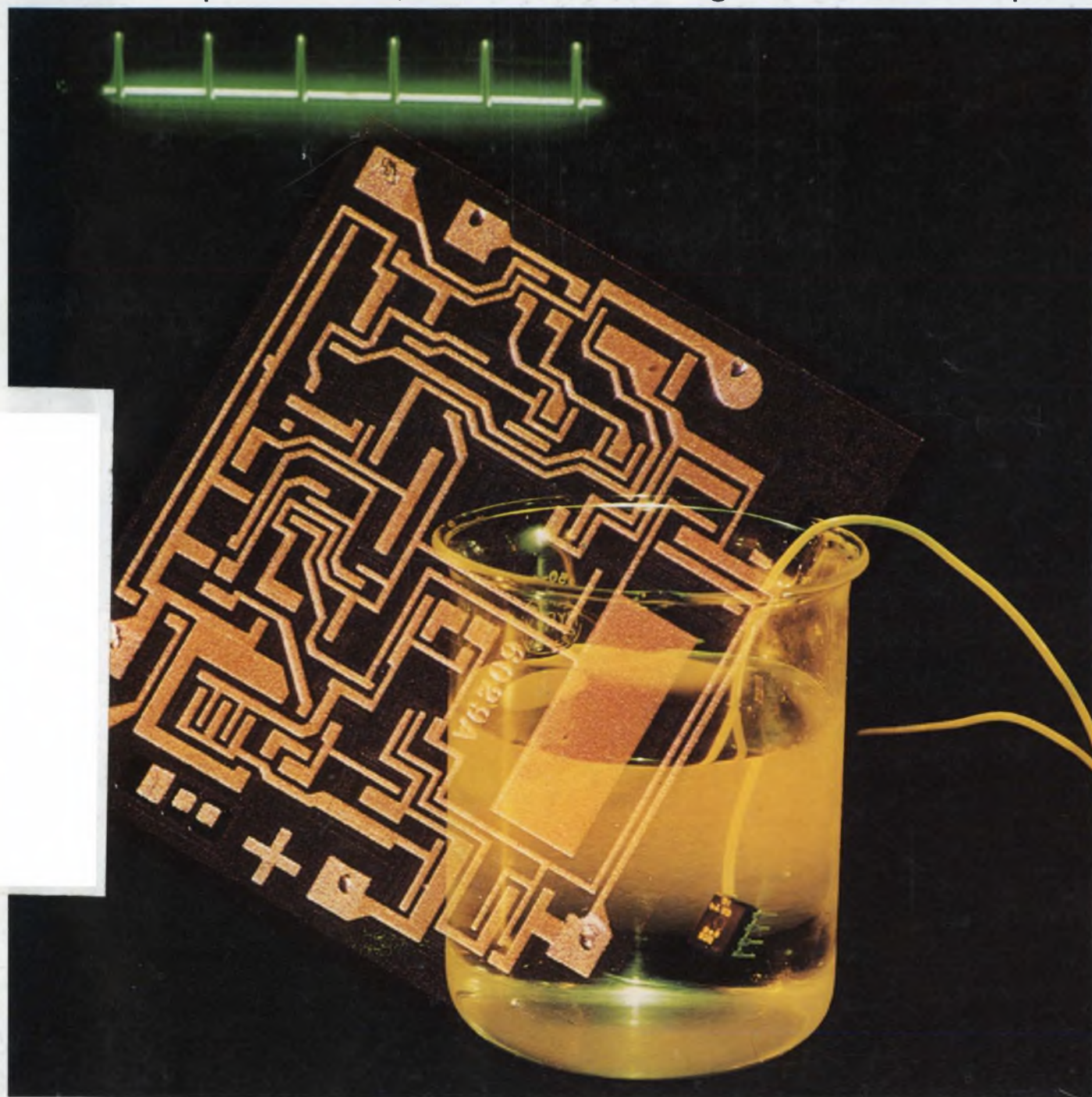

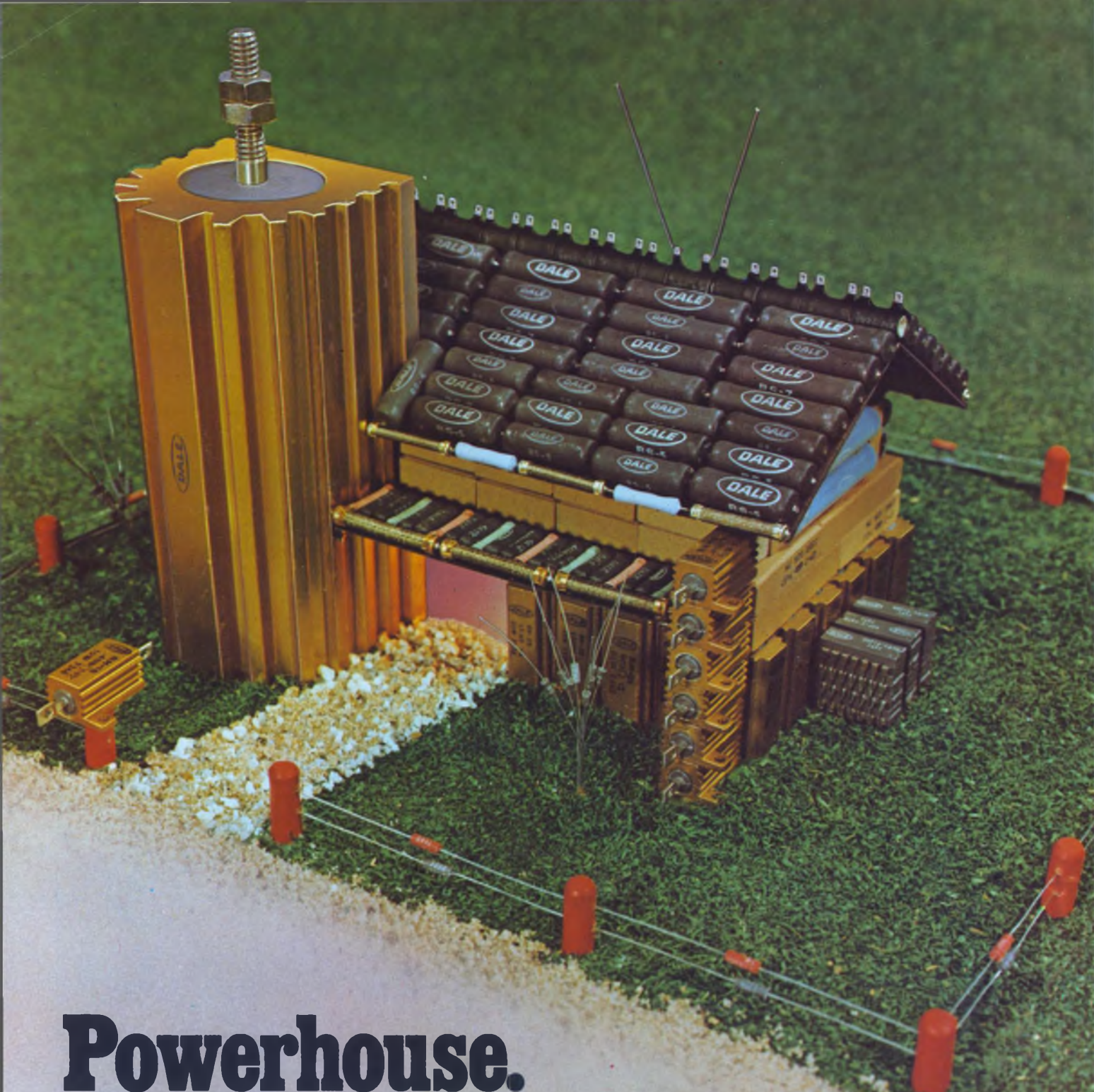

Powerhouse.

Dale makes more power wirewounds... E-Rel, precision, industrial, commercial... has more QPL's... more ways to meet your special housing and performance requirements... and just plain works harder to make sure you're satisfied.

Here are four ways to prove it:

- For Complete Cross Reference Guide, Circle 251
- For Comprehensive Wirewound Resistor Wall Chart, Circle 252
- For Guide to Non-Standard Wirewound Resistors, Circle 253
- Call 402-564-3131 for immediate information.

DALE ELECTRONICS, INC., 1300 28th Avenue, Columbus, Nebr. 68601

In Canada: Dale Electronics Canada Ltd.

In Europe: Dale Electronics GmbH, 8 Munchen 60, Falkweg 51, West Germany

A subsidiary of The Lionel Corporation

D-2 Our complete product line can be found in Electronic Design's GOLD BOOK.



More designers are choosing McMOS today

Because today it's the CMOS that offers more

As business has become increasingly tighter, more design and purchasing people have turned to Motorola's McMOS family of CMOS logic for new design requirements. Careful evaluation of relative merits convinced them that they would benefit more ways with McMOS.

broader

FUNCTIONAL COVERAGE

More than 80 different MC14000/14500 devices form a balanced mixture of the industry's richest MSI line-up and the necessary simple gate and flip-flop types. This includes functions most TTL and CMOS suppliers haven't even attempted yet; and 25 new line additions are scheduled in 1975.

RELIABILITY

Word gets around when product is reliable; and, of course, when it isn't. The word's around that McMOS is reliable. That's based on users' experience... and on test documentation. If the latter is important to you, contact the nearest Motorola sales office for a copy of the latest on plastic McMOS documented reliability. Motorola's standard off-the-shelf CMOS will do the job without gimmicky, expensive special programs.

Motorola McMOS vs. Major CMOS Competition (Testing completed December, 1974)

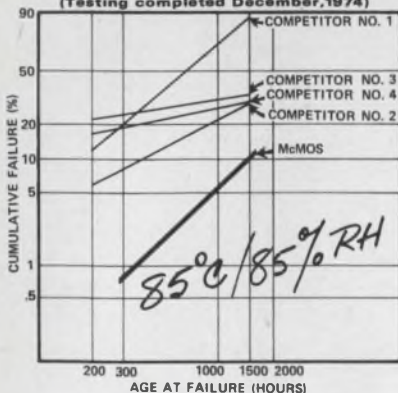

easy

TTL-CMOS CONVERSION

Now Motorola makes it easy to cross over to CMOS and get the low power, high noise immunity combination no other present logic form offers. There's an up-to-date TTL-CMOS Function Cross Reference you'll get if you circle the bingo number on this ad.

TTL-LIKE PRICING

Production and technological breakthroughs like those achieved at Motorola's ultra-modern CMOS facility in

CMOS follows the TTL pattern, but accelerates the pace

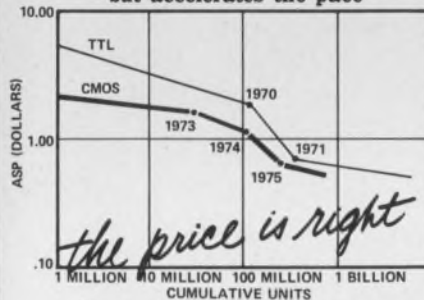

Austin, Texas have created record breaking availability and pricing. We're able to price McMOS much lower now than was originally anticipated for this time. Now, for comparable functions, CMOS is selling competitively with TTL.

most

MSI FUNCTIONS

That the McMOS family is heavy in MSI is no accident. It's been structured that way from the beginning because designers have indicated from the beginning that MSI had to be the cost-effective way to go in CMOS.

new

SPECIALIZED FUNCTION SERIES

Now there's a whole new dimension to McMOS. The MC14400 Series is a growing set of specialized function MSI subsystems. It all started with the MC-14435 A/D logic subsystem, followed by the MC14490 Hex Contact Bounce Eliminator, MC14411 Bit-Rate Generator and the MC14415 Quad Hammer Driver. Others, for specialized application in telephony, data handling, and watch/clock circuitry, will be available during 1975. Several of these are just coming out now: the MC14410 Two-of-Eight Tone Encoder, MC14440/50/51 Timepiece units, and MC14419 Keyboard Encoder.

more

INFORMATION AVAILABLE

McMOS, the CMOS of today; offering more, doing more, for more people. For information that will inform you if you're curious, and help you if you're serious, write to Motorola Semiconductor Products Inc., P.O. Box 20912, Phoenix, AZ 85036, or circle the reader service number.



MOTOROLA McMOS
- complementary MOS for contemporary systems

* TRADEMARK MOTOROLA INC.

**Now! A 5V, 120-amp switcher
with forced-air cooling, up to 3 outputs,
75% efficiency, measures only 8"W x 10"L x 5"H,
and weighs less than 12 lbs.**

The newest addition to the LH line of switching regulated power supplies is the super-compact forced-air cooled 120-amp series. With dimensions ideal for computer memory system installations, these switchers are available in single or multiple output models with extremely high efficiencies: 80% on primary output, an average of 75% on all others.

Up to three outputs

Primary output is 5 VDC, 120 amps; second and third outputs are ± 12 , or ± 15 at 8 amps. Combined load on all outputs is limited to 600 watts. All outputs are fully regulated as a standard feature, and all are adjustable from the front panel.

Outstanding features

Over-temperature protection and RFI line filtering are standard features; over-voltage protection is standard on primary output, optional on secondaries. Other options include remote on-off, master-slave paralleling, and paralleling of up to



10 units. Mounting is by side or bottom in any direction. They operate in ambient temperatures of up to 50°C without de-rating.

Selectable AC inputs

AC inputs can be externally selected 115/230V, 47 to 63 Hz, simply by changing a jumper on the front terminal strip.

**Easy maintenance,
high reliability**

In single-output models all components are mounted on just two circuit boards, multiple-output models use three, so the entire switcher can be disassembled in less than five minutes. Through the use of ribbon

cable, interconnections have been reduced 90%, greatly enhancing reliability.

**Ask for
full-line
folder**

Our new 6-page folder fully describes the new 120 amp units and other standard LH switchers, and discusses options for specific requirements.

Write for
a copy
today.



**Most comprehensive
switcher line made**

LH Research makes several hundred standard switchers, with single and multiple outputs from 250 to 600 watts, and AC or DC inputs. All are extremely compact and lightweight, with six package shapes to suit your assembly. Efficiencies are 75-80%, and costs are as low as 75 cents a watt. Among the newest is the double dual model, which has

two isolated 250-watt outputs plus two low power outputs, and weighs only 16 pounds.



LH RESEARCH, INC., 2052 South Grand Avenue, Santa Ana, CA 92705 • (714) 546-5279

INFORMATION RETRIEVAL NUMBER 3

NEWS

- 21 **News Scope**
- 26 **Coax and microstrip packaging techniques** are beginning to edge out microwave waveguide.
- 32 **Small, nonimpact printer** to cost less than \$25.
- 32 **Airline gets automatic printed-circuit board tester.**
- 33 **Low-cost digital setup** measures horse power.
- 37 **Washington Report**

TECHNOLOGY

- 44 **Speed microcomputer multiplication** with a CPU complementary circuit or peripheral multiplier. Here are typical examples that use available ICs.
- 54 **Motor control by PLL** can be achieved with a microprocessor. Software replaces the phase detector, and the internal clock provides the circuit timing.
- 60 **Cool through turbulence** with lightweight wire-mesh transpiration panels. They conserve space, take almost any shape and provide quiet operation.
- 84 **Apply topological graphs** to active-filter analysis. The graphs offer fast and accurate solutions to the circuit's node equations.
- 88 **Ideas for Design:** Two-phase clock generator and driver synchronize the 8080 microprocessor. . . . Phase-locked loop generates clock from nonreturn-to-zero data. . . . Passive low-pass filter recovers signals buried in high ripple.
- 94 **International Technology**

PRODUCTS

- 97 **Packaging & Materials:** IC circuits in plastic DIPs provide the reliability of hermetic packages.
- 100 **Instrumentation:** Measurement system includes calculator.
- 102 **Power Sources:** Lab supply offers choice of readout.
- 104 Modules & Subassemblies
- 106 Data Processing
- 108 Integrated Circuits
- 110 Discrete Semiconductors
- 114 Components

DEPARTMENTS

- 41 **Editorial:** To the rear, march!
 - 7 Across the Desk
 - 67 Top Ten Winners
 - 116 New Literature
 - 117 Design Aids
 - 120 Advertisers' Index
 - 122 Product Index
 - 122 Information Retrieval Card
- Cover:** Photo by Bruce Hull and John Semonish, courtesy of RCA Solid State Div., Somerville, NJ

If you need fast Intel has the competi

We've just added five new three state 2K and 4K PROMs to our Schottky bipolar PROM family. Intel is now the first supplier with a complete family of 1K, 2K, & 4K bipolar PROMs, and 1K, 2K, & 4K interchangeable metal mask programmable ROMs. Intel PROMs give you the competitive edge in speed, power, and reliability, at competitive prices.

When you're looking for 4K PROMs, Intel offers open collector or three state outputs, silicon fuse reliability, and immediate delivery from distributor stock. You can select the fast 4K (3604) with 70 ns guaranteed access time from 0° to +75°C

or the low power 4K (3604L-6) that dissipates 60% less power when deselected and has 20% less operating power.

Intel's 16 pin, 1K PROMs have the edge in speed with 50 ns guaranteed access time from 0° to +75° C. For military applications you can get 90 ns access time from -55° to +125° C.

Our 2K PROMs give you twice the memory in a 16 pin package, 70 ns access time, and your choice of two low power parts with either open collector or three state outputs.

All Intel PROMs are easily programmed with high programming yields on any one of several commercially available programmers. With a programming time of 1 ms/bit any PROM can be programmed in a

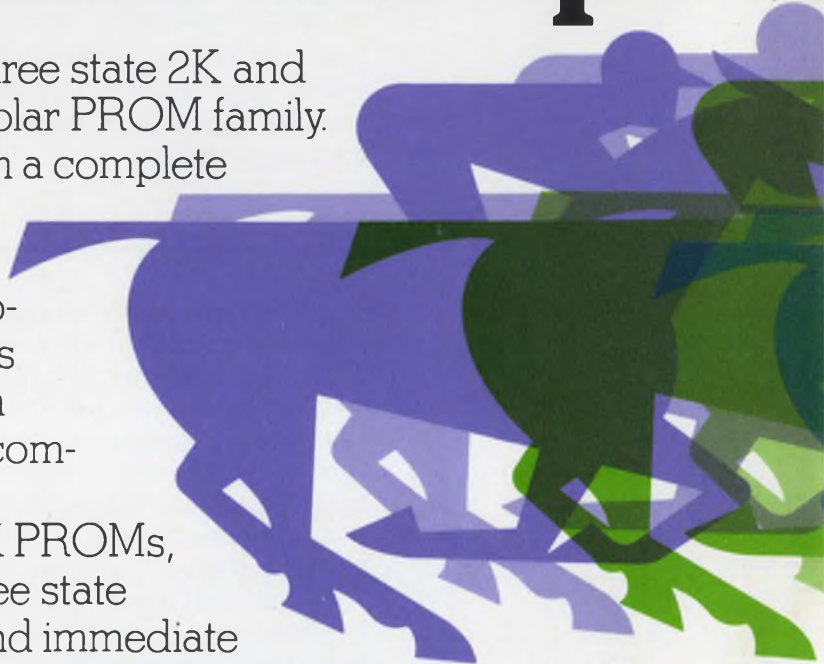
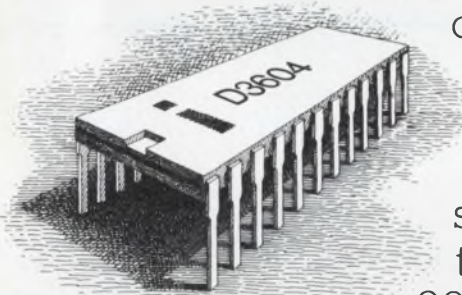

PROMs, you can bet tive edge.

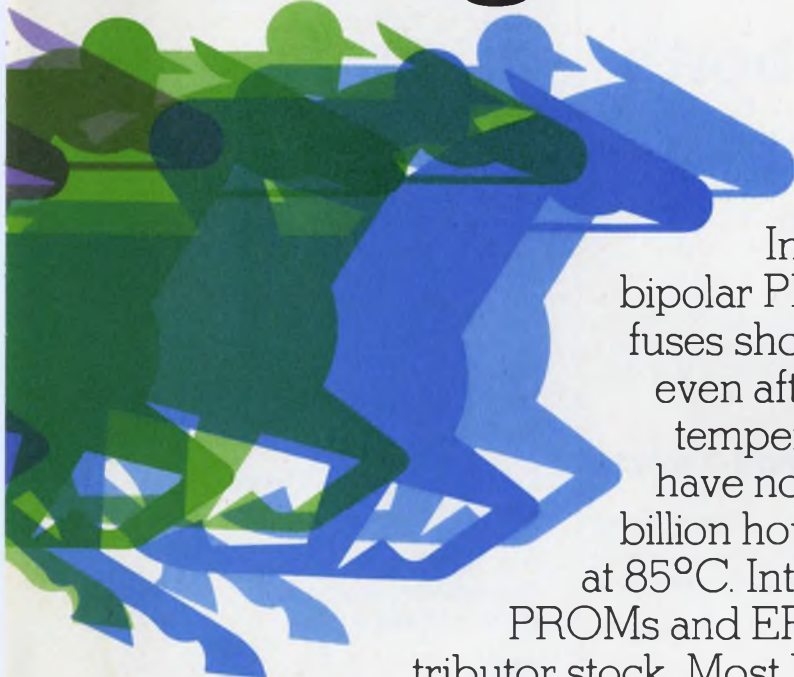

few seconds. With an order of 10,000 or more Intel bipolar PROMs, we'll provide the programmer.

Intel PROMs are the most reliable bipolar PROMs made. Our polysilicon fuses show no regrowth or opening — not even after billions of fuse hours of high temperature reverse bias at 125°C. We have not had a single failure in over 1.2 billion hours of operating system life tests at 85°C. Intel's complete family of bipolar PROMs and EPROMs are available from distributor stock. Most Intel distributors also offer free

programming for prototype quantities. Contact: Almac/Stroum, Component Specialties, Inc., Cramer, Hamilton/Avnet, Industrial Components, Inc., Sheridan and L.A. Varah Ltd. For more information call any Intel regional office: West, (714) 835-9642; Mid-America, (214) 661-8829; Great Lakes, (513) 890-5350; East, (617) 861-1136; Mid-Atlantic, (215) 542-9444. For your copy of the new application note AP-6 "Designing with Intel PROMs & ROMs" write Intel Corporation, 3065 Bowers Avenue, Santa Clara, California 95051.

INTEL BIPOLAR PROMS						
SIZE	PART NUMBER	ORGANIZATION	PINS	WORST-CASE ACCESS TIME (0° TO +75°C)	OUTPUT OPEN COLLECTOR OR THREE STATE	INTEL INTERCHANGEABLE ROM
1K	3601-1	256x4	16	50 ns	OC	3301A
	3601			70 ns	OC	3301A
	M3601			90 ns*	OC	M3301A
2K	3602	512x4	16	70 ns	OC	3302
	3602-4			90 ns	OC	3302-4
	3602L-6**			120 ns	OC	3302L-6
	3622			70 ns	TS	3322
	3622-4			90 ns	TS	3322-4
	3622L-6**			120 ns	TS	3322L-6
4K	3604	512x8	24	70 ns	OC	3304A
	3604-4			90 ns	OC	3304A-4
	3604L-6**			120 ns	OC	3304AL-6
	3624			70 ns	TS	3324A
	3624-4			90 ns	TS	3324A-4

* -55° to +125°C **Low Power

INTEL EPROMS						
SIZE	PART NUMBER	ORGANIZATION	PINS	WORST-CASE ACCESS TIME (0° TO +70°C)	OUTPUT OPEN COLLECTOR OR THREE STATE	INTEL INTERCHANGEABLE ROM
2K	1702A	256x8	24	1.0 μs	TS	1302
	1702A-6			1.5 μs		1302
4K	2704	512x8	24	0.45 μs	TS	2308
8K	2708	1024x8	24	0.45 μs	TS	2308 or 2316A

intel® delivers.

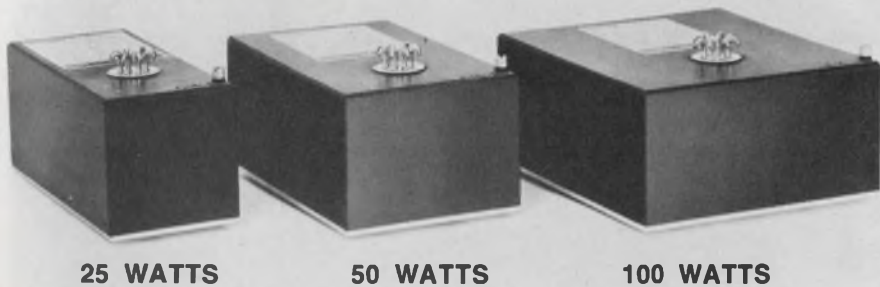

Save 5 Ways with Abbott's New 77% Efficient Power Supplies!

Abbott has a Hi-Efficiency series of power modules that can save 5 ways in your system. The Model "VN" series converts 47-440 Hz AC lines to regulated DC power and uses a new approach in switching technology that provides a highly reliable line of sixty-three high efficiency power modules.

The Model "VN" series saves in the following 5 ways:

- 1 SAVES POWER** — High frequency pulse width modulation and C/MOS digital IC control circuitry allow efficiencies of up to 77% in the Model "VN" series. This high efficiency realizes almost twice the output power per input watt than dissipative regulators.
- 2 SAVES SIZE** — Off line techniques and IC technology combine for packages of 70% less volume compared to dissipative regulators.
- 3 SAVES WEIGHT** — High efficiency means less power dissipated and less heat generated, thereby reducing or eliminating the need for bulky heat-sinking and forced air cooling. This translates into less total weight and smaller system size.
- 4 SAVES TIME** — You can quickly get the power supply you need because we have an extensive line of models to choose from. Outputs of 25, 50 and 100 watts are available at any voltage between 4.7 and 50.0 VDC. With popular voltages in stock, chances are the unit you need is available immediately.
- 5 SAVES MONEY** — At only \$282 for 25w, \$301 for 50w, and \$325 for 100w in small quantities, the "VN's" are among the lowest priced Hi-efficiency units on the market.

Abbott also manufactures 3,500 other models of power supplies with output voltages from 2.7 to 740 VDC and output currents from 4 milliamps to 20 amps. They are all listed, with prices, in the new Abbott Catalog. Included are:

60 A to DC
 400 A to DC
 28 VDC to DC
 28 VDC to 400 A
 12-38 VDC to 60 A

Please see pages 307-317 Volume 1 of your 1974-75 EEM (ELECTRONIC ENGINEERS MASTER Catalog) or pages 853-860 Volume 3 of your 1974-75 GOLD BOOK for complete information on Abbott Modules.

Send for our new 60 page FREE catalog.

abbott transistor

LABORATORIES, INCORPORATED
 general offices eastern office

5200 W. Jefferson Blvd./Los Angeles 90016
 (213) 936-8185 Telex: 69-1398

1224 Anderson Ave./Fort Lee, N.J. 07024
 (201) 224-6900 Telex: 13-5332

INFORMATION RETRIEVAL NUMBER 5

Vice President, Publisher
 Peter Coley

Editors

Editorial Offices
 50 Essex St.
 Rochelle Park, NJ 07662
 (201) 843-0550
 TWX: 710-990 5071
 Cable: Haydenpubs Rochellepark

Editor-in-Chief George Rostky

Managing Editors:

Ralph Dobriner
 Michael Elphick

Associate Editors:

Dave Bursky
 Jules H. Gilder
 Morris Grossman
 Seymour T. Levine
 John F. Mason
 Stanley Runyon
 Edward A. Torrero

Contributing Editors:

Peter N. Budzilovich
 Alberto Socolovsky
 Nathan Sussman

Editorial Field Offices

East

Jim McDermott, Eastern Editor
 P.O. Box 272
 Easthampton, MA 01027
 (413) 527-3632

West

David N. Kaye, Senior Western Editor
 8939 S. Sepulveda Blvd.,
 Suite 510
 Los Angeles, CA 90045
 (213) 641-6544
 TWX: 1-910-328-7240

Editorial Production

Marjorie A. Duffy

Art

Art Director, William Kelly
 Richard Luce
 Anthony J. Fischetto

Production

Manager, Dollie S. Viebig
 Helen De Polo
 Ann Molfetas
 Maxine Correal

Circulation

Manager, Evan Phoutrides

Information Retrieval

Peggy Long

Promotion

Manager, Walter G. Salm
 Karen Kerrigan (Reprints)

Creative Layout Services

Manager, Albert B. Stempel

Across the Desk

Calculator keyboards draw a 'boo and hiss'

In the rush to fill the swelling market for scientific and programmable calculators, the design of business calculators has taken an unfortunate turn. Adherents of the abacus will applaud the trend. However, adherents of the old adding machine with 10 digit keys and a few function keys—sized and located for low-error-rate, touch-typing input—will boo and hiss.

In the new pocket types and in some of the desk models, errors are encouraged by the built-in need to look away from the source document while entering. Proving a total and correcting errors are complicated by the absence of hard copy. When cost estimates are run through successive levels of management approvals, attached adding machine tapes are both a good discipline and useful for spot checks of cost entries, which contribute significantly to the totals.

Hard copy has been traded off against size and cost in the case of the pocket calculators, and that is a reasonable trade-off. However, there doesn't seem to be a good case for poor keyboard design. A better keyboard design would at least relieve the error problem and I hope that will be considered by manufacturers. At the very least, I look for a separated zero key that a large thumb can find.

Tom Owens
Group Manager

Zerex Corp.
1701 Research Blvd.
Rockville, MD 20850

The ostrich approach to service problems

Reading George Rostky's editorial "Service With a Smile" (ED No. 2, Jan. 18, 1975, p. 47) reminded me of a story about one company's service department. A field salesman had been complaining for several months that a certain item hadn't been working on the last several units that had been delivered. The service engineer's response had been typical:

"Just give us a chance to correct the problem. We're working on it, and you'll be the first to know when it's fixed. Meanwhile stop bugging us. We can't get our work done if we're on the phone."

So that's what the salesman did—stopped bugging. Six months later he thought he would follow up on the progress toward the solution. When he called the service engineer, the response was:

"Oh, we stopped getting complaints about that six months ago and decided that the problem had gone away."

Jerold W. Harrison
Chief Engineer

Electro-Mechanical Systems Inc.
531 Marcellene
Wichita, KS 67218

Woperson deplors 'masculine orientation'

The article "Job Ratings Hinge on Mutual Commitment" (ED No. 23, Jan. 18, 1975, pp. 68-70) has a masculine orientation that is unusual in today's egalitarian cli-

(continued on page 16)

Electronic Design welcomes the opinions of its readers on the issues raised in the magazine's editorial columns. Address letters to Managing Editor, Electronic Design, 50 Essex St. Rochelle Park, N.J. 07662. Try to keep letters under 200 words. Letters must be signed. Names will be withheld on request.



OPTRON OPTOELECTRONIC ASSEMBLIES

LOW PRICED
IMMEDIATE DELIVERY
CUSTOM DESIGNS AVAILABLE

OPTRON transmissive optical switch and reflective transducer assemblies consist of infrared LED's coupled with silicon phototransistors or photodarlington. Both use discrete hermetically sealed devices for maximum reliability and sensitivity. The assemblies feature non-contact switching, TTL compatibility and fast switching speeds. Low priced standard assemblies are immediately available and custom designed versions for special applications are available on request.



OPB 120 TRANSMISSIVE OPTICAL SWITCH uses an infrared LED aligned across a gap with a silicon phototransistor. The

OPB 120 replaces mechanical switching elements with solid state dependability. Typical applications include rotary encoders, tachometers and motion sensors. Standard gap widths are 0.125 and 0.200 inches.



OPB 125 OPTOELECTRONIC REFLECTIVE TRANSDUCER consists of a gallium arsenide infrared LED coupled with a silicon phototransistor in compact low-

cost molded plastic housing. It has extremely high sensitivity and is ideal for such applications as EOT/BOT sensing, line finding, and edge and flaw detection.

Detailed technical information on these and other OPTRON optoelectronic products . . . chips, components and PC board arrays . . . is available from your nearest OPTRON sales representative or the factory direct.



OPTRON, INC.

1201 Tappan Circle
Carrollton, Texas 75006
214/242-6571

Mixer/Amplifier Packages

We've engineered our WJ-C30 series of mixer/amplifier packages to be virtually off-the-shelf items, while still remaining flexible enough to meet your specific design needs.

All units consist of high quality W-J mixers and thin-film cascaded amplifiers. These components afford tremendous adaptability in responding to a wide range of RF and IF bandwidth, noise figure, conversion loss and power output requirements.

These packages have an RF coverage of 2.5 to 18.5 GHz, with each model offering options of eight different IF bandwidths ranging from 5 to 1500 MHz. Overall noise figures range from 7.5 to 12.0 dB (min.), depending on which IF option you select. Power output also varies.

One option delivers an IF bandwidth of 5 to 200 MHz, overall IF noise figure of 7.5 dB (min.) and power output of +12 dBm (max.), while a second option would give you an IF bandwidth of 10 to 1000 MHz, overall IF noise figure of 14.5 dB (min.) and power output of +23 dBm.

It's really very easy. You simply select the specifications and we'll deliver a high quality mixer/amplifier in a compact, economical package.

To find out more about these new mixer/amplifier packages, call your local W-J Field Sales Office or Watkins-Johnson Applications Engineering in Palo Alto, California at (415) 493-4141, ext. 637.

THE WJ-C30 SERIES

High Intercept Mixer/Amplifiers (+13 dBm L.O. Drive)

Model	Frequency
WJ-C32	2.5 to 5.2 GHz
WJ-C33	4.0 to 9.0 GHz

Low Level Mixer/Amplifiers (+7 dBm L.O. Drive)

Model	Frequency
WJ-C35	2.5 to 5.2 GHz
WJ-C36	4.0 to 9.0 GHz
WJ-C37	6.0 to 16.0 GHz
WJ-C38	8.0 to 18.5 GHz

You select the specs

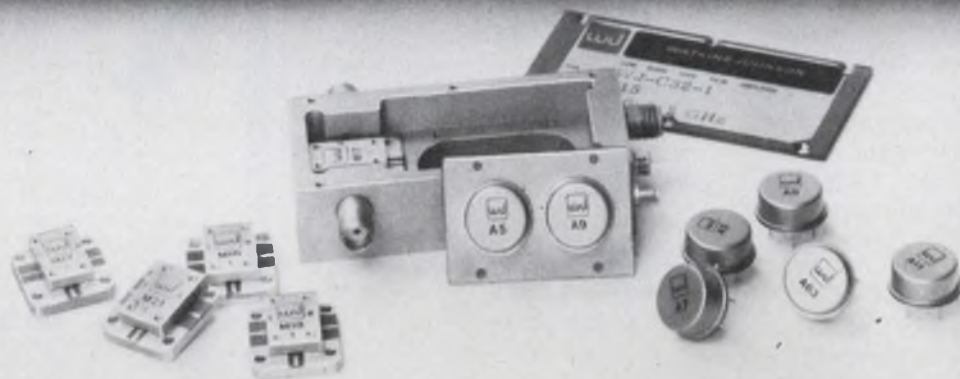

...all components are off-the-shelf.



WATKINS-JOHNSON

Watkins-Johnson—U.S.A.: 3333 Hillview Ave., Palo Alto, CA 94304 • (415) 493-4141 • TWX: 910-373-1253 • Telex: 34-8415 • Cable: WJPLA • 700 Quince Orchard Rd., Gaithersburg, MD 20760 • (301) 948-7550 • TWX: 710-828-0546 • Telex: 89-8402 • Cable: WJCEI • **United Kingdom:** Shirley Ave., Windsor, Berkshire SL4 5JU, England • Tel: Windsor 69241 • Cable: WJUKW-WINDSOR • Telex: 847578 • **West Germany:** 8033 Planegg, Muenchenerstr. 17 • Tel: (089) 859-9441 • Cable: WJDBM-Muenchen • Telex: 529401 • **Italy:** Piazza G. Marconi, 25 00144 Roma-EUR • Tel: 59 45 54 • Cable: WJROM-ROMA • Telex: 60117

INFORMATION RETRIEVAL NUMBER 7

Why you can afford the very finest in function generators.

Because Interstate's new F77 truly is a universal signal source. With F77's 0.00002 Hz to 20 MHz range, you can test with frequencies from infrasonics through video, and beyond. There are 6 output waveforms, 7 operating modes, and precision interface controls (waveform inversion and a 5/95% waveform variable symmetry vernier, for example) that can be actuated with remarkable variations. And output amplitude is specified at 15 volts p-p into 50 ohms — that's 50% more voltage swing than most 20 MHz function generators provide.

Because the F77 also incorporates a very capable, independent sweep generator offering linear and logarithmic performance, with a selection of auxiliary outputs. Sweep up or down, sweep reset control, and continuous, triggered, burst, sweep-and-hold modes, too. Interstate's special frequency dial has a direct-reading sweep limit cursor, plus two calibration scales (X1 and X2) to improve resolution and permit continuous tuning across the 20 Hz-to-20 KHz audio band.

Because this function generator is the first of its kind to deliver real pulse generator capability. The F77 produces a 15 ns rise time pulse to 20 MHz with



constant width setability from 30 ns to 10 milliseconds, and full offset and mode flexibility. The generator's fully-calibrated attenuator gives you 15-volt unipolar pulses into high impedance loads, particularly useful for testing MOS, or millivolt pulses down to 1.5 mv.

Because there's also a constant duty cycle pulse (in addition to F77's standard pulse) for a variety of digital signal response applications. Circuit sensitivity to duty cycle on/off times can be tested using varying pulse rates without adjusting the width control.

Because the F77 can be used as an analog power amplifier to amplify externally applied signals as much as 600%. Even TTL pulses can be amplified to drive 50-ohm loads, and the resulting output has controlled dc offset and attenuation.

Because the F77 gives you many other high performance and human engineering features, like VCF capability for sweeping frequency-sensitive devices, and "oscilloscope-style" triggering with a variable start-stop phase control to generate haversines and havertriangles. There's even a "brown-out" switch to allow the instrument to operate at low line voltages.

Because the F77 only costs \$1,095.*

*U.S. price; other 20 MHz Series 70 models available from \$695.



INTERSTATE ELECTRONICS CORPORATION
707 E. Vermont Ave., P.O. Box 3117, Anaheim, California 92803 (714) 772-2811

INFORMATION RETRIEVAL NUMBER 8

We unknot wire problems

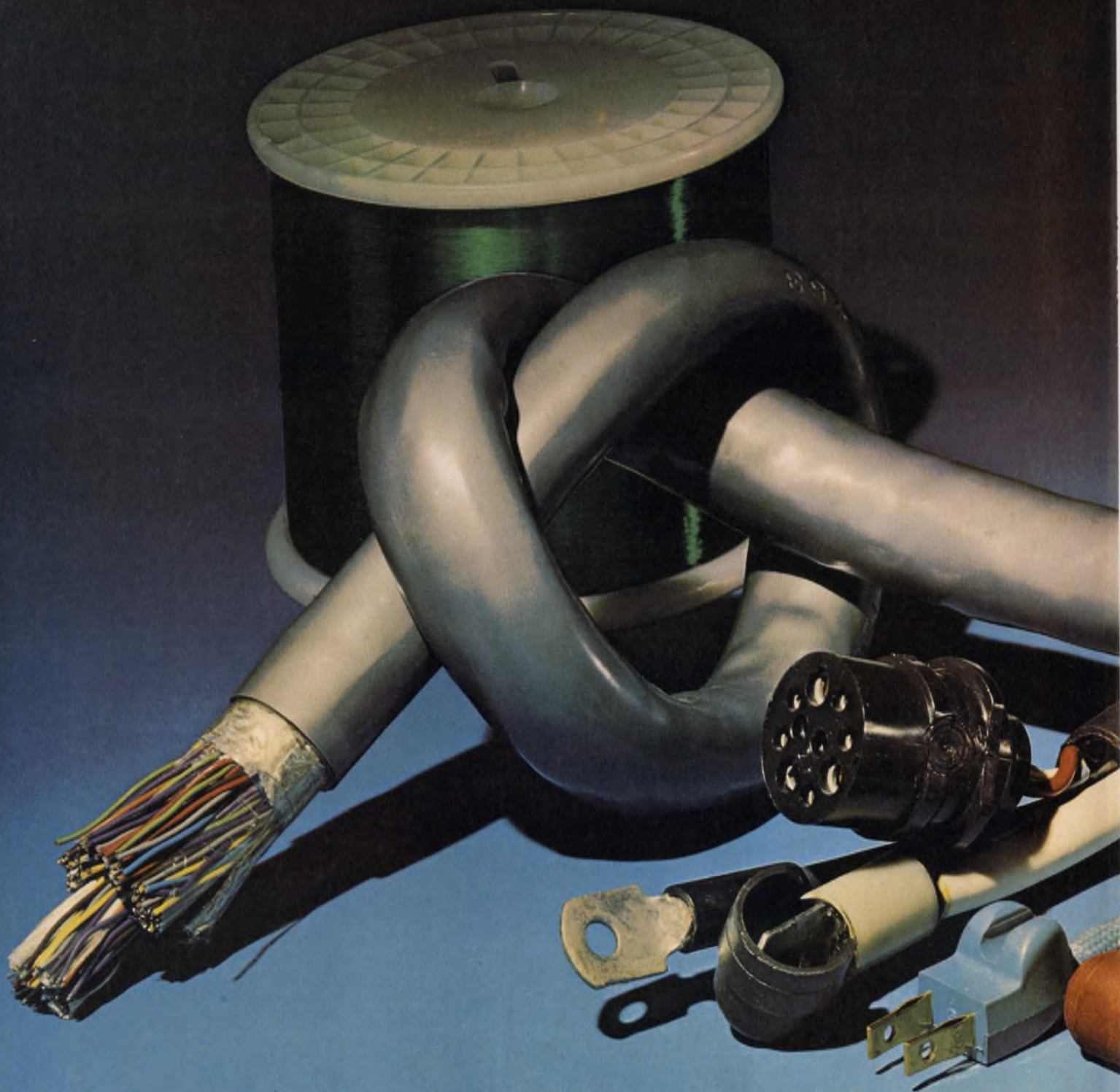

BELDEN 

... new ideas for moving electrical energy

Knotty problems in wire, cable, and cords can pop up at any stage of a project. Hopefully, they arise early in design. Oftentimes, they surface later. This can put an unexpected crimp in your product's profit or performance.

We're ready to offer backup help in performance, design, processing, assembly, installations, and ordering. Whatever wire and cable application idea you put on paper, Belden can help put life into it! Our total engineering approach to your problems can identify and analyze the "knots" before they tie up a major project.

If you have problems involving electrical parameters, space, compatibility, human

engineering, color coordination, precision, materials, fabrication, processing, put-ups, installation, Belden has the ability to engineer reliability and ease of assembly into wire, cable, and cords without letting costs run wild due to over-engineering.

When we can't get out the "kinks" using standards, we'll innovate a solution for your problem. We're here with service and multi-plant facilities that can meet your demands. Need answers? Phone:

(312) 681-8920, Electrical Division

(317) 966-6681, Electronic Division

(312) 887-1800, Transportation Division

Or, write Belden Corporation, 2000 South Batavia Ave., Geneva, Illinois 60134.

H-44



INTRODUCING THE WORLD'S FIRST

MEGA

THE INTERDATA 8/32—UNMATCHED LEVELS OF PERFORMANCE IN A MINICOMPUTER SYSTEM.

MEGAMINI ARCHITECTURE: AN ABUNDANCE OF SHEER POWER.

Interdata's new 8/32 Megamini has performance characteristics found only on large scale computers. Like direct addressing to one million bytes. Full 32-bit hardware with performance enhancers such as dual instruction

look-ahead stacks, multiple register sets, interleaved 32-bit memory, and fast floating-point hardware. What our 8/32 Megamini means to you is an unequalled combination of power, flexibility, and reliability in a compact package. All at a price that's fully competitive.

MEGAMINI SOFTWARE: POWERFUL, FLEXIBLE, EASY-TO-USE.

Today's hardware must be designed to ease your software effort. You shouldn't have to spend a lot of expensive programming time trying to figure out how to get around minicomputer hardware limitations. With the 8/32 Megamini you don't — because there are none.

For example. The direct addressing capability of the 8/32 Megamini allows you to build programs and data arrays in any size up to the amount of memory you have — no more 64K limits.

It also means we can give you versatile and powerful software to help lower the cost of building your system. Software with a multi-tasking operating system, OS/32MT, with unique multi-user

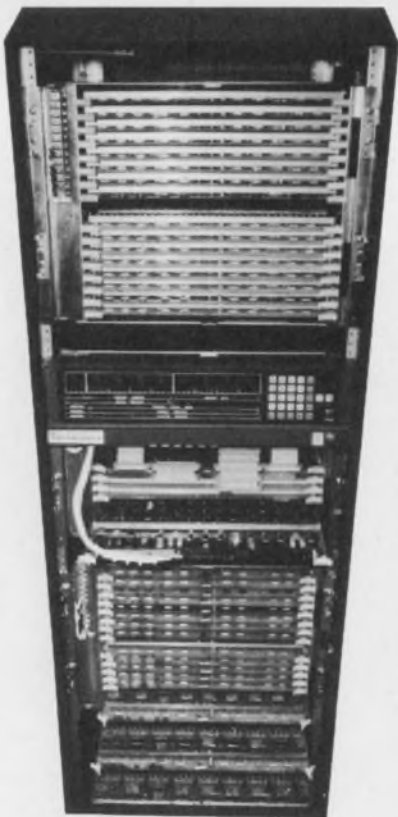

The 8/32 MEGAMINI — with a full Megabyte.

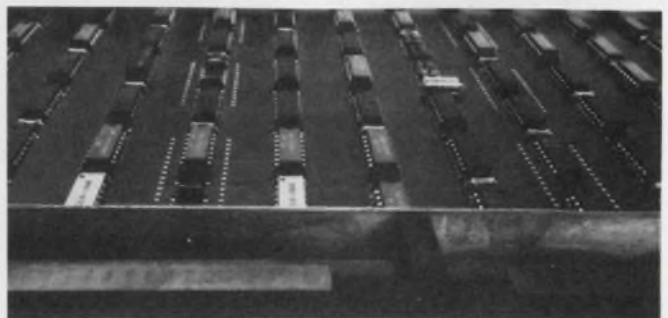

Multi-Wire Technology — a key to MEGAMINI performance.

MEGAMINI™

COMPARE: THE INTERDATA 8/32 MEGAMINI VS. THE-LESS-THAN-MEGAMINI COMPETITION.

	INTERDATA 8/32	XEROX 550	IBM 370/158	DEC 11/70	DG Eclipse
WORD LENGTH	32 bits	32 bits	32 bits	16 bits	16 bits
INSTRUCTION TIMES (Register to Memory)					
Integer Add	1.25	1.8	.9	1.8	2.5
Multiply	3.54	6.2	2.0	3.9	8.8
Divide	5.8	14.4	9.9	8.3	11.2
Floating Point Add	2.3	6.1	2.4	8.25	5.5
Multiply	3.0	9.1	2.3	11.25	7.2
Divide	5.35	23.3	8.9	12.25	7.9
HARDWARE I/O	Yes	Yes	Yes	No	No
MAX. DMA RATE/SECOND	6MB	4MB	6.7MB	4MB	2MB
DIRECT ADDRESSING RANGE	1MB	1MB	16MB	64KB	64KB
GENERAL PURPOSE REGISTERS	2 stacks 16 each*	4 stacks 16 each	1 stack 16 each	2 stacks 8 each	1 stack 4 each
PRICING (Basic Configuration)					
CPU + 128KB Memory	\$51,900	\$128,700	N/A	\$54,600	\$44,500
CPU + 1048KB Memory	\$179,400	\$478,700	\$1,905,700	\$163,800	N/A

*(6 Additional Stacks Optional)

program development capabilities. Software that has an optimizing macro assembler, MACRO CAL. And software with a sophisticated telecommunications access package, ITAM, that allows you to treat remote communications terminals and computers as if they were simply local devices.

Now, with all of this available, you can concentrate your efforts on the real problem at hand – your application.

THE MEGAMINI: NOT JUST A COMPUTER – BUT A SYSTEM.

The Interdata 8/32 Megamini gives you a full range of peripherals, software and advanced features to choose from in tailoring your system: 166MB disc systems, fast line printers, 1600 BPI tapes and graphic CRT's. Plus software modules like FORTRAN, BASIC, EDIT, AIDS and many more.

FOR MORE MEGADATA, CLIP AND MAIL.

Interdata, Inc., Oceanport, N.J. 07757

- All that power sounds marvelous. Send me more information on the Interdata 8/32 Megamini.
- You may have hit on the solution to my megaproblem. Have a representative call me.

Name _____ Title _____

Company _____

Address _____

City _____ State _____ Zip _____

Telephone _____



Subsidiary of Perkin-Elmer

Oceanport, N.J. 07757. (201) 229-4040

ED-4-26-75

Now! A better answer of connecting PCB's

Here's how to change your
from this...

to this...with

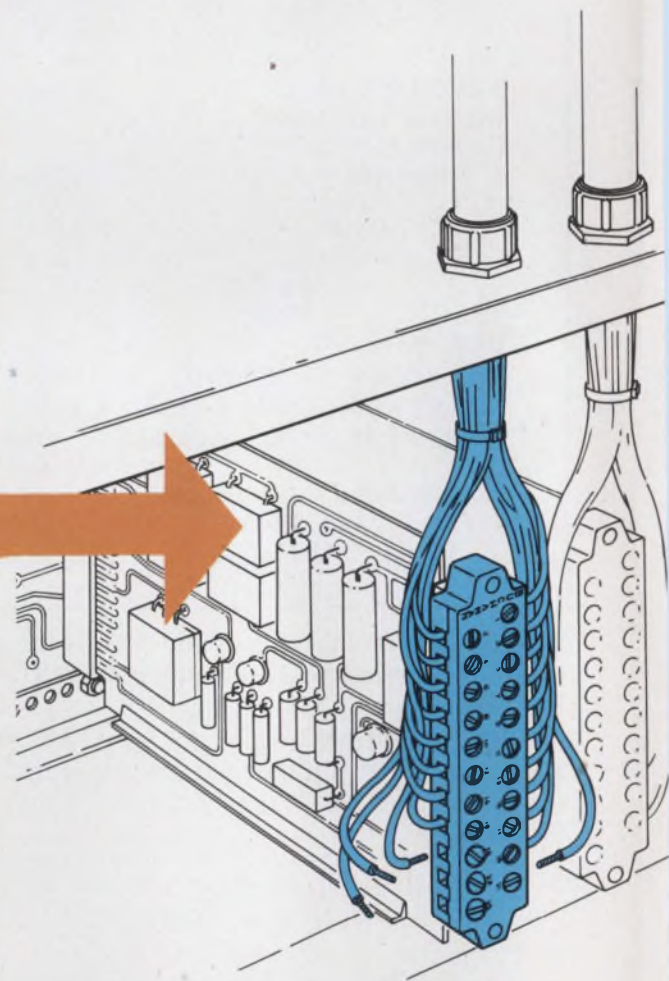
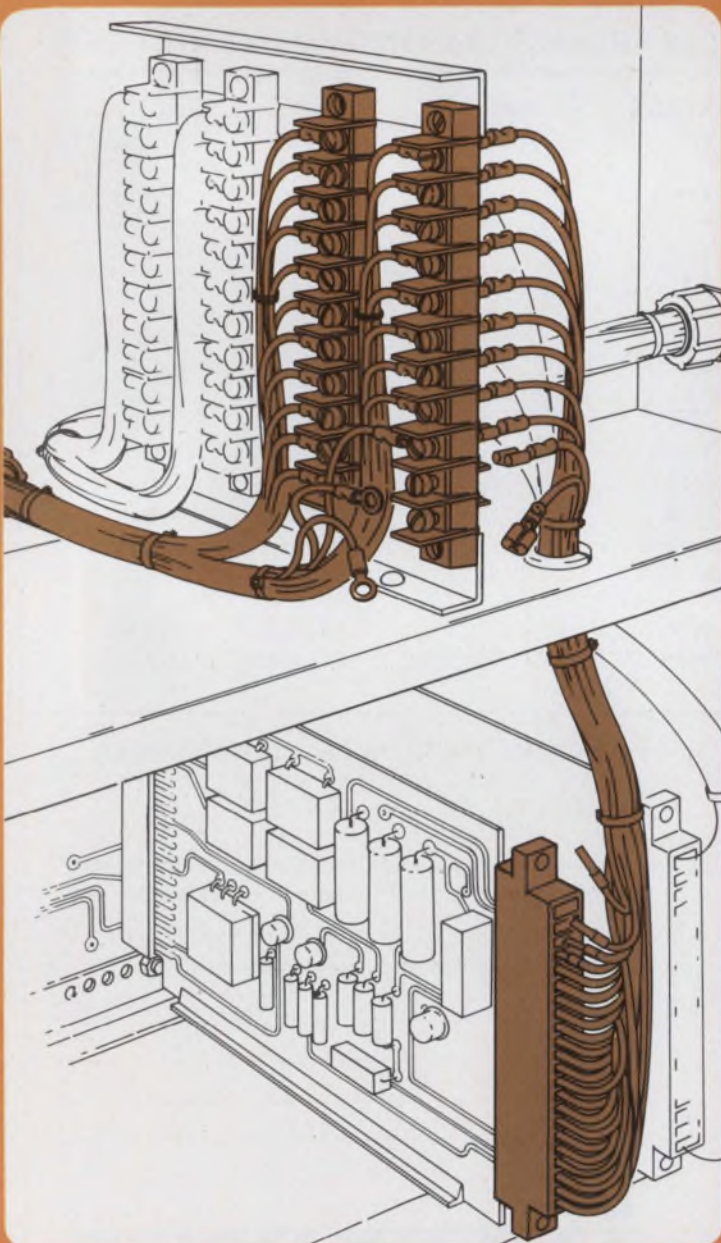

Just one Buchanan
Printed Circuit Board Connector replaces
the two barrier strips, the edge card
connector, the double wiring, and the 110
costly terminations shown at left.
Result: LTIC (Lower Total Installed Cost)!

to the problem to the outside world! system wiring

Buchanan® PC Board Connectors

- Accepts unterminated wires from 12 through 30 AWG
- Saves up to 5 connection points per circuit
- Eliminates barrier strips & terminal blocks
- Available for inside or through-the-panel wiring
- Saves time, money and cabinet space

If you're building control panels or other electrical/electronic equipment that uses printed circuit boards, here's a new PCB connector that's sure to give you LTIC (Lower Total Installed Cost)!

The new Buchanan connector eliminates hybrid interfaces between electronic circuitry and electrical connections. It replaces terminal blocks and barrier strips and the costly wiring between them and internal electronics. Actually saves you up to 5 separate connection points per circuit!

The unique screw terminals accommodate unterminated solid or stranded wires, #30 through #12 AWG. Models are available with .156" or .200" (.508 cm) centerlines; for up to 43 10-Amp circuits; and for inside panel or through-the-panel mounting. Many carry UL component recognition for field wiring.

For complete engineering and ordering information, use the Reader Service Card. Or, call one of our Factory Regional Offices shown below. They'll also be happy to talk to you about special configurations.

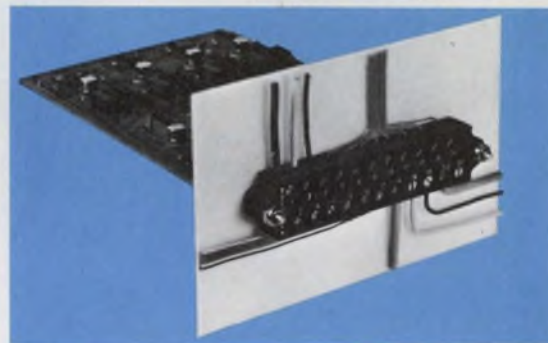

Models available for surface or through-the-panel mounting, with or without card guides and keys.



**CONTROL PRODUCTS
DIVISION**

Amerace Corporation
Control Products Division
Union, New Jersey

multi-conductor capability
...in all directions!

■ If you have a multi-conductor problem, just direct it to the wire company with multi-capability... design, engineering and efficient production. We have successfully designed and manufactured multi-conductor cable of all types. No matter how unusual your requirements, our engineers can work with you to achieve the results you want... with the dependable high quality that has made Victor the standard in wire, cable and cord sets. ■ Put our problem solving capability to work for you. At Victor! Write or phone with your specifications.

Victor Electric Wire & Cable Corp., 618 Main Street, West Warwick, Rhode Island 02893
 Tel. 401 821-1700
 TWX: 710-382-1534

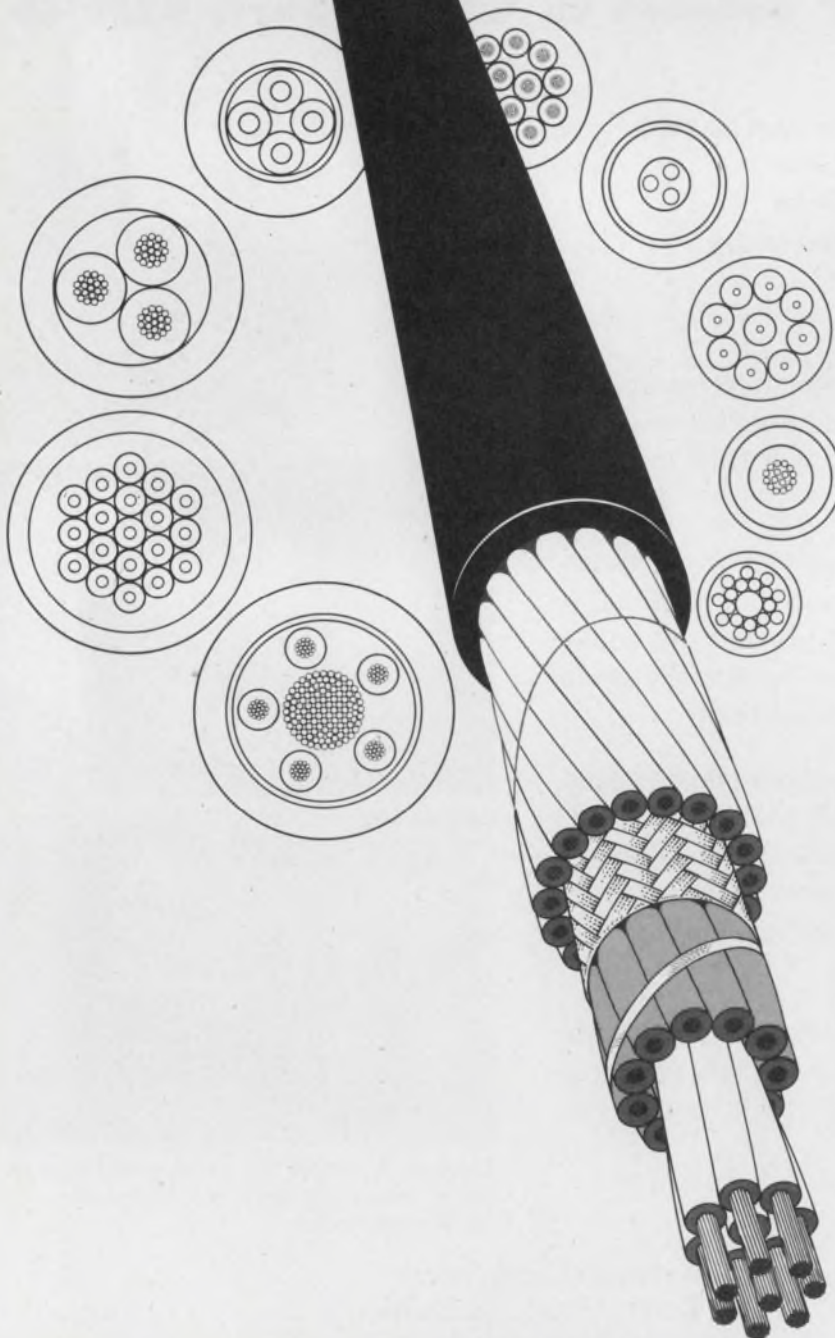

ACROSS THE DESK
(continued from page 7)

mate. "Man" and "engineer" are used almost interchangeably. More than 12% of the words in some paragraphs are masculine nouns or pronouns.

The pronoun usage is part of our language, although an occasional "he or she" would give the article a modern flavor. The use of masculine nouns is unnecessary and distorts the article. Why not use "engineer," "person," "worker," "employee," etc. instead of "man"?

Changes such as the following could be made:

"Forces the engineer and his manager to plan his work at least a year ahead."

Could become: "Forces engineers and managers to plan work at least a year ahead."

"When the engineer writes his own appraisal, he knows if he did a good job or a bad one."

Could become: "Engineers who write their own appraisals know if they did pretty well or poorly."

Martha Sloan

Assistant Professor

Michigan Technological University
 College of Engineering
 Dept. of Electrical Engineering
 Houghton, MI 49931

Standards Dept.



digital or analog



Heath's new laboratory power supplies set new performance standards

- Choice of four DC outputs: 0-7.5 V, 0-15 V, 0-30 V or 0-60 V
- 3½-digit or 3½" meter readout
- Constant voltage and constant current operation
- Remote voltage and current programming
- Precise load and line regulation — $\pm 0.05\%$ voltage, $\pm 0.1\%$ current
- Complete output protection
- Remote sensing automatically compensates for lead voltage drops
- Available factory assembled or in easy-to-build kit form

Heath's versatile new 2700-Series DC power supplies do much more than just provide the right voltage and current—they set new standards for precision and ease of operation.

Digital or analog readout. These power supplies are the first in their price range to offer a choice of readouts. The digital models have two-decade autoranging to provide high resolution for low voltage and current settings.

Constant current and constant voltage operation. And it's true constant current, not simple current limiting. Adjust two controls to get the voltage and current you need. And if one supply doesn't deliver exactly the output you require, just connect them in series or parallel—with no loss of regulation!

Remote programming and sensing. For systems use and remote applications, both voltage and current can be programmed. And all supplies provide remote sensing at the load to automatically compensate for voltage drops due to long leads and connectors.

Output protection. You don't have to worry about these power supplies. Short circuit operation or accidentally applied high voltages can't harm them.

All 2700-Series power supplies are available in easy-to-build kit form or completely factory assembled and calibrated. Either way you get a power supply with the precision and performance that your application demands. Send the reply card or coupon for our latest catalogs and get complete details.

Model	Readout	Maximum Rated Output		Price*
		Volts	Cur.	
IP/SP-2700	Analog	60 V	1.5 A	\$169.95 kit \$255.00 assem.
IP/SP-2701	Digital	60 V	1.5 A	\$219.95 kit \$340.00 assem.
IP/SP-2710	Analog	30 V	3.0 A	\$169.95 kit \$255.00 assem.
IP/SP-2711	Digital	30 V	3.0 A	\$219.95 kit \$340.00 assem.
IP/SP-2720	Analog	15 V	5.0 A	\$169.95 kit \$255.00 assem.
IP/SP-2721	Digital	15 V	5.0 A	\$219.95 kit \$340.00 assem.
IP/SP-2730	Analog	7.5 V	10.0 A	\$169.95 kit \$255.00 assem.
IP/SP-2731	Digital	7.5 V	10.0 A	\$219.95 kit \$340.00 assem.

HEATH COMPANY		HEATH	
Dept. 511-04		Schlumberger	
Benton Harbor, Michigan 49022			
<input type="checkbox"/> Send my free '75 Heathkit Catalog. <input type="checkbox"/> Send my free Heath Assembled Instruments Catalog.			
Name _____			
Title _____			
Address _____			
City _____		State _____	Zip _____
*MAIL ORDER PRICES; F.O.B. FACTORY. EK-456			
PRICES & SPECIFICATIONS SUBJECT TO CHANGE WITHOUT NOTICE.			

**You can buy
this Spectrum Analyzer
and take a big chunk
out of your budget.**

**You can rent
this Spectrum Analyzer
and get more
equipment out of
your budget.**



Even the best equipment budget can only go so far. And at the price you pay for electronic test equipment nowadays, that's not very far at all.

Unless you rent your equipment from REI.

When you rent from us, there's no large cash outlay. You pay only for the time you have your instruments, and you return them when you're through. So you never have to spend your money on idle equipment.

Getting more for your money is just one reason for renting from REI. Immediate delivery is another. We have over \$10 million in inventory in fully stocked centers around the country. And, when you have short-term needs, you can rent equipment for just as long as you need it, and make it pay for itself.

REI stocks over 8,000 fully checked-out test instruments, and they're ready whenever you are. For the full story on renting, as well as our low prices, send in the coupon for prompt delivery of our free illustrated catalog... or call us now for your immediate requirements.

Rental Electronics, Inc.
99 Hartwell Avenue, Lexington, Mass. 02173
Please send me your free instrument rental catalog:

Name _____ Title _____

Company _____

Address _____

City _____ State _____ Zip _____

Tel. Number _____

Rental Electronics, Inc. 

A PEPSICO LEASING COMPANY

Burlington, MA (617) 273-2770 • Gaithersburg, MD (301) 948-0620 • Oakland, NJ (201) 337-3757 • Ft. Lauderdale, FL (305) 771-3500
• Des Plaines, IL (312) 827-6670 • Dallas, TX (214) 661-8082 • Mountain View, CA (415) 968-8845 • Anaheim, CA (714) 879-0561
• Rexdale, Ontario (PLC Leasing Ltd.) (416) 677-7513

INFORMATION RETRIEVAL NUMBER 15

APRIL 26, 1975

Algorithm said to guarantee data security for 100 years

Computer data security may become a problem of the past if a proposed encryption algorithm becomes a standard, as the National Bureau of Standards hopes it will.

The algorithm uses a 64-bit key and codes data in blocks of 64 bits. According to Dennis Branstad, project leader for computer security at NBS, it would take several hundred years to decipher data coded by this algorithm if the key was not known.

Although it was developed by IBM, Branstad notes, the algorithm is being made available to anyone on a nonexclusive, royalty-free basis. It may open up a new market for semiconductor manufacturers, the NBS project leader indicates, because the entire algorithm should be able to fit on one MOS LSI chip. Chip implementation would have several advantages.

As hardware, it would be more efficient than a software counterpart. And, since an integrated circuit cannot be easily modified, an encrypting IC would enhance security.

The coding program can be implemented with MSI TTL, Branstad says, but it would require several hundred packages. The 12,000 to 16,000 gates needed, however, could probably fit on the single MOS chip, he believes.

Semiconductor manufacturers also indicate that the algorithm could fit on a single chip, especially since most of the required logic would be used to form ROMs. Semi makers point out that ROMs traditionally have higher density than random logic devices.

The potential market for data-encryption ICs, Branstad reports, is every computer terminal in use, and he's hoping that such a large

market will spur semi manufacturers to develop the IC on their own. But if no one volunteers to do it, he says, the Government will put out a general open bid so that someone will.

The semiconductor industry does not yet have enough information on the algorithm and its potential applications to make any decisions. But based on preliminary data, some manufacturers believe that the data-encrypting chip can be made on a piece of silicon measuring 170 mils on a side. Estimates on the cost of such a chip have ranged from \$8 to \$50.

Hot-air printer sears characters on paper

The latest addition to the growing family of nonimpact printers is a device that uses hot air to form printed characters on a sheet of ordinary paper. It will be on the market in two months.

Known as Terminair, the new serial printer is capable of producing 10, 15 or 30 characters per second and is designed to sell for only \$900.

The printer was developed by Universal Technology, Inc., of Verona, NJ, and according to John Brady, its inventor, the new device eliminates many of the electromechanical parts used in impact printers. It also does away with the special thermally sensitive paper or ink jets now used in nonimpact printers. But it introduces other electromechanical components: air valves.

Describing how the Terminair unit works, Brady notes that jets of hot air scorch letters and numbers onto ordinary paper. The jets, formed into a print head that consists of a 7-by-9 array, are

selectively activated to form all 128 ASCII characters. A small heating element, which can be an ordinary resistor, raises the temperature of air passing through the jets to about 450 F. This is enough to scorch paper lightly and produce a brown character, but not high enough to burn through the paper or to make it brittle.

The system uses compressed air that is stored in a 5 × 2 × 2-in. container. A noiseless compressor connected to the container maintains constant pressure of 15 psi.

Brady reports that the air valves are very reliable, even though they are mechanical, and should last for at least a million operations.

Universal Technology is also developing two hot-air line printers, one operating at 300 lines per minute and the other at 1100 lines. The 1100 line-per-minute printer will be priced at \$5000, compared with the \$15,000 to \$20,000 generally charged for such printers.

The new line printers will be able to produce facsimiles of line drawings and photos, Brady notes. This will be possible because the resolution of the printer will be the same as that of facsimile machines—96 dots per inch.

To produce multiple copies, Brady has designed a special print head that contains a wire in each of the air nozzles. When air passes through the nozzle, it scorches the paper of the original and pushes the wire forward, so that it applies pressure to the copies. Either carbon paper or special pressure-sensitive paper can be used to make the copies.

Silicon transistor hits 1 W at 8 GHz

A silicon transistor that puts out 1 W at 8 GHz—the highest power yet achieved with silicon at this frequency—has been developed by Texas Instruments.

Heretofore designers had felt that at 8 GHz and above it would be necessary to go to gallium-arsenide field-effect transistors for power applications.

The nearest competitor to the

TI device is a GaAs/FET power transistor, also putting out 1.6 W at 8 GHz. The GaAs transistor has about 9.3 dB of gain, while the Si transistor has 8 dB.

Another feature of the TI transistor is its high collector efficiency of 35%. According to Hanzong Yuan, a member of the TI technical staff in Dallas: "The transistor is composed of four transistor cells sharing a common collector. This technique allows for better thermal spreading and ease of impedance matching. The impedance matching is done inside the transistor package."

The transistor is packaged on a beryllia substrate that is mounted to a copper heat sink. Yuan notes that tests have been made on single cells up to 12 GHz with some useful power out.

"At 10 GHz," he says, "a single transistor cell has given us 220 mW. We feel that the technology might give 1 W at 10 GHz. At 8 GHz, with some more development, we should be able to get up to at least 2 W."

The TI transistor is not likely to be as good at small signal levels as GaAs/FETs, however, Yuan doesn't expect the gain and noise figure to be comparable here.

Further details on the new transistor will be outlined in a paper to be presented May 12 at the 1975 International Microwave Symposium in Palo Alto, CA.

A polymeric solid made superconductive

Superconductivity has been achieved in a polymeric solid, a material never suspected of possessing such capability.

And while the material is bound by many of the rigid and costly incumbrances that also plague superconductive metals, it's encouraging that the polymeric solid can become superconductive at all—a condition in which electrical resistance completely disappears. If this material can do it, the reasoning goes, then still other materials never put to the test might do the same, and under less stringent conditions.

The polymeric-solid conductivi-

ty was discovered by Richard L. Green and G. Bryan Street of IBM's San Jose (CA) Research Laboratory and Laurance J. Suter of Stanford University.

A main problem in rendering a material superconductive is the need to reduce the temperature enough for the phenomenon to take place. This has to be done with liquid helium, which is expensive and difficult to work with. Aluminum, for example, becomes superconductive at 1.175 K, titanium at 0.39 K, tin at 3.74 K, lead at 7.22 K, and niobium germanium at 23.1 K, which converts to a cold -250.18 C.

With more potentially superconductive materials to investigate, one might be found that will superconduct at reasonable temperatures, the discoverers hope. In their tests they used polysulfur nitride crystals—golden in color, fibrous in structure and typically 6 mm long. Structurally the material is composed of bundles of molecular chains, each containing alternating sulfur and nitrogen atoms. In previous tests, carried out at atmospheric pressure, this class of materials had never shown superconductivity.

In earlier studies with polysulfur nitride itself, in which samples were cooled down to 4 K, the conductivity increased but did not become superconducting. When the temperature was pushed down almost to absolute zero (0.25 K) the crystal suddenly switched to the superconducting state.

Success in causing polysulfur nitride to superconduct is particularly significant because of a similarity of structural characteristics hypothesized more than a decade ago by Dr. William A. Little at Stanford University.

In 1964, Dr. Little theorized that an organic polymer with a quasi-one-dimensional structure—a backbone made up of a carbon-based molecular chain with attached side links—could be made to superconduct at temperatures considerably higher than 20 K. Polysulfur nitride is not made up of organic molecules, but it does have a quasi-one-dimensional structure, similar to the backbone of Little's proposed material. As such, IBM says, the new finding may provide an understanding of

the nature of superconductivity in quasi-one-dimensional materials and, of course, intensify the search for a higher-temperature superconductor.

'Electronic checkbook' a specialized calculator

The pocket calculator has been packaged as an "electronic checkbook"—a thin, eight-ounce, battery-operated machine that makes checking-account transactions and retains in its memory for as long as a year the account's current balance.

The CheckMaster, as it is called by its developer, Mostek Corp. of Dallas, TX, manages to do this because the current to the memory is never actually turned off.

The memory feature could have been accomplished easily with CMOS, says a Mostek spokesman, Don Ward, but to keep costs down "we had to go with our low-cost, p-channel depletion process."

"We had to have a standby current for the memory that would not exceed 100 μ A," he notes.

Mostek proceeded in two ways:

First, a departure was made from the usual data-saving technique of placing the data into a continuously dynamic shift register. Instead, a static, shift-register memory was used. It is clocked only during operations requiring memory access. Use of this type of memory permits the entire circuit to be powered-down during the standby mode, with the sole exception of the 50 static loads in the memory.

The second part of the problem, Ward explains, was to reduce the current required by the memory to an absolute minimum (consistent with speed and leakage considerations). The solution involved use of depletion loads with very high effective resistances.

The CheckMaster will be sold by mail order only, at least until fall of this year, Mostek says. The sale and advertising campaign is being handled by JS&A National Sales Group, Northbrook, IL. The "checkbook with a brain" will sell for around \$40.

It doesn't matter that Mini-Circuits' mixers are used in more systems than any other.

What matters is why.

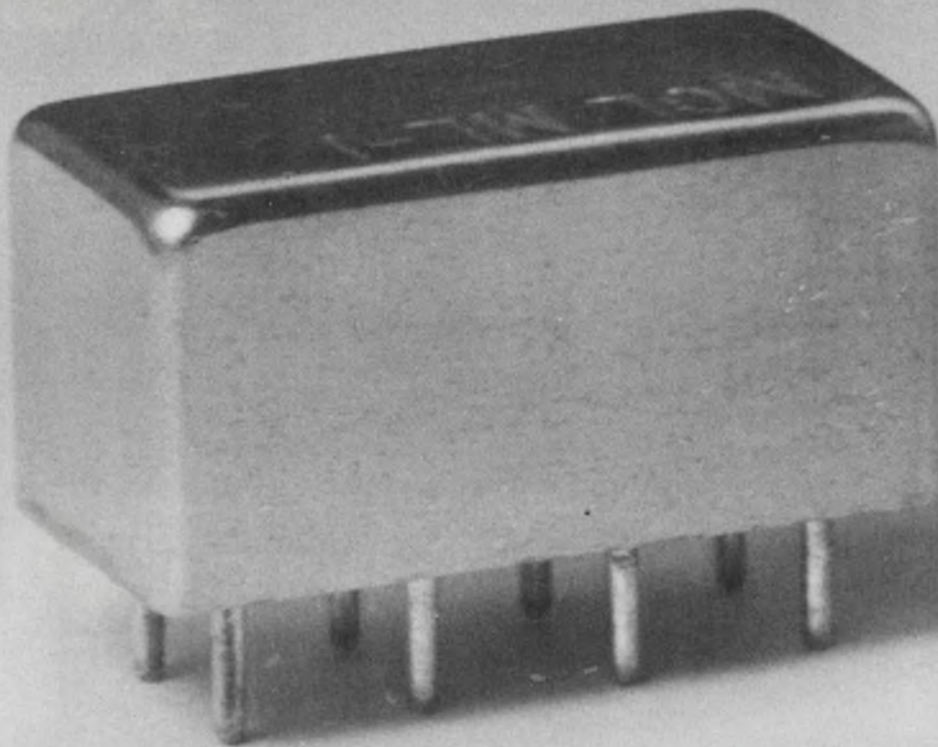

Mini-Circuits ships thousands of units each week to more than 500 companies throughout the world. These mixers are included in over 300 critical military programs as well as communications, medical, CATV, telephone transmission and instrumentation applications.

Our years of experience in high-volume production result in high reliability units with guaranteed repeatability of performance at lowest cost. That's why more and more systems engineers are specifying Mini-Circuits' mixers, directional couplers and power splitter/combiners as the industry's standard.

For complete specs, performance curves and application notes, see MicroWaves 1974 Product Data Directory (p. 187-311) or circle Reader Service No. for your personal 132-page catalog.



Mini-Circuits Laboratory

A Division Scientific Components Corp

MCL

**OUR NEW ADDRESS IS: 837-843 Utica Avenue,
Brooklyn, NY 11203 (212) 342-2500
Int'l Telex 620156**

Foreign Sales Representatives: **AUSTRALIA** General Electronic Services, 99 Alexander Street, New South Wales, Australia 2065; **ENGLAND** Dale Electronics, Dale House, Wharf Road, Frimley Green, Camberley Surrey; **FRANCE** S. C. I. E. - D. I. M. E. S., 31 Rue George - Sand, 91120 Palaiseau, France; **GERMANY, AUSTRIA, SWITZERLAND** Industrial Electronics GMBH, Klüberstrasse 14, 6000 Frankfurt/Main, Germany; **ISRAEL** Vectronics, Ltd., 69 Gordon Street, Tel-Aviv, Israel; **JAPAN** Densho Kaisha, Ltd., Eguchi Building, 8-1-1 Chome Hamamatsucho Minato-ku, Tokyo; **EASTERN CANADA** B. D. Hummel, 2224 Maynard Avenue, Utica, NY 13502 (315) 736-7821; **NETHERLANDS** Coimex, Veldweg 11, Hattem, Holland

US Distributors: **NORTHERN CALIFORNIA** Cain-White & Co., Foothill Office Center, 105 Fremont Avenue, Los Altos, CA 94022 (415) 948-6533; **SOUTHERN CALIFORNIA, ARIZONA** Crown Electronics, 11440 Collins Street, No. Hollywood, CA 91601 (213) 877-3550

For complete U.S. Rep listing and product line see MicroWaves' Product Data Directory

THIS ONE 70¢ A



The Danameter II

We guarantee this instrument will hold its specs for at least one year.

This means you won't have to re-calibrate it for a year. And you won't

have to change its battery for at least one year. (When you finally do, it'll cost you about 70 cents.)

You can take it out in the field and kick it around. And a year from the day you buy it, The Danameter II

RUNS FOR YEAR.



will still be the world's most accurate portable DVM.

It costs \$249. Not much for a man's peace of mind.

Call our Sales Department at (714) 833-1234 for your

nearest Dana representative, or write us at

DANA

Others measure by us.

2401 Campus Drive, Irvine, California 92664.

Coax and microstrip packaging edging out microwave waveguide

Microwave engineers are in danger of losing their nickname—the plumbers. The use of waveguide is on the downswing. All the way up to 40 GHz, coax and microstrip are taking over.

Most microwave devices are now being constructed with integrated-circuit packaging techniques. Microwave transistors and diodes are often used unpackaged, but the packages are getting better all the time. Even TWTs are being constructed with more economical techniques. When getting the heat out is important, heat pipes are making inroads.

Diode packages get smaller

When a diode package is required, it should have as little effect on diode performance as possible. The effect of the package is to add parasitic reactances that tend to reduce the over-all diode performance.

Hewlett-Packard Associates, Palo Alto, CA, makes a diode package that almost isn't there. Place a beam-leaded diode chip on a tiny ceramic substrate. Attach tiny foil strips to the beams and leave a small drop of epoxy on top of the chip to seal it from the outside world. David Struthers, product marketing engineer at HPA, says: "New diode packages are tending towards beam-leaded chips with convenience features. The current tiny packages are easier to use than an unpackaged beam-leaded chip."

When the application is not small-signal, the packages get larger. When 5 to 10 W must be

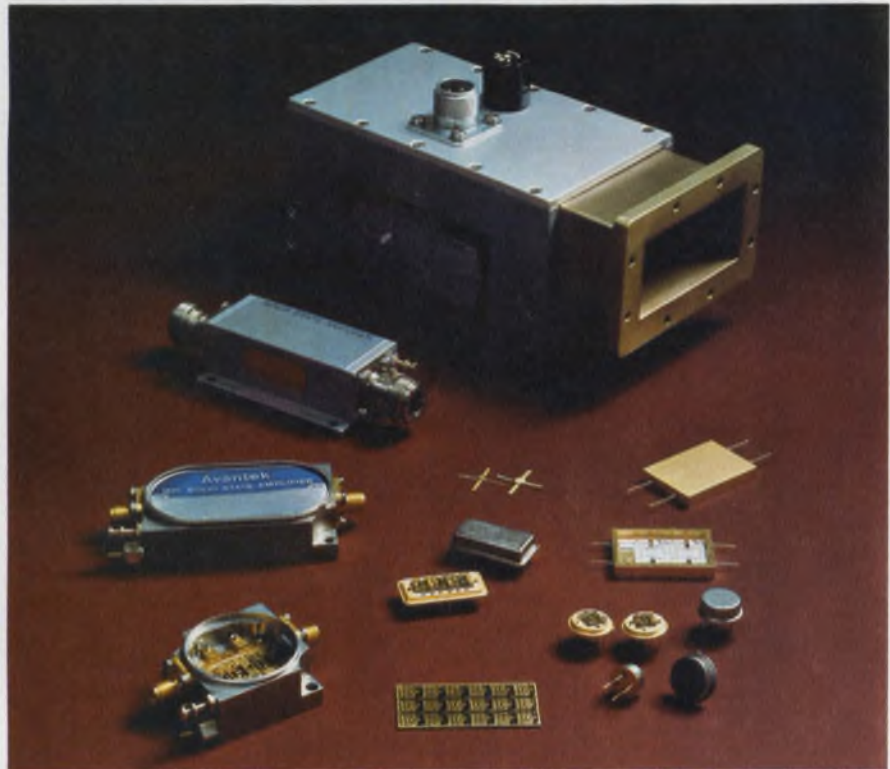

Microwave Integrated circuits come in a wide range of package types. Avantek offers both connector and connectorless packages at frequencies to about 4 GHz. Standard packages are made of welded steel.

handled, microwave diodes come mounted on studs.

Impatt diodes generate high thermal densities and usually have some kind of heat sink. Even unpackaged chip Impatts come with a plated-on heat sink on the base that is usually about 4 mils thick and 20×20 -mils square.

Struthers notes: "A chip Impatt with plated-on heat sink can generate about 2 W at 10 GHz, while the same chip with no heat sink could generate only about 1/2 W at the same frequency." Similar plated-on heat sinks are used by several manufacturers of Gunn diodes.

At millimeter-wave frequencies, the packaging of Impatt diodes has always been a problem. Therefore in the 40-to-100-GHz range Impatts have been used unpackaged in waveguide mounts. Recently, however, packages have been developed for these diodes by the Hughes Electron Dynamics Div., Torrance, CA, and TRW Systems, Redondo Beach, CA. The two packages are similar.

Hughes has the chip mounted on a copper base that is 50 mils in diameter by 10 mils thick. Around the chip is a 30-mil-diam quartz ring topped with a Kovar lid. According to Richard A. John-

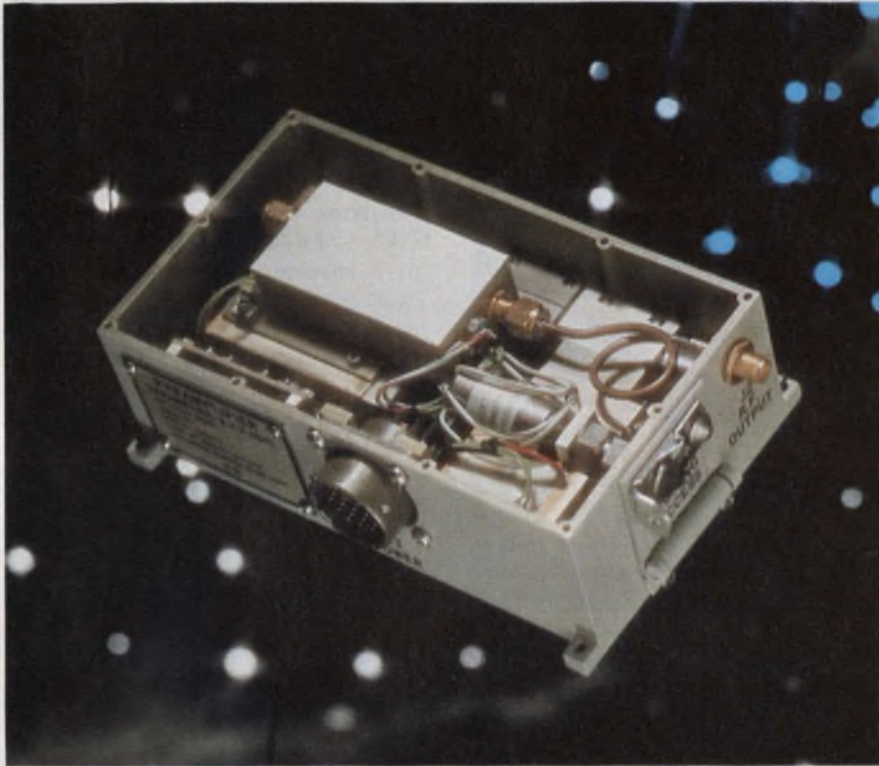

Temperature stabilization of this Micromega paramp system would normally require a 30-lb heat chamber. With thermal pads, ± 1.8 F stabilization is achieved in a 42 oz. package.

son, marketing manager for solid state at Hughes, "the package is virtually as good below 100 GHz as an unpackaged diode."

Dr. John L. Rogers, manager of the arrays department at TRW, says his package is very similar to the Hughes, except for the use of a gold lid and slightly different dimensions for the copper base and the quartz ring. Parasitic capacitance introduced by these packages is only about 0.05 pF.

Johnson of Hughes notes that the next step in package design is to go to a diamond heat sink instead of copper. This should at least double the output power

capability of the Impatt diode and, because of the diode's increased dynamic range, should allow the device to be tuned over a much broader bandwidth.

Transistors in chip form

"More and more users will be buying microwave transistors in chip form," says Richard Lucas, product manager for microwave transistors at Hewlett-Packard Associates. When chips are not used, most small-signal microwave transistors come in a ceramic package that is made in Japan.

The package starts with an

alumina or beryllia square metalized on one side. Then a second piece of ceramic is hot-pressed on top of the metalized surface of the first piece. Leads are brazed onto the metalization at the junction of the two ceramic pieces. The second ceramic is hollow, producing a cavity for placement of the transistor chip. The bottom of the inside of the cavity is plated, and the transistor chip is soldered to the metal. Wires are thermocompression-bonded to the leads, and a metal cap is soldered on. These packages are good up to about 10 GHz. Above 10 GHz, most microwave transistor manufacturers recommend the use of unpackaged chips.

For large-signal microwave transistors, the major trend in packaging has been toward incorporation of internal impedance matching within the package. Some manufacturers of small-signal microwave transistors expect impedance matching to be incorporated within the package as well. However, nobody has yet done this.

Although large-signal microwave transistors all come mounted to a heat sink, it is possible to buy the devices without the sink. Microwave Semiconductor Corp., Somerset, NJ, uses its own transistors without a heat sink. According to Harold Balshem, manager of microwave integrated-circuit engineering: "For good heat transfer, we solder the beryllia substrate of the transistor directly to the microwave integrated-circuit housing. Using this technique, we build power amplifiers up to 4 GHz, with output powers of up to 100 W, continuous or 1 kW pulsed."

Microwave transistors above 8 GHz will likely be gallium arsenide rather than silicon devices. Initially it will be difficult to get GaAs transistors in chip form. This is because GaAs cannot be readily passivated. Thus it is hard to protect the junction against contaminants. Silicon is readily passivated by growth of a natural oxide coating.

In early development at several companies are methods of protecting GaAs chips. Robert E. Brown, manager of microwave sources engineering at Varian Associates, Palo Alto, CA, explains: "We are

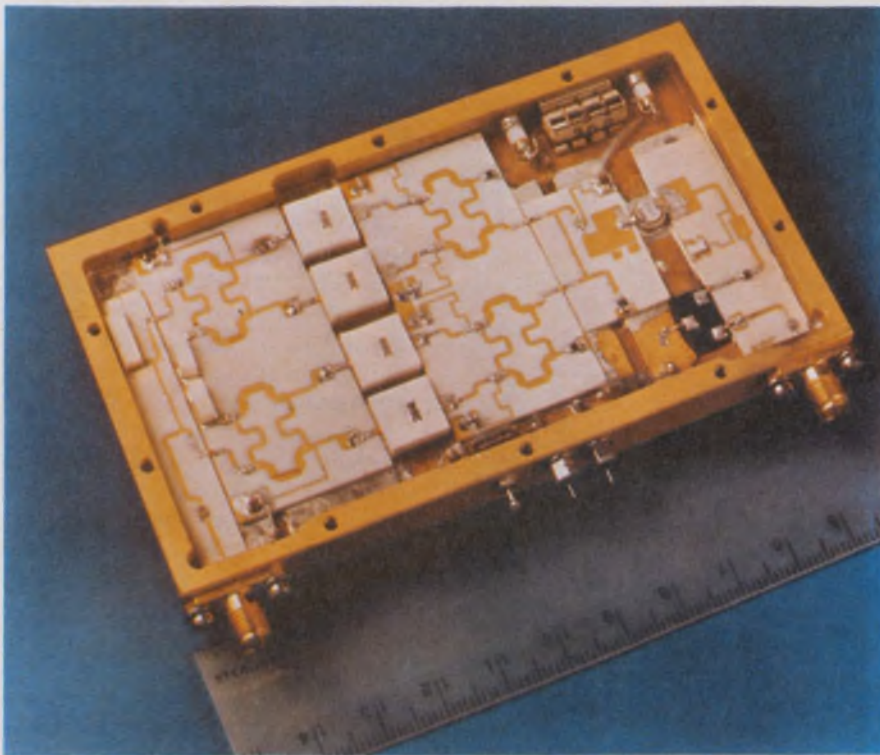

The 91024 S-band MIC power amplifier is offered in a small package by Microwave Semiconductor. The microwave transistors are mounted directly to the base to give 24 W at 55 C.

working on plastic coating of GaAs chips. However, we are quite far away from a workable solution."

Harry Cook, manager of transistor design at AvanteK, Santa Clara, CA, notes: "We are doing something about GaAs transistor contamination but consider the details to be proprietary. However, we are not using a plastic coating."

Much progress has been made in the packaging of stripline resistors and terminations at frequencies up to 18 GHz. Michael Giacalone, microwave engineering manager at KDI Pyrofilm Corp., Whippany, NJ, notes a trend away from coaxial terminations and towards flat terminations. He points out that a $1 \times 2 \times 1/8$ -in. structure can dissipate over 100 W. If the heat is spread out over a large surface, the termination is much more efficient than a coaxial structure.

These terminations are made on beryllia substrates. Nichrome is vacuum-deposited on the substrate. Then the terminals and the area to be connected to the heat sink are nickel-plated. The heat sink can be a stud or even the base of a microwave integrated circuit.

More packaging progress has been made in the area of microwave ICs than in any other microwave area. Many different approaches to the packaging are used. The differences lie in the type of substrate used, the way the substrate is bonded to the package, the way devices are bonded to the substrate, the way signals get in and out of the package, and the way the packages are sealed.

A choice of substrates

Most microwave ICs are constructed on alumina substrates. Alumina is the least expensive of the ceramic substrate materials and can be provided with high degrees of purity and flatness. In cases where surface finish is very important—if thin-film capacitors are to be deposited, say—the substrate of choice is sapphire.

Companies such as Hewlett-Packard and AvanteK use sapphire most of the time. When the ICs are designed at high microwave frequencies, it becomes desirable to use a substrate of lower dielectric constant. This allows the line widths to get larger, and the circuit becomes easier to construct.

Whereas the dielectric constant of alumina and sapphire are in the vicinity of 9.39 to 9.8, materials such as quartz, at 3.8, and RT/duroid, at 2.35 and 2.20, are more amenable to frequencies in excess of 20 GHz.

RT/duroid is a product of the Rogers Corp., Chandler, AZ. It is a glass fiber PTFE material of high-dimensional stability and low-loss tangent. According to George Archer, microwave product manager at Rogers: "Model 5880 duroid has a loss tangent of only 0.0009. We also produce the material clad with 1/16-in. or thicker aluminum on one side for heat-sinking." Some companies have experimented with duroid microwave ICs as high in frequency as 40 to 60 GHz.

Most companies solder the IC substrate to the base of the package. AvanteK solders the substrate to a carrier and then screws the carrier to the package. Some companies use conductive epoxy. And at millimeter-wave frequencies, Stanford Research Institute, Menlo Park, CA, screws down the substrate.

Donald Chambers, senior research engineer at SRI, explains: "We use very thin sapphire substrates up to about 40 GHz. At these frequencies, the bonding of the substrate is very critical, so as not to create any impedance mismatches. So we use several small screws and carefully attempt to get uniform contact across the substrate to the ground plane."

Most devices are soldered to microwave IC substrates. However, recently there has been a move toward the use of conductive epoxies for this purpose. According to Jesse Taub, a consultant with the AIL Div. of Cutler-Hammer in Deer Park, NY: "We have used silver-filled epoxies to bond die to substrates up as high as 60 GHz."

Connectors are one of the major problems in microwave systems. As a result, work is being pursued to develop connectorless packages. Packages of this type have been developed by AvanteK and by the Bendix Electrical Components Div., Sydney, NY.

Most microwave ICs have SMA-3.5-mm connectors. Above 18 GHz these connectors degrade rapidly. Work is being pursued to develop precision coaxial connectors that

Still fighting snap, crackle and pop?



Noise has a way of showing up in circuits. Bendix has a way of preventing it. Filter connectors. Boasting some of the best attenuation curves available, Bendix filter connectors solve a wide range of low-pass filter problems. Small wonder Bendix is first choice in the fight against snap, crackle and pop.

These versatile connectors, production tooled, are available in a wide range of cylindrical and rectangular configurations designed to meet most any industrial, commercial and military application.



Configurations that can be intermateable with most MIL-Spec and popular commercial connectors and special designs for advanced state-of-the-art equipment. There's sure to be one that meets your attenuation and frequency requirements. You'll like what you hear when it comes to the price, too. And that goes for delivery as well.

Write for our new catalog. It's yours for the asking. The Bendix Corporation, Electrical Components Division, Sidney, New York 13838.



will be good to 40 GHz. The first of these has been introduced by Maury Microwave, Cucamonga, CA. It is called the MPC-2. Connecting to 0.086 semi-rigid coax, it is a 2-mm dielectrically loaded connector.

Mario Maury, president of the company, reports: "The MPC-2 is good up to 40 GHz, with a maximum VSWR of 1.2:1. Coming later will be the MPC-1—good to 60 GHz. We also make a full line of transitions from the MPC-2 to microstrip or to other connectors."

Keeping out contamination

Most microwave ICs are hermetically sealed by a variety of different methods. They include welding, epoxy, screw and gasket and compression. Welding is the most common approach. According to Harry Cooke of AvanteK: "Our standard MIC package has been welded stainless steel. We are now moving to Heliarc-welded aluminum."

Tom Strouth, a packaging engineer at Teledyne MEC in Palo Alto, CA, says: "We resistance-weld the covers on our packages in a nitrogen-helium atmosphere. We use Kovar packages for temperature stability."

Chambers of the Stanford Research Institute uses gasket and screw sealing but says he is looking into conductive-epoxy sealing of IC packages.

One of the most novel methods of making the hermetic seal is being developed at Watkins-Johnson, Palo Alto, CA. Gary Yasumura, a member of the technical staff, reports: "We are using a new material developed by Ray-Chem, Menlo Park, CA. It is a 50-50 alloy of titanium and nickel. The material has the strange property that it is stiff at room temperature, but when you lower the temperature below some transition temperature, it becomes malleable."

Yasumura makes his IC package with a lip around the edge and a circular opening. He takes a disc of the material that is a little bit oversized for the opening and dips it into liquid nitrogen. Once malleable, the disc is shaped so that it is concave, and it is placed into the IC package opening. As it warms back to room temperature,

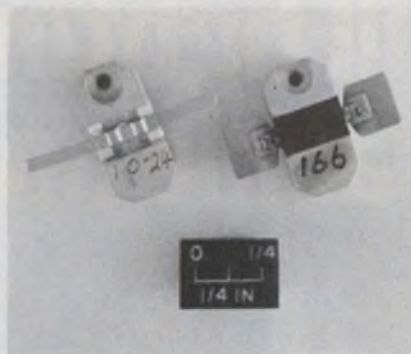

Over 500 W at 4.6 GHz in a p-i-n diode is tough to achieve. Motorola's wide gold lead is the key.

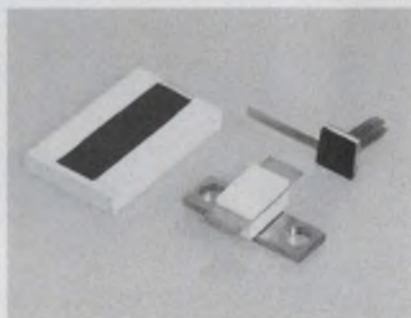

Conduction-cooled microwave resistors and terminations handle up to 100 W. These devices are from Pyrofilm on beryllia substrates.

the disc flattens and applies a uniform pressure against the lip of the package. The pressure is enough to give the package a solid hermetic seal.

Some companies are also looking into thermocompression bonding covers on IC packages for hermetic sealing. This isn't economical unless the volume of the production run is very high.

Monolithics and mm waves

Microwave ICs have always been hybrid structures. However, there has always been a dream of making them monolithic. Some researchers have been working on a transmission medium that might lead to the development of monolithic microwave ICs. It is called image line, and the process is the reverse of that used in a conventional microwave IC. Instead of metal conductors on a dielectric substrate, dielectric conductors are placed on a metal substrate.

Hughes Electron Dynamics Div. is one group working on the image-line technique. "We are using

image line for transceivers at 60 GHz," Johnson reports. "This type of transmission line allows for high-Q circuits to be built at frequencies in excess of 100 GHz."

Since the substrate that Hughes is working with is silicon, it is reasonable to expect that active devices, such as Impatt diodes, may one day be monolithically constructed in the same piece of silicon.

Most millimeter-wave IC work still uses more conventional media, such as a thin sapphire substrate with thin-film gold conductors.

Use of heat pipes growing

Heat transfer is often a packaging problem, and the solution offering most promise is heat-pipe transfer.

Al Basilius, engineering manager for thermal products at the Hughes Electron Dynamics Div., notes: "Heat pipes can be used either to transport heat from a device to a sink or as a heat spreader to eliminate hot spots."

Heat pipes have been applied with considerable success to the design of microwave amplifiers, oscillators and TWTs. Edwin L. Kyte, manager of solid-state amplifiers at Varian, is using heat pipes for temperature-stabilization of a Gunn diode amplifier. He says:

"Over a temperature range of 125 C, we can hold the amplifier to ± 4 C. Since a Gunn amplifier is only 3 to 4% efficient, the rest of the power is converted to heat by the diode and used to heat a heat-pipe base plate to the maximum temperature of the desired range. The heat pipes spread the heat and hold the amplifier at a stable temperature, without an external power source, as the ambient varies."

In TWTs, heat pipes are used to help remove the heat from the collector of the tube. Heat pads are also being used for temperature stabilization. The Micromega Div. of Bunker Ramo in Westlake Village, CA, uses rubber pads with heating elements in them to stabilize parametric amplifier systems; there is no need for large thermal enclosures. Using this technique, the company has reduced a 30-lb chamber-enclosed paramp system to a 42-oz package. ■■

ANOTHER REASON HEINEMANN IS NO. 1 IN OEM CIRCUIT BREAKERS.

THE UP-FRONT BREAKER

PRECISE PROTECTION IN A PRETTY PACKAGE—AND A POWER SWITCH FOR YOUR FRONT PANEL.

Put a Heinemann Type J breaker on your front panel, and you get a power switch for free. An ingeniously simple way to cut component and assembly costs. There's just no reason to keep your protection under cover when you can get such good-looking breakers, with a choice of handle types, colors, and mounting arrangements.

Maybe you think a fuse and a switch would be cheaper. But did you ever stop to think how much it costs when your technician makes a service call just to replace a blown fuse? An easily resettable Heinemann circuit breaker can keep that from happening. Saves you money and enhances your product's reliability reputation.

Remember, too, that nothing works like a hydraulic-magnetic circuit breaker—close-tolerance protection and freedom from temperature-caused nuisance tripping. Our Type J can be custom-tailored to your circuit requirements in any integral or fractional rating from 0.020A to 30A at 240V 60 Hz or 400 Hz, or

65V dc. In a choice of four time-delay ranges and seven special-function internal circuits.

Values like the Type J have helped make Heinemann the world's most respected name in OEM circuit breakers. Only Heinemann gives you such a complete selection of sizes and ratings. And now we offer you a choice of protection: electro-mechanical, hybrid, or all solid-state. Backed up with Quick-Draw delivery (most popular styles and ratings shipped in a day or two); the exclusive Heinemann five-year warranty; and manufacturing facilities in the U.S., Canada, West Germany, South Africa, and Australia.

We want to help you get the most for your protection dollar. Call us or your nearby Heinemann representative for knowledgeable applications assistance. For starters request our Type J bulletin. Heinemann Electric Company, Trenton, NJ 08602. Phone (609) 882-4800.



HEINEMANN

We keep you out of trouble.

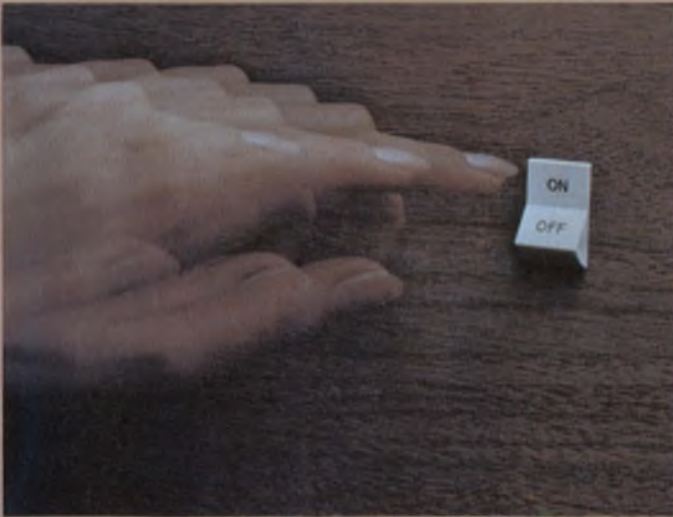

Thin-Trim[®] capacitors



Tucked in the corner of this Pulsar Watch is a miniature capacitor which is used to trim the crystal. This Thin-Trim capacitor is one of our 9410 series, has an adjustment range of 7 to 45 pf., and is .200" x .200" x .050" thick. The Thin-Trim concept provides a variable device to replace fixed tuning techniques and cut-and-try methods of adjustment. Thin-Trim capacitors are available in a variety of lead configurations making them very easy to mount.

A smaller version of the 9410 is the 9402 series with a maximum capacitance value of 25 pf. These are perfect for applications in sub-miniature circuits such as ladies electronic wrist watches and phased array MIC's.

Johanson Manufacturing Corporation, Rockaway Valley Road., Boonton, N.J. 07005. Phone (201) 334-2676, TWX 710-987-8367.

MANUFACTURING CORPORATION

NEWS

Small, nonimpact printer to cost less than \$25

A small, nonimpact printer, using an electrostatic head, has been announced by Panasonic for use in electronic calculators, instrumentation, cash registers and computers. The unit will cost as little as \$25 in quantity.

Called the Panaprinter, the unit is small because it eliminates the bulky mechanical equipment usually found in printers such as solenoids and type hammers.

The Panaprinter prints both alphanumeric and arithmetic symbols, based on a matrix structure of 7-row by 5-row dots. The characters are printed by a mechanical horizontal scanning operation of a 7-row-by-one-column head. The unit prints 20 characters per line, at a rate of 2 lines per second.

A voltage supply of -24 V dc is required. The average power amounts to 0.84 watt second per line. The unit operates at 90% relative humidity in an environment of -5 to 45 C.

The Panaprinter weighs 11.7 oz measures 3.54 in. by 1.614 in. by

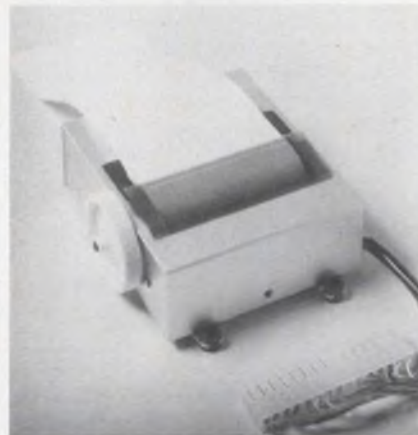

Readout from electronic calculators, instrumentation, cash registers and computers is printed electrostatically by Panasonic's nonimpact printer.

4.331 in.

The only external equipment needed is a driving module, which Panasonic says, the customer will probably want to build himself.

Panasonic says it has announced a similar nonimpact printer for sale in Japan that uses a thermal printing head. ■■

Airline gets automatic PC tester

A \$400,000 automatic test system that can troubleshoot more than 500 types of PC boards used in jetliner navigation communications and control equipment has been installed at the United Air Lines Maintenance Center in San Francisco.

The system—a Honeywell H-2100—tests boards that previously had to be returned to vendors. As a result, says James Valdez, technical support manager, the inventory of spare units can be substantially reduced.

The system includes a central data station and an independent circuit-board tester. The central

station can perform simultaneous testing, program development and compilation. The station has its own minicomputer with 24-k memory, as well as foreground and background operating capabilities. Included in the central station is a CRT terminal and keyboard, a 300-line-per-minute printer, a 3.5-Mbit disc file and two 1600 bit/in., nine-channel tape drives.

The circuit-board tester has an independent minicomputer with a 16-k memory. This tester can operate autonomously or with the central data station via a high-speed communications line. ■■

Low-cost digital setup measures horsepower

A shaft-horsepower measuring system for marine and industrial engines uses low-cost digital techniques that are said to provide improved performance over costly strain-gauge systems. The solid-state system measures up to a few thousand horsepower.

According to Clarence Casper, vice president of engineering for Advanced Electronics Development, Chester, CT, the developer of the system, it has these advantages over the present strain-gauge installations:

- The cost is reduced from about \$20,000 to \$1000.

- Exceptionally high noise immunity is obtained through the use of special magneto-sensitive transducers and CMOS circuitry.

- No slip rings are needed, such as those required to pick off strain-gauge signals from the shaft. The rings are a source of noise and other problems in a dirty environment. The new system operates by measuring the twist along a length of the engine-driven shaft, thus obtaining torque. Shaft speed is picked off, and both speed and torque are multiplied to give horsepower, which is displayed directly on a digital panel meter.

The key feature in providing a noise-immune signal to the system is two special magneto-sensitive pickups. These produce a discrete 5-V output compatible with the logic.

Two pieces of magnetic material are bonded to the engine shaft. As the shaft rotates, signals are produced in the two pickups. The magnitude of any shaft twist is obtained by comparison of the difference in time between the two sensor logic outputs. System timing is provided by a special logic one-shot multivibrator that uses a crystal oscillator, a divide-by-n counter and hexadecimal switches for stability and programmability.

Shaft speed is obtained when the output pulses from one of the sensors are counted.

The prototype system has been tested on a marine system, Casper says, and initial tests indicate better than a 5% accuracy. ■■

If the right hand doesn't
Persuade you, then
the left hand will!



*From out of the West,
we've combined our
S410 series of
switchlights with our
S190 series just to
prove 21 points to you.*

Compare our "Persuader Line" with other leading brands of switchlights. Check low cost, for example. The S190 comes in at \$1.62 in quantities of 1000—the S410 at \$2.53. Ask blunt questions about distributor stock, U.L. listing, wiping contacts. Go through the entire check list for economy, quality and versatility. Be bold and challenge your local distributor, because we're located in major cities world wide. Once you get connected to Clare-Pendar, you may never want to go anywhere else.

CLARE-PENDAR
Switchlights & Keyswitches



Box 785, Post Falls, Idaho 83854, (208) 773-4541.

Get more for your money!

Use This New 3/8" Square Cermet Trimmer From Allen-Bradley

Our new TYPE E trimmer is a high performer with a realistic price. It has some important advantages: • Immersion seal is tested in 85°C water (not 50° or 70°). • Temperature characteristic is 100 PPM/°C for stability. • Multifingered contact for excellent adjustability. • \$0.49 each—1000 piece price. For more information call your A-B distributor or write for Publication 5219.

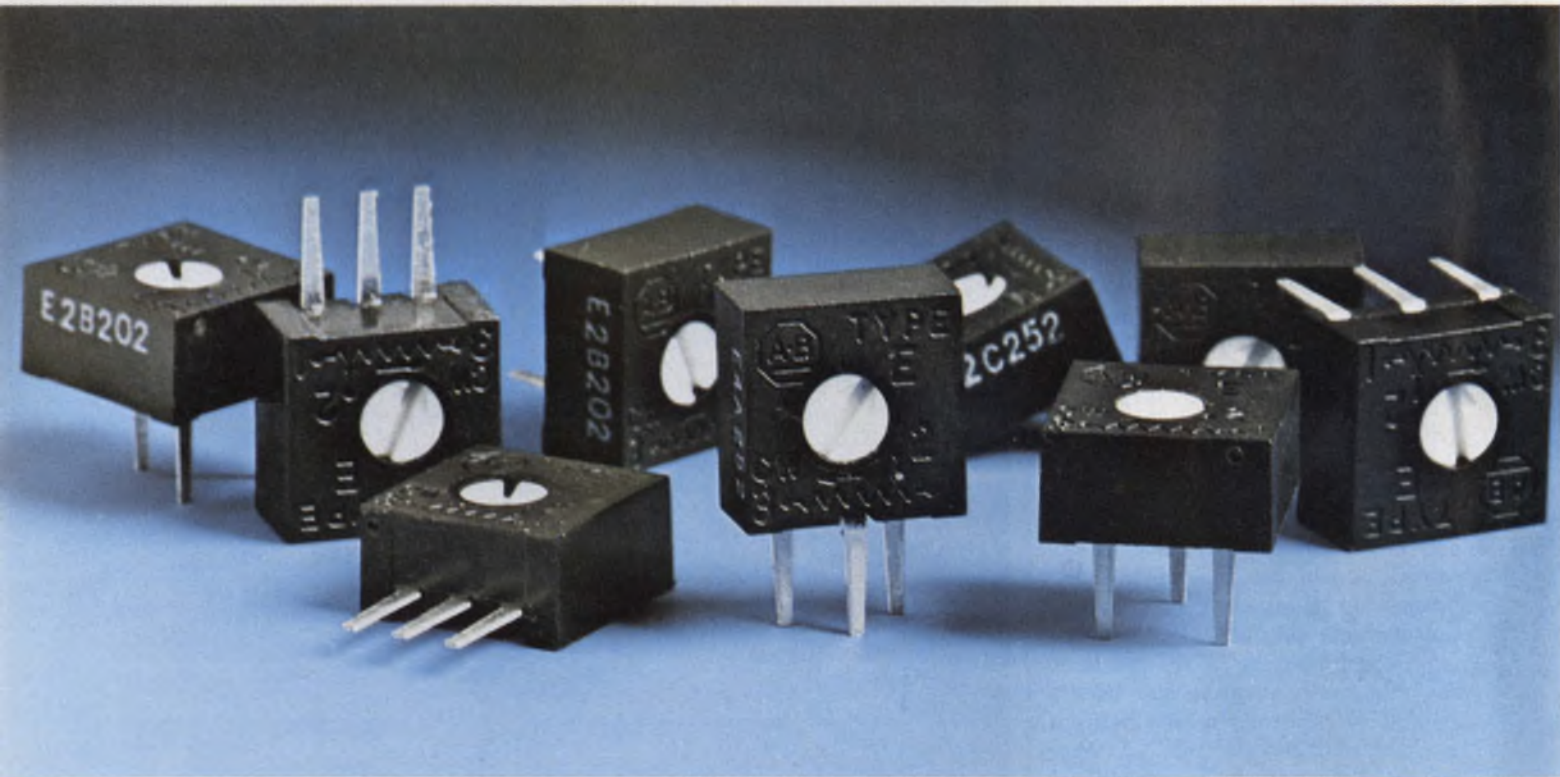
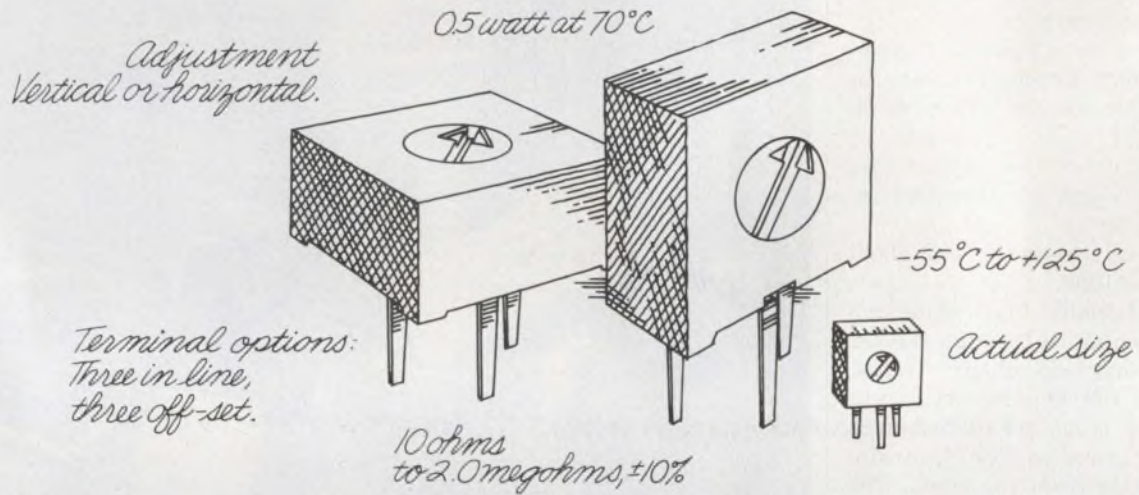

Quality in the best tradition.



ALLEN-BRADLEY

Electronics Division
Milwaukee, Wisconsin 53204

INFORMATION RETRIEVAL NUMBER 22

EC108

Send for this new brochure
by the originators of Solid-State
Photo-Isolated Power Relays.
It details the widest line available
and how to apply them.



Think
Crydom...
The Pacesetters.
"First and widest line in the field"

INTERNATIONAL RECTIFIER



1521 Grand Avenue, El Segundo, CA 90245 • 213/322-4987

INFORMATION RETRIEVAL NUMBER 121

TO: International Rectifier CRYDOM Division • 1521 Grand Avenue, El Segundo, CA 90245
Please send your brochure on Solid-State Photo-Isolated Power Relays to:

Name _____
Title _____
Company _____
Address _____
City _____ State _____ Zip _____
Phone _____

Microprocessors.



Microprocessing.



superhuman effort on the part of our Field Applications Engineers and sales personnel



software and firmware aids



you'll need some support hardware, too

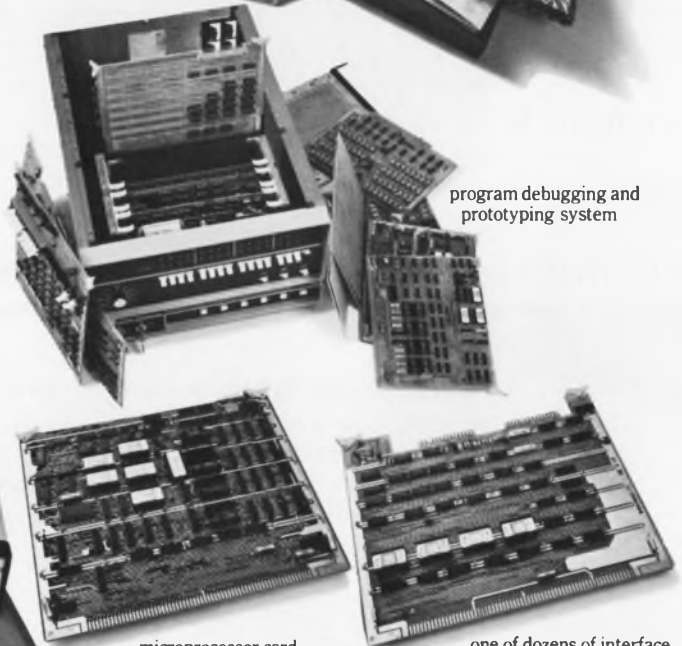

program debugging and prototyping system

microprocessor card

one of dozens of interface devices you may need



peripheral and support chips

Only National has it all.

Gentlemen,
I understand that there's a lot more to microprocessing than microprocessors, and that only you can give me everything I need, from chips through interfaces. Tell me more.

Name _____
 Company _____
 Address _____
 City _____ State _____ Zip _____
 Mail to: National Semiconductor, 2900 Semiconductor Dr.
 Santa Clara, California 95051 ED 426

National
 There's more to microprocessing than microprocessors.

INFORMATION RETRIEVAL NUMBER 122

If you're into linear microwave power:



FREQUENCY (GHz)	4 GHz	3 GHz	3 GHz	2 GHz	2 GHz	2 GHz
P_{gain} (linear) db	5.0	6.0	6.0	5.0	6.0	6.0
P_o (sat) W	.7	2.4	1.2	10.0	5.0	2.5
P_o (1 db comp) W	.5	1.8	.9	8.0	4.0	2.0
P_o (linear) W	.35	1.5	.75	6.0	3.0	1.5
VSWR	∞	∞	∞	3:1	∞	∞
PART NUMBER	TRW 54601	TRW 53602	TRW 53601	TRW 52604	TRW 52602	TRW 52601



TRW transistors deliver up to 6 W, off the shelf, at a very good price.

TRW's new family of linear microwave transistors develop up to 6 watts with low distortion and infinite VSWR. For reliability processing to any level, they're as tough as they come, gold metalized and diffused silicon ballasted. If you're into linear microwave power, look into these new 2, 3 and 4 GHz transistors. For complete specs, just fill out this coupon, or call Don Comm at (213) 679-4561.

TRW RF SEMICONDUCTORS

TRW RF Semiconductors
An Electronic Components Division of TRW, Inc.
14520 Aviation Boulevard, Lawndale, California 90260

Please send me data sheets on your new family of linear microwave power transistors.
I am particularly interested in _____ GHz parts.

NAME _____

COMPANY NAME _____

ADDRESS _____

CITY _____

STATE _____

ZIP _____

The Standard DPM

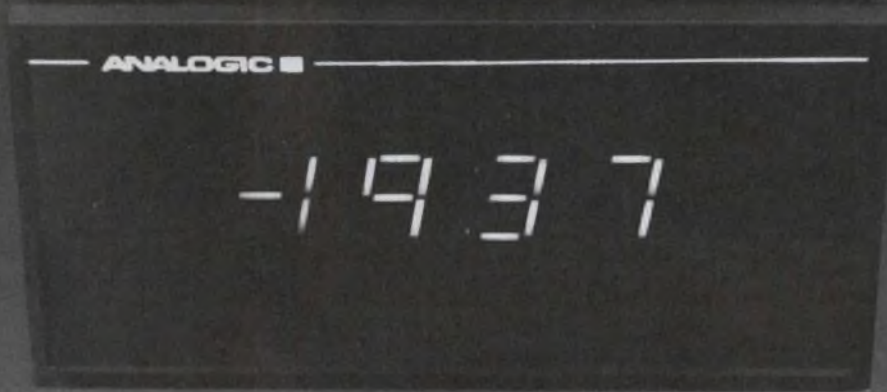

- 3½ digits
 - true instrumentation differential input
 - buffered parallel BCD output
 - DIN and NEMA mounting dimensions
- ... all **STANDARD** on Analogic's AN2537 for **\$89.***

The AN2537 is unquestionably the best price/performance value in a 3½ digit DPM on the market today. But don't take our word for it — compare.

Compare our standard features... true balanced differential, high impedance, instrumentation type input and **buffered** parallel BCD digital output eliminate the possibility of input ground loop problems and output interference reflections and mismatch noise problems. In addition, the AN2537 has a built-in universal transformer for pin-selectable powering from 100 to

240VAC, 49 to 63Hz sources.

As for specifications... compare these with our competition. 0.05% \pm one digit accuracy up to 60°C, only 2 watts power consumption, dual slope conversion, long period signal integration for noise rejection ratios conservatively rated at > 80 dB common mode, 30 dB (or 100 dB with optional low-frequency filter) normal mode, and temp. coef. better than < 50ppm/°C.

Other features that you naturally expect from Analogic include... choice of either .55"

Beckman plasma or ½" LED displays, extensive use of CMOS for < 10°C rise, tough LEXAN® case that meets both DIN and proposed NEMA mounting dimension standards, and 5-day burn-in of all completed assemblies.

There's more of course. To find out, call Analogic's Marketing Department at (617) 246-0300, or your local Analogic sales office. For our new 40 page Catalog/Handbook, write on your letterhead

to Analogic Corp.,
Audubon Rd.,
Wakefield, Mass.
01880.

ANALOGIC ■

... The Digitizers



*OEM quantities



One power supply, Model JMK 100-1M produces 0-100 volts controlled in 12-bit binary; and 0-1 ampere controlled in 8-bit binary. The other unit, Model JMK 15-6M produces 0-15 volts controlled in 3-digit BCD; and 0-6 amperes controlled in 2-digit

This, for example, is a dual-output power supply system comprised of a pair of Kepco JMK Power Supplies, each controlled in both voltage *and* current by type SN Digital Interface Cards.

BCD. The two SN Cards that program each power supply are mounted in pairs, each in a type CA-6 dual enclosure. The whole system is assembled in Kepco's RA-24 enclosure, that will occupy only 5 1/4" of space in your 19" rack.

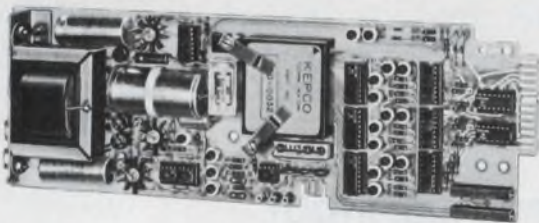

The SN Digital Interface Card accepts your data input on parallel lines, strobed for noise immunity, and stores the data in a buffer register. For isolation, the program is transferred across optical couplers so that your digital signal and the power supply it controls can be up to 1000V apart. The five types of SN Cards offer a choice of BCD or complementary binary programming.

The analog output from the SN Card is in the form of a 0-1V/0-10V range-selected signal* that is linearly amplified by the companion power supply to produce the desired output. In the illustrated combination of JMK 100-1M and SN-12, the power supply functions as a gain of 10 amplifier, with 12 bits (0.024%) resolution. The JMK 15-6M, programmed by SN-3, functions as a gain of 1.5 amplifier, with 3 digit (0.1%) resolution. The range selector on the SN allows the full resolution to be spread over the lowest 10% of the output.

*The SN Card also produces $\pm 10V$ & $\pm 5V$ outputs to control bipolar power supplies and 0.5V, 1.0V outputs to control current stabilizers.

SN CARDS AVAILABLE		
MODEL	RESOLUTION	LINEARITY
SN-2	2 BCD	$\pm 0.2\%$
SN-3	3 BCD	$\pm 0.05\%$
SN-8	8-bit	$\pm 0.2\%$
SN-10	10-bit	$\pm 0.05\%$
SN-12	12-bit	$\pm 0.01\%$

These SN Cards are fully self-contained digital programmers, featuring an on-card line-operated power supply. Kepco offers a variety of housings and accessories to accommodate them to various programmable power supplies. As many as eight cards can be accommodated in a standard 5 1/4" x 19" panel.

For complete specifications, write Dept. EX-5



KEPCO, INC. • 131-38 SANFORD AVENUE • FLUSHING, N.Y. 11352 • (212) 461-7000
TWX # 710-582-2631 • Cable: KEPCOPOWER NEWYORK

Washington Report

Bitter defense-budget battle shaping up

Rising tensions in the Middle East and the stunning defeat of South Vietnamese military forces by the Communists have added intensity to the upcoming battle in Congress over the fiscal 1976 defense budget. Facing those who seek a big cut in defense spending will be such stalwarts as Sen. John Stennis (D-MS), chairman of the Senate Armed Services Committee.

"Because of the uncertainty in the international situation," he says, "some very hard policy decisions would have to be made before any drastic reductions could be achieved this year."

Stennis has notified the Senate Budget Committee that while his committee made significant cuts in defense requests in past years, it would not go along with huge reductions in the new budget.

Obviously among the budget items receiving hard scrutiny is the Defense Dept.'s consolidated telecommunications program of over \$3-billion. About one-third of this, says Deputy Secretary of Defense Williams P. Clements Jr., is for hardware. Not included in that total is another half billion for command-and-control facilities and tactical warning systems. The ADP spending for the department will add \$2-billion further.

House bill would give electric cars a push

Electric-car manufacturers are elated over a new procurement bill just introduced in Congress. If passed, the Government would purchase 10,000 electric vehicles and set up a demonstration program involving leasing and field-testing throughout the nation during the next three years. The legislation, drafted by the House Committee on Science and Technology, would authorize \$40-million for each of the next three years to the Energy Research and Development Administration, which would operate the program.

Rep. Mike McCormack (D-WA), a sponsor, says the R&D portion of the program would include work in energy-storage systems, control systems and over-all design. Associated research would be directed toward urban design, traffic management and environmental studies. Individuals and businesses would have an opportunity to purchase or lease the vehicles.

Cost overruns found in nondefense projects

Cost overruns, it seems, are not a malady that afflicts only the Dept. of Defense. Reporting on the status of 269 other Federal projects, the General Accounting Office has found that original cost estimates of \$76-billion

have skyrocketed to \$133-billion.

The watchdog agency looked at projects involving \$25-million or more and found 59 of them had grown by more than 100 percent. So-called "engineering changes" accounted for 41 percent of the increase on the 59 projects that posted the largest overruns.

The major offender was the Interstate Highway System. The National Aeronautics and Space Administration was relatively clean—23 projects, originally estimated to cost \$8.27-billion, had an overrun of nearly \$1.9-billion. This estimate was based on the original Congressional authorization.

But the GAO also recently pointed its spotlight on the Defense Dept., and if its recommendations are followed, the department will be asking contractors to furnish life-cycle cost estimates with their proposals, including those for prototype competitions. Life-cycle costs haven't figured prominently in the past on major weapon development; however, the GAO concludes that despite the difficulty in making such estimates, they can be done. It recommends that Congress require the data.

Study examines effects of high-voltage transmission

Faced with the probability that as much as 10,000 miles of extremely high-voltage transmission lines will be in operation by 1990, the Environmental Protection Agency has begun a study of the health and environmental effects that may be involved. Several transmission lines are already operating above 700 kV, and the agency is seeking data and information from the public so it can make an evaluation. Under study are measurement and analytical techniques, electrostatic and electromagnetic induced voltages, electric discharge phenomena and health effects.

In the particular area of electric discharge phenomena, the EPA is asking for comments on the amplitude-frequency distribution of radio-frequency electromagnetic energy, its dependence on operating-line voltage, surface-voltage gradient and the influence of weather.

Capital Capsules: The Navy Air Development Center, Warminster, PA, is in the market for an integrated communication, navigation and identification system suitable for a wide range of airborne and surface platforms. . . . Users and producers of space-communication technology at 40 GHz and 80 GHz are being sought by the National Aeronautics and Space Administration, which has a program under way to predict technology developments likely to occur from 1980 to the year 2000. . . . The Air Force has successfully flight-tested a new electronic reconnaissance camera system that reduces the time lapse between photography and photo interpretation to about 10 sec. The system, designated the AN/UXD-1, uses a 4.5-in. return-beam vidicon camera developed by RCA. The pictures, transmitted instantly to ground, are displayed on a TV screen that has 2000-line resolution and are simultaneously recorded on film. . . . A system analysis of potential over-the-horizon sensor and relay systems is being made by the Naval Sea Systems Command. The Navy is interested in finding firms willing to participate in the yet unfunded study. The aim is to find out if such systems would be of value to surface ships in tactical situations. . . . The Communications Satellite Corp. (Comsat) is filing with the Federal Communications Commission for permission to offer Digital Data Satellite Service in the Atlantic ocean area. Comsat began providing such service between the mainland and Hawaii in mid-January.

MODEMS À LA MODE



Universal makes modems any way you want them — as OEM cards, rack-mountable units or free-standing packages. In a word, we combine the latest in modem technology with the ultimate in personalized applications aid.

For example, using CMOS technology, we've put a whole 201 modem on a single card in less than 50 square inches. Of course we also offer many choices of 103s and 202s.

Our custom design capability offers you the performance options you need, as well as complete compatibility with your mechanical layout. Besides cards, rack-mounted or free-standing units, Universal also provides multi-channel packages, with modems in any frequency mix up to 2400 bps.

In addition to our products, we're awfully proud of our customer service. Check us out: your telephone inquiry is never more than three hours away from a response by a UDS company principal.

For modems as you like them, write or phone Universal Data Systems.



Anaheim Convention Center,
Anaheim, Calif.
May 18-22, 1975

See us at Booth 2467



universal data systems

2611 Leeman Ferry Road • Huntsville, Alabama 35805 • Telephone (205) 533-4500 • TWX 810 - 726-2100

Created by Hall & Mikatze Advertising, Winter Park, Florida

INFORMATION RETRIEVAL NUMBER 25

New from Potter & Brumfield



All solid state relay solves high cyclic switching problems.

The P&B EOT Series opto-isolated relay delivers up to 100 million operations, many times the life of comparable electromechanical relays. Synchronous zero crossover switching virtually eliminates RFI and reduces transients to a minimum. Opto-isolation provides up to 1500 volt transient immunity between input and output circuits.

Accepting control signals from 4-32 VDC, the EOT is especially effective for interfacing TTL, DTL and MOS logic to tough AC loads like solenoids, motors, transformers and lamps. Output ratings are 2, 4, 5 or 7 amps (to 20 amps with factory recommended heatsinking) @ 120 VAC, 50-60 Hz, @ 25°C.

For additional information, contact the Potter & Brumfield sales representative or authorized distributor nearest you, or write Potter & Brumfield Division AMF Incorporated, Princeton, Indiana 47671. Telephone 812 385 5251.

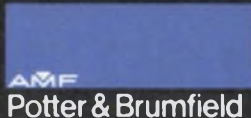

Solving switching problems is what we're all about.

To the rear, march!

On public TV's Nova show the other night, Dr. E. F. Schumacher of Intermediate Technology made a great case for going backwards. He argued that technology had gone too far and that, though labor saving might have been a fine goal in the 19th century, it's not so great now. He showed that much of our growing productivity in the past 100 years was based on the low cost of fuel. But now everything's been changed. The object now should be to conserve fuel and increase the use of manpower.



Not only would this alleviate unemployment, he said, especially in the poorer countries, it would help cut pollution in the wealthier lands. More important, this consummation was not merely desirable, it was almost inevitable. That's because the cost of centralized manufacture plus transportation would exceed the cost of local manufacture and distribution, though the latter would be less efficient in terms of units produced per man and per hour.

Hogwash.

Just as history is marked by daily sunrises and sunsets, so, too, is it marked by the frequent appearance of prophets proclaiming that the sky is falling down. Workers in the early days of the Industrial Revolution pitched their shoes into machinery, hoping to destroy what they thought was the cause of their oppression. Scholars at the time assured us that this proved that industrialization was a bad mistake. We'd have to go back to more primitive means of production.

Similarly, in the Nova show, Dr. Schumacher charged that we must go back if we are to survive. Fortunately, technology will move ahead regardless of the "let's go back to the good old days" urgings of Dr. Schumacher and others who will surely follow with similar views.

Should we make less-advanced equipment for those who don't need and can't afford the most sophisticated? Of course, just as we should provide three-digit voltmeters for those who don't need and can't afford four-digit machines. But should we therefore make more primitive technology a goal? Of course not.

In troubled times man has always looked back with faulty memory to a benign past. But never has he solved his problems by pushing technology backward. Throughout history, advancing technology has offered man the wherewithal for improving his lot. If man's social and political institutions weren't ready to accept this bounty, the fault lies there, not with technology.

A handwritten signature in dark ink, appearing to read "George Rostky". The signature is fluid and cursive, written over a light background.

GEORGE ROSTKY
Editor-in-Chief

DAK LIGHT EMITTING DIODE LOW PROFILE SWITCH

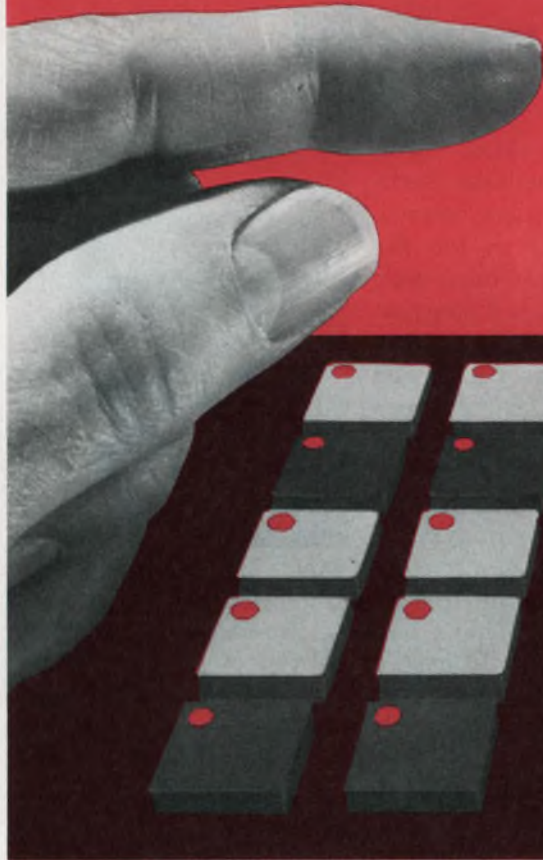

The
error
eliminator



This Series 415 LED is a momentary switch with an LED on an independent circuit.

Add another dimension of accuracy and speed of operation to your data systems with this reliable (10,000,000 operations minimum) Oak switch.

Use it to indicate key depression, input acceptance by computer, etc. Control the light by remote source, clearing key, automatic timing, or any other method that fits your system.

The 415 LED is .610" square, and is available in a wide range of keytop colors, with white, black, blue and gray as standard.

FOR IMMEDIATE DELIVERY FROM STOCK — through your Oak distributor. Call toll-free to 800-435-6106 for the location of the distributor nearest to you or write us for technical information.

FOR:
Point of Sale Terminals
Research Systems
Credit Card Systems
Security Systems
and other
data entry equipment

Keyboard and panel assemblies: Oak will build complete assemblies to your specifications including purchase of all required parts. Call our sales administrator for details.

DAK Industries Inc.

SWITCH DIVISION / CRYSTAL LAKE, ILLINOIS 60014
TELEPHONE: 815-459-5000 ■ TWX: 910-634-3353 ■ TELEX: 72-2447

INFORMATION RETRIEVAL NUMBER 27

NEW LOW PRICES!

A New Standard For Accuracy!

3½ Digit A/D Converter

The LD110/LD111 A/D converter sets the pace for accuracy with a specification of 0.05% of reading, ± 1 digit. The set consists of two ICs, and with the addition of a reference voltage and clock becomes a full 3½-digit analog-to-digital conversion system. LD110/LD111 features and specifications make the converter set an ideal choice for digital display processors in

- DPMs
- DVMs
- Controllers
- Instrumentation
- Thermometers
- Scales
- Tachometers

Specifications

- Accuracy of 0.05% of reading, ± 1 count
- $Z_{IN} > 1000 \text{ M}\Omega$
- 4 pA typical input bias current (25°C)
- 100 μV resolution (200.0 mV range)
- 40 dB NMRR @ 60 Hz

Features

- Auto-zero minimizes effect of offset, drift and temperature
- Auto-polarity
- Sampling rates from 1/3 to 12 samples/second
- Two voltage ranges: 2.000V and 200.0 mV
- TTL-compatible outputs
- ~~\$28.60~~ per set (100-set price)

\$19.60

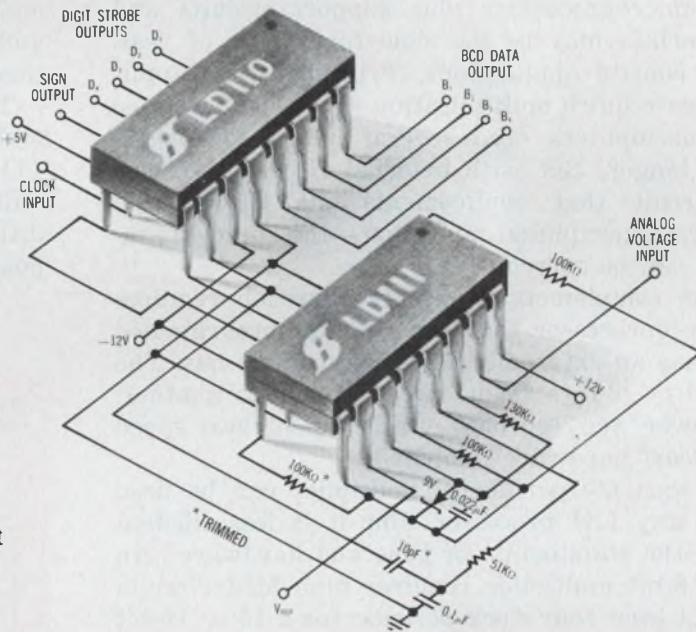

The unique conversion technique uses a single reference and a single full-scale adjustment to achieve a highly-accurate strobed 3½-digit output of up to 3100 counts plus sign. LD111 analog processor employs monolithic PMOS/bipolar construction and interfaces directly with the LD110 digital processor, which has a monolithic PMOS structure. For further information

\$16.40 PER SET
(1000 QTY)

write for data

IC Applications: (408) 246-8000, Ext. 120



Siliconix incorporated

2201 Laurelwood Road, Santa Clara, California 95054

INFORMATION RETRIEVAL NUMBER 28

AVAILABLE NOW!
FROM—
CRAMER
ELMAR
HAMILTON/AVNET

Speed microcomputer multiplication

with a CPU complementary circuit or peripheral multiplier.

Here are typical examples that use available ICs.

When required to multiply, microcomputers—LSI microprocessors plus support circuits and memories—may be too slow for a host of real-time control applications. Typically these applications require multiplication times of 5 to 50 μ s. Microcomputers need several orders of magnitude longer. But with external circuitry—either a circuit that complements the CPU or a separate, peripheral multiplier—the speed limitations can be overcome.

The complementary-circuit approach requires a microprocessor that can be microprogrammed and has an externally accessible control bus. The circuitry differs from one processor to another. However, the approach yields the highest speed and least hardware complexity.

A separate peripheral multiplier can be used with any LSI processor. But it is less efficient from the standpoints of time and hardware: An 8 \times 8-bit multiplier requires nine MSI circuits and at least four clock periods; for a 16 \times 16-bit multiplier, these requirements are doubled.

A complementary circuit for National Semiconductor's IMP-16C microcomputer¹ can be built with 16 standard SSI and MSI circuits. And these can be interconnected on a 3 \times 4-in. PC board that is mounted piggyback on the microcomputer.

The complementary circuit has been designed around the National unit, because it was the first available 16-bit model. Other models have been announced.

With the complementary circuit, the National microcomputer allows multiplication of two 16-bit unsigned operands in 16 microcycles, or 23 μ s, with a 6.5-MHz clock. Thus the multiplication time is reduced by a factor of 30 from the relatively fast 700 μ s needed by a conventional macro-software operation. It is reduced by a factor of seven from the 150 μ s needed by an optional microprogrammed instruction offered by National.

Speed benefits also result when a complemen-

tary approach is used for division or square-root operations, or for multiplication of signed operands. The same hardware technique is used for these operations, but with some increase in ICs.

The design of the complementary circuit for multiplication assumes these three requirements: (1) The basic operation of the microcomputer will not be disturbed or impeded; (2) The additional circuitry will provide the necessary bipolar or MOS interface levels, and (3) No addi-

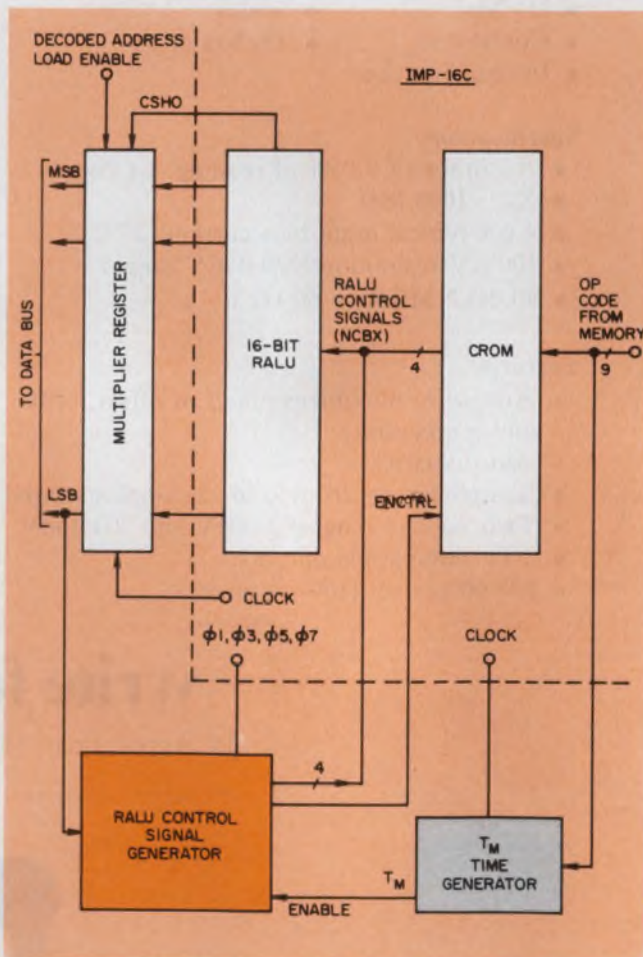

1. In this CPU complementary multiplication circuit, CROM outputs are replaced with special control signals that permit hardware multiplication operations. The additional circuit blocks consist of a time generator, signal generator and multiplier register.

Hermann Schmid, Senior Engineer-Computers, General Electric Co., Binghamton, NY 13902.

tional power supplies will be used.

The major blocks of the multiplication circuitry are connected to the RALU (register and arithmetic logic unit) and CROM (control read-only memory) of the IMP-16C (Fig. 1). The external circuitry consists of the T_M time generator, the RALU control-signal generator and the multiplier register (MR).

Key microcomputer operations

In a typical microcomputer operation, the CROM receives a 9-bit operational (op) code from memory and processes it into the RALU control signals (NCBX). This time-sequenced 16-bit control word instructs the RALU what to do at each phase of a microcycle. At each clock phase, the four lines determine the following:

- During phase ϕ_1 , which register (or stack) is connected to the "A" bus. The "A" and "B" buses constitute the two ALU input buses.

- During ϕ_3 , which register is connected to the B bus and also whether to complement the A bus.

- During ϕ_5 , which arithmetic logic and control operations are to be performed.

- During ϕ_7 , which signal bus is to be connected to the "R" bus (the ALU output bus) and into which register (or stack) the R bus is to be loaded.

For multiplication, the RALU control signals from the CROM are replaced with separately generated control signals. These are a function of the least-significant MR register bit. The switchover in control signals occurs upon detection of a special multiplication op code—not in the instruction repertoire. The op code simply turns the CROM off and the T_M time generator on.

The time generator provides a period 16 microcycles long for a 16-bit multiplier, and it starts one microcycle after receipt of the multiplication op code. Also, T_M connects the shift clock to the MR register. A function of this register is to

Digital multiplication: The basics

The use of hardware multiplication to speed microcomputer computations also entails the writing of software. Though not a difficult task, digital multiplication could present problems to designers not familiar with the procedure.

A simple example (top right) will show how to develop a basic multiplication subroutine (bottom right).

Assume that two binary numbers, $X = 13$ and $Y = 11$, must be multiplied. X is called the multiplier and Y the multiplicand. The procedure requires that Y be added to the partial product Z_i whenever the least-significant multiplier bit X_i is 1. When $X_i = 0$, zero is added. After each addition, the partial product and the multiplier are shifted to the right by 1 bit. Thus after multiplication of two n -bit operands, a $2n$ -bit or double-precision product results.

Most microprocessors perform multiplication sequentially by software. A typical multiplication subroutine consists of three steps:

- (1) Initialize,
- (2) Loop and
- (3) Finalize.

In Step 1, CPU registers AC0, AC2, AC3 are loaded with the operands X , Y and the index n ; AC1 is reset to zero. In Step 2, we add Y into AC0 when the LSB of AC0 $\neq 0$. We omit the addition when the LSB of AC0 = 0. The contents of AC0 and AC1 are shifted to the right 1 bit at a time, for each pass through the loop, while the index counter is decremented. In the last step we transfer the double-precision product from AC0 and AC1 to specified memory locations.

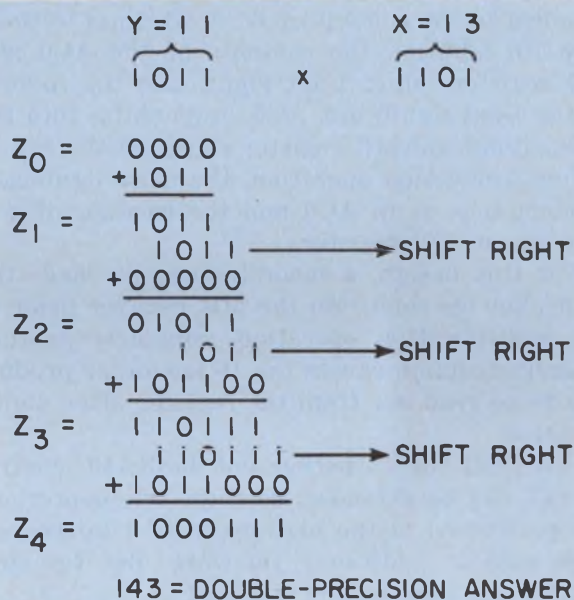

```

OPERATIONS: ACI, ACO ← ACO × AC2
INITIALIZE: ACO ← X, ACI ← 0, AC2 ← Y,
             AC3 ← n
LP: JUMP +2 IF ACO LSB = 0
    ADD ACI ← ACI + AC2
    RIGHT SHIFT ACI    LSB → L
    RIGHT SHIFT ACO    L → MSB
    DECREMENT COUNTER, SKIP IF ZERO
    JUMP TO LP
FINALIZE: STORE ACO AND ACI IN MEMORY
    
```

initially hold the 16-bit multiplier.

At each clock cycle, or microcycle, the multiplier shifts one bit to the right. And as the least-significant multiplier bit (MR-LSB) leaves the low side of the register, the least-significant product bit enters the top side. At the end of T_M , the MR register thus holds the 16 low-order product bits.

Use of an external register to store the multiplier operand eliminates the following:

- The need to shift through the "Link" flip-flop (CPU status flag), which would require two microinstructions.
- Testing of the multiplier LSB through software, which would require a conditional branch microinstruction.
- The need to establish, increment and test the index counter, which would require another two microinstructions.

The RALU control signals (NCBX) are generated with simple logic circuits and connected to the NCBX bus during T_M (Fig. 2). Only one transistor, four Tristate MOS buffers and six diodes are needed.

The multiplicand is loaded into accumulator AC2, and the multiplier into the external register. During each microcycle either the content of AC2 ($MR - LSB = 1$) or zero ($MR - LSB = 0$) is added to the content of AC0, which is initially zero. In addition the contents of the AC0 and MR registers shift 1 bit right, and the content of the least-significant AC0 stage shifts into the most-significant MR register stage. At the end of the multiplication operation, the most-significant product byte is in AC0 and the least-significant byte in the MR register.

For this design, a macroinstruction loads the multiplier operand into the MR register prior to the multiplication operation. Similarly another macroinstruction causes the 16 low-order product bits to be read out from the register after multiplication.

Obviously the T_M period and the RALU control signals can be extended, so these two operations are performed at the high speed of 1 microcycle each without additional software. But for simplicity, this approach is not used.

Control signal pattern easy to generate

To perform a hardware multiplication operation, two pseudo-microinstructions must be generated and then executed. These are the following:

- (1) $(AC0) \leftarrow [(AC0) + 0] 2^{-1}$ if $MR - LSB = 0$
- (2) $(AC0) \leftarrow [(AC0) + (AC2)] 2^{-1}$ if $MR - LSB = 1$

Translated, this means: (1) Add zero to the content of AC0 and shift the result 1 bit right if $MR - LSB = 0$; (2) Add the content of AC2

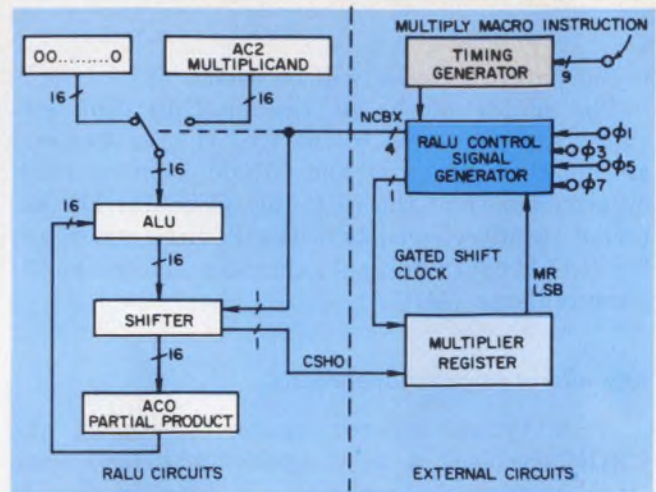

2. The complementary circuit provides alternative control signals, labeled NCBX, for the RALU. The technique can be used with the IMP-16C because it is a microprogrammable processor.

Table 1. Command codes for the RALU

ALU functions		Control functions	
NCB (1), (0) @ T5	Function	NCB (3), (2) @ T5	Function
11	AND	11	None
10	XOR	10	R-bus control
01	OR	01	Shift left
00	ADD	00	Shift right

A, B and R-bus addresses		R-bus control		
NCB (2) (1), (0)	Address	I/O NCB(3) @ T7	BYTE (SININ) @ T5	
111	ZEROS			
	FLAGS, STACK			
110	R1			
101	R2			
100	R3			
011	R4			
010	R5			
001	R6			
000	R7			
			R-bus value	
		1	0	Output of shifter
		1	1	Output of shifter
		0	0	Output of I/O mux
		0	1	Value of sign input on SININ @ T7

Table 2. RALU signal patterns that permit unsigned multiplication

	Time period	NCB3	NCB2	NCB1	NCB0	Operation
Multiplier $MR - LSB = 0$	ϕ_1	1	1	1	1	(A bus) $\leftarrow 0$
	ϕ_2	1	0	1	1	(B bus) $\leftarrow AC0$
	ϕ_3	0	0	0	0	SHIFT RIGHT, ADD
	ϕ_4	1	0	1	1	(AC0) \leftarrow (R bus)
Multiplier $MR - LSB = 1$	ϕ_1	1	0	0	1	(A bus) \leftarrow (AC2)
	ϕ_2	1	0	1	1	(B bus) \leftarrow (AC0)
	ϕ_3	0	0	0	0	SHIFT RIGHT, ADD
	ϕ_4	1	0	1	1	(AC0) \leftarrow (R bus)

to the content of AC0, then shift the result in AC0 1 bit right if $MR - LSB = 1$.

The two pseudo-microinstructions can now be translated into the required RALU control signals with the code definitions in Table 1. The result is a truth table (Table 2) that yields these logic equations:

$$NCB0 = \phi_1 + \phi_3 + \phi_7$$

$$NCB1 = \phi_{1S} + \phi_3 + \phi_7$$

$$NCB2 = \phi_{1S}$$

$$NCB3 = \phi_1 + \phi_3 + \phi_7,$$

where ϕ_{1S} denotes the clock phase, ϕ_1 , switched by the multiplier LSB.

The problem: Interfacing and timing

Implementing these logic equations in either TTL or MOS levels would be a cinch. However, the RALU and CROM have both types of inputs

and outputs, even though the chips use MOS techniques. The outputs may be either the standard pull-up/pull-down types, open collector or Tri-state.

As shown in Table 3, some of the RALU control signals perform different functions within the eight time periods of 1 microcycle. For example, CSHO (carry-shift-zero) accepts a carry input during period T_5 and outputs the shift pulse during T_n . Also, the NCBX signals are always driven to logic ZERO during even clock phases.

The timing of these signals is very critical. For example, the carry output signal (CSHO) is guaranteed to be available only during the last 70 ns of T_n . Similarly the pseudo-NCBX signal cannot be delayed by more than 85 ns from the start of the clock phase.

Consequently logic levels, impedances and the

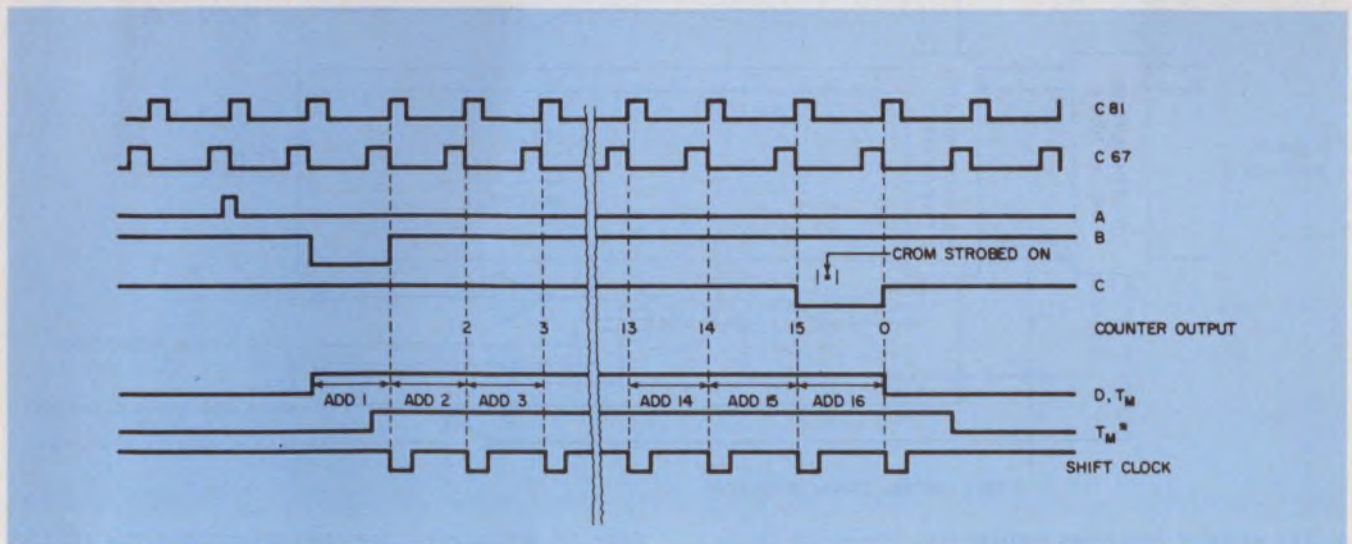
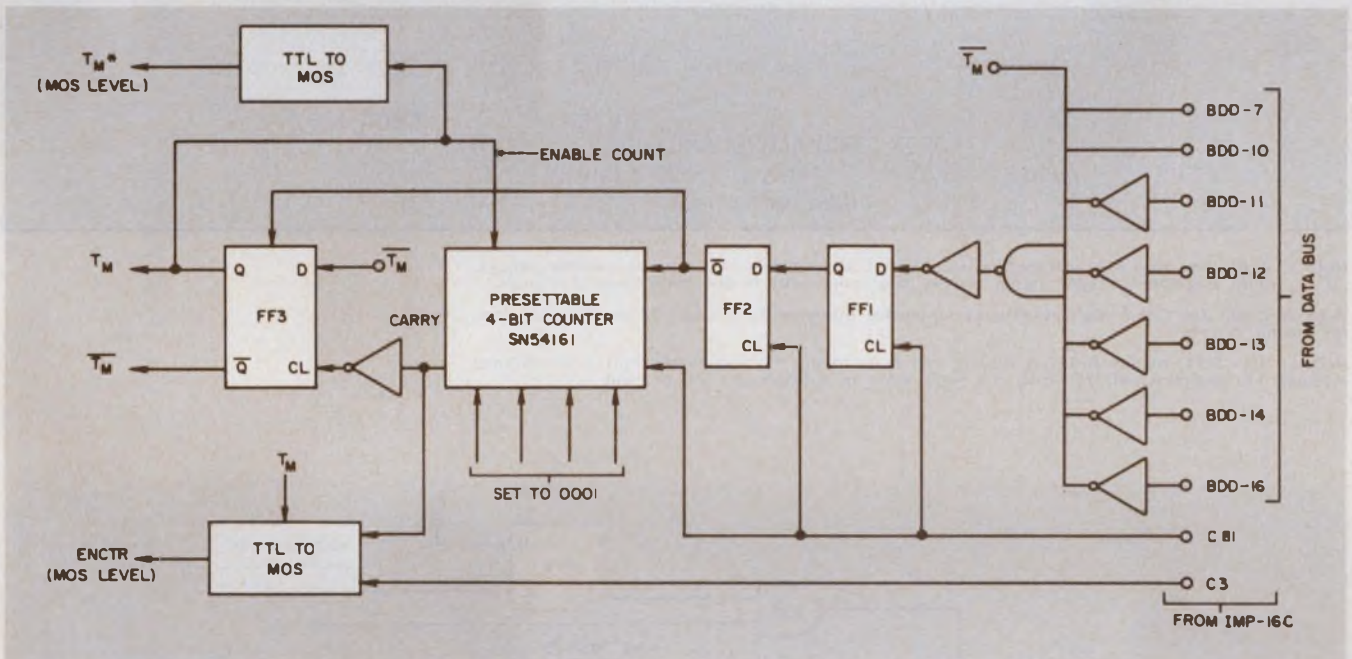

3. The 16-clock T_M period is generated when the multiplication op code is detected. FF2 provides an inverted

pulse that presets the counter to 0001. Unless otherwise indicated, TTL circuits and levels are implied.

Table 3. Critical timing for the RALU

Signals	Logic levels	Time intervals								Pin function	Pin No.
		T ₁	T ₂	T ₃	T ₄	T ₅	T ₆	T ₇	T ₈		
Clocks ϕ_1 ϕ_2 ϕ_3 ϕ_4	MOS MOS MOS MOS	[Timing diagram showing clock signals]								IN IN IN IN	2 1 23 22
Command NCB(0) NCB(1) NCB(2) NCB(3)	MOS MOS MOS MOS	$\overline{A0}$ $\overline{A1}$ $\overline{A2}$ STACK	"0" "0" "0" "0"	$\overline{B0}$ $\overline{B1}$ $\overline{B2}$ COMP	"0" "0" "0" "0"	$\overline{ALU0}$ $\overline{ALU1}$ \overline{CTLO} CTL1	"0" "0" "0" "0"	$\overline{R0}$ $\overline{R1}$ $\overline{R2}$ I/O	"0" "0" "0" "0"	IN IN IN IN	21 19 18 20
Data DATA(0),(1),(2),(3)	TTL	R BUS (OUT)		A BUS(OUT)		"1" (OUT) ³		DATA INPUT	"1" (OUT)	I/O	17, 5, 4, 7
Control FLAG	TTL	← FLAG →		← "1" →						OUT	16
Misc SININ CSH0 CSH3	MOS T5 TTL T7 MOS MOS	← Don't Care (DC) →			BYTE	DC	SIGN	DC	IN I/O I/O	10 14 11	
		"1" (OUT) OVCEN (IN)	HIGH IMPEDANCE ² HIGH IMPEDANCE	"0" (OUT)	CARRY (IN) CARRY (OUT)	"1" (OUT) "1" (OUT)	SHIFT I/O SHIFT I/O				

Note 1. A positive true logic convention is used for all signals—"1" = more positive voltage, "0" = more negative voltage. Signal names beginning with N are complemented signals.

Note 2. CSH0 and CSH3 high impedance states for intervals T₂ through T₇ are Tristate mode for output drivers.

Note 3. "1" (OUT) means RALU is driving this node to the "1" logic level during the defined interval. For bidirectional I/O lines the logic state is defined as "in" or "out."

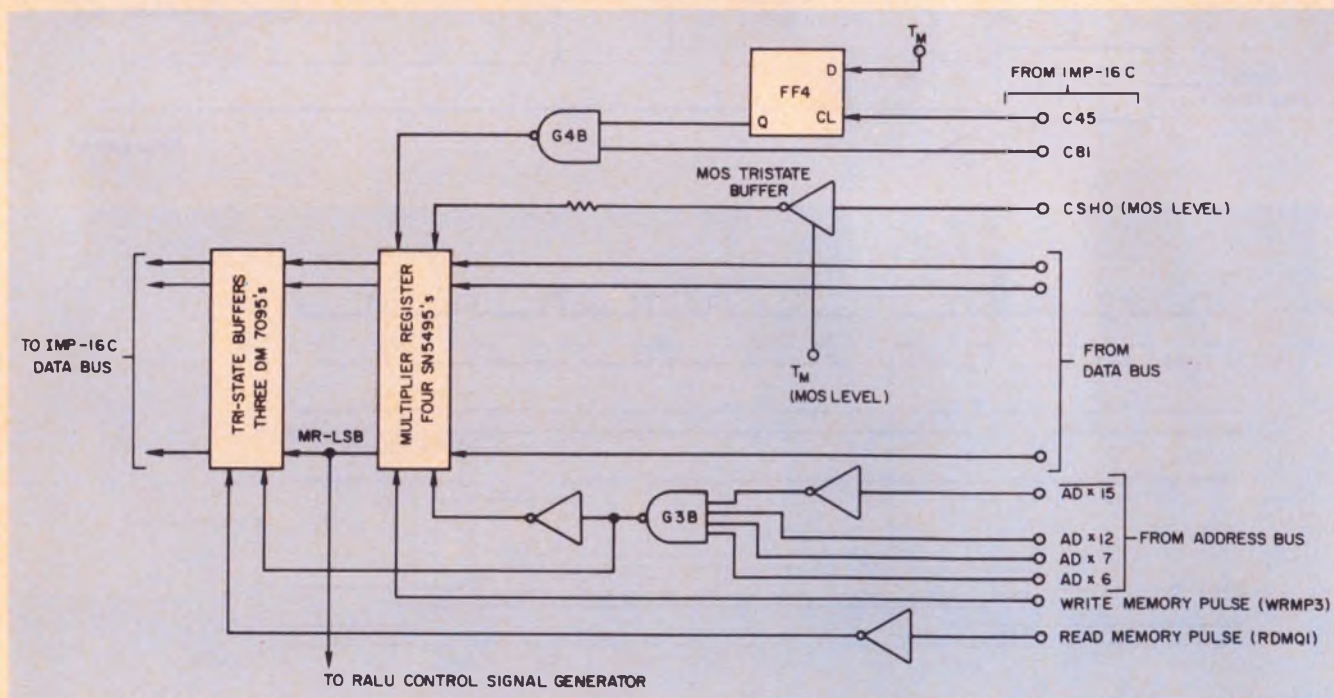

4. The external multiplier register first stores the multiplier operand, then shifts it right 1 bit per microcycle, and then injects the least-significant partial product bits.

After 16 microcycles, the register contains the 16 LSB double-precision product. The multiplier register employs four 4-bit universal shift registers.

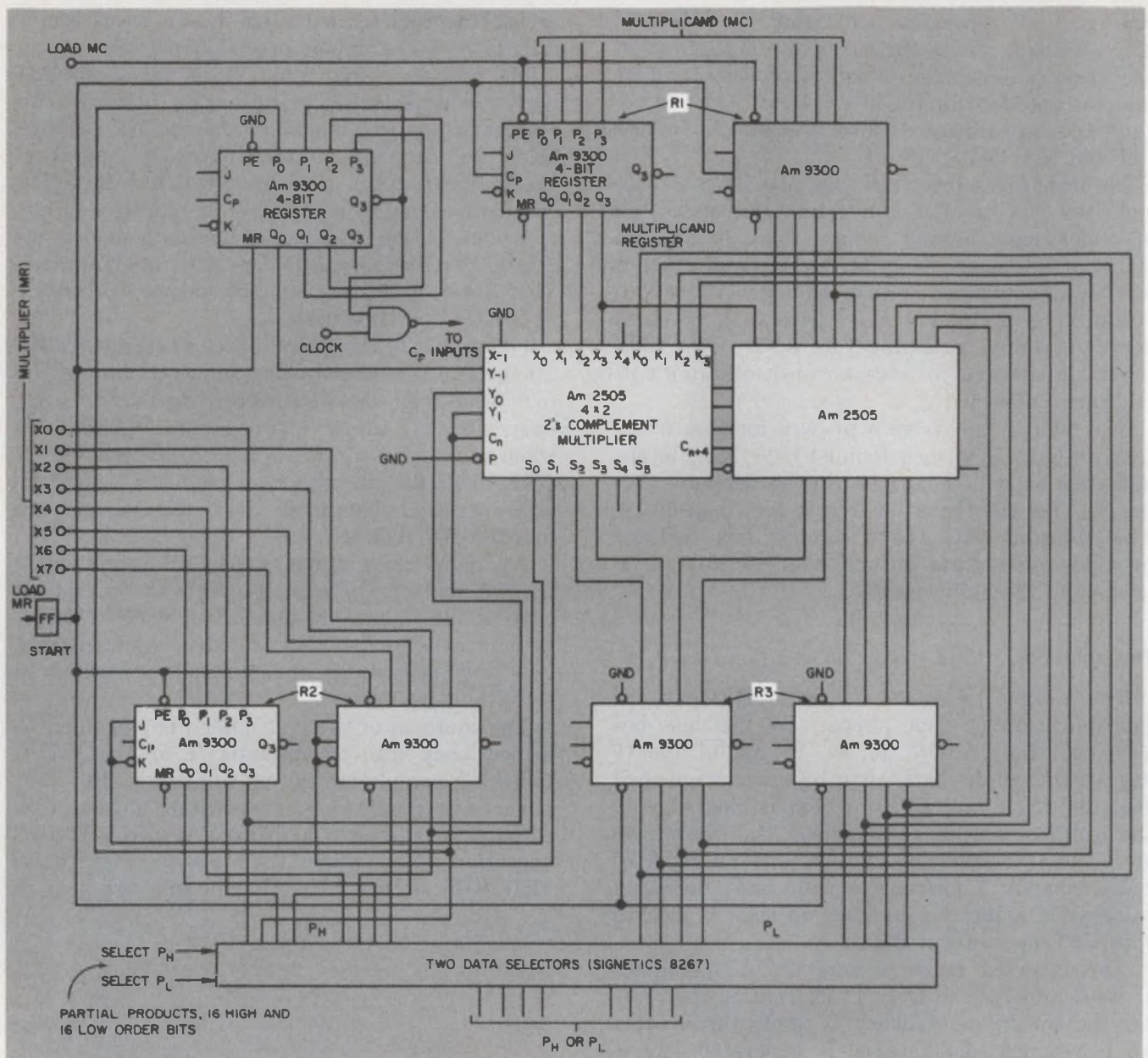

6. Two 4×2 -bit IC multipliers sequentially add the 8-bit parallel multiplicand into the partial product regis-

ter. Control of the operation is provided by the two least significant multiplier bits.

the data bus by a set of three noninverting Tri-state buffers. These buffers are enabled by the decoded address and the RDMQ1 pulse.

The RALU control signal generator produces four time-multiplexed NCBX signals (Fig. 5). The signals control the RALU, so it executes the required add and shift operations. The circuit consists of a transistor switch, two diode-OR gates and four strobed inverters.

The transistor connects the ϕ_1 clock pulse to the diode-OR gate when $MR - LSB = 1$. The six diodes form two three-input OR gates that combine the ϕ_3 and ϕ_7 clock pulses with either ϕ_1 or the switched clock pulse, ϕ_{1S} . The strobed MOS inverters are Tristate devices that connect the NCBX signal to the RALU control bus only during T_M .

Though peripheral multipliers can be built with a number of available MSI ICs, only serial-parallel (rather than all-parallel) multipliers are cost and speed-compatible with microprocessors. The 4×2 -bit IC multiplier in Fig. 6 is an example.

The 8×8 -bit peripheral multiplier consists of three single-length registers, a 2×8 -bit multiplier, an output data selector and some addressing and control logic. Register R_1 holds the multiplicand, while register R_2 holds the multiplier. Double-precision products are stored in registers R_2 and R_3 .

At the start of multiplication, the multiplicand and multiplier are loaded into registers R_1 and R_2 , respectively. During an operation the multiplier is shifted out, 2 bits at a time, and the

empty locations are filled with partial product bits.

The two Advanced Micro Devices multipliers provide a 2×8 -bit product during each clock cycle. Under control of the two least-significant multiplier bits, the multiplicand is added with appropriate weights to the eight LSBs of the partial product. The result is then stored again in the partial-product register.

The multiplier operand and the eight most-significant partial product bits are separated into odd and even parts, each of which is loaded into one 4-bit shift register. A shift of two places can thus be obtained with one clock pulse, with each register providing one least-significant bit as an output.

Four shift operations are needed to execute 8×8 -bit operations. This means that the basic multiplication execution time is four clock periods. Since these MSI circuits easily can operate at a clock rate of 4 MHz, the complete multiplication can be performed in 1 μ s.

Extending the technique

The technique can be extended easily to handle 16-bit multiplicand and multiplier operands and a 32-bit double-precision product. In the latter case, however, the length of all registers and of the actual multiplier must be doubled. Similarly

the execution time also increases by a factor of two, since eight shift operations must be performed now.

To use a peripheral multiplier in a microprocessor system, the multiplier must operate through the data bus and be treated like any other peripheral. When multiplication is performed, the microprocessor addresses a multiplier register and specifies whether the data are to be stored or fetched.

In a typical operation, the register would first store the multiplicand and multiplier operands and then fetch the high and low product bytes. This necessitates two output and two input operations, or four macroinstructions, and this would require much more time than the actual multiplication.

In the National IMP-16, each I/O operation requires approximately 10 μ s. Consequently the total multiplication execution time would be 40 μ s. And for a complete 16×16 -bit peripheral multiplier, with all the address decoding and control logic, approximately 18 MSI and eight SSI integrated circuits are required. ■■

References

1. IMP-16C Application Manual, 4200021B, National Semiconductor Corp., Santa Clara, CA, 1973.
2. Ghest, R. C., "A Two's Complement Digital Multiplier," Application Note, Advanced Micro Devices Corp., Sunnyvale, CA, 1971.

Weber laminar air flow systems keep the bugs out.

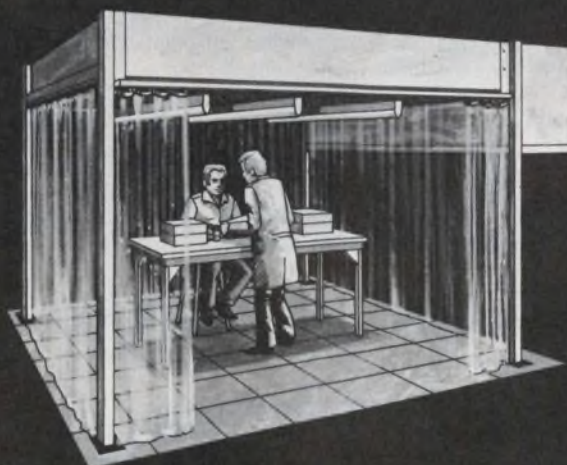

Weber vertical flow portable isolator illustrated. Horizontal flow systems also available.

If you're manufacturing microelectronic components or other precision products, you'll profit from a Weber laminar air flow system. You can install one virtually anywhere. Inside the clear vinyl side curtains a Class 100 laminar air flow cleanses the air of airborne contaminants, and protects against contamination from outside sources. Product quality will improve; reject rates will plummet. Write for literature and more details on how Weber — a division of Walter Kidde & Company — can contribute to the quality and profitability of your product.



WEBER TECHNICAL PRODUCTS

1340 Monroe Avenue N.W., Grand Rapids, Michigan 49505. (616) 363-7735
A Division of Walter Kidde & Company, Inc.

another Simpson first!

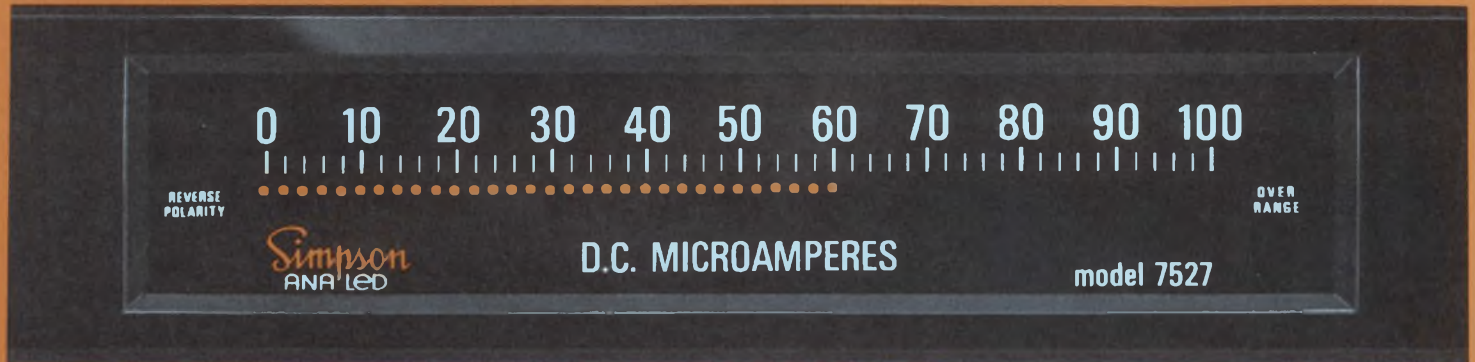

Simpson® ANA-LED

SURPRISINGLY VERSATILE, EXTREMELY RUGGED, TOTALLY SOLID-STATE . . . A new display concept combining the best of analog and digital panel meters . . . Opens a whole new world of application possibilities . . . Limited only by your imagination.

Light Emitting Diodes give pinpoint indication — no parallax, no guessing. Input changes are shown instantly in corresponding display changes, making it easy to spot trends and fluctuations. No response delays, no overshoot, no tracking error, plus near-perfect repeatability. ANA-LED is capable of operating under severe environmental conditions and still give years of accurate, trouble-free service.

Less than 8 x 2 x 3/4 inches size, including display and drive electronics, ANA-LED is available in horizontal or vertical style; with linear or non-linear conversion and display; expanded scale; zero left, right or center. Recorder and reference signal outputs included for driving digital set-point control modules which are also available from Simpson.

Need a special ANA-LED? Let Simpson help you design it. Send us your specifications and we'll return a quotation promptly. Check our catalog first, however — that special ANA-LED may be a standard Simpson stock item.

Get off-the-shelf delivery from your local electronics and electrical equipment distributors.

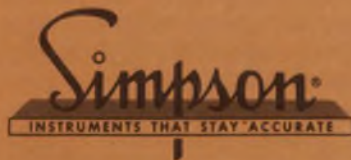

SIMPSON ELECTRIC COMPANY

853 Dundee Avenue, Elgin, Illinois 60120 • (312) 697-2260

CABLE: SIMELCO • Telex: 72-2416

IN CANADA: Bach-Simpson, Ltd., London, Ontario

IN ENGLAND: Bach-Simpson (U.K.) Ltd., Wadebridge, Cornwall

IN INDIA: Ruttonsha-Simpson Private, Ltd., Vikhroli, Bombay

KATY INDUSTRIES



INDUSTRIAL
EQUIPMENT
GROUP

Manufacturers of over 2,000 styles, sizes and ranges of analog, digital and ANA-LED panel meters



INFORMATION RETRIEVAL NUMBER 30

AND MANY MORE Write For Catalog 4400

TESTING SIMPLIFIED.

A while back, Fairchild Systems Technology decided to simplify incoming inspection of semiconductor devices. We established a design concept: "Make it easy for the user." Then we took our ideas a logical step further. It had to be foolproof.

The result? Fairchild's Qualifier™ 901, a benchtop tester for incoming inspection of CMOS, DTL and TTL logic IC's.

It's a low-cost, high-performance IC tester featuring simplicity of operation and maintenance. Designed primarily for incoming inspection, the Qualifier 901 system keeps faulty IC's out of finished products, thus eliminating expensive rework and repair.

OUR NEW BUSINESS CARD

The Qualifier 901 is easily programmed by the Qual-Card™ a



software entry device, made of plastic and optically coded for each program required. The Qual-Card is virtually indestructible and leaves nothing to chance.

To test a run of devices, an operator merely inserts the appropriate Qual-Card for the device to be tested into the optical reader in the Qualifier 901. There are no knobs to turn. No switches to select. No values to choose. The Qual-Card does it all.

It absolutely dictates what is to be measured, to what levels, and to what accuracy. In 60 to 200



milliseconds your 16 to 24-pin IC has been thoroughly tested functionally and parametrically.

A standard device library of several hundred Qual-Cards is available from Fairchild Systems Technology and can be delivered on a turnaround basis. If a custom card is required, it can be written and verified by Fairchild, then delivered by mail for your immediate use.

TWO SELECTIVE PROFIT CHARTS

Both charts in this column tell the same truth: the Qualifier 901's simplicity of programming and operation mean fewer testing costs, more profit.

Operator training: No operator training is required beyond basic equipment familiarization. There's no time lost training technicians to read time consuming data sheets. No programmers to hire or train. Nothing is left to chance.

Programming and testing: Testing with the Qualifier 901 is amazingly simple. There are basically only two things you have to remember: The device to be tested and the appropriate Qual-Card. You lose no time studying data sheets. The flexible Qual-Cards eliminate paper tapes and performance boards. Qual-Cards are easily stored for ready access.

To test, only four easy steps are required:

Power. Turn power on. The Qualifier 901 automatically performs a self-test sequence which checks out the tester hardware. When this is complete the Qualifier 901 is now ready for programming.

Program. The proper Qual-Card is selected to match the type of device being tested. The card is inserted into the slot on the front of the tester and the Ready light is observed.

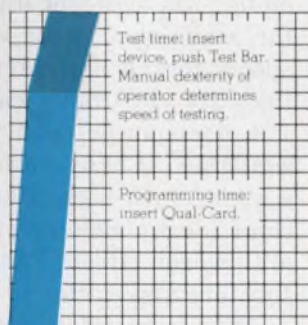

Test. The Qualifier 901 is ready for test and the device is inserted into the test head socket. The "Test Bar" is depressed and the device is tested in 60 to 200 milliseconds.

Observe. The test head indicator lights are observed. Green indicates PASS. Amber indicates FUNCTIONAL PASS. Red indicates FAIL.

Your operator can't miss.

DRO OPTION: FIRST LEVEL ANALYSIS WITHOUT TOP LEVEL COSTS

We've added a new option to the Qualifier 901: A digital readout (DRO) for first level analysis of voltage and current. More than expanded function, there's the true beauty of simplicity in the DRO option. Analysis as simple and foolproof as Qualifier 901 go/no-go testing.

Actually, there are two uses for the DRO. One is to monitor voltage levels of the +15 and -15 power supplies — from which analog voltages and currents are derived to be applied to the device. A reading is taken at the reference point of the system to indicate if the supplies are operating and properly adjusted.

The main function of the DRO option is to measure and digitally display the voltage or current of a device on test in a FAIL condition.

Let's pick up the analysis procedure from the last step of go/no-go testing. A red light indicates FAIL condition. The Qualifier 901 is in the STOP and FAIL mode, and on PROTECTIVE OVERRIDE. The operator pushes the START switch.

Qual-Card programming takes over. The program searches out the first failure and stops. An indicator lights opposite the appropriate pin number on a grid display.

The operator turns a pin selector rotary switch until the two digit display matches the pin number lit on the grid display. That's all. The FAIL pin is correctly identified.

Purposefully, there are no pin identification numbers for the

positions of the selector switch. The Qualifier 901 is a universal tester and pin numbers change from device to device, up to the 24-pin capacity. Pin selection, a confusing and error-prone task if left to the operator, is processed simply by Qual-Card programming.

Once the pin numbers are matched, the operator turns to the function range switch, and selects the appropriate parameter that should be measured, whether voltage or current.

To emphasize: the DRO option automatically converts from the fixed rotary positions of the pin selector via a microprocessor to actually map the pins of the device. The DRO tells the operator which pin he's on — not vice-versa. There is no way to test the wrong pin.



The DRO option: analysis as foolproof as go/no-go testing.

A SIMPLE OFFER

If you'd like more information on the Qualifier 901, now with DRO option, we'll send you a brochure, a list of representatives, and a growing library catalog of Qual-Cards now available. Call collect or write today.

Fairchild Systems Technology, A Division of Fairchild Cameras and Instrument Corporation, 1725 Technology Drive, San Jose, California 95110. (408) 998-0123, TWX: 910-338-0558.

FAIRCHILD
 SYSTEMS TECHNOLOGY
 A DIVISION OF FAIRCHILD CAMERA AND INSTRUMENT CORPORATION

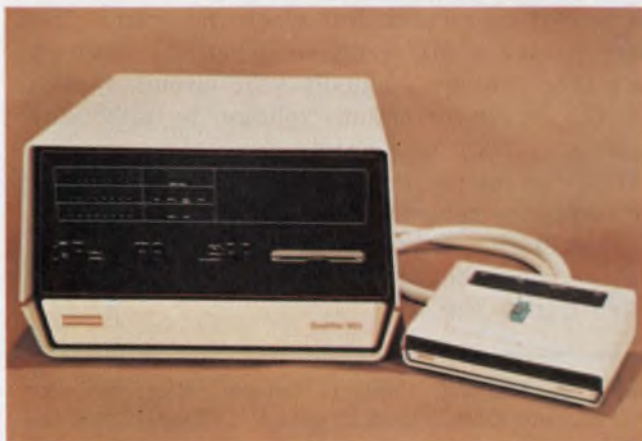

Motor control by PLL can be achieved with a microprocessor. Software replaces the phase detector, and the internal clock provides the circuit timing.

Microprocessors can offer important advantages in phase-locked loops for dc motor control. Though unusual, this all digital technique proves straightforward and effective for these reasons:

- The fixed cycle time of the processor is derived from a crystal-controlled clock. Use of this consistent timing provides the system accuracy.
- A digital PLL that uses pulse-width modulation performs a count-and-compare function. The processor's arithmetic and branching capabilities are admirably suited to perform these tasks.

A phase-locked loop consists of a reference frequency generator, phase comparator, loop filter and voltage controlled oscillator (Fig. 1). The circuit places the VCO frequency into step with the reference frequency. The loop begins to correct whenever the output phase drifts away from that of the reference. An error-correcting voltage, computed by the phase comparator, causes the VCO phase to realign with the reference.

Motor becomes the VCO

Substitution of a motor-tachometer for the VCO extends the circuit to motor control. As with the nonmechanical counterpart, the design calls for two operating modes: vernier in-lock and out-of-lock. In the first situation, the VCO (or motor) is merely out of phase with the reference but at the correct frequency or rotational speed. Low-duty-cycle dc pulses provide the needed correction. But when the output frequency is very different—as when the load on the motor changes suddenly—the circuit applies a gross error-correction voltage to alter the speed as quickly as possible.

With the microcomputer approach, the processor computes reference and error signal to better than 0.1%—thanks to crystal-derived timing and the consistent time intervals of all software instructions (Fig. 2).

Howard A. Raphael, Product Manager, Microcomputer Systems, Intel Corp., 3065 Bowers Ave., Santa Clara, CA 95051.

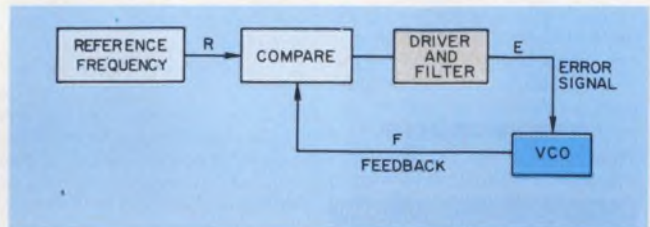

1. A conventional phase-lock loop makes the VCO frequency track that of a reference. For use with motor control, the VCO block is replaced by a motor-tachometer; comparator operation is not changed.

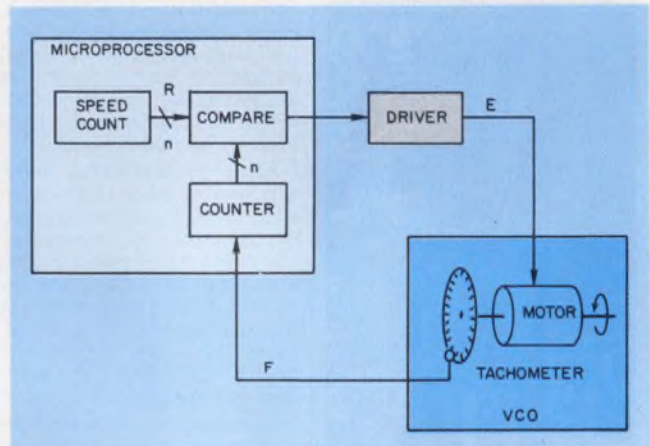

2. A microcomputer furnishes the speed reference and also performs phase and frequency comparisons under program control. Motor inertia provides the necessary loop filter.

The motor, tachometer and motor driver replace the VCO and the low-pass filter of the conventional electronic PLL. A dc motor with a permanent magnet stator, or a Hall-effect motor, has excellent linear VCO characteristics—for example, a linear relationship exists between speed, torque and current. Most motor applications for electronics call for ratings of less than 1/4 horsepower, and these motors are readily available. Where uniform velocity is required, a motor with high rotor inertia is desirable. The rotor inertia reduces variations in speed through a flywheel effect. Pancake motors are excellent for this application.

Any first-order servo requires a feedback

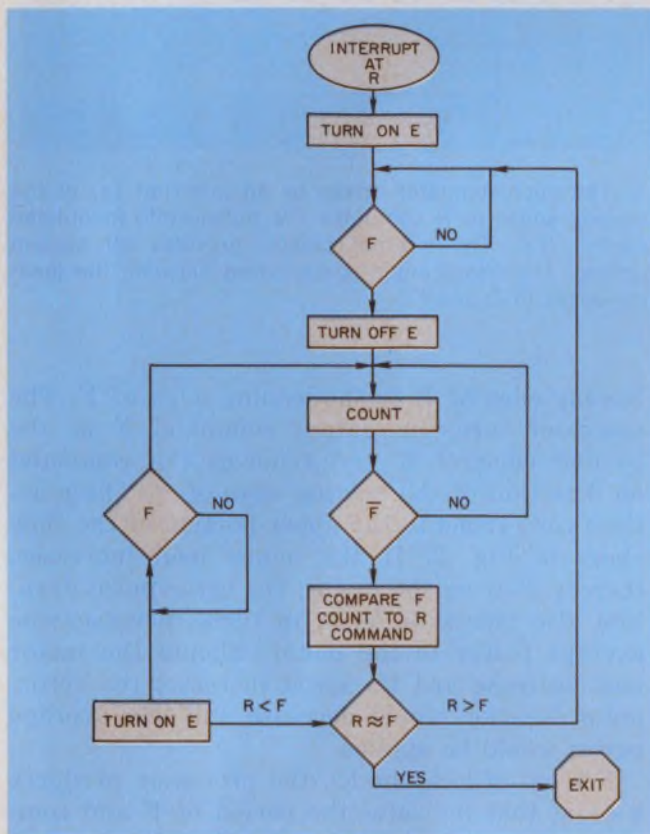

3. A variable-duty-cycle control signal is generated (upper section of program) when $R = F$ to control phase. The lower portion of the program checks for gross frequency error by counting for the duration of clock pulse F and comparing the count with the command value.

path. In this case it is from a digital tachometer attached to the motor shaft. The tachometer resolution—the number of pulses in a revolution per unit of time—should be sufficient to monitor the intended speeds. For high speeds, a coarse track of 100 to 1000 pulse per revolution suffices. For slow speed, 1000 pulses are appropriate.

One popular form of optical tachometer makes use of a rotary disc with transparent sections of equal size plus a light source and phototransistor. But be sure that the unit you choose provides a symmetrical pulse train.

The conventional low-pass filter is omitted (Fig. 2). Instead motor inertia serves to reduce

(filter) incremental variations in the motor-control signal that cause speed pulsations.

To perform the comparison function between the feedback and reference, the microcomputer must compute the frequency of the tachometer feedback signal, which is proportional to the motor velocity, and compare it with the reference frequency. This is done by counting the duration of one of the tachometer signal periods. Since the tachometer signal has a 50% duty cycle over the speed range of interest, counting over half the period will suffice.

The resulting count can be compared with a reference count, which is a function of the desired speed. If the count is larger than the reference count, the motor is running too slow and power must be applied. If the count is less than the reference count, the motor is running too fast and power must be reduced.

The processor uses a dual strategy

A count tolerance establishes the boundary between in-lock operation and gross error correction for the out-of-lock condition. Periodic bursts of full power of a prescribed rate keep the motor in step with the reference. Large differences between reference period and tachometer output period result in the application of full output power or none to the motor, until the difference again falls into the tolerance band (Fig. 3). By this means, the motor is brought into phase-lock as quickly as possible. The loop responds to changes in reference frequency at a rate that corresponds to the signal bandwidth of the motor.

A dedicated series of microinstructions implements the strategy (Fig. 3).

The computer cycle time and number of instructions used limit the maximum speed at which the processor can maintain synchronization. The speed limit depends on the microcomputer used, since cycle times vary. Typical figures are 200 ns for bipolar chip sets, 2 μ s for NMOS device sets, and 5 to 10 μ s for PMOS microcomputers. If you operate a motor at, say, 600 rpm or 10 rps and the tachometer provides

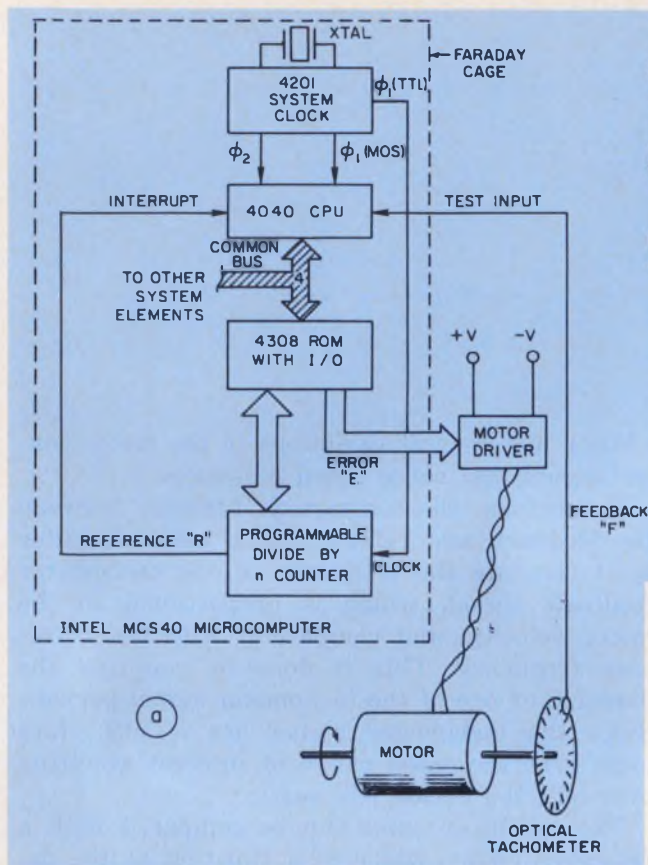

100 pulses per revolution, the response frequency is 1 kHz, a period of approximately 1 ms. Since the processor computes only during half of this period, the self-imposed program duration is 500 μ s. A microcomputer with a cycle time of 200 ns could execute 2500 instructions. If the microcomputer has a cycle time of 10 μ s, only 50 instructions can be executed within the time frame. Since computing for the PLL is done during one-half of the reference period, the other half can be used by the processor for other system tasks. This analysis assumes that a uniform phase difference is acceptable between an arbitrary reference and the feedback signal.

Implicit or explicit reference?

The explicit-reference technique is one of two suitable for implementation with a microcomputer. An external reference source, such as a series of programmable counters, furnishes a clock train that the motor locks onto. With the implicit scheme, the processor calculates the desired rotation period, then forces the motor to conform. No phase angle is used.

First consider the explicit technique (Fig. 4a). The clock signal or reference clock is labeled R and that of the feedback clock F. Speed synchronization occurs when $f_R = f_F$, although a phase difference may exist between the two signals. This phase difference is measured from the

4. The microcomputer driven by an interrupt (a) at the leading edges of R computes the pulse-width-modulated control (b). The internal crystal provides all system timing. The phase angle is measured between the leading edges of R and F.

leading edge of R to the leading edge of F. The processor turns on output command E at the leading edge of R and removes the command on detection of the leading edge of F. These actions correspond to the upper portion of the flow chart in Fig. 2. If the motor load increases, thereby slowing the motor, the error-pulse duration also increases. This, in turn, increases the average power to the motor. Should the motor load decrease and its speed increase, the error-pulse duration would decrease and less average power would be applied.

For out-of-lock checks, the processor produces a count that indicates the period of F and compares this with the current value for R. Any gross difference results in removal or application of E for the time needed to bring the motor into lock (bottom half of Fig. 2).

To calculate the count, the processor executes a software loop with a fixed number of instructions. Each execution of the loop takes a small, but fixed, interval of time. The loop is executed only while F is present. The number of executions, as counted by an increment-by-one instruction in the loop, equals the period of F.

It is unlikely that the counts for F and R will ever agree precisely. Therefore a tolerance is used so that F equals R plus or minus a count of n, where n is small relative to a count of $1/2$ F or R. The resolution of the tachometer count and the response to changes of load on the motor determine what value to use.

For example, if a motor with a high rotor-inertia load is used, the load will provide a fly-wheel effect to reduce speed pulsations; hence

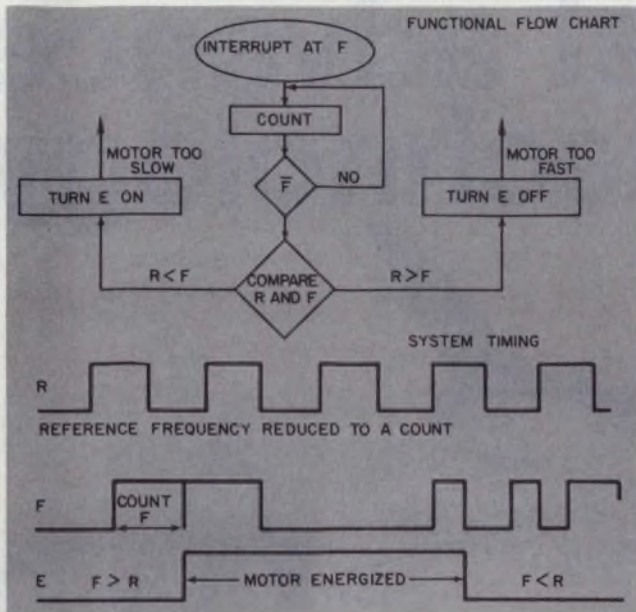

5. If the only concern is motor speed, an internally computed reference can be compared with the tachometer period. The operation resembles that of the PLL circuit in an out-of-lock condition.

the motor speed will always be within a very narrow count of R for a generally static load. If the motor has low inertia, precise synchronism will be harder to maintain. Hence a wider tolerance is desirable. If $T_R > T_F$, indicating that the motor is going too fast, power is removed until F gets back in tolerance. If $T_R < T_F$, indicating the motor is going too slow, full power is applied to the motor to bring its speed into tolerance.

A continuous error-correction signal is not necessary to obtain synchronous speeds for motors with large internal inertia. Once a specific speed is achieved, the flywheel effect of the motor absorbs any variations in load or energy input. Without need to correct for phase, the free-running reference clock becomes unnecessary. Only the reference frequency count is required to maintain speed.

The F signal half-period value is counted and compared with the reference count. If $R < F$, the error signal is applied. If $R > F$, the error signal is removed (Fig. 5). The alternate application and removal of energy must not cause the motor to pulsate. To change speed with this scheme, simply change the reference count, and a different comparison is in effect. Changes in direction are also easily initiated by alternate applications of positive or negative potential to the motor. ■■

Bibliography

- Gardner, Floyd M., "Phaselock Techniques," John Wiley and Sons, New York, 1966.
- Grossman, M., "Focus on Small Motors," *Electronic Design*, September 27, 1973, pp. 52-64.
- Milligan, L. V. and Cornicelli, E., "Phase Locked Loops Provide Accurate, Efficient DC Motor Speed Control," *EDN*, August 1, 1972, pp. 32-35.

WE'VE GOT THE POWER

... and five big digits to count it with.

It's AILTECH's Model 446 VHF-UHF Power Oscillator. We've added an easy-to-read, easy-to-tune 5 digit counter, with accuracy as high as .002%. And you can set and maintain Model 446 at that figure for truly tunable precision power. Model 446 has power output to 50 watts, with full AM-FM capability, and a range from 10 KHz to 2500 MHz, with plug-in heads for eight frequency ranges.

Model 446 offers reliability, abundant power, and a high resolution counter to keep track of that power. Its signal quality makes it ideal for RF testing. And it's just part of the AILTECH Power Source Line — a line with a range from 10 KHz to 8 GHz, and power up to 100 watts, with complete details, or for a demo, so that you can see for yourself.

AILTECH

A CUTLER-HAMMER COMPANY

EAST COAST • 815 BROADHOLLOW ROAD • FARMINGDALE, NEW YORK 11735
 WEST COAST • 19535 EAST WALNUT DRIVE • CITY OF INDUSTRY, CA. 91748
 FRANCE • LA GARENNE-COLOMBES • TELEPHONE 7885100 • TELEX 842-62821
 GERMANY • MUNICH • TELEPHONE (089) 5233023 • TELEX 841-529420
 UNITED KINGDOM • CROWTHORNE • TELEPHONE 5777 • TELEX 851-847238

The newest advance in resistor technology.

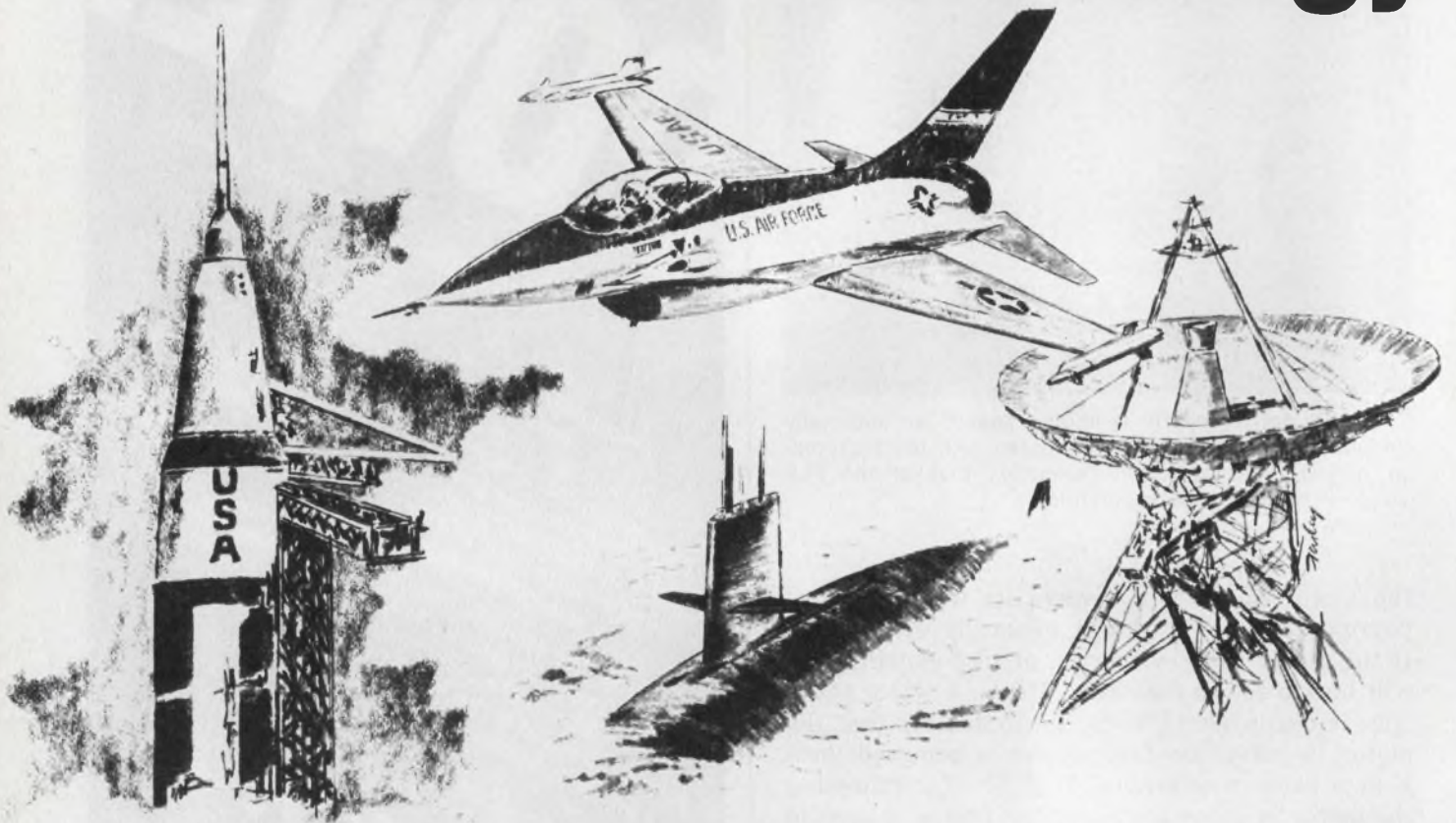

Vishay's S444

Established reliability per Mil R 55182/9

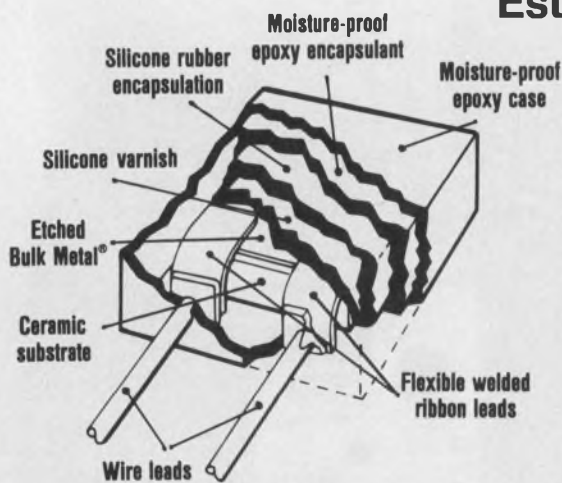

BULK METAL® BREAKTHROUGH now outpaces even further all other resistor technologies and surpasses even existing Vishay 'state-of-the-art' leadership.

SURPASSING ALL TECHNOLOGIES
Bulk Metal® S444 resistors continue . . .

- Tightest tolerances: to $\pm .005\%$
- TC: $1\text{ppm}/^\circ\text{C}$ (0-60 $^\circ\text{C}$)
- TC tracking: to $1/2\text{ppm}/^\circ\text{C}$
- High speed: 1 Nanosecond rise time
- Super stability: 25ppm per year
- Negligible noise: Non measurable by MIL-Std-202
- Negligible voltage coefficient: 0.0005%/V max.
- Small size: .100" x .300" Board space
- Non Inductive: 0.08 MicroHenry max.
- High Temp. Exposure: 175 $^\circ\text{C}$ max.
- Power Rating: .3 w @ 125 $^\circ\text{C}$



**VISHAY RESISTIVE
SYSTEMS GROUP**

OF VISHAY INTERTECHNOLOGY, INC.

63 LINCOLN HWY., MALVERN, PA 19355 (215) 644-1300

The end of compromise.

INFORMATION RETRIEVAL NUMBER 33

ELECTRONIC DESIGN 9, April 26, 1975

3½ oz. light ¾ in. thin

Sinclair Cambridge, \$29.95

Prompt Refund If Not Completely Satisfied

The incredibly small Sinclair Cambridge is now available at an unbelievably small price.

Which means you carry less in your pocket. And keep more in your wallet.

The Cambridge weighs in at a slight 3½ ounces. Measures a mere 4½" x 2" x ¾". And holds its own against heavier competition.

You see, we not only make it small. We make it better:

With a flexible constant that functions during mixed calculations.

And accuracy that extends beyond the 8-digit display. Which means that very large, or very small, intermediate results do not affect final answers.

The Sinclair Cambridge.

True convenience, without compromise. At a truly affordable price.

sinclairTM
Cambridge

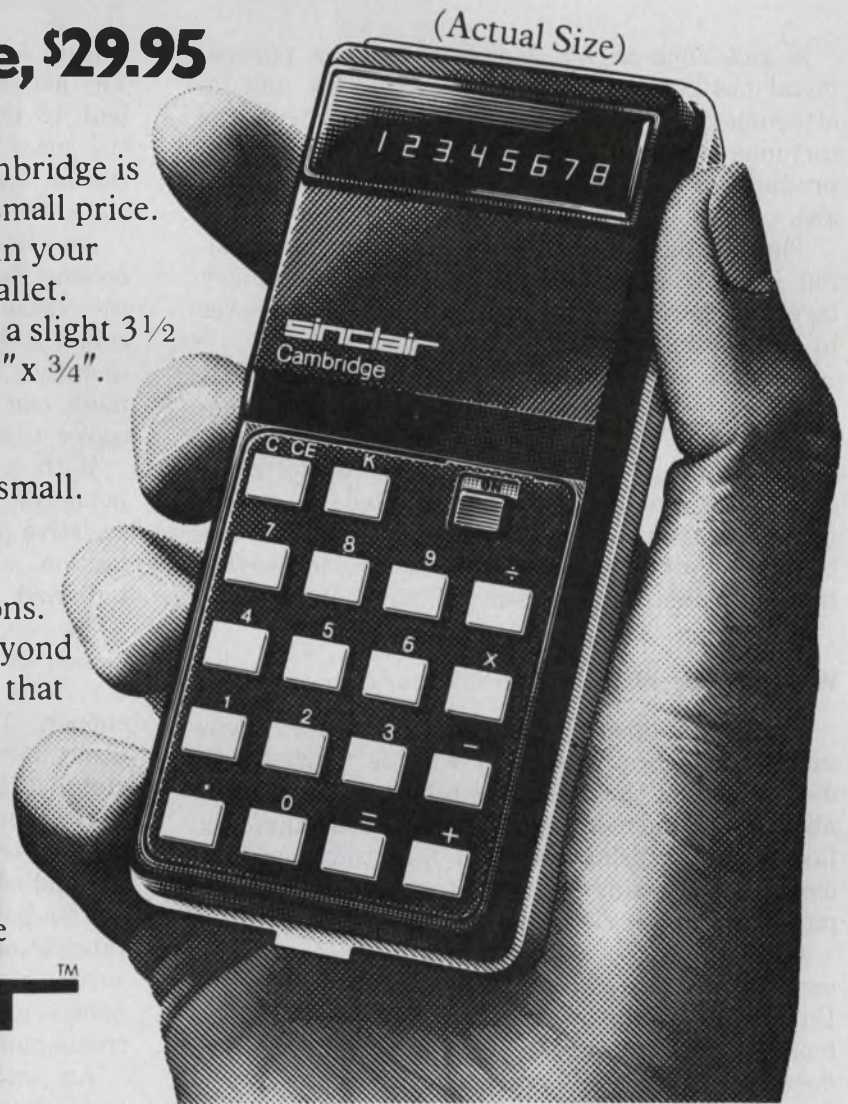

Specifications

Functions: +, -, ×, ÷, =

Constant: four functions

Display: 8-digits, sign, floating decimal

Power: 4 AAA batteries

Size: 4½" x 2" x ¾"

Weight: 3½ ounces

Warranty: one year

Made in England.

ORDER FORM

To: Hayden Mail Order Dept. ED-9
50 Essex St.
Rochelle Park, N.J. 07662

Please send me _____ Sinclair Cambridge Calculators at \$29.95 each (add \$3.50 per unit postage & handling). All units shipped with batteries, carrying case, instruction book and warranty. Enclosed is my check or money order for \$_____. (For immediate delivery please forward Cashiers Check. Please allow 3 weeks for delivery if personal check is enclosed. New Jersey residents please add sales tax.)

NAME _____ IF NOT COMPLETELY SATISFIED I

ADDRESS _____ MAY RETURN THE CALCULATOR

CITY _____ STATE _____ ZIP _____ FOR REFUND WITHIN 7 DAYS.

Cool through turbulence with lightweight wire-mesh transpiration panels. They conserve space, take almost any shape and provide quiet operation.

A gas, such as air, passes through a porous-metal heat sink. The gas cools the sink and its attachments. Turbulent flow that results from the tortuous passage of gas through the porous metal produces a high heat-transfer coefficient to the gas.

The technique is known as transpiration cooling. The turbulence breaks up stagnant boundary layers of laminar flow that impede heat transfer to the cooling medium.

Though this technique of porous-metal heat transfer is well-established in aeronautical engineering, it is only now beginning to make inroads in the electronics industry. In electronic assemblies, components are mounted on panels made of layers of wire mesh. The layers are bonded together by a sintering process to provide the equivalent of porous-metal air channels.

Wire-mesh panels create turbulence

The mesh openings are staggered for maximum turbulence. A typical wire is 0.025 in. in diameter, and the mesh has 0.1-in.-sq. spacing—about the dimensions of window screening. Six layers of the mesh are about 1/8-in. thick. A high-emissivity coating applied to completed mesh panels improves radiation heat transfer.

Copper mesh is usually used in electronic assemblies because of its high thermal conductivity. But for high temperatures, stainless-steel mesh is more durable. Material with high thermal conductivity is desirable to reduce the temperature differences between the cooling gas and components mounted on the mesh.

Transpiration panels can be fabricated into many shapes and sizes. The basic sheet form (Fig. 1) is usually 20 × 45 in. and 1/8 to 1/2-in. thick. This can be cut and shaped to almost any geometry. The more familiar extruded-fin heat sink, on the other hand, is limited by its mechanical rigidity and bulk.

A section of a 10-layer wire laminate offers six times the cooling surface of an extruded

smooth fin of equal envelope dimensions (Fig. 2). The heat-transfer surface is included within the bulk of the laminate. However with a solid fin, the space required is that taken by the bulk of the fin and the air space alongside it, but only the outer surface of the fin is heat-transfer area.

An important advantage of transpiration cooling is that it allows easy optimization of the space requirements. To improve laminate conductivity, thicker laminate can be used; to increase convection heat transfer, a tighter mesh can be selected. However, the size of the cooler can remain the same.

With extruded-section heat sinks, the preponderance of metal may provide a low thermal resistive path, but there also is a shortage of convection surface. And the relationship between bulk and surface is hard to change.

By contrast, transpiration panels consist largely of voids, thus their density is low—about 0.1 lb/in³, compared with 0.3 lb/in³ for solid copper. They are typically 25% smaller and about 35% lighter than conventional finned heat sinks. Finished panels are easily incorporated into cooling assemblies, with blowers and components readily arranged for convenient air ducting and efficient space allotment (Fig. 3).

The panel configuration lends itself to easy fabrication of structural walls and case enclosures—so called cold-wall cooling. Also, the panels provide excellent shielding against electromagnetic interference.

An extra bonus is noise-free operation. The low-velocity gas flows quietly through the mesh-metal passages. Also, the baffling action of large-area diffusion reduces noises normally generated by fans or blowers. Use of low air velocity is possible, because the technique attains turbulence by maximizing air-passage obstruction. More conventional air cooling requires far greater velocities for the same degree of turbulence.

Low air velocity and large cooling surface are associated with a low Reynolds number—a dimensionless number that can be defined in pipes and channels as

$$R_N = \frac{Lv\rho}{\mu}, \text{ or } \frac{\text{impulse forces}}{\text{laminar viscous forces}}$$

John Chisholm, P.E., Design Engineer, National Components, Inc., West Palm Beach, FL 33407.

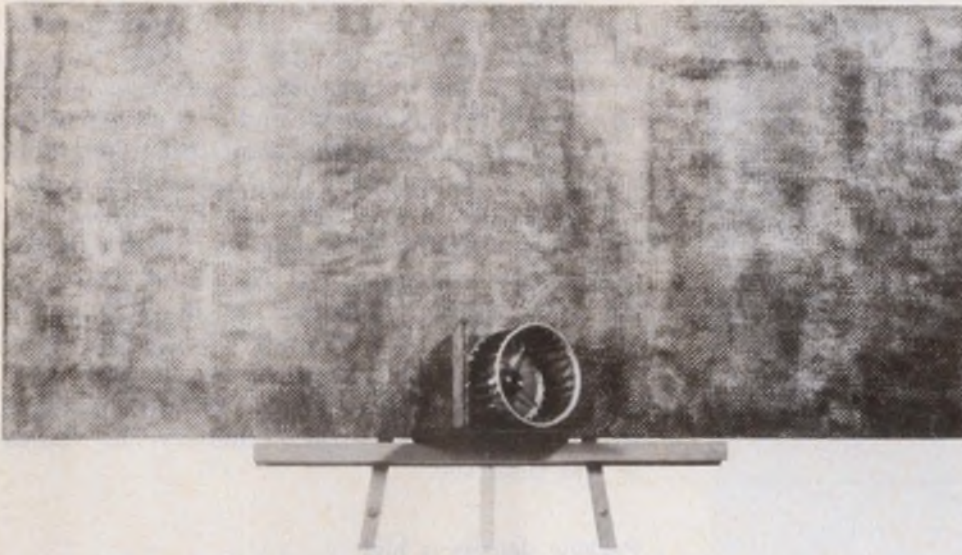

1. **Transpiration panels** consist of several staggered layers of wire mesh—copper is strongly suggested—sintered together. Basic panel laminates are usually 20 × 45 in. by 1/8- to 1/2-in. thick, and they can be cut and shaped to almost any configuration.

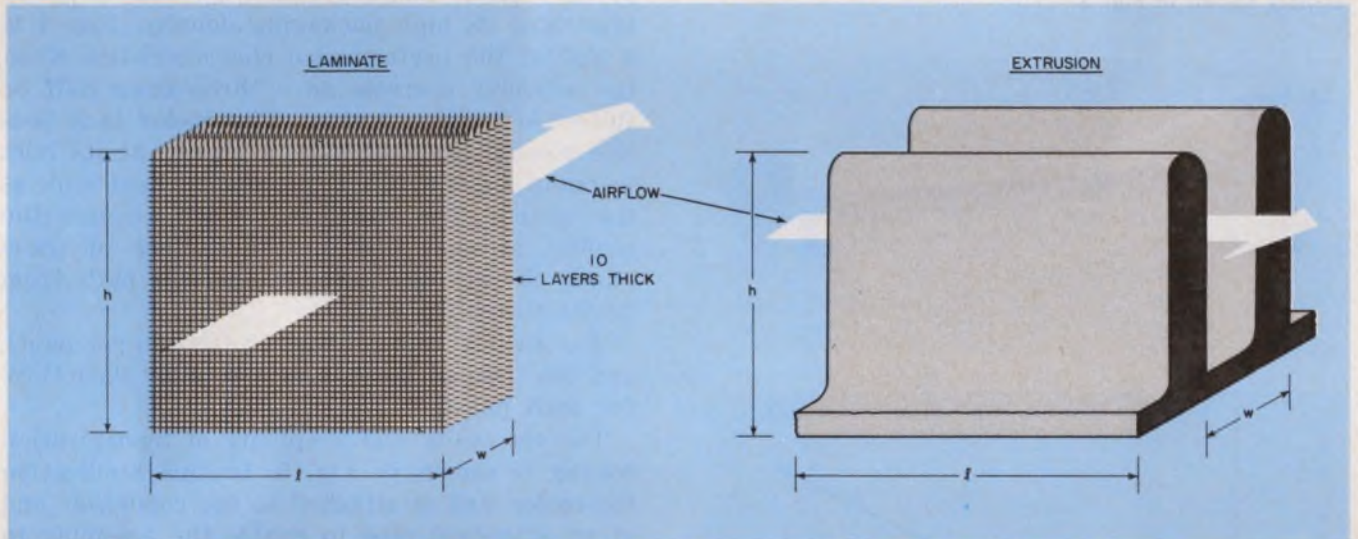

2. The cooling surface of a laminated panel is at least six times greater than that provided by an extruded fin

with equal space requirements. And turbulent flow in the panels further increases heat transfer.

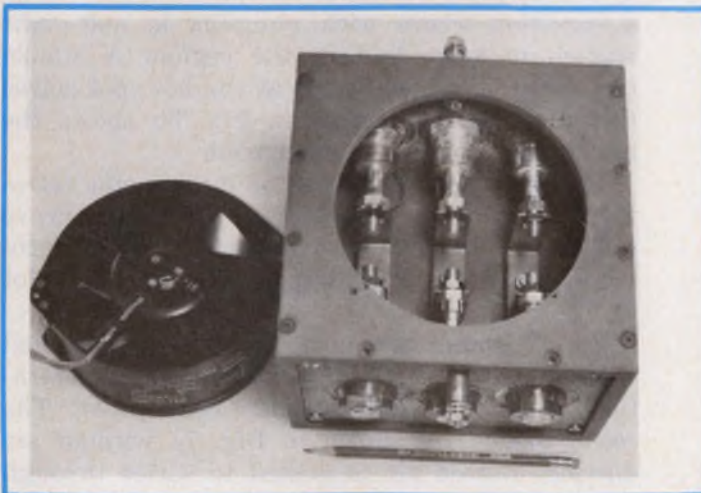

3. In this three-phase, full-wave power-rectifier assembly, six power diodes are mounted on panels that provide low thermal resistance to the cooling air. A half-wave unit would need only three diodes and a single panel.

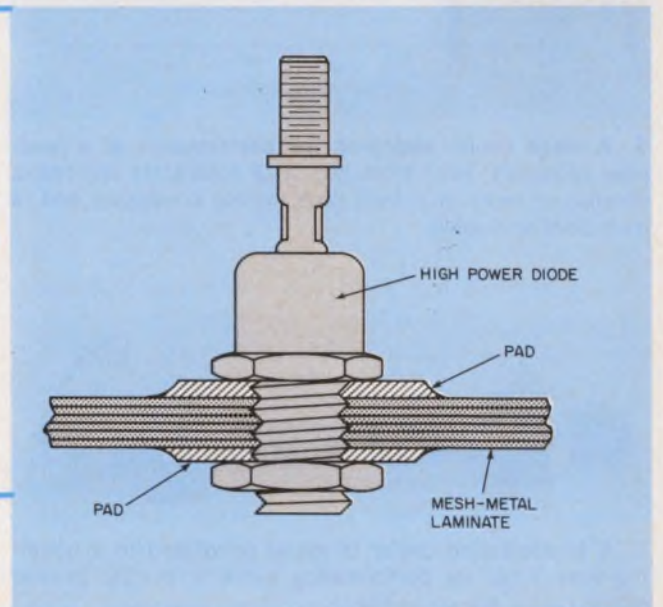

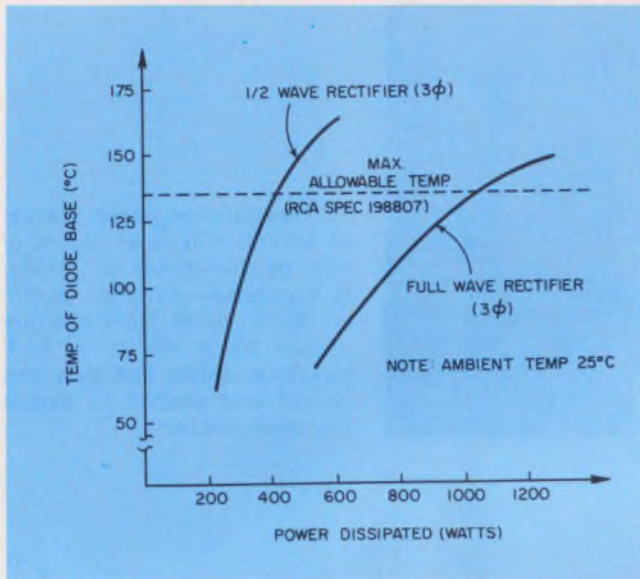

4. The cooling performance of the power-rectifier assembly shown in Fig. 3.

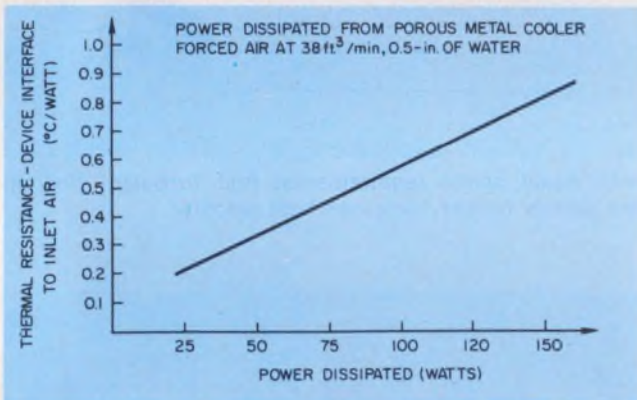
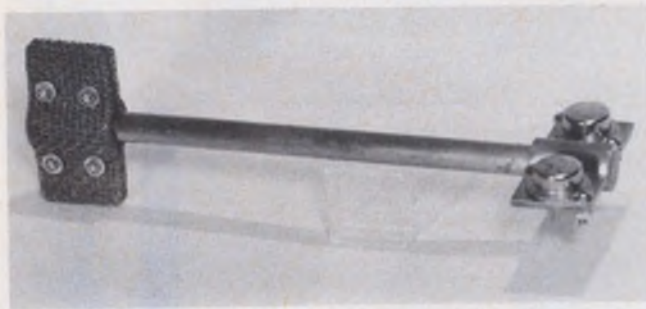

5. A mesh cooler improves the performance of a heat-pipe assembly. Heat from two TO-3 solid-state devices is conducted away by a heat pipe, whose condenser end is transpiration-cooled.



6. A transpiration cooler is easily retrofitted to a traveling-wave tube. Its performance curve is similar to that of the cooler shown in Fig. 5.

in a more general way, as in a wire-mesh matrix. In the pipe equation the gas flow velocity, v , is parallel to a flat, unobstructed surface of length, L , and ρ is the gas density and μ is its viscosity.

The transition from turbulent to laminar flow depends on the critical R_N of a system. Above the critical R_N , the flow is turbulent. But fortunately the transpiration matrix surfaces create turbulence at low values of R_N . And fluid-mechanics engineers associate low critical R_N with easily attained good mixing at quiet, low-gas velocities.

The familiar smooth-fin-extrusion heat sink usually has a critical R_N of several thousand in air, but the transpiration matrix has values of less than 100.

Packing density is high

The transpiration-cooling assembly for a high-power rectifier and regulation systems (Fig. 3) illustrates its high packaging density. Fig. 4 is a plot of the performance characteristics when the assembly operates as a three-phase half or full-wave rectifier system. The cooler is a box-like plenum chamber with a blower at its inlet to pump air through a mesh-panel heat sink at the outlets. The rectifiers, which require the cooling, are mounted on the surface of these panels to provide minimum thermal path from device to cooling air.

The air-flow rate is about 55 ft³/min per panel, and the thermal resistance is roughly 0.25°C/W for each panel.

The versatility and simplicity of transpiration cooling is shown in Fig. 5. In this application the cooler sink is attached to the condenser end of an axial-heat pipe to enable the assembly to operate more effectively near the limit of its transport capacity. This technique prevents hot spots. At either the evaporator or condenser end of a heat pipe, hot spots can produce "dry-out," a condition where wick pumping is not great enough to keep fluid in the region. A simple transpiration cooler placed at the hot spot solves this problem. The graph in Fig. 5b shows the performance of this arrangement.

In Fig. 6 a small length of mesh-metal retrofitted around the collector to a traveling-wave tube—a technique similar to that in Fig. 5—provides the cooling effect approximated by the plot of Fig. 5b.

Fig. 7 shows the geometry and operational characteristics of a high-performance transpiration cooler for high-capacity heat pipes. The cooler panels are shown in Fig. 7a without air ducting. Forced air is ducted in series through the two mesh-metal sinks in Fig. 7b. In another arrangement (Fig. 7c), air enters between the two sinks and flows out in parallel. There is little difference in performance between these

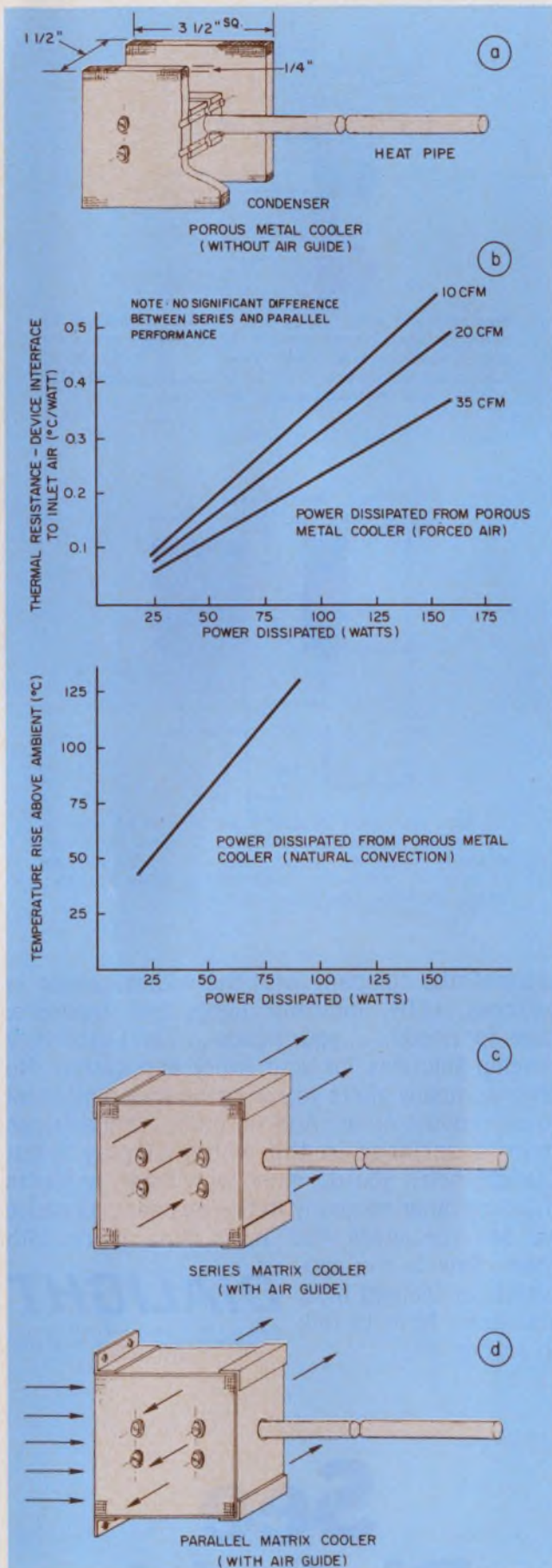

7. A high-performance condenser configuration for a heat pipe (a). There is no performance difference (b) between series (c) and parallel (d) air-flow patterns.

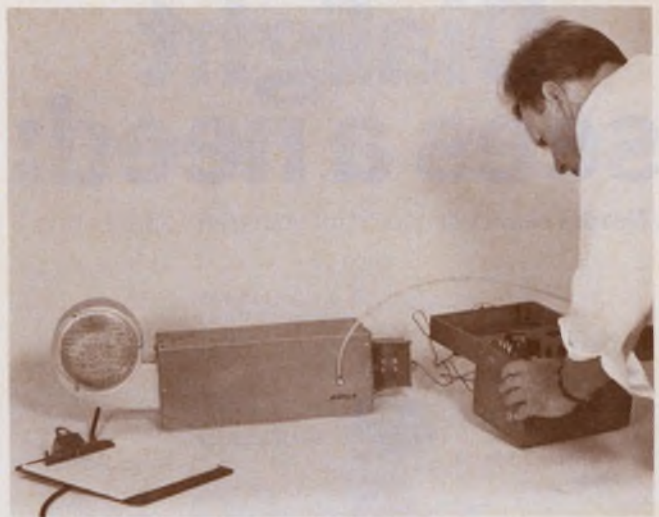

8. Test duct for transpiration coolers provides controlled, filtered air flow to allow measurement of component temperatures with a thermocouple. The blower housing contains a washable air filter.

two configurations.

The performance of the same cooler with natural convection is also shown in the curves. This depicts what can be expected in the event of fan failure. Clearly a significant amount of heat is dissipated simply by chimney effect.

The mesh-metal heat sink has such a high heat-transfer rate to air that the chimney effect is particularly effective if the system is oriented to take advantage of natural air movement. The normal upward convection movement of lighter heated air must be allowed to take place easily; the cool heavier air must be able to displace it. Clearly, vertical open-end ducting can greatly enhance the effect.

Dirt problems easily avoided

Of course, air pumped into a transpiration cooler should be first filtered to remove lint and other contaminants. Transpiration-panel openings are fairly large, and particles to 150μ easily pass through. However, without a filter, a panel can soon become matted with lint and dust.¹ Many types of air filter arrangements are possible. Fig. 8 shows a washable filter mounted directly to a blower housing.

But don't try to use metal-filter materials as cooling panels. Some engineers, in an attempt at a short-cut, have tried powder-metal filter stock instead of a copper-mesh panel. Filter stock will not work very well because it is usually made of bronze, which has low thermal conductivity. Experience has shown that the most satisfactory material is a bonded copper-wire laminate. Michigan Dynamics Inc. of Detroit custom fabricates such copper-mesh bonded panels. ■■

Reference

1. Edwards, Lawrence F., "Dust Filters Can Block Cooling Air," *Electronic Design*, Nov. 8, 1973, pp. 108-110.

Dialight sees a need:

(Need: The widest choice for your every application.)

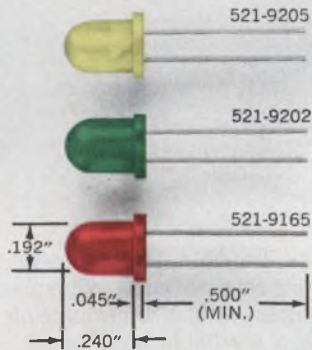

Now available in green, yellow and red. Mini-sized for maximum front panel density and easy panel mounting. High luminous intensity, low cost. Vibration/shock resistant. Solid state for long life. Wide viewing angles. Ideal for applications like panel lighting, film annotation and alpha-numeric displays.

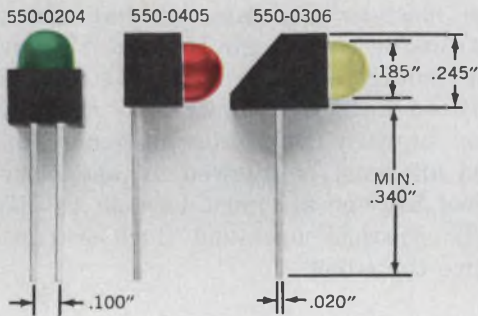

Mix 'em or match 'em. LED logic state fault indicators are available in red, yellow and green, in a variety of shapes, some with a built-in integral resistor. Can be driven from DTL and TTL logic. Designed for easy alignment on PC boards so that multiple functions can be displayed.

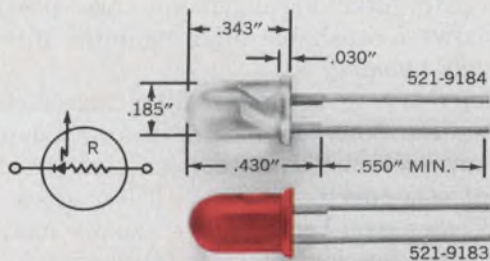

Available in red or clear LED packages with or without a built-in current limiting resistor. Red LED is also made without resistor. Suitable for circuit status indication, alpha-numeric displays and visual indicators. Features long wire-wrappable leads. IC compatible with solid state reliability. High luminous intensity, low power consumption, low cost.

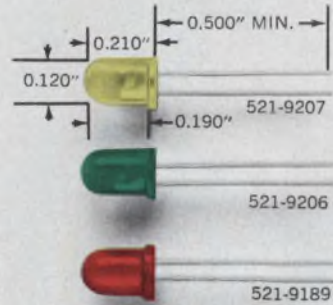

Your choice of green, yellow and red, with axial leads for dense packaging requirements. Wide viewing angle for easy readability. Low power consumption, low cost, IC compatible. 10mA operation for typical brightness. Size is identical to the most popular red LEDs.

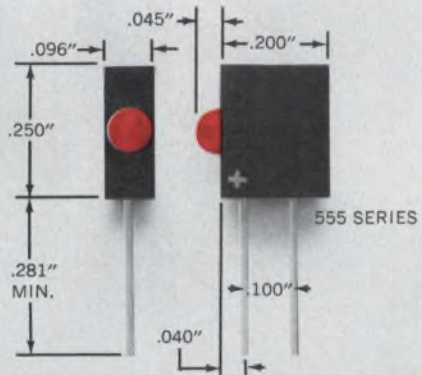

LED logic state fault indicators available in 14 models with voltage ratings from 1.7 to 14. Suitable for dense packaging on printed circuit boards—up to 10 units to the inch—IC compatible. With built-in series resistor. Polarity identified. Low power consumption.

Dialight, the company with the widest choice in switches, LEDs, indicator lights and readouts, looks for needs . . . your needs . . . and then they develop solutions for your every application. No other company offers you one-stop shopping in all these product areas. And no other company has more experience in the visual display field. Dialight helps you do more with these products than any other company in the business, because we are specialists that have done more with them. Talk to the specialists at Dialight first.

DIALIGHT
Dialight, A North American Philips Company
203 Harrison Place, Brooklyn, N. Y. 11237
(212) 497-7600

You won't have to talk to anyone else.

See Dialight.

Call us S.³

Call us Triple S.

Call us Solid State Scientific.

**BUT CALL US....
for RF Transistors.**

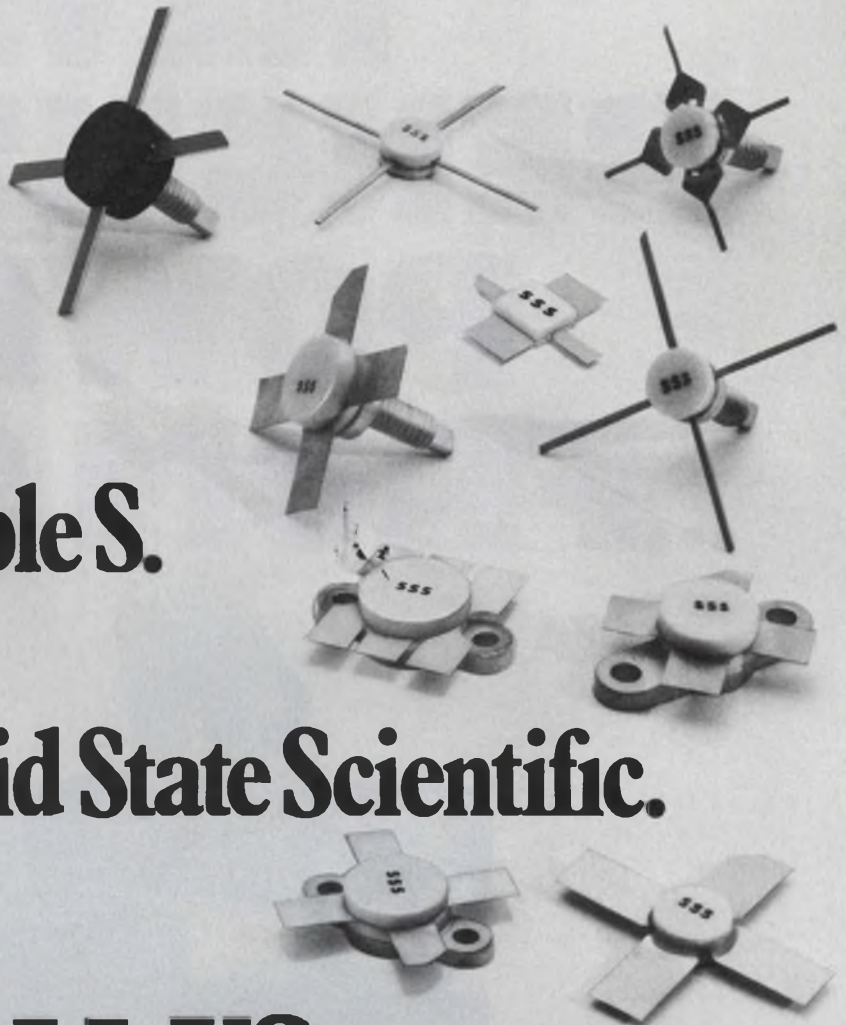

Call us for new designs. Tuned Q construction in the upper frequency bands, with wire bonds, geometries, package parasitics and internal matching networks controlled to tight tolerances. Many devices are available in our unique Miniature Chip Carrier package with extremely low parasitics.

- 900-MHz family . . . 1, 5, 15, 25 and 40 watts. The best that the industry can offer at 12.5 volts.
- 470-MHz transistors; discrete and internally matched devices from 1 watt to 40 watts at 12.5 volts.
- Pulsed DME transistors; in excess of 100 watts peak at 40 volts.
- 50-watt and 70-watt class B linear amplifiers, for sideband CB at 12.5 volts.

- Isolated collector TO39 transistors at VHF, UHF and Class E Citizens band.

- Internally matched VHF transistors at 40-watt and 70-watt levels at 12.5 volts.

Call us for better-than-equal transistors. Manufactured under stringent individual lot quality control and 100% tested in actual transmitter circuits to assure parametric performance beyond usual 2N specs. VHF and UHF, small signal and up to 90 watts.

For specifications and prices, call today. Or write.



SOLID STATE SCIENTIFIC INC.
Montgomeryville, Pa. 18936/(215) 855-8400/TWX 510-661-7299
The RF Power Specialists.

NEW BENCHTOP POWER ...FROM \$99



SEPARATE METERS FOR VOLTAGE AND CURRENT

These reliable, yet low-cost power supplies have the performance and features ideally suited for circuit development, component evaluation and other laboratory applications. Line and load regulation, $\pm 0.01\%$ or 2 mv. Ripple, 0.25 mv rms. All models have coarse and fine output voltage controls, and adjustable current limiting. Models K7S200 and K7S500 also have adjustable overvoltage protection. Dual and triple output models also available. Shipment from stock. Write for brochure.

OUTPUT VOLTAGE RANGE	OUTPUT CURRENT AMPS.	PRICE	MODEL
0-7	1.0	\$99	K7S100
0-7	2.0	135	K7S200
0-7	5.0	190	K7S500
0-18	0.6	99	K18S60
0-18	1.0	120	K18S100
0-32	0.35	99	K32S35
0-32	0.6	120	K32S60
0-50	0.35	120	K50S60



Corp., Easton, Pa. 18042. Telephone: (215) 258-5441.

INFORMATION RETRIEVAL NUMBER 37

Electronic Design

presents

the 'top-ten' winners

The following pages display advertisements of companies who won our "TOP TEN" contest with outstanding ads in the January 4 issue. The contest attracted thousands of readers who attempted to match their ratings of the 10 most memorable advertisements with the "recall-read" and "recall-seen" scores from ELECTRONIC DESIGN's regular Reader-Recall survey.

Winning advertisements combine attractive colors, tasteful design and well-written copy. The result: impact. Here are the winning companies in order of highest Reader-Recall score received:

1. Hewlett-Packard, Colorado Springs Div.
2. Tektronix, Inc.
3. Motorola Semiconductor Products
4. Robinson Nugent
5. Duncan Electronics
6. Litronix
7. Intel
8. Hamlin
9. Motorola Semiconductor Products
10. Bourns

Meet the first scope with a microprocessor.

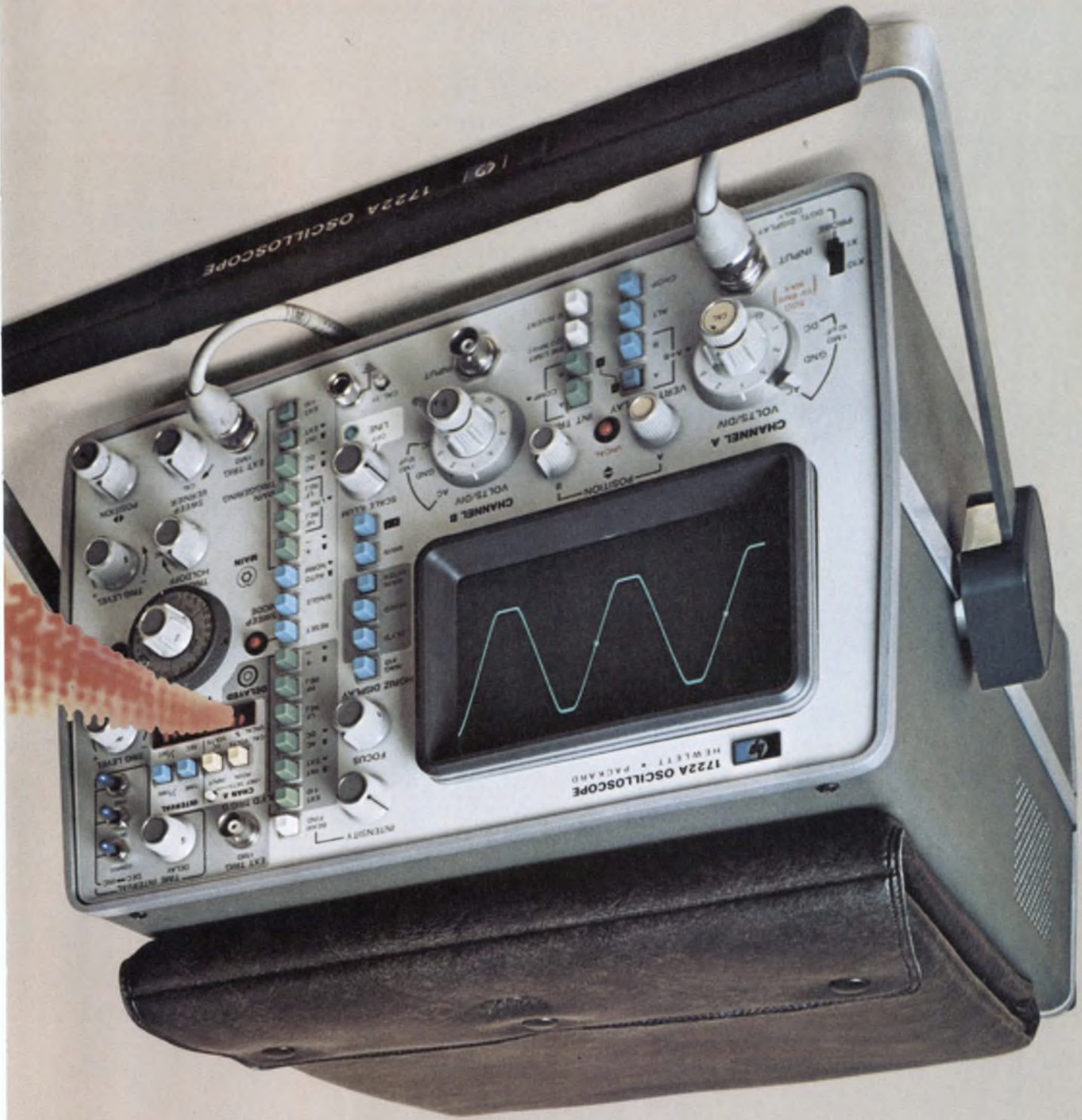

It counts, calculates, and improves accuracy too.

Now, HP has combined a high-performance scope, a microprocessor, and an LED display to put an end to graticule counting, mental calculations, and the conventional 5% scope error. The 1722A gives you a giant leap in measurement accuracy and convenience. It's a working lab partner that speeds measurements of time intervals, frequency, instantaneous or dc voltage levels, and relative amplitude. It allows you to make all these measurements more accurately...with less chance of human error.

The microprocessor takes over several tasks you used to perform.
It keeps track of

ing of your measurements...in seconds, hertz, volts, or percent. Working with the 1722A is like having an assistant that takes care of the mental gymnastics.

There's another reason for easier, more accurate measurements—HP's unique Dual Delayed Sweep. It gives you two adjustable intensified markers for displaying the start and stop points of a time interval. The microprocessor then gives you an automatic read-out of the time interval between the markers. This speeds digital timing measurements and simplifies the adjustment of circuits to meet a timing spec.

The combination of a proven 275 MHz dual-channel scope, microprocessor, LED display, and Dual Delayed Sweep gives you faster, more complete waveform characterization than you'll get from conventional scopes costing twice as much.

And instead of the conventional 3 to 5 percent reading errors typically associated with voltage and time

measurement's, the 1722A puts you in the 0.5 to 1 percent range.

The 1722A begins a new era of measurement technology by giving you faster answers, more accurate answers, even answers you couldn't get before. And at a price of just \$4,500.*

Let your local HP field engineer introduce you to the new scope generation. Call him today. Or, write for our informative 8-page brochure.

* Domestic USA price only.



dial settings, automatically computes time intervals and voltage levels, converts time measurements to frequency, and calculates percent. It even signals if you make an erroneous setting. In addition, the microprocessor drives a 3½-digit LED display to give you a direct digital read-

HEWLETT  PACKARD

Sales and service from 172 offices in 65 countries.
1501 Page Mill Road, Palo Alto, California 94304

Time is money

An old proverb states "Time is Money." Today's technical jargon might express this as: The logic which does the greatest work per unit time, per dollar, *can reduce equipment costs*. Naturally, we feel the logic is MECL. Here are a few actual case histories illustrating just that.

Case 1. A processor was designed in three ways: A. Schottky TTL, performance level X; B. MECL 10,000, same structure, performance 2X; C. MECL 10,000 architecture modified to exploit ECL speed and other design advantages, performance level X. The design team discovered the following:

	TTL (Schottky)	MECL 10,000
Performance	X	X
Package Count	Y	Y-25%
Power Consumption	P	P-28%
TOTAL SYSTEM COST	Z	Z-22%

Case 2. Existing equipment used 3 TTL (7400 series) boards (~100 packages each) to process 9 input lines of 2 to 10 MHz data streams. The system was redesigned and the 3 boards replaced with *one* MECL 10,000 board (~100 packages) which worked more than 3 times faster.

Design results: A. A small saving in basic IC component costs; B. A huge reduction in system complexity, together with increased reliability, smaller size, reduced power consumption, lighter weight, and reduced assembly costs.

Case 3. A memory system was designed which would have required high performance NMOS memories and would have used TTL control logic. In analyzing the system, designers realized that delay time subtracted from control logic operation could be added to NMOS cycle time specs. Thus, the use of cheaper, lower performance NMOS memory elements were combined with ECL control circuits. Design goals were met and the same level of performance was obtained — at reduced cost.

MECL and MECL 10,000 are trademarks of Motorola Inc.

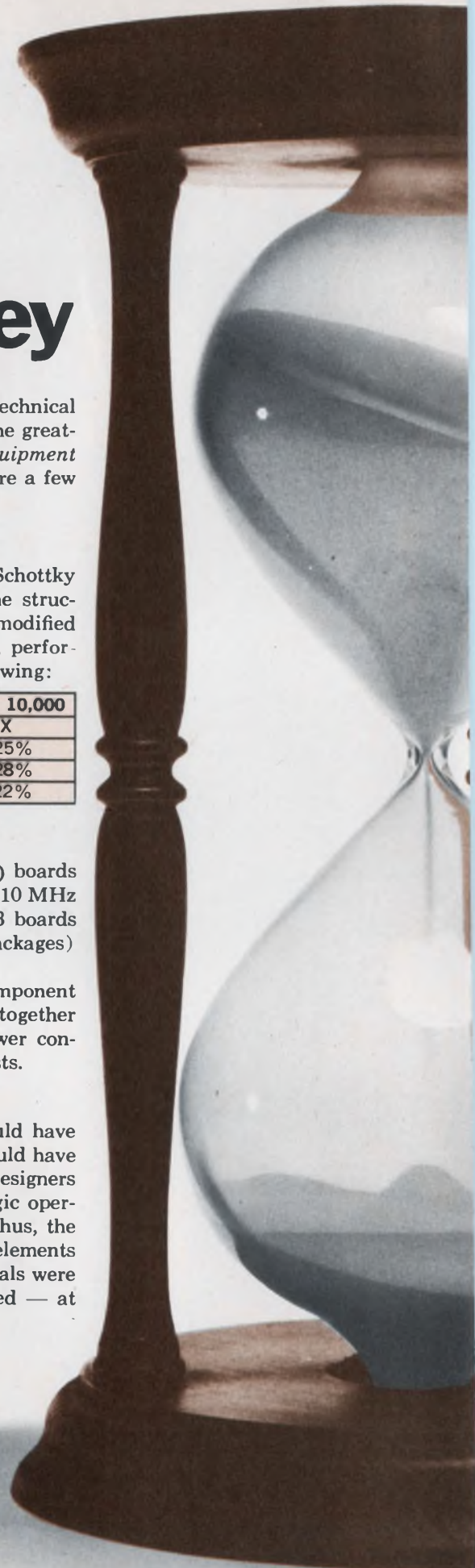

MECL saves time

MCM10149AL 256 x 4 PROM
The fastest, large field programmable ROM available today. A quick way to simulate logic, micro-programming, look-up table storage, and high speed code conversion.



MC10183 4 x 2 (2's complement) Multiplier
Multiply more with fewer packages. Ideal for high speed computers, image transfer equipment, digital filters, correlators, and "smart" instrument signal processing.



MC1699 ÷ 4, 1-GHz Counter
A low cost IC approach to high frequency counting problems by reducing IC and discrete component count. Applications include digital TV tuners, frequency synthesizers, and high performance instruments.



Six new ways to save time



MC1603 4/5-Input OR/NOR Gate

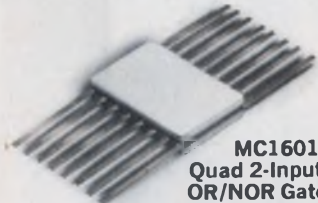

MC1601 Quad 2-Input OR/NOR Gate

MC1602 Triple 2-3-2 OR/NOR Gate



High-bandwidth devices designed for systems requiring up to 500 MHz bandwidths. Communicate more data with fewer packages — faster.



MOTOROLA MECL

—A fast way to save time

Evaluate and receive a free copy of the new MECL Data Book.

Evaluate one or more of the new devices and receive a free copy of the recently published MECL Data Book. Just list your name, company, and tentative application on your company letterhead, and attach it to your purchase order. Your local franchised Motorola distributor will include the book with your devices. This offer is limited to one book per order and expires March 31, 1975.

For device specifications, write to Motorola Semiconductor Products Inc., P.O. Box 20912, Phoenix, AZ 85036. And if you haven't viewed the MECL seminar, call your Motorola distributor or OEM sales office for a presentation. "Time is Money." Invest in a MECL evaluation. It could return a handsome profit.



HIGH RELIABILITY



Get the **high reliability** that eliminates trouble. RN DIP sockets make contact with the wide, flat sides of your IC leads. This provides **100% greater surface contact** for positive electrical connection.

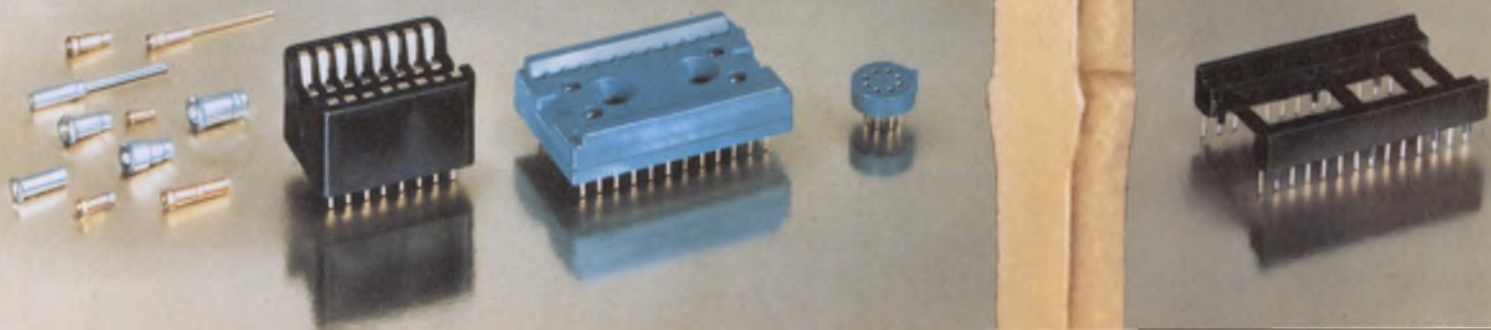

DIP SOCKETS **for the price you're paying for junk!**

Robinson Nugent "side-wipe" DIP sockets make 100% greater contact than any edge-bearing socket on the market.

This 100% greater contact with the wide, flat surface of your IC leads is your guarantee of unmatched reliability. This RN "side-wipe" contact provides constant low contact resistance. No edge-bearing contact can possibly deliver this long term dependability. This designed-in reliability of RN DIP sockets is your assurance of trouble-free IC interconnects—yet they cost no more than ordinary sockets.

Put an end to troublesome junk sockets! Write today for catalog and informative book "What to Look for in IC Interconnects." It's free from RN—the people who make more kinds of high reliability IC sockets than anyone.

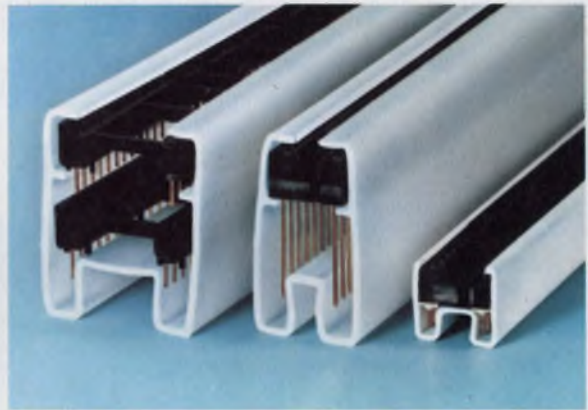

They're even packaged for high reliability.

"Protecto-pak"[®] packaging delivers consistently perfect RN sockets to your production line—for automated or manual assembly.



RN **ROBINSON NUGENT, INC.**

800 East Eighth Street • New Albany, Indiana 47150 • Phone: (812) 945-0211

INFORMATION RETRIEVAL NUMBER 40



High reliability IC sockets... we've got 'em all!

Announcing the Battery Status Indicator— a new LED/IC combination

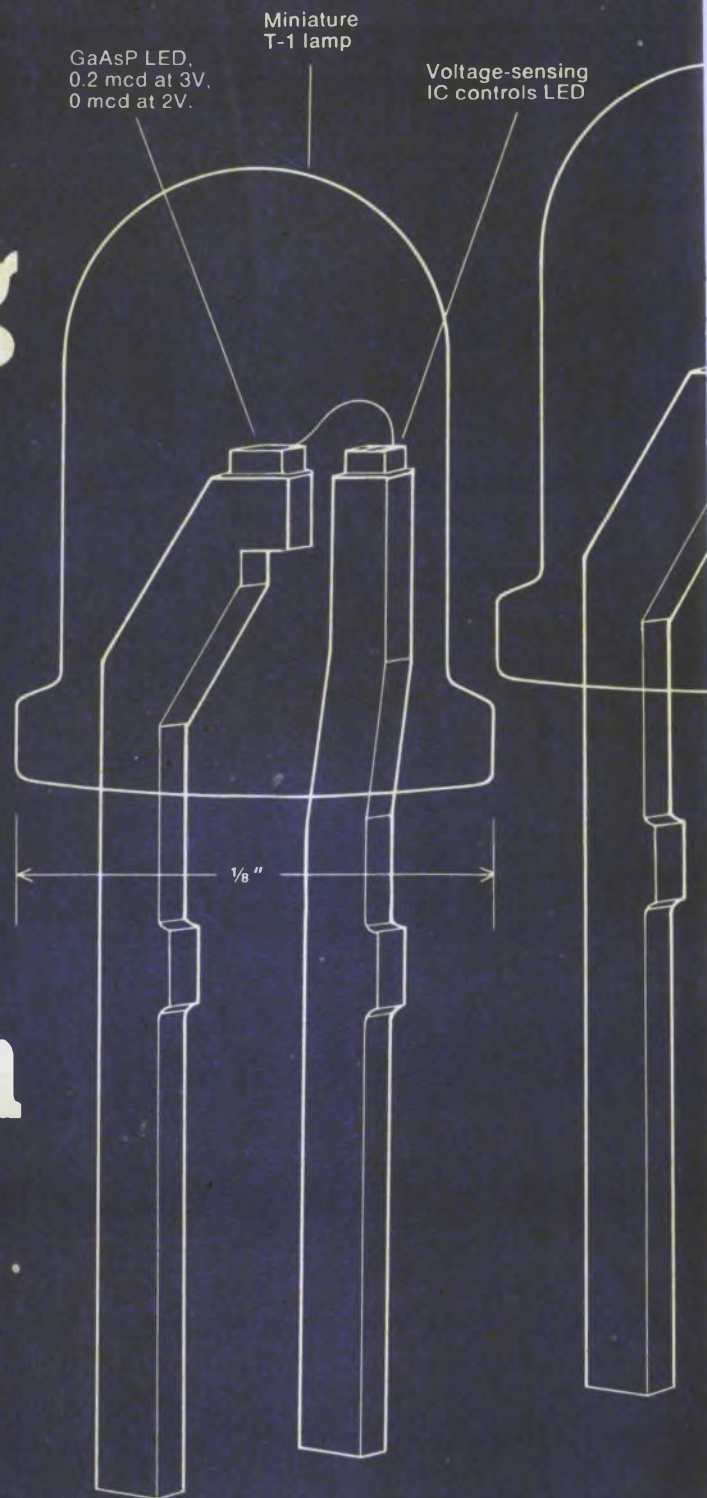



Dead batteries! Everyone hates 'em. And most battery powered equipment—cameras, tape recorders, calculators—don't warn you until it's too late.

Now Litronix—the world's largest manufacturer of LEDs—introduces the RLC-400 Battery Status Indicator. It's a red GaAsP warning light and voltage-sensing IC combined in one little T-1 lamp package. The light is on at 3V, off at 2V.

One of the nation's most prominent camera manufacturers uses it. Any battery-powered device that uses it may acquire an important competitive advantage at low cost.

The Litronix Battery Status Indicator will cost you only 60¢ in quantities of 1000. And you keep production costs down because you don't have to test, assemble and inventory several components.

If you need a warning light that goes on and off at different voltages, get in touch with us. We may be able to help you.

You can get a free sample of the Battery Status Indicator by writing us on your company letterhead. Or if you want more information quick, contact Litronix, 19000 Homestead Road, Cupertino, California 95014. Phone 408-257-7910. TWX 910-338-0022.

**No wonder
we're No.1
in LEDs**

litronix

The fastest single clock 4K NMOS RAM operates on the least power.

It's the only one with a second source.

There's just no doubt about it. Motorola's new MCM6605L NMOS 4K RAM is the coolest in operation, and the fastest single clock design available.

The tables tell the story. One makes device vs. device comparisons and the other shows what the differences mean in system applications.

It's a good idea to have a questioning attitude in this day and age, so we've provided the system power equations. Apply them to your own system size requirements, to any hypothetical system, or simply check the accuracy of our demonstrated figures. Go ahead, prove to yourself that the MCM6605 has the lowest system power requirements by a wide margin.

Results of these comparisons are significant for several reasons. The most obvious is probably the smaller battery required for battery back-up for non-volatile operation. Reduced cooling requirements and the ability to operate with smaller, less expensive standard power supplies are also important factors.

4K NMOS RAM COMPARISON

Device	MAX I _{DD} (Active) (mA)	MAX I _{DD} (Standby) (mA)	V _{DD} (Volts)	Number of refresh cycles/2 ms	Memory access time (ns)	Memory cycle time Read/Write (ns)
MCM6605	36	0.020	12	32	210	370/490
MK4096P	30	1.0	12	64	350	500/500
TMS4030	41	0.5	12	64	300	470/470
2107A	34	0.1	12	64	300	500/700



THE EQUATIONS FOR POWER

1. Active memory system power:

$$P_o = M \left(\frac{MCT}{SCT} \right) (I_{aa}) (V_{DD}) + (N-1) (M) \left[\left(\frac{MCT}{T} \right) (I_{aa}) (V_{DD}) + \left(\frac{T-MCT}{T} \right) (I_{ss}) (V_{DD}) \right]$$

2. Standby memory system power with refresh:

$$P_o = (N) (M) \left[\left(\frac{MCT}{T} \right) (I_{aa}) (V_{DD}) + \left(\frac{T-MCT}{T} \right) (I_{ss}) (V_{DD}) \right]$$

Where: $N = \frac{\text{System word size}}{4096}$ $T = \text{Period between refresh cycles} = \frac{2msec}{\# \text{ of ref cycles}}$
 $M = \text{Number of bits}$ $I_{aa} = \text{Active } I_{DD}$
 $MCT = \text{Memory cycle time}$ $I_{ss} = \text{Standby } I_{DD}$
 $SCT = \text{System cycle time}$

There are subtleties involved, too, such as the number of refresh cycles required, which can significantly increase standby power. But the best way to illustrate is with the tables. All pertinent dc parameters are taken directly from the most recently available data sheets of the manufacturers, themselves.

Plenty of MCM6605 Advantages

Speed: The device comparison table tells it all. With an access time of 210 ns and read/write cycle times of 370/490, none of the major competitive devices are as fast.

Optimized Pin-Outs: Voltages are on the corner pins, an advantage for several reasons. It's easier to lay out the PC board, and the larger allowable bus lines make line impedance lower, very important in dynamic memory systems because of the high dynamic surge currents. Bypassing is easier, too, which reduces the capacitance required.

New Interface Parts designed for 4K RAMs: Motorola circuit designers have recognized the unique interface requirements of NMOS memory systems. The first in a new family of interface devices is the MC3459, a Quad NMOS Memory Address Driver. The MC3460 Quad NMOS Memory Clock Driver will follow.

Only the MCM6605 Has a Second Source

Mere pin compatibility isn't interchangeability. As the photograph of an operational 16K by 16 bit add-on PDP-11 memory system demonstrates, the 6605 type RAMs supplied by AMI are direct, electrical, plug-in replacements for Motorola's MCM6605. No other 4K NMOS RAM has that type of second source. No other.

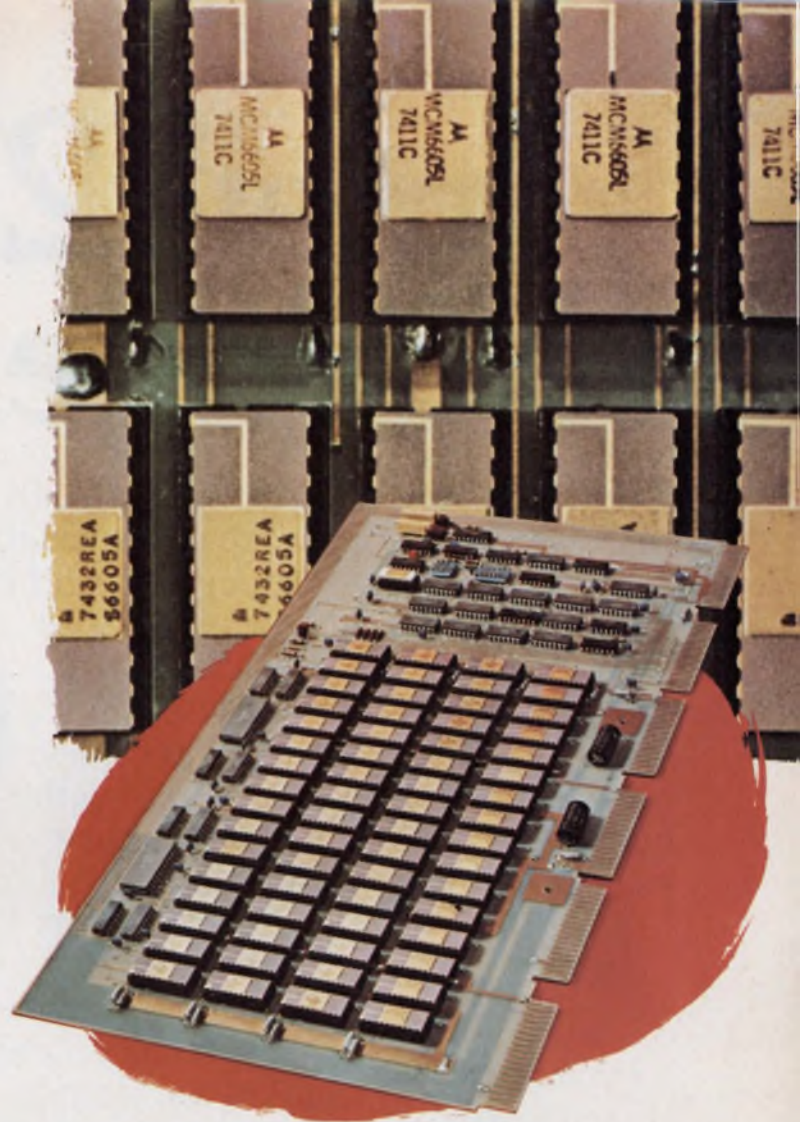

NMOS MEMORY SYSTEM COMPARISON

Memory System Organization	32 K Words X 8 Bits			256 K Words X 32 Bits		
	MCM6605	MK4096	TMS4030	MCM6605	MK4096	TMS4030
Semiconductor* Memory	MCM6605	MK4096	TMS4030	MCM6605	MK4096	TMS4030
Memory cycle time	490 ns	500 ns	470 ns	490 ns	500 ns	470 ns
Memory system cycle time	600 ns	600 ns	600 ns	600 ns	600 ns	600 ns
System power Active	3.0 Watts	3.4 Watts	3.8 Watts	18.6 Watts	45.1 Watts	39.2 Watts
Standby (with refresh)	0.23 Watts	1.13 Watts	0.85 Watts	7.4 Watts	36.0 Watts	27.2 Watts

*2107A comparison is not shown because the write cycle time is not fast enough to meet the chosen system cycle time.

Where to use the MCM6605

The MCM6605 will go just about anywhere there is a memory system. It's ideal for large main memories, for small main RAM memories, for microprocessors used with smart or POS terminals, and as a small buffer memory. We've indicated its application in add-on memories, and the MCM6605 can even be used as erasable ROM for debugging microcomputer system programs. How's that for usefulness.

At this time, the MCM6605 is available only from the

factory on orders placed through a Motorola Sales Office.

Applications and additional technical information is now available on request from Motorola Semiconductor Products Inc., P.O. Box 20912, Phoenix, AZ 85036, or by circling the reader service number. Your reward will be well worth your effort. MCM6605 . . . the fastest single clock 4K NMOS RAM. It has the lowest power requirements and it is the only one with a second source.



MOTOROLA MOS

— for the advantage in memory systems.

Intel's 2107B. The edge on speed,

Intel's new 2107B n-channel 4K RAM, with a 200 nanosecond access, is available now in production quantities. And because the 2107B chip is almost as small as a 1K RAM chip, we can

assure you it is the most producible 4K RAM with the lowest future cost potential.

The 2107B is already being shipped in quantities and replacing cores in many random access memory applications. Because of its low cost, it's also being used in serial memory applications. Intel distributors now stock two types: the basic 2107B accesses in 200 ns and cycles in 400 ns; the 2107B-4 runs at 270 ns access and 470 ns cycle times (all worst case from 0 to 70°C).

Our advanced, single-transistor cell design eliminates critical clock tolerances, special substrate voltage levels and double clocks. Like the 2107A, the 2107B has a single clock with solid $\pm 1V$ margins, operates on standard -5, +5 and +12V supplies, and comes in the industry standard, 22-pin configuration

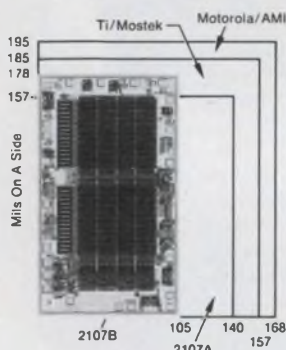

4K RAM CHIP SIZE COMPARISON WITH INTEL'S NEW 2107B.



new 4K RAM with price and delivery.

for single-clocked, fully decoded, 4K dynamic RAMs.

These new 4K RAMs improve your speed while reducing your system overhead costs by as much as 300% whether you're using 1K dynamic RAMs or core. Typical overhead is only .05¢/bit. To further reduce system

overhead, both the three state output and all inputs are TTL compatible. Intel also offers a low cost 3235 quad clock driver designed to drive the 2107B. And economical battery backup can be imple-

INTEL'S NEW 2107B 4K RAM FAMILY			
PART	MAX. ACCESS TIME (ns) ⁽¹⁾	MIN. CYCLE TIME (ns) ⁽¹⁾	AVAILABILITY
2107B	200	400	Now
2107B-4	270	470	Now
2107B-6	350	800	Now

(1) (All worst case from 0 to 70°C.)

mented because of the 2107B's low standby power.

The smaller die size of the 2107B means higher yields, lower cost and a more producible product. In comparison, competitive 4K RAMs are 55% to 75% larger than the 2107B.

Yet, the 2107B is processed with Intel's standard n-channel silicon gate MOS technology. The same process Intel has been using to produce high performance memory products with for over 3 years.

So put the 2107B or 2107B-4 in your memory system. You'll gain the edge in Speed, Price and Delivery right now, and for the future. Write Intel for 4K RAM family details. Or buy these new 4K RAMs from stock at Intel distributors: Almac/Stroum, Cramer, Hamilton/Avnet, Sheridan Sales, Industrial Components, and L. A. Varah.

Intel Corporation, 3065 Bowers Avenue, Santa Clara, California 95051 (408) 246-7501.

U.S. AND INTERNATIONAL SALES AND MARKETING OFFICES

U.S. MARKETING HEADQUARTERS

3065 Bowers Avenue
Santa Clara, California 95051
Tel: (408) 246-7501
TWX: 910-338-0026
TELEX: 34-6372

U.S. REGIONAL OFFICES

EASTERN

2 Militia Drive
Suite 4
Lexington,
Massachusetts 02173
Tel: (617) 861-1136
TELEX: 92-3493

MID-ATLANTIC

520 Pennsylvania Ave.
Fort Washington, PA 19034
Tel: (215) 542-9444

GREAT LAKES REGION

856 Union Rd.
Englewood, Ohio 45322
Tel: (513) 836-2808

MID-AMERICA

6350 L B J Freeway
Suite 178
Dallas, Texas 75240
Tel: (214) 661-8829
TWX: 910-860-5487

WESTERN

1651 E. 4th St.
Suite 228
Santa Ana, California 92701
Tel: (714) 835-9642
TWX: 910-595-1114

EUROPEAN MARKETING HEADQUARTERS

BELGIUM

Intel Office
216 Avenue Louise
Brussels B1050
Tel: 649-20-03

ORIENT MARKETING HEADQUARTERS

JAPAN

Intel Japan Corporation
Kasahara Bldg.
1-6-10, Uchikanda
Chiyoda-ku
Tokyo 101
Tel: 03-295-5441
TELEX: 781-28426

intel® delivers.

When "off the shelf" won't do, call us!

If you're talking precision pots, then talk to Duncan. For the past 15 years, Duncan's crack engineering team has designed literally thousands of 'specials.' We're proud to have some of the nation's finest technical minds to help solve your engineering problems. And a short step away is Duncan's modern production and testing facilities. Since 'specials' are a major part of our regular business, you'll be equally impressed by our competitive prices and unusually quick delivery schedules.

Duncan is keeping up and ahead of our times to meet

your growing requirements for better more reliable products; including non-wirewound Resolon® Conductive Plastic elements and single-turn or multi-turn precision wirewound pots, both available with linear or non-linear functions. Call us for design assistance or write today for technical literature.



DUNCAN ELECTRONICS
SUBSIDIARY

SYSTRON  **DONNER**

2865 Fairview Road • Costa Mesa, California 92626
PHONE: (714) 545-8261 □ TWX 910-595-1128



**Duncan: Your prime source for
custom designed pots.**

Our 31 Programmable Calculator.

Computer capabilities right at your desk.

The 31 rivals the mini for pure problem-solving power. But no mini can match the 31 for ease of use and low-cost operation. Its expandable memory (up to 8192 program steps or 1010 data registers) auxiliary plug-in mag tape, and optional flexible disc provide storage traditionally reserved for mini applications.

The 35 built-in functions and 24 user-definable keys let you tackle complex variables with natural math. No computer languages to learn. And no computer price either: just \$3550, including silent alphanumeric printer.

Use the 31 with other data tools. We have three new interfaces (like the 154 RS-232-C shown) that work with most instrumentation and I/O devices on the market. Then there's our Tektronix peripherals you can interface with. Like our digital plotter, graphic terminals. And software packages you add as you need.

But there's still more to the story on the 31. More interfaces, more peripherals, more power. And information on OEM and quantity discounts. Get it by calling your local Tektronix sales engineer. Or write us.

Tektronix, Inc.
Information Display Division
P.O. Box 500
Beaverton, Oregon 97077

Our programmable calculators. Natural. Powerful. Significantly less expensive.



The case for Liquid Crystal Displays

Dynamic Scattering or Field Effect

Liquid Crystal Displays; light emitting diodes; incandescent and fluorescent displays and "Nixie" tubes are becoming solidly established in circuit design as the trend to digital readout continues. The design engineer faces an unusually formidable task in determining the type of display most suitable and practical for his product. We make liquid crystal displays — dynamic scattering and field effect.

The display of the future? Our displays are as sandwiches of two glass plates, spaced typically about .0005" apart with a nematic liquid crystal solution between them and hermetically sealed at the perimeters.

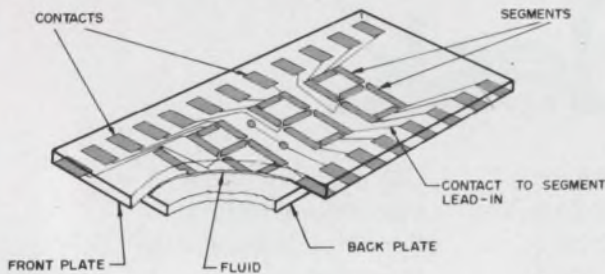

How they work. When the liquid is not electrically excited, its long cigar-shaped molecules are parallel to one another in a position perpendicular to the plates. The liquid appears transparent. When an electric current is applied, ion activity of the molecules leads to turbulence causing the liquid to scatter incident light. Depending on the type of nematic liquid used, either a dynamic scattering or field effect display results.

Dynamic scattering. We use a nematic liquid crystal solution in our dynamic scattering displays. This nematic liquid crystal is conductive, has negative dielectric anisotropy, and is oriented in either a homeotropic or homogeneous alignment. In either case the liquid is clear in the absence of an electric field. When an electric field is induced, the molecules scatter, giving the visual effect of a frosted piece of glass.

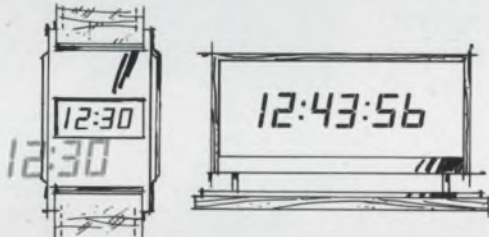

Field effect. These displays also utilize a nematic liquid crystal but with a different molecular orientation. The molecules are arranged in a helical stack, like a spiral staircase. The liquid is also sandwiched between two polarizers which are at right angles with each other. When current is applied the molecules rotate 90° so that they become perpendicular to the front polarizer. Light that passes through them is not rotated and therefore is absorbed by the rear polarizer. The result is a dark image on a light background. The image also can be reversed — light on dark.

Producing an image — digital or other — simply requires a conductive surface the shape of the desired image on the front glass plate. Current flowing from the conductive image through the liquid crystal to the common ground back plate causes the liquid to change from clear to a frosted appearance in the current-carrying areas.

The images almost always are in the form of seven segments formed on the front glass with transparent oxide and each with its own electrical lead. Energizing the proper segments produces the desired numerals. Lead-ins connect the segments to external contacts on the sandwich (display).

Consider the advantages. Liquid crystal displays have a number of distinct advantages. Simplicity is the reason for several of these. The elements are few and passive — very little can go wrong with an LCD and this means reliability and long life. Simplicity means low cost too — lower than that of most similar displays. Packaging costs are low because LCD's can be driven directly by MOS and C/MOS circuits. Very narrow character widths are possible and still provide a good viewing angle — 60 degrees in many cases.

Low power consumption makes LCD's a logical choice where power limitations rule other displays out. They do not generate light as do other displays so use no power for that purpose. Watch type field effect LCD's use only 3μW. for example with all segments energized at 7 Volts.

LCD's offer the greatest flexibility of any display type. Several standard displays, dynamic scattering or field effect, are immediately available from Hamlin's stock. Special displays with virtually any type of image can be produced with surprisingly low preparation or "tooling" cost. Because of the LCD's simplicity, lead time on specials is only a matter of weeks.

DYNAMIC SCATTERING

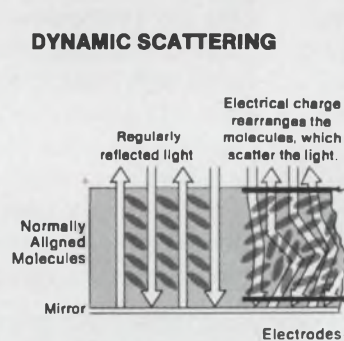

FIELD EFFECT

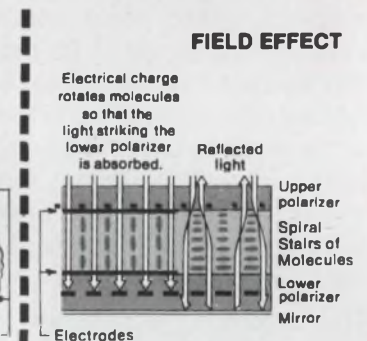

A few limitations. LCD's have limitations too. Operating temperature range is one. Liquid crystals slow down and may even cease to function at temperatures below 0°C. Above 50-60°C, crystals go into solution and will not function properly. But extremes do not damage LCD's. Once the temperature returns to normal, operation is automatically resumed.

LCD's are somewhat difficult to read under low ambient light conditions. (Side or back lighting can remedy this.) Visibility under medium to high ambient light conditions is excellent.

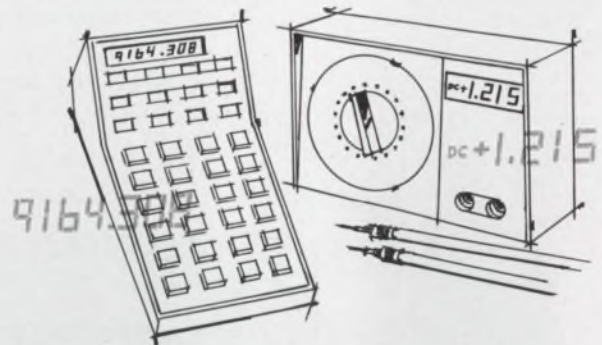

Conclusion. In the majority of display applications, MOS and C/MOS compatibility, reliability, flexibility and low power requirements are important considerations. No other display can match the liquid crystal display on these jobs. They could be the display of the future.

And that's the case for the LCD. For specifications, and application data, write Hamlin, Inc., Lake Mills, WI 53551 • 414/648-2361. Or dial toll-free 800-645-9200 for name of nearest representative. (Evaluation samples are available at moderate cost.)

HAMLIN

INCORPORATED

INFORMATION RETRIEVAL NUMBER 46

INFORMATION RETRIEVAL NUMBER 47 ►

BOURNS INTRODUCES THE FIRST INTEGRAL PUSHBUTTON POTENTIOMETER



If you're designing panels with precision data entry or set-point controls, consider the BOURNS Model 3680 KNOBPOT® Digital Potentiometer . . . another innovative idea from Bourns. The 3680 integrates a precision incremental decade potentiometer with an easy-to-read digital display, AND a speedy pushbutton control action. It is handsome, extremely accurate, and a "snap" to install. Everything is INSIDE the Model 3680 . . . no resistors or mini-PC boards are required . . . nothing clutters the back of the unit to steal precious space.

PUSHBUTTON ACTION



Simple, fast, precise. Push the PLUS button to increase; the MINUS to decrease. Rated life is 100,000 operations per decade.

IN-LINE DIGITAL READOUT

Large, easy-to-read numbers enable fast, "squint-free" data entry and information readout.



ACCURATE

You get what you set with the 3680 . . . every time. The unique Bourns design integrates precision laser-trimmed cermet resistor technology with a positive pushbutton detent action. The result is resolution of output of 1 part in 1000 discrete steps, and dependable repeatability of $\pm 0.1\%$.

COSTS LESS TO INSTALL

Snap-in mounting cuts installation time, eliminates mounting hardware. Integral bezel covers irregular panel cut outs and minor edge blemishes. Terminals match the AMP Series 110 receptacle . . . or can be soldered in the standard fashion.

FEATURES AND SPECIFICATIONS

- stable built-in cermet resistance elements
- 100 PPM/ $^{\circ}$ C tempco
- 2 watts power rating
- standard resistance range (3 decade unit) 5K ohms to 1 megohm
- $\pm 1.0\%$ resistance tolerance
- resolution 0.1%

COMPACT SIZE

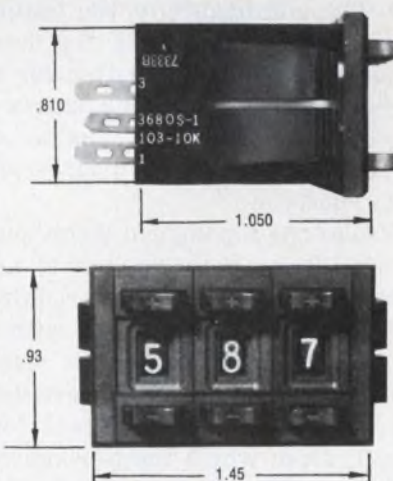

For the name and number of your nearest Bourns representative, dial EEM toll-free 800-645-9200.

when innovation counts, count on...



Apply topological graphs

to active-filter analysis. The graphs offer fast and accurate solutions to the circuit's node equations.

A topological flow graph will analyze active filters. This graphical technique will find transfer functions without the need to write and solve many equations simultaneously. And it is one of the fastest and most accurate techniques known. With other methods, such as the Mason signal-flow graph, the user must first write the network equations.

The topological flow graph^{1,2} represents the node equations of the circuit. Network solutions are obtained through simple geometric manipulation of the graph.

Topological graph depicts circuit

For node equations, the source currents and voltages are given; the node voltages are unknown. Information contained in the node equations is related to the topology (interconnection of branches) in the network. For the matrix of node equations:

- The sum of the admittance values of the branches connected to node i is the same as the term at the intersection of the i -th column and row.

- The admittance of the branch between node i and node j appears in the determinant as the negative of the term written for row j , column i .

Since operations on the matrix can furnish network voltage solutions, similar operations—performed on the graph itself—can also solve for node voltages.

Use of the topological technique allows analysis of any linear network, but to apply it to active filters, an op-amp model is required.

A conventional op amp with finite gain and nonzero output resistance is used first (Fig. 1). The voltage source is converted to an equivalent current source (to facilitate topological operations), from which the topological representation is taken (Fig. 1b). Arrowheads shown on the four solid branches signify that signal transmis-

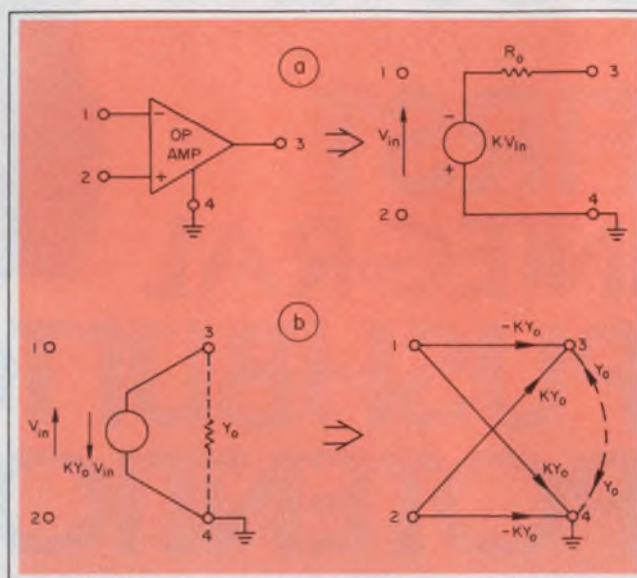

1. The topological graph of an op amp starts with the equivalent circuit (a), which is transformed to a current-source equivalent (b). This model is valid for infinite input impedance and finite output impedance.

sion is in one direction.

Passive circuit elements are described by their operational admittances (see table). These branches have arrowheads in both directions—to signify bilateral signal flow.

To obtain the over-all topological graph of a circuit, retain the nodes but replace the op amp and associated components with equivalent branches (Fig. 2a, b). Note that parallel branches are combined by algebraic addition of their admittance values at each node. Since the noninverting terminal is grounded, you can also eliminate the branch between nodes 4 and 5 to simplify the diagram further (Fig. 2c).

The formula

$$\frac{V_{out}}{V_{in}} = \frac{P_1 \Delta P_1 + P_2 \Delta P_2 \cdots + P_n \Delta P_n}{\Delta} \quad (1)$$

evaluates the transfer function between any pair of nodes. The numerator terms refer to the various paths from the input node (node 1) to the output node (node 3) that do not pass through the ground node.

Values $P_1, P_2 \cdots P_n$ are obtained through the multiplication of values along branches of the

John A. DeFalco, Section Head, Honeywell Information Systems, Inc., 300 Concord Rd., Billerica, MA 01821.

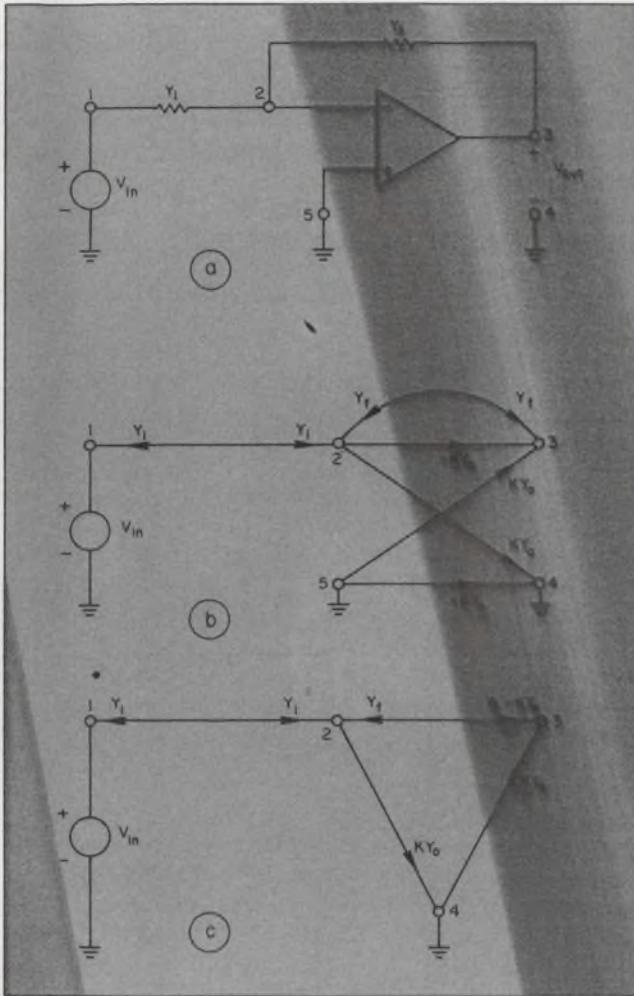

2. Use of the op-amp equivalent and passive-circuit representations helps model active filters (a, b). The algebraic addition of parallel branch admittances simplifies the final topological equivalent (c).

n paths that lead from input to output. In the circuit of Fig. 2,

$$P_1 = Y_i (Y_f - KY_o)$$

Also, P_1 is the only path in this case.

Subgraphs help evaluate determinant

The terms labeled with a Δ represent various determinants. Their evaluation involves the entire graph (for the denominator) and various subgraphs (for the numerator). The graphs that correspond to the P_i are those in which all nodes along path i are shorted to ground. Any path that passes through all nodes except ground has a ΔP equal to one.

The one path in the circuit of Fig. 3 passes through all nodes; so $\Delta P_1 = 1$ and

$$\text{Numerator} = Y_i \cdot (Y_f - KY_o) \cdot 1.$$

The denominator corresponds to a graph in which independent voltage sources are shorted and independent current sources are opened (Fig. 3a). To start, select a *reference node*—preferably the one with the largest number of, and most complicated, branches. This is node 3.

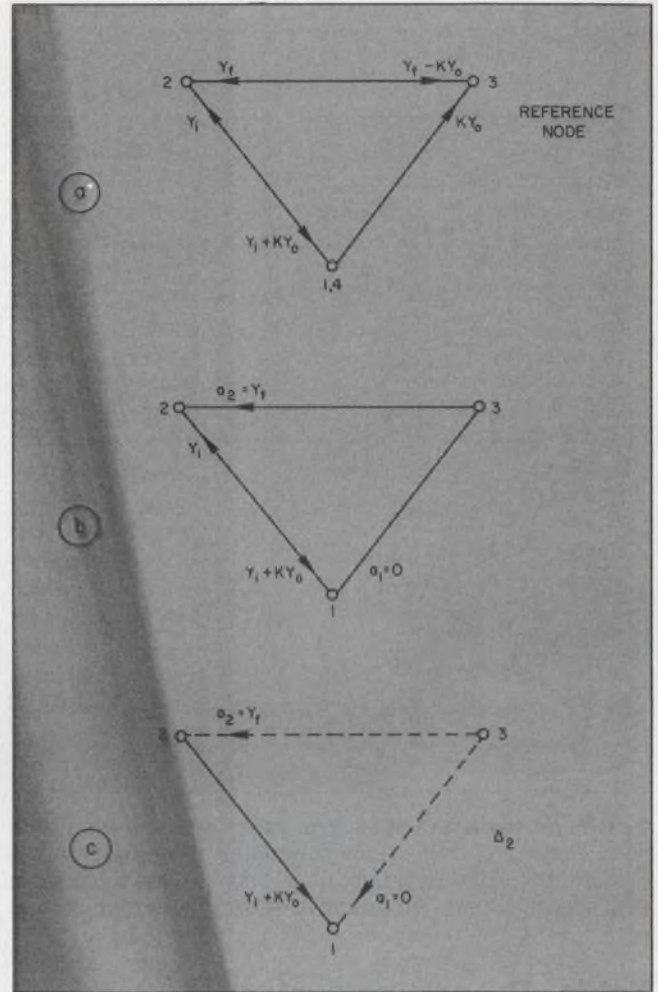

3. These transformations provide the graphic solutions. Node 3 is selected as the reference, and arrowheads directed to node 3 are removed. The single remaining branch and coefficients provide the circuit determinants.

Remove (ignore) arrowheads directed to this node; call all branches that leave the reference node *reference branches*. Also designate their respective admittance values as a_1, a_2 , etc.

To evaluate Δ use

$$\Delta = \sum a_i \Delta_i + \sum a_i a_j \Delta_{i,j} + \sum a_i a_j a_k \Delta_{i,j,k} + \dots + (a_1 a_2 a_3 \dots a_m) \Delta_{1,2,3,\dots,m} \quad (2)$$

Only two terms exist: a_1 and a_2 . But $a_2 = 0$, since there is no arrow that points away from node 3. In this case Eq. 2 reduces to

$$\Delta = a_1 \Delta_1 + a_2 \Delta_2 + a_1 a_2 \Delta_{12}.$$

Since a_2 is zero,

$$\Delta = a_1 \Delta_1 = Y_f \Delta_1$$

To obtain the subgraphs for the various Δ s in Eq. 2, remove the reference branches and all arrowheads that point toward the subscripted node (Fig. 3c). In this instance a single branch remains with value $Y_i + KY_o$, so for the denominator

$$\Delta = Y_f (Y_i + KY_o)$$

and the gain (from Eq. 1) is

$$\frac{V_{out}}{V_{in}} = \frac{Y_i (Y_f - KY_o)}{Y_f (Y_i + KY_o)} = \frac{Y_i Y_f - Y_i KY_o}{Y_f Y_i + Y_f KY_o}.$$

In the ideal case the op amp has zero output

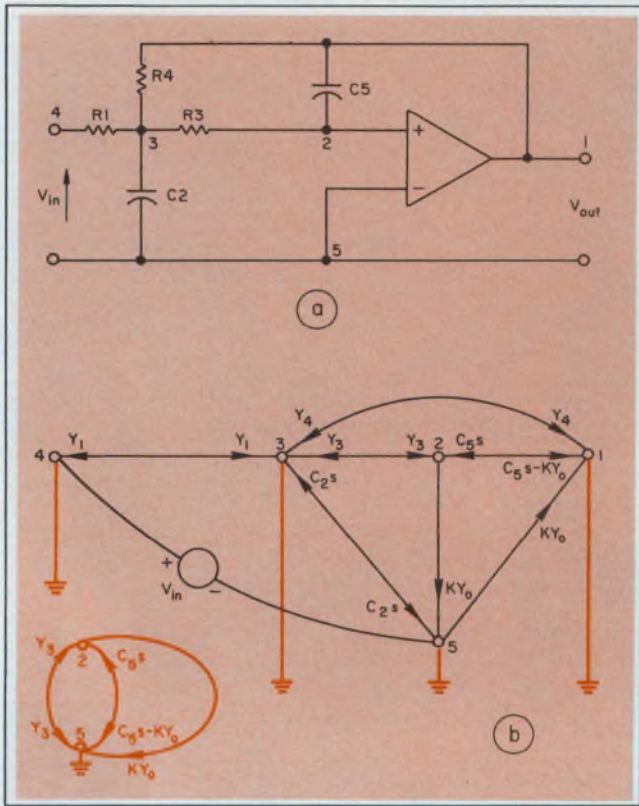

4. Ground the nodes that form paths between input and output to obtain numerator subgraphs. The circuit (a) is a multiple-feedback active filter and (b) its topological equivalent. A path subgraph is shown at bottom left.

Table. Branch equivalents of passive components

ELEMENT	EQUIVALENT
RESISTANCE R	$G = 1/R$
CAPACITANCE C	Cs
INDUCTANCE L	$1/Ls$

impedance $Y_o = \infty$ and infinite gain. Divide numerator and denominator by KY_o ; let KY_o approach infinity. And

$$\frac{V_{out}}{V_{in}} \frac{-Y_i}{Y_f} = \frac{-R_f}{R_i},$$

the familiar op-amp gain equation. Only terms multiplied by KY_o will be retained in the ideal op-amp equations, and only these terms need be used in the graph operations.

Evaluation of two-pole filter is easy

A more complicated network, representative of a two-pole low-pass filter, will illustrate the capabilities of the method (Fig. 4a). As seen from the network graph, there are two paths P_1 and P_2 between input node 4 and output node

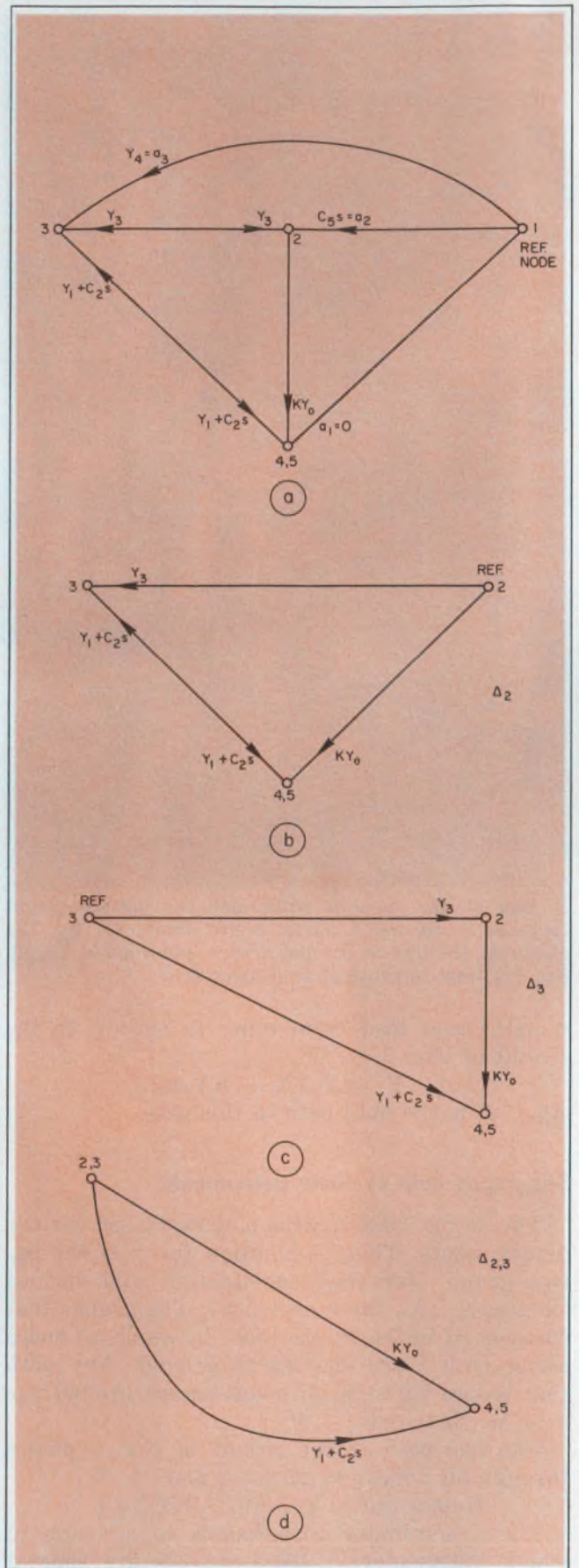

5. All voltage sources are grounded to obtain the overall subgraph for the denominator (a). The evaluation is accomplished from separate subgraphs (b, c and d) each of which may have a separate reference code.

1. These paths pass through nodes 4, 3, 2, 1 and 4, 3, 1, respectively. And their values are

$$P_1 = Y_1 Y_3 (C_5 s - KY_0)$$

$$P_2 = Y_1 Y_4$$

The first path involves all nodes so the corresponding determinant ΔP_1 is 1. Path P_2 does not pass through node 2; the graph for ΔP_2 is formed by the shorting of all nodes on P_1 to ground (heavy lines in Fig. 4b). Only three branches remain, all in parallel (bolded), so

$$\Delta P_2 = Y_3 + C_5 s$$

for the sum of the branch admittance at node 2. (The result would be the same for the sum of values at node 5.) The numerator value is now obtained:

$$\text{Numerator} = Y_1 Y_3 (C_5 s - KY_0) + Y_1 Y_4 (Y_3 + C_5 s)$$

In more complex cases, application of Eq. 2 will evaluate subgraphs such as ΔP_1 and ΔP_2 .

To evaluate the denominator, short the input voltage source to ground. Use node 1 as the reference. Three reference branches remain, one of which has zero value. The denominator equation has the form

$$\Delta = C_5 s \Delta_2 + Y_4 \Delta_3 + Y_4 (C_5 s) \Delta_{2,3}$$

To form the subgraphs for Δ_2 , Δ_3 and $\Delta_{2,3}$, remove all reference branches. Then delete all arrowheads directed toward the subscripted node (s). In addition superimpose all multiple nodes, such as those designated by $\Delta_{2,3}$. These steps are shown in Fig. 5b.

The determinant rule, Eq. 2, is reapplied to subgraphs Δ_2 and Δ_3 with their respective reference nodes 2 and 3 to give

$$\Delta_2 = KY_0 (Y_1 + C_2 s) + Y_3 (Y_1 + C_2 s) + KY_0 Y_3$$

and

$$\Delta_3 = Y_3 KY_0 + 0 + Y_3 (Y_1 + C_2 s)$$

Determinant $\Delta_{2,3}$ is simply the parallel combination of two branches, so

$$\Delta_{2,3} = KY_0 + Y_1 + C_2 s$$

And the resultant transfer function is

$$\frac{V_{out}}{V_{in}} = \{Y_1 Y_3 (C_5 s - KY_0) + Y_1 Y_4 (Y_3 + C_5 s) [C_5 s (KY_0 (Y_1 + C_2 s) + Y_3 (Y_1 + C_2 s) + KY_0 Y_3) + Y_4 (Y_3 KY_0 + Y_3 (Y_1 + C_2 s)) + Y_4 C_5 s (KY_0 + Y_1 + C_2 s)]\}$$

As KY_0 is allowed to be infinite, we get the transfer function for an ideal amplifier; namely,

$$\frac{V_{out}}{V_{in}} = \frac{-Y_1 Y_3}{C_2 C_5 s^2 + C_5 (Y_1 + Y_3 + Y_4) s + Y_1 Y_3}$$

Practice with the method will improve the speed of problem solving. Additional analysis examples are given in the references. ■■

References

1. Robichard, L. P. A., "Signal Flow Graphs and Applications," Prentice Hall, Englewood Cliffs, NJ, 1962.
2. DeFalco, J. A., "Speed Network Analysis with Topology," *Electronic Design* No. 7, April 1, 1969, pp. 56-61.

You get something extra with Kurz-Kasch logic probes!!



Kurz-Kasch logic probes do replace scopes for field service applications. Here's how you get that something extra.

They provide optimum performance with duty cycle information and open circuit detection at no extra cost. You may not find these benefits with other probes, even as optional extras.

There is no better way to check out digital electronic equipment than with a Kurz-Kasch logic probe. Besides duty cycle and open circuit information, they display logic Lo's, Hi's and Pulses through the unique Kurz-Kasch White, Red and Blue color system.

You really won't know until you try one FREE for 30 DAYS. Call us: Kurz-Kasch, Inc., Electronics Division, 2876 Culver Avenue, Dayton, Ohio 45401. Tel: (513) 296-0330.



FREE TEST DATA



Kurz-Kasch, Inc.

ELECTRONICS DIVISION
2876 Culver Avenue
Dayton, Ohio 45401
Telephone 513/296-0330

INFORMATION RETRIEVAL NUMBER 48

ALCOLITE®

A third dimension has been added to the pilot indicator. Besides telling you whether the equipment is "ON", our GT33 will also show if you are plugged into a SAFELY WIRED AC OUTLET, 7 ways. Available with or without "OK" designation on lens top.

Call (617) 686-0126 for complete information.



GT 33
Grounded Line
Monitor

ALCO ELECTRONIC PRODUCTS, INC.
1551 Osgood St., No. Andover, Mass. 01845

ALCOLITE®

INFORMATION RETRIEVAL NUMBER 49

ALCOLITE®

PILOT LIGHTS with large 3/8" diameter lens allow replacement from the front. Chromed brass body with TEFLON® insulation. Select from five lens colors. The MCM-100 uses a T-1 flanged base lamp and the MCM-175 uses a T-1 3/4 flanged base lamp.

Call (617) 686-0126 for details on our full line of ALCOLITE products.

ALCO ELECTRONIC PRODUCTS, INC.
1551 Osgood St., No. Andover, Mass. 01845

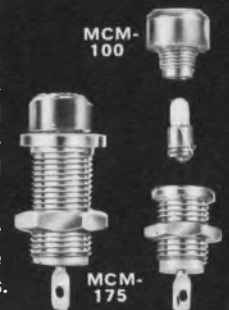

ALCOLITE®

INFORMATION RETRIEVAL NUMBER 50

Two-phase clock generator and driver synchronize the 8080 microprocessor

The applications data for the 8080 microprocessor do not describe a clock generator and driver circuit. Suitable generator and driver circuits are shown in Figs. 1 and 2. Together they provide a two-phase nonoverlapping high-level clock to the microprocessor, with a minimum clock period of 500 ns. TTL-level clock outputs also are available for use by other circuitry.

The frequency of a 20-MHz crystal oscillator is divided by five and then by two in a 7490 counter. The counter outputs are decoded to provide the Phase-1 and Phase-2 TTL clocks (Fig. 1).

The TTL signals then drive a National MH0026 IC, which provides an output swing from ground to +12-V with a fast rise time. A 91- Ω resistor to the diode at pin 3 supplies a -0.7-V bias to the driver circuit, which improves

the noise margin of the high-level outputs (Fig. 2). The two 47- Ω resistors provide series damping. This driver circuit should be placed near the processor to keep the leads short and reduce ringing.

Gundars Osvalds, Senior Technician, Communication Satellite Corp. Laboratories, Clarksburg, MD 20734.
CIRCLE NO. 311

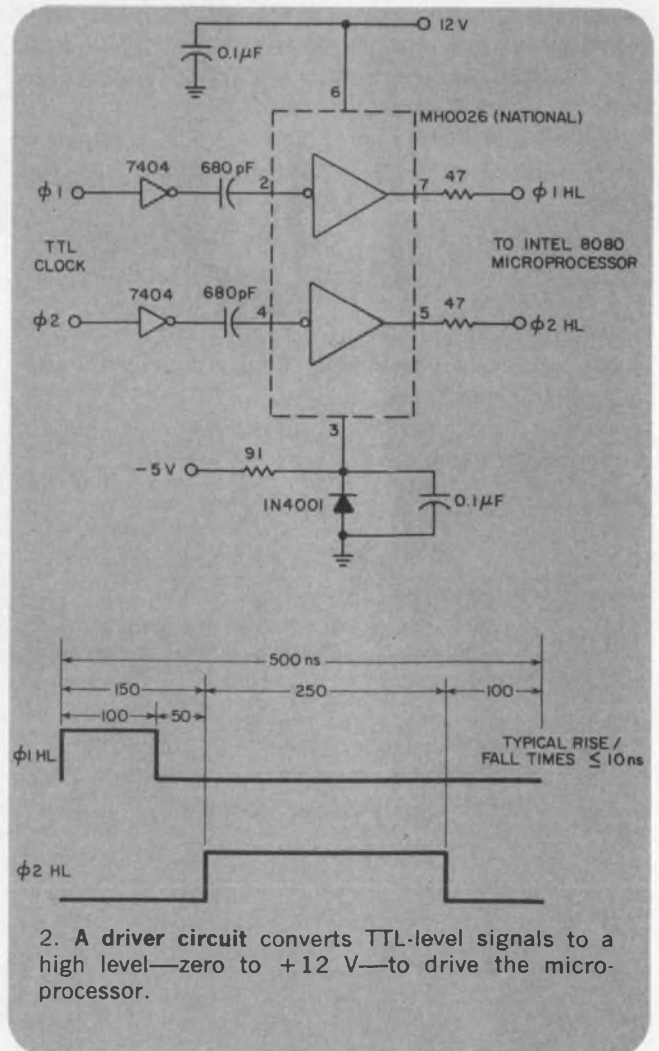
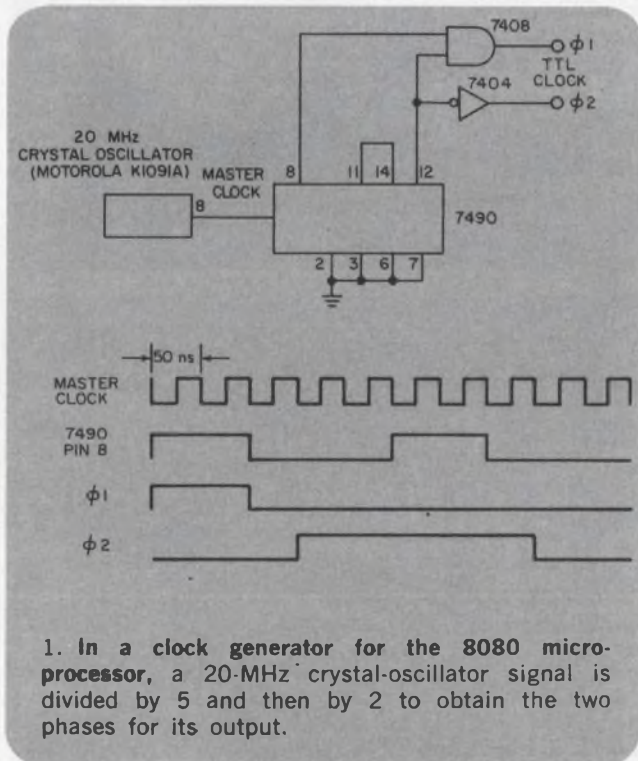

If you need panel instruments with **custom** dials, cases, accuracy, tracking, resistance, response time, or practically any combination of unusual specs...

Buy **Triplett's** designed-for-you **Panel Instruments**

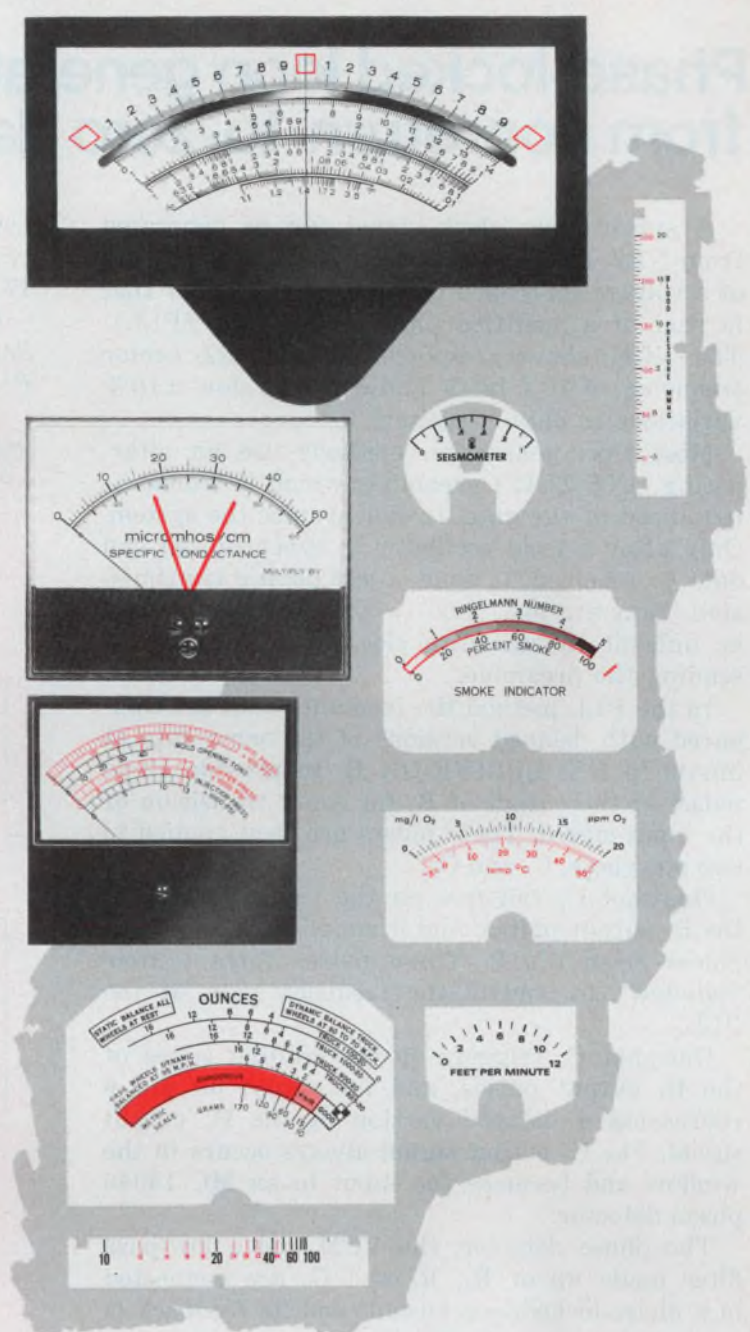

Although we stock some 1369 different styles, sizes and types of standard panel instruments, a very large proportion of our customers buy custom instruments.

Because they need:

custom dials

reading in such units as pH, roentgens, mm Hg, rpm, %, inches.

custom cases

square, round, rectangular, edge-wise (horizontal and vertical), wide, narrow, shallow.

custom accuracy

to within 1/2% with mirror scales and knife-edge pointers.

custom tracking

to match the specific needs of existing or new instrument designs.

custom resistance

for low circuit loading with tolerances as low as $\pm 1\%$.

custom damping

to meet stringent electrical and vibration requirements.

For instance, one of our customers had us design and manufacture a custom instrument to replace — in every detail of physical and electrical specifications — one which he was using on a delicate piece of medical instrumentation. Rejects from his previous source had risen to over 20%. He rejected only 3 of the first hundred we shipped—with almost negligible rejections from the many hundreds we've shipped since.

What custom panel instrument specifications do you need to make your

product more reliable, more accurate, more rugged and — in the long run — less expensive? For quick, dependable delivery of small quantities of Triplett's "designed-for-you" panel instruments, contact your Triplett Sales/Service/Modification Center. For prototypes or production quantities, contact your Triplett representative. He'll put you in touch with our Instrument Designers/Engineers who'll help you analyze the problem and suggest the optimum cost/result solution.

TRIPLETT
BLUFFTON, OHIO 45817
Manufacturers of the World's most complete line of V-O-M's

INFORMATION RETRIEVAL NUMBER 54

Phase-locked loop generates clock from nonreturn-to-zero data

A synchronous clock signal can be generated from NRZ (nonreturn-to-zero) data with the aid of a voltage-controlled multivibrator (VCM) that is part of a modified phase-locked loop (PLL). The VCM shown responds to an NRZ center frequency of 16 k bit/s, and it tracks slow $\pm 10\%$ variations in data frequency.

Most clock-generation methods use an alternating ONE-ZERO preamble, which is transmitted ahead of the data, to synchronize the system. Only after a local oscillator is synchronized can data be received. If sync is lost during transmission, data are lost. And in such systems it may be difficult to reacquire clock sync without re-sending the preamble.

In the PLL method the incoming data are compared with delayed versions of the same data at inputs to EXCLUSIVE-OR B₁ to provide 12- μ s pulses at the output of B₁ for every transition of the input signal. These pulses are then applied to two one-shots, C₁ and C₂.

One-shot C₂ triggers on the leading edges of the B₁ output pulses, and it supplies 22- μ s output pulses from pin 9. These pulses form a time "window" to control the feedback path of the PLL.

One-shot C₁ triggers on the trailing edges of the B₁ output pulses, and its output on pin 6 represents a delayed version of the B₁ output signal. The C₁ output signal always occurs in the window and becomes the input to an MC 14046 phase detector.

The phase detector, the VCM and a low-pass filter made up of R₄, R₅ and C₄ are connected in a phase-locked-loop circuit, and its feedback is controlled by gate A₃. When A₃ is enabled with a LOW signal on pin 13, the PLL tracks the NRZ input signal transitions. However, when A₃ is disabled, the PLL provides clock output at the last frequency tracked.

This circuit was successfully tested with NRZ data from a pseudorandom-bit generator. Though the VCM was initially synchronized to the data stream with a preamble—an alternating ONE-ZERO format of an 8-kHz square wave preceded the data—this approach is not necessary if data loss is permissible. The circuit can lock onto the raw NRZ data. The lock-on time to NRZ only is about 10 ms, compared with 8.2 ms for 65 cycles of a square-wave preamble.

The lock-on time is a function of the low-pass filter characteristics of R₄, R₅ and C₄. A change in the filter can shorten the lock-on time, but at the expense of output stability. The filter com-

ponent values in the figure are a compromise between stability and lock-on time for the 13.4-to-17.6-kHz passband.

Ken Veto, Application Engineer, Motorola Semiconductor Products, 5005 E. McDowell Rd., Phoenix, AZ 85008. CIRCLE No. 312

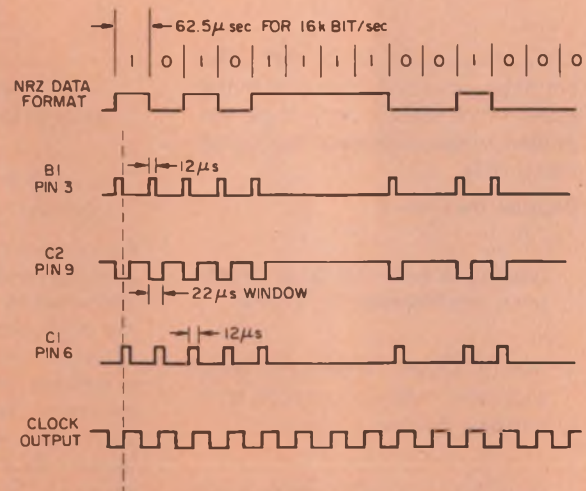
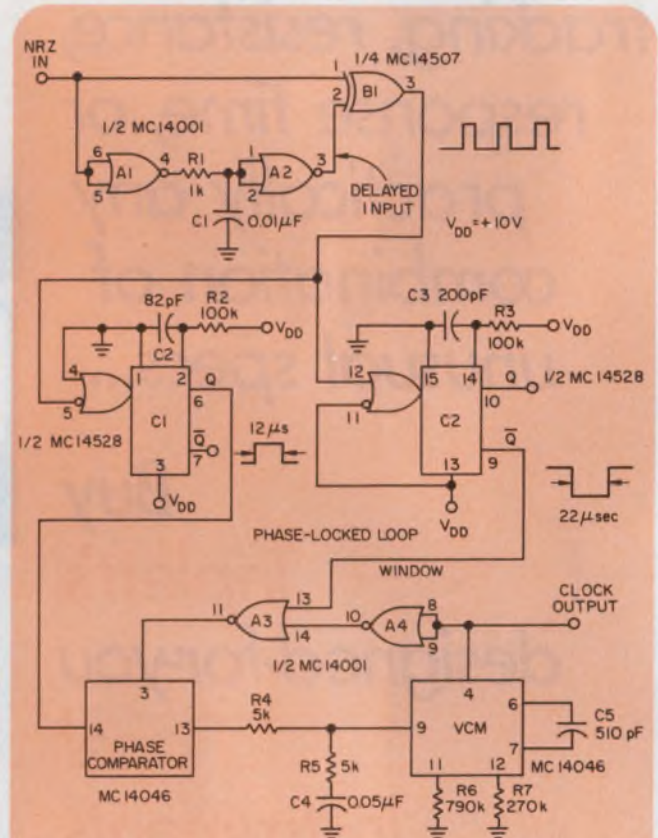

Phase-locked-loop circuit generates a synchronous clock signal from raw NRZ data and maintains a clock output even with temporary interruptions of the data.

\$6.50 BUYS THE *FASTEST* MOST *FLEXIBLE* MONOLITHIC D/A CONVERTER MADE!

- Logic inputs directly interface CMOS, TTL, ECL, HTL, DTL, etc.

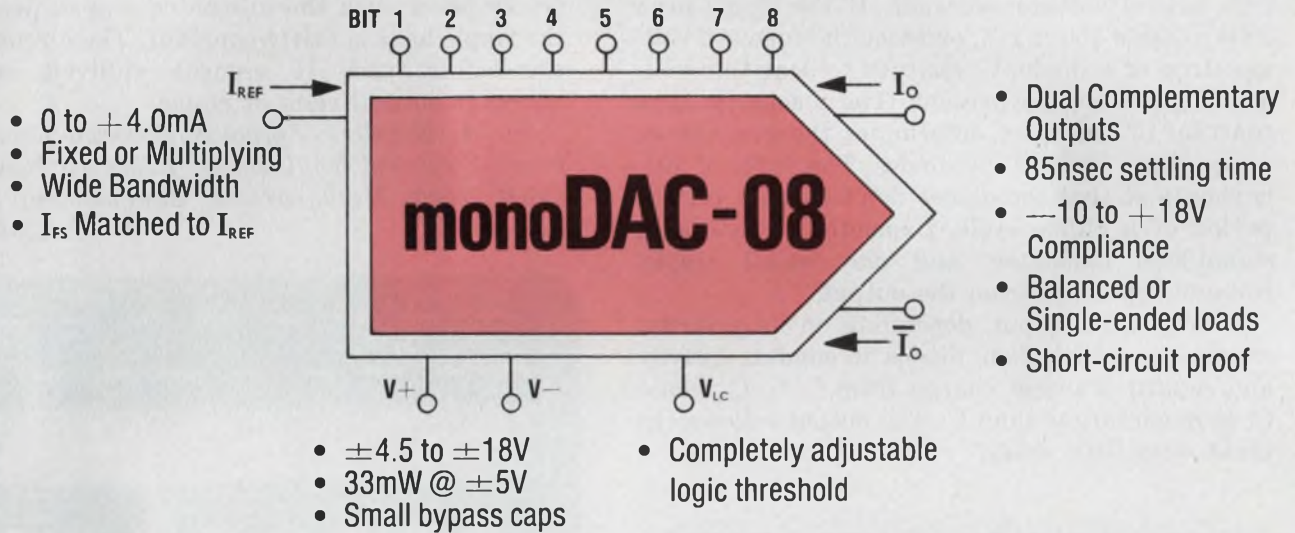

PHENOMENAL PERFORMANCE AT SUPER-LOW PRICES! Precision Monolithics' new monoDAC-08 is simply the fastest, most flexible monolithic D/A converter made! monoDAC-08 directly accommodates all popular logic families with its high swing, adjustable threshold logic inputs. The wide range multiplying reference input gives maximum performance in both fixed and wideband multiplying applications. And the tight reference-to-output current matching eliminates full scale trimming. Unique dual outputs provide true and complementary output currents. They can be used individually or to drive balanced or quasi-differential loads such as CRT deflections,

center-tapped transformers or coils and transmission lines, etc. And the -10 to $+18V$ output compliance allows direct current-to-voltage conversion without output op amps. The ultra-fast 85nsec settling time makes possible 1 μ sec 8 bit A/D converters at very low cost—request AN-16 for details. monoDAC-08's not fussy about power supplies either—33 mW @ $\pm 5V$, ± 4.5 to $\pm 18V$ supply range, and tiny 0.1 μ F bypass capacitors. All monoDAC-08 models guarantee monotonicity and linearity over the entire temperature range, and at these low prices they're ideal for all 8 bit applications. Get 'em off your PMI distributor's shelf right now!

MODEL	TEMP. RANGE	MONOTONICITY OVER TEMP. RANGE	LINEARITY OVER TEMP. RANGE	PRICE @ 100 PCS.
monoDAC-08CZ	0/70°C	8 BITS	0.39%	\$ 6.50
monoDAC-08EZ	0/70°C	8 BITS	0.19%	\$ 7.95
monoDAC-08Z	-55/+125°C	8 BITS	0.19%	\$12.95
monoDAC-08AZ	-55/+125°C	8 BITS	0.1%	\$20.00



1500 SPACE PARK DRIVE, SANTA CLARA, CALIF. 95050
TEL. (408) 246-9222 • TWX 910-338-0528 • CABLE MONO

AUTHORIZED DISTRIBUTORS:

NEW YORK METROPOLITAN AREA Harvey Radio, Westbury, N.Y.: (516) 921-8700 • **NEW ENGLAND AREA** Gerber Electronics, Dedham, Mass.: (617) 329-2400 • **UPSTATE NEW YORK** Harvey Federal Electronics, Binghamton, N.Y.: (607) 748-8211 • **NORTHEAST** Newark Electronics, Woburn, Mass.: (617) 935-8350 • **BALTIMORE-WASHINGTON** Whitney Distributors, Baltimore, Md.: (301) 944-8080 • **PENNSYLVANIA** Hallmark Electronics, Huntingdon Valley, Pa.: (215) 355-7300 • **Pioneer/Pittsburgh**: (412) 391-4846 • **MICHIGAN** RS Electronics, Detroit, Mich.: (313) 491-1000 • **SOUTHEAST** Kirkman Electronics, Winston-Salem, N.C.: (919) 724-0541 • **EAST CENTRAL** Pioneer/Cleveland, Cleveland, Ohio: (216) 587-3600 • **Pioneer/Indianapolis**, Indianapolis, Indiana: (317) 849-7300 • **Pioneer/Dayton**, Dayton, Ohio: (513) 236-9900 • **CENTRAL** Hallmark Electronics, Elk Grove Village, Ill.: (312) 437-8800 • **Minneapolis**, Minn.: (612) 884-9056 • **St. Louis**, Mo.: (314) 291-5350 • **TEXAS-OKLAHOMA** Sterling Electronics, Houston, Texas: (713) 627-9800 • **Dallas**, Texas: (214) 357-9131 • **SOUTHWEST** Sterling Electronics, Albuquerque, N.M.: (505) 345-6601 • **Phoenix**, Ariz.: (602) 258-4531 • **WEST** Westates Electronics Corp., Chatsworth, Calif.: (213) 341-4411 • **Sunnyvale**, Calif.: (408) 733-8383 • **Intermark Electronics**, Sunnyvale, Calif.: (408) 738-1111 • **Denver**, Colo.: (303) 936-8284 • **San Diego**, Calif.: (714) 279-5200 • **Santa Ana**, Calif.: (714) 540-1322 • **Almac-Stroum**, Seattle, Wash.: (206) 763-2300 • **Portland**, Ore.: (503) 292-3534 • **CANADA** Intek Electronics, Vancouver, B.C.: (604) 324-6831 • **Westburne-Haldane**, Toronto, Ont.: (416) 789-4181.

Passive low-pass filter recovers signals buried in high ripple

The nonlinear, passive filter circuit (Fig. 1) can reject ripple or other unwanted but fairly steady voltage without appreciably affecting the rise time of a signal. The filter consists of only seven components: a four-diode bridge, two capacitors and one resistor.

The circuit has characteristics similar to two peak-detecting sample-and-hold circuits in tandem with a voltage averager. If the ripple peak level exceeds about 1 V, or twice the forward voltage drop of a diode, C_1 charges to near this voltage with no signal present. The discharge time constant of RC_1 , then determines the conduction, or aperture, time of the diodes. The value of RC_1 is chosen so that the diodes don't conduct for the period of a ripple cycle. Capacitor C_2 acts as a signal-hold capacitor, and only small ripple-voltage steps appear on the output.

A step-signal input, depending on its polarity, causes two of the four diodes to conduct heavily and rapidly transfer charge from C_1 to C_2 . Since C_1 is much larger than C_2 , the output follows the input with little delay.

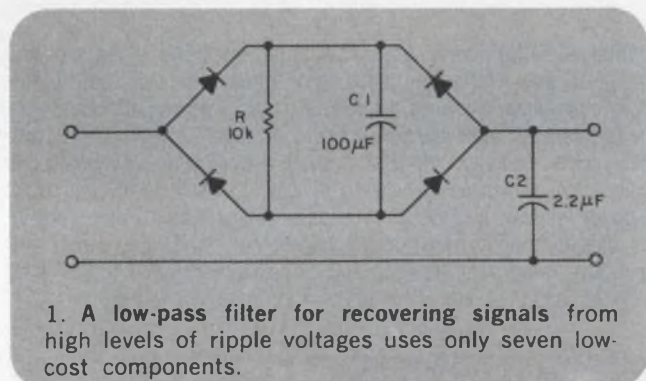

Component values are chosen for best compromise between ripple suppression and response time. For example, Fig. 2 shows the filter response for a 6.5-V_{pp} , 143-Hz sine wave superimposed on a 4-V_{pp} , 14-Hz square-wave signal. The rise time of the output is very fast, and the ripple is suppressed by nearly 40 dB. This circuit works well even when the signal level is considerably lower than the unwanted ripple, provided the ripple level is fairly constant. The circuit was successfully used to recover millivolt signals buried in several volts of ripple.

Dr. A. Engelter, Signal Processing Div., National Electrical Engineering Research Institute, CSIR Naval Headquarters, Simonstown, South Africa
CIRCLE NO. 313

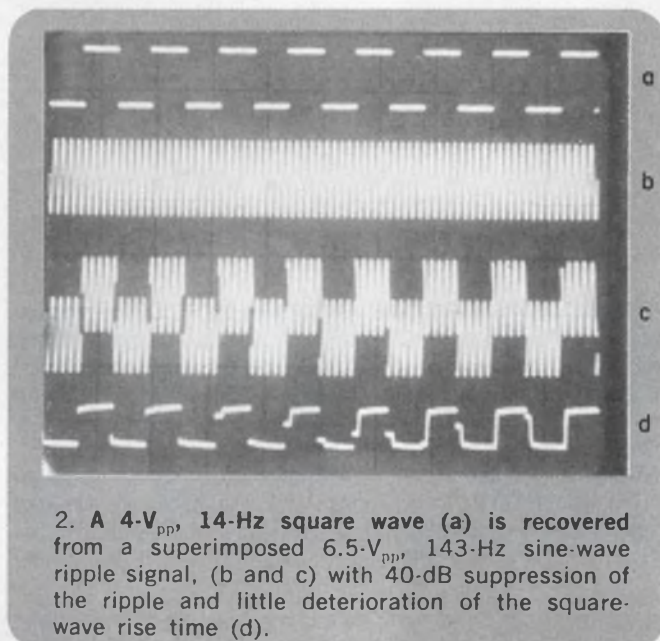

IFD Winner of December 20, 1974

Paul Galluzzi, Electrical Engineer, P.O. Box 352, Beverly, MA 01915. His idea "Circuit Provides Slow Auto-Wiper Cycling, With One to 20 Seconds Between Sweeps" has been voted the Most Valuable of Issue Award.

Vote for the Best Idea in this issue by circling the number for your selection on the Information Retrieval Card at the back of this issue.

SEND US YOUR IDEAS FOR DESIGN. You may win a grand total of \$1050 (cash)! Here's how. Submit your IFD describing a new or important circuit or design technique, the clever use of a new component or test equipment, packaging tips, cost-saving ideas to our Ideas for Design editor. Ideas can only be considered for publication if they are submitted exclusively to ELECTRONIC DESIGN. You will receive \$20 for each published idea, \$30 more if it is voted best of issue by our readers. The best-of-issue winners become eligible for the Idea of the Year award of \$1000.

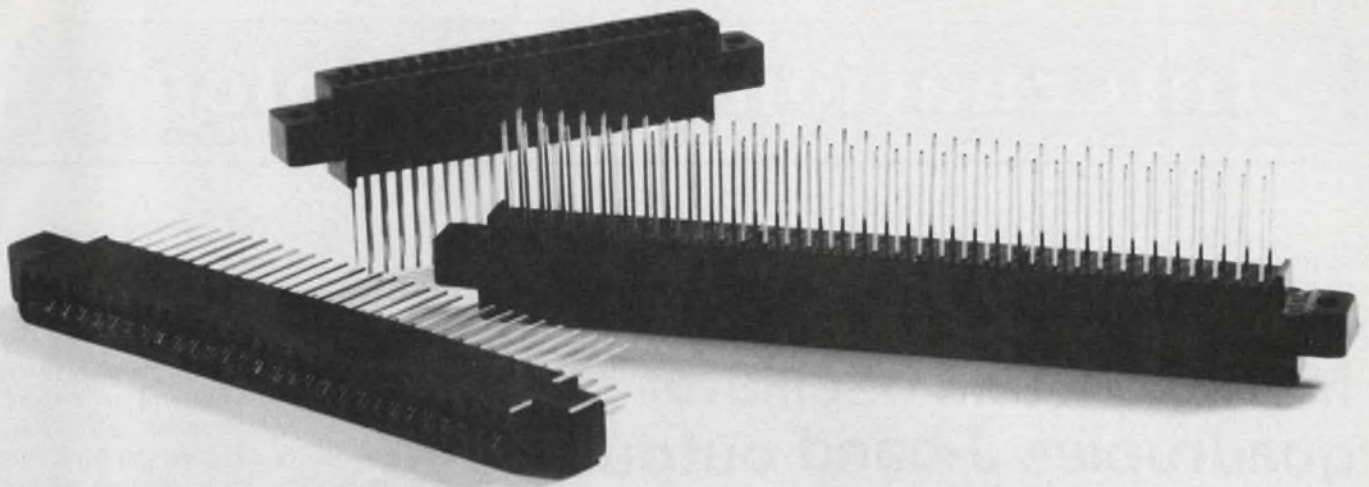

Presenting our better-mouse-trap line. No frills at all.

When you cut price without cutting quality, soon no one thinks of it as a cut price. That's where our Norsman line of Wire-Wrap* P/C connectors is headed. Here's why:

The insulator — it's tough, resilient, non-conductive — everything you need in a Wire-Wrap body. And it's made out of low cost phenolic, not the higher cost diallyl phthalate (if you need to meet mil specs, we have that in one of our other lines).

Contacts are semi-bellows and gold-plated — but

plated with our unique AuTac (TM) process. You get .000050" gold plate all along the mating surfaces for a sure, gouge-proof, pop-off-proof contact — but that's it. No wasted gold.

And you can find the size you need — Norsman is a full line from 15/30 to 50/100 contacts, in either .100 or .125 contact centers.

The whole Norsman idea is as simple as it is old: keep performance up and cost down. It works.

Send for details. We haven't told you everything.

*Wire-Wrap — registered trademark of Gardner-Denver Company.

Tell me everything. Send me detailed literature.

Name

Title

Company

Telephone

Address

City

State

Zip

 **Viking**
CONNECTORS

Viking Industries, Inc./21001 Nordhoff St./Chatsworth, Calif. 91311/(213) 341-4330

INFORMATION RETRIEVAL NUMBER 52

Multiple Gunn oscillator quadruples J-band output

The power output of Gunn-diode oscillators in the J-band (16 GHz) has been quadrupled by researchers at Plessey Co.'s Allen Clark Research Centre in England. Their solution is a new waveguide-cavity oscillator design that uses four Gunn diodes in an additive-power arrangement.

The researchers report that while a single diode can produce as much as 30 W at X band, its power declines to about 10 W in J band. To compensate for this, a two-diode and a four-diode structure were developed.

Two Gunn diodes in the waveguide structure (Fig. 1) give a pulsed output of 22 W. The diode separation is one-half the waveguide wavelength at the operating frequency.

The four-diode oscillator (Fig. 2) produces about 45 W and is tunable over a 1-GHz bandwidth by use of tuning stubs in the high-field regions between the diode locations. With the four diodes, however, device separation has to be experimentally altered to compensate for variations in the waveguide impedance.

The combined four-diode current is in the region of 30 A at a voltage of 25 V, which presents problems in producing a short rise-time output pulse.

A new active device for X-band operation

A new transistor that is reported to operate at five to 10 times higher frequencies than standard microwave transistors has been developed in the Dept. of En-

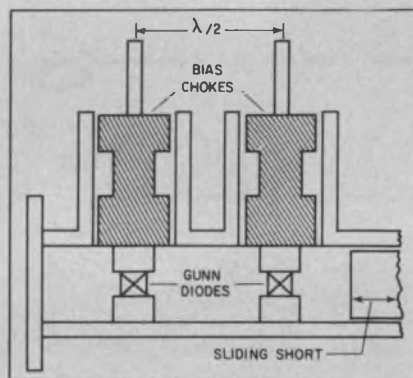

1. Two Gunn diodes in a waveguide structure provide 22-W pulsed output.

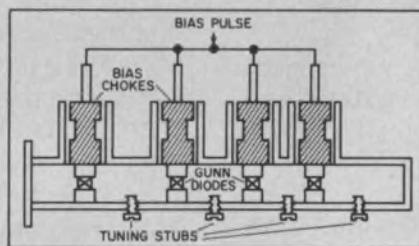

2. Four-diode oscillator produces about 45 W and is tunable over 1 GHz.

The Clark solution is use of the pedestal approach, in which a low-current pulse brings the diodes to a point just below switching threshold. At this point, a fast voltage increase produces an abrupt rise time—and a clean output pulse—without need for additional high-current input.

gineering at Cambridge University, England. Known as an Impistor, the device uses an Impatt diode as the collector structure.

Impatt multiplication is combined with Impatt negative conductance to give the improved performance, according to the re-

searchers. Impatt diodes alone give superior power outputs at X-band frequencies, compared with conventional transistors. In the Impistor's Impatt collector region there are avalanche zones between the collector and the emitter and there are drift zones near the collector contact.

In contrast with bipolar transistor biasing, the Impistor's base-collector region is biased into breakdown, usually with the base grounded. Very small emitter current is required if the emitter is reverse-biased with a grounded base.

Fast switching reported with MESFET structure

A gallium-arsenide MESFET structure with a switching rise time of 35 ps has been developed at the Institut für Halbleitertechnik at Aachen, West Germany. The fast-switching property, the researchers report, comes from the low transconductance and upper and lower saturation of the transistor-transfer characteristic.

A normally off MESFET was fabricated on an insulating chromium-doped gallium-arsenide substrate. The epitaxial layer was vapor-phase-grown (n⁺/n), and an undoped n⁻ region was operated as a buffer layer. A special etching technique—a combination of chemical etching and dc sputter—permitted adjustment of the channel thickness to within 100 Å.

The transistor was tested at 300 K and it was found that, even at a high forward bias of 600 mV, the gate current was limited by the channel current and the diode was not destroyed. When the switching behavior was tested, the input step had a rise time of 60 ps, whereas the output into a 50-Ω load resistance rose in 35 ps.

5 reasons why the Keithley model 168 should be your number 1 digital multimeter

- 1.** Autoranging. All you do is connect the signal to the two-terminal input and push the function you want. The 168 takes it from there to save you time.
- 2.** 5 Functions. Dc voltage from $100\mu\text{V}$ to 1000V , ac voltage from $100\mu\text{V}$ to 500V , ac and dc currents from $0.1\mu\text{A}$ to 1A and resistance from $100\text{m}\Omega$ to $20\text{M}\Omega$.
- 3.** Hi-Lo Ohms. Select ranges with 1-volt drop for turning on semiconductors or 100 millivolts for keeping them off.
- 4.** Full 1-Year Guarantee. It's a Keithley, no less. And that means all specs including accuracy are guaranteed for a full year. Maintenance is easy too.
- 5.** Low Price. Only \$315 puts the Model 168 in your hands. A complete line of accessories gives the 168 even more versatility.

The Model 168 Autoranging DMM will make your job easier . . . and that should make it your number 1 choice. Send for full details or phone (216) 248-0400 for a right-away demo.

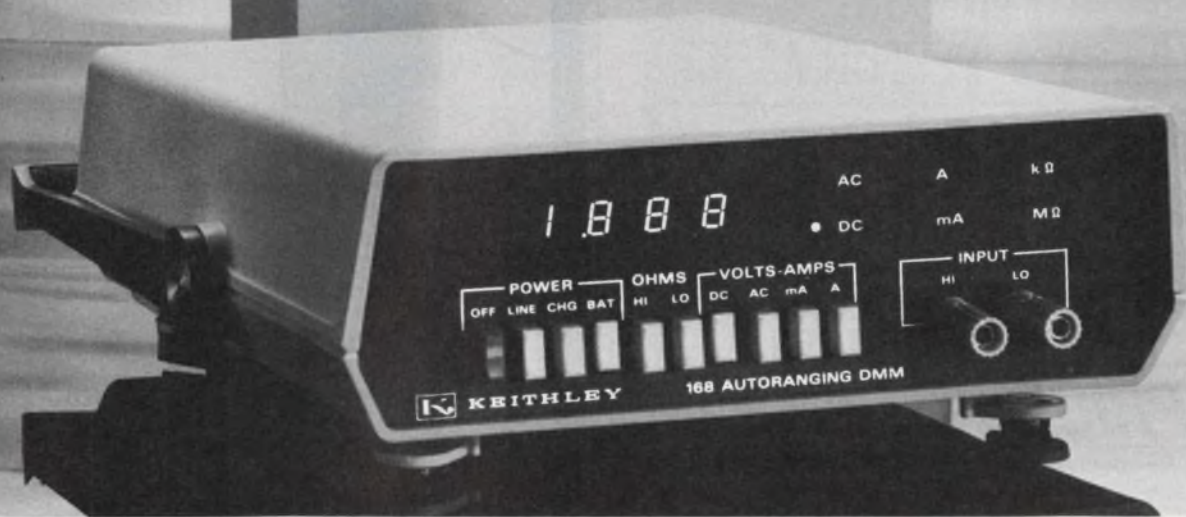

**KEITHLEY
INSTRUMENTS**
U. S. A. - 28775 AURORA ROAD, CLEVELAND, OHIO 44139
EUROPE - 14, AVENUE VILLARDIN, 1009 PULLY, SUISSE

INTRODUCING MURATA'S 100 VOLT, REDUCED TITANATE SUPERCAPS®!

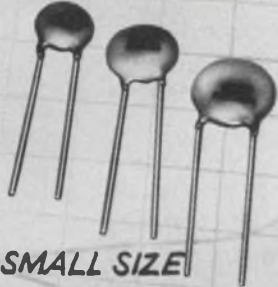

- HIGH CAPACITY, SMALL SIZE
- ±10% CAPACITY TOLERANCE
- X5P TEMPERATURE COEFFICIENT
- FAST DELIVERY

muRata

CORPORATION OF AMERICA
Rockmart Industrial Park, Rockmart, Georgia 30153
Phone: 404-684-7143 Telex: 54-2999

INFORMATION RETRIEVAL NUMBER 55



FREE

The Tucker Electronics Company General Catalog contains 160 pages of electronic instruments, 16 lines of low cost distribution products, and thousands of reconditioned instruments. Send for yours now.



TUCKER

ELECTRONICS • COMPANY

P. O. Box 1050 • Garland, Texas 75040

INFORMATION RETRIEVAL NUMBER 57

NEED A COMPETITIVE EDGE?
**CHECK OUT
WESTON POTS**
FOR COST
DELIVERY • PERFORMANCE

EXAMPLE:

Model #840P



**WESTON
SINGLE TURN
3/8" CERMET
TRIMMER**

PRICE (1000 Piece Orders) **\$.49** EA.

Comparable prices — all sizes — Square
• Round • Cermet • Wirewound

WESTON

WESTON COMPONENTS
ARCHBALD, PENNSYLVANIA 18403
TEL. (717) 876-1500
TWX 510 656-2902
TELEX 83-7443

Schlumberger

INFORMATION RETRIEVAL NUMBER 56

ANOTHER GREAT LOW COST LOAD CELL FROM INTERFACE



■ The inexpensive Super-Mini Load Cell from Interface offers guaranteed specifications of ±0.03% non-linearity, ±0.02% hysteresis, and ±0.01% non-repeatability. That's not all! The Super-Mini is available in standard ranges of 0 to ±50, ±100,

±250, ±500, and ±1000 pounds and is a direct replacement for lower performance, higher priced load cells in controlled environment applications.

■ Rated output is a full 3 mV/V, and deflection for full scale reading is from 0.003" to 0.007", depending on the weight range selected. And, the Super-Mini is super priced in unit quantities from just \$160.

■ In addition, Interface stocks a complete line of high accuracy load cells in ranges from 5 pounds to 100 tons for weighing, fatigue testing and thrust or torque measurement applications.

■ For complete information on Interface's price-conscious approach to force measurement, call or write Ted Johnson at Interface, today.

interface

7401 East Butherus Drive / Scottsdale, Arizona 85260
Telephone (602) 948-5555

INFORMATION RETRIEVAL NUMBER 58

ELECTRONIC DESIGN 9, April 26, 1975

IC circuits in plastic DIPs provide the reliability of hermetic packages

RCA Solid State Div., Route 202, Somerville, NJ 08876. (201) 722-3200. See text.

Instead of chasing after the elusive hermetically sealed plastic package, as most other IC manufacturers have done, RCA has attacked the major plastic-package failure modes and claims to have achieved a breakthrough in reliability. In tests by both RCA and the Army, the new chip-processing techniques have reduced failure rates by a hundredfold to levels achieved with truly hermetically sealed packages.

The usual aluminum metallization for intra-chip connections was replaced with a trimetal process and this was combined with silicon-nitride passivation. RCA concentrated on these five causes of failure:

1. Purple plague. Intermetallic compounds that form between gold bond wires and the aluminum metallization cause brittle joints.

2. Electrolytic corrosion. Moisture that seeps into plastic packages converts aluminum to aluminum oxides, especially when bias voltages are present. The oxides are nonconductors, and open circuits and failure of the device soon follow.

3. Electromigration. High temperature that is often accompanied by mechanical stress and high current density causes a transport of mass in the direction of electron flow in aluminum. Thin sections soon become open-circuited.

4. Aluminum-silicon reactions. Silicon that dissolves into the aluminum at ohmic interfaces produces electrical shorts.

5. Poor step coverage. Microcracks or thin areas that often occur with aluminization result in

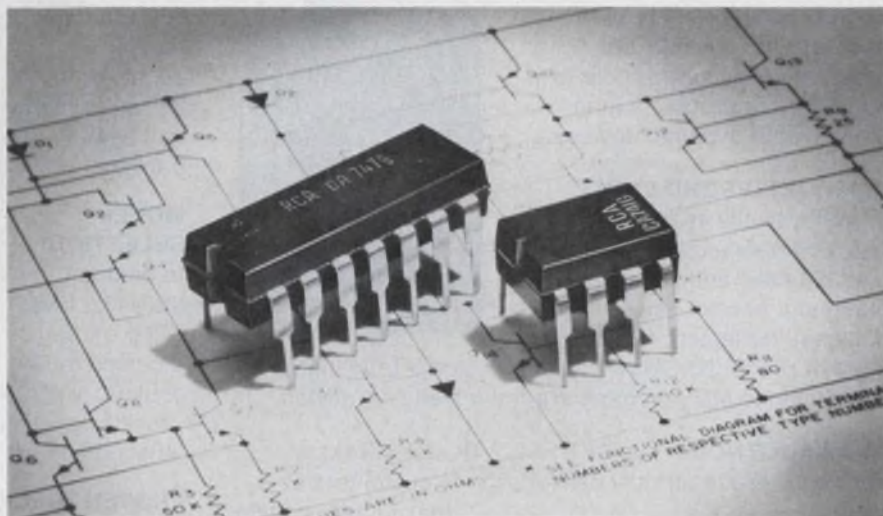

TRI-METAL STRUCTURE

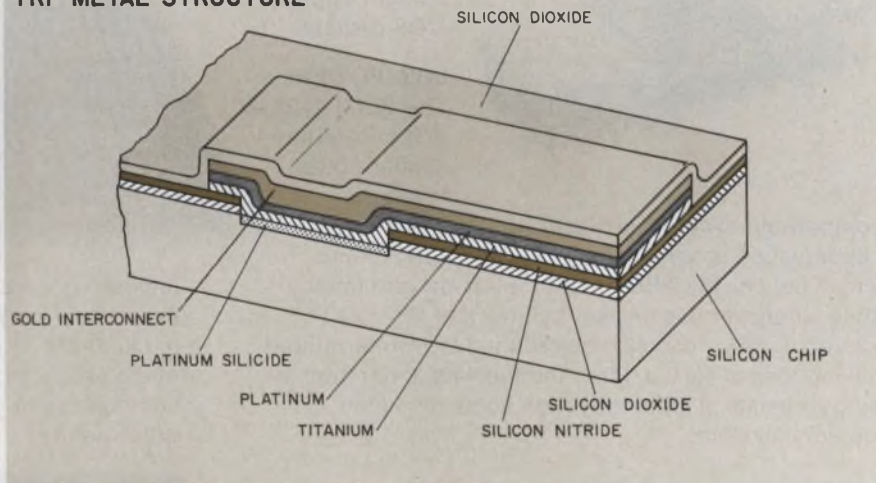

high current densities and eventual failure.

RCA says its titanium-platinum-gold combination overcomes these problems. And silicon-nitride passivation, it adds, protects the silicon substrate from moisture and other contaminants.

Gold is the primary conductive material. This eliminates purple plague, since gold metallization

now is attached to the usual gold bond wires in place of aluminum. Also, gold is noncorrosive and far less susceptible to electromigration than aluminum.

Low ohmic contacts to the device's silicon junctions are made with platinum nitride. A titanium layer is then used for good adher-

(continued on page 99)

SHIFT INTO HIGH PERFORMANCE WITH A 4K STATIC RAM

FULLY STATIC: The SEMI 4402 is a fully static 4K RAM. That's important. For one thing, it means you can now design a 250 nsec MOS memory system around a 4K device without worrying about refresh or charge pump circuitry. For another, static RAMs are inherently less susceptible to soft bit error problems than comparable dynamic devices.

350 NANOSECOND CYCLE: The SEMI 4402 4K static RAM has a complete cycle time of just 350 nsec and 200 nsec maximum access time. That makes it the fastest 4K static RAM in production. Now you can design a truly high performance MOS memory around a static 4K device.

AVAILABLE NOW: The SEMI 4402 4K static RAM is here now. We're already delivering it to customers at the memory system level. And it is second sourced by a major supplier of MOS devices.

LOW POWER: The SEMI 4402 4K static RAM has similar power levels to comparable dynamic devices. However, power conservation is achieved by the Chip Select Input, which causes the 4402 to enter a low power standby state whenever it is unselected. Normal V_{DD} is 12 Vdc, but V_{DD} can also be reduced to 5 volts without risking loss of stored data. And the 4402's differential output results in inherently high noise immunity memory systems.

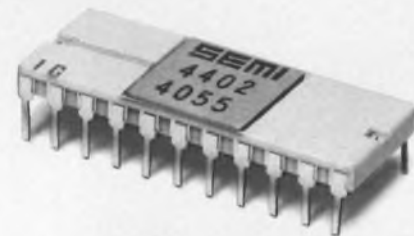

PERFORMANCE TESTED: Like all SEMI NMOS components, the 4402 4K static RAM must meet our own tough test standards, since we use it in our memory systems — for example the MICRORAM 3400N. With our reputation riding on its performance, you may be sure the acceptance standards are high indeed. In fact we 100% ac and dc test our components twice — at wafer and again in the package.

MODEL SELECTION: In addition to the 4402, EMM SEMI offers you a complete line of static NMOS RAM and ROM components to meet your design needs. Make your selection from the adjacent chart.

Part No.	Bit Org.	Access Time
RAMS		
SEMI-1801	1024 x 1	90 nsec.
SEMI-1802	1024 x 1	70 nsec.
SEMI RA-3-4256	256 x 4	1 usec.
SEMI RA-3-4256B	256 x 4	1 usec.
ROMS		
SEMI RO-3-4096	512 x 8	500 nsec.
SEMI RO-3-5120	512 x 10	500 nsec.
SEMI RO-3-16384	4096 x 4	1.0 usec.

More new products to come ... additional 4K static RAMs, ROMs

PROVEN TRACK RECORD: At EMM we've been making memory components and systems since 1961. Unlike memory suppliers who market components only, all EMM components are all performance proven in our own systems. When you buy from EMM, you get the benefit of the unusually high acceptance standards we

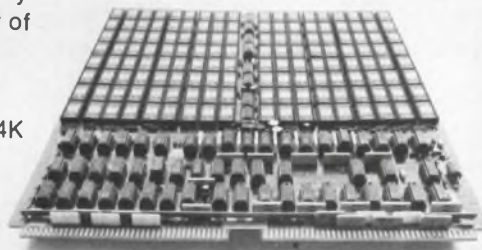

impose on ourselves, as well as our years of experience in meeting the needs of the memory marketplace. If you'd like further information about any of the products featured here, or any other EMM components or systems, contact your local EMM office today.

EMM SEMI

A division of Electronic Memories & Magnetics Corporation
3883 North 28th Avenue, Phoenix, Arizona 85017
Telephone (602) 263-0202

INFORMATION RETRIEVAL NUMBER 59

(continued from page 97)

ence to the platinum-nitride contact area and also to the silicon-nitride surfaces. Platinum between the titanium and gold acts as a diffusion barrier. Finally the gold interconnect pattern on the platinum provides high conductivity and excellent bond and step coverage (see illustration).

In this so-called hermetic-chip process, RCA follows the usual production process until the final oxidation step, where the silicon-nitride layer is applied to seal the junctions. A standard masking operation is used to open contact windows. Then platinum is sputtered over the wafer and sintered in the contact areas to form platinum silicide.

Titanium and platinum layers are sputtered sequentially on the surface of the wafer. The gold interconnect pattern is applied to the platinum layer with standard photoresist techniques. And a gold layer is electrolytically plated on the platinum interconnect paths through this resist mask. In the final step, as in the aluminum method, application of a silicon-dioxide layer protects the completed wafer during handling.

RCA has run a series of tests to establish the reliability of these "hermetic-chip" packages. On samples from four lots that total 250 units in a standard 15-V reverse-bias test at 85 C and 85% humidity, all devices survived for 5000 h. By contrast, RCA says, aluminum-metallized ICs began to fail at about 600 h under the same conditions, with 100% failure usually occurring within 1500 h.

Super solvent unsticks super glues

Edmund Scientific Co., 380 Eds-corp Bldg., Barrington, NJ 08007. \$4.25/oz: Stock No. 42, 225; stock.

Now users of the super glues can unglue their mistakes. A solvent quickly and safely releases the hold of super glues to allow re-alignment of work that has been incorrectly bonded. The solvent will get fingers unstuck, dissolve super glue bonds from skin (even eyelids), clothing, tools and instruments. It is said to be safe for external use on humans.

CIRCLE NO. 304

In "pressure-cooker" tests, where the devices were operated at 30 lb/in² and 121 C, 230 units survived for 250 h and 50 for 200 h, RCA reports. Equivalent aluminumized circuits showed an average of greater than 25% failures after 250 h, the company says.

In addition, the Army has been evaluating RCA's plastic devices since March, 1973, at its tropical test center in Panama. In seashore, salt-air environmental tests, 16 devices operated continuously for 14,232 h without failure in test racks that were protected only by wooden louvered enclosures, RCA reports. The failure rate was calculated to be less than 1%/1000 h, with a 90% confidence level.

In concurrent reverse-bias tests in 47 units at an inland jungle site—in similar louvered enclosures—the devices operated continuously also for 14,232 h, according to RCA. Here the failure rate was calculated to be less than 0.32%/1000 h, with a 90% confidence level.

The new ICs are priced the same as RCA's conventional aluminumized plastic-packaged devices. Six standard linear circuits are now available from stock, identified by suffix "G". They include the CA741G and CA747G widely used op amps and four other circuits: the CA324G quad op amp, CA-339G quad voltage comparator and CA3724G and CA3725G high-current npn transistor arrays.

Other devices are to follow, including both new circuits and circuits currently in RCA's product line.

CIRCLE NO. 301

Pure-metal anodes reduce sludge problems

Litton Industries, 4201 Wrightwood Ave., Chicago, IL 60639. (312) 235-1601.

New Ultrapure anodes have been developed for plating PC boards, copper wire, bus bars, terminals, eyelets and other electronic parts. According to Kester engineers, Ultrapure's special processing eliminates oxide inclusions, trapped gasses and sulphur and metallic contamination. No bagging is required, since there is a minimum of sludge and flaking.

CIRCLE NO. 305

There's an EMM office near you.

WESTERN REGION

Regional Office
SAN FRANCISCO
(408) 247-9711

LOS ANGELES AREA
(213) 644-9881

ORANGE COUNTY AREA
(714) 639-5811

MINNEAPOLIS AREA
(612) 941-2404

PHOENIX AREA
(602) 968-2492

DALLAS AREA
(214) 231-7207

EASTERN REGION

Regional Office
BOSTON
(617) 861-9650

CHICAGO AREA
(312) 297-7090

WASHINGTON, D.C. AREA
(703) 941-2100

NEW YORK AREA
(516) 423-5800

CLEVELAND AREA
(216) 842-8920

INTERNATIONAL OFFICES

European Headquarters
BELGIUM
(031) 76.69.75

UNITED KINGDOM
(01) 751-1213

WEST GERMANY
(089) 74.30.40

SALES REPRESENTATIVES

FLORIDA, ALABAMA,
GEORGIA, NORTH CAROLINA,
SOUTH CAROLINA, MISSISSIPPI,
TENNESSEE, LOUISIANA
Gentry Associates
(305) 894-4401
(205) 534-9771
(919) 227-3639

AUSTRALIA, NEW ZEALAND,
HONG KONG, SINGAPORE
Delairco Industries Pty. Ltd.
Sydney 29-2863

FINLAND
Digelius Electronics Finland OY
(90) 650-995

CANADA
Megatronix
(416) 742-8015
(514) 488-0404
(613) 729-4004
(604) 526-3312

INDIA
Southern Electronics
442-397, 445-983

ISRAEL
S.T.G. International Ltd.
(03) 53459

JAPAN
Nissho Electronics Corporation
(03) 542-2351

EMM ELECTRONIC MEMORIES & MAGNETICS CORPORATION.
12621 Chadron Avenue
Hawthorne, Calif. 90250
(213) 644-9881

convert 3V logic to 15V logic



with this new Solitron CMOS chip

TTL TO CMOS LOGIC
LEVEL CONVERSION
CMOS TO CMOS INTERFACE
CMOS TO PMOS INTERFACE

Our new CM 4104A consists of 4 low-to-high voltage level translators, with an output enable control pin. All inputs are level translated, and any input may be driven more positive than V_{LO} , up to a level equal to V_{HI} . True and complement outputs are simultaneously available. When the Enable input is "low", all outputs become a high impedance. Price, \$3.62 (100 pieces).

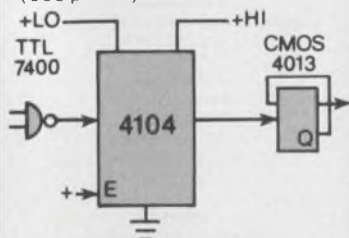

WATCH FOR NEW
DEVELOPMENTS IN OUR OVER
70 "4000 SERIES" DEVICES

Solitron

8808 BALBOA AVENUE
SAN DIEGO, CALIFORNIA 92123
TELEPHONE (714) 278-8780

INSTRUMENTATION

Measurement system includes calculator

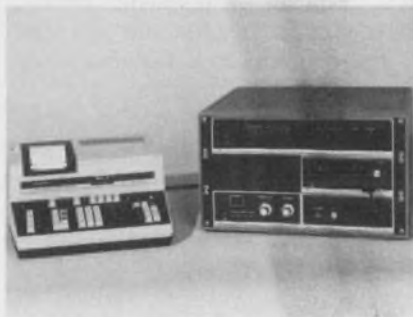

Keithley Instruments, 28775 Aurora Rd., Cleveland, OH 44139. (216) 248-0400. 90-120 days.

System 1—a calculator-based data-acquisition, control and measurement family—embraces a series of plug-to-plug compatible instruments, interfaces, other hardware, and software. The system allows the user to attain on-line measurement and computation capability with nearly the sophistication of a minicomputer system, but at a fraction of the total cost.

The heart of the System-1 family is a full-function, fully programmable calculating unit (PCU) with a paper-tape printer and controller. The PCU is integrally tied to an interface that permits direct connection of the company's digital multimeters, scanners, electrometers, nanovoltmeters and other instruments and peripherals. Provision is also made to connect to other manufacturers' instruments, with Keithley's guidance to ensure proper interfacing.

In its most sophisticated form, System 1 can control up to six DMMs and provide up to 180 channels of low-level voltage (microvolts) or low-level current (picoamps) input. The PCU itself has a memory of 512 words, expandable to 4 k. Additionally, mag-card storage is standard.

Communication with any instrument in the system is through simple keystrokes. Most of the commonly used mathematical functions, including logarithms, exponentials and trigonometric and statistical functions can be implemented and programmed by depression of a key. Another keystroke enables a program to be stored quickly on a magnetic card for further use.

CIRCLE NO. 302

\$295 buys 100-MHz, 7-digit counter/timer

Data Precision, Audubon Rd., Wakefield, MA 01880. (617) 246-1500. \$295.

Available for just \$295, Model 5740 is a 7-digit, 100-MHz counter/timer designed to measure frequency, period average, elapsed time and total events. The unit measures frequency from 5 Hz to 100 MHz; single period (sine wave) time from 1 μ s to 0.2 s; period average with 1-ns resolution to 99,999.99 μ s; event counting (totalizing) from 0 to 9,999,999; and time interval (stop watch) measurement covering 0 to 99,999.99 s (27.8 hrs). Sensitivity is 10 mV from 5 Hz to 20 MHz, rising linearly to a high-frequency of 50 mV rms at 100 MHz.

CIRCLE NO. 306

Microwave power meter gets 'high marks'



Hewlett-Packard, 1501 Page Mill Rd., Palo Alto, CA 93404. (415) 493-1501. \$1800; 8 wks.

Model 436A digital microwave power meter has built-in firmware "intelligence" to switch automatically among its 5 power ranges, to translate its reading into watts, dBm or dB relative, as desired, to locate the displayed decimal correctly, and to recognize which of several possible sensors is connected, and to calibrate its display accordingly. Instrumentation uncertainty is less than 0.5% of reading. Power and frequency range depend on sensor used and range from 100 kHz to 18 GHz in a power range from -30 to +35 dBm.

CIRCLE NO. 307

Single-slope DPM dissipates 3 W



Data Technology, 2700 S. Fairview St., Santa Ana, CA 92704. (714) 546-7160. \$189; stock to 30 days.

Though it is classified as a 3-1/2-digit instrument, Model 3362 6000-count DPM has a full 1 through 5 readout in the first position thereby providing 4-digit accuracy for measurements such as shaft rotation (over 360 degrees), temperature (up to 500 C) and similar applications. The unit has a conversion time of 60 ms max. The repetitive read rate is set at 4 readings/sec but can be increased to 8 readings/sec with an external resistor.

CIRCLE NO. 308

Scaling probe extends counter range to 0.6 GHz



Luff Research Associates, P. O. Box 449, Jackson Heights, NY 11372. (212) 429-5900. \$325; 4 to 12 wks.

Model 600 frequency scaling probe is a miniature assembly (2.5 × 1.5 × 1 in.) that attaches directly to a counter and extends the counter's frequency range to 600 MHz. The probe has a built-in switch that allows the input frequencies to be divided by either 10 or 100 and an extremely sensitive input amplifier that allows measurements typically to better than -30 dBm to 600 MHz. Power is supplied by a wall plug assembly with a 6-ft cord to the probe.

CIRCLE NO. 309

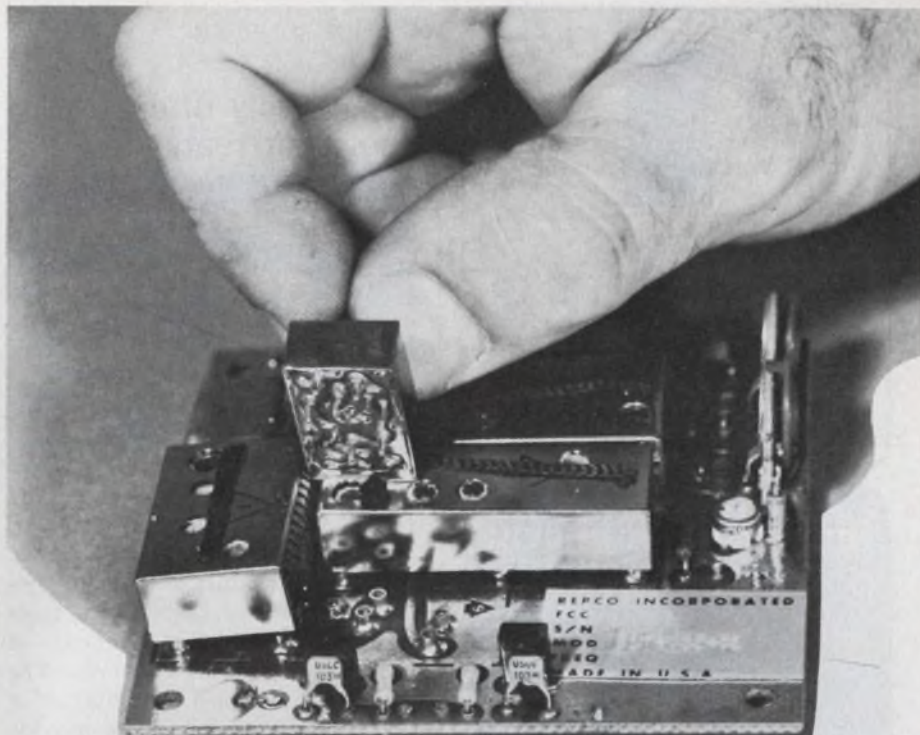

ACTUAL SIZE

Link up

with Repco RF transmitters and receivers

Repco's FCC type accepted RF links give you design flexibility with proven reliability (actual cases report systems in use for years with no RF failure), excellent MTBF, rapid MTRR (with low cost, off-the-shelf PBC modules). Suitable for voice, low-speed digital, or tone. 25-50 Mhz, 66-88 Mhz, 132-174 Mhz; and our new UHF 450-470 Mhz ranges. Repco's delivery, production capacity, and volume pricing will warm your heart! Write today for our free specs brochure and special evaluation unit price.

----- Special evaluation offer! -----

Repco, Incorporated
Special Products Department
P. O. Box 7065, Orlando, Florida 32804
(305) 843-8498 TWX 810-850-0120

Please send me free specs brochure and special low unit price available for evaluation of your RF links.



Name _____ Title _____

Company _____ Address _____

City _____ State _____ Zip _____

ED 4

Repco World's leading manufacturer of modular handheld portable radios.

INFORMATION RETRIEVAL NUMBER 61

1
AMERICAN MADE

Tolerance
SCHAUER
1-Watt
ZENERS

**Immediate Shipment
Low Prices**

ANY voltage from 2.0 to 16.0

Quantity	Price each
1-99	\$1.07
100-499	.97
500-999	.91
1000-4999	.86
5000 up	.82



All welded and
brazed assembly

No fragile
lead heads

Gold
plated
leads

Write for complete
rating data and other
tolerance prices.

**Buy the kit—
Save a lot**



Kit contains a 51-piece assortment of SCHAUER 1% tolerance 1-watt zeners covering the voltage range of 2.7 to 16.0. Three diodes of each voltage packaged in reusable poly bags. Stored in a handy file box. Contact your distributor or order direct.

A \$54.57 value for
ONLY \$24⁵⁰

Semiconductor Division

SCHAUER
Manufacturing Corp.

4511 Alpine Ave. Cincinnati, Ohio 45242
Telephone: 513/791-3030

POWER SOURCES

**Lab supply offers
choice of readout**



Heath Co., Benton Harbor, MI 49022. (616) 983-3961. Analog kit, \$169.95; Digital kit, \$219.95; stock.

Eight laboratory power supplies from Heath are the first in their price range to offer a choice of analog or digital readouts. The digital models (3-1/2 digits) offer two-decade autoranging to provide high resolution at low voltage and current settings.

Available in both kit and assembled form, the 2700 series operates in both constant-current and constant-voltage modes, which function independently of each other. And the units are true constant current not simply current limiting.

Adjustment of two front-panel controls is all that's needed to get exactly the voltage and current that is required. If one supply doesn't deliver the needed output, two or more units can be connected in series or parallel—with no loss of regulation.

Load regulation is $\pm 0.05\%$ +1 mV for voltage, and $\pm 0.1\%$ +3.5 mA for current. Line regulation is specified at $\pm 0.05\%$ +1 mV for voltage and $\pm 0.10\%$ +1 mA for current. Any of four output ranges are available: 0 to 75 V at 10 A, 0 to 15 V at 5 A, 0 to 30 V at 3 A, and 0 to 60 V at 1.5 A.

The analog readout supplies can be field calibrated to $\pm 3\%$ for voltage and current. And built-in standards in the digital versions allow calibration to within $\pm 1.0\%$ for voltage, and within $\pm 1.5\%$ for current. If lab standards are used, units can be calibrated within $\pm 0.5\%$ for voltage and $\pm 1.0\%$ for current.

Remote programming and sensing are standard in the 2700 series, as is output protection.

CIRCLE NO. 303

**Modular supplies
are rugged**



Abbott Transistor Labs, 5200 W. Jefferson Blvd., Los Angeles, CA 90016. (213) 963-8185. \$104 to \$131; stock.

The RN2.5 family provides 2.5 A at various voltages between 4.5 and 37 V dc. Line and load regulation are 0.1% and ripple is less than 0.02%. Standard features include short-circuit protection, input transient protection and remote error sensing. High reliability, with a predicted mean time between failure (MTBF) of more than 75,000 hours, is typical of these units. Anodized aluminum case construction permits sustained full-load operation at an ambient temperature of +160 F (+71 C) without the need for heat sinking or forced air cooling. A temperature coefficient of 0.03%/°C guarantees stability in a fluctuating thermal environment.

CIRCLE NO. 320

**Power supplies meet
UL hazard requirements**

Power-One, Inc., 531 Dawson Dr., Camarillo, CA 93010. (805) 484-2806. \$29.95; stock.

Two new supplies are UL approved (Class 2) for use in hazardous environments. In the event of a catastrophic regulator or component failure, the transformer is protected and will not overheat or burn. Listed as a recognized component under UL478 and UL114, Model B12-1.7 S113 and Model B24-1.2 S113 deliver 12 V, 1.7 A and 24 V, 1.2 A, respectively. These IC-controlled units have line/load regulation of $\pm 0.05\%$, with current limit/foldback built-in. OVP is an option. Input power is 115/230 V ac.

CIRCLE NO. 321

Standard interface weds digital power sources

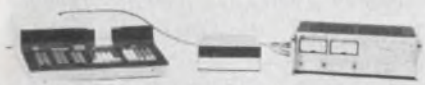

Hewlett-Packard, 1501 Page Mill Rd., Palo Alto, CA 94304. (415) 493-1501. \$2300 to \$3550; 1-8 wks.

Four of the company's existing digitally programmable voltage sources (6128C-6131C) and two digitally programmable current sources (6140A, 6145A) now can be ordered with Option J99 for compatibility with the Hewlett-Packard Interface Bus (HP-IB). The factory-modified units are designed to be connected through an ASCII-to-parallel converter, Model 59301A, to the company's programmable calculators. All J99-equipped units feature isolation between digital inputs and analog outputs, internal storage of digital data, digitally programmable current latch (on voltage sources) or voltage limit (on current sources) and analog input (both ac and dc) to modulate output.

CIRCLE NO. 322

High voltage supplies span 3 to 60 kV



Brandenburg Ltd., 930 London Rd., Thornton Heath, Surrey CR4 6JE, England.

A line of high-voltage power supplies features high stability (10 ppm) at voltage outputs ranging from 3 to 30 kV and 6 to 60 kV. The units measure 14 × 5.25 × 19 in. The output, which is via a removable connector at the rear, is controlled by 10-turn helical potentiometers. This gives a continuously variable coarse and fine adjustment. The fine control permits resetting to within 20 ppm. Two 3-in. scale analog meters indicate output voltage and current; a digital readout is optional. The units operate from standard line power at temperatures between 32 and 95 F.

CIRCLE NO. 323

Current source holds to 5 ppm per 100 h

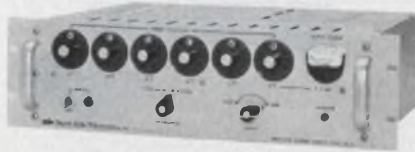

North Hills Electronics, Glen Cove, NY 11542. (516) 671-5700. \$1695; stock-30 days.

Ultra-stable dc current source, Model CS-31, features long-term

stability over 100 hours of 5 ppm, with output capability of 0 to 2 A at 60-V compliance. A six-decade, direct reading Kelvin-Varley voltage divider permits current setting with a resolution of 1 ppm of full-scale. Remote programming may be achieved by use of an external K-V divider. The instrument also features 0.01% absolute accuracy and 2-ppm regulation of output current over specified load and line variations.

CIRCLE NO. 324

What qualifies us as your display light measurement specialist?

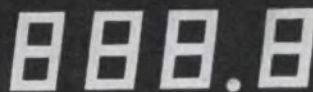

-1980

+1.000

A - 1.35
B - .75
C - 3.28

OPTIMUM DIMENSIONS FOR CUBE TO FIT XL 2



SWITCH ON

Three decades of design experience and demonstrated performance has led to one of the most versatile photometer systems today: the Spectra® Pritchard 1980. Offering *high sensitivity*, interchangeable optics, *zero polarization* and *automatic readout*, our 1980 has become the industry standard for measurement of luminance (brightness), uniformity, contrast and MTF of all kinds of displays — including CRT's, liquid crystals, LED's and gas discharge.

The 1980 Pritchard®

The 1980 can measure displays as fine as 0.0001" (0.0025mm) diameter — from pitch-dark (10⁻⁵ fL) to sun-bright (10⁷ fL). NBS-traceable calibration is maintained by a built-in, highly stable calibration light source.

For full data, write for brochure. Or call collect.



PHOTO RESEARCH
The light measurement people

3000 No. Hollywood Way, Burbank, CA 91505
(213) 849-6017 • Telex 69-1427



A Division of Kollmorgen Corporation

LVDT signal conditioner powered by ac line



Schaevitz, P.O. Box 505, Camden, NJ 08101. (609) 662-8000. \$164 (unit qty); stock.

The LPM series of signal conditioning modules is designed to condition linear variable differential transformer outputs. The modules operate from conventional ac line voltages and all that is required for a complete measurement system is the ac power, an LVDT, and a readout. Use of a passive diode demodulator makes phase adjustments unnecessary. Output is proportional to LVDT displacement, and the output is a low impedance, ± 5 -V-dc signal which can drive meters, high response recorders, or other dynamic indicators. An internal oscillator delivers a nominal 3-V-rms LVDT excitation. Some other specifications include frequency response from dc to 100 Hz (within ± 1 dB), minimum input of 50 mV results in a ± 5 -V-dc output, and nonlinearity and hysteresis is less than 0.1% of full scale.

CIRCLE NO. 325

Isolation amplifier designed for medical use

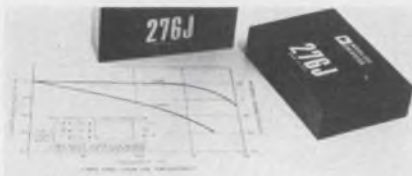

Analogy Devices, Rte. 1 Industrial Park, P.O. Box 280, Norwood, MA 02062. (617) 329-4700. \$49 (100-up); stock.

The Model 276J medical isolation amplifier is optimized for patient monitoring equipment. The unit surpasses the patient safety current limits proposed by UL, AAMI and other regulatory agencies. The input circuit design limits input fault currents to 10 μ A during amplifier failure. The isolator also limits ground leakage currents to under 0.01 μ A/V ac between input and output and to the power common while providing full defibrillator protection. The 276J has only 8 μ V pk-pk of input noise, a high, 115 dB (minimum), common-mode rejection ratio, when measured at 60 Hz, with a 5-k Ω source imbalance and a high, 50 M Ω in parallel with 20-pF, common-mode input impedance. The amplifier has a ± 0.5 -V input signal range; a 1-kHz, 3-dB frequency response; a 0.2% nonlinearity; and a ± 0.015 %/ $^{\circ}$ C gain tempco. The gain is optimized for 3 V/V to maximize signal gain while ensuring that skin-electrode potentials will not saturate the isolator. The 276J is packaged in a 3.5 \times 2.5 \times 1.25 in. (89 \times 64 \times 32 mm) module and operates over 0 to 70 C.

CIRCLE NO. 326

Active filters designed for audio frequencies

Siemens Aktiengesellschaft, D-8000 Munchen 1, Postfach 103, West Germany.

Active RC filters operate in the audio frequency range up to approximately 20 kHz. The desired filter parameters, such as frequency, Q-factor and gain, are set by laser trimming of specific resistors with tolerances better than 1%, the maximum temperature coefficient of the RC filter is 40 ppm/ $^{\circ}$ C. This temperature coefficient means that the frequency does not change by more than 0.2% for temperature changes of 50 C. Filters are available over a range of 100 Hz to 1 kHz with a Q of 100 and up to 10 kHz with a Q of 50. Various types of operational amplifiers can be used. So far ICs TAA 861, TAA 761 and TBA 221 have been used.

CIRCLE NO. 327

Hybrid instrumentation amp has 300 M Ω input Z

National Semiconductor, 2900 Semiconductor Dr., Santa Clara, CA 95051. (408) 732-5000. From \$12.10 (100-up); stock.

The LH0037 instrumentation amplifier uses three operational amplifiers and a precision, laser trimmed thin-film network. It has a high, 300-M Ω input impedance, and a common-mode rejection ratio of 100 dB. Only a single resistor is needed to set the gain over a 1 to 1000 range. The amplifier operates over ± 5 to ± 22 V and is housed in a 12-pin, TO-8 hermetic can.

INQUIRE DIRECT



ANALOG STAY IN CONTROL WITH INTECH'S INDUSTRIAL CONTROL ICs THE 303C AC DETECTOR DIFFERENTIAL OR SINGLE ENDED TO 1MHZ 3040 QUAD/MONITOR ALARM DRIVES EXTERNAL SPEAKER DIRECTLY. 3030 TEMPERATURE ALARM SETS OFF BELLS AND WHISTLES, EXCELLENT REPEATABILITY. THE 3020 TRI-STAGE ALERT/ALARM AND 3010 TONE ALARM DRIVE LEDs OR LAMPS. ALL 14-PIN DIP TTL COMPATIBLE. STOCK DELIVERY. LOW PRICES. WRITE US!

intech INCORPORATED
(408) 244-0500
1220 COLEMAN, SANTA CLARA CA 95050

D/a converters operate at CMOS power levels

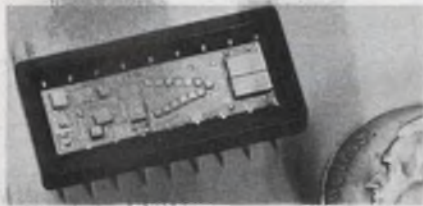

Micro Networks, 324 Clark St., Worcester, MA 01606. (617) 852-5400. \$129 (1 to 24); 2 to 5 wk.

Two 12-bit CMOS compatible d/a converters are available in 18-pin DIPs. The MN370 has a bipolar output of -10 to $+10$ V. The MN371 has a unipolar output of 0 to 10 V. Both units are complete with output operational amplifier and an internal reference supply. The total power dissipation for either device is 60 mW typical and 90 mW max. The MN370 and MN371 are available for operation over the full military temperature range of -55 to $+125$ C ("H" Models) and still guarantee linearity of ± 0.5 LSB max. over the entire temperature range. In addition, both converters are available screened 100% to the Class B requirements of MIL-STD-883.

CIRCLE NO. 328

Multimode motor driver delivers 4 A/phase

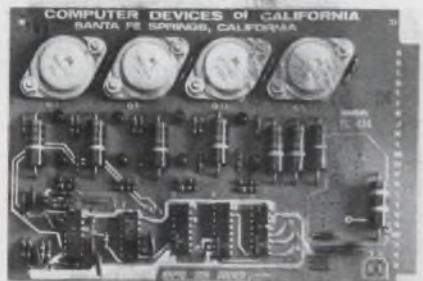

Computer Devices, 11901 Burke St., Los Angeles, CA 90670. (213) 698-2595. \$83; stock.

The Model PC-484 is a bidirectional driver capable of three different modes of excitation: single mode, dual mode, and half-step mode. This capability enables engineers to evaluate the motor exciting one winding, two windings or alternating between the two. Excitation modes can be selected by simply grounding pins Y or Z. This selection can be accomplished either before or during operation of motor.

CIRCLE NO. 329

Sprague Delivers!

YOU DON'T HAVE TO TAKE A SUBSTITUTE.



THE CAPACITOR:

Sprague's Type 192P Pacer®...
The Dependable Low-Cost
Miniature Polyester Film Capacitor.

THE DELIVERY CYCLE:

Large Production Quantities
4 - 8 Weeks ARO on All Popular
Ratings. Off-the-Shelf Delivery from
your Sprague Industrial Distributor.

THE CATCH:

None.
Sprague Delivers Film Capacitors.

Call your nearest Sprague district office or
sales representative for complete information.

Sprague Electric Company,
North Adams, Mass. 01247
Tel. 413/664-4411

SPRAGUE

THE MARK OF RELIABILITY

THE BROAD-LINE PRODUCER OF ELECTRONIC PARTS

LOW Phase Noise and FAST Switching Speed

... are two features of GR SYNTHESIZERS that no other synthesizer can match. Phase noise of GR's 1062 is the lowest available at 500 MHz. ... close to 100 dB down at 10 Hz from the carrier. ... one reason the 1062 is the popular choice for up-converting and multiplying into microwave-frequency bands. What's more, the 1062's switching speed is under 100 microseconds and guaranteed! Both features are explained in GR Application Notes; request your copies now. Other performance features include:

- DC to 160 MHz or 0.01 to 500 MHz
- Optional resolution to 0.1 Hz
- Non-harmonic spurs > 80 dB down
- A-M, F-M, and P-M capabilities
- Built-in search sweep
- Programmable (BCD parallel) frequency control
- Plug-in modular construction
- Proven record of high MTBF



For additional information, technical assistance, or a demonstration, call or write:



General Radio

300 BAKER AVENUE, CONCORD, MASSACHUSETTS 01742

NEW YORK (N.Y.) 212 964-2722, (N.J.) 201 791-8990
 BOSTON 617 646-0550 • DAYTON 513 294-1500
 CHICAGO 312 992-0800 • WASHINGTON, D.C. 301 948-7071
 ATLANTA 404 394-5380 • DALLAS 214 234-3257
 LOS ANGELES 714 540-9830 • SAN FRANCISCO 415 948-8233
 TORONTO 416 252-3395 • ZURICH (01) 55 24 20

GR COMPANIES • Grason-Stadler • Time-Data

Also available:

- Higher-frequency systems
- Keyboard frequency programmer
- Tracking synthesizer systems

INFORMATION RETRIEVAL NUMBER 66

DATA PROCESSING

Parallel processor extends Nova speed

Educational Data Systems, 17981 Sky Park Circle, Irvine, CA 92707. (714) 556-4242. \$2600; 60 days.

A microprogrammable processor, called the Micro-N, executes microprograms in parallel with that of the Nova CPU. Typical speeds for four-word floating point operations are up to 100 times faster than a Nova 1200 that uses software routines. The processor occupies one slot in any Data General Nova computer or DCC D-116. One or more Micro-N's can operate on the data channel in parallel with the standard CPU of the Nova. Each accesses macros and data from Nova core via the data channel.

CIRCLE NO. 330

Line switch is directed by a stored program

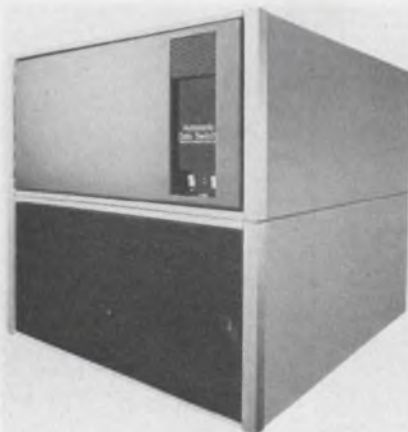

Multiplex Communications, 123 Marcus Blvd., Hauppauge, NY 11787. (516) 231-5350. See text: 4 to 6 mos.

A stored program directs a unit called the Automatic Data Switch. The device interconnects any number of lines, from 10 up to 256. It can be used as a local telegraph switching exchange, a data line concentrator or as a local data intercom system. The switch can also function as a computer line switch, time-share concentrator, or as a real-time circuit switch. System expansion is facilitated by additional modules and line terminators. A diagnostic facility displays program status and monitors line voltage and current. The basic 10-line system is available for less than \$13,000. 100-line systems are less than \$500/line.

CIRCLE NO. 331

High-quality serial printer does 30 char/s

Interdata, Terminal Products Corp., 2 Crescent Place, Oceanport, NJ 07757. (201) 229-4040. See text; May.

Digital stepper motors and a "Carousel" print cup combine to give high print quality at 30 char/s. The impact printer features a built-in microprocessor that is an integral part of the electro-mechanical system. The processor controls the stepper motors that move the print head, position the carousel and feed the paper. And the unit prints up to 132 char/line. For graphics use, the processor interprets ASCII control characters to move the paper up and down or slew the print cup at 600 steps/s with 0.01-in. increments. Vertical increment is 1/48-in. The barebones unit accepts 8-kit parallel ASCII input. A barebones printer sells for \$1478 (50 qty) while a complete ASCII terminal costs \$2009. The print cup, which is capable of 1M character impressions, costs \$8.75 to replace.

CIRCLE NO. 332

Nova 830: a lower cost option to the 840

Data General, Route 9, Southboro, MA 01772. (617) 485-9100. See text; 30 days.

A systems-oriented computer, the Nova 830, is a lower-priced version of the Nova 840 computer. It uses high-capacity 32 kbyte core memory (1 μ s) to permit large system size at moderate price. A Nova 830 processor with 128 kbytes of main memory, memory management option, power supply and console panel all in a 10-1/2-in. chassis with 10 additional slots available for system memory and I/O interfaces costs \$23,150. The Nova 830 has the same facilities as the faster Nova 840—full hardware-protected dual operations, standard dual-processor/shared disc operations, memory mapping with 2-kbyte boundaries and support of 256 kbytes of memory in one processor. The Nova 830 also supports Data General's operating systems, high level languages, utility programs and program development aids. A single 830 supports 30 time-shared terminals.

CIRCLE NO. 333

Low-cost column printer uses electro-discharge



Harry Gocho Enterprises, Copal Div., 56-01 Queens Blvd., Woodside, NY 11377. (212) 779-5252. See text.

A sample of the SF-30 electro-discharge printer costs \$85. Its capabilities include 2 line/s speed, and 11-digit width (5 × 7 dot-matrix). The unit supplies timing and start signals: one a 0.4-V pulse, the other a switch contact.

CIRCLE NO. 334

Digital LSI modem can perform at 4800 bit/s

Microelectronics Div., Rockwell International, PO Box 3669, 3430 Miraloma Ave., Anaheim, CA 92803. (714) 632-2321.

A 4800/2400 bit/s modem based on MOS/LSI circuits is available from Rockwell International Corp. The half-duplex modem, for use on voice-grade telephone line, uses digital modulation and demodulation techniques and includes adaptive equalization. The modem provides phase coherent, suppressed-carrier, double-sideband modulation on two quadrature carriers. Two amplitude levels are used for the 2400 bit/s rate and four levels at the 4800 bit/s rate. A phase-locked-loop corrects jitter. Complete initialization is achieved without any preamble or start up. Automatic equalization, timing, carrier phase and age are learned from the data signal alone. Even after major line disturbances, there is no need for the receiver to call for retransmission of a preamble to relearn the channel. Rockwell's Microelectronic Device Div. develops custom MOS/LSI modems that range from 1200 bps to 9600 bps for equipment manufacturers.

CIRCLE NO. 335



IN 40 STOCK DESIGN VALUES

40 MARKED POPULAR VALUES IMMEDIATELY AVAILABLE IN PROTOTYPE AND PRODUCTION QUANTITIES (BACKED BY A STOCK OF OVER ONE MILLION CHIPS IN THE DESIGN VALUES SHOWN BELOW):

DESIGN VALUE KIT B1 mini-cube® A trim kit (55 mil cube)			
QTY.	CASE	CAP. (pF)	TOL.
10	A	0.1	B
10	A	0.5	B
10	A	0.8	B
10	A	1.8	B
10	A	3.3	B
10	A	4.7	C
10	A	6.2	C
10	A	8.2	C
10	A	9.1	C
10	A	10.0	J

DESIGN VALUE KIT B2 mini-cube® A Tune Kit (55 mil cube)			
QTY.	CASE	CAP. (pF)	TOL.
10	A	12.0	J
10	A	15.0	J
10	A	18.0	J
10	A	22.0	J
10	A	27.0	J
10	A	33.0	J
10	A	47.0	J
10	A	62.0	J
10	A	82.0	J
10	A	100.0	M

mini-cube® is a registered trademark and MAXI-"O"UBET™ is a proprietary trademark of ATC.

DESIGN VALUE KIT B3 MAXI-"O"UBET™ B trim kit (110 mil cube)			
QTY.	CASE	CAP. (pF)	TOL.
10	B	1.6	C
10	B	1.8	C
10	B	2.4	C
10	B	4.7	C
10	B	5.6	C
10	B	6.2	C
10	B	7.5	C
10	B	8.2	K
10	B	10.0	K
10	B	12.0	K

DESIGN VALUE KIT B4 MAXI-"O"UBET™ B Tune Kit (110 mil cube)			
QTY.	CASE	CAP. (pF)	TOL.
10	B	18.0	K
10	B	24.0	J
10	B	27.0	K
10	B	30.0	J
10	B	43.0	J
10	B	68.0	J
10	B	110.0	J
10	B	120.0	J
10	B	180.0	J
10	B	220.0	J

BUY ANY DESIGN VALUE KIT OF 100 ATC 100 LOW LOSS PORCELAIN CHIP CAPACITORS FOR \$77.00.

If you need further information on these Design Value Kits, just circle the number below.

To place your order, or for samples of other ATC Capacitors, call Ralph Wood at (516) 271-9600.



ACTUAL SIZE: 55 MIL CUBE ▶

american technical ceramics
ONE NORDEN LANE, HUNTINGTON STATION, N.Y. 11746
(516) 271-9600 • TWX 510-226-6993

INFORMATION RETRIEVAL NUMBER 67

HIGH VOLTAGE Industrial Multipliers

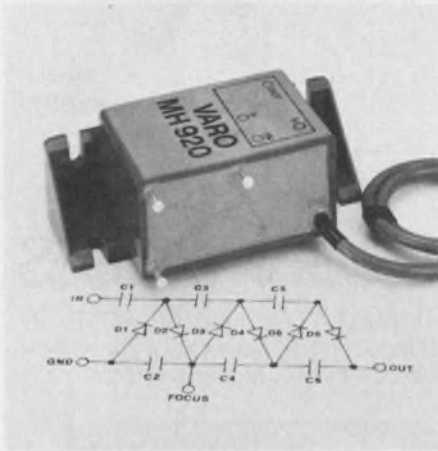

Photo shows typical tripler with focus tap

FEATURES OF VARO SEMICONDUCTOR, INC. HIGH VOLTAGE MULTIPLIERS

- Allows the use of smaller, lighter, less expensive transformers
- Does not require all high voltage to be derived from transformer
- Less corona and less precipitation of deposits on wires and connections at voltages above 10 kV

TYPICAL APPLICATIONS

- Any application using CRT
- Oscilloscopes
- Computer read-outs
- Air traffic control displays
- Electrostatic power supplies
- Electrostatic copiers, precipitators and paint sprayers
- Laser power supplies
- High voltage test equipment

These industrial multipliers are available in several doubler, tripler and quadrupler circuits. No load DC output ratings range from 80 kV to 40 kV. DC forward current is 10 mA. A variety of standard packages plus custom designs are available

For complete information call
Jim Garvin (214) 272-4551



VARO

VARO SEMICONDUCTOR, INC.

P.O. BOX 676, 1000 NORTH SHILOH,
GARLAND, TEXAS 75040
(214) 272-4551 TWX 910-860-5178

INTEGRATED CIRCUITS

Multiplier/divider has 1% accuracy

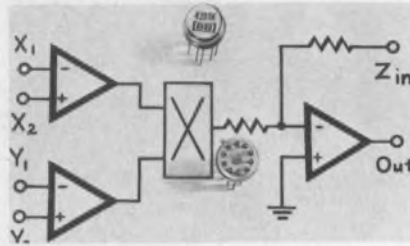

Burr-Brown, International Airport Industrial Park, Tucson, AZ 85734. (602) 294-1431. \$16 to \$31.50 (100); stock to 2 wks. (small quantity).

Laser trimmed and self-contained, a new series of IC multiplier/dividers needs no adjustments or external components to meet its guaranteed accuracies of 1% (4205K and 4205S) and 2% (4205J). And the units have differential inputs for flexibility in choosing algebraic sign for the operations of four-quadrant multiplying, dividing and square rooting—all of which the 4205 does without additional amplifiers. Other features include a 25-V/ μ s slew rate, 1-MHz bandwidth and overload recovery time of 3 μ s. Harmonic distortion reportedly remains low for frequencies well above 100 kHz.

CIRCLE NO. 336

Demodulate AM, FM or SSB

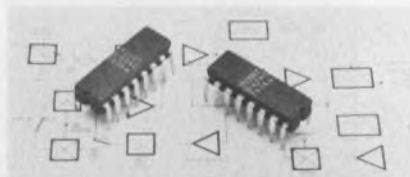

Plessey Semiconductors, 1674 McGaw Ave., Santa Clara, CA 92705. (714) 540-9979. \$4.44 (stock).

The SL624 IC can perform as a synchronous detector for AM, a quadrature detector for FM, and a product detector (with built-in oscillator) for SSB or cw. The IC can be completely switched to implement different modes, or two ICs can be used to reduce switching costs. Usable at frequencies to 30 MHz, the SL624 operates from voltages of 9 to 12 V, and it requires about 20 mA at 12 V. The circuit comes in a standard 16-pin ceramic DIP.

CIRCLE NO. 337

Interface peripherals to microprocessor

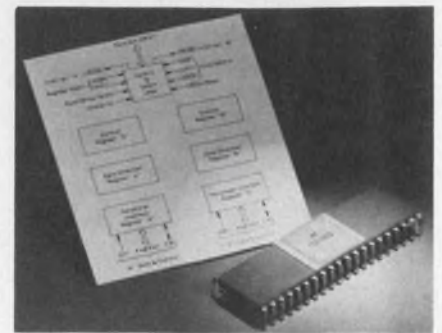

Motorola Semiconductor Products Inc., P.O. Box 20924, Phoenix, AZ 85036. (602) 244-3466. \$28 (1-24).

The MC6820 Peripheral Interface Adapter (PIA) provides a means of interfacing peripheral equipment to the company's MC-6800 microprocessor. Data flow between the processor and a PIA by means of an 8-bit bidirectional bus. Data transfer between the PIA and a peripheral occurs on 16 I/O lines organized as two 8-bit bi-directional busses. Each I/O line may be individually programmed to act as either an input or output of the PIA. The six registers in the PIA are accessible to the processor via its bidirectional data bus and as standard memory locations. The PIA comes in a 40-pin DIP.

CIRCLE NO. 338

Darlington arrays allow 600-mA peak

Sprague Electric Co., 347 Marshall St., North Adams, MA 01247. (413) 664-4411.

Three high-voltage, high current Darlington transistor arrays in DIPs consist of seven silicon npn Darlington pairs on a common monolithic substrate. All units feature open-collector outputs and integral suppression diodes for inductive loads. Allowable peak inrush currents reach 600 mA, or a suitable level for driving tungsten-filament lamps. The type ULN-2001A is a general-purpose array that can be used with standard logic circuits. The Type ULN-2002A has been specifically designed for use with 14-to-25-V PMOS circuits. The Type ULN-2003A has a series base resistor to each Darlington pair, and thus allows operation directly with TTL or CMOS operating at a supply voltage of 5 V.

CIRCLE NO. 339

Bipolar PROMs have byte structure

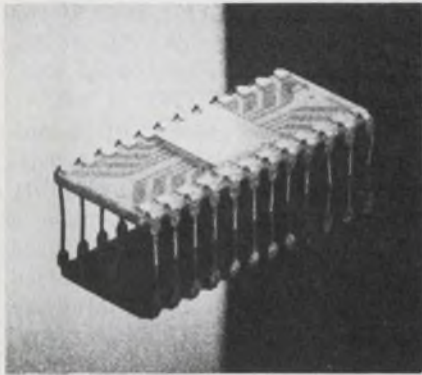

Signetics, 811 E. Arques Ave., Sunnyvale, CA 94086. (408) 739-7700. \$60 (100).

Two byte-organized bipolar PROMs, the 2-k bit 82S114 and the 4-k bit 82S115, feature typical access times of 35 ns. The 82S114 holds 256 eight-bit words, while the 82S115 holds 512 bytes. Other features include buffered address lines, on-chip decoding, on-chip storage latches, three-state outputs and input currents less than 100 μ A.

INQUIRE DIRECT

70-MHz, 8-bit SR reduces board space

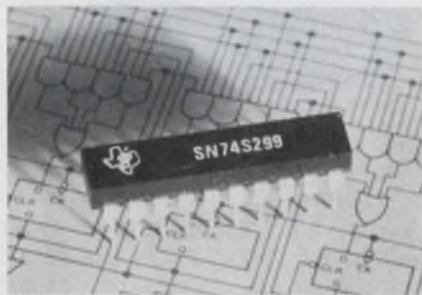

Texas Instruments Inc., P.O. Box 5012, M/S 308, Dallas, TX 75222. (214) 238-3741. \$5.60 (100); stock.

A 70-MHz parallel-access, 8-bit Schottky-TTL shift register—the SN74S299—provides the equivalent of two 16-pin SN54S/74S194 or one 24-pin SN54/74198 universal shift register in a single 20-pin package. With pin-row spacings of 0.300-in., the new 20-pin register can reduce PC board area requirements by 40% and 55%. The bi-directional register has full parallel access for loading or reading, with shift right, shift left, hold, and clear modes of operation controlled from two function-select inputs.

CIRCLE NO. 340

VERSATESTER I™

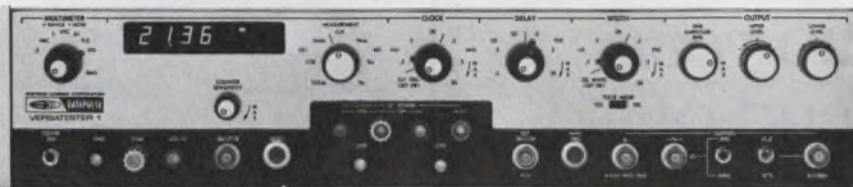

What is it? A labstrument*

VERSATESTER I Generates Pulses, Sine waves and Square waves to 20MHz Supplies dc power at +5v, +15v, -15v, \pm 30v Digitally Measures frequency from 20Hz to 20MHz, with autoranging; DC and AC volts, 0-500v; Resistance to 5 Megohms. Complete for only **\$1,650!** Contact your nearest Scientific Devices Office for specs or demo or Systron-Donner at 10 Systron Drive, Concord, CA 94518. Phone (415) 682-6161.

*lab-stru-ment \lab-strä-mənt \n 1: a complete test lab in one lightweight, portable, 3½" panel height Systron-Donner instrument.

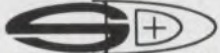
SYSTRON  DONNER

INFORMATION RETRIEVAL NUMBER 69

Hot Semis? Get relief fast!

IERC 

Heat Sinks

INTERNATIONAL ELECTRONIC RESEARCH CORPORATION / A SUBSIDIARY OF DYNAMICS CORPORATION OF AMERICA

INFORMATION RETRIEVAL NUMBER 70

5PPM/°C
and a
20 year
end-of-life...
all in
Angstrohm's
new
SAR
precision
metal film
resistors!

And that's not all! The new SAR Series of precision resistors is backed by Angstrohm's 15 year old reputation for providing a quality product that will outlast the equipment it's used in. Write for complete technical specifications today!



angstrohm
precision, inc.

one precision place
hagerstown, maryland 21740
telephone: 301-739-8722
twx: 710-853-6834

DISCRETE SEMICONDUCTORS
Ultraviolet photodiode
has low impedance



ITT Electro-Optical Products, 7635 Plantation Rd., Box 7065, Roanoke, VA 24019. (703) 563-0371. \$875; 30 to 60 day.

A 1.25-in. diameter ultraviolet sensitive biplanar photodiode, type F-4115, uses a magnesium fluoride entrance window. The cesium telluride photocathode is formed on a solid metal substrate, which assures a low impedance characteristic. This feature, in conjunction with the close spaced mesh anode, makes the diode useful as a fast, relatively high current laser pulse receiver. Due to the solar blind characteristic of the photocathode and its associated magnesium fluoride entrance window, the diode should find applications involving the detection of UV in the presence of high ambient visible radiation.

CIRCLE NO. 341

Transient suppressor
handles up to 60 kW

General Semiconductor, 20001 W. Tenth Pl., Tempe, AZ 85281. (602) 968-3101. \$79 (100 up); stock to 4 wk.

The 60KS200C TransZorb is a high power surge suppressor. The TransZorb suppressor has been designed around the Navy's MIL-STD-1399 (Interface Standard for Shipboard Systems, Electrical Power, Alternating Current). It is rated for 180-V peak voltage and has a maximum clamping voltage of 335 V at 180 A. The unit has a maximum surge power of 60 kW for 40 μ s and 350 kW for 1 μ s.

CIRCLE NO. 342

Power transistors handle
up to 30 A

Solitron Devices, 1177 Blue Heron Blvd., Riviera Beach, FL 33404. (305) 848-4311. For 100-up lots: \$3.75 (58); \$4.50 (59); 3 wk.

The 2N6258 series of homogeneous base npn power transistors has a peak current capability of 30 A. The transistors use a 0.284 \times 0.284 in. single-diffused chip. The transistors are identified as the 2N6258 and 2N6259 and are packaged in JEDEC TO-3 cases. Typical features of the 2N6258 include V_{CE0} greater than 80 V, V_{CHO} of 100 V and a minimum gain of 20 at 15 A. The 2N6259 offers a V_{CE0} greater than 150 V, a V_{CBO} of 170 V and a minimum gain of 15 at 8 A. Both devices offer typical $I_{S/B}$ greater than 250 W/s and a θ_{J-C} of 0.5 C/W.

CIRCLE NO. 343

Optical interrupters use
infrared light beams

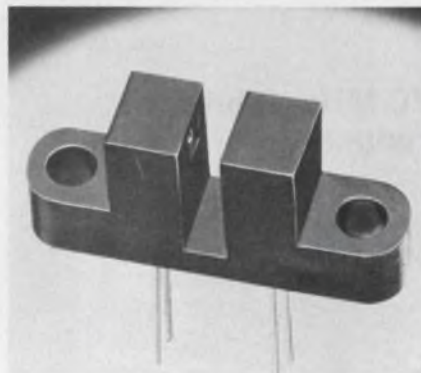

Optron, 1201 Tappan Circle, Carrollton, TX 75006. (214) 242-6571. For 100-up lots: \$1.70 (800), \$1.80 (803); stock.

The OPB 800 and OPB 803 optically coupled interrupter modules consist of a GaAs infrared LED coupled with a silicon photosensor in a plastic housing. The OPB 800 with a phototransistor sensor has a typical unblocked output of greater than 0.75 mA with a LED input of 20 mA. Typical output of the OPB 803 with a photo-Darlington sensor is 3 mA with an input of 10 mA. Both units have a high resolution aperture for shaft encoder or strobe bar applications, an infrared transmitting filter for applications in high ambient light applications and alternate pin separation to fit standard DIP sockets.

CIRCLE NO. 344

High speed rectifiers handle currents to 1.5 A

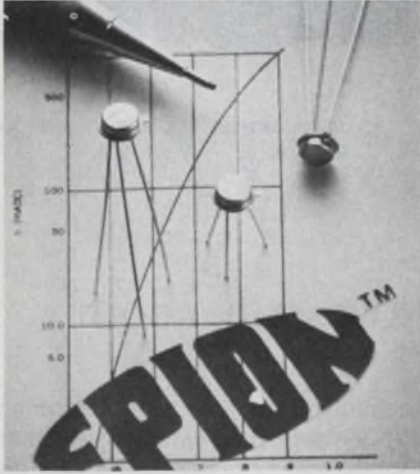

Solid State Devices, 14830 Valley View Ave., LaMirada, CA 90638. (213) 921-9660. \$1.98 (100-up); stock.

Ion-implanted 1-A silicon rectifiers have reverse recovery speeds of less than 10 ns. The diodes are available with voltages to 150 V. They have a capacitance of 20 pF maximum at 0 V, and can operate at temperatures from -65 to +200 C. Low threshold voltages of 300 mV at 1 mA and 900 mV maximum at rated currents to 1.5 A are available.

CIRCLE NO. 345

P-i-n and limiter diodes come with carrier choice

Alpha Industries, 20 Sylvan Rd., Woburn, MA 01801. (617) 935-5150. From \$4.50 (1 to 9); 10 to 30 day.

A line of p-i-n and limiter control diodes is designed for hybrid microwave circuits. The devices are available in basic chip form or mounted on a choice of standard carriers. The hybrid carrier choices include LID, mini-strip and post configurations. Chips are mounted on the carrier using a high temperature gold-germanium solder preform. Typical p-i-n diode characteristics of the CSB-7000 series include: V_R min at an I_R of 10 μ A is 50 to 200 V, C_T at a V_R of -50 V ranges from 0.13 to 0.45 pF and a T_s at an I_F/I_R of 0.05 that spans 3 to 100 ns. Characteristics of the CLA-3100 diode limiter series include: a V_R min of 25 to 70 V, a C_T of 0.15 to 0.3 pF, and a T_s of 3 ns.

CIRCLE NO. 346

Built to amplify, no matter what the impedance.



The DC-300A power amplifier drives low impedance loads at full rated power as long as needed. Dependable AC or DC power for servo motors or force transducers.

Rated power 150 watts per channel (600 watts balanced single channel) into 8 ohms. Maximum power

depends on exact load impedance and operation of thermal overload protection. Essentially flat frequency and phase response from DC to 20KHz. Not affected by shorted, mismatched or open loads. Will not self-destruct under any conditions of use.

Sounds expensive? For three years your total cost is the original list price of \$695.00. Crown guarantees that the DC-300A will work as specified during that time or we'll fix it free — and pay shipping costs.

Interested? Send for spec sheet.



CROWN INTERNATIONAL

Industrial Products Division
1718 W. Mishawaka Road, Elkhart, IN 46514

INFORMATION RETRIEVAL NUMBER 72

MAG TAPE FOR NOVA

A great minicomputer deserves a great mag tape transport! Don't hang second-rate peripherals on your top-notch NOVA. Digi-Data offers you the finest quality tape-handling equipment available anywhere at any cost.



Phase-encoded, NRZI, or both together, and tape speeds to 45 ips. Prices start at \$4,750 for complete systems which are thoroughly checked out on our own NOVA's and supplied with diagnostic software.

Digi-Data also manufactures mag tape systems for D.E.C.'s PDP-11 and Hewlett-Packard's HP2100.

SEE THE REEL EXPERTS FOR YOUR MAG TAPE NEEDS NOW.



DIGI-DATA CORPORATION

8580 Dorsey Run Road, Jessup, Md. 20794 (301) 498-0200

Digi-Data Europe

Fluestrasse 632 5313 Klingnau Switzerland TELEX: 845-58555

INFORMATION RETRIEVAL NUMBER 73

Electronic Design's YOUR OWN INSTANT



WANT TO KNOW MORE ABOUT A COMPANY?

You'll find 7,528 manufacturers listed in *Electronic Design's* GOLD BOOK — more than twice the number contained in EEM. But there's more, too. In addition to complete address and phone number, whenever provided by the company you'll find:

TWX
TELEX
CABLE ADDRESS
FACSIMILE EQUIPMENT
(make and call number)
QPL DESIGNATION
FEDERAL STOCK CODE
NUMBER

NUMBER OF ENGINEERS
NUMBER OF EMPLOYEES
DOLLAR VOLUME
KEY OFFICIALS
SALES OFFICES
FOREIGN OFFICES
U.S. & FOREIGN REPS
U.S. DISTRIBUTORS

SIMPLIFIES AND SPEEDS PRODUCT SEARCH

Want to know who makes what? Just turn to the GOLD BOOK's *Product Directory*. Each manufacturer's complete street address, State, zip, and phone is given every time it's listed. Contact is simplified . . . you (or your secretary) don't have to go to any other directory to get missing address information — a big help if you're contacting many suppliers at the same time.

Boldface type and page references steer you toward catalog pages on the products you're seeking that are bound in Volumes 2 or 3. And there are symbols to verify that the company really makes the product — not merely says it does.

LOOKING FOR A DISTRIBUTOR NEAR YOU?

Check the Geographical Section of the GOLD BOOK's *Distributors Directories*. You enter the section by state, then find your city — or one nearby — and the distributors located in that city. You can then go to the Alphabetic Section to find the complete address, zip, and phone. In most cases annual sales volume or net worth, year established, and names of key officials are included. (Distributors are also listed after the companies they represent in the *Manufacturers Directory*.)



LOOKING FOR A FOREIGN REPRESENTATIVE?

A good rep nowadays is hard to find. It's even hard to know where to start, especially if your company is looking for a rep overseas. Do your sales manager a favor and tell him that foreign reps are listed after each company in the *Manufacturers Directory*. (If you are an overseas subscriber, chances are you've already found this section very useful.)

GOLD BOOK

INFORMATION SYSTEM

**KNOW THE TRADE NAME BUT
NOT THE MANUFACTURER?**

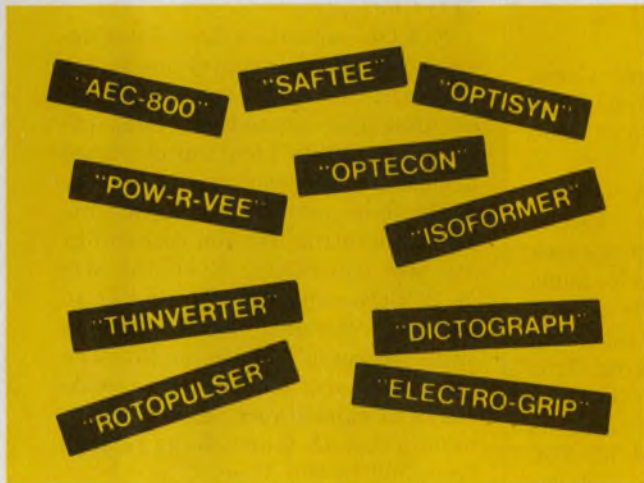

If you've always thought of a product in terms of its trade name, there's an easy way to find out what it is and who makes it. Check the GOLD BOOK's *Trade Names Directory*. Over 4,600 trade names are included from "A. P. Bondeze" to "Zoomator." You can then turn to the *Manufacturers Directory* for more information.

DID WE MISS SOMETHING? LET US KNOW ABOUT IT

The 1975-76 GOLD BOOK directories will be even more complete; more useful than our first edition. Has your company changed its address, phone, product lines or reps? Be sure your ad manager up-dates your listings. Better yet, if you know of any changes that should be made, drop a note to:

George Weingarten, Editor
Electronic Design's GOLD BOOK
50 Essex Street, Rochelle Park,
New Jersey 07662



CATALOG DATA FOR IMMEDIATE ACTION

Before you contact a supplier, check the catalog pages in the GOLD BOOK. The product information you need may already be at your fingertips. There are 2,820 catalog pages in all—more than any other industry directory. In some cases the specification data included in these pages may be sufficient to enable you to place your order. In others, the information can shorten the time required for you to discuss your specific needs.

WHEN YOU HAVE THE GOLD BOOK YOU DON'T NEED ANY OTHER INDUSTRY DIRECTORY

Research studies show that 99% of your fellow engineers rate the GOLD BOOK equal or *superior* to other industry directories. It's the "in" directory—the one that's being used and referred to. It's clearly the choice of engineers throughout the U.S. and overseas.

LOOK FIRST IN ELECTRONIC DESIGN'S GOLD BOOK

**BIGGEST, MOST COMPREHENSIVE
ELECTRONICS MASTER CATALOG
& DIRECTORY IN THE WORLD**

COMPONENTS

Proximity switch senses all metals

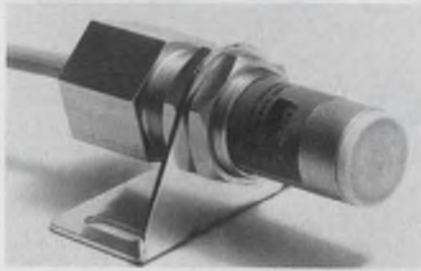

Eldec Corp., 16700 13th Ave. W., Lynnwood, WA 98036. (206) 743-1313. \$75 (100 up); 30 days.

An all-metal-sensing proximity switch, Model 8-250, fits a standard 1/2-in. conduit for easy adaptation to material handling and machine-tool applications. The unit is said to withstand extremely harsh environments. The sensing distance is 0.320 in. on steel with a repeatability of $\pm 10\%$. Response time is 10 ms. The operating temperature range is -40 to 180 F. The unit can switch 1 A.

CIRCLE NO. 347

Piezo element ignites commercial gas units

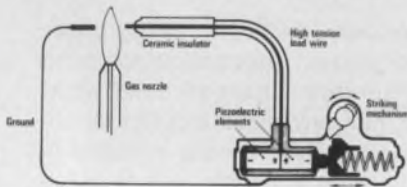

National Instrument Co., Inc., 4119-27 Fordleigh Rd., Baltimore, MD 21215. (301) 764-0900.

A piezoelectric gas igniter designed for original equipment manufacturers is available in seven different models. The gas igniter replaces dangerous, troublesome pilot lights. It is actuated automatically when the gas cock of the appliance is turned on to generate a high-voltage, low-amperage current that produces an electrical discharge into the gas stream. The gas ignites every time, without failure, according to the manufacturer. A spring-loaded striker hits the convex-shaped surface of a lead-titanate-zirconate ceramic piezo element. Rated life is 50,000 to 100,000 ignitions. Any type of commercially available gas, including natural gas, manufactured gas, propane, butane, etc., can be ignited.

CIRCLE NO. 348

Snap-action switch features short button

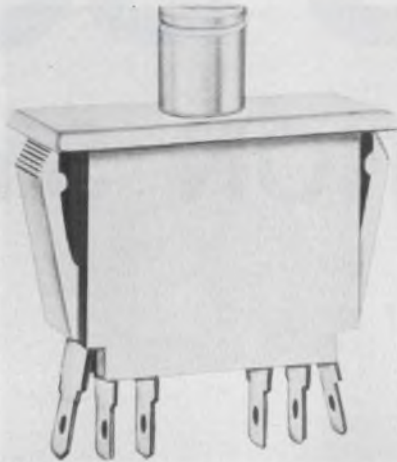

Cherry Electrical Products Corp., 3600 Sunset Ave., Waukegan, IL 60085. (312) 689-7702. \$0.78 (200 up); stock to 5 wks.

The Cherry E79-40A DPDT snap-action switch has special molded-in, serrated, spring-lock clips that facilitate snap-in panel mounting. Also featured is a short button that depresses flush with the top of the switch housing. This makes the switch ideal in door applications. The standard unit is rated at 10 A, 1/3 hp and 125/250 V ac, and the line also includes units with gold crosspoint contacts for low-energy switching applications.

CIRCLE NO. 349

Thumb switch needs no assembly hardware



Inter-Market Inc., 1946 Lehigh Ave., Glenview, IL 60025. (312) 729-5330. \$2 (500 up); stock.

ImLec, Series SM, subminiature thumbwheel switches assemble with built-in snap studs. The new design eliminates the need for threaded rods or bands. Front or rear-mounted, the switches are 0.312-in. wide with 10, 11 or 16-position wheels, and they have decimal or BCD boards with single or double-pole configurations. Minimum life expectancy is one-million detents in either direction. Units are 100% electrically and mechanically tested before shipment.

CIRCLE NO. 350

Capacitors free of toxic PCB



Sprague Electric Co., 347 Marshall St., North Adams, MA 01247. (413) 664-4411.

ECCOL capacitors have been designed to meet industry needs for nontoxic, PCB-free (polychlorinated biphenyl) capacitors. They exhibit essentially identical electrical performance characteristics to those of the long used askarel capacitors. Their operating life and readability are also equivalent. Even the size of ECCOL capacitors is similar to previous designs, except for a slight increase in case height. The capacitors are available in a wide range of capacitance values from 1 to 55 μ F, with four voltage ratings from 300 to 660 V ac.

CIRCLE NO. 351

Numerical display readable at 60 ft.



Info-Lite Corp., 46-10 104th St., Corona, NY 11368. (212) 476-1287. \$14.75: no logic (100 digits); 2 to 4 wks.

Series 68032 numerical readouts are 2-in. high and can be viewed at 60 ft. The units are supplied with the number of digits desired and with an anti-glare, blackout front panel, bezel and color filter ready to snap into a panel cutout. Message modules, \pm sign, colons and decimal points may be integrated into the package. Standard snap-in decoder-driver and memory logic packs are optional. T-1-3/4 light sources for each segment are dual redundant (lamps and logic) are socket mounted and accessible from the front for simple field servicing.

CIRCLE NO. 352

PERSONALIZED TRANSFORMERS

No matter what function.

Pulse, isolation, matching, converter, etc.

No matter what specs.

Tough electrical, environmental, or both.

No matter what package.

DIP, substrate, header, conventional, or...?

Technitrol has engineered transformers and transformer packages to meet the most stringent electrical and environmental requirements. Transformers have been produced mounted singly or in multiples in a broad spectrum of configurations.

Call Bill Chamberlin at 215-426-9105 or write. State your application; we'll put over 25 years of transformer know-how to work for you.



Technitrol, Inc.

1952 E. Allegheny Avenue
Philadelphia, Pa. 19134

Specialists in pulse transformers and completely transfer molded, welded DIP delay lines under $\frac{3}{16}$ " high — to 250 ns.

INFORMATION RETRIEVAL NUMBER 74

LOOKING FOR A DISTRIBUTOR NEAR YOU?

Electronic Design's GOLD BOOK lists 5,700 distributors with access both **alphabetic**, by distributor name, and **geographic** by location.

When you need
information...

**Electronic Design's
GOLD BOOK
IS THE PLACE
TO LOOK**

**SPEED PRODUCTION...
SAVE SPACE AND WEIGHT...
REDUCE ASSEMBLY COSTS...**

WITH BUCKBEE-MEARS FLEXIBLE CIRCUITRY

BMC flexible circuitry offers significant advantages over conventional hand wiring of discrete circuits. It can simplify assembly, reduce costs, and greatly improve wiring accuracy and reliability.

Buckbee-Mears' Circuits Division also can provide as much—or as little—engineering assistance as you require... from preliminary drawings through testing to finished products. This team of flexible circuit specialists can help define your requirements, then work with you in developing the circuitry to fit your exact application. For information, write or call Ed Dugan.

FLEXIBLE CIRCUITRY DIVISION

BUCKBEE-MEARS COMPANY

bmc

248 EAST SIXTH STREET
ST. PAUL, MINNESOTA 55101 612-228-6263

INFORMATION RETRIEVAL NUMBER 75

VERO... PRODUCT OF THE MONTH CARD FRAMES & MODULE RACKS

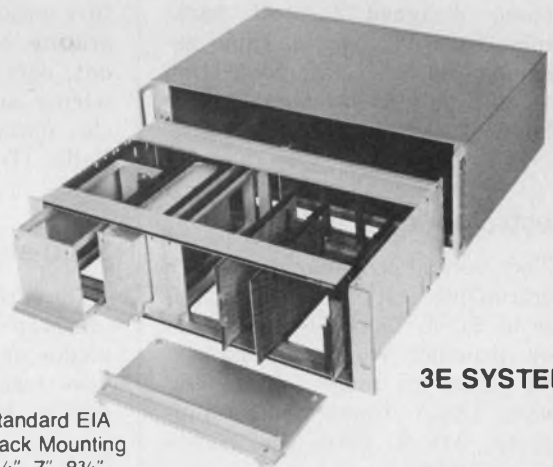

3E SYSTEM

- Standard EIA Rack Mounting
5 1/4", 7", 8 3/4"
Panel Heights
- VEROLOCK® System
Retains all Modules
with one Push/pull
action
- Rigid Construction
- FREE Design Service
- Off-the-shelf Delivery

We make your job easier...

Call or write today for more information:



Vero Electronics, Inc.

171 Bridge Road; Hauppauge, N.Y. 11787
Tel.: 516-234-0400 TWX: 510-227-8890
In Canada Call: EPS, 613-389-1025

INFORMATION RETRIEVAL NUMBER 76

New Literature

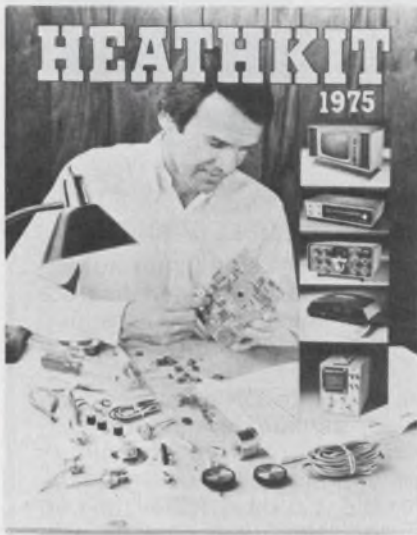

Electronic kits

The 1975 Heathkit catalog describes over 350 kits for virtually every do-it-yourself interest—TV, radios, stereo and four-channel hi-fi, marine, R/C modeling, home appliances, automotive, test instruments . . . and more. Heath Co., Benton Harbor, MI

CIRCLE NO. 353

Interconnection test system

The N151 interconnection test system, designed to test backplanes, bare PC boards, cable assemblies and other interconnection networks, is described in a 17-page catalog. Teradyne, Boston, MA

CIRCLE NO. 354

Electro-optics handbook

The second edition of RCA's Electro-Optics Handbook is available at \$4.95. This 256-page handbook provides reference material with dozens of tables, charts and graphs. RCA Commercial Engineering, 415 S. Fifth St., Harrison, NJ 07029

INQUIRE DIRECT

Microcomputers

Two pieces of literature describe two of the company's microcomputers—the MicroPac 80, a desktop microcomputer, and the MicroPac OEM. PCS, Flint, MI

CIRCLE NO. 355

Panel meters

An illustrated panel meter catalog and price supplement describes frequency meters, elapsed-time meters, ac motor-load indicators, edge-wise meters, meter relays, pyrometers, shunts and resistors. The catalog contains ordering information, dimensional drawings, an interchangeability guide and a glossary of terms. General Electric, Schenectady, NY

CIRCLE NO. 356

VOMs

The XL series volt-ohm-milliameters are featured in a four-page flyer. Simpson Electric, Elgin, IL

CIRCLE NO. 357

Thermoelectric products

Temperature control devices for applications such as microscopy, aerospace, IC wafer probing and diffusion furnace controls are covered in a 24-page catalog. The catalog contains model equivalent tables and metric and temperature conversion tables. Cambridge Thermionic, Cambridge, MA

CIRCLE NO. 358

Switchlights

Low-cost, 2 Form C, dual wiping, general-purpose switchlights are highlighted in a six-page catalog. Fully illustrated, the literature provides key dimensions, operating characteristics, panel cut-out data and lists the terminal wiring and quick-connect receptacle options. Clare-Pendar, Post Falls, ID

CIRCLE NO. 359

Solid-state cameras

Operation of cameras based on self-scanned linear arrays of photodiodes is described in an eight-page catalog. Integrated Photomatrix, Mountainside, NJ

CIRCLE NO. 360

Solenoids

Seventy-two colorful, information-packed pages feature solenoids, including long-life tubular solenoids, general-purpose solenoids and first generation tubular solenoids. Guardian Electric, Chicago, IL

CIRCLE NO. 361

Rotary switches

An eight-page brochure describes 1-5/16-in. diameter rotary switches—Type F—and contains circuit diagrams of the standardized 30°, 36°, 45°, 60° and 90° configurations. Oak Industries, Switch Div., Crystal Lake, IL

CIRCLE NO. 362

Heat-shrinkable tubing

Thermofit heat-shrinkable SFR tubing is described in a data sheet. Raychem, Menlo Park, CA

CIRCLE NO. 363

Hybrid microcircuits

A 20-page brochure features practical advice on electrical characteristics, packaging techniques and design of custom hybrid microcircuits. NEC Microsystems, Fort Lauderdale, FL

CIRCLE NO. 364

Display monitors

"Display Monitors," a 20-page booklet, is designed to help OEM buyers choose the right monitor for their system. Tektronix, Beaverton, OR

CIRCLE NO. 365

Digital instrument course

The first two parts of a course in digital techniques offer an in-depth understanding of digital circuits and the mathematical theory behind them. Both Digital Instrument Course, Part I, a 60-page soft cover book and Digital Instrument Course, Part II, a 64-page soft cover book are \$3.50 each. NY state residents add 7% tax. Philips Test & Measuring Instruments, 400 Crossways Park Dr., Woodbury, NY 11797

INQUIRE DIRECT

Rare gases

An 8-page brochure describes ultra-high-purity rare gases used in epitaxial growth processes. Purity levels are claimed to exceed 99.9999% in such gases as arsine, phosphine, silane and ammonia. Details are provided on specialized instrumentation and analytical techniques used to obtain purity data. Three H Corp., Wanamassa, NJ

CIRCLE NO. 366

Design Aids

Power tubes

Power grid tubes are listed in a 24-page selection guide according to the principle mode of service for which they are rated, rather than in alphanumeric order. The tube types are tabulated in descending order of the most significant tube parameter. EIMAC, div. of Varian.

CIRCLE NO. 367

Ceramic capacitors

Technical information on temperature compensating disc ceramic capacitors including temperature characteristic curves, temperature coefficient charts and curves, dimensional information and testing specifications are provided in a four-page guide. Murata Corp. of America.

CIRCLE NO. 368

English/metric converter

An English/metric converter in slide rule form contains conventional conversions of length, weight, area and volume. The converter has a slide rule chart showing the relationship between square millimeters, AWG and MCM size, circular mils, ohms per 1000-ft and ohms per kilometer for stranded tinned copper conductor at 20 C. Continental Wire and Cable Corp.

CIRCLE NO. 369

Electrolytic capacitors

A quick guide to MIL style CSR91 nonpolarized solid-electrolytic capacitors abstracts data from MIL-C-39003 in an easy-to-use format. Sprague Electric.

CIRCLE NO. 370

Optoelectronics guide

The Optoelectronics Status Guide lists numeric arrays, single numeric digits, LED lamps, opto-couplers, display dice and accessories. National Semiconductor, 2900 Semiconductor Dr., Santa Clara, CA 95051

INQUIRE DIRECT

DPM'S. . . At IMC We've Got Your Number



The IMC Series 300, the only DPM designed by a DPM user...not a DPM manufacturer...gives you accuracy, low cost, and function flexibility. You specify the input and we'll give you the number for your output.

- Eight different displays
- 3-1/2 digit readout in...
LED 0.3" or 0.4"
PLANAR 0.55"
- MUX or Parallel BCD output
- P-MOS reliability
- Accuracy to $\pm 0.05\%$
- 30PPM/ $^{\circ}$ C TC
- \$49.95 in OEM Quantities

imc

INTERNATIONAL MICROTRONICS CORPORATION

4016 E. TENNESSEE STREET / TUCSON, ARIZONA 85714 (602) 795-9440 TWX 910-952-1170

INFORMATION RETRIEVAL NUMBER 78

SUBSCRIBER SERVICE For prompt service include the addressed label when writing about your subscription.

CHANGE OF ADDRESS

city	company address	division/department	company	name	NEW ADDRESS
state				title	
zip					

If you're moving, please let us know six weeks before changing your address. If you have a question, place your magazine address label here and clip this form to your letter.

MAIL TO: ELECTRONIC DESIGN Circulation Dept. Hayden Publishing Co., Inc., 50 Essex Street, Rochelle Park, NJ 07662

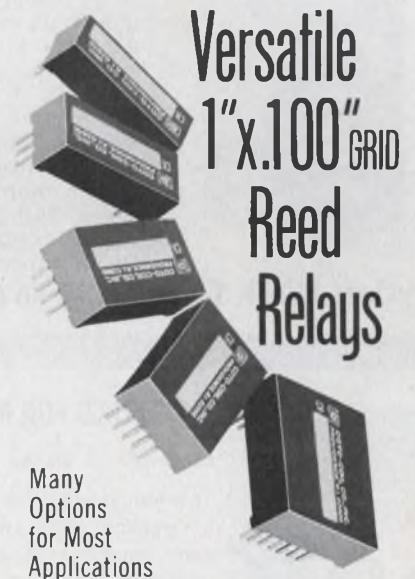

Versatile 1" x .100" GRID Reed Relays

Many Options for Most Applications

New CR-2000 Series utilizes the popular 1" x .100" grid pattern, with 1 to 6 poles and a variety of options and contact forms for almost any application. Reliable low-level switches may be conditioned by special run-in and dynamic testing. Models can be epoxy-encapsulated or simply encased for added economy. Ask for Bulletin MR 11.1 for full details.

COTO

COTO-COIL COMPANY, INC.
59 Pavilion Ave.
Providence, R. I. 02905
Tel: (401) 467-4777

INFORMATION RETRIEVAL NUMBER 79

Design Data from Manufacturers

Advertisements of booklets, brochures, catalogs and data sheets. To order use Reader-Service Card (Advertisement)

Electronic Design

ELECTRONIC DESIGN's function is:

- To aid progress in the electronics manufacturing industry by promoting good design.
- To give the electronic design engineer concepts and ideas that make his job easier and more productive.
- To provide a central source of timely electronics information.
- To promote communication among members of the electronics engineering community.

Want a subscription? ELECTRONIC DESIGN is sent free to qualified engineers and engineering managers doing design work, supervising design or setting standards in the United States and Western Europe. For a free subscription, use the application form bound in the magazine. If none is included, write to us direct for an application form.

If you do not qualify, you may take out a paid subscription for \$30 a year in the U.S.A., \$40 a year elsewhere. Single copies are \$1.50 each.

If you change your address, send us an old mailing label and your new address; there is generally a postcard for this bound in the magazine. You will have to requalify to continue receiving ELECTRONIC DESIGN free.

The accuracy policy of ELECTRONIC DESIGN is:

- To make diligent efforts to ensure the accuracy of editorial matter.
- To publish prompt corrections whenever inaccuracies are brought to our attention. Corrections appear in "Across the Desk."
- To encourage our readers as responsible members of our business community to report to us misleading or fraudulent advertising.
- To refuse any advertisement deemed to be misleading or fraudulent.

Microfilm copies are available of complete volumes of ELECTRONIC DESIGN at \$19 per volume, beginning with Volume 1, 1952 through Volume 20. Reprints of individual articles may be obtained for \$3.00 each, prepaid (\$5.00 for each additional copy of the same article) no matter how long the article. For further details and to place orders, contact the Customer Services Department, University Microfilms, 300 North Zeeb Road, Ann Arbor, Michigan 48106 telephone (313) 761-4700.

Want to contact us? If you have any comments or wish to submit a manuscript or article outline, address your correspondence to:

Editor
ELECTRONIC DESIGN
50 Essex Street
Rochelle Park, N.J. 07662

FFT Analyzer Provides Instant Results; Allows Continuous Viewing and Editing



Designed for operation by engineers rather than computer experts, the "DSP" Digital Signal Processor is portable and provides instant, Real Time answers for 12 distinct signal-analysis functions. It conditions and analyzes **two** signals, correlates their mutual properties, and displays results in a broad variety of forms and formats. Real Time operation is to 25 kHz. By means of a "joystick"-controlled cursor, data is traced for instant, **calibrated** 6-digit LED readout of frequency, amplitude, time and phase. Accepts analog waveforms or digital data for 57 analysis ranges from 10 Hz to 150 kHz with resolution narrow as 0.01 Hz. Averages up to 4096 ensembles. Throughput over 300,000 words/sec.

Spectral Dynamics Corporation

P.O. Box 671, San Diego, CA 92112
(714) 565-8211

CIRCLE NO. 171

Share in the nation's top managerial policies, strategies, techniques . . .

MANUFACTURING MANAGEMENT SYSTEMS

New Challenges and Opportunities Edited by Fred Gruenberger



By crystallizing the results of the 1973 Informatics/UCLA Symposium, this book offers a powerful blend of technical and managerial expertise for enhancing the overall success and profitability of today's manufacturing management systems. Some of the nation's top industrial and technical leaders speak freely and in depth of their organization's objectives and specific operations, as well as their personal strategies and methods. You'll find the newest computerized tools available to manufacturers . . . crucial managerial skills for directing progressive systems . . . the tact and care needed for the sensitive human problems of system implementation, and more. #5940-x, 160 pages, \$10.50. Circle the Info Retrieval No. to order a 15-day exam copy. When billed, remit or return book. No obligation.

CIRCLE NO. 172

Hayden Book Company, 50 Essex St., Rochelle Pk, N.J. 07662

MATERIALS FOR MAGNETIC FUNCTIONS

by Fennimore N. Bradley

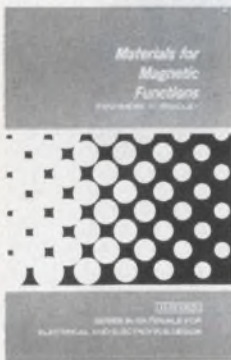

This valuable reference provides a thorough background as well as practical design techniques for the materials needed for magnetic functions. Included in its exhaustive coverage is detailed treatment of key parameters of about 30 classes of ferrite materials relating processing to costs and design trade-offs . . . and equally thorough coverage of about 40 classes of both conventional and exotic magnetic metals and processes. The book focuses on design problems encountered in a wide range of permanent-magnet applications . . . pinpoints design problems in nearly 30 categories of electromagnetic devices . . . and concludes with coverage of environmental influences such as corrosion, magnetic field, temperature, stress, etc. 360 pp., 6 x 9, illus., cloth, \$17.20. Circle the reader-service number to order a 15-day examination copy.

CIRCLE NO. 173



HAYDEN BOOK COMPANY, INC., 50 Essex St., Rochelle Park, N.J. 07662

classified
and
recruitment
ads

HERMETIC SEALING

Connectors • Headers • Relay Bases
Terminals • Custom Seals • Testing
Glass/Ceramic To Metal • Since 1959

DETORONICS CORPORATION

10660 E. Rush • S. El Monte, CA 91733
(213) 579-7130 • TWX 910-587-3436

CIRCLE NO. 243

**UNUSED WIRE AVAILABLE ON ORIGINAL REELS
NATIONAL CABLE CO.**

3800' NX 1524J 700' NX 5245J

CAROL

2500' 16-3 STO 600V E-27520 VINYL
750' 16-3 600V RUBBER COVERING

IF INTERESTED CALL
GREYHOUND COMPUTER CORP.
EL PASO, TEXAS • 915-544-2700

**Help college
help you.**

Businesses like yours gave over \$340,000,000 to higher education last year.

It was good business to do so. Half of all college graduates who seek work go into business. The more graduates there are, and the better educated they are, the more college serves the business community.

Your money was vital to colleges. It relieved financial pressures, made planning more flexible, and contributed to the kind of basic and applied research that puts new knowledge and technology at the service of industry.

So that colleges can continue to help you, give to the college of your choice now. For information on ways to do it, please write on your letterhead to Council for Financial Aid to Education, Inc., 6 East 45th Street, New York, N.Y. 10017. Ask for the free booklet, "How Corporations Can Aid Colleges and Universities."



Council for Financial Aid to Education, Inc.

Advertising contributed for the public good.



Electronic Design

Advertising Sales Staff

Tom W. Carr, Sales Director

Rochelle Park, NJ 07662

Robert W. Gascoigne
Daniel J. Rowland
(Recruitment, Quick Ads, Classified)
50 Essex Street
(201) 843-0550
TWX: 710-9990-5071

Philadelphia

Thomas P. Barth
50 Essex Street
Rochelle Park, NJ 07662
(201) 843-0550

Boston 02178

Gene Pritchard
P.O. Box 379
Belmont, MA 02178
(617) 489-2340

Chicago 60611

Thomas P. Kavooras
Berry Conner, Jr.
200 East Ontario
(312) 337-0588

Cleveland

Thomas P. Kavooras
(Chicago)
(312) 337-0588

Los Angeles 90045

Stanley I. Ehrenclou
Burt Underwood
8939 S. Sepulveda Boulevard
Suite 510
Los Angeles, CA
(213) 641-6544

San Francisco 94022

P. O. Box 1248
Los Altos, CA
(415) 965-2636

London, Amsterdam, Tokyo, Seoul

John Ashcraft
12, Bear St.
Leicester Square
London WC2H 7AS England
Phone: 01-930-0525

W. J. M. Sanders

John Ashcraft & Co.
Herengracht 365
Amsterdam C., Holland
Phone: 020-24-09-08

Haruki Hirayama

Electronic Media Service
5th Floor, Lila Bldg.,
4-9-8 Roppongi
Minato-ku, Tokyo, Japan
Phone: 402-4556

Cable: Electronicmedia, Tokyo

Mr. O-kyu Park, President
Dongbo Int'l Corp.—
World Marketing
C.P.O. Box 4010
Seoul, Korea
Tel. 76-3910/3911
Cable: DONGBO SEOUL
Telex: EBKOREA K27286

The Ultimate in Ignition Systems!

★ **ELIMINATES BREAKER POINTS.**
Perfect Timing and Dwell never change!

★ **Eliminates Tune-ups.**
Never wears out or needs any Maintenance.



★ **The Most Advanced
"OPTO-ELECTRIC SYSTEM"**

● The Allison Breakerless System eliminates the Points and Condenser, replacing them with an Opto-Electronic Trigger, using a Light-Emitting Diode and Phototransistor. Also completely eliminates wiper-arm "friction" wear. The only "TRUE" Electronic Ignition... that you can install for under \$100. Gives 40-times more Timing Accuracy than ANY system using mechanical Breaker-Points! Unlimited RPM Smoother running. (No timing fluctuation as with Magnetic units) Unaffected by Temperature, Moisture, or Vibration! All Solid-State Components Easier Starting under any condition! Increased Horsepower. Sparkplugs last longer. Perfect timing increases engine Efficiency and Gas Mileage up to 30%!

● **Quick and Easy Installation!**

★ **Tested and Proven reliability.**

Only **\$49.95** ● **SATISFACTION GUARANTEED!**

● Complete. ● **1-YEAR FACTORY WARRANTY.**

(State Make, Year, Engine Size). (Calif. Res. add Tax).

● **CONVERT YOUR "C-D" UNIT TO BREAKERLESS!**
"TRIGGER-UNIT" ONLY \$34.95

★ **Send Postcard for FREE BROCHURE Today.**

ALLISON AUTOMOTIVE CO.

P. O. Box 881-F, TEMPLE CITY, CAL. 91780

INFORMATION RETRIEVAL NUMBER 81



**WHEN
THE BLOCK
READS
"DIGITAL DISPLAY"**

**...don't get
involved!**

Let us fill the block for you.

When your lead time is short, our off-the-shelf PDC series display module can save you time and money on moderate volume or prototype applications. We have modules in a wide range of digit sizes. They include LED, incandescent, and seven-segment numeric as well as dot-matrix alphanumeric. They're pre-wired for BCD logic and are ready to mount to your panel with just two screws. Ask for our catalog.

In fact, contact us whatever the requirements of that digital display block may be; we also design and produce custom systems. We are digital display specialists and thrive on involvement.

Precision Dynamics Corporation

3031 Thornton Ave. • Burbank, CA. 91504
(213) 845-7606

INFORMATION RETRIEVAL NUMBER 82

Advertiser's Index

Advertiser	Page	Advertiser	Page	Advertiser	Page
Abbott Transistor Laboratories, Inc.	6	Hamlin, Incorporated	82	*Philips Electronic Components and Materials	43
Acopian Corp.	66	Hayden Book Company, Inc.	118	Photo Research, A Division of Kollmorgen Corporation	103
Ailtech, A Cutler-Hammer Company	57	Hayden Mail Order	59	Power/Mate Corp.	121
Alco Electronic Products, Inc.	87	Heath Company	17, 18, 19	Potter & Brumfield, Division of AMF Incorporated	40
Allen Bradley Co.	34	Heinemann Electric Company	31	Precision Dynamics Corporation	119
Allison Automotive Co.	119	Hewlett-Packard	68, 69	Precision Monolithics, Incorporated	91
Amerace Corporation, Control Products Division	14, 15				
American Technical Ceramics	107	Intech, Incorporated	104	RCA Solid State	Cover IV
Analogic Corporation	35	Intel Corporation	4, 5, 78, 79	Reader Service Card	122A, 122B
Angstrom Precision, Inc.	110	Interdata, Inc.	12, 13	Rental Electronics, Inc.	20
		Interface, Inc.	96	Repcor, Incorporated	101
		International Electronic Research Corporation	109	Robinson Nugent, Incorporated	72, 73
Belden Corporation	10, 11	International Rectifier, Crydom Division	34A	Rogers Corporation	121
Bendix Corporation, The, Electrical Components Division	29	International/Microtronics Corporation	117		
Bourns, Inc., Trimpot Products Division	83	Interstate Electronics Corporation	9	Schauer Manufacturing Corp.	102
Buckbee-Mears Company	115			Siliconix, Incorporated	43
		Johanson Manufacturing Corp.	32, 121	Simpson Electric Company	52
				Sinclair Cambridge	59
Clare-Pendar	33			Solid State Scientific, Inc.	65
Coto Coil Company, Inc.	117	Keithley Instruments, Inc.	95	Soliton Devices, Inc.	100
Council of Financial Aid to Education, Inc.	119	Kepeco, Inc.	36	Spectral Dynamics Corporation	118
Crown International Inc.	111	Kurz-Kasch, Inc.	87	Sprague Electric Company	105
				Systron-Donner	109
Dale Electronics, Inc.	Cover II			TRW RF Semiconductors, And Electronic Components Division of TRW, Inc.	34D
Dana Laboratories, Inc.	24, 25	LH Research, Inc.	2	Technitrol, Inc.	115
Dialight Corporation	64	Litronix, Inc.	74, 75	Tektronix, Inc.	81
Digi-Data Corporation	111			Teledyne Crystalonics	121
Duncan Electronics, Subsidiary of Systron-Donner	80			Triplett Corporation	89
				Tucker Electronics Company	96
				Universal Data Systems	39
EMM Semi, A Division of Memories & Magnetics Corporation	98, 99	Mini-Circuits Laboratory, A Division of Scientific Components Corp.	23		
Electro Space Fabricators	121	Modular Power, Inc.	121	Vactec, Inc.	Cover III
*Electronic Design	66	Modutec, Inc.	121	Valcor Engineering	121
		Motorola Semiconductor Products Inc.	1, 70, 71, 76, 77	Varo Semiconductor, Inc.	108
		MuRata Corporation of America	96	Vero Electronics, Inc.	115
				Victor Electric Wire & Cable Corp.	16
				Viking Industries, Inc.	93
Fairchild Systems Technology, A Division of Fairchild Camera and Instrument Corporation	53	National Semiconductor Corporation	34B, 34C	Vishay Resistive Systems Group	58
				Watkins-Johnson	8
General Radio Company	106			Weber Technical Products	51
Gold Book, The *20, *34, 112, 113, 122		Oak Industries, Inc.	42	Weston Components	96
Gulton Industries, Inc.	121	*Oscilloquartz, S. A.	34		
		Optron, Inc.	7		

*Advertisers in non-U.S. Edition.

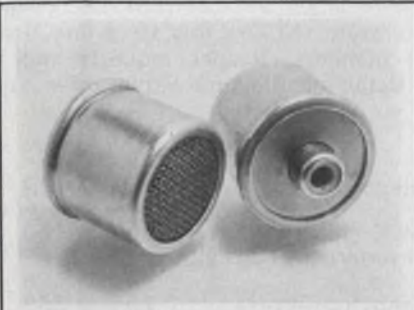

New ultrasonic transducer transmitters and receivers... team up for low cost, high reliability remote control switching, event counting, gas leak detection, acoustic surveillance and experimentation from 26KHz to 40KHz. Gulston Industries Inc., Electronic Components Div., 212 Durham Ave., Metuchen, NJ 08840 (201) 548-2800.

INFORMATION RETRIEVAL NUMBER 601

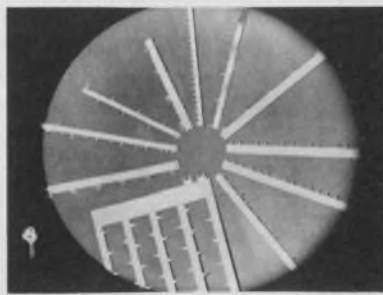

Mini/Bus® Evaluation Kit, \$25, in stock. Lets you try Rogers' low-cost, noise attenuating, high packaging density power distribution system for PC boards. Millions in use. Standard parts on 2 weeks delivery, or less! Customer parts 4 to 6 weeks delivery. Rogers Corporation, Chandler, Ariz. 85224. Phone (602) 963-4584

INFORMATION RETRIEVAL NUMBER 604



Thin-Trim variable capacitors provide a reliable means of adjusting capacitance without abrasive trimming or interchange of fixed capacitors. Series 9401 has high Q's and a range of capacitance values from 0.2-0.6 pf to 3.0-12.0 pf and 250 WVDC working voltage. Johanson Manufacturing Corporation, Boonton, New Jersey (201) 334-2676.

INFORMATION RETRIEVAL NUMBER 607

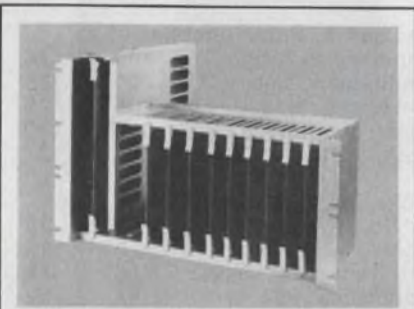

FREE VALUE ANALYSIS—Improve P.C. card rack design and reduce costs with Electro-Flex packaging. Our design group will do it all for you. No limitations on size, card spacing, connector or back plane mountings. Send prints or sample rack at no obligation to Electro-Space Fabricators, Inc., Centre Avenue, Tipton, Pa. 19562. (215) 682-7181.

INFORMATION RETRIEVAL NUMBER 602



High style low cost panel meters/indicators. Modutec's new M-Series in many types & ranges, 1" to 3 1/2", four styles including edge-reading. Sophisticated moving magnet mechanism is rugged, has exceptional ballistics and 5% full-scale accuracy (3% optional). Catalog MM115 from Modutec, Inc., 18 Marshall St., Norwalk, CT 06854 (203) 853-3636.

INFORMATION RETRIEVAL NUMBER 605

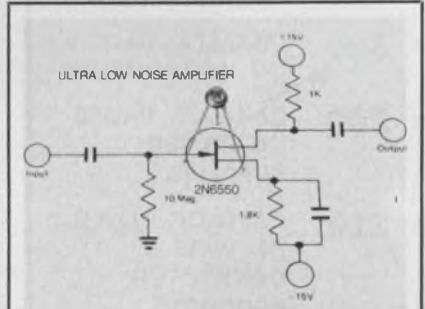

Ultra Low Noise Fet None quieter— $2nV/\sqrt{Hz}$ at 1 kHz—our 2N6550 silicon N-Channel junction FET gives highest G_m available, improved A_v , high I_{DSS} within a 10-250mA range and low output impedance. "Data in short transistor catalog." Samples. Prices: 100-999, \$10. Teledyne Crystals, 147 Sherman St., Cambridge, MA 02140. (617) 491-1670

INFORMATION RETRIEVAL NUMBER 608

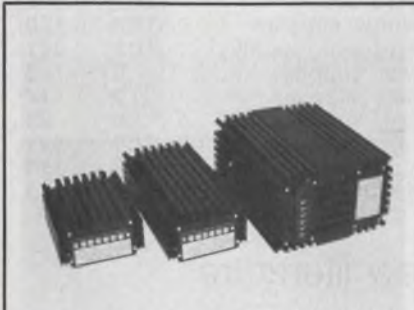

Logic and Linear DC Supplies available with single and multiple outputs ranging from 5V to 28V and currents to 25A. Line reg. is 0.05%, load reg. 0.1%. Features Internal OVP (STD on 5V), current fold-back, floating outputs. 220VAC input optional. 16 models in stock. Modular Power Inc., 4818 Ronson Ct. San Diego, CA 92111 (714) 279-1641

INFORMATION RETRIEVAL NUMBER 603

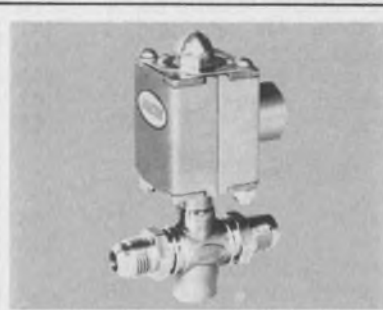

Cryogenic Solenoid Valves. New all stainless steel construction. Unique design provides high flow, long life and extreme reliability at temperatures down to $-423^{\circ}F$. All joints heliarc welded. Metal to metal seating. Coil suitable for 50,000 hours of operation. Valcor Engineering Corp., 5382 Carnegie Ave., Kenilworth, N.J. 07033 (201) 245-1665.

INFORMATION RETRIEVAL NUMBER 606



Free catalog of 34,500 power supplies from the worlds largest manufacturer of quality Power Supplies. New '74 catalog covers over 34,500 D.C. Power Supplies for every application. All units are UL approved, and meet most military and commercial specs for industrial and computer uses. Power Mate Corp. (201) 343-6294.

INFORMATION RETRIEVAL NUMBER 609

A GOLD MINE OF INFORMATION & DATA

- **520** CATALOG PAGES ON ICs & SEMICONDUCTORS
- **300** CATALOG PAGES ON INSTRUMENTS
- **290** CATALOG PAGES ON POWER SUPPLIES
- **210** CATALOG PAGES ON WIRE & CONNECTOR PRODUCTS
- **150** CATALOG PAGES ON SWITCHES
- **2800** CATALOG PAGES ALL TOLD IN 52 PRODUCT CATEGORIES

Electronic Design's GOLD BOOK puts the entire electronics industry at your fingertips. Use it for product search, selection, specification and purchase. It's the most thorough industry master catalog & directory ever compiled.

When you need Information . . .

Electronic Design's

GOLD BOOK IS THE PLACE TO LOOK

Product Index

Information Retrieval Service. New Products, Evaluation Samples (ES), Design Aids (DA), Application Notes (AN), and New Literature (NL) in this issue are listed here with page and Information Retrieval numbers. Reader requests will be promptly processed by computer and mailed to the manufacturer within three days.

Category	Page	IRN	Category	Page	IRN
Components			CMOS chip	100	60
capacitors	114	351	converter, 3-1/2 digit		
couplers	III	254	a/d	43	28
indicators	64	35	Darlington arrays	108	339
liquid crystal displays	82	46	demodulator	108	337
load cell	96	58	MECL	71	39
piezo igniter	114	348	multiplier/divider	108	336
pilot indicator	87	49	NMOS RAM	77	42
pilot lights	87	50	peripheral adapter	108	338
potentiometers	80	44	RAM, 4-k	79	43
potentiometers	83	47	shift register	107	340
potentiometers	96	56	static RAM, 4-k	98	59
proximity switch	114	347			
rf chip capacitors	107	67	Microwaves & Lasers		
readout, numerical	114	352	power oscillator	57	32
reed relays	117	79	rf links	101	61
relays, solid-state	40	26			
resistor cross-reference	II	251	Modules & Subassemblies		
resistors	8	7	amplifier, isolation	104	326
resistors	110	71	conditioner, signal	104	325
switch, snap-action	114	349	converters, d/a	105	328
switches, thumbwheel	114	350	driver, multimode	105	329
switchlights	33	21	filters, active	104	327
transformers	115	74			
			Packaging & Materials		
Data Processing			air flow systems	51	29
mag tape transport	111	73	cable	16	13
mega mini	13	11	card frames & racks	115	76
minicomputer	106	333	connectors, PC	93	52
modem, data	107	335	filter connectors	29	18
multiplexer, line	106	331	heat-shrinkable tubing		
printer, column	107	334	(NL)	116	363
printer, serial	106	332	heat sinks	109	70
processor, parallel	106	330	IC package	97	301
programmable calculator	81	45	pure metal anodes	99	305
			sockets, DIP	73	40
			solvent	99	304
			wire, cable and cord	11	9
Discrete Semiconductors					
diodes, p-i-n	111	346	Power Sources		
interrupter, optical	110	344	current source	103	324
LED/IC	75	41	lab supply	102	303
multipliers	108	68	modular supplies	102	320
optoelectronic assemblies	7	6	open-frame supply	102	321
photodiode, UV sensing	110	341	power supplies	6	5
rectifiers, fast	111	345	power supplies	19	14
suppressor, transient	110	342	power supplies, dc	36	24
transistors, power	110	343	programmed supplies	103	322
zeners	102	62	supplies, high-voltage	103	323
			switching power supplies	2	3
Instrumentation					
counter	100	306	new literature		
DMM	95	53	display monitors	116	365
DPM	101	308	electronic kits	116	353
function generator	9	8	heat-shrinkable tubing	116	363
instrument catalog	96	57	interconnection test		
lab instrument	109	69	system	116	354
logic probes	87	48	panel meters	116	356
measurement system	100	302	rotary switches	116	362
photometer systems	103	63	solenoids	116	361
power amplifier	111	72	switchlights	116	359
power meter	100	307	VOMs	116	357
scope	69	38			
synthesizers	106	66			
Integrated Circuits					
ac detector	104	64			

VACTEC Couplers

For putting it together, VACTEC is second only to RODIN*.

Vactec Optical Couplers (T.M. Vactrols) put together incandescent lamps, neon lamps or LEDs with photoconductors or phototransistors in a wide variety of packages and capabilities.

Couplers using photoconductive cells are useful for isolation where speed requirements are in the order of milliseconds. Applications include noiseless switching, noiseless potentiometers, signal modulators for audio, triac firing, and low cost RMS regulators.

Couplers using LEDs and phototransistors or photodarlington provide higher speed for output sensing, input driving, interfacing and coupling, solid state relays, and switching.

VACTEC really does put them together—we make our own photoconductive cells, phototransistors and photodarlington and do the assembly at our only factory near St. Louis. Write for all Vactrol bulletins.

*Reproduction of The Kiss by Rodin.



Vactec, Inc.
2423 Northline Industrial Blvd.
Maryland Heights, Mo. 63043 U.S.A.
(314) 872-8300

What's new in solid state ...

First feedback on our CA3130 op amp: "Great." "Super." "Terrific."

Engineers who expressed an interest in the RCA CA3130 received data and a free sample. Plus a reply card that asked for reactions to its characteristics.

The response? Enthusiastic! About ¾ of the first returns carry words like Great. Super. Very good. Terrific. Better than the industry standard. Some respondents used such terms to describe *all* of the CA3130's major characteristics. The second largest group used words like Good, Nice, Useful or Okay. A small group—less than 10%—didn't find it ideal for their application.

This wide acceptance of the CA3130 isn't really a surprise. We combined MOS/FET, bipolar

and COS/MOS to give you a good measure of the most wanted characteristics. Typical: Input resistance of $1.5 T\Omega$ ($1.5 \times 10^{12}\Omega$). 110 dB signal voltage gain. 22 mA output current. 10 V/ μ sec



slew rate. Wide voltage swing on single supply. Now, those who have tried the CA3130 confirm its usefulness.

If you're interested, mail the coupon and we'll send you a free CA3130 and data. For more information, contact your local RCA Solid State distributor. Or RCA.

Write: RCA Solid State, Box 3200, Somerville, New Jersey 08876; Ste. Anne de Bellevue 810, Canada; Sunbury-on-Thames, U.K.; Fuji Bldg., Tokyo, Japan.

RCA

Mail to: RCA Solid State, Box 3200, Somerville, N.J. 08876
Please send a free CA3130 sample and data to:

NAME _____	TITLE _____	
FIRM _____		
ADDRESS _____		
CITY _____	STATE _____	ZIP _____
My usual contact with RCA is <input type="checkbox"/> RCA salesman <input type="checkbox"/> RCA Solid State distributor		
My RCA Solid State distributor is _____		
Intended application for CA3130 _____		
Possible quantities needed _____		

RCA. Full house in Linear ICs.