

Electronic Design[®] 21

VOL. 22 NO.

FOR ENGINEERS AND ENGINEERING MANAGERS

OCT. 11, 1974

ICs make motors move. SCRs have been built into monolithic integrated circuits for control of small motors. Power Darlington transistors have paved the way for the use

of transistors in precision motor control. For programming, ROMs are entering the picture. Get an inside view of the growing role of semis in motors, turn to p. 38.

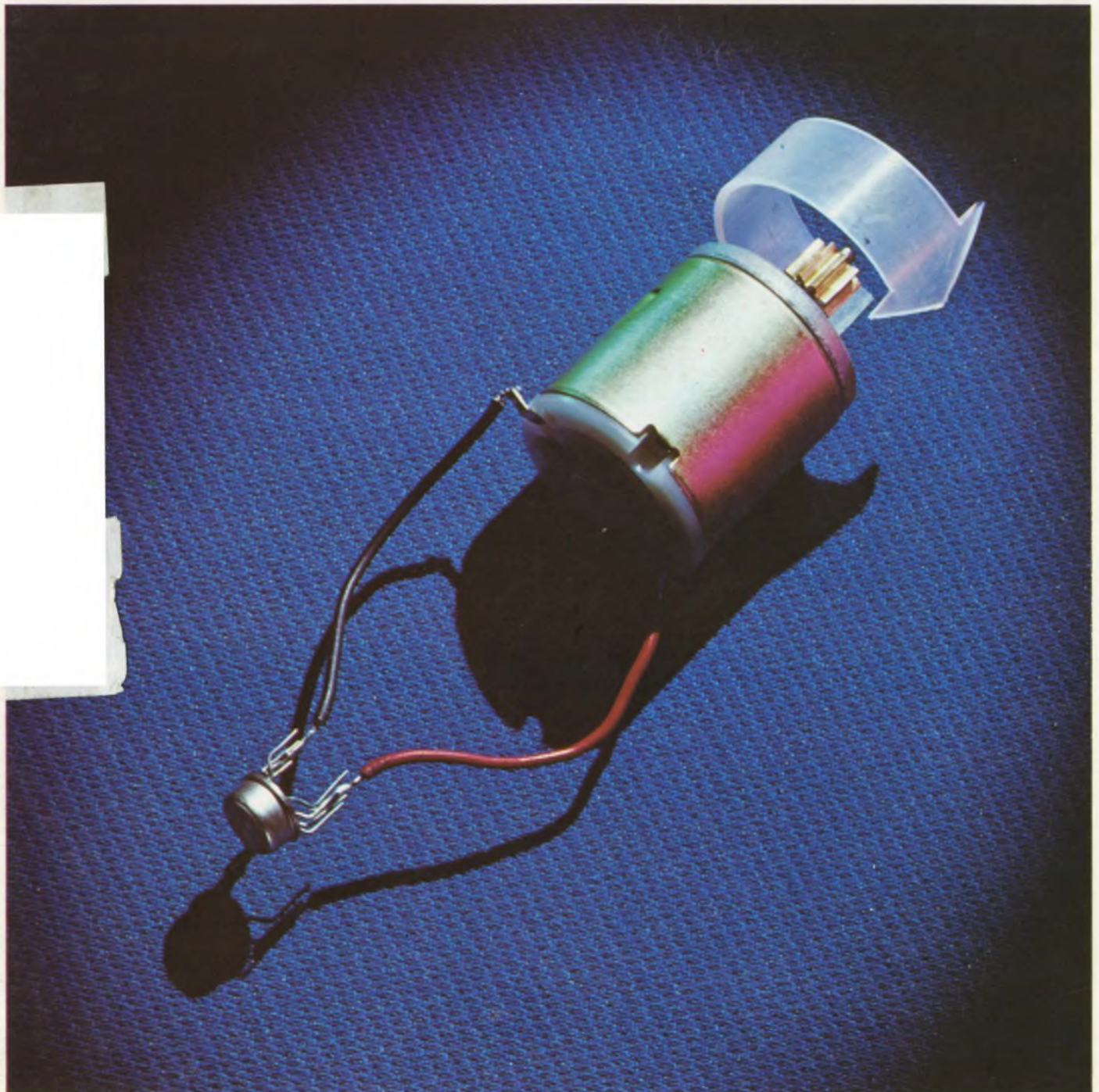

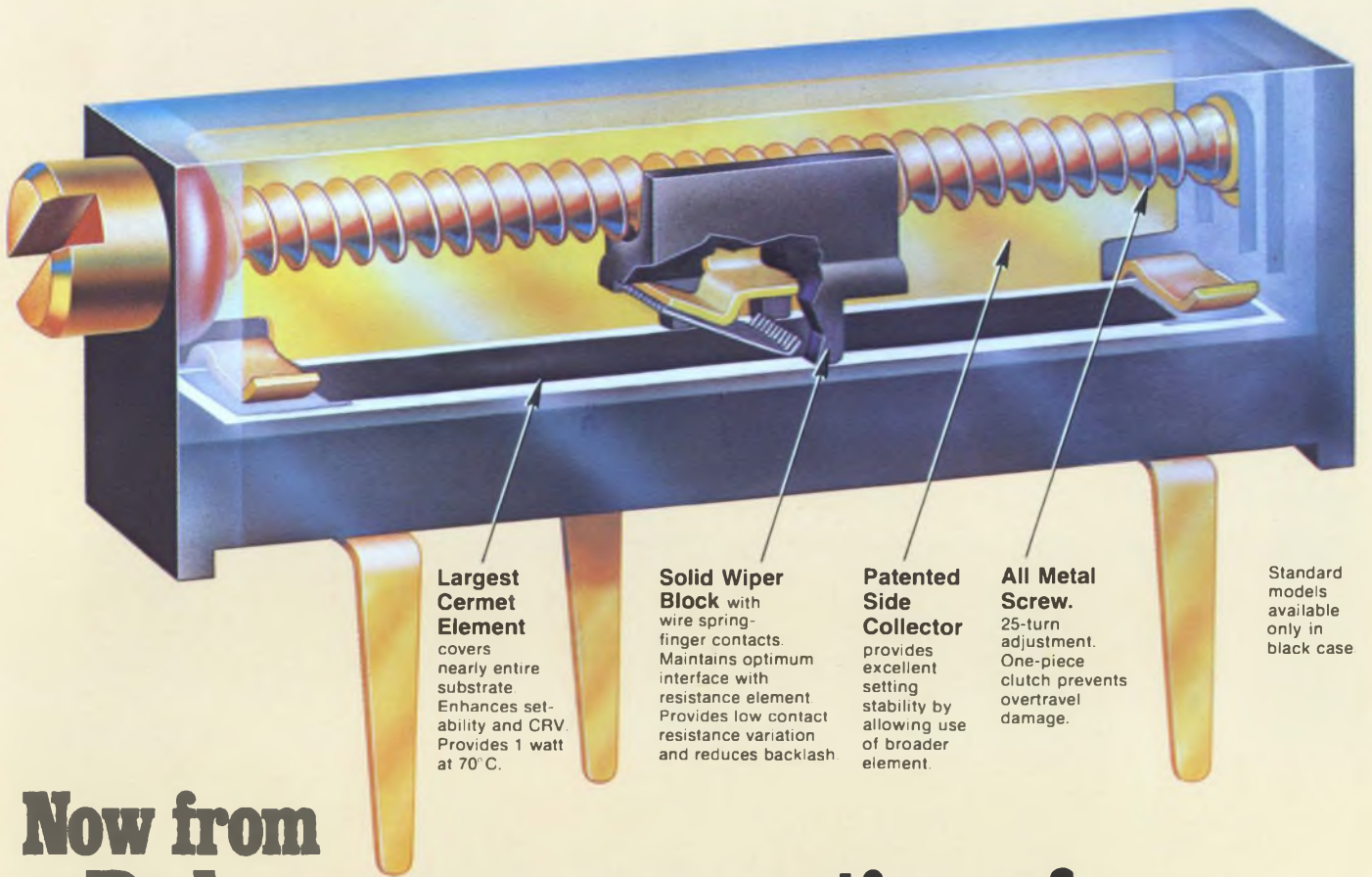

Largest Cermet Element covers nearly entire substrate. Enhances set-ability and CRV. Provides 1 watt at 70°C.

Solid Wiper Block with wire spring-finger contacts. Maintains optimum interface with resistance element. Provides low contact resistance variation and reduces backlash.

Patented Side Collector provides excellent setting stability by allowing use of broader element.

All Metal Screw. 25-turn adjustment. One-piece clutch prevents overtravel damage.

Standard models available only in black case

Now from Dale...a new generation of Low Profile Trimmers

Dale's new 700 Series gives you the best combination of production and performance advantages ever offered in a .250" low profile package. Choice of Cermet or Wirewound Element...plus good delivery and low price.

Better Adjustability: Cermet models provide output resistance of $\pm 0.10\%$ and output voltage ratio of $\pm 0.05\%$.

Higher Power: All models offer 1 watt power dissipation at 70°C.

Low T.C.: 100 PPM for all cermet models, 50 PPM for wirewound.

Low Noise: Cermet models with 3% contact resistance variation standard (1% available). Wirewound models have equivalent noise resistance of 100 ohms max.

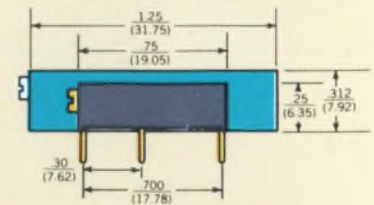

Improved package density

3 standard pin spacings allow fast interchange with many larger models.

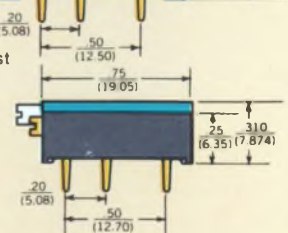
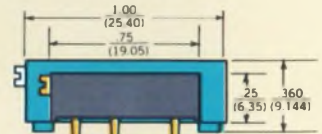

99 cents each in 1,000 quantity
Call today...
402-564-3131



DALE ELECTRONICS, INC.
 1300 28th Avenue, Columbus, Nebr. 68601
 In Canada: Dale Electronics Canada Ltd.
 In Europe: Dale Electronics GmbH
 8 Munchen 60, Falkweg 51, West Germany

A subsidiary of The Lionel Corporation

Our complete product line can be found in *Electronic Design's GOLD BOOK*.

THE FAMILY THAT PLAYS TOGETHER.

Compatibility.

You rarely see it on an RFQ.

Nobody talks much about it.

End users couldn't care less about it.

But the pros know. Volume users who have been the computerization route can tell you all about it.

A lot of them got smart the hard way when somebody sold them stripped-down end-user mini-computers. And end-user software.

They looked a lot like our NAKED MINI[®] hardware and software. Stripped down price included. Impressive specs, too. But let's face it, mainly it was a big name that impressed the buyer.

But if you're going to put your faith somewhere, it had better be in hardware and software designed expressly for product computerization. Because you're going to live with them for a long, long time. For better or worse.

What's the difference?

Plug-in interchangeability, for one thing. The NAKED MINI has it. No fine-tuning, adjustments, or calibrations. You pull out the old one and put in the new one. Just like a light bulb.

That's the way it has to be. Volume users can't afford to fiddle around with a system out in the field.

Profits won't hold still for it. And neither will the customer.

OEM-unique software, for another. Like our new FORTRAN IV which generates optimized programs to minimize run-time size. So you don't end up paying for more memory than you really need.

There's an even bigger difference. The entire family of NAKED MINI's are totally compatible. Which means, simply, that when your product changes (and it will), you can easily change to a different machine. Faster or slower. Bigger or smaller. For example, the lowest cost LSI-1, or the twice as fast LSI-2/10, or the four times as fast LSI-2/20. Or our brand new LSI-2/25 with special features for business and communication processing.

The mechanical interface is the same on all of our machines. The original programming will still work.

We've always built our machines and software that way. We always will.

Because we understand the problem.

 **ComputerAutomation**

Naked Mini-Division

18651 Von Karman

Irvine, California 92664 (714) 833-8830

INFORMATION RETRIEVAL NUMBER 2



RF switching to 500 MHz in a TO-5 package



RF circuit and packaging engineers are discovering that Teledyne TO-5 relays make excellent subminiature rf switches for frequency ranges up through UHF. Their reasons are: inherently low inter-contact capacitance and low loss contact circuit geometry. Typical rf performance: Isolation — 45db at 100 MHz, 35db at 500 MHz;

Insertion Loss — 0.2db at 100 MHz, 0.4db at 500 MHz.

And Teledyne Relays offer the widest possible selection: MIL relays in SPDT & DPDT standard, sensitive, and maglatch types, all available with internal diodes; commercial models in DPDT standard and sensitive types, also available with internal diodes. All Teledyne TO-5 relays feature hermetic sealing, gold plated contacts, and all welded construction for high reliability.

For Transmit/receive switching in hand-held transceivers or any low power remote band switching application, Teledyne TO-5 relays are an excellent choice. No other relay offers this combination of rf performance, low coil power dissipation, and small package size.

And they're **in stock** at your local Teledyne Relays distributor.



 **TELEDYNE RELAYS**

3155 West El Segundo Boulevard, Hawthorne, California 90250
Telephone (213) 973-4545

INFORMATION RETRIEVAL NUMBER 3

NEWS

- 23 **News Scope**
- 38 **ICs and transistors** provide brain and muscles for motor control.
- 48 **Lower atmosphere to be studied** by sensors on manned balloon.
- 52 **Heads-up laser-hologram display** gives fliers a wider field of view.
- 57 **Washington Report**
- 66 **International Technology**

TECHNOLOGY

- 68 **Shock and vibration transducers:** These devices offer many simple solutions to measurement problems. But you must understand how they work to use them properly.
- 78 **Aluminum electrolytics are hard to beat** for large capacitance in a small package and at low cost. But electrolytics are far from being ideal capacitors.
- 86 **Bypass multivariable Karnaugh maps.** This CAD program minimizes logic networks with up to nine variables, prints out both function and complement.
- 94 **For those bigger n-flops,** reach for decoders, ROMs or PLAs. These building blocks, connected in a tree structure, let you design with a minimum of hardware.
- 104 **Explore the lock-in amplifier.** With it, you can measure the ultra-low distortion components of a "linear" signal, and at super-high effective Qs.
- 112 **Measure power with a calculator chip** and a DPM. By direct multiplication of current and voltage, you can cover a dynamic range of almost seven decades.
- 118 **Diversity keeps engineers on their toes,** especially if they work for a small company that's competing in three markets with one basic product.
- 124 **Ideas for Design:** Inductance calculation simplified for small air-wound coils . . . Boost transistor-level supply voltages to make a low-power, high voltage supply . . . Burst of preset number of pulses obtained with easily expanded circuit . . . Differentiator circuit monitors stability of slowly changing dc signals . . . Precision timer can be used to make a stable, adjustable crowbar driver.

PRODUCTS

- 133 **Data Processing:** Mini addresses up to 1 Mword without increase in cycle time.
- 138 **Modules & Subassemblies:** V/f converters maintain specs while prices drop.
- 146 **Integrated Circuits** 166 **Packaging & Materials**
- 150 **Microwaves & Lasers** 172 **Components**
- 158 **Power Sources** 174 **Discrete Semiconductors**
- 160 **Instrumentation**

Departments

- 65 **Editorial:** Saying can make it so
- 7 **Across the Desk** 187 **Bulletin Board**
- 178 **Design Aids** 190 **Advertisers' Index**
- 178 **Application Notes** 192 **Product Index**
- 179 **Vendors Report** 194 **Information Retrieval Card**
- 180 **New Literature**

Cover: Photo by Mike Pazur and Bruce Hull, courtesy of RCA

Ride down faster with Intel's

Intel's 2107A n-channel 4K RAM family is your ticket to the fastest, smoothest ride down the cost curve for dynamic MOS memories. You can start right now for a mere \$12.

2107A 4K RAM FAMILY				
PART NO.	ACCESS (ns MAX)	READ CYCLE (ns MIN)	WRITE CYCLE (ns MIN)	AVAILABILITY
2107A-8	420	690	970	Now
2107A-4	350	570	840	Now
2107A	300	500	700	Now
2107A-1	280	450	550	Oct.

At only \$12 in 100-up quantities, the new 2107A-8

has already set a new low in 4K RAM prices. It's available now from stock at Intel distributors and in OEM volumes direct from Intel. But if you prefer to begin with only one at \$12, use the ticket.

Your system overhead costs will plunge, too. The 2107A family cuts system overhead costs in half, compared with 1K RAMs.

Furthermore, your system design will stay on the right track — with standard 22-pin packages and standard supplies. The industry has already accepted the 2107A's pin configuration and +5, -5 and +12V supply levels.

That's understandable. The 2107A provides all the system economies of a fully decoded, single clock, TTL compatible, standard voltage 4K RAM. A designer who detours to a 16-pin package to save a little board area, for example, runs into double clocks, extra logic and other drawbacks.

The 2107A allows 32 kilobytes to be stored on one small card which dissipates barely 4 watts.

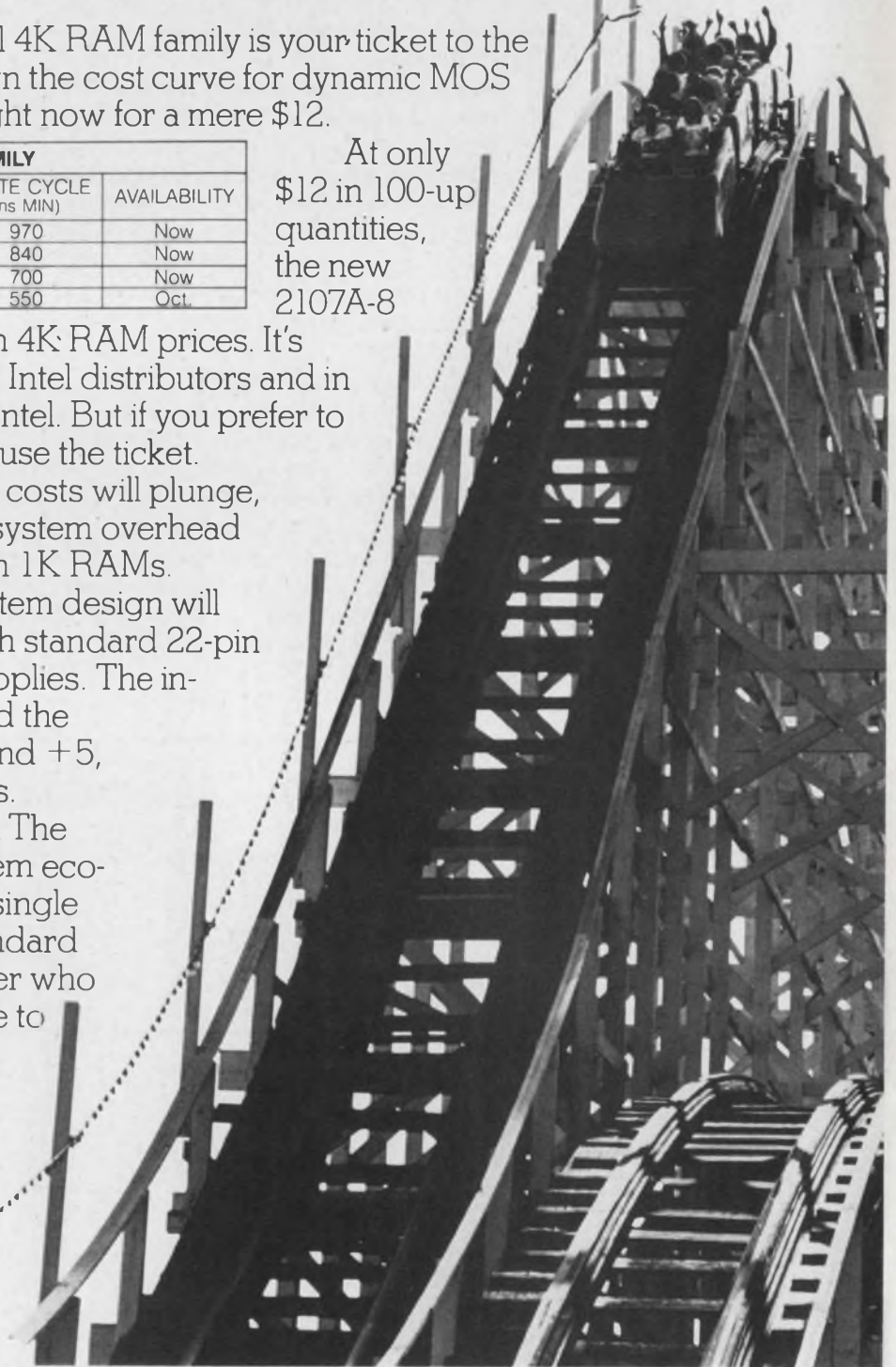

the 4K cost curve \$12 RAM.

In addition this new 4K RAM has been specifically designed for ease of use with battery backup. For systems that require maximum battery life, all versions of the 2107A may be ordered with a special low power data retention option.

Other exciting advantages of the 2107A include a choice of the right speeds, extremely low input capacitance, very comfortable $\pm 1V$ clock margins, readily available support components and, of course, Intel's n-channel production power.

For economical support, Intel's 3210 provides four address drivers and one clock driver in a single package, while Intel's 3404 buffers six output data bits.

Nobody is further along the n-channel production curve than Intel, and nobody makes a smaller 4K RAM chip (which assures you competitive pricing for years to come).

So start off by taking the 2107A-8 ticket to the nearest Intel distributor. It's good for one 4K RAM at \$12. Plus a free 3210 driver as a bonus if you act right now. And write us for the new 2107A application note that shows how to cut system overhead in half. Then, when you're ready to move faster down the memory cost curve, we'll ship you all the 4K RAMs you want at whatever speed you need. Now.

LOW POWER DATA RETENTION OPTIONS		
PART NO.	ACCESS (ns MAX)	STANDBY PLUS REFRESH POWER
2107AL-8	420	1 μ W/bit MAX
2107AL-4	350	1 μ W/bit MAX
2107AL	300	1 μ W/bit MAX
2107AL-1	280	1 μ W/bit MAX

Intel Corporation, 3065 Bowers Avenue, Santa Clara, California 95051 (408) 246-7501. Distributors: Almac/Stroum, Cramer, Hamilton/Avnet, Sheridan Sales.

intel® delivers.







Save 5 Ways with Abbott's New 77% Efficient Power Supplies!

Abbott has a Hi-Efficiency series of power modules that can save 5 ways in your system. The Model "VN" series converts 47-440 Hz AC lines to regulated DC power and uses a new approach in switching technology that provides a highly reliable line of sixty-three high efficiency power modules.

The Model "VN" series saves in the following 5 ways:

- 1 SAVES POWER** — High frequency pulse width modulation and C/MOS digital IC control circuitry allow efficiencies of up to 77% in the Model "VN" series. This high efficiency realizes almost twice the output power per input watt than dissipative regulators.
- 2 SAVES SIZE** — Off line techniques and IC technology combine for packages of 70% less volume compared to dissipative regulators.
- 3 SAVES WEIGHT** — High efficiency means less power dissipated and less heat generated, thereby reducing or eliminating the need for bulky heat-sinking and forced air cooling. This translates into less total weight and smaller system size.
- 4 SAVES TIME** — You can quickly get the power supply you need because we have an extensive line of models to choose from. Outputs of 25, 50 and 100 watts are available at any voltage between 4.7 and 50.0 VDC. With popular voltages in stock, chances are the unit you need is available immediately.
- 5 SAVES MONEY** — At only \$257 for 25w, \$274 for 50w, and \$295 for 100w in small quantities, the "VN's" are among the lowest priced Hi-efficiency units on the market.

Abbott also manufactures 3,500 other models of power supplies with output voltages from 2.7 to 740 VDC and output currents from 4 milliamps to 20 amps. They are all listed, with prices, in the new Abbott Catalog. Included are:

60  to DC
 400  to DC
 28 VDC to DC
 28 VDC to 400 
 12-38 VDC to 60 

Please see pages 581-593 of your 1973-74 EEM (ELECTRONIC ENGINEERS MASTER Catalog) for complete information on Abbott Modules.

Send for our new 60 page FREE catalog.

abbott transistor

LABORATORIES, INCORPORATED
 general offices eastern office

5200 W. Jefferson Blvd./Los Angeles 90016
 (213) 936-8185 Telex: 69-1398

1224 Anderson Ave./Fort Lee, N.J. 07024
 (201) 224-6900 Telex: 13-5332

INFORMATION RETRIEVAL NUMBER 5

Vice President, Publisher
 Peter Coley

Editors

Editorial Offices
 50 Essex St.
 Rochelle Park, N.J. 07662
 (201) 843-0550
 TWX: 710-990 5071
 Cable: Haydenpubs Rochellepark

Editor-in-Chief George Rostky

Managing Editors:

Ralph Dobriner
 Michael Elphick

Associate Editors:

Dave Bursky
 Jules H. Gilder
 Morris Grossman
 Seymour T. Levine
 John F. Mason
 Stanley Runyon
 Edward A. Torrero
 Richard L. Turmail

Contributing Editors:

Peter N. Budzilovich
 Alberto Socolovsky
 Nathan Sussman
 Robert Wollins

Editorial Field Offices

East

Jim McDermott, Eastern Editor
 P.O. Box 272
 Easthampton, Mass. 01027
 (413) 527-3632

West

David N. Kaye, Senior Western Editor
 2930 West Imperial Highway
 Inglewood, Calif. 90303
 (213) 757-0183
 Northe K. Osbrink, Western Editor
 112 Coloma St.
 Santa Cruz, Calif. 95060
 (408) 426-3211

Editorial Production

Marjorie A. Duffy

Art

Art Director, William Kelly
 Richard Luce
 Anthony J. Fischetto

Production

Manager, Dollie S. Vleblg
 Helen De Polo
 Anne Molfetas
 Christopher G. Hill

Circulation

Manager, Evan Phoutrides

Information Retrieval

Peggy Long

Promotion

Manager, Walter G. Salm
 Karen Kerrigan (Reprints)

across the desk

Some eruptions on corruption

As government employees, we took offense at George Rostky's remarks concerning corruption within our ranks ("A Ray of Hope," ED No. 12, Aug. 16, 1974, p. 69). Such corruption may be true of most politicians, but it applies to only a small percentage of the nonpartisan civil-servant force.

As for the monetary remuneration for an article of ours that you accepted, we never assumed that we would receive a check, since we are civil servants and it would be illegal. Publication of the article means more to us than any monetary remuneration.

For the red, white and blue.

Gerald P. Klein

Clark A. Hamilton

U.S. Dept. of Commerce
National Bureau of Standards
Electromagnetics Div.
Boulder, Colo. 80302

Over the years that I've been reading your publication; I have particularly enjoyed your editorials. "A Ray of Hope" hit a responsive note.

I went to work for the Government from private industry, and almost immediately I was struck by one thing: In private industry there is a choice as to whether or not one is going to lie or cheat on one's expense account. But in the Government there is no choice—you must do it to survive.

I was particularly shocked because the agency I worked for—the Census Bureau—has a reputation outside Government circles for probity. But I found that the last thing anyone wanted to do was to save money or do things

more efficiently. For example, the bureau was spending, until recently, about \$380,000 a year to operate some water-cooled, cold cathode-tubed line printers dating to Univac I days. An expenditure of about \$1500 a month would have provided twice the speed and three times the quality.

As a division chief in the computer area, I soon found that I really had no control over anything. I couldn't hire or fire; I had no control over my division's budget.

And over the whole data-processing area lay the omnipresence of the General Services Agency, which may know a good deal about buying toilet paper but absolutely nothing about computers.

So Watergate is no surprise to me. There are literally thousands of parallel baby "Watergates" still in existence, if by Watergate one means a lack of morality in the conduct of what is theoretically the people's business.

Needless to say, I'm no longer with the Census Bureau; I lasted about a year and a half.

Henry Clark

9305 Raintree Rd.
Burke, Va. 22015

I sometimes feel that everybody who works in journalism is a crook. It's probably not true but I get the feeling that integrity and morality simply don't go with journalism. What's really terrible about journalistic corruption is that it corrupts us. A part of us—the sense of justice and ethics and morality—wither and rots.

We are no longer aghast when an editor of a large magazine is kicked out of his office and black-

(continued on page 14)

Electronic Design welcomes the opinions of its readers on the issues raised in the magazine's editorial columns. Address letters to Managing Editor, Electronic Design, 50 Essex St. Rochelle Park, N.J. 07662. Try to keep letters under 200 words. Letters must be signed. Names will be withheld on request.

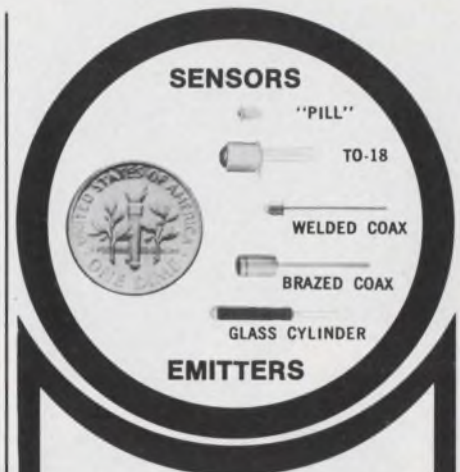

OPTRON OPTOELECTRONIC COMPONENTS

STANDARD DISCRETE PACKAGES
IMMEDIATE DELIVERY
COMPETITIVE PRICING

OPTRON'S competitively priced broad line of standard optoelectronic components range from solid state gallium arsenide emitters to silicon photodiodes, phototransistors, and photodarlingtons. They are immediately available in microminiature "pill," TO-18, welded or brazed coax, and glass cylinder packages.

OPTRON silicon photodetectors are compatible with either tungsten light sources or infrared LED's. The solution-grown epitaxial gallium arsenide LED's offer high efficiency and compatibility with the silicon photodetectors.

All OPTRON discrete components are available in other packages in moderate scale line quantities using standard chips. In addition, these units may be purchased as either standard or custom chips, monolithic arrays, printed circuit board assemblies, or molded assemblies.

Detailed technical information on discrete components and other OPTRON optoelectronic products . . . chips, assemblies and PC board arrays . . . is available from your nearest OPTRON sales representative or the factory direct.



NEW CONDENSED CATALOG

contains technical data on these and other OPTRON products. Request your copy today!



OPTRON, INC.

1201 Tappan Circle
Carrollton, Texas 75006
214/242-6571

SIEMENS

**Dickson
has a big
new name**

Siemens

Dickson Electronics Corporation has merged with Siemens Corporation as the Siemens Components Group. This means that Dickson Zener diodes, TC Zeners, tantalum capacitors and Dickson microelectronic products will now carry the Siemens brand, along with such quality products as Siemens capacitors, diodes, ferrites, flash tubes, surge voltage protectors, relays, switches, electro-optic products, microwave components and other semiconductors. Headquartered in Scottsdale, Arizona, the Components Group will provide local service through an existing organization of Group sales offices, representatives and stocking distributors.

For the phone number of your Siemens Components Group sales office, PHONE TOLL FREE 800-645-9200 (in New York call collect 516-294-0990).

Call us, today, But call us Siemens.

Siemens Corporation
Components Group

P.O. Box 1390, Scottsdale, Arizona 85252
(602) 947-2231 TWX 910-950-1292 Telex 667-406

**NOW. FOUR 1K
RAMS.**

**NMOS, PMOS, TTL and ECL.
And all Isoplanar.**

There are plenty of 1K RAM houses today.

But did you know that only Fairchild offers production quantities of 1K RAMs in all *four principal technologies?*

That's a fact.

Because we make all four *kinds* of 1K RAMs, we make it that much *easier* to choose the exact device that's best for your memory need. Whether it's mainframe or peripheral.

(Just point your finger anywhere on a power/performance matrix, and chances are you'll find it pointing at a Fairchild 1K RAM.)

And no matter which Fairchild device you choose, it'll have our exclusive *Isoplanar* fabrication to save space, maximize performance.

**1103 and 2102
MOS memory.**

For example, if you're looking at lower-cost mainframe memory, we've developed a high-speed (and completely compatible) 1103/1103-1 PMOS that does away with pattern sensitivity problems often found in ordinary 1103's.

And for peripheral memory, we now have our 2102F/2102-1/2102 NMOS series with access times from 350nS to 650nS. All are TTL compatible and require only a single 5V power supply. And all are available in either plastic or ceramic packages, in both commercial and full MIL temp grades.

**93415 and 10415
BiPolar memory.**

For cost-effective high-speed CPU and digital data processing applications, we offer the TTL industry standard 93415. In addition, we have a new low-power version, the 93L415 which combines access time of less than 100nS with power requirements comparable to MOS. Neither version

requires any special clocks, refresh or interface circuits. Both are available in plastic or ceramic 16-pin packages.

For even higher-speed applications, there's our voltage compensated 35nS access time 10415 ECL, the only 1K ECL memory available in quantity today.

And just for the record, we've shipped more TTL and ECL RAM bits than all other

makers put together.

The point is, if you're thinking about memory, this is definitely the time to think about your friendly Fairchild Distributor or Representative.

Give him a call today.

Semiconductor Components Group, Fairchild Camera & Instrument Corp., 464 Ellis St., Mountain View, CA 94040.

Telephone (415) 962-5011.

TWX: 910-379-6435.

Match-up of Fairchild 1K RAMS with typical memory applications

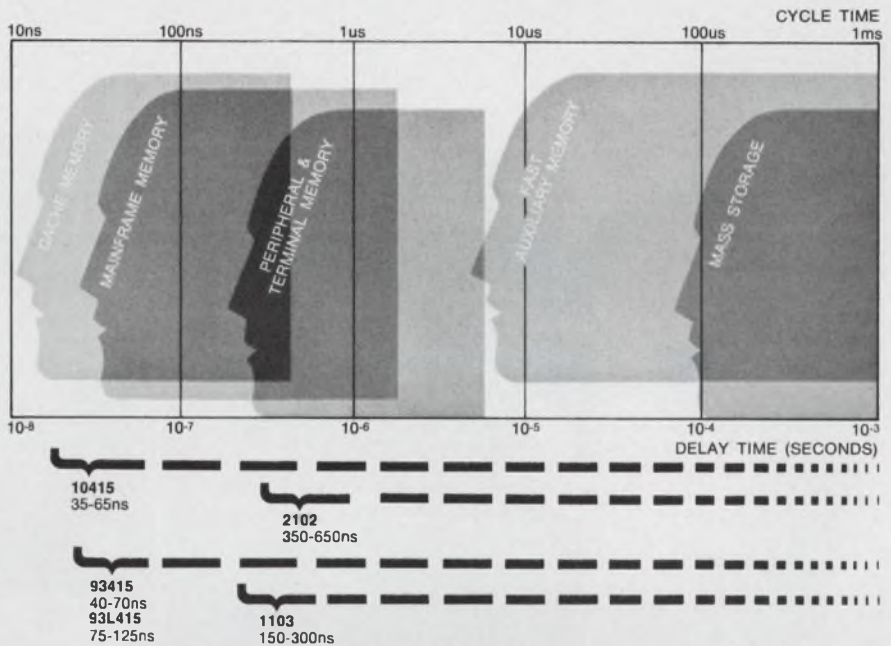

**MADE IN
FAIRCHILD
No.1 for memory.**

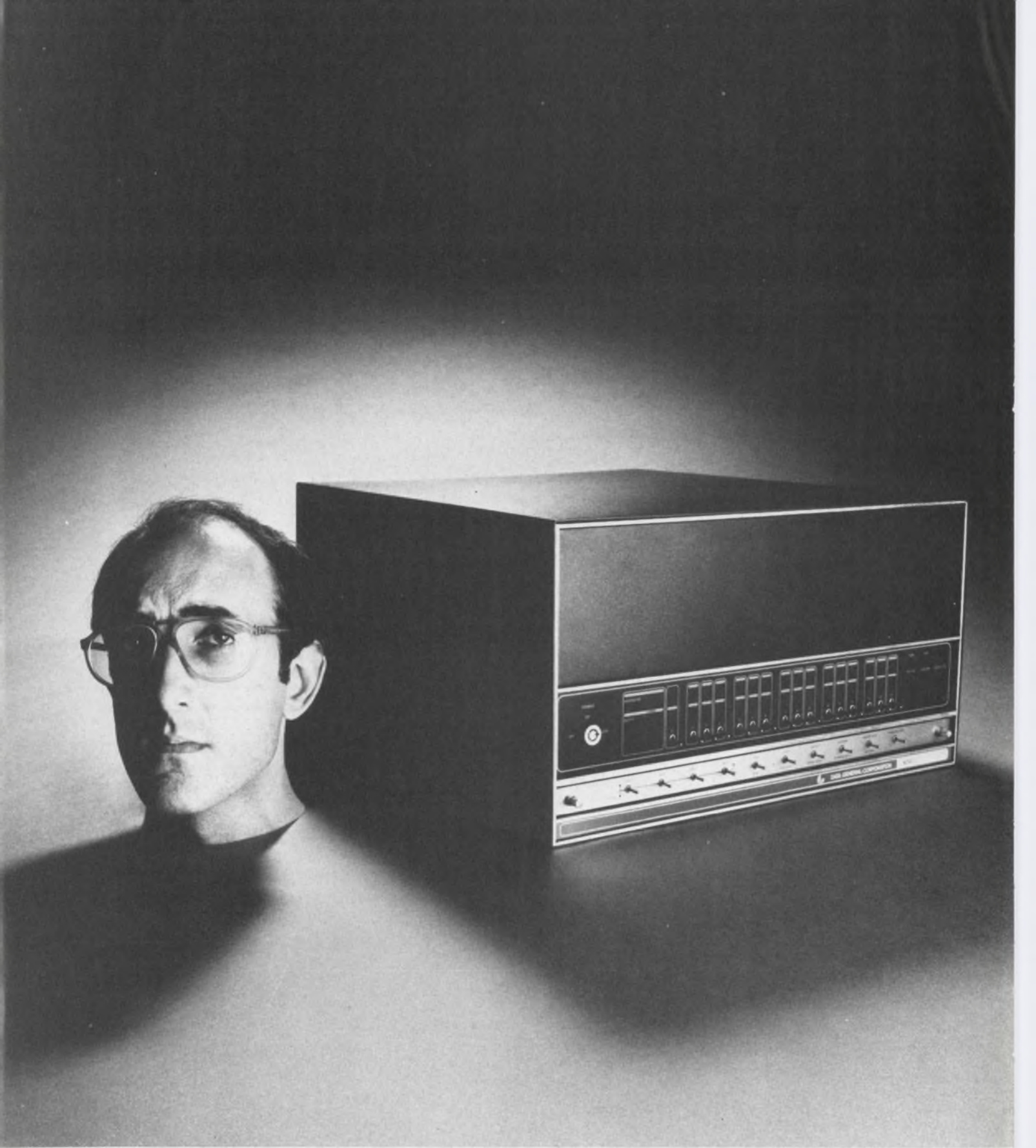

The brain on the left costs four times as much as the brain on the right.

These days, it's costing a lot more to get a computer programmed than it does to get the computer.

So anyone with any sense of proportion is now checking out systems software as carefully as they used to check out hardware.

Which is an idea we'd like to encourage.

Because we've designed our systems software to help you get your programming done faster, easier and for less money.

Our Real-Time Disc Operating System (RDOS) does a lot of work other operating systems expect programmers to do. To create a file named "FRED," for example, all you have to do is type in "CREATE FRED." You don't have to scout around for the best place for the file, or give it an address, or make sure it won't get disturbed. RDOS does all that for you.

And unlike a lot of other operating systems, you don't have to know RDOS inside out to put it to work for you. The commands are simple, straight-forward, easy-to-remember. To run a program named "BRAIN," just type in "BRAIN" (instead of gibberish like !#AREA, 3 @ 1000, 5 @ 2000! BRAIN @ 1000 @ 2000).

As a matter of fact, RDOS is so easy to use that anyone who's ever worked in FORTRAN should be able to develop programs with it.

Write for our brochure: "Software Isn't So Hard to Understand."

You may discover you don't need a lot of brains to write your software.

DataGeneral

The computer company you can understand.

Data General Corporation, Southboro, Massachusetts 01772, (617) 485-9100.
Data General of Canada, Hull, Quebec, J8Y3S6. Data General Europe, 116 Rue de la Tour, Paris 75016 France.
Data General Australia, Melbourne (03) 82-1361/Sydney (02) 908-1366.

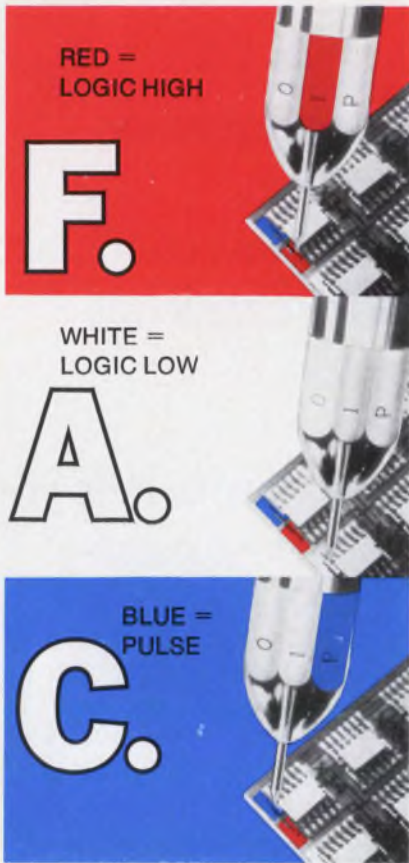

T a new, faster, low cost, digital system that cuts troubleshooting time to minutes ...or seconds.

You'll reduce setup time, increase field service cost efficiency, reduce training time, relieve documentation worries, and best of all speed analysis time, with the new F.A.C.T. system for digital troubleshooting.

Failure Analysis by Color Tracing is an exclusive Kurz-Kasch system. By comparing the color observed on a logic probe with the color marked on a print, schematic or overlay, anyone can troubleshoot digital logic. No decision making is needed. F.A.C.T. does it all. F.A.C.T. is faster than scopes, clips, meters or comparators and displays more information. Its low cost... \$149.50, includes a Kurz-Kasch logic probe and pulser, a protective pocket pouch and a F.A.C.T. software documenting procedure. For FREE literature, 30 day FREE TRIAL probes, or special F.A.C.T. information, telephone Tom Barth, General Manager, (513) 296-0330, 2876 Culver Avenue, Dayton, Ohio 45401.



INFORMATION RETRIEVAL NUMBER 10

ACROSS THE DESK

(continued from page 7)

balled. We aren't outraged when news reporters for some of the most important newspapers and magazines go to jail for perjury or obstruction of justice—or escape with laughably light sentences that would be overly light for a purse-snatcher.

If this statement sounds familiar, it should. These are words paraphrased from your own editorial ("A Ray of Hope," ED No. 17, Aug. 16, 1974, p. 69). Sounds absurd, doesn't it? That's exactly the impact it had on me. Your indictment of all government employees was unjustified, undignified and based upon colossal ignorance and an undeserved sense of self-importance and superiority. There are millions of government employees, outside of politics, without whom this country would suffer. These men and women are as honest and dedicated as any other segment of society, and your allegation that Gerald C. Stoker of Sandia Laboratories is a shining exception is unwarranted. I commend Mr. Stoker only for following regulations.

Finally, Mr. Rostky, I would like to say, it's a good thing you don't work for me. If you did, you wouldn't. Statements like the one you made in your editorial should, at least, deserve an apology.

*Howard M. Forrester
Government Employee*

Research and Development

No address listed

Your editorial "A Ray of Hope" spread a fundamental idea that I agree with entirely. Honesty is a virtue that is easily sold out.

Send a copy of your editorial to every Congressman and Senator, and to the heads of Government departments. Your publication is outstanding in our field. My sincere best wishes for its continued success.

*Abraham M. Fuchs
Vice President*

Bafco, Inc.
7171 Mearns Rd.
Warminster, Pa. 18974

Ironing out 2 wrinkles in the June 21 issue

In "Get High Voltage With Low-Cost Multipliers" (ED No. 13, June 21, 1974), the design example on p. 68 calls for "10 kV pk-pk" voltage, which I assume is peak-to-peak. How then does the output get to be $5 \text{ kV} \times 2 \sqrt{2} = 14.4 \text{ kV}$? The author probably meant to say 10 kV rms!

And in a letter in the same issue of the magazine, "Prof Gives High Mark to Basement Labs," Dr. W.B. Jarzembki says on p. 12 that Dr. Jan Nyboer used cardiograph monitors in the early 40's. The fact is that we at Rohm Instruments built Dr. Nyboer's Plethysmograph in the late 40's, but we designed the first "cardiograph monitor"—our name for a special-purpose oscilloscope—in about 1948 for the Anesthesiology Dept. at the University of Vermont's medical school. It was for use in the operating room, to provide the anesthesiologist with vital data. To my knowledge, this was the first monitor for EKGs and certainly the first commercial version. I was chief engineer at the time and did the electrical/electronic design.

*Walter I. Weiss, Consultant
Measurement and Controls Co.
102 S. Fullerton Ave.
Montclair, N.J. 07042*

Ed. Note: You're right. The 10 kV pk-pk input is wrong. It should be 10 kV rms.

Designer made linearizer for DENELCOR, Inc.

Will you let me know the source of the information for "Digital Method Linearizes Thermocouple Voltages" (ED No. 8, April 12, 1974, p. 118). It seems to be an abstract from *Electronic Letters*, published in Great Britain, where a letter I wrote was published.

Due to some misinterpretation, an error occurred in your article. I developed the digital linearizer for thermocouples for DENELCOR, Inc., Denver, Colo., and not Elektronska Industrija, Belgrade, Yugo-

(continued on page 16)



BOURNS®
New, Low-Cost
Cermet
Trimming
Potentiometer
outperforms
the other
"small-change"
models!

Bourns super cermet performance delivers again. Our new Model 3352 trimming potentiometer handles more power . . . takes more shock and vibration . . . has a lower CRV . . . and is easier to set than, for example, the "Model 91". Naturally, Bourns super cermet performance is comparably priced. You can depend on it.

The 3352 is a 3/8" diameter, single-turn device with an easy (but stable) three-way thumbwheel adjust. It can be wave-soldered, and withstands board washing processes with minimal (1%) TR shift. The 3352 is available TODAY in a variety of pin styles to suit your requirements.

Compare performance . . . specify Bourns Model 3352. For complete details, contact your local Bourns representative . . . or the factory direct.

COMPARE PERFORMANCE

	Model 3352	Beckman Model 91
Power	.75 watts at 40°C	.5 watts at 40°C
Electrical Angle	230°	180°
Adjustability	±0.05%	±0.05%
Torque	5 oz.-in. max.	6 oz.-in.
Shock	100G's max. ±2% VRS	50G's no VRS spec.
Vibration	30G's max. ±2% VRS	10G's no VRS spec.
Contact Resistance Var.	1%	2%
Rotational Life	200 cycles	200 cycles
Temp. Range	-55°C to +125°C	-55°C to +125°C



*Nobody knows more about
trimming potentiometers than we do*



TRIMPOT PRODUCTS DIVISION • 1200 COLUMBIA AVE., RIVERSIDE, CALIF. 92507

Solid Tantalums for Solid Performance

MOLDED, PLASTIC-ENCASED ECONOLINE™ TANTALEX® CAPACITORS

Type 198D

Economically priced. Flame-retardant case has flattened section and polarity indicator for easy-to-read marking and error-free insertion. High volume production-oriented design for efficient assembly. Molded straight-wall case eliminates cracking as well as soldering problems associated with epoxy rundown.



ASK FOR BULLETIN 3546

INFORMATION RETRIEVAL NUMBER 161

EPOXY-DIPPED TANTALEX® CAPACITORS

Type 196D

Low-cost capacitors that utilize high-quality tantalum pellet construction. Dipped coating is hard insulating resin highly resistant to moisture and mechanical damage. Designed for printed circuit board applications. Wide range of capacitance values with voltage ratings from 4 to 50 VDC.



ASK FOR BULLETIN 3545B

INFORMATION RETRIEVAL NUMBER 162

HERMETICALLY-SEALED METAL-ENCASED TANTALEX® TUBULAR CAPACITORS

Type 150D

Polarized units offer high capacitance, long life, low leakage current, low dissipation factor, and high stability. Also available to Spec. MIL-C-39003 as CSR09, CSR13, and CSR23.

Type 151D

Non-polarized capacitors with the same outstanding characteristics as Type 150D units. Also available to Spec. MIL-C-39003 as CSR91.



ASK FOR BULLETINS 3520G, 3520.2A, 3521B, 3521.7

INFORMATION RETRIEVAL NUMBER 163

MOLDED DOMINO® TANTALEX® CAPACITORS

Type 193D

For hybrid circuit and low-profile printed circuit board applications. Offer superior mechanical protection as well as excellent stability in severe operating and storage environments. Can be attached to substrates or circuit boards by conventional methods.



ASK FOR BULLETIN 3532A

INFORMATION RETRIEVAL NUMBER 164

ULTRA-MINIATURE TANTALEX® CAPACITORS FOR MINIATURE CIRCUITS

Types 182D and 183D

Cylindrical-shaped Type 182D and rectangular-shaped Type 183D capacitors, ideal for subminiature assemblies requiring the ultimate in component density, offer high volumetric efficiency. Housed in polyester-film sleeving with epoxy resin end seals, ensuring excellent moisture resistance.



ASK FOR BULLETIN 3517

INFORMATION RETRIEVAL NUMBER 165

MINIATURE RED TOP® TANTALEX® TUBULAR CAPACITORS

Type 162D

Capacitors in resin-sealed cases offer excellent stability. For use on printed wiring boards, in packaged circuit modules, and in applications where space is at a premium. Priced competitively with axial lead molded case units. Available on reels, with taped leads, for automatic machine insertion on PC boards.

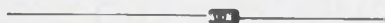

ASK FOR BULLETIN 3536B

INFORMATION RETRIEVAL NUMBER 166

For complete technical data on any of these Sprague solid tantalum capacitor types, write for the applicable Engineering Bulletin(s) to Technical Literature Service, Sprague Electric Company, 347 Marshall Street, North Adams, Mass. 01247.

SPRAGUE®
THE MARK OF RELIABILITY

ACROSS THE DESK

(continued from page 14)

slavia, where I am employed now.
Dragan Pantic

Elektronska Industrija
OOUR PIONIR
Bulevar Revolucije 403
11000 Belgrade, Yugoslavia

Feedback clears up a few Focus bugs

After reading your article "Focus on Data-Acquisition Equipment" (ED No. 12, June 7, 1973, pp. 70-85), I thought you might appreciate some feedback. First, thanks for including a mention of the Tektronix Digital Processing Oscilloscope (DPO). Second, because your article was rather wide in scope, some errors were to be expected. Some related to the DPO.

In the caption of the DPO photo on p. 73, you referenced a PDP-8 computer. A PDP-11/05 was shown. We don't offer a DPO configuration with a PDP-8. In addition the caption mentions a digital-processing plug-in Model 7001. In fact, the DPO's processor unit is not a plug-in, and is referred to as the P7001. The discussion in the text was better.

Also, the P7001 is no longer available as a stand alone item.

Maury Floathe
Assistant Program Supervisor

Tektronix, Inc.
P.O. Box 500
Beaverton, Ore. 97005

Our objectives are 'refreshing'

I would like to take a minute to tell you I appreciate your publicly stated objectives and accuracy policy. It is quite refreshing to find someone willing to go on record about such things. Too many people do not have well-defined goals and objectives. As a result, they often do not achieve any.

Dale W. Zobrist

9356 Doral Dr.
Pittsburgh, Pa. 15237

Ed. Note: ELECTRONIC DESIGN's stand is published near the back of every issue, and the magazine has gone on record like this since its inception 20 years ago.

- Data transceivers interface standard bus system.
- Bus data easier with three-state McMOS.

**new Motorola
semiconductors for**

Industry

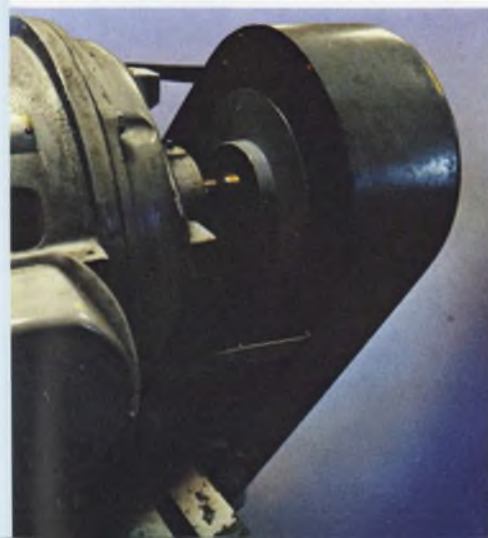
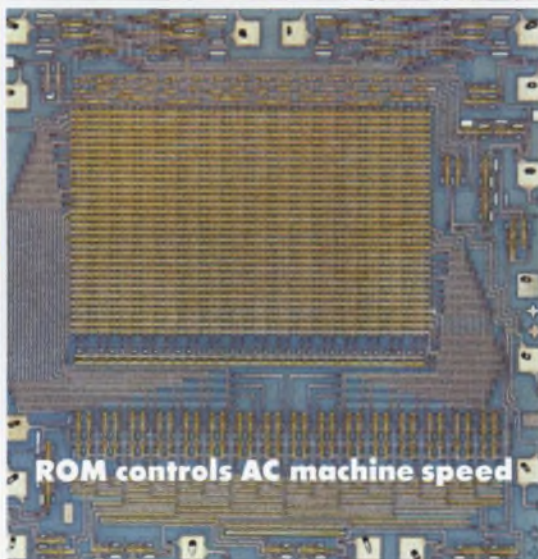

At the count of nine, it's one Megahertz...McMOS time

by Jerry Tonn, Group Leader,
Industrial Logic Applications

It often pays a designer to take advantage of the less ballyhooed benefits of a logic family. For example, in addition to its recognized low power dissipation and high noise immunity, CMOS possesses a higher-than-bipolar packing density that has resulted in MSI and LSI functions offering an attendant increase in system reliability and a decrease in assembly costs.

Consistent with this idea, Motorola has developed the McMOS MC14500 series containing many systems-oriented functions to aid in minimizing your logic circuit design. And this simple, yet ver-

satile, six digit, one megahertz frequency counter uses MC14500 devices in an example of minimization. It uses just nine McMOS devices.

The frequency counter consists of five basic sections: 1) the TIME BASE that provides a reference of fixed periods which set the desired sampling interval. 2) The CONTROL that uses the fixed reference to generate the gating window and operation sequences of the event counters. 3) the EVENT COUNTER that totals the number of events or transitions of the external signal input. 4) The SIGNAL CONDITIONER that amplifies and shapes the external input and drives the event counters. 5) the

DISPLAY which decodes the contents of the event counters and drives six seven-segment numerical displays.

Electra time in crystal

A standard 1 MHz crystal oscillator circuit is used as the reference for the time base. To provide the maximum sample interval of 1 second, a six decade divider is implemented from one-half of a MC14518 dual BCD counter and the MC14534 5-decade counter, truly an LSI part. The MC14534 has multiplexed BCD outputs with five active-high digit select lines. These digit select lines driving switch SW₁, along with the NOR gate provide a time base that may be varied

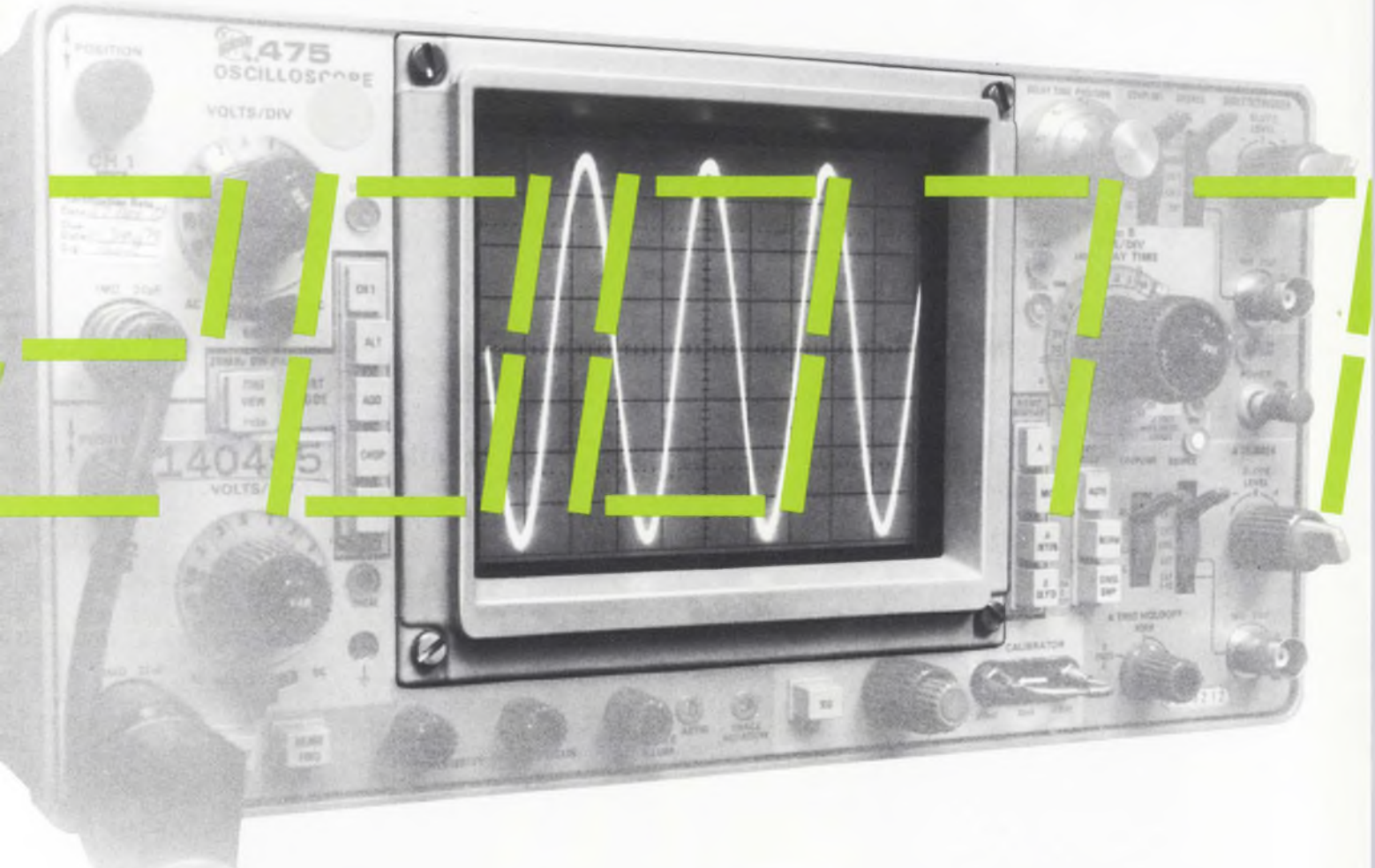

new semiconductors for
industry

Motorola Semiconductor Products Inc., P.O. Box 20912, Phoenix, AZ 85036

Editor: Ken Covey / Art Director: John McConnell / Photographer: Herb Blinn

The semiconductor systems described herein are intended only to illustrate typical applications. The information is believed reliable; however, no responsibility is assumed for inaccuracies. This publication does not alter Motorola's standard product warranty; nor, does the information convey any license under the patent rights of Motorola Inc. or others.

McMOS, MTTL, MDTL, MECL, MHTL and Beam-Fired are trademarks of Motorola Inc.

vol. one, no. two
© Motorola Inc. 1974

in decade increments from 100 μ s to 1 second. When the appropriate digit select line goes high, the multiplexer clock is inhibited and the BCD outputs are "locked" to the desired decade. By using the period between positive transitions of Q_3 as the time base interval, the ripple delays of the decade counters may be neglected.

You're all under control

The control section uses the other half of the MC14518 dual counter and a MC14022 Johnson counter (octal). In the initial state, both counters are reset and, at first, the MC14518 inhibits the MC14022. On the first positive edge from the time base, the disable signal is removed from the event counters and they begin counting. On the second positive edge from the time base, the disable signal is reapplied, counting is stopped and the MC14022 is enabled. The outputs of the Johnson counter sequentially go high for one period of the input clock

signal, in this case, one megahertz. Output Q_2 thus provides a 1 μ s latch pulse to the event counters 2 μ s after they were disabled. This delay time accommodates the ripple delay and latch setup times of the event counter. After the latch pulse is generated, Q_5 provides a delayed pulse to reset the counters. Next, the output Q_7 (delayed another 2 μ s) resets the MC14518 counter and locks up the control section until the carry-out signal of the MC14534 reinitiates the control section sequence. The 1 hertz carry-out waveform thereby allows a sampling or display update once every two seconds that is independent of the time base used.

Counters, synchronize your multiplexers

The event counters consist of two MC14553 three-decade counter/latch/multiplexers. This device, in addition to the three-decade counters, contains three 4-bit latches with multiplexed outputs and active low, digit selects. The multi-

plexing clock is generated internally and its frequency set by an external capacitor connected between C_A and C_B on one MC14553. The connection between C_B , of the first counter, and C_A , of the second, synchronizes the multiplexers so that just three PNP transistors are required to energize the anodes of the displays.

Display the count lightly

The display section contains two MC14543 BCD-to-seven segment liquid crystal display drivers, the three anode transistors and six common-anode LED displays. Since the multiplexed data is synchronized, the digit drive transistors are driven from a single MC14553 and they energize the display digits in pairs (one on each decoder). Therefore the display multiplexing duty cycle is thirty-three percent maintaining low peak segment current within the range of the MC14543's capability.

Get in signal condition

The signal conditioner or front end of the frequency counter consists of a MC14583 dual Schmitt trigger connected in cascade. The input signal is ac coupled to the A input which is dc biased to the center of the hysteresis band.

By eliminating the hysteresis resistor on this section,

the band is very small and an external capacitor may be required to eliminate oscillation. The "B" half of the MC14583 provides additional shaping with a small amount of hysteresis set by the 100 kilohm resistor. The input network with

back-to-back diodes provides an overvoltage limit for the MC14583 and the maximum input sensitivity is below 100 millivolts from 1 hertz to 1 megahertz.

Nine for design

Nine integrated circuits are used in this design. Note that four inverters, a two input NAND and a two input NOR gate are contained in one package – the MC14572 hex functional gate. This device alone reduced the package count by one. Another, more highly touted McMOS benefit, the niggardly use of power, held consumption by all nine devices below that of just one segment of the LED display. Indeed, McMOS is the ideal logic family for use in portable battery powered instruments.

McMOS packing density may not be much ballyhooed. But it's there. Take advantage of it.

For details, circle 211

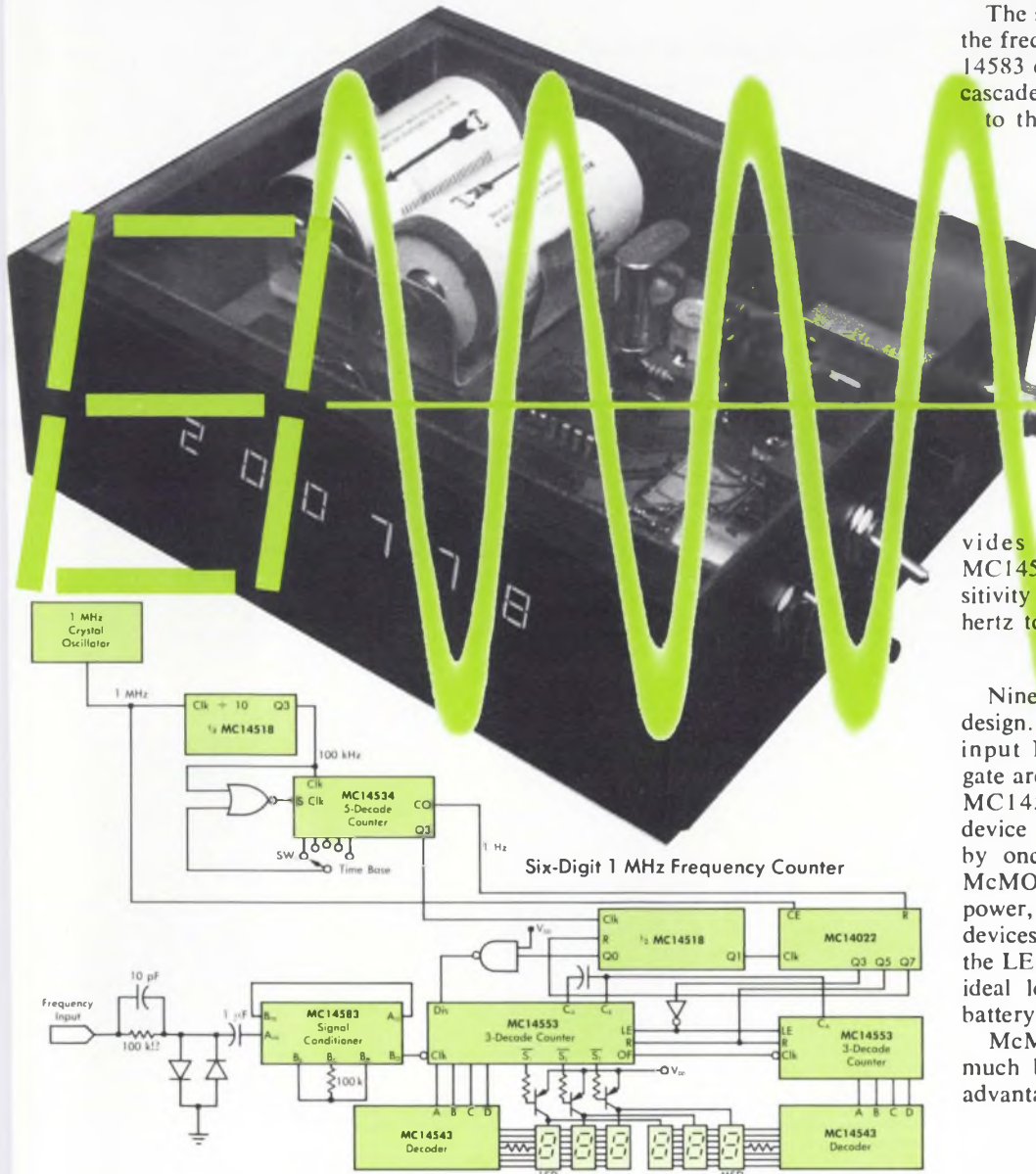

Give the brush-off to speed controls that use short-lived dc motors — use CMOS ROMs (read-only memories) to effect compact, reliable, variable frequency drives for single, two or three-phase ac motors.

The method employed is pulse-width modulation (PWM) using a mask-programmable ROM to generate sine-weighted pulse trains. The memory is organized so that four pulse trains, with fixed phase differences between their modulation envelopes, are produced to control single, two or three-phase ac motors. Opto couplers interface logic and power stages minimizing transient feedback from power stage to logic stage. In multiple motor drives where the motors may be powered from different sources, transient coupling from one power source to another is also minimized.

ROM addressing

The control scheme is shown in figure 1. A 1024 bit memory is utilized in a 4 word by 256 bit format. This allows four bit streams to be generated simultaneously. An 8 bit binary input provides 256 address words for the memory. An oscillator clocks a counter to step the address from Word ₀ (00000000₂) to Word ₂₅₅ (11111111₂). A delayed clock signal, (Clock #2), controls the memory. The

ROM generates variable speed AC control

by Thomas Mazur, Applications Engineering

delay, approximately 3 microseconds, allows the address counter to settle to a new state before the memory is accessed. The ROM addressing logic provides an up-down count pattern. Memory address cycles from W₀ to W₂₅₅ back to W₀, and so on.

ROM output coding

Each memory output represents a 90° segment of a sine modulated envelope. Figure 2 describes the coding for ROM output B_n. The first quadrant of a sine wave was divided into 8 equal angle steps and the sine value at each division was

determined. Each step was allotted 32 bits of memory. In this scheme, a logical "1" level produces an "On" condition at a power stage. Sine values were equated to duty cycle/step. The ideal "On" bits/step (duty cycle/step x 32) represent the most accurate sine weighting per step. However, since fractional bits cannot be obtained, the "On" bits were rounded off to integer values. The sine weighted modulation envelope illustrates one way in which the memory could be patterned. The actual output from B_n is a modified version of the sine weighted envelope. The "On" bits/step were divided into

FIGURE 1 — Block diagram — Polyphase motor control

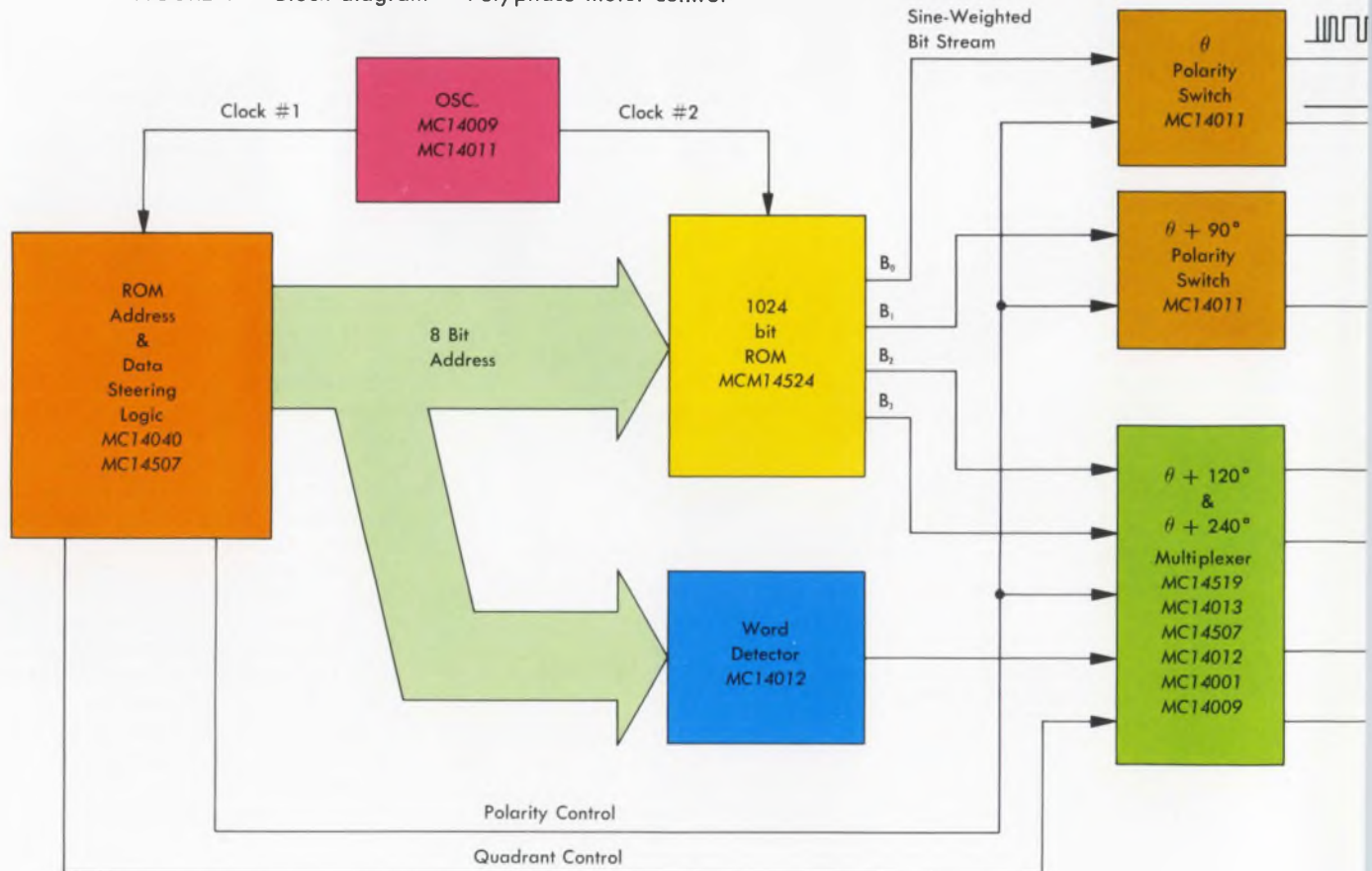
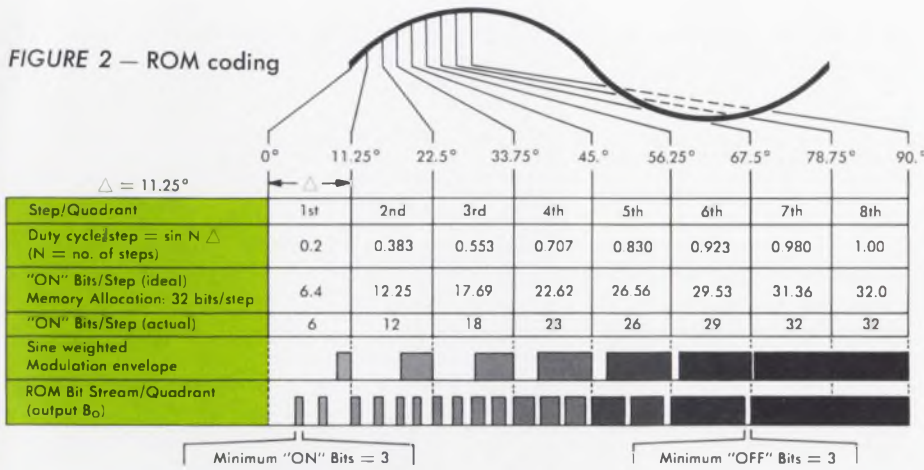

FIGURE 2 — ROM coding



smaller groups, with the result that a waveform of 68 steps/cycle of output drive is produced at the power stage. The reason for this modification was to improve a motor's operation at low speeds by reducing the effects of cogging. The minimum number of "On" or "Off" bits is three. At an output drive frequency of 100 Hz, the time interval per bit is 9.75 microseconds. A 30 microsecond interval is adequate to switch most transistors and some of the newer thyristors. At intervals less than 30 microseconds, the control of power devices becomes somewhat precarious.

Memory outputs B_1 , B_2 and B_3 contain the same "On/Off" bit structures as B_0 . The difference is in their order, with respect to the pattern of B_0 . The bit pattern of B_1 is in reverse order to the pattern in B_0 . That is to say, there is a sine-cosine relationship between B_0 and B_1 , as shown in figure 3. Output θ is constructed from B_0 ; output $\theta + 90^\circ$ from B_1 . In this manner, a pair of quadrature phased drive signals is available for two phase motors. The bit patterns of B_2 and B_3 are shared to form outputs $\theta + 120^\circ$ and $\theta + 240^\circ$. With respect to the 0° to 90° range of B_0 , B_2 changes

FIGURE (3) — Controller output signal synthesis idealized load current waveforms

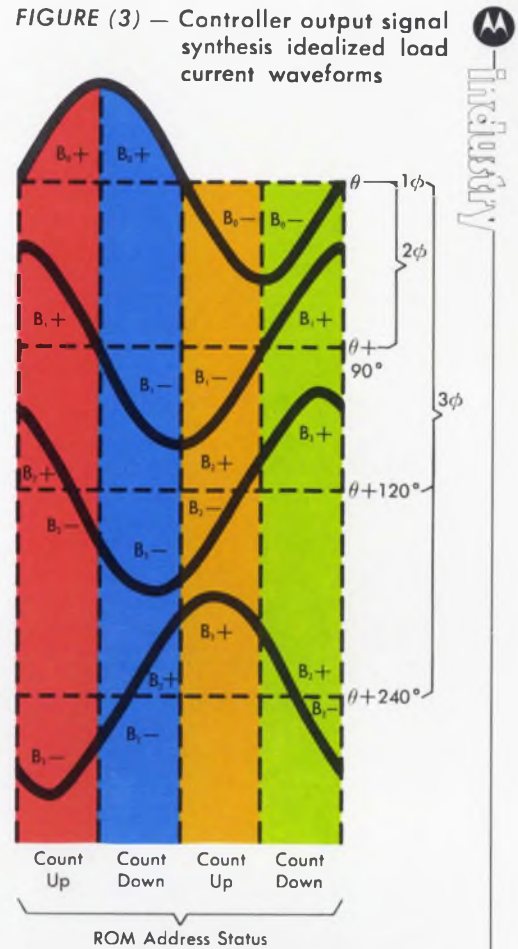

from 60° to 0° back to 30° . B_2 , on the other hand, changes from 60° to 90° back to 30° . Both outputs cover a 90° segment, but in different angular directions. Since the "end" values of B_2 and B_3 are the same, they can be switched alternately into a bit stream without causing discontinuities. B_1 , B_2 and B_3 form outputs θ , $\theta + 120^\circ$ and $\theta + 240^\circ$. These outputs are used to drive 3 phase motors.

A method of varying the duty cycle of the drive pulses to control motor currents for low speed operation was not provided in the logic described. For optimum simultaneous control of different motor/load combinations, duty cycle regulation should be performed at the power stages. Signals within the logic stage, in conjunction with current sensing signals at the motor windings, could be used to provide independent duty-cycle control for each motor.

CMOS offers excellent noise immunity and tolerance to power supply voltage variations. Additionally, its low power requirements make it ideally suited to high density chip architecture and could eventually result in a two or three element logic circuit. This can reduce the required parts inventory by standardizing the logic portion of the speed control systems that a manufacturer chooses to construct.

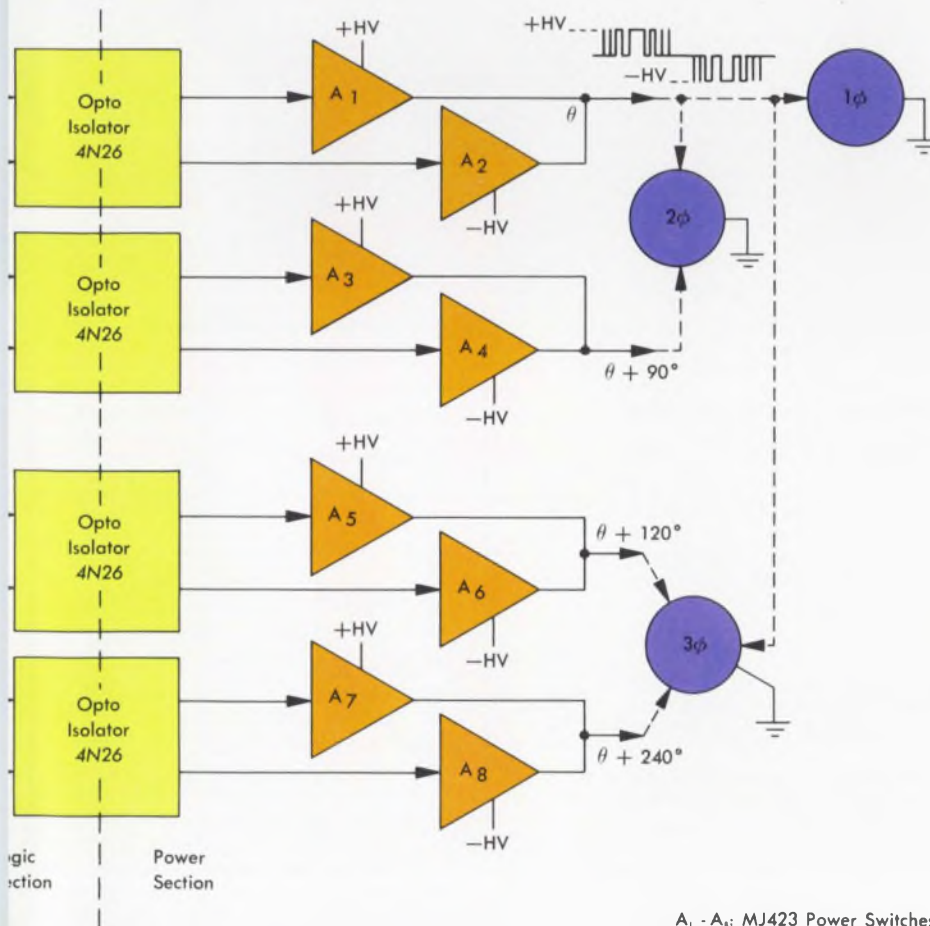

A₁ - A₈: MJ423 Power Switches

For details, circle 212

Versatile hex inverter/translator

Interfaces with most anything!

Accommodating . . . harmonious . . . compatible . . .

There are many ways of saying it. But they all add up to the same advantage — smooth interface! And Motorola's new MC691 monolithic hex inverter/translator has the low input drive characteristics to interface with 5 volt CMOS!

The 691 consists of six gates for interfacing between the nominal 5 volt logic levels — CMOS, DTL and TTL — and high logic levels from 12 to 20 volts. This plus the high-fan out make it ideal for driving CMOS or HTL high level devices. And, although it's a pin-for-pin replacement for older 9112 devices, it provides the additional advantage of higher fan-in.

These devices are available in dual-in-line ceramic or plastic packages, they're on the shelf, and you can get 'em in plastic for \$1.15 in 100-999 quantities. Call your local Motorola distributor or representative — today!

For details, circle 213

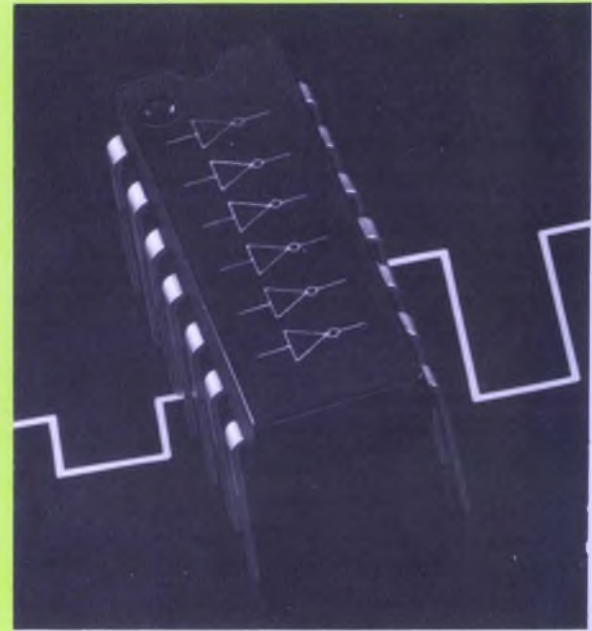

80 V optical couplers

Isolate control system interface problems

Two new couplers — the MOC8050, MOC8030 Darlington and the 4N38 transistor device — offer unprecedented 80 V breakdown voltage capability for general industrial use such as logic-to-logic, AC-to-DC, remote power control, etc. while providing 1500 V isolation capability. The Darlington furnishes super-high, 500% transfer ratio and is ideal where increased output currents are needed. Both offer quick, reliable answers to control system interfacing or isolation. Composed of an infrared light-emitting diode and either a photo-transistor or photo-Darlington, couplers represent simplicity itself in replacing transformers, relays, biasing and RC coupling networks. Use both where long life and low cost are prime goals. Circle the number for a copy of "Opto Couplers At Work" detailing applications, selection and cross-referencing.

For details, circle 214



Input-sensitive quad comparator

Makes design work a little easier

A conglomeration of traditional op amp specs has been condensed into one informative parameter in the MC3430-33 series high speed quad comparators. "Input Sensitivity" (V_{IS}); a blend of voltage gain effects, input offset voltage and input offset current, treats these comparators as digital devices while shunning the op amp heritage. This spec blending gives you the comparator's differential input requirements to guarantee a given logic state at the output. So you've got worse-case design at a glance!

These comparators show their new look as sense amps in 1103 type MOS memory systems, other computer interface applications, or even control systems.

Beyond the ordinary, we've included the effects of $\pm 5\%$ power supply variations, a ± 3.0 V common-mode voltage range and temperature changes from 0° to 70°C .

Choose between either ± 7.0 mV or 12 mV total sensitivity. Either 10 fan-out device is available in open-collector or three-state TTL compatible configurations. As low as \$4.00 100-up (MC3431P and 33P) off-the-shelf. And at your command.

For details, circle 215

Guaranteed output state versus input voltage

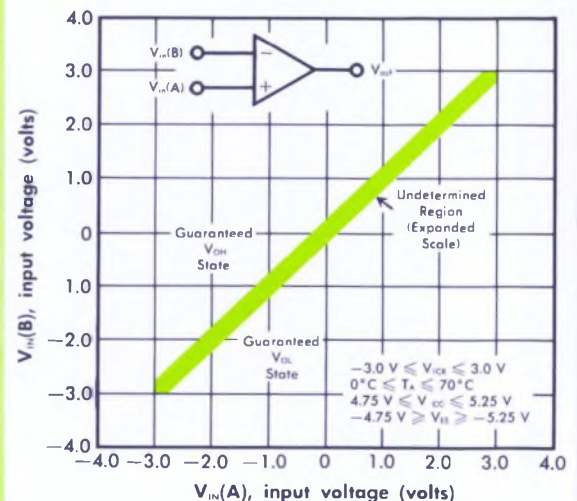

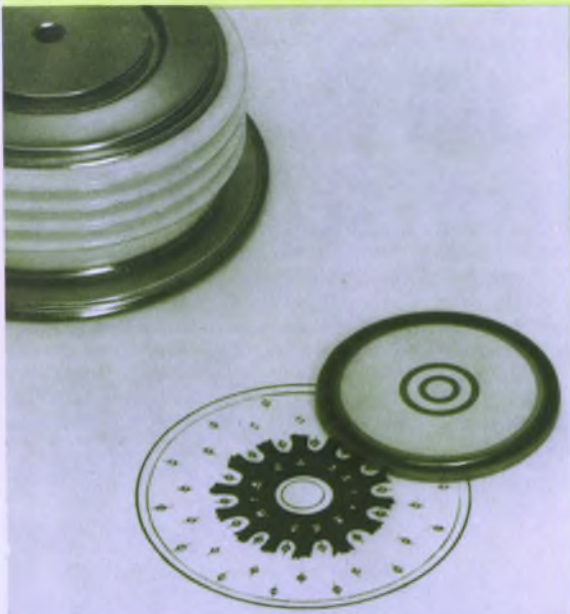

700 A fast switch SCRs

Improve reliability through beam-firing

Patent-applied-for Beam-Fired technology has taken another giant step forward for designers of dc choppers, induction heaters, inverters, uninterruptible power supplies, motor speed control and PWM with the new MCR700 fast switch series. The 700 A, 1200 V units offer 200 V/ μ s minimum dv/dt capability for improved reliability. Within 3 μ s, dynamic forward drop is down to 3 volts, switching up to 150 A. Speed comes from leading-edge, Beam-Fired technology: optimum cathode shunt placement . . . integrated gate cascade driver stages . . . simultaneous, large-area, multistage turn-on. Both 10 μ s and 30 μ s turn-off times are available in the series.

For details, circle 216



Negative voltage regulator

Complements positive programmable unit

For systems requiring both positive and negative power supplies, the new MPC900 and the standard MPC1000 offer unequaled opportunities for simplicity and space saving. Both are 10 A units with 100 W power capability and 0.10% line regulation with respective load regulations of 0.15% or 0.10%. Current limiting protection is built in. The '900 output voltage is adjustable from 4 to 35 V, the '1000 from 2 to 35 V. Both offer 5 A/30 Vdc safe operating current, common-ground connection and expandable output current to 50 A with external pass transistors. 250-up prices are saving, too: \$14.25 for the MPC900, \$10.93 for the MPC1000. One IC driving one Darlington does it all!

For details, circle 217

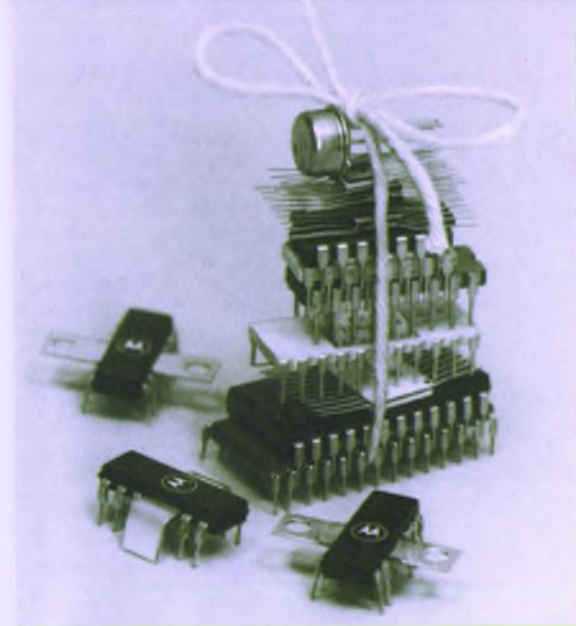

Interface problems?

The MC699 ties it all together

Motorola's new MC699 dual power AND gate makes interface life a little bit easier by helping solve compatibility problems. Naturally, it's MHTL!

The 699 is equally at home operating at supply voltages from 5 to 20 volts and its built-in hysteresis and varying threshold provides greater noise immunity over the entire range of supply voltages. Low input forward current $I_f \leq 0.2$ mA @ $V_{cc} = 5.0$ V makes it compatible with virtually any logic family, including CMOS, M TTL and MDTL, MECL and MHTL devices. It has a high-voltage, high-current 0.5 A output for driving relays, lamps, power discrete devices and the like, and open-collector and open-emitter outputs for either sinking or sourcing current.

The MC699 has two package options: the standard flat tab for chassis heat sinking for use in high power, or high ambient temperature applications; or, on special order, a package with the tab bent downward for PC board heat sinking. The price is \$2.63 in 100-999 quantities.

And if *that's* not enough to convince you, just dial the nearest Motorola salesman or distributor . . . you'll find that they'll gladly listen to your interface problems . . . and probably solve them too!

For details, circle 218

It's more than gossip... Listen to all the talk about GPIB transceivers

by Mike Maher

Efficient testing of today's complex electronics often requires systems under the control of programmable calculators, minicomputers or microprocessor units. To overcome the problems of interfacing with many different instruments, mini-computer makers and others offer a large variety of input/output cards and modules, so their users can achieve the desired interfaces. This is essentially a "custom" approach demanding a large amount of interface design and expense on the part of both makers and users.

Recognizing the custom approach to the interface problem solution wasn't feasible, a working group of the International Electrotechnical Commission was formed to study the instrument/controller interface and draft a standard* which consists of a bus system made of eight data lines and eight control lines.

The proposed standard, or GPIB, provides a bi-directional data bus for transfer of eight bit data bytes. A second eight bit bus serves for system control and management signaling.

Any of fifteen devices on the system can initiate and control information transfers between devices. Devices may be instruments, signal sources, printers, plotters, card tape readers, power suppliers, computers, calculators or dedicated system controllers. The overall concept is shown in figure 1.

Whatever a device's function, it must be able to present defined voltage signal and impedance levels to the system's bus

lines. It is in this area that Motorola has been able to make significant contribution to the realization of a practical interface system.

The MC3400 series of interface transceivers were designed specifically to meet the requirements of the IEC spec. These requirements are summarized in table 1, and were implemented for a single line as in figure 2.

TABLE 1

- A. Driver Requirements
 1. Open collector outputs on specific lines with option to tri-state on others.
 2. Low-state voltage ≤ 0.4 V at 48 mA.
 3. High-state leakage ≤ 0.25 mA at +5.5 V.
- B. Receiver Requirements
 1. Low-state: Input voltage ≤ 0.8 V
Input current ≤ -1.6 mA at 0.4 V.
 2. High-state: Input voltage ≥ 2.0 V
Input current ≤ 40 μ A at 2.4 V.
- C. Resistive Termination Requirements
 1. 3 K Ω to V_{CC} supply.
 2. 6.2 K Ω to ground.

FIGURE 2 — transceiver implementation

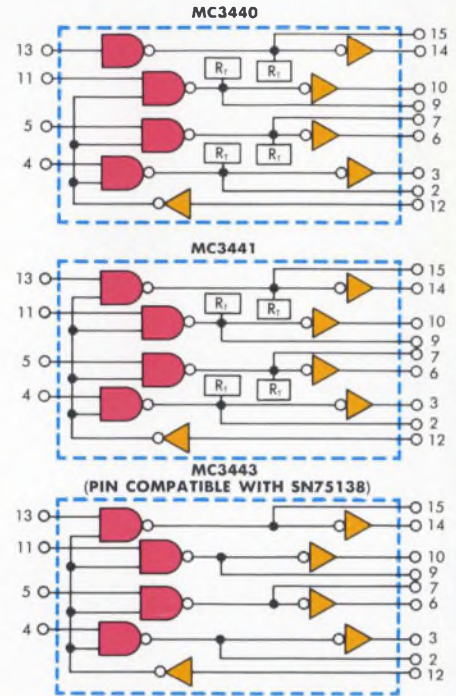
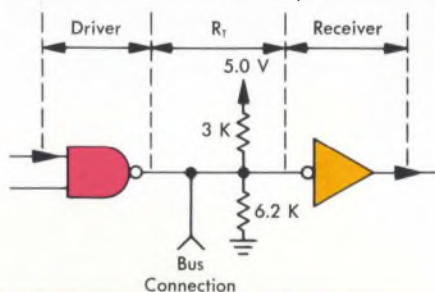

The MC3440 family of Quad Interface Bus Transceivers

Each transceiver contains the equivalent of four independent cells with a single pin for driver enable. The termination resistors are on chip in the MC3440 and 41 versions and are separately isolated to prevent clamping the bus in the event of supply failure. Ground for each driver output is brought to a common pin separate from logic ground to isolate bus noise from the internal logic ground.

The receiver portion of the chip has several distinct advantages over other interface circuits. First, a differential amplifier input minimizes bus loading in both the high and low states. Second, the receiver input has predictable, repeatable hysteresis to improve noise immunity.

At this time, three GPIB devices have been defined; each device is a metal option of a common diffusion set. Other devices will be introduced with the adoption of the recommended standard and as the market develops.

*This standard, as well as one under consideration by an IEEE subcommittee, is derived from one originally conceived by Hewlett-Packard.

For details, circle 219

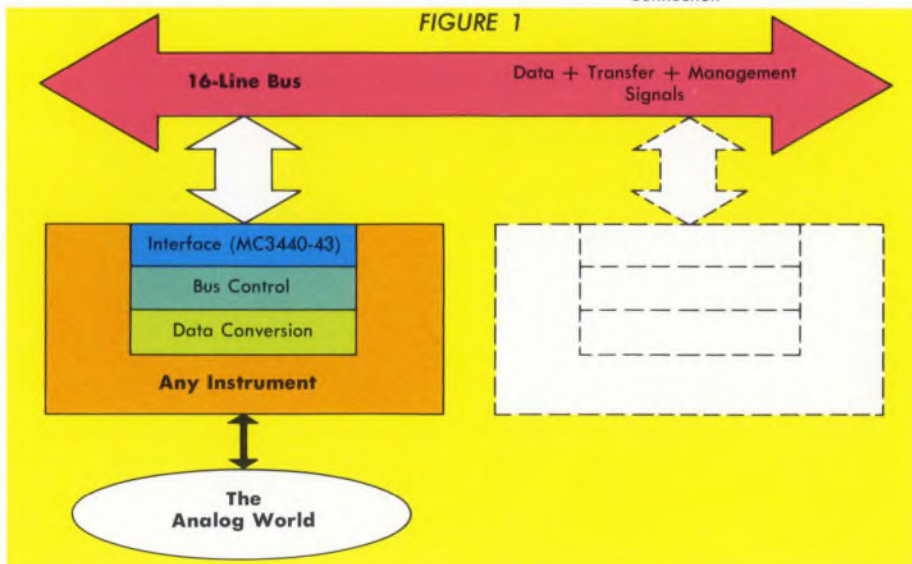

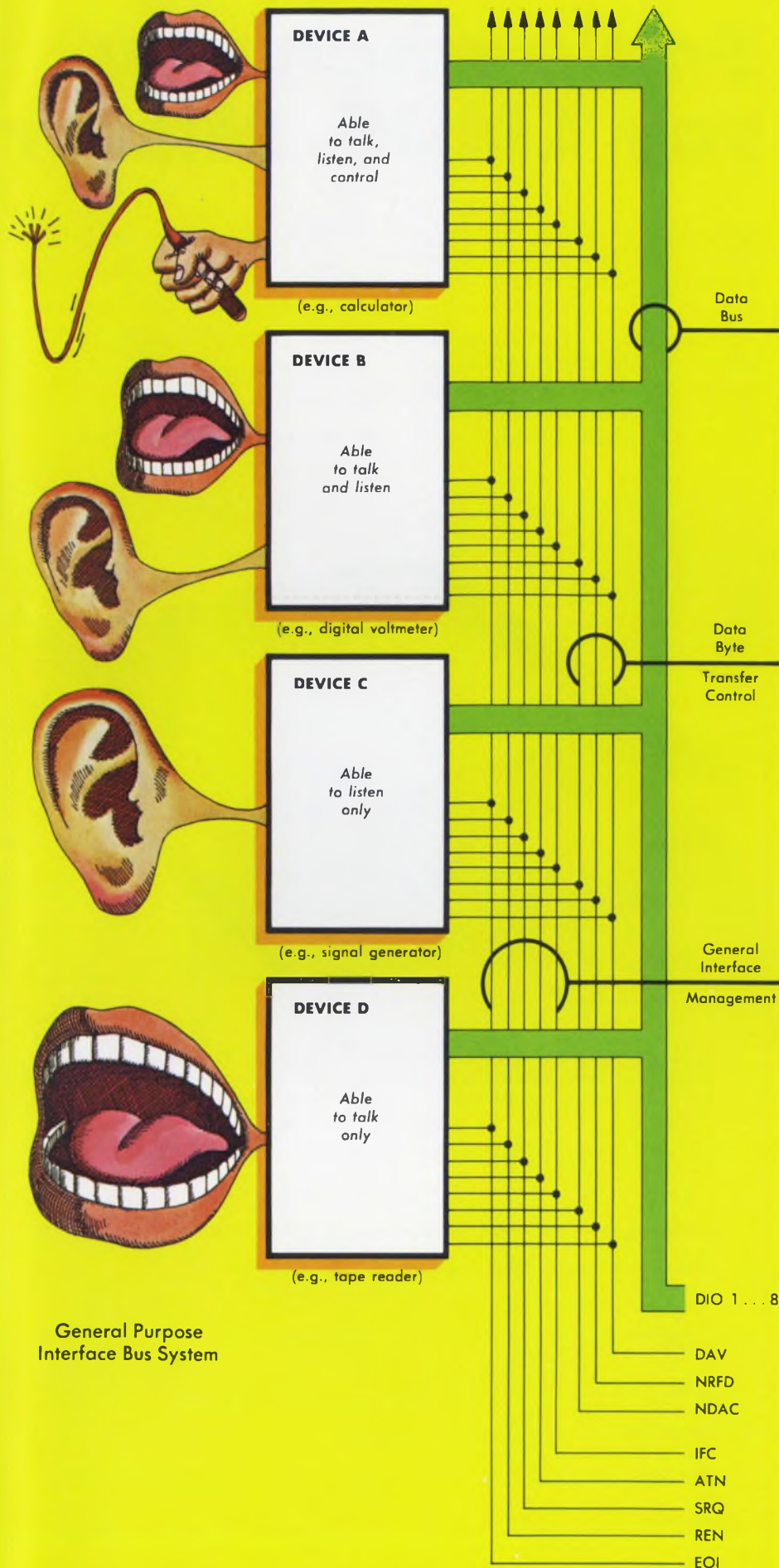

BUSINESS REPLY MAIL
NO POSTAGE NECESSARY IF MAILED IN THE UNITED STATES

POSTAGE WILL BE PAID BY:

MOTOROLA SEMICONDUCTOR PRODUCTS INC.
P. O. BOX 20924
PHOENIX, ARIZONA 85036

FIRST CLASS
Permit No. 2565
PHOENIX
ARIZONA



FOLD HERE

Application Notes

AN-568 A fuse-thyristor coordination primer

The use of fuses in protecting thyristors against short circuit fault currents. Philosophy is discussed and practical examples are given.

AN-574 CMOS: a new logic type for control systems

How to interface CMOS with other logic types plus a comparison of CMOS with the others.

AN-589 Generate custom waveforms digitally

A method of generating custom waveforms using IC counters, a read-only memory and a monolithic D/A converter.

AN-590 Servo drive amplifiers

The design of transformerless ac servo amplifiers using power Darlington transistors and IC op amps. Op amp preamplifiers, power amplifiers and 90° phase shifters are described.

SEAL HERE
(Please use tape - do not staple)

AN-591 Using CMOS in system designs — those all important details

How to use CMOS most efficiently. Important interrelationships between device features, performance specs, parameter sensitivities and operating subtleties are discussed.

AN-708 Line driver and receiver considerations

System description, definition of terms, measurement of important parameters, design procedures and applications of line drivers and receivers are presented along with a description of Motorola's extensive line of these devices.

AN-713 Binary D/A converters can provide BCD-coded conversion

The use of IC D/A converters in BCD-coded conversion.

AN-717 Battery-powered 5 MHz frequency counter

A description of a battery-powered, 5 MHz frequency counter using CMOS logic.

AN-719 A new approach to switching regulators

New techniques are used to shape the load lines of this 24-volt, 3-amp switching mode supply. An overall efficiency of 70% is achieved operating at 20 kHz from a 120 Vac line.

LITERATURE REQUEST FORM

NOTICE: Requests for literature on items described in new semiconductors for INDUSTRY cannot be honored after November 1, 1974.

Please circle the Reader Service number of item(s) you are interested in receiving.

211	212	213	214	215	
216	217	218	219	220	221

List Application Notes you wish to receive below (by number):

Phone No. _____ Area Code _____
 new Motorola semiconductors for INDUSTRY
 vol. 1 — no. 2

Please Print Clearly

NAME _____

TITLE _____

COMPANY NAME _____

DIVISION _____ DEPARTMENT _____

COMPANY ADDRESS (Street or P.O. Box) _____

CITY _____

STATE _____ ZIP CODE _____

Tear Along Perforated Line and Drop in Mail (No Postage Required)

Smile when you say CMOS, Mister

Don't Gamble. Be ready for any challenge in industrial logic design. Arm yourself with the best information this side of Medicine Bow. Here's how.

Take advantage of our smiling offer of both the CMOS Data Book and the new CMOS Handbook for only \$4.50 (bought separately they'd be \$5.50). Get nearly 700 pages of up-

to-the-state-of-the-art information on CMOS—the premium CMOS family.

Here are just a few topics covered:

- complete specs on 68 devices
- application information
- system design
- reliability
- general CMOS characteristics.

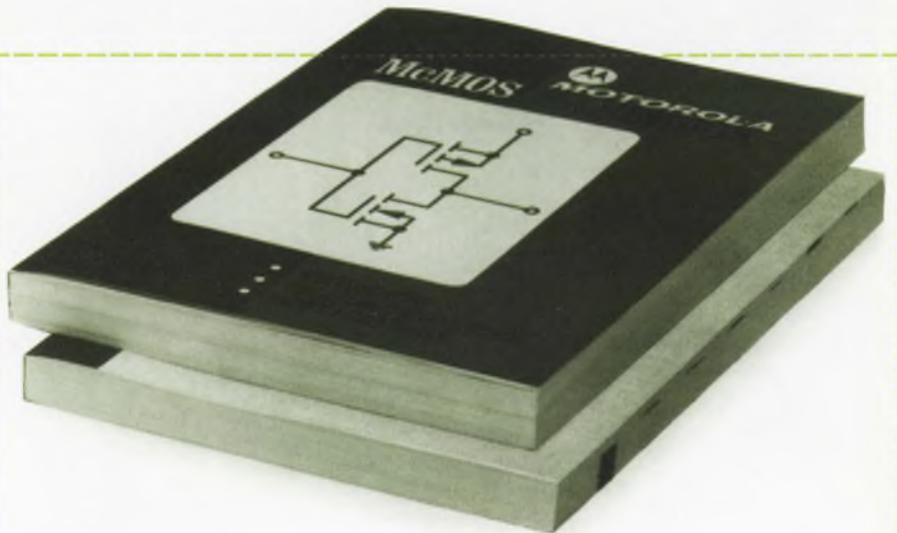

Pardners: I can't resist the combination of a good offer with a smile. I've printed my name and address real neat on the mailing label. I'm making out a check/money order for _____ book combinations at \$4.50 each for a total of \$_____. And I'm putting them both in their own envelope and mailing it to you at the address on the Literature Request Form. SO SEND ME MY BOOKS! !

NOTE: Use purchase order only for order of \$22.50 or more.

(This is your mailing label — please print carefully)

NAME _____

TITLE _____

COMPANY _____

DIVISION _____

ADDRESS _____

CITY _____ STATE _____ ZIP _____



The third state of McMOS declares independence for designers

by Jerry Tonn, Group Leader
Industrial Logic Applications

It's fantastic to have the option of driving a common data bus with a single element. Conversely, it's great to be able to hang more drivers on a common bus. And freedom from wire-ORing problems wins votes every day. So give three cheers for three-state McMOS — with the outputs that rang the liberty bell.

The output of a standard logic element has two stable defined states (a logic "1" or true state, and a logic "0" or false state). Both can be represented by a low impedance device coupling the output terminal to one of the power supply rails. A three-state logic element simply provides an additional state in which the output is effectively disconnected from both power supply rails and represents a high impedance.

When the output series switch of a three-state device is closed the output is enabled. Then the output exhibits the

same characteristics as non-three-state device outputs. With the switch open however, the output is in the disabled mode, and represents a very high impedance disconnecting the low impedance driving sources from the output terminal.

Three-state outputs can be implemented in several ways. One method uses a transmission gate to perform the switching function. The gate simply consists of N and P-channel transistors connected in parallel. By controlling these MOSFET gates with a two phase signal, the transmission gate can be enabled to present a low impedance path between input and output; or it can be disabled. Then, the input to output impedance will be on the order of 10^9 ohms.

Because of its bi-directional input/output characteristics, the transmission gate is also a very useful device for switching or multiplexing analog signals. The quad analog switch (MC14016) contains four specialized transmission gates for use in

analog applications. It can also be used with any standard McMOS device to generate the three-state output function.

The primary applications of three-state logic elements are in data routing, busing and multiplexing. An example of the latter would be the time division multiplexing of BCD data from a four line data bus into a single BCD to 7-segment decoder driver. In display applications with a large number of digits the package count and interconnecting wiring can be greatly reduced.

Application Note AN-715, "Introduction to CMOS Integrated Circuits With Three-State Outputs" describes the basic operation of three-state outputs and gives the rules for applying McMOS circuits with these outputs in digital busing multiplexing systems.

Use the reader service number below for your copy. Then get some three-state McMOS and feel free to design.

For details, circle 220

— And it's round-the-clock

McMOS time machine controls industrial events



by Don Aldridge and Al Mouton,
Applications Engineering

Set it. Forget it.

This modern digital time machine initiates pre-programmed industrial events on time even during a power outage without missing a hertz.

The clock/timer controls one or a number of operations, using 60 Hz or internal NiCd batteries, the latter used only during a power outage. Consumption is then reduced by shutting off the major user — the visual readout — eliminating the need for larger, more costly batteries. When line power returns, the display returns with the correct time and the batteries begin automatic recharging.

The timer comparator is capable of controlling on-off sequencing of as many events as desired by adding a digital comparator section for each on or off cycle desired. Actual on or off times are set by dialing thumbwheel switches. Settings are independent, making simple time changes easy and quick.

The entire clock/timer consists of just

seven blocks built around McMOS logic.

Its heart is a group of six MC14518 Dual Decade Counters, of which two pairs of two each are connected to divide by six. Each of these is coupled with a divide-by-10 counter to produce a divide-by-60 counter. The first divide-by-60 counter counts the 1 Hz input clock to provide the "seconds" output. The output of this stage is fed into the second divide-by-60 to provide "minutes" output. The remaining two decade counters are wired to divide by 24 to produce a 24-hour readout.

The counter outputs are multiplexed into a single 4 line BCD output which is decoded to drive the seven segment gas discharge display. (Display multiplexing depends on retinal persistence to create the appearance of a continuous display while allowing circuit components to be timeshared.) Multiplexing is performed with the MC14519s while an MC14017 Johnson counter keeps track of the digit presently being decoded.

The use of multiplexing lowers the number of BCD to seven segment

decoders from six to one and also reduces control comparator wiring. The decoder used is the MC14511 BCD-To-7-Segment Decoder.

The required 1 Hz reference for the clock counters is obtained from a 1 MHz crystal oscillator. The 1 MHz frequency is divided down to 1 Hz by MC14518 Decade Counters. The crystal oscillator is built from a McMOS inverter with the crystal used as a feedback element. This type of reference provides high accuracy and is independent of the power line in case of power outages. The higher frequency outputs from the frequency divider chain are used for initially setting the clock.

In addition to providing a visual readout of the time of day, the basic clock is combined with internal digital comparators to provide an industrial clock/timer function. In this case, a control comparator compares the time, preset on its input switches, to the multiplexed BCD output of the basic clock. When the preset time and the clock output correspond, a flip-flop is set to provide a signal that can be used, with appropriate circuitry, to energize an external event. The second internal comparator can be used to terminate the external event by resetting the flip-flop.

Though the non-multiplexed clock output was available for use, the multiplexed output was chosen for the comparison to provide more versatility and eliminate extraneous wiring. Since the multiplexed outputs are used, each clock digit must be compared in sequence and the results stored until all of the digits have been compared.

The clock/timer can compare only the hours and minutes, however, for more precise control the concept can easily be extended to include the "seconds" output also.

The digital comparators are built from versatile MC14519 4-Bit AND/OR Selectors that provide Exclusive NOR operation when both control lines are in the logic 1 state.

The flip-flop output is coupled to the load with an optical coupler for isolation and a triac for electronic switching of the load. Manual control is also provided with two push button switches.

The clock/timer power supply powers the logic and provides the high voltage needed for the gas discharge displays when line power is available. A low voltage back-up supply is provided for line failure by NiCd batteries. Their charge is automatically maintained during line operation.

For a more complete description of a system embodying this concept, circle the number below on your reader service card. We'll send you a copy of application note AN-718A.

For details, circle 221

BARGAINS GALORE on LEDs from DIALIGHT

FEATURES:

High luminous intensity
Low cost
Low power consumption
IC compatible
Vibration/shock resistant
Solid state reliability
Life measured in years
Wide viewing angle



Dialight's high brightness 521-9200 LED is an intense large area light source that has this typical luminous intensity:
@ $I_F = 20 \text{ mA}$ $I_0 = 2.0 \text{ mcd.}$

APPLICATIONS:

Panel lighting • Circuit-status indicators • Back lighting of annunciators • Alpha-numeric displays • Automobile dashboards • Appliances • Desk-top calculators • Housewares



9¢

Quality LEDs are 9¢ each when purchased in million piece quantities



21¢

LEDs from 100 to 999 are only 21¢ each.

17¢



If you need LEDs from 1000 to 9999, Dialight has them for 17¢ each.

28¢



Even if you only need LEDs from 1 to 99, Dialight has them for 28¢ each.



16¢

Quantities from 10,000 are a low 16¢ each and Dialight can fill your order today

FREE!

With this coupon you can get a free LED sample. Send this coupon to your nearest Dialight distributor or give him a call.

All prices are domestic and subject to change without notice.

DIALIGHT

Dialight, A North American Philips Company
203 Harrison Pl., Brooklyn, N.Y. 11237 (212) 497-7600

AVAILABLE NOW FROM THESE STOCKING DISTRIBUTORS

ARIZONA
Moltronics of Arizona, Inc.
602-272-7951

CALIFORNIA
Western Electromotive
213-870-7621
Bell Industries
408-734-8570
Fisher/Brownell
408-244-6182
Richey Electronics, Inc.
213-875-2862
Westates Electronics Corp.
213-341-4411

COLORADO
Meter Master Instrument Corp.
303-722-5766

FLORIDA
Hammond Electronics, Inc.
305-849-6060

ILLINOIS
Newark Electronics
312-638-4411

INDIANA
Graham Electronic Supply, Inc.
317-634-8202
Radio Distributing Co.
219-287-2911

MARYLAND
Pioneer Washington Elect. Co.
301-424-3300
Radio Electric Service Co.
301-823-0070

MASSACHUSETTS
Cramer Electronics, Inc.
617-969-7700
De Mambro Supply Co., Inc.
617-787-1200
Gerber Electronics, Inc.
617-329-2400
Sager Electrical Supply Co.
617-542-2281

MICHIGAN
RS Electronics
313-491-1000
Wedemeyer Electric Supply
313-665-8611

MINNESOTA
Gopher Electronics Co.
612-645-0241

MISSOURI
Lcomp-St. Louis, Inc.
314-647-5505

NEBRASKA
Scott Electronic Supply
402-464-8308

NEW JERSEY
Federated Electronics
201-376-8900
Newark Electronics
201-272-8460
Resco Electronics
609-662-4000
State Electronics
201-887-2550

NEW YORK METROPOLITAN AREA
Arrow Electronics, Inc.
516-694-6800
Harrison Radio Corp.
516-293-7990
Harvey Radio Co., Inc.
516-921-8700
Ancar Electronics Supply
914-592-7100
Peerless Radio Corp.
516-593-2121

NEW YORK STATE
Summit Distributors, Inc.
716-884-3450

NORTH CAROLINA
Hammond Electronics of Carolina, Inc.
919-275-6391

OHIO
Hughes-Peters, Inc.
614-294-5351
Lima Radio Parts Co.
419-228-1220
Pioneer-Cleveland Div.
Pioneer-Standard Electronics
216-587-3600
Stotts-Friedman Co.
513-224-1111
Sun Radio Co., Inc.
216-434-2171

OKLAHOMA
Radio, Inc.
918-587-9124

PENNSYLVANIA
Almo Electronics Corp.
215-676-6000
Barbey Electronics
215-376-7451
Cameradio Co.
412-288-2600
Philadelphia Elect. Inc.
215-568-7400

TEXAS
Harrison Equipment Co., Inc.
713-224-9131

UTAH
Standard Supply Co.
801-355-2971

WASHINGTON
Almac/Stroum Electronics
206-763-2300

WISCONSIN
Parts Mart Corp.
414-276-4160

CANADA
Saynor Electronics Ltd.
416-445-2340
L. A. Varah Ltd.
604-873-3211
Wackid Radio TV Labs. Ltd.
613-726-1821
Zentronics Ltd.
416-789-5111

FREE!



Ask for free LED Product Selector Guide. 60 pages of LEDs: discretes, indicators, displays, fault indicators, opto-isolators, etc.

Our family of high the broadest and fas

Here's proof.

Compare the performance characteristics of these monolithic high slew rate op amps. Device for device, ours offer more. Even the slower slew rates are fast. And nobody tops our fastest. What's more, the slew rates are guaranteed and tested. And where bandwidth limits are critical and you need wide bandwidths at high output levels, these are the op amps for you.

Other advantages are better settling times; space savings because of fewer external components; the best possible DC performance at the highest speeds; and availability in chip form. So, wherever you need high speeds and greater reliability in op amps, look to Harris. For details see your Harris distributor or representative.

comparative diagram

PRECISION
NON-COMPENSATED
5V/V GAIN STABLE

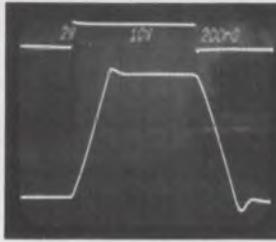

INTERNALLY COMPENSATED
UNITY GAIN STABLE

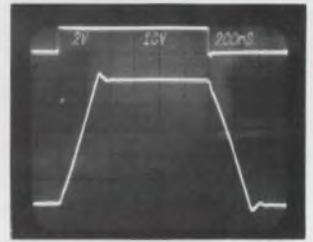

PARAMETERS	LOW SLEW RATE			LOW SLEW RATE		
	HA-2620	HA-2622	HA-2625	HA-2500	HA-2502	HA-2505
Slew Rate	± 25	± 20	± 20	± 25	± 20	± 20
Full Power Bandwidth	400	320	320	350	300	300
Gain Bandwidth Product	100	100	100	12	12	12
Settling Time	1000	1000	1000	330	330	330
Voltage Gain	100k	80k	80k	20k	15k	15k
Bias Current	15	25	25	200	250	250
Offset Current	15	25	25	50	50	100
Offset Voltage	4	5	5	5	8	8
100-999 Units	\$14.95	\$8.95	\$5.95	\$18.50	\$12.95	\$7.50

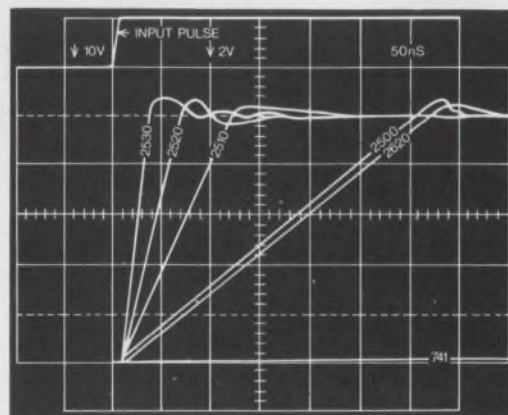

slew rate op amps is best in the industry.

NON-COMPENSATED
3V/V GAIN STABLE

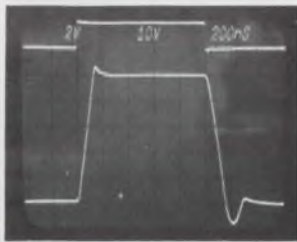

NON-COMPENSATED
3V/V GAIN STABLE

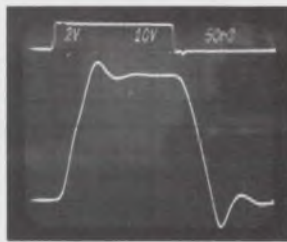

NON-COMPENSATED
10V/V GAIN STABLE
INVERTING ONLY

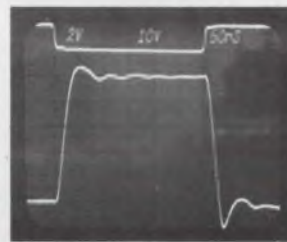

MEDIUM SLEW RATE

HIGH SLEW RATE

VERY HIGH SLEW RATE

MEDIUM SLEW RATE			HIGH SLEW RATE			VERY HIGH SLEW RATE			UNITS
HA-2510	HA-2512	HA-2515	HA-2520	HA-2522	HA-2525	HA-2530	HA-2535		
± 50	± 40	± 40	± 100	± 80	± 80	± 280	± 250	V/μS (MIN)	
750	600	600	1500	1200	1200	4000	4000	kHz (MIN)	
12	12	12	20	20	12	70	70	MHz (TYP)	
250	250	250	200	200	200	500	500	ns (TYP)	
10k	7.5k	7.5k	10k	7.5k	7.5k	100k	100k	V/V (MIN)	
200	250	250	200	250	250	100	200	nA (MAX)	
50	50	100	25	50	50	20	20	nA (MAX)	
8	10	10	8	10	10	3	5	mV (MAX)	
\$18.50	\$12.95	\$7.50	\$18.50	\$12.95	\$7.50	\$33.00	\$14.30		



HARRIS
SEMICONDUCTOR
A DIVISION OF HARRIS CORPORATION

P.O. Box 883, Melbourne, Florida 32901 (305) 727-5430

WHERE TO BUY THEM: ARIZONA: Phoenix—Hamilton Liberty Weatherford Scottsdale—HAR (602) 946-3556 CALIFORNIA: Anaheim—Weatherford El Segundo—Liberty Glendale—Weatherford Long Beach—HAR (213) 426-7687 Mountain View—Elmar Palo Alto—Weatherford HAR (415) 964-6443 Pomona—Weatherford San Diego—Liberty Weatherford COLORADO: Commerce City—Elmar Denver—Hamilton Englewood—Weatherford CONNECTICUT: Danbury—Schweber Norwalk—Harvey FLORIDA: Hollywood—Hamilton Schweber Melbourne—HAR (305) 727-5430 GEORGIA: Atlanta—Schweber Norcross—Hamilton ILLINOIS: Elk Grove Village—Schweber Schaumburg—HAR (312) 894-8824 Schiller Park—Hamilton INDIANA: Indianapolis—Pioneer KANSAS: Lenexa—Hamilton MARYLAND: Baltimore—Hamilton Rockville—Schweber MASSACHUSETTS: Burlington—Hamilton Lexington—Harvey Wellesley—HAR (617) 237-5430 MICHIGAN: Livonia—Hamilton Troy—Schweber MINNESOTA: Edina—Hamilton Schweber Minneapolis—HAR (612) 432-6111 MISSOURI: Hazelwood—Hamilton NEW JERSEY: Cedar Grove—Hamilton Mt Laurel—Hamilton Somerset—Schweber NEW MEXICO: Albuquerque—Hamilton Weatherford NEW YORK: East Syracuse—Hamilton Melville—HAR (516) 249-4500 Syracuse—HAR (315) 463-3373 Rochester—Schweber Westbury—Schweber Woodbury—Harvey NORTH CAROLINA: Raleigh—Schweber OHIO: Beachwood—Schweber Cleveland—Pioneer Dayton—Pioneer HAR (513) 226-0636 PENNSYLVANIA: Wayne—HAR (215) 687-6680 TEXAS: Dallas—Hamilton Weatherford HAR (214) 231-9031 Houston—Hamilton Weatherford UTAH: Salt Lake City—Hamilton WASHINGTON: Seattle—Liberty Weatherford WASHINGTON, D.C.: HAR (202) 337-3170 CANADA: Mississauga Ontario—Hamilton Montreal Quebec—Hamilton Ottawa Ontario—Hamilton

LEGEND FOR HARRIS SALES OFFICES & DISTRIBUTORS: Elmar Electronics (Elmar) Hamilton Avnet Electronics (Hamilton) Harris Semiconductor (HAR) Harvey Electronics (Harvey) Liberty Electronics (Liberty) Pioneer Standard Electronics (Pioneer) Schweber Electronics (Schweber) R V Weatherford Co (Weatherford)

INFORMATION RETRIEVAL NUMBER 14

Three New REED RELAYS from CLARE

Perfect blend of economy and reliability in a dry reed relay

Clare's new 951 dry reed relay is a product of Clare's automated manufacturing process that combines economy with reliability. This epoxy molded PCB relay houses the popular Picoreed capsule which gives you from 100 million operations at signal level loads to 5 million operations at 10 volt-amps. It's an excellent, rugged relay for telecommunications, process control and general electronic applications where reliability and long life is critical. Available in 1, 2 and 4 form A configurations.

951

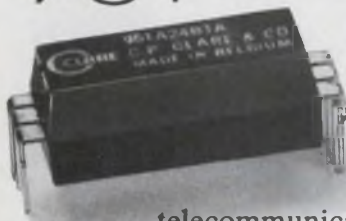

Longer life than a dry reed; less expensive than mercury wetted contact

The new 851 mercury wetted reed relay gives you as much as a billion bounce-free operations, plus switching capabilities from signal level to 50 volt-amperes. The epoxy molded PCB relay is in performance and price, somewhere between the popular dry reed and the more expensive mercury contact relays. And that makes it ideal for applications in telecommunications, computer peripherals, data acquisition and industrial control. Available now in 1, 2 and 4 form A configurations.

851



A new kind of self-latching reed relay

Clare's new relay is the 961 self-latching PCB dry reed relay which features a unique switch that provides the magnetic memory function without the external biasing magnets

961



found in conventional latching relays.

It is designed to operate on one millisecond pulse, but the pulse duration is limited only by coil heating. Once pulsed, the relay remains in that state until the opposite mode is selected.

Ideal for complex automatic test equipment or telecommunications systems, they're available in 1 to 6 pole configurations and have 5 volt-ampere contact ratings.

Availability? Right now!

All three relays are in production and in stock right now. For full technical specifications contact your nearest Clare Distributor. For more comprehensive application information, contact C. P. Clare & Company, 3101 W. Pratt Avenue Chicago, Illinois 60645 or phone (312) 262-7700.

QUALITY, SERVICE, RELIABILITY

C. P. CLARE & COMPANY a subsidiary of
GENERAL INSTRUMENT CORPORATION



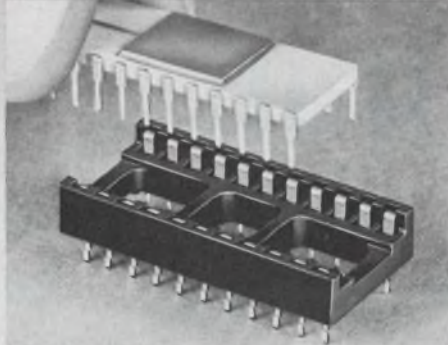
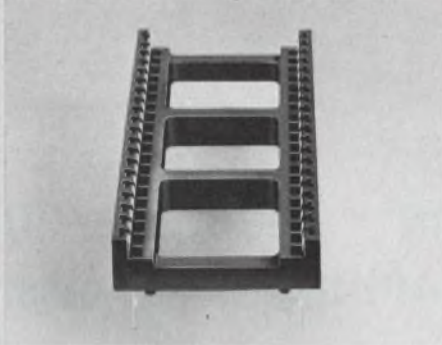
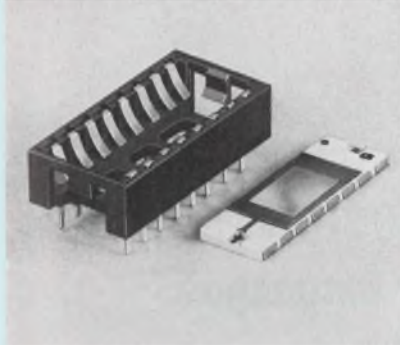
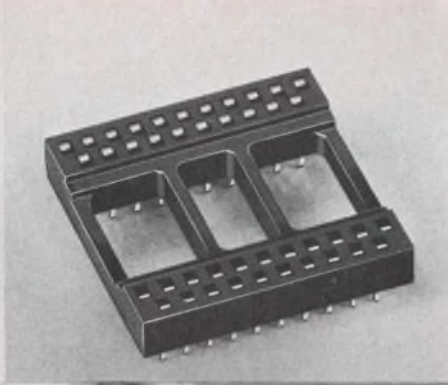
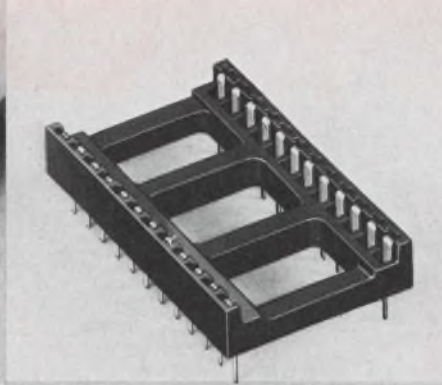
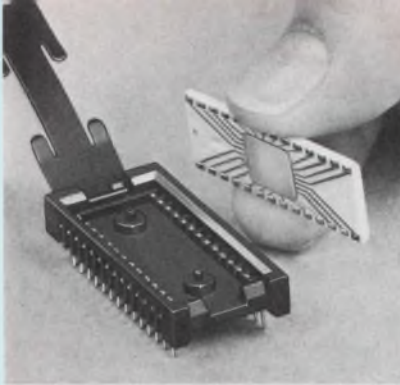

Whether you need leaded or leadless DIP connectors, Burndy leads the way.

We're the leaders in performance.
We're the leaders in savings.

Burndy makes pluggable DIP connectors to fit every need. Leaded or leadless. Standard or hybrid. Top, bottom or side pad. All required shapes and sizes.

But they all have one thing in common. They all use tin-plated contacts that give you gas-tight, high-pressure connections as good as gold. Without the cost of gold. And *that* can lead to some very big savings.

And that's not all our pluggable DIP connectors save you. Our unique contact design prevents wicking during soldering to save rejects. Our low profile saves space. And our entire connector can be repeatedly disconnected and reconnected to save field service time.



Where is all this leading?

It leads to the most reliable, most economical IC connectors you can buy. No matter what your application.

For more information on our complete line of pluggable DIP connectors, write: Burndy Corporation, Norwalk, Connecticut 06856. It could lead to a very nice relationship for both of us.

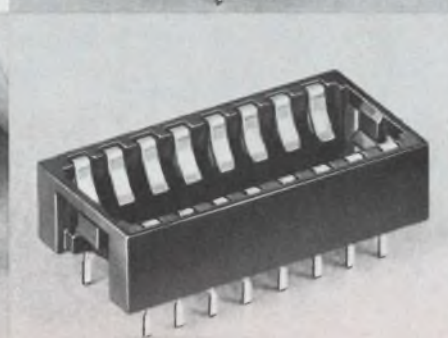
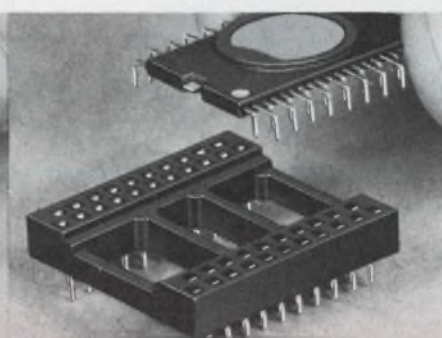
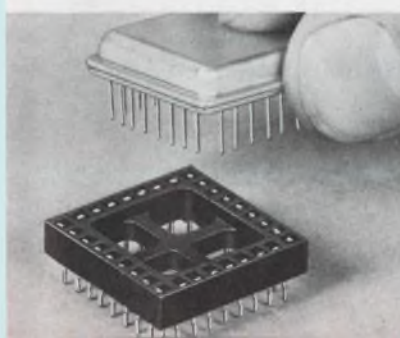
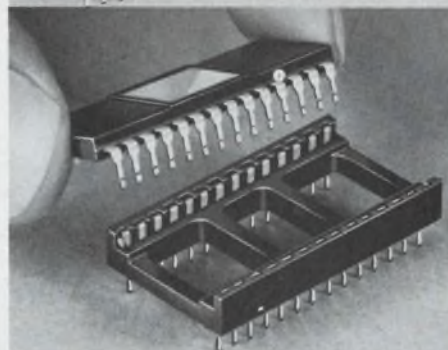
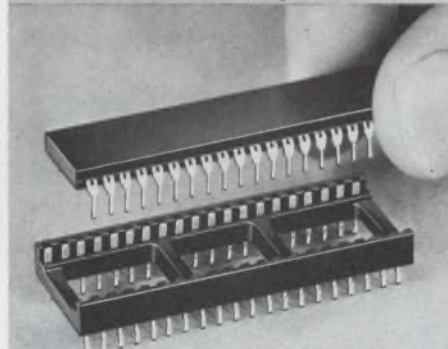
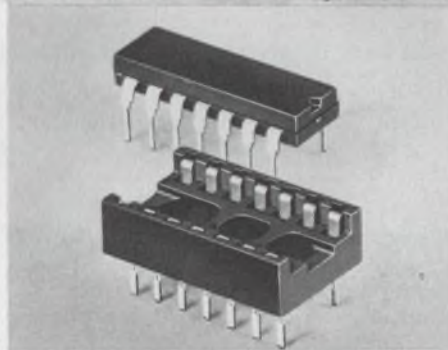

International Sales and Manufacturing: Brussels, Barcelona, Paris, Rotterdam, Stockholm, Stuttgart, Turin, Zurich, St. Helens (Eng.), Toronto, Sydney, Tokyo, Mexico City, Sao Paulo.

BURNDY CONNEXCTS

a **SELF-SCAN**[®] PANEL

says it all...

**ENGLISH • FRENCH • GERMAN • HEBREW • RUSSIAN
JAPANESE • SYMBOLS • GRAPHICS • and other languages**

No matter what you have to say or how you say it, a SELF-SCAN panel display provides the economical and practical solution to your readout problem. The only commercially available dot matrix pattern with five years of proven customer performance plus the following features:

- Low Cost
- Compact Packaging
- Few Connections
- Distinctive Appearance

The 5 x 7 dot matrix format of SELF-SCAN panels and our variety of MOS character generators allow you to communicate with maximum legibility and flexibility. Simultaneous bi-lingual display is also possible on certain models. SELF-SCAN panels are simple to interface to computers.

Single register displays of 16, 32, and 80 characters, and multi-register displays of 256 (8 x 32) characters are available. 0.2", 0.3", 0.4" characters with soft neon-orange glow are visible up to 25 feet.

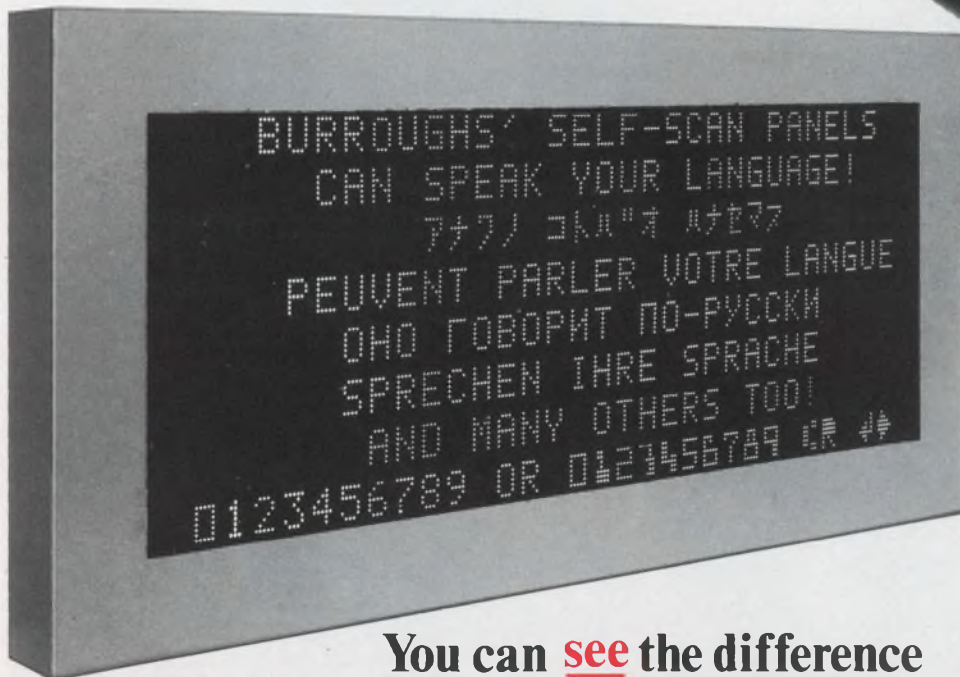

Call your Burroughs representative for a "briefcase" demonstration, or get in touch with Burroughs Corporation, Electronic Components Division, P.O. Box 1226, Plainfield, New Jersey 07061, Tel. (201) 757-3400 or (714) 835-7335.

You can see the difference

Burroughs



OCTOBER 11, 1974

New devices a possibility with IBM 'organic metal'

With the fabrication of new organic molecular crystals, IBM researchers have moved closer toward achievement of a major goal: the production of organic materials with the conductivity of metals.

With the crystals developed at IBM's Research Center, Yorktown Heights, N.Y., scientists foresee a new family of electronic elements and devices.

According to Dr. Edward M. Engler, the new crystal, called tetraselenofulvalenium tetracyanop-quinodimethanide, or (TSeF)(TCNQ), has a conductivity approaching that of metals. At room temperature, the IBM scientist points out, the conductivity is about $[800 (\Omega\text{-cm})]^{-1}$ —or, in the more familiar terms of resistivity, $1.25 \times 10^{-3} \Omega\text{-cm}$.

The resistivities of metal-like organic compounds—of which the IBM material has shown the best electrical characteristics—range from 10^{-2} to $10^{-3} \Omega\text{-cm}$. These decrease one or perhaps two orders of magnitude when the material is subjected to cryogenic temperatures, Engler says. These values compare with the resistivities of typical metals, which are about $10^{-4} \Omega\text{-cm}$. and decrease to more than $10^{-5} \Omega\text{-cm}$. at cryogenic temperature. For example, lead has a resistivity of about $2 \times 10^{-5} \Omega\text{-cm}$, while copper is about $2 \times 10^{-6} \Omega\text{-cm}$.

The IBM crystal consists of separate columns of positively and negatively charged organic molecules that permit the movement of electrical charges along the columns. Engler points out that the new crystals, which are black and needle-like in shape, are one of the most conductive "organic metals" reported to date. The resistivities of other typical molecular organic crystals are on the order of 10^{10} to $10^{17} \Omega\text{-cm}$, he

notes.

The unique properties of the IBM crystals, Engler says, act like one-dimensional metals because they conduct electricity well in only one direction—the direction of the needle-like structure. In the other direction (at right angles to the preferred orientation) the resistivity increases by several orders of magnitude because of the crystals' highly anisotropic structure.

The tempo of resistivity of the material is nonlinear and unusual. From room temperature down to about 40 K, Engler reports, the tempo is positive, like that of metals. This contrasts with the negative tempo of semiconductor materials.

The tempo increases, the IBM scientist points out, with decreasing temperature. It reaches a maximum and a turning point at 40 K. Below this the tempo reverses and becomes negative. The material then takes on the properties of a semiconductor.

The (TSeF)(TCNQ) crystal is a "fraternal twin" of another organic metal—(TTF)(TCNQ)—first reported two years ago by other laboratories. But the IBM compound differs in that it substitutes selenium atoms for sulfur atoms in the crystal. The substitution, which involves the creation of new synthesis procedures, doesn't affect crystal size or shape. But it doubles the electrical conductivity.

The IBM organic compounds provide unusual flexibility in applications, Engler says. The organic metals are composed of a donor and an acceptor; if the acceptor molecule is changed to chlorine, the resulting compound is a semiconductor with very high conductivity.

A prime advantage of the materials is that they provide controllable characteristics for the first

time, Engler says. Since the basic structures are the same, they can, in a sense, be alloyed like metals. They can be mixed in varying proportions to provide different properties. It is the first time that solid solutions have been made with such materials, Engler says.

As yet, the scientist adds, the materials are not well understood. The growth of single-crystal films made of the materials is now in progress.

One man radar relies on minicomputer control

Using a general-purpose minicomputer to minimize hardware and increase reliability and flexibility, engineers at RCA's Missile and Surface Radar Div., have built a transportable radar system that can be operated and maintained by one man.

The Digital Instrumentation Radar (DIR) was developed at Moorsetown, N.J., under a joint contract from the Army, Navy and Air Force and performs a variety of tracking functions. According to Lee Kithens, program manager at RCA, the radar which delivers 250 kW of power in C band, will be available in a stripped-down configuration, with provision for adding more than 30 modular options.

A Nova 800 minicomputer controls the radar's 16 basic functions. About half of these have previously been controlled by hard-wire logic. The computer, with 16 k of core memory, comes on four PC boards, and there is room in the mainframe to house 13 more boards. Four of these slots are filled by circuitry that performs all of the timing, range, tracking and mode-control functions. The remaining nine slots are used to accommodate the modular add-ons, such as magnetic-tape units, TV cameras and and electronic scan antenna.

3M substitutes tin for gold in connectors

To combat the rising price of precious metals, the 3M Co. is switching from gold to less costly, very pure—or "bright"—tin as the contact surface material for print-

ed-circuit connectors.

In making the substitution on the surface of the insulation-piercing contacts for all multiconductor flat-cable PC connectors, the Minneapolis company reports, performance equal to that of the gold-plated version in many applications where the environment is not hostile. Such application include computers and communications and home-entertainment equipment.

J. O. Knudson, 3M development engineering supervisor, reports that whereas the original company design employed 20 microinches of gold over 50 microinches of nickel plating on a copper base, the new design features 30 microniches of tin over a copper strike on a beryllium base.

In comparing performance, Knudson says that in test for moisture resistance, salt spray, thermal shock humidity, vibration and life under temperature cycling, in no case did the contact resistance of the tinplated contacts exceed that of the gold by more than 1 or 2 m Ω . In some tests, he reports, the change in contact resistance was less than for gold.

Microwave ovens get solid-state control

Solid-state control of magnetron output power is being offered for the first time in a commercial microwave oven. The controller is a variable width pulser for the magnetron. When less power is desired, the pulse width is decreased. The repetition of the system is one pulse every two seconds.

The controller is included in the Minutemaster Model 416 oven from Litton's Microwave Cooking Div., Minneapolis. It is called the Vari-Cook Oven Control.

With the controller, the power is variable from 65 to 650 W. The oven consumes 1500 W, and the magnetron has an average expected life of 2000 hr. The replacement cost of the magnetron is \$150.

With a list price of \$469, the oven is one of the higher-priced microwave ovens on the market.

According to William W. George, president of Litton Microwave Cooking: "Total industry sales of home microwave ovens this year

will be 650,000 units, a retail market of \$260-million. This compares with 440,000 units in 1973. Microwave ovens will be a billion-dollar market by 1980."

Mini system promises cheaper IC masks

A new hardware and software package is reported to speed IC design from rough layout to finished mask sets. And a significant reduction in IC design costs is indicated.

Introduced by Computervision Corp., Bedford, Mass., the package consists of a CRT design console, an interactive plotter/digitizer terminal and a powerful supporting software system in a Nova minicomputer. The mini is equipped with 16 k of core memory and a disc.

The design console, known as the Model 19S, is used for initial layout and design for IC mask areas. The console features the same 19-in. storage CRT used in the Model 4014 terminal from Tektronix, but it is produced entirely by Computervision.

The interactive plotter/digitizer, called the Interact IV, is used to draw IC mask diagrams and to plot the actual mask as well.

The interactive digitizer capability permits correction and modification of masks to be made while the designer views the complete artwork.

The software system, called CADS2/IC, is equipped with a complete library of standard IC graphic elements, including a selection of several different configurations of components, such as transistors. The designer can select which mask layer to work on and can skip from layer to layer, as required. A major feature of the operating system is that it can detect basic design errors.

According to Lee Rollins, regional marketing manager for Computervision: "The price of complete systems starts at about \$65,000 with one design console and plotter. The computer operating system can support up to four work stations, each involved with a different IC design. We have had a good response from our initial showing of the system and feel

that the current dip in semiconductor sales may have helped by making the manufacturer very cost-conscious."

Op amp combines CMOS and bipolars

Matching and threshold-control problems that have kept the monolithic MOSFET/bipolar/CMOS structure in the laboratory are overcome in a monolithic op amp developed by RCA.

The device, the CA3130, has a MOSFET front end and CMOS output structure and is the first of a line planned by the RCA Solid State Div. in Somerville, N.J. The process requires only one extra oxide cut and the use of ion implantation.

MOSFET matching problems have been overcome by use of an interdigitated transistor design that provides device matching to within several millivolts, instead of hundreds of millivolts.

Ion implantation has made the performance from device to device more uniform, RCA reports. And better process control, careful geometry design and simple circuit layout have helped keep thresholds uniform, according to the company.

The advantages of this new process include the following:

- Lateral pnp transistors can be eliminated and replaced with wider response p-channel FETs.

- The MOSFET front end provides a high input impedance (about 1 G Ω).

- The CMOS output stage permits output voltage swings with in several millivolts of ground or the power-supply levels—a feat that was impossible with bipolars.

The op-amp circuitry gives the circuit a 15-MHz frequency response, a 10-V/ μ s slew rate and an input impedance of 1.5×10^{12} Ω . Since the extra processing required is minimal, the op amp can be made in large production runs RCA says, at a price of only 75 cents each in 1000-piece lots.

Additional bonuses that result from the use of CMOS output transistors include single-ended operation from power supplies of from 5 to 16 V, or from dual supplies of ± 2.5 to ± 8 V.



MEASUREMENT COMPUTATION

innovations from Hewlett-Packard

NEWS

OCTOBER, 1974

in this issue

A new business
pocket calculator

Get two function
generators in one

New super-sensitive
x-y recorder



Desktop calculator now doubles as data terminal

New data communications capability for the 9830A allows it to be used as an interactive or batch terminal.

Thanks to a new interface, you can inexpensively and easily add data communications capability to 9830A desktop calculator systems. Now, you not only have a powerful programmable self-contained calculator, but you can also use the unit as an interactive terminal to communicate with a batch computer, timeshare system, or another 9830A calculator.

The 11285A data communications set includes an interface cable and a read-only-memory (ROM). New BASIC statements in the ROM enable the 9830A to send and receive data and strings from a remote terminal or computer via telephone lines. Programmable asynchronous or synchronous transmission and data rates

(continued on page 3)

The HP-70: new business companion to the HP-80 financial specialist



The HP-80 gave the financial world the first pocket-sized computing calculator designed specifically to handle over 100 most commonly used financial calculations. Now, Hewlett-Packard puts the same quality of design in a more generalized business pocket calculator, the new HP-70.

The versatile new HP-70 pocket calculator solves more than 100 complex financial problems...most of them in less than 20 seconds. It has more memory storage than any other business pocket calculator on the market, yet costs less than you'd expect.

Now, you can figure a loan payment, U.S./foreign currency conversions, or return on investments—at your fingertips. Use the HP-70 at work, at meetings, on sales calls, or on a plane. Wherever and whenever your time-and-money problems occur, the HP-70 helps solve them, with accuracy to 1 penny in a million dollars.

The HP-70's superior memory power gives you:

- Four memories in the memory stack that automatically store intermediate answers;

- Two addressable memories—one for accumulations, the other for constants;
- A financial memory bank that lets you change any number at any time. Thus, you can explore alternatives without having to key in all the information again.

Not only does the amazing HP-70 help at the office, it helps at home. Use it to figure mortgage payments, calculate your income tax, or help select the most profitable investment opportunities.

Like all HP pocket calculators, the HP-70 uses a non-algebraic approach that gives you answers you can trust.

For more on HP-70 versatility and value, check B on the HP Reply Card.

Now, cover UHF needs with precision AM/FM signal generators

A new internal doubler extends the frequency of HP 8640 AM/FM signal generators from 512 to 1024 MHz. With the new high-band option (002), total range is a wide 0.5 to 1024 MHz (overrange to 1100 MHz). Calibrated output in the extended band is +13 dBm to -145 dBm into 50Ω and is leveled to ±1.5 dB.

With new assignments for land mobile radio services in the 900 MHz region, the extended frequency capability of the 8640 gives you a precision test instrument to serve these applications, as well as needs in the HF/VHF/UHF bands.

We've preserved the desirable precision modulation, signal purity, and direct frequency and amplitude readout of the standard 8640 generators. Precision FM, with calibrated peak deviation to 5.12 MHz and rates to 250 kHz, is provided, as well as calibrated AM.

The frequency extension option is offered with both the 8640A (dial readout of frequency) and 8640B (digital readout). The 8640B includes internal phase-lock for highest stability plus a 500 MHz frequency counter.

If you already have an 8640 signal generator, you can purchase a field-installable kit to double your frequency coverage.

For more information, check N on the HP Reply Card.



The best RF signal generator, the 8640 now offers extended coverage to 1024 MHz.

Get the inside story on HP pocket calculators

If you're about to spend more than \$100 on a pocket calculator, you owe it to yourself to choose carefully. Before buying, you should know the differences between algebraic and non-algebraic logic systems, then determine the best one for your calculating needs.

HP's non-algebraic system lets you see each intermediate answer as you progress through a problem, so you can correct errors as you go. With this continuous feedback, you end up with answers you can trust.

A new informative booklet compares 3 representative calculators using "real world" scientific problems. After reading it, we think you'll agree that HP's non-algebraic approach offers the most efficient, most consistent way to solve complex problems.

For your free copy, check S on the HP Reply Card.



Calculator—data terminal

(continued from page 1)

from 110 to 9600 bits/second are available, as well as programmable parity, automatic dialing and answering, "end-of-transmission" character, and half- or full-duplex mode.

Two other ROMs add further capability. One provides remote batch capability using IBM binary synchronous line protocol. The other ROM provides timesharing capability and allows you to receive and transmit programs in other languages, such as FORTRAN.

For more information, check O on the HP Reply Card.

New generator gives you more functions for your money

HP's new 3312A function generator offers more variety in output selection than any comparably-priced generator on the market. It has sine, square, triangle, positive and negative ramps, as well as a number of other features.

It's actually two independent generators in one—the main generator delivers 0.1 Hz to 13 MHz in eight decade ranges, and the modulation generator delivers 0.01 Hz to 10 kHz in three ranges. You can trigger the main generator with the modulation generator to get sweep functions, AM, FM, frequency shift keying, gating and tone bursts. Output of the main generator is 10 V p-p into 50 Ω for all waveforms, adjustable over a 60 dB range. Its <18 ns risetime makes the 3312A an ideal source for applications that require medium speed pulse trains.

All these versatile functions enable you to use the 3312A for sonar testing, pulse doppler testing, and shock wave simulation, as well as traditional amplifier, receiver and filter testing.

For details and specs, check D on the HP Reply Card.



The new 3312A function generator has sine, square, triangle, positive and negative ramps. Accuracy is $\pm 5\%$ of full scale.

Now, measure to 23 GHz with HP microwave counter

Shown here with a satellite communications antenna, the 5340A microwave counter now measures higher carrier frequencies.



That's right—with special option H10, our proven 5340A microwave counter now counts signals as high as 23 GHz. Sensitivity is significantly better than that of other microwave counters, yet the 5340A is rugged enough to take +30 dBm inputs.

It's easy to use: simply apply your signal to a 50 Ω connector, then measurements are entirely automatic. The 8-digit display positions the decimal point automatically and specifies unit notation in kHz, MHz, or GHz. Frequency range is 10 Hz to 23 GHz. Dynamic range is 42 dB wide (-35 dBm to +7 dBm). If you need higher input impedance, a second input is available, 10 Hz to 250 MHz with 1 M Ω impedance.

The 5340A fits nearly every microwave application. Use it to measure carrier frequency, align receivers, calibrate signal generators, identify ECM carriers, automatically test VCOs, or test microwave communications systems.

For complete details, check J on the HP Reply Card.

Improve lab recording with HP's fastest and most sensitive x-y recorder

A special combination of acceleration and sensitivity, the 7047A x-y recorder is the fastest, most sensitive recorder that HP has ever built. Sensitivity ranges from 50 $\mu\text{V}/\text{in.}$ to 10 $\text{V}/\text{in.}$ (20 $\mu\text{V}/\text{cm}$ to 5 V/cm). Acceleration on the y axis is greater than 3000 $\text{in}/\text{sec.}^2$ (7620 $\text{cm}/\text{sec.}^2$) while on the x axis, acceleration is 2000 $\text{in}/\text{sec.}^2$ (5080 $\text{cm}/\text{sec.}^2$). Slewing speed is 30 $\text{in}/\text{sec.}$ (76 $\text{cm}/\text{sec.}$).

To meet the demands of the most exacting lab work, the 7047A recorder has a switchable input filter, fully-guarded input, 130 dB common mode

rejection, 11 scales of calibrated offset, an internal time base, and TTL remote control. And the 7047A is easier to use than any other x-y recorder available: its internal guard circuit enables you to use the 7047A with virtually any input connection configuration. In most applications, there's no need for external guard connections.

For details and specifications, check K on the HP Reply Card.

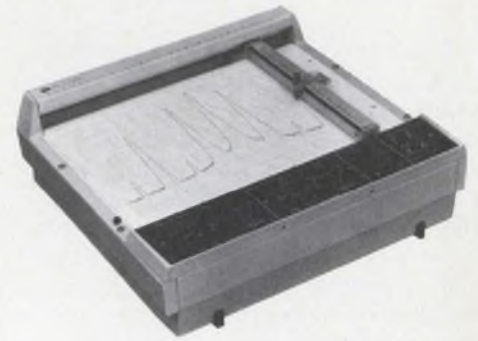

The 7047A: the best x-y recorder HP has ever developed.

Six models cover your high-voltage power supply needs

Set output voltage easily and precisely with the 3-decade thumbwheel switch plus a thumbwheel vernier providing 0.002% resolution.



When your application calls for a system or lab power supply in the range of 0-4 kV, HP has six models to fill your need. Three of them are constant voltage/constant current supplies with sufficient output current to power devices such as klystrons, magnetrons, backward-wave oscillators, high-power gas lasers, and electron-beam welding devices. Model 6521A delivers 0-1 kV at 0-200 mA; model 6522A delivers 0-2 kV at 0-100

mA; while model 6525A supplies 0-4 kV at 0-50 mA.

Two lower cost models are also available. The 6515A power supply delivers 0-1.6 kV at 5 mA, while the 6516A supplies 0-3 kV at 6 mA. Their small size, low price and short-circuit-proof operation make them the choice where current requirements are low.

For specs, check R on the HP Reply Card.

New pulse generator sets new standards in pulse fidelity

With 250 MHz repetition rate, variable transition times down to 1 ns, and low reactance 50 Ω source, the new 8082A pulse generator meets the stringent demands of today's fast logic like ECL and TTL-S. Yet it's easy to operate because of its logical front panel layout and switch-selectable ECL outputs.

The low-reactance 50 Ω source impedance helps provide a clean pulse at the input of the device to be tested. When operating without an external termination, the 8082A 50 Ω source absorbs 98% of reflections from

signals up to 4V, leaving only 2% distortion.

The low transition time degradation produced by the high quality 50 Ω source, combined with fast 1 ns transition time, lets you test ECL circuits at their maximum operating speeds and still leave a speed margin. The degradation of the transition times that always occurs under actual load conditions can be accommodated without exceeding the manufacturer's specifications.

Custom-made hybrid ICs eliminate the need for fans, reduce power con-



Maximum pulse rate is 250 MHz; maximum amplitude, 5V.

sumption, and contribute to high reliability.

For specifications, check L on the HP Reply Card.

New RF adapter extends handheld dmm ac range to 500 MHz

Here, a technician uses the dmm probe and RF adapter to check a printed circuit board in a TV camera.



A new RF probe adds 100 kHz to 500 MHz ac measurement range to HP's handheld 970A digital multimeter. Accuracy within this range is greater than 1 dB. The new 97003A RF adapter measures 0.25 to 30 V full scale. Maximum input is 30 V rms, plus 200 Vdc.

The pocket-sized digital multimeter measures ac and dc volts and ohms. Basic ac voltage range is 100 μ V to 500 V, 45 Hz to 3.5 kHz. Input resistance on the ac range is 10 M Ω . Input resistance of the new RF probe is >25 k Ω , shunted by <4 pF.

The 97003A adapter is a peak detector calibrated to read the rms value of a sine wave input, then convert it to dc voltage. Thus, you simply set the dmm to read dc volts when you use the RF adapter. No other adjustments are necessary since the 970A is fully autoranging with autopolarity.

For more information, check P on the HP Reply Card.

Three new scope probes simplify parallel triggering

Three new AND-gate trigger probes now enhance the use of oscilloscopes, logic analyzers, and other test equipment. Model 10250A works with TTL logic; 10251A, with MOS circuitry; and 10252A, with fast ECL. With any of the three, you can trigger on four parallel events. The four inputs can be switched to Hi, Lo or Off for convenient selection of the trigger point. And you don't need a separate power supply because power is obtained from the circuit under test.

The new trigger probes are great service, production and troubleshooting tools. Now, you can easily take electrical measurements that were almost impossible to make in complex digital sequences. The 10250A TTL trigger probe has an added "glitch filter." By varying the external trigger level of a scope, you can eliminate the effect of short glitches (<250 ns) that cause unwanted logic states.

These small probes directly connect to dual in-line packages and backplane pins. The tips easily slip off the



Trigger any oscilloscope from digital signals with HP's new TTL trigger probe.

probe wire for direct connections to 0.6 mm square pins, IC test clips, and wirewrap pins.

For more information, check Q on the HP Reply Card.

HP catalog for microwave measurements

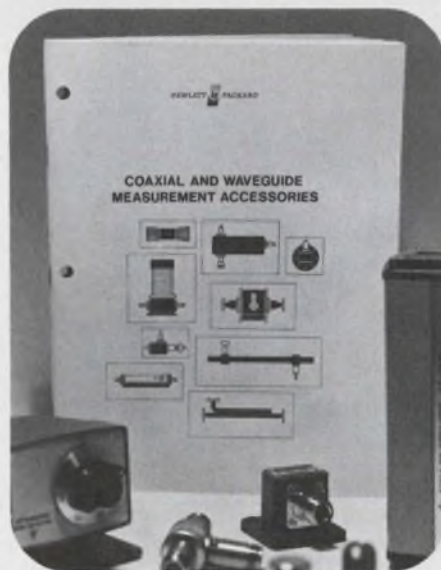

In case you missed it before, HP is again offering its 64-page catalog of coaxial and waveguide instrumentation. Specifications are presented for such items as:

- Directional couplers
- Slotted-line equipment
- Attenuators
- Frequency meters
- Detectors
- Mixers
- Filters
- Modulators
- Terminations

This book describes all the precision hardware you might need to help make accurate microwave measurements.

Check T on the HP Reply Card for your copy.

Get both batch and timesharing in new super-timeshare system

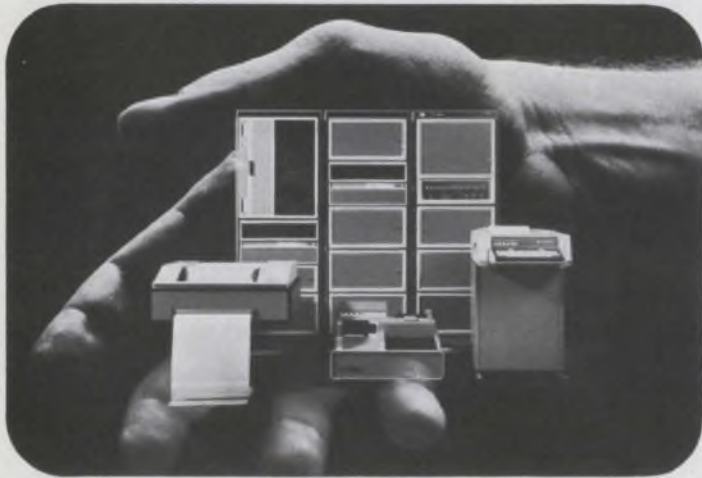

The new HP 3000/model 100 timeshare system is the most powerful BASIC system on the market. Besides offering terminal access to as many as 16 users, the new super-timeshare system simultaneously compiles and executes programs in batch mode, in FORTRAN, COBOL and our own system programming language (SPL). Unlike its competition, the HP system can handle integers, real, long-precision, and complex numbers, *all in the same program.*

This new disc-based system in-

cludes 96 bytes of core memory and storage of 9.8 million bytes on the disc. It's an outstanding in-house timesharing system for manufacturing, engineering, finance, operations research, technical centers, and universities. And the new advanced software, BASIC/3000, provides more power and capability with less programming effort.

For the complete story, check C on the HP Reply Card.

Three new application pacs for the HP-65

Now, we've taken common problems in the areas of finance, aviation, and navigation—and HP has written the programs for you. So, it's easier than ever to use your HP-65 fully programmable pocket calculator. Simply slip in a program card, key in your variables, and instantly your answers appear on the 10-digit display.

The new finance pac contains 38 programs including calculations for loans, savings, annuities, investment analysis, depreciation, leases and business statistics.

The new aviation pac with 31 programs lets you compute ETA, fuel consumption, fuel reserves, true ground speed, and more...in seconds, preflight and in flight.

The new navigation pac lets you make 25 tedious calculations without tables. It virtually replaces the tradi-



The new finance pac puts all the compound interest tables that you need on tiny magnetic cards.

tional nautical almanac.

To find out more about the HP-65 and HP application program pacs, check A on the HP Reply Card.

Universal counters fit virtually any application



Here are just 4 of the 6 models you can choose.

The HP 5326/5327 series of counters/timers make precise measurements for a wide range of applications. For communications applications, you can automatically measure the frequency of CW or burst signals to 550 MHz. An ultra-high stability oven oscillator (with aging rate $< 5 \times 10^{-10}$ /day) provides exceptional accuracy.

A unique time interval averaging technique gives resolution to 100 ps for applications such as precision logic timing measurements. That's 1000 times better than conventional techniques, and works for intervals as short as 150 ps.

A built-in DVM helps set trigger levels with digital accuracy, plus measure dc volts in three ranges. Thus, the counter becomes two instruments in one.

All functions can be remotely programmed for systems applications.

To learn more, check I on the HP Reply Card.

Expandable low-cost counters for changing needs

The 5300 series of electronic counters consist of a display, 6 functional units, a battery pack, and a digital-to-analog converter. You merely snap together the appropriate modules to meet your requirements.

The 5300A display mainframe combines with any of the following frequency and functional units:

- 10 MHz counter with totalize
- 525 MHz counter with optional time base
- 10 MHz timer/counter
- Digital multimeter (acV, dcV, Hz and ohms)
- High-resolution counter

You can add additional units later as your needs and budget grow.

The 5310A battery pack makes any of the above a rugged, lightweight, portable measurement system that you can carry into the field.

For easy strip-chart recording, the 5311A digital-to-analog converter converts any measurement into an analog signal.



Quality electronic counters needn't be expensive: the 5300 series offers several low-cost counter solutions.

Check H on the HP Reply Card for details.

HEWLETT-PACKARD COMPONENT NEWS

New high-speed dual isolator is TTL compatible

HP's new dual-channel hermetically-sealed isolator provides maximum ac and dc circuit isolation between each input and output while achieving TTL circuit compatibility. Isolation and coupling is achieved with a typical propagation delay of 55 ns. Standard and high-reliability screened versions are available.

The 5082-4365 isolator consists of a pair of inverting optically-isolated gates, each with an LED and a high-gain integrated photon detector in a hermetically-sealed ceramic package.

For prices and specifications, check F on the HP Reply Card.

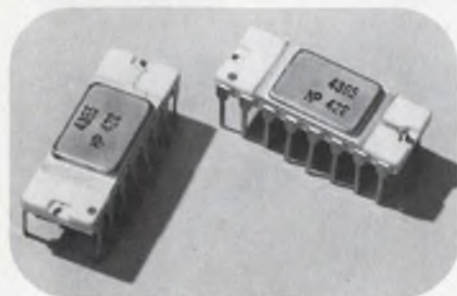

Use the 5082-4365 isolators in line receivers, logic ground isolation, and computer-peripheral interfacing.

New hermetic Schottky mixer diodes

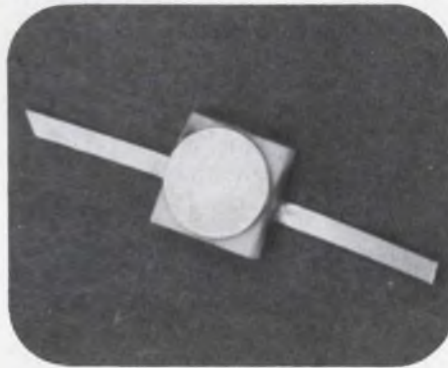

The new Schottky mixer diode has a low noise figure of <math><6\text{ dB}</math> at 9 GHz.

HP's new 5082-2200 series Schottky mixer diodes are designed for both broad and narrow band strip-line mixer assemblies (1-12 GHz) where low noise figure and hermeticity are important. Thanks to the excellent uniformity of RF characteristics, you can replace these devices in the field without circuit adjustments. You can use these diodes in telecommunication receivers, microwave synthesizers, and ECM/radar front ends.

For details, check E on the HP Reply Card.

Four new high-power IMPATT diodes

HP offers four new double-drift, high-efficiency IMPATT diodes. The 5082-0600 series is designed for CW power sources from 10 to 14 GHz, and provides a choice of 1.5W and 2.5W power output. Their high output power, efficiency and reliability make these devices ideal for X-band oscillators and amplifiers.

The 5082-0700 series IMPATT diodes are designed for X-band and Ku-band applications. Stable operation at high peak power levels makes them especially suitable for pulsed radar applications, lightweight man-pack radar, and active phased array radar.

To learn more, check G on the HP Reply Card.

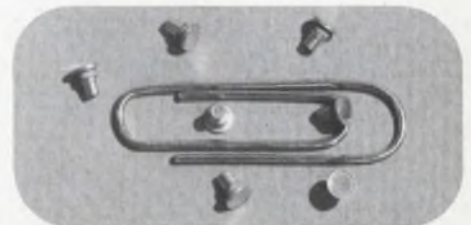

Besides greater power and efficiency, double-drift IMPATTs have lower junction capacitance and lower fm noise compared to single-drift IMPATTs.

New broadband sweeper: big in performance, small in size



Wide range (to 18 GHz) sweeper uses advanced microelectronics for lab precision and field portability.

able to offer a sweeper whose frequency, accuracy, linearity, stability and signal purity ratings rival octave-bandwidth signal generators. Output is at least +5 dBm over the entire 2-18 GHz range, and it's internally leveled to ± 1 dB.

Versatility is another major contribution: the 8629A/8620A is uniquely compatible with HP network analysis instrumentation for widest range, spurious-free swept measurements. And provision is made for effective phase-locking, for alternate leveling techniques, and for simplified remote programming (optional).

Advanced microwave technology now brings you a broadband 2-18 GHz sweeper with the performance precision needed for stringent lab and production tests, as well as size and weight advantages for field applications. The new 86290A plug-in in the 8620A mainframe is the smallest

2-18 GHz swept source available. You can easily carry this lightweight microwave sweeper (33 lb/15 kg) to field measurement sites.

By combining a YIG-tuned microwave oscillator with a broadband microwave power amplifier and a YIG-tuned frequency multiplier, we are

For full details about this new sweeper's many advantages, check M on the HP Reply Card.

HEWLETT  PACKARD

East-20010 Century Blvd., Germantown, MD 20767, Ph. (301) 428-0700.

South-P.O. Box 2834, Atlanta, Ga. 30328, Ph. (404) 436-6181.

Midwest-5500 Howard Street, Skokie, Ill. 60076, Ph. (312) 677-0400.

West-3939 Lankershim Boulevard, North Hollywood, Calif. 91604, Ph. (213) 877-1282.

Europe-Post Office Box 85, CH-1217 Meyrin 2, Geneva, Switzerland, Ph. (022) 41 54 00.

Canada-6877 Goreway Drive, Mississauga, Toronto, L4V 1L9, Ph. (416) 678-9430.

Japan-Yokogawa-Hewlett-Packard, 1-59-1, Yoyogi, Shibuya-ku, Tokyo, 151.

Another technical knockout

the first reliable 60 W gold UHF amplifier

J. R. Black did the first aluminum metallization research at Motorola in 1967¹...Louis Terry did the first gold metallization at Motorola in 1969²...now Motorola announces the first reliable, producible gold metallization system for RF power with the MRF306.

The process features ultra-accurate metal pattern delineation by ion beam etching ensuring correct finger widths and vertical finger walls... thick oxide step coverage... oxide-passivation... and very high figure-of-merit geometric design allowing rugged structuring without sacrifice of power gain.

It's a totally new, engineered system involving the latest equipment designed for the process — rather than process designed for available equipment.

Theoretical device metallization MTBF is 10⁷ hrs. @ 200°C.

The MRF306 is a Controlled Q* unit with 2-stage internal matching maximizing bandwidth due to lower input Q, ensuring easier circuit design. Typical G_{pE} is 10dB at 400 MHz.

*Trademark Motorola, Inc.

1. Proceedings of 1967 Annual Symposium, Reliability Physics, IEEE, Cat. #7-15C50, Nov. 1967.
2. IEEE Proceedings, Sept. 1969, "Metallization Systems for ICs."

The particulars are available in a new Engineering Bulletin, EB-26. Send for it and data sheets: Box 20912, Phoenix, AZ 85036.

Design UHF with the best products you can possibly get — and be first with the first...

ONE OF THE 48 INDIVIDUAL CELLS ON THE 60 x 165 MIL MRF306 CHIP

BASE BONDING PAD

12,000 Å OXIDE STEP

BASE FEED BAR

NICHROME RESISTORS

EMITTER FEED BAR



from Motorola, the RF producer.

INFORMATION RETRIEVAL NUMBER 18

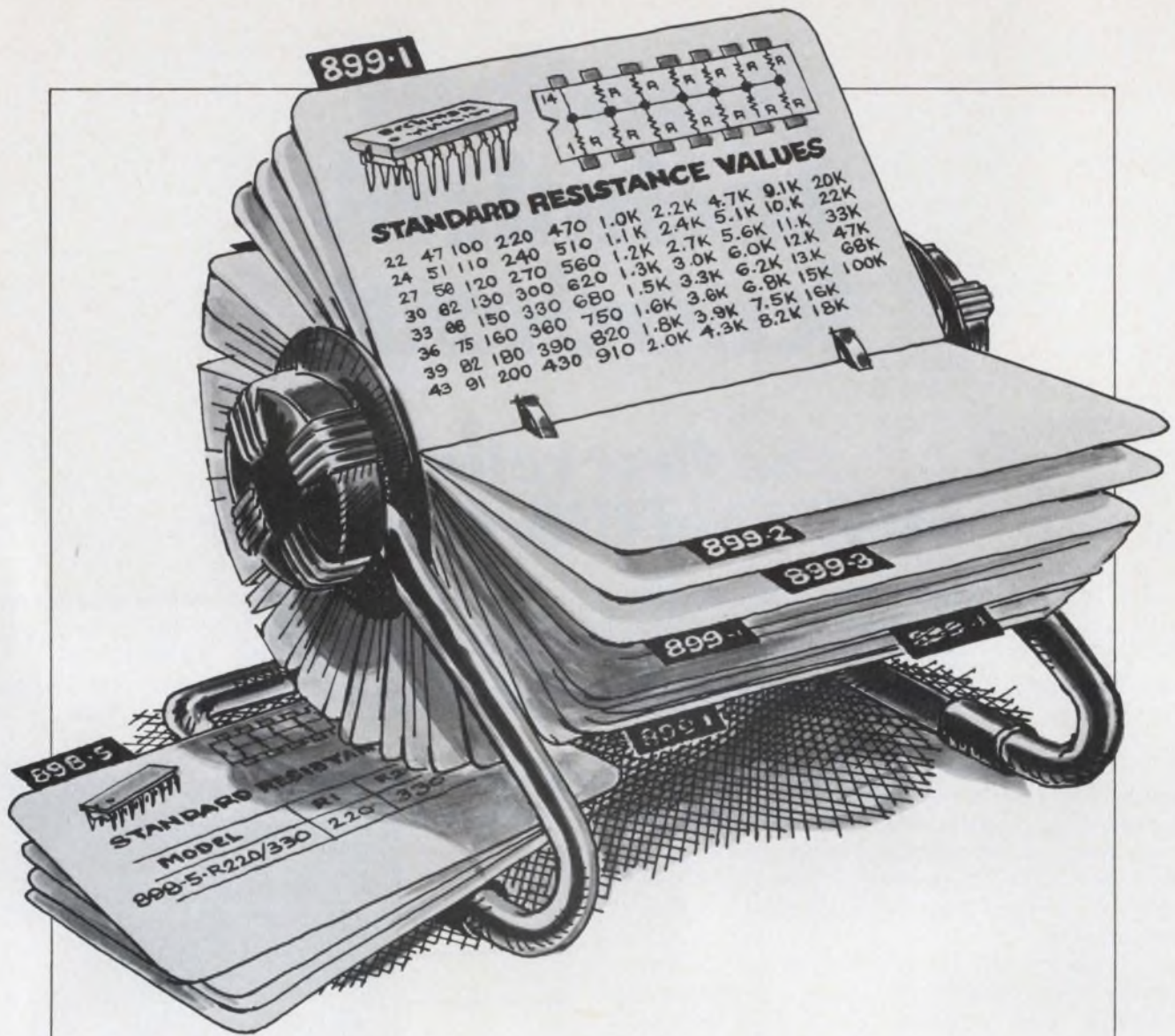

Still rolling up the score. Now, 223 standard Beckman DIPs.

We're adding more and more models to the RESNET™ DIP resistor line to make things easier for you.

Now there are 223 standard RESNET DIPs to give you wider selection, greater variety of resistance values, and less need for custom components.

Use them for applications involving pull-up/pull-down, line termination, LED current limiting, ECL termination, or interface networks. And most models are second-sourced, too.

RESNET DIPs are dimensionally uniform, ideal for automatic insertion techniques. They're also laser-tailored for precise resistance values. And every part is 100% tested.

Ours is the broadest line available and it's stocked locally by your Beckman/Helipot distributor for immediate delivery.

Prices? Truly competitive, actually giving you the quality of cermet technology at plastic prices.

Considering breadth of line, quality, availability, and good pricing, you don't have to look farther than Beckman for standard resistor networks. Or for expertly produced custom versions as well.

Check us out. For immediate literature or the phone number of your Beckman/Helipot representative, call toll-free (800) 437-4677. **HELIPOT DIVISION**

Beckman®

Assume your connector is made by TRW/Cinch



When your problem is to find a particular connector — in whatever category — assume it's made by TRW/Cinch Connectors. We're confident you won't be disappointed. Why? Because TRW/Cinch makes more types of interconnection devices, for more applications, than most other manufacturers in the world.

In the universe of connector categories, some that we cover completely include

- Printed circuit connectors
- Rack and panel connectors
- Cylindrical connectors
- Component and IC sockets
- Back panel assemblies
- IC logic panels
- Barrier terminal blocks
- Telephone system connectors...

And, if your concern is availability, assume that any reasonably standard connector is probably stocked by your Cinch distributor. We offer more types for immediate distributor delivery than any other connector supplier.

You can quickly prove for yourself that these assumptions can be safely made. Get full information in the detailed EEM listings or through your local TRW/Cinch sales office, or by calling toll-free (800) 645-9201 for the name of your nearest TRW/Cinch distributor.

Or write TRW/Cinch Connectors, an Electronic Components Division of TRW Inc., 1501 Morse Ave., Elk Grove Village, Ill. 60007. Phone (312) 439-8800.

CM-7402

TRW CINCH CONNECTORS

INFORMATION RETRIEVAL NUMBER 20

ICs and transistors provide brain and muscles for motor control

With devices like switching transistors and ICs, the control of ac and dc motors is stepping out of the traditional electrical world into the electronic.

Among the ICs being used are power Darlingtons, digital phase-locked loops, microprocessors, read-only memories (ROMs) and monolithic ICs with built-in SCRs.

Transistor choppers are starting to replace SCR choppers in dc mo-

tor drives, and transistorized variable-frequency inverters are replacing SCR inverters for ac motor controls.

A controversy among ac motor control designers is whether to use pulse-width modulation or multi-step amplitude modulation for variable-frequency inverter designs.

The main aspects of a motor that can be controlled are speed, torque and position. With a dc motor, both speed and torque are controlled by current. With an ac motor, speed is controlled by frequency, and torque

by current. Positioning in both ac and dc requires a feedback control system that monitors shaft position and feeds back an error signal till the correct shaft position is achieved.

Speed the key factor

For most applications, speed is the key factor. In a dc motor, varying the input current to the motor to adjust both speed and torque is usually done with a chopper. The chopper takes a dc input and switches it on and off. The amount of time that it is on determines the volt-second integral of the energy to the motor winding, and therefore the current that flows through the winding.

Most choppers now use SCRs as the switching elements. But several manufacturers are designing with switching transistors, which are easier and cheaper, since commutation circuitry is no longer needed.

Commutation circuitry is needed to turn off the SCR after it is turned on. Transistors turn off by themselves. Current transistors and power Darlingtons can be used up to power levels of 20 to 30 kVA. Above that, SCRs must still be used.

At very low levels—up to a few hundred mW—SCRs that are built into monolithic ICs can be used economically. For example, the CA-3097E thyristor/transistor array from RCA, Somerville, N.J., contains an SCR that can stand 150-mA forward current (max) with total average dissipation of 300 mW.

Deltec Corp. in San Diego uses a transistorized chopper to control a dc motor that drives wheelchairs. The chopper uses pulse-width modulation at a constant chopping

David N. Kaye
Senior Western Editor



Control of bursts of dc voltage can be used for motor speed control. Varying the width or repetition rate of these pulses changes the motor speed. Motorola uses an MCM14524 CMOS 1024-bit ROM to generate the pulse-width variations in a sine-weighted sequence. The color wheel was part of a strobe-lighted speed control demonstration.

1975 CERAMIC CAPS...NOW

MONO-KAP™. MONO-GLASS. Radial. Axial. USCC/Centralab has taken the lead for '75. You can be confident now of short delivery, plentiful supply and competitive pricing on reliable ceramic capacitors from the leader in monolithic technology.

DISCRETE ASSEMBLY

MONO-KAP™ radial-leaded epoxy coated capacitors are reliable performers; they're rugged enough to work in MIL environments. 4.7pF to 10Mfd., 50 to 200 WVDC in a variety of dielectrics and case sizes. Immediate delivery from stock; large volume production orders in *eight weeks* . . . and price competitive.



AUTOMATIC HIGH VOLUME INSERTION

MONO-GLASS axials are glass encapsulated, designed for automatic



PCB insertion; furnished reel-packed for high volume applications. They're available in 50 and 100 WVDC from .01 to 1.0Mfd.; three dielectrics: COG, X7R and Y5V.

Our basic materials research gives you the best in monolithic technology; our productivity engineering guarantees competitive prices and best delivery.

You can design confidently with USCC in 1975 for: calculators, computers, business machines, communications or any volume application using discrete or automatic assembly.

Some manufacturers are still solving problems; we can produce 25 million pieces per month and we're still expanding; at USCC we've got 1975's

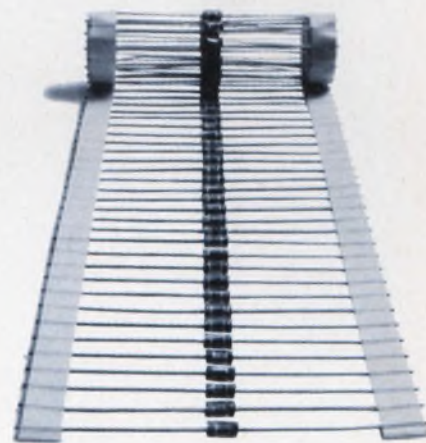

capacitors NOW. Write or call for large quantity quotations or evaluation samples.

Remember, USCC/Centralab.

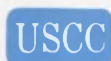

USCC/Centralab

Electronics Division • Globe-Union Inc.

2151 North Lincoln Street • Burbank, California 91504
(213) 843-4222 • TWX: 910-498-2222

INFORMATION RETRIEVAL NUMBER 21

frequency.

According to Delbert A. Johnson, president of Deltec: "We're using power transistors, mostly germanium, instead of SCRs to save commutation circuitry. We're switching at 400 Hz and using regenerative braking, by switching a resistor across the armature of the dc permanent magnet motor. The resistor serves as a load, while the motor serves as a generator. Reversing is done by reversing the polarity of the output of the chopper."

Inland Motor, a division of Kollmorgen Corp., Radford, Va., has a 5-kHz switching-transistor dc-motor drive. James Whited, systems-design engineer at Inland, says that the motor forms the center of an H-bridge. Switching transistors are in the legs of the bridge. Depending upon the switching sequence, the energy to the motor

can be controlled carefully to drive the motor either forward or reverse with varying speed.

Whited notes two main advantages of this drive scheme: There is less harmonic heating of the motor, and the response of the motor is several times faster and more accurate than with lower-frequency SCR controls. Above 15 to 20 kW of drive power, Whited would use SCRs as the switching elements in his bridge. Others, such as GE in Erie, Pa., and Control Systems Research in Pittsburgh, have tried a similar approach.

The controversial ac control

Much of the innovation in motor control revolves around ac motors. In ac, the speed is proportional to the input frequency. The precision of speed control is determined by the precision of frequency control.

Most modern ac-motor controllers use inverters to get from a precise dc level to an ac variable-frequency output. The inverters are of two basic types: The simplest and most widely used is the multistep, amplitude-modulated inverter. The second is the pulse-width-modulated variable frequency inverter (PWM). Good motor controls have speed accuracies of from 0.01 to 0.05%. With well designed synchronous motors, speed control precision can be even better. Induction motors are not as easy to control. Squirrel-cage motors require phase-locked loop frequency control to set speed to 0.01%. Some experimenters with phase locked loops have reported speed control to 0.001%. However, this has not been reported outside of a laboratory environment.

The first type is usually built with six, 12 or 24 steps per cycle of output. This inverter constructs its output sine wave from a staircase of discrete steps of voltage.

For example, to form the positive half cycle of the sine wave, the output of a six-step inverter has an intermediate positive-going step, followed by a peak positive-going step and another intermediate positive-going-step. This is fol-

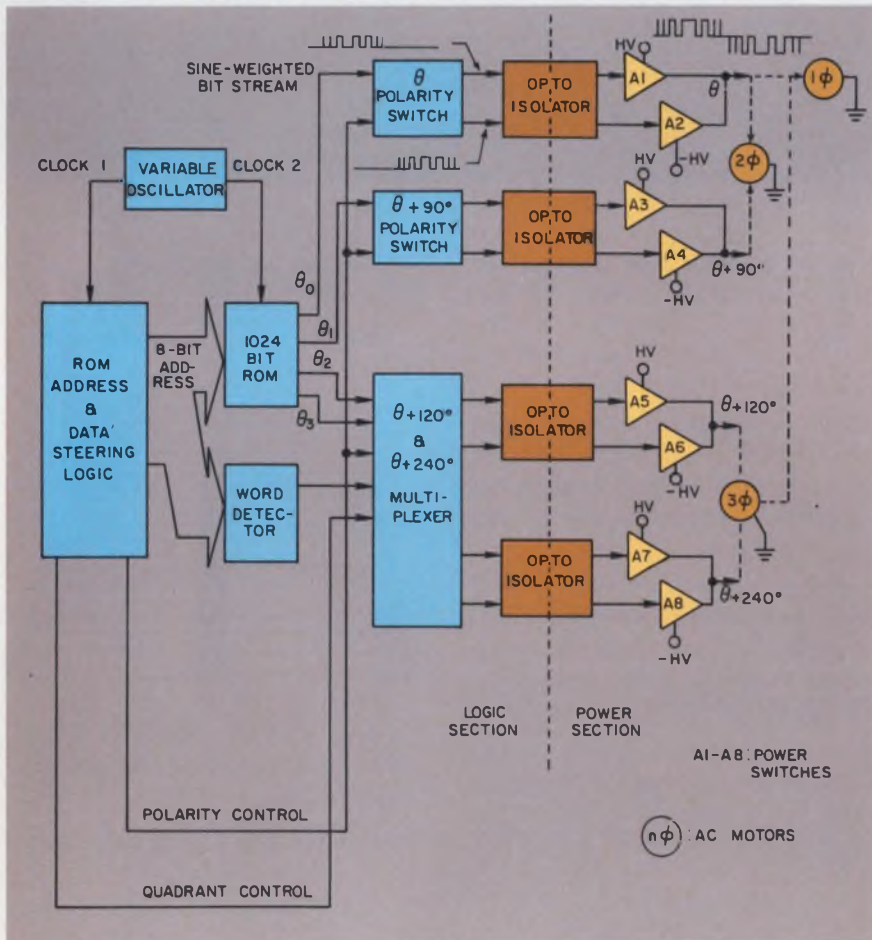

A versatile circuit capable of controlling the speed of four single-phase motors, one two-phase unit, or one three-phase device uses a 1024-bit ROM to generate sine-weighted, pulse-width-modulated trains of pulses having a variable repetition rate. The circuit, by Motorola, uses opto-isolators to decouple the low-level switching stages from the high-power driving stages.

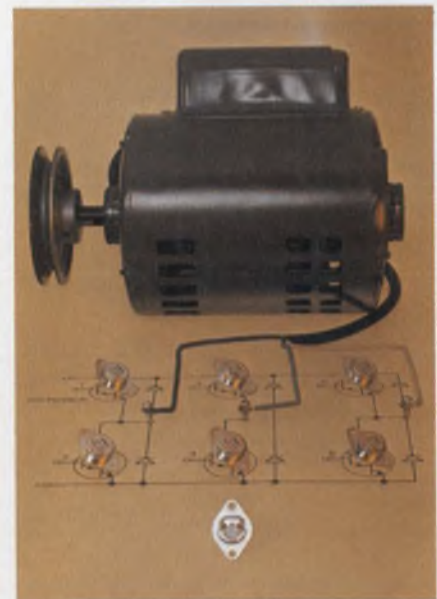

Power Darlingtons, such as these from TRW Semiconductor, are replacing SCRs in ac motor-control applications. They require less external circuitry than SCRs and are less prone to false triggering.

DIGITEC'S NEW DATA LOGGERS



HAVE ALL THIS VERSATILITY

- Models to measure Voltage, Current, Resistance, Temperature & other transduced parameters.
- 20 selectable scan points standard, expandable to 200.
- Real-time digital clock with program interval for unattended operation, standard.
- Digital printout arranged for quick, easy reading.
- BCD and system interlocks brought out to interface peripherals such as: comparators, tape punch, and mini-computer.
- Loss of power indication.
- All LED long-life displays.

WITH PRICES UNDER \$2500

To see the DigiTec 1200 or 1500 series Data Loggers, simply contact your DigiTec representative. Or, you can call or write; **United Systems Corporation**, 918 Woodley Rd., Dayton, Ohio 45403 Phone (513) 254-6251.

All DigiTec instruments are available for rental or lease through Rental Electronics, Inc.

DIGITEC
UNITED SYSTEMS CORPORATION
subsidiary of **Monsanto**

lowed by a similar negative-going half cycle. The more steps used, the more precise the sine wave is and the less harmonic content is present to heat the motor.

Robert Boyd, vice president of engineering at Ramsey Controls, Mahwah, N.J., says: "Six steps are usually sufficient for most applications. It is rarely worth the additional expense of switching elements needed to produce more steps."

Boyd is a firm proponent of the multistep, amplitude-modulated approach to ac motor control. He contends that his systems are less complex and easier to maintain than those designed with any other approach. All of Ramsey's drives use SCRs for the switching elements. The maximum frequency that they switch at is 250 Hz.

Many companies in the ac motor-control field share Boyd's views, and most produce multistep, amplitude-modulated drive systems. Several are switching to transistors instead of SCRs for low and medium-power motors. Robert A. Rauch, president of PTI Controls, Anaheim, Calif., observes: "We're using transistors and power Darlington's to 30 kVA."

Low-speed operation has always been a limitation of ac motors. For such operation, conventional or stepper dc motors have always been best. Rauch has achieved good low-speed operation with optical couplers, instead of transformers, to isolate the logic from the power switches. At low frequencies, and therefore low motor speeds, transformers saturate.

The new wave of ac-inverter technology centers on pulse-width-modulated, variable-frequency motor controllers. Whereas the multistep inverter simulates a sine wave with a series of steps, the PWM inverter simulates a sine wave with a series of pulses of varying width but constant amplitude. To simulate the volt-second integral of the energy under the sine wave, the PWM inverter starts with many narrow positive-going pulses and gradually widens the pulse width to a maximum at the middle of the positive-going half cycle. Then the pulse width narrows down towards the end of the first half cycle.

The process repeats for the negative-going half cycle. Since

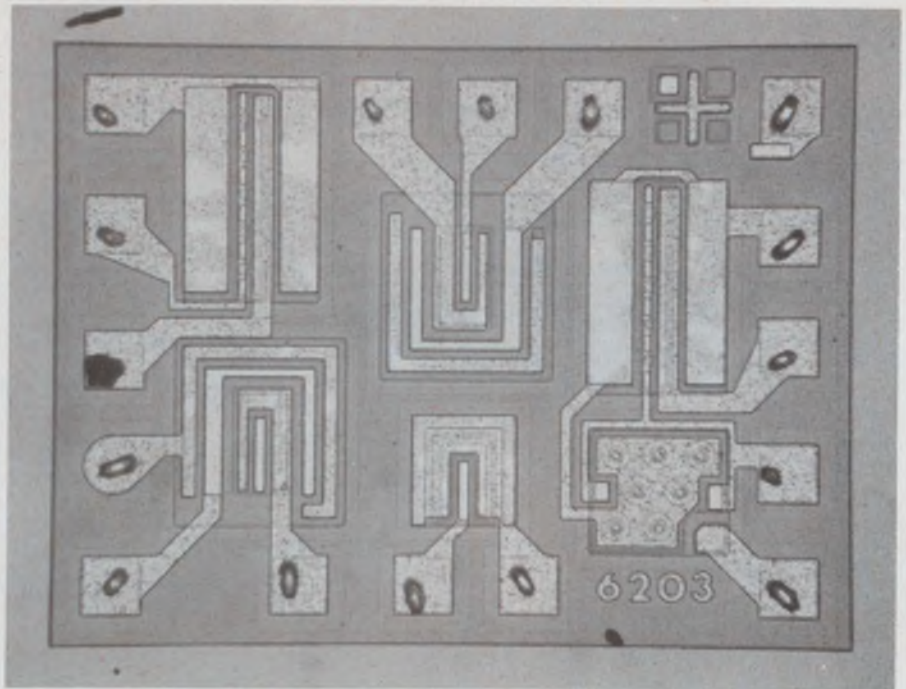

SCRs as part of monolithic ICs are bringing down the cost of controlling very small motors. The RCA CA3097E thyristor/transistor array contains an SCR with 150 mA max forward current, as well as an array of transistors and a zener diode.

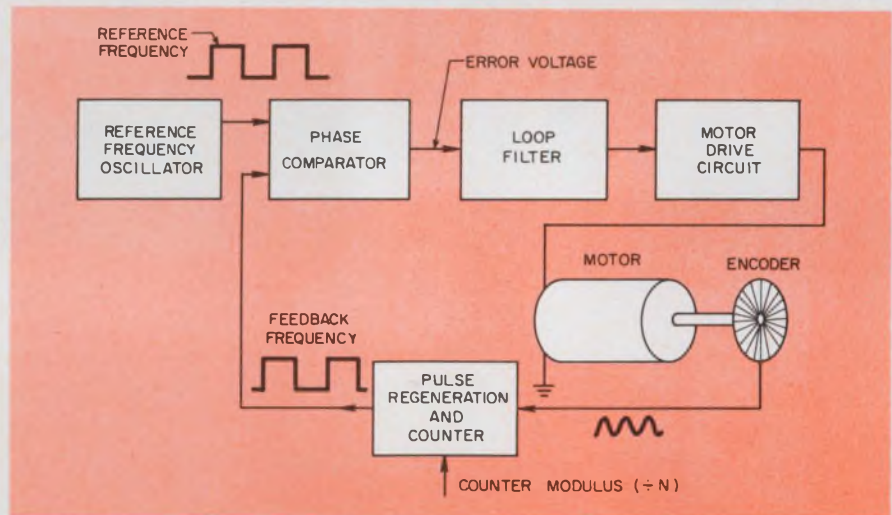

Digital phase-locked loops can be used for precision speed control as well as positioning. In this system, from Motorola, a shaft encoder is used to sense motor speed, and a pulse train is fed back to a comparator, to be checked against the reference pulse train. If the motor is not synced to the reference, an error voltage adjusts the motor speed.

many pulses can be used in each half cycle of the PWM inverter, a very accurate, low-harmonic-content sine wave can be simulated.

In addition wave shaping can be performed readily for outputs other than sine-wave. Jerry Pollack, manager of inverter products for Reliance Electric Co., Cleveland, says: "PWM inverters can give wide-ranging speed variation with

high precision and low harmonic content at a very reasonable cost. With transistor and power-Darlington switching, high toggle rates can be achieved, allowing for very high-speed motor operation."

Reliance builds a PWM inverter that uses adaptive-ratio modulation to get good control at low speeds as well as high. This inverter goes from 0 to 200 Hz and

Bigger and Better

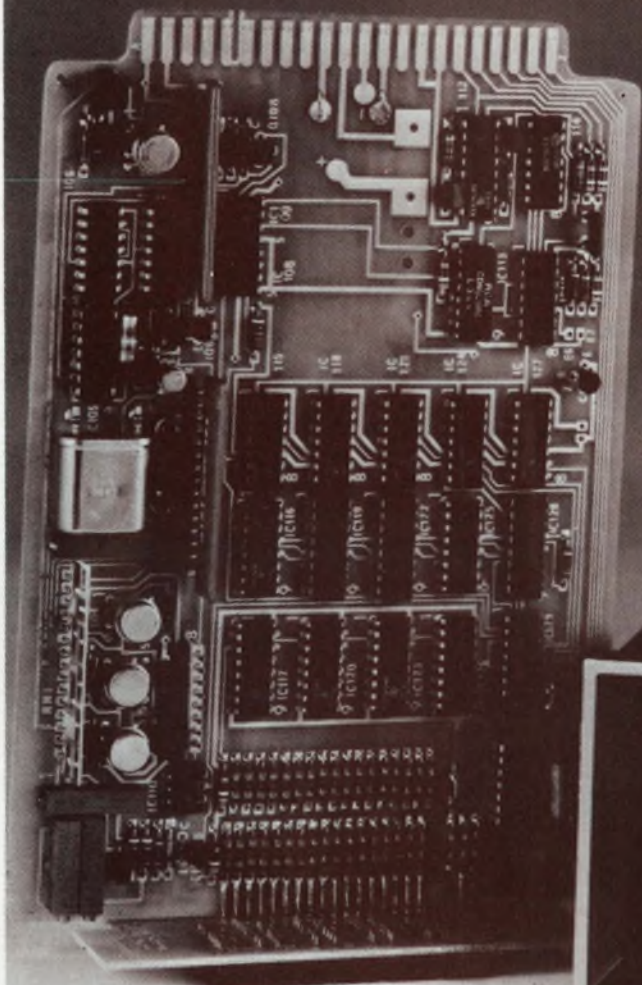

Series 3500

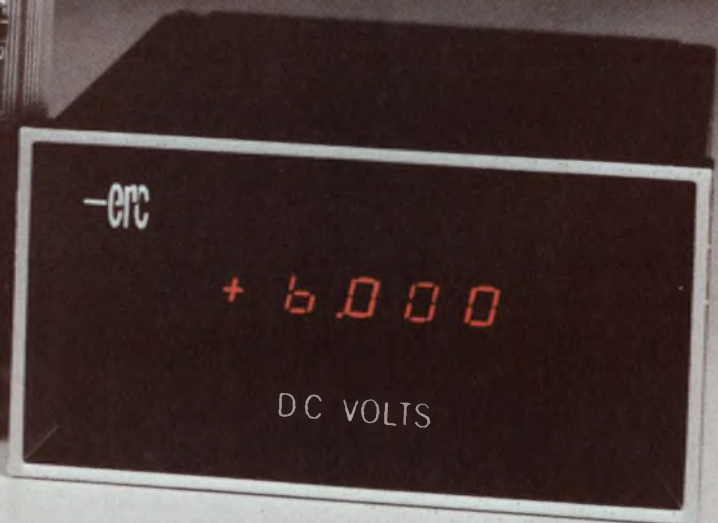

While most DPM manufacturers strive to compress their meters into a one inch cube, ERC has succeeded in making a producible and maintainable low-cost voltmeter with optically isolated parallel BCD outputs and 5999 count full-scale for reliability-conscious engineers in a package only 2.4" H x 5.06" W x 6.38" D, AND for only \$148 in quantities of 100...\$185 in single quantities. If the world's smallest DPM isn't your prime requirement but quality is, contact us for specs and delivery.

See *Electronic Design's Gold Book* for information on other ERC Digital Instruments

electronic research co. • a textron div

7618 Wedd
Overland Park•Kansas 66204
Mail to: P.O. Box 913
Shawnee Mission•Kansas 66201
TWX: (910) 749-6477
Telephone: (913) 631-6700

erc

breaks the frequency range down into three different switching rates. As the inverter frequency, and therefore the motor speed, gets lower, the number of pulses per half cycle gets larger. If only a single number of pulses were used, the spacing between pulses would get too large at low inverter frequencies.

According to David Wallace, manager of marketing for GE's Speed Variator Product Dept., Erie, Pa.; "In our pulse-width-modulated inverters, when we have to go to low speeds, we also increase the number of chops as the inverter frequency goes down. We have built a 3-1/2-to-220-Hz, 460-V inverter for the fiberglass industry."

General Electric, considered the largest factor in the ac motor-drive business, uses pulse-width-modulated inverters rather than amplitude-modulated multistep in its drives. At present GE is building SCR inverters almost exclusively.

However, Wallace notes: "We see power transistors and power Darlingtons being a significant factor to at least 10 kVA. Another switching device that will become a factor will be the gate turn-off SCR, when it is perfected. It eliminates the SCR commutation circuitry, but at the moment is still a laboratory item. GE is developing the devices, and I expect to see them coming into use by about 1976."

Power Darlingtons increase power

For transistor switching to become important in the control of larger motors, higher-power Darlingtons are being developed by several manufacturers. For low-voltage, high-current applications, the leader is PowerTech in Clifton, N.J. Alex Polner, vice president of marketing, notes: "We can go up to 1200 A at 60 V. Most of the customers for this device have been military so far."

David Cooper, vice president of engineering and development at International Rectifier, El Segundo, Calif., adds: "At higher voltages—say, 450 to 500 V—the current state of the art in power Darlingtons is 25 to 30 A. In the next year we should see 40 to 50 A at greater than 500 V."

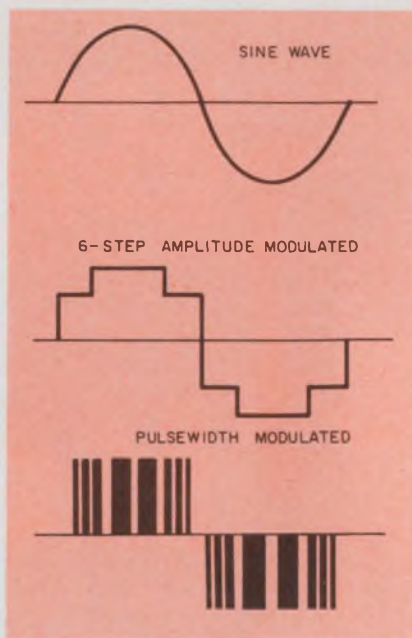

Inverter modulation schemes for variable-frequency ac motor control center on simulation of the desired sine-wave output of the inverter. The two primary modulation techniques are multistep amplitude modulation and pulse-width modulation. Pulse-width modulation allows a better approximation of the wave shape and seems to be the wave of the future in ac-inverter design.

Companies manufacturing these devices include International Rectifier, RCA, Motorola (Phoenix, Ariz.), Delco (Kokomo, Ind.) and TRW Semiconductors (Lawndale, Calif.). Although some companies switch transistors in inverters at up to 20 kHz, Dennis Roark, applications engineer at TRW, believes that it is rarely necessary to go above 7 kHz for good harmonic rejection.

ROMs for pulse generation

Generation of the sine-weighted pulse train necessary for the ac pulse-width-modulated inverter can be produced with an IC ROM. Tom Mazur, applications engineer with Motorola, built an ac pulse-width-modulated motor control with a ROM to generate four sine-weighted pulse trains. The pulse trains were phased θ , $\theta + 90^\circ$, $\theta + 120^\circ$ and $\theta + 240^\circ$. Thus the ROM could be used to control four single-phase motors simultaneously or a two-phase motor or three-phase motor. A variable oscillator

controls the clock rate of the ROM, and therefore the motor speed.

Reliance Electric has used ROMs for waveform shaping in pulse-width-modulated drives.

Position the shaft

Cooper of International Rectifier explains that positioning needs a feedback system. He points out that higher power-drive systems have used digital phase-locking for a long time. However, it is only since the development of the IC digital phase-locked loop that this technique has become practical for motors of all sizes.

Positioning of dc motors to better than $\pm 0.01\%$ with digital phase-locked loops has been demonstrated by Vinay Khanna, computer applications engineer at Motorola. He uses a shaft encoder to sense shaft position. He points out that the resolution of the encoder is the limiting factor in the system, not the IC. Use of an encoder with finer resolution can make the positioning accuracy much better than that achieved so far.

Analog phase-locked loops can also be used, but they have a slower position response time.

The microprocessor revolution

Microprocessors will also affect motor control. Although none has been designed yet into motor controllers, a survey of manufacturers indicates that they will be used for pulse-train generation in pulse-width-modulated systems. Applications include velocity profiling (programming of the speed of the motor as a function of time), position programming, torque programming and motor control self-testing and problem diagnosis.

According to Cooper, one problem yet to be solved is noise isolation of the microprocessor, so the device can operate in a harsh electrical environment. A motor control often has to operate around motors and machine tools with high electric fields.

"Without proper isolation, the IC can be swamped," Cooper says. But most specialists are confident that the problem will be solved and that the microprocessor will usher in a new revolution in motor control. ■■

The R10: our compact, multi-purpose relay.

You might say we designed it to be many things to many people.

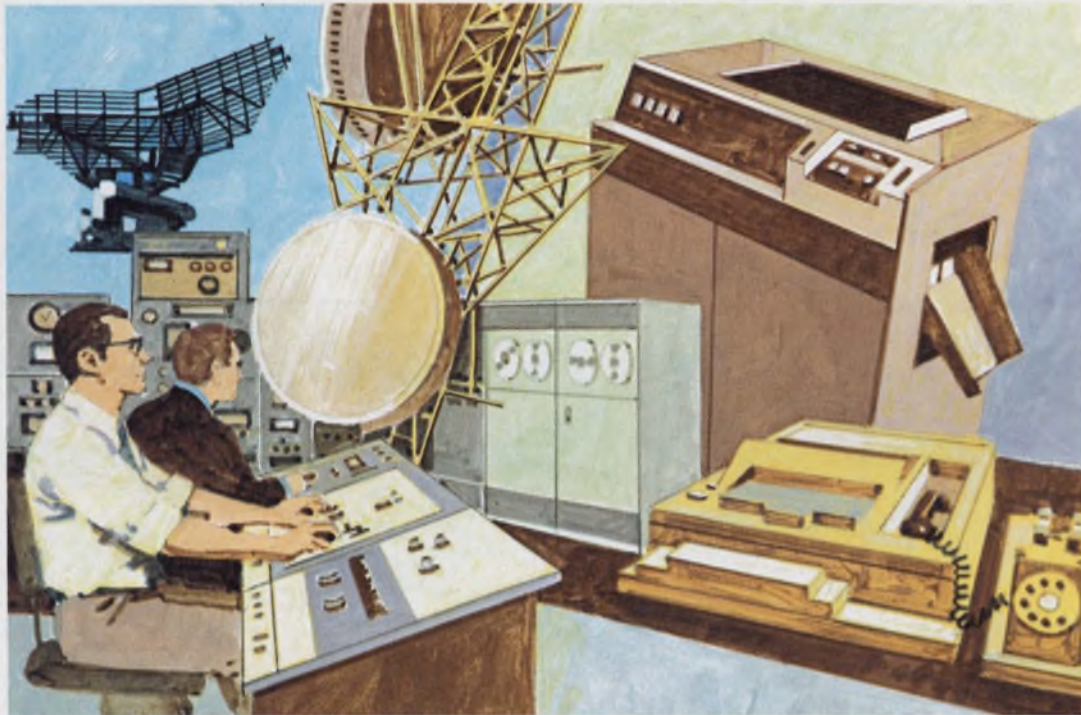

Copiers, computer peripherals, communication equipment, business machines, precision instruments—you'll find our R10 in a multitude of applications requiring a compact, reliable, multi-pole relay. That's because it probably gives you more design options than any other single relay.

Consider these choices: Contact arrangements to 8PDT. Ratings from dry circuit to 10 amperes. Six styles of contacts, including bifurcated. Sockets with solder or printed circuit terminals, including one for mounting the relay horizontal to a printed circuit board—and all with or without grounding provisions.

R10 relays have U/L Compo-

nent Recognition. Models to 6PDT have C.S.A. Component Recognition. Life expectancy is to 100 million operations, depending on contacts and load. The R10 is available with a voltage- or current-sensitive coil. Pick-up ranges from 2.25 to 86 VDC, 5 to 86 VAC, or 0.85 to 45 milliamp, with proper power supply. Depending on the number of contacts, the R10 weighs from 22 to 40 grams.

R10 relays are in stock at your leading electronic parts distributor;

or call your P&B representative. For your copy of the 226-page catalog showing the complete P&B line write Potter & Brumfield Division of AMF Incorporated, Princeton, Indiana 47670; or phone 812 385 5251.



Solving Switching Problems
is what we're all about.



INFORMATION RETRIEVAL NUMBER 24



The wide, wide world of AMP Circular Plastic Connectors.

No matter where you go, you won't find a more versatile line of circular plastic connectors. From mating plugs to panel-mount or free-hanging receptacles. From square flange to feed-thru pressure bulkhead receptacles. They're available with many types of contacts and arrangements. And in popular shell sizes.

Why plastic connectors are better than metal ones.

Besides offering greater versatility, AMP gives you high-strength, glass-filled nylon connectors

that are as reliable as metal ones—but cost much less. In some ways, they're even more rugged. Because AMP circular plastic connectors are resilient. Yet, up to 50% lighter. And nonconducting.

AMP automatic machines. For high-speed termination.

The contacts—you pay only for the ones you use—are supplied in continuous strip form. So termination is possible at volume production rates. And at the lowest possible cost to you.

AMP is at the core of reliable circular plastic connectors.

We can handle virtually all your requirements. No matter what industry you're in. And no matter where in the world you're doing business. To prove it, call (717) 564-0100 for information that deals with your specific needs. Or write AMP Incorporated, Harrisburg, Pa. 17105.





AMP
INCORPORATED

INFORMATION RETRIEVAL NUMBER 25

Lower atmosphere to be studied by sensors on manned balloon

Early this month, a huge manned balloon will lift up from the municipal airport at Las Cruces, New Mexico, to begin one of the most ambitious efforts ever made to explore and understand the lower atmosphere. A key objective of the 36-hour flight is to find out what happens to a body of air as it moves across the country.

Called Project da Vinci, the balloon flight is in effect a comprehensive meteorological experiment that will make substantial use of electronics technology.

The flight, which involves some 25 related scientific experiments and measurements, is jointly funded by the Atomic Energy Commission, the National Geographic

Society and the Dept. of the Army's Atmospheric Sciences Laboratory. Nearly 15 other organizations are providing experiments, support services or equipment.

The major goals of Project da Vinci are the following:

- To obtain a detailed picture of a single air parcel as it crosses mountains, open plains, forests and cities.
- To test some research instruments in airborne use.
- To determine the usefulness of multi-experiment, manned balloon flight as a fundamental tool for lower-atmospheric research.

The helium-filled, 70-ft.-diameter balloon will carry a two-level, 600-lb. aluminum gondola or control module that measures 10 feet in length, width and height.

The lower level contains provisions for food, water, batteries,

sanitary facilities, sleeping areas and experiment equipment for the four-member crew. The bathtub-shaped upper level is encased in fiberglass foam and has provisions for the pilot, navigator, project scientist and observer.

Some of the scientific instruments are mounted on top of the balloon. The rest are mounted on the gondola itself, on a boom that can be swung outward from the gondola and on a kilometer-long drop line, which can be raised and lowered by a winch.

The da Vinci balloon will float free at altitudes between 4000 and 14,000 feet above sea level. And it will stay with a single air parcel as long as possible while multiple, related measurements are taken of such things as temperature, humidity, air pressure, electrical fields, ozone and sulfur-dioxide pollution, and radiation.

Ralph Dobriner
Managing Editor

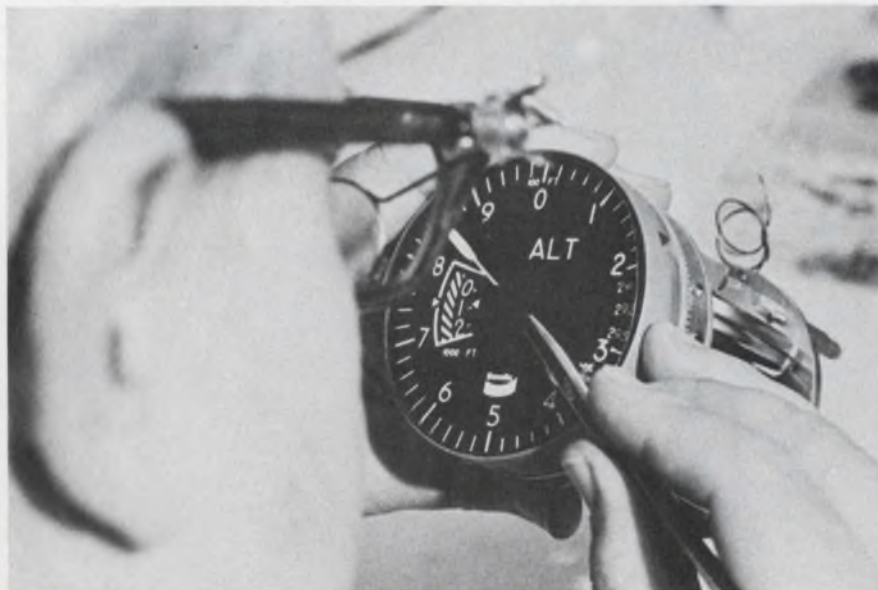

A 35,000-foot range encoding altimeter is assembled by a technician at Bendix Corp., Davenport, Iowa. It will measure and report the altitude of the da Vinci balloon in 100-foot increments. Used in conjunction with a transponder, the unit automatically transmits altitude signals to an air controller's ground control radar screen.

Air turbulence to be studied

One set of experiments will gather data about the structure of the air and its turbulence. Small-scale fluctuations, especially those in inversions (where an upper warm atmospheric layer covers a colder lower layer), will be studied with an acoustic atmospheric sounder—similar to a depth finder.

A 1/10-second sound pulse at about 1 kHz and 100 to 110-dB intensity will be emitted every 30 seconds in horizontal, up or down directions and the echo will be recorded as a trace on a strip-chart recorder. The acoustic sounder, in the shape of a four-foot-diameter parabolic dish antenna, is mounted on a seven-foot boom on the gondola.

For the interpretation of the acoustic sounder data, as well as for other project experiments,

Our motors do the things most motors can't do

Precise positioning / Precise speed regulation / Precise tension control

Only a DC servo motor can respond in milliseconds to rapidly programmed commands. It'll stop, go, accelerate or decelerate, reverse direction at full speed, maintain constant speed under variable torque load or hold constant tension under variable speed . . . precisely as you want it to.

That's the kind of performance you can expect from all Inland Motor DC servos with temperature-stable magnets and rugged, high-duty-cycle capability. They'll give precise control of position, rate or tension in computer peripheral sub-systems like magnetic tape drives, incremental transport drives, capstan drives and high speed printout systems.

Thirty-two off-the-shelf models range from tiny "inch-cube" size to a fist full of power . . . from 7 to 300oz. in torque . . . speeds to 8,000 RPM . . . as low as 20.6 watts at peak torque . . . and less than \$25 in quantity lots.

For specifications or technical data, call your local Inland Motor Representative or contact us direct.

INLAND MAKES A DIFFERENT KIND OF MOTOR

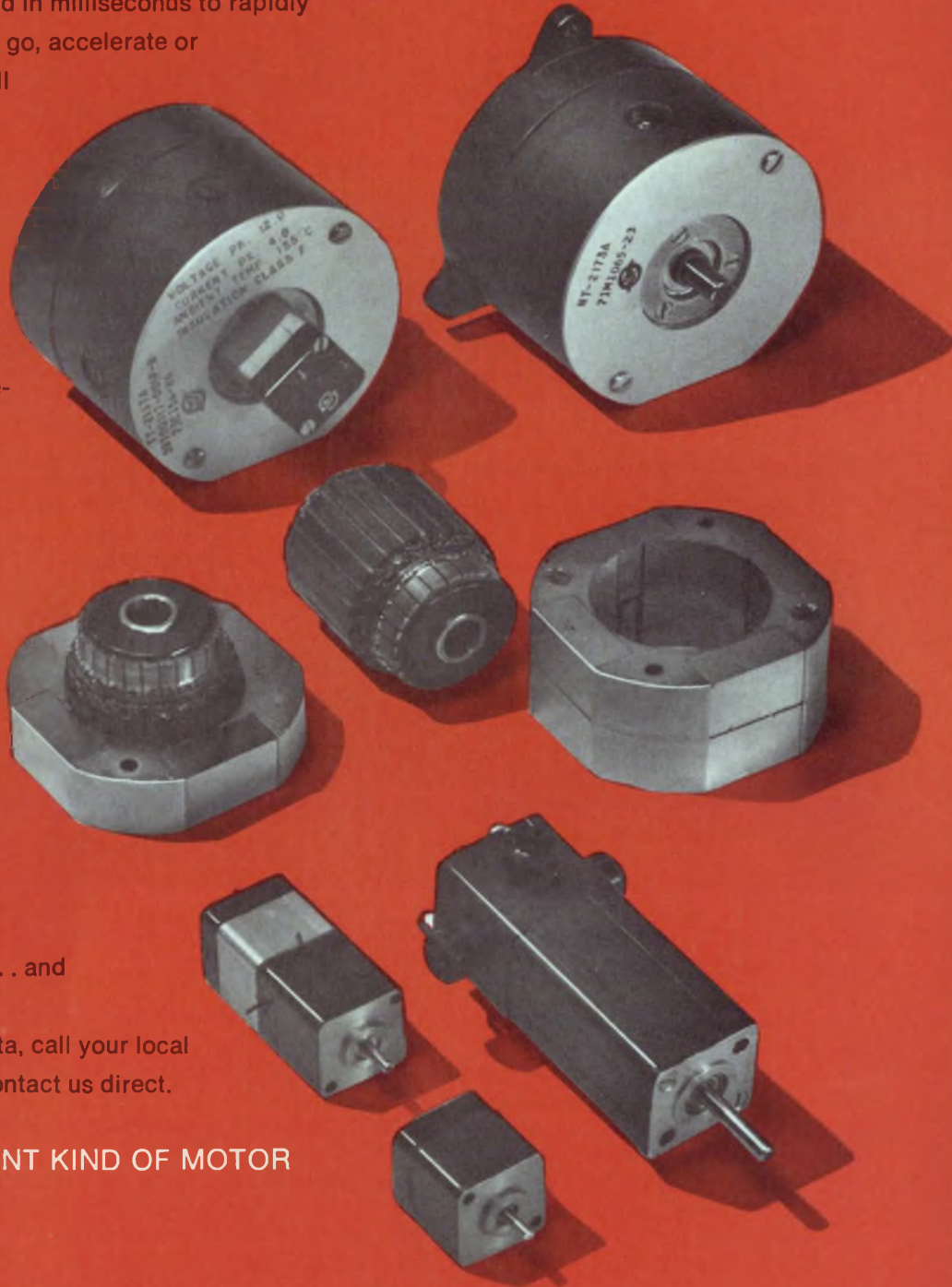

INLAND MOTOR DIVISION Kollmorgen Corporation

501 First St., Radford, Va. 24141, Phone: (703) 639-3973, TWX: 710 875-3740

three thermistors—one on top of the balloon, one on the gondola and the third on the down package suspended below the gondola—will record temperature variations.

Altitude calculations will be made by means of two pressure sensors, one located on the down package and the other on the gondola.

An experimental instrument called a betasonde or densitometer will be used to calculate atmospheric density. It consists of a radioactive source, promethium-147, which emits beta rays. These are reflected by air molecules and are measured in a geiger-counter tube.

Gravity waves, a class of organized air motion that contribute to clear air turbulence encountered by aircraft, will be investigated. To measure these waves and determine their characteristics, capacitor microphones will pick up the low-frequency sounds that gravity waves make. Gravity waves will also be recorded on the acoustic sounder.

What the atmosphere comprises

Another set of experiments will gather data on atmospheric constituents such as trace gases, moisture, particles, ozone, oxides of sulfur and scores of pollutants produced by man and nature.

The concentration, shape and size of aerosols, for example, are considered significant in weather formation. To detect aerosol layers, a ground-based lidar (laser-radar) will shoot a red-colored laser beam up into the atmosphere to scan the aerosols suspended there. The return signal will be compared to the aerosols measured from the gondola itself. The lidar will be supplemented by ground-based particle counters.

Another atmospheric constituent is water vapor. It has been measured customarily by a small carbon sensor that absorbs water vapor and translates this—by means of changes in electrical resistance—into relative humidity. Although used by weather stations around the world, the carbon sensor's reliability in measuring small amounts of water vapor is subject to dispute. Thus in conjunction with a carbon sensor, an experimental aluminum oxide sensor will be carried on the flight.

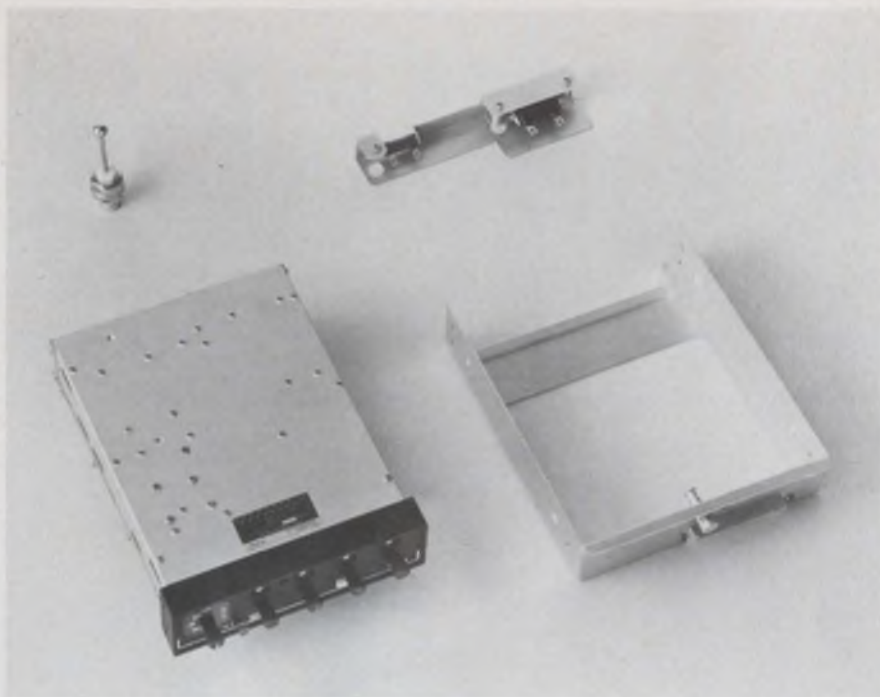

Transponder used on board the da Vinci balloon is an example of the latest technology used in avionics instrumentation. Developed by Bendix, the one chip replaces up to 200 discrete components required for previous designs.

Other experiments will study the electrical fields within the earth's atmosphere. A better understanding of variations in these fields is needed, among other reasons, for the design of piloting systems for remotely piloted aircraft (drones).

The earth's electrical field can be reduced or discharged by a chaff of fine aluminum needles. This has been proposed as a way to prevent strong field buildups that produce lightning. Chaff will be released from the gondola to see its effect on the weaker, fair-weather electrical field.

Finally, in another set of experiments, a comprehensive study will be made of the effects of various forms of radiation on the atmosphere and on land.

One experiment seeks to determine how much infrared radiation is absorbed by the earth and how much is reflected back into the atmosphere—factors that are thought to have a major effect on the climate of the earth.

An infrared radiometer operating in the 9.5-to-11.5- μm region will measure the brightness temperature of selected targets as a function of angle, altitude and time of day.

In addition, almost the entire spectrum of radiation—from 0.2 μm to the longest infrared wave-

length—will be scanned by equipment aboard the flight. Three Kuhn-Suomi broadband radiometers will record radiation at 0.4 to infinity wavelength levels coming in on the earth and reflected back. Two spectral pyranometers, will record radiation at the 0.2-to-4- μm level. A brightness spot meter will record radiation between 0.3 and 0.85 μm .

Supplementary to other data-gathering experiments, 49 radiosondes will be launched in succession from the ground at three points during the balloon flight. These radiosondes, which are lifted by small helium-inflated balloons, are standard weather instruments that will radio back to ground the temperature, humidity and pressure as they climb.

The da Vinci flight will be documented by video tape, film and still cameras. Continuous voice contact will be maintained with the crew from chase vehicles on the ground. These vehicles will be large vans equipped with radios and instrumented to receive data transmitted from the gondola.

The balloon, which will carry a radar reflector, a radar transponder and aviation radio equipment, will be tracked by Federal Aviation Administration flight controllers throughout its mission. ■■

CERAMIC TRIMMER CAPACITOR

TDK now offers linear temperature characteristics in small trimmer capacitors.

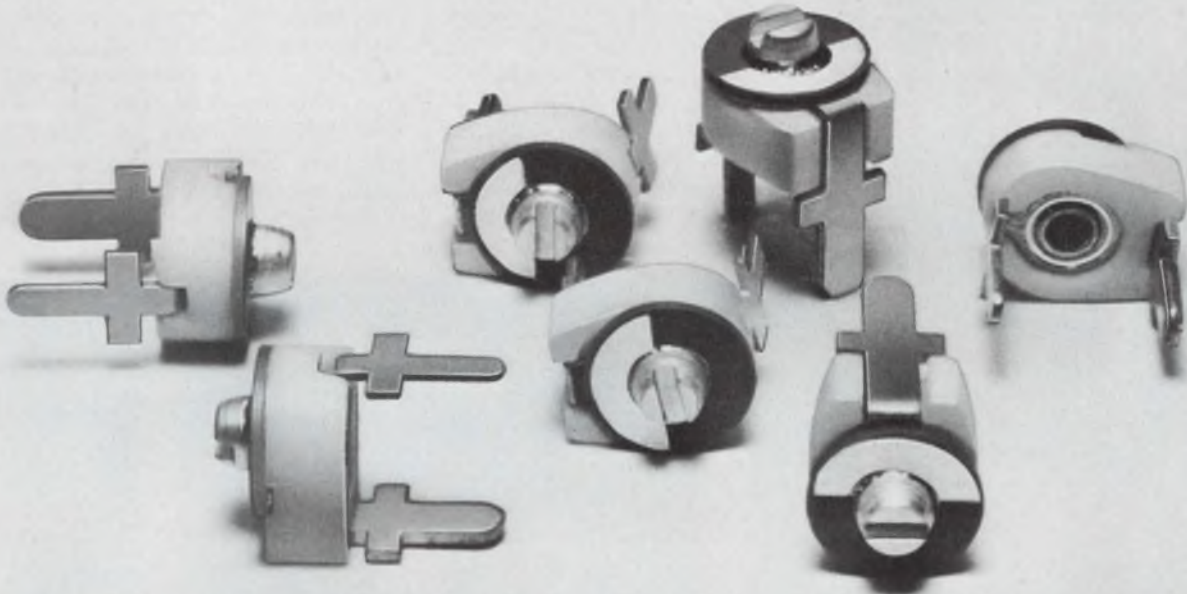

TDK's new dielectric material and improved configuration permits linear temperature characteristic with small-size ceramic trimmer capacitors (5mm in diameter).

Accurately processed contact surfaces of the rotor and stator, due to our optical finishing, produces precise capacitance trimming and minimized capacitance aging after setting. Furthermore, to avoid electrode migration, silver is not used as the stator electrode. If you are

searching for linear temperature characteristics in small trimmer capacitors, the solution is here.

Trimmer capacitors in both 7mm and 10mm diameters are also available from TDK. All our products are backed by long experience, excellent manufacturing techniques and superb materials to ensure quality products.

Features

- Linear temperature characteristic over -25°C to $+85^{\circ}\text{C}$
- High Q permits high efficiency

- Minimized residual inductance due to small electrodes enables use in high frequency ranges
- Optically finished contact surfaces insure linear capacitance trimming availability
- No stator electrode migration

Part No.	Temperature characteristics code	Rated minimum capacitance(pF)	Rated maximum capacitance(pF)	Rated voltage(V.DC)
CV05AIH030	A	1_{-1}^{+0}	$3_{-0}^{+1.5}$	50
CV05AIH050	A	2_{-2}^{+0}	$5_{-0}^{+1.5}$	50
CV05DIH100	D	4_{-4}^{+0}	10_{-0}^{+5}	50
CV05DIH200	D	8_{-8}^{+0}	20_{-0}^{+1}	50

Temperature characteristics

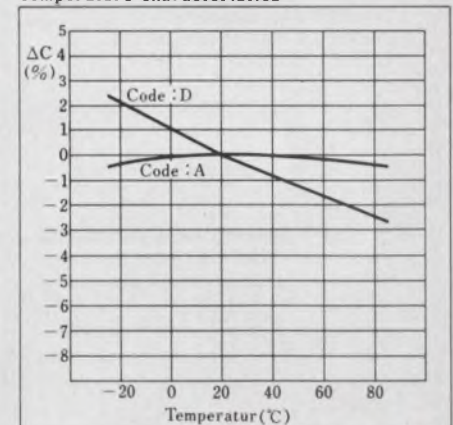

from
Grayhill

the different DIP Switch

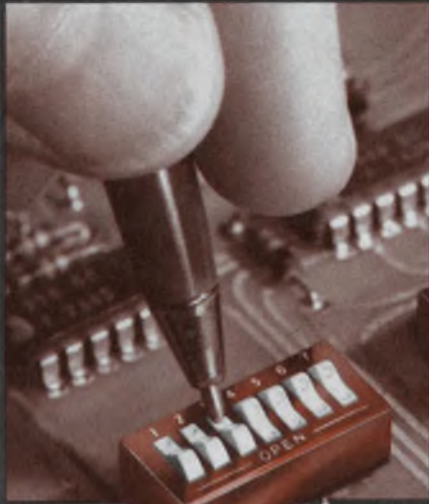

- Exclusive sliding ball contact system for positive wiping action



- Life tested to 50,000 mechanical operations, with commensurate electrical life

- Available in 9 sizes, even a hard-to-find 2 rocker version, on up to 10 rockers

- All SPST, each switch independent, rocker actuated

Of course, the different DIP Switch—Grayhill's Series 76—also offers the standard DIP benefits of easy PC board mounting, compact high density design and a multitude of cost savings. Get the full story, including detailed specifications and prices, in Grayhill Engineering Bulletin # 238, available free on request.



561 Hillgrove Avenue • La Grange, Illinois 60525
Phone (312) 354-1040

NEWS

Heads-up display gives a wider field of view

By combining a new hologram with a scanning laser beam, engineers at Hughes Research Laboratories in Malibu, Calif., have produced a heads-up aviation display system that eliminates much of the bulky optics and provides a wider field of view.

Donald H. Close, head of the hologram optics section at Hughes,

says that the system uses holography to produce the optical properties of a lens on a transparent plate in the pilot's line of sight. Information can be projected through the hologram lens and displayed directly in front of the pilot; he can view it without obstruction to vision outside the cockpit.

Although similar heads-up dis-

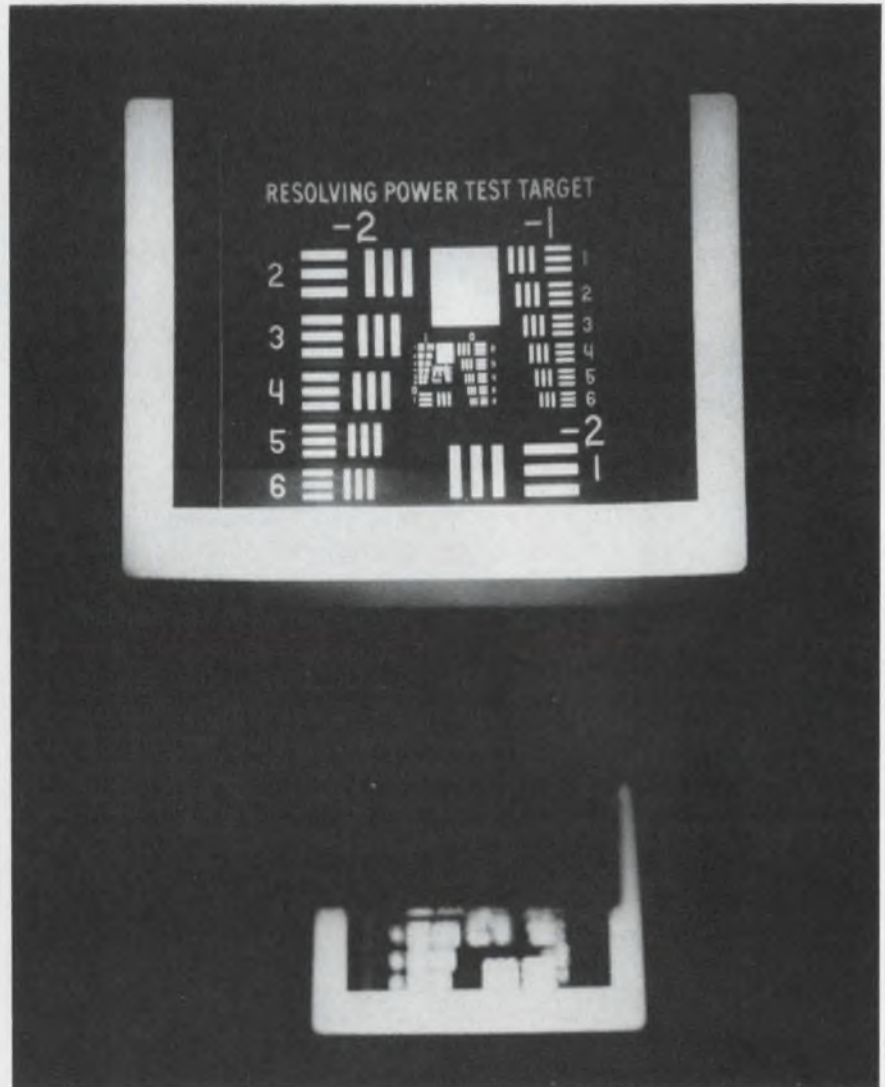

The image of a resolution chart projected by a heads-up display demonstrator and viewed at infinity shows the resolving capability of the unit. The blurred image below is the original resolution chart viewed without the hologram lens.

plays have been developed with conventional glass lenses, Close says, the new technique offers several advantages:

- The holographic system requires a spectrally narrow light, which makes it highly compatible with a laser source and leaves the color of the outside world unaffected.

- A large field of view can be achieved with relatively low weight, since the hologram is recorded in film a few microns thick.

- Unusual configurations of the optical plate are possible, since the optical function being performed is independent of surface curvature.

Point-source hologram used

According to Close, the system uses the wavefront transmission characteristic of a hologram to produce an optical element, rather than to record a three-dimensional scene, as in conventional holography. This is called a point-source hologram, and it may be used as a replacement for ordinary lenses and mirrors.

A point of light in the system is produced if the point-source hologram is illuminated with a reference beam, instead of the three-dimensional image seen with a regular hologram. With a change in the angle of the reference beam, it is possible to change the position of the point of light.

This is the basic mechanism involved in the new display. However, in application many reference beams at many angles are used to illuminate the hologram. When these beams are controlled, it is possible to write letters on a ground-glass screen in much the same way that an electron beam writes letters on a cathode-ray tube. A scanning laser, controlled by acousto-optic modulators, is used to produce these light beams.

Some advantages of the system, Close indicates, include a wider field of view and lighter-weight optics. Other heads-up displays are limited to a field of view of only 20°, Close says, adding that while the present Hughes system features 25°, it could easily go to 60°. If multiple-projection sources are used, the field of view might be increased to 180, Close speculates. But that's still a long way off. ■■

Which Heinemann overvoltage protector should watch over your electronics?

Below 5 amp dc Our tiniest hybrid (a thick-film microcircuit) packs a sensing amplifier, control circuit, and SCR "crowbar". When voltage equals the protector's rating, the SCR fires, shunting the load to ground in 500 nanoseconds—before any damage can be done.



5-30 amp dc These protectors are made from discrete electronic components, but they offer the same protection and economy as the hybrids. Series 10 can handle up to 10 amp. Series 30 is good for 30 amp. Both are available in a range of trip voltages.



Up to 1 amp ac A 200V trip rating makes our Series 1 protector ideal for electronic equipment operating from a 117V line.



Transient clipper This device absorbs the energy of a transient while clamping the line to a predetermined voltage, allowing your circuits to continue operating during a voltage transient.

You can't build protectors like these for anywhere near our low prices. And our single-package design eliminates all the multi-component assembly and mounting problems of do-it-yourself units. For complete technical data, have us send you Bulletin 3372. Heinemann Electric Company, Brunswick Pike, Trenton, N.J. 08602.



HEINEMANN

INFORMATION RETRIEVAL NUMBER 29

decoding the codes

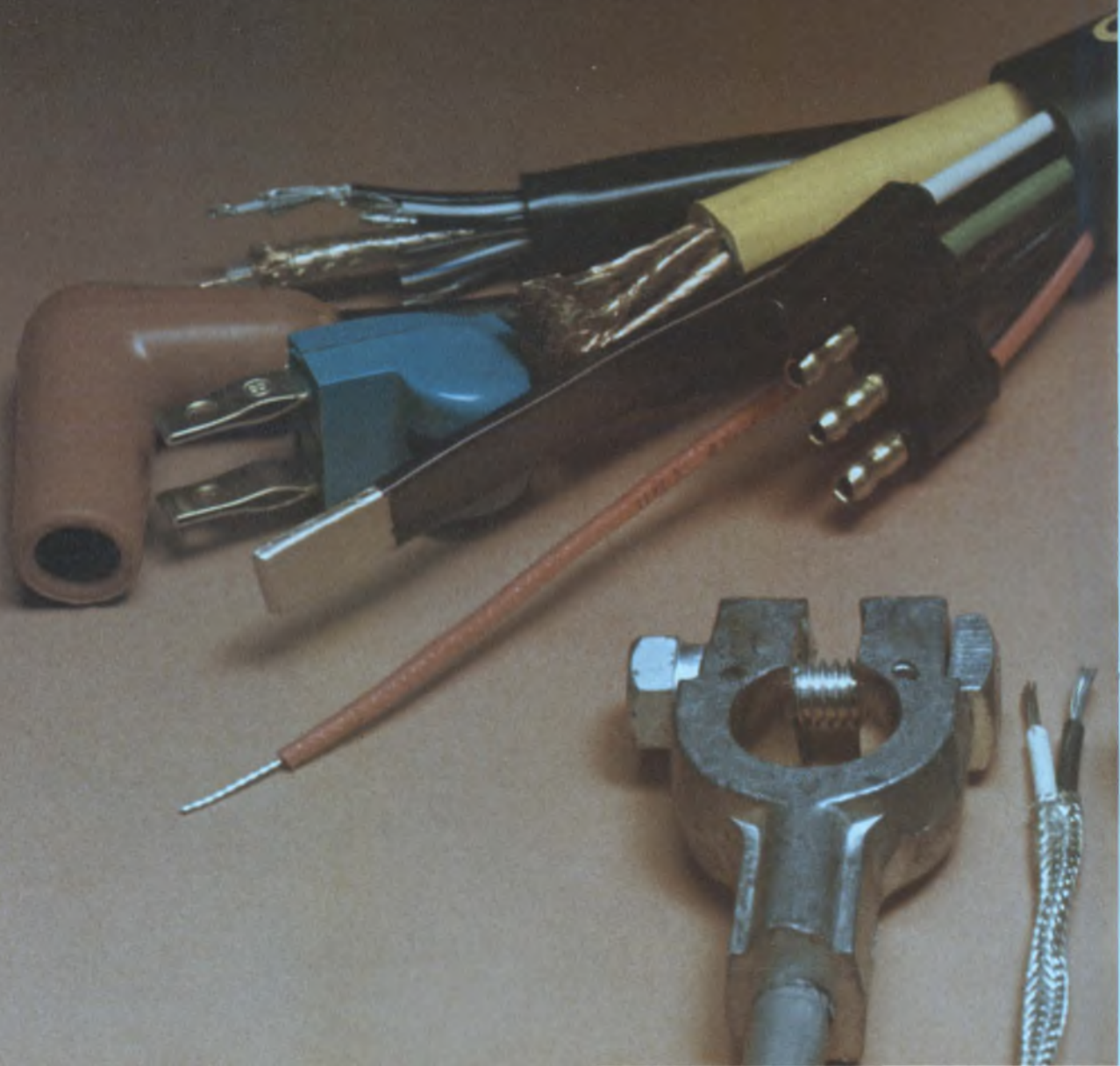

With ever-changing technology and increasing demands for innovative products, more precise safety guidelines are a must.

Belden knows the codes, standards, requirements and limits of acceptability in the wide world of industrial wire, cable and cord. As supplier of thousands of standard items for electrical, electronic and automotive needs we can readily help you select the right product for the job. Belden products meet or exceed industry code needs. And we can custom design and manufacture complex cable configurations to meet the most demanding specifications. If a code is puzzling you, or you have an application where you're not sure what the standards are, check with Belden. We cope with codes every day.

If you want answers right now, phone:
(312) 887-1800, Transportation Division
(312) 681-8920, Electrical Division
(317) 966-6681, Electronic Division
Or write Belden Corporation, 2000 South Batavia Avenue,
Geneva, Illinois 60134.

H-3-3

BELDEN 

INFORMATION RETRIEVAL NUMBER 234



There's only one cermet film resistor with enough design improvements to set a new standard of quality.

Ultra thick solder coated wire leads are both weldable and solderable.

Capless design does away with problems associated with end cap construction.

Conformal coating provides outstanding insulation properties.

Alumina core is physically and thermally strong to resist fractures.

Crisp, clear, dual markings for easy identification.

We blended our extensive fixed resistor knowhow with 15 years of cermet experience to produce an outstanding cermet film resistor. And we've developed unique manufacturing techniques that let us provide consistent quality.

Available in preferred resistance values (E96 Series) from 10 ohm to 1 meg; higher values available on special order. 1/4 watt at 70°C; 1/8 watt at 125°C; 1% tolerance; 100 PPM. Size 0.250 L. by 0.090 D.

Available in tape reels if you prefer.

Approved to MIL-R-10509 for Style RN55, Characteristic D. Write Allen-Bradley Electronics Division, 1201 South Second Street, Milwaukee, Wisconsin 53204 for complete technical details on Type CC. International Division, Milwaukee, Wisconsin 53204. Canada: Allen-Bradley Canada Limited, Cambridge, Ontario. United Kingdom: Allen-Bradley Electronics, Limited, Jarrow, County Durham NE32 3EN.

If you're really serious about cost, be serious about quality.



ALLEN-BRADLEY

Milwaukee, Wisconsin 53204

INFORMATION RETRIEVAL NUMBER 30

EC69

washington report

U.S. science board proposal pushed in Congress

Since it is highly probable that Congress will return for a lame-duck session following the November elections, there's an outside chance that President Ford will be presented with a bill this year authorizing a science and technology board.

Senate Bill 2495, which would establish a Council of Advisers on Science and Technology, got through the Commerce Committee early in September and was turned over to the Committee on Aeronautical and Space Sciences for its input. Not to be outdone, Sen. Charles C. Mathias Jr. of Maryland introduced a bill, S. 3980, on Sept. 11 to create a "United States Science and Technology Board." A chairman and 10-man board would serve as science and technology advisers to the President.

Mathias envisions all R&D funding requests going from Government agencies to the newly created board. The board would then have the task of carrying the total R&D funding torch to the Office of Management and Budget under present budgetary procedures.

FDA pressing for laser-emission standards

The Food and Drug Administration is getting closer to establishing laser-product emission standards. It has republished a proposal made 10 months ago and, with suggested changes incorporated, is once again asking for public comment.

Barring further changes, the laser regulation would require warning labels, protective housing, safety interlocks and scanning safeguards in five categories. The criteria would be based on a combination of emission level, emission duration and wavelength. Except for pea-powered lasers, the units also will need remote-control connectors, key-actuated master controls, radiation-emission indicators and beam attenuators.

The proposed regulation, which could go into effect late this year or early next, would apply to all laser products manufactured or assembled.

Blueberries vs OTH radar: A problem in Maine

The Air Force has found an unexpected hostile blip on the screen of its fledgling over-the-horizon radar program in Sen. Edmund Muskie, Democrat of Maine. If he has his way, none of the military construction funds appropriated for the OTH program in the fiscal 1975 budget could be spent until May 31, 1975.

Muskie's ire was aroused when the Air Force announced on June 25 that it had preferred sites in Maine in mind for the transmitter and receiver installations. Another OTH-B site is to be built in the Northwest.

The Maine receiver site would take 1000 acres that now produce 6% of the state's blueberry crop. Muskie argues that Maine citizens need more time to convince the Air Force of the "importance of the land to our economy." The full Senate concurred with a delaying amendment tacked onto the military construction appropriation bill. It's not that he doesn't want the site in Maine, the Senator says, but he wants unresolved problems solved. He'd like the Air Force to choose another receiver site to save the blueberries.

Manufacturing lead times getting longer

To assist Government procurement offices in determining delivery dates, the Defense Supply Agency is maintaining a box score on current manufacturing lead times. The agency warns that the electronics industry is seeing lead-time increases of 400 to 500% because of greater consumer demand and a lack of raw materials. If the shortage of silicon continues, it says, the situation will get even worse.

The agency pegs lead times on large electrolytics at between 50 to 60 weeks and on smaller types and miniatures at 26 weeks. Shortages in the supply of plastics, chemicals and basic metals are making printed-circuit boards difficult to obtain, it says. Government buyers are being alerted to a tight supply in semiconductors through this year and of greater demand for capacitors and resistors, especially RN and RL metal-film resistors. The lead time on deliveries of these components has increased to as much as 60 weeks.

FCC warns designers on interference

The Federal Communications Commission is calling on electronic designers to take care when planning the use of certain bands for space and aeronautical use to minimize potential interference with radio astronomy operations in adjacent bands. Of special concern to radio astronomers are the bands to be employed in space stations, which during normal use may appear within the main beam of highly directional radio telescopes.

Applicants for space-station assignments are being urged by the FCC to take all practical steps to protect observations in exclusive radio astronomy bands adjacent to 1427 to 1429, 2500 to 2690 and 5000 to 5250 MHz and 14.5 to 15.35, 15.4 to 15.7, 24 to 24.05, 31.5 to 31.8, 84 to 86, 122.5 to 130 and 220 to 230 GHz.

Capital Capsules: The Electronic Industries Association has published a new standard, RS-419, that lists values to be used in semiconductor device specifications and registration formats. The objective is to simplify the design or choice of equipment intended to use or make measurements on semiconductor devices . . . A program is under way to develop an Air Force night-helicopter rescue system. Off-the-shelf avionics will be used to package a low-level-navigation, search, homing and retrieval system. To perform the rescue mission, the Air Force will use a terrain-avoidance radar, infrared sensor, inertial measuring unit, doppler unit, projected map display and symbol generator coupled through a central avionics computer. . . . The Air Force is seeking a contractor to evaluate the electronic warfare vulnerability of the Laser Obstacle Terrain Avoidance Warning system.

The Easy, Low Cost Way to Display Difficult Signals

Slowly scanned, gray scale images, low repetition rate signals, and single-shot waveforms. All of these hard-to-view signals are easily displayed on the new TEKTRONIX 605 Variable Persistence Display Monitor—at normal intensity and without flicker. At the same time the 605 combines faster writing speed and wider bandwidth with low cost (\$1675) to provide more value for your display dollar.

Simply turning a dial varies the length of time a display is held on the 605 from a fraction of a second to more than 5 minutes. In the save mode viewing time is even longer.

Faster spot response time results from the 3 MHz bandwidth of the X and Y channels (3 times the bandwidth of comparable crt displays).

With the fast (1 div/ μ s) writing speed of the 605, even single-shot events are displayed as bright, easily viewed waveforms. The 605 has front panel controls and TTL compatible remote control inputs, a combination unique at such a low price. Real time monitoring applications are easy with the optional low cost time base (\$125), another feature not offered on other variable persistence displays.

Applications for the 605 are many and varied. Bright, gray scale raster scan plots are obtained for ultrasound, thermographic, and nuclear scanning and for viewing scanning electron microscope images. Resolution is improved in spectrum analysis. Valuable trajectory information is provided for radar

and sonar displays. With the time base option slow biophysical signals are easily monitored. In mechanical measurements flicker-free engine pressure/volume curves are readily plotted with no smear due to cycle-to-cycle variations. Uncluttered, single-shot vibration waveforms are easily displayed using the 1 div/ μ s writing speed.

For further information on how the 605 Variable Persistence Storage Monitor provides extra value in your display application contact your local Tektronix Field Engineer or write Tektronix, Inc., P. O. Box 500, Beaverton, Oregon 97005. In Europe write Tektronix, Ltd., P. O. Box 36, Guernsey, Channel Islands, U. K.

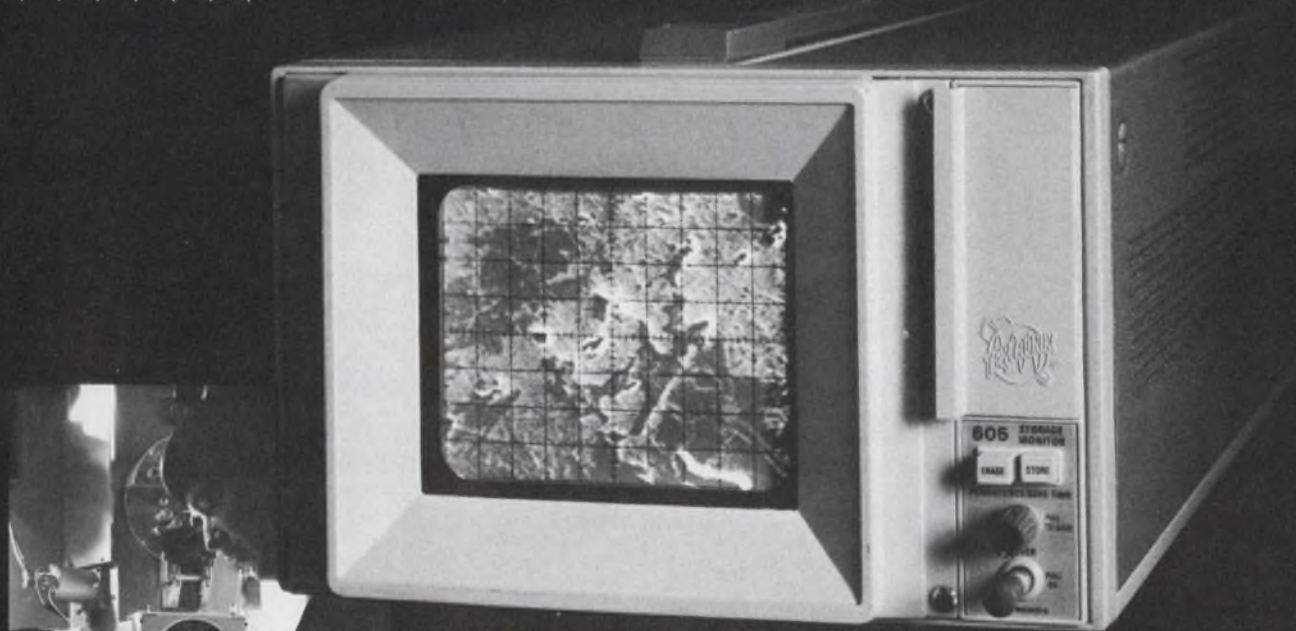
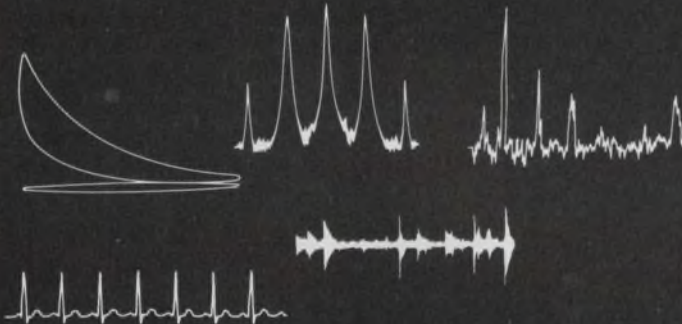

Gray scale capability and variable persistence storage of the 605 are used with a scanning electron microscope to study metal samples in a dental research laboratory.

"When engineers saw they didn't have any knobs, they were scared they'd lose control, but now they're in love with the thing!"

So happy, indeed, that when AMI offered to brief our people on their side of the story, we asked if we could publish some of their comments. They're reproduced here.

The validity of their comments? Each uses Sentry 600, relies on Sentry 600, and has one or more Sentry 600 systems in their department: Ed Carcher, Manager of Product Characterization; George Gray, Manager,

Test; Bill McNeally, Supervisor, Test; Bob Frohman, Supervisor, Systems Software Support; Fred Jenne, Director of Advanced Product Development.

"You'd need a wall full of knobs to let them do slowly what S-600 does fast."

"We have yet to find a device we couldn't test on the Sentry 600."

"Field service and support is very good, relatively speaking. Fairchild is the least worst in the industry."

They know semiconductor testing. And they know the Sentry 600.

The Sentry 600. Just one function-optimized component in the Fairchild Sentry family of six interrelated circuit testing systems.

Optimized for engineering, sophisticated production, and QA/test center operations, the Sentry 600 performs the widest range of tests for the broadest range of components. High speed MOS/LSI, PCB and bipolar testing simultaneously. Complete testing at wafer level and in automatic handlers at full rated device speeds. Finally, and most important to

AMI, extensive peripheral choice for massive data generating capacity. Manipulate. Analyze. Compute.

But don't take our word on it.

Listen to AMI: "When we went to buy a system, we could buy anything we wanted. We were not restricted by what the rest of the company had. We made an evaluation and chose the Sentry 600. It lived up to expectations fully."

AMI's experience: It's a good reason to check into Fairchild Sentry systems. Because it's time you had a semiconductor test system that lives up to your needs and expectations.

Fairchild Systems Technology, A Division of Fairchild Camera and Instrument Corporation, 1725 Technology Drive, San Jose, CA 95110 (408) 998-0123 TWX: 910-338-0558.

Slightly over a year ago, American Microsystems, Inc. ordered their first Fairchild Sentry 600.

Today, nine Sentry 600's are on line at AMI. Number ten is on its way. Each system was carefully evaluated by AMI. And then the next ordered. The result? AMI is now the largest purchaser of Fairchild's Sentry 600. It's a happy association.

"The thing we hate most about it is the thing we love most about it!"

"Without the Sentry I would never even try to get this type of data."

"One insertion goes through 50 different tests — we are checking parameters, not making Go/No-Go tests."



FAIRCHILD
SYSTEMS TECHNOLOGY
A DIVISION OF FAIRCHILD CAMERA AND INSTRUMENT CORPORATION

Our crack team of problem solvers

has the smooth, silent answer to many of your potentiometer requirements. It's called Resolon® — Duncan's outstanding conductive plastic element that adapts to the widest variety of non-wirewound applications.

Many users find it expedient to purchase only the element and wiper instead of a complete potentiometer assembly. Result: reduced space requirements, lower costs and a reduction in driving torque — plus total product reliability. Resolon elements, featuring an operating life of over 20 million traverses, can be supplied in an almost unlimited selection of sizes and configurations including sector,

rotary and rectilinear.

When precision pots are required, non-wirewound or wirewound, check with Duncan's 'Elite Design Team' first . . . the industry's high performance specialists. On-time delivery and competitive prices are all part of the package. Send today for technical literature.

DUNCAN ELECTRONICS

SUBSIDIARY

SYSTRON  DONNER

2865 Fairview Road • Costa Mesa, California 92626
PHONE: (714) 545-8261 □ TWX 910-595-1128



**Duncan: Your prime source for
custom designed pots.**

INFORMATION RETRIEVAL NUMBER 33

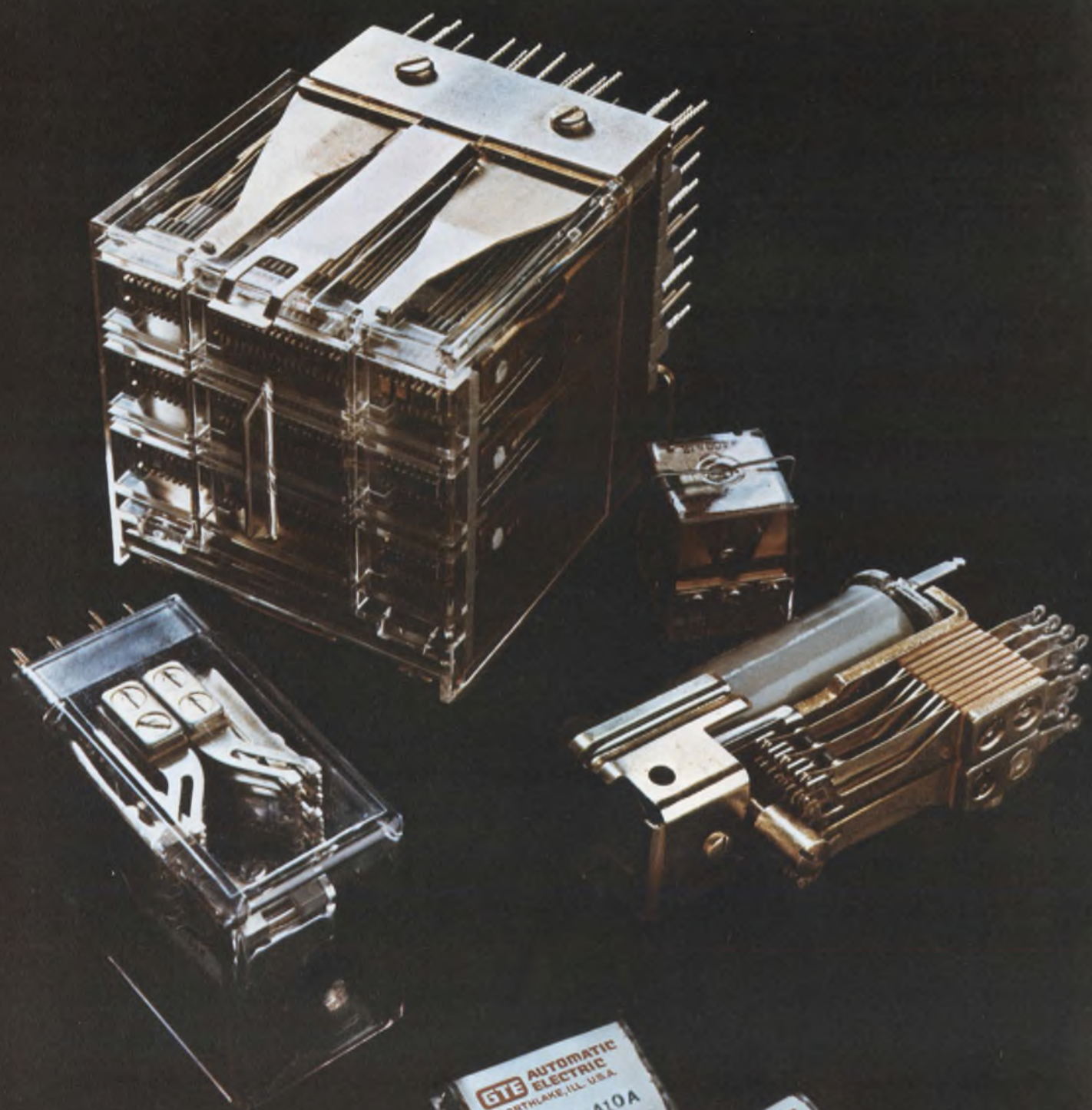

GTE AUTOMATIC
ELECTRIC
NORTHLAKE, ILL. U.S.A.

PD1311 A10A
1930 OHMS

GTE AUTOMATIC
ELECTRIC
NORTHLAKE, ILL. U.S.A.

PD1308 A11A
2600 OHMS

Announcing the rediscovery of the relay.

In an age when most people think solid state is the only way to go, some designers have rediscovered the good old electro-mechanical relay. They found relays still can't be beat when it comes to certain jobs. And when they're dealing with tight fisted cost control committees. Maybe you can save some effort and expense by rediscovering the relay whenever you need these things:

1. Simple logic:

Relays let you combine both power switching and logic functions economically. Memory can usually be retained, even after a power loss. And you don't need special power supplies or noise suppression techniques.

2. Easy troubleshooting:

Most relay failures (and they do occur occasionally) can be identified visually. You can see what's wrong. And fix it easily.

3. Heat resistance:

A relay shrugs off a short dose of overheating. Give a solid state device the same treatment while it's functioning near capacity and it's ruined forever. The amount of heat a solid state device can take is usually dependent on the heat sink used. It can take up all the room you expected to save with solid state in the first place. And finding the right heat sink design can become very involved.

4. Electrical isolation:

Relays have a natural isolation between input

circuits, between output circuits, and between output and input control circuits. You can't get that with junction type semiconductors.

5. High insulation resistance:

Open relay contacts have an insignificant amount of leakage (10^{10} ohms or more). Semiconductors can't match this. And, their leakage rates vary greatly with temperature changes.

6. Wide operating power range:

Relays work with operating power anywhere from milliwatts to watts. And they usually don't require regulated power. Semiconductors do.

7. Transient voltage immunity:

Transient voltage doesn't bother a relay. But high voltage, short duration transients can be sure death to semiconductors.

8. Forgiveness:

Relays give you a little margin of safety should you want to change your mind. Maybe you find you need more contacts, or uncover a timing problem, or discover a need for absolute input-output isolation. You can change your circuit design a lot easier with relays.

If your project or product needs any of these things, just ask our salesman to help you rediscover relays. GTE Automatic Electric, Industrial Sales Division, Northlake, Illinois 60164.

GTE AUTOMATIC ELECTRIC

INFORMATION RETRIEVAL NUMBER 34

G2 CAPS UNDER GLASS

Superbly designed and engineered G2-Caps offer increased durability and reliability . . . at less cost than conventional capacitors.



Banquet Order?

We cater to people with impossible needs. Our expanded production lines fill even the largest orders with ease!



Secret Recipe?

Give it to our Varadyne chefs! We'll cook up a batch of G2-Caps that will meet or exceed any specs you can name. Our Q/C people won't settle for anything less.

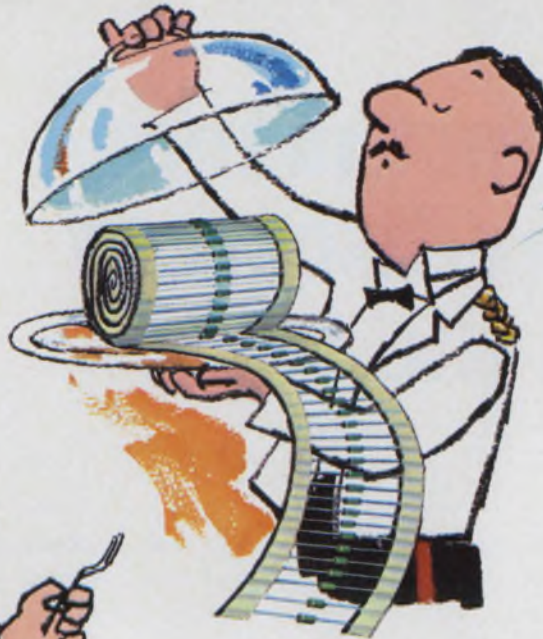

New Entree!

G2-Caps . . . Axial Leaded Ceramic Capacitors Hermetically Sealed in Glass

The new G2-Cap . . . winning approval from design engineers for dependability . . . from the toughest purchasing agents for low budget prices. Available, right now, in volume quantities!

G2-Cap capacitances range from 10 pF to 1.0 mFd and meet the requirements of MIL-C-11015 and MIL-C-39014.

Three formulations are offered: Type BN (Ultra Stable) NPO, Type BR (Stable) X7R and Type GM (General Purpose) Z5U/X5V.

Three standard case sizes are offered with maximum dimensions of .160 x .100, .260 x .100 and .400 x .155. Leads are tin plated, copper clad steel with a .020 diameter, 1 1/4" minimum length.

Reel packaged for automatic insertion with diode and resistor machines.

Fast Home Delivery!

We've made long lead times obsolete. Do you need four week delivery? Three weeks? We even cut that to a few days when we can fill your order from hot-off-our-shelf stock! You name the date and you'll get home-plant delivery. On time!



Bill of Fare?

We'll send you our complete menus — describing our radial leaded capacitors, chip capacitors and resistors, including our new axial leaded G2-Caps.

We'll include evaluation samples or applications information to meet *your* special requirements. Just phone: (213) 829-2991



We're on the move!

VARADYNE

Varadyne Industries, Inc.
1547 18th St., Santa Monica, California 90404
Phone: (213) 829-2991 • TWX (910) 343-6856



We've learned a lot!

Saying can make it so

I hate to read the papers these days. Almost any time I pick up a newspaper or financial magazine, I get the feeling that our economy is going down the drain. What with roaring inflation, soaring interest rates and an accelerating liquidity crisis, I sense that the end of the world is imminent; we have merely forgotten to be buried.

But I look at recent financial reports and I find companies reporting earnings increases from 20% to well over 100%. And that ain't bad. So I speak to lots of people about their business outlook and they're all moaning.

"Business looks lousy," they say. "This year we're up 40%. And it looks like next year we won't be up more than 20 or 25%." One fellow told me his company feels that business would be flat (meaning a growth rate of 5 to 10%) until February 1975, at which time it should start growing again at a more normal pace of 30% or so. Still another company is cutting back all expenditures (possibly mortgaging its future), in anticipation of earnings growth of 20% instead of its usual 35%.

I don't know whether to laugh or cry. I know loads of industries that have never seen growth rates of 20% per year. I know scores of executives in other fields who would see growth rates exceeding 6%—even with inflation-cheapened dollars—as stuff to write songs about.

But in the electronics industry we have been so spoiled by historic successes that we start whimpering when we see a year that's only 20% up. The problem is that, in business matters, saying can make it so. If we keep telling ourselves that business is going to be rotten, by golly, we will make it rotten. Our industry has just come through a few years of fantastic growth. Anybody who thinks such growth can be maintained forever is a fool.

I'm not an economist, so I'm willing to accept the near-term outlook for the economy as poor. And though I don't believe that the electronics industry can forever move up while the rest of the economy declines, I cannot believe that a temporary slow-down in growth rate, or even a temporary decline in earnings, spells disaster.

Our industry is strong. If we don't talk it to death, it will remain strong and healthy for a long time despite temporary set-backs.



A handwritten signature in dark ink that reads "George Rostky". The signature is written in a cursive, flowing style.

GEORGE ROSTKY
Editor-in-Chief

Etching improves yield of thin-film devices

A substantial increase in the production yield of thin-film devices, like magnetic heads and integrated circuits, is possible with a new etching method developed at the Philips Research Laboratories at Eindhoven, the Netherlands.

With the new method, etched thin films having gently sloping sides under the photoresist (as in figure a) can be produced. This technique overcomes a limitation of standard techniques that produce etched thin-films with relatively steep edges (b)—that is, when a network of conductors is subsequently applied over the etched pattern, the conductors develop discontinuities.

With the Philips' method, an auxiliary film is applied to the surface of the thin film before the photoresist is applied. This auxiliary film etches away faster than the thin-film material. By controlling the etching speed by variations in the composition of the etching agent or of the auxiliary

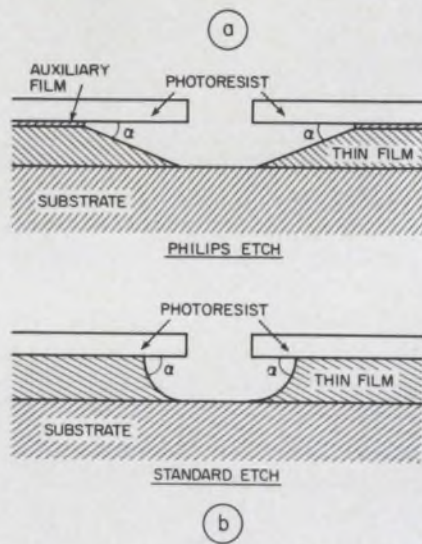

film, the fabricator can control slope of the thin film between 1 and 60 degrees. The Philips process has been fully developed for thin films of gold (to 5 μm thick), for Permalloy (to 3 μm thick) and silicon dioxide (to 10 μm thick).

Satcom echoes tamed by Siemens research

A solution to a difficult and annoying problem—echoes in satellite communications systems—has been found by researchers at Siemens AG Central Communications Laboratories in Munich, West Germany.

These echoes, with long propagation delays, are caused by mismatching at two-wire/four-wire interfaces in the telephone circuits. The Siemens research has produced a computer design algorithm that offers ideal echo compensation for such time-variant, linear hybrid

signal paths.

A simulated echo is generated that is opposite and equal in both phase and magnitude to the unwanted echo. The Siemens echocanceller has fast tracking capability, to keep the simulated echo correctly aligned in time with the unwanted echo.

There is another possible solution to the problem: voice-switching echo suppressers could be used. But the speech would be chopped during two-way conversations, inhibiting two-way transmission.

If your
copy of the
**Power Hybrid
Voltage
Regulator
brochure**
from Lambda
has been
removed...

please check
the proper
number on the
reader service
card for your
free copy.

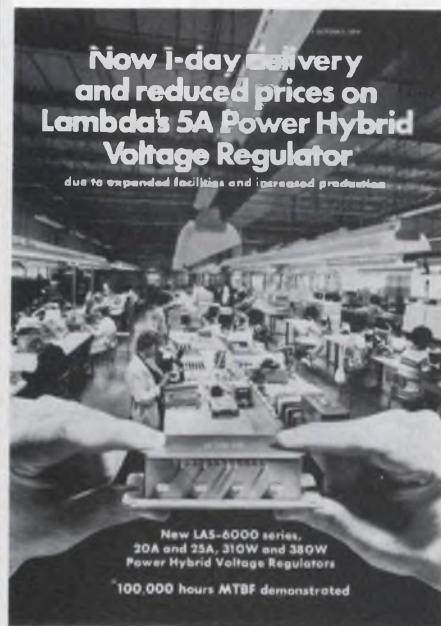

LAMBDA
ELECTRONICS CORP.

A Veeco Company

515 BROAD HOLLOW RD. MELVILLE, N.Y. 11746

INFORMATION RETRIEVAL NUMBER 248
ELECTRONIC DESIGN 21, October 11, 1974

A BETTER METER.

Data Precision's newest multimeter — the 5½ digit MODEL 3500 — is a second generation instrument that combines the best of both worlds.

More features.
For less money.

MODEL 3500 incorporates all of the proven circuitry advances that made our 2500 Series the internationally accepted price/performance leader.

Tri-phasic™ auto-zero, Ratiohmic™ 2- and 4-wire resistance, and Isopolar™ high stability referencing.

With a 6 month basic DC accuracy of ±0.007% of reading ±0.001% of full scale ±1 LSD, full autoranging from 1 microvolt to 1000V (DC or AC peak) and 1 milliohm through 12 megohms resistance, 20% overranging, DC Ratio, isolated BCD output, remote triggering and remote ranging, it represents the most sophisticated laboratory multimeter you can buy for less than \$1000.

\$995.
complete

MODEL 3500 features the industry's most reliable, field proven circuit technology packaged behind a big, bright and easy-to-read ½ inch planar gaseous display. And none of the bugs of an unproven design.

MODEL 3500 measures DCV, 1 microvolt to 1000 Volts; ACV, 1 microvolt to 700V RMS, 30 Hz to 100KHz; Resistance, 1 milliohm to 12 megohms; and Ratio.

AVAILABLE NOW

Contact your local Data Precision representative to arrange for a demonstration.

AL (205) 533-5896	MA (617) 273-0198	NY (S) (516) 482-3500
AZ (602) 994-9519	MD (301) 792-8661	OH (N) (216) 725-4560
CA (N) (408) 733-9000	MI (313) 482-1229	OH (S) (513) 885-4171
CA (S) (714) 540-7160	MN (612) 781-1611	OR (503) 238-0001
CO (303) 449-5294	MO (W) (816) 737-0066	TX (N) (214) 234-4137
CT (203) 525-7647	MO (E) (314) 731-2331	TX (S) (713) 461-4487
FL (813) 294-5815	NC (919) 787-5818	UT (801) 268-3181
GA (404) 457-7117	NJ (S) (215) 925-8711	WA (206) 763-2210
HI (808) 262-6286	NJ (N) (201) 863-5660	CAN (W) (416) 787-1208
IL (312) 593-0282	NM (505) 265-6471	CAN (W) (613) 772-5874
IN (317) 293-9827	NY (N) (315) 446-0220	CAN (E) (514) 731-9328

Data Precision Corporation
Audubon Road, Wakefield, MA 01880
(617) 246-1600

 **DATA PRECISION**
...years ahead

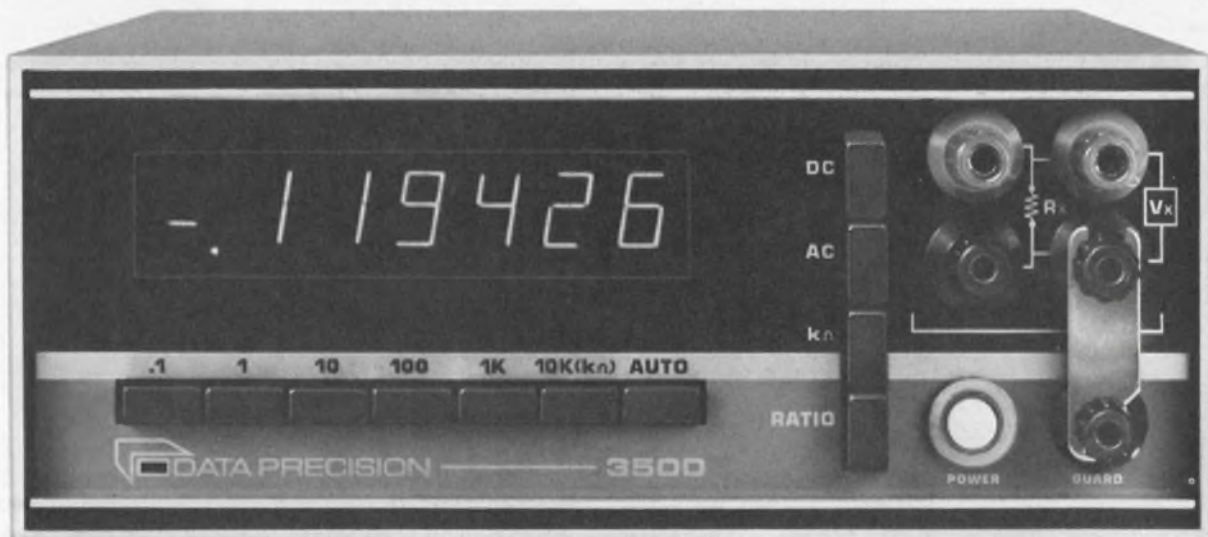

Shock and vibration transducers: These devices offer many simple solutions to measurement problems. But you must understand how they work to use them properly.

Once you understand the capabilities and limitations of shock and vibration transducers, they're very easy to use. Most of the devices, usually called accelerometers, provide an accurate method of determining stress levels, load factors, transmissibility coefficients and fatigue values of a structure being subjected to shock and/or vibration.

Basically the accelerometer is a seismic device that consists of a mass and a damped spring, both mounted in a housing.

A simple seismic accelerometer is a second order, single-degree-of-freedom system (Fig. 1). The viscous damping between the mass and the frame is represented in the equivalent circuit by dash pot, C. For frequencies well below the resonant frequency of the mass and spring, displacement is directly proportional to the acceleration of the housing, and is independent of frequency. Thus, if the device has a resonant frequency of 30 kHz, the output for a 1-g input would be the same at 75 Hz as at 5 kHz, when the correct load impedance is used.

The ideal seismic system in Fig. 1 has a mass M with infinite stiffness, a spring with zero mass, viscous damping that exists only between mass and housing, and a housing with infinite stiffness. In practical designs—piezoelectric accelerometers in particular—the resonant frequency of the piezoelectric combination is lower than indicated by theory.

The deflection of the spring-mass system, per unit acceleration, indicates its sensitivity as well as its natural frequency. A piezoelectric sensor has a typical mass displacement of 0.00005 in.; a strain-gauge type, typically 0.0005 in.; variable inductance of capacitance types, 0.005 in.; differential transformers, 0.05 in., and potentiometric types, 0.5 in. The table gives a comparison of several commonly used accelerometers and their characteristics. When checking the accelerometer specs, be careful—devices that measure



Piezoelectric accelerometers (shown without their cases) use one or two slices of piezo material.

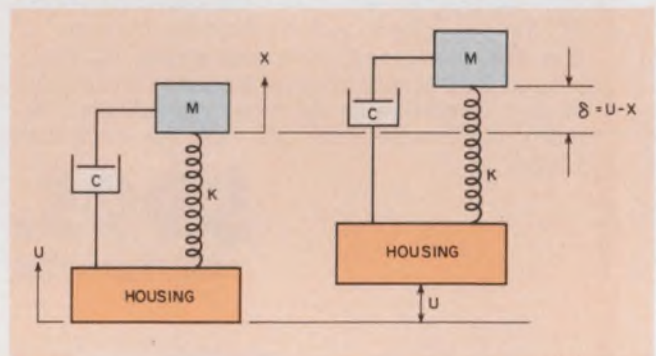

1. Ideal seismic systems can be modeled to simulate the transducer and the way it is affected by forces.

down to zero frequency (dc) normally have accuracy specified as a percentage of full scale, while piezoelectric types are typically specified as percent of reading.

Inside the piezoelectric transducer

The equivalent circuit (Fig. 2a) represents the generation of electrical charge across a piezoelectric element. The circuit can be converted symbolically into a voltage-generating circuit (Fig. 2b), if you place the capacitance in series with the generator instead of in parallel. When a shunt capacitor is added (Fig. 2c and 2d), usually in the form of an accompanying cable, you can manipulate the basic charge equations to show that the charge sensitivity is not altered. At the same time, you can see that the open-cir-

Anthony W. Orlacchio, Manager, Technical Services, Servionic Instrumentation Div., Gulton Industries, Metuchen, N.J. 08840.

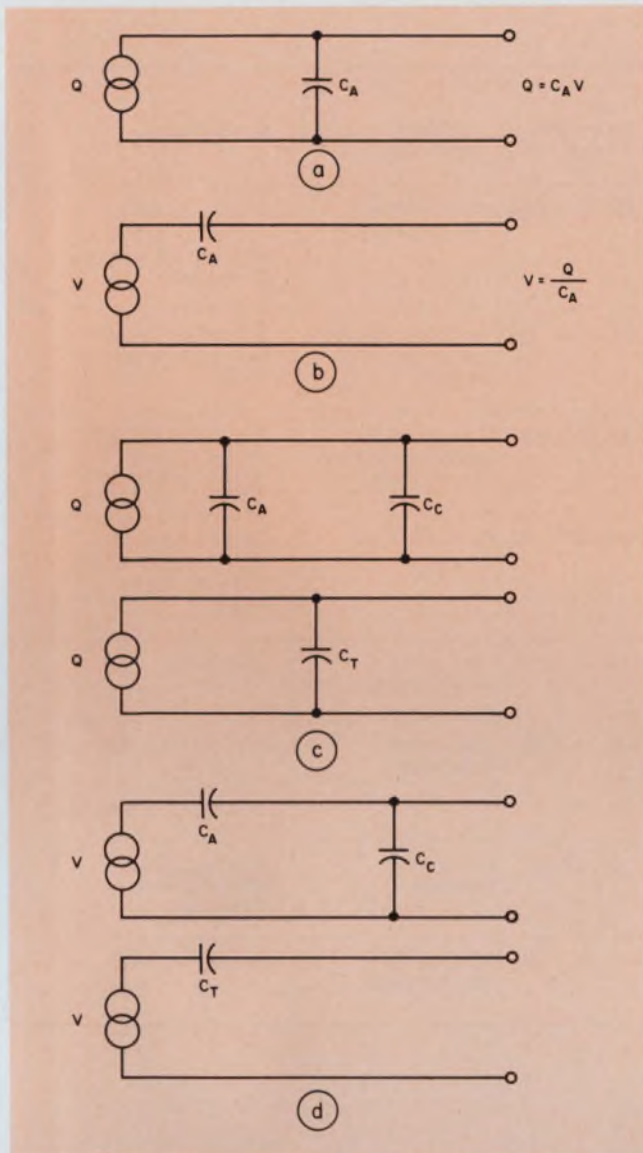

2. The piezoelectric accelerometer can be represented by a charge generator and a shunt capacitance (a) or by a voltage generator and a series capacitance (b). The effect of the cable capacitance can be added into the accelerometer models (c and d).

cuit output voltage decreases by the ratio of the accelerometer capacitor to the sum of the cable and accelerometer capacitances.

Charge and voltage accelerometers can be considered to be the same at room temperature. The only difference would appear when a temperature run is made. The voltage unit has a flat voltage output vs. temperature, while the charge output device has a flat charge sensitivity vs. temperature. Thus in both cases, the capacitance varies to keep the flat characteristic, $Q = CV$.

Piezoelectric materials¹ can be divided into two types: natural crystals such as quartz, and polarized ferro-electric materials like barium titanate and lead-zirconate-titanate. The second grouping of materials are synthetic crystals made from a powder fired in kilns at temperatures exceeding 2500 F. The material is then polished, silvered

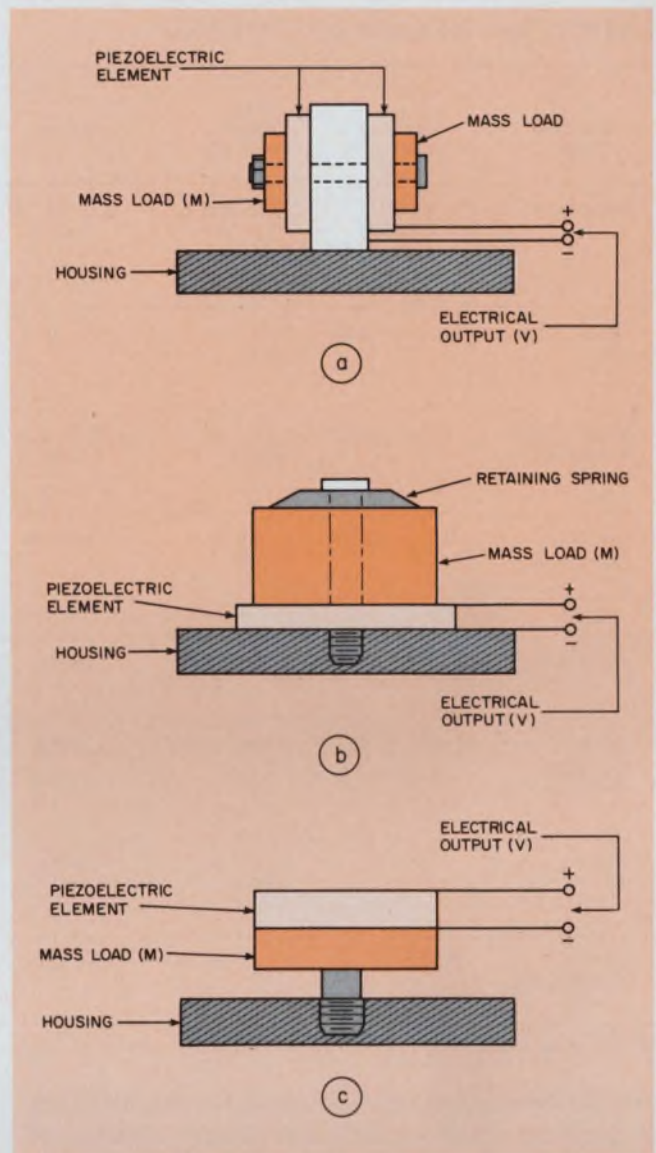

3. The piezoelectric accelerometer can be mounted to produce an output in either the shear (a), compression (b) or bender (c) mode of operation. In any of these operating modes, the accelerometer usually moves less than a thousandth of an inch.

and polarized. The poling process gives the material the piezoelectric properties. In natural crystals, the cut of the crystal determines the direction of stress sensitivity.

The synthetic ceramic materials have a much higher dielectric constant and a greater charge sensitivity than quartz crystals (typically 3 to 4 times). Some designs might require five quartz crystals to produce the same output as ceramic materials. Since both materials are capacitive, they do not respond to dc, since the output impedance becomes infinite at zero frequency.

Mechanical transducer design

Fig. 3 shows several different seismic systems that are used in piezoelectric accelerometers. In the shear design (Fig. 3a), the ceramic is poled

Types of accelerometers

Transducer type	Acceleration range G(pk)	Useful frequency range* Hz	Accuracy	Temperature range F	Primary advantages	Disadvantages
Piezoelectric	0.001 to 100,000	2 to 50,000	3 to 5% of reading	-425 to +1400	Self-generating high sensitivity	Requires emitter follower or charge amp, cannot measure dc response.
Strain gauge wire	0.01 to 1000	0 (dc) to 1500	1% of fs	-65 to +350	Low output impedance, can use ac or dc excitation	Low voltage output, requires balanced circuit.
Strain gauge solid-state	5 to 1000	0 (dc) to 10,000	±3% to 1/3 fs ±10% fs	-65 to +250	Dc response, low impedance (calibration capability)	Low sensitivity, can fracture crystal, thermal sensitivity.
Variable capacitance	0.1 to 10,000	0 (dc) to 12,000	±2% fs	-100 to +250	Dc response, gas damping	Requires balanced circuit & demodulator, relatively large weight.
Potentiometric	2 to 100	0 (dc) to 75	±3%	-100 to +250	High output, low impedance	Limited life
Variable reluctance (inductance)	0.1 to 75	0 (dc) to 300	±3%	-65 to +200	Low output impedance	Does not have high linear range, requires balanced circuit and demodulator
Vibrating wire	1 to 20	0 (dc) to 5000	±2%	130 ±5%	Output in frequency	Nonlinear output requires special electronics
Servo accelerometer	0.0001 to 100	0 (dc) to 100	0.5% fs	-65 to +250	Dc response, low impedance	Limited in g level

*These ranges are not for one instrument, but for several in each category.

in a different manner. The elements are polarized in the long direction, and the voltage is taken off the perpendicular surface.

The shear design offers low cross-axis response, excellent temperature characteristics and high sensitivity. In addition the base-bending or strain sensitivity of the bolted shear unit is in most applications. Normally the single-ended compression accelerometer will have strain sensitivities 250 $\mu\text{in./in.}$ that produce output levels of 2.5 g, while shear units go as low as 0.025 g. The compression design (Fig. 3b) is very sensitive and has excellent temperature characteristics at temperature extremes; namely, above 750 F. The bender (Fig. 3c) is particularly useful where small size and light weight are required. Recently developed ceramic materials have increased operating temperatures to over 1400 F in both the shear and compression modes.

Accelerometers have distinct output characteristics that depend upon orientation. The sensitivity plots shown in Fig. 4 are drawn in one dimension but can be extended to three.

In Fig. 4a, the maximum output from the accelerometer is in a plane directly perpendicular

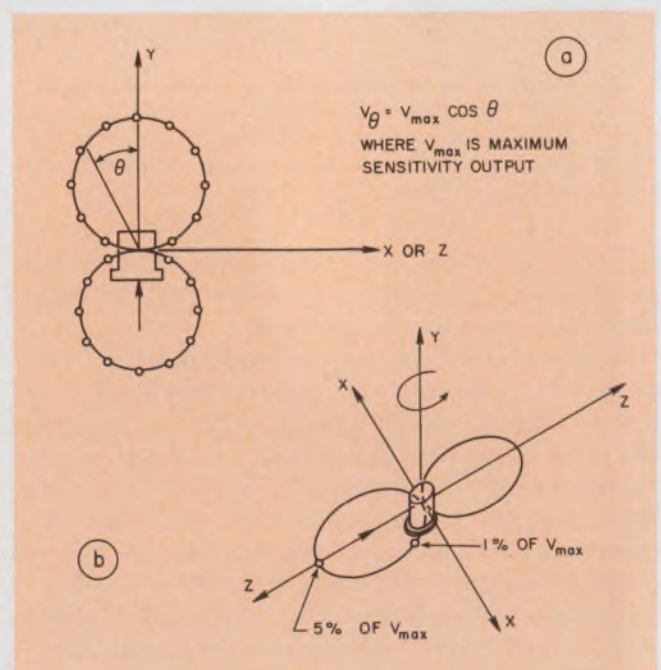

4. Vertical sensitivity of a piezoelectric pickup (a) allows a $\pm 10^\circ$ off-vertical displacement with only a 2% output variation. Transverse, or cross-axis sensitivity (b), caused the output to change by 7% for a similar angular rotation.

to the mounting surface. This output varies with the cosine of the angle θ . Thus, you could have a misalignment of about 10° and the accelerometer output would vary by only 2%. Of course, this is helpful in applications where absolute perpendicular alignment cannot be obtained.

For transverse or cross-axis sensitivity (Fig. 4b) the optimum angle would be 90° . A misalignment of 10° could vary the transverse sensitivity by 10%. And at small angles (1 to 5°) the transverse output is directly proportional to the angle. Since the nominal transverse sensitivity of the accelerometer is given as 5% of the on-axis output, a large error could be introduced by misalignment in this plane.

The transverse sensitivity of an accelerometer also has a maximum-minimum value that can be plotted. This information is only useful when you know the direction from which the shock and/or vibration will come.

Over certain frequency ranges, piezoelectric accelerometers have an almost flat frequency response. One major reason for the wide use of the piezoelectric devices is their high natural resonant frequency.

A typical accelerometer frequency response (Fig. 5) has a flat ($\pm 5\%$) frequency response from 5 Hz to 5 kHz, and a mounted resonant frequency of 35 kHz. At resonance, the unit has an amplification factor of about 20; thus its output at resonance will be 20 times larger than its output at frequencies well below resonance.

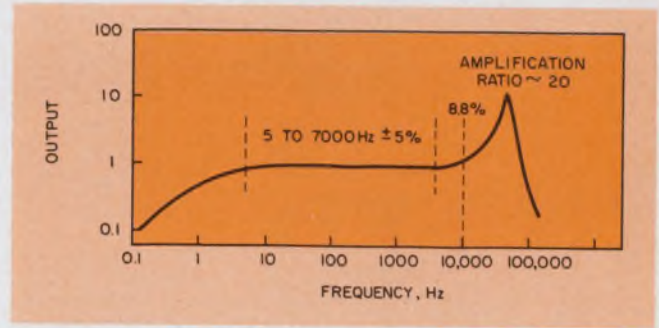

5. Typical output response of a piezoelectric accelerometer is very poor near dc, at input frequencies it is flat and at resonance it increases sharply.

To estimate what the upper-end frequency response will be, you can use the following formula to estimate the percentage rise in the output:

$$\% \text{ rise} = \frac{1}{1 - \left(\frac{f}{f_n}\right)^2}$$

where f_n is the resonant frequency of the sensor, and f is the upper frequency range that you want to measure.

A typical calculation with an accelerometer that has a 35-kHz resonant frequency shows that at 10 kHz the increase would be 8.8%. Thus if you permit a $\pm 10\%$ deviation the units can easily meet that performance requirement.

Be careful when you look at the amplification ratio: Any step-function or shock-pulse input will excite the accelerometer at resonance level,

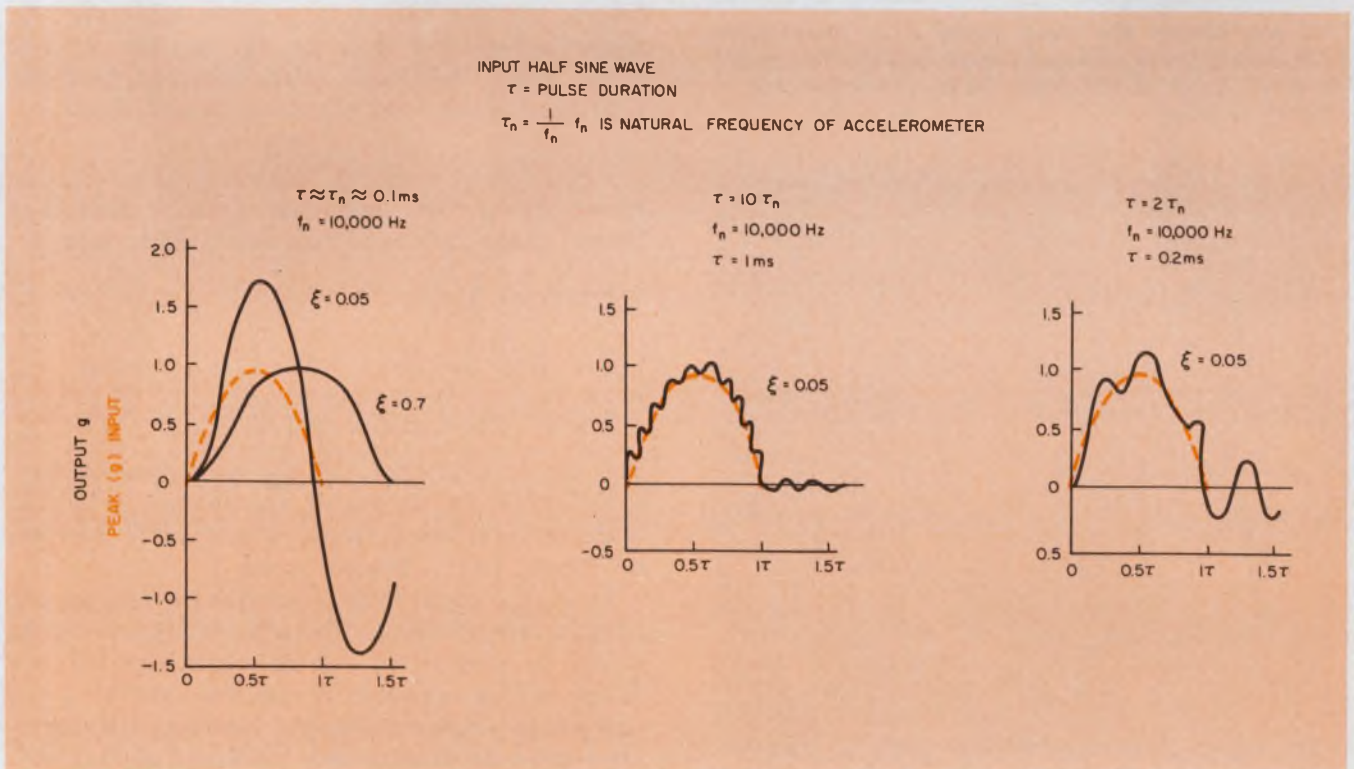

6. With an input of a half-sine-wave shock pulse, a typical transducer output doesn't necessarily follow

the input. The output signal will either exceed or go below the expected value.

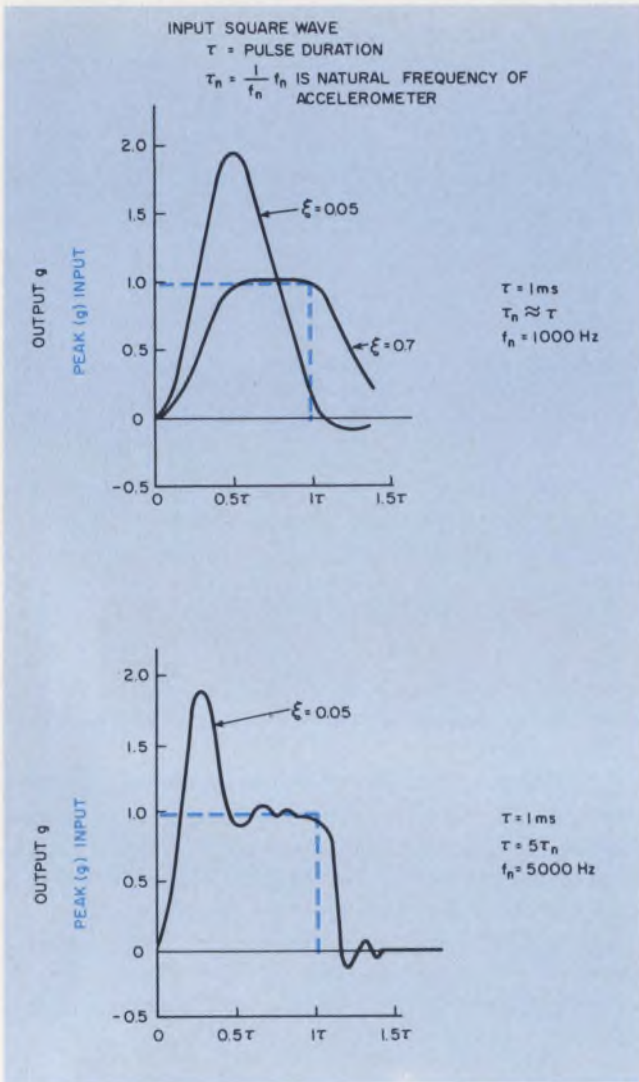

7. If you change the input signal to a square-wave shock pulse, the transducer output will usually exceed the actual value of the shock pulse unless the unit is critically damped.

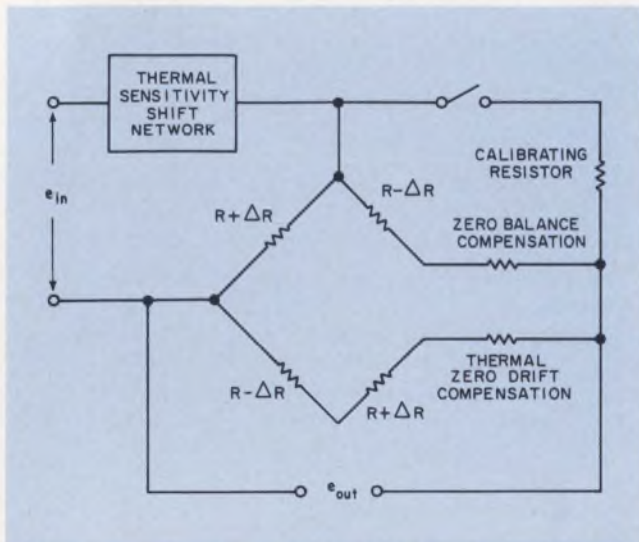

8. The strain-gauge accelerometer uses a balanced bridge network with thermal compensation added to maintain the zero drift and temperature sensitivity with specifications.

and could cause an overload voltage at the input of the associated amplifier.

Fig. 6 shows the response of an accelerometer to an input of a half sine-wave shock pulse. The pulse has a duration of τ , and the accelerometer has a typical damping factor, ξ , of 0.5 or less. But there are other accelerometers that have damping factors as high as 0.7 of critical; they can be used at up to 70% of the resonant frequency.

Another important example is the response to sharp square-wave pulses (Fig. 7). In this case, a square pulse, standardized to 1 g, is applied to the same accelerometer used in Fig. 6.

An ideal situation requires an accelerometer with a resonant frequency 10 times higher than the expected frequency range. The sensor should also have high capacitance and extremely high shunt resistance to produce true fidelity to the input force.

Measure acceleration in many ways

There are many ways to convert acceleration into electrical signals. One is to use a strain-gauge transducer.

A strain-gauge accelerometer measures the change in the resistance of a wire caused by input acceleration. Generally the resistors are connected to form the legs of a Wheatstone bridge circuit (Fig. 8). The actual resistance elements can be selected from a wide range—unbonded metal wire, bonded metal wire, metal foil, bonded semiconductor or fused semiconductor.

When you use the strain-gauge accelerometer, several factors can help you to calculate the gauge factors. For instance, for the wire or foil strain gauge, the simple relationship between the resistance change and the strain is as follows:

$$\frac{\Delta R}{R} = K \frac{\Delta L}{L}$$

If you take a cross-section of the wire, there are several other equations you might find useful:

$$R = \rho \left(\frac{L}{A} \right),$$

$$K = \left(\frac{\Delta R}{R} \right) / E,$$

$$K = 1 + 2\mu + (\Delta\rho/\rho) / \left(\frac{\Delta L}{L} \right).$$

K is the gauge factor, ΔR the resistance change, R the initial resistance, ΔL the change in length, L the original length, ρ the resistivity, E the elastic strain, and μ Poisson ratio.

To obtain good thermal sensitivity and proper temperature response, certain resistance values should be selected to ensure continuous balance of the bridge network. Sometimes special negative temperature coefficient elements (thermistors) are used to minimize unwanted drift.

Another acceleration sensor used is the servo accelerometer (Fig. 9). This device is used for

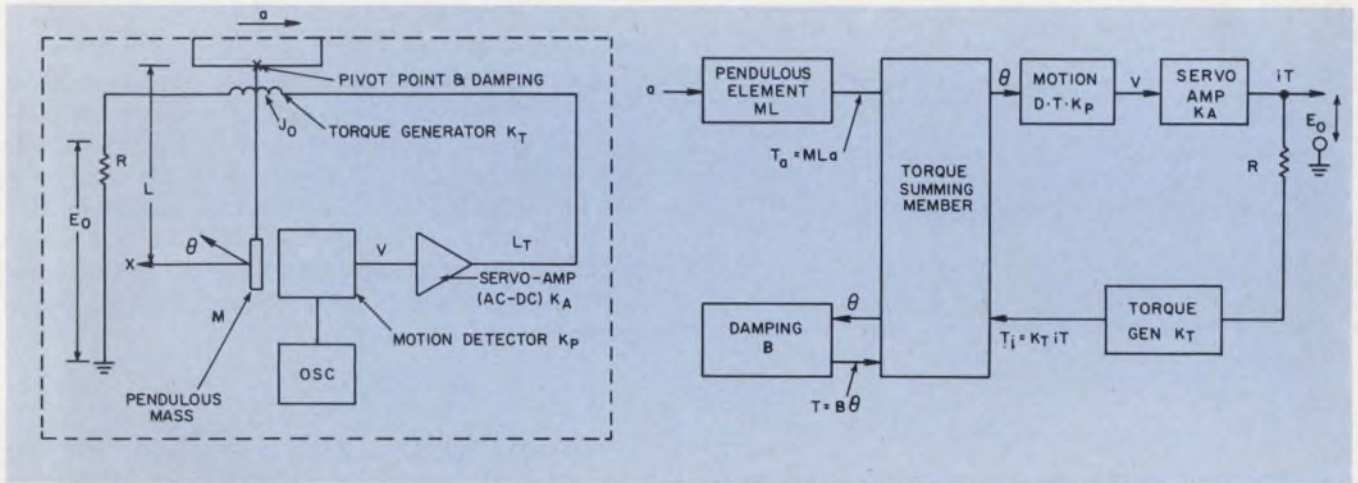

9. Servo accelerometers are closed-loop systems. They use a feedback loop to detect any forces.

low-frequency, low-g measurements. Of all the accelerometers available, this is a true closed-loop system, in which the input is directly coupled to the output in a feedback circuit.

In operation, a linear or pendulum element feeds a servo amplifier that provides a restoring torque or force balance to the input. Six basic functional blocks make up the over-all transducer. A practical unit might also include an active filter, a dc-to-dc converter and a bias supply. The frequency response of the device is usually set up so that a critically damped unit will be down 6 dB at the resonant frequency, and approximately 3 dB down with a critical damping factor of 0.7. A critically damped unit also exhibits a linear relationship between frequency and phase shift, but rapidly changes to 90° as the resonant frequency is approached. With proper filtering, the servo accelerometer can detect forces down to 0.00001 g.

There are two basic seismic elements available today: a pendulous mass and paddle; a linear suspension where the mass is integral with the restoring coil of the electromagnetic driver. The pendulous mass consists of a ruggedized meter movement with a paddle substituted for the pointer. When accelerated, the paddle moves towards a coil that is excited at high frequency. This combination is part of an oscillator circuit in the amplifier. As the paddle moves, it generates an error signal which, in turn, is detected and fed back to the torque coil in the meter movement. The torque coil then tends to restore the paddle to its original position and minimizes the error signal. At this point the servo system is in a torque-balance (also called force-balance or null-balance) condition.

The IR drop through a precision load resistor in the servo amplifier produces an output voltage E_o proportional to the applied acceleration.

The linear-variable-differential-transformer (LVDT) accelerometer uses a moving core with-

in an excited magnetic field to provide an output to measure acceleration (Fig. 10a). Basically the LVDT has several coils wound around a hollow tube. A ferrous material can move freely through the core of this fancy electromagnet. As the material moves, it changes the magnetic coupling between coils and therefore the output voltage. The coils in an LVDT are wired to yield the difference between their two output voltages.

Variable reluctance accelerometers (Fig. 10b) use two precisely wound flat coils instead of the differential transformer. Each inductive arm is wound within a magnetic shield built with an internal air gap. A seismically suspended magnetic armature controls the air gaps, in accord-

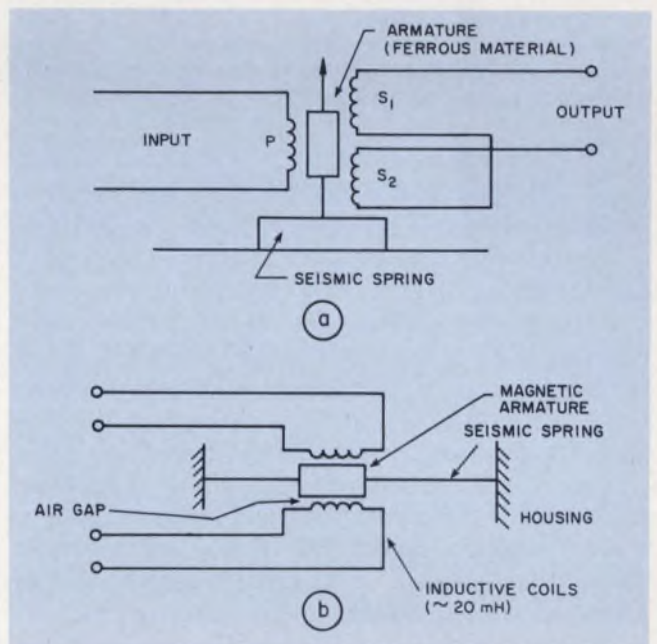

10. Differential transformer accelerometers (a) use a three-winding transformer that provides an output proportional to the displacement of a metal core within the coils. The variable reluctance accelerometer (b) uses a moving magnet to produce an electrical output due to mechanical shock.

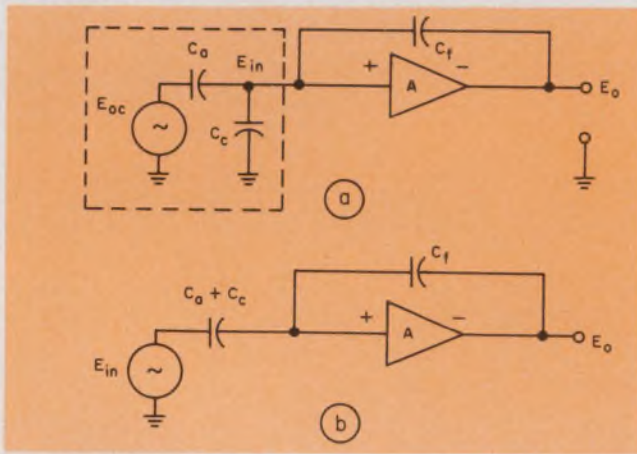

11. The basic charge amplifier allows different cable lengths, from 1 to 200 ft., to be used without affecting the charge sensitivity of the transducer system.

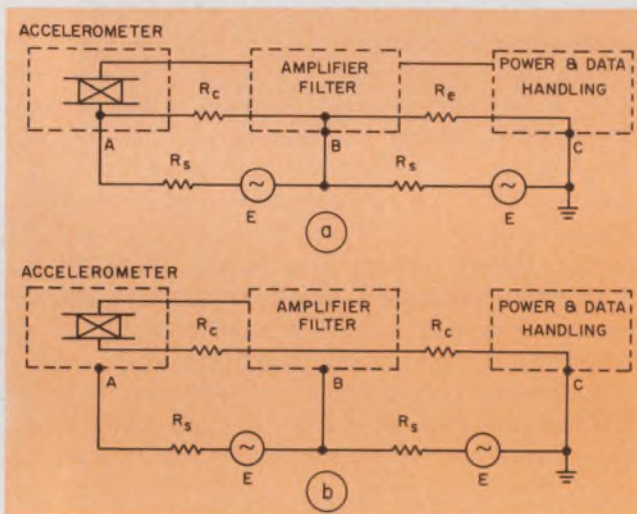

12. Ground-loop problems within a multicircuit measuring system can create many problems (a). If all the circuits use a common ground (b) the various pieces of equipment can work together.

ance with the applied acceleration. An output is produced that can be made linearly proportional to this acceleration. The variable-reluctance units can be made fairly small—typically 0.5 in³.

Accelerometers that are dc in nature—they operate down to zero frequency, as do the potentiometric, wire strain-gauge and piezoresistive types—can use dc amplifiers. In the variable capacitance, variable-reluctance and differential-transformer types, an ac input signal of specified frequency is required. And the output signal is a low-frequency modulated version of the input. These types require an ac demodulator circuit or a dc converter to condition the output signal.

Conditioning the transducer outputs

In general ac amplifiers can be made more stable than the equivalent dc types. However, since the output impedance is a fixed-value ca-

pacitor in piezoelectric accelerometers, a high-impedance, emitter-follower voltage amplifier, or a charge amplifier with capacitive feedback, must be used to provide the low-frequency response.

A charge accelerometer, symbolized by a voltage source, E_{oc} , and two capacitors, C_a and C_c , can be connected to an op amp that has capacitive feedback (Fig. 11). In this figure, C_a represents the accelerometer capacitance, and C_c , the cable capacitance. Two equations describe the transducer output voltage:

$$E_{in} = E_{oc} \frac{C_a}{C_a + C_c} \quad (1)$$

$$\text{Gain} = E_o/E_{in} = Z_f/Z_s = \frac{C_a + C_c}{C_f} \quad (2)$$

If Eq. 1 is substituted into Eq. 2, you get:

$$E_o = E_{oc} (C_a/C_f).$$

You can also equate the generator voltage, E_{oc} , to the charge on capacitor C_a :

$$E_{oc} = Q/C_a; \text{ thus } E_o = Q/C_f.$$

The cable capacitance doesn't enter into the calculation. The op-amp output is now expressed as volts/picocoulomb; thus if the feedback capacitor is 1000 pF, the gain of the amplifier will be 1 mV/pC.

A differential-input charge amplifier can also be used. This amplifier is especially good for twisted-pair, shielded-cable connections. In this design the seismic element must be completely isolated from the case, and two wires used for the power and ground connections. The accelerometer housing must also be shielded, and connected to the same shield ground.

The capacitive effect from the power terminals to case ground must also be considered. When differential-input amplifiers are used, the values of each side of the ceramic element to ground must balance, or the amplifier input will show a distinct unbalance and produce erroneous signal outputs. This capacitance ranges typically from 2 to 25 pF.

Account for amplifier characteristics

Accelerometers deliver signals that often have some undershoot or overshoot which the amplifier must withstand. The amplifier characteristics that must be observed include damped-undershoot return and amplifier-overload recovery, and are often mistaken for each other.

Undershoot, or negative overshoot, is the amplifier excursion at the termination of the shock pulse. The amplitude and duration of this damped undershoot depends upon the second order, low-frequency, transfer function. With a decrease in the amplifier's time constant, the amplitude and duration of the damped undershoot return increases.

Amplifier overload occurs when one of the amplifier stages reaches its saturation limit

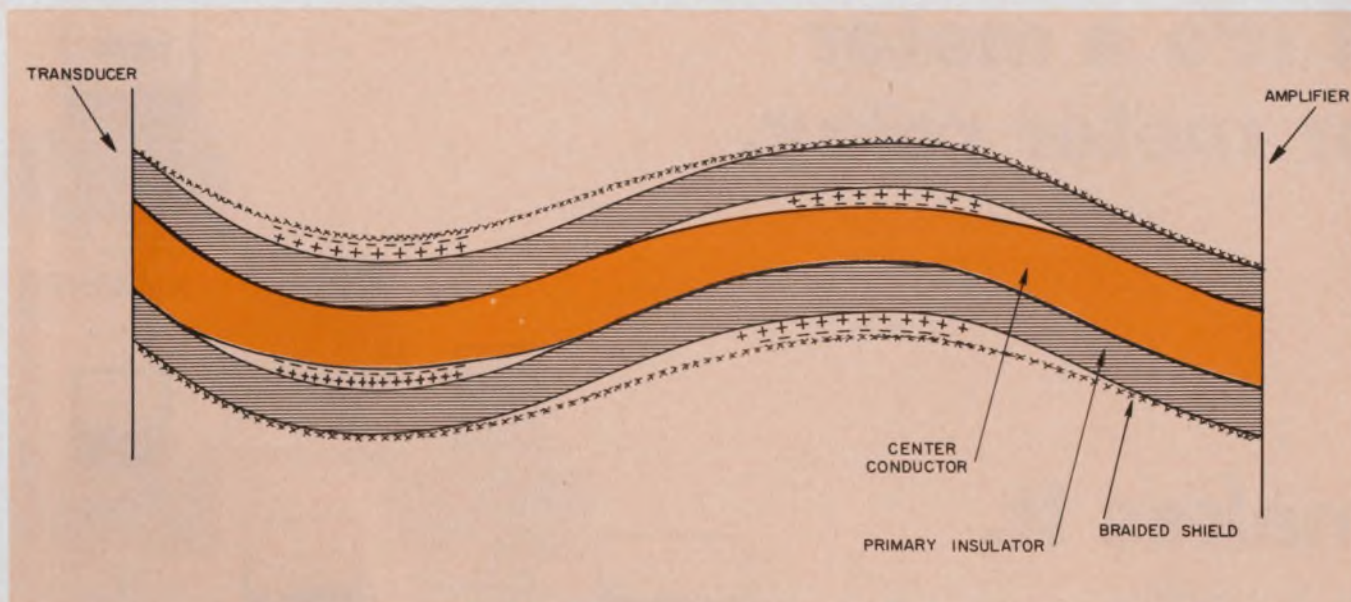

13. Noise generated by the vibrating cable gets amplified by the transducer's conditioning amplifier.

(usually an input stage). A finite time is required for the amplifier to re-establish its normal characteristics once overloaded (overload recovery time). To evaluate the transducer amplifier properly, you must know the incoming level of shock pulse. Saturation levels can be increased by correct selection of gain in a charge amplifier. For voltage amplifiers, a capacitor shunting the amplifier input will usually take care of any overload situation.

Thus one symptom of poor low-frequency response is that the amplifier exhibits output undershoot when subjected to long transients.

For simple half sine-wave shock pulses, the time constant can be approximated as 15 times the transient pulse width, to limit the undershoot to 2%. One problem that prevents easy connection of the transducer to the amplifier is interference from outside random noise.

Connecting the transducer

In many transducer systems, the weakest link is the connecting cable. This is due mostly to the stresses and vibration it undergoes, and, the cable is usually relatively small compared with the other equipment. If the cable isn't properly tied down, it can create spurious noise levels, and in some cases, discontinuities.

Yet another source of error comes from ground loops due to circulating ground currents generated by electrical potentials external to the system. A typical test system might have instruments grounded at three separate locations, a, b and c (Fig. 12a). One possible way to ground the system properly would be to remove the internal grounds from the accelerometer and associated equipment, and to tie them together with a single reference level (Fig. 12b).

Many problems come along with the transducer—the worst is the noise generated in the connecting cables. Since a piezoelectric accelerometer is capacitive, it has a high input impedance (typically 100 M Ω) at low frequencies (below 20 Hz). Thus any noise generated in the cable doesn't leak off rapidly. It reaches the conditioning amplifier where it is increased.

The noise is generated in the cable itself. Normal coaxial cables consist of stranded wire with an insulator covering of extruded polyvinyl or Teflon material. The outer shield covers the dielectric with a braided, stranded, silver plated, metal cover which, in turn, is covered with an outer insulating jacket. When this cable is manufactured, very little care is taken to minimize self-generated noise.

Thus when this conventional coax is used in a system that undergoes various forms of vibration, the inner conductor and outer shield can move relative to the dielectric insulator. When this movement is rapid, static friction can build up a positive charge in the inner layer of insulating material, and a negative charge on the inner conductor. Similarly, a positive charge builds up on the outer layer of the insulator and a negative charge builds up on the braided shield (Fig. 13).

When the cable is straightened out, the charges are removed. And since there is no low-impedance path, the discharge feeds directly into the conditioning amplifier and thus generates noise. ■■

Reference

1. Edmiston, C., "Piezoelectric Ceramic Transducers," *Electronic Design*, Sept. 1, 1974, pp. 78-82.

Bibliography

1. Harris and Crede, "Shock and Vibration Handbook," Vol. 1, McGraw-Hill, 1961.
2. Norton, Harry, "Handbook of Transducers for Electronic Measuring Systems," Prentice Hall, 1969.

if it's a meter or meter relay,

Stock or Special...

Simpson

makes it.



Stock:

Simpson distributors nationwide stock over 1,500 types, ranges, styles and sizes of panel meters, relays and controllers. They're all listed in Catalog 4200. Write for your free copy.

Special:

Need a special or unusual meter? Let Simpson help you custom design it. Send us your specs and we'll send you a quote. But check our catalog first—that "special" may be a standard Simpson stock item.

Get off-the-shelf delivery from your local electronics distributor.



SIMPSON ELECTRIC COMPANY

853 Dundee Avenue, Elgin, Illinois 60120
(312) 695-1121 • Cable: SIMELCO • Telex: 72-2416

IN CANADA: Bach-Simpson, Ltd., London, Ontario

IN ENGLAND: Bach-Simpson (U.K.) Limited, Wadebridge, Cornwall

IN INDIA: Ruttonsha-Simpson Private, Ltd., Vikhroli, Bombay

KATY INDUSTRIES



ELECTRICAL EQUIPMENT
GROUP

Announcing a new name for the people who make AlSiMag[®] Brand ceramics.

American Lava Corporation has changed its name.

After 20 years as a subsidiary of the 3M Company, we're now a division — The 3M Technical Ceramic Products Division.

We will continue to supply reliable components for discrete and hybrid circuitry — such as substrates for various applications.

Another 3M Division, the newly formed Electronic Products Division, will handle your needs for products used for the encapsulation of integrated circuitry. They will assure an uninterrupted supply of the same fine AlSiMag[®] "electronic packages" which have become an industry standard.

Two things haven't been changed: our address and our reputation for quality and service.

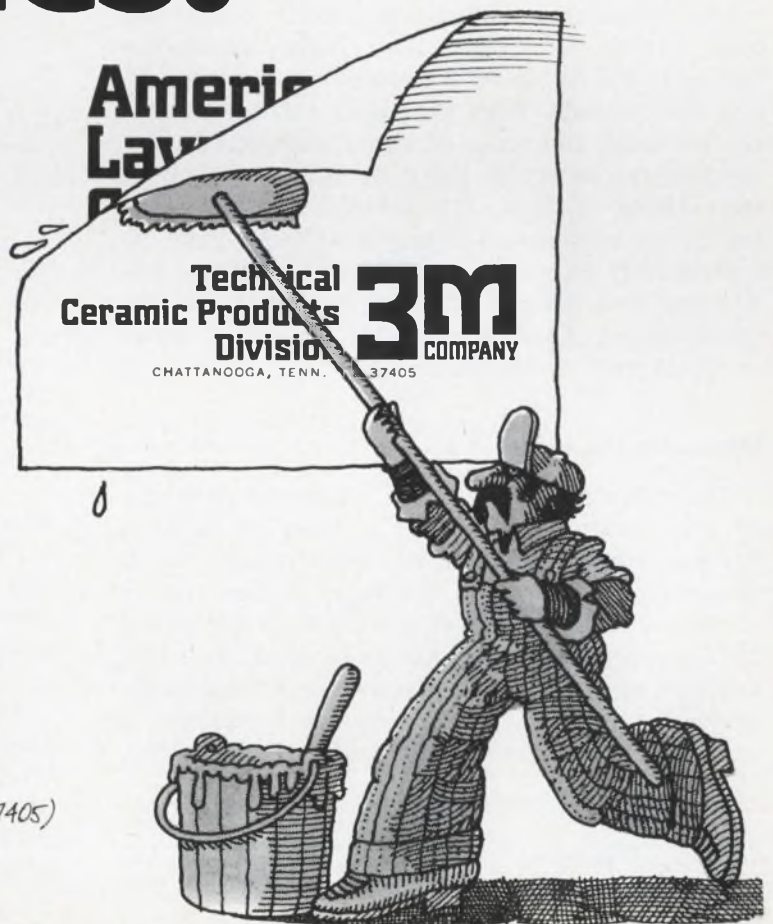

**Technical
Ceramic Products
Division** **3M**
COMPANY
3M CENTER • SAINT PAUL, MINNESOTA 55101

(Formerly American Lava Corp. Chattanooga, Tenn. 37405)

Visit us at Booth 4445 at ISHM.

INFORMATION RETRIEVAL NUMBER 38

Aluminum electrolytics are hard to beat

for large capacitance in a small package and at low cost. But electrolytics are far from being ideal capacitors.

Of all capacitors, the aluminum electrolytic probably deviates the most from the theoretically ideal type. In electrolytics, dielectric losses are relatively high. Losses result from direct current leakage (DCL), which together with many components of series resistance are combined into an over-all equivalent series resistance (ESR). And built-in unwanted inductance limits performance at high frequencies.

In addition, electrolytics suffer from low initial precision and poor low and high-temperature stability. An initial capacitance tolerance rating as broad as -10 to $+100\%$ is not unusual, and the capacitance gradually drops with age. An industrial grade unit might go from, say, $75 \mu\text{F}$ in 2000 hours at 85°C (Fig. 1). Also they can leak chemicals and can even explode when overloaded.

But in spite of these unwanted losses and other limitations, aluminum electrolytics are used extensively. They offer high capacitance values to hundreds of thousands of microfarads, and even farads. They are small (occupying less than a tenth the space of paper capacitors), are lightweight and cost about a tenth as much as the others. Except for tantalum—about four times the cost—aluminum electrolytics have no competition. Circuits in applications such as bypassing and filtering at power and audio frequencies can usually tolerate the imprecise values of aluminum electrolytics.

Measuring the losses

Capacitor losses are often expressed in terms of a dissipation factor (DF). Most capacitance bridges allow this form of measurement for a capacitor's losses. DF, the ratio of the energy stored to the energy lost per cycle, is expressed as a percentage or as the tangent of the loss angle of an equivalent resistance and capacitance in series (Fig. 2). Percent dissipation factor is expressed in terms of the ESR in ohms, fre-

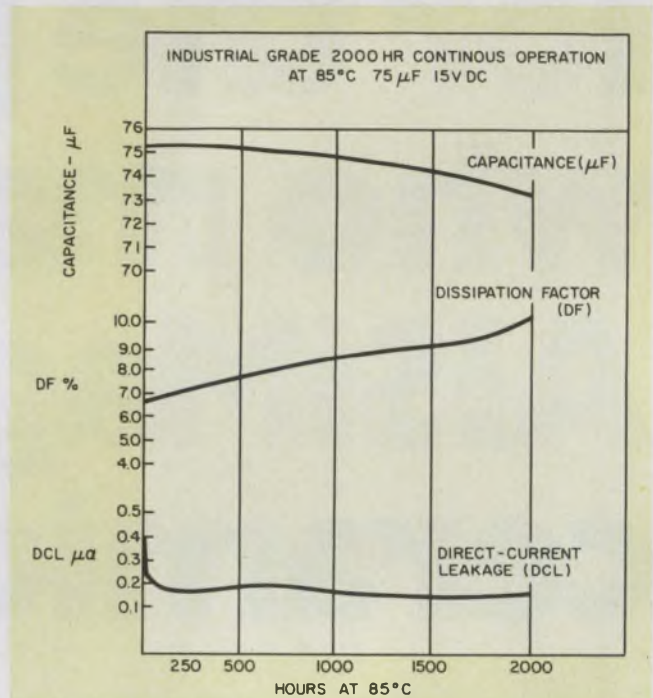

1. Even good grade aluminum electrolytic capacitors lose capacitance and experience an increase in dissipation factor with age.

quency f in Hz, and the capacitance C in μF , related by the formula:

$$(2\pi f C) (\text{ESR}) (10^{-4}) = \text{DF}$$

The power factor (PF) is the ratio of the capacitor's ESR resistance to its impedance, Z , as follows:

$$\text{PF} = \frac{\text{ESR}}{Z}$$

Since $Z = \sqrt{(\text{ESR})^2 + (1/2\pi f C)^2}$, at low values of DF or PF (to about 15%), dissipation factor and power factor are approximately equal. Power factor is usually only important for ac motor-start capacitors, and DF and ESR are important in dc applications.

DF takes into account all losses, and lumps them into a single ESR loss. The ESR loss includes the loss in the oxide film, the resistance of the electrolyte, the contact resistance of the foils, and the resistances of the tabs and lead wires or terminals.

In addition to the many components in its

Paul H. Forssander, Application Engineer, Mallory Capacitor Co., 3029 E. Washington St., Indianapolis, Ind. 46206.

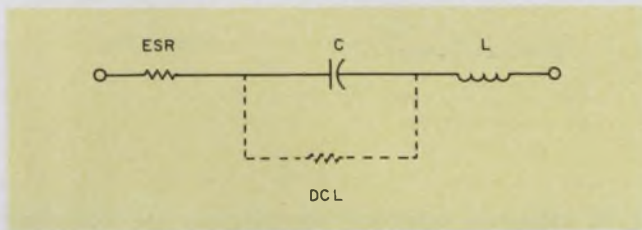

2. In addition to the desired capacitance, an electrolytic capacitor has unwanted dc leakage (DCL), equivalent series resistance (ESR) and inductance. These characteristics are much worse for electrolytics than for most other capacitors.

makeup, the equivalent-series-resistance concept has the following other complications:

- ESR varies inversely with ambient temperature. The change is small at the high end (above 25 C), but increases steeply by as much as 100 times its room-temperature value when the temperature drops to -55 C (Fig. 3).

- ESR changes with frequency. It decreases as the frequency rises to about 6 kHz, and then remains almost constant with further frequency increases.

Also DCL changes with voltage, capacitor size and temperature and depends strongly on imperfections in the oxide film.

- DCL increases with increased voltage. A 100- μ F capacitor might have a 1- μ A rated maximum leakage at 25 C for 1 to 3 Vw and 60 μ V when rated for 75 to 150 Vw.

- DCL increases as the capacitance increases. For a 50 to 75 Vw, a 1- μ F capacitor's DCL might be 3 μ A, but 100 μ F would allow 30 μ A of leakage.

- DCL increases with temperature. At 85 C it can be six to eight times the value at 25 C.

Electrolytic capacitors are rated mainly by:

- Nominal capacitance (μ F) at dc or rms ac working volts (Vw).
- Maximum allowed surge voltage (pk).
- Allowed ripple current (rms).
- Tolerance range.
- Operating and storage temperatures.

Of course, for a given container size, you get more capacitance at low voltage. Also the capacitance is measured at a specified frequency—120

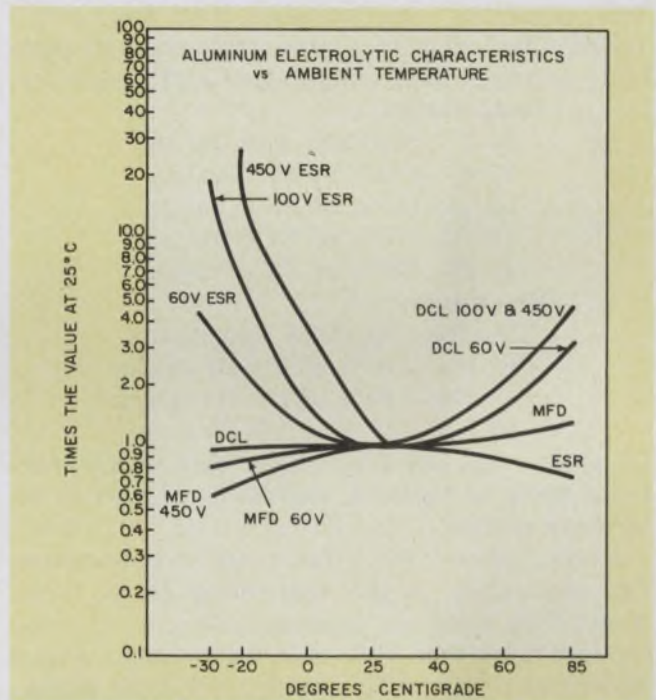

3. The important properties of an electrolytic depend strongly on the unit's temperature. DCL rises steeply but ESR drops with increasing temperature.

Hz is the usual industry standard. "Tight" tolerances are available, but a $\pm 20\%$ tolerance could cost 50% more than the standard value. Capacitance tolerances are usually related to working-voltage rating. Some typical values are:

Vw dc	Tolerance of capacitance
1 to 100 V	-10%, + 100%
101 to 300 V	-10%, + 75%
301 to 450 V	-10%, + 50%

An electrolytic can, of course, be operated at voltages below its rated working voltage. However, the popular belief that a capacitor's life is prolonged substantially by its operation below about 80% of its voltage rating is generally not true. In fact, with older capacitor making techniques, in time, oxide films reformed and the capacitor became a lower voltage unit, but newer methods have overcome this effect.

Surge voltage is most often defined as the maximum dc voltage that the capacitor can withstand for 30 seconds or less—applied at intervals

of at least 5 minutes. When ac ripple voltage is superimposed on dc, the sum of the dc and ac voltage should not exceed the dc rated Vw of the capacitor.

Peak operating temperatures for aluminum electrolytics are usually limited to between 65 and 85 C; the low temperature limits are between -20 and -55 C. High operating temperature can increase capacitance by as much as 30% above the room-temperature value. And the ripple-current capability is 50% more at 65 C than at 85 C, and about twice as much again at 45 C. This capability also increases with frequency.

For filter capacitors, the ripple-current capability changes with temperature and frequency:

Temperature:

- 85 C—Standard rms rating
- 75 C—130% of 85 C rating
- 65 C—150% of 85 C rating
- 55 C—175% of 85 C rating
- 45 C—200% of 85 C rating

Frequency:

- 120 Hz—Standard rms rating
- 360 Hz—110% of 120 Hz rating
- 1 kHz—110% of 120 Hz rating
- 60 Hz— 80% of 120 Hz rating

In special applications where high ripple currents must be handled, capacitors of special design are needed.

From -30 to -50 C, the capacitance decreases. The electrolyte is the controlling factor here. Along with a steeply increased ESR, a capacitor can lose more than 60% of its capacitance. Fig. 3 illustrates a typical aluminum-electrolytic capacitor's temperature characteristics.

Though electrolytic capacitors can be troublesome, a circuit designer can select, specify and apply them with confidence and obtain long life in his application—provided he understands their construction and the materials used.

Electrolytics are complex

Aluminum electrolytic capacitors are complex electrochemical devices. The capacitor plates must be very pure (99.5 to 99.99%) aluminum foil, 2 to 3-mils thick. An aluminum oxide, which is formed on the anode foil, is the dielectric. And an electrolyte between the oxide and cathode foil functions as the actual cathode. The cathode foil merely connects the electrolyte with the external circuit.

The electrolyte's exact chemical composition is considered proprietary by most capacitor manufacturers. Early aluminum electrolytics used aqueous solutions of such compounds as ammonium borates. Newer designs use nonaqueous solvents such as glycerin or ethylene glycol with aluminum phosphates or borates—so called dry electrolytics.

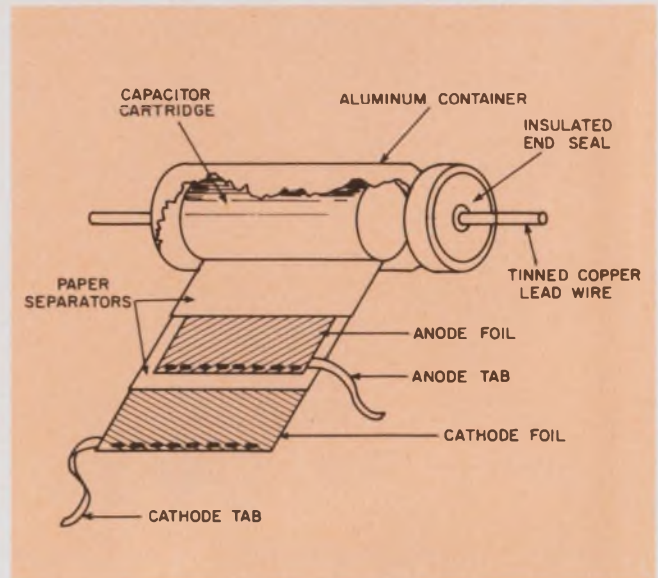

4. In axial-lead aluminum electrolytics, the container shell is usually connected to the cathode via a tab at one end. The anode lead passes through an insulating seal at the other end of the container.

Paper separators absorb and hold the electrolyte and provide mechanical and electrical separation between the anode and cathode foils. The foils and separators are tightly wound to form the capacitor cartridge, which is inserted into an aluminum case (Fig. 4). The materials used must all be of high purity, carefully selected and specially processed. The foil and other metal parts should be completely insoluble in the electrolyte and have high conductivity.

Chemical etching roughens the surface of a foil. The roughness increases the effective surface area and provides a larger capacitance than would a smooth surface. A plain foil might provide about 25 $\mu\text{F}/\text{in}^2$. This figure, though, varies very widely. Etching can increase capacitance by from two to over 20 times, but at the expense of increased DCL and ESR at low temperatures. Anode foils are generally etched and cathode foils are occasionally etched—as when the capacitor is designed for high-ac-ripple applications.

After the anode foil is etched, an electrochemical process "grows" an oxide film on the foil. A positive voltage is applied to the foil. The foil is then passed through a chemical bath that is maintained at a negative potential with respect to the foil. The magnitude of the applied voltage and the speed of passage of the foil through the bath determines the oxide's thickness, and thus the final working-voltage rating of the capacitor. Thickness is usually about $0.06 \times 10^{-6} \text{ in}/\text{Vw}$. Thus a 100-V capacitor might have an oxide film 0.006-mils thick.

The uniformity of the oxide film, of course, depends on the manufacturer's control over the foil's speed through the bath and regulation of

the applied voltage. A uniform thickness is necessary for low DCL. High-purity foil material helps to make good oxide film and to reduce DCL.

An oxide film behaves as a dielectric in only one polarity direction. The ideal dc polarized electrolytic would have a dielectric film that provides perfect valve action—zero dc resistance in one direction, and infinite resistance in the other.

The applied voltage should never be reversed on polarized capacitors. Voltage reversal can cause an oxide film on the cathode foil. Prolonged reversals can lower the capacitance. In addition, heating takes place. Where repeated or prolonged voltage reversals occur, a nonpolar capacitor should be used.

A nonpolar unit results when both plates are formed. This type can operate in ac circuits. But because of the double film, the capacitor has half the capacitance of the equivalent sized polar type, and its DCL is generally higher (Fig. 5).

In multisection electrolytics the cathode is usually common to all the capacitor sections included in the container. Each section can be rated and operated at a different voltage. In each section, the oxide film is formed to the thickness required for its working voltage. And since the electrolyte is common to all sections, the electrolyte will determine the highest voltage rating possible. Working voltages between 1 and 450 V dc are common.

Problems with tabs, leads and wound foils

Aluminum tabs that connect the foils to the external leads are a potential source of problems. Tab material must be high-purity aluminum. Aluminum is difficult to solder successfully, so the tab attachment must be firmly staked, crimped or cold-welded to both the internal foil and external leads or lugs. A defective connection caused by improper alignment, burrs or rough spots can produce shorts or intermittent performance. Such intermittents, usually not detectable by inspection, or easily measured, can be the source of untold hours of troubleshooting.

In small axial-lead capacitors, the cathode tab is often welded internally to the capacitor's aluminum, cylindrical-cup container. The anode tab, meanwhile, is attached to a lead or lug that passes through an insulating seal in the open end of the container. In large capacitors and computer-grade styles, both the positive and negative terminals come through the seal (Fig. 6).

Tabs introduce undesirable resistance and inductance. Thus in high frequency applications especially, the tabs should be as short as possible to minimize losses and inductance. The manner in which the tabs connect to the foil greatly influences the inductance. For low inductance, both the anode and cathode tabs should be attached to

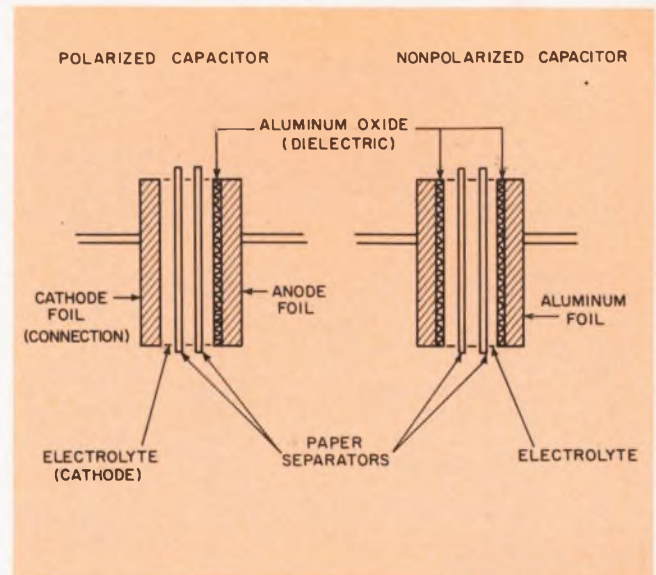

5. If there is any possibility that the circuit's polarity can reverse, only nonpolarized capacitors should be used.

the same ends of their respective foils. Multiple-tab connections along the foil can further reduce inductance. And a four-terminal lead configuration effectively reduces the inductive effect at high frequencies in filter networks.¹

Because the foil-electrolyte sandwich is wound, it becomes a major source of inductance. This inductance, plus the inductance that results from the tabs and leads, resonates with the capacitance—usually between 10 and 100 kHz. At resonance, the capacitor's impedance is lowest (Fig. 7).

The series impedances of electrolytics of standard construction are relatively high (0.1 to 10 Ω). However, special electrolytic capacitors with stacked-foil instead of rolled designs, can provide very low impedances—milliohms to tens of milliohms. At the low-frequency end, before the resonance region, the impedance is capacitive. In the resonance region, the impedance is resistive, and it becomes inductive at high frequencies.

An electrolytic's life is limited

The operational life of an electrolytic is governed by its operating temperature, and the imposed surge voltages and ripple currents. A high ambient temperature of 85 C, coupled with enough ripple current to cause an additional 8 to 10-C temperature rise above the ambient, can shorten substantially a capacitor's expected three to five, or more, years of rated life. Electrolytic capacitors can deteriorate while in storage or when too infrequently used. The amount of deterioration depends mostly upon the type of electrolyte and the ambient temperatures. At high temperatures, the oxide film reacts with the electrolyte. Over a long time period, the chemical reaction breaks down the oxide and a high DCL

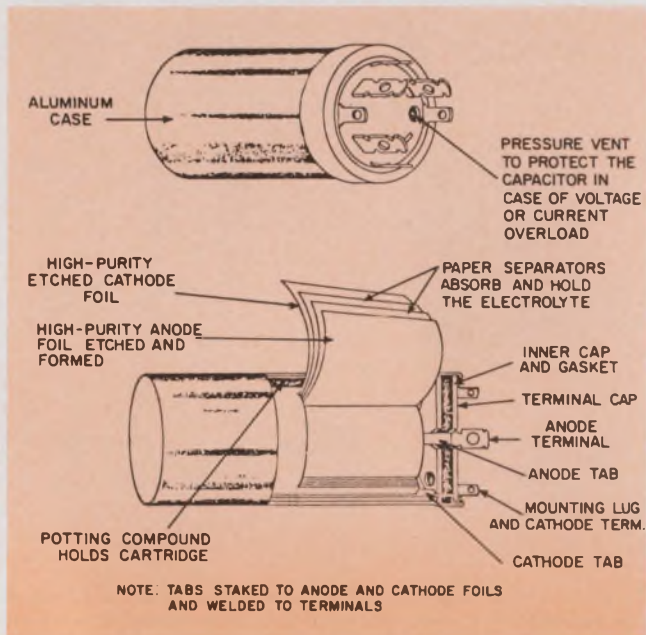

6. Large electrolytic capacitors have a vent to allow escape of any internal build-up of gas or vapor.

results, when the capacitor is finally energized.

It is possible to reform the capacitor's oxide film, if you start with a low dc voltage and gradually increase the voltage as the DCL decreases. But the sudden application of full-rated working voltage, after a long period of idleness, can destroy the capacitor.

Capacitors should be stored at refrigerator temperatures (near 5 C), when long shelf life is required. However, capacitors should be warmed to room temperature before they are energized.

The seal is very important to the life of an electrolyte. The capacitor cartridge is usually sealed in an aluminum container with high-purity rubber or a combination of rubber and plastic materials. The container edge is spun over the seal to provide a tight closure. In addition to retaining the electrolyte, a seal provides insulation between the anode and cathode terminals.

The seal material must be inert to chemicals and solvents, be a good insulator, be moisture-resistant and have good resiliency and thermal characteristics. It must withstand a range of temperatures from -55 to over 105 C. Contaminants such as chlorides in the seal material can corrode the tab-to-terminal connection and produce an open circuit. This is a sneaky defect that usually occurs after about 6 to 12 months of operation.

In capacitors rated above 150 Vw dc, a vent should be provided in the housing of the capacitor. The vent has a pressure-relief diaphragm, or rubber plug, that opens if internal pressure builds up because of internal gassing of the electrolyte. The vent is often located in the seal, but recent designs have placed it at other locations,

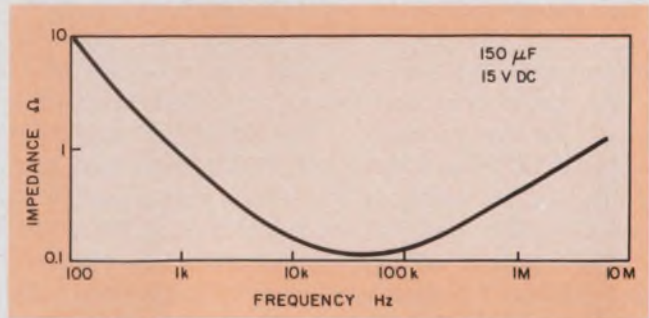

7. An electrolytic capacitor's impedance is equivalent to a series RLC circuit. Minimum impedance, which occurs at resonance, is resistive.

too. Excess ripple current, raw ac on the capacitor because of rectifier failure, and applied excess or reverse voltage, can cause the capacitor to overheat and to vaporize the electrolyte.

It is important to maintain adequate clearance near the capacitor's insulating seal so that the capacitor is able to vent in case of an overload. Failure to vent can result in an explosion.

To attain the full life potential of an electrolytic capacitor, its placement near heat radiators should be avoided. Mechanical stresses should be minimized by secure mounting, and only safe chemical solutions or vapors should be used in the clean-up of the circuit.

Internal heating that results from ripple-current losses must be allowed to radiate away to avoid heat build-up. Internal heat speeds the drying of the electrolyte and furthers decomposition of the oxide film. Temperature cycling, pressure build-up and chemical solvents and vapors can loosen the seal and force loss of electrolyte through openings that develop. Also, reduced atmospheric pressure can rupture the seal. A defective seal can allow humidity and moisture to penetrate the capacitor and shorten its life.

Shock and vibration can break lead wires or even break the cartridge loose inside the container. Axial-lead capacitors of greater than 3/4-in. diameter should be mounted in a horizontal position and held by metal straps or clips. And any insulating sleeving used around the metal case must have sufficient thickness to resist puncture by the mounting hardware. Plastic flexible tubing, heat-shrinkable sleeving or specially treated cardboard tubing can be used to insulate the case.

Some electrolytics are sold encased in an insulated envelope. An insulated case is often needed to prevent shorts or because the electrolyte provides an indeterminate electrical leakage path to the case even when the case is not connected to the cathode terminal. This leakage path can cause very sneaky and troublesome problems. ■■

Reference

1 Bowling, E.L., "Look Out! All Electrolytic Capacitors Are Not Alike," *Electronic Design*, Jan. 4, 1974, pp. 138-140.

Thinking wirewound?

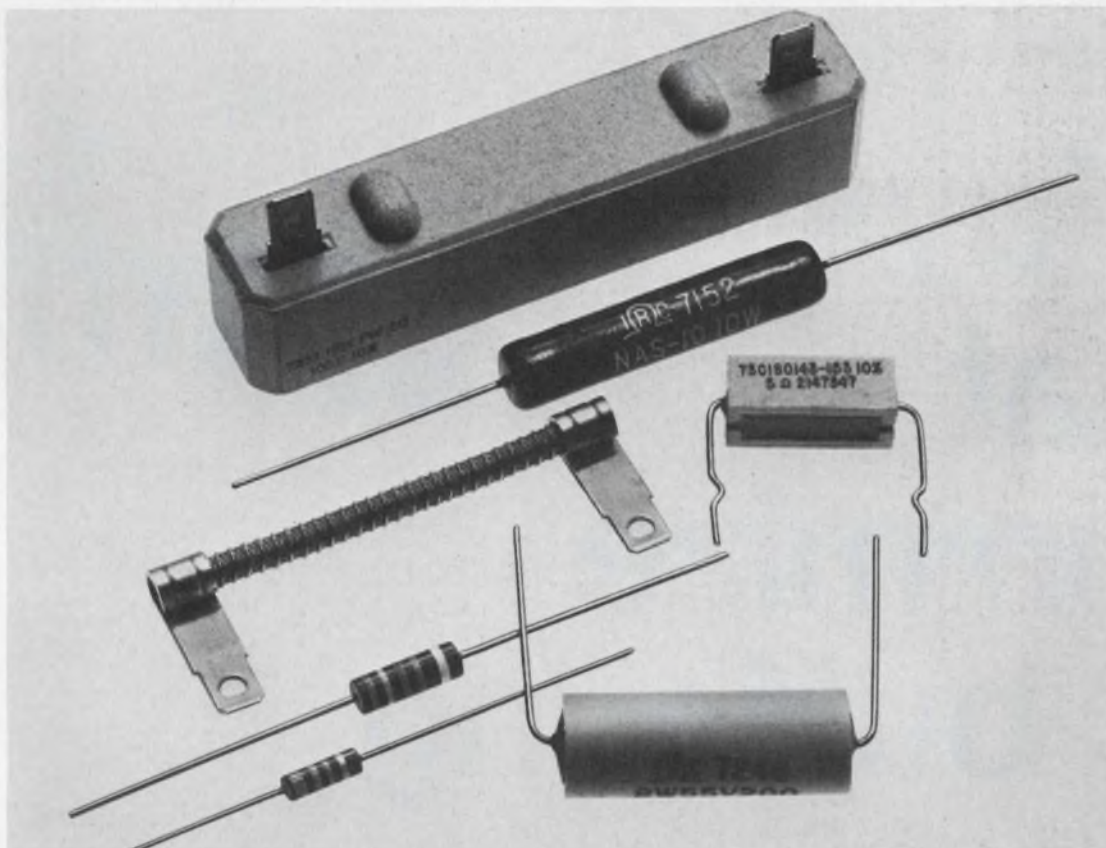

**For optimum cost/performance ratios,
see TRW/IRC—at the design stage.**

Why? Because we offer just about every type wirewound that's commercially feasible. So we can help you find the most for your money. Or more for less money. For example:

Watts/inch consumer types. For appliance, automotive, heater circuitry. To 6 w/in. Terminal options.

Machine insertable molded units. Often a carbon comp. replacement. Offer smaller size, lower resistance range, lower cost.

Ceramic insulated power. The standard for general purpose power—2 to 50 w. Fusing capabilities, special TC's available.

Fusible/flameproof units. Rated at 2 w., but won't burn or burn board under faults of 4x to 1000x rated power (or 1000 v, whichever is smaller). Special fusing characteristics if you wish.

Axial and radial power. ½ to 250 w., fixed or adjustable. Unmatched for power density/precision. Broad special design capability here.

Complete resistor choice. Understand, TRW isn't locked in to wirewounds. If we think your design will fly better with, say, precision film, we'll suggest it. In fact, TRW offers a total resistor capability—carbon comp., thin-film, Metal Glaze™, wirewound, networks.

For specs and application data on *wirewounds*, contact your local TRW sales representative. Or write TRW/IRC Resistors, an Electronic Components Division of TRW, Inc., 401 N. Broad St., Philadelphia, Pa. 19108.

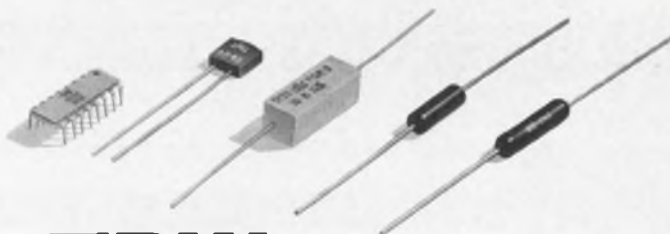

TRW[®] IRC RESISTORS

INFORMATION RETRIEVAL NUMBER 39

High sensitivity DIP reed relays that minimize IC buffering

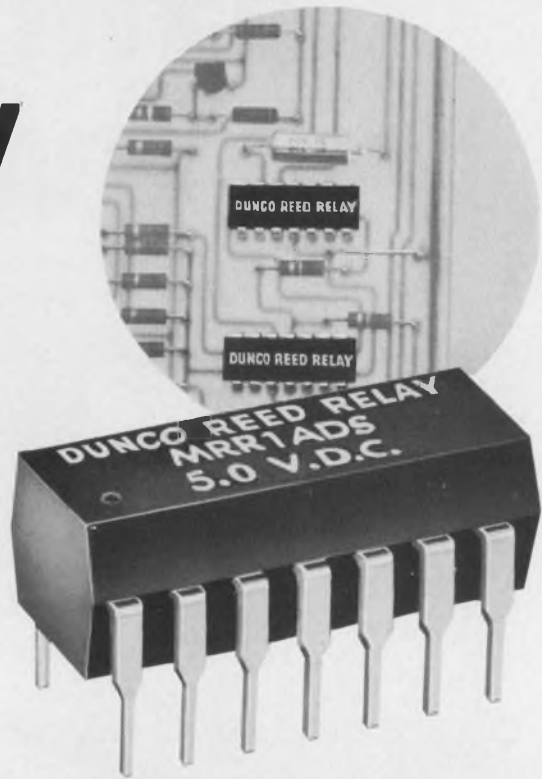

Dunco Dual In-Line Relay Series

9.0 mA from a 5-volt IC drives the Dunco MRR1ADSR reed relay without interface buffering. That makes it about the most sensitive DIP relay available.

Or, with a few more milliwatts, you save money by choosing from seventeen other basic models. All have terminal spacings that mate with 14-terminal dual in-line ICs. Types with 5, 6, 12, and 24-volt coils span DTL and TTL computer logic, High Noise Immunity Logic for industrial control systems, and general-purpose applications.

Stock types have one Form A, 10 VA miniature reed switch, one Form B switch, one Form C or two Form A switches. Electrostatic shielding and internal clamp diodes are available on all models.



Struthers-Dunn Relays Are Stocked by Over 125 Distributors
STRUTHERS-DUNN, INC.

PITMAN, NEW JERSEY 08071

Canada: Struthers-Dunn Relay Div., Renfrew Electric Co., Ltd.

1974 Catalog specs over 100 basic relays
—EM, Reed, Hybrid, Solid State—
plus solid state Programmable Controllers.
Circle reader service card with number
below for your copy.



Augat gives you eight.

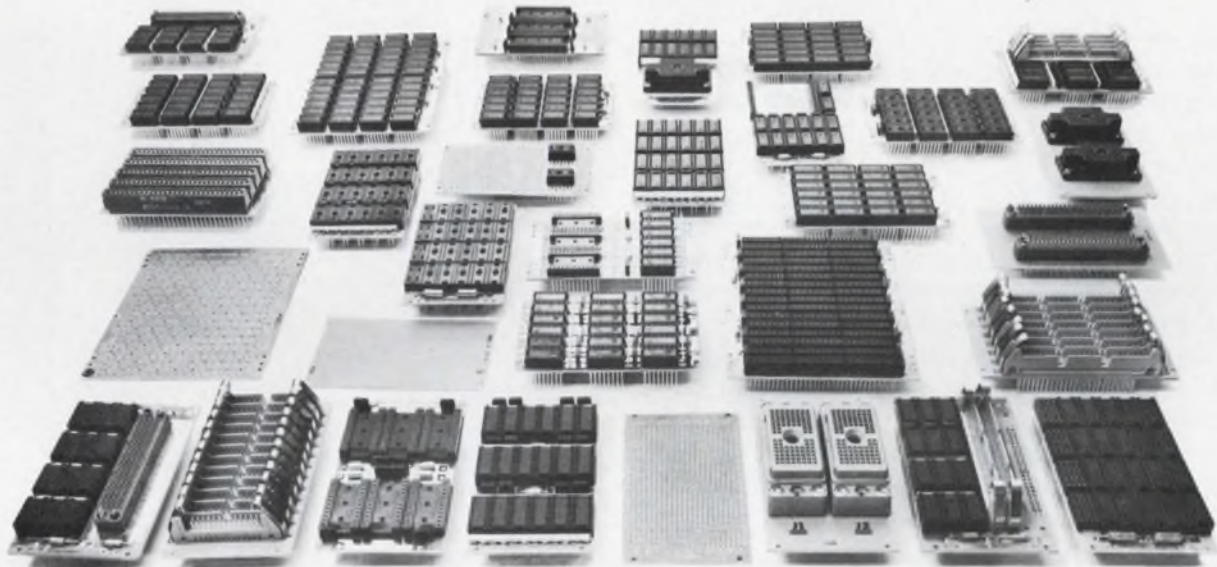

EECO gives you this.

Eight socket boards may be all that most designers need. Augat thinks so.

We don't.

We've got eight boards of our own to match Augat's. And we don't stop there.

Our other 24 boards are also needed. They provide off-the-shelf solutions to real design and packaging problems. However rare.

They give you more options and more design freedom. With

low-cost types, low-noise power distribution types, custom power-pin connection types, I/O connector types, and matrix and special types. And power supplies; fixed and swing-out frame assemblies; drawers; cabinets; and wire wrapping services.

They all make up our 2-D Dual-in-Line Socket Board line. Most of which can be ordered right out of our catalog.

Try us. We'll see you through.

INFORMATION RETRIEVAL NUMBER 41

EECO

1441 East Chestnut Avenue
Santa Ana, California 92701
Phone 714/835-6000

Also from G. S. Marshall Company nationwide.

FREE SOCKET BOARD AND PACKAGING
HARDWARE CATALOG!

We'll send it to you if you'll send us the
information below.

Name _____
Position _____
Company _____
Address _____

Bypass multivariable Karnaugh maps.

This CAD program minimizes logic networks with up to nine variables, prints out both function and complement.

First of three articles.

Asking a designer to minimize a logic network with six or more variables is one more example of man's inhumanity to man. In theory, it's straightforward. The designer manually constructs and minimizes a Karnaugh map. In practice, the probability that he will make a mistake along the way approaches certainty. Computer-aided design (CAD) provides a practical solution. A Fortran IV program can minimize up to 15 variables in logic networks without error.

CAD can increase logic design efficiency also. Either an integer format, in which the function is expressed as the sum of minterms, or the binary representation, in terms of AND and OR gates, is accepted. The computer prints out the minimized function or its complement, or both, as requested.

The program is written for IBM 360 and 370 Series machines that use the Fortran IV G level 20 compiler. It deals with "combinational" logic networks, without feedback or memory, that can be implemented with logic gates.

Minimize to simplify the function

The function obtained by the logic designer is usually derived from a truth table. Often the same function may be expressed in different forms, some requiring less hardware to implement. Thus the functions $(\overline{A}BCD + \overline{A}BC\overline{D} + \overline{A}B\overline{C}D + \overline{A}B\overline{C}\overline{D})$ and $\overline{A}D$ are identical, but $\overline{A}D$ takes far fewer gates to set up. The minimization process, as mechanized by the computer program, results in a simplified form of the logic function that generally requires fewer ICs to implement.

The CAD program flow chart (in a very high level form) is shown in Fig. 1. Designers interested in making program changes or in obtaining more complete information can find detailed flow charts¹ and the theoretical basis for the program algorithm.²

The minterms in the flow chart are product terms that contain all the variables (or their

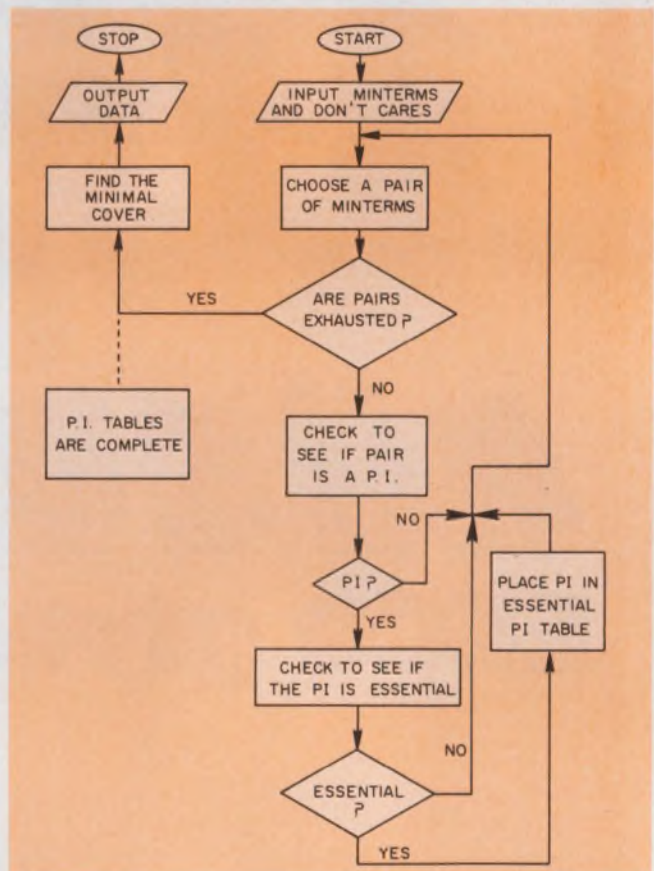

1. Flow chart of CAD program shows how logic functions are simplified. Minterm pairs are checked to find prime implicants in the final minimized function. A minimal cover process selects the fewest prime implicants to contain all minterms in the function. Essential prime implicants are always included.

complements) of the function. Thus $f(A, B, C) = \overline{A}B\overline{C} + \overline{A}B\overline{C}$ is written as the sum of two minterms. Functions of three variables can contain up to eight minterms; with n variables, there are 2^n minterms.

The flow chart starts with the function expressed in minterm form. Where the design process begins with a truth table, the function is already in minterm form. However, since inputs in binary form are also accepted, the computer can perform the conversion. "Don't cares" are minterms whose values don't matter; they may be either ZERO or ONE. They're also called

S. G. Shiva and H. Troy Nagel Jr., Electrical Engineering Dept., Auburn University, Auburn, Ala. 36830.

Table 1. Controls in a commercial air handling system

FAN ON		FAN OFF	
Control	Condition	Control	Condition
A	cold water < 35 F	D	Main power consumption control ON
B	Temperature > thermostat +2 F	E	Temperature < thermostat -2 F
C	Fan MANUAL ON control	F	Fan MANUAL OFF control
		G	Smoke & fumes are present

redundancies and irrelevancies and are combinations of Boolean variables that cannot occur or are prohibited. A 4-bit decade counter furnishes a good example. Combinations 10 through 15 (1010 through 1111 in binary) are prohibited. "Don't care" conditions are very useful for simplifying Boolean functions.

The computer examines the minterms in pairs and checks if a pair is a prime implicant. Thus the minterm pair $ABCD$ and $AB\bar{C}D$ can be combined into prime implicant $AB\bar{D}$:

$$ABCD + AB\bar{C}D = AB\bar{D} (C + \bar{C}) = AB\bar{D}$$

Finding a prime implicant is the first step in simplifying the function. The prime implicants are then checked to see if they are essential.

Essential prime implicants must be terms in the final function, because they contain a minterm not contained in any other prime implicant.

The final simplified function is derived from the minimal cover—a process that involves selection of the fewest prime implicants that contain, or cover, all the minterms of the Boolean function. All essential prime implicants must be included.

Designing a blower control

Let's design a blower control for an air-conditioner in a commercial building. The controls and conditions for operation are listed in Table 1.

Each control generates an on-off output and is on (logic ONE) when its associated condition is true; otherwise the output is off (logic ZERO). We want the fan off if any one of the following conditions for D, E, F or G is true:

- Control D is an energy conservation device operated by a central minicomputer.
- Control E operates when the temperature has dropped to the lower limit.
- Control F, when on, turns the blower off manually.
- Control G operates when smoke and fumes are present, preventing smoke from spreading through the air-conditioning system.

We want the fan on if none of the off conditions and if any one of these on conditions, A, B, C is true:

- Control A turns the fan on to keep the compressor from freezing the circulating water.
- Control B turns the fan on to cool the building.
- Control C is a safety switch to turn the fan on manually.

These conditions can be expressed as a switching function, f_{ON} , to turn the fan on:

$$f_{ON}(A,B,C,D,E,F,G) = A\bar{D}\bar{E}\bar{F}\bar{G} + B\bar{D}\bar{E}\bar{F}\bar{G} + C\bar{D}\bar{E}\bar{F}\bar{G} \quad (1)$$

Thus there are three product terms in Eq. 1 to be simplified by the computer. A number of "don't care" conditions are also available. For

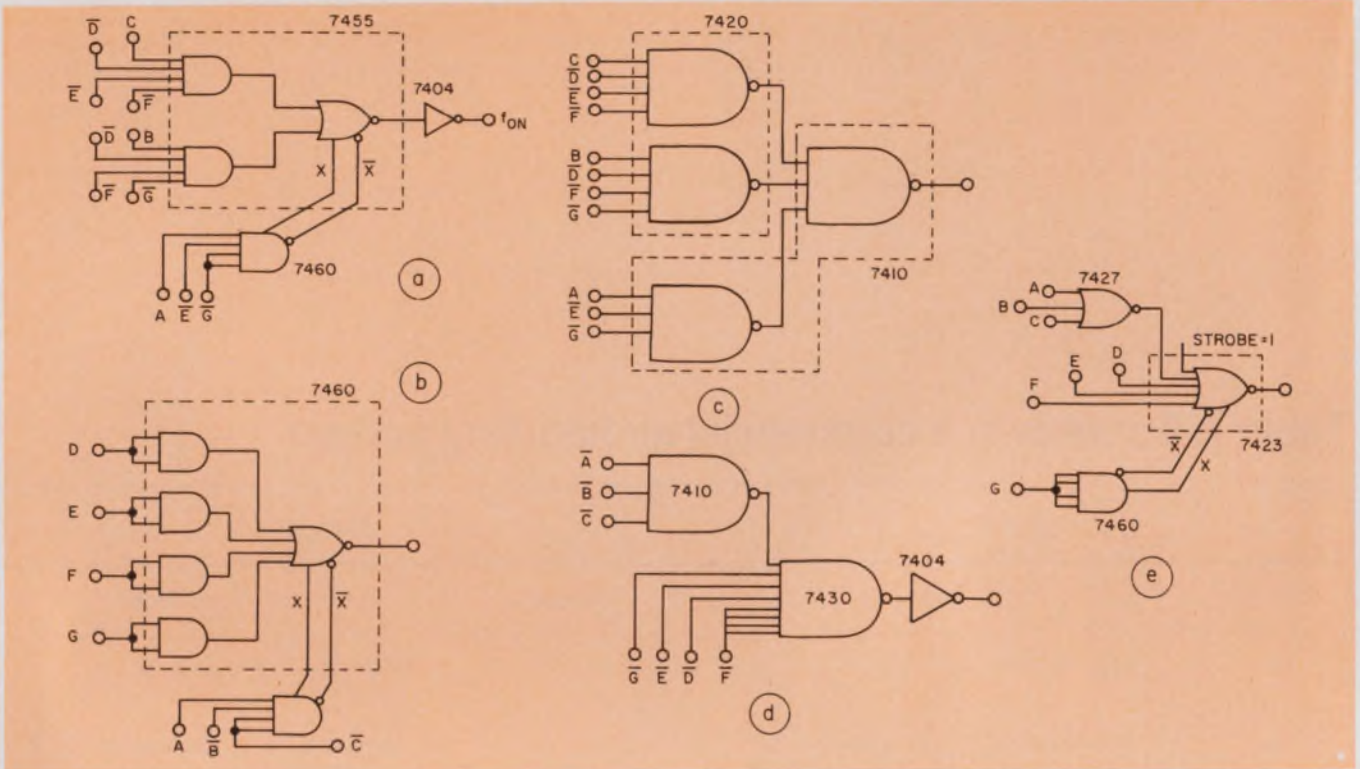

2. IC implementations of a CAD logic function problem (a) and (b) produce the function and complement, respectively, from the computer printout. A third circuit

(c) is derived when the function is complemented twice. Circuits d and e result from triple complementation. The preferred circuit is c.

example, control A (cold water $< 35^\circ$) and control D (computer samples cold-water temperature and turns fan off) will never be on simultaneously. Thus AD is a don't-care condition. So are BE, AF, CG and FG. The terms in Eq. 1 and the "don't cares" are programmed into the computer. It prints out the minimized function, f_{ON} , or its complement, \bar{f}_{ON} , or both:

$$f_{ON} = C\bar{D}\bar{E}F + B\bar{D}\bar{F}\bar{G} + A\bar{E}\bar{G} \quad (2)$$

$$\bar{f}_{ON} = \bar{A}\bar{B}\bar{C} + G + E + D + F \quad (3)$$

In this case each term is an essential prime implicant. Eqs. 2 and 3 can be implemented with AND-OR-INVERT gates (Figs. 2a and 2b). Other forms are derived when these functions are complemented. To write the complemented form of a function, we replace the components by their complements and OR by AND. Thus, from Eq. 2:

$$\bar{f}_{ON} = (\overline{CDEF}) (\overline{BDFG}) (\overline{AEG}) \quad (4)$$

The complement of \bar{f}_{ON} is f_{ON} :

$$f_{ON} = \overline{(\overline{CDEF}) (\overline{BDFG}) (\overline{AEG})} \quad (5)$$

Eq. 5 is implemented in Fig. 2c.

By complementing Eq. 3 three times, we get the forms implemented in Figs. 2b and e:

$$f_{ON} = \overline{(\overline{\bar{A}\bar{B}\bar{C}}) (\overline{\bar{G}\bar{E}\bar{D}\bar{F}})} \quad (6)$$

$$f_{ON} = \overline{(\bar{A} + \bar{B} + \bar{C}) + G + E + D + F} \quad (7)$$

Figs. 2a, b and e require three ICs, while Figs. 2b and c take only two ICs. But Fig. 2c costs the least, so it would be preferred.

Table 2 shows how data cards are prepared. Punch in the number of variables in column

1. The program is restricted to nine variables with a memory of 64 k bytes.

Up to 16 variables can be handled with large memories. Six data input formats can be used. Corresponding Data Flag numbers from 0 to 5 are used. Combinations of integer and binary format are permitted.

Consider the following minterms and "don't cares". Data Flag 2 is used for this situation:

$$f(A,B,C,D,E) = \Sigma [m(0,3,8,17,23,31) + d(2,9,27)] \quad (8)$$

This function has:

- Five input variables—A,B,C,D,E.
- Six minterms—0, 3, 8, 17, 23, 31.
- Three "don't cares"—2, 9, 27.

Minterm numbers are the decimal values of the minterm's binary representation. Binary representation assigns a given variable a value of 1 and its complement a value of 0.

Thus $\bar{A}\bar{B}\bar{C}DE$ is minterm 3, represented by 00011. Don't-care minterm numbers are also the decimal equivalents of their binary notation. For integer representation, the minterm numbers are punched in column 2.

Binary formats are often preferred when the function can be expressed in terms of AND and OR gates. In these instances the number of minterms can become large when there are many variables. Consider

$$f(U,V,W,X,Y,Z) = \bar{U}\bar{W}Z + \bar{X}\bar{Y} + VXY + WXYZ \quad (9)$$

In binary format, each true variable is repre-

Table 2. Formats of Data Entry Card

Punched in	Order of function (N)	Meaning
Column 1	2 to 9	The number of variables

(a)

Punched in	Data Flag (D)	Minterm format will be	Don't care format will be
Column 2	0	Binary	No Don't Cares
	1	Binary	Binary
	2	Integer	Integer
	3	Binary	Integer
	4	Integer	Binary
	5	Integer	No Don't Cares

(b)

Punched in	Form Flag (ID)	Function to be minimized will be
Column 3	0	Complemented Function \bar{f}
	1	True Function f
	2	Both f and \bar{f}

(c)

sented with a 1, each complemented variable with a 0, each absent value a dash. And there is no need to expand the function to individual minterms. Eq. 9 is represented simply by

$$f(U,V,W,X,Y,Z) = 0-1-1 + ---00 + ---00- + --111. \quad (10)$$

Since don't-care terms have not been specified, Data Flag would be 0. Data cards for binary notation contain strings of characters such as those written on the right-hand side of Eq. 10. The string is begun in Col. 1 of the card and punched with no spaces between the symbols.

The program outputs the essential prime implicants and other required prime implicants in binary representation. The function equals the sum of these two sets.

The CAD program can also save time and reduce effort for the designer in other ways. Given the function in binary form, the computer will generate the minterm list. For large functions, it's outstanding. Suppose you believe that a logic network can be simplified. Write down the network in binary form, ask the computer for both the minimum function and complement, then compare the results.

CAD is a real help when a programmable logic array (PLA) substitute is specified for a read-

Program for logic minimization

Fortran mainline

```

C MAIN PROGRAM TO READ DATA IN
  INTEGER I(4),ICONS(10),COUNT(10),NUM(200),
  11R(256),MINAX(256),C(256),MIN(256),DONT(256),MINT(256)
  INTEGER C,EMP,DIF,PRIMI(256),PRIMJ(256),ESENT(200),
  1ESENJ(256),LITCNT(16),CONSI(16),CONSJ(16),
  2SERV(10),B1,MASK(8),MTCNT(10),WAIT(10),
  3DNC,ZERO,DASH
  DATA DASH/1H-/
  COMMON N,EMP,IC
  COMMON/COM2/C
  COMMON/COM3/ID
C----- DATA CARDS -----
C FIRST DATA CARD HAS N,D,ID ON IT IN FORMAT(311)
C-----
C 0 MINTERMS DONTCARES
C-----
C 0 BINARY NONE
C 1 BINARY BINARY
C 2 INTEGER INTEGER
C 3 BINARY INTEGER
C 4 INTEGER BINARY
C 5 INTEGER NONE
C-----
C ID FUNCTION TO BE MINIMIZED
C-----
C 0 COMPLEMENTED FUNCTION
C 1 TRUE FUNCTION
C 2 BOTH
C-----
C WHEN DATA CARD IS IN INTEGER FORM, THERE SHOULD BE A CARD
  IN FRONT OF THE MINTERM AND DONT CARE CARDS
C TELLING HOW MANY TERMS ARE GOING TO FOLLOW IN FORMAT(14)
C DATA IS IN FORMAT(2014) ON EACH CARD, CONTINUE ON NEXT CARD
  IF EXCEEDS 20 TERMS.
C WHEN DATA IS IN BINARY FORM, NO SPECIAL CARD IS NEEDED.
  A 'H' SEPARATES EACH TERM
C-----
C READ N, MINTERMS AND DONTCARES
9901 READ(5,10,END=9901),N,D,ID
  10 FORMAT(311)
  GO TO 1121,122,123,124,125,10
  CALL REED(MIN,M)
  GO TO 5
121 CALL REED(MIN,M)
  CALL REED(DONT,D)
  CALL COMPR(MIN,M,DONT,D)
  GO TO 5
122 READ(5,126)M
  124 FORMAT(14)
  READ(5,127)(MINT(I),I=1,M)
  127 FORMAT(2014)
  READ(5,126)D
  READ(5,127)(DONT(I),I=1,D)
  CALL COMPR(MIN,M,DONT,D)
  GO TO 5
123 CALL REED(MIN,M)
  READ(5,126)D
  READ(5,127)(DONT(I),I=1,D)

```

```

CALL COMPR(MIN,M,DONT,D)
GO TO 5
124 READ(5,126)M
  READ(5,127)(MINT(I),I=1,M)
  CALL REED(DONT,D)
  CALL COMPR(MIN,M,DONT,D)
  GO TO 5
125 READ(5,126)M
  READ(5,127)(MINT(I),I=1,M)
  D=0
  5 CALL MINIM(MIN,M,DONT,D,N,LITCNT,CONSI,CONSJ)
  GO TO 9901
9901 STOP
  END

```

Fortran subroutines

```

SUBROUTINE REED(OUTPUT,K)
C THIS ROUTINE READS THE DATA IN BINARY FORM, GENERATES ALL
  THE MINTERMS AND ARRANGES IN INCREASING ORDER
C K IS THE NO. OF TERMS IN INPUT
  DIMENSION MINCEL(80),MMIN(8),MMAX(8),NUM(200),
  1IMIN(256),IDONT(256)
  INTEGER ZERO,DNC,DASH,BLANK,PLUS,DIF
  DATA ZERO,DASH,BLANK,PLUS/1H0,1H-,1H+,1H+/
  COMMON N,EMP,IC
  J=1
  L=0
C READ ONE DATA CARD
  1 READ(5,10)MINCEL
  10 FORMAT(I90)
  DO 100 I=1,80
    I=MINCEL(I),FO,PLUS,DNC,MINCEL(I),FO,BLANK GO TO 15
    I=MINCEL(I),FO,DASH GO TO 5
    I=MINCEL(I),FO,ZERO GO TO 2
    MMIN(J)=I
    MMAX(J)=I
    J=J+1
  GO TO 100
  CHARACTER IS A ZERO
  2 MMIN(J)=0
  MMAX(J)=0
  J=J+1
  GO TO 100
  CHARACTER IS A DASH, GENERATE MINIMUM AND MAXIMUM
  5 MMIN(J)=1
  MMAX(J)=1
  J=J+1
  GO TO 100
  CHARACTER IS A PLUS, INDICATES THE END OF A MINTERM OR CELL.
  15 J=1
  L=L+1
  MK=0
  MN=0
  DO 200 K=1,N
    MV=MK+MMAX(K)/2+(N-K)
    MN=MN+MMIN(K)/2+(N-K)

```

```

200 CONTINUE
DIF=MY-MN
IF(DIF.NE.0)GO TO 25
I=MIN(L)=M
IF(MINCE(L),FO,PLANK)GO TO 35
GO TO 100
C 25 GENERATE THE MINTERMS BETWEEN MIN AND MAX
ITEMP=1
ICNT=1
NUM(L)=MN
DO 400 K=1,N
I7=IAND(I2*(K-1),DIF)
IF(I7.EQ.0)GO TO 400
IC2=ICNT
DO 600 M=1,IC2
ICNT=ICNT+1
NUM(ICNT)=NUM(M)+I2
IMIN(L)=NUM(ICNT)
L=L+1
430 CONTINUE
470 CONTINUE
I=MIN(L)=MN
IF(MINCE(L),FO,PLANK)GO TO 35
100 CONTINUE
GO TO 1
C ELIMINATE REPEATED TERMS AND ARRANGE IN INCREASING ORDER
35 K=0
DO 300 I=1,L
IF(K.EQ.0)GO TO 650
DO 400 J=1,K
IF(MIN(I),EQ,OUT(J))GO TO 300
CONTINUE
650 K=K+1
OUT(K)=MIN(I)
300 CONTINUE
DO 302 I=1,K
DO 302 J=1,K
IF(OUT(I).GT.OUT(J))GO TO 302
MT=OUT(I)
OUT(I)=OUT(J)
OUT(J)=MT
302 CONTINUE
RETURN
END

SUBROUTINE COMPRIMIN,M,DONT,D
INTEGER MINI(256),DONT(256),D
IFLAG=0
DO 1 I=1,M
DO 2 J=1,D
IF(MIN(I).GT.DONT(J))GO TO 2
IF(MIN(I).LT.DONT(J))GO TO 1
WRITE(6,10)MIN(I)
10 FORMAT(' DOPS...',14,' IS FOUND BOTH AS MINTERM AND DONTCARE')
1' ASSUMED TO BE MINTERM')
DONT(J)=-1
IFLAG=1
2 CONTINUE
1 CONTINUE
IF(IFLAG.EQ.0)GO TO 6
K=0
DO 4 I=1,D
IF(DONT(I).EQ.-1)GO TO 4
K=K+1
DONT(K)=DONT(I)
4 CONTINUE
D=K
6 RETURN
END

SUBROUTINE MINIMIN,M,DONT,D,N,LICNT,CONSI,CONSJ
C SUBROUTINE TO MINIMIZE A BOOLEAN FUNCTION
C N IS THE ORDER OF BOOLEAN FUNCTION.
C M=NO. OF MINTERMS, D=NO. OF DONTCARES
C MIN -- ARRAY OF M MINTERMS
C DONT -- ARRAY OF D DONTCARES
C MINT -- COMBINED ARRAY OF (M+D) TERMS
C EMP -- NO. OF ESSENTIAL P.I.S
C MP -- NO. OF P.I.S
C -- ARRAY OF LENGTH 2**N
C PRIME IMPLICANTS....
C LOW--PRIM1, HIGH--PRIMJ
C ESSENTIAL PRIME IMPLICANTS...
C LOW--ESEN1, HIGH--ESENJ
C EACH ROW OF 'ESARY' CORR. TO ONE ESSENTIAL P.I.
CHANGES*** THIS ROUTINE CAN ACCOMMODATE AN 8TH
C ORDER FUNCTION. CHANGE ALL DIMENSIONS SUITABLY
C TO ACCOMMODATE A HIGHER ORDER FUNCTION.
C IRAY(N),ICONS(X,N),LITCNT(X),NUM(Y),COUNT(X),IR(Y),MINAX(2**N)
C C(2**N),MIN(2**N),DONT(2**N),MINT(2**N),PRIM(Y),PRIMJ(Y),
C ESEN(Y),ESENJ(Y),CONSI(X),CONSJ(X),ESARY(Y),M),
C MASK(N),MATCNT(X),WAIT(X)
C X IS ARBITRARY..APPROX. 10 TO 25
C Y IS NOT NECESSARILY 2**N, BUT VERY NEAR TO IT.
C*****
DIMENSION IRAY(16),ICONS(10,8),COUNT(10)
DIMENSION NUM(200),IR(256),MINAX(256)
INTEGER C(256),D,MINI(256),DONT(256),MINT(256),EMP
INTEGER DIF,PRIM(256),PRIMJ(256),ESEN1(200),ESENJ(200)
INTEGER LICNT(16),CONSI(16),CONSJ(16)
INTEGER ESARY(100,8),MASK(8),MATCNT(10)
INTEGER ONE,ZERO,DASH,WAIT(10)
DATA DASH/10-/
COMMON N1J,EMP,IC
COMMON/CON2/C
COMMON/CON3/D
C CONVERT MINTERMS AND DONTCARES INTO A SINGLE ARRAY ***
C IN INCREASING ORDER OF THEIR DECIMAL REPRESENTATION
N1J=N
M=2**N
K=N
WRITE(6,30)
30 FORMAT(' NUMBER OF INPUTS',14)
IF(I0.GE.1)GO TO 805
20 K=N
DO 809 I=1,M
MINAX(I)=1
DO 811 J=1,M
IF(MINAX(I).EQ.MINI(J))GO TO 809
811 CONTINUE
K=K+1
MINT(K)=MINAX(I)
800 CONTINUE
400 WRITE(6,910)
910 FORMAT('***** MINIMIZED COMPLEMENTARY FUNCTION *****')
GO TO 815
905 DO 15 I=1,M
MINT(I)=MIN(I)
15 CONTINUE
WRITE(6,125)
125 FORMAT('***** MINIMIZED TRUE FUNCTION*****')
M=M+1
M=M+D
IF(D.FO.0) GO TO 6
DO 25 I=MA,MB
25 MINT(I)=DONT(I)-M
A DO 35 N1=1,MA
DO 35 N2=N1,MB
IF(MINT(N1).LT.MINT(N2)) GO TO 35
MINTS=MINT(N1)
MINT(N1)=MINT(N2)
MINT(N2)=MINTS
35 CONTINUE
C PRINT MINTERMS AND DONTCARES
810 WRITE(6,40)(MIN(I),I=1,M)
40 FORMAT(' ',MINTERMS/'(' ',2014)
IF(D.EQ.0) GO TO 7
WRITE(6,50)(DONT(I),I=1,D)
50 FORMAT(' ',DONTCARES/'(' ',2014)
C SET TERMS IN C CORRESPONDING TO MINTERMS=1,DONTCARES=-1.
C AND ALL OTHERS TO ZEROS
7 J=1
K=1
MM=2**N
DO 333 I=1,MM
IF(J.GT.MB) GO TO 1
IF((I-1).EQ.MINT(J)) GO TO 3
1 C(I)=0
GO TO 333
3 IF(K.GT.D)GO TO 9
IF(MINT(J).NE.DONT(K)) GO TO 9
C(I)=-1
J=J+1
K=K+1
GO TO 333
9 C(I)=1
J=J+1
333 CONTINUE
C CHOOSE A COORDINATE PAIR ****
C II IS SMALLER AND JJ IS LARGER
MP=0
EMP=0
C WRITE(6,555)
555 FORMAT(' ',PRIME IMPLICANTS')
DO 200 I=1,MP
I)=MINT(I)
M)=MR-I+1
DO 300 J=1,M1
J1)=MR-J+1
JJ)=MINT(J)
C IS THIS PAIR A P.I.
IF(IAND(II,JJ).NE.II) GO TO 300
DIF=JJ-II
IF(DIF.EQ.0) GO TO 700
ITEMP=1
ICNT=1
NUM(I)=1
DO 400 K=1,N
I7=IAND(I2*(K-1),DIF)
IF(I7.EQ.0)GO TO 400
IC2=ICNT
DO 600 L=1,IC2
ICNT=ICNT+1
NUM(ICNT)=NUM(L)+I2
LL=NUM(ICNT)+1
ITEMP=IAND(C(LL),ITEMP)
IF(ITEMP.EQ.0)GO TO 300
400 CONTINUE
400 CONTINUE
700 IF(EMP.EQ.0) GO TO 800
DO 900 L=1,MP
IF(PRIM(L).LT.JJ)GO TO 900
IF(IAND(PRIMJ(L),JJ).NE.JJ) GO TO 900
900 CONTINUE
800 MP=MP+1
PRIM(MP)=I
PRIMJ(MP)=JJ
C WRITE P.I. *****
CALL CELRIN(II,JJ,IRAY)
300 CONTINUE
C CHECK IF II IS INCLUDED IN AN ESSENTIAL TERM
IF(C(II+1).LT.0) GO TO 200
CHECK FOR THE NO. OF P.I.S THAT COVER II
J=0
IC=0
DO 11 I=1,MP
IF(PPRIM(I).LT.J) GO TO 11
IF(IAND(PRIM(I),II).NE.PRIM(I))GO TO 11
IF(IAND(PRIMJ(I),II).NE.II) GO TO 11
IC=IC+1
11 P=0
11 CONTINUE
C IC IS THE NO. OF P.I.S THAT COVER II. IF IC=1
C AN ESSENTIAL P.I. IS DISCOVERED
IF(IC.GT.1) GO TO 200
EMP=EMP+1
ESENJ(EMP)=PRIM(I)ESEN1
ESENJ(EMP)=PRIMJ(I)ESEN1
CHECK OFF ALL THE TERMS COVERED BY THIS ESSENTIAL P.I.
CALL RESET(ESEN1(EMP),ESENJ(EMP))
200 CONTINUE
C PRINT ESSENTIAL P.I.
IF(EMP.EQ.0) GO TO 111
WRITE(6,80)
80 FORMAT(' ',10X,'ESSENTIAL PRIME IMPLICANTS ARE')
112 DO 113 I=1,EMP
CONVERT ESSENTIAL P.I. INTO ROWS OF MATRIX ESARY
CALL CELRIN(ESEN1(I),ESENJ(I),IRAY)
WRITE(6,999)(IRAY(L),L=1,N)
DO 115 J=1,N
115 ESARY(I,J)=IRAY(I,J)
113 CONTINUE
CALL MASK(ESARY,MASK)
GO TO 114
111 WRITE(6,41)
C FIND THE MINIMAL COVER
114 WRITE(6,110)
110 FORMAT(' ',10X,' OTHER PRIME IMPLICANTS ARE')
MESS=0
DO 2000 I=1,MP
I)=MINT(I)
IC=0
C IF C CORR. TO II IS -1 II HAS ALREADY BEEN COVERED
IF(C(II+1).LT.0) GO TO 2000
C IF C IS NOT EQ. -1 , FIND WHAT P.I.S COVER THIS TERM
DO 1000 L=1,MP
IF(PRIM(L).GT.I) GO TO 1000
IF(PRIMJ(L).LT.I)GO TO 1000

```

```

IF(IAND(IPRIM(L),I),NE,PRIMI(L))GO TO 1000
IF(IAND(IPRIM(L),I),NE,I) GO TO 1000
IC=IC+1
TR(IC)=L
1000 CONTINUE
DD 222 L=1,IC
CONSL(L)=PRIMI(IIR(L))
CONSJ(L)=PRIMJ(IIR(L))
COUNT(L)=0
DD 66 J=1,MB
LL=MINT(IJ)
IF(ILL+1).LT.OIGO TO 66
IF(CONSL).GT.LLGO TO 66
IF(CONSJ).LT.LLGO TO 66
IF(IAND(CONSL,LL).NE,CONSI(L))GO TO 66
IF(IAND(CONSJ,LL).NE,LL)GO TO 66
COUNT(L)=COUNT(L)+1
66 CONTINUE
LITCNT(L)=0
CALL CELBIN(CONSL),CONSJ(L),IRAY)
DD 522 K=1,N
ICONS(L,K)=IRAY(K)
IF(ICONSL,K).EQ.DASHIGO TO 522
LITCNT(L)=LITCNT(L)+1
522 CONTINUE
MATCNT(L)=0
222 CONTINUE
IF(EMP.EQ.O)GO TO 76
CALL SELECT(CONS,ASK,MATCNT)
DD 8 L=1,IC
8 WAIT(L)=5*COUNT(L)-3*LITCNT(L)+MATCNT(L)
LK=1
IIC=IC-1
DN 4 JK=1,IIC
IF(WAIT(JK+1).LE.WAIT(JK))GO TO 4
LK=JK+1
4 CONTINUE
WRITE(6,999)IICONS(LK,NNI,NN=1,N)
996 FORMAT(' ',35X,31A1)
999 FORMAT(' ',35X,31A1)
MESS=1
CALL RESET(CONSI(LK),CONSJ(LK))
2000 CONTINUE
IF(MESS.NE.O)GO TO 42
WRITE(6,41)
41 FORMAT(' ',35X,'*** NONE ***')
42 I1D1=10
I1D1=I1D1-2
IF(I1D1.EQ.O) GO TO 20
RETURN
END

```

```

SUBROUTINE CELBIN(I,JJ,IRAY)
C THIS CONVERTS I AND JJ INTO AN ARRAY
C IN BINARY FORM CONTAINING 1,0,-
COMMON N
DIMENSION IRAY(16)
INTEGER ONE,ZERO,DASH
DATA ONE,ZERO,DASH/1H1,1H0,1H-/
DD 997 K=1,N
I1=IAND(I,2**(K-1))
I2=IAND(JJ,2**(K-1))
IF(I1.EQ.O.AND.I2.EQ.O)GO TO 999
IF(I1.EQ.(2**(K-1)).AND.I2.EQ.(2**(K-1)))GO TO 998
IRAY(N-K+1)=DASH
GO TO 997
999 IRAY(N-K+1)=ZERO
GO TO 997
IRAY(N-K+1)=ONE
997 CONTINUE
RETURN
END

```

```

SUBROUTINE MASK(IMARY,ASK)
C THIS SCANS THROUGH THE MATRIX IMARY EACH ROW OF WHICH
C CORRESPONDS TO A P.I. AND FORMS A MASK
DIMENSION IMARY(100,8)
INTEGER ZERCNT,ONECNT,ONE,ZERO,DASH,TWO,ASK(8),EMP
COMMON N,EMP,IC
DATA ONE,ZERO,DASH,TWO/1H1,1H0,1H-,1H2/
DATA ZERCNT,ONECNT/2*0/
DD 15 NN=1,N
DD 1 MM=1,EMP
IF(IMARY(MM,NN).EQ.DASH)GO TO 1
IF(IMARY(MM,NN).EQ.ZERO)GO TO 2
IF(IMARY(MM,NN).EQ.ONE)GO TO 3
2 ZERCNT=ZERCNT+1
GO TO 1
3 ONECNT=ONECNT+1
CONTINUE
IF(ZERCNT.EQ.O.AND.ONECNT.EQ.O)GO TO 10
IF(ZERCNT.EQ.O.AND.ONECNT.GT.O)GO TO 11
IF(ZERCNT.GT.O.AND.ONECNT.GT.O)GO TO 12
C MASK(NN)=0, IF THE LITERAL EXISTS ONLY COMPLEMENTED.
IF(ZERCNT.GT.O.AND.ONECNT.EQ.O)MASK(NN)=ZERO
GO TO 13
C AN ELEMENT OF MASK IS -, IF THE LITERAL DOES NOT
C EXIST IN ANY ESSENTIAL P.I.
10 MASK(NN)=DASH
GO TO 13
C MASK(NN)=1, IF THE LITERAL EXISTS ONLY UNCOMPLEMENTED
11 MASK(NN)=ONE
GO TO 13
C MASK(NN)=2, IF THE LITERAL EXISTS IN BOTH COMPLEMENTED
C AND UNCOMPLEMENTED FORMS
12 MASK(NN)=TWO
13 ZERCNT=0
ONECNT=0
CONTINUE
RETURN
END

```

```

SUBROUTINE RESET(I,JJ)
C THIS GENERATES THE MINTERMS BETWEEN I AND JJ
C AND SETS THE CORR. TERMS IN C TO -1
INTEGER NUM(200),C(256),DIF
COMMON N,EMP,IC
COMMON/COM2/C
NUM(1)=1
PRISS=NUM(1)+1
C(PRISS)=-1
ICNT=1
DIF=JJ-1

```

```

IF(DIF.EQ.O)GO TO 200
DD 13 K=1,N
I2=IAND(I2**(K-1)),DIF)
IF(I2.EQ.O)GO TO 13
ICT2=ICNT
DD 14 L=1,ICT2
ICNT=ICNT+1
NUM(ICNT)=NUM(L)+I2
LL=NUM(ICNT)+1
14 C(LL)=-1
13 CONTINUE
200 CONTINUE
RETURN
END
SUBROUTINE SELECT(CARRY,ASK,COUNT)
INTEGER CARRY(10,8),ASK(8),COUNT(10)
INTEGER ONE,ZERO,DASH,TWO
COMMON N,EMP,IC
DATA ONE,ZERO,DASH/1H1,1H0,1H-/
DD 10 JK=1,IC
COUNT(JK)=0
DD 1 NN=1,N
IF(CARRY(JK,NN).EQ.DASH)GO TO 11
IF(CARRY(JK,NN).EQ.ZERO)GO TO 2
IF(MASK(NN).EQ.ZERO.OR.MASK(NN).EQ.DASH)GO TO 1
COUNT(JK)=COUNT(JK)+1
GO TO 1
2 IF(MASK(NN).EQ.ONE.OR.MASK(NN).EQ.DASH)GO TO 1
COUNT(JK)=COUNT(JK)+1
GO TO 1
11 IF(MASK(NN).EQ.DASH)COUNT(JK)=COUNT(JK)+1
CONTINUE
CONTINUE
RETURN
END

```

Assembly language routines

STMT	SOURCE STATEMENT	
1	* SUBROUTINE FOR LOGICAL 'AND'.	
2	* USE IAND(I1,J1)	
3	*	
4	IAND START	
5	STM 14,12,12(13)	SAVE REGISTERS
6	L 2,0(1)	LOAD ADDRESS OF I1
7	L 3,4(1)	LOAD ADDRESS OF J1
8	L 0,0(2)	LOAD I1
9	N 0,0(3)	AND J1
10	LM 14,15,12(13)	RESTORE REGISTERS
11	LM 1,12,24(13)	
12	BR 14	
13	* SUBROUTINE FOR EXCLUSIVE OR	
14	* USE IEXOR(I1,J1)	
15	IEXOR CSECT	
16	STM 14,12,12(13)	
17	L 2,0(1)	
18	L 3,4(1)	
19	L 0,0(2)	
20	X 0,0(3)	
21	LM 14,15,12(13)	
22	LM 1,12,24(13)	
23	BR 14	
24	* SUBROUTINE FOR LOGICAL OR	
25	* USE IOR(I1,J1)	
26	IOR CSECT	
27	STM 14,12,12(13)	
28	L 2,0(1)	
29	L 3,4(1)	
30	L 0,0(2)	
31	O 0,0(3)	
32	LM 14,15,12(13)	
33	LM 1,12,24(13)	
34	BR 14	
35	END	

only memory (ROM). Each ROM bit position may be thought of as a Boolean function whose input variables are the ROM address lines. Thus each ROM address that stores a ONE is a minterm for the equivalent PLA output bit position.

Make a list of these minterms. Set the Data Flag at 5 (format is integer and there are no don't cares). The computer will print out the PLA network. The program must be run once for each output bit or function. ■■

The second article in the series will discuss state minimization of sequential machines.

References

1. Shiva, S. G. and Nagle, H. T. Jr., "A Fast Algorithm for Complete Minimization of Boolean Functions," Project Themis, Report No. AU-T-24, Auburn University, June, 1972.
2. Nagle, H. T. Jr., Carroll, B. D., and Irwin, J. D., "An Introduction to Computer Logic," Ch. 4, Prentice-Hall Inc. 1975.

Watch Out.

The volts are out to ruin your computer, maybe your entire system!

Nobody needs to remind you that the erratic demand on electric power these days has created a potential "brownout" condition in just about every major industrial area. Protecting your computer or system from the crazy dips and surges in voltage is critical. A slight dip can cause a computer to drop a few digits, lose parity, distort information, or lose its memory entirely. A surge damages delicate components and ruins printed circuits.

Sola Electric's "brownout insurance" comes in the form of highly reliable constant voltage transformers and Solatron® Voltage Regulators

—in a wide range of specifications. Most are standard units and immediately available for off-the-shelf shipment. And our applications engineering people are ready to help right now —whether you're designing voltage regulation into your equipment or adding protection to an existing system.

Protect yourself. Contact your local Industrial Distributor or the AC Products Group at Sola Electric. Call (312) 439-2800 or write Sola Electric, 1717 Busse Rd., Elk Grove Village, Illinois 60007.



Get brownout "insurance" from SOLA

SOLA ELECTRIC



The long-billed heat sucker would like you to meet her family.

Our good friend, the Heat Sucker (better known as a Hughes heat pipe), is now the proud mother of an entire flock: round and flat bills, flexible round bills and the cold mounted plate bill. Each variant feels right at home in electronic, chemical and mechanical equipment; industrial processing; and medical applications. Anywhere you might need thermal control.

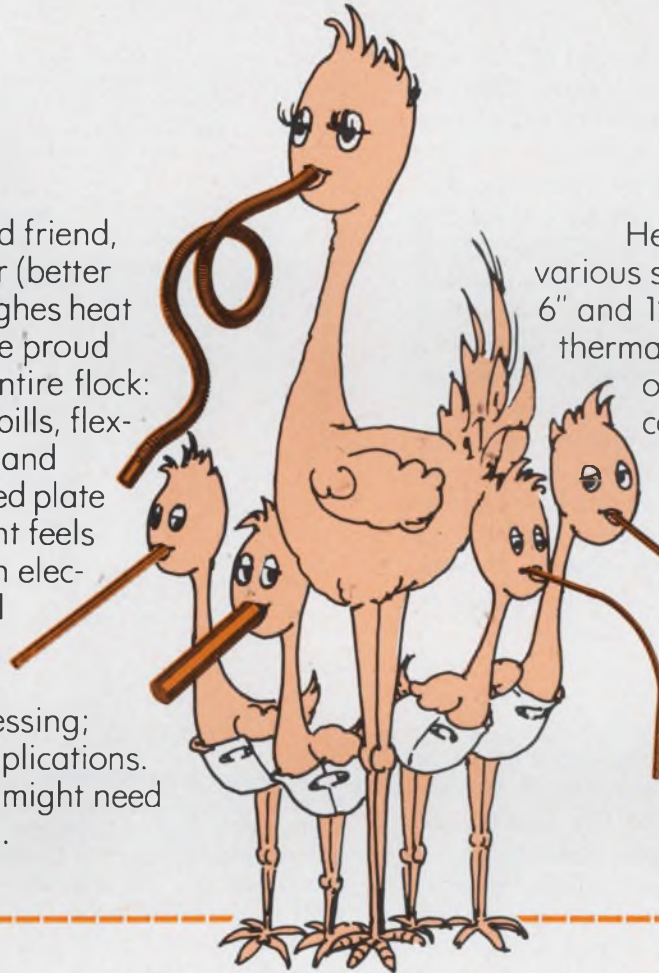

Heat Suckers come in various sizes: $\frac{3}{16}$ " to 1" diameter, 6" and 12" lengths. They have thermal transport capabilities of 10 to 2,000 watts covering temperature ranges from: -90°C to $+200^{\circ}\text{C}$.

Since the birds have mass migrated to our shelves, you can order right off the shelf for as little as \$37.00 (less in quantity).

HUGHES

HUGHES AIRCRAFT COMPANY
ELECTRON DYNAMICS DIVISION

Celebrate along with us. Send the coupon and get a cigar and literature. Hughes Electron Dynamics Division, Advertising Dept., 3100 W. Lomita Blvd., Torrance, California 90509. Or call (213) 534-2121, Ext. 451.

HUGHES

HUGHES AIRCRAFT COMPANY
ELECTRON DYNAMICS DIVISION



1350H Series —
stainless steel
and methanol.



1370H Series —
copper and water.



1333H —
stainless steel
and ammonia.



Custom
Designs —
flexible, flat, and base plates.

Name _____

Company _____

Address _____

City _____ State _____ Telephone _____

Application _____

ED-10

INFORMATION RETRIEVAL NUMBER 43

For those bigger n-flops, reach for decoders, ROMs or PLAs. These building blocks, connected in a tree structure, let you design with a minimum of hardware.

If you need an n-flop, reach for ROMs and decoders instead of flip-flops and gates. Used as building blocks, these MSI chips will save hardware, especially for large values of n.

The n-flop can be thought of as a set of n flip-flops connected so that an input to one of the flip-flops sets the one and resets all the others. However, a design based on such an approach will use n gates. And each gate must have n + 1 inputs. If n exceeds seven, then gate expanders are required for TTL implementation. Hence the need for a fresh approach.

N-flops have many applications, especially the larger ones. They can be used, for example, as lockout circuits in which only one switch may be latched at a time, or as voting circuits to detect the first button pressed in a group. In both of these cases the number of stable states, n, equals the number of buttons or circuits.

It's a decoder building block

The basic circuit for the n-flop is a 1-of-10 or a 1-of-16 decoder. If selected outputs of the decoder are properly connected to the inputs, the decoder will latch in four or five stable states.

Consider a 7442 decoder, a 1-of-10, binary-to-decimal converter connected as a tri-flop (Fig. 1a). Decoder outputs 3, 5 and 6 are connected to inputs C, B and A, respectively, and input D is held low. Examination of the partial truth table for the 7442 (Table 1) shows how the circuit operates.

If inputs A, B and C are all high, then output $\overline{Q_3}$ is low, and all other outputs are high. Since $\overline{Q_3}$, $\overline{Q_5}$ and $\overline{Q_6}$ (the lines fed back to the inputs) are all high, the decoder state is stable, and the circuit retains the input condition of DCBA = 0111, if left undisturbed. If input A is momentarily pulled low by an external ground, the input state goes to 0110. This input condition causes output $\overline{Q_5}$ to go low, and since $\overline{Q_5}$ is connected

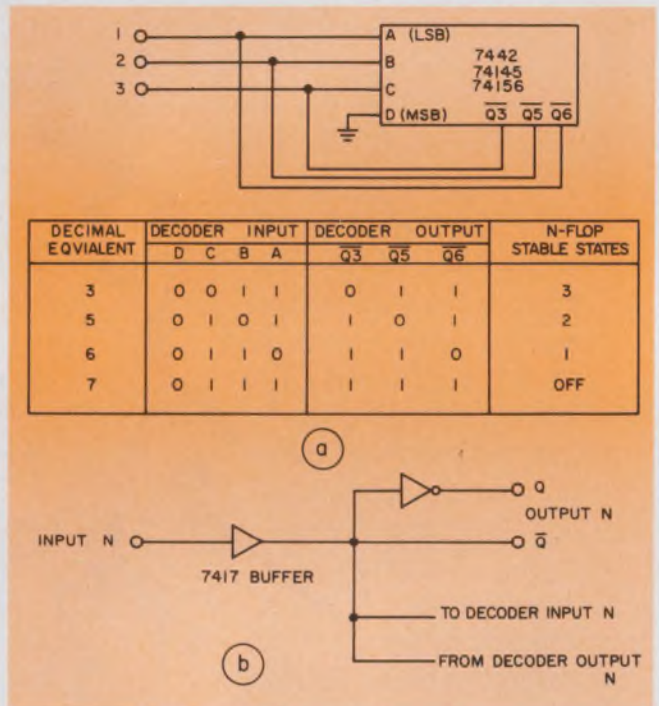

1. A tri-flop is constructed from a 1-of-10 decoder (a). A LOW placed on any one of the three input lines latches that line and releases the others. An open collector buffer attached to the feedback line isolates input and output (b). The inverter, if used, gives the complement of the n-flop state.

to input A, the input condition of 0110 is held, even after the external ground is removed. Input A is, therefore, latched on.

If input B is now grounded, the input state becomes 0100. Since this input causes only $\overline{Q_4}$ to go low, the latch on input A by $\overline{Q_4}$ is released, and A goes high. The resulting input condition is then 0101, which causes $\overline{Q_5}$ to go low, which in turn holds input B low. The decoder is again latched, but this time in a different state. A similar situation occurs if input C is pulled low. The latched state will become 0011, and it will be held in that condition by $\overline{Q_3}$.

As long as only one of the three inputs (A, B or C) is forced low, the decoder latches in a stable condition. If two or three of the inputs are forced low simultaneously, then none of the three outputs used as feedback will be low. The decoder

Table 1. Usable n-flop states for 7442 or 74145

Decimal equivalent	Input lines				Output lines								N-flop stable state		
	D	C	B	A	Q ₀	Q ₁	Q ₂	Q ₃	Q ₄	Q ₅	Q ₆	Q ₇		Q ₈	Q ₉
0	0	0	0	0	0	1	1	1	1	1	1	1	1	1	3
1	0	0	0	1	1	0	1	1	1	1	1	1	1	1	
2	0	0	1	0	1	1	0	1	1	1	1	1	1	1	
3	0	0	1	1	1	1	1	0	1	1	1	1	1	1	2
4	0	1	0	0	1	1	1	1	0	1	1	1	1	1	
5	0	1	0	1	1	1	1	1	1	0	1	1	1	1	1
6	0	1	1	0	1	1	1	1	1	1	0	1	1	1	
7	0	1	1	1	1	1	1	1	1	1	1	0	1	1	Off
8	1	0	0	0	1	1	1	1	1	1	1	1	0	1	
9	1	0	0	1	1	1	1	1	1	1	1	1	1	0	Off
15	1	1	1	1	1	1	1	1	1	1	1	1	1	1	
	All others				1	1	1	1	1	1	1	1	1	1	

will then be in an unstable condition. As soon as the inputs are removed, the circuit will switch to state 0111 (if all inputs are removed at the same time) or to the state that corresponds to the last of the inputs to be removed.

The inputs and outputs of the tri-flop share common signal lines. In some applications this can be used to advantage. But if it's necessary to have separate inputs and outputs, a simple input buffer can be used (Fig. 1b). Also, both the true and complement outputs are now obtained. In either case, n-flop inputs use negative logic, which makes the n-flop compatible with standard cross-connected TTL flip-flops.

The decoder tri-flop uses one 16-pin DIP. The corresponding circuit built from TTL gates would use three four-input NAND gates and occupy one and a half 14-pin packages. The space saving becomes even greater for larger n-flop structures. And with the decoder n-flop, there is also a saving in the number of connections required between circuit elements. Moreover 7442 tri-flops are easily used in a tree structure to form any n-flop size desired.

Converting the tri-flop to a quad-flop

An additional stable state can be added to the 7442 tri-flop by use of the D input and decoding of the condition for which the input state is 0111 or 1111. This circuit is shown in Fig. 2. If input D is high, any latches on A, B or C are removed, and the input state will be 1111. The D input can now be made low, and the latch condition on A, B or C will not recur.

The three-input NAND gate decodes the situation in which A B and C are unlatched and provides an output signal that indicates this fourth stable state. The fourth input and output

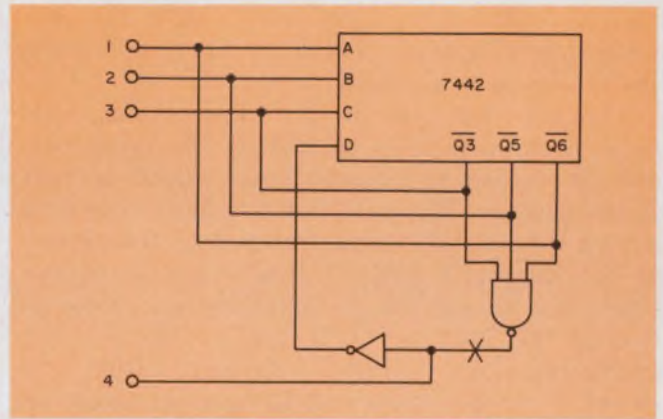

2. An auxiliary NAND gate adds a fourth stable state to the 7442 decoder. The connection can be broken at the point marked X if separate input and output terminals are desired.

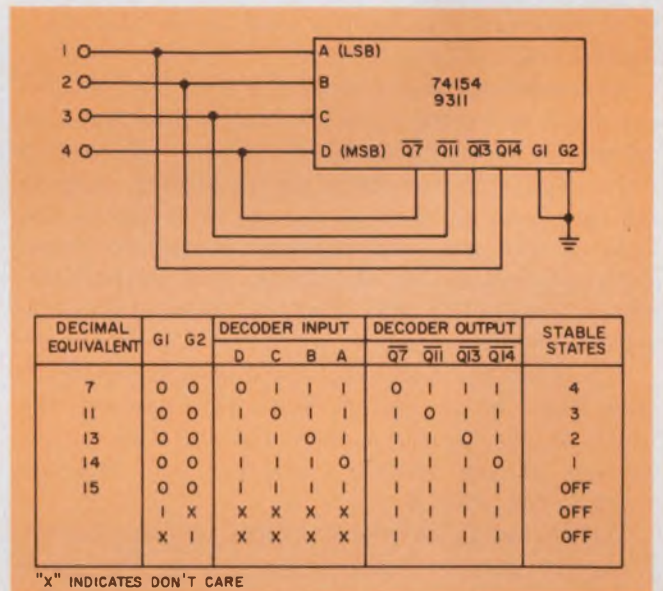

DECIMAL EQUIVALENT	DECODER INPUT		DECODER OUTPUT				STABLE STATES				
	G1	G2	D	C	B	A		Q ₇	Q ₁₁	Q ₁₃	Q ₁₄
7	0	0	0	1	1	1	0	1	1	1	4
11	0	0	1	0	1	1	1	0	1	1	3
13	0	0	1	1	0	1	1	1	0	1	2
14	0	0	1	1	1	0	1	1	1	0	1
15	0	0	1	1	1	1	1	1	1	1	OFF
	1	X	X	X	X	X	1	1	1	1	OFF
	X	1	X	X	X	X	1	1	1	1	OFF

"X" INDICATES DON'T CARE

3. This quad-flop is built with a 1-of-16 decoder, as shown by the input-output table. A fifth state (1111) could be extracted with an external decoder, if needed.

can be separate or they can share a common signal line, as in the figure.

The 74154 decoder, a 1-of-16, can be connected to form a tri-flop. But it can also be connected as a quad-flop without use of external gates, since additional input conditions are decoded. The quad-flop circuit can be analyzed in the same fashion as the 7442 n-flop (Fig. 3). Input states 0111, 1011, 1101 and 1110 are all stable. A fifth stable state (1111) can be extracted from the 74154 circuit, as was done to obtain the 7442 quad-flop. The major difference between the 74154 quad-flop and the 7442 tri-flop is that the 74154 is contained in a 24-pin DIP. Therefore the amount of space required for the 74154, including nominal interpackage spacing, is about 2.25 times more than that required for the 7442. A large n-flop made with 74154s is less desirable

than the same n-flop built from 7442s. The only advantage in using a 74154 for large n is a reduction in package count.

With all these circuits, the external input circuits must be capable of sinking the input current as well as the short-circuit output current of the decoder. When an input is high, it is held in that condition by the active pull-up transistors of the decoder's output circuit. For a typical equivalent circuit for an input/output combination of the 7442 or 74154 n-flop (Fig. 4), the maximum input current required initially to switch to a new state will be approximately 56 mA. Based on standard TTL loading rules, the n-flop has an effective input loading factor of 35. Once the n-flop has switched states and latched, the input current required drops to zero. The normal output loading factor of these decoders is 10, but the output loading factor of the n-flop is 9, since one unit load is used by the decoder's input lines.

Two methods can reduce the load factor. One approach is to use a 74156 dual two-to-four-line decoder or a 74145 decoder/driver in place of a 7442. Both devices have open-collector outputs and are just as easy to use in an n-flop as the 7442. If they are used, however, it may be necessary—depending on the input and output circuitry external to the n-flop—to have pull-up resistors on each line.

The other method is to add diodes in the feedback lines, as in Fig. 4. With this method, the input driver does not have to sink the output current of the decoder; however, the latching current can still flow.

With tri and quad-flops as basic building blocks, it is very easy to build larger n-flops. For small n (13 or less), a few special circuits can be devised. Figs. 5a and 5b show two such circuits; they use the 7442 and 74154, respectively. The first is either a hex-flop or a sept-flop. The seventh state of the sept-flop is decoded by an EXCLUSIVE-OR gate and corresponds to the situation where both 7442 tri-flops are in the OFF (0111) state. The 12-flop (Fig. 5b) uses the enable inputs of the 74154 decoders to release any latched condition, if one of the other decoders receives an input. A 13th state could be decoded by a circuit that monitors the Q_{15} outputs of the three decoders for an all-low condition. If two of the NAND gates are expanded to have five inputs, the extra inputs may be connected to form the 13th control signal.

Expanding the n-flop to any size

The basic blocks in a tree structure can be interconnected to build an n flop of arbitrary size. The 27-flop (Fig. 6) depicts the general method used to build a tree. The input latches are

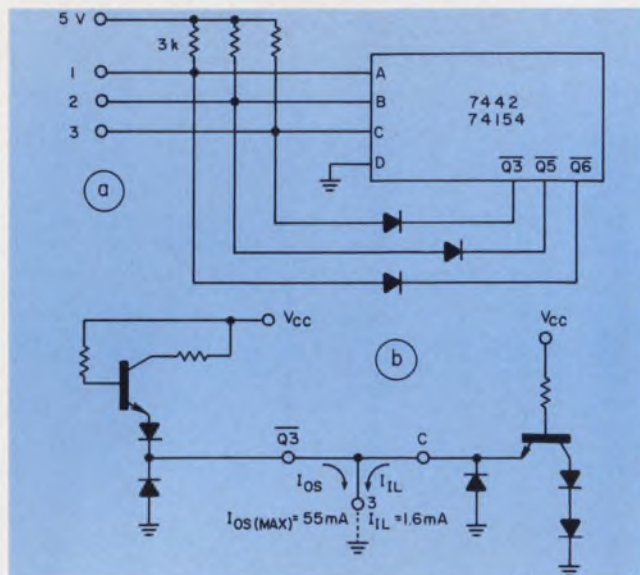

4. Isolation diodes reduce initial loading when the n-flop is switched to a new state (a). With the diodes, the input driver does not sink the output current of the decoder, which is generated by the active pull-up transistors inside the decoder (b).

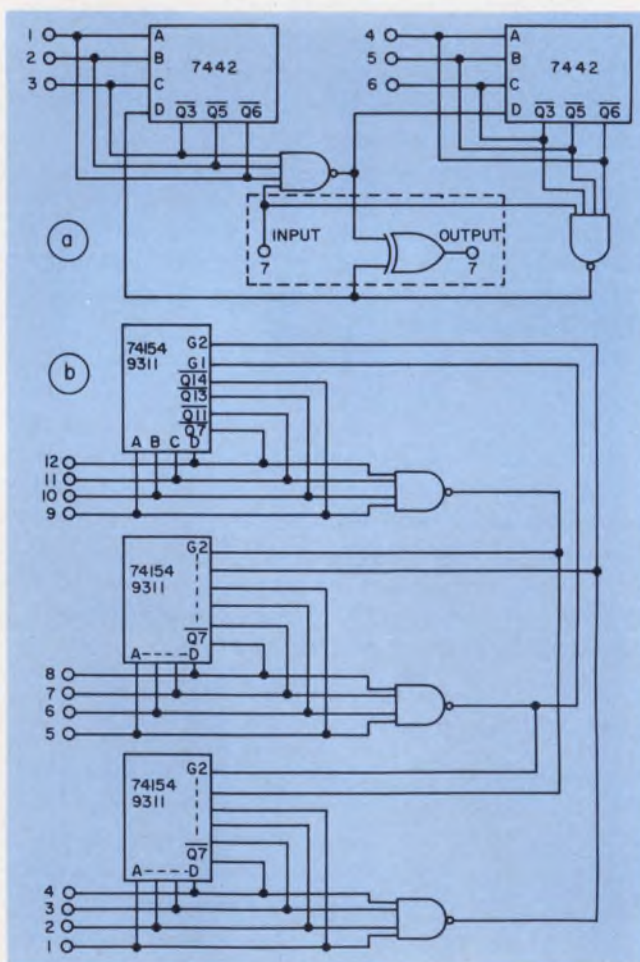

5. Larger n-flops can be built simply for special values of n. Two 7442 tri-flops gated together form a 6-flop (a). The decoder (dotted area) gives a seventh state. Three quad-flops form a 12-flop (b). The enable inputs release any latched condition if one of the other decoders receives an input.

nothing more than the familiar 7442 tri-flops. The input condition of each of these latches is sensed by the three-input AND gates. The outputs of these gates are used to propagate the input through the tree. The next level after the input latches are designated "intermediate" latches. Here the outputs of a decoder are not connected directly to the inputs, as with an input latch. Instead these signals are fed back to the previous level of the tree, and they enable or disable the previous latch by use of the D input. (A disabled latch corresponds to a latch in the OFF state.) Except for connection of the decoder outputs, the input and intermediate latches operate in the same fashion.

When any input to the n-flop is pulled low, all latches in the tree on the same branch as the input signal latch to the proper state. The latched states are achieved because the input signal is fed forward through the AND gates while the latching signal is fed backward through the decoders. Any previously latched input is released by the new input, since the signals in these forward and backward paths alter the states of the latches.

Additional intermediate latches can be added to expand the tree to whatever size is desired. The last latch in the tree is called a final latch, and it differs from the others by the absence of an AND gate to sum the inputs. The tree structure need not be symmetrical—that is, each branch at each level does not have to be identical to every other branch at that same level. For example, a 21-flop can be constructed by modification of the symmetrical 27-flop in Fig. 6. The lower two input latches and one intermediate latch of the tree are removed. The input latch for inputs 19, 20 and 21 can be controlled directly from the final latch. And 7442 tri-flops and 74154 quad-flops, can be mixed in the same tree. Or, to reduce the input loading factors, 74145 decoder/driver tri-flops can be used as the input latches and 7442 or 74154 decoders can be used elsewhere in the tree.

Because the n-flop tree structure has both forward and reverse signal paths—with input signals propagating forward and latch enable signals propagating backwards—the switching and latching times for the n-flop will vary as a function of the depth to which these signals travel.

If the n-flop of Fig. 6 is to be switched from state 1 to state 2, the only delay will come from the first input latch, and it will be a function of the switching times for a 7442 decoder. If, however, the state is changed from 1 to 4, additional delays will be inserted by two AND gates, one intermediate latch decoder and one more input latch decoder.

In both state changes, the final latch does

not affect the switching time, because it is not involved in the actual switch between states. If the switch is between states 1 and 10, the final latch will contribute to the delay.

To compute these times, extract turn-on and turn-off times from the manufacturer's data sheets and device logic diagrams. For the 7442 decoder, the turn-on time (output goes from high to low) is 22 ns for two logic levels and 23 ns for three logic levels. The turn-off time (output goes from low to high) is 17 ns for two levels and 26 ns for three.

The input-to-output levels are found to be as follows:

	$\overline{Q_3}$	$\overline{Q_5}$	$\overline{Q_6}$
A	3	3	2
B	3	2	3
C	2	3	3
D	2	2	2

The turn-on and turn-off times, together with the number of levels, give the delay times in Table 2.

As an example, use Table 2 to compute the delay to switch a decoder tri-flop (Fig. 1) from DCBA = 0110 to 0101. The latch on input A

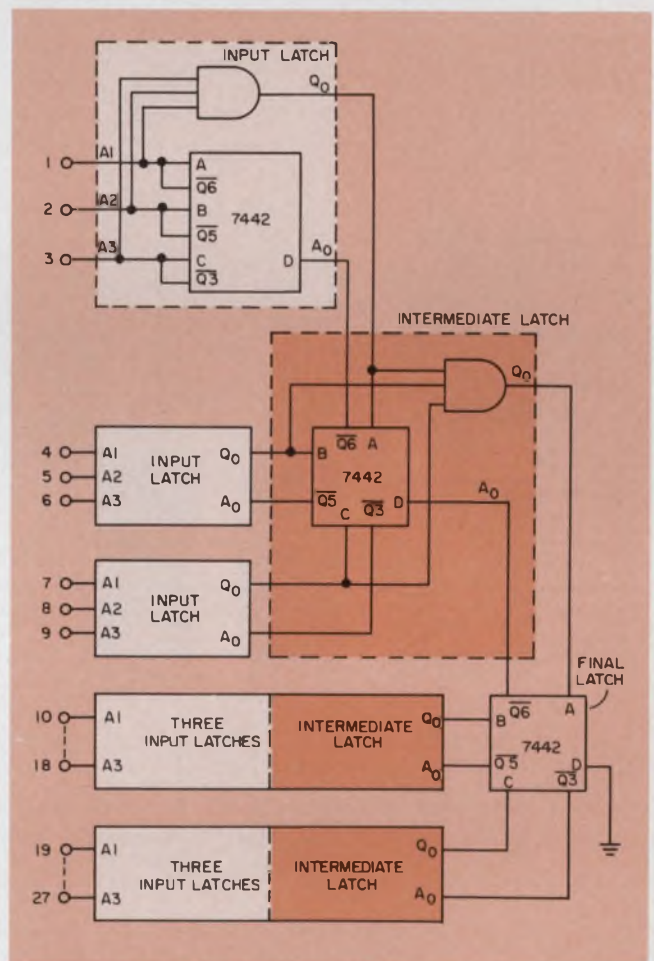

6. The tree structure allows construction of an n-flop of any desired size. Each stage of this 27-flop is essentially a 7442 tri-flop. The addition of more input and intermediate latches allows further expansion.

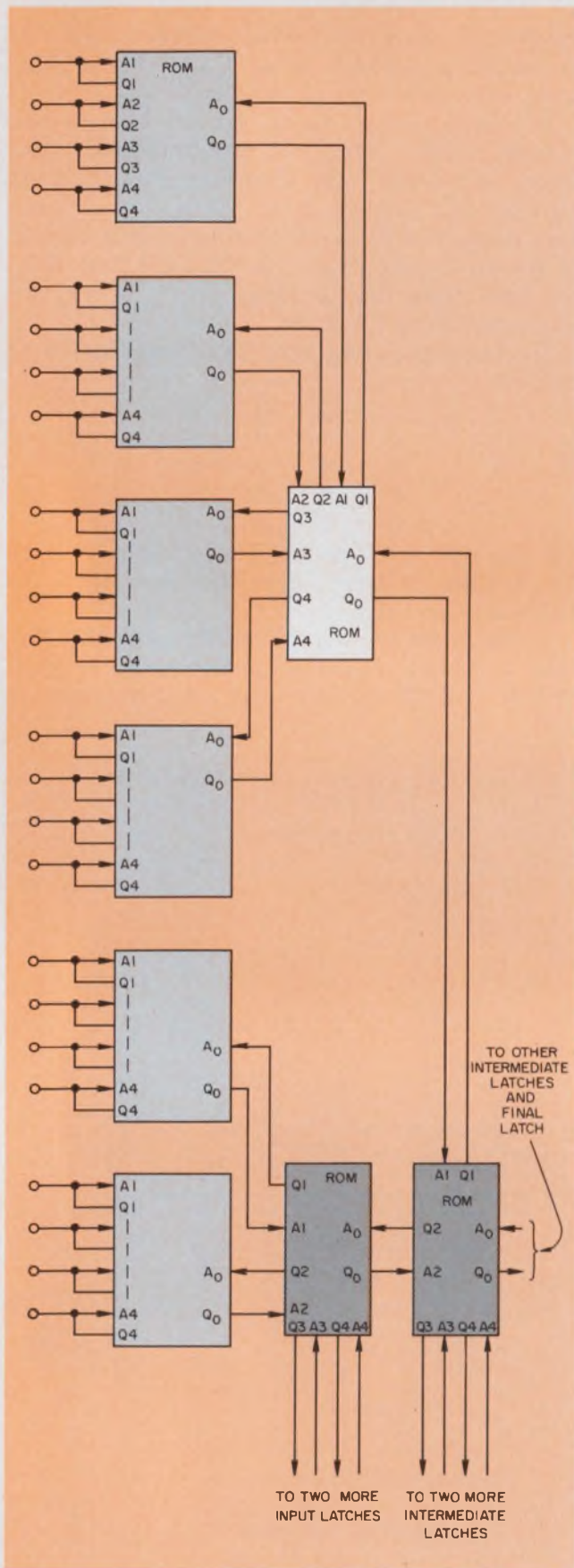

7. ROMs or programmable logic arrays (PLAs) can be the building blocks for large n-flops. Each ROM is a quad-flop. The circuit structure is a tree, and the over-all circuit has a lower package count than one built with decoders.

Table 2. Input-to-output logic delays (ns) for 7442 decoders

Input	Turn-on time			Turn-off time		
	$\overline{Q_3}$	$\overline{Q_6}$	$\overline{Q_8}$	$\overline{Q_3}$	$\overline{Q_5}$	$\overline{Q_{11}}$
A	23	23	22	26	26	17
B	23	22	23	26	17	26
C	22	23	23	17	26	26
D	22	22	22	17	17	17

is released, and the latch on B is set. When B is pulled low, the input state, which was 0110, becomes 0100. The delay time for $\overline{Q_{11}}$ to go OFF is 26 ns, a three-level delay. The input state now changes to 0101—the latch on A is released, but, as yet, there is no latch on B. The latch on B occurs 23 ns later when $\overline{Q_5}$ turns on. This is a three-level turn-on time from A to $\overline{Q_{11}}$. The total elapsed time to latch B is the sum of the delays, or 49 ns. And transitions between the other states also work out to 49 ns.

For transition of states in a tree that requires more than one latch to participate, the delay time will be a combination of a number of gate delays. To compute the delay, you must follow the signal path from the new input into the tree, go back out to the previous input (to unlatch it), follow the old input into the tree, and finally proceed backwards to the new input (to provide the latching signal).

For the particular case of a transition from state 6 to state 1 for the 27-flop, only two levels of the tree are involved. Table 3 shows the state transitions and computation of the switch-over time. The table also details the input and output states for the intermediate latch and the input latches—which serve inputs 1 and 6—as the signals propagate through the tree.

The total delay for this two-level switch is 120 ns. If another level participated in the transition, the delay would be increased by 71 ns more—the additional AND gate on and off delay plus the two-level decoder ON and OFF delays. Thus, the input latch contributes 49 ns, and each additional level contributes 71 ns.

The significance of these switching times is that they represent the minimum allowable input pulse widths for correct operation of the n-flop.

Denser circuits with ROM or PLA

If you have a substantial need for a large n-flop and are concerned about space restrictions, a ROM or PLA n-flop can be designed. This method allows a reduction in the total package count over a tree built with decoders.

For instance, a 256-bit ROM (a type 7488A

Table 3. Transition-time calculation for 27-flop

	Delay time (ns)	Input latch 1		Intermediate latch		Input latch 6	
		Input DCBA	Output 356	Input DCBA	Output 356	Input DCBA	Output 356
Initial state = 6		1111	111	0101	101	0011	011
Input 1 On		1110					
AND gate on-delay	14		0100				
Intermediate latch 3-level Off delay (A to Q _o)	26			111		1011	
#6 input latch 2-level Off delay (D to Q _o)	17						111
AND gate off delay	18					1111	
Intermediate latch 3 level on delay (D to Q _o)	23		0110				
Input latch 1, 2-level On delay (D to Q _o)	22			110			
Final state = 1		0110	110	0110	110	1111	111
Total delay	120 ns						

or 93434) organized as 32 words of 8 bits each, will function as a 4-flop as seen from its truth table (Table 4).

These ROMs have five inputs, eight outputs, and are contained in a 16-pin DIP. Only five of the eight outputs are used. Input A₀ is used as the latch enable signal and would be equivalent to the D input of the 7442 or a G input of the 74154. Output Q₀ is the signal that is fed forward if there are any further stages in the tree; it corresponds to the AND gate output of the decoder n-flop. Inputs A₁ through A₄ and outputs Q₁ through Q₄, are latching input and output signals. If A₁ through A₄ are connected to Q₁ through Q₄, respectively, these lines become the input/output combinations of a quad-flop. In a tree structure the four inputs of an intermediate latch are fed from the four Q_o lines of ROMs in the previous stage, and the four outputs of an intermediate latch are connected to the latch enable inputs of the previous stages. A part of such a tree structure is shown in Fig. 7. Note the similarity between this and the tree structure of the 7442 n-flop in Fig. 6.

The equations to use when ROMs or PLAs are used for an n-flop are:

$$Q_0 = \prod A_1 A_2 A_3 \cdots A_m$$

$$Q_i = \prod \bar{A}_0 A_1 A_3 \cdots A_i \cdots A_m$$

for i = 1 to m, where m is the number of latch-

ing inputs desired per device. Output Q_o is simply an AND function of all inputs except A₀. The other outputs are the latching signals. Input A₀ is the latch enable input, and A₁ through A_m are the latching inputs. Table 4 was derived from these equations by setting m = 4. For the general case, if ROMs are used, the number of memory bits each individual ROM must contain is $(m+1)2^{m+1}$.

All of the n-flops that use tree structures, whether built from decoders, ROMs or PLAs and whether symmetrical or not, have one additional state that can be controlled. The latch enable input of the final latch can be used to reset all n-flop inputs to the unlatched condition. This reset state can be decoded by the addition of one NAND gate connected across the inputs to the final latch. If the final latch is a ROM or PLA, its Q_o output will provide this signal.

For large n, tree structures that use a 7442, a 74154 or a ROM/PLA vary greatly in size for the same n. Table 5 gives the approximate package count and relative physical size of the tree as a function of n. A value of 2.25 is used as the relative size between a 74154 (24-pin DIP) and a 7442 or 7488 A (16-pin DIP). Account is also taken of the AND gates needed for the n-flop arrays built with decoders.

The ROM/PLA approach is superior in both respects. The more states per ROM or PLA, the

Table 4. Operation of ROM type 7488A or 93434 as a 4-flop

A ₀	A ₁	A ₂	A ₃	A _i	Q ₀	Q ₁	Q ₂	Q ₃	Q _i	Stable states
0	0	0	0	0	0	1	1	1	1	
0	0	0	0	1	0	1	1	1	1	
0	0	0	1	0	0	1	1	1	1	
0	0	0	1	1	0	1	1	1	1	
0	0	1	0	0	0	1	1	1	1	
0	0	1	0	1	0	1	1	1	1	
0	0	1	1	0	0	1	1	1	1	
0	0	1	1	1	0	0	1	1	1	1
0	1	0	0	0	0	1	1	1	1	
0	1	0	0	1	0	1	1	1	1	
0	1	0	1	0	0	1	1	1	1	2
0	1	0	1	1	0	1	0	1	1	
0	1	1	0	0	0	1	1	1	1	
0	1	1	0	1	0	1	1	0	1	3
0	1	1	1	0	0	1	1	1	0	4
0	1	1	1	1	1	1	1	1	1	Off
1	0	x	x	x	0	1	1	1	1	
1	x	0	x	x	0	1	1	1	1	
1	x	x	0	x	0	1	1	1	1	
1	x	x	x	0	0	1	1	1	1	
1	1	1	1	1	1	1	1	1	1	Off

ROM organization is 32, 8-bit words. The letter x denotes a don't-care condition.

smaller the array.

Now that you can build n-flops of any size by a variety of methods, let's consider a few typical applications.

Suppose a latching circuit is needed for a bunch of momentary pushbuttons. Perhaps momentary buttons are being used, because numerous switching stations must control the same functional circuits. And let it be required that the switches be interlocked—that is, only one of the switches may be latched at a time. When one switch is operated at any station, it must cause all other switches to release.

An n-flop can handle all of these requirements. There won't be any need for complicated circuitry to sense multiple latched states or to issue pulses for releasing the latches on other buttons. Fig. 8a shows one method of connection

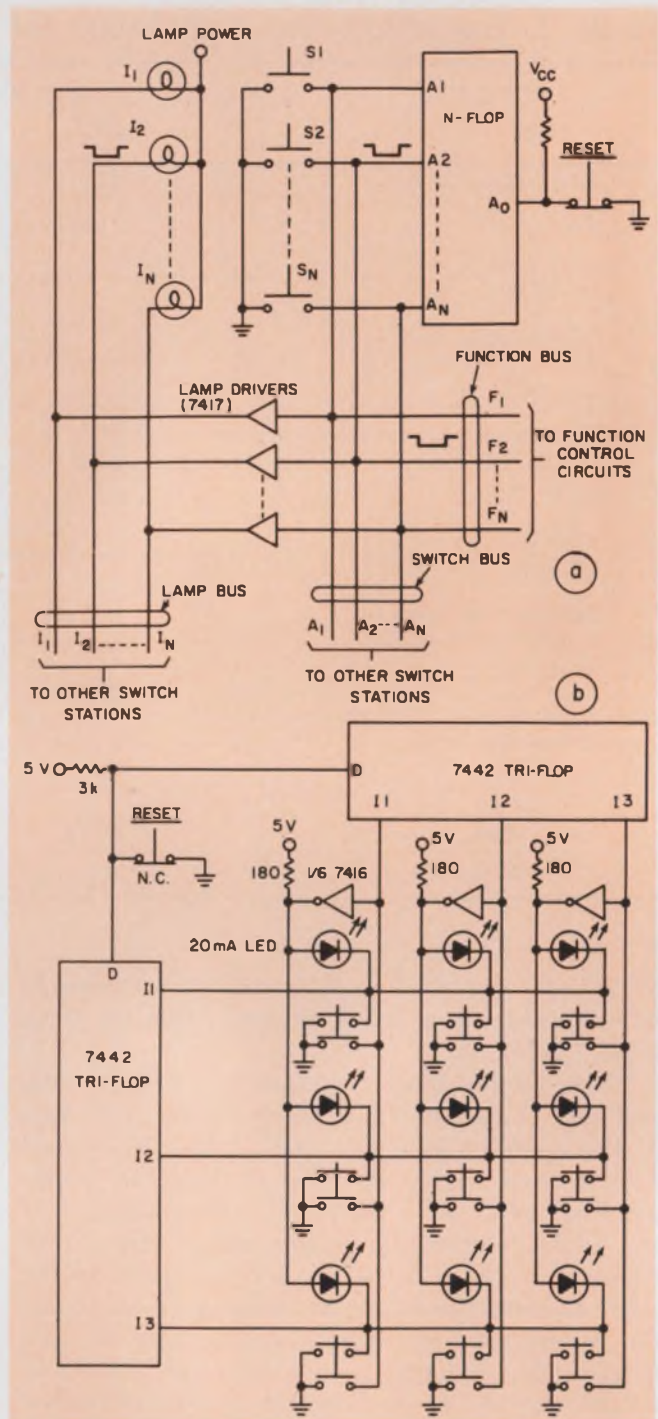

8. These n-flops latch for the most recent button pushed. The first circuit (a) uses single-contact switches. The $m \times m$ arrangement (b) uses smaller n-flops.

Table 5. Package count and size of n-flop designs

Tree construction method	7442 tri-flops	74154 quad-flops	ROM/PLA (m = states/device)	7488A ROM (m = 4)	7400 Series SSI
Package count	$\frac{2n}{3}$	$\frac{n}{2}$	$\frac{n}{m-1}$	$\frac{n}{3}$	$\frac{n^2}{8}$
Size, including interpackage spacing relative to 16-pin DIP	$\frac{2n}{3}$	$\frac{11n}{12}$	$\frac{kn}{m-1}$	$\frac{n}{3}$	$\frac{n^2}{8}$

For 16-pin DIP, k = 1; for 24-pin DIP, k = 2.25

LOOKING FOR SWITCHES?

ACCELERATION AIR FLOW ACTUATED AIR PRESSURE HIGH TEMPERATURE HIGH VOLTAGE
 CAPACITIVE CENTRIFUGAL COAXIAL CROSSBAR INTERLOCK KEYBOARD KEY-LOCK
 R-F ELECTROCHEMICAL EXPLOSIVE ACTUATED INERTIA KNIFE
 LOAD FOOT PEDAL FREQUENCY RESPONSE LEVER
 HALL-EFFECT HERMETICALLY SEALED
 LIMIT LIQUID LEVEL

ROCKER
 NEED
 TARY
 TAP
 SLIDE
 ELDED
 DGGLE
 IGGER
 OLENOID
 JMBWHEEL
 AP ACTION
 SHBUTTON

Sec 1400 Switches

CENTRALAB SELECTASHAFT ROTARY SWITCH ORDER FORM

SHIP TO: _____
 Name _____
 Address _____
 City _____
 State _____
 Zip _____

COMPLETE STEPS 1-3 TO SPECIFY DESIRED SWITCH

1 SWITCH
 Select the desired switch for its (two assembly) part number from the catalog and enter number.

2 SHAFT
 Select the desired shaft and enter number below.

3 FLAT ANGLE
 Select the desired shaft flat angle using Diagram 1, and enter the shaft flat angle number below.

EXAMPLE: 20 (1 SHAFT)
 EXAMPLE: 080 (1 FLAT ANGLE)

IN PARTS

COMPLETE SELECTASHAFT SWITCH PART NUMBER

HOW TO SPECIFY SHAFT FLAT ANGLE

SHAFT FLAT ANGLES CAN BE SPECIFIED IN INCREMENTS OF 15° AS SHOWN ON OUTER CIRCLE OF DIAGRAM 1.

1 Using the dotted circle, draw an end detail outline of shaft with flat in the desired position.

2 Draw a perpendicular line from the surface of the flat out to the corresponding angle position (degree) circle number.

EXAMPLE: 150° 225° 150°

3 Enter the angle position code number above to complete switch part number.

NOTE: Angle indicates knob set screw position, not knob position.

CENTRALAB Electronics Division • GLOBE-UNION INC.
 3157 NORTH GREEN BAY AVENUE • MILWAUKEE, WISCONSIN 53201 • (414) 228-1230

Reference GOLD BOOK 8828 numbers when you call or write.

Vol 2/1016

Sec 1400 Switches

CHERRY

DISCOUNT SCHEDULE FOR ALL SNAP-ACTION SWITCHES

Quantity	1-100	101-500	501-1000	1000+
1-100	1.00	0.75	0.50	0.30
101-500	0.75	0.50	0.30	0.20
501-1000	0.50	0.30	0.20	0.15
1000+	0.30	0.20	0.15	0.10

NOTES apply to all products in this publication list:
 1. Cash Terms - 10% 10 days, net 30 days.
 2. Dimensions and 300 Shipping Code, 2000000, or other code.
 3. Prices and Discounts are subject to change without notice.
 4. Minimum order quantity may be determined by multiplying quantity and discount.
 5. Delivery and shipping charges will be added to the net price.
 6. Delivery and shipping charges will be added to the net price.
 7. Delivery and shipping charges will be added to the net price.

GENERAL PURPOSE - SINGLE POLE E13 SERIES/E14

E13 SERIES - 10 AMPS, 125-250 VAC, 1/2 H.P., 125 VDC
 E14 SERIES - 20 AMPS, 125-250 VAC, 1 H.P., 125 VDC

Part No.	On	Off	Part No.	On	Off
E13-100	1/2" x 1/2" x 1/2"	1/2" x 1/2" x 1/2"	E14-100	1/2" x 1/2" x 1/2"	1/2" x 1/2" x 1/2"
E13-101	1/2" x 1/2" x 1/2"	1/2" x 1/2" x 1/2"	E14-101	1/2" x 1/2" x 1/2"	1/2" x 1/2" x 1/2"
E13-102	1/2" x 1/2" x 1/2"	1/2" x 1/2" x 1/2"	E14-102	1/2" x 1/2" x 1/2"	1/2" x 1/2" x 1/2"
E13-103	1/2" x 1/2" x 1/2"	1/2" x 1/2" x 1/2"	E14-103	1/2" x 1/2" x 1/2"	1/2" x 1/2" x 1/2"
E13-104	1/2" x 1/2" x 1/2"	1/2" x 1/2" x 1/2"	E14-104	1/2" x 1/2" x 1/2"	1/2" x 1/2" x 1/2"
E13-105	1/2" x 1/2" x 1/2"	1/2" x 1/2" x 1/2"	E14-105	1/2" x 1/2" x 1/2"	1/2" x 1/2" x 1/2"
E13-106	1/2" x 1/2" x 1/2"	1/2" x 1/2" x 1/2"	E14-106	1/2" x 1/2" x 1/2"	1/2" x 1/2" x 1/2"
E13-107	1/2" x 1/2" x 1/2"	1/2" x 1/2" x 1/2"	E14-107	1/2" x 1/2" x 1/2"	1/2" x 1/2" x 1/2"
E13-108	1/2" x 1/2" x 1/2"	1/2" x 1/2" x 1/2"	E14-108	1/2" x 1/2" x 1/2"	1/2" x 1/2" x 1/2"
E13-109	1/2" x 1/2" x 1/2"	1/2" x 1/2" x 1/2"	E14-109	1/2" x 1/2" x 1/2"	1/2" x 1/2" x 1/2"
E13-110	1/2" x 1/2" x 1/2"	1/2" x 1/2" x 1/2"	E14-110	1/2" x 1/2" x 1/2"	1/2" x 1/2" x 1/2"

GENERAL PURPOSE - DOUBLE POLE E18 SERIES/E20

E18 SERIES - 10 AMPS, 125-250 VAC, 1/2 H.P.
 E20 SERIES - 20 AMPS, 125-250 VAC, 1 H.P.

Part No.	On	Off	Part No.	On	Off
E18-100	1/2" x 1/2" x 1/2"	1/2" x 1/2" x 1/2"	E20-100	1/2" x 1/2" x 1/2"	1/2" x 1/2" x 1/2"
E18-101	1/2" x 1/2" x 1/2"	1/2" x 1/2" x 1/2"	E20-101	1/2" x 1/2" x 1/2"	1/2" x 1/2" x 1/2"
E18-102	1/2" x 1/2" x 1/2"	1/2" x 1/2" x 1/2"	E20-102	1/2" x 1/2" x 1/2"	1/2" x 1/2" x 1/2"
E18-103	1/2" x 1/2" x 1/2"	1/2" x 1/2" x 1/2"	E20-103	1/2" x 1/2" x 1/2"	1/2" x 1/2" x 1/2"
E18-104	1/2" x 1/2" x 1/2"	1/2" x 1/2" x 1/2"	E20-104	1/2" x 1/2" x 1/2"	1/2" x 1/2" x 1/2"
E18-105	1/2" x 1/2" x 1/2"	1/2" x 1/2" x 1/2"	E20-105	1/2" x 1/2" x 1/2"	1/2" x 1/2" x 1/2"
E18-106	1/2" x 1/2" x 1/2"	1/2" x 1/2" x 1/2"	E20-106	1/2" x 1/2" x 1/2"	1/2" x 1/2" x 1/2"
E18-107	1/2" x 1/2" x 1/2"	1/2" x 1/2" x 1/2"	E20-107	1/2" x 1/2" x 1/2"	1/2" x 1/2" x 1/2"
E18-108	1/2" x 1/2" x 1/2"	1/2" x 1/2" x 1/2"	E20-108	1/2" x 1/2" x 1/2"	1/2" x 1/2" x 1/2"
E18-109	1/2" x 1/2" x 1/2"	1/2" x 1/2" x 1/2"	E20-109	1/2" x 1/2" x 1/2"	1/2" x 1/2" x 1/2"
E18-110	1/2" x 1/2" x 1/2"	1/2" x 1/2" x 1/2"	E20-110	1/2" x 1/2" x 1/2"	1/2" x 1/2" x 1/2"

CHERRY ELECTRICAL PRODUCTS CORPORATION
 3800 SUNSET AVENUE / WAUWATON, ILLINOIS 60085 (312) 488-7700 - TWX 8101 228-1872

See the Manufacturers Directory, Vol 1, for local office.

Electronic Design's

DECADE
 MAGNETICALLY ACTUATED
 MERCURY MOTOR-DRIVEN POWER
 PRESSURE-ACTUATED PRINTED CIRCUIT
 MATRIX PLUNGER
 TOUCH ACTUATED WAVEGUIDE PHOTOELECTRIC PROXIMITY
 SPEED-ACTUATED

LOOK FIRST IN Electronic Design's GOLD BOOK

More than 52,500 of *Electronic Design's* qualified subscribers recommend or specify switches & relays for purchase. To aid in product search and selection, the PRODUCT DIRECTORY of *Electronic Design's* GOLD BOOK lists manufacturers of switches & relays in 95 sub-categories. For example there are 53 classifications of switches ranging from *Acceleration* through *Waveguide*; 42 classifications of relays from *Capacitance* through *Voltage Band*. To make it easier for you or your secretary to contact many manufacturers about a given item, each supplier's name is followed by complete street address, city, state, zip and phone every time it appears—no need to refer to other directories for missing portions of address.

CATALOG PAGES Volume 2 of *Electronic Design's* GOLD BOOK contains 235 catalog pages on *Switches; Relays & Solenoids*. You'll find most major manufacturers represented; many units contain detailed specs and ordering information, configurations, etc. Check these pages carefully before you specify . . . you may find the exact product you need.



PASS THE WORD TO YOUR SALES & MARKETING PEOPLE

Electronic Design's GOLD BOOK is the place to look for information about products and suppliers in this industry. Be sure your company takes full advantage of *your* catalog pages. Ask your advertising people to call attention to your pages at every opportunity, especially in your regular advertising program.

Explore the lock-in amplifier. With it, you can measure the ultra-low distortion components of a "linear" signal, and at super-high effective Qs.

If you have to measure distortion components with relative magnitudes of 100 ppm or less—or if you can't use excitations of greater than 10 mV in distortion testing—the lock-in amplifier may provide the solution.

With it, you can do the following:

- Measure weak distortion components in the presence of obscuring background noise.
- Measure directly the distortion of a linear system without concern for the spectral purity of the excitation sources.

Of course, the lock-in amplifier has limitations, too—chiefly the frequency range, which is limited to 0.1 Hz to 200 kHz.

Other instruments also measure distortion—for example, the total-harmonic-distortion (THD) meter and the wave analyzer. But the lock-in can do what each of these does—and at ultra-low levels.

The THD meter operates by notching out the strong fundamental and measuring the weak residuals with a broadband detector; while the wave analyzer measures the intensities of specific harmonics, from which the THD can be computed.

To do this, the device under test is excited with a sinusoid, and a narrowband analyzer measures the harmonics. As distortion decreases, more analyzer gain is needed. But as gain is increased, the equivalent noise bandwidth must be narrowed to avoid overload from related harmonics, power-line pickup, random noise and even the fundamental.

Thus frequency stability becomes critical and what's needed ideally is a driftless, super-high-Q analyzer: Enter the lock-in.

How it works

The name "lock-in amplifier" suggests to many engineers a tracking filter or phase-locked oscillator. However, it would be more appropriate to

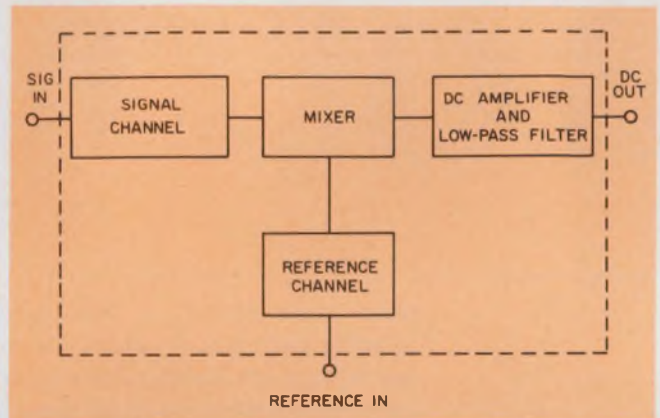

1. Basically the lock-in amplifier detects weak signals by the process of synchronous demodulation. Extraneous signals, which are not synchronized to the reference, are rejected.

liken the lock-in to a synchronous demodulator or phase-sensitive detector.

Actually the lock-in is a specialized ac voltmeter that uses synchronous demodulation to measure signal strength or phase, even under severe noise conditions—that is, where the noise-to-signal ratio approaches 130 dB. Full-scale sensitivities of 10 nV or 0.1 pA are typical. The instrument can be used wherever the signal of interest can be synchronized with or derived from a suitable reference signal.

The output of the lock-in—a phase-sensitive dc voltage proportional to the signal—is available for recorders or for further processing. Or it can serve as a control signal in a servo feedback-loop system.

The lock-in can be divided into four main sections: a signal channel, reference channel, mixer (phase-sensitive detector) and dc amplifier/low-pass filter (Fig. 1).

In the signal channel, the input signal (and noise) is conditioned by the low-noise preamplifier and postamplifier, with a filter sandwiched in between. The filter can be a tunable bandpass, notch, low or high-pass network. Sometimes it's referred to as a predetection filter, since its purpose is to reduce the possibility that the mixer will overload during severe noise conditions.

Seymour G. Letzter, Senior Applications Engineer, Princeton Applied Research Corp., P.O. Box 2565, Princeton, N.J. 08540.

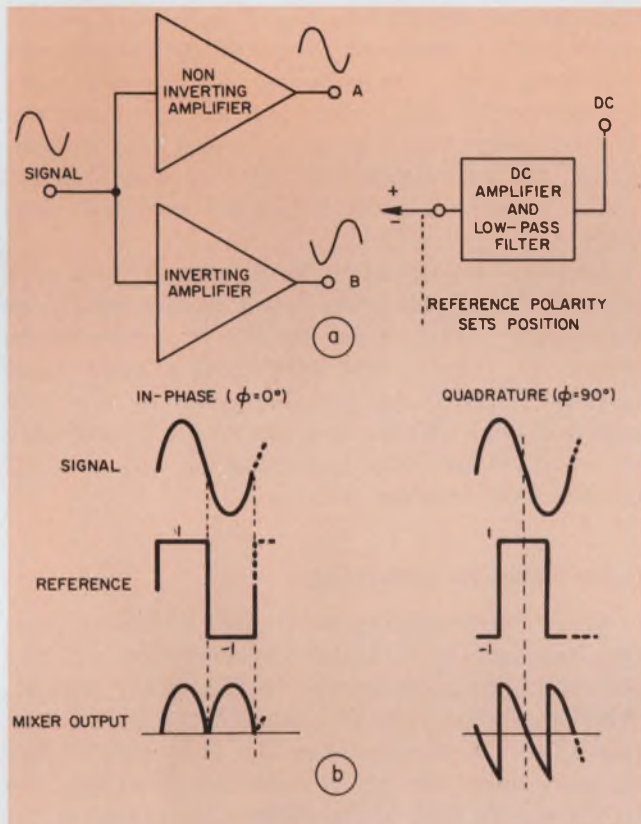

2. Key element of the lock-in is the mixer, which operates as a phase-sensitive switch (a). The switch position depends on the polarity of the reference square-wave drive, so that the input signal is commutated at the reference frequency (b).

However, the biggest improvement in signal-to-noise is contributed by the mixer and dc-amplifier/low-pass filter sections, and not the pre-detection filter.

The reference channel transforms the externally applied reference to a suitable square wave (at the reference frequency) to drive or switch the mixer. The lock-in's output is independent of the reference amplitude, as long as the reference exceeds a specified threshold—typically 100 mV.

However, the output does depend on the phase difference between the signal and the reference. Since the phase difference is usually unknown, a manually controllable 0-to-360° phase shifter is

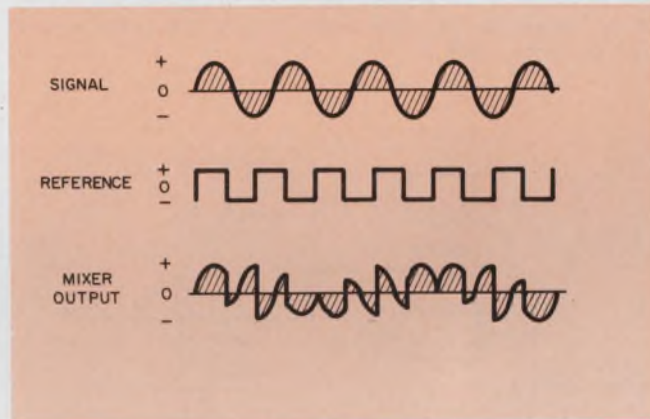

3. When the signal isn't synchronized with the reference, as in the case of noise, the average (dc) level of the mixer output is zero.

incorporated into the reference channel to facilitate signal-level measurements. Some lock-in amplifiers have an $f/2$ mode to permit the mixer to be driven at twice the reference frequency—a useful feature for second-harmonic measurements, for example.

You may wonder how, or where, to get a reference—and to get it synchronized to the signal, no less. If you think of an ac-bridge balancing application—where the bridge excitation is the reference and the null is the signal of interest—it's apparent that a lock-in amplifier is really an extremely sensitive null detector.

Mixer is the key stage

Often referred to as a phase-sensitive detector or synchronous demodulator, the mixer stage is actually the heart of the lock-in instrument (Fig. 2). The mixer can be thought of as an electronic reversing switch whose sense or position is determined solely by the square-wave drive polarity. Thus the signal-channel output is commutated at the reference frequency.

There are two basic ways to analyze the demodulation process—graphically and mathematically. In the graphical, the signal-channel output consists of two equal-amplitude sinusoids—one in and the other out of phase with the reference.

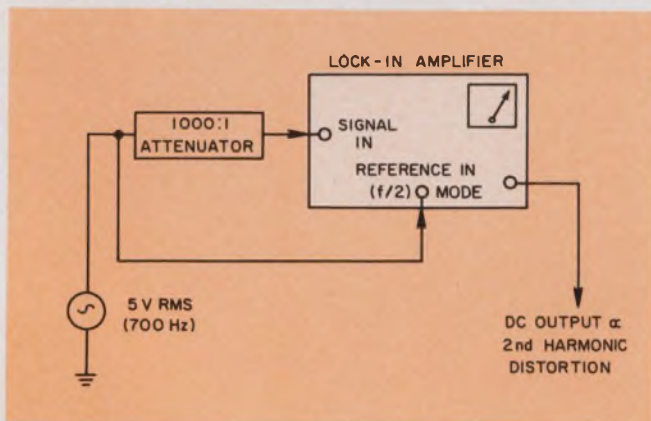

4. To measure the second-harmonic distortion generated in an amplifier (in this case, the lock-in itself), this test setup is used.

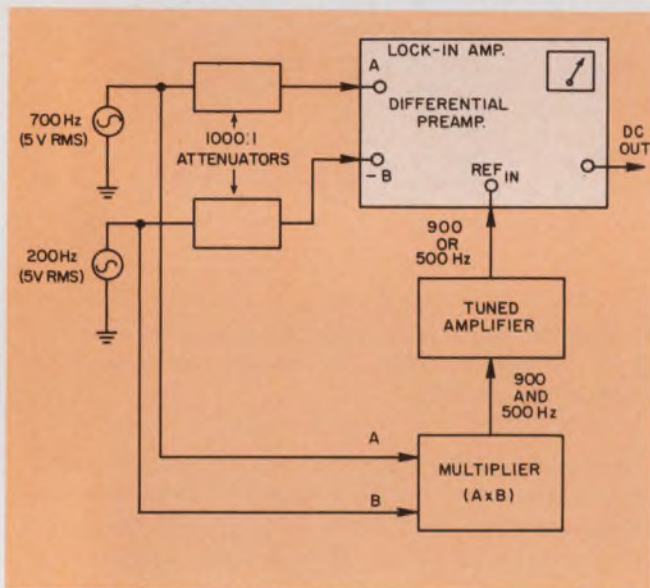

5. Intermodulation products can be measured with a differential preamp in the lock-in's front end. Harmonic distortion can then be calculated from the measured products. In this way the spectral purity (impurity, actually) of the excitation source can be neglected.

During the first half cycle the reference drive is positive and the switch in Fig. 2 is in position A. The mixer output is a positive, half-wave sinusoid during this interval. During the second half cycle the switch is in position B, but the mixer output is still positive.

Clearly, when the reference and sinusoidal signal are in phase at the mixer input terminals, the mixer output is a full-wave rectified sinusoid whose fundamental is twice the reference frequency and whose dc component is proportional to the signal of interest. When the reference drive and signal are in quadrature—that is, their phase difference ϕ is 90° —there is no dc component. In general, the dc component is phase-sensitive—it varies as the cosine of ϕ .

When the reference is not synchronous with the signal-channel output (as in the case of

noise), though ac fluctuations exist, there will be no dc component regardless of the reference-channel phase-control setting (Fig. 3).

In the mathematical analysis of the demodulation process, the mixer output, $m(t)$, can be thought of as the product of the signal-channel output $s(t)$, and a ± 1 V pk-pk square wave. With the reference represented by a Fourier series, $m(t)$ may be written as:

$$m(t) = \sum_{n=0}^{\infty} s(t) \frac{4}{(2n+1)\pi} \sin[(2n+1)\omega t + \phi_n].$$

If $s(t)$ has a frequency component in common with any of the reference components (usually only the fundamental), there will be a phase-sensitive dc component. Note that ac components will always exist, composed of sum and difference frequencies of the signal and all the reference Fourier components. If $\phi_n = 0$, and $s(t)$ is sinusoidal, the expression for $m(t)$ is the Fourier-series expansion of a full-wave rectified sine wave.

Actually the signal to be measured is usually somewhat more complex—such as the square or trapezoidal waveforms found in photometry, where the signal is derived from a mechanical or electro-optical chopper. However, by the time such a signal reaches the mixer, its appearance is nearly sinusoidal, depending on the type of predetection filtering used.

Noise makes no contribution

Nonsynchronous inputs (noise) share no common frequencies with the reference and will not contribute dc components to the mixer output. When the mixer output is passed through a low-pass filter to remove the ac fluctuations, the signal to noise (dc/ac) is enhanced in proportion to the square root of the filter time constant.

The final section of the lock-in—the low-pass filter and dc-amplifier combination—amplifies the dc component of the signal and attenuates the ac components. The attenuation depends on the frequencies, the low-pass-filter time-constant (T)—usually 1 ms to 300 s—and the number of filter sections used. A choice of -6 dB/octave or -12 dB/oct is usually available.

Since the equivalent noise bandwidth (ENBW) is determined by the low-pass filter, and not the signal-channel filter, bandwidth can be extremely narrow. For single and double-section filters, ENBW equals $1/(4T)$ and $1/(8T)$, respectively. Thus a 300-s time constant at -12 dB/oct roll-off rate gives an ENBW = 0.00042 Hz.

In the distortion measurement in Fig. 4, the lock-in amplifier is used to detect a 1.4-kHz signal with a time-constant setting of 1 s at a -6 dB/oct attenuation rate.

Since the noise-induced fluctuations of the

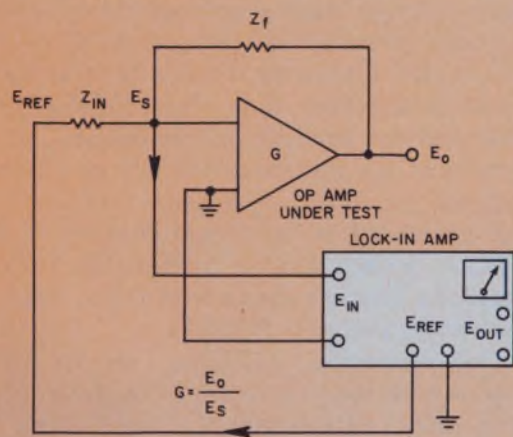

(a)

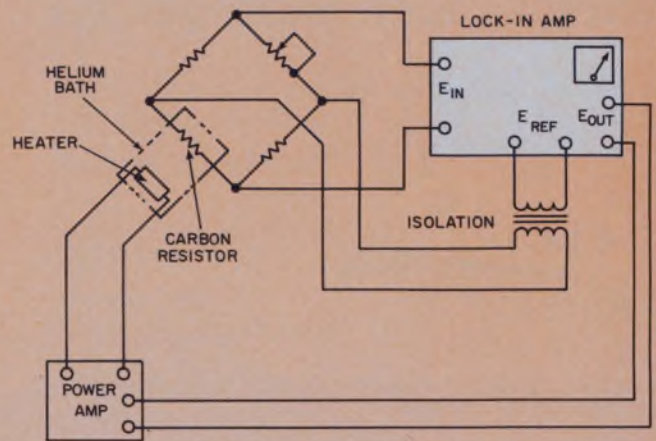

(d)

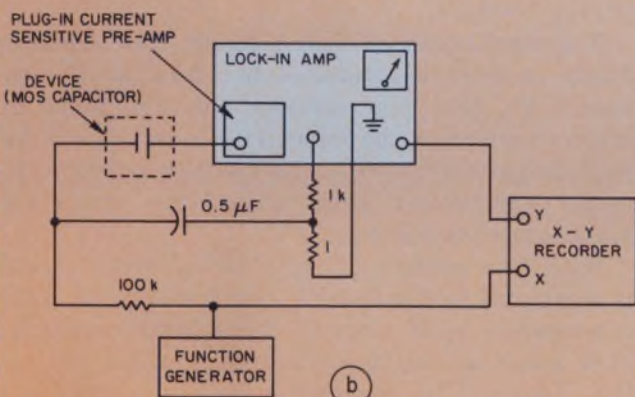

(b)

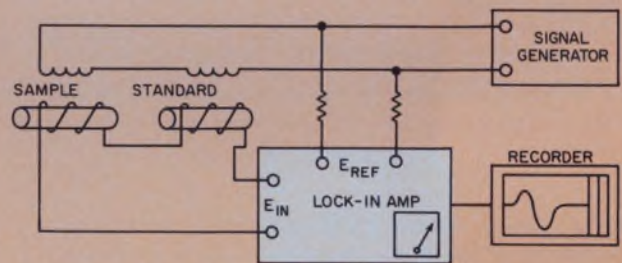

(e)

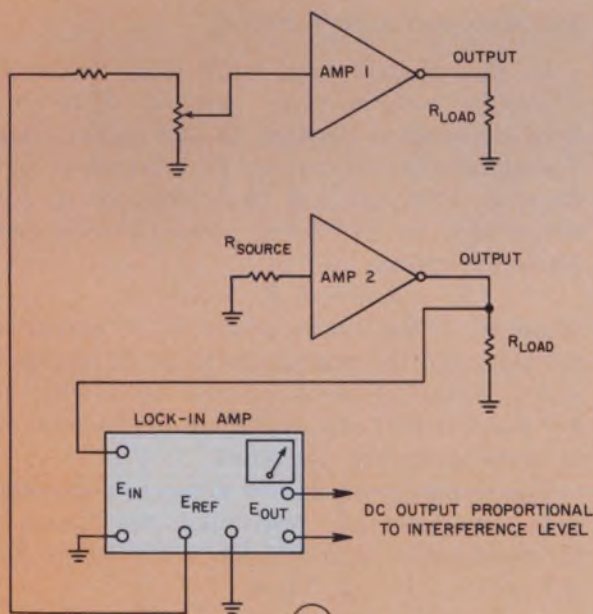

(c)

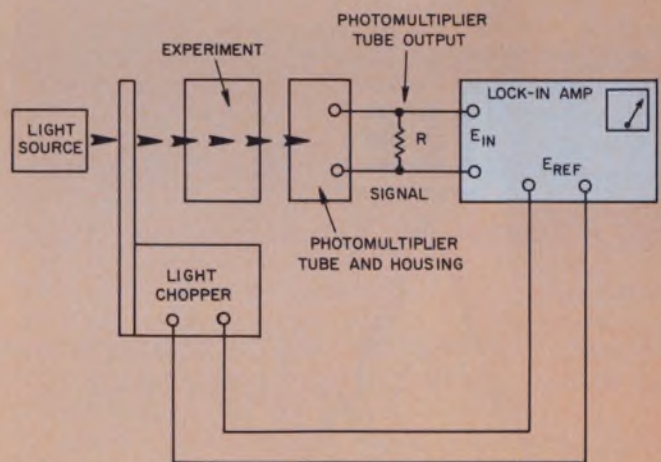

(f)

6. In typical applications, the lock-in is used to measure the open-loop gain of an op amp (a); to determine the C-V (capacitance-voltage) characteristics of an MOS semiconductor (b); and to measure amplifier crosstalk

(c). But the lock-in's versatility is demonstrated by its use as a temperature controller (d), eddy-current tester (e), and photometric instrument (f). In some cases, the lock-in's oscillator acts as reference and excitation.

IEE-POLARIS™

FIELD EFFECT LIQUID CRYSTAL DISPLAYS

- Ideal for high ambient lighting and low power, portable equipment applications



- Individual left hand decimals, overflow ± 1 , & colon (:) for clock and counter applications

- 200 lines/cm resolution; 25:1 contrast

- Reflective or transmissive, 3½ decade arrays with .43" high, 7-segment characters

- 40-50 msec switching time

- Extremely low power (<1/2 μ W per segment @ 10-15VAC, 30-1000 Hz)



- Slim profile (.125")

- Long life (20/000 hours @ 12VAC); broad operating range (-10 to +65°C)

For your every man/machine interface requirement, IEE has a solution. From "the Olympus of Displays," the world's most diversified selection of display products, technologies, and design expertise, IEE offers you your choice of:

- Multiple Message Displays — rear projection; status indicator/annunciators; mini-CRT's
- Dynamic Message Displays — 64 & 256 character dot matrix panels
- Numeric & A/N Displays — line filament; neon; transilluminated;



LED's (with integrated electronics); liquid crystals; gas discharge; fibre-optics

- Subminiature Lamps — LED & incandescent
- Low Profile Switches — completely sealed, illuminated, custom arrays
- Peripheral Accessories — universal mounting hardware; bezels;

interface circuitry

- Customized Products & Multi-Function Systems. Never has so much been available to so many from a single source. Hadn't you better write or call today for your copy of IEE's Product Selector?

the Olympus of displays

Industrial Electronic Engineers, Inc.
7740 Lemona Ave., Van Nuys, Calif. 91405
Phone: (213) 787-0311 TWX 910-495-1707

European Office: 6707 Schifferstadt, Eichendorff-Allee 19, Germany.

DIAL-A-SOURCE: Call toll-free 800-645-9200

meter are acceptably small, no further filtering is needed. These figures correspond to an output bandwidth of 0.159 Hz. If system Q is defined as the center frequency divided by the 3-dB bw, the lock-in amplifier Q is approximately 8700—a super-narrow band by any definition.

Details of the measurement are as follows:

Suppose you want to measure the second harmonic generated in the signal channel of a typical lock-in with a plug-in preamplifier; the lock-in amplifier thus serves as both the system under test and the analyzer (Fig. 4).

A low-distortion oscillator, set to 700 Hz, serves as both the lock-in amplifier reference and, with a 1000:1 attenuator, the 5-mV input to the preamp. With the reference-channel mode switch in the f/2 position, the lock-in amplifier responds to only 1400 Hz.

The signal-channel notch mode (predetection filter) is used to attenuate the fundamental by nearly 80 dB. This reduces the likelihood of mixer overload as the sensitivity is increased. An oscilloscope connected to the monitor output connector (premixer) helps adjust the notch for maximum effectiveness.

With this configuration, a 130-nV rms signal is measured on the 200-nV full-scale range. This corresponds to 26 ppm of the second harmonic. How much of this is contributed by the excitation source? To determine this, an alternate method can be implemented—one that doesn't require the excitation source to be stringently pure (Fig. 5).

Excitation source isn't critical

In this method two 5-mV rms uncorrelated sinusoidal sources are applied differentially with the plug-in preamp to the signal channel. The signal-channel output, E_o (disregarding predetection filtering), can be determined by substitution of $E_i = A(9 \cos x + \cos y)$ in the power-series expansion:

$$E_o = K_1 E_i + K_2 E_i^2 + K_3 E_i^3 + \dots, \quad (1)$$

where E_i = the input voltage, K_1 = signal-channel gain, and the remaining K_2 = distortion constants. Since the measurement deals with ultra-low distortion effects and small excitations, higher order terms are neglected.

The response consists of many ac components: each fundamental, respective harmonics and intermodulation products $ax \pm by$, where $1 \leq a \leq 2$ and $1 \leq b \leq 2$. Thus

$$E_o = K_1 A (\cos x + \cos y) + K_2 A^2 \left[1 + \frac{\cos 2x + \cos 2y}{2} + \cos(x+y) + \cos(x-y) \right] + K_3 A^3 \left[\cos \frac{3x + \cos 3y}{4} + \dots \right]$$

$$\frac{9}{4} (\cos x + \cos y) + \frac{3}{4} [\cos (y+2x) + \cos (y-2x) + \cos (x+2y) + \cos (x-2y)] .$$

To determine the system's second-harmonic distortion, measure either of the intermodulation products $(x+y)$ or $(x-y)$ without worrying about the purity of either excitation source.

The useful relationships between harmonic distortion and the intermodulation products are obtained when Eq. 1 is expanded for a single input ($E_i = A \cos x$), and then compared with the two-input expansion (Eq. 2).

When this is done, the second harmonic distortion then equals one half the magnitude of the intermodulation component at frequency $x+y$ (or $x-y$), divided by the magnitude of the fundamental.

Similarly, the third-harmonic distortion equals one third the magnitude of the intermodulation component at frequency $ax + by$ (or $ax-by$), divided by the magnitude of the fundamental. Therefore:

$$\text{2nd harmonic distortion} = \frac{K_2 A}{2K_1}$$

$$\text{3rd harmonic distortion} = \frac{K_3 A^2}{4K_1}$$

where $a \neq b \neq 0$.

With a measured 120 nV at both the sum and difference frequencies (700 ± 200 Hz), the second-harmonic distortion is $1/2 \times 120 \times 10^{-9} / 5 \times 10^{-3}$, or 12 ppm. It can be claimed that the oscillator contributes $130 - 60 = 70$ nV of second harmonic, well within the manufacturer's specifications. The assumption made here is that the second harmonics generated by the oscillator and lock-in are in phase at the signal-channel output. The signal-channel predetection filter is placed in the bandpass, rather than notch, mode because two strong components are present at 700 and 200 Hz.

To obtain the lock-in amplifier reference drive, multiply the oscillator outputs and tune the selective amplifier to the desired frequency, 500 or 900 Hz. Similarly you can find the third-harmonic distortion by measuring one of the intermodulation components associated with the K_3 coefficient—that is, the $(y+2x)$ term. This requires an additional multiplier (squarer) to obtain a suitable reference.

The results should not imply that 12 ppm is the measurement limit. Actually one to two orders of magnitude less distortion can be measured with the lock-in method. Typical applications are shown in Fig. 6.

Note that in some cases no external generator is needed since the lock-in's internal oscillator serves as both the reference and excitation source. ■■

IEE-TITAN™

PROJECTION READOUT DISPLAYS

- World's most extensively used message displays • Completely versatile — displays any image, color, message, type style reproducible on film
- Bright, easily legible, single plane, 160° wide angle viewing with variable brilliance
- Displays from 12 to 48 messages per module • Easily combined into multi-module, integral assemblies for added information capacity • 14 different models — character heights from 3/8" to 3 3/8"; Mil-Spec option • Ultra-reliable, non-mechanical, passive operation; easy unitized installation; long life, low power, subminiature incandescent lamps



From the very beginnings of information display, IEE has been a leader in the innovative design, successful introduction, reliable manufacture, condensed packaging, and effective application of high quality, display devices and integrated systems for commercial, industrial and military use. Based on two decades of experience, and a dedication to quality, IEE today offers: • the world's most diversified selection of display products • the design, human factors, and

systems integration expertise to fulfill your most sophisticated requirements. • the pricing, product availability, and productive capacity to meet your most demanding schedules • and the ingenuity and sincere desire to help solve your most complex display problems. Information Display is OUR business; why not contact the experts for YOUR solutions? Call or write today for information regarding introductory offers on prototype evaluation quantities of many of IEE's display products.



the Olympus of displays

Industrial Electronic Engineers, Inc.
7740 Leona Ave., Van Nuys, Calif. 91405
Phone: (213) 787-0311 TWX 910-495-1707

Announcing: 164 assemblies per hour

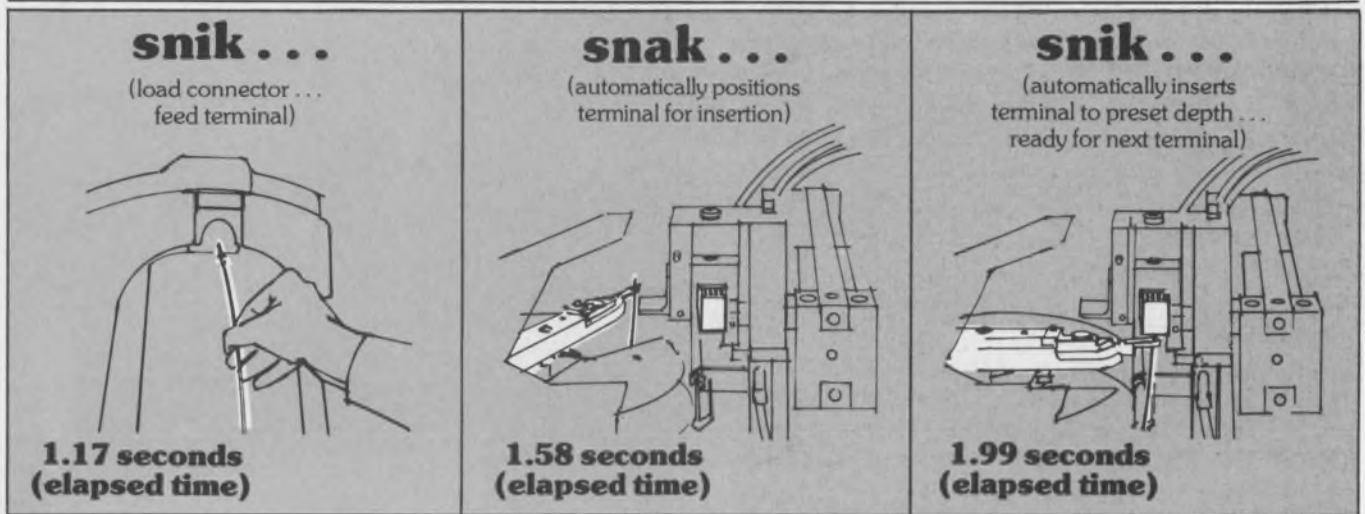

. . . times 11 terminals

one completed connector every 21.9 seconds*
or 164 connector assemblies per hour

*Based on an inexperienced operator using a new Molex-A-Matic machine to insert 11 wire leads with Molex .093 dia crimped terminals into 12-circuit Molex connectors.

You'll need two hand assemblers to keep up with the new Molex-A-Matic machine.

Molex first brought you economy with its .093 crimped terminals and connectors.

Now we bring you *speed* . . . with the new Molex-A-Matic assembly machine that puts Molex connectors together 50% faster than you can by hand.

All the operator does is load the Molex-A-Matic with connector housings and feed it wires terminated with Molex .093 male or female leads. Molex-A-Matic is programmed



to do the rest: position housing . . . insert terminal to exact depth and lock it in place . . . repeat until the preset number of terminals are inserted . . . then eject the completed connector—*all automatically*.

Molex-A-Matic can cut your per unit assembly costs in half while it cuts rejects, and helps eliminate the need for visual inspection. It's designed to handle 14-24 AWG wire, 3 to 36" long with insulation diameter .058 to .125.

molex . . . *Affordable Technology*

Molex Incorporated, Dept. ED1074, 2222 Wellington Court, Lisle, Illinois 60532

WHEN DIP RELAYS ARE CALLED FOR, CALL FOR US



You can call on us for help in solving any relay-related problem. That's how we built our reputation in the first place. We took on the toughest applications problems you could hand us. And we solved them — with innovative engineering, advanced production techniques, tight

quality control. We still invite your custom business, though our standard product lines will meet most any need.

If you have an application that calls for DIP packages, for instance, you'll be interested in our complete line of form A, B and C DIP reed relays. They are contained in the standard 14-pin DIP package capable of insertion in standard 14-pin DIP sockets or automatic insertion in P.C. boards. Available in either 3 or 10 watt form A and form B contacts, and 3 watt form C contacts, they can be driven directly by TTL logic, and provide total isolation between input and output circuits. The hermetically sealed reed switch contacts provide millions of trouble free operations.

Elec-Trol DIP reed relays are available with 8 or 14 terminals, with or without internal clamping

diode across the coil, and with optional electrostatic shielding and contact run-in. (The internal lead frame serves as a magnetic shield.) Epoxy encapsulation yields high shock and vibration immunity and provides total protection to coil and reed switches in hazardous environments.

If you'd like specific technical information, call or write us at the address below. Ask for our DIP Reed Relay Catalog No. 103. We'll send it by return mail.

ELEC-TROL INC.

26477 North Golden Valley Road
Saugus, California 91350
Telephone: (805) 252-8330
(213) 788-7292 TWX 910-336-1556

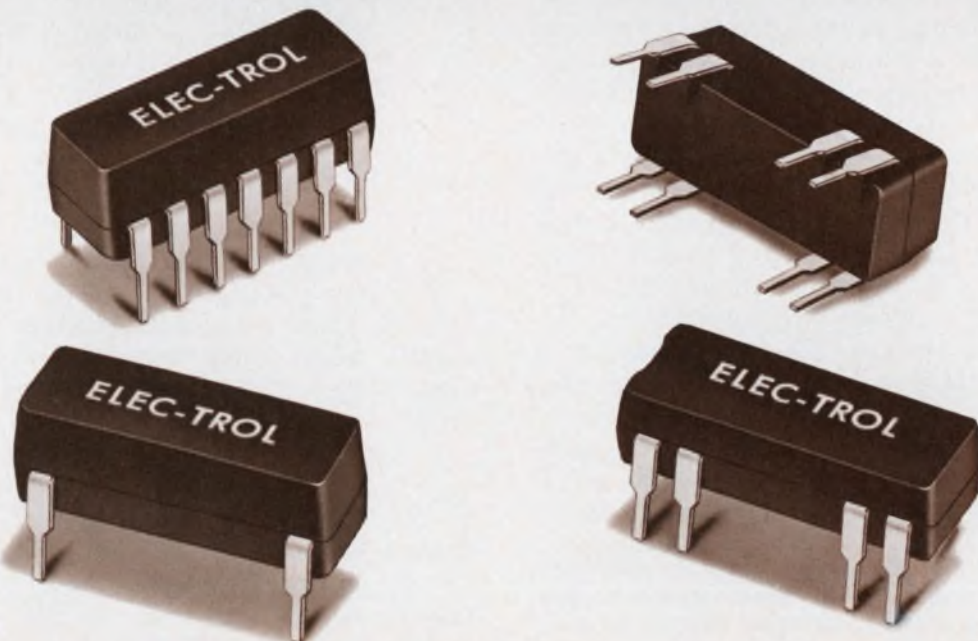

Measure power with a calculator chip and a DPM. By direct multiplication of current and voltage, you can cover a dynamic range of almost seven decades.

With an inexpensive digital panel meter and a calculator chip, a new mode of power measurement is now possible—one that is more accurate, more stable and less expensive than analog methods. The method uses direct digital multiplication of voltage and current to get the power.

Other advantages accrue. First, multiplication automatically doubles the dynamic range. With a 3-1/2-digit DPM, you can measure almost seven decades of power. Second, autoranging is provided—an almost accidental benefit that stems from the output format of the chip.

The power-measuring system uses a modified DPM to convert the analog voltage and current signals to digital format and to display the calculator-chip output. This dual role results in significant parts savings and is made possible by electrical separation of the conversion and display functions within the panel meter.

Analog switch samples voltage and current

Fig. 1 shows how the voltage and current in the load resistor, R_L , are measured and multiplexed into the DPM's a/d converter. A precision resistor, R_1 , with a value roughly equal to the load resistance, is connected in series with the load. A DPDT analog switch alternately switches between the two resistors in synchronism with the DPM's conversion clock at approximately 5 Hz.

When the switch is in the down position, the voltage across the load is amplified and sent to the DPM. With the switch in the up position, the DPM's input is the voltage across R_1 and therefore proportional to the load current. Thus the digitized V and I signals alternately appear at the DPM's BCD outputs. Both the voltage and current are sampled to make it possible for the instrument to handle an unstable load resistance.

The differential amplifier provides gain with which to calibrate the system and set the limits of the power measurement. If the full-scale, even-

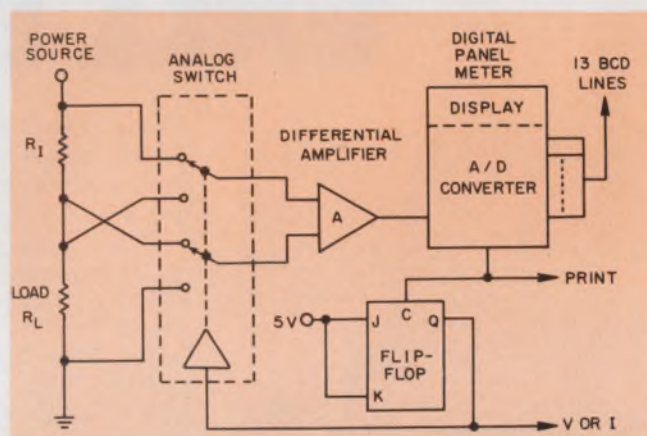

1. Load voltage and current are sampled by the analog switch and then multiplexed to the DPM, where both are changed to digital form by the DPM's a/d converter. The sampling process is controlled by the internal clock of the panel meter. Since voltage and current are measured independently, the meter can handle unstable loads.

decade reading of the DPM is V_{FS} , the required gain is:

$$A = V_{FS} (R_1 P_{FS})^{-1/2}$$

where P_{FS} is the desired full-scale power reading. If the DPM has a 100% overrange capability, the power meter will have a 300% overrange. Typical design parameters are:

$$\begin{aligned} R_L &\approx 100 \Omega \pm 20\% \\ R_1 &= 100.0 \Omega \pm 0.1\% \\ V_{FS} &= 1.000 \text{ V, } 3\text{-}1/2 \\ &\quad \text{digits with } 100\% \\ &\quad \text{overrange} \\ P_{FS} &= 100 \text{ mW} \\ A &= 0.3162 \end{aligned}$$

$$\text{Dynamic range} = 100 \text{ nW to } 399 \text{ mW}$$

It is important that R_L and R_1 have the same nominal value to give the voltage and current signals nearly equal resolution. As the values spread, the dynamic range of the system decreases.

It's simple to separate the display and conversion functions in most DPMs. (A quick call to the manufacturer yields a full circuit diagram.) The BCD outputs of the a/d converter are usually available at the back panel, and all that is needed is to bring out the inputs of the BCD-to-seven-segment decoder drivers.

G. P. Klein, Electronic Engineer, and C. A. Hamilton, Electronic Engineer, Institute for Basic Standards, National Bureau of Standards, Quantum Electronics Div., Boulder, Colo. 80302

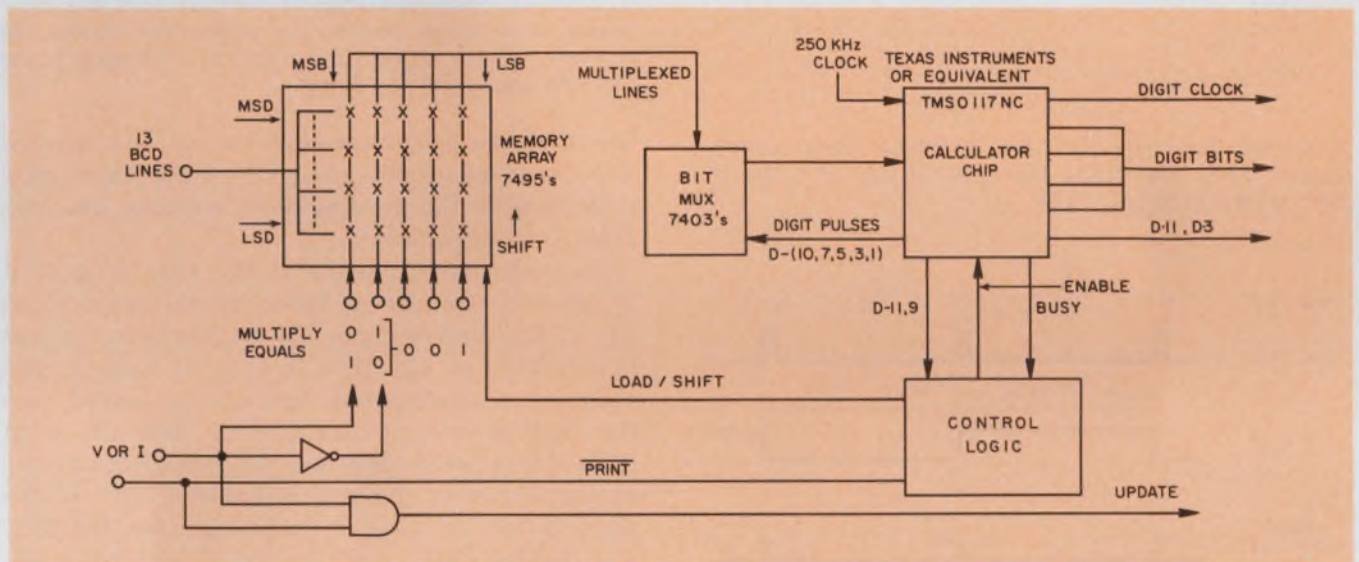

2. Power is derived by direct multiplication in the calculator chip of the BCD numbers for voltage and current.

To do this, sever the BCD input leads of the decoder DIP with a rotary-cutting tool, and attach leads from those pins to unused pins on the back panel. It may also be necessary to alter the DPM's input filter to ensure that the settling time is less than the time interval between conversions.

The calculator chip, a four-function device with BCD inputs and outputs (for compatibility with the panel meter), requires a 250-kHz external clock with a voltage swing from $V_{GG}(-)$ to $V_{SS}(+)$ as shown in Fig. 2. The chip then provides sequential digit pulses at 11 terminals; the 12th terminal gives a shorter, digital-clock pulse nested within each of the 11 others. The digit pulses run from D11 to D1, then repeat each 1.7 ms.

During the D10 to D1 times, numeric data appear on the four BCD lines. The output is thus bit-parallel and digit-serial MSD to LSD. During the D11 time either a "busy" or "ready" status is indicated (busy line HIGH). Output data are valid during the digit-clock pulses.

Data input is in the form of a five-bit word, with four bits for data/instruction code and the fifth bit to determine whether the four-bit code is interpreted as data or as an instruction.

A memory array stores and a multiplexer subsequently enters the data into the chip.

To conserve pins, the data input is bit-serial and digit-serial MSD/D to LSB/D.

Serialization of each digit occurs when the five-bit input code is multiplexed with the D10, D7, D5, D3 and D1 digit-pulse lines. Five NAND gates make up this bit multiplexer, and the data input is initiated by a HIGH on the chip-enable line.

Since the calculator chip is an MOS device, a TTL/MOS interface is required at the inputs and outputs. For inputs, open-collector gates can be used; for outputs, a simple voltage divider referenced to $V_{GG}(-)$ will suffice.

Data from the panel meter a/d converter are in parallel form and must be loaded into a memory array to convert to the format needed by the calculator chip. Further, a command—"multiply" or "equals"—must be entered at the end of each set of digits. This is accomplished with the shift registers shown in Fig. 2. At the end of an a/d conversion, the 13 parallel output bits of the DPM are loaded into the presets of the shift registers.

The three other data latches, plus the fifth-bit register, are loaded with ZEROs. The enable line is now taken HIGH, and the five-bit code for the first digit is multiplexed into the chip

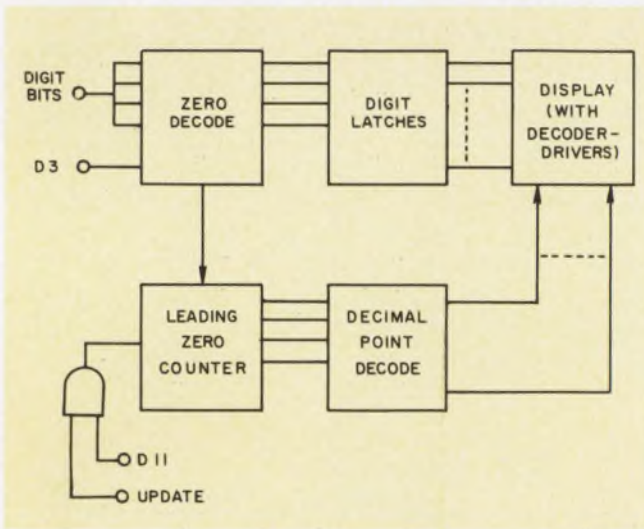

3. Output logic receives the calculator data, counts leading zeros and loads the DPM display with the 3-1/2 most-significant digits.

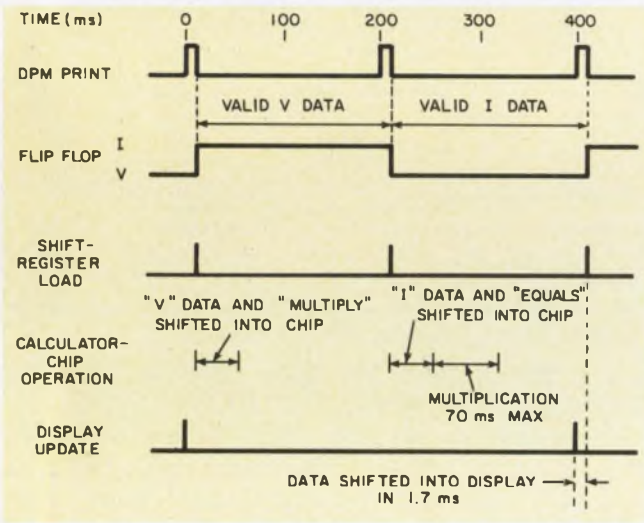

4. Timing of the power calculation is controlled by the DPM's conversion clock. The display is updated after two conversions, or about twice a second.

in one digit cycle.

At the end of this cycle, the chip goes "busy" for two digit cycles, during which no data are accepted. When "busy" returns to "done," a shift pulse is generated and the next digit is loaded.

As the digits are shifted out, the command is shifted into the registers. When the command reaches the output lines, further shift pulses are inhibited, the command is loaded into the chip, and the enable line is taken LOW until the next a/d conversion. After the "equals" command is received, the chip goes busy for up to 70 ms while the multiplication is performed. The beginning of the next a/d conversion produces a display update pulse.

Fig. 3 shows how the 3-1/2 most-significant

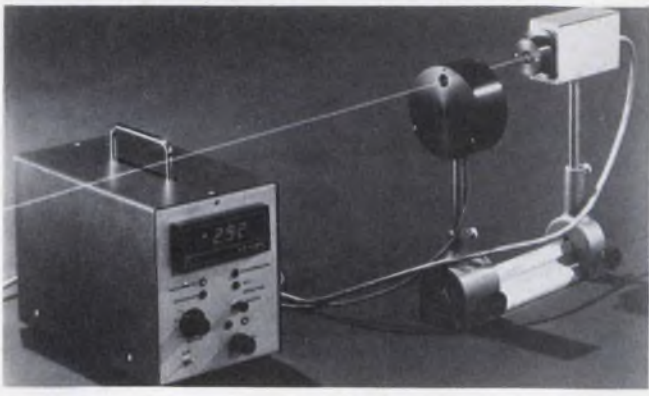

5. Electrical power is computed and displayed in a pyroelectric laser power meter. The instrument makes use of a null balance between the electrical calibration power and the laser's optical power.

digits of the calculator-chip output are selected and displayed. During the D11 time the update pulse resets the leading-zero counter and enables the output logic.

As each digit appears at the chip output, it is decoded, and one of three operations occurs: (1) If the digit is zero, the leading-zero counter is incremented. (2) If it is one, the leading-zero counter is incremented, the one is loaded into the leading one of the display and the next three digits are loaded into the remainder of the display. Further digits are ignored. (3) If the digit is two to nine, it is loaded into the first full display digit, and the next two digits fill the remainder of the display.

If no nonzero digits have been detected at the D3 time, D3, D2, and D1 are loaded regardless of value. At the end of this sequence the display will contain the 3-1/2 most-significant digits of the chip output, and the leading-zero counter will contain a number that can easily be a display that autoranges over five decades.

Fig. 4 shows how the free-running conversion clock of the DPM controls the sequence of a power-calculation cycle. With the analog switch in the V position, an a/d conversion is completed in about 10 ms. The V data are loaded into the shift-register memory and, together with a multiply command, shifted into the calculator chip.

Meanwhile the analog switch moves to the I position. Similarly at the end of the I conversion, the I data and an "equals" command are sent to the chip. The beginning of the next V conversion produces an update pulse and loads the display.

In a typical application the power meter is used to calibrate a thermal detector (See "Photodetector Calibrated by Electrical Method," ED No. 2, Jan. 18, 1974, p. 28). The detector, in turn, is used to measure the optical power output of a laser (Fig. 5). ■■

ERIE RESPONDS. that's why WE'RE NO. 1 WORLDWIDE in Ceramic Capacitors



Forty years ago, ERIE foresaw a need and introduced the first ceramic capacitor to U.S. markets. Today, more than 7000 people—working in a million-plus square feet of plant space—in seven nations . . . are still dedicated to fulfilling customer needs. Our state-of-the-art ceramic technology continues to lead the way in the development of smaller, more efficient ceramic capacitors, both fixed and variable. And ERIE's line of high quality components is as broad as the markets we serve. So when knowledgeable people think ceramic capacitors, increasingly, they think ERIE. To remain number one in our competitive industry, we have to be responsive to your needs. We think we are. Try us.

ERIE TECHNOLOGICAL PRODUCTS, INC.
Erie, Pennsylvania 16512
INFORMATION RETRIEVAL NUMBER 142



How National gets of a falling

This is our temperature transducer (A) that is activated by the heat of the cigar and transmits a signal by the 2-Wire Transmitter (B) to the device that tips the steel ball off its perch, activating — as it rolls down the ramp causing a whoosh of air — the pressure transducer (C), which signal is transmitted again via the 2-Wire Transmitter (B) to the A/D Converter (D) which converts this analog signal to a digital signal which feeds into our IMP-16 microprocessor (E) which is programmed to react to this particular

input by activating a digital read-out (F) which flashes a coded warning to the unsuspecting man (H), and in case this warning isn't heeded, activating, after going through a D/A Converter (D), a device which pushes the man out of the way of the falling steel ball.

What's the point?

The fact that nowadays the

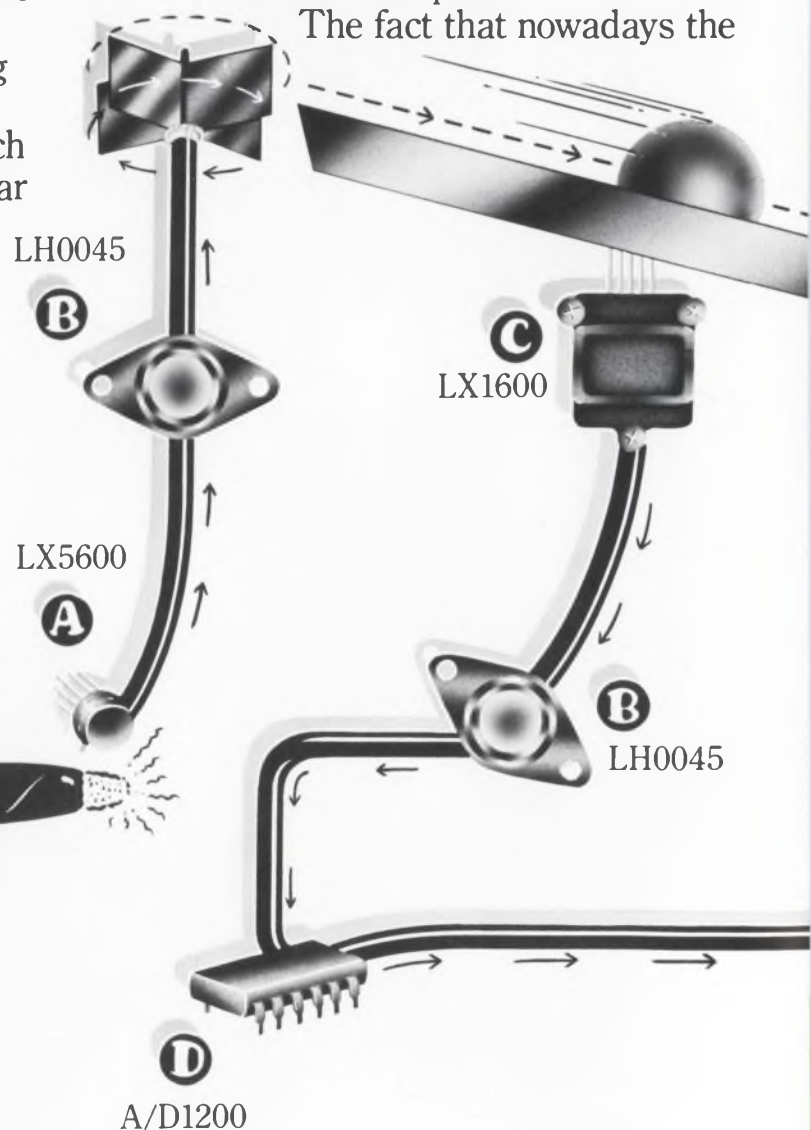

you out of the way steel ball.

heart of just about any new control system is a microprocessor...and National Semiconductor makes 'em. In 4, 8 and 16-bit versions. In chip, card and system form.

Of course, the microprocessor must communicate with the "outside world." And we make most of the stuff you'll ever need for that, too...some of which is shown here.

We also have technical field application engineers in your area to work with you on your particular problem.

Even problems more prosaic than getting out of the way of a falling steel ball.

Please rush me the following information:

- | | |
|--|---|
| <input type="checkbox"/> Interface | <input type="checkbox"/> MICROPROCESSOR |
| <input type="checkbox"/> Special Function | <input type="checkbox"/> Transducer |
| <input type="checkbox"/> Send a Field Application Engineer | <input type="checkbox"/> LED |

Name _____ Title _____

Company _____

Address _____

City _____ Zip _____

National Semiconductor 2900 Semiconductor Drive,
Santa Clara, Calif. 95051 Attn: Marketing Services

NATIONAL

INFORMATION RETRIEVAL NUMBER 143

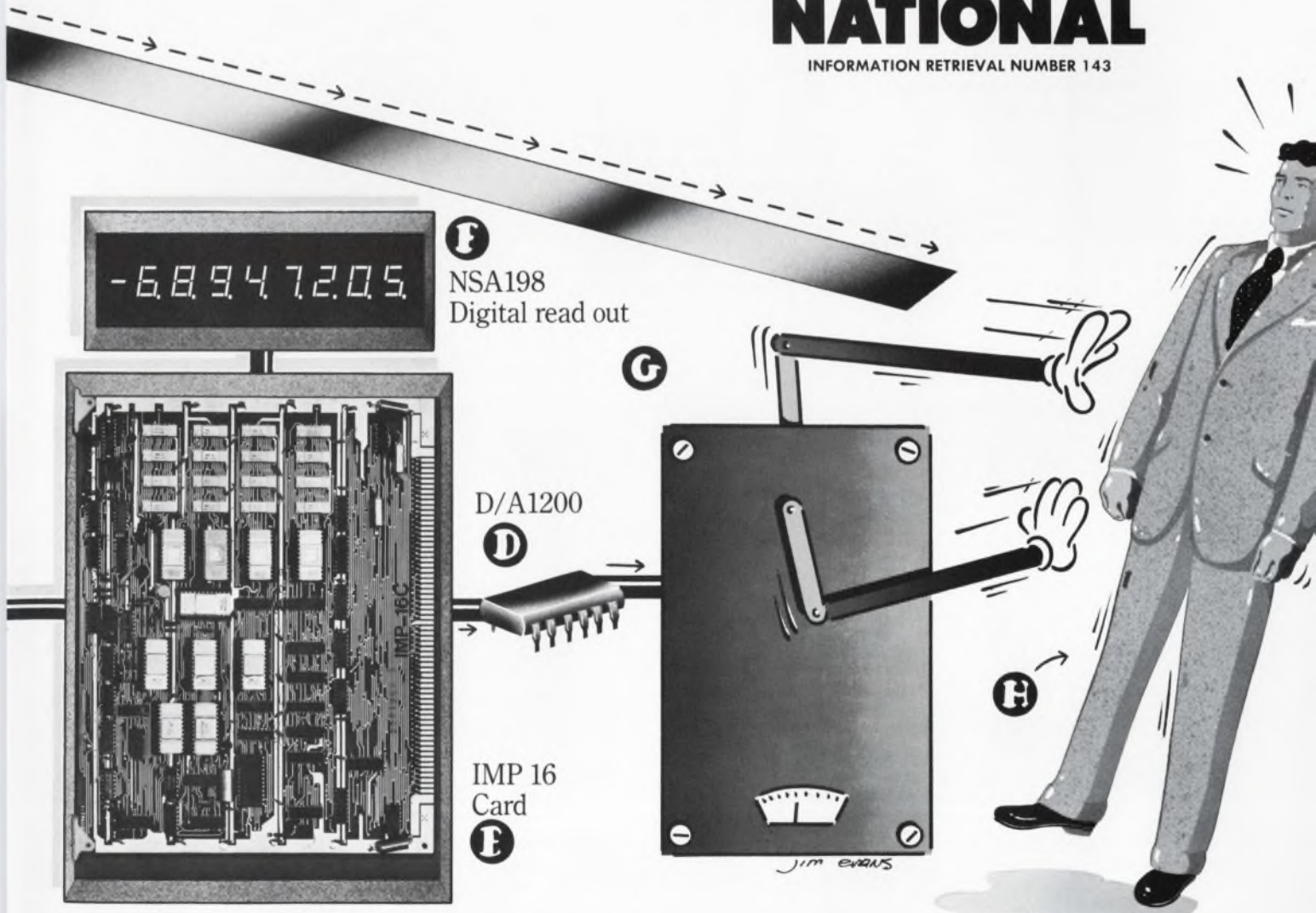

A NEW FIELD-OF-ONE IN LIGHTED PUSHBUTTON SWITCHES.

Switchcraft's "PUSH-LITE" switch offers reliable leafspring switching in a neat little package.

This whole new field of compact ($1'' \times 1\frac{1}{6}'' \times 1\frac{3}{4}''$) pushbutton switches reduces the size of your control panels, consoles—and cost, too! Our new field-of-one consists of 6 series—including non-illuminated and illuminated single and twin-lamp units in two housing colors (black or grey). Up to 4PDT switching in momentary and push-lock/push-release functions. Ratings range from dry circuit switching, up to 3 amps., A.C., non-inductive load.

A rugged molded housing encloses the highly reliable leafspring switching and protects against dust, dirt and mishandling.

Pick from flange or barrier mounting—individually or in matrix configurations. Series PL "PUSH-LITE" switches mount from front of panel with clamp brackets, simply and quickly. No mounting screws show!

Design with up to two lamps and either full or split display screens—vertically or horizontally. Full display provides up to 3 lines of 6 characters each. Virtually unlimited lighting versatility

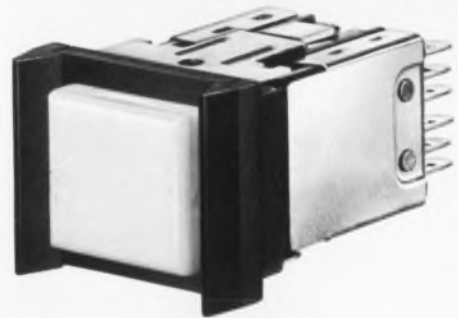

ACTUAL SIZE

provided by 7 different colors of pushbuttons, insert filters and silicone boots.

For additional information, contact a Switchcraft Representative or write for Catalog S-345. SWITCHCRAFT, INC. 5529 N. Elston Avenue Chicago, Illinois 60630

INFORMATION RETRIEVAL NUMBER 144

SWITCHCRAFT
INC.

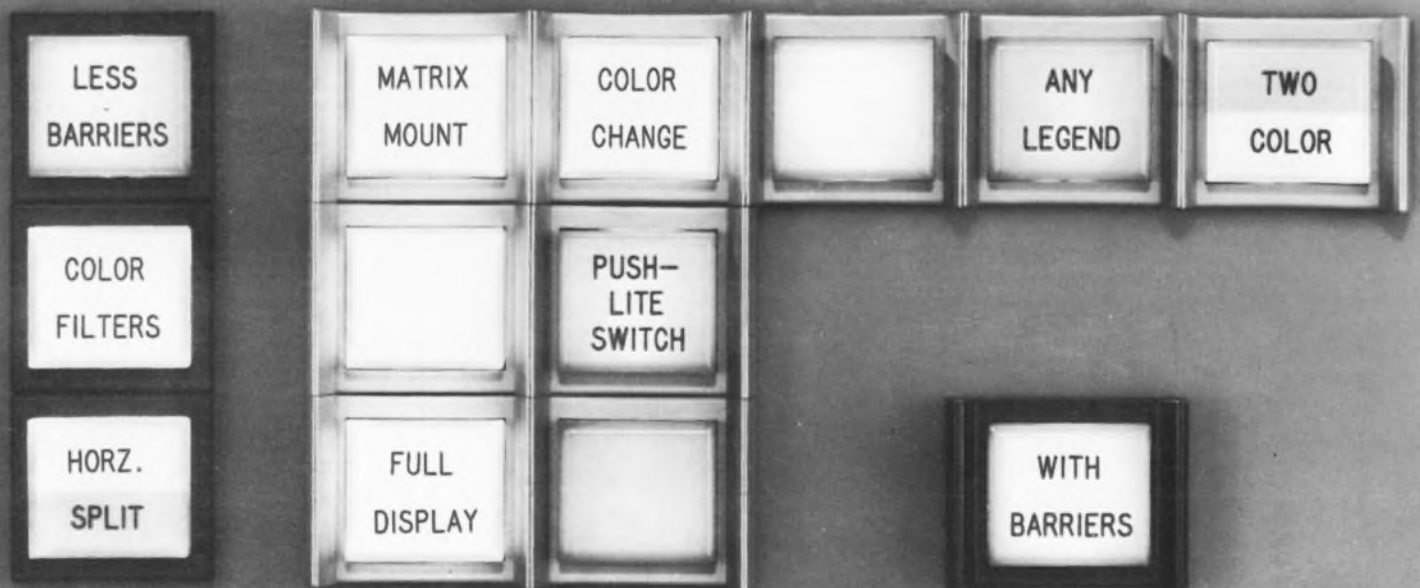

A new concept in packaged power circuits as convenient as the TV dinner.

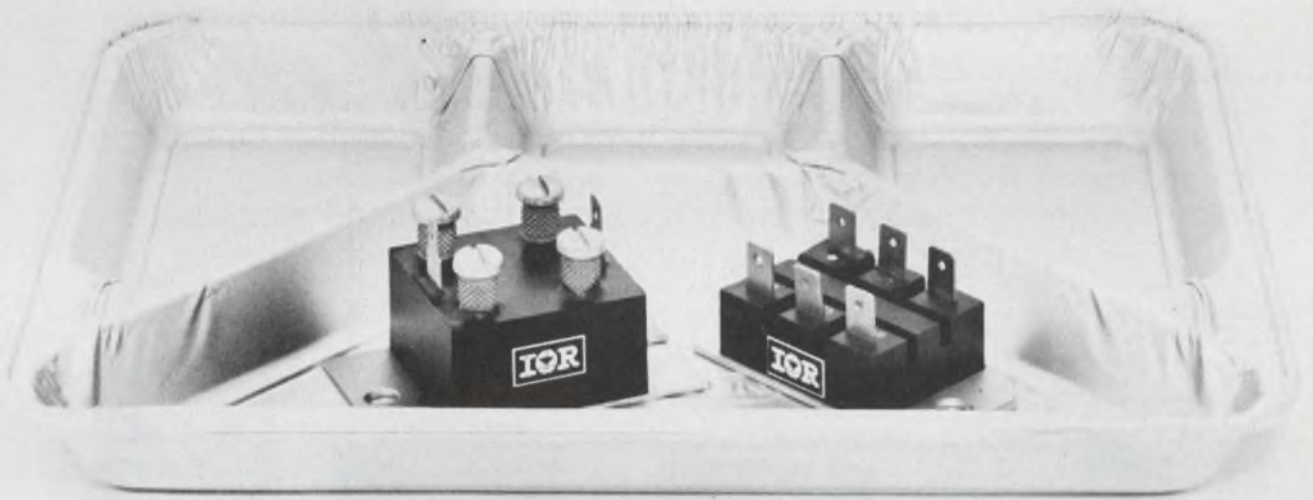

The International Rectifier PACE/pak™ is the device behind this new concept.

They are power integrated circuits, made up of SCRs, diodes, triacs, etc. which give you a complete control circuit function in a single package. And like the TV dinner, they take most of the shopping and assembly times out of the job.

But that's just the beginning of the benefits they offer.

Smaller size. PACE/paks (Passivated Assembled Circuit Elements) are electrically isolated up to 2.5 kV. There's no need for a separate isolated heat-sink, so you get up to 60% reduction in space requirements.

A better designed system. With the smaller size of these power hybrid control circuits you get more design and packaging flexibility. And since you don't have to spend time designing with discrete components, you have more time to make other improvements.

One-fifth the assembly time. No more do you have to assemble five to seven devices for single and 3-phase functions. With the PACE/pak there is just one part to mount, one part to interconnect with push-on or screw terminals. Your system reliability is higher, too.

Just think of the other savings you can make in testing, inspection and field servicing.

Lower inventory costs. We estimate a 7-to-1 reduction in inventory, plus savings in procurement time and costs. Standard PACE/pak circuits now cover 90% of single-phase power circuit requirements, with more in development for 3-phase applications.

They are available as standards with 25 or 42.5 Amp current ratings, in either 120 or 230 Volt RMS versions.

Find out how PACE/paks will revolutionize your designs like dc motor controls, inverters, chopper drives, generator exciters, solid-state circuit breakers, battery chargers and variable dc power supplies.

Call your local IR sales office for details or contact the factory: *International Rectifier • 233 Kansas Street, El Segundo, CA 90245 • (213) 678-6281 • TELEX: 67-4666.*

International Rectifier

... the innovative power people 

ADVERTISING SELLS A LOT MORE THAN CARS, COOKIES AND COMPUTERS.

Just name the good cause and chances are awfully good that advertising has given it a helping hand.

Corporations, advertising agencies, and communications media — through the Advertising Council — have been donating their time, talent and money for 30 years.

Because advertising works for cars and cookies and computers. And it works just as hard for education and health and peace.



Advertising contributed for the public good



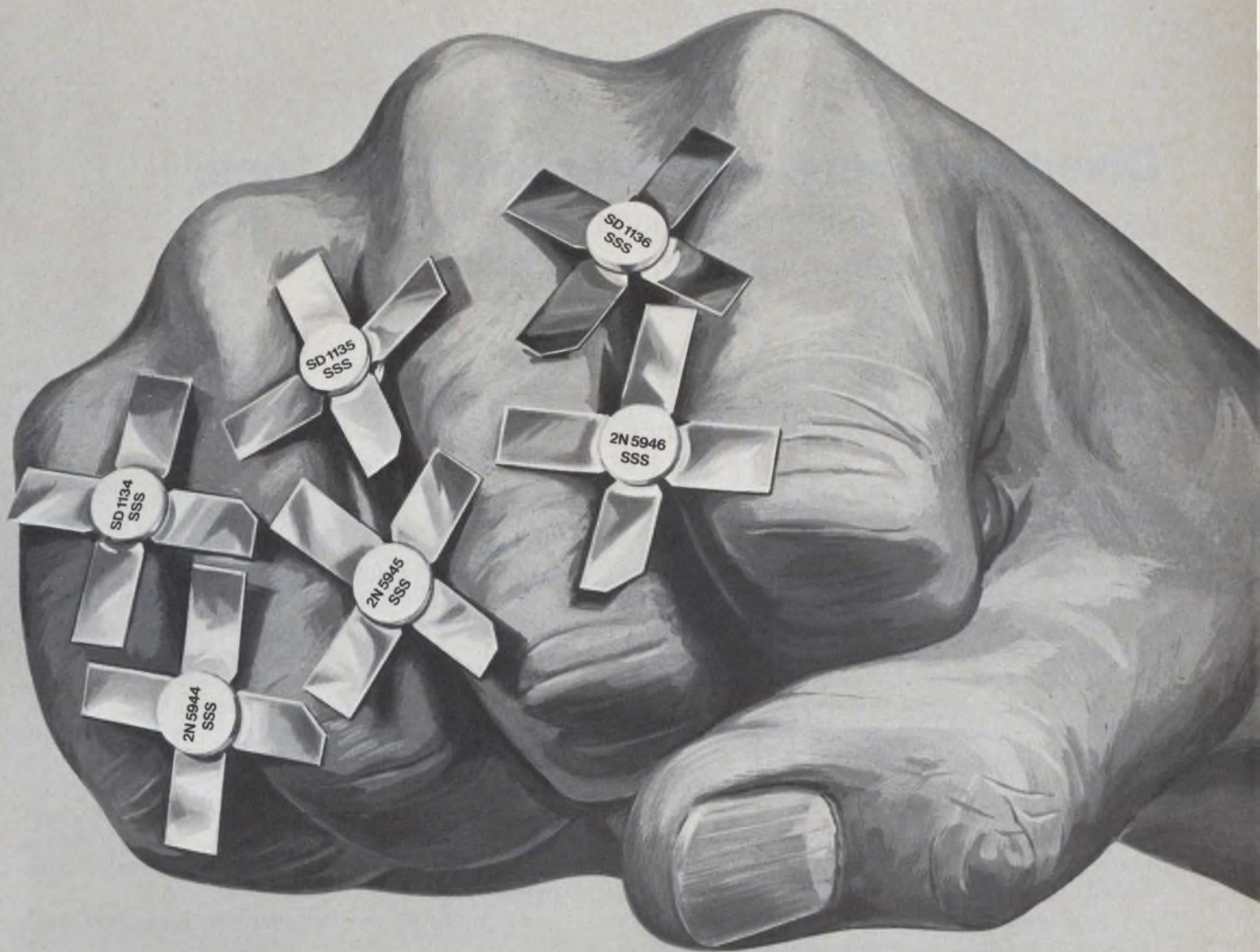

470 MHz power.

From the alternate source that's better than equal.

Six new RF power transistors. The SD1134, SD1135 and SD1136 are equivalent to the PT8809, 10, and 11 (2.0, 5.0 and 10 watts) respectively; three are equivalent to 2N5944, 45, and 46 (2.0, 4.0, and 10 watts) respectively. All are standard MT-90s. Available immediately.

These Solid State Scientific transistors are precisely identical, in all performance values, to those they replace. They're the products of our own rigorous internal lot and process controls, which assure com-

plete reproducibility of significant electrical characteristics.

They're 100% tested for VSWR and other RF parameters in end-use radios. And our outgoing inspection matches or exceeds your incoming.

We also produce a great many other RF power transistors for land, mobile, marine and aircraft radios; and CATV. All made by people who know exactly what they're doing. Write or call for data sheets, prices and consultation on circuit applications.



SOLID STATE SCIENTIFIC INC.

Montgomeryville, Pa. 18936/(215) 855-8400/TWX 510-661-7267

The RF power specialists

INFORMATION RETRIEVAL NUMBER 146

Diversity keeps engineers on their toes, especially if they work for a small company that's competing in three markets with one basic product.

The biggest challenge to engineering and to the management of our company is that we diversify one basic product to meet three different markets. We did it by decentralizing and giving engineering managers full rein to run the three lines of business.

Our product is a microprocessor computer system that's based on the latest technology in semiconductors, logic and memory. Most companies our size—\$5-million, 100 employees—that have one basic product usually concentrate on a single marketplace and sell to the OEM. We sell to the end-user, which means that we have to develop a lot more engineering insight about his problems than we ever did with the OEM.

We've taken our computer-based system into three vertical markets: (1) word processing, where we have a range of competitors from automatic typewriters all the way up to very sophisticated time-sharing word-processing systems; (2) intelligent terminals; and (3) business functions, such as data processing and accounting.

Learning to divide and conquer

To pursue three markets with the same basic product, we decided a year ago to apply the management that is characteristic of much larger companies. We formed three product-line departments—a word-processing department, an intelligent terminal department and a data-processing department—and an operations group that is responsible for manufacturing the product.

Managers of the product-line departments maintain their own software development, engineering and product marketing. Each is also responsible for his own profit and loss.

Giving product managers the profit and loss responsibility is done in many large companies, but in a small company that's only four years old it's unusual.

To motivate the manufacturing people—those in the operations group—we measure what they do on a cost basis rather than a profit-and-loss

basis. We transfer the product at cost from the manufacturing area into the three product centers, where the markup of profit is taken.

Product engineering, which supports manufacturing, is also under the control of the operations manager. His biggest problem, of course, is keeping three different product managers happy at the same time.

We don't believe in having a centralized engineering staff in either hardware or software. We put our engineers with the other members of whatever program they're working on. I think that engineers enjoy the interaction of the marketplace. In larger companies I think that the engineer often gets too far away from the customer. If we centralized, the engineers would not be exposed to the day-to-day running of the business. I like to think that we're creating potential business managers out of these engineering managers.

All three of our product-line managers have

Richard L. Petritz and Linolex

Dr. Petritz, President of Linolex Systems, Inc., came into the computer field via the semiconductor business. In 1969 he was a founder and the first president of Mostek Corporation, a successful semiconductor company. Both Mostek and Linolex received their initial capital from New Business Resources (NBR), a Dallas based venture capital company of which Dr. Petritz is a founder and general partner.

Prior to the formation of NBR, Dr. Petritz was Director of the Semiconductor Research and Development Laboratory at Texas Instruments, during which time he was an early forecaster and spokesman of the importance of Large Scale Integration. His keynote address

Richard L. Petritz, President, Linolex, North Billerica, Mass. 01862.

come up through engineering. A good engineering manager in this company has a good opportunity to run a total business. He has a career development path that is unlimited. This is another benefit of our decentralized system.

The right ratio of chiefs and Indians

Besides profit and loss, what else are the product-line managers responsible for?

In the word-processing department he's responsible for the design of the peripheral devices that make the basic computer system a word processor, such as printers and magnetic card readers.

The intelligent-terminal engineering manager concentrates on communications—emulating various other terminals on data entry, magnetic tapes and other peripheral devices that are used in the communications business.

Peripherals that are pertinent to data-process-

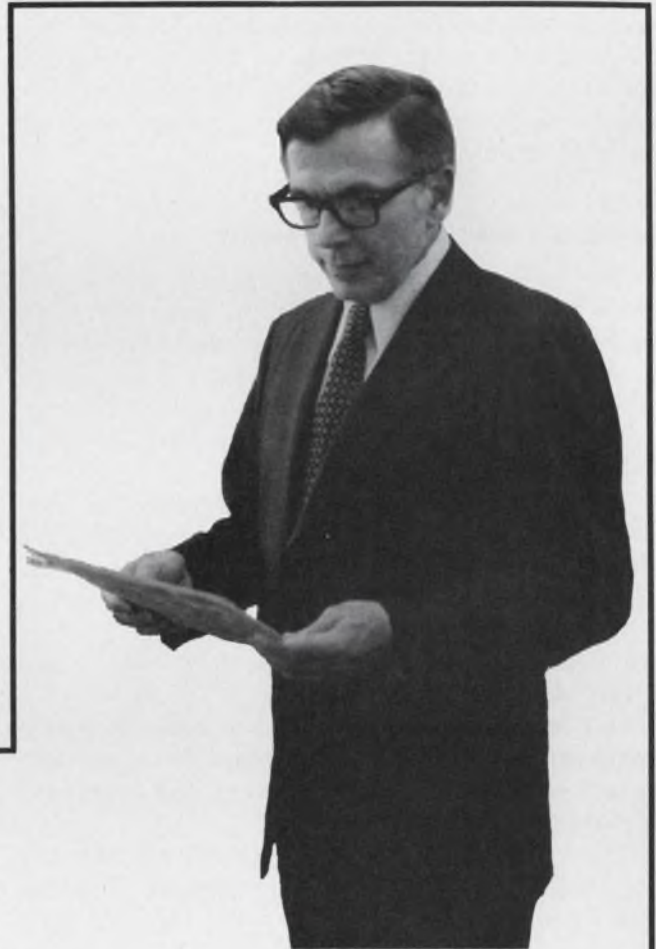

at the 1966 Fall Joint Computer Conference, "Technological Foundation and Future Diversions of Large Scale Integration," still stands as a landmark forecast of the direction and impact of LSI on electronics.

Holding a PhD degree in Physics and a Bachelor and Masters degree in Electrical Engineering from Northwestern University, Dr. Petritz has published more than 25 technical papers on the subject of transistors, integrated circuits, LSI, physics of photoconductors and information theory. Several of his papers have been cited by professional organizations including his original paper on the theory of noise in transistors which received the Browder J. Thompson Award of the IEEE.

Dr. Petritz presides over a five-year-old Massachusetts corporation that manufactures and sells a small computer system which contains a video display, a keyboard and three cassette magnetic tape drives integral with the

central processor. This configuration of equipment combines a business-oriented computer with a flexible medium for local storage and an operator-oriented man/system interface to give stand-alone processing power.

The company also delivers asynchronous and synchronous communications adaptors, type-font and matrix printers, data processing magnetic tapes and card readers to adapt the system to the needs of several specific markets into which its products are sold. Disc storage is proposed to enhance the local storage characteristics of the system.

ing applications, including high-speed printers, floppy discs and hard discs, are the responsibility of the data-processing manager.

So the engineering talent is spread among these three departments, plus manufacturing. Coordinating the work of all four departments is the responsibility of the manager of operations, who must be a very solid engineer. He holds a council meeting with the engineering managers from his own group. This group is responsible for the computer system itself—its design and manufacture.

This engineering council has representation from the three other departments that are concerned with peripheral engineering. Through frequent meetings, the group is able to keep different people from working on the same problem and to make sure that someone is always working on vital problems.

Giving the basic product versatility

You may wonder how we make a single machine perform satisfactorily in three different markets. For example, in the word-processing market customers would like to have a very large CRT for a large screen. In the intelligent-terminal market, a large screen isn't needed; it would only add to the cost.

We've tried to arrange a compromise. We present a relatively large screen to both markets. We show a person a screen of 20 lines by 80 characters. We can also "fold" our line, so that the width can be extended to 158 characters, and we can scroll vertically in case they want to see a full page sequentially.

Our engineers are motivated to take this basic concept, that of the same machine, to three different markets and to try to turn the disadvantages into advantages.

Creative engineering has enabled us to come up with good solutions to customer's problems and to enlarge our markets. To do this, we need to have a close relationship with the customer. This is why we formed the product-line organizations. We have marketing people in each of the product lines who return daily with customer feedback.

Each of the three markets present very different competition. The competitors in word processing hard-wire their machines. These machines are designed to do a very specific function, and they get locked into the hard-wired approach.

From an engineering point of view, you might think that these machines could process words better, because the product is designed specifically to do that. We've countered that by programming our machine with software. Our software engineers are constantly looking for ways to improve our word processor. Every three months

we ship software releases to our customers to enhance the use of our word processors. But there are drawbacks. Keeping track of the support for all these software releases is a major logistics problem.

A number of competitors also make hard-wired data-communications equipment in the intelligent-terminal area. Here again, our engineering counterthrust is to add power and flexibility to the machine through software. With advanced software, we can emulate many communications terminals. Occasionally we will update the hardware—for example, replace the communication adapter with one of a higher speed.

Making it universal and maintainable

We tried to figure out how to make a single keyboard that would function effectively in three markets.

For word processing, we had a keyboard that resembled the Selectric Typewriter. We had a teletypewriter layout for the intelligent-terminal area and a slight variation of that for the data-processor product. We decided on a universal keyboard, which combines the best features of the Selectric layout. The control is a shift-lock key.

If we hadn't decided to develop a universal keyboard for the three markets, it would have been impossible for a company our size to support the product in the field. It would have been too difficult and too expensive to produce the different programs and the different keyboards. It was far easier to make compromises with our customers.

To service this machine, we're using upgraded typewriter repairmen. This presents an interesting engineering problem: how to make a machine serviceable by relatively untrained people. We designed the machine for board replacement, making it diagnostic so the serviceman can determine the faulty board and replace it, rather than trying to repair any part of it.

The biggest problem that a company like ours has is trying to introduce new products at a rapid enough pace. As a small company, we can have a new product that's exciting for X number of years, but technology moves on, and we've got to compete with someone else who's using that new technology.

How do we do it quickly enough so we don't become obsolete?

Small companies are limited financially; it's hard enough for big companies. Modest-sized companies are not so apt to be blind to the need for these products, but they may not have the physical resources to do the job. Keeping our engineers closely coupled to our customers' needs or requirements is our best insurance against product obsolescence. ■■



INGENUITY
in creating gearmotors.

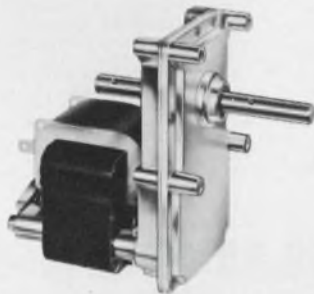

Right from the start. Our people apply inventive skill and practical imagination to your specific gearmotor needs.

Initial concept. Prototypes. Manufacturing techniques. — Every step of the way. Creating gearmotors from 1/100 to 1/10 hp.

With individual, personalized attention-to-detail that earns the confidence of OEM design engineers and purchasing agents alike. Plus in-plant facilities and experienced know-how in volume production that all adds up to "custom capability second to none."

No wonder leading manufacturers of computers, vending machines, business equipment, appliances and others look to Molon.

For innovations in rotary electrical motion . . . due to Molon Ingenuity in creating gearmotors. Right from the start.

And that's not all you get at

 **MOLON**

3737 INDUSTRIAL AVE., ROLLING MEADOWS, ILL. 60008 312/259-3750

INFORMATION RETRIEVAL NUMBER 50

hurst INSTRUMENT MOTORS

"The **BIG LINE** of small motors!"

MODEL K
REVERSIBLE
SYNCHRONOUS
AND
NORMAL SLIP
INDUCTION

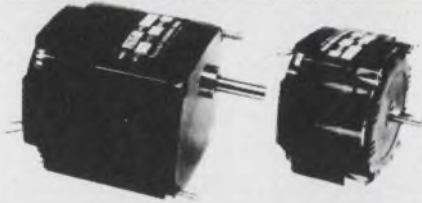

"Heli-Spur" gearing. Primary gear stage is "HELICAL" for quiet operation. Secondary gears precision-machined steel "SPUR" with the heavier load carrying gears case-hardened for longer service life.

Sealed ball bearings on the rotor shaft. Stainless steel output shaft supported by bronze inboard and output bearings with axial thrust provisions. All motors sealed, require no maintenance lubrication.

Output speeds .9 thru 1800 RPM. STOCK SPEEDS: RPM 1-1/2-2-3-4-6-10-15-25-30-60-100-150-200-300-1800-9-1.9-5.5-8.8-26-52-1550

Gear train rating 250 oz. in. @ 1 RPM

Geared models, \$25.75 up in 1000 lots incl. capacitor
Direct drive models, \$19.40 in 1000 lots incl. capacitor

MODEL T
REVERSIBLE PERMANENT
MAGNET SYNCHRONOUS

For continuous-duty applications

High Torque: 8 1/2 oz. in. at 300 RPM

Recommended Gear Train Loading: 250 oz. in. at 1 RPM

Fast Start/Stop

Heat Rise: 40° Full Load

Stock Speeds: 1-2-4-6-10-30-60-120-300

(For other Speeds, contact Factory.)

Geared models \$17.12 up in 1000 lots incl. capacitor.

Direct Drive model 300 RPM \$10.31 in 1000 lots incl. capacitor.



GEARED



DIRECT DRIVE 300 RPM



MINI-BEE
1/100 HP
1800 RPM

MODEL MB
HYSTERESIS SYNCHRONOUS MOTOR, LOCKED ROTOR TORQUE 6 OZ. IN (1800 RPM)

The "Mini-Bee" is also ideally suited for numerous other direct drive applications where synchronous characteristics are advantageous in the power range of 1/100 HP. 1800 RPM in 1000 lots \$27.89 incl. capacitor.



CASSETTE DRIVES/VIDEO RECORDING/INSTRUMENTATION/TAPE RECORDING DATA HANDLING/TELE-METERING/HIGH SPEED PRINTERS

NEW HIGHER TORQUE



1/35 HP
1800 RPM

MODEL HB
HYSTERESIS SYNCHRONOUS INVERTED ROTOR DESIGN, LOCKED ROTOR TORQUE 23.5 OZ. IN. (1800 RPM) REVERSIBLE. CAPACITOR INCLUDED

ALSO AVAILABLE AT 900 RPM, 1200 RPM AND DUAL SPEED.

900/1800 RPM

Single Speed 1800 RPM \$37.33 in 1000 lots incl. capacitor.



MODEL EA

MODEL EA HYSTERESIS SYNCHRONOUS 3600 RPM THRU 2/3 RPM MOTOR TORQUE 150 OZ. IN. AT 1 RPM

Unidirectional, CW or CCW Rotation

STOCK SPEEDS: CW ROTATION: 1-2-4-6-8-10-12-20-30-60-120 RPM
For other speeds or CCW Rotation "BUILT-TO-ORDER", CONTACT FACTORY.
Geared models \$8.06 in 1000 lots
Direct Drive 3600 RPM \$4.82 in 1000 lots

MODEL DA REVERSIBLE HYSTERESIS SYNCHRONOUS

Motor Torque 150 OZ.-IN. AT 1 RPM

Reversible (with SPDT switching), this heavy duty motor maintains complete timing accuracy both clockwise and counter-clockwise.

STOCK SPEEDS: RPM 1-2-4-6-8-10-12-20-30-60-120
FOR OTHER SPEEDS CONTACT FACTORY \$11.17 in 1000 lots capacitor incl.

MODEL CA REVERSIBLE HYSTERESIS SYNCHRONOUS

1200 RPM Thru 1/3 RPM

Motor Torque 100 oz. -in. at 1 RPM

STOCK SPEEDS: RPM 1/3-1/2-1-1 1/2-2-3-4-5-6-8-10-12-15-20-30-40-60-120-150-200-240-400-600
Also available in direct drive 1200 RPM
FOR OTHER SPEEDS CONTACT FACTORY
Price \$10.32 in 1000 lots for geared models
Capacitor Incl.



MODEL DA



MODEL CA



MODELS PC-DA AR-DA

MODEL PC-DA REVERSIBLE BRAKE AND CLUTCH MOTOR STARTS AND STOPS IN 20 MILLISECONDS

STOCK SPEEDS: RPM 1-2-4-6-8-10-12-20-30-60-120
Reversible. Capacitor incl. For other speeds contact factory \$15.30 in 1000 lots

MODEL AR-DA HYSTERESIS SYNCHRONOUS AUTOMATIC OR MANUAL RESET REVERSIBLE

STOCK SPEEDS: RPM 1-2-4-6-10-30-60
FOR OTHER SPEEDS CONTACT FACTORY
Price \$17.99 in 1000 lots
Capacitor included



MODEL GA

MODEL GA HYSTERESIS SYNCHRONOUS MOTOR TORQUE 600 OZ. -IN. AT 1 RPM

Designed for long life and higher torque applications. Offers instrument manufacturers high performance as well as economy. Output gears are heat-treated alloy steel for maximum torque capacity and long life. Gears near output end of the gear train run in bearings of special alloy bronze for added strength and durability. Higher speed gears attached to hardened and polished steel pivots, which run in inserted bearings, one on each end of the pivot.
STOCK SPEEDS: RPM 1-2-3-4-5-6-10-18-30-60-100-120-150-300
FOR OTHER SPEEDS, CONTACT FACTORY
Price range \$19.95 up in 1000 lots incl. capacitor

hurst MFG. CORP.

MOTOR DIVISION
PRINCETON, INDIANA 47670

Phone (812) 385-2564

Circle Number for General Catalog and Price List.

NOTE: All prices subject to change without notice.

Only Sylvania gives you so many ways to beat the real estate squeeze in PC-board indicator lamp arrays.

When you're laying out an indicator lamp array in tight spacing, you need solutions to a wide range of applications problems . . . not just lots of sizes. That's why we've packed so much versatility into our line of PC-board compatible bi-pin lamps.

For example, our new T-2 Tu Pin line offers a wide range of voltages and currents in flat-top bulbs designed for maximum end light output—all engineered with the legendary reliability we've perfected for the telephone industry over the years. For that matter, we've even come up with a special reflectorized version for dramatically increased light output.

But that's just the start. Add our T-1 $\frac{3}{4}$ and T-1 Bi Pin lamps to the breadth of the T-2 line and you've got lamps with ratings of from 3 to 48 volts, in sizes to meet all needs.

For still more design freedom, our Pin Socket Lamps (another Sylvania first) come with sockets installed on the lamp pins. Solder them into your PC-board, and presto—the lamp is field-replaceable without desoldering. You can even order the lamps with leads bent to 90° so that the lamp lies parallel to the board.

Any way you look at it—if you want versatility in PC-board compatibility, what you want is what we've got. Write or call: Sylvania Miniature Lighting Products Inc., a subsidiary of GTE Sylvania, 526 Elm St., Kearny, N. J. 07032; (201) 997-1850.

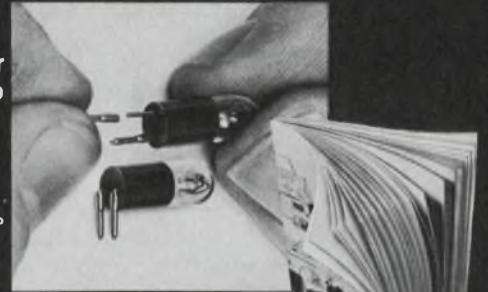

TYPICAL APPLICATIONS: keyboards • busy field arrays • switches • circuit resistors • electronic POS

	Design Volts Range	Design Amperes Range	MSCP Range	Rated Avg. Life Hours Range
T-1	5.0 to 28.0	.021 to .115	.030 to .15	10,000 to 60,000
T-1 $\frac{3}{4}$	3.0 to 28.0	.014 to .350	.004 to .650	1,000 to 60,000
T-1 $\frac{3}{4}$ Pin Socket Lamps	1.35 to 28.0	.014 to .350	.01 to .650	600 to 50,000
T-2 Tu-Pins	4.0 to 14.0	.010 to .080	.01 to .50	5,000 to 50,000
T-2 Tu-Pin Reflectors	4.0 to 48.0	.010 to .200	.01 to .50	5,000 to 50,000

ONE SOURCE, ONE CATALOG
Send for the 56-page Design Data Handbook and full-line Catalog written specifically for the practicing engineer and designer

GTE SYLVANIA

Pack 'em in.

Inductance calculation simplified for small air-wound coils

Use the accompanying graph to design vhf inductors quickly. You need only decide on the physical dimensions of your inductor, and you can find the required number of turns with the graph. The graph provides the specific-inductance value, L_0 , in nanohenries (nH) for a single-turn inductor over a range of dimensions. The curve covers 2 to 50-mm average diameter and up to 50-mm of length. The inductance, L , of any inductor is then given by $L = L_0 n^2$, where n is the number of turns. The graph is derived from the equation

$$L = \frac{n^2 r^2}{9r + 10 \ell},$$

converted for metric dimensions.

Suppose you need 200 nH and your coil is to be 20-mm long on a 6-mm diameter form. You're using 1-mm-diam wire. The average coil diameter is thus 7 mm, and the L_0 value from the graph is approximately 2 nH. The number of turns is then

$$\sqrt{\frac{200}{2}} = 10 \text{ turns.}$$

Martin Mann, Chartered Engineer, 45 Old School Lane, Milton, Cambridge, England CB4 4BS.

CIRCLE No. 311

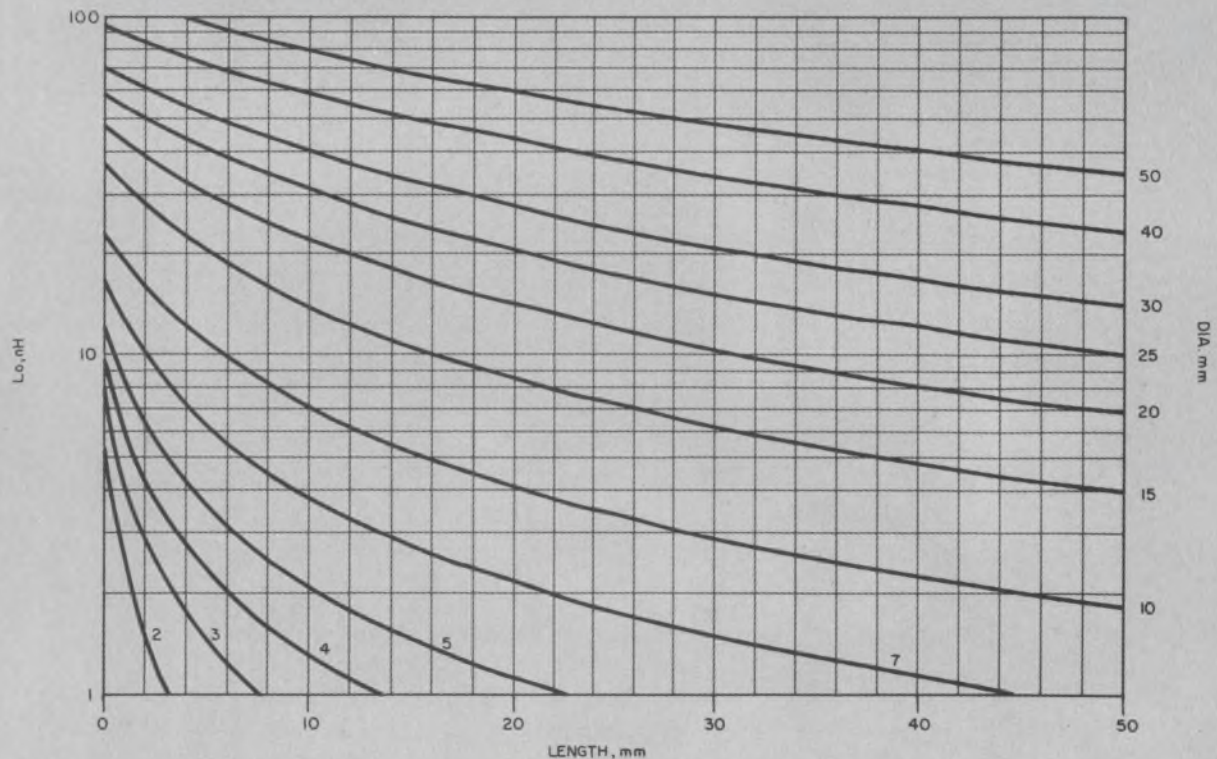

The specific inductance of a small coil can be obtained if you know its length and average diameter.

±15 VOLT POWER MINI'S FOR OP AMPS

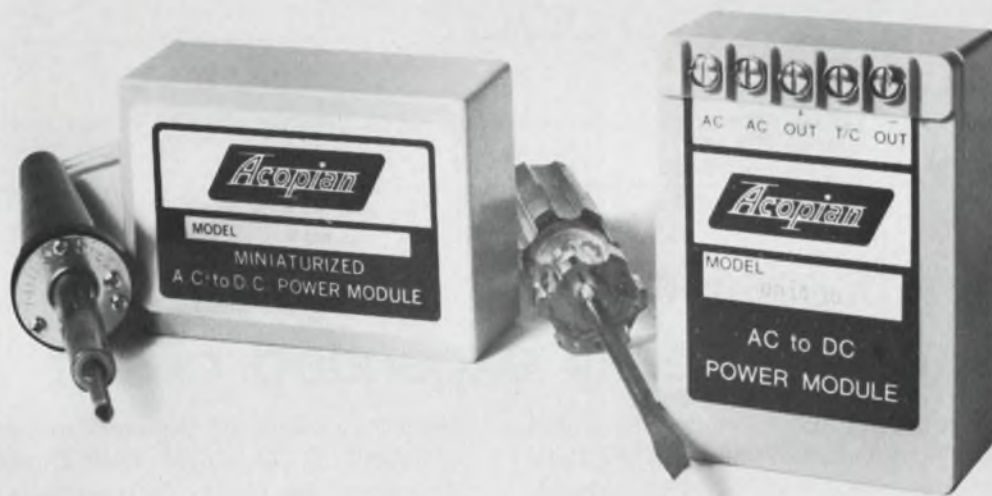

ALL MODELS U.I. RECOGNIZED

PC-BOARD MOUNTING

OUTPUT CURRENT MA	SIZE INCHES	PRICE	MODEL
25	2.3 x 1.8 x 1.00	\$24	D15-03
50	2.3 x 1.8 x 1.00	39	D15-05
100	3.5 x 2.5 x 1.00	49	D15-10A
200	3.5 x 2.5 x 1.00	69	D15-20
300	3.5 x 2.5 x 1.25	105	D15-30
500	3.5 x 2.5 x 2.00	130	D15-50

CHASSIS MOUNTING

OUTPUT CURRENT MA	SIZE INCHES	PRICE	MODEL
100	3.5 x 2.5 x 1.38	\$55	DB15-10
150	3.5 x 2.5 x 1.38	65	DB15-15
200	3.5 x 2.5 x 1.38	75	DB15-20
300	3.5 x 2.5 x 1.63	105	DB15-30
350	3.5 x 2.5 x 1.63	110	DB15-35
500	3.5 x 2.5 x 2.38	135	DB15-50

Line/load regulation, $\pm 0.1\%$ or better; ripple, 1 mv; input, 105-125 VAC. Other single and multiple output models from 1 to 75 volts, to 2.5 amps. Liberal quantity discounts. Three-day shipment guaranteed.

Complete details on these plus a comprehensive line of other power supplies and systems are included in the Acopian 74-75 catalog. Request a copy.



Corp., Easton, Pa. 18042. Telephone (215) 258-5441.

INFORMATION RETRIEVAL NUMBER 54

Boost transistor-level supply voltages to make a low-power, high-voltage supply

Need a small amount of high-voltage power in your transistor circuit? The simple circuit shown uses an inductor and a high-voltage switching transistor to perform a 10-to-15-times voltage multiplication with about 75% efficiency.

When transistor Q is driven into conduction by the drive input, inductor L stores energy in its magnetic field. When Q cuts off sharply, L generates a high-voltage pulse ($e = L di/dt$) at Q's collector. Diode D directs and isolates the

pulse to a 10- μ F filter capacitor and the load. The 25- μ F solid-tantalum capacitor completes the discharge path for L, and bypasses the 28-V power source.

For a load of 100-k Ω , about 250 V at 2.5 mA is delivered.

James Williams, Senior Engineer, Dept. Nutrition & Food Science, Instrumentation Laboratory, Massachusetts Institute of Technology, Cambridge, Mass. 02139. CIRCLE NO. 312

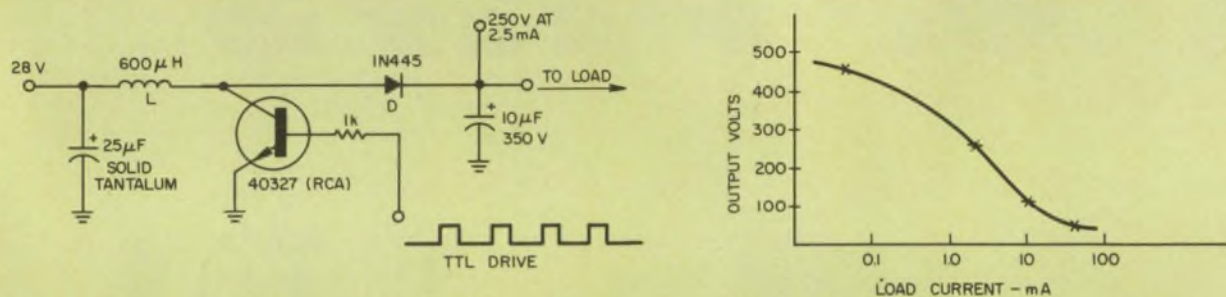

Small amounts of high-voltage power can be obtained with a simple inductor and high-voltage transistor.

Burst of preset number of pulses obtained with easily expanded circuit

With a BCD-coded thumbwheel switch and a 7490 decade counter per decade—plus a 7402 NOR gate and some diodes—any number of presettable decades may be cascaded to produce a burst of a specific number of pulses.

In the figure, when the burst-complete line is LOW, the clock-enable HIGH and the reset LOW, the clock-in pulses are gated through G₃ and the resultant burst-out pulses enter the input of the first decade counter. When the number of output pulses equals the number set on the thumbwheel switches, the burst-complete line goes HIGH and the clock-enable LOW to disable output gate G₃. Also, the reset line goes HIGH to reset the counters. At this point the burst-complete lines goes LOW again, but the enable line is still disabled through the bistable action of G₁ and G₂.

A positive-going pulse-start signal will initiate such a sequence and a burst of pulses from the output of G₃, but the pulse must return to ZERO before another burst can be started. The pulse-start signal must be long enough to toggle G₂. Note that the output burst is a complement of the clock input and that the counter increments on

the rising edges of the clock pulses.

Russell L. Gephart, Test Equipment Design Engineer, Beckman Instruments, SpincO Div., 1117 California Ave., Palo Alto, Calif. 94304.

CIRCLE NO. 313

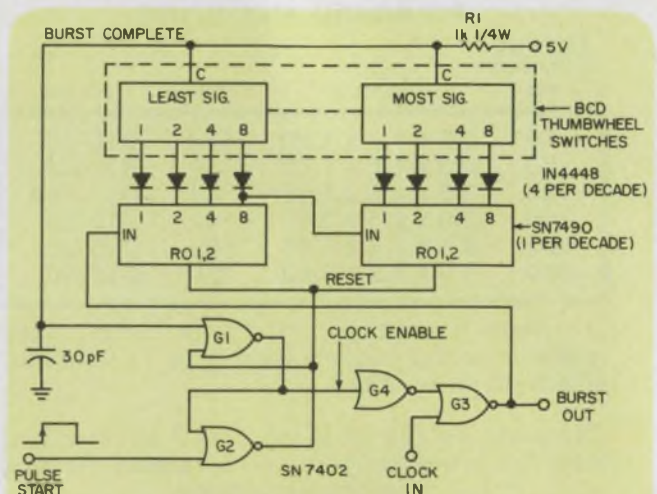

One 7402 NOR gate can control the switching for a large number of thumbwheel-programmed pulses.

GI expands automatic insertion

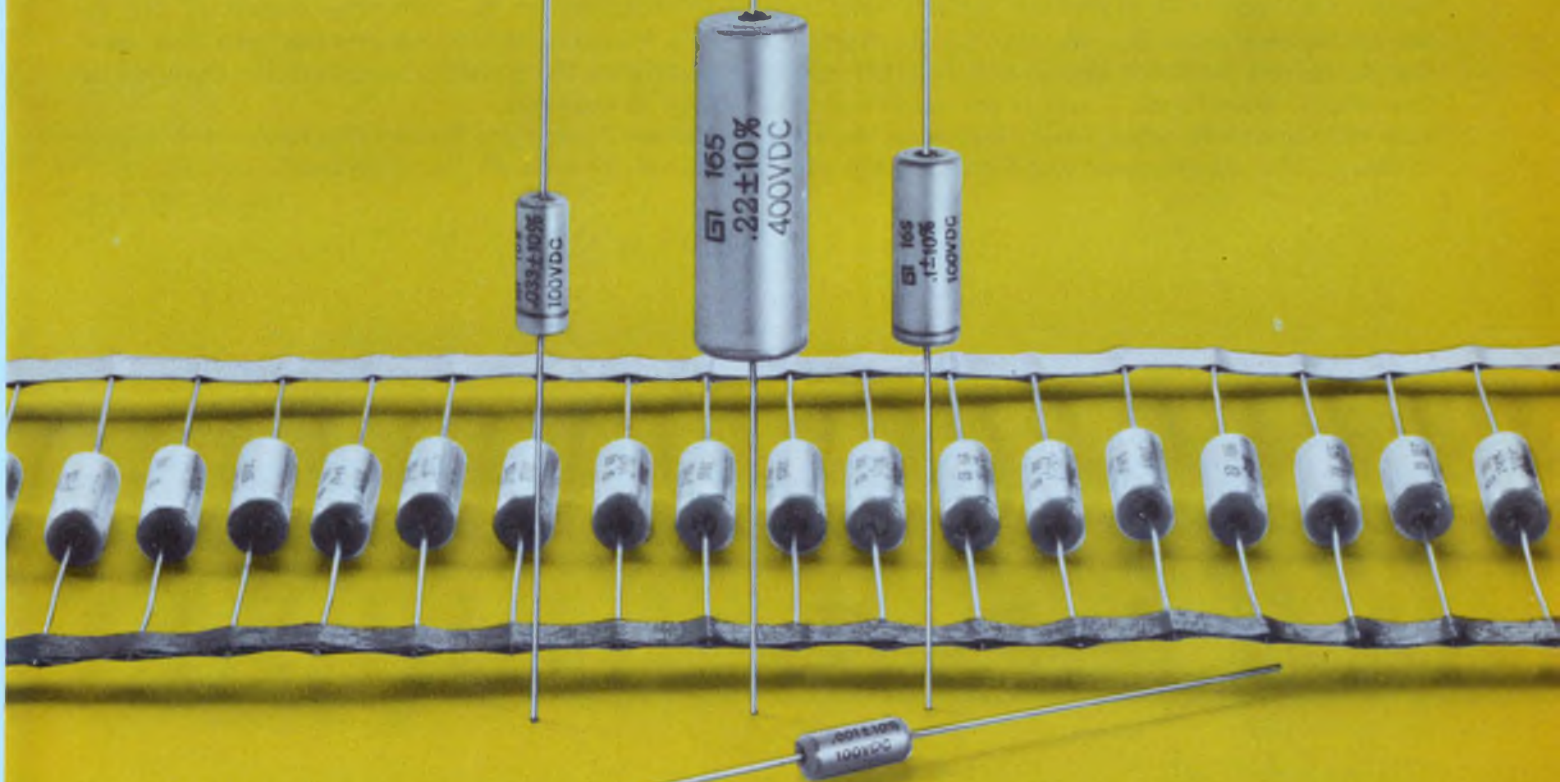

GI capacitors, size for size, give you more capacitance in a smaller package. That's volumetric efficiency. And it can mean the difference between automatic or manual insertion. For example, a GI type 165 film capacitor at a 400 rated working voltage (.375* diameter) delivers up to 372% more capacitance than competitive types. The terminal wires are concentric. Tape and reel packaging is available.

Send for the new GI catalog. Capacitor Division, General Instrument Corporation, 165 Front St., Chicopee, MA 01014. (413) 594-4781. In Canada, 61 Industry Street, Toronto 337, Ont. (416) 716-4133.

*Maximum dia. for automatic insertion equipment

**GENERAL INSTRUMENT
CORPORATION**



Differentiator circuit monitors stability of slowly changing dc signals

Control systems that employ slowly varying dc signals often need a circuit to detect when the signal has stabilized or reached a peak. Such a circuit needs a differentiator to detect the slope of the signal and voltage comparators to determine when the slopes exceed preset limits.

The example in waveform A presents all possible signal conditions. Amplifier A₁ differentiates this signal and produces waveform B. The two amplifiers, A₂ and A₃, operate as voltage comparators on waveform B. The comparators provide logic-HIGH outputs C and D when signal B falls within a small hysteresis voltage band between ±40 and ±60 mV. This voltage band is set by resistor pairs R₁₅, R₁₀ and R₆, R₇. Amplifier A₂ detects negative slopes, and A₃, the positive slopes. Waveforms C and D are combined in gate G₁. Output E, when LOW, indicates the attainment of a stable signal and lights a LED via a 2N3906 transistor.

When a signal is changing, as in regions I, III and V of waveform A, its slope is steep, and when differentiated, it provides a high output voltage. As the signal stabilizes, its slope flattens in region II and IV. The differentiated output voltage drops and passes through zero when the signal slope is zero (points b, c and f on waveform B). Stabilized regions II and IV are bounded by points a and d and e and g, respectively. As waveform B passes 40 or 60-mV comparator trip levels, comparator A₂ detects negative levels, as at points d and e, and comparator A₃ detects the positive levels, as at points a and g.

Potentiometer R₅ nulls the output of A₁ at TP1. Potentiometer R₈ adjusts the gain of A₁ and establishes the circuit's sensitivity to changes in slope at the input.

Dean T. Farrish, Project Engineer, Monaghan, 4100 E. Dry Creek Rd., Littleton, Colo. 80122.

CIRCLE No. 314

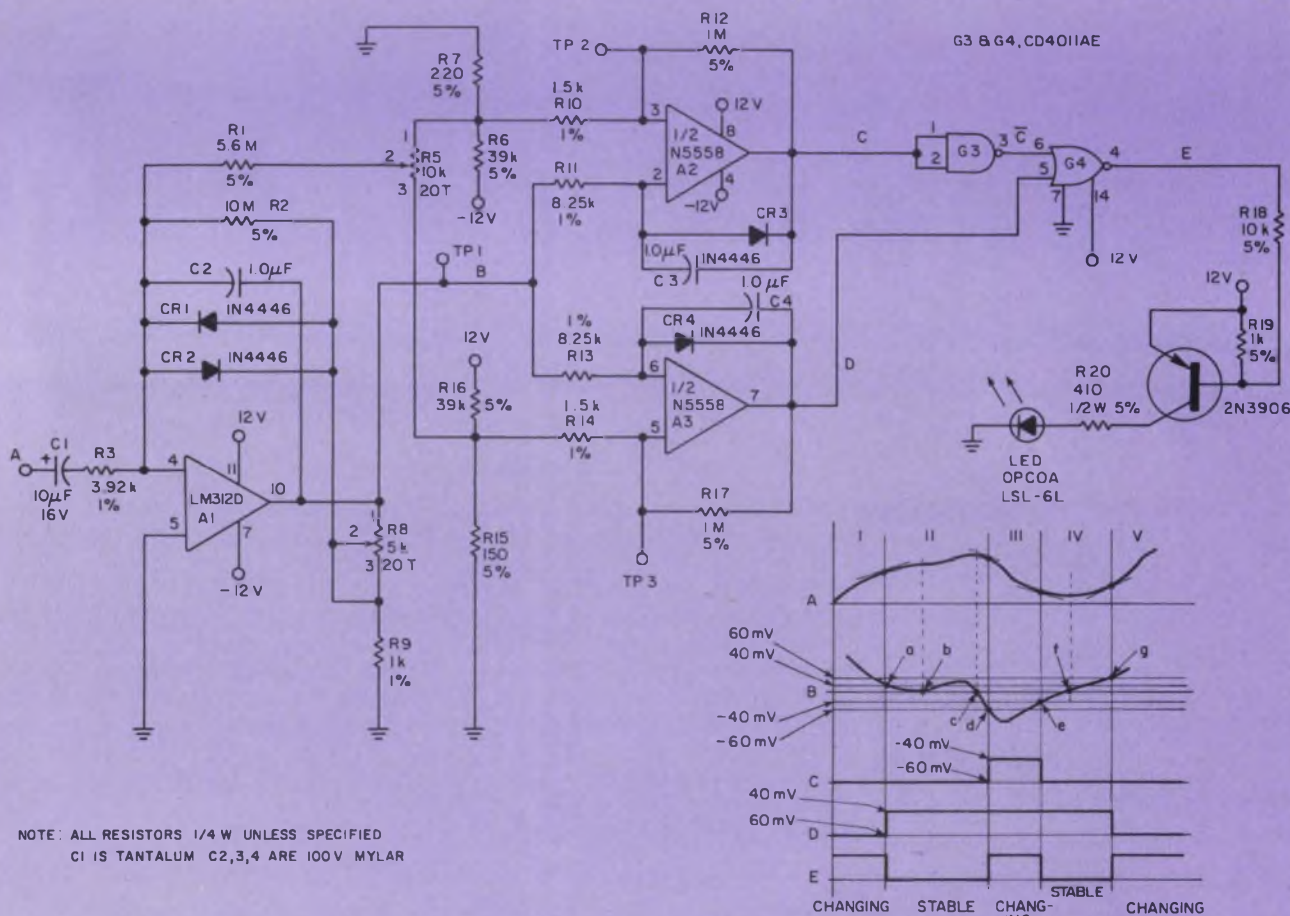

A LED lights when a slowly varying dc signal stabilizes. A changing signal causes the output

from differentiator A₁ to trip comparator A₂ or A₃ and turn the LED off.

**This
Green
Light
Says,**



**“Go ahead
with
slim trim
display
equipment
ideas.”**



Go ahead because Ise lights your way to smaller, snappier equipment with a new wafer-thin multi-digit display. Then in addition to lighting the way, gives you a choice of two displays to work with. The DP-AS

Multi-Digit Display with nine, eleven or thirteen digits. Or the FG type Multi-Digit Display with nine or twelve digits.



Digits on <FG> models measure a mini 5mm high to help you be as small in your thinking as you want. Both new displays are glass-enclosed all around. And have easy-mounting pin connectors. But mounting isn't the only thing that comes easy with these trimmed-down displays. Reading the indication they give comes easy, also. Because Ise keeps with the past. Gives these new multi-displays the same eye-easy green glow and planer construction that make their forerunners so popular. In addition, they also give you low-voltage advantages for direct LSI drive.



If you've been holding back on a headful of ideas simply because the right multi-digit display wasn't available, it's time to stop.



1. FG95A (NEW)
2. FG125A2 (NEW)
3. DMCL19E1
4. DG12H1
5. DG19E1
6. DP128AS (NEW)

The Brighter Side of Electronics



Creator of Fluorescent Digital Display:

ISE ELECTRONICS CORP. P.O. Box 46 Ise-city, Mie Pref., Japan
Tel: (05963) 5-2121 Telex: 4969523

International Sales Div.:

ISE INTERNATIONAL CORP. 2-7-7, Higashi-Shinbashi, Minato-ku, Tokyo, Japan
Tel: 433-6616-9 Telex: J26546 Cables: "ISEWORLDREP" TOKYO

Sales & Technical Office:

ISE CORP. OF AMERICA 1472 West 178th Street, Gardena, Calif., 90248 U.S.A.
Tel: (213) 532-0470 Telex: 230674910

Representative: Paris Munich Amsterdam Stockholm Vienna Milan Bombay Hong Kong Taipei

INFORMATION RETRIEVAL NUMBER 56

Precision timer can be used to make a stable, adjustable crowbar driver

The circuit in the figure has excellent temperature stability, is readily adjusted and has a minimum of parts. An LM 122 "precision timer" makes an excellent overvoltage crowbar driver. The crowbar circuit uses the timer's 3.15-V temperature-stable reference voltage and comparator to detect overvoltages.

The circuit operates as follows: When $V_{R/C}$ exceeds the V_{REF} of 3.15 V, the LM 122 output goes low and turns on Q_1 . This fires the SCR, Q_2 , which shorts the load and protects it from excessive overvoltage.

The crowbar firing voltage can be set from 4.5 to 40 V with ratio R_1/R_2 :

$$\frac{R_1}{R_2} \cong \frac{V_{CC} (\text{Crowbar})}{3.15} - 1.$$

The component values in the figure are for V_{CC} (crowbar) set to 6.3 V. A temperature stability of 20 mV can be expected over a range of -55 to 125 C when R_1 and R_2 are metal-film resistors.

Glenn Gulbranson, Senior Engineer, Control Data Corp., 3101 E. 80th St., Minneapolis, Minn. 55420.
 CIRCLE NO. 315

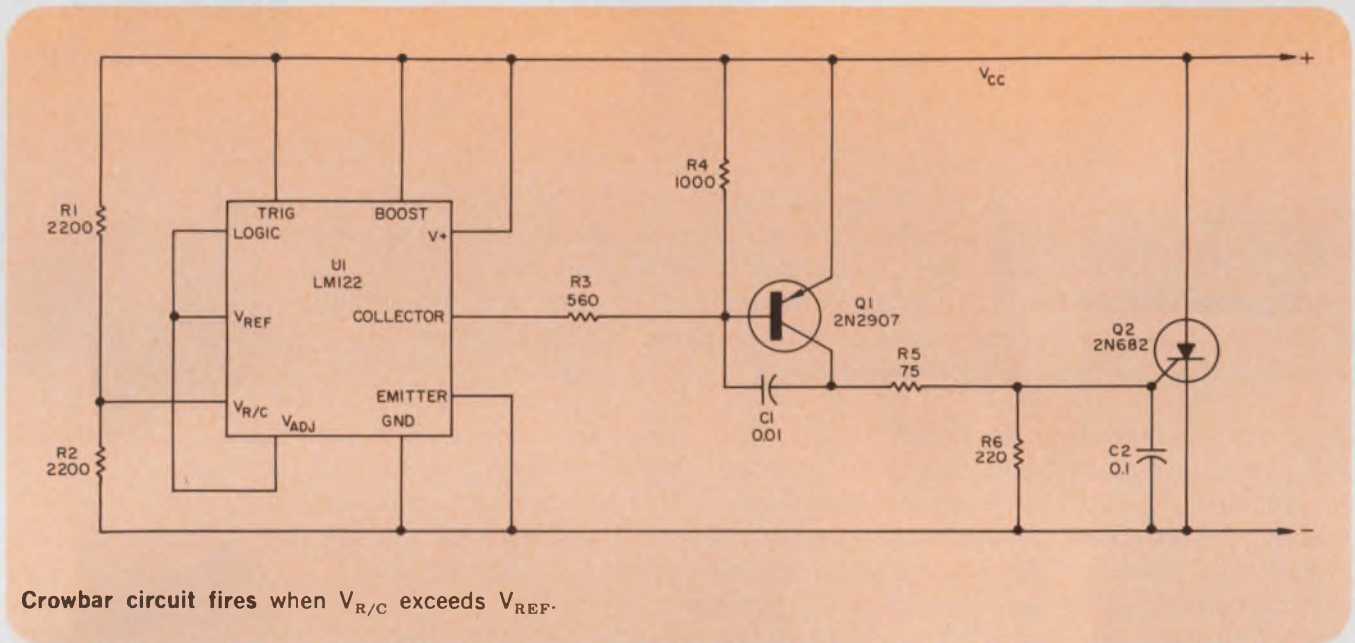

IFD Winner of June 7, 1974

Paul Lutus, Design Engineer, Philips Broadcast Equipment Corp., Government Systems Div., One Philips Parkway, Montvale, N.J. 07645. His idea "Simplified Biofeedback Circuit Detects Alpha-Wave Activity" has been voted the Most Valuable of Issue Award.

Vote for the Best Idea in this issue by circling the number for your selection on the Information Retrieval Card at the back of this issue.

SEND US YOUR IDEAS FOR DESIGN. You may win a grand total of \$1050 (cash)! Here's how. Submit your IFD describing a new or important circuit or design technique, the clever use of a new component or test equipment, packaging tips, cost-saving ideas to our Ideas for Design editor. Ideas can only be considered for publication if they are submitted exclusively to ELECTRONIC DESIGN. You will receive \$20 for each published idea, \$30 more if it is voted best of issue by our readers. The best-of-issue winners become eligible for the Idea of the Year award of \$1000.

ELECTRONIC DESIGN cannot assume responsibility for circuits shown nor represent freedom from patent infringement.

We're shipping two million CMOS circuits a month. Which gives you a second source that's really prime.

Not bad when you consider that after five years in the business we've become the world's second largest producer of CMOS. And rapidly gaining. In the last two years alone, our production capacity has increased 500%.

So it's a pretty sure bet we've got what you want. When you want it.

Because we're alternate-sourcing all of the big guy's most popular 4000 series. Plus a lot of the other guys' standard CMOS devices. We're also turning out a lot of our own originals.

Actually, we're an alternate source that's better than equal. Because we *specialize* in CMOS. Nobody else does. And that's important to you in a number of ways.

We do all of our own development and process work, and plow more than 10% of our net income back into R & D. Nobody else does. We've got a brand new three-inch wafer facility; backed by ion implantation, automatic wire bonding, computer-controlled testing. That all adds up to high quality and high yield. Consistent availability. In volume.

In fact, volume is our whole thing. We already deliver one out of every five CMOS circuits bought today. Worldwide. And we've always been the leading supplier of CMOS watch circuits.

So if you're thinking big numbers, please start with us. Meanwhile, let us send you our new catalog. Just write "CMOS" on your business card, and mail it to us.



SOLID STATE SCIENTIFIC INC.

Montgomeryville, Pa. 18936/(215) 855-8400/TWX 510-661-7267

The alternate source that's better than equal.

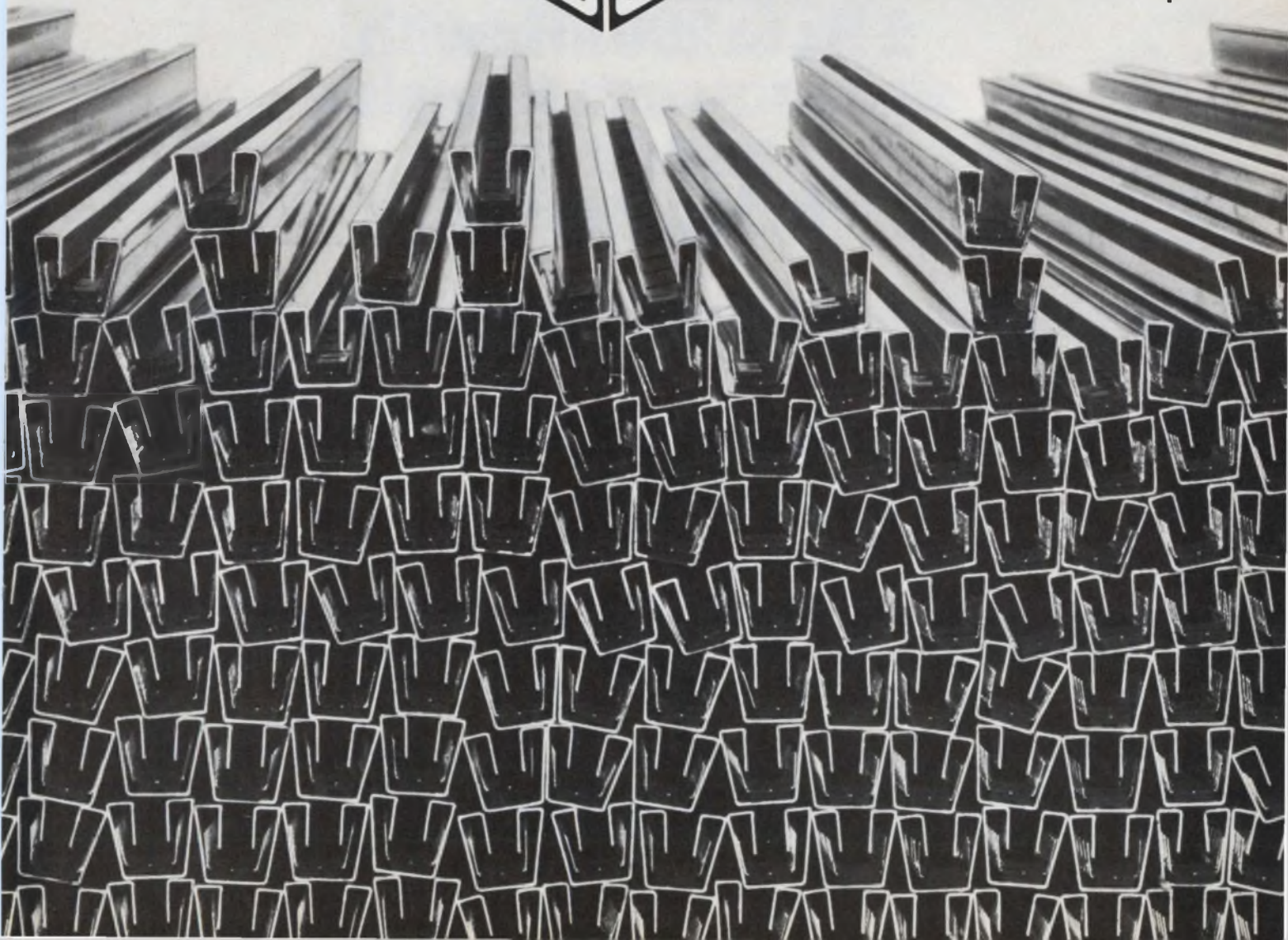

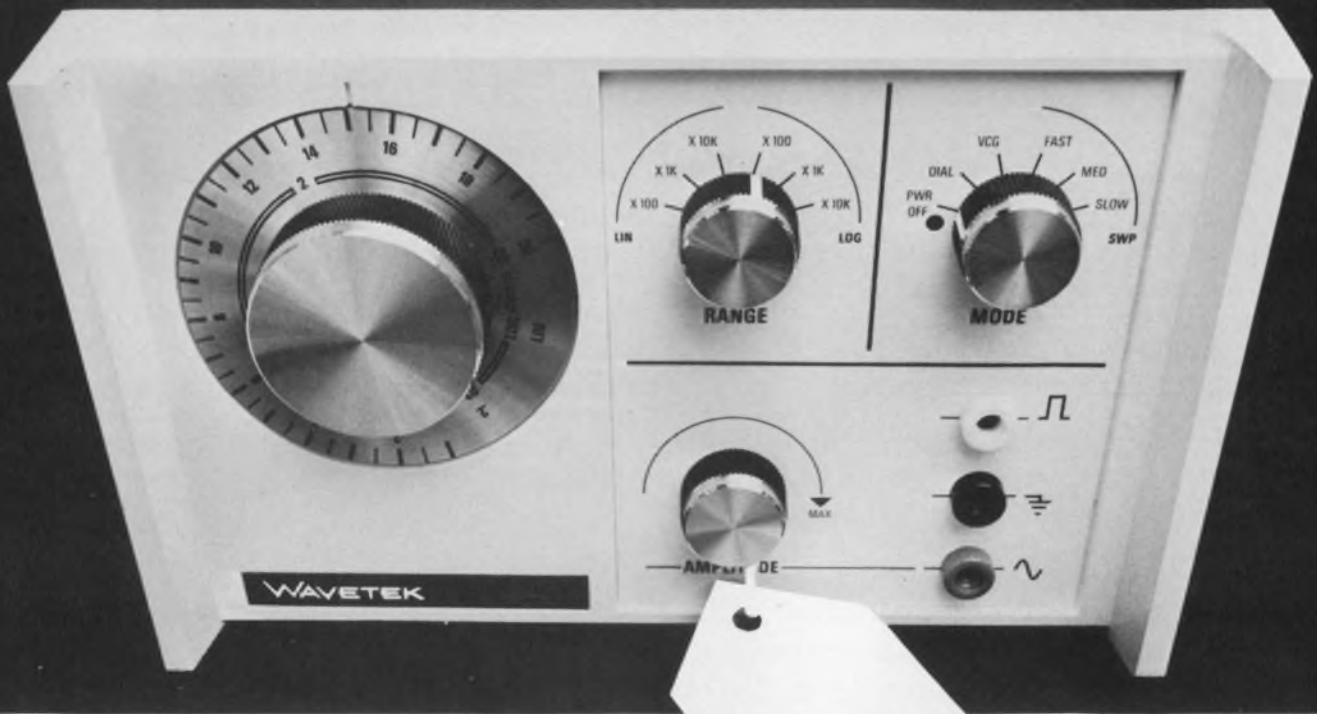

**This Model 30
portable function generator
goes from
2 Hz to 200 kHz with
sines, squares, triangles,
and linear
or log sweeps.**

**And it goes for
\$149.⁹⁵**



WAVETEK®

P.O. Box 651, San Diego, Calif. 92112
TWX 910-335-2007 Tel (714) 279-2200

INFORMATION RETRIEVAL NUMBER 58

new products

Mini addresses up to 1 Mword without increase in cycle time

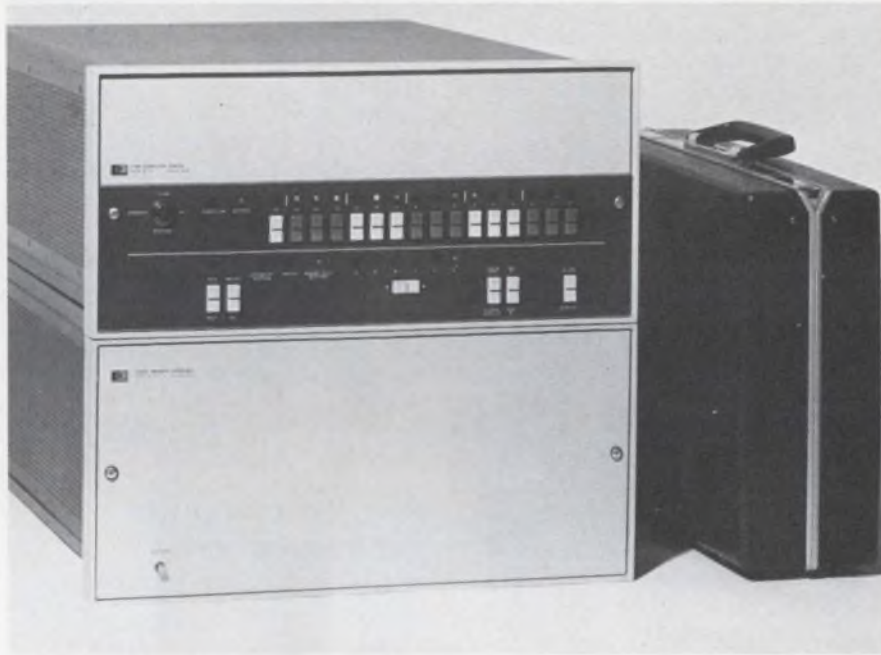

Hewlett-Packard, 1501 Page Mill Rd., Palo Alto, CA 94304. (415) 493-1501. See text: February.

A memory management system with microcoded instructions lets the newest versions of HP's 21MX minicomputer address 196,608 words of 4-k RAM with no increase in cycle time. And HP is willing to quote on million-word capacities.

The large-memory versions of the 21MX retain their 650-ns speed because microcode manages the mapping registers. The management unit (\$1950) expands the address range from 15 to 20 bits and provides read/write protection on a page basis. The five most significant bits of the 15-bit address bus selects one of 32 high-speed registers in the Dynamic Mapping System (DMS) hardware.

Each register points to one out of a possible 1024 pages of 16-bit words. Two bits of read/write information control access to a given page. The remaining 10 bits (of the 15-bit address) select a word on the page. This quasi-virtual memory scheme closely resembles that used with Xerox's

Sigma Series and other computers (see "New Tricks in Hardware Are Making it Easier to Improve the Software," (ED No. 11, May 24, 1973, pp. 102-103).

In HP's DMS, there are four independent and dynamically alterable register blocks. Two blocks serve user programs and the operating system—one block for each. The other two blocks serve the dual-port channel controller for direct memory access operations.

Twenty-five new microcoded instructions in DMS firmware such as cross-map moves and block transfers give extensive control over memory-allocation and read/write protection. And the user can implement his own instructions as needed, since complete control of the DMS function is available through user microcode.

The price of the newer 21MX with 65,536 words is \$17,358 (50 qty). Prices for machines with larger memories are \$31,812 (131,072 words) and \$43,956 (196,608 words). And retrofits are available for older models.

CIRCLE NO. 250

Floppy-disc drive is IBM-compatible

Remex, 1733 Alton St., Santa Ana, Calif. 92705. (714) 557-6860. \$750; 2 wks.

A floppy-disc drive, designated the RFD 7400, is fully IBM-compatible. The unit stores 3.2 Mbits, has a 250 kbit/s transfer rate and offers a 6-ms track-to-track access time. The unit is configured for ease of mounting in a 19-in. rack and has a door for insertion of the floppy discs.

CIRCLE NO. 257

Controller fits tape decks to many minis

Kennedy Co., 540 W. Woodbury Rd., Altadena, Calif. 91001. (213) 798-0953. See text; 45 days.

A line of magnetic tape controllers allows multitransport operation and provides the format and control signals between the manufacturer's 9000/9800/9700 tape decks and popular minicomputers. The units interface up to four parallel transports in any combination of 7 or 9-track tapes with speeds of 12.5 in/s to 75 in/s. The controllers are hardware and software compatible with DEC's PDP-8, -9, -11, -12, and -15; all Data General Novas; General Automation SPC-16; Hewlett-Packard 21XX series, Honeywell 116, 316, 516; Varian 620/73 series; or Univac 1616, UYK-20, UYK-15. Unit prices range from \$4489 to \$7245, according to minicomputer model, tape format, and cabling required.

CIRCLE NO. 258

Portable unit exercises disc drives

Ava Instrumentation, 10234 Parkwood Dr., Suite 1, Cupertino, Calif. 95014. (408) 253-4400. \$275 (25 quan).

The Model 113 tester exercises disc drives made by Caelus, Wangco, Pertec, Diabolo and Iomec. The portable unit lets you select cylinders and heads and transfer rate (1.58 MHz or 2.5 MHz). The 1.5-lb unit handles cartridge drives with 100 or 200 tracks/in. and requires no external power other than +5 V available at the drive's I/O connector.

CIRCLE NO. 259

Portable disc-drive tester is intelligent



Wilson Laboratories, Inc., 2536-D E. Fender Ave., Fullerton, Calif. 92631. (714) 992-0410. \$2295 (quan 10); 45 days.

An off-line tester designated the RMX-2000 evaluates a broad range of fixed disc and removable disc drives. An Intel microcomputer chip is the heart of the unit and is mated to a minicomputer-type disc formatter. The RMX-2000 runs a series of switch-selectable tests that range from simple continuous "restore" operations through complex data exercises. The data tests vary from unformatted patterns to formatted data transfers that include preamble, header, data block, 16-bit polynomial check character and postamble.

CIRCLE NO. 260

Process and computer linked by phone line

Computer Products, 1400 N.W. 70 St., Box 23849, Fort Lauderdale, Fla. 33307. (305) 974-5500. \$895.

The RTP 7420/30 remote serial link keeps your mini in control possibly miles from the factory. Data and commands are sent serially between computer and interface while the interface acts on parallel signals between itself and the data acquisition equipment. The unit handles mode conversion, control decoding and interrupt operations. If desired, standard modems (in full duplex mode) can be used to extend control to any distance via phone lines at baud rates to 19.2 k.

CIRCLE NO. 261

Interfaces available for printed and disc

Coltec Data Systems, Ltd., 17 Elm St., London, England WC1X0BJ. (01) 837-0647. See text.

Users of Texas Instruments 960 and 980 series printers are offered interfaces for use with Diablo Model 4043 disc units and any Centronics printer. The printer interface costs \$500 and includes cable and software driver. An adaptor for \$375 joins the disc to TI's Series 30 disc controller without software modification.

CIRCLE NO. 262

Abbreviated terminal facilitates data entry



VMF Industries, 216 N. Fehr Way, Bay Shore, N.Y. 11706. (516) 242-3939. \$875; 30 days.

The TR-10 terminal for data entry and retrieval displays a single 32-character buffered alphanumeric line and is equipped with a 10-key numeric board. Ten additional keys (alphanumeric or special) can be selected by the customer at no additional cost. Transmission is RS232-compatible with rates from 110 to 1200 baud. Additional options include two-line display and interfaces to storage and printing peripherals.

CIRCLE NO. 263

Low-cost calculator available for consumer

National Semiconductor Corp., Consumer Products Div., 2900 Semiconductor Dr., Santa Clara, Calif. 95051. (408) 732-5000. \$19.95.

The NOVUS 650 is a six-digit calculator that adds, subtracts, multiplies and divides. The 5-oz machine has a fixed two-place decimal point and has a price tag of \$19.95. Incidentally, NOVUS is the consumer products division of National Semiconductor Corp.

INQUIRE DIRECT

Reader and punch are offered in a single unit



Remex, 1733 Alton St., Santa Ana, Calif. 92705. (714) 557-6860. \$2345; 90 days.

The RAB 6375 tape reader/punch can perforate eight-level or six-level tapes at a speed of 75 char/s. The reader operates continuously or asynchronously at 300 char/s in either direction. Five to eight-track tapes with infrared transmissivity to 57% can be used. The stand-alone reader and punch can operate separately or concurrently.

CIRCLE NO. 264

Rugged computer goes anywhere



Varian Data Machines, 2722 Michelson Dr., Irvine, Calif. 92664. (714) 833-2400. \$19,500; see text.

For airborne, shipboard, and truck-mounted applications, there's the ruggedized R620/L-100 systems computer. Priced at \$19,500, the unit is scheduled for December deliveries. The R620/L-100 withstands vibration, shock, EMI/RFI, humidity, and temperature extremes that can destroy commercial-grade computers. Ruggedization includes hermetically sealed ICs and conformally-coated circuit card assemblies. The computer is available in 16 or 18-bit versions. Features include 950 ns cycle times, over 100 basic commands, six addressing modes, up to 32 k-words of memory, and nine hardware registers. Software is compatible with all 620-series machines.

CIRCLE NO. 265

our 1975 economy compact models

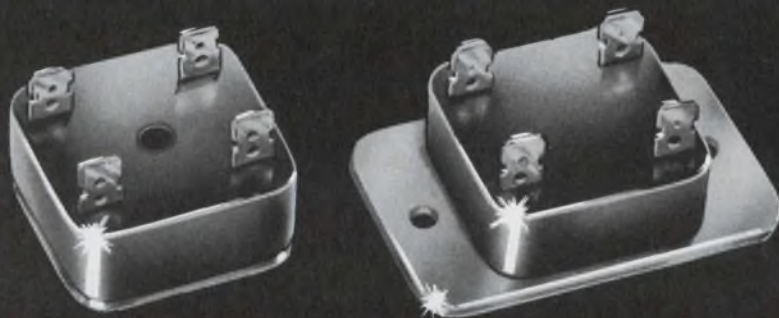

It's the year of the compact and our 25 amp ELF Bridge packs all the power of more bulky encapsulated assemblies. Our double diffused diode is available with ratings up to 1200 PRV. Designed to be an economical bridge, it meets NEMA creepage clearances and Hi-pot standards. Suitable for extreme temperature conditions to -55°C , it is available in single hole (Series EMF) or flange mounting (Series ELF).

Our 32 amp assembly (HELF or HEMF) facilitates even higher demands.

For detailed information, contact:
FMC Corporation
Semiconductor Products Operation
Homer City, Penna. 15748
(412) 479-8011

FMC Special
Products

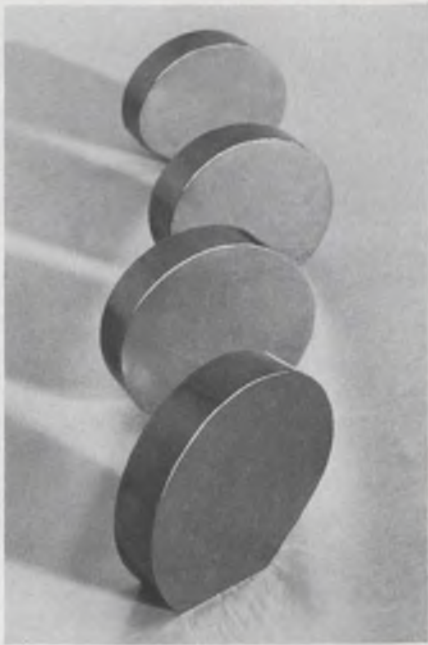

Our compounds are your right answer for...

DIODE DISPLAYS, INFRARED DEVICES, ELECTRONIC COMPONENTS

Asarco Intermetallics Corporation offers a wide range of III-V compounds used in the production of light emitting diodes (LED) and photoluminescent displays.

We provide gallium arsenide, gallium phosphide and indium phosphide in both polycrystalline and single crystal form. All polycrystalline materials are available as ingots. Gallium phosphide and indium phosphide are also available in granular form.

Gallium arsenide single crystals are boat grown with typical cross-sections of 19mm x 47mm for a (111) orientation and 33mm x 47mm for a (100) orientation.

You can order single crystals of our III-V compounds as ingots or slices, as cut or polished.

All materials are furnished in small quantities for evaluation or in large volume for production use. For more information contact us at 120 Broadway, New York, N.Y. 10005. Or call 212-732-9500.

ASARCO INTERMETALLICS CORPORATION

INFORMATION RETRIEVAL NUMBER 60

DATA PROCESSING

Interface puts calculator in control



Tektronix, Box 500, Beaverton, Ore. 97005. (503) 644-0161. \$1150.

A BCD interface provides calculator control over storage readers, meters, counters and even multi-channel analyzers. The Model 152 BCD Interface allows users of the Tektronix 31 or 21 to have direct parallel access to the calculator's display register and to the internal memory. A calculator peripheral presents the data to the 152 interface in bit parallel, digit-parallel format. The 152 then transfers the data to the calculator for display register in bit parallel, digit-serial format. When the Tektronix 31 calculator is in the Direct Memory Access mode, the transfer of data can take place at a rate up to 15,000 samples/second. Data samples are processed after the transfer is completed. The 152 can also translate the calculator's output to issue commands, as well as data, to the peripherals. The commands can be to start or stop as well as to execute certain remote operations. Information on data limits, ranges and frequencies can be passed on.

CIRCLE NO. 266

Mass storage capacity increased for PDP-11

Digital Equipment Corp., 146 Main St., Maynard, Mass. 01754. (617) 897-5111. See text; stock.

With double the data capacity of their predecessors, the RJP04 disc drive stores 44-Mwords, the TU16 tape unit has 1600 bit/in capacity. Both peripherals are designed for use with the PDP-11. The moving-head disc drives can be used in groups to provide over 350 M words of storage. The access rate is good—28 ms average seek time with 2.5 μ s/word transfer rate. The tape unit transfer rate is 72,000 byte/s. The base price for the RJP04 is \$32,000 with additional drives priced at \$25,900. Prices for the TU16 start at \$8500.

CIRCLE NO. 267

Smart terminal offers versatile data entry



International Communications Corp., 8600 N.W. 41st St., Miami, Fla. 33166. (305) 592-7654.

Versatility gained from micro-computer use enable the ICC 40+ terminal to format, edit and verify data as well as provide local off-line printout. Calculation firmware lets the user implement arithmetic functions into his forms such as subtotals and grand totals. The unit will operate with a local processor or over telephone lines (direct dial if desired) at speeds to 2400 bit/s. If desired a number of terminals can be placed on a single line and polled (if that option is selected). The CRT display contains up to 1920 characters composed of 24 lines with 80 characters per line.

CIRCLE NO. 268

Tape recorder speeds up microprocessor design



iCOM, 6741 Variel Ave., Canoga Park, Calif. 91303. (213) 348-1391. \$995; 2 wks.

A paper-tape reader, designated the Model R8016P, interfaces directly with National Semiconductor's microprocessors IMP-8P and IMP-16P. Features of the R8016P reader include: plug compatibility with the card reader interface; assembler program loading in less than 120 seconds; use of photoelectric character detector for reliable loading; and a compatible software package.

CIRCLE NO. 269

Scientific calculator outspeeds slide rule



Melcor Electronics Corp., 1750 New Highway, Farmingdale, N.Y. 11735. (516) 694-5570. \$159.95; stock.

The SC-535 scientific calculator performs trig functions, logs, exponentiation and of course the four basic calculations. The unit displays a 10-digit mantissa, sign and two-digit exponent. A light indicates the radian mode; the user can also perform trigonometric operations in degrees. Selection of scientific notation is automatic.

CIRCLE NO. 270

Monitor examines up to 1000 channels



Vidar Autodata, 265 N. Whisman Rd., Mountain View, Calif. 94040. (415) 965-3050. \$4950.

A monitoring system designated the Autodata Eight scans 40 channels at 25 readings/s. The unit provides alarm indications that include input type, channel number, polarity and reading. With printer the scan rate is 2.5 readings/s. Channel digitization is done with voltage-to-frequency conversion with $10 \mu\text{V}$ resolution. Readings can be in terms of voltage or temperature when thermocouple input is used. The unit offers expansion capability to 1000 channels.

CIRCLE NO. 271

Mod Squad



Sorensen's new generation of modulators—PTM series pass DC power supplies in both single and dual output versions. Now 33 models in the squad—and every one packs *more* power into *less* space than comparable modulators—at low, low cost per watt. New outputs ranging from 12 to 170 watts (2.8 to 29 volts) . . . built-in overvoltage protection . . . low noise and ripple . . . automatic current limiting . . . exceptional operating reliability are the major PTM features. For complete data, contact the Marketing Manager at Sorensen Company, a unit of Raytheon Company, Manchester, N.H. 03103. (603) 668-4500.

Representative Specifications—PTM

Regulation (comb. line & load)	0.05% + 5 mV (single) 0.02% (dual)
Ripple (PARD)	rms: 1 mV p-p: 5 mV
Temp. Coefficient	0.01%/°C or 1 mV/°C whichever is greater
Prices	\$94-\$200

Sorensen
POWER SUPPLIES

V/f converters maintain specs while prices drop

GENERAL DESCRIPTION

Both the frequency converter, a single and low impedance of constant output current, and the voltage-to-frequency converter, a single and low impedance of constant output current, are available in the form of a 1.5 x 1.5 x 0.4 in. modular unit.

The Burr-Brown Model VFC12 voltage-to-frequency converter and the Model VFC15 frequency-to-voltage converter are available in the form of a 1.5 x 1.5 x 0.4 in. modular unit.

The Burr-Brown Model VFC12 voltage-to-frequency converter and the Model VFC15 frequency-to-voltage converter are available in the form of a 1.5 x 1.5 x 0.4 in. modular unit.

THEORY OF OPERATION

The Burr-Brown Model VFC12 voltage-to-frequency converter is a precision integrated circuit which converts an analog input signal into a digital pulse train whose frequency is proportional to the magnitude of the analog input signal.

The Burr-Brown Model VFC15 frequency-to-voltage converter is a precision integrated circuit which converts a digital pulse train into an analog output signal whose magnitude is proportional to the frequency of the digital input signal.

The Burr-Brown Model VFC12 voltage-to-frequency converter is a precision integrated circuit which converts an analog input signal into a digital pulse train whose frequency is proportional to the magnitude of the analog input signal.

The Burr-Brown Model VFC15 frequency-to-voltage converter is a precision integrated circuit which converts a digital pulse train into an analog output signal whose magnitude is proportional to the frequency of the digital input signal.

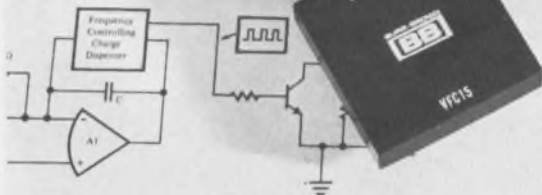

SPECIFICATIONS

MODEL	VFC12	VFC15	4701
FREQUENCY RANGE	0-10 kHz	0-20 kHz	0-10 kHz
INPUT	0-10 V	0-20 V	0-10 V
ANALOG INPUT	0-10 V	0-20 V	0-10 V
TRANSFER CHARACTERISTICS	0.01% non-linearity	0.01% non-linearity	0.01% non-linearity
ACCURACY	±0.005% FSR	±0.005% FSR	±0.005% FSR
TEMPERATURE RANGE	0-50°C	0-50°C	0-50°C
OUTPUT	0-10 V	0-20 V	0-10 V
PRICES	\$35	\$37	\$57

a specific application.

Both units are available from stock.

- Burr-Brown **CIRCLE NO. 252**
- Datel **CIRCLE NO. 253**
- Dynamic Measurements **CIRCLE NO. 254**
- North Hills Electronics **CIRCLE NO. 255**
- Teledyne-Philbrick **CIRCLE NO. 256**

Signal transmitter handles any range

Rochester Instrument Systems, 275 North Union St., Rochester, N.Y. 14605. (716) 325-5120.

The PSC-300 signal transmitter is designed to make process signals and instrument signal ranges compatible. The unit accepts any standard process signal range (1 to 5, 4 to 20, 10 to 50 mA dc, 0 to 1, or 1 to 5 V dc) and converts it to any other standard signal range. In addition, it can both accept and generate zero-based signals and offset-zero signals. The PSC-300's input signal, output signal, and power source are fully isolated, making it possible for the unit to accept and transmit grounded signals, as well as signals operating at a potential above or below ground. The output signal is automatically limited at 30% overrange, to protect the load from possible damage from excess voltage or current. The transmitter has a calibration accuracy of ±0.1% of span, a linearity of better than ±0.1% of span and a response time of less than 200 ms. Its operating temperature range is 0 to 50 C, and its stability and drift is 0.02% of span/°C. The unit is available for use with either a 115/230-V-ac or 24-V-dc power source, and the power supply variations affect span by less than 0.1% for a ±10% supply change.

CIRCLE NO. 272

Burr-Brown, International Airport Industrial Park, Tucson, Ariz. 85706. (602) 294-1431. P&A: See text.

Build it better, make it smaller, make it cheaper—That's what Burr-Brown has done with the Models VFC12 and VFC15 voltage-to-frequency converters.

The VFC12 converter delivers a 0-to-10-kHz output for input signals from 0 to 10 V. The VFC15 delivers a 0-to-20-kHz output for inputs of 0 to 20 V, -10 to +10 V, or 0 to 20 mA. Both units are only 1.5 x 1.5 x 0.4 in.—the smallest modular units on the market.

In 100-up lots, the VFC12 sells for a low \$35, and the VFC15 only \$37—almost 50% less than competing units.

Some of the v/f converter specifications include: maximum non-linearity of 0.01%, maximum accuracy drift of 50 ppm/°C, input impedance of 33 kΩ and power supply sensitivity of ±0.005% of FSR%. Further specs include a response time of two output pulses of new frequency plus 20 μs, for

an input step of 10 V, and one to two pulses of the new frequency for overload recovery.

The Burr-Brown VFC12 is pin-compatible with the Teledyne-Philbrick 4701. In unit pricing, both cost about the same—\$57 for the VFC12 and \$59 for the 4701. Comparing some specs between the units, you can see that the linearity of the VFC12 is five times better than the 4701; the drift is half as much; and dynamic overrange is 10 times higher—100% for the VFC12, compared with 10% for the 4701.

Several other companies offer competing units: Datel, the VFC-10K; Dynamic Measurements, the 801A, and North Hills Electronics, the DF-10-310. Their unit prices range from \$69 to \$145.

Both the VFC12 and VFC15 operate from standard ±15-V power supplies, and are specified for operation over a 0-to-70-C temperature range. Gain and offset adjustments for both converters are externally trimmable. Simple external circuits can convert the input for best compatibility with

Flat pack amplifiers provide 10 dB gain

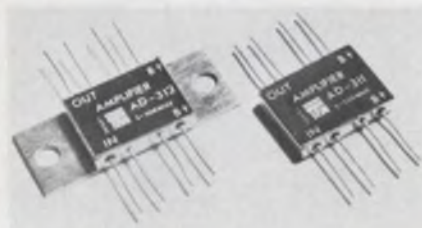

Technical Research & Manufacturing, Inc., Kelley Ave., Grenier Field, RFD #3, Manchester, N.H. 03103. (603) 668-0120. From \$79 (1 to 4); stock to 3 wk.

The AD-300 series of broadband flat-pack amplifiers covers the 5 to 500 MHz frequency range. These amplifiers with 10 dB gain, are available in case sizes of $3/8 \times 1/2 \times 1/8$ in. The transistors used are hermetically sealed. The AD-300 series is manufactured in accordance with MIL-E-5400. The amplifiers have characteristics of 1 dB output compression points of +16 dBm and maximum noise figures of 3 dB. VSWR input is 1.8:1 and VSWR output is 2:1 (max).

CIRCLE NO. 273

Voltage tunable filter uses analog multipliers

Frequency Devices, Inc., 25 Locust St., Haverhill, Mass. 01830. (617) 374-0761. \$130 (100 up).

The Model 320VT universal voltage-tunable active filter provides a notch output as well as the standard bandpass, low-pass and high-pass outputs. Voltage tuning is done with internal analog multipliers. The frequency of the filter can be set to any value from 0.1 Hz to 20 kHz and the voltage tuning range can be set up to 20:1 with external resistors and capacitors. Narrower voltage tuning ranges may be used to improve noise and offset characteristics. Gain and Q are externally variable. Either constant bandwidth or constant Q tuning can be realized and a unique Q enhancement adjustment permits the realization of deep notches and constant bandpass gain with voltage tuning. In addition, the 320 VT can be used as a voltage controlled oscillator with low distortion quadrature outputs. The unit is housed in a $2 \times 3 \times 0.6$ in. encapsulated module.

CIRCLE NO. 274

With MINI BUS[®]

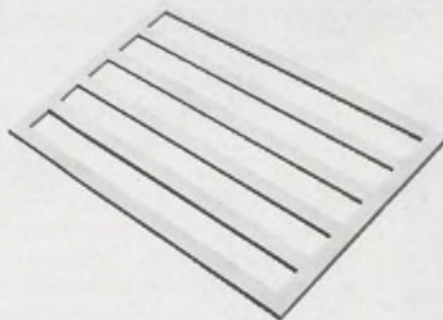

It's the PC card bus bar that saves space on a PCB. Saves money too. Makes board design and layout easier.

all these DIPs



How can you put 36 DIPs on a 30 sq. inch board without using costly multi-layer PCBs?

go on a 5" x 6" 2-sided PCB

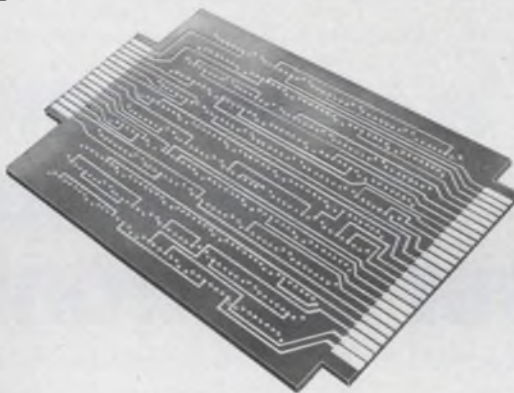

Take Voltages and Grounds off the board with MINI/BUS. Use all the board geometry for interconnecting DIPs.

like this

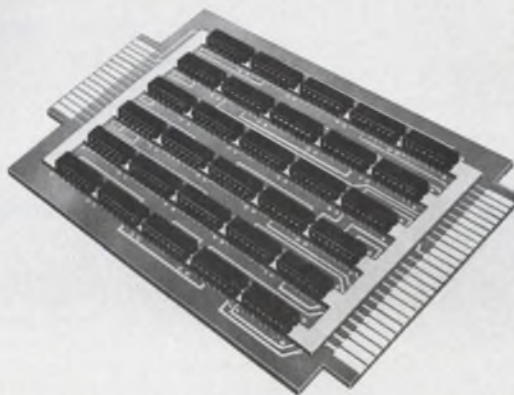

With MINI/BUS, you'll save design and layout time. You'll save space on the board. And you'll save money — up to half the cost of a typical 4-layer PCB.

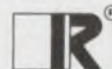

Rogers Corporation Chandler, Arizona 85224 Phone: (602) 963-4584

Represented in Canada by LLOYD A. MEREDITH,
1560 Watersedge Road, Clarkson, Ontario L5J 1A4 Phone: (416) 533-2367

INFORMATION RETRIEVAL NUMBER 62

Ac switches handle up to 100 A rms

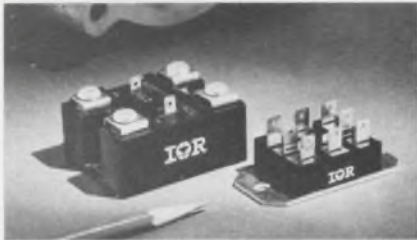

International Rectifier, 233 Kansas St., El Segundo, Calif. 90245. (213) 678-6281. \$22 to \$26 (large quantities); 6 to 8 wk.

The IR P640 and IR P340 series of high-current/high-voltage ac switches feature ratings up to 100 A rms for line voltages of 120, 240 and 480 V rms. The 480 V Pace/pak has blocking voltages in excess of 1000 V. The switches can operate at line frequencies of 50 to 400 Hz and higher. The packaging of the Pace/pak line eliminates the need for a separate electrically isolated heat sink and provides electrical isolation of up to 2.5 kV from the base plate.

CIRCLE NO. 275

High power of amps claim high reliability

RCA, Box 3200, Somerville, NJ 08876. (201) 722-3200. From \$125 (15 to 24 pc).

The RCA-HC2000H/1-4 high-reliability, high-power hybrid operational amplifier is intended for use in aerospace, military, and critical industrial applications. The unit, rated at 100 W and 7 A, is screened to four reliability levels (/1, /2, /3 and /4) that approximate MIL-STD-883. Screening level /1 approximates MIL-STD-883 class A with the addition of condition B precap visual inspection. The /2 level approximates MIL-STD-883 class A plus condition B precap visual inspection, but with centrifuge and radiographic inspection omitted. Screening levels /3 and /4 approximate MIL-STD-883 class B and class C, respectively. The RCA-HC2000H/1-4 series units use a quasicomplementary class B output circuit with hometaxial output transistors and built-in load-fault protection. These devices can be operated from single or split power supplies.

CIRCLE NO. 276

12-bit DACs housed in DIP size packages

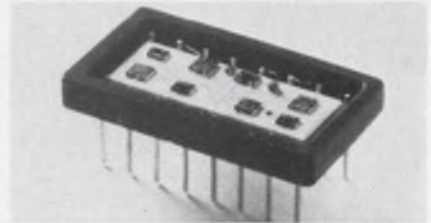

Hybrid Systems Corp., 87 Second Ave., Burlington, Mass. 01803. (617) 272-1522.

The current output DAC345I and its companion voltage output DAC346V are complete IC sized d/a converters available with 12-bit linearity and drift. Both models have linearity of 1/2 LSB and linearity tempcos of 1 ppm/°C typical. The DAC345I has a scale factor tempco of 25 ppm/°C and a scale factor accuracy of ±5%. The DAC-346V has a 15 ppm/°C tempco and 0.1% accuracy. Analog output on the 345I has a ±1 mA full scale range with ±0.25 V compliance and a 4.25 kΩ impedance of less than 0.1 Ω. The DAC-345I is housed in a 16-pin DIP and the 346V in an 18-pin.

CIRCLE NO. 277

1/32 of an ounce of prevention for your electronic circuits.

MICROTEMP SAFETY THERMAL CUTOFFS*

With a MICROTEMP installed on the winding of your motor or transformer, you'll get positive fail-safe protection without adding

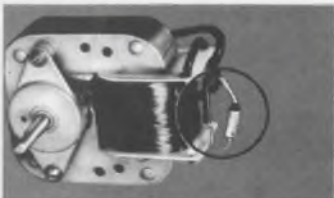

any appreciable weight or size. Facilitating transformer and motor compliance with many UL specifications, especially UL506, UL544, and UL547, MICROTEMP will sense excessive temperature and interrupt the power circuit



ACTUAL SIZE

should a fault condition develop. An alternate means of protecting the transformer can be provided by a MICROTEMP which has a small heating element fitted to



its case. This heating element is connected in series with the secondary coil winding and its load, transferring heat to the MICROTEMP with the flow of current. Should the current flowing through the element exceed normal operating levels, the resulting heat will cause the

MICROTEMP to open, thus also opening the primary or secondary coil winding to which it is connected. Reliable, inexpensive and accurate to ±3°F, MICROTEMPS are available in ratings to fit your application. Add our little prevention to your product now!

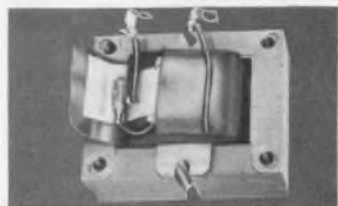

MICRO DEVICES CORP.
1881 Southtown Blvd.
Dayton, Ohio 45419
(513) 294-0581

See us at the
ASEC Show.
Booth #411

* UL/CSA Recognized Component
MICRO DEVICES CORP.

INFORMATION RETRIEVAL NUMBER 63

Multifunction converter has high accuracy

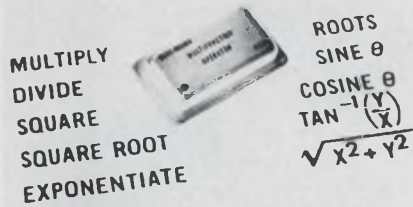

Burr-Brown, International Airport Industrial Park, Tucson, Ariz. 85734. (602) 294-1431. \$48 (100-up); stock.

The Model 4301 hybrid multifunction converter provides a solution to many analog conversion needs. The general transfer function produced by the 4301 can be stated by the following: $E_o = V_Y (V_Z/V_X)^m$, where V_Y , V_Z and V_X refer to the input voltages or reference levels which are applied to produce the required output function. The exponent m can be selected over the range of 0.2 to 5 by two external resistors. Output of the 4301 at 25 C is ± 10 V at 5 mA. Supply voltage required for operation is ± 15 V dc. Some of the typical accuracies expressed as a percentage of output full scale are as follows: Multiply or divide, $\pm 0.25\%$; square, $\pm 0.03\%$; square root, $\pm 0.07\%$; sine, $\pm 0.5\%$; cosine, $\pm 0.8\%$; and arctangent, $\pm 0.6\%$.

CIRCLE NO. 278

Solid-state timer gives delays up to 180 s



Connor Winfield, P.O. Box L, West Chicago, Ill. 60185. (312) 231-5270. From \$25 to \$32 (single qty); 3 wk.

Model T200A flat package solid state timing module measures $2 \times 2 \times 0.6$ in. (exclusive of adjustment shaft). The unit provides time delay ranges from 1 to 180 s for 120 V ac relays, and from 0.1 to 180 s for 24 V dc relays. The timer has a repeat accuracy of $\pm 1\%$ and is simply connected in series with load.

CIRCLE NO. 279

Problem solving... with Victoreen High Voltage Technology

1 UNORTHODOX CRT DRIVE

How did we meet ever-expanding requirements for increased bandwidth and lower power consumption, coupled with the availability of high-voltage zener-type diodes (Victoreen Corotrons)? With an unorthodox drive scheme for CRT's.

Instead of supplying the CRT anode with very high voltage, we ground the anode and supply a drive signal, riding at approximately —1800 volts, to the grid. The advantages? Being direct-coupled there are no reactive components to limit high-end frequency response or cause roll-off at the low end.

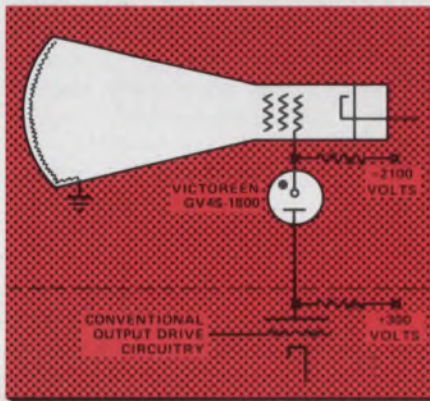

Even though the Corotron operates in the corona mode of discharge, it has no voltage jumps or jitters. Corotrons are not tied to "natural" operating voltages and are adjustable in manufacture from 350 to 30,000 volts.

2 FROG MUSCLES TO BRAIN WAVES

Colleges and universities, medical research laboratories and R&D firms need amplification of low level signals. Such signals are derived from frog-muscle experiments, brain-wave measurements, cardiac research, avalanche-breakdown, currents in ionization chambers as well as from a range of constant-current sources.

Victoreen MINI-MOX resistors are used widely to modify op-amp characteristics to:

1. Stabilize output and eliminate oscillation.
2. Define gain so measurements can be quantified.
3. Restrict bandwidth to the region of specific interest.

They typically have a voltage coefficient of —5 ppm/volt, full-load drift of less than 2% in 1000 hours, temperature coefficient of 100

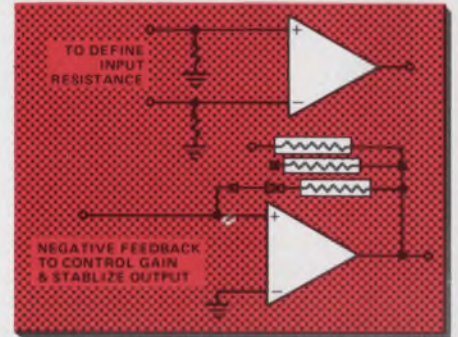

ppm, and a Quantech noise of less than 1.5 V/volt at 20M ohms. They are available in values from 100K to 10,000M ohms in 1, 2, 5 and 10% tolerances.

3 A PROBE FOR HIGH POTENTIAL

Two Victoreen MAXI-MOX resistors used in series can serve as a probe in radar circuitry capable of measuring voltages up to 60,000 volts. The probe, compatible with a number of voltmeters of different manufacture, has both short- and long-term stability. Short-term stability assures negligible drift and fluctuation during measurement, while long-term stability maintains the original calibration accuracy of the probe.

Each MOX-5 resistor used in the probe has a maximum operating voltage of 37,500 volts with a power rating of $12\frac{1}{2}$ watts. The voltage coefficient is 1 ppm/volt over the complete voltage range of the MOX-5, while the temperature coefficient is better than 300 ppm for —55° to 125°C.

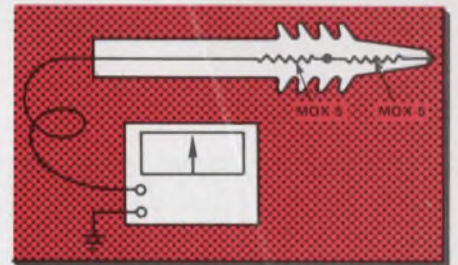

MAXI-MOX resistors have full-load drift less than 1% in 2000 hours of operation, and are available in tolerances of 1, 2, and 5% in values from 10K to 2,500M ohms. A silicone varnish conformal coating provides environmental protection while allowing a maximum hot-spot temperature of 220°C.

Victoreen Instrument Division
of VLN Corp.
10101 Woodland Avenue
Cleveland, Ohio 44104



INFORMATION RETRIEVAL NUMBER 64

Thermocouple amplifier spans 30 to 1000 C



Interdesign, 1190 Elko Dr., Sunnyvale, Calif. 94086. (408) 734-8666. \$63.20 (100-up).

The Model 1201 thermocouple amplifier is available as a plug-in module that consists of a single PC board. The module amplifies the thermocouple signal, linearizes it, and provides an ice point reference voltage at the same time. The output of the module ranges from -30 to +1000 C, and can be displayed directly by a digital voltmeter. The Model 1201 is designed for chromelalumel thermocouples; amplifiers for other thermocouple types are available on special order. Accuracy to NBS standards is $\pm 1.5\text{ C} \pm 0.5\%$ of reading. The amplifier is chopper stabilized, resulting in a drift of less than $2\ \mu\text{V}/^\circ\text{C}$. Output is 1 mA source or sink with short-circuit protection. The amplifier requires a 5 V unregulated power supply; current drain is 6 mA. The operating temperature range spans from -10 to +70 C.

CIRCLE NO. 280

Monitor 1 to 512 points over a copper wire pair

Electronic Modules Corp., P.O. Box 141, Timonium, Md. 21093. (301) 666-3300.

A data acquisition system uses a two-wire remote multiplexing technique and can work with equipment separated by almost four miles. The system consists of a control station (mainframe and display panel) linked by a single #22 copper pair to from 1 to 32 remote multiplexers up to 20,000 ft. away. Each multiplexer can accommodate 16 sensors (any type), and are intrinsically safe in Class I, Groups B (hydrogen) and D (methane, etc.), Division II hazardous atmospheres and may be located near the sensors to double as junction boxes. Thermocouple extension wire is not required; neither is any field calibration or adjustment. New multiplexers may be added to the two-wire link at any time, bringing new points into the system without causing downtime. The operator uses a telephone-type pushbutton keyboard to address a process variable point for display. The system's mainframe accommodates 512 data points and mounts in a standard 19-in. rack. Power requirement is 115 V 60 Hz. Each of the one to 32 remote multiplexers may accommodate thermocouples, RTDs, 1 to 5/4 to 20, 10 to 50 mA, voltages, or contact closures. Power requirement is 12 V at 50 mA operating, 15 mA standby. Standard multiplexer housing is a NEMA weatherproof enclosure measuring $16 \times 14 \times 6$ in.

CIRCLE NO. 281

A/d converter resolves to 1 part in 20,000



Analog Devices, Rte. 1 Industrial Pk., P.O. Box 280, Norwood, Mass. 02062. (617) 329-4700. J, \$115; K, \$150 (100-up); stock.

The ADC1105 dual-slope a/d converter uses external counters and registers. This allows the user to pick any resolution up to 14 bits or 4-digits BCD as well as choice of coding and counting schemes. The ADC1105 provides 100% overrange plus sign, has the capability for ratiometric operation, and comes with the choice of either 0.1% or 0.01% accuracy. The unit is housed in a $2 \times 4 \times 0.6$ in. module. The performance specifications of the ADC1105 include $2\ \mu\text{V}/^\circ\text{C}$ zero stability, 5 ppm/ $^\circ\text{C}$ gain temperature coefficient and $\pm 0.0015\%/V_s$ power supply sensitivity. The converter accepts unipolar inputs of both ± 10 and ± 1 V full scale range, and its outputs are compatible with TTL/DTL and certain RTL systems. The converter is specified for operation from 0 to 50 C. It comes in two versions of accuracy: The ADC1105J, accurate to 0.1% of reading ± 1 digit, and the ADC1105K, accurate to 0.01% of reading ± 1 digit.

CIRCLE NO. 282

ANA & LOG

CHARLIE SAYS HE'LL FIRE ME UNLESS I PITCH IT HIGH AND TIGHT AT 250 NANOSECONDS!

OKAY, WE'LL USE THE A-862 DAC.

I'M GLAD YOU'RE NOT YOGI BERRA!

INTECH DA'S KLUGES

ANALOGY

THE A-862 IS IN THE CATCHER'S MITT BEFORE YOU KNOW IT WITH ITS 250NS 1DAC SPEED AND LINEARITY TEMP CO OF ONLY 2PPM/°C. IF VOLTAGE TURNS YOU ON, TRY IT AS A 1.5µS VD AC AT 6PPM/°C.

intech INCORPORATED
 (415) 344-2500
 1720 COLEMAN, SANTA CLARA CA 95050

Discover new performance and economy for your stepper applications.

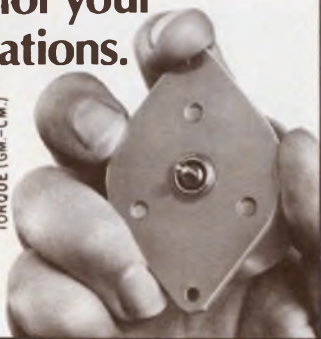
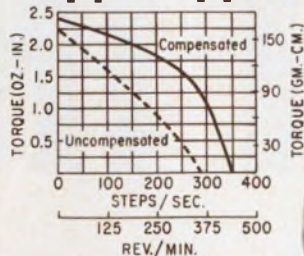

4-phase PM logic motors for under \$9ea.*

Get information today on our new low cost 82401 Series reversible permanent magnet logic stepper motor. It will achieve an optimum cost vs. performance ratio for you. End uses include analytical instrumentation and computer peripheral applications such as printer drives, X-Y plotter drives and chart drives.

Coil design assures low wattage operation.....3.5 watts for both 5 vdc and 12 vdc models. Stable stepping operation is achieved by using a permanent magnet construction. Maximum pull-in/out torque is 2.4 oz-in. with a compensation network. Also a maximum pull-in rate of 350 steps/sec and pull-out rate of 480 steps/sec can be attained. Basic step angle is 7.5°, but integral gearing can be furnished to provide a variety of stepping angles and torques.

*In 500 quantities.

Send for information today!

A. W. HAYDON CO. PRODUCTS

NORTH AMERICAN PHILIPS CONTROLS CORP.

Cheshire, Conn. 06410 • (203) 272-0301

INFORMATION RETRIEVAL NUMBER 66

A CAMBION® Double "QQ" Product Line

As often as you want, too. The design of the jack and the materials from which it is produced give it the strength to be cycled more than 50,000 times (we've done it) without appreciable change in contact resistance.

And we didn't just do it once "in the lab."

We have tens of millions of these jacks out, in use by customers. ID's range from .016" to .080". And are available in different shapes and types for mounting components, patching, plugging, or whatever you have in mind.

All CAMBION cage connectors are standard, immediate delivery items. You can have them fast in whatever number you want. That's the CAMBION Double "QQ" approach, the quality stands up as the quantity goes on. Ask for a sales engineer or a catalog. Cambridge Thermionic Corporation, 445 Concord Avenue, Cambridge, Mass. 02138. In Los Angeles, 8703 La Tijera Blvd. 90045.

This cage jack was built for recycling!



INFORMATION RETRIEVAL NUMBER 67

ELECTRONIC DESIGN 21, October 11, 1974

YEW's POWERFUL FAMILY!



AC WATTS

And, that's a lot of accuracy, even with low power factors and distorted waveforms. The YEW 2885 is renown throughout the world as the AC power measuring instrument. YEW's APR-2, on the right is used as a standard by many countries in the world.



TRUE RMS V-A-W

Accuracy and versatility have generated a reputation for the YEW 2503 True RMS V-A-W instrument that's hard to beat. Distorted waveforms and low power factor hardly phase it at all.

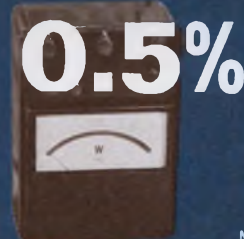

Model 2041

PORTABLE WATTMETERS

YEW has made more precision analog portables than anyone else in the world . . . and they're usable to 2 KHz and not expensive.

To find out all about YEW's extensive family of power instrumentation, just write or call. We'll be happy to prove why we're #1 in power.



YEWTEC CORPORATION

1995 Palmer Avenue
Larchmont, N.Y. 10538

© Yokogawa Electric

Telephone: 914-834-3550

60 Years of Measuring and Recording Instrumentation

INFORMATION RETRIEVAL NUMBER 68

LOOK FIRST IN

FOR POWER SEMICONDUCTORS

■ WHO MAKES THEM

You'll find 97 manufacturers of power semiconductors beginning on pages 353, 428 and 457 of *Electronic Design's* GOLD BOOK (Volume 1—Product Directory). For your convenience, each manufacturer is listed with complete street address, city, state, zip and phone number.

■ SALES OFFICES—REPS DISTRIBUTORS

To find information about each power semiconductor manufacturer, turn to the *Manufacturers Directory*. Whenever possible it lists names of key officials, sales offices, export offices, foreign offices, U.S. and foreign reps followed by a list of U.S. distributors. In many cases there is additional data, when provided by the company: TWX, TELEX, cable address, facsimile equipment (make and call number), 800 (toll-free numbers) as well as number of engineers, number of employees and financial data.

■ CATALOG PAGES

Here's a rundown of the catalog pages you'll find on power transistors in *Electronic Design's* GOLD BOOK.

Manufacturer	Starts in Vol. 2, Page:	Manufacturer	Starts in Vol. 2, Page:
DELCO ELECTRONICS	379	RCA SOLID STATE	511
GENERAL ELECTRIC	414	RSM SENSITRON	537
INTERNATIONAL RECTIFIER	451	SEMTECH	542
MOTOROLA	471	SOLITRON	545
POWER TECH, INC.	507	TEXAS INSTRUMENTS	547
		TRW	554

KEEP *ELECTRONIC DESIGN'S* GOLD BOOK
HANDY WHEN YOU CALL

Refer to your copy of *Electronic Design's* GOLD BOOK before you dial your next vendor. Referral to specific product pages can shorten your long distance phone calls. LOOK FIRST in *Electronic Design's* GOLD BOOK.



Electronic Design 's

GOLD BOOK

FOR COOLING EQUIPMENT

■ WHO MAKES IT

You'll find eleven categories of cooling equipment and related products listed in the *Product Directory of Electronic Design's GOLD BOOK*. For blowers and fans 38 manufacturers are listed. For thermoelectric cooling/heating modules, 17; circulating liquid cooling units, 21; heat sinks and dissipators, 50; thermal conductive coatings, 23; insulators and insulating hardware, 52; transistor mounting pads, 23; epoxy potting compounds, 41; silicone greases, 17; and washers, 18. As with power semiconductors, data about each manufacturer, his reps and distributors can be found by referring to the *Manufacturers Directory*.

■ HERE'S A RUNDOWN OF THE CATALOG PAGES YOU'LL FIND ON HEAT SINKS AND DISSIPATORS ALONE

Manufacturer	Number of Catalog Pages	Starts On Page:
AHAM	3	Vol. 2, 1286
Hughes Aircraft Co.	4	Vol. 2, 1289 Vol. 3, 1264
Hughes Connecting Devices	2	Vol. 3, 1442
Intl. Elec. Research	4	Vol. 2, 1291
Intl. Rectifier	2	Vol. 2, 458
Jermyn	1	Vol. 2, 1295
Thermalloy Inc.	1	Vol. 2, 1304
Unitrack	1	Vol. 3, 271
Wakefield Engrg. Inc.	42	Vol. 2, 1307

■ TAKE WAKEFIELD ENGINEERING, FOR EXAMPLE

Wakefield Engineering's 42 page catalog of semiconductor cooling products begins on page 1307 of Vol. 2. In addition to detailed specs and information about its heat sinks and thermal cooling products (most show curves of natural and forced convection characteristics) the pages include diagrams of 99 heat sink extrusion shapes with dimensions, surface area, and thermal characteristics. Wakefield's unit also provides guides on HOW TO SELECT HEAT SINKS, ENGINEERING DATA, HEAT SINK MOUNTING SPECIFICATIONS, HOLE PATTERNS, U.S. DISTRIBUTORS, EUROPEAN SALES AGENTS, U.S. FIELD SALES ENGINEERS, and lists other available Wakefield catalogs.



Two 512-stage BBDs come on chip

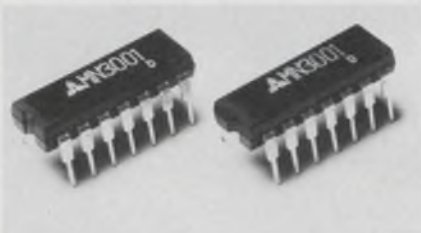

Matsushita Electric Industries Co. Ltd., Kadoma, Osaka 571, Japan.

A new dual 512-stage bucket-brigade device (BBD), the Model MN-3001, offers variable delays for audio equipment. Series connection of two 512-stage BBDs—each with a maximum delay of 25.6 ms—yields 51.2 ms in a 1024-stage BBD. Connection of two units in parallel doubles the output voltage. The MN-3001 operates from a -15-V supply and handles clock rates in the range of 10-to-800 kHz.

CIRCLE NO. 283

SOS/CMOS turns to plastic packaging

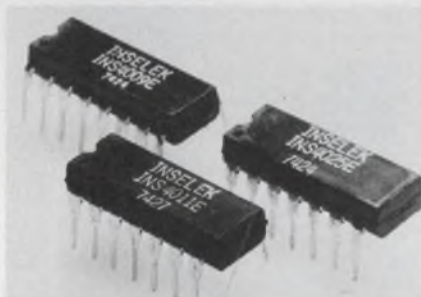

Inselek, Inc., 743 Alexander Rd., Princeton, N.J. 08540. (609) 452-2222.

The company's SOS/CMOS logic family (INS4000) is now offered in plastic packages. The SOS/CMOS family represents a high-speed pin-compatible replacement for the popular RCA CD4000 line. Representative specs are offered by the INS4024E, a seven-stage binary counter; it has a minimum operating frequency of 10 MHz at 10 V. Worst-case switching times for all products are specified over the -40 to 85 C temperature range and with load capacitances of 15 and 50 pF. Typical unit prices in quantities of 1000 are \$2.02 for the INS4024E and \$1.08 for the INS4016E. Delivery is from stock.

CIRCLE NO. 284

Op amps replace standards

RCA Solid State Div., Route 202, Somerville, NJ 08876. (201) 722-3200. 52¢ to \$6.35 (1000).

Eight general-purpose IC op amps provide direct replacements for like-numbered industry standards. The new amplifiers are the CA107T/207T/307T, the CA101T/AT, CA201T/AT and the CA30AT. The CA107T, CA207T and CA307T amplifiers feature a 30-pF on-chip capacitor to provide internal frequency compensation and low input currents of 100 mA maximum over the operating temperature range.

CIRCLE NO. 285

S-TTL circuit drives MOS RAMs

Fairchild Semiconductor, 464 Ellis St., Mountain View, CA 94042. (415) 962-3816. \$2.70 (1000); stock.

Quad driver for MOS RAMs uses Schottky-TTL technology for high-speed. Called the 9607, the new IC converts TTL signals to the higher voltage and current levels required to drive MOS dynamic RAMs. Typical operating speed is 31 ns for a 15-V output swing with a 200-pF load. The 9607 is an alternate unit for the Intel 3207A device, but reportedly uses an average of 40% less static power.

CIRCLE NO. 286

4-k RAM extends number of sources

Western Digital Corp., 3128 Red Hill Ave., P.O. Box 2180, Newport Beach, CA 92663. (714) 557-3550. \$27 (100 up).

A 4096-bit MOS RAM, the RM1701H, features functional equivalence and pin compatibility with models announced by Texas Instruments and Intel. The NMOS memory has a maximum access of 300 ns and a maximum cycle of 470 ns. Refresh requires only 16 cycles, and the circuit features single-clock input. Power dissipation is only 400 mW operating and 2 mW standby. Except for clock, all inputs are TTL-compatible and don't require pull-up resistors. Three-state outputs guarantee a fanout of two standard-TTL loads.

CIRCLE NO. 287

1-k static RAM accesses in 275 ns



Mostek Corp., 1215 W. Crosby Rd., Carrollton, Tex. 75006. (214) 242-0444. \$24 (100-999); stock.

The MK 4102-6, a 1-k static RAM, features a 275-ns access time. The new 1024 × 1-bit RAM employs n-channel MOS, silicon-gate, depletion-mode technology. The IC, a higher speed pin-for-pin replacement for the 2102 RAM, also features TTL/DTL-compatible inputs.

CIRCLE NO. 288

1-k NMOS RAM accesses in 60 ns

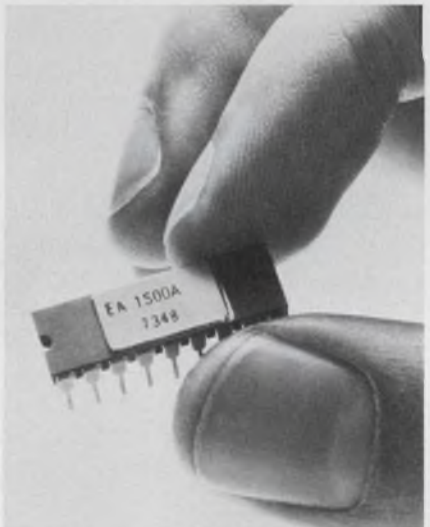

Electronic Arrays Inc., 550 E. Middlefield Rd., Mountain View, Calif. 94043. (415) 964-4321. \$13 (500); stock.

A 1024-bit n-channel MOS RAM, the EA 1500A, guarantees an access time of 60 ns. The memory can be OR-wired to expand capacity and requires only two power supplies of ±15 V. Power dissipation is only 0.22 mW/bit in operation and 0.045 mW/bit on standby. The dynamic RAM employs one pulse on one pin to refresh the entire memory. The refresh pulse may occur anytime within a 2-ms interval.

CIRCLE NO. 289

DIGITAL AMPERE MINUTE/HOUR METER with Exclusive Corrosion- Proof Counter Reset System



A PVC Bezel seals the reset system, yet is easily reset with teflon push buttons thru teflon seals!

Solid state design provides superior accuracy of less than $\pm 5\%$ of the input current from 1% to 100% of range. You get instant readout of current and time converted into ampere minutes or hours on electromechanical counters. Preset systems are supplied with Sonalert sound alarm, flashing light signal. All-plastic corrosion-resistant enclosure. \$295 to \$375.

Panel-mounted models available for existing systems.

Send for catalog and name of local sales office.



Equipment Division

DEPT. 548

3543 East 16th Street, Los Angeles, CA 90023, (213) 262-1151

INFORMATION RETRIEVAL NUMBER 69

ABSOLUTELY

the world's most accurate rulings using vacuum deposit chrome, etch and fill or emulsion processes. They're produced on the world's largest 1 micro inch numerically controlled ruling engine with interferometric feedback controls. Need precision scales, grids, slits, reticles, Ronchis numbers, letters, circles, dots, or nickel mesh? We stock many items for immediate delivery. Send for brochure No. 38-36.



**SCALES RULINGS RETICLES
& GRIDS FROM THE WORLDS
LEADING SCALE MAKERS.**

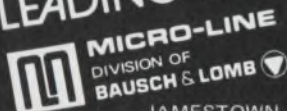

JAMESTOWN, NY 14701 716/488-1958

INFORMATION RETRIEVAL NUMBER 70

INFORMATION RETRIEVAL NUMBER 71 ▶

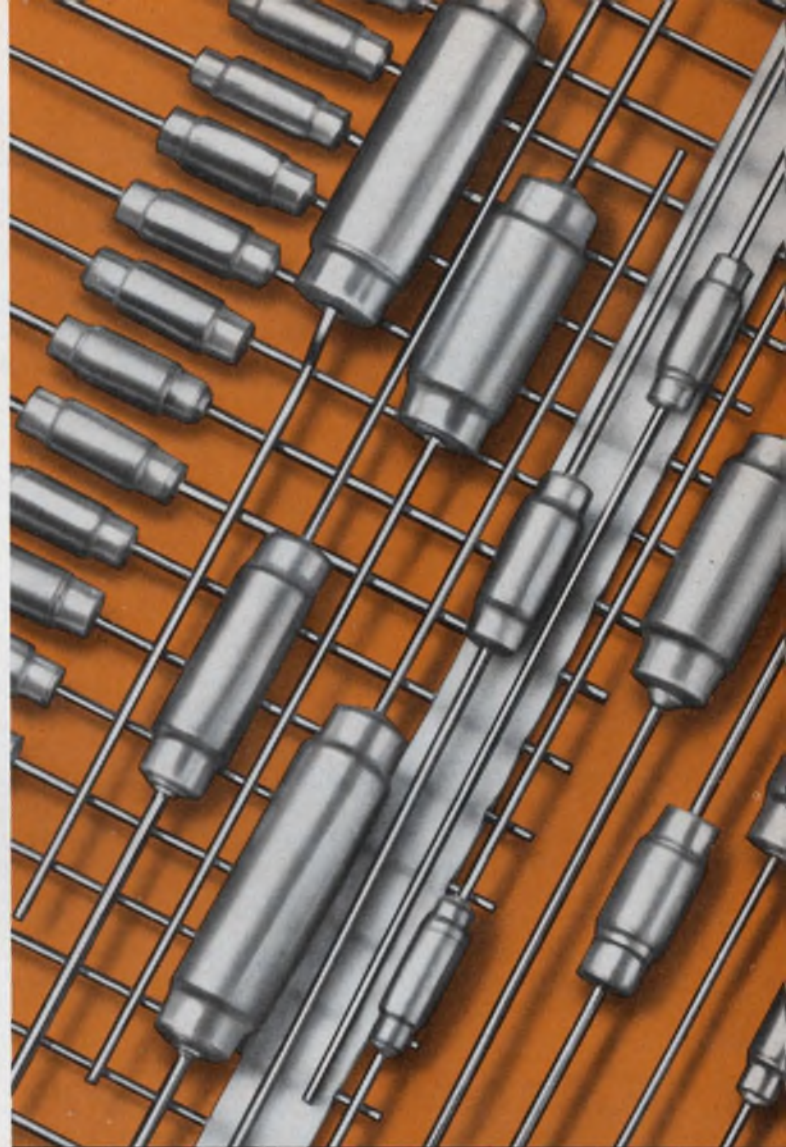

Last year these
Paktron[®] film capacitors
were revolutionary.

Now they are the standard.

And for good reasons. The Micromatic[®] capacitor, revolutionary for being wound on its own leads—and for its self-encased construction. Both polyester and polypropylene versions are widely accepted in industrial applications. Tape reeled for automatic insertion. Send for test samples and data.

PAKTRON, Division Illinois Tool Works Inc.,
900 Follin Lane, S. E., Vienna, Virginia 22180.
Phone (703) 281-2810. TWX 710-833-0682.



ITW PAKTRON[®]
innovators in film capacitors

The Innovative Electronic Group of ITW...
PAKTRON ■ LICON ■ EMCON

© ILLINOIS TOOL WORKS INC. 1974

Op amps aim for low-power uses

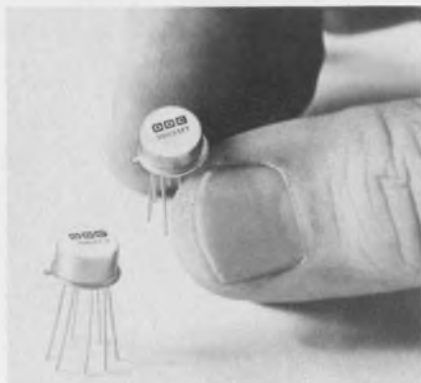

ILC Data Device Corp., 100 Tec St., Hicksville, N.Y. 11801. (516) 433-5330. P&A: See below.

A line of low-power op amps, the 1003 series, allows adjustment of electrical characteristics through an external quiescent-current setting resistor. The series features pin-for-pin compatibility with the 741 and is priced from \$2 through \$15. Availability is stock to 4 weeks.

CIRCLE NO. 290

CMOS ICs priced at 47¢ per gate



Signetics, 811 E. Arques Ave., Sunnyvale, CA 94086. (408) 739-7700.

The manufacturer enters the CMOS field with circuits costing 47¢ per logic gate in lots of 1000. The price is reportedly the lowest for any source of COS/MOS-type RCA circuits. The initial offering includes 10 gates, two flip-flops and two buffers. All units are in the N4000A/B version of the series, indicating plastic packaging and operation over the -40 to 85 C temperature range. Standardized output specs provide fanout of two 74L gates, and output characteristics at loadings of 15 and 50 pF.

INQUIRE DIRECT

CMOS ICs use Cer-dip packages

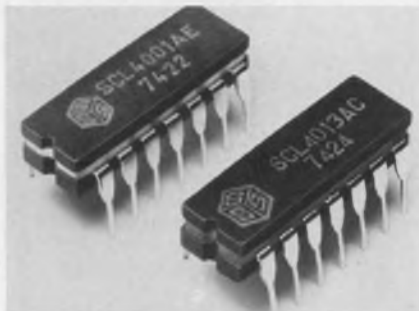

Solid State Scientific Inc., Montgomeryville, Pa. 18936. (215) 855-8400.

Ceramic Cer-dip packages now encapsulate the company's SCL 4000 series of CMOS circuits. Designed for severe environmental situations, the new products operate over the -55 to 125 C temperature range. All 14 and 16-pin circuits are available in the Cer-dip package, identified by the suffix AC. Representative unit prices in 1000 quantities are 84¢ for the SCL 4001AC, \$1.74 for the SCL 4027AC and \$4.04 for the SCL 4511AC.

CIRCLE NO. 291

RCA's new 3-inch scope...an entire servicing system for only \$229.*

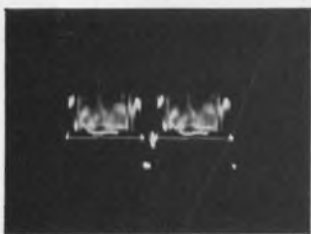

1. It's an 8 MHz general-purpose scope. Typical composite TV video signal.



3. It's a Vectorscope for color TV AFPC alignment. Color bar generator used for test signal.

For fast delivery and full information on the new WO-33B, contact any one of the more than 1,000 RCA Distributors worldwide.

Or write: RCA Electronic Instruments Headquarters, Harrison, N.J. 07029.

Specialists demand the best tools of their trade.



2. It's a "Quicktracer" Transistor/Diode and Component Tester. Typical junction waveform.

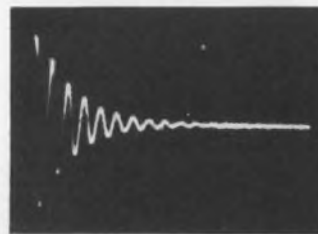

4. It's a "ringing" tester for coils, yokes, transformers. Typical ringing test pattern.

5. It includes the WG-400A Direct/Low-Capacitance Switch Probe and Cable with BNC type connector, and a special "Quicktracer" probe.

*Optional price

RCA Electronic Instruments

INFORMATION RETRIEVAL NUMBER 72

Access 1-k static RAM in 350 ns

Fairchild, MOS Products Div., 464 Ellis St., Mountain View, Calif. 94042. (415) 962-3816. Samples available.

The 2102 n-channel 1024-bit static RAM has access times as fast as 350 ns over the rated temperature range. In addition to the high-speed version (suffix F), other models have guaranteed access times over the 0-to-70-C temperature range of 650 ns (basic model) and 450 ns (suffix 1). MIL versions are also available. The 2102 uses Isoplanar processing, comes in a 16-pin DIP and requires only a single +5-V supply.

CIRCLE NO. 292

Voltage reference has stability of 40 ppm/°C

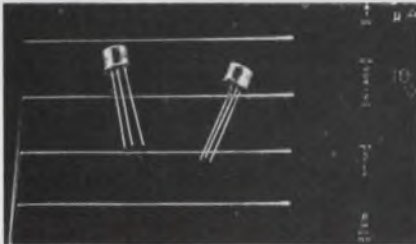

Analog Devices, Route 1 Industrial Park, P.O. Box 280, Norwood, Mass. 02062. (617) 329-4700. \$3 to \$11.25 (small qty); stock.

Temperature-compensated voltage reference provides stabilities to 40 ppm/°C and 25 μ V/month. The AD580 three-terminal band-gap reference has a fixed 2.5 V \pm 2% output for inputs between 1.5 and 30 V without any external components. Other features include a 1.5-mA maximum quiescent current and 6- μ s turn-on time.

CIRCLE NO. 293

7-segment display decoder has BCD, too

Scarpa Laboratories Inc., 46 Liberty St., Braintree Station, Metuchen, N.J. 08840. (201) 549-4260. P&A: See below.

The SC-426 display decoder provides BCD outputs in addition to the seven-segment outputs needed to drive LED displays. The IC comes in a standard 16-pin DIP. Priced at \$15 (1 to 99), the unit has an availability of stock to two weeks.

CIRCLE NO. 294



Tele-Dynamics Series HR... 30 models in 5 case sizes... interchangeable with Lambda LM and similar... output 5-28 Vdc, 1.3-20 A... ripple 1 mV rms... line & load regulation each \pm 0.05%... input 105-125 / 210-250 V, 47-63 Hz... unit price \$113-\$256.

Are you paying too much for modular 5-28Vdc power supplies?

If you're buying from Lambda, you are.

Tele-Dynamics HR Series supplies have same performance, lower cost, and are available at 110 stocking locations. Call toll-free (800) 645-9200* for the distributor or engineering representative nearest you.

*N.Y. state, call (516) 294-0990 collect.



Distributors • Allied • Arrow-Angus • Cramer • Intermark • Newark • Olive Radio • Philadelphia Electronics • Pioneer Standard • RPS Electronics • Ralph's • Stark • Sterling (Calif.) • Summit • Testco • T. I. Supply • Zack
Distributed in Europe by Texas Instruments, Ltd. and Tisco

WANLASS POWER SUPPLIES

TELE-DYNAMICS

DIVISION OF **AMBAC**

525 Virginia Drive, Fort Washington, PA 19034 (215) 643-3900

Career opportunities for power supply engineers—write Mr. W. Booth.
AN EQUAL OPPORTUNITY EMPLOYER M/F

Bandpass filters absorb skirt frequencies

Microwave Filter Co., Inc., 6743 Kinne St., East Syracuse, N.Y. 13057. (315) 437-4529. \$220; 10 days.

Series 3261 vhf-uhf bandpass filters reportedly don't reflect skirt frequencies, as do conventional filters, but absorb them. Hence random-system reflections are reduced. Filters can be supplied with 1% to 10% passbands in the 10-to-300-MHz frequency range. Impedance is 50 Ω (BNC connectors) or 75 Ω (Type F).

CIRCLE NO. 295

Low-noise amps fill many needs

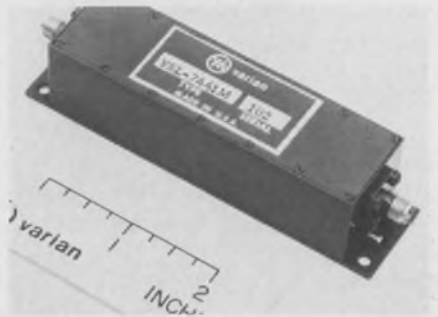

Varian, 611 Hansen Way, Palo Alto, Calif. 94303. (415) 493-4000. 30-60 days.

Low-noise solid-state amplifiers are available for communication, wideband and radar systems. The VSG-7421G, typical of devices for communication systems, covers the frequency band from 3.7-to-4.2 GHz. Maximum noise figure is 4.5 dB and minimum power output at 1-dB gain compression point is 7 dBm. Typical of wideband units, the VSS-7451J has a frequency range of 2-to-4 GHz. Maximum noise figure is 4.5 dB and minimum power output at 1-dB gain compression point is 10 dBm. Also, transistor amplifiers cover all the standard radar bands from 0.4 to 3.6 GHz. The VSL-7441M, for example, has a frequency range of 1.1-to-1.4 GHz. Maximum noise factor is 2.25 dB, and minimum power output at 1-dB gain compression point is 4 dBm.

CIRCLE NO. 296

industries' largest selection of SCR Phase Controlled Power Supplies

CALL TOLL FREE 800-631-4298

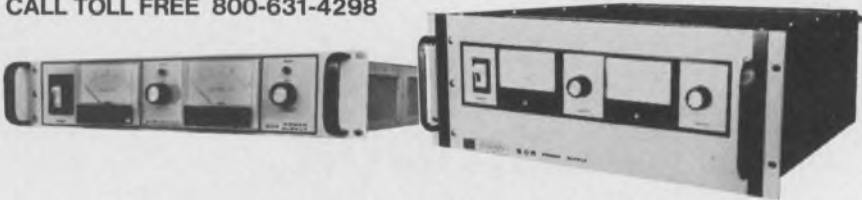

E/M has expanded its former 2.5, 5.0 and 10.0 kw SCR Models to now include 27 new models with power ratings of 600w, 1200w and 2000 watts. All models are 0.1% regulated in both the voltage and current mode of operation with automatic crossover. Remote programming and sensing are standard on all models as well as forced air cooling and automatic over-temperature protection. The three lower power ratings are all single phase input, while the three higher power ratings are all three phase input. As expected, E/M has maintained its position of providing the highest power output per mechanical volume in the industry for equipment of this type. Front panel heights being 3 1/2" on 600w, 5 1/4" on 1200w, 7" on 2000w and 2500w, 8 3/4" on 5000w and 12 1/4" on 10,000w models.

Volts	600w		1200w		2000w		2500w		5000w		10,000w	
	Amps	\$	Amps	\$	Amps	\$	Amps	\$	Amps	\$	Amps	\$
0-6									600	2200		
0-7.5	85	500	125	850	200	1000	300	1400				
0-10	60	500	100	850	150	1000	250	1400	500	2200		
0-20	30	425	50	750	90	900	125	1300	250	1800	500	2700
0-30							100	1300	200	1800		
0-40	16	425	30	750	50	900	60	1300	125	1700	250	2500
0-50											200	2700
0-60	11	425	20	750	35	900						
0-80	8	425	14	750	25	900	30	1300	60	1700		
0-100											100	2700
0-120							20	1300	40	1700		
0-150	4	425	7	750	13	900						
0-160							15	1300	30	1700	60	2500
0-250							10	1300	20	1800	40	2700
0-300	2	450	3.5	850	6	1000						
25-500							5	1600	10	2200	20	2700
10-600	1	450	1.5	850	3	1000						

SEE EEM VOL. 1-673-675 FOR ADDITIONAL PRODUCT INFORMATION

ELECTRONIC MEASUREMENTS INC.

405 ESSEX ROAD, NEPTUNE, NEW JERSEY 07753
Phone: (New Jersey) (201) 922-9300 • (Toll-Free) 800-631-4298
Specialists in Power Conversion Equipment



INFORMATION RETRIEVAL NUMBER 74

2-GHz, 0.5-W tunable osc holds noise down

Frequency Sources, 166 Middlesex St., North Chelmsford, Mass. 01863. (617) 251-8747.

The Model FS-2137-1 high power, transistorized cavity oscillator features a $\pm 0.1\%$ afc option and low FM noise. The unit can be mechanically tuned over any 200-MHz band between 1.5 and 2.0 GHz with output power levels to 500 mW. Afc tuning sensitivity is typically 0.7 MHz/V over a $\pm 0.1\%$ bandwidth. Harmonic rejection is -30 dBc with all nonharmonic signals down -60 dBc/Hz at 1 kHz from the carrier and -120 dBc/Hz at 100 kHz from the carrier. Power input is typically 28 V dc at 100 mA.

CIRCLE NO. 297

Elliptical guides are copper corrugated

Prodelin, Inc., Dept. G, Box 131, Hightstown, N.J. 08520. (609) 448-2800. \$3.80 to \$7 per foot; stock to 60 days.

Copper-corrugated elliptical waveguides, covering the 3.7-to-13.2-GHz range, are offered in the company's Spir-O-guide CC series. The waveguides come in two versions—standard and "super-premium." Each type differs only in the VSWR of the waveguide assembly. Super-premium guides list maximum VSWRs at 1.03, while standard guides have maximum VSWRs of 1.15.

CIRCLE NO. 298

System eases laser beam analysis



Apollo Lasers, 6357 Arizona Circle, Los Angeles, Calif. 90045. (213) 776-3343. \$8500; 45-60 days.

Beam profile monitoring can be performed with the Model PLB-2 system. It displays the spatial intensity distribution of cw, pulsed, Q-switched or mode-locked lasers in near real time. And the system delivers analog signals which allow point-by-point or line-by-line intensity measurements. The system consists of a silicon-array target video camera mounted on a tripod and equipped with a zoom lens, a stop-action video recorder, a high resolution TV monitor and a video analyzer. Video tape provides a permanent record of each laser firing. The system is designed to operate with laser outputs varying from the visible to the near infrared, including Nd:glass and YAG lasers.

CIRCLE NO. 299

New and improved General Electric lamps provide for increased design flexibility.

Two new sub-miniature halogen cycle lamps ideal for miniaturization.

These new T-2, 6.3V, 2.1 amps, 75 hour GE halogen cycle lamps are the smallest of their type (.265") and set industry standards for size and light output (16-20 candlepower). They are perfect for miniaturization of equipment such as reflectors, housings and optical systems. They also save on overall cost of equipment and are less than half the cost of the #1973 quartz lamp they replace.

Two terminal configurations are available. #3026 (20 candlepower) has wire terminals. #3027 (16 candlepower) has a new two pin, ceramic base that plugs in to make installation and removal a snap. Samples of the #3027 lamp are available in limited quantities now; production quantities will be available in the first quarter of 1975. These lamps have an iodine additive that creates a regenerative cycle that practically eliminates normal bulb blackening. They will produce approximately 95% light output at 75% of rated life.

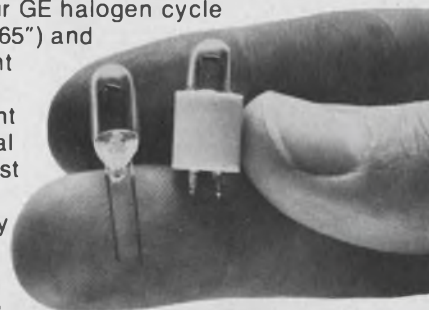

An expanded line of Wedge Base Lamps for simple, low-cost circuitry.

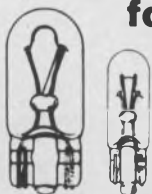

Now you can have greater design freedom than ever before with wedge base lamps. GE now offers six large lamps in its line of T-1 3/4 (.230" max.) all-glass, sub-miniature wedge base lamps. In addition to our three 14V lamps (#37, #73 and #74), we now also offer two 6.3V lamps (#84 and #86) and a 28V lamp (#85).

These lamps are ideal for applications where space is at a premium. Their wedge-based construction allows you to design for low-cost sockets and virtually ends corrosion problems because they won't freeze in the sockets. And the filament, which is always positioned in the same relation to the base, offers more uniform brightness.

Green Glow Lamp has been improved over previous lamp.



Actual Size

Now our G2B Green Glow Lamp, the only domestic green lamp on the market today, gives a more uniform, purer green light than our previous model. It's bright enough for your circuit component applications. With appropriate current limiting resistors, it can be used for 120/240 volt green indicator service. Or used together with our high-brightness C2A red/orange/yellow glow lamps to emphasize multiple functions with color.

All GE glow lamps give the benefits of small size, rugged construction and low cost — 12¢ each for the G2B, 4.4¢ each for the C2A in 100,000 quantities.

Send today for newest literature.

For the most up-to-date technical information on any or all of these lamps, write: General Electric, Miniature Lamp Products Department, #7410-L, Nela Park, Cleveland, Ohio 44112.

GENERAL  ELECTRIC

INFORMATION RETRIEVAL NUMBER 75

Nitrogen laser has high rep rate

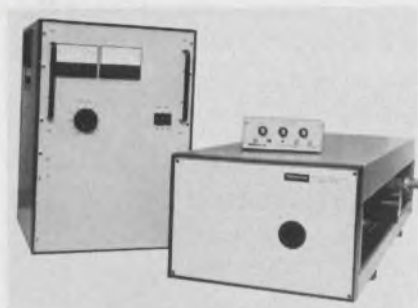

Molectron Corp., 177 N. Wolfe Rd., Sunnyvale, Calif. 94086. (408) 738-2661. \$14,900; stock to 30 days.

Operation at 100 Hz and a peak power of 400 kW at 10 Hz and 300 kW at 50 Hz are featured in the company's UV-400 nitrogen laser. The unit requires no cooling water, and it provides a single output beam (no wall modes). Specifically designed for dye-laser pumping, the unit is just over 4-feet long with a separate power supply.

CIRCLE NO. 300

YIG-tuned osc tunes 1-4 GHz with 40 mW out



Electronic Surveillance Components, Inc., 991 Commercial St., Palo Alto, Calif. 94303. (415) 321-4820. \$1195; 45 days.

The Model 323-2 YIG oscillator tunes from 1-to-4 GHz and delivers 40 mW minimum with 4-dB power variation. Harmonics are -12 dB and nonharmonic spurious signals are -50 dB. Pulling is less than 1 MHz into a 3:1 VSWR (any phase angle). The unit has a tuning sensitivity of 10 MHz/mA and a linearity of $\pm 0.3\%$. Power requirements are 15 V and 150 mA.

CIRCLE NO. 301

Tunable bandpass filters span 1-20 GHz



Telonic Altair, 21282 Laguna Canyon Rd., Laguna Beach, Calif. 92652. (714) 494-9401.

Continuously tunable bandpass filters feature accuracies of 1% and bandwidths of 10-to-30 MHz. The series consists of Models TYG-100 and TYG-400 for the 1-to-20 GHz and 4-to-18-GHz range, respectively. The new filters use YIG, two-element construction, and they measure 4-1/2 x 4-1/2 x 3 in. Resolution on the frequency reading dial is 10 MHz. Other specifications include 40 dB off-band attenuation, and 100 mW maximum average rf power.

CIRCLE NO. 302

Here's everything you'd expect from a high-priced portable FET meter.

Except a high price.

Compare our major features: Both high and low power ohms ranges; a .1 V low voltage scale (AC & DC); a DC current range of 1 μ A full-scale; fuse protection; input impedance of 15 M Ω on DC; 1% precision resistors; a 4 1/2 inch, 50 μ A mirrored scale meter; frequency response flat to 150 kHz and 59 ranges; battery operated.

You'd expect to pay a lot more for a portable multi-meter like the B & K 277. Check the specs. Call your B & K distributor or write Dynascan Corporation.

\$102⁰⁰



B&K Very good equipment at a very good price.
Product of Dynascan Corporation
1801 West Belle Plaine Avenue, Chicago, Illinois 60613

Here's everything you'd expect from a high-priced Hi-Low FET multimeter.

Except a high price.

Introducing the B & K Model 290 solid-state FET Multimeter. Just by glancing at its specs, you can tell that the 290 is capable of more applications than any other multimeter in its class. 75 ranges. Hi-Lo power ohms ranges (low power only 33 mV). 15 megohms input impedance. A large 7" meter. 50 mV to 1500V full-scale sensitivity on both AC and DC. 50 micro-amp current range. Rx0.1 ohm range with 1 ohm center scale lets you measure low resistance down to .01 ohm. Circuit provides automatic overload protection with fuses and spark gaps. More multimeter for your money - that's

just what you expect from B & K.

Contact your distributor, or write Dynascan Corporation.

Model 290 Hi-Low FET Multimeter including Model PR-21 Probe:

\$151⁰⁰



B&K Very good equipment at a very good price.
Dynascan Corporation
1801 West Belle Plaine Avenue, Chicago, Illinois 60613

Step attenuators span 18-GHz range



Weinschel Engineering, P.O. Box 577, Gaithersburg, Md. 20760. (301) 948-3434.

Step attenuators operate from dc up to 1, 4, 8, 12.4 or 18 GHz. The series provides a choice of maximum incremental attenuation—up to 99 dB in 1 or 10-dB steps—and connector and knob types. Precision switching allows repeatability of better than 0.05 dB to 18 GHz.

CIRCLE NO. 303

Phase-locked source outputs 10 mW



Varian, Salem Rd., Beverly, MA 01915. (617) 922-6000. Under \$400 (large qty); 60 days.

Operating over the 5855-to-6455-MHz range the VXC-9928 crystal-reference, phase-locked source outputs 10 mW. The unit has a frequency stability of $\pm 0.005\%$ over the temperature range of -30 to 60 C, and it produces an output frequency 60 times that of the reference frequency. Maximum load VSWR is 1.5:1.

CIRCLE NO. 304

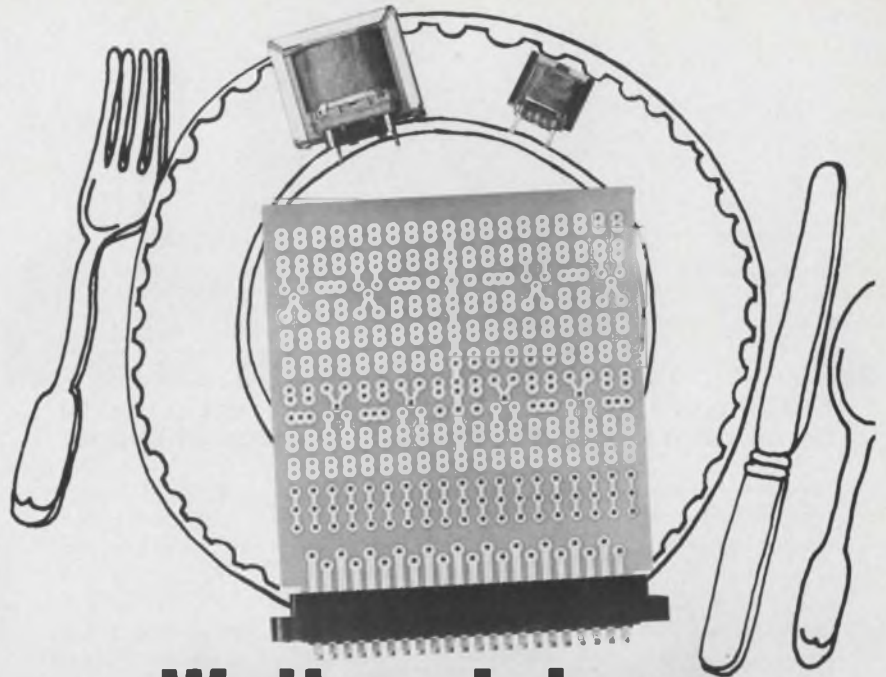

Wait watchers special for busy engineers

If you're interested in wait reduction, we urge you to order Triad's combination plate—plug-in transformers, circuit cards and mating connectors—from your industrial electronic distributor. Triad not only gives you more transformers and inductors to plug in, but a versatile line of integrated and universal circuit cards to plug into. And—to save you a search for the applicable connector, you need only put a "CO" prefix ahead of the card number to get the right Winchester connector in the same package with the card—ready for you to put together.

Triad has a standard series of plug-in telephone coupling transformers to interconnect remote data entry and display terminals to computers over voice grade telephone lines. Triad also makes many standard plug-in power transformers for transistorized control and instrumentation with single and dual primaries. Secondaries may be connected in series or parallel to obtain a wide range of voltage and ampere combinations.

Get a catalog from your distributor. Or write Triad Distributor Services, 305 North Briant Street, Huntington, Indiana 46750.



Voltage Stabilizer Transformers



Commercial Grade Powers and Audios



Transistor Power Supply Transformers

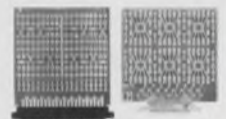

Integrated Circuit Cards



Litton

TRIAD-UTRAD

Distributor Services

INFORMATION RETRIEVAL NUMBER 78



Multilayer Ceramic Interconnects... we'd like to be more than someone's secret source of supply.

People come to us with ceramic interconnect problems. One customer asked if we could provide a substrate with interconnections for all active components of an electronic digital watch. We did it. Another wanted an interconnect with high thermal conductivity and precise circuit definition to



maintain exactly 50 ohm microstrip and strip line impedances. We did that too. We've solved hundreds of complex ceramic interconnect problems. And, as usual, the customer tells us we're his secret source of supply. We'd like everyone to know about us. Let's not keep us a secret.



Call or write for further information:

CERAMIC SYSTEMS

Telephone: (714) 459-2935
3422 Tripp Court San Diego, CA 92121

INFORMATION RETRIEVAL NUMBER 79

Before you buy

COMPARE MODULATION METERS

We invite you to use Radiometer's Type AFM2 or AFM3 in your laboratory on a 10 day trial. Check features, specifications and especially performance in your own precise measurements of FM deviation and AM modulation on carriers from 5 MHz to over 1 GHz. Determine distortion levels of signal generators or transmitters and make sensitive measurements of incidental AM or incremental FM on carriers.

You can check all these and more.

For details contact us at
811 Sharon Drive,
Cleveland, Ohio 44145
Phone 216/871-8900



A quality product of



INFORMATION RETRIEVAL NUMBER 80

MICROWAVES & LASERS

Laser system outputs up to 9 W TEM₀₀



Quantronix, 225 Engineers Rd., Smithtown, N.Y. 11787. (516) 273-6900. \$10,990 up.

Up to 9 W in a TEM₀₀-mode are provided by a Nd:YAG crystal laser series (Model 114). In multi-mode operation the output reaches 100 W. The series features krypton arc lamps that can be changed in 5 min. and a flooded cavity that can be disassembled and reassembled in less than 15 minutes. The series is available in four configurations that differ in the number of lamps and accessories. The Model 114-6, for example, is a dual ellipse 3 × 63 mm Nd:YAG crystal. It has a one-package power-supply/cooler, acousto-optic Q-switch and a spatial-mode selector. The Q-Switch (Model 303) has a pulse repetition rate up to 50 kHz.

CIRCLE NO. 305

Test system performs SWR, loss measurement



Alford Manufacturing Co., 120 Cross St., Winchester, Mass. 01890. (617) 729-8050

The Type 5130 swept-frequency SWR and insertion-loss measuring system combines a precision 7-mm swept slotted line set with a matched pair of high-directivity couplers. The result is a broad band system with a frequency range of 2 to 18 GHz. Included are the necessary detectors and interconnecting cables. For increased utility, both the slotted-line measuring port and terminating coupler port are equipped with CA-45 precision connectors.

CIRCLE NO. 306

94-GHz circulator has 2% bandwidth

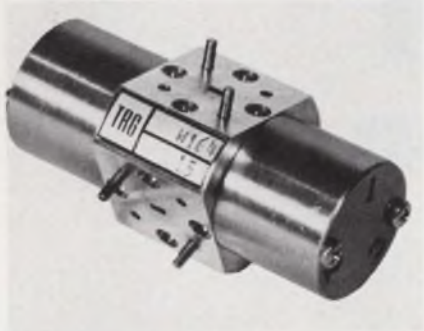

Alpha Industries Inc., 400 Border St., East Boston, MA 02128. (617) 569-2110.

The Model W164 circulator operates at 94 GHz with a 2% bandwidth. The new unit is an E-plane Y-junction device for use in WR-10 waveguide (75 to 110 GHz). Typical isolation specs range from 25 to 30 dB at the design frequency, and insertion loss doesn't exceed 0.7 dB. The circulator operates over the 0-to-50-C temperature range, and it weighs 6 oz.

CIRCLE NO. 307

Plug-in doubles unit's range to 1.3 GHz



Singer Instrumentation, 5340 Alla Rd., Los Angeles, Calif. 90066. (213) 822-3061. \$1295; 8 wks.

Use of a plug-in module increases the maximum frequency capability of the company's FM-10C Communication Service Monitor from 512 MHz to 1.3 GHz. The module has an input sensitivity that is variable from 20 μ V to 20 mV, and it equips the FM-10C to service transmitters and receivers in the following bands: common carrier, TACAN/DME, control links and air-traffic control beacons. The RFM-11A module can also service the proposed new 900-MHz frequency assignments.

CIRCLE NO. 308

PRECISION CONTROL

with the **SERIES 300
CONTROL TACHOMETER**

**"The EVENT CONTROLLER
that DOES IT ALL"**

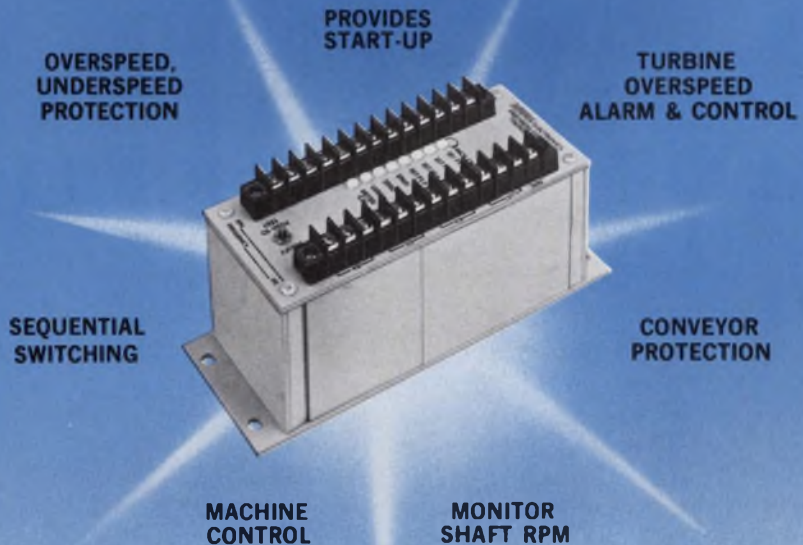

The 300 Tachometer is compact and solid state. It will accept signals from many types of sensors . . . will operate from signals produced by magnetic or zero-velocity type pick-ups mounted in proximity to a rotating gear. Up to 4 switch points can be provided. Analog control outputs, verify features, selectable relay logic and other standard options are available.

Bulletin 8511-574 gives complete details and specifications.

AIRPAX Controls Division P.O. Box 8488
Fort Lauderdale, Florida 33310 Phone: 305/587-1100

AIRPAX™

INFORMATION RETRIEVAL NUMBER 81

LOOKING FOR CONNECTORS?



VIKING INDUSTRIES, INC.
STANDARD PRODUCTS DIVISION

BUNKER RAMO

AMPHENOL



Bendix
Electrical
Components
Division

AMP
INCORPORATED

SWITCHCRAFT

See 3100 Connector Products & Terminal Guards



ROBINSON
NUGENT INC.



nolex

T&B
ENGINEERED

CANNON
PLUGS

Jermyn

Scotchflex®

PE POMONA
ELECTRONICS

CAMBION®

DALE

BURNDY

AUGAT®

LOOK FIRST IN Electronic Design's GOLD BOOK



IT'S ALL THERE For example for CONNECTOR PRODUCTS you'll find source information listed for the following categories in the PRODUCT DIRECTORY (each listing gives *complete* manufacturer's name, street address, city, state, zip and phone for convenience in contacting suppliers):

CONNECTOR ADAPTERS • CONNECTOR BOXES AND STRIPS • CONNECTOR CAPS • ANTENNA CONNECTORS • AUDIO CONNECTORS • BATTERY CONNECTORS • CIRCULAR CONNECTORS • COAXIAL CABLE CONNECTORS • CORD CONNECTORS • FILTERED CONNECTORS • HIGH VOLTAGE CONNECTORS • INTERLOCK CONNECTORS • PRINTED CIRCUIT CONNECTORS • QUICK DISCONNECT & PUSH-ON CONNECTORS • RACK & PANEL CONNECTORS • RF CONNECTORS • SOLDERLESS CONNECTORS • STRIPLINE CONNECTORS • UMBILICAL CONNECTORS

YOU'LL FIND 216 CATALOG PAGES ON WIRE & CABLE AND CONNECTOR PRODUCTS

Volume 3 of *Electronic Design's* GOLD BOOK leads off with catalog pages on wire and cable and is followed immediately by connector products and terminal boards. Forty-three manufacturers are represented in these two sections. Amphenol has 24 pages packed with detailed specifications; AMP Incorporated emphasizes its flexible flat cable products, miniature and pin socket connectors; Augat has 10 pages; Robinson Nugent, Inc. offers 8 pages, and so on. Check these pages first before you contact a supplier. You may find the exact item you need—and that goes for each one of the 52 product categories in *Electronic Design's* GOLD BOOK. There are 2,820 catalog pages in all right at your fingertips for immediate reference. And TWICE the number of directory pages available from any other industry source.

**WHEN YOU'RE LOOKING FOR MANUFACTURERS,
DISTRIBUTORS, OR PRODUCT INFORMATION...
ELECTRONIC DESIGN'S GOLD BOOK
IS THE PLACE TO LOOK**

3- ϕ power monitor protects equipment



Time Mark Corp., P.O. Box 15127, Tulsa, OK 74115. (918) 939-5811. \$97 to \$165.

Model 259 three-phase power monitor prevents damage to motors and other sensitive equipment. Inputs to the device are connected directly to the power lines at the point to be monitored. The output is a set of DPDT 10-A contacts which trip upon a loss of phase, low-voltage condition or phase reversal. Delay in tripping is adjustable from 1 to 5 s. An indicator lamp lights when a failed condition occurs. Reset is automatic.

CIRCLE NO. 320

CRT supplies give variable anode voltages



Spellman, 1930 Adee Ave., Bronx, N.Y. 10469. (212) 671-0300. CRT-30, \$1400, CRT-40, \$1650; 4-6 wks.

Known as the CRT-30 and CRT-40, these high-voltage power supplies feature fully adjustable ranges of anode and focus voltages. Model CRT-30 has anode voltage adjustment from 0-30 kV and Model CRT-40 from 0-40 kV. Maximum output current for either model is 4 mA. Maximum output power is 120 W. Line regulation is $\pm 0.01\%$ for $\pm 10\%$ line change; load regulation is 0.01% for full-load change; ripple is 0.02% rms; stability is $0.02\%/hr.$ or $0.05\%/8$ hrs.; and tempco is $0.02\%/^{\circ}C.$

CIRCLE NO. 321

Modular supplies give 24 new models



Dynamic Measurements Corp., 6 Lowell Ave., Winchester, Mass. 01809. (617) 729-7870. \$23 to \$90 (1-9); stock to 2 wks.

Twenty-four new modular power supplies feature 0.01% regulation against all line and load conditions. $100\text{-}\mu V$ rms total noise and ripple and $0.02\text{-}\Omega$ maximum output impedance. Included are bipolar models for $\pm 6, \pm 8, \pm 12, \pm 15, \pm 18$ and ± 24 V, as well as 5 V at up to 1 A. Two supplies provide ± 15 and 5 V in the same package. Other specs include 0.01% tracking between output voltages and zero derating at maximum operating temperature. Warm-up drift is 10 mV max.

CIRCLE NO. 322

High-voltage packs have simple controls



Hipotronics, Inc., Brewster, N.Y. 10509. (914) 279-8091. \$395.

These power packs are now available with simplified control panels for relay-rack mounting. Standard models range from 2 to 5 mA, with output voltages to 60 V. All components are industrial grade. Both an output-connected kilovolt meter and current meter are provided on all models, along with a continuously adjustable output control. Optional extras include a benchtop cabinet and a short-circuit limiter for capacitor charging, flocking and electrostatic operations.

CIRCLE NO. 323

Airborne source works from 3- ϕ power

Teledyne MEC, 3165 Porter Dr., Palo Alto, CA 94304. (415) 493-1770. \$4500; 120 days.

Designated the M8242, this military airborne power supply provides regulated dc power for logic and signal processing circuitry. The supply operates from 115-V, 400-Hz, three-phase prime power in accordance with MIL-STD-704, and provides outputs of $\pm 5, \pm 12$ and ± 15 V dc. Output power is up to 250 W dc. Size is $4 \times 6 \times 3$ in. and weight is 4.5 lb.

CIRCLE NO. 324

Lithium battery comes in 9-V transistor size



Power Conversion, Inc., 70 MacQuesten Parkway S., Mount Vernon, N.Y. 10550. (914) 699-7333. \$10 (small quan), \$3 (large quan); stock.

The popular 9-V transistor-size primary battery is now available in a lithium design. The Eternacell Model 400-9 has a rated capacity of 525 mA-h at a 20-mA current drain. Shelf life is in excess of five years. Operating temperature ranges from -65 to $+165$ F. Eternacell batteries are available in 10 standard configurations, including AA, C, and D-cell sizes, in capacities of 10 A-h. The single cell unit yields 2.80 V per cell, twice ordinary primary cells.

CIRCLE NO. 325

Ballantine, 3 to 1 in your favor!

New 15MHz Precision Voltmeter
replaces three old designs
100 μ V sensitivity
unmatchable performance
from \$385

Call your local Ballantine field engineer.



BALLANTINE LABORATORIES, INC.
P.O. Box 97, Boonton, New Jersey 07005
201-335-0900, TWX 710-987-8380



INFORMATION RETRIEVAL NUMBER 82

The Brush 222 battery operated portable recorder.

The Brush 222 is a self-contained 2 channel recorder. It comes complete with signal conditioners, internal battery supply and charger.

The battery supply gives you up to 12 hours of continuous operation. There's pressurized ink writing and linearity guaranteed to 99½%.

Write Gould Inc., Instrument Systems Division, 3631 Perkins Avenue, Cleveland, Ohio 44114. Or Kouterveldstraat Z/N, B 1920 Diegem, Belgium.



 **GOULD**

INFORMATION RETRIEVAL NUMBER 83

ELECTRONIC DESIGN 21, October 11, 1974

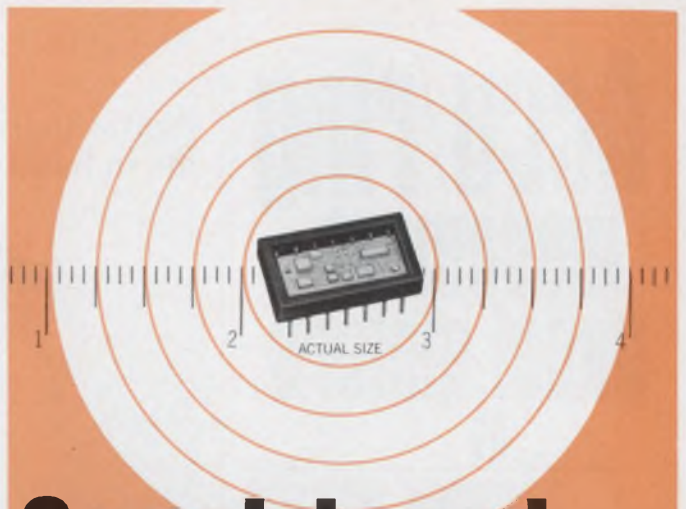

Complete and Adjustment-Free Sample/Hold

Model MN343 S/H in a dip features:

- HIGH SPEED ... 7.5 μ sec acquisition time.
... 60 nsec aperture time.
- LOW DROOP RATE ... 100 μ V/msec.
- GUARANTEED ACCURACY ... $\pm .02\%$ at 25C.
... $\pm .05\%$ (0 to 70C and -55 to +125C).
- SMALL SIZE ... 14 pin hermetic dip.

Micro Networks continues to lead the field in the engineering and production of complete, adjustment-free conversion products.

Model MN343—with internal holding capacitor—is the first complete and adjustment-free S/H in a dip. It is laser trimmed for offset and gain, eliminating the need for external components and trim pots. Because of its high speed and low droop characteristics it is a perfect match to the 12 bit high speed A/D converters such as Micro Networks' MN5200. For the operating range -55 to +125C, the MIL-range unit MN343H will lose only 1 mV—or less than $\pm 1/2$ LSB out of 12 bits in 50 μ sec.

For additional
information,
prices and
specifications,
write or call.



Micro Networks Corporation

324 Clark Street • Worcester, Mass. 01604 / Tel: 617-842-5400

INFORMATION RETRIEVAL NUMBER 84

Accu/ring movement panel meters by

HOYT

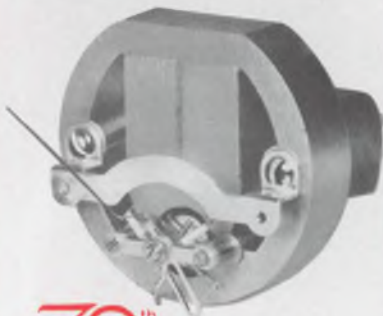

70th
OUR YEAR

Now you can appreciate
these Accu/ring features!

- SELF SHIELDING • BETTER LINEARITY, tracking, repeatability • ACCURACY not affected by steel panel or magnetic fields
- HIGH DENSITY sintered iron ring and pole piece for even flux distribution • HIGH TORQUE with fast response for quick readings • UNIQUE DOUBLE BRIDGE construction for best alignment of all components • TROUBLE-FREE, rugged meter 100° movement • AVAILABLE in all Hoyt's panel meter cases, 2½" and up • COMPETITIVELY PRICED

NEW TOLL-FREE PHONE (800) 225-1375

HOYT ELECTRICAL INSTRUMENT WORKS, INC.
BURTON-ROGERS COMPANY Sales Division
556 Trapelo Rd. Belmont MA 02179

HOYT

QUALITY INSTRUMENTS
SINCE 1904

INFORMATION RETRIEVAL NUMBER 85

INSTRUMENTATION

Digital thermometer fits in hand



Noronix Ltd., 8 Thomas St., London SE18 6HR, England. \$249; 6 wks.

Mintemp portable battery-powered digital thermometer features an accuracy of 0.1%. The unit covers the range 0 to 1200 C using Chromel-Alumel thermocouples, digital techniques and automatic cold-junction and linearizing circuits. The only control is a press-to-read button and there is a clearly defined overrange and low-battery indication. Accuracy is maintained right up to the battery end point by means of stabilizing circuits and is independent of thermocouple lead length and thickness.

CIRCLE NO. 326

Unit tests floppy discs

Three Phoenix Co., 10632 N. 21st Ave., Phoenix, Ariz. 85029. (602) 944-2222. \$18,500; 90 days.

A floppy-disc tester, called the Testette, is said to be the first of its type to be offered commercially. Model 33 FD tests for modulation, missing pulse, and extra pulse with a throughput of 1, 1.6, or 3.2 m. Tests are made at singular, adjustable analog clipping levels and performed over 234 tracks. When an error is encountered in the production mode, the certifier will abort the test automatically, return the carriage home and indicate on the front panel the type of error detected.

CIRCLE NO. 327

Multiplying counter handles harmonics



Telesis Laboratory, 41-1/2 S. Paint St., Chillicothe, Ohio 45601. (614) 773-1414. \$640; stock.

The Model 440 multiplying counter automatically processes harmonic laden and multiple-zero crossing signals over a 60-dB range. The unit's Nixie display is accurate to ± 0.1 Hz and updates twice each second. When a tone burst is applied to the input, the unit begins a frequency scan from 25 to 1000 Hz. The display is enabled only when phase lock with the fundamental component has been obtained. Amplitude compression and high frequency roll off are used to permit counts even when the input signal varies between 5 mV and 5 V peak.

CIRCLE NO. 328

PC test station needs no software



Fluke/Trendar, 500 Clyde Ave., Mountain View, Calif. 94040. (415) 965-0350. Approx. \$26,000.

A new production-line test station for high-volume PC-board testing is an improved version of the TRENDAR 2000. The TRENDAR 2000A now provides the added capability of single board go/no-go tests for boards with up to 64 outputs. Additionally a transition count and pulse width measurement capability has been added, making the 2000A fully compatible with the portable 1000A. Both features enable operators to test boards without a known good board for comparison. Up to 4-million tests per second are generated by the 2000A from 128 signal sources. Software is virtually eliminated.

CIRCLE NO. 329



FREE CATALOG

CHOOSE FROM OVER 4,500 UNUSUAL BARGAINS

OPTICS • SCIENCE • ELECTRONICS

1,000's OF HARD-TO-FIND BUYS FOR INDUSTRY

Brand new 164-page easy-to-read edition packed with new products, charts, diagrams, illustrations. On-the-job helps; quality control aids, unique, exclusive items to speed your work, improve quality, cut development and production costs! Loaded with optical, scientific and electronic equipment available from stock for industry, research labs, design engineers, experimenters, hobbyists.

ONE SOURCE FOR ALL YOUR NEEDS

Tremendous variety. Terrific savings. Countless hard-to-get surplus bargains. Many "one-of-a-kinds" nowhere else. Ingenious scientific tools. Thousands of components: lenses, prisms, wedges, mirrors, mounts, all types of accessories. Hundreds of instruments: pollution testing equipment, lasers, comparators, magnifiers, microscopes, projectors, telescopes, binoculars, photo attachments, ecological items, black light equipment and America's largest collection of unique lighting products.

BUY DIRECT WITH MONEY-BACK GUARANTEE

Edmund ships over 5,000 orders monthly to America's largest industrials — every item guaranteed! You must be satisfied, or return your purchase in 30 days for your money back. Shop the catalog of America's largest Science-Optics-Electronics Mart with confidence! Get your FREE copy without obligation. No salesman will call. Write now for free catalog. DA



EDMUND SCIENTIFIC CO.
300 EDSCORP BUILDING
BARRINGTON, NEW JERSEY 08007
TELEPHONE: 609-547-3488

INFORMATION RETRIEVAL NUMBER 86



DESIGNERS!

Practical • Reliable • Creative Ideas for Superior Results!

Get optimum results with this essential guide to the design, manufacture, and testing of BCD circuits—

Decimal Computation

By Hermann Schmid, *General Electric Company*

This book clearly describes the principles involved in BCD computation and covers algorithms, the operation and performance of BCD computing techniques, and BCD circuits. 1974 304 pages \$16.95

The only guide to the vast array of devices and techniques for photometric and radiometric design and testing—

Photometry and Radiometry for Engineers

By Allen Stimson, *Eastman Kodak Company*

If you're an engineer or technician who must work with light and color, but aren't familiar with photometric and radiometric instrumentation and measurement, this book introduces you to the great variety of devices and techniques you could be using right now! Written in a clear, readable style, with a minimum of mathematics notation, all information in the book is geared to easy, effective application. 1974 (Sept.) 416 pages \$19.95

Improve your design criteria for mobile radio systems at microwave frequencies—

Microwave Mobile Communications

By William C. Jakes, *Bell Laboratories*

This is the first and only book that treats specific problems of mobile communications as a unified subject. It relates vital communication, electromagnetic and traffic theory to propagation phenomena and mobile customer requirements... and provides you with the analytical techniques for calculating mobile communication system performance. 1974 720 pages

Practical, proven design ideas for linear integrated circuits—

Applications of Linear Integrated Circuits

By Eugene Hnatek, *DCA, Inc.*

This book finally meets the tremendous demand for a practical encyclopedic coverage of linear ICs. It gives you basic principles and a multitude of application ideas... to help you design the most practical and reliable circuits. 1974 approx. 570 pages

WILEY-INTERSCIENCE

a division of JOHN WILEY & SONS
605 Third Avenue, New York, N.Y. 10016
In Canada: 22 Worcester Road, Rexdale, Ontario



Mail this coupon to:

Wiley-Interscience, Dept. 318, Box 4569
Grand Central Station, New York, N.Y.

Please send me the book(s) I have checked below.

- My check (money order) for \$ _____ is enclosed.
- Please bill me. (Restricted to the continental United States.)
- Please send me a list of local bookstores carrying your titles.
- Decimal Computation** (0 471 76180-x) @ \$16.95.
- Photometry and Radiometry** (0 471 82531-x) @ \$19.95.

Name _____ Title _____

Firm (college) _____

Address _____

City _____ State _____ Zip _____

Please add state and local taxes where applicable. Prices subject to change without notice. 092 A4741-W1

run long, strong and profitably

Bodine FHP motors and gearmotors

Bodine's K-2 line has a history of dependability, long life, and consistent motor-to-motor performance. You get greater economy in the long run. Ball bearing rotors and individual run-in are standard. Performance options include high starting torque for inertia loads, low inertia rotor for fast response in servo applications, dynamic braking capability, torque motor application, and reluctance synchronous operation. Two new bulletins from Bodine covering K-2 motors and gearmotors are now available. Get both from...

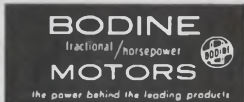

Bodine Electric Co., 2528 West Bradley Pl., Chicago, Ill. 60618

INFORMATION RETRIEVAL NUMBER 87

ELECTRONIC DESIGN 21, October 11, 1974

INFORMATION RETRIEVAL NUMBER 88

ask for Free Samples from **Eby**

HIGHER RELIABILITY FOR
COMMERCIAL APPLICATION
AT LOW COST

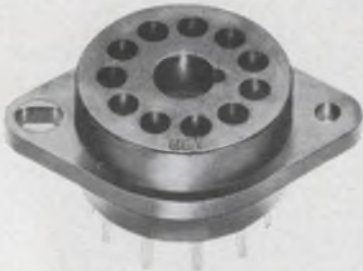

RELAY SOCKETS
heavy duty—8 & 11 pins



TRANSISTOR SOCKET
for TO-66 outline

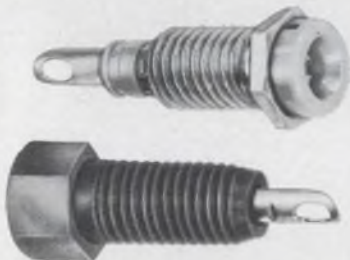

TEST JACKS
for .080 diameter probe

Consult us for other Connector
Packaging Items—and for
information on our Custom
Manufacturing Service

Circle reader service number
for your free samples and for
technical bulletins



HUGH H. EBY CO.

4701 GERMANTOWN AVENUE
PHILADELPHIA, PA. 19144
(215) 842-3000
a division of REDM Corp.

E-101

INSTRUMENTATION

Digital ac power meter also handles V and I



Yokogawa Electric Works, 2-9
Nakacho, Musashino-shi, Tokyo
180, Japan.

Model 2503 digital ac power meter measures true-rms voltage, current and power. Used for single-phase circuits, the unit has six voltage ranges (3 to 600 V), seven current ranges (100 mA to 30 A) and power (300 mW to 18 kW) over a wide range of frequencies. Measurement accuracy is 0.1% even for nonsinusoidal or distorted waves. Built-in features include BCD-coded output, remote control and analog output (optional) for interfacing with a recorder.

CIRCLE NO. 330

Sweep/function gen carries \$350 price tag



Exact Electronics, Box 160, Hills-
boro, Oregon 97123. (503) 648-
6661. \$350; stock.

Model 196 sweep/function generator has a price tag of \$350. The new instrument produces sine, square, triangle, ramp, pulse and swept waveforms as well as a ramp sync output and a separate TTL pulse output. Frequency range is 0.1 Hz to 1 MHz in seven ranges, with 20-V pk-pk output. An internal generator gives sweep widths from zero up to 1000:1 (3 decades) at sweep rates adjustable from 1 ms to 10 s. The operator can sweep either narrow or wide band. Typical sine distortion of the Model 196 is less than 0.5%.

CIRCLE NO. 331

Digital pocket 'scope' comes in kit form



MITS Inc., 6328 Linn, N.E., Box
8636, Albuquerque, N.M. 87108.
(505) 265-7553. \$127.50 (kit),
\$189.50 (assembled); 6-8 wks.

MS-416 digital pocket scope is a four-channel, digital-logic hand-held "scope" with full memory capability. The signal is displayed on a four-line, 16-row LED matrix, one line for each channel. The clock time-base ranges from 0.5 μ s to 200 ms. The range is selected by three controls on the front panel. A store mode enables the scope to remember the information on all four channels within the time-base range, and display continuously.

CIRCLE NO. 332

Logic checker offered for HTL



Jermyn, 712 Montgomery St., San
Francisco, CA 9411. (415) 362-
7431. \$120.

The new HTL Logic Checker, A23-2087, automatically locates V_{cc} , ground and unused pins, and can be clipped either way round onto ICs with up to 16 pins. Instantly the logic states are shown on the LED arrays with "lamp on" indicating logic state 1, open circuit or unused pins, and "lamp off" indicating logic state 0 or ground.

CIRCLE NO. 333

Logic probe detects coincidence



Tektronix, P.O. Box 500, Beaverton, Ore. 97005. (503) 644-0161. \$90.

A hand-held DTL/TTL logic probe, the P6401, identifies logic states with red and green indicator lamps in the probe tip. The unit detects steady HIGH state, steady LOW state, intermediate logic levels, excessive positive or negative voltages, pulse trains, open circuits or a single logic pulse. A store mode indicates that a pulse has or has not occurred. The strobe and store modes can be used simultaneously to detect coincidence of two pulses. Input impedance is 7.5 k Ω .

CIRCLE NO. 334

Plug-in gives scope four 100-MHz channels



Hewlett-Packard, 1501 Page Mill Rd., Palo Alto, Calif. 94304. (415) 493-1501. \$2100; 30 days.

Four channels, each 100-MHz wide, can be displayed simultaneously on the screen of any of the company's 180-series scopes when equipped with a new vertical amplifier plug-in, the Model 1809A. With dc coupling, 10-mV/div. deflection factor, and a chop rate of 500 kHz for four channels and 1 MHz for two channels, the unit is especially useful for high-resolution timing measurements in digital circuits. Each input has switch-selectable 1-M Ω /12 pF or precision 50- Ω input.

CIRCLE NO. 335

Temperature indicator displays °F or °C

Sentel Corp., 4015 Fabian Way, Palo Alto, Calif. 94303. (415) 324-1761. \$195; stock to 30 days.

This dedicated digital temperature indicator, the Model 200, is intended to replace analog indicators in the OEM and process-control industries, and displays either °F or °C with J, K and T

type thermocouples. Standard features include: 1° resolution and repeatability, the Beckman planar display (3-1/2 digits, bipolar), an automatic cold-junction reference, and a thermocouple break detector which automatically blanks the last three digits to indicate an open thermocouple circuit. The Model 200 weighs less than 1 lb and needs less than 2 W.

CIRCLE NO. 336

INTRODUCING THE UGLIES.™

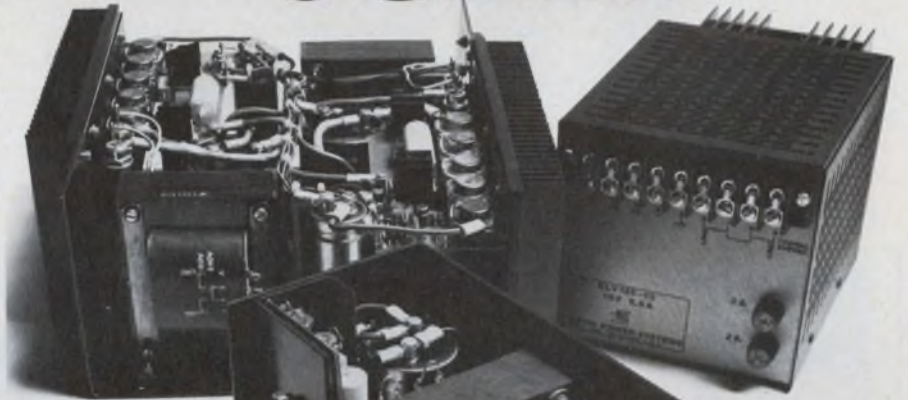

Okay, so they're not pretty.

But that's only because we spent our time designing our OEM dc supplies, instead of styling them. And now we've got a complete family of dc power supplies that solve 90% of your computer, peripheral and instrumentation applications just as they come off the shelf:

With a choice of 16 voltages from 4-28V, adjustable $\pm 5\%$. Currents to 50 A, rated to +55°C. $\pm 0.1\%$ regulation, ripple-and-noise. Remote sensing/programming, spike suppression and foldback current limiting. And 120/240 V, 50/60 Hz inputs.

All standard features for as little as 60¢/W (unit qty). Now what could be prettier than that?

For more info, use the bingo card or call 714/979-4440. Or call your local Cramer or Newark distributor and get UGLY today.

Elexon Power Systems

Get UGLY wherever you are: New England: Coakley, Boyd & Abball 617/444-5470 Upstate N.Y.: Kehoe Component Sales 315/524-2491 N.Y.: Metro, New Jersey: Ed Glass Assoc. 201/592-0200 Penn.: Del., So. N.J.: T.O.E. Sales 215/348-2212 Va.: S.C., Md., N.C.: Component Sales, Inc. 301/484-3647 Kentucky, Ohio, Ind.: Frank J. Campisano Co. 513/662-1616 Michigan: Villani-Pitcher, Inc. 313/271-4600 No. Carolina: Component Sales, Inc. 919/782-8433 Ga., Ala.: BJR Manufacturing Reps 205/881-3569 Florida: Orbe, Inc. 813/894-0687 Ill.: Wisc.: Iowa: Balhorn & Welch 312/889-5011 Minn.: N. & S. Dakota: Lew Cahill & Assoc. 612/646-7217 Mo., Kansas: K & M Sales Co. 816/471-2355 Colo.: Utah: J. S. Heaton Co., Inc. 303/758-5130 Texas: La.: Carter Assoc., Inc. 214/276-7151 Okla., Ark.: Hugh J. Daly Co. 918/627-4159 Arizona: J. S. Heaton Co. 602/264-7887 New Mexico: J. S. Heaton Co. 505/293-3900 Wash., Ore.: Blum & Associates 206/782-1600 N. Calif.: J. S. Heaton Co. 415/369-4671 S. Calif.: RLS Associates 714/644-7497



ELPAC © Copyright 1974 Elpac, Inc.

INFORMATION RETRIEVAL NUMBER 90

INSTRUMENTATION

Pulse generator brags 1-ns variable rise time



Hewlett-Packard, 1501 Page Mill Rd., Palo Alto, Calif. 94304. (415) 493-1501. \$3350.

Model 8082A is claimed to be the first pulse generator with rise time variable down to 1 ns, and also to be a near perfect 50-Ω signal source. Linearity of pulses is equal to or better than 5% for transition times greater than 5 ns. Reflection coefficient is 1.02 and pre-shoot, overshoot and ringing are held to ±5% of pulse amplitude. Dc offset can be adjusted ±2 V, pulse delay 2 ns to 0.5 ms, and pulse width from less than 2 ns to 0.5 ms. Pulse period, delay, and width jitter are held to less than 0.1% of setting pulse 50 ps.

CIRCLE NO. 337

\$200 buys 3-1/2 digit, 0.5% DVM



Dynascan Corp., 1801 W. Belle Plaine Ave., Chicago, Ill. 60613. (312) 327-7270. \$200.

Model 282 DVM, a 3-1/2-digit unit, features dc accuracy of 0.5%. The 282 also offers automatic polarity and automatically positioned decimal point; positive out-of-range indication; 100% overrange capability on all ranges; 1-mV resolution; 10-MΩ input impedance on both ac V and dc V; full overload protection on all ranges, and 100% solid-state circuitry. The unit reads voltage to 1000 V; current to 1000 mA; resistance to 10 MΩ. Resolution is 1 mV. The flat display is large, bright and non-blinking.

CIRCLE NO. 338

Unit multiplies freq by variable ratio



TDL of Las Cruces, P.O. Drawer H, Las Cruces, N. M. 88001. (505) 382-5574. \$769.

The Model 700 multiplies the frequency of an input signal by the ratio A/B, where both A and B can be preset to any integer from 1 to 1023 by front-panel switches. For example, if A = 19 and B = 3, the input frequency will be multiplied by 6.3333+. The input audio-frequency signal can have any waveshape: sine, triangle, square or complex, such as produced by a musical instrument. The output is a square wave with 50% duty cycle. Additional features include internal or external input gating and an input envelope follower mode in which the output level tracks the input level.

CIRCLE NO. 339

INNOVATIVE SWITCHES by CDI



Sealed Switch Module. Completely sealed and/or RFI shielded.



Series TSM Mini Thumb-wheel switch mounts on 1/2" centers. Retrofits most miniature thumb-wheel switch panel openings.



Series SL (Pat. Pending) Linear Slide Switch. Up to 100 or more positions. Mounts EITHER left/right OR up/down. Single or multiple position selectors.



No Down-Time Rotary Switch. 5-Second wafer replacement. Mfd. under Tabet U.S. Patent 2,956,131 & others.



Miniature Add/Subtract Pushbutton units retrofit most mini-thumb-wheel switch panel openings. Pat. #3,435,167.



Series SP Rotary Switch. Economical, flexible, compact. More options on one wafer than previously available.

CDI earns its reputation every day for Consistently High Quality, Consistently Good Delivery. Request catalog.



CHICAGO DYNAMIC INDUSTRIES, INC.

PRECISION PRODUCTS DIVISION

1725 Diversey Blvd., Chicago, Illinois 60614 Phone (312) 935-4600, TELEX 25-4689

Plotter zips along at 7.5 in/sec

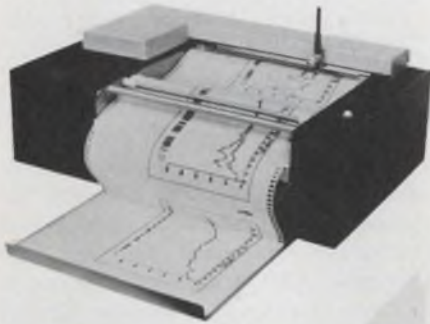

Zeta Research, 1043 Stuart St., Lafayette, Calif. 94549. (415) 284-5200. \$4950.

Model 1200 ultra-high-speed plotter is said to operate at roughly 2-1/2 times the speed of current plotters. The unit has an operating speed of 3000 increments per second at 2.5 mils or 1500 increments per second at 5.0 mils (7.5 to 10.5 in.). The current upper limit for similar units now in service is 3 in. per second. Model 1200 is designed to operate from standard incremental subroutines and X-Y plotter interface. Plotting area is 11 in. by 144 ft.

CIRCLE NO. 340

Skinny digital ammeter is only 9/16-in. thick

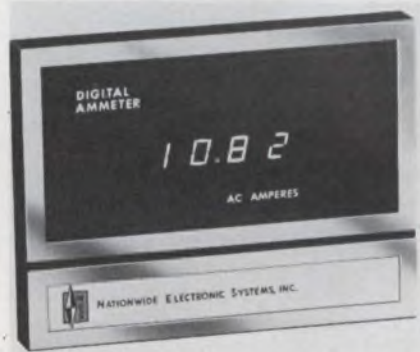

Nationwide Electronic Systems, 1536 Brandy Pkwy., Streamwood, Ill. 60103. (312) 289-8820. From \$208; 4-6 wks.

The Slimline digital ammeter provides full 3-1/2-digit resolution. One of the unique features of this instrument is its compact size: the entire package is only 9/16-in. thick, so it can be mounted flat on the front of a panel without using up any room behind the panel. The ammeter features an accuracy of $\pm 0.05\%$ of full scale and comes in a variety of ranges that cover ac or dc current.

CIRCLE NO. 341

Unit counts events, triggers scope

Tektronix, P.O. Box 500, Beaverton, Oregon 97005. (503) 644-0161. \$495; 2 wks.

DD 501 Digital Delay, is a delay-by-events counter packaged as a plug-in for the modular TM 500 line of test and measurement instruments. Using five thumbwheels on the control panel, the operator

can set any desired digital count from 0 through 99,999. When the number of input pulses reaches the preset count, the DD 501 puts out a pulse that can be used to trigger an oscilloscope. Because the unit delays by pulse count, rather than by analog timing of an interval, jitter is not a problem. Events can be counted at frequencies up to 80 MHz.

CIRCLE NO. 342

PLUG UGLY.™



\$49 (unit qty)
5V, 6A

They're not much to look at.

Because instead of fancy front panels, we designed our standard open-frame dc power supplies to cover 90% of your OEM applications. And once you plug them into your computers, peripherals or instrumentation, they're so reliable that chances are you'll never see them again.

They're designed and built conservatively, so you get full rated power all the way up to +55°C. Regulation, ripple and noise are specified by the book. And with no expensive options, you can now get your dc power for as little as 60¢/W (unit qty).

If you've looked at the competition, we know that has to be a sight for sore eyes.

For more info, use the bingo card or call 714/979-4440. Or call your local Cramer or Newark distributor and get UGLY today.

OPEN-FRAME OLV SERIES: 4-28 Vdc, 15-250 W

STANDARD FEATURES: Choice of 16 voltages, adjustable $\pm 5\%$. Currents to 50A, no derating to +55°C. $\pm 0.1\%$ IC regulation. $\pm 0.1\%$ ripple and noise. Remote sensing/programming. Spike suppression. Foldback current limiting. 120/240 Vac. 50/60 Hz inputs.

OPTIONS: QVP crowbar. PRICES: \$29.00 to \$219 (unit qty)

Elexon Power Systems

Get UGLY wherever you are: New England: Coakley, Boyd & Abbott 617/444-5470 Upstate N.Y.: Kehoe Component Sales 315/524-2491 N.Y. Metro, New Jersey: Ed Glass Assoc. 201/592-0200 Penn., Del., So. N.J.: T.O.E. Sales 215/348-2212 Va., S.C., Md., N.C.: Component Sales, Inc. 301/484-3647 Kentucky, Ohio, Ind.: Frank J. Campisano Co. 513/662-1616 Michigan: Villani-Plicher, Inc. 313/271-4600 No. Carolina: Component Sales, Inc. 919/782-8433 Ga., Ala.: BJR Manufacturing Reqs. 205/861-3559 Florida: Orbe, Inc. 813/894-0667 Ill., Wisc., Iowa: Balthorn & Welch 312/889-5011 Minn., N. & S. Dakota: Law Cahill & Assoc. 612/646-7217 Mo., Kansas: K & M Sales Co. 816/471-2355 Colo., Utah: J. S. Heaton Co., Inc. 303/758-5130 Texas: La. Carter Assoc., Inc. 214/276-7151 Okla., Ark.: Hugh J. Daly Co. 918/627-4159 Arizona: J. S. Heaton Co. 602/264-7887 New Mexico: J. S. Heaton Co. 505/293-3900 Wash., Ore.: Blum & Associates 206/782-1600 N. Calif.: J. S. Heaton Co. 415/369-4671 S. Calif.: RLS Associates 714/644-7497

ELPAC © Copyright 1974 Elpac, Inc.

INFORMATION RETRIEVAL NUMBER 92

Keystone THERMISTOR TASK MINDERS

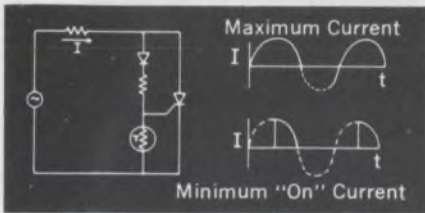
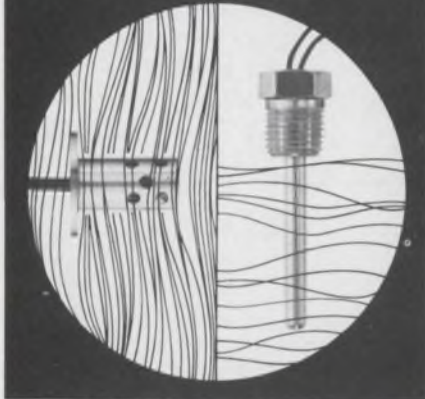

LOW-COST TEMPERATURE CONTROL

As the resistance of the thermistor decreases, a larger voltage is required to fire the SCR. In this circuit, conduction angles from 90° to 180° can be achieved. Thus, the minimum "on" current will be 50% of the maximum "on" current.

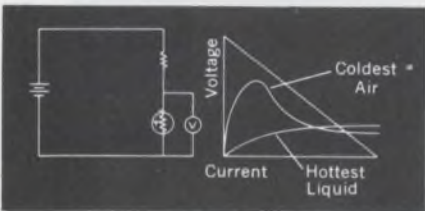

LIQUID LEVEL DETECTION

Taking advantage of the difference in dissipation constant between a liquid and a gas enables thermistors to serve as liquid level sensors over a wide range of temperatures.

Send for 12-page thermistor probe catalog detailing 23 styles and 6 applications.



Keystone
CARBON COMPANY
Thermistor Division
St. Marys, PA 15857
814/781-1591 • Telex 91-4517

INFORMATION RETRIEVAL NUMBER 93

PACKAGING & MATERIALS

Cooler tube has no moving parts



Wilkerson Corp., 1200 W. Mansfield, Englewood, Colo. 80110. (303) 781-7801. Model 6200: \$89 (unit qty); stock.

Electronic circuit cooling for testing or troubleshooting requires only a source of compressed air with Wilkerson's cooler tubes. The tubes have no moving parts—only a vortex tube to create a stream of cold air at one outlet and hot air at the other. With an inlet supply of 70-F air at 100 psi, the cold nozzle delivers an air stream as cold as -40 F. With adjustable models a variable control orifice at the hot-air outlet provides control of air temperature at the cold nozzle. Several different models give a choice of air flow rate from 2 to 25 cfm. The nonadjustable Model 6200 includes a magnetic mount and swivel base for ease of directing the cold-air flow. Two adjustable models (6201 and 6202) cover a wide range of air flow, but do not include the mount.

CIRCLE NO. 343

Solder-iron stand is human engineered

Solder Removal Co., 1077 E. Edna Pl., P.O. Box 1678, Covina, Calif. 91724. (213) 966-8321.

A human-engineered soldering-iron stand and maintenance station combines a safe shielded iron rest, a replaceable Re-Tip cleaning cartridge and long-life sponges all on one base. The iron rest has minimum contact with the iron and accommodates any iron with a case diameter to 3/4 in. and length to 5 in., including the tip. You simply insert and withdraw the hot tip to remove contaminants and leave the tip uniformly tinned.

CIRCLE NO. 344

Packaging system meets NAFI standards

Westinghouse, One Maritime Plaza, San Francisco, Calif. 94111. (415) 445-2146.

A new packaging system for electronic-circuit cards and relays, called Loc-4-Shock, is a virtually solid unit of high strength to weight ratio, has a high shock and vibration resistance, provides fast thermal dissipation and offers excellent corrosion resistance. Almost unlimited package configurations are possible. It meets the basic dimension standards developed by the Naval Avionics Standard Hardware Program (NAFI) and it can be modified and adapted for a wide variety of other military and industrial applications. Aluminum sections are locked together to form a receptacle, or holder, for different sized wire-wrappable plates, modules and PC cards. Previously, such assemblies were custom machined out of solid-bar aluminum, or other metal.

CIRCLE NO. 345

Piercing terminal lugs eliminate stripping



International Telephone & Telegraph Corp., 29000 Aurora Rd., Cleveland, OH 44139. (216) 248-8800.

By piercing wire insulation and penetrating the conductive core of 26 to 22-AWG stranded or tinsel wire, these spade terminals completely eliminate stripping. They are supplied in continuous strip form in brass or tin-plated brass for high-speed crimping production. They have a 0.064 to 0.075-in. crimped height on 0.045/0.050-in. insulation diameters. The terminals accommodate 0.130 to 0.145-in. stud sizes with 0.250-in. width and 0.215-in. clearance. Their over-all length is 0.634-in. Though designed for use with the ETC Model EP-3125K high-speed crimping press, these terminals are also compatible with other presses.

CIRCLE NO. 346

Large variety of pins meet connection needs



Precision Metal Products Co., 41 Elm St., Stoneham, Mass. 02180. (617) 438-3650.

Mini-Pins for modules, plug-in components and PCs are now available in a variety of materials custom machined to any size or finish. Standard pins are made of free-cutting brass that conforms to specification QQB-626, composition 22. They are available with gold flash, nickel or silver plating in diameters from 0.050 to 0.093 in. and lengths to 1 in. The pins can mate with many standard female assemblies now on the market.

CIRCLE NO. 347

Pad-to-pad connections by pressure only

Amp Inc., Harrisburg, Pa. 17105. (717) 564-0101.

A new elastomate micrometalized connector provides reliable interconnection of microminiature devices by pressure alone. The connector has no large, space-consuming connector housing or associated hardware. It is therefore especially useful with liquid crystal displays in electronic watches and calculators where maximum packaging density is required. The connector consists of a nonconducting elastomeric core wrapped with parallel lines of gold plated conductors on thin, flexible film. When compressed between two parallel planes, the metallized lines around the circumference interconnect the circuitry on each plane with assured contact redundancy. Standard connector conductors are 0.003-in. wide on 0.007-in. centerlines, but a variety of configurations are available. Typical pad-to-pad performance characteristics with liquid crystal displays are: contact resistance, 150 m Ω ; contact rating, 500 mA; and minimum insulation resistance, 300 M Ω .

CIRCLE NO. 348

New shield termination reduces harness bulk



Kern Engineering & Manufacturing Corp., 1136 E. Ash St., Fullerton, Calif. 92631. (714) 879-7961.

ton, Calif. 92631. (714) 879-7961.

Excessive diameter build-up in high-density crimp-type connectors when conventional shield termination techniques are used is eliminated by a new connector adapter. In addition, shielding effectiveness is greatly improved, according to the manufacturer. The photo illustrates a 68-conductor cable that has 29 individual shields.

CIRCLE NO. 349

MEAN AND UGLY.™



\$79 (1-9) 3 outputs

Our OEM dc supplies have always been stark, but now they're twice as ugly (also 3x).

Because instead of working up a new color scheme, we've combined two and three of them on a single chassis to make them an even better buy for your computers, peripherals and instruments.

We've taken out redundancies, but they still offer the widest range of voltages you can get in a modular dc supply. Still deliver all the power we promise across the full temperature range (even with 50 Hz inputs). And still include all the features you need as standards, not expensive options.

So that now if you check us out against the competition, they're liable to tell you that we're not just ugly.

We're downright mean.

For more info, use the bingo card or call 714/979-4440. Or call your local Cramer or Newark distributor and get UGLY today.

MULTIPLE OUTPUT DLM/TLV SERIES: 1st output: 5 V at 3-15 A, OVP standard; 2nd and/or 3rd output: each 4-28 V & 15 W, OVP optional. All outputs isolated; may be used as positive or negative supplies.

STANDARD FEATURES: Choice of 18 voltages, adjustable $\pm 5\%$; Currents to 15 A, no derating to $+55^\circ\text{C}$, $\pm 0.1\%$ regulation; $\pm 0.1\%$ ripple and noise; Remote sensing/programming; Spike suppression; Foldback current limiting; 120/240 Vac; 50/60 Hz inputs.

OPTIONS: Enclosure. PRICES: \$29 to \$151 (1-9)

Elxon Power Systems

Get UGLY wherever you are: New England: Coakley, Boyd & Abbott 617/444-5470 Upstate N.Y.: Kehoa Component Sales 315/524-2491 N.Y.: Metro, New Jersey: Ed Glass Assoc. 201/592-0200 Penn., Del., So. N.J.: T.O.E. Sales 215/348-2212 Va., S.C., Md., N.C.: Component Sales Inc. 301/484-3647 Kentucky: Ohio, Ind.: Frank J. Campisano Co. 513/662-1616 Michigan: Villani-Pitcher, Inc. 313/271-4600 No. Carolina: Component Sales, Inc. 919/782-8433 Ga., Ala.: BJR Manufacturing Repts. 205/881-3569 Florida: Orbe, Inc. 813/894-0687 Ill.: Wisc., Iowa: Balhorn & Welch 312/889-5011 Minn., N. & S. Dakota: Lew Cahill & Assoc. 612/646-7217 Mo.: Kansas: K & M Sales Co. 816/471-2355 Colo., Utah: J. S. Heaton Co., Inc. 303/758-5130 Texas, La.: Carrier Assoc., Inc. 214/276-7151 Okla., Ark.: Hugh J. Daly Co. 918/627-4159 Arizona: J. S. Heaton Co. 602/264-7887 New Mexico: J. S. Heaton Co. 505/293-3900 Wash., Ore.: Blum & Associates 206/782-1600 N. Calif.: J. S. Heaton Co. 415/369-4671 S. Calif.: RLS Associates 714/644-7497



ELPAC © Copyright 1974 Elpac, Inc.

INFORMATION RETRIEVAL NUMBER 94

"off the shelf"

a rugged, well constructed, high quality switch from Capitol it has the same solid reputation as our custom ordered switches

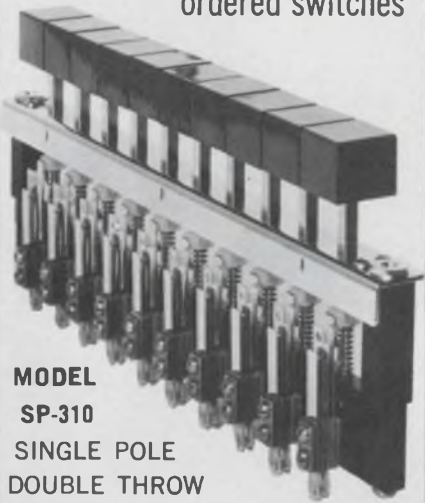

MODEL
SP-310
 SINGLE POLE
 DOUBLE THROW
 CONTACT
 SQUARE BUTTON,
 NON-ILLUMINATED

Contacts: Palladium
 rated at 3 amp, 110VAC, non-inductive

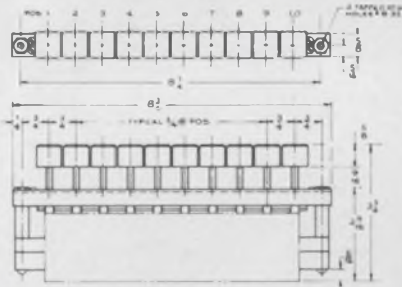

NOTES: 1. CONTACTS: FORM C EACH POS. SEC. 1.
 2. MECHANICAL ACTION: INTERLOCKING WITH POSITIVE LOCKOFF BETWEEN POS.
 3. BUTTONS: SS 313 SS

We manufacture top quality push button and lever circuit selector switches single switches or banked assemblies. Write for our catalog.

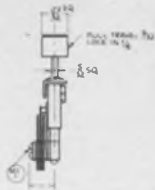

Representatives in principal cities.

CAPITOL SWITCHES

THE CAPITOL MACHINE & SWITCH CO.
 87 NEWTOWN RD. DANBURY, CONN. 06810
 (203) 744-3300

PACKAGING & MATERIALS

High-density drawer is only 1.75-in. high

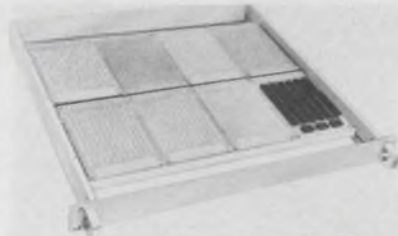

Vector Electronic Co., Inc., 12460 Gladstone Ave., Sylmar, Calif. 91342. (213) 365-9661. \$36.38 (500 up) stock.

Only 1.75-in. high, a new high-density card drawer accommodates up to 200, 14 or 16-pin DIP sockets in a single plane and accepts a wide variety of card sizes. The Slim-Line CCL-10 cage lends itself to standard rack-mounted subsystems where panel space is at a premium. A system of recessed brackets permits the card-mounting struts to be positioned anywhere in the frame. The 6-lb cage is constructed of anodized aluminum 19 W x 1.73 H x 15.77 D in. Up to eight 4 x 6-in. cards, or equivalent, may be placed in the 226-in.² frame. Component clearance height is 5/8 in. with 13/16 in. available for wire wrapping.

CIRCLE NO. 350

Epoxy cases fabricated from tube stock



Stevens Tubing Corp., 128 N. Park St., East Orange, NJ 07019. (201) 672-2140. From \$0.35.

Fiberglass laminated epoxy is used as the case for medical electronic modules and components. Cases are made with pieces cut to size from 18-in.-long black, glass-laminated epoxy tubes. The open ends are closed with a matching header plate. The epoxy conforms to MIL-R-9300 and the glass cloth to MIL-C-9084. Open-stock tooling is available in thousands of sizes.

CIRCLE NO. 351

Miniprogramming aided with option blocks

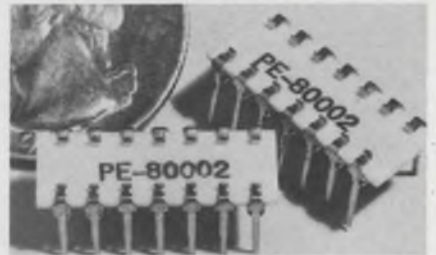

Pulse Engineering Inc., P.O. Box 12235, San Diego, CA 92112. (714) 279-5900.

The "option block" for single or multiple-circuit interconnections minimizes the need for jumper wires. Interconnect patterns are changed by changing option blocks. Patterns can be modified by cutting off individual leads. The blocks are available in standard 14 and 16-pin ceramic DIP packages.

CIRCLE NO. 352

Wire-wrappable board converted to PC type

Jardon Engineering, 364 E. First St., Tustin, Calif. 92680. (714) 838-3311. \$18 to \$40 (unit qty); stock.

Direct conversion of wire-wrapable PC prototypes to production quantity PC boards is now possible with Jardon's convertible modules. The low-cost convertible boards have physical dimensions, power distribution and I/O connections that are interchangeable from wire-wrapping to PC board types. Interchangeability saves design steps and assures that any design wrapped on a Jardon board will convert to a PC unit without the need for reconfiguration for production. Wrapping on the component side assures an identical dimension in prototype and PC. This is possible because the modules have two holes for each IC pin. Any standard connector of 56 or 86 pins with pin-to-pin dimension of 0.156 in. is accepted by the boards. No special connectors are required. The four 1/16-in. thick convertible modules are "universal" boards. Available in 6 x 8, 8 x 8, 8 x 10 and 8 x 12-in. sizes, the boards offer 36, 48, 64 or 80 dual in-line IC locations. The accuracy of the IC locations allows automatic wire wrapping.

CIRCLE NO. 353

FOR THE UTMOST IN RELIABILITY



TIME DELAY TIMER Series CSF

It is one of industry's most versatile compact delay timers, offering dial adjustability, automatic reset, external clutching and 10 amp. SPDT snap action load contacts. Repeat accuracy is $1\frac{1}{2}\%$. Resets in $\frac{1}{2}$ second at maximum settings. Voltages: 120, 240/50-60 hertz. All of our timers are made to give you service far beyond what you'd reasonably expect. Our line consists of 17 basic types, each available in various mountings, voltages, cy-

cles, circuits and load ratings... and with whatever special wrinkles you may need. Bulletin 305 tells all about our reliable Delay Timers. Write for it or a catalogue of the entire line. If you have an immediate timer requirement, send us your specifications. Or for fastest service call (201) 887-2200.



Industrial Timer Corporation, U.S. Highway 287, Parsippany, N.J. 07054

INFORMATION RETRIEVAL NUMBER 96

i'm free



1 CASE of Mail-Lite FREE when you buy my \$50 table model heat sealer.

2 CASES of Mail-Lite FREE when you buy my \$100 floor model heat sealer.



MAIL-LITE



FLOOR MODEL \$100 OFFER



TABLE MODEL \$50 OFFER

*Labor Savings: Can be heat sealed closed in 2 seconds
Postal Savings • Waterproof • Pufferproof • Lightweight • Clean*



WRITE TODAY FOR INFORMATION ON OUR MAIL-LITE SHIPPERS AND THE SPECIAL HEAT SEALER OFFER.

Sealed Air Corporation

19-01 State Highway 208, Fair Lawn, New Jersey 07410

INFORMATION RETRIEVAL NUMBER 97

ELECTRONIC DESIGN 21, October 11, 1974

DI-MAG[®]

... SUPER SENSORS

THE SENSIBLE CHOICE...

- **DIGITAL OUTPUT** — Constant amplitude pulses independent of surface speed or air gap.
- **COMPATIBILITY** — Direct interface with TTL, DTL or HTL logic.
- **NOISE IMMUNITY** — High signal-to-noise ratio not achievable in analog sensors.

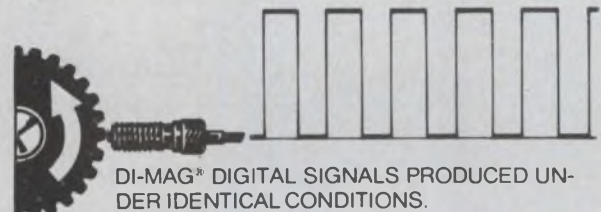
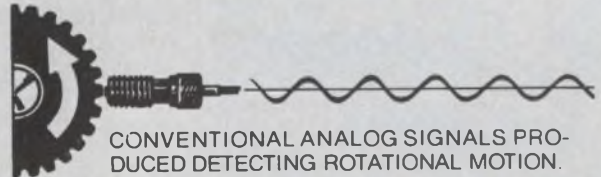

DI-MAGS[®] work particularly well in these computer peripheral functions and applications:

- FEED RATE CONTROL
- PRINT HAMMER SYNCHRONIZATION
- DISK POSITION INDICATION
- DISK AND TAPE DRIVE RPM MEASUREMENT
- INDEXING CONTROL
- CONTROL SIGNAL FOR CLOSED-LOOP SERVO SYSTEMS.

THAT'S WHY I'M CALLED THE SUPER SENSOR!



Send for your free copy of our Di-Mag[®] AIR GAP V/S SENSITIVITY selector

ELECTRO CORPORATION

1845 57TH STREET, SARASOTA, FLORIDA 33580
AREA CODE (813) 355-8411 • TELEX 5-2683

SEE OUR LISTING IN ELECTRONIC DESIGN'S GOLD BOOK.
INFORMATION RETRIEVAL NUMBER 98

THE NEXT GENERATION OF Broadband Power Amplifiers Starts with The **ifji M403**



.01-250MHz
100W min.
50db gain | **SMALLER**
LIGHTER
QUIETER

**DESIGNED FOR RELIABILITY
AND
EASE OF MAINTENANCE**

Solid State protection and control circuitry with complete remote control capability. *Write or Call.*

**ifji instruments
for industry,
inc.**
151 Toledo Street,
Farmingdale, N.Y. 11735
(516) 694-1414

INFORMATION RETRIEVAL NUMBER 99

PACKAGING & MATERIALS

Card file comes in over 100 combinations

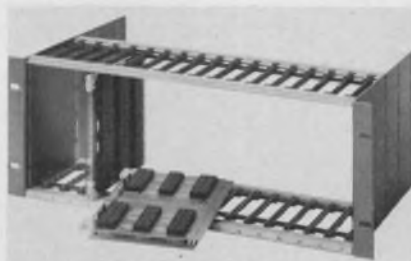

Electronic Engineering Company of California, 1441 E. Chestnut Ave., Santa Ana, CA 92701. (714) 835-6000. Typical \$18.85 (25 up).

EECO's new Card-Pak files can hold almost any PC card from 2 to 9.5-in. high and 4 to 8.84-in. long in standard assemblies. Card spacing can be 0.3 in. or larger. The files are assembled from modular components, and over 100 different combinations are available from standard parts. Files can be ordered as complete assemblies or as individual components for custom applications. Card guides, made of self-extinguishing Noryl, feature a slight bow that holds cards firmly.

CIRCLE NO. 354

Gas detector measures 1 ppm vinyl chloride

Matheson Gas Products, Div. of Will Ross, Inc., P.O. Box 85, East Rutherford, N.J. 07073. (201) 933-2400.

A simple-to-use gas-detector kit can measure 5-500 ppm of vinyl chloride in the atmosphere. And with a vinyl-chloride tube, #132B, the kit can detect a lower level of 1 ppm. Government regulations (NIOSH) on permissible levels of vinyl chloride have become much more strict (TLV = 50 ppm). Precise atmospheric samples are drawn into the reagent-filled tube by means of a precision-calibrated pump #8014-400. Employees without technical training find no difficulty in operating the pump and correctly reading the results on the detector tubes. The detector system is designed to measure the atmospheric levels of eighty-two hazardous gases.

CIRCLE NO. 355

Identify bundled wires by touching them



Cable Scan, Inc., 145 E. Emerson Ave., Orange, Calif. 92665. (714) 998-1961. \$380 (unit qty); stock.

The LD-25 uses body conductance to locate and identify individual wires and wire groups without the use of cumbersome probes or tools. As the operator touches a wire end, its designated termination location is indicated by a lit lamp. The LD-25 can accommodate harnesses of 25 conductors. Conductors can be grouped for multistep identification in the case of larger wire assemblies.

CIRCLE NO. 356

Flameless heat pen heats to 800 F



Instruments America, Inc., 823 N.W. 57th St., Fort Lauderdale, Fla. 33309. (305) 776-5831. \$79.50 (unit qty).

Heat Pen is a new flameless heat device. The pen uses less than 300 W of electricity and only 1.5 cfm of pressurized air at 12 psi and meets OSHA standards. It weighs only 5 oz, is comfortably held like a pen, is cool to the touch the length of the instrument, concentrates a pinpoint of controlled heat up to 800 F, and is quiet and vibration free. An air-pressure switch turns off power to the heating element if air pressure is insufficient. This feature eliminates overheating and element burnout. Interchangeable plug-in heating elements can be changed in seconds with no tools.

CIRCLE NO. 357

Vernitorg long life motors should be used for any positioning requirement where continuous rotation is not essential. Infinite resolution and high linearity allow these motors to provide high accuracy in positioning, actuating, tensioning, measuring, and indicating applications. These motors provide smooth operation with no slot effect. They also offer high torque with low input power and high acceleration rates as well as no gears, no mechanical or electrical noise, no explosion hazard, no friction, and no ripple torque. Vernitorg brushless DC torque motors are available in two and four-pole designs, in a variety of sizes and outputs. Peak torque ratings range from 5 to 600 oz-in. Frameless or housed versions are available. Special designs to your requirements also supplied. Vernitron Control Components, A Division of Vernitron Corp., 2440 West Carson Street, Torrance, California 90501, Telephone (213) 328-2504.

Vernitron Limited Rotation Wide Angle Brushless DC Torque Motors



vernitorg

INFORMATION RETRIEVAL NUMBER 100

the smallest digital multimeter

→ **LM-4**

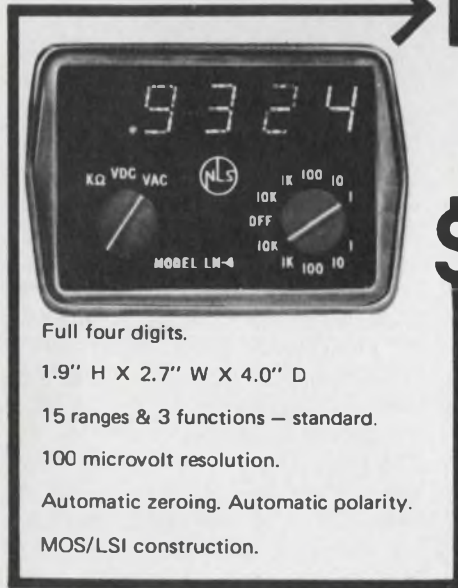

\$197

.02% accuracy

- Full four digits.
- 1.9" H X 2.7" W X 4.0" D
- 15 ranges & 3 functions — standard.
- 100 microvolt resolution.
- Automatic zeroing. Automatic polarity.
- MOS/LSI construction.

Call Tom Cox collect at 714-755-1136 (TWX 910-322-1132) for more details or delivery



NON-LINEAR SYSTEMS, INC.
Originator of the digital voltmeter
P.O. Box N, Del Mar, California 92014

INFORMATION RETRIEVAL NUMBER 101

ELECTRONIC DESIGN 21, October 11, 1974

Power Modules 500 Series

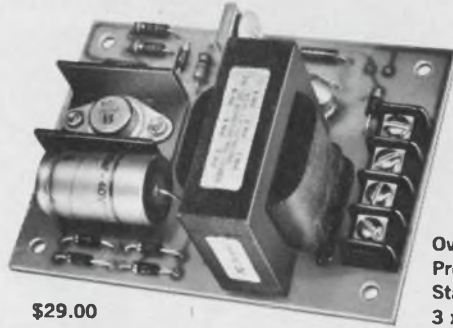

Overvoltage Protection Standard
3 x 4 x 1 3/4

\$29.00

MOD	VOLT	MA
86-500	5	500
86-501	6	400
86-502	10	400
86-503	12	350
86-504	15	300
86-505	24	250

Simple, economical, card supplies. Connection for AC power and DC output is by means of a screw type barrier terminal. Power supply can be mounted to a chassis by screws and standoffs. Or it can be mounted on a mother board by means of "Y" lugs. Foldback current limiting and overvoltage protection are standard.

REQUEST BULLETIN PS-501
115 Marine St., Farmingdale, N.Y. 11735 • (516) CH 9-2336

VOLTEX

INFORMATION RETRIEVAL NUMBER 102

FREE 1975 HEATHKIT CATALOG



World's largest selection of electronic kits — starring Heathkit digital-design color TV, digital date & alarm clocks, calculators, weather instruments, stereo & 4-channel hi-fi, fishing & marine gear, metal locators, automotive tune-up gear, a comprehensive Amateur Radio line-up, R/C modeling, test instruments... hundreds more.

See them all in the new Heathkit catalog — yours free for the asking. Just fill out & mail in the coupon below.

Heath Company, Dept. 60-10
Benton Harbor, Michigan 49022

HEATH
Schlumberger

Send my FREE 1975 Heathkit Catalog

Name _____

Address _____

City _____ State _____ Zip _____

CL-531

INFORMATION RETRIEVAL NUMBER 103

Green, Yellow, Amber
or Red . . .



Our LED Panel Light Story is a Lot Brighter!

- LED panel lights brighter than incandescent lamps at 1/2 the current (2.5 mcd @ 10 mA).
- All four colors at the same low price as RED's (\$1.19 in 1000 quantities—includes built-in resistor and mounting hardware).
- Sub-miniature sizes with standard or low profile lens projections.
- Attractively styled and ruggedly built.
- Immediate availability of all colors.

TURN ON THE "LITTLE" LIGHT PEOPLE . . . phone or write for more information today!

DATA DISPLAY PRODUCTS

5428 W. 104th St., Los Angeles, Ca. 90045
(213) 641-1232

INFORMATION RETRIEVAL NUMBER 104

COMPONENTS

PC rotary switch eliminates hand wiring

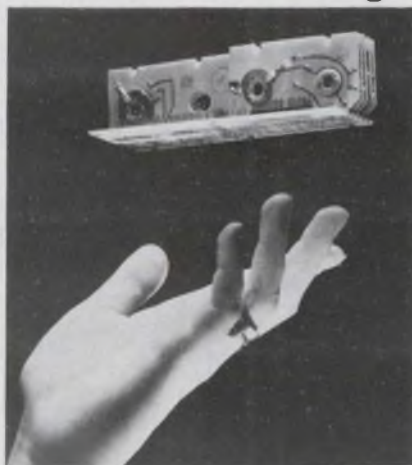

Standard Grigsby Inc., 920 Rathbone Ave., Aurora, IL 60507. (312) 897-8417.

Standard Grigsby's new ganged rotary PC-board switch is custom modified for each specific application. It consists of a PC board with soldered double-wipe contacts—sized to specific needs—and metal PC edge mounts ready to be plugged and flow soldered into a mother board. This eliminates hand-wiring operations. Precise alignment of successive rows of boards allows multiple functions to be activated with a single detent mechanism for up to 20 positions per deck.

CIRCLE NO. 358

Pressure transducer uses strain-gauge elements

Transducers, Inc., 12140 E. Rivera Rd., Whittier, Calif. 90606. (213) 945-3741. GP-60: \$110; GP-75: \$130 (unit qty).

Applications are diverse for the GP-60 new flush-diaphragm, general-purpose pressure transducer, which features bonded-strain-gauge ruggedness. Uses range from subway-car brake-pressure measurement, to intra-uterine pressure measurement during childbirth. The unit operates in a range from 300 to 12,500 psi, with an output signal of 3 mV/V. The GP-75 complements the GP-60, but in the lower ranges, from 10 to 300 psi with 10 mV/V output. This is achieved through the use of semiconductor strain gauges.

CIRCLE NO. 359

Ceramic capacitors suit automatic insertion

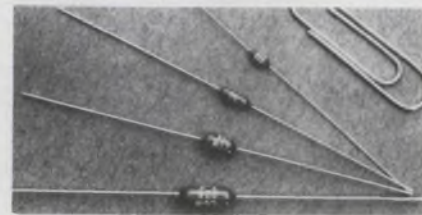

Corning Glass Works, Corning, N.Y. 14830. (607) 974-9000.

Corning's conformal-coated, axial, ceramic capacitors are made with dimensional uniformity and handling characteristics suitable for automatic-insertion equipment. Available in four sizes, the spin-seal capacitors provide capacitances from 0.027 to 0.47 μ F at 50 V and from 0.001 to 0.22 μ F at 100 V. The components are available in tolerances of $\pm 20\%$ or $+80\%$, -20% . Lengths range from 0.190 to 0.42 in. and diameters from 0.1 to 0.145 in.

CIRCLE NO. 360

Make your own shunts with resistor kit



Chronomite Laboratories, 21011 S. Figueroa St., Carson, Calif. 90745. (213) 320-9452. \$12.95.

A kit for making resistors, shunts or multipliers on the spot contains six resistance-wire materials that range from 0.5 to 30 Ω /ft, 11 epoxy bobbins, instructions and simple schematics. The complete kit is housed in an acrylic-plastic container. Both Manganin and Karma wire are used in the kit because of their low temperature coefficient of resistance. These fine wire alloys were formerly available only in bulk. Some specifications include: low noise, .05 mV/ $^{\circ}$ C; a high thermal stability of + 10 ppm; polyurethane enamel insulation; non-magnetic properties; an average tensile strength of 180,000 psi; and a thermal emf against copper of less than 0.003 mV/ $^{\circ}$ C.

CIRCLE NO. 361

SEASTROM OFFERS ITS ALL NEW COMPREHENSIVE CATALOG #40B. This 250 page catalog features the company's full range of products in a colorful book specially indexed for ready reference.

Including such items as . . .

- Flat Round Washers—Metallic
- Flat Round Washers—Non-Metallic
- Spring Washers
- Shoulder Washers
- Tab & Notch Washers
- Washers—Miscellaneous Configurations
- Expansion Plugs
- Military Standards
- Clamps & Brackets
- Spring Clips
- Solder Lugs
- Solid State Insulators
- Bus Bars, Terminal Blocks & Insulating Strips
- Miscellaneous Electrical/Electronic Hardware/Tags
- Sheet Metal Nuts & Strips
- Engineering Tables, Materials & Finish Specifications
- Numerical & Alphabetical Index of Parts

No need to design it . . . you will undoubtedly find it in Seastrom's Catalog all stocked for immediate delivery . . . write to



SEASTROM

MANUFACTURING CO., INC.

701 SONORA AVE., DEPT. E-10
 GLENDALE, CALIF. 91201
 (213) 245-9121 • TWX 910-497-2271

INFORMATION RETRIEVAL NUMBER 105

PREP



BERG Minisert™

. . . Low-Profile P.C. Socket provides repeated pluggability for IC's, DIP's, etc.

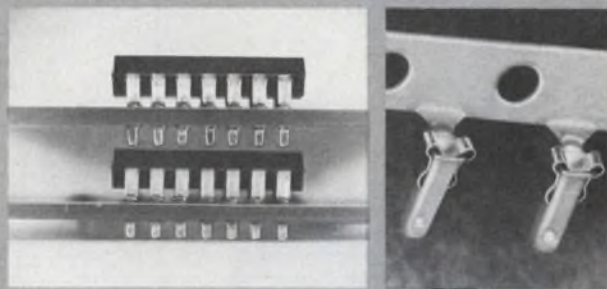

For use where space is restricted; extends just .030" above and .088" below board, allows .400" board-to-board spacing. One size MINISERT® socket fits wide range of hole sizes—.050" to .058" in diameter. RTV diaphragm seals foreign matter out of the socket. MINISERT socket accepts round or flat leads of DIP's, LED's and LSI's. Free-standing design can be used in any socket pattern. Semi-automatic machine inserts at rates up to 2000 per hour. Write for Bulletin 120, or call:



BERG ELECTRONICS
 Division E-1 du Pont de Nemours & Co. (Inc.)

New Cumberland, Pa. 17070 Phone: (717) 938-6711

*Terminals sell for \$20 to \$30 per thousand in volume quantities.

INFORMATION RETRIEVAL NUMBER 107

KNOB KNOW-HOW

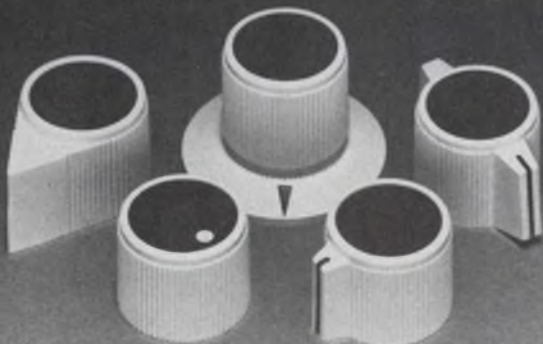

We know how to build quality and attractive styling into our knobs & dials. We've been doing it for more than 30 years.

ROGAN CORPORATION

Telephone (312) 498-2300
 3455 Woodhead Drive, Northbrook, Illinois 60062

INFORMATION RETRIEVAL NUMBER 106

ELECTRONIC DESIGN 21, October 11, 1974

QUICKIE® CONNECTOR . . . FOR THE RAPID, RELIABLE TERMINATION OF FLAT FLEXIBLE CABLE.

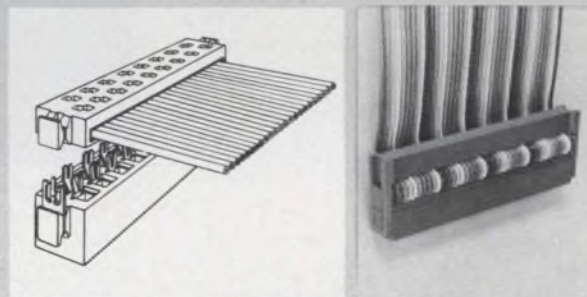

The Berg QUICKIE, a female connector, simultaneously terminates multi-lead flexible round cable *without* pre-stripping. The askewed tines of the contact effect a stripping action which terminates virtually any brand of cable, regardless of insulation material, in about 10 seconds. Design assures redundant electrical contact, and allows for visual inspection *before* assembly. QUICKIE can be used to interface cable on .050" centers to .025" square wire-wrapping posts on .100" sq. grid. Write for Catalog 125 or call:

*Berg Electronics Trademark



BERG ELECTRONICS
 Division E-1 du Pont de Nemours & Co. (INCORPORATED)

New Cumberland, Pa. 17070 Phone: (717) 938-6711

INFORMATION RETRIEVAL NUMBER 108



hot stuff

or cold, CHR's family of TEMP-R-TAPE of Kapton provides outstanding endurance. They retain their excellent mechanical and electrical properties over a wide temperature range, -100 to $+500\text{F}$.

Available in thicknesses from .001" to .0045" with a choice of several adhesive systems including adhesive two sides.

Find your CHR distributor in the Yellow Pages under "Tapes, Industrial" or in industrial directories. Or write for complete specification kit and sample. The Connecticut Hard Rubber Company, New Haven, Conn. 06509.

CHR

an ARMCO company

INFORMATION RETRIEVAL NUMBER 109

174

DISCRETE SEMICONDUCTORS

Opto-isolator available in two versions

Spectronics Inc., 830 East Arapaho Rd., Richardson, Tex. 75089. (214) 234-4271. SPX 2001, \$0.90; SPX 2002, \$1.33; (1000-up); stock to 30 day.

An optically coupled isolator housed in a six-pin dual in-line package is available in both phototransistor and photoDarlington versions. The phototransistor version, Model SPX 2001 and the photoDarlington version, Model SPX 2002 are pin-for-pin interchangeable with standard industrial six-pin isolators. Voltage isolation is 1.5 kV. Both versions provide good direct current transfer ratios and high-speed switching. The isolators are packaged in black electrically nonconductive plastic, which will easily withstand soldering conditions without deformation.

CIRCLE NO. 362

Zener diodes provide low-voltage avalanche

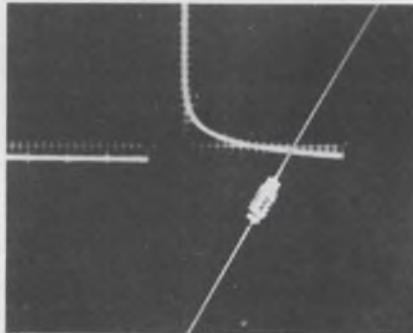

TRW Power Semiconductors, 14520 Aviation Blvd., Lawndale, Calif. 90260. (213) 679-4561. \$1.80 to \$2.50 (1000-up); stock.

The LVA zener has a low current drain and very tight voltage regulation, ideal for battery operated equipment. Conventional zeners—the 1N746 to 1N759 series, for example—have a test current of 20 mA, the LVA 362A has an avalanche breakdown point at less than $10\ \mu\text{A}$. The LVA can thus operate at a much lower current level. As an example of LVA zener specifications, the LVA 362A has a zener voltage of 6.2 V and reverse leakage of $0.5\ \mu\text{A}$ at 5.6 V dc. Typical knee accuracy is within 5%.

CIRCLE NO. 363

Npn transistors deliver up to 8 W at 900 MHz

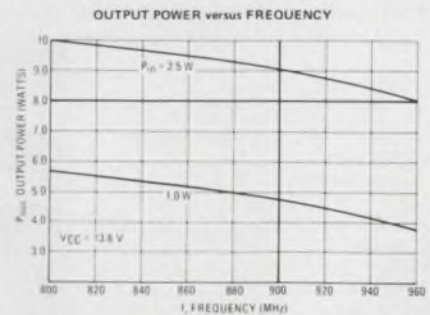

Motorola, P.O. Box 20924, Phoenix, Ariz. 85036. (602) 244-3466. From \$10.50 to \$20 (unit qty.).

The MRF816, MRF817 and MRF818 are npn power transistors characterized for operation over the 806-to-960-MHz band. These 900-MHz transistors designed for common-emitter circuits enable the designer to circumvent the turn-on and stability problems that are inherent in a high frequency, common-base configuration. At 900 MHz, the MRF816, MRF817, and MRF818 are rated at 0.75, 2.5 and 8 W, respectively, and have a collection efficiency of 50%, minimum. Device characterization includes, in addition to performance curves, input/output series-equivalent impedance plots over the frequency band plus test circuit schematics, and for the MRF817-818, circuit layout and mask drawings.

CIRCLE NO. 364

Power diodes recover in 150 ns or less

Solitron Devices, 1177 Blue Heron Blvd., Riviera Beach, FL 33404. (305) 848-4311. From \$1.40 (100-up); stock.

Two series of fast switching silicon planar diodes have fast recovery characteristics. The SPD 605-640 series handles 6 A and the SPD 1205-1240 series 12 A. Each can handle peak reverse voltages up to 400 V. The 6 and 12 A diodes offer typical recovery times of 125 ns and 150 ns, respectively. Other features include an operating range from -65 to $150\ \text{C}$; typical thermal resistance of 2 C/W (DO-4) and 1.2 C/W (TO-3); and storage temperature of $200\ \text{C}$.

CIRCLE NO. 365

Red LED now available with axial leads

Dialight, A North American Philips Co., 203 Harrison Pl., Brooklyn, N.Y. 11237. (212) 371-8800. \$0.15 (1000-up); stock.

Model 521-9189, red diffused GaAsP LED is available with axial leads. Typical operating characteristics at 25 C are: Wavelength at peak emission is 6500 Å; static forward voltage is 1.6 V; static reverse current is 0.1 μ A; and luminous intensity is 0.5 mcd. Maximum ratings include: reverse voltage at 25 C ambient-air temperature is 3 V; continuous forward current at (or below) 25 C ambient-air temperature is 40 mA; storage temperature range is -55 to 100 C; and lead temperature 1/16 in. from case for 5 s is 230 C.

CIRCLE NO. 366

Phototransistor array handles nine channels

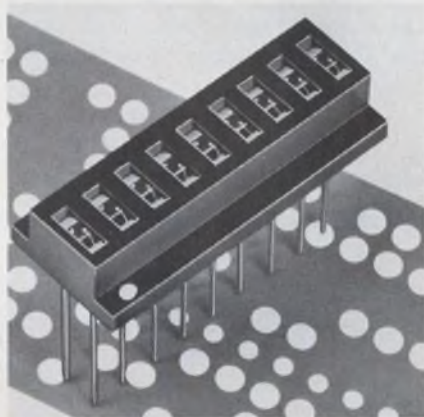

HEI, Jonathan Industrial Ctr., Chaska, Minn. 55318. (612) 448-3510. Stock to 6 wk.

The SA609, a nine-channel phototransistor array, is available in a plastic package with a clear epoxy window. Other packages are available for use in photodetection, fiber optics and similar applications. The array uses nine npn phototransistors mounted on 0.1 in. centers. It has a matched set of gain characteristics with a minimum gain range of 80 μ A at 2 mW/cm². The unit is designed to be plugged into printed circuit boards and the alignment of the active elements is within ± 0.005 in. Two sensitivity matching ratios are available: 0.5 for the SA-609 and 0.75 for the SA-609A.

CIRCLE NO. 367

You get a lot in a little package with General Electric Reed Switches

GE Reed Switches feature rugged design, fast operation, long life. For complete information, use the reader service card, or write GE, 316 E. 9th St., Owensboro, Ky. 42301



Hi-voltage 2" (DR680) closed-contact resistance less than 0.1 Ω , open-contact IR greater than $10^{12} \Omega$, and dielectric strength to 15 KVDC; contacts rated 50 watts, up to 10 KVDC, up to 2A.

Standard 2" (DR600), a rugged and dependable switching device; contact ratings of 15, 50, and 100 watts; up to 250 VDC, up to 3A.

Miniature (DR400) low, stable contact resistance and dielectric strength to 750 VDC, contacts rated 10 watts, up to 250 VDC, up to 0.5A.

Intermediate (DR500) gold-silver alloy contacts (10 watts) for alloy applications requiring low, stable dynamic contact resistance; rhodium contacts (15 watts) for heavier loads; dielectric strength to 1000 VDC.

Sub-miniature (DR300) low-level keyboard loads; power-loads up to 10 watts for relay, auto, other applications requiring minimum package size.

GENERAL  ELECTRIC

364-01

INFORMATION RETRIEVAL NUMBER 110

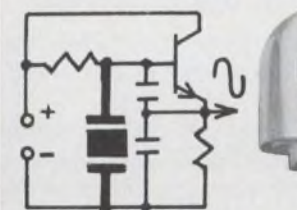

SN7413

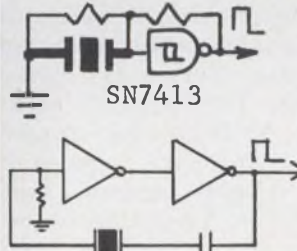

SN7404

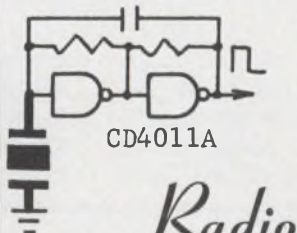

CD4011A

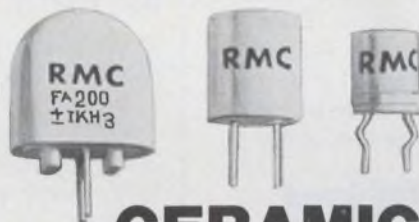

CERAMIC OSCILLATOR CONTROL RESONATORS

Squarewave Generator-Sinewave Oscillator-Clock Generators-Timing Functions- Sequencing Operations- Data Transmission- Numerical Control
 Frequency Range: 190-500 KHz
 Standard Tolerance: ± 1 KHz
 Temp. Stability: Better than $\pm 0.2\%$
 Temp. Range: -20°C to 65°C

Radio Materials Company

Div. of P. R. Mallory & Co. Inc.

4242 West Bryn Mawr Avenue Chicago, Illinois 60646

(312) 478-3600

INFORMATION RETRIEVAL NUMBER 111

Pro-Log Eliminates Hard Wired Logic

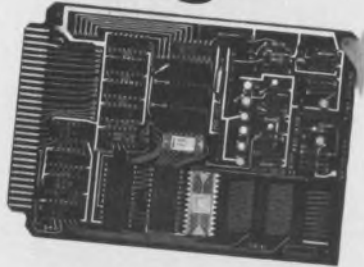

Our 4-bit microprocessor system can replace a rack full of your TTL chips. You'll save design time and production costs. No big redesign jobs for options or changes because the logic is stored in reprogrammable ROMs. Our programmed logic systems are available now, off the shelf.

Our PLS-401 microprocessor system costs less than \$400 in a quantity of one, with substantial OEM discounts. Plus we've got all the support you need: Design manuals, 2-day intensive design course, ROM Programmers, System Testors, special interface cards and support hardware to make your system go together smoothly.

and Mini Computers

Our MPS-800 microprocessor systems are modular production systems with mini-computer features such as: Expandable RAM, DMA, and 8 level priority interrupt. From under \$950 in a quantity of one with RAM. We have special interface cards and support hardware.

Micro Processor Systems from Pro-Log



852 Airport Road
Monterey, Calif. 93940
(408) 372-4593

INFORMATION RETRIEVAL NUMBER 112

DISCRETE SEMICONDUCTORS

Mini bridge rectifiers have 50 to 800 V PRVs

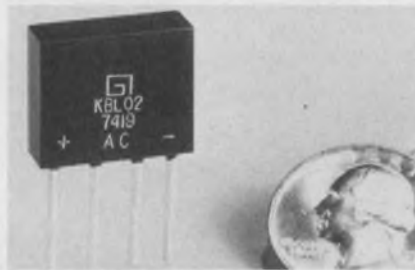

General Instrument, 600 W. John St., Hicksville, NY 11802. (516) 733-3000. From \$0.85 (5000).

The KBL series of miniature bridge rectifiers can handle currents of up to 4 A. Units are available with voltage ratings from 50 to 800 V PRV, with a peak surge rating of 200 A. These plastic encapsulated rectifiers use a flame-retarding material (classified 94V-0). KBL units have silver-plated copper leads, can be mounted in any position, and have an operating temperature range of -55 to +150 C.

CIRCLE NO. 368

Power transistors made for many applications

RCA, Solid State Div., Rte. 202, Somerville, N.J. 08876. (201) 722-3200.

Three series of developmental power transistors in the company's RCP plastic package, the TA8879, TA8943 and TA8944 are available with 12 devices in each series. In addition, a high-voltage series in the popular Versawatt plastic package, the TA8863 is also available. The TA8863-series transistors are high-voltage types with $V_{CEO(NUR)}$ voltages ranging from 100 to 350 V. TA8879-series devices have $V_{CEO(SUS)}$ voltages that range from 100 to 350 V. The TA8943 and TA8944-series devices are, respectively, npn and pnp complements with $V_{CEO(SUS)}$ voltages ranging from 30 to 100 V. All of these devices are supplied in molded plastic packages. The TA8863 series is provided in the JEDEC TO-220AB straight-lead version of the Versawatt package. The devices in the other three series are supplied in a similar plastic package.

CIRCLE NO. 369

Uhf power transistor delivers 45 W

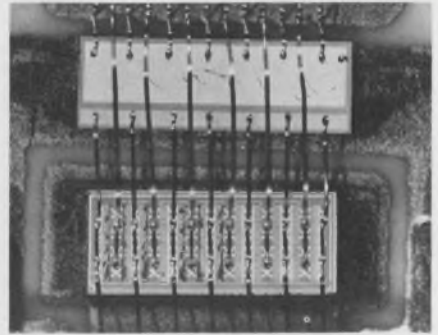

Motorola, P.O. Box 20924, Phoenix, Ariz. 85036. (602) 244-3466. \$34.50 (25-up); stock.

The MRF621 uhf power transistor is designed for 12.5-V-dc operation in the 406-to-512-MHz region. This device is rated for 45 W P_{out} at 470 MHz, 12.5-V-dc collector supply, with a minimum power gain of 4.8 dB and a collector efficiency of 55% minimum. No degradation in output power occurs when working into a 20:1 VSWR at any phase angle. The MRF621 provides a low-pass Chebyshev transformation to raise the base impedance for ease of circuit design.

CIRCLE NO. 370

Optocoupler has 25 kV isolation capability



Optron, 1201 Tappan Circle, Carrollton, Tex. 75006. (214) 242-6571. \$7.50 (100-up); stock.

The OPI 120, 25 kV optically coupled isolator consists of an npn silicon planar phototransistor coupled with a high efficiency GaAs infrared emitter. Both are mounted in a high voltage plastic package. The phototransistor and the LED are housed in hermetically sealed TO-18 type cans separated by a high dielectric optically transparent material. The coupler is also available in a photo-Darlington version. Minimum 25 C free air isolation breakdown voltage of the OPI 120 is 15 kV which may be increased to 25 kV by special encapsulation. Typical current transfer ratio is 50% with an input of 10 mA.

CIRCLE NO. 371

FREE technical catalog on photoelectric controls



Complete reference on application and performance data in one big book! Technically-advanced information includes design characteristics and 61 application drawings and dimensional diagrams.

AUTOTRON, INC.
3629 N. VERMILION ST.
DANVILLE, ILL. 61832
PHONE 217-446-0650

for every purpose

- AUTOMATION
- COUNTING
- PACKAGING
- CONVEYORS
- CUT-OFF
- DIE PROTECTION
- PROCESSING
- JAM-UP
- REGISTRATION
- MEASURING
- SMOKE DETECTION
- SORTING
- FAULT DETECTION
- LIMITING
- ORIENTATION
- POSITIONING
- INSPECTION
- TENSION
- TRAFFIC CONTROL
- WEIGHING
- WINDING

INFORMATION RETRIEVAL NUMBER 113

THE SPACE SAVER

THE WORLD'S SMALLEST THUMBWHEEL SWITCH

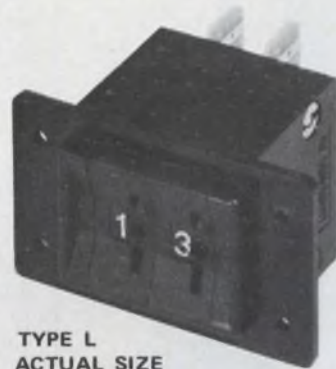

TYPE L
ACTUAL SIZE

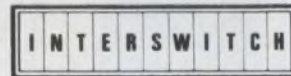

ONE OF THE PURDY GROUP OF COMPANIES

770 Airport Blvd • Burlingame, Ca 94010 (415)347-8217

INFORMATION RETRIEVAL NUMBER 115

Here's **HOW** to choose the right **ROTARY SWITCH** for your needs!



With this handy new guide, you can cross-check over 50 basic specifications against each of our 15 switch "families". In just a few minutes, you can narrow your applications down to a few possibilities...save hours of catalog search and research! Covers our Rotary Switch lines from 10A-240V to 200A-600V. Send for your free copy today.



INFORMATION RETRIEVAL NUMBER 114

ELECTRONIC DESIGN 21, October 11, 1974

DIP-ALARM^{T.M.}

Unique, miniature solid state sound device with unlimited applications



- Plugs into DIP sockets or PC boards
- Rugged, reliable, loud
- Models for 3, 5, and 12 VDC, 35 mA
- Dependable solid state construction means no mechanical contacts, arcing or RF noise
- 76 dB at 400 Hz tone radiates in all directions for positive alarm, warning, fault detection
- Use in conjunction with DIP-FLASHTM for pulsing operation.



projects[®] 3680 Wyse Road
Dayton, Ohio 45414
unlimited Tel. 513-890-1918
TWX 810-450-2523

IN EUROPE
projects unlimited/
Europe B.P. 15;
6100 Mont Sur
Marchienne
Belgium. Telex 51-390
Tel (071) 36.84 86

D.I.A.L. 800-645-9200 for the name of your nearest representative. In New York call 516-294-0990 collect.

INFORMATION RETRIEVAL NUMBER 116

Stacoswitch stacks up with the finest



Here's a stack of answers to your illuminated pushbutton switch problems. Staco's full line of pushbutton switches and indicators provides a wide selection of circuitry, size, switch action, legend display style, and mounting method. Whatever your control panel design requirements... whether its an individually mounted switch or sixty in a matrix mount, low cost commercial/computer grade or rugged Mil Spec reliability... there's a Stacoswitch to correctly fit the need.

In addition to the finest in design and performance features, Stacoswitch gives you realistic delivery schedules. Many switches are available from factory stock in one week. Optional switch features are assembled to order from factory parts in four to six weeks.

Check out Staco's stack of fine illuminated switches and indicators. Write today for GC-5 Catalog and Product Selector Guide. When you think switch... think STACOSWITCH.



1120 BAKER STREET, COSTA MESA, CALIF. 92626
(714) 549-3041 TWX 910 595 1507

Other STACO Company products: Fixed Ratio Transformers, STACO, INCORPORATED, Richmond, Indiana; Variable Transformers, STACO, INCORPORATED, Dayton, Ohio.

design aids

Thermistor slide rule

Key features of a thermistor slide rule calculator help determine maximum power or voltage for desired minimum temperature error in design of temperature control and measurement circuits, resistance ranges at 25 C, dissipation and time constant, maximum operating temperature and thermistor resistance at any temperature point. Fenwall Electronics.

CIRCLE NO. 372

Programming summary

A pocket-sized brochure can be used as an aid when programming Versaplot-I and Versaplot-II graphics plotting programs. The reference summary consists of descriptions and calling sequences. The brochure has three summary tables on call mode, initial mode table settings and functions for argument IDS. Versatec.

CIRCLE NO. 373

Insulation board

A four-page selection guide on electrical insulation board covers product description, average test values and features. Johns-Manville.

CIRCLE NO. 374

SCR cross-reference

A 10-page silicon rectifier cross-reference lists nearly 2000 devices with the suggested IR replacement. Typical voltage code suffixes are provided in addition to IR rectifier case styles. International Rectifier.

CIRCLE NO. 375

Strip weight calculator

A compact slide rule calculates alloy strip weights in both metric and English units. Calibrated for magnetic alloys, the rule has a conversion scale for quick computation of other alloys. On the reverse side are handy English-metric conversion scales for length, weight, area, volume and Fahrenheit-Centigrade, in addition to C and D scales. Magnetics, Specialty Metals Div.

CIRCLE NO. 376

application notes

Dual one-shots

"The HiNIL 347—A Dual Retriggerable One-Shot with High-Noise Immunity" discusses the design of timing networks for this monolithic circuit. Applications for pulse generating designs, coincidence detectors, v/f and f/v converters, pulse absence detectors, coincidence and envelope coincidence detectors, ac line detectors and frequency devices are included. Teledyne Semiconductor, Mountain View, Calif.

CIRCLE NO. 377

Power transistors

"Accurate Measurement of Sustaining Voltage of Power Transistors—A Pulsed-Breakdown Test Set" gives a brief critique of common methods of primary breakdown voltage testing and describes a test set intended to give highly accurate sustaining-voltage measurements. It contains six pages of text complemented with block diagrams, schematic diagrams and curves. The test set is discussed from digital circuitry to calibration and set-up. RCA, Somerville, N.J.

CIRCLE NO. 378

Boxcar signal integration

An application note deals with boxcar signal integration using sampling oscilloscope techniques to extend the measurement capability for a repetitive signal into the gigahertz frequency range. Tektronix, Beaverton, Ore.

CIRCLE NO. 379

Printed circuits

Can you define the difference between and applications of (a) single-sided etched and coated PC boards, (b) double-sided etched and plated-through circuits, (c) additive plated-through-hole circuits, (d) multilayer circuits and (e) flexible circuits? You can after reading "Printed Circuits," a 16-page catalog. It is illustrated with diagrams and photographs. Methode Electronics, Chicago, Ill.

CIRCLE NO. 380

vendors report

Annual and interim reports can provide much more than financial-position information. They often include the first public disclosure of new products, new techniques and new directions of our vendors and customers. Further, they often contain superb analyses of segments of industry that a company serves.

Selected companies with recent reports are listed here with their main electronic products or services. For a copy, circle the indicated number.

Bunker Ramo. Electronic components and information systems and services.

CIRCLE NO. 381

Singer. Consumer, industrial and aerospace products and information systems.

CIRCLE NO. 382

Nashua. Copy machines and supplies, computer products and coated and printed products.

CIRCLE NO. 383

Siri. Research, consulting and advisory services.

CIRCLE NO. 384

Pfizer. Chemicals, materials science products and pharmaceuticals.

CIRCLE NO. 385

UV Industries. Electrical equipment, copper-fabricated products and natural resources.

CIRCLE NO. 386

Western Union International. Telex services, cablegram, satellite communications, stock ticker and teletypewriter services, international metered communications, leased-channel computer systems, digital-data services, electronic mail service, and radio paging and mobile two-way radio services.

CIRCLE NO. 387

Data 100 Corp. Data processing equipment.

CIRCLE NO. 388

Philip A. Hunt Chemical Corp. Chemical systems and equipment.

CIRCLE NO. 389

Our single-chip concept:

Copper grid distributes current most efficiently for lowest $V_{CE(sat)}$.

Integral solid copper leads and heat sink make pre-bond chip test and inventory possible.

Meet stringent MIL requirements best with the NPN silicon transistor that's single-minded about performance. The concept: a unique single-chip design that packs the highest current rating in its class... keeps saturation voltage low and eliminates second breakdown problems. $V_{CE(sat)}$ is .60V max. @ 50 Amps, and guaranteed at 90 Amps. $E_{S/b}$ is 6 joules. And because its very simplicity allows pre-rating

One bigger, beefier chip.

Void-free bonding techniques eliminates hot spots.

and pre-testing, you can order our PT 7511 device off-the-shelf for switching regulators, motor controls and other hi-rel power circuits. For tech. data and application assistance, write or call, PowerTech, Inc., 9 Baker Ct., Clifton, N.J. 07011; (201) 478-6205

PowerTech
BIG IDEAS IN
BIG POWER

Top of its class. 200v, 90A silicon transistor

INFORMATION RETRIEVAL NUMBER 118

CUSTOM ELECTRONICS' MICA CAPACITORS: short on DELIVERY long on RELIABILITY

That describes our CMR type capacitor, ideal for "potted-in" applications where minimum size and low per-unit cost are important. All our dielectric is screened before production to avoid failure in the field.

Installation No.	Cap.	WVDC	TYPICAL UNITS:			Price
			L	W	x T Max	
CMRIA102104K	0.1 μ f	1,000	2.062"	1.425"	0.200"	\$8.05
CMRIA302104K	0.1 μ f	3,000	2.562"	1.620"	0.270"	9.25
CMRIA103103K	0.01 μ f	10,000	2.562"	1.800"	0.350"	8.80

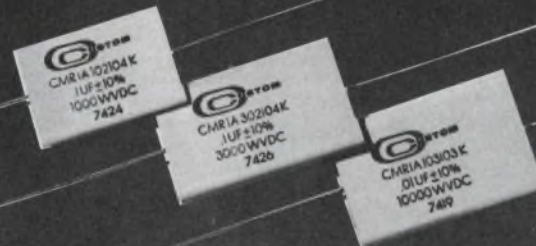

FREE: Descriptive TechniTip, includes Mica Sample. Write:



CUSTOM ELECTRONICS, Inc.

4 Browne St., Oneonta, N.Y. 13820
PH: (607) 432-3880 TWX: 510-241-8292

INFORMATION RETRIEVAL NUMBER 119

for
quality
control

STANDARDIZE ON
WESTON
"TOTAL-CONTROL"
POTENTIOMETERS

#840P "Squaretrim"
3/4" Cermet

#1000-00HS
1/2" Wirewound

#830P "Rectilinear"
3/4" Cermet

**CERMET and WIREWOUND
GENERAL PURPOSE POTS**

SQUARE • RECTANGULAR • ROUND
Full range of sizes . . .
military grade also available

Weston "Total-Control" Potentiometers are produced under controlled environmental conditions. Step by step the design concept provides for rigid quality requirements beginning with material through parts production, assembly and final test and inspection. Product control for the ultimate in reliability extends even to kilning our own ceramics for the Weston Cermet Line. Custom-design service is available where no Standard Model in any series meets exact individual requirements. Consult your Weston Representative.

Write for Weston Bulletin
"Lots of Pots."

WESTON

Schlumberger

WESTON COMPONENTS
ARCHBALD, PENNSYLVANIA 18403
TEL. (717) 876-1500
TWX 510 656-2902
TELEX 83-7443

INFORMATION RETRIEVAL NUMBER 120

new literature



Logic tester horror film

Dr. Frankenstein and his demented assistant Igor have turned to electronic technology to help solve their production testing problems in this brief, but extremely clever seven-minute film. The premise of the film is that inadequate logic testing is what originally did the good doctor in. The fun builds along with an approaching storm, and in a chaotic laboratory scene that follows, the latest version of Frankenstein's monster springs to life . . . with some big surprises for the viewer. "Dr. Frankenstein and the CAPABLE Tester," is available in 16-mm or Super-8 prints for engineering seminars, conferences and special groups having interest in computerized logic testing. Write to Computer Automation, Inc., Industrial Products Div., 18651 Von Karman, Irvine, Calif. 92664.

INQUIRE DIRECT

Cermet trimmers

Nine 3/8-in. single-turn, cermet-trimmer configurations are shown in a four-page catalog. Electrical, mechanical and environmental specifications are given. CTS of Berne, Berne, Ind.

CIRCLE NO. 390

Distribution systems

A 74-page catalog describes the Series 6500 distribution amplifiers. Block diagrams and specifications are included. Scientific Atlanta, Atlanta, Ga.

CIRCLE NO. 391

PC-board cleaners

An illustrated brochure on products for cleaning PC boards includes information on brushes and deburring wheels for PC boards and finishing flap brushes for PC-board cleaning. 3M, St. Paul, Minn.

CIRCLE NO. 392

Disc-drive system

A four-page brochure describes, illustrates and gives specifications for a high-speed, high-density, random-access storage system that offers mini users the advanced recording technology of IBM 3330 type drives with the reliability of an IBM 2314 type drive. Diva, Eatontown, N.J.

CIRCLE NO. 393

Instrumentation

An abbreviated catalog covers instrumentation used in home electronics, communications, industrial and broadcast-station equipment. Meguro Denpa, Meguro-ku, Tokyo, Japan.

CIRCLE NO. 394

Programmable controller

A four-page, two-color bulletin presents details on the MC-16 programmable controller. The bulletin provides a description of the architecture of the controller and is illustrated with a block diagram and photograph of the MC-16, both assembled and disassembled, as well as a photograph of the accessory programming panel. FX Systems, Saugerties, N.Y.

CIRCLE NO. 395

Analog and digital ICs

A 200-page analog and digital special-function catalog contains design and application information on high-performance amplifiers, buffers, sample-and-hold amplifiers, comparators, analog switches, MOS clock and digital drivers and power-supply modules. National Semiconductor, 2900 Semiconductor Dr., Santa Clara, Calif. 95051.

INQUIRE DIRECT

'SNO DRIFT



No temperature drift is just one of a pile of features of PSG

SOLID STATE THERMOSTATS

- NO TEMPERATURE DRIFT FROM SET POINT - SSTC series thermostats drift less than 0.05°C over a minimum life of 2 million cycles.
 - ACCURACY - +0.25 to 3°F standard depending on model, other tolerances on request.
 - DIFFERENTIAL - 0.25 to 2°F standard depending on model, other ranges on request.
 - SHOCK & VIBRATION RESISTANT - Withstand 100 g's shock and 30 g's vibration at 2000 cps.
 - LOW COST - Solid state dependability at bimetal prices.
- WRITE OR CALL FOR THE SSTC SERIES DATA SHEET.



PSG Industries, Inc.
 MANUFACTURER OF PRECISION THERMO AND ELECTRONIC CONTROLS
 NINTH & RIDGE AVENUE • PERKASIE, PA. 19094
 TELEPHONE (215) 257-3621

INFORMATION RETRIEVAL NUMBER 121

SPACE-SAVING BARRIER TERMINAL STRIPS FOR P. C. BOARDS

Resilient break resistant U.L. grade material.

Backstop contains wires, protects components from field wiring.

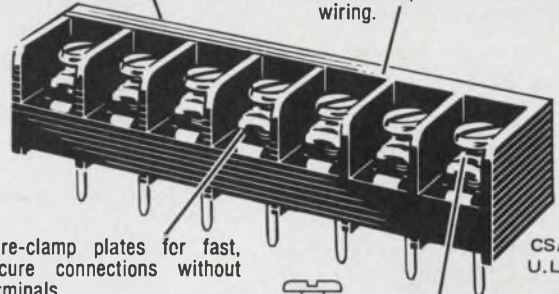

Wire-clamp plates for fast, secure connections without terminals.

CSA U.L.



Screws in raised position, saves 50% wiring time.

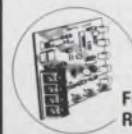

Featuring Right Angle mount option.

3 sizes available from Distributor stock:

- #4-40 screws, pins on .325" centers
- #6-32 screws, pins on .375" centers
- #8-32 screws, pins on .4375" centers

WRITE FOR CATALOG 200

RDI/Reed Devices Inc.

21W183 Hill Avenue • Glen Ellyn, Il. 60137

Tel: 312/858-2050 • Telex: 72-1527

In Canada: Renfrew Electric, Toronto • Tel: 416/461-3511

INFORMATION RETRIEVAL NUMBER 123

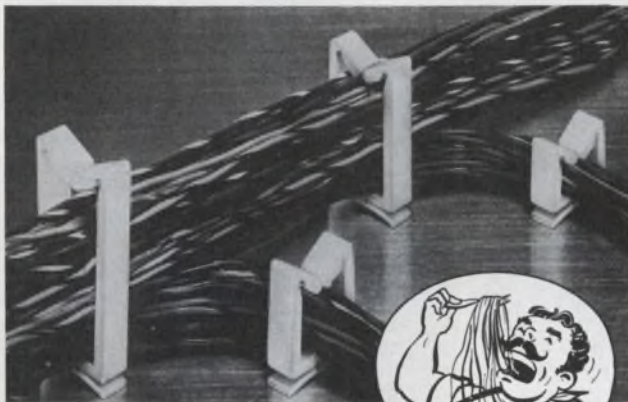

Eliminate spaghetti with

RICHLOK® WIRE SADDLE FASTENERS

Channel wires and cable over a given course . . . neatly, accurately and safely. Insert load through saddles, snap firmly into .187" dia. holes. Mount in any position.

Choice of four sizes .225" to 1.12" high, .437" wide. Nylon or flame retardant plastic.

There's a time and place for everything . . . even spaghetti. But it shouldn't be in your wiring systems.

Write for literature and free samples.



RICHLOK® CORPORATION

5835 N. Tripp Ave. • Chicago, Ill. 60646 • (312) 539-4061

INFORMATION RETRIEVAL NUMBER 122

ELECTRONIC DESIGN 21, October 11, 1974

If you think there are no other ways to cut your **POWER SUPPLY** costs, get proven performers and realistic delivery... you didn't figure on

UX SERIES
 Regulated low-cost
 OEM Power Supplies

from **\$59.00**

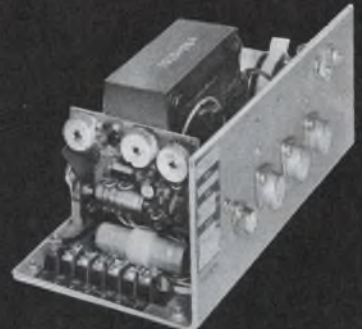

TODD PRODUCTS CORP.

123 Milbar Blvd., Farmingdale, N.Y. 11735 • (516) 293-3440

INFORMATION RETRIEVAL NUMBER 124

Save on Calculators

Before you buy a calculator, check our prices.

Hewlett-Packard

The utmost and ultimate in high quality, precision, sophisticated calculators. Made in USA. (Beware of imitations.)

- HP-35 Scientific, hand-held 4 memories incl. charger
 - HP-45 Scientific, hand-held 10 memories incl. charger
 - HP-65 Scientific, hand-held 100 step programming
 - HP-80 Hand-held for business, banking, finance, 10 memories
 - HP-70 Hand-held for business and finance, 6 memories
 - HP-46 Printing, Scientific, 48 functions, 10 memories
 - HP-46 Option 001, printing and display combination
 - HP-81 Printing for business, 20 memories, fantastic
 - HP-81 Option 001 combination printer and display
 - HP-81 Option 002 Printing with buffered keyboard
 - HP-81 Option 003 Printing, display and buffered keyboard
- All calculators by HP carry one full year warranty by HP
All HP hand-held calculators include charger, instruction manual, etc

Texas Instruments

- SR-10 Hand-held Scientific including charger
- SR-11 Hand-held Scientific including charger
- SR-50 Hand-held Scientific (quantity limited, waiting period)
- SR-20 Desktop Scientific, 12 digits
- TI-2500 Hand-held, four functions with charger
- TI-1500 Hand-held with charger plus percent key
- TI-2550 Hand-held with charger, MEMORY and PERCENT
- TI-2300 Desktop with constant, 10 large digits
- TI-4000 Desktop, 12 digits with Full MEMORY
- TI-500 Printing electronic calculator
- TI-450 Desktop Scientific, very sophisticated

Bowmar

- MX 100 Hand-held Scientific with charger
- MX 140 10 Digits SCIENTIFIC NOTATIONS, Fantastic—with natural problem entry, calculating horse-power
- MX 90 10 large digits, dual memory, 8 functions, square root
- MX 35 8 digits, hand-held, memory and % key Many other models.

Kingspoint

- SC-40 Sophisticated hand-held Scientific, multi-memories, parentheses, 10 digits plus 2 digits mantissa and 2 digits exponent

Thousands of calculators, adding machines, typewriters of all makes: REMINGTON, SMITH CORONA, VICTOR, COMPUCORP, ST. CLAIR, OLIVETTI, 3 M, ROCKWELL INTERNATIONAL, SONY TVs and Stereos

Olympic Sales Co. is one of the largest, if not the largest distributor, of electronic calculators representing the best products on the market. Because we deal in volume we can pass the savings on to you. Call us before buying any kind of calculator. Call us or write us and ask for our calculator catalogue so we can give you the best possible deal.

OLYMPIC SALES COMPANY, INC.

216 South Oxford Avenue
P.O. Box 74545
Los Angeles, CA 90004
Phone (213) 381-3911 • (213) 381-6031
Telex 67-3477

NEW LITERATURE



Heat sinks/dissipators

An eight-page catalog gives all critical dimensions and includes performance curves for heat sinks/dissipators and other devices for thermal management. IERC, Burbank, Calif.

CIRCLE NO. 396

Fractional hp motors

Complete information on its Type "N" fractional horsepower motors is contained in a bulletin. Typical applications, dimensional data and mounting instructions are presented as well as information on ac and dc winding types, electrical operation, design and construction features and normal operating conditions. Bodine Electric, Chicago, Ill.

CIRCLE NO. 397

Heat systems

Operating descriptions and specifications of heat systems for laboratory and pilot plant applications are contained in a 16-page brochure. Charts illustrate recovery time, heat-up rate, power required to hold temperature and the cooling rate. Lindberg, div. of Sola Basic, Watertown, Wis.

CIRCLE NO. 398

OEM computer products

A 26-page catalog contains photos and descriptions of HP's line of OEM computer products. Hewlett-Packard, Palo Alto, Calif.

CIRCLE NO. 399

RF power sources

An rf power sources brochure describes high-power sources covering the 200-to-8000-MHz range. Ailtech, City of Industry, Calif.

CIRCLE NO. 400

Wire/cable harnessing

A 16-page brochure describes wire/cable harnesses, markers, duct and accessory products. Each type is illustrated with dimensional drawings, and tables provide physical and chemical properties, applications, ordering data and specifications. Electrovert, Mount Vernon, N.Y.

CIRCLE NO. 401

Vacuum contactors

Specifications and ordering information for vacuum contactors with voltage ratings of up to 50 kV peak are given in a 12-page catalog. Catalogued units include single-pole configurations for ac, dc and rf applications, and high-voltage overcurrent units used to trigger vacuum contactors for circuit protection. ITT Jennings, San Jose, Calif.

CIRCLE NO. 402

CID imaging systems

"CID (Charge Injection Device) Imaging Systems" presents features, performance characteristics and applications of the company's 1/4 x 3/8-in. solid-state sensor. General Electric, Owensboro, Ky.

CIRCLE NO. 403

Discrete resistors

Thick-film discrete resistors are described in a 24-page handbook. It gives applications and design

HANDBOOK 71

TRW/IRC RESISTORS

METAL GLAZE:
design refresher on
TRW's low cost,
thick metal film
technology



information, and it is illustrated with photos, drawings, charts, tables and graphs. TRW/IRC Resistors, Philadelphia, Pa.

CIRCLE NO. 404

**FROM
BREADBOARD
TO FINAL
PACKAGING
HARDWARE...**

**ALL AVAILABLE
FROM ONE SOURCE**



★ **ADHESIVE BACKED
CIRCUIT SUB-ELEMENTS**
(Over 200 Pre-Drilled component mounting
patterns available "off-the-shelf.")

★ **EPOXY GLASS BOARD
MATERIALS**

- 76 Standard "Off-the-Shelf" Boards.
- Including Unclad, Copper Clad, Cut & Peel Copper Clad, Pre-etched "X-Y" Pattern and Plated thru Hole Copper Clad.
- .100" Grid Hole Pattern or Undrilled.



★ **GP CIRCUIT BOARDS and ACCESSORIES**

- Highest Quality — Choose from 74 "Off-the-Shelf" Boards.
- Sockets — Low & Standard Profile, P.C. and Wire Wrap. • Highest Quality Gold Contacts.
- Adapter plugs • Connectors
- Card Pull Handles.



**CIRCUIT-STIK'S
NEW CUT &
PEEL BOARDS**

SEND FOR OUR NEW CATALOGS #502 & #801

circuit-stik

P.O. BOX 3396 • Torrance, California 90510
Phone (213) 530-5530

Measurement equipment

A 16-page brochure groups precision electronic measuring equipment according to level measuring techniques, distortion measuring techniques, measured value acquisition and evaluation as well as general measuring techniques. A typical measuring set from each group is illustrated. Wandel u. Golterman, D-7410 Reutlingen, West Germany.

CIRCLE NO. 405

Dc power supplies

Sub-modular dc power supplies (SM series) are detailed in a 16-page brochure. Specifications and pricing data are furnished for each of the 10 basic power packages and 60 different models. Also covered are transformers, thermostats and heat sinks, which are compatible with the sub-modules. Powertec, Chatsworth, Calif.

CIRCLE NO. 406

Cathode-ray tubes

An eight-page brochure describes the company's CRT line featuring the Laminarflo electron gun. Fully illustrated, the brochure discusses the advantages of the Laminarflo gun, direct-replacement CRT electron guns, comparative analysis and applications. Watkins-Johnson, Palo Alto, Calif.

CIRCLE NO. 407

Industrial controls

Eight application stories, three ideas from the field, four new products and a photo essay on quality control make up issue No. 53 of the company's quarterly publication, "Uses Unlimited." Micro Switch, Freeport, Ill.

CIRCLE NO. 408

Electrical connectors

"Secrets of Connector Success," a 10-page brochure, describes seven different lines of electrical connectors. Photographs and specifications on environmental, electronic packaging connector operation, low-cost rectangular, micro-miniature, RFI/EMI filter contact. CATV and coaxial connectors are included. ITT Cannon, Santa Ana, Calif.

CIRCLE NO. 409

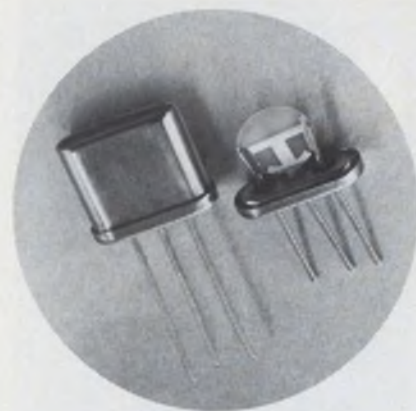

**175 MHz
MONOLITHIC
OVERTONE
CRYSTAL
FILTERS?**

**YES!..
FROM
BULOVA**

We're offering, right now, monolithic crystal filters covering the range from the upper limits of the fundamental frequencies all the way to the fifth overtone — 30 MHz to 175 MHz. We've made a breakthrough in manufacturing techniques that enables us to produce these crystal filters for the complete overtone range, and we've developed computer programs that enable us to design them efficiently and speedily. If you are looking at the VHF frequencies you undoubtedly would be interested in filters which will:

Save space (they're packaged in 3-pin,
HC-18 cans 0.38.0" high);

Simplify circuit design, and
Cut production expenses.

If you are in a rush call 212-335-6000, Ext. 744
or write:

BULOVA

FREQUENCY CONTROL PRODUCTS
Electronics Division Bulova Watch Co., Inc.
62-10 Woodside Avenue, Woodside, N.Y. 11377

*Of course we're still interested in your requirements for
other crystal filters, for crystals and for crystal oscillators*

INFORMATION RETRIEVAL NUMBER 127

free The "NEW LOOK"
1975
LAFAYETTE
ELECTRONICS
CATALOG

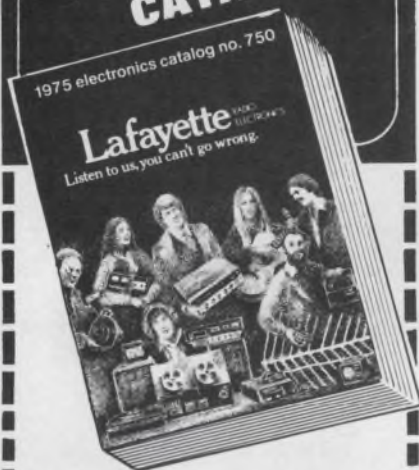

NEW! Larger Page Size
NEW! More Full Color
NEW! Easy-Read Type

SAVE ON LAFAYETTE
 PRODUCTS PLUS BEST
 MAJOR BRAND NAMES

The catalog you NEED if you're interested in electronics! Filled with colorful, accurate, interesting descriptions of all the latest electronics products, plus the "bits and pieces" you need to keep everything in top shape. It's the "energy saving" way to shop too—order by mail from your easy chair!

Lafayette

Listen to us, you can't go wrong.

Mail this coupon today **FREE!**

DEPT. 45104

Lafayette Radio Electronics
 111 Jericho Tpk., Syosset, LI, NY 11791

Send me your FREE 1975 Catalog

Name Apt.

Street

City State

Zip

Send a 1975 Catalog to my friend

Name Apt.

Street

City State

Zip

INFORMATION RETRIEVAL NUMBER 128

NEW LITERATURE

Intelligent terminal

A 12-page brochure describes the company's Model 1100, a stand-alone intelligent terminal incorporating a sophisticated general-purpose computer, 4 or 8 kword fully programmable memory, 12-line-by-80-character video display, full ASCII keyboard and dual cassette tape decks. Datapoint, San Antonio, Tex.

CIRCLE NO. 410

5-1/2-digit multimeter

Model 3500 5-1/2-digit multimeter with ac and dc voltage, resistance and remote triggering is described in an eight-page brochure. Data Precision, Wakefield, Mass.

CIRCLE NO. 411

Switches, keyboards

A 72-page catalog offers complete listings, engineering draw-

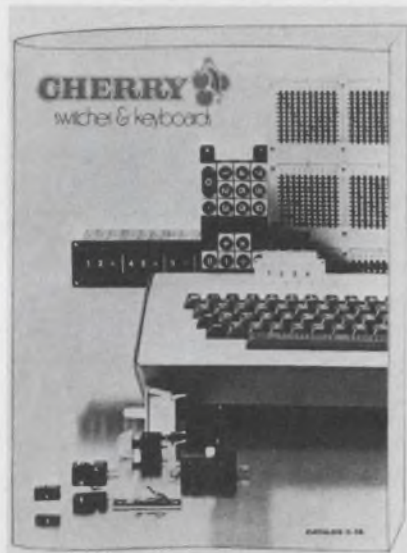

ings, operating characteristics and technical data on switches and keyboards. Cherry Electrical Products, Waukegan, Ill.

CIRCLE NO. 412

Electronic test accessories

A 68-page catalog provides illustrations and complete engineering information on electronic test accessories, including dimensional drawings, schematics, specifications, features and operating ranges. Pomona Electronics, Pomona, Calif.

CIRCLE NO. 413

Attenuators

A 24-page guide on attenuators includes information on design, special controls, types, uses and VU or dBm vs power and voltage. Tech Laboratories, Palisades Park, N.J.

CIRCLE NO. 414

Data conversion systems

A 100-page systems reference design manual together with a six-page technical sales presentation brochure provide all you need to know about the Series AN5800—completely integrated computer-compatible data conversion systems. Analogic, Wakefield, Mass.

CIRCLE NO. 415

Power diodes

Power diodes for use in power control and conversion circuits, featuring reverse recovery times as low as 25 ns, are described in a two-page data sheet. Maximum rating specifications, electrical characteristics and circuit schematics are included. TRW Power Semiconductors, Lawndale, Calif.

CIRCLE NO. 416

SUBSCRIBER SERVICE For prompt service include the addressed label when writing about your subscription.

CHANGE OF ADDRESS

NEW ADDRESS	name	company	division/department	company address	city	state	zip

If you're moving, please let us know six weeks before changing your address. If you have a question, place your magazine address label here and clip this form to your letter.

MAIL TO: ELECTRONIC DESIGN Circulation Dept. Hayden Publishing Co., Inc., 50 Essex Street, Rochelle Park, NJ 07662

LOOKING FOR LOW RANGE LOAD CELLS?



INTERFACE HAS THEM!

When your requirements call for load cells in a 5, 10, or 25 pound range, and your specifications demand high accuracy, better contact Interface. We've just introduced a new version of our proven Minibeam series that's low range, high performance, and affordable.

What about performance? Non-linearity, hysteresis, and non-repeatability combine to a total error band, based on a straight line through zero, of less than $\pm 0.04\%$. That's performance. All three ranges carry a list price of only \$225.00. That's less than half of what you'd pay for competitive units, and the performance is substantially better. The other plus features include a rated output of 3mV/V to simplify instrumentation, off-the-shelf small quantity delivery to ease your production scheduling, and proven reliability.

For complete information on these load cells and others in ranges up to 100 tons, call or write Ted Johnson at Interface, today.

interface

7401 East Butherus Drive/Scottsdale, Arizona 85260
Telephone: (602) 948-5555

INFORMATION RETRIEVAL NUMBER 129

IT'S NO GAMBLE with... AET



Proven Winners!

APPLIED ELECTRO TECHNOLOGY, INC. has a large variety of products which are adaptable to many Commercial or Military requirements including aerospace, missile, automation, instrumentation, safety equipment, industrial equipment and controls.

AET also specializes in designing equipment to particular specifications whether the order is a modification of an existing basic design or an all new configuration. Our product lines consist of Time Delay Relays, Phase Sequence Relays, Phase Sequence Indicators, Flashers, Warning Tone Generators, R.P.M. Sensors, Power Supplies, Voltage and Frequency Sensors, Lamp Drivers, Lamp Dimmer-Flashers, Programmable Controls, Analog to Digital Converters, Digital Counter, Timers, and Digital Clocks.

How can you lose ?

AET Applied Electro Technology, Inc.

2220 S. Anne St. / Santa Ana, Cal 92704 / Tel (714) 556-6570 / TWX 910-595-1797

INFORMATION RETRIEVAL NUMBER 130

From the Voltmeter House

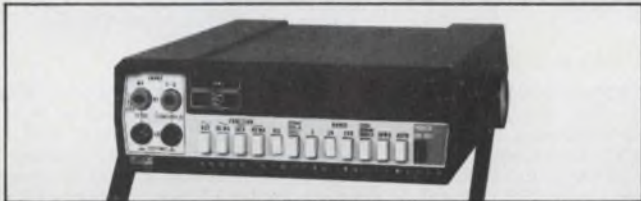

The new 20,000 count Fluke 8600A Automatic Multimeter

- Twenty six ranges, five functions, \$599. Measure from ± 200 mV through ± 1200 volts ac and dc, 200 μ A through 2000 mA ac and dc and 200 ohms through 20 megohms resistance. Basic dc accuracy, 0.02%. Up to 1,000 megohms input resistance.
- Design uses advanced Fluke LSI technology. Almost everything most people want is built-in. They are small, tough and reliable, ready to go to work just as they come from the box.
- Fully protected, fully guarded, autozero and autorange.
- Rated for minimum 10,000 hour MTBF.
- Low cost options include built-in rechargeable battery pack for up to 8 hours off-line operation and isolated DOU for printer drive.
- Abundant low cost accessories include HV probe, two RF probes, 600 A. current probe, deluxe test leads, rack kits, dust covers and carrying cases.



For data out today,
dial our toll-free hotline,
800-426-0361

John Fluke Mfg. Co., Inc., P.O.
Box 7428, Seattle, WA 98133

INFORMATION RETRIEVAL NUMBER 150

IT'S YOUR MOVE TO BETTER MATRIX BOARDS

125 CENTERS	RELIABILITY • ECONOMY AND STANDARDIZATION		UP TO 8 DECK SWITCHING
ISOLATED CONTACT	.250 CENTERS	.100 CENTERS	BUSSED CONTACT
CLOSED ENTRY DESIGN			DUAL CONTACT STRIPS
SHORTING PINS			MIXED CONTACTS
WRITE FOR CATALOG	DIODE PINS	TERMINAL OPTIONS	MOUNTING OPTIONS
		LIGHTED PINS	COLORED PANELS
SPECIAL TENTH INCH MATRICES AT \$.08 PER POINT			
CO-ORD SWITCH A DIVISION OF LVC INDUSTRIES INC. 135-25 37th AVE. FLUSHING, N.Y. 11354 • 212-939-9777			

INFORMATION RETRIEVAL NUMBER 131



Thin-Trim variable capacitors provide a reliable means of adjusting capacitance without abrasive trimming or interchange of fixed capacitors. Series 9401 has high Q's and a range of capacitance values from 0.2-0.6 pf to 3.0-12.0 pf and 250 WVDC working voltage. Johanson Manufacturing Corporation, Boonton, New Jersey (201) 334-2676.

INFORMATION RETRIEVAL NUMBER 181

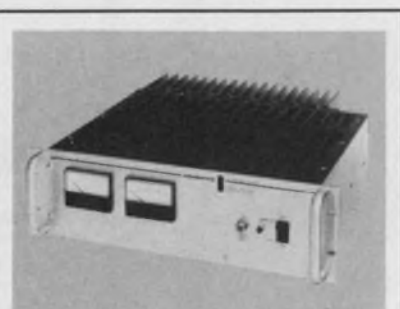

REGULATED DC POWER SUPPLIES in 15 models—up to 28V, up to 120A. Full-rack mountable, 3 1/2" or 5 1/4" high. Master/slave operation of up to 3 units; fully metered output voltage and current. Logic inhibit function, remote programming, and over voltage/thermal protection. From \$495.00. Powertec, Inc., Chatsworth, CA. (213) 882-0004.

INFORMATION RETRIEVAL NUMBER 184



"Synchro to digital converters - 10, 12, or 14 bit output, errorless tracking up to 4 r.p.s., accuracy ± 4 min. of arc $\pm .9$ LSB, resolution - 1.3 minutes, 60 or 400 Hz input, Module 2.6 x 3.1 x .82" H, Price From \$350 in qty. Computer Conversions Corp., East Northport, N.Y. 11731 (516) 261-3300."

INFORMATION RETRIEVAL NUMBER 187



Great Connections! Connectors for Ribbon Cable assemblies. DIP Plugs and Sockets, Straight, Right-Angle and Protected Pin Headers, Insulation Displacement Connectors, Contacts, Housing—everything for interconnection assemblies PLUS widest variety of Ribbon Cable. Spectra-Strip Corp., 7100 Lampson Ave., Garden Grove, CA 92642. 714 892-3361.

INFORMATION RETRIEVAL NUMBER 182



IDEAL FOR trade shows & information retrieval cards, this handy professional name and address stamp comes in a convenient, pocket size pack, complete with ink pad. \$4.95 Post Paid. (CA res. add .30 tax.) STAMP-CO, P.O. BOX 942, Los Angeles, CA 90028 or circle number for order form. BankAmerica or Master Charge.

INFORMATION RETRIEVAL NUMBER 185



Model PT55 Trigger Generator \$295. Feature 55kV output, 75ns wide, rise time 2ns, negligible jitter. Will fire most any triggered gap, including hi-capacitive Mid-plane, and Lo-impedance Rail-switches. With 1000:1 output monitor std. Pacific-Atlantic Trading Co. Inc. Electronics Div. P.O. Box 754 El Cerrito, Ca. 94530 (415) 788-5258.

INFORMATION RETRIEVAL NUMBER 188

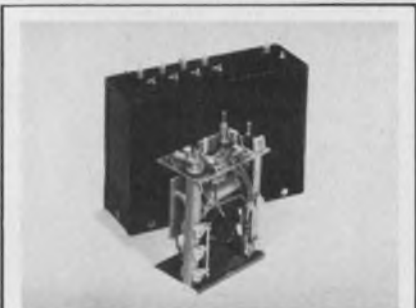

Modular DC-DC power converters. Designed to meet military/aerospace specs . . . priced for industrial applications. 12, 28, 48, 115 VDC inputs. 1-6 isolated, regulated (1% & 0.1%) outputs. 1-500 watts. Efficiencies to 85%. 1200 design-as-you-order configurations using standard modules. Arnold Magnetics, Culver City, Ca. (213) 870-7014.

INFORMATION RETRIEVAL NUMBER 183

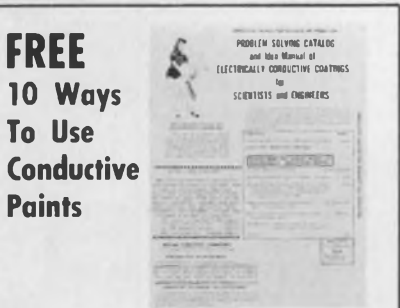

**FREE
10 Ways
To Use
Conductive
Paints**

Our electrically conductive paints are solving "impossible" lab problems and reducing unit production costs. One customer saves a fortune each year PAINTING on four MILLION pin head 1000 meg resistors. Add that up. Why not request "Ten Ways To Use Conductive Paints"? Micro Circuits Co., New Buffalo, Mich. 49117. (616) 469-2727.

INFORMATION RETRIEVAL NUMBER 186

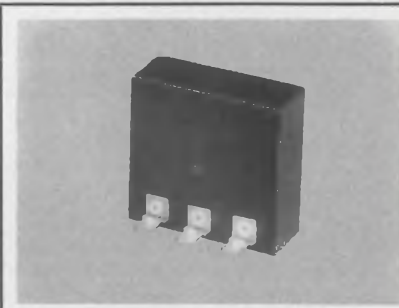

Solid-state timers—TS Series Delay On Make, N.O. or N.C. Operating voltages: 12, 24 - 230 v. Operating temps from -40°C to $+60^{\circ}\text{C}$. Adjustable delay ranges or factory fixed. Encapsulated circuitry. Transient protected. DC units reverse polarity protected. SSAC PRECISION PRODUCTS, INC., Box 395, Liverpool, N.Y. 13088 (315) 457-9610.

INFORMATION RETRIEVAL NUMBER 189

bulletin board



Rugged and low-cost 36-pin connector. Suberly designed and produced with simplified construction. Cut your costs up to 50%. Moisture-resistant glass-filled nylon insulator Recessed contacts in both male and female housings. Hood provides positive cable strain relief. Interchangeable. E. F. Johnson Co., Waseca, MN. (507) 835-2050.

INFORMATION RETRIEVAL NUMBER 190

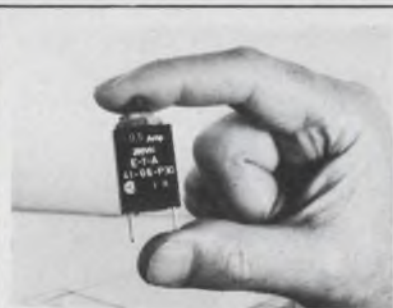

Overcurrent Protector, manual reset eliminates fuse replacement. Convenient panel mounting. 15 fractional ratings from 0.1 to 3 amp. Other models up to 400 amp. Trip-free and fool-proof, UL and CSA approved. High quality, low cost \$1.20 ea. in 1000 lots. E-T-A Products Co. of America, 7400 N. Croname Rd., Chicago, Ill. 60648. Tel: (312) 647-8303. Telex: 253780.

INFORMATION RETRIEVAL NUMBER 191



Free catalog of 34,500 power supplies from the worlds largest manufacturer of quality Power Supplies. New '74 catalog covers over 34,500 D.C. Power Supplies for every application. All units are UL approved, and meet most military and commercial specs for industrial and computer uses. Power Mate Corp. (201) 343-6294.

INFORMATION RETRIEVAL NUMBER 192

Modular Computer Systems' MAX I will replace four smaller, more specialized software packages—SAX I, SAX III, MIN I and the old MAX I.

CIRCLE NO. 417

Ampex Corp.'s data products division has announced price increases of 4 to 12% on analog and digital tape and disc products.

CIRCLE NO. 418

Mosfet * Micro * Labs has announced that it will sell its technology in MOS/LSI wafer processing to companies who wish to enter advanced product development through microelectronics.

CIRCLE NO. 419

A series of off-the-shelf computer systems, capable of fulfilling simple or complex real-time industrial automation requirements, has been announced by **Digital Equipment Corp.** The integrated hardware-software packages have been designated as the Industrial 800 Series, for systems using the PDP-8 computers, and Industrial 1100 Series for systems using PDP-11s.

CIRCLE NO. 420

Bunker Ramo's Information Systems Div. has announced a software capability for its on-line 2001 Universal Teller Terminal. Off-line check writing, customer information file editing and check-digit generation can be incorporated in the 2001's repertoire by use of a universal assembly program.

CIRCLE NO. 421

A complete "ECL 10,000" series of emitter-coupled logic circuits, formerly available from Signetics, 811 E. Arques Ave., Sunnyvale, Calif. 94086 in costly ceramic packages, is now being packaged in epoxy plastic. Prices of the plastic packages will be less than half the price of ceramic packages.

INQUIRE DIRECT

The Modular Instrumentation Div. of Analog Devices has increased prices approximately 4% on analog modules, a/d and d/a converters and DPMs.

CIRCLE NO. 422

Varian Data Machines is offering V70 hardware, software and firmware options to accelerate floating-point arithmetic. Model 3400 Floating Point Processor (FPP) can increase the speed of floating-point calculations by a factor of 15:1, compared with conventional software subroutines.

CIRCLE NO. 423

Electronic Memories and Magnetics has announced a 3 to 50% price increase on its Caelus disc cartridge drive products.

CIRCLE NO. 424

Transene Co. has developed a chemical process for the manufacture of gallium-phosphide light-emitting diodes.

CIRCLE NO. 425

An exclusion seal assembly designed for direct incorporation into disc drive spindles has been introduced by **Ferrofluidics Corp.**

CIRCLE NO. 426

Fairchild Camera & Instrument Corp. has added a line of 20 JANTX and JANTXV diodes to its standard product line.

CIRCLE NO. 427

Price reductions

A price reduction of 10% has been announced by **Siemens** for its TO-92 transistors.

CIRCLE NO. 428

Sinclair Radionics has cut the price of its "Sinclair Scientific" pocket calculator to \$99.95 from \$119.95.

CIRCLE NO. 429

Monsanto has announced price reductions of its yellow and green gallium phosphide epitaxial materials to \$50 per sq. in.

CIRCLE NO. 430

Prices of Motorola's MECL 10,000 integrated circuits have been reduced 45%.

CIRCLE NO. 431

Design Data from Manufacturers

Advertisements of booklets, brochures, catalogs and data sheets. To order use Reader-Service Card (Advertisement)



REAL-TIME SIGNAL PROCESSORS CONDENSED CATALOG. FREE.

For instant diagnosis of noise & vibration in real time, new 8-pg. catalog describes well-known . . .

- UBIQUITOUS® 500-line combined Real-Time Spectrum Analyzer-Calculator that automatically computes digitally
- UBIQUITOUS® 256-point & 512-point real-time Correlators
- OMNIFEROUS™ Dual Channel Hi-Speed instrument-type FFT Processor
- Memory & non-storage large-screen displays for real-time spectrum analyzers
- Range Translators
- Rotating Machinery Order Normalizers
- Digital Recorders & Post-Processors

Immediate, circle No 170
Routine, circle No. 171

Nicolet Scientific Corp. (formerly Federal Scientific Corp.)

245 Livingston St., Northvale, New Jersey 07647 (201) 767-7100. TWX: 710-991-9619

QUAN-TECH MODEL 420 RANDOM NOISE GENERATOR



The Model 420 provides a precisely calibrated random noise source with Gaussian amplitude distribution. Spectral density distribution is independent of frequency (white) with lower cut-off approaching D. C. Analog outputs from 0.01 to 1000 μ V per root Hertz continuously variable and metered. Response is flat from D.C. to 100 KHz.

Call or write for technical data on the Model 420 and other Quan-Tech Noise Generating Instruments.

CIRCLE NO. 172

Quan-Tech Div. of Scientific-Atlanta, Inc.

Randolph Park West, Route # 10
Randolph Township, N. J., 07801

Low-Noise High-Gain Preamplification



Complete specifications of a variable-bandwidth high-gain preamplifier are contained in the Model 113 data sheet, T-224. Included are typical noise figure contours illustrating the amplifier's exceptionally low noise, which is as low as .05 dB at mid frequencies with a 1 megohm source. Other illustrations include typical plots of the equivalent input noise and common mode rejection, which exceeds 100 dB at 60 Hz at all gain settings. The data contained in the specification sheet will be of interest to all engineers and researchers looking for a preamplifier with calibrated gain and rolloffs from dc to 300 kHz.

CIRCLE NO. 173

Princeton Applied Research Corporation

Box 2565, Princeton, New Jersey 08540 - (609) 452-2111

Electronic Design

ELECTRONIC DESIGN's function is:

- To aid progress in the electronics manufacturing industry by promoting good design.
- To give the electronic design engineer concepts and ideas that make his job easier and more productive.
- To provide a central source of timely electronics information.
- To promote communication among members of the electronics engineering community.

Want a subscription? ELECTRONIC DESIGN is sent free to qualified engineers and engineering managers doing design work, supervising design or setting standards in the United States and Western Europe. For a free subscription, use the application form bound in the magazine. If none is included, write to us direct for an application form.

If you do not qualify, you may take out a paid subscription for \$30 a year in the U.S.A., \$40 a year elsewhere. Single copies are \$1.50 each.

If you change your address, send us an old mailing label and your new address; there is generally a postcard for this bound in the magazine. You will have to requalify to continue receiving ELECTRONIC DESIGN free.

The accuracy policy of ELECTRONIC DESIGN is:

- To make diligent efforts to ensure the accuracy of editorial matter.
- To publish prompt corrections whenever inaccuracies are brought to our attention. Corrections appear in "Across the Desk."
- To encourage our readers as responsible members of our business community to report to us misleading or fraudulent advertising.
- To refuse any advertisement deemed to be misleading or fraudulent.

Microfilm copies are available of complete volumes of ELECTRONIC DESIGN at \$19 per volume, beginning with Volume 1, 1961 through Volume 20. Reprints of individual articles may be obtained for \$2.00 each, prepaid (\$.50 for each additional copy of the same article) no matter how long the article. For further details and to place orders, contact the Customer Services Department, University Microfilms, 300 North Zeeb Road, Ann Arbor, Michigan 48106 telephone (313) 761-4700.

Want to contact us? If you have any comments or wish to submit a manuscript or article outline, address your correspondence to:

Editor
ELECTRONIC DESIGN
50 Essex Street
Rochelle Park, N.J. 07662

Circuit Savers

DC **95¢**
1000 pcs.
TRANSIENT SUPPRESSOR

The TSD-1.5 Series are ideal for protection of long signal lines from damage from induced lightning etc. Reaction time is in nanoseconds.

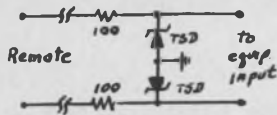

2 units (back to back) will protect sensitive components from a 5KV, 1ms duration transient. Clamp voltages from 5V to 200V. Call Mike Coyle for applications assistance. Full line of protection modules for every hi-lo voltage/current requirement. Write or call for Catalog 749.

279 Skidmore Road
Deer Park, New York 11729
Telephone: 516 - 586-5125

MCG Electronics

See Gold Book Vol. 2, Page 1277
INFORMATION RETRIEVAL NUMBER 134

KEEP

Electronic Design's

GOLD BOOK

HANDY



When You Call

Save time when you contact suppliers. Check their catalog pages first in *Electronic Design's* GOLD BOOK. Maybe the information you need is right at your fingertips.

Electronic Design

Advertising Sales Staff

Tom W. Carr, Sales Director

Rochelle Park, N.J. 07662

Robert W. Gascoigne
Daniel J. Rowland

(Recruitment, Quick Ads, Classified)

50 Essex Street
(201) 843-0550
TWX: 710-990-5071

Philadelphia

Thomas P. Barth
50 Essex Street
Rochelle Park, N.J. 07662
(201) 843-0550

Boston 02178

Gene Pritchard
P.O. Box 379
Belmont, Mass. 02178
(617) 489-2340

Chicago 60611

Thomas P. Kavooras
Berry Conner, Jr.
200 East Ontario
(312) 337-0588

Cleveland

Thomas P. Kavooras
(Chicago)
(312) 337-0588

Los Angeles 90303

Stanley I. Ehrenclou
Burt Underwood
2930 Imperial Highway
Inglewood, Calif.
(213) 757-0183

San Francisco 94022

Jerry D. Latta
P.O. Box 1248
Los Altos, Calif.
(415) 965-2636

London, Amsterdam, Tokyo, Seoul

John Ashcraft
12, Bear St.
Leicester Square
London WC2H 7AS England
Phone: 01-930-0525

W. J. M. Sanders
John Ashcraft & Co.
Herengracht 365
Amsterdam C., Holland
Phone: 020-24-09-08

Haruki Hirayama
Electronic Media Service
5th Floor, Lila Bldg.,
4-9-8 Roppongi
Minato-ku, Tokyo, Japan
Phone: 402-4556

Cable: Electronicmedia, Tokyo
Mr. O-kyn Park, President
Dongbo International
Corporation
1.P. O. Box 4010
Seoul, Korea
Phone: 28-1911
Cable: Dongbo Seoul



Versatile 1" x .100" GRID Reed Relays

Many
Options
for Most
Applications

New CR-2000 Series utilizes the popular 1" x .100" grid pattern, with 1 to 6 poles and a variety of options and contact forms for almost any application. Reliable low-level switches may be conditioned by special run-in and dynamic testing. Models can be epoxy-encapsulated or simply encased for added economy. Ask for Bulletin MR 11.1 for full details.



**COTO-COIL
COMPANY, INC.**
59 Pavilion Ave.
Providence, R. I. 02905
Tel: (401) 467-4777

INFORMATION RETRIEVAL NUMBER 132

PIEZOELECTRIC TUNING FORK

LOW PRICE
HIGH RELIABILITY

TYPE : TFQ 697.5Hz~1492.5Hz



20^L × 8.0^H × 6.5^W %

TYPE : TFD 360Hz~2000Hz



32^L × 7.8^H × 7.8^W %



IWATA ELECTRIC CO., LTD.

Mansei Bldg. Rm. 36 1-16, 1-Chome
Soto-Kanda, Chiyoda-ku, Tokyo 101, Japan

INFORMATION RETRIEVAL NUMBER 133

advertiser's index

Advertiser	Page	Advertiser	Page	Advertiser	Page
AMP, Incorporated	46, 47	EECO	85	Johanson Manufacturing Corp.	186
Abbott Transistor Laboratories, Inc.	6	E-T-A Products Co. of America	187	Johnson Company, E. F.	187
Acopian Corp.	125	Eby Co., Hugh H.	162		
Advertising Council	116	Edmund Scientific Company	161		
Airpax Electronics, Controls Division	155	Electro Corporation	169		
Allen Bradley Co.	56	Electro Switch Corp.	177	Keystone Carbon Company	166
American Smelting & Refining Co.	136	Elec-Trol, Inc.	111	Kurz-Kasch, Inc.	14
Applied Electro Technology, Inc.	185	*Electronic Design	36		
Arnold Magnetics Corp.	186	Electronic Research Corporation	43		
Autotron, Inc.	177	Electronic Measurements, Inc.	150		
		Elaxon Power Systems	163, 165, 167		
		Erie Technological Products, Inc.	114A		
				LVC Industries, Inc., Co-ord Switch	185
B & K Division of Dynascan Corp.	152	FMC Corporation	135	Lafayette Radio Electronics	184
Ballantine Laboratories, Inc.	159	Fairchild Semiconductor, A Division of Fairchild Camera and Instrument Corporation	10, 11	Lambda Electronics Corp.	66, 66L-1 thru 66 L-24
Beckman Instruments, Inc., Helipot Division	36	Fairchild Systems Technology, A Division of Fairchild Camera and Instrument Corporation	60	Litton Triad-Utrad	153
Belden Corporation	54, 55	Fluke Mfg. Co., Inc., John	185	London Company, The	154
Bell Industries/Electronic Components Division	194				
Berg Electronics	173	GTE Automatic Electric	62, 63	3M Company, Technical Ceramic Products	77
Bodine Electric Company	161	GTE Sylvania	123	MCG Electronics	189
Bourns, Inc. Trimptop Products Division	15	General Electric Company	175	Micro Circuits	186
Braun Company, Inc.	194	General Electric Company, Miniature Lamp Products Department	151	Micro Devices Corp.	140
Bulova Frequency Control Products	183	General Instrument Corporation, Capacitor Division	127	Micro-Line, Division of Bausch & Lomb	147
Burdy Corporation	21	Gold Book, The	102, 103, 144, 145, 156, 157	Micro Networks Corporation	159
Burroughs Corporation	22	Grayhill, Inc.	52	Microtran Company, Inc.	194
		Gould Inc., Instrument Systems Division	159	Mini-Circuits Laboratory	193
				Molex, Incorporation	110
Cambridge Thermionic Corporation	143	H B S Equipment Division	147	Molon Motor & Coil Corp.	121
Capitol Machine & Switch Co., Inc., The	168	Harris Semiconductor, A Division of Harris Intertype Corporation	18, 19	Motorola Semiconductor Products, Inc.	16A thru 16H, 35
Ceramic Systems	154	*Hayden Book Company, Inc.	62	MuRata Corporation of America	194
Chicago Dynamics Industries, Inc.	164	Heath Company	171		
Circuit Stik, Inc.	183	Heineman Electric Company	53	National Semiconductor Corporation	114B, 114C
Clare & Co., C. P.	20	Hewlett-Packard	25 thru 34	Nicolet Scientific Corp.	188
Computer Automation, Inc.	1	Hoyt Electrical Instrument Works, Inc.	160	Non-Linear Systems, Inc.	171
Computer Conversions	186	Hughes Aircraft Company, Electron Dynamics Division	93	North American Philips Controls Corp.	143
Connecticut Hard Rubber Co., The	174	Hurst Manufacturing Corp.	122		
Coto Coil Company, Inc.	189			Olympia Sales Company, Inc.	182
Custom Electronics, Inc.	179	ISE International Corporation	129	Optron, Inc.	7
		Industrial Electronic Engineers, Inc.	108, 109		
		Industrial Timer, A Unit of Esterline Corporation	169	PSG Industries, Inc.	181
Dale Electronics, Inc.	Cover II	Inland Motor Division, Kollmorgen Corporation	49	Pacific Atlantic Trading	186
Data Display Products	172	Instruments for Industry, Inc.	170	Paktron, Division Illinois Tool Works, Inc.	147
Data General Corporation	12, 13	Intech, Incorporated	142	*Philips Industries, Test and Measuring Instruments Dept.	63
Data Precision Corporation	67	Intel Corporation	4, 5	Power/Mate Corp.	187
Datel Systems, Inc.	Cover III	Interface	185	Power Tech, Inc.	179
Dialight Corporation	17	International Rectifier	115	Powertec, Inc.	186
Duncan Electronics, Subsidiary of Systron-Donner	61	Interswitch	177	Potter & Brumfield, Division of AMF Incorporated	45
		Iwata Electric Co., Ltd.	189	Princeton Applied Research Corp.	188
				Projects Unlimited	177
				Pro-Log Corporation	176

Advertiser	Page
Quan-Tech, Division of Scientific Atlanta, Inc.....	188
RCA Electronic Instruments.....	148
RCA Solid State.....	Cover IV
Radio Materials Company	175
Reader Service	194A, 194B
Reed Devices, Inc.....	181
Richlok Corporation	181
Rogan Corporation	173
Rogers Corporation	139
SSAC Precision Products, Inc.....	186
Sealed Air Corporation.....	169
Seastrom Manufacturing Co., Inc.....	173
Siemens Corporation, Components Group	8, 9
Simpson Electric Company	76
Sola Electric, Division of Sola Basic Industries.....	92
Solid State Scientific, Inc.....	117, 131
Sorensen Company, A Unit of Raytheon Company	137
Spectra Strip Corp.....	186
Sprague Electric Company.....	16
Stacoswitch	178
Stamp Co.,	186
Struthers-Dunn, Inc.	84
Switchcraft, Inc.	114D
TDK Electronics	51
TRW/Cinch Connectors, an Electronic Components Division of TRW, Inc.	37
TRW/IRC Resistors, an Electronic Component Division of TRW, Inc.	83
Tektronix, Inc.	59
Tele-Dynamic/Wanlass Division of Ambac.....	149
Teledyne Relays, A Teledyne Company	2
Todd Products Co.....	181
USCC/Centralab Electronics, Division, Globe-Union, Inc.....	39
United Systems Corporation.....	41
Varadyne Industries, Inc.....	64
Vernitron Control Components.....	171
Victoreen Instruments, Div. of VLN Corp.	141
Voltex	171
Wavetek	132
Weston Components	180
Wiley-Interscience	161
Yewtec Corporation	143

*Advertisers in non-U.S. edition

BOEING Engineers

Communications, Software and Computing Systems

The Boeing Aerospace Company has openings in the beautiful Pacific Northwest for beginning and experienced engineers on a number of its programs that include information and avionics systems, strategic and technical systems, personal rapid transit, and commercial hydrofoils.

Challenging assignments are available in the following specific fields:

COMMUNICATIONS

- Radio Systems
- Antennae
- Intercoms
- Communications Techniques
- Communications Equipment and Systems

SOFTWARE AND COMPUTING SYSTEMS

- Project Management
- Computing Systems Development
- Software Design & Implementation
- Software / Computing Systems Test

A BSEE, BS in Computer Science, or comparable experience, and U.S. citizenship are required.

Please send your resumé to The Boeing Company, P.O. Box 3707-MDN, Seattle, WA 98124.

An equal opportunity employer.

BOEING
Getting people together.

Custom Active Filter Design
Thick and thin film
process development

James Estep, Consultant
213-889-4414

High Blood Pressure?

**ONLY YOUR
DOCTOR
CAN TELL**



Ask your Heart Association

SAME DAY SHIPMENT

Minis & Peripherals
PRINTERS

"BRAND NEW"

DATA PRODUCTS

2440- 700LPM

2470-1250LPM

MDS 4320-300LPM

ALSO

CENTRONICS, POTTER, CDC

A. B. DICK, IBM, HIS, UNIVAC

617/261-1100

Send for Free Report
"Maintenance of Computers"

AMERICAN USED COMPUTER CORP.

P.O. Box 68, Kenmore Sta., Boston MA 02215
member COMPUTER DEALERS ASSOCIATION

product index

Information Retrieval Service. New Products, Evaluation Samples (ES), Design Aids (DA), Application Notes (AN), and New Literature (NL) in this issue are listed here with page and Information Retrieval numbers. Reader requests will be promptly processed by computer and mailed to the manufacturer within three days.

Category	Page	IRN	Category	Page	IRN	Category	Page	IRN
Components			trimmers, low-profile	11	245	delay counter	165	342
capacitor	127	55	tuning fork	189	135	digital test system	14	10
capacitor	194	138	vacuum contactors (NL)	182	402	digital thermometer	160	326
capacitor, trimmer	51	27	Data Processing			digital thermometer	163	336
capacitors	16	161	CID imaging systems	182	403	disc tester	160	327
capacitors	64	35	calculator	137	270	display monitor	59	31
capacitors, ceramic	172	360	calculators, electronic	182	125	electronic test accessories	184	413
capacitors, film	147	71	controller, tape	133	258	5-1/2 digit multimeter (NL)	184	411
capacitors, mica	179	119	data conversion systems (NL)	184	415	frequency multiplier	164	339
catalog (NL)	161	86	data link	134	261	function gen	162	331
catalog, photoelectric controls (NL)	177	113	data loggers	41	235	Heathkit catalog (NL)	171	99
cathode-ray tubes	183	407	disc drive system (NL)	180	393	instrumentation (NL)	180	394
cermet trimmers	180	390	distribution systems (NL)	180	391	logic analyzer	162	332
circuit savers	183	127	exerciser, disc	133	259	logic probe	163	334
DIP alarms	177	116	intelligent terminal (NL)	184	410	logic tester	162	333
delay timers	169	96	interface, calculator	136	266	measurement equipment (NL)	183	405
discrete resistors	182	404	interface, computer	134	262	meter	67	36
displays	129	56	memory, floppy-disc	133	257	meter, FET	152	76
filters, ceramic i-f	194	141	minicomputer	133	250	meters	76	37
fractional hp motors	182	397	minicomputer	134	265	meters, modulation	147	69
gearmotors	121	50	monitor, process	137	271	multimeter, digital	154	80
guide, rotary switches	177	114	OEM computer products (NL)	182	399	multimeter, FET	171	101
indicator lamp arrays	123	53	programmable controllers (NL)	180	395	PC tester	152	77
industrial controls (NL)	183	408	programming summary (NL)	178	373	panel meters	160	329
lamps	151	75	reader, paper tape	136	269	plotter	160	85
load cells	185	127	storage, disc	136	267	power amplifiers	165	340
logic motors	143	66	tape reader/punch	134	264	power instrumentation	170	99
metal-film resistors (NL)	182	400	terminal, CRT	136	268	power meter	143	68
motors	49	26	terminal, data	134	263	power meter	162	330
motors	122	52	tester, disc-drive	134	260	pulse generator	164	337
motors & gearmotors	161	87	Discrete Semiconductors			recorder, portable	159	83
motors, torque	171	100	array, phototransistor	175	367	scales	147	70
potentiometers	15	11	bridge, 25-A	135	59	scope	148	72
potentiometers	180	120	coupler, opto	176	371	scope plug in	163	335
pressure transducer	172	359	diodes, power	174	365	strip weight calculator	178	376
reed relays, DIP	84	40	diodes & resistors	141	65	voltmeter	43	23
relay	63	34	diodes, zener	174	363	voltmeter, precision	159	82
relay, multipurpose	45	24	isolator, opto	174	362	Integrated Circuits		
relays	185	130	LED, red	175	366	bucket-brigade devices	146	283
relays, DIP	111	49	LEDs	17	13	CMOS	131	57
relays, reed	20	15	opto-electronic components	7	6	CMOS	148	291
relays, reed	189	134	panel lights, LED	172	104	decoder, display	149	294
resistor kit	172	361	power diodes (NL)	184	416	diodes, zeners & micro-electronic components	9	7
resistors, DIP	36	19	power transistors, rf	117	146	direct, MOS-RAM	146	286
resistors, film	56	30	rectifiers, bridge	176	368	op amps	146	285
resistors, wirewound	83	39	SCR cross-reference	178	375	op amps	148	290
resonators	175	111	transistor, uhf	176	370	RAM	146	288
rotary switch, PC	172	358	transistors	183	126	RAM	146	289
sensors	169	98	transistors, 900 MHz	174	364	RAM	149	292
switch, DIP	52	28	transistors, power	176	369	RAM, 4-k	146	287
switch, thumbwheel	177	115	Instrumentation			SOS/CMOS	146	284
switches	164	91	ammeter	165	341	voltage reference	149	293
switches	168	95	audio counter	160	328	Microwaves & Lasers		
switches, keyboards (NL)	184	412	catalog, electronics (NL)	184	128	amplifier, uhf	35	18
switches, pushbutton	178	117	circuit test system	60	32	amps	150	296
switches, reed	175	110	DVM	164	338	attenuators (NL)	184	414
thermal cutoff	140	64				attenuators, step	153	303
thermistor probes	166	93				circulator	155	307
thermistor slide rule (NL)	178	372				filters, bandpass	150	295
thermostats, solid state	181	123						
transformers	153	78						
transformers	194	139						

Category	Page	IRN
filters, bandpass	152	302
lasers, nitrogen	152	300
lasers, system	154	305
monitor, laser beam	151	299
oscillator	150	297
oscillator, YIG tuned	152	301
plug-in	155	308
power devices, rf/micro-wave	IV	247
source, phase-locked	153	304
test system	154	306
waveguide, elliptical	151	298
Modules & Subassemblies		
amp, thermocouple	142	280
amplifier, miniature	139	273
amplifiers, power	140	276
converter, a/d	142	282
converter, d/a	140	277
converter, d/a	142	65
converter, f/v or v/f	III	246
converter, multifunction	141	278
converter, s/h	159	84
converter, v/f	138	252
filter, tunable	139	274
modular supplies	158	322
monitor, line	142	281
switch, ac	140	275
timer, solid-state	141	279
transmitter, signal	138	272
Packaging & Materials		
assembly machine	110	48
boards, PC, wire-wrap	168	353
bus	139	63
card files	170	354
cases, epoxy	168	351
catalog, packaging	173	105
ceramics	77	38
compounds	136	60
conductive plastic element	61	33
connector	173	108
connector packaging	162	89
connectors	37	20
connectors	121	51
connectors, circular	47	25
connectors, DIP	21	16
connectors, pad-to-pad	167	348
contacts	194	140
cooler tube	166	343
drawer, card	168	350
electrical connectors (NL)	183	409
fasteners, wire saddle	181	121
gas detector	170	355
harness tester	170	356
heat pen	170	357
heat pipes	93	43
heat sinks/dissipators (NL)	182	396
heat systems (NL)	182	398
insulation board (NL)	178	374
interconnects	154	79
jacks	143	67
knobs & dials	173	106
matrix boards	185	131
option blocks	168	352
PC board cleaners (NL)	180	392
packaging system	166	345
pins, terminal	167	347
sealing products	169	96
sockets	173	107
solder-iron stand	166	344
tapes, industrial	174	109
terminal lugs	166	346
termination, shield	167	349
terminal strips, barrier	181	124
wire, cable and cord	55	234

Category	Page	IRN
wire/cable harnessing (NL)	182	401
Power Sources		
airborne supply	158	324
battery	158	325
CRT supplies	158	321
dc power supplies (NL)	183	406
dc supplies, OEM	163	90
dc supplies, OEM	167	94
high voltage supply	158	323
overvoltage protectors	53	29
power modules	171	102
power monitor	158	320
power supplies	6	5
power supplies	66L1-24	248
power supplies	125	54
power supplies	149	73
power supplies	165	92
power supplies	181	124
power supplies, dc	137	61
power supplies, phase-controlled	150	74
voltage regulator	92	42

new literature

attenuators	184	414
books	161	88
CID imaging systems	182	403
catalog	161	86
catalog, electronics	184	128
catalog, packaging	173	105
catalog, photoelectric controls	177	113
cathode-ray tubes	183	407
cermet trimmers	180	390
dc power supplies	184	406
data conversion systems	184	415
disc drive system	180	393
discrete resistors	182	404
distribution systems	180	391
electrical connectors	183	409
electronic test accessories	184	413
5-1/2-digit multimeter	184	411
fractional hp motors	182	397
guide, rotary switches	177	114
heat sinks/dissipators	182	396
heat systems	182	398
Heathkit catalog	171	99
industrial controls	183	408
instrumentation	180	394
intelligent terminal	184	410
measurement equipment	183	405
metal-film resistors	182	400
OEM computer products	182	399
PC board cleaners	180	392
power diodes	184	416
programmable controllers	180	395
switches, keyboards	184	412
vacuum contactors	182	402
wire/cable harnessing	182	401

application notes

boxcar signal integration	178	379
dual one-shots	178	377
printed circuits	178	380
power transistors	178	378

design aids

insulation board	178	374
programming summary	178	373
strip weight calculator	178	376
thermistor slide rule	178	372

DOUBLE-BALANCED MIXERS

Great Value at

\$7.95
500 piece quantities.

\$9.95 in quantities of 1 to 49 pieces

DC-500MHz
6dB conversion loss
40dB isolation
EMI shielded case



A breakthrough in technology and high production volume enables Mini-Circuits Laboratory to offer these new products at an unprecedented low price.

In today's tough competitive market can you afford not to use these remarkably low priced and high performance units?

Ruggedness and durability are built in the SRA-1. These new units are packaged within an EMI shielded metal enclosure and hermetically sealed header. They use well matched hot-carrier diodes and uniquely designed transmission line transformers.

We invite you to convince yourself. Place your order now and check our delivery, product performance and reliability.

Mini-Circuits Laboratory

837 Utica Avenue, Brooklyn, N.Y. 11203
(212) 342-2500

A Division Scientific Components Corp.

*FRANCE: S.C.I.E., *31, rue George-Sand, Palaiseau 91, France *GERMANY: AUSTRIA, SWITZERLAND: Industrial Electronics GMBH, *Klüberstrasse 14, 6000 Frankfurt/Main, Germany *UNITS IN STOCK

ENGLAND: Dale Electronics: Dale House, Wharf Road, Frimley Green, Camberley, Surrey. JAPAN: Denisho Kaisha, Ltd.: Eguchi Building, 8-1, 1-Chrome, Hamamatsucho, Minato-Ku, Tokyo.

*UNIT IN STOCK.

INFORMATION RETRIEVAL NUMBER 137

Now Epoxy Coated Capacitors

Low Cost - NPO and K1200 - 1 pf to 3.3 uf

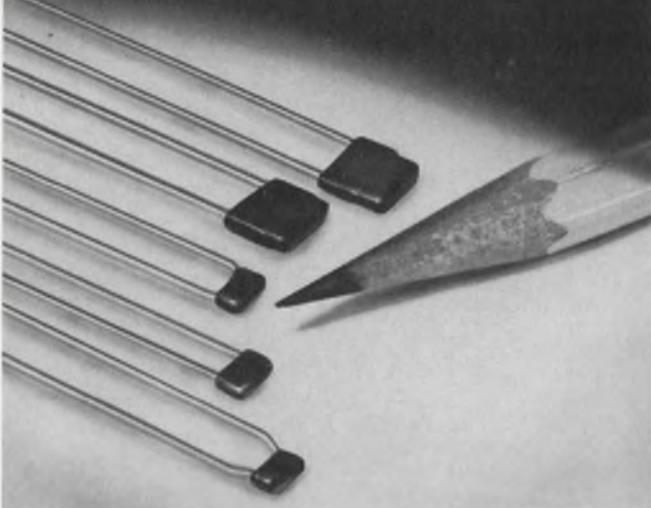

Many values off the shelf, other deliveries 6-8 weeks. NPO from 1 pf through .10 uf . . . K1200 from 1 pf through 3.3 uf . . . can be ganged before dipping for high density stacking . . . can be furnished with $\pm 2\%$, $\pm 5\%$, $\pm 10\%$, $\pm 20\%$ tolerances or GMV.

Write for full line ceramic capacitor catalog.



BELL INDUSTRIES / Electronic Components Division

150 WEST CYPRESS AVE. • BURBANK, CALIFORNIA 91505
(213) 846-9302 • TWX 910-498-2207

INFORMATION RETRIEVAL NUMBER 138

How welded contacts cut material costs up to 80%

- Improve physicals, performance and reliability
- Maintain original specified resistance

With welded contacts, only the exact amount of contact metal needed is applied to the base material. This eliminates indiscriminate use of precious metals compared with plating. You also save metal compared with riveted contacts. Welded contacts never increase in resistance as do riveted contacts. Heat conductivity and full strength of the base material are retained because there is no perforation. Let us quote on your contact sub-assemblies with welded contacts. Send for our FREE 20-page catalog. See our Ad in the Gold Book

RIVETED CONTACT

WELDED CONTACT



Riveted contact loses strength, increases resistance loss. Welded contact saves metal

braun

company inc.

4200 31st Street North St. Petersburg, Florida 33714
813/526-9104

INFORMATION RETRIEVAL NUMBER 140

TRANSFORMERS AUDIO POWER



NEW!

PLUG-IN
PC POWER

TELEPHONE
COUPLING

DC-DC
CONVERTER

STUDIO
BROADCAST

REQUEST NEW
CATALOG # 741

COMMERCIAL / M / L

COMPLETE LINE OF STOCKING TRANSFORMERS
IMMEDIATE DELIVERY FROM DISTRIBUTORS



MICROTRAN

COMPANY, INC.

145 E. Mineola Ave., Valley Stream, N.Y. 11582

INFORMATION RETRIEVAL NUMBER 139

Solid! Murata ceramic IF filters

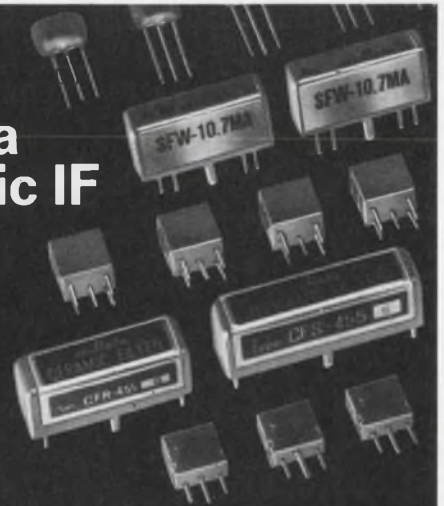

They're sharp. They're small. And, they're solid . . . for years! Murata's ceramic IF filters provide the solid-state performance in AM, FM, TV and Communications IF's that's expected by every one of our customers . . . consumer, industrial or military. Find out all there is to know about Murata's renown ceramic IF filters. Complete information is yours for the asking.

muRata

MURATA CORPORATION OF AMERICA

2 Westchester Plaza, Elmsford, New York 10523

Telex: MURATA EMFD 137332 / Phone: 914/592-9180

A Subsidiary of Murata Mfg. Co., Ltd., Japan

INFORMATION RETRIEVAL NUMBER 141

ELECTRONIC DESIGN 21, October 11, 1974

A new winner from Datel Systems . . .

Two-for-One SALE!



Take your pick.

A voltage-to-frequency or frequency-to-voltage converter.
We've put them both together in one little module.

Our VFV-10K has a highly linear (50ppm max.) pulse train output (10kHz full scale) and is ideal for analog-to-pulse rate conversion or in data transmission applications. These fast-settling designs will change pulse rate within one cycle of the new frequency and will drive up to 1000pF of capacitive load or 12 TTL loads.

A 100kHz full scale version (VFV-100K) offers greater resolution in the same 2" x 2" x .375" modular package as its 10kHz brother.

PROGRAMMABLE I/O

Both the VFV-10K and VFV-100K include a built-in inverter stage so that positive or negative, current or voltage inputs may be used. The digital section provides DTL/TTL or CMOS compatible short-circuit-proof positive or negative pulses.

Use the VFV-10K or -100K for a multitude of signal applications such as those suggested below. At only \$59.00 and \$79.00 each, they're a bargain.

Applications

Use a VFV for:

1. Remote isolated analog V/F data transmitter using optoisolators.
2. Linearize a sine wave VCO using an F/V in the feedback loop.
3. Accurate low drift super long term integration using a V/F and a 5 or 6 decade counter. (The total area under the curve is proportional to the total accumulated counts. Wideband noise following integration).
4. Single, scalable frequency meter or tachometer using a F/V and a DPM.
5. Simple analog addition or subtraction for frequency difference or frequency sum.
6. V/F-type analog-to-digital converter and readout. Use a V/F and Datel's DM-3000 universal counter/display/DPM in its clocked-counter configuration.
7. Specified linearity all the way down to zero for wide dynamic range applications.

QUICK SPECS

Input Ranges
0 to +10V, -10V, +1mA or -1mA min.

Nonlinearity
±.005% max. (VFV-10K)
±.05% max. (VFV-100K)

Output Pulse
75 usec. wide (VFV-10K)
7.5 usec. wide (VFV-100K)
DTL/TTL or CMOS selectable logic levels
12 TTL loads

Settling Time to .01%
Within one cycle of new frequency

F/V Operation
500 usec. filter time constant (VFV-10K)
50 usec. filter time constant (VFV-100K)

Stability
Gain
20ppm/°C Max. (VFV-10K)
200ppm/°C (VFV-100K)

Zero
10uV/°C max. (both models)

Power
±15V at 25mA

Mechanical and Pinning
2" x 2" x .375" DIP spaced

Send today for
your FREE 72 page
Engineering
Product Handbook



D **DATEL**
SYSTEMS, INC.

1020 Turnpike Street, Canton, Mass. 02021
• TEL (617) 828-8000 • TELEX 924461
• TWX 710-348-0135

WESTERN REGIONAL OFFICE: SANTA ANA, CALIF.
714-835-2751

INTERNATIONAL SUBSIDIARIES

W. Germany Datelek Systems, GmbH, 8 Muenchen 71
Becker-Gundahstr. 1

TEL 089/784045, Telex 5212855

France Datel Systems SARL,

11 Rue Ferdinand Buisson 75016 Paris, Fr.

TEL 603-06-74/603-05-31

United Kingdom Datel (UK) Ltd., Sealine House,

Priestley Road, Basingstoke, Hampshire RG 24 9NT
Tel Basingstoke (0256) 66721



The Walkie-Talkie-Lookie. **If you want to design one tomorrow, we're ready** **with your RF/Microwave power devices today.**

We've got the RF/Microwave devices to turn on a hand-held radio. VHF or UHF transmitter, cross-country data link or any other RF/Microwave design you have in mind. Including military.

We've got technology you can use.

Because at RCA we're working to make our technical leadership important to your product's performance. And to you.

But we're not only technological innovators in RF power devices. We're also a commodity supplier of power transistors; a recognized leader in CMOS; developers of liquid crystal displays; a leading producer of linear ICs and a major supplier of thyristors.

In addition to comprehensive technical product data, RCA also gives you professional and experienced field engineering and appli-

cations support. As well as a commitment to excellence in everything from research to manufacturing.

So whatever you're into, and whatever you need, check with us first. Chances are one or more of our products anticipate your needs. A good place to start is to check our handy product line guide. Write RCA Solid State, Section 57J11, Box 3200, Somerville, N.J. 08878. Phone (201) 722-3200.

RCA Solid State