

# Electronic Design 9

VOL. 22 NO.

FOR ENGINEERS AND ENGINEERING MANAGERS

APRIL 26, 1974

**Large single-computer systems** are increasingly being replaced by decentralized installations, consisting of multiple minis, data networks, microprocessors and

intelligent terminals. The results? More flexible operation, simplified software and reduced computer downtime. For the latest trends in computer design, turn to P. 61.





# How to save time and money on .156" connectors.

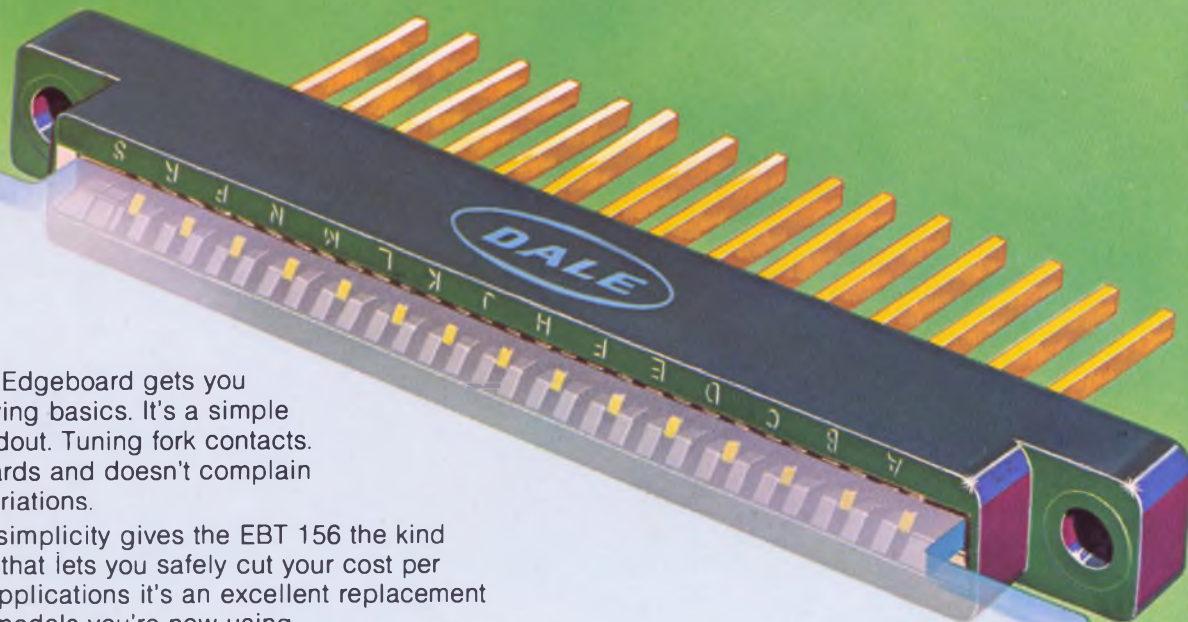

Dale's EBT 156 Edgeboard gets you back to money-saving basics. It's a simple design. Single readout. Tuning fork contacts. Handles 1/16" boards and doesn't complain about thickness variations.

Best of all, this simplicity gives the EBT 156 the kind of basic reliability that lets you safely cut your cost per contact. In many applications it's an excellent replacement for the bifurcated models you're now using.

EBT 156 models are available with 6, 10, 12, 15, 18, or 22 contacts in a choice of wire wrap, eyelet and dip solder terminations. Polarizing can be done at the factory or in the field.

Add to this the fact that we can deliver in from 2 to 4 weeks and you have all the makings of a really good deal. To find out just how good call the factory—605-665-9301 or dial 800-645-9200 for the name of your nearest Dale Representative.

## 2-4 week delivery.

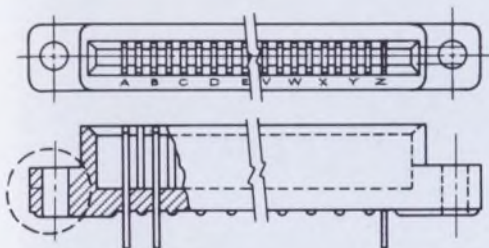

DALE ELECTRONICS, INC.  
East Highway 50, Yankton, S.D. 57078  
A subsidiary of The Lionel Corporation  
In Germany: Dale Electronics GMBH,  
8 Munchen 60, Falkweg 51  
In Canada: Dale Electronics Canada, Ltd.

INFORMATION RETRIEVAL NUMBER 246



# SURPRISE!

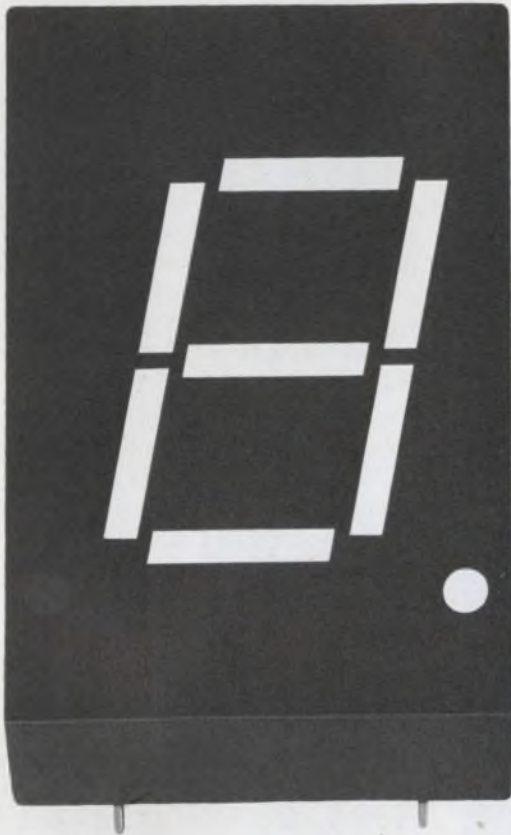

HP's new 5082-7750 series

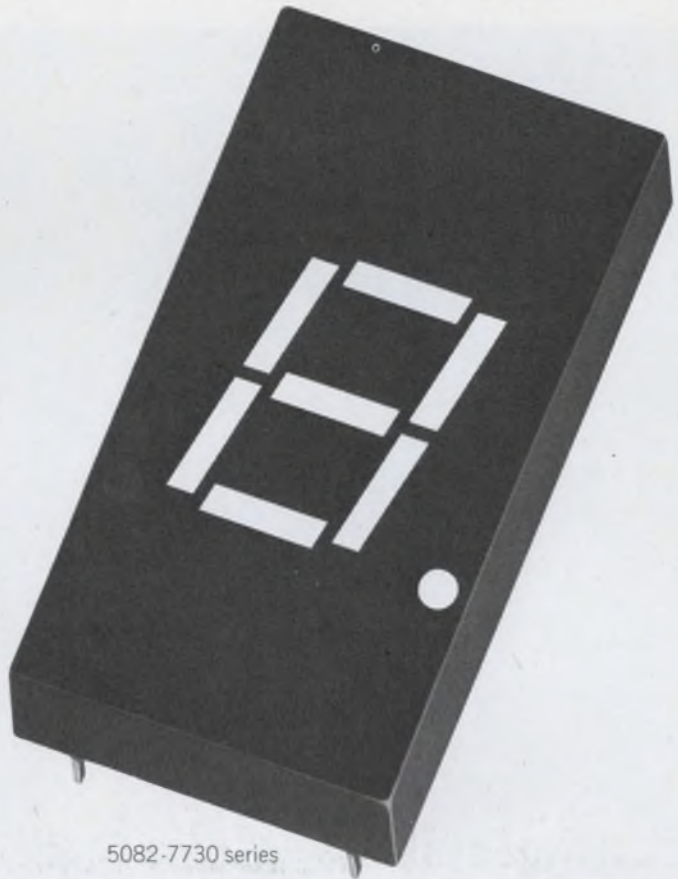

5082-7730 series

## HP displays are bigger than ever!

Now you can get a big, readable 0.43 inch LED display without sacrificing the simplicity and economy of single chip per segment design.

Bright enough to clearly see 20 feet away. HP's 5082-7750 series display features the same wide viewing angle, excellent readability and the same pin configuration as our 0.3 inch 5082-7730 series displays.

Just \$3.50 each in 100 quantities\*.

Contact Schweber, Hall-Mark or the Wyle Distribution Group for immediate delivery. Or, write us for more details. This is one display you won't want to miss.

01403A

\*Domestic USA price only.

HEWLETT  PACKARD

Sales and service from 172 offices in 65 countries.  
1501 Page Mill Road, Palo Alto, California 94304

INFORMATION RETRIEVAL NUMBER 2



# We shaped up DC

## Solid state relay with controlled rise and fall time



Take a good solid state DC relay — Teledyne's 603, for example — add some shaping circuitry so its response waveshape is carefully altered (rise time, turn-off slope, etc.), and something good happens for designers. In-rush currents for capacitive and lamp loads are limited, and so are turn-off transients for inductive loads. Also, controlled rise and fall time minimize EMI and switching transients.

An excellent choice for applications like process control systems, and machine tool controls, the 603 is optically isolated, with sensitive control input (directly compatible with TTL). It's available for loads up to 5 amps, 50 VDC.

The 603 also features Teledyne's exclusive "adaptive" packaging . . . screw or quick-disconnect terminals for chassis mounting, pins for PC boards.

If your application is less critical about in-rush currents and transients, you can order the 603 without controlled rise and fall time; it's identical, with a fast clean conventional waveshape. If you want to switch even higher level loads, shape up and call Teledyne.

 **TELEDYNE RELAYS**

3155 West El Segundo Boulevard Hawthorne, California 90250  
Telephone (213) 973-4545

INFORMATION RETRIEVAL NUMBER 3



---

## NEWS

- 29 **News Scope**
- 61 **Computer '74 special issue**, featuring current trends in computer technology. Topics covered include: Trends in distributed computing; applications of microprocessors; software in minicomputers; all about intelligent terminals and floppy discs; the computer in industrial process control; optics and computers; an interview with a pioneer in the computer industry and shortages in the computer industry.
- 41 **Washington Report**
- 

## TECHNOLOGY

- 142 **Basic microcomputer software:** Algorithm for a traffic-light controller illustrates principles that can be used with any MOS/LSI microprocessor.
- 150 **Microprocessor ICs improve instruments.** With the newer designs, an increasing variety of test functions can be provided by software and additional memory.
- 158 **Hitch your telemetry system to a mini.** For modest cost, you get high data rates, real-time conversion to engineering units and tape output in standard formats.
- 168 **Minimize computer "crashes."** Analysis of asynchronous conditions within a machine points to unavoidable errors, but there are eight ways to ease the problem.
- 176 **Approximate logs easily** with a simple combinatorial circuit. A few ICs let you multiply, divide, and calculate any root of any power of two.
- 186 **Program cuts logic-design costs** by letting you select with a computer the set of prime implicants that best meets your requirements.
- 192 **Program gives filter time response** based on Laplace transform techniques. Exact solutions are provided for a variety of pulsed waveforms.
- 198 **New rules for faster design.** Shortages of components, market changes, diminishing lead times—all call for a shrewder, more informed engineer.
- 202 **Ideas for Design:** 10-MHz differential video line receiver built with monolithic IC transistor array . . . Transistor reduces output variation in three-terminal regulator circuit . . . A few extra components adapt 741 op amps for high-voltage-swing applications.
- 208 **Design Decisions:** DPM forms the basis for inexpensive laboratory temperature measurements.
- 210 **International Technology**
- 

## PRODUCTS

- 214 **Computer Conference products**
- 225 **Data Processing:** Time-share graphics plotted automatically on a scope.
- 226 **Data Processing:** Fiber-optic link transmits data at 80 Mbit/s for 100 ft.
- 230 **Data Processing:** Optical tape reader speeds at 450 characters a second.
- 236 **Instrumentation:** Spectrum analyzer takes dynamic-input-range title.
- 244 **Modules & Subassemblies:** 16-channel acquisition system includes controls.
- |                         |                             |
|-------------------------|-----------------------------|
| 254 Integrated Circuits | 266 Discrete Semiconductors |
| 258 Components          | 271 Power Sources           |
| 264 Microwaves & Lasers | 278 Packaging & Materials   |
- 

## Departments

- |                                   |                                |
|-----------------------------------|--------------------------------|
| 51 <b>Editorial:</b> We lie a lot | 290 Bulletin Board             |
| 7 Across the Desk                 | 291 Vendor's Report            |
| 284 Design Aids                   | 296 Advertisers' Index         |
| 285 Application Notes             | 298 Product Index              |
| 286 New Literature                | 300 Information Retrieval Card |

**Cover:** Photo by Frank Chow, courtesy of General Automation, Inc.

---

# INTRODUCING MONO-GLASS

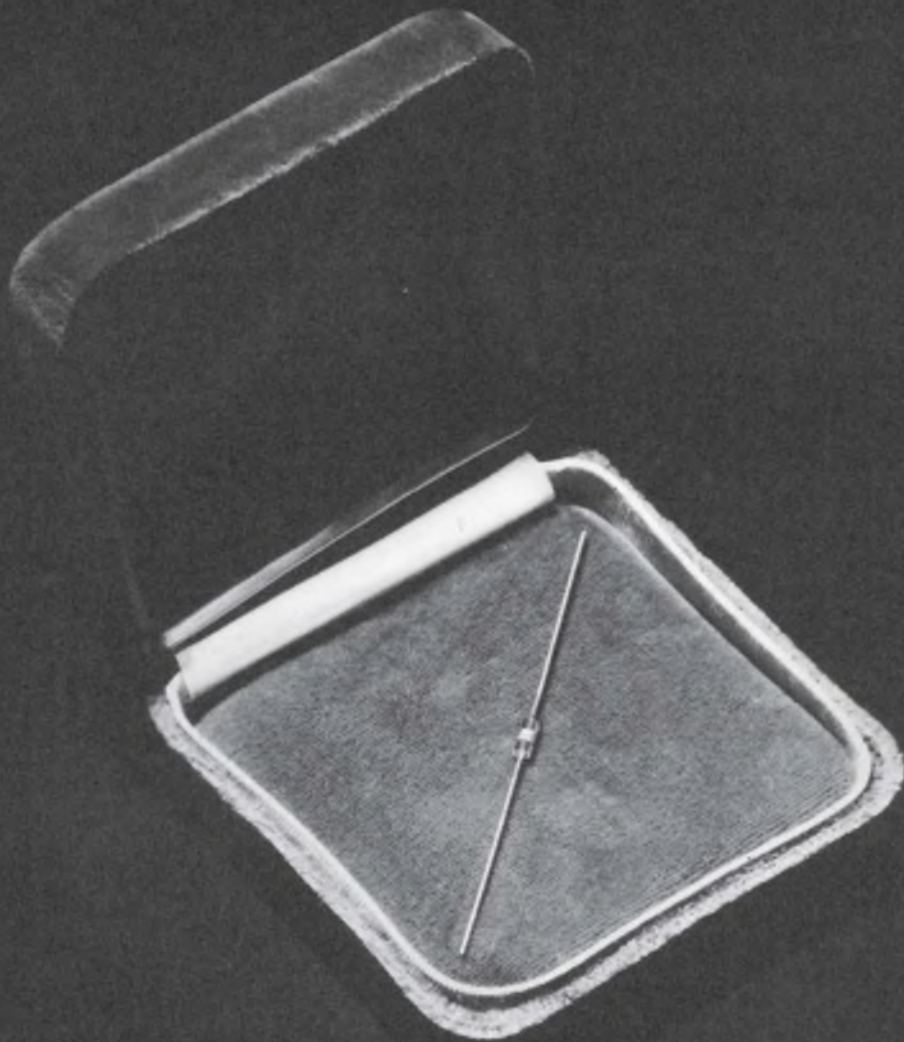



# A JEWEL OF A CAPACITOR

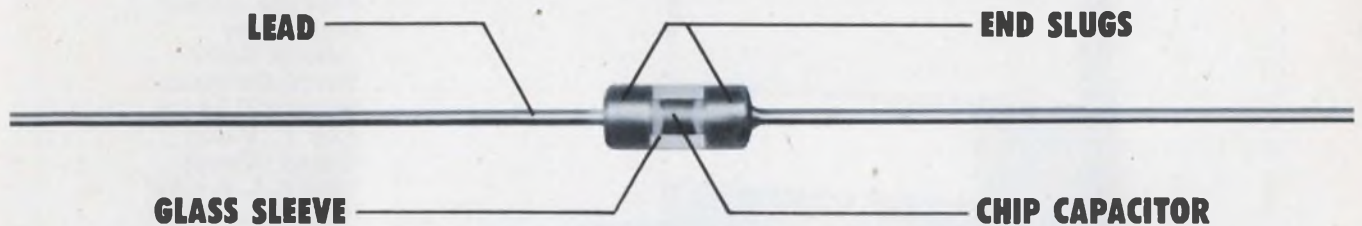

U.S. Capacitor Corp. has done something elegant for high volume capacitor users . . . MONO-GLASS.

This glass encapsulated monolithic ceramic capacitor offers something special: for the Design Engineer looking for cost reduction and dependability; for the purchasing agent looking for low price with fast delivery; for the incoming Q.C. inspector who is looking for reliability.

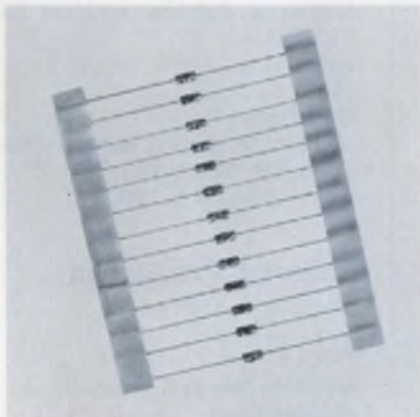

## AUTOMATIC INSERTION:

If you use it, you know the substantial savings in time and cost. MONO-GLASS is designed for automatic insertion with the same equipment used for diodes and resistors. Reel packed and ready for your machines.

## DURABILITY:

Our hermetically sealed, glass-to-metal construction offers these advantages: solderless internal contacts that won't reflow in your wave-soldering process; no glass fracturing during lead forming—stress is transferred to the end slugs rather than the glass sleeve.



## HIGH VOLUME; LOW PRICE

USCC's production capability for chip capacitors is second to none. MONO-GLASS is produced by a simple assembly technique. Combine these two and you get the best possible delivery for high quantity requirements, at a budget price.

## WIDE SELECTION:

Four case sizes are available . . . .200 x .100; .250 x .100; .300 x .150 and .400 x .150. The 50 and 100 WVDC units offer up to .01 mfd in COG dielectric, to .18 in X7R and up to 1.0 mfd in the Y5V dielectric.

## RELIABILITY:

USCC is the proven leader in state-of-the-art, demonstrated on N.A.S.A. life support and guidance systems. Commercial as well as military aerospace applications benefit from the high reliability features of our products—the best available.

MONO-GLASS is our lowest priced ceramic axial lead capacitor, offering a new quality capability for communications, navigation and guidance, computer business machines or anywhere that high volume, low price is required.

Write or call for an evaluation sample, more technical data or applications help for your special requirements. Remember, USCC-Centralab.

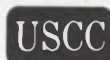

**USCC/Centralab**

Electronics Division • Globe-Union, Inc.

2151 North Lincoln Street • Burbank, California 91504

(213) 843-4222 • TWX: 910-498-2222

INFORMATION RETRIEVAL NUMBER 4



# A Smart Way to Beat Your Power Supply Size Problem



1½" thin, 2¾" narrow, 2¾" short

yet this converter produces 1000 volts DC, regulated, from a battery input of 28 VDC! It weighs less than 15 ounces. This is only one of our wide variety of many small light weight converters, inverters and power supplies — there are over 3000 models listed in our newest catalog, including size, weight and prices. If you have a size problem, why not send for an Abbott catalog?

**MIL SPEC ENVIRONMENT** — All of the power modules listed in our new catalog have been designed to meet the severe environmental conditions required by modern aerospace systems, including MIL-E-5272C and MIL-E-5400K. They are hermetically sealed and encapsulated in heavy steel containers. New all silicon units will operate at 100°C.

Please see pages 581-593 of your 1973-74 EEM (ELECTRONIC ENGINEERS MASTER Catalog) for complete information on Abbott Modules.

Send for our new 68 page FREE catalog.

**RELIABLE** — Highest quality components are used in Abbott power modules to yield the high MTBF (mean time between failure) as calculated in the MIL-HDBK-217 handbook. Typical power modules have over 100,000 hours MTBF — proving that the quality was built in from the beginning.

**WIDE RANGE OF OUTPUTS** — Any voltage from 5 volts DC to 3,650 VDC is available by selecting the correct model you need from our catalog with any of a variety of inputs including:

- 60 ∞ to DC, Regulated
- 400 ∞ to DC, Regulated
- 28 VDC to DC, Regulated
- 28 VDC to 400 ∞, 1 ∅ or 3 ∅
- 24 VDC to 60 ∞, 1 ∅

**abbott transistor**

**LABORATORIES, INCORPORATED**

5200 W. Jefferson Blvd./Los Angeles 90016  
(213) 936-8185

1224 Anderson Ave./Fort Lee, N.J. 07024  
(201) 224-6900

INFORMATION RETRIEVAL NUMBER 5

**Vice President, Publisher**  
Peter Coley

## Editors

Editorial Offices  
50 Essex St.  
Rochelle Park, N.J. 07662  
(201) 843-0550  
TWX: 710-990 5071  
Cable: Haydenpubs Rochellepark  
**Editor-in-Chief** George Rostky

## Managing Editors:

Ralph Dobriner  
Michael Elphick

## Associate Editors:

Dave Bursky  
Jules H. Gilder  
Morris Grossman  
Seymour T. Levine  
John F. Mason  
Stanley Runyon  
Edward A. Torrero  
Richard L. Turmail

## Contributing Editors:

Peter N. Budzilovich  
Robert Wollins

## Editorial Field Offices

### East

Jim McDermott, Eastern Editor  
P.O. Box 272  
Easthampton, Mass. 01027  
(413) 527-3632

### West

David N. Kave, Senior Western Editor  
2930 West Imperial Highway  
Inglewood, Calif. 90303  
(213) 757-0183  
Northe K. Osbrink, Western Editor  
112 Coloma St.  
Santa Cruz, Calif. 95060  
(408) 426-3211

### Washington

Heather M. David, Bureau Chief  
2506 Eye St., N.W.  
Washington, D.C. 20037

## Editorial Production

Marjorie A. Duffy

## Art

**Art Director**, William Kelly  
Richard Luce  
Anthony J. Fischetto

## Production

**Manager**, Dollie S. Viebig  
Helen De Polo  
Anne Molfetas  
Christopher G. Hill

## Circulation

**Manager**, Nancy L. Merritt

## Information Retrieval

Peggy Long

## Promotion

**Manager**, Jeffrey A. Weiner  
Karen Kerrigan



## across the desk

### Author defends design of v/f converter

This is in reply to Joel Cohen's letter "Promises, Promises—Watch Those Specs" (ED No. 6, March 15, 1974, p. 7), in which he contended the article promised too much.

I don't think the article "Linearize Your V/F Converter" (ED No. 23, Nov. 8, 1973, p. 112) is misleading. The question is whether the figure of accuracy is related to the fsd or the measured value. A glance at the table gives an immediate answer.

The deviation from a straight line is calculated as if the whole error is in the converter. There is, however, an error in the reference source used, as in every other, and the reference level can't be determined exactly. The nonlinearity of the converter is easily covered by the error of  $V_{in}$ , seen in the table, even if the frequency is measured with an error of only one digit. One can't really say what has been checked, the v/f converter or the voltage reference.

Look at the number of decades. There are two trimming points in the v/f converter. One is for zero-frequency output adjustment, with the input short-circuited. The other is used to set the conversion factor (Hz/V). Of course, you can't set the v/f so that the transfer curve passes exactly through origin. But it's not unreasonable to set the v/f to oscillate at 0.01 Hz max, with the input short-circuited.

The table and title state that the transfer curve does not diverge more than 0.2 Hz from a

straight line. If a voltage-to-frequency curve is plotted—one that exhibits an ideal transfer function—the measured transfer and allowable deviation show that the number of decades would be more than five, rather than less. You can easily increase the upper-frequency limit by a factor of 2 simply by doubling the clock frequency.

Look at the figures of a 0.005%, five-decade v/f converter. Even if the lower voltage limit is as high as 1 mV, it has to be measured with an accuracy of  $\pm 50$  nV and kept within this small band for a long period. There is a large noise problem involved in such measurements—as well as other problems.

I have shown a way to build, with only two trimming points, a v/f converter that can be compared with a voltage reference where the absolute error is only 10  $\mu$ V. This was the main purpose of the article. The four hints on how to minimize the absolute error at low levels therefore refer to a further development.

*Bengt Alvesten*

Fysiska Institutionen  
Lunds Universitet  
Lund, Sweden

### Temporal-priority circuit raises design questions

The circuit in the Idea for Design, "Temporal-Priority Circuit Latches After Receipt of First Input Signal" (ED No. 23, Nov. 8, 1973, p. 132), has at least two problems that will bag the unsuspecting designer.

First, it is possible for none of  
*(continued on page 12)*

Electronic Design welcomes the opinions of its readers on the issues raised in the magazine's editorial columns. Address letters to Managing Editor, Electronic Design, 50 Essex St. Rochelle Park, N.J. 07662. Try to keep letters under 200 words. Letters must be signed. Names will be withheld on request.

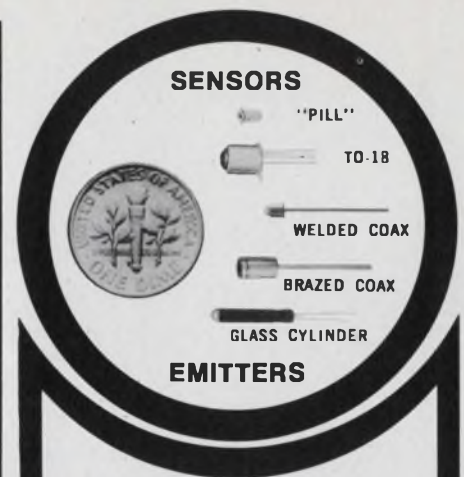

## OPTRON OPTOELECTRONIC COMPONENTS

STANDARD DISCRETE PACKAGES  
IMMEDIATE DELIVERY  
COMPETITIVE PRICING

OPTRON'S competitively priced broad line of standard optoelectronic components range from solid state gallium arsenide emitters to silicon photodiodes, phototransistors, and photodarlingtons. They are immediately available in microminiature "pill," TO-18, welded or brazed coax, and glass cylinder packages.

OPTRON silicon photodetectors are compatible with either tungsten light sources or infrared LED's. The solution-grown epitaxial gallium arsenide LED's offer high efficiency and compatibility with the silicon photodetectors.

All OPTRON discrete components are available in other packages in moderate scale line quantities using standard chips. In addition, these units may be purchased as either standard or custom chips, monolithic arrays, printed circuit board assemblies, or molded assemblies.

Detailed technical information on discrete components and other OPTRON optoelectronic products . . . chips, assemblies and PC board arrays . . . is available from your nearest OPTRON sales representative or the factory direct.



NEW  
CONDENSED  
CATALOG

contains technical data on these and other OPTRON products. Request your copy today!



OPTRON, INC.

1201 Tappan Circle  
Carrollton, Texas 75006  
214/242-6571



surround it  
with something special

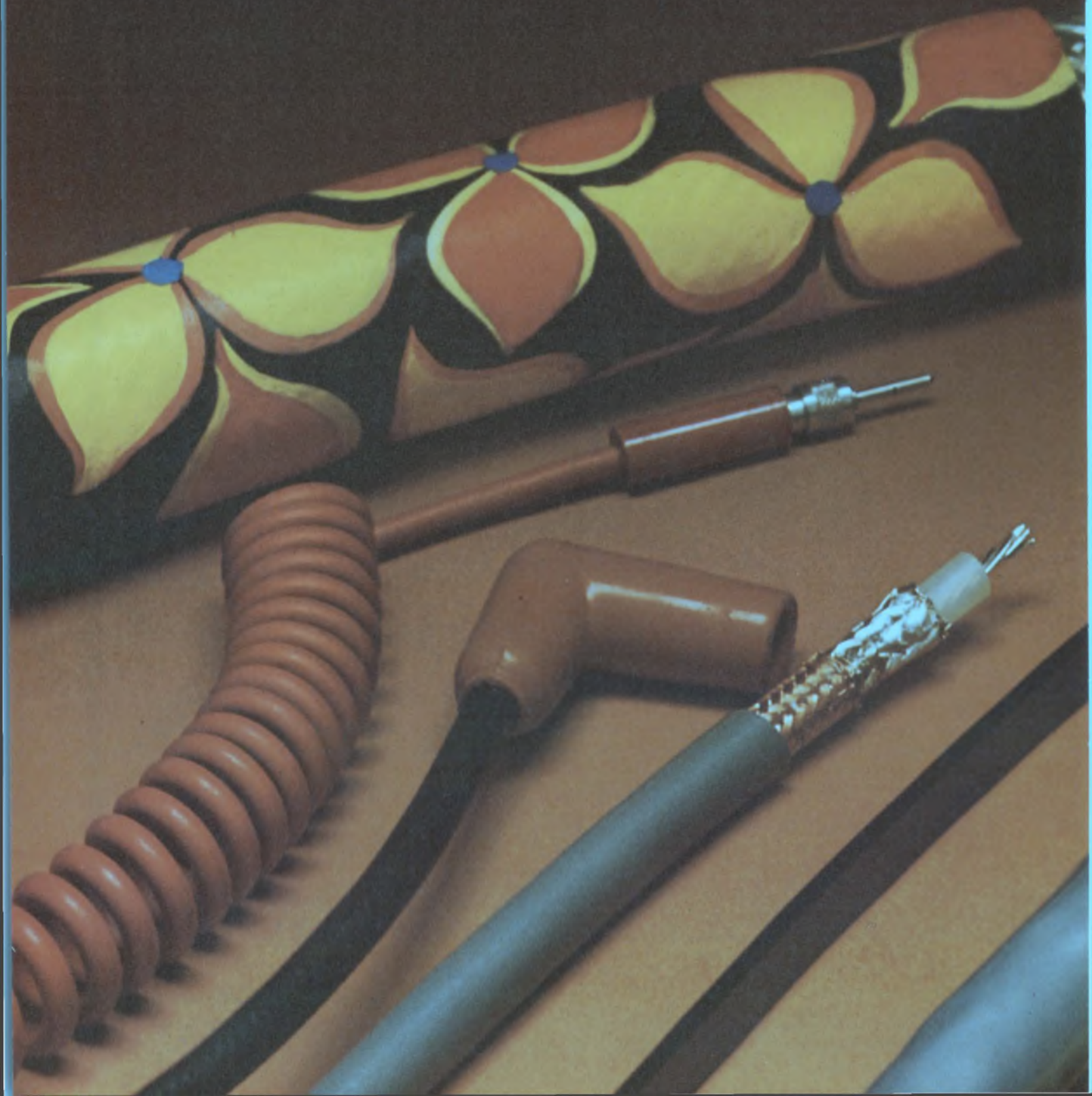





Safety. Reliability. Long-haul performance. Cost. They all have an effect on your product's design parameters and capabilities.

Belden has a custom design capability in wire, cable, and cord that can help you meet the most demanding performance for your products. We've helped solve some extraordinary problems. Can provide definitive data and answers on flex life, oil resistance, electrical characteristics, aging that can cope with practically any environment your specific job criteria calls for.

Talk to your Belden specialist about it. He understands design requirements. Can give you straight answers on cable or cord design feasibility. What modifications are possible. What the trade-offs are. The costs involved. We haven't perfected that "fancy" jacketing yet, but can improve the wire, cable, or cord package you need to meet the most challenging electrical, physical and thermal applications you might be faced with.

If you need answers right now, phone:  
(312) 887-1800, Transportation Division  
(312) 681-8920, Electrical Division  
(317) 966-6681, Electronic Division  
Or write Belden Corporation, P. O. Box 386, Geneva, Illinois 60134.

H-2-3

**BELDEN** 

INFORMATION RETRIEVAL NUMBER 234





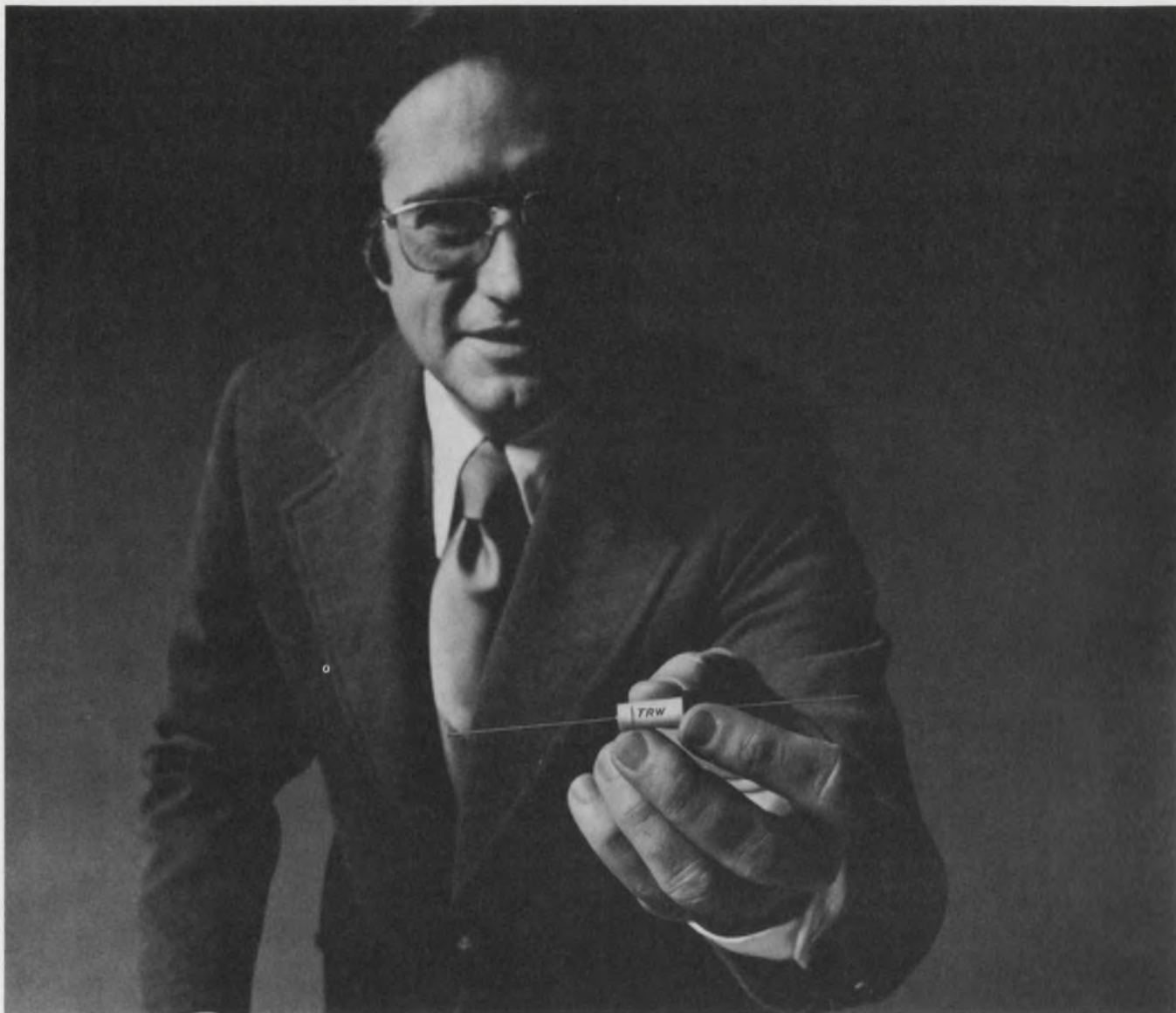

## Tell you what we're not going to do.

Sure, we know *how* to make cheaper capacitors. But not with "TRW" stamped on them. No way. Because we figure you can't make quality capacitors and me-too capacitors under the same roof. Not without one operation eventually goofing the other one up.

So if it's marked "TRW," you *know* you're getting the top technology in wound—both metallized and film foil—and solid tantalum capacitors.

You're also getting a pipeline to some of the best minds in capacitor R&D, design, QC, and application engineering—ready to help you with *any* capacitance problem. From TV to aerospace.

All this will cost you a little more per capacitor. In return, it can help *your* product earn a reputation for "no headaches, no surprises." What better edge in today's marketplace?

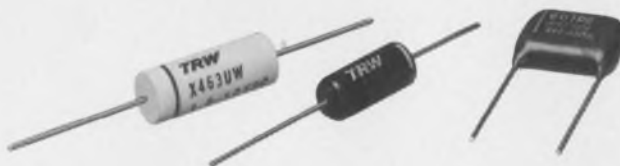

TRW Capacitors, an Electronic Components Division of TRW, Inc., Box 1000, Ogallala, Nebraska 69153.

# TRW<sup>®</sup> CAPACITORS



# Due to a major industry breakthrough it is now possible to get gassed automatically.



The breakthrough: \$990 for a full-blown OEM computer in quantities of 200—the NAKED MINI®/LSI. The possibilities? Virtually endless.

With our new mini, for example, you can build the gas station of the future. Right now. Because the NAKED MINI/LSI makes it economically feasible to handle even the most mundane jobs by computer.

For instance: complete self-service gas pumping by inserting credit cards or cash. Automatic card verification. Taking “bad” cards out of circulation. Volume profiling by hour, day, month or year. Round-the-clock monitoring of activities. Alerting security centrals to vandalism, excessive gas fumes or fires.

But there's a lot more. Our computer can also run station vending machines. Help plan gas delivery schedules. Talk to motel/hotel computers so the traveler can make advance reservations by credit card.

Still, with all these added tasks, you're only using a small percentage of our available computer power. The power of our full-scale LSI processor with 168

instructions, 4K x 16 memory and fully implemented input/output for low-cost interfacing.

At \$990 per mini, you can afford to take new design routes. Develop new functions that result in better mileage and more convenience for you and your customers. It could be an innovative drive for gas stations or any other business that would profit from computer automation.

Write or call: Computer Automation, Inc., 18651 Von Karman, Irvine, California 92664. Tel. (714) 833-8830. TWX 910-595-1767.

**THE NAKED MINI® COMPANY**  
**Computer Automation, Inc.**

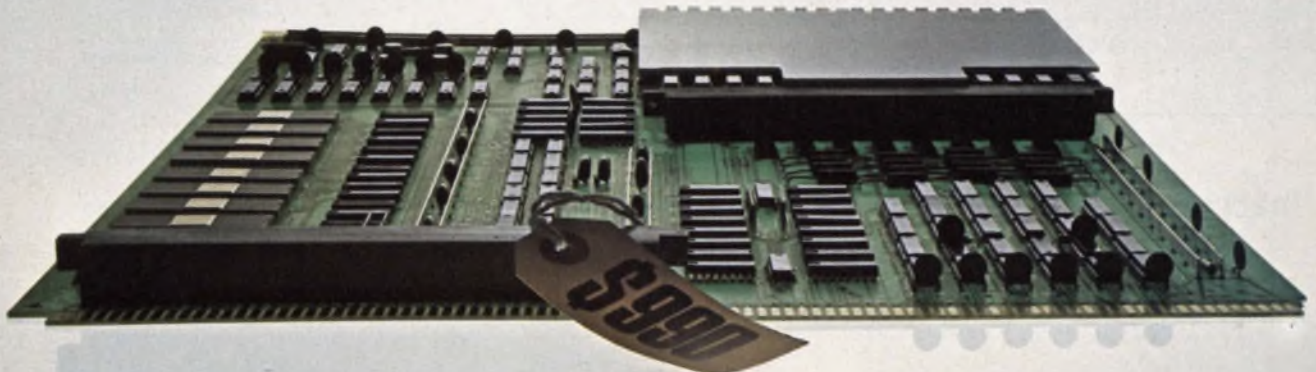

®NAKED MINI is a registered trademark of Computer Automation, Inc.



(continued from page 7)

the 174 outputs to be true and to have the  $G_1$ - $G_2$  latch set. Using Texas Instruments' specifications for the devices, one finds the following:

$$S04 \text{ Tphl (min)} = 2 \text{ ns,}$$

$$H30 \text{ Tphl (min)} = 3.4 \text{ ns,}$$

$$174 \text{ Tsetup (min)} = 20 \text{ ns.}$$

Therefore the 174 can be clocked before the data setup spec has been met, resulting in all ZERO outputs.

Second, a timing condition exists where the output of the 174 (or any other flop that I am aware of) will glitch for a period of several times the specified maximum propagation delay of the device. The final result of this glitch may be either ONE or ZERO from the flop. There seems to be a narrow window prior to the clocking edge, during which a change in the steering term drives the flop mad. This glitch can adversely affect downstream logic.

The logic in the illustration will provide unambiguous outputs, at the expense of degraded time resolution and additional components. The delay line tap  $T_1$  is selected such that the minimum

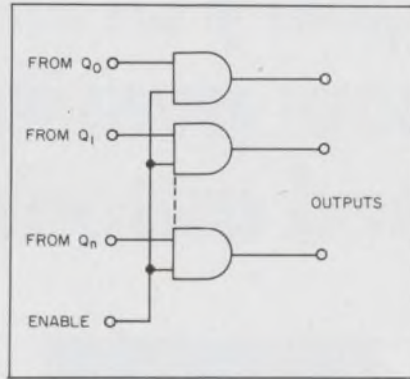

delay of  $G_1 + T_1$  is greater than the minimum setup time for the flip-flop used. This ensures that at least one of the  $Q_N$  will be set after the strobe.

$T_2$  is selected such that  $(T_2 - T_1) + \text{Tphl (F1) min.}$  is greater than the glitch width of the input flops + the priority encode delay + the decode delay. This combination ensures a valid output at  $\approx T_2$  after the initiating event.

*J. M. Brown*  
Senior Member of the  
Technical Staff

Modular Computer Systems  
1650 W. McNab Rd.  
Fort Lauderdale, Fla. 33309

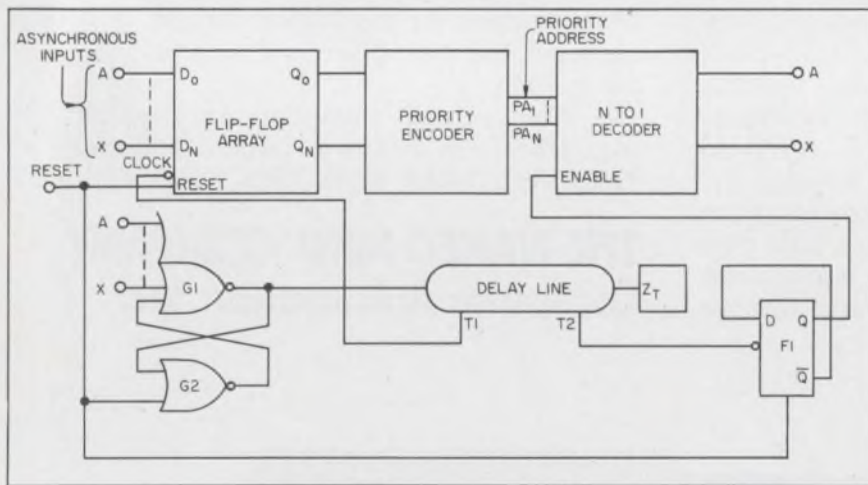

## 'Inaccuracies' reported in log-amp article

There are inaccuracies in the article "The Hows and Whys of Log Amps" (see ED No. 3, Feb. 1, 1974, p. 52).

Logarithmic diodes with seven ranges are available—off the shelf. The contention "...diodes have a

(continued on page 16)

## Your closest SIGNETICS distributor is...

- ARIZONA**  
Phoenix: Hamilton/Avnet Electronics (602) 275-7851  
Phoenix: Kieruff Electronics (602) 273-7331
- CALIFORNIA**  
Culver City: Hamilton Electro Sales (213) 870-7171  
El Segundo: Liberty Electronics (213) 322-8100  
Los Angeles: Kieruff Electronics (213) 685-9525  
Mountain View: Hamilton/Avnet Electronics (415) 961-7000  
Palo Alto: Kieruff Electronics (415) 968-6292  
San Diego: Cramer Electronics (714) 565-1881  
San Diego: Hamilton/Avnet Electronics (714) 279-2421  
San Diego: Kieruff Electronics (714) 278-2112  
Sunnyvale: Cramer Electronics (408) 739-3011
- CANADA**  
Downsview: Cesco Electronics (416) 661-0220  
Downsview: Cramer Electronics (416) 661-9222  
Montreal: Cesco Electronics (514) 735-5511  
Montreal: Hamilton/Avnet Electronics (514) 735-6393  
Ottawa: Cesco Electronics (613) 729-5118  
Ottawa: Hamilton/Avnet Electronics (613) 725-3071  
Quebec: Cesco Electronics (418) 524-2518  
Vancouver: Bowtek Electric Co. Ltd. (604) 736-7677
- COLORADO**  
Denver: Cramer Electronics (303) 758-2100  
Denver: Hamilton/Avnet Electronics (303) 534-1212
- CONNECTICUT**  
Hamden: Arrow Electronics (203) 248-3801  
Georgetown: Hamilton/Avnet Electronics (203) 762-0361  
North Haven: Cramer Electronics (203) 239-5641
- FLORIDA**  
Hollywood: Hamilton/Avnet Electronics (305) 925-5401  
Hollywood: Schweber Electronics (305) 927-0511  
Orlando: Hammond Electronics (305) 241-6601
- GEORGIA**  
Atlanta: Schweber Electronics (404) 449-9170  
Narcross: Hamilton/Avnet Electronics (404) 448-0800
- ILLINOIS**  
Elk Grove: Schweber Electronics (312) 593-2740  
Einhurst: Semiconductor Specialists (312) 278-1000  
Schiller Park: Hamilton/Avnet Electronics (312) 678-6310
- INDIANA**  
Indianapolis: Semiconductor Specialists (317) 243-8271
- KANSAS**  
Lenexa: Hamilton/Avnet Electronics (913) 888-8900
- MARYLAND**  
Hanover: Hamilton/Avnet Electronics (301) 796-5000  
Rockville: Pioneer Washington Electronics (301) 424-3300  
Rockville: Schweber Electronics (301) 881-2970
- MASSACHUSETTS**  
Burlington: Hamilton/Avnet Electronics (617) 273-2120  
Newton: Cramer Electronics (617) 969-7700  
Waltham: Schweber Electronics (617) 890-8484
- MICHIGAN**  
Detroit: Semiconductor Specialists, Inc. (313) 255-0300  
Livonia: Hamilton/Avnet Electronics (313) 522-4700  
Troy: Schweber Electronics (313) 583-9242
- MINNESOTA**  
Edina: Hamilton/Avnet Electronics (612) 941-3801  
Minneapolis: Semiconductor Specialists (612) 854-8844
- MISSOURI**  
Hazelwood: Hamilton/Avnet Electronics (314) 731-1144
- NEW MEXICO**  
Albuquerque: Hamilton/Avnet Electronics (505) 765-1500
- NEW YORK**  
Buffalo: Summit Distributors (716) 884-3450  
Farmingdale, L.I.: Arrow Electronics (516) 694-6800  
Rochester: Schweber Electronics (716) 328-4180  
Syracuse: Hamilton/Avnet Electronics (315) 437-2642  
Westbury: Hamilton/Avnet Electronics (516) 333-5800  
Westbury: Schweber Electronics (516) 334-7474
- NORTHERN NEW JERSEY**  
Cedar Grove: Hamilton/Avnet Electronics (201) 239-0800  
Saddlebrook: Arrow Electronics (201) 797-5800
- SOUTHERN NEW JERSEY AND PENNSYLVANIA**  
Cherry Hill, N.J.: Milgray-Delaware Valley (609) 424-1300  
Moorestown: Arrow/Angus Electronics (609) 235-1900  
Mt. Laurel, N.J.: Hamilton/Avnet Electronics (609) 234-2133
- CENTRAL NEW JERSEY AND PENNSYLVANIA**  
Somerset, N.J.: Schweber Electronics (201) 469-6008
- NORTH CAROLINA**  
Greensboro: Hammond Electronics (919) 275-6391
- OHIO**  
Beechwood: Schweber Electronics (216) 464-2970  
Dayton: Hamilton/Avnet Electronics (513) 433-0610  
Cleveland: Arrow Electronics (216) 464-2000  
Cleveland: Pioneer Standard Electronics (216) 587-3600  
Kettering: Arrow Electronics (513) 253-9176
- TEXAS**  
Dallas: Cramer Electronics (214) 350-1355  
Dallas: Hamilton/Avnet Electronics (214) 661-8661  
Houston: Component Specialties (713) 771-7237  
Houston: Hamilton/Avnet Electronics (713) 526-4661
- UTAH**  
Salt Lake City: Alta Electronics (801) 486-7227  
Salt Lake City: Hamilton/Avnet Electronics (801) 262-8451
- WASHINGTON**  
Bellevue: Hamilton/Avnet Electronics (206) 746-8750  
Seattle: Cramer Electronics (206) 762-5722



# Now, a 576-bit RAM for men of few words.

## Target-designed 64 x 9 for 45ns buffers and scratch pads.

Making small talk just got easier. With still another world's first from Signetics. Our 82S09 RAM of 576 bits: the largest bit count ever put into a bipolar RAM with more than one bit per word. This 64 x 9 is available now in volume, and multiple-sourced.

What's in it for you? Say you've got a scratch pad or buffer that only calls for 16 to 128 words. Till now your choices were all bad news. Either you wasted memory capacity with oversized organization and gadgety multiplexing schemes, or you strung together a lot of little RAMs. Either way, you lost. In terms of high tabs for extra circuitry, bigger boards, and the power to keep them going. Not to mention penalties in memory speed.

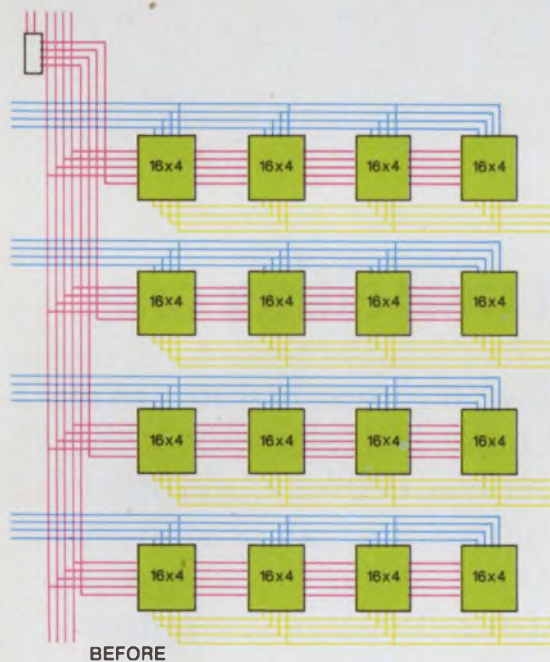

BEFORE

For small, dense memory applications, the unique 82S09 RAM—with new cell design and enhanced 64 x 9 organization—shrinks board space requirements, lowers component count and power cost, but slams out all the speed you can handle. (Schottky technology delivers 45ns, worst case.) With all the traditional bipolar RAM features in the bargain. Full decoding. Chip enable. Open collector. And a vital bonus, the ninth bit for parity.

If the picture still needs a little focussing, take a minute to scan our Comparison Chart, based on production of 200 systems.

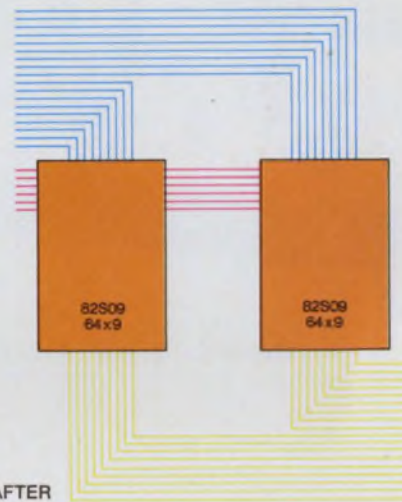

AFTER

		"Before"	"After"
Parts Cost*	Decoder	\$ 2.80	\$ 0.00
	8225/7489	96.00	85.20
		<u>\$98.80</u>	<u>\$85.20</u>
Board Space		1.5	1.0
Access Time (1)	Decoder	20ns	0
	8225/7489	50ns	45ns
		70ns	45ns
Power Dissipation	Decoder	0.1 Watt	0
	8225/7489	6.4 Watts	1.7 Watts
		6.5 Watts	1.7 Watts
Solder Connections	Decoder	16	0
	8225/7489	256	56
		272	56

(1) Even with 3101A (35ns), the total 64 x 16 array access time is 55ns.  
\*Signetics 100-up published price.

Okay, talk may be cheap. So make us lay it on the line. Today, from your local distributor.

CLIP THIS COUPON AND ATTACH TO LETTERHEAD FOR FAST ACTION.

Signetics—RAMs  
P. O. Box 3004-12  
Menlo Park, California 94025

Spec sheets first, please, on the 82S09, the new bipolar 45ns Schottky RAM you've raved about and said is available now.

Name \_\_\_\_\_

Title \_\_\_\_\_ Mail Stop \_\_\_\_\_

Signetics Corporation, a subsidiary of Corning Glass Works

**signetics**



# Here are two of the world's best oscilloscopes.

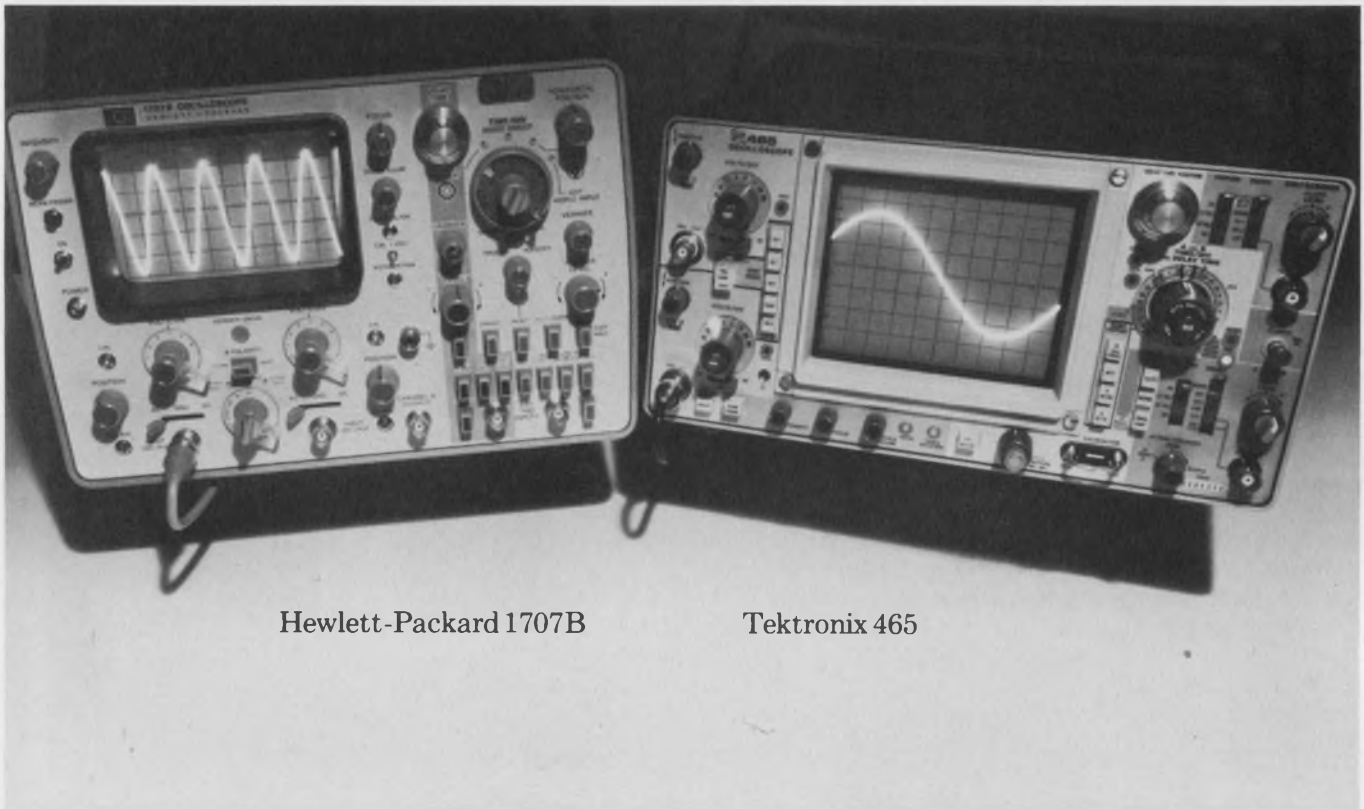

Hewlett-Packard 1707B

Tektronix 465

## Here's why you shouldn't own either one.

You can lease one for as little as \$45 per month.

We can give you immediate delivery on either the Hewlett-Packard 1707B or the Tektronix 465, in quantity.

The Hewlett-Packard scope lease is \$45 per month for 36 months.

The Tektronix 465 is \$50 per month for 36 months.

Anyway you choose, leasing is the best thing that ever happened to a tight capital equipment budget.

You pay for your scope as you use it ... and you pay for it out of the profits it generates.

Call your closest Instant Inventory Center and ask us about short term rentals, delivery, and other lease terms for scopes or any other electronic equipment you need, up to and including minicomputers.



Anaheim, California (714) 879-0561  
Dallas, Texas (214) 661-8082  
Fort Lauderdale, Florida (305) 771-3500  
Gaithersburg, Maryland (301) 948-0620  
Burlington, Massachusetts (617) 273-2770  
Mountain View, California (415) 968-8845  
Oakland, New Jersey (201) 337-3757  
Rexdale (Toronto) Ont., Canada (416) 677-7513  
Des Plaines, Illinois (312) 827-6670

## Rental Electronics, Inc.

A **PEPSICO** leasing company.





Back panels completely assembled and inspected at Elco.

AT NCR'S  
ACCOUNTING  
COMPUTER  
DIVISION...

# Elco Back Panels Cut Packaging Costs By Over 50%

The NCR 399 high-speed accounting system is an excellent example of expertise in design and manufacturing skills. The combination of powerful hardware and sophisticated software gives the 399 capabilities previously offered only with computers of much higher price. One reason is due to a new concept in electronic packaging — Elco's Economist™ press fit card-edge connector system. The press fit technique combines the economy and reliability of printed wiring (without soldering) with the versatility of solderless wrapping.

Elco supplied NCR with a custom p.c. back panel, loaded with Economist™ connectors and hardware. Assembled. Ready for wiring and installation. This cut NCR's interconnecting costs by over 50%. High quality, good turn-around time, and excellent engineering assistance and back-up are extras that accompany every Elco system.

As with NCR, Elco works with you to provide your manufacturing facilities with every packaging advantage they know. One source. To make production easier, less costly and more reliable.

Find out how much you can save and improve on interconnections through Elco's Economist™ systems. Contact your local Elco representative for full details or specifications, or:

Elco Corporation  
Willow Grove, Pa. 19090  
(215) 659-7000

Elco Corporation  
2200 Park Place  
El Segundo, Calif. 90245  
(213) 675-3311



Operations in USA, Australia, Belgium, Canada, Denmark, England, France, Germany, Israel and Japan. Sales offices throughout the world. In Europe, Elco Belge, 77 Blancefloerlaan, Antwerp, Belgium, Tel. 03-190064. In the Far East, Elco International, TBR Building, 2-10-2 Nagatacho, Chiyoda-ku, Tokyo 100, Japan, Tel. 580-2711/5. Copyright © 1973 Elco Corp. All rights reserved.

INFORMATION RETRIEVAL NUMBER 12



Higher component density...  
Lower insertion costs...with



# MULTI-COMP® DIP MONOLYTHIC® CERAMIC CAPACITORS



STANDARDIZED DESIGN\* FOR  
BETTER AVAILABILITY, BETTER PRICES

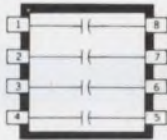

TYPE 939C  
(4 capacitor sections)



TYPE 934C  
(7 capacitor sections)

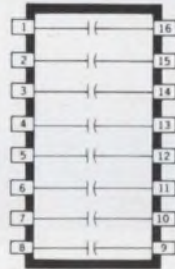

TYPE 936C  
(8 capacitor sections)

Compatible with ICs and other standard DIP devices. Especially useful for noise bypassing and signal coupling in high-frequency signal or data processing systems. Molded package provides mechanical protection and reliability under severe environmental conditions. Monolythic® construction . . . alternate layers of ceramic dielectric material and metallic electrodes are fired into an almost indestructible homogeneous block. Standard ratings, 18pF to 0.1 μF @ 100WVDC. Temperature range, -55C to +70C.

\*Other circuit configurations (including internally-paralleled capacitor sections, commoned capacitor leads, and various ratings within single package) are available on special order.

## Sprague puts more passive component families into dual in-line packages than any other manufacturer:

- TANTALUM CAPACITORS
- CERAMIC CAPACITORS
- TANTALUM-CERAMIC NETWORKS
- RESISTOR-CAPACITOR NETWORKS
- PULSE TRANSFORMERS
- TOROIDAL INDUCTORS
- HYBRID CIRCUITS
- TAPPED DELAY LINES
- SPECIAL COMPONENT COMBINATIONS
- THICK-FILM RESISTOR NETWORKS
- THIN-FILM RESISTOR NETWORKS
- ION-IMPLANTED RESISTOR NETWORKS

For more information on Sprague DIP components, write or call Ed Geissler, Manager, Specialty Components Marketing, Sprague Electric Co., 347 Marshall St., North Adams, Mass. 01247. Tel. 413/664-4411.

THE BROAD-LINE PRODUCER OF ELECTRONIC PARTS



ACROSS THE DESK  
(continued from page 12)

limited logarithmic range" did not consider that the dual, matched transistor design has a smaller range. Codi abrupt-junction devices can be specified with maximum deviations of  $\pm 2, 5$  or 10 mV from the theoretical diode equation.

*Sy Glasser*  
Assistant to General Manager  
Codi Semiconductor  
Pollitt Drive  
Fair Lawn, N.J. 07410

### The author replies

Mr. Glasser's point is well taken. Special-purpose diodes, such as abrupt-junction types, can be fabricated or selected for wide logarithmic range. Then the diodes can be computer-matched in pairs for I, temperature compensation.

In the paragraph following the one quoted, I did say that diode-connected, dual-matched transistors were better than *general-purpose* diodes, which are usually optimized for characteristics other than log behavior.

However, that doesn't tell the whole story. High- $\beta$  duals, with geometry like that of the AD811, typically cost less than \$1 a transistor. And they are inherently capable of as many as six decades of accurate logarithmic behavior when connected as two-terminal diodes—and even more as transdiodes.

Such diodes are inherently matched, and because they are essentially isothermal, they retain the match with either transient or steady-state temperature changes. A 1-C difference is equivalent to a 2-mV mismatch, which corresponds to an input ratio of  $\log^{-1}(2/70) = 1.07$ , or an error of 7%, assuming  $mkT/q = 70$  mV per/decade.

Your readers may find it interesting to reinterpret the 2, 5 and 10-mV initial log-conformity errors in terms of percentage of the input in a log-ratio circuit, by use of the formula  $\% = 100(\log^{-1} \Delta V/70 - 1)$ . For example, a 10-mV error corresponds to a ratio-error of 39%.



# The wide, wide world of AMP Circular Plastic Connectors.



No matter where you go, you won't find a more versatile line of circular plastic connectors. AMP has a variety of design options. From mating plugs to panel-mount or free-hanging receptacles. From square flange to feed-thru pressure bulkhead receptacles. They're available with many types of contacts and arrangements. And in popular shell sizes: 11, 17, 23. What's more, there are sealing boots, strain relief/shield components, posted or solder contacts, plus standard or splashproof models.





## Why plastic connectors are better than metal ones.

Besides offering greater versatility, AMP gives you high-strength, glass-filled nylon connectors that are as reliable as metal ones—but cost much less. In some ways, they're even more rugged. Because AMP Circular Plastic Connectors are resilient. Yet, up to 50% lighter. And nonconducting.

### Contacts to fit every need.

AMP supplies a great variety of contacts for #8AWG to #28AWG wires. The pins and sockets are stamped and formed from top-quality copper alloys, and are available

with either a gold or tin finish. And with AMP, you pay only for the contacts you use.

### AMP automatic machines. For high-speed termination.

The contacts are supplied in continuous strip form. So termination is possible at volume production rates. And at the lowest possible cost to you. To be certain that you'll be able to take full advantage of these savings, AMP worldwide has over 1,000 field service and sales engineers to assist you with design and production applications. No matter where in the world you're using AMP commercial connectors.

### Features that lead to more savings.

Built-in pin and socket protection. Quick connect/disconnect capability. Thread-assist coupling ring with positive detent locking. 5-key polarization is built in to assure proper connector mating.





AMP INCORPORATED











**AMP is at the core  
of reliable circular  
plastic connectors.**

**No matter what  
industry you're in.**

- Aircraft
- Office Equipment and  
Business Machines
- Computers and  
Peripheral Equipment
- Automotive
- Space Vehicles
- Appliances and Home  
Entertainment Products
- Industrial Equipment
- Instruments

AMP has some 100 manufacturing plants, warehousing facilities and sales offices worldwide. So we can handle virtually all your circular plastic connector needs no matter where you're doing business. Call (717) 564-0100. Or write AMP Incorporated, Harrisburg, Pa. 17105.

**AMP**  
INCORPORATED

AMP is a trademark of AMP Incorporated.



# Problem solving... with Victoreen High Voltage Technology

## 1 UNORTHODOX CRT DRIVE

How did we meet ever-expanding requirements for increased bandwidth and lower power consumption, coupled with the availability of high-voltage zener-type diodes (Victoreen Corotrons)? With an unorthodox drive scheme for CRT's.

Basically, this scheme is a mirror-image of the conventional method. Instead of supplying the CRT anode with very high voltage, we ground the anode and supply a drive signal, riding at approximately — 1800 volts, to the grid. The advantages? Being direct-coupled there are no reactive components to limit high-end frequency response or cause roll-off

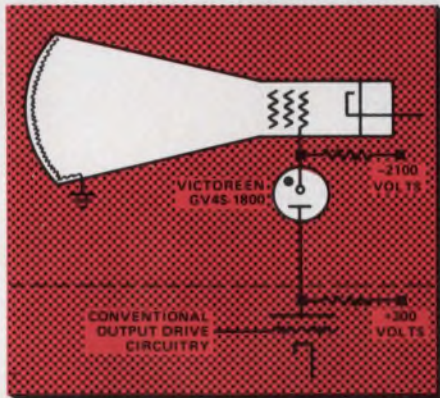

at the low end. Second, the face plate of the CRT does not build up static charges which can distort the display.

Even though the Corotron operates in the corona mode of discharge, it has no voltage jumps or jitters. Corotrons are not tied to "natural" operating voltages and are adjustable in manufacture from 350 to 30,000 volts. Corotrons also have a positive regulation curve eliminating possible relaxation oscillation.

## 2 FROG MUSCLES TO BRAIN WAVES

Colleges and universities, medical research laboratories and a number of R&D firms are faced daily with the need for controlled high-amplification of a wide variety of extremely low level signals. Such signals are derived from frog-muscle experiments, brain-wave measurements, cardiac research, avalanche-breakdown, currents in ionization chambers as well as from a range of constant-current sources.

The operational amplifier provides the amplification required because of theoretical infinite-gain characteristics. However, at full gain an op-amp tends to be unstable and go into oscillation; further, amplified signals are difficult to fully analyze if the gain is unknown.

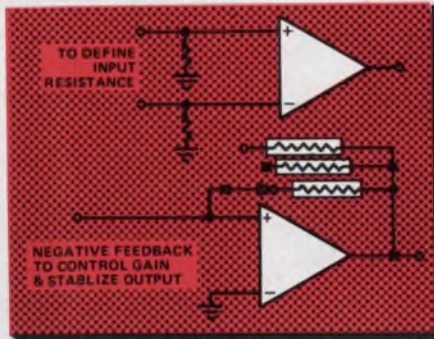

Victoreen MINI-MOX resistors are used widely to modify op-amp characteristics to: 1. Stabilize output and eliminate oscillation. 2. Define gain so measurements can be quantified. 3. Restrict bandwidth to the region of specific interest.

Smaller than a conventional resistor and compatible with a TO-3 can, MINI-MOX resistors are ideal for highly-stable, low-level, miniature electronic circuitry.

They typically have a voltage coefficient of —5 ppm/volt, full-load drift of less than 2% in 1000 hours, temperature coefficient of 100 ppm, and a Quantech noise of less than 1.5  $\mu$ V/volt at 20M ohms. They are available in values from 100K to 10,000M ohms in 1, 2, 5 and 10% tolerances.

## 3 A PROBE FOR HIGH POTENTIAL

Two Victoreen MAXI-MOX resistors used in series can serve as a probe in radar circuitry capable of measuring voltages up to 60,000 volts. The probe, compatible with a number of voltmeters of different manufacture, has both short- and long-term stability. Short-term stability assures negligible drift and fluctuation

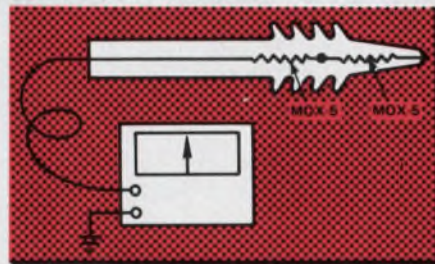

during measurement, while long-term stability maintains the original calibration accuracy of the probe.

Each MOX-5 resistor used in the probe has a maximum operating voltage of 37,500 volts with a power rating of 12½ watts. The voltage coefficient is 1 ppm/volt over the complete voltage range of the MOX-5, while the temperature coefficient is better than 300 ppm from

—55° to 125°C.

MAXI-MOX resistors have full-load drift less than 1% in 2000 hours of operation, and are available in tolerances of 1, 2, and 5% in values from 10K to 2,500M ohms. A silicone varnish conformal coating provides environmental protection while allowing a maximum hot-spot temperature of 220°C. In addition, it is compatible with commonly-used potting compounds.

## 4 SPARK GAPS SPARK INTEREST

Victoreen SGSP spark gaps normally protect electrical circuits from damage from transient voltage spikes; however, Optical Radiation Corporation, Azusa, Ca. uses them to ignite a Xenon lamp in a theatrical lamphouse to project motion pictures. Xenon lamps provide two

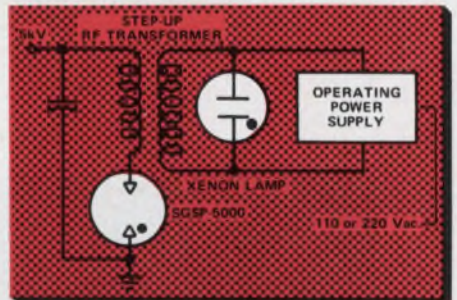

advantages; one, being very small and brilliant, light radiation is easier controlled; second, efficiency is higher, so smaller lamphouses with greater output result. The design won the company an Academy Award in technical achievement.

In operation, the capacitor is charged until the SGSP-5000 breaks down. The stored energy is released through the transformer primary, producing a very high voltage pulse in the secondary which ignites the Xenon lamp. This provides an extremely reliable method of starting the lamp. Once ignited, operation is sustained by a lower-voltage line operated power supply.

Victoreen Instrument Division  
of VLN Corp.  
10101 Woodland Avenue  
Cleveland, Ohio 44104





**TREAT THIS 300 NSEC,  
NMOS MEMORY  
LIKE A COMPONENT**

**JUST  
PLUG  
IT IN**

You're looking at the new MICRORAM 3000N, a complete NMOS semiconductor memory on a single printed circuit card assembly. Just plug in a power supply ( $\pm 15\text{VDC}$ ,  $+5\text{VDC}$ ) and you have a fully functional memory system that cycles at 300 nsec, and accesses at 180. (A high speed version that cycles at 180 nsec. is available, too.)

The MICRORAM 3000N is available for delivery to meet your production schedules. It mounts on a printed circuit card 11.74" by 15.4", and is basically compatible with our MICROMEMORY 3000 core memories. The standard 16K by 20 configuration is alterable to 32K by 10. Numerous other capacities and word lengths are also available.

Like all members of the MICROMEMORY 3000 Family, the MICRORAM 3000N is available either as a single card memory or as a multi-card system in a chassis containing up to 16 memory cards, power supply, self-test and interface cards and various other options.

Get the full story on the MICRORAM 3000N from your local EMM office or call Commercial Memory Products Marketing Department at (213) 644-9881.

**EMM ELECTRONIC  
MEMORIES  
COMMERCIAL MEMORY PRODUCTS**

A Division of Electronic Memories & Magnetics Corporation  
12621 Chadron Ave., Hawthorne, Calif. 90250  
Belgium 03/76.69.75; United Kingdom 01/751-1213; W. Germany 0811/74.30.40

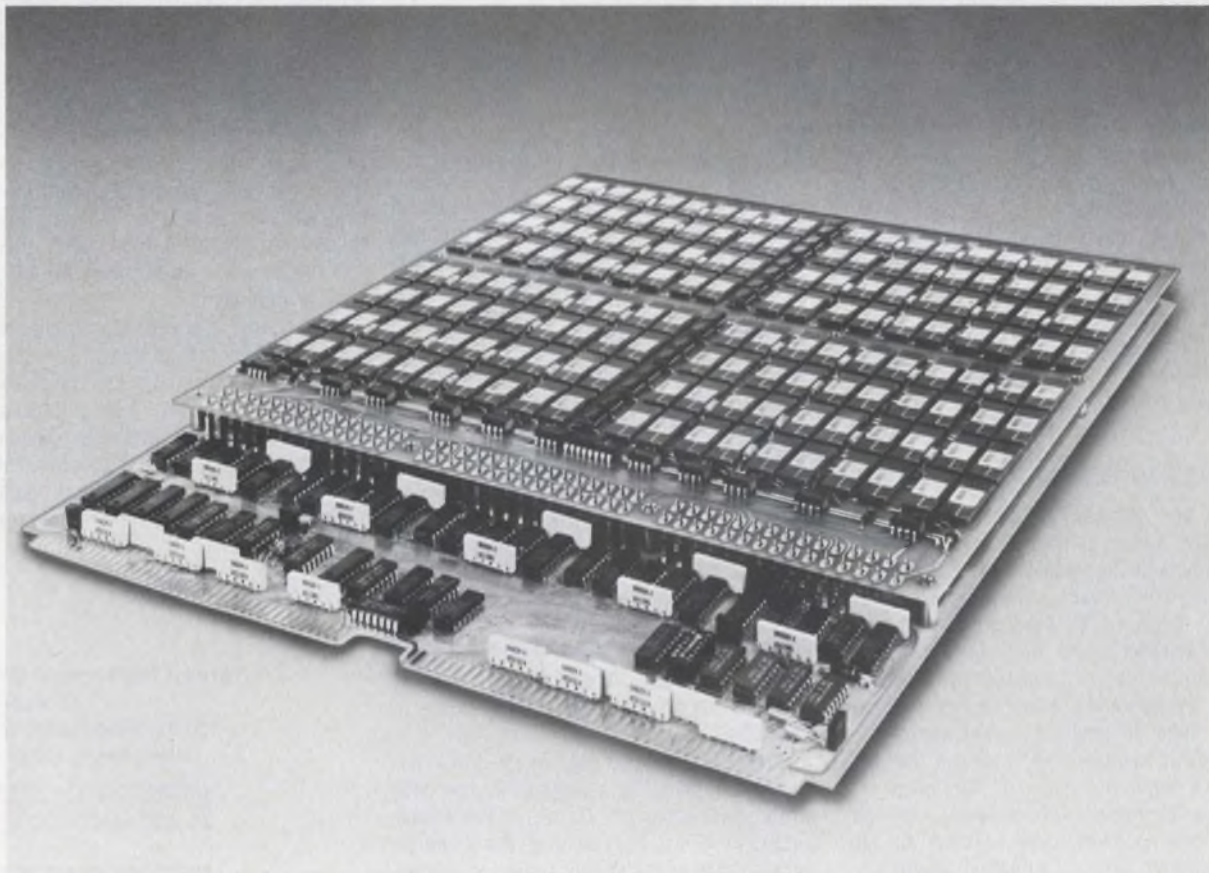

"See us at the NCC Show in Chicago, Booth 671"

INFORMATION RETRIEVAL NUMBER 15



now...  
**RESISTOR  
NETWORKS**  
from  
**BOURNS**

The Leader in resistive component technology now brings you a line of thoroughly tested and qualified DIP and SIP Resistor Networks . . . that live-up to their specifications, stand-up to your applications. BOURNS® Resistor Networks are available off-the-shelf in a selection of standard configurations to replace the most popular Allen-Bradley, Beckman, Dale, Sprague, CTS, Centralab, and Mepco part numbers.



**CONSIDER WHY BOURNS IS BETTER:**

- Proven thick-film production expertise
- Proprietary resistor ink system provides  $\pm 100\text{ppm}/^\circ\text{C}$  tempco through all resistances . . . from  $33\Omega$  to  $220\text{K}\Omega$
- Better power handling characteristics
- Design qualified and life tested to meet or exceed tough Mil-Standards.

Inquiries for special values, schematics and specifications invited.

Your local Bourns representative has complete specs, cross-reference data and order forms at the ready. Call him today . . . or the factory direct.



BOURNS, INC., TRIMPOT PRODUCTS DIVISION  
1200 COLUMBIA AVENUE  
RIVERSIDE, CALIF. 92507

INFORMATION RETRIEVAL NUMBER 16

BOURNS

TRIMPOT®  
PRODUCTS

ADJUSTMENT POTENTIOMETERS  
PRECISION POTENTIOMETERS  
CONTROLS/VARIABLE RESISTORS  
RESISTOR NETWORKS



TRIMPOT®  
PRODUCTS

TRIMPOT PRODUCTS







*Ked Smith*





## The world's biggest little black box is coming your way

It's a unique display of TRW Electronic Components' newest, most exciting products, circuit applications and ideas. A walk-through exhibit of TRW state-of-the-art technology, coming right to you.

And its form is every bit as unique as its content!

Picture a typical electronics chassis, grown to mammoth proportions. In fact, to the size of a 40-foot tractor-trailer; far and away the world's *biggest* "little black box." Inside are scale models of all the most familiar components, but looking like nothing you've ever seen before—because the scale is *giant*. Five feet high for some.

Our technical experts will be on hand to answer specific questions. And you'll get a close-in view of more than 1000

life-sized products. They represent the 14 separate divisions that, together, form TRW Electronic Components—a single entity that can be the source for all your electronic component needs. That's why it takes the world's biggest little black box to show-and-tell our story of electronic components from A (actuators) to Z (Zener diodes).

And the show is on the road right now—right into your plant's parking lot, or somewhere nearby. We're zig-zagging our way across country, stopping at 155 plants in 27 states.

Watch for announcements of when we'll be in your area. TRW's little black box is where electronics is, and we're bringing it to where you are.

Because we *are* TRW.

**TRW<sup>®</sup> ELECTRONIC COMPONENTS**

10880 Wilshire Boulevard, Los Angeles, CA 90024

Connectors • Resistors • Semiconductors • Capacitors • Motors • PC Boards • Potentiometers • Transformers • Coils and Inductors • Wire and Cable



**When Viking talks to us from Mars  
it'll use cores by Magnetics.**



**Best reason on earth to rely on us  
for your own communications components.**

Magnetics' miniature tape cores were used in the computers that sent our astronauts to the moon and back. And now we're exclusive supplier of tape cores, powder cores, nickel-iron C cores and bobbin cores for the Viking Mars Lander.

In addition to reliability, we offer you a choice when it comes to your magnetic components—whether they're off-the-shelf or something specially developed for your needs.

Low core loss, temperature stability,

frequency stability, Hi Q, low cross talk, low dc shift, time stability—these are just a few of the demanding properties we can fill. For applications like filters, inverters, oscillators, load coils, bridge lifters and many others. From telephone circuits and mobile communications to space communications.

To learn more about us and our broad range of components, including ferrite cores, send for our application and product literature, Bulletin APB-1.



A DIVISION OF SPANG INDUSTRIES INC.

Butler PA 16001.

INFORMATION RETRIEVAL NUMBER 18



**For years,  
people thought  
Teletype<sup>®</sup>  
machines only  
talked to  
themselves.**



Teletype is a trademark registered in the United States Patent Office.

Fact is, Teletype machines have been carrying on intelligent conversations for years with some of the fastest information movers in the world. Computers.

We've earned a good, solid name for ourselves in computer communications because our equipment is compatible with practically any computer-based system.

Our product line proves the point.

The number one standard-duty data terminal in the industry is our model 33 series. And our

new wide-platen model 38 offers big system features at economy system prices.

Heavy-duty operation with minimum maintenance? Check out our model 35. And our model 37 series delivers the utmost in flexibility and vocabulary for complex data systems.

We also build equipment for paper tape systems, as well as a magnetic tape terminal for greater on-line savings. As you can see, our reputation in point-to-point communications has served us well in computer terminals. No one comes close to us in reliability, flexibility and economy.

It takes more than manufacturing facilities to build the machines Teletype Corporation offers. It also takes commitment. From people who think service is as important as sales. In terminals for computers and point-to-point communications.

That's why we invented a new name for who we are and what we make. The computer-communications people.



For more information about any Teletype product, write or call: **TERMINAL CENTRAL**, Teletype Corporation, Dept. 89F, 5555 Touhy Avenue, Skokie, Illinois 60076. Phone 312/982-2500

INFORMATION RETRIEVAL NUMBER 19



# you can see why...



THE PERFECT MAN-MACHINE LINK IN YOUR APPLICATION. THESE PANELS CAN DISPLAY NUMEROUS LANGUAGES, WITH SIMPLE INTERFACE AND BRIGHT CLEAR, EASY-TO-READ, DOT-MATRIX FORM CHARACTERS, AVAILABLE WITH 16, 32, & 256 CHARACTER POSITIONS AND BURROUGHS' QUALITY.

a

## SELF-SCAN<sup>®</sup> PANEL

# is the best choice

SELF-SCAN panels are best because they can provide alphanumeric display of data — 16 to 256 characters per message — for data entry, automatic checkout systems, wherever man-machine interface takes place.

SELF-SCAN panels are best because they are brighter. Burroughs technology makes possible sharp characters with no fuzziness, no loss of focus, no distortion, a 120-degree viewing angle, and readability up to 25 feet with minimum glare and reading fatigue.

SELF-SCAN panels are best because they are the most versatile self-contained display panels commercially available. A wide variety of character generators offers 45 different displays, including Cyrillic, Hebrew and Karakana alphabets as well as standard ASCII code.

SELF-SCAN panels are best because they can be packaged in less than 1/2" depth and are less costly than CRT's with comparable message capability. The cost per light-emitting dot will amaze you.

Want to see SELF-SCAN panels in operation? Write the Electronic Components Division, P. O. Box 1226, Plainfield, New Jersey 07061, or call (201) 757-3400 or (714) 835-7335 for a demonstration.

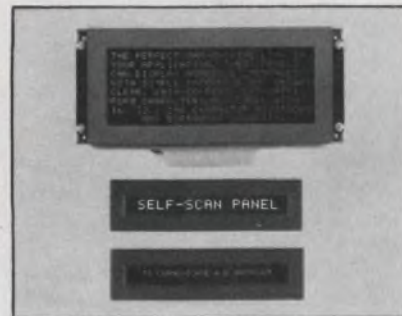

## You can see the difference



## Hand-held computer terminal gives a full ASCII display

A hand-held computer terminal that looks more like a pocket calculator than a computer input device will be introduced next month at the National Computer Conference in Chicago.

Called Termiflex, the pocket-sized terminal features a 20-switch keyboard that, along with three special shift keys, can generate all 128 ASCII characters.

William Turner, vice president of Termiflex Corp., manufacturer of the terminal in Nashua, N.H., notes that as data are received,



they appear as one or two-line displays. A display line consists of 10  $5 \times 7$  LED dot-matrix characters. When a line is filled, the display scrolls automatically. A 1000-character scrolling memory is built into the unit. And by operating one switch, the user can move forward or backward in this memory, to recover any part of a message that has been sent or received.

The hand-held feature lets engineers perform diagnostics anywhere in the computer room. And production engineers can start up, direct or monitor a system, without need to walk back to a teletypewriter or command console

whenever they want to input an instruction.

Other applications for the terminal include use as an auxiliary in debugging systems, as a control device for automated drafting systems, in field service and in demonstration of computer equipment.

The Termiflex also features several selectable parameters. These include communication speed, which can be 10, 15, 30 or 120 characters per sec. Parity can be chosen as either odd, even, mark or space. And the transmission mode can be selected as either half or full duplex. Other selectable features include upper or lower-case letters and line justification.

The basic terminal, with a one-line display and a 500-character memory, costs \$1190. For a two-line display with a 1000-character memory, the price is \$1570. For \$480 more, an acoustic coupler, power supply and carrying case are available.

## Heart monitor replaces skin-piercing methods

With the development of an instrument called an impedance cardiograph, the mechanical pumping activity of the heart can now be monitored without puncturing of the skin. Heretofore implanted sensors or the injection of tracer elements into the blood were required.

According to Winston Hagen, vice president of Instruments for Medicine, Greenwich, Conn., which manufactures the new machine, the impedance cardiograph can measure cardiac output, stroke, volume and contractility, as well as peripheral circulation and chest fluid changes—all with an accuracy equal or superior to commonly used skin-puncturing methods.

Four band electrodes are connected to a patient—two around the neck and two around the chest, Hagen explains. The lower neck electrode and the upper chest electrode are both used to set up a reference impedance, which eliminates the need for external calibration. The other two electrodes provide information that enables the instrument to generate a continuous flow trace.

The flow trace is an electronic analog of the information normally obtained by the surgical implantation of an electromagnetic flowmeter on the ascending aorta. Any standard recorder or cardiograph can be interfaced with the impedance cardiograph to display the trace.

While the use of impedance monitoring is not new, notes Hagen, its successful application to cardiac monitoring is. Previous applications of the impedance technique have been largely in the area of respiration monitoring.

The basic idea for the system, says Hagen, came from the instrumentation developed to monitor the Mercury astronauts. However, circuit improvements, particularly in oscillator stability, were necessary.

A major advantage of the impedance cardiograph, Hagen points out, is that it can monitor a patient continuously. This is not possible with skin-puncturing, which inject dyes or radioactive tracers into the blood.

## Large-scale display to use 3-color LEDs

A large-scale, three-color LED display is under development for the Army by the Data Systems Div. of Litton Industries in Van Nuys, Calif.

According to David M. Piatt, manager of advanced display technology, the contract calls for a 36-in.<sup>2</sup> feasibility model for the Electronics Command in Ft. Monmouth, N. J. It is, says Piatt, the first step toward development of a 4-ft.-square, 3-in.-thick, three-color flat panel that will be overlaid by a standard, printed military map for tactical display.

The display is to contain an array of 1024  $\times$  1024 LEDs on 45-mil centers, of a type produced by



Texas Instruments in Dallas and Bowmar Ltd. in Ottawa, Canada. The display will present alphanumeric symbols, vectors and graphics in red, green and yellow at a resolution of 22.5 lines per in.

The 36-in.<sup>2</sup> feasibility model will be constructed with 32 LED modules, each  $3/4 \times 1-1/2 \times 4$  in. deep. Each module will contain 512 LEDs, arranged  $16 \times 32$ , plus column and low-driver electronics, and a dual, 512-bit MOS refresh memory. One-half of the memory will control the red-diode mode, and the other half will control the green mode. When both red and green are called for, the diode will glow yellow. The diodes will be of GaP material and will emit a color determined by drive level.

The large display will be built of rows of these modules—32 across and 64 down, for a total of 2048. Using a proprietary multiplexing scheme, all 2048 modules, including over a million LEDs, will be addressable with approximately 127 lines from the display generator.

The updating of a character, symbol or vector on the display is to be accomplished in 64  $\mu$ s, and display surface is to consume only about 350 mW/in.<sup>2</sup> of power.

## Acoustic microscope nearing production

The first acoustic microscope—a device that uses microwave sound instead of light to see details inside materials heretofore impossible to see—is ready for production, according to Lawrence W. Kessler, president of Sonoscope, Inc., Bensonville, Ill.

Kessler, who was one of the original researchers at Zenith Radio, where the system was developed, reports that a demonstration model is under construction at Sonoscope. The company is build the microscopes under an exclusive license from Zenith, Kessler says.

The acoustic system is a true microscope, the Sonoscope president points out, having a field of view that is limited to about 3 mm, which is typical of standard optical instruments.

"We can get resolutions down to about 3  $\mu$ m at sonic frequencies

of 500 MHz," Kessler says. The resolution of present equipment is on the order of 15 to 20  $\mu$ m with frequency in the range of 100 to 200 MHz, he points out.

Real-time images are obtained with 100 and 200-MHz sound, Kessler says, while the pseudo real-time images are produced at 500 MHz.

In operation, the acoustic microscope illuminates the specimen with vhf or uhf sound. The sound is transmitted through the specimen to impinge on an optical mirror. This mirror becomes distorted by the sound pattern, which carries details of the specimen's internal structure. The mirror distortions are read out with a scanning laser beam. The beam is synchronized with the raster of a TV monitor, and the laser image is picked off the mirror and produced on the TV screen.

Because the sonic picture contains details of the internal structure of the material under examination, it is substantially different in appearance from a surface view with an optical microscope. For orientation, Kessler points out, the sonic microscope also gives the user an optical, surface image of the area being scanned at the same time he gets the sonic picture.

If there are many useful details in both pictures, Kessler says, the operator can superimpose both visual and sonic pictures on a color TV monitor. The visual picture is presented in one color and the sonic picture in another.

## 2 new ways reported to detect trespassers

Changes in the capacitance of buried, sensitive wire and a coaxial cable rigged to function as an electret microphone are two of the newer techniques being tested by the electronics industry to detect trespassers. The work was described last week at the University of Kentucky in Lexington, at the Carnahan Conference on Electronic Crime Countermeasures.

In the wire technique, standard Teflon-covered hookup wire is used because it has electret qualities. The wire is threaded into a metallic tube and buried a few inches beneath the ground. The device

detects personnel or a vehicle passing above it, according to Fred S. Geil, manager of audio and ultrasonic technology at the Westinghouse Research Laboratories in Pittsburgh, where the setup is being investigated.

In tests to date, the tube has been an ordinary refrigerator tube. The wire acts as a capacitance sensor, detecting capacitance changes between it and the tube. Such changes occur through pressure and vibration. If a person crosses the buried wire slowly, the tube bends very slightly, causing a small displacement of the wire and thus a low-frequency response. The impact of the intruder's step also causes vibration—a rattling of the wire in the tube. This causes a high-frequency response. The redundancy provided by these two responses insures a high immunity to false alarms.

The second device to foil the bad guy is a standard Teflon coaxial cable that functions as an electret microphone. The device detects intruders climbing or cutting a wire fence, or passing over a road, if it's buried, according to Kirby Miller of GT&E Sylvania's Western Div. in Mountain View, Calif., which is developing the alarm.

The cable is processed under elevated temperature and high voltage, which transforms it into an electret transducer. When the cable is attached to a fence with ties, vibrations in the fence can be detected. With a special processor, it's possible to detect signatures that reveal whether someone is climbing the fence or cutting it, Miller says, and the device discriminates against unwanted alarms. The readout is either a flashing light or an audio tone.

## DOD standard designs

Defense officials say the current shortage of components for military programs is leading to standardized designs and the coordination of requirements among programs. The Pentagon is looking towards a program instituted by the Air Force's space and missile systems organization which requires designers to check approved parts lists during design and to justify any deviations from them.



# The first modular instrumentation calculator.

## Just \$5905 as shown.

### It's our 31/53 Calculator Instrumentation System

A powerful, yet inexpensive calculator combined with our TM 500 power supply and system software. You add the instrumentation modules you need. It's all there and it's portable. Now that's versatility!

With our 31 Calculator, you can read input from our DMM's and counters. You can log data selectively, calculate results and output data or trigger signals.

Programming? Little more than natural math. Go ahead, write your own. Also, our standard software gives you data logging (on the optional printer) and data capture on the 31 at operator selected intervals.

For numerical monitoring or

analysis, there's our 21/53 for \$2895 less plug-ins. And in case you wondered, our TM 500 plug-ins are less expensive, too.

### Energy monitoring.

Quality control testing. Laboratory and production instrumentation.

The applications go on, and so does our system's potential. Just add the main-

frames and modules you need. We have a graphic calculator system, too. Let our sales engineer fill you in. Pick up your phone and call our nearest center. Or write

Tektronix, P.O. Box 500,  
Beaverton, Oregon 97005

**Our programmable calculators. Natural. Powerful. Significantly less expensive.**









# Like A Puppet On A String

The MC1505L performs the diverse roles required of analog-to-digital converter subsystems. Instrumentation, data acquisition, industrial controls, or remote sending. Wherever you call for an analog signal to be displayed or controlled digitally, the MC1505L A/D Converter Subsystem can be your marionette.

## Behind The Scenes

The tried and true "dual ramp" technique. Your assurance of system immunity from all but the most rapid changes in external component values, temperature drifts, etc.

## In The Spotlight

**Accuracy.** Outstanding accuracy. With the digital system of your choosing; counters, a clock, and some gates, you can show off an A/D converter of either 3½ or 4½ BCD bits or up to 13 bits in the binary code.

**Simplicity.** Since the MC1505L provides its own voltage reference, two calibration potentiometers (full scale and zero adjust) and one integrating capacitor are all you need for normal operation in the A/D subsystem itself.

**Compatibility.** The digital logic system is yours for the choosing. Digital inputs and outputs are equally at home with either TTL or CMOS.

**Conservation.** Keep Watts under your thumb with the MC1505L's low power consumption of 42 mW @ +5.0 V. Tailor-made for battery operated instrumentation systems. Like those using CMOS. And, single power supply operation (+5.0 to +15.0 V) lets you eliminate extra circuitry.

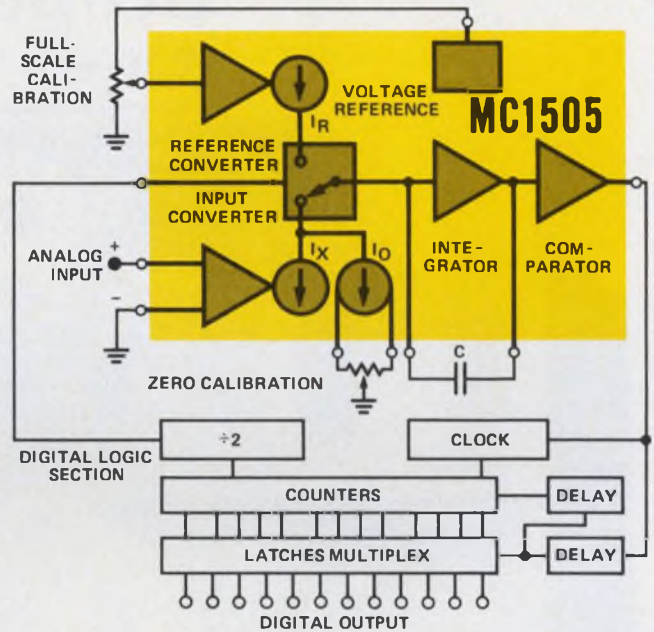

## Budget Production

An A/D converter doesn't need to cost the typical hundred dollar plus figure associated with many twelve bit modular units. Comparable accuracies can be yours simply by building onto the MC1505L with a few dollars worth of counters and gates. For a thrifty \$5.95 (100-up) you can get started with our limited temperature range version MC1405L subsystem.

## Put It All Together, It Spells Success

Try it in a 3½ or 4½ digit A/D converter — combined with either CMOS or bipolar logic for the complete A/D converter function. Particulars can be found in the detailed 14-page data sheet. The data sheet can be found at P. O. Box 20912, Phoenix, Arizona 85036, or circle the reader service number below.

Try the MC1505L wherever you want to digitally display, process, measure, control or store an analog function.

Try it in quantity, off-the-shelf today. The MC1505L analog-to-digital converter subsystem. Your wish is its command.



**MOTOROLA LINEAR**  
—practical innovations for systems design.



# Handle Troublesome Signals Easily With HP Variable-Persistence Scopes.



Because the unique capabilities of variable persistence in HP's 180 systems tackle these difficult measurement problems with much more ease than the conventional scope you're probably now using.

**Dim traces**—low rep-rate signals are brightened by the integrating characteristics of variable persistence so you can observe them clearly in normal ambient light...even at rep-rates below 1 Hz.

**Transients**—digital noise pulses or other single-shot events are made visible by the high writing speed of HP's mesh-type storage and variable persistence.

**Slow-moving waveforms**—electromechanical events or transducer outputs that appear as a "bouncing ball" on conventional scopes will be displayed as a continuous trace with variable persistence, allowing more accurate voltage

and timing measurements.

Two storage mainframes give you a choice of writing speeds. And a broad selection of plug-ins lets you tailor your scope to meet specific needs. To get the maximum performance for your storage-scope dollar, look to HP.

For more information about the 180 system, contact your local HP field engineer. Or, write Hewlett-Packard, 1501 Page Mill Road, Palo Alto, California 94306.

HEWLETT  PACKARD

Sales and service from 172 offices in 65 countries.  
1501 Page Mill Road, Palo Alto, California 94306



INFORMATION RETRIEVAL NUMBER 23

INFORMATION RETRIEVAL NUMBER 24 ►



# New Tool New Board New Method

**it's part of the TY-RAP® System**

**Now tie quicker than ever before...**

Our new high speed tool does it all . . . feeds a TY-RAP tie around bundle, cinches to a preset tension, locks securely and trims evenly . . . all in  $\frac{8}{10}$  of a second. There is no tool adjustment needed regardless of bundle diameter from  $\frac{1}{32}$ " to  $\frac{3}{8}$ ".

The off-the-board harnessing method allows the tool optimum use. This technique utilizes our new harness board and harnessing aids. The board is reusable and reversible. It's modular too . . . snaps together for larger work areas. It's constructed of polyethylene foam sandwiched between two metal screens — nails are pushed in by hand. It's all part of the TY-RAP System to lower your costs of harness fabrication.

Write for new catalog, The Thomas & Betts Company, Elizabeth, New Jersey 07207 (201) 345-4321. In Canada, Thomas & Betts Ltd., P. Q.

**Sold Only Through Authorized T&B Distributors**

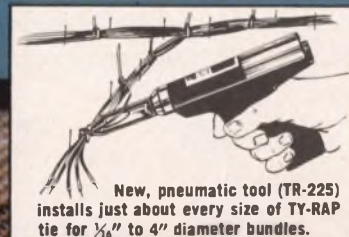

New, pneumatic tool (TR-225) installs just about every size of TY-RAP tie for  $\frac{1}{32}$ " to 4" diameter bundles.



**THOMAS & BETTS**

Division of Thomas & Betts Corporation



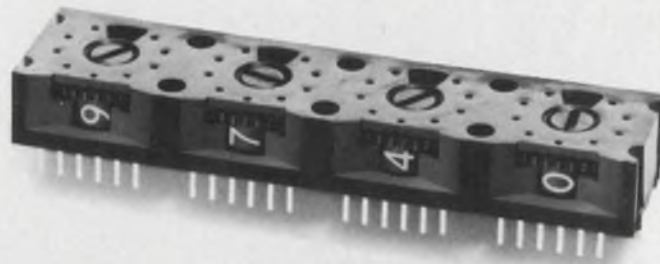

# Introducing the programmable memory with visual readout.

We're talking about our unique Stripswitch,<sup>™</sup> the miniswitch for direct printed circuit board



mounting or panel installation. This little marvel is molded of impervious Valox<sup>\*</sup>, and is guaranteed for two years.

Other facts: it comes in one, two, three, four, five, and six station models (\$1.95 per station, standard); in a variety of codes, including decimal, BCD, Complimentary, Special Binary, and 1, 2, 3, and 4 pole.

On a custom basis we can do lots of other things to your Stripswitch. Like interconnections, markings and legends, color coding, stops, number of switch positions, additional stations, et cetera.

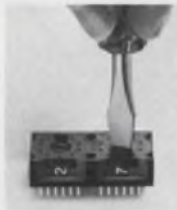

A 10¢ stamp will get you an immediate reply, or your finger on the dial of your telephone will get you instant answers. Call us collect. Or one of our distributors: G.S. Marshall, Hall\*Mark, or Schweber.



**Your sample awaits.**

\*Registered General Electric trademark

## EECO

1441 East Chestnut Avenue  
Santa Ana, California 92701  
Phone 714/835-6000



# ADD A CARD, ANY CARD

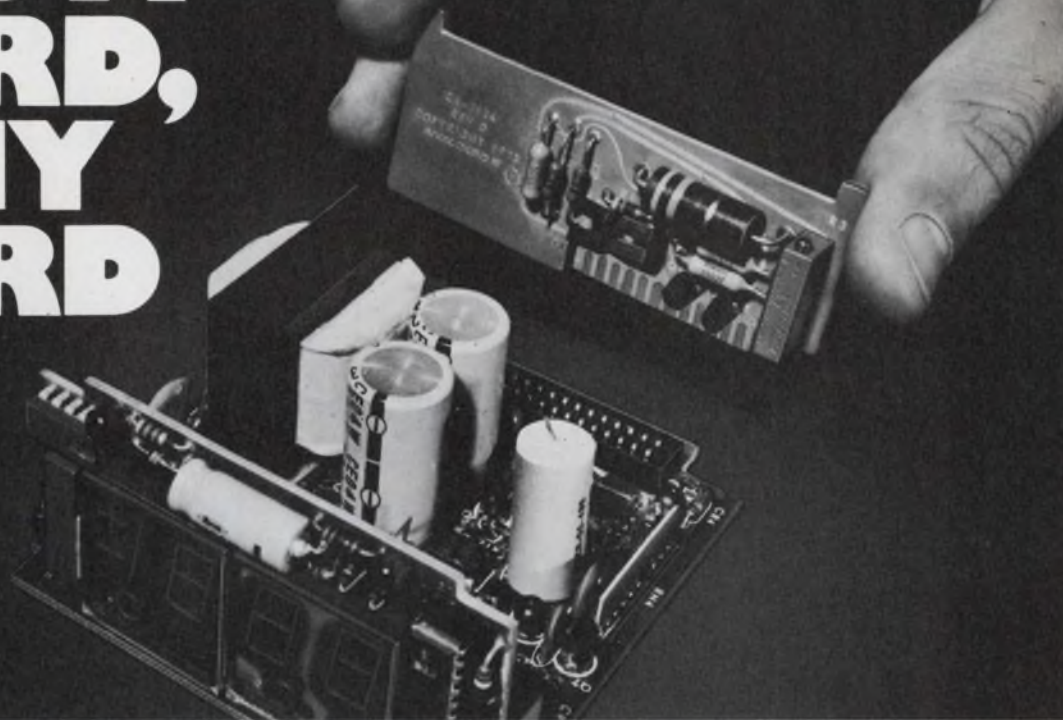

**The first DPM  
that transforms  
into your own  
product by  
simply plugging  
in a P.C. card.**



#### AN2553/AN2533 DESIGN SPECIFICATIONS

**ANALOG INPUT**  
Configuration: Bipolar balanced symmetrical differential inputs

**Dynamic Input Impedance:** 1000 megohms nom

**Common Mode Rejection Ratio:** 80 dB standard, up to 160 dB optional

**ACCURACY/STABILITY**  
Accuracy: 0.05% of reading  $\pm$  1 count

**Range Tempco:** 35 ppm of reading

**CONVERSION TECHNIQUE**  
Dual-slope integration

**DISPLAY**  
DIGITAL SIGNALS  
Logic Levels (all inputs and outputs): 55" 7 seg. Sperry or 5" L.E.D.

**EXTERNAL SIGNALS:** External Blanking, Hold, Overload, Clock, Latch, Carry, EOC, Polarity

**UNIVERSAL POWER INPUTS:** 100, 117, 220, and 240 VAC  
RMS  $\pm$  10%; 49 to 63Hz @ 2W

**Operating Temperature:** -10°C to +60°C

**Dimensions:** DIN-STANDARD 96mm bezel width x 48mm bezel height; 95.4mm max depth

NOTE: Model AN2553 offers additional capabilities  
**\$89.00 Base Price AN2533 quantity 100**

- Universally powered
- True differential inputs
- Low power consumption
- DIN Int'l Std. case size
- Surprisingly low cost
- Bright self-illuminating display
- High reliability

Build any required circuit on the uncommitted analog interface card we furnish. Then just plug it into the special powered signal interface connector in our AN2553 3½-digit DPM. It's that easy to incorporate the value-added options that make your product more profitable... or specify application requirements, and we'll build them in before shipment.

Either way, you can get interface and signal conditioning flexibility never available before—including linearized thermocouple cold-junction compensation, load cell transducer excitation, auto ranging, current shunts, active multiple filtering—virtually any functional add-on, in fact, that you need. And, because the circuit card fits right in the internationally accepted DIN standard package your system or instrument is simplified and much more economical and there's less to debug.

We've put in power and space for an optional digital circuit card, too. So you can

add isolated and buffered parallel BCD output, linearization, and set point control... go all the way and expand the basic DPM up to the subsystem level—at the lowest cost.

Don't need all the flexibility? Order the even more economical, general-purpose, basic AN2533. Fill all your 3½ digit DPM needs with the exceptionally high quality and reliability ensured by premium-components, worst-case design techniques, low parts count, and the cool-running generously derated operation that has made Analogic the number one supplier of OEM digital panel instrumentation in the world.

Write for more information: Analogic, Audubon Rd., Wakefield, Mass. 01880; phone (617) 246-0300.

*Northeast*, 617-235-2330, 203-966-2580, 315-466-0220, 201-652-7055, 212-947-0379

*Mid Atlantic*, 215-272-1444, 215-687-3535, 703-790-5666, 301-252-8494

*Midwest*, 314-895-4100, 913-362-0919, 216-267-0445, 513-434-7500, 313-892-2500, 412-892-2953, 312-283-0713, 414-476-1500, 317-844-0114

*South*, 713-785-0581, 214-620-1551, 305-894-4401, 919-227-3639, 205-534-9771, 305-773-3411, 813-867-7820

*West*, 303-744-3301, 505-523-0601, 602-946-4215, 505-292-1212, 714-540-7160, 415-398-2211, 206-762-7664, 503-643-5754

*Canada*, 613-836-4411, 604-688-2619, 416-499-5544, 514-636-0525, 902-434-3402

**ANALOGIC**  
... The Digitizers



# The Rolm 1602 has the power to get your program off the ground

For \$18,750  
the 1602 Ruggednova is the most powerful,  
yet lowest priced mil spec,  
16-bit processor with 8K of memory  
on the market



The 1602 is loaded with power features. 450 nanosecond semiconductor memory read cycle time. Memory expansion to 256K words. Dual Port memories. Floating point hardware. Stack processing. Double precision arithmetic. 32-bit instructions and powerful interrupt processing.

We could go into detail on how each of these features improves your system . . . but better yet here are five ways the 1602's power improves your overall program.

**1. Reduce programming costs.** The 1602 allows you to program in less time because you have more power per instruction. In addition to instruction power ROLM also provides a wide selection of documented software proven in over 8000 commercial and military installations.

**2. Reduce risks.** You don't have to worry about underestimating size of computer with the 1602. With its execution speed and expandability, there's plenty of computer to do the job. You can get out of speed binds with our semiconductor memory or custom microcode. And don't worry about memory binds with our external memory which is expandable up to 256K words.

**3. Reduce I/O processing problems.** With the 1602 power, the expanded interrupt structure, the DMA, and Dual Port memories you can handle more data on your computer system. To aid you in utilizing this I/O power, ROLM has available over 30 general purpose interfaces for the 1602. Your special interfaces can

even be placed right inside the 1602 with no time lost in designing an extra chassis or power supply.

**4. Reduce hardware costs.** A lot of the extra hardware normally needed can be eliminated since the 1602 has the power and capacity to do a wide range of tasks. You can reduce your costs by reducing the number of computers needed, not to mention the fact the 1602 is the least expensive full mil-spec machine available.

**5. Avoid qualification tests.** The powerful 1602 Ruggednova has already met Mil-E-5400 airborne environments, Class II; Mil-E-16400 shipboard environments, Class I; and Mil-S-901 for high impact shock. Its military name is AN/UYK-19(V). The 1602's performance is qualified and guaranteed after delivery with a 90-day warranty. This saves a lot of your time.

These are just a few of the ways the 1602 takes the risk out of selecting the right computer. If you would like those specific technical details we mentioned about the 1602, drop us a line . . . or, if your program needs to get off the ground faster, call:

**ROLM**  
CORPORATION

18922 Forge Drive  
Cupertino, Ca. 95014  
(408) 257-6440  
TWX 910-338-0247

Regional Sales Offices: Boston 617-237-5752; Cincinnati/Dayton 513-874-5406; Dallas 214-661-8905; Los Angeles 213-784-8500; New York 914-297-9533; Palo Alto 415-965-2224; Washington, D.C. 703-893-2696.

Domestic Representatives: Colorado 303-355-3521; Kansas 913-362-0919; Missouri 314-895-4100; Washington 206-624-9020.

An Equal Opportunity Employer



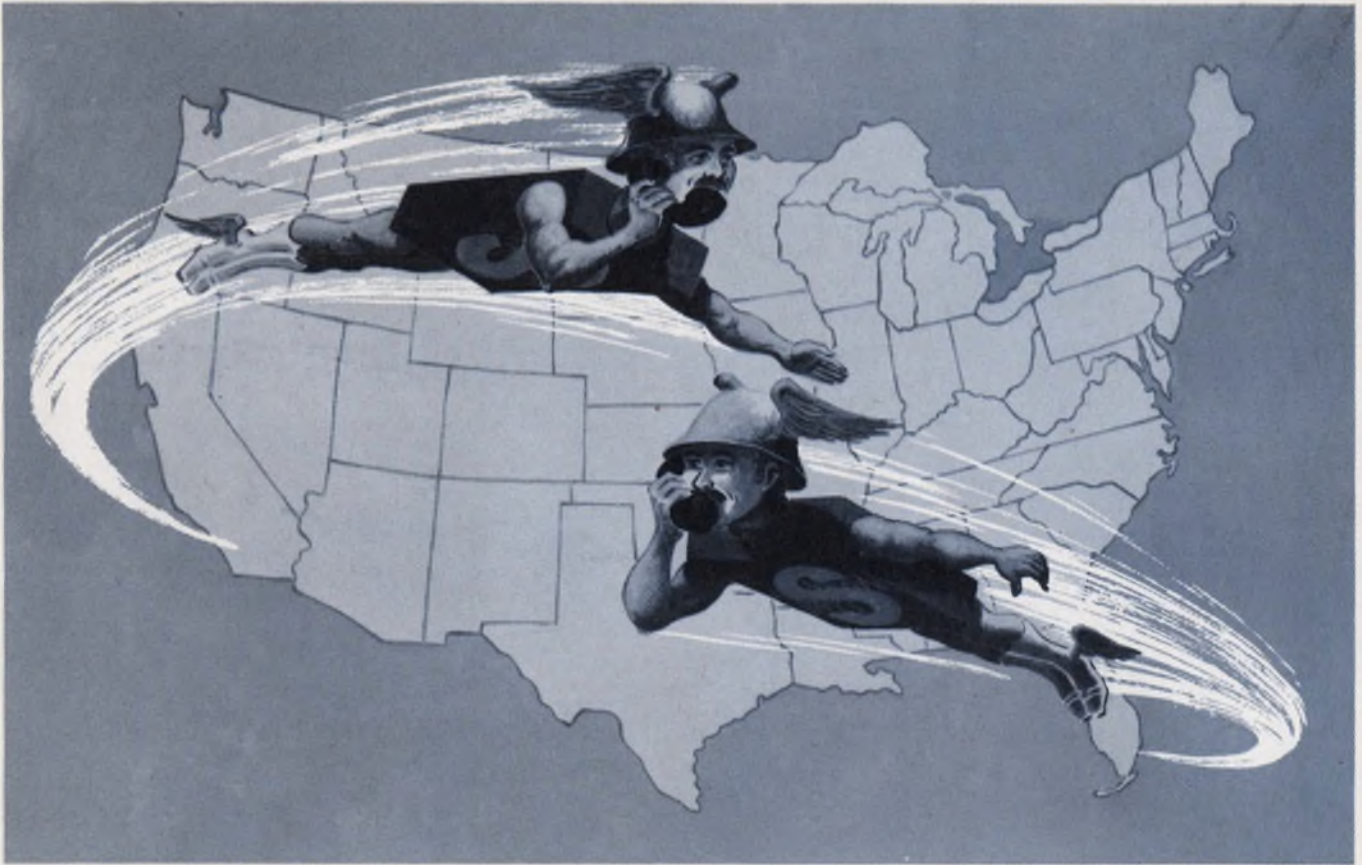

FROM COAST TO COAST

# we've got your number

We've got the greatest numbers game in the country.  
California: 800-854-2799. Florida: 800-327-3243.

Dial either one of these toll-free exchanges anytime for information on 60,000 semi-conductor part numbers. CMOS. FET's. PMOS. Power Transistors. All Hybrids. Diodes. Rectifiers. Virtually any Semi-conductor, Custom or Standard. We'll provide on-the-spot price information along with in-depth technical assistance.

Just call us first for any of your semi-conductor requirements.  
After all, we've got your number. And now you've got ours!

CALL TOLL-FREE

**800-854-2799**

8808 Balboa Avenue  
San Diego, California 92100

CALL TOLL-FREE

**800-327-3243**

1177 Blue Heron Blvd.  
Riviera Beach, Florida 33404

**Soliton**  
DEVICES, INC.

PLANTS IN: CALIFORNIA • FLORIDA • NEW YORK • ENGLAND • HONG KONG • MEXICO

INFORMATION RETRIEVAL NUMBER 28



# Monsanto introduces its **HT** SERIES *(a breakthrough in High Technology)* with three new Frequency Counters

Monsanto's new HT Series (High Technology) instruments designed specifically for communications, is the 8700 family of Frequency Counters. As a part of Monsanto's ongoing R & D program to produce digital instrumentation of optimum reliability and performance, these counters offer outstanding specifications. Only through the judicious use of tested technology, human engineering prin-

ciples, and state-of-the-art circuitry and components, could the demanding standards of this series be accomplished. To further fulfill the promise of the series, each instrument is housed and protected in a contemporary, designer-styled aluminum enclosure that facilitates calibration and maintenance while providing an appearance as advanced as the technological innovations it contains.



8700 Series  
 prices range from  
**\$595.**

The 8700 Series of Frequency Counters consists of three separate models with ranges of 150 MHz, 550 MHz and 1 GHz.

All models feature: Frequency and Ratio mode/Opti-ranging for optimum display resolution/Full 9 digit, Monsanto, easy-to-read amber LED display/10 mV rms sensitivity with AGC/Selectable input impedances of 50 ohms and 1 megohm/High stability oven controlled crystal oscillator/Options included: parallel BCD output, IF subtraction, higher stability TCXO oscillator, high overload input protection/Available from stock/Generous OEM quantity discounts.

UNITED SYSTEMS CORPORATION  
 918 Woodley Road, Dayton, Ohio 45403  
 Ph. (513) 254-6251 Twx. (810) 459-1728  
 a subsidiary of

**Monsanto**

**Monsanto**



# washington report



Heather M. David  
Washington Bureau

## **U.S. acts to screen exporting of technology**

Secretary of Commerce Frederick B. Dent has asked Congress to extend and amend the Export Administrative Act and add a requirement that U.S. companies and their affiliates abroad report within 15 days "any written understanding that would be likely to result in the export to a Communist territory, other than Yugoslavia, of any technical data of U.S. origin that is not generally available." According to Dent, the Dept. of Commerce, "and indeed the Government as a whole," are frequently not aware of the nature of these agreements until the American company applies for an export license. The reason for the new clause, the Commerce Secretary says, is "to deal with the U.S. party to the transaction, as appropriate, to minimize the risk that significant strategic technology will inadvertently seep to the Communist country in question."

The Senate Banking, Housing and Urban Affairs Committee will hold hearings on the extension of the export legislation, which expires June 30.

## **Global technology data net proposed**

Rep. Richard T. Hanna (D-Calif.) proposes a U.S. International Science and Technology Transfer Institute to permit instantaneous exchange of information between experts in this country and other nations. The institute would use Intelsat and NASA global telecommunication systems, as well as prototype satellite models and microwave communications, so data could be transferred by voice, video, teletypewriter, facsimile, computer retrieval and interactive television and cathode-ray devices. The institute, an idea developed in a staff study prepared for the House Science and Astronautics Subcommittee on International Cooperation in Science and Space, would be linked to the National Science Foundation. Existing governmental mechanisms for technology transfer are not adequate, Hanna says, and "the transfer of technical information to other countries will undoubtedly hasten the creation of new outlets for American industry and commerce."

## **Defense Dept. refocuses its electronics research**

The Defense Dept. has reorganized some of its basic electronics research programs to focus on efforts that promise practical military weapons according to Dr. Malcolm Currie, Defense Research and Engineering Director. Display research programs, which until now have concentrated on advanced technology, are being brought down to earth. Research is being directed toward making displays part of a military system that can be easily operated by people.



In other developments, infrared research is emphasizing the 8-to-14  $\mu$  spectral region. And integrated-circuit research is stressing designed-in reliability rather than what Currie indicates has been the usual practice of testing ICs after design, then going back to correct reliability problems. In the development of radiation-hardened ICs, the Pentagon has asked researchers to concentrate on metal-insulator semiconductor (MIS) circuits instead of hardened bipolars. MIS devices, Currie says, offer higher packing density, lower power and potentially lower cost.

## **New jet landing procedure would need more electronics**

A new two-segment landing procedure designed to cut jet noise levels would require some \$130-million in new electronic equipment. The procedure is being considered by the Federal Aviation Administration for 58 airports in this country. The agency is proposing that the airports require a shorter, steeper glide slope during the first part of the landing approach and a leveling off to the usual angle for the actual landing. The technique, developed jointly by the FAA and NASA, would require the installation of distance-measuring equipment (DME) on the 100 runways serving jets, to give pilots precise navigational information, and corresponding receiver equipment in the aircraft. The FAA would foot the \$5-million bill for ground equipment, but it estimates that it would cost some \$66.6-million to outfit airliners with the new avionics, and a similar amount to outfit general-aviation jets.

## **Coast Guard studies coastal navigation aids**

Coast Guard officials have concluded that the increased shipping that will result from the construction of the trans-Alaskan pipeline will make critical the need for a precision surface radio navigation system in the Pacific coastal region. But after studying the various alternative systems, they are also reluctantly concluding that no single system appears capable of providing positional fixes both on the high seas and in the narrow confines of a harbor. At present, Loran-C is the leading candidate for precise navigation in coastal waters and harbor areas, but the longer-range, easy-to-use Omega seems superior for navigation on the high seas.

**Capital Capsules:** The Naval Air Systems Command, which is pushing the design of a minicomputer for tactical applications, is **asking industry to provide information on the interface characteristics of off-the-shelf mini peripherals** so the computer design will be compatible with commercial devices. . . . The Rome (N.Y.) Air Development Center is **planning to contract a study to determine whether fiber optics can be used instead of a microwave link for communications between the ground and a high-altitude balloon.** A fiber-optic cable would be incorporated into the balloon tether. . . . Gordon Rule, controversial civilian Navy procurement specialist, has **warned Congress that a \$3.5-billion patrol-ship program is heading for disaster unless production schedules are slowed** to make sure an Italian gun and Dutch-designed fire-control system will work. Rule says foreign guns and control systems have never been successfully "Americanized." . . . The Army will **put a new infrared sensor and side-looking airborne radar on the OV-1 Mohawk Observation plane.** The infrared equipment, the Army says, can detect a man from an altitude of approximately one mile, even though his temperature may differ only slightly from that of his surroundings.



# another handful ... with more measurement solutions

## **THIS 5 MHz PORTABLE ADDS EXPANDED BANDWIDTH TO THE TEKTRONIX LINE OF MINIATURE OSCILLOSCOPES**

You've got to keep your computer installation running; downtime is too costly to treat lightly. When it happens, you must get there with the proper troubleshooting equipment, find the problem and quickly correct it. The 221 from Tektronix will help get the job done.

At 5 MHz bandwidth, 5 mV/div sensitivity, and 1  $\mu$ s/div sweep, this battery-operated miniscope displays the waveforms encountered in today's computer environment.

Many operator conveniences save set-up time and make the display easy to interpret. The integral 1 M $\Omega$  probe is always there when you need it. Deflection factors are easy to read. Trigger level and slope are simplified in one rotary control. AUTO trigger mode automatically triggers the scope trace from its input signal. And in AUTO mode, a bright reference trace eliminates confusion. Rotate the switch out of AUTO mode and you can select any combination of trigger slope and trigger level. With all this, you carry just 3½ pounds.

In its 3" x 5¼" x 9" package, the 221 has rechargeable batteries. It can be operated and charged from practically any power source from 90 to 250 V, 48 to

62 Hz AC, or 80 to 250 V DC without switching. Double insulation protects the operator while making elevated voltage measurements. Its impact-resistant case absorbs the rough treatment you expect in field maintenance.

221 Portable Oscilloscope, including batteries and probe ... \$775  
Other 200-Series miniscopes offer 500 kHz bandwidth in single- or dual-trace, or dual-trace storage models.

Call your nearest field office for a look at the 221. Or write Tektronix, Inc., P.O. Box 500, Beaverton, Oregon 97005. In Europe, write Tektronix Ltd., P.O. Box 36, St. Peter Port, Guernsey, C. I., U. K.



**TEKTRONIX®**  
committed to  
technical excellence

INFORMATION RETRIEVAL NUMBER 30

FOR DEMONSTRATION, CIRCLE 210





# Some of the best things about our new Digivac<sup>®</sup> 1000 are what you can't see.

When you look at our vacuum fluorescent readout, you won't see the low voltage requirements making it directly compatible with available MOS IC logic packages.

You won't see the exclusive mica substrate which supplies mechanical strength and helps emphasize lighted segments through a desirable halo effect.

You won't see the low cost, lower than competing readouts with fewer customer advantages.

Of course, there are things about our Tung-Sol<sup>®</sup> Digivac 1000 you can see.

Like the Digivac 1000's brightness. 50% more brightness and greater uniformity than ever before.

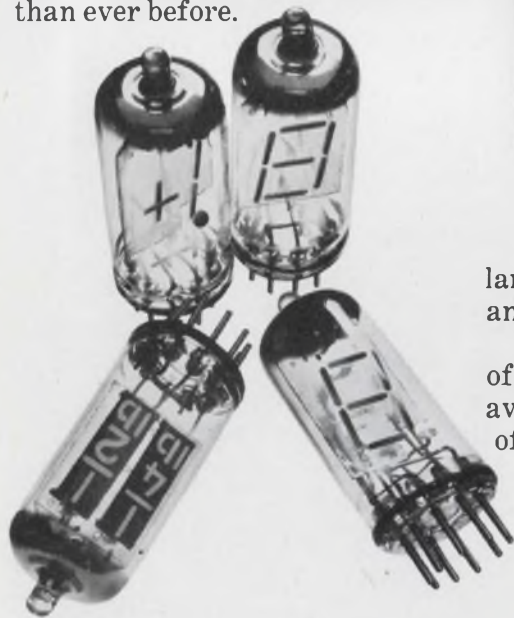

You can see the flexible language with alpha, numerical and symbolic figures.

You can see the wide range of colors, including white, available with common types of filters.

And because of the unique construction, you can see the accurate viewing assured from virtually any angle.

With the Digivac 1000 readout, whether you see it or you don't... it's still nice to know it's all there.

For additional information on the Digivac 1000, write to: Wagner Electric Corporation, 1 Summer Avenue, Newark, New Jersey 07104.

*Wagner makes other quality products in volume for the electronics industry, including bridges, power supplies and subsystems, silicon rectifiers, resistors, miniature lamps and status indicators. And Wagner offers contract manufacturing.*

## **WAGNER<sup>®</sup>**

**We've got a lot more riding for you.**



# NOW AVAILABLE IN THE U.S.A.— FUTABA FLUORESCENT READOUTS KEYBOARDS



With over 35 years of electronics experience, FUTABA is well known for high quality, reliable fluorescent readouts and compact, attractive keyboards. Widely used by most major electronic calculator manufacturers in Japan and other countries, these items are now available for the first time in the U.S.A. in quantity. FUTABA guarantees prompt delivery!



•For additional information, please contact:  
**FUTABA INDUSTRIES U.S.A.**  
630 West Carob Street, Compton, California 90220, U.S.A.  
Phone: (213) 537-9610 Telex: 69-1227

## FLUORESCENT READOUTS

※CT, CR Series for Hand Calculators  
..... Available in 6, 8 and 9 digits with or without symbol.

- FEATURES:**
- Compact.
  - Bright blue/green.
  - Easy to read.
  - Low voltage, low power.
  - Direct LSI drive.

※MT, MR Series for Desk-top Calculators  
..... Available in 8, 10, 12, 14, and 16 digits.

- FEATURES:**
- Plug-in type flat package.
  - Easy to read blue/green readouts (0.3" high).
  - Low voltage, low power.

## KEYBOARDS

M-2B: Individual mechanical switch, plug-in mounting.  
M-3: Same as M-2B, but smaller.  
FX, SD Series: Thin keyboards for hand calculators.

Standard keyboard switches and key tops available from FUTABA stock for instant keyboard layout on your mounting plate.

## OTHER FUTABA PRODUCTS:

- Press die sets.
- Mold bases for plastics.
- Material feeders for press work.
- Automatic stopping devices for automatic machinery.
- Radio control for: hobby aircraft, race cars, etc.

*"FUTABA—THE BRIGHT PRODUCER"*

**FUTABA ELECTRONIC INDUSTRIES LIMITED**  
Super Bldg., 1-11-5, Sotokanda, Chiyoda-ku, Tokyo, Japan. Phone: 255-5881  
Telex: J26532



# this is one of the two best 5½ digit multimeters ever made . . .



DMM-51  
\$795

Compare the price/performance features of the DMM-51 with units offered by the other big three DMM manufacturers. No other 5½-digit multimeter that's anywhere near the price of the DMM-51, provides the wide choice of functions available on this, the lowest cost, autoranging, 5½-digit meter on the market.

The basic unit measures DC volts and DC/DC 3-wire ratios with 1 $\mu$  volt sensitivity. To this you can add your choice of: resistance to 1 milliohm and AC volts—choice of averaging or true RMS; 4-wire bipolar ratio; AC and DC current; high voltage DC to 30 KV; and fully isolated data outputs. And, you can buy them with the DMM-51 or add them later.

## and **CIMRON** makes the other one, too.



DMM-50  
\$1195

The world's finest 5½-digit systems multimeter combines all the features and functional capability of the DMM-51 . . . plus the unique Saint Logic A/D conversion technique affording high speed, high accuracy measurements even when measuring extremely noisy inputs. When equipped with the Data Output/Remote Control option, data is available in both parallel and serial-character format. The DMM-50 is the ideal systems DMM whether you're interfacing to a computer or a printer. It's also available with directly compatible interfaces which eliminate the cost of changing software and cabling, and provide you with a second source if you're already committed to a competitive DMM.

For complete details, call or write:



5150 CONVOY ST. • SAN DIEGO, CA 92111 • (714) 279-8620



# Remember the time you wanted something special in 3½ digits?

## Your time has come.

When we at Analog Devices introduced the 5-volt digital panel meter, we said there'd be more—a lot more. Look what we can offer you in 3½ digits alone.

Why so many? To give you a choice. So you won't have to order or build specials anymore. Because now we've made what you need a standard.

Let's say you need 3½ digit resolution. You can get it displayed in Numitron, LED, or even Sperry.

In Numitron, we can even give you a choice of green or red.

Now you have to power it. Most of our meters are 5 volts DC

because so much of what you're working on is in TTL logic. But if you need one that can run on 115 volts AC, you've got it. The AD2006 with Sperrys—in AC or DC. It's our latest DPM. But not our last.

You may even be designing something that will end up in another country. We can help you there too. With meters that will operate on voltages in Europe, the U.K., Japan, and just about anywhere else.

If you look closely, you'll see that one meter isn't a meter at all. It's a remote display. Sometimes you need that kind of thing.

But then giving you what you need is what it is all about. Like reliability. And extra features like card edge connectors. Ratiometric inputs. .05% accuracy. And low prices. Ours start at \$49 in hundreds for the remote display.

Now, would you like to see what we can do for you in 4½ digits—or 2½ digits? Give us a call. We'll see that you get a copy of the "Designer's Guide to Digital Panel Meters." And any other help you may need.

Analog Devices, Inc., Norwood, Mass. 02062. On the East Coast, call (617) 329-4700. In the Midwest, (312) 297-8710. And on the West Coast, (213) 595-1783.

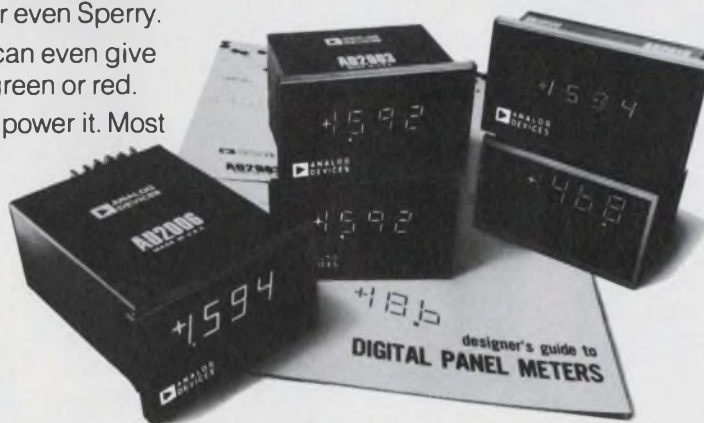

 **ANALOG  
DEVICES**

## Then it was special. Now its a standard.



Many people using our head-per-track disc and drum memories never heard of us. The computer and systems manufacturers who buy our product keep it inside their own cabinets. The end-user remembers only the name on the front panel: Foxboro, Control Data, Hewlett-Packard, Texas Instruments, Modular Computer Systems, International Computers Ltd., or one of our many other customers. But there's a more important reason why we're known to the most discerning customers. Head-per-track disc memory systems are a vital but unobtrusive part of a computing system. They call attention to themselves only when they aren't working. We've built an enviable record from our memories working properly . . . year after year after year. That's no happy accident. We work hard at it. We have a proven track record of reliability, from design right through manufacturing. When you select our equipment, we stand behind you—as a company—all the way. Call or write today for technical data and names of customers who'll tell you that our staying behind them is why we stay out front.

## Our head-per-track memories are right behind the best names in computing systems



**DIGITAL DEVELOPMENT CORPORATION**

5575 Kearny Villa Road, San Diego, CA 92123. Phone: (714) 278-9920  
European Sales Office: Radix House, Staines, Middlesex, England. Phone: Staines 51444



Dearborn....

foremost in film capacitors...

gives you 45 designs to choose from.

**There's one to meet your exacting requirements.**

**HERMETICALLY-SEALED  
METAL CASE TUBULAR CAPACITORS**

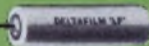

**BARE METAL CASE**

Style LP8, metalized polycarbonate film  
Style LM8, metalized PETP-polyester film  
Style LS8, metalized polystyrene film  
Style AP8, polycarbonate film  
Style AM8, PETP-polyester film  
Style AS8, polystyrene film  
Style AF8, PTFE-fluorocarbon film

**METAL CASE WITH INSULATING SLEEVE**

Style LP9, metalized polycarbonate film  
Style LM9, metalized PETP-polyester film  
Style LS9, metalized polystyrene film  
Style AP9, polycarbonate film  
Style AM9, PETP-polyester film  
Style AS9, polystyrene film  
Style AF9, PTFE-fluorocarbon film

**EPOXY-CASE  
RECTANGULAR CAPACITORS**

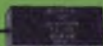

**AXIAL-LEAD**

Style LP7A, metalized polycarbonate film  
Style LM7A, metalized PETP-polyester film  
Style LS7A, metalized polystyrene film  
Style AP7A, polycarbonate film  
Style AM7A, PETP-polyester film  
Style AS7A, polystyrene film

**RADIAL-LEAD**

Style LP7S, metalized polycarbonate film  
Style LM7S, metalized PETP-polyester film  
Style LS7S, metalized polystyrene film  
Style AP7S, polycarbonate film  
Style AM7S, PETP-polyester film  
Style AS7S, polystyrene film



**HERMETICALLY-SEALED  
METAL CASE RECTANGULAR CAPACITORS**



Style CML, high voltage paper/PETP-polyester film, inserted tab construction.

**HERMETICALLY-SEALED  
CERAMIC CASE TUBULAR CAPACITORS**

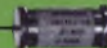

Style SML, high voltage paper/PETP-polyester film, inserted tab construction.  
Style SMLE, high voltage paper/PETP-polyester film, extended foil construction.

**HERMETICALLY-SEALED  
GLASS CASE TUBULAR CAPACITORS**

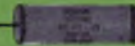

Style GML, high voltage paper/PETP-polyester film, 85 C  
Style GTL, high voltage paper/PETP-polyester film, 125 C

**WRAP-AND-FILL  
ROUND TUBULAR CAPACITORS**



Style LP66, metalized polycarbonate film  
Style LP88, met. polycarb. film (Fuz-ion Sealed\*)  
Style LM66, metalized PETP-polyester film  
Style LS66, metalized polystyrene film  
Style AP66, polycarbonate film  
Style AM66, PETP-polyester film  
Style AS66, polystyrene film

**WRAP-AND-FILL  
OVAL TUBULAR CAPACITORS**

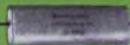

Style LP77, metalized polycarbonate film  
Style LM77, metalized PETP-polyester film  
Style LS77, metalized polystyrene film  
Style AP77, polycarbonate film  
Style AM77, PETP-polyester film  
Style AS77, polystyrene film

**EPOXY CASE  
RECTANGULAR CAPACITORS**



Style EFX, high voltage paper/PETP-polyester film.

**Write for engineering bulletins on those capacitor styles in which you are interested.**

\*Trademark

SPRAGUE ELECTRIC COMPANY

**Dearborn** electronics division

P. O. BOX 1076, LONGWOOD, FLORIDA 32750

**SPRAGUE**  
THE MARK OF RELIABILITY

45D-4105



# 150 Microwatt Triple Op Amp

The L144 monolithic triple op amp draws only  $50\mu\text{A}$  of current per amplifier, from a  $\pm 1.5\text{ V}$  supply. What's more, it is

**AVAILABLE NOW FROM YOUR LOCAL DISTRIBUTOR!**

L144 features include:

- Monolithic triple op amp in DIP or Flatpac packages
- Wide power supply range— $\pm 1.5\text{ V}$  to  $\pm 15\text{ V}$
- Internal compensation
- Programmable power dissipation
- Programmable input bias current
- Single programming resistor
- 80 dB gain with  $20\text{ K}\Omega$  load
- Cost effective: \$1.63 per single op amp<sup>(1)</sup>

<sup>(1)</sup>L144CJ 100-piece price

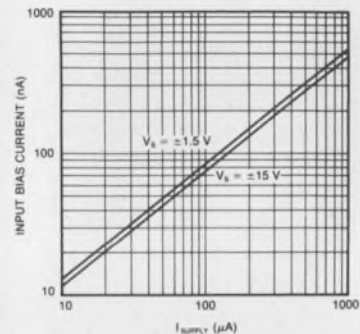

Applications examples:

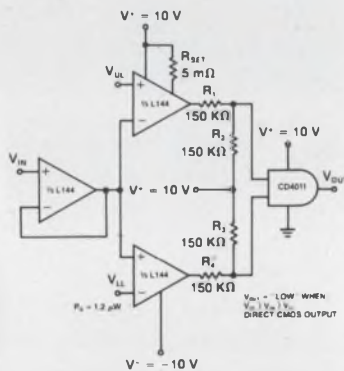

DOUBLE-ENDED LIMIT COMPARATOR

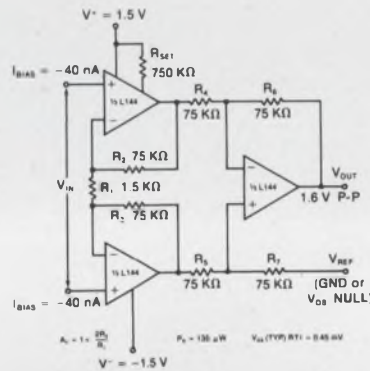

INSTRUMENTATION AMPLIFIER

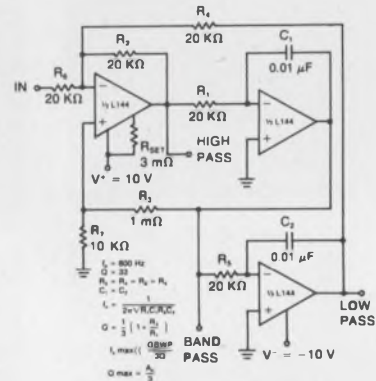

ACTIVE FILTER

The L144 is a practical industry-standard operational amplifier for use when low current drain, low voltage, low power, or very small physical size are controlling criteria. If your circuit requirements are unique—and whose aren't—our applications people are eager to help.

For complete information

**write for data**

IC Applications: (408) 246 8000, Ext. 120



**Siliconix incorporated**

2201 Laurelwood Road, Santa Clara, California 95054

INFORMATION RETRIEVAL NUMBER 37



## We lie a lot

I don't think I've ever met an honest man. All of us lie. These days many of us justify it because there's obviously one hell of a lot of lying in the highest government circles and, after all, "If it's OK for them, it can't be too bad for me."

But our lying goes further back. Most of us learned to lie as babes; we lied to avoid pain or the displeasure of our parents. We would do something pleasurable, but forbidden, then deny it to avoid unpleasant consequences. Later we learned to deliver half-truths. We wailed that "Johnnie belted me in the eye," while conveniently forgetting, "I socked him in the teeth, first." Later, as adults, we lied because it's socially acceptable and proper. When our neighbor's youngster scratches away at his violin, it's unlikely that we'll say to our neighbor, "Gad, that's awful. Can't you burn that thing?" And we're not likely to tell our own children they were dreadful in the school play.

In business life we lie to protect our jobs or advance our competitive positions—just as politicians do. When we write specifications to describe the products we sell, we tend to omit those specs that cast our products in a less than lovely light. We suggest more than we can deliver and conceal our product's weaknesses. We use qualifiers like "up to" and "as low as" to describe specs our customers may never encounter. We highlight multiple specifications that may not be concurrent. And we give the best specs of different products leaving the reader to assume that these specs cover a single product. We "forget" to indicate conditions that may limit the achievement of headlined performance levels. And it's the rare engineer who will confess, "Wow! I really loused up that design." So we lie by omission, by commission and by expression of partial truth.

Yet, lying, *per se*, isn't necessarily bad. Only a hard-hearted purist would argue that we should crush our children by telling them they were rotten in the school play. Only a misogynist would argue that we should stop telling ugly old ladies how young and lovely they look. And only a hermit would demand that we destroy our relationships with our neighbors by telling them their children are untalented brats.

It's not likely we'll quit lying. But we all might be more comfortable if we could make ourselves more conscious of why others lie and more aware of why we do.



A handwritten signature in dark ink, which appears to read "George Rostky". The signature is fluid and cursive.

GEORGE ROSTKY  
Editor-in-Chief



# LARGEST LINE OF

## FLOW SOLDER TERMINATION PRINTED CIRCUIT CONNECTORS

### SERIES 600-121

Available Sizes: 20,30,52,  
60,66,72,80, 86 and 100 Contacts  
.100" Contact Centers  
Single & Dual Readout  
For 1/16" PC Board

WRITE OR PHONE  
FOR COMPLETE  
PRINTED CIRCUIT CATALOGS:  
(212) 899-4422

#### "BELLOWFORM" CONTACT

HOOKED INTO  
POCKET OF  
MOLDING AND  
FULLY SUPPORTED  
AGAINST MOLDING  
WALL FOR COIL  
SPRING ACTION

ILLUSTRATIONS ACTUAL SIZE

*For the Sales Representative Nearest You, See Our Listings in EEM and VSMF Directories.*

# CONTINENTAL CONNECTORS

CONTINENTAL CONNECTOR CORPORATION • WOODSIDE, NEW YORK 11377



**Why is Corning  
running an 8-page ad  
on its components,  
now, during the worst  
component shortage  
since 1942?**

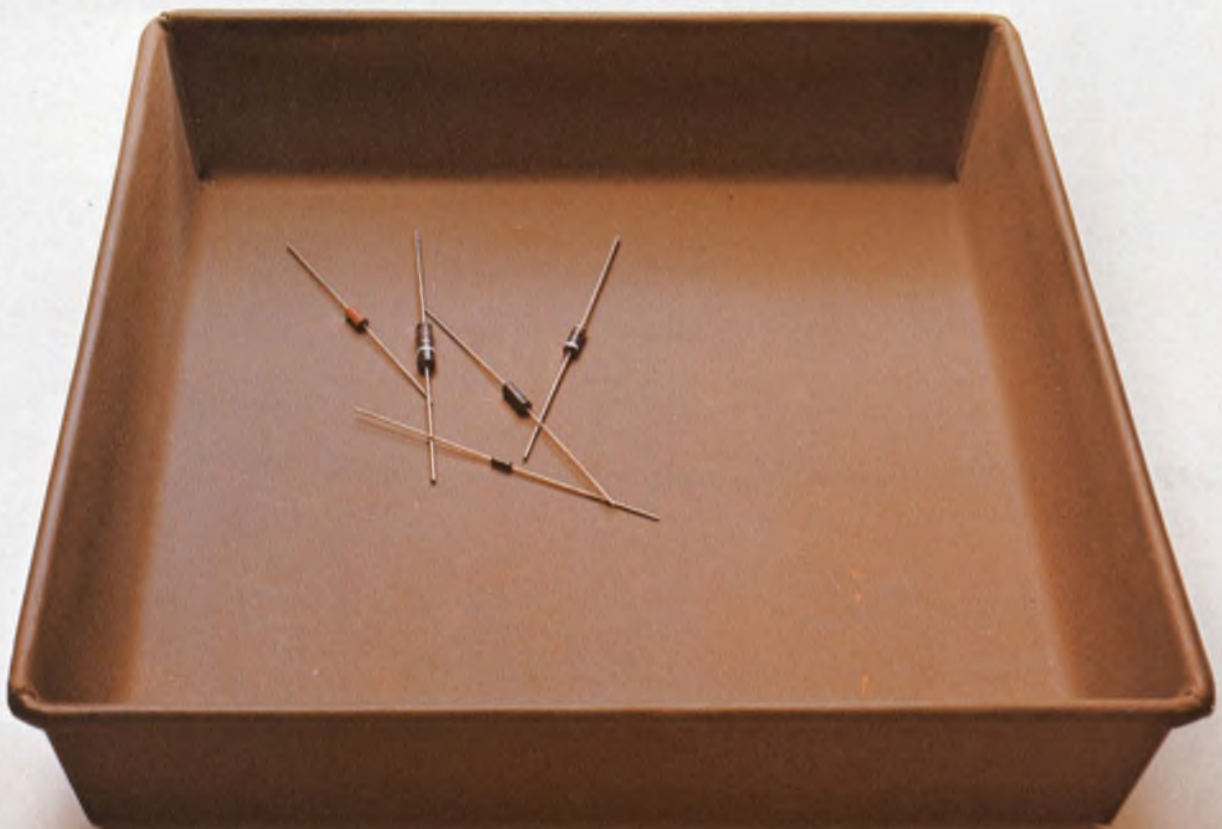



# Here's why:

To our customers— We know your production and design plans depend on a clear and accurate picture of component availability. And since Corning's components represent such a large percentage of total supply, we'd like to show you where we stand today... and tell you what you can expect from us in the future.

To our prospects— We believe we're the first component supplier to emerge from a backlog situation. We'd like to update you on our new capacity, expanded lines, and developments.

That's why we're running this 8-page report.

## The metal film resistor shortage and what we're doing to end it-

Demand for our metal film resistors soared during the past 18 months. There were two reasons...

First, designers continued their move away from carbon comps and wirewounds to metal films as they recognized the superior price/performance value that metal film resistors offer. The effect of lower metal film prices combined with the tighter tolerance needs of upgraded circuits suddenly created demands far beyond the industry's most optimistic forecasts.

And second, we were deluged with larger metal film resistor orders because other suppliers couldn't deliver as fast as we could. Demand was heaviest for the  $\frac{1}{4}$  and  $\frac{1}{2}$ -watt styles.

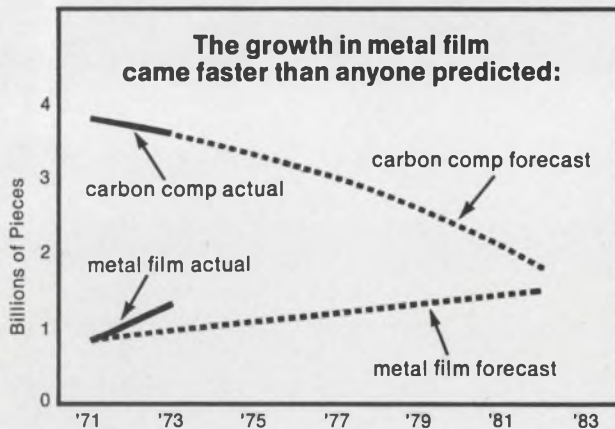

## Industry demand vs. Corning production.

At its worst, order lead times ranged from 24 to 60 weeks and longer— compared to 6-week deliveries that were normal for us the year before.

But fortunately we had already begun a major metal film resistor expansion program. As such, we were able to meet an exceptionally high percentage of all promised shipments, and then gradually reduce lead times to a current

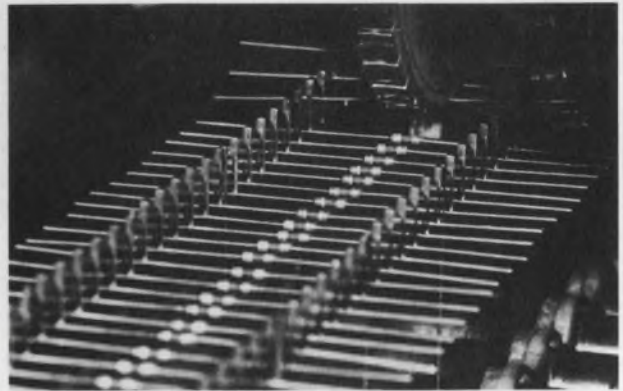

Our engineering staff developed many new techniques in all phases of resistor production.

average of 12 weeks— with 6-week delivery on several styles.

Our expansion program came in three phases, which let us move faster than the “brick and mortar” route to expansion.

Immediately, we moved to a full 3-shift-per-day 7-day-per-week production schedule. Our production and quality control staff was expanded quickly by transferring many experienced people back to our plants. And many more were hired and trained.

Secondly, we designed, tested and installed new high speed automated equipment and improved techniques in practically every stage of manufacturing. More than 18 state-of-the-art devices were developed by our engineering staff in this program.

Thirdly, we significantly expanded our basic resistor manufacturing operations at both Wilmington, N.C. and Bradford, Pa. This included a doubling of our resistor substrate capacity to keep us free from shortages in basic raw materials.

Just these last two stages required a multi-million dollar investment in capital equipment and facilities— all geared to increase output.

Throughout, our chief concern was keeping absolute control on product quality. More resistors—but bad resistors—is no progress at all! So we moved quickly—but at a pace and on a plan that would not risk quality problems that could cancel out production gains.



# Corning is a major supplier of metal film resistors.

As a result of this expansion, we're now shipping more than twice as many metal film resistors as we did in 1970. We supply more metal film resistors than anyone else in the U.S. today.

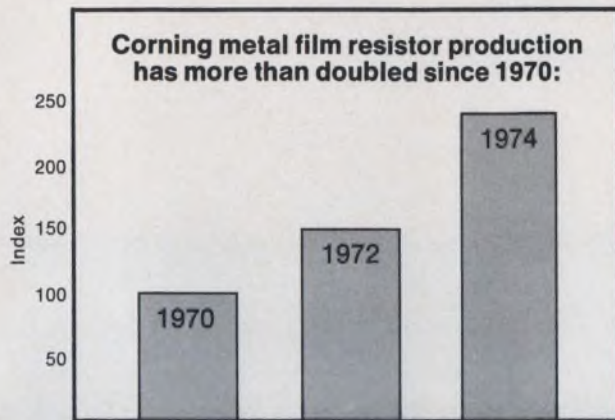

## New additions you can expect to see this year.

Our current resistor line includes precision, semi-precision and general purpose parts—in a wide range of sizes and styles including ER and our flame-proof resistor line.

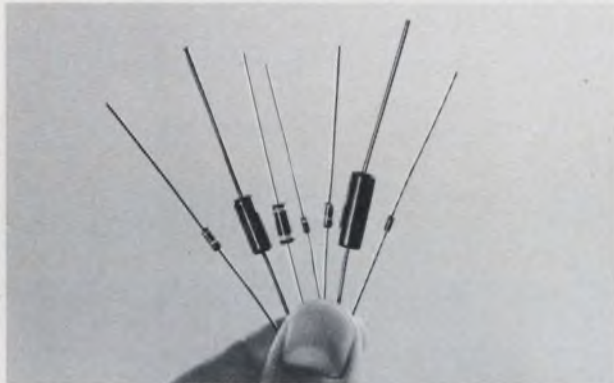

We are adding substantially increased capacity for precision parts with temperature coefficients of 50ppm/°C. And 25ppm/°C. parts are in the final stages of development. This will extend the range of our metal film performance capabilities significantly. As soon as samples of our 25 ppm resistors are available for evaluation, we'll let you know.

## What to expect in the next 3 to 5 years.

We believe the metal film resistor supply situation will greatly improve in the second half of this year. But we also expect metal films to continue

to be the fastest growing segment of the discrete resistor market.

As the lower power requirements of new designs make wirewounds less popular, and the needs for greater precision (particularly in automotive and instrumentation applications) make carbon comps less suitable—we expect to see an annual demand growth of at least 10 to 12 percent. And we've geared our production to meet this demand.

## Keeping tabs on our progress.

Throughout the shortage, we've regularly surveyed our customers to measure how we're doing versus other suppliers.

The result of the latest reading is shown below...

How users rate Corning's metal film resistors				
	Corning	Firm A	Firm B	Firm C
<u>Buyers' ranking of</u>				
—best quality	#1	#3*	#3*	#2
—best value for cost	#1	#4	#3	#2
—best distributor availability	#1	#4	#3	#2
<u>Engineers' ranking of</u>				
—best quality	#1	#4	#2	#3
—best value for cost	#1	#4	#2	#3

\*tie

We're pleased—but not totally.

Obviously, we're still having to say "no" too often to new orders from new customers.

We hope we can change that soon. We're working at it. And we'll keep you posted as our metal film resistor supply backlogs further ease.





# The Capacitor Shortage:

**And what we're doing to end that too-**

Corning has begun a major expansion into the ceramic capacitor market. And we're gearing our initial operations to very large volume production of a relatively tight line of low cost parts.

For the past three years we've been supplying a major portion of the computer industry's axial monolithic ceramic capacitor needs. And have initially concentrated on miniature size, epoxy-cased ceramic capacitors for automatic insertion applications.

Now, with a number of new product developments nearing completion, we are planning the introduction of a high volume low cost commercial axial ceramic line and an expansion into commercial radials in a major way.

## Corning's expansion into ceramic capacitors.

During the past year, we've more than doubled our capacitor production. And because capacitor production is far more labor-intensive than resistor production, this has required a significantly enlarged technical and manufacturing staff, plus facilities expansion at our Raleigh, N.C. plant.

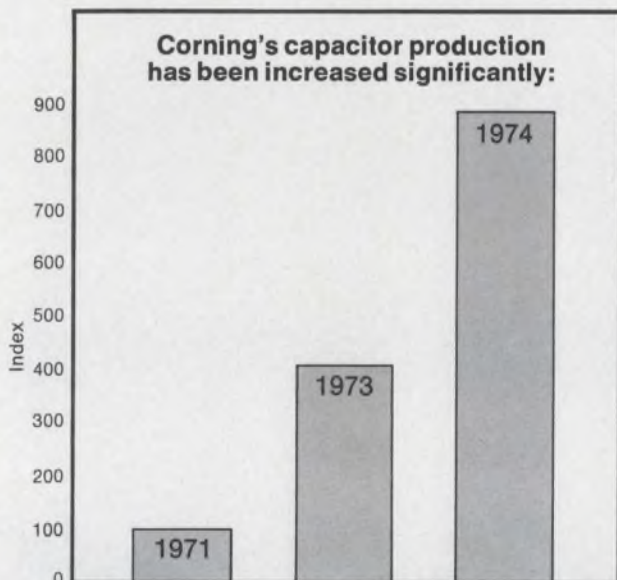

But 1973 increases will be eclipsed by the size of our expansion schedule this year and beyond.

1975 production will triple 1973 levels. 1978 production will have tripled again. And 1980 production will be 70 percent over 1978 levels.

But our expansion program is just beginning.

And the impact on longer term ceramic capacitor supply will go far in precluding another ceramic capacitor shortage.

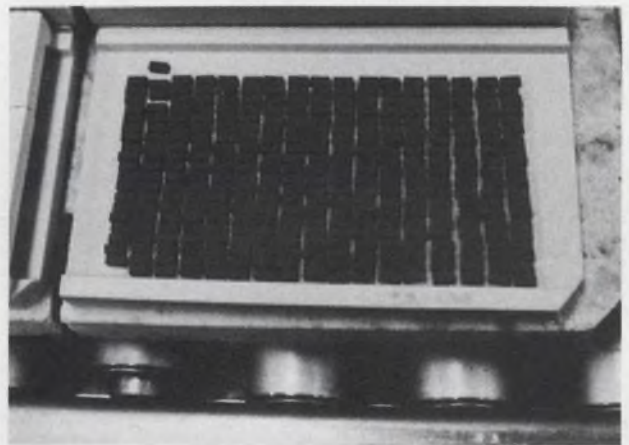

Ceramic chip inventories are being built at this very minute.

## Glass and Glass-K™ Capacitors.

Our glass-dielectric capacitors have been in strong demand for applications where high stability



over a wide temperature range is required. In the fall of '73, delivery lead times rose to 30 weeks, but 8- to 10-week schedules are now more typical and distributor stocks are being rapidly replenished. Soon availability will be back to normal.

The same holds true for our Glass-K glass-ceramic capacitors — which combine the volumetric efficiency of a monolithic ceramic with the stability of a glass-dielectric.

## New developments nearing completion.

Our new "spin-seal" conformal-coated axial could be the industry's long-term answer to a truly low cost automatically insertable ceramic capacitor.

Using techniques we originally developed for — and currently use in producing — our resistor line, this epoxy-jacketed series has the uniformity and handling characteristics necessary for automatic insertion. But at lower cost in larger volume production. The "spin-seal" technology permits us to manufacture axials at much higher speeds than are possible with molded case styles. Throughout, coating thickness is automatically gauged and controlled to keep uniformity and performance exact.

As soon as evaluation samples are available in quantity, we'll announce their availability.

## Industry demand forecasts:

Currently, molded axials represent 25 percent of the leaded ceramic capacitor market. Through 1980 they'll continue to move in on radials based on current trends to automatic insertion. As such, axials will remain a prime area of concentration for us.

When our "spin-seal" axials are ready, we expect to be able to supply axials at prices that

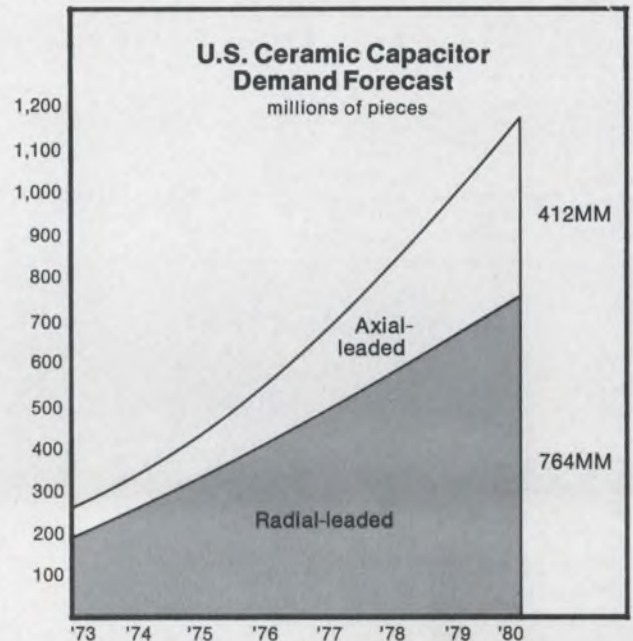

encourage a switch away from radials. This should push axial growth even faster.

But we'll also be ready with our radial line, to provide whichever types of ceramic capacitors your production requires.

In short, Corning plans to become a major factor in all types of ceramic capacitors in the years ahead.





# The Tantalum Capacitor Shortage:

## And what's available now-

During 1973, we concentrated on keeping our distributors supplied as fully as possible with tantalum capacitors from our Components Incorporated subsidiary.

By year end, this meant that a major percentage of the tantalum capacitors being sold through distribution were ours.

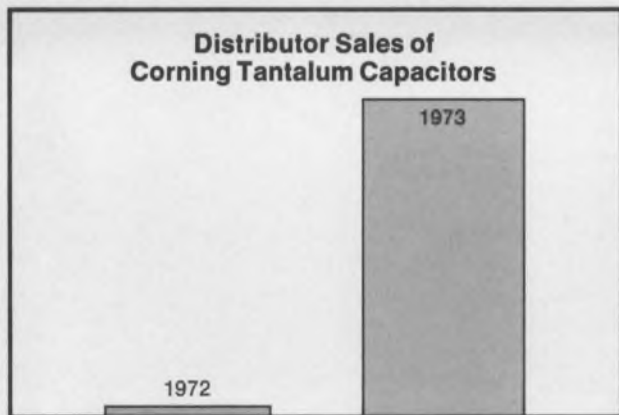

Recently, we introduced two more tantalum lines into distribution and availability on both should be excellent soon in most areas of the country.

## 1. Our TK line:

These low cost, radial leaded, epoxy dipped solid tantalum capacitors have capacitance values in the 0.1 to 330MFD range—with working voltages of 6 to 50VDC and tolerances of  $\pm 10\%$  and  $\pm 20\%$ . Their low-profile configurations

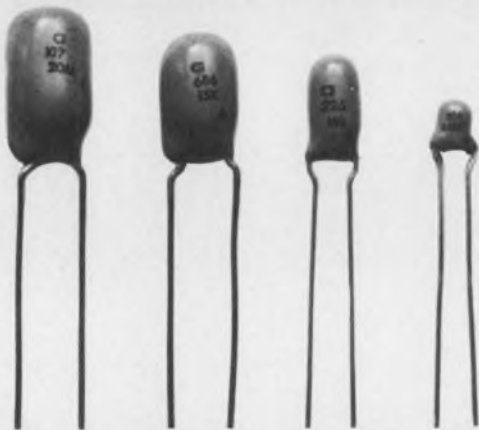

and availability with a choice of lead bends make them well suited for convenient insertion and assembly.

Incidentally, our companion line of DIPATAN<sup>®</sup> TD series epoxy-coated radials are now in fairly good availability in most areas, too.

## 2. Our MINITAN<sup>™</sup> line:

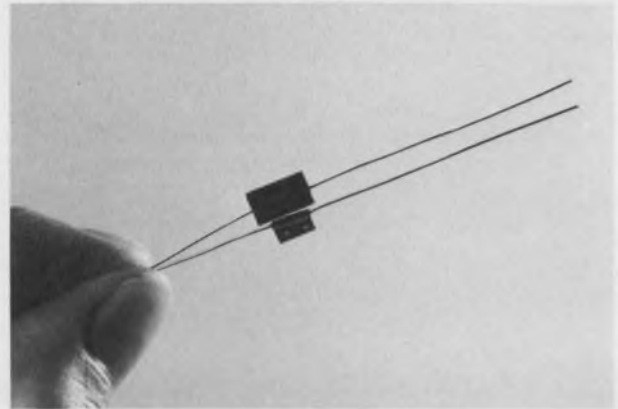

These microminiature solid tantalum capacitors are epoxy-sealed in a polyester sleeve. They're available in both cylindrical cordwood and rectangular modular form, with a choice of axial or radial leads. Capacitance values are 0.001 to 220MFD, working voltages are 2 to 50VDC, and tolerances are  $\pm 10\%$  and  $\pm 20\%$ . They're in excellent supply. We can meet your needs now.

## Supply problems exist elsewhere.

Industry wide, supply problems are still enormous for axial-leaded, metal-can-enclosed solid tantalum capacitors. These parts have soared in demand because of their wide use in high volume machine-insertion applications.

Corning, like other suppliers, has been unable to gear up quickly to new demand levels for these metal-cased parts, because their fabrication is labor intensive and the very skilled workmanship required cannot be expanded rapidly without risk of quality.

We are in the process of training additional personnel and have supplemented existing facilities, but frankly it will take months to catch up with current demand levels for both our MILITAN<sup>®</sup> hermetically sealed ER line and our ECONOTAN<sup>®</sup> epoxy-sealed consumer and industrial line.

## In the meantime...

In the meantime, we suggest you take a closer look at our MINITAN and TK series as good alternatives to your immediate needs.



# Our distributors have assumed a pivotal role:

## Corning component availability -

In spite of shortages, we've made significant gains in distributor availability across all three Corning component lines. Progress here can be seen in the chart below.

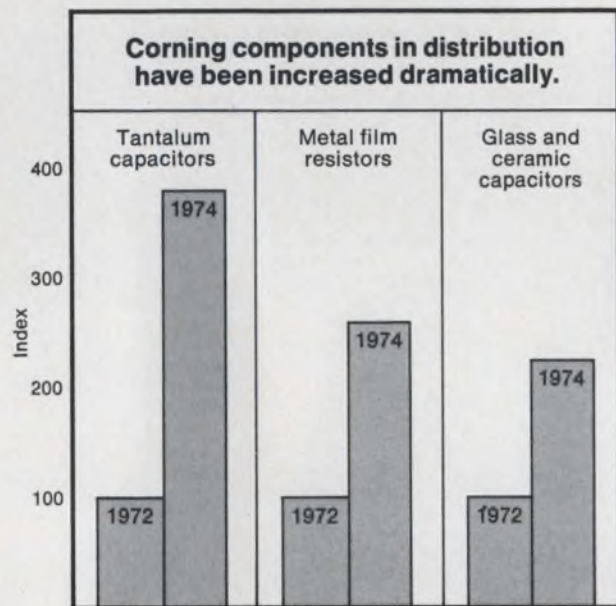

We believe that a strong, well supplied authorized distributor network is the *only way* a component supplier can responsively meet the large and growing needs of the thousands of firms across the electronics marketplace.

That's why our distributors are now our largest "customer," and why they'll be assuming an even more pivotal role in Corning's future marketing and supply plans.

## An expanded distributor supply center.

To make this work, we've added a major new distributor supply center at a location separate from our plants. This supply center literally buys Corning components from all locations in anticipation of future distributor needs. In the fullest sense, it's become a "Distributor's distributor." And it operates under a strict policy that prevents our OEM sales group from tapping into distribution supplies.



Frankly, it will take a few months before our new distributor supply center builds inventory to levels where we can once again meet our goals of shipping distributor orders directly from off-the-shelf stocks.

But each week we're making progress. For example, our lead time on RN55D metal film resistors has dropped from 22 to 11 weeks. CK12, 13, 14 BX ceramic capacitors are now available for off-the-shelf delivery from your local distributor.

Strong emphasis on distribution means more firms will be introduced to Corning components than ever before. Engineers and buyers who've never used our resistors and capacitors will be buying them in future months.

## We'll keep you posted.

By being first to ease component supply, Corning hopes to make new friends and win new long-term users. This in turn will let us keep expanding in increments large enough to achieve low cost pricing for our parts.

We'll keep you posted.





# What Corning makes:

**Metal film resistors**—precision, semi-precision and general purpose—including ER and flame-proof types. Precision resistors with TC's down to 50ppm/°C.—with 25ppm/°C. parts coming on later in the year.

**Ceramic capacitors**—miniature, precision multi-layer axials with molded epoxy cases have been our main area of emphasis. Lower cost commercial axials and commercial radials will be our major area of expansion in future months.

**Solid tantalum capacitors**—axials in metal cans (in both hermetically sealed and epoxy-sealed

types). Low cost, low profile epoxy-dipped radials in a range of types and sizes. Microminiature axials and radials—epoxy-sealed in both cylindrical and rectangular cases.

**Glass capacitors**—a complete line of precision, fused monolithic glass-dielectric capacitors. Introduced 30 years ago and still the ultimate in stability.

**Glass-K™ capacitors**—miniature, multilayer, molded-case axials that combine the volumetric efficiency of ceramics with the stability that only a glass dielectric can provide.

## Our Distributor Network:

**ALABAMA:** Huntsville; Cramer/EW (205)539-5722. **ARIZONA:** Phoenix; Liberty Electronics (602)257-1272. **CALIFORNIA:** Culver City; Avnet\* (714)522-8220/(213)836-7200. Gardena; Bell Industries Electronics Corp. (213)321-5802. Los Angeles; Liberty Electronics (213)322-8100. Mountainview; Elmar Electronics (415)961-3611. San Diego; Liberty Electronics (714)565-9171. Sunnyvale; Acacia Sales\* (408)735-0100. **COLORADO:** Commerce City; Elmar Electronics (303)287-9611. Denver; Cramer Electronics (303)758-2100. **CONNECTICUT:** North Haven; Cramer Electronics (203)239-5641. **FLORIDA:** Hollywood; Cramer/EW (305)923-8181. Hamilton/Avnet Electronics (305)925-5401. Orlando; Cramer/EW (305)894-1511. **ILLINOIS:** Chicago; Bell Industries (312)282-5400. Schweber Electronics (312)593-2740. **INDIANA:** Indianapolis; Graham Electronics Supply (317)634-8202. **MARYLAND:** Baltimore; Radio Electronics Service Company (301)823-0070. **MASSACHUSETTS:** Watertown; Sterling Electronics (617)926-9720. Newton Centre; Cramer Electronics (617)969-7700. **MINNESOTA:** St. Paul; Ragon Electronics (612)488-0201. **NEW JERSEY:** Cherry Hill; Cramer Electronics (609)424-5993. **NEW MEXICO:** Albuquerque; Cramer Electronics (505)265-5767. **NEW YORK:** Freeport; Milgray Electronics (516)546-6000. Hauppauge; Cramer/Long Island (516)231-5600. Rochester; Cramer/Rochester (716)275-0300. Syracuse; Cramer/Eastern (315)437-6671. Westbury; Schweber Electronics (516)334-7474. Woodbury; Harvey Electronics (516)921-8700. **NORTH CAROLINA:** Winston-Salem; Cramer/EW (919)725-8711. **OHIO:** Cincinnati; Sheridan Associates (513)761-5432. Cleveland; Schweber Electronics (216)464-2970. Columbus; Hughes-Peters (614)294-5351. **PENNSYLVANIA:** Philadelphia; Almo Electronics (215)676-6000. **TEXAS:** Dallas; Solid State Electronics (214)352-2601. Houston; Hamilton/Avnet Electronics (713)526-4661. **UTAH:** Salt Lake City; Cramer Electronics (801)487-4131. **WASHINGTON, D.C.:** Cramer/EW (301)948-0110. Milgray/Washington (301)864-1111. **WASHINGTON:** Seattle; Liberty Electronics/NW (206)763-8200. Almac/Stroum\* (206)763-2300. **CANADA:** Montreal; Cesco Electronics, Ltd. (514)735-5511. Toronto; Cesco Electronics, Ltd. (416)661-0220.

\*Tantalum Capacitors only.



**CORNING**  
ELECTRONICS



A man in a dark grey suit and a patterned tie is walking from left to right. He is carrying a dark briefcase in his right hand. The background is a dark, solid color. The text is positioned in the lower right quadrant of the image.

**It's smaller, powerful  
and more independent**



# The liberated computer







## Fresh off the shelf. Ribbon cable from Hughes.

It could be as good an idea as penny candy: getting your ribbon cable from the same people who crack your tough flat conductor-cable problems.

We offer it by the foot, or as you like it. We not only make it, but we cheerfully cut it, strip it and terminate it for you.

Our new ribbon cable comes in widths from two to 100 conductors. The conductors are round (solid or stranded),

and have color-coded PVC insulation. You can get 22 to 28 AWG.

Of course, all our cable comes with Hughes quality built-in. And we handle your order with the helpful attitude of one of the most competitive companies in the cable business.

So write us soon. Hughes Connecting Devices, 500 Superior Ave., Newport Beach, Ca. 92663. Or call (714) 548-0671.

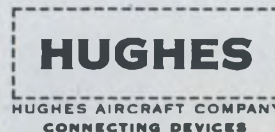

**We crack the tough ones.**

INFORMATION RETRIEVAL NUMBER 39



# Computer '74

## A Special Issue

- Decentralized networks** are allowing the computer to be moved to the job ..... 66
- Take-your-pick software** is making the minicomputer mighty, but watch out—it costs ..... 78
- Microprocessors are showing promise** in test equipment, but they haven't made it big yet ..... 90
- How to be a top designer** and remain a success—an interview with James E. Thornton ..... 100
- Smarter terminals are joining with floppy-disc drives** to stretch data capability ..... 108
- Minis, minis everywhere**, when it comes to control of a variety of industrial processes ..... 118
- Optical data systems** are finding a niche in the world of fast, fast computing ..... 126
- Shortages of components** are forcing engineers to alter their thinking and design ..... 136

Cover photo by Barry O'Rourke, courtesy of Prime Computer Inc.



## Big, small and tiny,

Is the era of the general-purpose supercomputer at an end? Will it be replaced by new generations of midis, minis and microprocessors now on the market or on the drawing boards? The answer depends on whom you talk to.

There is general agreement that in many applications it's a lot more efficient and economical

to decentralize the computing workload—distributed computing—particularly in industrial process control and communications networks. On the other hand, a supercomputer designer, James Thornton (see p. 100), sees a growing role for the big machines. For many applications in the aerospace, scientific and Government fields,





# computers advance

he says, the small computer just won't hack it. "How else, for example, can aerodynamicists simulate a giant swept-back aircraft wing, except by a gigantic computer," Thornton notes.

Nevertheless most of the talk in the computer industry these days is about the small-to-medium-sized machines. The still new, but promising,

"computer-on-a-chip (or chips)" microprocessor still has a way to go to live up to its potential as a major circuit element. Although microprocessors are now found in data-entry and point-of-sale terminals, electronic scales, specialized medical instruments and a number of other applications, they still have not been designed into industrial process-control and test and measuring instruments to any appreciable degree.

And despite their lower cost and size, microprocessors are not expected to make significant inroads into traditional minicomputer territory for some time. The microprocessor is no match yet for the mini in speed, word length, memory capacity, number of instructions and computing power.

But the explosive growth of the minicomputer in recent years has not been without its problems. A major area of concern has been the high cost of preparing, debugging and executing the application programs—an expense that may cost 10 times the original investment in hardware. The minicomputer industry is attempting to cut these costs by providing system software that requires less programming time.

Peripherals also are being affected by a significant development—the combining of the intelligent terminal, and its built-in memory and processing capability, with floppy discs. The discs can provide up to 5 million bits of random-access at relatively low cost.

And yet another area that is beginning to attract attention is the storing, processing and retrieval of data with optical techniques.

For a fast look at what's available in computers and what's to come turn the pages of this special section.



---

Today's computers handle many jobs concurrently, from batch input to graphics, as this IBM setup shows.



## Decentralized networks allowing the computer to be moved to the job

Seymour T. Levine, Associate Editor

The 1970s may mark the end of a dinosaur: the super-sized central computer. Low-cost, high-performance minicomputers—and their LSI counterpart, the microprocessor—make it economical to decentralize the computing workload.

Moreover present experiments with medium-sized computers point to the possibility that their work may be subdivided, too.

With few exceptions, the more ambitious computer designs of the 60s attempted to construct one remote general-purpose machine for use with all problems. Today computation is more personalized. The topology of the network is geared to individual jobs. Minicomputers and microcomputers are placed where the work is.

### Job helps define architecture

With the subdivide-and-conquer approach, each processor performs a clearly defined job, communicates with its neighbor processors, as needed, and perhaps also responds to commands from a higher-ranking, or host, machine. In this way the software breaks down to a manageable level, programming time and costs are slashed, and data are available where needed. The relatively low cost of today's minicomputers—typically \$2000 to \$4000—makes it economical to operate them at less than 90% of their capacity while still achieving a targeted operational economy.

The leader in this trend is not the hardware systems designer but the sophisticated end user. He either sets up and programs the particular network or frequently hires a software consulting firm to set, configure and program his system. The computer manufacturer supplies the ancillary electronics that bind the system into a manageable unit.



Rows of carburetor-flow test stands are individually controlled by SPC-16 minicomputers from General Automation. Groups of 31 stands report to an IBM System/7 supervisory computer, which, in turn, acts as a data concentrator for a 370/145. This hierarchical computer organization operates at the Rochester Products Div. of General Motors.

For example, data-communications systems often use ring or network configurations. The minis at each node route the messages through the links according to the appropriate algorithm, which maximizes throughput. The communication shares resources from several sites—like time-sharing. And the organization becomes leveled—that is, each element is equally important.

Factory control systems inevitably use a hierarchial configuration, where each mini is assigned specific tasks but reports key results to a central, or control, computer one level above. The resulting configuration closely resembles a line organization chart.

Networks with one host computer and a group



of terminals often take on a star structure, in which data radiate outward or inward toward the host. If communication becomes necessary between terminals, the host acts as a central message switch to pass the data between them. This configuration makes the network simple to control, because all data flow in and out of a single node. However, failure of the one node stops the entire system.

As a low-cost alternative, the ring, or loop, system is often used when buffered terminals and more than one host are in close proximity. Data are passed between any pair of interfaces on a multiplexed basis. Control passes in succession to each interface, which, if it has a message, addresses a given destination. The need for proximity occurs because the loop (actually a data bus) must handle the peak data rate for the en-

vironment and bulk-data transmission. Message tables in the minis route the incoming data to the intended destination. If a data link fails, the operator can inform the mini to route the request to an alternate computer. The latter reacts as if the message arrived from a terminal attached directly to it.

The over-all traffic load determines the number of computers and the links between them. As more message centers are needed, more minis are placed, and links are established to balance or prevent blockage at the nodes.

Arpanet, a more elaborate switching system, was placed in operation in 1969, and has grown from four cities to 34. The minis form the nodes of this topological network. They break up data into 1000-bit packets at the sending site, route each packet over a separate link, then reassemble all at the receiving site. Hosts of all sizes interface via the minis, which are called IMPs (for interface message processors).

In the GE Mark III Information Services Network, remote concentrators feed central concentrators, which in turn connect to large computer systems. The network, composed of more than 100 interconnected communication and data-processing computers, serves over 360 cities in the world.

The Tymshare, Inc., network, called TYMNET, uses 120 communications minis, which access at least 35 host computers. The topology resembles a multiple ring. A user calling into a particular node is assigned a route through the network to an appropriate CPU.

The Collins C-System is both a computer communications system and part of a dispersed computing facility. The inner loop forms a data-ring topology that operates at 32 Mbit/s and provides 16 channels, each with a capacity of 2 Mbit/s. Front ends to the hosts mimic standard terminal controllers and little modification to host software is made. The facility interconnects high-speed peripherals, such as tapes and discs, to multiple hosts. Slower outer loops join unit-record devices, character-oriented terminals and so on to the main data path.



The finished product tests other System/7's at IBM before shipment. The System/7 under test (left) is linked to the computer that monitors memory operation, control functions and data flow. Test data are printed out on a console (right, background) and relayed to a central System/360. A single System/7 can test up to four processors.

tire system without degradation.

Computer communication networks are expanding in two major directions—network control and distribution of information—according to Jack Branch, president of Incotel, Ltd., New York City, a software consulting house. The first use involves message switching, line switching and circuit (data) concentration. The second shows more imagination, since the network is used in conjunction with host computers to perform inquiry/response, data entry, information retrieval and related functions.

One example of a geographically distributed system designed by Incotel uses a network of three PDP-11 minis to support nationwide terminal-to-terminal communications, inquiry-re-

### Real-time control achieved in factories

The automation of a factory with a single large computer invites disaster. If the computer fails, the entire factory halts—as with any single-node system.

The more logical approach is to automate the job a piece at a time, then interconnect the pieces to complete the job. In the resulting system, individual minicomputers perform such dedicated tasks as control of 240 aluminum reduction cells, or control of a single paper machine that converts pulp to finished rolls. Analysis functions



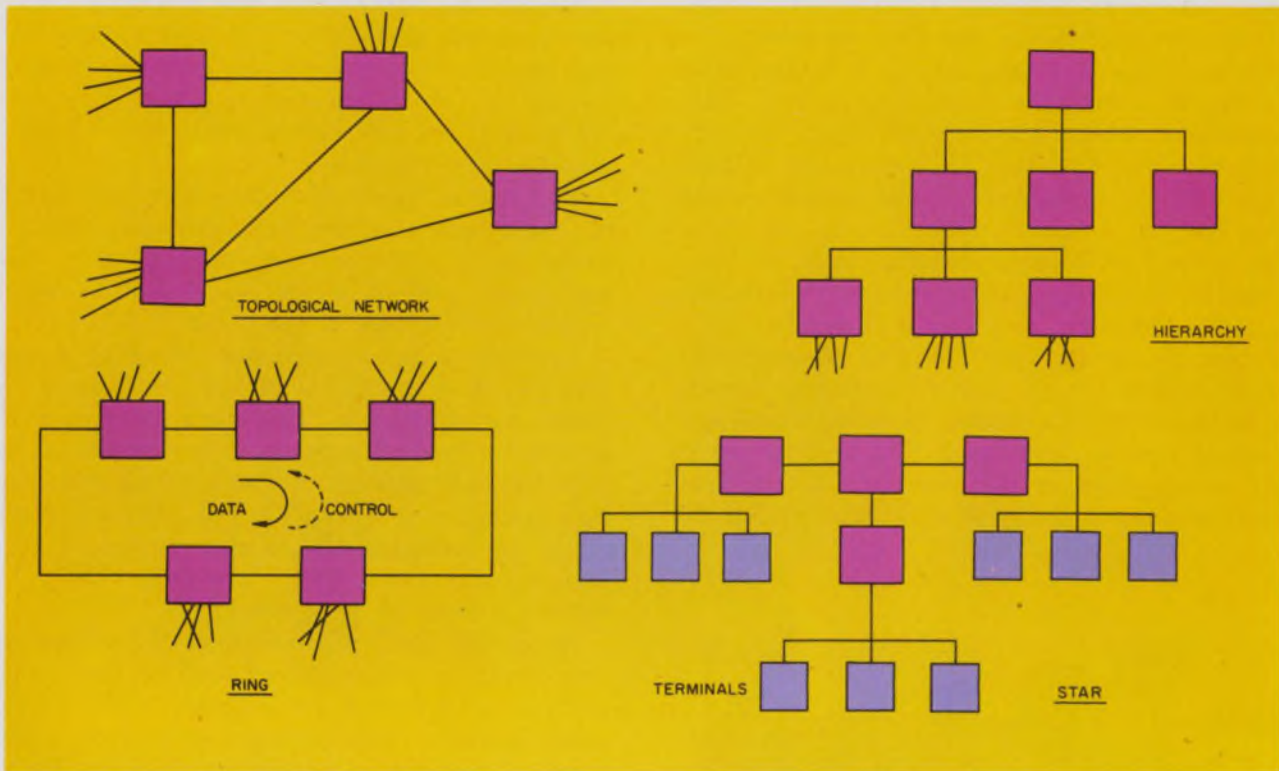

Configurations often seen in practical computer networks include the topological network, ring, hierarchy and star. The topological network handles distributed data communications, and the

hierarchy is used for factory control. The star predominates when satellites are controlled by a single host, the ring when more than one host and buffered devices are in close proximity.

are split off from data collection and summary operations. The user must provide some form of data-transmission path between the "worker" computers and the hosts.

The operation of the lower-level computers is oriented towards real-time control. As noted by Terry McMullen, manager of manufacturing automation systems marketing at Texas Instruments, programs at this level consist of brief re-entrant tasks or modules that are scheduled on a priority basis by a software monitor. A real-time clock periodically (about every 100 ms) initiates the scheduler, which, in turn, passes control (allocates the CPU) to active tasks on priority basis.

Command and control with the host has relatively low priority and is the function of a brief telecommunications package. The host interrupts the worker machine to activate the module, but the worker machine schedules the communication at its own convenience. Of equally low priority are summary transmissions from worker to host. These low priorities ensure that the worker computer remains alert to the real-time process under its jurisdiction. Excessive machine-to-machine communications could cause serious lags in reaction to time-critical events. The data rates between host and workers is fairly low—200 to

1000 baud—when compared with the tens of kilobauds for data-communication work. As a result, asynchronous telephone-line communication techniques are the most common medium. Yet the over-all system handles thousands of bits a second from an aggregate of hundreds of input lines.

#### Managing large hosts

The simplest network relieves a large host of such functions as combining characters into blocks, acknowledging transmission of each character and checking for error. A minicomputer, often referred to as a front end, takes over these functions while delivering complete blocks of data to the host. The host, in turn, sees the mini as a standard peripheral. The user applies the manufacturer's software without need for costly investment in terminal support programs.

This interface between small and large machines is almost universal in the world of distributed computation. For example, the ARPA network appears to the large hosts as a data file.

Computerized graphic systems also make use of the front-end interface. Applicon of Burlington, Mass., provides a system for PC network layouts. A mini performs software editing and dis-



play from digitizer to CRT terminal. The host performs the large-scale computation algorithm that provides routing and interconnects. The mini appears to the host as a standard remote job-entry terminal, and the applications programs can be written in Fortran.

The hierarchy can be extended a step further, explains Richard Diephius, a senior designer at Applicon. Microcomputers can relieve the mini by picking up coordinates and tracking the input pen with the CRT beam.

### Extensive hardware support provided

An ample abundance of practical hardware and software exists for those who want to take advantage of distributed computing.

Users of maxis and midis can exploit the architecture of computers like Control Data's Cyber 70 series or the Xerox 550 and 560 computers. These have an internal hierarchical system that allows the addition of processing capability in semiautonomous modular groups.

The major subdivision of tasks in these machines is between peripheral processors and a central processor or processors. The peripheral processors (PPUs) control, direct and disseminate I/O data between central memory or extended storage on an as-needed basis with the 70-series. These small processors operate independently of the central processor. Both types share central storage on separate data paths.

With the Cyber series, the CPU with its 60-bit word length, executes programs, does high speed computations and performs time-critical operations. But the operating system is controlled by a monitor program in a peripheral processor. System software coordinates the units.

The subdivision of labor is more straightforward with the Xerox 550 and 560—both 32-bit midicomputers. And the tasks performed by each component are more specialized.

The Xerox CPU is subdivided into a system control processor and basic processor. The system processor is a centralized interface that controls the operation of the basic processor and all I/O processors; the basic processor contains the arithmetic and logic unit.

The I/O processors are connected in groups to individual memory blocks, but they can share memory with other processor groups. Also, the system processor can control a direct interface to the basic processor. The direct interface equips the 550 and 560 for data-acquisition and control operations.

Multiplexed I/O processors handle unit-record equipment and magnetic tapes. Rotating memory processors handle disc data and perform such procedures as error correction, angular position sensing and automatic seeks for alternate tracks.



The Collins C-System uses a localized high-speed ring to join hosts and storage devices. Low-speed loops drive terminals and input devices. The system shown provides a statewide Iowa police network, with access to more than seven million traffic records and 250,000 criminal records on file in a System/370 complex at Des Moines.

Data-communication hardware for minis includes plug-in PC boards that handle up to eight asynchronous channels, each with rates to 19,200 baud—the Digital Computer Controls Model 116431. Digital Equipment's DH 11 interface handles 16 asynchronous channels at rates to 9600 baud each. A single PDP-11 computer accommodates up to 16 DH 11's (256 lines). Synchronous adapters include Data General's 4073, which handles four synchronous lines at up to 2400 baud each. A single Nova mini accommodates 16 units.

The software for data communications performs the following functions:

- Performs error checks.
- Acknowledges the message.
- Formats the message for use by the requesting program.
- Routes the message to the requesting program.

A hierarchy for factory automation and testing that operates via telecommunications is IBM's System/7 which can test other System/7's before shipment to customers. The latest System/7's, available since last December, handle up to 384 analog sensors and can communicate with the System/370 at speeds to 50-k bit/s in binary synchronous format.

As the processing tempo increases—for





Four interactive graphics terminals, each linked to its own minicomputer, help design electronic circuits with Applicon's system. The host, also a mini, provides additional support for this star configuration and can act as a front-end to an IBM 360, which calculates the PC art-work routings.

example, with nuclear power-plant control or aircraft flight-simulator control—character-by-character communication gives way to memory-to-memory transfers. For example, Data General's 4038 multiprocessor communications adapter (MCA) allows up to 15 Nova minis to communicate with one another at rates to 140-k words/s. Elystec's MCI-10 offers the same capability with a 1-MHz rate. Also, the allowable computer-to-computer distance is increased from 50 feet to 250 feet.

Interdata of Oceanport, N.J., plans to introduce a shared memory system similar to that used in Xerox's 550 and 560 computers. Each machine addresses a portion of shared core assigned to it as if it were an extension of its own address. Other machines can read from the assigned portion but cannot write into it. A message area allows the machines to check if others have left data from them to pick up. For more rapid response, the machines nudge each other through external interrupts. The ability of the 32-bit Model 7/32 to address a million words of memory directly allows the compiler to insert the shared references in a straightforward way—through the definition of a multiprocessor or global COMMON statement.

Digital Equipment's bus window, the DA-11F, performs a similar function, but between two processors. Computer 1 requests access to a block of memory data from Computer 2. When Computer 2 acknowledges the request, the first computer can treat an 8-k-bit module as an extension of its own memory. Computer 2 can also access

a block in Computer 1 in a similar fashion.

With low memory costs, today's minis do not suffer from a lack of high-level languages and operating systems. And a number of features in these systems lend considerable support to dispersed computing.

Communications capability often accompanied by time-sharing and multi-tasking (CPU time multiplexed among small jobs that run independently) are harbingers of distributed intelligence. For example, the MAX III operating system performs real-time and time-sharing operations on Modular Computer Systems MODCOMP II and MODCOMP IV computers.

The MAX III system shares time between as many as 256 program segments (called tasks). Through an extension of the time-sharing capability, a satellite computer attached to the host can perform a job normally assigned to the host. In fact, the satellite has access to all the main peripheral equipment attached to the host.

In a related development, this time in the intelligent-terminal market, Linolex of North Billerica, Mass., has introduced a terminal that can broadcast a program from one terminal to another for execution. The system lets the user generate the program in an interactive mode, then transmit the result by telephone to any remote site.

#### Experiments unlock new potential

Maxis are still best for processing the large volumes of data found in astronomical, seismic and weather-forecasting calculations. Also, software support for high-level languages tends to be better with large-scale machines than with minicomputers.

Yet, less than a year ago, use of large centralized data bases was also cited as a reason for use of the maxis. Since then, minis have been mated to IBM 3330 disc drives that store 1.6 billion bytes. A controller called the Computroller, manufactured by Diva of Eatontown, N.J., performs the feat.

Experiments conducted by David J. Farber, associate professor of the University of California, Irvine, could ease the general-purpose maxi out of small-to-medium data-processing jobs. At Irvine, a network of four minis (three Lockheed Sue's and a Varian 620i), joined in a ring configuration, divide program tasks in accordance with the capacity available at each machine. The goals of the experiment are twofold:

- To create a network in which one machine can request services of another machine, such as a file, printer or card reader.
- To create a larger distributed machine that can link microprocessors—say, in a typewriter—



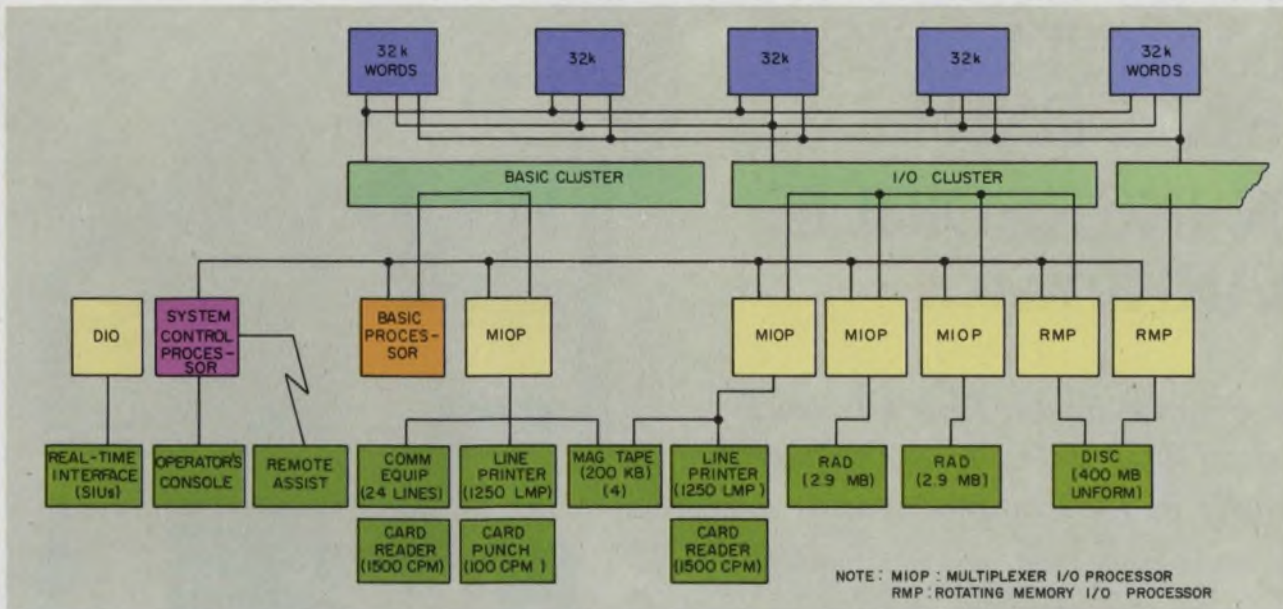

A very modern midi, the Xerox 560, makes use of an hierarchical architecture. Input-output and arithmetic processors have distinct functions but

are controlled by a single system control processor. Each processor can share memory with other clusters when needed.

with the file-handling and processing capability of minis.

An interface between each machine and the ring stores the names of programs and files for the machine. The programs send messages around the 2.3-Mbit/s ring and receive answers from machines that can perform the task. The sender need not know which mini has the program. The data are processed between the programs themselves. No one machine is the exclusive controller.

Programs can move from one computer to another to balance the load. As a program runs, a periodic request for a bid to do the job is sent around the ring. Each machine in the ring has an algorithm that it uses to price the bid. The lowest available bidder "wins" the job. The system has been in operation at Irvine for seven months. Future research will center on improvement of the present simple cost algorithm, to gain a good general sharing of resources.

While minis seem to dominate the distributed computer scene, the midis and general-purpose maxis are striving for their debut. Control Data Corp. is impressed enough with its Cyber 70 series to supersede them with the Cyber-170, announced this month. The new series continues the distributed architecture present in the Cyber-70 series, with an upgrade to bipolar and MOS LSI circuitry. The machines, which feature increased speed and reduced size, are designed to operate in a computer network.

One of the projects at Bolt Beranek & New-

man Inc., the consulting and R&D firm in Cambridge, Mass. is on distributed computing. Dr. William R. Sutherland explains that the project group is looking into how the 10 computers on the ARPA network—which support the Tenex operating system, developed by BBN—can operate as a single, unified system. One difference between this work and the Irvine experiments is that Tenex runs on a midi, the PDP-10.

Another concept in the beginning stages, but in operation, is a distributed data base. This extension to the time-sharing ability to append files works as follows: Say, file F00 is at Stanford Research Institute in California and file TEXT is at BBN. The command APPEND F00 TO TEXT causes one file to move across the country to join the other on its disc. And the new file can be made to reside at a third location.

In an unusual demonstration of load leveling, a different program runs for a while, stops, then picks itself up and migrates over the network to another machine, then executes there for a time. For the demonstration, a user prods the program to move on, but in the future, the programs could migrate automatically when they sense that the machine they are running on is heavily loaded. The migration, of course, would be to a more lightly loaded machine.

Dr. Sutherland cautions that these exotic capabilities are now still in the research stage, but he expects that their enormous commercial potential will make them tomorrow's reality. ■■



# DIVA'S COMPUTROLLER, PDP 11, AND 3330 TYPE DISC DRIVE UNITE.

## AN INCREDIBLE MARRIAGE.

*An Episode in the True Chronicle of the DIVAS, Proudest Peripheral Family in the Computeworld.*

The computeworld stares in awe at the incredible wedding scene which has unfolded before them. The bride is minicomputer PDP 11, offspring of the illustrious maxi-computer clan, begat of Abacus. The bridegroom is DIVA COMPUTROLLER, scion of this proud, most respected peripheral family. Officiating at the ceremony is Duke DIVA Disc Drive, direct descendant of IBM compatible 3330 type disc drives.

Realizing the great impact this interfacing will have on the computeworld, our happy guests monitor the wedding with joyous solemnity.

"Mated," Interdata 70 whirrs, "PDP 11 will have access to 100 million bytes of data on a single spindle or 200 million bytes on a dual spindle disc drive unit within an average access time of 32 msec."

"And with COMPUTROLLER providing a buffering sector, data will be transferable at the rate of 645,000 bytes/sec," marvels Nova II.

"And keep in mind," interrupts a breathless TI 980A, "that with COMPUTROLLER controlling eight drives, mini will have access to 1.6 billion 8-bit bytes of data!"

But, hush! Listen to Duke DIVA repeating those always-inspiring words: "With the data stored in me, and with provided interconnecting cables and distribution panel, I now pronounce you linked in holy matrimony."

Resounding cheers befitting the occasion arise from the crowd. "A toast! A toast! A toast!" they roar. As is the custom, the proud parents, mini processor and DIVA controller, propose the toast to the dazzling couple: "To the most splendid and significant union in all our memories."



Mini PDP 11

"Vive, DIVA! Vive, DIVA! Vive, DIVA!" Everyone unwinds.

But even as we listen to the clink of ceremonial glasses and the exuberant laughter, we sense an underlying sadness. Those unchosen minis — do they count for nothing now? Will they not be able to enter the world of high speed data storage/access and low cost/bit performance? And why — throughout this entire festivity — has COMPUTROLLER remained hidden under his purple robe? Is there more to

COMPUTROLLER than meets the eye? Be sure to join us for the next episode in the True Chronicle of the DIVAS when we will hear the horrendous accusation: "Bigamy! BIGAMIST!"

In the meantime, learn COMPUTROLLER'S inside story. Find out about the free implementation and training courses, the software packages, and warranties that go with each disc system. All you PDP 11 users call George Roessler at 201-544-9000 for cost and delivery information. Or write: DIVA, Inc. 607 Industrial Way West Eatontown, N.J. 07724 TWX 710-722-6645.

### REGIONAL SALES OFFICES:

CT: 203-526-3222

CA: 415-349-3482

Wash. DC: 703-370-5211.

GSA CONTRACT NO.  
GSS-OOC-00159.





# **THE MICRO- PROCESSORS**



# THE CHIPS

Microprocessors for do-it-yourselfers. From National Semiconductor. On distributors' shelves now.

Our chips are two P-MOS/LSI circuits that can be slapped together like building blocks to yield computer systems ranging from simple 4-bit processors for control functions to a powerful 32-bit system that handles complex calculations.

National's building blocks are the Register and Arithmetic Logic Unit (RALU) and Control and Read-Only Memory (CROM). Together they contain all the gates and flops you used to have to wire together to build your own processor.

## The thing that does the work.

### RALU.

A 4-bit slice of the Register and Arithmetic portion of a general purpose computer.

In one 24-pin package using standard +5V and -12V supplies

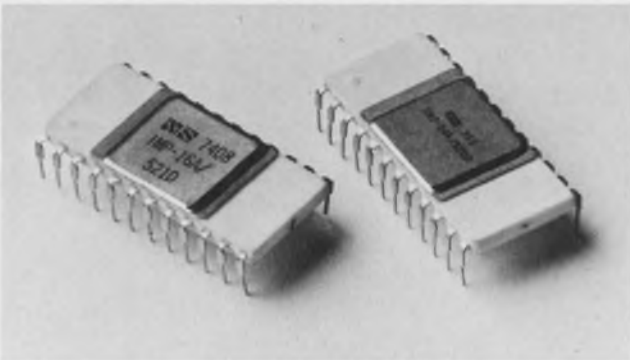

we've crammed all of the following: seven general-purpose registers, a status flag register, an arithmetic

logic unit, an I/O multiplexer, and a 16-word LIFO stack that improves speed and performance while conserving main memory. The RALU number is IMP-00H/520D.

## The thing that tells the other things what work to do.

The only trouble with RALUs is that they don't understand English. Or even the zeros and ones that you feed into the microprocessor.

CROMs do understand zeros and ones.

They're souped-up ROMs that translate your binary instructions into operational commands. A single instruction to the CROM triggers a series of commands to the RALUs.

CROMs are currently available in three varieties:

A standard-instruction 16-bit CROM, IMP-16A/521D, with 43 instructions.

An extended-instruction 16-bit CROM, IMP-16A/522D, that speeds up processing with 17 additional powerful instructions including divide, multiply, double precision add/subtract, etc.

And an 8-bit CROM, IMP-8A/520D with 38 instructions.

You can buy the RALUs and CROMs in these set numbers: IMP-16A/500D: 16-bit standard set; IMP-16A/502D: 16-bit extended set; IMP-8A/500D: 8-bit standard set.



# THE CARDS

For people who want to save time, National offers its "ready-mades."

Complete, fully-debugged 8 and 16-bit microprocessors on 8½ by 11 inch p.c. cards ready for your application program.

## Our big ones.

The IMP-16C is a 16-bit microprocessor built around four RALUs and one or two CROMs.

The one-CROM version has a standard-instruction-set CROM and

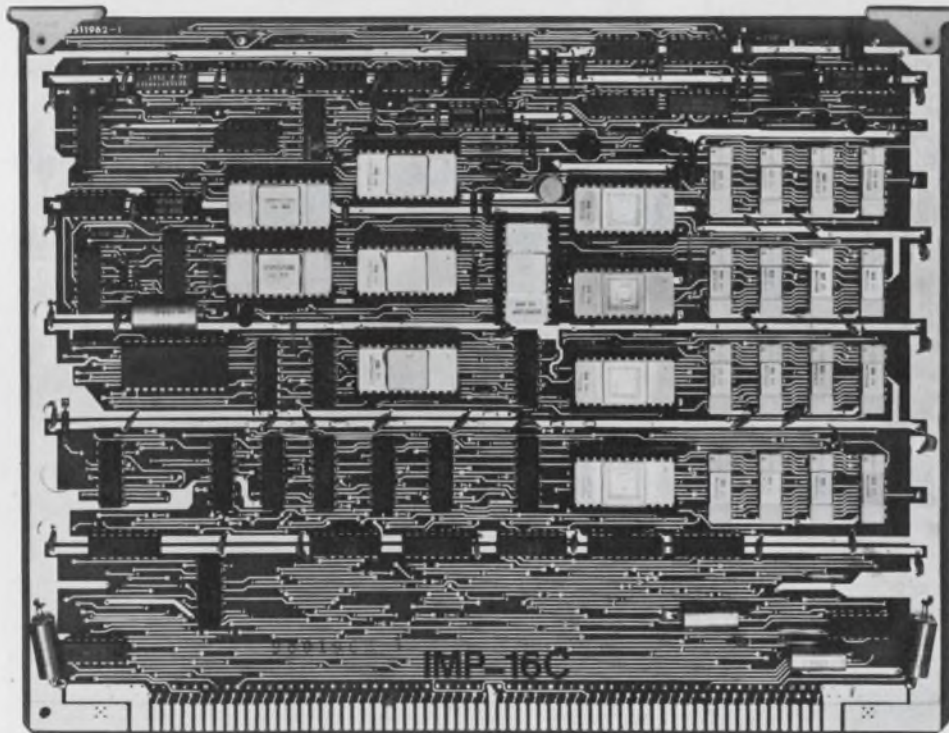

an empty socket for another (IMP-16C/200). Add the extended instruction-set CROM and you've got the IMP-16C/300.

The IMP-16L/300 card is similar to the 16C/300, but we optimized it for high performance applications

with a Direct Memory Access bus controller and multi-level interrupts.

## Our little one.

IMP-8C, 8-bit microprocessor. Small, but oh my!

A flexible, low-cost, self-contained processor and controller containing two RALUs, an IMP-8A/520 CROM, and provisions for the addition of a second CROM to expand the instruction set.

If 8-bits is your thing, you'll find

some things here to turn you on: 8 addressable control flags—control jump multiplexer provides 16 programmable branch conditions. Eight-bit buffered-data-out bus. Memory addresses 16 bits wide to provide a memory address range of 65,536 bytes. On-card memory expandable to 2304 bytes, consisting of 256 bytes of read/

write memory and up to 2048 bytes of read-only memory (ROM/pROM).

But whether you go for 8-bit or 16-bit, cards or chips, the question is, what are you going to do with them once you've got 'em?

Please turn the page.



# THE BOXES

The advantages of the whole microprocessor thing lies in the fact that it is standard hardware designed and built for you to *program* to your specific application.

Our boxes help you do that.

They're program debugging and prototyping systems, providing everything you need to develop and test both the interfaces and application programs.

Each box includes a microprocessor card, programmers control panel, peripheral interfaces, memory, power supply and chassis.

## Box #1

The IMP-16P.

A microcomputer for use with the IMP-16C microprocessor cards. With a Teletype, the IMP-16P provides all equipment necessary for the immediate evaluation and use of the IMP-16C (both 200 and 300) cards and chips.



## Box #2

The IMP-16L.

A prototyping system for the IMP-16L/300 card. (And if you're starting to get confused by all the different numbers, the chart on this page should help unconfuse you.)

The basic IMP-16L and options provide an unusually versatile tool for developing a variety of OEM equipment, software, and full-scale processing systems.

## Box #3

The IMP-8P.

For 8-bit fans this is the prototyping tool for the IMP-8C card. Like the others, IMP-8P puts all you need for hardware and software development all in one box.

## What goes with what.

	CROM Types:	# of RALUs	Cards:	Boxes:
standard 16-bit	IMP-16A/521D	4	IMP-16C/200	IMP-16P/204
extended 16-bit	IMP-16A/521D IMP-16A/522D	4	IMP-16C/300	IMP-16P/304
extended 16-bit with DMA	IMP-16A/521D IMP-16A/522D	4	IMP-16L/300	IMP-16L/304
8-bit	IMP-8A/520D	2	IMP-8C/200	IMP-8P/208

So that's our basic hardware. Our boxes, our cards, and our chips. But we're not quite through yet...



# THE WORKS

National wouldn't leave you out on a limb. We support our hardware with software, firmware, and accessories that help make the whole thing easier to apply.

## The assemblers.

What we have here is a communications problem.

RALUs don't understand what binary instructions are talking about (so we have CROMs to act as interpreter). And CROMs don't understand what human beings are talking about.

What's needed in the latter case is an assembler, which is a computer program that automatically converts English to binary language (something CROMs can understand). You just feed the program language and the assembler program into the computer and out pops the computer language.

We offer three kinds of assemblers, in both 8 and 16-bit versions. A self-assembler that needs no "outside" computer if you have one of our prototyping systems...a cross-assembler for use on your in-house IBM 360/370 computer... and a cross-assembler for use on a timesharing utility.

## Other goodies.

We offer a strong software support package. Things that help you write the program you need, and check it out. Application, interfacing

and programming manuals...extensive diagnostic programs for hardware testing...loader programs...soft-

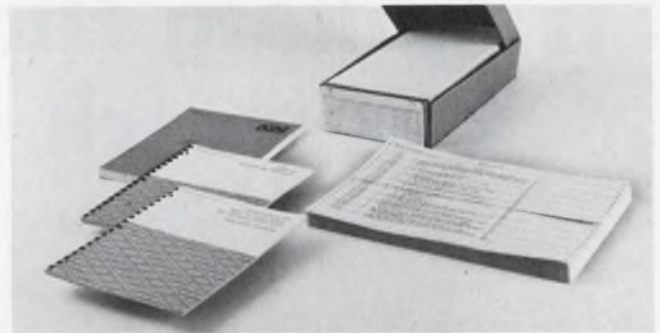

ware debug routines...utility routines, etc.

And there's also a passel of support hardware such as card cages, memory cards, extender cards, prototyping cards, peripherals, plus training courses to make you an expert in a hurry.

In other words...the works.

For further information use the coupon or call us at (408) 732-5000.

NATIONAL SEMICONDUCTOR  
2900 Semiconductor Drive, Santa Clara, California 95051

Please send me the following literature:

- 16-bit Microprocessor Product Descriptions
- 8-bit Microprocessor Product Descriptions
- GPC/P Microprocessor Chip Product Data Sheets
- National Training Courses
- Have a salesman call.

Name \_\_\_\_\_

Title \_\_\_\_\_

Company \_\_\_\_\_

Address \_\_\_\_\_

City \_\_\_\_\_ State \_\_\_\_\_ Zip \_\_\_\_\_

Phone \_\_\_\_\_

2

# NATIONAL

See us at Booth #753 National Computer Conference in Chicago.



## Take-your-pick software is making the mini mighty, but watch out—it costs

Jim McDermott, Eastern Editor

A "smorgasbord" of operating software and application systems developed by both manufacturers and users is giving today's minicomputers power usually associated with the larger computers. But with the advances have come problems.

The operating software—a collection of inter-related programs that tell the individual computer elements how to interact—provides the intelligence for the machines so they can perform tasks. These tasks, defined by software applica-

tion systems, range from the monitoring of a simple industrial process to real-time, multiple-user, foreground-background operation.

But one problem is the high cost of preparing, debugging and executing the application programs. This cost has widely outstripped that of the minicomputer mainframe. The software for a typical system may cost 10 times the original investment in hardware, according to Philip Stein, minicomputer consultant at the National Bureau of Standards, Washington, D.C.

Michael A. Ford, vice president of General Automation, Inc., Anaheim, Calif., agrees.



Software—the programs and routines that run a computer—are stored on media like paper and

magnetic tape. Magnetic discs, cartridges and cassettes plus punched cards are also used.



"A month of programming," Ford says, "can cost as much as a minicomputer. And you can buy a whole computer system for the price of one programmer's services for a year. Moreover salaries are rising, while the cost of computer hardware is falling."

### Efforts under way to cut costs

There is a genuine effort in the minicomputer industry to cut costs by providing system software that requires less programming time. Evidence of this is the growing quantity of both off-line and real-time software with higher-level languages like Fortran and Basic, which are easier to use than the machine-oriented assembly-language programs. While hardware costs are higher for real-time, higher-level languages, because more memory is required, that expense can be offset by reduced programming costs.

For example, Van Diehl, product manager for the Hewlett-Packard Automatic Measurements Div., Sunnyvale, Calif., points to many years of controversy between the proponents of assembly languages and those of higher-level languages.

"It's still going on in some quarters," he notes, "because with assembly language you can develop shorter and faster programs with a minimum of memory. But with the price of 4-k of core down to a few thousand dollars, it's hardly worth saving a couple thousand words of core when, to do that, you have to spend three to six man months more programming in assembly

language. For the cost of a highly sophisticated programmer for this period, you can buy not only the 4 k of core but another computer."

Picking the best software for the job can be very difficult. Software specs can mean different things to the hardware-oriented designer and the software salesman. Robert Oakley, product manager of computer systems for Varian Data Machines, Irvine, Calif., says:

"There is a type of specmanship and there are interpretations of terminology in the software area that exceeds the exceptions and differences in the terminology used for computer hardware. For example, because one manufacturer says he has a Fortran software compiler doesn't mean he has the same one as a competitor. There are a number of different specifications for Fortran compilers. And not investigating this can be costly.

"A user may have a system which runs Fortran, and he wants to upgrade to a newer system. If he isn't knowledgeable about the differences in the various Fortrans offered, he could buy a computer which he thinks meets his needs. But he'd be in for a shock."

For other high-level languages, like Basic, RPG or Cobol, a number of nonstandard modifications can be a trap, Oakley points out.

How can the designer protect himself? Andrew Breslin, applications analyst for Computer Automation in Irvine, takes a pessimistic view.

"There is no way that someone who is not familiar with software can protect himself from

## Software code generation and translation

Programs for computers can be written as a binary code that the machine can directly accept and use. But generating programs in this fashion is impractical because it is a very difficult and time-consuming task. Instead, coded terminology of differing levels of complexity have been devised for easier understanding and manipulation.

The first improvement on binary coding is in the form of machine instructions that are small groups of letters and numbers, called assembly language. These groups are decoded in the computer by a software package called an assembler. The output of the assembler—binary-coded machine instructions and addresses—is directly usable by the machine.

To get the computer to do much of the routine work involved with programming, higher-level languages were devised. Instructions in these languages are written in the form of statements. Depending upon their complexity and the machine task which they are to perform, they are translated into machine code by compilers or interpreters.

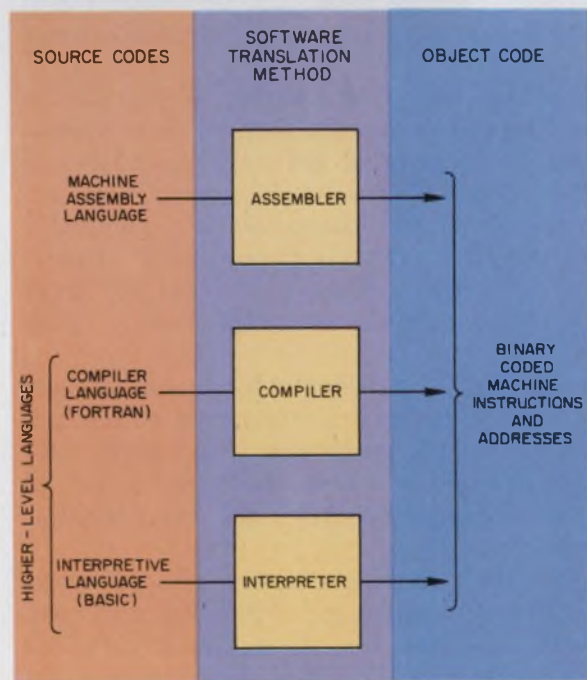



an unscrupulous salesman," Breslin says. "If you decide he's giving you a snow job, get rid of him. If not, listen to him."

R. Stockton Gaines, technical staff member with the Institute of Defense Analysis, Princeton, N.J., insists that the hardware designer, to protect himself, should learn something about programming. "It's an effort to learn," he points out, "but once you have, you're better off in many situations than calling on someone else. And at least you can communicate with vendors."

Gabe d'Annunzio, marketing services manager for Prime Computer, Natick, Mass., says that the application of software to hardware can be simplified by a new approach. "Instead of looking at each element of software as an individual item, with individual specifications and qualifications, put the software into the total system concept," he suggests. "Evaluate it on the basis of total system performance."

Software and hardware incompatibilities will show up more easily under the system-analysis concept, d'Annunzio insists.

"We suggest you look at software from two viewpoints," he says. "First, much system software now offered is three or four years old in its basic design. But it's attempting to support new minicomputers that, from a hardware standpoint, are probably less than six months old. A principal problem here is, 'Does the system software even know that many advanced features exist in the new machines they're trying to run?'"

Surprisingly in many cases, the software doesn't, d'Annunzio notes.

A second major aspect for the mini system designer to consider, d'Annunzio says, is whether the computer manufacturer has built features into the hardware to make it more responsive to the software. In many cases, he says, the answer is no.

"Neglecting the system aspect of software—the fact that it has to work with the hardware—and looking at isolated software specifications doesn't tell a thing," d'Annunzio warns. "For example, if you look at the specs on a particular Fortran compiler, you only determine whether it produces a Fortran code or not. What you don't know is how it works with the rest of your system."

Some 99% of all minicomputer manufacturers offer a Fortran compiler, d'Annunzio points out. But significant differences exist between the compilers, he says—not within the compiler but in how the compiler makes use of computer features.

For instance, some computers offer floating-point arithmetic hardware. While Fortran compilers are available for those systems, several don't generate code that will automatically use that hardware.



Low-cost software development systems, like this 980A system by Texas Instruments, support users who do not need large, disc-based computers.

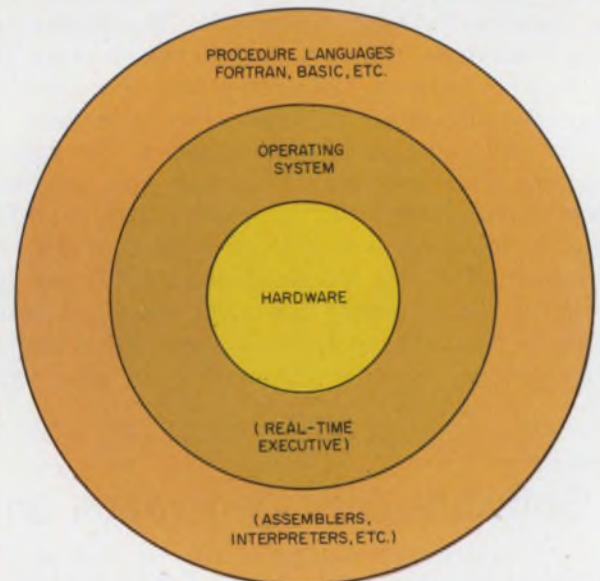

For industrial real-time minicomputer applications the buyer not sophisticated in software should be sure, says Van Diehl of Hewlett-Packard, that the software elements of the outer circles are also provided by the minicomputer vendor.

On the other hand, d'Annunzio says, if the Fortran compiler can use floating-point hardware, there is this basic question: How easily can it do it?

For example, different mini vendors put the floating-point hardware in different places in the computer. Some treat the floating-point processor as a peripheral device and hang it on the input-output bus of the computer. The vendor will tell you what the floating-point add time is—the time it takes to add inside that unit—not the overhead time necessary to address the floating-point processor as a peripheral device, bring



the information in, put it in the memory and then produce the results.

Some vendors, including Prime Computer, treat the floating-point processor as a central processor. It's directly linked to the CPU, and memory-reference instructions are used to access the floating-point unit. Which means that you can use direct addressing and call the instructions automatically from the Fortran compiler.

Another point that may be concealed by software specsmanship is lack of file-structure compatibility. With various vendors offering large memories and disc-operating systems, it's now possible to have the minicomputer process large data files. And the larger machines can create programs for smaller ones in their line.

But with some computers the file structure used by the disc-operating system when it develops a program is incompatible with the file structure used when that program is run by a real-time operating system. This means that the files must be reformatted by a programmer, and this takes time and money and adds the risk of mistakes.

Some minicomputer manufacturers, following IBM's lead, provide a file structure that is compatible with all the software systems for the company's line of machines.

### File compatibility reaps benefits

An advantage of such complete file compatibility, according to Richard Farwell, marketing manager of software systems for Data General, Southboro, Mass., is that programs can be developed by real-time, disc-operating systems for later use in stand-alone operating systems or in stand-alone, core-only, real-time operating systems.

"Our paper-tape formats, magnetic-tape formats, cassette formats and disc formats are fully compatible," Farwell says, "As a result, a Data General user can start with a small—perhaps a stand-alone—system and do program development. By extending the system with core or disc, it can be expanded to a larger system without reprogramming what's previously been done."

With some disc software operating systems, the space on the disc is not allocated to individual files. The customer must identify the file locations himself, at considerable programming time and expense. In other systems the disc-base allocation is provided automatically and referenced by name as well.

The problems of compatibility have been of considerable concern to Digital Equipment Corp.

"While it's been difficult, if you've written a user program to move from one system to another in the PDP-11 line, we've taken positive steps to remove those difficulties," says Peter van

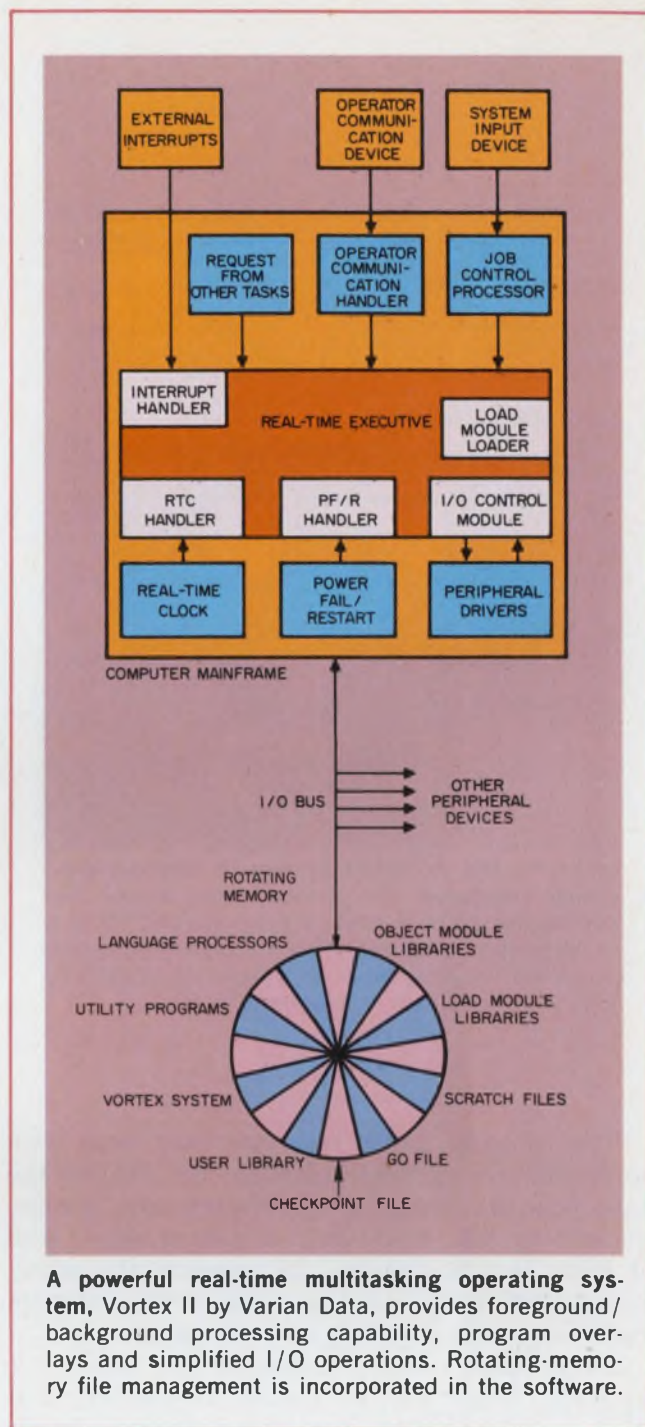

**A powerful real-time multitasking operating system, Vortex II by Varian Data, provides foreground/background processing capability, program overlays and simplified I/O operations. Rotating-memory file management is incorporated in the software.**

Roekens, manager of PDP-11 medium and large development.

"The problem has been software. But in the operating systems coming out now there are compatible paths, so the users can move programs from one system to another. We have several systems that are now compatible. They require only a relinking of programs to go from one to another, van Roekens points out.

"Part of a new series of systems that are coming out—some have been already released—have both compatible user interfaces and compatible file interfaces."



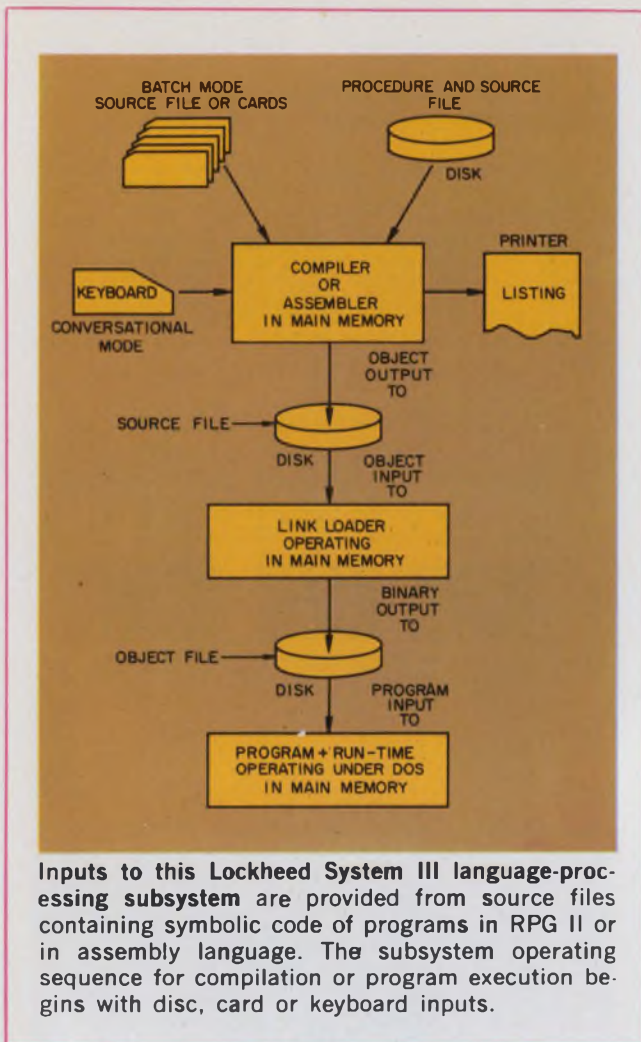

Inputs to this Lockheed System III language-processing subsystem are provided from source files containing symbolic code of programs in RPG II or in assembly language. The subsystem operating sequence for compilation or program execution begins with disc, card or keyboard inputs.

Traditionally paper tape has been used with minicomputer systems software. But loading the tape into the computer has always been a time-consuming job, frequently requiring days. And if there is a mistake in the program, it's necessary to return to the beginning of the program reel and do the program all over again.

As a result, many companies now offer disc systems, which can be loaded in minutes. But discs aren't as safe as paper tape. There's always the possibility that the disc will "crash" either through mechanical failure or sloppy programming.

For example, the program may access a file when it's not supposed to be accessed. Some vendors take the attitude that if the user makes such a mistake, lotts a luck. Others provide system software that makes checks. Some of this software can help identify a file that has crashed and also help reconstruct a destroyed file.

Questions to ask here are: What has the vendor done to ensure the integrity of the file? What will he do to bail you out once you've made a mistake? Is it going to take a couple of days to reconstruct the file from cards—or can you go in

in-line and do the job?

There are several levels of minicomputer software, and the level selected depends upon the size of the machine and its task, notes Andrew Breslin.

Usually, says Breslin, you can execute programs on most any machine—although that isn't always true—but it frequently takes a large-scale minicomputer to compile the programs. For example, a basic mini will have a small memory of 1 or 2 k—which is nowhere near enough to run a Fortran compiler. However, the compiler's output—the compiler code—can be run on the small computer.

Not all systems will let you mix Fortran and assembly languages, and that can be critical—for example, in process control. It's necessary to distinguish between the ability to run and the ability to run usefully. An assembler that can just barely run in a 4-k memory may not be able to assemble a large enough program to be useful.

And you want to make sure that the language will be able to support the required peripheral devices. "For example," says Breslin, "we have a Fortran compiler that we sell which will run on as little as 4 k. But it doesn't support a line printer or a card reader."

The minimum of software needed for any job, Breslin says, must include a language translator that accepts a program statement written in mnemonic code. For example, statements like "HALT" or "LOAD A" might be used to instruct a machine to load one of the registers. The language translator converts these statements into "object text." Also required are software loaders—programs that take object text and put it into the machine in a form suitable for running the machine.

Translators, Breslin says, come in a variety of forms, particularly assemblers, compilers and interpreters. Assemblers and compilers produce code, or machine-language programs that are executed on the computer in binary form. Interpreters—a Basic-language interpreter is a prime example—produce an intermediate language that is closer to machine language. And this intermediate language is, in turn, interpreted by yet another program called the "run-time" program.

Breslin points out that the compilers and assemblers—which produce ready-to-run code in machine language—execute the program considerably and with less memory than the interpreters do. On the other hand, the interpreters provide a much easier alteration of the program once it's done.

For industrial-control applications, interpreters are not generally used, Breslin notes. More common, he says, is the assembly language, which is a one-to-one representation of the machine language. The assembly language, he adds,



calls for a higher level of programmer's skill than Fortran—a one-to-many conversion—does. One Fortran statement produces many machine-language statements and instruction. Fortran and assembly language account for the vast majority of all minicomputer programming, Breslin says.

Most people approach the development of mini-computer software by first trying to determine the language that the program will be written in, says David Waks, vice president, Applied Data Research, Princeton, N.J. But he continues, there are at least two questions that must be answered before the language step: How are you going to get the system debugged and running? And what kind of a computer are you going to use to get the program working?

### Choosing a computer language

The choice of language and the choice of systems approach is ultimately going to be governed by how you get the system working. From there, the choice of language follows. It's a question of what language or mixture of languages you're going to fit into that operating environment.

Minicomputers today are all essentially the same, Waks says. The prices, the features and what you can do with them are comparable. "But when I choose a machine for an application," he stresses, "I choose it on the basis of the degree of software support I get from the manufacturer, because it costs a fortune to develop the software. Take a typical operating system. No manufacturer has an operating system out that has cost him less than \$200,000—probably closer to a million—to build. No one has a working, field-tested Fortran compiler that cost less than \$50,000 to \$100,000."

Many minicomputer manufacturers recommend that a purchaser use the machine on which he's going to perform his system tasks to develop the program as well. But in a real-time environment, Waks feels, this is "the worst possible choice.

"The computer configuration typically chosen to run in a real-time environment," he says, "is not optimized for program development. It's optimized for the application problem. To be optimized for program development, it has to have a disc; it almost necessarily has to have a line printer, and it probably has a high-speed paper tape.

"And it's got to have a fair amount of core in order to run the various computer utilities. Also, it has to be big enough to support an operating system that's going to run the program generation systems—the macroassemblers, the Fortran compilers, or whatever. For example, if you're talking about a Nova computer, you're committed to a 24-k machine with a fairly large disc

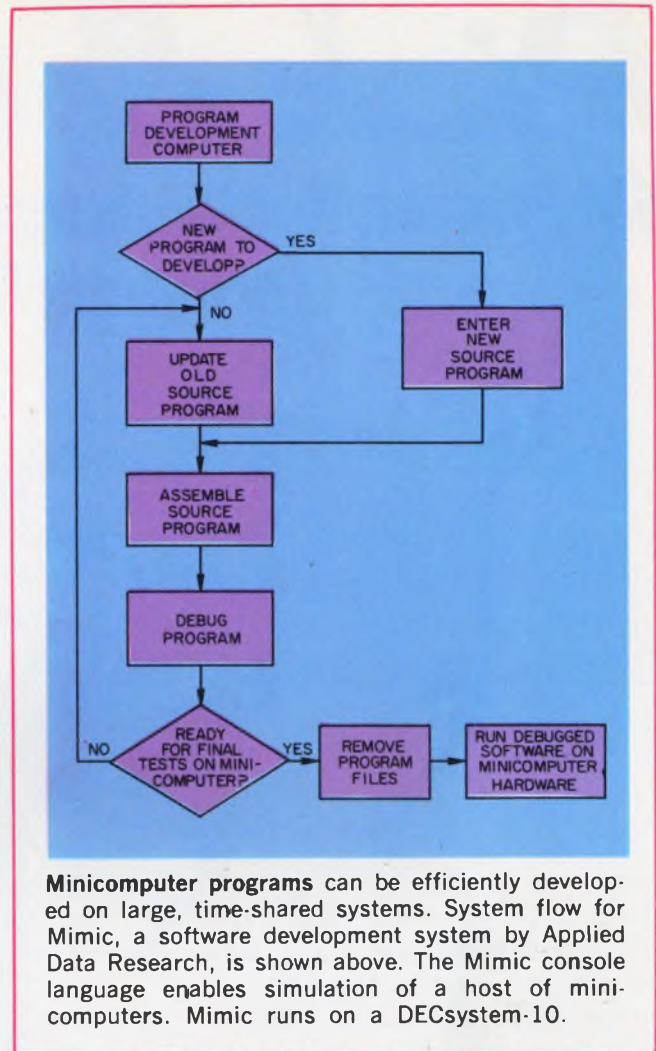

Minicomputer programs can be efficiently developed on large, time-shared systems. System flow for Mimic, a software development system by Applied Data Research, is shown above. The Mimic console language enables simulation of a host of minicomputers. Mimic runs on a DECsystem-10.

and line printer.

"You can size your mini to the application if you're going to use some other machine for program development. But if not, the machine must be large enough for the latter task."

To reduce the programming time required by the higher-level languages, some larger minicomputer systems incorporate software that performs what is termed "global optimization."

The key to this system is a multipass compiler that makes the code more efficient by recirculating the program elements several times through the compiler. Many of the program revisions routinely done by the programmer to optimize a program are performed rapidly by the machine.

Data General uses global optimization in its Nova systems.

"With global optimization," says Farwell, "a multipass compiler looks at the total program as it is compiling it and resolves any common references to variables and to pieces of code that are common to multiple parts of the program. If the same calculations are made in multiple places in the program, the global compiler pulls them out and only calculates them once." ■■



# *Pick & Choose*

## *OEM Printer Mechanisms and Complete Teleprinter Terminals from SINGER*



You pick from our basic 30 cps impact printer mechanisms in 80 or 132 column OEM configurations and choose from many completely packaged ASR, KSR and RO terminals with interface. Or, if you need something in-between we can supply that too; the power supply, printer and communication interfaces and/or logic sub-assemblies to meet your exact requirements.

So whatever you need in OEM printer mechanisms and terminals, it's available at Singer . . . Call, write or circle the reader service number for our new printer brochure today and see how Singer can satisfy *your* printer requirements. International Teleprinter Corporation, The Singer Co., 493 Washington Avenue, Carlstadt, New Jersey 07072 — (201) 438-1770 — TWX 710-989-0111.

# **SINGER**

**INTERNATIONAL TELEPRINTER CORP.**

INFORMATION RETRIEVAL NUMBER 41

34



# The digital world is a COS/MOS world.

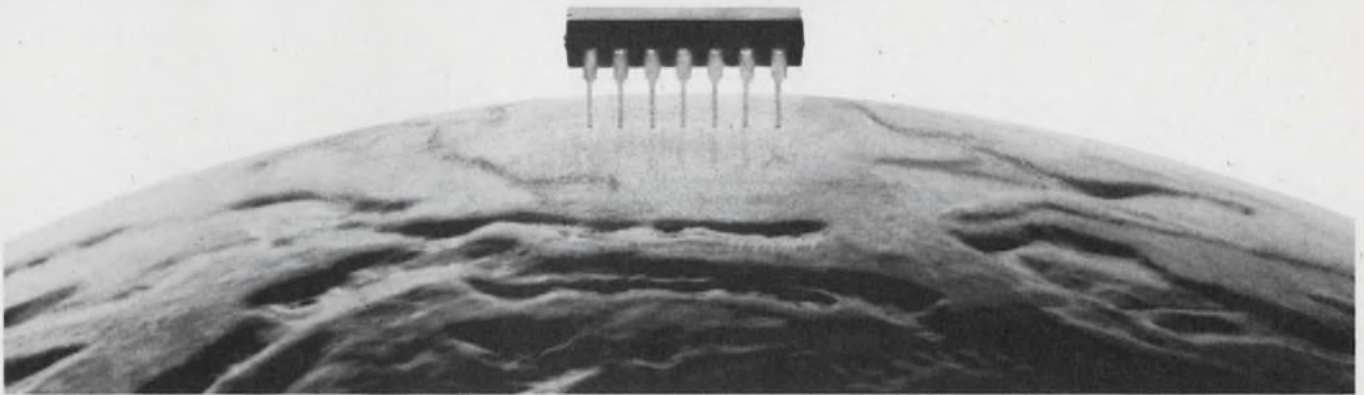

RCA COS/MOS widens your world of digital applications. It offers a combination of features that can't be matched by other digital technologies.

Features like ultra-low power consumption... 10 microwatts per gates! This permits high chip-packing density, use of small power supplies, and a money-saving reduction in cooling requirements.

So COS/MOS is ideal for battery-operated equipment. No longer do you need to be tied down by the power cord.

COS/MOS circuits work great from 3 to 15 volts. That means you can use inexpensive power supplies without fancy regulators. You can use long wires and simple low cost P.C. boards without worrying about signal attenuation.

COS/MOS noise immunity is among the highest of any technology (typically 45% of supply voltage), making it suitable for use in high noise environments such as the automotive and industrial control industries.

The stable transfer character-

istics of COS/MOS typically change less than 3.0% over the full military temperature range. So you can place COS/MOS circuits just about anywhere without worrying about them being overheated.

And you get more system cost effectiveness in the broad selection of COS/MOS circuits: from simple gates like the CD4011 Quad NAND to highly complex functions like the CD4057 Arithmetic Logic Unit.

Let RCA, originator and the world's largest producer of the industry standard CD4000 Series, introduce you to the world of digital COS/MOS. We believe you'll soon be convinced that RCA COS/MOS is the best answer for your digital system designs.



Send for complete data packet, including the latest COS/MOS Product Guide. Write: RCA Solid State, Section 57D26 Box 3200, Somerville, N.J. 08876. Or phone: (201) 722-3200.

**RCA** Solid State



# EVEN THE BIGGIES HAVE TO BEAT THEIR OWN DRUM SOMETIMES.

It's about time we made some noise about the fact that we're one of the top three manufacturers of modular regulated DC power supplies. What does that mean to you? Plenty! ACDC Electronics provides one of the most extensive lines of standard power supplies in the industry...over 500 models ranging from approximately 6 watts to over 500 watts. There are five series in our series-pass power supply line. Of these, the most popular is the OEM. Although they are known for their economy, these OEM power supplies offer the same reliability you have come to expect from all ACDC products. Our new high efficiency switching power supplies offer the latest in technology. They're smaller, cooler, and more efficient than series-pass supplies and operate quieter and more reliably than most other competitive models. And, there's even more for us to "boom" about. ACDC's ability to tailor a power supply to specific applications is virtually unlimited. Some typical units range from miniature 400 Hz airborne power supplies to 3000 amp power systems for state-of-the-art computer complexes, incorporating such features as auto-progression, margining, sequencing, transistor switching, phase control and series regulation as well as special packaging configurations. Complete information is contained in our new 1974 catalog. To get your personal copy, just write to us on your letterhead, or, if our short form catalog service number. *Like the broken drum, you just can't*



Name \_\_\_\_\_

Company Name \_\_\_\_\_

Address \_\_\_\_\_

City \_\_\_\_\_

State \_\_\_\_\_

Zip code \_\_\_\_\_

**acdc electronics inc**

Oceanside Industrial Center Oceanside, CA 92054  
(714) 757-1880





# COS/MOS is Power Conscious

Plagued by expensive power supplies and cooling systems? Having a rough time trying to cram too many system functions into a mini-package? Heat causing a reliability problem?

"Yes" to any of these problems means you have a need for RCA COS/MOS IC's.

COS/MOS power dissipation is negligible at dc and increases linearly with frequency. Since many logic elements in a digital system are idle much of the time, or switch at lower rates than the maximum clock frequency, a substantial net power saving can be achieved with COS/MOS in comparison with other logic families whose dissipation remains constant with frequency.

For example, a Digital Clock with 21 COS/MOS IC's takes only 6.3 milliwatts for the countdown from a 262 KHz crystal and the logic to drive an hours, minutes and seconds display. A comparable TTL

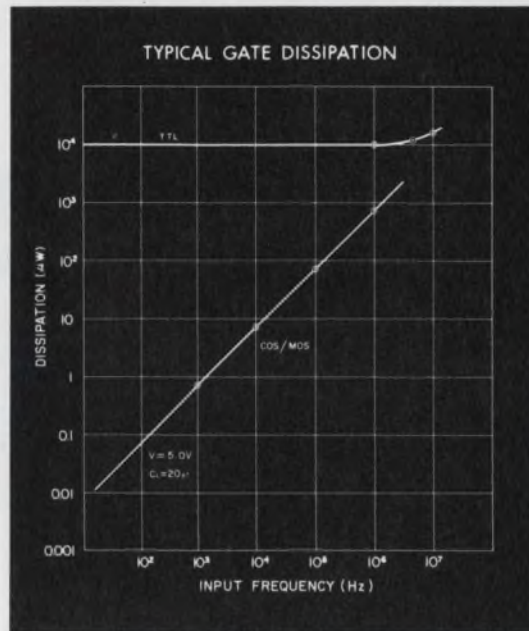

system will consume 600 milliwatts—a difference of almost 100 to 1 in power cost savings with COS/MOS.

Power conscious? You bet it is. But ultra-low power consumption is not the only great feature you get.

□ COS/MOS circuits

work from 3 to 15 volts, eliminating expensive regulators.

□ COS/MOS noise immunity is among the highest of any technology (typically 45% of supply voltage).

□ COS/MOS features stable transfer characteristics—less than 3.0% change over the full temperature range of -55°C. to +125°C.

It all adds up to ease of use and cost-effective designs. Try it. You'll

be convinced that the digital world is a COS/MOS world.

Send for your guide to the ever-growing COS/MOS Product Family. Write: RCA Solid State, Section 57D-26,

Box 3200, Somerville, N.J. 08876.

Or phone: (201) 722-3200, Ext. 2565.

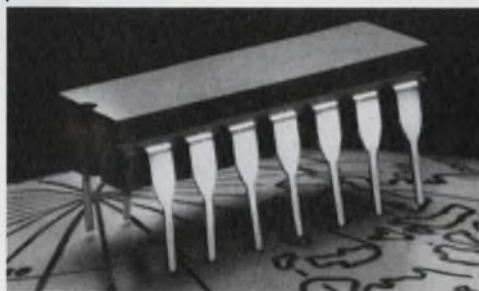

**RCA Solid State**  
products that make products pay off





## Minicomputers, we've got you surrounded.

So take a closer look.  
The MDS family of OEM  
peripherals is growing.

Newest are the 2021/2022 car-  
tridge tape drives, first in the industry to  
use 3M's versatile data cartridge.

Almost as new are our auto-  
loading, 125 ips vacuum-buffered rack  
mount tape drives.

Plus the 2 to 8 million bit

head-per-track disk drive.

They add even greater muscle  
to Mohawk's existing line-up of OEM  
peripherals.

- Products such as a 300 or  
600 lpm chain printer. A clean-picking  
225 to 600 cpm card reader. A multi-  
tude of proven digital lister printers.

And slow speed, low-cost  
paper tape readers and punches.

INFORMATION RETRIEVAL NUMBER 45

Phone us at (215) 337-1910  
for more details, OEM pricing, or a  
demonstration.

Or write OEM Marketing,  
Mohawk Data Sciences Corp., 781  
Third Ave., King of Prussia, Pa. 19406.

**MDS.**

**Mohawk Data Sciences**  
Quality OEM Products



# The COS/MOS world is growing.

## Announcing 21 new 4000 types from RCA.

Gates/Inverters		MSI		LSI	
CD4066	Quad Bilateral Switch	CD4060	14-Stage Counter/Oscillator (Multiple Output)	CD4059	4-Decade Divide-By-N Counter
CD4069	Simple Hex Inverter	CD4518	Dual BCD Up Counter	CD4061	256-Bit Static RAM
CD4071	Quad 2-Input OR Gate	CD4520	Dual Binary Up Counter	CD4062	200-Bit Shift Register
CD4072	Dual 4-Input OR Gate	CD4063	4-Bit Magnitude Comparator		
CD4075	Triple 3-Input OR Gate	CD4514	4-to-16 Line Decoder (Outputs High)		
CD4081	Quad 2-Input AND Gate	CD4515	4-to-16 Line Decoder (Outputs Low)		
CD4082	Dual 4-Input AND Gate	CD4085	Dual 2-Wide 2-Input And-Or-Invert Gate		
CD4073	Triple 3-Input AND Gate	CD4086	Expandable 4-Wide 2-Input And-Or-Invert Gate		
CD4068	8-Input NAND Gate				
CD4078	8-Input NOR Gate				

# RCA Solid State

International: RCA, Sunbury-on-Thames, U.K., or Fuji Building, 7-4 Kosumigaseki, 3-Chome, Chiyoda-Ku, Tokyo, Japan. In Canada: RCA Limited, Ste. Anne de Bellevue 810, Canada.

INFORMATION RETRIEVAL NUMBER 46



## Microprocessors showing promise in test equipment, but haven't made it big yet

Stanley Runyon, Associate Editor

Though powerful, the microprocessor hasn't quite made it yet in test and measuring instruments. Most microprocessors are currently finding homes in commercial, OEM and computer-oriented products—such as traffic-control systems, blood analyzers, data-entry terminals, point-of-sale terminals, check processors and automatic typesetters.

Exactly what is it that has kept the microprocessor—a glamour product if there ever was one—from being more prolifically used in test instruments? Several reasons.

For one, it's relatively expensive. While the CPU by itself may cost under \$100, the hardware cost can zoom when all the needed memory, I/O devices, clocks and other ICs are added.

For another, the microprocessor's relatively sluggish data cycle limits its use in all but low and medium-speed applications.

Add to these limitations the minimal software support now on hand, then top it off with a lack of familiarization among designers used to hard-wired logic. (And don't forget that, up to now, only two vendors offered them.)

### Rethinking design habits

All of this points to a time delay, probably two to three years, before the microprocessor surfaces as a major circuit element—a time delay during which prices must tumble, performance must rise and engineers must learn to design with software rather than hardware.

It's true, however, that practically every major instrument manufacturer has bought one. But they've been purchased only for evaluation and not for a specific instrument. Thus, at least for most instrument vendors, the microprocessor is a

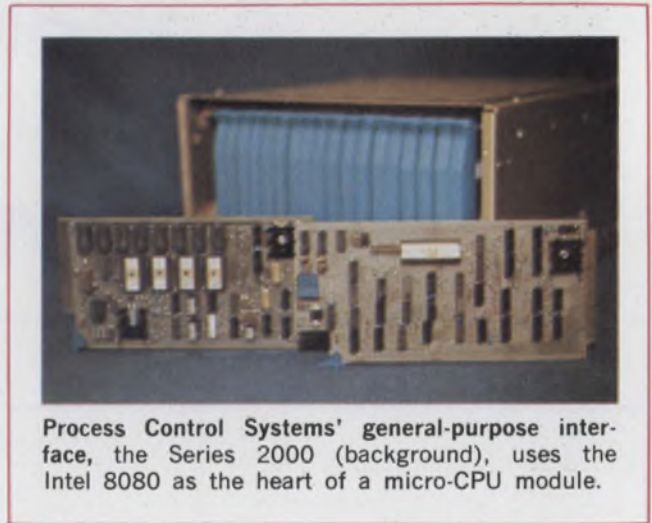

Process Control Systems' general-purpose interface, the Series 2000 (background), uses the Intel 8080 as the heart of a micro-CPU module.

solution looking for a problem.

Right now, probably the only measuring instrument with an internal commercial microprocessor is Boonton's Model 76A Capacitance Bridge.

In this automatic, programmable unit, an Intel MCS-4 microprocessor controls the various front-panel, display and I/O functions, as well as digitally controlling the bridge balance and computing the unknown capacitance, conductance, Q factor and dissipation (D).

On top of this, the 76A automatically corrects all predictable bridge errors, autoranges over 0 to 2000 pF and digitally displays the results.

Boonton's solitude isn't to suggest that the microprocessor—that is, a general-purpose MOS or bipolar LSI CPU on a chip, surrounded by ROMs, RAMs, I/O devices or other ICs—isn't being applied. It is. But the viable products merge into a trickle rather than a torrent.



And even though it's a sure bet that the next few years will bring microcontrolled DVMs, synthesizers, sweepers and other instruments, it's not so sure that the microcontroller or micro-computer role will be played by a commercial microprocessor.

One reason for this is that some potential customers, big companies like Hewlett-Packard, have opted to design their own hardware or firmware to implement the concept of a microprogrammable processor. Or they are building what can be termed a specialized microprocessor.

And, of course, the role of a built-in digital controller, calculator, processor or data shuffler can be, and is being, filled by ROMs, RAMs, PLAs and random logic—all rivals to the commercial microprocessor.

Examples are HP's 3330 frequency synthesizer, which has an internal digital processor, and the Tektronix' 7704A Digital Processing Oscilloscope, a unit that can perform calculations on its input signals.

And Computer Automation, a well-known mini-computer vendor, offers a one-card mini with a rather complex MOS/LSI PLA (which some people mistakenly label a microprocessor).

Because of this functional rivalry, the definition of a microprocessor is often confused. There's little doubt that, more and more, the word microprocessor will come to mean the MOS/LSI—or bipolar—component and not the microprogrammable processors currently being implemented in MSI, SSI, and with minicomputers or even large-scale computers.

It should be noted that some commercial microprocessors—such as National Semiconductor's GPC/P and the AMI 7300 (from American

Microsystems, Inc.)—are microprogrammable.

Illustrative of the microprocessor concept is the Model 400 graphic-display system built by Adage Inc. of Boston. Because microprocessors of the commercial variety couldn't handle the fast I/O required by the refreshed CRT graphics, Adage built its own microprogrammable display processor.

To get the speed, Adage couples fast Schottky TTL MSI with either a high-speed bipolar RAM or a fusible-link pROM, depending on the configuration. The result: a processor with a multiplication time of 240 ns.

In contrast, Iomec, Inc.—a Santa Clara-based firm—was able to use the Intel MCS-4 in its Porta-verter line of remote data-entry terminals. The big difference, of course, is that data entry is a relatively slow job.

### Terminals: A natural home for microprocessors

For Iomec, the commercial microprocessor appears to have been a godsend. When it became apparent that the Porta-verter's original LSI hard-wired logic chips weren't going to be delivered on time for Iomec to meet its delivery commitments, the company was able to replace the chips with off-the-shelf microprocessors at about the same cost.

And not only did the microprocessor fulfill the terminal's original design goal; it allowed Iomec to offer such extras as special character keys, operator prompts, error correction and unattended operation. Even with all options, Iomec says its price is two to eight times less than that of intelligent terminals.

One intelligent terminal that was conceived

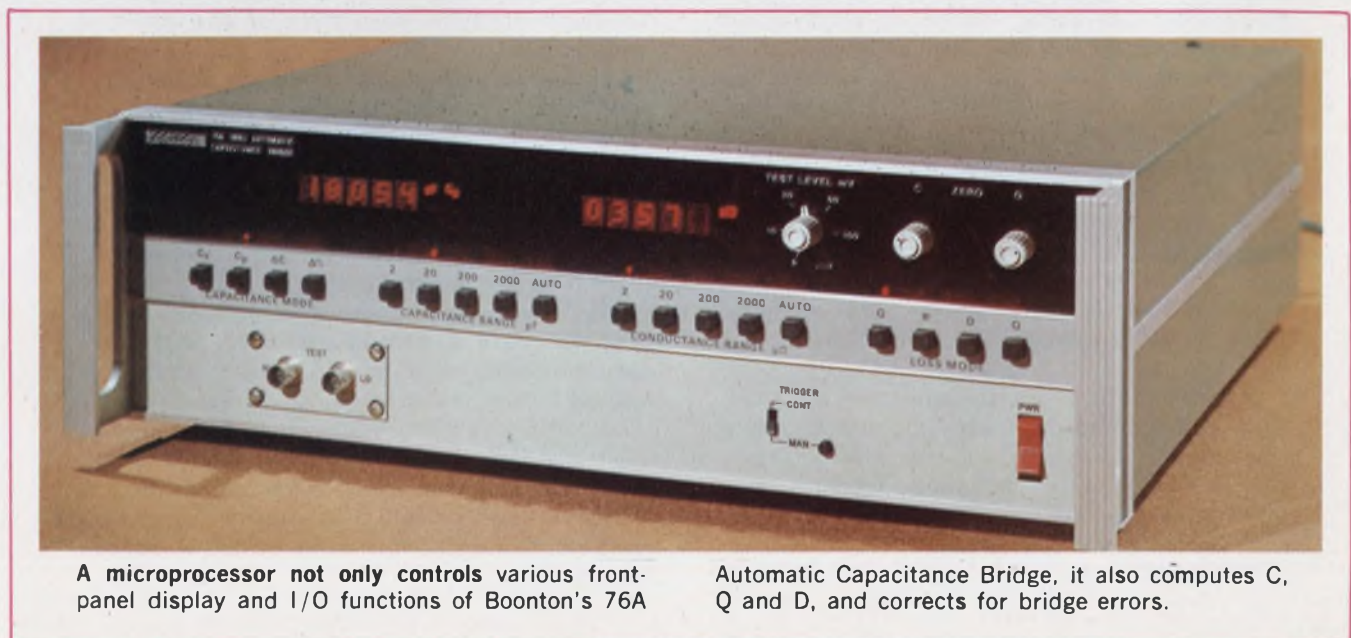

A microprocessor not only controls various front-panel display and I/O functions of Boonton's 76A

Automatic Capacitance Bridge, it also computes C, Q and D, and corrects for bridge errors.



from scratch with a microprocessor as the central control unit is the Microterm series from Digi-Log Systems, Horsham, Pa.

Because of the microprocessor and the Microterm's modular design, Digi-Log reports, designers with unique terminal requirements can just about write their own specs. Such features as display formats, code structure, baud rate, keyboard format and editing can be personalized if custom-written software is combined with selected hardware modules.

To get the identical capabilities with a hardware design, Digi-Log estimates that 600 to 700 ICs would have been needed.

Applications such as Iomec's and Digi-Log's—in which the microprocessor replaces hard-wired logic or minicomputers—now dominate the product scene and are likely to do so for the next few years.

In a blood analyzer built by Helena Laboratories of Beaumont, Tex., for example, a microprocessor bumped hardware to provide more complex, faster and more accurate data handling—in a smaller package yet at less cost.

The analyzer, through the microprocessor, performs mathematical and operational routines on raw data received from a sensor and gives a printout, in medical units, of blood protein content.

In still another application, four PC cards were knocked out by Intel's 8008 microprocessor in a computing integrator built by the Autolab Div. of Spectra-Physics.



This remote data-entry terminal—the Porta-verter from Iomec, Inc.—offers intelligent operation. Credit goes to a four-bit microprocessor.

Designed expressly for chromatographic data processing, Autolab's System 1 can replace a general-purpose mini or a programmable calculator. Autolab notes these benefits with the microprocessor: The design was simplified, the instrument shrank, reliability went up and costs were reduced.

How did Autolab and Helena save money by

## A 'micro' what?

What's a microprocessor? Confusion seems to result when the prefix "micro" is plugged into the front end of a word. And no wonder. Generic names are few, and vendors like to coin words to describe their "unique" products. Here is an attempt to clear the confusion:

**Microprocessor:** An LSI central processing unit (CPU) on one—or a few—MOS or bipolar chips. Along with arithmetic functions, the CPU may perform input/output (I/O) jobs and may contain a scratch pad or other memory. To form a working system, at least one external ROM, RAM or other memory device is usually used with the CPU.

**Microcomputer:** Microprocessors are sometimes called microcomputers. But so are "small" computers—such as bare-bones minicomputers, built on one or a few PC cards. Minicomputers built around a commercial microprocessor are often called microcomputers.

To make things worse, computers that use

microprogramming are sometimes referred to as microcomputers, regardless of the size and packaging of the CPU.

**Microprogrammed processor or computer:** The term "microprogrammed" refers to any computer whose instruction set is not fixed but can be tailored to individual needs by the programming of ROMs or other memory devices. Consequently whether the computer is a mini, midi, maxi—or a microprocessor—theoretically it can be microprogrammed.

**Microcontroller:** Another all-purpose word, this can mean a microprogrammed machine, a microprocessor or a microcomputer used in a control operation—that is, to direct or make changes in a process or operation. But there's a narrower definition, more in keeping with the prefix, in which microcontroller refers to any device or instrument that controls a process with high resolution, usually over a narrow region.



substituting microprocessors, while others point to their high cost?

The answer, of course, depends on what the microprocessor replaces. For simple jobs with few components, random logic is less expensive. But at the other extreme, if the microprocessor shoves a minicomputer aside, the cost savings—as well as the volume reduction—can be substantial.

### Micros vs minis and other hardware

Dr. Robert E. Jackson of Applied Computing Technology, Irvine, Calif., offers this rule of thumb to determine the cost tradeoff between random logic and microprocessors: A 50-IC system costs about the same as a microprocessor plus 20 interface ICs. Included in the rule are parts cost and the cost of handling, testing and interconnections.

Does the microprocessor's inroads into minicomputer territory worry minicomputer vendors? Not yet. Punch for punch, the microprocessor—at least at present—is no match for the mini in speed, word length, memory capacity, number of instructions, computing power and software availability.

But where the mini is being used as a 50-mm cannon when a BB gun will do, watch out. In dedicated control applications that don't need complicated calculations, the microprocessor can fill the need for a programmable device; a mini here would be overkill. Where a mini is used



The Microterm series, built by Digi-Log Systems, are microprocessor-based, intelligent terminals that can be customized to a user's specs.

primarily to compute but a built-in computer with low power consumption is preferred, a microprocessor may slip in.

Road traffic controllers, such as the Model 901 from Multisonics of San Ramon, Calif., are applications in which microprocessors may also replace minis. The job is so easy for a mini that it loafs half of the time. Buried in the 901 is Intel's 8008 microprocessor. This 8-bit unit—coupled with 14 pROM pages and other memory—forms the heart of a computer that, though invisible to the user, optimizes traffic flow in many separate intersections.

The advantages of the microprocessor approach here? Foremost, the manufacturer can tailor the system to individual applications by first changing the software and then just plugging in new ROMs. Other benefits include a significant size reduction and easier troubleshooting and maintenance.

### Micros turn up in minis

Apparently the minicomputer makers aren't too concerned about a potentially serious microprocessor threat. In fact, one mini vendor—General Automation—has just unwrapped a 12-bit *microcomputer* that uses a silicon-on-sapphire (SOS) microprocessor made by Rockwell International.

General Automation defines a microcomputer as a full system computer on a board, with the processor on a single chip.

Digital Equipment Corp.—the largest mini manufacturer—also appears to view the micro-



Microprocessors bring sophistication to video games, such as Atari's Quadrapong—a hockey-like diversion for four people.



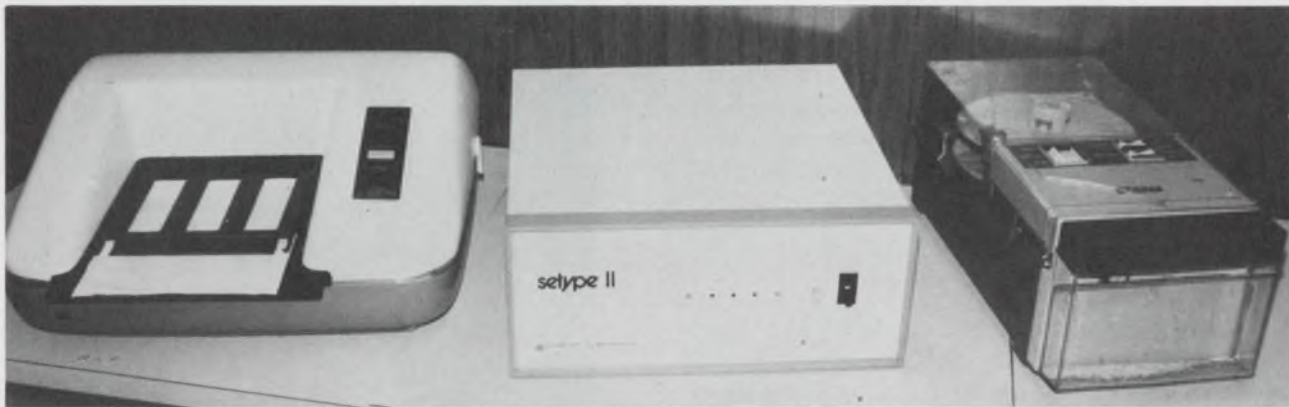

By replacing a minicomputer with a four-bit microprocessor, Data Type Corp. was able to cut costs

and slim down the size of its newspaper-oriented optical page reader—the DFR 300.

processor as a friend and not a foe.

DEC has unveiled a dedicated control system built around a microprocessor—the MPS Series. Consisting of five modules, the MPS can be built into terminals, process-control systems and other instrumentation.

Thus we can anticipate a three-way rivalry for equipment space—with microcomputers getting squeezed from below by microprocessors and from above by bare-bones minicomputers.

However, some engineers feel that just as the introduction of the mini spawned entirely new applications, rather than cut into the applications of medium and large-scale machines, so will microprocessors and microcomputers.

But what will happen as microprocessors grow in complexity, speed and power, and the line between micro and at least the low-end mini begins to blur? Perhaps we'll see a vertical shift, with minis creeping into applications now dominated by the medium and big computers.

In the meantime newly conceived products—like the Staid Corp.'s Datacash, a point-of-sale terminal—will use microprocessors instead of hard-wired logic. And many existing products will no doubt convert to microprocessor-based designs to compete.

In Staid's case, an MCS-4—coupled with pROMs—allowed the company to build a terminal that is easily tailored to a customer's needs. Datacash—primarily intended for restaurants and cafeterias—has 110 keys, each of whose legends can be changed on site with a peg matrix, plus six function keys for special applications. And the unit keeps a running inventory of each key strike. With hard-wired circuitry, Staid says, 30 TTL cards would have been required.

One company that has already converted an existing product—at the expense of a mini—is Data Type of Miami. The company's DFR 300

optical page reader started out with either PDP-16s or NOVA 1200s as the code-translator controller.

But, says Data Type, the PDP-16 costs substantially more than the MCS-4 that replaced it, and the NOVA 1200 was three-quarters asleep on its job as a start-stop controller, error detector and buffer.

At present the MCS-4 controller portion of the page reader, which reads font for the newspaper trade and functions as a terminal in the graphic arts, has been designed as a separate, retrofit package to replace the mini directly. Future models, however, will have the microprocessor built in.

#### Distributed intelligence—a new trend

Some applications enable the microprocessor and the mini to work together symbiotically. This appears to be the case with the Telecontroller—a programmable, front-end data-communications processor built by Action Communications of Dallas, Tex.

Instead of replacing a mini, an Intel microprocessor in the Telecontroller freed the computer to take on more work. The microprocessor, which serves as a message switcher in a high-speed binary interface, efficiently handles the high-speed data and then passes it on to the mini.

With an intelligent function distributed in this way, more computer core becomes available, and many more terminals can come on line to be served by the mini. Thus look for distributed intelligence—via microprocessors—to appear in more and more new terminal systems and to be retrofitted to existing systems.

One terminal supplier that will probably be doing both is the Digital Systems Div. of Texas



Instruments. TI sees the microprocessor as an opportunity to give its customers a "rubber" terminal system—one that can grow as data-processing functions change.

Intelligence was redistributed in still another interface—the Series 2000, by Process Control Systems. In this general-purpose process-control interface, a micro CPU and memory were designed to slip in and, in some applications, replace a mini. Built around the 8-bit Intel 8080—the first n-channel MOS microprocessor—the interface can be used as a down-line satellite of another computer or as a stand-alone data-acquisition system. In the latter case the interface bumps the computer.

By building in the microprocessor, Process Control Systems not only saved hardware dollars, but cabling costs in remote processes were also considerably reduced. For example, Ford Motor Co. uses a number of the interfaces at carburetor-flow tests stands. Here the micro CPU serves as a satellite to a down-line Interdata 70, and it multiplexes the interface data to the computer. In a similar application, the Buick Div. of General Motors puts the interface at its assembly line in a torque-monitoring system.

In the torque monitor, the micro CPU converts parallel data to serial and funnels the information stream into a dual-conductor cable. The cable then carries the data downstream, where it is finally dumped into an HP 2100 mini. Another interface, between the computer and the cable, reconverts the serial stream to parallel data.

### Other microprocessors surface

The 8080 microprocessor used by Process Control Systems in its interface is Intel's newest and most powerful unit and is sure to boost the semiconductor company's competitive lead time even more. Because of the lead, Intel now dominates the market in terms of available microprocessor-based products.

But National's IMP-16C microprocessor and GPC/P MOS/LSI system kit are being built into prototypes and may soon pop up in such applications as aircraft control systems, flight-status indicators, analog computers (strangely enough), nuclear instrumentation and symbol generators.

And, of course, the other semi houses aren't sleeping—AMI, General Instrument, Electronic Arrays, Motorola, Signetics and Western Digital will all have general-purpose units available soon. RCA has already announced the first CMOS microprocessor, which it expects to offer initially on a sampling basis.

With all this activity in microprocessors, it's only natural for a designer to ask: Is there one

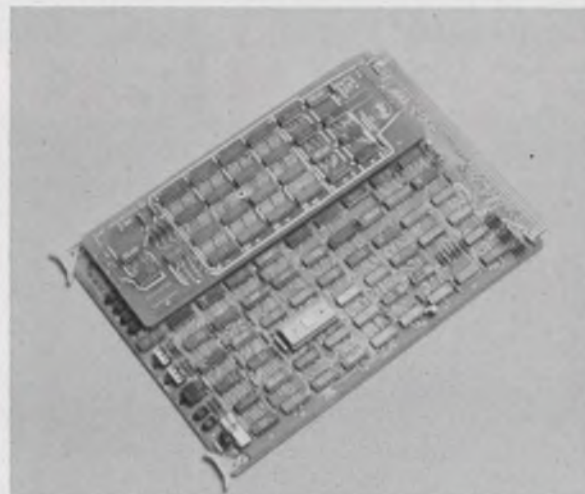

**General Automation's LSI-12/16**—an 8-bit automation microcomputer—is built around the first silicon-on-sapphire microprocessor.



**Staid Corporation's Datacash**—a microprocessor-based point-of-sale terminal for restaurants—keeps an inventory of every key strike.

in my future? The answer: Inevitably, yes. In the meantime, though, designers are more likely to run into one at their ophthalmologist's, at the butcher's or at their favorite watering hole.

At the eye doctor, look for Coherent Radiation's Dioptron—an optical instrument that measures and analyzes the eye's focal characteristics and prints out the results.

At the meat market, check for the butcher's thumb on a Toledo digital-computer scale—a unit that converts weights to prices, prints labels and displays unit price, weight and total price.

And at the bar, try to beat the gal standing next to you at a new video game, from Atari, in which a cat chases a mouse through a constantly changing maze. If you lose, the game—but win the lass—thank the microprocessor. ■■



# Our Extra Specials... read all about them.



**CONTINUOUS SOCKET SYSTEMS.** Low-cost, high-quality, uninterrupted IC socket system with interlocking units can maximize board use when wire-wrapping. **CAMBION® BUTTABLE SOCKETS** make it happen. And there's a total IC packaging capability.



**JUMPER SWITCHES.** Tiny jumpers that mate with spring-loaded receptacles serve as low cost, trouble free circuit switches. 50,000 cycles (insertions/ extractions) prove longevity. Color coding and positive position indication suggest limitless application possibilities. The variety is extra special.

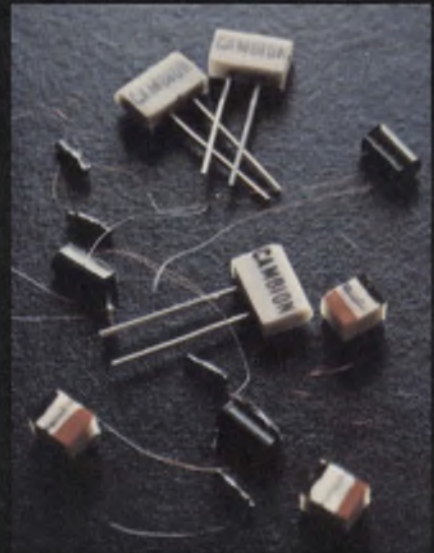

**SPACE AGE INDUCTORS.** The smallest, .075" by .170", "fits" anywhere. Hundreds of thousands in electronic watches. More in the new lightweight telephone headsets. Plus a broad line of conventional inductors. Where can you use them?







**HARDWARE VERSATILITY.** Low cost battery holders that are both shock and vibration resistant for portable equipment. Stand-offs. Metric spacers. Handles. All with CAMBION quality.



**TERMINALS OF THE TIMES.** Modern versions of the traditional solder terminals, .025" and .045" square for back panel wire-wrapping and/or soldering. Rugged, tough terminals in two and three wrap lengths.



The thousands of applications our customers find for versatile CAMBION components make them "extra special" to many. Available in the same quality - in any quantity. That's CAMBION's Double "QQ" approach. For additional news on CAMBION's full line of quality products write: Cambridge Thermionic Corporation, 445 Concord Avenue, Cambridge, Massachusetts 02138. Phone: 617-491-5400. In Los Angeles, 8703 LaTijera Blvd. 90045. Phone: 213-776-0472.

Standardize on

**CAMBION®**

The Guaranteed Electronic Components  
INFORMATION RETRIEVAL NUMBER 47

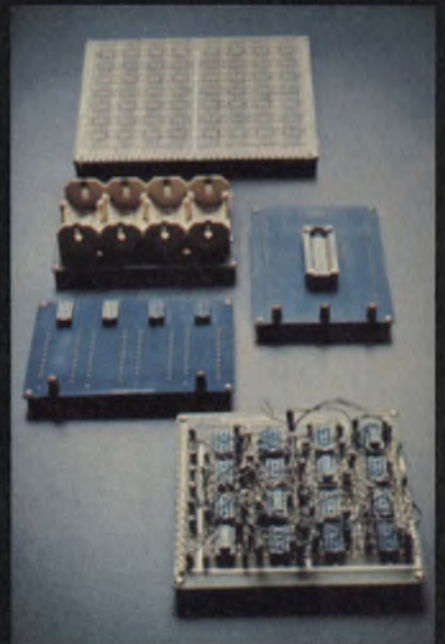

**PLUGGABLE BREADBOARDS.** Entirely pluggable for use and re-use. No soldering mess or fuss. Fast and convenient with all the accessories for developing your own circuitry.







# NEW SCR CONTROLLED BRIDGE RECTIFIERS AND POWER SWITCHES

The VCB series of 25A and 50A controlled bridges and power switches are available in a 3/4" press-fit package, with three mounting options and in epoxy packages. All units are hermetically sealed.

The epoxy packages are explosion proof and electrically isolated with double isolation available. SCR's are glass passivated. All chips are soldered to an integral copper mounting pad for improved thermal characteristics, typically  $<1^{\circ}\text{C}/\text{W}(\text{R}_{\theta\text{JC}})$ . Epoxy barriers have been placed between standard .250" Faston and/or #10-32 terminals. Spacing exceeds NEMA standards.

Typical applications include DC motor speed controls, temperature controllers, battery chargers, inverters, frequency changers, D.C. power supplies, and servo systems.

All units are available in 60V, 115V or 230V, ( $V_{\text{RMS}}$ ).

Typical economical pricing: VCB252-7 (200V, 25A) \$9.00 ea., 100 qty.



Design us in . . . we'll stay there

**VARO**

**VARO SEMICONDUCTOR, INC.**

P.O. BOX 676, 1000 N. SHILOH, GARLAND, TEX. 75040 (214) 272-4551 TWX 910-860-5178

INFORMATION RETRIEVAL NUMBER 48

## PRESS-FIT

## ELEC. ISO. EPOXY BARRIER PACKAGES

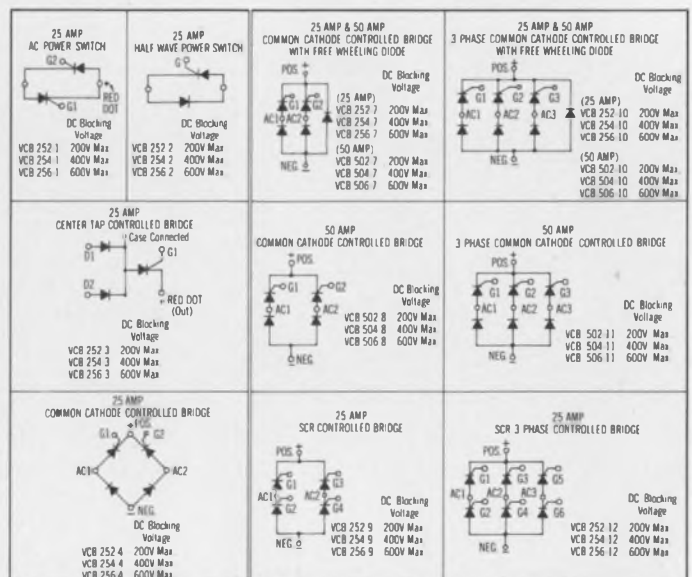



Datacraft® SLASH 4 Virtual Memory  
Computer System.

Delivers power, economy, flexibility and versatility. All you'll ever want. Or need. For concurrent multi-batch processing. Critical real-time. Remote job entry. Time sharing.

Whatever your application, the SLASH 4 VM's 750 nanosecond cycle time, automatic program relocation, re-entrant processors, and effective memory utilization deliver higher throughput for you. Big single programs... up to 256K... are handled with ease in a multi-task oriented architecture that virtually eliminates costly software penalties.

That's Efficiency.

That's Money Saved.

That's the SLASH 4 VM Computer System.

You'll be amazed at what you get. And how much you can do. Contact us for all the facts. Datacraft®, 1200 Gateway Drive, Fort Lauderdale, Florida 33309, Telephone (305) 974-1700. For international inquiries write: Techmation N.V. Gebouw 105/106, Schiphol-Oost, Holland.

***Datacraft***®  
SUBSIDIARY OF HARRIS-INTERTYPE CORPORATION

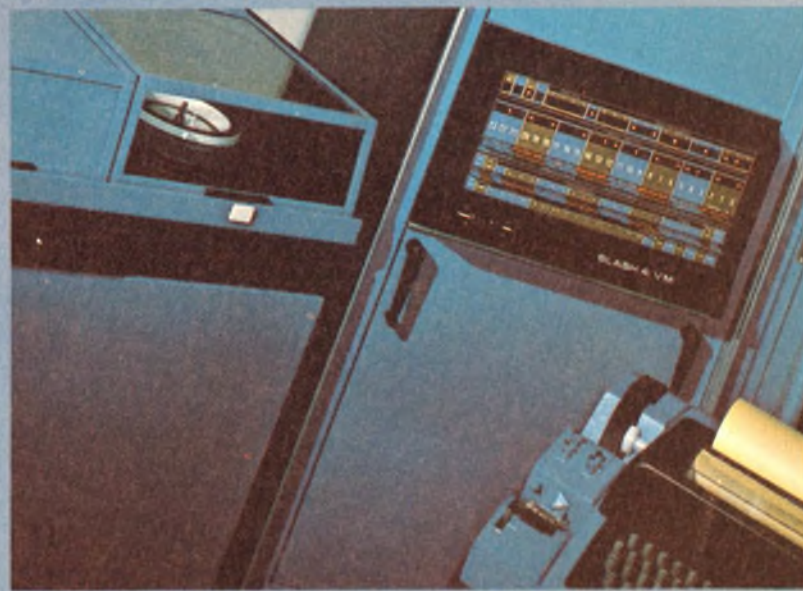

SLASH 4 VM COMPUTER SYSTEMS

INFORMATION RETRIEVAL NUMBER 49



## How to be a top designer and remain a designer, despite corporate lures

John F. Mason, Associate Editor

How many creative engineers build something great, get trapped in a maze of marketing strategy and never get back to creating anything else?

Far too many, James E. Thornton decided early in his career of designing super-computers. And, taking matters firmly in his own hands, he has, with a few minor delays, shrewdly steered a course through such corporate snares ever since.

So far, so good. But what happens now? Thornton's future course isn't 100 per cent clear. But whose is?

Thornton had little soul-searching to bother him when he reached that fork in the road that eventually every engineer must face: Should he go into administrative work or try to make it as a creative designer? Thornton chose design without batting an eye, and he's never questioned the choice.

Today at 48, he has five big machines to his design credit, and feels he has time for two or three more. Whether the forces in the world of giant computers will allow him that many, he doesn't know. But so far his formula has worked, and it may see him through whatever lies ahead.

"Some people—good, creative designers—manage to be part of only two, or maybe just one, project in an entire lifetime," Thornton says, looking slightly distressed at the thought of such a waste.

Designing a big data-processing machine can take from four to five years, he explains, and if you get pulled into market strategy meetings, sales briefings and modifications to the product for its 10-year life, you've shot 14 or 15 years.

"How many 14-year periods does a man have"?

he asks rhetorically. "Two"?

Even if you escape the corporate marketing trap, he notes, you can still become obsolescent. While you've been working on one project for five years, the state of the art has moved on. You need a good year just to catch up before tackling another big job.

What are the sirens along the way to lure a creative engineer to beach his future as a designer and become a sales-briefing artist?

"Job security," Thornton says, "and opportunity."

He speculates: "Let's say you finish a big five-year job. Everybody's happy. But your company isn't ready to launch another big project right away. . . . You can spend your year getting caught up with new technology, hoping that meanwhile a new program will emerge. You can try to change companies, or you can become a consultant."

Thornton thinks a moment. "Or maybe you just sit tight and sweat it out a little more."

His own record is enviable, and he attributes it to two things: He decided early in the game what he wanted, and he stuck to his goal. And, second, he had some degree of luck: He happened to work for companies that launched big projects in relatively quick succession. And his projects didn't all take five years.

Thornton's first design job was Engineering Research Associates' 1103, the first commercial scientific computer. It took three years to design.

His next project took only two years. It was Univac's Naval Tactical Data System computer. (Thornton hadn't changed jobs. Univac had acquired Engineering Research Associates and Thornton along with it. He didn't even change desks.) The naval computer was designed quickly, Thornton explains, because transistors had suddenly become available.



"Switching to transistors was no problem," he recalls. "The transistor was so powerful that we were able to build a very competitive, uncomplex machine, and we built it quickly."

Subsequent machines haven't been that easy to design, nor has the time between two generations been so brief. Going from vacuum tubes to transistors was a jump that automatically clobbered its predecessor, competitively speaking. Since then succeeding improvements in technology haven't been that dramatic. They don't categorically outmode everything else.

Right after the tactical-data computer was delivered to the Navy in 1958, Thornton moved from Univac in St. Paul, Minn., to Control Data Corp. across the river in Minneapolis. There he had plenty of exciting work to do for the next 15 years. It was always innovative because the



James E. Thornton, now a consultant, has five big data processing machines to his design credit and believes he's good for at least two or three more.

company's approach to beating the competition was to build machines that would outperform their predecessors. Other companies took the opposite tack, following a big machine with a smaller version that was cheaper. IBM often takes the middle course, building a middle-aged machine and then moving out in both directions, a bigger one and a smaller one.

Thornton's first machine for Control Data, and the third of his career, was the 1604, a system that introduced a number of new features. Seymour Cray, a senior design engineer with whom Thornton would collaborate closely and successfully for almost 12 years, was already six months into the design of the machine when Thornton arrived. But Thornton developed an important feature for the 1604—the floating point, which has survived steadfastly and is now almost standard on all kinds of data processors, including pocket calculators.

Thornton is proud of another important innovation that emerged in the 1604 program—the interleaved magnetic core memory. Although Thornton gives Cray credit for originating the idea and "having the strength to carry it through," he did help with the design and feels it's been a milestone in data-processing machines.

Luck helped in the design of the 6600, Thornton says. "We had expected to use the germanium transistor, but at precisely the right moment Fairchild announced the silicon planar transistor, so we used it."

This permitted much higher packaging density, substantially higher basic speed of the subsystems and an allowable heat that would not have been possible with germanium.

The high density unexpectedly spawned yet another innovation. "We were afraid the density wouldn't tolerate an air-cooled system," Thornton says, "so we went to Freon, which turned out to be a major factor in the machine's design."

Freon became more than just a way to cool the machine. It allowed such precise, selective temperature control throughout the system that the machine could be operated at greater speeds than had been planned. Another advantage to Freon is that it's quiet.

But the most important innovation in the 6600, Thornton says, was the addition of 10 small processors, called peripheral processing units, for the I/O processors. "For these processors," he recalls, "we built a software system that allowed them to really manage all the I/O, all the channels and, in a way, the central processor. So for the first time, we had the beginnings of what we think of today as a real system structure of the large central machines."

In mid-1960 Thornton restated his determination to be an innovator rather than an admini-



## The case for the super machines

Why big computers? Won't several smaller machines do the same thing? The answer is no if you're talking to people in the scientific community or the Defense Dept. The intelligence is too fragmented in a group of minis, they will tell you. You need only one big central processor. And you only get that in a very big machine.

Other advocates of the super processors are in the aerospace industry. How else can aerodynamicists simulate a giant swept back aircraft wing they want to design except with a gigantic computer?

Many government agencies need big machines for the vast amounts of data they must handle: the census bureau, meteorologists, and the groups that collect earth resources data from satellites.

But the biggest users of the big processors are still to come, and are still unidentified, according to James E. Thornton, designer of five large, elaborate machines with a sixth in the works. "Every time we've built a new machine it's created new markets—markets we hadn't expected," he says.

This really big influx of users, he predicts, will probably join the crowd in a fairly simple, inexpensive way—via a time-sharing arrangement. They will plug into a vast network that ties their small terminals to a giant central machine.

The network concept is absolutely essential in thinking about large machines of the future, Thornton believes—"not only about how they will be used, but how they should be designed." In the past, he explains, large specialized machines were built as stand-alones. Future large, specialized machines will be built as part of networks operating in unison with intelligent terminals, with minicomputers somewhere along



the line and with other large specialized machines.

To support these networks a number of new products must be developed, Thornton says, adding: "We're not even coming close to providing for such systems yet." The terminals and modems that go onto telephone lines, for instance, are all "relatively low-grade things, and in no sense do they appear to be what's ultimately needed," Thornton says.

"We're already beginning to see on-line storage as the way to operate," he continues. "People are using more discs now than ever before—at least three to four times greater than expected."

Why? People want to put information on a

strator. He and Cray asked to be separated from the corporation, administratively and physically. Such a request could have caused waves, because the company was new and probably not ready for the departmental specialization they wanted. They asked that a laboratory be set up strictly for design; it would have nothing to do with marketing. Control Data complied.

A year later—and this move was mainly Cray's idea—the two designers really asked to get away. They wanted a place in the woods. Trees, birds, lakes—the works. They'd take along a small group of talented, free-thinking engineers who would come up with a computer that would outperform the 1604. Again, Control Data came through.

The result was a laboratory, about as rural as

you can get, in Chippewa Falls, Wis. Most of the design work for Control Data's 6600 was done there.

Cray liked living in the woods, and he's still there. But Thornton and his wife and their seven children began to miss St. Paul. This, plus a decision by both Cray and Thornton to build two variations of the 6600, caused Thornton eventually to go back to town. There he developed a cheaper version of the 6600, with less performance: it was called the 6400. Cray, staying on in Chippewa Falls, developed a unit with more performance, first called the 6800 and later the 7600.

Thornton added a feature to his 6400 that he found satisfying. "To give it redundancy and more power," he says, "I built one 6400 with two



disc and leave it there. They don't want to put it in and out through tape or punched cards. And they're storing more data.

"We have people now in large sites that have not just 10 spindles of discs but hundreds of spindles," Thornton says. "This represents a trillion-bit storage. And the only processor that can manage capacity like that is the large scientific processor. The large machine is here to stay. What's needed is specialized peripherals to back it up."

Already designed for a network system is Control Data's Star 100. "This machine will depend on a network," Thornton says. "It doesn't have any I/O functions in it, and its peripheral system is fairly rudimentary."

One feature used in Star, and also in other powerful machines that might set trends for the future, is pipelining. Separate functional operations are broken down into steps that are taken sequentially, in the manner of an assembly line. Because the steps are independent, one may be started while another is still in progress.

Illiac, NASA's huge computer by Burroughs, takes the opposite tack. It uses multiple processors in a structured way. "They all do the same functions in parallel," Thornton says, adding, "but at this stage both Illiac and Star are relatively unknown. They are two different structures. And we don't know yet whether either is going to be a really powerful machine, useful for a general class of activities or not."

Thornton sees a big future for virtual memory. He says: "This is a very fundamental concept that's been very slow in getting to operational status, and will take even more time to really arrive. Star uses a large-scale, brute-force virtual memory—a technique that is highly appropriate for networks."

central processors instead of one. They were both coupled to the same memory. I had designed some latent control logic in the memory to allow for the additional processor, and it worked very well."

Thornton then asked management if they'd like such a design. Yes, they said, but how long would it take? It was very gratifying, he recalls, that he could tell the company it was already done. This version of the 6400 was called the 6500.

But Thornton paid for leaving the woods. Within months he was so involved with the manufacturing, engineering and marketing of the 6600 that he hardly had time to work on the 6400. Finally he got another designer to work with him, "and inside of 18 months we had the

new machine ready to operate."

But Thornton's administrative demands continued to grow. At one point he found himself directing five Control Data groups throughout the U.S. One, in Arden Hills, Minn., is still developing the Star 100 computer. Thornton is no longer involved with the Star project, but he and three other engineers originated the machine, and he was very much a part of it for a long time.

Of Star, Thornton says: "The machine is about two years late, because it's had design problems. It contains more than 100,000 ICs. The system is unusual, and it's going to be many years before it's really understood. But when it is, it's going to have a very significant impact on the large-machine business."

But Thornton was losing sight of his original goal. "I felt my strengths weren't there, in all that administrative work," he says. "I needed a narrower and more creative environment. While running labs was interesting in some ways, running a lot of labs wasn't. So about a year and a half ago I began to fill my key spots with people who could take over. And by early 1973, I was out of a job."

Thornton requested a leave of absence from Control Data, became a consultant and took on Control Data as his only client. He is working on a project that he started for the company while he was still an employee.

How is this working out?

"Well, it's the other extreme," he explains. "I'm working completely alone. My current project is big and it's interesting—as well as proprietary—and I can't talk about it. But who knows when Control Data will initiate another job of this scale"?

Thornton pauses as he considers his future. "I could stay on as a consultant and troubleshoot projects for other people who are in a jam. I solve other people's problems very well, but that's not creative."

Thornton studies the clear, bare white wall of his office in St. Paul as if he will find the answer there. "What I really should do," he says, "is maneuver toward a smaller, structured technical activity. I have managerial aptitude in a structured climate.

"Yes," he says, now satisfied with his decision. "I think that is my solution."

His reason for this compromise makes great sense as Thornton's decisions apparently always have. "It's impossible for one man to keep up on all the new semiconductor technologies as they emerge," he says. "These kids coming out of school have got more real understanding now by direct training than we ever had. Alone you get obsolescent." ■■



**Before we wrote the only  
Computer User Plan, we built  
today's best planned computer.  
The Prime 300.**

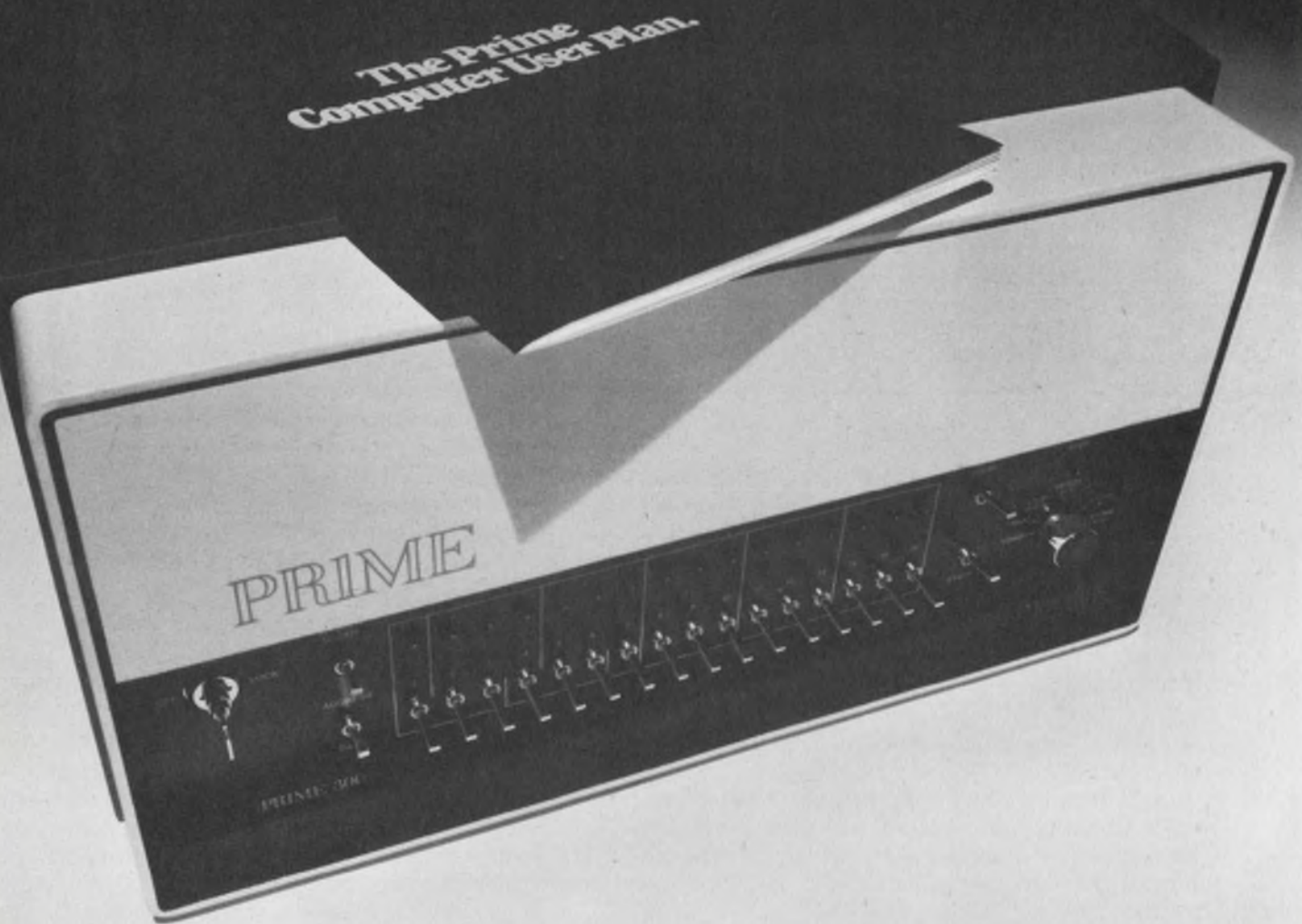





The Prime Computer User Plan brings common sense to buying a computer. It recognizes the simple fact that your needs might change someday.

The Plan introduces the first two-year guaranteed trade-in policy. It details the upward and downward compatibility features only Prime offers. In short, it gives every assurance you can always put a Prime system to use.

We consider The Plan a new way to buy, use and upgrade computer systems. We also give you the systems to consider: The Prime 100, 200 or 300. The chart below is a preview of what to expect in each.

Standard Processor Features	
Prime 300 Central Processor (1 board)	<ul style="list-style-type: none"> <li>Virtual Memory – automatic paging, mapped address translation to 256K words, restricted execution mode, and memory protect.</li> </ul>
Prime 200 Central Processor (1 board)	<ul style="list-style-type: none"> <li>Stack Procedure Instructions</li> <li>Micro Verification Routines**</li> <li>Hardware Multiply/Divide and Double Precision Arith.*</li> <li>DMC/DMT Capability*</li> <li>Automatic Program Load From Input Devices (PTR, TTY, CR, MT, Disk)*</li> <li>Memory Byte Parity</li> <li>Processor Byte Parity</li> </ul>
Prime 100 Central Processor (1 board)	<ul style="list-style-type: none"> <li>Full Addressing Modes – direct, indirect, and indexed in both sectored and relative modes</li> <li>Virtual Instruction Package (VIP) – automatic trapping of unimplemented instructions and substitution of functionally equivalent software subroutines.</li> </ul>
<ul style="list-style-type: none"> <li>8-Channel Programmable DMA</li> <li>4 Channel Full Duplex Asynchronous Serial Interface</li> <li>Multi-level Vectored Priority Interrupt System</li> </ul>	
<ul style="list-style-type: none"> <li>* Optionally available on Prime 100 and 200</li> <li>**Optionally available on Prime 200</li> </ul>	

The chart suggests there's a little 300 in every Prime computer. Naturally, we planned it that way. Our 300 is just the reverse of the big box with a little computer inside.

Other 300 features will tell you just how big it is. For instance, there's high-speed MOS memory with 32K words per board. Up to 256K words per system. There's floating point arithmetic and writable control store, too. In short, there's everything you'll need in the computer you can plan with. Work out a multi-function system or plan a multi-user arrangement. The diagram that follows is just one way to go.

The Prime 300 supports a multi-user, virtual memory Disk Operating System (DOS VM) and a foreground/background Real Time Operating System (RTOS VM).

A Prime 300 with virtual memory easily accommodates over a dozen users. What's more, each is guaranteed 64K words of virtual memory available to program in FORTRAN, BASIC, Macro Assembler and Micro Assembler.

The system files and paging space are all provided by cartridge disk. Our new diskettes offer low cost storage for personal user files.

A Prime 300 is good. How good can best be seen in The Plan. It shows how to upgrade from the 100 right on to the 300. In the process, you don't change software. The time and expense of reprogramming are gone. You can also use the 300 as a software development system. The software will run on 100's or 200's without modification. The Plan guarantees this kind of system compatibility.

The Plan also goes into system integrity features. Memory Byte Parity and Processor Byte Parity are standard in the Prime 300. Micro-verification routines (also standard) and controller loop-back allow you to isolate faults to a single board.

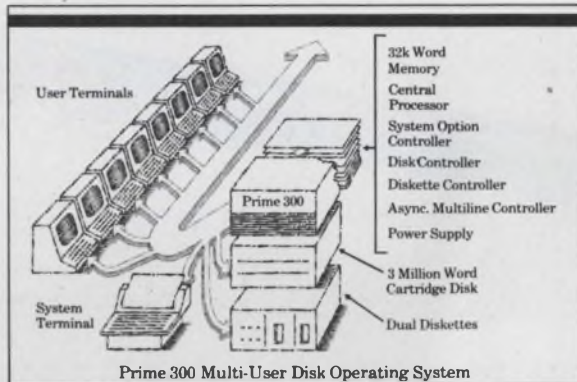

The Plan then spells out our total service options. They run from comprehensive on-call service contracts to Prime's unique Air Spare System. With Air Spare, we'll air express, for a minimal charge, any backup boards you may need from our nearest service center. We'll make repairs on faulty boards and have them back in no time. Meanwhile, you'll be operating full-time thanks to Prime.

There's more to The Plan. The best way to discover how much is to have your own. Send for it. The coupon below, like the Prime 300, will make it all possible.

To: Prime Computer, Inc.  
23 Strathmore Rd.  
Natick, Ma. 01760

Send The Plan  
 Send the Planner  
(He'll call for an appointment.)

Name \_\_\_\_\_  
Title \_\_\_\_\_  
Company \_\_\_\_\_  
Address \_\_\_\_\_  
City \_\_\_\_\_ State \_\_\_\_\_ Zip \_\_\_\_\_

**PRIME**

Learn more about The Plan at the National Computer Conference, Booth 109.



# Singer can supply any stepper motor you need, even if it's a real oddball.

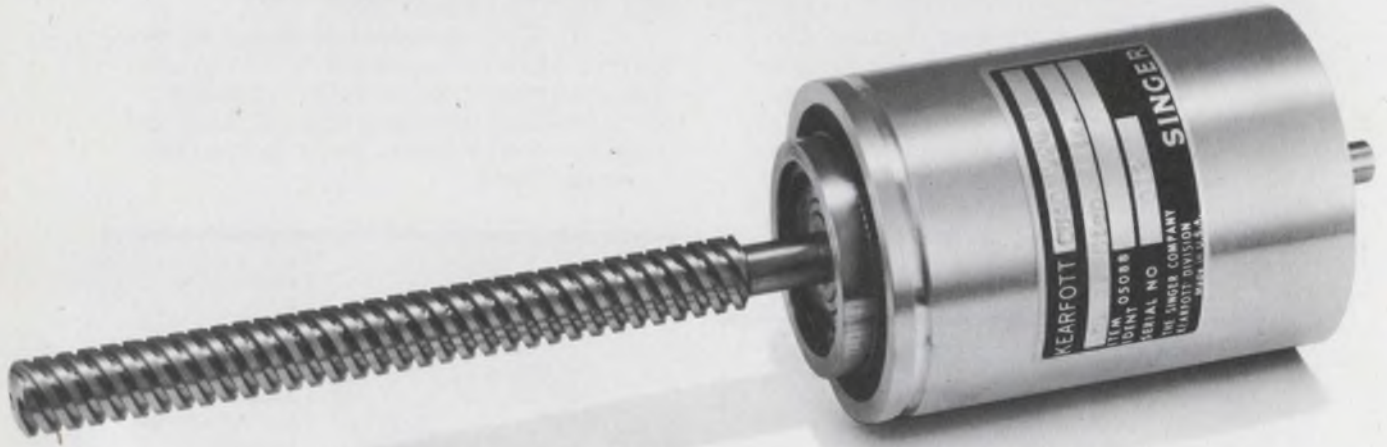

The motor shown above was specially designed with a head positioning lead screw for a "floppy-disc" computer memory.

You're not designing floppy-disc memory systems right now? Singer-Kearfott still can come up with the right stepper motor for *anything* you have that needs the right stepper motor.

Our single-source capability is based on the most complete line available today. You can choose from either permanent magnet or variable reluctance motors; stepping angles from 1.8° to 90°; maximum stepping rates from 100

to 2000 steps/sec.; and frame sizes from 8 through 40.

All these motors feature high detent torque; stable, continuous/instantaneous response; and precision accuracy. So they're ideal for applications where magnetic or punch-tape drives are used for print-out—business machines,

data processing equipment, communication input-output terminals, etc.

We also supply a universal, solid-state logic driver that's compatible with all Kearfott stepper motors.

The motors and logic driver are in production right now, making them readily available. Only the oddballs take a little longer. So write for our new, comprehensive stepper motor catalog, or phone us about your special requirements.

The Singer Company, Kearfott Division, 1150 McBride Avenue, Little Falls, New Jersey 07424. Phone: (201) 256-4000.



Size 18



Size 23



Size 20



Size 35

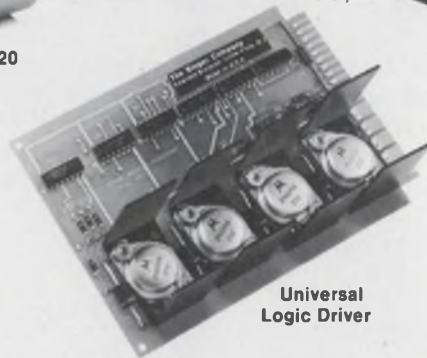

Universal Logic Driver

# SINGER

AEROSPACE & MARINE SYSTEMS

INFORMATION RETRIEVAL NUMBER 51



# NEW

## PANDUIT® Fully Automatic Cable Tie Installation Tool

**Automatically feeds cable tie around the bundle, tensions the tie, and cuts it off flush — all in less than 1 second!**

Panduit introduces the first lightweight fully automatic cable tie installation tool to be conveniently hand held. Now you can gain high-volume production with minimum fatigue.

**Lightest, Most Compact.** The PAT1M tool weighs just 1¾ lbs. — a fraction of competitive tools — and is sized to fit the operator's hand. Separate dispenser unit can be conveniently placed out of the way.



Dispenser Unit

**Fast Operation.** Simply place jaws around the bundle and touch the start button. The tool automatically installs a one-piece PAN-TY® cable tie around the bundle, tensions the tie and cuts it off flush — all in less than 1 second. The all-nylon tie meets MIL. STD. MS3367-4. The dispenser magazine holds 100 ties, twice the capacity of competitive units, reducing reload time by 50%.

**Versatile.** The unique design of the PAT1M allows cable tie installation closer to harness board accessories. The tool and dispenser operate in any angle or position. This tool can be used on bundle diameters from 1/16" to 3/4".

The PAT1M automatic tool is part of a complete line of cable tie installation tools including PPTS pneumatic, GS2B and GS4H hand operated. The PAT1M tool is available for lease from Panduit Corp. Panduit's full line of wiring components, including PAN-TY® and STA-STRAP® cable ties, PANDUCT® plastic wiring duct and PAN-TERM® terminals, is sold through authorized Panduit Stocking Distributors.

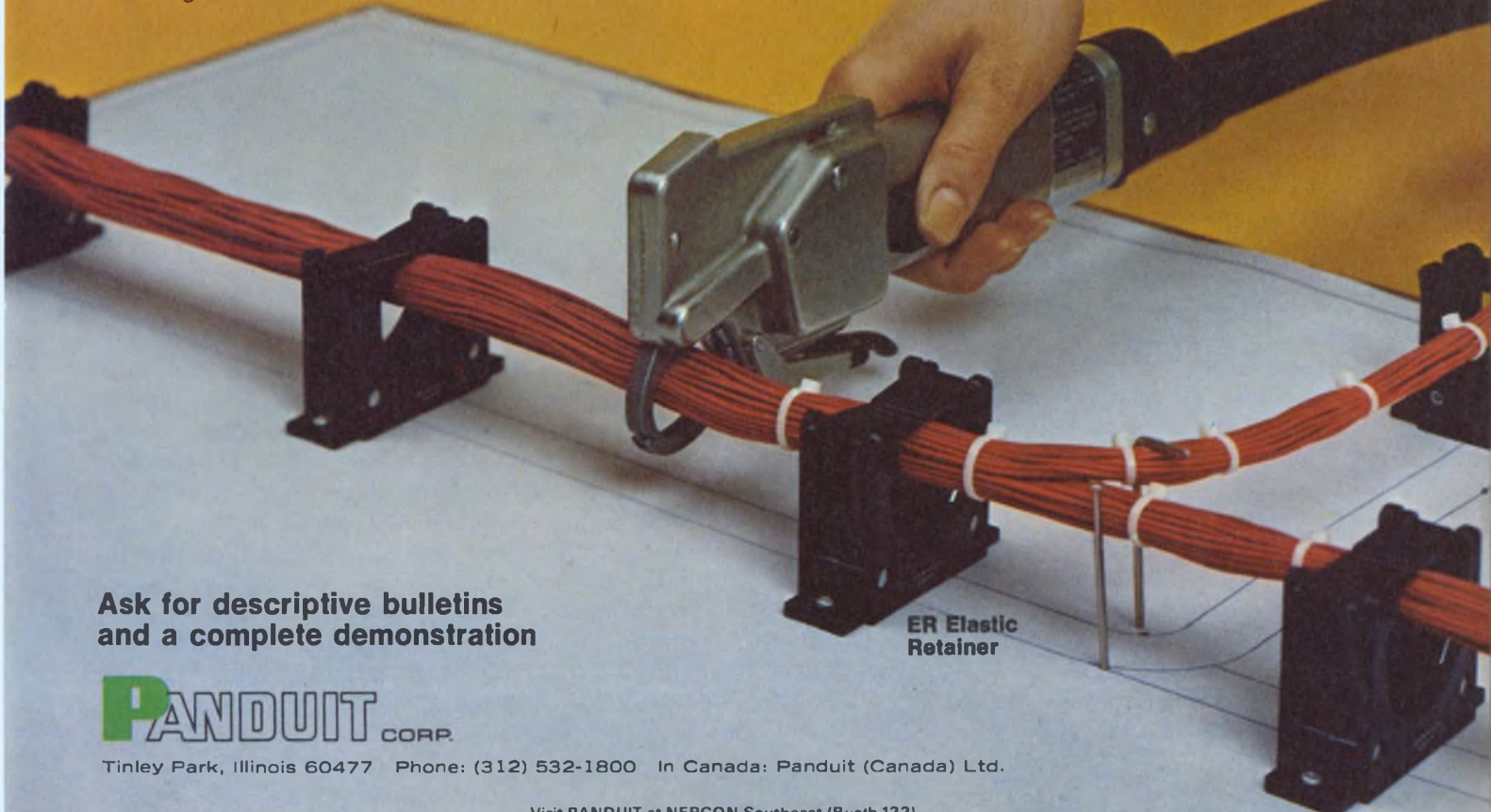

Ask for descriptive bulletins and a complete demonstration

ER Elastic Retainer

**PANDUIT** CORP.

Tinley Park, Illinois 60477 Phone: (312) 532-1800 In Canada: Panduit (Canada) Ltd.

Visit PANDUIT at NEPCON Southeast (Booth 122)



## Smarter terminals join with floppy-disc drives to stretch data capability

David N. Kaye, Senior Western Editor

A new-product explosion is occurring in computer peripherals. It centers on intelligent terminals and flexible, or floppy, disc drives.

Intelligent terminals are usually CRTs with keyboards and built-in processing capability, including memory. Floppy discs, which look like 45-rpm records, use a coated Mylar medium and provide from 0.5 to 5 million bits of random-access data storage. By combining the two products, users are getting a powerful distributed computer system.

Intelligent terminals are getting smarter all the time. Faster and more powerful processors are being incorporated. More memory is being added. And software approaching that developed for minicomputer systems is being offered.

So many other peripherals are now available for intelligent terminals that the capabilities of the terminals are nearing those of stand-alone minicomputers. The floppy-disc drive gives the terminal random access to a large amount of data stored locally—data that previously had to be stored by a large host computer remote from the terminal. As a result, the host computer might not have to be so large any more.

None of this would be practical if the disc drive were not relatively inexpensive. It can be obtained, including a controller, for less than \$1000. And it's getting cheaper all the time.

### Introducing the smart guys

Is it a computer terminal, a minicomputer with display and keyboard built in, or a sophisticated desk-top programmable calculator? The boundary between these categories is getting hazier. The intelligent terminal can be any or all. The only requirement that makes it a terminal is that

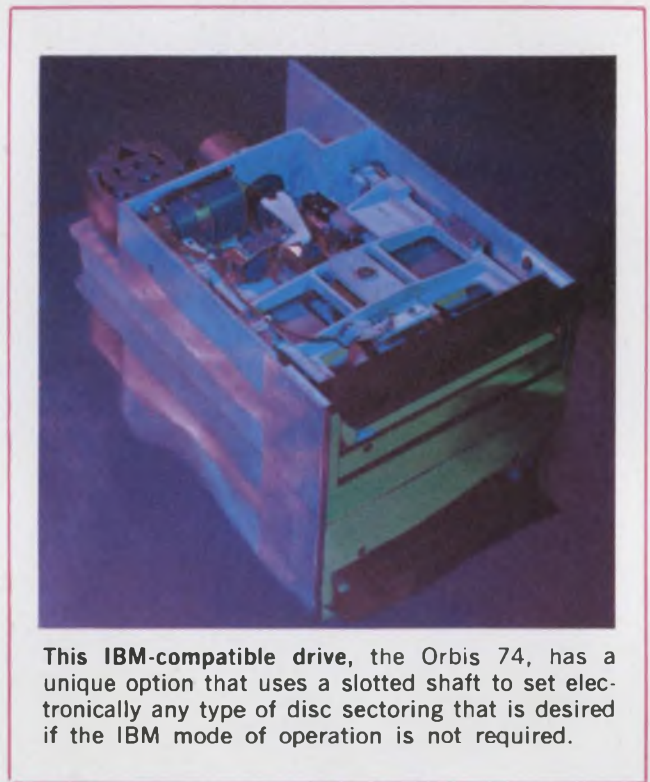

This IBM-compatible drive, the Orbis 74, has a unique option that uses a slotted shaft to set electronically any type of disc sectoring that is desired if the IBM mode of operation is not required.

it must be able to communicate with a computer.

Wang Laboratories, Tewksbury, Mass., builds the System 2200, originally introduced as a sophisticated programmable calculator. Since it is programmed in Basic, many users think of it as a minicomputer. But it has a 300-bps asynchronous data line which qualifies it as an intelligent terminal.

Intelligent terminals fall into two basic categories. The first type can emulate or replace the IBM 3270 intelligent terminal. It must be able to work in clusters of many terminals around a large central computer. The software for these



terminals is usually predetermined by the manufacturer. The operator at the terminal rarely does more than enter and edit data, seeking a reply to a relatively simple question from the host computer. The terminal formats and condenses the data before it's sent to the host computer. This makes processing by the host more efficient. Also the display gives the operator a choice of predetermined data-entry forms to guide his data input. In addition the terminal checks the input data for errors and allows for several forms of data editing at the terminal prior to transmission.

The second type of terminal is user-programmable. It can always be programmed at the keyboard, sometimes in a fairly high-level language. It can do most any problem that the operator can feed it. Sometimes the terminal can do some of

local data-transfer rates of up to 650,000 characters per second and remote line speeds of up to 7200 bps. The terminal operates with either a System/360 or System/370 host computer. Terminal programming can only be done at the host computer.

Emulators for the 3270 are offered by several companies. They include Delta Data, Cornwells Heights, Pa.; GTE Information Systems, Stamford, Conn.; Olivetti, New York, N. Y.; Raytheon Data Systems, Norwood, Mass.; Sanders Associates, Nashua, N. H., and Sycor, Ann Arbor, Mich. In most cases, these terminals can replace a 3270 directly, and they offer more capability at a lower price.

A good example of an IBM 3270 replacement system is the Raytheon PTS 100. The remote processing and memory are in a single console that feeds up to 96 display stations. The display station is a CRT with deflection electronics and a keyboard. Everything else is at the central processor. It is a TTL processor with multiple port MOS random-access memory (RAM). The displays are refreshed from a section of the RAM. The RAM has an 800-ns memory cycle time. The processor is expandable up to 64-k bytes of storage.

According to Alan Geller, manager of mini-computer engineering at Raytheon: "An interesting feature of our system is that any peripheral controllers that we use can cycle-steal from the main processor and do not need any additional processing in them."

An alternative approach to 3270 replacement is represented by the Sanders 8170 interactive terminal system. Here the user can program the terminal at the keyboard. Included are such things as user-definable special function keys and a built-in microprocessor with memory. Up to 600,000 bytes of information can be stored on a digital cassette recorder. Screen sizes of up to 1920 characters are offered. Since each terminal in a cluster has its own processing, a central processor is not needed away from the host computer.

Most terminal companies strongly favor programming the terminal directly. As Ephraim Gitelman, vice president of engineering at Computek, Cambridge, Mass., points out: "You have to give control of the problem to the guy sitting at the terminal. If not, his effectiveness is greatly decreased."

Computek produces an extremely versatile intelligent terminal, the Model 200. It features a TTL processor with up to 8 k of semiconductor RAM. The processor has a fast 1.3- $\mu$ s instruction time that is accomplished with an overlapping instruction fetch and execution. The basic architecture of the terminal is dual-bus, with one bus for instructions and the other for



IBM's 3270 terminal is the most widely used intelligent terminal in the field. It is intended for data-entry systems with up to 32 terminals in a cluster to an IBM host computer.

the necessary processing by itself. The terminal initiates a call for assistance from the host computer when necessary. Thus, this type of terminal can be used often as a stand-alone minicomputer.

### IBM terminals predominate

There are more IBM 3270 intelligent terminals in use than any other type. The terminal, made by the IBM Data Processing Div., White Plains, N. Y., is designed to operate either by itself or in a cluster of up to 32 terminals. It provides





Dasyn's 101 universal terminal uses single-bus architecture and an Intel 8008 CPU to provide considerable flexibility. A variety of memory boards and I/O interface boards and peripheral controller boards can be plugged into the bus.

data and input/output (I/O).

The display shows 200 characters in an 80-character-by-25-line format, in which each character is formed by a  $14 \times 20$ -dot matrix. Typical is  $5 \times 7$  or  $7 \times 9$ . This large matrix allows for better character formation than that of any other terminal on the market. Random-access display refresh uses 2 k of 10-bit characters. Two of the bits are used for such things as blinking, blanking and intensity control. The terminal sells for \$7500, including 8 k of RAM.

Most intelligent terminals not of the 3270 type are much smarter and more flexible.

Lowest in cost of the intelligent terminals is the 8025 from Omron Systems of Sunnyvale, Calif. It sells for \$2350 with 2 k of semiconductor memory. Its architecture is a single-bus type in which the CPU, memory and I/O interface boards all plug into a common data bus. This setup is found in many of the terminals on the market. It can be readily expanded with more memory and additional I/O interfaces.

Billy W. Goodner, manager of systems engineering at Omron, notes that it is even easy to add additional CPUs. In this way the terminal can become a multiprocessing system. Omron does not yet do this, and several other companies are talking about adding this capability, particularly in situations where there is no host computer.

Omron's terminal uses the Intel 8008 microprocessor as the basis for its CPU. This terminal is expandable to 16 k bytes of memory. As with most terminals, an RS-232 standard interface is available along with other schemes. The data rates available go up to 2400 bps in an asynchronous mode and 9600 bps in a synchronous mode.

Another low-priced terminal is the SB2 from Beehive Terminals, Salt Lake City, Utah. It sells for \$3295, with 2 k of semiconductor RAM. It also uses a CPU based on the Intel 8008 and displays 2048 characters on a 12-in. CRT. Lines of text in memory can be displayed on the CRT in pages, and flipped from one page to the next and back, or the text can be shifted one line at a time up or down in scroll fashion. A repeating control key on the keyboard allows scrolling of as many lines as desired in either direction.

Harvey Girard, head of engineering at Beehive, is not sure that most applications of intelligent terminals require a full-blown CPU. "We are looking at developing an LSI sequencer or programmed logic array for future terminals," he says, "that, while not as powerful as a general-purpose microprocessor, will be cheaper and more efficient at performing many of the jobs that an intelligent terminal must do."

Two more companies that base intelligent terminals on the Intel 8008 microprocessor are Digi-Log Systems of Horsham, Pa., and Dasyn of Santa Ana, Calif. Tom Emory, vice president of engineering at Digi-Log, points to the company's Microterm as a flexible terminal that can be configured to any custom need. Microterm uses a  $7 \times 11$ -dot matrix to form characters and has an expandable single-bus structure. Programming is in Intel assembly language. Almost any terminal feature that is desired can be incorporated. Prices start at \$1800 for a very simple terminal, Emory says.

Dasyn makes the Model 101 universal terminal. It is also single-bus, and it rivals the Digi-Log in versatility. However, it is sold as a standard unit with many options, while Digi-Log sells on a custom basis.

More powerful intelligent terminals that rival larger minicomputers in capability come from companies like Datapoint, San Antonio, Tex.; Sycor, Ann Arbor, Mich.; Four-Phase Systems, Cupertino, Calif.; Incoterm, Natick, Mass., and Sanders.

Datapoint makes a series of terminals—the 1100, 2200 and 5500—that the company calls computers. They range in price from \$8000 to over \$50,000. Each is based on a TTL central processor, with MOS memory and external bulk cassette storage. Both assembly and higher-level languages are available, and the units can work either by themselves or in clusters. William L.





The smallest, lightest and cheapest IBM-compatible drive is from Pertec. The D0330 is also the only totally dc driven drive. All others use an ac motor to spin the disc.

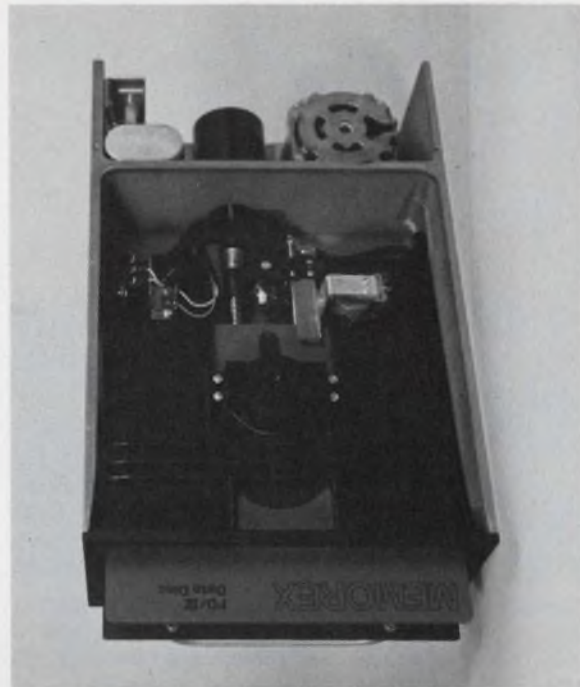

The most widely used non-IBM floppy-disc drive is the Memorex 651. More than 3000 of these are in the field. The drive uses a disc with a thicker coating, for longer life.

Borgerding, director of engineering at Datapoint, notes that the company has already shipped systems with multiprocessing capabilities, while others are just talking about doing this. Many different types of peripherals work with the Datapoint terminals.

Sycor's Model 340 has a fast 1.25- $\mu$ s TTL processor and a dual-bus architecture. One bus is for input to the terminal and the other for output. This terminal also has a direct memory-access feature. It contains 8 k of control memory ROM and 8 k of MOS RAM. Screen refresh and system buffers use 1 k of the RAM. A user application language called TAL allows easy data editing and data validation at the terminal as well as simple programmability for other functions. This terminal sells for about \$6600.

#### Floppy disc: Low cost, bulk storage

Intelligent terminals and minicomputers need a low-cost, random-access, bulk-storage medium. Hard discs have been the best means to date—that is, if you don't mind spending a few thousand dollars. If a few hundred dollars sounds more attractive and access time is not extremely important, floppy discs are the way to go. While still an immature technology, with a variety of approaches to choose from, floppies have proved themselves and are being used by the standard-maker, IBM. Since any computer peripheral that IBM makes becomes a de facto standard, floppy-disc drives are divided into two camps: IBM-

compatible and others.

When used as a peripheral for an intelligent terminal, the choice will usually be IBM-compatible. In this way the terminal can be used as a key-to-disc data entry system and the discs can be run on any IBM-compatible drive regardless of location. The drive also serves the terminal as part of a disc operating system, providing about 1.95 Mb of random-access storage. Most IBM-compatible drives have a track-to-track access time of 10 ms.

All IBM-compatible drives have an average latency (time for disc to rotate 1/2 revolution) of 83.3 ms, a data-transfer rate of 250,000 bps and a recording mode of double frequency, and they use the same medium for storage. The medium is a 7.88-in.-diameter, 3-mil-thick Mylar disc with a large hole in the center. This disc contains 77 recording tracks of which one is an index track containing all of the format coding and library information for the disc. Seventy-three are data tracks that come preformatted with sector address marks, data marks, cyclic redundancy coding and a track address mark. Two tracks are spares, and one is being reserved for some future use by IBM.

Each track is divided into 26 sectors, and each sector can contain 128 bytes of data. The disc also contains a physical hole that can be sensed optically to indicate the beginning of each track or the location of the track address. Most manu-





**Kennedy Data Systems' KDS-28** contains a pair of Century Data Systems floppy-disc drives and a controller. Interface electronics are included to mate the disc drives to Datapoint terminals.



**Sanders 810 intelligent terminal** has a 12-in. cathode-ray tube with 1920 characters. It can support up to eight "dumb" terminals with its processor, and it sells for \$6900.

facturers feel that the disc is good for at least one million head passes over any given track.

Donald Taylor, product manager on the D0330 flexible-disc drive for Pertec in Chatsworth, Calif., says: "Our tests indicate that the IBM disc is good for at least five million passes per track."

The discs cost \$8 from IBM and less than \$5 in large quantities from some of the other suppliers, the largest being Memorex of Santa Clara, Calif.

Many companies have introduced IBM-compatible drives, including Century Data Systems, Anaheim, Calif.; Control Data, Hawthorne, Calif.; General Systems International, Anaheim, Calif.; Innovex, Bedford, Mass.; Memorex, Orbis Systems, Costa Mesa, Calif.; Pertec; Potter Instruments, Melville, N. Y.; Shugart Associates, Sunnyvale, Calif., and Sycor. Their drives are compatible with that in the IBM 3740 data-entry terminal.

The most compact and least expensive of these drives is the D0330 from Pertec. It measures 3-1/2 x 8-3/4 x 14 in. and weighs 10 pounds. It sells for \$475 in 200 quantities. Most of the other drives are at least 20% larger, 20% more expensive and weigh 50% more. The Pertec drive is also completely driven from +24 V and  $\pm 5$  V. All other drives use an ac motor to rotate the disc, and practically every drive has different dc requirements.

Next smallest of the drives is the Model 210 from Innovex. It measures 4.3 x 9 x 14-in. but weighs 15 pounds. As with most other drives,

it can be mounted in any orientation for incorporation into a system. This drive is unique in that it is a sealed one, with filtered air passing over the disc to increase media life by preventing dust from jamming between the head and the disc. All IBM-compatible drives have the read/write head in contact with the disc. The head is moved across the disc by a dc stepper motor, which, in all cases except Pertec's, steps at one track per step. Pertec uses three steps per track for higher accuracy.

Shugart Associates has more IBM-compatible floppy disc drives in the field now than any other manufacturer. Called the Model 900, their drive has very few adjustments, and head penetration is referenced to the body casting for ready interchangeability of heads in the field. The Shugart head is a proprietary design that uses no epoxy in the recording gap area. Even under extreme temperature variation, nothing can expand beyond the head surface to scratch the disc. Most other manufacturers claim that this is not a problem, as long as the drive is used within the specified temperature limits—typically +10 to +40 C.

Since the recording head is in contact with the disc during operation, all drives provide a means of unloading the head from the disc, either when the disc is being put into or taken out of the drive and during an idle condition. This is accomplished with a controller command to the drive. This command is usually given if the disc has revolved about five times without a read, write or seek command. In most drives the pres-



sure pad that holds the head to the disc is retracted by a solenoid. In the Pertec drive, the head is also physically retracted about 30 mils from the disc.

### The non-IBM world

Most popular of the non-IBM-compatible drives is the 651 from Memorex. More of these drives are in the field, says Keith Plant, director of OEM marketing at Memorex, than all other manufacturers' drives with the exception of IBM. The 651 uses a different type of disc than the others. It appears to look the same, but it has an 80% thicker coating than the IBM disc and will wear longer. Also, it is permanently subdivided into 32 sectors, with holes spaced along the disc. The maximum capacity of this disc is 2.1 Mb of formatted data. All other characteristics of the drive are similar to the IBM-compatible drives.

Three drives are very different from all the rest. They are made by Innovex; Dynastor, Denver, and Intelligent Memory Systems, Newport Beach, Calif. All three use heads that are not in contact with the disc for long life. The Model 110 from Innovex uses a recording medium that is a square plastic frame with coated Mylar stretched across the frame. A circular section of the medium is used as the recording surface. The frame does not move; rather the head rotates in a circular path over the surface. It also moves in and out for random-access operation.

The head is moved by a rack-and-pinion mechanism and rotates at 390 rpm for an average latency of 77 ms. The average access time of this drive is 208 ms, with a track-to-track access time of 6 ms. With eight sectors, the capacity of the drive is 1.22 Mb. This drive sells for \$620 in quantities of 200.

### Plastic cartridge is used

Dynastor uses a plastic cartridge containing a free-floating, thin Mylar disc. When the cartridge is inserted in the drive, the disc is removed and spun up against an aluminum base plate. The flying head is controlled by a servo-driven, cable-pulley assembly to the proper disc track. The disc is rotated at 3600 rpm for an average latency of 8.33 ms. But the track-to-track access time is 100 ms. However, the head can move across the entire disc in 320 ms. The data-transfer rate is 2540 bps. With 32 preformatted sectors, the usable capacity of the disc is about 2.2 Mb. In a single-drive configuration, called the Model 30, the drive sells in 200 quantities for \$650. In a dual-drive configuration, called the 40, the price is \$1115 for 200 units.

Similar in concept to the Dynastor drive is

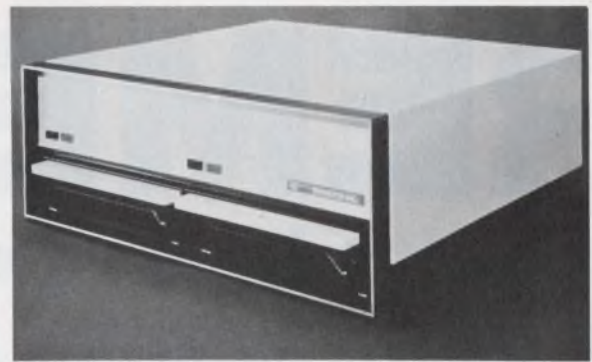

Two fly-head disc drives are contained in the Dynastor Model 40. Each disc has 32 sectors and can store about 2.2 Mb of data. The transfer rate on this drive is 2540-k bits per second.

the Model 300 from Intelligent Memory Systems. The difference is that while the Dynastor drive uses a moving head, this drive is a fixed head-per-track type. With 16 tracks and 32 sectors, the capacity is 0.5 Mb. The average access time is only 16.7 ms.

This drive, according to Kjell Hovik, vice president of Intelligent Memory Systems, is aimed at minicomputer real-time operating systems. The entire drive consumes only 5 W of dc power and 10 W of ac. The cost of the drive in 200 quantities is only \$375. A version of the drive is also available with up to three fixed discs.

All of the other non-IBM compatible drives are similar to the Memorex 651 with a variety of small improvements. One of the more novel features is an electronic sectoring scheme from Orbis. According to J. V. Howell, vice president of engineering:

"We use the IBM reference hole to give us a track start reference pulse, and we have a slotted disc mounted on the drive shaft. The slotted disc has 256 holes that can be sensed by an optical coupler. Once the track starts, we count 128 pulses between every hole on the slotted disc. This divides the disc into 32,768 pulses per revolution. These pulses can be used to set any number or size of sector that is desired." This feature is an option on the Model 74 drive.

### The floppy and the terminal joined

With the addition of a controller/formatter, the floppy-disc drive can be married to an intelligent terminal. The first terminal manufacturer to do it is Sycor. Dieter Heidrich, director of product development, reports: "We have developed our own floppy-disc drive and married it to our 340 terminal. It is an IBM-compatible drive that can accommodate two discs at once with a fast 2.5-ms, track-to-track access time." ■■



# REMEX . . .

## peachy keen peripherals at plain vanilla prices

Peripherals unlimited, with unmatched price performance. Remex delivers on this promise with a complete lineup of advanced, reliable peripherals to meet any minicomputer requirement.

Punched tape? Remex is the leading producer of P/T peripherals, with more units of all kinds in service than any other manufacturer.

Considering digital cassette? Remex puts you ahead of the game with a complete line of equipment and systems. Including the world's first Punched Tape Emulator, that can turn any punched tape system into a high-speed, high-capacity digital cassette tiger.

Floppy disk drives and systems? Remex has 'em, ready to deliver.



If you know what you need, let's talk delivery. If you're not sure what you need, talk to us about the most efficient peripherals approach. We have no axe to grind, because we have them all.

Write or call Remex, 1733 Alton St.,  
Santa Ana, California 92705. (714) 557-6860.  
*In Europe and the U.K., contact S.p.A.,  
Microtecnica, Torino, Italy.*

**We work with you!**

# REMEX

High speed punched tape reader/spoolers

Versatile punched tape readout units

High performance digital cassette drives

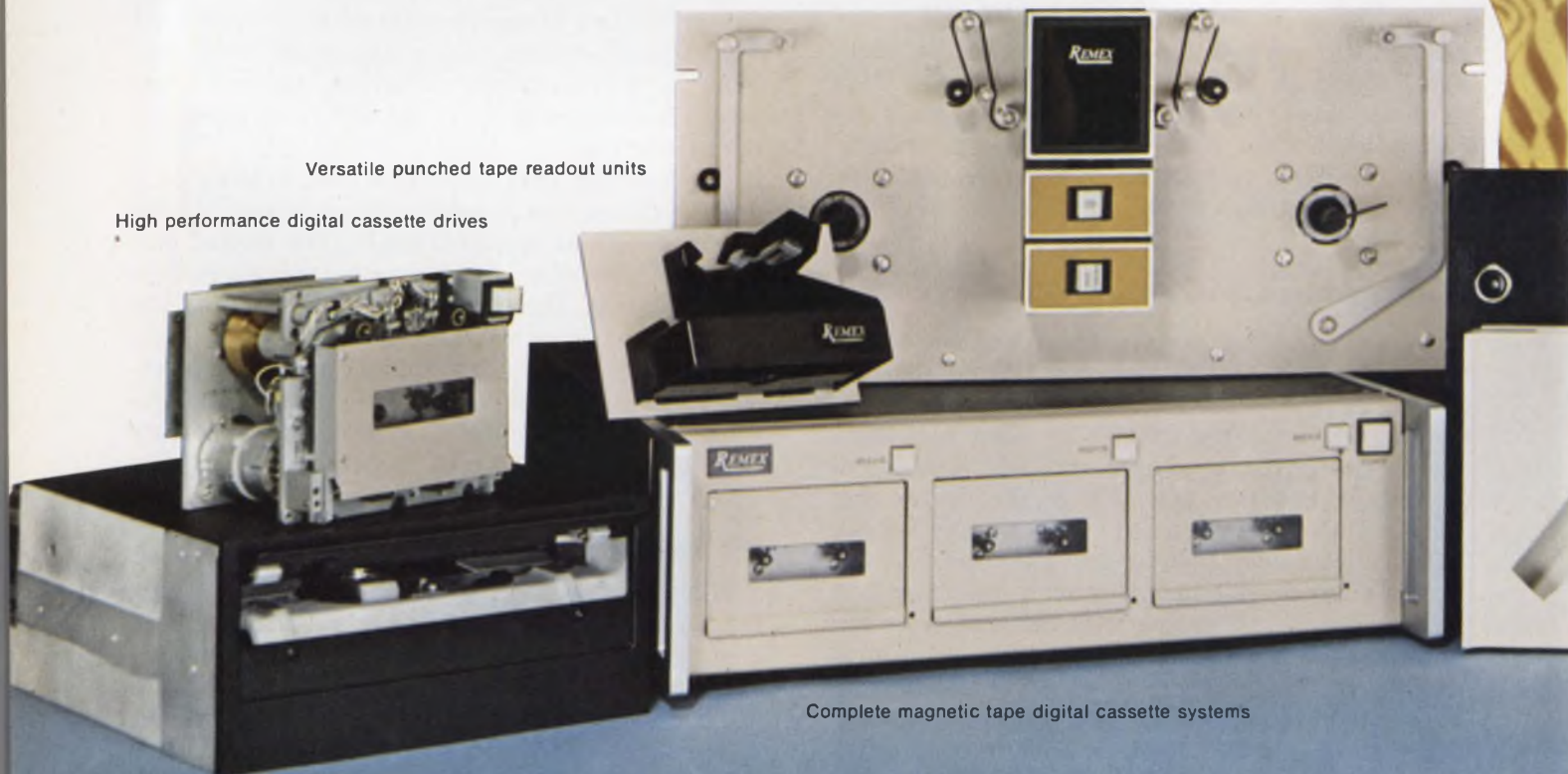

Complete magnetic tape digital cassette systems

Modular floppy disk drives





High speed punched tape perforator/reader combos



Complete floppy disk systems

World's first Punched Tape Emulator

A UNIT OF



EX-CELL-O CORPORATION

INFORMATION RETRIEVAL NUMBER 53



# OUR CASSETTE RECORDER WAS JUST TOO GOOD TO KEEP TO OURSELVES.



We designed the Sycor Model 135 cassette recorder to stand up to the toughest standards in the world.

Our own. For use in our own Sycor terminals.

But when we finished, we knew we had a cassette recorder capable of meeting a world of OEM and other users' needs.

The 135, for instance, has a unique capacity for record overwrite. You can edit a complete data block without disturbing the data on either side of the new record.

The 135 reads/writes at a fast 12.5 ips with quick starts and stops for high throughput. A dual-gap head gives it the capacity for Read-After-Write verification. And when you need quick access to specific data, it'll search through a cassette at a rapid 60 ips.

Every day, in 34 countries around the globe, over 20,000 Sycor cassette recorders prove their reliability. Look into our Sycor 135 yourself. You'll find why we found it too good to keep to ourselves.

## SYCOR

**SI**  
SYCOR INC

For complete product information—or for assistance with any design or application problem you may have—contact OEM Department, Sycor, Inc., Ann Arbor, Michigan 48104. Telephone (313) 971-0900.

*Internationally represented by Munzig International in London, Paris, Munich, and Geneva, and by STG International in Tel Aviv.*

INFORMATION RETRIEVAL NUMBER 54



*New!*

# "The Persuader"

For complete S190 data and/or sample switches, visit the N.C.C. Show C.P. Clare Booth No. 934-936 or call your closest Clare-Pendar sales office:

- ALABAMA**  
Huntsville: C. P. Clare & Co. (205) 534-5438
- ARIZONA**  
Phoenix: Spectrum Assoc. (602) 997-6324
- ARKANSAS**  
Fort Smith: J. R. Masterson (501) 646-7756
- CALIFORNIA**  
Mountain View: C. P. Clare & Co. (415) 968-2831  
Santa Ana: Spectrum Assoc. (714) 835-4114
- FLORIDA**  
Ft. Lauderdale: R. I. Smith Assoc. (305) 772-5100  
Largo: R. I. Smith Assoc. (813) 585-2980
- GEORGIA**  
Atlanta: Austin Brown & Assoc. (404) 457-6381
- ILLINOIS**  
Chicago: C. P. Clare & Co. (312) 262-7700
- INDIANA**  
Ft. Wayne: Baehr Greenleaf & Assoc. (219) 447-1608
- KANSAS**  
Shawnee Mission: Lowell-Kangas Assoc. (913) 631-3515
- MARYLAND**  
Ellicott City: Doss Electronics, Inc. (301) 465-1336
- MASSACHUSETTS**  
Needham: C. P. Clare & Co. (617) 449-4780
- MICHIGAN**  
Southfield: C. P. Clare & Co. (313) 356-3988
- MINNESOTA**  
St. Paul: Repor, Inc. (612) 645-8618
- MISSOURI**  
St. Louis: Lowell-Kangas & Assoc. (314) 821-4050
- NEW YORK**  
Great Neck: C. P. Clare & Co. (516) 466-2100  
Fayetteville: C. P. Clare & Co. (315) 637-3939
- NORTH CAROLINA**  
Charlotte: R. W. Chapman & Co. (704) 525-2421  
Raleigh: R. W. Chapman & Co. (919) 782-2624
- OHIO**  
Cleveland: Baehr Greenleaf & Assoc. (216) 221-9030  
Cincinnati: Baehr Greenleaf & Assoc. (513) 891-3826  
Columbus: Baehr Greenleaf & Assoc. (614) 486-4046
- PENNSYLVANIA**  
Ft. Washington: C. P. Clare & Co. (215) 643-5321  
Pittsburgh: Foster-McClinton, Inc. (412) 561-4803  
Erie: Foster-McClinton, Inc. (814) 455-9111
- SOUTH CAROLINA**  
Greenville: R. W. Chapman & Co. (803) 232-5391
- TEXAS**  
Dallas: Robert E. Nesbitt Co. (214) 357-4601  
Houston: Gettys-Eads-Adair, Inc. (713) 781-3005
- VIRGINIA**  
Richmond: Advance Control Equipment (804) 264-2588
- WEST VIRGINIA**  
Huntington: Foster-McClinton, Inc. (304) 736-5161
- WISCONSIN**  
Wauwatosa: Larson Assoc. (414) 258-0529

INFORMATION RETRIEVAL NUMBER 55

Rugged...versatile

*New!*

# "The Persuader"

The S190 switchlight outguns everything its size... costs only \$1.62\*

In every era, new products come along to keep the competition honest, with all the cards on the table. So we invite you to compare our S190 series with other switchlights. Check our variety of lens colors and easy mount panel adaptors... our wide terminal spacing for easy and fast wiring: solder, quick connect, PCB... our no-tool lamp replacement, long life wiping contacts, rugged molded case. Consider the low cost when you realize that the S190, with its 2 Form C action, has greater circuit flexibility than most switchlights on the market. And it's easily available at your local distributor! Call our sales office in your area for applications assistance... we're located in major cities, world wide. Clare-Pendar Co., Box 785, Post Falls, Idaho 83854, (208) 773-4541.

\*In quantities of 1000



**CLARE-PENDAR**

Switchlights & Keyboards





## Minis, minis everywhere, when it comes to control of industrial processes

Northe K. Osbrink, Western Editor

Without the minicomputer, computerized industrial process control might easily have remained a novelty for rich corporations. The large computers of the 1960s were expensive, and they also had to be modified for process control. Most companies were reluctant to use them unless the machines could also be programmed to perform a variety of other plant functions.

But what a difference a mini makes. Today there are minis on the production line . . . minis in the quality-control test area . . . minis in the warehouse . . . hierarchies of minis. Not-so-expensive minicomputer systems are working efficiently in applications ranging from the control of machine tools and oil and gas pipelines to concrete and asphalt production and weaving looms.

### Two major classes of computers

There are two major classes of industrial process control. The first is the traditional, continuous-flow process found in a chemical plant, refinery, pipeline or power-distribution system. The second, the intermittent (or step) process, encompasses everything else—batch processing of materials and production lines or, with a little stretching, machine-tool control.

A computer finds very little difference between the various processes; much that applies to one process applies to another. The differences are in the hardware required outside the central processor—the input/output interfaces, operator interface and communications links.

The speed of a process computer is not as important as reliability, hardware and software flexibility, the availability of software and pro-



For harsh environments, Rolm minicomputers, produced to MIL specs, offer up to four times the MTBF of commercial counterparts.

gramming languages, and I/O interfaces.

In addition the process-control computer should have power-failure protection and a priority-interrupt structure. The former assures that the data and programming are not lost if power is lost. The latter structure—either hardware or software—assures the safe shutdown of machines or processes in case of failure.

### For testing and control jobs

One application of computers to industry today is the automatic gauging and inspection station.



In a high-capacity industrial plant, such a test system can operate with little or no human supervision. An example is the new Digital Tire Uniformity Optimizer Computer System, designed jointly by Electronic Associates Inc., West Long Branch, N.J., and the Akron Standard Corp.

The system force-tests tires, and it controls the grinding of rubber from them to achieve uniformity in the tires. The delivery of tires from a waiting station, their testing, grinding, grading, marking and delivery to a pick-up station—all are guided by the computer. The computer control is based on the Electronic Associates Datapacer 16-bit mini, with 32 k of core memory. All required test parameters and machine-control instructions are stored in software

production changes. With a computer in the system either controlling the machines directly or providing the program for the control, productivity rises. The program for any number of controllers can be stored and recalled whenever needed.

Lawrence W. Delong, product manager for computer control systems at the Allen-Bradley Systems Div., Highland Heights, Ohio, says: "Our Model 1795 computer system can maintain a parts program in its bulk memory and feed up to 16 programmable controllers. The computer can simultaneously monitor the machines for parts counts, cycle times, machine failures and jam-ups, and relay statistical data to a higher-level computer. Perhaps most importantly, it can also be used to perform parts-program editing



A Western Electric plant in Massachusetts uses a DEC PDP-8 minicomputer to monitor and control several coil-winding stations. The stations are

supervised by PDP-14 programmable controllers. This is an example of the industry trend toward the creation of computer hierarchies.

tables, so tires can be custom-fashioned to the requirements of a specific automobile suspension. In addition to testing tires, the system collects and displays statistics on the results, enabling changes to be made in the tire-production process.

Computer control of industrial machines is a direct outgrowth of digital numeric control, which relied on hard-wired controllers or paper tape readers. The computer-controlled system eliminates the time and expense of paper-tape generation and handling, as well as the need to modify a hard-wired controller program to make

and modification."

A hierarchy of computers is formed when an on-floor computer is used to deliver data to a higher-level supervisory machine. The availability of computers of varying sizes—inexpensive and capable of collecting data from other computers and sending data to them—has led to increasing use of the computer hierarchy in industry. Ron Roberts, manager of special systems marketing and development for General Automation, North Hollywood, Calif., explains:

"The technology of a computer hierarchy is to have a direct link from a process [satellite]



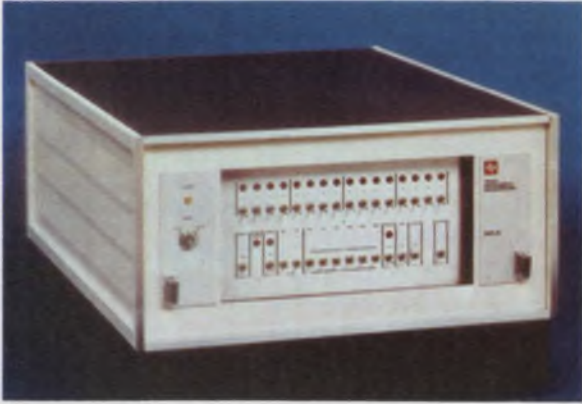

Designed specifically for industrial automation is the Texas Instruments Model 960A minicomputer. A wide selection of interface modules and a special machine architecture are available.

computer to higher-level [host] computer—which in many cases can be another mini. The important thing is to reserve control of the machine or process locally, without depending on the host computer to control the process directly. That way failures are localized. If the host computer goes down, the satellite will keep the process going. And, in some cases, if the process computer goes down, the host can tell it where to begin when service is resumed.”

One way to establish a computer hierarchy in a plant that is automating gradually is to use similar minis for both the satellite and host functions. The satellite computers are installed first, and when the amount of information handled becomes enough to warrant it, one computer is upgraded to a host function. F. G. Seeberger, manager of manufacturing automation for Texas Instruments, Houston Tex., notes:

“Some of our customers have had good success using our Model 960 computers to automate an industrial plant. First they use a single 960 to control a simple task—but buy it with a disc, so they have in-house software development capability. Then they add other 960s doing other tasks, and finally upgrade the disc-equipped 960 to host—and replace its original position with a new, smaller unit. The host computer has many uses as a data collector, a real-time source of factory information for management and also for software development.”

In the Canadian Interprovincial Pipeline Network, a Digital Equipment Corp. System-10 computer acts as host to 44 PDP-8 minis. The latter are at pumping stations along the 1900-mile oil pipeline. Each mini controls several large pumps and monitors flow, viscosity, station environment and electricity consumption of the pump motors. DEC says that a 30% savings in electricity use

was achieved on the pipeline during the first year of operation.

### Minis go with the environment

Once the decision is made to use a computer in industry, most engineers tend to worry about the reliability and suitability of the minicomputer in the traditionally severe factory environment. The usual concerns are interface between computers and operators, interface between the computer and machines and the effect of electrical interference, harsh temperatures and vibrations on the computer.

The interface between process computers and operators is almost universally CRTs or typewriter terminals. As one engineer at Leeds & Northrup, North Wales, Pa., explains it: “We are using computer consoles with graphic recorders, CRTs and printers. Most factory personnel are readily able to pick up the operation of a console—and we can provide a training program if the customer wants.”

The discrete lamp-and-switch-control panel—so long connected with industrial control—is not very common in computer installations. Computer and systems suppliers generally agree that it is expensive to design custom panels for each plant installation, and they are concerned about possible excessive maintenance. In addition a lamp panel does not provide for easy modification if the system needs changing, and it displays only a relatively limited amount of data. Computers, on the other hand, can generate a great deal of data and be modified simply.

Some industries still require the old panel concept, though. Peter L. Andersen, director for the Electronics Div. of Phoenix Engineers, Orange, Calif., explains: “Our field is automating concrete and asphalt batching plants. We initially tried to use a CRT terminal but had to drop it. We discovered that many of the operators, with many years’ experience, were unable to adapt to using a terminal. Also, many of our customers wanted to minimize any retraining of operators. Now most of our systems have operator-control panels, and the computer remains practically invisible.”

Andersen does point out, however, that sometimes the display capability of such a panel is too limited and he is forced to go to a computer terminal.

### Conversational English preferred

Another way to avoid confusing the operator is to have the computer “talk” to him in conversational English. It’s easy to program a computer to talk an operator through his process, step by step, designers say. It takes a lot of





Automated batching systems by Phoenix Engineers are built around Cincinnati Milacron 8000-series

minicomputers. Phoenix adds its own interfaces and software, using 8-to-24-k bits of memory.

memory space, but memory is cheap—certainly cheaper than having to bring in an engineer to run things.

The interface between computer and machine has been greatly simplified by the large variety of modules and corresponding software available from mini manufacturers. Most computer systems will accept analog, TTL, HTL and various switch-closure signals—both ac and dc. Most manufacturers are well aware that noise may get into the computer via signal inputs, and many use optical isolation in their modules. According to Roberts of General Automation:

“Optical isolation is the modern solution to receiving signals from electrically noisy environments. In the past we had to use complex filter techniques. Through the use of signal conditioning and programming techniques, input signals can be pulled through some very nasty noise.”

#### Environment no problem

Most minis—particularly that breed of ruggedized machine designed for industrial use—can easily stand up to industrial plant temperatures and vibrations. And the elimination of wired connections in the machines, as well as better knowledge of materials and manufacturing, has made them relatively dust and fume-proof. As long as they are supplied with a flow of air—even approaching their upper ambient temperature limits—most will perform well.

In severe cases of power-line voltage fluctuation or transients, it may be necessary to condition the power line being fed to the computer. Minicomputer power supplies are very tolerant of line noises and voltage fluctuations, and

modern digital circuit design makes computers much less likely to “see” noise anyway. The problems are usually associated with the power fed to rotating peripherals, such as drum or disc memories or tape drives. For that reason, most industrial installations do without them and rely on core memory when possible.

#### Energy conservation a new field

A new industrial market is emerging because of the current interest in energy consumption: energy demand and monitoring. In a typical case, a large steel mill using arc melting furnaces buys electricity at reduced rates, so long as its consumption remains below a contracted level. As soon as energy use in the plant approaches the penalty level, a minicomputer produces an alarm or shuts off loads. If the mini is fully supplied with process information—what furnaces are in what stage of their process and which are due to be started and which stopped—the mini can adjust voltages and timing to prevent the load from exceeding the contract.

Terence K. McMahan, who has just completed a survey of the process-control field for Frost & Sullivan, market researchers of New York, says:

“The biggest buyers of process-control computers will remain the petroleum and chemical industries for some time—with the biggest growth in the next 10 years being in nonferrous metals and the paper industry.

“The mini has already taken over. With a few exceptions, there will be no significant number of computers as large as the IBM 1800 going in—although the petroleum industry will make some installations using IBM System/370s as central computers.” ■■



Do you face  
a make or buy  
decision on  
power supplies?

# BUY LAMBDA'S LZ SERIES MOUNTABLE POWER SUPPLY.

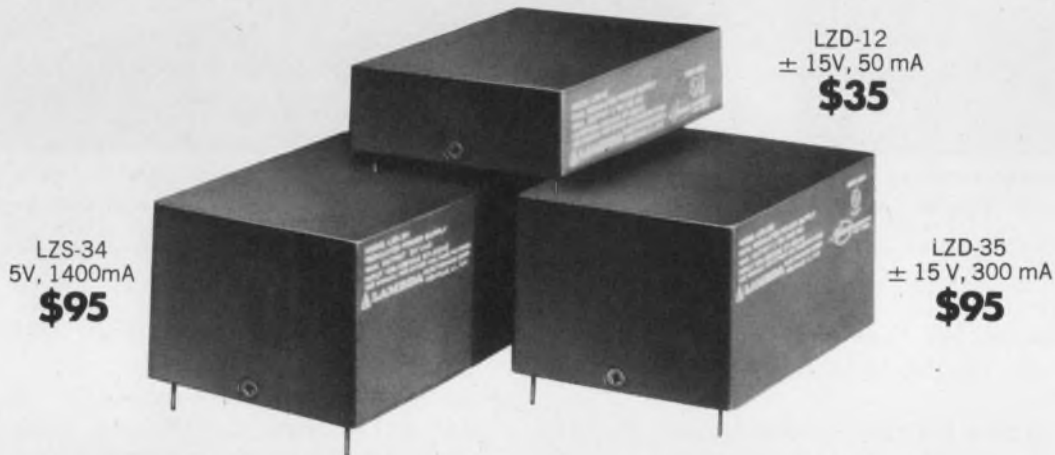

## LZ-10 SERIES SINGLE OUTPUT

2½" x 3½" x 7/8"

MODEL	VOLTAGE <sup>(1)</sup> VDC	CURRENT mA	PRICE <sup>(2)</sup>
LZS-10	3	317	\$35
LZS-10	4	384	35
LZS-10	5	450	35
LZS-11	10	225	35
LZS-11	12	195	35
LZS-11	15	150	35

## LZ-10 SERIES DUAL TRACKING OUTPUT

2½" x 3½" x 7/8"

MODEL	VOLTAGE <sup>(1)</sup> VDC	CURRENT mA	PRICE <sup>(2)</sup>
LZD-12	±15V	50	\$35

## LZ-20 SERIES SINGLE OUTPUT

2½" x 3½" x 1¼"

MODEL	VOLTAGE <sup>(1)</sup> VDC	CURRENT mA	PRICE <sup>(2)</sup>
LZS-20	10	247	\$55
LZS-20	12	268	55
LZS-20	15	300	55
*LZD-22	24	73	40
*LZD-23	24	129	55
*LZD-22	28	84	40
*LZD-23	28	143	55

\*Single output ratings for dual output models connected in series

## LZ-20 SERIES DUAL TRACKING OUTPUT

2½" x 3½" x 1¼"

MODEL	VOLTAGE <sup>(1)</sup> VDC	CURRENT mA	PRICE <sup>(2)</sup>
LZD-21	± 3	217	\$55
LZD-21	± 4	258	55
LZD-21	± 5	300	55
LZD-22	±10	61	40
LZD-23	±10	114	55
LZD-22	±12	73	40
LZD-23	±12	129	55
LZD-22	±15	90	40
LZD-23	±15	150	55

## LZ-30 SERIES SINGLE OUTPUT

2½" x 3½" x 1¼"

MODEL	VOLTAGE <sup>(1)</sup> VDC	CURRENT mA	PRICE <sup>(2)</sup>
LZS-30	3	633	\$65
LZS-30	4	767	65
LZS-30	5	900	65
LZS-33	10	293	65
LZS-33	12	336	65
LZS-33	15	400	65
LZS-34	3	950	95
LZS-34	4	1180	95
LZS-34	5	1400	95
*LZD-32	24	186	65
*LZD-32	28	208	65
*LZD-35	24	240	95
*LZD-35	28	280	95

\*Single output ratings for dual output models connected in series



# ...PRINTED-CIRCUIT BOARD

## LZ-30 SERIES DUAL TRACKING OUTPUT

MODEL	2½" x 3½" x 1⅞"		PRICE <sup>(2)</sup>
	VOLTAGE <sup>(1)</sup> VDC	CURRENT mA	
LZD-31	± 3	333	\$65
LZD-31	± 4	417	65
LZD-31	± 5	500	65
LZD-32	±10	163	65
LZD-32	±12	186	65
LZD-32	±15	220	65
LZD-35	±10	200	95
LZD-35	±12	240	95
LZD-35	±15	300	95

## LZ-30 SERIES TRIPLE OUTPUT

MODEL	2½" x 3½" x 1⅞"		PRICE <sup>(2)</sup>
	VOLTAGE <sup>(1)</sup> VDC	CURRENT mA	
LZT-36	5	500	\$70
	±15	50	

NOTES: (1) LZ models are adjustable between the following limits: LZS-10 2.5 to 6V LZS-11 8 to 15V LZS-20 8 to 15V LZS-30 2.5 to 6V LZS-33 8 to 15V LZS-34 2.5 to 6V LZD-12 ± 14.5 to ± 15.5V LZD-21 ± 2.5 to ± 6V LZD-22 ± 8 to ± 15V LZD-23 ± 8 to ± 15V LZD-31 ± 2.5 to ± 6V LZD-32 ± 8 to ± 15V LZD-35 ± 8 to ± 15V LZT-36 2.5V-6V for + 5V output only, ± 14.5 to ± 15.5 for ± 15V output only. Contact factory for current ratings at voltage settings not indicated in the tables. (2) All prices and specifications are subject to change without notice.

## SPECIFICATIONS FOR LZ SERIES

### Regulation

0.15%—line or load; models LZS-10, LZS-30, LZS-34, LZD-21 and LZD-31 have load regulation of 0.15% + 5mV; model LZD-12 has line or load regulation of 0.25%; LZT-36 line regulation 0.15% (+5V) 0.25% (±15V); load regulation 0.15% + 10mV (+5V), 0.25% (±15V).

### Ripple and noise

1.5mV RMS, 5mV, pk-pk

### Temperature coefficient

0.03%/°C

### Overshoot

no overshoot on turn-on, turn-off, or power failure

### Tracking accuracy

2% absolute voltage difference for dual output models only and only for the ±15V output in LZT-36; 0.2% change for all conditions of line, load and temperature

### Ambient operating temperature range

continuous duty from 0°C to + 50°C

### Wide AC input voltage range

105 to 132 Vac, 57-63 Hz

Storage temperature range  
-25°C to +85°C

Overload protection  
fixed automatic electronic current limiting circuit

Input & output connections  
printed circuit solder pins on lower surface of unit. For model LZT-36 the ± 15V outputs are independent from the 5V output.

Controls  
screwdriver voltage adjustment over entire voltage range.

Mounting  
tapped holes on lower surface

Physical data  
Size  
see tables  
Weight  
LZ-10 series 10 oz. net 18 oz. ship.  
LZ-20 series 17 oz. net 25 oz. ship.  
LZ-30 series 24 oz. net 32 oz. ship.

60-day guarantee  
60-day guarantee includes labor as well as parts

## LZ SERIES NOW AVAILABLE IN NEW TRIPLE OUTPUT MODEL



MODEL	VOLTAGE <sup>(1)</sup> VDC	CURRENT mA	PRICE <sup>(2)</sup>
LZT-36	5V	500	\$70
	±15V	50	

**1 DAY DELIVERY  
60 DAY GUARANTEE**



**LAMBDA  
ELECTRONICS CORP.**

A Varco Company

MELVILLE, NEW YORK 11746 515 Broad Hollow Road Tel. 516-694-4200 ARLINGTON HEIGHTS, ILL. 60005 2420 East Oakton St., Unit Q Tel. 312-593-2550 NORTH HOLLYWOOD, CALIF. 91605 7316 Varna Ave. Tel. 213-875-2744 MONTREAL, QUEBEC 100C Hymus Blvd., Pointe Claire, Quebec 730 Tel. 514-697-6520 HIGH WYCOMBE, BUCKS, ENG. Abbey Barn Road, Wycombe Marsh Tel. High Wycombe 36386/7/8 ORSAY, FRANCE 91 Gometz le Chatel. ACHERN-FAUTENBACH, W. GERMANY 1m. Holzbosch 14 Tel. 078-41-5527

INFORMATION RETRIEVAL NUMBER 56



# The case for Liquid Crystal Displays

**Liquid crystal displays;** light emitting diodes; incandescent and fluorescent displays and "Nixie" tubes are popping up frequently in circuit designs as the trend to digital readout continues. Each has a purpose and the design engineer should become familiar with all types. We make liquid crystal displays.

## The display of the future?

Our display is a sandwich of two plates, joined and hermetically sealed at the perimeters. A space of about .005" separates the plates, and this is filled with a nematic liquid crystal solution.

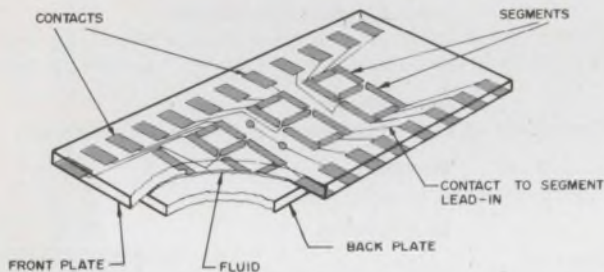

When the liquid is not electrically excited, its long, cigar-shaped molecules are parallel to one another in a position perpendicular to the plates. Thus, the liquid appears transparent. Applying an electric current creates ion activity which leads to turbulence and causes the liquid to scatter incident light. The visual effect is that of a frosted glass. LCD's can be made completely transmissive for back-lighting, reflective for ambient light or semi-reflective for dual mode operation.

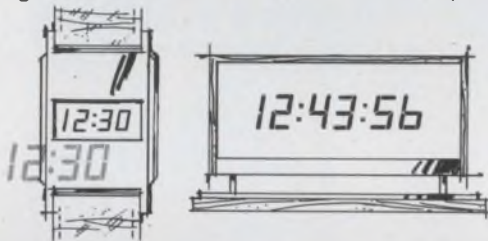

Producing an image — digital or other — simply requires a conductive surface the shape of the desired image on the glass plate toward the viewer. Current flowing from the conductive image on the front plate through the crystal liquid to the common-ground back plate causes the liquid to change from clear to a frosted appearance in the current-carrying area.

These images are almost always in the form of seven segments that make up the numerals 1 through 0. Energizing the proper segments produces the desired numerals. Lead-ins connect the segments to external contacts on the sandwich (display).

## Consider the advantages.

Liquid crystal displays have a number of distinct advantages. Simplicity is the reason for several of these. The elements are few and passive — very little can go wrong with an LCD and this means reliability and long life.

Simplicity means low cost, too — lower than that of most comparable displays. Packaging costs are low because LCD's can be driven directly by MOS and C/MOS circuits. In our dynamic scattering displays very narrow character widths are possible and still provide a good viewing angle — 60 degrees in many cases.

Low power consumption makes the LCD a logical choice where power limitations rule out other display types. Watch type LCD's use only 30  $\mu$ W, for example, with all segments energized at 15 volts.

LCD's offer the greatest flexibility of any display type. Several standard displays are immediately available from Hamlin's stock. Special displays with virtually any type of image can be produced with surprisingly low preparation or "tooling" cost. Because of the LCD's simplicity, lead time on specials is only a matter of weeks.

## A few limitations.

LCD's have limitations, too. Operating temperature range is one. Liquid crystals slow down and may even cease to function at temperatures below 0°C. Above 50-60°C, crystals go into solution and will not function normally.

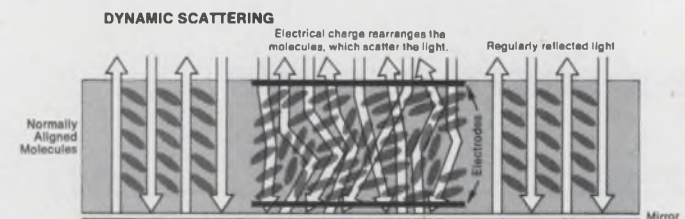

Extremes do not damage LCD's. Once the temperature returns to normal, operation is automatically resumed.

LCD's do not generate light, and they are somewhat difficult to read under low ambient light conditions. (Side or back lighting can remedy this.) Visibility under medium to high ambient light conditions is excellent.

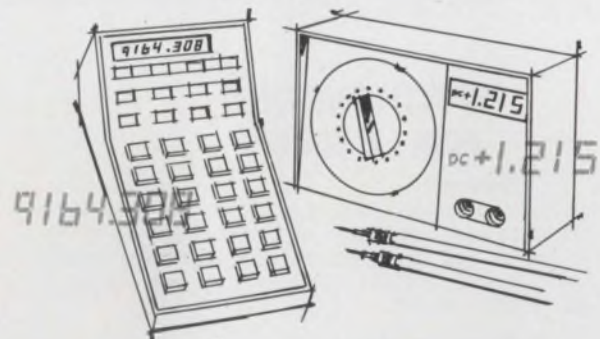

In the majority of display applications, MOS and C/MOS compatibility, reliability, flexibility and low power requirement are important considerations. No other display type can match the liquid crystal display on these jobs. They could become the display of the future. And that's the case for the LCD. For specification and application data, write Hamlin, Inc., Lake Mills, Wisconsin 53551. Or call, 414/648-2361. (Evaluation samples are available at moderate cost.)

# HAMLIN

INCORPORATED

INFORMATION RETRIEVAL NUMBER 57



# When the questions are about enclosures, Optima has beautiful answers.



Whether packaging small, digital multimeters or a huge, communications center, you need enclosures with structural integrity, access, and versatility. Doing their job and doing it well.

How do you get them? Consider the alternatives...job shop?...in-house construction?...a manufacturer? To decide, it is important to ask the right questions and get the right answers.



## Sales Appeal

*The first ten seconds of display for an electronics unit focus simply on its style, color and finish. They won't break a sale—the equipment inside does that. But they can sure help make one.*

- Is an industrial designer with packaging skills involved?
- Can you get the superior vinyl finishes so much in demand today? Or woodgrains? Or special textures?
- Is a total range of designer colors on hand?

## Versatility

*An important sales tool is the ability to adapt to the changing needs of a client.*

- Does a source offer hundreds of configurations to choose from? If, for instance, your client is thinking vertical rack, but wants the operator seated, can you offer a console desk?
- Does a client need a ventilating grille? a blower? stabilizers? Wouldn't drawer slides help his operations? What about writing surfaces, storage areas, drawers, casters? Are they in production, on line and ready to go?

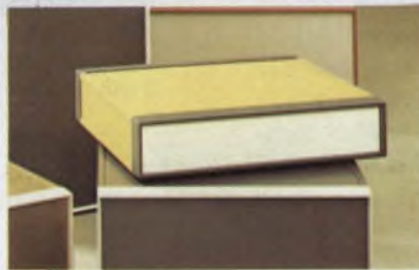

## Customer Service

*Are your own needs being served?*

- Can you get personal service from engineers, designers, and production people?
- Can you get special applications assistance?
- Does your source have a knowledgeable customer-service representative?

## The Optima Line

Our line of enclosures for electronics is the product of finding good answers to tough questions. Whether your question is component access, cooling, special applications or new product development and even safe shipping—we're ready!

Ready with Small Cases in 24 sizes from 133.6 to 1445.4 cubic inches; Instrument Cases and Racks in 124 sizes for 19- and 24-inch panels; Desk Consoles which are adaptable systems of instrument housing, counter and storage space; and the unique combination of chassis and case—Optima 17.



Computer scheduled manufacturing assures you of top quality control. We finish each unit inside and out with rugged vinyl and assemble them for final inspection—including most options and accessories—right at the plant.

Optima is the best answer. No question about that.

Write Optima Enclosures, 2166 Mountain Industrial Blvd., Tucker, Ga. 30084 or call (404) 939-6340.

# OPTIMA



## Optical data systems find a niche in the world of fast, fast computing

Jules H. Gilder, Associate Editor

Optical techniques for storing, processing and retrieving data are turning up in computer systems, spurred by demands for larger memories with faster access times and more rapid processing of data. Noise immunity and data security have also prompted interest in optics.

Although some optical data systems are commercially available today, work on optical computing is still confined to the laboratory, for the most part.

Development is proceeding in three major areas: memories, processors and peripherals. Optical storage of digital information promises significant improvements in capacity and access times over magnetic discs and tapes, which are currently used for mass storage.

According to Di Chen, a scientist at Honeywell's Corporate Research Center, Bloomington, Minn., magnetic discs and tapes will continue to dominate the mass memory area into the late 1970s. But by then, he goes on, they will reach the saturation point, and new storage technologies will be required to supplement or replace them. Optical memories promise to have capacities and costs equal to those of discs and tapes while achieving speeds that approximate those of random-access memories.

### Two major techniques used

Two techniques are being used to store optical data: the bit-by-bit method, which reads out information serially, and the page method, which outputs information in parallel.

The bit-by-bit method is easier to implement, and a commercial system of this type is already available. It is known as the System 190 Laser Mass Memory and is produced by Precision In-

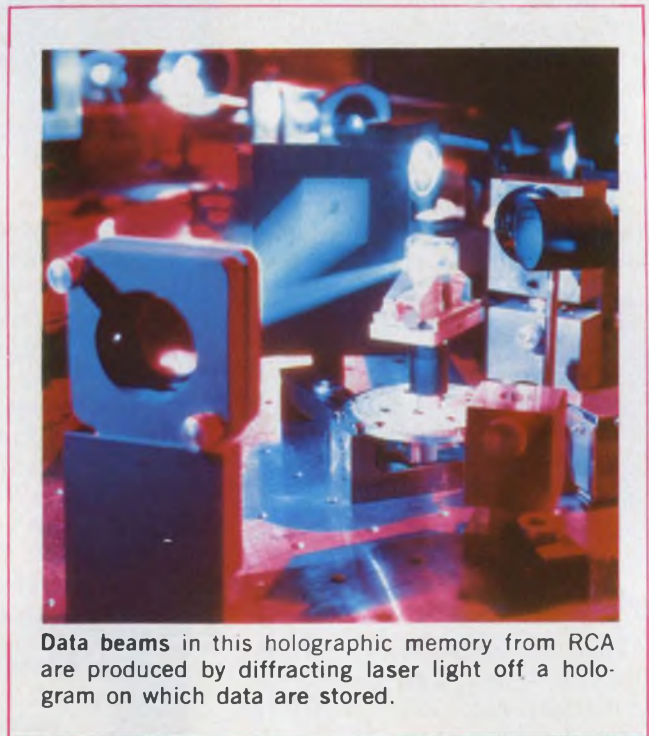

Data beams in this holographic memory from RCA are produced by diffracting laser light off a hologram on which data are stored.

struments, Palo Alto, Calif.

The System 190 is an improved modular version of the company's earlier Unicon 690, a trillion-bit memory developed for the Illiac IV computer. The 190 uses a laser to write on a nonerasable storage medium and offers a packing density of over 20 million bits per square inch. This high packing density gives a memory that has a lower cost per bit than any other today—0.0001¢ per bit. Another advantage of the 190's high packing density is that it requires about a tenth the storage space of conventional magnetic-tape systems.

The storage medium for the laser memory is a rhodium-coated Mylar data strip. Information





**Optical memories** like this one from Sperry Univac are being designed to store up to  $10^{10}$  bits of in-

formation. When completed, it will have an access time of between 1 and  $10 \mu\text{s}$  and no moving parts.

is stored when a precisely focused laser beam vaporizes minute holes in the metallic surface of the data strip. The laser is modulated so that it is turned on to burn a hole for writing a ONE and turned off for a ZERO. The holes in the data strip change the strip's reflectivity and thus make it possible to read out the stored information.

While the 190 memory offers many advantages, it suffers from the fact that it uses a nonerasable storage medium. Efforts to overcome this problem are under way at several companies. One approach being developed at IBM's Research Div. in San Jose, Calif., uses a rotating glass disc covered with a thin thermomagnetic film.

According to Byron R. Brown, one of the developers of the IBM system, this approach yields a memory that is similar to the standard disc memory. The results of recent experiments, with the reversible thermomagnetic film, notes Brown, indicate that rotating optical memories with storage densities of  $10^8$  bits/in<sup>2</sup> and data rates from 10 to 25 Mbits/sec appear feasible. By combining these new materials with an improved high-track-density servo system, IBM says it can build an optical file with 1 Gbyte of storage per surface on a 14-inch disc.

In explaining how the thermomagnetic optical memory works, Brown notes that the material's magnetization is initially all in one direction—

normal to the plane of the film. To write in information, the magnetization is reversed locally by application of a thermal pulse—produced by a focused laser beam—and a gross magnetic field that is opposite to the initial field in the film.

To read out information, Brown continues, the same laser beam, operating at reduced power, is used to detect a rotation of the plane of polarization of the light. This rotation of light is known as the Faraday effect, and it results from the local reversals in the magnetic field.

Unlike most other approaches to laser memories, the IBM uses semiconductor lasers that are batch-fabricated in linear arrays. Twenty lasers per array on 100-micron centers are being used.

Brown notes that the IBM memory approach offers the potential of permanent, nonvolatile, semireversible, high-resolution digital data storage. But, on the negative side, the commercial magnetic recording densities are already over  $8 \times 10^5$  and projected to go to  $3 \times 10^7$ , he says. An optical storage system would be attractive only if it could achieve a density of about  $6.25 \times 10^8$  bits/in<sup>2</sup>. The reason, Brown explains, is it would then be possible to fit a memory with a capacity of  $10^{12}$  bits on a recording surface of only 1 m<sup>2</sup>.

Because the bit-by-bit system is less sophisticated than the holographic memory, it is gener-



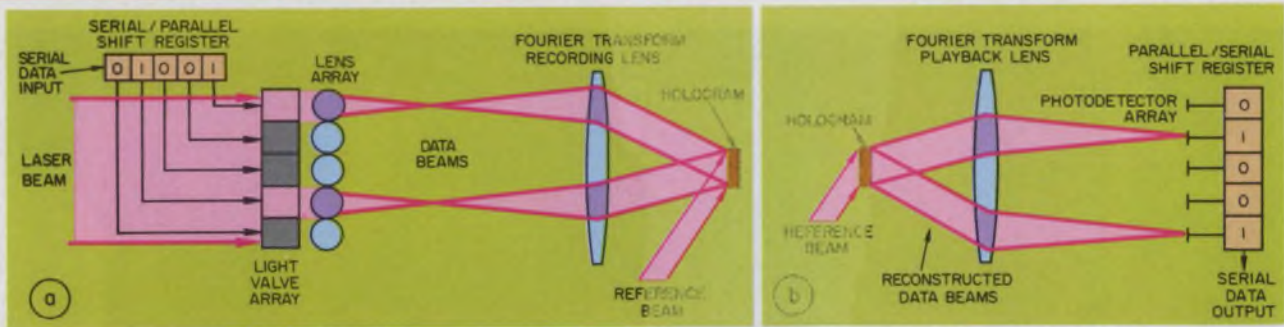

In holographic memories, serial electronic data are converted to parallel optical data and recorded on a holographic storage medium (a). When illumi-

ser, the hologram generates data beams are then sensed by a photo-

ally believed that the bit-by-bit memory will be widely available first. However, the holographic memory appears to be the goal of most developers of optical memories, because it offers higher speed and redundancy of data.

### Holographic approach studied

In the holographic memory a page composer converts a block of data consisting of thousands of bits into optical form. The page composer consists of an array of light valves that are opened and closed, depending on the value of each bit. Once the valves are set, a laser beam is applied to the light-valve array. The valves that are open form multiple data beams that strike the holographic storage medium, along with a reference beam, to create a hologram. Since the resulting holograms are small, a new block of data can be recorded simply by repetition of the process on an unexposed area of the storage medium.

According to Honeywell's Chen, a holographic memory with a capacity of  $10^9$  to  $10^{10}$  bits and page-access time of  $10 \mu\text{sec}$  should be possible.

To retrieve information that has been stored in a hologram, a laser beam is allowed to strike the hologram. This causes multiple data beams to be diffracted from the hologram. These beams pass through the readout optics and are focused to form an array of bright spots that coincide with a photodetector array and that represent the stored data. Each light spot activates one detector element, and the element converts the optical signal into an electrical one.

To get the information in serial form—the way it was originally entered—the detector elements are sampled by a shift register.

A big plus for holographic memories is this: Since each data bit is mapped into a plane grating pattern on the hologram, a slight mis-registration of the hologram does not alter the alignment of the data spots relative to the photo-

detector array. This means that high positional accuracy is not required for addressing. Another advantage of the holographic technique is that information loss due to dust, scratches or other imperfections in the storage media is eliminated. Since each data bit is recorded over the entire hologram area, small imperfections on the hologram will only result in a slightly lower signal-to-noise ratio for all the bits, instead of the complete loss of some of them.

About a year ago two experimental read/write holographic memories were introduced—one by RCA, the other by Harris-Intertype Corp. The RCA unit stores 1000 bits of information on 1000 pages, for a total storage capacity of about a million bits, while the Harris device stores 16-k bits of information on 25 pages, for a capacity of 400,000 bits. Except for the size and number of pages, both systems appear to be similar.

Both use a thermoplastic medium to store the holographic image instead of photographic film, and both are working models. One noticeable difference between the two is the page composer. In the RCA memory, liquid-crystal cells act as the light valves for the page composer; in the Harris unit a ferroelectric ceramic material is used.

According to Wilber C. Stewart, a researcher at RCA's Sarnoff Laboratories, Princeton, N.J., much development work must still be done before a holographic memory becomes practical for mass-storage applications.

"It's easy to build a 1-million-bit memory with a 3-to-4-second cycle time, but a lot tougher to build a memory of  $10^{10}$  or  $10^{11}$  bits with a cycle time of  $10^{-4}$  to  $10^{-3}$  seconds," he says.

Stewart notes that there are five critical areas that must be developed before holographic memories become a reality. The first need is for a reliable laser in the 200-mW-to-1-W power output range. The only laser with that power today, and in the right frequency range, is the argon-





Holographic data retrieval unit from IRW is used to read data stored on 35 mm film. A holographic recorder is used to store data.

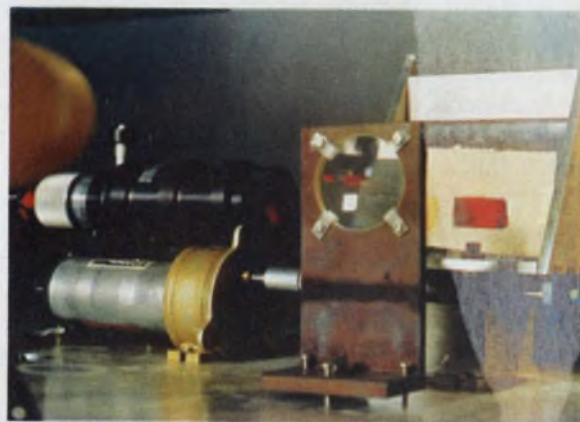

Optical processors can filter, convolute and correlate analog signals after the signals have been converted to the optical domain.

ion. But it has very poor reliability.

Another need is for a large-capacity— $10^6$  bits—laser-deflection system. Stewart indicates that acousto-optical deflectors will probably do the job nicely.

One of the most important needs—and probably one that will require the most work is the page composer. It must be fast and have many elements. Lowell D. Overvold, product marketing manager for Harris' Electro-Optics Operation, indicates that PLZT, a ferroelectric ceramic, looks promising but that there are still some bugs to be worked out. One of the problems, he explains, is that PLZT is not a uniform material and not readily available. Stresses caused by the nonuniformity of the material have caused breakage and made it difficult to construct large light-

valve arrays for the page composer.

Two other important needs are the photodetector array and a reversible holographic storage medium. It is generally conceded that present silicon technology will be sufficient to fabricate the photodetector arrays. In the area of storage mediums, the most promising material seems to be a thermoplastic-photoconductor sandwich.

In use, such a sandwich is initially charged with a corona discharge to a potential of several hundred volts. The photoconductor alters the potential across the thermoplastic in proportion to the light intensity, and the resulting differential electrostatic forces cause the thermoplastic to deform when it is heated. The deformations are a replica of the original light pattern, and, upon cooling, the pattern is stored as a phase-relief hologram. Erasure, when desired, is accomplished by heating the thermoplastic to a temperature somewhat higher than that used for writing. Once erased, the thermoplastic may be used over again. The principal disadvantages of this material are its slow record and erase times and its limited recycling capability.

While RCA's Stewart maintains that it will take at least 10 years to complete all the developments needed for a good commercial optical memory, Harris' Overvold says that one will be commercially practical in only two years. This will be made possible, he says, by use of a special human-readable/machine-readable holographic memory. Prototypes of the memory use standard 4-by-6-in. microfiche cards to store information.

This digital-storage concept consists of 60 images arranged in five rows of 12 images that contain human-readable data plus a 6.4-mm-wide strip of one-dimensional holograms recorded along an unused portion of the title block of the microfiche. This hologram contains 2.5 Mbits of data, which is the encoded equivalent of 60 pages.

The memory can also operate in a machine-read-only mode, in which case the storage capacity is increased to 37 Mbits. An unusual aspect of this system, and one of the reasons for its early availability, is the fact that it doesn't require a page composer. Instead the system computes the Fourier transform of the block of data to be stored and uses a laser scanner to record these data as a one-dimensional synthetic hologram. The input data rate to the system is fairly low—250-k bits/sec—and thus there is enough time to calculate the Fourier transform. Data are read out of the memory at 500 kbits/sec.

When this holographic memory is interfaced with an automated storage and retrieval module capable of holding between 100,000 and 600,000 microfiche films, it is possible, says Overvold, to construct a mass memory capable of storing between  $4 \times 10^{12}$  and  $2.4 \times 10^{13}$  bits of data. Such



a system would be competitive with other mass memories, such as the one made by Precision Instruments.

A different optical memory technique is used by Opto-Logic Corp. of Long Beach, Calif. Its approach involves the use of multiple incoherent light sources, a removable information storage medium for discrete bit patterns and an area photodetector array for the output device.

The storage medium in the Opto-Logic memory is a photographic slide that has a high-resolution, silver halide emulsion, reports Albert S. Jackson, the company's president. Each slide, he says, contains up to 1024 pages of information. The information may either be in the form of bit patterns or actual characters. A separate LED is associated with each page, and when the LED is energized, it projects the entire contents of the page onto a photodetector array.

For an information-retrieval device, such as a read-only memory, the stored pages are selected one at a time when a single LED is addressed. Each of the 1024 pages contains up to 288 bits of information, for a total storage capability of 294,912 bits. The access time for this memory is 80 ns.

### Optical systems speed processing

Not all of the computer-oriented optical systems are memories. Optical data processors are being developed with a potential for exceeding substantially the data-handling rates of the fastest digital computers.

The reason optical processors are so promising, notes IBM's Brown, is that they are parallel devices. With optical processors, he explains, it is possible to process simultaneously an entire frame of imagery—whether it contains a hundred bits or a million bits. This contrasts with electronic systems in which information is processed sequentially, bit by bit or in some cases a few bits at a time. To deblur a photograph of reasonable quality with a digital computer takes an hour. To do the same thing with an optical processor takes only a second.

The high speed of optical processors does not mean, however, that they will replace digital computers completely, most designers believe. Optical computers, they say, will be used only in special applications, particularly those involving some sort of imagery. Two of the major applications are in pattern-detection and recognition and image deblurring. These applications are based on the fact that a simple coherent optical system can produce the Fourier transform of an arbitrary two-dimensional function and allow a wide class of spatial filtering operations.

In pattern recognition an optical matched spatial filtering system offers a number of advantages that apply both to two-dimensional and multichannel, one-dimensional signals. Such a system performs a cross-correlation across the entire input field simultaneously, without scanning.

Pattern detection is performed independent of the location of the signals. The locations are preserved in the detection process, and thus correlation peaks in the output plane are geometrically related to the positions of the signals in the input.

Pattern recognition with an optical processor, for example, can be used in aerial reconnaissance to automate several routine photo-interpretation jobs. These include the elimination of badly focused, improperly exposed or cloud-covered imagery. In addition the processors can be used to detect automatically signals of interest and to establish a list of frame and location priorities for the photo-interpreter to investigate in greater detail. Pattern recognition also has application in word and character recognition. A hologram of a word or character is made and used to search an entire page of print. Correlation peaks appear in the output whenever the word or character is present.

In image deblurring, optical processing makes it possible to remove the characteristic contrast inversions that result from a blurred image. This technique can be applied to images that have been improperly focused or to images that have been blurred by movement or even lens imperfections.

Other applications of optical processing include fingerprint recognition, cloud-movement analysis and photographic mapping. In fact, optical processing is useful in most operations that require correlation of two or more two-dimensional patterns.

While the optical processor offers the possibility of ultra-high-speed processing, much work remains to be done on the interfacing of circuits for the optical computer. At present the optical processor's speed is limited by the ability of interfacing circuitry to input and output data.

### Fiber optics looks for a place

In the realm of digital computers, fiber optics is being used in peripherals and data communication. One example of peripherals is the Memorex 1603 Microfilm Printer, which combines fiber-optic bundles with light-emitting diodes to produce a device with a printout rate of 10,000 132-character lines per minute. This is nearly 10 times the speed of the IBM 1403 or 1443 printers, with which the 1603 is designed to be used.





**Image enhancement** was used on photographs taken by the Mariner 9 spacecraft. The raw photo-



graph (left) of Mars surface becomes clearer after only five minutes of computer enhancement.

Digital signals in the 1603 are applied to combinations of diodes by an electronic translation matrix. Pulsed light from the LEDs is transmitted through the fiber-optic strands to produce a display of alphanumeric characters that is used to expose the microfilm.

In data communications, fiber optics is providing isolation—and thus eliminating electrical noise and ensuring data security. James Mills, marketing manager for the Quadri Corp. of Phoenix, Ariz., says his company's Opticable can be used to transfer computer data over short distances.

Opticable consists of a fiber-optic bundle with

a transmitter and a receiver attached to opposite ends of the bundle. Data in electrical form enter the transmitter at one end and drive a LED. At the other end of the cable, a photosensor detects the light pulses and converts them back to electrical pulses. The system is TTL-compatible and requires a 5-V power supply at both ends. The data-transmission rate of the cable varies with length from 0.9 MHz for 100 feet to 5 MHz or better for 10 feet.

Since optical cables do not radiate energy and cannot be easily tapped, they are used in applications where data must be transferred securely. ■■



# The Place of Clad Metals in Electronics

Science is simply common sense at its best — that is, rigidly accurate in observation, and merciless to fallacy in logic.

— T. H. Huxley

## The Gold Saver—I

As the price for an ounce of gold climbs, it becomes increasingly important to utilize this precious metal in the most efficient and economical manner.

One of the ways to save gold is to use clad metals. TMI specializes in stripe-inlay, overlay, and all types of solder cladding. Part I deals with the first method.

### Clad Metals (Stripe-inlay)

Stripe-inlay cladding imbeds a stripe, or several stripes, of precious metals such as gold, silver, brazing alloy, or any non-refractory metal in a base metal with top surface of the inlay flush with the base metal. A permanent bond between the two materials is obtained by rolling under high pressure in a bonding mill.



### Cladding vs. Plating

There is no single answer to which process (cladding or selective plating) is superior. From a design point of view, cladding has these advantages:

1. It is a wrought surface with a fully dense, non-porous layer, offering superior wearability.
2. Alloys of various elements can be used.
3. It has superior formability permitting forms or dimpling without fracturing the clad surface.
4. Cladding is free of high surface stresses which can cause excessive spring-set.
5. A greater range of precious-metal thickness is possible.
6. Cladding is almost always lower in cost than overall plating.



### What Karat Gold?

Perhaps the most significant cost savings can be achieved by using a lower karat gold. Historically, the 24-karat gold has been used for contacts simply because it was available for plating. Clad metals, however, have opened up the opportunity of utilizing alloys having a lower percentage of gold without sacrificing design requirements.

The most frequently used gold combination is the 18-karat gold (75% gold and 25% silver). Recently, however, there has been a trend toward even lower karat gold such as 16, 14, and even 12. Savings are really two-fold: gold costs less if you use less, and since the alloy combinations weigh less they cover more area. As an example: 18-karat gold offers about a 37% gold reduction (compared to 24-karat gold) when taking the lower weight of the alloy into consideration in addition to the cost of gold.

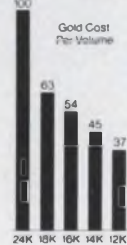

Just how low a karat gold is practical depends upon the particular application. There are several factors that play an important part, such as corrosive

conditions, amount of current, number of cycles, and type of wiping action. It seems probable that a large number of applications in the electronics industry would perform satisfactorily with a 14-karat gold.

### Dimensions

In addition to the karat gold used, there is another area that permits considerable savings: the thickness and the width of a stripe.

Thickness can range from .00002" up to one-third of the base metal thickness, with a standard tolerance of  $\pm 10\%$ . The present methods for testing thickness include metallography, betascope, weight loss, or etching away base metal. It is important that there is an agreement on the method of testing.

The width of a stripe needs to be no larger than the actual contact area. There is no fracture or peeling while forming or bending in the clad area. This helps to further save gold by avoiding excessively wide stripes.

Write for our "Handbook for Clad Metals" containing comprehensive information for design purposes.

### PRECIOUS METAL ALLOY GUIDE

TMI	Designation Other	Nominal Composition Wt. % Essential Elements	Density T. oz./cu. in.
101	24Kt. Gold	99.99 + Au	10.18
102	18Kt. Gold	75 Au, 25 Ag	8.41
103	16Kt. Gold	67 Au, 33 Ag	7.96
104	14Kt. Gold	58 Au, 42 Ag	7.52
105	12Kt. Gold	50 Au, 50 Ag	7.16
106	—	72 Au, 26.7 Ag, 1.8 Ni	8.20
107	W.E. #1	69 Au, 25 Ag, 6 Pt	8.39



## TECHNICAL MATERIALS, INC.

25 Holden Street  
Providence, Rhode Island 02908  
Tel: (401) 272-4343



# Now you can intermix low level, high level and simultaneous sample & hold inputs

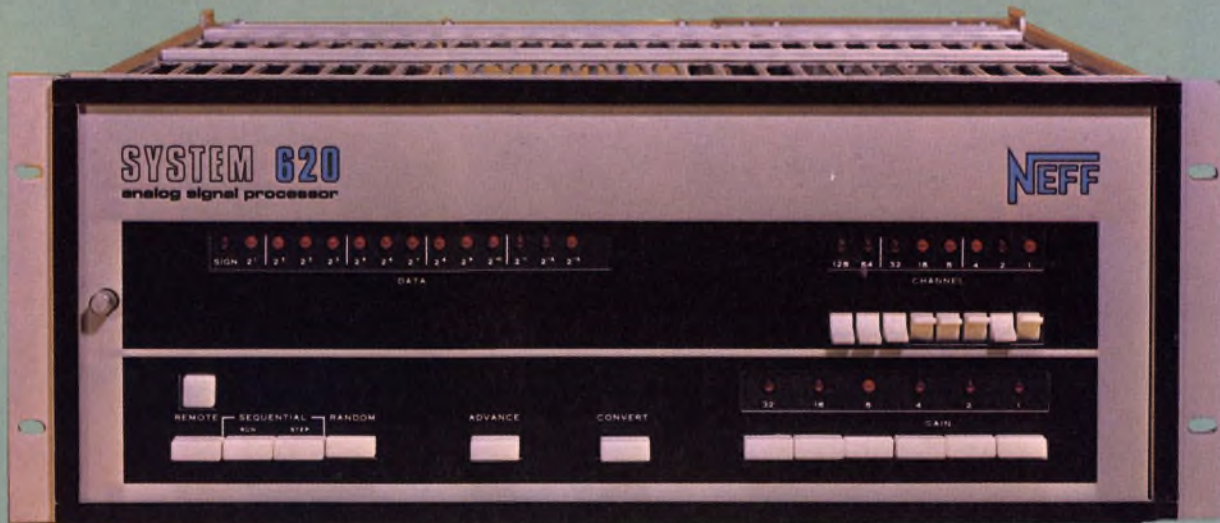

## With amplifier-per-channel System 620

### SYSTEM 620. A BETTER MOUSETRAP

In less than 2 years, our amplifier-per-channel System 620 has become industry's most popular high speed data acquisition system. Today, thousands of channels are performing reliably in the field. In scores of applications from Turbine Engine Test to Earthquake Engineering. Now System 620 is even more flexible than before. With 3 input amplifier options, four analog-to-digital converters and several computer interfaces to choose from. So here's the latest chapter on System 620, the new approach in data acquisition.

### LOW LEVEL AMPLIFIERS

Our field proven low-level differential amplifiers are perfect for strain gages & thermocouples since transducer signals are isolated right at the source. Our specs are impressive, too. With gain accuracy of 0.01%, 2 microvolt stability and 120 dB common mode rejection. More protection, too. If one channel gets wiped out by an overload, the rest don't feel a thing.

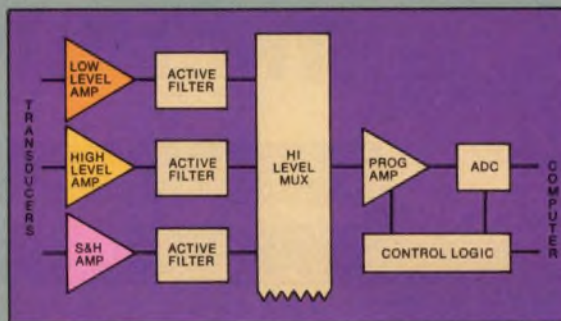

### NEW HIGH LEVEL AMPLIFIERS

Since high gain isn't always required, we've added an amplifier option which, for just \$80 a channel, provides system gain of 1 to 400. That's more than adequate for many applications. Yet, retains all the features of our low-level amplifiers.

### NEW SIMULTANEOUS SAMPLE & HOLD AMPLIFIERS

Low level sample & hold amplifiers are absolutely necessary in applications such as transient and vibration analysis, where data must be grabbed in a few nanoseconds or time correlation of data is important.

Low level, high level and sample & hold amplifiers can be freely intermixed in System 620.

And each amplifier in the system includes an active low pass filter with selectable cutoff frequency. Another important point. Continuous analog output is available on all channels.

### FOUR ADC OPTIONS

System 620 now has four analog-to-digital converters to choose from. If you need high accuracy, we can give you 14 bits at 20kHz. In most systems our economical 12 bit, 10 kHz analog-to-digital converter will suffice. Or if higher speed is your need, specify 12 or 15 bits at 50 kHz.

### COMPUTER INTERFACE

System 620 has been interfaced with a number of computers, both large & small. Interface hardware and software is available for most popular computers.

For the up-to-date story on System 620 — the new approach to data acquisition — phone or send for our brochure today.



1088 E. Hamilton Rd., Duarte, Calif. 91010  
Tel. (213) 357-2281 TWX 910-585-1833







# J. W. MILLER Fifty Years of Quality Service RF Coils and Electronic Components



**BELL INDUSTRIES / J. W. Miller Division**

19070 REYES AVENUE • P.O. BOX 5825 • COMPTON, CALIFORNIA 90224

Write on your letterhead for 50th anniversary full line catalog.

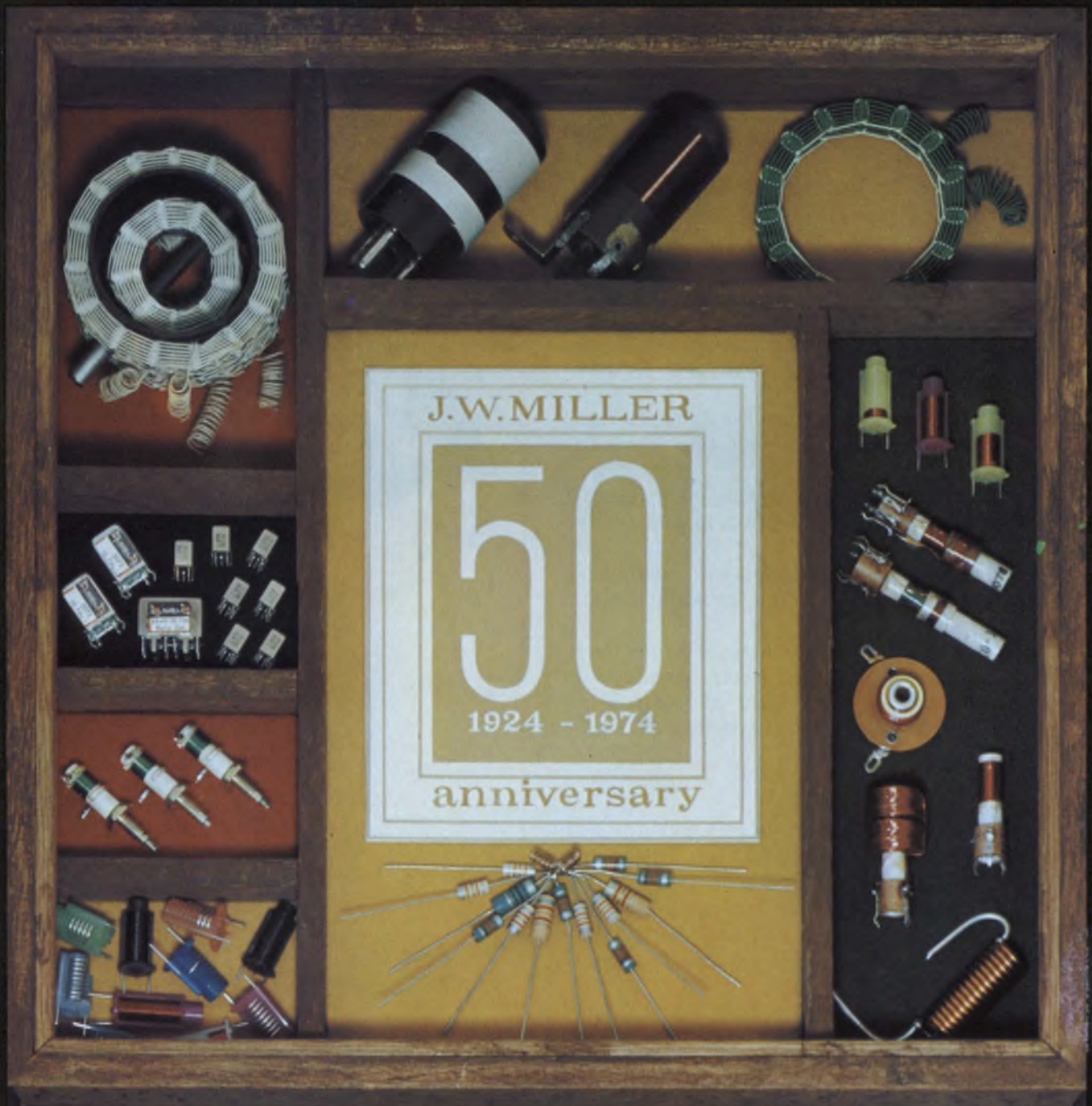



## Shortages of components forcing engineers to alter their thinking and designs

Dick Turmail, Associate Editor

Component shortages have created additional responsibilities and longer working hours for computer engineers.

A spot check by *ELECTRONIC DESIGN* shows that the computer designer must now:

- Spend more time with his purchasing department or in the marketplace to know what components are available.
- Use more substitutes—for example, TTL is continuing to replace DTL, and medium-scale integration is supplanting the older and simpler ICs.
- Design many of the same components into different products so that his shortages won't be as widespread.
- Be more suspect when testing new components, because high demand often means faulty production.
- Travel more to meet suppliers' engineers personally to discuss new and substitute components.

Although computer makers have had to extend their lead times well beyond their usual limit, most are weathering the storm of component shortages by extra planning, the survey found.

### Dual and triple-sourcing now

Some computer component users who formerly specified a vendor when ordering from distributors are now dual-sourcing and even triple-sourcing their components. They list metal-film resistors; ceramic, aluminum foil and electrolytic capacitors, and digital ICs as the hardest components to find.

Single-sourcers feel they've built up a reservoir of good feeling with their suppliers, many reporting that their practice of never going back





for a second bid, ordering in quantity and well in advance, and paying on time is paying off.

As for the component suppliers, they are no longer waiting to see what will happen to the economy as they did a year or so ago. Lead times on ICs and resistors are beginning to soften now, mainly because suppliers have been investing heavily in production equipment to meet the demand. Some suppliers report shortages of raw materials, including copper, plastics, ceramics, resistor wire and gold-plated leads. But on the whole, the spot check shows, shortages have occurred mainly because suppliers failed to gear up for the demand, rather than because of any scarcity of raw materials.

### Forecasting of needs extended

The poll of both computer component users and suppliers turned up responses like these:

"We have no shortages that affect our deliveries," says Pat McGrath, materials manager of Interdata, Oceanport, N.J. "We're still delivering a system in 45 to 90 days—30 days for a CPU—which is pretty much off-the-shelf in the computer business."

He says that about 17 months ago his company extended its ordering policies with a programmed system. It now forecasts component needs up to 14 months, and it gives suppliers solid orders, not forecasts.

"Also we have an advantage," McGrath says. "We use 250 components in six to eight major units—that's a lot of commonality of parts, and that spreads our shortage problems a little thinner." He says that about 18 months ago they had trouble getting printed circuit card assemblies until they tooled up and started making the cards themselves. "Now," he says, "the toughest thing to get is copper, and that's really tough!"

The four components that Texas Instruments' Equipment Group in Austin finds in shortest supply, according to Gene Towry, purchasing manager, are aluminum-foil capacitors (delivery in 48 to 60 weeks), film resistors (25 to 30 weeks), MOS memories (25 to 30 weeks) and digital integrated circuits (30 to 35 weeks).

"We've managed to stay ahead of the game so far," Towry says. "We're using alternate sourcing; we haven't had to delay any of our computer delivery schedules, but our lead times have gone up by about three weeks in the past three months, and we've had to forecast our needs about a year in advance."

Components that have lengthened Digital Equipment Corp.'s lead time have been tantalum capacitors (36 weeks) and aluminum-electrolytic capacitors (30 weeks), MOS devices (32 to 36 weeks), resistors (8 to 14 weeks) and metal film resistors (14 weeks).

"Our shipments to customers haven't been held up at all," says Fred Wilhelm, manager of DEC's Large Computer Engineering Dept. in Maynard, Mass. "We're triple-sourcing and writing longer term contracts. Suppliers want two-year contracts, but we're able to keep them to a year because we have some buying power."

Wilhelm is optimistic, mainly because he hasn't seen any big shortage problems in his area.

"But we've got to plan more in engineering," he says, "particularly in gearing up for new products." And, he adds, "we've really got to make sure that new components are well-tested before we get involved in a long-term contract."

At Dale Electronics, Columbus, Ohio, George Burdine, materials manager, says: "Compared to six months ago, our lead times are getting better. Ceramics and good resistor wire are the materials that make resistors hard to get."

Dale supplies resistors to the computer industry, and recently it has invested heavily in machinery to extend its capacity.

"We've been working night and day, six and seven days a week, to improve our manufacturing ability," Burdine says. "Also, we're negotiating personally with our suppliers all over the country."

Last year metal film resistors had lead times of from 24 to 60 weeks; a year before the average was six weeks. Corning, a major supplier of resistors and capacitors to the computer industry, has already begun a major metal-film expansion program, which, according to a company source, has allowed it to reduce lead times to 32 weeks.

Three years ago Corning expanded to ceramics and has been a major supplier for axial monolithic ceramic capacitors to the computer industry. It is concentrating on miniature epoxy-cased ceramic capacitors for automatic insertion, and reportedly has doubled production capacity in the last year. The company is making a high-volume, low-cost commercial axial line and a commercial radial line.

A spokesman for Hewlett-Packard in Palo Alto, Calif., says that it had to plan well ahead to get semiconductors, high-quality capacitors and transformers. "Our lead times are growing," the spokesman says, "and although we expect them to get worse before they get better, we're not crying. Our suppliers are delivering on schedule—25 years of not going back for a second bid and of paying on time have earned us a spot on the preferred customers' list."

Bill Schwartz, distribution program manager for United Transformer Co., a division of TRW in New York City, says that its purchasing department is planning bigger blanket orders to help get hard-to-find materials, such as plastic



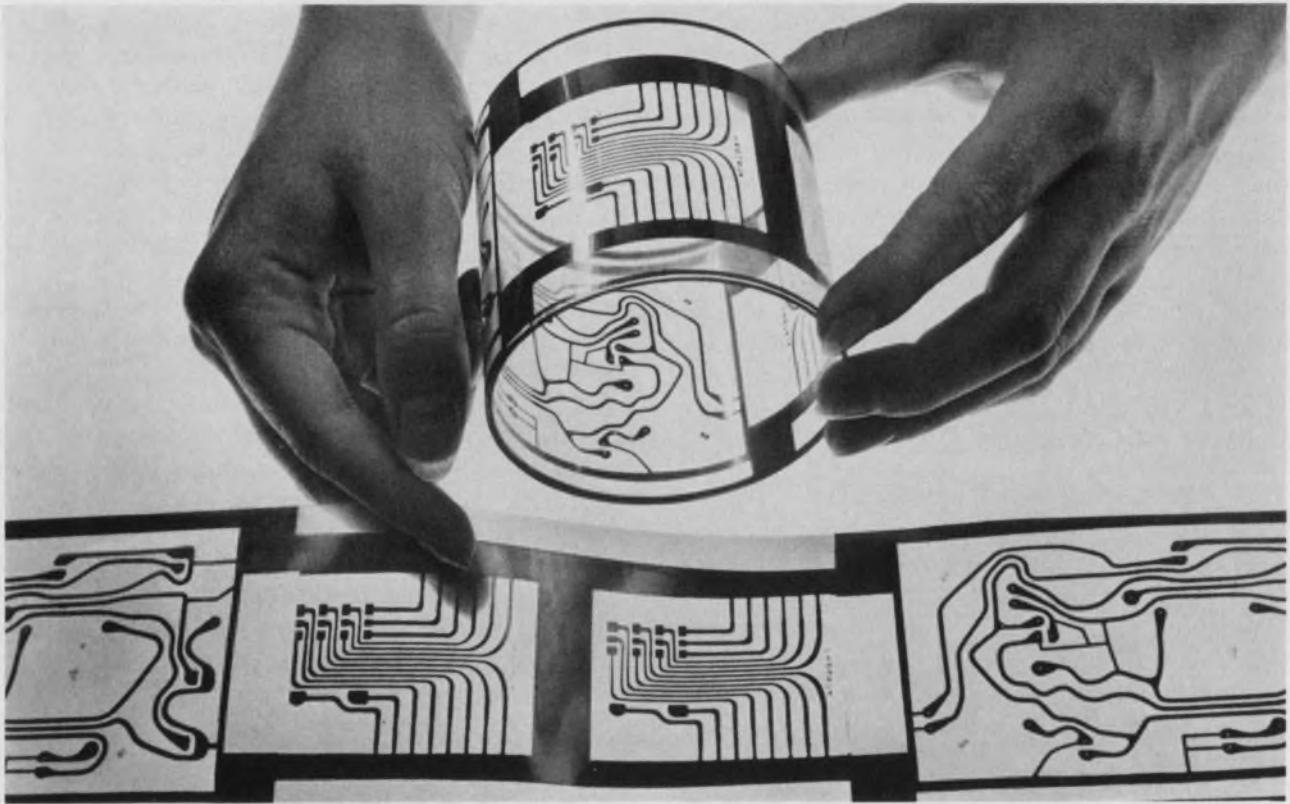

**Copper conservation** is an objective of this printed-circuit process introduced a number of years ago by Western Electric Co. In the process, copper cir-

cuitry is added where needed, reversing the traditional method of coating plastic—also in short supply—then etching away the unwanted metal.

lead wire, copper and the gold-plated leads used on small transformers. The computer industry represents only one part of United Transformer's market.

"We've had to extend our deliveries a bit," Schwartz says. "Our regular catalog pieces at six-to-eight week delivery are now up to eight-to-10 weeks delivery. And custom pieces are up from 10-to-16 weeks delivery."

Stancor, Fort Wayne, Ind., sees the shortage as a boom and realizes that it can't supply both its distributors and its OEM customers and keep everybody happy.

"So we've been soft-pedaling the OEM special transformer business," says the company's general manager, Bob Reigel. "We're a 95% standard stock item, and a lot of our transformers end up with computer manufacturers as the best way to get delivery."

Reigel says his company's inventory is good on standard items and, on the average, he can deliver in six weeks. A special OEM transformer takes six to eight months to deliver. He adds that Stancor's OEM business is growing rapidly.

"On the standard item, we may not always have the transformer model they want," Reigel says, "but electrically and physically it will do the job, in many cases."

Shortages of computer components haven't been critical, IBM reports. According to a spokesman at the Systems Development Div., Kingston, N.Y., components that used to take 30 days to get now take 40 days, but IBM's delivery times haven't lengthened. Component suppliers are asking the company to order earlier, so it's ordering annually instead of quarterly.

At Xerox Data Systems in El Segundo, Calif., Myles Connelly, group manager for electronic purchasing, lists ceramic capacitors (33 to 38 weeks), ICs (23 to 43 weeks) and TTLs as in short supply. He says that some suppliers are referring his company to standard components or to distributor stock for small quantities.

"That means," he says, "that we must then go through an engineering and quality review, and generally we won't accept that."

What Xerox Data Systems does do is book national contracts 18 months in advance to buy in capacity, and make certain that its engineers meet the suppliers' engineers and design a product that follows the state of the art.

"We're not as concerned about price as we are about delivery," Connelly adds.

A spokesman for Motorola Semiconductor in Phoenix, Ariz., says that it is backlogged in every area. The company keeps careful tabs on mate-



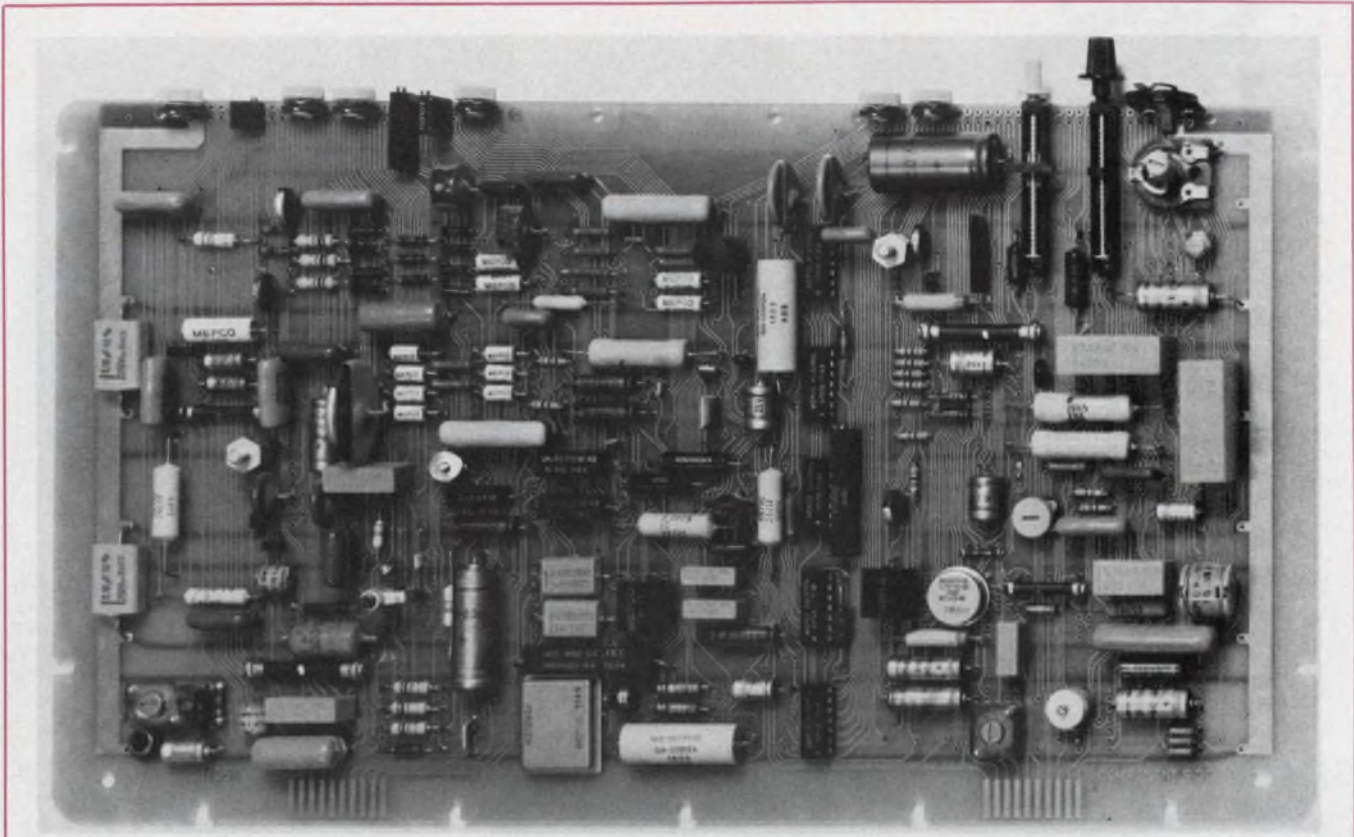

Vital to any computer system are components like these. This circuit board illustrates the Mepeco/Electra, Inc., line of resistors, capacitors, thermis-

tors, varistors, DIP networks, and hybrid micro-circuits. Some are in various degrees of short supply, as reported by users and suppliers nationwide.

rials, and right now there's a silicon shortage. While there's hardly a scarcity of sand, it appears that the equipment used for converting silicon tetrachloride to purified polycrystalline silicon has not been expanded fast enough to keep pace with the demand.

While Signetics of Sunnyvale, Calif., hasn't recommended any component substitutions, it has tried to recommend the use of MSI to replace numerous SSI parts.

"We use less silicon to accomplish the same function," says Michael Harkworth, manager of corporate marketing, "and it's more economical. But it's a design change, so it's not practical for a short-term pick."

The company makes ICs, logic and memory circuits for the computer industry.

The difficulty in getting silicon wafers has stretched Signetics' lead time, but, according to Harkworth, the company has managed to keep its deliveries on schedule. He says that the purchasing group has maintained good relations with materials suppliers.

"When times were tough, we were the last people to cancel or change orders with our vendors," Harkworth says. "We paid on time at the risk of having a little bit of inventory. Those relationships have paid off, and it helps, too, to

give our vendors a year or a year and a half notice of what our requirements are going to be."

Pertec Corp. of Chatsworth, Calif., supplies computer makers with such peripherals as tape transports, disc drives and flexible discs. According to Darrell Lloyd, advertising manager, semiconductors, plastic materials, capacitors, resistors and some fabricated parts, like cabinets, have been in short supply.

"But we think that the shortage is cresting," he says, "because we believe that the pipeline is filled up."

Multiple-sourcing and negotiating with suppliers in person are two of the ways the company has tried to neutralize shortages.

"In some cases we get a faster deliver," Lloyd says, "and in some others we've had to pay a premium in price. We had to pass a 3% to 5% price hike along back in February."

Lloyd says that Pertec asked its customers to plan further ahead so it could, in turn, give its suppliers greater visibility of its needs.

"In November we delivered in 120 days, when 60 was the norm," Lloyd says. "Now we're dropping down to 90 days, but it's hard to say when we'll get back to 60, because business is increasing by 25% per year, and most peripheral houses are experiencing the same things we are." ■■



yes,  
yes,  
no,  
yes,  
no.

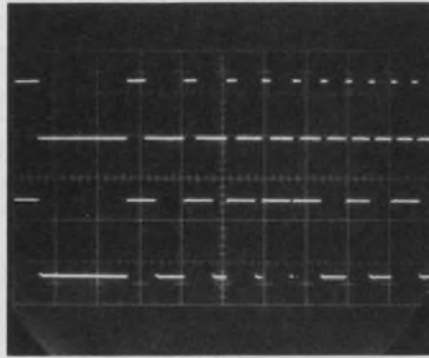

Upper trace: Constant Duty Cycle pulses over a 10:1 frequency range  
Lower trace: Normal pulses over same range.

"Standard pulses with predetermined width are fine for most requirements, but when I'm changing repetition rates I have to fiddle with the width control to make sure that I don't lose the pulse. Does your 'Constant Duty Cycle' mode let me set width as a percent of pulse period so I can change rep rates *without* tweaking the other controls?" (YES)



A single control selects all 7 modes

"That Duty Cycle mode could come in handy, but I also want the regular pulses that I'm used to, and double pulses, and 50% squarewaves to 50 MHz. How about trigger, gate, triggered double pulse, and pulse shaping? (And all of these modes better be easy to set!)" (YES)

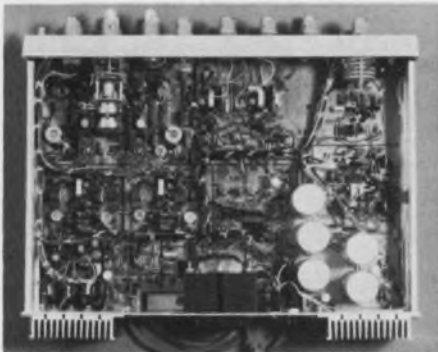

All components are fully accessible

"Reliability and maintainability count, too. I want a generator that works! But in case it needs service I'd like to specify plug-in sockets for dual in-line IC's, and a parts list minus factory widgets. If I put my money on your model, will my QC man hate me?" (NO)

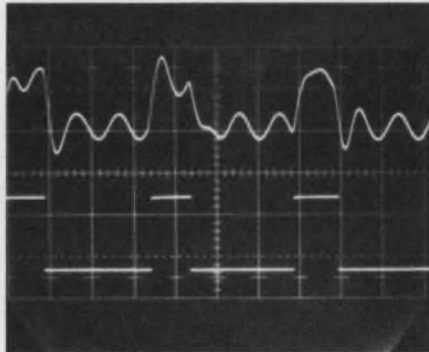

Upper trace: distorted, noisy input.  
Lower trace: pulse generator output (Pulse Amplifier Mode)

"My application calls for pure pulses with a bare minimum of overshoot and squiggles. And I need to clean up distorted signals — you know, send in a crummy pulse train and get out a nice squared-up pulse with the offset, amplitude, and rise/fall times I've set up on the generator. Can do?" (YES)



Four SERIES 20 models are available from \$575

"Your \$1095 P25 Pulse Generator has it all, including simultaneous positive and negative outputs, each with adjustable d-c offset and variable rise/fall times from 5 nanoseconds. But if I only need a single output or faster, fixed rise times, am I out of luck?" (NO)

## ask a 50-MHz pulse generator these 5 questions if the answers are yes, yes, no, yes, no, it's INTERSTATE

the Interstate man with all the answers is John Norburg—call collect (714) 772-2811



**INTERSTATE ELECTRONICS CORPORATION**  
Subsidiary of A-T-O Inc.

U.S. HEADQUARTERS: Dept. 7000, Box 3117, Anaheim, CA. 92803; OVERSEAS SALES OFFICES: AUSTRALIA, Parameters Pty., Ltd.; BELGIUM-LUXEMBOURG, Regulation-Mesure S.P.R.L.; FINLAND, Havulinno Oy; FRANCE, Tekelec Airtronic, S.A.; ITALY, Tekelec Airtronic; ISRAEL, Radat International Company Ltd.; JAPAN, Asahi & Co., Ltd.; NETHERLANDS, Tekelec Airtronic, N.V.; NEW ZEALAND, David J. Reid, Ltd.; REPUBLIC OF CHINA, Bons International Co., Ltd.; SPAIN, Telco, S.L.; SWEDEN, M. Stenhardt AB; SWITZERLAND, Traco Trading Co., Ltd.; UNITED KINGDOM, Euro Electronic Instruments, Ltd.; WEST GERMANY, Tekelec Airtronic GMBH; CANADA, Radionics, Limited; TWX U.S.A. 910-591-1197; TELEX U.S.A. 655443 & 655419

INFORMATION RETRIEVAL NUMBER 63



# THE MULTI'S ARE HERE ... on our shelf, ready for delivery *now!*

and they're from **Powertec**...the recognized leader in open-frame power supplies!

The most economical power/cost ratios in the power supply industry...now available in four high-quality multiple output models...for immediate delivery!

## SPECIFICATIONS:

**INPUT CHARACTERISTICS:** 105 to 125 VAC,

47 to 63 Hz (derate unit 15% for 50 Hz operation). For wider range or 400 Hz operation, consult factory. **REGULATION:**

Line  $\pm 0.1\%$ , Load  $\pm 0.1\%$ : load regulation based on 50% load change; line regulation based on 10 V line change. **RIPPLE:** 1 mV RMS.

**TRANSIENT RESPONSE:** 50  $\mu$ sec for 50% load change. **TEMPERATURE:** 0° C to 40° C derated to 71° C. Percent of full rated load current at ambient temperature: 100% / +40° C;

75% / +50° C;

50% / +60° C;

35% / +71° C.

### OVERLOAD PROTECTION:

Unit is protected from overload and short circuit using foldback type current limiting.

## THE MULTI'S



**\$49 \$79 \$89 \$149**

MODEL NO.	DUAL OUTPUT 2K15D-1.3	DUAL OUTPUT 2L15D-2.8	TRIPLE OUTPUT 2R-70T	TRIPLE OUTPUT 2S-140T
OUTPUT #1	+12V, 1.5A or +15V, 1.3A	+12V, 3.0A or +15V, 2.8A	+12V, 1.5A or +15V, 1.3A	+12V, 3.0A or +15V, 2.8A
OUTPUT #2	-12V, 1.5A or -15V, 1.3A	-12V, 3.0A or -15V, 2.8A	-12V, 1.5A or -15V, 1.3A	-12V, 3.0A or -15V, 2.8A
OUTPUT #3	---	---	5V, 6.0A or 6V, 5.0A	5V, 12A or 6V, 8.0A

All outputs are floating; can be connected in any common configuration. For other outputs and quantity prices, consult factory.

SIZE:	MODEL	DEPTH	WIDTH	HEIGHT
	2K15D-1.3	2.95 in.	7.87 in.	4.00 in.
	2L15D-2.8	3.20 in.	9.38 in.	4.88 in.
	2R-70T	3.32 in.	11.00 in.	4.88 in.
	2S-140T	4.50 in.	15.00 in.	4.88 in.

See us at NCC  
Booth Nos.  
928, 930, 932

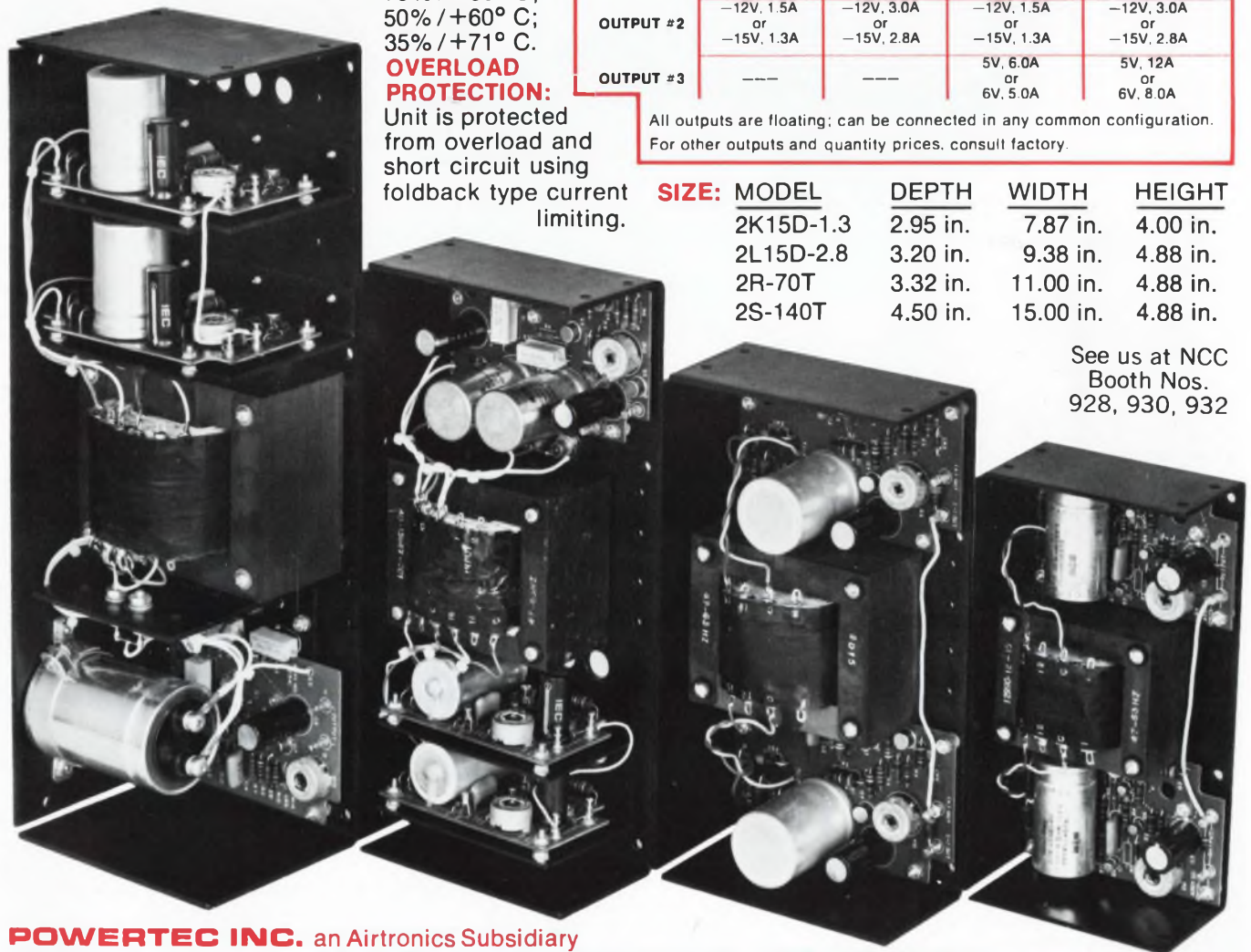

**POWERTEC INC.** an Airtronics Subsidiary  
9168 DeSoto Ave., Chatsworth, California 91311 • (213) 882-0004 • TWX (910) 494-2092

# POWERTEC

INFORMATION RETRIEVAL NUMBER 240



# Introducing CONTROL DATA® Cartridge Disk Drive Model 9427H.



New and improved, smaller and simpler, 3 to 12 megabyte capacities.

#### Features:

- Self contained power supply. Universal power input; 100-250 VAC, 50/60 Hz. Autotransformer and quick change belt and pulley for fast power supply adjustment.
- Independent blower motor assures continuous standby capability and clean disk area — thus improves reliability.
- Interface versatility: Choose Elco, Amp, Winchester or 3M connectors. DIP resistor packs for terminators. Unit in daisy chain is removable without affecting other units.
- Optional Fault Isolation and Retention Module diagnosis to board level and — even with power removed — stores fault information.
- Mounts in 10½ inches of standard 19-inch rack.
- Board space in the logic sector. New models have interface board and an open slot for a custom board.
- Modular design for easier maintenance. Individually replaceable subassemblies utilizing one size (8/32 screws) assembly hardware.
- Industry standard 200 TPI recording media.
- Removable control panel module to remotely locate the control function.

The new Control Data Model 9427H Cartridge Disk Drive has **proven** 200 TPI deliverability. We invite you to send coupon or contact your Control Data OEM Representative nearest you.

**CONTROL DATA**  
CORPORATION

Control Data Corporation  
Tom Farrell, OEM Marketing Manager,  
Hawthorne Operations, 2815 W. El Segundo Blvd.,  
Dept. ED-44, Hawthorne, CA 90250

Name \_\_\_\_\_

Title \_\_\_\_\_

Company \_\_\_\_\_

Address \_\_\_\_\_ Phone \_\_\_\_\_

City \_\_\_\_\_ State \_\_\_\_\_ Zip \_\_\_\_\_

I want to see a demonstration of the Control Data Model 9427H Cartridge Disk Drive. Have my Representative call.



made for  
each other...



*your equipment and EMCOR custom enclosures*



What better way to house your electronic equipment than in EMCOR® custom enclosures! Whether your design . . . or ours to meet your needs and specifications . . . EMCOR cabinetry provides not only the protection and function you require but also the visual impact of uniquely distinctive styling.

Our infinite design and construction capabilities permit high styling combined with exceptional quality at attractive pricing.

Cabinets, racks, consoles, instrument cases, data work stations . . . whatever your custom enclosure need, EMCOR has the design, engineering and production capabilities to meet it. For full details and name of your nearest EMCOR representative, write or call INGERSOLL PRODUCTS, 1000 W. 120th St., Chicago, IL 60643. (312) 264-7800.

*everything looks better in* **EMCOR** *custom enclosures*

**Ingersoll Products**

DIVISION OF BORG-WARNER CORPORATION



INFORMATION RETRIEVAL NUMBER 64



# Basic microcomputer software: Algorithm for a traffic-light controller illustrates principles that can be used with any MOS/LSI microprocessor.

## Last of three articles

How does the basic software for a MOS/LSI microcomputer differ from that for larger computers? Not fundamentally. The differences are in emphasis. With microcomputers, you must give more attention to such things as program size, execution times of critical routines and real-time interactions with peripheral devices.

A traffic-light controller provides a good example of how a microcomputer is programmed for a specific application.

Usually the basic algorithm must be selected first. Then working routines can be identified and common memory specified. A generalized program for coding can be easily adapted to any specific microcomputer.

In the traffic-light controller in Fig. 1, the goal is to feed a maximum number of cars through the intersection in any time period. The maximum duration of a red light for each route represents the primary constraint.

Fig. 2 shows the traffic lights that are visible to cars on each route. The lights are controlled by loading latches, which drive relays inside the traffic-light units. The through-traffic and left-turn parts of the display in Fig. 2a can be set independently to red, yellow or green.

Vehicles that cross switch plates on the roadway actuate switches that can be sampled by the microcomputer. The input port contains six input lines, each of which carries a ONE or ZERO logic signal. Each time an axle passes over a switch plate, the switch toggles and the logic level changes. The logic level is maintained until the next axle toggles the switch.

## Assumptions clarify problem

The following six points clarify the design problem:

1. The duration of GREEN signals for each ROUTE must be varied to optimize traffic flow, because traffic varies during the 24-hour day.

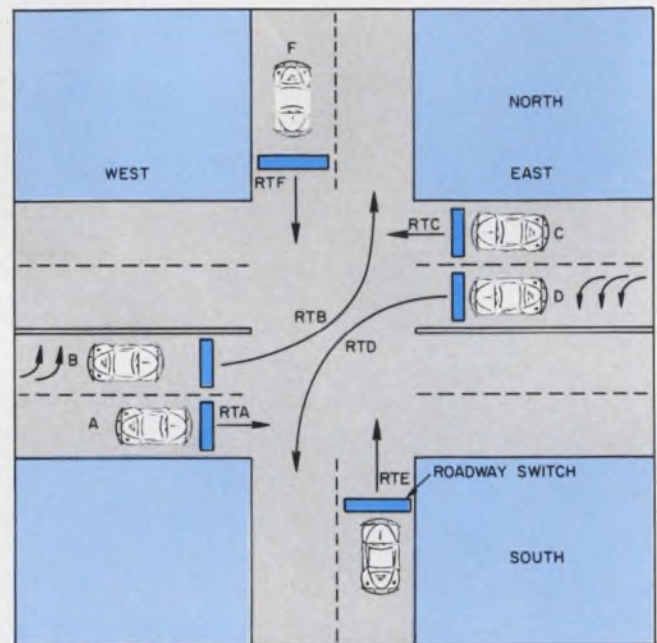

1. Traffic-light intersection contains six routes: four through lanes and two turn lanes. The six roadway switches toggle each time an axle crosses a switch plate in the corresponding route.

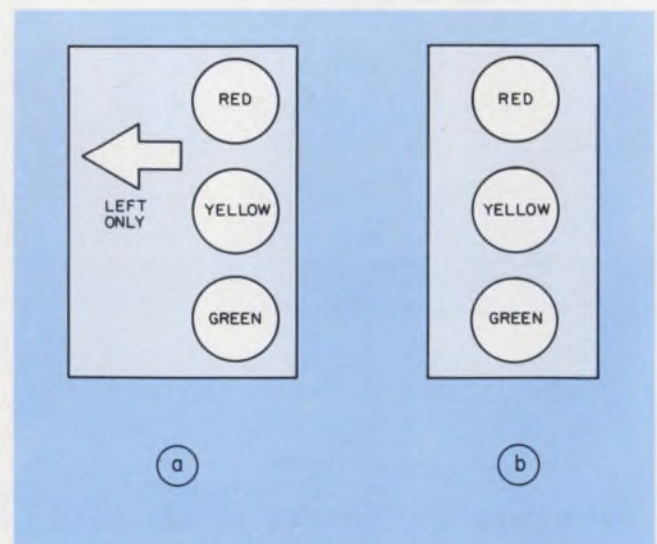

2. Traffic signals under microcomputer control consist of east-west lights (a) and north-south lights (b). The left-turn signal in east-west lights can be independently set to red, yellow or green.

C. Dennis Weiss, Ph.D., Member of the Technical Staff, Bell Telephone Laboratories, Holmdel, N.J. 07733.



Since the roadway switches cannot provide information on the length of a queue, the controller algorithm must contain a delay; the number of vehicles crossing a switch during the current GREEN cycle determines the duration of the next GREEN cycle.

2. Two toggles of a switch indicate one car has passed. Vehicles with more than two axles represent, therefore, more than a single car for

STATES	ROUTES					
	A	B	C	D	E	F
1	0	1	0	1	0	0
2	1	1	0	0	0	0
3	1	0	1	0	0	0
4	0	0	1	1	0	0
5	0	0	0	0	1	1

3. The five valid STATES for traffic signals. A numeral 1 entry signifies a ROUTE has GREEN in the corresponding STATE; a zero implies RED.

traffic measurement.

3. Traffic on a ROUTE should not be measured for the full GREEN cycle. Otherwise an unstable situation would exist. Lengthening the GREEN cycle would let more traffic through. This in turn would require lengthening it still more on the next cycle. Instead use a fixed initial period, BASETIME, during the GREEN cycle of each ROUTE to measure the traffic. Each GREEN cycle must, of course, last a minimum of one BASETIME.

4. The duration of a GREEN for any ROUTE consists of BASETIME plus DELTATIME, both in seconds. To satisfy a MAXREDTIME constraint on the duration of RED for each ROUTE, limit the sum of the DELTATIMES used by all those ROUTES that get GREEN while one ROUTE holds at RED. Also constrain the number of ROUTES that get GREEN while one ROUTE has RED.

5. The only states allowed for the traffic signals are those in which the ROUTES with GREEN cannot interfere with one another. Obviously east-west and north-south lanes cannot be GREEN at the same time. Also ROUTE B and ROUTE C will not be GREEN concurrently. This feature avoids wasted time while cars yield, start and stop.

6. There is enough real time to do the job with a microcomputer. The only possible time-

critical task involves a count of toggles of the roadway switches. Assume that vehicles travel at less than 60 mph and that minimum axle spacing is 48 inches. These figures yield a minimum of 45 ms for the time interval between toggles on each ROUTE. Hence a microcomputer is certainly fast enough.

A stable STATE for the intersection is defined by specifying which ROUTES have

CONTROL STATE SETS	ROUTES					
	A	B	C	D	E	F
{1,3,5}	1	1	1	1	1	1
{2,4,5}	1	1	1	1	1	1
{2,3,4,5}	2	1	2	1	1	1
{1,2,3,5}	2	2	1	1	1	1
{1,3,4,5}	1	1	2	2	1	1
{1,2,4,5}	1	2	1	2	1	1
{1,3,5}, {5}	1	1	1	1	2	2

4. Row integers give number of GREEN intervals for a ROUTE. State sets labeling each row constitute the control sequence for the GREEN intervals.

GREEN; the remainder are RED. Transitions from GREEN to RED occur between stable states.

From point 5, the only stable STATES are those five tabulated in Fig. 3. Note that exactly two ROUTES have GREEN lights in each stable STATE.

#### Define a valid sequence

A valid sequence of STATES is one in which each ROUTE gets some GREEN time from a cycling of the sequence. Fig. 4, based on Fig. 3, lists sets of states from which valid sequences can be made. Sets {1,3,5} and {2,4,5} are equivalent, minimum "covers" of the table in Fig. 3, or solutions to the classical set-covering problem.<sup>1</sup>

For simplicity, and to satisfy the constraints of point 4, let's establish in advance a repertory of valid SEQUENCES to be used. The ones chosen (Fig. 5) are all those that give a single BASETIME interval of GREEN to each ROUTE and a DELTATIME to exactly two ROUTES or to none.

In Fig. 5 the nonequivalent sequences represent sequences that are ordered to eliminate unnecessary light changes. For example, if SEQUENCE3 were changed to STATE1, STATE3, STATE2, STATE5, then ROUTE B would see



SEQ1: STATE2. STATE4. STATE5  
 SEQ2: STATE2. **STATE3.** STATE4. STATE5  
 SEQ3: STATE1. **STATE2.** STATE3. STATE5  
 SEQ4: STATE1. STATE3. **STATE4.** STATE5  
 SEQ5: **STATE1.** STATE2. STATE4. STATE5  
 SEQ6: STATE1. STATE3. STATE5. **STATE5**

5. The ordering of preferred sequences eliminates unnecessary light changes. STATES shown bold provide DELTATIMES to two ROUTES.

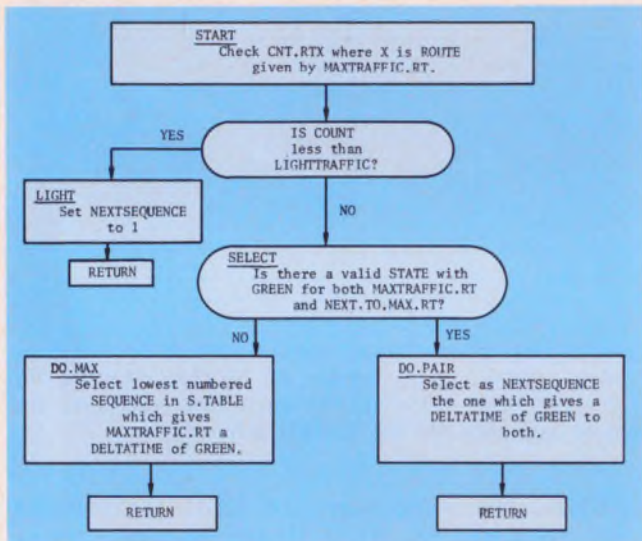

6. Flow chart selects a SEQUENCE of traffic-light STATES. Traffic counts for the two ROUTES with most BASETIME traffic determine the selection.

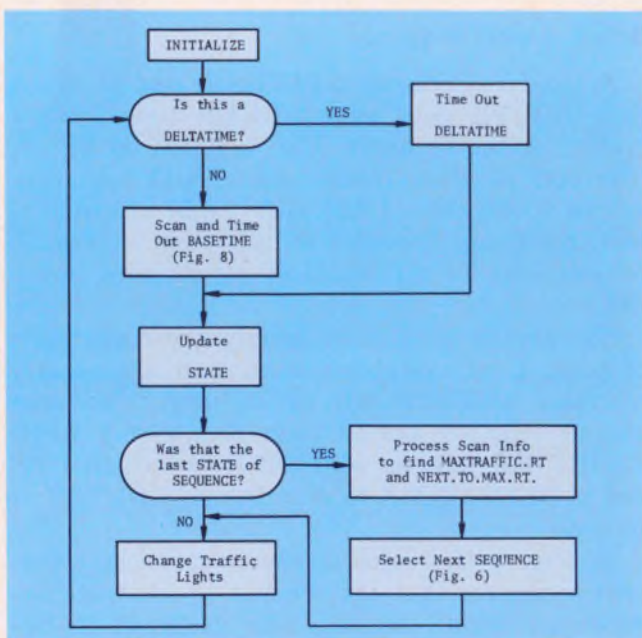

7. The complete controller algorithm contains the Select Next SEQUENCE algorithm of Fig. 6.

GREEN, RED, GREEN, RED, resulting in wasted start and stop times. The sequence, STATE2, STATE4, STATE5 is chosen over a sequence based on {1,3,5} so that both east-bound or west-bound lanes will move together.

The algorithm that selects a new SEQUENCE from Fig. 5, based on traffic during BASETIMES of the previous SEQUENCE, appears in Fig. 6. The algorithm allocates DELTATIMES of GREEN to the two busiest ROUTES, if possible. If this is not possible, it favors the busiest ROUTE in conjunction with a through ROUTE. Also, if traffic is light—the busiest ROUTE has less than a preset threshold—no DELTATIME is allocated, since this would not result in greater vehicle throughput but only in longer RED times.

The value for BASETIME is normally given, while the choice of DELTATIME must satisfy the MAXREDTIME constraint. From the given BASETIME and an analysis of all possible pairs of SEQUENCES in Fig. 5, you can easily solve for the maximum allowed DELTATIME. Express the resulting RED time for each ROUTE in the form  $N_1 \text{ DELTATIME} + N_2 \text{ BASETIME}$ .  $N_1$  is the number of DELTATIMES that occur during the RED time, and  $N_2$  is the number of BASETIMES.

The entire controller algorithm is given by the flow chart in Fig. 7, which incorporates the basic Select Next SEQUENCE algorithm of Fig. 6. If the state of the intersection provides DELTATIME, then you simply create that delay with a program loop. Otherwise scan the toggle switches to count toggles and thus measure the traffic during the BASETIME.

When the current STATE is completed, the STATE must be changed to the next one in the current SEQUENCE. This changes the traffic lights. If the SEQUENCE is completed, a new one must be selected before a return to the start of the major loop.

### The working routines

It is now possible to identify the routines to make the controller algorithm work. There are six principal ones:

1. Initialize:
  - Select a starting SEQUENCE, SEQ1.
  - Set all traffic counts to zero.
  - Set other pointers and counters to zero.
2. Time Out:
  - Do a loop of NOPS (do nothing but count) for a DELTATIME period.
3. Scan and Time Out (see Fig. 8):
  - Scan toggle switches every 20 ms, and count the 20-ms intervals until the BASETIME has been spent.
  - Update toggle counts for each ROUTE



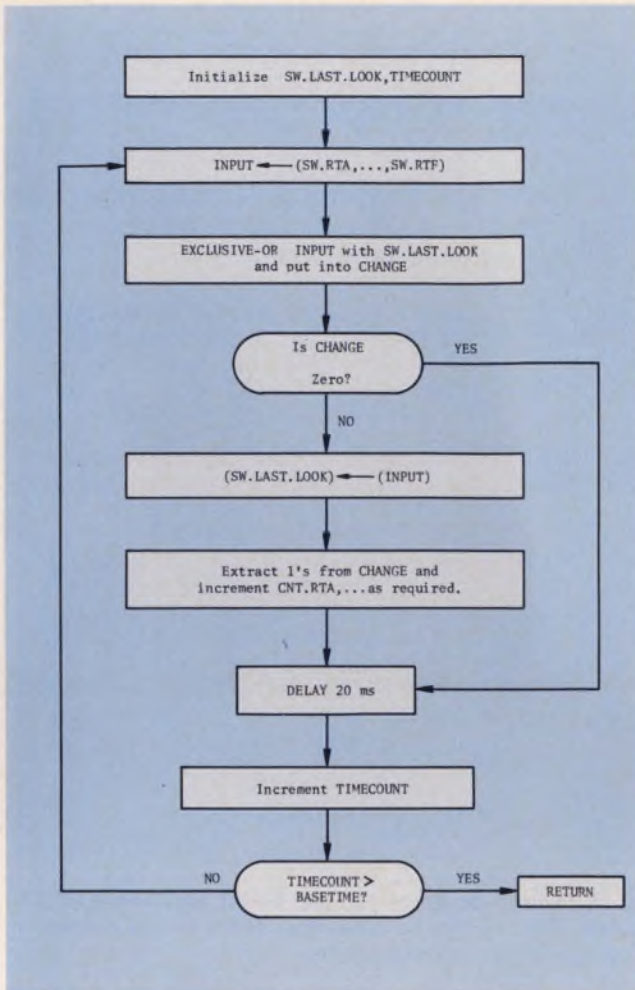

8. Scan and Time Out routine, one of the working routines, is outlined in this flow chart.

S.TABLE.POINTER	X
/An address in the S.TABLE whose content is the current STATE in the current SEQUENCE/	
CNT.RTA	X
CNT.RTB	X
CNT.RTC	X
CNT.RTD	X
CNT.RTE	X
CNT.RTF	X
/Counts of number of toggles (of switch in that ROUTE) since last initialization/	
SW.LAST.LOOK	X
/Last toggle positions read for all toggle switches/	
TIMECOUNT	X
/Location incremented once every 20 ms until BASETIME exceeded. More than 8 bits required/	
LASTSTATE	X
THISSTATE	X
MAXTRAFFIC.RT	X
NEXT.TO.MAX.RT	X
/X = 1,2,4,8,16,32 for RTA, ..., RTF/	
NEXTSEQUENCE	X
/X = 1,2,3,4 or 5/	

9. Some common memory locations and content description. Data format for each memory location X must be specified throughout.

S.TABLE1	2 /2 means use STATE2/
	4
	5
END1	0
S.TABLE2	2
	203 /Use STATE3 as a DELTATIME state/
	4
	5
END2	0

/The SEQUENCE TABLE contains octal numbers defining the sequences of STATES in each SEQUENCE. A "1" in the left-most bit flags that STATE as the DELTATIME STATE for that SEQUENCE/

STATES	12
	3
	5
	14
	60

/Five octal data words for STATES 1 through 5 defining pairs of ROUTES which can be GREEN together.

FORMAT of 8-bit word:  
0 0 RTF RTE RTD RTC RTB RTA/

10. Two required constant-data tables. These can be stored conveniently in read-only memory.

as required.

#### 4. Process Scan Information:

- Use toggle counts for the just completed SEQUENCE to determine the busiest ROUTES, MAX.TRAFFIC.RT and NEXT.TO.MAX.RT, as required in Fig. 6.
- Initialize route counts CNT.RTA,...and CNT.RTF to zero.

#### 5. Select Next SEQUENCE (Fig. 6).

#### 6. Change Traffic Lights:

- Use LASTSTATE and THISSTATE to determine the required traffic-light control signals. Create the required GREEN-to-YELLOW-to-RED and RED-to-GREEN transitions.

Note that routines 2 and 3 create real time delays with instruction loops. The much shorter execution times outside these major delay loops—which vary from one pass to another—can be neglected in comparison.

#### Plan memory and register use

Some of the common storage locations are labeled and described in Fig. 9. These may be memory locations or registers, depending on the number of registers available in the microcomputer. Each of these locations is used by more than one working routine.

Two fixed-data tables, shown with labels and memory contents in Fig. 10, could appear in



# DO-IT-YOURSELF grabber



**NEW**

- Simplified Assembly
- Versatile
- Comfortable Finger Grip Action
- Completely Field Serviceable
- Molded of Tough Lexan\*

Model 3925  
Mini Test Clip  
Shown Actual Size

This test clip with gold plated hook is excellent for rapid testing of components and Wire Wrap† pins. Clip is completely insulated to point of connection. Build any combination of test leads with wire up to .090 dia. Easy and comfortable to operate. Molded of rugged Lexan to resist melting when soldering. Write for literature and prices.



**MODEL 3925**  
hooks onto components or slips over square Wire-Wrap pins

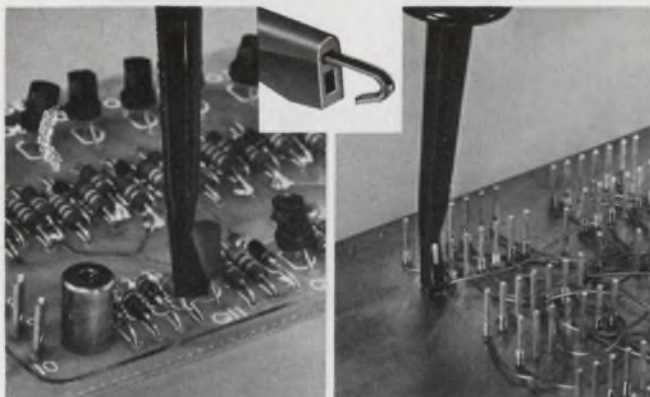

\*Lexan is a General Electric trade-mark. †Registered trade-mark of Gardner - Denver Co.



**POMONA ELECTRONICS**

A Division of ITT

1500 East Ninth St., Pomona, Calif. 91766  
Telephone (714) 623-3463

INFORMATION RETRIEVAL NUMBER 65

```

START      ■ Get MAXTRAFFIC.RT and shift word
            until a 1 is found.
            Bit1=1-RTA ..., Bit6=1-RFT.
            Let RTX be found.
            ■ Compare (CNT.RTX) against the constant
            (LIGHTTRAFFIC).
            If (CNT.RTX) is less, go to LIGHT.
            Otherwise, go to SELECT.

LIGHT      ■ (NEXTSEQUENCE)←1
            ■ RETURN

SELECT     ■ Compute (MAXTRAFFIC.RT)U(NEXT.
            TO.MAX.RT) and store in MAXPAIR.
            ■ Compare MAXPAIR against every data word
            in STATES table (Fig. 10).
            If match found, go to DO.PAIR.
            If no match, go to DO.MAX

/NOTE:    If a match occurs, let I be the line
            in STATES table at which it occurs.
            Then STATEI will give the DELTA-TIME
            to the two ROUTES./

DO.PAIR    ■ Search S.TABLE2, ... until a byte is
            found with bit8=1 and low order
            7 bits match line I of STATES table.
            Let this byte be found in S.TABLEJ.
            ■ (NEXTSEQUENCE)←J
            ■ RETURN

DO.MAX     ■ Search S.TABLE2, ... until a byte
            is found with bit8=1 and a 1 in the
            same position as in MAXTRAFFIC.RT.
            Let this byte be found in S.TABLEK.
            ■ (NEXTSEQUENCE)←K
            ■ RETURN
    
```

11. A "word" program for the Select Next SEQUENCE routine (Fig. 6) can be converted easily to the assembly language of any microcomputer.

ROM. S.TABLE defines the SEQUENCES chosen in Fig. 5. STATES represents the information in Fig. 3 used by the Select Next SEQUENCE routine. If the S.TABLE.POINTER is an 8-bit storage location, the S.TABLE of Fig. 10 should be positioned to fall on a single 256-word page. In this way only the 8-bit pointer has to be incremented to sequence through the STATES. This approach is usually efficient with 8-bit microcomputers.

Instead of a detailed instruction sequence for a particular microcomputer, Fig. 11 shows a general "word" program for the Select Next SEQUENCE routine. The flow chart for the routine is in Fig. 6, which also contains the program labels. The word program can be converted easily to the assembly language of any microcomputer. ■■

**Reference:**

1. McCluskey, E. J., "Introduction to the Theory of Switching Circuits," McGraw-Hill, New York, 1965. (see Prime Implicant Tables)

*The first article in the series discussed instruction sets and appeared in the April 1 issue. The second article, in the April 12, issue, dealt with microcomputer coding.*



# There's more to a Unimax product than meets the eye.



More quality. More reliability. More choice. More service.

When it comes to switches, you'll find that our models cover almost any conceivable snap-acting switch requirement.

BASIC PRECISION switches that are the first choice of the volume OEM users.

The most complete GENERAL PURPOSE line in the industry.

All styles of MINIATURE, SUBMINIATURE, and MINIATURE SUBMINIATURE types.

Big, rugged, METAL-CASED LIMIT

switches. Thousands of specials in minimum turn-around time, at minimum cost.

And to see the light, ask about our ILLUMINATED PUSHBUTTON CONTROLS. They offer you the broadest variety of styles in the business—in the widest choice of displays, colors, illuminations and actuations. From simple pilot light applications to the most

sophisticated multi lamp—multi switch—multi legend control, you'll find a Unimax LPB to meet your requirements. At a competitive price.

You'll also find special key lock or mushroom cap models. Mountings that are simplicity itself. Electrical and mechanical performances that are uniformly high.

Let us give you more. Write for detailed information concerning your applications to Unimax Switch Corporation, a Riker-Maxson Subsidiary, Ives Road, Wallingford, Conn. 06492. Or call (203) 269-8701.

 **Unimax**  
We give you more.

INFORMATION RETRIEVAL NUMBER 66



# TOKO

high-quality parts for the electronics industry

Factories in major cities around the world make it possible for us to supply local needs for parts in a hurry.

## Type 10K Coil

Toko's 10K coil has a wide range of application—10.7 MHz radio, SIFT, TV set VIF, CHROMA circuits, acoustic and communication equipment. Amazingly stable and reliable.



## Ceramic Filter Type: CFR-107M

The CFR-107M is a high-performance filter developed by TOKO to achieve adjustment-free FM IF circuits.

A new-type super-miniature ceramic filter with superior selectivity characteristics.



## HS-200S II-HIGH-SPEED LARGE-CAPACITY MEMORY SYSTEM

A high-speed, large-capacity, low-cost memory bank designed for use as the main memory in medium-to-large computers and various data processing systems. Access time operating speed, 200ns; cycle speed, 350ns. Memory capacity, 65k bytes. Memory capacity readily increased by combining as many HS-200S II units as desired.



## Polyethylene Capacitor

The CY2 Series polyethylene variable capacitor is highly stable and only 20mm square. It was developed



by challenging the limits of parts precision and by making radical improvements over all existing products.

## Pulse Transformer Dual In-Line

IC circuits are currently replacing all other elec-



tronic circuits. There is also an increasing demand to combine active as well as activated elements into identical IC packages. In particular, the Dual In-Line Package (DIP) is gradually becoming the standard for IC packages. Used in electronic computers and other electronic machinery.

EXCELLENT SET WITH TOKO PARTS



**TOKO, INC.**

Head Office: 1-17, 2-chome, Higashi-Yukigaya, Ohta-ku, Tokyo, Japan

### Toko America Inc.

350 Fifth Avenue, New York, N.Y. 10001 U.S.A.  
Tel: 212-565-3767 Cable: "NEWTOKO" Telex: 224114 NEWTOKO

### Toko America Inc., Los Angeles Branch

3440 Wilshire Boulevard Los Angeles, California 90010 U.S.A. Tel: 213-380-0417 Telex: 0674873 LA TOKO

### Toko America Inc., Chicago Branch

3601 West Devon Avenue, Chicago, Illinois, 60659, U.S.A. Tel: 312-267-8855

### Toko Elektronik GmbH

4000 Düsseldorf, 1, Grafenberg Burgmuellerstr. 7, F.R. Germany Tel: 0211-682281~3 Telex: 8582643 TOKO D

### Toko U.K. Ltd.

Shirley Lodge, 470 London Road Slough, Bucks, England Tel: Slough 48444 Telex: 847185 WWT SLOUGH

### Toko, Inc. Hong Kong Branch

49, Hoi Yuen Road, 3rd Fl., Kwun-Tong, Kowloon, Hong Kong, Tel: 3-428131-6 Telex: HX 3820 TOKOMFG

11 factories and 9 branch offices world-wide

INFORMATION RETRIEVAL NUMBER 67





**ANNOUNCING  
IMMEDIATE  
DELIVERY ON  
MICROPLATE  
CERAMIC  
CAPACITORS**

**... FROM  
MEPCO/ELECTRA**

No lead time problems. We maintain a large and varied stock of microplate ceramic capacitors to meet your specifications. These devices offer extremely high capacitance per unit volume. The unique design and technology employed in their manufacture provide unusually tight capacitance tolerances ( $\pm 2\%$  or 0.25pF on values less than 10pF). *Our silver free metalization process which eliminates silver migration, assures very low losses and negligible DC leakage.*

Other design features include; Wide range of controlled T.C.'s. Working voltage of 100 VDC. Ideal for high-volume assembly.

*For more information, call (201) 539-2000 or write Mepco/Electra Inc., Morristown, N.J. 07960.*

**Talk to the  
man from  
MEPCO/  
ELECTRA**



**MEPCO/ELECTRA, INC.**  
A NORTH AMERICAN PHILIPS COMPANY

Sold through  
North American Philips  
Electronic Component  
Corporation

Plant Locations:  
Morristown, New Jersey  
San Diego, California  
Mineral Wells, Texas  
Canandaigua, New York  
Oakland, California.





# Microprocessor ICs improve instruments.

With the newer designs, an increasing variety of test functions can be provided by software and additional memory.

It's a whole new—and better—ball game for instrument designers, now that microprocessors are available. Their application makes practical a different organization of instrument circuitry (Fig. 1). Here the microprocessor has a central and dominant role in data-transfer operations. As a result, the digital processor performs any required signal averaging, shaping or other linear or nonlinear operations to deliver the desired type of information.

In fact, use of microprocessors allows virtually any digital transformation, and at fairly low incremental cost for additional memory. And the instrument transducer—or analog “front end”—need not perform any signal processing beyond the minimum of conditioning required for interface with the a/d converter. Without the availability of microprocessors, such digital processing would be too costly.

Heretofore most digital-readout instruments have used analog, rather than digital, signal-processing. The only digital circuits needed for these instruments were code converters and readout drivers (Fig. 2). The reason was simple: Until recently analog operations were less expensive than digital, and few instrument designers were skilled in digital-circuit design beyond counting and summing circuits.

## An end to interface confusion

In a traditional analog instrument, a microprocessor would offer few obvious advantages. Most newer instruments, however, have some, or all, of these characteristics: digital readout of data, external programmability and external data outputs. But these characteristics are interrelated, and they imply the basic functions of digital data transfer—a hitherto neglected area of instrument design.

Primarily because of this neglect, there are a

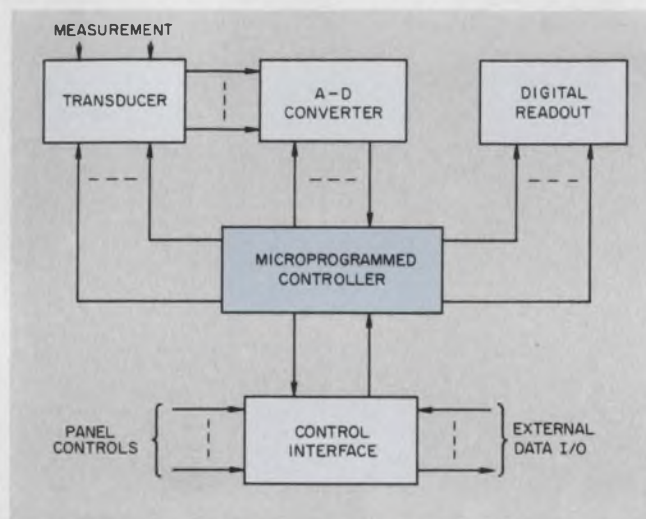

1. A microprocessor, functioning as a microprogrammed controller, allows the economical use of digital techniques for the required operations.

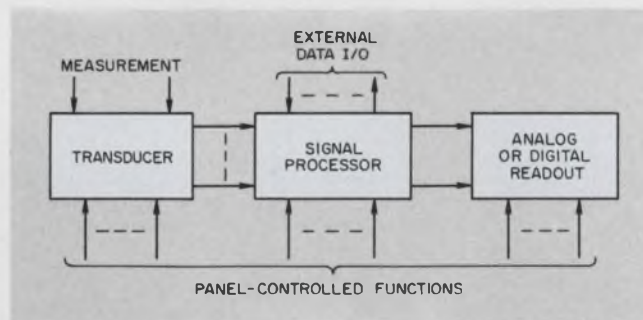

2. Traditional instrument designs use analog signal-processing techniques to obtain readouts of measured values. Such techniques used to be cheaper.

bewildering variety of interfaces in instrumentation today. Older designs have emphasized the transducer functions and minimized data-processing capability. Output and input data formatting have been sacrificed for measurement-function design.

With the microprocessor as the instrument controller, this picture changes. In most applications a standardized interface, based on a character-serial data transfer using ASCII code, re-

Richard Lee, Head of Development Engineering, Boonton Electronics Corp., Route 287 at Smith Road, Parsippany, N. J. 07054.



sults in minimum hardware costs. And this standardization of the interface requirements reduces instrument software development costs.

Moreover the data and control interface logic for a diverse range of instruments can use the same basic hardware. Hence the manufacturer can develop new types of instruments at minimum cost and also cut component and assembly costs. Also, because microprocessors substantially reduce the parts count, reliability increases.

Further, the use of more common hardware among various instruments makes maintenance easier; no longer is it necessary to unravel the design of each new instrument before it can be calibrated or repaired.

The programmability of microprocessors allows inclusion within the instrument of diagnostic aids for troubleshooting and self-checking. More generally, programmability simplifies tailoring for the user of instrument function and interface characteristics. As things stand now, the manufacturer has very limited ability to make custom changes unless a quantity order is involved.

Finally microprogrammed instruments, because of adaptability through software, promise to resist obsolescence longer than conventionally designed instruments. Control programs may be changed in the field to update and improve the performance of microprogrammed instruments.

#### But there are problems, too

Some words of caution, however: The programming of microprocessors differs greatly from the operations encountered in conventional logic design. Few designers are familiar with machine or assembly-language programming; a significant amount of design time can be eaten up during the learning period.

Accordingly, users should note the range of software aids available with a microprocessor in any evaluation of competitive circuits. Need for extensive software development would preclude the use of time-consuming machine-language programming. Hence a minimum requirement con-

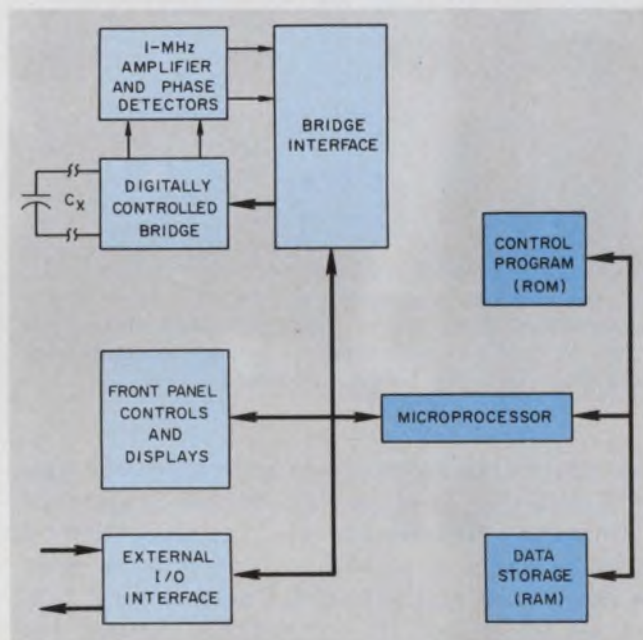

3. A 1-MHz automatic capacitance bridge uses a microprocessor to transform measured capacitance and conductance into various quantities useful to the designer.

sists of an assembly-language program to translate symbolic programs into actual machine language. The availability of a higher-level language would help reduce program costs further. But at present few vendors have such a package available.

Writing programs is only part of the problem. These programs must also be tested and corrected before they are stored in production instruments. A simulator program can test the bulk of the programming, but there is no practical substitute for actual system performance tests. At this stage of the design, the use of programmable ROMs for control memory allows a short turn-around time for the inevitable changes that will be required.

A range of new test equipment must be available to test and repair microprocessor systems effectively. The use of data multiplexing simplifies the design and minimizes interconnections. But at the same time multiplexing makes diffi-



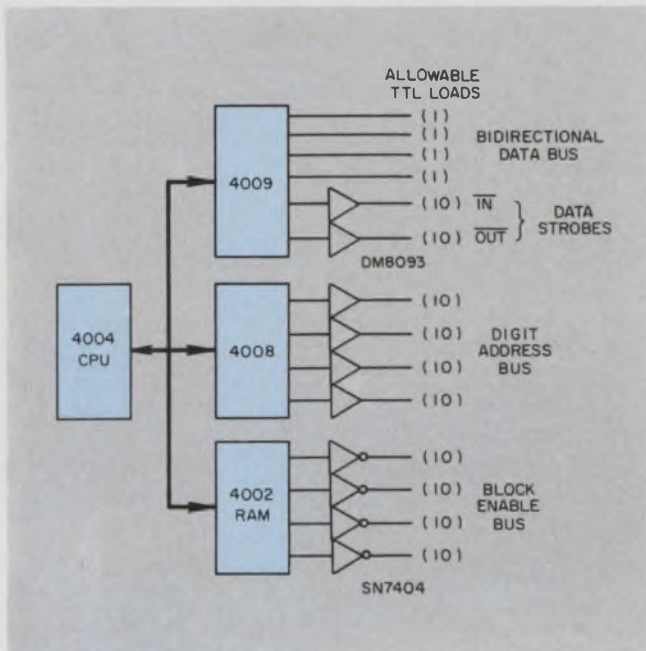

4. I/O operations and interfaces constitute much of the design effort. The I/O bus connections and loading are shown for a 4-bit microcomputer system, expanded for more than the basic 16-digit addresses.

cult the troubleshooting of microprocessor systems with the use of conventional test equipment.

Once the instruments are in production, a strict program of software documentation must be established and enforced. These systems cannot be traced out by conventional means; the program listing is just as important as the schematics that describe the hardware. Failure to maintain the software information makes subsequent troubleshooting extremely difficult and can even nullify many of the advantages of using software.

#### Example: an automatic capacitance bridge

A 1-MHz automatic capacitance bridge—the Model 76A from Boonton Electronics—provides a design example of an instrument using a microprocessor for control functions (Fig. 3). A convenient control organization for the bridge consists of a 4-bit data bus and a 4-bit address bus. The microprocessor system selected—Intel's 4-bit MCS-4 system—can readily handle such an organization.

Any design using microprocessors should begin with a demonstration of a functioning control unit. The demonstration unit involves a complete prototyping PC card containing a working microprocessor system—a SIM4-01 microcomputer card, in this case. The microcomputer card interfaces the prototype bridge with LED-numeric test readouts.

A complete demonstration unit should also include manually operated pROM-programming circuitry. With this the user can load programs for the system. Once a complete demonstration unit has been obtained, the control program can be written directly in machine language to prove the feasibility of the microprocessor control.

Further software development involves additional hardware: A Teletype-based program assembler and pROM-programming system—put together with programs and modules from the vendor—help simplify program development. The system reads paper tape containing assembly-language programs and translates them into machine-language programs, also on paper tape. The latter tape can be reread to program the control pROMs.

#### I/O considerations are important

Applications literature tends to emphasize operations internal to the microprocessor itself, with little attention to the problems of getting data into and out of the processor. But the user soon discovers that input/output operations and interfaces constitute the bulk of the circuit design effort, as well as a considerable part of the programming. Design decisions must take into account the programming involved, and the subtle tradeoffs can become fairly involved.

For example, the MCS-4 family includes two devices that provide pROM and input/output interfacing: the 4008 and 4009 ICs. These circuits activate a bidirectional, 4-bit data bus, a 4-bit address bus and read and write strobes in response to RDR (read ROM port) and WRR (write ROM port) commands (Fig. 4). The interface signals are all TTL-compatible and can drive at least one standard load.

When the available 16-digit addresses prove insufficient, a 4-bit block address bus can be generated by use of one of the RAM output ports (RAM-0). But software must be written to make the circuitry work.

Let's examine how the I/O bus interfaces with the front panel-control pushbuttons. The switch circuitry has two functions: First, it logically senses the switch closures. Second, it provides switch-status information by lighting a corresponding LED indicator when a switch closure is read and accepted by the microprocessor. Since 18 status indicators and 20 switches are involved, the design combines the switch-reading and indicator-data storage functions in a shift register. The schematic for this circuit block appears in Fig. 5.

Switch data are transferred in parallel to the



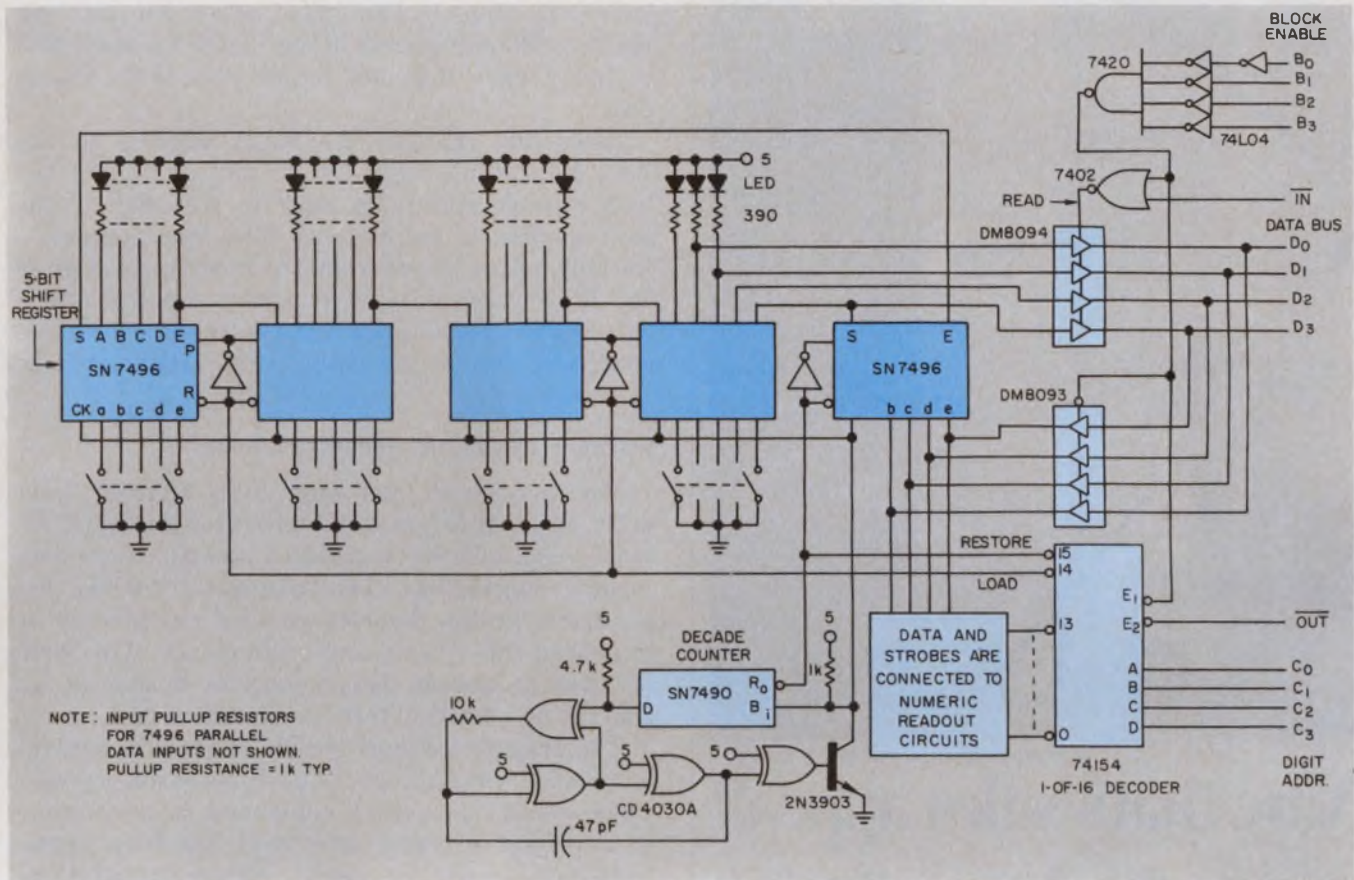

5. The functions of the switch circuitry include the sensing of switch closures in an addressable format.

Also, the circuitry must provide switch-status information conveyed through a LED indicator.

switch register by pulsing the LOAD line. At this point switch-closure information replaces the status information. The end 4 bits of switch data transfer to the data bus with a pulsing of the READ line. The status information can be replaced by a pulsing of the RESTORE line while the required information is presented on the data bus.

The RESTORE line triggers a gated clock that generates four clock pulses to shift the data along the register. The clock pulses also position the next 4 bits of switch data for reading. The READ and RESTORE operations repeat for a total of five operations each—sufficient to read in 20 data bits.

### Program executes I/O operations

A listing of the programs required for these operations appears in Fig. 6. Five digit positions in a RAM register store the existing switch-status information. Program steps 370 to 372 write the proper block access word to enable the panel I/O functions. Steps 373 and 374 initiate two register pairs in the CPU unit for the desired RAM and I/O addresses. They also pre-set a loop counter (Index Register 13).

PGM ADDR	INST CODE	MNEMONIC INSTRUCTION	COMMENTS
0370	299	LDM 1	/LOAD 1 TO ACCJ BLOCK ENABLE FOR PANEL
0371	081	JMS BLE	/JUMP TO SR AND WRITE 1 TO RAM PORT 0
0372	046	FIN 14 96	/INIT. REG 14,15 TO ADDRESS DIGIT 0
0373	096		
0374	044		
0375	235	FIN 12 235	/INIT. REG 12 = 14 FOR WRR. REG 13 = 11
0377	045	SRC 12	/PREPARE FOR WRR WITH DIGIT ADDR. = 14
0378	226	WRR	/CREATE SWITCH LOAD PULSE
0379	108	INC 12	/INCREMENT REG 12 FROM 14 TO 15
0380	047	SWL SRC 14	/PREPARE TO READ DIGIT FROM RAM
0381	232	RDM	/READ DIGIT (STATUS DATA) TO ACC.
0382	244	CMA	/COMPLEMENT LAMP ON FOR LOGIC ZERO
0383	176	XCH 0	/SAVE TEMPORARILY IN REG 0
0384	234	RDR	/READ SWITCH DATA
0385	244	CMA	/COMPLEMENT SWITCH CLOSURE = LOGIC 0
0386	224	WRM	/WRITE SWITCH DATA IN PLACE OF STATUS
0387	168	LD 0	/GET STATUS DATA FROM REG 0
0388	045	SRC 12	/PREPARE TO RESTORE STATUS INDICATION
0389	224	WRR	/RESTORE STATUS AND SHIFT 4 PLACES
0390	111	INC 15	/CHANGE RAM ADDRESS TO NEXT DIGIT
0391	125	ISZ 13 SWL	/INCR. REG 13J JUMP TO SWL IF NOT 0
0392	124		
0393	223	LDM 15	/LOAD 15 TO ACCUMULATOR
0394	081	JMS BLE	/JUMP TO SR AND WRITE 15 TO RAM PORT 0
0395	080		
0256	032	BLE, FIN 0 0	/ADDRESS RAM 0
0257	080		
0258	033	SRC 0	/SEND ADDRESS TO RAM
0259	225	WMP	/WRITE BLOCK ENABLE CODE
0260	192	BBL 0	/RETURN TO CALLING POINT

6. Software for I/O operations and interfacing is provided in this listing.

Steps 377 and 378 perform the LOAD operation for the switch circuitry when the WRR pulse is decoded out of line 14. Step 379 addresses line 15 for subsequent I/O operations. Steps 380 to 392 perform the READ and RESTORE operations. The first 4 bits of status information are fetched from the RAM and placed in Index Reg-





Photo courtesy Burroughs Corporation

## Now, that's sales appeal!

The ILLIAC IV, one of the world's largest computers, is another masterpiece of electronic engineering . . . and it looks it. Even sophisticated equipment such as this requires housing design that says beauty, purpose and durability. And nothing says it better than unique MET-L-WOOD® panels.

Met-L-Wood is a structural laminate combining the best qualities of wood and metal. It features high rigidity, strength, durability and lightweight. It has the solid feel and characteristics of steel plate without the weight, and a beautiful, smooth surface for immediate and lasting eye appeal.

First impressions often influence *final* decisions and acceptance. Met-L-Wood panels add more sales appeal than any other material you can use. Send for complete information today. Write: MET-L-WOOD CORPORATION, 6755 West 65th Street, Chicago, Illinois 60638.



**MET-L-WOOD Corporation**  
STRUCTURAL LAMINATES SINCE 1925

INFORMATION RETRIEVAL NUMBER 69

ister 0 by steps 380 to 383. The switch data are read in 384 and stored in the RAM by steps 385 to 386. Finally steps 387 to 389 restore the status data.

Steps 390 changes the RAM address to the next digit, while steps 391 to 392 increment the loop counter and jump back to step 380 if the loop counter is not at zero. The loop counter—initially set to 11—increments from 15 to 0 after the fifth pass, and the program executes steps 393 to 395. These steps remove the block enable code, and disable the front panel I/O functions.

### Software transforms measured data

The processors can only add, subtract and shift data. Multiplication and division must be performed with software that uses the three elementary operations. The arithmetic for the capacitance bridge involves various transforms of measured capacitance and conductance. The form of these measured parameters is based on an equivalent, parallel, three-terminal circuit.

The transformations provided include equivalent-series capacitance and differential capacitance—both the actual value and a percentage of a reference capacitance that has been measured and stored internally. Other transformations consist of equivalent-parallel resistance, equivalent-series resistance, dissipation and Q.

The value of the reference capacitor is stored internally on command of front-panel controls. The percentage differential capacitance can be used to sort capacitors into tolerance bands or perform temperature coefficient tests.

The selected information appears on two panel displays. Alternate readout modes can be displayed since the instrument retains the original balance data between tests.

### Accuracy vs speed: a major tradeoff

Generally a tradeoff of calculation accuracy against calculation time is the major constraint for microprocessor users. Multiplication or division by repeated add or subtract and shift resembles a matrix operation. Hence the time required tends to increase as the square of the number of digits.

This relationship forces designers to define their requirements carefully to optimize performance. A useful technique uses truncated products and quotients when possible, thus avoiding unneeded resolution in calculation results. Software support from vendors—limited at present—can be expected to prove helpful as application libraries stockpile more programs for common arithmetic operations. ■■





# SCHOTTKY RAMS

## Performance for pennies.

TI's new SN54S/74S189 and SN54S/74S289.  
Fast. Stable. Versatile.

Either one of these fully-clamped Schottky RAMs will outperform standard TTL RAMs. As much as 60% at the system level and up to 40% at the component level—whether in processors or peripherals, military or industrial applications.

Their highly useful organization—16 words of 4-bits each—and fast 35-ns maximum address access time (enable time 17-ns) make them ideal candidates for your new designs. Or, as a pin-for-pin replacement for older 64-bit RAMs you're now using.

The SN54S/74S189 has a

3-state totem pole output that drives system data bus-lines directly. External pull-up resistors are not required.

The SN54S/74S289 (3101A

equivalent) has an open-collector output to use whenever data-bus line impedances are defined by other sources. Both have PNP inputs biased for standard 54S/74S threshold levels.

But the best is price. Both the SN74S189N and SN74S289N are only \$4.24 in the 100-piece quantity. At under 7¢/bit, that's less than other 64-bit Schottky RAMs now on the market.

For data sheets, indicate by type number and write: Texas Instruments Incorporated, P. O. Box 5012, M/S 308, Dallas, Texas 75222.

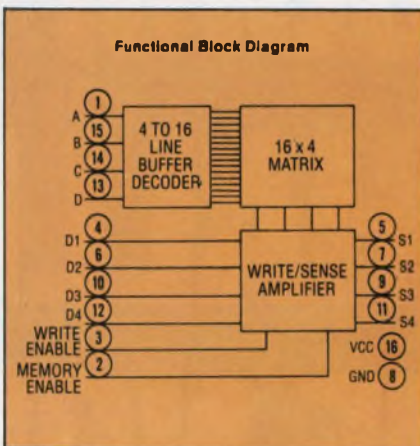

**TEXAS INSTRUMENTS**  
INCORPORATED



**INTERDATA  
ANNOUNCES  
THE INDUSTRY'S  
FIRST \$3200  
MINICOMPUTER  
TO CHALLENGE  
THE NOVA.**



# PDP-11 PERFORMANCE AT A NOVA 2 PRICE.

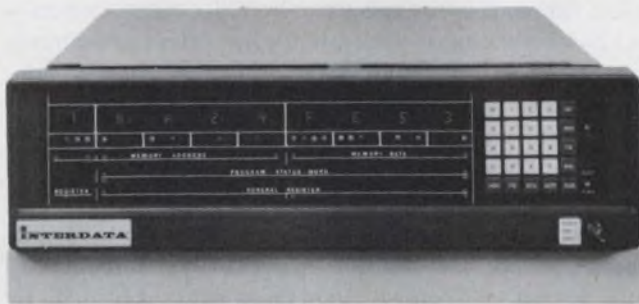

Minicomputer myths you can live without:

1. There is no such thing as a high-performance, low-cost minicomputer.
2. You have to choose between two extremes – pay a ton for a machine like the PDP-11 and save on software costs, or buy a cheapie like the Nova 2 and pay the price later.

All wrong.

Because now there's the Interdata 7/16 – an extremely flexible 16-bit OEM minicomputer that combines the best of both worlds.

It's easier to program than the PDP-11 because it has 16 hardware registers, up to 64K bytes of directly addressable main memory, 255 I/O interrupts with automatic vectoring to service routines and a comprehensive set of more than 100 instructions. That's a lot of muscle.

It's completely modular in design – plug-in options can be installed in the field to meet your specific application requirements.

Options like multiply/divide, programmers' console with hexadecimal display, power fail/auto restart, memory protect and a high-speed Arithmetic Logic Unit that includes floating point hardware. In fact, you can expand the low-cost 7/16 all the way up to the 32-bit Interdata 7/32.

Yet it costs as little as \$3200. Just like the machines that give you the barest minimum. And quantity discounts can reduce that low price by as much as 40%.

Performance	7/16	Nova 2/4	PDP-11/05
Data word length (bits)	4, 8, 16	16	1, 8, 16
Instruction word length (bits)	16, 32	16	16, 32, 48
General-purpose registers	16	4	8
Hardware index registers	15	2	8
Maximum memory available (K-bytes)	64	64	64
Directly addressable memory (K-bytes)	64	2	64
Automatic interrupt vectoring	Standard	Not available	Standard
Parity	Optional	Not available	Special order
Cycle time (usec.)	1.0 or 0.75	1.0 or 0.8	0.9
Available I/O slots	4	2	2

Price	7/16	Nova 2/4	PDP-11/05
8 KB processor	\$3,200	\$3,200	\$4,795
16 KB processor	3,700	3,700	6,495
32 KB processor	5,300	5,300	10,895
Multiply/Divide option	\$950	\$1,600	\$1,800
Floating Point option	\$4,900	\$4,000 plus \$1,000 for 2/10 configuration	Not available

Source: Data General Price List, Copyright 1973, and addendum dated 5/15/73. Nova 2/4 bulletin 012-000060, 1973. DEC OEM & Product Services Catalog, 1972. Auerbach Minicomputer Characteristic Digest, June, 1973. "How to use Nova Computers", 1973.

So you no longer have to make the painful choice between good performance and good price. Or between hardware economy and software efficiency. Now you have a minicomputer that gives you both.

The Interdata 7/16.

We put our muscle where their myth is.

**INTERDATA®**

2 Crescent Place, Oceanport, New Jersey 07757 (201) 229-4040.  
 Boston – (617) 890-0557. Washington – (703) 525-4806. Philadelphia – (215) 436-5579.  
 Orlando – (305) 851-6962. Chicago – (312) 437-5120. Detroit – (313) 356-5515.  
 Dayton – (513) 434-4193. Kansas City – (913) 384-1606. Houston – (713) 783-3060.  
 Dallas – (214) 238-9656. Denver – (303) 758-0474. Los Angeles – (213) 640-0451.  
 Phoenix – (602) 968-2477. San Diego – (714) 565-0602. San Francisco – (415) 969-1180.  
 Seattle – (206) 455-0680. Toronto – (416) 677-8990. Tokyo – (270) 7711.  
 Sydney – 439-8400. London – Uxbridge 52441. Munich – 0811-8543887.



# Hitch your telemetry system to a mini.

For modest cost, you get high data rates, real-time conversion to engineering units and tape output in standard formats.

Combine a minicomputer and a peripheral to demultiplex data, and you have a reasonably priced integrated system that can handle millions of telemetry data points a day at megabaud rates. Today's test programs call for such capacity.

You could use a large-scale digital computer to do the same job. But the odds are against it. Such a computer requires an expensive interface to format the data, costly software and more time than a minicomputer to do such workhorse tasks as channel identification, data blocking and checks on channel status.

The mini system can handle data in the following ways:

- Raw telemetry data can be buffered into block form and outputted to magnetic tape with appropriate headings and gaps for processing by a data-reduction facility.
- Independent data sources can be correlated and merged before the mini puts out the final tapes.
- The mini can convert raw data collected from sensors to engineering units prior to formatting or make the data available for a quick look.

Dave Colin, Senior Engineer, EMR Telemetry, P.O. Box 3041, Sarasota, Fla. 33578.

The basic components of such a system (Fig. 1) include the front-end peripheral to demultiplex the data—a process called decommutation—a buffered data channel with direct memory access, the minicomputer and the mini's conventional peripherals.

## Operator controls startup

For most operations, once the software has been loaded, the system is controlled initially by an operator from a teletypewriter. Guided by the computer, the teletypewriter asks the operator to define the telemetry front-end data links that will be required, and the operator responds with the information. The teletypewriter then asks for equipment setup information. The operator may have the option of typing in each piece of information, as requested, or of directing the system to read this information from a paper tape, disc or card deck.

Once the system has been set up and a data run started, the telemetry equipment dumps data continuously into memory blocks. The computer reads these blocks continuously, manipulates the information and outputs the formatted data to the magnetic tape unit or units.

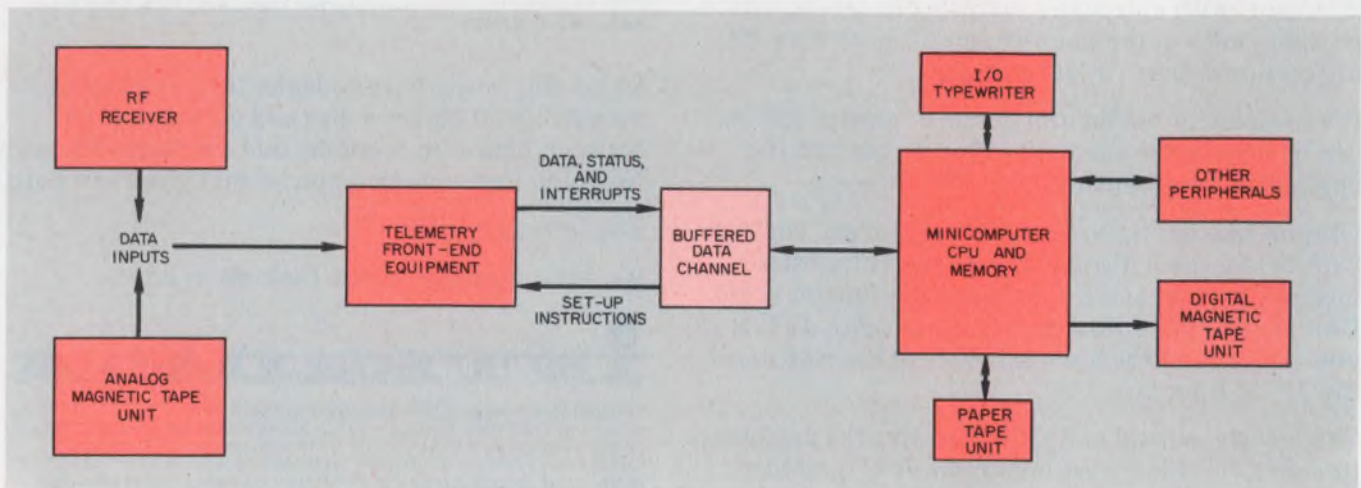

1. Raw telemetry data are buffered and converted to block form for processing by the computer. External

interrupts force the computer to exchange control between program routines.



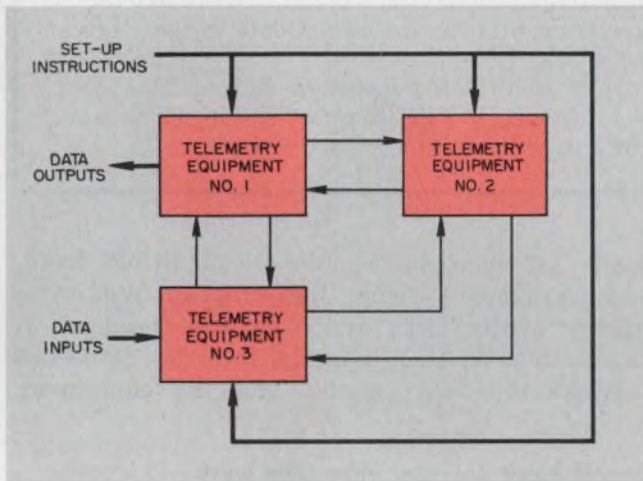

2. Telemetry systems often have multiple devices that require computer setup. However, a single output channel is typical.

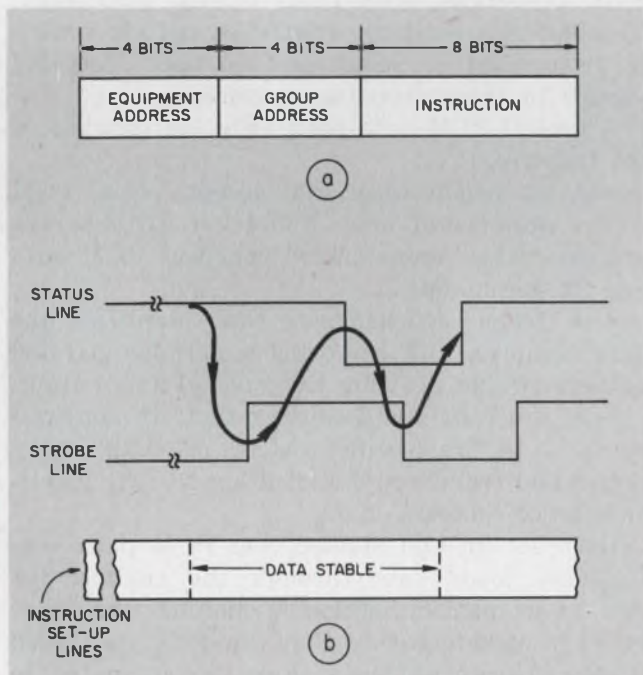

3. Telemetry control words (a) specify device address, type of instruction and the value associated with the instruction. For an FM path, the group address could signify center frequency deviation and the last eight bits the value. The status and strobe lines (b) control the transfer of information.

As shown in Fig. 1, there are interrupts along with data and status inputs. The interrupts are signals that force the computer to change from one program or routine to another. Consider the case of formatting the output tapes into spaced blocks of information. When the buffered data channel has completed a block transfer, it sends an interrupt signal to the computer. This signal directs the computer to call up the routine that puts the correct header and gap on the tape before the machine starts to output the next block of information.

Telemetry equipment must accept control information from a computer data channel and respond by transmitting the required data. The computer often must control many pieces of telemetry hardware but receive data from only one. Thus it is convenient to connect the control inputs to the equipment in parallel on a single data-channel output port (Fig. 2).

The control information lines normally contain several lines, or bits, of setup information; a strobe line to load the information, and another line that accepts and acknowledges the data.

Fig. 3a shows typical 16-bit setup information. The first four bits represent the address of the equipment to be controlled. The address is usually defined via jumper wires in the telemetry equipment. The next four bits—the group address—define the type of instruction. In the case of an FM data path, the group address may signify that a particular instruction represents the center frequency, deviation or a similar parameter. The last eight bits are the data associated with any parameter defined by the group address.

A timing diagram (Fig. 3b) shows the loading cycle for the telemetry equipment addressed. The status line indicates to the data channel whether the equipment is ready to accept information. If the data channel has stable information to send, it changes the level of the strobe line. The addressed equipment then responds by forcing the status line low. This acknowledges receipt of the information and also indicates that the strobe pulse is no longer needed. The status line then stays low, inhibiting further strobes until the equipment is ready to receive new data.



## Two major telemetry techniques

There are two major telemetry techniques: (1) frequency-division multiplex (FDM), and (2) time-division multiplex (TDM).

In FDM each data channel modulates a separate subcarrier oscillator. The oscillator outputs are mixed or summed to form a composite signal. FDM systems are usually frequency-modulated and structured to be proportional or constant bandwidth. For a proportional system, each oscillator is modulated a fixed percentage for full-scale input. Thus the higher the subcarrier frequency, the larger the bandwidth. For a constant-bandwidth system, all oscillators are modulated the same amount for full-scale input.

In TDM, channels are separated in time rather than frequency. Each channel is sampled in sequence by a commutator. When all channels

have been sampled, the sequence is repeated. TDM systems generally fall into three types: Pulse Amplitude Modulation (PAM), Pulse Duration Modulation (PDM) and Pulse Code Modulation (PCM).

For PAM data, the channel amplitude contains the information. For PDM, the channel duration at some fixed level represents the data. For PCM, the data are represented by binary bits. In general, the recovery equipment for PAM, PDM and PCM presents the synchronized data output in digital format. FDM recovery equipment presents the output data in the original analog form.

FDM and TDM techniques can be blended. For instance, a PCM encoder can modulate an FM carrier to form a PCM/FM link.

Telemetry data output normally is presented as parallel data lines (typically 8 to 16 bits), along with a load strobe. Unlike setup information coming from the computer, the telemetry data output cannot use an acknowledge signal, since the data transfer rates are, in general, fixed by the telemetry rates. Thus the telemetry equipment will continue to update data, irrespective of the data channel's ability to accept and process the data through to the computer. This can become a problem in cases where a system is attempting to operate on many high-speed data streams at the same time. It's up to the user to see to it that he does not overload the system.

It's best if all of the front-end equipment is compatible and from one manufacturer. However,

most systems require some incompatible front-end equipment—items like programmable frequency synthesizers and time-code readers. If these are to be used, a special interface is needed between the data channel and the equipment.

### Digital input sources: How they work

Typical of the digital data sources that provide parallel inputs are PCM and FM systems and time tags (see box). These sources accept, respectively, serial PCM, FM multiplex and serial time codes, often from an analog recorder. In addition a computer-controlled matrix switch is often used to select and connect incoming signals to these decoding systems.

A typical PCM data path (Fig. 4) consists of the following:

- A bit synchronizer that accepts serial PCM in the presence of noise and other disturbances and generates reconstructed coherent PCM data and timing signals.
- A frame synchronizer that identifies the data channels and performs a serial-to-parallel conversion that provides the parallel data output.
- A subframe synchronizer that, in conjunction with the frame synchronizer, provides timing pulses and frame count indication for the identification of subframe data.

Once set up and started, the PCM path continuously loads data through the channel for storage in memory blocks. A channel start command is used to ensure that the data are loaded in the correct sequence. For the computer to sort out subframe information, a frame count is included with the data transfers (Fig. 5). The computer can easily identify mainframe data and, using the frame count, also identify subframe data.

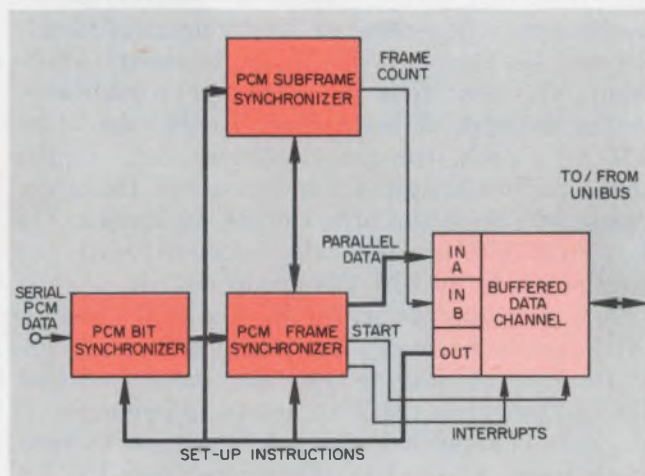

4. A typical PCM data path uses three pieces of equipment. The bit synchronizer extracts coherent serial PCM data and timing signals. The frame synchronizer identifies the data channels and provides parallel outputs. The subframe unit provides the frame count. Once started, the PCM path continually loads data into the computer via the buffer channel in a DMA mode.



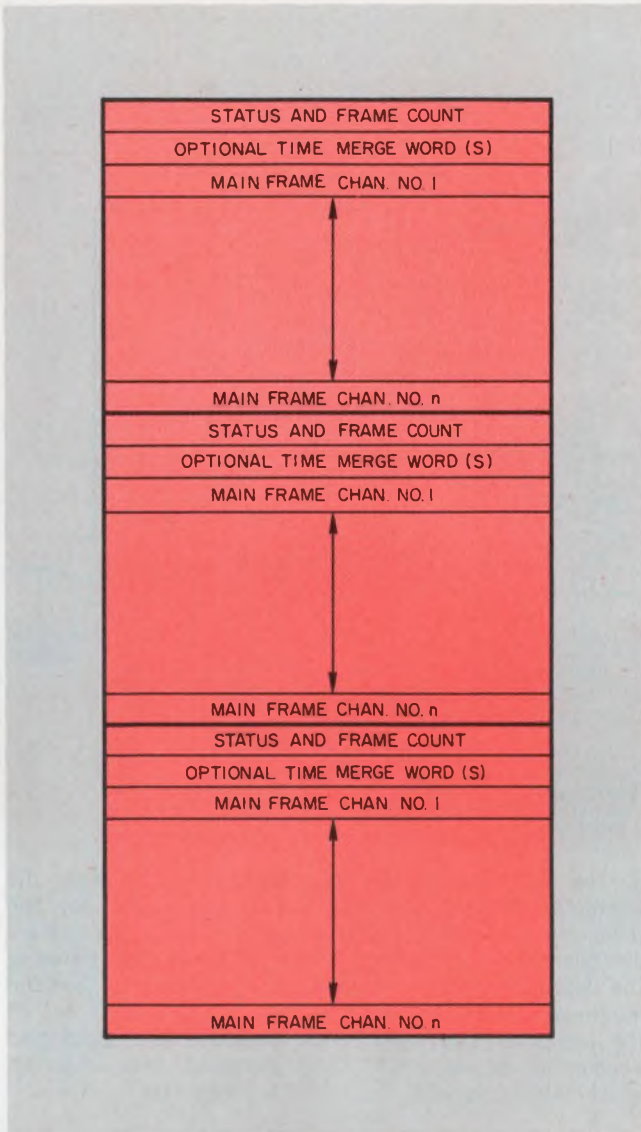

5. A typical data block in memory starts at location  $x$  and consists of  $y$  words. The status block permits the computation of the subframe or channel at which sampling began. The buffer signals the computer via an interrupt when a block is completed and begins a new block in an alternate buffer area.

PAM/PDM data are handled in much the same way that PCM are. Once set up, the path continuously sends data into memory.

### Analog-to-digital conversion needed

A representative FM data path consists of a group of FM discriminators and a multiplexer/analog-to-digital converter. The analog outputs of the discriminators are thus digitized and sent to the data channel (Fig. 6).

For a data run, the discriminators are set up and then allowed to operate. The multiplexer sampling is under control of the buffered data channel. This allows the sampling plan to be stored in memory and altered to handle different data rates. The multiplexer can also be sampled sequentially, if desired, without use of stored sampling, thereby eliminating computer inter-

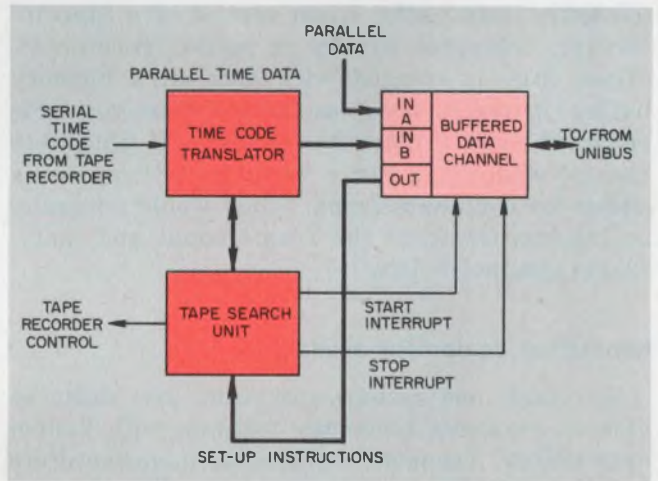

7. Time codes from separate tape channels permit addressable tape searches. The search unit controls the recorder and furnishes a start interrupt that informs the computer to begin processing the telemetry data.

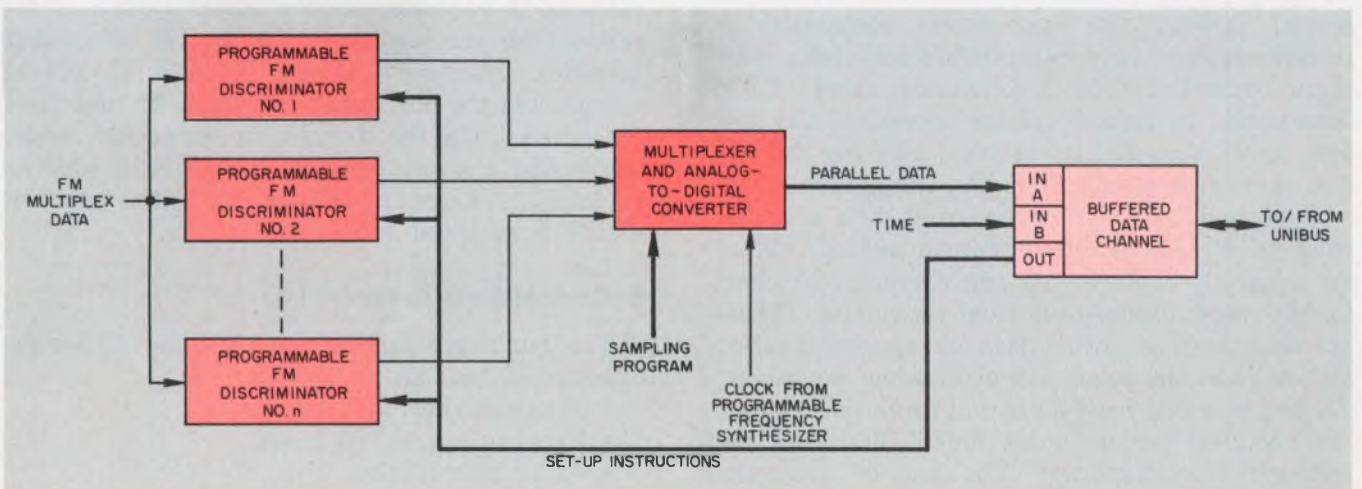

6. FM analog data must be digitized before being inputted to the buffer. The multiplexer controlled by the

computer via the channel selects the appropriate sampling plan in accordance with the data rates.



vention during data acquisition.

IRIG or other time codes often accompany recorded telemetry data on separate tracks. These codes allow the data-reduction operation to search out and run a particular segment of the tape as well as to time-correlate the data in different paths, if all were recorded at the same time. The time-tagging path is shown in Fig. 7.

The time equipment is made up of two units: (1) a time-code translator, which reads the incoming serial time code and converts it to parallel format for processing through the data channel and merging with telemetry data, and (2) a tape-search unit, which is set up and started by the data channel. The search unit, which contains two interrupts; then controls the tape recorder.

When the desired starting point on the tape is reached, a Start interrupt is activated. This calls up the correct program for processing the telemetry data paths. Upon receipt of a Stop interrupt, computer control is again transferred. When time is merged with data in a memory buffer, it usually occupies three successive words before the actual data. For example, if time were merged with PCM, Fig. 5 would have three words added for each data frame. They would generally be inserted between the frame count and main-frame channel 1 data.

### Simulation equipment available

To check out system operation, you must be able to construct telemetry formats with known data values. Telemetry-equipment manufacturers build simulators. A PCM/PAM/PDM simulator can be obtained in a single unit and programmed through the buffered data channel. Thus, under computer control, the simulator can be programmed for a particular format and the format's data values, and the output can be routed through the appropriate equipment. A programmable frequency synthesizer under computer control provides a convenient check of FM data paths. In typical system operation, the user sets up all required telemetry paths for the run and then inputs data from the simulators.

Equipment to monitor essential data channels consists of, among other things, analog, binary and digital displays, printer drivers, bar-chart drivers and digital-to-analog converters. These are capable of accepting data and synchronization pulses from the telemetry-processing equipment. All the operator need do is dial up the data channel required for a "quick look." The data are automatically displayed. The use of programmable distributors allows computer control of the quick-look function.

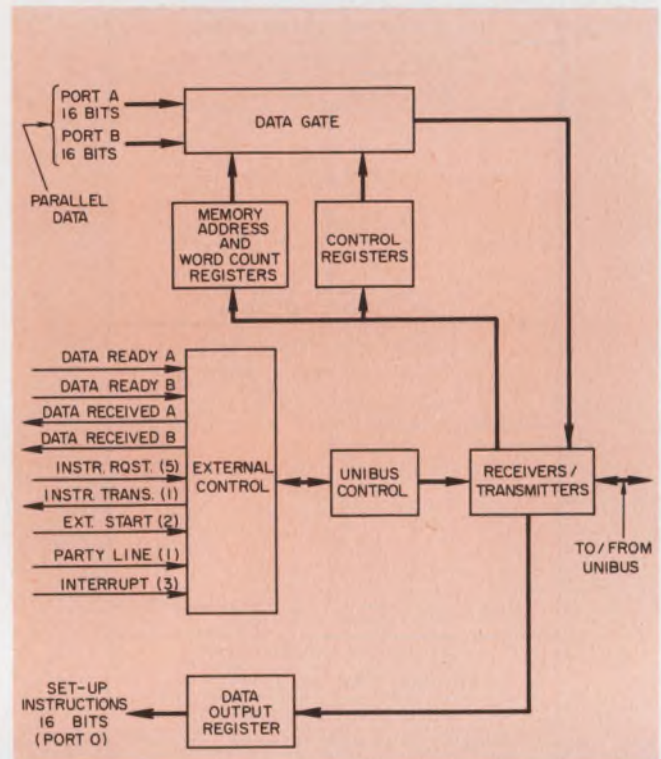

8. The computer buffer interfaces the bus with the telemetry devices and acts as the controller for the telemetry equipment. The control and memory registers establish the alternating memory buffers for entering the data blocks. Use of the buffer also ensures that the continuous telemetry data do not lock the CPU out of the computer bus. This block diagram is a simplified schematic of the EMR 2763 buffered data channel, which interfaces with the PDP-11 computers.

You can think of the buffered data channel as a gate that allows the computer to talk to the telemetry equipment and vice versa (Fig. 8). The buffer accepts each set of parallel data plus strobe from the telemetry front end, then places the data onto the computer's I/O bus. The buffer seizes the bus when a data word is ready, then releases it once the acknowledged signal is received from the computer. The buffer subsystem provides interface between front-end control signals and the bus. Since the telemetry data are transferred via the direct-memory-access mode, the buffer also contains the control and address registers to direct the data blocks to the memory locations reserved for input buffers.

### Buffer augments computer I/O

The hardware buffer provides the following operational features:

- Program-controlled output.
- Program-controlled input.
- Automatic output.
- Automatic input.
- Interrupt provisions.



In the program-controlled mode, all operations are under computer control—that is, the program must specifically call for input or output data transfer. Program-controlled modes are particularly useful for acquiring system-status information. For instance, under certain interrupt conditions, the program might direct the computer to freeze the time-code-translator data register and then direct the input to take this information into the computer.

In the automatic mode, the data channel, which is initially set up by the computer, takes control and transfers block information to or from the computer memory on a cycle-stealing basis. For example, the setup information for a given data path might be located in a block memory of X words in length. Upon gaining control from the computer, the data channel would sequentially output these words to the equipment involved until the block ends were reached, at which time output would stop. The same would be true of inputting a block of data.

In general, the automatic mode has two conditions: cyclic or noncyclic. The operation just described would be noncyclic—upon completion of a block transfer, the data channel is stopped. In the cyclic condition two blocks in memory are used. While the data channel is loading block 1, the computer program is working on block 2, and vice versa.

One other important function of the data channel is the ability to merge input data from two sources. Once the channel is running and taking data on one port, a control signal—either from the computer or external—can switch ports to allow data into the block from another source. A typical example of this is the frame-count information shown merged with data in Fig. 5.

### Picking the right mini

The basic mini differs from larger computers in the following ways: It has a smaller memory word (typically 16 bits or less), a smaller amount of memory, no floating-point hardware and no multiply and divide hardware. The mini memory usually is about 8 k for a typical CPU, but this can generally be expanded in increments of 4 or 8 k. Floating-point and multiply-and-divide hardware usually are available at extra cost. They are a must if you plan to have the system do any scaling or other reduction of data, particularly in real time.

Since the main purpose of the computer is to handle large amounts of continuous data, the I/O structure is probably the single most important feature. Direct memory access (DMA) for both

data input and output is essential. Most machines have this feature, which allows data to be transferred in and out of memory on a “cycle-stealing” basis. This allows the central processing unit (CPU) to continue execution of a program at essentially the same time that the external data are being loaded.

Good nonpolling hardware interrupt capability is essential. With multidata systems, nesting interrupts (interrupting an interrupt) and the ability to assign independent priorities to a device interrupt and its service routine are also important. These capabilities that input information will not be lost while the CPU attempts to process it. For instance, a system may be handling PCM data at 100 thousand words a second and PAM data at five thousand words a second. The interrupt associated with the PCM must be handled immediately, whereas the PAM interrupt can wait.

Besides extended arithmetic and floating-point hardware, other CPU options are usually available. Some of these include:

- *Interleaved Memory.* This allows the system to read the next consecutive memory address while the previous address is undergoing the restore process (write cycle), thus saving processing time.

- *Real-time programmable clock.* This allows for timed interrupts at program-specified intervals.

- *High-speed solid-state memory.* This increases processing speed, because of a faster cycle rate.

- *Memory parity.* This allows the CPU to check the validity of all memory words read.

### Basic computer peripherals used

As a minimum, every CPU must provide manual input. Many machines include an ASR 33 Teletype terminal as standard. It reads and punches paper tape at 10 characters a second and has a hard-copy output. This device is, in general, too slow. Just loading a typical assembler program will take an hour or more, not to mention the time taken for punching out the object tape. If you intend to do any development software at all, a high-speed paper tape system is a must. Such equipment reads, typically, at 300 characters a second and punches at 50 characters. A 30-character-a-second I/O typewriter also is convenient for hard-copy output.

For outputting formatted telemetry information, a digital magnetic tape unit is needed. Even the slowest data rates are far too high for paper tape. Magnetic tape-packing densities up to 1600



bits per inch and speeds to 125 inches per second are available. The choice depends upon the system data rates and your budget.

Various other peripherals should be considered, depending upon system size and use. Some of the more common that are available include:

- *High-speed line printer*—for obtaining reports and software listings. The speeds vary from 60 to 1200 lines per minute.

- *High-speed card reader*—for entering blocks of data and system parameters where changes will be made frequently. Only the cards affected need be changed, whereas with paper tape a new tape must be made. The cards are also very convenient for use with source decks in a disc-operating system. Corrections can be made easily by the addition and removal of source cards, followed by quick reassembly.

- *Disc storage*—for use in larger systems, where numerous programs will be required. In essence, all of the operating system program modules are stored on the disc. Once the disc system executive is in core, these programs can be accessed rapidly. This is extremely useful in a telemetry processing, where numerous users are requesting reduction of different data formats. It is a must if there is going to be considerable software development.

### Telemetry software needed

Over and above the software offered by the computer manufacturer to support his machine are various modules written especially for support of the telemetry equipment. EMR Telemetry has developed an extensive library of this type of software, called TELEVENT. Included in TELEVENT are the following:

- *Telemetry executive.* This allows communication and control between operator and software. It lets the operator call up the telemetry software modules to handle his job. In general, the operator need only describe to the executive in conversational mode the functions desired. The executive automatically selects the software modules.

- *Telemetry language translator.* This software, when called up by the executive, decodes the operator commands that define the telemetry equipment and functions to be set up, and it calls up the setup driver for that equipment.

- *Setup drivers.* These modules, when called up by the translator, decode the parameter values—bit rate, frame sync code, etc.—of the operator command and store these in data blocks in the correct form to load the telemetry equipment. The setup driver then returns control to the telemetry executive.

- *Data acquisition software.* When called up

by the executive, this software communicates with the telemetry equipment via a data channel I/O driver. It sends the setup data, previously stored by drivers, to the telemetry units, sets up data buffers in memory and commands the data channel to get data. The software also handles the data-acquisition interrupts. This type of software can be considered "standard," in that most systems will require it. In many cases it will be unique to the user, and he will probably want to write most of it himself.

A unique feature of the PDP-11 series computers is that all I/O devices connect to a common bus and appear to the CPU as memory locations. I/O software is simplified. And expansion of the system is allowed by the wiring of additional I/O units, including data channels, to the bus.

### Permissible data rates

Estimating the rate at which data can be loaded into the computer can be confusing. The fact that the computer data bus can handle information at memory cycle rates (typically 1  $\mu$ s) may lead to an erroneous conclusion. When large blocks of data are to be inputted to the computer infrequently, the input channel acquires the bus and transfers its data at a high rate then relinquishes the bus. But telemetry data are continuous, yet the bus cannot be dedicated to inputting this data. To process the data, control must be constantly transferred from the telemetry input to the CPU and back again—a task that is performed by the data channel.

To calculate the data rate that can be handled, the following parameters come into play:

- How long does it take to acquire the bus?
- How much time does the CPU require for formatting the data between inputs?

Both parameters are also affected by the number of data streams being processed. A good rule of thumb for a mini-based system that simply formats and outputs to tape is about 150 k words/sec for a single-stream system. For a multistream system, divide 150 k words/sec by the number of streams.

Since most telemetry data are stored on analog tape prior to processing, the tape recorder can simply be played back at a slower speed to keep the data rate from exceeding the computer system's capability. For example: you want to process a 2-Mbits/sec, 8-bits/word serial PCM data stream. This equals 250 k words/sec. If the analog input tape is played at half the speed it was recorded at, the rate is reduced to 125 k words/sec and can be formatted to a nine-track digital tape at a rate of 125 k characters/sec. ■■



# Ferrite power supplies are more efficient and cost less.

## Inverter-Rated ferrites™ end the guesswork.

Replace metal laminations with ferrite components and get a lot of trade-offs going in your direction. Less weight. Higher efficiency. Smaller size. Better regulation. And lower system cost.

### New applications

High frequency, low loss ferrites from Indiana General have improved the efficiency of inverters and power supplies in everything from computers to portable test equipment.

Whenever you need high efficiency power transfer, our Inverter-Rated components will also give you better regulation and vastly simplify your filter requirements.

### Today's answer

Improved ferrite technology has made it economically feasible to operate inverter systems at 2KHz and beyond.

Inverter-Rated® ferrite components from Indiana General are designed and tested specifically for high frequency operation and feature low power loss to 150°C.

With our full line of components you can select the circuit characteristics you need in meeting your specific application requirements.

### Ferrites for inverters

We specify and guarantee inductance and core loss under maximum and recommended conditions to end guesswork. By giving you circuit performance data instead of routine magnetic parameters, we make your design task easier and more precise.

Inverter-Rated components are tested under square wave drive so the performance you design in—stays in.

### Free design guide

Our new design guide has all the

facts you need; component specifications, temperature characteristics and application data. The design procedure we outline in this guide and an afternoon of your time will tell you if higher frequency operation is the solution to your specific power supply requirements.

Circle the Bingo card for your copy or call (201) 826-5100 and ask us for specific answers to your requirements. Either way, if you're talking high efficiency power supplies, talk to the ferrite experts.

That's us.

Indiana General  
Keasbey, N.J. 08832

National distribution through Permag locations in Atlanta, Boston, Chicago, Dallas, Detroit-Toledo, Los Angeles, New York and San Francisco.

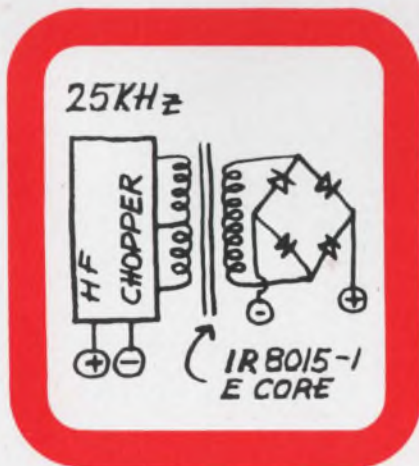

**indiana general**

a division of Electronic Memories & Magnetics Corporation

INFORMATION RETRIEVAL NUMBER 71



This chip  
is the world's first  
SOS processor.



It makes all the  
stuff on the next page  
possible.



Silicon-on-sapphire isn't new. The aerospace industry and the military have recognized its high-speed, high-density and high-reliability characteristics for years.

But no one was ever able to use it in a computer processor.

Until now.

Now General Automation designers have built the world's first commercial processor using SOS technology.

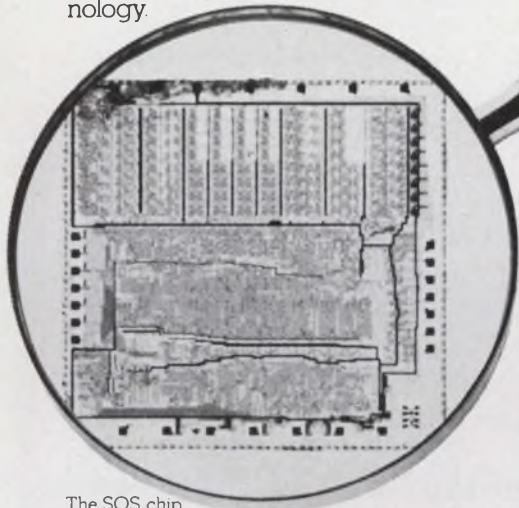

The SOS chip magnified 16 times

They've placed 2000 gates or the equivalent of 4000 to 5000 transistors on a single semiconductor chip.

An 800 times size reduction from its predecessor product, the SPC-12.

### The world's first microcomputer.

That tiny SOS chip has made it possible to bring you the LSI-12/16. A complete digital automation microcomputer with from 1K to 32K bytes of semiconductor memory.

We call it the world's first microcomputer because it's the only



The board-only system

microproduct available that gives you the performance, the systems features, the reliability and the applications support you would normally expect from a minicomputer.

### More work, less money.

In the past this kind of size reduction

always meant you had to make major concessions in performance.

With SOS you make none.

The LSI-12/16 has an instruction execution cycle time of 2.64 microseconds.

It's faster than any microprocessor on the market.

It's more powerful. And lower in cost. In board-only configuration with 1K memory, it costs only \$495 in minimum OEM quantities of 1000 per year. In short, we offer all the performance of a minicomputer at microprocessor prices.

### Breakthroughs across the board.

The LSI-12/16 is the first microproduct to successfully put all of the following on a single board:

A processor, power fail/auto

restart, remote cold start, 16 bit parallel I/O interface and up to 2K bytes of semiconductor memory.

But we didn't stop there.

GA engineering has also overcome the problems associated with semiconductor memory. Like loss of data in the event of power failure.

We handled that by developing an auxiliary battery backup system that will activate immediately upon loss of power and will retain the contents of memory for up to 15 hours.

In case you're interested in more memory, we've designed a piggyback board that will give you an additional 2K of RAM or 8K of ROM.

And if there's ever an error in ROM programming, it can be corrected. The LSI-12/16 has a

unique built-in ROM patch that lets the user retrofit new instructions to any ROM.

### Custom tailoring.

There's one more advantage the LSI-12/16 has that no other microproduct can offer.

It's the systems backup and application expertise that General Automation gives you. Helping solve customer problems has always been our long suit. It still is.

We can customize I/O boards and match the LSI-12/16 exactly to your requirement.

Our microcomputer is available in one of two different configurations:

As a board-only system, packaged with memory, control console and processor on a single 7-3/4 by 10 inch printed circuit board.

Or the same board packaged in an enclosure with power supply, battery backup for semiconductor memory and card slots for additional I/O boards.

For more information, write

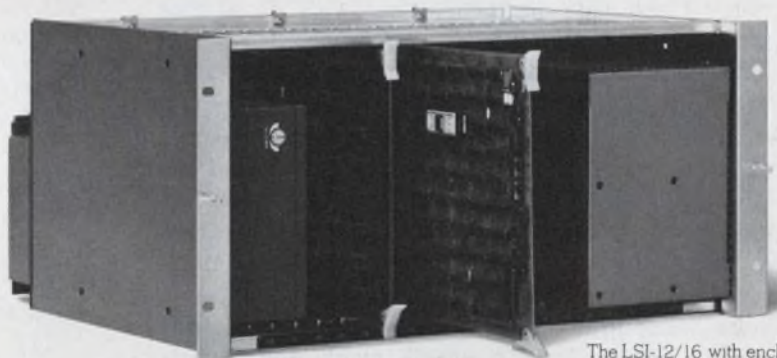

The LSI-12/16 with enclosure.

General Automation, 1055 South East Street, Anaheim, California 92805. Or call us at (714) 778-4800.

Our European headquarters is at Centre Silic, Cidex L242, 94533 Rungis, Paris, France. Call 686-7431.

# GENERAL AUTOMATION

A new generation of computer processors is beginning. All because of this



See the LSI-12/16 in the Computerworld Caravan — and at the National Computer Conference.



# Minimize computer 'crashes.'

Analysis of asynchronous conditions within a machine points to unavoidable errors, but there are eight ways to ease the problem.

There is reason to believe that the unexplained, intermittent faults that occur in some of today's complex computer systems—random errors that computer people call "crashes"—may be unavoidable. But there are at least eight ways to minimize the problem.

Basically it appears that the problem is caused by "races" between pulses derived from asynchronous clocks—races that can result in arbitrarily narrow signal pulses (spikes). With ever smaller currents and voltages combining with narrowing pulse durations, circuits strain to operate at the limit with mere dozens of electrons. When this happens, the laws of atomic physics come into play.

With the trend toward higher-speed computers and multiplicity (multi-use, multiprocessor, multiprogram)—and also toward massive on-line data bases and many communications lines—the problem of random racing errors will become more frequent. Observance of the following rules, however, can minimize the problem:

(1) *Minimize the number of asynchronous clocks.* Though running all processors and memory banks from a single clock does create problems in clock design and product factoring, the avoidance of spikes within the mainframe more than pays for the extra cost.

(2) *Move asynchronous boundaries out to the interfaces with the lowest possible speeds.*

(3) *Partition the system according to the regions governed by each asynchronous clock.* Ordinarily this corresponds to a natural partitioning. However, with peripheral controllers, boundaries may go through the controllers.

(4) *Identify all asynchronous boundaries and define the simplest possible asynchronous interfaces—that is, minimize the number of timing signals that cross these boundaries.*

(5) *Adopt a suitable, "handshaking" protocol for each asynchronous interface and minimize*

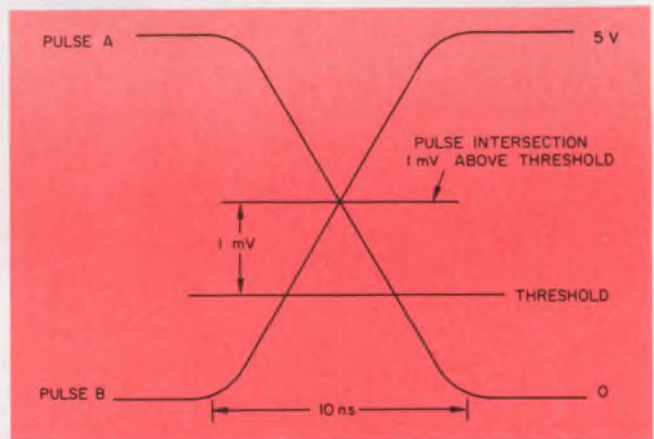

1. Problems can arise in a gate when the leading edge of an incoming pulse intersects the trailing edge of the second incoming pulse at a point near the threshold of the gate.

*the number of elements directly subject to asynchronous signals.*

(6) *Provide specially designed high-speed regenerators for the elements subject to asynchronous signals.*

(7) *Analyze the probability of spikes and the system impact of spikes.* Confine the errors caused by spikes to data rather than control, if possible. System lockups or crashes are a much greater hazard.

(8) *Design in a spike detector that will cause an immediate machine-fault interrupt—that is, use such a detector if the impact of a spike is not limited to the data but could cause a system crash.* Software designers should be alerted to this problem and advised on means of containment and recovery.

## Hardware not at fault

Crashes due to spikes differ from the usual errors—such as parity—because they are not caused by hardware malfunctions. Let's take a closer look at them.

Virtually every large digital-computer system incorporates more than one clock. In addition to the main clock, which drives the CPU, some systems have an independent, asynchronous clock

---

David Mayne, formerly of Pertec Corp., 17112 Armstrong Ave., Santa Ana, Calif. 92705 and Ralph Moore, formerly of Xerox Corp., Data Systems Division, Aviation Boulevard, El Segundo, Calif. 90245.



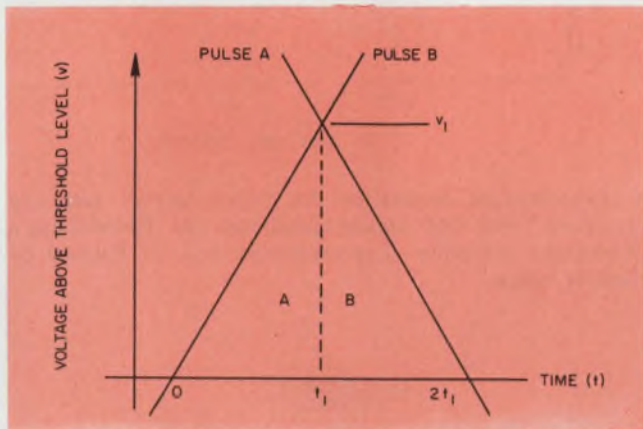

2. The amount of energy "injected" into a gate by two overlapping pulses can be determined by calculation of the area under the intersection. The amount injected decreases rapidly as the overlap narrows.

for each memory bank. In systems with more than one processor—input/output processors, multiple CPUs or special processors—each processor has its own independent clock. Also, most moving-media peripherals, such as disc packs, RADs, tapes—incorporate an independent asynchronous clock within the moving medium.

Real-time systems respond to interrupts that are normally asynchronous to the main CPU clock; communications lines ordinarily use their own clocks. At some point within these multi-clock systems, a pulse derived from one clock will be ANDed with a pulse derived from another clock. Since the clocks are asynchronous with respect to one another, the pulses will also be asynchronous. Thus the leading edge of one pulse may occur at any time with respect to the trailing edge of the other pulse.

Consequently the AND result of the two pulses may be an arbitrarily narrow spike, and the peak amplitude of the spike may be arbitrarily close to the threshold of whatever amplifier follows the AND gate.

Normally this amplifier is latched—that is, regenerative. The regenerator decides if the spike should be regarded as a logic ONE or ZERO. With an arbitrarily narrow spike, the energy that is injected into the regenerator can

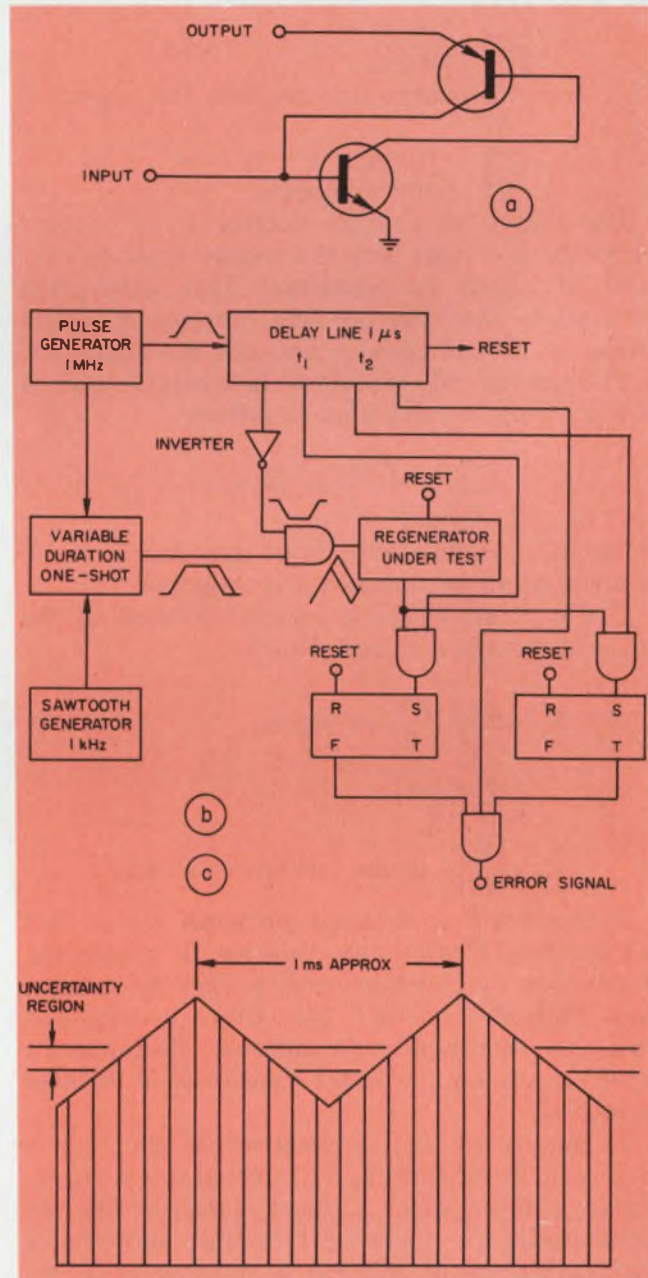

3. Typically, a regenerative circuit (a) follows a gate in a computing chain. When an arbitrarily small spike enters the regenerator, the circuit may delay in resolving the spike into a ONE or ZERO. The "uncertainty" can be measured (b) if an asynchronously modulated spike stream (c) is fed into the gate-regenerator and the error signals are monitored.



drop to an arbitrarily small level.

Consider the case in which the fall of pulse A intersects in a gate with the rise of pulse B and both pulses have rise and fall times of 10 ns (Fig. 1). Assume the intersection of the pulses is 1 mV above the threshold of the regenerator to which the gate output is connected.

The duration for which the spike exceeds the threshold is

$$\frac{2 \times 10^{-3} \text{ V}}{5 \text{ V}} \times 10^{-8} \text{ sec} = 4 \text{ ps.}$$

With a regenerator input impedance (R) of 1000  $\Omega$ , the average current flow during the time the spike exceeds the threshold is

$$\frac{1}{2} \times \frac{10^{-3} \text{ V}}{1000 \Omega} = 1/2 \times 10^{-6} \text{ A.}$$

Therefore the charge injected into the regenerator is

$$\begin{aligned} &1/2 \times 10^{-6} \text{ A} \times 4 \times 10^{-12} \text{ sec} \\ &= 2 \times 10^{-18} \text{ coulombs.} \end{aligned}$$

The charge on a single electron is  $1.6 \times 10^{-19}$  coulomb, so in this case the charge injected consists of about 12 electrons! This calculation emphasizes that the problem involves considerations of atomic physics and not macrophysics.

The energy, E, contained in areas A and B of Fig. 2 can be calculated as follows:

$$E = 2 \int_0^{t_1} \frac{v^2}{R} dt \text{ joules,}$$

where R = regenerator input impedance, which is assumed to be constant and resistive.

But  $v = kt$ , where k equals the slope of the pulse in volts per second. Hence

$$\begin{aligned} E &= 2 \int_0^{t_1} \frac{k^2 t^2}{R} dt \text{ joules,} \\ &= \frac{2 (k^2 t_1^3)}{3R} \end{aligned}$$

$$E = \frac{2v_1^3}{3kR} \text{ joules (where } v_1 = kt_1 \text{).}$$

Heisenberg's uncertainty principle states that the product of the uncertainties in measuring momentum and position will always be greater than Planck's constant (h). Since energy and time are conjugate dimensions, Heisenberg's principle also applies to the measurement of these quantities.

If this is so, the implication is that, for a small amount of energy,  $E_1$ , injected into a regenerator, a finite time,  $t_s$ , must elapse before the regenerator can "make up its mind" and resolve the uncertainty of whether a spike is to be regarded as a ONE or a ZERO.

If the output of the regenerator is sampled before  $t_s$  and decisions are later based on the result, then, clearly, the system can malfunction—that is, the regenerator may change state *after* the system has sampled the regenerator's output.

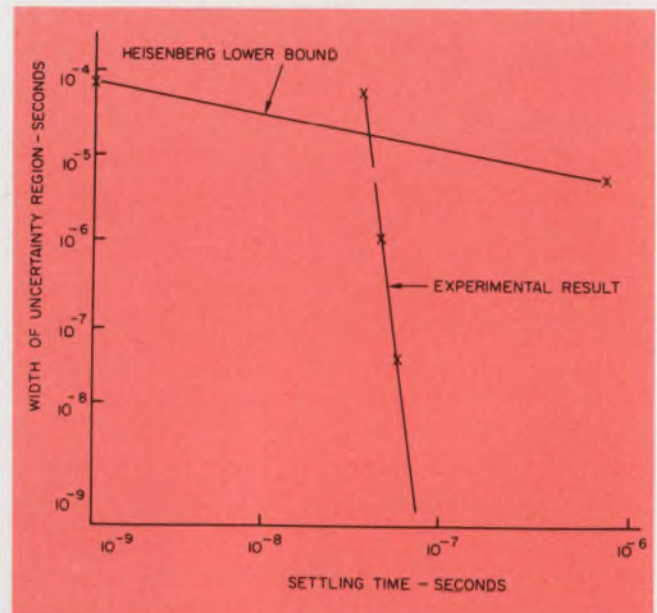

4. Experimental results of the "uncertainty" test are compared with the values predicted by Heisenberg's uncertainty principle. Discrepancies may be caused by thermal noise.

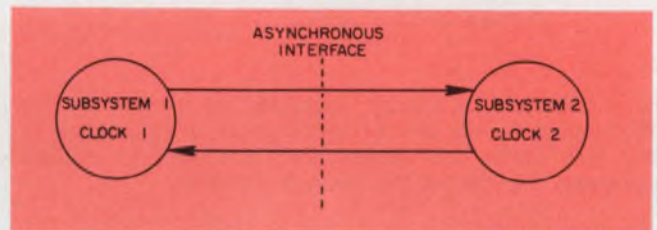

5. In a complex computer system each subsystem is likely to have its own clock. With this arrangement, problems can occur at the asynchronous interface of the subsystems, and errors can result.

Consider this example:

If a settling time of 50 ns is allowed for the regenerator before its output is sampled, the minimum spike amplitude for satisfactory resolution can be calculated as follows: Planck's constant (h) equals  $6.624 \times 10^{-34}$  joule-seconds. Hence the minimum energy injected must be

$$E_1 = \frac{h}{t_s} = \frac{6.624 \times 10^{-34}}{50 \times 10^{-9}} = 1.3 \times 10^{-26} \text{ joules.}$$

$$\text{But } E_1 = \frac{2 v_1^3}{3kR}.$$

$$\therefore v_1 = \left( \frac{3kE_1 R}{2} \right)^{1/3}.$$

If rise and fall times of 10 ns are assumed for 5-V pulses,

$$k = 5 \times 10^8 \text{ V/s.}$$

$$\begin{aligned} \therefore v_1 &= \left( \frac{3 \times 5 \times 10^8 \times 1.3 \times 10^{-26} \times 10^3}{2} \right)^{1/3} \\ &= 2.14 \times 10^{-5} \text{ V.} \end{aligned}$$

This result implies that for spikes with an amplitude of less than 21  $\mu\text{V}$ , the uncertainty of resolution is greater than the 50 ns allowed, and a malfunction will probably occur. Although an



uncertainty region of  $21 \mu\text{V}$  seems quite small, significant errors may result. Let's see how, using the same example.

#### Four errors a second possible

With the intersecting pulses, assume a 10-ns gating window in which an interrupt is presented asynchronously at a 1-MHz rate. As a fraction of 5 V,  $21 \mu\text{V}$  is approximately  $4 \times 10^{-6}$ . This is the probability that an interrupt will cause a spike of less than  $21 \mu\text{V}$ , and hence an error.

Since the rate at which decisions are made is 1 MHz, about four errors per second can be expected. Thus the application of Heisenberg's uncertainty principle results in error-rate predictions that are quite significant for present computer systems.

To get a better understanding of the practical effects, consider the physical behavior of the gate-regenerator circuit. All regenerative circuits are characterized by the following:

(a) A region where the loop gain is zero—below threshold, where changes of input do not produce changes of output.

(b) An active region of high loop gain.

(c) Another region where the loop gain is, again, zero and further changes of input produce no output change.

There is a point between the regions listed in "a" and "b" and also between those in "b" and "c" where the loop gain is unity. One can postulate an input signal or spike that would carry the regenerator to this point and leave it there in a position of unstable equilibrium. The question then is: How long will it remain in this state? The situation is similar to that of a pencil balanced on its point on a table: How long will the pencil take to fall over?

To attempt to measure the width of the uncertainty region, a regenerator with a high gain-bandwidth product can be constructed with pnp and npn transistors in a pseudo pnpn arrangement. Spikes are applied at a 1-MHz rate to a standard logic input, which precedes the regenerator (Fig. 3).

The spike amplitude is asynchronously modulated at approximately 1 kHz (Fig. 3c). The output is sampled twice during the microsecond following the generation of the spike—first at a variable time,  $t_1$ , which represents the "settling" time,  $t_s$ , and then at a time,  $t_2$ , about 500 ns later in the cycle. An error is detected if the regenerator changes state after the first, but before the second, sample.

Note that the errors are counted over a period of several hours for each value of  $t_1$ . From this information, along with the pulse rate, modulation rate and amplitude, it is possible to cal-

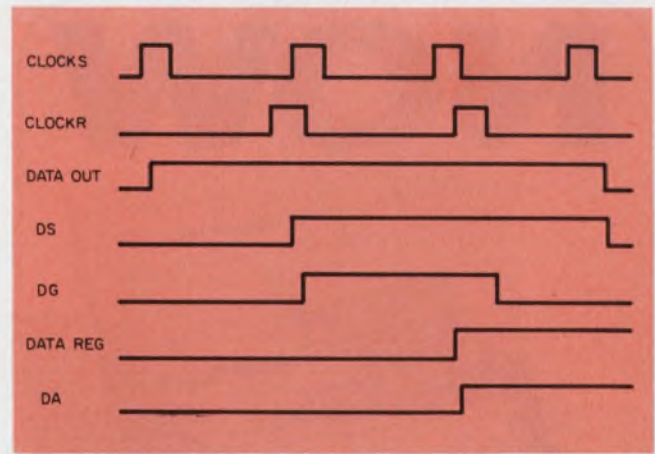

6. Typical signal interchange of a send-receive subsystem in which the sender and receiver each have clocks. The key signal here is DG, an internal gating signal upon which subsequent computing depends.

culate and plot the width of the uncertainty region.

The experimental results are shown in Fig. 4, along with the predictions based on the Heisenberg principle. The gross discrepancy between the Heisenberg "lower bound" and the experimental results may be caused by thermal noise. Observe that the Heisenberg lower bound seems to be valid for settling times close to the propagation time of the regenerative circuit (approximately 10 ns).

Because of bandwidth limitations, noise should have little effect under these conditions. For settling times that are greater than the propagation time, the circuit's behavior is analogous to that of a pencil balanced on a shaking table. Despite the enormous improvement that noise evidently makes, the basic problem remains.

For analysis, consider a simple, two-clock system (Fig. 5). The system has been partitioned into two subsystems separated by an asynchronous interface. Within each subsystem the corresponding clock controls the timing of all events. Hence a conventional logic-design approach can be used within a subsystem with no problem. However, problems occur at the asynchronous interface.

#### Isolating the interface error

Generally a well-designed asynchronous interface uses a handshake protocol to exchange data between the subsystems. Under this protocol, the sending subsystem outputs a data-strobe (DS) signal to indicate the presence of data on the sender's output lines. The receiving subsystem senses DS on its next clock and uses its presence to set an internal data-gating signal (DG).

On the next receiver clock, DG causes the data to be clocked into a receiving register. At the



# NOW



## Put your Minicomputer to work in Automatic Test and Control Systems...with an HP MULTIPROGRAMMER

In automatic test systems, the Multiprogrammer provides stimulus and collects responses. In control systems it adjusts set-points and monitors process feedback.

This low-cost building block system provides a bi-directional data link between a single computer I/O channel and up to 240 individually addressable plug-in cards.

Available plug-in card functions include:

- Analog Input and Output
- Relay Contact Closures
- Solid-State Digital Input and Output
- Stepping Motor Control
- Power Supply Control
- Programmable Amplifier Control
- Pulse Counting
- Programmable Timers

Write for your 40 page Multiprogrammer Brochure... detailing applications; interface information; operating features; prices, complete specifications for the 6940A/6941A Multiprogrammer mainframes and plug-in cards.

**HEWLETT  PACKARD**

Sales and service from 172 offices in 65 countries.  
1501 Page Mill Road, Palo Alto, California 94304

21402

INFORMATION RETRIEVAL NUMBER 74

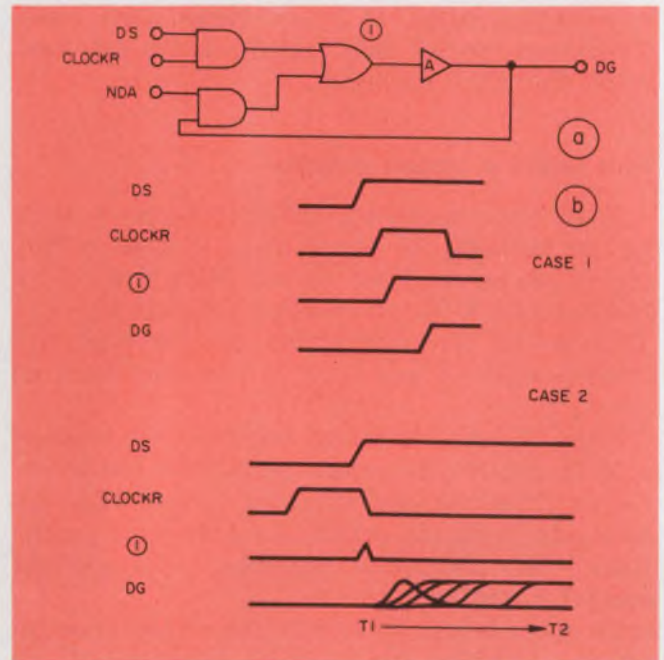

7. Simplified schematic to generate DG points to possible source of an error (a). Since DS and CLOCKR are not synchronized, the two signals can be arbitrarily overlapped. In case 1, the pulses fully overlap and no problems occur. But in case 2, DG and CLOCKR don't fully coincide and an uncertainty can result (b).

same time the receiver outputs a data-accepted signal (DA) to the sender to indicate that the data can now be taken off the sender's output lines. When the sender detects this signal, it terminates transmission and resets DS. (Fig. 6).

Now concentrate upon the events within the receiver. From the send-receive scenario, it can be seen that the asynchronous problem in the receiver is reduced to generation of one signal, DG. Once DG has been successfully generated, strobing the actual data into the receiving register becomes a fully synchronized operation.

In a simplified implementation of DG, the receiver clock (CLOCKR) is used as a pulse (Fig. 7). Elsewhere in the receiver the rising edge of CLOCKR is used to set flip-flops. Thus the receiving register, for example, will be set on the next clock after the one that sets DG.

Consider node 1 in Fig. 7. Since DS and CLOCKR are asynchronous, they can overlap to any degree. In the figure, DG and CLOCKR are fully overlapped in case 1. A pulse is generated that is substantially larger than the threshold of the regenerative circuit, and the output DG is immediately set.

However, DG and CLOCKR don't fully coincide in case 2 of Fig. 7, and a spike is applied to the regenerative circuit. Now if the spike is in the uncertainty region, the circuit output DG may take additional time to settle. In this case it is important that subsequent operations of the system do not depend on a sampling of the circuit during its meta-stable state,  $T_1$  to  $T_2$ . ■■

INFORMATION RETRIEVAL NUMBER 75 ►



# Dialight sees a need:

(**Need:** The right switch for the right price.)

# See Dialight.

For the switch buyer, choice of function and esthetics, reliability, ease of mounting, and low cost are his prime concerns. He may need a pushbutton switch for panel, sub-panel or snap-in mounting. He may need a choice of bezels with or without barriers in black, gray, dark gray or white. He may need a legend that's positive, negative, or hidden until ener-



gized...one that's white when "off" and red, green, amber, blue or light yellow when "on"...or colored both "on" and "off." He may need a highly reliable switch proven in thousands of installations. Matching indicators with same front-of-panel appearance are also available. Obtainable from our world-wide distributor network.

The cap has a metal insert designed for proper heat dissipation. Cap is illuminated by a T-1 3/4 incandescent lamp in voltage range to 28V. Lamp can be easily replaced without special tools from front of panel.

More than 12 colors available in round, square, or rectangular shapes in six basic sizes—1/8" to 1 1/2". Choice of engraved, hot stamped or replaceable film legends with positive or negative presentations.

Available with or without bezels. Bezel allows for simple snap-in mounting. Without bezel, switch can be used for panel or sub-panel mounting.

Terminals are gold plated for oxidized free solderability, and come in choice of solder blade or pc terminations.

NOW LISTED IN UNDERWRITER'S  
RECOGNIZED COMPONENTS INDEX

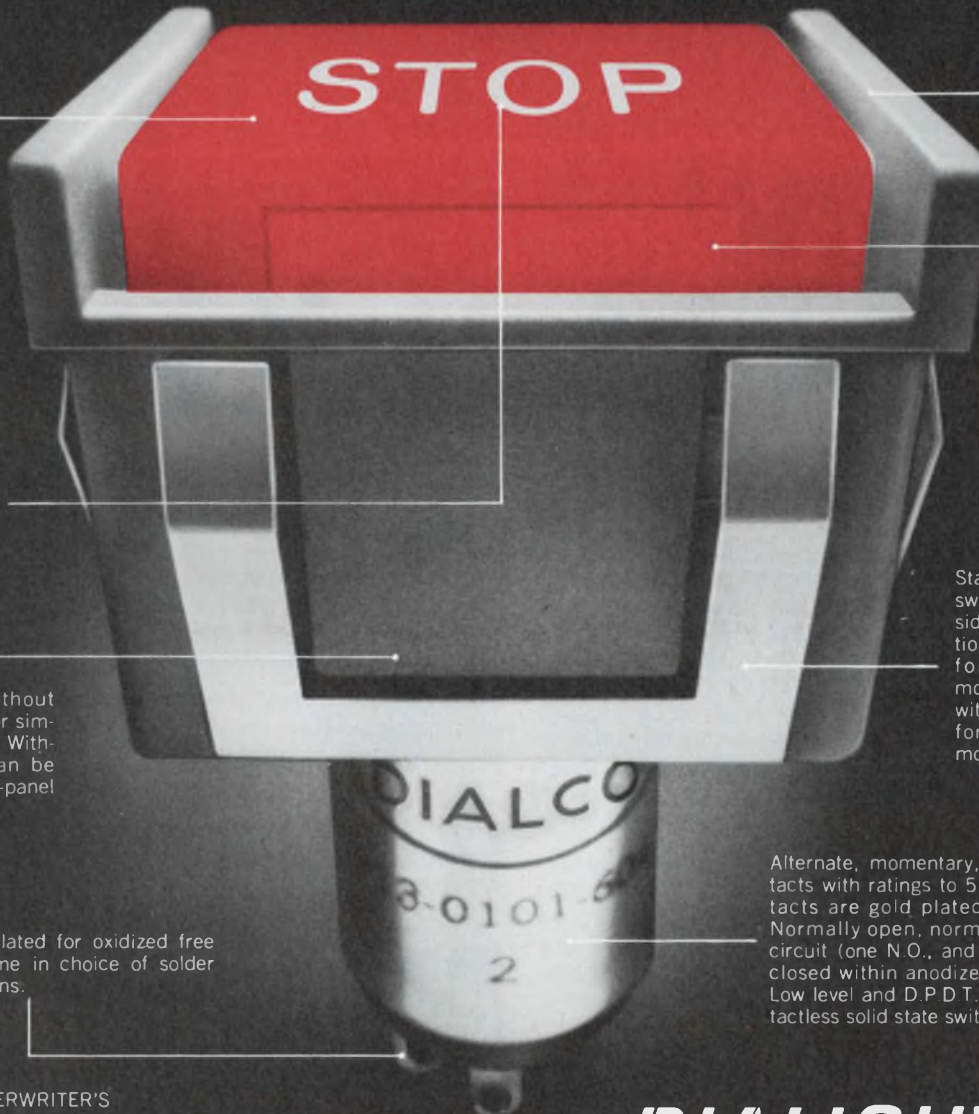

Bezels available in black, gray, dark gray or white and in round, square or rectangular shapes.

Fingertip grip simplifies insertion or replacement of pushbutton cap.

Stainless-steel clips lock switch into panel on four sides. No tools or additional hardware required for installing. Panel mounting switches come with required hardware for panel or sub-panel mounting.

Alternate, momentary, and snap-action contacts with ratings to 5 amps. All switch contacts are gold plated for high reliability. Normally open, normally closed, and two-circuit (one N.O., and one N.C.). Totally enclosed within anodized aluminum housing. Low level and D.P.D.T. snap action, and contactless solid state switches also available.

## DIALIGHT

Dialight Corporation, A North American Philips Company • 60 Stewart Avenue, Brooklyn, N.Y. 11237 (212) 497-7600



# New Markets...

# New Challenges...

# New Opportunities...

At Digital, our commitment to the penetration and service of new market areas has created career opportunities of major magnitude. These opportunities, which encompass our Data Communications, OEM, Industrial Products, Lab Data Products and Computational groups, present a quantum career move to qualified professionals who would like to join us in what will probably be the most rewarding and exciting expansion undertaken in the industry.

What this expansion means to you personally will depend almost entirely upon your own specific talents and ability. And in two of these groups — Lab Data Products and Computational — the demand for diversified skills has created these immediate career opportunities for aggressive individuals.

At present, our Lab Data Products Group is responsible not only for product development activity in the laboratory and analytical instrument market, but also for major product efforts in the field of graphic displays.

Our Computational Group, with its solid record in the scientific, educational and engineering fields, is now expanding into civil engineering and other computational applications areas.

These new markets, with their unique challenges and opportunities, should be of special importance to the following professionals.

*Please direct your resume to Don Mooradian,  
Digital Equipment Corporation, Main Street,  
Maynard, Mass. 01754*

**digital**

**digital equipment corporation**

The above positions are open for application to men and women regardless of race, national origin, age, religion or creed.



## **CIVIL ENGINEERING MARKETING MANAGER**

This newly created sales and marketing oriented position requires a professional who can assume total business responsibility for our activities in the civil engineering area. Supported by a strong corporate commitment and the technical and sales resources of Digital, you will direct a major marketing effort for civil engineering applications. Ideally, your background will include demonstrated management ability as well as ability in sales, product management and software support. In addition you will have an in-depth understanding of applications in this market gained through user or vendor experience.

## **CIVIL ENGINEERING APPLICATIONS MANAGER**

You will assume complete responsibility for developing and supporting civil engineering applications software. In concert with the marketing manager, you will develop a highly skilled effort to service and support this market.

You should be project management and marketing oriented and have an in-depth knowledge of civil engineering (architectural, construction, etc.) and civil engineering software needs. In addition to your functional knowledge, you must be a "doer" with a strong personal commitment to getting the job done. Specific technical knowledge should be in the area of Coco, Stress, Interactive Graphics, Finite Element Analysis, etc.

## **SYSTEMS ENGINEERING MANAGER**

This position requires a top level systems engineering manager with an advanced degree and 8-10 years' experience. Ideally, you should have responsible experience with a large scale main frame manufacturer and/or as manager of a large scale scientific computer operation. Directing the efforts of existing product managers and in concert with corporate development engineers, you will specify and develop new basic products involving the PDP-11 hardware, software plus language for computational applications. As you will be one of the major product specifiers in the corporation, a high degree of technical and business acumen is essential.

## **APPLICATIONS MARKETING MANAGER**

This is an excellent opportunity for a professional with 2-3 years' software sales experience to assume a newly created position running our computational applications software product business. Although you may not currently be a manager, you should have sufficient computational software knowledge and motivation to impact the development of proprietary software packages and successfully market these products to existing and new markets.

## **PROJECT ENGINEER Analog/Digital Design**

An immediate opening exists for a qualified engineer within the Computer Graphics Section of our Laboratory Data Products Group.

You will be responsible for the development and implementation of interface design efforts for existing and new products. Working on a project management basis, you will also work closely with Marketing and Manufacturing to assure quality finished products. If you have a creative design background in utilizing MSI, MOS and discrete components Analog/Digital and Digital/Analog interface design background with video experience and a working knowledge of software, this is your opportunity to maximize your personal and professional growth. 2-4 years with a MSEE is preferred, but a BSEE with equivalent experience is acceptable.

## **COMPUTER GRAPHICS DISPLAY**

Working within the Computer Graphics Section, you will be primarily responsible for adding your previous graphics design experience to that of a small, but rapidly expanding group.

A BS degree with 2 years' analog circuit design experience is required, ideally in Graphics Display. An ability to take a systems view, and most importantly, the ability to interface effectively with marketing and potential customers is also required. This is an extremely attractive opening for an aggressive individual who is willing to take on responsibility and grow as fast as abilities will allow.

## **INSTRUMENTATION MARKETING**

This position requires a professional with a BS in Science and an in-depth knowledge of computer applications in the instrumentation market. This knowledge could have been gained from association with a computer manufacturer or an instrument manufacturer.

You will be primarily concerned with the investigation of new markets and the development and successful introduction of complete new systems (hardware, software and display) for existing and new markets. Working closely with sales, development, engineering and the customer, you will follow new products from conception to customer application. Your activities will be directed to all markets where the automation of analytical instruments is desirable and feasible.

## **GRAPHICS DISPLAY MARKETING**

This is an excellent opportunity for a creative and innovative marketing development specialist to significantly impact our graphics display business. Your background should be computer oriented in a sales, development, hardware or software support activity with a manufacturer, user or service organization. However you should have approximately 2 years of customer interface experience.



# Approximate logs easily with a simple combinatorial circuit. A few ICs let you multiply, divide, and calculate any root of any power of two.

The logarithm is a powerful tool in manual computation. It also can be very handy for calculations with digital circuits—if you can generate the logarithms simply. The Mitchell algorithm<sup>1</sup> for finding logarithms to the base 2 is simple to employ, now that complex, single-package MSI digital functions are available. Only two standard MSI chips are needed to convert an 8-bit binary word to its base-2 logarithm. The circuit uses strictly combinational logic without need for clocking.

Once the logarithm of a binary number is obtained, multiplication or division becomes simply addition or subtraction, and taking the square root is merely division by 2. If the logarithm is to the base 2 in binary form, division by 2 is a simple shift of the number, one bit to the right.

But the Mitchell algorithm is an approximate method and when used to find the square root, it can yield a maximum error of about 6%. When multiplying, it can give an error of about -11%, and when dividing, 12.5%. The accuracy can be improved, but even without improvements the algorithm is accurate enough for many applications.

Before we delve into the various circuits, let's take a look at the basic algorithm itself.

## The algorithm is simple

To avoid continual writing of the log-base subscript, let's designate

$$\log_2 N \text{ as } \lg N.$$

Table 1 lists selected binary logarithms, and the familiar logarithmic curve is plotted in Fig. 1. A line-segment approximation of the binary logarithm results when all integer points of  $\lg N$  ( $N = 2, 4, 8, 16 \dots$ ) are joined by straight-line segments. The approximations that correspond to the line segments are also listed in Table 1, along with their binary representations.

Note that the characteristic parts of  $\lg N$  in

**Table 1. Binary logarithms and their straight-line approximation**

N	N(binary)	$\lg N$	APPROX. $\lg N$	APPROX. $\lg N$ (binary)
1	00001	0.00000	0.000	000.0000
2	00010	1.00000	1.000	001.0000
3	00011	1.58496	1.500	001.1000
4	00100	2.00000	2.000	010.0000
5	00101	2.32193	2.250	010.0100
6	00110	2.58496	2.500	010.1000
7	00111	2.80735	2.750	010.1100
8	01000	3.00000	3.000	011.0000
9	01001	3.16992	3.125	011.0010
10	01010	3.32193	3.250	011.0100
11	01011	3.45942	3.375	011.0110
12	01100	3.58496	3.500	011.1000
13	01101	3.70043	3.625	011.1010
14	01110	3.80735	3.750	011.1100
15	01111	3.90689	3.875	011.1110
16	10000	4.00000	4.000	100.0000
17	10001	4.08747	4.0625	100.0001

decimal form take the value of the exponent of the most-significant ONE bit of  $N$ . For instance, if the most-significant ONE is in the  $2^2$  position, the characteristic is 2; if in the  $2^5$  position, the characteristic is 5, etc.

The remaining bits of the original binary number become an approximation to the mantissa when they are placed to the right of the logarithm's "decimal," or binary, point. It is easy to see that this mantissa represents a binary fraction within the range 0 to 1 between two adjacent integral logarithms.

Consider the approximate logarithm curve. The coordinates of both ends of each straight-line segment start and end at some whole power of 2 on the  $N$  axis. The corresponding  $\lg N$ s are the whole-number characteristics. Thus each line segment spans the distance from one characteristic to the next with a unit increase in the characteristic's value at each step, and the bits that

Joseph L. Voyer, Senior Engineer, Martin Marietta Aerospace, Orlando, Fla. 32805.



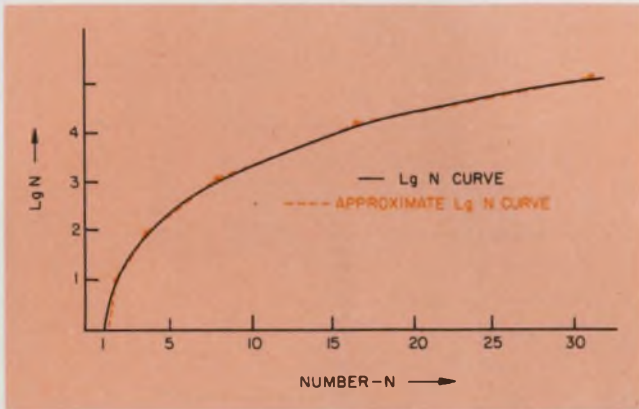

1. A plot of logarithms is closely approximated by straight-line segments between whole powers of 2, which are the logs<sub>2</sub> of the binary-number sequence.

follow the most-significant ONE of N represent a linear proportion along the line segment. These bits, as a binary fraction, are approximations of the true mantissa.

As an example, consider the problem of finding  $\lg 14$ . The binary representation of  $14_{10}$  is  $1110_2$  and its most-significant ONE bit is in position  $2^3$ . Thus the characteristic of  $\lg 14$  is 3, or 11 in binary. The remaining bits form the approximate mantissa, or fraction 0.110, which is equal to 0.750 in decimal notation. Thus the approximate  $\lg 14$  is 3.750 in decimal, or 11.110 in binary notation. From Table 1 note that this is in error by 0.05735. A maximum absolute error of 0.086 occurs when the approximate mantissa is 0.44.

### Implementing $\lg N$ conversion

Binary-to-logarithm (base-2) conversion can be implemented with a Signetics 8243, 8-bit position scaler and a Fairchild 9318 or Texas Instruments 74148 priority encoder (Fig. 2). The priority encoder chip determines the characteristic of the logarithm by detecting the most-significant ONE bit in the input word and providing a 3-bit output code that corresponds to this bit's position. Inverters are necessary at the inputs to the priority encoder, since it operates on inverted

Table 2. Truth table of 8243 scaler

Inhibit	Enable 1 & 2	S <sub>0</sub>	S <sub>1</sub>	S <sub>2</sub>	O <sub>0</sub> O <sub>1</sub> O <sub>2</sub> O <sub>3</sub> O <sub>4</sub> O <sub>5</sub> O <sub>6</sub> O <sub>7</sub>
0	1	0	0	0	$\bar{O}_0 \bar{O}_1 \bar{O}_2 \bar{O}_3 \bar{O}_4 \bar{O}_5 \bar{O}_6 \bar{O}_7$
0	1	1	0	0	$\bar{O}_1 \bar{O}_2 \bar{O}_3 \bar{O}_4 \bar{O}_5 \bar{O}_6 \bar{O}_7 1$
0	1	0	1	0	$\bar{O}_2 \bar{O}_3 \bar{O}_4 \bar{O}_5 \bar{O}_6 \bar{O}_7 1 1$
0	1	1	1	0	$\bar{O}_3 \bar{O}_4 \bar{O}_5 \bar{O}_6 \bar{O}_7 1 1 1$
0	1	0	0	1	$\bar{O}_4 \bar{O}_5 \bar{O}_6 \bar{O}_7 1 1 1 1$
0	1	1	0	1	$\bar{O}_5 \bar{O}_6 \bar{O}_7 1 1 1 1 1$
0	1	0	1	1	$\bar{O}_6 \bar{O}_7 1 1 1 1 1 1$
0	1	1	1	1	$\bar{O}_7 1 1 1 1 1 1 1$
1	X	X	X	X	1 1 1 1 1 1 1 1
X	0	X	X	X	1 1 1 1 1 1 1 1

X indicates "don't care."

data. The encoder's outputs also are in inverted form.

The 8-bit position scaler performs a shift operation on the input word. It shifts the input the number of places determined by the 3-bit word from the priority encoder. For instance, 000 = no shift, 001 = shift one place and 111 = shift seven places (Table 2). The output of the 8243 forms the mantissa of the word.

Note that output  $O_0$  of the 8243 is left open, since the most-significant bit of the input, or characteristic-determining bit, must always appear at this output, and the mantissa consists of only those bits to the right of this most-significant ONE. The outputs of the 8243 are also delivered in inverted form, thus the  $\lg N$  appears in ones complement form at section AA' in Fig. 1. The  $\lg N$  is left in complement form, since the subsequent antilog conversion inputs require inverted inputs.

As a more detailed example of the binary-to-log conversion of Fig. 1, let's convert the number  $N = 21_{10} = 00010101_2$  to a log-binary form as a preliminary step to obtaining  $\sqrt{21}$ . Table 4 shows the operation in algorithm form, and the binary numbers in Fig. 1 correspond to all logic inputs and outputs for obtaining  $\sqrt{21}$ . To calculate  $\lg 21$ , which corresponds to section AA' on Fig. 1, the following occurs:



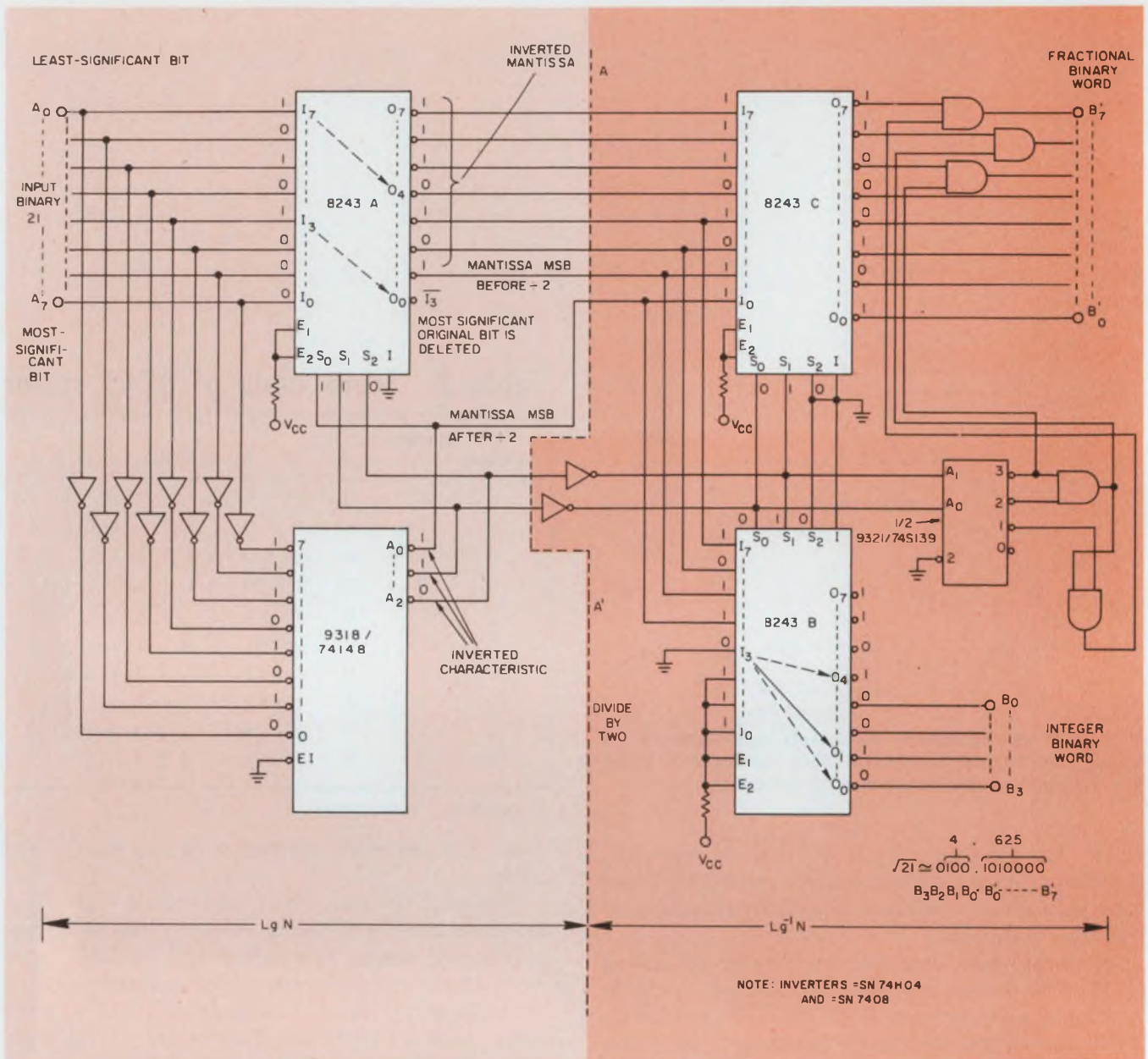

2. A combinational 8-bit square rooter needs only a  $\log_2$  circuit, a wired divide-by-2 and an antilog<sub>2</sub> circuit.

Number  $N$  enters the circuit at terminals  $A_7$  (most-significant bit) through  $A_0$  (least-significant). A brief examination of the 8243 truth table (Table 2) shows that the value of the binary number for shift inputs  $S_2 S_1 S_0$  corresponds to the subscripts of the inverted inputs that appear at output  $0_0$ .

Thus if  $S_2 S_1 S_0 = 101 = 5$ ,  $I_5$  would appear at  $0_0$ , and so on. Then, in the case of  $N = 21 = 0010101$ , the most-significant ONE bit enters  $I_3$  and appears at  $0_0$ , because the priority encoder provides output  $A_2 A_1 A_0 = S_2 S_1 S_0 = 011 = 3$  (Table 3). All higher subscript inputs,  $I_1$  to  $I_7$ , also shift down by three positions in the output, so that  $I_7$  appears at  $I_4$ , etc., and all  $I_3$  and lower subscripted inputs are lost.

In other words, the scaler input subscripts are

arranged in reverse order from the customary sequence ( $I_7$  is least-significant and  $I_0$  most-significant). This arrangement can then work properly with the outputs of the priority encoder in complement form.

### Dividing by 2 is easy

Most operations with logarithms require the  $\log_2$ 's conversion back to ordinary numbers at some point. Finding the square root of a number involves, first, obtaining the  $\log_2$ , then division-by-2 and then the antilog. With binary numbers, the divide-by-2 is easy to do.

In the circuit of Fig. 1, the divide-by-2 process is hard-wired into the system. Since the required shift entails a shift of the least-significant from

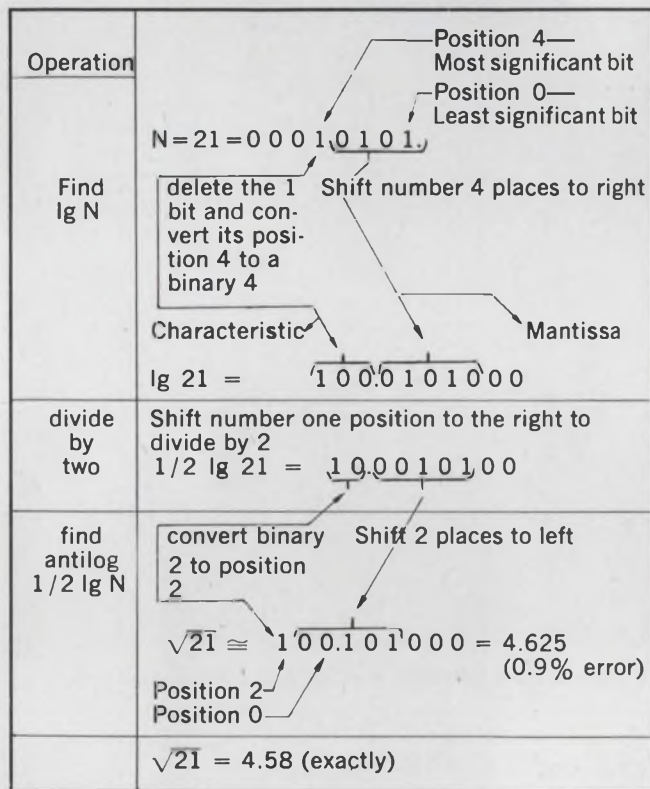

**Table 3. Truth table of 9318/74148 priority encoder**

Enable EI	Outputs			Inputs								Output	
	A <sub>0</sub>	A <sub>1</sub>	A <sub>2</sub>	0	1	2	3	4	5	6	7	G <sub>s</sub>	E <sub>0</sub>
1	1	1	1	X	X	X	X	X	X	X	X	1	1
0	1	1	1	1	1	1	1	1	1	1	1	1	0
0	0	0	0	X	X	X	X	X	X	X	0	0	1
0	1	0	0	X	X	X	X	X	0	1	0	0	1
0	0	1	0	X	X	X	X	0	1	1	0	0	1
0	1	1	0	X	X	X	0	1	1	1	1	0	1
0	0	0	1	X	X	0	1	1	1	1	1	0	1
0	1	0	1	X	X	0	1	1	1	1	1	0	1
0	0	1	1	X	0	1	1	1	1	1	1	0	1
0	1	1	1	0	1	1	1	1	1	1	1	0	1

X = don't care condition

**Table 4. Finding the approximate  $\sqrt{21}$**



the characteristic to the mantissa, the least-significant bit of the characteristic, A<sub>0</sub>, is wired into the most-significant bit of the mantissa (see Table 4), which becomes I<sub>0</sub> of the 8243-B. Note that A<sub>0</sub> is kept in its inverted form to correspond to the other inverted bits of the logarithm.

The integer part of the square-root result of any 8-bit binary number can have only 4 bits. And except for the integer's most-significant bit, the three other bits are formed from the most-significant bits of the mantissa of 1/2 lg N. Note that these four bits, which are the inputs

to 8243-C, are also connected to 8243-B of the antilog section. Only two bits, A<sub>2</sub>A<sub>1</sub>, are sufficient to locate the output's binary point.

To prove that the integer part of a square root in binary form has only half as many bits as the input word, consider our 8-bit case. Its maximum possible characteristic is 7<sub>10</sub> = 111<sub>2</sub>. After a divide-by-2 operation the maximum characteristic becomes 3<sub>10</sub> = 11<sub>2</sub>. Thus, when 1/2 lg N is converted back to an ordinary binary number, a ONE must be placed in the 2<sup>3</sup> position. This corresponds to the fourth bit to the left of the binary point. Thus for an 8-bit input, its square root results in a maximum of 4 bits as the integer part of the answer.

### Finding the antilog

Now we can concentrate on the antilog circuit. The inputs to 8243-B at I<sub>3</sub> to I<sub>7</sub> become, after proper shifting by the chip's control lines, S<sub>2</sub> S<sub>1</sub> S<sub>0</sub>, the integer part of the output word.

Examine the algorithm in Table 4, and you will find that the antilog operation converts the most-significant bit of the mantissa into the second most-significant bit of the square-root answer. The most significant bit is, of course, always a ONE bit. Thus I<sub>3</sub> of 8243-B is always at ground, or a ZERO, which converts to a ONE at the output. Input I<sub>3</sub> can shift from output 0<sub>3</sub> to 0<sub>0</sub> to cover the maximum of the four possible bit positions of the integer part of the answer.

Shifter 8243-C provides the fractional portion of the output and converts the binary value of the characteristic, after the hard-wired division-by-2 process, into an equivalent number of shift positions. Thus, in the  $\sqrt{21}$  example, the (1/2) lg 21 characteristic has a weight of 2, and the inputs of 8243-C therefore must shift in the chip's outputs two places to the left. Note that for 8243-B and C, the S<sub>1</sub>S<sub>0</sub> inputs are inverted to their true form. When the log was found, the number was shifted to the right; now, for the antilog, the shift is to the left.

And, finally, for values of S<sub>1</sub>S<sub>0</sub> that are greater than ZERO, corresponding trailing bit positions of the answer must be forced to ZERO in the outputs. One-half of a Fairchild decoder 9321, or its T174S139 equivalent, decodes the S<sub>1</sub>S<sub>0</sub> values and forces the least-significant bits to ZERO. For the  $\sqrt{21}$  example, S<sub>1</sub> S<sub>0</sub> = 2; therefore the B'<sub>6</sub> and B'<sub>7</sub> outputs are forced to zero.

### Multiply and divide with lg N

The approximate square-root processor is very simple to implement, and multiplication and division are easy, too. Multiplication requires only a single addition process, and division only a subtraction step.



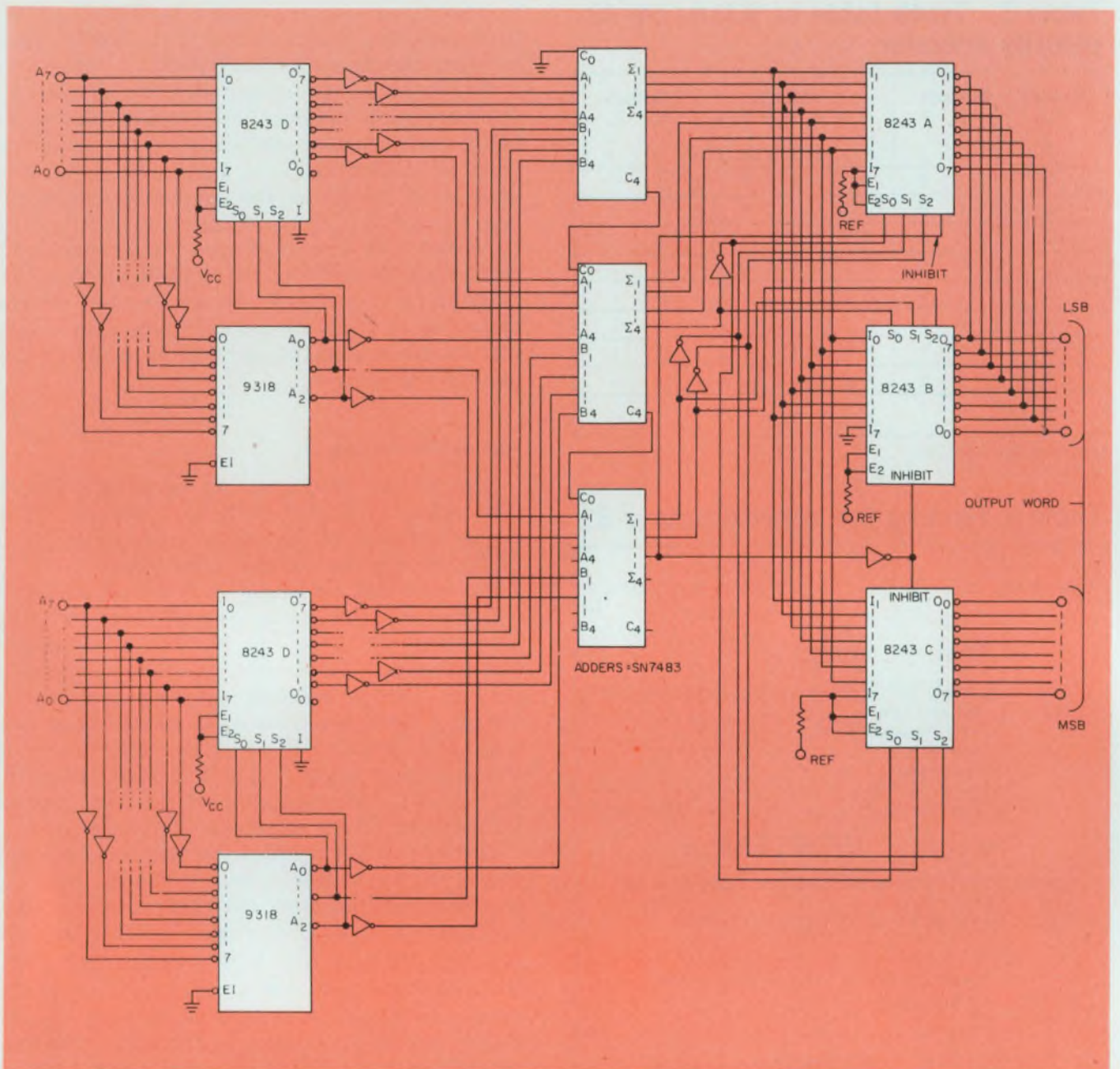

3. A combinatorial multiplying circuit for two, 8-bit words uses adders between the log and antilog sections.

To illustrate multiplication with the linear approximation approach, let's multiply 61 by 99:

$$\begin{aligned}
 N_1 = 61 &= 00111101 \\
 N_2 = 99 &= 01100011 \\
 \lg N_1 &= 101.1110100 \\
 \lg N_2 &= 110.1000110 \\
 P = \lg N_1 + \lg N_2 &= 1100.0111010 \\
 N_1 \times N_2 = \lg^{-1} P &= 1011101000000. \\
 &= 5952 \text{ (-1.4\% error)} \\
 61 \times 99 &= 6039 \text{ exactly}
 \end{aligned}$$

Note that although the input numbers are each limited to 8-bits in length, the adder must process 10-bit inputs. And the result may have as many as 16 bits, since the characteristic of P can have 4 bits. Thus the amount of hardware needed for a multiplier circuit increases very rapidly

with the size of the operands.

The logarithm-to-binary converter must be capable of shifting 15 places. Fig. 3 shows an 8-bit multiplier that uses the 8243s as converters (see Table 5 for antilog conversion); however, MSI multiplier ICs—such as the AM 2505 and SN 4284, and 9344, which allow high-speed combinatorial implementation of binary multiplication with no approximation error—might be more attractive for multiplication.

Division is a more attractive application for the logarithm method. For example, divide 5839 by 61:

$$\begin{aligned}
 N_1 = 5839 &= 0001011011001111 \\
 N_2 = 61 &= 0000000000111101 \\
 \lg N_1 &= 1100.011011001111
 \end{aligned}$$



**Table 5. Truth table for multiplier antilog converter**

$S_2 S_1 S_0$	8243 C								8243 B								8243 A							
$O_2 O_1 O_0$	$O_2 O_1 O_0$	$O_2 O_1 O_0$	$O_2 O_1 O_0$	$O_2 O_1 O_0$	$O_2 O_1 O_0$	$O_2 O_1 O_0$	$O_2 O_1 O_0$	$O_2 O_1 O_0$	$O_2 O_1 O_0$	$O_2 O_1 O_0$	$O_2 O_1 O_0$	$O_2 O_1 O_0$	$O_2 O_1 O_0$	$O_2 O_1 O_0$	$O_2 O_1 O_0$	$O_2 O_1 O_0$	$O_2 O_1 O_0$	$O_2 O_1 O_0$						
0 0 0 0	1	1	1	1	1	1	1	1	1	1	1	1	1	1	1	1	1	1	0					
0 0 0 1	1	1	1	1	1	1	1	1	1	1	1	1	1	1	1	1	1	1	$\overline{M}_6$					
0 0 1 0	1	1	1	1	1	1	1	1	1	1	1	1	1	1	1	1	1	0	$\overline{M}_n$ $\overline{M}_5$					
0 0 1 1	1	1	1	1	1	1	1	1	1	1	1	1	1	1	1	1	0	$\overline{M}_n$ $\overline{M}_5$ $\overline{M}_4$						
0 1 0 0	1	1	1	1	1	1	1	1	1	1	1	1	1	1	1	1	0	$\overline{M}_n$ $\overline{M}_5$ $\overline{M}_4$ $\overline{M}_3$						
0 1 0 1	1	1	1	1	1	1	1	1	1	1	1	1	1	1	1	0	$\overline{M}_n$ $\overline{M}_5$ $\overline{M}_4$ $\overline{M}_3$ $\overline{M}_2$							
0 1 1 0	1	1	1	1	1	1	1	1	1	1	1	1	1	1	0	$\overline{M}_n$ $\overline{M}_5$ $\overline{M}_4$ $\overline{M}_3$ $\overline{M}_2$ $\overline{M}_1$								
0 1 1 1	1	1	1	1	1	1	1	1	1	1	1	1	1	1	0	$\overline{M}_n$ $\overline{M}_5$ $\overline{M}_4$ $\overline{M}_3$ $\overline{M}_2$ $\overline{M}_1$ $\overline{M}_0$								
1 0 0 0	1	1	1	1	1	1	1	0	$\overline{M}_n$	$\overline{M}_5$	$\overline{M}_4$	$\overline{M}_3$	$\overline{M}_2$	$\overline{M}_1$	$\overline{M}_0$	1	1	1	1					
1 0 0 1	1	1	1	1	1	1	0	$\overline{M}_n$	$\overline{M}_5$	$\overline{M}_4$	$\overline{M}_3$	$\overline{M}_2$	$\overline{M}_1$	$\overline{M}_0$	1	1	1	1	1					
1 0 1 0	1	1	1	1	1	0	$\overline{M}_n$	$\overline{M}_5$	$\overline{M}_4$	$\overline{M}_3$	$\overline{M}_2$	$\overline{M}_1$	$\overline{M}_0$	1	1	1	1	1	1					
1 0 1 1	1	1	1	1	0	$\overline{M}_n$	$\overline{M}_5$	$\overline{M}_4$	$\overline{M}_3$	$\overline{M}_2$	$\overline{M}_1$	$\overline{M}_0$	1	1	1	1	1	1	1					
1 1 0 0	1	1	1	0	$\overline{M}_n$	$\overline{M}_5$	$\overline{M}_4$	$\overline{M}_3$	$\overline{M}_2$	$\overline{M}_1$	$\overline{M}_0$	1	1	1	1	1	1	1	1					
1 1 0 1	1	1	0	$\overline{M}_n$	$\overline{M}_5$	$\overline{M}_4$	$\overline{M}_3$	$\overline{M}_2$	$\overline{M}_1$	$\overline{M}_0$	1	1	1	1	1	1	1	1	1					
1 1 1 0	1	0	$\overline{M}_n$	$\overline{M}_5$	$\overline{M}_4$	$\overline{M}_3$	$\overline{M}_2$	$\overline{M}_1$	$\overline{M}_0$	1	1	1	1	1	1	1	1	1	1					
1 1 1 1	0	$\overline{M}_n$	$\overline{M}_5$	$\overline{M}_4$	$\overline{M}_3$	$\overline{M}_2$	$\overline{M}_1$	$\overline{M}_0$	1	1	1	1	1	1	1	1	1	1	1					

MSB

OR-tied

LSB

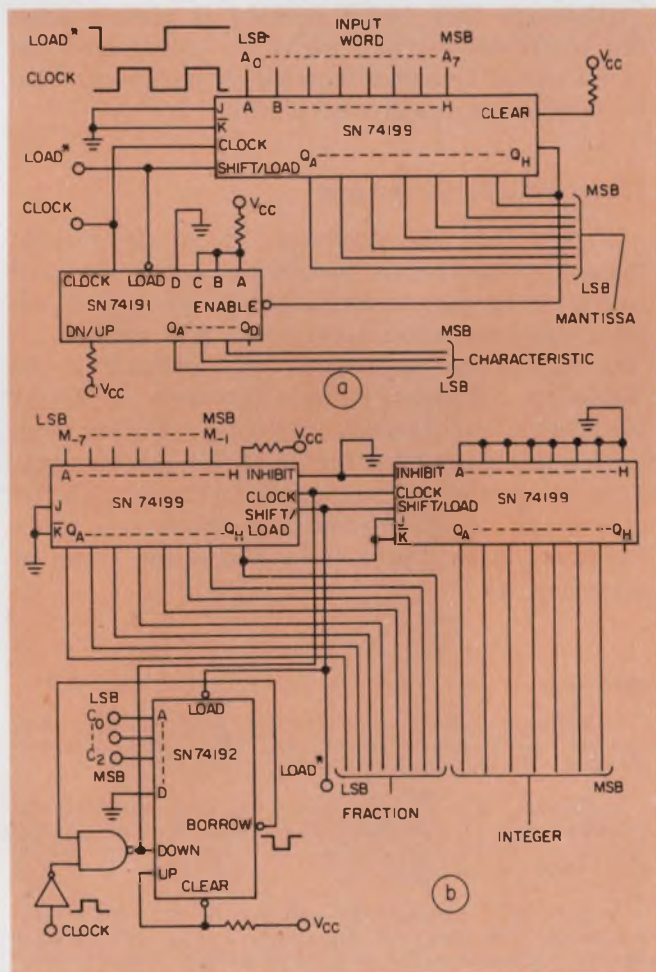

4. Sequential converters for log (a) and antilog (b) circuits require less hardware for handling larger numbers, but they need clocking circuits and they are much slower in operation than combinatorial circuits.

$$\begin{aligned}
 \lg N_2 &= 0101.111010000000 \\
 \lg N_1 - \lg N_2 &= 1100.011011001111 \\
 &- 0101.111010000000 \\
 &0110.100001001111 \\
 \lg^{-1} Q' &= 1100001.001111 \\
 &= 97.234375 \\
 &\quad (1.78\% \text{ error}) \\
 &= 99 \text{ exactly.}
 \end{aligned}$$

Division differs from multiplication in the use of subtraction instead of addition. This introduces a problem, because the result of the subtraction can produce a result that is larger or smaller than one. This depends upon whether the dividend is larger or smaller than the divisor. When the result is larger than one, as in the example, to find the antilog requires that the difference be shifted to the left. However, a right-shift operation is needed for a result that is less than one. The logic designer may then construct his circuit to handle only one of the two cases, and use scaling methods to properly place the decimal point. Or, he can devise more complex logic to directly handle either case.

A final note of caution: Since this logarithm method operates only on positive numbers, the multiplication and division of negative operands require special preprocessing of the numbers into suitable form before the Mitchell algorithm is used.

#### Serial converters need less hardware

The increase in hardware for numbers of more than 8 bits can be a serious problem. An alter-



# REDUCE REJECTS!

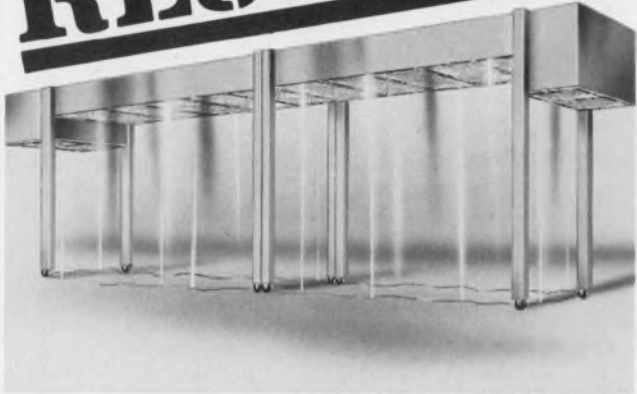

Reject rates plummet when critical electronic component production operations are performed in a Weber Class 100 Mobile Process Isolator. For good reason. Inside the Isolator the atmosphere is ultra-clean — 99.99%-free from airborne contaminants 0.3 microns and larger.

Overhead vertical laminar flow filter modules generate a sterile air flow downward, "washing" contamination from your personnel and production line. As an added safeguard, optically clear side curtains prevent cross-contamination without hindering personnel access to the area.

You can install the Weber Isolator over a critical production point. Or protect an entire line. And as your needs change, the modular design of all Weber components permits easy, economical system relocation or expansion.

In addition to the Mobile Process Isolator, Weber offers total clean rooms and portable equipment designed to meet the specific needs of the electronics industry. Write today for illustrated literature.



## WEBER TECHNICAL PRODUCTS

1340 MONROE AVE. N.W., GRAND RAPIDS, MICH. 49505 • A DIVISION OF THE JADE CORP., SUBSIDIARY OF WALTER KIDDE & CO., INC. PHONE (616) 363-7735

INFORMATION RETRIEVAL NUMBER 77

nate approach to generating approximate logs and antilogs is blocked out in Figs. 4a and b. In the binary-to-logarithm converter of Fig. 4a, the number  $N$  is loaded into a SN74199 shift register while a counter is reset to the  $n-1$  condition ( $n =$  number of bits). The number in the register is shifted right, while the counter is decremented. When a ONE is detected on the  $Q_H$  output of the SN74199, the operation of the shift register and counter is disabled. At this time the counter contains the characteristic of  $\lg N$ , and the shift register contains its mantissa. The total length of the shift register should be the length of the full binary input word.

Fig. 4b shows how to convert the logarithm back to binary. The mantissa is loaded into a shift register, and a logic ONE is forced into the MSB + 1 position. The characteristic is loaded into a parallel load counter with the same pulse that loads the mantissa. Clock pulses then decrement the counter and shift the contents of the shift register to the right. When the counter decreases to zero, the borrow inhibits the clock to the antilog converter. The shift register then contains the resultant binary word.

Although this serial process is slower than the combinatorial approach, the advantage lies in the serial's smaller increase in hardware with an increase in the size of words.

### The errors can be reduced

Errors that are produced by single-line-segment approximations to the log curve, as used in Fig. 1, can be considerably less when more refined approximation techniques are applied. A four-part linear approximation,<sup>2</sup> instead of the single-line segments, reduces the error by a factor of 6; a four-interval, least-squares-fit method<sup>3</sup> lowers the error by a factor of 7.8; and a parabolic fit<sup>4</sup> provides a reduction factor of 18.5. Of course, all these improved methods use more hardware than the simple single-line segment approach. ■■

### References:

1. Mitchell, J.N. Jr., "Computer Multiplication and Division Using Binary Logarithms," *IRE Trans. Electron. Comput.*, Vol. EC-11, Aug., 1962, pp. 512-517.
2. Combet, M., Van Zonneveld, H. and Verbeek L., "Computation of the Base Two Logarithm of Binary Numbers," *IEEE Trans. Electron. Comput.*, Vol. EC-14, Dec., 1965, pp. 863-867.
3. Hall, E.L., Lynch, D.D. and Dwyer, S.J., III, "Generation of Products and Quotients Using Approximate Binary Logarithms for Digital Filtering Applications," *IEEE Trans. Comput.*, Vol. C-19, Feb., 1970, pp. 97-105.
4. Marino, D., "New Algorithms for the Approximate Evaluation in Hardware of Binary Logarithms and Elementary Functions," *IEEE Trans. Comput.*, Vol. C-21, Dec., 1972, pp. 1416-1421.



# Our motors do the things most motors can't do

**Precise positioning / Precise speed regulation / Precise tension control**

Only a DC servo motor can respond in milliseconds to rapidly programmed commands. It'll stop, go, accelerate or decelerate, reverse direction at full speed, maintain constant speed under variable torque load or hold constant tension under variable speed . . . precisely as you want it to.

That's the kind of performance you can expect from all Inland Motor DC servos with temperature-stable magnets and rugged, high-duty-cycle capability. They'll give precise control of position, rate or tension in computer peripheral sub-systems like magnetic tape drives, incremental transport drives, capstan drives and high speed printout systems.

Thirty-two off-the-shelf models range from tiny "inch-cube" size to a fist full of power . . . from 7 to 300oz. in torque . . . speeds to 8,000 RPM . . . as low as 20.6 watts at peak torque . . . and less than \$25 in quantity lots.

For specifications or technical data, call your local Inland Motor Representative or contact us direct.



**INLAND MAKES A DIFFERENT KIND OF MOTOR**



**INLAND MOTOR DIVISION** Kollmorgen Corporation

501 First St., Radford, Va. 24141. Phone: (703) 639-3973, TWX: 710 875-3740

INFORMATION RETRIEVAL NUMBER 78



# THE MAXI KEYBOARD FAMILY

Shopping for keyboards? Don't buy more — or less — than you need. Maxi can supply keyboards to your mechanical and electronic requirements, in standard or custom configurations.

Economy? Our 3100 Series encoded keyboard with mechanical contacts is priced as low as the \$50.00 range in quantity. Dual bifurcated gold contacts have a life of over  $10^7$  operations under load.

Need the option of glass reed switching? The Maxi 2700 Series keyboard combines low cost and high reliability. All reeds are pre-tested before assembly, and switch modules are machine-adjusted for accurate operating point.

Special key actions? The Maxi 1800 Series keyboard offers more action options than any other keyboard on the market. Interlatch and lockout, accumulative latch, solenoid hold and release to name a few. Even illuminated buttons if you need them. Its metal frame construction makes the 1800 Series the strongest keyboard of the market.

The Maxi keyboard line includes double-shot and engraved buttons in a variety of sizes and colors. Encoding is another flexible Maxi option. Specify USASCII, EBCDIC or special codes in up to nine bits. The Maxi keyboard family has a member exactly suited to your needs. Call or send your specs for a firm quote on cost and delivery.



THE

(See Maxi in EEM)

## Maxi-SWITCH CO.

9697 East River Road • Minneapolis, Minnesota 55433 • (612) 755-7660



INFORMATION RETRIEVAL NUMBER 79

## RUGGED INSIDES DON'T NEED PROTECTION

... that's why most T-D power supplies have no covers. You save money, space, weight with a no frills approach that concentrates the value in engineering and component quality. Fractional-amp to 50 amp models and line conditioners available overnight at over 100 stocking distributors. Our Catalog 103 tells the story once you separate its covers.

**NUDE** DC POWER

**TELE-DYNAMICS / WANLASS**

DIVISION OF **AMBAC**

525 VIRGINIA DRIVE • FORT WASHINGTON, PA. 19034 • 215-643-6161

INFORMATION RETRIEVAL NUMBER 80



# Why horse around with words? Get the picture from Hughes.

Turning into the stretch, it's LUCKY LADY in front by one length. DANCING PRINCESS is second by a length and a half. On the inside, MISTER GEORGE is third by a head. In the middle of the track, FAST DRIVER. Here comes FAST DRIVER.

In the stretch it's LUCKY LADY in front...DANCING PRINCESS and MISTER GEORGE. And on the inside, FAST DRIVER. LUCKY LADY, DANCING PRINCESS and MISTER GEORGE. LUCKY LADY and DANCING PRINCESS. LUCKY LADY in front.

Down to the line of finish, it's LUCKY LADY and DANCING PRINCESS. And it's LUCKY LADY, the winner by a nose. DANCING PRINCESS is second by a length and a half in front of MISTER GEORGE.

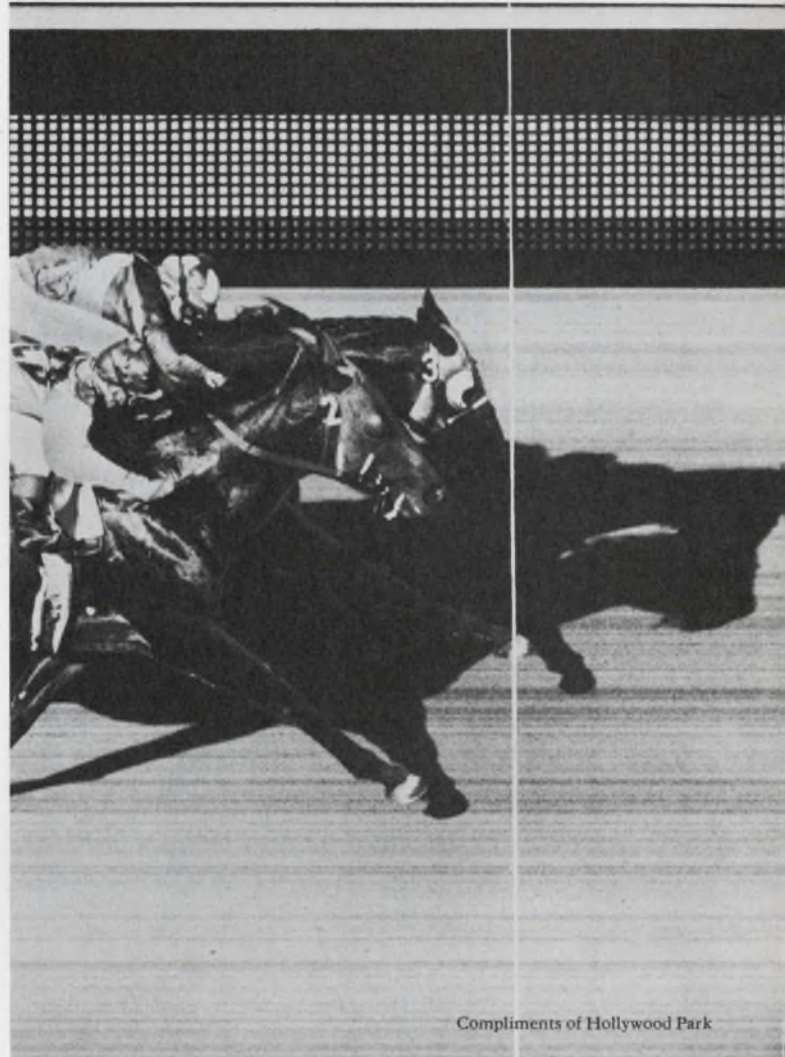

Compliments of Hollywood Park

The picture on the right says the same thing as the words on the left. But so much faster. And clearer.

And when you consider the growing mountains of data you have to deal with, pictures become more a necessity than a luxury.

To answer the need in the burgeoning industrial and commercial markets, Hughes has used its high technology to develop advanced methods for the sensing, storage and display of pictorial data.

Now, this image processing tech-

nology has developed into a whole family of components, systems, subsystems and software. Our products include image memories, image processors,



**HUGHES**  
HUGHES AIRCRAFT COMPANY  
INDUSTRIAL PRODUCTS DIVISION  
IMAGE DEVICES

**Creative Image Processing.**

INFORMATION RETRIEVAL NUMBER 81

special display systems, graphic terminals, direct view storage tubes, scan converter tubes, visible and IR sensors.

We also have an applications engineering staff available to provide systems support and OEM assistance. (Both our products and our services can be tailored to your special requirements.)

Today, more than ever, Hughes is ready to help you get the picture. For a new Creative Image Processing Capabilities brochure, write: 6855 El Camino Real, Carlsbad, California 92008. Or call (714) 729-9191.



# Program cuts logic-design costs

by letting you select with a computer the set of prime implicants that best meets your requirements.

If you want to design logic to have a minimum parts cost, here is a topological computer algorithm to help you select a minimal set of prime implicants. The program finds all irredundant prime-implicant sets to cover the minterms in the original function.

The designer chooses the set that best satisfies his design objective. The sets are irredundant covers because if one term is removed, the set no longer covers all minterms. Even a minicomputer suffices to handle many implicants. And you can use a higher-level language, such as Fortran. The algorithm is also useful for the minimization of the number of states in sequential logic.

The program accepts the problem in the form of a covering closure table, with the horizontal rows representing prime implicants and the vertical columns minterms of the function. To encode a given function, place a one in each column covered by the prime implicant of the row (Fig. 1). Closure tables for prime implicants do not contain zero entries.<sup>1,2,3</sup> However, similar tables are used when the number of states is minimized in sequential machines,<sup>4,5</sup> and these tables can have zero entries. The algorithm minimizes either form of covering closure table, so it's useful for either logic or sequential circuit design.

## The extraction operation

The first step is to encode the columns of the table. If we let an x represent blank spaces in the table, the columns of the table in Fig. 1 are encoded as follows:

$$\begin{aligned} C_1 &= 11xxxx \\ C_2 &= x1xxx1 \\ C_3 &= xxx11 \\ C_4 &= xx11xx \\ C_5 &= xxx11x \end{aligned}$$

A column encoded in this way is called a Boolean cube. The minimization algorithm uses a single topological operation on these cubes to obtain a minimum cover. That operation is the extraction

	PRIME IMPLICANTS	MINTERMS				
		2	6	7	13	15
(a)	x010	1	x	x	x	x
(b)	0x10	1	1	x	x	x
(c)	1x01	x	x	x	1	x
(d)	11x1	x	x	x	1	1
(e)	x111	x	x	1	x	1
(f)	011x	x	1	1	x	x

$F = \sum 2, 6, 7, 13, 15 + (\sum 9, 10)$  DON'T CARE

1. List prime implicants horizontally. Place a "1" under the minterms covered, otherwise an x. This gives a covering-closure table from which the algorithm extracts sets of irredundant prime implicants.

		b <sub>i</sub>		
#		0	1	x
a <sub>i</sub>	0	Z	Y	Z
	1	Y	Z	Z
	x	1	0	Z

	CASE 1	CASE 2	CASE 3
A	10x10	10xx0	10xx1
B	10xxx	10101	1010x
RESULT	$\phi$	10xx0	100x1 10x11

2. Extraction operation deletes common minterms from A and B. The operation has three outcomes: (1) Vacuous result if all elements are Z; (2) Copy A if one or more Y's occur; (3) Copy A for each occurrence of 1(0), with the 1(0) placed in that column's position. The initial source of A's and B's is the covering-closure table columns; x denotes a blank space in the table.

Terry L. Dollhoff, Computer Specialist, Naval Electronics System Command, Washington, D.C. 20360.



operation defined by Miller.<sup>5,6,7</sup>

The extraction operation on Boolean cubes A and B removes from cube A all sub-cubes common to both A and B. Let  $[A = (a_1 a_2 \dots a_m)]$  and  $[B = (b_1 b_2 \dots b_m)]$  represent typical encoded cubes of m elements. Then the extraction operation, denoted #, is formally defined as:

Case 1:  $A \leq B$  ( $a_i = b_i$  or  $b_i = x$  for all i); then  $A \# B = \phi$ .

Case 2:  $A \cap B = \phi$  ( $a_i = 0(1)$ ,  $b_i = 1(0)$  for some i); then  $A \# B = A$ .

Case 3: Neither condition holds; then  $A \# B = \bigcup_{i=1}^m (a_1 a_2 \dots q_i \dots a_m)$  for all  $a_i = x$ ,  $b_i \neq x$ ,

and  $q_i = 1(0)$  if  $b_i = 0(1)$ .

The pictorial representative of these rules (Fig. 2) illustrates outcomes for each of the three cases:

$$10x10 \# 10xxx = \phi$$

$$10xx0 \# 10101 = 10xx0$$

$$10xx1 \# 1010x = 100x1 \text{ and } 10x11.$$

The outcome of the operation is also a cube of m elements.

#### Four-step minimization algorithm

The algorithm uses a four-step loop to generate a series of cubes labeled  $L_1, L_2 \dots L_p$ . If  $\{C_i\}$

## Fortran subroutines for minimization of prime-implicant covers

### Main subroutine for cover calculation

```

SUBROUTINE XTRACT
CDC 6600 FTN V5.0-P308 OPT-1

SUBROUTINE XTRACT (C1)
C
C THIS ROUTINE EXTRACTS C1 FROM L AND PUTS THE RESULTS IN LTMP.
C
5 COMMON NROW, NCOL, NSOL, NTMP, MASK, C(100), LTMP(100), L(100)
INTEGER C1, C, AND, XOR, NOT, OR
NOT(1) = -1
XOR(1,1) = OR (AND (1, -1), AND (-1, 1))
NTMP = 0
10 DO 40 I=1,NSOL
J = AND (L(I), NOT (C1))
IF (J .EQ. 0) GO TO 40
J1 = XOR (L(I), C1)
J1 = AND (AND (J1, J1*2), MASK)
IF (J1 .NE. 0) GO TO 30
MASK = 3
DO 20 K=1,NROW
J1 = AND (J, MASK)
IF (J1 .NE. 0) GO TO 10
NTMP = NTMP+1
20 LTMP(NTMP) = XOR (L(I), AND (C1, MASK))
MASK = MASK*4
20 CONTINUE
GO TO 40
25 30 NTMP = NTMP+1
LTMP(NTMP) = L(I)
40 CONTINUE
RETURN
END
    
```

### Reduction operation

```

SUBROUTINE REDUCE
CDC 6600 FTN V5.0-P308 OPT-1

SUBROUTINE REDUCE
C
C THIS ROUTINE SETS L = REDUCTION(LTMP)
C
5 COMMON NROW, NCOL, NSOL, NTMP, MASK, C(100), LTMP(100), L(100)
INTEGER C, AND, NOT
NOT(1) = -1
NSOL = 1
L(1) = LTMP(1)
10 IF (NTMP .EQ. 1) RETURN
DO 30 I=2,NTMP
DO 20 J=1,NSOL
K = AND (L(J), NOT (LTMP(I)))
IF (K .NE. 0) GO TO 10
L(J) = LTMP(I)
GO TO 30
10 K = AND (LTMP(I), NOT (L(J)))
IF (K .EQ. 0) GO TO 30
20 CONTINUE
NSOL = NSOL+1
L(NSOL) = LTMP(I)
30 CONTINUE
RETURN
END
    
```

### Extraction operation

```

SUBROUTINE SOLVE
CDC 6600 FTN V5.0-P308 OPT-1

SUBROUTINE SOLVE
C
C THIS ROUTINE CALCULATES ALL POSSIBLE IRREDUNDANT COVERS FOR A
C COVERING-CLOSURE TABLE WHOSE COLUMNS ARE STORED IN
5 C(1) ... C(NCOL). EACH COLUMN CONTAINS NROW ELEMENTS. THE
C POSSIBLE SOLUTIONS ARE STORED IN L(1) ... L(NSOL)
C
COMMON NROW, NCOL, NSOL, NTMP, MASK, C(100), LTMP(100), L(100)
10 INTEGER C
NSOL = 1
L(1) = 4**NROW - 1
MASK = 0
DO 10 I=1,NROW
15 MASK = MASK*4 + 2
10 CONTINUE
DO 20 I=1,NCOL
C
C EXTRACT C(I) FROM L, AND PLACE RESULTS IN LTMP
C
20 CALL XTRACT (C(I))
C
C SET L = REDUCTION (LTMP)
C
CALL REDUCE
CONTINUE
RETURN
END
    
```



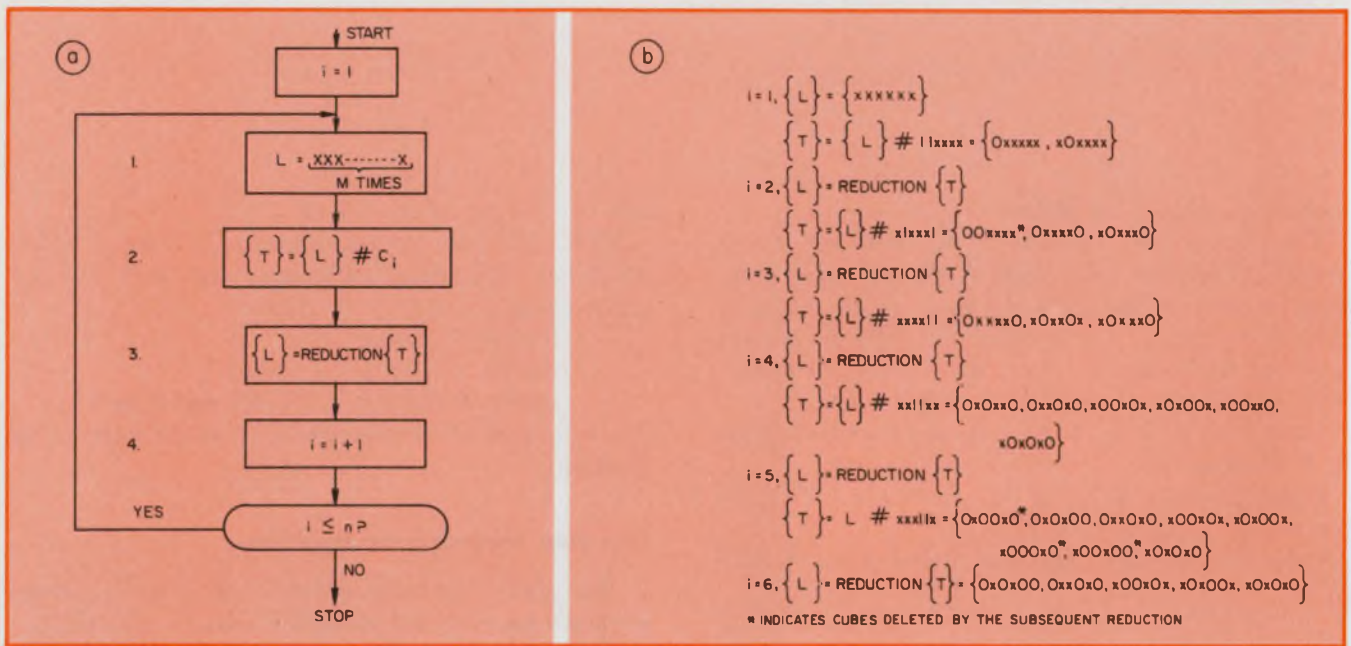

3. Side-by-side comparison of algorithm and problem shows the types of results expected. The five-column table requires six iterations and has five possible ir-

redundant covers. Zeros indicate the row (prime implicant) used for a given cover. The one used as the solution depends on various cost criteria.

is the set of columns of a covering-closure table with  $n$  columns and  $m$  rows, then:

1.  $i = 1$   
 $\{L\} = x x x \cdots x$  ( $m$  times).
2.  $\{T\} = L \# C_i$ .
3.  $\{L\} = \text{REDUCTION } \{T\}$ .
4.  $i = i + 1$ .

If  $i \leq n$ , go to Step 2.

Elimination of redundant cubes in  $T$  occurs in Step 3. Start with  $\{L\} = \{T_1\}$ . Compare each remaining  $T_i$  with every element of  $\{L\}$ . If an all-Z result is obtained at any point (Case 1), discard that  $T_i$  since it is a subset of some other member of  $\{L\}$ . If no comparison produces an all-Z result, add that  $T_i$  to  $\{L\}$ .

On completion of Step 4, set  $L$  will contain  $P$  cubes, each with  $m$  elements. Each  $L_j$  is a unique solution to the covering-closure table. The rows (prime implicants) are indicated by a "0" in  $L_i$ . If  $\{L\}$  is empty at any point in the calculation, then no cover exists for the table.

A side-by-side comparison between the algorithm and computational results (Fig. 3) for the five-column table shows five possible covers of the minterms.

1.  $0x0x00 = a, c, e, f$ .
2.  $0xx0x0 = a, d, f$ .
3.  $x00x0x = b, c, e$ .
4.  $x0x00x = b, d, e$ .
5.  $x0x0x0 = b, d, f$ .

The optimal solution depends on the cost criteria. If both the inputs and the complements of inputs are available, all prime implicants require one three-input AND gate and solutions 2, 3, 4 and 5 would yield equal costs.

When the complements are not available and must be generated by an inverter, the prime implicants can be assigned costs based upon the number of gates required for implementation. These costs are:

- (a) 3
- (b) 3
- (c) 2
- (d) 1
- (e) 1
- (f) 2

In this case, solution 4 is one gate less expensive than 2, 3 and 5. A number of algorithms exist for cost criteria where each row is assigned a fixed cost.

Some cost criteria, however, cannot be handled by existing techniques—say, when you assign costs based on the number of gates needed for implementation but allow sharing of the outputs from the inverters. In this case, if a complement is required by two different prime implicants (for example, b,f), the same inverter will be used for each. Therefore solutions 4 and 5 have equal cost.

**Computer implementation**

Primitive bit-by-bit operations—usually available as simple assembly-language commands—can perform the extraction operation and the data manipulation. These operations—bit-by-bit, OR, XOR and NOT—are also available in most Fortran implementations so higher-level languages are applicable.

Each cube or column is condensed to one or



more computer words. The possible values 1,0,x become:

0 = 01  
1 = 10  
x = 11

A MASK word that consists of n repetitions of a bit pattern—in this instance, 10—is frequently used.

With these definitions, the three cases are determined by the following operations:

Case 1:  $AND(A, NOT(B)) = 0$ .

Case 2:  $AND(T, T*2, MASK) \neq 0$   
 $T = XOR(A,B)$ .

Case 3: Neither Case 1 nor Case 2.

The AND operation for Case 2 ANDs the three entities T, T\*2 and MASK. The extraction operation consists of the copying of A into the storage location that has been designated to receive the result.

Additional processing is required for Case 3. And multiple results can occur. Assign S to be a set of words with member  $S_j$ . Then do the following:

Step 1.  $i=1; j=0; T = AND(A, NOT(B));$   
 $MASK=3$ .

Step 2.  $Y = AND(T,MASK);$   
if  $Y \neq 0$  then  $j = j + 1;$   
 $S_j = XOR(A,AND(B,MASK)).$

Step 3.  $MASK = MASK *4;$   
 $i = i+1; if i \leq m, go to Step 2.$

Three Fortran subroutines can perform the four-step algorithm. The major subroutine SOLVE performs Step 1, then calls XTRACT and REDUCE to do Steps 2 and 3, respectively. A DO loop in SOLVE corresponds to Step 4. The program stores column data and answers in integer words, so the word length of the particular computer determines the number of rows that can be handled (one-half the word length). For example, the 60-bit CDC-6600 word permits entry of a 30-row table. Larger numbers of rows or smaller word lengths require storage of data in multiple words or possibly in separate arrays. Repeated multiplication by four, along with integer addition, suffices to map the input data to the desired binary pattern. ■■

#### References

1. Bowman, R. M., and McVey, E. S., "A Method for the Fast Approximate Solution of Large Prime Implicant Charts," *IEEE Trans. Comput.* (Short Notes), Vol. C-19, February, 1970, pp. 169-173.
2. Gimple, J. F., "A Reduction Technique for Prime Implicant Tables," *IEEE Trans. Electron Comput.*, Vol. EC-14, August, 1965, pp. 535-541.
3. Luccio, F., "A Method for the Selection of Prime Implicants," *IEEE Trans. Electron. Comput.*, Vol. EC-15, April, 1966, pp. 205-212.
4. Grasselli, A., and Luccio, F., "A Method for Minimizing the Number of Internal States in Incompletely Specified Sequential Machines," *IEEE Trans. Electron. Comput.*, Vol. EC-14, June, 1965, pp. 350-359.
5. Miller, R. E., *Switching Theory*, Vol. I, Wiley, New York, 1965, pp. 172-175.
6. Dollhoff, T. L., and Weinberg, B. L., "A Result on Set Extraction and Application to CC-tables," *IEEE Trans. Comput.* (Short Notes), Vol. C-21, June, 1972, pp. 603-606.
7. Su, S. Y. H., "Trade your Karnaugh Maps," *Electronic Design*, Vol. 21, No. 21, October, 1973, pp. 88-92.

# VIDEO COMPRESSOR



## FOR LAB AND COMMUNICATION SYSTEMS

The CVI Model 260 Video Compressor samples conventional "real time" television signals to achieve a large reduction in bandwidth. The compressor also digitizes the signals for computer input and image analysis. A special 260 feature incorporates a "real time" video output which allows users to monitor the sampling process.

### TYPICAL APPLICATIONS INCLUDE:

- Computer data input, linear or semi-random scanning
- Communications: transmission of TV images over voice grade circuits for conference or data distribution purposes
- Environmental monitoring: transmission of TV signals for remote observation and computer analysis
- Data recording: utilization of conventional audio cassette or reel-to-reel tape recorders for image storage
- Biomedical image analysis
- Industrial control
- Computer image enhancement

Video instruments for data acquisition, processing, transmission, and display.

# CVI

Colorado Video, Inc.

P.O. Box 928 Boulder, Colorado 80302 (303) 444-3972



# **INTERDATA wanted the most reliable cassette tape system available.**

## **They chose Raymond for their INTERTAPE II.**

The INTERTAPE cassette system was devised to provide users of Interdata's quality mini-computers with a low-cost, sequential mass storage device. The Intertape system functions as a convenient input/output medium for the storage of data and program files.

If your data processing system calls for OEM digital cassette transports with maximum performance and reliability characteristics, follow the lead of Interdata and other industry leaders, specify the outstanding digital cassette recorder—Raycorder by Raymond.



**Raymond Engineering Inc.**  
 217 Smith St., Middletown, Conn. 06457  
 Telephone: (203) 347-5611  
*A subsidiary of Raymond Precision Industries Inc.*

INFORMATION RETRIEVAL NUMBER 83

**IC** Kyodo Electronic Laboratories Inc.

# Numerical Indication Tube Driver

- |                                   |                                   |                                 |                                    |
|-----------------------------------|-----------------------------------|---------------------------------|------------------------------------|
| KB-6400 LED Segment Driver        | KH-6288 Nixie Tube Segment Driver | KH-6814 Nixie Tube Digit Driver | KH-6298 Printer Driver             |
| KB-6401 LED Digit Driver          | KH-6800 Nixie Tube Digit Driver   | KM-6608 Fluorescent Tube Driver | KH-6275 Printer Driver             |
| KB-6402 LED Digit Driver          | KH-6811 Nixie Tube Digit Driver   | KM-6609 Fluorescent Tube Driver | KH-6269 Printer Driver             |
| KH-6286 Nixie Tube Segment Driver | KH-6813 Nixie Tube Digit Driver   | KH-6270 Printer Driver          | KB-5404 Clock Generator Dual Phase |

# Trademark of Burroughs corporation.

**IC KYODO**  
 ELECTRONIC  
 LABORATORIES INC.

11-18, 2 Chome, Sonan, Sagami-hara-shi,  
 Kanagawa-ken, Japan  
 TEL: 0427-42-6731-6  
 CABLE ADDRESS: KELIC MACHIDA  
 TELEX: 2872-239 KELIC

INFORMATION RETRIEVAL NUMBER 84



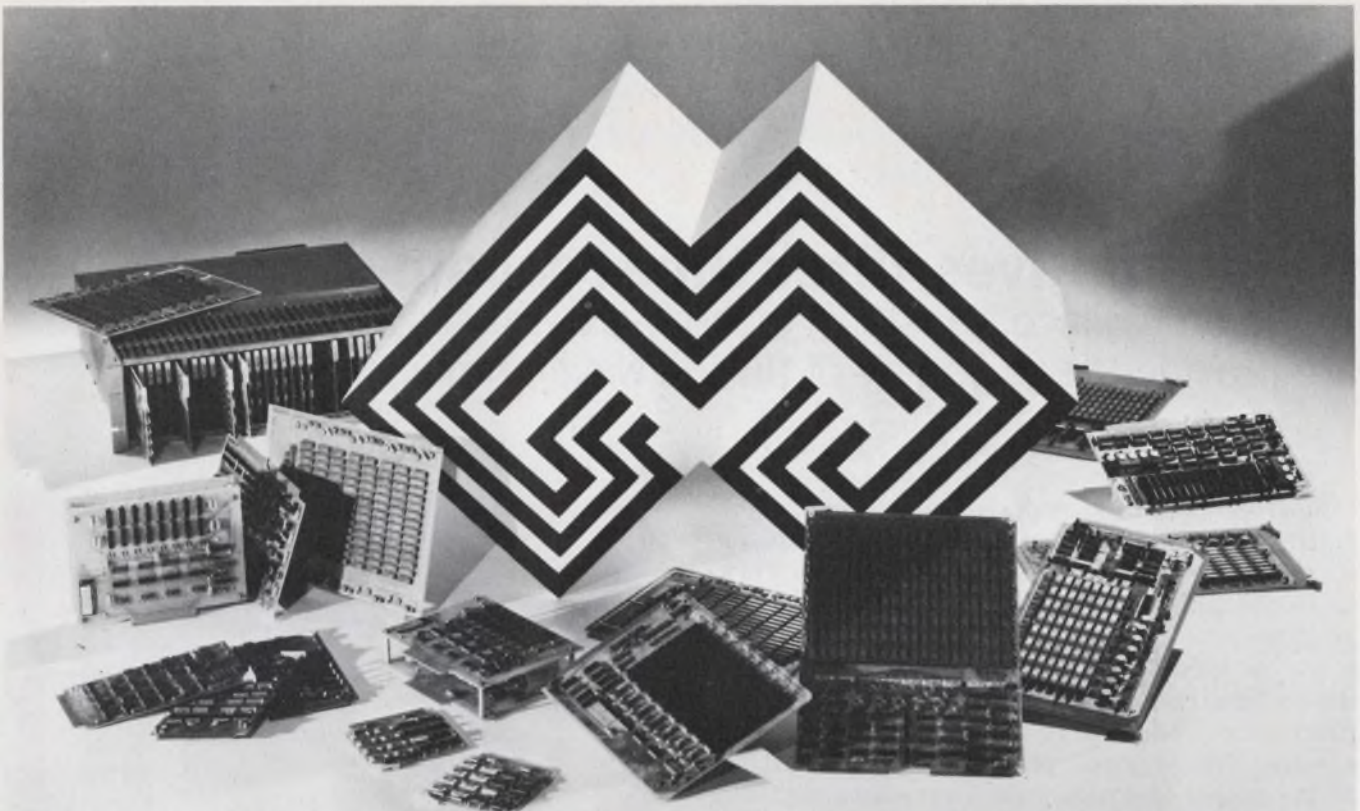

## We Have Your Semiconductor Memory System On The Shelf. Or We'll Deliver A Special Within 45 Days.

You can have the latest in memory technology without investing time and money in a development program. We've already made the investment to bring you proven random-access semiconductor memory systems with low power consumption, small size and up-to-date design. And we give you fast delivery at competitive prices. You avoid the problems of design and component selection, debugging and redesign, slow component delivery and expensive testing.

Our MONOSTORE semiconductor systems provide memory capacities from 256 bits for buffer memories to 3.9 megabits for mass memory systems. Eight standard systems give you a wide choice of bipolar or P and N-channel MOS memories. For example, our Planar systems are single-board units with capacities up to 4K x 20. MONOSTORE/PLANAR boards include timing, control, address register, input data register, refresh circuitry (when required) and the memory array...you supply only DC voltages and signals for address, data and cycle initiate.

For larger systems, our MONOSTORE/MODULAR Systems are packaged rack-mounted units with capacities up to 65K x 60. These systems can be sup-

plied with DC power supplies, Livestore non-volatility battery packs and cooling fans if required.

These are just our standard products. We do custom designs and modifications too. And because of our memory-system experience and IC stock, we can deliver your prototypes in 30 to 45 days...production units in 60 days. In addition to all that you'll find us competitive with core systems. Planar prices, in OEM quantities, run about 0.76c/bit and Modular Systems run 1.1 to 1.2c/bit depending on the system.

Since Monolithic Systems Corporation gives you the advantages of the latest technology, fast delivery and low price, you'll want to think twice about specifying core or designing your own semiconductor memory systems. Write to us or give us a call. We'll be happy to send additional information and discuss your memory system needs with you.

---

Plan to visit our exhibit at the National Computer Conference, May 6-10, McCormick Pl., Chicago, Illinois, booth 127-129. We'll be there with hardware and operating systems.



Monolithic  
Systems corp.

2700 S. Shoshone, Englewood, Colorado. Phone 303/761-2275



# Program gives filter time response

based on Laplace transform techniques. Exact solutions are provided for a variety of pulsed waveforms.

Most computer-aided design procedures make much ado of filter frequency response and s-plane singularities but leave the designer in the dark as to the filter's time-domain response. A short program gives the time response when the input is a connected series of waveform segments and the system transfer function is described by a ratio of polynomials in the complex frequency domain. The program provides a tabular listing of the output and algebraic expressions that describe the response of the network to each segment of the input.

The type of output furnished is particularly useful for work with pulsed data systems, in which the network's time response is often as important as group-delay and frequency-attenuation characteristics.

## Program uses partial fractions

The response of the network to each input segment can be written in the form of a ratio of polynomials in  $s$ . Once the response to each segment is calculated, the over-all response, by superposition, equals the sum of the individual responses.

The program input includes the system transfer-function coefficients, the number of forcing-function segments, the start time for each segment and the time between output data points.

The driving function (Fig. 1) consists of four Laplace transformable functions:

1. A unit step  $u(t)$ ,  $t > 0^+$ .
2. A ramp  $f(t) = t$ ,  $t > 0^+$ .
3. A ramp  $f(t) = -(t-7.854)$ ,  $t \geq 7.854$ .
4. A negative step  $f(t) = -2$ ,  $t \geq 15.708$ .

The program requests numerator and denominator coefficients for each input segment as well as the transfer function, which in this case is the fifth-order, unity-gain Butterworth filter

$$F(s) = 1/(s^5 + 3.2631 s^4 + 5.2361 s^3 + 5.2361 s^2 + 3.2361 s + 1).$$

Thomas H. Lecklider, Design Engineer, Gould, Inc., Instrument Systems Div., 3631 Perkins Ave., Cleveland, Ohio 44114.

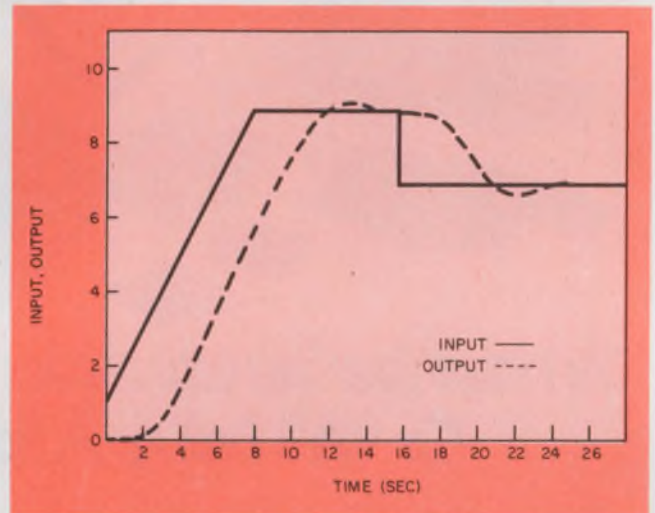

1. Exact responses of linear systems to commonly used waveforms are computed in segments and combined. The forcing function, in this example, is inputted as a sequence of unit-step, positive-ramp, negative-ramp and negative-step waveforms.

All entries, system-transfer functions and input segments must be represented as a ratio of polynomials, with the coefficient of the highest-order denominator term normalized to unity (Fig. 2). The product of the input-function polynomial and transfer function must give a ratio of polynomials, in which the numerator polynomial is at least one order less than the order of the denominator. The program handles denominators of 10th order or less and up to fourth-order poles. Since poles of an order greater than four are seldom used, the only important restriction is on the order of the combined forcing and system functions.

## Program has three parts

The Fortran IV computer program, named LAPTR, is organized into three parts: input, computation and output.

The input section accepts transfer-function coefficients as well as the time interval between data output points. The transfer function is



LPTR 1104EST 12/10/73

```

ENTER SYSTEM TRANSFER FUNCTION
ENTER NUMERATOR ORDER?0

ENTER NUMERATOR COEFFICIENTS; HIGHEST ORDER FIRST?1.
ENTER DENOMINATOR ORDER?5

ENTER DENOMINATOR COEFFICIENTS; HIGHEST ORDER FIRST.
HIGHEST ORDER COEFFICIENT MUST BE NORMALIZED TO 1.0. ?1..3.2361
?5.2361.5.2361.3.2361.1.

ENTER NUMBER OF SEGMENTS IN FORCING FUNCTION?4
ENTER STARTING TIME FOR EACH SEGMENT?0..0..7.854.15.708
ENTER OUTPUT TIME STEP?1.5

ENTER FORCING FUNCTION TRANSFORM 1
ENTER NUMERATOR ORDER?0

ENTER NUMERATOR COEFFICIENTS; HIGHEST ORDER FIRST?1.
ENTER DENOMINATOR ORDER?1

ENTER DENOMINATOR COEFFICIENTS; HIGHEST ORDER FIRST.
HIGHEST ORDER COEFFICIENT MUST BE NORMALIZED TO 1.0. ?1..0.0.

```

```

G( 1 ) =
1.00000 * EXP(( 0.      )T) *T** ( 0 )
EXP(( -0.80904 *T) *T** ( 0 ))*( 0.00030 *COS( 0.58775 *T)
-2.75292 *SIN( 0.58775 *T)
EXP(( -0.30901 *T) *T** ( 0 ))*( 0.89435 *COS( 0.95106 *T)
-0.00002 *SIN( 0.95106 *T)
-1.89466 * EXP(( -1.00000 *T) *T** ( 0 )

```

```

ENTER FORCING FUNCTION TRANSFORM 2
ENTER NUMERATOR ORDER?0

ENTER NUMERATOR COEFFICIENTS; HIGHEST ORDER FIRST?1.
ENTER DENOMINATOR ORDER?2

ENTER DENOMINATOR COEFFICIENTS; HIGHEST ORDER FIRST.
HIGHEST ORDER COEFFICIENT MUST BE NORMALIZED TO 1.0. ?1..0.0.

```

```

G( 2 ) =
1.00000 * EXP(( 0.      )T) *T** ( 1 )
-3.23610 * EXP(( 0.      )T) *T** ( 0 )
EXP(( -0.80904 *T) *T** ( 0 ))*( 1.61778 *COS( 0.58775 *T)
2.22741 *SIN( 0.58775 *T)
EXP(( -0.30901 *T) *T** ( 0 ))*( -0.27634 *COS( 0.95106 *T)
0.85059 *SIN( 0.95106 *T)
1.89466 * EXP(( -1.00000 *T) *T** ( 0 )

```

```

ENTER FORCING FUNCTION TRANSFORM 3
ENTER NUMERATOR ORDER?0

ENTER NUMERATOR COEFFICIENTS; HIGHEST ORDER FIRST?1.
ENTER DENOMINATOR ORDER?2

ENTER DENOMINATOR COEFFICIENTS; HIGHEST ORDER FIRST.
HIGHEST ORDER COEFFICIENT MUST BE NORMALIZED TO 1.0. ?1..0.0.

```

```

G( 3 ) =
-1.00000 * EXP(( 0.      )T) *T** ( 1 )
3.23610 * EXP(( 0.      )T) *T** ( 0 )
EXP(( -0.80904 *T) *T** ( 0 ))*( -1.61778 *COS( 0.58775 *T)
-2.22741 *SIN( 0.58775 *T)
EXP(( -0.30901 *T) *T** ( 0 ))*( 0.27634 *COS( 0.95106 *T)
-0.85059 *SIN( 0.95106 *T)
-1.89466 * EXP(( -1.00000 *T) *T** ( 0 )

```

```

ENTER FORCING FUNCTION TRANSFORM 4
ENTER NUMERATOR ORDER?0

ENTER NUMERATOR COEFFICIENTS; HIGHEST ORDER FIRST?2.
ENTER DENOMINATOR ORDER?1

ENTER DENOMINATOR COEFFICIENTS; HIGHEST ORDER FIRST.
HIGHEST ORDER COEFFICIENT MUST BE NORMALIZED TO 1.0. ?1..0.0.

```

```

G( 4 ) =
-2.00000 * EXP(( 0.      )T) *T** ( 0 )
EXP(( -0.80904 *T) *T** ( 0 ))*( -0.00061 *COS( 0.58775 *T)
5.50584 *SIN( 0.58775 *T)
EXP(( -0.30901 *T) *T** ( 0 ))*( -1.78871 *COS( 0.95106 *T)
0.00005 *SIN( 0.95106 *T)
3.78932 * EXP(( -1.00000 *T) *T** ( 0 )

```

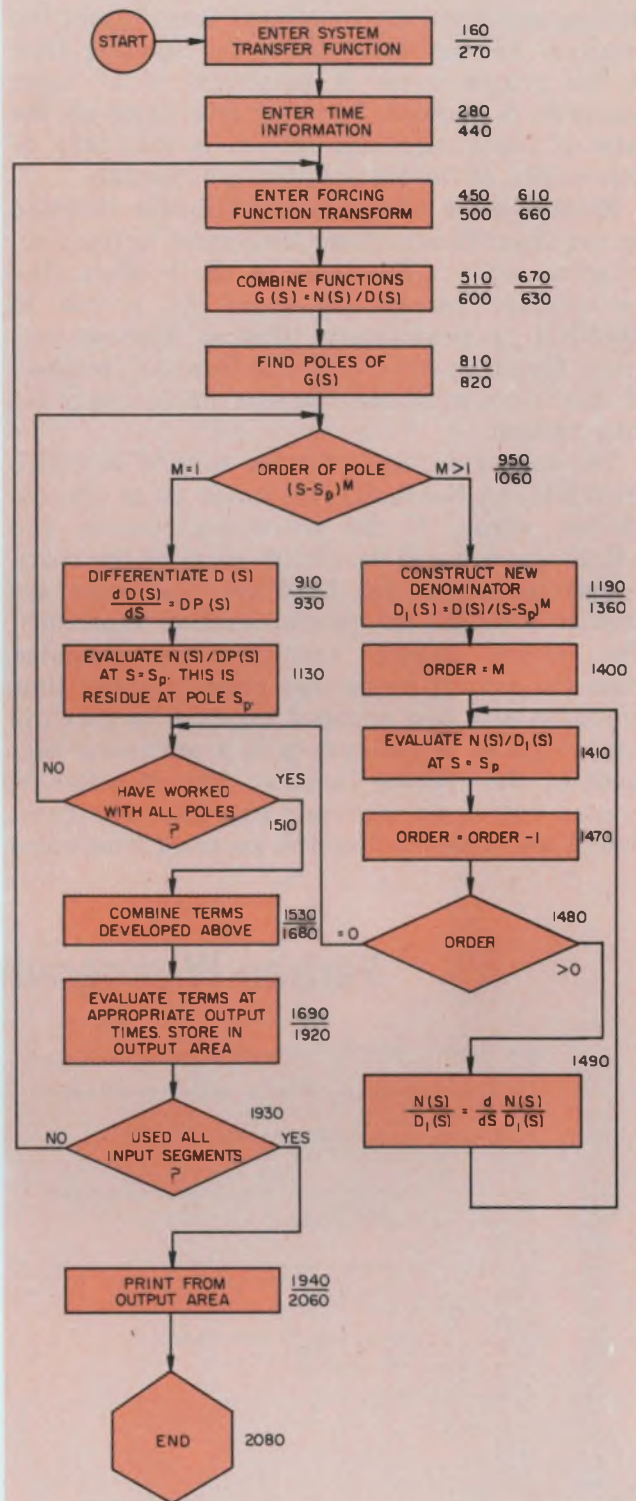

NOTE: THE NUMBERS NEXT TO EACH BOX REFER TO THE CORRESPONDING GROUP OF LINES IN THE PROGRAM LISTING

2. Program input is in the complex frequency domain as a ratio of polynomials. The user inputs the system transfer-function coefficients as well as those of each forcing-function segment. The algebraic expression is the exact response of the system to each input segment, a unique feature of the program. The Laplace transform of each response must be of order 10 or less.

3. Inversion of the Laplace transform by partial fractions supplies the time-domain response. The program computes the response to each segment separately, then adds the results to obtain the complete response in accordance with the principle of superposition. Program operation is divided into three parts: input, computation of inverse Laplace transform and output accumulation.



entered first, followed by each of the driving function segments. The Laplace coefficients for the segments are the undelayed transforms; the program automatically shifts the starting time to the proper value. A maximum of 11 input segments is allowed. The only restriction on the type of input segments allowed is that they be expressible as the ratio of two polynomials.

Multiplication of the system-transfer function by the input-forcing function occurs in the computation section. The poles of the product (the denominator zeros) are found by a call to DOWNH, a proprietary General Electric program based on the "downhill-Newton" method. If this is not available, the user must supply his own version.

The calling sequence for the routine is CALL DOWNH (A,N,AR,AI) in which A is the coefficient array, N the polynomial degree and AR, AI the real and imaginary parts of the roots.

Once calculated by DOWNH, the poles are used to evaluate the partial-fraction expansion. The inverse Laplace transform is calculated from the sum of terms that result. Similar time functions are then grouped together to give the time response of the system to a particular segment of the forcing function. This function is printed out as an algebraic equation. The function is also evaluated at the specified time steps

T	0.500	1.000	1.500	2.000	2.500	3.000	3.500	4.000	4.500	5.000
G	0.000	0.006	0.035	0.116	0.262	0.552	0.932	1.411	1.963	2.559
T	5.500	6.000	6.500	7.000	7.500	8.000	8.500	9.000	9.500	10.000
G	3.167	3.762	4.330	4.864	5.367	5.847	6.315	6.778	7.239	7.686
T	10.500	11.000	11.500	12.000	12.500	13.000	13.500	14.000	14.500	15.000
G	8.098	8.453	8.731	8.920	9.023	9.052	9.028	8.972	8.907	8.849
T	15.500	16.000	16.500	17.000	17.500	18.000	18.500	19.000	19.500	20.000
G	8.809	8.789	8.786	8.775	8.716	8.574	8.338	8.021	7.662	7.307
T	20.500	21.000	21.500	22.000	22.500	23.000	23.500	24.000	24.500	25.000
G	7.000	6.773	6.639	6.593	6.617	6.685	6.769	6.848	6.907	6.937

4. Tabular output contains 50 values of system output and the corresponding times. The output is taken directly from data accumulated in the output area. The same area can be used for input to user-supplied plotting routines.

and the results stored in an output area.

Output data for each forcing function are calculated separately, then added to the output area. In this way the complete response is built up segment by segment.

The output section provides a tabular listing of the data accumulated in the output area. The program outputs 50 time-output pairs (Fig. 4). The user can add his own plotting routines or use the vendor's if graphical output is desired. ■■

## Fortran IV program for transient analysis

```

100 REAL N(100),IM,IMD,NF(100),IMN,NF(11)
110 REAL N3(11),D3(11)
120 INTEGER DORD,DFORD,DI,DF1,DRD
130 DIMENSION D(100),RTR(11),RTJ(11),M(10),DF(100),ANS(2,10,10)
140 DIMENSION D2(100),GWT(2,51),S1(11)
150 DATA RTR/11*973461.2/
160 PRINT,"ENTER SYSTEM TRANSFER FUNCTION "
170 PRINT,"ENTER NUMERATOR ORDER"
180 INPUT, NORDI
190 NI= NORDI+1
200 PRINT,"ENTER NUMERATOR COEFFICIENTS; HIGHEST ORDER FIRST"
210 INPUT,(N3(NI+1-I),I=1,N1)
220 PRINT,"ENTER DENOMINATOR ORDER"
230 INPUT, DORDI
240 DI= DORDI+1
250 PRINT,"ENTER DENOMINATOR COEFFICIENTS; HIGHEST ORDER FIRST."
260 PRINT,"HIGHEST ORDER COEFFICIENTS MUST BE NORMALIZED TO 1.0."
270 INPUT,(D3(DI+1-I),I=1,D1)
280 PRINT,"ENTER NUMBER OF SEGMENTS IN FORCING FUNCTION"
290 INPUT, NSEG
300 PRINT,"ENTER STARTING TIME FOR EACH SEGMENT"
310 INPUT, (ST(ISEG),ISEG=1,NSEG)
320 PRINT,"ENTER OUTPUT TIME STEP"
330 INPUT, DT
340 DC 5000 ISEG=1, NSEG
350 DO 7 J=1,10
360 DC 7 J=1,10
370 K=10*(J-1)+J
380 M(K)=0.
390 NF(K)=0.
400 D(K)=0.
410 DF(K)=0.
420 D2(K)=0.
430 ANS(1,I,J)=0.
440 7 ANS(2,I,J)=0.
450 PRINT,"ENTER FORCING FUNCTION TRANSFORM", ISEG
460 PRINT,"ENTER NUMERATOR ORDER"
470 INPUT, NFORD
480 NF1=NFORD+1
490 PRINT,"ENTER NUMERATOR COEFFICIENTS; HIGHEST ORDER FIRST"
500 INPUT,(NF(NF1+1-I),I=1,NF1)
510C MULTIPLY TOGETHER NUMERATORS OF SYSTEM
520C AND FORCING FUNCTIONS.
530 DO 10 I=1,N1
540 DO 10 J=1,NF1
550 10 NP(I+J-1)=NF(I+J-1)*N3(I)*NF(J)
560 NEND= NENDI+ NFORD
570 NI= NORDI+1
580 DO 11 I=1,N1
590 NCI=NF(I)
600 11 NP(I)=0.0
610 PRINT,"ENTER DENOMINATOR ORDER"
620 INPUT, DFORD
630 DF1=DFORD+1
640 PRINT,"ENTER DENOMINATOR COEFFICIENTS; HIGHEST ORDER FIRST."
650 PRINT,"HIGHEST ORDER COEFFICIENTS MUST BE NORMALIZED TO 1.0."
660 INPUT,(DF(DF1+1-I),I=1,DF1)
670C MULTIPLY TOGETHER DENOMINATORS OF SYSTEM
680C AND FORCING FUNCTIONS.
690 DO 13 I=1,D1
700 DC 13 J=1,DF1
710 NP(I+J-1)=NP(I+J-1)*D3(I)*NF(J)
720 DORD= DORDI+ DFORD
730 DI= DORD+1
740 DO 14 I=1,D1
750 D2(I)=NP(I)
760 M(I)=0
770 14 NP(I)=0.0
780 DO 40 I=1,D1
790 40 D(I)=D2(I)
800 LI=DORD
810C FIND POLES OF COMBINED SYSTEM AND FORCING FUNCTION.
820 CALL DOWNH(D2,LI,RTR,RTJ)
830 DO 45 J=1,11
840 D2(J,4)=0.
850 IF(ABS(RTR(J,4))-0.001) 41,41,49
860 41 RTR(J,4)=0.0
870 49 IF(ABS(RTJ(J,4))-0.001) 43,43,45
880 43 RTJ(J,4)=0.0
890 45 CONTINUE
900C SORT POLES ACCORDING TO THEIR MULTIPLICITY
910 DO 100 II=1,DORD
920 I=DORD+1-II
930 DF(I)=1+D(I+1)
940 IF(RTR(I)-973461.2) 50,100,50
950 50 M(I)=1
960 II=I-1
970 .IF(I)100,100,55
980 55 DO 90 KK=1,11
990 K=11+1-KK
1000 IF(ABS(RTR(K)-RTR(I))-0.01)60,60,90
1010 60 IF(ABS(RTJ(K)-RTJ(I))-0.01)70,70,90
1020 70 M(I)=M(I)+1
1030 RTR(K)=973461.2
1040 M(K)=0
1050 90 CONTINUE
1060 100 CONTINUE
1070C EVALUATE COMBINED SYSTEM AND FORCING FUNCTION
1080C AT ALL FIRST ORDER POLES.
1090 DO 1000 I=1,DORD
1100 IF(RTR(I)-973461.2)120,100,120
1110 120 IF(NC(I)-1) 1000,130,1000
1120 130 END=NC(I)
1130 CALL PEVAL(RTR,RTJ,N,NF,DF,1,CRU,DCH,ANS,DE)
1140 1000 CONTINUE
1150C EVALUATE COMBINED SYSTEM AND FORCING FUNCTION
1160C AT ALL HIGHER ORDER POLES.
1170 DO 2000 I=1,DORD

```







# IM6523

## New 256 bit CMOS RAM.

### Less than 0.002 $\mu$ W/bit standby.

**And it's  
so easy to use.**

It's the Intersil IM6523 256 bit CMOS silicon gate RAM, a low, low power memory any designer will love working with.

It typically uses less than 2 nanowatts per bit standby and 20 microwatts per bit active power, and works from a single power supply. Supply voltage may be anything from 3 to 7 volts.

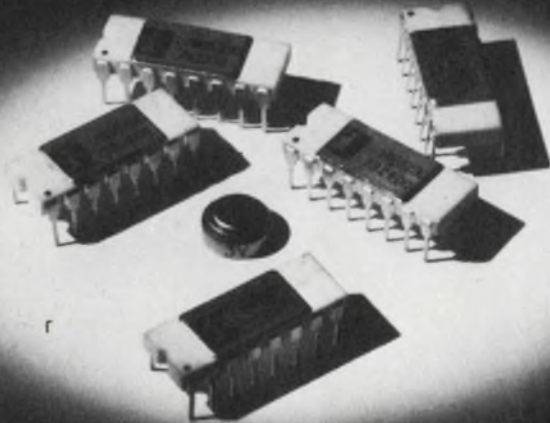



## Memories, memories everywhere

Use the IM6523 as medium speed buffer and main-frame memory in computers, calculators, point-of-sale systems, avionic systems and portable instrumentation... wherever low power consumption and simplicity of design are important.

Mount 48 of them on a board with a small battery and presto! You have a 1024 × 12 bit non-volatile memory plane with simple timing, 600nS access and 0.4 Watt power dissipation. Or use the battery-equipped memory planes for re-writable ROMs.

Send for product data and application details.

### Engineering opportunities.

Write or call John Waller, Intersil, Inc., 10900 North Tantau Ave., Cupertino, CA 95014. Phone (408) 257-5450.

# Intersil



### Intersil stocking

**distributors.** Elmar/Liberty Electronics. Schweber Electronics. Semiconductor Specialists. Weatherford.

### Intersil area sales offices.

Boston (617) 861-7380.  
Chicago (312) 371-1440.  
Los Angeles (213) 532-3544.  
Minneapolis (612) 925-1844.  
New York (201) 567-5585.  
San Diego (714) 278-6053.  
San Francisco Bay Area (home office) (408) 257-5450.  
Upstate New York (315) 463-3368.

**Representatives in all major cities.**

It's fully decoded and buffered, provides static asynchronous operation. Typical access time is 350 nanoseconds.

Packaging is in 16-pin DIPs. Price in ceramic DIPs at 100-999 quantities is \$25.60 for commercial (0° to +75°) version and \$46.00 for military (-55° to +125°C), immediately available from Intersil distributors.

# Intersil means memory



## **New rules for faster design.** Shortages of components, market changes, diminishing lead times—all call for a shrewder, more informed engineer.

It used to take as long to design a product as it does to have a baby, but faster and faster evolving markets and technology have changed that. Now designers must create a product in six months instead of nine, and tomorrow they'll probably have to do it even faster.

To meet the challenge, the engineers in our company, Data Precision, have had to alter their working habits. They had been following the trend of making the product less expensive and more convenient by using the latest technologies. But the ground rules for design have changed in the last few years in the following ways:

- Because of component shortages, today's designer must be more concerned about their price and availability than ever before.
- Unlimited design changes and improvements are a thing of the past; unlike the old aerospace market, in the commercial area it's still a question of price and field service.
- Customers don't want versatility any more. They are looking for small, inexpensive dedicated instruments, and here complex ICs are fulfilling the need.
- Engineers must learn to interface with all departments to be better informed about customer problems.
- Engineers must keep up with current events, particularly as they relate to overseas technology and competition.

### **New points of view needed**

The older engineers tend to be conservative people; they resist change. The newer designers don't resist as much because they think that computer technology is a panacea, and that's not realistic either. To beat those attitudes, I had to make believers out of those fellows. I didn't tell them what to do; I told them what's happening.

For background, I told them that during the days of the big aerospace market, the engineer

---

Harold Goldberg, President, Data Precision, Wakefield, Mass. 01880.

## **Harold Goldberg**

As a company president, Harold Goldberg has made good use of the courses in engineering economics he learned at Cooper Union in New York City where he graduated in 1944. But then he has found a knowledge of finances very helpful throughout his career in a large variety of jobs with many companies.

He started designing at Press Wireless, Radio Receptor, and Northern Radio, after a stint in the army. He earned an MEE at Brooklyn Polytech in 1950 and immediately got a job at the Allen B. Dumont Labs in New Jersey where he worked his way up to assistant production manager responsible for test facilities. He designed conveyORIZED test systems for radar and military receiver/transmitters, and TV receivers.

Later he joined Emerson Radio as head of engineering fabrication where he set up short-run manufacturing facilities. He left to become chief development engineer of Consolidated Avionics Corp., and, some years later, he became engineering manager of EPSCO, Systems Div. There he helped develop advanced data handling systems, multipoint analog inputs to computer formatted digital tape, PCM telemetry, manual, automatic and computerized automatic test equipment.

In 1962 he helped form Lexington Instrument Corp., a maker of medical instrumentation, as vice-president for R&D. He developed patient monitoring systems, coronary care units and measuring instrumentation, ectopic beat monitors, and multichannel EKG monitors.

When the company turned out to be more

was insulated from problems other than those of design. He was separated from management, purchasing, sales and manufacturing because that's the way the system seemed to work best.

But what seems to work best now is for the engineer to interface with all departments, and especially with his customers. He should find out, for example, how shortages are affecting his



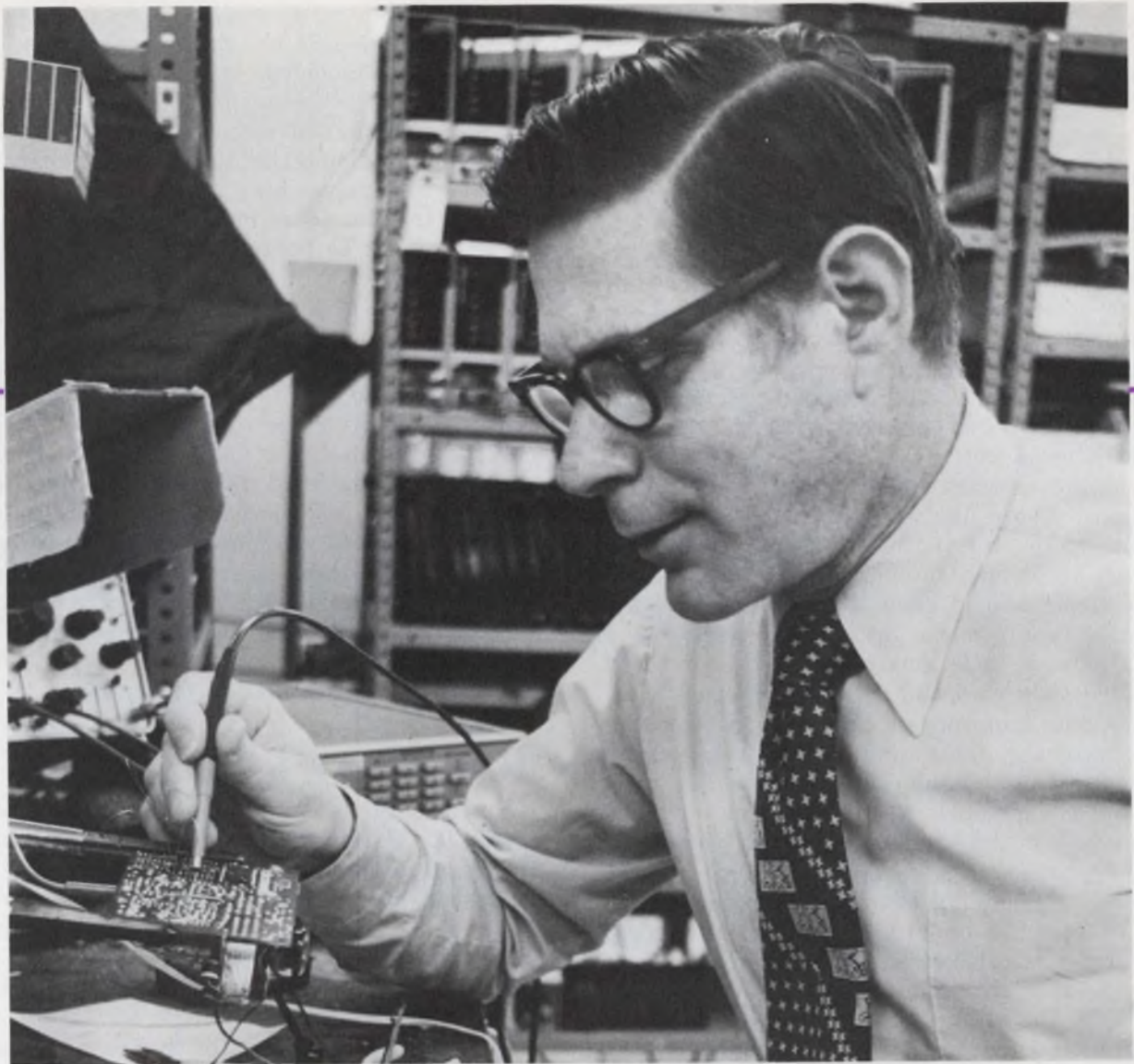

of a technical success than a financial one, he left in 1966 to join Avco Research Labs at Everett, Mass., as part of Dr. Arthur Kantrowitz medical heart register research team. There for only 18 months, Mr. Goldberg designed the instrumentation and control to run the balloon counterpulsation research still in progress.

After joining ORION research in 1968 as operations manager and chief engineer of manufacturing electro-chemical instrumentation, he helped to develop the selective chemical measurement techniques that are changing the clas-

sical field of chemical analysis. In 1971 he helped start Data Precision Corporation, developing primarily digital multimeters. In the past three years the company has grown and prospered.

Mr. Goldberg is a member of the IEEE Board of Directors, and vice chairman of the Institute's technical activities board. When he finds time, he skis. When he doesn't find time to ski, he plants trees. He has turned a perfectly good pasture into a forest around his Lexington, Mass., home where he lives with his family.

customers and perhaps find a way to compensate.

The designer should accompany the salesman on his field trips. So often the salesman doesn't know what the engineer's design options are, and the engineer can be of valuable assistance if he's exposed to the problem personally. The designer must listen to his marketing people more than he ever did. The day of telling the sales

people, "Look I'll design it, you go out and sell it," is gone, because the sales people know where the market is.

It's helpful, too, if the designer thinks the way the user of his equipment does—as a medical technician, for example, if it's medical equipment he's designing. It's not easy for an engineer to think this way, because seldom has he been



trained in that direction. You might gently remind him that the ground rules have probably changed since he graduated from engineering school.

### Current events influence designs

I also told our engineers that they must know more about current events and economics, because these affect their designs. The designer has to know more about foreign trade, because the government has put restrictions on items that are manufactured overseas. A lot of the designer's suppliers are manufacturing overseas, and they have their own problems that the designer should know about.

Current events are affecting us more than they ever have. Every day we read that electronics is moving more and more into other industries, such as medicine, automobiles and recreation. The designer should know that a couple of these industries may move into quasi-recessions. I hope we're a little smarter than we were in 1969-1970, when we said it couldn't happen to us.

What has happened is that for 30 years we were marching along singing our song totally oblivious to the outside world because our markets weren't affected. All of a sudden we're as much a kite in the wind as any other industry.

But the winds of change are prevalent even in our own industry. For one thing, very few people seem to want the versatile instrument any more; they prefer the dedicated instrument. The idea, in my field, of combining the capacitor measurement with the digital voltage or a counter with a voltmeter is very easy to do technically, but there's no market for it now. If the customer wants a voltmeter, that's what he wants. One large electronics company has found this out and changed its product structure to reflect this.

The usual engineering trick is to say that I can give the guy more because technically I can add this additional feature to it and it'll only cost me X number of bucks, and I steal a march on my competitors. But that doesn't work now.

Another thing I tell our engineers is to design smart without making the customer pay more. This doesn't mean the company absorbs the difference but rather the wise use of today's technology. No one has a monopoly on brains. The other guy is just as smart as I am, maybe smarter. Fortunately, for me, there can be more than one winner.

### Flexibility to counter shortages

Shortages have taught our engineers a little humility. They can't afford to ignore the parts salesman as they used to. And they can no longer rely on one vendor or one technology to see them

through a project. We make the designs flexible, so we can use LSI or multiple chips, in case some of the components we've ordered don't arrive. Also, we've designed a PC board that can use ICs and/or discrettes. In good times we'd never think of doing that, but who can guarantee that ICs will keep coming in.

We've tried to figure out what might be stolen or what might be hoarded as a result of shortages. We make a miniaturized product that could be carried off by a thief easily. We're now designing it with a benchstand so it's not so easy to steal; the benchstand itself is very difficult to take apart. And we're coming out with a larger model that won't fit into a lunch pail.

We used to design a piece of equipment with a removable line cord for the customers' convenience. If it isn't removable, it dangles and gets in the way as you move it. Line cords today, if you can get them, are delivered in 26 to 52 weeks. You don't design a product with a removable line cord today because they walk. You have no way of knowing that unless you go into the customer's plant and he tells you.

### The need to think ahead

Finally I think the designer has to do a little crystal-ball gazing to get a feel for the direction of designs in the future.

The computer industry, at the moment, is relatively unaffected by design changes, because we're still in the throes of moving computerized systems into new areas, such as inventory control and accounting systems.

The new design area for instruments is to move digital output instruments into the field formally served by analog instruments. With the advent of molded plastics, we've been able to move into the analog domain with the \$200 multimeters. The LSI chip has enabled us to move in size and complexity into the analog world and compete effectively. Obviously the market is looking for instruments that are both portable and inexpensive.

In components, more and more people want complex ICs, because there's a major space saving, a major power-dissipation savings and, in many cases, a major cost savings. The ticket of admission is very high. What the IC manufacturer tries to do is develop his own proprietary product, which he can then sell to the instrument or device manufacturer. He's second-guessing the guy who's making the instrument.

We have to find a way to control the situation, because, for one thing, the maker is forced to design around what the IC maker has to offer, and I don't believe anyone thinks that's healthy—to have an IC maker dictate what we're going to design. ■■



If you need  
**top-quality**  
**panel**  
**instruments**  
 with a clean,  
 modern look...

Buy  
**Triplett's**  
 Series GL  
 or GL/B

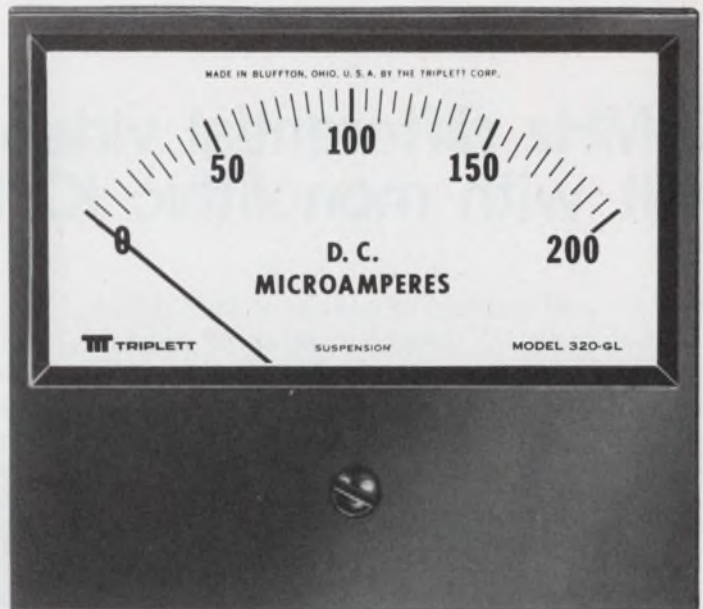

GL



GL/B (mounted appearance)

Triplet's newest panel instruments, the Series GL and GL/B, feature glass windows, matte-finish phenolic cases and a dial design that can readily accommodate multiple scales. They are available in 3½", 4½" and 5½" sizes.

The GL Series features a standard 2-stud mount with 3- and 4-stud mounts available.

The feature of the GL/B Series is behind-the-panel mounting with a bezel which is an integral part of the case.

There's a choice of more than 275 stock sizes and ranges — in DC microammeters, milliammeters, ammeters, millivoltmeters and voltmeters; AC milliammeters, ammeters, and voltmeters; RF thermoammeters; dB meters and VU meters. For those who need special instruments . . . custom dials, pointers, scales, accuracy, tracking, resistance, response time or practically any combination of unusual specs can be put into these new cases. For quick, dependable delivery

of small quantities of these adaptable new instruments, contact your Triplet Sales/Service/Modification Center or distributor. For prototypes or production quantities, contact your Triplet representative. Triplet Corporation, Bluffton, Ohio 45817.

**TRIPPLETT**  
 BLUFFTON, OHIO 45817  
 Manufacturers of the World's  
 most complete line of V-O-M's

INFORMATION RETRIEVAL NUMBER 88



# ideas for design

## 10-MHz differential video line receiver built with monolithic IC transistor array

Use the well-matched properties of the CA3046 monolithic npn IC transistor array to build a differential video line receiver. The circuit amplifies signals between a coaxial cable's center conductor and shield, but rejects common-mode voltages to ground. Video-signal levels can be 2 V pk-pk, with a  $\pm 5$ -V common-mode range.

The circuit shown exploits the matching of the five transistors in the array. Transistors  $Q_3$  and  $Q_4$  form a degenerated (controlled gain) differential pair with  $Q_1$  and  $Q_2$  used as an emitter-current source. With no signal coupling between the  $Q_3$  and  $Q_4$  emitters, the common-mode amplification is very low, due to the low output conductance of  $Q_1$  and  $Q_2$ . The low conductance produces a common-mode rejection of 60 dB, while the differential signal transfer through  $R_6$  and  $R_7$  results in nominal unity gain for differential signals. The actual gain is very close to the ratio of  $R_{11}$  to  $R_6 + R_7$ .

A common-mode swing of 10 V pk-pk is provided by  $Q_1$  and  $Q_2$ . The transistors are biased to feed 1 mA into each side of the differential pair,  $Q_3$  and  $Q_4$ . Parasitic suppression resistors are used in the  $Q_3$  and  $Q_4$  input base leads to prevent vhf oscillations. The remaining array transistor is used as an emitter feed for the discrete output buffer,  $Q_6$ .

The high  $f_t$  of the transistors, low circuit time constants and the common-collector/common-base drive of  $Q_3$  and  $Q_4$  give the circuit a video bandwidth greater than 10 MHz.

The input impedance is high enough to bridge a 75  $\Omega$  coaxial line without excessive loading, and does not reflect Miller capacitance to the input line. Loads should be 2 k $\Omega$  or greater, and  $Q_6$  will deliver a 2-V pk-pk linear output.

Walter Jung, 1946 Pleasantville Rd., Forest Hill, Md. 21050.

CIRCLE No. 311

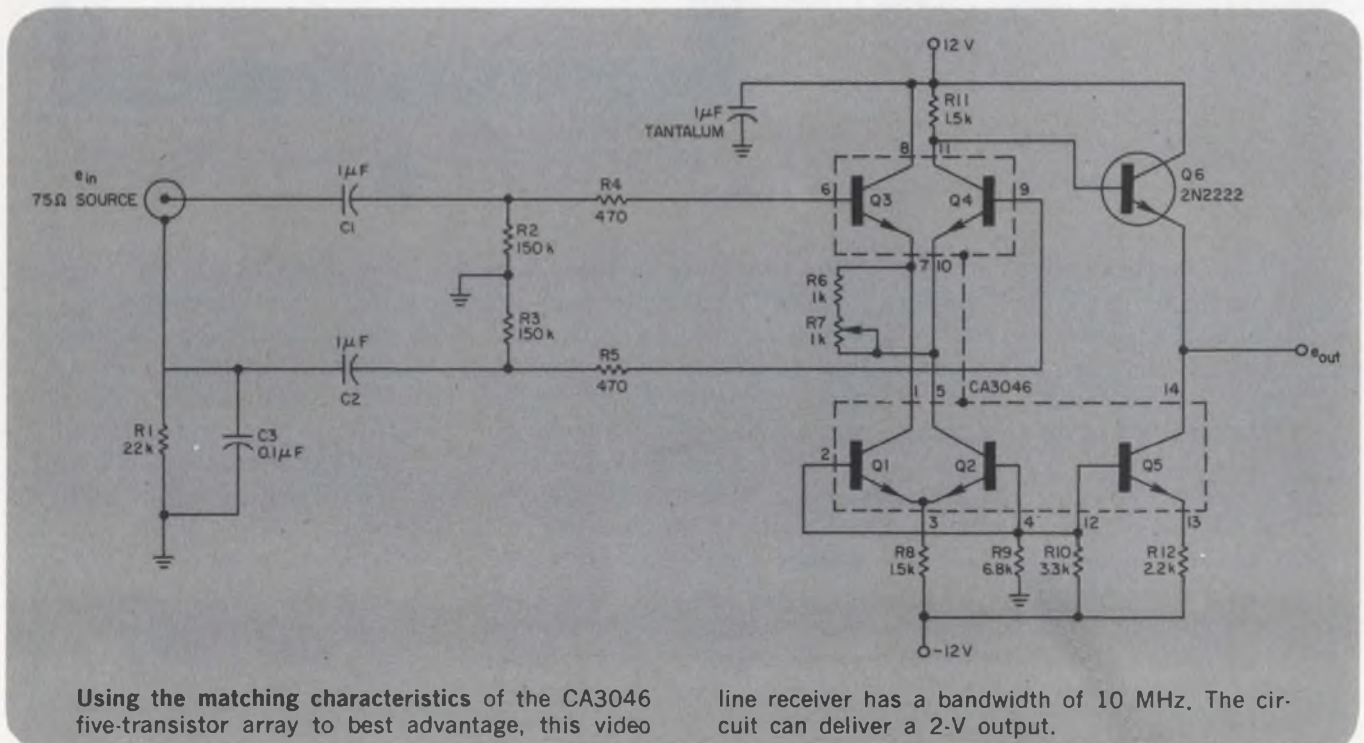



# OUR 5V POWER MINI'S STACK UP LIKE THIS



OUTPUT VOLTAGE	OUTPUT CURRENT AMPS.	REGULATION LOAD $\pm\%$	REGULATION LINE $\pm\%$	RIPPLE MV RMS	PRICE	MODEL	SIZE INCHES
5	.250	.05	.05	0.5	\$39.00	5E25	2.3 x 1.8 x 1.00
5	.500	.1	.05	1	49.00	5E50A	3.5 x 2.5 x 1.00
5	1.0	.2	.05	1	69.00	5E100	3.5 x 2.5 x 1.25
5	1.5	.3	.1	1	98.00	5E150	3.5 x 2.5 x 1.25
5	2.0	.15	.05	1	110.00	5E200	3.5 x 2.5 x 2.00
5	2.5	.15	.05	1	125.00	5E250	3.5 x 2.5 x 2.00

... and the model you choose will be shipped 3 days after Acopian receives your order. With a 105-125 VAC input, use it at full rated load to 71° C. Short circuits won't damage it. These mini-modules can be mounted on a printed circuit

board in a space of only a few square inches. Generous quantity discounts are available. Or, if you're working with other voltages, choose from hundreds of other models. Single outputs from 1 to 75 volts.

Duals for op-amps with output currents from 25 to 500 ma. Even triple outputs. Complete details on these plus a comprehensive line of other power supplies and systems are included in the Acopian 73-74 catalog. Request a copy.



Corp., Easton, Pa. 18042. Telephone: (215) 258-5441.

INFORMATION RETRIEVAL NUMBER 89



# Transistor reduces output variation in three-terminal regulator circuit

The addition of a transistor buffer improves regulation by a factor of  $\beta$  when a three-terminal regulator is used in conjunction with a resistive divider. The divider circuit is often used to obtain adjustable or nonstandard output voltages.

The voltage divider (Fig. 1a) biases the ground lead so that the output voltage  $V_o$  equals

$$V_o = V_{XX} (1 + R_2/R_1) + R_2 I_Q \quad (1)$$

Output regulation is degraded by changes in  $I_Q$  in accordance with

$$\frac{d V_o}{d I_Q} = R_2 \quad (2)$$

For the LM340 series,  $I_Q$  can vary by 1.5 mA with line and load changes, so that the output change varies by as much as 150 mV for  $R_2 = 100 \Omega$ .

Use of the transistor (Fig. 1b) improves voltage regulation by a factor of  $\beta$ , as shown by the equation for the output voltage:

$$V_o = V_{XX} (1 + R_2/R_1) + (R_2 I_Q) / \beta + V_{BE}$$

For example, if  $Q_1$  has a  $\beta$  of 100, the output change is 1.5 mV instead of 150 mV. Use of di-

ode  $CR_1$  minimizes the effect of  $V_{BE}$  drift on  $V_o$ .

A similar scheme improves regulation of a current source built from a three-terminal current regulator. Without the transistor (Fig. 2a):

$$I_o = \frac{V_{XX}}{R} + I_Q \quad (3)$$

Use of the transistor (Fig. 2b) gives

$$I_o = \frac{V_{XX}}{R} + \frac{I_Q}{\beta} \quad (4)$$

so that the effects of variation in  $I_Q$  on the output is reduced by a factor of  $\beta$ .

Eqs. 1 to 4 apply to positive regulators, such as National's LM109 and LM340 series, Fairchild's A7800 series and Beckman's 805 series. The method also works with negative regulators, such as National's LM120 series and Beckman's 855 series. However, an npn transistor is required, and the diode polarity must be reversed.

*J. C. Anderson and R. E. Shipp, Beckman Instruments, Inc., Helipot Div., 2500 Harbor Blvd., Fullerton, Calif. 92634.*

CIRCLE NO. 312

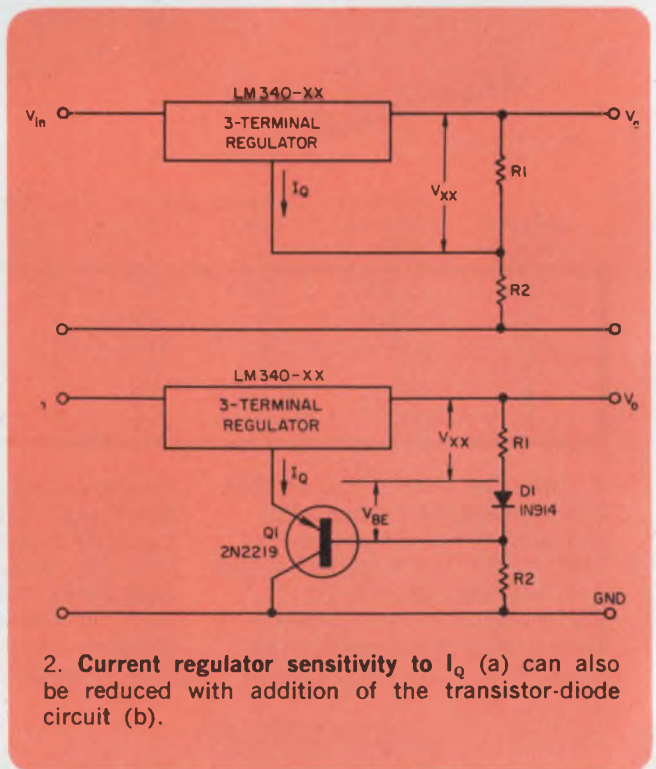
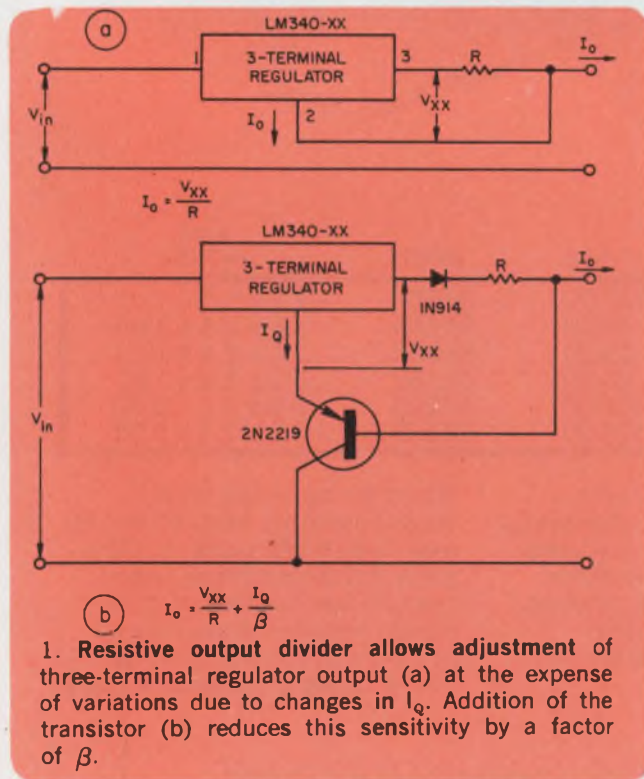



# There's no such thing as an "Augat-like" socket.

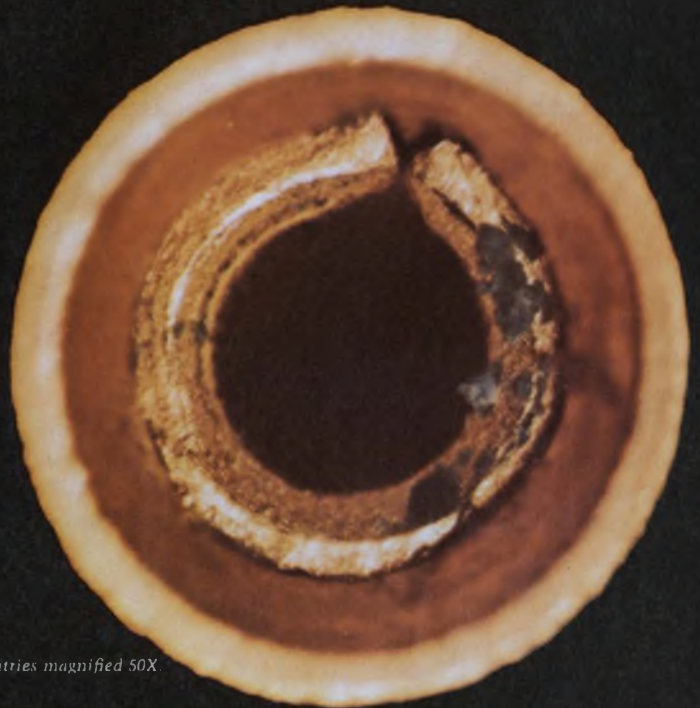
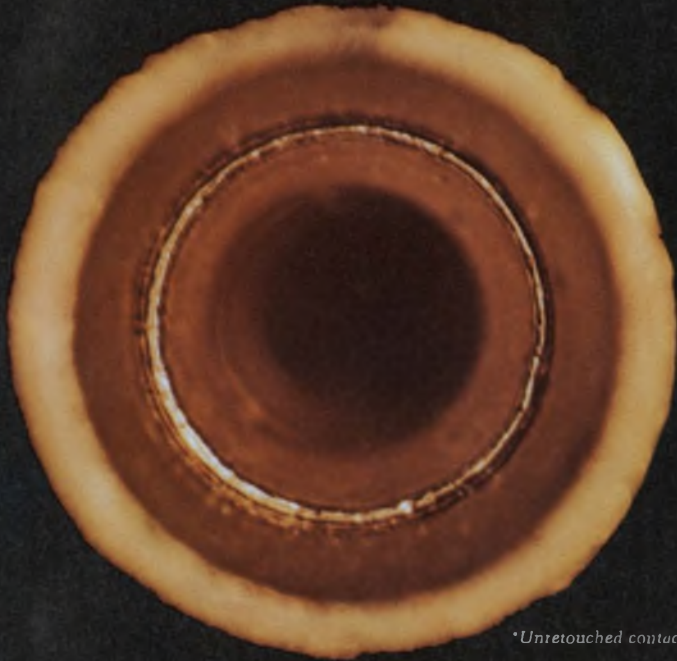

*\*Unretouched contact entries magnified 50X.*

**Either it is...**

**or it isn't**

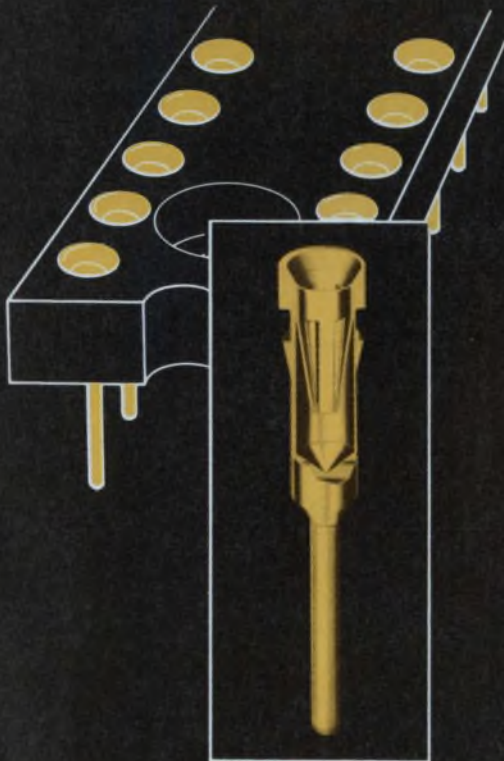

Lots of our competitors call their stamped contacts "Augat-like". But frankly they're not. Because no stamped contact can compare to the Augat machined assembly.

Look for yourself. Note how both the sleeve and contact of the 500 Series socket are precision-machined. Not stamped. Not formed. And how the contact is completely and uniformly covered with gold. Guaranteed .000030" minimum.

Augat's contact offers firm retention and excellent reliability for a wide range of lead sizes. Also, the wide-angle tapered entry makes IC insertion easier, faster and virtually error-free.

The extremely low profile 500 Series socket is available in sizes from 8 through 40 contacts, and features Augat's unique closed end sleeve that completely eliminates solder wicking problems.

So you see, there is no such thing as an "Augat-like" socket. The closer you look, the more you see why.

**AUGAT**® Augat Inc.  
33 Perry Avenue  
Attleboro, Mass. 02703  
(617) 222-2202

Europe - Augat International, Inc., Boulevard A. Reyers, 103, 1040 Brussels, Belgium, Tel. (02) 36-93-99.  
Japan - Kyokuto Boeki Kaisha Ltd., New Otemachi Bldg., 2-1, 2-Chome Otemachi, Chiyoda-Ku, Tokyo 100-91, Japan, Tel. (03) 244-3788.

INFORMATION RETRIEVAL NUMBER 90



# A few extra components 741 op amps for high-voltage-swing applications

Have a special application where large output swings and high voltages are required? With the circuit shown, you can boost the voltage capability of the 741 op amp to handle  $\pm 45$ -V supply voltages, deliver output swings of 70 V pk-pk and even have adjustable gain.

Resistors  $R_1$ ,  $R_2$ ,  $R_3$  and  $R_4$  form a voltage divider that splits the  $\pm 45$ -V supply down to  $\pm 22.5$  V. Transistors  $Q_1$  and  $Q_2$  drop the  $\pm 22.5$  V still further, by 0.7 V. Thus the op-amp supply terminals never see more than a 43.6-V differential.

Transistors  $Q_1$  and  $Q_2$  always conduct, and thus maintain the 43.6 V across the op-amp supply terminals under all signal conditions. You can prove this with the following three equations:

$$+V = + \left( 45 - \frac{45 - V_o}{2} - 0.7 \right) = 21.8 + \frac{V_o}{2} \quad (1)$$

$$\begin{aligned} -V &= - \left( 45 - \frac{45 + V_o}{2} - 0.7 \right) \\ &= - \left( 21.8 - \frac{V_o}{2} \right) \end{aligned} \quad (2)$$

$$\begin{aligned} (+V) - (-V) &= \left( 21.8 + \frac{V_o}{2} \right) + \left( 21.8 - \frac{V_o}{2} \right) \\ &= 43.6 \end{aligned} \quad (3)$$

Resistors  $R_F$  and  $R_{IN}$  adjust the gain as usual. The table shows that a 72-V pk-pk output signal is possible without the op-amp specs being exceeded and by use of a 2-k $\Omega$  load.

*Surjan Dogra, Gull Airborne Instruments Inc., 55 Engineers Rd., Smithtown, N.Y. 11787.*

CIRCLE NO. 313

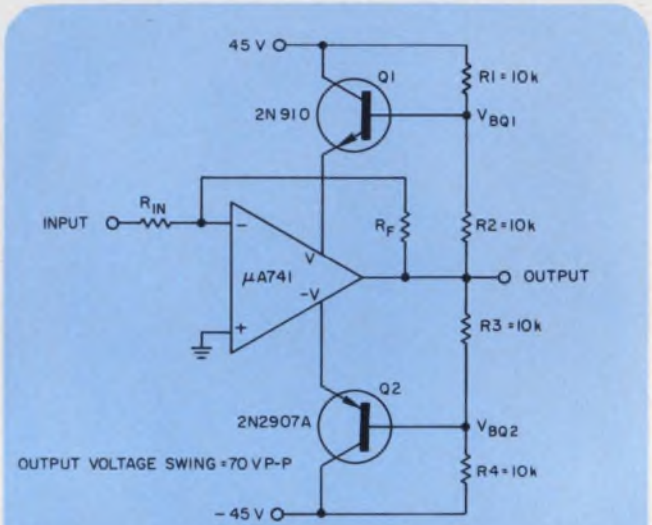

$V_o$	$V_{BQ1}$	$V_{BQ2}$	V	-V	(V) (-V)
0	22.5	-22.5	21.8	-21.8	43.6
36	40.5	-4.5	39.8	-3.8	43.6
-36	4.5	-40.5	3.8	-39.8	43.6

Two transistors and a few resistors help the 741 op amp handle 72-V pk-pk output-voltage swings and  $\pm 45$ -V supply voltages.

### IFD Winner of December 20, 1973

**Robert W. Wedwick**, Senior Engineer, Honeywell Information Systems, Inc., 13430 N. Black Canyon Highway, Phoenix, Ariz. 85029. His idea "Detector Gives Computer Warning of ac Power-Line Failure in 150  $\mu$ s" has been voted the Most Valuable of Issue Award.

**Vote for the Best Idea in this issue** by circling the number for your selection on the Information Retrieval Card at the back of this issue.

**SEND US YOUR IDEAS FOR DESIGN.** You may win a grand total of \$1050 (cash)! Here's how. Submit your IFD describing a new or important circuit or design technique, the clever use of a new component or test equipment, packaging tips, cost-saving ideas to our Ideas for Design editor. Ideas can only be considered for publication if they are submitted exclusively to ELECTRONIC DESIGN. You will receive \$20 for each published idea, \$30 more if it is voted best of issue by our readers. The best-of-issue winners become eligible for the Idea of the Year award of \$1000.

ELECTRONIC DESIGN cannot assume responsibility for circuits shown nor represent freedom from patent infringement.



# We have a keyboard to fit every need and every budget.

At MICRO SWITCH, we have the world's most complete line of solid-state keyboards. Which means unmatched design flexibility for you.

Our application engineers will custom tailor a keyboard to your exact specifications. Whether from our time-proven SW series or our new low-profile SD series.

Choose from keys offering over 8,000 legends, 30 colors, and 60 shapes, including standard, sculptured or re-legendable keys.

Or create new keys to fit your needs. Even lighted and two-level keys are available.

MICRO SWITCH keyboards are available with features like MOS, TTL and DTL encoding, and with two-key or N-key rollover. Your choice of arrays include standard touch typing and point-of-sale.

Working with MICRO SWITCH, you draw on our extensive solid-state experience. We've been designing reliable keyboards for hundreds of

applications since 1968 and are presently producing over 1,000 units a week. Each offering a 1% AQL and two-year warranty. This means we can supply you quickly at lower unit prices.

So whatever your needs, and whatever your budget, we'd like to supply a keyboard to fit. Contact a MICRO SWITCH Branch Office for complete information.



**MICRO SWITCH**

FREEPORT, ILLINOIS 61032

A DIVISION OF HONEYWELL



## DPM forms the basis for inexpensive laboratory temperature measurements

If you've got a DPM that can measure ratios, you can follow the lead of Analog Devices and use the meter to build an inexpensive instrument to measure temperature. And if the DPM outputs dc power, then you'll need only a few additional components to complete the unit.

With the DPM and components shown in the diagram, the instrument has a range of  $-55$  to  $+125$  C, can resolve  $0.1$  C and has an accuracy of  $1$  C.

The thermistor is a YSI-44211, available from Yellow Springs Instrument Co., Yellow Springs, Ohio. The  $2$ -V excitation needed by the thermistor was derived from the DPM's internal reference via the op amp, used as a buffer and scaler.

Trimming pots are used to calibrate the zero and the scale factor. Thus the  $50$ - $\Omega$  pot is adjusted so that  $0$  C gives a reading of zero volts,

and the  $2$ -k $\Omega$  pot sets the scale factor to read  $10$  mV/ $^{\circ}$ C. Calibration can also be set for Fahrenheit readings.

The result: an accurate measuring tool that is in continuous use at Analog Devices' engineering laboratories to check the temperature rise of new products.

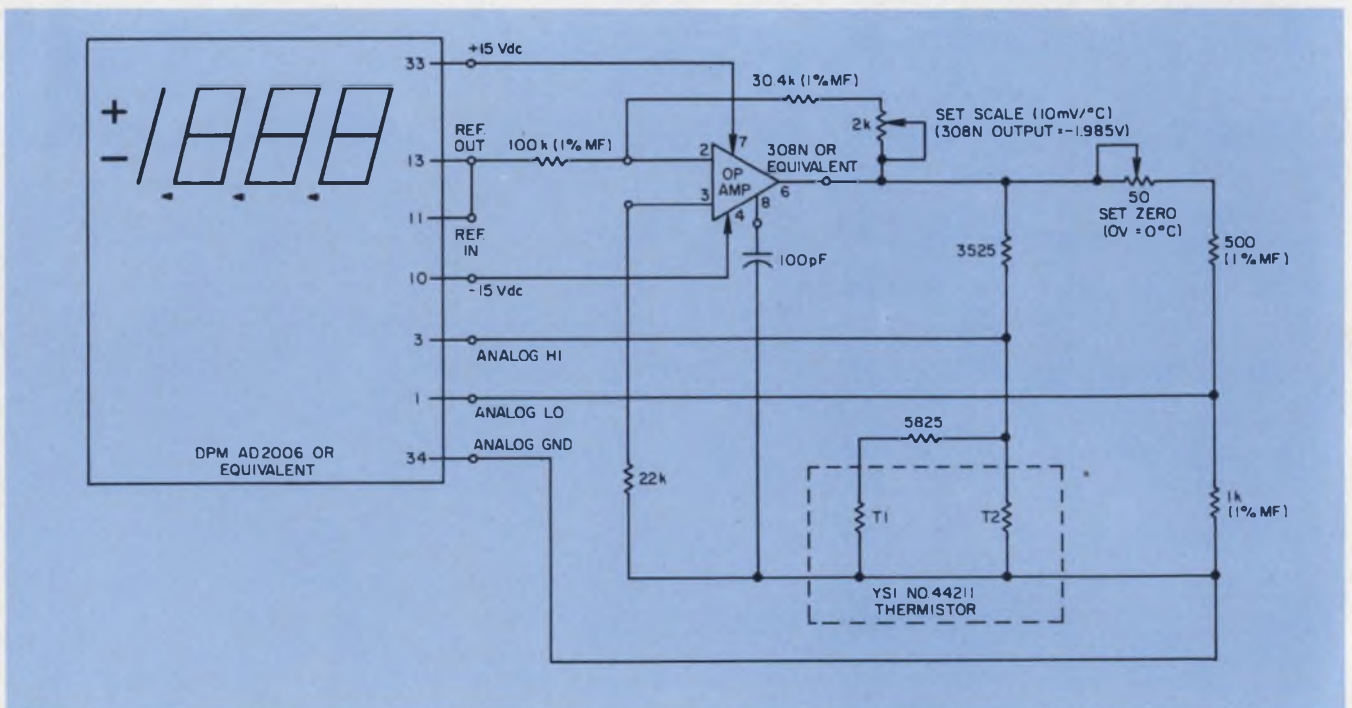



# VCF/Sweep/Start-Stop/Pulse/Ramp/ Sync/Trigger/Search/2-in-1 Function Generator...and then some!

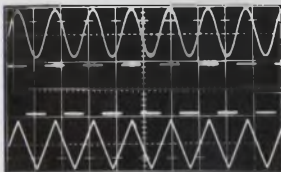

Sine, square and triangle waveforms.

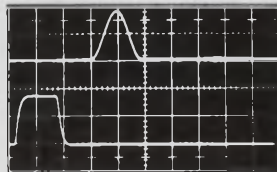

Sine<sup>2</sup> pulse (top waveform) and 100 ns pulse (bottom waveform).

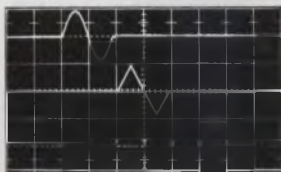

Single shot waveforms.

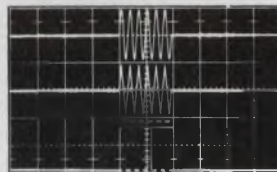

Burst mode.

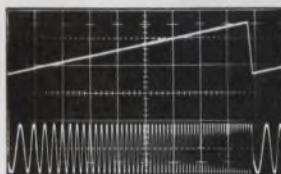

Sweeping with internal ramp.

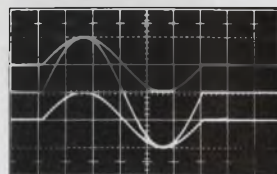

Fixed D.C. offset halves amplitude and offsets waveform positive or negative in relation to ground.

The Exact Model 7260 VCF/Sweep Generator is one in a series of higher performance instruments designed to be more useful in more test applications.

Its frequency range, from 0.0001 Hz to 20 MHz, expands the versatility of function generators into new areas. For instance, the Model 7260's ability to produce sine<sup>2</sup> waveforms to 20 MHz now provides a signal source for transmission line testing. Frequency response is flat all the way out to 20 MHz, with high quality waveforms even at the highest frequencies.

For sweep applications, the Model 7260 offers "start" and "stop" frequency controls that let you precisely set starting and stopping frequencies. Accurate Kelvin-Varley dividers tell you exact frequencies without using a counter.

As a pulse generator, the Model 7260 produces pulses with widths variable from 100 ns to 1000 seconds, and repetition rates from 0.0001 Hz to a full 20 MHz. Ramp waveforms with ramp times from 100 ns to 1000 seconds are another plus in this instrument.

The Model 7260 sets the pace in D.C. offset, too, with the ability to select either fixed positive or negative or variable  $\pm 15V$  offset. Offset also can be externally programmed with an analog voltage.

Two complete generators in one, the Model 7260 generates sine, square, triangle, ramp, pulse and sync waveforms, sweeps over a 1000:1 range and has push-button control of the operating modes of both generators. The main generator can operate in internal and external trigger modes. In the internal trigger mode, the ramp/pulse generator triggers the main generator. Other features include 80 db step attenuation, V:f (voltage proportional to frequency) output, search mode, floating output, sync input for locking to an external frequency or clock and 30V P-P open circuit (15V P-P into 50 ohms) output.

## 20 MHz Models:

**Model 7260** VCF/Sweep Generator . . . . . \$ 895.00  
**Model 7271**, same as Model 7260 with the addition of lin or logarithmic sweep plus gated sweep . . . . . \$1,145.00

## 11 MHz Models:

**Model 7060**, with all the capabilities of the Model 7260, except 11 MHz upper frequency limit . . . . . \$ 845.00  
**Model 7071**, same as Model 7060 with the addition of lin or logarithmic sweep plus gated sweep . . . . . \$1,095.00

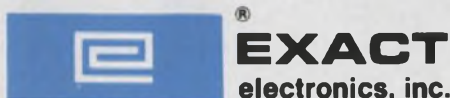

(A Subsidiary of Danalab, Inc.)

BOX 160, HILLSBORO, OREGON 97123  
 (503) 648-6661 TWX 910-460-8811

In Europe, Africa and the Middle East, contact:  
 Danalab International S.A., 119/121, Rue Anatole France 1030  
 Brussels, Belgium. Tel.: 02-414550



## Ultra-fine wiring for IC chips saves space on PC boards

A system that uses ultra-fine, insulated copper wires to interconnect IC chips requires one-tenth the area of comparable multilayer circuit boards. Developed by researchers at the Laboratoire d'Electronique et de Technologie de l'Informatique in Grenoble, France, the wire has a diameter of 30  $\mu\text{m}$  and an insulation of 10  $\mu\text{m}$ .

With this system, the wires can lie a few micrometers apart, compared with separation of at least 1000  $\mu\text{m}$  for regular PC board connectors. The heat resulting from the ultra-compact wiring is

dispersed when the circuits are mounted on a copper plate.

The developers estimate that production runs of less than 500 could pay for the setting-up costs. By contrast, production runs of several thousand are needed to justify the preparation costs for conventional multilayer circuits.

The wired-up circuits can be combined with PC boards where required. The French researchers are working on a system that uses 15- $\mu\text{m}$  wire suitable for welded connections. Commercial production of the system is expected this year.

---

## Common Market studies linear-motor TRANSIT

A proposed 186-mph rapid-transit system powered by linear motors is being studied by the Commission of the European Communities (Common Market).

A group of European manufacturers of linear-propulsion equipment presented the initial outline to the Commission in Brussels. The system would link major cities in Europe.

No details of the mode of suspension have been made public so far. However, the linear motor has been mentioned often in conjunction with the tracked air-cushion vehicle which travels in the 150-to-200-mph range. Air-cushion work in Europe centers on Ste. de l'Aerotraine of France, in which Rohr Corp. holds a majority interest.

---

## A flight simulator for the Concorde due

A supersonic flight simulator for the Concorde SST will be built by Redifon Flight Simulation, in

Crawley, England, in collaboration with the British branch of Link-Miles (Singer Co.). A contract,

awarded by the British Aircraft Corp. calls for use of a Link six-axis motion system, a Redifon Duoview color closed-circuit display, and Redifon R200A computers and interface equipment.

---

## Depletion-mode load sets MOS thresholds

Advances in p-channel MOS integrated circuits have been made in West Germany by use of depletion-mode load transistors, which provide currents proportional to the square of their threshold voltage. With ion implantation, limits are set on the maximum obtainable threshold voltage, depending on the implantation parameters.

Researchers at Dortmund University have reported that optimum parameters have been calculated for threshold voltage shifts exceeding 6 V. The calculations were done for 10- $\Omega$  cm silicon bulk material. The oxide thickness was assumed to be 1200 Å. The results were in good agreement with experimental data at 35 keV.

---

## Cordless headphone receives ultrasonics

A cordless headphone system developed by Philips Research Laboratories in Hamburg, West Germany, modulates an ultrasonic carrier with the same audio used for wired headphone listening. The phones contain an ultrasonic receiving transducer/demodulator, eliminating the need for a cord.

---

## Auto-ignition timed by digital unit

A digital electronics unit for auto-ignition timing control has been announced by Robert Bosch GmbH of Stuttgart, West Germany. The company compares the complexity of the unit with that of a desk-top calculator. Timing is determined from engine, air and catalyst temperatures. The company also has a magnetic ignition timer.



# CAUTION: 50,000 VOLTS

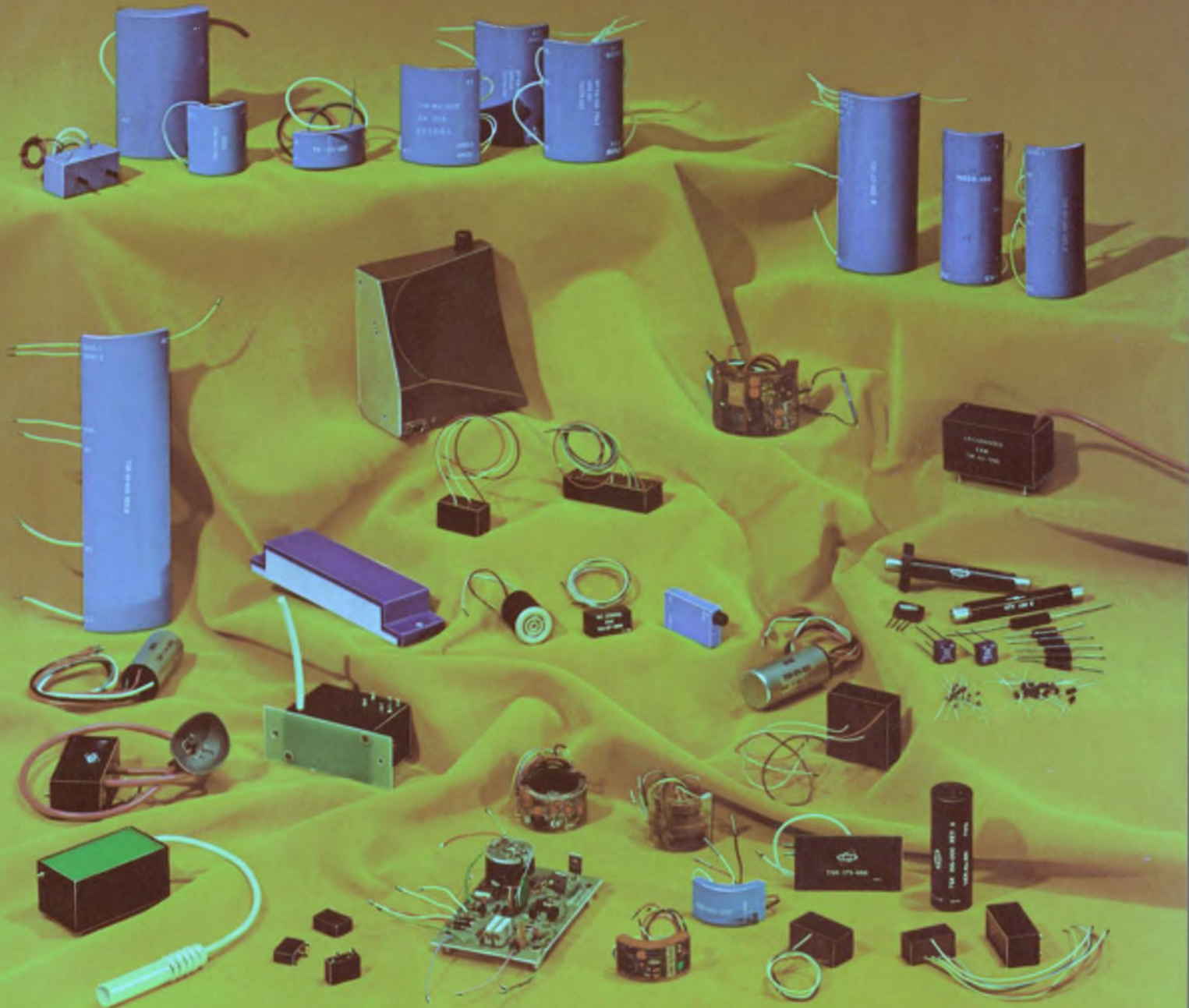

## LET ERIE DESIGN and BUILD YOUR HIGH VOLTAGE POWER SUPPLIES and VOLTAGE MULTIPLIERS

When you talk about designing and packaging miniature, low current High Voltage Power Supplies and Voltage Multipliers, the name ERIE should come to mind first. Why? *No other manufacturer of these sophisticated devices has its own capacitor and rectifier technology in-house.* Only ERIE does it all. Our many years experience in producing State of the Art high voltage capacitors and high voltage silicon rectifiers — plus an unsurpassed technology in circuit designing, packaging and encapsulation, makes ERIE an ideal source for your high voltage component needs. From very low input voltages, ERIE can produce output voltages up to 50,000 volts. Application for these compact, high reliability devices includes night-vision image intensification systems. Apollo TV cameras. CRT displays. Avionics systems exposed to rugged environments. Industrial, commercial and military equipments . . . an almost infinite variety of applications. So bring ERIE in early. Let us design and build *your* High Voltage Power Supplies and Voltage Multipliers. We're equipped to handle large or small volume orders . . . in-house.

Write for our 32-page catalog . . .  
*High Voltage Components and  
Devices . . . or for technical  
assistance, call*  
613/392-2581

ERIE TECHNOLOGICAL PRODUCTS, INC.  
Erie, Pennsylvania 16512







For the great mass of products and services, the yellow directory is your quick guide to local sources. Likewise, for precision potentiometers and trimmers — especially high-performance cermet types — the Beckman catalogs are your books. Broad standard lines, stocked for you by a nationwide network of dependable local distributors.

In precision pots, you'll find wirewound, cermet, single-turn and multiturn types ranging from 3 up to 40 turns. And, in size, the line goes from 40-turn master pot variety to units as small as 7/8" diameter.

Our cermet trimmers come in low-cost single-turn, multiturn, or DIP types. They typify our long experience and proven

control in materials technology. We develop, improve, and manufacture the materials in these highly stable trimmers. And they assure you wide resistance range, good high temperature/power characteristics, and complete moisture resistance. These are the trimmers for now and the future — their design advantages over wirewound types are many.

Look into our dials, too. The RB vernier-readout, for instance, with 100 graduations per turn. And the 2620, the perfect answer where position setting is a must but the budget permits less than highest precision.

For the complete reading on these Beckman components, ask your nearest distributor for applicable catalogs. They may become your favorite source books.



# Find it fast in these standard reference books.

## Beckman Electronic Component Distributors

### EASTERN REGION

**Arrow/Angus**  
P.O. Box 126  
Moorestown, N.J.  
(609) 235-1900  
(215) 928-1800

**Arrow Electronics, Inc.**  
5207 East Dr.  
Baltimore, Md.  
(202) 737-1700  
(301) 247-5200

**Arrow Electronics, Inc.**  
900 Route 110  
Farmingdale, N.Y.  
(516) 694-6800

**Arrow Electronics, Inc.**  
295 Treadwell St.  
Hamden, Conn.  
(203) 248-3801

**Arrow Electronics, Inc.**  
No. 15 A Street  
Burlington, Mass.  
(617) 273-0100

**Arrow Electronics, Inc.**  
285 Midland Ave.  
Saddle Brook, N.J.  
(201) 797-5800

**Harvey R & D Electronics**  
44 Hartwell Ave.  
Lexington, Mass.  
(617) 861-9200

**Kierulff Electronics, Inc.**  
49 Bestpage Rd.  
Hicksville, N.Y.  
(516) 433-5530

**Kierulff Electronics, Inc.**  
5 Industrial Dr.  
Rutherford, N.J.  
(201) 935-2120

**Lynch-Gentry Associates, Inc.**  
1932 Drew Street  
Clearwater, Fla.  
(813) 443-2697

**Lynch-Gentry Associates, Inc.**  
3470 Bowman Dr.  
Winter Park, Fla.  
(305) 671-7649

**Marshall Industries**  
**G. S. Marshall Products Group**  
88 Needham St.  
Newton Highlands, Mass.  
(617) 965-5115

**Marshall Industries**  
**G. S. Marshall Products Group**  
230 Sherwood Ave.  
Farmingdale, L.I., New York  
11735 (516) 293-4141

**M & C Sales**  
1106 Burke St.  
Winston-Salem, N.C.  
(919) 723-1001

**M & C Sales**  
904 Bob Wallace Ave.  
Huntsville, Ala.  
(205) 539-8476

**Ossmann Component Sales Corp.**  
395 Cleveland Dr.  
Buffalo, N.Y.  
(716) 832-4271

**Ossmann Component Sales Corp.**  
411 Washington Ave.  
Kingston, N.Y.  
(914) 338-5505

**Ossmann Component Sales Corp.**  
280 Metro Park  
Rochester, N.Y.  
(716) 442-3290

**Ossmann Component Sales Corp.**  
132 Pickard Building  
Syracuse, N.Y.  
(315) 454-4477

**Ossmann Component Sales Corp.**  
1911 Vestal Parkway East  
Vestal, N.Y.  
(607) 785-9949

### CENTRAL REGION

**Magnuson Electronics**  
2420 Oakton St.  
P.O. Box 130  
Mount Prospect, Ill.  
(312) 956-0700

**Magnuson Electronics**  
1246 West 7th St.  
St. Paul, Minn.  
(612) 227-8495

**Norvell Electronics**  
10210 Monroe Dr.  
Dallas, Tex.  
(214) 350-6771

**Norvell Electronics**  
6440 Hillcroft Ave.  
Houston, Tex.  
(713) 774-2568

**Norvell Electronics**  
3340 S. Memorial Dr.  
Tulsa, Okla.  
(918) 663-1247

**Sheridan Sales Co.**  
Box 37826  
Cincinnati, Ohio  
(513) 761-5432

**Sheridan Sales Co.**  
Box 4457  
Cleveland, Ohio  
(216) 524-8120

**Sheridan Sales Co.**  
Box 423  
Dayton, Ohio  
(513) 277-8911

**Sheridan Sales Co.**  
33708 Grand River Ave.  
Farmington, Mich.  
(313) 477-3800

**Sheridan Sales Co.**  
P.O. Box 677  
Florissant, Mo.  
(314) 837-5200

**Sheridan Sales Co.**  
Suite 5009  
1717 Penn Ave.  
Wilksburg, Penn.  
(412) 244-1640

### WESTERN REGION

**Almac/Strom Electronics**  
8888 S.W. Canyon Rd.  
Portland, Ore.  
(503) 292-3534

**Almac/Strom Electronics**  
5811 Sixth Ave. South  
Seattle, Wash.  
(206) 763-2300

**Marshall Industries**  
**G. S. Marshall Products Group**  
5633 Kendall Court  
Arvada, Colo. 80002  
(303) 423-9670

**Marshall Industries**  
**G. S. Marshall Products Group**  
835 W. 22nd Street  
Tempe, Ariz. 85282  
(602) 968-6181

**Marshall Industries**  
**G. S. Marshall Products Group**  
9674 Telstar Ave.  
El Monte, Ca.  
(213) 686-0141

**Marshall Industries**  
**G. S. Marshall Products Group**  
17975 Sky Park Blvd.  
Irvine, Ca. 92707  
(714) 556-6400

**Marshall Industries**  
**G. S. Marshall Products Group**  
8057 Raytheon Rd.  
San Diego, Ca.  
(714) 278-6350

**Marshall Industries**  
**G. S. Marshall Products Group**  
788 Palomar Ave.  
Sunnyvale, Ca.  
(408) 732-1100

### Wyle Distribution Group:

**Elmar Electronics**  
6777 East 50th Avenue  
Commerce City, Colo.  
(303) 287-9611

**Elmar Electronics**  
2288 Charleston Road  
Mt. View, Ca.  
(415) 961-3611

**Liberty Electronics**  
124 Maryland Street  
El Segundo, Ca.  
(213) 322-8100

**Liberty Electronics**  
3130 North 27th Avenue  
Phoenix, Ariz.  
(602) 257-1272

**Liberty Electronics**  
8248 Mercury Court  
San Diego, Ca.  
(714) 565-9171

**Liberty Electronics**  
5305 Second Avenue South  
Seattle, Wash.  
(206) 763-8200

**Beckman**

HELIPOT DIVISION

INFORMATION RETRIEVAL NUMBER 94



## Computer Conference products

### IBM-compatible disc and tape heads offered

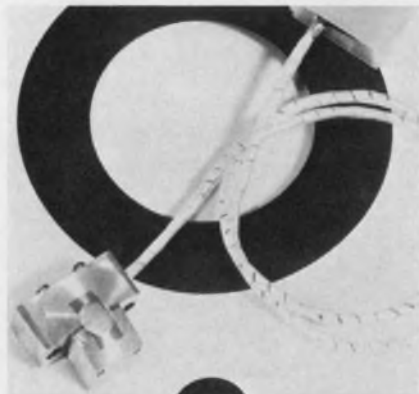

Nortronics Co., Inc., 8101 Tenth Ave. N., Minneapolis, Minn. 55427. (612) 545-0401.

Among the magnetic heads introduced will be a floppy-disc head and a 6250 bit/in tape head—both IBM-compatible. The Model FD-TE4 head is designed for disc speeds of 360 to 375 rpm. It provides a density of 3200 bit/in, 48-tracks/in and a transfer rate of 250-k bit/s. The LTC tape head reads and records data at speeds to 200 in/s with 6250 bit/in density. Maximum crossfeed, write-to-read, is six percent. Other products include heads for 3M cartridge systems, cassette read-after-write heads and heads for credit-card readers.

Booth No. 849 Circle No. 258

### Four new peripherals to be shown

Okidata Corp., 111 Gaither Dr., Moorestown, N.J. 08057. (215) 546-6537.

Four new computer peripheral products: a 500 lpm printer, for heavy-duty applications; a low-cost, 110-cps printer; a line of double-density, head-per-track disc drives, with capacities to 38-million bits; and alphanumeric plasma display panels in 64 and 128-character configurations for use where the CRT is impractical as part of Okidata's display. In addition, a new optical mark reader for punched and marked cards in 300, 450, and 600-card reading speeds, available with an optional RS 232 interface will be shown.

Booth No. 250-252 Circle No. 259

### Strip printer handles two ASCII channels

Electro-Tec Corp., 1600 N. Main St., Blacksburg, Va. 24060. (703) 552-2111. \$750; 30 days.

A dual channel unit, the Model W strip printer, delivers up to 120 char/s for each line printed. The unit can print all 64 upper-case ASCII characters on each of two independent lines. The 5 × 7 dot-matrix characters are spaced eight-to-the-inch on 0.5-in. electro marking tape. Data input to each channel are serial by character. All logic and data lines are TTL compatible.

Booth No. 375 Circle No. 260

### Mix cassette and printer peripherals with CRT



Omron R&D, 432 Toyama Dr., Sunnyvale, Calif. 94086. (408) 734-8400. \$2450 (terminal).

Two peripherals, Model 1020 cassette storage and the Model 2306 printer, can interface with the 8025 CRT terminal. The 8025 terminal is an intelligent unit with modular hardware and modular software design. RAM and ROM memories and interfaces are accommodated by use of printed circuit boards. The designer may select the precise amount of terminal memory and I/O he needs. If he needs to change, the terminal may be expanded in the field, on site. For example, if a system requires a printer, merely plug in an interface PC board and run cable to the printer. If additional RAM (working memory) is desired, add a PC board in 2 k or 4 k increments.

Booth No. 821 Circle No. 261

### Data format controllers work with 4 tape drives

Ampex, 401 Broadway, Redwood City, Calif. 94063. (415) 367-4151. From \$1100; 60 to 90 day.

The DE-800 family of data format controllers includes NRZI only, PE only, or PE/NRI data electronics and operates at tape speeds up to 125 ips. The units operate with up to four tape drives. Model DE-810 is a basic data electronics unit designed to be mounted within a TMA or TMB drive. Either NRZI, PE or both are provided with a digital input/output interface compatible with the current industry standards. Model DE-830 is a data electronics unit providing either NRZI, PE, or both with single-bit on-the-fly error correction capability. Model DE-840 is a format control unit with all of the features of the DE-830 with Pertec, Wangco, or Datum compatible format control features and interface. The DE-850 is a data electronics unit providing either NRZI, PE or both with error correction capabilities that correct unlimited single-bit errors in a record, or up to six consecutive errors in a track. Model DE-860 is a format control unit with all the features of the DE-850 and Pertec, Wangco, or Datum compatible format control features and interface. All DE-800 series units are provided in a standard 19 in. rack mounting chassis requiring 5.25 in. of rack height and 16.3 in. in depth.

Booth No. 645 Circle No. 262

### Magnetic tape drive speeds off-line plotting

Houston Instrument, One Houston Square, 8500 Cameron Rd., Austin, Tex. 78753. (512) 837-2820. 45 days.

The MTR-3 magnetic tape reader is designed specifically for use with the company's COM-PLOT Plotter series. It is available as either a seven or nine-track reader with 200, 556 or 800 bit/in density. The buffered unit for off-line plotting use features forward and reverse block advance and a hardware vector generator to reduce computer preparation time.

Booth Nos. 1011, 1110

Circle No. 263



PROVISIONS  
FOR LEGEND  
STAMPING

NON-SLIP  
ROCKER WITH  
RIBBED ENDS

CAN TAKE THE  
PLACE OF MORE  
EXPENSIVE RELAYS AND  
ROTARY SWITCHES

EXCLUSIVELY DESIGNED  
SWITCHING ELEMENT

INHERENT  
SNAP-ACTION

NO  
MOUNTING  
HARDWARE  
REQUIRED

COMES IN  
3 SERIES -  
8 DIFFERENT  
COLORS

More switching  
COMBINATIONS  
than any other  
ROCKER SWITCH ON  
the MARKET  
TODAY

# NEW SNAP-ACTION ROCKER SWITCHES

At Littelfuse, we've made a switch for the better. But you'll probably consider it a switch for the best.

Especially after you've examined the many features our new snap-action rocker switches have to offer.

To find out more about our three new series of snap-action rocker switches, write for Product Bulletin #1002 . . . or contact your nearest Littelfuse representative.

## LITTELFUSE

SUBSIDIARY OF TRACOR

800 E. Northwest Highway  
(312) 824-1188  
Des Plaines, Illinois 60016



# Centralab perspectives

FOR USERS OF ELECTRONIC COMPONENTS



CENTRALAB

Electronics Division  
GLOBE-UNION INC.

5757 NORTH GREEN BAY AVENUE  
MILWAUKEE, WISCONSIN 53201

## Ceramic capacitors are now available with lead times as short as 6 weeks.

In the last year, Centralab increased production and established a new distribution center. That means they have larger inventories of quality ceramic disc capacitors to meet today's requirements.

In January 1973, when industry-wide lead times on capacitor deliveries were at an unprecedented high, Centralab took positive action. As a result, today they are able to assure the electronics buyer of 12 to 16 week delivery on any of their broad line of reliable disc capacitors. And some types in 6 weeks!

The first step in Centralab's Capacitor Service Program was a drastic one. In January 1973 they began refusing orders rather than accepting them for extended delivery. They then moved to bring to full production a new capacitor assembly plant in Juarez, Mexico. To provide dual sources for raw fired ceramic discs, they increased capacity at their plants in Milwaukee and Mexico City. At the same time, a new Service and Distribution Center was established in El Paso, Texas. Its 40,000 square feet provided for broadening capacitor inventories received from Centralab's five manufacturing locations.

Within six months most large OEM orders were on schedule, the backlog reduced and, with inventories of selected types available, orders were again accepted. Today, with inventories of all types and production facilities running at full capacity, Centralab offers capacitor buyers the only reasonable answer to meet their requirements. A buyer placing an order at the beginning of his 13 or 20 week planning cycle, for example, can be certain of on-time delivery of the types he needs.

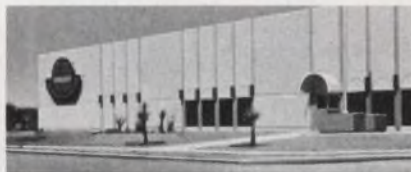

Located just across the border from Centralab's Distribution Center in El Paso, this Juarez, Mexico plant has helped shorten lead times on capacitor delivery.

Centralab's Distribution Center in El Paso is a key reason why today they can provide better service on capacitor orders. Its 10 man customer service staff is equipped to handle any capacitor delivery problem from order entry through special shipments. An application engineering staff is also on call to help with design problems. After reviewing a cus-



Inventories of Centralab capacitors from its Distributor Products stock in Menomonee Falls, Wisconsin are in addition to those in the 40,000 square foot Distribution Center at El Paso to assure customers of off-the-shelf delivery.

tomers' specifications, for example, they may even be able to recommend stock types which eliminate the need for special requirements. That could be important when delivery is critical.

Customer service is important — to the buyer and to Centralab. It requires more than fancy promises. It takes positive action. Centralab has done just that to help you meet your capacitor needs. For further information or assistance, call Bob Michaels at 915/779-3966 or write Centralab, Milwaukee.

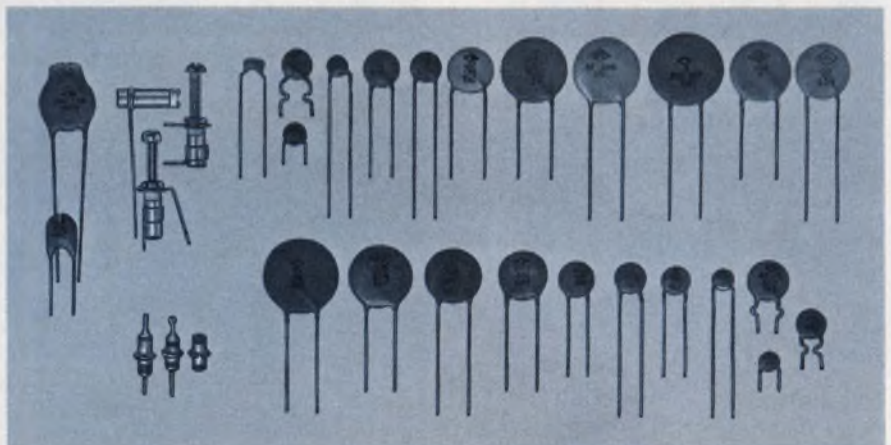

The extensive line of Centralab capacitors includes both disc and tubular types, with sizes and ratings designed for a variety of functions.



## Centralab perspective:

### WHEN THE CHIPS ARE DOWN WE DELIVER!



CAPACITORS  
THAT IS

We said it and we meant it. We're USCC/Centralab and we said we were preparing to meet the capacitor delivery crisis by substantial commitment to automated production machinery and facilities expansion.

We did it, and we've got the chips to prove it — ELEVEN MILLION in stock, most in the following popular sizes:

- BC - .080±.010x.050±.010
- BF - .100±.010x.050±.010
- BI - .150±.010x.050±.010
- DJ - .180±.010x.080±.010
- FH - .125±.010x.095±.010

We'll also deliver non stock and custom chips in not more than 8 to 12 weeks A.R.O.

Whether it's an immediate or future requirement, contact our applications engineering department now at (213) 843-4222.

USCC/Centralab  
2151 N. Lincoln Street  
Burbank, California 91504



## Centralab perspective:

### Trimmer resistors.



### Now, with new Snap-Tite® rigid PC mounts.

When you specify the new Snap-Tite rigid mount you can simplify both installation and assembly. Available on both Centralab Series S carbon and cermet trimmer resistors, it lets you snap them into a PC board. Easy. The mount locks the trimmer securely into the board prior to soldering.

Centralab gives you more of the things you want in trimmers. Ceramic bases for higher wattage in a smaller space. Smooth positive adjustment. A variety of choices in mountings, terminations and knobs. And multiple sections too.

Send for Bulletin 1549T so you'll have all the specs.



## Centralab perspective:

### Pushbutton switches.\* With 4 lockout options.

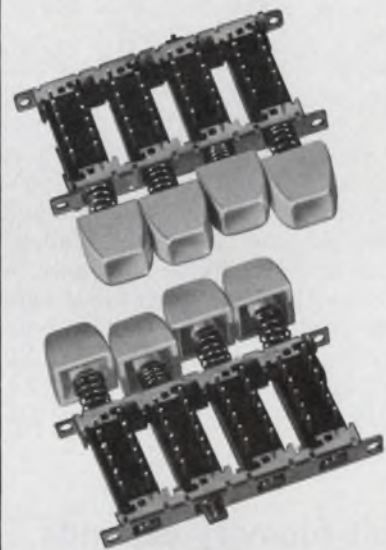

Centralab offers four lockout options for its momentary, push-push and interlocking action pushbutton switch modules. Lockout prevents actuating more than one switch at the same time — even if they're *not* adjacent. Another example of design flexibility. Other features include:

- 10, 12.5, 15, 17.5 and 20 mm spacing options.
- Epoxy sealed terminals.
- Modular LINE SWITCH — mounts in any station.
- 25 button styles and 18 colors.

Write Centralab for  
Bulletin 1550.

\*Isostat licensed





## Semicon memory matches PDP-11 speeds



*Monolithic Systems Corp., 2700 S. Shoshone, Englewood, Colo. 80110. (303) 761-2275. See text.*

Monostore III, a new add-on semiconductor memory designed especially for the PDP-11, expands the system by up to 32-k × 16 bits. Because its 450-ns access and 650-ns cycle times match the optimum speed of the PDP-11's Unibus, Monostore III offer a 20% gain in throughput over conventional core memories. It's fully Unibus compatible and priced at just 1.2 cents/bit.

*Booth No. 127      Circle No. 264*

## Fast memory expands to 128-k, 18-bit words



*Dataproducts Corp., 6219 De Soto Ave., Woodland Hills, Calif. 91364. (213) 887-8465. \$2000 (quan); 120 days.*

A planar core-memory system designated the Store/1618 provides a capacity of 16,384, 18-bit words. The 3-D, 3-wire, planar memory system features 700-ns cycle time and 275-ns access time. Up to eight, 16-k modules can be daisy-chained to form a system with a capacity up to 128-k words. Core arrays and all electronics are housed in a module that measures 12 by 14 by 0.85 in. and contains two circuit boards.

*Booth No. 309      Circle No. 265*

## Disc drives feature 200 tracks per inch



*Wango Inc., 5404 Jandy Pl., Los Angeles, Calif. 90066. (213) 390-8081. Start at \$3200; 60 days.*

This new series of magnetic disc drives features 200 track per inch capability and is said to provide twice the data storage capacity of comparable devices in only 7 in. of rack height. The front-loading Series-F, Model F-2222, has a capacity of 100 Mb, recording 2200 bpi on 200 tracks/in. The top-loading Series-T, Model T-2422, has a capacity of 200 Mb, recording at a density of 4400 bpi. The Model T-2222, recording 2200 bpi, has a capacity of 100 Mb.

*Booth Nos. 843, 845, 847*

*Circle No. 266*

## Intelligent terminal uses microprocessor



*Digi-Log Systems, Babylon Rd., Horsham, Pa. 19044. (215) 672-0800. From \$1600; 30 days.*

The Series 3300 CRT terminals are microprocessor controlled and can be tailored to the users' needs. User selectable features include page formats of up to 80 char. × 24 lines, protected fields, and addressable cursor. Editing capabilities include line insert, character insert and line delete. The wide variety of communication disciplines includes transmission by character, page, line or message; self-generated or remote polls, and programmable speed switching (75—9600 bit/s).

*Booth No. 478, 480 Circle No. 267*

## Minicomputer systems offer wide versatility



*Microdata, 17481 Red Hill Ave., Irvine, Calif. 92704. (714) 540-6730.*

The 1600 series of minicomputers is microprogrammed and microprogrammable. The 3200 series computer has a 32-bit microinstruction word length, 16 bit data path, MOS main memory and push-down stack processor architecture. One of these computers (32/S) is programmed by using a high-level language called MPL which is patterned after the popular PL/I language. The series 6000 tape drive is IBM compatible, runs at speeds between 12.5 and 45 ips and uses 10.5 in. reels. The series 6800 is identical to the series 6000 except for size—it uses 8.5 in. reels. The series 9000 disc drive has a 200 tpi density and a 2400 rpm rotational speed.

*Booth No. 751      Circle No. 268*

## Clutchless tape readers offer quiet operation

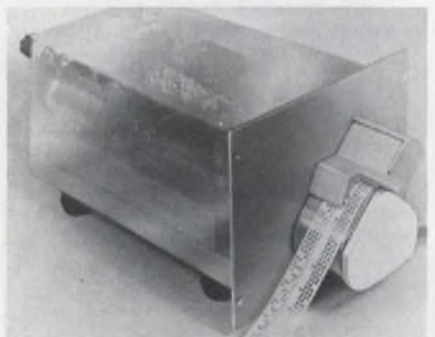

*Electro-Tec Corp., 1600 N. Main St., Blacksburg, Va. 24060. (703) 552-2111.*

The AR Series of paper tape readers offers speeds up to 500 char/s with asynchronous operation. The units feature LED light sources and TTL signal levels. The absence of clutches and brakes assures quiet operation.

*Booth No. 375      Circle No. 269*



## Time-share terminal shows 1920 characters



Westinghouse Canada Ltd., P.O. Box 510, Hamilton, Ontario, L8N 3K2, Canada. (416) 528-8811. \$1100.

1620 CRT Terminal meets the needs of time-share and minicomputer users for an unbuffered, interactive terminal. The unit displays up to 1920 characters, transmits and receives at various data rates to 9600 BPS (960 characters per second) and can operate with a tape cassette and/or printer either on or off line. Standard features include a keyboard with numeric pad and 80 characters  $\times$  24 lines presentation.

Booth No. 941-3 Circle No. 270

## Reader handles punched or marked cards



Documation, P.O. Box 1240, Melbourne, Fla. 32901. (305) 724-1111. 60 days.

One head of the "T" series card reader handles conventional punched data. The second head reads in two optical-mark modes: cards with registration marks and cards without registration marks. The three-in-one readers are available in speeds of 150, 285, 300, 600, 1000 and 1200 cards/min. The system is expected to save users 40% of the cost of two readers.

Booth No. 867-869 Circle No. 271



## We can deliver the world's smallest 180° air variable capacitors. On time.

And since we're nice people, we don't even charge much for them. So if you have an application that calls for a sub-miniature capacitor that you can "tweak" to a specific frequency, these Johnson trimmers are ideal.

You can choose from either PC or stripline mount, either vertical or horizontal tuning. These Type "T" capacitors are about one-third the size of the familiar type "U" capacitors, so you can save space, cut costs and insure improved performance in the most compact electronic equipment.

Rotors and stators are precision-machined from solid brass extrusions, resulting in exceptional stability and uniformity. High Q—typically 2000 at 150 MHz. Temperature coefficient is a low plus  $30 \pm 15$  ppm/°C. High torque (1½ to 8 oz./inches) holds rotor securely under vibration. They're designed to meet or exceed EIA-RS 204 and MIL Standard 202C Methods 204A and 201A.

In short, these capacitors may be just what you've been looking for. It'll only cost you a stamp to get more information. And if you give us your phone number, we'll call you and send free samples after we have clarified your application.

E. F. JOHNSON COMPANY  
3005 Tenth Ave. S.W. / Waseca, MN. 56093

- Please send me technical information on the type T.  
 Also, include information on your entire line of variable capacitors.  
 I want test samples. Please call me at \_\_\_\_\_  
 NAME \_\_\_\_\_  
 TITLE \_\_\_\_\_  
 FIRM \_\_\_\_\_



ADDRESS \_\_\_\_\_  
 CITY \_\_\_\_\_ STATE \_\_\_\_\_ ZIP \_\_\_\_\_

**E. F. JOHNSON COMPANY**



Electronic Design, The Financial Times (London)  
 Electronics Weekly (London) and BOAC  
 announce the sponsoring of

# "TOMORROW IN WORLD ELECTRONICS"

a major international conference to coincide  
 with the International Instruments, Elec-  
 tronics and Automation Exhibition (IEA).

**GROSVENOR HOUSE, LONDON – MAY 14-15, 1974**

This conference, to be addressed by a panel of the electronics commu-  
 nity's most distinguished members, will consider current and future  
 technological developments in the world, and assess the challenges they  
 pose for management, marketing and financial functions in the interna-  
 tional electronics industry.

**Day One - May 14**

Chairman: Dr. C. Lester Hogan  
 President, Fairchild Camera and  
 Instrument Corporation

Mr. Earl Wantland  
 President, Tektronix, Inc.

Mr. Edward Fennessy, CBE  
 Managing Director  
 Post Office Telecommunications

Mr. Sebastian de Ferranti  
 Chairman and Managing Director  
 Ferranti Ltd.

Speaker to be announced

Dr. Ieuan Maddock, CB, OBE  
 Chief Scientist  
 Department of Trade and Industry

Mr. David Price, MP  
 Chairman, The Parliamentary  
 Committee for Technology

Speaker to be announced from  
 Commission of the  
 European Communities

Mr. Gordon Haley  
 Manager, Systems Technology  
 ICL Computer Development Div.

**Prospects for  
 Semiconductors**

**Prospects for  
 Electronic Instruments**

**Prospects for  
 Telecommunications**

**Electronics  
 in the 1980's**

**The International  
 Military Market for  
 the Electronics Industry**

**The Commercial  
 Exploitation of  
 Electronics Research**

**Government Policies  
 for Electronics  
 (Luncheon Speaker)**

**The Growth Potential  
 of Electronics in the  
 European Community**

**Future Computer  
 Technology**

**Day Two - May 15**

Chairman: M. R. J. Clayton, CBE  
 Technical Director  
 The General Electric Company Ltd.

Dr. J. Fred Bucy, Jr.  
 Executive Vice President  
 Texas Instruments Inc.

Mr. J. C. Akerman  
 Managing Director  
 Mullard Limited

Dr. Robert Heikes  
 Managing Director  
 Motorola Europe, Switzerland

Speaker to be announced

Mr. John Fluke, Sr.  
 Chairman  
 John Fluke Manufacturing Co., Inc.

Dr. Edward David  
 Executive Vice President  
 Gould, Inc.  
 Former Science Adviser to the  
 President of the United States

Dr. William Hittinger  
 Executive Vice President  
 RCA Corporation

Monsieur Edouard Guigonis  
 Directeur Delegee and Directeur  
 Commercial General, Thomson CSF

**Vertical Integration:  
 Components to Systems**

**Performance and  
 Prospects in the World's  
 Electronics Industries**

**The Role of an  
 American Multi  
 National in Europe**

**Japanese Electronics  
 in World Markets**

**New Challenges to the  
 Instrument Industry  
 (Luncheon Speaker)**

**Electronics and Energy**

**The Future of World  
 Consumer Electronics**

**International  
 Cooperation  
 in Electronics**

To register for the conference use the coupon below. We will be pleased to assist  
 you in securing trans-atlantic flight reservations and London hotel accommodations.  
 Registration fee for "Tomorrow in World Electronics" is \$200.

**REGISTRATION FORM**

**"TOMORROW IN WORLD ELECTRONICS"**

A major international conference sponsored by Electronic Design, The Financial Times, Electronics Weekly and BOAC.  
 Please register the following individual:

Name \_\_\_\_\_ Title \_\_\_\_\_

Additional registrations:

    Name \_\_\_\_\_ Title \_\_\_\_\_

    Name \_\_\_\_\_ Title \_\_\_\_\_

Company \_\_\_\_\_ Division \_\_\_\_\_

Address \_\_\_\_\_ Telephone \_\_\_\_\_

City \_\_\_\_\_ State \_\_\_\_\_ Zip \_\_\_\_\_

**Mail this registration form to:**  
 Ms. Gay Donnelland  
 Electronic Design / Financial  
 Times Conference  
 Financial Times  
 Publications, Ltd.  
 Suite 1006  
 516 Fifth Avenue  
 New York, N.Y. 10036  
 (212) 869-3971

Registration fee: \$200 per person.  
 Make check payable to: Financial Times Ltd.  
 Payment enclosed.     Please bill me. I would like assistance in  flight  hotel reservations.



## CONFERENCE PRODUCTS

### Interactive terminal gives 16 functions



Lear Siegler Inc., 714 N. Brookhurst St., Anaheim, Calif. 92803. (714) 774-1010. Under \$3000; 3 mos.

ADM-2 interactive display terminal provides the user with flexibility of format, editing, interface and transmission. Sixteen function keys permit the operator a wide choice of commands. The basic keyboard is a standard 53-key TTY and, in addition to the 16 function keys, also contains a numeric 10-key pad. The CRT measures 12 in. diagonally, with a P4 phosphor, and can display 960 or 1920 characters, upper or lower case, on a 12 or 24-line format.

Booth No. 216-217 Circle No. 272

### Semiconductor memory delivers 1.28 G bit/s

Intel Corp., Memory Systems Div., 365 Middlefield Rd., Mountain View, Calif. 94040. (408) 246-7501.

First developed as a custom memory for a large systems manufacturer, the unit consists of two independent bipolar memories each containing 8-k, 16-bit words. The system has an effective data rate of 1.28 gigabit/s. One memory can be read while the other is loaded (and vice versa.) Or, both memories can operate in parallel to form a 16-k  $\times$  16-bit system. The IN-50 PC cards are used in this ECL memory. Each card contains 1-k, 8-bit words and offers 100 ns cycle and access times. Other memories to be shown include the in-26 available in increments of 4-k  $\times$  9 (1¢ a bit) and the in-60 a semiconductor memory that stores 200-k bits serially on each PC card.

Booth No. 711 Circle No. 273

# if you're into...

# ANALOG FILTERS

- **WIDE RANGE**—CUT-OFF FREQUENCIES FROM 0.001 Hz to 1.1 MHz
- **DIGITAL TUNING**—INSTANT RESETTABILITY
- **FLEXIBILITY:**
  - Modes:** Low pass, high pass, band pass, band reject, notch.
  - Roll-Offs:** 24, 48, & 96 db/octave
  - Functions:** Butterworth, Bessel, RC.
  - Passband Gains:** 0, 20, 40 db
- **REMOTE PROGRAMMABILITY**—A *ROCKLAND EXCLUSIVE!*

## DUAL HI/LO: Models 1022F and 1042F



**Frequency Range:** .001 Hz to 111 KHz  
**Roll-Off:** 24 db/octave/section (1022F)  
48 db/octave/section (1042F)  
(Cascading sections doubles roll-off)  
**Responses:** Butterworth, RC.  
**Passband Gains:** Selectable 0, 20, 40 db.

## VARIABLE ANALOG: Models 1100 and 1200



**Frequency Range:** 10 Hz to 1.1 MHz  
**Roll-Off:** 24 db/octave  
**Response:** Butterworth and Bessel  
**Passband Gain:** 0 db.

## PROGRAMMABLE DUAL HI/LO: Series 1500



**Programming:** Local and/or Remote of all Functions

**Frequency Range:** 0.001 Hz to 111 KHz  
**Roll-Off:** 24 db/octave/section  
(Cascading sections doubles roll-off)  
**Response:** Butterworth, RC.  
**Passband Gain:** 0, 20, 40 db.  
**Programming options:**  
02; 1-2-4-8 BCD positive logic,  
03; 1-2-2-4 BCD positive logic.

# ...you're into ROCKLAND

For immediate information on how Rockland can meet your specific application and delivery requirements — call our local rep or Dave Kohn directly at:

**Rockland Systems Corporation** 230 W. Nyack Road, West Nyack, N.Y. 10994  
(914) 623-6666 • TWX 710-575-2631

INFORMATION RETRIEVAL NUMBER 97



## Floppy disc drive has IBM compatibility

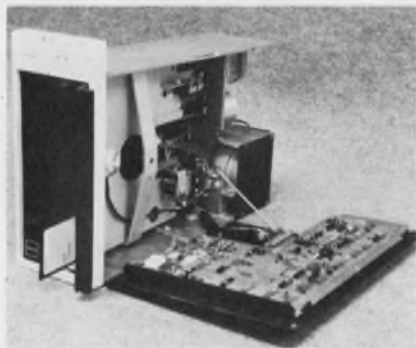

*Innovex, 75 Wiggins Ave., Bedford, Mass. 01730. (617) 275-2110. \$750; 45 day.*

The Model 210 disc drive is compatible to the disc drive used in the IBM 3740 data entry system. A number of operator oriented features have been incorporated into the 210. The drive can be operated in any orientation without modification. In the vertical position, four drives fit in one 19 in. rack, occupying 10.5 in. of rack height including mounting hardware. The 210 has a capacity of 3.1-million bits, a track-to-track seek time of 10 ms, and an average latency of 83 ms. Diskette cartridges written on any of the IBM 3740 line of equipment can be read on the Model 210 drive and vice versa.

*Booth No. 348, 350 Circle No. 274*

## Tape-cassette drive offers $1 \times 10^8$ error rate

*Interdyne, 14761 Califa St., Van Nuys, Calif. 91401. (213) 787-6800. \$390 (100); 30 days.*

The IC-2400 digital tape-cassette drive offers mechanical reliability, low error rate and useful life, equivalent to present IBM compatible reel-to-reel tape handlers. Featured are a servo capstan drive; a rugged die cast frame; an error rate of less than  $1$  in  $10^8$  bits recoverable and  $1$  in  $10^9$  bits nonrecoverable; full compliance with ANSI/ECMA standards; cassette interchangeability; cassette pressure bypass pad; no mechanical brakes, clutches or belts; and flexibility of bidirectional write/read at any speed between 4 ips and 20 ips. Speeds may be programmed separately.

*Booth No. 1124 Circle No. 275*

## Lighted dpdt pushbutton switches go 100-k cycles

*Clare Pendar, P.O. Box 785, Post Falls, Idaho 83854. (708) 773-4541. For 1000 up: \$1.62 (momentary), \$1.92 (alternate action).*

The S190 lighted pushbutton switch series offers dpdt switching in momentary or alternate action. The switches use dual wiping contacts, and can switch 100,000 cycles at 2 A resistive or 250,000 cycles at 100 mA resistive. Widely spaced silver inlay terminals accept either two #22 AWG soldered wires or 0.11-in. quick connect receptacles. All molded parts are thermoplastic material SE-O rating (new U.L. designation is 94VE-O). Neck bushings are provided for sub-panel installations while front panel mounting is accomplished with any of five differently sized mounting adaptors, with or without barriers. Lenses, available in square, rectangular and round configurations, are custom engraved in letter sizes ranging from 0.093 to 0.25 in. high.

*Booth No. 934, 936 Circle No. 276*

## Printer/plotters deliver 500-ft drawings silently

*Versatec, 10100 Bubb Rd., Cupertino, Calif. 95014. (408) 257-9900. \$12,300 (Model 2030); \$14,900 (Model 2030A).*

The Model 2030 matrix plotter and 2030A printer/plotter use 20-in. wide paper in lengths up to 500 ft. and print electrostatically. The plotter provides 100 nib/in. resolution for a total of 1856 nibs (18.56-in. plot) and 232 bytes provide one scan of the plotted data. An incremental stepper motor drives the paper at speeds up to 3-in/s. The printer/plotter has the same plotting characteristics as the matrix plotter and, in addition, can print 232,  $7 \times 9$  dot-matrix characters across the page from ASCII input data. The 20-in. paper width permits 80 or 132 column printing on one side and simultaneous raster-scan plotting the remainder of the paper width. Also, print and plot data can be intermixed. The manufacturer offers controllers as well as software for use with many mini and mid-computers.

*Booth No. 937, 939 Circle No. 277*

## CRT terminals come with six formats



*Ann Arbor Terminals, 6107 Jackson Rd., Ann Arbor, Mich. 48103. (313) 769-0926. See text.*

The Design III series of CRT terminals features contemporary molded-case design. Each terminal includes a 14-in. CRT monitor and modular circuit cards that are interchangeable with the manufacturers series 200 display controllers and keyboards. The series is available in 16 RO, KSR and ASR models. Users are offered six display formats (up to 3200 characters) plus upper and lower-case displays. Prices start at under \$1000. For greater economy the user can assemble CRT terminals around the Series 200 controllers which offer a display capability of up to 3200 characters plus a choice of seven display formats.

*Booth No. 379 Circle No. 278*

## Modems use MOS LSI circuits

*International Communications Corp., 7620 N.W. 36th Ave., Miami, Fla. 33147. (305) 691-1220.*

Modem 20-LSI and 24-LSI transmit data at 2000 bps and 2400 bps, respectively. A remote test feature provides error diagnosis in point-to-point or multi-point systems from a single site. A status panel display enables on-line evaluation of the data communication system. The LSI series also features ICC's Fastar, which reduces personnel time and telephone company toll charges by minimizing turn-around delay on dial circuits. The modems operate over the public dial-up network as well as dedicated lines. They are on-line compatible with ICC's Modem 2200 series, as well as Telco's 201 series data sets.

*Booth No. 517 Circle No. 279*





# STRIKE GOLD

## ...every time you depress a CHERRY KEYBOARD SWITCH

Cherry's unique gold "crosspoint" contacts plus simplified electronics enhance reliability and provide long life . . . low profile . . . lower power consumption . . . low, low cost. The crossed knife-edge contact configuration has been tested to 50,000,000 operations and beyond. Available from stock with a wide variety of key legends and colors. Or, buy them as part of a keyboard package, ready to slip into your panel. Either way is economical the Cherry way.

When you need keyboard switches or complete keyboards for numerical control, calculators, computer terminals or other applications, strike gold with Cherry—and save silver at the same time.

**FOR A FREE TEST SAMPLE** and a copy of our latest complete-line catalog just TWX 910-235-1572 . . . or PHONE 312-689-7700 . . . or circle appropriate reader service number.



# CHERRY



**CHERRY ELECTRICAL PRODUCTS CORP.**  
3609 Sunset Avenue, Waukegan, Illinois 60085

**Cherry Worldwide:** (Subsidiaries) Hirose Cherry Precision Co., Ltd., Tokyo • Cherry Mikroschalter GmbH, Bayreuth, Germany  
• Cherry Electrical Products (U.K.) Ltd., St. Albans, Herts • (Licensee) G.W. Engineering Pty. Ltd., Sydney



INFORMATION RETRIEVAL NUMBER 98





**One thousand one...  
 one thousand two...  
 one thousand three...  
 one thousand four...  
 one thousand five...  
 one thousand eight  
 hundred one...  
 two thousand...  
 two thousand one...  
 that's how you count  
 to 1.4 GHz in sweepers.**

It's also how to tell the story of the most complete line of sweepers in the business. Our latest additions include the 1801A for CATV equipment testing and the 2000—a less expensive version of the spectacular 2001. All of our sweepers have rugged, solid-state designs and are suited for laboratory, production and systems use. They are available with both 50-ohm and 75-ohm calibrated RF outputs and feature pin-diode leveling, crystal-controlled markers and excellent display linearity characteristics. All include remote programming of frequency and sweep width, and can be AM or FM modulated. If you'd like more information, use the reader service card or get in touch with us directly. You can count on an immediate response.

**SWEEPER MODELS\***

1001A	0.5 MHz to 300 MHz	\$ 995
1002	1 MHz to 500 MHz	1095
1003	350 MHz to 650 MHz	995
1004	500 MHz to 1 GHz	995
1005	700 MHz to 1.4 GHz	995
1801A	1 MHz to 950 MHz	1445
2000	1 MHz to 1.4 GHz	1375
2001	1 MHz to 1.4 GHz	1695

\*We also offer a complete line of attenuators and detectors covering the same frequency ranges.

**WAVETEK®**

INDIANA INCORPORATED  
 P.O. Box 190, 66 North First Avenue  
 Beech Grove, Indiana 46107  
 Tel: (317) 783-3221 TWX 810-341-3226

INFORMATION RETRIEVAL NUMBER 99



## new products

### Time-share graphics plotted automatically on a scope

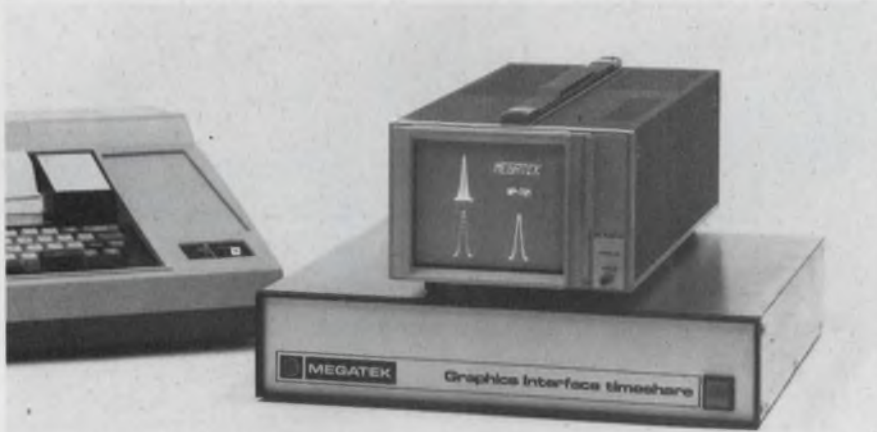

Megatek, 1055 Shafter St., San Diego, Calif. 92106. (714) 224-2721. See text; stock to 30 day.

Plotting curves from data received on a time-shared computer terminal is tedious if you do it by hand. It can be done automatically on any oscilloscope or other X-Y display with the BP-734 Time-share Graphics Interface, by Megatek. The unit operates directly from a computer's RS-232 communications port.

Installation requires no mechanical or electrical modifications either to the time-shared terminal or the oscilloscope. You merely apply either a current loop or RS-232 serial data to the terminal's data-set connector, switch to the desired baud rate and connect the analog outputs to the X, Y and intensity inputs of your display.

An optional semiconductor memory provides refresh to display from 256 to 1024 points in a flicker-free mode. Vectors can be drawn with 16 combinations of vector and end-point intensity. With 8 and 10-bit versions of the interface,

resolutions of  $\pm 0.2\%$  and  $\pm 0.05\%$ , full scale, are available. Selected parts of the display can be changed at will without need to erase and rewrite the entire display.

The baud rate is selectable to provide 10 or 30 characters per second for time-share users or up to 2400 baud for direct connection to a local computer.

Megaplot, a subroutine callable from Fortran or Basic, is supplied with the system for use on the major time-sharing services. Entry or change of a displayed vector requires the transmission of six characters, which are generated by the subroutine when called in place of a Print statement in the user's program. When operated in parallel with a 30-character-per-second terminal, the BP-734 can plot five vectors a second. Forty vectors a second can be plotted when the interface is used with a high-speed communications line at 2400 baud.

Prices range from \$1595 for the 8-bit model, with 256-vector capacity, to \$2495 for the 10-bit model, with 1024-vector capacity.

CIRCLE NO. 255

### Display controller makes TV a CRT terminal



Digi-Log Systems, Babylon Rd., Horsham, Pa. 19044. (215) 672-0800. See text; 30 days.

A portable ASCII display controller/RO terminal capable of outputting data to both video monitors and ordinary TV sets, the Series 300 Display Controller measures  $4 \times 11 \times 12$ -in. and weighs 10 pounds. The Series 300 is capable of driving multiple displays (up to 10) in different locations. The user can replace the existing Model 33 TTYs where a keyboard is not required, or use both the TTY and the controller so that large groups can observe what is taking place at the TTY. Standard units provide a 7-bit parallel interface with an asynchronous data rate to 1200 char/sec. Optional serial interfaces (RS 232 and current loop) are available. The Model 305 (\$790) displays up to 40 characters by 16 lines, the Model 306 (\$875) outputs 80 characters by 16 lines.

Booth No. 478, 480 Circle No. 280

### Digitizing system has 0.001-in. resolution

Broomall Industries, 682 Parkway, Broomall, Pa. 19008. (215) 353-4610. \$8900.

The model D100 digitizing system includes a  $40 \times 60$ -in. table plus all electronics. The system records sequentially numbered points of x-y coordinate data on card or tape punches, TTYs or magnetic tape. Resolution is 0.001 in. Data are accepted in parallel and presented sequentially (one character at a time) to the output recorder. The data are sequenced in accordance with a patchboard program format. The unit features multiple output to any number of customer selected devices.

CIRCLE NO. 281



# Our line is open

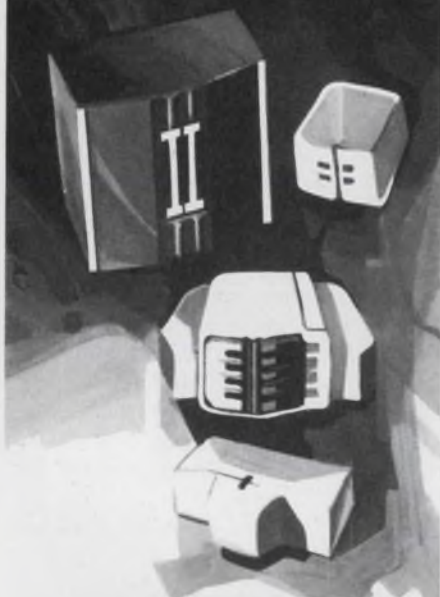

Nortronics is ready to fill your digital head needs for 1/2" IBM Compatible, 1/4" Cartridge, .150" Cassette and Floppy Disk applications.

Nortronics also manufactures the broadest range of audio heads in the world.

Our engineering department is prepared to work with your engineering group on new product development.

Call us.  
Our line is open.



## NORTRONICS

Company, Inc.  
8101 Tenth Ave. North, Minneapolis, Minn. 55427  
Telephone (612) 544-0381

## Fiber-optic link transmits data at 80 Mbit/s for 100 ft.

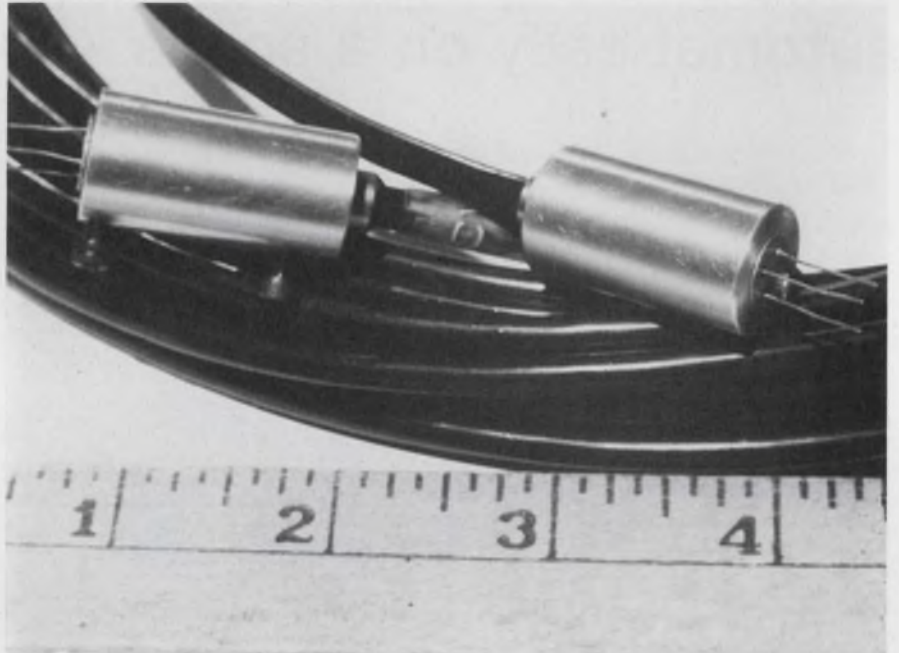

*Meret, 1815 - 24th St., Santa Monica, Calif. 90404. (213) 828-7496. See text; stock to 2 wk.*

Data rates of up to 80 Mbit/s can be transmitted up to 100 ft. with little signal degradation with the Modal cable from Meret. This tops the performance of its closest competitor—the Opticable from Quadri (2950 W. Fairmont, Phoenix, Ariz. 85017). The latter handles 5 Mbit/s for 10 ft. or 900 kbit/s for 100 ft.

In the MDL300 Modal Series, various cables are available, depending upon the data rate required. For a 100-ft. length of 4 Mbit/s cable, the signal-to-noise ratio at the output terminal is better than 2000:1. For the 50 Mbit/s cable, the S/N is better than 50:1, and for the 80 Mbit/s cable, it's 10:1.

The transmitter and receiver terminations of the cable are housed in modified 3-pin, TO-5 header packages. These electrically terminate ferrule-ended fiber-optic cables 1 to 3 mm in diameter, with

minimum loss at the 850-to-900-nm signal wavelength. The transmitter requires +5.5 V, and it has a current drain at 50% duty cycle of 200 mA at maximum power output. Trigger signals are applied at the third pin on the header.

Power-supply requirements for the receiver are for a single B+ of between +5.5 and +15 V at a current drain of less than 6 mA. The single power supply provides bias for the p-i-n photodiode and for the voltage requirements of the receiver transimpedance amplifier.

A 100-ft. cable, including the terminating modules, weighs less than 250 grams.

Prices for the Modal cable assemblies range from \$270 to \$600 in single quantities, depending upon the data rate. Though designed for TTL digital input, the transmitter can be converted to an analog emitter for about \$100.

Quadri's Opticable sells for \$185 for a 10-ft. length and \$197.50 for 100-ft.

For Meret  
For Quadri

CIRCLE NO. 256

CIRCLE NO. 257



# Cooling, lifting, holding, pulling, damping, drying...

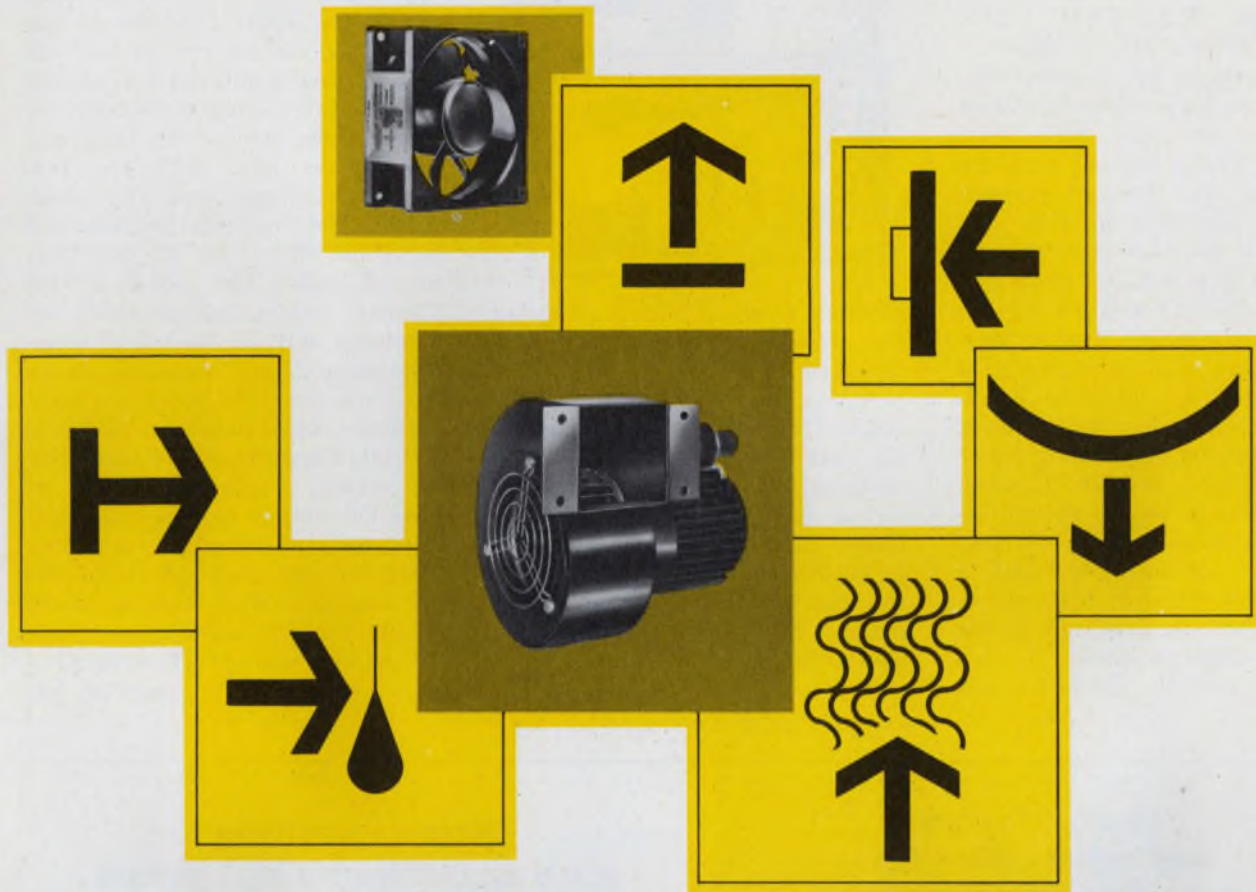

## Rotron has a way...with air

Air, in the hands of the world's most advanced manufacturer of precision air moving devices, has a potential for doing things that designers and manufacturers are beginning to appreciate.

Forced convection cooling of electronic equipment—providing for more densely packaged components with equal or even greater system reliability—is just one of the jobs air, by Rotron, performs so well.

In buffer columns and tape hold downs and a dozen other non-cooling applications within the electronics industry alone, air moving devices from Rotron simplify system design, increase both efficiency and reliability.

Rotron's extensive line of air movers require an absolute minimum of space (as little as 1 cu. inch). They're quiet. (As low as NC 20). They consume surprisingly little power (a low of 5 watts). And they are exceptionally reliable. (Ten years and more of continuous duty without maintenance.)

Learn more about the Rotron line of fans and blowers, with pressures to 165" wg., flows to 2600 cfm. Contact your local Rotron representative or distributor or write us directly.

*Why settle for less when the best costs no more.*



**ROTRON INC.**

Woodstock, N. Y. 12498 □ 914 • 679-2401 □ TWX 510-247-9033  
Pacific Div., Burbank, Cal. 91506, 213•849-7871 • Rotron B.V., Breda, Netherlands, Tel: 79311, Telex: 844-54074

INFORMATION RETRIEVAL NUMBER 101



## Stable modem needs no alignment

Timeplex, 100 Commerce Way, Hackensack, N.J. 07601. (201) 646-1155. From \$205; 30 days.

The Timeplex 202 modems feature zero foldover distortion with operation to 1800 bit/s over direct-dial phone lines at very low error rates. And the unit, compatible with Bell System 202C and 202D units, operates at 2000 bit/s on private lines with C2 conditioning. The stability attained by use of crystal-controlled transmitters and receivers eliminates the need for alignment or retuning. Available options include a synchronizer for synchronous data and a 5-bit/s or 50-bit/s reverse channel. Other products to be shown include a 96-channel time division multiplexer, Model T-96, and a channel concentrator that allows 32 calling terminals to contend for up to 16 computer ports.

Booth No. 358-360 Circle No. 282

## Card-to-tape converter boasts high speed



Datatex Corp., 10935 S. Wilcrest Dr., Houston, Tex. 77072. (713) 495-3100. From \$7000; 60-90 days.

A tape converter designated the Model CTP-60 punches at rates to 75 char/s and reads 60 to 150 cards/min. Paper tape output can be in EIA, ASCII or Modified codes. Card input formats of up to 65 characters are decoded. And the unit rejects cards with punch errors. Mark-sense capability is also available.

CIRCLE NO. 283

## Low-cost modems can replace Bell datasets

Tele-Dynamics, 525 Virginia Dr., Fort Washington, Pa. 19034. (215) 643-3900. See text.

Priced in the \$200 to \$400 range, the 7103-LC series of low speed modems can replace Bell 103 and 113 series data sets. The units provide full duplex operation over private line, or over the DDD network when used with the Dial Access Arrangements. The interface to the business machine can be either EIA, TTY 20 ma, TTL, or MIL-188C. The models in the 7103-LC Series include types for originate only, answer only, originate/answer, and automatic originate/answer. All accept asynchronous serial data at rates up to 300 bit/s and use FSK modulation. A switch provides loopback of terminal output to input for isolated tests of terminal equipment. Desk top and rack-mounted units are available. With integral power supply, the desk top unit measures 4 high by 6 wide by 12-in. deep.

CIRCLE NO. 284

## 10MHz 5" scope with easier calibration and voltage measurement



Model 1465 \$400

Here are some B&K extra touches. Besides DC-to-10MHz bandwidth, triggered sweep, automatic sync, 16.6mV/cm vertical sensitivity, DC-coupled amplifier and front-panel Vectorscope capability, Model 1465 also has 5X magnification to increase sweep speed to 0.2usec/cm for complex waveform analysis. And Cali-Brain®, which collapses horizontal sweep to let you measure instantaneous peak-to-peak voltage easily while simultaneously displaying the full-scale voltage range. Now in stock at your local distributor or write Dynascan.

**B&K** PRODUCTS OF  
**DYNASCAN**  
1801 W. Belle Plaine Ave.  
Chicago, IL 60613 • (312) 327-7270

INFORMATION RETRIEVAL NUMBER 102

## Here's everything you'd expect from a high-priced signal generator.

### Except a high price.

Our new B&K Model 2050 Solid-state RF Signal Generator has features other companies charge much more for. Look at our specs: 100% Solid-state silicon circuitry with FET's in RF and audio oscillator stages. 6 bands with 1.5% accuracy from 100 kHz to 30 MHz. 3 outputs: RF, modulated RF (400 Hz), and externally modulated RF. Positive anti-backlash dial drive. Zener-regulated power supply. You needn't pay high prices for versatility, accuracy and reliability—now there's the Model 2050. And that's just what you'd expect from B&K.

Contact your distributor, or write Dynascan Corporation.

**\$100<sup>00</sup>**



**B&K** Very good equipment at a very good price.  
Dynascan Corporation.  
1801 West Belle Plaine Avenue, Chicago, Illinois 60613

INFORMATION RETRIEVAL NUMBER 103

ELECTRONIC DESIGN 9, April 26, 1974



## Terminal's IQ ranges from dumb to genius

Incoterm Corp., 6 Strathmore Rd., Natick, Mass. 01760. (617) 655-6100.

The SPD-20/20 can be anything a user wants it to be—from a dumb communications terminal to a powerful remote data processing system. A single SPD-20/20 processor is capable of controlling the passage of data to and from up to 56 different devices simultaneously—including eight I/O channels, 16 printers, 16 keyboards and 16 visual display units. Each of the major components of a SPD-20/20—memory, controllers, keyboard, and display—can be operated completely under software control. From 8-k to 32-k bytes of programmable main memory are available with the terminal. Complementing the flexible processing power of the system is a full range of peripheral equipment and communications options that allow the system to perform the following terminal processing functions, including: inquiry, data entry, remote batch and transaction processing.

CIRCLE NO. 285

## Plug compatible core memory holds $16 \times 16$ k

Dataram, Princeton-Hightstown Rd., Cranbury, N.J. 08512. (609) 799-0071. \$2840.

The DR-1200,  $16 \times 16$  kbit core memory fits on one  $15 \times 15$  in. circuit board. It is plug-compatible with the Data General Nova 1200, 1210 and 1220 minicomputers and all standard Nova 1200 peripheral devices. It is also compatible with Digital Computer Control's 116875 memory used in its D-116 and D-116E minicomputers. System construction permits 0.5 in. center-to-center spacing between adjacent memory modules. Cycle and access times are 1200 and 400 ns, respectively. Half-cycle read or write operations require 600 ns. Address strapping is accomplished by appropriate wiring of a 16-pin IC socket which is accessible via a cutout in the protective shield which covers the entire component side of the memory module. Temperature range is 0 to 55 C. Booth No. 269, 271 Circle No. 286

NEW  
FROM  
AIRPAX



## Edge-reading Control Meter the ER-35

The solid state AIRPAX "Parkermeter" Series ER 35 Control Meter... the finest ultra-compact, contactless, edge-reading meter available today... improved switching... more reliable meter movement... extremely rugged precision-molded case... state-of-the-art manufacturing throughout. The ER-35 is available with one or two set points and provides four control switching configurations... is only 7/8" thick... can be panel mounted or stacked in any quantity as required... horizontal or vertical displays available. Truly the most modern and dependable of all.

For detailed information write for Catalog 0200G.

AIRPAX Controls Division P.O. Box 8488  
Fort Lauderdale, Florida 33310 Phone: 305/587-1100

# AIRPAX™

INFORMATION RETRIEVAL NUMBER 104



## Optical tape reader speeds at 450 characters a second

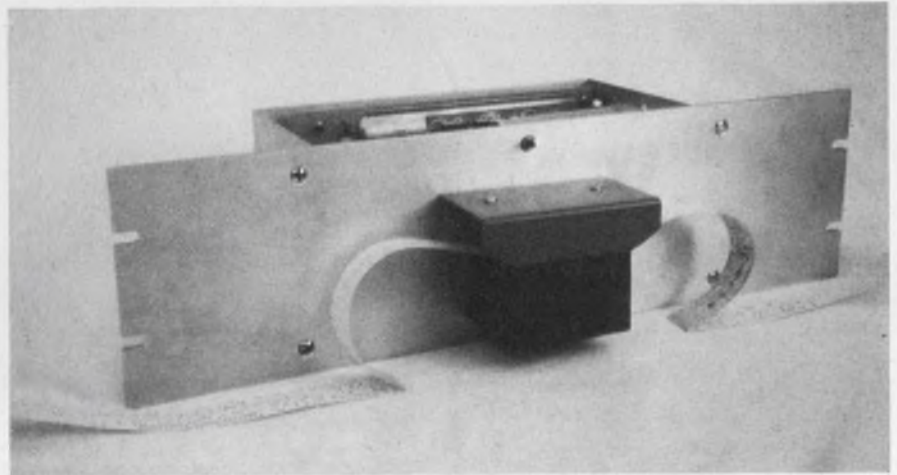

*Teleterminal Corp., 12 Cambridge St., Burlington, Mass. 01803. (617) 272-8504. \$625 (1 to 10); stock to 60 day.*

The Fly Reader 45, a photoelectric punched-tape unit, has a continuous or random read speed of 450 characters per second. It can handle standard 1-in. punched tapes, as specified by ANSA  $\times$  3.18, with tape transmissivities of up to 60%.

The reader uses an on-the-fly read technique and is bidirectional. It accepts either randomly spaced pulse input commands or level inputs for continuous reading. Control outputs consist of ready/busy levels, a tape jam/out alarm and an output that indicates an open read head during tape loading.

The tape-drive is a sprocket-and-stepper-motor assembly with sealed, heavy-duty roller bearings. The sprocket engages the tape with seven teeth and is said to give traction without tape wear or tearing.

All control signal inputs are TTL-positive true, and they feed Schmitt triggers. This gives the input lines a 2-V noise immunity. Data and control outputs are all buffered TTL signals.

Options for the unit include open-collector TTL outputs that can provide a 4-mA sink at 30 V for driving CMOS or long lines and capability to read both 1-in.

and advance-feed-hole typesetting tapes.

The Fly Reader 45 operates over 10 to 50 C. It uses a nine-transistor optical array and an incandescent lamp, rated for 15,000 hours. The reader is completely modular: all sections interconnect with plugs for easy servicing.

The unit mounts on a 5.25-in.-high panel, that fits 19-in. racks. The depth behind the panel is 5.5 in., while the external panel protrusion is 2.5 in. Optional fan-fold trays occupy a total of 7 in. of panel height. The unit weighs 8 lb. Power requirements are 105 to 124 V ac, 60 Hz at 1/3 W, or 210 to 240 V ac, 50 Hz.

A close competitive unit is the Model 2031 from Digitronics (1 Albertson Ave., Albertson, N.Y. 11507). It has a continuous-read speed of 400 char/s and a random-read speed of 300 char/s. This unit costs \$730. A less-expensive unit, the TR6303, is available from Oktronics Data (12000 E. Skelly Dr., Tulsa, Okla. 74128). It has a max random or continuous-read speed of 300 char/s and costs \$580. Both are bidirectional readers that use stepper motor drives, and the prices include the electronics and power supplies.

Teleterminal **CIRCLE NO. 252**

Digitronics **CIRCLE NO. 253**

Oktronics **CIRCLE NO. 254**

# triacs & SCRs

### 3 Ampere

Sensitive Gate TRIAC's.  
3mA, 4mA, 5mA, 10mA and  
25mA DC Gate Current.  
All Quadrant Gating.  
50 to 600 Volts (V<sub>DRM</sub>)

### 4 Ampere

Sensitive Gate SCR's.  
200 Microamp,  
1mA DC Gate Current.  
30 to 600 Volts (V<sub>DRM</sub>)

If it's a TRIAC or SCR you need, Hutson's state-of-the-art thyristor technology assures reliability and economy. All Hutson TRIAC's and SCR's available as void-free, glass-passivated chips or in standard package configuration. Call or write Hutson for complete information.



Box 34235 • 2019 W. Valley View  
Dallas, Tex. 75234 (214) 241-3511  
TWX 910-860-5537

**Hutson Ind., International**  
30 Rue Pierre Semard, Yerres.  
91 France Tel. Paris 925-8258  
TELEX 21-311

#### Distributors:

New York City 201/399-4350, Seattle  
206/454-0300, Los Angeles 213/240-  
3151, Dallas 214/231-6181, Baltimore  
301/944-8262, Denver 303/757-7679,  
Ft. Lauderdale 305/772-5100, Chicago  
312/286-1500, Detroit 313/499-0188,  
Syracuse 315/699-2671, Indianapolis  
317/888-2260, Atlanta 404/427-0241,  
Canada 416/638-1322, Beaverton 503/  
643-1644, Dayton 513/433-2511,  
Phoenix 602/968-9037, Minneapolis  
612/866-3035, Waltham 617/890-8040,  
Kansas City 816/765-2998

#### Distributors:

Elizabeth 201/345-2420, Los Angeles  
213/240-3151, Denver 303/934-5505,  
Chicago 312/323-9670, Canada 416/  
635-9880, Rochester 716/454-7800,  
Belgium 02362.135, Brussels  
02352.135, Denmark (01) 295622,  
Norway 472702272, Spain 234-62-62,  
Sweden 08-28-5940, Switzerland  
051-852201



# **Bowmar** KEYBOARDS



Sure, we make keyboards for calculators — some are mighty sophisticated, too.

But we are also applying Bowmar keyboard technology to TV control tuners, appliance controls, machinery controls, telephone equipment, point-of-sale equipment, and many other applications . . . unlimited!

#### **What can we do for you?**

Remember, in addition to utilizing Bowmar keyboard expertise and engineering abilities, you can also customize your keyboards with combinations of 17 colors in Bowmar key tops and 5 colors in bezels.

*Give us a call. We'd be happy to discuss your requirements. Send for the new colorful brochures on Bowmar keyboards . . . free.*

 **Bowmar**

**Bowmar Instrument Corporation**  
8000 Bluffton Road  
Fort Wayne, Indiana 46809  
Phone 219/747-3121



## Minicomputers also do remote-job entry

Varian Data Machines, 2722 Michelson Dr., Irvine, Calif. 92664. (714) 833-2400. From \$60,000.

A new applications program is part of a system that allows Varian 70 Series computers to have concurrent communications with a

large host while performing a full range of foreground and background tasks. The system which includes synchronous communications hardware interfaces with IBM 360/370 computers that use HASP and ASP remote job entry procedures. The system supports data rates to 50 k bit/s. The minimum configuration which includes 24-k memory V70 CPU, printer, disc and card reader costs less than \$60,000.

CIRCLE NO. 287

# Easygoing Vector Graphics, it's basic.

```

100 REM MEGATEK DESIGN
110 LET P=15
120 LET Q=6
130 FOR N=1 TO P-1
140   FOR M=N+1 TO P
150     LET A=(N-1)*6.2832/P
160     LET B=(M-1)*6.2832/P
170     CALL 1,127*(1+SIN(A)),127*(1-COS(A)),6,0
180     CALL 1,127*(1+SIN(B)),127*(1-COS(B)),3,0*1
190   NEXT M
200 NEXT N
210 NEXT N
220 END

```

You can now use BASIC language (as this program developed the pattern shown below) to easily plot lines and points. Megatek interfaces your mini (now available for all NOVA series) with your

x-y scope and supplies the software needed to allow interactive, dynamic displays. With 50 Hz refresh rate from its built-in memory, a wide variety of real-time flicker-free plots and even alphanumeric can be generated.

And the price is really right. Think of the possibilities. Better yet, see for yourself. Just call us for complete details on NOVA, PDP-11 and NAKED MINI/ALPHA 16 - (714) 224-2721 or write Megatek, 1055 Shafter Street, San Diego, CA. 92106.

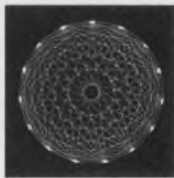

**MEGATEK**  
BUDGET PERIPHERALS

## Graphics Interface: it goes for \$1095.

INFORMATION RETRIEVAL NUMBER 107

## Memory modules come in 16 or 32 k stacks



Ampex, 401 Broadway, Redwood City, Calif. 94063. (415) 367-4151. 0.5¢/bit, 90 to 120 day.

The 1600 Series modules are available in a variety of capacities, access times and cycle times. For 16 k word modules access times vary from 300 to 450 ns and cycle times from 650 to 900 ns. The 32 k modules have access times of 550 and 650 ns and cycle times of 1200 and 1500 ns. Up to eight 1600 series modules can be combined to provide a 128 k system using 16 k modules or a 256 k system using 32 k modules. Module select decoding and negative-true open-collector outputs simplify interface requirements. Each 1600 series module is two boards, a timing-drive board and a plug-in 16 k or 32 k planar stack. The module is 15.76 × 11.5 in. with a thickness of either 0.95 or 1.3 in., for 16 k or 32 k, respectively. The modules operate from 0 to 55 C without current compensation. The 1600 module requires a 5 V dc logic supply and either + or - 15 V dc drive supplies at the customer's option.

Booth No. 645 Circle No. 288

## Compact reader handles 300 card/min silently

Mohawk Data Sciences, OEM Marketing, Box 362, Utica, N.Y. 13503. (215) 337-1910. \$1300; 60-90 days.

The desk-top Model 6050 card reader offers 300 card/min along with speed quiet operation. The 6050, priced at \$1300, is designed for low-cost OEM applications. The input hopper holds 1000 cards and the output hopper holds 1100. Reader functions include a double-strobe read of each column, a re-synch on data and a light and dark current check.

CIRCLE NO. 289



# Who's got the track record for automotive IC development?

When you need custom-developed integrated circuits for automotive applications, why go with a company that hasn't won its spurs? Pick ITT instead. We've already developed circuits for speedometers, tachometers, digital clocks and flashers; they're being installed daily by the automotive industry. And we have more developments on the way. When you need custom circuits for electronic ignition, instrument voltage regulators, fuel injection, automatic dimmers or any of the other automotive applications, look up the company that has the track record. Write today for details of our custom circuit capability.

## ITT...Logically

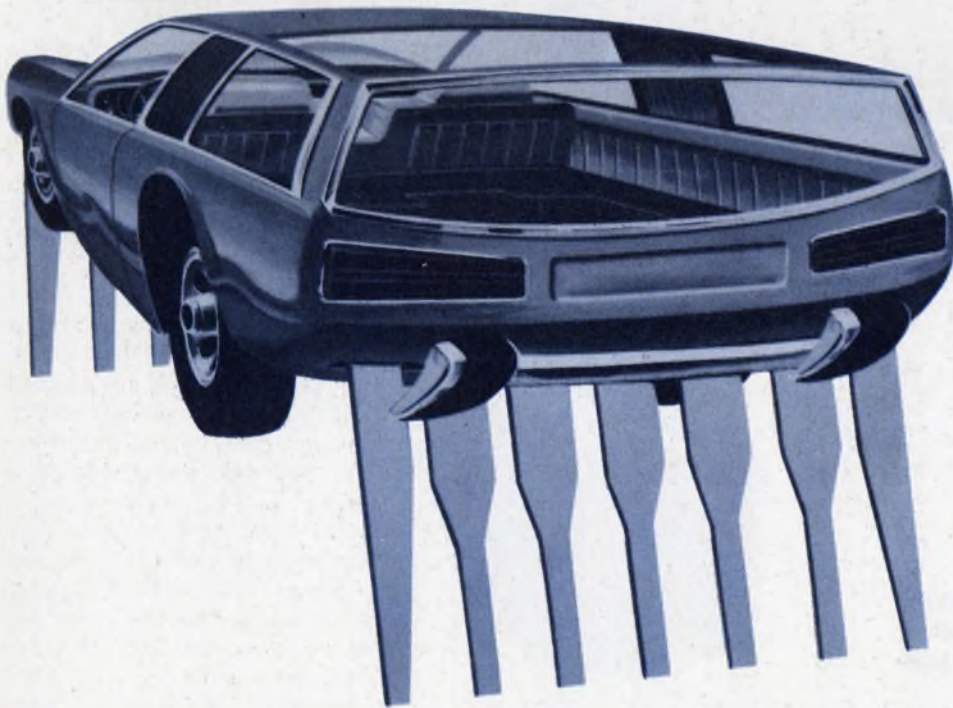

# semiconductors

ITT Semiconductors is a division of International Telephone and Telegraph Corporation, 500 Broadway, Lawrence, Mass. 08142 Phone 617-688-1881. Factories in West Palm Beach, Florida • Lawrence, Massachusetts • Footscray, England • Colmar, France • Freiburg, Germany • Cascais, Portugal • Taipei, Taiwan • Sydney, Australia

# ITT



# All in the Family

Addmaster's famous Model 601 Paper Tape Reader reads any standard tape at 150 characters per second asynchronously. It has a solid state light source, bi-directional stepper motor drive and the lid lifts for easy loading. It is available with or without TTL-interface including end-of-tape-sensing. Can be purchased in a stand-alone model with parallel or serial output . . . or with a fanfold box holding 150' of paper tape.

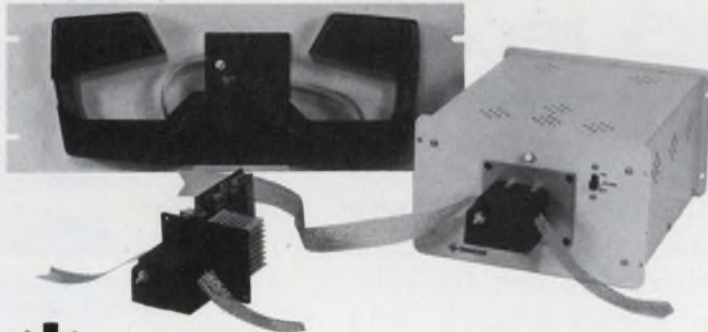

Write for catalog of Addmaster computer peripherals.

416 Junipero Serra Drive • San Gabriel, California 91776

INFORMATION RETRIEVAL NUMBER 109

## IMC FAN FACTS

Fan the size of an ice cube delivers high volume

This easy to install, one inch cube powerhouse does wonders for spot cooling critical components. It's called the IMCube and delivers air at 11,000 times its own volume each minute. Also available in one inch diameter cylinder configuration. For further information please call Gene Egan, V.P. Sales—516/334-7070 or write:



**IMC MAGNETICS CORP.**  
EASTERN DIVISION

570 MAIN STREET, WESTBURY, NEW YORK 11590



400 HZ SPOT COOLER

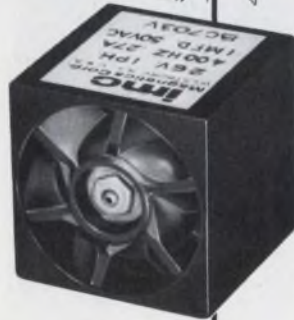

INFORMATION RETRIEVAL NUMBER 110

## DATA PROCESSING

### Electrostatic printers speed at 1000 lpm

Versatec, 10100 Bubb Rd., Cupertino, Calif. 95014. (415) 326-2000. \$5600 (1175); \$6400 (1110).

The LP1175 electrostatic printer and the 1110 or 1110A plotter print at 1000 lines per minute and plot at 2.4 ips, respectively. All of the units are 19 × 18 × 38 in. and weigh 160 lb. Power requirements are 115 V ac, 60 Hz; 100 V ac, 50 or 60 Hz; or 230 V ac, 50 Hz; 600 W maximum. The printer font is 132, 7 × 9 dot matrix characters per line. A MOS ROM character generator produces a standard 64 or optional 96 (upper and lower case letters) character set. The unit has both parallel TTL voltage level and serial RS 232 standard input connectors for accepting ASCII input data. The 1110 is a raster scan plotter which operates in an asynchronous mode. Plotting may be done in an area 10.24 in. wide by any length up to 500 ft. The 1110A printer/plotter operates in three separate modes: printing, plotting, or optional simultaneous printer/plot. It has the same plotting characteristics as the 1110 plotter, plus the printing characteristics of the 1175.

Booth No. 937, 939 Circle No. 290

### Intelligent key entry system has 16 stations

Inforex, 21 North Ave., Burlington, Mass. 01803. (617) 272-6470. From \$780/mo.

The 1303 intelligent key entry system has binary synchronous communication capabilities. Printing or communication of blocked or unblocked tapes may take place on System 1303 without interruption of data entry and verification procedures, in local or remote sites. Both line and serial printers are fully formattable for printing listings, edited data, and computer formatted tapes. The processor and software will support up to 16 key-stations, each with its own CRT and electronic keyboard. All key-punch and keytape functions are supported plus a large number of automatic functions.

Booth No. 671 Circle No. 291



## CRT terminal allows extensive editing

Lear Siegler, Electronics Instrumentation Div., 714 N. Brookhurst St., Anaheim, Calif. 92803. (714) 774-1010. \$3000; 90 days.

Flexibility of format, editing, interface, and transmission characterize the ADM-2 CRT terminal. The operator can change, insert and delete characters or insert and delete entire lines. Cursor control permits the user to skip, backspace, forespace, move up, down, return, home and originate a new line. A "field protect" mode enables the unit to retain forms, instructions, or other fixed data, while transmitting only the "unprotected" information. The terminal has the standard 53-TTY keys, 16 function keys, and a numeric 10-key pad. The 12-in. CRT can display 960 or 1920 characters on a 12 or 24-line format in upper and lower case.

CIRCLE NO. 292

## Line monitor helps debug data lines

Digi-Log Systems, Babylon Rd., Horsham, Pa. 19044. (215) 672-0800. \$1420 to \$1995; 30 days.

The Series 400 line monitor is a compact ASCII device which displays all line and data information flowing between two separate EDP devices. This information can be displayed on either a video monitor or an ordinary TV set. In the line monitor mode, all information is displayed on the screen including the alphanumeric equivalents of normally transparent control characters. The unit can also be switched to operate as a read-only terminal with control signal display suppressed. Either receive, transmit, or both receive and transmit data may be displayed. Both parity and framing errors are detected and indicator lights report various data set control lines. Synchronous and asynchronous models are available. Asynchronous versions include switch-selectable baud rates of 110, 150, 300, 600, 1200, 2400, 4800, and 9600 as well as page and roll mode switches. Display formats include 40 and 80 character by 16 line configurations.

Booth No. 478, 480 Circle No. 293

ALL NEW...  
an infinitely

# VARIABLE

stroke solenoid  
from Ledex for  
proportional  
positioning.



The new Ledex electro proportional solenoids are a major breakthrough in technology and in cost reduction.

Here's what they provide:

- $\pm 1\%$  positional accuracy for precision control system use.
- Up to 40 pounds of work force at continuous duty provides the power for most applications in a compact size.
- Direct linear motion ranging to  $\frac{1}{2}$  inch eliminates complicated gearing and motion converters.
- Life of 10 million maintenance free cycles will increase your system's reliability.
- Prices for electro proportional solenoids begin at about \$40 per unit.
- 18 standard models with various sizes, strokes, and outputs to fit your specific application requirements.
- Reduce your design expense, when you buy the electro proportional solenoid, controller and feedback sensor as a system.

The Ledex electro proportional solenoids are designed to provide fast, accurate, high force positioning for hydraulic and pneumatic valves, fuel control systems, machine tool cutter heads, automatic gages and other precise positioning applications.

Make a significant contribution toward lowering your proportional positioning control costs. Send today for complete details and catalog on this new cost effective electro proportional solenoid.

Toll free number for name of your nearest  
Ledex representative: 800-645-9200.



**LEDEX INC.**

123 Webster Street  
Dayton, Ohio 45401  
(513) 224-9891





# THE LINE PRINTER FOR THE LONG RUN



## OEMs select it because users prefer it.

This line printer is designed for the long runs—applications where printing is measured in hours instead of minutes. It's a line printer. Full 132 columns, 200 lines per minute. That means 200 lpm regardless of line length!

It's reliable. Quiet. Quality print. No duty cycle limitations. A one year warranty to back it up.

Drive it as hard as you want. Over a thousand Tally Line Printers in the field and not a single mechanical failure! As an OEM, that means Tally printers won't eat you alive in service calls.

Tally has the data processing printer. A printer with all the data processing features your user expects. Eight channel VFU. 64 character set. 96 character upper and lower case option. Various fonts. Foreign languages.

Enhance your computer system with this super reliable, long run line printer. Find out all the features. Write or call Tally Corporation, 8301 So. 180th Street, Kent, Washington 98031. (206) 251-5647.

# TALLY

INFORMATION RETRIEVAL NUMBER 112

236

## Spectrum analyzer takes dynamic input range title



Adret Corp., 1887 Lititz Pike, Lancaster, Pa. 17601. (717) 569-7059. P&A: See text.

With a dynamic range of 120 dB from 0 to 11 MHz, Adret's 6303 spectrum-analyzer plug-in leads all others in input range.

From 1 to 110 MHz, the dynamic range of the Adret unit drops to 100 dB—a spec that's matched, but not exceeded, by Marconi's recently introduced 110-MHz analyzer, the TF 2370.

The two units don't compete head-on, however. The \$10,375 Adret unit is a plug-in for a frequency-synthesizer mainframe, has no CRT display and offers limited features compared with most analyzers.

The \$14,750 Marconi (Englewood, N.J.) is a complete, top-of-the-line unit, with such features as digital storage, a TV-like display, counter readout and automatic computation and setting of sweep rate and other performance factors.

But if you need a super-wide dynamic range—to check high-purity crystal oscillators, for ex-

ample—Adret's 6303 fills the bill. The minimum input signal is 100 mV rms. And the 6303 doubles as an eight-digit, programmable frequency synthesizer with a range of 10 kHz to 110 MHz and a resolution of 1 Hz.

The total frequency range of the Adret unit is covered by two submodule plug-ins: the 0-to-11-MHz 63032 and the 1-to-110-MHz 63031. Total dispersion of the lower-frequency module ranges from  $\pm 200$  Hz to  $\pm 10$  kHz, while the high-frequency unit disperses from  $\pm 200$  Hz to  $\pm 100$  kHz. Noise in a 1-Hz bandwidth is listed as 30 nV for the 11-MHz 63032 and 0.3  $\mu$ V for the 110-MHz 63031.

Once the user sets the dispersion, he loses control of sweep time—that is, the sweep is a function of the dispersion and ranges from 100 to 2000 s.

The 6303 outputs a signal that drives a storage scope or an X-Y plotter. A front-panel attenuator and vernier, coupled to a level meter, lets the user adjust the out-

(continued on page 238)



# Frame them any old way

## Or any new way.

Then sit back and watch your Ise display electronics get your ideas across. Beautifully.

In an eye-easy fluorescent green glow.

At the same time, they're low on voltage and current drain.

High on stability.

Pick the readouts that offer more of everything, including variety, for a whole host of digital display ideas.

They're a difference you can see.

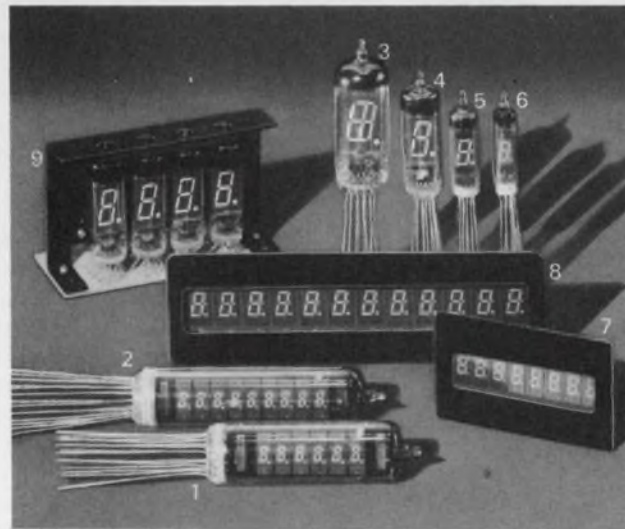

- 1 DP60A
- 2 DP90A
- 3 DG19E
- 4 DG12H
- 5 DG10F1
- 6 DG 8F
- 7 DP 89A
- 8 DP127F
- 9 DMCL12H (NEW)

Display module w/counter & latch

- Fluorescent green glow.
- 12-pin connector.
- Three performance perfect models.
- Custom ROM programming with other than BCD and seven-segment output

The Brighter Side of Electronics



Creator of Fluorescent Digital Display:

**ISE ELECTRONICS CORP.** P.O. Box 46 Ise-city, Mie Pref., Japan  
Tel: (05963) 5-2121 Telex: 4969523

International Sales Div.:

**ISE INTERNATIONAL CORP.** 2-7-7, Higashi-Shinbashi, Minato-ku, Tokyo, Japan  
Tel: 433-6616~9 Telex: J26546 Cables: "ISEWORLDREP" TOKYO

Sales & Technical Office:

**ISE CORP. OF AMERICA** 1472 West 178th Street, Gardena, Calif. 90248 U.S.A.  
Tel: (213) 532-0470 Telex: 230674910

Representative: Paris, Munich, Amsterdam, Stockholm, Vienna, Milan, Bombay, Hong Kong, Taipei.

INFORMATION RETRIEVAL NUMBER 113



# DIT-MCO THE DIFFERENCE IN TESTING!

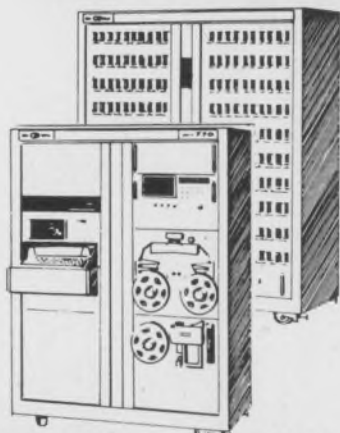

## DIT-MCO's 770 SERIES

**Tape Programmed Random Access Wire-Circuit Analyzers With The Speed, Reliability, And Capacity To Meet Almost Every Conceivable Connection-Testing Need!**

For a random access analyzer that really meets the test, look to the leader—DIT-MCO. Dependable. Versatile. Fast. Accurate. Whether you require basic test or sophisticated systems capabilities, DIT-MCO gives you more features, dollar for dollar, than competitive units.

### 772°

WDB bar relay switching. solid state drive. Up to 1,200 TPM. Insulation test voltage to 1,500 VDC.

### 773°

Reed switching. solid state drive. Up to 4,000 TPM. Insulation test voltage to 500 VDC.

### 774°

Reed switching. solid state drive. Up to 4,000 TPM. Insulation test voltage to 1,500 VDC.

### 775°

Designed for high voltage AC testing. EQA switching. Up to 1,000 TPM. Insulation test voltage to 1,500 VAC.

### 776°

Low voltage tests at extremely high speeds. Reed switching. Up to 10,000 TPM with optional input equipment. Insulation test voltage to 100 VDC.

**The 770 Series also includes computer controlled models with Solid State Switching!**

**Show Us A Problem, And We'll Put It To The Test!**

\*Computer System Control option available on all 770 Series Units.  
Our brochure lists standard features and options.



DIT-MCO: The difference in testing.

### DIT-MCO INTERNATIONAL

A division of Xebec Corporation  
5612 Brighton Terrace • K.C., Mo. 64130  
Telephone (816) 363-6288  
Telex Number 42-6149

European Technical Representative  
RADIX HOUSE

Central Trading Estate  
Staines, Middlesex, TW18-4-XA, England  
Telephone (0784) 51444  
Telex 935023

## INSTRUMENTATION

(continued from page 236)

put to a plotter's full-scale reading.

An averaging mode, also selected by panel button, smooths any instantaneous minor fluctuations in the output signal.

Other important specs of the Adret 6303 include a filter, or analysis, bandwidth of 10 Hz; a filter shape factor of 10 (ratio of 60-dB to 3-dB bandwidths) and a frequency accuracy of  $\pm 5$  Hz.

Amplitude accuracy from 0 to 11 MHz is  $\pm 2$  dB to 100 dB down and  $\pm 4$  dB to 120 dB down. With the 1-to-110-MHz module, accuracy is  $\pm 2$  dB.

The 6303 costs \$10,375, which includes both sub-modules. With just one module, the price drops to \$9975. Delivery is stock to 30 days.

For Adret **CIRCLE NO. 250**

For Marconi **CIRCLE NO. 251**

## Notch-peak filter is tunable



SEG Electronics, 120-30 Jamaica Ave., Richmond Hill, N.Y. 11418. (212) 441-3200. \$545; stock.

Model 850A tunable notch-peak filter tests and analyzes voice-band telephone channels over the 35-to-3500-Hz range. The portable unit can be used for notched noise measurements and waveform analysis with 3.5 and 35-Hz bandwidths. Originally designed per the Bell Telephone Reference Guide PUB 41009 for harmonic wave analysis, the 850A can also make other measurements on standard telephone measuring equipment. An interesting feature is a front-panel controlled switchable output amplifier with selectable 0, 10, 20 and 30-dB gain to facilitate low-level measurements.

**CIRCLE NO. 294**

## Tester diagnoses data networks



Intertel, 6 Vine Brook Park, Burlington, Mass. 01803. (617) 273-0950. \$7500; 60-90 days.

MPT500 Multipoint Tester is a compact diagnostic center for data communication networks. The unit allows communication personnel at a central site to immediately diagnose and isolate a wide variety of fault conditions at any remote site in a large communication network. The network may include as many as 12 private lines, with up to 40 drops on each line. The Multipoint Tester runs diagnostics while the network is fully operational. Test results are displayed in numerals and English abbreviations at the Tester front panel, which also includes a speaker for monitoring line signals.

**CIRCLE NO. 295**

## Measure height to accuracies of 0.0002 in.

LK Tool Co. Ltd., Lodge Works, Aston-on-Trent, Derby DE7, 2AJ, England.

The Mini-Check One, single-axis electronic inspection instrument, eliminates calculations and vernier readings. The unit incorporates an 8 character digital readout and offers repeatability on a solid contact probe to within  $\pm 0.0002$  in. All marking-out operations normally done with a height gauge can be carried out, including direct measurement of hole centers. The measuring element is a tape transducer along which a multi-element reader traverses to measure the deflection of a magnetic field. Signals are transmitted to a solid-state electronic pulse counter and displayed on the digital readout panel. Two versions are available to measure maximum heights of 20 or 40 in., and interfaces can be supplied for coupling to teletypewriter units and computers.

**CIRCLE NO. 296**



**FUJI**

## Non Volatile, Low Cost & High Reliability

### SMALL CAPACITY **RAM PERFECTION**

## POS TERMINAL, CASH DISPENSER, MICRO PROCESSOR, CREDIT CARD CERTIFIER, ELECTRONIC CASH REGISTER

It has been generally assumed that MOS IC memory systems are less expensive and more suitable to use than a ferrite core memories to employ in a field of small-capacity random access memories whose capacities are smaller than 8K bytes.

However, today this assumption shall be contradicted. FUJI's new series of memories, Small-capacity Ferrite Core Memory Modules, incorporated with Hybrid integrated circuit as its peripheral circuits, offering a more economical price and better reliabilities rather than MOS IC memories.

Everyone knows that volatility and reliability of stored information is the most important factor in handling of cash transactions at banking system as well as operating cash registers, POS terminal machines, and on-line devices. Consequently, at least the last digits of calculation must be nonvolatile.

Which do you think is more rational...a system designed by a MOS IC memory with the last calculated digits to be stored by a nonvolatile core memory or a whole entire system simply designed with a nonvolatile core memory? Answer is clear, that is FUJI Core Memory!

### STANDARD MODELS

A wide variety of standard models are available over a wide range of memory capacities from 128 words-4 bits to 8K words-9 bits. Furthermore, we are ready to design and manufacture special systems with quick delivery service, according to your requirements.

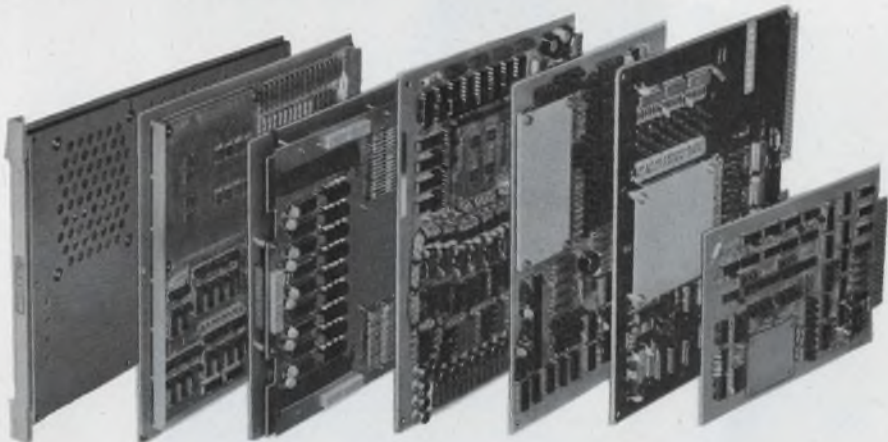

MODEL	CAPACITY	CYCLE TIME	POWER	DIMENSIONS (size in inch)
CMS2101A	128W-4B	3 $\mu$ s	$\pm$ 5V	5.8x8.7x0.5
CMS2101B	256W-4B	3 $\mu$ s	$\pm$ 5V	5.8x8.7x0.5
CMS2112	512W-4B	3 $\mu$ s	+5V	6.0x8.0x0.5
CMS2113	1024W-4B	3 $\mu$ s	+5V	6.0x8.0x0.5
CMS2114	2048W-4B	3 $\mu$ s	+5V	8.0x10.0x0.5
CMS2115	4096W-4B	3 $\mu$ s	+5V	8.0x10.0x0.5
CMS2116	1024W-9B or 512W-18B	1.5 $\mu$ s	$\pm$ 5V, +24V	9.8x11.8x0.6
CMS2201A	1024W-10B	1 $\mu$ s	$\pm$ 5V	9.5x10.5x0.5
CMS2201B	2048W-10B	1 $\mu$ s	$\pm$ 5V	9.5x10.5x0.5
CMS2107	1024W-18B	1.5 $\mu$ s	$\pm$ 5V, +24V	7.4x8.3x1.4
CMS2401	4096W-18B or 8192W-9B	1 $\mu$ s	$\pm$ 5V, +15V	10.0x15.0x0.5
CMS2403	4096W-18B or 8192W-9B	1.5 $\mu$ s	+5V	10.0x15.0x0.6

## FUJI ELECTROCHEMICAL CO.

Head Office: Hamagomu Bldg., 5-36-11, Shinbashi, Minato-ku, Tokyo, Japan  
TEL: 434-1271

Overseas Office: New York, TEL: (212) 532-5630  
Los Angeles, TEL: (213) 620-1640  
Dusseldorf, TEL: (211) 89031

TAD. ISHIZUKA  
SAM. YOSHINO  
TAD. KOMURO

**FUJI**  
**MEMORIES**



**Unit covers 2 to 18.5 GHz in one sweep**

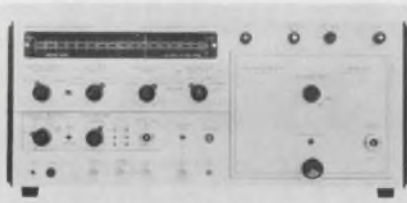

Wiltron, 930 E. Meadow Dr., Palo

Alto, Calif. 94303. (415) 321-7428. \$11,700 (plug-in); 5 wk.

Model 6237 plug-in sweeps 2 GHz to 18.5 GHz in one continuous sweep. The unit is said to be considerably less expensive than any previous sweeper covering this frequency range. Leveled power output is 7 dBm compared to a typical 2 dBm for the nearest competitor and the leveling flatness of  $\pm 1$  dB is said to be the best offered by any manufacturer.

CIRCLE NO. 297

**S/d unit offers scale-factor choice**



ILC Data Device, 100 Tec St., Hicksville, N.Y. 11801. (516) 433-5330. 3 digits, \$450; 4 digits, \$550; 6 wk.

SR300 is a solid-state four-digit synchro-resolver angle indicator. The unit may be purchased with custom scale factors, permitting the display of actual engineering units. Worst case error of the 3-digit and 4-digit indicators are  $\pm 30' \pm 1$  LSB, and  $\pm 6' \pm 1$  LSB, respectively, over 0 to 70 C. The SR-300 uses a sampling s/d with 40 conversions/sec as standard for degrees of rotation. Input signals are transformer isolated and transient protected. A DTL/TTL-compatible BCD output is standard.

CIRCLE NO. 298

**Our new IC Op Amp Tester is a cheap little know-it-all.**

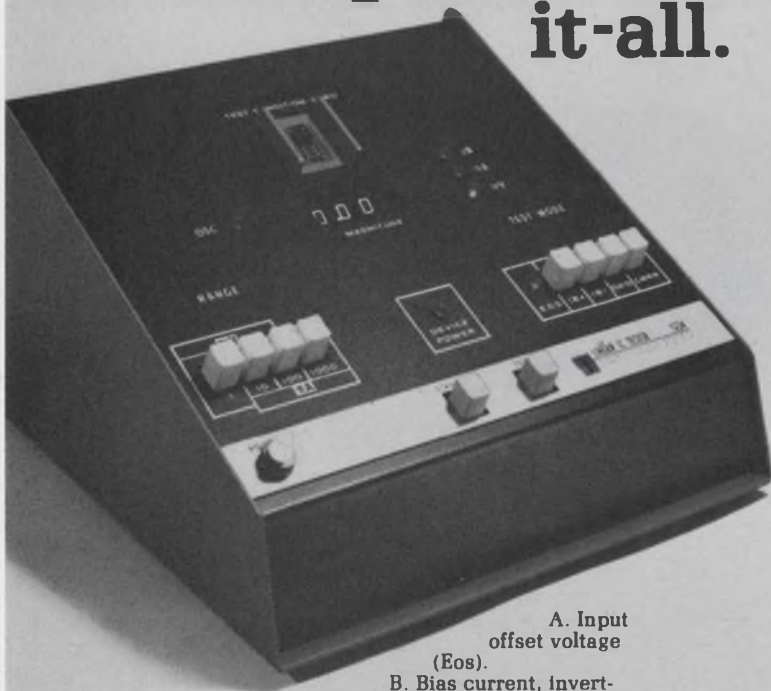

A. Input offset voltage (Eos).

B. Bias current, inverting input (IB-).

C. Bias current, non-inverting input (IB+).

D. DC open loop gain.

E. DC common mode rejection ratio (CMRR).

F. Oscillation detection.

All you really need to know about our New Model 1234 IC Op Amp Tester is that it costs less than \$700 and is smart enough to do the following:

1. Test virtually all IC op amps, monolithic and hybrid, in DIP and TO-5 configurations with or without plastic carriers.

2. Perform the six most important measurements previously accomplished only by testers costing at least three times as much. These are:

Now you can't afford NOT to weed out your incoming disasters and sort your devices by accurate test results.

Write for the complete information on this new tester, our companion instrument to the Model 1248 functional tester for digital ICs.



Electro Scientific Industries  
13900 N.W. Science Park  
Dr., Portland, Ore. 97228.  
Phone (503) 646-4141.  
Telex 38-0273.

Openings: Application Engineers, Product Manager.

INFORMATION RETRIEVAL NUMBER 116

**12-V recorder works in remote location**

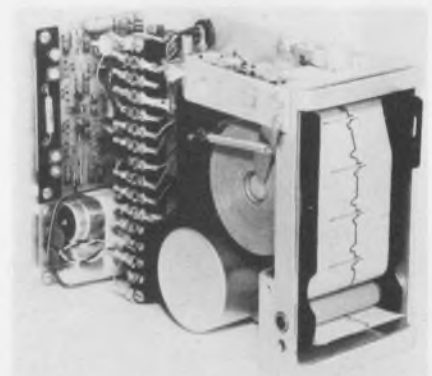

MFE Corp., Keewaydin Dr., Salem, N.H. 03079. (603) 893-1921. Starts at \$520; 60-90 days.

This 12-V-dc single-channel OEM or packaged recorder is for applications requiring complete isolation or remote operation. Features include: built-in 12-V inverter; power consumption of 1.5 A; event marker; simple paper loading; inkless thermal recording; 50-mm wide chart; speed accuracy of  $\pm 2\%$ ; frequency response full scale dc to 40 Hz; 10 mm D-P dc to 100 Hz.

CIRCLE NO. 299





# \$9225 buys this complete high-performance computer system from Texas Instruments

Combine a *Silent 700*\* Model 733 twin-cassette ASR data terminal and a 980A minicomputer with 8K of memory. You have a fast, powerful computer system, including a cassette operating system, for much less than you would normally expect to pay.

And delivery is only 30 days.

This system is useful for such applications as business data processing and batch data retrieval. Add more *Silent 700* terminals and

do multiple terminal data entry. Or run multi-user BASIC. With 16K of memory, run high-level languages like FORTRAN IV.

By adding a disc, you can run the powerful DX980 operating system. This way, for less than \$25,000, you get a system that is substantially equivalent to other systems with price tags of \$35,000 or more.

With *Silent 700* ASR terminals, you get the speed, quietness and

reliability that have made them a standard of comparison. And, the convenience of tape cassettes and non-impact printing make the *Silent 700* terminals a powerful alternative to conventional paper-tape teletypewriters.

Want more information? Call the nearest TI office listed below or contact Texas Instruments Incorporated, P.O. Box 1444, Houston, Texas, 77001.



\*Trademark of Texas Instruments Incorporated

Arlington, Va. (703) 527-2800 • Atlanta, Ga. (404) 458-7791 • Boston, Mass. (617) 890-7400 • Chicago, Ill. (312) 671-0300 • Clark, N.J. (201) 574-9800 • Cleveland, Oh. (216) 464-1192 • Dallas, Tx. (214) 238-5318 • Dayton, Oh. (513) 253-6128 • Denver, Co. (303) 758-5536 • Detroit, Mich. (313) 353-0830 • Hamden, Conn. (203) 281-0074 • Houston, Tx. (713) 777-1623 • Huntsville, Ala. (206) 837-7510 • Indianapolis, Ind. (317) 248-8555 • Milwaukee, Wis. (414) 475-1690 • Minneapolis, Minn. (612) 835-5711 • New York, N.Y. (212) 541-9540 • Orange, Ca. (714) 547-9221 • Orlando, Fla. (305) 644-3535 • Philadelphia, Pa. (215) 643-6450 • Phoenix, Az. (602) 249-1313 • Rochester, N.Y. (716) 461-1800 • San Francisco, Ca. (408) 732-1840 • Seattle, Wash. (206) 455-1711 • St. Louis, Mo. (314) 993-4546 • Amstelveen, Holland 020-456256 • Bedford, England 58701 • Copenhagen, Denmark (01) 917400 • Frankfurt, Germany 0611/39 9061 • Manchester, England 33411 • Milano, Italy 6888051 • Montreal, Canada (514) 332-3552 • Paris, France (1) 630-2343 • Stockholm, Sweden 67 98 35 • Sydney, S. Australia 837-015 • Toronto, Canada (416) 889-7373 • Tokyo, Japan 402-6181

**TEXAS INSTRUMENTS**  
INCORPORATED



**ATTENUATE  
ATTENUATE  
ATTENUATE  
ATTENUATE  
ATTENUATE  
ATTENUATE  
ATTENUATE  
ATTENUATE  
ATTENUATE  
ATTENUATE  
ATTENUATE  
ATTENUATE  
ATTENUATE  
ATTENUATE  
ATTENUATE  
ATTENUATE  
ATTENUATE  
ATTENUATE  
ATTENUATE  
ATTENUATE  
ATTENUATE**



**To 110 dB  
Accurately  
Dependably  
DC to 2 GHz**

**In steps of 1 or 10 dB  
50 and 75 ohms at power ratings to 3 watts**

And do it all with Telonic's series 8000 thick-film miniature rotary attenuators. Available in 12 panel-mounting and bench units, at prices from \$88.00 in single quantities (with OEM discounts). Write for our Attenuator brochure or contact your Telonic representative. Telonic Altair, 21282 Laguna Canyon Road, Box 277, Laguna Beach, California 92652, Tel: 714 494-9401 • TWX: 910-596-1320

**TelonicAltair**

INFORMATION RETRIEVAL NUMBER 118

**INSTRUMENTATION**

**Backplane tester checks 120 points**



*Automatic Production Systems, Inc., 1602 Hylton Rd., Pennsauken, N.J. 08110. (609) 663-7812. \$7500; 60 days.*

OmniTester 600 is a fully automatic comparator tester for production checkout of cables, wired harnesses and backplanes. The unit requires no input device or program tapes. A known good product or simulated sample is used as a reference to determine the testing pattern for the unit under test. Test speed is 2400 continuity tests per minute. The standard unit includes front panel programmable continuity and leakage resistance at hipot values up to 500 V dc, including test capacity for 120 access points.

**CIRCLE NO. 300**

**OEM synthesizer programs remotely**

*Rockland Systems, 230 W. Nyack Rd., West Nyack, N.Y. 10994. (914) 623-6666. \$1880; 4 wk.*

Intended for use by OEMs, the Model 5110 synthesizer features direct digital synthesis, a frequency range of dc to 2 MHz, 0.001 Hz resolution, remote binary or BCD programmability with integral buffer storage, and programming speed of less than 1.5  $\mu$ s. Spectral purity includes -70 dB spurious and -55 dB harmonic. Standard features include fixed 1-V rms output with 50- $\Omega$  source impedance, 1-MHz reference output and front-panel output monitor connector.

**CIRCLE NO. 301**

**Unit tests converters and displays errors**



*C-O Manufacturing Co., 646 Summer St., Brockton, Mass. 02403. (617) 584-4710. \$4400; stock.*

Model ADF1A tests both a/d and d/a converters. The unit measures and displays converter accuracy, monotonicity and noise. Analog inputs and outputs are displayed on a precision zero-centered meter. Direct error readings are also displayed, with a two-bit full-scale sensitivity. LED indicators provide a digital display of number inputs and outputs. Dynamic operation may be displayed as a two-dimensional CRT presentation of input vs output or input vs error.

**CIRCLE NO. 302**

**Miniature scope weighs just 4 lb.**



*Telonic Industries, 21282 Laguna Canyon Rd., Laguna Beach, Calif. 92652. (714) 494-9401. Start at \$595; 30 days.*

Weighing only 4 lb., this mini-scope, Model 9601A, can be handheld or hung from a neck strap. The unit measures 3.5 x 5 x 7.75 in. and contains a 1.5-in. CRT screen that is enlarged to 2.25 in. by a snap-on magnifier. It is powered by ac or a battery pack. Bandwidth is dc to 5 MHz and sensitivity is 10 mV per division. Max sweep rate is 0.3  $\mu$ s per division.

**CIRCLE NO. 303**



# HOT PRESSED FERRITE

Mn-Zn hot pressed ferrites  
with excellent high frequency characteristics.

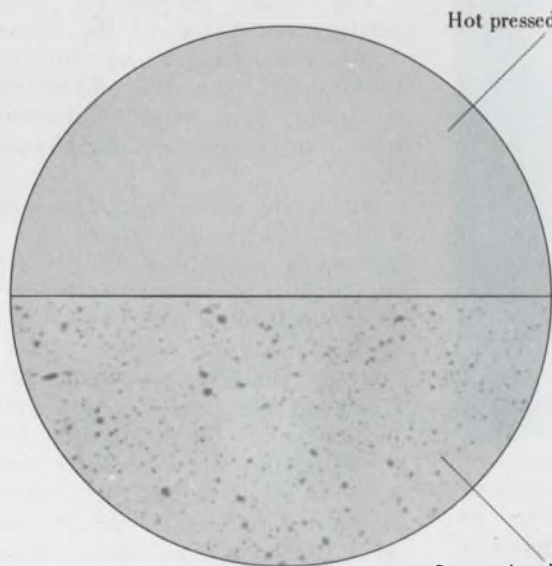

Hot pressed ferrite (Micrograph: x100)

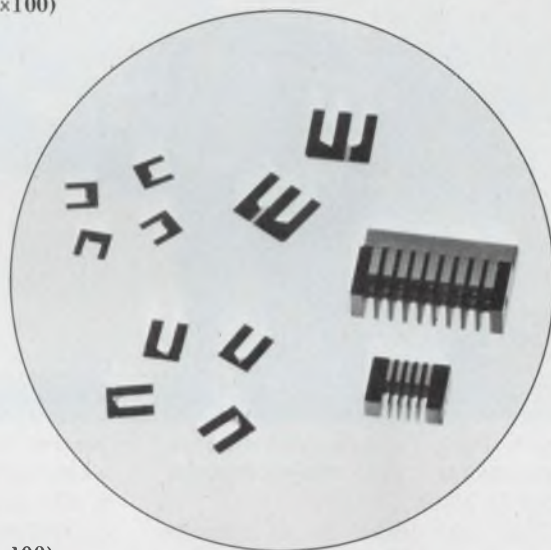

Conventional ferrite (Micrograph: x100)

TDK is now producing manganese-zinc ferrite combinations with optimum performance characteristics for computer application. The crystalline powder of these ferrite materials is ground to uniform granular size, hot pressed and sintered into molded head pieces of high density. TDK's Mn-Zn hot pressed ferrite head pieces are free of voids, smooth in finish and have excellent contact wear resistance.

TDK also offers high quality head pieces for industrial, audio and video applications. The dual-gap and multi-track configurations are already available. All these new TDK products benefit from TDK's exacting production processes including accurate shaping of sintered

pieces and newly developed glass bonding techniques.

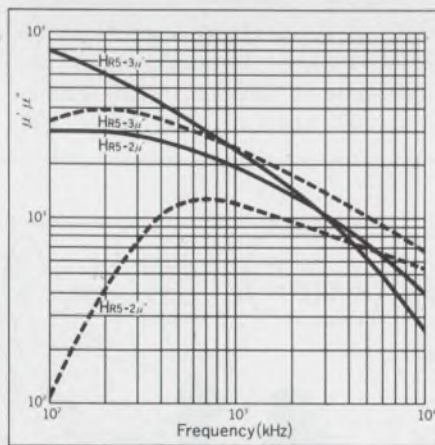

**TDK ELECTRONICS CO., LTD.**  
14-6, 2-chome, Uchikanda, Chiyoda-ku, Tokyo 101, Japan  
Telex: J24270, J26937 (TODENKA)  
Cable: TDKCORE TOKYO  
**TDK ELECTRONICS CORP.**  
**LOS ANGELES BRANCH**  
931 South Douglas Street, El Segundo, California 90245  
Phone: (213) 644-8625  
Telex: WUD 653-456 (TODENKA ELSD)  
**CHICAGO BRANCH**  
2906 West Peterson Avenue, Chicago, Illinois 60659  
Phone: (312) 973-1222  
Telex: TWX 910-221-4211 (TDK CHGO)

	Initial permeability	Flux density (at 15 Oe)	Coercive force	Specific density	Material composition
HR3S	18,000±20%	>3,700 gauss	<0.05 Oe	>5.10g/cm <sup>3</sup>	Mn-Zn
HR5-2	3,000±15%	>4,900 gauss	<0.1 Oe	>5.05g/cm <sup>3</sup>	Mn-Zn (Hot pressed ferrite)
KR4	1,500±15%	>3,200 gauss	<0.2 Oe	>5.30g/cm <sup>3</sup>	Ni-Zn
KR6	2,000±15%	>3,200 gauss	<0.15 Oe	>5.30g/cm <sup>3</sup>	Ni-Zn
KRZ	2 max.	—	—	>5.30g/cm <sup>3</sup>	—



# 16 channel acquisition system includes controls

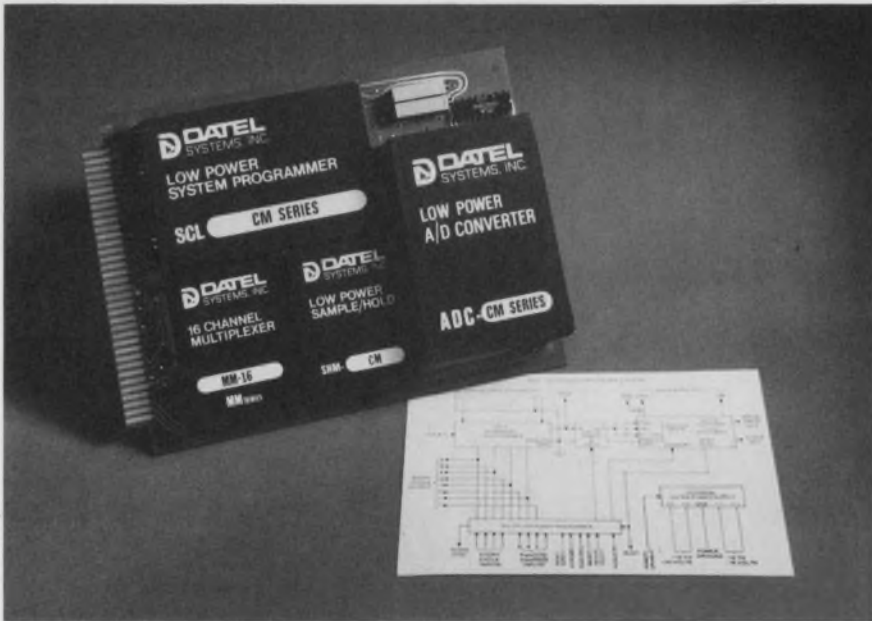

Datel, 1020 Turnpike St., Canton, Mass. 02021. (617) 828-8000. \$750; stock to 4 wk.

The DAS-16-LP is a complete 16-channel data acquisition system. It contains a 16 channel analog multiplexer, a sample-and-hold module, an 8 or 12 bit analog-to-digital converter along with all the necessary control logic for both random and sequential channel selection.

The system uses a gated power supply that turns on when a con-

version is requested, and turns off when the conversion is complete. While operating, the system requires only 100 mW and when in the standby state less than 120  $\mu$ W. The 16 single-ended analog input channels can accept either +5 or  $\pm 5$  V swings and have a  $10^9 \Omega$  input impedance.

System accuracy is  $\pm 0.025\%$  with a temperature coefficient of  $\pm 0.004\%/^{\circ}\text{C}$ . Dynamic input acquisition is 150  $\mu$ s, with sample and hold aperture time below 100

ns. Data conversion time is 450  $\mu$ s so the maximum system throughput rate is 2.2 kHz. The control logic includes input command storage that allows party line or computer bus operation.

The controls provide for either random addressing of the analog input channels or an internal counter for sequential addressing. A frame sync output indicates when the counter is at channel one.

Since the 16-LP operates from a 12-V battery, and draws only 8 mA while converting and 10  $\mu$ A in standby, it is well suited for field operation where power lines are not readily available.

Both Analogic (Audibon Rd., Wakefield, Mass. 01880) and Data Translation (109 Concord St., Framingham, Mass. 01701) also have 16-channel data acquisition systems. Their units, though, are not CMOS and thus require many times more power. The 6912 from Analogic has a 100 kHz throughput and sells for \$695, and the 1640 from Data Translation has a throughput of 25 kHz but sells for a low \$495.

Datel	CIRCLE NO. 317
Analogic	CIRCLE NO. 318
Data Translation	CIRCLE NO. 319

**ANALOGY**

WHEN YOU WANT DIRECT CONVERSION FROM DC LEVEL TO A SERIES OF TTL COMPATIBLE PULSES ACCURATELY AND CONVENIENTLY, USE AN A-847. OUTPUT IS 0 TO 10 KHZ, INPUT IS 0 TO 10V. 0.008% LINEARITY AND 10% OVER-RANGE. ADJUSTABLE FROM 9.900 TO 10.000V AT 10 KHZ OUT. CONVERT NOW, WRITE ANA-

**intech** INCORPORATED  
 (408) 244-0500  
 1220 COLEMAN, SANTA CLARA CA 95050



# *CTS put the squeeze on 3 more cermet resistor networks.*

*Now 23 standard CTS designs—3 lead styles  
Series 750 Edge Mount Packages.*

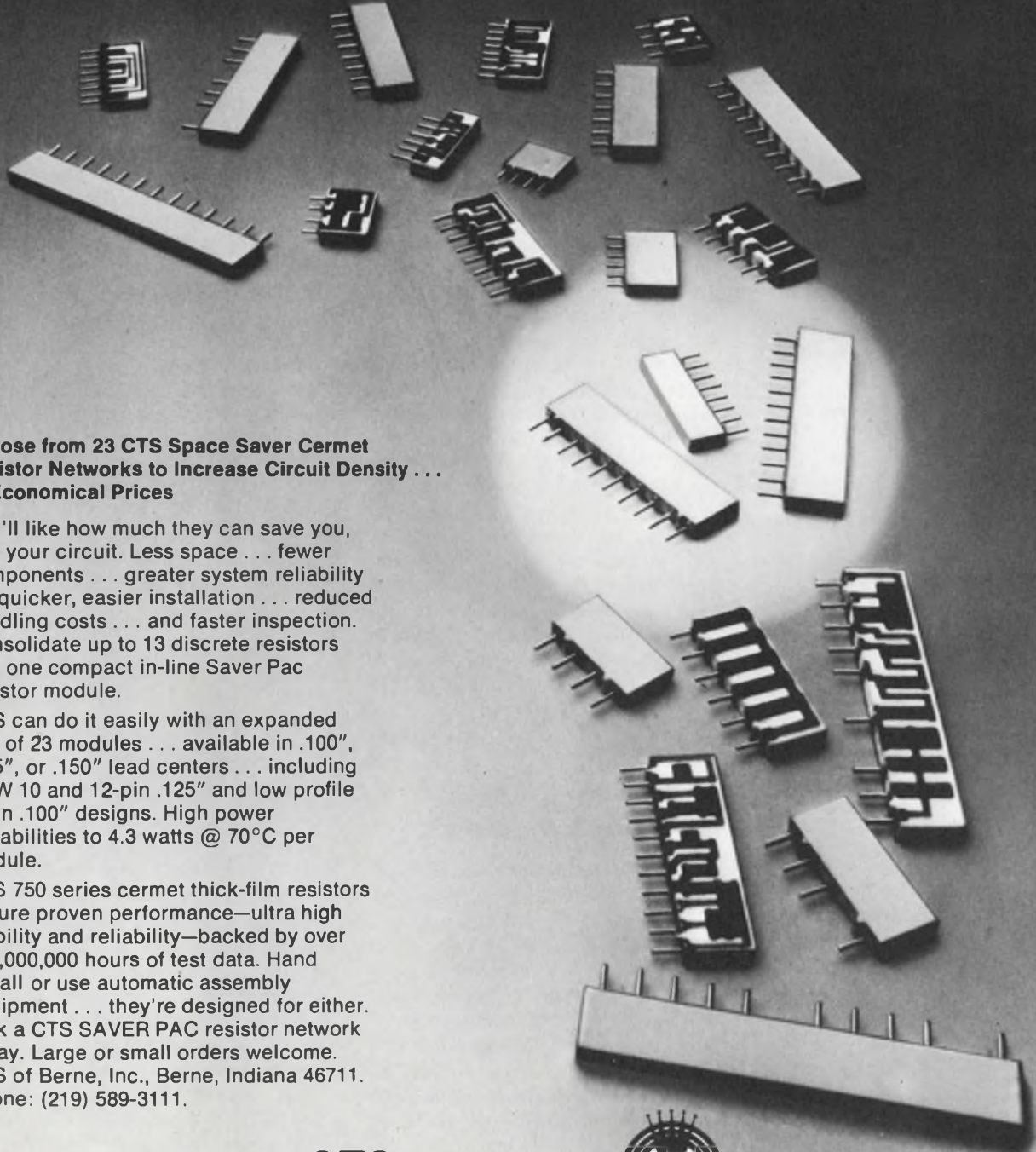

**Choose from 23 CTS Space Saver Cermet Resistor Networks to Increase Circuit Density . . . At Economical Prices**

You'll like how much they can save you, and your circuit. Less space . . . fewer components . . . greater system reliability . . . quicker, easier installation . . . reduced handling costs . . . and faster inspection. Consolidate up to 13 discrete resistors into one compact in-line Saver Pac resistor module.

CTS can do it easily with an expanded line of 23 modules . . . available in .100", .125", or .150" lead centers . . . including NEW 10 and 12-pin .125" and low profile 8-pin .100" designs. High power capabilities to 4.3 watts @ 70°C per module.

CTS 750 series cermet thick-film resistors assure proven performance—ultra high stability and reliability—backed by over 700,000,000 hours of test data. Hand install or use automatic assembly equipment . . . they're designed for either. Pick a CTS SAVER PAC resistor network today. Large or small orders welcome. CTS of Berne, Inc., Berne, Indiana 46711. Phone: (219) 589-3111.

**CTS CORPORATION**   
Elkhart, Indiana

*A world leader in cermet and variable resistor technology*

INFORMATION RETRIEVAL NUMBER 122



# SCR

## POWER CONTROLLERS and GATE DRIVES



1  $\phi$  AND 3  $\phi$   
TO 90 AMPS

PHASE-ANGLE  
FIRING

ZERO VOLTAGE  
SWITCHING

"RED-PAC"

CURRENT  
LIMITING



MILLIAMPER  
RTD INPUT

BACK-TO-BACK  
SCR RELIABILITY

WIDE CHOICE  
OF OPTIONS

INFORMATION RETRIEVAL NUMBER 207



PLUG-IN OR  
HARD WIRED

GATE DRIVES  
1  $\phi$   
3  $\phi$ , 3SCR Hybrid  
3  $\phi$ , 6SCR

VOLTAGE  
REGULATORS

PHASETROL<sup>®</sup>

CURRENT  
REGULATORS



VOLTAGE AND  
CURRENT  
REGULATORS

CURRENT  
LIMITERS

PULSE  
AMPLIFIERS

INFORMATION RETRIEVAL NUMBER 208



**VECTROL INC.**

1010 WESTMORE AVE. ROCKVILLE  
MD 20850 U.S.A. (301) 424 6900

## MODULES & SUBASSEMBLIES

### Mechanical reset timers offer many variations



360 C-Z

Conrac Corp., Mill Rock Rd., Old Saybrook, Conn. 06475. (203) 388-3574.

Model 360 is a fully adjustable, automatic, surface mounted reset timer. It is designed for applications that require time delay, interval timing and if two timers are interconnected, repeat cycle timing. Several models of the 360 are available. Model 360A-A incorporates an instantaneous switch. Model 360C-Z employs a single, high current capacity load switch for heavy industrial control circuits, rated at 20 A. Four time ranges, from 5.5 s to 5.25 min. are available. Time settings are easily adjusted by moving the indicator arm around the notched dial. Repeat accuracy is 0.75% of full scale and setting accuracy is 5% of full scale exclusive of human setting error. The timer is available in operating voltages of 115 or 220 V and 50 or 60 Hz.

CIRCLE NO. 305

### Active notch filters offer five bandwidths

Polyphase Instrument Co., Bridgeport, Pa. 19405. (215) 279-4660. \$45 (1 to 4).

The series 8000 active filter modules have useful notches to 40 dB (1% of 3 dB rejection bandwidth). Five 3 dB bandwidths of 10%, 25%, 50%, 75% and 100% of center frequency are available. All filters are complete function modules with no additional circuitry required and are made for PC board mounting. Case size is 1.9 x 1.25 x 0.5 in.

CIRCLE NO. 306

### Tunable oscillators use a single resistor

Controlec, Box 48132, Niles, Ill. 60648. (312) 966-8435. \$79 (unit qty.).

The Model 73 tone generator uses separate switched resistors to determine the operating frequency. Continuously variable frequency can be obtained by using a variable resistor. Tuning resistor termination may be a spst switch to ground, an open collector gate or a transistor collector. Resistance changes of 5% result in only a 0.05% frequency change, so economy pots and/or 0.5-W carbon resistors can be used to set frequency. Output frequency is almost independent of power-supply voltage and of signal output loading. Eleven modules cover the range of 300 to 3000 Hz. The output signal is a 1-V-rms sine wave.

CIRCLE NO. 307

### Monitor module is transparent to line

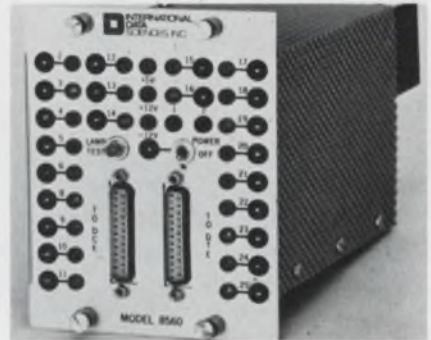

International Data Sciences, Inc., 100 Nashua St., Providence, R.I. 02904. (401) 274-5100. \$635; stock.

The Model 8560 bridge and monitor module allows on-line monitoring of data communications traffic. It handles all 25 leads in the EIA data interface between modems, terminals and multiplexers. The unit is transparent and is installed on line between the modem and terminal. Installation takes seconds and is accomplished merely by plugging the modem and terminal into two connectors located on the front panel. Each of the 25 signals is monitored by a test point and a visual LED indicator. Supply voltages of +5 V and  $\pm 12$  V and a lamp test push-button are also provided. The dimensions of the unit are 8 x 5-1/4 x 7-1/2 in.

CIRCLE NO. 308



# Get Less For Your Money.

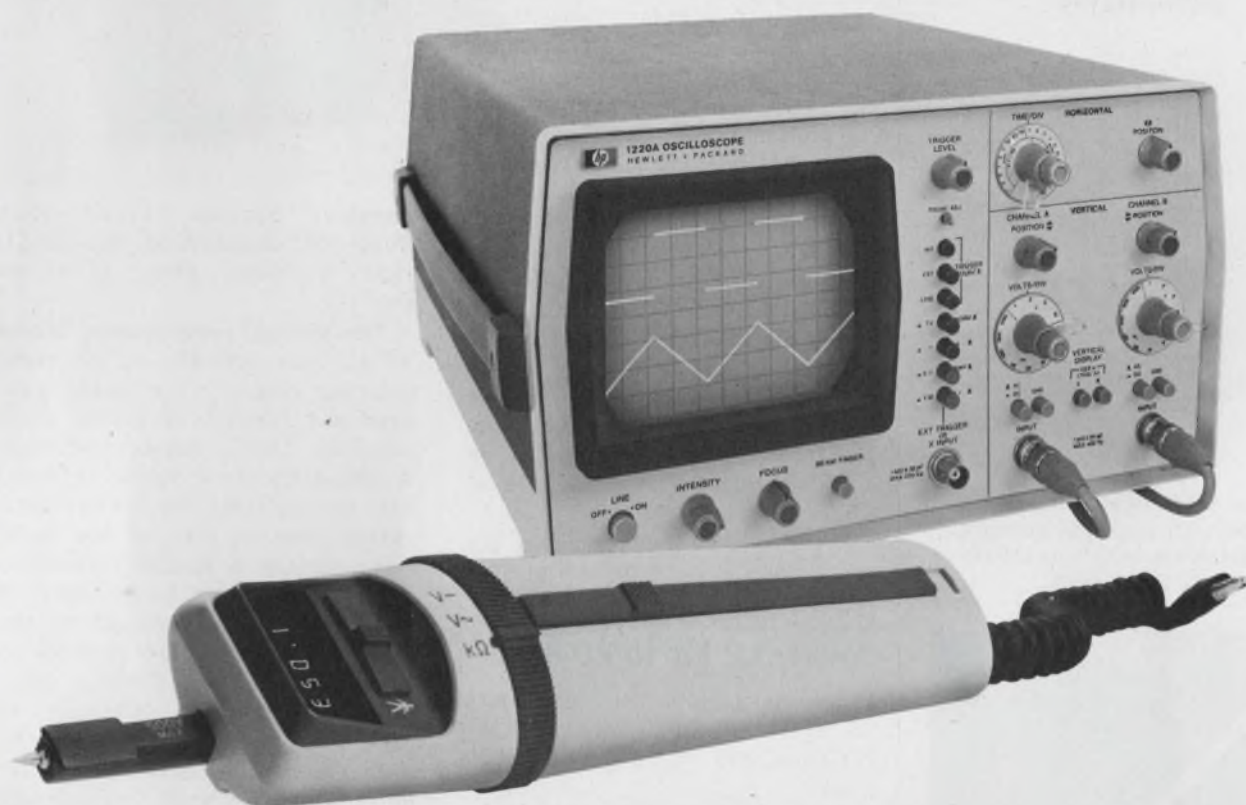

Get a pair of HP basic test instruments that give you less—less measurement hassle because they're so easy to use. Less downtime because they're all solid-state. Less weight and bulk because this scope and probe multimeter were designed to be part of your light-weight travel kit.

Imagine a 3½-digit probe multimeter that is completely self contained, weighs only seven ounces, fits in the palm of your hand—and so advanced it AUTO ranges, AUTO zeros, and has AUTO polarity. It's practically foolproof. Completely portable. And it's absolutely unique—there's nothing else like it anywhere. At any price. And it's just \$310\*. That's a surprisingly low price for a state-of-the-art instrument built to HP's

most exacting standards.

Or get our bright, full 5-inch diagonal display oscilloscope that gives you a whole lot less of those squinting, guessing, knob-tweaking measurements you'd just as soon do without. It's a dual channel, 15 MHz lightweight (only 15 pounds) with the sensitivity, accuracy, and big-scope conveniences most troubleshooters are likely to need. And best of all, it sells for only \$695\*.

There you are, a top-quality scope and probe multimeter for a lot less money. They're backed by HP's reputation and worldwide service and support facilities. So why gamble? There's less chance of error when you get your measurement instruments from the measurement leader. To get the full

story on our 970A probe multimeter or the 1220A oscilloscope, just fill out and return the coupon.

\*Domestic U.S.A. prices only

**HEWLETT  PACKARD**

Sales and service from 172 offices in 65 countries.  
1501 Page Mill Road, Palo Alto, California 94306

Send information about your  
 probe multimeter  scope.  
 Name \_\_\_\_\_ Dept. \_\_\_\_\_  
 Company \_\_\_\_\_  
 Address \_\_\_\_\_  
 City \_\_\_\_\_  
 State \_\_\_\_\_ Zip \_\_\_\_\_  
 Hewlett-Packard Co.  
 1501 Page Mill Road  
 Palo Alto, California 94306  
 ED4/26/74



# NEW!

## LINISTORS™

sensitive linear  
negative temperature  
coefficient thermistor  
assemblies

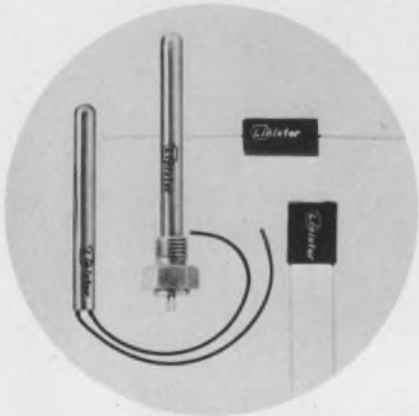

Linistor assemblies will provide you with an accurate straight line resistance/temperature plot from 0°C to 100°C.

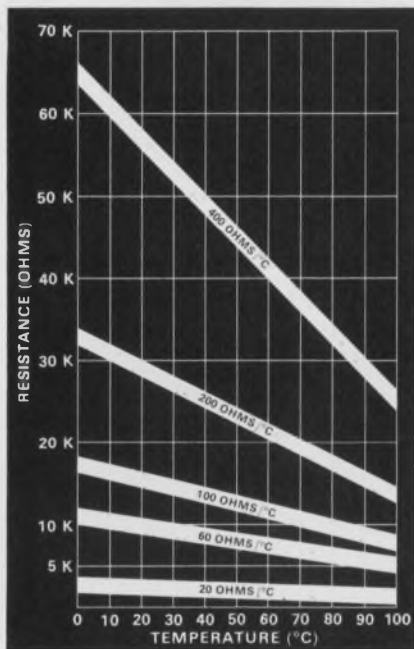

Linistors are ideal for temperature sensing and temperature compensating devices. They are now available in four standard encasements to satisfy most design applications. Write for Data Bulletin L-601.

**Keystone**  
CARBON COMPANY

Thermistor Division  
St. Marys, Pa. 15857  
Phone 814/781-1591

INFORMATION RETRIEVAL NUMBER 125

MODULES & SUBASSEMBLIES

### Sine/cosine converters deliver dc or binary

Transmagnetics, 210 Adams Blvd., Farmingdale, N.Y. 11735. (516) 293-3100. \$495 (NV); stock to 6 wk.

The Model 655NV sine/cosine converter produces a dc output that is suited for radar display systems. Model 655NVDIG produces a digital output that permits the engineer to perform many digital calculations prior to storing the data. Multiplexing of various inputs is easily accomplished with either unit. Accuracy for the 655NV is 6 min. and 5 min. for the 655NVDIG. Either model can be supplied to operate over 0 to +70 C or -55 to +85 C. They can also meet all applicable military specifications. Size of the 655NV module is 3.2 × 3.4 × 0.82 in. while the Model 655NVDIG is supplied on a PC board measuring 4.5 × 8 × 5.82 in.

CIRCLE NO. 309

### Band-reject filters cover 0.2 Hz to 20 kHz

Frequency Devices, Inc., 25 Locust St., Haverhill, Mass. 01830. (617) 372-6930. \$75 (1 to 9); stock to 4 wk.

Series 780 modular active filters have resistive tunable band-reject transfer functions. The design permits tuning over a 1000:1 frequency range. The notch depth is independent of the accuracy or matching characteristics of the frequency tuning resistors. Three models cover overlapping frequency ranges from 0.2 Hz to 20 kHz. Frequencies are set via two external resistors. Q is externally adjustable from 0.5 to 100. Notch depth of 50 dB (Q = 0.5) is maintained over the entire frequency tuning range and is adjustable to 70 dB via an external potentiometer. Power requirements are ±5 to ±18 V at 8 mA and the input voltage swing is ±10 V. The input impedance is 20 kΩ and the output impedance is less than 10 Ω with a voltage swing of ±10 V at 5 mA. The operating temperature range is 0 to 70 C while the size is 1.5 × 2 × 0.4 in.

CIRCLE NO. 310

### Timing programmer has 0.01% timing accuracy



Bayshore Systems, 5406A Port Royal Rd., Springfield, Va. 22151. (703) 321-9625. \$890; 45 to 60 day.

The timing programmer, Model TP-41, can activate up to eight external relays in an easily programmed fashion. A digital clock provides 0.01% timing accuracy. A simple matrix of screw-in terminals accomplishes the desired activating time of each of the eight relay signals. A special feature allows the relays to be actuated in numerical sequence or all of the relays to be actuated relative to the starting time. Timing capability is selectable internally in 0.25, 0.5, or 1 s increments up to over 1000 s. The input power requirement is 28 V dc. Over-all size is 2.5 × 2 × 5 in. and the unit is constructed to MIL and NASA specifications.

CIRCLE NO. 320

### Instrumentation amp has ±1 μV/°C temp drift

Optical Electronics, P.O. Box 1140, Tucson, Ariz. 85734. (602) 624-8358. \$47.50 (10-up); stock.

The 9071 differential instrumentation amplifier uses a single resistor to fix voltage gain over a 1000:1 range. The amplifier has a voltage drift of ±1 μV/°C and a nonlinearity of ±0.003% of full scale, maximum. The unit's offset voltage is ±100 μV maximum, adjustable to zero. Other features include: a 1 MHz gain-bandwidth product, ±10 V out into a 1 kΩ load, 1.125-in.-square-by-0.44-in.-high package and operation over a ±4 to ±20 V supply voltage range.

CIRCLE NO. 321



# THERE'S A BETTER WAY TO GO.



Energy shortages tell us we have to change our driving style. Now! It doesn't mean we have to go back to horse and buggy days. But it does mean we have to make every drop of gas give us the most go for our money. Anyone with horse sense knows that a well-tuned car gets better mileage, and in times of fuel shortages, better mileage means a lot.

The Mark Ten B Capacitive Discharge System keeps your car in better tune so it burns less gas. Using Mark Ten B is more than horse sense. It's the smart move under the hood, helping a nation survive an energy crisis and keeping you on the road. Delta Mark Ten. The best way to go.



## DELTA PRODUCTS, INC.

P.O. Box 1147, Dept. ED  
Grand Junction, Colo. 81501  
(303) 242-9000

Please send me free literature.

Enclosed is \$\_\_\_\_\_  Ship ppd.  Ship C.O.D.

Please send: \_\_\_\_\_ Mark Ten B assembled @ \$59.95 ppd. \_\_\_\_\_ Mark Ten B Kit @ \$44.95 ppd.

(12 volt negative ground only) \_\_\_\_\_ Standard Mark

Ten assembled, @ \$44.95 ppd. \_\_\_\_\_ 6 Volt: Neg. Ground Only \_\_\_\_\_ 12 Volt: Specify \_\_\_\_\_ Pos. Ground

\_\_\_\_\_ Neg. Ground \_\_\_\_\_ Standard Mark Ten Deltakit® @ \$29.95 ppd. (12 Volt Positive or Negative Ground Only)

Car Year \_\_\_\_\_ Make \_\_\_\_\_

Name \_\_\_\_\_

Address \_\_\_\_\_

City/State \_\_\_\_\_ Zip \_\_\_\_\_



## Data acquisition system fits on single card

Data Translation, 109 Concord St., Framingham, Mass. 01701. (617) 879-3595. \$495; 4 wk.

The DT1640 data acquisition system provides 16-channels of multiplexing, sample/hold, 12-bit analog-to-digital conversion, and

all programming/control logic in a small, compact 0.375 in. high plug-in module. The DT1640 has a throughput rate of 25 kHz for each 12-bit word. Both single-ended and differential inputs are available at an over-all system accuracy of  $\pm 0.03\%$  worst case. The unit's temperature coefficient is  $\pm 30$  ppm/ $^{\circ}\text{C}$ , and full scale voltage inputs of  $\pm 5$ ,  $\pm 10$  and 0 to +10 V are pin selectable.

CIRCLE NO. 322

## Regulator module drives motor adjusted Xformer



Philips, P.O. Box 523, Eindhoven, the Netherlands.

The automatic stabilizer module accepts the output voltage of a motor driven variable transformer rectifies it and compares it with an adjustable dc reference voltage. The reference is derived from an internal regulated power supply fed from the input to the transformer. The difference voltage output from a comparator controls a switching amplifier which operates either of two reed relays. The relays control the drive motor of the variable transformer which turns and thus reduces the comparator output voltage to zero. A wide range of variable mains transformers, motor drive units, and accessories is available.

CIRCLE NO. 323

## Crystal clock oscillator operates at ECL levels

Vectron Labs, 121 Water St., Norwalk, Conn. 06854. (203) 853-4433. Stock to 60 days.

The CO-233ME crystal oscillator operates from a -5.2-V-dc supply. It provides a stable ECL compatible output at any specified frequency in the 5-to-200-MHz frequency range. The 1.5-in-square-by-0.625-in. high module is designed for PC board mounting and provides a stability better than  $\pm 0.0025\%$  over 0 to 70 C. The oscillator is preset to within 0.001% of the specified frequency, but a frequency adjustment to within 0.0001% is optionally available. Other options include the MIL range CO-233ME-2 with stability of  $\pm 0.005\%$  over -55 to +125 C and the high stability CO-233ME-3 with stability of  $\pm 0.0003\%$  over 0 to 50 C.

CIRCLE NO. 324

## 8 CASES FOR SWITCHING TO NATIONAL<sup>®</sup> SCRs



16-1600 Amperes rms  
25-1700 Volts  
Power and Inverter SCRs  
Patented Regenerative Gate

Call or write for full details



**NATIONAL ELECTRONICS**

a varian division

geneva, illinois (312) 232-4300



# FOR PEOPLE WHO WANT TO READ ALL ABOUT IT!



We have nothing less than a fully illustrated, systematic, easy-to-use survey of the entire field of data management as it exists today. It covers it all, from A to Z, so it's for everybody. The programmer tightening up his files. The analyst working out a workable timesharing program. Top management needing industry-wide perspective on competitive system designs.

It's a rare publication that takes a unique "blueprint approach" to current know-how. Beginning with the single data item as the first building block in total system design. And progressing through specific techniques for data structures, streams, files . . . total hardware and operating system control . . . the latest advances in timesharing and multiprogramming . . . system modeling and simulation . . . complete

designs for various types of commercial accounting and document-oriented storage and retrieval systems. It all adds up to a vast and impressive "top to bottom" view.

And it does it all in fresh, jargon-free language, with scores of illustrations and diagrams for a rapid, visual grasp.

Whether you use it as an on-the-job manual, as a desk-top reference, or as a conference room companion with all the answers, it's an indispensable tool guaranteed to broaden your perspective and practical skill in a field that knows no limits to growth and progress. And generally give you the professional confidence that comes from knowing just about everything that's going on.

#5100-X, 6 x 9, 300 pages, cloth \$14.95

## *To Order:*

Circle the **Information Retrieval Number** to order your 15-day free examination copy of **Data Management for On-Line Systems** by **David Lefkowitz**. At the end of that time please remit payment or return the book with no further obligation.



**Hayden Book Company, Inc., 50 Essex Street, Rochelle Park, N. J. 07662**

INFORMATION RETRIEVAL NUMBER 128



**TEC LITE**

**24-HOUR DELIVERY!**



**SWITCHES**

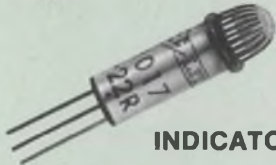

**INDICATORS**



**LAMPS**

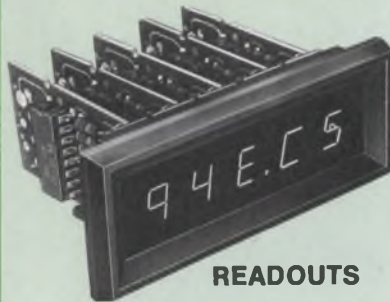

**READOUTS**

**SAME-DAY SERVICE ON POPULAR TEC-LITE DEVICES & ACCESSORIES FOR 1-99 UNITS**

That's right, your order is shipped within 24 hours of receipt — even if you order just 1 item!

We've picked a number of various indicating devices — including our broad line of LED's — for this unique turnaround service. Choose from —

- Switch/Indicators and indicators with replaceable lamps
- Green, red and yellow LED's
- Momentary action switches
- LED readouts in sizes to .770"
- Incandescent, neon and LED lamps, plus LED displays

You'll find all the above — and more — in TEC's QUICK DRAW Catalog No. 955, which includes detailed descriptions, prices and ordering information. See your TEC-REP or write or call direct.



9800 North Oracle Road  
Tucson, Arizona 85704  
(602) 297-1111

INFORMATION RETRIEVAL NUMBER 129

**MODULES & SUBASSEMBLIES**

**64 channel acquisition system fits 2 ckt cards**



*Data Translation, 109 Concord St., Framingham, Mass. 01701. (617) 879-3595. \$1195 per system; 4 wk.*

A complete modular 64-channel data acquisition system includes a basic DT1620 data acquisition module and a DT-4EX expander module, all in two compact 0.375 × 3 × 4.6 in. plug-in packages. The 64-channel DATA system provides a throughput rate of 50,000 12-bit words per second at a system accuracy of ±0.03%. Alternately, operation can be short-cycled to a lesser resolution than 12-bits with a corresponding increase in throughput speed—short-cycling by pin strapping to 10-bits, yields a 40% increase in throughput. The units are housed in metal cases to prevent electrostatic and magnetic coupling from affecting the analog circuits inside.

**CIRCLE NO. 325**

**Rf thick-film amplifier spans 5 to 300 MHz**

*Optimax, P.O. Box 105, Advance Lane, Colmar, Pa. 18915. (215) 822-1311. \$75 (1 to 9); stock to 2 wk.*

Model AH-60 thick film rf modular amplifier provides high linear output power of +20 dBm. These units are designed for direct insertion into microstrip circuitry and are encased in a hermetically sealed TO-3 package. They operate over a broad bandwidth of from 5 to 300 MHz, and have a nominal gain of 9 dB at +24 V dc, and an 8 dB noise figure with a 50 Ω line impedance.

**CIRCLE NO. 326**

**D/a resolver module has 1/2 LSB accuracy**

*Perkin-Elmer, Main Ave., Norwalk, Conn. 06856. (203) 762-1000. \$520 (11 bits), \$670 (12 bits); 12 wk.*

The Varidac-4 d/a resolver module provides outputs that can be summed to generate  $\sin(\alpha + \beta)$  and  $\cos(\alpha + \beta)$  from four separate inputs. The unit uses two dual transformer-based linear MDACs in a 2.4 × 2.4 × 0.5 in. case. The module's output provides axis rotation without translation by accepting the analog  $\sin \alpha$  and  $\cos \alpha$  from a resolver, and two digital inputs,  $\sin \beta$  and  $\cos \beta$ . It provides 11 bits of resolution and 1/2 LSB of absolute accuracy for each output channel over -55 to +125 C. It is TTL/CMOS compatible and will operate in either a unipolar or bipolar mode. Also available are units with 12 bits of resolution with 1/2 LSB absolute accuracy for each output channel.

**CIRCLE NO. 327**

**Temp compensation built into tone generator**

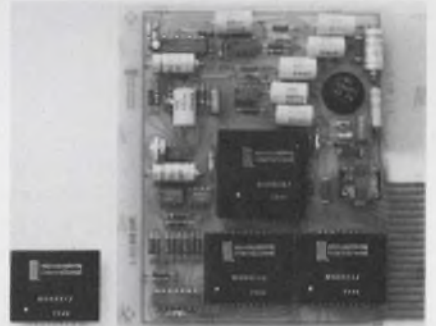

*Microsystems International, Box 3529, Station C, Ottawa, Canada K1Y4J1. (613) 828-9191. Unit qty. prices: \$18 (8900) \$295 (8800); stock.*

The dual frequency tone generator, MH8900, is a compact (less than 1.5 × 1.2 in.) 16-pin dual-in-line style case. It can be keyed by most pushbutton assemblies or interfaced to key electronically. Temperature compensation, wide supply range and optional polarity protection are among the other features. The tone receiver, ME-8800 series, is a small (5 × 5 in.) circuit board assembly with all the functions of prefiltering, agc, active filtering and detection. A two-of-eight open collector transistor array is provided on the output.

**CIRCLE NO. 328**



## SOUTH BAY CABLE SOLVES TOUGH CABLE PROBLEMS!



For computer applications, business machines . . . or a custom design to fit your particular requirement. Write for catalog or send details of your needs.

Manufacturers of cable for electronic use both military and commercial.

**SOUTH BAY**  **CABLE CORP.**

Idyllwild, California 92349 • Tel. (714) 659-2183

INFORMATION RETRIEVAL NUMBER 130

## POWER SUPPLIES FOR SYSTEM USE

IN ONLY 3½", USES  
LESS VERTICAL RACK SPACE.

5 case sizes — all in 3½" size. Mix 'n Match all types in standard rack adapters — again, the same convenient size.  L Series — 5 to 25 VDC to 75 amps. O/V standard. Best for logic systems. Good efficiency.  H Series — High performance slot supply for critical applications. 0.5 VDC to 250 VDC.  K Series — Dual tracking supplies — for heavy duty service.  WR — Wide range series, adjustable from 0 up to 50 VDC.

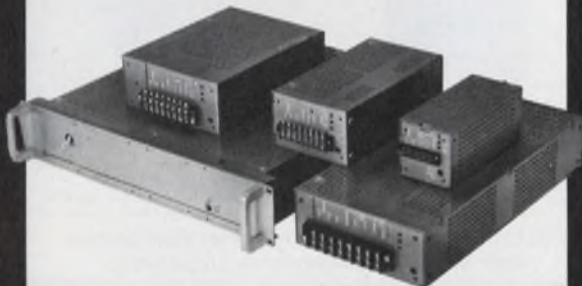

For faster service call (203) 243-0315

**DYNAGE inc.**  
1331 Blue Hills Avenue, Bloomfield, CT 06002

INFORMATION RETRIEVAL NUMBER 132

ELECTRONIC DESIGN 9, April 26, 1974

## Now with DESC Qualification Approval\*



### Simplify MIL fault signal detection with this manual reset BITE Indicator.

Use our L21603/01 manual reset BITE indicator to monitor faults in systems and components and provide an automatic warning when operation falls outside design parameters. Only a minimum of circuitry is required. Miniature size permits compact grouping, and its rugged construction allows it to meet MIL spec reliability standards —Mil-I-83287C(USAF).

In use, the indicator has a normal all-black appearance. If a fault signal occurs in a monitored circuit, the face of the indicator immediately turns to a sharply contrasting black-and-white cloverleaf design. A built-in magnetic fail-safe memory latches the indicator in the "fault" mode until it is manually reset. As a result, transient as well as permanent fault signals are detected and there is no possibility of the indicator being accidentally reset until servicing is undertaken.

\*Approval letter #EQA 73-756 dated Dec., 11, 1973

Send for information now!

A. W. HAYDON CO. PRODUCTS

**NORTH AMERICAN PHILIPS CONTROLS CORP.**

Cheshire, Conn. 06410 • (203) 272-0301

INFORMATION RETRIEVAL NUMBER 131

## 10 amps of switching in a 1" cube



### Series 19 Relay. One of the most compact and reliable relays you'll ever use.

In just one cubic inch, the remarkable Series 19 relay combines the advantages of miniaturization with a capacity to handle heavy switching loads. Result: more performance in a smaller overall package. Yet the cost is low — less than \$2.00 each in 100-piece quantities.

Contact arrangement is SPDT. Rating is 10 amps, 28 vdc or 115 v, 60 hz. Available coil voltages range from 3 to 24 vdc.

Consider the Series 19 relay for low level to 10 amp switching applications such as remote control, alarm systems and similar industrial and commercial uses.

Send for information now!

PRICE ELECTRIC RELAYS

**NORTH AMERICAN PHILIPS CONTROLS CORP.**

E Church & 2nd St. • Frederick, Md. 21701 • (301) 663-5141

INFORMATION RETRIEVAL NUMBER 133



INTEGRATED CIRCUITS

**MOS chip generates rhythms**

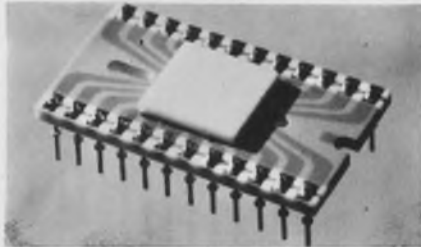

SGS-ATES Semiconductor, 435 Newtonville Ave., Newtonville, Mass. 02160. (617) 969-1610. \$15 (100-999); stock (sample qty.).

A single-chip rhythm generator, called the M250, is arranged as a ROM with an internal automatic row decoder that allows one of 32 rows to be scanned at a time. By means of an appropriate program, 12 rhythms can drive eight single outputs. An internal reset allows the counter to stop at any point from 1 to 32 to fit the number of beats required by a given rhythm. The output can directly drive eight blocking oscillators simulating the percussion instruments.

CIRCLE NO. 329

**Chip set for watches dissipates 15  $\mu$ W**

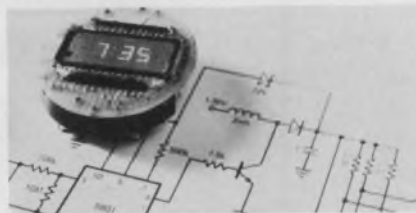

Intel Corp., 3065 Bowers Ave., Santa Clara, Calif. 95051. (408) 246-7501. 5801/5201: \$27.50; 5801/5202: \$25 (sample units).

A two-chip digital watch set, using silicon-gate ion-implanted CMOS technology, has a total average power consumption of less than 15  $\mu$ W. When used with a 32-kHz crystal, they operate for greater than one year from a single 1.35-V battery cell maintaining an accuracy of better than one minute per year. The two-chip set consists of the 5801 oscillator/divider circuit and a decoder/driver circuit available in two versions: the 5201, featuring hours, minutes and seconds on-command, and the 5202, displaying the conventional hours and minutes.

CIRCLE NO. 330

**16-bit register reads while it writes**

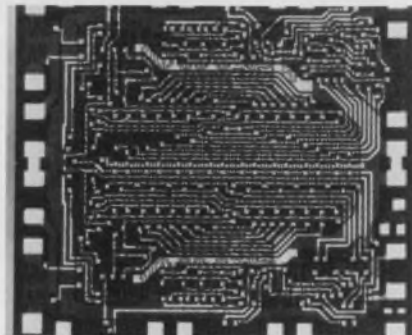

Motorola Semiconductor Products, P.O. Box 20924, Phoenix, Ariz. 85036. (602) 244-3465. \$29 (100-999); stock.

A 16-bit multiport register file can read 4-bits and/or write 2 bits at the same time. Called the MC-10143L, the MECL RAM offers an access time to any four bits of 10 ns, while simultaneously writing in new data. Clock to data out is typically 5 ns, and read enable to data output is 3.5 ns, typically. Power dissipation is 610 mW and the IC comes in a 24-pin ceramic DIP for the -30 to +85 C temperature range.

CIRCLE NO. 331

**No down-time in rotary switches**

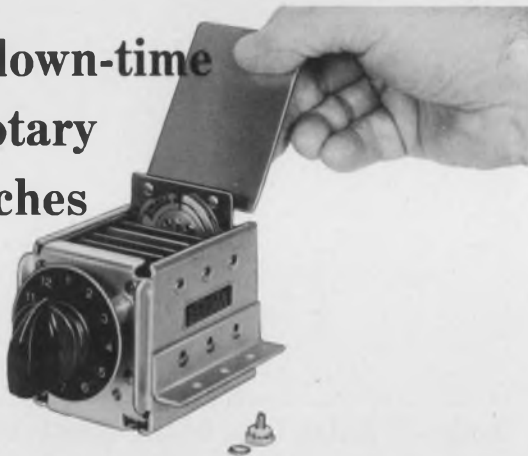

Unique 5-second wafer replacement obsoletes other switches. Simply lift out old wafer, slip in new wafer. No unsoldering . . . no disassembling . . . no wire removing.

CDI patented switches with dust covers are available in sizes 2" x 2", 3" x 3", and 4" x 4" with lengths to accommodate up to 36 wafers. Switches can be customized to your specifications.

Operation may be manual, motor or solenoid for use in any rotary selector switch application. Now supplied for numerous military and commercial applications.

Mid. under Tabel U. S. Patents 2,841,660, 2,971,066, 3,015,000, 2,956,131, 2,988,607.

**CHICAGO DYNAMIC INDUSTRIES, INC.**

PRECISION PRODUCTS DIVISION

1725 Diversey Blvd., Chicago, Ill. 60614 Phone 312. WE 5-4600

INFORMATION RETRIEVAL NUMBER 134

**NO ONE**

**Customizes Switches Like CDI Nor Has a More Complete Line**

**THUMBWHEEL SWITCHES**



Completely sealed against hostile environments.



Mounts on 1/2" centers, retrofits most panel openings for miniature thumbwheel switches.

**ROTARY SWITCHES**

Snap-in, snap-out modules in seconds, eliminating downtime.

Tabel Pat. 2841660, 2971066, 3015000, 2956131, 2988607.



**PUSHBUTTON SWITCHES**



Miniature add/subtract units retrofit most minithumbwheel switch panel openings.

**CDI earns its reputation every day for Consistently High Quality, Consistently Good Delivery.**



**CHICAGO DYNAMIC INDUSTRIES, INC.**

PRECISION PRODUCTS DIVISION

1725 Diversey Blvd., Chicago, Ill. nois 60614 Phone: 312, 935-4600

INFORMATION RETRIEVAL NUMBER 135

ELECTRONIC DESIGN 9, April 26, 1974



## Serial analog memories make debut

Reticon Corp., 450 E. Middlefield Rd., Mountain View, Calif. 94040. (415) 964-6800. \$100 (sample qty.); stock.

The SAM 64 series represents the first commercial line of monolithic serial analog memories. A typical device provides 64 capacitive memory cells, each of which is individually addressable by two independent shift registers—for read-in and read-out. Several devices can be cascaded to store a complete TV line. Over 10-MHz sampling rates and 50-dB S/N ratio are reported.

CIRCLE NO. 332

## Calculator chip set handles hard problems

MOS Technology, Valley Forge Corporate Center, 950 Rittenhouse Rd., Norristown, Pa. 19401. (215) 666-7950. \$32.50 (100 k).

A set of two MOS arrays, for full-function scientific calculators, permits the entry of problems with up to two levels of parenthesis. Called the MPS 2525-001 and the MPS 2526-001, the chip set performs basic arithmetic, as well as more complex functions such as inverse trigonometric functions and common and natural logarithms. Entry and result data are prepared for entry on a 14-character display. Supplies required are  $\pm 6$  and  $\pm 8.5$  V. The chip set dissipates 200 mW.

CIRCLE NO. 333

## COS/MOS divide-by-N counter makes debut

RCA Solid State Div., Route 202, Somerville, N.J. 08876. (201) 722-3200. \$13.60 (1000).

The first 4-decade divide-by-N counter using complementary MOS technology can be programmed to divide a clock frequency by any number from 3 to 15,999. Three mode-select controls are used for programming flexibility. Called the CD4059AD, the IC comes in a 24-lead ceramic package and operates from 3-to-15-V supplies. The output has TTL drive capability. Applications include digital frequency synthesizers, and a variety of program-counter, instrumentation and industrial-counter needs.

CIRCLE NO. 334

# Quick Change Artist



The Sorensen QRD—best of the compact bench-top supplies. With high speed programming to 10  $\mu$ sec, programmable by resistance, voltage and current—up to 100 kHz in normal and high speed modes. Voltage and current modes for increased application flexibility. 7 models offer outputs from 30 to 90 watts with these key operating features: automatic crossover; adjustable current limiting (auto. recovery); wide bandwidth ripple specs (to 25 MHz); 50  $\mu$ sec. transient response; full range of options and accessories. For complete data, contact the Marketing Manager at Sorensen Company, a unit of Raytheon Company, Manchester, N.H. (603) 668-4500.

### Representative Specifications—QRD

- Voltage Mode
  - Regulation (combined line & load)  $\pm 0.005\%$
  - Ripple (PAR) rms: 200  $\mu$ v
  - p-p: 3 mv.
- Voltage Ranges
  - 0-15 volts to 0-60 volts (7 models)
- Current Mode
  - Regulation (combined line & load)  $\pm (.01\% + 125 \text{ or } 250 \mu\text{a.})$
  - Ripple (PAR) rms: 150-400  $\mu\text{a.}$
  - p-p: 2 ma.
- Price Range
  - \$178 to \$285

**Sorensen**  
POWER SUPPLIES



# WAVE & SPECTRUM ANALYZERS

Quan-Tech manufactures a large selection of high quality, low frequency instruments to meet a wide range of requirements for wave and spectrum analysis.



From the low cost Model 2449 (priced at only \$2050.),



to the high-performance Model 306 TDL (\$3875.), this line of quality instruments offers features found only in Quan-Tech products.

- High accuracy at low cost.
- Selectable bandwidths from 1 Hz to 1000 Hz.
- Frequency ranges from 1 Hz to 10 MHz.
- Automatic tracking without a reference.
- Electronic sweep and AFC.
- LED display of actual frequency.
- Stable oscillator requires no warm-up.

Call or write for complete technical data or to arrange for demonstration.

## Quan-Tech®

Division of SCIENTIFIC-ATLANTA, Inc.

Randolph Park West, Route #10, Randolph Township, N.J. 07801 • Tel: (201) 361-3100

## INTEGRATED CIRCUITS

### McMOS static RAM holds 256 bits

*Motorola Semiconductor, Box 20924, Phoenix, Ariz. 85036. (602) 244-3465. CL version: \$35 (100-999).*

A 256-bit static RAM offers the medium-speed and micropower-operation features of complementary MOS. The MCM 14537 McMOS circuit consists of eight address inputs, one data input, one write-enable input, one strobe input, two chip-enable inputs, and one data output. Use of both chip-enable inputs permits a 10-bit address scheme. Four of these devices may be used to build a 1024-bit RAM without additional address decoding.

CIRCLE NO. 335

### 256-bit bipolar RAM accesses in 30 ns

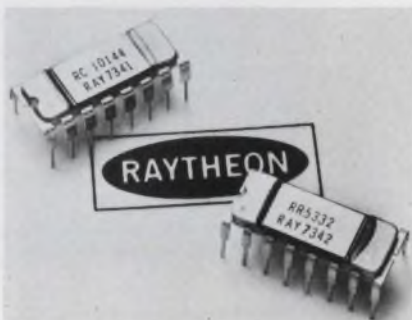

*Raytheon Semiconductor, 350 Ellis St., Mountain View, Calif. 94040. (415) 968-9211. TTL versions: \$24; ECL versions: \$32.50 (100); stock.*

A 256-bit bipolar RAM comes in both TTL and ECL versions. TTL versions of the new RAM are called RC 5332/42 for three-state or open-collector outputs and feature a typical access time of 37 ns. They are interchangeable with similar memories, such as the 74S200/206 and 82S16/17. ECL versions run at 30 ns typical. Their designations are RC 10144 (MECL 10k compatible), RC 95410 (Fairchild 95k compatible) and RC 10410 (Fairchild 10k compatible). The RAMs dissipate 250 mW, have a chip select time of 13 ns, and operate over the 0-to-75-C temperature range. They are available in a ceramic 16-pin DIP.

CIRCLE NO. 336

### Linear IC simplifies AM radio receivers

*RCA Solid State, Route 202, Somerville, N.J. 08876. (201) 722-3200. \$1.23 (1000).*

The CA3123E linear IC AM receiver provides an rf amplifier, i-f amplifier, mixer, oscillator, agc detector and voltage regulator on a single chip. Intended for super-heterodyne AM-radio applications, the CA3123E comes in a 14-lead DIP and operates over the full military-temperature range of -55 to 125 C. Features include a low-noise rf stage in cascode connection, mixer-oscillator stage with internal feedback and frequency-counter-type agc circuit.

CIRCLE NO. 337

### PLL stability spec'd at 20 ppm/°C

*Plessey Semiconductors, 1674 McGaw Ave., Santa Ana, Calif. 92705. (714) 540-9979. \$17.60; stock.*

A phase-locked-loop chip, the SL650C, contains a current-controlled oscillator, phase comparator, 2-bit binary interface circuit and an auxiliary amplifier that provides a CCITT interface. The IC has a temperature stability of 20 ppm/°C and its oscillator frequency can be swept over a 1000:1 range by an external control current. The SL650C operates from a supply that can range from ±4.5 to ±9.0 V and comes in a ceramic 24-pin DIP.

CIRCLE NO. 338

### 8-bit latch offers 22-ns delay

*Advanced Micro Devices, 901 Thompson Pl., Sunnyvale, Calif. 94086. (408) 732-2400. 9334PC: \$3.57 (100 up).*

An 8-bit addressable latch, the Am 9334, offers a typical average data propagation delay of 22 ns and operates from a 5-V supply, drawing a typical current of 56 nA. The latch is pin-compatible with the like-numbered circuit from Fairchild and features four separate modes of operation—addressable latch, memory, 8-channel demultiplexer and clear. The IC contains eight individual parallel outputs and has an active-low common clear and input enable.

CIRCLE NO. 339



## Bipolar pROMs expand line

Fairchild Semiconductor, 464 Ellis St., Mountain View, Calif. 94042. (415) 962-3816. \$22 (100-999).

Two TTL 1024-bit programmable ROMs, called the 93416 and the 93426, are now offered by the company. The pROMs are fully decoded, high-speed devices, organized as 256 words  $\times$  4 bits. The 93416 has uncommitted collector outputs, while the 93426 has three-state outputs. The pROMs have typical access time of 45 ns at 25 C and 5 V and two chip-select inputs for memory expansion and wired-OR capability.

CIRCLE NO. 340

## 16-k ROM accesses in 450 ns

MOS Technology, Valley Forge Corporate Center, 950 Rittenhouse Rd., Norristown, Pa. 19401. (215) 666-7950. \$14.50 (100 k); 12-14 wk.

A 16,384-bit read-only memory, the MCS 2026, features an access time of only 450 ns. The ROM can operate in either a static or dynamic mode. A special clocking system allows direct feedback of output signals to the input, permitting the use of the MCS 2026 for a variety of logic functions. The ROM operates from +5 and -12-V supplies. It dissipates less than 500 mW, even when operating at the highest speed—2.2 MHz.

CIRCLE NO. 341

## 256-bit RAMs access in 30 ns

Signetics, 811 E. Arques Ave., Sunnyvale, Calif. 94086. (408) 739-7700. Plastic: \$28 each (100 up); 4 wk.

Two 256-bit RAMs consist of the 82S16, which has Tri-State outputs, and the 82S17, a version with open-collector outputs. Access time is less than 30 ns in both models. Read time is also 30 ns. Write time is 20 ns. Each model dissipates 1.5 mW per bit typical. Input loadings consist of 25  $\mu$ A (logic ONE) and -100  $\mu$ A (logic ZERO). The memories operate from a single 5-V supply.

INQUIRE DIRECT

# If the timing diagram says your logic should look like this...

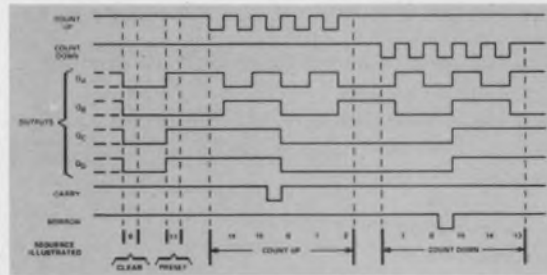

## ...now you can see if it does.



## Introducing the Glitch Fixer: Biomation's new 810-D Digital Logic Recorder makes any scope a data stream display.

Analyzing a complex logic circuit—especially asynchronous logic—used to be a tough assignment. No longer. Not if you put Biomation's new Glitch Fixer—the 810-D Digital Logic Recorder—between your troubled circuit and any oscilloscope. It lets you record up to eight digital signals simultaneously. Presents them in the same format you're used to seeing on data sheets. And lets you expand the 250-bit data line (x5) to get a closer look at what you've got.

Best of all, it features an input latch that grabs hold of any random logic pulse—the glitch you're looking for—as narrow as 30 nanoseconds.

Here are some other features to mull

- over: records 8 logic channels using 1 M $\Omega$  inputs
- selectable logic thresholds, including TTL and EIA levels
- synchronous clock input to 10 MHz or internal clocking selection from 20Hz to 10MHz
- storage of selected data ahead of trigger
- digital output for computer analysis or mass storage.

The Glitch Fixer is a new basic piece of diagnostic instrumentation designed for (and at the request of) logic circuit designers and troubleshooters. If you work with logic circuits, our 810-D Digital Logic Recorder will do the job. For \$1950 (without display). Get the product literature and see for yourself. Write, wire, or phone Biomation at 10411 Bubb Road, Cupertino, CA 95014, (408) 255-9500, TWX 910 338 0226.

# biomation



## Now — Build your own High-Speed Digital Test Equipment

**From DC to 100 MHz. Choose From Over 20 Plug-In Modules:** • Signal Sources . . . Oscillators Used to Drive Other Modules • Data/Word Generators . . . Serial/Parallel/Pseudo Random Outputs

- Digital Width and Delay . . . Wide Range with 1 Nanosecond Resolution • Signal Conditioning . . . Amplifiers to Vary Width, Delay, Amplitude, Offset
- PCM BERT . . . Transmitter/ Receiver with Auto Sync and Counter. Buy only what you need to synthesize the exact complex waveform you want. You can add on, later . . . even specialized modules.

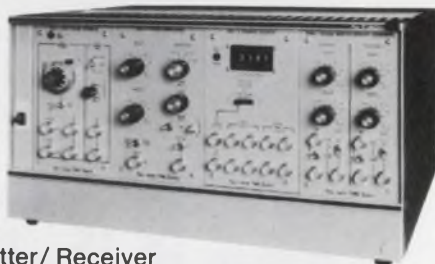

**tau-tron**  
INC

11 Esquire Road, North Billerica, Mass. 01862 Tel: (617) 667-3874

INFORMATION RETRIEVAL NUMBER 139

# cut costs 40% on parts like this

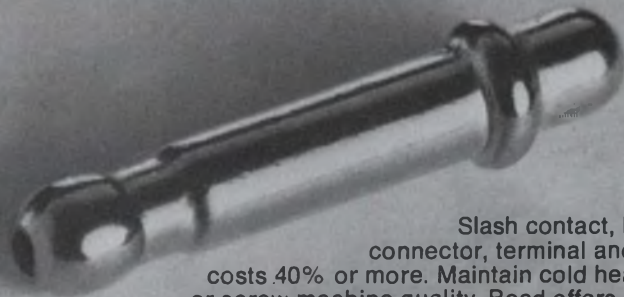

Slash contact, lead, connector, terminal and pin costs 40% or more. Maintain cold headed or screw machine quality. Bead offers a full line of standard products. Formed by our fast, accurate virtually waste free multi-swaging process to give you fast delivery, low prices. We provide custom engineering to meet your special requirements. Write or call for our new catalog.



**bead electronics**

A Division of Bead Chain Mfg. Co.  
58 Mountain Grove St., Bridgeport, Conn. 06605  
Phone: (203) 334-4124

INFORMATION RETRIEVAL NUMBER 140

## COMPONENTS

### Neon bar graph provides 0.5% resolution

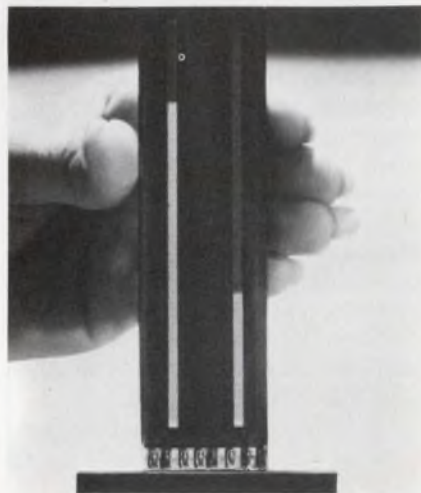

Burroughs Corp., P.O. Box 1226, Plainfield, N.J. 07061. (201) 757-5000. \$29 (1000 up).

Self-Scan, an electronic bar-graph analog display, has two separate 4-in. bar graphs and each contains 200 elements that provide 0.5% resolution. The display-element glow blends into a continuous, but precisely controllable, bar length. This device is the first of a series of digitally-controlled analog displays that can substitute for a panel meter. The unit's neon-orange glow is flicker free and can be easily seen in direct sunlight. By using gas-discharge technology, thick-film processing, and an internal self-scanning technique, this bar graph eliminates the need for most drive electronics and requires only eight connections to control the two independent 200-element displays. The device is only 0.2 in., excluding tubulation, and can be provided in special shapes and different configurations for custom applications.

CIRCLE NO. 342

### Neon lamp responds in less than 100 $\mu$ s

Glow-Lite Corp., Pauls Valley, Okla. 73075. (405) 238-5541.

A new technique for neon lamps guarantees a response time of less than 100  $\mu$ s, regardless of ambient light conditions. The technique can be applied to any of Glow-Lite's indicator lamps, if a minimum voltage of 25% above breakdown voltage is supplied.

CIRCLE NO. 343

ELECTRONIC DESIGN 9, April 26, 1974



## Ferrite reader head has 10 $\mu$ s rise time

Information Magnetics Corp., 5743 Thornwood Dr., Goleta, Calif. 93107. (805) 964-6828.

A glass-bonded ferrite head for use with standard oxide-coated cards, designated the FCH-3, is a single-track, read-after-write head. Its ferrite-head structure with glass gaps and glass bonding prevents epoxies from contacting the medium surface. This results in improved card wear. Designed for a surface-to-head speed of 20 ips, the head provides a packing density of 400 fci, a read output of 15.8 mV and a track width of 0.0180 in. Write current is 18 mA with a rise time of 10  $\mu$ s. The write-head track width is 0.0410 in. Resolution is greater than 80% and cross-talk is less than 5%. Self-erasure, after 50 passes, is less than 6%.

CIRCLE NO. 344

## Light controlled door opener is trip-proof



Scott Automatics, 86 Broadfields Ave., Edgware, Middsex, England.

Hinged or overhead garage doors can be opened and closed from inside a car with a high-security remote control system. The system employs a hand-held gun tuned to emit one coded beam from any of 40 light frequency variations. The wide band of frequencies ensures a high degree of security for the user. Effective range is 25 ft. The coded beam, fired through the windshield, is received by a photo-receptor and passed to a receiver inside the garage, where it is analyzed. The receptor can be mounted behind a glass panel or behind a hole in the garage wall.

CIRCLE NO. 345

# SYSTRON-DONNER POWER SUPPLIES



## NEW DIGITAL POWER SOURCE from \$1275

Dual Power Supplies ... 0 to 50V, 1 amp  
or ... 0 to 100V, 0.5 amps

**Digitally Controlled ...  
Independently Programmable ... for  
OEM & Automatic Test Systems**

- Use for computer controlled test sets
- Use for complex process control operations
- Use for automated production routines
- 3 digit BCD (0.1% resolution) or 4 digit BCD (0.01% resolution)

**FEATURES** ● Addressable memory ● programs up to 16 sources from only one computer I/O circuit ● optional programmed polarity, overcurrent limit, overvoltage protection level, and range change X1 to X0.1 ● fully isolated to eliminate ground loops ● self verification options include data parity check, overcurrent alarm flag, equilibration ready flag, BCD display of input command.

*Write directly or call your local Scientific-Devices sales office for complete specifications and applications.*

TRYGON ELECTRONICS  
SUBSIDIARY

SYSTRON  DONNER

CORPORATION

1200 SHAMES DRIVE ■ WESTBURY, NEW YORK 11590 ■ PHONE (516) 997-6200



# NOW... LITTLE LIGHTS WITH STYLE

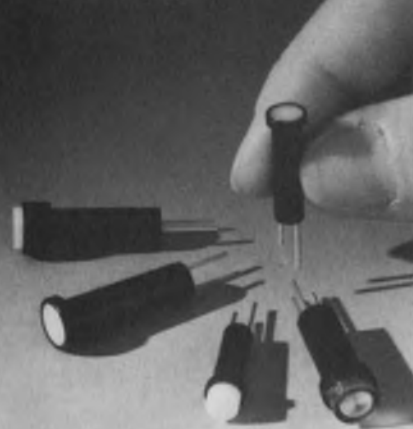

**Plus  
High Performance...  
Low Cost...  
Immediate Availability**

**LED's** — with built-in resistors for 3 to 28 volt applications.

**SELF DRIVEN INCANDESCENTS** — with built-in drivers & keep alive bias. Interface directly with TTL and MOS. Life ratings to 10+ years.

**STANDARD INCANDESCENTS AND NEONS** — single unit prices start below \$1.00.

#### CUSTOMS TOO!

All Data Display Products panel indicator lights are ruggedly built. They are available with low profile or standard lens projections.

*Call or write for more information today!*

*the little light people*

## DATA DISPLAY PRODUCTS

5428 W. 104th St., Los Angeles, Ca. 90045  
(213) 641-1232

INFORMATION RETRIEVAL NUMBER 142

## COMPONENTS

### Oval speakers use ferrite magnets



*International Importers Inc., 2242 S. Western Ave., Chicago, Ill. 60608. (312) 847-6363. 128EF-02: \$0.93 (5000 up); stock.*

A new family of nine ferrite-magnet oval speakers, the EF series manufactured by Hokutone (Japan), are available in a wide range of sizes from 2-3/4 by 4 in. through 4 by 10 in. The Hokutone 128EF-02 Model, for example, has a nominal size of 3 by 5 in. Resonant frequency is 170 Hz over a frequency range of 7000 Hz and maximum power is 2 W. The ferrite magnet weighs 1.94 oz. All speakers are available in 3.2, 8 and 16- $\Omega$  impedances, as well as 30 and 45- $\Omega$  versions for solid-state applications.

CIRCLE NO. 346

### Cross-bar switch makes use of optical isolation

*Opto-logic Corp., 3250 E. Spring St., Long Beach, Calif. 90806. (213) 595-1631. 180 days.*

These opto-electronic cross-bar switches can connect any input signal line to any output line. A removable optical slide determines the interconnection matrix which for some models is as large as 256  $\times$  256. An optical system links LEDs driven by the input signals to p-i-n photodiodes that sense the data signals. The unit handles signals with bit rates to 2 MHz. Standard TTL logic levels are provided at the input and output interfaces.

CIRCLE NO. 347

### Chip thermistors match to $\pm 0.2$ C or better

*Western Thermistor Corp., 303 Via El Centro, Oceanside, Calif. 92054. (714) 433-4484. See text.*

According to Western Thermistor, the chip thermistor's electrical predictability, stability and miniature dimensions (less than 0.100 in.) make it a low-cost alternate to small disc and bead-type thermistors for use between  $-50$  and  $150$  C. The economy of chips over beads and small discs may be greater than 60%, since phenolic-coated chips with a 10% resistance tolerance may sell for as little as \$0.25 each in 1000 quantities. Chip thermistors can be matched to  $\pm 0.2$  C or better, with resistances at 25 C of 500 to 50,000  $\Omega$ . Wider tolerance chip thermistors, in five negative temperature coefficients and with resistance at 25 C of 2  $\Omega$  through 200 k $\Omega$  are available from stock to four weeks.

CIRCLE NO. 348

### Clutch-brake units have high-torque-dia. ratio



*Inertia Dynamics Inc., P.O. Box 295, 12 Bridge St., Collinsville, Conn. 06022. (203) 693-0203. \$15 to \$30; stock.*

A new electromagnetic clutch and brake line, Series 22, which has a high torque-to-diameter ratio (50 lb-in. vs 30 and 40 lb-in. for competitive units), employs an axially-slotted magnet that accommodates more ampere turns per unit of body diameter. Units are equipped with sintered-bronze bearings, UL approved lead wire, zinc and yellow-chromate finish and long-life friction material. The unit's high static torque rating allows design engineers to use smaller size units and save anywhere from \$10 to \$25 per unit. Four standard dc voltages; 90, 28, 24, and 12 and two standard shaft sizes: 3/8 and 1/2 in. are offered. Special shaft bores up to 5/8 in. are also available.

CIRCLE NO. 349



# Quiet Power

TINY PACKAGE TINY PRICE

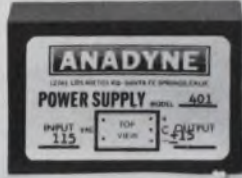

**\$2500\***

\*1 UNIT ONLY  
FOR 1ST TIME  
CUSTOMERS

Regular Prices  
\$31.50 (250-999)

Small, high performance power packages at the right price -- with regulation, ripple and temperature stability of larger, more expensive units. That's Anadyne's Series 400 miniature power supplies. Wrapped up in just 1" x 2" x 3", for instance, is our Model 401, with  $\pm 15$  V, 100 ma outputs, 115VAC input and ripple of only 1.4 mV pk. to pk. Operating temperature range is 0-70° C with line regulation  $\pm 0.005\%$  max. Our tiny regular price is \$31.50 (250-999). For 1st time customers the price is an even tinier \$25.00 for a single unit. Call or write today for complete specs and details.



12741 Los Nietos Road  
Santa Fe Springs, Ca. 90670

Tel. (213) 698-7991 · TWX: 910-586-1881

INFORMATION RETRIEVAL NUMBER 143

# DC to AC Sine Wave Inverters



## SPECIFICATIONS

### Output Voltage Regulation:

less than  $\pm 5\%$  for line and load

### Frequency Stability:

$\pm 0.5\%$  of fixed frequency; 0.05% optional

### Total Harmonic Distortion:

less than 5% at full load and nominal line

GW Series — Typical 60 Hz Models				
Power (VA)	Input (VDC)	Output (VAC)	Priced from	Delivery
250	12/24, 28, 48, 125	115, 230	\$ 695	Stock
500	12/24, 28, 48, 125	115, 230	1195	Stock
1000	12/24, 28, 48, 125	115, 230	1700	Stock
2000	12/24, 28	115, 230	3000	3 days
3000	12/24, 28	115, 230	4400	3 days

(50 and 400 Hz models available)

**TOPAZ**  
ELECTRONICS

SOLUTIONS TO  
POWER PROBLEMS

3855 Ruffin Road, San Diego, CA 92123 Phone (714) 279-0831

INFORMATION RETRIEVAL NUMBER 145

ELECTRONIC DESIGN 9, April 26, 1974

new

## COS/MOS Logic Probes Available Now



Kurz-Kasch logic probes replace  
oscilloscopes for digital logic testing.

New Model LP-576 tells you everything you need to know in 5 through 15V COS/MOS circuits: lows, highs, open circuits and pulses are all indicated. Send for free literature. For a 30 day Free trial Probe or special information, telephone Tom Barth, General Manager, Kurz-Kasch, Inc., Electronics Division, 2876 Culver Avenue, Dayton, Ohio 45429, Telephone: (513) 296-0330. Department ED.

Free test data



**Kurz-Kasch, Inc.**

ELECTRONICS DIVISION  
2876 Culver Avenue  
Dayton, Ohio 45429  
Telephone 513/296-0330

INFORMATION RETRIEVAL NUMBER 144

## LOWEST COST COMPACT PAGE PRINTER FACIT 4553

Available with or without RS232C Interface and/or power supply.

- 15 cps
- 80 column
- 5 x 7 dot matrix for character flexibility
- Few moving parts — easy operation, quiet running
- Single print hammer
- No ribbon
- Easy paper loading
- Contains drive circuits and control electronics with character generation
- ASCII code standard
- Also same print method in a strip printer-4552
- Delivery from stock



Facit-Addo, Inc.  
501 Winsor Drive  
Secaucus, N.J. **FACIT-ADDO, INC.**

Gentlemen: I am interested in receiving detailed data on your  4553 Page printer  4552 Strip printer

Name  Title

Phone

Company

Address

City  State  Zip

INFORMATION RETRIEVAL NUMBER 146



### Audible signal source provides 1000 Hz



C. A. Briggs Co., P.O. Box 151, Glenside, Pa. 19038. (215) 885-2244.

A new Bleepitone, Model BT-101 that emits a 1000-Hz audible signal (formerly 2500 Hz) is now available. This less strident, lower frequency is particularly desirable and useful as an alerting tone for business machines and medical equipment. The device produces a 70-to-86-dB-sound-pressure signal at 1 m when 8 to 16 V are applied. No RFI is produced and the current drain is 5 to 9 mA. A nylon, panel-mount adapter provides mounting versatility.

CIRCLE NO. 350

### Line of switches needs key for actuation

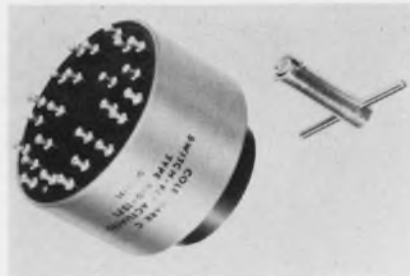

Cole Instrument Corp., 2034 Placentia Ave., Costa Mesa, Calif. 92627. (714) 642-8080.

Key actuated switches guard against accidentally turning equipment on or off, once the switch has been actuated. When the switch is turned to the desired position, a spring-loaded key ejects itself from the switch and the key must be reinserted before the switch can be turned again. These switches are available in a wide selection of configurations. A spring-return position for test purposes can also be added. The switches can be enclosed in dust and dirt-proof enclosures.

CIRCLE NO. 351

### Keystitches mounted on metal plate

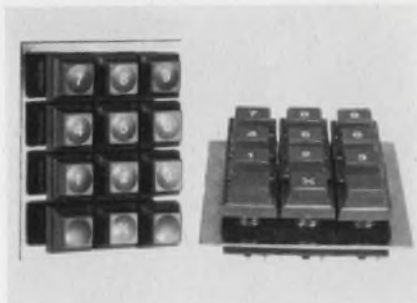

Stackpole Components Co., P.O. Box 14466, Raleigh, N.C. 27610. (919) 828-6201.

Arrays of Stackpole's Lo-Pro keystitches can now be provided pre-mounted and completely aligned in a metal plate, ready for insertion into a PC board. This eliminates the handling of individual switches, an extra PC board, cables and connectors. The pre-assembled keystitches are available in 1 x 4 to 4 x 4 arrays. The mounting plates are also available in special shapes to receive other components such as LED indicators.

CIRCLE NO. 352



### \$1.59 a Megacycle?

#### The WB Series

Texscan's WB Series Sweep Generators are designed to make production swept measurements at low cost. Three instruments from .5 MHz to 950 MHz.

WB-711 1MHz to 500 MHz \$795.00

# Texscan

A WORLD LEADER IN ELECTRONICS  
"And Coming On Strong"

Texscan Corporation  
2446 North Shadeland Avenue  
Indianapolis, Indiana 46219  
Ph: 317 357-8781  
TWX: 810-341-3184 Telex: 272110

INFORMATION RETRIEVAL NUMBER 147

### NEW LED LOGIC CHECKER



Displays logic state of most 14 or 16 pin IC's with no external controls. Simply clip over DIP package and appropriate LED will light to indicate a high logic state at each associated lead. For use on popular 5V systems. Completely portable for shop, lab, or field use—fully guaranteed. Detailed instructions and handy carry case supplied. Free set of 24 logic templates included. Post paid — \$99.95.

## ALCO

ELECTRONIC PRODUCTS, NORTH ANDOVER, MASS.

INFORMATION RETRIEVAL NUMBER 148

### ALCOSWITCH®

#### Mini . . . BI-DIRECTIONAL

Smallest coded switches feature a pushbutton action which moves the digit wheel in either direction. Decimal, Binary or other codes available. Bold numerals, easy to read. Two larger families too! Modular mounting. Call or write today for details.



SMC  
SERIES

## ALCO

ELECTRONIC PRODUCTS, INC.  
1551 OSGOOD STREET, NO. ANDOVER, MASS. 01845

INFORMATION RETRIEVAL NUMBER 149

ELECTRONIC DESIGN 9, April 26, 1974



## Proximity switch detects any metal



Electronic Automation Inc., 732 Crofton St. S.E., Grand Rapids, Mich. 49507. (616) 949-0779.

The Auto-Prok self-contained proximity switch is a solid-state device that produces a digital signal in the presence or absence of any metal within its sensing range. Stable operation is provided over the range of -40 to 185 F. It has an electrically adjustable sensing distance and an uncommitted 200 mA dc output. Wiring to the unit can be run with other wiring through standard 1/2-in. fittings. Its wiring length is limited only by losses in the cable. The physical construction permits installation with standard 1/2-inch electrical fittings.

CIRCLE NO. 353

## Pressure transducers deliver 5-V-dc output

Consolidated Controls Corp., Bethel, Conn. 06801. (203) 743-6721.

Type 41SG30, precision, miniature, bonded, strain-gauge, pressure transducers deliver 0-to-5-V-dc output from an unregulated 28-V-dc input power supply. Within their compensated temperature range of 0 to 150 F, the total error band, including nonlinearity, hysteresis and nonrepeatability, is within  $\pm 0.100$  V dc. The total operating temperature range extends from -65 to 250 F. Variation of output signal with changing line voltage is within 0.03% of full-scale-per-volt change in input level. The effects of acceleration are minimal. They vary from 0.01% of full scale per g for a 100 psi unit to 0.0005% for a 5000 psi unit. The units are 1-3/8 in. in diameter and approximately 3-in. long. Weight, depending on the pressure range, is from 5 to 6-1/2 oz.

CIRCLE NO. 354

# When it comes to one-source savings on solid-state power relays...



## COME TO CRYDOM...

### We're first with the most of the best!

After all, we originated and patented (#3,723,769) what has become the industry standard for solid-state power relays. Of course, we make the broadest line available, 18 models, all in the same field-proven package. What's more, they're UL recognized and CSA certified. And since you can satisfy every application need from one source, you'll simplify procurement, lower expenses.

So, whenever you need to control rugged AC loads from low voltage ICs or AC line voltage signals, you're sure to quickly find the most appropriate and reliable solution with the leader - Crydom.

LINE VOLTAGE (VAC)	FULL-LOAD CURRENT RATING (AMPS)				
	2.5	8	10	25	40
120	D1202 A1202		D1210 A1210	D1225 A1225	D1240 A1240
240	D2402 A2402		D2410 A2410	D2425 A2425	D2440 A2440
480		D4808 A4808			

CONTROL VOLTAGES: D PREFIX - 3-32VDC/A PREFIX - 90-280VAC

Call your local Crydom authorized distributor for off-the-shelf deliveries of any of our 18 models. And, when you need production quantities in a hurry, contact us at the factory for all the facts.

## CRYDOM CONTROLS IOR

DIVISION OF INTERNATIONAL RECTIFIER

1521 Grand Ave., El Segundo, California 90245 · (213) 322-4987



it's new!  
it's free!  
it's the greatest!

NEWARK  
CATALOG  
102



Your indispensable Reference and Buying Guide.

**MORE PAGES**—656 jam-packed with data, specs, and OEM prices.

**MORE PRODUCTS**—100,000 items in 18 commodity and specialty categories.

**TOP LINES**—Brand-Name products from 177 important manufacturers—The prestige leaders in their fields—

LINES LIKE

### AMF/Potter & Brumfield P&B Offers You a Choice of over 1,000 Standard Relays.

Specifying P&B is easy. After all, P&B makes more different types of relays than anyone else. Electro-mechanical... read... solid state/hybrid... time delay. P&B's broad line of standard relays provides a type for nearly any application. All in stock, available for fast, economical, off-the-shelf delivery.



Newark is your experienced Potter & Brumfield distributor with regional inventories, and the big plus of dependable, knowledgeable service from the people who know the line thoroughly.

Backed by multi-million dollar inventories for off-the shelf delivery from a nearby warehouse wherever you are.

### Compare Catalogs

and see the Shades of Difference that make a Big Difference to You!

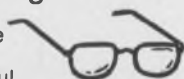

NEWARK ELECTRONICS

Subsidiary of  
Premier Industrial Corporation  
Warehouses and Sales Office Nationwide

WRITE OR PHONE: 500 North Pulaski Road  
Chicago, Illinois 60624  
Phone (312) 638-4411  
TELEX 25 3218  
or your nearest Newark Facility

INFORMATION RETRIEVAL NUMBER 152

## MICROWAVES & LASERS

### Linear p-i-n modulator has 50-dB range

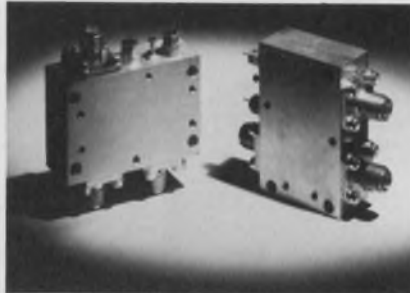

GHz Devices, 16 Maple Rd., Chelmsford, Mass. 01824. (617) 256-8101. \$510 (small qty.); 4 wk.

A series of p-i-n diode modulators provides linear attenuation vs voltage over a 0-to-50-dB range (with voltage drive of 0 to 5 V), while maintaining drive modulation to rf-envelope response time of 40 ns. Typical characteristics over the 0.5-to-1.5-GHz bandwidth include a maximum insertion loss of 2.5 dB and a maximum VSWR of 1.5:1. Maximum spec for pulse width is 200  $\mu$ s; for pulse repetition rate, it's 2000 pps.

CIRCLE NO. 355

### Ku-band oscillator outputs 60 mW

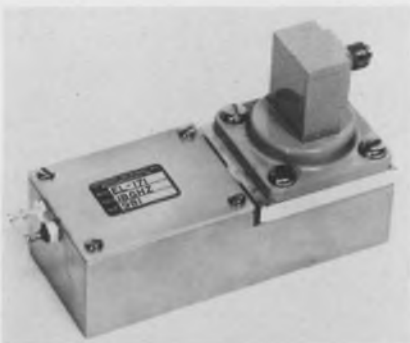

Greenray Industries, 840 W. Church Rd., Mechanicsburg, Pa. 17055. (717) 766-0223. \$1128 up; 6-8 wk.

The Model EL-171 cavity-stabilized Gunn-diode oscillator has a  $\pm$  150-MHz mechanical tuning range in the 12-to-18-GHz frequency range. Power output is specified as 40 mW minimum with typical outputs of 60 mW. Frequency stability is  $\pm$ 0.5% over the entire  $-54$  to  $+72$  C temperature range. The oscillator package measures only  $3.2 \times 1.3 \times 2.0$  inches.

CIRCLE NO. 356

### X-band Gunn oscillator outputs 30 mW minimum

Thomson-CSF Ltd., Bilton House, Uxbridge Rd., Ealing, London W5 2TT, England.

An X-band Gunn oscillator module provides an output power of 30 mW minimum—50 mW typical—with a supply voltage of less than 10 V and supply current under 400 mA. The oscillator operates at a center frequency between 8.5 and 10.6 GHz; a mechanical adjustment permits a  $\pm$ 250-MHz variation. Frequency drift is less than 0.5 MHz/ $^{\circ}$ C.

CIRCLE NO. 357

### SWR bridge spans 7.9-to-18.5-GHz range



Wiltron Co., 930 E. Meadow Dr., Palo Alto, Calif. 94303. (415) 321-7428. \$725; 3 wk.

The company's new SWR bridge combines a frequency range of 7.9 to 18.5 GHz with a directivity of 35 dB. The improved directivity means that the bridge has a residual SWR of only 1.04. Typical reflectometers used with the best available directional coupler reportedly provide a directivity of only 26 dB.

CIRCLE NO. 358

### Chip capacitor line operates up to Ku band

Varian Solid-State East Div., Salem Rd., Beverly, Mass. 01915. (617) 922-6000.

A line of chip capacitors for MICs—the VCC-600 through 604—provides capacitances ranging from 5 to 125 pF. Blocking voltages are 70 and 50 V dc. Frequencies range up through high Ku band.

CIRCLE NO. 359



## 5-channel multiplexer covers two octaves

*Frequency Contours, 3140 Alfred St., Santa Clara, Calif. 95050. (408) 984-7820.*

A five-channel multiplexer covers two octaves in the 200-to-800-MHz frequency range. The multiplexer has one common port and five output ports, with each channel centered at 300, 400, 500, 600 and 700 MHz, respectively. Each channel consists of a 6-pole band-pass filter with a minimum bandwidth of 60 MHz, insertion loss of 1.0-dB maximum and VSWR of 1.5:1 maximum.

CIRCLE NO. 360

## Coax attenuators work up to 18 GHz



*Systrom-Donner, 14844 Oxnard St., Van Nuys, Calif. 91409. (213) 786-1760.*

A series of compact, coaxial attenuators can be used at frequencies up to 18 GHz. The Model 441A uses Type N connectors, while the Model 447 uses APC-7 connectors. Fixed attenuation values of 3, 6, 10 and 20 dB are available. The VSWR is typically less than 1.15 at 12.4 GHz and less than 1.25 at 18 GHz. Frequency sensitivity is normally less than 0.05 dB/GHz.

CIRCLE NO. 361

## Hardy coax rotary joint spans 1.7 to 2.4 GHz

*Sage Laboratories, 3 Huron Dr., Natick, Mass. 01760. (617) 653-0844. \$1500; 90 days.*

A noncontacting junction coaxial rotary joint, the Model FRJ1007, reportedly provides premium performance from sea-level to deep space environments. Over the frequency range of 1.7 to 2.4 GHz, insertion loss is 0.25 dB maximum and VSWR is 1.35. Starting torque is only 10 oz-in maximum, and continuous rotational speed is 50 rpm. The unit can handle 20 W of cw power.

CIRCLE NO. 362

# So you're looking for low frequency filters...

Like 10.2 kHz  
11.3 kHz  
13.6 kHz

Very Small

but High Performance

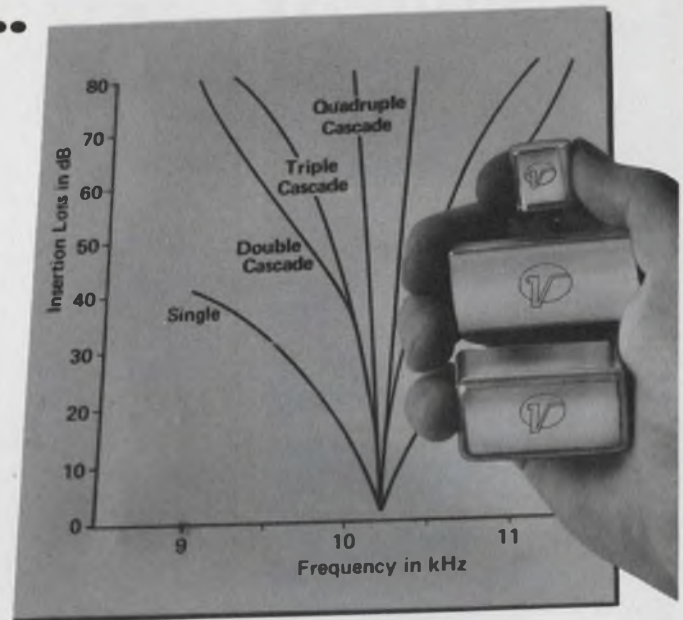

## better check Vernitron... (the filters people)

For VLF receivers, Mil-Nav systems, Omega systems, command-destruct systems, underwater sound — these miniature ceramic LF filters are about one-tenth the size and weight of comparable low-frequency types, yet have narrower bandwidths, lower insertion loss and greater stability. This means you can pack more performance into one-tenth the space — and have no worries about shock, vibration, thermal drift. Available in any discrete operating frequency from 7.5 kHz to 50 kHz — including the Omega  $f_o$ 's of 10.2, 11.3 and 13.6 kHz. They're fixed-tuned, so you have no installation adjustments to make. Hermetically-sealed, immune to environments... and there's no need for shielding.

Performance? Just the single-resonator models have 20 dB/3 dB bandwidth ratios less than 13, stopband attenuation to beyond 30 dB from dc to above 100 kHz. Less than 5 dB insertion loss. And that's not all!

### Cascaded Models for Higher Selectivity, Higher Rejections

Great thing about ceramic LF filters — they can be cascaded together in the same package, for quantum jumps in selectivity and rejection — with minimum sacrifice to volume and weight. Vernitron supplies them in 2-, 3- and 4-resonator models. Some examples:

**2-resonator Models**—40 dB/3 dB ratios of 10; stopbands to above 60 dB.

**3-resonator Models**—60 dB/3 dB ratios of 10; stopbands to above 80 dB.

**4-resonator Models**—80 dB/3 dB ratios of 13.5; stopbands to above 90 dB.

Both Mil-spec and commercial models. Prices will surprise you. They're at least competitive with conventional types, and often considerably less. If it's in the 7.5 kHz to 50 kHz range, it will pay you to check Vernitron. Send us your requirements. We'll send complete specs and technical data.



**Vernitron Piezoelectric Division**

232 Forbes Road / Bedford, Ohio 44146 / (216) 232-8600

INFORMATION RETRIEVAL NUMBER 153



# THE NEXT GENERATION OF Broadband Power Amplifiers

Starts with  
The

**isi** M403



.01-250MHz  
100W min.  
50db gain

SMALLER  
LIGHTER  
QUIETER

DESIGNED FOR RELIABILITY  
AND  
EASE OF MAINTENANCE

Solid State protection and control circuitry with complete remote control capability. *Write or Call.*

**isi** instruments  
for industry,  
inc. 151 Toledo Street,  
Farmingdale, N.Y. 11735  
(516) 694-1414

INFORMATION RETRIEVAL NUMBER 154

## DISCRETE SEMICONDUCTORS

Infrared LEDs have a  
choice of lens options



Monsanto, 3400 Hillview Ave., Palo Alto, Calif. 94302. (415) 493-3300. From \$1.30 (1 to 9); stock.

The ME712x series of infrared LEDs has four lens options that range from a wide angle power spread for noncritical detector location to sharp-angle concentration of power for detectors located a significant distance from the emitter. For all products in the ME712x series, the typical total external radiated power is 3 mW at 50 mA with a wavelength of 940 nm. Light turn-on and turn-off time is 500 ns with a 50  $\Omega$  load. The ME7161 is an IR source, only 0.09 in. at the narrowest base point. Its total external radiated power is typically 2 mW. The ME7140 is mounted on a TO-46 header. It has a 100 mA drive current and a total external radiated power of 4 mW.

CIRCLE NO. 363

Transistor arrays reduce  
temperature drift

Sescosem, 101, B<sup>D</sup> Murat, Paris XVI, France.

Three transistor-array ICs provide improved matching characteristics and reduced temperature drifts. The SFC 2018 contains a Darlington stage plus two insulated transistors. The SFC 2046 is a double Darlington and the SFC 2054 offers a double differential with current source. The ICs feature a  $\Delta V_{BE}$  of  $\pm 5$  mV maximum and a  $\Delta V_{BE}/\Delta T$  of 2 mV/ $^{\circ}$ C.

CIRCLE NO. 364

# For Low-Level Data Scanning

Ultra Low-Thermal  
EMF Reed  
Relays

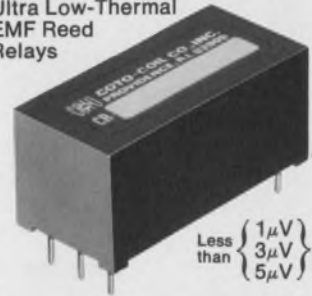

Less than  $\left\{ \begin{array}{l} 1\mu\text{V} \\ 3\mu\text{V} \\ 5\mu\text{V} \end{array} \right\}$  Take Your Pick!

Perfect for low-level scanners and multiplexers! Coto's new CR-3250 ultra low-thermal EMF reed relays include 2 low thermal contacts plus a third for guard switching... all specially conditioned and tested for reliable low-level switching. Relays are graded and priced according to magnitude of thermal offset; you pay for no more accuracy than you need! Write for new Bulletin MR-10.3.



**COTO-COIL  
COMPANY, INC.**  
59 Pavilion Ave.  
Providence, R. I. 02905  
Tel: (401) 467-4777

INFORMATION RETRIEVAL NUMBER 155

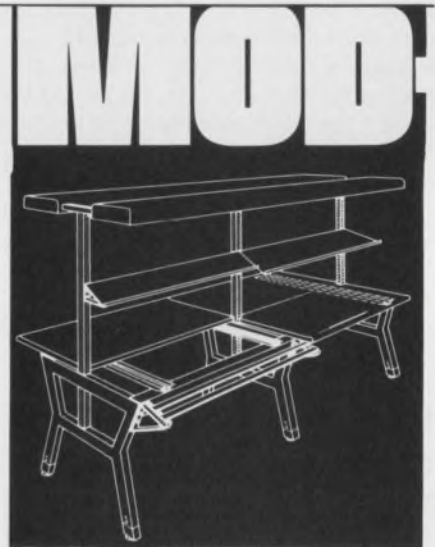

ALL-NEW PRODUCTION BENCH

features custom flexibility, durability and economy. Constructed of prime cold-rolled steel in four foot modules to fit every assembly need. Choice of 10 colors. Write or telephone... (312) 498-6090

**CABTRON  
SYSTEMS INC.**

200 N. ANETS DRIVE, NORTHBROOK, ILL. 60062

**ULAR**

INFORMATION RETRIEVAL NUMBER 156

ELECTRONIC DESIGN 9, April 26, 1974



## Solid-state JFET kits replace vacuum tubes

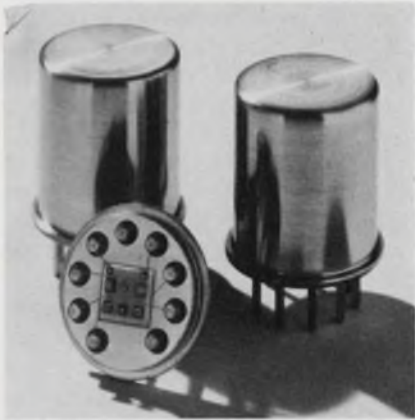

Teledyne Semiconductor, 1300 Terra Bella Ave., Mountain View, Calif. 94043. (415) 968-9241. HP-400 kit: \$48; CA: \$110 (1-5); stock.

FETRON kits, for the solid-state conversion of both the HP-400 voltmeter and the Tektronix CA oscilloscope plug-in module, are the first two of a series of kits designed for replacing vacuum tubes in electronic instruments with solid-state devices. The FETRON duplicates vacuum-tube performance with a hybrid JFET circuit, which plugs directly into the tube socket. Unlike vacuum tubes, the FETRON doesn't drift and doesn't require filament, screen grid or support power. The HP400 VTVM conversion kit replaces all five meter-circuit tubes. The CA plug-in kit replaces all 15 tubes.

CIRCLE NO. 365

## Rectifiers use disc packages

Westinghouse Electric, Gateway Center, Pittsburgh, Pa. 15222. (412) 255-3329.

The R620 and R920 Pow-R-Disc rectifiers come in disc-type packages for single or double-sided cooling and reversible mounting polarity. The Type R620 rectifiers feature average current ratings ranging from 300 to 500 A, surge-current capabilities to 6500 A and reverse-blocking voltages as high as 3000 V. Type R920 rectifiers, reportedly the largest commercially available solid-state diodes, have an average current of 2000 A, surge-current rating to 22,000 A and blocking voltage of 3000 V.

CIRCLE NO. 366



# PLAY IT AGAIN, SAM.

Sam is the name of Decitek's new low-cost 100 cps photoelectric tape reader. Sam? We could tell you that it's short for something like Superior Alignment Motion, which is precisely what our patented dual sprocket drive provides. But it isn't. We simply felt that Sam has a nice friendly ring to it and is easy to remember.

Sam offers good credentials.

This new reader incorporates the same unflappable tape transport that is the heart of Decitek's eye-blinking 600 cps reader. This drive doesn't need edge guides or keepers, there's no tape skew. Positive registration is assured—repeatedly through thousands of reruns with no measurable tape wear.

Fiber optic lighting from a single light source plus photo-transistor sensing are features that deliver dependable high-quality performance.

All this at a cost that compares favorably with mechanical readers!

For all the details on this new low-cost, highly reliable reader, just drop us a note or card with the words "Play it again, Sam."

When reading matters

## DECITEK

A DIVISION OF JAMESBURY CORPORATION  
15 SAGAMORE ROAD, WORCESTER, MASSACHUSETTS 01605, (617) 757-4577

INFORMATION RETRIEVAL NUMBER 157



# Everything in precision voltage sources from A to B.



**6-digit Model M106 A.** Accuracy  $\pm 0.002\%$ . Range  $\pm 1$  microvolt to  $\pm 1,000$  VDC in 4 ranges. Solid-state voltage selections and digital display. **Isolated remote BCD programming optional.** A proven, versatile performer for bench, production or computer-controlled test systems... with a low basic price of \$2,375.



**5-digit Model M106 B.** Same as A version except: Accuracy  $\pm 0.008\%$ , range  $\pm 10 \mu\text{V}$  to  $\pm 100$  VDC in 3 ranges. ( $\pm 1000$  VDC ranges optional). No need to pay for super-precision if you don't need it: basic price is only \$1,795.

For further details on both A and B. Contact your Scientific Devices office or Systron-Donner at 10 Systron Drive, Concord, CA 94518. For immediate details, call our Quick Reaction line (415) 682-6471 collect.



**SYSTRON-DONNER**

INFORMATION RETRIEVAL NUMBER 158

## DISCRETE SEMICONDUCTORS

### Laser diodes operate at 25 or $-196$ C



RCA Commercial Engineering, Harrison, N.J. 07029. (201) 485-3900. \$45 (3001), \$500 (C30020), \$715 (C30021); stock, 30 to 60 day.

A gallium-arsenide stacked diode laser, Model SG3001, and two gallium laser diode array modules, Models C30020 and C30021, can operate at room or cryogenic temperatures, respectively. Typical peak radiant flux (peak power output) from the SG3001 is 30 W at a drive current of 40 A and room temperature. The radiant flux is emitted at the peak wavelength of 904 nm. It is supplied in a coaxial stud package. Typical average radiant flux (average power output) from the C30020 and C30021 is 1 and 2 W, respectively, at a drive current of 6 A and a temperature of 77 K ( $-196$  C). The wavelength of peak radiant intensity for these modules is 852 nm.

CIRCLE NO. 367

### Ultra low current TC diodes work with 0.1 mA

Codi Semiconductor, Pollitt Dr., Fair Lawn, N.J. 07410. (201) 797-3900.

The C8000 and C8001 series of reference diodes operates at currents as low as 100  $\mu\text{A}$ . The temperature coefficients of these devices are as low as 5 ppm/ $^{\circ}\text{C}$  over a temperature range of  $-55$  to 100 C, and as low as 10 ppm/ $^{\circ}\text{C}$  with a 50% change in operating current. The diodes are encapsulated in hermetically sealed DO-7 glass packages and can be provided with long-term stabilities as low as 10 ppm/year.

CIRCLE NO. 368

### Stripline transistors 50% efficient at 400 MHz

Motorola Semiconductor, P.O. Box 20924, Phoenix, Ariz. 85036. (602) 244-3466. 1 to 24 prices: \$6 (5174), \$12.50 (5175), \$17 (5176); stock.

The MRF5174, MRF5175 and MRF5176 are three rf transistors designed for 28-V-dc transmitter use. The MRF5174 delivers 2 W and 12 dB of gain at 400 MHz, while the MRF5175 provides 5 W and 11 dB of gain at the same frequency. The MRF5176, highest powered of the three devices, has 15 W at a gain of 10 dB. All outputs and gains are at 50% efficiency. These devices are in stripline, opposed-emitter, ceramic stud packages with low inductance dual emitter bonding. All are characterized from 200 through 600 MHz and for series equivalent impedances to facilitate broadband amplifier design.

CIRCLE NO. 369

### Hyperabrupt vhf diodes span full or half octave

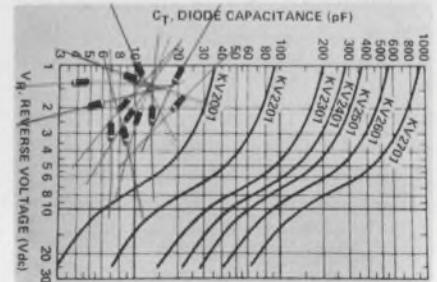

KSW Electronics, S. Bedford St., Burlington, Mass. 01803. (617) 273-1730. From \$0.93 (100-up); 60 day.

The KV2001-2701 series of hyperabrupt vhf diodes offers a full octave tuning range, or, alternatively the KV2002-2702 diodes have half-octave tuning with straight-line frequency performance. The 2001 series has capacitance ratios as high as 7:1 and capacitances from 20 to 500 pF at 4 V. They are for octave tuning over a 4 to 20 V bias range or for half-octave tuning with ultra-high Q applications over an 8-to-20-V range. The 2002 devices are tuned over 2 to 8 V to give straightline frequency performance with typical linearity of  $\pm 1\%$ . Diodes are available as close tolerance parts ( $\pm 5\%$ ), or for economy applications.

CIRCLE NO. 370



## New PM

The people at Bodine have a new permanent magnet field D-C motor line: The 42A. Powerful and compact: Only 4.3" in diameter with continuous duty ratings of 1/8, 1/6 and 1/4 hp at 2500 rpm, 115V D-C. Plus parallel-shaft gearmotors in ratios up to 300:1. Output torques to 350 lb-in.

Delivers: exceptionally consistent output; high starting torque; low-speed operation; self-braking; surprising control capabilities; cool and quiet operation; outstanding brush life. Write for bulletin.

**BODINE  
ELECTRIC  
COMPANY**

BODINE MOTORS  
GEARMOTORS  
SPEED CONTROLS



Bodine Electric Co., 2528 W. Bradley Place, Chicago, Illinois 60618  
INFORMATION RETRIEVAL NUMBER 159

## NOW! SOLDERLESS STRIP BUS\* by Rogers

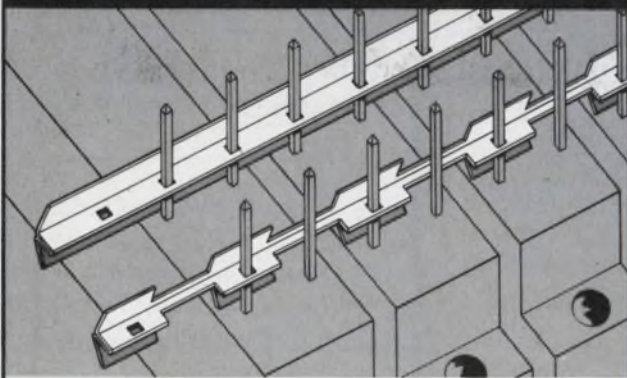

- Easy installation and removal
- Low cost    ■ Low profile
- High current-carrying capacity

Write or call for details    \*Pat. App. For



Rogers Corporation / Rogers, Connecticut 06263  
West: (602) 963-4584    East: (203) 774-9605

INFORMATION RETRIEVAL NUMBER 160

ELECTRONIC DESIGN 9, April 26, 1974

# THE MOST RELIABLE STANDBY POWER SYSTEMS HAVE



## A HEART OF GOLD.

**GENERAL ELECTRIC GOLDTOP® BATTERIES  
... THE MAINTENANCE-FREE POWER SOURCE  
FOR LONG LIFE DEPENDABILITY IN YOUR  
STANDBY POWER APPLICATION**

In addition to maintenance-free dependability and long life, Goldtop rechargeable nickel-cadmium batteries offer you:

- Convenient small size for mounting anywhere in any position. Ideal for those hard-to-get-to applications.
- High temperature capability for hot ambient locations.
- High current discharge capability. This small battery does a big job.
- A sealed battery to eliminate venting of corrosive gases.
- Simple constant current charging. No voltage cutoff circuitry required.

These are just a few reasons why you should put a heart of gold into your next standby power system. For more information circle the reader service card, or write General Electric Company, Section 452-05, Schenectady, N. Y. 12345

**GENERAL  ELECTRIC**

INFORMATION RETRIEVAL NUMBER 161



**PERIPHERAL HEADACHE # 7:**  
**Every time there's a brown-out (Remember the energy crisis?) you run the risk of writing incorrect data on your disc.**



**THE MICRODATA CURE:**  
**Build a disc drive that automatically cuts the write current off the head when the voltage drops or the power fails.**

If you have a peripheral headache, take the cure. Microdata manufactures superb quality 5440-compatible disc drives and 8.5 and 10.5 inch reel tape transports. With the highest performance and lowest prices in the industry. Equipped with significant new features you can't get anywhere else. Get the whole story today, before your headache gets worse. Microdata Corporation  
 17481 Red Hill Avenue  
 Irvine, California 92705  
 714/540-6730



**Microdata**  
**Bring us your problems.**

"See our problem-solving peripherals at NCC Booth 751"

INFORMATION RETRIEVAL NUMBER 162

270

DISCRETE SEMICONDUCTORS

**High-power SCR handles 40 A from 200 to 1200 V**



*Brown Boveri, 1460 Livingston Ave., North Brunswick, N.J. 08902. (201) 932-6066. For 400 V and 100-pcs. \$18.80 (39/49), \$7.28 (35); stock.*

SCR type CS39/49 can handle an average current of 40 A. It is available with voltage ratings from 200 to 1200 V in a TO-94 or modified TO-48 package. The SCR has a  $t_q$  of less than 20  $\mu$ s. Diode type DSD 35 has a 30-A average current rating and is available in the same voltage ratings as the 39/49 but in a DO-5 package. The diode has a 0.3  $\mu$ s recovery capability.

CIRCLE NO. 371

**Green LEDs provide 1.8 millicandela**

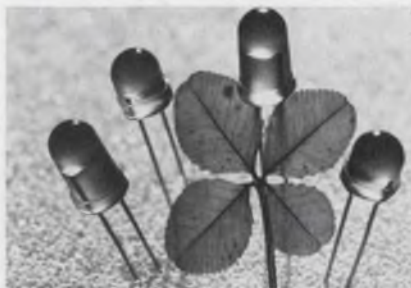

*General Electric, Nela Park, Cleveland, Ohio. 44112. (216) 266-2258. From \$0.35 (10 K).*

The SSL44-2 and the slightly longer SSL44L-2 green LEDs provide a guaranteed minimum initial light output at 20 mA of 1.8 millicandela with a typical output of 2.4 mcd. Equivalent guaranteed light outputs for the lower priced SSL44-1 and SSL44L-1 are 0.8 minimum and 1.4 mcd typical at 20 mA.

CIRCLE NO. 372

**IT'S  
 CONCORD  
 FOR...**

**CONNECTORS/P.C.**

**JACKS**

**BERYLLIUM  
 COPPER  
 CAGES**

**& PINS**

**CONCORD ELECTRONICS CORPORATION**

37 GREAT JONES STREET • NEW YORK, N.Y. 10012  
 (212) 777-6571 • TWX 710-581-4930

FREE CATALOG AVAILABLE.

STANDARD & CUSTOM

INFORMATION RETRIEVAL NUMBER 163

**THERMISTORS**

BY

**THERMOMETRICS**

- BEADS
- PROBES
- FLAKES
- RODS
- ASSEMBLIES

obtain state-of-the-art performance at costs lower than your present commercial products

SPECIAL CURVE MATCHES  
 HIGHEST STABILITY  
 0.05% TOLERANCES &  
 INTERCHANGEABILITY  
 PRECISION CALIBRATION  
 FAST RESPONSE  
 ASSEMBLIES (TO 3MS)

**THERMOMETRICS INC.**

15 JEAN PLACE  
 EDISON, N.J. 08817  
 (201) 548-2299

INFORMATION RETRIEVAL NUMBER 164  
 ELECTRONIC DESIGN 9, April 26, 1974



## Dual output supplies have 0.01% regulation

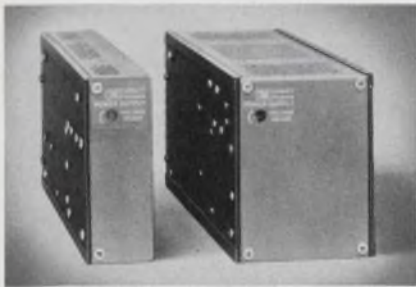

Hewlett-Packard, 1501 Page Mill Rd., Palo Alto, Calif. 94304. (415) 493-1501. From \$165.

The HP 62200 series of dual output power supplies includes four models covering two voltage ratings:  $\pm 12$  V at 1.4 or 3.3 A; and  $\pm 15$  V at 1.25 or 3 A. A single front-panel control provides  $\pm 5\%$  adjustment of both outputs. These series-regulated supplies deliver full-rated output from 0 to 40 C with derated operation up to 71 C. All four models are specified at 0.01% line or load regulation, 1 mV rms, 5 mV pk-pk ripple and noise,  $\pm 1\%$  tracking accuracy and 50  $\mu$ s transient response following a load change from 100% to 50% and 50% to 100%. Cutback current limiting, overtemperature, reverse voltage protection, and remote sensing are standard features on all models.

CIRCLE NO. 373

## 28-V dc/dc converters output 5 to 5000 V dc

Tecnetics, P.O. Box 910, 1625 Range St., Boulder, Colo. 80302. (303) 442-3837. 9591: \$186 to \$306; 9586: \$200 to \$324: 4 wk.

Two new series of dc-dc regulated converters operate from 28 V dc nominal input and include models from 5 to 5000 V dc, plus four dual-output models. The 9591 Series provides 6 W and the 9586 Series has 10 W output. The cases are all metal with black anodizing to increase thermal dissipation. Features common to both series are an output voltage adjustment range of  $\pm 10\%$  at full power, and to 60% of the nominal output voltage at reduced power; input-output isolation; and short-circuit protection by current limiting.

CIRCLE NO. 374

# LOOK TO US FOR TOTAL CAPABILITY

## EMI FILTERS

**Pi Filters**  
Bushing sizes from .156 hex. to .500 hex.  
Rated 50 Vdc to 2500 Vdc



**L Section Filters**  
Available in these outside diameters .250, .312, .375 & .690  
Rated from 10 to 25 amps and from 50 Vdc to 240 Vac



**L, Pi, T Section Styles**  
.375, .410, .690 max. o.d.  
Ratings range from 50 Vdc to 150 Vdc 125 Vac to 240 Vac 10 amps to 25 amps



**Multi-section Filters**  
6 section, 12 section and many custom styles. U. L. types also available.

**L Filter**  
Solder Mount  
Rated 500 Vdc

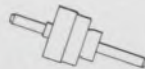

**Pi Filters**  
Solder Mount  
Rated 250 Vdc to 500 Vdc



—EMC CONSULTING—  
APPROVED TESTING FACILITIES TO MEET:  
MIL-STD-461 HEW 90-602  
MIL-I-6181 FCC PARTS 15 & 18



**SPECTRUM CONTROL INC.**  
152 EAST MAIN ST. • FAIRVIEW, PENNSYLVANIA 16415  
specialists in electromagnetic compatibility

SPECTRUM CONTROL, INC. has purchased the ALLEN BRADLEY COMPANY'S entire line of filters and capacitors, as well as their technology and patent rights. This acquisition now gives SPECTRUM CONTROL the broadest line of EMI/RFI filters and feed-thru capacitors in the electronics industry. We also hold more QPL listings to MIL-F-15733 than any other filter manufacturer. So whenever you need total capability, look to SPECTRUM CONTROL.

## FEED-THRU CAPACITORS

The most complete ranges of sizes, cap. values, and ratings, for your selection. MIL-C-11015 types.



## CERAMIC TRIMMERS

A full line of variable capacitors available in .218, .375 & .500 dia. MIL-C-81 types.

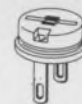

## MULTI-LAYER FEED-THRU CAPACITORS

These unique components are available in a wide range of capacitance values to 1 MFD.

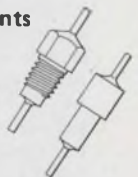

Multi-layer feed-thru capacitors and miniature feed-thru filters designed for filtered connector pins.

## CERAMIC CHIP CAPACITORS

Available in sizes from .080 x .050 x .050 to .375 x .285 x .090 and the following dielectric characteristics: COG, X7R, X7S and X7U.







# Spectronics

For **Optoelectronics**

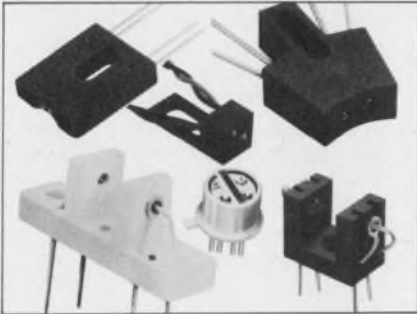

### SENSOR AND EMITTER ASSEMBLIES

Reflective sensor and optical switch assemblies, utilizing phototransistors or photodarlingtons, are available in several configurations. From a mirror reflection, the phototransistor version generates a 600 microamp signal with 30 milliamps of current on the LED. The photodarlington unit will generate a typical signal of 8 milliamps. These devices are designed for optimum performance at distances ranging from 0.075 to 0.5 inch and are TTL compatible.



### LIGHT EMITTING DIODES

Spectronics LEDs utilize the high efficiency of solution-grown epitaxial gallium arsenide, and range in power from 200 microwatts to 300 milliwatts. LED configurations such as SE1450, SE2450, and SE5455 provide components with glass lenses, metal cans, and hermetic seals (where required).



### PHOTOTRANSISTORS

The most complete choice of photodiodes, photodarlingtons, and phototransistors are available from Spectronics in a wide range of configurations as standard components. Spectronics photosensors (i.e. SD 1440, SD 2440, and SD5443) are manufactured with glass lenses, metal cans, and hermetic seals (where required).

### YOUR INTEREST:

**RS231** ALL COMPONENTS AND ASSEMBLIES

**RS232** IR EMITTERS AND SENSORS

**RS233** VISIBLE EMITTERS ONLY

**Spectronics**  
INCORPORATED



830 East Arapaho Road  
Richardson, Texas 75080 (214) 234-4271

## POWER SOURCES

### Uninterruptible power with reserve battery

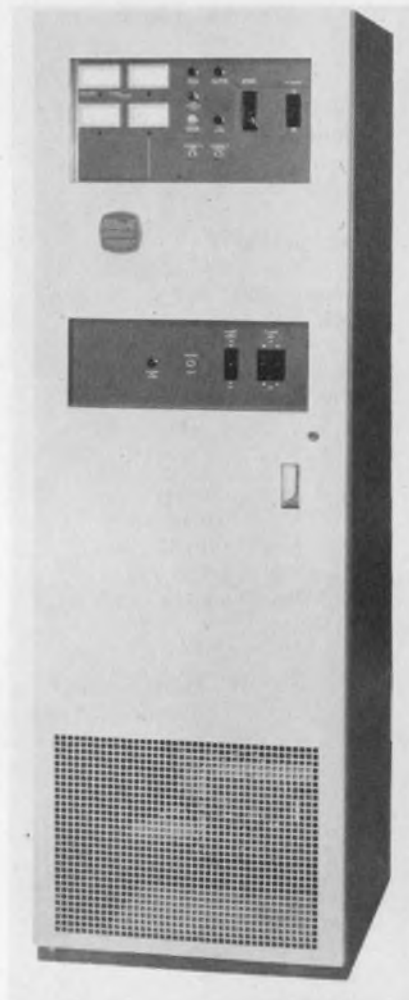

Lorain Products Corp., 1122 F St., Lorain, Ohio 44052. (216) 288-1122.

The Lorain Model 202CAB uninterruptible-power system operates as a continuous monitor/buffer with a reserve battery plant between the commercial ac power source and a minicomputer to guarantee regulated voltage and frequency despite failures and fluctuations on the commercial ac line. A minicomputer protected by the Lorain UPS is unaffected by blackouts, brownouts, or transients on the commercial ac line. The unit is a standard 2-kVA system with static switch. Other systems are available in capacities ranging from 500 VA to over 600 kW to accommodate almost any computer installation.

Booth No. 122-124 Circle No. 375

### Dc card supplies operate up to 70 C

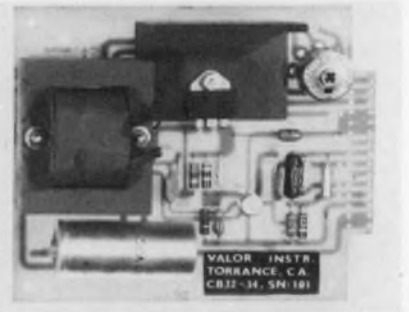

Valor Instruments, Inc., 1122 Llewellyn, Torrance, Calif. 90501. (213) 320-5471. \$138; stock to 3 wk.

The CB series of modular card regulated power supplies include foldback short-circuit protection. Thermally self-contained, the supplies will operate in temperatures to 70 C. The printed-circuit card is designed to bolt on a chassis or mount in standard 5.25 in. racks with 2 in. centers. Connector pads are provided for direct solder connections or a PC connector. The input voltage range is 105 to 125 V ac, 47 to 400 Hz. Outputs are factory preset from 5 to 32 V dc. Line and load regulation is 0.1% and the ripple and noise is 2 mV rms max. The temperature coefficient is 0.02%/°C.

CIRCLE NO. 376

### Ac power source can't be interrupted

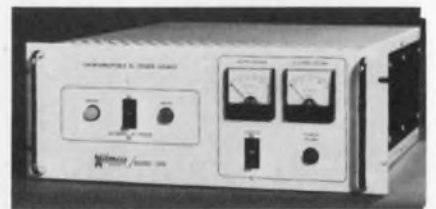

Wilmore Electronics Co., Box 2973, West Durham Station, Durham, N.C. 27705. (919) 489-3318. \$975; stock to 60 days.

Model 1202 is an uninterruptible ac power source (UPS) that provides regulated 115-V sine-wave output. Features include built-in "float" battery charger and sealed long-life batteries and electronic overload protection. Model 1202 is rated at 250 VA. Depending upon load, reserve time for internal-battery operation varies from a minimum of 10 min. to more than one hour.

CIRCLE NO. 377



## FOR THE UTMOST IN RELIABILITY



### INTERVAL TIMERS Series PAB.

This is an automatic reset interval timer with an extremely accurate timing mechanism built to stand up under hard usage in modern manufacturing processes. Due to the simplicity and reliability of its special clutch we can offer it in a range of time intervals from 1 second (1/60" dial divisions) to 3 hours (3' dial divisions), twelve in all. It is also available in a panel mount model PAF.

All of our timers are made to give you service far beyond what you'd reasonably expect. Our line consists of 17 basic types, each avail-

able in various mountings, voltages, cycles, circuits and load ratings . . . and with whatever special wrinkles you may need.

Bulletin #403 tells all about our line of reliable Interval Timers. Write for it or a catalogue of the entire line. If you have an immediate timer requirement, send us your specifications. Or for fastest service, give us a ring at (201) 887-2200.



Industrial Timer Corporation, U.S. Highway 287, Parsippany, N.J. 07054  
INFORMATION RETRIEVAL NUMBER 167

## The Kluge Vs. Monochip

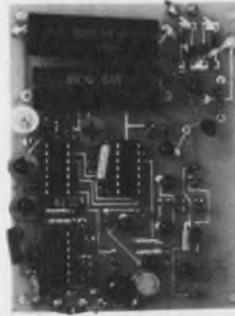

**Costs**  
Parts and material \$4.50  
Assembly and testing 3.00  
7.50

**Delivery**  
2 to 16 weeks if you can get all the components.

**Performance**  
It works if all the parts work.

**Costs**  
\$2.90 total (or typically 50% less than a discrete assembly).

**Delivery**  
Prototypes in 2 weeks followed by volume delivery. Fully tested.

**Performance**  
Monolithic IC reliability. Equivalent performance.

Monochip contains all the components you might use in a wide variety of circuits. But the last metalization layer is left unfinished to make the exact circuit you want. A designer's kit for \$39 complete with easy-to-use design rules and parts gets you started. You can design your special circuits into a standardized product available at standard prices. And the Monochip is multisourced.

Beat the kluge, call us. **INTERDESIGN**  
Interdesign, Inc. 1255 Reswood Ave.  
Sunnyvale, CA 94086  
(408) 734-8666

INFORMATION RETRIEVAL NUMBER 168

## OTTO® Sub-subminiature Switches

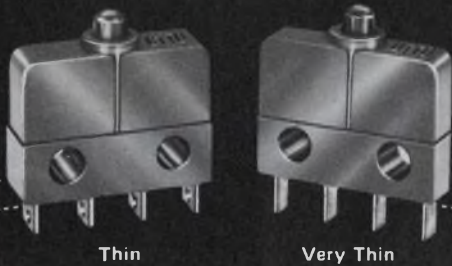

snap-action • precision • 8 A. to dry circuit!

Less than 10 millionths contact resistance in a ten million cycle switch! That's the OTTO B3 series with patented\* design featuring high contact force and minimal contact bounce. Commercial or military, your options include "thin" and "very thin" sizes, contact arrangements to form Z, terminals, and contact materials. Load ratings to 8 A. resistive. Actuators available, too.

For full details including prices and local distributors, write for Bulletin B3.

\*U.S. Pat. No. 3,612,793

**OTTO CONTROLS** Division, OTTO engineering, Inc.  
36 Main Street, Carpentersville, Illinois 60110 • Phone: 312/428-7171  
© OTTO engineering inc.

INFORMATION RETRIEVAL NUMBER 169

ELECTRONIC DESIGN 9, April 26, 1974

## THE WORLD'S FASTEST N-MOS RAM Delivering now as a device, card or memory system



**AMS 7001 STATIC MOS RAM** 60 ns access time and 180 ns cycle time make this the fastest 1K MOS RAM (1024 words by 1 bit) The 7001 RAM has been proven in a working system where it has been exercised with all standard patterns under wide operating margins. It is static. So there is no need for costly and difficult refresh circuits; and the 7001 consumes less power than equivalent speed bi-polar RAMs. Distributors have the AMS 7001 in stock and it is multiple sourced. Ask us for design help and for an absolutely free data sheet and a price list.

**AMS 7001 MEMORY CARD** Using the AMS 7001 RAM, this card offers a cycle time of 200 ns, a 100 ns access time (from address) at ECL levels, and only one load per input. This AMS memory card is now in

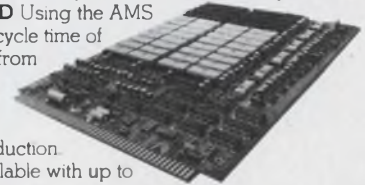

production. Available with up to 48K bits addressable as 1, 2, or 4 bit words. The AMS 7001 card provides the cost and power advantages of MOS plus the speed advantages of bi-polar.

**AMS 7001 MEMORY SYSTEM** 110 ns access time from address at the backpanel with ECL levels. Cycle time for the 7001 System is 200 ns. The 7001 system can be organized in words or bytes. It is modular and contains up to 4 bays within one integral assembly. Each bay can be organized in 48K × 18 bits, 24K × 36 bits, or 12K × 72 bits. Shipping now.

**AMS Advanced Memory Systems®**  
1276 Hammerwood Avenue, Sunnyvale, California 94086 (408) 734-4330

INFORMATION RETRIEVAL NUMBER 170





## specialist or general practitioner?

Specialist, of course... in the art of reducing or eliminating unwanted, troublesome signals from electronic circuits. Rtron specializes in the design and manufacture of RFI/EMI filters to cure virtually every electronic interference problem. UL Recognized data processing filters, MIL-F-15733 types and filters for every industrial application are readily available... from stock to custom designed, tubular, rectangular or bathtub types, in single or multi-circuit units.

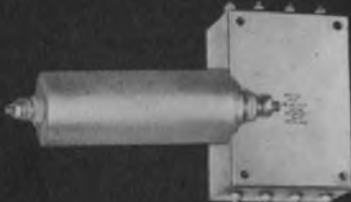

If you like our specialist, you'll like our treatment... phone or write...

# Rtron

Dept. ED-4

P.O. Box 743 Skokie, Illinois 60076

Phone 312 • 679-7180

INFORMATION RETRIEVAL NUMBER 461

274

## POWER SOURCES

### Dual output mini supply includes power-line cord

*Intronics, 57 Chapel St., Newton, Mass. 02158. (617) 332-7350. From \$55; stock.*

The "SL" series of modular power supplies has an attached line cord with three-wire plug, off-on switch, and output binding-post terminals. Dual units deliver  $\pm 12$  or  $\pm 15$  V dc outputs at either 100 or 200 mA. Single output units provide 5 V dc at either 500 or 1000 mA. All units have a line regulation of 0.05% over a 105-to-125-V-ac input and load regulation (no load to full load) of 0.1% for the same input range. These supplies have output short-circuit protection and in addition, the 5 V units include overvoltage protection. An internal transformer provides input/output isolation. Case size measures  $3.5 \times 2.5 \times 1.25$  in.

CIRCLE NO. 378

### Switching supplies have efficiencies up to 80%

*Abbott Transistor Labs, 5200 W. Jefferson Blvd., Los Angeles, Calif. 90016. (213) 936-8185. \$230 (1 to 4); stock.*

The VN25 high-efficiency series of switching power modules converts 47 to 440 Hz ac lines to 25 W of regulated dc power with up to 80% efficiency. Any output voltage between 4.7 and 50 V dc is available in a package that measures  $2.75 \times 6.25 \times 2.75$  in. Line and load regulation are held to 0.4% and ripple to 30 mV rms maximum. A baseplate temperature range of 0 to 71 C and a maximum temperature coefficient of  $0.03\%/^{\circ}\text{C}$  assures stable performance. The VN25 models are hermetically sealed and encapsulated to meet the severe environmental requirements of MIL-STD-810B, MIL-E-5400K, and MIL-E-5272C. Standard features for the units include isolated outputs, short-circuit protection, input transient protection, remote error sensing, remote programming and EMI filters. Optional features such as overvoltage protection and military connectors are available.

CIRCLE NO. 379

### Single output supply efficient to over 50%



*Power One, 6324 Variel Ave., Bldg. E., Woodland Hills, Calif. 91364. (213) 887-1360. \$27.95 (1 to 9); stock.*

The Model B5-3 is a 5 V ( $\pm 5\%$ ) 3 A series pass, dc power supply. It has an efficiency greater than 50%. The supply is also available in 6, 12, 15 and 24 V models. All units feature reverse voltage protection as standard, with overvoltage protection available as an option. Input power is 105 to 125 V ac, 47 to 440 Hz with an operating temperature range of 0 to 50 C at full output, derated at 70 C to 40%. Line regulation is  $\pm 0.01\%$  for a 10 V input change while load regulation is  $\pm 0.02\%$  for a 50% load change. Output ripple is 1.5 mV pk-to-pk, 0.4 mV rms. The supplies meet the vibration and shock requirements of MIL-STD-810B. Their over-all size is  $2.12 \times 4.87 \times 4$  in. and their weight is 2 lb.

CIRCLE NO. 380

### CRT supply offers any output from 10 to 20 kV

*Keltron Corp., 225 Crescent St., Waltham, Mass. 02154. (617) 894-0525. Model 810: \$115 (100); stock to 3 wk.*

Series 800 is a high voltage power supply specifically designed for use in CRT display systems. Up to four optional additional plus-or-minus output voltages can be added with the same line regulation as the high voltage output. Specs include 10-to-20-kV output at 10 W max; line plus load regulation of 0.1%; ripple of 0.05% pk-pk; and a full-load transient response of 0.03% peak, recovering in less than 2 ms.

CIRCLE NO. 381



# KEYBOARD-ENCODER



- \* Fully professional
- \* 49 Keys
- \* ASC II Encoder
- \* For: Terminals
- Displays
- CATV
- Video Titlers
- RTTY

At long last, a quality data entry keyboard at a price that everyone can afford. This 49 key system has internal ASC II encoder and debouncer. Keys are full travel typewriter style, in a modified ANSI layout. Spacebar is full length with equalizer system.

ASC code (external Parity), trimode includes shift and control functions. Two user defined keys. Parallel output—will drive RTL, DTL, TTL, MOS, CMOS, etc.

Fibreglass circuit board base with plated through holes, makes assembly quick and sure.

KBD-1 Keyboard Kit ----- 3 lbs. \$39.595

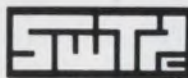

Southwest Technical Products Corporation,  
DEPT. ED  
219 W. Rhapsody, San Antonio, Texas 78216

INFORMATION RETRIEVAL NUMBER 462



## THE PITTMAN CORPORATION

A Subsidiary of Penn Engineering & Manufacturing Corp.  
SELLERSVILLE, PENNSYLVANIA 18960  
Phone: (215) 257-5117 • TWX: 510-661-5086  
© 1974

Pitmo Gearmotors offer d-c servo motor performance combined with a rugged spur gear reducer to provide shaft speeds under load approximately from 5 to 650 rpm. The GM8200 series, now in production, has a gearbox diameter of 1.375" and lengths from 3" 3.4", excluding output shaft extension.

Gears are sintered iron to precision tolerances except for the first gear after the armature pinion which is molded acetal resin to AGMA 8E tolerances. Torque limit on the gearbox is 250 oz. -in.

Three standard motor lengths combined with many possible variations in armature windings permit tailoring of outputs to a wide range of performance requirements.

For more information, write now.



120

New  
Pitmo®  
Gearmotors

INFORMATION RETRIEVAL NUMBER 463

INFORMATION RETRIEVAL NUMBER 464



## Licon takes the "butterflies" out of holding patterns.

By putting its double-break, double reliable Butterfly® switches to work in today's modern aircraft.

Waiting to touch down. Critical moments for a jet flying a tight holding pattern in heavy air traffic. No room for ordinary switching performance. Which is why Licon® patented double-break Butterfly switches are on board so many jetliners today. Performing with beautiful precision.

Even if you're not designing jumbo jets, you can be sure of the same quality and dependability throughout the entire Licon switch line. Basic Switches, Lighted Pushbutton Switches, Keyboards. Shorten your design time—put Licon's engineering know-how to work for you. Your Licon representative or distributor has a switch solution for you.



Division Illinois Tool Works Inc.  
6615 W. Irving Park Road  
Chicago, Illinois 60634  
Phone (312) 282-4040  
TWX 910-221-0275



# LICON

puts ideas to work  
in electronics

The Innovative Electronic Group of ITW...

LICON ■ ELECTRO MATERIALS ■ PAKTRON

© ILLINOIS TOOL WORKS INC. 1974





Your source  
for Electronic  
Discharge  
Printers

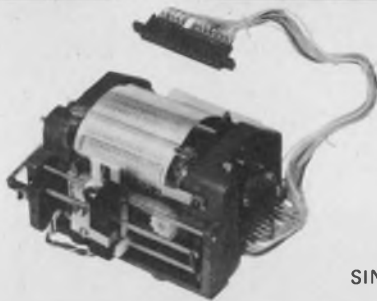

**\$130**

1606A  
16 COLUMN

**\$150**

2106A  
21 COLUMN

SINGLE QUANTITY PRICE  
VOLUME DISCOUNTS

**FAST** 6 LINES PER SEC.

**SMALL** 3.3" X 4.5" X 4.5"

**LONG LIFE** MTBF 5.5 MILLION LINES

**QUIET** NON IMPACT PRINTER

**LIGHT** ONLY 1.5 POUNDS

HOOK UP WITH HYCOM. These quick, quiet and compact alphanumeric printers need no ribbons and have fewer moving parts . . . adding up to economy and reliability. Get them from the source . . .

**HYCOM**

16841 Armstrong Avenue, Irvine, California 92705, Telephone (714) 557-5252

Your source for Microelectronic Systems  
Custom MOS/LSI • Communication Systems • Dedicated Calculators

INFORMATION RETRIEVAL NUMBER 465

**DIRECT DRIVE TO  
Counters, Stepping Motors,  
Printers, Relays**

**A SHAFT ENCODER  
FOR**

**\$35<sup>00</sup>\***

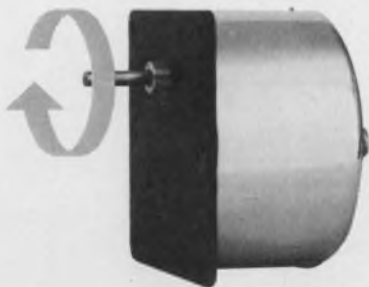

Model 111 ROTASWITCH®  
Shaft Encoder

No power supply or logic required — The Model 111 ROTASWITCH® Pulser is a unique shaft position encoder using a mercury wetted, no-bounce switch with a service life of 1 billion closures. Since it can handle 100 volt-ampere loads and its output is pulsed, the Model 111 can drive a variety of electronic and electromechanical devices without the need for extra power supplies, amplifiers, or logic circuits—a real plus benefit where design costs must be kept minimal.

The Model 111 is available in various gear ratios to provide from 1 to 360 pulses per revolution to a maximum of 6000 pulses per minute. (For higher rates inquire about our photoelectric encoders). It may also be specified without a housing for direct installation.

Complete details and price list available. Write for Bulletin 100.

\*In quantity

INFORMATION RETRIEVAL NUMBER 466

POWER SOURCES

**Dual output supplies  
deliver 60 W/output**

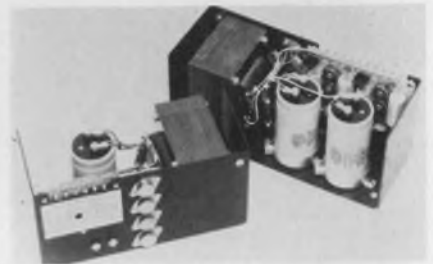

Abbott Transistor Labs, 5200 W. Jefferson Blvd., Los Angeles, Calif. 90016. (213) 936-8185. From \$99 (1 to 24); stock.

The "LLC" series of dc power supplies converts 115 V ac, 47 to 420 Hz to dual outputs of either  $\pm 12$  or  $\pm 15$  V dc. These  $\pm 12$  and  $\pm 15$  V models can deliver 15, 30 or 60 W of power per output. Line and load regulation are better than 0.1% and ripple is 10 mV rms with a 30 mV pk-pk maximum. Full output power is available up to 50-C ambient with no derating, forced air cooling or heat sinking. Standard features include short-circuit protection, remote error sensing and input transient protection. In addition, both outputs are isolated and nontracking so each output can be used as a completely separate power supply. Overvoltage protection is available as an option.

CIRCLE NO. 282

**Line demonstrates power  
engineering basics**

McLean Engineering Labs, 70 Washington Rd., Princeton, N.J. 08550. (609) 799-0100. \$3000; 12-14 wk.

This new line of Electro-Mechanical Energy Conversion Equipment is for use in advanced courses of electrical, electronic and electro-mechanical engineering to illustrate power-engineering fundamentals, such as those of Faraday's Law, Lenz's Law and the Constant Flux Linkage Theorem. System elements consist of unitized motor-generator sets; transformers and saturable reactors; and peripheral equipment such as synchronizing panels and metered variac panels. The system is compatible with ampere, volt and wattmeters, oscilloscopes, X-Y plotters, strip chart recorders, variac, and capacitor decades.

CIRCLE NO. 283



DISC Instruments, Inc.  
102 E. Baker St., Costa Mesa, Calif. 92626  
Phone (714) 979-5300

Disc Instruments Division  
Finnigan GmbH  
Dachauer Strasse 511, 8 Munchen 50, Germany  
Phone: (0811) 142291 (2)

Disc Instruments Division  
Finnigan Instruments Ltd.  
Paradise, Hemel Hempstead, Herts, England  
Phone: (0442) 57261



## POWER SOURCES

### Lab supply gives current, voltage and foldback



Grumil Corp., 4626 Idlewilde Lane S.E., Albuquerque, N.M. 87108. (505) 265-2320. \$189; stock.

Model 202S laboratory power supply features a current-foldback mode in addition to the fully regulated voltage and current modes. The supply is rated at 30 V, 1.5 A continuous duty, and features 100% solid-state circuitry. Output impedance can be varied from 4 m $\Omega$  through zero to -4 m $\Omega$ , and output capacitance can be reduced from 1000  $\mu$ F to 0.45  $\mu$ F while maintaining full loop stability. Output is protected against overload as well as positive and negative external forcing within the limits of  $\pm 30$  V and  $\pm 1.5$  A.

CIRCLE NO. 384

### Converters power 12-V CMOS logic

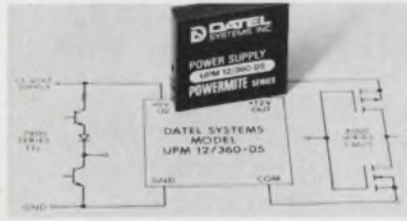

Datel Systems, 1020 Turnpike St., Canton, Mass. 02021. (617) 828-6395. 80-D5: \$49; 360-D5: \$79.

Two new dc/dc converters power 12-V CMOS logic from the 5-V system supply normally used for TTL/DTL logic. These converters have an input voltage tolerance of -10 to +25% and an efficiency of 50%. Line and load regulation is 0.02% with a tempo of 0.02%/°C. Model UPM 12/80-D5 supplies 80 mA and Model UPM 12/250-D5 supplies up to 250 mA. Both models have current limiting on the outputs. Model UPM 12/80-D5 is a 1.5 x 2 x 0.4 in. encapsulated module and Model UPM 12/360-D5 is a 2 x 2 x 0.4-in. module.

CIRCLE NO. 385

### Compact lab supply costs just \$89

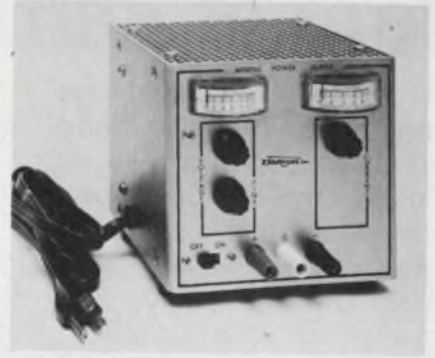

Deltron Inc., Wissahickon Ave., North Wales, Pa. 19454. (215) 699-9261. \$89; stock to 3 wk.

MINIPAC laboratory power supplies feature IC regulation and automatic tracking crowbar. Three models give adjustable voltages of 0 to 12, 0 to 20, and 0 to 40 at a maximum delivered current, respectively, of 0 to 1, 0 to 0.65 and 0 to 0.35 A. Line and load regulation is 0.01% and ripple is 250  $\mu$ V. Size is 5 x 5 x 5-in. and weight is 4.5 lb.

CIRCLE NO. 386

# Series 2000 General Purpose Interface THE VITAL LINK

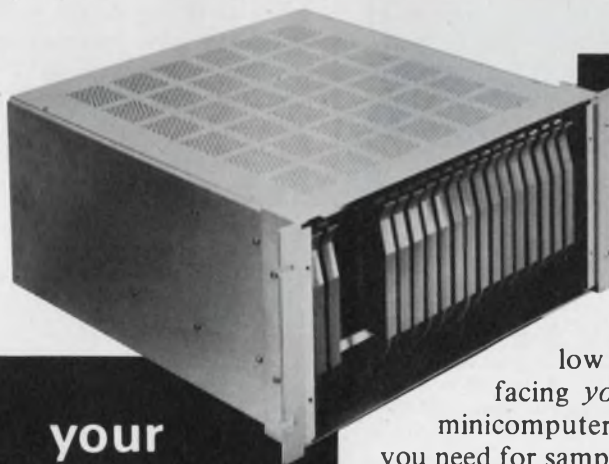

your  
computer

your  
industrial  
process

Series 2000 is a pre-engineered, easy-to-install, low cost solution to the critical problem of interfacing *your* industrial process with *your* local or remote minicomputer. The analog and digital input/output capabilities you need for sampling, reporting, control, data logging, or complete automation already exist as standard Series 2000 plug-in functions. And future system expansion is as simple as plugging new cards into the Series 2000 printed circuit backplane.

Avoid costly custom engineering, extensive documentation, and installation delays. Series 2000 is ready for your system. Now.

**pcs**

PROCESS COMPUTER SYSTEMS, INC. • PROCESS INTERFACE DIVISION  
5467 HILL 23 DRIVE • FLINT, MICHIGAN 48507 • TEL: (313) 744-0225 • TWX: 810-235-8667

INFORMATION RETRIEVAL NUMBER 467



# The wire stripper that refutes Kerchuk's Law.

Kerchuk's Law has always maintained that automatic wire strippers must operate on air. And that therefore they shall always be noisy, overly complex and hard to maintain. If you're in the market for an automatic

wire stripper, or if you already have one that goes "kerchuk, kerchuk", meet our new Model EWS-6K.

It's airless, kerchuk-less and best of all, totally electric. The EWS-6K is proven, portable, economical, and so much quieter than the other ones. Need we say more? We do, in our brochure describing the world's first airless automatic wire stripper. Standard Logic, 2215 So. Standard Ave., Santa Ana, Calif. 92707. Telephone: (714) 979-4770.



**STANDARD LOGIC, INC.**

**SEND** for information on the EWS-6K today! (If you already have a kerchuker, send anyway. Then, unplug your ears.)

"See us at the National Computer Conference Booth #960"

INFORMATION RETRIEVAL NUMBER 468

**WHICH IS FASTER, MORE RELIABLE, AND EASIER TO USE FOR PROGRAM PREPARATION?**



**LINC TAPE**  
and it comes

**with a Complete Operating System**

Computer Operations has plug-compatible, mass-memory for NOVA, DEC PDP-11, HP-2100, and many other mini-computers. The LINC Tape Operating System provides complete support for assemblers, loaders, text editors, BASIC, FORTRAN and file utilities.

LINC Tape is 28 times faster than paper tape and 15 times faster than cassettes. And it has proven error-free performance and reliability.

- Low Price and quick delivery
- Complete plug-to-plug compatibility
- Block addressable disc format
- 8400 bytes/sec transfer rate
- 100,000 passes without error guaranteed
- 204,800 or 335,872 data bytes per reel in blocks of 512
- Utility software drivers - complete operating system for most popular minis
- Expandable to 16 drives
- Optional compatibility with DEC tape®



LINC TAPE  
TRANSPORT

For your own satisfaction, see LINC Tape demonstrated before you decide on any mass-memory system.

**Computer Operations, Inc.**

10774 TUCKER ST. BELTSVILLE, MD.  
20705 301-937-5377

INFORMATION RETRIEVAL NUMBER 469

## Heater etched onto Kapton weighs little



Sierracin/Thermal Systems, 13920 S. Broadway, Los Angeles, Calif. 90061. (213) 321-4350.

Spiral Wrap is an electrical heater for aerospace piping systems and other precision applications that features virtually negligible weight and volume, yet produces up to 50 W/in<sup>2</sup>. It weighs less than 1 oz/ft<sup>2</sup> and it employs etched-foil techniques to produce intricate heater-element patterns. The 0.001-in.-thick element is etched on a 0.0025-in.-thick Kapton substrate and then is sandwiched by another Kapton layer for a total thickness of just 0.006 in. The heater can operate at temperatures to 550 F and exhibits zero outgassing. It is available in widths of 1/4, 1/2, 1 and 2 in. and lengths up to 42 in.

CIRCLE NO. 387

## Teflon tape uses silicone adhesive

Dilectrix Corp., 69 Allen Blvd., Farmingdale, L.I., N.Y. 11735. (516) 249-7800.

A Teflon pressure-sensitive tape with a silicone-based adhesive, designated DF 2200, offers the user better surface conformability, high dielectric strength and a smoother surface profile that is free of skive marks. Also, the silicone adhesive provides high temperature resistance and the tape can be easily wrapped over irregular surfaces. The tape is available in a clear or assortment of colors, and it comes in 36-yd rolls with widths of 1/4 to 22 in.

CIRCLE NO. 388



## Kit provides all for rapid wiring



United Wiring & Manufacturing Co., 3405 Shiloh Rd., Garland, Tex. 75041. (214) 271-2586. \$285; stock.

The Solder-Wrap prototyping kit, catalog #100432, provides a fast way of interconnecting ICs and discrete components. A routing speed, including soldering time, of up to 300 electrical connections per hour is possible. The prototyping kit is packaged in a foam-padded-vinyl attache case. The kit includes wire and a total of 26 components.

CIRCLE NO. 389

## Screw-terminal strips fit PC boards

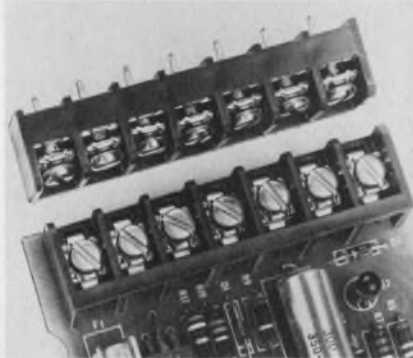

Reed Devices Inc., 21W 183 Hill Ave., Glen Ellyn, Ill. 60137. (312) 858-2050. 10 position: \$0.91 (1000 up); stock.

A new terminal strip designed for PC boards features 6-32 screws on 3/8-in. centers. The standard-mount unit is called the 6PCV series, and a right-angle version is called the 6PCR series. In addition to PC pins, thru-panel solder-turrets and wrap terminals are also available. Captive wire-clamp plates eliminate the need for spade or hook terminals. The terminals are available with three to 24 points.

CIRCLE NO. 390

## Ruler replaces T-square and triangles

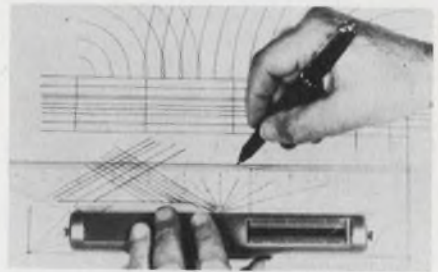

Professional Aids Co., 1 S. Wacker Dr., Chicago, Ill. 60606. (312) 263-7622. \$6.95 (unit qty).

Rol Ruler permits the user to make equally spaced horizontal and vertical parallel lines, as well as circles, arcs and cross-hatches in either the inch or metric system. It does the job of a T-square, triangle and parallel ruler. The ruler rolls back and forth with a touch of the finger and a calibrated scale indicates spacing in 10ths and 16ths of an inch. And it eliminates the necessity of "pointing-off." The ruler also allows the user to make uniformly spaced circles and arcs up to 22-in. diameter and other geometric forms.

CIRCLE NO. 391

# Series 2000 Micro CPU Industrial Processor THE COMPUTER ELIMINATOR

The equivalent programmable processing power of a good minicomputer. More local or remote analog and digital I/O and signal conditioning performance than you'd expect from a sophisticated custom-built interface. At a fraction of the system design, documentation, installation, maintenance, and cost of such hardware.

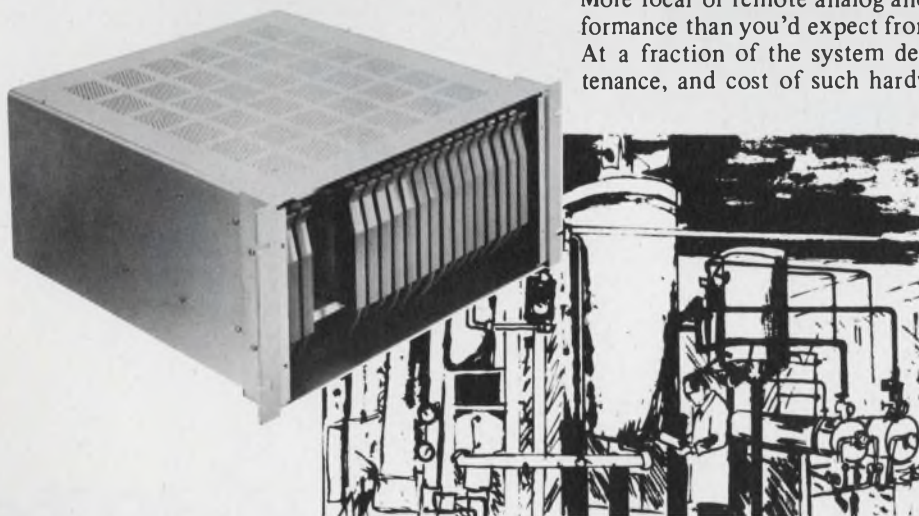

The Series 2000 Micro CPU Industrial Processor incorporates advanced microprocessor circuitry for reliable data handling at speeds to match virtually every process or peripheral control application. Up to 64k bytes of user-programmable MOS ROM and RAM lets you operate in ambient temperatures where minicomputer core would turn up its toes. And the widest available range of off-the-shelf analog and digital process-compatible I/O modules makes configuring, updating, or expansion as easy as adding or replacing plug-in modules on the standard printed circuit backplane.

Before you invest in a mini, maybe you should check out the Series 2000 Micro CPU Industrial Processor. It's a PCS first. Built to last.

**PCS**

PROCESS COMPUTER SYSTEMS • PROCESS INTERFACE DIVISION  
5467 HILL 23 DRIVE • FLINT, MICHIGAN 48507 • TEL: (313) 744-0225 • TWX: 810-235-8667

INFORMATION RETRIEVAL NUMBER 470



# Electronic Design's

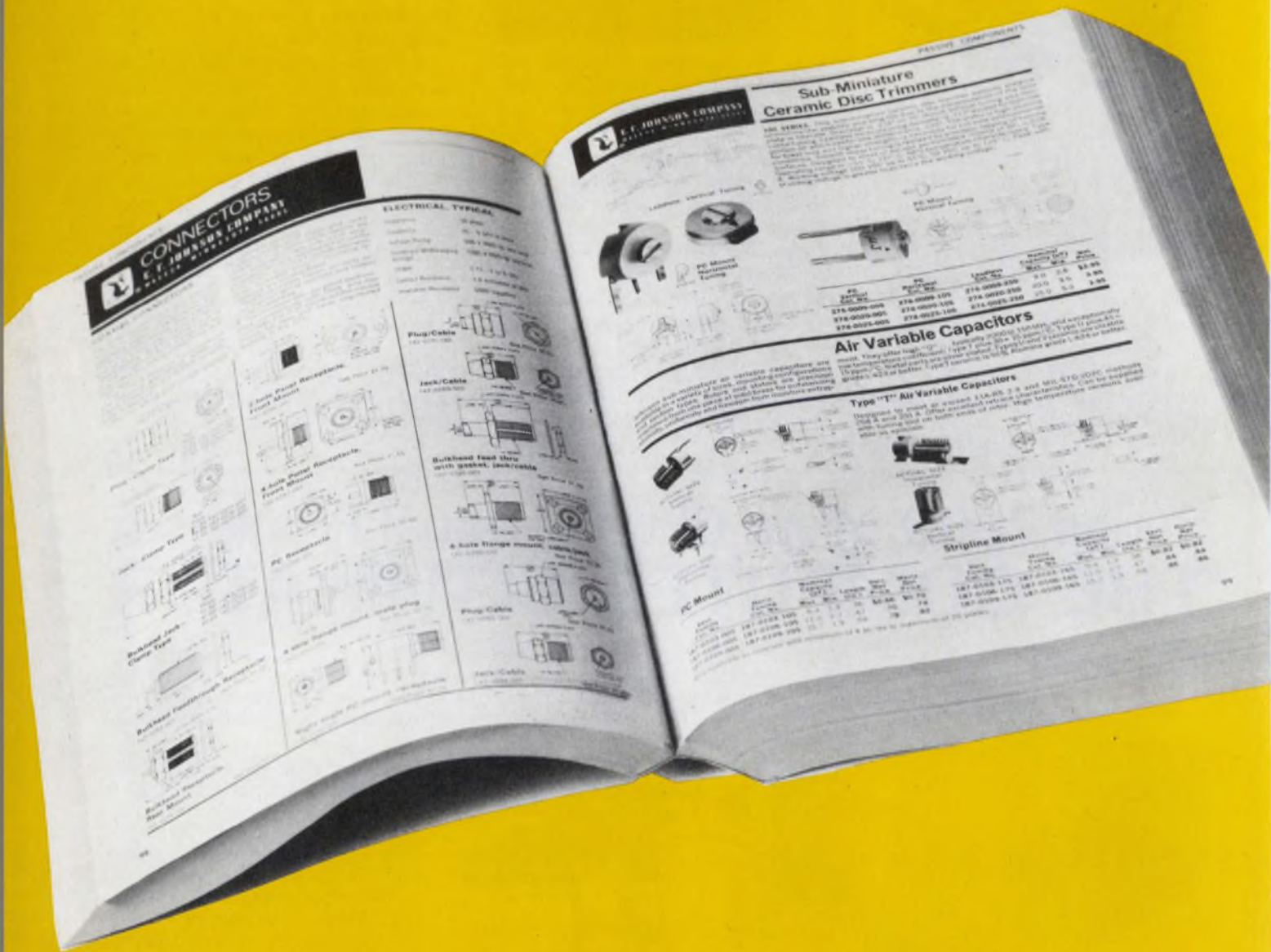

**WATCH FOR IT... JULY 1974**



# GOLD BOOK

MASTER CATALOG AND DIRECTORY OF SUPPLIERS TO ELECTRONICS MANUFACTURERS

## ***PUTS THE ELECTRONICS INDUSTRY AT YOUR FINGERTIPS***

- **MAKES ALL OTHER MASTER DIRECTORIES SEEM OBSOLETE**
- **A COMPLETE ONE-STEP PURCHASING TOOL**
- **MORE DIRECTORY LISTINGS AND INFORMATION THAN EVER PUBLISHED BEFORE**
- **52 PRODUCT CATEGORIES**

If you've never used a directory before, *Electronic Design's* GOLD BOOK will amaze you with its convenience and utility. Manufacturers' catalogs, spec sheets, and application data notes will be right on your desk in one convenient package. The directory listings are the most complete and detailed to date. From mid-year on you'll be referring to it daily for purchasing information and catalog data. It's the most massive compendium of product information ever compiled . . . the one-step purchasing and reference source that can save you untold hours in the search, selection and specification of the products you need.

***Another FREE Service for Readers From...***

# **Electronic Design**



## TO-5 contactor loads with zero force

*Wells Electronics, Inc., 1701 S. Main St., South Bend, Ind. 46623. (219) 287-5941. \$1 to \$4; 2 wks.*

A new zero-insertion-force family of TO-5 contactors for test, burn-in and aging, designated Series 608, combs the device leads into grooves of the carrier to minimize the possibility of an open contact. The contactors are available in 8 and 10-lead versions in various materials capable of withstanding continuous temperatures from -55 to 250 C. The unit is operated by raising the lid to its upward stop. This cams the contacts outwards. The carrier containing the TO-5 device is then placed on the contactor. The lid is then pushed downward. This allows the contacts to spring inward and wipe the device leads while combing them into position.

CIRCLE NO. 392

## Adhesive repairs glass-to-metal seals



*Aremco Products, Inc., P.O. Box 429, Ossining, N.Y. 10562. (914) 762-0685. \$25 (1 pint); 2 wks.*

Graphi-Bond 551-R is a new graphite-base adhesive that can repair glass-to-metal seals. The adhesive is suitable for use at temperatures to 5400 F. Most other adhesives tried in this application have broken down rapidly when exposed to the sealing atmospheres at temperatures in the 1900-F range. The new adhesive has outlasted the base material in many instances.

CIRCLE NO. 393

## High-voltage connector has 20-kV-dc rating



*Caton Connector Corp., 425 Northern Blvd., Great Neck, N.Y. 11021. (516) 466-9288. \$10 to \$25; stock.*

A new line of high-voltage connectors features a corona-suppressing interfacial seal with resilient silicone inserts. The connectors have the following characteristics: 1 to 8 contacts; a 20-kV-dc rating, pin to shell; a temperature range of -40 to 65 C; and the shell sizes of #12 through 24 in a modified MS-3100 series with MIL-C-5015 hardware. Molded and potted silicone cable assemblies are available from stock for most applications. These connectors are suited for electrostatic printers, holography, airborne radar, flash-lamp power supplies, infrared and CRT devices.

CIRCLE NO. 394

# TRIGGER IT,

Series 500 Function Generators can. Five models — three with trigger/gate. They're capable of sine, square, triangle, ramp, pulse and tone-burst waveforms, with frequency ranges from 0.005 Hz to 20 MHz. Other features: Built-in lab amplifier; regulated variable DC voltage source and front-panel input to the amplifier. Want to trigger things in your test lab? Write today.

**ALTECH**  
A CUTLER-HAMMER COMPANY



815 Broadhollow Road • Farmingdale, New York 11735 • (516) 595-6471  
19535 E. Walnut Dr. • City of Industry, CA. 91748 • (213) 965-4911

INFORMATION RETRIEVAL NUMBER 471

Sb+Cs, BIALKALI, MULTIALKALI,  
MULTIALKALI, Ag+O+Cs, Cs+Te, Ga,  
GaAs(Cs), RNOX Sb+Cs, BIALKALI, MULTI..

## QUALITY DETECTORS FOR INSTRUMENTATION

A complete line of side on, end on, photomultipliers and phototubes including the new GaAs and RNOX.

FREE CATALOG call or write  
**HAMAMATSU CORP.**  
120 Wood Avenue  
Middlesex, New Jersey 08846  
201 - 469-8640

INFORMATION RETRIEVAL NUMBER 472

ELECTRONIC DESIGN 9, April 26, 1974



## Heat sink for TO-5 needs no hardware

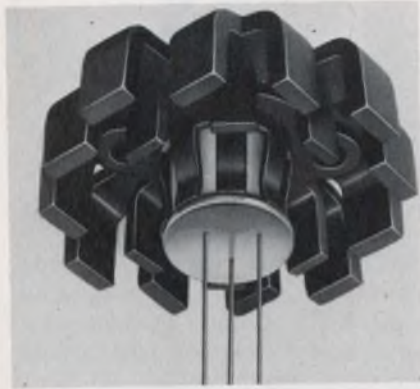

International Electronic Research Corp., 135 W. Magnolia Blvd., Burbank, Calif. 91502. (213) 849-2481.

With no mounting hardware, the 3925-1B heat sink slips smoothly onto a TO-5 can and occupies only 1.06 in.<sup>2</sup> of board space. With this heat sink, a TO-5, 2N1837 transistor can operate at 3 W and hold the case temperature rise to 70 C above ambient. Without the heat sink, the transistor can dissipate only 600 mW for the same temperature rise.

CIRCLE NO. 395

## Cut wiring costs up to 50% with flexible PCs

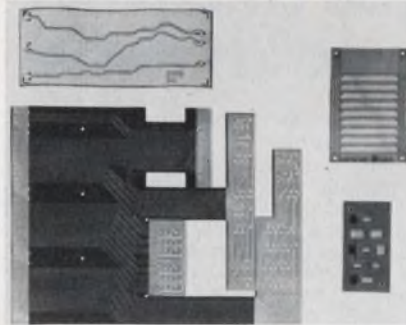

N. V. Philips Gloeilampenfabrieken, Elcoma Division, P.O. Box 523, Eindhoven, the Netherlands.

Savings of up to 50% in overall wiring costs can be achieved with flexible printed circuits. Two processes can meet most customer requirements. A subtractive process uses copper-clad, flexible, polyester and polyimide base materials and obtains the required conductor patterns by an etching. The PD-R process (physical development by reduction) selectively deposits the conductor pattern on a layer of insulating material.

CIRCLE NO. 396

## Plastic parts fabricated for electronic use



Severna, 555 Eagle Rock Ave., Roseland, N.J. 07068. (201) 228-0600.

Severna can extrude, machine, mold or otherwise fabricate Teflon, nylon, Kel-F, polystyrene, Delrin and Rexolite to very close tolerances and at high production speeds. They are now producing such parts as capacitor-end seals, coaxial-connector insulators, coil bobbins, electrical insulators, feed-through insulators, multipin-connector insulators, precision dielectric components, stand-off insulators, tube sockets, special shapes and other miniature and subminiature components.

CIRCLE NO. 397

## P.C. CARD CAGES

Ready to Assemble — All parts in stock.



**\$15.00**

(not including  
UNITRACK card guides)

Another feature of Versa-Cage: P.C. cards are held in vibration and shock dampening UNITRACK card guides with snap-in buttons for quick, easy assembly.

VERSACAGE™ standard 19" card cages are rigid, sturdy, low cost and assemble in less than 5 minutes. Hold 30 p.c. cards on ½" centers. Standard End Plates adjust for cards up to 4½" x 6½". Pre-punched card guide holder bars and connector bars available on ½", ¾" and .200" centers.

(All parts are available for special cabinets you may wish to make. Catalog lists prices.)

# UNITRACK™

UNITRACK Division, Calabro Plastics, Inc.  
8738 West Chester Pike Upper Darby, Pa. 19082  
Telephone (215) 789-3820

## IN/COUNTER IT.

Series 507/517/527. A built-in precision 5-digit counter with four ranges of 0.1 (low end) resolution (XXXX.X Hz) to XX.XXX Kiloherzt at the high end make Series 505 an invaluable test instrument. They're trigger/gated and have frequency limits of 5, 10 and 20 MHz with frequencies as low as .005 Hz. All the waveforms you know and love. Get the full picture — write today.

**AILTECH**   
A CUTLER-HAMMER COMPANY



815 Broadhollow Road • Farmingdale, New York 11735 • (516) 595-8471  
19535 E. Walnut Dr. • City of Industry, CA. 91748 • (213) 965-4911

INFORMATION RETRIEVAL NUMBER 473

INFORMATION RETRIEVAL NUMBER 474



# NEW! Build and test circuits as fast as you can think! No soldering or patch cords!

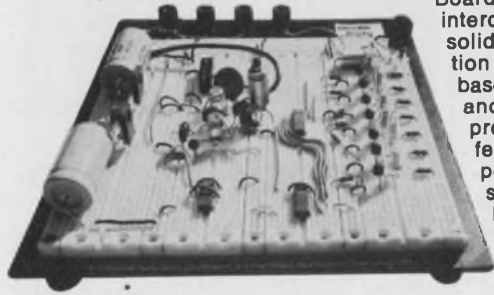

Four new Continental Specialties Proto Boards let you make all circuit and power interconnections with common #22 AWG solid hook-up wire, while power distribution buses make wiring a snap. Aluminum base plates offer solid work surfaces and perfect ground plane. Rubber feet prevent scratching. Each Proto Board features one or more 5-way binding posts to tie into system or power supply gnd. All are compatible with ICs (digital or linear), in TO5s, DIP packs and discrete components. Each is completely assembled, ready-to-use.

PAT. PENDING

Proto Board Model No.	14 Pin DIP Capacity	Size (L"xW")	Price (U.S. only)
101	10	5.8"x4.5"	\$29.95
102	12	7.0"x4.5"	\$39.95
103	24	9.0"x6.0"	\$59.95
104	32	9.5"x8.0"	\$79.95

Order today — or send for free selection guide, with applications, photos, specs and more.



**Continental Specialties Corp.**  
325 East St., Box 1942  
New Haven, CT 06509  
Telephone (203) 624-3103

CANADA: Available thru Len Finkler, Ltd., Downsview, Ontario

INFORMATION RETRIEVAL NUMBER 475

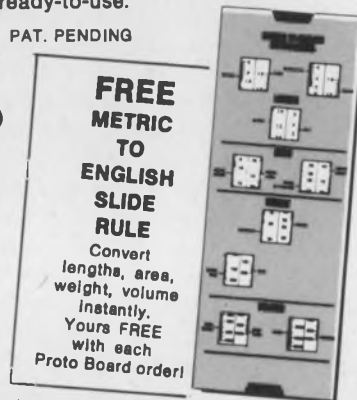

## design aids

### Photographic glass plates

A chart, "Characteristics of Kodak Plates for Ultraviolet, Visible Light, and Infrared Photography," contains capsule descriptions and applications for each plate, data on availability, safelight recommendations, meter settings and image structure characteristics. All rms granularity data are given in terms of diffuse values. Eastman Kodak.

CIRCLE NO. 398

### Darlington transistors

Design tips, application notes, process technology and quick selector guides for Darlington power transistors are included in a wall chart. Motorola.

CIRCLE NO. 399

### Silicon power transistors

A wall chart describes high-current high-voltage silicon power transistors. Major specifications of each type are included for device selection. Powertech.

CIRCLE NO. 400

### Switches

An eight-page guide to basic switches contains a multicolor, single-page chart designed to provide easy access for selection of standard and miniature snap-action precision switches. Micro Switch.

CIRCLE NO. 401

### Conductor calculator

A double-sided slide chart enables users to find conductor resistance and current carrying capacity. It covers single, flat conductors laminated with 0.002-to-0.005-in. flexible laminate and an allowance of a 10-C rise at 20-C ambient. The ruler is also useful to find the current capacity of copper circuits etched in the company's GT5500 polyester or GT17510 polyimide laminates. The user can read current carrying capacity at various temp rises above ambient of 20 C. G.T. Schjeldahl, Northfield, Minn. 55057.

INQUIRE DIRECT

Before you buy

# COMPARE MODULATION METERS

We invite you to use Radiometer's Type AFM2 or AFM3 in your laboratory on a 10 day trial. Check features, specifications and especially performance in your own precise measurements of FM deviation and AM modulation on carriers from 5 MHz to over 1 GHz. Determine distortion levels of signal generators or transmitters and make sensitive measurements of incidental AM or incremental FM on carriers.

You can check all these and more.

For details contact us at  
811 Sharon Drive,  
Cleveland, Ohio 44145  
Phone 216/871-8900

 **THE  
LONDON  
COMPANY**

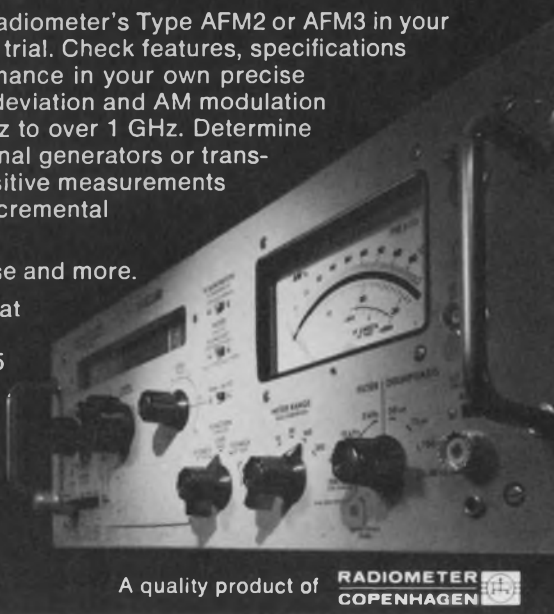

A quality product of **RADIOMETER  
COPENHAGEN**

INFORMATION RETRIEVAL NUMBER 476



# DO COLLEGES HELP BUSINESS AS MUCH AS BUSINESS HELPS COLLEGES?

Yes, they do. But not in the same proportion.

Business contributes about 15% of the total voluntary support received by colleges.

But today, business gets half the college-trained people who are employed. Tomorrow, it will need even more.

As a result, businessmen should think seriously about increasing the level of corporate giving to education. Can you, as a businessman, think of a better investment?

For the latest national figures on corporate giving to higher education, write on your letterhead for "CFAE Survey of Corporation Support of Higher Education," and enclose \$2.00 to help cover costs. Mail to: Council for Financial Aid to Education, 6 East 45th Street, New York, N.Y. 10017.

Give to the college of your choice. Now.



Advertising contributed for the public good.

## application notes

### FET basics

A brochure provides a brief but concise introduction to the nature of field-effect transistors and touches on characteristics, terminology, test parameters and applications. The 20-page brochure covers both major types of FET devices (junction FETs and MOS FETs) in both their n and p-channel configurations. Defined terminology includes drain current, pinchoff voltage, gate-to-source voltage, breakdown voltage, transconductance, capacitance and Y-parameters. Siliconix, Santa Clara, Calif.

CIRCLE NO. 402

### Epoxy adhesives

"Epoxy Adhesives" encompasses everything from the basic advantages of epoxy adhesives to methods of application, mixing and storage. Surface preparation is discussed and specific advice given. High Strength Adhesives, Chicago, Ill.

CIRCLE NO. 403

### Tangential sensitivity

Tangential sensitivity is a measure of noise performance of a detector. An application note answers questions about various factors involved in making the measurement. A useful production test system using an rms voltmeter to compare signal output to noise output is shown. Hewlett-Packard, Palo Alto, Calif.

CIRCLE NO. 404

### CMOS

A brochure describes the characteristics of CMOS logic and how best to apply it. The brochure includes details on the characteristics of CMOS logic elements and system considerations, including information on data bussing, power-supply filtering, and minimizing system power. Data on interfacing CMOS with other logic families are included. National Semiconductor, 2900 Semiconductor Dr., Santa Clara, Calif. 95051

INQUIRE DIRECT

# DOUBLE-BALANCED MIXERS

Great Value at

**\$7<sup>95</sup>**  
500 piece quantities.

\$9.95 in quantities of 1 to 49 pieces

DC-500MHz  
6dB conversion loss  
40dB isolation  
EMI shielded case



A breakthrough in technology and high production volume enables Mini-Circuits Laboratory to offer these new products at an unprecedented low price.

In today's tough competitive market can you afford not to use these remarkably low priced and high performance units?

Ruggedness and durability are built in the SRA-1. These new units are packaged within an EMI shielded metal enclosure and hermetically sealed header. They use well matched hot-carrier diodes and uniquely designed transmission line transformers.

We invite you to convince yourself. Place your order now and check our delivery, product performance and reliability.

## Mini-Circuits Laboratory

2913 Quentin Rd., Brooklyn, N.Y. 11229  
(212) 252-5252, Int'l Telex 620156  
A Division Scientific Components Corp.

\*FRANCE S.C.I.E., \*31, rue George-Sand, Palaiseau 91, France \*GERMANY AUSTRIA SWITZERLAND: Industrial Electronics GMBH, \*Klüberstrasse 14, 6000 Frankfurt/Main, Germany \*UNITS IN STOCK

ENGLAND: Dale Electronics: Dale House, Wharf Road, Frimley Green, Camberley, Surrey, JAPAN: Deniso Kaisha, Ltd.: Eguchi Building, 8-1, 1-Chrome, Hamamatsucho, Minato-Ku, Tokyo. ISRAEL: Hamashbir Electronics, 76 Giborei Israel St., Tel-Aviv, Israel. \*UNIT IN STOCK.

INFORMATION RETRIEVAL NUMBER 477



# 2000 pole double throw switch

How do you direct 2,000 low level transducer lines into a back-up computer without changing 200 cables? Easy. T-Bar® 48-pole latching relays. T-Bar makes high density switches and relays . . . designs and fabricates special switching systems . . . reliably and economically. If you switch a lot of lines — all at once or a few at a time — write or phone today for complete T-Bar literature.

**T-Bar**  
INCORPORATED  
SWITCHING TECHNOLOGY

141 Danbury Road  
Wilton, CT 06897  
Phone: 203/762-8351



(4966) SWITCHING COMPONENTS DIVISION AD #1

INFORMATION RETRIEVAL NUMBER 479

286

## new literature

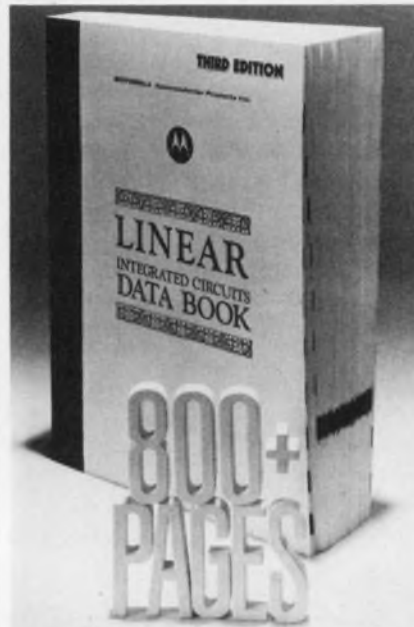

### Linear IC handbook

The third edition of the Linear Integrated Circuits Data Book has been expanded to over 800 pages, 100 pages more than the previous edition. An interchangeability guide and listing of available application notes are included. Package outlines, pinouts and schematics are provided. Quick selector guides for each category of device facilitate the use of this handbook. It is priced at \$3 per copy. Motorola, P.O. Box 20924, Phoenix, Ariz. 85306.

INQUIRE DIRECT

### Pulse magnetizing system

Specifications and operational description for the Model HE-20 pulse magnetizing system are contained in a two-page data sheet. Indiana General, Valparaiso, Ind.

CIRCLE NO. 405

### Linear IC TV circuits

Comprehensive data on three recently announced linear integrated circuits for color and monochrome TV receiver applications—a TV chroma amplifier/demodulator, a TV signal processor and a TV chroma processor—are described in a catalog. RCA, Somerville, N.J.

CIRCLE NO. 406

### SCRs

A series of 710-A rms fast switching inverter SCRs is described in a six-page data sheet. The literature contains graphs, ratings, specifications and a dimensional outline drawing. International Rectifier, Semiconductor Div., El Segundo, Calif.

CIRCLE NO. 407

### Dielectric ceramics

A high-permittivity dielectric ceramic for microwave applications is featured in a brochure. Hirst Research Center, Wembley, Middlesex, England.

CIRCLE NO. 408

### Power converters

Dc-to-dc converters, 115-V-ac, 400-Hz input high efficiency power supplies, ac-to-dc modules and power-supply kits are detailed in a 28-page catalog. Tecnetics, Boulder, Colo.

CIRCLE NO. 409

### Instrumentation

"Electronic Precision" provides 20 pages of information on the product line and pioneering activities of Rohde & Schwarz. Rohde & Schwarz, Munich, West Germany.

CIRCLE NO. 410

### Magnetic circuit breakers

The fourth edition of "The Choice of Protection" discusses the advantages and disadvantages of protective devices for electrical equipment and electronic circuits. Coverage includes short-circuit capacity considerations, transient tripping, motor protection, environmental conditions, magnetic time-delays, undervoltage protection, ground fault circuit interruption and other topics. Fifty illustrations include performance curves, diagrams, cutaway drawings and photographs. Airpax Electronics, Fort Lauderdale, Fla.

CIRCLE NO. 411



## Axial fans

A line of axial fans designed to cool diverse commercial, industrial and military electronic equipment is described in a six-page brochure. Operating characteristics, performance curves and line drawings are provided. Amphenol, Broadview, Ill.

CIRCLE NO. 412

## Vibration feeders

A 16-page catalog describes the Viba-Trex line of vibratory feeders. Specifications, bowl dimensions and control unit information are included. Ex-Cell-O Corp. of Canada, London, Ontario.

CIRCLE NO. 413

## Data communications

A "data communications primer" graphically explains the company's system's ability to extend digital communications between central IBM System/360-370 computers and remote I/O sites, eliminating the need for remote computers. Computer Transmission, El Segundo, Calif.

CIRCLE NO. 414

## Photomultiplier tubes

A replacement guide lists near and direct equivalents of photomultiplier tubes and contains an application index of about 150 tube types. EMI Electronics, Hayes, Middlesex, England.

CIRCLE NO. 415

## Instrumentation

Oscilloscopes, digital multimeters, pattern, marker, rf wideband and sine/square wave generators are illustrated in a 24-page catalog. Also included are FM multiplex stereo generators, volt/ohm meters and curve tracers. Leader Instruments, Plainview, N.Y.

CIRCLE NO. 416

## Plastic injection molding

A 112-page manual, "Cutting Costs in Short-Run Plastics Injection Molding," covers all phases of prototype and short-run practice. The manual includes parts design, material selection, mold building, part production and other helpful data. The manual is \$5. Morgan Industries, 3311 E. 59th St., Long Beach, Calif. 90805.

INQUIRE DIRECT

## Radio Shack catalog

A 52-page electronic parts catalog contains more than 2000 hard-to-find electronics items. It includes a variety of special-purpose tubes, transistors, readouts, PC and IC equipment, relays, resistors, capacitors, potentiometers, transformers, sophisticated test instruments, connectors and power supplies. Radio Shack, Fort Worth, Tex.

CIRCLE NO. 417

## Bioengineering abstracts

A monthly publication, entitled "Bioengineering Abstracts," is designed to provide up-to-date concise source information on the growing volume of literature in this field. The abstracts contain a summary of article content, title, author, citation source, date, number of article pages and references. Engineering Societies Library, New York, N.Y.

INQUIRE DIRECT

# PLUG UGLY.™



~~\$44~~ (1-9)  
**5V, 6A**

They're not much to look at.

Because instead of fancy front panels, we designed our standard open-frame dc power supplies to cover 90% of your OEM applications. And once you plug them into your computers, peripherals or instrumentation, they're so reliable that chances are you'll never see them again.

They're designed and built conservatively, so you get full rated power all the way up to +55°C. Regulation, ripple and noise are specified by the book. And with no expensive options, you can now get your dc power for as little as 68¢/W (1-9 qty).

If you've looked at the competition, we know that has to be a sight for sore eyes.

For more info, use the bingo card or call 714/979-4440. Or call your local Cramer or Newark distributor and get Ugly today.

OPEN-FRAME OLV SERIES: 4-28 Vdc, 15-250 W

STANDARD FEATURES: Choice of 18 voltages, adjustable ±5%  
Currents to 50A, no derating to +55°C ±0.1% IC regulation  
±0.1% ripple and noise, Remote sensing/programming  
Spike suppression, Foldback current limiting, 120/240 Vac  
50/60 Hz inputs

OPTIONS: OVP crowbar PRICES: \$24.95 to \$179 (1-9)

# Elexon Power Systems

Copyright 1974 Eipac, Inc. ELPAC

INFORMATION RETRIEVAL NUMBER 480



Circuit Designers, Packaging and Production Engineers will find a complete family of easy-to-use, low cost production aids and PCB hardware in this 24 page Packaging Products catalog.

Complete specifications and pricing are included for Permanent and Temporary Mounting Spacers, Snap-in Card Guides and new Card Ejectors.

Easy-to-find data and prices on over 600 standard parts makes this handy digest a must. All items are available from factory stock or through leading local distributors. **BIVAR, Inc.** 1617 E. Edinger Ave., Santa Ana, Ca. 92705 (714) 547-5832.



# circuit & packaging problem solver.

*a brand new digest of cost saving ideas:*

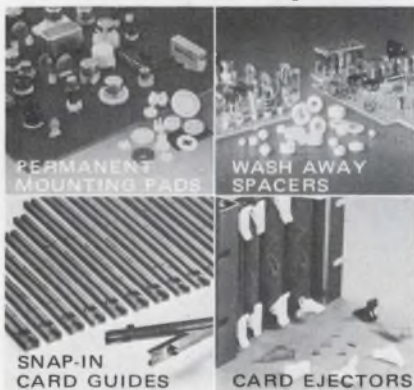

*specific samples on request.*

PACKAGING PROGRESS  
BY **Bivar**

INFORMATION RETRIEVAL NUMBER 481

## NEW LITERATURE

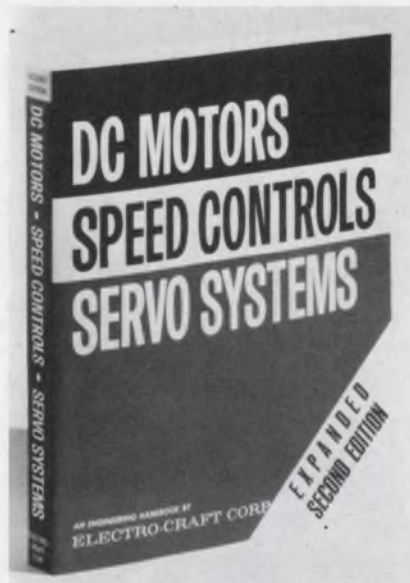

### Motor handbook

The 400-page "DC Motors—Speed Controls—Servo Systems" presents theory, design considerations and application notes on various types of dc motors and generators, servo systems and associated control devices. This edition contains all notations in both metric and English values. The handbook can be purchased for \$1 to cover handling and postage by engineers writing on their company letterhead or enclosing their business card. Electro-Craft, Box 664, Hopkins, Minn. 55343.

INQUIRE DIRECT

### Ac voltage regulators

Technical data on a concept of maintaining truly flat regulation using ac voltage regulators or dc power supplies, with instantaneous attenuation of line and load fluctuations, are given in a 16-page catalog. Advanced Power, Anaheim, Calif.

CIRCLE NO. 419

### S/d converters

A 14-page guide covers a continuous tracking or multiplexed s/d converter, binary-to-BCD converter, d/s converter, two-speed s/d or d/s converters, digital-to-synchro converter, two-speed processor, control transformer, control differential transmitter or synchro angle display meter. Analog Devices, Norwood, Mass.

CIRCLE NO. 420

## TV cameras

Multi-adaptable single tube color TV cameras for ETV, ITV, CATV and CCTV are described in a four-page data sheet. Cohu, San Diego, Calif.

CIRCLE NO. 421

## Miniature reed relays

A four-page bulletin describes the series 46 miniature reed relays which are offered in mercury-wetted, dry reed and magnetic latching types. Specifications, model types, dimensional drawings and contact rating performance curves are provided. North American Philips Controls, Cheshire, Conn.

CIRCLE NO. 422

## Connectors

A connector selection guide lists popular connector configurations. The six-page guide includes eight photographs, environmental specifications and model differences. Connectors discussed include rectangular rack/panel, circular, micro-miniature, PC/input, output, filters and special applications such as audio, CATV and rf. ITT Cannon, Santa Ana, Calif.

CIRCLE NO. 423

## PC connectors

Receptacle-type printed-circuit connectors with 0.025-in. and 0.045-in. sq. terminations for wrapped wire are covered in a 16-page catalog. Specifications, outline drawings, illustrations and ordering information are included. Continental Connector, Woodside, N.Y.

CIRCLE NO. 424

## Memory system

A four-page brochure describes a compact memory system. Specifications and a schematic diagram are included. Fuji, Minato-ku, Tokyo, Japan.

CIRCLE NO. 425

## PVC coatings

A standard describes external plastic coatings which are applied to galvanized rigid conduit and galvanized steel electrical metallic tubing. The standard may be purchased for \$1.25. National Electrical Manufacturers Assoc., 155 E. 44th St., New York, N.Y. 10017.

INQUIRE DIRECT



## Heat-transfer fluid

Ucon Fluid 500, a synthetic heat-transfer fluid that is miscible with water at temperatures below 110 F, is described in a bulletin. Union Carbide, New York, N.Y.

CIRCLE NO. 426

## LED products

A catalog of light-emitting diode products also doubles as a LED second-source directory. The 12-page catalog lists alternate parts, where available, for each type of the company's LED lamp, infrared emitter, opto-isolator, phototransistor, single and multiple-digit numeric and alphanumeric displays. Litronix, Cupertino, Calif.

CIRCLE NO. 427

## Zener and TC diodes

Three quick-reference, voltage-regulating diode charts show power dissipation, package type, nominal voltage breakdown and applications. Dickson Electronics, Scottsdale, Ariz.

CIRCLE NO. 428

## PC breadboards

An eight-page catalog shows off-the-shelf printed-circuit breadboards. Card racks, instrument cases, connectors, ejectors, IC sockets and computer interface breadboards are described. The catalog illustrates more than 50 IC breadboards for dual inline, TO-5 and flatpack ICs. Douglas Electronics, San Leandro, Calif.

CIRCLE NO. 429

## Decoders and receivers

A series of specification sheets describes decoders, receivers, measurement units, power supplies, dividers, squarers, rf wattmeters and a two-channel CB crystal calibrator. Amtron, 20092 Cinisello Balsamo (MI), Italy.

CIRCLE NO. 430

## OEM rotating memories

Low-to-medium capacity rotating memory products, including cartridge and "floppy" devices, are featured in an eight-page catalog. Control Data, Hawthorne, Calif.

CIRCLE NO. 431

## Laser trimmer

Data on the System-25 laser trimmer are given in a 12-page, fully illustrated booklet. Included are descriptions of the laser beam positioning and measurement subsystems, system operation, process control hardware and software, programming and functional trimming applications and options. Electro Scientific Industries, Portland, Ore.

CIRCLE NO. 432

## Liquid-crystal displays

The fundamentals of liquid crystals and LCDs—what they are, how they work, types available (dynamic scattering and field-effect), and their advantages and disadvantages—are covered in an eight-page catalog. Other displays explored are light-emitting diode, incandescent, fluorescent and gas-discharge. Hamlin, Lake Mills, Wis.

CIRCLE NO. 433

# MEAN AND UGLY.™



**\$79 (1-9)**  
**3 outputs**

Our OEM dc supplies have always been stark, but now they're twice as ugly (also 3x).

Because instead of working up a new color scheme, we've combined two and three of them on a single chassis to make them an even better buy for your computers, peripherals and instruments.

We've taken out redundancies, but they still offer the widest range of voltages you can get in a modular dc supply. Still deliver all the power we promise across the full temperature range (even with 50 Hz inputs). And still include all the features you need as standards, not expensive options.

So that now if you check us out against the competition, they're liable to tell you that we're not just ugly.

We're downright mean.

For more info, use the bingo card or call 714/979-4440. Or call your local Cramer or Newark distributor and get Ugly today.

**MULTIPLE OUTPUT DLV/TLV SERIES:** 1st output: 5 V at 3-15 A, OVP standard. 2nd and/or 3rd outputs: each 4-28 V, 0-15 W, OVP optional. All outputs isolated, may be used as positive or negative supplies.

**STANDARD FEATURES:** Choice of 16 voltages, adjustable  $\pm 5\%$ . Currents to 15 A, no derating to  $-55^\circ\text{C}$ ,  $\pm 0.1\%$  regulation,  $\pm 0.1\%$  ripple and noise. Remote sensing/programming. Spikes suppression. Foldback current limiting. 120/240 Vac, 50/60 Hz inputs.

**OPTIONS:** Enclosure. **PRICES:** \$29 to \$151 (1-9)

# Elexon Power Systems

© Copyright 1974 Elpac, Inc. **ELPAC**

INFORMATION RETRIEVAL NUMBER 482



# CLOCKING WITH A DELAY LINE?

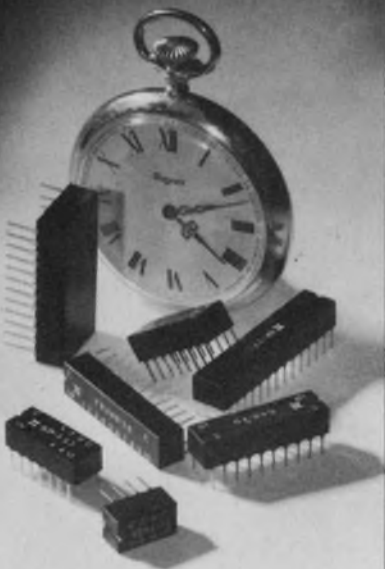

## TRY US!

### TWO TYPICAL EXAMPLES

Total delay = 7.5 nano sec. } 14 lead "DIP"  
Five taps @ 500 pico sec. }

Total delay = 42 ns }  
Twelve taps @ 3 ns } 12 lead "DIP"  
Four taps @ 1.5 ns }

- Frequency capabilities to 300 MHz
- Temperature coefficient of 70 PPM/°C
- Operating temperature from -55°C to +125°C
- Tap stabilities to ±250 ps

### PLUS . . .

- Tap capabilities from 500 ps to 25 ns
- Delays from 5 ns to 1000 ns
- Rise time ratios from 5:1 to 30:1
- Standard impedances of 50, 75 and 100 ohms (±5%)
- All Dual In-line packaged (8 to 28 leads)

Custom clocking applications are available—within the series—without engineering costs. **Phone, wire or write for more information today!**



**RHOMBUS  
INDUSTRIES INC.**

22119 S. Vermont Ave., Torrance, Ca. 90505  
(213) 325-7440 • TWX 910-349-7512

## bulletin board

An advanced COBOL source code analysis and optimization system, STAGE III, has been introduced by Tesdata Systems for IBM OS/DOS/VS users.

CIRCLE NO. 434

A triple line driver and receiver pair, the Am9616 and Am9617 designed to the specifications of the EIA, have been introduced by Advanced Micro Devices for use in data terminals, teleprinters and other communications equipment.

CIRCLE NO. 435

Ferrocube Corp. is marketing ferrite memory cores, stacks, systems and MOS semiconductor systems for the computer industry.

CIRCLE NO. 436

A central processor accelerator that increases the performance of IBM System/370 Model 155 computer by up to 28% has been introduced by Cambridge Memories. The accelerator is available as an option with the company's 370/STOR 155 add-on main memory system for Model 155 processors.

CIRCLE NO. 437

Complete flexible disc systems including both software and hardware are available for DEC and Data General minicomputers from Xebec Systems.

CIRCLE NO. 438

The Peripheral Equipment Div. of Pertec Corp. has raised the prices 3% to 5% on some models of digital magnetic tape transports, disc drives and spare parts.

CIRCLE NO. 439

Twelve types of opto-isolators manufactured by Litronix have received UL approval.

CIRCLE NO. 440

A new software package that enables users to write computer-assisted instruction (CAI) materials in IBM's Course Writer language on HP's 2000F and 2000C computers has been developed by Hewlett-Packard's data systems division.

CIRCLE NO. 441

With the change of voltage ratings from  $V_{CBO} = 250$  V to  $V_{CBO} = 350$  V and  $V_{CEO} = 150$  V to  $V_{CEO} = 225$  V, Siemens' BU 114 transistor is now suited for line-synchronous power packs in black-and-white TV sets as well as for general switching applications.

CIRCLE NO. 442

Fairchild Camera & Instrument Corp. has introduced a line of complementary MOS logic circuits that use Isoplanar processing to achieve high density and high performance. First products in the 34000 family are six logic gates.

CIRCLE NO. 443

Metalized Ceramics has developed a quality technique for spot-plating gold on the critical device areas of its all-alumina MOS/LSI packages at production rates.

CIRCLE NO. 444

An expanded line of 520 series modular instruments offered by the Industrial Instruments Div. of Barber-Colman has been designed to accept the output of standard thermocouples, resistance bulbs, radiation pyrometers and other millivolt sources.

CIRCLE NO. 445

## Price reductions

A 23% price reduction on its TA11 and TA8 dual DECCassette units has been announced by Digital Equipment. The units have been reduced to \$2990 from \$3900.

CIRCLE NO. 446

Monsanto has announced price reductions of its thin and thick-film gallium arsenide phosphide epitaxial materials to \$12 per sq. in. and \$14 per sq. in., respectively.

CIRCLE NO. 447

Beckman Instruments, Information Display Operations has cut prices on its seven-segment planar gas discharge displays. The SP300 and SP700 series with 1/3-in. and 1/2-in. high characters have been dropped over 21% to \$2.33 per digit from \$2.95 (100). Other models show similar reductions.

CIRCLE NO. 448



# vendors report

Annual and interim reports can provide much more than financial-position information. They often include the first public disclosure of new products, new techniques and new directions of our vendors and customers. Further, they often contain superb analyses of segments of industry that a company serves.

Selected companies with recent reports are listed here with their main electronic products or services. For a copy, circle the indicated number.

**Analog Devices.** Modular analog circuits, modular converters, linear integrated circuits, DPMs, input/output peripherals and transducers.

CIRCLE NO. 449

**Decision Data.** Peripheral and data preparation equipment.

CIRCLE NO. 450

**Eltra.** Electric vehicles, engine electrical systems, batteries, communications equipment and instrumentation.

CIRCLE NO. 451

**Cordura.** Commercial data processing services and engineering reference books.

CIRCLE NO. 452

**Burroughs.** Business machines, computer systems and peripheral products and components.

CIRCLE NO. 453

**The Superior Electric Co.** Numerical tape controls, tables and positioning systems, variable voltage transformers and automatic voltage regulators, synchronous/stepping motors, controls and drives, lighting controls and connectors.

CIRCLE NO. 454

**Allied Chemical.** Chemicals, metal alloys, insulating materials, plastics.

CIRCLE NO. 455

**Bunker Ramo.** Telecommunications, data processing systems, connectors and automotive electronics.

CIRCLE NO. 456

**Visual Sciences.** Facsimile equipment.

CIRCLE NO. 457

**Airpax Electronics.** Magnetic circuit breakers, tachometers, industrial controls, electronic glass and electroplating, choppers, state-of-the-art video and communications equipment, switches and components.

CIRCLE NO. 458

**Computer Communications.** Data communications equipment and systems.

CIRCLE NO. 459

**Hewlett-Packard.** Electronic test and measuring instrumentation, electronic data products, medical electronic equipment and instrumentation for chemical analysis.

CIRCLE NO. 460

**Signetics,** 811 E. Arques Ave., Sunnyvale, Calif. 94086. Logic, memory and analog circuits and aerospace ICs.

INQUIRE DIRECT

# GET UGLY™ (wherever you are)

	ELEXON REPRESENTATIVE	CRAMER	NEWARK
New England	Coakley, Boyd & Abbott 617/444-5470	Newton 617/969-7700 North Haven 203/239-5641	Woburn 617/935-8350 Westport 203/226-6921
Upstate N.Y.	Kehoe Component Sales 315/524-2491	Endwell 607/754-6681 Rochester 716/275-0300 E. Syracuse 315/437-6671	Rochester 716/473-6600 Canandaigua 315/394-0941 Red Hook 914/758-8229
N.Y.-Metro New Jersey	Ed Glass Assoc. 201/592-0200	Hauppauge 516/231-5600 Moonachie 201/935-5600	Plainview 516/822-5000 Kenilworth 201/272-8410
Penn., Del., So. N.J.	T.O.E. Sales 215/348-2212	Cherry Hill 609/424-5993	
Va., S.C., Md., N.C.	Component Sales, Inc. 301/484-3647	Gaithersburg 301/948-0110 Hanover 301/796-5790 Winston-Salem 919/725-8711	Beltsville 301/937-5085
Kentucky, Ohio, Ind.	Frank J. Campisano Co. 513/662-1616	Cleveland 216/248-8400 Cincinnati 513/771-6441	Cleveland 216/641-2800 Cincinnati 513/874-5115 South Bend 219/272-2992 Carmel 317/846-2673 Oak Park 313/548-0250 Wyoming 616/241-6681
Michigan	Villani-Pitcher, Inc. 313/271-4600	Livonia 313/425-7000	
No. Carolina	Component Sales, Inc. 919/782-8433	Winston-Salem 919/725-8711	
Ga., Ala.	BJR Manufacturing Reps 205/881-3569	Atlanta 404/448-9050 Huntsville 205/539-5722	
Florida	Orbe, Inc. 813/894-0687	Orlando 305/894-1151 Hollywood 305/923-8181	Ft. Lauderdale 305/587-2372
Ill., Wisc., Iowa	Balhorn & Welch 312/889-5011	Mt. Prospect 312/593-8230 Milwaukee 414/764-1700	Chicago 312/638-4411 Des Plaines 312/298-1420 Milwaukee 414/781-2450 Minneapolis 612/331-6350
Minn., N. & S. Dakota	Lew Cahill & Assoc. 612/846-7217	Edina 612/835-7811	
Mo., Kansas	K & M Sales Co. 816/471-2355		St. Louis 314/843-2080
Colo., Utah	J. S. Heaton Co., Inc. 303/758-5130	Denver 303/758-2100 Salt Lake City 801/487-4131	Denver 303/757-3351 Salt Lake City 801/486-1048
Texas, La.	Carter Assoc., Inc. 214/278-7151	Dallas 214/350-1355	Dallas 214/271-2511 Houston 713/782-4800
Okla., Ark.	Hugh J. Daly Co. 918/627-4159		
Arizona	J. S. Heaton Co. 602/284-7887	Phoenix 602/263-1112	
Wash., Ore.	Blum & Associates 206/782-1600	Seattle 206/762-5755	
N. Calif.	J. S. Heaton Co. 415/369-4871	Sunnyvale 408/739-3011	
S. Calif.	RLS Associates 714/644-7497	Irvine 714/979-3000 San Diego 714/565-1881	Inglewood 213/678-0441

We make the OEM dc supplies that only an engineer could love. No fancy front panels, but loaded with everything you need for 90% of your applications off-the-shelf:

15 voltages from 4-28V, adjustable  $\pm 5\%$ .  
Currents to 50A, with no derating to  $+55^\circ\text{C}$ .  $\pm 0.1\%$  IC regulation. 120/240 Vac, 50/60 Hz inputs. And even remote sensing/programming.

All standard for as little as 68¢/W. And all yours from Cramer or Newark. (For more info, use the bingo card or call 714/979-4440.)



# Elexon Power Systems

©Copyright 1974 Elpac, Inc. ELPAC



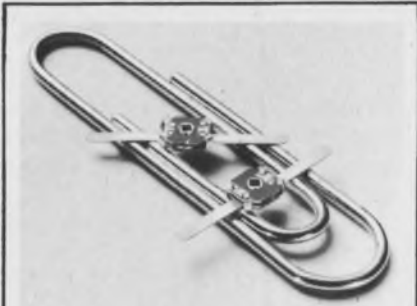

Thin-Trim variable capacitors provide a reliable means of adjusting capacitance without abrasive trimming or interchange of fixed capacitors. Series 9401 has high Q's and a range of capacitance values from 0.2-0.6 pf to 3.0-12.0 pf and 250 WVDC working voltage. Johanson Manufacturing Corporation, Boonton, New Jersey (201) 334-2676.

INFORMATION RETRIEVAL NUMBER 491



Snap Action Switches (zero plus) available with or without integral actuators. Compatible fixing and size dimensions with comparable types. Screw, solder and 3/16" or 1/4" Faston terminals. Plastic actuator hinge ensures minimum side play. Pye TMC Canada, 15 Sheffield Street, Toronto, Ontario. (416) 249-7044.

INFORMATION RETRIEVAL NUMBER 492

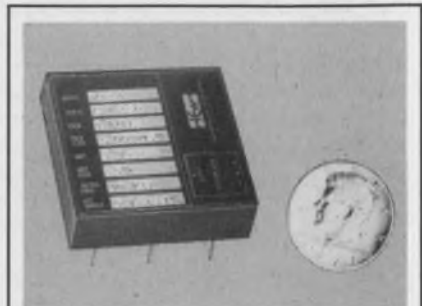

VCXO Crystal Clock Oscillator at freqs. from .00005 Hz to 50 MHz freq. tol.  $\pm .0005\%$   $0^{\circ}\text{C}$  to  $+50^{\circ}\text{C}$ , control voltage range  $+4\text{V}$  to  $-4\text{V}$  changing freq. 20 ppm/V, linearity  $\pm 2\%$ , 1.75" sq. x 0.5", Supply 5Vdc  $\pm 1\%$ , Sq. wave 2.4V into 200 $\Omega$  at Vdd = 5V, stock to 5 weeks; Connor-Winfield Corp., W. Chicago, Ill. 60185. 312-231-5270

INFORMATION RETRIEVAL NUMBER 493

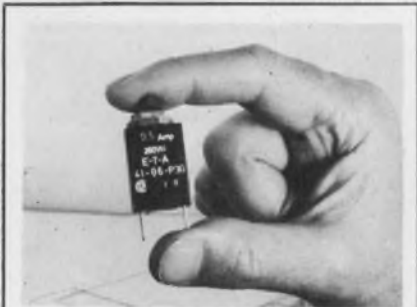

Overcurrent Protector, manual reset eliminates fuse replacement. Convenient panel mounting. 15 fractional ratings from 0.1 to 3 amp. Other models up to 400 amp. Trip-free and fool-proof, UL and CSA approved. High quality, low cost-\$1.12 ea. in 1000 lots. E-T-A Products Co. of America, 6284 N. Cicero Ave., Chicago, Ill. 60646. Tel. (312) 545-1553.

INFORMATION RETRIEVAL NUMBER 497

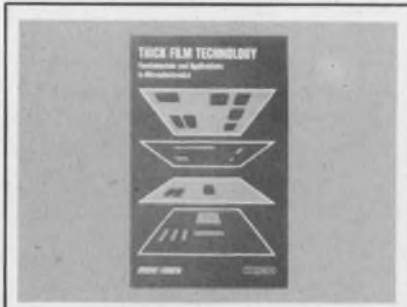

Thick Film Technology—Fundamentals and Applications in Microelectronics, by Jeremy Agnew. From design to finished product, this book details each processing phase, describing what to do and what pitfalls to avoid. 176 pp., 6 x 9, illus., cloth, \$8.50. Circle number for 15-day examination copy. Hayden Book Company, Rochelle Park, N.J. 07662.

INFORMATION RETRIEVAL NUMBER 498

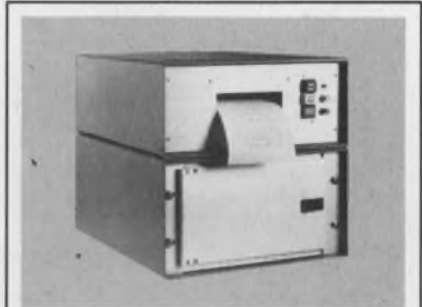

Low cost scanning printer records readouts from several digital data sources (DPM's, counters, machine tool readouts, scales, etc.) sequentially on command. Standard models up to 48 columns per scan. TELSTAR ELECTRONICS CORP., 700 Hummel Ave., Southold, NY 11971. (516) 765-9292.

INFORMATION RETRIEVAL NUMBER 499



Free catalog of 34,500 power supplies from the worlds largest manufacturer of quality Power Supplies. New '74 catalog covers over 34,500 D.C. Power Supplies for every application. All units are UL approved, and meet most military and commercial specs for industrial and computer uses. Power Mate Corp. (201) 343-6294.

INFORMATION RETRIEVAL NUMBER 503



The new Computer Labs DRA Series D/A's eliminate harmonic distortion and produce clean "glitchless" pictures for reconstructed TV or other video signals. Input word rate for all models is 15 MHz with accuracies to  $\pm 0.05\%$ . Min. settling time to either 8-bit or 10-bit accuracies. Computer Labs, 1109 S. Chapman St., Greensboro, N.C. 27403.

INFORMATION RETRIEVAL NUMBER 504



Complete minicomputer mag tape systems for the PDP-8, PDP-11, and NOVA feature IBM compatibility with low price. Three reel sizes to choose from, and all standard densities, including 1600 bpi phase encoded. These systems incorporate the best-designed transports built today. Digi-Data, 8580 Dorsey Run Rd., Jessup, MD 20794, (301) 498-0200.

INFORMATION RETRIEVAL NUMBER 505





Advance through continuing education. 5 complete design courses in Digital Circuits, IC Logic, Power Supplies, MOS/FET & J/FET Ckts and UJT Ckts. Programmed testing, instructor aided courses help you perform better on the job. Write Gene Presta, V. P., Academic Affairs, The Center For Technical Development, 2876 Culver Ave., Dayton, Oh. 45429.

INFORMATION RETRIEVAL NUMBER 494

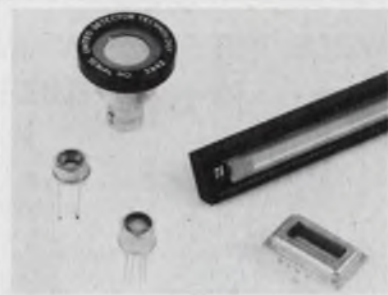

UDT offers a complete line of silicon photodiodes. Schottky for large area and enhanced UV responsivity, planar diffused for low noise and extended responsivity, photops (detector/amplifier combinations), special arrays and detectors to customer specifications. United Detector Technology, 1732 21st St., Santa Monica Ca 90404. (213) 829-3357.

INFORMATION RETRIEVAL NUMBER 495

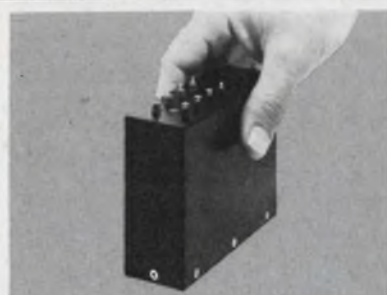

Big power supply for little spaces. 115 VAC, 50-500 Hz input. 1 to 6 isolated & regulated DC outputs. 120 W per output. 3.9 W delivered per cu. in. Modular construction lets you "Design-As-You-Order". Over 1200 configurations using off-the-shelf modules. Immediate deliveries! Arnold Magnetics Corp., Culver City, Ca. (213) 870-7014.

INFORMATION RETRIEVAL NUMBER 496

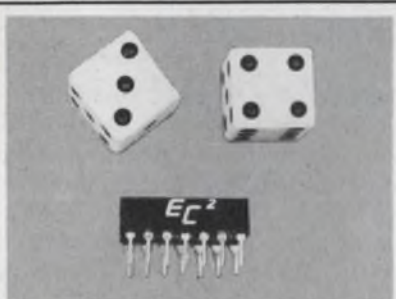

Win with EC<sup>2</sup>'s "DIP Series" lumped constant delay lines. Packaged in a low silhouette epoxy encapsulated 14-pin dual in-line configuration, EC<sup>2</sup> offers over 200 variations of either fixed or tapped delays, from 4 to 150 nanoseconds. Engineered Components Company, 3580 Sacramento Drive, San Luis Obispo, Ca. 93401. 805-544-8000.

INFORMATION RETRIEVAL NUMBER 500



A collector's item . . . 20th anniversary issue of Electronic Design (11/23/72) salutes 25th anniversary of the transistor, features milestones in design over past quarter century. Rare nostalgic view of industry. Fascinating reading. \$2 per copy prepaid. Checks, money orders: Electronic Design, Promotion Mgr., 50 Essex St., Rochelle Park, N.J. 07662.

INFORMATION RETRIEVAL NUMBER 501



Electrolytic Capacitors with a wide range of capacitance and working voltages in a computer grade electrolytic. Temperature range -40°C to +85°C. Screw terminal, solder tag, single ended and axial lead types available. Pye TMC Canada, 15 Sheffield Street, Toronto, Ontario. (416) 249-7044.

INFORMATION RETRIEVAL NUMBER 502

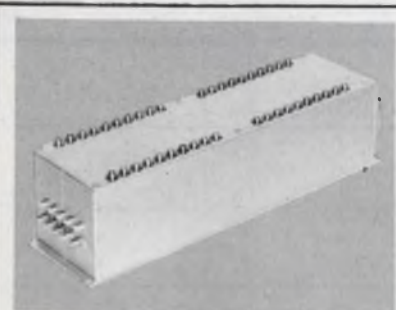

5 x 20 COAXIAL RELAY MATRIX features thruput connection for indefinite X, Y, expansion. Unit employs high reliability reed switches which may be computer controlled thru plug-in compatible control logic. Dual 5 x 10 unit also available in same package size. MATRIX SYSTEMS CORP., 9411 Lurline Ave., Chatsworth, Ca. (213) 882-2008.

INFORMATION RETRIEVAL NUMBER 506

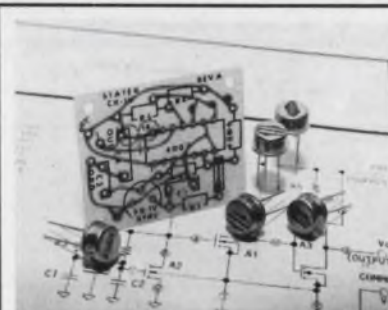

Quartz Crystal Oscillator Kits for \$27. Make bipolar series or CMOS parallel resonant oscillators. Kits include 5 or 6 SX-1 crystals (10 kHz to 240 kHz), in low profile TO-5 cans, a PC board (1.3" x 1.6") and design note. Statek Corp., 1233 Alvarez Ave., Orange, Calif. 92668. (714) 639-7810.

INFORMATION RETRIEVAL NUMBER 507



Digital to synchro converters—14, 12 or 10 bit input, 11.8/90V, 400 or 60Hz transformer isolated output, accuracy ±4, ±15 or ±30 min. Driving 1VA, 2VA (2.6" x 3.1" x 82"H module) or 5 VA loads (4 1/2" x 9 1/4" pc card). Price from \$350 in qty. Computer Conversions Corp., East Northport, N.Y. 11731, (516) 261-3300.

INFORMATION RETRIEVAL NUMBER 508



ELECTRONIC DESIGN's function is:

- To aid progress in the electronics manufacturing industry by promoting good design.
- To give the electronic design engineer concepts and ideas that make his job easier and more productive.
- To provide a central source of timely electronics information.
- To promote communication among members of the electronics engineering community.

**Want a subscription?** ELECTRONIC DESIGN is sent free to qualified engineers and engineering managers doing design work, supervising design or setting standards in the United States and Western Europe. For a free subscription, use the application form bound in the magazine. If none is included, write to us direct for an application form.

If you do not qualify, you may take out a paid subscription for \$30 a year in the U.S.A., \$40 a year elsewhere. Single copies are \$1.50 each.

If you change your address, send us an old mailing label and your new address; there is generally a postcard for this bound in the magazine. You will have to requalify to continue receiving ELECTRONIC DESIGN free.

**The accuracy policy of ELECTRONIC DESIGN is:**

- To make diligent efforts to ensure the accuracy of editorial matter.
- To publish prompt corrections whenever inaccuracies are brought to our attention. Corrections appear in "Across the Desk."
- To encourage our readers as responsible members of our business community to report to us misleading or fraudulent advertising.
- To refuse any advertisement deemed to be misleading or fraudulent.

Microfilm copies are available of complete volumes of ELECTRONIC DESIGN at \$19.00 per volume, beginning with Volume 9, 1961. Work is now in process to complete the microfilm edition of Volumes 1-8. Reprints of individual articles may be obtained for \$2.00 each, prepaid (\$.50 for each additional copy of the same article) no matter how long the article. For further details and to place orders, contact the Customer Services Department, University Microfilms, 300 North Zeeb Road, Ann Arbor, Michigan 48106 telephone (313) 761-4700.

**Want to contact us?** If you have any comments or wish to submit a manuscript or article outline, address your correspondence to:

Editor  
ELECTRONIC DESIGN  
50 Essex Street  
Rochelle Park, N.J. 07662

## HOW REAL-TIME SPECTRUM ANALYSIS PINPOINTS THE CAUSES OF FLUTTER & WOW IN TAPE RECORDERS.

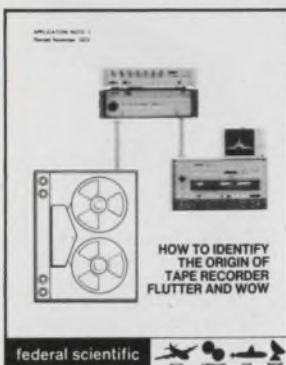

Even the finest magnetic tape recorders/reproducers exhibit some unwanted tape-speed fluctuations due to flutter, wow, stiction, & imperfections in tape itself. 4-page technical paper presents actual data which illustrates the diagnostic value of on-line high-resolution spectrum analysis in the maintenance & evaluation of tape transports. A fine-resolution (500-line) spectrum analyzer easily resolves otherwise-missed flutter & wow contributions due to unbalance in reels, capstans, idlers, etc. In contrast, measurements taken with commercial flutter & wow meters lump together the effects of these disturbances, thereby greatly diminishing the diagnostic value of these measurements. Also shows how to convert flutter data, obtained with a high-resolution spectrum analyzer, to percentage peak-to-peak flutter, & how to make an on-line measurement set-up.

CIRCLE NO. 171

**Federal Scientific Corporation** An Affiliate of Nicolet Instrument  
615 West 131st St., New York, N.Y. 10027 (212) 286-4400 TWX: 710 581 4059

## Low-Noise High-Gain Pre amplification



Complete specifications of a variable-bandwidth high-gain preamplifier are contained in the Model 113 data sheet, T-224. Included are typical noise figure contours illustrating the amplifier's exceptionally low noise, which is as low as .05 dB at mid frequencies with a 1 megohm source. Other illustrations include typical plots of the equivalent input noise and common mode rejection, which exceeds 100 dB at 60 Hz at all gain settings. The data contained in the specification sheet will be of interest to all engineers and researchers looking for a preamplifier with calibrated gain and rolloffs from dc to 300 kHz.

CIRCLE NO. 172

**Princeton Applied Research Corporation**  
Box 2565, Princeton, New Jersey 08540 - (609) 452-2111

SEMINARS ABOUT INTEL MICROPROCESSORS	PHILADELPHIA	WASHINGTON	NEW YORK	BOSTON
<b>INTRODUCTORY WORKSHOP</b> In this two-day program you'll be introduced to the Intel MCS-4, MCS-8 and 8080, with hands-on experience in wiring, assembling and debugging of small programs. (2 days, Monday & Tuesday, \$325 or \$300)*	May 13-14	June 3-4	July 8-9	August 19-20
<b>PROGRAMMING LANGUAGES AND SOFTWARE</b> For experienced users or those who've attended the workshop, this seminar provides understanding of the programmer's tools. How to exploit the assemblers and simulators, the proper use of debugging software, and programming in PL/M will be covered. (1 day, Wednesday, \$150 or \$125)	May 15	June 5	July 10	Aug. 21
<b>INTRODUCTION TO MICROPROCESSORS</b> For those too busy to attend the workshop we offer this one-day condensed seminar at which the features of the MCS-4, MCS-8 and 8080 are as described. This seminar relies on hands-on experience. (1 day, Wednesday, \$150 or \$125)	May 15	June 5	July 10	Aug. 21
<b>DESIGNING WITH MICROPROCESSORS</b> This seminar is aimed at the system designer who understands the overall features of the MCS-4, MCS-8 and 8080, but needs to know how to interface to TTL and CMOS, and how to make the best hardware/software trade-offs. (2 days, Thursday & Friday, \$225 or \$200)	May 16-17	June 6-7	July 11-12	Aug. 22-23
SEMINARS ABOUT NATIONAL MICROPROCESSORS	WASHINGTON	NEW YORK	PHILADELPHIA	ATLANTA
<b>APPLICATION OF NATIONAL 8 MICROPROCESSORS</b> This short-course is an intensive introduction to National Semiconductor's IMP-8 IMP-16 and QPC-8. Emphasis will be on how to use these products in systems, how to interface, and how to program them. Limited hands-on experience will be provided. (3 days, Mon, Wed. or Wed.-Fri., \$350 or \$325)	May 29-30-31	June 17-18-19	July 24-25-26	August 1-2

\*The lower price always prevails if you attend another of our seminars in this series.

**MICROCOMPUTER TECHNIQUE, INC.**

11227 Handlebar Rd. Reston, Va. 22091  
(703) 620-9676

CIRCLE NO. 173



# Manufacturers

Advertisements of booklets, brochures, catalogs and data sheets. To order use Reader-Service Card  
(Advertisement)

## FAST FOURIER TRANSFORM PROCESSOR FOR \$6,000



The 306/MFFT Fast Fourier Transform Processor is delivered with all control programs and plugs directly into any Data General Nova computer. It offers a complete Fourier Transform capability including Forward and Inverse FFT, Spectral magnitude, Hanning Weighting, and Complex Multiplication. Arrays from 16 to 16,384 real samples can be processed. An array of 1024 real samples is transformed in only 139 ms.

Time domain signal processing functions, such as correlation and convolution, can be calculated utilizing the high speed array operations  $X$ ,  $\div$ ,  $+$ ,  $-$ ,  $\sqrt$  and  $\Sigma$ .

Call or write today for brochures on 306/MFFT or Elytec's complete line of Fourier Spectrum Analyzers and Higher Speed Hardware Fast Fourier Transform Processors.

CIRCLE NO. 174

### ELSYTEC INC.

212 Michael Drive, Syosset, New York 11791 (516) 364-0560

## NEW, LOW COST COMPUTERIZED CARD TESTER

New 8-page brochure details low priced, automatic system for Production or R & D testing of p.c. cards and other assemblies. Available in 80- or 160-pin versions. Requires no software or special computer programming skills.

Ideally suited for go-no-go testing, depot troubleshooting and fault isolation. Recording and reloading of test procedures through magnetic cards. Exceptionally easy to operate. Request Bulletin 2000 describing the Series 2000 Tester from Technology Marketing Incorporated, 3170 Red Hill Ave., Costa Mesa, CA. 92626.

CIRCLE NO. 175

### Technology Marketing Incorporated

3170 Red Hill Ave., Costa Mesa, CA. 92626



## LOW POWER CASSETTE DATA ACQUISITION AND LOGGING SYSTEM

- Sixteen channel analog input
- Digital input for timing information
- 12 bit A/D resolution
- 12VDC battery operated
- 900 milliwatts maximum power consumption
- C/MOS logic throughout
- True incremental recording
- Certified Phillips cassette
- 2.2 million bit capacity
- Total weight 2 lbs.
- Cassette reader for computer entry

CIRCLE NO. 176

**D** **DATTEL**  
SYSTEMS, INC.  
**DATA LOGGER**

1020 Turnpike Street, Canton, Mass. 02021

# Electronic Design

## Advertising Sales Staff

Tom W. Carr  
Vice President &  
Sales Manager

### Rochelle Park, N.J. 07662

Robert W. Gascoigne  
Daniel J. Rowland  
(Recruitment, Quick Ads, Classified)  
50 Essex Street  
(201) 843-0550  
TWX: 710-990-5071

### Philadelphia

Thomas P. Barth  
50 Essex Street  
Rochelle Park, N.J. 07662  
(201) 843-0550

### Boston 02178

Gene Pritchard  
P.O. Box 379  
Belmont, Mass. 02178  
(617) 489-2340

### Chicago 60611

Thomas P. Kavooras  
Berry Conner, Jr.  
200 East Ontario  
(312) 337-0588

### Cleveland

Thomas P. Kavooras  
(Chicago)  
(312) 337-0588  
(call collect)

### Los Angeles 90303

Stanley I. Ehrenclou  
Burt Underwood  
2930 Imperial Highway  
Inglewood, Calif.  
(213) 757-0183

### San Francisco 94022

Jerry D. Latta  
P.O. Box 1248  
Los Altos, Calif.  
(415) 965-2636

### London

For United Kingdom and Europe  
John Ashcraft  
John Ashcraft & Co.  
12, Bear St.  
Leicester Square  
London WC2H 7AS England  
Phone: 01-930-0525  
W. J. M. Sanders  
John Ashcraft & Co.  
Herengracht 365  
Amsterdam C., Holland  
Phone: 020-24-09-08

### Tokyo

Haruki Hirayama  
Electronic Media Service  
5th Floor, Lila Bldg..  
4-9-8 Roppong  
Minato-ku  
Phone: 402-4556  
Cable: Electronicmedia, Tokyo





# advertiser's index

Advertiser	Page
ACDC Electronics, Inc.	86
AMP, Incorporated	17, 18, 19, 20
AVX Ceramics	134
Abbott Transistor Laboratories, Inc.	6
Acopian Corp.	203
Acrodyne Industries, Inc.	261
Addmaster Corporation	234
Advanced Memory Systems, Inc.	273
Ailtech, A Cutler-Hammer Company	282, 283
Airpax Electronics, Controls Division	229
Alco Electronic Products, Inc.	262
Allen Bradley Co.	Cover III
Analog Devices, Inc.	47
Analogic Corporation	37
Arnold Magnetics Corp.	293
Augat, Inc.	205
Bead Electronics	258
Beckman Instruments, Inc. Helipot Division	212, 213
Belden Corporation	8, 9
Bell Industries/J. W. Miller Division	135
Biomation	257
Bivar, Inc.	288
Bodine Electric Company	269
Bourns, Inc., Trimpot Products Division	23
Bowmar Instrument Corporation	231
Burroughs Corporation	28
CTS Corporation	245
Cabtron Systems, Inc.	266
California Instruments, A Division of Aiken Industries, Inc.	46
Cambridge Thermionic Corporation	96, 97
Center for Technical Development	293
Centralab, The Electronics Division of Globe-Union, Inc.	216, 217
Cherry Electrical Products Corp.	223
Chicago Dynamics Industries, Inc.	254
Clare-Pendar	117
Colorado Video, Incorporated	189
Computer Automation, Inc.	11
Computer Conversions Corp.	293
Computer Labs, Inc.	292
Computer Operations, Inc.	278
Concord Electronics Corporation	270
Conner-Winfield Corp.	292
Continental Connector Corporation	52
Continental Specialties Corporation	284
Control Data Corporation	140D
Corning Glass Works, Electronic Products Division	53 thru 60
Coto Coil Company, Inc.	266
Crydom Controls, Division of International Rectifier	263
Dale Electronics, Inc.	Cover II
Data Display Products	260
Datacraft, A Subsidiary of Harris-Intertype Corporation	99
Datascan Electronic Products	195
Datel Systems, Inc.	295
Decitek, A Division of Jamesbury Corp.	267
Delta Products, Inc.	249
Dialight Corporation	173
Digi-Data Corporation	292

Advertiser	Page
Digital Development Corporation	48
Digital Equipment Corporation	174, 175
Disc Instruments, Inc.	276
Dit Mco	238
Diva, Inc.	72
Dynage Inc.	253
Dynascan Corporation	228
ECCO	36
E-T-A Products Co. of America	292
Elco Corporation	15
Electro Scientific Industries	240
Electronic Design	220, 293
Electronic Memories & Magnetics Corporation	22
Elexon Power Systems	287, 289, 291
Elsytec, Inc.	295
Engineered Components Company	293
Erie Technological Products, Inc.	211
Exact Electronics, Inc.	209
Facit-Addo, Inc.	261
Federal Scientific Corporation	294
Fuji Electrochemical Co., Ltd.	239
Futaba Industries	45
General Automation, Inc.	166, 167
General Electric Company	269
Gold Book, The	280, 281
Hamamatsu Corp.	282
Hamlin, Inc.	124
*Hayden Book Company, Inc.	58, 59, 251, 292
Hewlett-Packard	1, 34, 172, 247
Hughes Aircraft Company, Connecting Devices	62
Hughes Aircraft Company, Industrial Products Division	185
Hutson Industries	230
Hycom	276
IMC Magnetics Corporation	234
ISE Electronics Corp.	237
ITT Semiconductor, A Division of International Telephone and Telegraph Corporation	233
Indiana General	165
Industrial Timer, A Unit of Esterline Corporation	273
Ingersoll Products, Division of Borg Warner	141
Inland Motor Division, Kollmorgen Corporation	183
Instruments for Industry, Inc.	266
Intech, Incorporated	244
Interdata	156, 157
Interdesign, Inc.	273
International Teleprinter Corporation, The Singer Company	84
Intersil	196, 197
Interstate Electronics Corporation	140
Johanson Manufacturing Corp.	292
Johnson Company, E. F.	219

Advertiser	Page
Keystone Carbon Company	248
Kurz-Kasch, Inc.	261
Kyodo Electronic Laboratories, Inc.	190
Lambda Electronics Corp.	122, 123
Ledex, Inc.	235
Licon, Division of Illinois Tool Works, Inc.	275
Littelfuse, Subsidiary of Tracor	215
London Company, The	284
Magnetics, A Division of Spang Industries, Inc.	26
Matrix Systems Corp.	293
Maxi-Switch Co.	184
Megatek	232
Mepco/Electra, Inc.	149
Met-L-Wood Corporation	154
Microcomputer Technique Inc.	294
Microdata Corporation	270
Microswitch, A Division of Honeywell	207
Mini-Circuits Laboratory	285
Mohawk Data Sciences Corp.	88
Monolithic Systems Corp.	191
Motorola Semiconductor Products, Inc.	32, 33, 36A—L
National Electronics, A Varian Division	250
National Semiconductor Corporation	73, 74, 75, 76, 77
Neff Instrument Corporation	133
Newark Electronics	264
North American Philips Controls Corp.	253
Nortronics Company, Inc.	226
Optima Enclosures	125
Opron, Inc.	7
Otto Controls Division, Otto Engineering, Inc.	273
Panduit Corp.	107
*Philips Industries, Electronic Components and Material Division	57
Pittman Corporation, The	275
Pomona Electronics Co., Inc.	146
Power/Mate Corp.	292
Powertec, Inc., An Airtronics Company	140C
Prime Computer, Inc.	104, 105
Princeton Applied Research Corp.	294
Process Computer Systems, Inc.	277, 279
Pye TMC Canada	292, 293
Quan-Tech, Division of Scientific Atlanta, Inc.	256
RCA Solid State	85, 87, 89, Cover IV
Raymond Engineering, Inc.	190
Remex, A Unit of Ex-Cello Corporation	114, 115
Rental Electronics, Inc.	14
Rhombus Industries, Inc.	290
Rtron Corporation	274
Rockland Systems Corporation	221
Rogers Corporation	269
Rolm Corporation	38
Rotron, Inc.	227



Advertiser	Page
Signetics Corporation	12, 13
Siliconix, Incorporated	50
Singer Company, Inc., Kearfott Division	106
Solitron Devices, Inc.	39
Sorensen Company, A Unit of Raytheon Company	255
Southwest Technical Products	275
South Bay Cable Corp.	253
Spectrum Control, Inc.	271
Spectronics, Incorporated	272
Sprague Electric Company	16
Sprague Electric Company, Dearborn Electronics Division	49
Statek Corp.	293
Standard Logic, Inc.	268
Systron-Donner	278
Sycor, Inc.	116
T-Bar, Inc.	286
TDK Electronics Co., Ltd.	243
TEC, Incorporated	252
TRW Capacitors, an Electronic Components Division of TRW, Inc.	10

Advertiser	Page
TRW Electronic Components	24, 25
Tailey Corporation	236
Tau-Tron, Inc.	258
Technical Materials, Inc.	132
Technology Marketing Incorporated	295
Tektronix, Inc.	31, 43
Tele-Dynamics/Wanlass Division of Ambac	184
Teledyne Relays, A Teledyne Company	2
Teletype Corporation	27
Telonic Altair	242
Telstar Electronics Corporation	292
Texas Instruments, Incorporated	155
Texas Instruments, Incorporated, Digital Systems Division	241
Texscan Corporation	262
ThermoMetrics, Inc.	270
Thomas & Betts Company, The	35
Toko, Inc.	148
Topaz Electronics	261
Triplett Corporation	201
Trygon Electronics	259
USCC/Centralab Electronics Division, Globe-Union, Inc.	4, 5

Advertiser	Page
Unimax Switch Corporation	147
Unitrack Division, Calabro Plastics, Inc.	283
United Detector Technology, Inc.	293
United Systems Corporation	40
Varo Semiconductor, Inc.	98
Vectrol, Inc.	246
Vernitron Piezoelectric Division	265
Victoreen Instruments, Div. of VLN Corp.	21
Wagner Electric Corporation	44
Wavetek Indiana Incorporated	224
Weber Technical Products	182
Zeltex, Inc.	300

\*Advertisers in non-U.S. edition.

## recruitment and classified ads

## NUCLEAR INSTRUMENT & CIRCUIT DESIGN ENGINEERS

Analog circuit design and instrument engineers needed for the development and design of nuclear reactor instrumentation. The work will include a mixture of analog and digital approaches to the solutions of light water heavy water, and High Temperature Gas-cooled Reactor instrumentation problems. MSEE and 5 years experience in analog circuit design required.

To apply, please send resume in confidence to Manager of Employment, Dept. 583, General Atomic Company, P.O. Box 81608, San Diego, CA 92138.

### GENERAL ATOMIC COMPANY

An equal opportunity M/F employer

**IMMEDIATE DELIVERY**  
**Minis & Peripherals**  
**DEC - HIS - NOVA**  
**SEL - HP - MOHAWK**  
 CPU, Card, Printer, Tape, Disk  
**NEW • MOHAWK 4320**  
**PRINTERS**  
**PDP11 PERIPHERALS**  
**CPU, MEMORY**  
**PDP 8 CPU \$1500**  
**\$750 Minis**  
**TELETYPE 35 & 37**  
**DEC & HONEYWELL Modules**  
**617/261-1100**  
 Send for Free Report "Maintenance of Computers"  
**AMERICAN USED COMPUTER CORP.**  
 P.O. Box 68, Kenmore Sta.  
 Boston, MA 02215  
 Member Computer Dealers Association

**ENGINEERS**  
 Over 15 years of Engineering and Professional placement coast to coast. Entry level to Management with openings cutting the spectrum of the engineering disciplines. All fees paid.  
**E. B. HENDRICK ASSOCIATES, INC.**  
 "The Village Mall", Vine Street  
 Liverpool, NY 13088  
 Phone: 315-451-0121



**Take stock in America.**

**Buy U.S. Savings Bonds**  
 Now E Bonds pay 5 1/2% interest when held to maturity of 5 years, 10 months 1/4% the first year. Bonds are replaced if lost, stolen, or destroyed. When needed they can be cashed at your bank. Interest is not subject to state or local income taxes, and federal tax may be deferred until redemption.

CIRCLE NO. 242



# product index

**Information Retrieval Service.** New Products, Evaluation Samples (ES), Design Aids (DA), Application Notes (AN), and New Literature (NL) in this issue are listed here with page and Information Retrieval numbers. Reader requests will be promptly processed by computer and mailed to the manufacturer within three days.

Category	Page	IRN	Category	Page	IRN	Category	Page	IRN
<b>Components</b>			switches	262	149	peripherals	214	259
attenuators	242	118	switches	275	464	peripherals, data	214	261
audible-signal source	262	350	switches, -custom	254	135	plotter, graphic	222	277
bar graph display	258	342	switches key	262	351	printer, electrostat	234	290
capacitor	5	4	switches, rocker	215	95	printer mechanisms	84	41
capacitors	10	8	switches, rotary	254	134	printer, page	261	146
capacitors	219	96	switches, subminiature	273	168	printer, strip	214	260
capacitors, ceramic	16	13	thermistors	270	164	processor, 16-bit	38	27
capacitors, ceramic	134	61	thermistors, chip	260	348	reader, card	219	271
capacitors, ceramic	149	68	timers	273	167	reader, card	232	289
capacitors, film	49	36	tube drivers	190	84	reader, tape	218	269
catalog (NL)	264	152				reader, tape	230	252
clutch-brake	260	349	<b>Data Processing</b>			recorder, cassette	116	54
coils, rf	135	62	calculator	31	21	semi memory system	191	85
components, resistive	III	247	cassette drive	222	275	switches, lighted	272	276
controls	271	165	cassette tape system	190	83	system, computer	232	287
delay lines	290	483	compressor, video	189	82	systems, computer	218	268
displays, liquid crystal	124	57	computer	105	50	TTL interface	234	109
encoder, shaft	278	469	computer, OEM	11	9	TV cameras (NL)	288	421
ferrites	243	119	computer system	99	49	tape reader	267	157
garmotors	275	463	computers	27	19	terminal, CRT	222	278
keyboards	184	79	controller, display	225	280	terminal, CRT	235	292
keyboards	207	91	controller, format	214	262	terminal, intelligent	218	267
keyboards	231	106	converter, card/types	228	283	terminal, intelligent	229	285
keyswitch arrays	262	352	cores, tape	26	18			
liquid-crystal displays (NL)	289	433	data acquisition system	133	60	<b>Discrete Semiconductors</b>		
magnetic circuit breakers (NL)	286	411	data communications	287	414	arrays, transistor	266	364
miniature reed relays (NL)	288	422	data-link, optical	226	256	detector	282	472
motor	183	78	digital heads	226	100	diodes	272	166
motors	269	150	digitizer, coordinate	225	281	diodes, laser	268	367
motors, stepper	106	51	disc and drum memories	48	35	diodes, ultra low I	268	368
neon lamps	258	343	disc drive	218	266	diodes, vhf tuning	268	370
opener, door	259	345	disc drives	72	40	displays	1	2
photomultiplier tubes (NL)	287	415	disc drives	191	85	FET kits replace tubes	267	364
potentiometers	213	94	disc drives	270	162	LED products (NL)	289	427
pressure transducer	263	354	display, graphics	225	254	LEDs	260	142
proximity switch	263	353	drive, floppy disc	222	274	LEDs, green	270	372
Radio Shack catalog (NL)	287	417	heads, recording	214	258	LEDs, infrared	266	363
reading head, card	259	344	image processors	185	81	optoelectronics	7	6
readout	44	31	interactive terminal	219	270	rectifier	98	48
readout	36	25	interactive terminal	221	272	rectifiers	267	366
readouts	45	32	interface, g-p	277	467	SCR, high power	270	371
readouts	237	113	interfaces	232	107	SCRs	250	250
relays	2	3	key entry system	234	291	SCRs (NL)	286	407
relays	253	133	keyboard encoder	275	462	SCRs and triacs	230	105
relays	263	151	mass memory	276	466	transistors	249	126
relays	266	155	memory, bipolar	221	273	transistors, stripline	268	369
resistor networks	23	16	memory, core	218	265	zener and TC diodes (NL)	289	428
resistor networks	245	122	memory, core	229	286			
solenoids	235	111	memory, semicon	218	264	<b>Integrated Circuits</b>		
speakers	260	346	memory system (NL)	288	425	CMOS RAM	197	87
switch	173	75	memory, tape	214	263	COS/MOS	87	44
switch	286	479	minicomputer	157	70	calculator chip set	255	333
switch, keyboard	223	98	minicomputers	88	45	converters subsystem	33	22
switch, matrix	260	347	modem, data	228	284	counter, divide-by-N	255	334
switches	117	55	modem, data	228	282	ICs	13	10
switches	252	129	modems	222	279	ICs	233	108
			modules, memory	232	288	ICs, linear	IV	248
			monitor, data	235	293	latch, 8-bit	256	339
			OEM rotating memories (NL)	289	431	linear IC TV circuits (NL)	286	406
			peripherals	115	53			



Category	Page	IRN
MOS IC memories	239	115
MOS chip	254	329
memories, serial analog	255	332
memory, NMOS	22	15
monochip	273	168
NMOS RAM	273	170
PLL	256	338
processor, SOS	167	73
RAM, bipolar	256	336
RAM, CMOS static	256	335
ROMs	257	341
ROMs, bipolar	257	340
receiver subsystem, linear	256	337
register file, multiport	254	331
semiconductors	36A	211
watch set, digital	254	330
<b>Instrumentation</b>		
analyzers	238	114
analyzers, wave	256	137
angle indicator	240	298
backplane tester	242	300
control meter	229	104
counter, 5-digit	283	474
DPM	195	86
DPM, 3-1/2 digit	47	236
data communication tester	238	295
decoder and receivers (NL)	289	430
digital logic recorder	257	138
digital test equipment	258	139
filter	238	294
filters, analog	221	97
frequency counters	40	205
generator, function	282	471
generator, pulse	140	63
generators, sweep	262	147
indicator, bite	253	131
instrumentation (NL)	286	410
instrumentation (NL)	287	416
instruments, panel	201	88
isolator, mobile process	182	77
logic checker	262	148
meter, modulation	284	476
multiprogrammer	172	74
multimeter, 5-1/2 digit	46	33
oscilloscope	228	102
oscilloscope	242	303
oscilloscopes	34	23
oscilloscopes, miniature	43	30
printer, alphanumeric	278	468
printer, line	236	112
probe, electronic	238	296
probe, logic	261	144
processor, industrial	279	470
recorder	240	299
signal generator	228	103
spectrum analyzer	236	250
sweeper	224	99
sweeper	240	297
synthesizer	242	302
test clip	154	69
test instruments	247	124
tester, converter	242	302
tester, op amp	240	116
<b>Microwaves &amp; Lasers</b>		
attenuators, coax	265	361
bridge, SWR	264	358
capacitors, chip	264	359
joint, rotary	265	362
laser trimmer (NL)	289	432
mixers, double-balanced	285	477
modulators, diode	264	355
multiplexer, 5-channel	265	360
oscillator, Gunn	264	357
oscillator, Ku-band	264	356

Category	Page	IRN
<b>Modules &amp; Subassemblies</b>		
amp, instrumentation	248	321
amplifier, power	266	154
amplifier, rf	252	326
controller, motor	250	323
converter, sine/cos	248	309
converters	244	121
filters, rfi/emi	274	461
filters, active	248	310
filters, active notch	246	306
filters, low-frequency	265	153
generators, tone	252	328
monitor, data line	246	308
oscillator, clock	250	324
oscillator, tunable	246	307
programmer, timing	248	320
resolver, d/a	252	327
SCR power controllers	246	208
s/d converters (NL)	288	420
system, acquisition	244	317
system, data acquis	250	322
system, data acquis	252	325
timer mechanical	246	305
<b>Packaging &amp; Materials</b>		
adhesive, glass-to-metal	282	393
axial fans	287	412
benches	266	156
bus	269	160
cable, ribbon	62	39
cables	253	130
clad metals	132	59
connector, high volt.	282	394
connectors (NL)	288	423
connectors, PC	52	38
contact pin	258	140
contactor, TO-5	282	392
dielectric ceramics (NL)	286	408
edgeboard	11	246
enclosures	125	58
enclosures, custom	141	64
fan	234	110
fans and blowers	227	101
heat sink, TO-5	283	395
heat-transfer fluid (NL)	289	426
heater	278	387
jacks, pins	270	163
PC boards, flexible	283	396
PC breadboard (NL)	289	429
PC card	37	26
PC card cages	283	473
PC connectors	288	424
panels	146	66
panels, back	15	12
plastic fabrications	283	397
pneumatic tool	35	24
protoboards	284	475
rental equipment	14	11
ruler	279	391
sockets	205	90
stripper, wire	276	465
tapes, Teflon	278	388
temperature sensors	248	125
terminal strip	279	390
tool, cable tie	107	52
vibratory feeders	289	413
wire, cable & cord	9	234
wiring kit	279	389
<b>Power Sources</b>		
ac source	272	377
ac voltage regulators (NL)	288	419
dc/dc converter	271	374
drives, CRT	21	14
educational equipment	276	383
inverter, sine wave	261	145
power converters (NL)	286	409
power supplies	123	56

Category	Page	IRN
power supplies	165	71
power supplies	184	80
power supplies	203	89
power supplies	211	93
power supplies	289	482
power supplies	291	484
power supply	6	5
power supply	255	136
power supply	261	143
power supply	287	480
power supply, dc	86	43
power system	272	375
precision voltage	268	158
pulse magnetizing system (NL)	286	405
supplies, dual-output	271	373
supplies, dual-output	274	378
supplies, open frames	276	382
supplies, switching	274	379
supply, ac-to-dc card	272	376
supply, high voltage	274	381
supply, high voltage	277	384
supply, laboratory	277	385
supply, laboratory	277	386
supply, single-output	274	380

## new literature

ac voltage regulators	288	419
axial fans	287	412
catalog	264	152
connectors	288	423
data communications	287	414
decoder and receivers	289	430
dielectric ceramics	286	408
heat-transfer fluid	289	426
instrumentation	286	410
instrumentation	287	416
LED products	289	427
laser trimmer	289	432
linear IC TV circuits	286	406
liquid-crystal displays	289	433
magnetic circuit breakers	286	411
memory system	288	425
miniature reed relays	288	422
OEM rotating memories	289	431
PC breadboards	289	429
PC connectors	288	424
photomultiplier tubes	287	415
power converters	286	409
pulse magnetizing system	286	405
Radio Shack catalog	287	417
SCRs	286	407
s/d converters	288	420
TV cameras	288	421
vibratory feeders	289	413
zener and TC diodes	289	428

## application notes

epoxy adhesives	285	403
FET basics	285	402
tangential sensitivity	285	404

## design aids

Darlington transistors	284	399
photographic glass plates	284	398
silicon power transistors	284	400
switches	284	401





# $\mu$ verter™

## ZAD1012

GAIN ADJ ● 1  
 ANALOG IN ● 2  
 ANALOG GRD ● 3

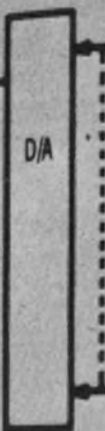

OFFSET ADJ ● 21

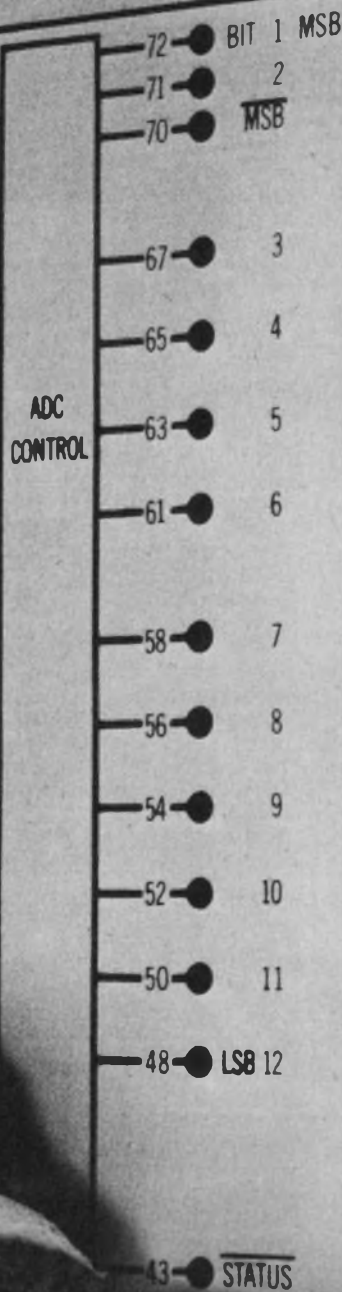

And, aside from performance like 8 bits at 3  $\mu$ seconds up to 12 bits at 10 or 20  $\mu$ seconds, you get:

- Lowest noise/repeatability error of any ADCs on the market
- Zeltex' unique thick film small size packaging
- Fully monotonic over their full specified temperature range
- All fully specified to  $\pm 1/2$  LSB linearity
- Models pin interchangeable for upgrading specs.
- Plus they truly meet their specifications so you are getting a lot of converter for your money.

The new ZAD 1000 Series is a result of Zeltex' unique product design and manufacturing technologies which have produced a comprehensive line of D/A and A/D converter problem solvers.

So phone (415) 686-6660 to find out how you can put Zeltex' great Micro Giants to work solving your systems design problems.

ZELTEX, INC.  
 940 Detroit, Concord  
 California 94518  
 (415) 686-6660  
 TWX 910-481-9477



The Micro Giants.  
 CIRCLE NUMBER 485

12 BIT ADC



# There's more to resistors than resistance

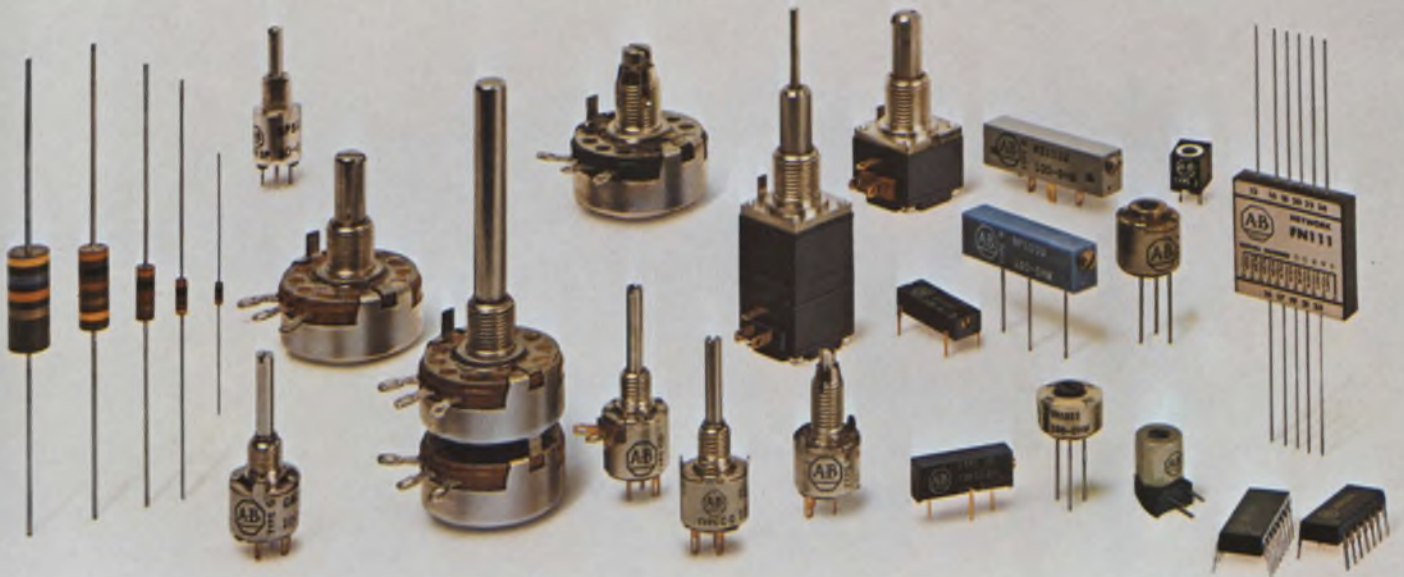

## If you're really serious about cost, be serious about quality.

If you think all resistive components are the same, listen to what these users have to say about Allen-Bradley fixed composition resistors:

**Buyer**—"A-B has shipped nearly four million parts without a single reject or problem. The quality is superb. I've spent 12 years in production control and purchasing. I've seen the amount of down-time, rework and field retrofit caused by others:"

**President**—"We have used many millions of Allen-Bradley hot-molded resistors. The uniformity of quality from one shipment to the next is truly outstanding."

**Engineer**—"When we use A-B resistors instead of some other make, it's one less component we have to worry about."

"We learned the hard way. The subtle things make the difference. They all

add up to the top quality we want in our products."

**Purchasing Agent**—"We wish we had more Allen-Bradleys."

Write for Publication RD. Allen-Bradley Electronics Division, 1201 South Second Street, Milwaukee, WI 53204. Export: Bloomfield, NJ 07003. Canada: Allen-Bradley Canada Limited, Cambridge, Ontario. United Kingdom: Jarrow, Co. Durham NE32 3EN.



**Allen-Bradley**

Milwaukee, Wisconsin 53204





## **The flat-as-a-pancake TV. If you want to design one tomorrow, we're ready with your linear IC's today.**

Whatever the idea you put on paper, we can probably help bring it to life.

Whether you want to design the world's flattest TV or the world's most advanced oscilloscope, chances are we've got the devices for the circuit functions you need to achieve your goals. Ready now to help your product perform the way you design it. And supply your needs in numbers from one to one million and beyond.

We're a full house in linear IC's offering standard as well as custom and proprietary types; a commodity supplier of power transistors; a recognized leader in CMOS building blocks; developers of liquid crystal displays; technology innovators of RF power components; and a major supplier of thyristors.

In addition to comprehensive technical product data, RCA gives you professional and experienced field engineering and applications

support. As well as a commitment to excellence in everything from research to manufacturing.

So whatever you're into, and whatever you need, we're here when you need us. With products that can anticipate your needs. And service that can meet your demands. A good place to start is to check our handy product line guide. Write RCA Solid State, Section 57D26, Box 3200, Somerville, N. J. 08876.

**RCA** Solid State