

Electronic Design

FOR ENGINEERS AND ENGINEERING MANAGERS

VOL. 22 NO.

4

FEB. 15, 1974

Connector problems piling up? Round multipins have thousands of variations. Chances are some can do even your toughest jobs. But you easily can get plugged

into the wrong choice. Rear or front release, crimped or soldered terminals, bayonet or threaded couplings—the choices are many. Make the right connection. P. 54.



Our new low-profile keyboard is solid-state. Our new low price is mechanical.



We've expanded your keyboard options dramatically with our new SD low-profile keyboard.

It makes MICRO SWITCH solid-state prices (based on 1975 delivery) competitive with less reliable mechanical-contact keyboards.

So price is no barrier. No matter what your need. Be it word processing, point-of-sale or other data entry applications.

We've coupled our unique Hall effect switch with an advanced "flip chip" ceramic mounting technique to further increase the reliability of our solid-state keyboards.

And our new low-profile design is ideal for modern

compact terminal needs.

Picture a MICRO SWITCH keyboard in your system design. We're ready to talk prototypes now, with production in late 1974. Contact a MICRO SWITCH Branch Office for complete information.

It's the change you've really been looking for.

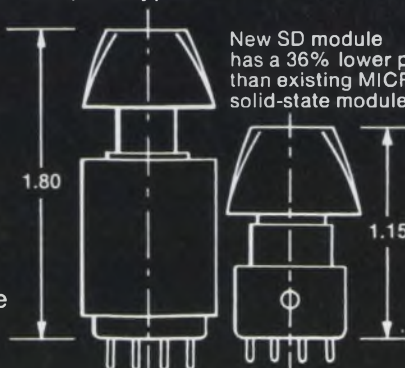

New SD module has a 36% lower profile than existing MICRO SWITCH solid-state module.

MICRO SWITCH

FREERPORT ILLINOIS 61032
A DIVISION OF HONEYWELL

MICRO SWITCH products are available worldwide through Honeywell International.

THE NEW XR-2207 IS A PRECISION VOLTAGE CONTROLLED OSCILLATOR WITH SIMULTANEOUS SQUARE AND TRIANGULAR WAVE OUTPUTS, EXCELLENT FREQUENCY STABILITY, SUPER-WIDE SWEEP RANGE, MINIMAL FREQUENCY DRIFT, AND ULTRA-LINEAR SWEEP DRIVE.



By providing 30 ppm/°C frequency stability, 3000:1 sweep range, and 0.15%/V frequency drift in the XR-2207, Exar produced a precision VCO that can easily do those tough FSK, FM generation jobs. With a minimum of external circuitry, you can use the XR-2207 in applications such as two-channel FSK generation for modems, as the VCO portion of phase-locked loop systems, and voltage to frequency conversion that formerly required crystal controlled oscillators.

With only one capacitor and four resistors, four discrete precision frequencies are generated; two TTL keying inputs enable selection between frequencies. You can also sweep your frequency over a wide 3000:1 range with the use of one extra resistor and a little voltage.

So, if you've been putting together lots of parts

for tough waveform generation, the XR-2207 can save you time and money. It's the easy way to generate variable-frequency square and triangular waves (pulse and sawtooth too!) for every application.

The XR-2207 operates with either single or dual supplies from $\pm 4V$ to $\pm 13V$ over a 0.1 to 1 MHz frequency range. Seven device types are available in 14 pin ceramic and plastic packages for both commercial and military applications. Call or write for the XR-2207 data sheet and application notes.

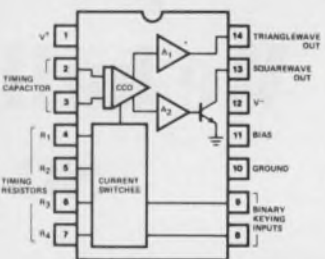

EXAR SPEAKS YOUR LANGUAGE



EXAR INTEGRATED SYSTEMS

750 Palomar Sunnyvale, California 94086 (408) 732-7970 TWX 910-339-9233

EXAR DISTRIBUTORS Semiconductor Concepts: Woodland Hills: (213) 884-4560 Hauppauge, L. I.: (516) 273-1234 EEP Corporation: Culver City: (213) 838-1912 Intermark Electronics: San Carlos: (415) 592-1641 San Diego: (714) 279-5200 Santa Ana: (714) 279-1322 Denver: (303) 963-8284 Seattle: (206) 767-3160 Graham Electronics: Indianapolis: (317) 634-8202 Lafayette: (317) 742-4006 Ft. Wayne: (219) 742-4346 Cincinnati: (513) 733-1661 Radio Electric Service Co.: Baltimore: (301) 823-0070 Gerber Electronics: Dedham: (617) 329-2400 Yankee Electronics Supply: Londonderry: (603) 625-9746

INFORMATION RETRIEVAL NUMBER 2

SURPRISE!

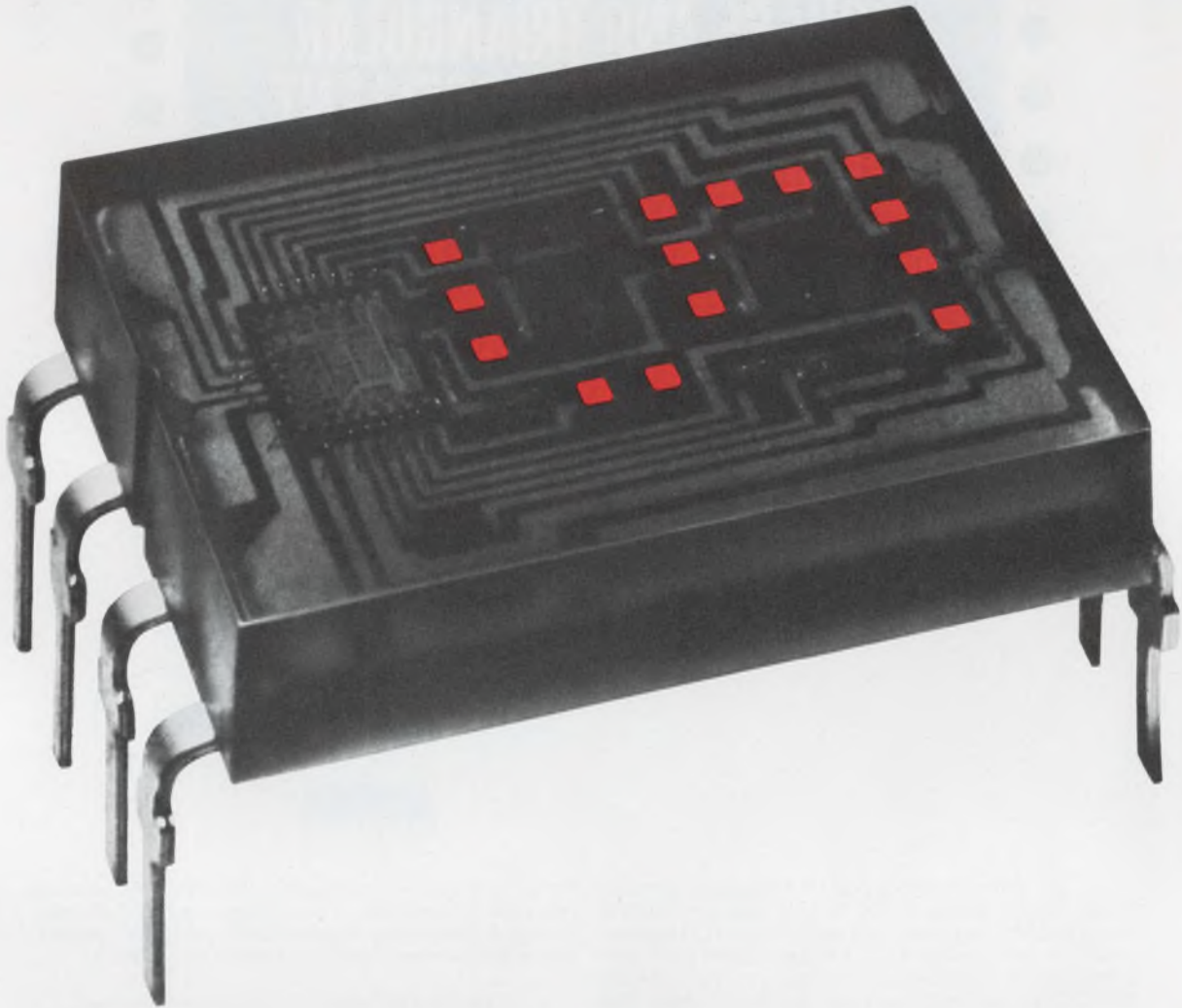

We built in the decoder/driver so you don't have to.

Not only the decoder/driver, but the memory too! It's all in the HP 5082-7300 series solid state display. Available *now*. In quantities to meet your production needs.

It's completely TTL compatible. All you do is address it directly with four-line BCD input. The on-board IC allows for either the storage of input data or real-time display. You save design time, space and money, and get a completely reliable integrated display system.

A bright 0.290 inch high, shaped character gives excellent readability over a wide viewing angle in a compact 0.600 inch by 0.400 inch package.

And best of all, the price is only \$8.25* in 1K quantities. If you need a larger character write for information on our 1.5" 5082-7500 solid state display.

It's also TTL compatible and has the decoder/driver built in. For immediate delivery on the HP 5082-7300 or 5082-7500 call your nearby HP distributor today.

01329

* Domestic USA price only

HEWLETT  PACKARD

Sales, service and support in 172 centers in 65 countries.
Palo Alto, California 94304. Offices in principal cities throughout the U.S.

INFORMATION RETRIEVAL NUMBER 3

NEWS

- 25 **News Scope**
- 28 **And yet another national shortage:** Basic research—the lifeblood of new electronic systems—is suffering across the board.
- 34 **How HP engineers designed the first programmable pocket calculator.**
- 36 **Automatic sonobuoy locator** spots up to 31 beacons simultaneously.
- 43 **Washington Report**

TECHNOLOGY

- 54 **FOCUS on round multipin connectors:** A special report that updates the engineer on new types and pinpoints problems in specifying them.
- 64F **Protect against nuclear transients.** Simple RC T-network replaces expensive radiation-hardened ICs to prevent scrambling of digital data.
- 66 **True rms voltage conversion** can be achieved without slow, bulky and expensive equipment. New building blocks simplify the task.
- 76 **A guide to good air cooling:** The heat to be dissipated, air flow and pressure drop are the prime considerations in choosing the best air mover.
- 84 **Simplify UJT relaxation-oscillator design** with a procedure that directly selects the right capacitor. An improved formula for pulse width ends trial-and-error.
- 90 **Algebra finds logic-circuit glitches** without need for involved three-valued Karnaugh maps. Simple equations are written for each gate and combined.
- 96 **Measure sheet resistance easily.** The only things needed to determine R per square are two voltage readings and a simple calculation.
- 100 **Stop second-guessing on projects.** First thoughts can save time and labor, a manager finds. Here's how he applies the principle of concurrent design and manufacture.
- 106 **Ideas for Designs:** Circuit converts unipolar digital data to alternate-mark inverse format . . . Character-generation circuit uses a single Y-axis scope input to display alphanumeric . . . Multiplexer lets single-channel scope monitor eight analog signals.
- 112 **International Technology**

PRODUCTS

- 115 **ICs & Semiconductors:** 3-1/2-digit a/d chip set shrinks converter designs.
- 120 **Data Processing:** The HP-65 calculator arrives: First pocket programmable.
- 142 **Instrumentation:** 20-MHz synthesizer unit offered for less than \$2000.
- 132 **Components** 154 **Power Sources**
- 138 **Microwaves & Lasers** 156 **Packaging & Materials**
- 148 **Modules & Subassemblies**

Departments

- 51 **Editorial:** Human rights and the engineer
- 7 **Across the Desk** 169 **Bulletin Board**
- 160 **Application Notes** 172 **Advertisers' Index**
- 162 **New Literature** 174 **Product Index**
- 168 **Vendors Report** 176 **Information Retrieval Card**

Cover: Photo by Jim Grigar, courtesy of Amphenol Connector Division/
Bunker-Ramo Corp.

Do you face
a make or buy
decision on
power supplies?

BUY LAMBDA'S NEW 65 AMPERES. LX SERIES NOW AND 11 PACKAGE SIZES.

SPECIFICATIONS FOR LX SERIES

DC Output

Regulated Voltage

regulation, line	0.1%
regulation load	0.1%
ripple and noise	1.5 mV RMS, 5 mV pk-pk with either positive or negative terminal grounded
temperature coefficient	0.03%/°C

AC input

line	105-132 VAC; 47-440 Hz. For 187-242 VAC, see A.C. input options. For operation of LXS-E, LXS-EE, LXS-7, and LXS-8 units at 50 Hz or at 400 Hz, consult factory. Ratings apply to 57-63 Hz. For all other models delete 40°C rating for 50 Hz operation.
------	---

Ambient operating temperature range

continuous duty from 0° to +71°C with corresponding load current ratings for all models of operation.

Storage temperature range

-55°C to +85°C

Overload protection

Thermal

thermostat, automatic reset when over-temp. condition is removed. (Not applicable to LXD-3); circuit breaker must be reset on LX-7 and LX-8 models.

Electrical

external overload protection, automatic electronic current limiting circuit limits the output current to the preset value, thereby providing protection for load as well as power supply.

Overshoot

no overshoot on turn-on, turn-off or power failure.

Input and output connections

through terminal block on chassis; output terminals on LX-7, LX-8 models are two heavy duty studs.

Power hybrid voltage regulator or integrated circuit regulation

some models have Power Hybrid Voltage Regulator providing complete regulation system while others have an integrated circuit providing regulation system except for input and output capacitors, rectifiers and series regulation transistors.

Controls

DC Output Control

simple screwdriver voltage adjustment over entire voltage range.

Remote sensing

provision is made for remote sensing to eliminate effect of power output lead resistance on DC regulation.

Transformer

MIL-T-27C, Grade 6

Tracking accuracy (dual models)

2% absolute voltage difference; 0.2% change for all conditions of line, load and temperature.

5 VOLTS ±5% SINGLE OUTPUT

MODEL	MAX. AMPS AT AMBIENT OF:				PRICE
	40°C	50°C	60°C	71°C	
LXS-A-5-OV*	4.0	3.4	2.7	2.0	\$ 85.
LXS-B-5-OV*	5.8	5.0	4.0	3.0	125.
LXS-4-5-OV*	7.4	6.5	5.4	3.9	135.
LXS-C-5-OV*	9.0	8.0	6.8	5.3	150.
LXS-CC-5-OV*	16.0	14.5	12.7	10.5	200.
LXS-D-5-OV*	27.5	24.2	20.5	16.5	235.
LXS-E-5-OV*	35.0	30.0	24.0	17.5	300.
LXS-EE-5-OV*	45.0	39.0	32.0	25.0	425.
LXS-7-5-OV**	65.0	56.0	46.0	35.0	515.
LXS-8-5-OV**	85.0	77.0	68.0	56.0	650.

*Includes fixed overvoltage protection at 6.8V ±10%

**Built-in continuously adjustable overvoltage protection crowbars output when trip level is exceeded. Included on all LXS-7, LXS-8 models

6 VOLTS ±5%

MODEL	MAX. AMPS AT AMBIENT OF:				PRICE
	40°C	50°C	60°C	71°C	
LXS-A-6	3.7	3.1	2.5	1.9	\$ 85.
LXS-B-6	5.5	4.7	3.8	2.9	125.
LXS-4-6	6.6	5.8	4.8	3.5	135.
LXS-C-6	8.8	7.8	6.7	5.2	150.
LXS-CC-6	15.2	13.8	12.1	10.0	200.
LXS-D-6	26.5	23.4	19.8	16.0	235.
LXS-E-6	34.0	29.0	23.0	16.5	300.
LXS-EE-6-OV**	42.0	36.0	30.0	22.0	425.
LXS-7-6-OV	59.0	50.0	41.0	32.0	515.
LXS-8-6-OV	70.0	70.0	68.0	56.0	560.

**Includes fixed overvoltage protection at 7.4V ±10%

12 VOLTS ±5%

MODEL	MAX. AMPS AT AMBIENT OF:				PRICE
	40°C	50°C	60°C	71°C	
LXS-A-12	2.7	2.2	1.8	1.5	\$ 85.
LXS-B-12	3.8	3.6	3.0	2.2	125.
LXS-4-12	4.4	3.8	3.1	2.5	135.
LXS-C-12	6.5	6.1	5.5	4.6	150.
LXS-CC-12	10.5	9.4	8.2	5.0	190.
LXS-D-12	16.0	14.0	11.9	8.0	235.
LXS-E-12	21.0	18.0	15.0	12.5	300.
LXS-EE-12	32.0	27.0	22.0	16.0	400.
LXS-7-12-OV	40.0	36.0	30.0	23.0	515.
LXS-8-12-OV	50.0	45.0	40.0	34.0	560.

15 VOLTS ±5%

MODEL	MAX. AMPS AT AMBIENT OF:				PRICE
	40°C	50°C	60°C	71°C	
LXS-A-15	2.4	2.0	1.6	1.3	\$ 85.
LXS-B-15	3.2	2.8	2.5	1.5	125.
LXS-4-15	4.0	3.5	2.8	2.3	135.
LXS-C-15	6.0	5.6	5.1	4.5	150.
LXS-CC-15	9.5	8.6	7.4	4.8	190.
LXS-D-15	14.0	12.3	10.4	7.5	235.
LXS-E-15	19.0	17.0	14.0	12.0	300.
LXS-EE-15	28.0	24.0	19.5	14.0	400.
LXS-7-15-OV	36.0	32.0	26.0	20.0	515.
LXS-8-15-OV	45.0	41.0	36.0	30.0	560.

LX-7 UP TO 28 VOLTS, UP TO AVAILABLE IN 68 MODELS

20 VOLTS $\pm 5\%$

MODEL	MAX. AMPS AT AMBIENT OF:				PRICE
	40°C	50°C	60°C	71°C	
LXS-CC-20	7.7	7.2	6.5	4.4	\$190.
LXS-D-20	11.5	10.2	8.6	6.8	235.
LXS-E-20	15.0	13.0	10.5	7.0	300.
LXS-EE-20	22.0	18.5	14.5	10.0	400.
LXS-7-20-OV	28.0	25.0	20.5	15.5	515.
LXS-8-20-OV	32.0	29.0	25.0	17.0	560.

24 VOLTS $\pm 5\%$

MODEL	MAX. AMPS AT AMBIENT OF:				PRICE
	40°C	50°C	60°C	71°C	
LXS-CC-24	6.8	6.4	5.7	4.4	\$190.
LXS-D-24	10.0	8.8	7.5	6.0	235.
LXS-E-24	13.0	11.0	9.5	6.0	300.
LXS-EE-24	19.0	16.5	13.0	9.5	400.
LXS-7-24-OV	25.0	22.0	18.0	14.0	515.
LXS-8-24-OV	30.0	27.0	23.5	17.0	560.

28 VOLTS $\pm 5\%$

MODEL	MAX. AMPS AT AMBIENT OF:				PRICE
	40°C	50°C	60°C	71°C	
LXS-CC-28	6.0	5.6	5.0	4.3	\$190.
LXS-D-28	9.0	8.0	6.8	5.5	235.
LXS-E-28	11.0	10.0	8.5	5.5	300.
LXS-EE-28	17.0	15.0	12.0	9.0	400.
LXS-7-28-OV	22.0	19.5	16.0	12.5	515.
LXS-8-28-OV	28.0	25.5	22.5	17.0	560.

± 15 TO ± 12 VOLTS DUAL OUTPUT

MODEL	ADJ. VOLT. RANGE VDC	MAX. AMPS AT AMBIENT OF:				PRICE
		40°C	50°C	60°C	71°C	
LXD-A-152	± 15	1.0	1.0	0.9	0.7	\$125.
	to ± 12	0.8	0.8	0.7	0.6	
LXD-B-152	± 15	1.6	1.4	1.2	0.7	150.
	to ± 12	1.4	1.3	1.1	0.6	
LXD-C-152	± 15	2.5	2.3	1.9	1.5	160.
	to ± 12	2.0	1.8	1.5	1.2	
LXD-CC-152	± 15	4.0	3.7	3.2	2.4	235.
	to ± 12	3.0	2.7	2.3	1.8	
LXD-D-152	± 15	6.2	5.6	4.9	4.0	280.
	to ± 12	4.5	4.1	3.7	3.0	
LXD-EE-152	± 15	12.5	11.0	9.0	7.0	435.
	to ± 12	10.0	9.0	7.8	6.0	

± 12 TO ± 15 VOLTS/-12 TO -15 VOLTS

MODEL	ADJ. VOLT. RANGE VDC	MAX. mA. AT AMBIENT OF:				PRICE
		40°C	50°C	60°C	71°C	
LXD-3-152	+(12 to 15)	400	370	340	300	\$85.
	-(12 to 15)	400	370	340	300	

± 6 TO ± 3 VOLTS

MODEL	ADJ. VOLT. RANGE VDC	MAX. AMPS AT AMBIENT OF:				PRICE
		40°C	50°C	60°C	71°C	
LXD-B-062	± 6	2.7	2.4	1.9	1.4	\$160.
	to ± 3	2.1	2.0	1.6	1.2	
LXD-C-062	± 6	3.5	3.3	2.7	1.7	\$170.
	to ± 3	2.6	2.4	1.9	1.3	

24 TO 30 VOLTS

MODEL	ADJ. VOLT. RANGE VDC	MAX. mA. AT AMBIENT OF:				PRICE
		40°C	50°C	60°C	71°C	
LXD-3-152	24-30	400	370	340	300	\$85.

5 VOLTS $\pm 5\%$, ± 15 TO ± 12 VOLTS TRIPLE OUTPUT

MODEL	ADJ. VOLT. RANGE VDC	MAX. AMPS AT AMBIENT OF:				PRICE
		40°C	50°C	60°C	71°C	
LXT-D-5152	5 $\pm 5\%$	12.0	11.5	11.0	9.5	\$375.
	± 15	3.1	2.7	2.2	1.7	
	to ± 12	2.3	2.0	1.7	1.3	

*5 volt output has fixed overvoltage protection at 6.8V $\pm 10\%$.
 ± 15 to ± 12 output is dual tracking output.

NEW LX-7 DESIGNED TO MEET MIL ENVIRONMENTAL SPECIFICATIONS.

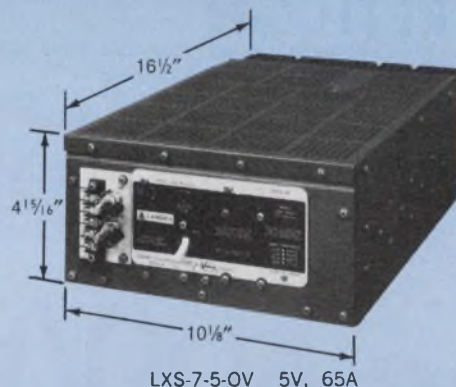

\$515

5-YEAR GUARANTEE



LAMBDA
ELECTRONICS CORP.

A  Company

515 BROAD HOLLOW ROAD, MELVILLE, L. I., NEW YORK 11746

INFORMATION RETRIEVAL NUMBER 4

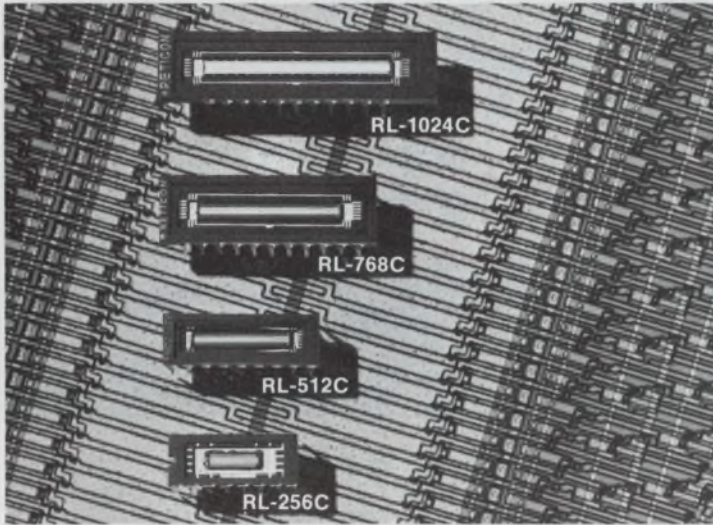

Solid State Image Sensing

Reticon offers the most complete line of solid state image sensors for OCR, facsimile, page/document reader, film scanning, real time spectroscopy, non contact measurement and inspection applications.

High resolution of up to 1024 elements on 1 mil centers is available on a single monolithic chip with serial video readout. Charge storage mode operation provides high sensitivity with scan rates up to 10 MHz. Low power dissipation of less than 10 mwatts and the highest quality silicon gate process assures minimum dark currents and maximum dynamic range.

Circuit cards (RC series) containing complete drive and video amplifier circuits are also available from inventory for any Reticon image sensor.

Our RL256C through RL1024C devices are much improved pin compatible replacements for previous designs.

Write or call for detailed data sheets and external circuit information.

RETICON®

450 E. Middlefield Road, Mountain View, CA 94043
 (415) 964-6800 TWX 910-379-6552
 HOTLINE (415) 964-3033

This SPECIAL OFFER is to introduce our "C" devices, which will be shipped complete with the RC series circuit cards providing all external drive and video amplifier circuits. Specify RL256C/RC, RL512C/RC, RL768C/RC and RL1024C/RC. Order must be received within 30 days from publication date and must be entered directly with the factory. Only one per customer. Offer is for U.S.A. domestic sale only.

\$100/bit
 plus \$250 (for inclusion of complete drive & video circuitry)

as low as 25¢/bit in large OEM quantities

Vice President, Publisher

Peter Coley

Editors

Editorial Offices
 50 Essex St.
 Rochelle Park, N.J. 07662
 (201) 843-0550
 TWX: 710-990 5071
 Cable: Haydenpubs Rochellepark
 Editor-in-Chief George Rostky

Managing Editors:

Ralph Dobriner
 Michael Elphick

Associate Editors:

Dave Bursky
 Jules H. Gilder
 Morris Grossman
 Seymour T. Levine
 John F. Mason
 Stanley Runyon
 Edward A. Torrero
 Richard L. Turmail

Contributing Editors:

Peter N. Budzilovich

Editorial Field Offices

East

Jim McDermott, Eastern Editor
 P.O. Box 272
 Easthampton, Mass. 01027
 (413) 527-3632

West

David N. Kaye, Senior Western Editor
 2930 West Imperial Highway
 Inglewood, Calif. 90303
 (213) 757-0183
 Northe K. Osbrink, Western Editor
 112 Coloma St.
 Santa Cruz, Calif. 95060
 (408) 426-3211

Washington

Heather M. David, Bureau Chief
 2506 Eye St., N.W.
 Washington, D.C. 20037
 (202) 338-3470

Editorial Production

Marjorie A. Duffy

Art

Art Director, William Kelly
 Richard Luce
 Anthony J. Fischetto

Production

Manager, Dollie S. Viebig
 Helen De Polo
 Anne Molfetas
 Christopher G. Hill

Circulation

Manager, Nancy L. Merritt

Information Retrieval

Peggy Long

Promotion

Manager, Jeffrey A. Weiner
 Karen Kerrigan

across the desk

We've got inflation —amen, brother

Your editorial "The Real Inflation Fighters Are Those Who Innovate" (ED No. 24, Nov. 22, 1973, p. 155) really tells it like it is. Amen, brother.

Especially pertinent is your comment about trade barriers erected for manufacturers who are scared to compete with foreign producers—not unable to compete, but scared. Foreign manufacturers have been building cars with almost 1 hp/cu. in. and with good efficiency on regular gas for years. Detroit, even though technically capable of doing the same, would rather crank out loose-tolerance, low-efficiency, gas-guzzling monsters. No wonder there's an energy crisis!

I drive one of the Japanese imports (27 mpg) that has practically been priced out of the market. Today the same model costs over \$1000 more than it did two years ago, due not only to inflation (devaluation of the dollar) but also to large trade-barrier increases.

Now that the domestic manufacturers have succeeded in erecting these barriers, they are raising their prices to "catch up" with those "overpriced" imports. They haven't fooled anyone with any discernment; they've just ruined the bargain those imports used to be.

*Larry Cannady
Product Marketing*

Motorola Inc.
Semiconductor Products Div.
2200 W. Broadway
Mesa, Ariz. 85202

What inflation?

Your editorial "The Real Inflation Fighters Are Those Who In-

novate" (ED No. 24, Nov. 22, 1973, p. 155) is somewhat misleading. You should look up the definition of the word "inflation" in a good dictionary. Inflation can be caused only by an increase in the money supply. High prices have many causes, but high prices DO NOT cause inflation; they are one of the results of inflation.

The first transistor cost several million dollars, but today a better one can be bought for a few cents.

*J.P. Cheedleigh
Senior Staff Engineer*

P.O. Box 3
Houston, Tex.

EE jobless rate: Who's kidding whom?

In Heather David's "Washington Report" (ED No. 22, Oct. 25, 1973, pp. 47-48), it was stated that 6000 scientists and engineers are expected to lose their jobs in the aerospace industry by June, 1974. It is increasingly difficult to reconcile these and other reports from the field with the glowing predictions of lowered unemployment rates made by IEEE and the Engineering Manpower Commission. Indeed, both of these groups claim a current unemployment rate of 1.32%—down from the 1972 figure of 1.9%.

However, in 1972 the IEEE took its own survey, and more than 43,000 replies were received. The very first question concerned the employment status of the members. Fully 6.03% indicated that they were unemployed, while an additional 5.37% indicated that they were underemployed.

Why has the IEEE ignored its own findings? Maybe the IEEE is

(continued on page 16)

Electronic Design welcomes the opinions of its readers on the issues raised in the magazine's editorial columns. Address letters to Managing Editor, Electronic Design, 50 Essex St. Rochelle Park, N.J. 07662. Try to keep letters under 200 words. Letters must be signed. Names will be withheld on request.

THIN-TRIM[®] CAPACITORS FOR HYBRID-CIRCUIT DESIGNERS



ACTUAL SIZE



THIN-TRIM capacitors are a new development in miniaturized variable capacitors for application in circuits where size and performance is critical. The Thin-Trim concept provides a variable device to hybrid circuit designers which replaces fixed tuning techniques and cut and try methods of adjustment.

FEATURES

- Low profile for HYBRID CIRCUIT applications.
- High capacity values for BROADBAND applications.
- High Q - low capacity values for MICROWAVE applications.

U.S. Patent 3,701,932

Johanson

MANUFACTURING CORPORATION

ROCKAWAY VALLEY ROAD
BOONTON, N.J. 07005
PHONE (201) 334-2676
TWX 710-987-8367

A better answer.

TI's unique modular building block construction permits custom configurations at minimal cost.

Standard .150 inches travel with 2.0 ounces actuating force. Also available with .100 inches travel and lower profile.

High quality double shot molded thermoplastic keytops available in many colors. Or you can buy keyboards alone.

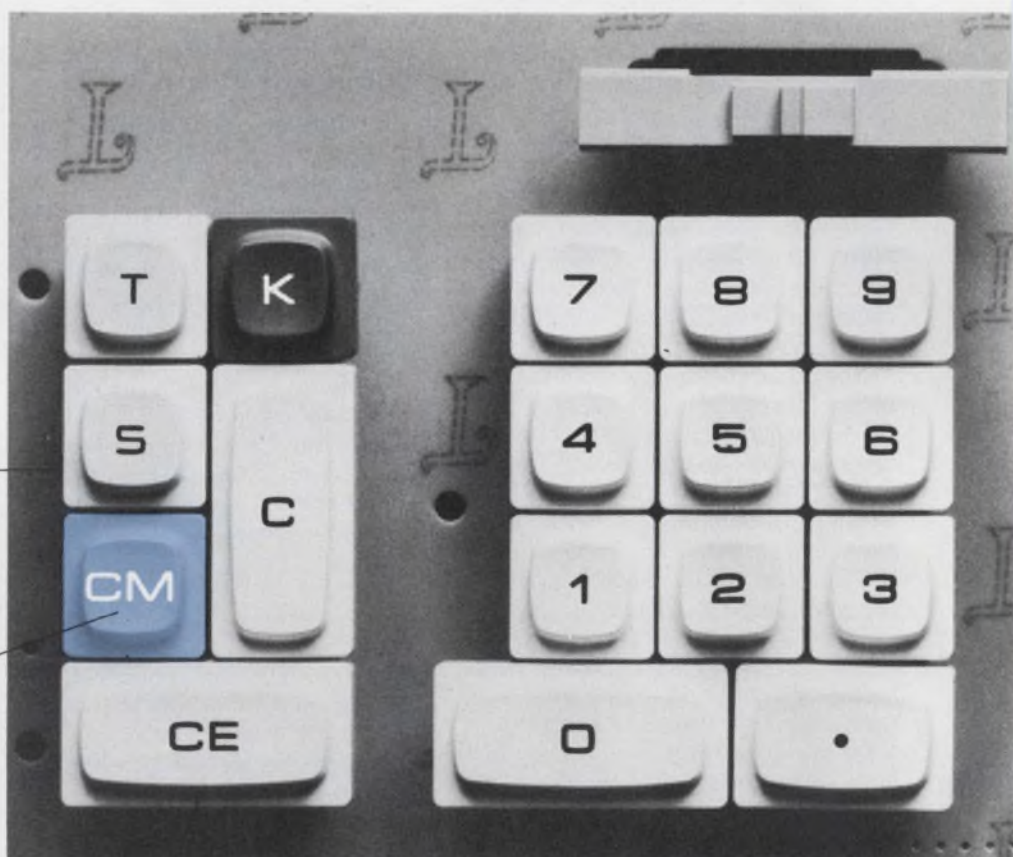

Keyswitch materials and a high length-over-diameter ratio provide the smooth, quality feel necessary for professional users.

Fully assembled on a circuit board to reduce your assembly costs.

The new 5KS desktop keyboard from Texas Instruments, the world's leading supplier of pocket calculator keyboards. A new money-saving modular keyboard system provides the design flexibility desktop calculator manufacturers need for quick and inexpensive model changes.

Before Texas Instruments modular keyboard systems, you could get keyboards for desktop calculators two ways. First you could buy individual keyswitches or keyswitch rows and assemble them yourself. (This assembly, which includes mounting on PC boards, soldering and testing, adds at least 25% to the price of the keyswitch alone.) Secondly, you could buy a custom molded assembly which requires a high tooling charge.

Now the people who brought you the pocket calculator keyboard bring you the best of two worlds. The first complete travel keyboard that gives you economy and flexibility using a unique modular keyboard system.

The keyswitches consist of only four parts for simple trouble-free operation and low cost. The keyboard assembly is a series of keyswitch clusters that can be arranged on a printed circuit board in any desired layout. Using TI's established library of available cluster modules, calculator manufacturers can change models with only a low cost circuit board revision.

This is the new 5KS from TI, a dependable low cost keyboard for desktop calculators, credit card verifiers, point-of-sale terminals, and other equipment where a keyboard is required. For more information, fill in the coupon.

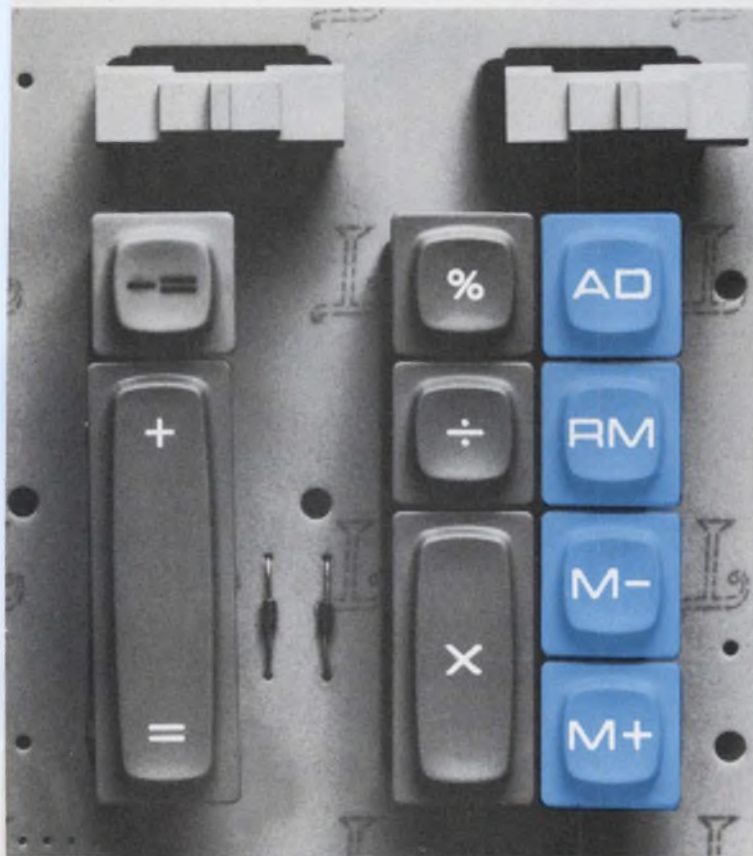

Actual size.

Texas Instruments Incorporated
 Keyboard Products Marketing
 MS 12-33/DE
 Attleboro, Mass. 02703

Name _____
 Title _____
 Company _____
 Address _____
 City _____
 State _____ Zip _____

Keyboard application:
 Desk-top Calculator Pocket Calculator
 Point of Sale Terminal Credit Card Verifier

Other _____
 Application is new or existing

Approximate annual usage _____ units
 Please have a TI Field Engineer call

TEXAS INSTRUMENTS
 INCORPORATED
Putting new technologies at your fingertips.

Pick & Choose

OEM Printer Mechanisms and Complete Teleprinter Terminals from SINGER



You pick from our basic 30 cps impact printer mechanisms in 80 or 132 column OEM configurations and choose from many completely packaged ASR, KSR and RO terminals with interface. Or, if you need something in-between we can supply that too; the power supply, printer and communication interfaces and/or logic sub-assemblies to meet your exact requirements.

So whatever you need in OEM printer mechanisms and terminals, it's available at Singer . . . Call, write or circle the reader service number for our new printer brochure today and see how Singer can satisfy *your* printer requirements. International Teleprinter Corporation, The Singer Co., 493 Washington Avenue, Carlstadt, New Jersey 07072 — (201) 438-1770 — TWX 710-989-0111.

SINGER
INTERNATIONAL TELETYPE CORP.

INFORMATION RETRIEVAL NUMBER 8

34

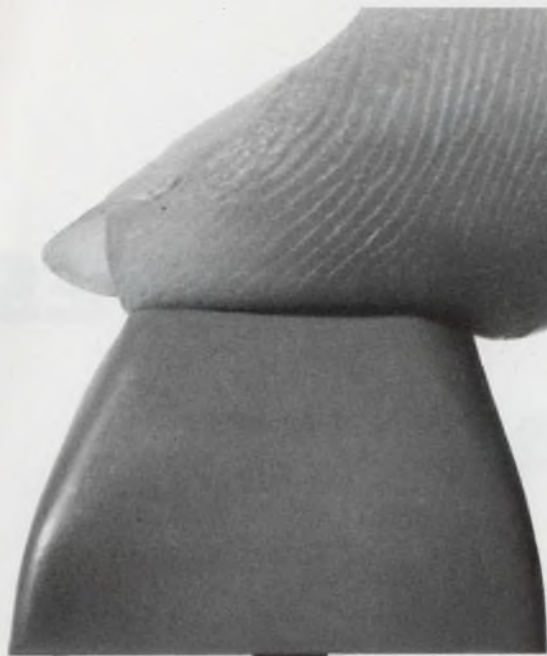

PLUNGER STEM

GOLD "CROSSPOINT" CONTACTS

STRIKE GOLD

RETURN SPRING



**...every time
you depress a
CHERRY KEYBOARD SWITCH**

Cherry's unique gold "crosspoint" contacts plus simplified electronics enhance reliability and provide long life . . . low profile . . . lower power consumption . . . low, low cost. The crossed knife-edge contact configuration has been tested to 50,000,000 operations and beyond. Available from stock with a wide variety of key legends and colors. Or, buy them as part of a keyboard package, ready to slip into your panel. Either way is economical the Cherry way.

When you need keyboard switches or complete keyboards for numerical control, calculators, computer terminals or other applications, strike gold with Cherry—and save silver at the same time.

FOR A FREE TEST SAMPLE and a copy of our latest complete-line catalog just TWX 910-235-1572 . . . or PHONE 312-689-7700 . . . or circle appropriate reader service number.



CHERRY 

CHERRY ELECTRICAL PRODUCTS CORP.
3609 Sunset Avenue, Waukegan, Illinois 60085

Cherry Worldwide: (Subsidiaries) Hirose Cherry Precision Co., Ltd., Tokyo • Cherry Mikroschalter GmbH, Bayreuth, Germany
• Cherry Electrical Products (U.K.) Ltd., St. Albans, Herts • (Licensee) G.W. Engineering Pty. Ltd., Sydney



INFORMATION RETRIEVAL NUMBER 9

**OUR POWER
SEMICONDUCTORS
ARE SO GOOD
WE USE THEM OURSELVES.**

20,000 TIMES A DAY.



That's the rate at which Delco Electronics supplies a variety of products for GM cars.

Under one roof we design and manufacture complete systems, including the power semiconductors that help make those systems work. This can mean a lot to you. Here's why:

We know the requirements and standards that must be met to produce over 20,000 systems a day. We know what it means to deliver on time, to meet our own production schedules. And we know the importance of component quality in assuring reliability of the end product.

Our semiconductor devices are used

in the Delco AM radios, AM/FM radios and stereo tape systems we produce for GM cars. They are also used in the GM high-energy ignitions systems, I.C. voltage regulators, alternators, and in the new combination front seat/shoulder belt interlock systems you find in all the 1974 GM cars.

And all the capabilities that go into Delco semiconductors can work for you, too.

There are select distributors with stock on hand strategically located coast to coast. For the distributor nearest you, phone

your closest Delco Electronic regional sales office: Kokomo, Ind. (317) 459-2175, El Segundo, Cal. (213) 640-0518, Union, N.J. (201) 687-3770.

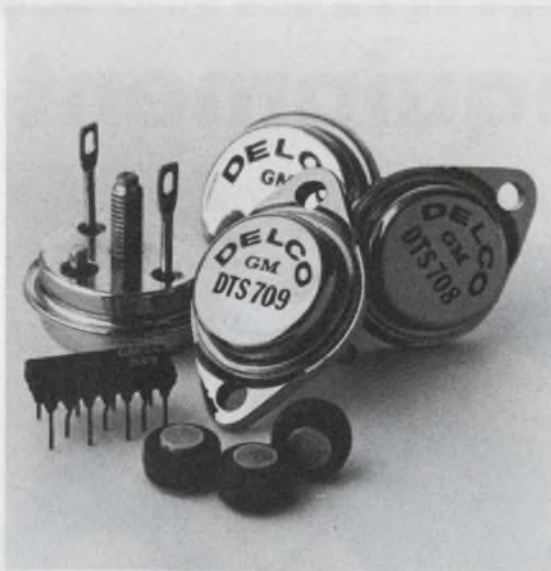

your closest Delco Electronic regional sales office: Kokomo, Ind. (317) 459-2175, El Segundo, Cal. (213) 640-0518, Union, N.J. (201) 687-3770.

DELCO ELECTRONICS



Division of General Motors Corporation



Profits in motion for communications equipment



You can reduce assembly and inventory costs, get reliable total functions in minimum space, and obtain application help when you ask TRW/Globe to build your motion package.

Four builders of communications equipment can affirm this from their experience with the packages on this page.

1. TRW/Globe supplies this complete cassette drive module for a telephone answering system. The customer avoids assembly costs as well as the problem of aligning the two output shafts.

2. This blower was built to fit the space available after most of a military transceiver had been designed. TRW/Globe also helped the customer de-

termine the system's resistance to air flow.

3. TRW/Globe meets all functional requirements in this rotary actuator for switching bands on a military transceiver. The package includes gearing, limit switch, mechanical stop, slip clutch, electro-mechanical brake, and filter.

4. This package drives the scanner in a facsimile transceiver. TRW/Globe's experience with hysteresis synchronous motors assures that both the transmitter and recorder will be synced.

To get your profits in motion, call or write: TRW/Globe Motors, an Electronic Components Division of TRW Inc., Dayton, Ohio 45404 (513-228-3171).

TRW GLOBE MOTORS

INFORMATION RETRIEVAL NUMBER 11



“CANNON® RFI FILTER CONNECTORS UNSCRAMBLED OUR PROCESS COMPUTER, and made me a success.”

“We used to call our plant ‘glitch city.’

“With all that machinery going, our process controller was hearing more signals than a weak-side linebacker. And finding them just about as tough to sort out.

“My boss said, design a filter circuit. But I had costed out the design time and packaging, and factored in the inherent unreliability, and it didn't add up. So I told him. He flipped. I suggested integral filtering instead. He listened.

“I pointed out low cost, ease of installation.”



“The accountant seemed interested.”



“I showed him Cannon connectors with a built-in low pass filter assembly on each contact. They get rid of RFI/EMI, save space and weight, and offer reliability no discrete filter can match. And at less cost than doing it all ourselves.

“The boss believed me. Cannon delivered. And now our process controller purrs along. So do I. So can you.”

So send for detailed data sheets on RFI filter connectors – and get our new guide to everything you need to know about Cannon connectors.

ITT Cannon Electric, International Telephone and Telegraph Corporation, 2801 Air Lane, Phoenix, Arizona 85036. Call (602) 275-4792.

“Got the secrets of my success—free.”



CANNON ITT

Higher component density...

Lower insertion costs...with



MULTI-COMP[®] DIP MONOLYTHIC[®] CERAMIC CAPACITORS

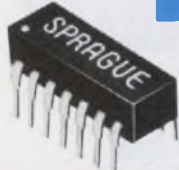

STANDARDIZED DESIGN* FOR BETTER AVAILABILITY, BETTER PRICES

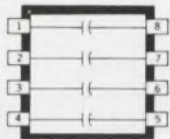

TYPE 939C
(4 capacitor sections)



TYPE 934C
(7 capacitor sections)



TYPE 936C
(8 capacitor sections)

Compatible with ICs and other standard DIP devices. Especially useful for noise bypassing and signal coupling in high-frequency signal or data processing systems. Molded package provides mechanical protection and reliability under severe environmental conditions. Monolythic[®] construction . . . alternate layers of ceramic dielectric material and metallic electrodes are fired into an almost indestructible homogeneous block. Standard ratings, 18 pF to 0.1 μ F @ 100 WVDC. Temperature range, -55C to +70C.

*Other circuit configurations (including internally-paralleled capacitor sections, commoned capacitor leads, and various ratings within single package) are available on special order.

Sprague puts more passive component families into dual in-line packages than any other manufacturer:

- TANTALUM CAPACITORS
- CERAMIC CAPACITORS
- TANTALUM-CERAMIC NETWORKS
- RESISTOR-CAPACITOR NETWORKS
- PULSE TRANSFORMERS
- TOROIDAL INDUCTORS
- HYBRID CIRCUITS
- TAPPED DELAY LINES
- SPECIAL COMPONENT COMBINATIONS
- THICK-FILM RESISTOR NETWORKS
- THIN-FILM RESISTOR NETWORKS
- ION-IMPLANTED RESISTOR NETWORKS

For more information on Sprague DIP components, write or call Ed Geissler, Manager, Specialty Components Marketing, Sprague Electric Co., 347 Marshall St., North Adams, Mass. 01247. Tel. 413/664-4411.

THE BROAD-LINE PRODUCER OF ELECTRONIC PARTS

SPRAGUE[®]

THE MARK OF RELIABILITY

INFORMATION RETRIEVAL NUMBER 13

ACROSS THE DESK

(continued from page 7)

run by a cabal of academicians and top-level corporate executives, whose best interests are served by maintenance of the present glut of EEs.

Irwin Feerst

Committee of Concerned EEs
P.O. Box 19
Massapequa Park, N.Y. 11762

A fuller explanation of energy meter

I should like to correct certain items presented in "Energy Meter Improves Aircraft Performance" (ED No. 23, Nov. 8, 1973, p. 65)

1. The parameters provided by the meter are:

(a) Total aircraft energy (potential plus kinetic) displayed on the outer scale.

(b) Rate of change of total energy, displayed on the inner scale.

2. While initial investigation of the concept was funded by Honeywell's Internal Investment Program, as stated, the Office of Naval Research provided primary support for the hardware development and subsequent flight evaluation.

N. R. Zagalsky

Systems Project Engr.

Honeywell Systems & Research Center
Aerospace & Defense Group
2600 Ridgway Parkway
Minneapolis, Minn. 55413

Make it 140 C, not 240 C, in Focus

In "Focus on High-Temperature Materials" (ED No. 22, Oct. 25, 1973) it's stated on p. 56 that a material is listed by Underwriters Laboratory up to "240 C or 284 F." Who's confused? The value 240 C is equal to 464 F, which would confirm the claim of "over 400 F," but 284 F is only 140 C, not 240.

Robert A. Pease
Engineer

Teledyne Philbrick
Allied Drive
Dedham, Mass. 02026

Ed. Note: A typographical error sneaked in. The 240 C should read 140 C.

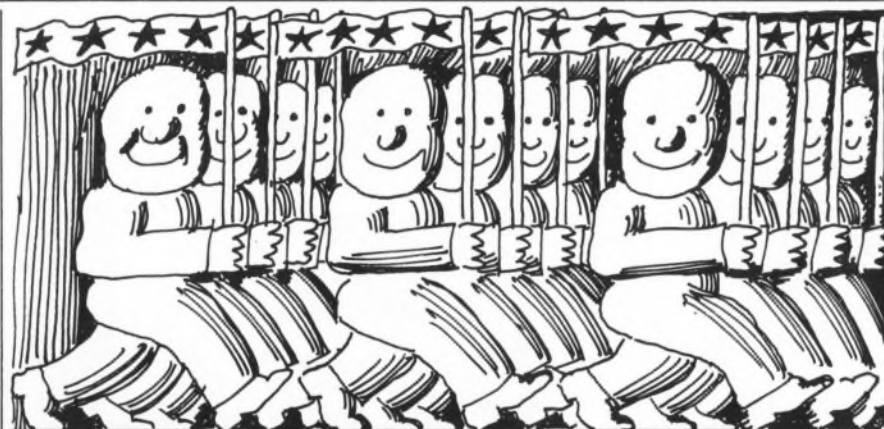

LINEAR QUADS ARE COMING !



A new batch of JFET devices from National

National's extensive line of FET devices is growing all the time. One year ago we had only five geometries for all our FETs; today we have 17 geometries to meet all requirements. Several of our latest JFET products are described below.

The 2N5911/2N5912 are the industry's first and only wideband, low-frequency, low-capacitance dual FETs that are monolithic. Offering greater stability than comparable non-monolithic devices, these dual JFETs are ideal as the front end of a wideband oscilloscope or as the input of a high speed op amp. They can be used as a matched switch and can be sold non-packaged for use in custom hybrid circuits. The 2N5911 and 2N5912 differ only in their match and track: the 2N5911 has a match of $<10\text{mV}$ and a track of $<20\mu\text{V}/^\circ\text{C}$; the 2N5912 has a match of $<15\text{mV}$ and a track of $<40\mu\text{V}/^\circ\text{C}$. (Continued on page A4)

For many years now, quad devices have been quite common in the field of digital circuit design, but until recently they were unavailable to the linear designer. However, in the space of little more than a year, the linear quad has come into its own. In fact, the world of linear is rapidly converting to quads. And for very good reasons! When compared with individually purchased linear components, the linear quad is seen to have greater reliability, lower insertion costs, and lower inventory costs; it takes up less board space; and its purchase price (at present about the same as that of individual components) is more likely to go down, as there is more room for improvements in the newer quad technology.

National Semiconductor has the broadest and most widely accepted line of linear quads on the market today and is the acknowledged leader in the field. Among the outstanding linear quads offered by National are (Continued on page A4)

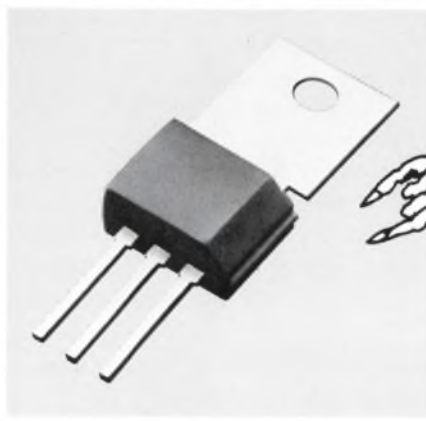

Cool News in the Plastic Power Transistor Market.

DURAWATT.™ Remember that name! It stands for National's entry into the plastic power transistor field. DURAWATT series transistors generate from seven to 12 watts with case temperature held to 25°C . They have the same pin-out and electrical characteristics as Motorola's UNIWATT series MPS-U01-95 and G.E.'s D40 series. They are superior to the Motorola and G.E. devices in the following respects:

- DURAWATT transistors are the only power transistors that are encapsulated in epoxy B, making them unexcelled in reliability.
- DURAWATT transistors have higher free air dissipation.

Applications for DURAWATT series transistors include high-voltage video amplifiers, one-amp NPN and PNP complementary pairs, and one-amp Darlington.

The first product available in the DURAWATT line is the SP7056, a high-voltage video amplifier that uses the same highly acclaimed process-48 die that is used in National's metal can transistors. In the DURAWATT package, free air dissipation is increased to 1.75W, allowing the SP7056 to be operated without a metal heat sink. Circle No. 180 on Bingo Card





New Literature:

- **TO-92 Selection Guide.** This guide lists all the TO-92 transistors, both U.S. and Pro-Electron series, that are currently manufactured by National, and gives all the lead configurations for these devices.

Circle No. 183 on Bingo Card

- **FET Selection Guides.** Three two-page guides on National's extensive line of JFET devices are now available. The first guide describes JFET amplifiers; the second, dual FETs; and the third, JFET switches. The values of key parameters are given, and stock items and preferred items are indicated.

Circle No. 184 on Bingo Card

- **AN-78 Static RAM system can also be built with dynamic RAM elements.** Many designers would like to take advantage of static memory elements in their systems, but not too many are aware that static memories can be implemented with dynamic integrated circuits. This app note explains how.

Circle No. 185 on Bingo Card

- **AN-79 IC Preamp challenges choppers on drift.** A new IC Preamplifier is now available that features drift as low as 0.2 microvolts per degree C. It's used with conventional op amps to produce circuits that are free from both drift and offset. Its use and characteristics are detailed in this note.

Circle No. 186 on Bingo Card

- **AN-80 MOS Keyboard encoding.** The use of MOS large scale integration has made it possible to provide all of the components necessary to implement the complete keyboard encoding function in a single IC. The circuit is the MM5740, and this app note explains its use in practical circuits.

Circle No. 187 on Bingo Card



Display users benefit from National's LED digit, segment drivers and LED module.

The DM8861, a new LED segment driver designed to be used in conjunction with MOS integrated circuits and common-cathode LEDs in serially addressed multi-digit displays, is now available from National. Unlike the standard LED drivers, which have four inputs and four outputs, the DM8861 has five inputs and five outputs and hence provides the user with an extra segment per digit. Also available from National is the DM8863 LED digit driver, a device that permits the user to display eight digits per package, as compared with the six digits per package possible with standard LED digit drivers. Like the DM8861, the DM8863 is designed for use with MOS integrated circuits and common-cathode LEDs in serially addressed multi-digit displays. The DM8861 has a source or sink capability per driver of 50mA and the DM8863 has a sink capability per driver of 500mA.

In addition to the above two devices, National is at present offering the widely used DM75491 LED 4-segment driver and the DM75492 LED 6-digit driver.

9-Digit LED Module Simplifies and Lowers the Cost of Calculator Displays
National's NSN-98, a 9-digit LED module designed for multiplex operation in hand-held calculators, is now in volume production. The unit comes mounted on a dark pc board with a flat, red lens cover having an extremely wide viewing angle. All nine digits are pre-aligned and matched for brightness and are 110 mils high without magnification. A low current drive of 1mA (avg) per segment provides excellent brightness in typical applications. *Circle No. 188 on Bingo Card*

National literature describes the TO-92 product line in great detail.



National Semiconductor offers the widest line of TO-92 transistors in the industry. This line includes each of the three lead configurations (EBC, ECB, and BEC). All these transistors use Epoxy B as encapsulant, making them unexcelled for reliability, and all have copper lead frames for better power dissipation. And we're not stopping there! By October of this year, we will have expanded our lead-form capability, which will give us the ability to second source virtually every small-signal transistor currently available.

The TO-92 Selection Guide and the TO-92 Reliability Brochure together will provide a detailed description of the entire line of TO-92 devices. The Selection Guide, available now, lists all the TO-92 transistors, both U.S. and Pro-Electron series, that are currently manufactured by National, and gives all the lead configurations for these devices. The TO-92 Reliability Brochure, which will be available soon, will describe the performance of all National TO-92 transistors under a variety of environmental conditions.

Circle No. 189 on Bingo Card

Linear Quads

(Continued from page A1)

the LM3900N, the LM339, and the LM324.

The LM3900N, which was introduced about a year ago, is a quad amplifier consisting of four independent, dual-input, internally compensated amplifiers designed specifically to operate off a single power supply voltage and to provide a large output voltage swing. The LM339, which was brought out more recently, is a low-voltage offset voltage quad comparator designed to interface directly with CMOS logic. The LM324, a new device that is being offered now for the first time, is a quad operational amplifier with the following unique characteristics:

- In the linear mode, the input common-mode voltage range includes ground and the output voltage can also swing to ground, even though the device is operated from only a single power supply voltage.
- The unity gain cross frequency and the input bias current are temperature compensated.

Circle No. 181 on Bingo Card

New JFET Devices

(Continued from page A1)

An N-channel VHF/UHF FET amplifier/oscillator/mixer, the U310 features a typical power gain of 11dB, a typical noise of 3dB at 450MHz common gate, and a typical input impedance of 50 (which optimizes impedance match). The device is easy to use; no neutralization is required.

The 2N5564-66 are monolithic dual JFETs that are used as wideband, low-noise differential amplifiers and commutators. All three devices feature a typical transconductance of $9000\mu\Omega$ at 2mA, a typical noise voltage of $1.5nV/\sqrt{Hz}$ @ 1kHz, and an R_{DS} that is $<100\Omega$. They differ only in match and track.

The 2N5515-24 are monolithic dual FETs that are designed for 0-100Hz applications. These ten devices differ in match and track and show some differences in electrical characteristics. Several of them can guarantee a noise voltage of $<15nV/\sqrt{Hz}$ @ 10Hz and a CMRR of 100dB min. They are all particularly suited for applications that require critical transducers or $M\Omega$ input impedances. Circle 182 on Bingo Card

COMPREHENSIVE GUIDES FOR NATIONAL JFET DEVICES!



The brochure on JFET amplifiers is divided into six categories:

- Ultra-low input current amplifiers (1pA max.)
- Low frequency/low noise amplifiers ($<10nV/\sqrt{Hz}$ @ 10Hz)
- VHF/UHF amplifier/mixer/oscillators (400-600MHz)
- RF/VHF amplifiers (200MHz)
- General-purpose N-channel amplifiers listed in ascending order of minimum I_{DSS} , with I_{DSS} range shown pictorially
- General-purpose P-channel amplifiers listed in ascending order of minimum I_{DSS} , with I_{DSS} range shown pictorially

The brochure on dual JFETs is divided into five application areas:

- General-purpose devices
- Low-frequency / low-noise devices ($<15nV/\sqrt{Hz}$ @ 10Hz)
- Wideband/low-noise devices for fast slew rate op amps and low-noise oscilloscope displays
- Low leakage/high CMRR/wideband devices -- the ultimate in general-purpose dual JFETs
- Replacement types for the old SU and FM series

The brochure on JFET switches lists the more popular N-channel and P-channel switches in ascending order of "on" resistance.

Circle No. 191 on Bingo Card

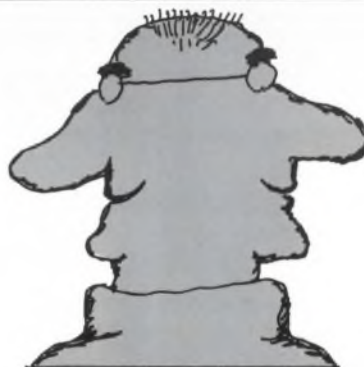

NEW DUAL SENSE AMPS AND LINE RECEIVERS

SANTA CLARA, CA—A new series of dual-function bipolar monolithic integrated circuits from National Semi-

conductor Corp. offers the systems designer flexibility in implementing digital data transmission and MOS memory sensing circuits.

Called the LM75107A, LM75108A, LM75207, LM75208, LM363, and LM363A, the devices are TTL compatible dual high speed circuits intended for sensing voltages in a broad range of systems applications. While their primary use will be as line receivers or MOS sense amplifiers, any of the new products may be employed as voltage comparators, level translators, or window detectors. As digital line receivers, the devices are intended to be used with the LM75109, LM75110, or the DM7830 line drivers, but they may also be used with other balanced or unbalanced party-line data transmission systems.

Circle No. 192 on Bingo Card

Announcing: High Speed Voltage Comparators

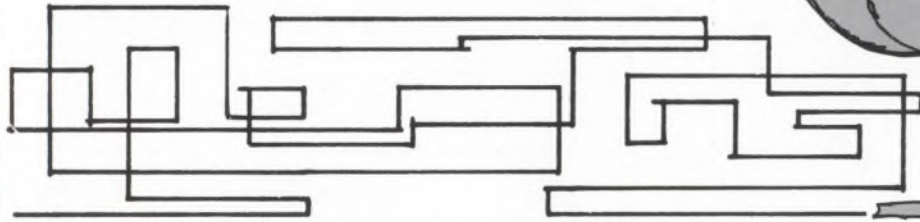

Santa Clara, Calif. . . . Two new high speed differential voltage comparators featuring guaranteed response times of 20 nanoseconds maximum are now available from National.

Called the LM160 and LM161 series, the new comparators are bipolar monolithic integrated circuits with high speed differential inputs and complementary TTL outputs. Typical delay on either series varies only 3 nanoseconds for overdrive variations of from 5 to 500 millivolts. And both feature tightly matched delays on each output.

The LM160 offers improved characteristics over the μ A760 and μ A760C comparators for which it is a pin-for-pin replacement. It is faster, has a lower input offset voltage, higher input impedance and larger fanout than the 760 and has a lower input offset voltage. Pinouts for the LM160

series include plus and minus inputs, plus and minus outputs, plus and minus power supply (up to 8 volts max.) and ground.

The LM161 is an improved pin-for-pin replacement for the SE529/NE529. It too has been optimized for greater speed performance and lower input offset voltage. The pinouts for the LM161 series include plus and minus inputs and outputs, plus and minus power supply (up to 15 volts), ground, a separate VCC supply for the output section, and strobe enable inputs for each output. Thus the front end of the LM161 may be run on plus/minus 15 volt op amp supplies, while the TTL output section is run on plus 5 volts and ground.

Applications for the new comparators include zero-crossing detectors in tape and disk memory systems, and in high speed analog to digital converters.

The LM160, which is intended for operation over the full military temperature range of from -55°C to $+125^{\circ}\text{C}$ is available in a 14 lead flat-pack, a 14 pin cavity dual in-line package, or an 8 lead TO-5 can. The LM260, which is for operation over the industrial temperature range of from -25°C to $+85^{\circ}\text{C}$, and the LM360 which is for operation over the 0°C to $+70^{\circ}\text{C}$ commercial temperature range are also available in the same three packages. In addition, the LM360 is available in a 14 pin Epoxy B DIP.

The LM161 (-55°C to $+125^{\circ}\text{C}$) is available in a 14 lead flat pack, a 14 pin cavity DIP, or a 10 lead TO-5 can; the LM161 (-25°C to $+85^{\circ}\text{C}$) is available in a 14 pin cavity DIP or a 10 lead TO-5; and the LM361 is available in a 14 pin cavity DIP, an Epoxy B DIP, or a 10 pin can.

Circle No. 193 on Bingo Card

National's pressure transducer sharply lowers the cost of transponders that contain altimeters.

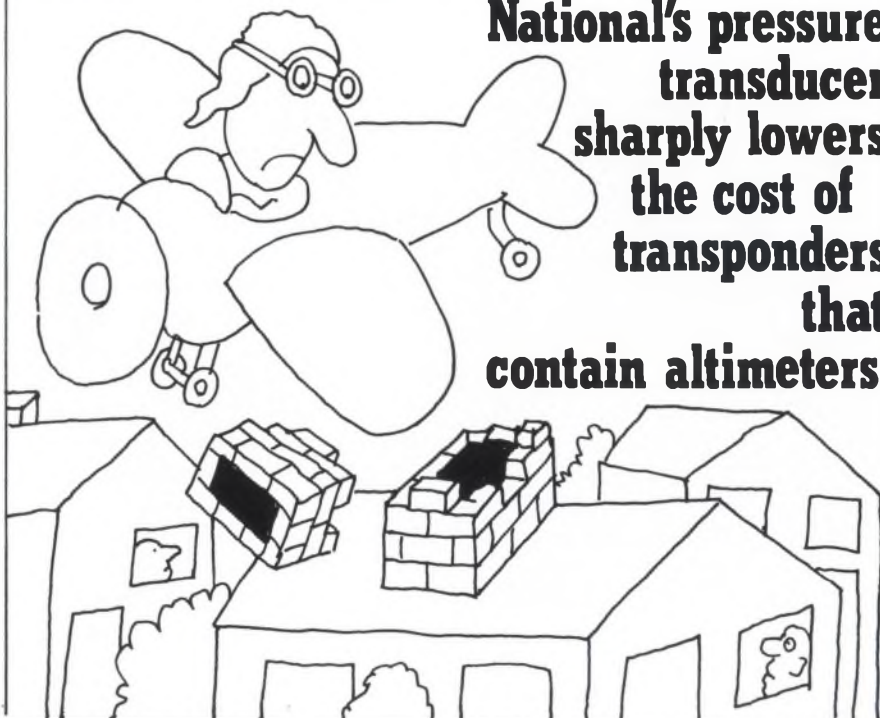

Owners of light aircraft have cause for celebration -- they will soon be able to purchase an inexpensive altitude-reporting transponder. This breakthrough has been made possible by National Semiconductor's LX1602A pressure transducer. The LX1602A costs a mere \$70 (equivalent devices cost \$1500) and meets all FAA requirements for light aircraft from $-1,000$ feet to 50,000 feet. With this device, transponder manufacturers will be able to include altimeter capabilities in their transponders without pricing the typical light aircraft owner out of the market.

Application assistance in designing both altimeter portion of the transponder is now available from National. For a detailed description of the use of the LX1602A in designing altimeters, see Application Note 91.

Circle No. 194 on Bingo Card

SPECTACULAR

Second sourcing diode arrays and transistor arrays.

ARRAYS!

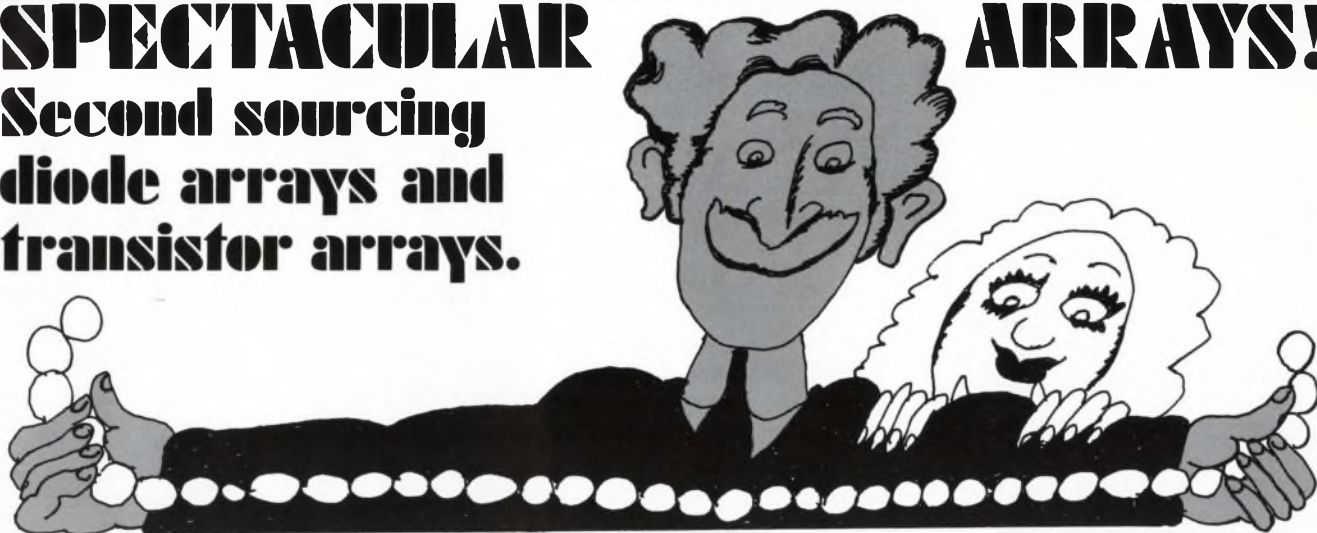

National Semiconductor is now second sourcing two very popular diode arrays -- the LM3019 and the LM3039 -- and four widely used transistor arrays-- the LM3018, the LM3045, the LM3046, and the LM3086.

The LM3019 consists of one silicon diode "quad" and two isolated silicon diodes on a common monolithic substrate. The LM3039 is made up of six ultra-fast, low-capacitance silicon diodes on a common monolithic substrate. Five of the diodes are independently accessible, while the sixth shares a common terminal with the substrate.

The LM3018 consists of four general-purpose silicon NPN transistors on a common monolithic substrate. Two of the four transistors are connected in the Darlington configuration.

The LM3045, the LM3046, and the LM3086 each consist of five general-purpose silicon NPN transistors on a common monolithic substrate, with two of the transistors internally connected to form a differentially connected pair. The LM3045 is supplied in a 14-lead cavity dual-in-line package rated for operation over the full military temperature range. Both the LM3046 and the LM3086 are electrically identical to the LM3045, but are supplied in 14-lead molded dual-in-line package for applications requiring only a limited temperature range.

All four transistor arrays are well suited to a wide variety of applications in low-power systems in the DC through VHF range.

Circle No. 190 on Bingo Card

THE AMAZING STORY OF THE 2K RAM THAT ATE TOPEKA, KANSAS.

Once upon a time there was a 2K RAM named MM5262.

Born at National, MM5262 was very big and very strong.

Much bigger than the little 1K RAMs around him, yet just as fast.

MM5262 could read and write, you know. And he had a wonderful memory.

Well, although he was bigger and better than the little 1K RAMs, MM5262 was, of course, not the only 2K RAM around.

But MM5262 never worried too much about them, because they were never around. You could never seem to find one of those 2K RAMs when you wanted them. But MM5262 was there, ready and waiting for people who wanted him.

And people loved and wanted him because of many things.

He drank only half as much power as 1K RAMs, for example. His standby power was only 2.5 milliwatts per bit. And he cost 10-20% less on a system basis.

And he had within him address registers, chip select registers and data output latches so people could easily and inexpensively implement his memory.

He also had a couple of brothers who often traveled with him: A sense amp named DM8806 (which offered Tri-State[®] Logic output), and a driver named MH0026.

But one day MM5262 got very nervous. He heard rumors about a big brute of a RAM called 4K.

He worried about what might happen to him.

He worried so much that one day he went out and ate Topeka, Kansas. (You may have read about it in the newspapers.)

But later MM5262 calmed down.

Because he learned

that the big 4K RAMs wouldn't really be around much for some time yet, and that even when they got to town people would still need and love him, too.

Which proves that you shouldn't go around eating Topeka, Kansas prematurely.

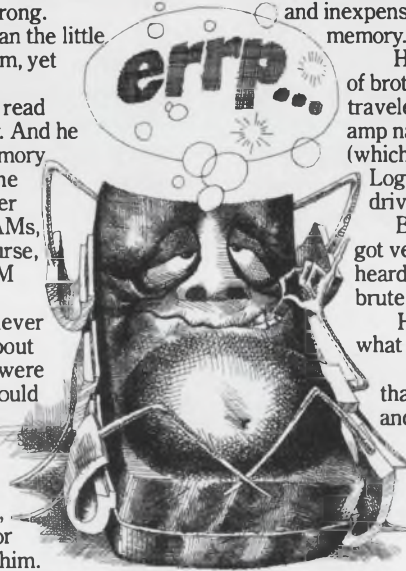

NATIONAL.



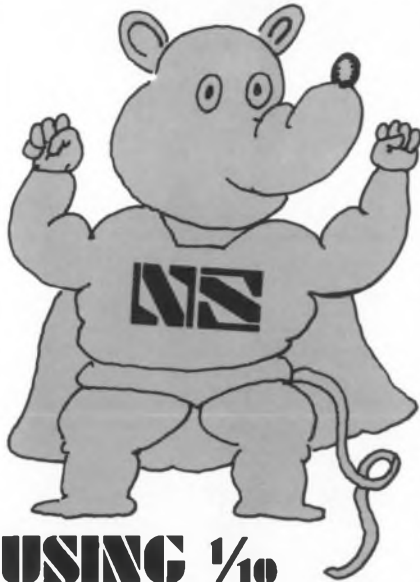

USING 1/10 THE POWER: High Speed Tri-State RAM

National is now introducing the DM76L99/DM86L99, a fully decoded 64-bit RAM organized as sixteen 4-bit words, whose power dissipation is approximately one-tenth that of comparable standard 54/74 RAMs. Typical power dissipation for this device is 55mW and typical access time is 80ns. The DM76L99/DM86L99 is compatible with the series 54L/74L; it has the same pin-out as the SN5489/SN7489, the DM7599/DM8599 the 3101, and the 5501; and it is expandable to 1200 4-bit words without additional resistors.

Circle No. 195 on Bingo Card

Easily programmed ROMS team with versatile programmer.

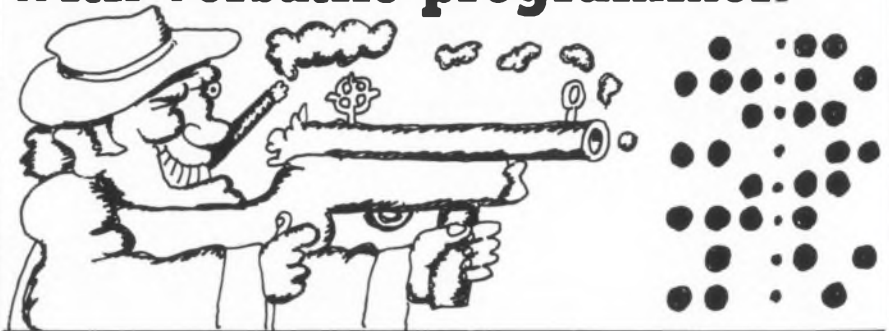

National's line of programmable read only memories has been expanded with the addition of the MM5202A, which is a pin-for-pin equivalent to the popular 1602A/1702A in the read only memory mode.

The MM5202A is a 2,048-bit programmable read only memory configured as 256 words by 8 bits. It's a static, silicon gate device that is bipolar compatible on both the inputs and outputs. Power supply requirements of +5 and -12 volts are also bipolar compatible. Access time is 1.0 microseconds.

Designed for such applications as code converters, random logic synthesis, look-up tables, and character generators, the MM5202A is easy to use since it is a static device which doesn't require any external clocks, and it has Tri-State® outputs which allows the user to tie several devices to a common output line.

Programming of the MM5202A is accomplished on an approved MM5203 programmer such as the Data I/O

programmer. The programming is done by applying a 50 volt pulse to the desired location. The generated charge is then stored in that location and the device acts as a ROM. If the data is to be changed, the device, which has a quartz lid, is exposed to short-wave ultraviolet light for a period of time and the charge is dissipated so the device can be reprogrammed.

The MM5202A is available in a 24 pin Ceramic package and is priced at \$40.00 each in quantities of 100. Delivery is from stock.

For fast and easy field programming of the MM5202A, and National's other PROMS including the MM5203A, and DM7573. The programmer manufactured by Data I/O Corp. in Bellevue, Washington, is ideal. Called the Programmer I, the device can program any type of programmable semiconductor memory made by any manufacturer. The Data I/O programmer uses a "personality card" which sets up the machine for the different types of PROMS. These cards, which include types for all National Proms, are available from Data I/O.

The machine consists of an eight-key keyboard, a tape perforator and a tape reader, a display panel which allows visual observation of bit patterns from any source and any output, and an LED word count display. An internal RAM memory is also provided allowing additional flexibility in the data source.

Data to be programmed may be entered via the keyboard or punched tape into the built-in RAM, and then the data in the RAM program the pROM. An alternate method is to employ a ROM or a pre-programmed pROM as the data source.

Circle No. 196 on Bingo Card

BINGO!

Complete card and mail to:
NATIONAL SEMICONDUCTOR
 2900 Semiconductor Drive
 Santa Clara, Ca 95051
 Att: Marketing Services

For FREE technical data,
 circle the numbers that correspond
 to the Bingo numbers at the bottom of the articles.

This will be used as a mailing list.
 Please print clearly.

NAME _____ TITLE _____

COMPANY _____

ADDRESS _____

CITY _____ STATE _____ ZIP _____

180	181	182
183	184	185
186	187	188
189	190	191
192	193	194
195	196	197

PRICED TO FIT YOUR WALLET

BOURNS LOW COST FAMILY

JF INDUSTRIAL TRIMPOT® POTENTIOMETERS

POWER: ½ WATT (OR BETTER) AT 70°C

TEMPCO: CERMET— AS LOW AS 100 PPM/°C
WIREWOUND — AS LOW AS 70 PPM/°C

TEMPERATURE RANGE: -55° UP TO +150°C

Join the growing population of industrial equipment designers who have discovered that *Bourns quality has never cost so little.*

Bourns LOW-COST FAMILY of industrial TRIMPOT® potentiometers was designed specifically to give cost-conscious industrial electronics equipment manufacturers superior product quality and performance . . . AT LOWER PRICES.

We invite you to compare price and specs on Bourns LOW COST FAMILY models with those of our prime competitors.

AVAILABILITY

The Cermet and Wirewound models shown are stocked in-depth . . . RIGHT NOW, so delivery is off-the-shelf from your local Bourns distributor or factory-direct.

Complete data, price and delivery details on all LOW-COST FAMILY models is available upon request. Just write, or call, your local Bourns Sales Office, representative, or distributor.



**AVAILABLE FOR IMMEDIATE DELIVERY
FROM YOUR LOCAL BOURNS DISTRIBUTOR**



BOURNS, INC., TRIMPOT PRODUCTS DIVISION • 1200 COLUMBIA AVENUE, RIVERSIDE, CALIFORNIA 92507

INFORMATION RETRIEVAL NUMBER 14



We make components for guys who can't stand failures.

Even the coolest and calmest among us somehow comes unglued when there's a "little" electronics systems failure. Because before it's done, that little systems failure often becomes a big, big systems failure. One that takes a long, long time to fix. And to forget.

But that's where Corning comes in. We make reliable components for guys who can't stand failures in their systems. Components like metal film resistors—both standard and flame proofs. Components like our glass, ceramic and glass/ceramic capacitors. Like our solid tantalum capacitors—hermetic and non-hermetic, polar and non-polar, miniature and microminiature. And like our discrete component networks.

An example:

Take our CORDIP™ discrete component networks, for example. They're unique packages of custom combinations of discrete microminiature resistors, capacitor chips and diodes in a dual in-line package.

Combinations of up to 20 and 23 components are available in 14-pin and 16-pin packages, respectively. Circuit complexity is almost unlimited, with all interconnection made inside the pretested package.

Their specs:

With CORDIP component networks, resistance values can be selected from 10Ω to 150K. And with tolerances from 1% and TC's from 100ppm, they offer better resistance ratios than other DIP networks. Capacitance values are from 10-47,000 pf. Tolerances from 5%. Diodes are low-signal silicon planar types. And different types of components—with different values, tolerances and TC's—can be readily mixed in the same network.

The special packaging construction of CORDIP component networks permits the use of Corning's discrete metal film resistors, discrete ceramic capacitor chips, and discrete glass hermetically sealed diodes.

Their extra benefits:

CORDIP component networks bring the designer almost unlimited circuit complexity, great flexibility and economy—and bring the packaging/production engineer substantially reduced board size. And insertion costs can be reduced by as much as 23-to-1.

Get the full story on CORDIP discrete component networks and all of Corning's extra reliability components. Write for our new "General Design Guide" to: Corning Glass Works, Electronic Products Division, Corning, New York 14830.

CORNING
ELECTRONICS

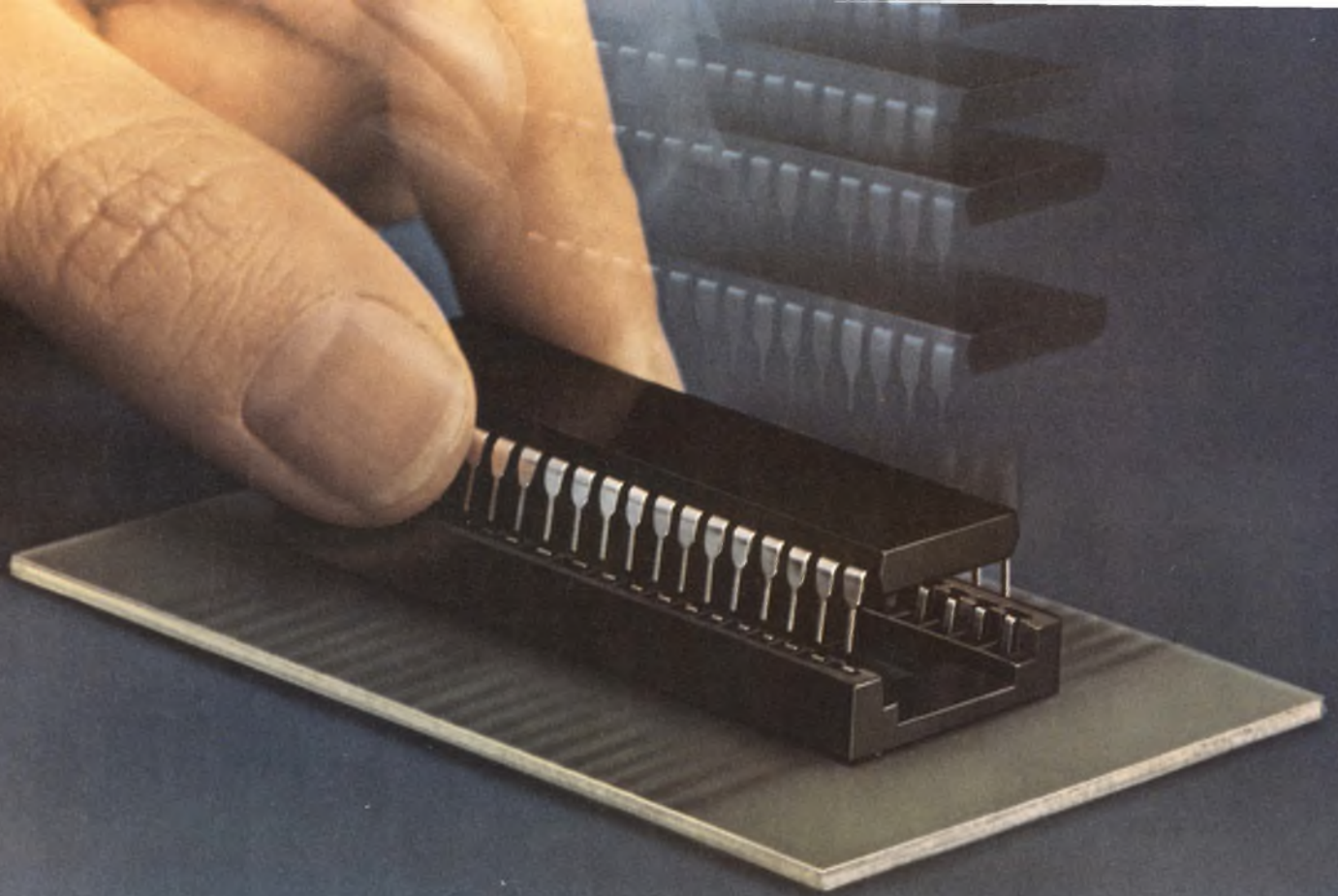

If you don't go for our leadless connectors, try our leaded.

They also give you low-cost, high-density packaging of MSI and LSI substrates. They're pluggable, too.

Both AMP lines have stored-energy contacts. Just to assure you of electrically reliable, uniform connections. While the gold or tin plating gives you optimum solderability to pc boards.

You probably know of AMP's ability to give you a wide selection of leadless sizes. To satisfy virtually all your needs.

The same is true for our leaded connectors: 40-, 28- and 24-position, dual in-line configurations. Standard on .100 x .600" centers (others available). The low-profile housing provides an overall height of less than .250".

So when it comes to high-performance connectors, take our lead. Whether they're leaded or leadless. Call (717) 564-0101. Or write AMP Incorporated, Harrisburg, Pa. 17105.

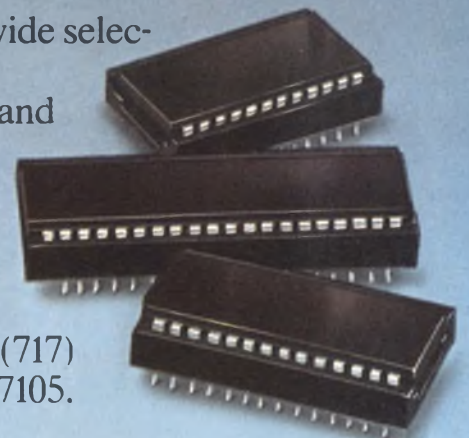

AMP

INCORPORATED

AMP is a trademark of AMP Incorporated

INFORMATION RETRIEVAL NUMBER 245

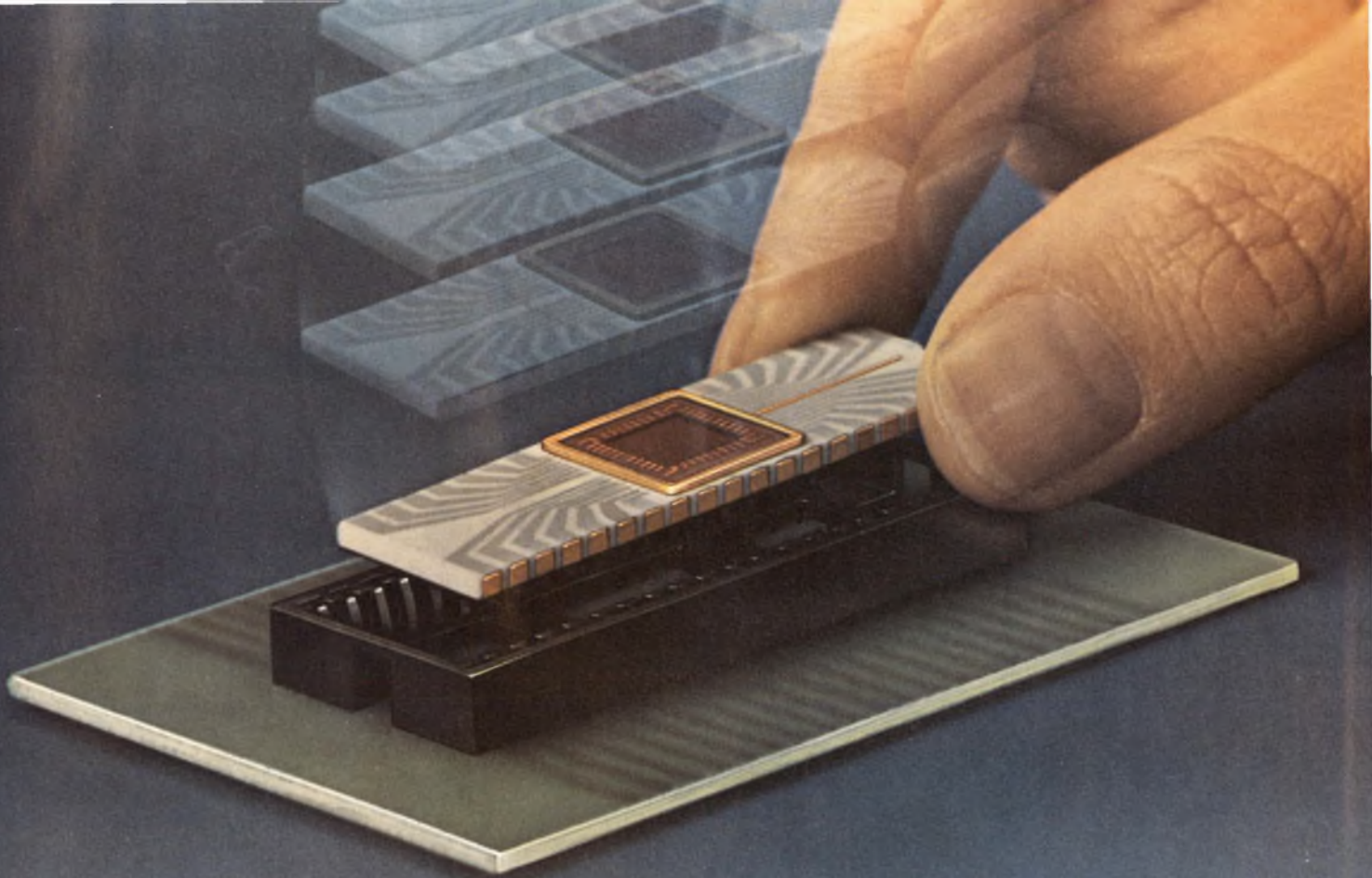

If you don't go for our leaded connectors, try our leadless.

They also give you low-cost, high-density packaging of MSI and LSI substrates. They're pluggable, too.

Both AMP lines have stored-energy contacts. Just to assure you of electrically reliable, uniform connections. While the gold or tin plating gives you optimum solderability to pc boards.

You probably know of AMP's ability to give you a wide selection of leaded sizes. To satisfy virtually all your needs.

The same is true for our leadless connectors: 40-, 28- and 24-position, dual in-line configurations. Standard on .100 x .600" centers (others available). The low-profile housing provides an overall height of less than .250".

So when it comes to high-performance connectors, take our lead. Whether they're leadless or leaded. Call (717) 564-0101. Or write AMP Incorporated, Harrisburg, Pa. 17105.



AMP
INCORPORATED

AMP is a trademark of AMP Incorporated

INFORMATION RETRIEVAL NUMBER 246

High-Speed Pulse Amplifier



**now
available
from W-J!**

A new type of high-speed switching device, the Electron Bombarded Semiconductor (EBS), has been developed by Watkins-Johnson for high-speed, low-delay, fast-rise-time switching and modulation applications.

The WJ-3653, weighing only 2¼ pounds and measuring 4.5 x 2.65 inches, will provide up to 400 volts peak output into a

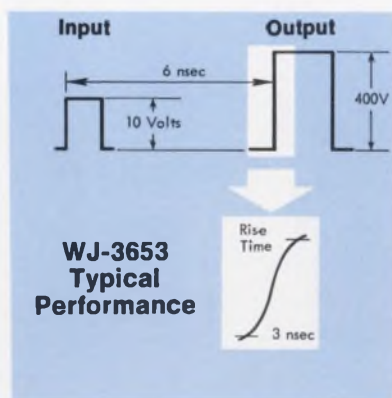

nominal 100-ohm load with less than 3.0 nsec rise time and a total delay from input pulse to amplified output of less than 6 nsec. The WJ-3653 offers over 4 A peak output current capability for operation into primarily capacitive loads.

Applications include:

- Grid modulation of high-power microwave tubes
- Pulsers for electro-optical modulators
- CRT modulation
- Modulation of power semiconductors

High-current, low-voltage versions with peak output current up to 100 A are available for solid-state laser modulation. The WJ-3653 is currently supplied with duty factors up to 4%.

For further information, contact your nearest Watkins-Johnson Field Sales Office or EBS Applications Engineering in Palo Alto at (415) 493-4141, ext. 391.

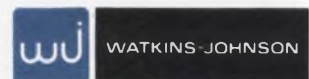

Watkins-Johnson—U.S.A.: 3333 Hillview Ave., Palo Alto, CA 94304 • (415) 493-4141 • TWX: 910-373-1253 • Telex: 34-8415 • Cable: WJPLA • 700 Quince Orchard Rd., Gaithersburg, MD 20760 • (301) 948-7550 • TWX: 710-828-0546 • Telex: 89-8402 • Cable: WJCEI • **United Kingdom:** Shirley Ave., Windsor, Berkshire SL4 5JU, England • Tel: Windsor 69241 • Cable: WJUKW-WINDSOR • Telex: 847578 • **West Germany:** 8033 Planegg, Muenchenerstr. 17 • Tel: (089) 859-9441 • Cable: WJDBM-Muenchen • Telex: 529401 • **Italy:** Piazza G. Marconi, 25 00144 Roma-EUR • Tel: 59 45 54 • Cable: WJROM-ROMA • Telex: 60117

INFORMATION RETRIEVAL NUMBER 17

VACTEC optoelectronics



New High Speed Silicon Photovoltaic Cells

Ten times faster with excellent linearity, high temperature stability, and high low-light sensitivity.

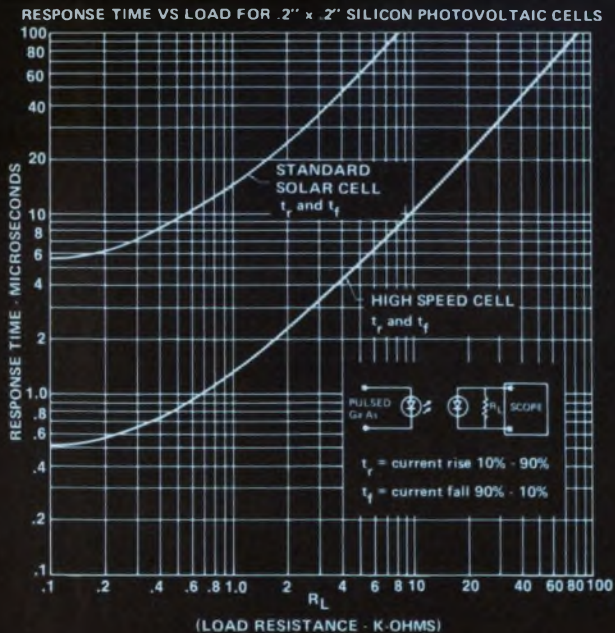

THE INDUSTRY'S BROADEST LINE:

- A. Standard and high speed silicon photovoltaic cells.
- B. Phototransistor and photodarlington.
- C. Opto-Couplers (three types).
LED/Photoconductor
LED/Phototransistor
Lamp/Photoconductor
- D. Selenium photovoltaic cells.
- E. C-MOS and Bi-polar custom I-C's.
- F. CdS and CdSe Photoconductors.

Write today for more details.



Vactec, Inc.
2423 Northline Industrial Blvd.
Maryland Heights, Mo. 63043
Phone (314) 872-8300

What would a power supply designer want to know about TRW's new Darlington family?

We asked our sales and applications engineers. And they said we should tell you 5 things:

1. It operates up to 450 Volts.
2. It offers fast switching – 250 Nsec.
3. It operates up to 25 Amps continuously.
4. It costs under \$5.00 (in quantity).
5. It is immediately available, in quantity, right off the distributors' shelves.

They assured us those five facts were enough to get any power supply designer pretty excited about our new Darlington. Were they right? Signify in the usual manner—casting your vote at the nearest office of any authorized TRW distributor. Or call John Powers, collect, at (213) 679-4561; or write TRW Semiconductors, an Electronic Components Division of TRW, Inc., 14520 Aviation Blvd., Lawndale, California 90260.

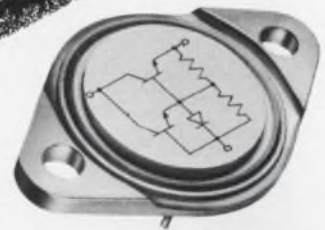

TRW SEMICONDUCTORS

These products are available through the following authorized distributors:

Almo Electronics
Bell Industries
Cramer Electronics Inc.
De Mambro Electronics

Eastern Radio Corp.
Electronics Marketing Corp.
Elmar Electronics Inc.
Hall-Mark Electronics Corp.

Harvey-Michigan Inc.
Liberty Electronics
Powell Electronics
Pyttronics

Semiconductor Concepts Inc.
Summit Distributor
R. V. Weatherford Co.
Westates Electronics Corp.

INFORMATION RETRIEVAL NUMBER 16

Portable printing calculators expected this year at \$100

The next goal for manufacturers in the highly competitive electronic calculator field is a portable, battery-operated calculator that prints like a mechanical adding machine and costs less than \$100. The company that comes up with that first stands to reap a fortune. So says Ed Rothchild, calculator product manager for NS Electronics, Sunnyvale, Calif.

"There are still about one million mechanical adding machines sold each year," Rothchild notes. "If we could come out with an electronic one that would take the same size paper roll, the mechanical adding-machine market would vanish."

When will such an electronic calculator be available? Before the year is out, Rothchild predicts. Not only his company, but Bowmar, Unicom and Texas Instruments, among others, are reported working on the concept.

Printed output on a vertical tape is important, Rothchild says, particularly in business and accounting applications. And while it is true that there has been a portable printing calculator available for some time—the Cannon Pocketronic—it sells for about \$180 and produces its output on horizontal tape, much like a ticker-tape machine.

Most current efforts to build a competitive printing calculator center on use of a thermal print head to reduce size and cost. In this approach, heat-sensitive paper is heated by a matrix of semiconductor elements to form an impression (see "Thermal Printer: Hot Challenger to the 'Flying Hammer' Method," ED No. 8, April 13, 1972, p. 26).

The print head can consist of either a single-digit matrix or a multidigit. The single-digit approach is less desirable for a portable machine, Rothchild says, be-

cause it requires a stepping motor to move it and adds weight, parts, cost and assembly time. The multidigit stationary, parallel readout approach, however, has a minimum of mechanical parts and requires only a mechanism to move the paper.

"This is the approach that will probably be most popular with calculator makers," Rothchild says.

The portable printing calculators that should debut later this year, he reports, will probably have a capacity of from eight to 14 digits. About a year after they appear, Rothchild goes on to predict, calculators that combine a digital readout with a printer will be available. This machine will probably cost about \$20 to \$30 more than the printing calculator alone.

The main problem to be overcome is to reduce the voltage requirements of the thermal print heads. At present they need between 24 and 30 V. Efforts are under way to reduce this to 9 or 12 V.

In addition to printing calculators, Rothchild sees other specialized calculators appearing in the next two years: more combination devices, such as the calculator/clock, and features like programmability and special function keys.

The main emphasis in the next year, however, will be on price slashes. According to Rothchild, calculator prices will drop 30 to 50%.

Skylab's balking gyros to be used on shuttle

Despite the problems experienced with Skylab's control-moment gyros, the space agency still plans to use them on some of the space-shuttle's payloads.

Designed to keep the manned

orbiting laboratory stable as well as to change its attitude for a variety of experiments, the three gyros were supposed to have a lifetime of eight months. The first of the 22-inch-in-diameter gyros failed on Nov. 23, after six months and a week of operation. A second began behaving erratically on Dec. 17, chalking up a few days more than seven months of trouble-free operation.

Though posing a problem for Skylab in its last weeks, the gyros have proved more than adequate for space-shuttle payload missions, which will probably last about 30 days, a spokesman for NASA says. These missions might involve putting a telescope into orbit for a specific short period of time.

The space agency doesn't know why one gyro failed and a second is behaving erratically. In fact, the second gyro still has its good days. Most of the time, however, "its rpms drop off from a desired 8912 to about 8850, the amperage rises slightly, and the temperature of the bearings goes up three or four degrees," the NASA spokesman reports.

Technicians on the ground have tried to work around the problem, but with only temporary success.

"At first they thought the problem was due to the low ambient temperature, so they managed to heat up the gyros' environment," the NASA spokesman says. "For a few days the gyro's performance improved, but then it went back to behaving as badly as before."

The ground crew still believes, however, that there was some connection between the elevated temperature and the gyro's temporarily improved performance.

If the faulty gyro should go out completely, NASA says, the craft could operate safely with its gas thrusters, but the astronauts would have to forget about experiments that require a change in craft attitude.

Skylab's control-moment gyros are mounted in gimbals, with their axes nominally mutually perpendicular. To maneuver the spacecraft, the astronaut inputs the desired attitude to a digital computer, which compares this with the present attitude. If rotation is required, the axis of one or more of the gyros is shifted by computer command.

The gyros were designed by the Marshall Space Flight Center in Huntsville, Ala., and built by the Bendix Navigation and Control Div. in Teterboro, N.J.

Sensor-computer setup troubleshoots cars fast

Ask any garage mechanic, and you'll hear increasing complaints about the difficulty in servicing today's cars. New complex safety and emission-control equipment and shortage of skilled mechanics have made troubleshooting the family car an often frustrating, time-consuming job. One solution has been unveiled by Hamilton Standard, a division of United Aircraft Corp. in Windsor Locks, Conn.

It's called Autosense, a computer-based sensing system that automatically finds out the cause of a



Autosense system employs sensors attached to engine and other parts of the car to measure vehicle operating performance. Computer is housed in console. Hand-held unit controls and monitors the test system.

car problem, then prints out the action required to fix it—all in 10 minutes or less.

Autosense uses sensors to measure ignition system, exhaust emission and other conditions programmed into its digital computer—a 16-bit serial machine. The computer contains a tape-cassette memory with a maximum capacity of 5.2 Mbits.

The computer compares problem conditions against performance specs stored on the cassettes, and then issues a printout that lists what conditions passed or failed the test and what repairs, adjustments or other actions are needed. A single standard compact cassette, for example, would contain the performance specs of all General Motors passenger cars for five years.

Sun Oil and the GMC Truck and Coach Div. of General Motors are among the early buyers of Autosense, according to Richard F. Gamble, president of Hamilton Standard. The unit is priced at \$6895, with delivery scheduled to begin in April.

Semi laser and detectors to use common substrate

An optical integrated-circuit detector has been developed that will allow semiconductor lasers and optical detectors in the 0.9- μ -to-1.15- μ range to be fabricated in monolithic form on a common substrate.

The detector uses a GaAs, dielectric waveguide structure implanted with high-energy protons in the region where a detector is to be formed, according to its developers, Robert Hunsperger, a member of the technical staff at Hughes Research Laboratories in Malibu, Calif., and Harold Stoll, Ammon Yariv and Gregory Tanguan of the California Institute of Technology in Pasadena, Calif.

For example with 300-keV protons a 3- μ -thick structural disorder layer is formed with a disorder peak occurring approximately 2.5 μ below the surface.

This structural disorder causes the previously low-loss waveguide to become highly absorptive for radiation of greater than 0.9 μ .

At 0.9 μ and above, the typical waveguide loss in the unimplanted case is less than 2 dB/cm. According to Hunsperger, one mechanism for the absorption is the liberation of free carriers that become trapped at defect centers. A photodetector results when these carriers are swept through the depletion layer generated by a reverse-biased Schottky barrier, which is deposited over the implanted region.

Devices fabricated to date have shown response times of less than

200 ns and detection efficiencies of about 16%. Better performance is expected with refinements in the procedure.

Video recording system employs low-cost discs

A prototype video recording and playback system that uses low-cost discs appears to be a strong contender for the home and educational market.

The system was developed by i/O Metrics/Videonics Corp. of Sunnyvale, Calif., and according to Peter G. Wohlmutter, the company's president: "In production we expect the home playback unit to sell for about \$300 and one-hour color program discs for \$5 or less."

The video disc is 12 inches in diameter and made from photographic films with a laminated protective coating over the emulsion. The master disc is recorded by means of a modulated laser focused with a microscope objective. Duplicate discs can be made with standard photographic techniques and can provide 10-MHz bandwidths.

The video playback units can be quite simple. A prototype home player places the disc on a transparent turntable rotating at 30 rpm. A 50-W microscope illuminator bulb provides the light source that shines through the rotating disc. Information detection focusing and tracking data come from a three-photodiode array.

Wohlmutter says the company does not intend to manufacture or market the video disc system but is negotiating with a number of manufacturers in this country and abroad.

CMOS microprocessor stirring design race

At least three companies are racing to produce the first microprocessor using CMOS—Intersil, Motorola and RCA. Software for one of the CMOS devices will be identical to that used in some minicomputers. This will sidestep the special, less familiar software required for some general-purpose MOS microprocessors now in use.

Need a DMM with a difference? ...Keithley's got 'em!

Tired of "general purpose" Digital Multimeter performance? Want that something extra that'll make your job easier? Then we've got the Multimeters for you. Take our new 5-1/2 digit, $10\ \mu\text{V}$ resolution, \$750, ac/dc Model 190...or our new 5-function, 32-range Model 165. It's even got a built-in 1 mA source for semiconductor testing. Then there's our model 171... a real do-it-all DMM. $4\frac{1}{2}$ digits, $1\ \mu\text{V}$ resolution, dc volts, ac volts, ac/dc amps, ohms too.

But the Keithley family doesn't end there. We can give you resolution to 30 nanovolts, or let you measure currents of 10^{-15} amp, or resistances to over 10^{14} ohms...we've even got a DMM that has the read-out in a probe.

If you have a job that needs a DMM and then some, we can help. Send for our Digital Multimeter selector guide or call for a demo now. Phone (216) 248-0400



Our latest "How sweet it is" proclamation is on a marble base paperweight. It's free when you request a DMM demo. Get one now!



**KEITHLEY
INSTRUMENTS**
U.S.A.: 28775 AURORA ROAD, CLEVELAND, OHIO 44139
EUROPE: 14, AVENUE VILLARDIN, 1009 PULLY, SUISSE

INFORMATION RETRIEVAL NUMBER 19

And yet another national shortage: Basic research, across the board

Basic research, the lifeblood of new electronic systems and components, is being watered down in the United States across the board—by Government, universities and industry—and leading researchers see trouble ahead as a result.

When research becomes scarce, they point out, so do new prod-



Extremely valuable research was halted by the Mansfield Amendment, says Edward E. David, Jr., former scientific advisor to President Nixon.

ucts, and, in turn, profits. Next, foreign competition flows in as naturally as water to low ground, and, if the situation isn't reversed,

John F. Mason
Associate Editor

it just never goes away.

"The United States is beginning to lag in technology," says Charles A. Anderson, president of Stanford Research Institute, Menlo Park, Calif. "We are not making adequate investments in technology."

Raymond L. Bisplinghoff, deputy director of the National Science Foundation in Washington, D.C., fears that there "will be a lack of fundamental knowledge for solving our national problems"—things like the need for new energy sources and a cleaner environment. "We really haven't done enough in understanding the processes of such things as the gasification of coal," he points out as one example.

Paul G. Shewmon, NSF's new director of materials research and an expert on nuclear physics and nuclear reactors, reports: "Tightened research budgets are patently decreasing our technical base for new developments." He notes:

"We've fallen behind the British, French and Russians in the development of nuclear breeder reactors. Six years ago we were in the lead."

In high-energy physics, another important research indicator, Shewmon says: "The CERN group in Switzerland and a joint French-German group at Grenoble, France, are farther along in this area than we are."

And Edward E. David Jr., who for two and a half years was the chief scientific adviser to President Nixon, sums up the trend: "It amounts to a tremendous erosion in our technological progress." David is now executive vice president for research and development for Gould, Inc., in Chicago.

The early signs of the research lag are already showing up:

- Schools are slowly going out of the research business.

- Bright young research engineers are an endangered species. The number of federally supported graduate students in science and engineering in the United States



Billions were spent for research in the '60s to get to the moon. Now the romance with space has dried up, and with it, another research source.

was down by 10% last year over the year before, and 60% over five years previous to 1973.

- Laboratory instrumentation is aging, and not very gracefully, with funds for replacements being squeezed hard.

Where research work is needed

Most experts see a number of areas where more research should be done in the United States. Here are some of the major ones:

Materials. "This is the biggest single area," says Edward E. David Jr., executive vice president for R&D for Gould, Inc. "Light-sensitive materials, for example, need study. Attempts to develop electroluminescent materials at lower cost for larger displays could be very important. And substitute materials must also be developed for all those used in electronic components that are going to be in short supply, such as copper and all those made from petrochemicals."

The processing of LSI devices and microelectronics. "Processing these devices is still a statistical procedure," says Frank Sullivan, director of the Guidance, Control and Information Systems Div. of the National Aeronautics and Space Administration's Office of Aeronautics and Technology in Washington, D.C. "We need to know more about the ions in a given batch and how they influence the electronic function we're trying to get out of that batch. We want to model it so we can tell 99.99% of the time what's going to happen in the molecular structure of the particular material."

Thermoplastics for use with holography. "We have a 10^5 -bit holographic memory down at Marshall Space Flight Center in Huntsville that operates in two dimensions," Sullivan says. "We want a 10^{10} -bit memory and three dimensions."

A truly nonmechanical storage. This is one of IBM's objectives, according to the company's vice president and director of research, Ralph E. Gomory. IBM is working hard to increase the density of discs and tapes, but far better, says Gomory, would be "a device that doesn't move, wouldn't wear out, wouldn't have to be repaired and would be dense and cheap." A real possibility to get all this, he says, lies in the magnetic bubble.

Josephson tunneling. This is an alternate technology being pursued by IBM in the logic

and memory area. A joint effort is under way by the company's Yorktown, N.Y., and Zurich laboratories. This work, Gomory points out, involves totally different phenomena and totally different materials compared with conventional work. It involves, for example, an experimental electronic device capable of being switched in 10 trillionths of a second. "The technology's advantages are its super low power and super high speed," Gomory says. "A disadvantage, since it is a cryogenic device, is that it must be cooled to exceedingly low temperatures."

Better materials for microwave solid-state device technology. George H. Heilmeier, assistant director of electronics and physical sciences in the Defense Dept.'s Office of the Director of Defense Research and Engineering in Washington, D.C., notes: "We are rapidly approaching fundamental material limits with silicon and gallium arsenide. On the basis of dielectric constant, thermal conductivity and saturation velocity, silicon carbide appears to be promising, but the materials problems are horrendous and we need some fresh ideas." Heilmeier adds: "This does not mean that we should forget about the further development of silicon and gallium arsenide. There are still many unresolved problems that should not go begging. We should recognize, however, that while the end, in terms of existing concepts and materials, may not yet be in sight, we should begin to address the question of beyond Si and GaAs."

Acoustic surface-wave device materials with higher coupling coefficients, lower loss and lower temperature coefficients. "At present," Heilmeier says, "the materials adopted from the electro-optics community that have the highest coupling coefficients also have the highest temperature coefficients. The ability to handle long delays is also limited. While progress is being made, long delays are not readily achievable at present, due to loss and acoustic energy spreading problems."

Display memories. Heilmeier

praises the silicon storage tube as a rugged, relatively simple device with a number of interesting possibilities, but he says its limitations need work: "At present it does not possess simultaneous read/write capability, and storage times under continuous read conditions are limited to less than a half hour."

A rugged color CRT for field use. "The shadow mask tube has problems of registration, vibrational stability and electromagnetic environment," Heilmeier points out. "On the other hand, color tubes based on penetration phosphor concepts are limited in color range and require the switching of several kilovolts at video rates. Prospects for both approaches in tough operational environments are not particularly encouraging at this time, although shadow mask color tubes incorporating new automatic dynamic convergence schemes are worth evaluating."

Software. J. S. Gansler, assistant director of planning for the Director of Defense Research and Engineering, says that "we should be putting more emphasis on software since it has become the predominant cost in computer systems, yet a proportionate share of research is not being spent on it." IBM's Gomory says his company is tackling software problems on a number of fronts: "data-base architecture, automatic generation of data bases and the merits of the various data-base organizations."

Robotics, or intelligent machines. "A roving, unmanned vehicle on another planet," NASA's Sullivan says, "must be able to make an experiment and, depending on what it discovers, make the appropriate next step—all based on software."

High-energy laser work. The need for improvement is recognized by many, including Patrick E. Haggerty, chairman of Texas Instruments.

High-temperature superconducting materials are "a very promising area," says Paul G. Shewmon, director of material research for the National Science Foundation.

■ Foreign competition is becoming stronger.

If that isn't cause enough for alarm, the research leaders cite this clincher: The fruits of present American R&D—the blueprints for technological advances—are being sold abroad at what many consider bargain rates. Japan has been the major customer, with the Soviet Union showing increasing enthusiasm for purchases.

How it started

When and why did the research lag begin? It started subtly in



The Government should ease up on antitrust restraints to promote technological progress, says SRI's president, Charles A. Anderson.

1963 when the R&D money in the nation's Gross National Product stopped moving up and started down. At the same time R&D in the Soviet Union, Japan and West Germany began to move up.

Hard cash has continued to flow into this country's R&D hoppers, hitting \$30-billion last year—\$18-billion by the Government and \$12-billion by industry—but inflation has been eating away at the appropriations. For all practical purposes, 1968 was the last big research year.

Money to compensate for inflation wasn't pumped in for a num-

ber of reasons. Everyone was feeling the money squeeze. Cities and universities, for example, were spending fortunes just to keep from falling apart. And the U.S. was supporting a very expensive war in Indochina. Something had to give, and research was it.

At the same time engineering-school enrollments dropped markedly, the glamour of engineering—a by-product of Sputnik and the man-on-the-moon effort—had worn thin.

"The number of students interested in a career in engineering declined sharply over the past few years," says Irwin W. Sizer, dean of the Graduate School at the Massachusetts Institute of Technology in Cambridge, Mass. He gives these reasons for the drop:

■ Lack of Federal support: "Six years ago there were 800 Federal fellowships at MIT; today there are 350."

■ Lack of jobs. Cutbacks in aerospace and defense work left students with poor prospects for finding engineering work.

■ Rejection of industry values by youth. "During the Vietnam years, youth turned away from big industry. It was 'bad.' They wanted nothing to do with it."

Youth largely turned off

David of Gould, Inc., agrees that the nation's youth was largely turned off by R&D during the Vietnam War years. He notes:

"A whole counterculture sprang up that held that technology is not good, that the rational point of view is inhuman. Research aided war."

A number of colleges started refusing Government contracts. And many young people who might have become physicists did other things.

A tremendous amount of very valuable R&D was wiped out in 1970 by the Mansfield Amendment, David points out. The amendment forced the Defense Dept., which had been the nation's biggest sponsor of basic and applied research in the physical sciences, to award research contracts only if the results could be predicted and if the findings could be used in a weapon system. In other words, basic research was out; only very

selective research was permitted.

"It was a very unwise move," David says. "The biggest supporter of R&D in the physical sciences was forced to halt work on materials, circuitry, electron devices and even electronic systems on the basic and applied research levels.

"Theoretically the National Science Foundation was supposed to pick up the research effort, and some of the projects were transferred out of the Pentagon to NSF, but not with the same vigor or at the same level; they were no longer coupled with real, tangible projects."

Bisplinghoff, the NSF's deputy director, notes: "We just didn't have the budget to pick up the Dept. of Defense projects that had been cut back."

Soviet forging ahead

Meanwhile the Soviet Union has not been idle. "The Soviets spend about twice as much as we do for military R&D," says J. D. Gansler, assistant director of planning for the Director of Defense Research and Engineering in Washington, D.C. "It's about the same in dollars, but it amounts to 12% of their GNP while we're spending 6%."

The Russians have stepped up research in the civilian sector in a very organized way. Pravda, the official Communist Party newspaper in the Soviet, reports that the government recently formed research and production associations that are responsible for the design and development of new products up to the initial production stage.

Besides doing more research work at home, the Russians are buying as much technology from abroad as they can—an activity that has created controversy in the United States.

Hasn't the Government tried?

All experts agree that an important step to revive basic research in the U.S. is to link research efforts by the Government, industry and universities. And the Government has tried to do this. Cross-fertilization programs have been worked out by the National Science Foundation and the National Bu-

Due to a major industry breakthrough it is now possible to get gassed automatically.



The breakthrough: \$990 for a full-blown OEM computer in quantities of 200—the NAKED MINI®/LSI. The possibilities? Virtually endless.

With our new mini, for example, you can build the gas station of the future. Right now. Because the NAKED MINI/LSI makes it economically feasible to handle even the most mundane jobs by computer.

For instance: complete self-service gas pumping by inserting credit cards or cash. Automatic card verification. Taking “bad” cards out of circulation. Volume profiling by hour, day, month or year. Round-the-clock monitoring of activities. Alerting security centrals to vandalism, excessive gas fumes or fires.

But there's a lot more. Our computer can also run station vending machines. Help plan gas delivery schedules. Talk to motel/hotel computers so the traveler can make advance reservations by credit card.

Still, with all these added tasks, you're only using a small percentage of our available computer power. The power of our full-scale LSI processor with 168

instructions, 4K x 16 memory and fully implemented input/output for low-cost interfacing.

At \$990 per mini, you can afford to take new design routes. Develop new functions that result in better mileage and more convenience for you and your customers. It could be an innovative drive for gas stations or any other business that would profit from computer automation.

Write or call: Computer Automation, Inc., 18651 Von Karman, Irvine, California 92664. Tel. (714) 833-8830. TWX 910-595-1767.

THE NAKED MINI® COMPANY
Computer Automation, Inc.

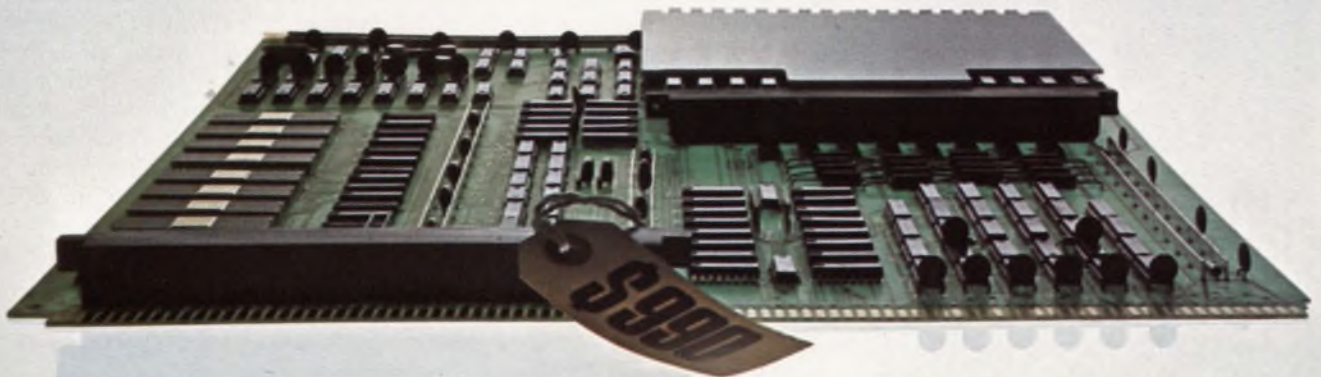

*NAKED MINI is a registered trademark of Computer Automation, Inc.

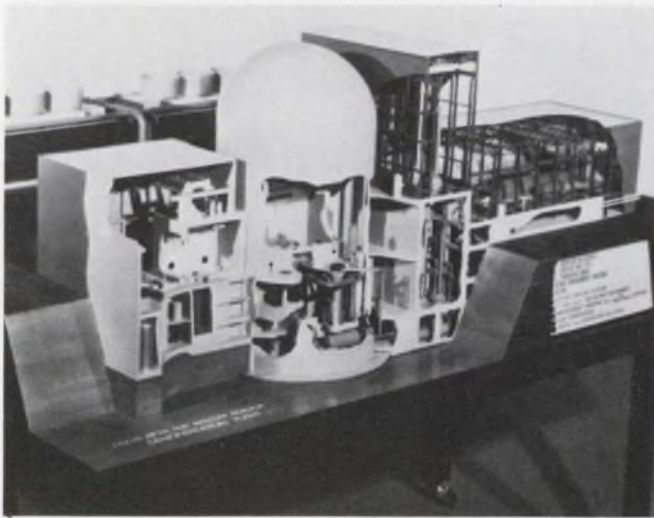

First commercial-size, light-metal, fast, breeder-reactor demonstration plant is scheduled for completion by West-

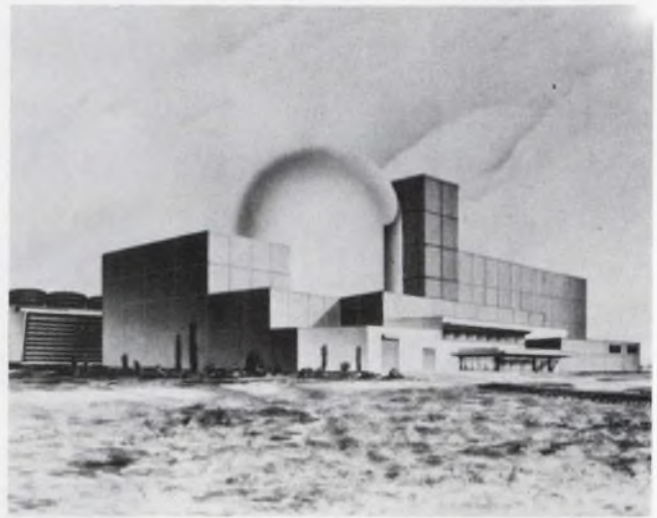

inghouse by late 1980. France, Britain and Russia are already putting plants of this size on line.

reau of Standards, but the results haven't been too good, according to Anderson, the Stanford Research Institute's president.

"There seems to be an inordinate bureaucracy built up around these efforts," he says. "The problems that seem to receive attention are global in scope while . . . the more discrete, tangible and real problems faced by the industry are not being addressed—problems such as automating the assembly line, removing SO₂ from stack gases and developing high temperature alloys. And, also, industry has yet to believe that the program is a serious effort by the Government."

Badly needed, Anderson says, is a move by the Government easing up on antitrust restraints, so that big corporations can work together to solve technological problems.

An IBM vice president and that company's chief scientist, Lewis M. Branscomb, also sees room for



A system of radio telescopes in New Mexico is getting off to a rocky start, the National Science Foundation reports, with only half enough money appropriated to finish the project.

Government action—and industry action as well.

"There are not enough effective Government policies that are specifically designed to encourage the linkage between academic and industrial sciences," he asserts. "There are too few companies prepared to invest in long-range exploratory research, and there is too little attention given by state and local governments, as well as the Federal, to the capabilities of industrial technology to deliver useful new tools for addressing public needs."

Politics doesn't help

One big obstacle, David contends, is politics. "If you're going to get support for a program you've got to make it big and visible with definite goals," he says. "You've got to tell people what you're going to do and what you're going to get. You have to make promises—hopefully ones you can fulfill."

Such guidelines may be helpful in industry, David says, but they don't work well in basic research. The very nature of basic research means you don't know what you're going to get until you get it.

One answer: Educating the public. "But the right kind of education," David says. "Take the supersonic transport. People tried to judge it on aspects they didn't understand. They didn't need to understand supersonic flight, swept-back wings, titanium technology nor the physics of the atmosphere. They needed to under-

stand that scientists and engineers needed to make experiments to determine whether an SST was a technologically and economically sound venture."

Two hopeful signs

On the bright side, there are two hopeful signs.

"I think the antagonism of youth to industry has modified," MIT's Sizer says. "They understand our dependence on industry a little better. Big industry, after all, is going to have to pull us out of the energy problem."

Also, the employment picture has turned around dramatically. "There's big demand for engineers now," Sizer reports. MIT is combating the lack of Federal fellowships by hiring students to work part-time in its newly created energy laboratory.

"Enrollment at MIT for 1973 was back to normal," Sizer notes.

But it takes 10 years to train a good research engineer, and the harvest from the dry years is about to emerge.

"There's already a great scarcity of engineers competent to work in this field of energy conversion," Sizer says. "And in another two years there'll be a scarcity of engineers in other fields."

Virgil L. Stout, manager of the Federal Electric Solid State and Electronics Laboratory in Schenectady, N.Y., agrees.

"We're going to be hard-pressed, a year or two from now, to find qualified young people for creative engineering jobs," he says. ■■

Even when it was only \$35 an ounce, gold was expensive. That's why we started long ago to reduce the amount of gold in our contacts to a minimum.

In 1958 we developed a really reliable gold dot contact. And no matter what anyone else says, only silver and copper are better electrical conductors than gold

(but gold doesn't oxidize or corrode).

Over the years we've been able to reduce the cost because we reduced the gold.

And we've been reducing the amount over the years without reducing the mechanical or electrical quality of our connectors.

Now, after all these years, we

find out that we not only reduced cost but we've been making our own small contribution to solving our country's gold problem.

And all because we wanted to design a more economical, more reliable gold-contact connector.

GTE SYLVANIA

INFORMATION RETRIEVAL NUMBER 21

Our small contribution to solving the gold problem.

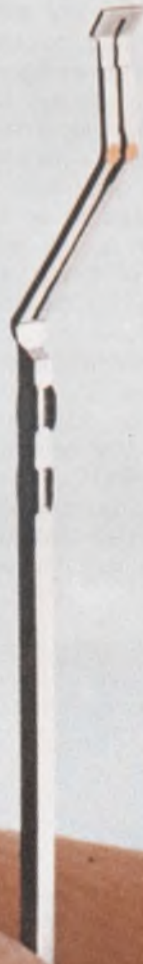

How HP engineers built world's first pocket programmable calculator

How do you put 12 IC chips and a card reader in a case originally designed to hold five chips?

That essentially was the problem Hewlett-Packard faced when it decided to build the world's first pocket programmable calculator—the HP-65. The problem was solved by a combination of three semiconductor technologies—NMOS, PMOS and bipolar—hybrid-circuit techniques and clever mechanical design.

Two years ago HP introduced the world's first pocket electronic slide rule—the HP-35—a five-chip calculator. From this, the company's designers have come up with the HP-65, a pocket machine that offers the capabilities of a desk-top programmable calculator at about one-third the cost (see "The HP-65 Calculator Arrives: First Pocket Programmable," p.

Jules H. Gilder
Associate Editor

120, this issue).

While the HP-65 looks much like the company's earlier calculators—the HP-35, HP-45 and HP-80—the similarity is only superficial. Except for the case, keyboard and display, the inside of the new calculator is quite different.

According to Chung C. Tung, engineering group manager for the HP-65, a primary requirement was that the calculator fit into the same case as its predecessors. This was no easy task. The computing power had to be enhanced by an increase in the number of chips from five to 12, and a magnetic card-reading mechanism had to be included.

Three new chips were developed for this calculator: a bipolar sense amp chip for the card reader, a PMOS program storage chip that would interface with the other PMOS chips already developed for the earlier calculators and an NMOS card reader logic chip.

NMOS was chosen, Tung says, because HP has NMOS capability and it wanted to do the job in-house.

Tung notes that the designers realized fairly early that it would be impossible to fit 12 discrete integrated circuits into a space originally designed to hold only five. So they decided to use hybrid circuit construction.

Six of the IC chips were bonded to a ceramic substrate and interconnected to form one large hybrid IC (see photo). This reduced significantly the space needed for the electronics.

The next major problems, reports Tung, was the magnetic card reader. "At first we thought we might use a motor and a gear arrangement, similar to that found in watches," he explains. But that proved to be too big and complicated; there were too many mechanical parts that could go bad. The reading-mechanism problem

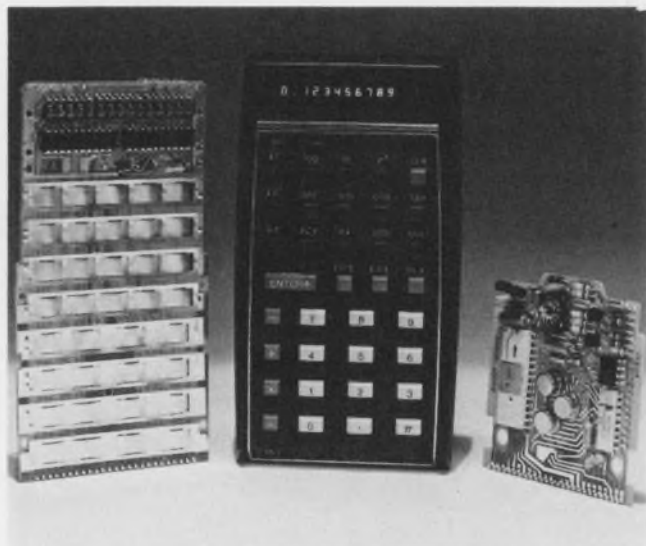

The HP-35, the first pocket electronic slide rule to be introduced, contains five ICs.

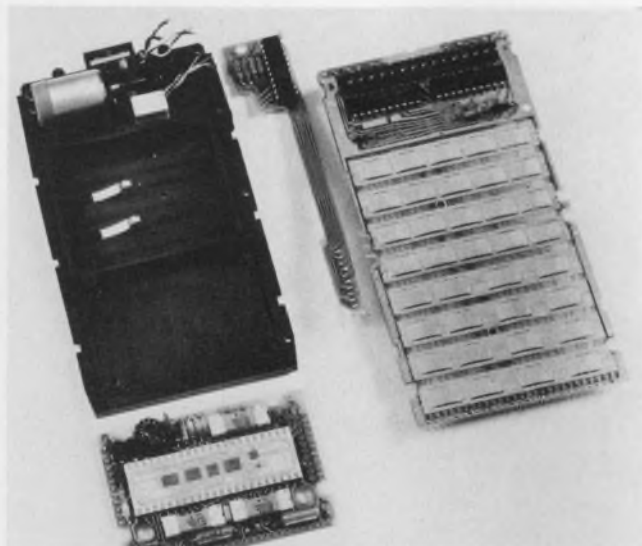

The programmable HP-65 uses hybrid techniques to accommodate 12 chips. A card reader is also included.

Another OEM doesn't go to the devil.

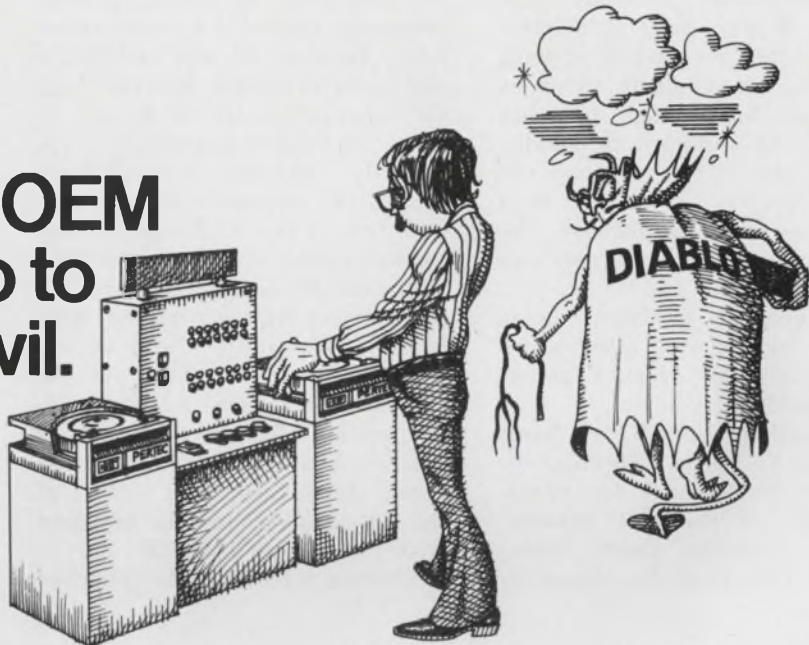

He went to Pertec for his disk drives. And he's buying drives that exceed Diablo capabilities while interfacing just as they do. A good business decision. And very good drives for his systems.

He had his choice from Pertec's top and front loading versions. Both are plug compatible and identical in interface and size. They offer 35 msec access time (twice as fast as Diablo), margin testing, a choice of electronic or mechanical sectoring, and an optional fixed platter.

And they offer many standard features that you cannot even get as options on a Diablo Series 30 or 40 drive. Like independent write-protect for each platter, track offset and a built-in power supply.

And all of these features fit into a serviceable and compact 8¾ x 26 inches. We can even provide a cost free Diablo Series 30 compatible interface and align our heads to offset the tracks just as they do. So there is no costly redesign time if you're currently buying Diablo drives.

Of course you get the same assistance in design, development and maintenance of your system with our disk drives as you do with our tape drives and printers... Factory training for your service people. And back up by a sales, service and support network spanning major U.S. cities and many foreign countries.

All at surprisingly low prices.

Pertec is serious about satisfying your disk drive requirements. And we'd like to prove it. Call us collect in the area nearest you: Boston (617) 890-6230; Chicago (312) 696-2460; Los Angeles (213) 996-1333; London (Reading) 582-115. Or write us at 9600 Irondale Avenue, Chatsworth, California 91311.



The best values in
computer peripherals
come from

PERTEC

Already the world's
largest independent
manufacturer
of tape transports.

INFORMATION RETRIEVAL NUMBER 22

was solved by use of a small brushless motor and a simple worm gear. The gear drives a roller that moves the card through at a steady rate.

Another problem was getting the desired information—100 program steps—onto a small card. "In one of our early attempts," Tung reports, "we wound up with a card that was about twice as long as our final design, but that proved to be awkward to handle. Then the size of the card was cut in half, but to use it, the card would have to pass through the reader twice. But Mr. Hewlett was against that."

The card-size problems were overcome by use of a new recording technique on which a patent is now pending.

Commenting on HP's latest achievement, Michel Ebertin, director of development for microelectronics at Rockwell International in Anaheim, Calif., notes: "HP is a pioneer in the magnetic-

card business. Back in 1967 they came out with the 9100, which was one of the first programmable desk-top calculators to use magnetic cards."

Rockwell originally discounted the possibility of putting a magnetic-card reader in a pocket calculator, because of size, reliability and noise problems. But now that HP has demonstrated it can be done, Rockwell engineers have apparently changed their attitude toward this approach. Ebertin now says that if one of Rockwell's customers wants a calculator similar to the HP-65, he can have working prototypes within six months. And, he adds, it would probably be less expensive than the \$795 for the HP-65. The reason a lower price is possible, Ebertin explains, is that such a calculator would use fewer chips. Rockwell's version of the HP-35 uses one chip compared with the five used by HP.

Ebertin notes that Rockwell had

the capability 18 months ago to produce a programmable calculator that did not use magnetic cards. "We didn't do very much with that because none of our customers wanted a calculator like that at that time," he reports. "Since we do not sell directly to the consumer, what we produce is determined by our customers."

But apparently someone does want such a programmable calculator now. Ebertin says that Rockwell has lab prototypes of a cardless programmable calculator, and he hints that the company will be showing "something exciting" at the IEEE show next month.

As for further developments in the pocket-calculator field, industry rumors are that a pocket printing calculator might be available next. Just how this would be accomplished no one is saying, but speculation is that thermal print heads will be used with some sort of replaceable paper cartridge. ■■

Automatic sonobuoy locator spots up to 31 beacons simultaneously

With 10 sets of antennas and a Univac 1832 computer, the Navy's new S-3A antisubmarine warfare aircraft can pinpoint simultaneously up to 31 sonobuoys in the ocean. It's not necessary for the plane to fly over a sonobuoy to locate it, or for the crew to spot it visually. The buoy need only be within line of sight of the aircraft, and it is pinpointed in the day or night in any weather.

And the new system has wider applicability; it can be adapted for the location of any beacon. Potential applications include aircraft instrument-landing systems, navigation update, scientific studies of ocean currents and the location of transmitters in electromagnetic warfare.



In the slant-range measuring mode, a signal is sent to the sonobuoy via the aircraft's uhf command transmitter. The signal is converted to vhf in the buoy and sent back to the aircraft. The phase delay of the signal is a measure of slant range.

Called the Sonobuoy Reference System by its developer, Cubic Corp. of San Diego, it works basically as follows:

Two types of sonobuoys can be dropped by the S-3A. One type—

the one most commonly used—is a nonrepeater; the other is a repeater. Both transmit signals to the aircraft on one of 31 standard channels in the 162-to-174-MHz band. A sonobuoy is a listening

David N. Kaye
Senior Western Editor

There's no such thing as an "Augat-like" socket.

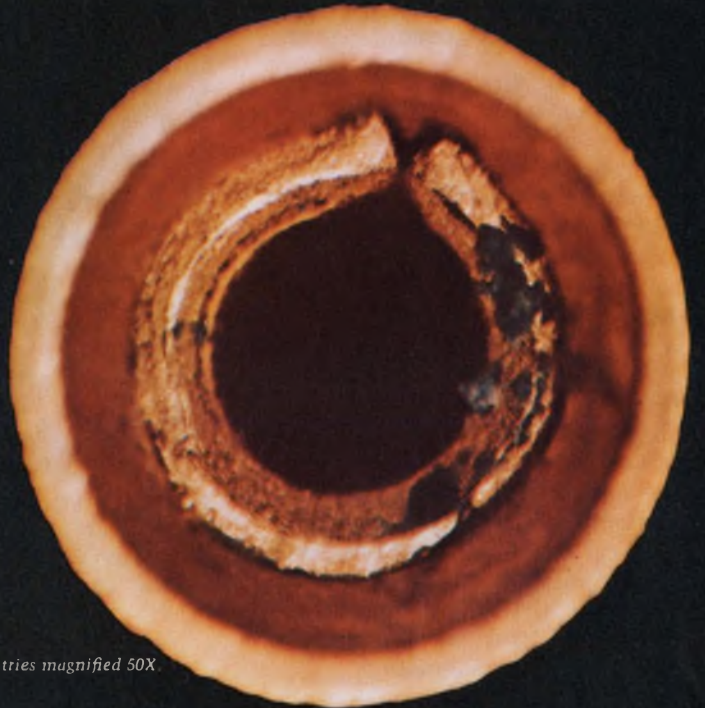

**Unretouched contact entries magnified 50X*

Either it is...

or it isn't



Lots of our competitors call their stamped contacts "Augat-like". But frankly they're not. Because no stamped contact can compare to the Augat machined assembly.

Look for yourself. Note how both the sleeve and contact of the 500 Series socket are precision-machined. Not stamped. Not formed. And how the contact is completely and uniformly covered with gold. Guaranteed .000030" minimum.

Augat's contact offers firm retention and excellent reliability for a wide range of lead sizes. Also, the wide-angle tapered entry makes IC insertion easier, faster and virtually error-free.

The extremely low profile 500 Series socket is available in sizes from 8 through 40 contacts, and features Augat's unique closed end sleeve that completely eliminates solder wicking problems.

So you see, there is no such thing as an "Augat-like" socket. The closer you look, the more you see why.

AUGAT [®] Augat Inc.
33 Perry Avenue
Attleboro, Mass. 02703
(617) 222-2202

post with a sensitive microphone that picks up underwater submarine noise.

When a modulated signal is sent to a buoy via the aircraft's uhf command link, it is returned to the aircraft over the standard vhf sonobuoy channel.

Ten antenna sets used

With the first type of buoy—the nonrepeater and the least expensive of the two—the aircraft receives the signal on a pair of antennas spaced less than a half wavelength apart. The S-3A has 10 sets of 10-inch blade antennas spaced along the wings and fuselage for ultra-accuracy.

The difference in the time of arrival of the signal at any antenna pair is equivalent to the phase difference. This phase difference and the spacing between the antennas is related to the direction cosine of the sonobuoy—the bearing of the buoy relative to the aircraft. This bearing is measured with the aircraft in two different positions, and the sonobuoy is located by triangulation.

To cancel out inaccuracies caused by such things as multipath distortion and phase differences in the cables and connectors, data are processed in the on-board computer. A modified Kalman digital filtering technique is used. The Univac 1832 computer uses 36-bit data words and requires about 4000 words of memory. It stores the last known position of a buoy and compares it with the 10 measurements from the antenna pairs. The pair measurements that are closest to where the computer estimates that the buoy should be are the measurements that are assumed to be correct. Each time that the computer scans the antennas, the measurement becomes more and more accurate. An average scan of the 10 antenna pairs takes about a half second.

Slant range measured

If a buoy has the repeater capability, the slant range, or distance from the aircraft to the buoy, can be measured directly. When this information is added to the bearing, the buoy can be located without triangulation. This

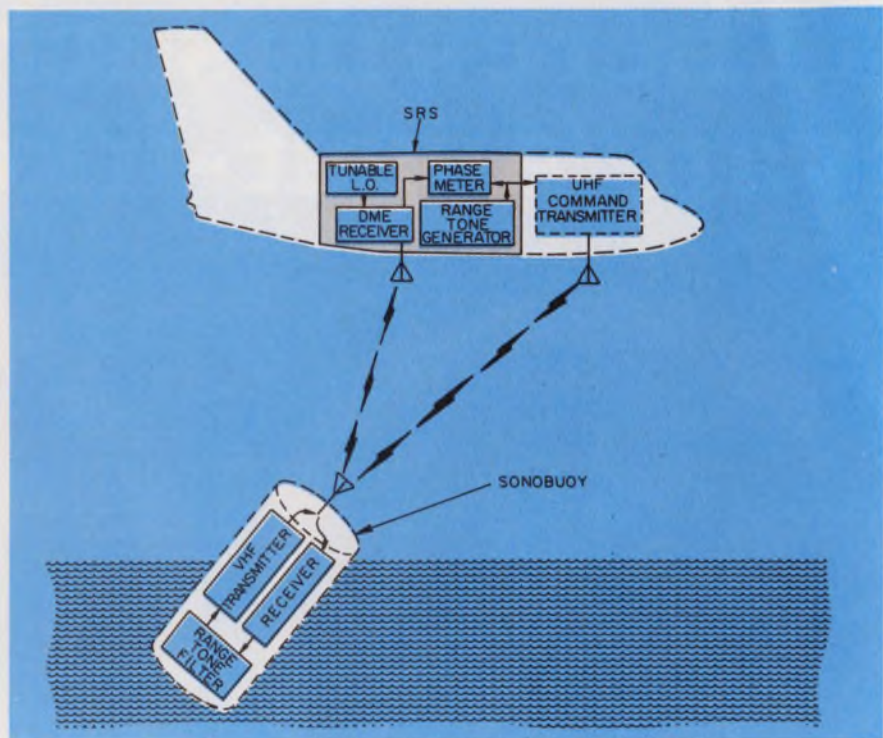

The S-3A aircraft operates on carriers and hunts the seas for potential enemy submarines. A unique feature of the plane's electronics is the Cubic sonobuoy location system. Three of the 10 antennas, with 10-inch blades, can be seen under the fuselage of the aircraft.

method of determining position is much faster than the first technique.

A phase-comparison technique is also used with the repeater buoys. But instead of measuring the phase difference between an rf signal arriving at two antennas, as in the angle-measuring case, measurement is made of the phase delay of a low-frequency modulation. The phase delay is a function of the number of wavelengths between the aircraft and the buoy, and therefore is readily converted into distance or slant range.

To get the highest accuracy, the S-3A system uses two different modulation frequencies. These tones do not interfere with the buoy's normal functions. One is high enough in frequency so extremely precise total system accuracy is obtained. To remove any system ambiguity, a second frequency, called the coarse tone, is also used; this frequency is one-eighth that of the fine tone.

The position of the sonobuoys is not only available digitally; a CRT display with two modes of operation can be used. One mode shows an aircraft in the center of the screen, with dots for each of the

buoys; the other shows the buoys as almost stationary dots, with the aircraft moving about. Another indicator on the panel can also be used to let the pilot know when the aircraft is directly above a particular buoy.

Autocalibration featured

"Any system that requires a precise determination of phase is worthless unless it can be readily and often calibrated," says Richard Keller, product manager for Cubic. So a self-calibration feature is built into the system. Every 15 minutes the computer orders calibration of all component parts on board the aircraft. This includes the antennas, cables and connectors. A signal simulating reception from a buoy is generated by a small transmitter at the base of each antenna. The signal is sent through the antenna and down the transmission line to the receiver. Measurement of phase delay is made by the computer. The phase delay of antenna pairs is compared, and any changes due to temperature or other factor are noted by the computer and accounted for in the next buoy location measurement. ■■

GI stable mates

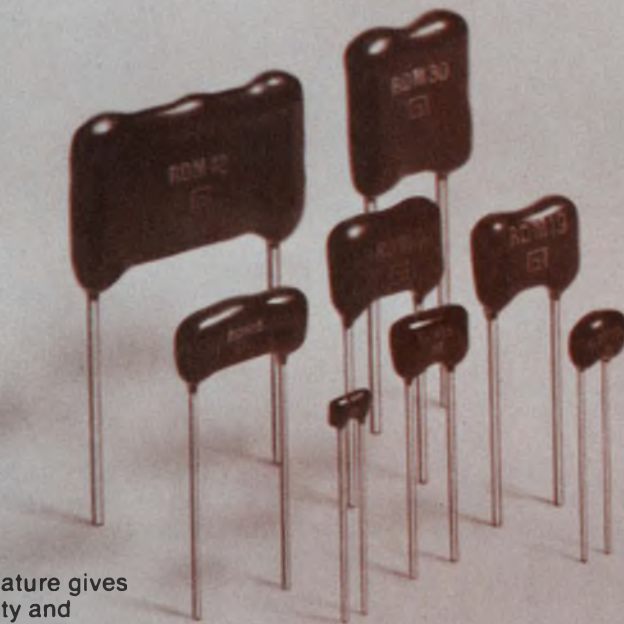

Stable because nature gives mica its conformity and volumetric efficiency. Mica capacitors are perfectly mated to the needs of communications, instrumentation and navigation circuitry. They're best suited for critical circuits requiring maximum long life stability over a temperature range of -50°C to $+150^{\circ}\text{C}$. For circuits involving delay, timing and frequency discrimination.

A tough epoxy coating provides a long lasting moisture barrier. GI mica capacitors deliver close capacitance tolerance, are available in commercial and military types, from 1 to 100,000 pF and working voltages from 100 to 2,000.

For more information write for a copy of "Mica Capacitor Technical Bulletin MC-2". Capacitor Division, General Instrument Corporation, 165 Front Street, Chicopee, Mass., 01014, Phone (413) 594-4781. In Canada (416) 763-4133.

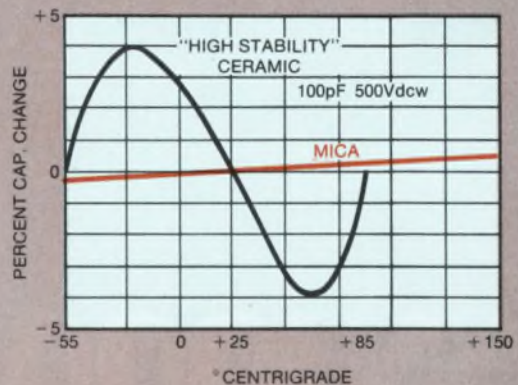

**GENERAL INSTRUMENT
CORPORATION**



Design

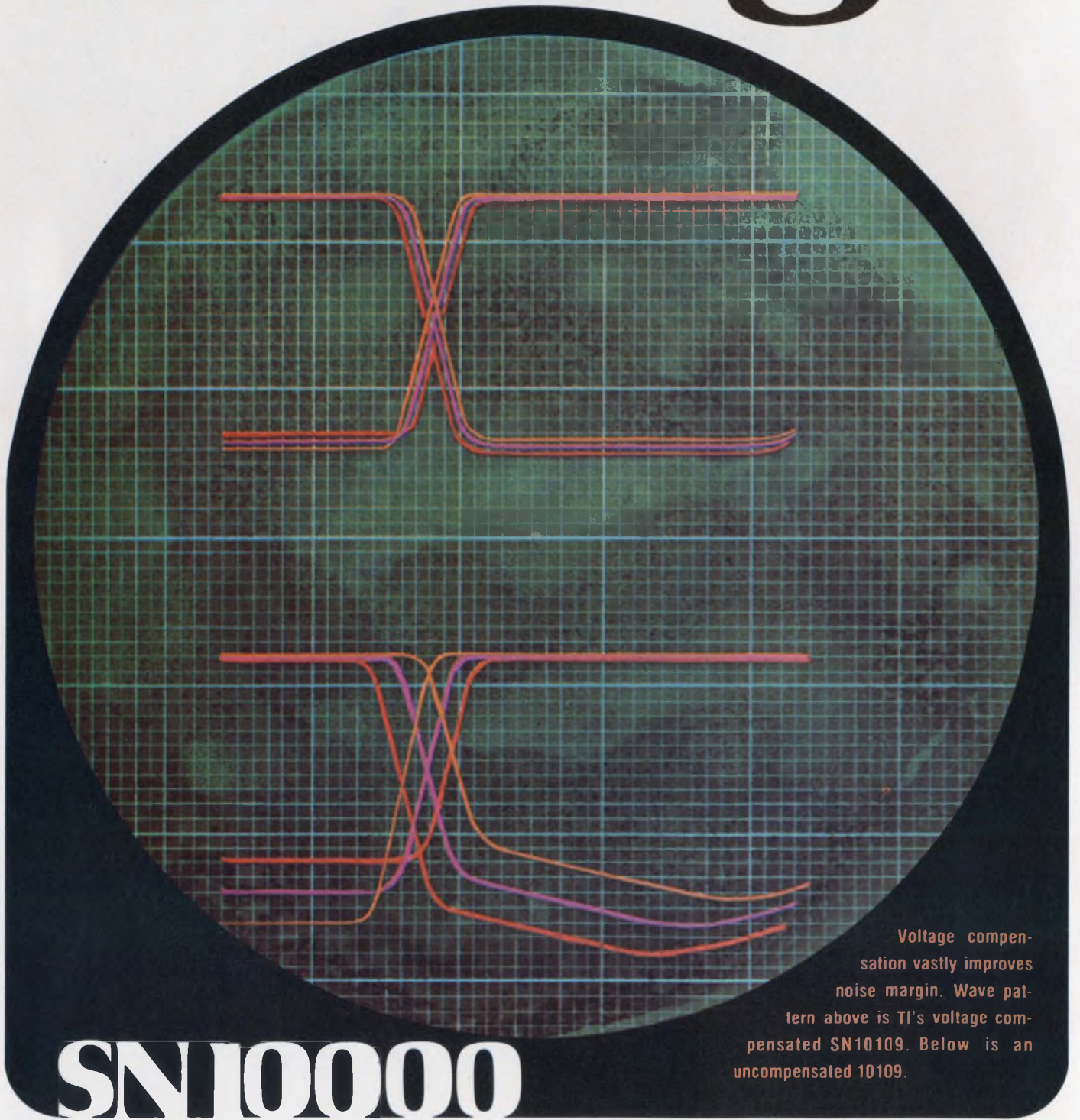

Voltage compensation vastly improves noise margin. Wave pattern above is TI's voltage compensated SN10109. Below is an uncompensated 10109.

SN10000

Latitude

34 voltage compensated ECL functions ease power distribution constraints...up to $\pm 10\%$.

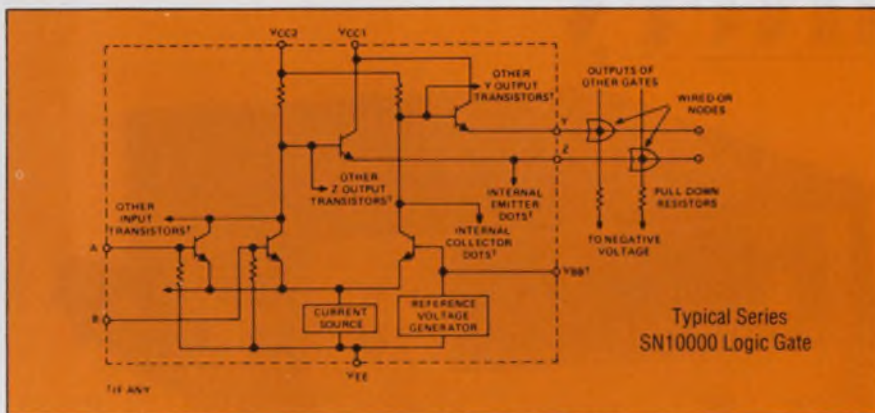

Most ECL functions on the market today are not voltage compensated. Texas Instruments SN10000 devices are. All 34 of them.

Here are some reasons why:

Voltage compensation improves noise margin—by as much as 140%. It also increases power distribution tolerance—up to $\pm 10\%$ —giving you greater design latitude.

SN10000 devices also let you reduce your system IC count. Especially over logic forms that do not offer complementary OR/NOR outputs with wired-OR connection capability. Conventional or controlled circuit boards can be used.

So voltage compensated SN10000 devices offer you both relaxed design rules and reduced system costs. Plus, you get high ECL speed (2 ns) with low power (25 mW/gate). And, pin-for-pin compatibility with other 10000 families. Operation is guaranteed from 0° to 85° C.

SN10000 devices are available now in 16-pin plastic, dual-in-line packages through TI distributors or directly from Texas Instruments.

For a data sheet booklet covering the SN10000 Series, write on company letterhead to Texas Instruments Incorporated, P. O. Box 5012, M/S 308, Dallas, Texas 75222.



Gates, Drivers and Receivers

	100-Piece Price
SN10100	Quad 3-Input NOR Gate (One Input Common) \$1.40
SN10101	Quad 2-Input OR/NOR Gate (One Input Common) 1.40
SN10102	Quad 2-Input Gate (3 NOR, 1 OR/NOR) 1.40
SN10103	Quad 2-Input Gate (3 OR, 1 OR/NOR) 1.40
SN10104	Quad 2-Input AND Gate 1.76
SN10105	Triple OR/NOR Gate (2, 3, 2 Inputs) 1.40
SN10106	Triple NOR Gate (4, 3, 3 Inputs) 1.40
SN10107	Triple 2-Input Exclusive OR/NOR Gate 1.76
SN10109	Dual OR/NOR Gate (4, 5 Inputs) 1.40
SN10110	Dual 3-Input OR Line Driver 1.76
SN10111	Dual 3-Input NOR Line Driver 1.76
SN10112	Dual 3-Input OR/NOR Line Driver 1.76
SN10115	Quad Line-Receiver 1.40
SN10116	Triple Line-Receiver (Complementary Outputs) 1.40
SN10117	Dual 2-Wide 2-3 Input OR-AND/OR-AND Invert Gate 1.76
SN10118	Dual 2-Wide 3-Input OR-AND Gate 1.76
SN10119	4-Wide 4-3-3-3 Input OR-AND Gate 1.76
SN10121	4-Wide 3-Input OR-AND/OR-AND Invert Gate 1.76

Complex Functions

SN10124	Quad TTL to ECL Translator 3.66
SN10125	Quad ECL to TTL Translator 3.66
SN10130	Dual D-Type Latch 3.66
SN10131	Dual D-Type Master Slave Flip-Flop 4.78
SN10132	Dual D-Type Latch 3.80
SN10160	12 Bit Parity Checker/Generator (Odd) 5.61
SN10161A	3 to 8 Line Decoder (1 of 8 Lines Low) 4.92
SN10164A	8 to 1 Multiplexer 5.61
SN10174A	Dual 4 to 1 Multiplexer 5.61
SN10175	5 Bit Register 5.61
SN10179A	Carry Look-Ahead 5.61
SN10184	Quint ECL to MST Translator 5.61
SN10185	Hex MST to ECL Translator 5.61

Memories

SN10140JE	64 x 1 RAM (15 ns) 90 Ω Load 11.88
SN10147JE	128 x 1 RAM (15 ns) 50 Ω Load 15.00
SN10148JE	64 X 1 RAM (15 ns) 50 Ω Load 10.00

TEXAS INSTRUMENTS
INCORPORATED

83020

ac, dc, volts, amps, ohms

25 ranges

\$595 complete

5-day delivery



INTRODUCING Systron-Donner's all-function 7004A Digital Multimeter Measures dc and ac voltage, dc and ac current and resistance New improved circuitry expands AC response to 100 KHz New color-coded pushbuttons help distinguish functions New carry case option New simplified calibration Optional battery pack with recharger (\$95) mounts internally 1,000 megohm input impedance on 3 lowest ranges 0.01% dc accuracy. For lab, field or systems use (with DTL/TTL compatible BCD outputs, \$45 additional).

Contact your local Scientific Devices office for more 7004A details or: Concord Instruments Division, 10 Systron Drive, Concord, CA 94518. In **Europe**: Systron-Donner GmbH Munich W. Germany; Systron-Donner Ltd., Leamington Spa, U.K.; Systron-Donner S.A. Paris (Port Marly) France. In **Australia**: Systron-Donner Pty. Ltd. Melbourne.

We made a good DVM better!

SYSTRON  DONNER

The Systron-Donner Instruments Group:

Concord Instruments Computer Systems Datapulse Kruse Electronics Microwave Trygon Electronics

INFORMATION RETRIEVAL NUMBER 26

washington report



Heather M. David
Washington Bureau

The S-3 may be Navy's new early warning plane

As a shortcut to finally getting a fleet of 20 to 30 early warning aircraft to protect the fleet the Navy is thinking about using the Lockheed S-3 antisubmarine warfare aircraft frame (see p. 36 this issue). Instead of ASW equipment, the Navy would equip the plane with an electronic intelligence gathering package consisting of signal intelligence and communications intercept equipment that would detect, locate and identify hostile emitters. Lockheed has been told to come up with a plan to modify the airframe, and two teams—Sanders and E-Systems and Litton and ESL—will be awarded competitive subcontracts to design the electronic package. Litton's Amecon Div. was also awarded a contract from the Naval Air Development Center for a limited-range, wide-open broadband receiver for instantaneous frequency measurements, a technology that may be applied to the S-3 electronic intelligence gathering aircraft.

Pentagon sharpening nuclear-warhead potential

The Defense Dept. plans major improvements in nuclear warheads to increase their accuracy and versatility. The Army is looking at a smaller and more accurate warhead for the Pershing missiles based in Europe, with the objective of reducing potential damage to areas outside any target range. The key to the development is a radar map-matching guidance system that would compare in-flight radar data with stored map information.

The Navy plans to build a prototype model of a new warhead for the Trident missile, with separately maneuvering re-entry vehicles (MARV). Unlike the MIRVs, which are dropped off into ballistic trajectory, the MARVs would be able to evade enemy defensive systems through programmed course changes. Some \$200-million will be spent in the next few years for the prototype MARV program.

AF pressing all-digital avionics development

Boeing Aerospace has won a key contract in the Air Force's drive toward a centralized, all-digital avionics system. Boeing, together with Honeywell and Softech, will develop a Digital Avionics Information System (DAIS) to organize aircraft electronics systems around common computer modules, thereby eliminating the proliferating black boxes and separate electrical wiring now installed in sophisticated military aircraft. The centralized computer complex would handle sensor information (radar, infrared electro-optical), make computations according to function

and display the information to the crew on screens. The system will be designed so that one set of sensors could be substituted for another, depending on the mission. Boeing will specify the core elements of the system and deliver plans to the Air Force for a "hot bench" ground simulation system. The Air Force Avionics Laboratory at Wright-Patterson AFB, Ohio, will contract for development of mission software, language compilers and other work.

Atomic energy transmission projects suggested

Dixie Lee Ray, chairman of the Atomic Energy Commission, has proposed a joint Government-industry development program to produce demonstration projects for 1100-kV, ac overhead transmission systems and a 100-MV, dc terminal system by 1979. The effort would be part of a multibillion-dollar R&D attack on the energy problem. Dr. Ray also recommends that improved battery development be pursued, with emphasis on sodium-sulfur and lithium-sulfur designs. When it is clear which is the most promising, she says, a 10-MW pilot model should be built for testing. The concept of storing energy in a superconducting magnet or a flywheel should be examined and taken into engineering development, she also suggests.

Capital Capsules: United Air Lines will develop, test and fly on a 747 jetliner, an air-sampling and data-recording system to measure dust particles and gases in the air under a \$1.1-million NASA contract. . . . The Navy has awarded competing \$1-million contracts to LTV Aerospace and General Dynamics to design and develop a new dual-purpose strategic and tactical cruise missile system. A separate contract will be awarded for an updated inertial-guidance system design for the strategic version of the missile. . . . The National Science Foundation is planning a series of experiments to explore the costs and benefits of cable television. It will contract with a research organization to work with a cable operator. . . . The President's Cabinet Committee on Cable Television has concluded that the CATV industry should be divided into cable-system operators, who would act as common carriers, and independent programming companies, which would be largely freed from Federal Communications Commission control and be able to use the CATV channels for a fee. . . . The Air Force is testing the first total simulator for a helicopter at Hill AFB, Utah. The simulator is driven by a digital computer, has a six-degree freedom-of-motion system and duplicates the CH-3E helicopter in every way, including sound. Use of the simulator will save \$500,000 annually in flight costs and compress flight training time, the Air Force says. . . . Hughes Aircraft has been given the go-ahead to build the first satellite data system spacecraft for the Air Force. It will be used for communications, command and control of strategic aircraft flying in the northern polar region. . . . Raytheon has received a \$18.3-billion Air Force contract to build seven AN/TFM-19 phased-array, airport-approach-control radars. The portable equipment, intended for tactical use, scored 100% success in tracking tests of aircraft approaching a runway in rains up to five inches an hour. . . . Japanese business editors meeting with WEMA representatives have expressed fear that American multinational companies will eventually dominate electronics manufacturing in Japan, especially in the computer field, as a result of the Japanese Government's decision to permit up to 100% foreign ownership of subsidiaries in Japan. . . . The Congressional Office of Technology Assessment, created to give Congress expertise in dealing with technological subjects, is still accepting applications for its professional staff. OTA Director Emilia Q. Daddario has received 3500 applications thus far, but hiring will wait until the Board decides what the staff makeup should be.

the TEKTRONIX DIGITAL PROCESSING OSCILLOSCOPE...

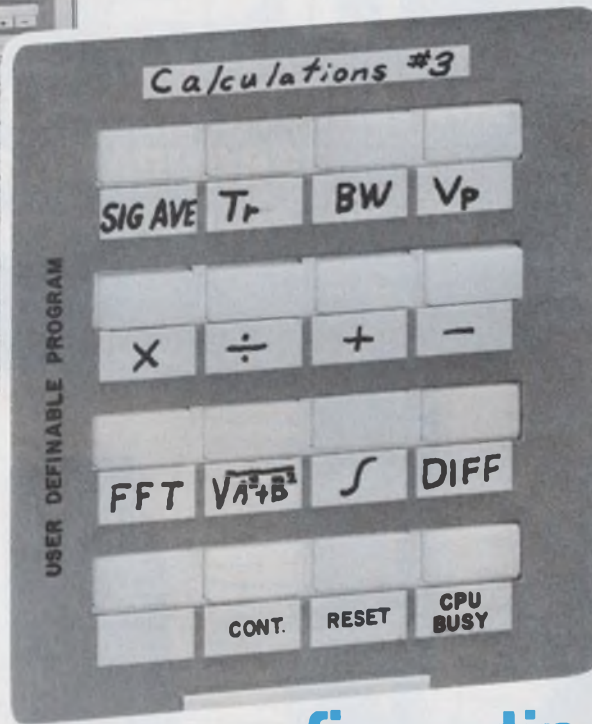
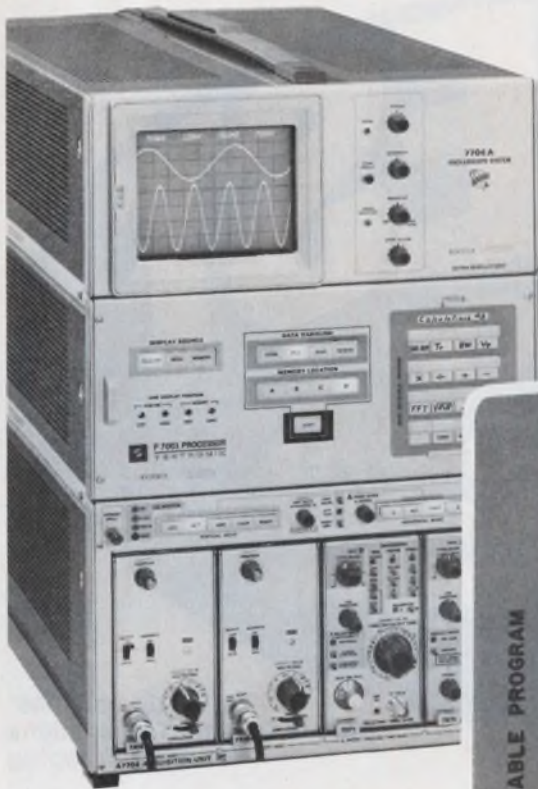

...fingertip selection
of entirely new waveform measurements.

See your needed measurements at a glance, just select the program functions you need, and our "Brain Powered Scope" (so named by a leading electronics magazine) will display the results immediately.

A press of the button is all that's required for a program to be implemented that gives you immediate results without manual calculations. Many functions, such as differentiation, signal averaging, fast Fourier transforms, peak-to-peak voltage, and instantaneous horsepower may be handled easily by this new product.

However, the Digital Processing Oscilloscope isn't a specialized one-capability unit. It combines the general-purpose 7704A Laboratory Oscilloscope and powerful PDP-11 Minicomputer. These units are linked by the P7001 Processor which provides complete In/Out interfacing. Capabilities include A/D and D/A conversions, waveform storage, recall, and display of those waveforms. The total package is an easy-to-use and significant state-of-the-art product.

This significance is increased by the scope's signal acquisition capabilities, which include more than 25 plug-ins from the TEKTRONIX 7000-Series Family . . . and by the developed software packages APD BASIC I and APD BASIC II (for PDP-11's with 8-k and 16-k core memories respectively) . . . and of course CRT READOUT on the large display screen.

If you would like to learn more about the many uses of the user Definable Program overlay (shown above), and of the Acquisition-Processing-Displaying capabilities of this oscilloscope — please write for your copies of The Digital Processing Oscilloscope Brochure, the magazine feature article reprint "Scope with Brain Power" and the 7000-Series Oscilloscope Catalog. Write: Tektronix, Inc., P. O. Box 500A, Beaverton, Oregon 97005 or check the reader service box.



LARGEST LINE OF

SOLDERLESS WIRE-WRAPPED TERMINATION PRINTED CIRCUIT CONNECTORS

**.025" and .045"
Square Contact Terminations
for Wire-Wrapping**

Various sizes from 12 to 100
terminals with a choice of
.100", .125", .156" or .200"
contact centers. Accept
.054"-.071" printed circuit
board (1/16").

**WRITE OR PHONE
FOR COMPLETE
PRINTED CIRCUIT
CATALOGS:
(212) 899-4422**



For the Sales Representative Nearest You, See Our Listings in EEM and VSMF Directories.

CONTINENTAL CONNECTORS

CONTINENTAL CONNECTOR CORPORATION ■ WOODSIDE, NEW YORK 11377

INFORMATION RETRIEVAL NUMBER 28

the 30Hz Resolution Revolution

Spectrum Analysis in the 0-to-1800 MHz region

The TEKTRONIX 7L13 adds revolutionary measurement power to spectrum analysis: 30 Hertz Resolution that is useful all the way to 1800 MHz.

There is no smearing from drift or FM in this 200 Hz/div display, even though the total sweep time is 20 seconds. Signals are resolved to 70 dB down even though they are only 500 Hz apart. Center frequency is 1555 MHz.

It is generally understood that High resolution means the ability to distinguish between signals differing little in frequency. Actually, the design that makes 30 Hz resolution possible results in more than just the ability to distinguish between close together signals. The design of the 7L13 means better sensitivity, -128 dBm; less drift, under 2kHz per hour; less FM, under 10 Hz phase locked; it means less noise . . . it means the revolutionary analyzer performance that is available from Tektronix, Inc. in the 7L13.

Because of the resolution revolution, the performance of your edge-of-the-art circuitry and devices can now be quantified, not guessed at. A discussion or demonstration of TEKTRONIX Spectrum Analyzer performance can be arranged by any Tektronix Field Engineer. Call him or use one of the two reader service numbers below.

7L13 Spectrum Analyzer—\$6500
7613 Variable Persistence Mainframe—\$2500

TEKTRONIX, INC., P. O. Box 500
Beaverton, Oregon 97005

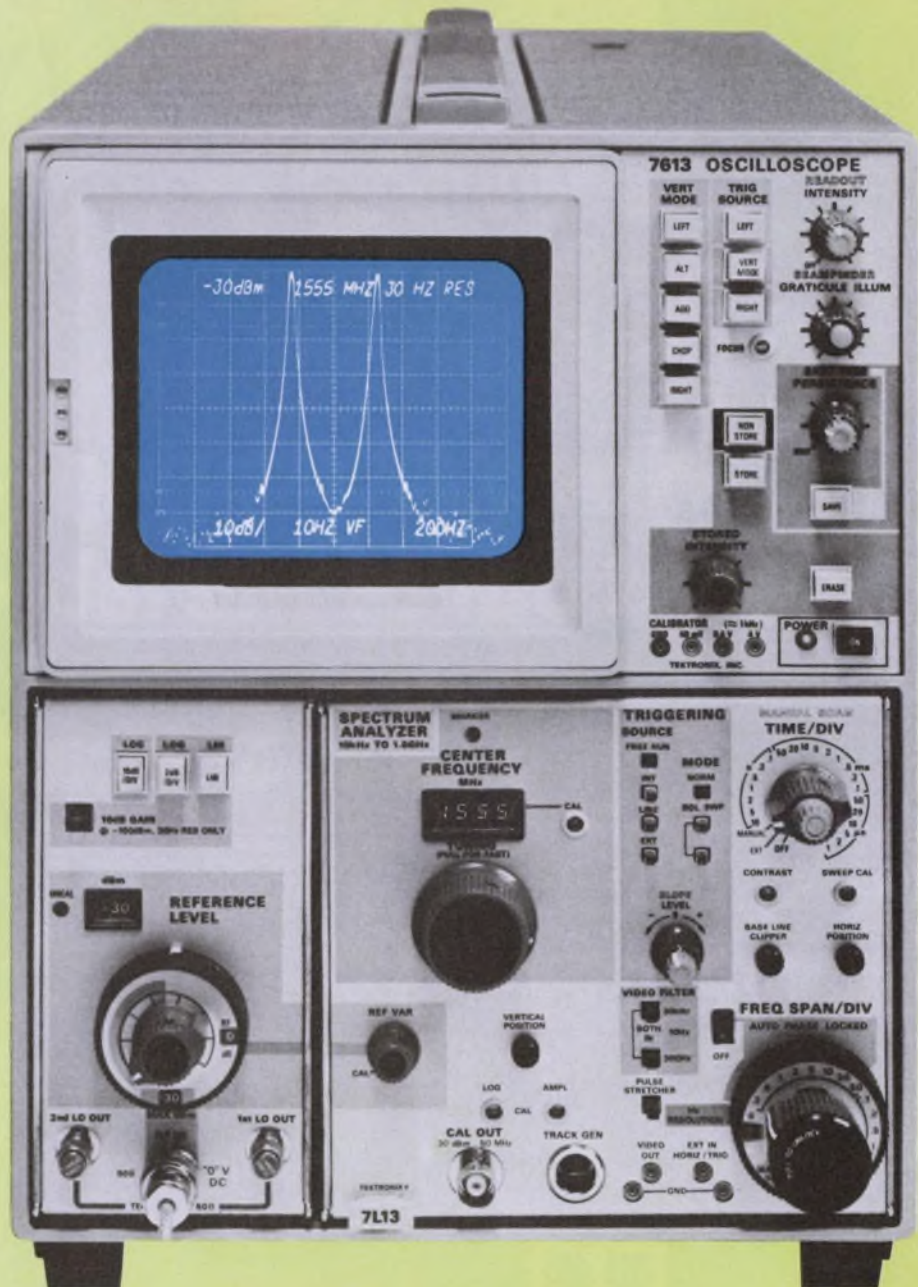

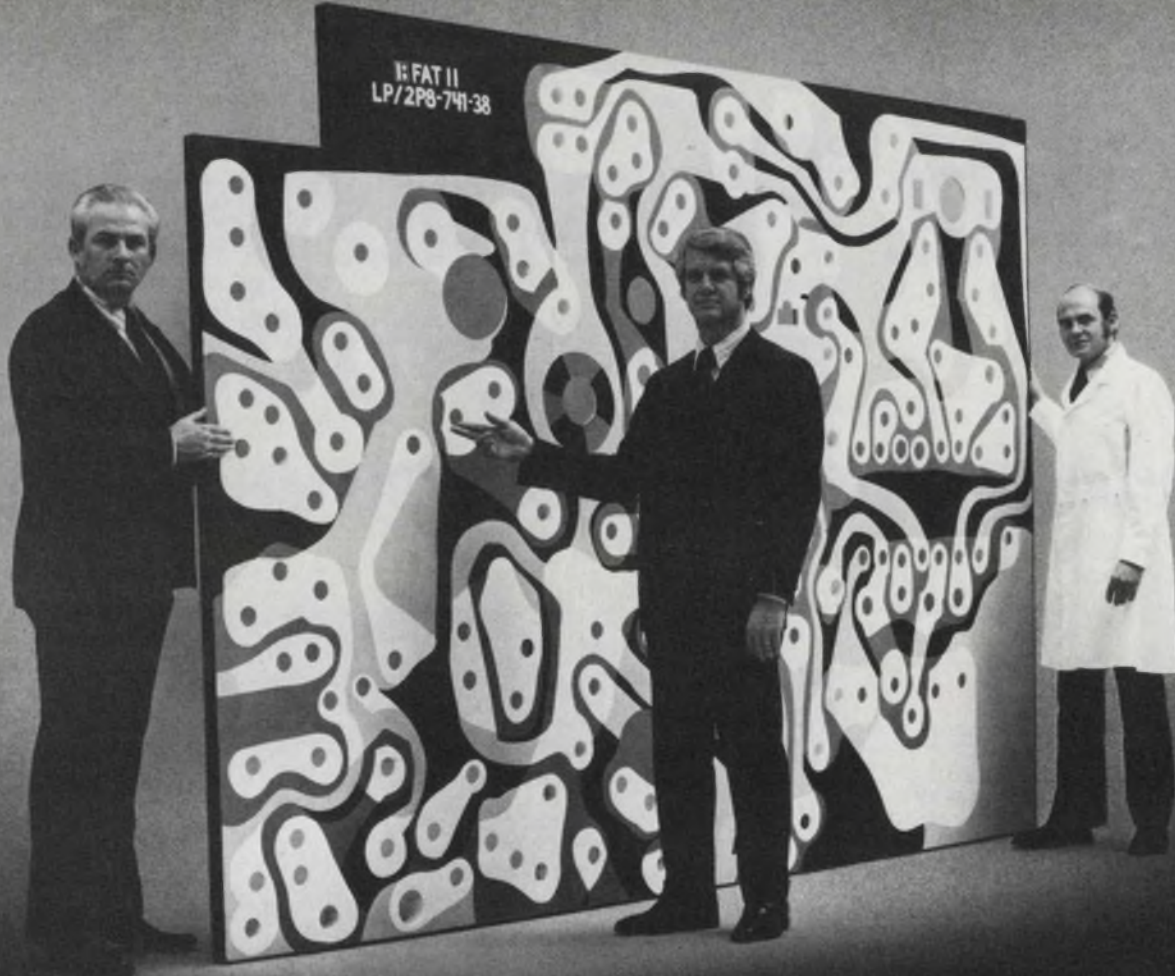

When ACD brings a new board out of the lab—it's ready.

FAT'S Ready.

FAT™—Fully Additive Technology—is the volume user's ticket to cost efficiency. And it's ready now to be mass produced.

Why do we make a big thing out of being ready? Our reputation. Even though our FAT board is less expensive than conventional boards—we want you to know it's a precision piece of circuitry. And even though the holes are pierced instead of drilled, you'll find them ACD reliable. We've been

perfecting the undrilled hole for years—we're pros at the pierced through process. With FAT you'll find no slivering or undercut characteristics that can cause bad circuitry.

So if you're a volume house looking for economical per-board cost, don't need conventional, multilayer or exotic boards, or require military documentation, you should call us. We're ready to quote production orders on our FAT boards right now.



ADVANCED CIRCUITRY

4811 West Kearney Street, Springfield, MO 65803 • (417) 862 0751

another handful ... with more measurement solutions

THIS 5 MHz PORTABLE ADDS EXPANDED BANDWIDTH TO THE TEKTRONIX LINE OF MINIATURE OSCILLOSCOPES

You've got to keep your computer installation running; downtime is too costly to treat lightly. When it happens, you must get there with the proper troubleshooting equipment, find the problem and quickly correct it. The 221 from Tektronix will help get the job done.

At 5 MHz bandwidth, 5 mV/div sensitivity, and 1 μ S/div sweep, this battery-operated miniscope displays the waveforms encountered in today's computer environment.

Many operator conveniences save set-up time and make the display easy to interpret. The integral 1 M Ω probe is always there when you need it. Deflection factors are easy to read. Trigger level and slope are simplified in one rotary control. AUTO trigger mode automatically triggers the scope trace from its input signal. And in AUTO mode, a bright reference trace eliminates confusion. Rotate the switch out of AUTO mode and you can select any combination of trigger slope and trigger level. With all this, you carry just 3½ pounds.

In its 3" x 5¼" x 9" package, the 221 has rechargeable batteries. It can be operated and charged from practically any power source from 90 to 250 V, 48 to

62 Hz AC, or 80 to 250 V DC without switching. Double insulation protects the operator while making elevated voltage measurements. Its impact-resistant case absorbs the rough treatment you expect in field maintenance.

221 Portable Oscilloscope, including batteries and probe ... \$745
Other 200-Series miniscopes offer 500 kHz bandwidth in single- or dual-trace, or dual-trace storage models.

Call your nearest field office for a look at the 221. Or write Tektronix, Inc., P.O. Box 500, Beaverton, Oregon 97005. In Europe, write Tektronix Ltd., P.O. Box 36, St. Peter Port, Guernsey, C. I., U. K.



TEKTRONIX®

committed to
technical excellence

INFORMATION RETRIEVAL NUMBER 31
FOR DEMONSTRATION, CIRCLE 233



150 Microwatt Triple Op Amp

The L144 monolithic triple op amp draws only $50\mu\text{A}$ of current per amplifier, from a $\pm 1.5\text{ V}$ supply. What's more, it is

AVAILABLE NOW FROM YOUR LOCAL DISTRIBUTOR!

L144 features include:

- Monolithic triple op amp in DIP or Flatpac packages
- Wide power supply range— $\pm 1.5\text{ V}$ to $\pm 15\text{ V}$
- Internal compensation
- Programmable power dissipation
- Programmable input bias current
- Single programming resistor
- 80 dB gain with $20\text{ K}\Omega$ load
- Cost effective: \$1.63 per single op amp⁽¹⁾

⁽¹⁾L144CJ 100-piece price

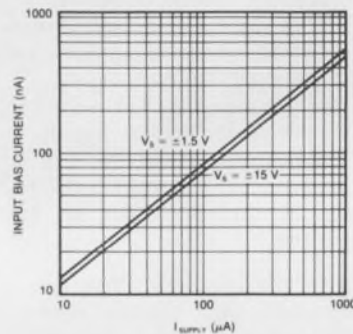

Applications examples:

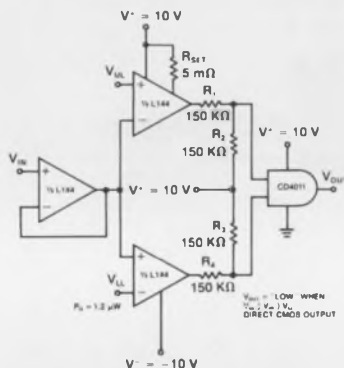

DOUBLE-ENDED LIMIT COMPARATOR

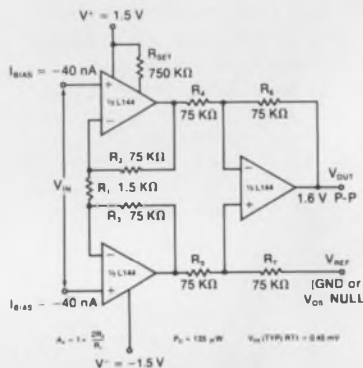

INSTRUMENTATION AMPLIFIER

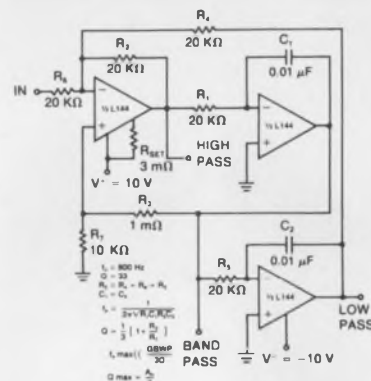

ACTIVE FILTER

The L144 is a practical industry-standard operational amplifier for use when low current drain, low voltage, low power, or very small physical size are controlling criteria. If your circuit requirements are unique—and whose aren't—our applications people are eager to help.

For complete information

write for data

IC Applications: (408) 246 8000, Ext. 120



Siliconix incorporated

2201 Laurelwood Road, Santa Clara, California 95054

INFORMATION RETRIEVAL NUMBER 32

Human rights and the engineer

Over the years we have frequently disagreed with some of the policies and activities of the Institute of Electrical and Electronics Engineers. At other times—particularly of late—we have applauded them. We heartily commend the IEEE on an important, but little publicized, resolution by the organization's board of directors last September.

The resolution deals with the basic human rights of engineers and scientists. The text is as follows:

"The board of directors of the Institute of Electrical and Electronics Engineers, an organization of approximately 160,000 electrical engineers all over the world, is keenly interested in the welfare of engineers and scientists everywhere.

"This board views with great concern the infringement on basic freedoms wherever they occur, particularly when engineers and scientists are singled out as the victims because of their profession.

"This board regrets that many engineers and scientists and their families have been denied their right to emigrate in violation of recognized international practices, often solely because of their professional qualification in science and engineering.

"These practices seriously endanger the spirit of trans-national friendship and cooperation on which the operation of this institute is based. The board of directors of the Institute of Electrical and Electronics Engineers appeals to its sister organizations, and to the National Academies of Science and Engineering or similar institutions in every country, to join in support of equal human rights for engineers and scientists."

In view of the recent harsh treatment given to Jewish scientists and engineers in the Soviet Union who have expressed the desire to emigrate—most notably the famed physicist Andrei Sakharov—this resolution is particularly appropriate. We applaud the IEEE and urge all other professional organizations to adopt a similar statement.



Ralph Dobriner

RALPH DOBRINER
Managing Editor

From ele to blood analy



Smart system designers use Intel Microcomputers for almost everything.

Right now, Intel Microcomputers are being used to replace hardwired control logic, cut component and assembly costs, raise reliability and make systems easier to maintain. With control programs stored in read-only memories, Intel Microcomputers are replacing hundreds, in some instances even a thousand TTL packages.

Intel Microcomputers are making systems smarter, opening new markets and preventing product obsolescence. Our customers are adapting the Microcomputer to new applications and markets by programming ROMs instead of hardwiring logic. Products get to market faster since software takes months, perhaps man-years less time to develop than hardwired logic.

General purpose Microcomputers, invented two years ago by Intel, have already outmoded hardwired logic and expensive custom MOS/LSI in hundreds of applications:

computer terminals, traffic light controllers, medical instruments, business machines, mass-transit equipment, reservation systems, cash registers, inventory computers for fast-food restaurants, process controllers, electronic test instruments

and even pinball and slot machines.

You'll soon be seeing a new Toledo digital computing scale at the corner food store. Accurate to the penny, it converts weights to prices and operates a



Electronic games winners.

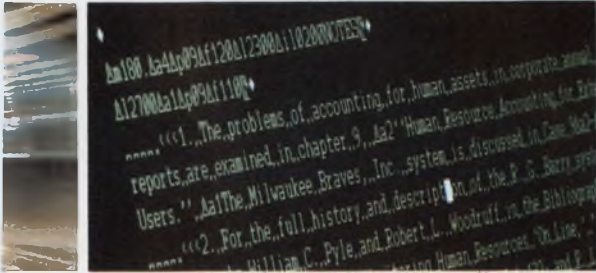

display, label printer, or both with an Intel Microcomputer. With equal ease, a similar Microcomputer handles graphics composition and editing in Automix Keyboard's Ultra Comp intelligent terminal for typesetting.

In a Helena Laboratory blood analyzer, an Intel Microcomputer translates the raw data from a sensing instrument into medically meaningful numbers and prints out separate quantitative readings of several different proteins.

The Microcomputer reduced the electronics cost of the system about 30%. Another Microcomputer automated instrument is

Coherent Radiation's Dioptron™

While a patient reads an eye chart, the central processor analyzes the eyes' focus and prints out the results. Even kids too young to read the chart are tested rapidly and accurately.

Finally, just for fun, look at Atari's new video game, "Gotcha"™. Cat chases mouse (or boy chases girl) through a constantly changing maze. In this case, the Intel Microcomputer acts just dumb enough to let people win once in a while.

We started the Microcomputer revolution and we continue to lead the industry in the development, production, applications support and delivery.

To find out how you can enhance your product's capability, take advantage of our know-how, software library and programming aids, subscribe now to Microcomputer News. Just for asking, we'll also send you our new Microcomputer catalog.

Intel Corporation, 3065 Bowers Avenue, Santa Clara, California 95051 (408) 246-7501.



intel® Microcomputers. First from the beginning.

FOR ROUND multipin connectors

Perhaps the best design approach is to avoid round multipin connectors, or for that matter all connectors, if you can.

One victim of Murphy's Law has described them as a "source of trouble that connects two other sources of trouble."

The troubles can come from many sources. They can come from the user's inadequate knowledge, from misuse, from difficulties in selecting the right connector from the many available, from not understanding the interactions of various connector-design factors, from ambiguous specs and from a lack of industry agreement on standards.

For commercial connectors, the user generally specifies performance and lets the vendor determine the design and materials. The manufacturer is, after all, in the best position to know design and material limitations and how the final product should perform.

But even the best vendor can't come up with the right connector unless you give him your complete requirements—and sufficient lead time. With justification, vendors complain that the connector is usually the last component specified. For new designs of course, this occurs because you don't know how many contacts you'll need or how much current each will carry, until the design is nearly complete. Nevertheless to avoid costly mistakes, start talking to vendors early.

But does the vendor know best? Probably no two vendors will agree exactly in their recommendations. The user must always fall back upon his own knowledge to make a final decision.

One of your first decisions is to choose the shape for the connector. Of the many possible shapes, the round multipin connectors probably provide the greatest amount of latitude in performance and packaging characteristics. But be-

fore you commit yourself, let's look closely at circular connectors.

Are round connectors for you?

Circulars can handle a high density of contacts, a wide range of voltages and currents and extremes of environment. They're readily available from many manufacturers, and many types are second-sourced. In addition the round configuration offers these benefits:



Both Amphenol's Merlin I and Bendix's Pygmy (bottom) lines feature dielectric retention discs. The discs eliminate the need for individual metal clips. This results in lighter and shorter connectors. Also, both lines employ a rear-release method for contact insertion and extraction and crimp-type terminations.

Morris Grossman
Associate Editor

- It's easier to seal than any other shape.
- It's a natural shape for manufacturing with standard machine tools.
- It makes connector couplings easier to design for rapid engagement and disconnection as well as positive locking.
- It comes with a variety of accessories not available with other connector types.

The disadvantages of circulars? Yes, there are some. They aren't compatible with the burgeoning flat cable. When many connectors are arrayed on a panel, the circular shape—especially in large diameters—can waste a lot of panel space. Rectangular connectors can have several hundred contacts, and the user can locate a particular pin more easily than in a round unit.

The shortcoming of circulars, however, are usually outweighed by their formidable advantages. Unless your application has very special needs, you're probably best off with the round shape.

How to pick a round type

What do you need to know to select a round connector? Most of the factors are common to choosing any type of connector. A few—coupling methods and assembly and repair problems—apply only to the circular configuration. The factors include:

- Number of contacts and their construction.
- Voltage rating and contact spacing.

- Current rating and wire size.
- Crimped vs soldered terminations.
- Connector-assembly and contact-retention methods.
- Coupling methods.
- Materials, ruggedness and reliability.
- Mounting, shell styles and environment.
- Standardization and MIL specs.

A decision on nearly every one of these factors depends on at least one of the others. Voltage and current determine the spacing and size of the pins, which then set a limit to the number of contacts that can be squeezed into a shell size. Mounting arrangements and the environment determine the shell style and coupling methods. And reliability, environment, ruggedness current and voltage influence the choice of materials.

Let's look first at voltage ratings. These define, in rms volts, the voltage that a connector can withstand without dielectric breakdown or flashover. Most common maximum ratings lie between about 1000 and 2000 V rms. But voltages to 6000 V can be handled by some special types. However, watch out. Altitude and temperature derating factors are frequently not spelled out in the data sheet.

Voltage ratings are, of course, related to contact spacing. A 50-mil air gap at sea level can easily handle 600 V rms, but at 50,000 ft., it is perilously close to flashover (see graph). Thus reduced air pressure at high altitudes markedly reduces voltage flashover levels.

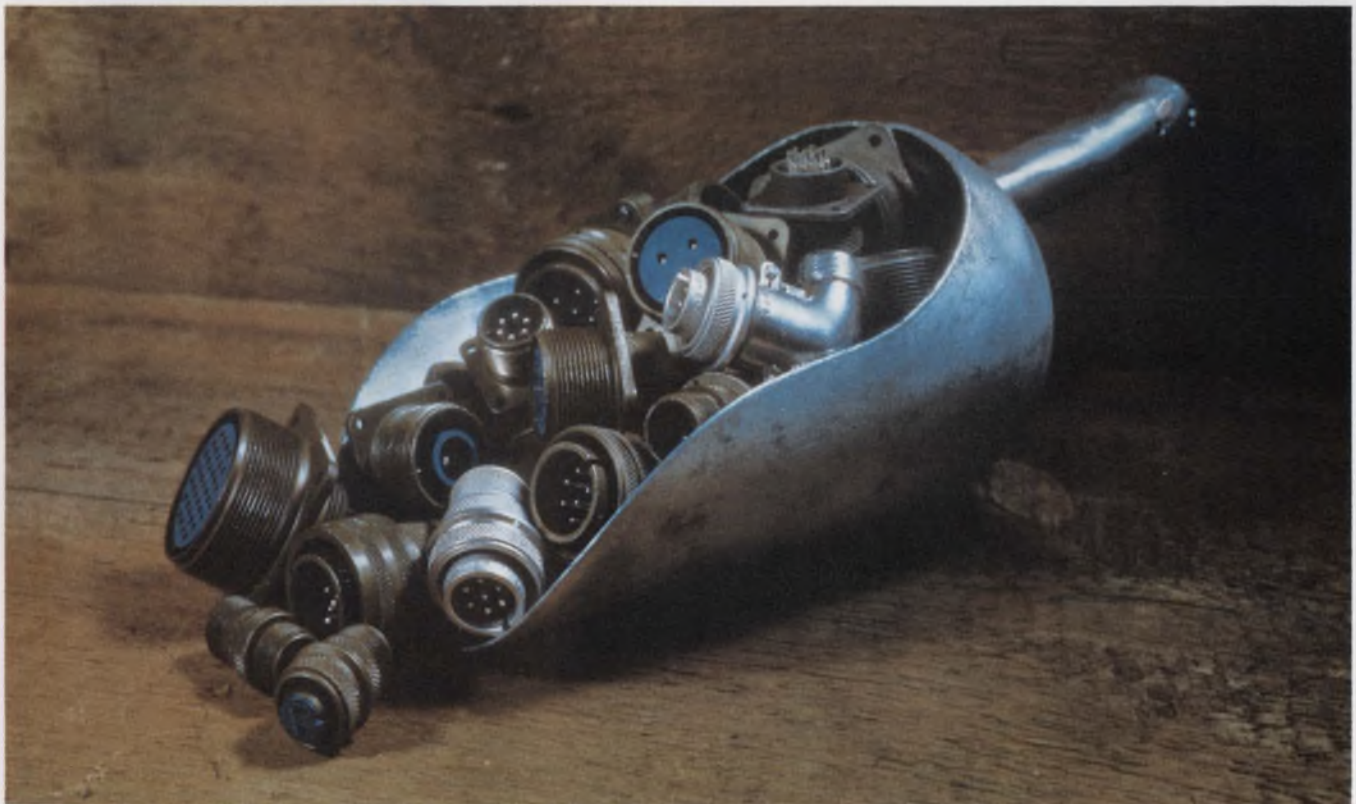

You can't pick a connector with a scoop! You must carefully weigh each factor to pinpoint the right choice.

Round multipin connectors, such as these Amphenol units, come in thousands of versions.

But even below flashover levels, corona discharges can start to disrupt the performance of electrical equipment. And, in time, corona can seriously deteriorate a connector's insulating and metallic materials.

Thus for operation over 50,000 ft., you need connectors that are filled with potting materials or that have hermetic seals. Grommets and O-ring seals are helpful for short exposures at intermediate altitudes, but such resilient seals are used primarily for sealing against humidity and fluid exposure.

Heat, too, lowers voltage-breakdown levels. Either prolonged exposure to elevated temperatures, or short-term exposure to extreme heat, can permanently damage insulation. Along with lowered breakdown voltage, this damage shows itself in lowered insulation resistance and increased moisture absorption.

On the other hand, very low temperatures (below -65 C for MIL connectors) are also harmful. Extreme cold may crack, distort and otherwise change the insulator so that its breakdown voltage is lowered.

A common MIL temperature range for connectors is -55 to 200 C , but some special types can take very high temperatures. ITT Cannon's HRM types operate as high as 700 C with alumina inserts and stainless-steel shells.

As with voltage, current ratings also depend on diverse factors. It is totally inadequate to say merely that a single isolated connector contact can carry a maximum of 5 A. A connector's allowable ambient temperature goes down as the root-mean-square average of all the contact currents increases (see graph). In addition high altitude reduces the allowable current and ambient temperature.

Thus you generally can't allow all or even two ratings to go to their maximums at the same time. Many connector data sheets fail to point this out clearly. And by not providing important qualifying information, data sheets can be dangerously misleading. In one blatant example, a manufacturer failed to state that his "maximum current rating" meant only that a fire would result if the current were on for more than two minutes.

To crimp or to solder?

Endless debates continue over soldering vs crimping. There has been a growing trend away from solder-terminated connectors. But a soldering iron is a convenient, low-cost tool. For low-volume jobs, soldering can still be the most economical approach.

And in the field, what does the technician do when he must make a repair and he doesn't have the right crimping tool for a contact? Crimping

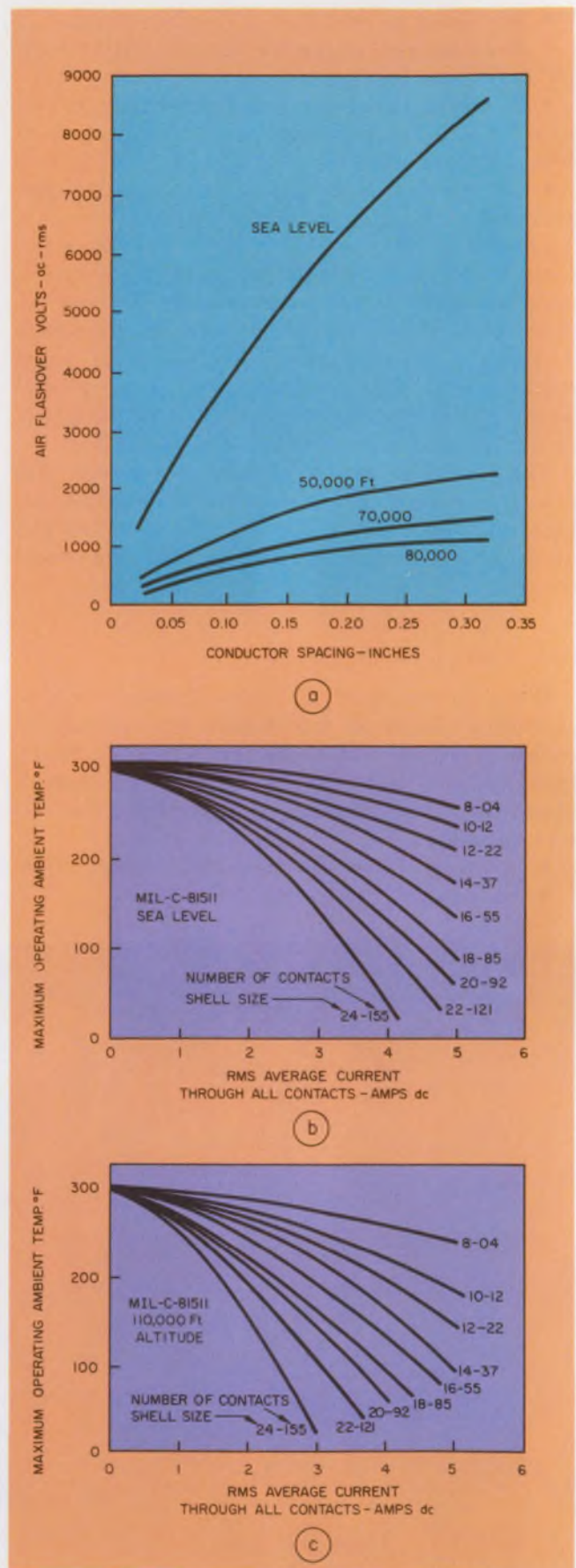

Altitude and temperature strongly influence the voltage and current ratings of connectors. Voltage flashover (a) drops drastically with increased altitude and allowed current (b and c) decreases with both increased ambient temperature and altitude.

Table 1. Front and rear-release advantages and disadvantages

Factors	Front release	Rear release
Contact servicing	Identification of contacts easier from mating end; male pins can be bent during removal operation.	Minimizes contact bend damage; allows contact removal while mated; not easy to identify with high-density wire bundles.
Connector wiring	Less stripped wire needed between connector and lacing or cable jacket.	More stripped wire needed.
Wire shielding	More effective RFI shielding. Shielding can be closer to the grommet surface.	Shield is stripped to provide tool clearance.
Wire breakage	Standard tools will remove broken wires at crimp joints.	Special tool required.
Wire accommodations	Accepts larger diameter wire sizes.	Restricts wire size because tool needs space.
Plastic vs. metal service tools	Uses costly metal tools for inserting and removing contacts; they are more durable than plastic ones, but can scratch contacts and produce metal chips.	Inexpensive plastic tools provided with connectors; ensures use of correct tool in field maintenance, but tool life is low, may last for only one connector; and can produce chips to spoil connections.
Closed-entry socket	Available in both front and rear-release connectors that are hard dielectric material. Helps guide bent pins into socket contact. But rear-release designs less complex.	

tools come in hundreds of styles and sizes and tend to be bulky and costly. In a well-equipped aircraft factory, a request for the crimping tools can literally bring a whole truckload. A small soldering iron has the important advantage of versatility. This largely offsets its well-known disadvantages—burned insulation, too much or too little solder, cold joints and the need for skill.

The advantages of crimping range from speed to reliability and ease of joint inspection. Terminals can be applied at up to 8000 an hour with automatic machines, against only about 250 solder joints an hour for a good operator. Crimping produces uniform connections regardless of the operator, and repairs are readily made—provided you have the proper crimping tool. The advantages of crimp terminations accrue, however, mostly to well-financed, high-volume operations.

Assembly methods are controversial

Two more endless debates rage over fixed vs removable and front-vs-rear-release contacts. These arguments seem to be just as hot today as they were 10 years ago.

Fixed contact connectors are factory-assembled, which eliminates the labor and errors in their assembly. Their contacts can't be improperly inserted, or the wrong ones used. Also fixed contacts are more easily pressurized and hermetically sealed. And, perhaps most important, connectors with fixed contacts generally cost less.

Removable contacts, on the other hand, simplify assembly and repair of high-density cables. And, of course, crimping works only with removable contacts.

On the question of front-vs-rear release for removal or insertion of the contacts, there are strong arguments for both methods. But both need a tool to expand the contact retainer. With a wire attached to the contact, both insertion and removal are from the rear (wire side) of the connector for either method of release.

In selecting one of the two release methods, the designer must consider at least eight important factors (see Table 1).

One engineer may prefer front-release connectors because they allow easy identification of wires and can accept larger wire diameters. Another may insist that rear release is better because he can remove a single contact and its wire, while troubleshooting, without unplugging the connector.

The front-rear controversy came to a climax in 1966, when after many military tri-service meetings with representatives of the connector industry, the military accepted Amphenol's then new Astro-348 (MIL-C-81511) front-release connector. It became the official standard for the Defense Department's round multipin, high-density connectors. Of course, Amphenol was delighted, but competitors charged that the Defense Department had erred. In spite of the 1966 decision, however, the rear-release method continued to be used. Today both release methods are

widely accepted and many connector series are available in front or rear-release versions.

Amphenol now makes the MIL-C-81511 in both front and rear-release versions. Also some manufacturers of MIL-C-5015 and 26482 types offer both styles, though ITT Cannon has stayed with the rear-release approach.

Here's another important question that involves connector assembly: Should you buy connectors unassembled, in kit form, or fully assembled?

The advantage of the kit is that damaged parts can be replaced separately, thus saving the cost of having to discard a complete connector. But, obviously, connector assembly takes labor and skill. Kits for sealed connectors, in particular, demand skill and care in fitting grommets, gaskets and close-tolerance parts. Densely packed pins require especially skillful assembly.

Thus the choice between kits or assembled units may depend primarily on the skill of the manpower you have available.

Four ways to couple

Common couplings for circular connectors include threaded, bayonet, push-pull with rotate-to-lock and quick-disconnect push-pull.

Threaded coupling is the oldest and most widely used method. Most low-cost, industrial round connectors use this method, but engagement and disengagement call for considerable muscle in the fingers and wrist, especially with large connectors. Close connector spacing causes scraped knuckles. The screwing action is slow and tedious when many connectors must be engaged. And they tend to loosen under heavy vibration; thus safety wiring is needed in aircraft applications.

Bayonet types can be coupled faster than threaded types. Pins on the receptacle ride up ramps on the plug and fall into notches to hold



ITT Cannon says that it's the only supplier that's currently producing a high-environmental connector to meet all the dimensional and performance requirements of the soon-to-be-issued MIL-C-5015G tri-service coordinated specification.

fast against vibration. TRW Cinch NuLine has an improved locking mechanism on its MIL-C-26500 bayonet-coupled connectors, which is used primarily for high-vibration aircraft applications. But bayonet types generally require more torque than a threaded system, and thus are used mostly on small and medium-sized connectors.

Push-pull mechanisms use a ball detent to provide the fastest method for engaging connector halves. Awkwardly placed connectors are good

Table 2. Connector-insert insulator characteristics

Property*	Thermosets		Thermoplastics		Elastomers			
	Epoxy	Phenolic	Nylon	Polycarb	Polysulf	Neoprene	Silicone	Diallyl
Dielectric strength (V/mil)	350	350	400	350	450	300	500	400
Thermal exposure (°C @ 1000 h)	225	200	120	250	130	120	240	170
Tensile strength (lb/in ²)	8000	10,000	7-13,000	13,000	8-9500	1200	1200	6000
Low-temp exposure	Good	Good	Good	Good	Fair	Poor	Exc.	Good
Fluid exposure	Good	Good	Good	Good	Good	Good	Exc.	Good
Insulation resistance	Good	Good	Good	Good	Good	Good	Exc.	Exc.
Outgassing @ 150 C	—	—	Fair	Low	Fair	Fair	Low	Low

*The properties of plastics are sensitive to exact mix and treatment.

candidates for their use. But they are not as rugged and are more complicated than the bayonet types. The quick-disconnect variety requires only a straight push-or-pull action, but there is no mechanical advantage to help overcome pin-engagement forces. Also, there is little protection against vibration. The rotate-to-lock version is more positive than the simple push-pull, but the rotary action is only for locking and does not help in pin engagement. Users familiar with bayonet couplings often turn the connector before pushing it, and this frustrates engagement.

Push-pull methods provide a tactile and audible click indication of full engagement; also they can give a visible display. And remote-control methods can be applied to the straight push-pull coupler for quick umbilical-cord disengagement.

Which material?

Shells for round connectors are generally made of aluminum, often treated with a corrosion-resistant finish. However, special jobs may call for gold-plated stainless steel, which is much more difficult and costly to fabricate. Aluminum, of course, is easy to machine or die cast, and it is also much lighter.

Inserts—the insulating structures that hold the contacts—are made from a wider variety of materials than are the shells. Though ceramics can be used for the high-temperature ranges to over 600 C, the more popular inserts are made from either the resilient elastomers, such as neoprenes and silicones, or the rigid plastics, such as the phenolics, epoxies or diallyl phthalates.

Table 2 summarizes the characteristics of plastic insulation materials. Formulations are generally proprietary and continually under development. Also individual characteristics are frequently altered to improve characteristics. Thus the table can provide only a rough comparison.

Contacts are made mostly of copper and its alloys to obtain the best compromise among conductivity, spring properties, wear resistance, strength, formability and cost. Plating with noble metals is often a requirement for dry-circuit use and corrosion resistance. Gold is a popular choice.

However, the recent surge in gold prices has sent connector manufacturers scrambling for substitutes or methods for using less gold. The search is still on. Each \$10 rise in gold price adds about 1.5% to the over-all cost of a connector, according to Charles C. Sloane, director of marketing of ITT Cannon. MIL specs are rather unyielding in specifying the thickness (generally 50 to 100 microinches) and the extent of coverage, when gold is required. Connector specialists have proposed that contacts should be specified by performance, rather than by materials and

methods as practiced in most MIL specs.

Selective plating is an obvious way to reduce use of gold. Gold can be limited to the contact-mating areas only. Another is to keep the gold thickness close to the lower-tolerance limit. The manufacturer then trades off tighter control costs against the rising price of gold.

The use of other metals for contacts has so far run into the strictures of MIL specs. Palladium and rhodium are substitute candidates. They are not cheap, but their hardness permits the use of less material. Some types of connectors are being built with tin and tin-nickel-plated contacts; but the round multipin connector probably will not



Commercial versions of round multipin connectors, such as TED Manufacturing's Navajo series (top) and Lemo USA's Quick-Lok line, can provide industrial-quality performance at lower cost than MIL-spec types.

lend itself to this substitution, especially in dry-circuit and MIL applications.

Costs are rising not only in gold, but also in copper, brass and the insulating materials that go into a connector. And the prices of connectors must rise accordingly, manufacturers warn. Amphenol, ITT Cannon, Bendix, Malco and others have applied, or are planning to apply, to the Cost of Living Council for price boosts.

Meeting military specs

When specific MIL specs are imposed, your selection problem is almost solved. The specs usually leave the user little choice. Even the supply sources are often dictated. Only with persistence, and then for special circumstances, can variances be obtained.

However, when in search of MIL-spec connectors, the engineer should be particularly wary of commonly used statements like "designed to meet military specs." The connector may not even have been submitted for testing. And if it has, it probably has not yet qualified. It may never become qualified.

Another buzz word is "equivalent." How equivalent is it? Performance and test procedures

should be carefully checked. And, though a connector may meet a particular military-spec requirement, it may not meet all the other requirements of the MIL spec.

And don't be misled by the designation "MS style." This doesn't mean the connectors meet MIL specs. The relationship may consist of having only some of the outward characteristics and appearance of military types.

Another area of confusion can come from misinterpretation of MIL-spec test requirements. Too often test requirements are interpreted by users as connector performance ratings. Some tests provide data for establishing the life expectancy of a connector—not normal operational limits. For example, a high-temperature life test that exposes connectors to 200 C for 1000 h, under MIL-C-5015F class D and W specifications, is equated by the military to mean 20 years of connector life at 125 C. Thus though the test is at 200 C the rating for operating performance is only 125 C.

MIL specs provide their own problems. The long list of overlapping and sometimes conflicting specifications can be just as much of a problem as the specsmanship snares of commercial enterprise (Table 3). However, help may be on

Table 3. Short list of Military specifications for round multipin connectors

Spec number*	Title	Contact termination	Contact release	Temp range	Mating technique
MIL-C-5015 (Navy)	Connector, electric, MS type (formerly AN)	Solder	fixed / front / rear	-55 to 125, 175, 200 C	Thread
MIL-C-25955	Connector, electrical, environmental resisting, miniature, with snap-in contacts	crimp solder	front	-55 to 125 C	Thread
MIL-C-26482 (Navy)	Connector, electric, circular, miniature, quick disconnect, environment resisting	crimp solder	fixed / front / rear	-55 to 125 C	Bayonet Push-pull
MIL-C-26500 (Air Force)	Connector, general purpose, electrical, miniature circular, environment resisting	crimp solder	front	-55 to 200 C	Bayonet Thread
MIL-C-27599	Connector, electric, miniature, quick disconnect, weapons systems, established reliability	solder	fixed	150, 177 C	Bayonet
MIL-C-38300	Connector, electrical circular, multi-contact, high environment, quantitative reliability	crimp solder	front / closed entry	—	Bayonet
MIL-C-38999 (Air Force)	Connector, electrical, circular miniature, high density [▲] , quick disconnect	crimp	rear	-65 to 200 C	Bayonet
MIL-C-81511	Connector, electric, circular, high density [▲] , quick disconnect, environment resisting	crimp	front / rear	-65 to 200 C	Bayonet
MIL-C-83723** (Air Force)	Connector, electric, circular environment resisting	crimp & solder	rear / closed entry	-55 to 175 C -65 to 200 C	Bayonet Thread

* Consult specification of latest issue.

** Covers Series 1, interchangeable with 26482; Series 2 with 5015; and Series 3, with 26500; deletion of Series 1 and 2 under consideration.

▲ Contact centers are 0.1 in. or less.

the way from a new tri-service agency.

After over 10 years of proliferating styles and specs for round connectors, the military is now making another attempt to narrow the choice to just a few standard lines. Tri-service rivalry, departmental specialization and manufacturers' pressures all contribute to proliferation. The diversity of types has grown so that the index of MIL specs for round connectors runs to about eight pages. As a contrasting example, composition resistors fill only about one page.

But now the Defense Electronics Supply Center, which advises the three military departments, has taken a swipe at the list and has started to trim it. So far it has tackled duplications in connector specifications, MIL-C-5015, MIL-C-26482 and MIL-C-83723. The changes made thus far are as follows:

- In 5015, the MS 3400 series of front-release connectors has been canceled, except for the class D type, and the MS 3450 series is preferred over the inactivated 83723, Series-2 connectors for power applications.

- In 83723, Series 1 is now preferred over 26482, Series 2 (after a flip-flop in decision last August).

- The preferred-parts list for aerospace designs has been abbreviated to the following: 83723, Series 3; 38999, Series 1 and 2; and 85111, Series 3 and 4.

- For ground-support use, the active series of 5015 and 26482 connectors are preferred.

The changes seem to be modest, but some vendors like ITT Cannon, are very pleased. Others, like the Society of Automotive Engi-

neers, Aerospace Industries Association and Electronic Industries Association, called upon the Defense Electronics Supply Center to standardize further and perhaps to eliminate MIL-C-81511. At this time the center is considering cutting back to only one of the high-density specs—either 81511 or 38999. Some vendors, who fear they will be stuck with tooling for canceled types, aren't pleased.

Commercial vs military-spec connectors

Because of the military's high connector standards, many industrial users specify MIL types for commercial use, even though they cost much more.

The military's bible for connector testing is MIL-STD-1344, "Test Methods for Electrical Connectors." It establishes uniform methods for electrical, mechanical and environmental tests.

But Robert Wersen, National Manager of Lemo USA, sees a gradual shift from the military orientation of round multipin connectors to a quality commercial/industrial approach. "Most connectors in this category have been developed for military applications, except for a few small audio types. If a designer wants to specify a six-pin connector for a shielded cable, his choices of nonmilitary connectors are very limited. Of those available, few—if any—are suitable for use on a front panel."

Wersen expects that change in the military orientation of this market will result mainly from the predicted rise in automotive applications. "Truck manufacturers are likely to be interested in low-cost round connectors, because they will probably use rugged round cable between tractor and trailer, not flat cable."

Vendors make improvements

The circular connector has been around for more than 25 years, and most avenues for technical improvement have been well explored. Improvements in materials, processes and cost can still be expected, however. For instance, contact-retention methods that use metal clips to hold individual contacts in place may be on the way out; so-called dielectric retention systems are the new trend. Bendix has converted its Pygmy line to dielectric retention, using a molded polyarylsulfone thermoplastic retention disc. Amphenol and Deutsch have comparable dielectric-retention versions for their 81511 lines and other MIL-series.

Polymer retention systems are claimed to achieve savings in labor and material and increased performance. Connectors can be from 10 to 40% lighter than earlier designs, and some versions allow as much as a half-inch reduction

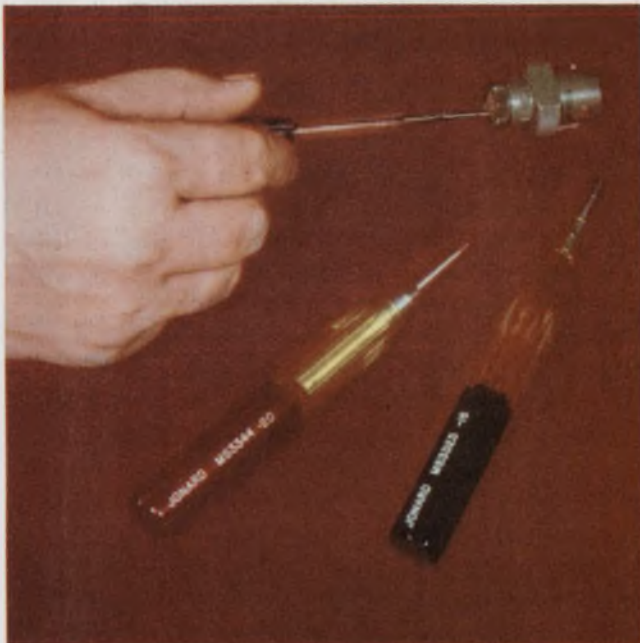

Just three contact insertion and removal tools, made by Jonard Industries, can service most MIL-C-81511, Astro/348 series connectors.



Empire Products' Cam-Lok commercial connectors are made in a non-MIL-spec, "MS style" with the cable vulcanized directly to the connector to replace cable clamps. Rigid clamps can cause breakage of cables that are subjected to continual flexing.

in over-all mated-pair length. Higher contact densities can also be achieved.

"No scooping" is another feature that may spread to more connector lines. It is already available in some lines, such as Amphenol's 81511 and Bendix's LJT and SJT connectors. This feature prevents damage to pin contacts that can be caused by the shell of a mating connector in accidentally wiping across the pins. And it also helps ensure that mechanical and electrical engagement of the contacts are made only after the plug and receptacle are properly aligned. The coupling ring then draws the two halves together. Of course, the no-scooping feature requires longer shells. This may be a disadvantage in some applications.

For safety, connector shells should preferably engage and provide a ground path before any of the contacts mate. Amphenol's 81511 connectors have special shell-to-shell grounding fingers to ensure a good electrical path, and the long shell needed for the no-scoop feature allows the shells to engage before the contacts. ■■

Need more information?

We wish to thank the companies that provided information for this report. The products cited in the report have been selected for their illustrative, or in some cases, unique qualities. However, manufacturers not mentioned in the report may offer similar products. Readers may wish to consult manufacturers listed here for further details.

- AMP Inc., Ind'l Div., Box 3608, Harrisburg, Pa. 17105. (717) 564-0101. **Circle No. 410**
- Amphenol Connector Div., 2801 S. 25th Ave., Broadview, Ill. 60153. (312) 261-2000. **Circle No. 411**
- Appleton Electric Co., 2950 N. Paulina St., Chicago, Ill. 60607. (312) 327-7200. **Circle No. 412**
- Atlas Wire & Cable, 72 N. Broadway, Yonkers, N.Y. 10701. (914) 969-5158. **Circle No. 413**
- Bendix/Electrical Components Div., Sydney, N.Y. 13838. (607) 563-0511. **Circle No. 414**
- Burndy Corp., Richards Ave., Norwalk, Conn. 06856. (203) 838-4444. **Circle No. 415**
- Cannon ITT, P.O. Box 929, Santa Ana, Calif. 92702. (714) 557-4700. **Circle No. 416**
- Caton Industries Inc., 45 Walnut Ave., Clark, N.J. 07066. (201) 382-9119. **Circle No. 417**
- Cinch Div. of TRW, 150 Morse Ave., Elk Grove Village, Ill. 60007. (312) 439-8800. **Circle No. 418**
- Connector Industries of America, 639 N. Wayne Ave., Cincinnati, Ohio 45215. (513) 733-3680. **Circle No. 419**
- Dale Electronics/Columbus Div., 1342 28th Ave., Box 609, Columbus, Neb. 68601. (402) 564-3131. **Circle No. 420**
- Dale Electronics/Yankton Div., E. Hwy. 50, Box 180, Yankton, S.D. 57078. (605) 665-9301. **Circle No. 421**
- Deutsch Co., Municipal Airport, Banning, Calif. 92220. (714) 849-6701. **Circle No. 422**
- Edco Electronics, 7019 Canoga Park, Canoga Park, Calif. 91303. (213) 883-7455. **Circle No. 423**
- Empire Prod./Cam-Lock Div., 10540 Chester Rd., Cincinnati, Ohio 45215. (513) 771-3171. **Circle No. 424**
- Flight Connector Corp., 14128 Lamoli Ave., Hawthorne, Calif. 90250. (213) 679-9701. **Circle No. 425**
- G & H Technology Inc., 1649 17th St., Santa Monica, Calif. 90406. (213) 451-1631. **Circle No. 426**
- General Connector Corp., 80 Bridge St., Newton, Mass. 02158. (617) 244-5706. **Circle No. 427**
- Glenair Inc., 1211 Air Way, Glendale, Calif. 91201. (213) 247-6000. **Circle No. 428**
- Hermetic Seal Corp., 4232 Temple City Blvd., Rosemead, Calif. 91770. (213) 283-0411. **Circle No. 429**
- Hughes Aircraft Co., Connecting Device, 500 Superior Ave., Newport Beach, Calif. 92663. (714) 548-0671. **Circle No. 430**
- Johnson, E. F. Co., 299 10th Ave. S.W., Waseca, Minn. 56093. (507) 835-2050. **Circle No. 431**
- Jonard Industries Corp., 134 Marbledale Rd., Tuckahoe, N.Y. 10707. (212) 549-7600. **Circle No. 432**
- Kings Electronics Co., Inc., Tuckahoe, N.Y. 10707. (914) 793-5000. **Circle No. 433**
- Lemo USA, Inc., 2015 Second St., Berkeley, Calif. 94710. (415) 548-1966. **Circle No. 434**
- Litton Precision Products International, Main St. & Hillside Ave., Oakville, Conn. 06779. (203) 274-5941. **Circle No. 435**
- Malco/Microdot Co., 5150 W. Roosevelt Rd., Chicago, Ill. 60650. (312) 287-6700. **Circle No. 436**
- Microtech, Inc., 777 Henderson Blvd., Folcroft, Pa. 19032. (215) 532-3388. **Circle No. 448**
- Multi-Tech Electronics Inc., P.O. Box 351, Florence, Colo. 81226. (303) 784-4161. **Circle No. 437**
- National Tel-Tronics Corp., State Rd. Hill, Meadville, Pa. 16335. (814) 336-2177. **Circle No. 438**
- North Electric Co./Elexs Div., Box 688, Galion, Ohio 44833. (419) 468-8100. **Circle No. 439**
- Plessey Connector Div., Inc., 400 Moreland, Commack, N.Y. 11725. (516) 543-5000. **Circle No. 440**
- Sogie, 101 rue Philibert Hoffman, 93116 Rosny-sous-Bois, France. **Circle No. 441**
- Stanford Applied Engineering, Inc., 2165 S. Grand Ave., Santa Ana, Calif. 92705. (714) 540-9256. **Circle No. 442**
- Switchcraft Inc., 5555 N. Elston Ave., Chicago, Ill. 60630. (312) 792-2700. **Circle No. 443**
- TED Manufacturing Corp., 11415 Johnson Dr., Shawnee Mission, Kan. 66203. (913) 631-6211. **Circle No. 444**
- Thomson-CSF, Paris Cedex 08, France. **Circle No. 445**
- Viking Industries, Inc., 21001 Nordhoff St., Chatsworth, Calif. 91311. (213) 341-4330. **Circle No. 446**
- Western Intl/Connector Div., 72 N. Broadway, Yonkers, N.Y. 10701. (914) 969-5888. **Circle No. 447**

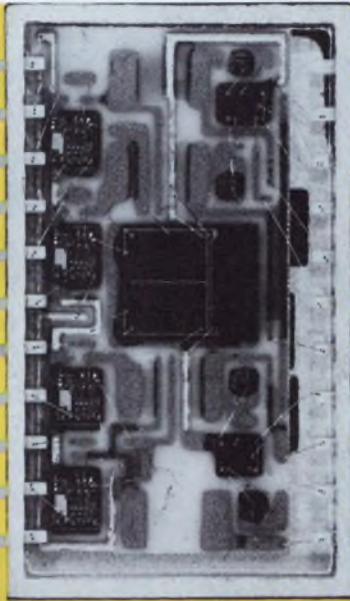

We're in the chips . . .

Hybrid Systems now offers a broad line of thin-film products, including single resistors and multiple resistor arrays, as well as an expanded capability in the design and manufacture of custom hybrid microcircuits . . . a result of our acquisition of Sprague's Worcester hybrid microelectronics operation.

We're in the chips . . . with thin-film resistors

Precision nickel-chromium or tantalum nitride thin-film resistor chips. Resistance values from 10Ω to $510K\Omega$ in standard 30 mil sq. designs; values up to $8\text{Meg}\Omega$ in larger chip sizes. Features include low noise, uniform tracking, and excellent temperature characteristics. Individual resistors with 1%, 5%, or 10% tolerances. Laser trimmed to $\pm 0.01\%$.

We're in the chips . . . with thin-film resistor networks

High-performance nickel-chromium and tantalum nitride designs in chips, wafer, or hermetic packages. Ladder, scaling, and adapter networks. Accuracies to 14 bits. Laser trimmed to exact tolerances. NiCr types feature high temperature stability. TCR from 0 to $+50\text{ppm}/^\circ\text{C}$, tracking to better than $1\text{ppm}/^\circ\text{C}$, and noise $< 0.1\mu\text{V}/\text{V}$ decade of frequency.

We're in the chips . . . with custom hybrid microcircuits

High-reliability custom hybrid assemblies using chip and wire technology as well as thin and thick-film processes to meet your specific needs. Typical circuits include transceivers, demodulators, oscillators, drivers, and comparators.

All of our thin-film components and custom hybrid circuits are manufactured and tested to MIL-STD-883, MIL-E-5400N, and other stringent standards.

For more information, contact us.



HYBRID SYSTEMS CORPORATION

87 Second Avenue, Burlington, Massachusetts 01803 • Tel: 617-272-1522 • TWX: 710-332-7584

Open a Savings Account with our new megapower SCRs



When you invest in IR's new Megapower SCR Family Savings Plan you start earning dividends three important ways.

First, you can eliminate over 70% of the devices and parts normally needed (see the 3-phase converter "savings account" below for full details). That gives you a lower total system cost, plus more reliability.

Second, having fewer parts cuts assembly time sharply, increases reliability and makes your field servicing that much easier, too.

Third, Megapower SCRs give you more production power with only a minimum change in your equipment size.

If you want to parallel Megapower SCRs, there's a special bonus. Our epitaxial process

yields SCRs of virtually identical switching characteristics, so you eliminate expensive current balancing equipment. It also produces the high voltage SCRs you need. Specifically: 700A(av), 500 to 2100V; 850A(av), 500 to 2000V; 1000A(av), 500 to 1500V, and 1600A(av), 500 to 1200V.

There is also an extra dividend in overall productivity because Megapower SCRs will keep your equipment on line longer. Their surge capability is so high, they can ride through massive overloads without resorting to protective fuses.

Open a savings account today. Call your IR branch office, or bank headquarters (213) 678-6281; Telex: 67-4666. International Rectifier, 233 Kansas Street, El Segundo, CA.

IR'S 4800 Amp, 3-PHASE CONVERTER SAVINGS ACCOUNT

Parts Per Assembly	4800A Assy. Using 3-550A SCRs Per Leg	4800A Assy. Using 1-1600A SCR Per Leg	Parts Saved Per Assy.
1. SCRs	18	6	12
2. Heat Sinks	21	9	12
3. Clamps	18	6	12
4. Fuses	18	6	12
5. Balancing Reactors	18	0	18
6. Trigger Pulse Pwr. Amplifiers	6	0	6
7. Isolated Gate Drive Windings	18	6	12
Totals	117	33	84

International Rectifier

International Rectifier, 233 Kansas Street, El Segundo, CA 90245. . . . *the innovative power people*



INFORMATION RETRIEVAL NUMBER 35

Our High-Rel Team is set to tackle your linear IC RFQ's.



Anytime you need High-Rel Linear IC's for military aerospace or industrial applications, come to RCA. Your RFQ's will receive first class "team" attention.

RCA has come on strong to meet your needs for High-Rel Linear IC's. With a team dedicated exclusively to High-Rel IC's and a MIL-M-38510 approved facility, we are keeping pace with the industry's increasing demand for high-reliability linears.

Our team can bring you a variety of High-Rel circuits, such as Operational Amplifiers, Differential Amplifiers, Transistor Arrays, RF Amplifiers, and Voltage Regulators, all processed to MIL-STD-883. Here are just some of the more popular amplifier circuits offered.

Industry Designation	RCA Number	100-999 Price
Class B* Type 741	CA741T/3	\$4.50
Class B* Type 747	CA747T/3	5.50
Class B* Type 748	CA748T/3	4.50
Class B* Type 1558	CA1558T/3	5.50

*Parts processed to MIL-STD-883 Method 5004 Class B

Send for our free 20-page brochure which tells the complete story of RCA's COS/MOS and linear high-reliability IC's.

Also available . . . RCA's new, 1974, 576-page Solid State "High-Reliability Devices" DATABOOK (SSD-207B). This handy reference provides complete Technical Data Sheets and other useful information on the broad range of RCA High-Rel integrated circuits and transistors.

Send for your copy today. Only \$2.00.

RCA Solid State
Section 57B-15 Box 3200
Somerville, New Jersey 08876

- Please rush my order for _____ copies of the 1974 "High-Reliability Devices" DATABOOK (SSD-207B). My cost, \$2.00 each.
- Please send a free copy of RCA's High-Rel IC Brochure (RIC-200).

Name/Title _____

Company _____

Address _____

City/State/Zip _____

I enclose payment by: Check Money Order

Offer good only in U.S. and Canada. Direct other inquiries to RCA Sales Offices or Distributors.

RCA Solid State
products that make products pay off

International: RCA, Sunbury-on-Thames, U.K./RCA, Fuji Building, 7-4 Kasumigaseki, 3-Chome, Chiyoda-ku, Tokyo, Japan/RCA, 103 Nanking E. Road, Sect. 2 2nd Floor, Taipei, Taiwan. In Canada: RCA Limited, Ste. Anne de Bellevue 810, Canada.

INFORMATION RETRIEVAL NUMBER 211

All kinds of thyristors.

As simple as this:

No rationing. No sales by appointment. No waiting in line. No energy crisis.

In the face of an ever-increasing industry crunch on availability of SCRs, Triacs, unijunctions and trigger devices, Motorola has and will have the capability, deliverability and devices in nearly all current categories to keep you on top of your production lines in '74.

Our competition will say "exaggeration."

Because they can't boast a doubled '73 production capacity over '72 like Motorola can.

They didn't ship 100 million thyristors during the last 5 years . . . 30 million of that in one year like Motorola did.

They couldn't expand to 3 world-wide thyristor manufacturing locations like Motorola could.

They didn't add 418 new thyristor devices in the last 18 months to an existing broad line like Motorola did.

They can't ship from 1,000 to 100,000 of all devices listed on the next page within 4 to 6 weeks like Motorola ships.

And they've never been known as "production house of the industry." Motorola has. And will be through thick, thin and '74.

Prove it to yourself. Contact your Motorola distributor about quantities of any listed device.

He's got all kinds of them. The factory's got all kinds of them.

They're all available . . .

You can quote

Motorola has more Thyristor availability than any other supplier. Pick the series you need from the

SCRs

Current Rating	GE Series	RCA Series	Motorola Series
800 mA	C103	—	2N5060
7 A	—	40654, 40655	MCR320
7 A	—	40833	MCR320
8 A	C122	40867-40869	2N4441
16 A	2N1842	2N1842	2N1842
20 A	C20	—	MCR3818
20 A	C22	—	MCR3818
20 A	C220	40737-40740	MCR3818
20 A	C222	40741-40744	MCR3918
20 A	—	40745-40848	2N6167
20 A	—	40749-40752	MCR3818
20 A	—	40753-40756	MCR3918
20 A	—	40757-40760	2N6167
25 A	2N681	2N681	2N681
35 A	C30	—	MCR3935
35 A	C31	—	MCR3935
35 A	C32	—	MCR3835
35 A	C33	—	MCR3935
35 A	—	2N3870-73	2N3870-73
35 A	—	2N3896-99	2N3896-99
35 A	—	40680-40683	2N6171
80 A	C45	—	MCR81
80 A	C147	—	MCR81

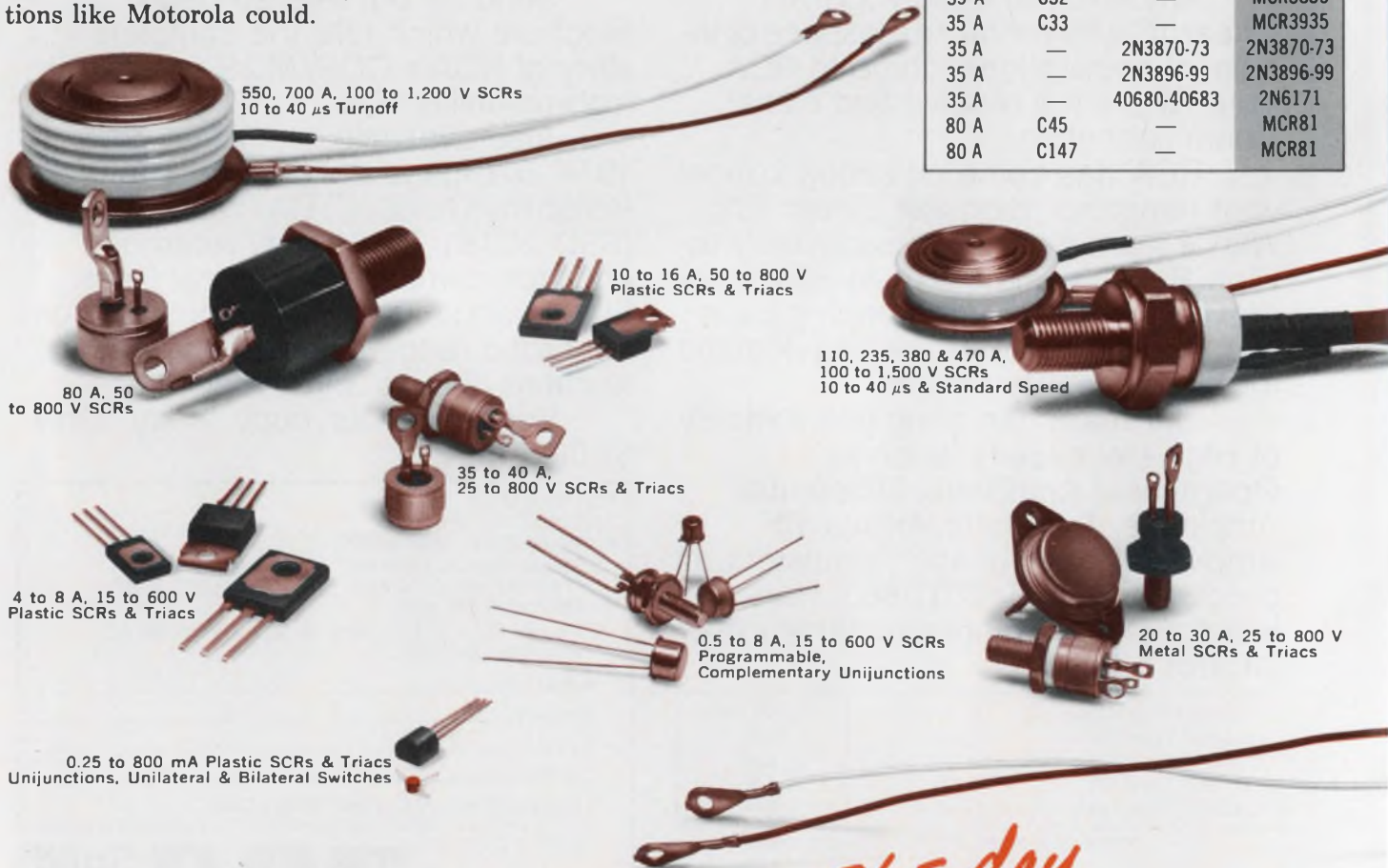

365-day

From Motorola, the thyristor

All kinds of availability.

us on that.

list below, fill in the coupon and find out for yourself.

With the quote we'll send our

latest brochure detailing Thyristor specs, characteristics, symbols, definitions, terminology, and cross-referencing of more than 350 indi-

vidual SCRs, Triacs, unijunctions and trigger devices.

There's a Motorola Thyristor to fit your design need in '74.

Triacs

Current Rating	GE Series	RCA Series	Motorola Series
10 A	SC141	—	2N6151
10 A	—	40668-40669	2N6151
10 A	—	40842	2N6151
10 A	SC146	—	2N6151
10 A	SC240	—	2N5571-72
10 A	SC240-23	—	MAC40799-40801
10 A	SC241	—	2N5567-68
10 A	SC245	2N5569-70	2N5569-70
10 A	SC245-23	40799-40801	MAC40799-40801
15 A	SC246	2N5567-68	2N5567-68
15 A	SC250	2N5573-74	2N5573-74
15 A	SC251-23	40802-40804	2N6145
15 A	SC251	2N5571-72	2N5571-72
25 A	SC60	—	MAC38
25 A	SC61	—	MAC37
30 A	SC60-23	—	2N6163
30 A	—	40660-40661	2N6157
30 A	—	40662-40663	2N6157
30 A	—	40805-40807	2N6163

High Current SCRs

RMS Current Rating	GE Series	Motorola Series
55 A	C45/46	MCR45/46
110 A	C50	2N1909-16
110 A	C60	2N2023-30
110 A	C52	2N1792-98
110 A	C62	MCR62
110 A	C150/152	MCR150/152
110 A	C154	MCR154
110 A	C155	MCR155
110 A	C156	MCR156
110 A	C157	MCR157
110 A	C158	MCR158
110 A	C159	MCR159
225 A	C354	MCR235A
225 A	C355	MCR235C
225 A	C358	MCR235D
275 A	C364	MCR380A
275 A	C365	MCR380C
400 A	C380	MCR380
400 A	C385	MCR380C
500 A	C387	MCR550D
500 A	C388	MCR550C
550 A	C392	MCR550C
550 A	C393	MCR550D
800 A	C390	MCR800
800 A	C501	MCR800



UJTs & Triggers

Device	GE Series	RCA Series	Motorola Series
UJT	D5G515/2N2417A	—	2N4851
UJT	D5G516/2N2422A	—	2N4852
UJT	2N4221B	—	2N4948
PUT	2N6027	—	2N6027
PUT	2N6028	—	2N6028
DIAC	—	—	1N5758/A
DIAC	—	45411	1N5759/A
SBS	2N4991	—	MBS4991

Mail your *request-for-Thyristor-Quote* coupon to: Box 20912, Mail Drop TB 209, Phoenix, Az. 85036.



10 to 16 A, 25 to 600 V Metal SCRs & Triacs

800 A, 100 to 1,500 V SCRs

producer.

Give me price and delivery on the . . .

Series/device: With these prime specs: In this quantity:

Name _____

Company _____

Address _____

City _____ State _____ Zip _____

**INTERDATA
ANNOUNCES
THE INDUSTRY'S
FIRST 32-BIT
MINICOMPUTER
FOR UNDER
\$10,000.**

WITH UP TO A MILLION BYTES OF DIRECTLY ADDRESSABLE MEMORY.

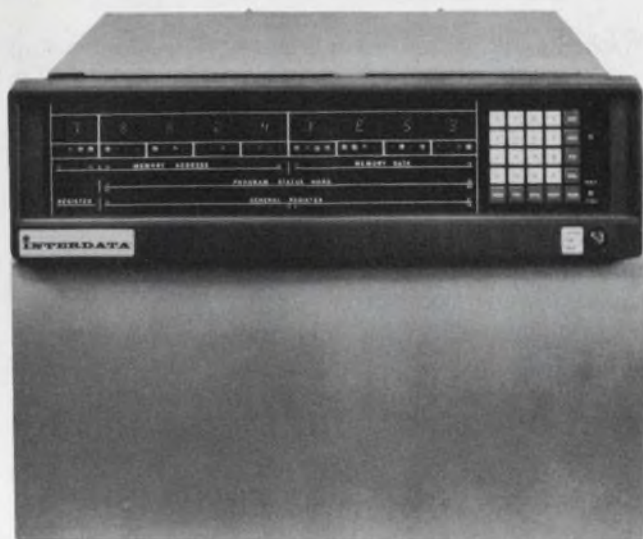

Minicomputer myths you can live without:

1. There's no such thing as a 32-bit minicomputer.
2. Minicomputers have an absolute 64K addressing limit.
3. The only way to even access more is to resort to some sort of hardware kluge with a hairy software scheme that'll cost you an arm and a leg.

All wrong.

Because now there's the Interdata 7/32 – a powerful new 32-bit minicomputer with main memory expandable up to a million bytes and direct addressing up to 16 million bytes.

Big it is. But hairy it isn't.

Because it's simple, straightforward and efficient. And it's the industry's first uncomplicated extended-memory software environment.

Backed up by a lot of hardware muscle like thirty two, 32-bit registers, 1024 I/O interrupts with automatic vectoring, 239 instructions. And a lot more. All of which would lead you to expect to pay a lot more money, right? Well, that's also a myth.

Performance	7/32	Nova 840	PDP-11/40
Word length	32	16	16
Memory speed (nanoseconds)	750	800	900
Maximum memory capacity (bytes)	1,048,576	262,144	262,144
Addressing range (bytes)			
Direct	1,048,576	512	65,536
Relative	±16,384	±256	±32,768
Indexed	1,048,576	65,536	65,536
Double indexed	1,048,576	No	No
General-purpose registers	32 32-bit	4 16-bit	8 16-bit
Index registers	30 32-bit	2 16-bit	8 16-bit
Vectored interrupt levels	Yes	No	Yes
Minimum interrupt overhead time (usec)	6.5	47.5	46.5

Price	7/32	Nova 840	PDP-11/40
32 KB processor	\$ 9,950	\$12,930	\$15,345
64 KB processor	14,450	19,330	26,925
128 KB processor	23,450	35,630	44,725
256 KB processor	41,450	61,230	80,825
1 Megabyte processor	171,650	Not available	Not available

Source: Data General Price List, 5/15/73. DEC PDP-11/40 Price List, 6/73. DEC OEM & Product Services Catalog, 1972. Auerbach Minicomputer Characteristic Digest, June, 1973. "How to use Nova Computers", 1973.

The software muscle is all there, too. A new FORTRAN V compiler. An optimizing assembler called CAL. And the first extended operating system that's both powerful and simple – OS/32. Plus all the other field-proven Interdata software – it's all compatible.

The new Interdata 7/32.

We put our muscle where their myth is.

INTERDATA®

2 Crescent Place, Oceanport, New Jersey 07757 (201) 229-4040.
 Boston – (617) 890-0557. Washington – (703) 525-4806. Philadelphia – (215) 436-5579.
 Orlando – (305) 851-6962. Chicago – (312) 437-5120. Detroit – (313) 356-5515.
 Dayton – (513) 434-4193. Kansas City – (913) 384-1606. Houston – (713) 783-3060.
 Dallas – (214) 238-9656. Denver – (303) 758-0474. Los Angeles – (213) 640-0451.
 Phoenix – (602) 968-2477. San Diego – (714) 565-0602. San Francisco – (415) 969-1180.
 Seattle – (206) 455-0680. Toronto – (416) 677-8990. Tokyo – (270) 7711.
 Sydney – 439-8400. London – Uxbridge 52441. Munich – 0811-8543887.

Protect against nuclear transients.

Simple RC T-network replaces expensive radiation-hardened ICs to prevent scrambling of digital data.

A transient burst of nuclear radiation—such as that produced by a distant nuclear blast—can scramble data stored in memory and register circuits, interfere with the execution of commands and garble data communications. Can such damage be prevented? Several ways exist, and one is so simple that many engineers overlook it.

One way is to surround the equipment with heavy shielding. Another is to use semiconductors that have been specially processed to resist moderate radiation. A third way is to use passive storage networks in critical locations.

Of these methods, the third is the least expensive. Moreover weight restrictions obviously limit the use of heavy shielding in aircraft, satellites and space vehicles.

Latching devices—flip-flops, cross-coupled gates, storage registers and retriggerable one shots—are particularly vulnerable to transient impulse bursts, which can randomly reset or change circuit states. And the simple, symmetrical T network, with two resistors and one capacitor, can protect against these bursts, if the network is designed for worst-case conditions.

For example, two cross-coupled NAND gates are commonly used to form the flip-flop so common in memories and storage registers (Fig. 1a).

Antonio N. Paolantonio, P.E., 17806 Elkwood St., Reseda, Calif. 91335.

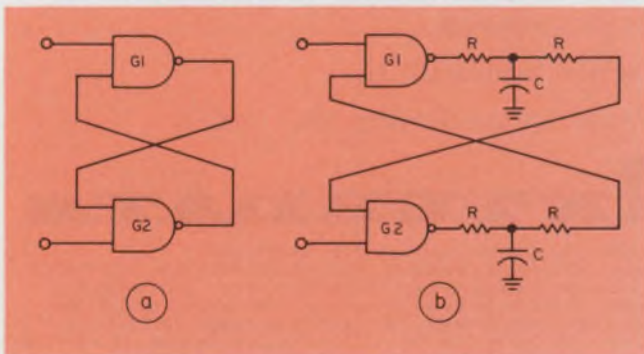

1. Cross-coupled NAND gates are commonly used to form the flip-flop in memories and registers (a). A simple RC T-network connected between gates can prevent the network from changing states when a nuclear transient burst occurs (b).

With the addition of two T networks, the flip-flop can be “hardened” to resist transient upset (Fig. 1b).

Basically the circuit works by maintaining a voltage at the input of each gate. If large enough, the voltage prevents either gate from changing state in the event a transient momentarily forces the other to change state. Let’s look at the detailed design procedure.

Note that although a worst-case analysis is given here for a TTL IC, the procedures can also handle discrete designs and other types of logic.

Broad worst-case analysis needed

In general, a worst-case analysis should also consider other factors that can affect circuit behavior. These include initial, or nominal, component-tolerance variations (for both active and passive devices), temperature effects; component-tolerance drift caused by aging, and degradation caused by cumulative, long-term exposure to nuclear radiation.

For instance, a carbon-composition resistor, with an initial rated tolerance of $\pm 5\%$, will actually degrade about $\pm 15\%$ as a result of dissipation stress, ambient temperature variations and other environmental conditions and aging.

The design procedure consists of the following eight steps:

1. Draw a schematic for the condition when the input to the T network is HIGH.
2. Calculate the maximum allowable value for the resistors in the T for the HIGH state.
3. Redraw the schematic for the condition when the input to the T is LOW.
4. Compute the maximum allowable value for the resistors in the T for the LOW state.
5. Select the lower of the two values determined in Steps 2 and 4 for use in subsequent calculations.
6. Compute the steady-state dc voltage across the capacitor in the T for the HIGH state.
7. With the circuit in the transient state, determine the value required for the capacitor, C.
8. Calculate the maximum throughput, or bit

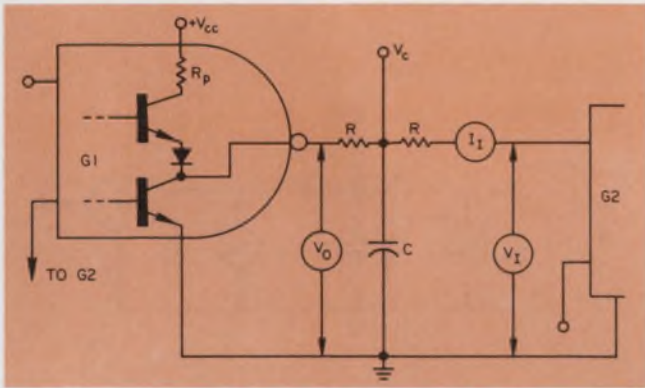

2. Simplified schematic of NAND flip-flop and T network depicts the critical voltages and currents.

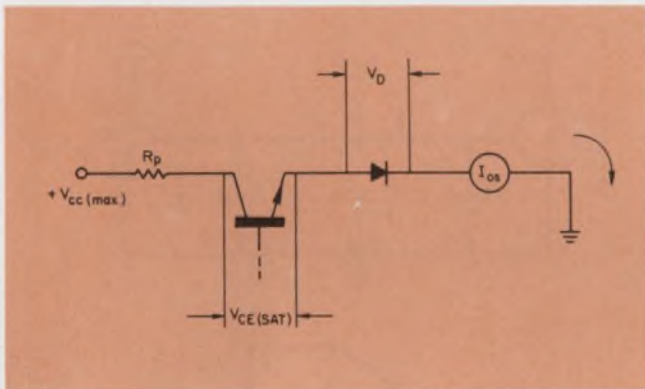

3. Short-circuit condition of gate is used to calculate the maximum value of the gate pullup resistor, R_p .

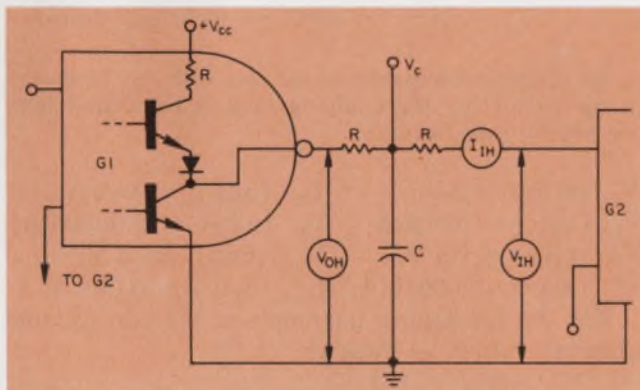

4. Equivalent circuit of gate with the output of G_1 in the HIGH condition.

rate, for the hardened circuit.

Network parameters computed from these steps provide for circuit operation at the maximum throughput under worst-case conditions.

The simplified schematic for the cross-coupled NAND is shown in Fig. 2. As a preliminary step, draw the equivalent circuit for a short-circuit and compute the maximum value for the pull-up resistor, R_p , inside G_1 . Note that the maximum supply voltage and the minimum short-circuit current are used for this step (Fig. 3). Thus

$$R_p(\max) = \frac{V_{CC}(\max) - V_{CE}(\text{sat}) - V_D}{I_{OS}(\min)} \quad (1)$$

Next determine the maximum allowable value for the resistors in the network for the HIGH state (Fig. 4). Note that the minimum supply voltage is used in this step:

$$R_H(\max) = \frac{K_R}{2} (y) - R_p(\max), \text{ where } y = \left[\frac{V_{CC}(\min) - V_{CE}(\text{sat}) - V_D - V_{IH}(\min)}{N I_{IH}(\max)} \right] \quad (2)$$

Compute the maximum allowable value for the resistors when the output of G_1 is in the LOW state (Fig. 5):

$$R_L(\max) = \frac{K_R}{2} \left[\frac{V_{IH}(\min) - V_{OL}(\max)}{N I_{IL}(\max)} \right] \quad (3)$$

In Eqs. 2 and 3, $K_R = (1 - \rho)$ where ρ is the worst-case design tolerance for the type of resistor used in the circuit. The lower of the two values for $R_L(\max)$ and $R_H(\max)$ is used in subsequent computations.

Now, with the output of G_1 in the HIGH state (Fig. 4), compute the steady-state dc voltage, V_C , across the capacitor in the T. This is given by

$$V_C = V_{CC}(\min) - V_{CE}(\text{sat}) - V_D - I_{IH}(\min) \times (R_p + R) \quad (4)$$

Enter the transient

Assume now that the output of G_1 is HIGH. Suddenly a transient nuclear burst occurs, which momentarily forces the output of G_1 to the LOW state for the duration of the radiation burst (Fig. 6).

A minimum value is required of the capacitor in the T network to maintain a sufficiently high voltage at the input of G_2 to prevent G_2 from changing state. For this condition to prevail, the instantaneous transient voltage across C , e_c , must never exceed $V_{IH}(\min)$ —the threshold for a change of state.

Since the discharge path for C is through resistor R (Fig. 6), the equation for the instantaneous voltage across C is

$$e_c = V_C \epsilon^{-\tau/RC} + V_{OL}(\max) \times (1 - \epsilon^{-\tau/RC}) \quad (5)$$

$$\text{and } V_{IH}(\min) = V_C \epsilon^{-\tau/RC} + V_{OL}(\max) (1 - \epsilon^{-\tau/RC}).$$

Solving for C and introducing a worst-case design tolerance factor, K_c , for the type of capacitor used in the circuit, we get

$$C(\min) = \frac{\left(\frac{\tau}{R}\right) \log \epsilon}{K_c \log \left[\frac{V_C - V_{OL}(\max)}{V_{IH}(\min) - V_{OL}(\max)} \right]} \quad (6)$$

To determine the maximum throughput, consider the condition when a data bit has arrived at the input to G_1 —that is, the input is HIGH and output is LOW. Compute the steady-state dc voltage across C when the output of G_1 is LOW:

$$V_C = V_{OL}(\max) + R \times I_{IL}(\max), \quad (7)$$

where the value of R is the lowest value for $R_L(\max)$ and $R_H(\max)$.

At the end of the data bit, the output of G_1 is HIGH. The capacitor charging cycle at this instant is illustrated in Fig. 7a. To solve for the time, t , required to charge the capacitor to a voltage sufficiently high to toggle G_2 , first note that e_c must equal or exceed $V_{IH}(\min)$ —the threshold for a change of state.

During the charging cycle the instantaneous voltage across C is given in Eq. 5 (this is a valid, close approximation), with t substituted for τ .

Rearranging terms in Eq. 5 and solving for t , we get

$$t = RC \frac{\log \left[\frac{V_{OH}(\min) - V_C}{V_{OH}(\min) - V_{IH}(\min)} \right]}{\log \epsilon} \quad (8)$$

If an allowance of 10% is made for the sum of the rise and fall times for a data pulse, the minimum duration of the data pulse may be computed as follows (Fig. 7b):

$$T = 1.1 [t + t_{(hold)} + t_{(setup)}] \quad (9)$$

Finally the maximum bit rate is given by

$$f = \frac{1}{2T} \quad (10)$$

Sample problem illustrates technique

As a sample problem, let's use the parameters for a Texas Instruments SN5400, connected in a cross-coupled flip-flop.

From the data sheets, the values are:

$$V_{CC}(\max) = 5.5 \text{ V}, \quad V_{CC}(\min) = 4.5 \text{ V},$$

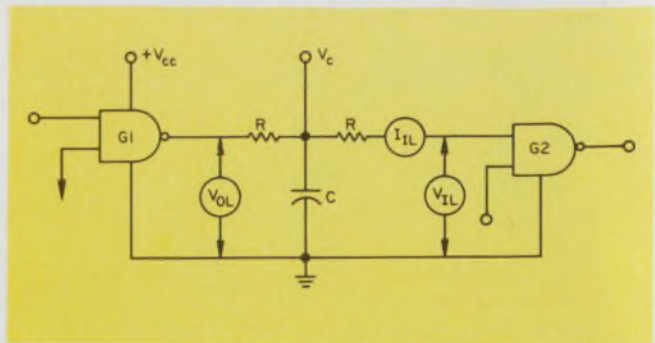

5. When G_1 goes low, the important circuit parameters are V_{OL} , I_{IL} and V_{IL} .

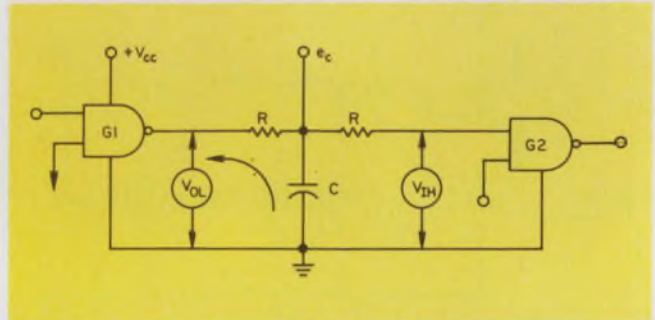

6. When a transient occurs, G_1 is momentarily forced to LOW. But the T network maintains the input of G_2 at V_{IH} to prevent the gate from changing state.

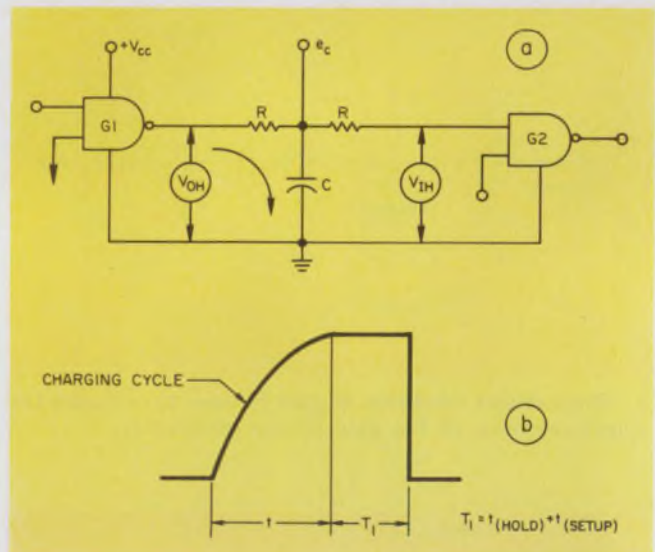

7. To maintain the maximum bit rate with the T network in the circuit (a), the charging time is calculated from the waveform across C (b).

$$\begin{aligned} V_{IH}(\min) &= 2 \text{ V}, & I_{OS}(\min) &= 0.02 \text{ A}, \\ V_{IH}(\max) &= 0.001 \text{ A}, & I_{IH}(\min) &= 0.00004 \text{ A}, \\ V_{OL}(\max) &= 0.4 \text{ V}, & V_{OH}(\min) &= 2.4 \text{ V}, \\ I_{IL}(\max) &= 0.0016 \text{ A}, & I_{IH}(\max) &= 0.001 \text{ A}. \end{aligned}$$

For the remaining parameters, we can assume nominal values as follows:

$$V_{CE}(\text{sat}) = 0.4 \text{ V},$$

$$V_D = 0.6 \text{ V},$$

$$K = (1 - \rho) = 1 - 0.15 = 0.85 \text{ for a}$$

When our compression springs lasted *100 times* longer, we stopped the tests!

How long do you run a test? We didn't have space on this page to show the true life of Instrument Specialties' beryllium copper compression springs, so we stopped testing.

A test was conducted, based on specifications furnished by a spring user. Samples of an I/S compression spring, hardened after forming, and a competitive spring made of pre-tempered beryllium copper were placed in an oven and stressed equally at a moderate 27,000 lbs./sq. in. The springs were removed from the oven at various intervals and checked at room temperature with standard loads.

The competitive springs failed to meet the customer's load test after 2½ hours at 200° F. I/S springs were still within the tolerance limits after more than 200 hours. Projecting the slope of the curves, it is probable that the I/S coil springs would still be within tolerance on both tests after 1000 hours! That's performance! It's also a testimony to the advantages of hardening beryllium copper *after forming*, an I/S specialty!

And that's typical of what you can *always* expect when you specify I/S beryllium copper compression springs. Moreover, we can supply even small lots at lower prices than you have been paying for less stable springs. So, if you need a coil spring with the highest possible performance, or have been experiencing a problem with ordinary springs, let us know about it. We can probably help. Write to us at Dept. ED-66.

Specialists in beryllium copper springs since 1938

Both springs were same length and made to same specifications of user. After test, the difference in length represents the "set" taken by the inferior spring.



AMOUNT
OF
SET

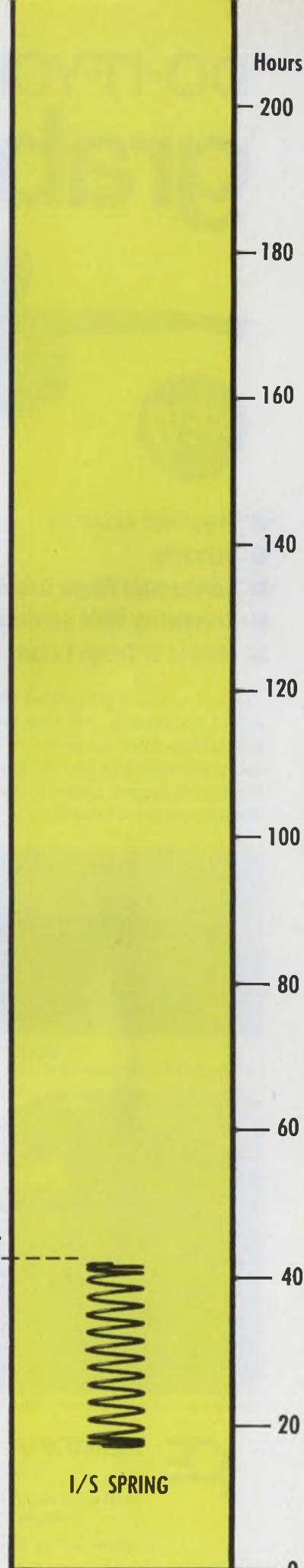

DO-IT-YOURSELF grabber



NEW

- Simplified Assembly
- Versatile
- Comfortable Finger Grip Action
- Completely Field Serviceable
- Molded of Tough Lexan*

Model 3925
Mini Test Clip
Shown Actual Size

This test clip with gold plated hook is excellent for rapid testing of components and Wire Wrap† pins. Clip is completely insulated to point of connection. Build any combination of test leads with wire up to .090 dia. Easy and comfortable to operate. Molded of rugged Lexan to resist melting when soldering. Write for literature and prices.



MODEL 3925
hooks onto components or slips over square Wire-Wrap pins

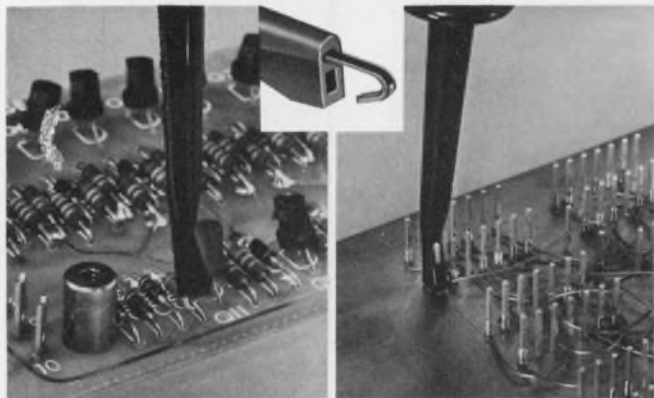

*Lexan is a General Electric trade-mark. †Registered trade-mark of Gardner-Denver Co.



POMONA ELECTRONICS

A Subsidiary of ITT

1500 East Ninth St., Pomona, Calif. 91766
Telephone (714) 623-3463

INFORMATION RETRIEVAL NUMBER 215

carbon-composition resistor that degrades $\pm 15\%$ over a period of time—say, three years,

$$N = 1 \text{ (single gate loading),}$$

$$t_{(\text{hold})} = 200 \times 10^{-9} \text{ s,}$$

$$t_{(\text{setup})} = 100 \times 10^{-9} \text{ s.}$$

Using Eq. 1 to compute the maximum value of the pull-up resistor, R_p , we get

$$R_p \text{ (max)} = \frac{5.5 - 0.4 - 0.6}{0.02},$$

$$R_p \text{ (max)} = 225 \Omega.$$

With the circuit in the HIGH state, calculate the value of the T resistor, R , from Eq. 2:

$$R_H \text{ (max)} = \frac{0.85 \left[\frac{(4.5 - 0.4 - 0.6 - 2)}{1 \times 0.001} - 225 \right]}{2},$$

$$R_H \text{ (max)} = 542 \Omega.$$

With the circuit in LOW, use Eq. 3 to calculate R :

$$R_L \text{ (max)} = \frac{0.85 \left[\frac{(2 - 0.4)}{1 \times 0.0016} \right]}{2},$$

$$R_L \text{ (max)} = 425 \Omega.$$

Now use the lowest value found for R to select a standard resistor. The closest catalog value that is less than 425Ω is 390Ω .

Thus R (Tee) = $390 \Omega \pm 5\%$.

Next compute V_c with the flip-flop in HIGH. From Eq. 4,

$$V_c = 4.5 - 0.4 - 0.6 - 0.00004 (225 + 390),$$

$$V_c = 3.48 \text{ V.}$$

Assume that a transient burst forces G_1 to LOW for a time duration, τ , equal to 1×10^{-6} s. Note that τ includes the actual event duration plus charge-storage time within the semiconductor device.

We can calculate the value of the T capacitor, C , from Eq. 6, assuming a value of $K_c = 0.9$ ($\pm 10\%$ capacitor design tolerance):

$$C \text{ (min)} = \frac{\left(\frac{1 \times 10^{-6}}{390} \right) \log(2.718)}{0.9 \log \left(\frac{3.48 - 0.4}{2 - 0.4} \right)},$$

$$C \text{ (min)} = 0.00433 \mu\text{F.}$$

The next higher value of a catalog capacitor is 4700 pF . Thus C (Tee) = 4700 pF .

With G_1 in LOW, V_c is given by Eq. 7:

$$V_c = 0.4 + 390 \times 0.0016,$$

$$V_c = 0.624 \text{ V.}$$

From Eq. 8, the time, t , to charge C when G_1 goes LOW is

$$t = (390 \times 4700 \times 10^{-12}) \frac{\log \left[\frac{(2.4 - 0.624)}{(2.4 - 2)} \right]}{\log 2.718},$$

$$t = 2.69 \times 10^{-6} \text{ s.}$$

The duration of the data pulse, from Eq. 9, is $T = 1.1 (2.69 \times 10^{-6} + 200 \times 10^{-9} + 100 \times 10^{-9})$, $T = 2.99 \times 10^{-6} \text{ s.}$

Finally Eq. 10 gives the maximum bit rate:

$$f = \frac{1}{2(2.99 \times 10^{-6})},$$

$$f = 167,000 \text{ bits/second. } \blacksquare \blacksquare$$

Now. Sylvania sharpens your designer's edge.

...with the only miniature lamp handbook written specifically for the practicing engineer and designer

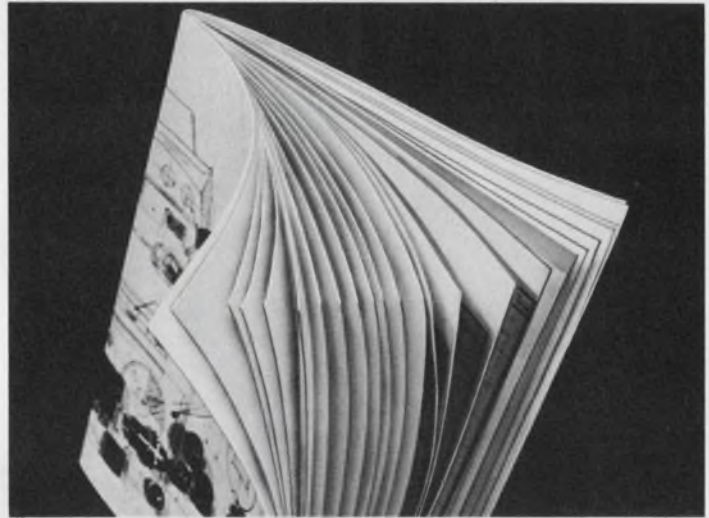

Tired of those four-page brush-offs that pass for application engineering data — that pat you on the head with the same old candlepower-lumen-Watt-Lambert equation, and then leave you flat?

Sylvania engineers think you deserve more. More information. On more subjects. On a more practical level. And, more respect — both for the complexity of the design problems you must solve, and the expertise you bring to solving them. That's why the new Design Data Handbook skips the spoonfeeding, and devotes about half its 56 pages to the theory and *practice* of designing with miniature lamps.

To illustrate what we mean by a practical approach, take the problem of making one indicator light on a panel more important than others. Should you opt for optics? Boost voltage for shorter wavelengths and higher-visibility blues?

For that matter, did you know that you can actually do more harm than good by isolating the indicator from the rest of the group? When you're dealing with questions of color, brightness and placement, you've got to treat them as crucial factors.

That may involve anything from the effects of filament orientation to overcoming early failures caused by bulb base heating. But one thing is certain: if you need it, it's here in the most useful, interesting, *grown-up* reference you've ever seen.

But don't take our word for it. Take the Design Data Handbook, with our compliments. A fresh light on the subject of miniature lamps may be all you need to sharpen your competitive edge in automotive, aircraft or instrument panel design.

Send for your copy and see what we mean.

Sylvania Miniature Lighting Products Inc., 526 Elm St., Kearny, N. J. 07032; (201) 997-1850

GTE SYLVANIA
...where the designer's edge originates

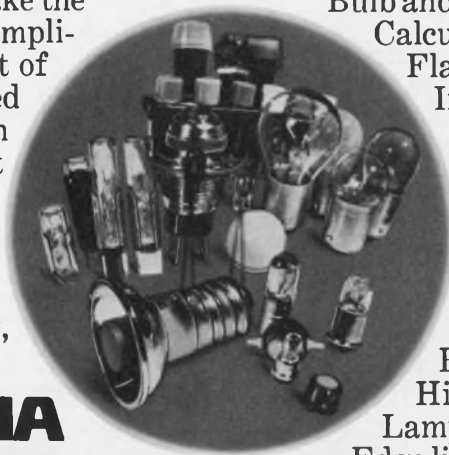

To whet your appetite, here's a brief summary of the design data section

THEORY

- Electromagnetic radiation
- The optical spectrum
- The laws of thermal radiation
- The visible spectrum
- The human eye
- Color vision
- Photopic and scotopic vision
- Aging effects
- Visual acuity
- Background luminance effects

PRACTICE

- Filament orientation
- Inrush current
- Shock and vibration
- AC vs DC operation
- Bulb and base heating
- Calculating temperature rise
- Flashing
- Indicator voltage variations
- Reinforcement
- Contrast
- Legibility
- Pilot-signal service
- Multi-level signals
- Illumination service
- Battery operation
- High-intensity lamps
- Lamps that use optics
- Edge lighted panels

Fujitsu Quality on Sale in Reed Switch

Fujitsu reed switches combine ultra-small size with reliability and superior performance.

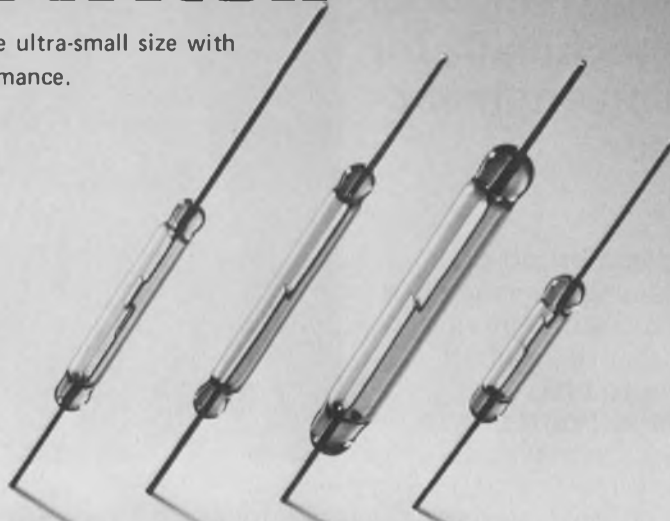

Select the most suitable reed switch for your requirements from the following:

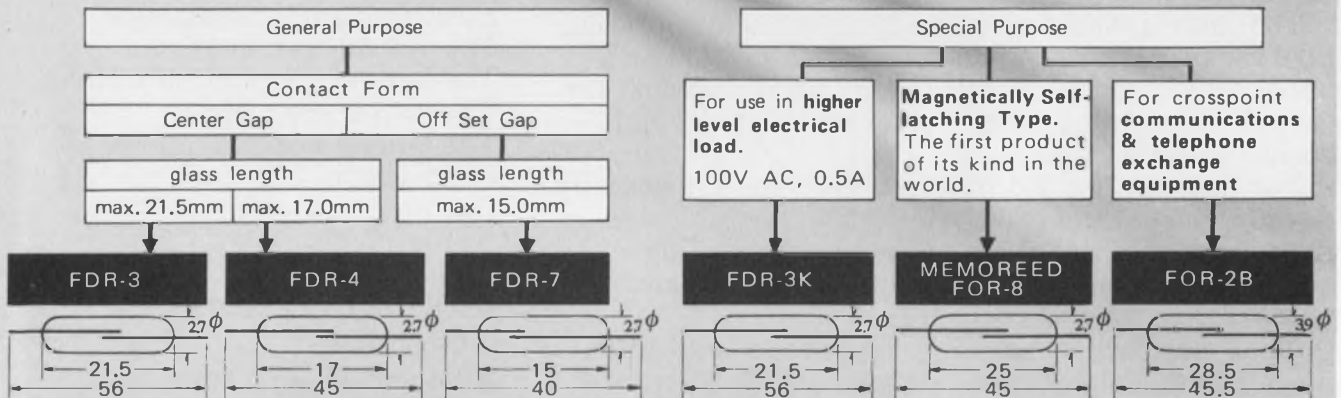

Reed Switch	Contact Form	Contact Rating	Pull-in Ampereturns	Drop-Out Ampereturns	Operate Time	Release Time	Initial Contact Resistance	Dielectric Withstanding Voltage
FOR-3	A(make) Center Gap	10VA DC (0.5A DC max.) (100V DC max.)	20 ~ 60	8 min.	800μS max. (including contact bounce)	50μS max.	150mΩ max.	250/500V DC (1min.)
FDR-4	A(make) Center Gap							250/350V DC (1min.)
FDR-7	A(make) Off Set Gap							250/500V DC (1min.)
FDR-3K	A(make) Center Gap	30VA DC (1A max.) 50VA AC (1A max.)	20 ~ 60	8 min	1.5mS max. (including contact bounce)	0.1mS max.	100mΩ max.	600V DC (1min.)
FDR-8	A Self-latching Type	5VA DC (0.5A max.)	85 ± 10	-28 ± 6				800V DC (1min.)
	B		110 ± 15	-24 ± 10				800V DC (1min.)
FDR-2B	A(make) Center Gap	10VA DC (0.5A max.)	40 ~ 60	15 ~ 25				800V DC (1min.)

FUJITSU LIMITED
Communications and Electronics
Marunouchi, Tokyo, Japan

For further information, please contact:
Head Office: 6-1, Marunouchi 2-chome, Chiyoda-ku, Tokyo 100, Japan Telex: J22833
New York Office: 680 Fifth Avenue, New York, N.Y. 10019, U.S.A. Phone: (212) 265-5360
Fujitsu California Inc.: 1135 East Janis Street, Carson, California 90746, U.S.A. Phone: (213) 636-0858, (213) 537-8930

MAIN PRODUCTS □ Telephone Exchange Equipment □ Carrier Transmission Equipment □ Radio Communication Equipment □ Space Electronics Systems □ Electronic Computers & Peripheral Equipment (FACOM) □ Telegraph & Data Communication Equipment □ Remote Control & Telemetry Equipment □ Electronic Components

INFORMATION RETRIEVAL NUMBER 217

“Delivery In 42 Weeks?”



For some companies that's a death sentence.

Picture yourself waiting—42 weeks!—for a 10-cent part you desperately need to complete your product. That's typical of the leadtimes being quoted for all kinds of components and materials as industry after industry gets hit by shortages. And there you are with your overhead costs soaring, your unhappy customers demanding shipment, and your production line at a standstill. It's a chilling thought. But for a lot of people, it's real, and right now. And from the looks of things it's going to get worse.

What can you do about it? Line up alternate suppliers and investigate substitute materials. But do it now before your shortage becomes a crisis. Be prepared to spend a lot of time pouring through catalogs, talking on the telephone, and pounding on doors. Or save yourself this hassle and start with Visual Search Micro Film. The vital information you need is all right there—up to the minute information about products and manufacturers. All researched, indexed, and orga-

nized for instant retrieval. If there's a second source for the things you need, odds are it's listed in VSMF. The cost? Less than you now pay a file clerk. One of the small costs of doing—or staying—in business.

Just send in the coupon and we'll give you the complete story on what VSMF can do for your company.

Information Handling Services, Denver Technological Center, P.O. Box 1154, Englewood, Colorado 80110, (303) 771-2600.

O.K. Give me a no-nonsense explanation of how VSMF can solve my delivery problems. Have a representative call.

NAME _____

COMPANY _____

ADDRESS _____

CITY _____ PHONE _____

STATE _____ ZIP _____



Information Handling Services

An Indian Head Company

INFORMATION RETRIEVAL NUMBER 218



The U. S. Government does not pay for this advertisement. It is presented as a public service in cooperation with The Department of the Treasury and The Advertising Council.

Invest in the United States of America.

**Almost 200 years
at the same location.**

The U.S.A.'s been in business a long time. So it's pretty solid.

And that's what makes U.S. Savings Bonds such a reliable and sure way to build a nest egg.

Bonds are completely safe, too. Lost, stolen, burned. It makes no difference. Your Bonds will be replaced if anything happens to them.

Why not turn a few green dollars into some blue chip U.S. Savings Bonds? Join the Payroll Savings Plan where you work or

buy Bonds at your bank.

U.S. Savings Bonds. They're a solid way to save.



Now E Bonds pay 5½% interest when held to maturity of 5 years, 10 months (4% the first year). Bonds are replaced if lost, stolen, or destroyed. When needed they can be cashed at your bank. Interest is not subject to state or local income taxes, and federal tax may be deferred until redemption.



Take stock in America.

Bonds are a safe way to save.

Fastest.

This new wide band inverting op amp is so fast no other monolithic device can match its speed.

Until now the only way you could obtain the performance speed of our new HA-2530 wide band inverting op amp was with expensive discrete modules. Say at around \$50 each. Now, for far less money you can have it all on

one cost-saving chip. For example, typical slew rate at + 25°C is 320V/μS, settling time (0.1%) is 550nS. No other monolithic op amp can match these speeds. Application range is excellent, too. Among applications are video

summations, high speed integrators, wave form generators, coaxial line drivers, and fast D/A outputs. For details see your Harris distributor or representative.

Features:

Offset voltage	0.8mV
Average offset voltage drift	5μV/°C
Slew rate	±320 V/μS
Power bandwidth	5 MHz
Gain bandwidth	70 MHz
Settling time	550nS
Open loop voltage gain	140db
Power consumption	100mW
Supplied	TO-99 pin out
	100-999 units

HA-2535	
0°C to + 70°C	\$14.30
HA-2530	
- 55°C to + 125°C	\$33.00

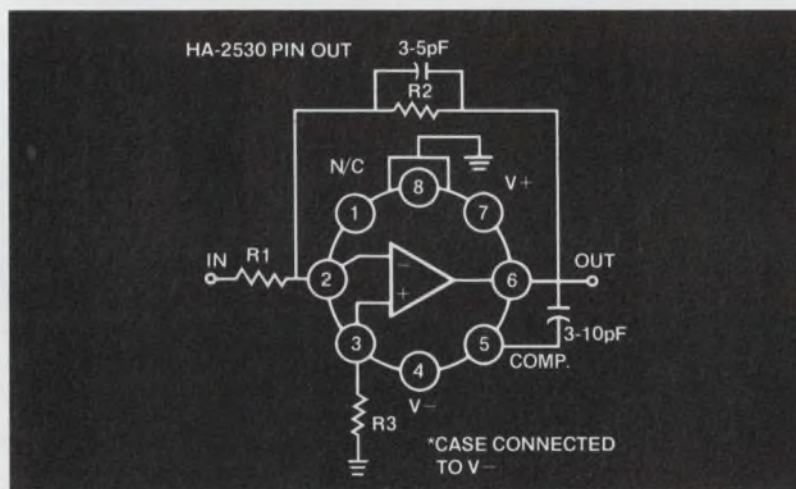

Harris



HARRIS
SEMICONDUCTOR
A DIVISION OF HARRIS-INTERTYPE CORPORATION

P.O. Box 883, Melbourne, Florida 32901
(305) 727-5430

WHERE TO BUY THEM: ARIZONA: Phoenix - Liberty, Weatherford, Scottsdale - HAR (602) 946-3556 CALIFORNIA: Anaheim - Weatherford, El Segundo - Liberty, Glendale - Weatherford, Long Beach - HAR (213) 426-7687, Mountain View - Elmar, Palo Alto - Weatherford, HAR (415) 964-6443, Romona - Weatherford, San Diego - Liberty, COLORADO: Denver - Elmar, Weatherford, WASHINGTON, D.C.: HAR (202) 337-3170
FLORIDA: Hollywood - Schweber, Hamilton, Melbourne - HAR (305) 727-5430 GEORGIA: Atlanta - Schweber ILLINOIS: Chicago - Schweber, Schaumburg - HAR (312) 894-8824, Schiller Park - Hamilton INDIANA: Indianapolis - Pioneer KANSAS: Lenexa - Hamilton MARYLAND: Baltimore - Hamilton, Rockville - Schweber MASSACHUSETTS: Lexington - R&D, Waltham - Schweber, Wellesley - HAR (617) 237-5430 MICHIGAN: Livonia - Hamilton, Troy - Schweber MINNESOTA: Edina - Hamilton, Minneapolis - Schweber HAR (612) 432-6111 MISSOURI: Hazelwood - Hamilton, NEW JERSEY: Cedar Grove - Hamilton, Mt. Laurel - Hamilton, Somerset - Schweber NEW MEXICO: Albuquerque - Weatherford NEW YORK: Melville - HAR (516) 249-4500, East Syracuse - Hamilton, Syracuse - HAR (315) 463-3373, Rochester - Schweber, Westbury - Schweber NORTH CAROLINA: Raleigh - Schweber OHIO: Beachwood - Schweber, Cleveland - Pioneer, Dayton - Pioneer, HAR (513) 226-0636 PENNSYLVANIA: Wayne - HAR (215) 687-6680 TEXAS: Dallas - Hamilton, Weatherford, HAR (214) 231-9031, Houston - Weatherford WASHINGTON: Seattle - Liberty, Weatherford

LEGEND FOR HARRIS SALES OFFICES & DISTRIBUTORS: Harris Semiconductor (HAR), Elmar Electronics (Elmar), Hamilton Avnet Electronics (Hamilton), Harvey/R&D Electronics (R&D), Liberty Electronics (Liberty), Pioneer Standard Electronics (Pioneer), Schweber Electronics (Schweber), R.V. Weatherford Co. (Weatherford), Western Radio (Western).

INFORMATION RETRIEVAL NUMBER 219

5 books that should be in your personal library... order now for 15-day free examination!



DURABILITY AND RELIABILITY IN ENGINEERING DESIGN

by Gilbert Kivenson

A unique combination of materials science, reliability, and design. Examines crucial concepts of material strength, service longevity, and reliability and describes the fundamentals of breakdown analysis. Covers new materials, design techniques and fabricating methods. 200 pp., #5851-9, cloth, \$9.95.

PRACTICAL VALUE ANALYSIS METHODS

By John H. Fasal

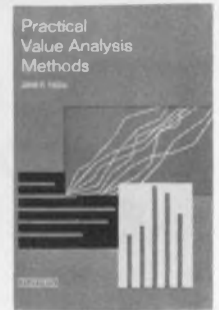

An applications-oriented guide offering a working knowledge of the latest methods and techniques in value engineering and value analysis. Provides ways of evaluating and supplementing the internal cost reduction techniques that enable a company to keep pace with competition. 272 pp., #5845-4, cloth, \$11.95.



PRACTICAL RELAY CIRCUITS

by Frank J. Oliver

Logically groups relay circuits according to the functions they perform, to help you quickly select the best circuit for your purposes. Covers the whole gamut of relay circuits and is illustrated with many circuit diagrams. 363 pp., #5802-0, cloth, \$14.95.

ELECTRICAL/ ELECTRONIC CHECKLISTS

Written and edited by W. B. Rossnagel



Twenty-two detailed checklists on subjects including cables and connectors, communication radios, multi-coders, GSE/AGE/TSE, EMI/RFI, lasers, radar, systems, transmitters and transponders, as well as other subjects. 172 pp., #9181, cloth, \$14.00.

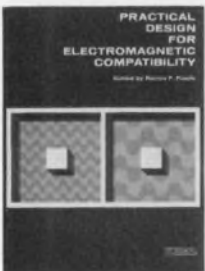

PRACTICAL DESIGN FOR ELECTROMAGNETIC COMPATABILITY

Edited by Rocco F. Ficchi

A convenient manual giving electronic designers techniques for analyzing, predicting, controlling, and reducing unwanted signals. Gives advantages and disadvantages of latest methods for reduction and control. Provides ways of selecting equipment for interference reduction. 272 pp., #5685-0, cloth, \$13.95.



HAYDEN BOOK COMPANY, INC.

50 Essex St., Rochelle Park, N.J. 07662

Please send the book(s) checked on 15-day free examination. At the end of that time, I will remit payment plus postage, or return the book(s) with no further obligation.

5851-9 5802-0 5685-0 5845-4 9181

\$10.00 minimum for free exam orders.

Because of higher billing and collection costs, we must ask for payment in full with any order for less than \$10.00. Books will be shipped postpaid. Same 15-day return privilege for full refund if not satisfied.

Save Money! On all prepaid orders Hayden pays postage — same return privilege.

Name _____

Firm _____

Address _____

City/State _____ Zip _____

ISBN Prefix 0-8104

73-65b

WORLD FAMOUS SIMPSON 260

OVER 2,000,000 SOLD

The pace-setting VOM for over 30 years

The finest **260**[®] SERIES 6

NOW... with
special Amp-Clamp dial ranges
for easy AC current
measurements up to 250 amps.

New Amp-Clamp, Model 150 Adaptor.

Measures AC current without breaking the circuit being tested. Plugs into the 260—reads directly on the new Amp-Clamp scales. Use with any 250, 260 (Series 3 thru 6) or 270.

Ranges: 0-5, 25, 50, 100, 250 amperes.



260-6, Complete with batteries, test leads and manual \$70.00

260-6P (overload protected), complete with batteries, test leads and manual \$102.00

260 CARRYING CASES:

Vinyl, DeLuxe #00805 \$17.50

Vinyl, standard #01818 \$14.50

AMP-CLAMP, Model 150 Adaptor with test lead \$25.00

Many other 260 models and accessories to choose from.

GET "OFF THE SHELF" DELIVERY FROM YOUR LOCAL ELECTRONIC DISTRIBUTOR . . . AND WRITE TODAY FOR CATALOG 4200.

KATY INDUSTRIES



ELECTRICAL EQUIPMENT GROUP

SIMPSON ELECTRIC COMPANY

853 Dundee Avenue, Elgin, Illinois 60120

Telephone: (312) 379-9090 • Cable: SIMELCO • Telex: 72-2416

IN CANADA: Bach-Simpson, Ltd., London, Ontario

IN ENGLAND: Bach-Simpson (U.K.) Limited, Wadebridge, Cornwall

IN INDIA: Ruttonsha-Simpson Private, Ltd., Vikhroli, Bombay



True rms voltage conversion can be achieved without slow, bulky and expensive equipment. New building blocks simplify the task.

Designers of systems and instruments are rapidly adopting an exciting new component of the nonlinear function module family—the modular operational rms-to-dc converter. With recent advances in semiconductor technology and clever design tricks, it's possible to build very accurate rms-to-dc conversion circuits that can match the capabilities of good digital voltmeters. Accurate measurement of rms levels is no longer limited to the calibration laboratory.

What is true rms voltage?

The mathematical expression for the rms value of any voltage $V_{in}(t)$ over the time interval of zero to time T_0 is:

$$V_{rms} = \sqrt{\frac{1}{T_0} \int_0^{T_0} [V_{in}(t)]^2 dt} \quad (1)$$

In most practical applications, however, you need a continuous measure of rms level rather than the rms level over a specific time interval. So a subtle, but very important, approximation is made: The expression under the radical is changed to "average of $[V_{in}(t)]^2$." This is also written as $[V_{in}(t)]^2$. Provided the signal frequency is high, relative to the desired response time, then low-pass filtering of the squared input voltage will provide a running average.

Though the need for a continuous measure of rms provides a rationalization for the leap from the exact integral expression for averaging to low-pass filtering, later this will cause difficulty in accurate performance for low-frequency input signals. If the simplification is accepted for now, two methods are suggested that directly compute rms levels by operational techniques (Fig. 1). In both cases a simple, one-pole active filter performs the averaging function. But note that the time constant is $R_1C_1/2$ for the implicit method rather than R_1C_1 for the direct method.

The second method, which requires an a^2/b operation, is actually the easiest to implement if

transconductance techniques are used. The basic transconductance circuit is shown in Fig. 2. To simplify the analysis, assume that the current sources, I_A , I_B , and I_C can be varied in such a way as to make any three of the collector currents into variables that depend only on the input signal or a constant. One of the collector currents will be chosen for the dependent output current. Also assume that the transistors are operating in their linear region, where the collector current is related to the base-to-emitter voltage by the equation:

$$I_c = I_s e^{\frac{qV_{BE}}{kT}} \quad (2)$$

If we assume further that the four transistors are well matched, have high β and are at equal temperature, then they will have all terms equal except for their I_c and V_{BE} . With these assumptions, the key equations are readily developed:

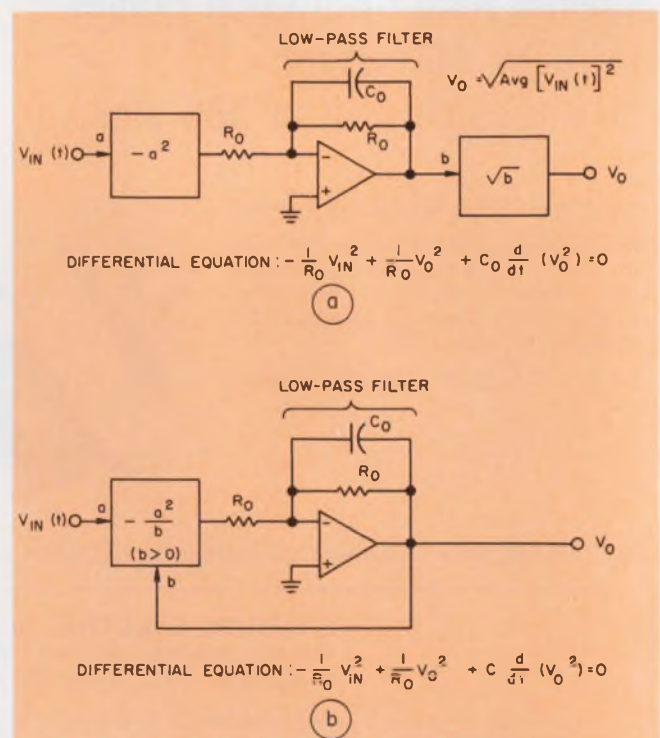

1. The direct (a) and implicit (b) methods operationally compute rms values of sine wave and other ac inputs.

Dr. Howard Handler, Engineering Manager; and Tom Cate, Consultant; Function Modules, Inc., Irvine, Calif. 92664.

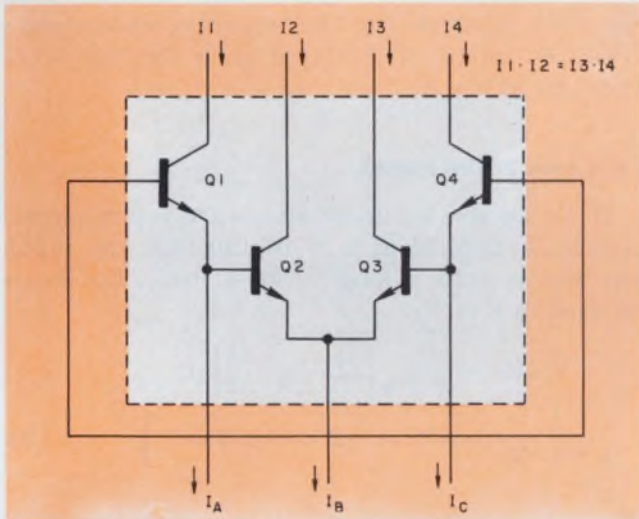

2. The basic nonlinear multiplication circuit uses four matched transistors and three current sources.

$$V_{BE1} + V_{BE2} - V_{BE3} - V_{BE4} = 0 \quad (3)$$

$$\frac{kT}{q} \left[\ln \frac{I_1}{I_s} + \ln \frac{I_2}{I_s} - \ln \frac{I_3}{I_s} - \ln \frac{I_4}{I_s} \right] = 0. \quad (4)$$

Therefore $I_1 I_2 = I_3 I_4$.

To obtain an a^2/b operation, just make I_1 equal to I_2 and make either I_3 or I_4 the denominator. An operational circuit that uses this approach and satisfies the earlier assumptions is shown in Fig. 3. If we go one step further and assume ideal op amps (infinite gain, zero offset voltage and zero bias current), then the collector currents are:

$$I_1 = \frac{1}{R_1} |V_1| \quad I_3 = \frac{1}{R_o} V_o + C_o \frac{dV_o}{dt}$$

$$I_2 = I_1 \quad I_4 = \frac{1}{R_2} V_o$$

Combining these expressions with Eq. 4 yields the differential equation:

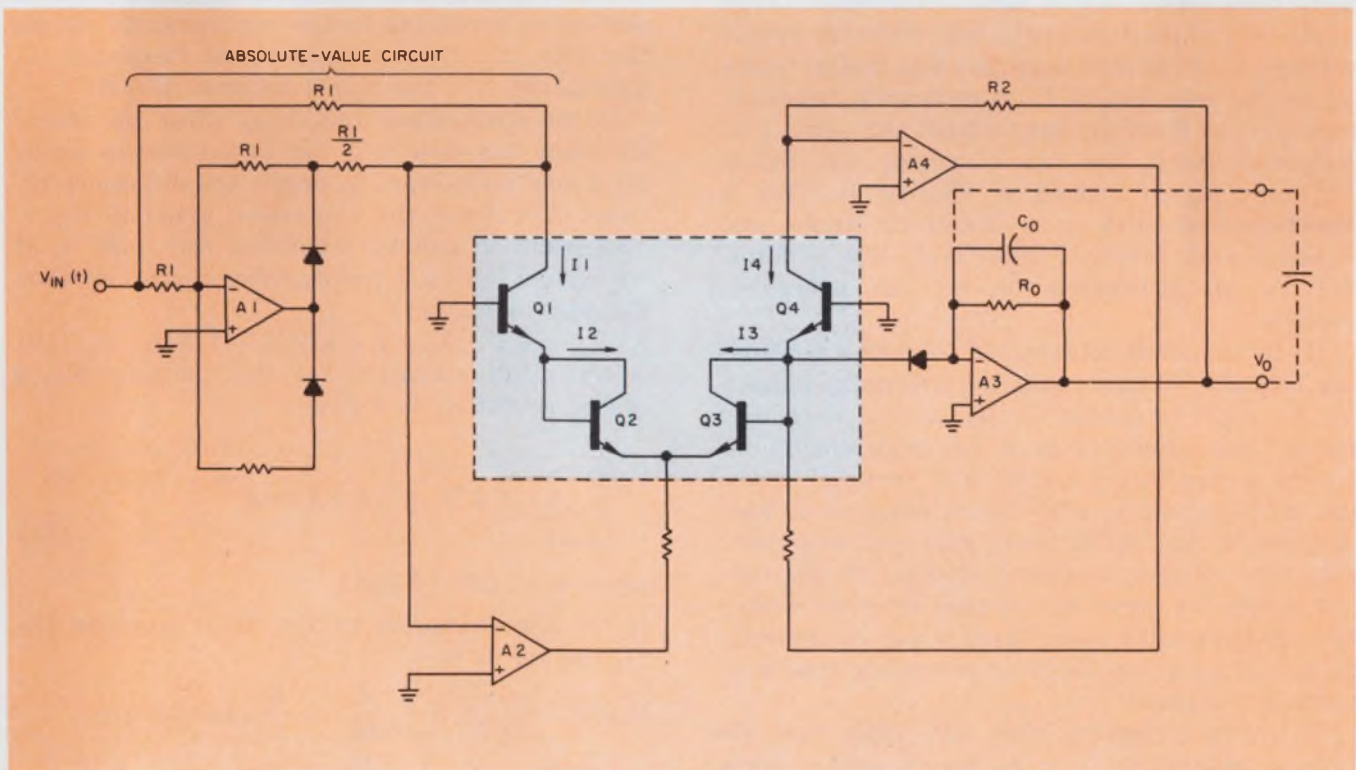

3. If implicit operational conversion techniques are used, a fairly simple rms-to-dc converter can be built.

$$\frac{R_1 R_2}{R_1^2} V_{in}^2 = V_o^2 + \frac{R_o C_o}{2} \frac{d}{dt} (V_o^2). \quad (5)$$

If $R_1 R_2 / R_1^2$ is chosen to be unity, then

$$V_{in}^2 = V_o^2 + \frac{R_o C_o}{2} \frac{d}{dt} (V_o^2). \quad (6)$$

Eq. 6 shows that $[V_o(t)]^2$ is the exponentially weighted average of $[V_{in}(t)]^2$ with a time constant of $R_o C_o / 2$. Thus Eq. 6 can compute the response of any operational-type rms converter that uses a one-pole low-pass filter. This is an exact equation, and departures from it are entirely due to practical limitations of components. Since V_o has been constrained by the circuit to be positive only (and a diode ensures that only this state is allowed), then if we take the square-root of both sides we get the output

$$V_o = \sqrt{V_{in}(t)^2}, \quad (7)$$

where the averaging time constant is $R_o C_o / 2$.

While the circuit diagram of Fig. 3 is sufficient to describe the operations that take place within an rms-to-dc converter, it is not a practical design. A variety of capacitors, diodes, and resistor networks are needed to optimize the frequency response and to compensate for the inherent limitations of practical op amps and transistor pairs.

Choosing the low-pass-filter time-constant

The engineer must make one critical decision—the size of the filter capacitor, C_o . A small, nominal value of C_o is often included inside the module by the manufacturer, but the summing junction of A_3 is usually made accessible so that more capacitance can be added externally. Large electrolytic capacitors can be used since the output voltage, V_o , is always unipolar. The design trade-off in the selection of C_o is primarily response-time versus low-frequency cutoff. At some low-frequency input, the rms converter will follow the input signal instead of filtering it. This is sometimes referred to as flutter or ripple, and is actually an inherent uncertainty due to filtering as an approximation to the averaging process.

If the output is constrained to yield a continuous measure of rms value, the averaging capacitor, C_o , must be chosen for the desired frequency range. The capacitor must be large enough to ensure a ripple-free output and minimal error, yet small enough to allow rapid response to step changes in rms level. Since rms converters are nonlinear devices, low-pass filtering of the output is not the same as low-pass filtering within the rms-computing loop. There is a dc error term, as well as an ac ripple, if the averaging time constant is too small.

To evaluate response time and ripple, first obtain a general solution to Eq. 6. After some mathematical manipulations, we find that

$$V_o = \sqrt{\frac{1}{\tau} e^{-\frac{t}{\tau}} \int e^{\frac{t}{\tau}} [V_{in}(t)]^2 dt + C_1 e^{-\frac{t}{\tau}}}, \quad (8)$$

where τ is $R_o C_o / 2$ and C_1 is an integrating constant for the initial condition ($t = 0$). With these assumptions, Eq. 8 is valid only for positive voltages under the radical; thus V_o must always be positive.

Eq. 8 is too complex for general use, but it can be useful for computing the ideal operational-rms converter response to inputs of particular importance—sinusoids, pulse trains and step changes. The results can then be extended to more complex input signals. An alternative to Eq. 8 is to solve for the square-of-the-output: treat the square-of-the-input as a forcing function—as in Eq. 6.

Let's look at the inputs

If we assume a simple sine wave input signal, $A \sin \omega t$, is applied at $t = 0$, and that the input has been zero for a long period of time, Eq. 8 can be used to find V_o :

$$V_o(t) = \frac{A}{\sqrt{2}} \sqrt{\left(1 - e^{-\frac{t}{\tau}}\right) \left[1 + \frac{1}{1 + 4\tau^2\omega^2} (\cos 2\omega t + 2\tau\omega \sin 2\omega t)\right]} \quad (9)$$

The output voltage starts at zero and rises to a final dc value plus a ripple term. If the constant τ is large relative to the signal period $1/\omega$, then $\tau\omega$ is large and the ripple is minimized. The output then becomes $A/\sqrt{2}$, which is the rms level of a sine wave, according to the mathematical definition (Eq. 1). As the input-signal frequency, ω , approaches $1/\tau$, the ripple becomes larger.

In the steady-state condition, after the initial transient has died out, the instantaneous error for a sine wave input is simply the difference between $A/\sqrt{2}$ and the expression given in Eq. 9. This equation can be simplified for small x , if we expand it into a power-series approximation. The approximation

$$\sqrt{1 + X} = 1 + 1/2 X - 1/8 X^2 \quad (10)$$

is sufficiently accurate for this purpose. Eq. 9 can be rewritten as follows:

$$V_o(t) \Big|_{\text{steady state}} = \frac{A}{\sqrt{2}} \sqrt{1 - \frac{1}{1 + 4\tau^2\omega^2} \cos(2\omega t - \theta)} \quad (11)$$

where $\theta = \tan^{-1} 2\tau\omega$.

If the approximation of Eq. 10 is used on Eq. 11, the result is

$$V_o(t) \Big|_{\text{steady state}} = \frac{A}{\sqrt{2}} \left[1 - \frac{K^2}{16} - \frac{K}{2} \cos(2\omega t - \theta) - \frac{K^2}{16} \cos(4\omega t - 2\theta) \right] \quad (12)$$

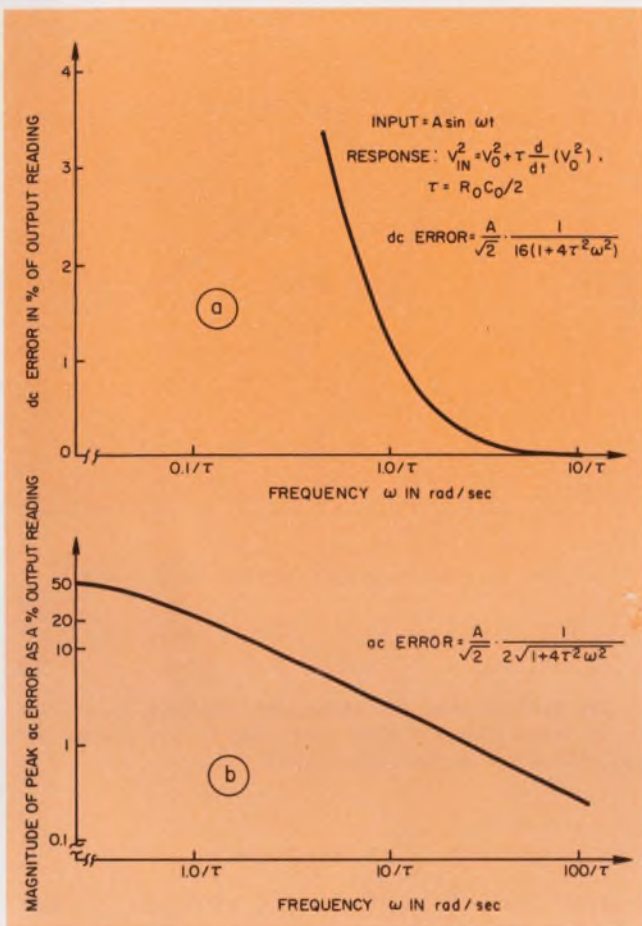

4. The dc error can be plotted (a) as a percentage of output reading; it decreases as ω increases. The magnitude of the peak ac error if plotted (b) as a percentage of output reading, also decreases as the frequency ω increases.

where $K = \frac{1}{\sqrt{1+4\tau^2\omega^2}}$.

When the input-signal frequency is high, relative to the low-pass filter corner frequency $1/\tau$, K will be small; therefore the error will be very small. If the input-signal frequency is near the corner frequency of the low-pass filter ($\omega\tau$ is near unity), there will be both a dc and an ac error term.

Errors due to inadequate low-pass filtering can also occur in "averaging-type" circuits for measuring ac. These circuits rectify and filter the sine wave input to determine the average value. For very low frequency inputs to an operational rms circuit, $\omega\tau$ goes to zero and the output approaches $A|\sin\omega t|$, which has an average value of $2A/\pi$. Thus, if an operational rms-to-dc converter is followed with a perfect low-pass filter to extract the dc value, the output would be $A/\sqrt{2}$ at high frequency and $2A/\pi$ at very low frequency.

The proper time constant for a given level of error can be chosen directly from graphs of the ac error (Fig. 4). For example, if the minimum signal frequency of interest were 10 Hz ($\omega = 63$

rad/sec) and the maximum dc error allowed were 0.5% at 10 Hz, then the time constant τ would have to be greater than 1/63 s or 16 ms.

The ac component of the error can be reduced in many applications by simple low-pass filtering of the rms-converter output. For example, a DVM that uses an operational-rms converter will integrate the ripple while it's digitizing the rms converter output. If the rms output is then read from a D'Arsonval meter, the meter itself will provide low-pass filtering and will reduce the ripple still further. In general this procedure gives a better answer. But the average value of this output is not the same as the ideal output of $A/\sqrt{2}$, so there is still a dc error caused by insufficient filtering.

The limiting factor against making τ very large is the response time of the converting circuit. Consider the response to a high-frequency sine wave ($\tau\omega \gg 1$) that starts at $t = 0$. The final value is $A/\sqrt{2}$ and the initial value is zero. The output response, from Eq. 9, is

$$V_o = \frac{A}{\sqrt{2}} \sqrt{1 - e^{-t/\tau}} \quad (13)$$

If we call the 1% response time, t_1 , then,

$$0.99 = \sqrt{1 - e^{-t_1/\tau}}$$

Approximately four time constants are needed to get to within 1% of the final value for a "step input" of ac.

What is the response time to go from $A/\sqrt{2}$ to within 1% of zero? Surprisingly enough, it is not the same as the response time to go from zero to $A/\sqrt{2}$. The time needed to decay to with-

in 1% of zero is 9.2τ . This is because $\sqrt{1 - e^{-t_1/\tau}}$

does not equal $\sqrt{e^{-t_1/\tau}}$ in response time. The second expression is the equation for a decaying response. Fig. 5 shows the time required for settling to within a specified accuracy for steps up or down. For example, if we took the 16-ms time constant from the previous case, then from Fig. 5, about 144 ms would be required to settle to within 1% for a step change towards zero. A step increase in rms level would require only 64 ms to settle to within 1% of final value.

What about pulse-train inputs?

Low duty-cycle pulse trains have a high crest factor and an rms value that is very different from the average value. An rms converter that accurately measures the rms level of sine waves may be very inaccurate with pulse-train inputs.

The pulse train shown in Fig. 6 varies between an upper value, V_A , and a lower value, V_B . The

exact rms value can be found by substitution into Eq. 1:

$$V_{rms} = \sqrt{(V_A^2 - V_B^2) \frac{T_1}{T} + V_B^2} \quad (14)$$

For a pulse train with no dc level this simplifies to $V_A \sqrt{T_1/T}$.

An operational rms-to-dc converter responds to this pulse train as follows: At high pulse-repetition rates and moderate duty cycles, the time constant τ of the averaging circuit will be much larger than the period T . The output of the operational converter—as computed by Eq. 8—will provide the same answer as Eq. 14. And at the other extreme, where the pulse-repetition rate is very low and τ is much less than T , the converter output will follow the rectified input. The response time is the same as for a step-function ac input. Between these two extremes is the pulse train that is just fast enough to be converted into a dc-plus-ac signal by the low-pass filter. Then the converter output will be a dc level proportional to the rms level, plus some ripple voltage and a dc error term.

With some mathematical manipulation, the waveform of Fig. 7, which is the square of the output, can be separated into a dc and ac component. The dc component is $V_A^2 T_1 + V_B^2 T_2$, divided by the period T . The peak-to-peak value of the ac voltage (V_{pp}) is

$$V_{pp} = (V_A^2 - V_B^2) \cdot \left[\frac{\left(1 - e^{-\frac{T_1}{2\tau}}\right) \left(1 - e^{-\frac{T_2}{2\tau}}\right)}{1 - e^{-\frac{T}{2\tau}}} \right] \quad (15)$$

This equation represents a triangular wave; for large τ , the peak-to-peak voltage can be approximated by the expression

$$V_{pp} \approx (V_A^2 - V_B^2) \left(\frac{T_1 T_2}{2\tau T} \right) \quad (16)$$

This equation can be expressed in terms of the duty cycle D as

$$V_{pp} \approx (V_A^2 - V_B^2) \left(\frac{T}{2\tau} D \right) (1 - D),$$

$$\text{where } D = \frac{T_1}{T} \quad (17)$$

The output V_o of the rms-to-dc converter is the square root of the sum of the dc term and the triangular wave whose peak-to-peak voltage is V_{pp} . If we use a series approximation for the square-rooting function, the output becomes

$$V_o(t) \approx \sqrt{V_{DC}} \left[1 + \frac{S(t)}{2V_{DC}} - \frac{1}{8} \frac{S^2(t)}{V_{DC}^2} \right], \quad (18)$$

where $V_{DC} = V_A^2 D + V_B^2 (1 - D)$ and $S(t)$ is a triangle wave that varies between $V_{pp}/2$ and $-V_{pp}/2$. The average value of the squared triangle is $1/12 V_{pp}^2$: Thus the dc error as a percentage of the output is approximately

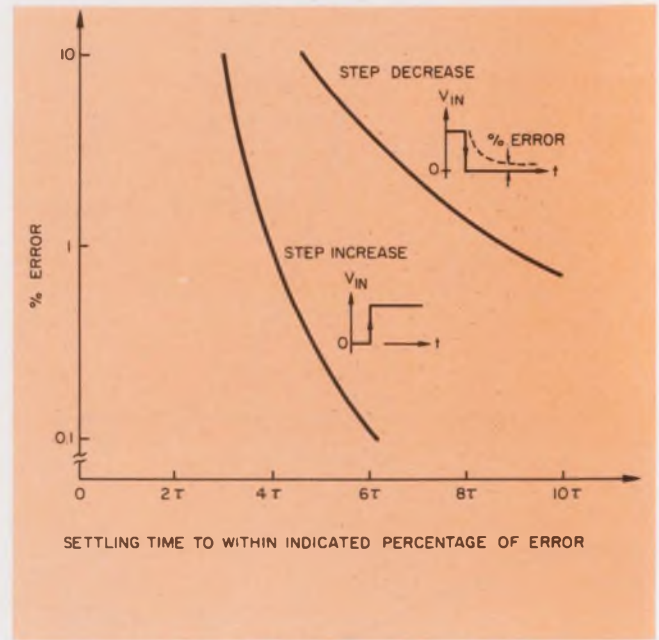

5. The settling time for input-step changes is shorter for an input-step increase than for an input-step decrease due to internal capacitance.

$$\text{dc error} \approx -\frac{1}{8} \cdot \frac{1}{12} \frac{V_{pp}^2}{V_{DC}^2} \times 100\% \quad (19)$$

For the special case where $V_B = 0$,

$$\text{dc error} \approx -\frac{1}{96} \left(\frac{T}{2\tau} \right)^2 (1 - D)^2 \times 100\% \quad (20)$$

Remember that this error equation is valid only when there is enough low-pass filtering to make the response triangular for the given input duty cycle. For example, consider a zero-based, 1-kHz square wave. The time constant τ must be less than $1/16$ ms for a dc error of less than 1%.

In addition to the dc error, there is also a ripple voltage. The peak-to-peak ripple can be calculated from Eq. 18.

Some converter limitations

Once the proper time constant for the low-pass filter has been chosen, the next step is to interpret the converter specifications. Two fundamental problems arise when you specify the performance of any rms-to-dc converter:

- The squaring and square-rooting operations make the output a nonlinear function of the input. Therefore percentage error is amplitude dependent.

- The averaging process inside the computational loop makes the percentage error dependent on the frequency content of the input signal.

As previously stated, the operational rms-to-dc converter only approximates the true-rms function. In the frequency range between dc and the cutoff frequency of the low-pass filter, the

averaging time constant is insufficient. The errors that result are shown in Fig. 4.

Another frequency-dependent error can occur at low signal amplitudes because the module computes absolute value as part of the rms conversion (Fig. 3). At low amplitudes and high frequencies, the op amp will spend a significant portion of time during each cycle slewing from one output polarity to the other. And during this interval both feedback diodes will be in a nonconducting high-impedance state. The high impedance of the diodes, coupled with stray capacitance, creates a large time constant. This large value of τ distorts the signal waveform and rounds off the corners. Or if you look at this from a Fourier-series viewpoint, a rectified sine wave has high-frequency components in addition to the fundamental. A varying time constant that increases at the zero-crossing point will attenuate the higher harmonics; thus the average value will differ from the calculated value.

Of course, design tricks can minimize the distortion, but these generally increase the cost of the design. To test an rms-to-dc converter for distortion, simply apply a low-amplitude sine wave of moderate frequency to the input. Adjust the converter offset to obtain the correct output, then gradually raise the input-signal frequency. At some frequency the error should rapidly increase.

Gain symmetry errors may result from the circuit's intrinsic absolute-value computation. These dc errors can cause trouble in some applications. For example, if the gain is 0.1% high for positive inputs and 0.1% low for negative, and if it is measured with a sine wave input, there will be no error. But if a dc level is added to the sine wave, there will be a gain error. If the gain were calibrated on a positive dc input and the actual input signal were always negative, then there would be a gain error of -0.2%. Measurement of the output error for several dc inputs of both polarities will uncover this problem.

When components aren't ideal

For large inputs at high frequencies the input op amp of operational rms-to-dc circuits may become slew-rate limited. A small amount of slew-rate limiting merely distorts the waveform and has little effect. But as the limiting becomes more severe, the average of the absolute value changes and there will be an error. The source of error is most easily observed by applying a full-scale sine wave to the input and increasing the frequency, while maintaining constant input-signal amplitude. At some frequency the error will increase significantly because of slew-rate limiting of the input amplifier.

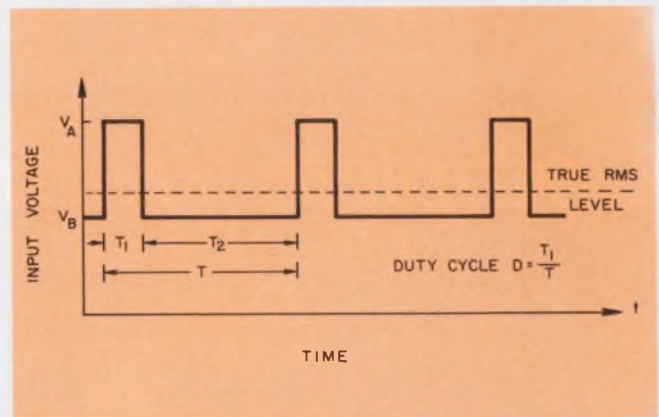

6. An input pulse train with a short duty cycle but high peaks provides a low true-rms level.

The heart of an operational rms-to-dc converter is the a^2/b section. The transistor quad is critical—and even the transistor geometry is important. Variations in β and departures from the desired logarithmic characteristics cause errors. Variations in temperature, signal frequency, and supply voltages also pose potential problems. Another factor to be considered is the crest factor of the original signal. This is defined as the ratio of acceptable peak input voltage to its rms level. Thus it is actually a characteristic of the input signal rather than the converter itself. A crest-factor specification, which defines the range of acceptable input waveforms, should always be tied to a specific accuracy. Generally the error becomes larger for signals with high crest factors. This is because the required dynamic range is greater and frequency content broader for high crest-factor signals. Since general purpose op amps are often used in operational rms-to-dc converters, the input circuit is generally scaled to accept peak input voltages of ± 10 V. The minimum usable rms level is limited by the errors and noise.

Many operational rms-to-dc converters can maintain their rated accuracy over a crest factor range of 1 to 7 for a rated output level of 1-V rms. Errors within the a^2/b section of the converter depend inherently on signal range. Some designs have corrective circuitry to compensate for this error. The effect of the compensation circuits is most obvious on signals with high crest factors.

How do you test crest factor?

A pulse-train input is very useful to test crest factor. A zero-based pulse train, with peak amplitude V_A and duty cycle D , has an rms level of $V_A D$. So the crest factor is simply \sqrt{D} . An excellent test for an rms converter is to apply a zero-based square wave with a peak amplitude of 1.414 V—that is an rms level of 1 V and a

Complete Trimmer Satisfaction

One design...9 pin styles

Still the industry's best trimmer value
... Less than **50¢** each in production quantities



Stability of $\pm .03\%$ and environmental performance requirements of characteristic C of Mil-R-22097

- 1.5% average ENR noise resistance
- 0.5% average CRV
- 1/2 watt @ 70°C

You can choose from an expanded line of compact trimmers. .150" — .125" — .100" in-line terminal spacing and TO-5 pin spacing all available in top and side adjust. Plus .200" delta (.100 grid) in top adjust. All available from your CTS Distributor. **Still the best value in the industry.** CTS of Berne, Inc., Berne, Indiana 46711. Phone: (219) 589-3111.

INFORMATION RETRIEVAL NUMBER 37

CTS CORPORATION
Elkhart, Indiana



A world leader in cermet and variable resistor technology

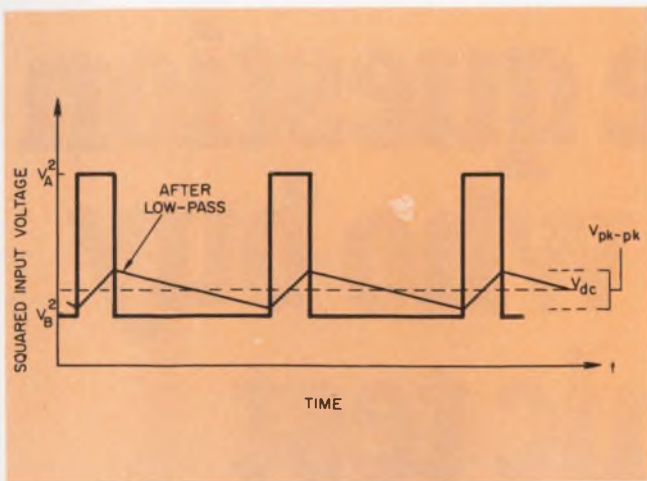

7. If you square the pulse train of Fig. 6 and then low-pass filter it, you can get a triangular waveform.

50% duty cycle. If the duty cycle is now altered and the new rms level computed, the converter error can readily be measured. Another test is to hold a constant rms-input level while the amplitude and duty cycle are varied.

The significance of crest factor depends upon the application—distorted sine waves have low crest factors, while pulse trains, SCR waveforms, and ramps have high crest factors.

Accuracy is difficult to define for an rms-to-dc converter module because of the nonlinear relationship between input and output. Also, the frequency limitations of the circuit affect the readings. The easiest measurement is simply to apply a dc input and to compare it with the output. But rms converters are actually used with both ac and dc inputs, so the dc measurement alone is not sufficient. A better approach is to specify the error for a sine wave input over some range of amplitude and frequency. This error is usually given as a percentage of full scale, plus a percentage of reading (output voltage level). The fixed portion of error is primarily due to offsets, noise and distortion in the absolute-value circuit. The portion of error that is amplitude dependent is primarily a combination of gain error and errors in the a^2/b section.

In practice, rms-to-dc converters are often able to measure complex ac signals with greater accuracy than would be apparent. A complex ac waveform will have a fundamental and higher harmonics. For example, the rms level of a complex waveform can be calculated from this equation:

$$V_{rms} = \sqrt{V_{dc}^2 + V_r^2 + V_1^2 + \dots + V_n^2}$$

where V_{dc} is the dc level, V_r is the amplitude of the fundamental, and V_n is the amplitude of n-th harmonic.

It's true that the rms converter may not be very accurate in measuring the rms weight of the higher harmonics. But these harmonics are often only a very small part of the total. ■■

INFORMATION RETRIEVAL NUMBER 38▶



Licon takes the "butterflies" out of pioneering.

By putting its double-break, double reliable Butterfly® switches to work in radar tracking stations around the world.

If you are doing some pioneering on your own, such as the initial design of equipment requiring lighted pushbutton switches, put the Licon team to work for you.

The same quality and reliability required to track the endless reaches of space are yours in every Licon® switch you specify.

Licon's lighted pushbutton switches are offered in a wide variety of switching configurations, button styles and current capabilities.

Your Licon representative or distributor has a switch solution for you.

 **LICON**

Division Illinois Tool Works Inc.
6615 W. Irving Park Road
Chicago, Illinois 60634
Phone (312) 282-4040
TWX 910-221-0275



LICON

puts ideas to work
in electronics

The Innovative Electronic Group of ITW...
LICON ■ ELECTRO MATERIALS ■ PAKTRON

© ILLINOIS TOOL WORKS INC. 1974

REI has one question for people who buy electronic test equipment.

Why?

When you need it fast . . . rent it. Purchasing equipment usually involves long delivery lead times. When you rent your electronic test equipment from REI it's a safe bet that you can get what you need within 36 hours of the time you call in your order, sometimes sooner. This fast service is possible because we maintain 9 Instant Inventory Centers throughout the U.S. and Canada, stocking millions of dollars worth of equipment.

When you need it for only a short time . . . rent it. Need equipment for a short-term project? Rent it from REI. When you don't need it any more, return it to us. It's the easy, low-cost way to use the equipment you need for just the time that you need it.

When you care about what it costs . . . rent it. Renting from REI can be less expensive than purchasing. There's no capital investment to adversely affect your company's cash flow. This means you'll get more mileage from your equipment budget. And your controller will tell you that your low monthly payments are tax deductible.

All REI rental equipment is tested to meet manufacturers' specifications prior to delivery, with free maintenance included. Certification and calibration are available upon request. Our flexible arrangements include rental, rental-purchase and leasing packages to give you the use of equipment from one week to three years or more.

Get your free copy of our 1974 catalog that lists virtually every item in our rental inventory. Just circle our reader service number on the postcard in the catalog directory section and drop it in the mail. For immediate information, call your local REI instant inventory center listed below. Once you rent from REI, you may never buy electronic test equipment again.

Rental Electronics, Inc.

A **DEPSICO** LEASING COMPANY

Lexington, MA (617) 861-0667 • Gaithersburg, MD (301) 948-0620 • Oakland, NJ (201) 337-3757 • Ft. Lauderdale, FL (305) 771-3500
Des Plaines, IL (312) 827-6670 • Dallas, TX (214) 661-8082 • Mountain View, CA (415) 968-8845 • Anaheim, CA (714) 879-0561
Toronto, Canada (PLC Leasing Ltd.) (416) 677-7513



When you think about renting, it's the only way to go.

We'll deliver 3/4" trimmers NOW...in any quantity. We're TRW/IRC Potentiometers

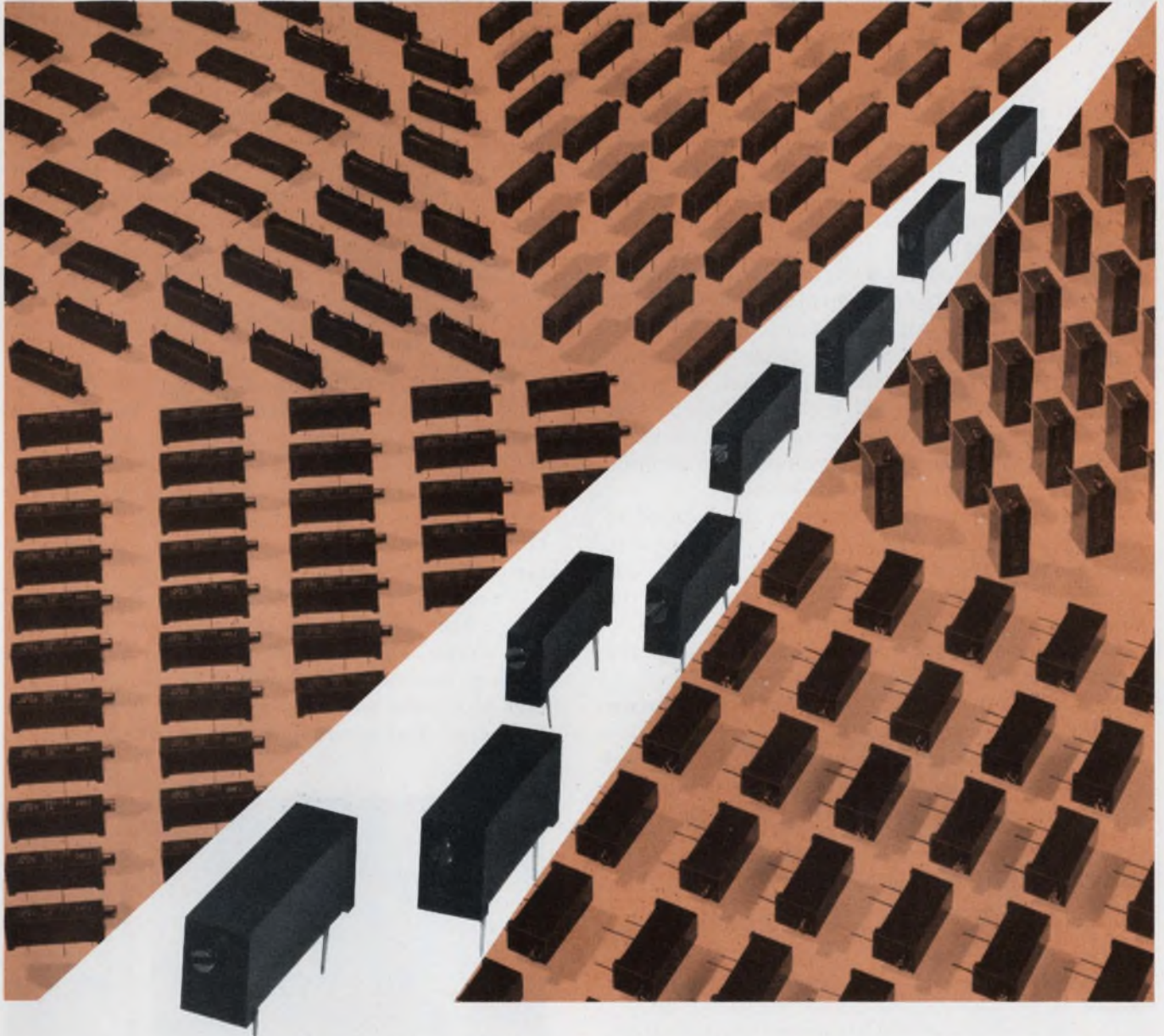

For prototype or production quantities to meet your industrial equipment requirements, you can have immediate delivery on any 3/4" rectangular trimmers. Choose from standard height or low profile, two pin spacings, wirewound or exclusive Metal Glaze® cermet . . . in any standard resistance.

Or pick from the complete industrial line—15 types of trimmers, from 1/4" round to 1 1/4" rectangular—available now from in-depth stock or on short delivery cycles. All ensure reliability through the use of mini-

mum parts and complete sealing against environmental and production contamination.

For fast delivery now, call any TRW/IRC Potentiometer distributor.

Call toll-free, 800-645-9201 for the name and phone number of the distributor nearest to you.

For information on the complete line, contact your distributor or TRW/IRC Potentiometers, an Electronic Components Division of TRW Inc., 2801—72nd Street, N. St. Petersburg, Florida 33733. Phone (813) 347-2181.

TRW® IRC POTENTIOMETERS

INFORMATION RETRIEVAL NUMBER 40

A guide to good air cooling:

The heat to be dissipated, air flow and pressure drop are the prime considerations in choosing the best air mover.

Many an engineer who takes pains to design electronic equipment accurately will often give only perfunctory thought to cooling it. Yet allow the temperature of many electronic components to rise 10 C higher than expected and their life is likely to be halved.

There are, obviously, many ways to cool equipment; they range from natural air convection to complicated refrigeration systems. But for most systems with moderately dense packaging (Fig. 1), the most popular approach is forced-air cooling. And there are methodical steps that every designer should follow to ensure selection of an air mover that will give optimum cooling. They can be summarized as follows:

- Make an accurate estimate of the number of watts generated by the equipment to be cooled. Heat must be removed at the same rate that it is generated or the temperature will rise until the generated heat equals the removed heat.
- Calculate the air flow needed to keep the temperature rise within the desired limits.
- Measure the pressure drop that the required air flow must overcome.
- Select an air mover based upon the required air flow and pressure, and other criteria, such as noise, efficiency and physical size and shape.

Calculating air flow

Forced-air cooling can be described by the simple heat equation

$$Q = MC_p \Delta T, \quad (1)$$

where Q = Rate of heat absorbed by the air,
 M = Mass of the air moved per unit time,
 C_p = Specific heat of air at constant pressure,
 ΔT = Temperature change of the air.

When the heat is expressed in watts, the temperature change ΔT in degrees C, and the constants for the density and specific heat of air at sea level are substituted into Eq. 1, the equation can be transformed into

$$CMF = 1.76 Q / \Delta T \text{ (ft}^3/\text{min)} \quad (2)$$

David J. Nevala, Manager, Mechanical Engineering Dept., Digital Equipment Corp., Maynard, Mass. 01754.

Note that since C_p changes with altitude, the constant in Eq. 2 will change with altitude.

To illustrate the use of this simple equation, consider a system that has an allowable temperature rise of 10 C and generates 500 W of heat. The required air-flow rate is found by Eq. 2 to be

$$CMF = (1.76 \times 500) / 10 = 88 \text{ ft}^3/\text{min}$$

Selecting a fan

To select the right fan or blower, the designer must establish the pressure drop that an air mover must overcome to force the air through the system. Fig. 2 shows how this pressure drop might vary with air flow in a typical case. The curve represents the impedance that the electronic system's air passages offer to the flow of air.

Though semi-empirical formulas for calculating a system's impedance have been developed for simple shapes like ducts and pipes, this method becomes excessively laborious for complex electronic packages with their irregular air passages. And even for simple shapes, most of

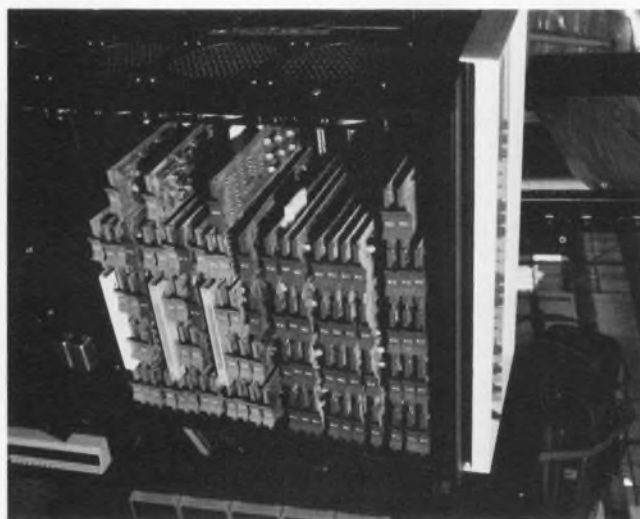

1. Most moderately-dense electronic system packages, as represented by this minicomputer chassis, use forced-air cooling. The use of several fans allows both a more uniform distribution of air and the separation of high-power portions (lower section is the power supply) from the more heat-sensitive logic cards.

the equations are not particularly reliable.

Thus the practical way to find the pressure drop in electronic equipment is to measure it with a test assembly² like that in Fig. 3. The test chamber forces a known amount of air through the equipment, and the pressure drop between the equipment's input and exhaust ports is measured. By changing the amount of air flowing through the unit in several steps, the engineer can obtain the data needed to plot a complete impedance curve.

If an actual unit is not available for the impedance measurement, a mock-up made from cardboard, wood or other convenient material can provide good results.

Performance curves of available air movers as supplied by manufacturers may be plotted on the same coordinates as the electronic equipment's impedance curve (Fig. 4).

The intersection of an air mover's performance curve and the equipment impedance curve represents the cooling system's operating point. This combined curve is one of the most useful tools the engineer has.

Note that the impedance curve rises exponentially. Thus a twofold increase in flow—from, say, 50 to 100 CFM—might increase the pressure requirements four times—perhaps from 0.1 to 0.4 in. of water. Thus the designer should try to open air passages in the system to reduce flow impedance, rather than overpower the system with a high-pressure air mover.

Specific speed is a figure of merit

Since several types of air movers can often provide the needed flow rate and pressure head, additional selection criteria are needed. An important one is noise. An air mover is a prime source of noise, and, as noise tends to increase with speed, a figure of merit called "specific speed" is useful. Specific speed is defined as the air mover's fan or propeller speed necessary to move 1 ft³/min of air against a pressure of 1 in. of water. For different flow rates and pressure drops, the formula is

$$N_s = N Q^{1/2} / H^{3/4}, \quad (3)$$

where

- N_s = the specific speed
- N = the rotational speed (rpm)
- Q = the volumetric flow rate (ft³/min)
- H = the head developed, in. of water

A family of air movers of different sizes, but built with the same proportions, will generally fall within a narrow range of specific speeds. A lower specific speed generally gives lower noise. However, specific speed is not the only factor in noise generation, although it is a major one. An air mover's structural rigidity, its bearings and degree of balance also affect the noise generation.

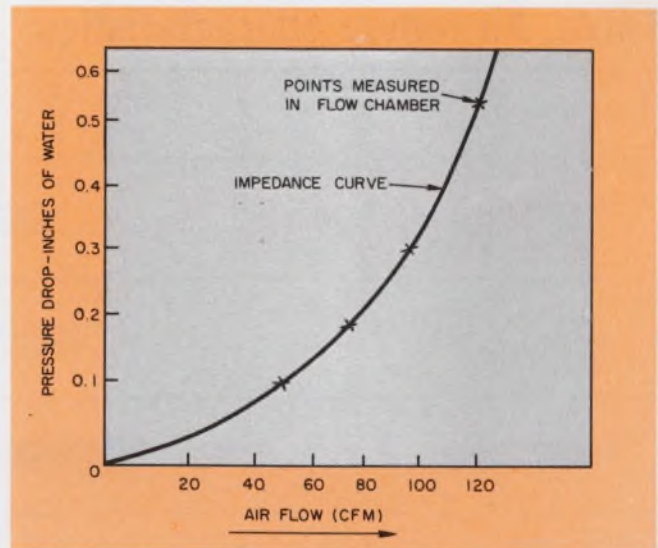

2. Pressure drop across an air-cooled electronic assembly varies exponentially with increasing air flow. The most practical way to obtain such an impedance curve is to measure the data with a test chamber as in Fig. 3.

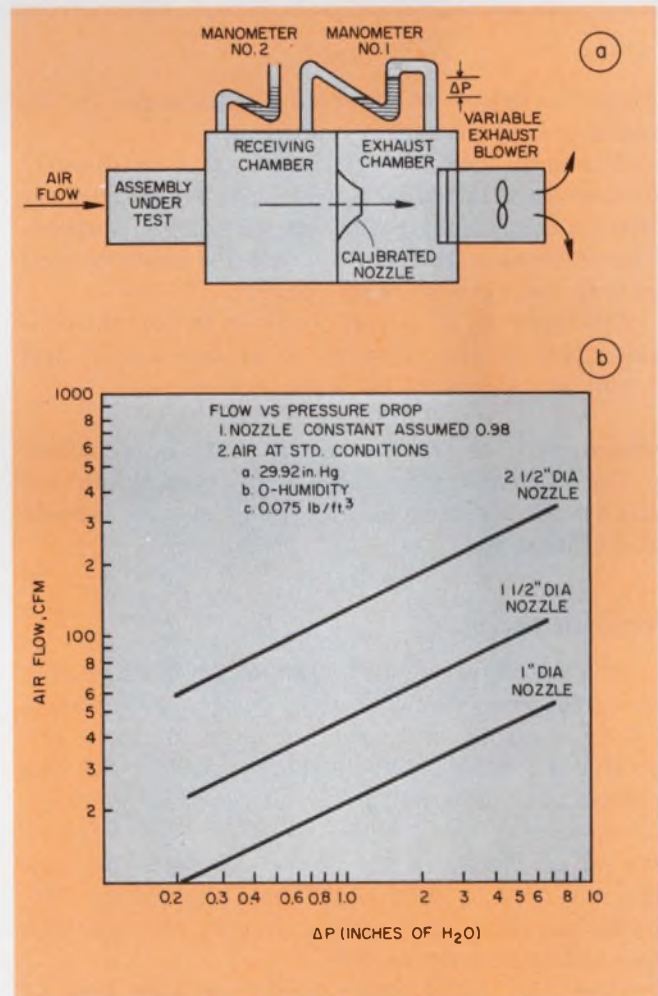

3. Two chambers connected by a calibrated nozzle (a) provide a measure of the air-flow rate. A calibration chart (b) converts the pressure difference read on manometer 1 into air flow. Manometer 2, which is open to the atmosphere at one end, indicates the pressure drop that the cooling fan needs to generate to force the given air-flow rate through the assembly.

Table. Air-mover characteristics:

TYPE OF FAN	SPECIFIC SPEED								EFFICIENCY	DESCRIPTION			
	1,000	2,000	5,000	10,000	20,000	50,000	100,000	200,000			400,000	% MAX	% TYP
PROPELLER FANS											45	28	VERY HIGH FLOW, LOW PRESSURE
TUBEAXIAL											55	35	HIGH FLOWS, RELATIVELY LOW PRESSURE, EXHAUST FANS
VANEAXIAL											80	60	HIGH EFFICIENCY, SMALL VOLUME, USABLE OVER WIDE RANGE. LOW NOISE LEVEL. WELL SUITED FOR AIRBORNE APPLICATIONS, DUCTING
CENTRIFUGAL											52	33	GENERAL-PURPOSE COOLING IN ENCLOSED VOLUMES. FOR MODERATE PRESSURE, LOW FLOWS
CENTRAXIAL											60	40	SIMILAR TO CENTRIFUGAL, EXCEPT HIGHER EFFICIENCY AND LOWER NOISE LEVEL AT LOWER PRESSURE

Also, the design of internal air passages in the electronic equipment is important.

Although specific speed appears to be directly proportional to actual speed (Eq. 3), it does not change appreciably with an air mover's speed. This is because the other parameter changes tend to keep the specific speed constant.

Efficiency is, of course, another important consideration in the selection of an air mover, and it can be calculated by

$$e = 0.211 \cdot H \cdot Q / \text{SHP}$$

where SHP is the fan input-shaft horsepower.

The accompanying table lists some important classes of air movers and their specific speeds and efficiencies.

Avoid air pockets

In a forced-air cooling system, air must be able to move freely through the chassis, card stacks, power supplies and other components, and the cooling air must make intimate contact with the components. Stagnation areas must be avoided. Components susceptible to high temperature should be placed in the coolest location—nearest the air intake port—and heat-generating elements should be near the exit port or separated and independently cooled.

Inlet and outlet areas should be kept free of obstructions. Restricting surfaces produce turbulences, pressure losses and reduce the flow rate. Air filters can present great resistance to air flow and they are often the largest single source of pressure loss.¹ By increasing the area of the filter—the larger the better—and installing a

venturi-shaped area transition between the filter and the air mover, the engineer can reduce pressure loss dramatically. A large filter area needs less air velocity for a given flow rate. This not only reduces the pressure loss in the filter by approximately the square of the velocity, but it also increases the filter's dust catching ability and the filter's life. A thinner filter might then allow a further reduction in pressure loss.

Grills, vanes, safety guards and escutcheons also cause pressure loss. They must be carefully located or avoided.

The air flow can be directed to high heat-generating components by judicious placement of baffles and vanes. By arranging baffles to narrow the flow of air, the increased velocity can provide greater cooling in concentrated regions.

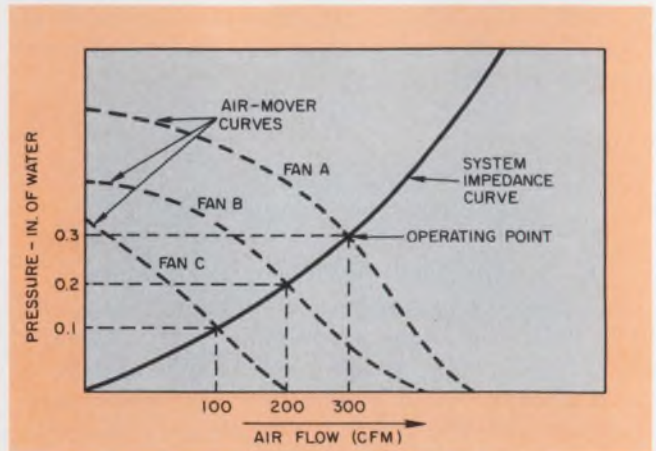

4. The intersection of an air-mover's flow characteristics curve and the impedance curve of the cooled assembly is the operating point of the system.

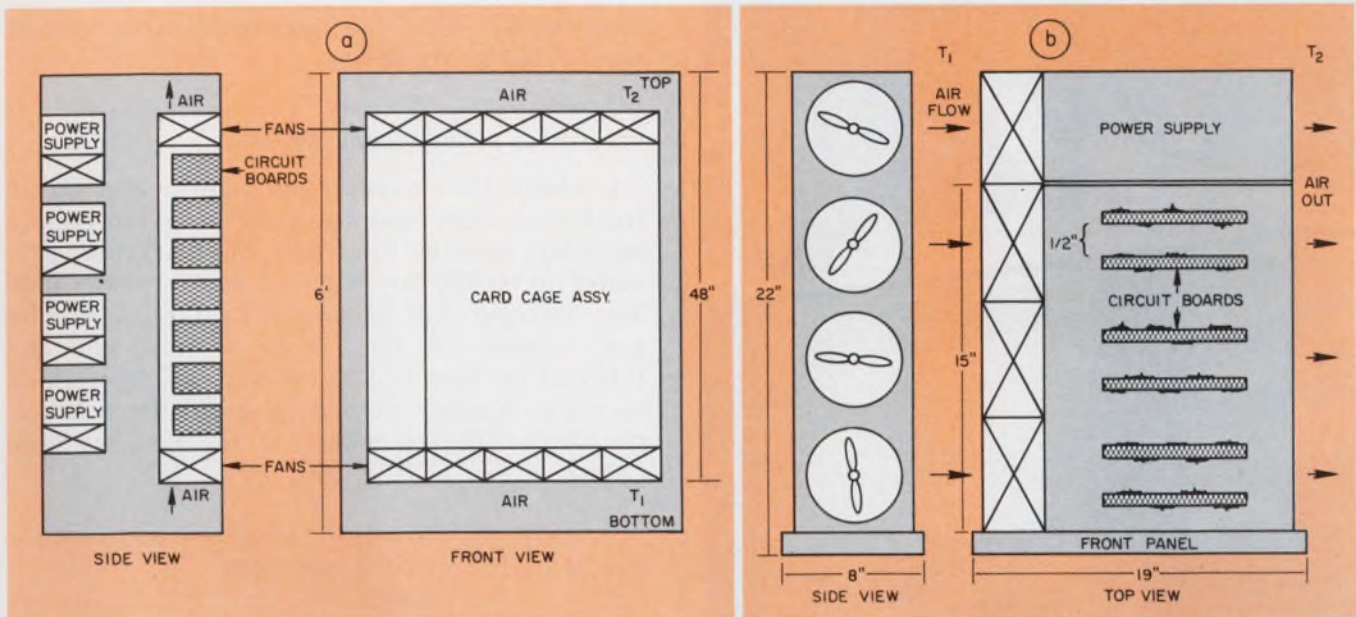

5. Multiple fan systems have advantages. A series fan configuration (a), with one set at the input port and the other at the output, provide double the pressure capability that a single set would. And the parallel arrange-

ments of both (a) and (b) allow more uniform distribution of cooling air, and the flexibility of separating the high-heat power supply from the other circuits. Low pressure, small fans may also generate less noise.

But remember that abrupt transitions, such as forcing air to make sharp right-angle changes in direction, should be avoided because of pressure loss.

Though air takes the easiest flow path, this is not always the shortest. An open area may short-circuit most of the air, so that a shorter but smaller passageway gets very little air and forms stagnated pockets that can overheat. Short-circuiting should be particularly avoided across the region of highest pressure, between the input and output of the air mover.

The air-moving device must be baffled so that a minimum of the output air can flow back to the inlet. The air-moving equipment itself, when properly placed, can act as a baffle to help separate the high and low pressures and reduce back flow.

If the air mover is placed at the intake of the electronic equipment, its own heat loss must be added to the power that it must dissipate. However, if the air mover is placed at the exhaust end, it will operate at a higher temperature, and this may reduce its life.

Fig. 5a shows a vertical section of a typical rack-mounted minicomputer with an enclosed card cage. Two sets of fans are used. One is placed above and the other below the cage. This arrangement reduces the pressure head that each bank of fans must produce. Thus there is less tendency toward back-flow losses and the fans can be of lower speed and lower pressure than if a single set were used.

Fig. 5b shows the fans mounted on one side so that the air flow is from left to right. In

both Figs. 5a and 5b the use of multiple fans also helps to distribute the air over the electronic components more uniformly. Note that the power supplies are separated from the more sensitive logic circuits and are cooled by separate fans.

Heat sinks cool the hot spots

Some components generate a lot of heat but have small surface areas. For adequate air cooling, a heat-sink assembly is attached to such components. Aluminum and copper are the two most widely used heat-sink materials. Copper has twice the conductivity of aluminum, but it costs considerably more and is heavier. But more important than a sink's material, is its surface area that is exposed to the air, and the thermal conductivity of the surface that mates with the component.

Metallic-oxide silicone greases can improve the mating thermal conductivity. They fill the minute scratches and air gaps between part and heat sink with a nonhardening conductive material. For minimum thermal resistance both large mating contact area and large air surface are desirable. Manufacturers of heat sinks and thermal greases generally provide thermal-resistance-to-air data in °C/W. The information can be used to select a heat sink for a given temperature rise and power dissipation.

An important point to remember is the direction in which electronic components are mounted in the air stream. In most cases the best component or heat-sink-to-air orientation is obvious. The unit should be arranged for least air-flow



NOW

put backbone
in your housings
and sell
in your machines

First impressions often influence final decisions and acceptance. Even sophisticated machinery cries out for housing design that says... beauty purpose... versatility. And nothing says it better than unique Met-L-Wood® panels. They have the solid feel and characteristics of steel plate without the weight, and the beautiful, durable surface to help the machine sell itself.

Met-L-Wood panels are fast and easy to assemble... almost impossible to damage... add more sales appeal than any other material you can use. Get complete information. Send for Bulletin 661 today: MET-L-WOOD CORPORATION, 6755 West 65th Street, Chicago, Ill. 60638



MET-L-WOOD Corporation
STRUCTURAL LAMINATES SINCE 1925

INFORMATION RETRIEVAL NUMBER 41

restrictions, with the maximum area placed parallel to the air flow.

Analysis of a fan cooling system

Consider the computer package in Fig. 5b. It contains a logic-card cage and a power-supply assembly, and the total heat dissipation is estimated to be 400 W—half lost in the power unit and the other half dissipated by the cards. The power-supply air flow is 80 ft³/min, and the card-section flow is 240 ft³/min, as determined by a test-chamber method (Fig. 2). From Eq. 2, we obtain the following for the power-supply section: $\Delta T = (1.76 \times 200) / 80 = 4.4$ C.

And for the logic-card area, the temperature rise is $\Delta T = (1.76 \times 200) / 240 = 1.45$ C.

These calculations can't, of course, provide any information on how temperature might be distributed within the cooled areas. The temperature rises are only over-all averages between the input and output ports. And though the results seem very low, some circuits can be expected to run considerably hotter than the calculated average. In the PDP-11 computer, for example, the core-memory drivers generate more heat than the logic circuits. Let's check the temperature rise of such a worst-case circuit board.

The card compartment's cross-section is 15 × 8 in.—and, say, 50% of it is occupied by boards and parts. Then:

$$\begin{aligned} \text{Total flow area} &= L \times W \times 50\% \\ &= 15 \times 8 \times 50\% \times \frac{1}{144} \\ &= 0.416 \text{ ft}^2. \end{aligned}$$

$$\text{Air velocity} = \frac{240 \text{ ft}^3/\text{min}}{0.416 \text{ ft}^2} = 577 \text{ ft}/\text{min}.$$

If the space between boards is about 1/2 in. and about 50% of the air impinges on each surface, then:

$$\begin{aligned} \text{Flow area of one board} &= 1/2 \times 8 \times 50\% \times \frac{1}{144} \\ &= 0.014 \text{ ft}^2 \end{aligned}$$

$$\begin{aligned} \text{Flow rate on board} &= 577 \text{ ft}/\text{min} \times 0.014 \text{ ft}^2 \\ &= 8 \text{ ft}^3/\text{min}/\text{Bd}, \end{aligned}$$

$$\begin{aligned} \text{and} \quad \Delta T &= \frac{1.76 \times 50}{8} \\ &= 11 \text{ C} \end{aligned}$$

Note that though the previously calculated average temperature rises seem to indicate too much cooling, a worst-case check shows that the flow is only barely adequate to keep the core drivers close to a 10-C rise. ■■

References

1. Edwards, Lawrence F., "Dust filters can block cooling air," *Electronic Design*, Nov. 8, 1973, pp. 108-110.
2. Bulletin-210, "Specifications for air chambers," Air Moving and Conditioning Association, 205 W. Touhy Ave., Park Ridge, Ill.

Here's a display breakthrough

New plug-in display modules from Beckman ...buy the numbers



3 digit module

Easy to use

Ready for operation

— horizontally stackable to any length

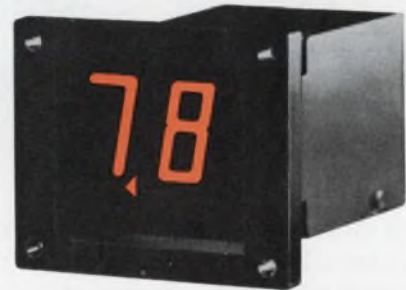

2 digit module

In readability . . . size . . . and reliability — Beckman Displays lead the way. Now, Beckman pioneers with a brilliant new line of "plug-in" display modules designed for both high and low volume applications. And, top convenience.

Circuitry is built in. All you do is apply BCD and voltage inputs: the modules are ready to use. They feature the big 1/2" Beckman Displays that have an even centerline spacing of 0.531". The solid characters are visible at angles up to 130° in bright sunlight . . . easily readable up to 40 feet. Color? The same distinctive orange featured in all Beckman Displays (Red is available with filters).

The basic Beckman SM-850 Series modules include the display, a monolithic decoder/driver and a latch. A companion series even includes a counter. All you really

need to do is apply voltage and BCD input. And you can get the complete 2 digit unit, without counter, for only \$19.50 per digit in single unit quantity. If you order 100 the price is only \$14.25 per digit.

Beckman designed these modules to save you circuit design headaches and assembly time. Whether you use just a few displays or a million, you owe it to yourself to find out more about these neat little black boxes. Get the whole story today. Contact your local Beckman representative or stocking distributor.

Beckman INSTRUMENTS, INC.

INFORMATION DISPLAYS OPERATIONS

P. O. Box 3579, Scottsdale, Arizona 85257. Telephone (602) 947-8371.

There's more eye appeal in Beckman Displays!

FOR THE NAME OF YOUR BECKMAN DISPLAYS DISTRIBUTOR OR REPRESENTATIVE

CALL TOLL-FREE 800-645-9200

(IN N.Y. STATE, CALL COLLECT, 516-294-0990)

Mohammed, The Mountain, and IEEE Intercon

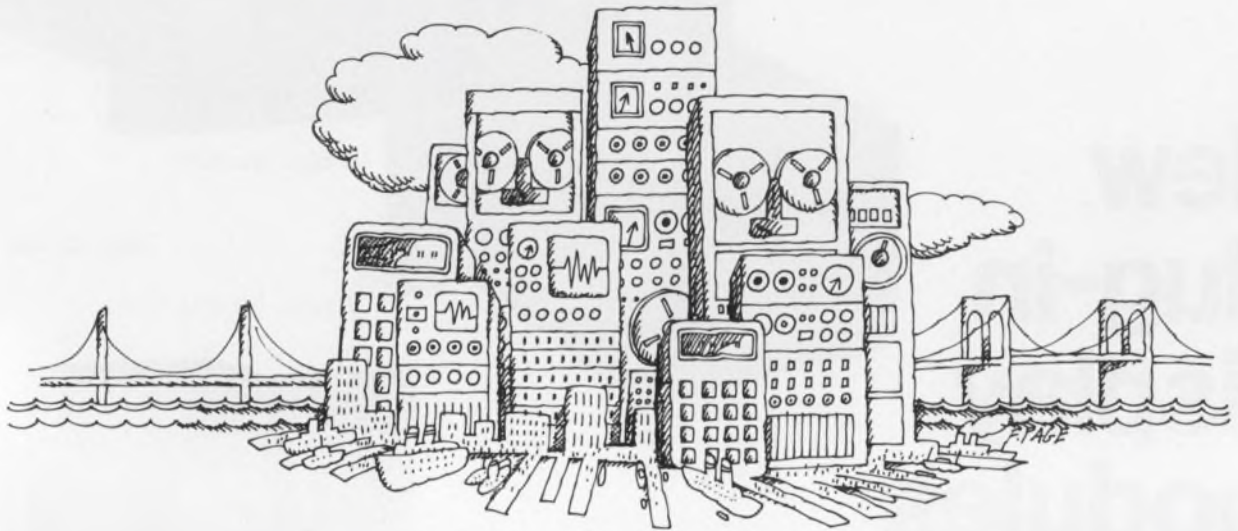

Moving mountains has never been a really cost-effective concept, even in ancient times. In the absence of an unlikely miracle, Mohammed had to go to the mountain instead of vice versa.

There's a whole mountain of exciting new electronics hardware and software ready for introduction this Spring. With energy in short supply, however, the innovators just can't bring the mountain to you this season.

Instead, nearly 300 companies and a couple of hundred first-rate

engineering authors are building their mountain in a central location — the island of Manhattan — where all of you can see it and hear it all at once.

The name of the event is IEEE Intercon/74, and it's a "getting down to business" high-technology show and conference.

It's got an outstanding 40-session program that tells you how to put the newest technology to work. Plus special workshops and short-courses.

It's got a mountain of brand-new components, devices, instrument systems, and EDP equipment ready for your on-line evaluation.

With severe restraints on sales travel, it just makes good sense to bring everything that's new and significant into one accessible place for thousands of professional engineers — by public transportation.

As a matter of fact, it's clearly in line with national policy to do so. And it is an excellent way to "energize" the surging electronics economy that's coming in the months ahead.



This is going to be an outstanding show and program. Maybe the best Intercon in several years. It's in your own best interest to "come to the mountain" and take home a wealth of practical new ideas to your organization.

Plan now to get your full share at Intercon in New York.



ieee intercon

March 26-29, New York Coliseum / Statler Hilton Hotel

The International Convention and Exposition of the Institute of Electrical and Electronics Engineers Inc.

INFORMATION RETRIEVAL NUMBER 43

“Service and replacement costs are skyrocketing. First, more is expected of my equipment and it’s a lot more complicated.



Next, the cost of sending a man out to remove and replace a simple component keeps going up. Add to that the cost of simple human error, and maintenance

costs go right out of sight.”

The obvious answer is maintenance-free components. When it comes to relays, it's a simple choice: use capsule instead of open-faced electromechanical relays. And that's where Clare can help.

Clare's family of dry reed relays—PRME, MRB and remnant reed relays—eliminate the need for oversensitive, complex electromechanical devices. You cut maintenance costs and hike performance levels by designing out

your problems. And Clare makes every part of your relays—including the hermetically sealed capsules. Capsules are manufactured in a white-room environment and every single one is inspected for physical and electrical reliability. So, when you specify Clare reed relays, you know you're getting maximum reliability and quality.

Our expertise lies in the advanced design and manufacture of relays of all kinds, but our energy lies in the

application of relays to help you solve specific problems. We specialize in getting down to work.

If you need help—or just some good information—get in touch with us right now. The “right now bunch” is ready to go to work for you.

Contact your local Clare Distributor or Sales Engineer. C. P. Clare & Co., 3101 Pratt Avenue, Chicago, Ill. 60645 312/262-7700.

QUALITY/SERVICE/RELIABILITY

we help. get in touch with us. CLARE the “right now” bunch.

a GENERAL INSTRUMENT company

GENERAL PURPOSE RELAYS MERCURY-WETTED RELAYS REED RELAYS SOLID STATE RELAYS TELEPHONE RELAYS STEPPING SWITCHES

INFORMATION RETRIEVAL NUMBER 44

Simplify UJT relaxation-oscillator design

with a procedure that directly selects the right capacitor. An improved formula for pulse width ends trial-and-error

Why use time-consuming trial-and-error techniques to get the right operating frequency in the design of a unijunction-transistor (UJT) relaxation oscillator? You can calculate the right capacitance on the "first cut" with a more accurate design equation based on pulse width, t_p :

$$t_p = R_T C \ln \frac{(V_o - V_D) R_o}{(e_o)_{\min} R_T}$$

The schematic diagram (Fig. 1) identifies capacitor C , resistance R_o , and voltage e_o . The minimum value of e_o occurs at pulse turnoff. Voltage V_o represents the maximum level reached by the capacitor just prior to discharge. Voltage V_D and resistance R_T involve UJT parameters and represent, respectively, the diode drop between emitter-to-base 1 and total resistance of R_o and base-1 equivalent resistance, R_{B1} (Fig. 2).

Most designers use an approximate formula for the frequency and get a ballpark value for the timing capacitor needed in the circuit. The basic frequency formula is

$$f = \frac{1}{RC \ln (1/1 - \eta)}$$

when η represents the UJT's intrinsic standoff ratio and is usually given on the data sheet.

For any UJT, the approximate design equation requires only that the product of R and C be specified. One need not specify R or C alone.

Two periods must be considered

But the conventional design oversimplifies the operation of the relaxation oscillator. The operation involves two separate time periods. In the first, capacitor C charges and the transistor characteristics are of secondary importance—except, of course, for η . In the second period, capacitor C discharges through the transistor.

This second part of the relaxation period is totally neglected by a conventional design. There's a good reason: The base-1 resistance, R_{B1} , is a variable. Its value depends on the magni-

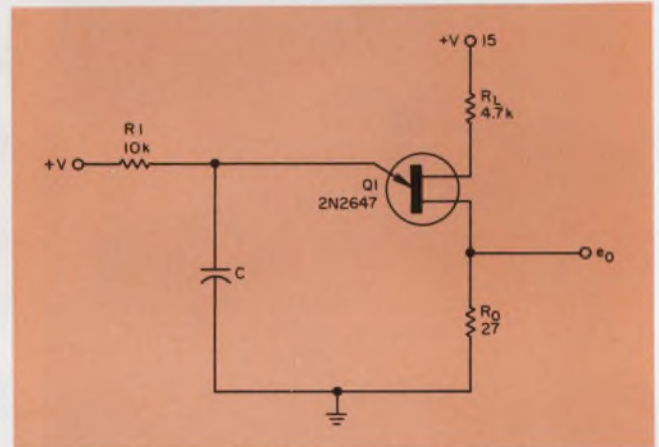

1. A unijunction-transistor relaxation-oscillator design involves trial and error when you use a conventional approach to obtain the capacitance.

tude of the current through it. Hence the capacitor discharges nonlinearly through the transistor.

Many nonlinear problems cannot be solved. But fortunately our case is an exception. In fact, the variation of R_{B1} during the capacitor's discharge can be approximated by a constant.

Measurement backs up theory

To verify this conclusion, let's perform measurements of the output-signal magnitude vs time. The data provide information on the variation of R_{B1} with time and, consequently, with current through the emitter-base-1 junction. The steps are as follows:

1. At time t , note the value of the voltage across capacitor C . Call this $v_c(t)$.
2. At the same time, note the value of the output voltage e_o .
3. Approximate the equivalent diode drop, V_D , as a constant 0.5 V.
4. Calculate the value of R_{B1} , and ignore the second-order effects due to the presence of R_{B2} and R_L —

$$R_{B1} = \frac{R_o [v_c(t) - V_D]}{e_o(t)} - R_o$$

5. Plot this equation against the magnitude of the current through resistor R_{B1} . The current equals $e_o(t)/R_o$.

Gordon Silverman, Ph.D., Affiliate, Electronics Laboratory, Rockefeller University, New York, N.Y. 10021.

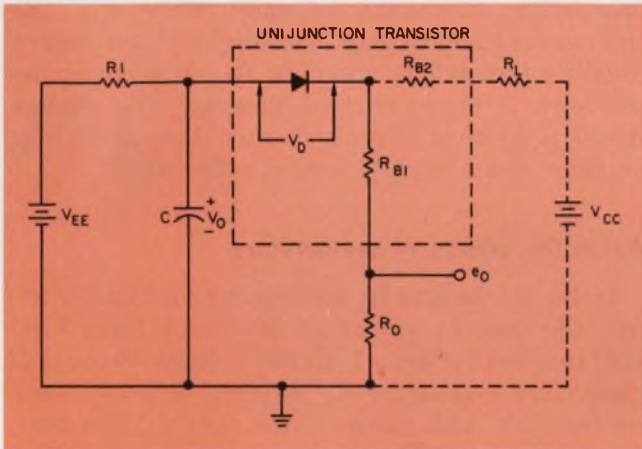

2. The equivalent relaxation-oscillator circuit reveals UJT parameters— V_D and R_{B1} . These parameters can be used to simplify the oscillator circuit design.

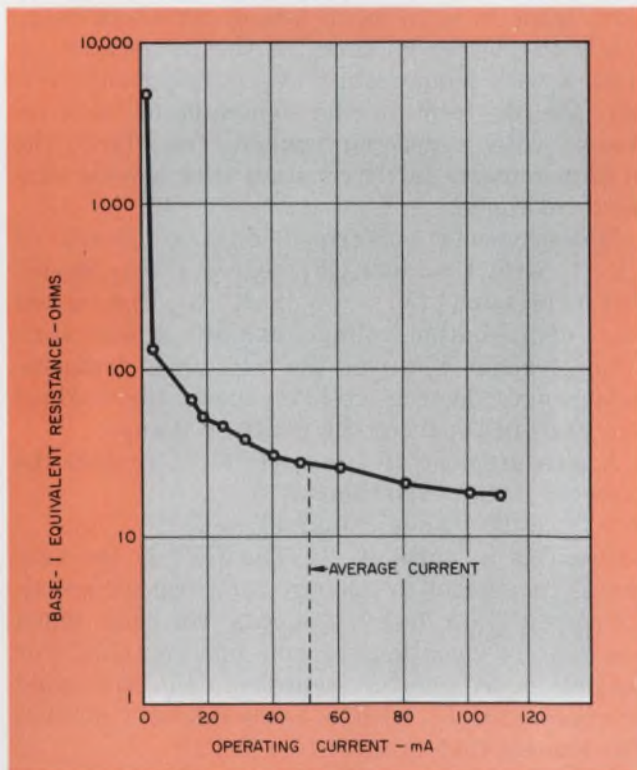

3. The equivalent base-1 resistance can be approximated by a constant—the resistance corresponding to an average current value. The constant gives the resistance for the discharge period of the circuit capacitor.

Fig. 3 shows the results of the measurements. For most current values, R_{B1} remains relatively constant. For current values below 3 mA, R_{B1} rises very sharply. The steep rise occurs only at the very end of the discharge of the capacitor.

Approximate R_{B1} with a constant

We now solve the nonlinear problem by assuming a constant value for R_{B1} . Refer again to Fig. 2. The solution reduces to that for a capacitor discharging through a resistor:

$$e_o(t) = e_{\text{final}} - (e_{\text{final}} - e_{\text{initial}}) e^{-t/\tau}$$

where τ = circuit time constant.

A substitution of circuit components yields the following result:

$$e_o(t) = (V_{EE} - V_D) \frac{R_o}{R_1 + R_T} u(t) + \left[(V_o - V_D) \frac{R_o}{R_T} - (V_D - V_{EE}) \frac{R_o}{R_1 + R_T} \right] u(t) e^{-t/\tau}$$

where $R_T = R_{B1} + R_o$,

$$\tau = \frac{R_1 R_T C}{R_1 + R_T} \text{ and}$$

$u(t)$ represents the unit-step function.

The result can be simplified by use of two approximations that usually prevail:

$$V_D \ll V_{EE} \text{ and } R_1 \gg R_T$$

When these are included, the result becomes

$$e_o(t) \approx \frac{(V_o - V_D) R_o}{R_T} e^{-t/R_T C} u(t) \quad (1)$$

We can verify Eq. 1, and also our linear model, by showing the following:

1. For a particular value of C , Eq. 1 agrees with the observed output waveform.

2. An equation to be developed between the pulse width and C agrees with the observed results.

The circuit of Fig. 1 serves as a convenient example for the verification of Eq. 1. V_o —the initial voltage across the capacitor—could be found by noting the voltage at which the UJT enters its negative resistance region of operation. That voltage is approximately ηV_{BB} , where V_{BB}

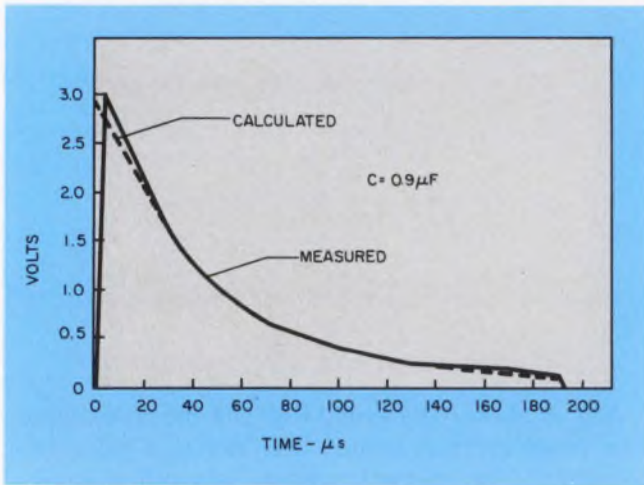

4. Close agreement results between measured output voltages and those calculated from the improved formula for pulse width.

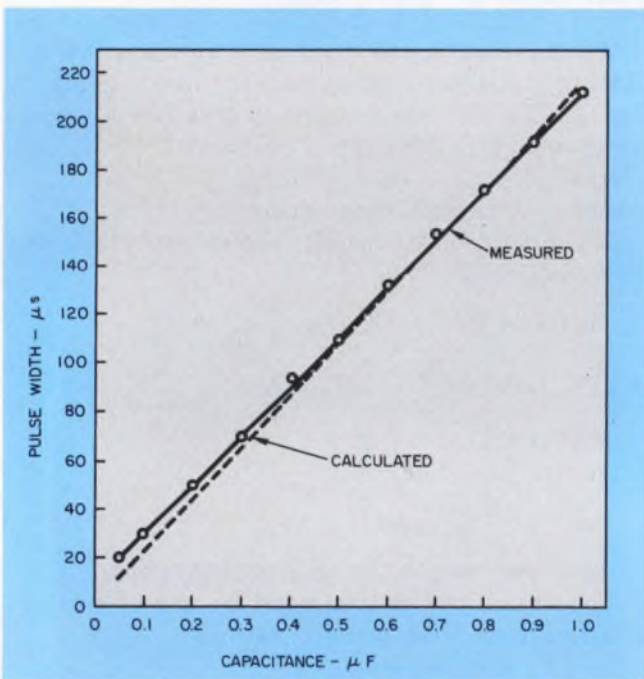

5. Measured pulse width for different capacitance values provides an additional verification of the circuit model.

equals the voltage from base-2 to base-1. But for our example, a direct measurement gives V_o as 6.4 V.

An estimate of R_{B1} —needed to calculate R_T —follows from Fig. 3. The average current in the junction during discharge—about 50 mA—corresponds to an R_{B1} of 29 Ω . Since $R_T = R_{B1} + R_o$, the value of R_T becomes 56 Ω .

Next we substitute into Eq. 1 the value of R_T , 0.5 V for V_D , and 0.9 μF for C , to find the following:

$$e_o(t) = 2.9e^{-t/50 \times 10^{-6}} u(t).$$

A plot of this equation, along with measured

values, appears in Fig. 4. The two curves depart significantly only during the initial 10% of the pulse width, where the worst error is 12%.

To find a relationship between pulse width and C , solve Eq. 1 for the time that it takes $e_o(t)$ to reach 0.06 V—the level at which the pulse ends:

$$t_p \approx R_T C \ln \frac{(V_o - V_D) R_o}{0.06 R_T}. \quad (2)$$

For our example, Eq. 2 simplifies to the following equation:

$$t_p = 214 C.$$

A plot of this equation and measured data appear in Fig. 5. Except for small values of C , the two curves agree closely. The slight disagreement could be lessened by altering R_{B1} to account for the lower average current flowing. The change would produce a slightly higher R_{B1} , a slightly higher τ and a slightly longer pulse width.

Watch the effects of temperature

In Eq. 2, changes in temperature primarily affect the base-1 resistance, R_{B1} —and thus R_T —and the emitter-base-1 diode voltage drop, V_D . Equivalent resistance R_{B1} exhibits a near linear relationship with temperature over a wide temperature range. The resistance has a positive temperature coefficient. The diode drop, V_D , decreases with increasing temperature.

From the R_T term in Eq. 2, a change in R_{B1} causes a linear change in the value of t_p . The \ln term tends to have much less of an effect on t_p . While the $V_o - V_D$ term in the numerator increases with temperature (V_D is being subtracted), the R_T term in the denominator also increases with increasing temperature. Hence the \ln term remains fairly constant over a wide temperature range.

Measurements performed on the circuit of Fig. 1, with $C = 0.9 \mu\text{F}$, bear out this model. The expression $(V_o - V_D) R_o/R_T$, the initial value of the output voltage, exhibits a total variation of about 4% over the 0-to-100-C temperature range. As you might expect, the highest temperature produces the greatest change.

A measurement of pulse width, t_p , reveals the expected linear variation:

$$\% \text{ change} = 0.27 (T - 25),$$

where T is in units of $^{\circ}\text{C}$. The UJT is the only circuit component to undergo temperature stress.

Compensation techniques can be used when temperature variations become unacceptable. For example, a temperature-sensitive capacitor could be chosen for C , with a temperature variation that cancels that produced by R_T .

Of course, care should be exercised to ensure that the other components— R_1 , R_o , and R_i —don't contribute to additional temperature-induced changes in t_p . ■■

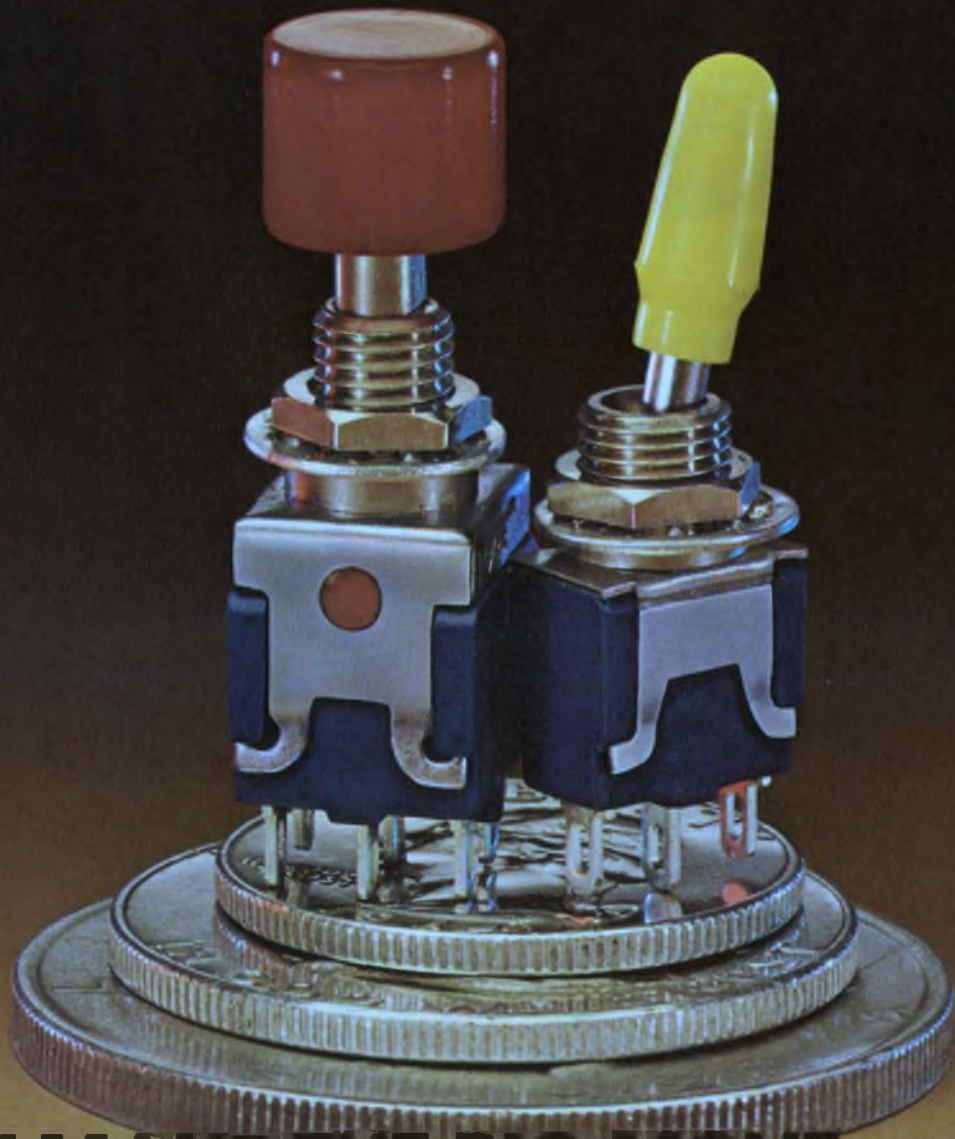

NOW MAKE THE BIG MOVE TO MINIATURIZATION WITH CUTLER-HAMMER.

As you miniaturize your products, rely on these space-saving new Cutler-Hammer ultra-miniature switches. They deliver additional quality, together with a full choice of style, color, and shape.

You get full current-carrying capacity at 115 V.A-c in toggles or pushbuttons. One or two poles in 5 different circuits.

Superior construction details include: a 1/4-inch bushing for con-

venient one-hole mounting, silver-alloy contacts with initial contact resistance of only 0.010 ohm maximum, a polyester base partially jacketed in steel for extra switch-mechanism protection, and either solder-lug or PC terminals.

Cutler-Hammer's remarkable application flexibility continues externally with a wide range of decorator caps, buttons, and bezels in many colors.

And all circuits are in stock for fast delivery.

To learn more about how this highly adaptable new line can add function and style to your products, check with your nearest Cutler-Hammer Sales Office, or Authorized Stocking Distributor.



Cutler-Hammer ultra-miniature switches are available in a variety of designs and colors. In both toggles and pushbuttons.

Switch
to No.1

More than just switches:
prompt availability,
field help, innovation,
quality assurance, too.

INFORMATION RETRIEVAL NUMBER 45

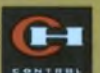

CUTLER-HAMMER
SPECIALTY PRODUCTS DIVISION, Milwaukee, Wis. 53201

**NEW ISOPLANAR
CMOS.
IT DOES WHAT
COMMON CMOS
CAN'T.**



Fairchild's new high-density Isoplanar CMOS costs about the same as ordinary CMOS.

And uses the same popular 4000 series pinouts for direct plug-in replacement.

After that, Fairchild CMOS leaves common CMOS far behind.

"Isoplanar." It makes a difference.

In the first place, Isoplanar fabrication reduces chip area substantially. Which means Fairchild CMOS designers have had plenty of room to include full buffer circuitry with every CMOS device. Even SSI.

Conventional CMOS utilizes buffered outputs only on MSI and driver devices. So a conventional unbuffered CMOS 2-input NAND Gate, for example, is organized like this:

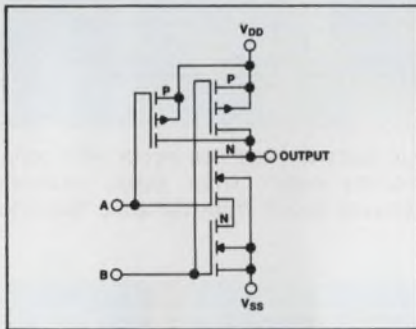

A Fairchild fully-buffered NAND Gate, on the other hand, looks like this:

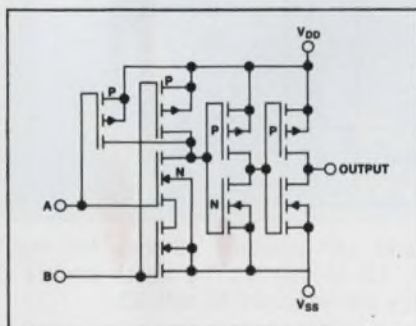

The device utilizes small geometry input and logic transistors to generate the required logic function, then utilizes low impedance output buffers.

For the system designer, there are several benefits:

1.

Highest guaranteed noise immunity.

Because buffering permits an increase in voltage gain, transfer characteristics are almost ideal.

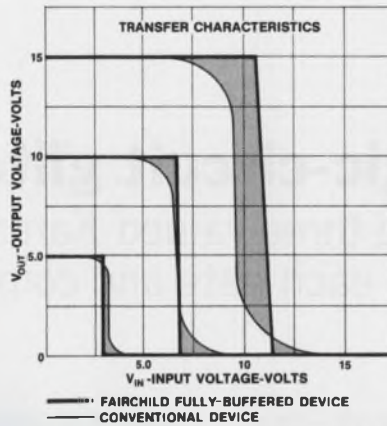

As a result, guaranteed noise immunity limits for Fairchild CMOS Gates are the highest in the industry.

2.

At last, standardized outputs.

Full buffering also means that output drive characteristics are finally standardized across all part types. And every husky Fairchild CMOS device drives a guaranteed 400 uA at 5 volt power supply.

Which means it can drive low power TTL and low power Schottky TTL directly.

3.

Increased system speeds.

With the buffers in service, output impedance and propagation delay in CMOS Gates become independent of the input pattern. Just look at the typical propagation delay for a Fairchild fully-buffered 34012 4-input NAND Gate vs. a conventional 4012 4-input NAND Gate at 15pF output capacitance.

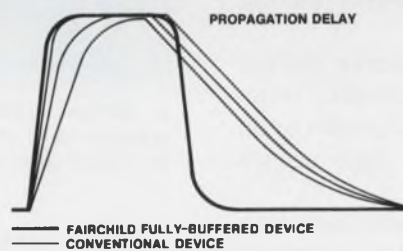

With 1, 2, or 3 simultaneous logic changes, conventional CMOS Gates exhibit differing propagation delays with input pattern. Fairchild CMOS doesn't.

System speeds using fully-buffered CMOS are sharply improved.

Add to that the inherent speed advantages of Isoplanar manufacture – including silicon

gate self-alignment and reduced sidewall capacitance – and you've got CMOS that beats all others.

Fairchild CMOS. Think of it like TTL, only not so hungry for power.

If you really want to see what CMOS can do for you, maybe you should think of it like TTL. Only in some ways, better.

Because instead of burning up 10mW per gate, Fairchild CMOS requires only 10nW at static conditions. That's only one-millionth of the power needed for TTL.

Fairchild CMOS also works over a broad 3V to 15V power supply range.

It's more immune to noise. (And makes less noise itself.)

It operates from -40°C to +85°C, commercial. And from -55°C to +125°C, military.

And instead of a dc fanout of 10 like TTL, Fairchild CMOS fanout is almost unlimited.

Just tell us what you want. We deliver.

Right now, a variety of Fairchild CMOS devices are in-stock and available for sampling, with more devices on the way.

Available now.

- 34001 Quad 2-Input NOR Gate
 - 34002 Dual 4-Input NOR Gate
 - 34011 Quad 2-Input NAND Gate
 - 34012 Dual 4-Input NAND Gate
 - 34023 Triple 3-Input NAND Gate
 - 34025 Triple 3-Input NOR Gate
 - 34027 Dual JK Flip-Flop
 - 34028 One-of-Ten Decoder
 - 34030 Quad Exclusive-OR Gate
 - 34811 Quad Exclusive-NOR Gate
- Available soon.*
- 34019 Quad AND/OR Select Gate
 - 34049 Hex Inverter
 - 34050 Hex Buffer
 - 34512 Digital 8-Chn. Multiplexer

Just check the devices that interest you, and call your Fairchild Sales Office or Distributor.



Algebra finds logic-circuit glitches

without need for involved three-valued Karnaugh maps. Simple equations are written for each gate and combined.

Glitches in a multilevel logic network—those brief spikes that occur at the output of the circuit during input-signal changes—can be detected with a simple algebraic method instead of tedious Boolean techniques.

Simple equations are written for each logic gate and are combined algebraically. The resultant polynomial, used in conjunction with a theorem of Eichelberger,¹ offers these advantages:

- Detection of all potential static hazards.
- Ease of use for multilevel networks.
- Applicability to networks composed of any type of threshold gate.
- Ease of automation.

By contrast, the Boolean techniques require three-valued Karnaugh maps, which are painstaking to prepare for multilevel networks.

In the description of the new technique, upper-case characters are used for Boolean expressions and lower-case characters for the analogous arithmetic expressions.

Transients in logic circuits

Logic-circuit inputs cannot change levels instantaneously, nor can the output signal. Instead both signals assume intermediate levels during the transitional period.

Two kinds of hazards commonly occur during the transition period of the input signals: function and logic. The function hazard depends upon the actual logic function, while the logic occurs because of inherent circuit delays.

The hazards can be further subdivided into static and dynamic types. These give rise, respectively, to glitches and multiple transitions that resemble contact bounces (Fig. 1).

A simple network illustrates both types of response (Fig. 2). An input transition from $W, X, Y, Z = 1111$ to $W, X, Y, Z = 1001$ can occur in two ways:

Cell 15 (1111) → Cell 11 (1011) → Cell 9 (1001)
or

Christian Rey, Research Engineer, University of Montreal, Department d'Informatique, Montreal 101, Quebec, Canada.

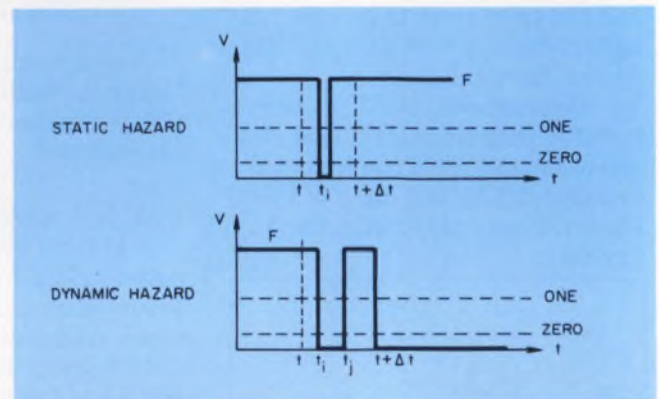

1. Two common logic hazards that can occur with input signal changes. Glitches result from static hazards; contact-bounce waveforms result from dynamic hazards.

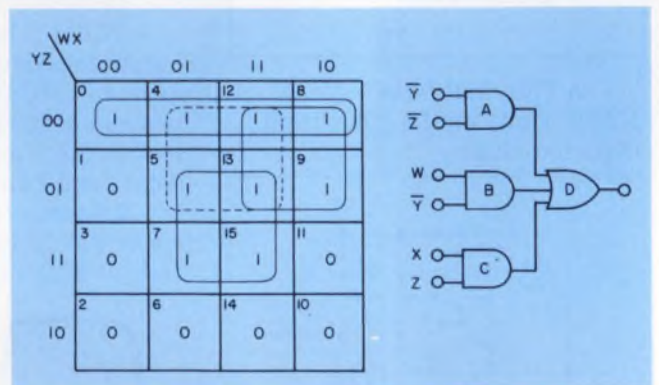

2. Simple logic circuit can produce glitches for input transitions from cell 15 to cell 9. The glitch occurs if the input momentarily corresponds to cell 13.

Cell 15 (1111) → Cell 13 (1101) → Cell 9 (1001)
In the first case, the output goes from 1 to 0 to 1 and a glitch may occur. For the second case, the output is always ONE.

A transition from cell 9 to cell 14 includes the possibility that an intermediate cell sequence—9, 11, 15 and 14—will occur. The resultant output sequence 1, 0, 1, 0 shows the possibility of a functional bounce transition.

A logic glitch can occur with a transition from cell 5 to cell 4. For cell 5, the gate-C output is ONE, whereas A and B are ZERO. For cell 4, C = ZERO, A = ONE and B is unchanged. If gate

C is faster than gate A, the temporary 000 input to gate D produces a ZERO output during the transition.

Theory of static hazard detection

In Eichelberger's theory, a logic signal can have three values: 0, 1 and r (or indeterminate). The value r is assigned to the open interval $0 < r < 1$, and is supposedly the value of the signal during a transient.

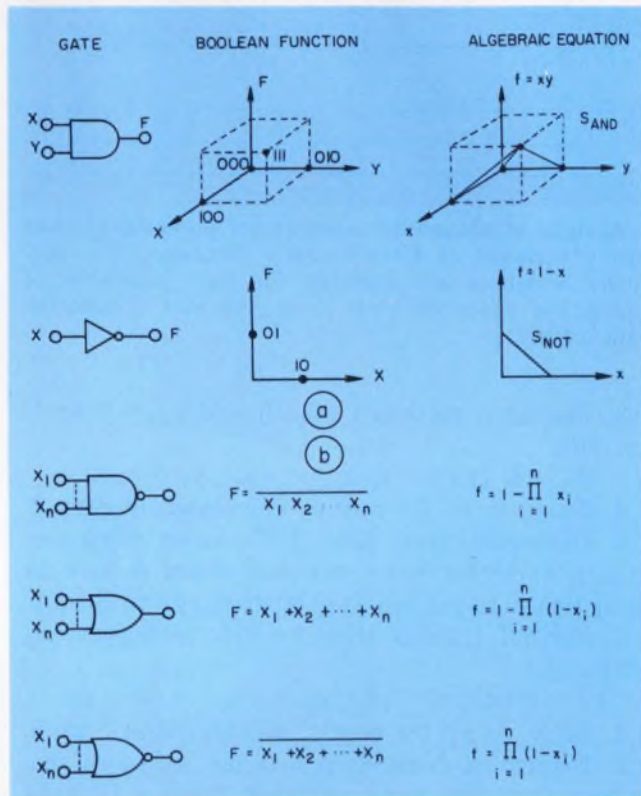

3. Recognition of potential static hazards requires ternary algebra with permissible levels of 0, 1 and r, where $0 < r < 1$. Logic functions, such as these basic types, can be approximated by simple polynomial equations (a). The polynomials have values in the closed interval (0,1) and represent ternary functions. The equations are easily combined by ordinary algebra to represent multi-input gates (b).

Eichelberger proves further that a combinatorial logic network contains a static hazard for the following input change:

$$X(t) = (X_1, X_2, \dots, X_p, X_{p+1}, \dots, X_n)$$

to

$$X(t + \Delta t) = (\overline{X_1}, \overline{X_2}, \dots, \overline{X_p}, X_{p+1}, \dots, X_n),$$

if

$$F[X(t)] = F[X(t + \Delta t)]$$

and

$$0 < F^*(r, r, \dots, r, X_{p+1}, \dots, X_n) < 1,$$

where F^* is the ternary output function and the X_1 to X_p change to $\overline{X_1}$ to $\overline{X_p}$.

There are several methods to evaluate F^* . The

most direct uses ternary Karnaugh maps. The entire function is built up from the maps of individual gates. Each variable in the map has three possible values: 0, r and 1.

The more advantageous method—and the one used here—makes use of polynomial approximations to the gate functions. The over-all function is built up with the laws of ordinary algebra. The theorem allows examination for glitches directly from the function.

As a start, define a continuous polynomial approximation for a two-input gate by four points (Fig. 3a). One approximation to the logic output for an AND gate is

$$f = a_0 + a_1 x + a_2 y + a_3 xy.$$

Substitution of the four possible input values in the equation gives

$$\begin{aligned} a_0 &= 0 \\ a_1 &= 0 \\ a_2 &= 0 \\ a_3 &= 1 \end{aligned}$$

and the result

$$f = xy.$$

The variables x, y are the continuous versions of logic variables X and Y. They can vary over the range $0 \leq x \leq 1$.

For an inverter, a two-point polynomial approximation is

$$f = 1 - x.$$

Since the operations AND and NOT form a complete set, the equations can be extended to equations for such gates as NAND, OR and NOR (Fig. 3b).

All properties of ordinary algebra apply to networks of gates or Boolean expressions. For the circuit in Fig 2:

$$\begin{aligned} g_A &= (1-y)(1-z) \\ g_B &= w(1-y) \\ g_C &= xz \end{aligned}$$

and

$$f = 1 - [1 - (1-y)(1-z)][1 - w(1-y)][1 - xz].$$

The polynomial expression for a single logic gate obeys the ternary convention—the value of g lies between 0 and 1—if all input variables have values between 0 and 1. The same property holds true for the over-all approximation f.

The use of f in place of F^* makes Eichelberger's theorem particularly easy to apply. The steps are as follows:

1. Determine the polynomial f of the network $f(x_1, x_2, \dots, x_{p+1}, \dots, x_n)$.
2. Select the input transition for analysis and compute

$$f_r = f(r, r, r, x_{p+1}, \dots, x_n).$$

Note that only the first p variables change. If $f_r = r$ (has a value between 0 and 1), then a static hazard can exist; otherwise the circuit switches properly.

The combinatorial network (Fig. 4) has two outputs for which

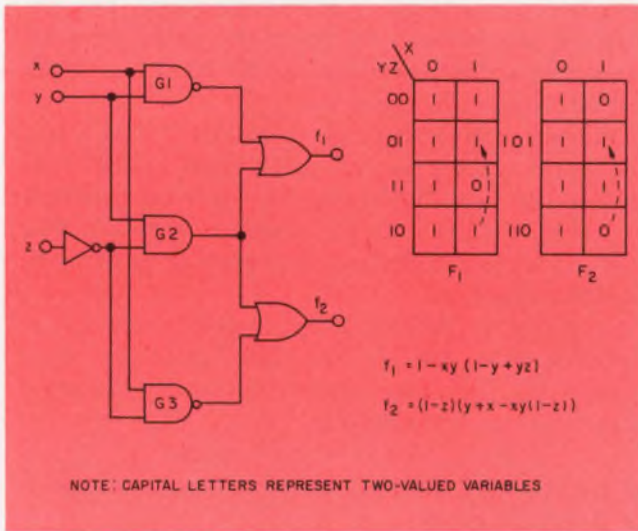

4. A combinational network can produce glitches for a specified input transition if the ternary function also has values between 0 and 1. The algebraic equation represents the ternary function. Outputs f_1 and f_2 can have glitches for the transition $XYZ = 110$ to $XYZ = 101$. Both equations equal $1 - r + r^2 - r^3$ since y and z are indeterminate (equal to r) for this transition. The Karnaugh maps show a function hazard for f_1 and both function and logic hazards for f_2 .

$$f_1 = 1 - xy(1 - y + yz)$$

$$f_2 = (1 - z)(y + x - xy(1 - z)).$$

For the transition $XYZ = 110$ to $XYZ = 101$, find

$$f_1(1, r, r) = 1 - r + r^2 - r^3$$

$$f_2(1, r, r) = 1 - (r - r^2 + r^3).$$

Both f_1 and f_2 equal r , since

$$0 < r - r^2 + r^3 < 1,$$

and glitches are possible on both outputs.

The algebraic method permits the detection of static hazards in sequential circuits. The polynomials relate the secondary value outputs to the feedback inputs and primary inputs.

First determine the k polynomials, one for each of the k secondary variables:

$$y_1' = f_1(x_1, x_2, \dots, x_p, x_{p+1}, \dots, x_n, y_1, y_2, \dots, y_k)$$

$$y_2' = f_2(x_1, x_2, \dots, x_p, x_{p+1}, \dots, x_n, y_1, \dots, y_k)$$

$$y_k' = f_k(x_1, x_2, \dots, x_p, x_{p+1}, \dots, x_n, y_1, \dots, y_k)$$

in terms of the feedback inputs y_1 to y_k and primary inputs x_1 to x_n .

Select an input transition from

$$x_1^0, x_2^0, \dots, x_p^0, x_{p+1}^0, \dots, x_n^0$$

to

$$\bar{x}_1^0, \bar{x}_2^0, \dots, \bar{x}_p^0, x_{p+1}^0, \dots, x_n^0,$$

along with the corresponding initial values of the secondary variables

$$y_1^0, y_2^0, \dots, y_k^0.$$

The p primary variables change from their initial values, x_j , to their complements \bar{x}_j . The remaining primary variables stay the same. All initial values are either 0 or 1.

The algorithm consists of the following eight steps, some of which may have to be repeated:

1. Set $y_i = y_i^0$ for $i = 1$ to k .

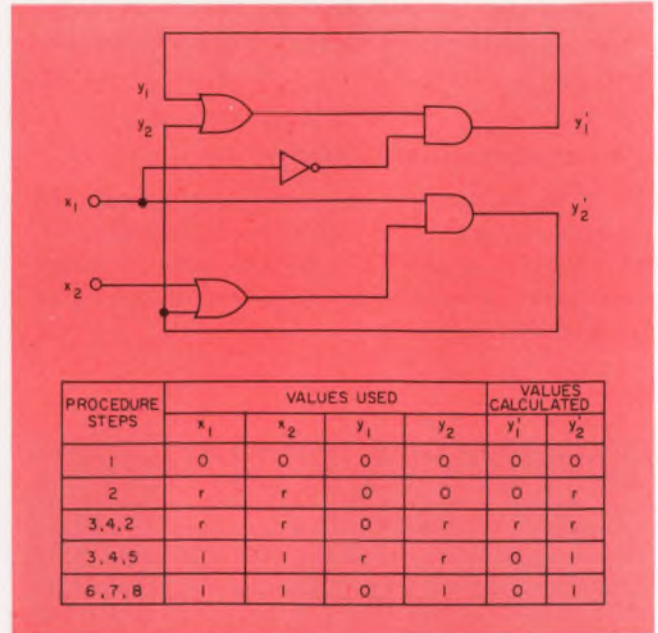

5. Analysis of sequential networks for potential glitches uses a variation of Eichelberger's theorems. The secondary variables are analyzed for their sequence of values. The sequence 0-r-0 for y_1' denotes a potential static hazard.

2. For all i , so that $1 \leq i \leq k$ and $y_i = 0$ or 1, compute

$$y_i' = f_i(r, r, \dots, r, x_{p+1}^0, \dots, x_n^0, y_1, \dots, y_k).$$

3. Set $y_i = y_i'$ for any y_i' calculated in Step 2.

4. Determine from Step 3 if one or more secondary variables have switched from 0 to r or from 1 to r . If yes, do Step 2; if no, go to Step 5.

5. For all i , such that $1 \leq i \leq k$ and $y_i = r$, compute

$$y_i' = f_i(\bar{x}_1^0, \bar{x}_2^0, \dots, \bar{x}_p^0, x_{p+1}^0, \dots, x_n^0, y_1, \dots, y_k).$$

6. Set $y_i = y_i'$ for any y_i' calculated in Step 5.

7. Determine from Step 6 if one or more secondary variables have switched from r to 0 or from r to 1; if yes, do Step 5, if no, go to Step 8.

8. The final values of the secondary variables are $y_1^* = y_1 \dots y_k^* = y_k$.

If $y_i^* = 0(1)$, then the variable remains stable for this transition.

If $y_i^* = r$, the variable is not stable. The equations for the secondary variables of the circuit in Fig. 5 are

$$y_1' = (1 - x_1) [1 - (1 - y_1)(1 - y_2)]$$

$$y_2' = x_1 [1 - (1 - y_2)(1 - x_2)].$$

For the transition $x_1, x_2 = 0, 0$ to $x_1, x_2 = 1, 1$ with $y_1^0 = 0$ and $y_2^0 = 0$, the algorithm shows a 0-r-0 transition for y_1' that indicates a static hazard malfunction can occur. The table shows the procedural steps to follow before the final answer is obtained. ■■

References

1. Eichelberger, E.B., "Hazard Detection in Combinational and Sequential Switching Circuits," *IEEE International Conference Record on Switching Circuits, Theory and Logical Design*, Vol. 12, 1964, pp. 111-121.

SOLVE YOUR CIRCUIT DESIGN PROBLEMS WITH VERSATILE **AlSiMag** CERAMICS



TO GET RID OF HEAT

Substrates of AlSiMag® 794 ceramic conduct heat about like the metal aluminum. This remarkable thermal conductivity plus its excellent electrical insulation characteristics and ability to accept metallization have solved many problems of how to dissipate heat from electronic circuits. Bulletin 724 on request.

Phone 615/265-3411.

Telex 558432.

CIRCLE NO. 201

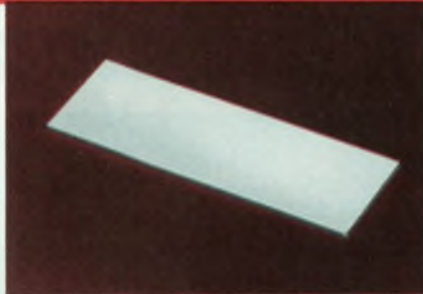

TO MATCH THERMAL EXPANSION OF GLASS

Where a hermetic seal to glass is needed, AlSiMag® 842 ceramic can solve your problem. Its thermal expansion closely matches that of the most frequently used glass and forms a reliable hermetic seal. Substrates can be made to the dimensional accuracy you require and with holes, slots, or depressions as needed.

Phone 615/265-3411.

Telex 558432.

CIRCLE NO. 202

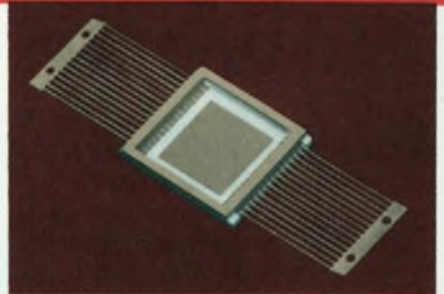

FOR MAXIMUM RELIABILITY

Hybrid packages of all ceramic construction plus brazed-on leads for maximum reliability. Co-fired monolithic ceramic structure eliminates hermeticity problems, greatly increases thermal conductivity and structural strength. Ceramic construction permits mounting the package over conductors on circuit board. Custom made or write for current list of standard packages. Phone 615/265-3411.

Telex 558432.

CIRCLE NO. 203

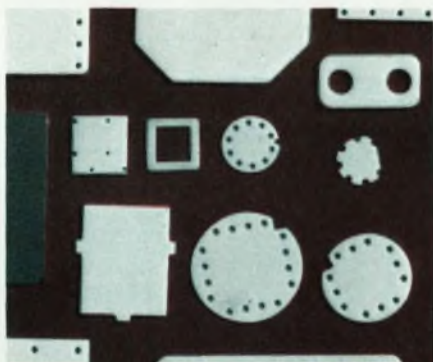

FOR THICK AND THIN FILM CIRCUITS

Extra strong ceramic substrates for thick and thin film processes. Special purpose substrates to get rid of heat, to save space, to match thermal expansion of glass, for light sensitive devices or for a contrasting background. Substrates with high dielectric constants. Bulletin 712 on request.

Phone 803/682-3215.

Telex 570449.

CIRCLE NO. 204

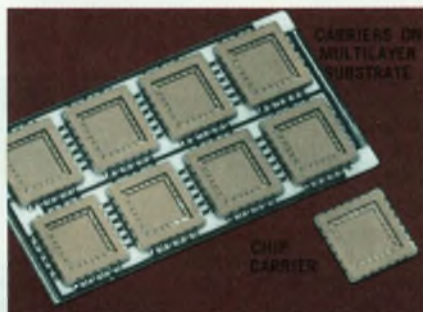

FOR CIRCUIT DENSITY

These small hermetic chip carriers allow far greater circuit density. Electrical testing after hermetic sealing allows storage of good devices in a less expensive package before committing to the circuit. The design permits conventional die attach, wire bonding and lid sealing operations . . . and re-flow solder attachment to a multilayer ceramic substrate, hybrid substrate or phenolic circuit board. Phone 615/265-3411.

Telex 558432.

CIRCLE NO. 205

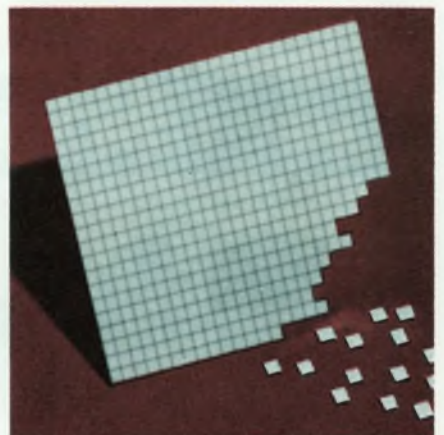

TO REDUCE PROCESSING COSTS

From tooling for economy or from laser for accuracy, Snap-Strates are a proven cost reducer. Have you considered how much Snap-Strates and multiple processing can save you? Bulletin 712 on request. Phone 803/682-3215.

Telex 570449.

CIRCLE NO. 206

You save time and money with single-source responsibility for substrates, pattern generation, metallization and plating.

See Us At
BOOTH 642-44
NEPCON WEST

American Lava Corporation

A SUBSIDIARY OF **3M** COMPANY

Chattanooga, Tennessee 37405 Laurens, South Carolina 29360

INTERNATIONAL: American Lava Corp., Chattanooga, Tenn. 37405, U.S.A., 615/265-3411, TELEX 558432

If you've got the timepiece, we've got the electronics.

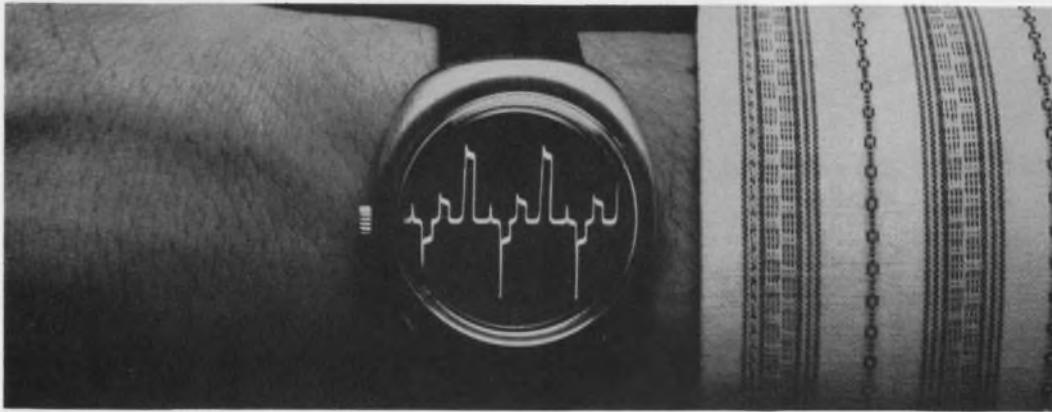

We've got
CMOS integrated circuits.
quartz crystals.
liquid crystals.
micro stepping motors.
analog systems.
digital systems.

We help solve your problems by being a single, reliable source for virtually all of your electronic timepiece needs. Please call or write Marketing Director Motorola Timepiece Electronics, 3102 North 56th Street, Phoenix, Arizona 85036. (602) 244-4406.

MOTOROLA
Timepiece Electronics
Bringing more than 45 years of
electronic experience to
the world's watch makers.



INFORMATION RETRIEVAL NUMBER 49

VECTOR FITS IT ALL TOGETHER, BETTER

MODULE CAGES



CMA SERIES

Strong, rugged all aluminum units supplied assembled for slide-in EFP modules in 3 1/2", 5 1/4", 7" and 8 3/4" heights and up to 15 3/4" deep.



**EFP
MODULES**

Sleek aluminum cases with slide-off side covers, extruded top and bottom rails hold cards 2.73", 4.5" and 7.98" wide and 4.5", 6.5", 9.6" and 11.31" long. 59 models available in widths from 1" to 4 1/2".

CARD FILES AND CAGES



CCK-13 SERIES

Rugged all aluminum, card height adjustable card files supplied assembled ready for connectors which mount on 4-way adjustable struts. The cages are designed for cards with width ranges of 1.0" to 2.73"; 2.73" to 4 1/2"; 6.2" to 7.98"; and lengths up to 9.6". Plastic or metal guides available. *Continuous extruded aluminum plate style* has 106-0.075" wide continuous grooves on 0.150" centers for cards allowing maximum flexibility.

Visit NEPCON Booth 818
Visit INTERCON Booth 1221

MULTI-USE CAGE KITS



CA-HP SERIES

Supplied unassembled in 11 different models for maximum flexibility to house cards and/or modules. Order card and module guides separately. Slotted side walls and bracket-mounted connector mounting struts provide wide adjustability. Available in 3 1/2", 5 1/4", 7" and 8 3/4" heights and 9", 12", and 15 3/4" depths. All parts and hardware of any Vector cage are available separately. For custom card or module cages, request our "design your own" form drawing.

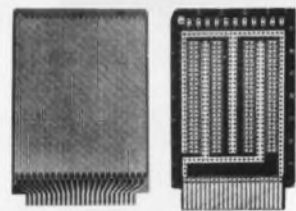

- PLUGBORDS
- TERMINALS
- CONNECTORS



See **ECM** vol. 3, pg. 954-958

**PACKAGING
HARDWARE FROM:**

Vector ELECTRONIC CO., INC.
12460 Gladstone Ave. Sylmar, California 91342



Phone (213) 365 9661
TWX (910) 496 1539

34113

INFORMATION RETRIEVAL NUMBER 50

If you knew what we know about subminiature lamps, you'd specify Chicago Miniature.

The smaller the lamp the tougher the job.

First, subminiature lamps are usually applied in critical situations where a lot more than light is demanded. Where reliability is essential. Like system warning lights. Or status signals. Or critical instructions. And that's why you find Chicago Miniature lamps in tough jobs like the manned space flights.

Second, subminiature lamps are a lot tougher to make. They have all the same components as larger lamps, but everything's reduced to almost impossible manufacturing dimensions. The filaments, complicated assembly, critical material and atmosphere control—all are magnified problems when you work in the subminiature range.

Chicago Miniature specializes in subminiature lamps.

We're expert when it comes to doing tiny things in a big way. For example, we have a special method for coiling the filament to precisely the right fraction of a turn to give you exactly the light output for your application. We also know the importance of precise filament mounting. Our filament mounting process is automated to eliminate the human variable. Both mean you get lamps with uniformity of brightness, and significantly longer life under typical operating conditions. All this and more, and within the subminiature range.



(ACTUAL SIZE)

We invest in flexibility.

It takes a lot of skill and imagination to consistently make dependable subminiature lamps. And Chicago Miniature invests in skilled people and special automated systems no other company can provide. It means that whether you need a standard lamp or a special component, Chicago Miniature has the capability to support you. Right now. Even special requirements are handled systematically and quickly.

Quality control comes naturally. It has to.

We're addicted to detail. All along the line. And that's the best kind of quality control. Chicago Miniature practices "controlled quality"—carefully monitoring key processes all the time. You get only those lamps that measure up. Nothing is left to chance.



**CHICAGO MINIATURE
LAMP WORKS**
4433 N. Ravenswood Ave.
Chicago, Illinois 60640
(312) 784-1020

a GENERAL INSTRUMENT company

THE LIGHTING BUGS

We help you avoid costly specials.

Chicago Miniature already has more subminiature lamps than any other manufacturer. Immediately available are the T-3/4, T-1, T-1 1/4, T-1 1/2 and T-1 3/4 sizes. We offer standard wire terminals, flanged and bi-pin bases and a variety of other configurations.

As much service as you need.

For problem solving application assistance, call your Chicago Miniature Sales Representative. Or call us directly for applications engineering assistance. Phone 312/784-1020. For off-the-shelf delivery, call your local Chicago Miniature Electronic Distributor.

Chicago Miniature also publishes technical data on subminiature lamp performance, under various operating and environmental conditions. This document represents over 9 million lamp hours of test data. Send the coupon for your free copy.

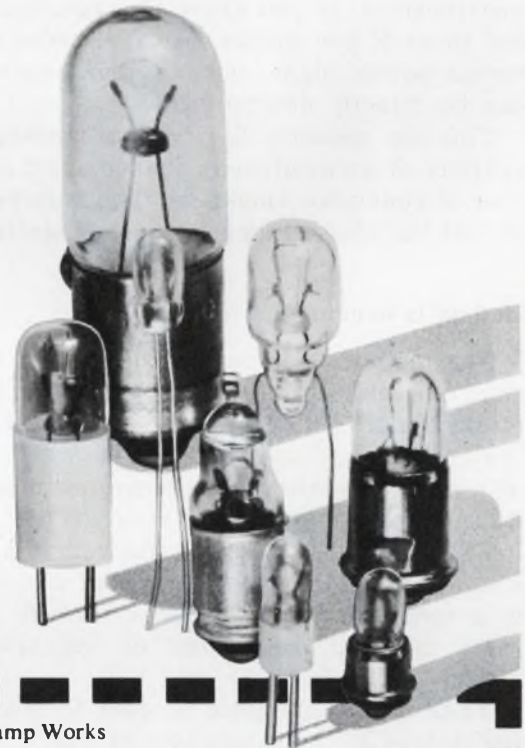

Chicago Miniature Lamp Works
4433 N. Ravenswood Ave., Chicago, Illinois 60640

- Please send me your free booklet on Subminiature Lamp Performance, including 9 million hours of test data.
- Please send me your catalog.

Name _____

Title _____

Company _____

Address _____

City _____ State _____ ZIP _____

Comments: _____

Measure sheet resistance easily.

The only things needed to determine R per square are two voltage readings and a simple calculation.

Sheet resistance (R_{\square})—the resistance of a sheet of conductive material with uniform thickness—is often needed as a design parameter in the analysis of printed-circuit signal and power distributions. If you know R_{\square} , commonly referred to as R per square, the resistance of an internal power plane or of a printed-circuit line can be directly determined.

You can measure R_{\square} by first finding the resistivity of an arbitrarily shaped sheet as a function of conductor thickness. The only restriction is that the sheet thickness must be uniform.¹

Method is nondestructive

The method is important because it is nondestructive and because it is applicable to geometry of any shape. The technique can be applied directly to hardware that represents the internal planes of a card or board before clearance holes, which impede the distribution of current, are drilled.

The method depends on the fact that the resistance between opposite edges of a square sheet is a constant for all squares formed from the same material, regardless of the size of the squares (Fig. 1a).

Thus if an ohmmeter is used to measure the resistances of the conductors of Fig. 1, the readings of all three would be identical. Consider the calculation for resistance:

$$R = \frac{\rho L}{A} = \frac{\rho L}{wt}$$

where ρ = material resistivity

L = Length

A = Cross-sectional area = width (w) × thickness (t).

From Fig. 1

$$R_1 = \frac{\rho L_1}{L_1 t}; R_2 = \frac{\rho L_2}{L_2 t}; R_3 = \frac{\rho L_3}{L_3 t}$$

and $R_1 = R_2 = R_3 = \rho/t = R_{\square}$

From this analysis, R_{\square} can be defined as the resistivity of the conductor divided by the conductor thickness. Now let's assume that R_{\square} must be determined for an irregular sheet of

copper with a uniform thickness (Fig. 1b). Points A, B, C and D in the figure can be located anywhere on the circumference of the conductor.

First feed a current, I, into point D and out through point C. Measure V_1 —the absolute potential difference between points A and B. Next feed the same current through either points A and D or points B and C. Measure V_2 —the absolute potential difference between points B and C for I_{AD} or between points A and D for I_{BC} . Al-

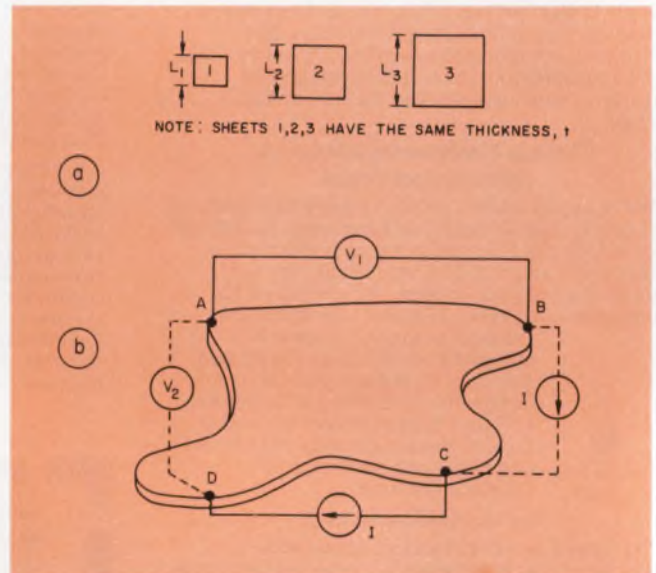

1. Measurement of R_{\square} depends on the fact that the resistance between the edges of a square sheet is independent of size (a). Thus R_{\square} can be determined from just two voltage measurements (b).

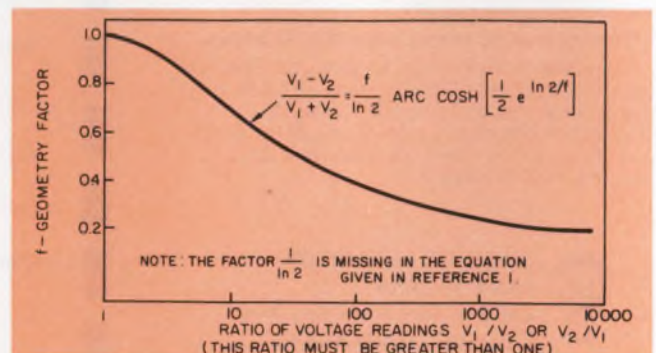

2. To account for current distributions in irregularly shaped conductors, a geometry factor, f, is plotted as a function of the ratio of the voltage readings.

Ken T. Stevens, Associate Engineer, IBM System Products Div., P.O. Box 6, Endicott, N.Y. 13760.

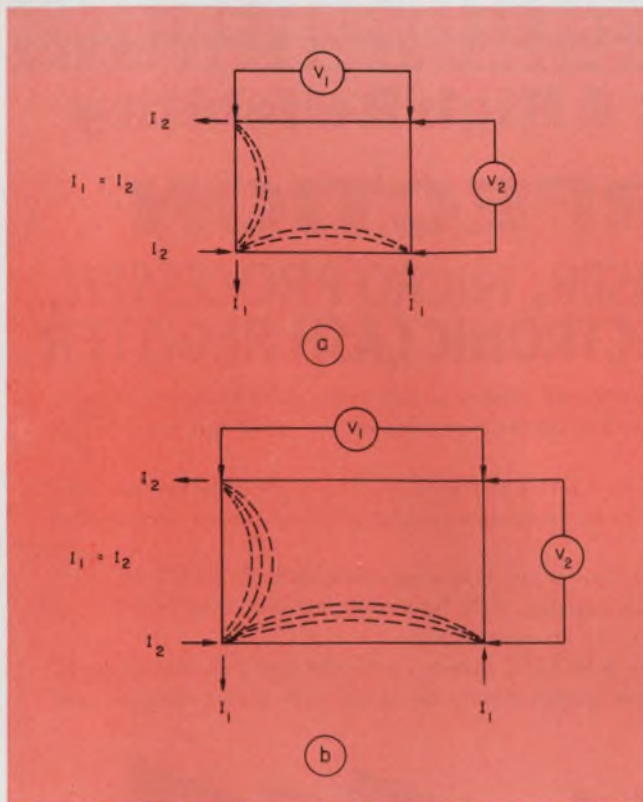

3. Two conductors of different shape illustrate the significance of the geometry factor. In (a), $f = 1$. In (b), f equals about 0.2.

Table R_{\square} s of various 5-mil copper conductors

	I (amps)	V_1 (μ V)	V_2 (μ V)	f	R_{\square} ($m\Omega/\square$)
Triangle	2	70	65	1	.156
	2	65	63	1	.148
	5	164	148	1	.144
Square	2	69	64	1	.154
	2	70	65	1	.156
	5	165	153	1	.147
Circle	2	65	61	1	.155
	2	70	67	1	.147
	5	161	155	1	.146
Rectangle	2	325	4	.4	.152
	2	316	4	.4	.148
	5	791	10	.4	.148
Irregular	2	145	23	.8	.155
	2	142	23	.8	.152
	5	355	48	.75	.140
Long rectangle (In-line method)	2	276	—	—	.138
	2	262	—	—	.131
	5	710	—	—	.142

$$R_{\square} = \frac{\pi}{\ln 2} \left(\frac{V_1 + V_2}{2I} \right) f$$

V_1 = voltage AB with I at CD * (Fig. 1a).

V_2 = voltage BD with I at AC (Fig. 1a).

f = geometry factor

* For the long rectangle, V_1 is the voltage across a square in the middle of the conductor. V_2 is not defined in this method.

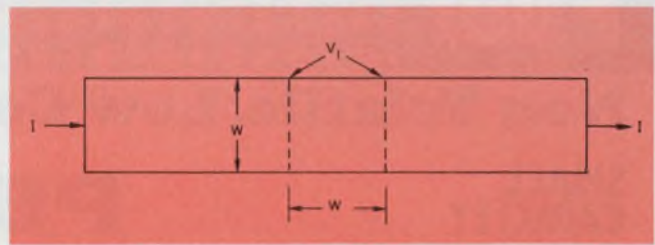

4. With the in-line method of determining R_{\square} , a uniform current distribution is established in a long, narrow conductor and voltage V_1 is measured.

ways measure the voltage at the points not used for feeding current.

R_{\square} is then calculated from the equation for resistivity given in reference 1:

$$R_{\square} = \frac{\rho}{t} = \frac{\pi}{\ln 2} \left(\frac{V_1 + V_2}{2I} \right) f, \quad (1)$$

where V_1 , V_2 are voltage readings made on the circumference of the conductor, I is the current flowing in the conductor, $\ln 2$ is the natural log of 2, and f is a geometry factor found from Fig. 1.

The geometry factor, f , can be determined from the ratio V_1/V_2 and is plotted in Fig. 2 as a function of the ratio.

Current distributions accounted for

Geometry is significant since current distributions vary according to the sheet configuration. For example, the geometry factor for a square is 1 because V_1 and V_2 are equal (Fig. 3a). But for a rectangle the geometry factor might be 0.2 (Fig. 3b).

When the voltage readings in Fig. 2b are analyzed, V_1 is found to be much greater than V_2 . This is because the current, I_1 , that establishes V_1 flows through a greater portion of the conductor than does the current I_2 for the V_2 reading. This difference in current distribution is accounted for with the geometry factor, f .

To verify Eq. 1, R_{\square} can be measured for a copper square, triangle, circle, rectangle and an irregular conductor, each five mils thick. The results, listed in the table, show 10% variations in R_{\square} .

Included in the table are values of R_{\square} measured with the in-line method. In this method, current flows into one end of a long, narrow conductor, and out the opposite end. A square is marked off in the middle of the conductor and the voltage measured across the square (Fig. 4).

It is assumed that a uniform current distribution exits through the center square. The voltage across the square divided by the current that flows in the conductor yields R_{\square} . ■■

Reference:

1. VanderPauw, L. J., Phillips Research Report 13, 1958, pp. 1-9.

FUJI

Non Volatile, Low Cost & High Reliability

**SMALL
CAPACITY**

RAM PERFECTION

POS TERMINAL, CASH DISPENSER, MICRO PROCESSOR, CREDIT CARD CERTIFIER, ELECTRONIC CASH REGISTER

It has been generally assumed that MOS IC memory systems are less expensive and more suitable to use than a ferrite core memories to employ in a field of small-capacity random access memories whose capacities are smaller than 8K bytes.

However, today this assumption shall be contradicted. FUJI's new series of memories, Small-capacity Ferrite Core Memory Modules, incorporated with Hybrid integrated circuit as its peripheral circuits, offering a more economical price and better reliabilities rather than MOS IC memories.

Everyone knows that volatility and reliability of stored information is the most important factor in handling of cash transactions at banking system as well as operating cash registers, POS terminal machines, and on-line devices. Consequently, at least the last digits of calculation must be nonvolatile.

Which do you think is more rational...a system designed by a MOS IC memory with the last calculated digits to be stored by a nonvolatile core memory or a whole entire system simply designed with a nonvolatile core memory? Answer is clear, that is FUJI Core Memory!

STANDARD MODELS

A wide variety of standard models are available over a wide range of memory capacities from 128 words-4 bits to 8K words-9 bits. Furthermore, we are ready to design and manufacture special systems with quick delivery service, according to your requirements.

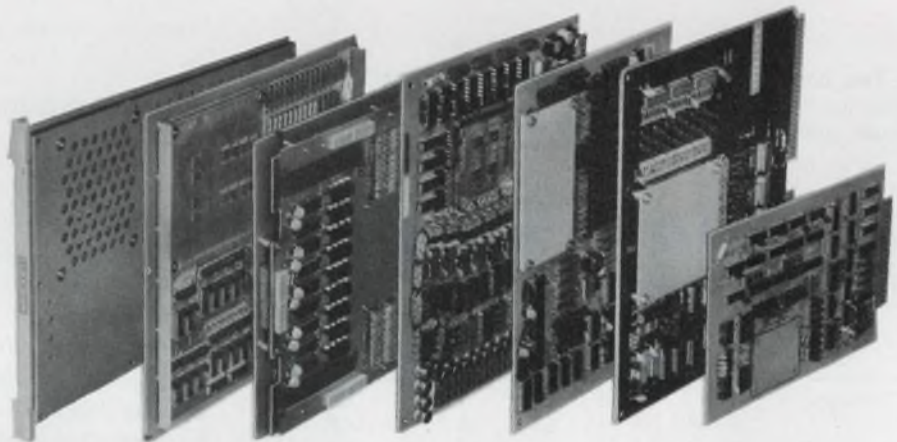

MODEL	CAP.	CT.	POWER	SIZE
CMS2101A	128W-4b	3 μ s	\pm 5V	5.8x8.7x0.5 inch
CMS2101B	256W-4b	3 μ s	\pm 5V	5.8x8.7x0.5 inch
CMS2112	512W-4b	3 μ s	+5V	6.0x8.0x0.5 inch
CMS2113	1024W-4b	3 μ s	+5V	6.0x8.0x0.5 inch
CMS2114	2048W-4b	3 μ s	+5V	8.0x10.0x0.5 inch
CMS2115	4096W-4b	3 μ s	+5V	8.0x10.0x0.5 inch
CMS2116	1024W-9b or 512W-18b	1.5 μ s	\pm 5V, +24V	9.8x11.8x0.6 inch
CMS2201A	1024W-10b	1 μ s	\pm 5V	9.5x10.5x0.5 inch
CMS2201B	2048W-10b	1 μ s	\pm 5V	9.5x10.5x0.5 inch
CMS2107	1024W-18b	1.5 μ s	\pm 5V, +24V	7.4x8.3x1.4 inch
CMS2401	4096W-18b or 8192W-9b	1 μ s	\pm 5V	10.0x15.0x0.5 inch
CMS2403	4096W-18b or 8192W-9b	1.5 μ s	+5V	10.0x15.0x0.6 inch

FUJI MEMORIES

FUJI ELECTROCHEMICAL CO.

Head Office: Hamagomu Bldg., 5-36-11, Shinbashi, Minato-ku, Tokyo, Japan
TEL: 434-1271

Overseas Office: New York, TEL: (212) 532-5630
Los Angeles, TEL: (213) 620-1640
Düsseldorf, TEL: (211) 89031

TAD. ISHIZUKA
SAM. YOSHINO
TAD. KOMURO

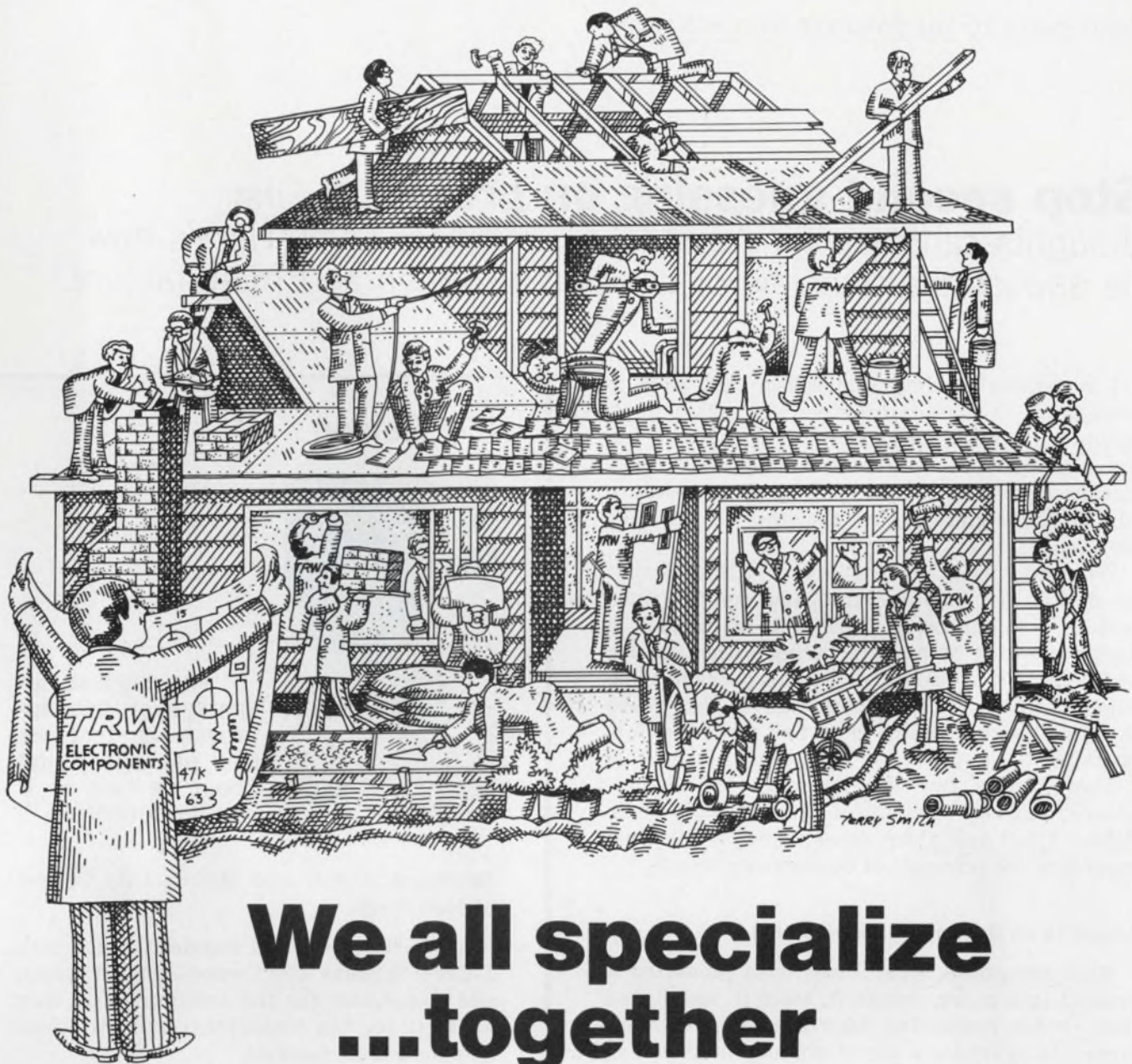

We all specialize ...together

TRW. CAPACITORS

TRW. CINCH CONNECTORS

TRW. CINCH-GRAFIK

TRW. CINCH-MONADNOCK

TRW. CONSUMER INTERNATIONAL

TRW. GLOBE MOTORS

TRW. HOLYOKE WIRE & CABLE

TRW. IRC POTENTIOMETERS

TRW. IRC RESISTORS

TRW. SEMICONDUCTORS

TRW. SUPERMET PRODUCTS

TRW. UTC TRANSFORMERS

We are the Electronic Components Divisions of TRW Inc. Each of us specializes in a particular area of manufacturing, making over 300 different kinds of electronic components.

But for all our specialization, we are still part of a single entity. We all follow the same basic TRW plans, operate under the same TRW standards of quality, reliability and service.

Individually we specialize; together we build.

And what we have built is a source for whatever you need in the way of electronic components. Either we already make it, or we can make it. High-technology or high-volume—or both. Among our specialties, we cover the field. So, as a group, you might say our real specialty is... serving your needs.

Because we are TRW.

TRW® **ELECTRONIC COMPONENTS**

10880 Wilshire Boulevard, Los Angeles, CA 90024

Stop second-guessing on projects. First thoughts can save time and labor, manager finds. Here's how he applies the principle of concurrent design and manufacture.

I remember reading somewhere that none is more liable to mistakes than he who acts only on second thoughts. I think of that whenever I use the principle of concurrent design and manufacture to help me manage my projects, because with it, the engineers' first thoughts are the ones that count.

What do I mean by "concurrent"? Simply that we design and manufacture parts for the same project simultaneously. The idea is to send a design drawing to manufacturing rather than a prototype. This means that we can package a job about as fast as it can be conceived. It also means that the designer has to think fast and make few mistakes.

There are a few disadvantages to this approach, but the advantages far outweigh them. Before I tell you about those, though, I'll illustrate how the principle of concurrency works.

Accent is on design and development

Most companies, when faced with producing a product in a hurry, design it, build it, test it and then render production drawings of it. Our approach is to render a set of production drawings first and then test the concept. We're committed to design and development, not research and development. We're not looking for new principles; we're looking to apply known principles—and as rapidly as possible. To do that, we have to get all the needed information on the drawings on the first go-around.

Job security here is not based on the knowledge that we have; it's based on the ability to transmit our knowledge of a job to paper quickly, so that we're physically free to work on the next job. We do packaging and manufacture complex electronic controls, computer interfaces and unattended common-carrier interfaces with command signals coming off teletypewriters.

Even though we vary our system concepts from design to design, we use pretty much the

L. J. Seiden, Manager, Engineering, T-Bar, Inc., Wilton, Conn. 06897

L. J. Seiden



"The biggest advantage of this approach is that we can package a job about as fast as it can be conceived."

Education: B.E.E. and M.E.E., City College of New York.

Responsibility: Directs engineering for both T-Bar's Systems and Components Divisions, and responsible for the engineering of new products for the computer, communications and industrial markets.

Experience: Management and engineering positions with AMF, Inc., Springdale, Conn., and Grumman Aircraft Engineering Corp., Bethpage, N.Y., in controls and communica-

same basic design drawings for most of our standard black boxes. When a different design is required during the manufacturing process, we get it down on paper. We can't just file it away in our heads, because then we'll be tied to that job every time it comes in.

It's like writing final manuals before the job is finished. Any company, no matter what its size, can use this principle, provided the project is not too large—say, under the scope of reason of one or two men.

One project on which we used the concurrency principle used six racks of our switching equip-

"The idea behind the principle of concurrency is to send a design drawing to manufacturing rather than a prototype."



tions; over 15 years in R&D engineering of electromechanical systems. Specialized experience in engineering supervision and systems analysis.

Publication: "Some Basic Pulse and Sequential Circuits," *Electromechanical Design*, January, 1966.

Personal: Married, two daughters; hobby: scuba diving.

Employer: Founded in 1960 as Electronic

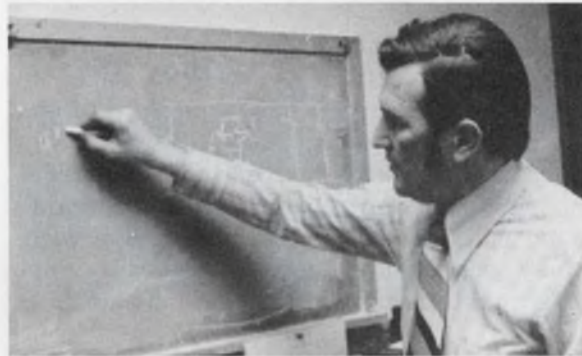

"The biggest disadvantage is that we need people who've worked with our hardware and who know where to leave room for changes."

Controls Inc., T-Bar designs and manufactures high-density, multicontact switches, relays and switching systems. T-Bar products are marketed individually as components and as systems for interfacing communications and computer equipment. The company changed its name in 1971 to reflect its increased emphasis on switching products and systems. Today more than 1000 companies use the patented switches that are available in more than 600 different models.

ment with a computer-controlled interface—a sizable job. After we had agreed on what the system was supposed to do, we designed the interfaces, the control circuits and the common packages simultaneously.

If we hadn't worked on the packaging and the circuitry at the same time, we would have had to design 21 unique packages. So we picked a concept of packaging that would allow repetition in wiring. We drew three or four circuit schematics and one or two sketches of the packages. We ended up with a half dozen individual packages instead of 21 different types. That required us

to do a lot of cross-wiring, but because of our packaging concept, we were able to design the assembly at the same time, and the first package was finished within a week.

Why a prototype project takes longer

Compared with a prototype project, the concurrency project cuts lead time by about one-third, and shorter lead time means reduced labor and material costs. A prototype project takes longer because when engineers design a product and build it as they go along, each designer makes a

little improvement in the product, because he's a little smarter when he has the hardware in hand. These little improvements come at a cost in materials and time. Since prototype designers don't have to think as far ahead as they would on a concurrent project, they don't.

Then, too, when the next design in line comes to them, they don't know how it fits into the finished product until it's all assembled. And when they finally do put it all together, they have to reassemble and disassemble the product to rework or rewire it. Before the project is finished, the product gets taken apart and put together quite a few times. Sometimes the product is even scrapped.

With the concurrent approach, we design the entire unit at the start as best we can, based on our experience. Less rework is required. We end up with some minor bugs, but we don't end up scrapping the product. We've pre-thought out the problems, and we've made a lot of generalized ground rules that we've decided to live with. They may not always be the best rules, but they're adequate, and we get the job out in a hurry.

Another drawback of the prototype approach is that the over-all time of the project is based on an initial design concept. The engineer orders some parts and waits for them to come in. While he's waiting, he's working on something else, but he has lost time. When he picks it up again to put it together, it always takes him time to get the job back in mind.

With the concurrent approach we don't work with hardware, so we need people who can "see" hardware and work with it in their mind's eye. While we're putting out drawings, we're putting out parts lists. The first part that has to be listed is the one we think is going to take the longest to get. The second priority for getting parts out is in the order they're needed for standard manufacturing cycles.

Concurrency helps stamp out assumptions

One big advantage of the concurrency approach is that it forces you to organize the job fast and efficiently and cuts down on your engineering assumptions. When a job comes in, the first thing we do is to make sure that we've got the interfaces specified, that we've got a good clear reading on the desired operation and that we know what the specifications are. With this information in hand at the front end of the project, we don't have to make too many engineering assumptions. I've had jobs where I piled up assumptions because I felt I had time to review them later. Not until the review did I find out that some early assumptions were wrong.

Another advantage of concurrency is knowing where you can leave room for error. Here, I design the product on paper and send it to the customer for review and discussion as quickly as possible. Together we define the items that are critical for him. Those items will control me; the other items I'll be able to control myself.

One of the disadvantages to making this system work is that you need people who have worked with your hardware, who can plan and discuss ideas, who can draw on their experience fast and who know where to leave room for changes. The manager has to know the strongest point of each engineer to make sure that he's matching up strong points for the job at hand. Most managers try to work that way, but if they're assigned a prototype project, they end up having to use whoever is available. Using the concurrency method you can get the right people at the right spots.

Better packaging through concurrency

In engineering, for example, you have to have a guy who is able to decide what parts are going to need clarification on the assembly line. And this is where his mind's eye comes into play. He must know in advance whether the product should be laid out and assembled on the production line or whether it should be assembled piecemeal, segment to segment.

With the prototype approach you can tell production people, "Yeah, you can run this item off the same as the last job." But with the concurrency approach, the information on the drawings has to be clear enough for the product to be made on the shop line. The size at which the wire is cut is important to us. If the cut is too long, we end up with loops, which will give us signal problems with our high-density switches. So we have to plan early to isolate the wires.

With the concurrency approach you have to think the project through in hours instead of days; you also have to look at everything from the physical standpoint instead of the circuit standpoint. The result is a clearer picture earlier of the physical aspects of the job.

The approach hasn't made it any easier for us to modify standard box designs for communication switches. But it has given us an opportunity to create new packaging concepts.

Not only are we creating the special product for the customer in the shortest time, but by thinking ahead, we can see what we can use on other jobs. The packaging aspect is usually the last thing considered after the design is finished. But we have to think about it in the beginning, and this has helped us come up with totally new packaging concepts. ■■

New options & accessories

Low ohms
2 and 20 Ω ,
0.001 Ω
resolution

High
current
10A cont.
20A
momentarily

Low
cost
RF
Probe



Recharge-
able
battery
pack

Deluxe
test
leads

High
voltage
probe,
1kV to 40kV

Clamp on
AC current
probe,
2 to 600A

Carrying
cases

Dust
cover

Digital
printer
output

Rack
mount
kits

Options and accessories already available

Fluke adds **MEASURE
POWER**

The best selling 3½ digit DMM. Now even better.

More new options & accessories. New AC/DC high current option lets you measure 10 Amps continuously or up to 20 Amps momentarily. New low ohms capability with 2 and 20 ohms full scale ranges provides maximum resolution of 0.001 ohms. New RF measurement capability available with low cost probe.

The Fluke 8000A Digital Multimeter brought a new standard of excellence and reliability to the low cost field. Today, with expanded capability, the 8000A brings that standard to even more of your measurement applications.

And don't forget what you get in the standard instrument.

With or without options and extras, the Fluke 8000A is the best digital multimeter for the money. You get a basic

dc accuracy of 0.1%. You get 26 ranges to measure ac/dc volts from 100 microvolts to 1200 volts, current from 100 nanoamperes to 2 amperes and resistance from 100 milliohms to 20 megohms.

We back the instrument with a guaranteed 20,000 hour Mean Time Between Failures. We expect you'll get 56,000 hours service . . . roughly the equivalent of 15 years everyday use.

Or the options already offered.

The option list includes in addition to those described above, a rechargeable battery pack, digital printer output, deluxe test leads, 40 kV high voltage probe, 600 ampere ac current probe, two types of carrying cases, dust cover and rack mounts.

For data out today, dial our toll-free hotline, 800-426-0361

In the continental U.S., dial our toll free number 800-426-0361 for the name and address of your nearest local source. Abroad and in Canada, call or write the office nearest you listed below. John Fluke Mfg. Co., Inc., P.O. Box 7428, Seattle, Washington 98133. Phone (206) 774-2211. TWX: 910-449-2850. In Europe, address Fluke Nederland (B.V.), P.O. Box 5053, Tilburg, The Netherlands. Phone 013-67-3973. Telex: 844-52237. In the U.K., address Fluke International Corp., Garnett Close, Watford, WD2 4TT. Phone, Watford, 33066. Telex: 934583. In Canada, address ACA, Ltd., 6427 Northam Drive, Mississauga, Ontario. Phone 416-678-1500. TWX: 610-492-2119.

FLUKE®



“CANNON’S PRESS-T-MATE CONNECTORS GOT US CONNECTIONS AT HALF THE COST, and me congratulations all around.”

**“But it started out
a disaster.”**



“Management yelled. ‘You mean you want to jam metal contacts into the plated through-holes in our multi-layer boards?’ I said sure, if it cuts our costs from 8-10¢ per wrapped connection down to 4-5¢ by using Cannon Press-T-Mate that eliminates wrapping.

“Naturally someone brought up soldering instead. I cut him down fast, by just pointing out soldering’s disadvantages versus the interference fit of Press-T-Mate connectors. And that’s all there is to it.

“You see, I showed him, with Press-T-Mate, contacts

are pressed into the plated through-holes of the motherboard, making contact in any number of planes. Then the insulator is pressed on over the contacts, and forms an integral edgecard connector.

**“Simple. Serviceable.
Secure.”**



“And it really cuts costs on the big jobs — disk drives, central processors, communications controllers and the like. I knew I had them thinking, so I clinched it by saying that Cannon can do a lot more.

“Their zero-force rectangular DL and universal Burgun-D connectors can handle all I/O connections between computer and peripherals, too. That’ll cut

our cost and improve our reliability.

“They caved in, Cannon came through on time, in budget; and I accepted congratulations all around. It’s a good feeling. And you can share it by writing for ‘Secrets of Connector Success.’ It’s a sort of the ‘how to’ book for ‘can do’ guys like us.”

ITT Cannon Electric, International Telephone and Telegraph Corporation, 666 East Dyer Road, Santa Ana, CA 92702. (714) 557-4700.

**“From ‘how to’ to
‘can do’ free.”**



CANNON ITT

If you've been looking for a miniature crystal-controlled clock oscillator in a 14 pin DIP package to fit standard PC board sockets, stop looking and start ordering. Get details on model K1091A from Motorola Component Products Dept. 2553 No. Edgington Franklin Park, Ill. 60131  **MOTOROLA**

INFORMATION RETRIEVAL NUMBER 56

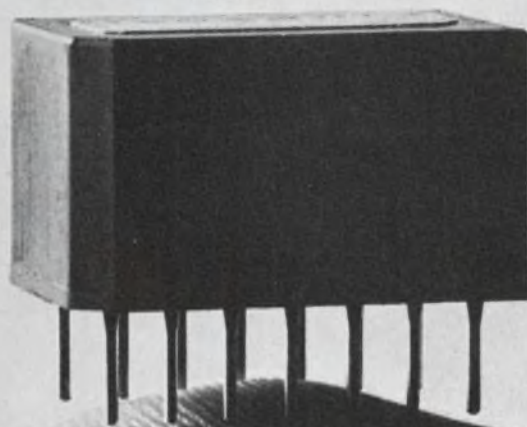

Specifications: 4 to 20 MHz range; 0.01% stability; prototype quantities available for immediate delivery in 4.9152 MHz, or 5.0, 10.0 or 20.0 MHz.

Circuit converts unipolar digital data to alternate-mark inverse format

Alternate-mark inverse signals, used for the transmission of data over limited-bandwidth channels, can be generated from unipolar TTL data with three NAND gates and a single flip-flop (Fig. 1).

The circuit sifts out alternate ONEs in the incoming bit stream. The $Q \cdot \bar{Q}_F$ line furnishes negative-going pulses for the alternate ONEs; the $\bar{Q} \cdot \bar{Q}_F$ line furnishes positive pulses for the remaining ONEs. Transistor Q_1 conducts, to provide a 5-V output when $Q \cdot \bar{Q}_F$ is low; Q_2 conducts to give a -5-V output when $Q \cdot \bar{Q}_F$ is high.

The logic circuits prevent simultaneous conduction of Q_1 and Q_2 , since the condition $Q \cdot \bar{Q}_F = 0$ and $\bar{Q} \cdot \bar{Q}_F = 1$ cannot occur. The output is ZERO when $Q \cdot \bar{Q}_F = 1$ and $\bar{Q} \cdot \bar{Q}_F = 0$ —for which case both transistors are cut off.

M. V. Subba Rao and Surinder Singh, Central Electronics Engineering Research Institute, Pilan (Rajasthan), India 333031. CIRCLE No. 311

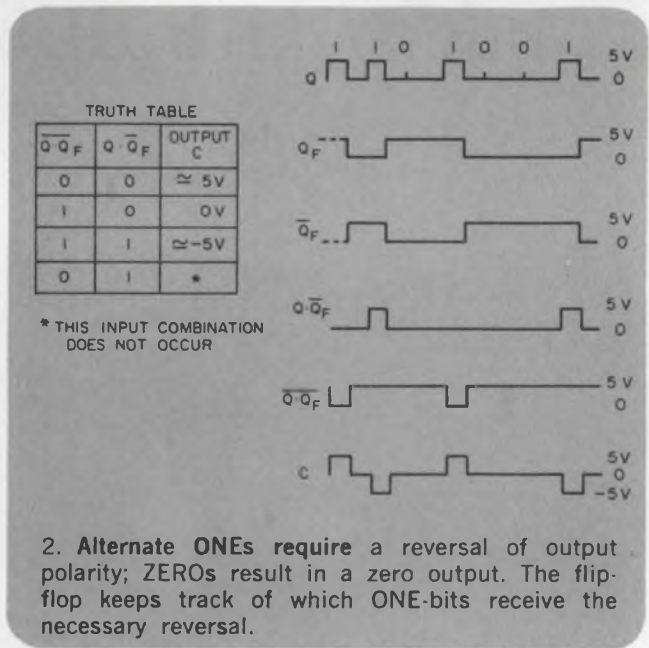

2. Alternate ONEs require a reversal of output polarity; ZEROs result in a zero output. The flip-flop keeps track of which ONE-bits receive the necessary reversal.

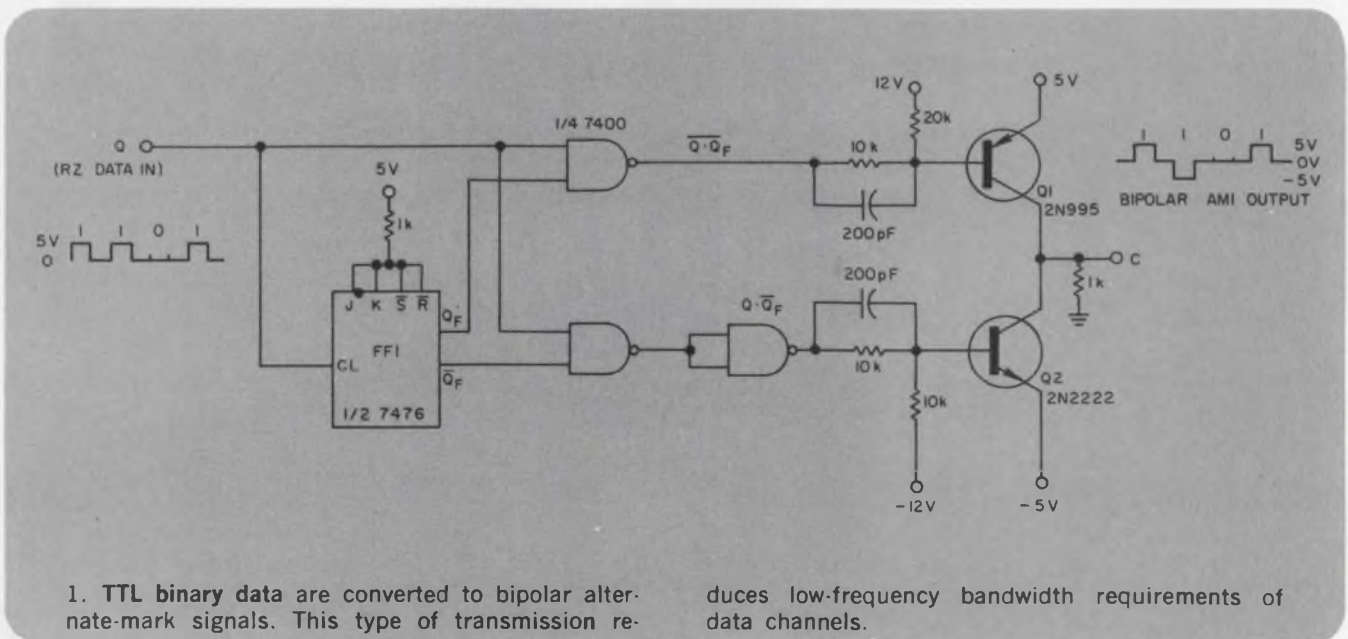

If you need
a tester
with **special**
scales, ranges,
accessories
or any
combination...

Buy a
Triplett tester
custom-designed
for you

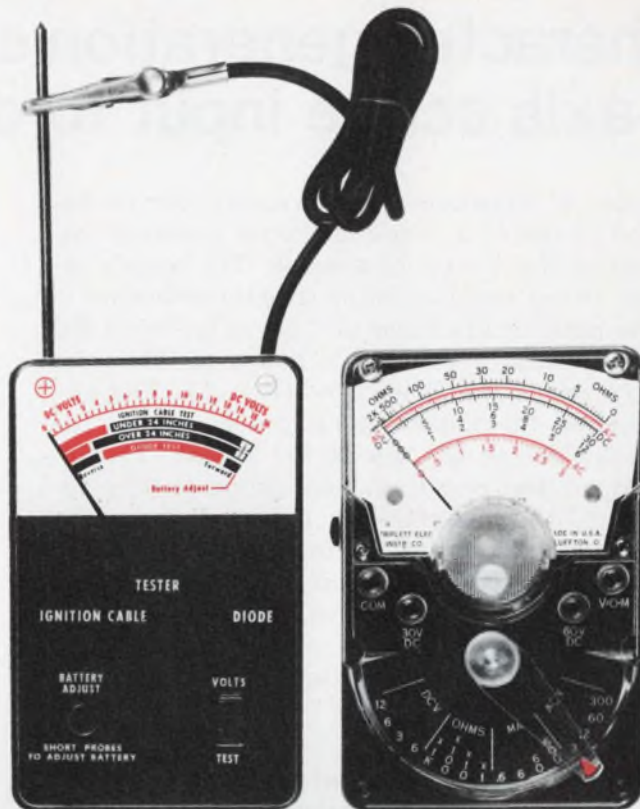

A

B



C

Triplett, manufacturer of the World's most complete line of V-O-M's, is ready, willing and able to design and manufacture special testers of virtually any size, style or type to meet your specifications.

Tester A (above) was designed to give auto mechanics a simple, rugged tester for "go/no go" tests that would otherwise be measured in electrical units unfamiliar to them.

Tester B is a modification of a

standard Triplett tester incorporating only the specific ranges needed by the field service engineers for whom it was designed.

Tester C has special ranges and special input connectors and cables to permit a single-point connection for trouble-shooting and servicing all the circuits of a complex business machine.

Several other buyers of standard Triplett test equipment request their company name on the dial to personalize their testers.

If you think a custom tester may solve some problems for you, contact your Triplett representative. He'll put you in touch with the Tester Designers and Engineers at Triplett who'll help you analyze the problem and suggest the optimum cost/result solution. Triplett Corporation, Bluffton, Ohio 45817

TRIPLETT
BLUFFTON, OHIO 45817

Manufacturers of the World's
most complete line of V-O-M's

INFORMATION RETRIEVAL NUMBER 57

Character-generation circuit uses single Y-axis scope input to display alphanumeric

A line of alphanumeric information can be displayed by use of a simple character generator attached to the Y axis of a scope. The scope's internal sweep supplies the horizontal deflection.

The periodic discharge of a capacitor in an RC circuit generates the raster, and a modified dot matrix forms the characters (Fig. 1). The circuit blanks the display by rapid deflection of the scanning dot to the top of the screen. The intensity of the resulting trace is practically invisible to the observer, yet it leaves the necessary blanks for character formation.

The raster-blanking circuit is connected to the display-control system (Fig. 2). Capacitor C charges linearly over the first third of time-constant RC. The time constant is selected so that

$$\frac{RC}{3} = \frac{7}{f_{\text{clock}}} \quad (1)$$

During the charging period the voltage across the capacitor attains the value

$$V_p = V_{cc} (1 - e^{-1/3}) \approx \frac{V_{cc}}{4} \quad (2)$$

The components shown provide an acceptable level of display flicker and a display time of approximately 1 ms/character.

Inputs from the row counter provide the condition for retrace of a single scan. Each character requires six scans—five are used for the character, and the sixth for a space.

Signals generated by the row counter shift

blanking signals for all columns in parallel fashion from the ROM. The multiplexer, SN74151, uses the column-counter output for the address signals to select the proper display column. The ROM, addressed by the refresh memory, can generate any of 64 ASCII characters. The memory contains addresses for display of up to 32 characters.

Gary Steinbaugh, Engineer, Westinghouse Research Laboratory, Pittsburgh, Pa. 15235.

CIRCLE NO. 312

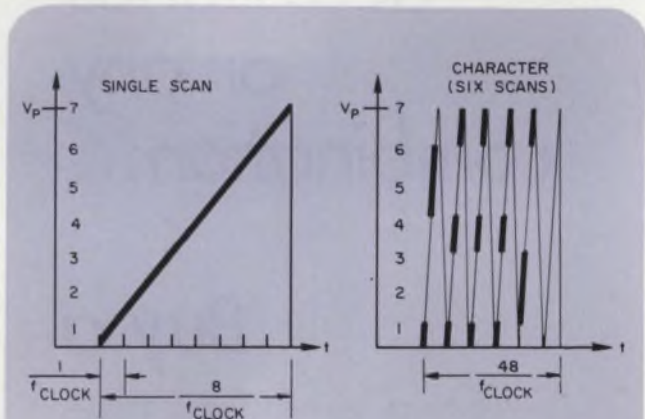

1. Series of six vertical scans provides the raster for character generation. Blank portions of the character are formed by deflection of the CRT spot off the scope face.

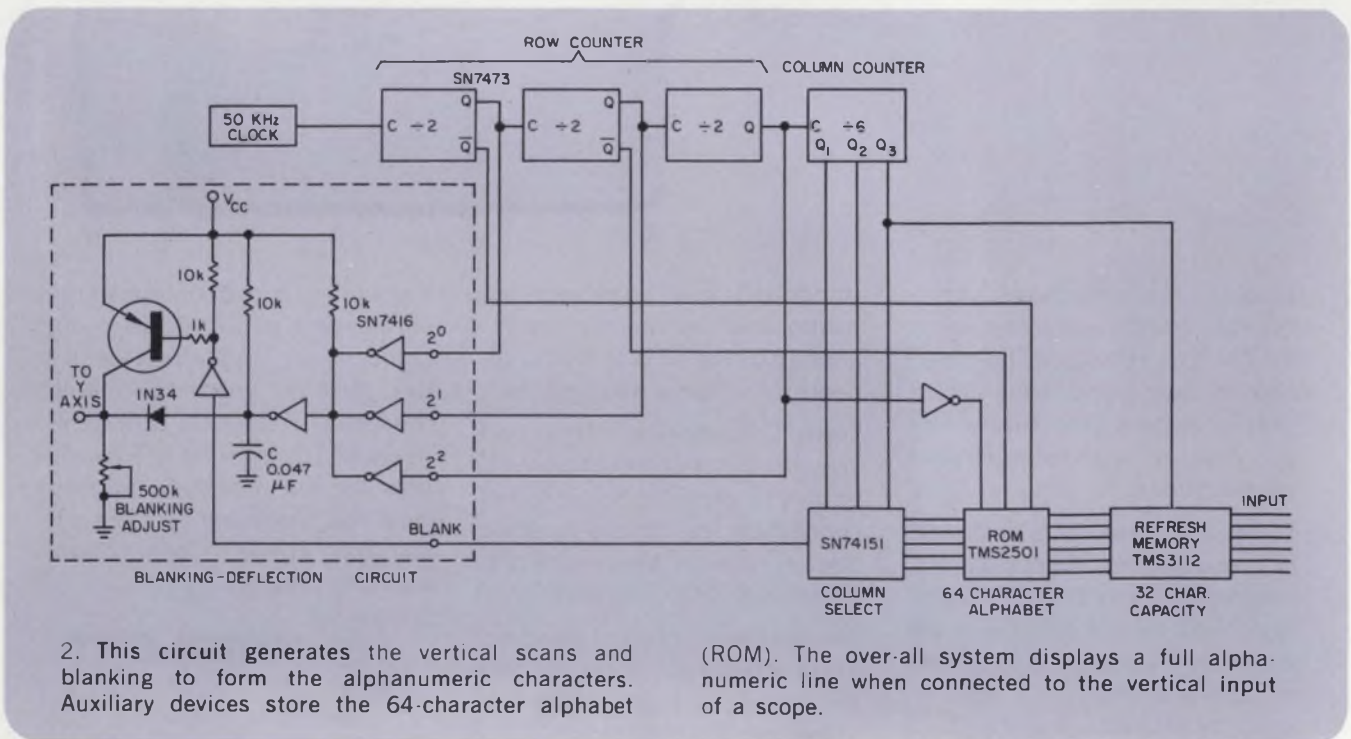

2. This circuit generates the vertical scans and blanking to form the alphanumeric characters. Auxiliary devices store the 64-character alphabet

(ROM). The over-all system displays a full alphanumeric line when connected to the vertical input of a scope.

POWER FOR YOUR IC'S OR OP AMPS

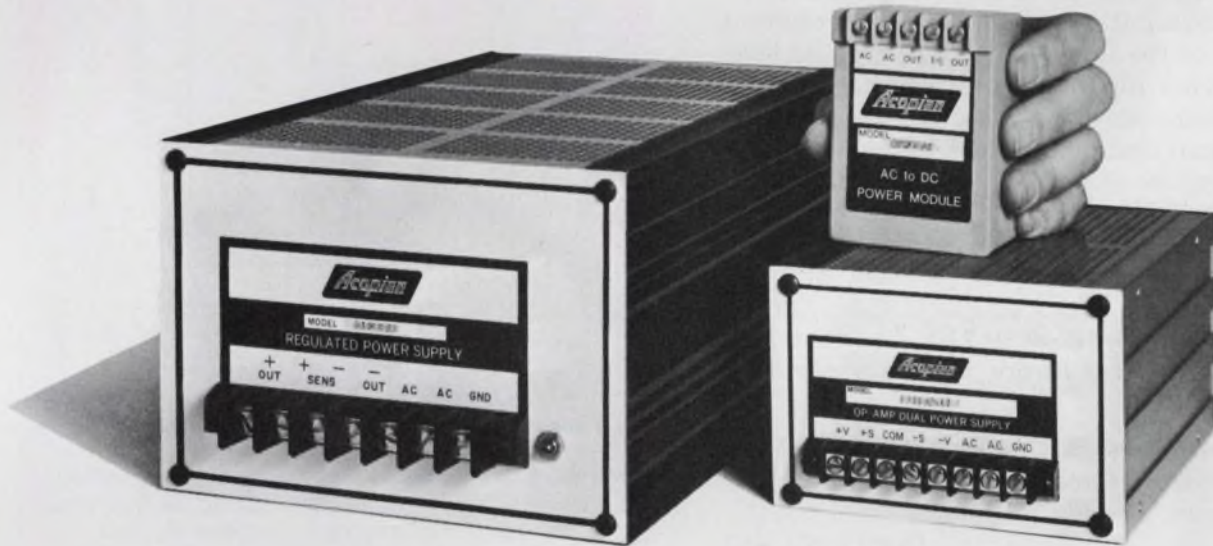

5 VOLTS

OUTPUT CURRENT AMPS	SIZE INCHES	PRICE	MODEL
.5	3.5 x 2.5 x 1.4	\$55	5EB50
1.0	3.5 x 2.5 x 1.6	75	5EB100
2.0	3.5 x 2.5 x 2.4	115	5EB200
2.5	3.5 x 2.5 x 2.4	130	5EB250
5.1	3.4 x 5.1 x 6.6	150	A5MT510
9.0	3.4 x 5.1 x 9.3	180	A5MT900
12.0	3.4 x 5.1 x 13.3	200	A5MT1200
22.0	5.1 x 7.4 x 11.3	270	A5HT2200
32.0	5.1 x 7.4 x 16.0	320	A5HT3200

±15 VOLTS

OUTPUT CURRENT AMPS	SIZE INCHES	PRICE	MODEL
.1	3.5 x 2.5 x 1.4	\$55	DB15-10
.15	3.5 x 2.5 x 1.4	65	DB15-15
.2	3.5 x 2.5 x 1.4	75	DB15-20
.4	3.4 x 5.1 x 5.1	85	TD15-40
1.0	3.4 x 5.1 x 5.1	125	TD15-100
1.6	3.4 x 5.1 x 6.6	150	TD15-160
2.5	3.4 x 5.1 x 9.3	160	TD15-250
4.5	3.4 x 5.1 x 13.3	225	TD15-450
8.5	5.1 x 7.4 x 11.3	299	TD15-850

Line/Load Regulation: $\pm 1\%$ or better; Ripple: 1.5 mv or less; Input: 105-125 VAC

Three day shipment guaranteed. Complete details on these plus a comprehensive line of other power supplies and systems are included in the Acopian 73-74 catalog. Request a copy.



Corp., Easton, Pa. 18042. Telephone: (215) 258-5441.

INFORMATION RETRIEVAL NUMBER 58

Multiplexer lets single-channel scope monitor eight analog signals

A single-beam oscilloscope can monitor eight analog signal channels with the aid of a counter and an analog multiplexer. The individual channels are sampled at a specific clock rate. A dc bias, whose value varies in synchronism with the clock, displaces the successive sweeps.

A three-bit scaler, IC₁, addresses the multiplexer, which acts as an eight-position switch. The scaler also feeds the op amp, IC₂, which functions as a three-bit d/a converter. The resultant step signal to the input of IC₂ fixes the dc level for each signal input to be displayed.

For a continuous display, set the sweep period to be less than that of the clock period.

The maximum signal input is 10 V, but use of signals below 1 V prevents overlap of the traces. The diode pairs connected to each signal line prevent multiplexer damage in the event of large voltage spikes.

Crosstalk is -34 dB at 20 kHz. Use of a padding capacitor across R_f provides an upper 3-dB point of 150 kHz.

R. J. Donato and R. G. Diment, National Research Council of Canada, Div. of Building Research, Ottawa, Canada K1A 0R6.

CIRCLE NO. 313

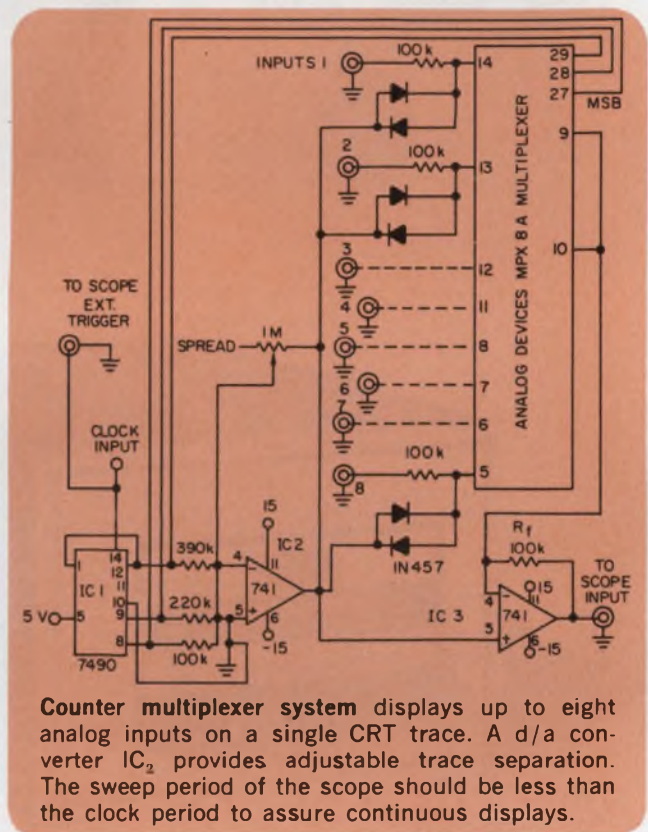

Counter multiplexer system displays up to eight analog inputs on a single CRT trace. A d/a converter IC₂ provides adjustable trace separation. The sweep period of the scope should be less than the clock period to assure continuous displays.

IFD Winner of October 11, 1973

Lewis Counts, Manager, Analog Engineering, Analog Devices, Route 1 Industrial Park, P.O. Box 280, Norwood, Mass. 02062. His idea "Make a true rms-to-dc converter, using only one IC multiplier and an op amp" has been voted the Most Valuable of Issue Award.

Vote for the Best Idea in this issue by circling the number for your selection on the Information Retrieval Card at the back of this issue.

SEND US YOUR IDEAS FOR DESIGN. You may win a grand total of \$1050 (cash)! Here's how. Submit your IFD describing a new or important circuit or design technique, the clever use of a new component or test equipment, packaging tips, cost-saving ideas to our Ideas for Design editor. Ideas can only be considered for publication if they are submitted exclusively to ELECTRONIC DESIGN. You will receive \$20 for each published idea, \$30 more if it is voted best of issue by our readers. The best-of-issue winners become eligible for the Idea of the Year award of \$1000.

Dialight sees a need:

(Need: The right switch for the right price.)

See Dialight.

For the switch buyer, choice of function and esthetics, reliability, ease of mounting, and low cost are his prime concerns. He may need a pushbutton switch for panel, sub-panel or snap-in mounting. He may need a choice of bezels with or without barriers in black, gray, dark gray or white. He may need a legend that's positive, negative, or hidden until ener-



gized...one that's white when "off" and red, green, amber, blue, or light yellow when "on"...or colored both "on" and "off." He may need a highly reliable switch proven in thousands of installations. Matching indicators with same front-of-panel appearance are also available. Obtainable from our world-wide distributor network.

The cap has a metal insert designed for proper heat dissipation. Cap is illuminated by a T-1 3/4 incandescent lamp in voltage range to 28V. Lamp can be easily replaced without special tools from front of panel.

More than 12 colors available in round, square, or rectangular shapes in six basic sizes—1/2" to 1 1/2". Choice of engraved, hot stamped or replaceable film legends with positive or negative presentations.

Available with or without bezels. Bezel allows for simple snap-in mounting. Without bezel, switch can be used for panel or sub-panel mounting.

Terminals are gold plated for oxidized free solderability, and come in choice of solder blade or pc terminations.

Bezels available in black, gray, dark gray or white and in round, square or rectangular shapes.

Fingertip grip simplifies insertion or replacement of pushbutton cap.

Stainless-steel clips lock switch into panel on four sides. No tools or additional hardware required for installing. Panel mounting switches come with required hardware for panel or sub-panel mounting.

Alternate, momentary, and snap-action contacts with ratings to 5 amps. All switch contacts are gold plated for high reliability. Normally open, normally closed, and two-circuit (one N.O., and one N.C.). Totally enclosed within anodized aluminum housing. Low level and D.P.D.T. snap action, and contactless solid state switches also available.

NOW LISTED IN UNDERWRITER'S
RECOGNIZED COMPONENTS INDEX.

DIALIGHT

Dialight Corporation, A North American Philips Company • 60 Stewart Avenue, Brooklyn, N.Y. 11237 (212) 497-7600

Pulse-delay circuit allows study of rotating parts

A pulse-delay circuit has been developed to overcome the limitations of conventional stroboscopy at the National Gas Turbine Establishment in Pyestock, England. The circuit allows selected parts of a rotating component under study to be "stopped" and "rotated" slowly for examination.

The need arose during observations of ice buildup on the turbine blades of an aircraft engine operating in simulated very-high-altitude conditions. A closed-circuit television camera was set up to view the leading edge of a single blade, and ice formation was observed on a monitor in a remote-control room. This procedure proved time-consuming because the unmodified strobe system allowed only one blade to be studied in each test run. The camera and lighting had to be repositioned to change the view, and this could be done only by shutting down the test cell.

The pulse-delay circuit varies the timing of the flash relative to a reference pulse generated by the rotating machinery that is being viewed. A pulse is taken from a reference point on the periphery of the fan of the engine under test. It is then fed into a delay unit, where it is delayed by a time equal to the rotational time difference between the reference point and the blade to be viewed. Any of the blades can be selected by varying the delay.

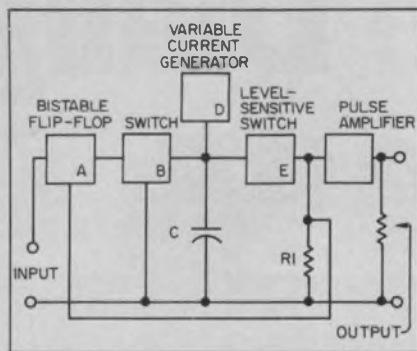

Pulse-delay circuit aids stroboscopic observation of parts.

A bistable flip-flop circuit (A in diagram) comes on to operate switch B and short out capacitor C. An input pulse switches A to its second state, turning off the switch and allowing the capacitor to charge linearly from a variable current generator, D.

A level-sensitive switch, E, closes when the capacitor voltage reaches a set level, and this produces a pulse across R_1 . This pulse is delayed from the input pulse by the time taken for the capacitor to charge to the set level, and is amplified to produce a large pulse at the output terminal. It is also used to switch A back to its original state. The cycle is repeated by the next input pulse.

The prototype equipment provides a delay variable between 400 ms and 50 ms in two ranges.

Monolithic IC systems control SCRs or triacs

Two monolithic integrated circuits—each of which acts as a complete control system for SCRs or triacs—are being offered through SGS-ATES Ltd. in England.

One IC, the L120, is intended for use as a phase controller in industrial and consumer applications. The firing angle of the SCR or triac can be varied continuously and linearly between 0 and 180 C. The output pulses have the same polarity as the ac power line.

The other device, L121, is for use as a burst controller. Its action determines the number of half cycles of output power to be transferred to the load in a set base period. The duty cycle in each base period can be varied from 0 to 100%. The firing pulses produced have the same polarity as the ac power line.

Both devices operate directly from ac power lines or a dc supply. They are available in 16-pin, dual in-line plastic packages and operate from 0 to 70 C.

CIRCLE NO. 501

Dual-reflector antenna solves feedhorn flaws

A new dual-reflector antenna eliminates some of the disadvantages of coma effects, high side-lobes and small bandwidths in offset-feedhorn systems. Developed as a multibeam system for satellite communication, the antenna focuses an inclined incident plane wave to a point away from the axis of symmetry of the reflector.

The design, drawn up at the University of London in England, is a modification of a concept used for a dielectric bifocal lens. Both reflectors are fixed, but the feed is movable.

Pyrometer measures heat above 600 C

An automatic pyrometer—apparently with no upper limit to temperature measurement—has been built at the University of Salford in England. The device uses a silicon-germanium heterojunction de-

detector of n-type material.

Because the slope of heterojunction-detector spectral response to black-body radiation changes from positive to negative at high temperature, a given dc bias exists

for any temperature at which there is no photo response. At present the minimum temperature measurable is 600 C, but lower temperatures can be taken by cooling the device.

Centralab perspectives

FOR USERS OF ELECTRONIC COMPONENTS

DISTRIBUTOR PRODUCTS



CENTRALAB

Electronics Division
GLOBE-UNION INC.

5757 NORTH GREEN BAY AVENUE
MILWAUKEE, WISCONSIN 53201

The engineering data in this 40 page catalog makes it indispensable.

Performance curves, dimensional drawings and EIA specifications make it a virtual handbook on a complete line of standard capacitors and ceramic substrates available from Centralab Distributors.

Traditionally, distributor catalogs have consisted of condensed product descriptions and catalog listings. They've seldom provided the engineer with all of the information he would like to have in specifying the exact component to fit his particular application.

That's why engineers will find the new Distributor Catalog on

Centralab's complete line of electro-ceramic products such a radical and welcome departure. It not only provides all the product specifications needed on capacitors and ceramic substrates, but includes comprehensive technical data such as performance curves, test specifications and dimensional drawings. It's a real aid in the proper selection of the right component

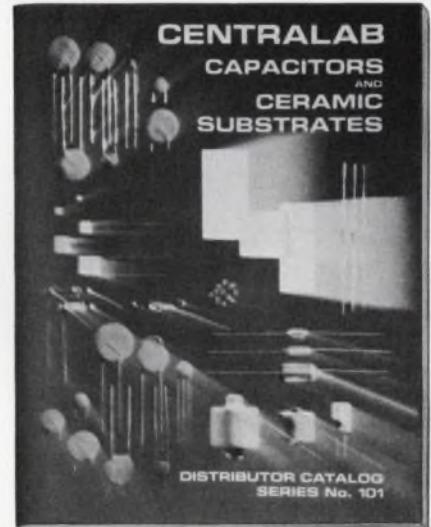

to meet specific application requirements.

There are 535 new items alone in this catalog. They include alumina substrates, now available in 10 standard sizes from Centralab Distributors. The broad line of capacitors include ceramic discs, new monolithics — chips, axial and radial lead—aluminum electrolytics, polystyrenes and special application ceramics including RF, feed-thru and high voltage. Four capacitor kits are also described.

Off-the-shelf availability of the standard products in this catalog make it an indispensable specification tool. You can get your copy from your nearest Centralab Distributor. Ask for Catalog 101. Or write Centralab Distributor Products, Dept. C-1.

This new Distributor Catalog is graphically simplified and color keyed to make selection of individual requirements easier than ever before.

CENTRALAB DISC CERAMIC CAPACITORS

LOW VOLTAGE SEMICONDUCTOR TYPE 3 VDC Thru 50 VDC ULTRA-KAP™

SPECIFICATIONS

ULTRA-KAP capacitors are axially leaded devices of high ceramic high dielectric and resistive size. These reduced volume semiconductor type devices provide CAPACITANCE RANGE: 0.001 to 1.0 µF; VOLTAGE: 3 VDC thru 50 VDC; 100% tolerance; 100% reliability; 100% test; 100% inspection; 100% quality.

TEMPERATURE RANGE: -55°C to +125°C (100% test)

WORKING VOLTAGE: 3, 10, 16, 25, 35, 50 VDC (100% test)

DIELECTRIC STRENGTH: Same as rated working voltage

DISPERSON FACTOR: 0.1 to 0.15, maximum at 100°C; 0.1 to 0.15, maximum at 100°C and 100% test; 0.1 to 0.15, maximum at 100°C and 100% test.

INSULATION RESISTANCE RANGE: Same as rated working voltage

TEMPERATURE CHARACTERISTIC: Same as rated working voltage

TEMPERATURE RANGE: -55°C to +125°C

ENVIRONMENTAL TEST: Same as rated working voltage

LEADS: Same as rated working voltage

MARKING: Same as rated working voltage

TYPE	CAPACITANCE RANGE	VOLTAGE	TEMPERATURE RANGE	RELIABILITY	TEST METHOD
UK1-SERIES 3 VOLT DCW YZF	0.001 to 1.0 µF	3 VDC	-55°C to +125°C	100%	100%
UK1-SERIES 10 VOLT DCW YZF	0.001 to 1.0 µF	10 VDC	-55°C to +125°C	100%	100%
UK1-SERIES 16 VOLT DCW YZF	0.001 to 1.0 µF	16 VDC	-55°C to +125°C	100%	100%
UK1-SERIES 25 VOLT DCW YZF	0.001 to 1.0 µF	25 VDC	-55°C to +125°C	100%	100%
UK1-SERIES 35 VOLT DCW YZF	0.001 to 1.0 µF	35 VDC	-55°C to +125°C	100%	100%
UK1-SERIES 50 VOLT DCW YZF	0.001 to 1.0 µF	50 VDC	-55°C to +125°C	100%	100%

CAPACITANCE CHANGE VS. TEMPERATURE

CENTRALAB TYPICAL PERFORMANCE CURVE

EIA SPECIFICATION

YZF CHARACTERISTIC: 100% test; 100% inspection; 100% quality.

YZF CHARACTERISTIC: 100% test; 100% inspection; 100% quality.

P&B low-profile R50 Relays let you tee off on critical printed circuit board spacing problems.

New low profile R50 relays with 0.1" grid spacing are designed for switching currents where larger relays are usually required. Up to 2 amps @ 26 VDC or 1 amp @ 115 VAC, resistive.

While retaining a small package size—0.415" height—some R50 operating parameters exceed those of reeds. Special 1 Form C contacts, for example, will switch capacitive or lamp loads that normally would weld reed relay contacts.

Additional features include contact resistance of less than 50 milliohms, sensitivity to 125 mw, and

standard coil voltages from 6 to 115 VDC with operate and release times of less than 6 ms.

Enclosures are ultrasonically welded to their base making them ideal for use with production techniques requiring flow soldering and spray cleaning.

R50 relays can be used in most applications demanding high density packaging such as 0.6" center to center spacing of printed circuit cards. Other applications include: Annunciator circuits that only require a single contact and limited mounting space for switching device . . .

communication systems such as intercoms, modems, auxiliary tape devices, interfacing systems and read out devices . . . machine tool control circuits.

For complete information, contact your local P&B representative or call Potter & Brumfield Division of AMF Incorporated, Princeton, Indiana 47670. Telephone: 812 385 5251.



Potter & Brumfield

Solving switching problems is what we're all about.

INFORMATION RETRIEVAL NUMBER 61



3-1/2-digit a/d chip set shrinks converter designs

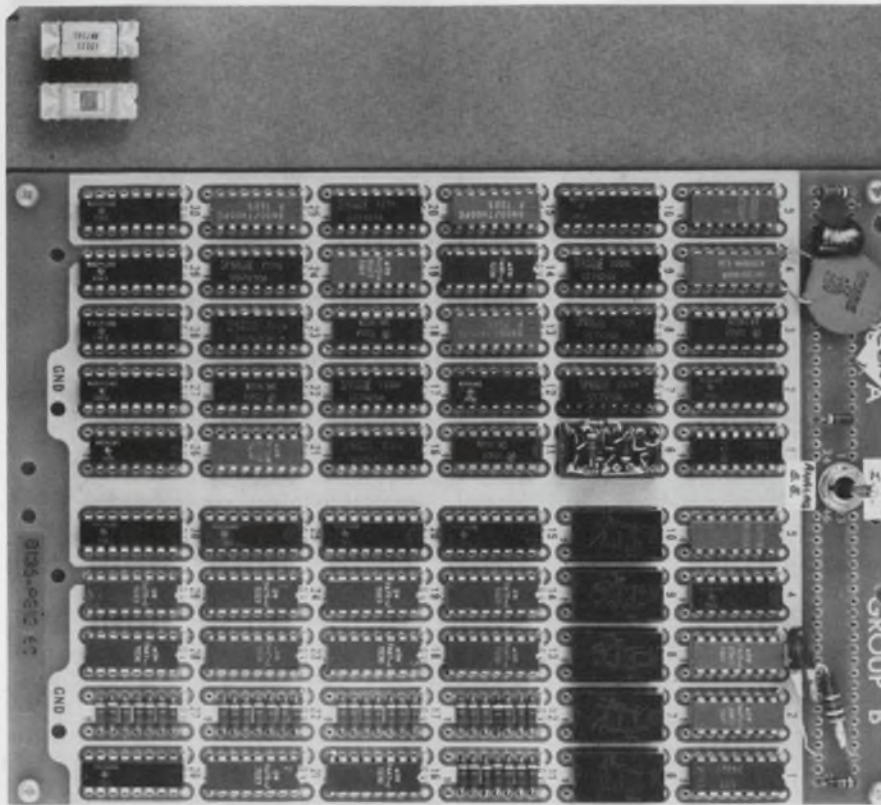

Siliconix Inc., 2201 Laurelwood Rd., Santa Clara, Calif. 95054. (408) 246-8000. P&A: See below.

The first available two-chip set for 3-1/2 digit a/d converter designs—the Siliconix LD 110 digital IC and LD 111 analog IC—sets the pace for accuracy with a spec of 0.05% of reading ± 1 digit. The only other available integrated 3-1/2-digit converter—the Integrated Photomatrix MC904/P—contains the necessary analog and digital circuitry on a single PMOS chip but has the lower accuracy of 0.1% of reading ± 1 digit.

Both converters have voltage ranges of 1.999 V and 199.9 mV and do the job of an array of IC packages at a corresponding reduction in cost. The Integrated

Photomatrix chip offers the convenience of a single package and a lower price. The MC904/P comes in a 28-pin DIP and cost \$15 (1 to 999). Delivery is 4 to 6 weeks. The Siliconix chips come in 16-pin DIPs and cost \$28.60 per set (100 to 999). They are available from stock.

Both converters require an external clock, feature auto-polarity and obtain the two voltage ranges with an external scaling resistor. But the MC904/P needs both positive and negative reference supplies whereas the Siliconix chip set needs only one.

Capacitors for stabilization and offset correction are required when the Integrated Photomatrix chip is used. Also, an offset adjustment is

required with use of the 200-mV scale. The Siliconix chip set has auto-zero and uses internally compensated amplifiers.

The LD 111 analog circuit operates from +12 and -12-V supplies, and the LD 110 from 5 and -12 V. Each has a maximum power rating of 750 mW. The MC904/P operates from ± 14 -V supplies and lists a maximum dissipation of 280 mW.

The LD 111 contains a bipolar comparator, bipolar integrating amplifier, two MOSFET input unity-gain amplifiers and p-channel enhancement-mode analog switches. In addition the IC includes the necessary level shifting drivers for the direct interface of the two chips. Also the analog circuit permits the use of conversion rates of 1/3 to 12 samples per second. The input amplifiers provide input impedances that exceed 1000 M Ω .

The LD 110 circuit, a PMOS synchronous digital processor, includes the counting, storage and data multiplexing functions. It also contains the random logic to control the conversion circuitry on the analog chip.

Seventeen static latches store the 3-1/2-digit BCD data, as well as overrange, under-range and polarity information. Nine push-pull output buffers can drive one TTL load each. The buffers provide the sign, digit strobe and multiplexed BCD data outputs.

The digit scan is an interlaced format of digits 1, 3, 2 and 4, permitting the use of a variety of displays. The overrange and under-range signals are accessible to provide an auto-range capability.

The Siliconix chip set uses a quantized charge-balancing technique in the analog portion to perform the conversion. Unlike the more common dual-slope technique that the Integrated Photomatrix chip uses, the input signal and reference are sampled during the same time interval. An integrating capacitor is charged in quantized steps of up to seven out of eight clock-pulse intervals. The charge is depleted in the same interval instead of following the charge-up, as in dual slope.

For Integrated Photomatrix **CIRCLE NO. 250**

For Siliconix **CIRCLE NO. 251**

Efficiency Experts



Built to save energy—modular STM switching-transistor power supplies from Sorensen. Exceptional power density and efficiency. Up to 1.5 watts per cu. in., and up to 75% efficiency in half the space of comparable competitive units. 40 models offer outputs from 72 to 780 watts (3 to 56 volts)—all with these features: cool running... excellent performance characteristics... built-in overvoltage protection... quiet operation... adjustable current limiting. For complete data, contact the Marketing Manager at Sorensen Company, a unit of Raytheon Company, Manchester, N.H. (603) 668-4500.

Representative Specifications—STM

Regulation (comb. line & load)	0.05%		
Ripple (PARD)	rms: 3 to 10 mv. p-p: 30 mv. typ. 50 mv. worst case		
Module Sizes & Prices	Module	Size	Price
	III	5.12" x 3.31" x 9.50"	\$240-270
	IIIA	5.12" x 3.31" x 14"	\$300-330
	IYA	7.5" x 4.94" x 10.5"	\$475-495
	VI	7.5" x 4.94" x 14"	\$600-650

Sorensen
POWER SUPPLIES

INFORMATION RETRIEVAL NUMBER 62

ICs & SEMICONDUCTORS

IC generates polynomials

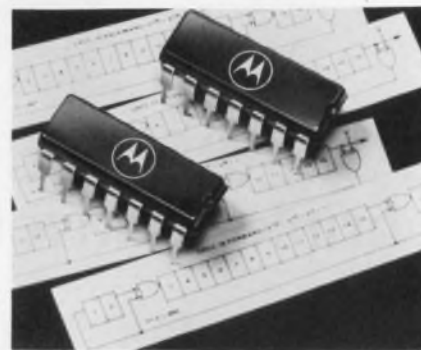

Motorola, P.O. Box 20924, Phoenix, Ariz. 85036. (602) 244-3466. \$22 (25-99); stock.

A 160-gate bipolar LSI circuit—the MC8503 universal polynomial generator—can be used for error detection in serial data-handling systems. The circuit divides the serial data stream by a selected polynomial, and the division remainder is transmitted at the end of the data stream as a Cyclic Redundancy Check Character. Polynomials are selected with a binary select code and include terms raised to the sixteenth power. Fully compatible with TTL, the MC8503 features both read forward and read backward and has a power dissipation of 400 mW or only 2.5 mW per gate. Typical data rates are 5 MHz. The MC8503 is available in a 14-pin dual-in-line plastic package for the 0-to-70-C temperature range.

CIRCLE NO. 253

ECL multiplexers speed data processing

Signetics, 811 E. Arques Ave., Sunnyvale, Calif. 94086. (408) 739-7700. 10132F and 10134F: \$4.80 (100).

Two dual clocked D-type latch circuits feature a 2-to-1 data multiplexing capability. The model 10132 has a reset feature, while the model 10134 permits independent selection. The ICs have low typical propagation delay times: 2.5 ns for data, 3.7 ns for select, 3.0 ns for reset in the 10132 and 4.0 ns for clock. Typical power dissipation is only 225 mW per package with no load. Both devices can drive 50-Ω lines.

INQUIRE DIRECT

“Scotchflex” Flat Cable Connector System makes 50 connections at a time.



SCOTCHFLEX IS A REGISTERED TRADEMARK OF 3M CO.

Build assembly cost savings into your electronics package with “Scotchflex” flat cable and connectors. These fast, simple systems make simultaneous multiple connections in seconds without stripping or soldering. Equipment investment is minimal; there’s no need for special training. The inexpensive assembly press, shown above, crimps connections tightly, operates easily and assures error free wiring.

Reliability is built in, too, with “Scotchflex” interconnects. Inside of connector bodies, unique U-contacts strip through flat cable insulation, grip each conductor for dependable gas-tight connections.

“Scotchflex” offers you design freedom, with a wide choice of cable and connectors. From off-the-shelf stock you can choose: 14 to 50-conductor cables. Connectors to interface with standard DIP sockets, wrap posts on standard grid patterns, printed circuit boards. Headers for de-pluggable connection between cable jumpers and PCB. Custom assemblies are also available on request.

For more information, write Dept. EAH-1, 3M Center, St. Paul, Minn. 55101.

**“Scotchflex” Your
systems approach
to circuitry.**



The new 420L offers everything but the pedestal you'll want to put it on.

The pedestal's optional, but the broad frequency coverage of 100 kHz to 280 MHz and a power output up to 20 watts are standard in this state-of-the-art RF power amplifier

Linear Class A circuitry will faithfully reproduce input modulations including AM, FM, SSB, TV and pulse with minimum distortion. Completely solid-state, the 420L will supply full power output into any load impedance (from an open to a short circuit).

Driven by any signal generator, frequency synthesizer or sweeper, the 420L is a flexible and versatile source of RF power for general laboratory work, RFI/EMI testing, signal distribution,

RF transmission, laser modulation and ultrasonics.

The new 420L. Offering everything but the pedestal you'll want to put it on, at \$2950.

For further information or a demonstration contact ENI, 3000 Winton Road South, Rochester, New York 14623 (716) 473-6900 or TELEX 97-8283

ENI

The world's leader in solid state power amplifiers



INFORMATION RETRIEVAL NUMBER 64

ICs & SEMICONDUCTORS

MECL 10,000 includes two new RAMs



Motorola, P.O. Box 20924, Phoenix, Ariz. 85036. (602) 244-3466. MCM-10142AL: \$30.40; MCM10147AL: \$40 (100-999).

Two more RAMs are now available in the MECL 10,000 logic family. The MCM10147AL—a 128-word-by-1-bit RAM—offers a maximum address access time of 12 ns, is pin compatible with the AMS-1003 and meets or exceeds all 1003 specs. The MCM10142AL—a 64 × 1 RAM—boasts a maximum address time of 10 ns. Both ICs have full address decoding and two chip enables to facilitate memory expansion.

CIRCLE NO. 254

FET op amp slews at 120 V/μs



Teledyne Philbrick, Allied Dr. at Route 128, Dedham, Mass. 02026. (617) 329-1600. \$16 (1-24); stock.

The 1432 and 143201 FET op amps come in a TO-99 can with a 741-compatible pin-out and offer slew rates of 120 V/μs. The models are fully differential and deliver a full ±10 V into a 560-Ω load at frequencies up to 2 MHz. The settling time is 400 ns to 0.1% for a 10-V step. The FET input provides 10¹²-Ω input impedance and 1-pA bias current.

CIRCLE NO. 255

High Voltage Diffused Silicon Rectifiers

- For commercial and industrial applications that require high reliability at economical cost. Examples: CRT power supplies, RF transmitters, microwave ovens and TV receivers
- Wide range of minimum sized packages
- 1 KV to 40 KV (V_R)
- 5 mA to 2A (I_O)
- Fast recovery series, 250 nsec. (t_{rr})
- Low leakage currents



(ACTUAL SIZE) SERIES VG20
20 KV PRV \$149 ea. (1000 qty)

INDUSTRIAL MULTIPLIERS

- Doublers, Triplers, and Quadruplers
- For CRT terminal display systems, TV receivers and similar high voltage applications
- Nominal output voltages: 19 KV to 24 KV with 10 KV to 6 KV peak-to-peak maintained (no load conditions)

Other Varo Semiconductor, Inc. high voltage rectifiers include series connected diodes containing stacks of avalanche chips and PC board mounted for X-Ray apparatus.

Design us in —
We'll stay there



VARO

VARO SEMICONDUCTOR, INC.

P.O. BOX 676, 1000 NORTH SHILOH,
GARLAND, TEXAS 75040
(214) 272-4551 TWX 910-860-5178

INFORMATION RETRIEVAL NUMBER 65

ELECTRONIC DESIGN 4, February 15, 1974

Stereo-demodulator IC uses phase-locked loop



Exar Integrated Systems, 750 Palomar, Sunnyvale, Calif. 94086. (408) 732-7970. \$3.30 (100); stock.

An FM stereo demodulator IC uses a phase-locked-loop technique to derive the right and left audio signals from the composite signal. As a result, the XR-1310 demodulator needs no external LC tuning tanks. Also, an external stereo/monaural switch has a 100-mA direct-lamp drive capability. The device offers 30-dB minimum channel separation, 0.3% total harmonic distortion, and inherent SCA rejection of 80 dB. It also allows maximum composite or monaural input signal of 600 mV rms or 2.8 V pk-pk.

CIRCLE NO. 256

10-bit CMOS DAC consumes only 30 mW

Analog Devices, Route 1 Industrial Park, P.O. Box 280, Norwood, Mass. 02062. (617) 329-4700. P: See below; stock.

The first monolithic CMOS d/a converter performs four-quadrant multiplication with 10-bit accuracy, resolution and linearity at a lower price than hybrid bipolar devices. Called the AD7520, the new DAC costs \$17 to \$33 (100 up) and lists a maximum power dissipation—including ladder dissipation and power drain—of only 30 mW. The DAC is accurate to 0.05% of full scale range (FSR). Its linearity temperature coefficient of 1 ppm of FSR/°C and gain temperature coefficient of 5 ppm of FSR/°C guarantee monotonicity over the full military-temperature range. The settling time of the DAC is better than 0.5 μ s to 0.05% when turning all switches ON with a 10-V reference. The feedthrough error of the AD7520, resulting from capacitive coupling, is less than an LSB at 130 kHz.

CIRCLE NO. 257

INFORMATION RETRIEVAL NUMBER 66 ►

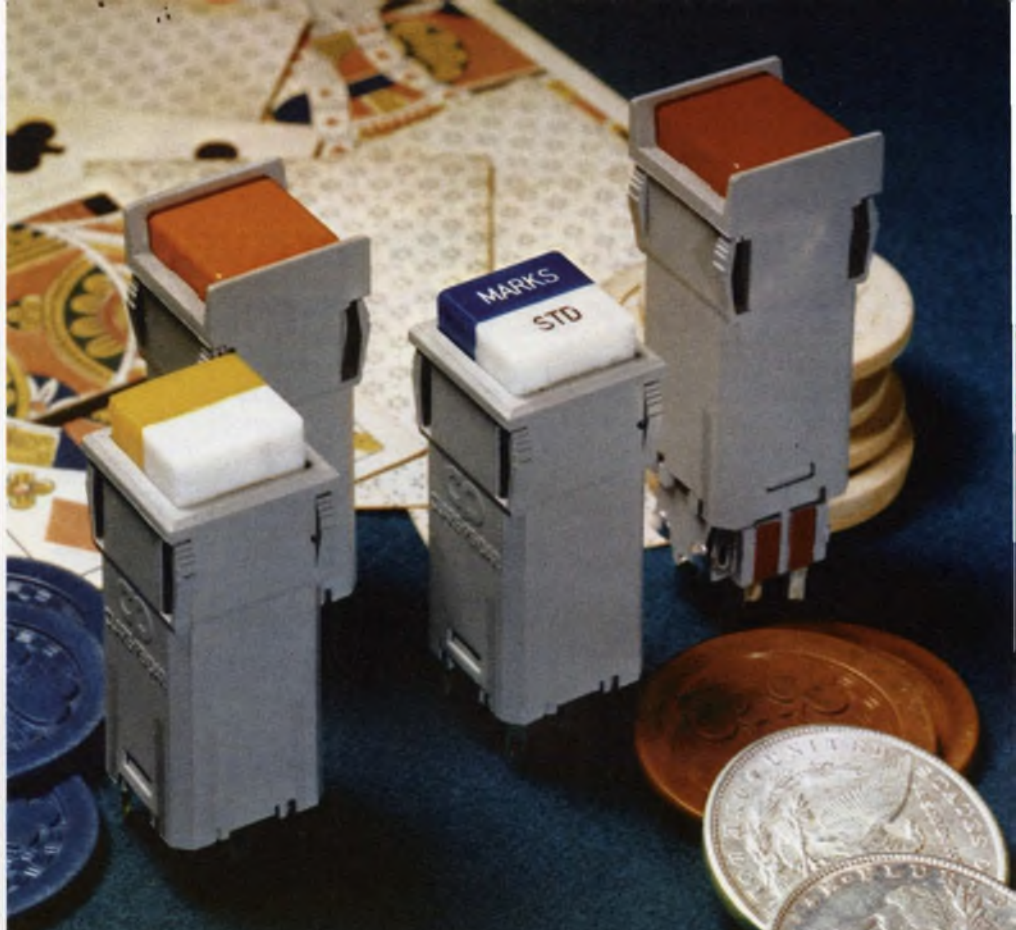

Just two bucks for a sure thing!

monoform switchlights

A whole family from out of the West

There are still plenty of places where you can lay your money down and take your chances. We're not one of them. We don't believe in luck at Clare-Pendar. When you invest two silver cartwheels for a switchlight, we deliver a unit that's so dependable and versatile that people think it has to be expensive. It's not. And there's a whole low-cost family.

Monoform I (the single lamp, momentary & alternate, rated 2 amp 120 Vac).

Monoform II (two independent lamps for horizontal split legends, mom. & alt., 2 amp 120 Vac).

Monoform III (10 amp, 1/4 H.P. power switch).

So, when the chips are down . . . when you want fast delivery of a fine product, depend on Clare-Pendar.



CLARE-PENDAR

Phone 208-773-4541

P.O. Box 785 Post Falls, Idaho 83854

Telex 32-6448

HP-65 calculator arrives: First pocket programmable

Hewlett-Packard Co., 1501 Page Mill Rd., Palo Alto, Calif. 94304. (415) 493-1501. \$795; 30 days.

The first pocket-sized electronic slide rule to provide full programming capability has come from Hewlett-Packard—the HP-65. It allows users to write and edit their own programs and to store them on tiny magnetic cards; to use prerecorded programs developed by HP and to operate the 51 keyboard functions preprogrammed into the machine.

The battery-operated calculator uses the same basic keyboard, case and 10-digit display as previous HP pocket calculators. Like the HP-45, this unit has nine addressable memory registers that permit register arithmetic, as well as the same four-register operational stack for storing intermediate answers.

Unlike the first electronic slide rule—the HP-35, which used only five ICs—the new one has 12 chips: one NMOS, four bipolar and seven PMOS.

The NMOS IC contains the control circuitry for the card reader, while the four bipolar chips contain the motor control, clock and display driver and sense-amp circuitry. The seven PMOS chips consist of three quad ROMs, a processor, a controlled timing chip, a data-storage chip and a program-storage chip. Hybrid circuit construction was used to allow all of them to fit into the small space available.

In performance, the HP-65 is said to rival larger desktop units costing between \$1500 and \$4000. It can, for example, perform all the functions of the now discontinued HP-9100, whose last price was about \$3000. The major differences between the two are that the HP-65 does not have three output displays—it has one, and it cannot interface with other equipment, such as plotters.

The programming capability of



the new calculator enables the user to write and store on magnetic cards a program containing up to 100 steps or several programs totaling 100 steps. When the recorded program is no longer needed, the magnetic card can be erased on the same machine and reused to record another program. Accidental erasures can be prevented through clipping of a corner of the magnetic card.

A program can be edited at any time. It is not necessary to rewrite the entire program when an error is made, as is the case with other programmable calculators.

As an aid to more efficient programming, the HP-65 allows the user to perform branching, logic comparisons and conditional skips in his programs. It also has five master keys (A to E), which can be used to store subroutines or other programs.

While the unit is designed to support 100 step programs, by storing partial answers in memory registers, it is possible to chain several cards together and use programs that have several hundred steps.

In addition to doing his own programming, the user can expand the capability of the machine with a series of prerecorded programs available from HP. Initially a total of six such Application Pacs are

(continued on p. 122)

Your closest SIGNETICS distributor is...

ARIZONA
Phoenix: Hamilton/Avnet Electronics (602) 275-7851
Phoenix: Kierulff Electronics (602) 273-7331

CALIFORNIA
Culver City: Hamilton Electro Sales (213) 870-7171
El Monte: G. S. Marshall (213) 686-1500
Los Angeles: KT/Wesco Electronics (213) 685-9525
Mountain View: Hamilton/Avnet Electronics (415) 961-7000
Palo Alto: Wesco Electronics (415) 968-3475
San Diego: Hamilton/Avnet Electronics (714) 279-2421
San Diego: Kierulff Electronics (714) 278-2112
Sunnyvale: Cramer Electronics (408) 739-3011

CANADA
Downsview: Cesco Electronics, Ltd. (416) 661-0220
Downsview: Cramer Electronics (416) 661-9222
Montreal: Cesco Electronics, Ltd. (514) 735-5511
Montreal: Hamilton/Avnet (514) 735-6393
Ottawa: Hamilton/Avnet Electronics (613) 725-3071
Ottawa: Cesco Electronics, Ltd. (613) 729-5118
Quebec: Cesco Electronics, Ltd. (418) 524-3518

COLORADO
Denver: Hamilton/Avnet Electronics (303) 534-1212
Denver: Cramer Electronics (303) 758-2100

CONNECTICUT
Hamden: Arrow Electronics (203) 248-3801
Georgetown: Hamilton/Avnet Electronics (203) 762-0361
North Haven: Cramer Electronics (203) 239-5641

FLORIDA
Hollywood: Hamilton/Avnet Electronics (305) 925-5401
Hollywood: Schweber Electronics (305) 927-0511
Orlando: Hammond Electronics (305) 241-6601

GEORGIA
Atlanta: Schweber Electronics (404) 449-9170
Norcross: Hamilton/Avnet Electronics (404) 448-0800

ILLINOIS
Elk Grove: Schweber Electronics (312) 593-2740
Elmhurst: Semiconductor Specialists, Inc. (312) 279-1000
Schiller Park: Hamilton/Avnet Electronics (312) 678-6310

INDIANA
Indianapolis: Semiconductor Specialists (317) 243-8271

KANSAS
Lenexa: Hamilton/Avnet Electronics (913) 888-8900

MARYLAND
Hanover: Hamilton/Avnet Electronics (301) 796-5000
Rockville: Pioneer Washington Electronics, Inc. (301) 424-3300
Rockville: Schweber Electronics (301) 881-2970

MASSACHUSETTS
Burlington: Hamilton/Avnet Electronics (617) 273-2120
Needham Heights: Kierulff/Schley (617) 449-3600
Newton: Cramer Electronics (617) 969-7700
Waltham: Schweber Electronics (617) 890-8484

MICHIGAN
Livonia: Hamilton/Avnet Electronics (313) 522-4700
Detroit: Semiconductor Specialists, Inc. (313) 255-0300

MINNESOTA
Minneapolis: Semiconductor Specialists, Inc. (612) 854-8844
Edina: Hamilton/Avnet Electronics (612) 941-3801

MISSOURI
Hazelwood: Hamilton/Avnet Electronics (314) 731-1144

NEW YORK
Buffalo: Summit Distributors, Inc. (716) 884-3450
Farmingdale, L. I.: Arrow Electronics (516) 694-6800
Rochester: Schweber Electronics (716) 328-4180
Syracuse: Hamilton/Avnet Electronics (315) 437-2642
Westbury: Schweber Electronics (516) 334-7474
Westbury: Hamilton/Avnet Electronics (516) 333-5800

NEW MEXICO
Albuquerque: Cramer Electronics (505) 265-5767

NORTH CAROLINA
Greensboro: Hammond Electronics (919) 275-6391

NORTHERN NEW JERSEY
Cedar Grove: Hamilton/Avnet Electronics (201) 239-0800
Saddlebrook: Arrow Electronics (201) 797-5800
Moorestown: Arrow/Angus Electronics (609) 235-1900

SOUTHERN NEW JERSEY AND PENNSYLVANIA
Mt. Laurel, N. J.: Hamilton/Avnet Electronics (609) 234-2133
Cherry Hill, N. J.: Milgray-Delaware Valley
New Jersey (609) 424-1300 Philadelphia (215) 228-2000
Somerset, N. J.: Schweber Electronics (201) 469-6008

OHIO
Beechwood: Schweber Electronics (216) 464-2970
Cleveland: Arrow Electronics (216) 464-2000
Cleveland: Pioneer Standard Electronics (216) 587-3600
Kettering: Arrow Electronics (513) 253-9176

TEXAS
Dallas: Hamilton/Avnet Electronics (214) 661-8661
Dallas: Cramer Electronics (214) 350-1355
Houston: Component Specialties (713) 771-7237
Houston: Hamilton/Avnet Electronics (713) 526-4661

UTAH
Salt Lake City: Alta Electronics (801) 486-7227
Salt Lake City: Hamilton/Avnet Electronics (801) 262-8451

WASHINGTON
Bellevue: Hamilton/Avnet Electronics (206) 746-8750

BCD arithmetic, all in a single IC.

Figure on whopping savings in parts, design time, systems costs.

NEW MATH

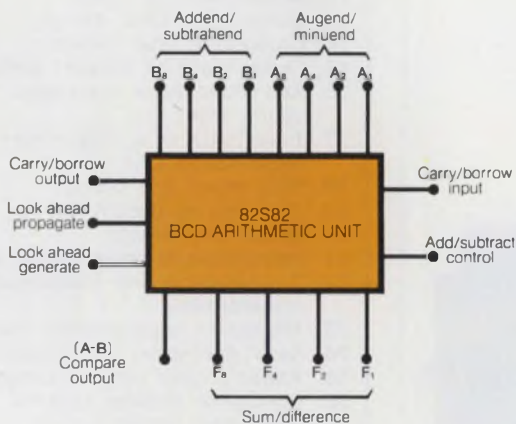

OLD MATH

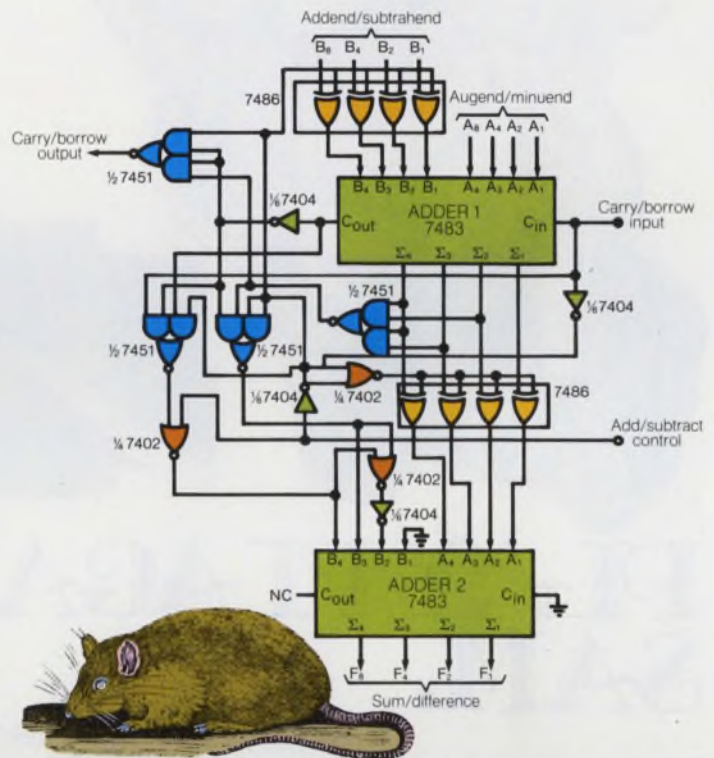

We've cut BCD arithmetic down to size. By applying Schottky MSI to those functions where it counts, we're delivering revolutionary tools in superfast processing — that are real power misers at a fraction (about half) of conventional circuitry costs. A lot more of exactly what you need. For less cost going in and coming out.

Available from Signetics, the under ten buck (100 up) 82S82 Adder-Subtractor slashes inventory requirements. Replaces four MSIs, and a rat's nest of gates and connections, now wasting valuable board space. With a staggering improvement in performance. Quadruples speed (22ns typical propagation delay). Cuts power 50%-67%. Wipes out a huge chunk of design, checkout and assembly time.

Versatile? Stand back. This unique Arithmetic Unit adds and subtracts in BCD directly, compares two BCD words, and can even be used for binary-to-BCD conversion. Cascades to operate on multiple decades. If you need ultra-high speed, get complete look-ahead carry with our 74182 fast-carry extender. What does the 82S82 do? Everything.

For a straight BCD add without all the bells and whistles, our companion 82S83 Adder gives you the same bonuses as the 82S82 Arithmetic Unit. Eliminates two MSI packages and a fistful of logic elements. Saves time, saves dollars — works better, faster, cheaper. Has to, for the same reasons as with the 82S82. It's less than seven bucks per 16-pin device, in 100-up quantity.

The way to get big, rich and famous: deliver faster, smaller, more powerful processors. Now you can. Get the facts quick. (And for immediate evaluation quantities, see your local Signetics Franchised Distributor. His name and telephone number are in the adjoining column.)

FOR SPEED ATTACH COUPON TO LETTERHEAD AND MAIL FAST

Signetics—BCD AU/Adder
811 East Arques Avenue
Sunnyvale, California 94086

You have what counts, can't miss it. Send me your new, comprehensive MSI 82S Data Booklet with full specs of the BCD AU/Adder. (containing also your complete family of 100MHz counters, 60MHz universal shift registers, parity checkers, decoders, multiplexers, and exclusive OR/NOR functions.)

Name _____

Title _____

Signetics Corporation — A subsidiary of Corning Glass Works

signetics

EE PAC Programs

1. Reactance chart
2. Series resonant circuit
3. Parallel resonant circuit
4. Impedance of ladder network
5. T attenuator
6. PI attenuator
7. Wye-delta or delta-wye transformation
8. Minimum-loss pad matching
9. PI network impedance matching
10. Band pass filter
11. Active filter-low pass
12. Active filter-high pass
13. Butterworth filter design
14. Chebyshev filter design
15. Capacitance of parallel plates
16. Self inductance of straight round wire
17. Inductance of a single-layer close-wound coil
18. Skin effect and coil Q
19. Transformer design
20. Reed relay design
21. Impedance of transmission line
22. Transmission line impedance transformer
23. Microstrip transmission line
24. $S \Rightarrow Y$ parameter conversion
25. Power supply rectifier circuits
26. Controlled rectifier circuits
27. Integrated circuit current source
28. Transistor bias
29. JFET bias and transconductance
30. Phase lock loop
31. Fourier series
32. Decibel conversion
33. Voltage to dBm
34. Wire tables Al & Annealed Cu
35. Heat sink

available for electrical engineering, mathematical, statistical, medical and surveying applications. Each costs \$45, contains between 27 and 40 programs and comes with a comprehensive instruction manual. Additional sets of prerecorded programs will be offered as they are developed.

Included in the purchase price of \$795 is a 115/230-V-ac adapter-recharger, a soft carrying case and a hard travel case, adhesive name tags, manual and a Standard Application Pac. The latter contains some prerecorded programs, diagnostic program cards, a magnetic-head cleaning card and 20 blank magnetic program cards.

Users also receive a one-year subscription to the HP-65 User Library Catalogs, which offer low-cost program documentation for a large number of user-contributed and individual HP Application Pac programs.

CIRCLE NO. 258



PLAY IT AGAIN, SAM.

Sam is the name of Decitek's new low-cost 100 cps photoelectric tape reader. Sam? We could tell you that it's short for something like Superior Alignment Motion, which is precisely what our patented dual sprocket drive provides. But it isn't. We simply felt that Sam has a nice friendly ring to it and is easy to remember.

Sam offers good credentials.

This new reader incorporates the same unflappable tape transport that is the heart of Decitek's eye-blinking 600 cps reader. This drive doesn't need edge guides or keepers, there's no tape skew. Positive registration is assured—repeatedly through thousands of reruns with no measurable tape wear.

Fiber optic lighting from a single light source plus photo-transistor sensing are features that deliver dependable high-quality performance.

All this at a cost that compares favorably with mechanical readers!

For all the details on this new low-cost, highly reliable reader, just drop us a note or card with the words "Play it again, Sam."

When reading matters

DECITEK

A DIVISION OF JAMESBURY CORPORATION
15 SAGAMORE ROAD, WORCESTER, MASSACHUSETTS 01605, (617) 757-4577

INFORMATION RETRIEVAL NUMBER 68

FUSEHOLDERS UNLIMITED



3AG Fuseholders

Standard version features knurled or screwdriver slot knobs; straight or right angle terminals. Other styles available; watertight, "shock-safe", and the aesthetically-styled low profile fuseholder.



3AG Miniature Fuseholders

8 different styles. Knurled or fluted knobs; straight, right angle or Q.C. terminals.



RF Shielded Fuseholders

To eliminate possible transmission or reception of R.F. signals. Accommodate 3AG or 8AG fuses and subminiature microfuses.



Subminiature Fuseholders

For use with subminiature micro and picofuses for front panel, chassis, or p.c. board mounting.



4AG, 5AG & 8AG Fuseholders

Available in standard or watertight versions with different knobs and terminal styles.



Indicating Fuseholders

For a variety of applications where visual indication of blown fuse is desired. Neon or incandescent lamps - 3AG or microfuse sizes.



In-Line Fuseholders

Two styles available; spring locked, bayonet-style knob or new twist-lock version, both SFE & 3AG fuses.

For Complete Information

For complete information on all Littelfuse fuseholders, write today for Catalog #18.

LITTELFUSE

Subsidiary of Tracor

800 E. Northwest Highway • (312) 824-1188 • Des Plaines, Illinois 60016



Now Beckman cermet trimmers drop to small-change price!

We've knocked down the prices of our Model 91 cermet trimming pots to as little as 25¢ each, depending on quantity ordered.

And they're ready for immediate delivery — in production quantities — from your local Beckman distributor.

You'll find just what you need, too. Five different pin spacings in both top and side adjustment styles, each in 19 standard resistance values. A big range of stock models, all rated at ½ watt at 40°C.

Your Beckman representative has all the technical information — and the stock — right at hand.

Call now (toll-free 800-437-4677) and start saving big by using high-quality Beckman cermet trimmers at these new small-change prices.

Beckman
HELIPOT DIVISION

INFORMATION RETRIEVAL NUMBER 70

DATA PROCESSING

Device interfaces bench instruments to calculator



Data Graphics Corp., 8402 Speedway Dr., San Antonio, Tex. 78230. (512) 342-9486. \$1150; 30 days.

The DATOS 305 can interface digital instrument outputs to any of the popular programmable calculators. Parallel BCD or binary data from the instrument are serialized, formatted and decoded, then sent to the calculator. A 26-step program counter in the DATOS 305 allows the calculator to select any character at random. No modification of existing calculator software is necessary.

CIRCLE NO. 259

Cartridge tape drive can record on four channels



Mohawk Data Sciences Corp., Box 362, Utica, N.Y. 13503. (315) 792-2202. See text.

The model 2022 cartridge tape drive features a separate write-enable line and amplifier for each channel. The unit uses the 3M Data Cartridge and can record on one, two, three or four active tracks—individually or in any combination. Operating characteristics include 30 in/s read/write speed, 90 in/s search/rewind, 250 to 1600 bit/in. recording density and a 48-k bit/s transfer rate. Three basic configurations are available: the mechanism alone, a panel-mount assembly and a desk-top console unit. A two-track unit with casework and electronics sells for less than \$500 in quantity.

CIRCLE NO. 260

We think of our enclosures as silent salesmen. The first ten seconds of display for an electronics unit focus simply on the package. Its color (and the other colors available), its finish and style. It won't *break* a sale—the equipment inside does that. But it sure can help *make* one. Our award winning designs and

total color range have proved it.

Does a client need a ventilating grille? A blower? What about writing surfaces, drawers, casters? We have them in production, on line and ready to go—offering the access, flexibility and mobility your clients require. We even paint our units inside and out, and assemble

them for final inspection—including most options and accessories—at the plant.

We're ready with all this, and more. Ready right now.

Write Optima Enclosures, 2166 Mountain Industrial Blvd., Tucker, Georgia 30084 or call (404) 939-6340.

OPTIMA

Before you choose your next enclosure, show this ad to your salesmen.



Other Scientific-Atlanta Inc. Divisions are • Cable Communications • Instrumentation • Electro-Systems • Southern Tool and Machine • Security

INFORMATION RETRIEVAL NUMBER 71

Do-it-yourselfers don't always save money

You can buy enough Cirkitblock™ modules to equip a pilot run for less than it costs to build a single prototype of your own

Why build power modules when you can buy all the proven, immediately-available power modules you need from Powercube? Especially when you think of all you'd have to go through to build your own: feasibility, circuit design, breadboarding, vendor selection, parts procurement and qualification, full-scale prototyping, pilot run, test and evaluation, trouble-shooting and checkout, plus several ECO's.

Besides the savings, Powercube Cirkitblock™ power modules assure reliability in hostile environments, from -20 to +85°C. These rugged power modules, whose designs trace their heritage to military and space programs, offer high efficiency conversion at low thermal rise. Fully self-contained and easy to install, Cirkitblock modules are used in railroad signaling equipment, portable data gathering systems, automotive testing equipment, commercial aircraft, navigation systems, oceanographic research equipment, and portable communications equipment.

We can deliver you enough Cirkitblock modules to equip your pilot run for less than it will cost you to engineer and build a single prototype of your own. Just look in our Power Module Application Handbook. If you don't have a copy, write or phone us today.

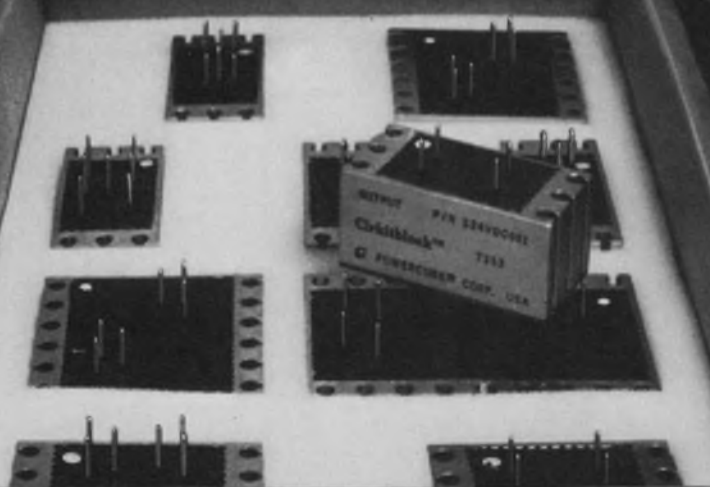

POWERCUBE CORPORATION
214 CALVARY STREET, WALTHAM, MASS. 02154 (617) 891-1830
SUBSIDIARY OF UNITRODE CORPORATION

INFORMATION RETRIEVAL NUMBER 72

DATA PROCESSING

Front-loading tape drive has 125-in/s speed



Mohawk Data Sciences Corp., Box 362, Utica, N.Y. 13503. (315) 792-2202. \$6000; 3 mo.

An attractive slope-front cabinet houses the model 4010 tape drive. The unit provides recording densities to 1600 bit/in, data-transfer speeds to 125 in/s and a rewind speed of 500 in/s. Automatic tape threading is standard; cartridge loading is available as an option. Performance features include a single capstan drive, vacuum buffering optical servo control. A hinged swing-out gate provides easy access to the logic and data electronics assemblies.

CIRCLE NO. 261

Printer gets the message across with less paper

Potter Instrument Co., 532 Broad Hollow Rd., Melville, N.Y. 11746. (516) 694-9000. See text.

Considerable savings in paper costs are possible with an impact printer called the GRAND SLAM. The unit prints computer output at 1500 line/min. with respective densities of 15 char/in. horizontally and 8 or 10-line/in. vertically. Ordinary line printers use 10 char/in. and 6 line/in. Printing is done by a belt chain and free-flight hammer on 8.5-in. paper. An operator can change character sets simply by changing the chain module. The purchase price of \$54,950 includes the printer, and built-in 360/370 interface and control unit. A lease plan is also available.

CIRCLE NO. 262

INFORMATION RETRIEVAL NUMBER 73 ►

NEW THE VERSATILE COAXIAL CONNECTORS OMQ-OSQ

- **ALL CRIMP DESIGN**

Crimp center conductor and crimp braid.

- **COST SAVINGS**

Semi-automated pneumatic tooling available. Assembly cost savings up to 35%.

- **QUICK CONNECT — POSITIVE LOCK**

The straight-in locking feature permits rapid reliable connections. No twisting or threading of coupling nuts is required.

- **WIDE VARIETY OF CABLES**

Available for 50, 75, 95 ohm coaxial cables.

- **EXCELLENT ELECTRICAL CHARACTERISTICS**

Typical VSWR: 1.10 dc-5.0GHz

- **BETWEEN SERIES ADAPTERS**

Adapters to BNC, SMB, SMC, OSM, N, APC-7, GR-874.

- **COMPONENTS**

Attenuators, Terminations and Tees

- **WIDE VARIETY OF APPLICATIONS**

Communications, Video, Aircraft, Instrumentation, Test Equipment, Computers, Data Transmission, Avionics, Satellite and Industrial Systems.

- **LOW COST/IMMEDIATE DELIVERY**

Readily available from stock. Factory direct or local authorized distributors.



PLUG JACK
(CABLED RG 58 C/U)

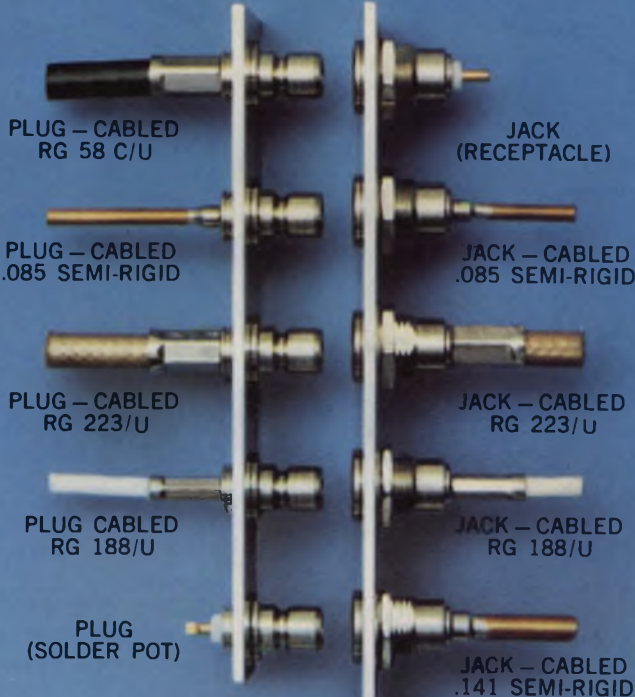

PLUG — CABLED
RG 58 C/U

JACK
(RECEPTACLE)

PLUG — CABLED
.085 SEMI-RIGID

JACK — CABLED
.085 SEMI-RIGID

PLUG — CABLED
RG 223/U

JACK — CABLED
RG 223/U

PLUG CABLED
RG 188/U

JACK — CABLED
RG 188/U

PLUG
(SOLDER POT)

JACK — CABLED
.141 SEMI-RIGID

PLUG — RIGHT ANGLE
CABLED — RG 58 C/U

JACK — RECEPTACLE
(SOLDER POT)



Send for New 1974 OMQ/OSQ Catalog. 40 pages of miniature and sub-miniature coaxial connectors, between series adapters and components. Complete specifications, outline drawings and performance data.





Triad gives you a lot less for your money

If size makes the big difference in your design, chances are that Triad makes the size you need. Triad's famous Red Spec series, designed specifically for use in transistor and printed circuit applications, have maximum base dimensions of only .310 by .410 inches and meet MIL-T-27 Grade 5 Class S specifications. Many input, output, driver, interstage and reactor types are available from stock—plus plug-in designs for your miniature solid state circuits. Open-type miniatures are also ready for immediate delivery from your nearest distributor in a wide range of ratings, mounting types and sizes. You get modest cost, minimum size and consistently stable characteristics.

Triad's new series of transformers for transistorized control and instrumentation include units for both audio and power applications. Fifteen of these transformers provide a voltage stepdown and isolation from power lines at relatively low power levels of 1½, 4½ and 7 watts at 4 to 38 volts when connected in parallel, and 8 to 76 volts when series-connected. Precision spaced plug-in terminals provide fixed mounting centers—the kind usually found only in costly molded units. You get the benefits without the high cost. For maximum power with optimum equipment miniaturization, see your industrial electronic distributor today. Available from stock. Triad-Utrad Distributor Services, 305 North Briant Street, Huntington, Indiana 46750.

 **TRIAD-UTRAD**
Litton Distributor Services

INFORMATION RETRIEVAL NUMBER 74

DATA PROCESSING

Tape reader/punch has long life expectancy

Iomec, Inc., 3300 Scott Blvd., Santa Clara, Calif. 95050. (408) 246-2950. \$2090.

The model 7470 tape reader/punch handles Mylar or paper tape. The unit perforates tapes at 70 char/s, reads synchronously at 400 char/s and asynchronously to 300 char/s. Bin capacities are 1400 ft supply for the punch, 140 ft takeup for the punched tape and 140 ft (bidirectional) for the reader. All supply and takeup accessories are accessible from the front panel. The punch accepts five or eight-level tapes without the need for adjustment. According to the manufacturer, the life expectancy of the punch head is 200 M characters with paper tape and 60 M for Mylar. Echo-back for read-after-punch signals is available as an option.

CIRCLE NO. 263

Intelligent terminals have multiprogramming



DataPoint Corp., 9725 Datapoint Dr., San Antonio, Tex. 78284. (512) 696-4570.

The Datapoint 1100 and Datapoint 5500 intelligent terminals have added additional capabilities to the company's line. The 1100 consists of a processor with up to 8-k of RAM memory, dual cassette drives, an 80-horizontal by 12 vertical display and full ASCII keyboard. The lease price is \$138/mo. The top-of-the-line model 5500 features memory segmentation, string and arithmetic instruction and a processing speed that is three to four times greater than that of the 2200. Memory sizes to 64-k bytes are available. The 5500 is capable of performing simultaneous operations by means of its multiprogramming operating system.

CIRCLE NO. 264

New HEATH/SCHLUMBERGER INSTRUMENTS CATALOG

FREE



**12 New
Test Instruments
New \$335,
10mV-10V, 10 Speed
Chart Recorder**

**New \$325, auto-ranging
110MHz Counter**

from Heath/
Schlumberger

HEATH
Schlumberger
Copyright Heath Company 1973
Catalog 811-02

The latest issue . . . includes complete details and specifications on dozens of high performance, low cost instruments for design, R&D and teaching applications. Here are just a few examples:

New 10 mV to 10 V Strip Chart Recorder . . . only \$335*. Four calibrated, hi-Z input ranges . . . full 10" chart . . . ten digitally-derived chart speeds from 10 to 0.01 inches or cm/minute . . . switchable input filtering . . . complete remote programming capability . . . easy conversion to metric work . . . pushbutton chart advance . . . rack mount design.

600 MHz Frequency Counter . . . just \$795*. 1 Hz to 600 MHz guaranteed range . . . input sensitivity: 10 mV @ 35 MHz, 15 mV @ 200 MHz, 50 mV @ 600 MHz . . . 50 and 1 megohm inputs . . . high stability TCXO time base . . . complete remote programming capability for all inputs, outputs & functions, plus BCD output . . . FCC type-approved for AM & FM broadcast.

Dual Trace 15 MHz scope . . . only \$595*. 15 MHz vertical bandwidth with 24 ns risetime . . . 50 mV/cm sensitivity . . . 1 megohm/35 pf input impedance . . . 9 position attenuator . . . 18 calibrated sweep rates from 0.2 us/cm to 100 ms/cm . . . Chop, Alternate, Ch. 1, Ch. 2 and X-Y modes . . . Internal/External, AC/DC, +/- triggering . . . external trigger input, sweep gate output. Standard camera mount bezel.



For your FREE copy, use postcard or coupon NOW!

HEATH	
Schlumberger	
Heath/Schlumberger Instruments	
Dept. 531-264	
Benton Harbor, Michigan 49022	
Please send electronic instruments catalog.	
Name _____	
Title _____	
Company/Institution _____	
Address _____	
City _____	State _____ Zip _____
*Mail order prices; FOB factory.	
EK-415	

You've probably experienced the big squeeze — components demanding uneven board spacing — board entry hang ups — restricted air circulation — problems you could get upset about.

Now you can accurately file your 1/16" cards with uniform, reinforced nylon ECON-O-GIDE® card guides on any spacing, and you pick the density. Specially designed entrance ramps make insertion fast and positive.

Economical ECON-O-GIDEs easily snap into drilled or punched holes in any type of sheet, plate or channel and are stocked in 24 lengths from 2 1/2" through 14" in 1/2" increments.

Details, pricing and specific samples on request.

BIVAR, INC. 1500 South Lyon Street, Santa Ana, Ca. 92705. Phone (714) 547-5832

**don't get
upset by
the
p.c. card
filing
squeeze.**

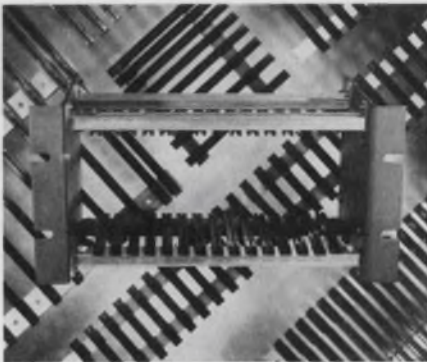

PACKAGING PROGRESS
BY **Bivar**

INFORMATION RETRIEVAL NUMBER 76

DATA PROCESSING

Array processors do FFT in less than 5 ms



CSP, Inc., 209 Middlesex Tpke., Burlington, Mass. 01803. (617) 272-6020. See text.

The CSPI-4000 series of FFT processors compute a 1024 complex-point transform in less than 5 ms. And all models perform array manipulations such as complex multiply, magnitude-phase calculation and polar conversion. Units are available that use the host computer's memory or contain their own multiport memories. The calculation range includes array sizes of 64 to 8192 real or complex points. Adaptive scaling and use of 16-bit real and imaginary array components maximize accuracy and dynamic range. Prices of individual models range from \$20,000 to \$40,000 depending on the options selected.

CIRCLE NO. 265

Disc controller allows compatible data files

Memorex Corp., San Tomas at Central Expressway, Santa Clara, Calif. 95052. (408) 987-2200. 6 mo.

The 3673 disc-controller attaches directly to the IBM's System/370 Model 125 or to the System/370 Model 135 Integrated File Adapter. The controller allows use of disc files on the 370/125 that are compatible with those of larger System/370s. In addition a new model of the company's 3670 disc drive module (model 2) provides a single spindle capacity of 100 M-bytes.

CIRCLE NO. 266

CANNON DISTRIBUTORS ARE INNOVATIVE, TOO. CALL THEM.

ALABAMA
Hall-Mark Electronics
Corp.
Huntsville
205/539-0891

ARIZONA
Liberty Electronics/
Arizona
Phoenix
602/264-4438

CALIFORNIA
Kieruff Electronics, Inc.
Los Angeles
213/685-5511

Kieruff Electronics, Inc.
Palo Alto
415/968-8292

Liberty Electronics
El Segundo
213/322-8100

Richey Electronics, Inc.
Sun Valley
213/875-2862

Time Electronics
West, Inc.
Inglewood
213/873-5900

Western Radio/
Liberty
San Diego
714/235-6571

COLORADO
Cramer Electronics, Inc.
Denver
303/758-2100

CONNECTICUT
A.S.I./Connector
Corporation of
America
New Haven
203/824-0127

FLORIDA
Hall-Mark Electronics
Corp.
Orlando
305/855-4020

GEORGIA
Electro Air Corp.
Atlanta
404/351-3545

ILLINOIS
Cramer Electronics, Inc.
Mt. Prospect
312/593-0230

Radio Distributing
Company, Inc.
Chicago
312/237-1105

INDIANA
Radio Distributing
Company, Inc.
South Bend
219/287-2911

KANSAS
Hall-Mark Electronics
Corp.
Lenexa
913/888-4747

MARYLAND
Schweber Electronics
Rockville
301/881-2970

MASSACHUSETTS
Cramer Electronics, Inc.
Newton
617/969-7700

Schweber Electronics
Waltham
617/891-8484
Time Electronics/
New England
Woburn
617/935-8080

MINNESOTA
Cramer/Bonn
Minneapolis
612/941-2770
Hall-Mark Electronics
Corp.
Minneapolis
612/925-2944

MISSOURI
Hall-Mark Electronics
Corp.
St. Louis
314/521-3800

NEW JERSEY
A.S.I./Resco
Electronics
Pennsauken
609/682-4000

NEW MEXICO
Cramer Electronics, Inc.
Albuquerque
505/265-5767

NEW YORK
A.S.I./Progress
Electronics Co., Inc.
Plainview, L.I.
516/433-1700

Schweber Electronics
Westbury, L.I.
516/334-7474

Summit Distributors, Inc.
Buffalo
716/884-3450
Time Electronic Sales
Hauppauge, L.I.
516/273-0100

OHIO
Radio Distributing
Company, Inc.
Cleveland
216/481-9090

OKLAHOMA
Hall-Mark Electronics
Corp.
Tulsa
918/835-8458

PENNSYLVANIA
Aercon, Inc.
Clifton Heights
215/822-2500

Philadelphia
Electronics, Inc.
Philadelphia
215/568-7444

TEXAS
Hall-Mark Electronics
Corp.
Dallas
214/231-5101

Hall-Mark Electronics
Corp.
Houston
715/781-6100

Harrison Equipment
Co., Inc.
Houston
713/224-9131

Kieruff—Dallas
Garland
214/271-2471

UTAH
Cramer Electronics, Inc.
Salt Lake City
801/487-3681

WASHINGTON
Kieruff Electronics, Inc.
Seattle
206/763-1550

WISCONSIN
Cramer Electronics, Inc.
Milwaukee
414/482-8300

CANNON IIT



“CANNON® BACKPLANES BROUGHT ME FAME AND FORTUNE IN ONLY 6 WEEKS.”

**“The initial response
was not enthusiastic.”**



“I’ll never forget that meeting. I specified Cannon for our backplane assemblies, and the project team came apart. You see, in those days they still connected Cannon with Mil-Spec. And you know what Mil-Spec means to a lot of guys.

“But Cannon’s six weeks normal delivery (three weeks turnaround on prototypes) made believers of us all.

“What Cannon could do was just as important as how fast they could do it. Either deliver conventional

backplane assemblies at real cost savings. Or deliver them with rack and panel I/O connectors (like their zero-force rectangular DL; crimp, snap-in Burgun-D; and Adapta-Con for connecting to 0.025” square posts).

**“Cannon quality—
the real payoff.”**



“With us, Cannon came in at preliminary design stage, and carried the ball from helping in the design to handling the whole assembly. Saved us money as well as headaches.

“And headaches were what we’ve been having all along. Our current suppliers just weren’t hacking it anymore. Maybe we’d

outgrown them, and were ready for Cannon performance.

“What tipped me to Cannon? Their ‘Secrets of Connector Success’ — it’s invaluable to today’s innovative thinker. I got it just by writing Cannon. So can you.”

ITT Cannon Electric,
International Telephone and
Telegraph Corporation,
666 East Dyer Road, Santa
Ana, CA 92702.

(714) 557-4700.

**“Share the wealth,
I always say.”**



CANNON ITT

your best value is a

TRYGON

SYSTRON-DONNER POWER SUPPLY

QUALITY/RELIABILITY/SERVICE

NEW



DIGITAL POWER SOURCE

from \$1275

Dual Power Supplies ... 0 to 50V, 1 amp
or ... 0 to 100V, 0.5 amps

Digitally Controlled ...
Independently Programmable ... for
OEM & Automatic Test Systems

- Use for computer controlled test sets
- Use for complex process control operations
- Use for automated production routines

FEATURES ● Addressable memory ● programs up to 16 sources from only one computer I/O circuit ● optional programmed polarity, overcurrent limit, overvoltage protection level, and range change X1 to XO.1 ● fully isolated to eliminate ground loops ● self verification options include data parity check, overcurrent alarm flag, equilibration ready flag, BCD display of input command.

Write directly or call your local Scientific-Devices sales office for complete specifications and applications.

TRYGON ELECTRONICS
SUBSIDIARY

SYSTRON  DONNER

CORPORATION

1200 Shames Drive, Westbury, N.Y. 11590 (516) 997-6200

The Sysstron-Donner Instruments Group:

Concord Instruments Computer Systems Datapulse Kruse Electronics Microwave Trygon Electronics

INFORMATION RETRIEVAL NUMBER 79

COMPONENTS

Network provides precise volt ratio



Dale Electronics, Inc., Dept. 860,
P.O. Box 609, Columbus, Neb.
68601. (402) 564-3131.

Special Dale networks use a combination of discrete film resistors to meet the voltage division and stability needs of precision power supplies and accurate ratio tracking in high-voltage equipment. Resistor network maximums are: 167 M Ω , 7 kV, 1/2 W at 70 C. Network size is 2-1/8 L \times 5/16 D in.

CIRCLE NO. 267

Lighted pushbutton switch has 92 versions

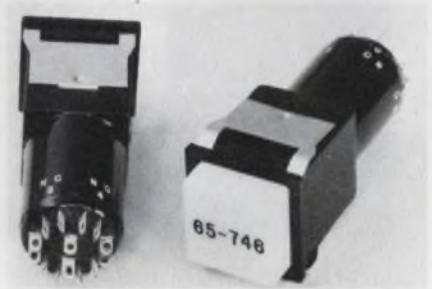

Electro-Mech Components, Inc.,
1826 N. Floradale, South El Monte,
Calif. 91733. (213) 442-7180. \$3.45
(1000 up); stock to 4 wk.

Available in 92 combinations, Model 60 series lighted, pushbutton switches have two to six-pole assemblies, unitized housings and 3/4-in. square illuminated buttons. Switching actions include: momentary, push-on/push-off, push-on/stay-in, and momentary with a snap feel. All are available in snap-in for hardmount configurations, with a selection of three front-panel mounting adapters: flush, single-side barrier, or double-side barrier. Standard specifications of the line include: contacts rated at 30 V dc, 115-V ac, 2-A resistive, 1-A inductive; operational life exceeding 100,000 actuations; and an operating pressure of 2 \pm 1 lb.

CIRCLE NO. 268

**attenuator-
rated™**

quiet!

**Ferramic® components
guarantee circuit
performance.**

Attenuator-Rated components are new—and they're processed specifically for highest interference suppression.

End guesswork

This new breed of slip-on Ferramic components puts an end to cut-and-try selection. Now you can choose from a full line of our *Attenuator-Rated* components and get known attenuation properties.

Our complete specifications include the data you need to get dependable attenuation characteristics matched to your circuit requirements. And we back our specs with our own testing program.

Highest attenuation

An ordered series of nine components give you total flexibility in optimizing

attenuation to your specific circuit.

With each of these components you can select the attenuation properties you require. The highest suppression in the industry from 10 KHz to 10 Mhz or maximum attenuation from 10 to 250 Mhz.

New design guide

Selection of optimum noise attenuation couldn't be easier. Our complete design guide gives you the facts you need. You get typical attenuation and impedance curves, application data and specs that relate directly to your circuit requirements.

If your circuit impedance is known, you can determine attenuation characteristics directly from our graphs. And once your problem is

solved—it stays solved. Our testing program insures that each *Attenuator-Rated* component will meet its attenuation specs.

For complete design information and the answers to your attenuation requirements, use the reader service card for your copy of our design guide. Or call (201) 826-5100 and talk to the men who wrote it. Either way, if you're talking attenuation, talk to the ferrite experts.

That's us.

Indiana General
Electronic Products
Keasbey, N.J. 08832

*National distribution
through eight
Permag locations.*

indiana general 

a division of Electronic Memories & Magnetics Corp.

INFORMATION RETRIEVAL NUMBER 80

Ceramic capacitor made in dual-inline package

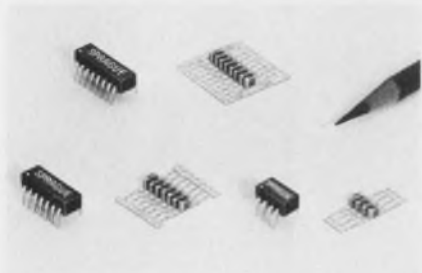

Sprague Electric Co., Marshall St., North Adams, Mass. 01247. (413) 664-4411.

Sprague's DIP type 934C, 936C and 939C ceramic capacitors are especially useful for noise bypassing and signal coupling in high-frequency signal or data-processing systems. The units operate over the temperature range of -55 to 70 C and capacitance values from 18 pF to 0.1 μ F at 100 wV dc are standard.

CIRCLE NO. 269

There's still nothing like vacuum tubes for an exceptional TWT amplifier



Sure our amplifier uses solid state components—everywhere, in fact, except in the high voltage regulator and the TWT itself.

Why a vacuum tube regulator? Because of the greater reliability with this inherently high voltage component.

It qualifies our TWT amplifier especially for antenna pattern measurement, EMI susceptibility testing and r-f power instrument calibration.

But we utilize contemporary concepts when they add to reliable performance. Our modular construction and plug-in boards will accommodate a variety of TWTs for example.

And we can and do add VSWR protection, harmonic filtering and variable output, where required.

Octave band width 10, 20, 100 and 200 watts TWTAs from 1 GHz to 18 GHz. For detailed specifications write MCL, Inc., 10 North Beach Avenue, La Grange, Illinois 60525. Or call (312) 354-4350.



INFORMATION RETRIEVAL NUMBER 81

Reflective transducer rejects ambient light

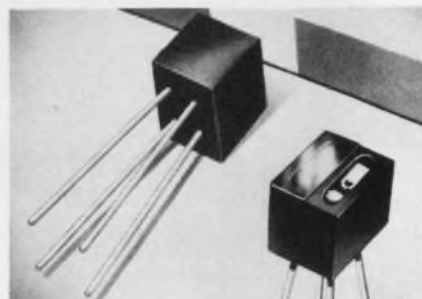

Sensor Technology, Inc., 21012 Lassen St., Chatsworth, Calif. 91311. (213) 882-4100.

Opto-Pair reflective transducers STRT-850/850 A/F combine an emitter and detector in a single compact package. Also included is an infrared bandpass filter over the phototransistor detector to assure operation under adverse ambient conditions caused by stray fluorescent or other short wavelength lights. The transducers have been specially designed for beginning and end-of-tape sensing, character recognition and mark sensing. The units use gallium-arsenide, infrared emitting diodes and silicon npn phototransistor chips. Both the emitter and detector elements are positioned on the same plane. The unit responds only when a reflective surface comes into the field of view of the phototransistor. Typical rise and fall times are 60 μ s and a typical current output is 0.5 mA when the unit is positioned at 0.2 in. from a 90% reflective white surface.

CIRCLE NO. 270

LED emits yellow light; can show standby mode

Motorola Semiconductor Products, Inc., P.O. Box 20912, Phoenix, Ariz. 85036. (602) 273-6900. \$0.89 (100 to 999); stock.

Panel-mounting MLED850 is a yellow light-emitting diode. The new device complements Motorola's existing lines of the MLED650 (red) and MLED750 (green) devices by sharing an identical package and mounting design. Traditionally, the red device is used to indicate a no-go condition, while the green device serves to indicate an operational mode. Thus the new yellow LED can be used to indicate a standby mode.

CIRCLE NO. 271

Another introductory offer to new members of the ELECTRONICS AND CONTROL ENGINEERS' BOOK CLUB

	404/445 ELECTRONIC CIRCUITS MANUAL by J. Markus Pub. price, \$22.00 Club price, \$15.75		286/515 INTEGRATED CIRCUITS: A Basic Course for Engineers and Technicians by R. G. Hibberd Pub. price, \$10.25 Club price, \$8.45	
	637/458 DESIGNING WITH TTL INTEGRATED CIRCUITS by Texas Instruments Inc. Pub. price, \$19.50 Club price, \$13.50		100/810 MOS/LSI DESIGN AND APPLICATION by Carr & Mize Pub. price, \$18.50 Club price, \$13.50	
	404/437 SOURCEBOOK OF ELECTRONIC CIRCUITS by J. Markus Pub. price, \$21.50 Club price, \$17.50		313/059 HANDBOOK OF SEMI-CONDUCTOR ELECTRONICS, 3/e by P. Hunter Pub. price, \$29.85 Club price, \$21.50	
	484/368 COMMUNICATION SYSTEMS DESIGN by P. F. Panter Pub. price, \$19.50 Club price, \$13.50		287/341 STANDARD HANDBOOK OF ENGINEERING CALCULATIONS by T. G. Hicks Pub. price, \$19.50 Club price, \$14.25	
	491/364 THE DESIGN OF DIGITAL SYSTEMS by J. B. Peatman Pub. price, \$15.50 Club price, \$11.75		124/035 HANDBOOK OF PHYSICS, 2/e by Condon and Odishaw Pub. price, \$37.45 Club price, \$14.95	
				
				
				

Save time and money by joining the
Electronics and Control Engineers' Book Club



HERE is a professional club designed specifically to meet your day-to-day engineering needs by providing practical books in your field on a regular basis at below publisher prices.

How the Club operates: Basic to the Club's service is its publication, the *Electronics and Control Engineers' Book Club Bulletin*, which brings you news of books in your field. Sent to members without cost, it announces and describes in detail the Club's featured book of the month as well as alternate selections which are available at special members' prices.

When you want to examine the Club's feature of the month, you do nothing. The book will be mailed to you as a regular part of your Club service. If you prefer one of the alternate selections—or if you want no book at all for that month—you notify the Club by returning the convenient card enclosed with each *Bulletin*.

As a Club member, you agree only to the purchase of four books over a two-year period. Considering the many books published annually in your field, there will surely be at least four that you would want to own anyway. By joining the Club, you save both money and the trouble of searching for the best books.

MAIL THIS COUPON TODAY

ELECTRONICS AND CONTROL ENGINEERS' BOOK CLUB
582 Princeton Road, Hightstown, New Jersey 08520

Please enroll me as a member of the Electronics and Control Engineers' Book Club and send me the two books indicated below. I am to receive the higher priced of the two for just \$1, and my first selection at the special Club price. A small charge for postage and handling will be included. These books are to be shipped on approval, and I may return them both without cost or further obligation. If I decide to keep the books, I agree to purchase as few as four additional books (including this first selection) during the next two years at special Club prices (guaranteed 15% discount, often more).

Write Code No. of
bonus book
here

Write Code No. of
first selection
here

Name _____

Address _____

City _____

State _____ Zip _____

E33242

INFORMATION RETRIEVAL NUMBER 82

Lowest Cost



Synchro Converter Modules

- Synchro-to-Digital
- Digital-to-Synchro
- Synchro-to-DC

Binary and BCD Codes
High-Speed Multiplexing

Single Speed — 8 to 12 bits and 360 and 1000 counts

Dual Speed — 11 to 18 bits and 0.01° BCD

Send for your 10 page application bulletin today.

asi

astrosystems, inc.

6 Nevada Drive, Lake Success, New York 11040 (516) 328-1600

For your local rep, phone toll-free 800-645-9200

or in New York State, call collect (516) 294-0990

INFORMATION RETRIEVAL NUMBER 83

TC CHIPS BY RMC



TEMPERATURE
COMPENSATING
MULTILAYER
CAPACITORS

VOLTAGES

25 V DC
50 V DC
100 V DC

SIZES

.050 x .100
.125 x .175*
.250 x .225*

*Leaded Units
Available

TCs

P100
NPO
N80
N150
N220
N330
N470
N750

Radio Materials Company

Div. of P. R. Mallory & Co. Inc.
4242 West Bryn Mawr Avenue
Chicago, Illinois 60646
(312) 478-3600

INFORMATION RETRIEVAL NUMBER 84

COMPONENTS

Concentric-shaft switch saves panel space



Grayhill, Inc., 565 Hillgrove Ave.,
La Grange, Ill. 60525. (312) 354-
1040.

A new concentric-shaft switch, now added to the miniature Series 71 rotary-switch line, is only 0.750 in. in diameter over the terminals. The behind-the-panel distance of a switch with one deck in each section is less than 1.5 in. Thus this line of rotary switches provides both the front-panel space saving of a dual control and minimum volume behind the panel. The switch is available with 10 positions and 1 or 2 poles per deck or 12 positions and 1 to 6 poles per deck. A maximum of three decks in each section can be operated by each shaft.

CIRCLE NO. 272

Three-pole toggle switch features small size

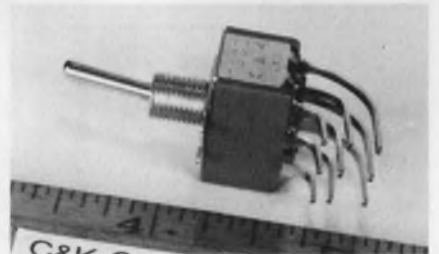

C&K Components, Inc., 103 Morse
St., Watertown, Mass. 02172. (617)
926-0800. \$2.47 (100 to 499); 30
to 60 day.

A small, 3PDT vertical-mounting toggle switch, designated AV, has a bushing diameter of only 0.245 in. and a case size of 0.50 x 0.65 in. Contacts make on the side opposite the toggle thrown, and standard contacts and terminals are brass with a 100 millionths gold plate. Terminal support is 1/2 hd. brass, electrotin-plated. Some other important specifications include: electric life of 100,000 cycles for all models ending in -01 (40,000 cycles on all others); insulating resistance of 1000 MΩ; and dielectric strength of 1000 V rms at sea level.

CIRCLE NO. 273



Identical Twins (almost)

Now, you can have twice the action!

Put these fantastic PC board connectors by your side. They're absolutely beautiful. And identical. Almost. The only real difference is that Series 7000 is spaced on .100" contact centers. And Series 8100 is on .125".

This dynamic duo comes feature-packed to delight and amaze you. They've bifurcated bellows contacts. Your choice of thru-hole or tapped insert mounting styles. Black phenolic or green diallyl insulation and housings. Wire wrap or dip-solder terminations. Extra-large chamfer board entry. Replaceable contacts. Molded contact identification. In-between contact polarizing. And plenty of other sexy traits.

Cast your eyes on a bevy of contacts. Series 7000 has them from 10/20 to 70/140 pairs. And Series 8100 from 15/30 to 60/120 pairs.

Add a double dash of romance to your life. You've been bending over that tired old drawing board too long. Ask for all the racy details, and we'll send along a 16" x 20" poster of our tasty twosome.



Stanford Applied Engineering, Inc.

340 Martin Avenue, Santa Clara, CA. 95050
408 243-9200 TWX 910-338-0132

INFORMATION RETRIEVAL NUMBER 85

Test module limits rise, fall to 10 ns



Trak Microwave, 4726 Eisenhower Blvd., Tampa, Fla. 33614. (813) 884-1411. \$520; 60 days.

The Model 5044-1010 test module contains a shielded crystal-controlled source and an rf switch in a miniature package. The module operates at a frequency of 1075 MHz and has a 10-ns rise and fall time. Output power is 10 mW minimum. The unit measures 1.33 x 1.33 x 0.49 inches. It operates from a ±24-V dc supply and draws 50 mA maximum.

CIRCLE NO. 274

1 to 12 GHz antennas come dual polarized



Watkins-Johnson, 3333 Hillview Ave., Palo Alto, Calif. 94304. (415) 493-4141.

A family of quad-ridged horn antennas features dual polarization and covers the standard 1 to 2, 2 to 4, 4 to 8, 8 to 12 and 12 to 18-GHz operating frequency bands. Called the WJ-8326 Series, these antennas provide high gain, directional patterns over octave bandwidths. Each pyramidal horn has two orthogonally placed input feeds that provide the capability for horizontal, vertical and—with a 90° hybrid—right or left-hand circular polarization.

CIRCLE NO. 275

Power transistors have 70% to 90% efficiencies



Transistor Power Technology, Douglas Hill, Me. 04023. (207) 787-2020. \$7.45; stock to 4 wk.

The TPT 1001 and TPT 1002, direct replacements for the 2N-4440 and 2N3375 overlay transistors, feature a "true overlay" structure for improved efficiencies. The TPT 1001 and TPT 1002 are specified for 5 W and 3-W output, respectively, at 400 MHz. They operate from a collector voltage of 28 V and have typical collector efficiencies in the 70% to 90% range.

CIRCLE NO. 276

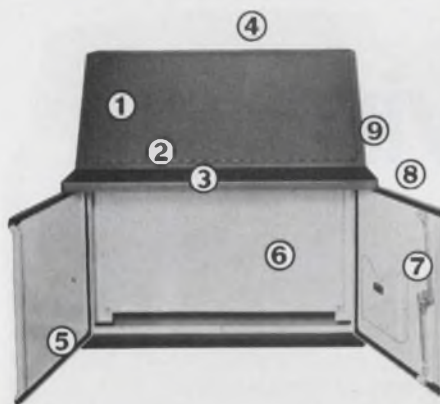

1. 24", 36", 48", or 60" width. 2. Hinged sloping control panel. 3. Optional writing desk. 4. Instrument panel top available. 5. Neoprene gaskets for complete oil tightness. 6. Accessory subpanel. 7. Three-point latches and key-locking handles. 8. Doors on both front and back. 9. All seams continuously welded. 10. NEMA-12 construction. 11. Many modifications available. Write for Bulletin C-14.

CONSOLES

Hoffman
HOFFMAN ENGINEERING COMPANY
Division of Federal Cartridge Corporation
Anoka, Minnesota, Dept. ED54

ELECTRICAL ENCLOSURES

INFORMATION RETRIEVAL NUMBER 86

HUNT: THE CASE PLACE



Need thyristors (triacs and SCR's) in a variety of cases? You can get 'em at the case place. Write Hunt for a brochure, or call toll-free 800-645-9200.



HUNT ELECTRONICS
2639 Mañana, Dallas, Texas 75220
(214) 350-5571

aem

INFORMATION RETRIEVAL NUMBER 87

ELECTRONIC DESIGN 4, February 15, 1974



All Thumbs

It's so beautiful when you're all thumbs.

We've something to fit your wildest counting and switching daydreams. Our dreamy new line of miniature programming devices can directly retrofit today's most popular models.

Find new freedom, versatility, dependability, and economy with our proven "thumbmanship". Name it. We'll deliver.

Large wheel characters. A unique contact spring that can deliver **any present** switching or custom code. Eight, 10, 11, 12 and hexi-decimal position wheels. Four PCB lengths. Mounting boards in virtually any output code. Complete circuits on PCBs. Switch assemblies with "Mother Boards" Custom colors or markings for wheels, spacers, or housings.

And don't overlook our diminutive, behind-the-scene DipswitchTM. This devilish little clicker comes in 4 through 10 SPST switches, plugs into an IC socket, or mounts directly onto a PCB on .300" x .100" centers.

Make life a snap. Specify SAE. Why not switch over today? We're all thumbs. Ask for our detailed thumbwheel switch catalog, and we'll send along a 16" x 20" poster of our snappy little thumbster.



Stanford Applied Engineering, Inc.

340 Martin Avenue, Santa Clara, CA. 95050
408 243-9200 TWX 910-338-0132

INFORMATION RETRIEVAL NUMBER 88

**90-V varactors
operate up to 4 GHz**

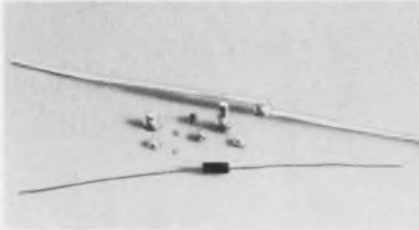

GHz Devices, 16 Maple Rd.,

Chelmsford, Mass. 01824. (617) 256-8101.

A series of silicon varactors, the GC-1800 series, provides a reverse breakdown voltage of 90 V minimum at 10- μ A maximum current. The abrupt-junction devices operate up to 4.0 GHz and reportedly offer the highest Q values and lowest resistance available in 90-V tuning varactors. The varactors are available in any one of 16 package styles.

CIRCLE NO. 277

**6-GHz coax attenuator
has motor drive**



Waveline Inc., P.O. Box 718, West Caldwell, N.J. 07006. (201) 226-9100.

The Model 91185 motor-drive coaxial attenuator operates over the 5.9-to-6.5-GHz frequency range with a maximum insertion loss of 0.5 dB. It has a minimum attenuation range of 0 to 20 dB and a maximum VSWR of 1.25:1. The attenuator uses a 115-V, 50-to-60-Hz supply and has a stopping accuracy of ± 0.1 dB.

CIRCLE NO. 278

**Tecnetics
watts
line**



**DC-DC regulated power supplies 28Vin
25, 10, 6, 3 and 1 watt**

The tecnetics watts line. The 9500 Series.

- 25, 10, 6, 3 and 1 watt DC-DC regulated power supplies 28Vin with proven built-in reliability.
- Output voltages in 3V to 5000V models. Single, dual and triple outputs available.
- Small, rugged and lightweight.
- Input/output isolation.
- Designed to meet MIL-E-5400K.
- Overload and short circuit protection available on some models.

Availability: stock to four weeks.

Prices range from \$153 to \$330 each.

Write or call for more details on specifications, applications and the new 1974 catalog from tecnetics.

tecnetics The Power Conversion Specialists

P. O. Box 910 1625 Range Street, Boulder, Colorado 80302
(303) 442-3837 TWX 910-940-3246

**Gunn oscillators
offer stable operation**

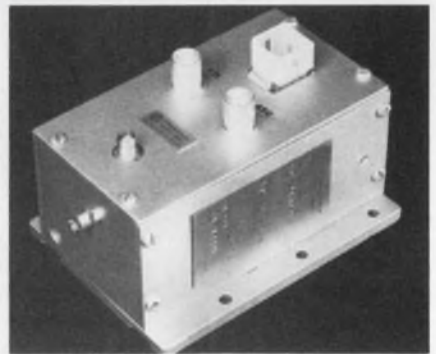

Frequency-West, 3140 Alfred St., Santa Clara, Calif. 95050. (408) 249-2850.

Four linearly modulated, free-running Gunn oscillators for common-carrier systems feature a stability of $\pm 0.07\%$ from -30 to $+60$ C. Called the GS-600 series, the oscillators are rated for 10 or 50 mW, and they operate over various bands in the 5.9-to-6.4-GHz frequency range. FM noise—per 3.1-kHz bandwidth with 200-kHz-rms test-tone level equal to 0 dB—is 80 dBmO max at an offset frequency from the carrier of 100 kHz and 84 dBmO max at 1 MHz from the carrier.

CIRCLE NO. 279

Countdown
to
shipment . . .
72 hours!

That's

INSTANT **EMCOR** MODULAR CABINETRY

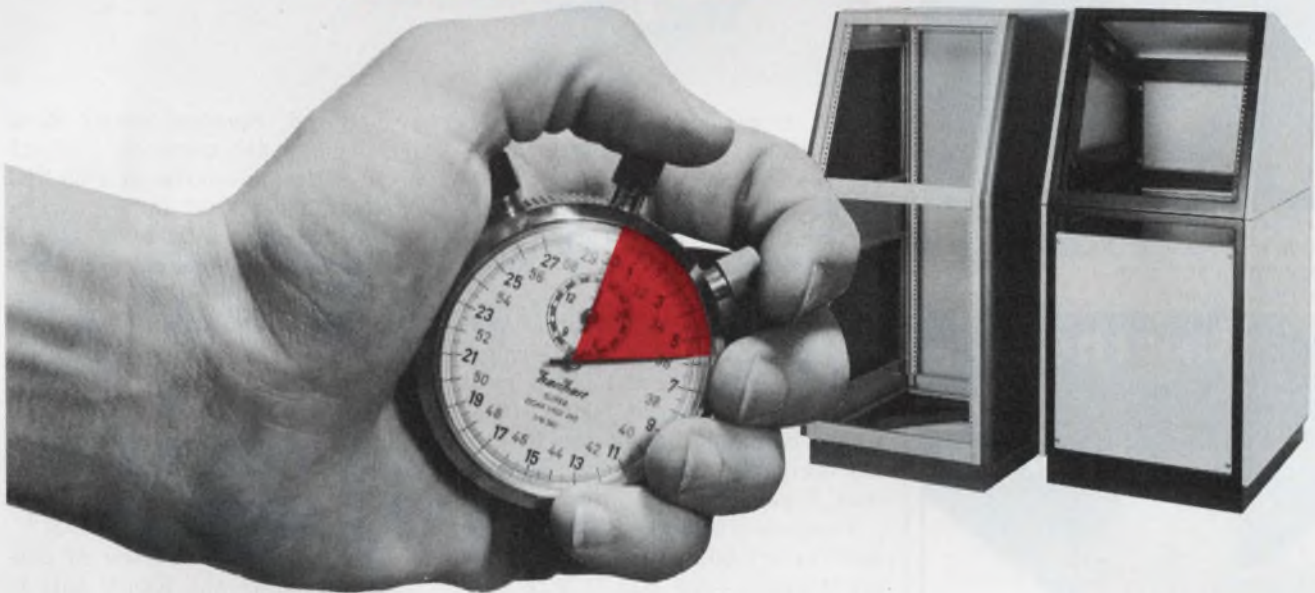

When time is of the essence . . . and you need equipment enclosures "yesterday" . . . it's good to know you can count on INSTANT EMCOR to ship your requirements **within 3 days**. That's because we stockpile 77 models of our EMCOR I and EMCOR II series of modular enclosure frames—vertical, slope front, turret, desk and counter height, instrument, low silhouette and steel work/writing top . . . ready to go on 72 hour notice.

Plus — doors, drawers, shelves chassis guides, panels, you name it . . . literally thousands of components and accessories to meet virtually any equipment housing need.

That's INSTANT EMCOR — the enclosures you order "off-the-shelf."

Call our hot line—312/264-7800

Ingersoll Products, 1000 W. 120th St., Chicago, IL 60643

Ingersoll Products



DIV. OF BORG-WARNER CORP.

INFORMATION RETRIEVAL NUMBER 91

1
AMERICAN MADE
Tolerance
SCHAUER
1-Watt
ZENERS

**Immediate Shipment
Low Prices**

ANY voltage from 2.0 to 16.0

Quantity	Price each
1-99	\$1.07
100-499	.97
500-999	.91
1000-4999	.86
5000 up	.82

All welded and
brazed assembly

No fragile
nail heads

Gold
plated
leads

Write for complete
rating data and other
tolerance prices.

**Buy the kit-
Save
a lot**



Kit contains a 51-piece assortment of SCHAUER 1% tolerance 1-watt zeners covering the voltage range of 2.7 to 16.0. Three diodes of each voltage packaged in reusable poly bags. Stored in a handy file box. Contact your distributor or order direct.

A \$54.57 value for
ONLY \$24⁵⁰

Semiconductor Division

SCHAUER
Manufacturing Corp.

4511 Alpine Ave. Cincinnati, Ohio 45242
Telephone: 513/791-3030

20-MHz synthesizer unit offered for less than \$2000



Exact Electronics, 455 S.E. 2nd Ave., Hillsboro, Ore. 97123. (503) 648-6661. \$1995.

The unveiling of the Model 801 marks the entry of Exact Electronics into the frequency synthesizer market.

With its under \$2000 price and its 3-1/2-digits, plus two vernier digits, the 20-MHz 801 drops into a price-performance slot somewhere between that of the RC or LC oscillator and the high-resolution, high-cost synthesizer.

Frequency accuracy of the \$1995 unit is $\pm 0.001\%$ —with the first 3-1/2 digits—and 0.01% with the vernier engaged. The half digit is tacked onto the full three digits to describe the unit's 100% over-range capability.

If you need even higher accuracy, a phase-lock input is provided so that you can slave the 801 to an external frequency standard.

By bandswitching in decade ranges, Exact has been able to maintain a constant dial resolution over a wide range. For example, 18.8888 MHz on the high band becomes 1.88888 kHz on the low band. And with the optional low-frequency-extender card, the reading becomes 18.8888 Hz.

Frequency stability of the 801 is listed as 10 ppm/year with the

vernier out. Spectral purity specs include a phase noise of -40 dB at 10 MHz—measured in a 30-kHz bandwidth centered on the carrier and excluding ± 1 Hz band around the carrier—a nonharmonic spurious output of -60 dB and harmonics, at full amplitude, of -50 dB to 1 MHz and -40 dB to 20 MHz.

Phase noise, of course, is important in measurements on sensitive, narrow-band receivers, while low harmonic distortion is desirable for wideband circuit tests.

Rear-panel access to the Δf control line allows the Exact unit to be fine-tuned from a remote voltage source. Thus you can use the 801 as a stable VCO or tracking filter to recover a noisy carrier signal.

The 801 delivers an adjustable output of 0 to 13 dBm, plus two auxiliary outputs: a 1-MHz, fixed frequency of 100-mV rms amplitude into 50 Ω ; and a 30-to-50-MHz offset frequency, also 100-mV rms into 50 Ω .

Performance of the unit is guaranteed over 0 to 55 C. Options include full digital programming, a serial ASCII interface card, a low-frequency extender and optional amplitude of -70.00 to 26.99 dBm.

CIRCLE NO. 252

RF Admittance Bridges 1MHz to 100MHz



MODEL 33

Boonton Model 33 bridges measure two-terminal capacitance and conductance of high-Q diodes, varactors, and capacitors at 7 crystal-controlled frequencies from 1 to 100MHz, and provide accurate, high resolution balance at the low signal levels necessary for testing solid-state devices. Both internal and external DC bias facilities are standard. Contact: Boonton Electronics, Parsippany, N.J. 07054.

INFORMATION RETRIEVAL NUMBER 151

Full Programmability is standard on RF Millivoltmeters 10kHz to 1.2GHz



ANALOG 92B DIGITAL 92BD

Boonton rf millivoltmeters offer state-of-the-art sensitivity, accuracy, and bandwidth with an unrivaled choice of features and options. Analog or digital versions, both with linear dc outputs. Digital version has ancillary analog dBm meter and BCD outputs, optional autoranging and dB display (0.01 dB resolution). Contact: Boonton Electronics, Parsippany, New Jersey 07054.

INFORMATION RETRIEVAL NUMBER 152

Inductance Bridges measure nanohenries to henries



MODEL 63

Boonton Model 63 direct-reading inductance bridges have extremely wide useful ranges for both series L and R. Internal wide-range oscillator provides constant current, independent of balance condition. Three versions span 0.2nH to 11H, 0.4kHz to 500kHz. Contact: Boonton Electronics, Parsippany, N.J. 07054.

INFORMATION RETRIEVAL NUMBER 153

INFORMATION RETRIEVAL NUMBER 154 ▶



Who said a digital-readout signal generator has to be hard to handle, hot and heavy, and cost \$4,450?

Not us!

Our Model 102A, at \$2,975, has everything you need for just about any AM/FM application — plus seven performance and convenience features you won't get in the \$4,450 design.

What did we leave out?

Phase-lock synchronization, for one (but our dc-coupled FM channel can be externally locked if you need better stability than our typical 4 ppm); and narrow-pulse modulation (belongs in a different class of generators).

What did we add?

Four different signal-generation techniques — for optimum performance in each band, from 4.3 to 520 MHz, without the usual compromises in noise, stability, or residual-distortion characteristics.

The most logical panel layout and convenient control setup you've ever seen. And a unique adjustable "feel" main drive mechanism for narrow-band receiver setting with ease — even without our electrical vernier.

Separate meters for modulation and output — no annoying autoranging or out-of-range annunciators . . . we don't need them.

15 minute warmup to typically

meet 10 ppm/10 minute stability — made possible by low internal dissipation (only 30 watts; no fan!)

Wider FM deviation at low carrier frequencies than any other design in this class (how does 2 MHz peak-to-peak grab you?)

A detected-AM-output option, to verify our negligible phase-shift for VHF-omni testing.

Versatile modulation features — like five internal frequencies, 30% and 100% AM scales, and true-peak-responding AM and FM metering.

All these performance pluses are coupled with low spurious and close-in noise, excellent low-frequency phase integrity, really effective leveling, a low and flat VSWR curve, accurate wide-range attenuation, high output power . . . all of it buttoned up tight for low leakage in a lightweight 30 pound package.

. . . and it's all yours for \$2,975. Get the full specs today — before you spend 50% more .

For complete data or a demonstration write or call Boonton Electronics Corp., Rt. 287 at Smith Road, Parsippany, N.J. 07054, (201) 887-5110.

BOONTON

INSTRUMENTATION

12 binary-bit a/d unit converts in 0.5 μ s



Tustin Electronics, 1656 S. Minnie

St., Santa Ana, Calif. 92707. (714) 835-0677. \$4800; 60 days.

Model 2012, 12 Binary Bit, a/d Converter will convert a $\pm 10,000$ V input to a 12 binary-bit digital word in 0.5 μ s. Tempco is 5 ppm/ $^{\circ}$ C. The unit can be used with a sample and hold amplifier to convert an analog signal to a digital word in 1.0 μ s. An input multiplexer may be included for multiple channels. Throughput time is 1.5 μ s.

CIRCLE NO. 280

3-1/2-digit DVM handles 10 Hz to 10 MHz



Aventronics, 14545 Keswick St., Van Nuys, Calif. 91405. (213) 994-8161. \$279; 6 to 8 wk.

Model KE 301 3-1/2-digit DVM indicates 1 to 200 mV and 1 to 200 mA ac or dc. Ac accuracy is 5%, and dc is 0.1%. The instrument features a Field Effect Liquid Crystal Display. The ac-coupled, differential 1-M Ω input is especially suitable for digital display of read-back signal amplitude from magnetic recording heads, video monitoring and general ac voltage and current measurements. Optional are parallel BCD output, external read command and higher voltage ranges.

CIRCLE NO. 281

6-1/2-digit DMM resolves 10 nA



Julie Research, 211 W. 61st St., New York, N.Y. 10023. (212) 245-2727. \$6930; 2 to 12 wk.

DM-1050 is a one-part-per-million (0.0001%) completely programmable multimeter with a 6-1/2-digit readout, and measures dc volts, volts ratio and dc current (0 to 11.99999 A, self-contained). This instrument adds a five range dc current mode of operation from ± 1.99999 mA fs to ± 11.99999 A fs to the basic DM-1010 capability of 0.000000 to 1.199999 full scale voltage ratio and ± 1.199999 V full scale to ± 11.99999 V full scale dc voltage ranges. This results in a 10-nA resolution on the 1-mA dc-current range.

CIRCLE NO. 282

Hi!—I'm
PLASMAC

TOTAL CREDIT

the **New**
DISPLAY PANEL
from
NATIONAL ELECTRONICS

- Numeric, alpha numeric and fixed messages are available in a single panel.
- Custom design displays to suit your needs.

Call or write for full details

NATIONAL ELECTRONICS
a varian division
geneva, illinois 60134 (312) 232-4300

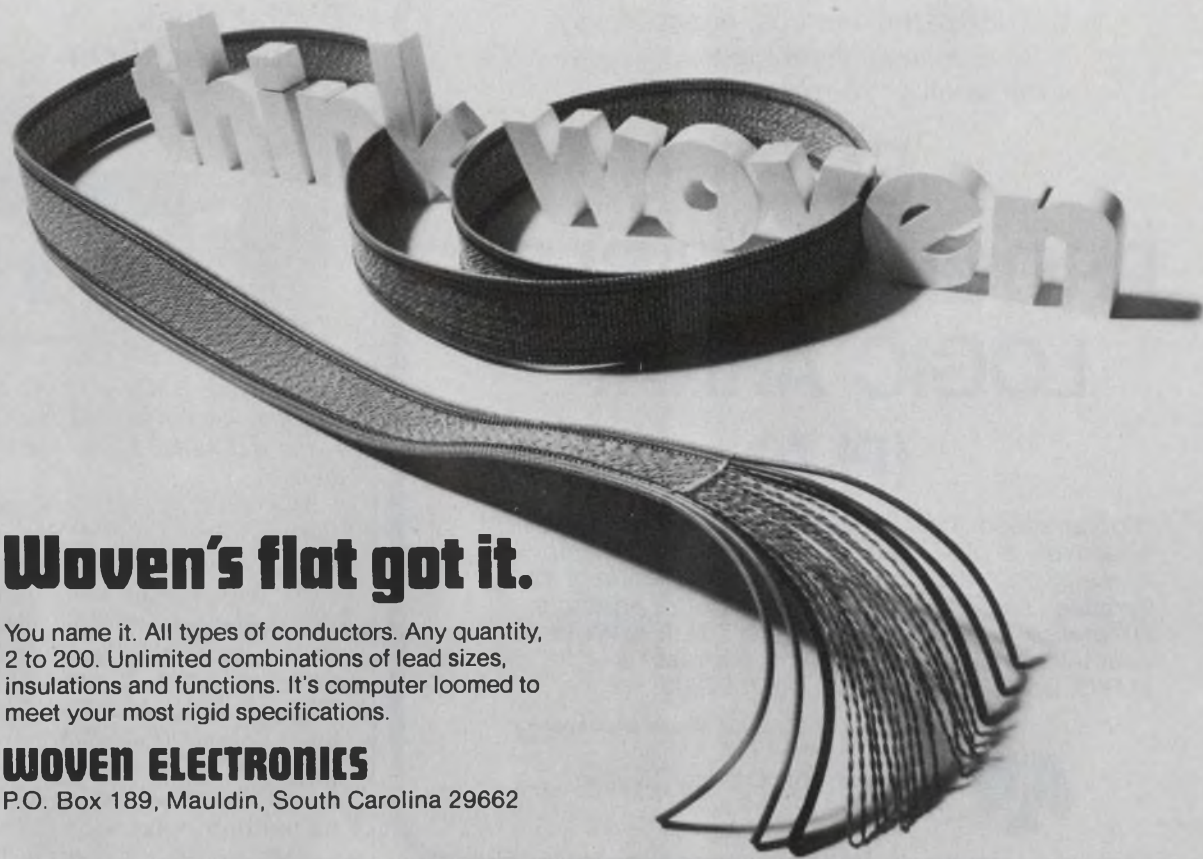

Woven's flat got it.

You name it. All types of conductors. Any quantity, 2 to 200. Unlimited combinations of lead sizes, insulations and functions. It's computer loomed to meet your most rigid specifications.

WOVEN ELECTRONICS

P.O. Box 189, Mauldin, South Carolina 29662

INFORMATION RETRIEVAL NUMBER 97

OTTO®

Sub-subminiature Switches

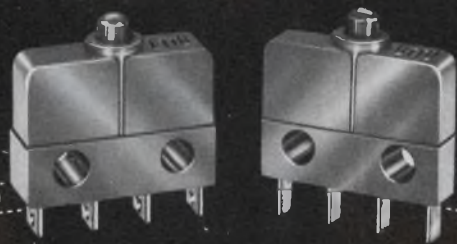

snap-action • precision • 8 A. to dry circuit!

Less than 10 milliohms contact resistance in a ten million cycle switch! That's the OTTO B3 series with patented* design featuring high contact force and minimal contact bounce. Commercial or military, your options include "thin" and "very thin" sizes, contact arrangements to form Z, terminals, and contact materials. Load ratings to 8 A. resistive. Actuators available, too.

For full details including prices and local distributors, write for Bulletin B3.

*U.S. Pat. No. 3,612,793

OTTO CONTROLS Division, OTTO engineering, Inc.
36 Main Street, Carpentersville, Illinois 60110 • Phone: 312/428-7171
© OTTO engineering inc.

INFORMATION RETRIEVAL NUMBER 96

ELECTRONIC DESIGN 4, February 15, 1974

NOW! SOLDERLESS STRIP BUS* by Rogers

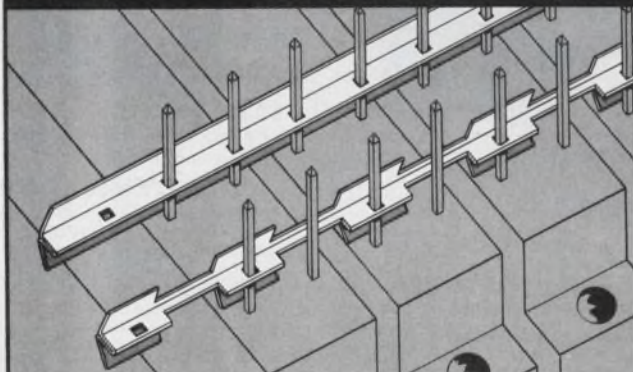

- Easy installation and removal
- Low cost ■ Low profile
- High current-carrying capacity

Write or call for details

*Pat. App. For



Rogers Corporation / Rogers, Connecticut 06263
West: (602) 963-4584 East: (203) 774-9605

INFORMATION RETRIEVAL NUMBER 95

DESIGNERS: the new cost-effective way
to implement logic
is Rockwell's 128-row by 46-column

SOS* PROGRAMMABLE LOGIC ARRAY (PLA)

Bipolar speed: 15MHz. MOS densities: each row is effectively an AND gate of 45 input terms. Example: one SOS-PLA can compute value of function of 22 variables expressed as sum of up to 128 products. Otherwise, you'd need 400 8-gate TTL ICs. Write on your letterhead for data sheets. Address us at P.O. Box 3669, Anaheim, Calif. 92803.

*SOS: Silicon-on-Sapphire



Microelectronic Device Division
Rockwell International

INFORMATION RETRIEVAL NUMBER 98

We Stock What We Catalog in the 1974 Allied Electronics

ENGINEERING MANUAL & PURCHASING GUIDE

Allied has a reputation for delivery! We stock what we catalog, at three key locations for immediate nationwide delivery. If you see it in our Engineering Manual & Purchasing Guide, it's because we've got it ready for your use!
THE MOST WIDELY USED BOOK IN THE COUNTRY!

TECHNICAL INFORMATION

Complete information on all items. Both electrical properties and physical dimensions.

\$5.00 VALUE

Special Offer! Only \$1.00 to readers of Electronic Design

ALL ITEMS IN STOCK

Highest percentage of order filling in the country on standard and stock items.
Thousands of popular and hard-to-get items.

NEW FROM COVER TO COVER

The only up to date annual in the electronics field.

EASY TO USE

Find what you're looking for - Fast!

It has always been the "Answer Book" for Purchasing Agents, Plant, Research, Product, and Maintenance Engineers. Used in all industries. Our 1974 edition is loaded with more information than ever. Complete engineering drawings on most components. It's

The Best Order Filling System In The Country —

Mail Coupon and \$1.00 to cover cost of handling to:
Cat. 910-9999-5

Allied Electronics Corporation
2400 W. Washington Blvd. Chicago, Ill. 60612

Name _____

Company _____

Address _____

City _____

State _____

Zip _____

ALLIED ELECTRONICS DIVISION OF TANDY CORP.

INSTRUMENTATION

Digital clock doubles as timer



Data Graphics Corp., 8402 Speedway Dr., San Antonio, Tex. 78230. (512) 342-9486. \$450; stock to 30 days.

The DATOS 509 is a numeric display clock designed as a modular instrument for users who build data acquisition, data logging, process control data reduction systems. The clock has a basic resolution of seconds with full scale up to 365 days in Julian time. Elapsed time models are also available. An optional battery back up is available. The timer has a six-position range switch from 0.1 s to 1 h and a two-digit thumb-wheel switch multiplier that yields a continuous selection of timer periods from 0.1 s to 99 h.

CIRCLE NO. 283

Sampling scope programs remotely

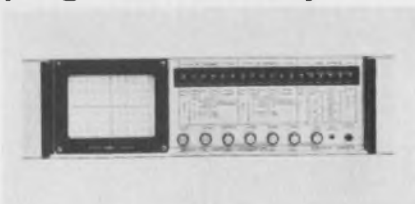

Systron-Donner, Datapulse Div., 10150 W. Jefferson Blvd., Culver City, Calif. 90230. (213) 871-0410. \$5500; 120 days.

Model 774 Sampling Oscilloscope is a new dual-channel instrument that uses remote sampling probes. It can be operated manually or can be remotely programmed. The unit operates with two probes without external multiplexers, or if more signal inputs are required, with probe multiplexers. One multiplexer operates active sampling probes with bandwidths to 1 GHz. Another operates FET impedance-converter probes with bandwidths to 100 MHz.

CIRCLE NO. 284

The standard power supply is a minor consideration... until it fails.

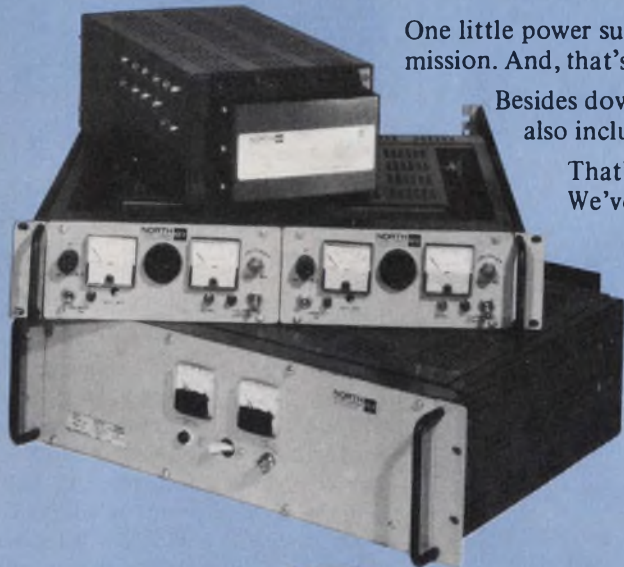

One little power supply can put a big piece of equipment out of commission. And, that's when "bargain-level power" can get very expensive.

Besides downtime and repairs, the cost of 'unreliability' may also include some loss of reputation.

That's why it will pay you to take a good look at North. We've been the leading producer of custom power units for over 40 years. And our standard modules get the same reliability treatment—including rugged life tests, EMI analysis plus shock, vibration and humidity tests.

If reliability is worth more to you, send for a bulletin, or call your North Standard Power Manager at 419/468-8874.

Listed here are the more popular models—many other voltages are available.

MODEL	10000
VDC	AMPS
0 7.5	2.10
0 16	1.25
0 25	0.85
0 33	0.68

MODEL	11000	12000	13000	14000	15000	16000	17000	18000
VDC	AMPERES							
5.0	3.9	5.3	11.3	13.0	20.0	32.5	49.0	82.0
12.0	2.8	4.2	8.0	10.5	15.0	23.0	36.0	58.0
15.0	2.4	3.7	7.5	9.5	14.0	20.5	27.0	47.0
18.0	2.1	3.3	6.0	8.0	13.0	18.0	26.0	40.0
24.0	1.5	2.8	4.2	7.0	11.0	15.0	21.0	33.0
28.0	1.4	2.4	4.0	6.3	9.0	14.0	20.0	29.0
36.0	1.2	2.2	3.1	5.6	8.0	11.0	14.0	23.0
48.0	.95	1.8	2.6	4.2	6.0	8.0	10.0	18.0

DUAL OUTPUT SUPPLIES	
MODEL	N03052
VDC	AMPS
±15 12	400MA
MODEL	N60052
VDC	AMPS
±15 12	1.0A

NORTH 
ELECTRIC COMPANY

North Electric Company / Galion, Ohio 44833 / A United Telecom Co.

SP-20

INFORMATION RETRIEVAL NUMBER 99

i'm free



I'M A MAIL-LITE® SHIPPER

1 CASE of Mail-Lite FREE when you buy my \$50 table model heat sealer.

2 CASES of Mail-Lite FREE when you buy my \$100 floor model heat sealer.



*Labor Savings: Can be heat sealed closed in 2 seconds
Postal Savings • Waterproof • Pilferproof • Lightweight • Clean*



WRITE TODAY FOR INFORMATION ON OUR MAIL-LITE SHIPPERS AND THE SPECIAL HEAT SEALER OFFER.

Sealed Air Corporation

19-01 State Highway 208, Fair Lawn, New Jersey 07410

INFORMATION RETRIEVAL NUMBER 100

ELECTRONIC DESIGN 4, February 15, 1974

Our Amps Don't Quit in a Mismatch!

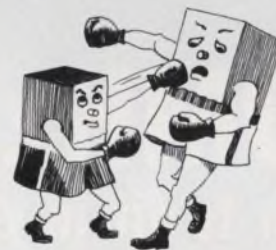

Amplifier Research has a tough line of broadband amplifiers -- all unconditionally stable and built to take on any mismatched load. These amplifiers sweep the spectrum from DC to 700 MHz and provide up to 5000 watts of RF power. Rugged design makes them perfect for antenna and component testing, equipment calibration and EMI susceptibility testing -- you'll never have to throw in the towel! Amplifier Research will also provide custom OEM packaging to meet your special requirements. Get the facts, contact:

Amplifier Research, 160 School House Road, Souderton, Pa. 18964 • Phone: 215-723-8181



INFORMATION RETRIEVAL NUMBER 101

147

We've pulled a switch. DC input to drive an AC airmover. We call it, "The DC Boxer."

An integrally mounted solid state converter does it. Eliminates brush wear, arcing and attendant noise problems and adds years to service life.

Fan mounts with all the ease of a standard Boxer (4-11/16" sq., 1/2" deep), no extra connections or fasteners required. Eight models deliver up to 120 cfm cooling output.

Available with patented Grand Prix sleeve, or rugged ball bearings, both rated at 10 or more years operating life.

Other airmovers? Of course!

Send for our full-line catalog No. ND4r. It's free, and contains performance data, electrical and mechanical specifications on more than 100 units.

And valuable application information too.



For immediate service, contact us at **IMC Magnetics Corp., New Hampshire Division**, Route 16B, Rochester, N.H. 03867, tel. 603-332-5300. Or the IMC stocking distributor in your area. There are more than 50 nationwide and overseas.



INFORMATION RETRIEVAL NUMBER 103

MODULES & SUBASSEMBLIES

Capacitive keyboard can cycle 100 million times



Controls Research Corp., 2100 S. Fairview, Santa Ana, Calif. 92704. (714) 557-7161. \$69 (1000-up); 2 to 6 wk.

The CS-6000 series of capacitive keyboards can operate for more than 100 million cycles. The standard keyboard has 53 keys—47 coded, four function and two control. The unit is an ASR-33 array with N-key rollover and ASCII coding. Key spacing is on 0.75 in. centers with 0.375 × 0.1875 × 0.375 in. offsets. Power requirements are +5 V at 200 mA and -15 V at 20 mA.

CIRCLE NO. 285

Full-wave rectifier handles up to 40 A



Power Physics, Industrial Way West, Eatontown, N.J. 07724. (201) 542-1393. 40PPR20: \$2.30 (100 up); stock.

A 40-A full-wave rectifier in a single package is designed to replace two discrete semiconductor devices in power supply and high current applications. The units in the 40PPR Series are electrically isolated to permit direct chassis or PC board mounting. Diodes are rated at a maximum repetitive peak reverse voltage of 400 V and currents up to 40 A per diode are possible. Other electrical specifications include: V_R (dc blocking), 50 to 400 V; rms input, 35 to 280 V; dc output current, 40 A and peak one-cycle surge current, 1000 A.

CIRCLE NO. 286

20MHz ... and small enough to fit in your brief case!

- Mini-portable Oscilloscope ● Battery or AC powered
- DC-20 MHz bandwidth ● 10 mV/div sensitivity
- Recharging circuitry ● Rack mountable ● Laboratory Quality

The PS900's are the first mini-portable scopes to bring lab-quality to "on-site" DC to 20 MHz test and measurement applications. These are "true" portables, since they are of rugged construction, small size (will fit into your tool kit or brief case) and light weight (only 7 pounds with batteries), and since they will operate from internal batteries for up to 5 hours. Recharging circuitry is included, and standard "C" size cells can be used... nickel-cadmium, alkaline or in a pinch, even common flashlight batteries!

- Interested? Call Bill Kraus at (714) 279-6572, or write us at 7170 Convo Court, San Diego, California 92111.



PS920A
"STACK-PACK"

Two configurations are available...
"FLAT-PACK"—
1 3/4" H x 8 1/2" W x 12" D
"STACK-PACK"—
3 1/2" H x 4 1/4" W x 12" D

\$595

AVAILABLE NOW FROM

From the leader in Multi-Channel Monitor Oscilloscopes



INFORMATION RETRIEVAL NUMBER 104

RELAX....

Line-voltage reductions, to conserve energy, won't affect most of your equipment at all. However, if a problem does occur with your critical equipment, there is a ready solution — a GR Variac® automatic line-voltage regulator.

GR regulators handle reductions up to 20% and provide outputs constant to 0.5%. There are over 100 stock models to choose from, with inputs of 115, 230, or 460 volts and outputs to 85 amperes.

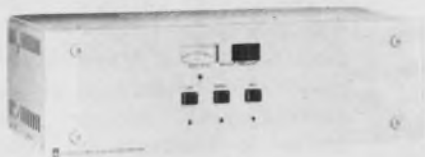

For your critical equipment, choose a regulator from —



INFORMATION RETRIEVAL NUMBER 105

SPDT DPDT 3PDT 4PDT

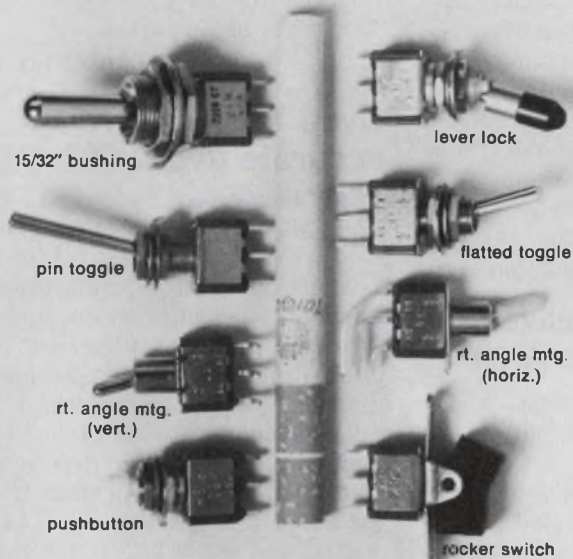

We'd rather switch than fight.

And have we ever switched! If you put any one of these 8 new subminiature switches on your "whatever", you'll have a better performing "whatever."

All C&K switches are competitively-priced and Made-in-America. How's that for a switch?

Ask for our new catalog.

C&K COMPONENTS, INC.

103 Morse Street, Watertown, Massachusetts 02172

Tel: (617) 926-0800

Engineering samples on request.

SEE US AT NEPCON WEST

INFORMATION RETRIEVAL NUMBER 106

ELECTRONIC DESIGN 4, February 15, 1974

Ronor custom electronic assemblies and sub-components eliminate production headaches

... and may cut your costs, too!

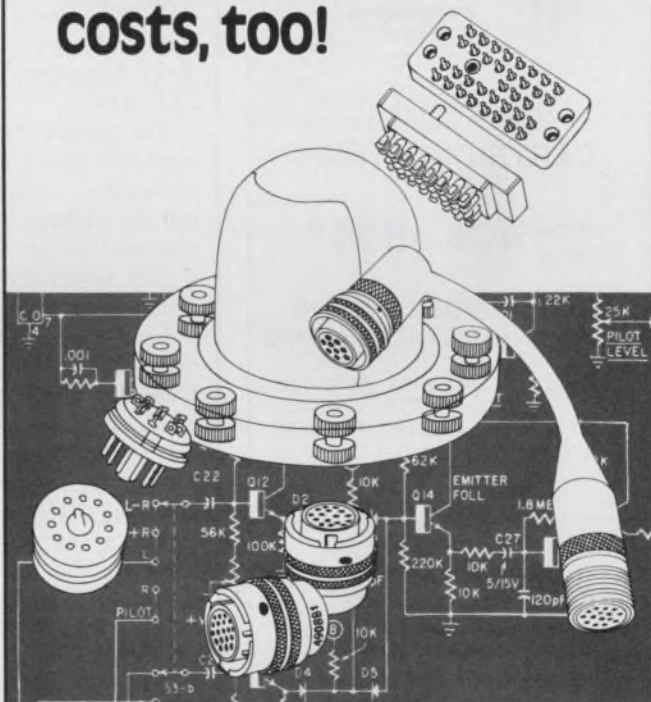

Capabilities to meet your exact requirements: Ronor has the extensive facilities, know-how and test equipment to assure meeting the toughest specs. And, we offer valuable engineering assistance, mold design and fabrication, sub-component assembling, molding, encapsulation, potting, testing. We work in thermosets or thermoplastics . . . common or rare metals . . . bonding dissimilar materials. And, no production run is too small.

You avoid costly investments: Eliminate start-up costs, additional personnel, capital investment. You can count on Ronor quality and delivery commitments. So, why not consider Ronor an extension of your own production facilities?

For full information: Send a drawing of the part or write for facilities brochure.

RONOR

SYSTEMS, INC.

321 Sandbank Road, Cheshire, Connecticut 06410

INFORMATION RETRIEVAL NUMBER 107

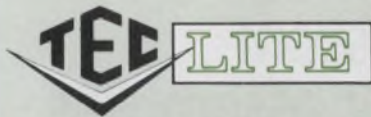

**PRICES CUT
37% to 66%**

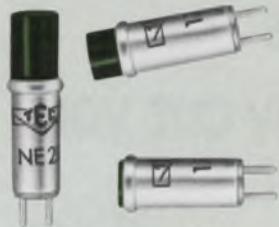

**REPLACEABLE
CARTRIDGE LITES**

Now only **40¢ to 86¢***

**IMMEDIATE DELIVERY ON
MANY LENS COLORS & LAMPS**

Low-cost RCL Series Cartridge Lites are offered in 3 lens styles, 10 lens colors, a full range of voltages and incandescent or neon lamps. Clear anodized aluminum body is also available in other colors and finishes—including iridite—on special order.

Devices mount in panel with spring steel clip, lead wire connectors or solderless cartridge holders shown below. Lens may be imprinted with up to two symbols. Stainless steel terminals are offset to provide neon lamp polarity and to align legends in holders.

*Each in 100-499 quantities.



**PRICES ALSO REDUCED ON
CARTRIDGE LITE HOLDERS**

Save 33% to 67%... RCLH Series Holders now priced from 25¢ to 70¢. Available in front- and rear-mounted versions, solder cup and turret lug terminals and printed circuit board mounting.



9800 N. ORACLE ROAD
TUCSON, AZ. 85704
(602) 297-1111
TWX 910-952-1377

INFORMATION RETRIEVAL NUMBER 108

MODULES & SUBASSEMBLIES

**Tone signaling system
offers many options**



Speedcall Corp., 2020 National Ave., Hayward, Calif. 94545. (415) 783-5611.

The Model 400 line of signaling products provides selective calling, automatic number identification, billing printout and toll-restricted dialing. Caller identification, with a full seven-digit RCC subscriber number, is automatically transmitted via tones to the operator whenever a subscriber goes on or off hook. The Model 400 line includes operator display units for vehicle ID, and billing printers to record air time or connect time on area code calls. The key products in this line are the Model 412 individual call decoder and the Model 408 automatic number identification encoder. Each unit has an eight-digit tone capacity to provide nationwide RCC numbering. Both the decoder and the encoder can be used independently, or may be used together in a more complete mobile signaling system.

CIRCLE NO. 287

**A/d converter delivers
3-1/2 digits plus sign**

Zeltex, 1000 Chalomar Rd., Concord, Calif. 94518. (415) 686-6660. \$85 (1 to 24); stock.

The ZD501 a/d converter can handle a bipolar, 10 V analog signal. It is designed to deliver a 3-1/2 digit plus sign BCD output with overflow signal. The converter uses an integrating conversion scheme. The 3.6 x 1.96 x 0.4 in. module is intended for process control data acquisition that requires high linearity and temperature stability with moderate measurement speed. BCD outputs are TTL compatible and can be interfaced easily to digital readouts.

CIRCLE NO. 288

**Adjustable setpoint unit
can save furnace power**



Lindberg, Div. of Sola Basic Ind., 304 Hart St., Watertown, Wis. 53094. (414) 261-7000.

The Energy Saver, an adjustable setpoint device, reduces diffusion furnace tube temperatures to reasonable holding levels during nonprocessing periods without abuse to elements or tubes. In addition, process setpoint is not altered nor is profile flatness adversely affected. Reheat process is nominal compared to the savings to be gained in reduced kilowatts consumed. The unit can be installed on each tube of any diffusion furnace currently marketed in less than 15 minutes. Direct savings in power consumption will more than pay for the saver in less than 12 months of operation.

CIRCLE NO. 289

**Oven temp controller
accurate to ±0.005 C**

Oven Industries, Inc., P.O. Box 229, Mechanicsburg, Pa. 17055. (717) 766-0721. \$141.35 (1 to 9).

A compact, 50 W, full proportional dc controller meets specifications over a -54 to +85 C ambient range. Model 3C2-51 has a control accuracy to ±0.005 C of set point at the sensor probe. This temperature controller has a set point stability of ±0.0025 C/°C for ambient changes from -54 to +85 C and ±0.001 C/V for input voltage changes from 24 to 30 V dc. The company's TP series of sensor probes can be used for control over temperature ranges from -20 to +250 C. The package size is 1.50 in. square by 1.25 in. high and the unit is hermetically sealed. A seal screw access is provided for set temperature adjustment. An optional heat sink assembly is offered for safe free air mounting.

CIRCLE NO. 290



international coil winding association

(Devoted Entirely To The Coil Winding Industry)

PRESENTS

COIL WINDING CHICAGO '74

CONVENTION and EXHIBITION
Sheraton O'Hare Hotel, 21, 22, 23,
Rosemont, Illinois, U.S.A. May, 1974.

FOR FURTHER DETAILS CONTACT:-
INTERNATIONAL COIL WINDING ASSOCIATION
EUROPEAN & HEAD OFFICE N. AMERICAN OFFICE
Cleveland House Suite 106
344A Holdenhurst Road 3158 Des Plaines Ave
Bournemouth BH8 8BE Des Plaines
Hampshire Illinois 60018
England U.S.A.
TEL: Bournemouth 38738 TEL: (312)696 1688
TELEX: 417123
INFORMATION RETRIEVAL NUMBER 109

SHARP OPTOELECTRONICS

Use our reputation to assure yours.



SILICON PHOTODETECTOR



GA P GREEN LED



PULSE AMPLIFIER



GAASP NUMERIC DISPLAY



SILICON READOUT CELL

Sharp. The known quantity. The known quality. With established reliability on 5 continents, in 100,000,000 circuits. You'll find it pays to be a Sharp decision maker.

Silicon photodetectors and arrays: Photodiodes, phototransistors, monolithic photodiode arrays, and photodetectors with peak spectral response in the visible region.

LEDs and displays: GaAs, GaP, and GaAsP LEDs; red and green LEDs; numeric displays; negative-resistance green and infra-red emitters.

Subassemblies: LED/phototransistor photocouplers, photoisolators, and optical mark sensors; photodiode/pulse amplifier packages; custom integrated circuit combinations.

For more information, data and spec sheets, write

Shigoto Industries Ltd.

Exclusive marketers of Sharp Optoelectronic Devices in the U.S.A.
350 Fifth Avenue, New York, N.Y. 10001
(212) 695-0200 / TELEX 224219

INFORMATION RETRIEVAL NUMBER 110

MONDAY 1

APRIL 1 2 3 4 5 6 7 8 9 10 11 12 13 14 15 16 17 18 19 20 21 22 23 24 25 26 27 28 29 30

JUNE 1 2 3 4 5 6 7 8 9 10 11 12 13 14 15 16 17 18 19 20 21 22 23 24 25 26 27 28 29 30

APPOINTMENTS

8:00
8:30
9:00
9:30
10:00
10:30
11:00
11:30
12:00
1:00
1:30
2:00
2:30
3:00
3:30
4:00
4:30
5:00
5:30

*memo to myself -
Next job opening
interview a
disabled vet
FIRST!*

The President's Committee on Employment of the Handicapped
Washington, D.C. 20210

BUILD

the new HEATHKIT[®] Semiconductor Curve Tracer



ONLY
\$89.95*



This easy-to-build kit lets you see on your oscilloscope screen the operating parameters of virtually all types of semiconductors. Use it for sorting, inspecting, testing of bipolar transistors, diodes, SCRs, triacs, FETs, etc. The IT-1121 Semiconductor Curve Tracer can be used with any scope with horizontal sensitivity of 0.5 V/div. and vertical sensitivity of 1 V/div. All major controls are stepped in a 1, 2, 5 sequence for maximum parameter resolution. Kit includes connecting leads, extra test leads for large devices or in-circuit testing, comprehensive fully illustrated manual. Order one for your lab today.

Kit IT-1121, 11 lbs. 89.95*

Send for your
FREE
Heathkit
catalog

HEATH
Schlumberger

HEATH COMPANY, Dept. 60-2
Benton Harbor, Michigan 49022

Please send FREE Heathkit Catalog. Please send IT-1121. Enclosed is \$89.95, plus shipping.

Name _____
Address _____
City _____ State _____ Zip _____
*Mail order prices; F.O.B. factory. TE-301

INFORMATION RETRIEVAL NUMBER 111

GET READY



In a few months *Electronic Design's Master Directory* — THE GOLD BOOK — will be rolling off the presses and moving on to desks, lab benches, reference shelves, and information centers throughout the U.S. and Europe. It's the directory that will change your thinking about directories . . . the most massive compendium of product information ever compiled . . . a one-step reference source for the data you need to specify, select and buy.

Recognizing potential paper shortages, rising printing, postage and mailing costs, many manufacturers have taken action to be sure their catalog material will reach you no matter what happens. They're choosing THE GOLD BOOK to be their personal industry representative. But please do us a favor. Note the warning below and remind the right people. Don't let your company miss its share of the action.

PASS THE WORD!

WARN YOUR TOP MANAGEMENT AND ADVERTISING PEOPLE NOW

1. Be sure your company gets its **FREE PRODUCT LISTINGS** in THE GOLD BOOK. If they haven't received a questionnaire tell them to phone or write to us today.
2. Be sure your company gets its share of the **FREE ADVERTISING PAGES** being offered for your catalog data and technical information. (A page free for every page of advertising your company places in *Electronic Design* in 1974!). But they must act promptly. Closing date for reservations is February 19, 1974. There's not much time. Other companies are waiting to take your place. The line is forming . . . we can't protect your option much longer.

TO REACH FOR THE GOLD BOOK

Electronic Design's 1974 Master Directory

PRODUCT CATEGORIES

- | | | |
|---|---|---|
| 0100 Amplifiers | 1700 Engineering Aids (Copying Equipment, Drafting Equipment & Supplies) | 3100 Meters, Panel (Analog & Digital) |
| 0200 Audio Equipment | 1800 Environmental Testers & Chambers | 3200 Microwave, Radar Components/Accessories |
| 0300 Books | 1900 Fans, Blowers, Cooling Devices & Cooling Equipment | 3250 Microwave, Radar Systems & Subsystems |
| 0400 Cabinets, Chassis, Containers, Racks, etc. | 2000 Filters, Electrical | 3300 Motors, Rotating Components |
| 0500 Calculators | 2100 Function Modules | 3400 Multiple Products |
| 0600 Capacitors (Fixed & Variable) | 2200 Hardware and Panel Components (Non-Current Carrying) | 3500 Optoelectronic and Laser Components, Equipment & Systems (except Discrete LEDs and Displays) |
| 0700 Circuit Breakers, Fuses and Other Protective Devices | 2300 Inductors & Transformers (Fixed and Variable) | 3600 Panel Lamps, Discrete LEDs & Lampholders |
| 0800 Communications Equipment | 2400 Instruments, Measuring and Testing (except Panel Meters) | 3700 Power Supplies, Batteries |
| 0900 Computer Peripherals (including I/O Equipment, except Storage Equipment) | 2450 Instruments, Recording | 3800 Production Machinery & Automation Equipment |
| 0950 Computer Peripherals, Storage (including Disc, Drum and Tape Equipment) | 2470 Instruments, Signal Source | 3900 Relays & Solenoids |
| 1000 Computers and Data Handlers (except Peripherals) | 2500 Integrated Circuits (Monolithic), MSI, LSI | 4000 Resistors, Fixed |
| 1100 Connectors, Sockets, Terminals & Terminal Boards | 2560 Integrated Circuits, Hybrid | 4050 Resistors, Variable |
| 1200 Controls, Control Components & Control Systems | 2600 Keyboards & Keystitches | 4100 Semiconductors, Discrete (except LEDs) |
| 3450 Corporate Profiles | 2700 Manufacturing, Subcontracting, Fabrication Services | 4200 Services (Engineering, Software, Timesharing, etc.) |
| 1300 Crystals, Oscillators, Timing Devices | 2800 Magnetic Components & Materials (except Memory) | 4300 Switches |
| 1400 Delay Lines | 2900 Materials, Chemicals and Printed Circuits, Fabricated & Non-Fabricated (except Magnetic) | 4400 Thermal Devices |
| 1500 Displays & Readouts (Alpha, Numeric & Graphic) | 3000 Memory Components, Equipment & Systems (except ICs and Peripherals like Discs, Drums, Tape Drives) | 4500 Tools, Soldering Supplies |
| 1600 Distributors | | 4600 Transducers |
| | | 4700 Tubes |
| | | 4800 Wire & Cable |

Parallel Entry Printer

Prints 3 lines per second, 11 character locations per column with a capacity up to 16 columns. Print mechanism is small (5¼" x 10" x 8").



Options available:
Serial or parallel BDC interface
Power supply
Attractive case



With the addition of calculator logic, it becomes our "Intelligent Printer".

Write for catalog of Addmaster computer peripherals.



416 Junipero Serra Drive
San Gabriel, California 91776
Telephone (213) 285-1121

POWER SOURCES

Voltage reference is stable and accurate



General Resistance, Inc., 500 Number Ave., Mount Vernon, N.Y. 10550. (914) 699-8010.

Model DAV-46G voltage reference has an accuracy of $\pm 0.0015\%$. Output voltages of either polarity are "dialed" via a six digit in-line front panel thumbwheel switch assembly over a range of 0 to 10 V dc with a stability of ± 5 ppm/8 hrs, (± 15 ppm/yr) and resolution of 1 ppm. Model DAV-46G is available (optional) with a matched output attenuator, Model NAV-453. This provides output attenuation of $10^4:1$ with a ratio accuracy of $\pm 0.01\%$ of output at 25 C. The optional attenuator provides output increments of 0.1 nV per step while the basic instrument provides for 1 μ V per step. The voltage divider section may be used independently of the internal voltage source as a high accuracy divider with a terminal linearity of $\pm 0.003\%$. The standard unit is a bench model with case dimensions of 6 x 6-7/16 x 7 in.

CIRCLE NO. 291

Alkaline battery pack gets ultra-thin shape

P. R. Mallory & Co., 3029 E. Washington St., Indianapolis, Ind. 46206. (317) 636-5353. \$1.95.

The Flat-pak 6 V battery, Model 7K67, is composed of four alkaline cells in a package only 1-7/8 x 1-3/8 x 1/3 in. The unit is intended for shirt-pocket-sized electronic calculators and other electronic gear.

CIRCLE NO. 292

Dc supply has built-in batteries for hold-up

Power Supplies Inc., P.O. Box 579, Wallingford, Conn. 06492. (203) 265-5661.

Uninterruptable dc power supplies are available in voltages to 30 V and currents up to 25 A. Model 360U2-5 is rated at 5 V dc and 5 A. The unit will supply full output power for 30 min. after power interruption. The internal battery is charged to manufacturers recommended float voltage when ac power is on. Other hold-up times, voltages and current ratings are available.

CIRCLE NO. 293

High voltage supply made for spectral lamps



The Ealing Corp., Optics Div., 2225 Massachusetts Ave., Cambridge, Mass. 02140. (617) 491-5870. \$225.

The high voltage universal power supply can operate both Osram and Philips spectral lamps. The supply combines the 500 V starting potential required to strike Philips lamps with precise 0.9 to 1.5 A current adjustment necessary for optimal performance with Osram lamps. A direct reading ammeter on the front panel permits the operator to set the lamp current to within 0.01 A. Current is controlled by a coarse and fine adjustment knob. Also on the front panel are a push-to-start switch for striking Philips lamps; an on/off switch; an "on" indicator light; and two, 4 mm binding posts. A three wire grounding type receptacle is located on the back panel. The power supply measures 9.25 x 5 x 8 in. and weighs 20 lb. It operates direct from either a 115 V ac, 60 Hz or a 230 V ac, 50 Hz supply. Power consumption is 90 W.

CIRCLE NO. 294

SALON INTERNATIONAL DES

composants électroniques

PARIS 1-6 / 4 / 74

COMPONENTS
MEASURING
MATERIALS
EQUIPMENT



Organisation S D S A - 14, rue de Presles 75740 Paris Cedex 15

FRENCH TRADE SHOWS
1350 Avenue of The Americas NEW YORK, N.Y. 10019
Tel.: (212) 582.4960.1

INFORMATION RETRIEVAL NUMBER 113

now available

from your Bodine distributor

He'll give you off-the-shelf service on our new 42R A-C motors and gearmotors.

From 1/12 through 1/4 hp ■
High output-to-size and weight
■ Totally enclosed, fan cooled (TEFC) ■ NEMA 42 frame configuration ■ Ball bearings standard ■ Available in split-phase, permanent split capacitor and three-phase designs ■ Gearmotor torques to 342 lb.-in. ■ High overhung load capacity.



BODINE
ELECTRIC
COMPANY

Call your nearby Bodine distributor.

Bodine Electric Co., 2528 West Bradley Pl., Chicago, Ill. 60618
INFORMATION RETRIEVAL NUMBER 114

DC to AC Sine Wave Inverters



SPECIFICATIONS

Output Voltage Regulation:

less than $\pm 5\%$ for line and load

Frequency Stability:

$\pm 0.5\%$ of fixed frequency; 0.05% optional

Total Harmonic Distortion:

less than 5% at full load and nominal line

GW Series — Typical 60 Hz Models				
Power (VA)	Input (VDC)	Output (VAC)	Priced from	Delivery
250	12/24, 28, 48, 125	115, 230	\$ 695	Stock
500	12/24, 28, 48, 125	115, 230	1195	Stock
1000	12/24, 28, 48, 125	115, 230	1700	Stock
2000	12/24, 28	115, 230	3000	3 days
3000	12/24, 28	115, 230	4400	3 days

(150 and 400 Hz models available)

TOPAZ

ELECTRONICS

SOLUTIONS TO
POWER PROBLEMS

3855 Ruffin Road, San Diego, CA 92123 Phone (714) 279-0831

INFORMATION RETRIEVAL NUMBER 115

ELECTRONIC DESIGN 4, February 15, 1974

MICROTEMP Time Delay MultiProtector

Actual Size

MICROTEMP Thermal Cutoff senses excessive ambient temperature and interrupts circuit.

Wirewound resistor senses sustained excessive current creating temperature increase to trigger MICROTEMP.

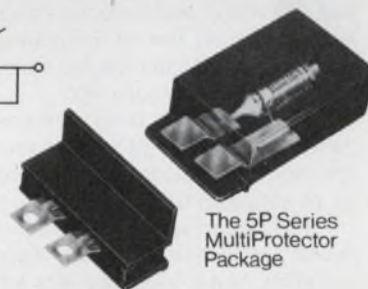
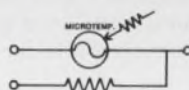

The 5P Series
MultiProtector
Package

The wide selection of MICROTEMP temperature ratings and resistor values provide an infinite selection of time delay factors. Small overload surges are ignored by the MultiProtector. Available in convenient terminations or packages for installation ease, MICROTEMP Time Delay Multi-Protectors are custom designed to fulfill your specific current and/or thermal overload condition. For illustrated brochure and details regarding your application, call or write:



MICRO DEVICES CORP.
1881 Southtown Blvd., Dayton, Ohio 45439
Ph. (513) 294-0581 Telex 28-8087

INFORMATION RETRIEVAL NUMBER 116

Pressure-sensitive tape comes in NEMA colors

Zippertubing Co., 13000 S. Broadway, Los Angeles, Calif. 90061. (213) 321-3901.

Previously available only with alphabetical and numerical symbols

on a white background, large cartridges of ZipTape over 1000-in. long can now be obtained in all NEMA-code colors. The tape is plasticised and pressure sensitive for instant use. ZipTape comes in quick dispensing cartridges with a built-in spooling device. The Model ZTLB bench dispenser features a Saf-T-Gard quick cut-off blade and it has a capacity of 10 cartridges with all colors readily visible.

CIRCLE NO. 295

Masking tape withstands 375 F for one hour



3M Company, P.O. Box 33600, St. Paul, Minn. 55133. (612) 733-5755.

A new, improved, high-temperature crepe masking tape, Scotch No. 214, will withstand bake cycles to 375 F for one hour. Its backing is treated with a very-high heat and stain-resistant polymer, and it is thicker than normal for easier handling and removability. The adhesive will not stain most surfaces. The tape does not contain sulfur. It therefore can be used for short periods on copper and silver-plated surfaces.

CIRCLE NO. 296

OUR ANGLE: More Synchro Conversion For Less Cost



with our
S/D and
D/S modules

How does a choice of 14-bit resolution (greater for 2-speed S/D), 60 or 400 Hz data frequency, high accuracy, 11.8V to 90V line-line voltages and all kinds of self-protection circuitry — look from your angle? Not to mention that as few as 5 modules make up a complete S/D or D/S converter, or that all modules are replaceable one-for-one without trimming! And, economically too!

New 2-speed S/D sets are now available with accuracies typically better than 20 seconds from all error sources including resolution. D/S specifications include 4 minute accuracy, 1.25 VA output with optional 20 VA output for torque receiver applications.

Key performance specifications for both converters include 14-bit (0.022°) resolution over 360°, 4000°/sec analog data rates and 0-70°C operation. Some units available for operation from -55°C to +105°C. All units are DTL and TTL compatible.

Prices start at \$650.00 for a set of modules. Delivery from stock. Call toll-free (800) 645-9200 for the name and address of your local sales engineering representative.



NORTH ATLANTIC industries, inc.

200 Terminal Drive, Plainview, New York 11803 • Phone (516) 681-8600
California District Office: 13418 Wyandotte Street, N. Hollywood, CA 91605 • Phone (213) 982-0442

All-purpose drafting tool speeds layout work

Design Instrument Manufacturing Co., 10431 Brookhurst St., Anaheim, Calif. 92804. (714) 533-6451. \$12.50 (unit qty).

Multidraft is a compact instrument that can replace standard drafting tools such as triangles, straight edges, T-squares, protractors and even the drafting board. With it you can draw precise parallel, angular and radical (for perspectives) lines with perfect control, on any flat surface, and when held in a vertical or horizontal position. There is a push-bar for parallel and a pushbutton for angular or circular movements. To switch from angular to parallel travel movement, a magnetic clutch disengages the roller-assembly. One-hand operation is easy, and it makes no difference if you are left or right-handed.

CIRCLE NO. 297

at prices from \$50
Hipotronics offers you
delivery from stock
on over 800 standard
models of

hv dc power supplies

... with output voltages
from 1 to 1000 KV and
current outputs from
2 ma to 50 amperes.



model 860-6.5
60 KV, 6.5 ma.

ALSO:

■ **Custom design units:** for wide range of applications — electrostatics, accelerators, lasers, monocylic charging, high power radars, high voltage testing, and more.

■ **HV power packs:** wide range of compact, miniaturized power packs, with output voltages from 2.5 to 100 KV and current ratings of 2 to 10 ma. Also, standard 5-ma and 2-ma HV power packs with simplified controls.



model R-30B

Send for our 24-page catalog, "High Voltage DC Power Supplies and Components," or call our Sales Department and ask for the Power Supplies Manager.

HIPOTRONICS
HIPOTRONICS, INC.
Brewster, N. Y. 10509 / (914) 279-8091
TWX: 710-574-2420

Hot-air attachment fits soldering iron



Edsyn Inc., 15958 Arminia St.,
Van Nuys, Calif. 91406. (213)
989-2324.

With a hot-air-tip attachment, Part No. HA120 for Edsyn's Loner soldering instrument, it is now possible to make hot air (up to 400 F) for shrinking tubing, troubleshooting and drying and still do routine soldering. The operator merely blows into a mouthpiece or connects the blow tube into the shop air supply and directs the instrument at the desired work area.

CIRCLE NO. 298

Ferrite beads provide precise performance



Indiana General, Electronic Products, Crows Mill Rd., Keasbey, N.J. 08832. (201) 826-5100.

Attenuator-rated Ferramic beads provide excellent suppression from 10 kHz to 10 MHz and high attenuation from 10 to 250 MHz. They have precise characteristics that allow design engineers to select the exact bead needed, and Indiana General guarantees their performance. The beads are available in two series—AR-9100 and AR-9700—and each has nine versions with different dimensions. For example, the AR-9703 has an OD of 0.260 in., an ID of 0.080 ±0.005 in. and a height of 0.160 in. With zero amp-turns, the AR-9703's attenuation is 28 dB at 100 MHz and 6.5 dB at 50 kHz, minimum.

CIRCLE NO. 299

WIDE BAND RF TRANSFORMERS

Great Value at

\$2⁹⁵
10 piece quantities

Some Models \$3.45

0.1 - 500 MHz
50 Ohm impedance
1:1 to 16:1
impedance ratio
micro-miniature case



A breakthrough in technology and high production volume enables Mini-Circuits Laboratory to offer these new products at an unprecedented low price.

Ruggedness and durability are built in the T-series transformers. These new units are packaged within a 1/3 D.I.P. package. They use uniquely designed transmission line transformers for extra wide bandwidth.

Impedance ratios of standard models are 1:1, 2:1, 4:1, 9:1 and 16:1. MCL kit TK-1 includes 2 units of each type and sells for \$32.

We invite you to convince yourself. Place your order now and check our delivery, product performance and reliability.

Mini-Circuits Laboratory

2913 Quentin Rd., Brooklyn, N.Y. 11229
(212) 252-5252, Int'l Telex 620156
A Division Scientific Components Corp.

*FRANCE: S.C.I.E., *31, rue, George-Sand, Palaiseau 91, France. *GERMANY, AUSTRIA, SWITZERLAND: Industrial Electronics GMBH, *Klüberstrasse 14, 6000 Frankfurt/Main, Germany. ENGLAND: Dale Electronics, Dale House, Wharf Road, Frimley Green, Camberley Surrey. JAPAN: Denso Kaisha Ltd., Eguchi Building, 8-1 1-Chrome, Hamamatsucho, Minato-Ku, Tokyo. *ISRAEL: Hamashbir Electronics, 76 Giborei Israel St., Tel-Aviv, Israel

*UNIT IN STOCK

INFORMATION RETRIEVAL NUMBER 119

Solder flux works well with wave-solderers

London Chemical Co., Inc., Dept. EI-2, 240 Foster Ave., Bensenville, Ill. 60106. (312) 766-5902.

A newly developed RA type flux offers greater soldering capabilities than military R and RMA fluxes, according to London Chemical. Known as Lonco Resin Flux

#106-A, its wetting ability and solder-flow characteristics are especially suitable for single-sided or through-hole solder-plated circuits. The corrosion potential is 60,000 Ω /cm as measured per MIL-F-14256-C. The flux can be completely removed with either a mild organic solvent or a water-wash detergent without leaving white residues. It can be applied with foam or wave fluxers or by spraying, dipping or brushing.

CIRCLE NO. 300

DIP CMOS handling tools ground static

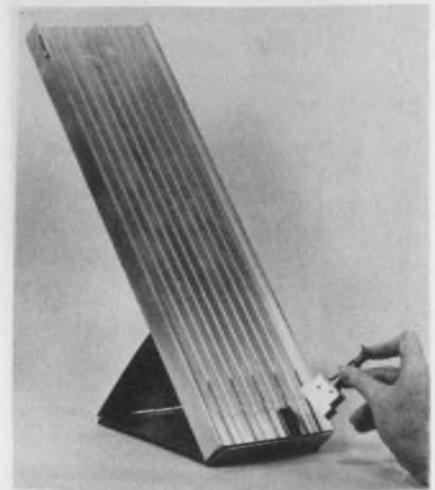

Micro Electronic Systems, Inc., 8 Kevin Dr., Danbury, Conn. 06810. (203) 746-2525. \$87 (unit qty); stock.

DIP handling tools and accessories, which include the Dip-a-Dip insertion tool and the Pic-a-Dip dispenser, can be grounded together with a flexible cable to prevent static-electric problems in CMOS devices. The Pic-a-Dip is a 10-channel, 0.3-in. dispenser that becomes a 5-channel, 0.6-in. DIP dispenser by simply turning it over. Thus, most CMOS devices can be accommodated with the same universal dispenser. The dispenser is made of aluminum, which is not anodized for better electrical conductivity. The insertion tool has nickel-plated steel side plates and shorts all of the DIP leads together.

CIRCLE NO. 301

Dielectric is mixed to control capacitor TC

DuPont Co., Public Affairs Dept., Wilmington, Del. 19898. (302) 774-2358. \$24 per troy oz. (1000 oz. up).

Designated dielectric composition 9427 (NP0) and 9428 (N150), these new members of a thick-film, temperature-compensating, dielectric series are fireable at 850 C. The blending of these two new formulations can yield almost any positive or negative capacitance temperature coefficient. They can provide capacitors with TCs that can compensate for changes in other circuit elements.

CIRCLE NO. 302

a NEW approach to ferroresonant transformer design

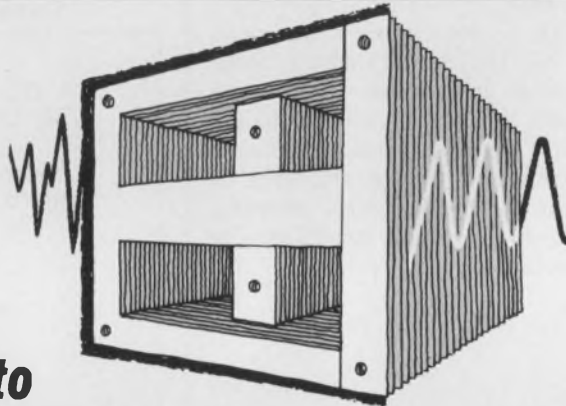

The Magnetic Metals FR series of laminations was developed to take into consideration the total transformer construction . . . optimizing performance, while minimizing space requirements and manufacturing cost.

This new series of EI shapes provides the utmost in versatility and the most effective utilization of grain-oriented materials.

The FR laminations are designed to:

- provide a smooth overlapping transition from high to low transformer output ratings without excessively large stacks
- lower winding time and copper costs
- reduce mean-length of turn through long windows which minimize coil build-up
- allow ferroresonant transformers of different ratings to have a family resemblance because of the similarity of lamination proportions . . . thus eliminating the problems of changing form-factors, winding proportions, and other relationships encountered with conventional laminations.

The exclusive Magnetic Metals 33B grade of grain-oriented silicon steel provides relatively low losses and high permeability, especially in the saturated region. These improved properties enhance performance and provide greater freedom of design.



For more information on Ferroresonant Transformer Laminations, materials and shunts for FR series . . . contact your local Magnetic Metals Representative or write for our new catalog to:

MAGNETIC METALS

Hayes Avenue at 22nd Street, Camden, N. J. 08101 • (609) 964-7842

Cambion's® new *what's what* in the world of fixed and variable standard inductors.

For new designs incorporating inductors, CAMBION's Catalog 501 has all the answers. This new free catalog of fixed and variable inductors includes coils, chokes, PLUS baluns, miniature RF and IF transformers, micro-miniature inductors, LC filters and a host of configurations, values and mounting methods. All products are readily available and have known operating characteristics so design and production engineers can plan circuits and systems with complete confidence. For your free CAMBION Catalog 501 write: Cambridge Thermionic Corporation, 445 Concord Avenue, Cambridge, Massachusetts 02138. Phone: (617) 491-5400. In Los Angeles, 8703 La Tijera Blvd. Phone: (213) 776-0472.



Standardize on

CAMBION
The Guaranteed Electronic Components

INFORMATION RETRIEVAL NUMBER 121

UNICORP

The one source you'll ever need for **INSULATING WASHERS** Precision Machined Shoulder Insulating Washers • Flat Insulating Washers

NYLON—TEFLON—GLASS FILLED LEXAN—PHENOLIC

New! Illustrated guide to Insulating Washers. Write or phone today for Catalog No. H-4S!

ONE SOURCE — TOTAL ELECTRONIC HARDWARE CAPABILITY

Manufactured in strict accordance with quality requirements of MIL-STD-105A *Off-the-Shell Delivery!*

And check our Prices!



UNICORP UNICORP

585 Nassau Street, Orange, New Jersey 07050
(201) 674-1700

INFORMATION RETRIEVAL NUMBER 122

ELECTRONIC DESIGN 4, February 15, 1974

You'd probably expect a portable oscilloscope as rugged and reliable as this one to cost a lot.

You'd be wrong.

Introducing the B&K Model 1403 3" Solid-state oscilloscope. It's so compact, reliable, and inexpensive that it's the perfect scope for most on-the-line monitoring applications. Look at its specs: DC to 2MHz bandwidth at 20mV/cm. Recurrent sweep speeds from 10Hz to 100KHz. New wide-angle CRT to reduce case depth to a minimum. Direct-deflection terminals for waveforms up to 150 MHz. Weighs only 8½ pounds. And has a smoked acrylic graticule for trace sharpness and easy reading. All the reliability and accuracy you need in a monitor scope — at a surprisingly low price.

Contact your distributor, or write Dynascan Corporation.

\$180⁰⁰



B&K Very good equipment at a very good price.

Dynascan Corporation
1801 West Belle Plaine Avenue, Chicago, Illinois 60613

INFORMATION RETRIEVAL NUMBER 123

Here's everything you'd expect from a high-priced portable VOM.

Except a high price.

The B&K Model 120P VOM gives you more accuracy, reliability, and versatility than any other battery-powered portable VOM. Resettable overload protection. 20,000 ohms/volt sensitivity on DC with 2% accuracy. 35 ranges, including DC volts and current with 0.25 volt and 50 μ A low-range scales; AC RMS volts, output volts, and decibels; and ohms. Precision taut-band self-shielding annular meter movement. Easy-access battery and fuse compartment. Plus many other features you'd expect to pay much more for. Contact your distributor or write Dynascan Corporation.

\$90⁰⁰



B&K Very good equipment at a very good price.

Dynascan Corporation
1801 West Belle Plaine Avenue, Chicago, Illinois 60613

INFORMATION RETRIEVAL NUMBER 124

159

SHOPPING FOR SHELLS? We've Got Them! Over 2,000 for

- D/A CONVERTERS
- RESISTOR NETWORKS
- SEMI-CONDUCTORS
- THIN FILM MODULES
- DISCRETE MODULES
- TRANSFORMERS
- CAPACITORS
- POWER SUPPLIES
- DELAY LINES
- OP AMPS, ETC.



We offer the broadest selection of standard encapsulation shells and headers in the World, and are constantly developing new shells to satisfy your specific requirements. Four styles are available: Round, Square, Oblong and Module. Shells are precision molded of black flame-proof glass-fibre filled Diallyl Phthalate, conforming to MIL-M-14, type SDG-F. **SEND FOR FREE CATALOG!**
NO CUSTOMER TOO SMALL OR TOO LARGE!



ROBISON ELECTRONICS, INC.

3580 Sacramento Drive, San Luis Obispo, California 93401
Telephone (805) 544-8000

INFORMATION RETRIEVAL NUMBER 125

DOUBLE BALANCED



MIXER

MODEL MD-525-4

- 5 MHz-4 GHz Frequency Range
- +17dBm Input Intercept
- Usable as a Spectrum Analyzer
- 9dB Conversion Loss

anzac
ELECTRONICS



39 Green Street, Waltham, Mass.
(617) 899-1900 • TWX 710-324-6484

INFORMATION RETRIEVAL NUMBER 126

application notes

Outlook of PC-board market

The 136-page Future Outlook for the Manufacturing and Marketing of Printed-Circuit Boards includes not only papers presented at the annual meeting seminar but comments and observations by panel members. Over 40 illustrations, tables and graphs are included. The cost of the proceedings is \$5. Institute of Printed Circuits, 1717 Howard St., Evanston, Ill. 60202.

INQUIRE DIRECT

Power switching

"Power Switching Using Solid-State Relay," a six-page brochure, describes the triac as a power switching element. Basic parameters, such as surge in-rush capability, transient-voltage ratings, suppression network, turn-off consideration and the various modes of triac gating are discussed. RCA, Somerville, N.J.

CIRCLE NO. 303

Flame spray coatings

A practical, easy-to-use 12-page guide to selecting flame sprayed coatings describes over 150 metallic and ceramic coatings and the functions they serve. Metco, Westbury, N.Y.

CIRCLE NO. 304

Tank weighing system

An application note describes the principle components of the company's electronic tank weighing system, with sketches and photographs illustrating the actual load cell installation. Transducers, Whittier, Calif.

CIRCLE NO. 305

Ferrites

Complete data for selection of Attenuator-Rated Ferramic components appear in a 16-page design guide. The brochure includes typical attenuation and impedance curves, application data and specifications. Indiana General, Keasby, N.J.

CIRCLE NO. 306

The pollution problem.

Maybe your engineers deserve a little help.

The engineers will be the ones to find the technical solutions to pollution problems. There's no doubt about it.

But pollution is a people problem, too. And the engineers' technological approach to pollution isn't going to solve people problems.

Maybe this booklet can help. It lists some of the things all people can do to fight pollution. And with all the people supporting your engineers we'll have a better chance of winning the fight.

For a free copy or a list of bulk rates write to Keep America Beautiful, Inc., Box 1771, Radio City Station, New York, New York 10020.

Keep America Beautiful

Advertising contributed for the public good

Zero is a large number



of aluminum carrying cases.

5 lines of aluminum carrying cases . . . each in a variety of sizes. Light-weight, economical, handsome appearance & rugged protection for electronic, electromechanical or instrumental equipment. Available in 2 weeks from stock.



Write for Catalog FV. It's FREE.

Zero Manufacturing Co.

777 FRONT STREET • BURBANK, CALIFORNIA 91503
 Design and Manufacturing | ZERO-WEST • BURBANK, CALIFORNIA
 Manufacturing | ZERO-EAST • MONSON, MASSACHUSETTS
 Facilities | ZERO-SOUTH • ST. PETERSBURG, FLORIDA



INFORMATION RETRIEVAL NUMBER 127

METAL CARD GUIDES

FOR GROUNDING or SHIELDING

FOR HEAT DISSIPATION

Positive grip of boards with 3/4 hard phosphor bronze or beryllium copper spring fingers effectively solves problems of grounding p.c. boards directly through the card guide and into the surrounding chassis. This not only affords grounding but shielding as well. For "hot boards" the metal card guide acts as a heat transfer to dissipate heat from the board into the chassis.



Metal Versamount for isolated boards on chassis. Card guide rivets to Versamount.

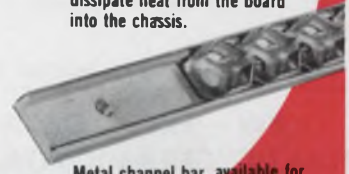

Metal channel bar, available for spanning open areas with metal card guide.

UNITRACKTM

UNITRACK Division, Calabro Plastics, Inc.
 8738 West Chester Pike, Upper Darby, Pa. 19082
 Telephone (215) 789-3820

INFORMATION RETRIEVAL NUMBER 128

who cares what a control knob looks like?

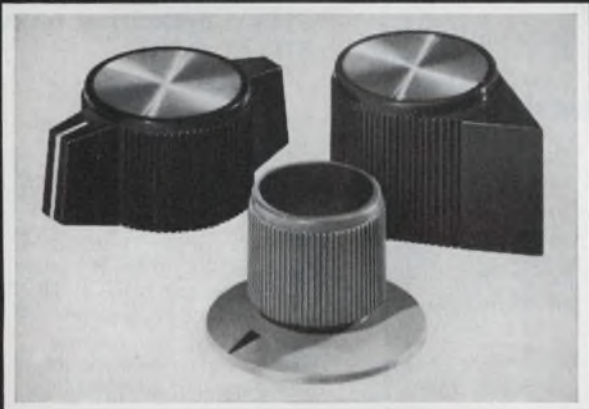

we do.

ROGAN

Outline your requirements for quotation and free knob sample. Also write for free, full-color catalog.

3455 WOODHEAD DR., NORTHBROOK, ILL. 60062, (312) 498-2300

INFORMATION RETRIEVAL NUMBER 129

ELECTRONIC DESIGN 4, February 15, 1974

The active designer's active filter

For all audio signal conditioning—modems, Tone encoders/decoders—our μ AR 2000 is ready, able, and available to do oscillator, timer or active filter jobs in your system. High pass, low pass, band pass or notch filtering. Can even oscillate and filter *at the same time*.

Price? \$12.85 (100-999). Comes packaged in a 16-pin double-width DIP. Available now.

Ask us for the data sheet and we'll also tell you why we call the μ AR 2000 an Active Resonator.



1215 Terra Bella Avenue
 Mountain View, CA 94043
 (415) 965-3900

THE
HYBRID
 PROFESSIONALS

INFORMATION RETRIEVAL NUMBER 130

SPECIFIER'S GUIDE TO INDUSTRIAL ADHESIVES



New ECCOBOND® booklet and fold-out wall chart gives specifications and use criteria for a broad line of industrial/electrical adhesives, epoxies and others. Send for FREE copy.

INFORMATION RETRIEVAL NUMBER 241

NEW -- FREE -- DATA PLASTIC/CERAMIC FOAMS



ECCOFOAM® is the broadest line of plastic and ceramic foams for electronics. Foam-in-place; sheet stock; pourable syntactic; artificial dielectrics all described and properties tabulated in new booklet. Send for copy.

INFORMATION RETRIEVAL NUMBER 242

NEW BOOKLET DESCRIBES SURFACE COATINGS FOR ELECTRONICS



ECCOCOAT® Surface Coatings include transparents for PC boards and components; dip-coats for transformers and coils; easy-mix and one-part systems for automatic production; and a wide range of special properties such as 500°F capability; resistivities to 10¹⁴ ohms/sq. Several chemical types. Send for copy.

INFORMATION RETRIEVAL NUMBER 243

Emerson & Cuming, Inc.



CANTON, MASS.
GARDENA, CALIF.
NORTHBROOK, ILL.
Sales Offices
in Principal Cities

EMERSON & CUMING EUROPE N.V., Oevel, Belgium

new literature



Heathkit catalog

A large selection of electronic kits can be found in a catalog. Included are color TVs, 12-in. to 25-in. models, amateur radio equipment, automotive test equipment, pocket calculators, security systems, etc. Heath, Benton Harbor, Mich.

CIRCLE NO. 307

Printer/plotters

Matrix electrostatic plotters and printer/plotters are featured in a 12-page bulletin. Several plot samples are reproduced and a discussion of the Matrix electrostatic wiring technique is included. Versatec, Cupertino, Calif.

CIRCLE NO. 308

Ion implantation service

Ion implantation service for industrial, university and government research laboratories is described in a bulletin. Available systems are illustrated and listings of available ions, beam currents and energy ranges are included. KSW Electronics, Burlington, Mass.

CIRCLE NO. 309

Thermocouples

The AerOpak line of metallic-sheathed, ceramic-insulated thermocouples are highlighted in a six-page bulletin. ARi Industries, Franklin Park, Ill.

CIRCLE NO. 310

design guide to better Prototyping and Packaging



16 pages of design ideas and a catalog of high-quality, nickel-plated aluminum boxes, connectors and hardware to spark your prototyping imagination and cut production packaging costs.

WRITE FOR YOUR FREE COPIES

MODPAK™ Features:

- RF Shielding
- 1/8"-thick Nickel-plated Aluminum
- Choice of Connectors
- Easy Access to P.C. Boards - Top and Bottom
- Sizes from 2 to 40 Cubic Inches
- Prices Start at \$9.75
- Immediate Availability

SPECIAL INTRODUCTORY KIT AT \$99



Includes eight boxes, 20 connectors (including BNC, TNC, SMA and type N), a dozen extra mix and match connectors, and 8 feedthroughs. Everything you need to build prototypes that look like production hardware. Your finished product costs will be significantly reduced with MODPAK™ enclosures.

31A Green St. Waltham, Mass. 02154

Semi data handbook

A 1484-page Semiconductor Data Handbook consists of three sections—index and interchangeability guide, product selector guides and product specification sheets. The handbook lists suggested replacements for 1N, 2N, 3N, 4N and industry house numbers. The handbook costs \$4.95 plus tax. General Electric Semiconductor Products Dept., Electronics Park, Bldg. No. 7, Mail Drop 49, Syracuse, N.Y. 13201.

INQUIRE DIRECT

Mating flanges

A data sheet describes mating flanges for 2, 4 and 6-in. diffusion pumps and matching components. Varian, Palo Alto, Calif.

CIRCLE NO. 320

A/d and d/a converters

An eight-page short-form catalog describes 50 different data-conversion products. The product listing contains electrical and mechanical specifications for d/a and a/d converters and multiplying d/a converters. Micro Networks, Worcester, Mass.

CIRCLE NO. 321

Ammeters and ohmmeters

Clamp-on volt/ammeters and volt/amp/ohmmeters are illustrated in a brochure. Amprobe Instrument, Lynbrook, N.Y.

CIRCLE NO. 322

Memory systems

The SENTINEL memory series, offering the OEM user a high-quality, low-cost, modular core memory system, is described in a six-page catalog. Lockheed Electronics, Los Angeles, Calif.

CIRCLE NO. 323

IC industry report

The sixth annual report on the integrated circuit industry, "Status 74," includes data on applications and market needs, supplier positions, profit and loss equation and technology. The price of the report is \$75. Integrated Circuit Engineering Corp., 6710 E. Camelback Rd., Suite 211, Scottsdale, Ariz. 85251.

INQUIRE DIRECT

Proximity systems

A 20-page handbook defines the multiple-input Versa-Prox proximity system. The handbook covers plug-in modular systems and includes data on signal-conditioning, signal-processing and control outputs. Specifications and descriptions are included for the systems control amplifier, the amplifier's five plug-in sockets and the 21 standard plug-in function modules. Electro Corp., Sarasota, Fla.

CIRCLE NO. 324

Components

A 452-page catalog presents data and pricing on an array of semiconductors, tubes, controls, capacitors, transformers, fuses and batteries, relays, switches, miniature lamps, connectors, wire and cable, hardware and tools, racks and cabinets, test instruments, antennas, sound equipment and books. The catalog is indexed by both manufacturer and product. RS Electronics, Detroit, Mich.

CIRCLE NO. 325

INTRODUCING THE UGLIES.™

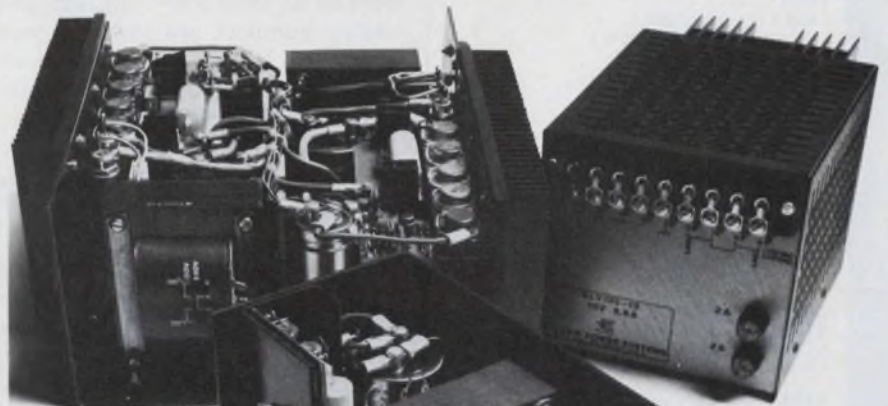

Okay, so they're not pretty. But that's only because we spent our time designing our OEM dc supplies, instead of styling them. And now we've got a complete family of dc power supplies that solve 90% of your computer, peripheral and instrumentation applications just as they come off the shelf:

With a choice of 16 voltages from 4-28V, adjustable $\pm 5\%$. Currents to 50 A, rated to $+55^\circ\text{C}$. $\pm 0.1\%$ regulation, ripple-and-noise. Remote sensing/programming, spike suppression and foldback current limiting. And 120/240 V, 50/60 Hz inputs.

All standard features for as little as 68¢/W (1-9 qty). Now what could be prettier than that?

For more info, use the bingo card or call 714/979-4440. Or call your local Cramer or Newark distributor and get Ugly today.

Elexon Power Systems

Copyright 1974 Elpac, Inc. EL PAC

INFORMATION RETRIEVAL NUMBER 133

CIRCUIT-STIK introduces

GP BOARDS

**GENERAL PURPOSE
CIRCUIT BOARDS**
Plug-in & Chassis Mounting
and **ELECTRONIC
PACKAGING MATERIALS**

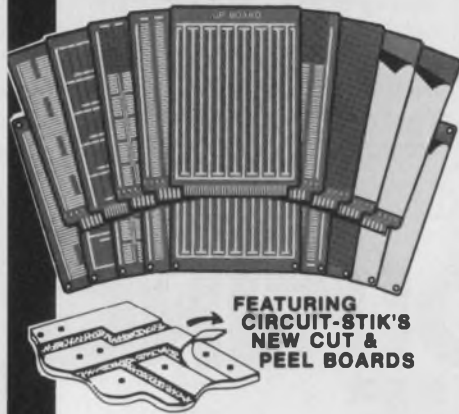

**FEATURING
CIRCUIT-STIK'S
NEW CUT &
PEEL BOARDS**

GP CIRCUIT BOARDS

HIGH QUALITY

- FR-4 Blue Epoxy Glass
- Computer "DRILLED", High Accuracy Holes (not punched)
- Mil-Spec Plating
- Precision Routed Edges

VERSATILITY

- Mix All Types of DIP Sockets (8 to 40 Leads)
- Low, Medium and High Profile Interconnections
- Hybrid Designs for Mixing Discretes and Sockets
- Designed for Edge Connector "Plug-In" or Chassis Mounting
- RFI Shielding

HIGHEST DENSITY

- Up to 50 DIP's on one 4 1/2" x 6 1/2" Plug-In Card
- Plus Space for 50 Decoupling Capacitors

COMPLETENESS of STANDARD DESIGNS

- Choose from 74 Off-the-Shelf Boards
- 4 Sizes of Boards available

APPEARANCE

- Beautiful Gold, Blue and Bright Tin

FULL LINE of ACCESSORIES (HIGH QUANTITY PRICING AVAILABLE)

- Sockets - Low and Standard Profile, P.C. and Wire Wrap - Molded Nylon and Highest Quality Gold Contacts
- Adapterplugs
- Connectors
- Card Pull Handles

EPOXY GLASS BOARD MATERIALS

- 76 Standard off-the-Shelf Boards
- Including Unclad, Copper Clad, Cut & Peel Copper Clad, Pre-etched "X-Y" Pattern and Plated thru Hole Copper Clad
- .100" Grid Hole Pattern or Undrilled

SEND FOR YOUR FREE CATALOG



P.O. BOX 3396
Torrance, California 90510
Phone (213) 530-5530

NEW LITERATURE



Silicon-bridge rectifiers

A colorful 12-page cross-index reference guide covers silicon-bridge rectifiers ranging in current from 1 to 25 A and in voltage from 50 to 1000 PRV. Ratings and catalog numbers are given as well as outline drawings of the company's bridges and those of 10 other manufacturers. General Instrument, Hicksville, N.Y.

CIRCLE NO. 326

Bus bars

A 48-page "Omny-Bus" catalog highlights bus bars. Eight sections of the catalog contain descriptions, specifications, dimensional drawings and application information. There is also a section on custom-design bus bars. Methode Manufacturing Corp., Rolling Meadows, Ill.

CIRCLE NO. 327

Relays

A 36-page, two-color catalog describes over 1060 stock relays for custom applications. Photos, dimensional drawings, specifications, prices and ordering information are included. Magnecraft, Chicago, Ill.

CIRCLE NO. 328

Hermetically-sealed products

A four-page brochure lists the company's line of hermetically sealed products. Hermaseal, Elkhart, Ind.

CIRCLE NO. 329

DIT-MCO THE DIFFERENCE IN TESTING!

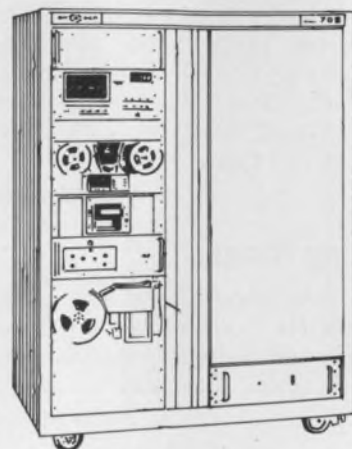

DIT-MCO's 700 SERIES

Random Access Analyzers To Give You The Test Speed And Reliability You Want At The Price You Want To Pay!

For a random access analyzer that really meets the test, look to the leader—DIT-MCO Dependable Economical. Fast Accurate. Whether you require basic test or sophisticated systems capabilities, DIT-MCO gives you more features, dollar for dollar, than competitive units.

701

WQB bar relay switching... up to 1,000 TPM. Insulation test voltage up to 500 VDC.

702

WQB bar relay switching... up to 1,200 TPM. Insulation test voltage up to 1,500 VDC.

703

Reed switching. Solid state drive. Continuity test up to 3,500 TPM. Insulation test voltage up to 500 VDC.

704

Reed switching. Solid state drive... up to 3,500 TPM. Insulation test voltage up to 1,500 VDC.

Show Us A Problem, And We'll Put It To The Test!

Our brochure lists standard features and options



DIT-MCO: The difference in testing.

DIT-MCO INTERNATIONAL
A division of Xebec Corporation
5612 Brighton Terrace • K.C., Mo. 64130
Telephone (816) 363-6288
Telex Number 42-6149

European Technical Representative
RADIX HOUSE
Central Trading Estate
Staines, Middlesex, TW18-4-XA, England
Telephone (0784) 51444
Telex 935023

INFORMATION RETRIEVAL NUMBER 135
ELECTRONIC DESIGN 4, February 15, 1974

PTC thermistors

A specification sheet covers positive-temperature-coefficient thermistors. The two-color bulletin includes dimensional drawings, temperature and resistance curves, electrical specifications and application notes. Victory Engineering, Springfield, N.J.

CIRCLE NO. 330

Tekscope

The Nov./Dec., 1973, issue of *Tekscope* contains information on a new way to look at transients, a fast a/d plug-in for the oscilloscope, digitizing and displaying fast pulses and a *Tekscope* 1972-73 index. Tektronix, Beaverton, Ore.

CIRCLE NO. 331

Dual FETs and transistors

A 32-page summary contains specifications, prices and applications of 10 different families of dual monolithic bipolar and field-effect transistors. Analog Devices, Norwood, Mass.

CIRCLE NO. 332

Time-delay relays

A data bulletin includes diagrams of the timing operation and circuit along with operating characteristics and specifications of the Model 44 solid-state time-delay relay. Ordering information and module dimensions are included. Struthers-Dunn, Pitman, N.J.

CIRCLE NO. 333

IEEE standards catalog

A 32-page Standards 1974 Catalog lists more than 350 standards publications by subject as well as in numerical sequence. Included are many of the American National Standards published by IEEE. IEEE Standards Dept., New York, N.Y.

CIRCLE NO. 334

IC tester

A 70-page price list and program card catalog covers the J133C analogical circuit test instrument. The catalog lists the family cards and device cards needed to test current digital ICs, including 54LS/74LS, CD4000A and MC-14000-series devices. Teradyne, Boston, Mass.

CIRCLE NO. 335

Instructional video tapes

Approximately 150 instructional video tapes are described in a catalog. The tapes provide training in eight major categories, tutorial, electronic instruments, calculators, data products, medical, analytical, lasers and video products. In addition, a special 15-tape practical transistor course is offered. Tapes can be ordered on cassette or reel-to-reel video formats. Hewlett-Packard, Palo Alto, Calif.

CIRCLE NO. 336

Pollution control

A monograph entitled "Pollution Control Through Computer Simulation Models" describes how the use of computer simulation models makes it possible for highly accurate predictions which indicate the maximum impact on air and water quality during worst-case conditions. The 21-page paper includes 10 figures depicting pollution concentrations. Systems, Science and Software, La Jolla, Calif.

CIRCLE NO. 337

PLUG UGLY.™

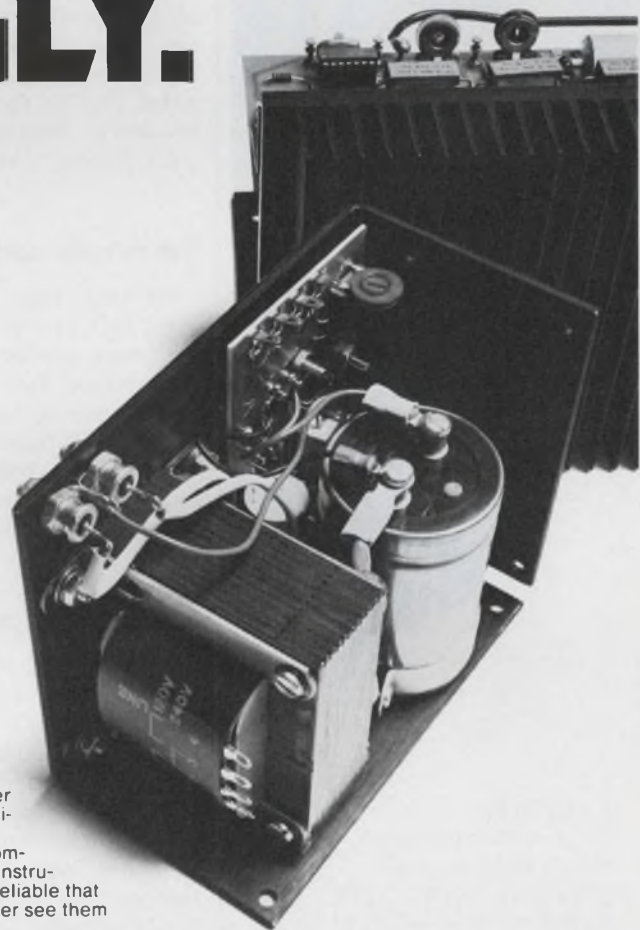

\$44 (1-9)
5V, 6A

They're not much to look at.

Because instead of fancy front panels, we designed our standard open-frame dc power supplies to cover 90% of your OEM applications. And once you plug them into your computers, peripherals or instrumentation, they're so reliable that chances are you'll never see them again.

They're designed and built conservatively, so you get full rated power all the way up to +55°C. Regulation, ripple and noise are specified by the book. And with no expensive options, you can now get your dc power for as little as 68¢/W (1-9 qty).

If you've looked at the competition, we know that has to be a sight for sore eyes.

For more info, use the bingo card or call 714/979-4440. Or call your local Cramer or Newark distributor and get Ugly today.

OPEN-FRAME OLV SERIES: 4-28 Vdc, 15-250 W

STANDARD FEATURES: Choice of 16 voltages, adjustable ±5%. Currents to 50A, no derating to +55°C ±0.1% IC regulation, ±0.1% ripple and noise. Remote sensing/programming. Spike suppression. Foldback current limiting. 120/240 Vac. 50/60 Hz inputs.

OPTIONS: OVP crowbar. PRICES: \$24.95 to \$179 (1-9)

Elexon Power Systems

©Copyright 1974 Eipac, Inc. ELPAC

Up
your
density
per dollar

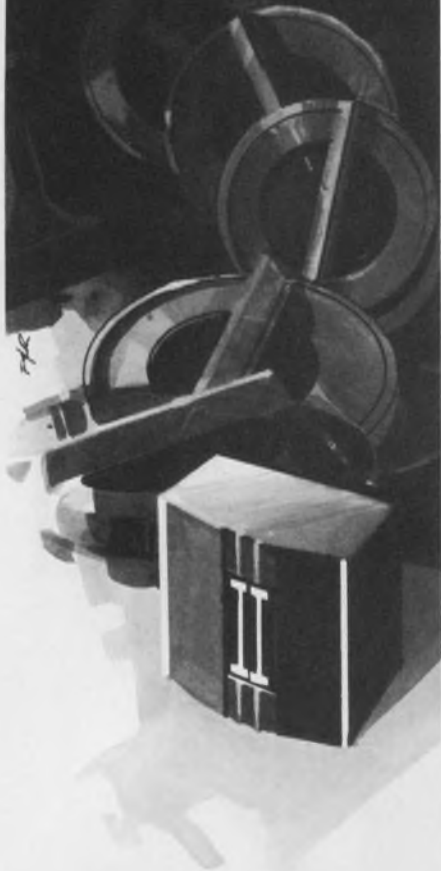

To 6250 bpi.
That is four times as
much data as you
presently store . . . yet
in the same volume, at
one fourth the cost.

We have the head, our
6250. You have the
system.

Let's put it all together.



NORTRONICS
Company, Inc.
8101 Tenth Ave. North, Minneapolis, Minn. 55427
Telephone (612) 544-0361

INFORMATION RETRIEVAL NUMBER 137

NEW LITERATURE



Altimeter counters

Advantages of the company's internal pinion counters, such as low torque, large numeral display, continuous and reversible, are given in a four-page, two-color brochure. Bowmar Instrument, Fort Wayne, Ind.

CIRCLE NO. 338

Terminals and connectors

Seventy pages detail solderless terminals, connectors and splices for most wiring and circuitry requirements. Information is provided on what to look for and how to select and "spec out" the proper terminal or connector. All illustrations are actual size. Teledyne Ansonia, Ansonia, Conn.

CIRCLE NO. 339

Coaxial components

Hundreds of components and accessories for high-frequency applications to 9 GHz are described in a 32-page pamphlet. Specifications for general-purpose and precision 50-Ω and 75-Ω connectors, adaptors, attenuators, terminations, coupling elements, cables, air lines and a low-cost rf bridge are included. General Radio, Concord, Mass.

CIRCLE NO. 340

Bar solder

"The Black Magic of Making and Using Bar Solder" discusses and debunks the various claims made for bar solders used in the electronics industry. Refinery for Electronics, Jersey City, N.J.

CIRCLE NO. 341

1 day
and
2 day

printed circuit design & manufacturing seminars

- ... a lecture series designed for those concerned with P.C. board rising costs, quality and delivery. Many problems are created in design and get written off in Q.C. without ever solving the problem.
- ... a two day lecture series in key cities across the country for those that can afford the time to cover all subjects in greater detail.
- ... a condensed one day lecture series for those that cannot afford two days away from their job.

- This Seminar was developed to enrich your background with practical manufacturing "Knowhow".
- If you missed this seminar last year you can catch us this year as we will be in key electronic cities from coast to coast . . . it is a must for the engineer, designer, Q.C. Manager, Production Manager and purchasing agent.
- This Seminar eliminates the so called "Black Magic" in P.C. Manufacture. We will direct your design to reducing costs . . . not quality and show you where you many times push the state of the art beyond any suppliers capabilities.
- Do you know why your purchasing department has nightmares when buying P.C. Boards
- You will receive the CIR-CON MANUAL, COMPLETE with diagrams and illustrations describing the manufacturing process and design techniques to help give you more trouble free boards.

2 DAY SEMINAR SCHEDULE

BURLINGTON MASS MARCH 4-5 <i>(Holiday Inn Burlington)</i>	ORLANDO FLA MAY 12 <i>(Sheraton Inn McCoy Rd.)</i>
BLOOMINGTON MINN MARCH 26-27 <i>(Sheraton Inn Airport)</i>	CHICAGO ILL MAY 18 <i>(Holiday Inn Des Plaines)</i>
DETROIT MICH APRIL 2-3 <i>(Sheraton Metro Inn)</i>	DALLAS TEXAS MAY 18-19 <i>(Sheraton Inn Mockingbird West)</i>
SAN FRANCISCO CALIF APRIL 23-24 <i>(Holiday Inn Kearney Street)</i>	LOS ANGELES CALIF JUNE 11-12 <i>(Holiday Inn Airport)</i>

FEE: fee includes attendance, coffee breaks, luncheon & CIR-CON MANUAL.
* 1-3 Applicants \$235 each. * 4-7 Applicants \$220 each. * 8 or more \$200 each

1 DAY SEMINAR SCHEDULE

LONG ISLAND N.Y. FEB 20 <i>(Holiday Inn Plaquemine)</i>	CINCINNATI OHIO APRIL 11 <i>(Sheraton Gibson Walnut St.)</i>
BRIDGEPORT CONN FEB 21 <i>(Holiday Inn Airport)</i>	LOS ANGELES CALIF APRIL 25 <i>(Holiday Inn Airport)</i>
MONTREAL CANADA FEB 25 <i>(Holiday Inn Cote de Lasse)</i>	SAN DIEGO CALIF APRIL 26 <i>(Holiday Inn Downtown)</i>
TORONTO CANADA FEB 26 <i>(Holiday Inn Downtown)</i>	ST LOUIS MO MAY 9 <i>(Sheraton Inn Bridgeton)</i>
SYRACUSE N.Y. FEB 28 <i>(Sheraton Inn Liverpool)</i>	HOUSTON TEXAS MAY 16 <i>(Holiday Inn N Bell East)</i>
NEWARK N.J. MARCH 12 <i>(Holiday Inn Saddlebrook)</i>	WASHINGTON D.C. MAY 21 <i>(Holiday Inn Natl Airport)</i>
PHILA PENN MARCH 13 <i>(Sheraton Inn Ritzworth Blvd)</i>	BURLINGTON MASS MAY 24 <i>(Holiday Inn Burlington)</i>
BALTIMORE MD MARCH 14 <i>(Sheraton Inn Ritzworth Blvd)</i>	PHOENIX ARIZ MAY 29 <i>(Sheraton Inn E. Sun Harbor Blvd.)</i>
DES MOINES IOWA MARCH 28 <i>(Holiday Inn Fleur Dr.)</i>	ALBUQUERQUE N.M. MAY 30 <i>(Holiday Inn Manual)</i>
CLEVELAND OHIO APRIL 4 <i>(Sheraton Inn Brook Park)</i>	DENVER COLO MAY 31 <i>(Sheraton Inn Quebec St.)</i>
LITTLE ROCK ARK APRIL 4 <i>(Sheraton Inn Ferry St.)</i>	SAN FRANCISCO CALIF JUNE 13 <i>(Sheraton Palace Hotel)</i>
ATLANTA GA APRIL 10 <i>(Sheraton W. Peachtree St.)</i>	

FEE: fee includes attendance, coffee breaks, luncheon & CIR-CON MANUAL.
* 1-3 Applicants \$135 each. * 4-7 Applicants \$120 each. * 8 or more \$100 each

CIR-CON SEMINARS

279 Cambridge Street
Burlington, Massachusetts
01803
(617) 272-0938

INFORMATION RETRIEVAL NUMBER 138
ELECTRONIC DESIGN 4, February 15, 1974

Research radiometers

Features and applications of the SpectralMaster research radiometers, Models 12-550 and 12-660, are given in an eight-page brochure. Included are an introduction to the available detectors, a review of the optical design and a survey of the available spectral filters. Barnes Engineering, Stamford, Conn.

CIRCLE NO. 342

Relays and accessories

Over 1200 stock relays and accessories are contained in a 32-page catalog. Among them are general-purpose relays, hybrids, time delays, reeds—both dry and mercury wetted—and solid-state relays. Potter & Brumfield, Princeton, Ind.

CIRCLE NO. 343

Fast recovery rectifiers

A 400-A fast recovery rectifier, series 401PDL, is described in a data sheet. The literature contains five graphs, a dimensional outline drawing and a photograph of the device. Specifications and ratings are provided. International Rectifier, Semiconductor Div., El Segundo, Calif.

CIRCLE NO. 344

Connectors

Electrical and physical characteristics for nearly 200 components of the CHAMP connector family are illustrated in a 20-page catalog. Included are data about connectors for cable, panel, PC and flat-cable applications; connector hardware; modular connecting blocks; PC terminals; as well as field and production tooling. AMP, Harrisburg, Pa.

CIRCLE NO. 345

Technical report

An 11-page report, "Troubleshooting Check List for Wave Soldering of Printed Wiring Boards," investigates the problems of pin hole solder voids, heavy filleting (excess solder), bridging and webbing, solder rough, solder icicles and spikes, improper fluxing, etc. The price per copy is \$3 to IPC members and \$5 for nonmembers. Institute of Printed Circuits, 1717 Howard St., Evanston, Ill. 60202.

INQUIRE DIRECT

Ultramin connectors

A handbook describes the use of ultraminature connectors and cables for high density miniature packaging. Microtech, Folcroft, Pa.

CIRCLE NO. 346

Card guides

Ejectors, pullers and guides for PC cards are listed in a four-page catalog. Thermalloy, Dallas, Tex.

CIRCLE NO. 347

Silicon rectifiers

A totally new 216-page Silicon Rectifier Handbook, second edition, is well illustrated with tables, graphs and circuits on almost every page. Much material is presented that has never appeared in a rectifier handbook before. At \$2.50 it should be a welcome addition to the solid-state bookshelf. Motorola, P.O. Box 20924, Phoenix, Ariz. 85036.

INQUIRE DIRECT

MEAN AND UGLY.™



\$79 (1-9)
3 outputs

Our OEM dc supplies have always been stark, but now they're twice as ugly (also 3x).

Because instead of working up a new color scheme, we've combined two and three of them on a single chassis to make them an even better buy for your computers, peripherals and instruments.

We've taken out redundancies, but they still offer the widest range of voltages you can get in a modular dc supply. Still deliver all the power we promise across the full temperature range (even with 50 Hz inputs). And still include all the features you need as standards, not expensive options.

So that now if you check us out against the competition, they're liable to tell you that we're not just ugly.

We're downright mean.

For more info, use the bingo card or call 714/979-4440. Or call your local Cramer or Newark distributor and get Ugly today.

MULTIPLE OUTPUT DLV/TLV SERIES: 1st output: 5 V at 3-15 A. OVP standard 2nd and/or 3rd outputs: each 4-28 V, 8-15 W. OVP optional. All outputs isolated, may be used as positive or negative supplies.

STANDARD FEATURES: Choice of 16 voltages, adjustable $\pm 5\%$. Currents to 15 A, no derating to $+55^\circ\text{C}$, $\pm 0.1\%$ regulation, $\pm 0.1\%$ ripple and noise. Remote sensing/programming. Spike suppression. Foldback current limiting. 120/240 Vac. 50/60 Hz inputs.

OPTIONS: Enclosure PRICES: \$29 to \$151 (1-9)

Elexon Power Systems

Copyright 1974 Elpac, Inc. ELPAC

INFORMATION RETRIEVAL NUMBER 139

Pistoncap™ TUBULAR TRIMMER Capacitors

**NOW IN EXPANDED
RANGE DESIGNS**

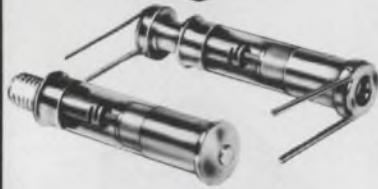

Expanded capacitance range is featured in a new series of sealed PISTONCAP tubular trimmer capacitors.

Ten different capacitance range ratings are available in both panel mounting and printed circuit mounting styles. Capacitance ranges may be selected from 1 pF min. to 14 pF max. to 1 pF min. to 120 pF max.

A low-loss glass dielectric embedded electrode construction results in high stability under conditions of changing frequency, voltage, temperature, and other environmental parameters.

All of these new PISTONCAP capacitors feature a multi-lobe seal at the adjust end with a simplified long-life adjust mechanism. All meet or exceed MIL-C-14409C requirements.

For full technical information, ask the Sprague Electric district office or sales representative nearest you for Bulletin 203.

PISTONCAP trimmer capacitors are available for immediate delivery from stocking Sprague distributors.

**SPRAGUE
GOODMAN**

**Sprague-Goodman
Electronics, Inc.**

(An Affiliate of the Sprague Electric Company)

371 Willis Ave., Mineola, N.Y. 11501
516/746-1385

vendors report

Annual and interim reports can provide much more than financial-position information. They often include the first public disclosure of new products, new techniques and new directions of our vendors and customers. Further, they often contain superb analyses of segments of industry that a company serves.

Selected companies with recent reports are listed here with their main electronic products or services. For a copy, circle the indicated number.

Beckman Instruments. Environmental monitoring and control systems, analytical and nuclear instruments and systems, potentiometers, hybrid microcircuits and medical electronics.

CIRCLE NO. 348

Systems Engineering Laboratories. Real-time computer systems.

CIRCLE NO. 349

Pertec. Tape transports, disc drives, line printers, hardware, software and computers.

CIRCLE NO. 350

Gould. Electrostatic printer/plotters, data loggers, measurement instruments, controls, computers, medical electronics, rectifiers, vehicular electronics, power systems, batteries, heating and cooling products.

CIRCLE NO. 351

Collins Radio. Avionics, telecommunications, microwave systems, communications switching, broadcast equipment and components.

CIRCLE NO. 352

Methode Engineering. Printed circuits, connectors, resistive and conductive pastes, controls, switches, jacks, bus bars and high-voltage leads and harnesses.

CIRCLE NO. 353

Polarad Electronics. Microwave instruments, spectrum analyzers, airborne systems, defense electronics, marine and security electronics and solid-state microwave components.

CIRCLE NO. 354

MONOLITHIC CRYSTAL FILTERS

**the
State
of the
Art**

OF HIGHER THINGS . . .

By international convention, the VHF frequency range extends from 30 to 300 MHz. At 30 MHz a monolithic quartz crystal filter element is about .002 in. thick and typically .25 in. in diameter. Fragile? Yes indeed. Maybe that's why only a handful of manufacturers offer crystal filters in the VHF range. Of these few, one is head and shoulders above the rest. Needless to say, that's us. (If we weren't, we wouldn't be writing this ad.) Our first monolithic—way back in 1966—had a center frequency of 112 MHz. We pioneered the VHF monolithic crystal filter. And we're still pioneering. We supply production quantities of VHF monolithics at frequencies to 175 MHz. No one else can make that statement, and believe us—we're pretty high on our product.

NOW FOR THE LOW-DOWN

Although we're mighty proud of our VHF Monolithic Crystal Filters, much of our bread and butter is earned at lower frequencies. As low as 3 MHz in special cases. And at 10.7 and 21.4 MHz, we offer the industry's widest selection of stock model monolithic crystal filters—over 50 models in all. We can help you with all your production requirements for monolithics. More and more people are saying our low down is on the up and up.

. . . AND WHAT TO DO WITH THEM

Our VHF Monolithics are used as front-end filters and as up-converter filters. They're found in satellites and in commercial equipment. In the U.S. and in most other major countries of the world. In VHF two-way radios, paging receivers, and HF receivers and transmitters. And in a variety of special applications, like spectrum clean-up in frequency synthesizers.

What's your application? Whether it's one of the above or something brand-new we'll be glad to work with you. Just give us a call, or a brief note outlining your requirements. We'll take it from there.

Pi

Piezo Technology Inc.

2400 Diversified Way Orlando, Florida 32804
305 425 1574

The Standard in monolithic crystal filters.

bulletin board

Monsanto Co.'s electronic materials business group has introduced a thin-film gallium arsenide phosphide epitaxial wafer selling for \$14 per sq. in.

CIRCLE NO. 355

More than 30 types of JAN TXV transistors for ultra-high rel industrial and military applications are available from Raytheon Semiconductor.

CIRCLE NO. 356

Five new Schottky TTL integrated circuits have been added to Texas Instruments 54S/74S integrated series. They are the SN54S/74S08, S09, S32, S37 and S38. These new functions are pin-for-pin equivalents of their standard 54/74 counterparts.

CIRCLE NO. 357

Ampex has announced price increases of 12 to 15% on TMX and TMZ tape drive series manufactured for the OEM market by the company's computer products division.

CIRCLE NO. 358

Honeywell has increased prices by 2% on computer products and services.

CIRCLE NO. 359

The National Bureau of Standards is planning a FORTRAN program to assist manufacturing companies in metric conversion. The package is based on a computer program that converts metric units on engineering drawings to their U.S. customary equivalents.

CIRCLE NO. 360

Fairchild Camera & Instrument Corp. has introduced a military version of its Isoplanar 1024-bit TTL RAM, designated the 93415-DM.

CIRCLE NO. 361

Ten standard sizes of 95% alumina substrates are being made available on a localized basis through Centralab Distributors.

CIRCLE NO. 362

Xerox Sigma 6 and Sigma 9 computers running under the CP-V (control program-five) operating system can use an extended APL package that includes graphics processing.

CIRCLE NO. 363

Micro Switch has increased prices 5-1/2% on four product groups—manual, basic and enclosed switches and industrial control products.

CIRCLE NO. 364

Alessi Industries has introduced modular probe systems and components for specific testing applications in all areas of solid-state and hybrid circuit manufacture.

CIRCLE NO. 365

RCA Solid State Div. is the first company to receive approval for listing complementary MOS (COS/MOS) products under the Class A category of the Qualified Products List for MIL-M-38510.

CIRCLE NO. 366

GET UGLY™

at Cramer... at Newark.

Newton, Mass. 617/969-7700
 North Haven, Conn. 203/239-5641
 Endwell, N.Y. 607/754-6661
 Rochester, N.Y. 716/275-0300
 East Syracuse, N.Y. 315/437-6671
 Hauppauge, L.I., N.Y. 516/231-5600
 Moonachie, N.J. 201/935-5600
 Cherry Hill, N.J. 609/424-5993
 Gaithersburg, Md. 301/948-0110
 Hanover, Md. 301/796-5790
 Cleveland, Ohio 216/248-8400
 Cincinnati, Ohio 513/771-6441
 Livonia, Mich. 313/425-7000
 Winston-Salem, N.C. 919/725-8711
 Atlanta, Ga. 404/448-9050
 Orlando, Fla. 305/894-1511
 Hollywood, Fla. 305/923-8181
 Huntsville, Ala. 205/539-5722
 Mt. Prospect, Ill. 312/593-8230
 Milwaukee, Wis. 414/764-1700
 Edina, Minn. 612/835-7811
 Dallas, Texas 214/350-1355
 Denver, Colo. 303/758-2100
 Salt Lake City, Utah 801/487-4131
 Albuquerque, N.M. 505/265-5767
 Phoenix, Ariz. 602/263-1112
 Seattle, Wash. 206/762-5755
 Sunnyvale, Calif. 408/739-3011
 Irvine, Calif. 714/979-3000
 San Diego, Calif. 714/565-1881
 De San German, P.R. 809/892-1130
 Roma, Italy 51-393-87
 Downsview, Ont., Canada 416/661-9222
 Woburn, Mass. 617/935-8350
 Westport, Conn. 203/226-6921
 Rochester, N.Y. 716/473-6600
 Canandaigua, N.Y. 315/394-0941
 Red Hook, N.Y. 914/758-8229
 Plainview, N.Y. 516/822-5000
 Kenilworth, N.J. 201/272-8410
 Beltsville, Md. 301/937-5085
 Cincinnati, Ohio 513/874-5115
 Cleveland, Ohio 216/641-2800
 Ft. Lauderdale, Fla. 305/587-2372
 Oak Park, Mich. 313/548-0250
 Wyoming, Mich. 616/241-6681
 South Bend, Ind. 219/272-2992
 Carmel, Ind. 317/846-2673
 Chicago, Ill. 312/638-4411
 Des Plaines, Ill. 312/298-1420
 Milwaukee, Wis. 414/781-2450
 Minneapolis, Minn. 612/331-6350
 St. Louis, Mo. 314/843-2080
 Dallas, Texas 214/271-2511
 Houston, Texas 713/782-4800
 Denver, Colo. 303/757-3351
 Salt Lake City, Utah 801/486-1048
 Inglewood, Calif. 213/678-0441

We make the OEM dc supplies that only an engineer could love. No fancy front panels, but loaded with everything you need for 90% of your applications off-the-shelf:

16 voltages from 4-28V, adjustable $\pm 5\%$.
 Currents to 50A, with no derating to $+55^\circ\text{C}$. $\pm 0.1\%$ IC regulation. 120/240 Vac, 50/60 Hz inputs. And even remote sensing/programming.

All standard for as little as 68¢/W. And all yours from Cramer or Newark. (For more info, use the bingo card or call 714/979-4440.)



Elexon Power Systems

© Copyright 1974 Etpac Inc. ELPAC

INFORMATION RETRIEVAL NUMBER 142

ELECTRONIC DESIGN's function is:

- To aid progress in the electronics manufacturing industry by promoting good design.
- To give the electronic design engineer concepts and ideas that make his job easier and more productive.
- To provide a central source of timely electronics information.
- To promote communication among members of the electronics engineering community.

Want a subscription? ELECTRONIC DESIGN is sent free to qualified engineers and engineering managers doing design work, supervising design or setting standards in the United States and Western Europe. For a free subscription, use the application form bound in the magazine. If none is included, write to us direct for an application form.

If you do not qualify, you may take out a paid subscription for \$30 a year in the U.S.A., \$40 a year elsewhere. Single copies are \$1.50 each.

If you change your address, send us an old mailing label and your new address; there is generally a postcard for this bound in the magazine. You will have to requalify to continue receiving ELECTRONIC DESIGN free.

The accuracy policy of ELECTRONIC DESIGN is:

- To make diligent efforts to ensure the accuracy of editorial matter.
- To publish prompt corrections whenever inaccuracies are brought to our attention. Corrections appear in "Across the Desk."
- To encourage our readers as responsible members of our business community to report to us misleading or fraudulent advertising.
- To refuse any advertisement deemed to be misleading or fraudulent.

Microfilm copies are available of complete volumes of ELECTRONIC DESIGN at \$19.00 per volume, beginning with Volume 9, 1961. Work is now in process to complete the microfilm edition of Volumes 1-8. Reprints of individual articles may be obtained for \$2.00 each, prepaid (\$.50 for each additional copy of the same article) no matter how long the article. For further details and to place orders, contact the Customer Services Department, University Microfilms, 300 North Zeeb Road, Ann Arbor, Michigan 48106 telephone (313) 761-4700.

Want to contact us? If you have any comments or wish to submit a manuscript or article outline, address your correspondence to:

Editor
ELECTRONIC DESIGN
50 Essex Street
Rochelle Park, N.J. 07662

Dual Hi-Speed FFT Processor Easy to Operate



Conceived from the point of view of the operating engineer rather than the computer programmer, the new Omniferous™ FFT Analyzer operates like an instrument, calculates like a computer. This Series OF-400 Analyzer is a universal digital signal analysis system for real-time viewing of changing functions, a complete instrument with all signal conditioning and display calibration built-in. For the first time an operator can observe transfer function, cross-spectra or coherence as the signal is changing without waiting for the analyzer to perform successive laborious calculations.

Features include high speed of 60,000 samples/sec throughput, and high resolution with a 2048 transform size and extra-sharp input anti-aliasing filtering. Calculates FFT, IFFT, power spectra, auto-correlation, cross correlation, and signal enhancement (time averaging), as well as the averaging of any calculated function in sum, peak or exponential mode.

The system excels in high dynamic range, ease of use, display flexibility with two simultaneous display outputs, frequency coverage to 100 kHz, and reasonable cost. Designed by the originators of the famous Ubiquitous® family of real-time spectrum analyzers.

CIRCLE NO. 171

Federal Scientific Corp.

An affil. of Nicolet Instrument
615 West 131st St., New York, N.Y. 10027 (212) 286-4400

SIGNAL TRACKING WITHOUT A REFERENCE



Two new analyzers which provide wave and spectrum analysis with selectable bandwidths described in new Quan-Tech brochure. Model 304 covers range from 0.5 kHz with selectable passbands of 1, 3, 10, 30 and 100 kHz. Model 306 covers 0 to 50 kHz with 10, 30, 100, 300 and 1000 Hz bandwidths. Six operating modes, including automatic tracking of a signal without a reference or pilot frequency. Selectable averaging times for optimum results in random signal analysis. Panel contains 5 digit LED display. Amplitudes available in linear and log meter displays and analog outputs.

CIRCLE NO. 172

Quan-Tech

Div. of Scientific-Atlanta, Inc.
43 South Jefferson Road
Whippany, N.J., 07981

Measure Vector Angle, Magnitude And Components



The new Princeton Applied Research Model 129A Two Phase Lock-In/Vector Voltmeter, enables you to simultaneously measure the magnitude and phase angle with respect to a reference signal of virtually any low-level signal within its range of 0.5 Hz to 100 kHz—even if the signal is buried 60 dB beneath background noise. At the flip of a switch, you can also measure the in-phase and quadrature components of the vector. The Model 129A features fully automatic reference tracking, independent output expansion and filtering for each channel. Complete specifications are contained in bulletin T-314, available on request.

CIRCLE NO. 173

PRINCETON APPLIED RESEARCH CORPORATION

P.O. Box 2565
Princeton, New Jersey 08540 (609) 452-2111

DO COLLEGES HELP BUSINESS AS MUCH AS BUSINESS HELPS COLLEGES?

Yes, they do. But not in the same proportion.

Business contributes about 15% of the total voluntary support received by colleges.

But today, business gets half the college-trained people who are employed. Tomorrow, it will need even more.

As a result, businessmen should think seriously about increasing the level of corporate giving to education. Can you, as a businessman, think of a better investment?

For the latest national figures on corporate giving to higher education, write on your letterhead for "CFAE Survey of Corporation Support of Higher Education," and enclose \$2.00 to help cover costs. Mail to: Council for Financial Aid to Education, 6 East 45th Street, New York, N.Y. 10017.

Give to the college of your choice. Now.



Advertising contributed for the public good.

Electronic Design

Advertising Sales Staff

Tom W. Carr
Vice President &
Sales Manager

Rochelle Park, N.J. 07662

Robert W. Gascoigne
Daniel J. Rowland

(Recruitment, Quick Ads, Classified)

Allen Weinberg
50 Essex Street
(201) 843-0550
TWX: 710-990-5071

Philadelphia

Thomas P. Barth
50 Essex Street
Rochelle Park, N.J. 07662
(201) 843-0550

Boston 02178

Gene Pritchard
P.O. Box 379
Belmont, Mass. 02178
(617) 489-2340

Chicago 60611

Thomas P. Kavooras
Berry Conner, Jr.
200 East Ontario
(312) 337-0588

Cleveland

Thomas P. Kavooras
(Chicago)
(312) 337-0588
(call collect)

Los Angeles 90303

Stanley I. Ehrenclou
Burt Underwood
2930 Imperial Highway
Inglewood, Calif.
(213) 757-0183

San Francisco 94022

Jerry D. Latta
P.O. Box 1248
Los Altos, Calif.
(415) 965-2636

London

For United Kingdom and Europe

John Ashcraft
John Ashcraft & Co.
12, Bear St.
Leicester Square
London WC2H 7AS England
Phone: 01-930-0525
W. J. M. Sanders
John Ashcraft & Co.
Herengracht 365
Amsterdam C., Holland
Phone: 020-24-09-08

Tokyo

Haruki Hirayama
Electronic Media Service
5th Floor, Lila Bldg.,
4-9-8 Roppong
Minato-ku
Phone: 402-4556
Cable: Electronicmedia, Tokyo



Sky Caps



... in
quantity
from the
world's largest
manufacturer of
ceramic capacitors

Sky Cap® is a dip-coated version of the best in multilayers. That's because nobody makes more or better multilayers than AVX.

Sky Caps come in six basic sizes and a new rectangular configuration with 1/4-inch lead spacing. Capacities range between 2.2 pf and 4.7 MF. Standard tolerances. Temperature coefficients include NPO, X7R and Z5U.

Working voltages of 50, 100 and 200 volts — with 25 to 500 volt ratings available on special order. For complete information, request a copy of the AVX Short Form Catalog. Write, AVX Ceramics, P.O. Box 867, Myrtle Beach, S. C. 29577. Telephone: (803) 448-3191. TWX: (810) 661-2252.



THE CERAMIC CAPACITOR MANUFACTURER

INFORMATION RETRIEVAL NUMBER 143

advertiser's index

Advertiser	Page
AMP, Incorporated	20, 21
AVX Ceramics	171
Acopian Corp.	109
Addmaster Corporation	154
Allen Bradley Co.	Cover III
Allied Electronics, Division of Tandy Corp.	146
American Lava Corporation	93
Amplifier Research	147
Anzac Electronics	160
Astrosystems, Inc.	136
Augat, Inc.	37
Beckman Instruments, Inc., Information Displays Operations	81
Beckman Instruments, Inc., Helipot Division	124
Bivar, Inc.	130
Bodine Electric Company	155
Boonton Electronics Corporation	143
Bourns, Inc., Trimpot Products Division	17
C & K Components Inc.	149
CTS Corporation	72
Cambridge Thermionic Corporation	159
Centralab, The Electronics Division of Globe-Union, Inc.	113
Cherry Electrical Products Corp.	11
Chicago Miniature Lamp Works	95
Cir-Con Siminars	166
Circuit Stik, Inc.	164
Clare & Co., C. P.	83
Clare-Pendar	119
Computer Automation, Inc.	31
Continental Connector Corporation	46
Corning Glass Works, Electronic Products Division	18, 19
Cutler-Hammer	87
Decitek, A Division of Jamesbury Corporation	122
Delco Electronics, Division of General Motors Corporation	12, 13
Dit-Mco	164
Dialight Corporation	111
Dynascan Corporation	159
E-T-A Products Co. of America	173
Electronic Navigation Industries	118
Electronics & Control Engineers' Book Club	135
Elxon Power Systems	163, 165, 167, 169
Emerson & Cuming, Inc.	162
Exar Integrated Systems	1
Fairchild Semiconductor, A Division of Fairchild Camera and Instrument Corporation	88, 89
Federal Scientific Corporation	170
Fluke Mfg. Co., John	103
Fuji Electrochemical Co., Ltd.	98
Fujitsu Limited	64L
GTE Sylvania	33
General Instrument Corporation	39
General Radio Company	149
Gold Book, The	152, 153
Harris Semiconductor, A Division of Harris-Intertype Corporation	64O
Hayden Book Company, Inc.	64P

Advertiser	Page
Heath Company	151
Heath/Schlumberger Instruments	128A, 128B, 129
Hewlett-Packard	2
Hipotronics Inc.	157
Hoffman Engineering Company	138
Hunt Electronics	138
Hybrid Systems Corp.	63
IEEE Intercon	82
IMC Magnetics Corporation	148
ITT Cannon Electric, A Division of International Telephone and Telegraph Corporation	15, 104, 130, 131
Indiana General, Electronic Products	133
Information Handling Services	64M
Ingersoll Products, Division of Borg Warner Corporation	141
Instrument Specialties Company, Inc.	64I
Integrated Microsystems, Inc.	161
Intel Corporation	52, 53
Interdata	64D, 64E
International Coil Winding Association	151
International Teleprinter Corporation, The Singer Co.	10
International Rectifier	64
Johanson Manufacturing Corp.	7, 173
Keithley Instruments, Inc.	27
Lambda Electronics Corp.	4, 5
Laurier Associates Inc.	173
Licon, Division of Illinois Tool Works, Inc.	73
Littlefuse, Subsidiary of Tracor	123
Liton Industries, Advanced Circuitry	48
Liton Industries, Triad-Utrad	128
3M Company	117
MCL, Inc.	134
MDB Systems	173
Magneto, Inc.	173
Magnetic Metals	158
Met-L-Wood Corporation	80
Micro Devices Corp.	155
Microelectronic Device Division, Rockwell International	146
Micro Switch, A Division of Honeywell	Cover II
Mini-Circuits Laboratory	157
Modpak	162
Motorola Components Products Dept.	105
Motorola Semiconductor Products, Inc.	64B, 64C
Motorola Timepiece Electronics	94
National Electronics, A Varian Division	144
National Semiconductor Corporation	16 A-1 thru A-6
North Atlantic Industries, Inc.	156
North Electric Company	147
Nortronics Company, Inc.	166
Omni Spectra, Inc.	127
Optima Enclosures	125
Otto Controls Division, Otto Engineering Inc.	145

Advertiser	Page
Pertec Corporation	35
*Philips Industries	112A, 112C
Piezo Technology, Inc.	168
Pomona Electronics Co., Inc.	64J
Power Cube Corporation	126
Potter & Brumfield, Division of AMF Incorporated	114
Princeton Applied Research Corp.	170
Quan-Tech, Division of KMS Industries, Inc.	170
RCA Solid State	64A, Cover IV
Radio Materials Company	136
Rental Electronics Inc.	74
Reticon	6
Robison Electronics, Inc.	160
Rogan	161
Rogers Corporation	145
Ronor Systems, Inc.	149
S.D.S.A.	155
Schauer Manufacturing Corp.	142
Sealed Air Corporation	147
Shigoto Industries, Ltd.	151
Signetics Corporation	120, 121
Siliconix, Incorporated	50
Simpson Electric Company	65
Sorenson Company, A Unit of Raytheon Company	116
Sprague Electric Company	16
Sprague-Goodman Electronics, Inc.	168
Stanford Applied Engineering, Inc.	137, 139
Systron-Donner	42, 176
Sylvania Miniature Lighting Products Inc.	64K
TEC, Incorporated	150
TRW Electronic Components	99
TRW Globe Motors, An Electronic Components Division of TRW Inc.	14
TRW/IRC Potentiometers, An Electronic Components Division of TRW, Inc.	75
TRW Semiconductors, An Electronic Components Division of TRW, Inc.	24
Tecnetics, Inc.	140
Tektronix, Inc.	45, 47, 49
Texas Instruments, Incorporated	8, 9, 40, 41
Topaz Electronics	155
Triplet Corporation	107
Trygon Electronics	132
Unicorp	159
United Detector Technology, Inc.	173
Unitrak Div., Calabro Plastics	161
Vactec, Inc.	23
Varo Semiconductors, Inc.	118
Vector Electronic Co., Inc.	94
Vu Data Corporation	148
Watkins-Johnson	22
Woven Electronics	145
Zero Manufacturing Co.	161

*Advertisers in non-U.S. edition.

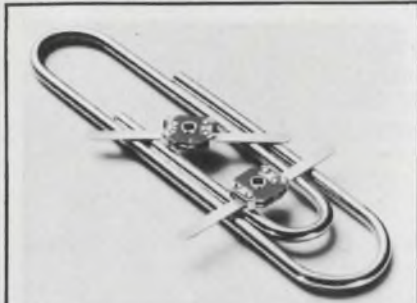

Thin-Trim variable capacitors provide a reliable means of adjusting capacitance without abrasive trimming or interchange of fixed capacitors. Series 9401 has high Q's and a range of capacitance values from 0.2-0.6 pf to 3.0-12.0 pf and 250 WVDC working voltage. Johanson Manufacturing Corporation, Boonton, New Jersey (201) 334-2676.

INFORMATION RETRIEVAL NUMBER 235



SA202 "EPOBONDER" Epoxy Die Bonder—can be used with LSI's, MOS's, diodes, transistors, chip capacitors and resistors. Picks up, locates, places and bonds chips quickly and accurately. Ultra-reliable operation. Laurier Associates, Inc., Littleton, Mass. 01460 (617) 486-8100

INFORMATION RETRIEVAL NUMBER 236

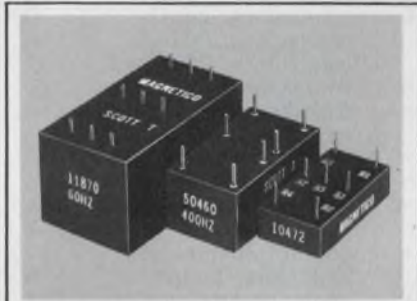

Scott T Transformer. 11870: 60HZ, 90v, L-L In. 1.1x2.1x1.1. 50460: 400HZ, 90v, L-L In. 7/8x1-5/8 x11/16. 50642: 400HZ, 11.8v, L-L In. 7/8x1-5/8x11/16. 10472: 400-HZ, 11.8v, L-L In. 3/4x1-1/2x3/8. All with 6v RMS sine & cosine output. MAGNETICO, INC., E. Northport, N.Y. 11731. 516-261-4502.

INFORMATION RETRIEVAL NUMBER 237



UDT-80X Opto-Meter offers low cost photometric/radiometric measuring capability from 10^{-10} watts or 10^{-4} footcandles for \$865. The 80X has $3\frac{1}{2}$ digit readout, silicon detector, radiometric (flat 450-950 nm) photometric filters, AC and battery operation. United Detector Technology, 1732 21st St Santa Monica Ca 90404 (213) 829-3357

INFORMATION RETRIEVAL NUMBER 238

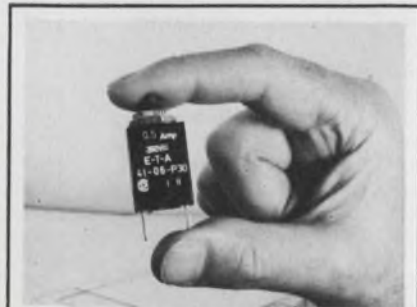

Overcurrent protector, manual reset eliminates fuse replacement. Convenient panel mounting. 15 fractional ratings from 0.1 to 3 amp. Other models up to 400 amp. UL and CSA approved. 93 cents ea. In 1000 lots. E-T-A Products Co. of America, 6284 N. Cicero Ave., Chicago, Ill. 60646. Tel: (312) 545-1553.

INFORMATION RETRIEVAL NUMBER 239



NOVA/DCC-116 General purpose interface board provides multiple device selection, 4 I/O registers, DMA zero word count detect, 105 socket positions for 14, 16, 24 and 40 PIN ICS. Basic board (all features of data general 4040 plus multiple device select) \$350.00. MDB Systems, Inc., 981 N. Main, Orange, CA 92667. (714) 639-7238.

INFORMATION RETRIEVAL NUMBER 240

Advertisers wishing to reserve Quick Ad units should note the following mechanical requirements: Specs—Supply glossy photo of product and approximately 40 words which will set no more than 10 lines of 34 characters each. AFTER SUBMISSION NO COPY CHANGES CAN BE ACCEPTED. Quick Ads cost only \$300 per insertion, less for frequency advertisers.

RATES:

1x
\$300

7x
\$280

13x
\$255

19x
\$250

26x
\$245

39x
\$240

52x
\$235

104x
\$230

product index

Information Retrieval Service. New Products, Evaluation Samples (ES), Design Aids (DA), Application Notes (AN), and New Literature (NL) in this issue are listed here with page and Information Retrieval numbers. Reader requests will be promptly processed by computer and mailed to the manufacturer within three days. *Appears in the International Technology Section outside the USA.

Category	Page	IRN	Category	Page	IRN	Category	Page	IRN
Components			ICs & Semiconductors			tone signaling		
capacitor, ceramic	174	143	adder-subtractor	121	67	equipment	150	287
capacitors	7	6	CMOS	88	46	Packaging & Materials		
capacitors	168	140	chip set	115	251	assemblies	149	107
capacitors, ceramic	16	13	DAC, CMOS	119	257	assemblies, backplane	131	77
capacitors, ceramic	113	166	diodes, zener	142	92	beads, ferrite	157	299
capacitors, DIP	134	269	generator, polynomial	116	253	boards, general-purpose	164	134
capacitors, mica	39	24	logic array,			boxes, connectors	162	132
capacitors, TC	136	84	programmable	146	98	bus	145	95
components	19	15	op amp, FET	118	255	cable and connectors	117	63
components	133	80	RAMs	118	254	connector, gold-contact	33	21
fan	148	103	rectifiers and SCRs	IV	249	connectors	20	245
filters, crystal	168	141	rectifiers, silicon	118	65	connectors	21	246
inductors	159	121	SCRs	64	35	connectors, card*	D	195
LED, yellow	134	271	stereo-demodulator IC	119	256	connectors, PC	46	28
lamps, subminiature	95	51	Instrumentation			connectors, PC board	137	85
lites, cartridge	150	108	analyzer, random-access	164	135	connectors, RFI	15	12
microswitch*	A	181	analyzer, spectrum	47	29	dielectric material	158	302
mixer, double-balanced	160	126	clock, digital	146	283	enclosures	125	71
motors	155	114	controllers, process*	A	182	enclosures	138	86
network, resistor	132	267	converter, a/d	144	280	fuseholders	123	69
opto-electronics	151	110	counter/timer*	D	193	hardware, packaging	94	50
panel, display	144	94	DMM	144	282	heat sealer	147	100
photosensor, area*	D	192	DMM, 3-1/2-digit	103	54	hot-air attachment	157	298
pots, trim*	B	191	DVM	144	281	indicators, temp*	B	186
relays	114	61	generator, data	176	144	knob, control	161	129
relays, dry-reed	83	44	generator, pulse*	B	187	laminations	158	120
resistors, thin-film	III	248	oscilloscope	45	27	masking tape,		
sensors, image	6	5	oscilloscope	159	123	high temp.	156	296
springs, compression	135	82	oscilloscope, miniature	49	31	panels	80	41
switch, keyboard	11	9	recorder, chart*	A	183	rental equipment	74	39
switch, pushbutton	132	268	scope	146	284	screw, clamping*	B	190
switch, rotary	136	272	scope, mini	148	104	seminar, packaging	166	138
switch, toggle	136	273	synthesizer, frequency	142	252	solder flux	158	300
switches	73	38	VOM, portable	159	124	substrates	93	201
switches, subminiature	145	96	VOMs	65	36	tape, marking	156	295
switches, subminiature	149	106	Microwaves & Lasers			test clip	145	97
switches, thumbwheel	139	88	amplifier, multichannel*	A	185	tool, drafting	156	297
switches, ultraminiature	87	45	antennas	138	275	tools, DIP handling	158	301
switchlights	119	66	attenuator, coax	140	278	washers, insulating	159	122
transducer, optical	134	270	joints, rotary*	B	188	Power Sources		
transformers	128	74	magnetron*	D	194	battery, alkaline	154	292
trimmers	72	37	mixers, double-balanced	157	119	inverters, sine wave	155	115
trimmers, cermet	124	70	module, test	138	274	power source, digital	132	79
Data Processing			oscillators, Gunn	140	279	reference, voltage	154	291
calculator, keyboard	9	7	termination, power*	B	189	regulator, line-voltage	149	105
calculator, pocket	120	258	transistors, power	138	276	supplies, power	116	62
computer	31	20	varactors, silicon	140	277	supplies, power	140	90
controller, disc	130	266	Modules & Subassemblies			supply, lamp	154	294
interface, calculator	124	259	amplifier, rf power	118	64	UPS, dc	154	293
keyboard	II	247	controller, oven	150	290			
memories	166	137	controller, setpoint	150	289	application notes		
printer	154	112	converter, a/d	150	288	ferrites	160	306
printer, line	126	262	converters, synchro	136	83	flame spray coatings	160	304
processor, array	130	265	filter, active	161	130	power switching	160	303
recorder, cartridge	124	260	keyboard, alphanumeric	148	285	tank weighing system	160	305
tape drive, magnetic	126	261	modules, s/d and d/s	156	117			
tape reader	122	68	op amps	147	101			
tape reader/punch	128	263	oscillator	1	2			
terminal, graphics*	A	184	rectifier, full-wave	148	286			
terminal, intelligent	128	264						
terminals, teleprinter	22	7						

recruitment
and
classified ads

**IMMEDIATE
DELIVERY**

Minis & Peripherals
**DEC - HIS - NOVA
SEL - HP - MOHAWK**

CPU, Card, Printer, Tape, Disk
NEW • MOHAWK 4320
PRINTERS

**PDP11 PERIPHERALS
CPU, MEMORY**

PDP 8 CPU \$1500

\$750 Minis

TELETYPE 35 & 37

**DEC & HONEYWELL Modules
617/261-1100**

Send for Free Report "Maintenance
of Computers"

AMERICAN USED COMPUTER CORP.
P.O. Box 68, Kenmore Sta.
Boston, MA 02215

CIRCLE NO. 207

**DESIGN ENGINEERS
DIGITAL OR ANALOG**

Register with the Specialists
in electronic recruiting. Com-
prehensive nationwide list-
ings. Fee/reloc. paid. Please
include current salary and
reloc. information. All in-
quiries will be immediately
acknowledged. Send resume
or call

**TECHNOLOGY
RECRUITERS — 2000
Employment Consultants
3100 Richmond Ave.
Houston, Texas 77006
713/522-5192**

**400 SCIENTIFIC BOOKS
NO BOOK MORE THAN \$10.00 —
MOST LESS THAN \$5.00**

New Free Catalog has extensive listing in
engineering, physics, chemistry, mathe-
matics, design, astronomy, biology, psy-
chology. Complete Heidelberg & Wykeham
Science Series. SPECIAL OFFER ON ELEC-
TRONICS TECHNOLOGY SERIES.
H. SHPRENTZ CO., BOX 83-HA,
IRVINGTON, NY 10533

CIRCLE NO. 208

**GIVE...
HEART
FUND**



Surplus Equipment Sale

Various Machine Tools, Electronic Test
Gear Available For Sale.

Partial Listing

MACHINE TOOLS

• Delta Drill Presses No. 1012 • War-
ner & Swasey Turret Lathe No. 4 •
Exello Boring Machines • Bryant In-
terna Grinder No. 1209

ELECTRONIC TEST GEAR

• Oscilloscopes • Vacuum Tube Volt-
meters • Power Supplies • Amplifiers
• Tools & Fixtures • Ratiometers •
Synchro Ind. & Trans.

Many more miscellaneous machines,
and test gear available. Inspection by
appointment only. Please contact one
of the following:

Machine Tools: Mr. William Fairclough,
Phone: 201-288-2000, Ext. 1619 or
1620

Electronic Test Gear: Mr. Robert Rath-
geb, Phone: 201-288-2000, Ext. 1608
or 5407



**Navigation &
Control Division**
Teterboro, NJ 07608

POLYHEDRONS

(round & square pegs, too)

TECH-AGE, Ltd. specializes in
matching your objectives with
needs of client companies na-
tionwide. Just send one resume
(in confidence) with salary re-
quired, location desired, etc. We
do the rest. All fees paid, of
course.

TECH-AGE Ltd.

5 East 51st St. DEPT. E
New York, N.Y. 10022

**PERSONNEL
RECRUITMENT
ADVERTISING
IN
Electronic Design
REACHES THE
RIGHT PEOPLE
AT A LOWER COST
PER THOUSAND**

*Call the
HOTLINE
today
for complete
information:
(201) 843-0550
extension 203*

Some data generators can do only **one** thing.

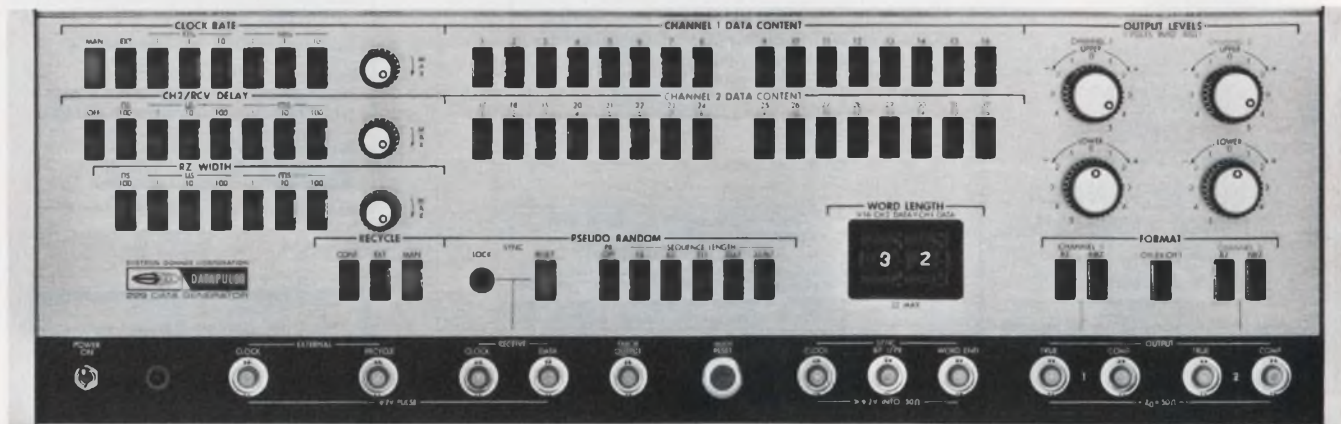

But S-D's Model 229 offers **all** these capabilities:

1. Single/Dual Channels

32/16 bits with variable word length. Variable delay between channels. Data rate to 10 Mbps. Output formats: RZ (with variable width) and NRZ. Adjustable output levels.

2. Psuedo-random

sequence generator with word lengths from 15 to 32,767 bits per word.

3. Comparator

bit-by-bit error check simultaneous with data generation for full duplex operation with either pseudo-random or programmable data patterns.

All of this capability comes standard on Systron-Donner's Model 229 for \$2,025.00. Remote programming and error display are optional. Applications include testing of tape/disc memory systems and high speed digital communication systems. Get in touch with us and we'll tell you about others especially suited for the 229.

For details or a demo, contact your local Scientific Devices office or Systron-Donner at 10 Systron Drive, Concord, CA 94518. Phone (415) 682-6161.

SYSTRON  DONNER

INFORMATION RETRIEVAL NUMBER 144

47A-9

Repeatability in
thin film networks
is a matter of
experience.

If you're really
serious about cost,
be serious about quality.

Our chrome-cobalt technology, for example, has been proven in dozens of applications ranging from D/A and A/D conversion, voltage division in digital multimeters and telemetry equipment, to communications paging devices.

In seventeen years of film resistor production, we've solved many problems that others are yet to encounter. This hard earned experience allows us to respond quickly to your custom needs. We regularly duplicate prototype performance in virtually any quantity. You get excellent delivery along with greater assurance of part-to-part quality.

Profit from the practiced teamwork of our

application, quality control and production engineers. Write for Publication 5801. Allen-Bradley Electronics Division, 1201 South Second St., Milwaukee, WI 53204. Export: Bloomfield, New Jersey 07003. Canada: Allen-Bradley Canada Limited, Cambridge, Ontario. United Kingdom: Jarrow, County Durham NE32 3EN.

Performance specifications

TCR: 10 to 25 ppm/°C
Absolute tolerance: as low as .01%
Interconnections: metal film (no soldered or welded joints)
Stability: 50 ppm/year
Packaging: chip, conformal coated, encapsulated



ALLEN-BRADLEY

Milwaukee, Wisconsin 53204

More than 6,000,000 good reasons...

To insist on RCA Rectifiers and SCR's for your fast-switching applications.

If you have an immediate need for fast-switching devices, come to RCA where large quantity production of quality products is a way of life.

We produced over six million fast-switching thyristors for TV production during the past twelve months ... and millions of fast-switching rectifiers and SCR's for other industry needs during the same period.

These low cost dependable devices represent a lot of good reasons why you should insist on RCA Thyristors and Rectifiers.

Want more good reasons?

RCA offers a large selection of fast-switching devices for your most demanding applications. High-speed inverters, choppers, high-current pulse circuits, or "free-wheeling" diode circuits... whatever your needs

are... you'll find the right SCR or rectifier to match your circuit design.

RCA's all-diffused SCR's bring you the best combination of features...

- fast turn-off time
- high di/dt and dv/dt
- high peak current capability
- exceptional uniformity and stability of characteristics

Match this combination with RCA's fast recovery rectifier features...

- low reverse-recovery current
- low forward-voltage drop
- low thermal-resistance design... and you can rest assured that your equipment is backed by the industry's leader in fast-switching technology.

No need to be concerned about quantity, availability, or cost. RCA fast-switching devices are available in quantity... at prices you can afford.

Want more information? Write: RCA Solid State, Section 57B-15, Box 3200, Somerville, N.J. 08876. Or phone: (201) 722-3200,

Fast Switching SCR's		40555	S3704	S5210	2N3653	2N3658
Package		TO-66	TO-66	¼" stud	TO-48	TO-48
I _{RMS}		5 amps	5 amps	10 amps	35 amps	35 amps
T _{OFF} (Microseconds)		2-6	6-10	5-10	10-15	6-10
1K Price:	200V	1.67	.90	3.00	7.24	7.89
	600V	2.89	1.30	12.20	15.60	17.20

Fast Recovery Rectifiers		TA7895	44938	43884	43894	43904	40960
Package		DO-26	DO-15	DO-4	DO-4	DO-5	DO-5
I _{AV}		1 amp	1 amp	6 amps	12 amps	20 amps	40 amps
T _{RR} (Nanoseconds)		50-500	150-500	150-350	150-350	150-350	150-350
1K Price:	200V	.44	.42	1.79	2.42	3.20	3.40
	600V	.72	.66	3.13	4.37	6.00	6.70

RCA Solid State
products that make products pay off

International: RCA, Sunbury-on-Thames, U.K., or Fuji Building, 7-4 Kasumigaseki, 3-Chome, Chiyoda Ku, Tokyo, Japan. In Canada: RCA Limited, Ste. Anne de Bellevue 810, Canada.

INFORMATION RETRIEVAL NUMBER 249