

# Electronic Design 24

VOL. 21 NO.

FOR ENGINEERS AND ENGINEERING MANAGERS

NOV. 22, 1973

Instruments are more powerful than ever before. They come in smaller packages, cost less and do more. Advances in packaging, digital displays and integrated

circuits have led to instruments that measure, digest information and take action. And many can talk to other instruments. This special report begins on P. 38.



# Nylon. A new twist in cutting circular connector costs.

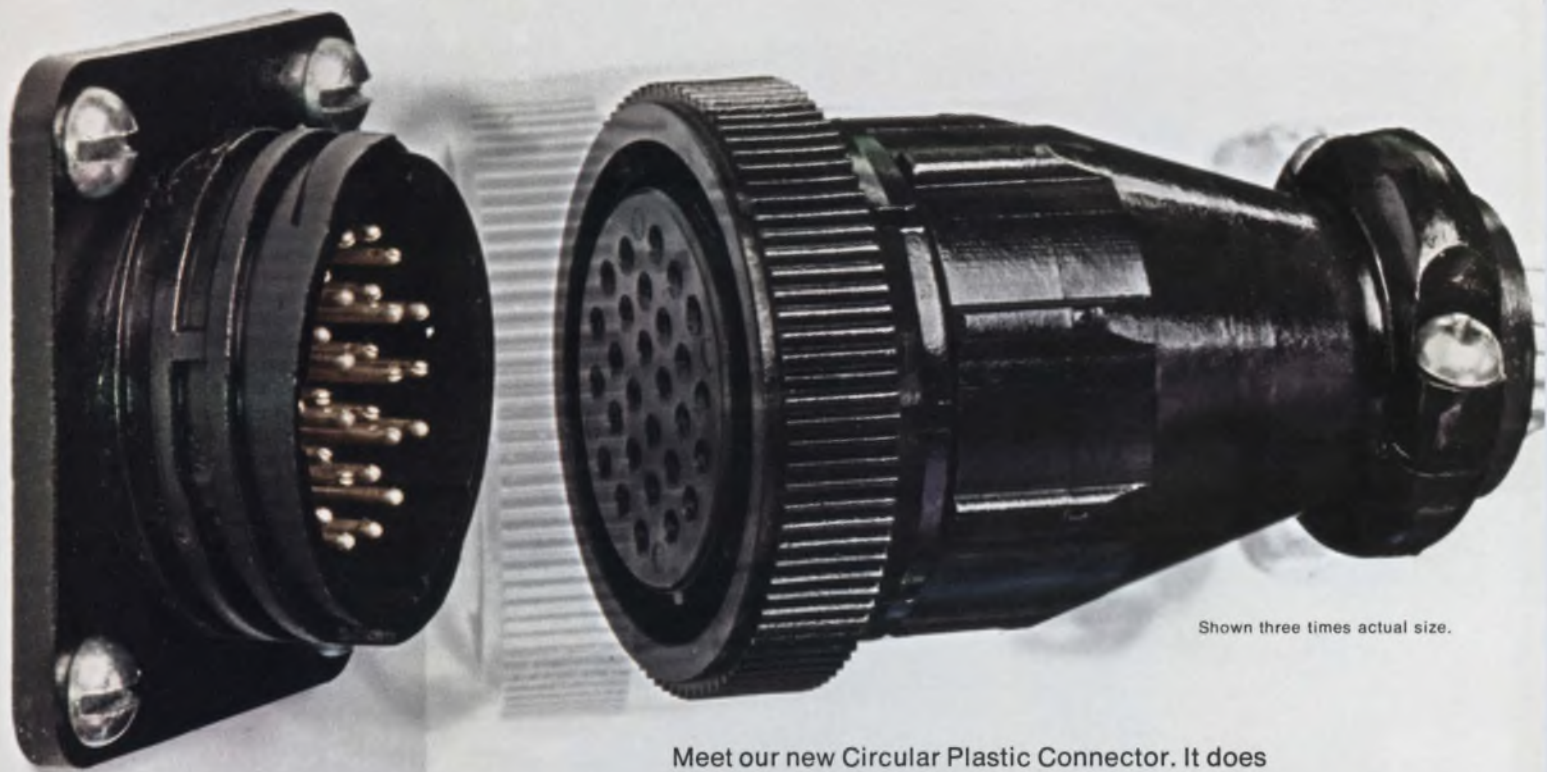

Shown three times actual size.

Meet our new Circular Plastic Connector. It does everything a metal-shell connector will do. Except cost lots of money. We make it of high-strength, glass-filled nylon. So it's just as rugged . . . but lighter, nonconducting and less expensive.

Circular Plastic Connectors cost less to buy. And less to use . . . because you can terminate their pin and socket contacts on our high-speed, automated customer-provided machines. And load only the contacts you need.

We make this new nylon connector in most popular sizes, including 63-position,  $1\frac{1}{8}$ -inch O.D.; 28-position,  $1\frac{1}{8}$ -inch O.D.; and 8-position,  $1\frac{1}{8}$ -inch O.D. Mountable or free-hanging. Standard or splashproof. Rated 7.5 to 15 amp.

Ready for a new twist in circular connectors? Write for details to **AMP Incorporated, Harrisburg, Pa. 17105.**

**AMP**  
INCORPORATED

Manufacturing and direct sales facilities worldwide: Barcelona, Brussels, Buenos Aires, Frankfurt, London, Mexico City, Paris, Puerto Rico, Sao Paulo, s'Hertogenbosch (Holland), Sydney, Stockholm, Tokyo, Toronto, Turin, Vienna.

INFORMATION RETRIEVAL NUMBER 243

# THE FIRST OF THE BIG COUNT TIMERS

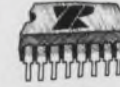
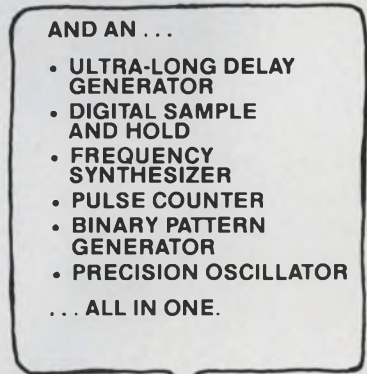
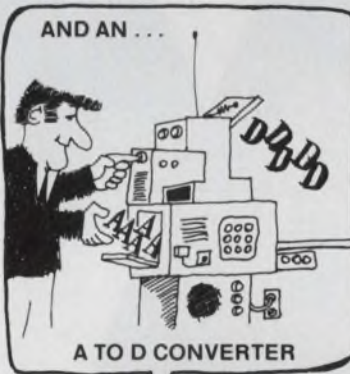
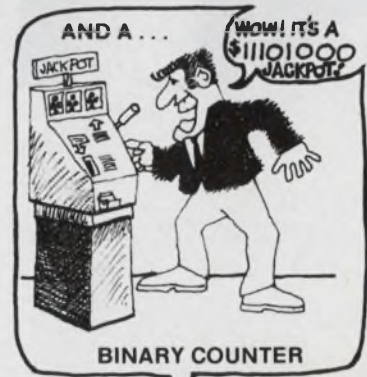
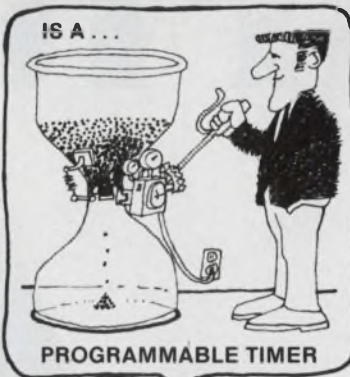
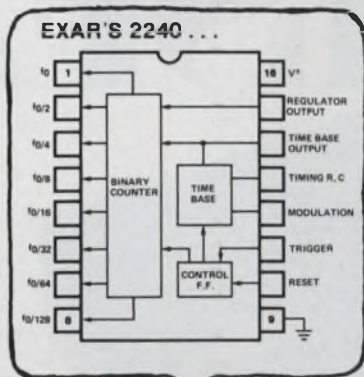

Exar's new XR-2240 counter/programmable timer solves so many tough problems that designers will unanimously agree that it's really the universal timer.

With its unique combination of analog and digital timing methods, you can now replace inadequate and complex assemblages of monolithic and electromechanical timers with the much simpler XR-2240. As a bonus, you get greater flexibility, precision operation, and a reduction in components and costs for most applications.

Because of built-in programmability, you can also use the XR-2240 for frequency synthesis, electronic music synthesis, digital sample and hold, A to D conversion, binary counting and pattern generation, and more.

With a single XR-2240 you can now generate pre-

cision time delays programmable from 1RC to 255RC, a range of microseconds to 5 days. By cascading only two XR-2240 timers, you can extend the maximum delay by a factor of  $2^N$ , where  $N = 16$  bits, resulting in a total delay of 3 years!

The XR-2240 operates over a 4V to 15V supply range with an accuracy of 0.5% and a 50 ppm/°C temperature stability. It's available in either a 16-pin ceramic or plastic dual-in-line package for military or commercial applications. Prices start at \$3.00 in 100 piece quantities.

For the more conventional timing applications, look to our other timers: the XR-220/230 timing circuit and the XR-2556 dual timers. Call or write Exar, the timer leader, for complete information.

**EXAR SPEAKS YOUR LANGUAGE**



**EXAR INTEGRATED SYSTEMS**

750 Palomar Sunnyvale, California 94086 (408) 732-7970 TWX 910-339-9233

**EXAR DISTRIBUTORS** Semiconductor Concepts: Woodland Hills: (213) 884-4560 Hauppauge, L. I.: (516) 273-1234 EEP Corporation: Culver City (213) 838-1912 Intermark Electronics: Sunnyvale: (408) 738-1111 San Diego: (714) 279-5200 Santa Ana: (714) 540-1322 Denver: (303) 963-8284 Seattle: (206) 767-3160 Graham Electronics: Indianapolis: (317) 634-8202 Lafayette: (317) 742-4006 Ft. Wayne: (219) 742-4346 Cincinnati: (513) 733-1661 Radio Electric Service Co.: Baltimore: (301) 823-0070 Gerber Electronics: Dedham: (617) 329-2400 Yankee Electronics Supply: Londonderry: (603) 625-974F

INFORMATION RETRIEVAL NUMBER 2

# SURPRISE!



## New common cathode display just \$2.70\*

Now, the great-looking HP display is available in either common cathode and common anode configuration. Both at the new low price of just \$2.70\* in 1K quantities. Both have the same wide viewing angle and large 0.3 inch character and uniform segment illumination that assures excellent readability.

Specify either the 5082-7730 series (common anode) or -7740 (common cathode) for any commercial application. Reduce your display system costs by choosing the display that complements your drive electronics.

And get traditional HP quality.

Contact your HP distributor for immediate delivery. Or, write us for more details. These displays are worth a closer look.



Sales, service and support in 172 centers in 65 countries.  
Palo Alto, California 94304. Offices in principal cities throughout the U. S.

01332

\*1K quantity: Domestic USA Price Only.

INFORMATION RETRIEVAL NUMBER 3

---

## NEWS

- 27 **News Scope**
- 38 **Instrument '73 special issue**, featuring current trends in instrumentation. Topics covered include: Inside the instrument; packaging concepts; new instrument types; systems compatibility; oscilloscopes and spectrum analyzers; signal sources; E-I-R meters; time and frequency instruments; component and circuit testers; recording equipment; standards and calibration and interviews with pioneer designers.
- 33 **Washington Report**

---

## TECHNOLOGY

- 158 **DPMs vs analog meters**: Is there a clear victor in the battle for panel space? The answer is neither can handle every job. Find out which is best for you.
- 166 **DVMs aren't what they used to be**. More and more, they're being used as systems components. Here's what you should know to interface them with your system.
- 172 **Select digital testers systematically**. Flow charts help match your requirements to the equipment and show management what its money is buying.
- 178 **Don't clobber your circuit with repeated waveforms**. Tickle it with a single pulse and get all your results—faster, more accurately and with less heating.
- 184 **Don't eyeball noise**. Measure it accurately—and repeatedly—with just a two-channel scope. The secret lies in a unique tangential method.
- 190 **Ideas for Design**: Measuring system uses white noise to indicate temperature from 10 to 2500 °K . . . Comparator and CMOS switch build versatile circuit for detecting changes in voltage or frequency . . . Chroma demodulator chip makes low-distortion AM detector.
- 198 **International Technology**

---

## PRODUCTS

- 217 **Packaging & Materials**: Thin, copper-clad laminate replaces ceramic substrates in hybrids.
- 221 **ICs & Semiconductors**: Two-wire line-drivers come in TO-packages.
- 223 **Data Processing**: Minicomputer interface card speeds data at a million words per second.
- 224 **Instrumentation**: Measure GHz power and freq with only one instrument.
- 229 **Instrumentation**: 500-MHz synthesizer switches in under 100  $\mu$ s.
- 230 **Instrumentation**: Lightweight 15-MHz scope sells for just \$500.
- 240 **Modules & Subassemblies**: Get true-rms ac equivalents regardless of the input waveshape.
- 244 **Modules & Subassemblies**: Eight-bit a/d converter is smallest available in size, price and power.
- 248 Components
- 252 Microwaves & Lasers
- 262 Power Sources

---

## Departments

- 155 **Editorial**: The real inflation fighters are those who innovate.
- 7 Across the Desk
- 268 Design Aids
- 270 Application Notes
- 272 New Literature
- 278 Bulletin Board
- 282 Advertisers' Index
- 284 Product Index
- 286 Information Retrieval Card

**Cover**: Designed by Art Director Bill Kelly.



# We make components for guys who can't stand failures.

You can't court martial a resistor or capacitor for refusing to carry out orders. But at Corning we make our resistors and capacitors for guys who are demanding enough to wish that they could.

Corning makes components that give you an extra measure of performance. Components that let you make sure your system delivers all you designed into it. Because, like you and the guys who use your equipment, we can't stand failures either.

#### Some examples:

We build extra reliability into all our components. Components like our metal film resistors—both standard and flame proofs. Components like our glass, ceramic and glass/ceramic capacitors. Like our solid tantalum capacitors—hermetic and non-hermetic, polar and non-polar, miniature and microminiature. And like our discrete component networks—available with custom combinations of discrete microminiature resistors, capacitor chips and diodes in a dual in-line package.

#### Consider our glass capacitors:

Take our high reliability glass capacitors, for example. Their fused

monolithic construction offers outstanding stability, dependability and electrical performance and is virtually immune to environmental stresses. That's why they have been designed into so many major aerospace and missile projects. And why industry has designed them into the most important EDP and instrument applications.

#### And our ceramic capacitors:

Take our miniature multilayer ceramic capacitors, which are QPL to MIL-C-11015 and MIL-C-39014. The dielectric provides high volumetric efficiency and superior reliability. The monolithic units are molded into rugged flame proof cases and are ideally suited for automatic insertion.

Or take our exclusive miniature multilayer ceramic Glass-K™ capacitors, which also meet or exceed all requirements of MIL-C-11015. The special Glass-K dielectric—fused into a compact monolithic structure and sized for automatic insertion—produces high volumetric efficiency and reliable performance. Available in three different stability characteristics, these capacitors are suitable for both military and com-

mercial applications in miniature circuitry.

Our CGC miniature multilayer ceramic capacitors provide increased volumetric efficiency and an extended range of capacitance values. This series is available in four automatically insertable case sizes.

#### We'd like to tell you more:

For all the details on all of Corning's extra reliable components, write for our new "General Design Guide" to: Corning Glass Works, Electronic Products Division, Corning, New York 14830.

And for information on availabilities, call your local authorized Corning distributor or D.I.A.L. EEM: (800) 645-9200, toll-free. Or in New York state, call collect: (516) 294-0990.

**CORNING**  
ELECTRONICS



(2X actual size)



**Vice President, Publisher**  
Peter Coley

**Editors**

Editorial Offices  
50 Essex St.  
Rochelle Park, N.J. 07662  
(201) 843-0550  
TWX: 710-990 5071  
Cable: Haydenpubs Rochellepark  
**Editor-in-Chief** George Rostky

**Managing Editors:**

Ralph Dobriner  
Michael Elphick

**Associate Editors:**

Dave Bursky  
Jules H. Gilder  
Morris Grossman  
Seymour T. Levine  
John F. Mason  
Stanley Runyon  
Edward A. Torrero  
Richard L. Turmail

**Contributing Editors:**

Peter N. Budzilovich  
Steven A. Erenburg

**Editorial Field Offices**

**East**

Jim McDermott, Eastern Editor  
P.O. Box 272  
Easthampton, Mass. 01027  
(413) 527-0183

**West**

David N. Kaye, Senior Western Editor  
2930 West Imperial Highway  
Inglewood, Calif. 90303  
(213) 757-0183

Northe K. Osbrink, Western Editor  
112 Coloma St.

Santa Cruz, Calif. 95060  
(408) 426-3211

**Washington**

Heather M. David, Bureau Chief  
2506 Eye St., N.W.  
Washington, D.C. 20037  
(202) 338-3470

**Editorial Production**

Marjorie A. Duffy

**Art**

**Art Director**, William Kelly  
Richard Luce  
Anthony J. Fishetto

**Production**

**Manager**, Dollie S. Viebig  
Helen De Polo  
Anne Molfetas  
Christopher G. Hill

**Circulation**

**Manager**, Nancy L. Merritt

**Information Retrieval**

Peggy Long

**Promotion**

**Manager**, Jeffrey A. Welner  
Karen Kerrigan

# the EMI suppressors

**Series JX2000/3000 Subminiature Filters . . .  
Broadest Line of Ultra-Small Interference  
Control Components Available . . .  
in 4 weeks or Faster!**

- High performance filters available in 5 different circuits—Feed-thru, L, PI, T, 2L . . . for a wide variety of applications, including power and control lines.
- High insertion loss characteristics . . . based on requirements of MIL-F-15733.
- Hermetically-sealed . . . with glass-to-metal seals in corrosion resistant metal cases.
- Small in size yet big in reliability . . . particularly useful for industrial and military high-density packaging applications.
- Excellent stability, even under adverse environmental conditions, over operating temperature range of -55 C to +125 C.
- Threaded-neck construction . . . effectively isolates input and output terminals.

**selected units NOW available  
OFF-THE-SHELF from your  
Sprague Industrial Distributor**

*For complete information, write for our new 16-page Engineering Bulletin 8132 to: Technical Literature Service, Sprague Electric Company, 347 Marshall St., North Adams, Mass. 01247.*



THE BROAD-LINE PRODUCER OF ELECTRONIC PARTS

INFORMATION RETRIEVAL NUMBER 5



## across the desk

### WOM 'neither novel nor revolutionary'

This is to note that the WOM (Write-Only Memory) described by Signetics' Dr. John Curtis ("WOM Details Aired," ED No. 18, Sept. 1, 1973, p. 7) is neither novel nor revolutionary. Dr. Curtis' development was a two-terminal device, while my invention was a more generalized four-terminal block. Here are the true, startling facts:

■ In November, 1961, I disclosed to my employer, the Perkin-Elmer Corp., the concept of a "Zero-Degree Phase-Shift Standard (ZDPSS)." Later this was test-marketed in New York City as a "Power Line Frequency Booster," with poor results. (The marketing concept here was that appliances such as electric clocks, TV receivers, etc., run slower at the top of tall buildings and thereby require first-order compensation for "frequency drop" effects.)

■ In the pursuit of the above developments, a colleague, Theodore Meier of Ridgefield, Conn., discussed work that he had originated at a nearby telemetry company. He referred to his 1959 "Analog/Digital/Analog Converter." Salient characteristics and specifications were, as I recall:

Digital output—not available.

Output bandwidth—equal to input BW.

Input impedance—equal to  $R_1$ .

Output impedance—equal to  $R_2$ .

Gain accuracy— $< .001$  dB.

Phase linearity— $1 \mu$ rad.

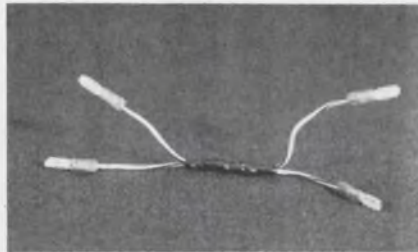

Power required— $< 1$  nW.  
Price—\$350 (1-3); \$450 (4-7); \$750 (8-9).

These first units were so difficult to fabricate that the manufacturer wished to discourage multi-quantity orders.

*George H. Keats*  
Engineering Manager  
Princeton Applied Research Corp.  
Analytical Instruments Div.  
P.O. Box 2565  
Princeton, N.J. 08540

### Engineering guidelines

An old buddy popped into the office the other day with almost a dozen guidelines that many of us follow anyway. He felt that formalizing them might prove of some value. They follow.

1. Never change a line on your drawing if someone else can make the equivalent change by altering 10 lines on his drawing.

2. Always treat a delivery date on the first of the month as if it was really the 30th.

3. If the prototype doesn't meet specs, try to have the specs changed. The customer doesn't need that kind of performance anyway.

4. Always specify 1% compo-

*(continued on page 13)*

Electronic Design welcomes the opinions of its readers on the issues raised in the magazine's editorial columns. Address letters to Managing Editor, Electronic Design, 50 Essex St., Rochelle Park, N.J. 07662. Try to keep letters under 200 words. Letters must be signed. Names will be withheld on request.

## low cost ceramic trimmer capacitors

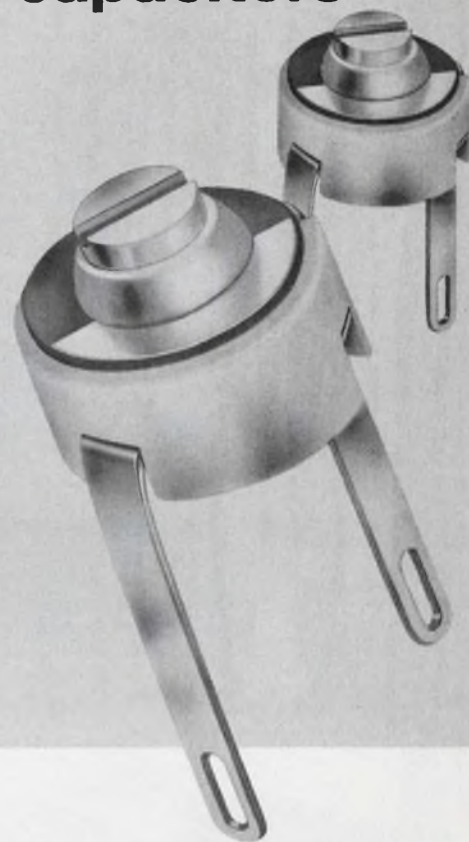

These ceramic trimmer capacitors are designed for broadband application, from audio to 500 MHz and afford an ideal *low cost* means of "trimming" circuitry such as crystal oscillators, CATV amplifiers and all varieties of communication and test equipment.

### FEATURES

- Capacitance values from 1-3 to 5-25 pf
- Low profile - .208 above board height
- Low cost - 75c in 1000 quantities
- Delivery from stock

*Johanson*

MANUFACTURING CORPORATION

BOONTON, NEW JERSEY 07005  
201 / 334-2676  
TWX 710-987-8367

# More ideas from Amphenol's

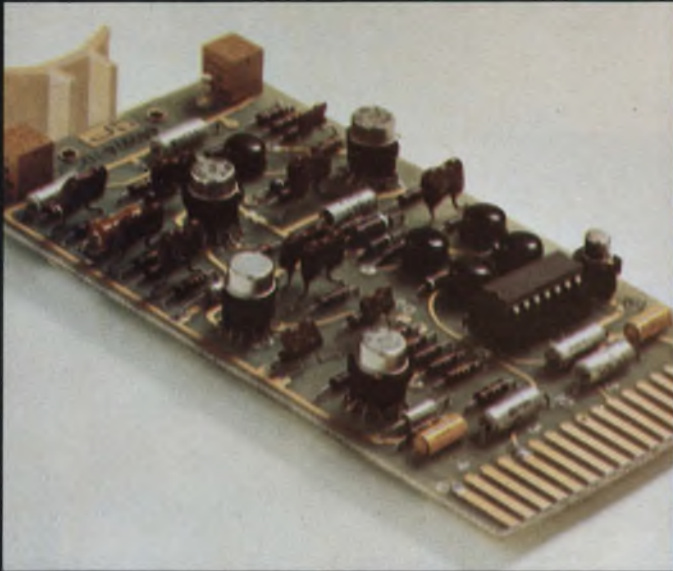

**level 1** Low-cost sockets for transistors in TO packages (above) allow easy replacement and service. ■ New IC sockets are end and side stackable for maximum single board density. Low profile design also allows maximum multi-board density.

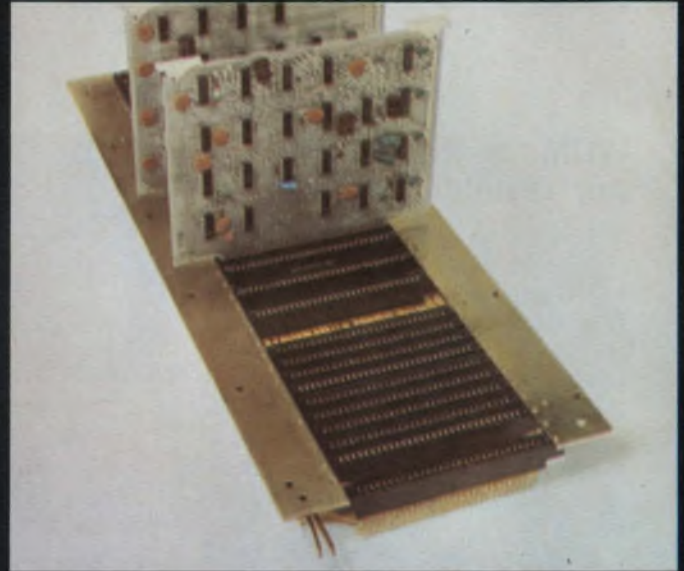

**level 2** Back panel edge board connectors with bifurcated contacts (above) can be wire wrapped or clip-terminated. ■ Bellows contact PC connectors (below) cut interconnection costs without sacrificing performance.

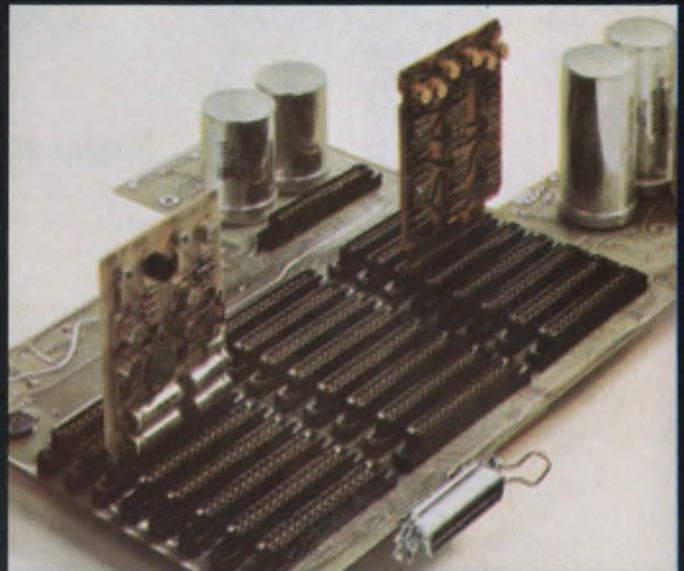
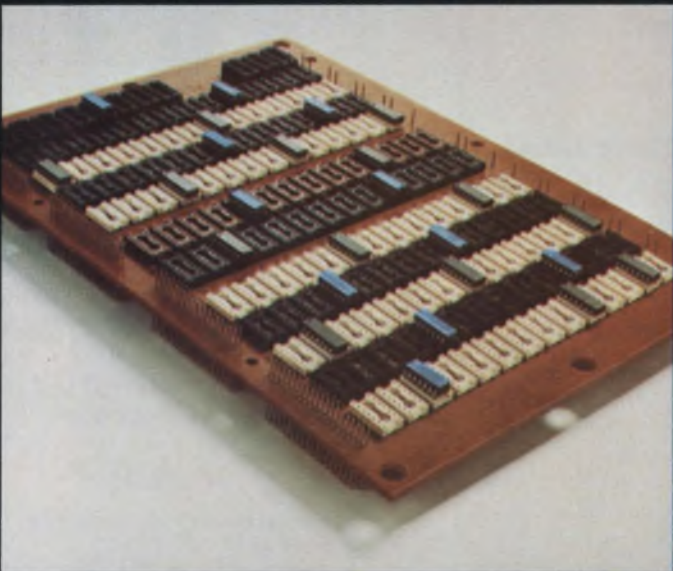

Above are seven new ideas from Amphenol Industrial Division's Spectrum of interconnection capability.

Amphenol's SPECTRUM offers you *all four* levels of interconnections from our unmatched breadth of product line:

**Level 1 . . . DEVICE TO BOARD OR CHASSIS.** We offer interconnections for components such as tubes, relays, transistors, IC packages, trimmers, resistors or capacitors to a PC board or chassis.

**Level 2 . . . BOARD TO MOTHERBOARD OR BACK PLANE.** We offer interconnections for PC boards or

other sub-circuit modules to a motherboard or to a back plane.

**Level 3 . . . MOTHERBOARD OR BACK PLANE WIRING.** We offer interconnections for levels to each other and to other sub-circuits with multi-layer circuit boards, wire wrapping, clip terminations, jumper techniques and dip-soldering.

**Level 4 . . . INPUT/OUTPUT CONNECTIONS.** We offer interconnections for power and signals to and from a system. This interface may be between sub-assemblies within the same enclosure or between individual units.

# Spectrum of interconnections.

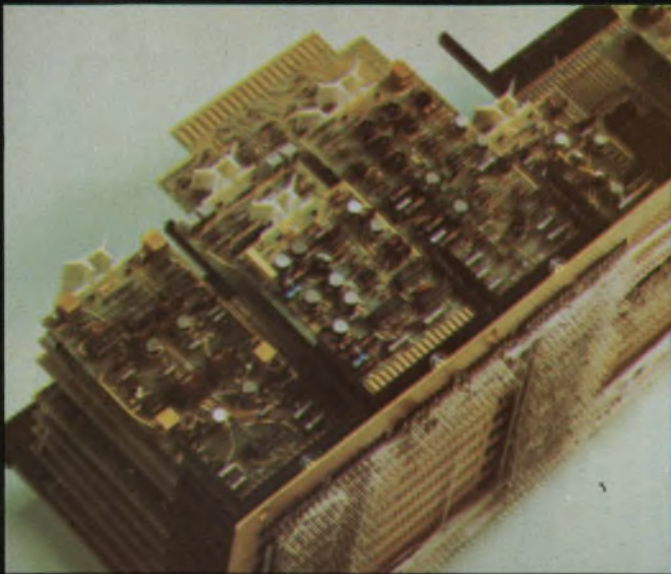

**level 3** Direct entry plate assembly offers modular packaging flexibility. Custom designed plates accommodate any size or style PC board with no tooling cost to you. Rectangular posts are true positioned for automatic wire-wrapping.

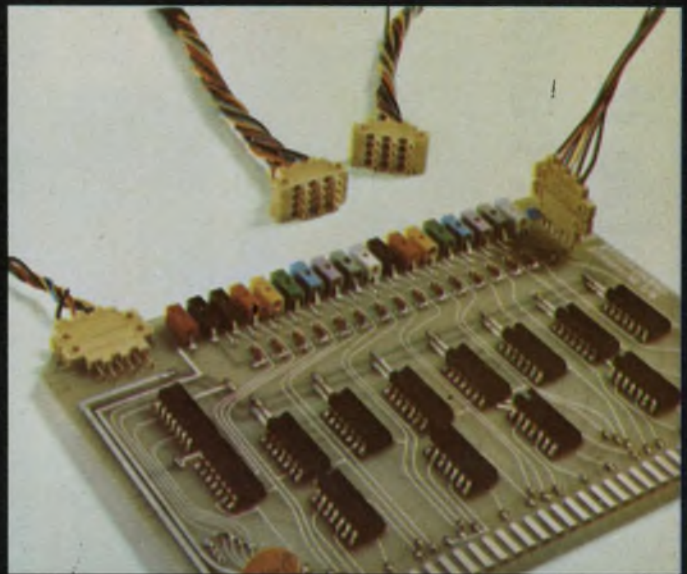

**level 4** Miniature contact (3 input, 3 output) hermaphroditic connectors can be snapped together to connect as many circuits as required. ■ Single finger-tip mounting of low cost connector saves assembly time. Available in UL Class SE-1 flammability rated material.

Write for our Spectrum brochure covering all levels of interconnections.

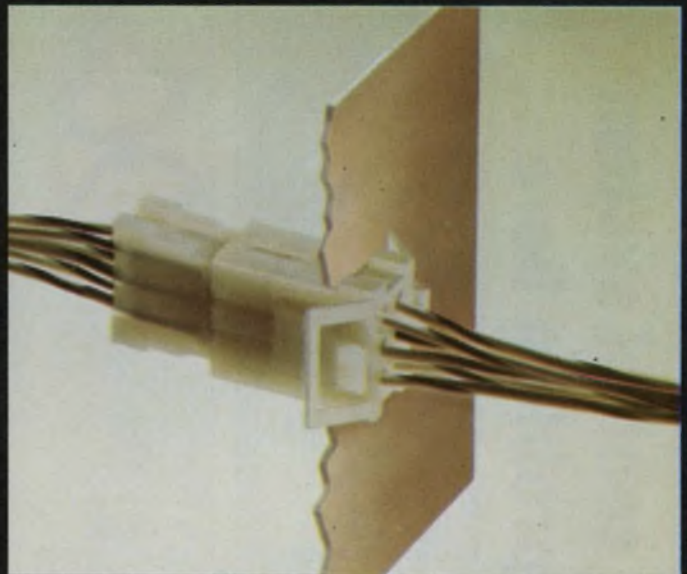

From the simple tube socket—to a myriad of electrical/electronic connectors—to complete and complex termination systems . . . SPECTRUM.

But SPECTRUM is far more than products. It is a depth of capability in engineering, manufacturing and quality control. Amphenol's SPECTRUM is a new height of service, availability and distribution backed by seven Amphenol interconnection-oriented divisions.

Amphenol can fulfill your total interconnection requirements because we are not limited to specifics such as one or two product lines, one or two levels.

Therefore we approach your interconnection needs with complete open-mindedness.

For more new ideas and specific information, write for your copy of "SPECTRUM." Amphenol Industrial Division, Bunker Ramo Corp., 1830 South 54th Ave., Chicago, Illinois 60650.



# AMPHENOL

# Find your control system interface problem here...

1. Incompatible Logic Families

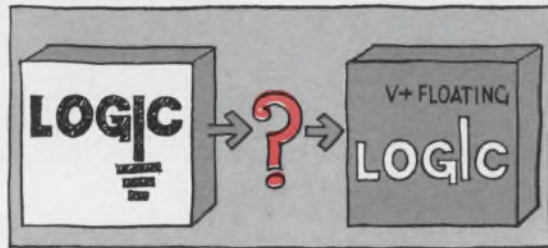

2. AC-to-DC Control

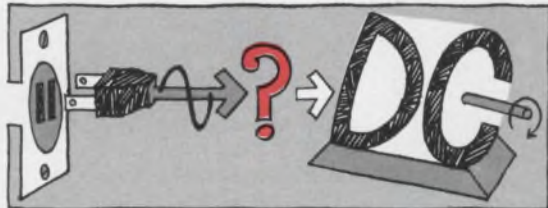

3. Controlling Remote Power Supplies

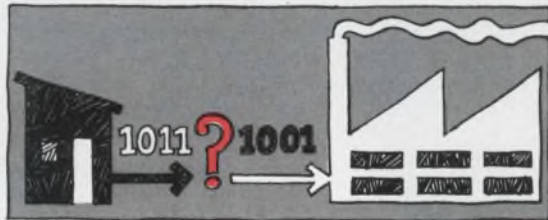

4. Voltage Transient Feedback

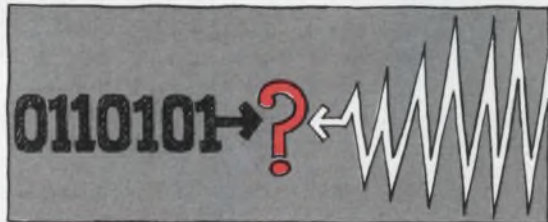

5. DC-to-AC Control

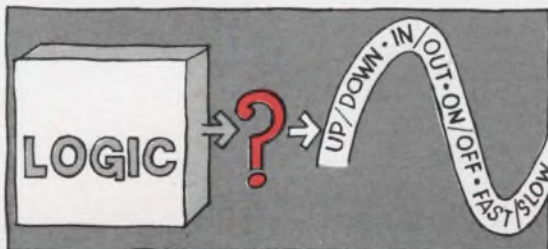

# Then solve it with an optical coupler

## 1. Logic-to-Logic Interfacing

Optical couplers afford total flexibility in logic family interfacing. Logic supplies can float with respect to each other, ground loops and intricate interface techniques involving voltage translators are eliminated.

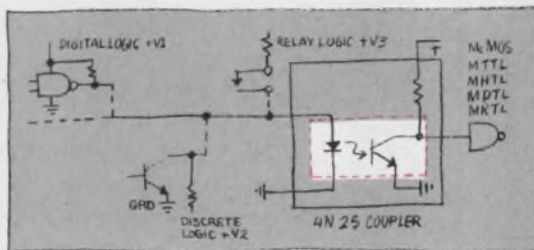

## 2. AC-to-DC Interfacing

AC signals actuate the optical coupler which controls the current through the DC load. Highly economical, the coupler replaces step-down transformers and obviates transient feedback.

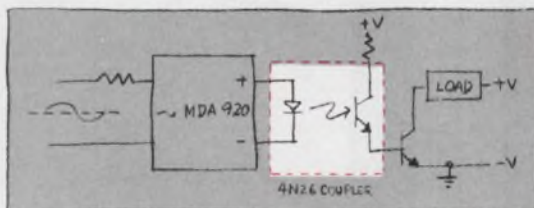

## 3. Remote Control Of Digitally-Programmed Power Supply

100-billion-ohm isolation affords control of a remote floating power source from the computer/peripheral without intricate biasing networks.

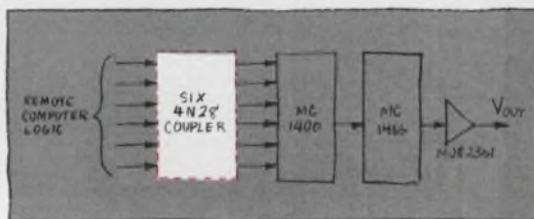

## 4. Logic-to-High Power Interfacing

One unidirectional optical coupler minimizes transient feedback from high power loads conventionally isolated through bidirectional transformers or RC coupling.

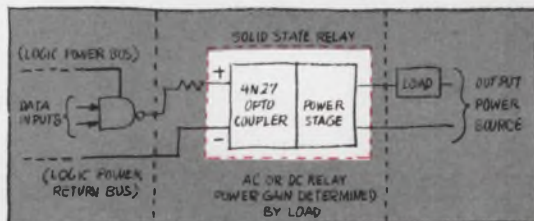

## 5. Logic-to-AC Control/Motor

Easy, economical control of high-level AC power without electromechanical relays and transformers is possible using low-level, 500-2500 V optical isolation. Miniature packaging and PCB plug-in are bonuses.

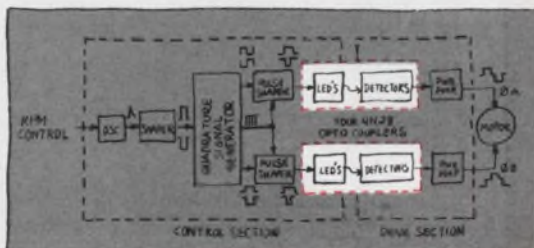

6. Zero-Crossing Detection

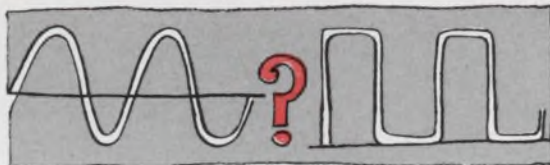

7. Logic Control Of DC Motors

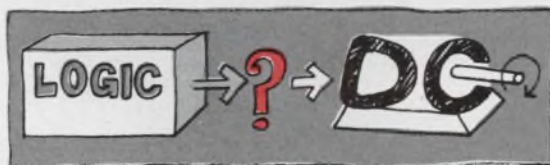

8. Logic-to-AC Relays



9. Long Time Delay Relays

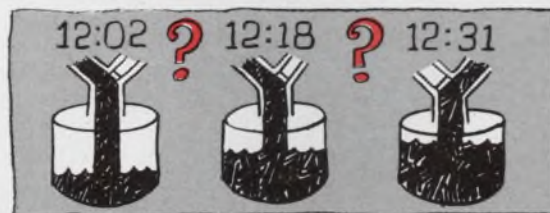

10. Telephone Ringing Current Interrupt

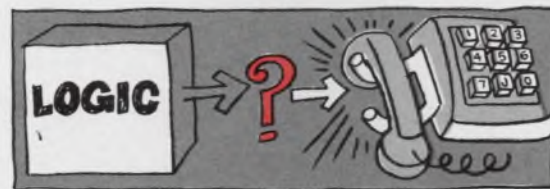

6. Zero-Crossing Detection

For applications requiring use of line voltage for synchronization purposes, an economical approach uses a coupler in place of a transformer.

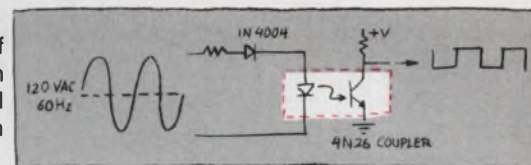

7. Logic-to-DC Motors

Traditional, long-term solid-state operation without arcing, bounce or wear-out is ensured with a no-moving-parts optical coupler and power Darlington transistor.

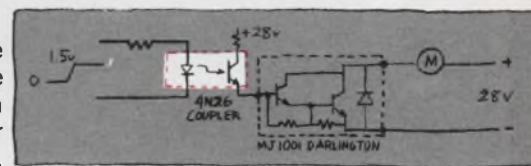

8. Logic-to-AC Relay

Control of AC loads from logic is easily implemented using optical isolation. Speed for zero-crossing actuation unavailable through E-M means, is provided by the total solid-state approach.

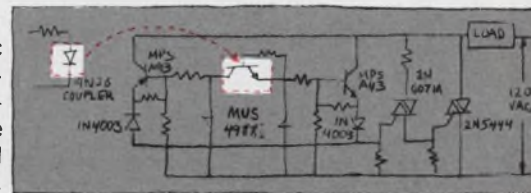

9. Long Time Delay Relays

Processing requirements needing precise mixing/metering through time delay can be met using the MC1555 timer and a coupler to isolate the logic/AC power source.

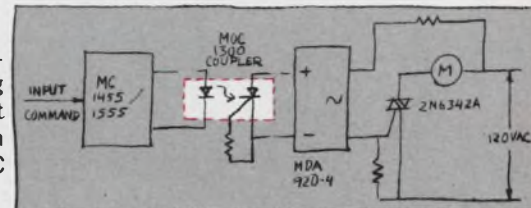

10. Telephone Bell Ringing Actuator

Limited contact life, high maintenance and EMI problems are eliminated with an optically-coupled bell actuator.

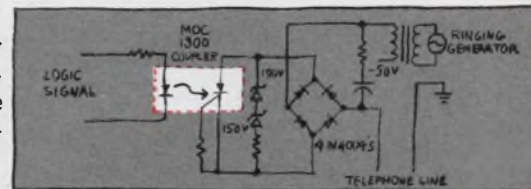

Quick. Simple. Reliable. Optical couplers furnish today's optimized answer to control system interfacing or isolation. Prices

low as 94¢, 1000-up. Find out all about them. Send for "Optical Couplers At Work" P. O. Box 20912, Phoenix, Arizona,

85036. You'll get better answers on interfacing...

INFORMATION RETRIEVAL NUMBER 8

*Problem solving*

from Motorola, the semiconductor source.



**Dow Corning silicones  
protect this Time Computer<sup>®</sup>  
against a 2,500-g impact.**

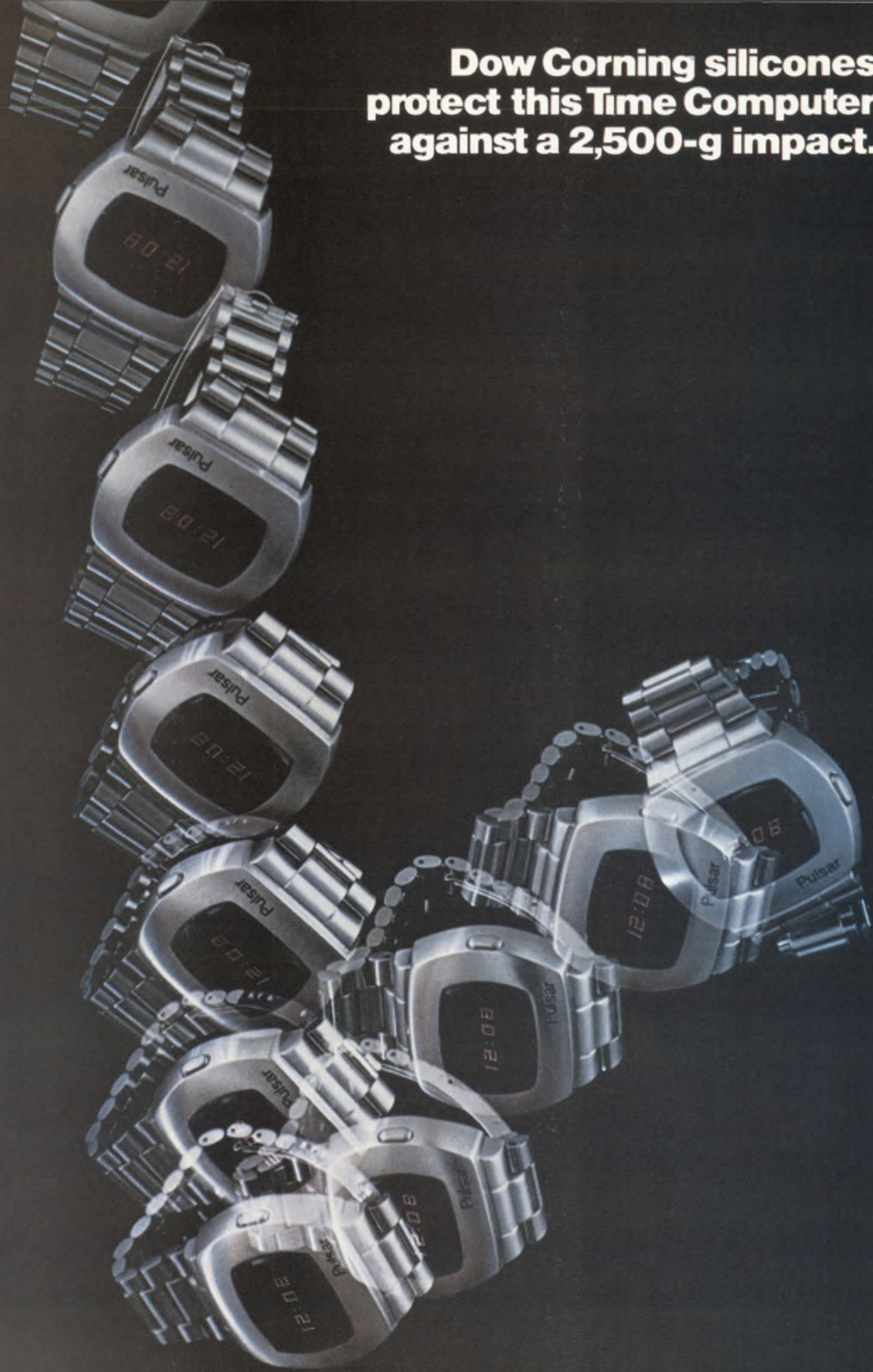

# They also protect against heat, moisture and thermal shock.

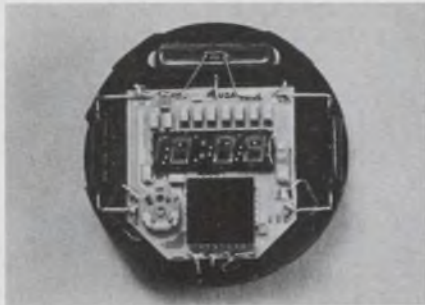

This Pulsar computer circuit uses Dow Corning silicones for shock protection, for positioning individual components, and as a moisture barrier. They all help Pulsar maintain an accuracy of  $\pm 5$  seconds per month. A major production advantage with silicones: only one hour primary cure is required before further assembly work. Yet if a circuit element is improperly placed or doesn't test out, the clear sealant can easily be cut away and the individual component replaced without complete rework. Circle No. 121.

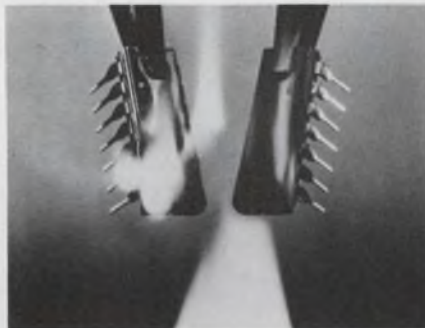

ICs, MOS, CMOS, and other devices made with flame resistant silicone molding compounds provide in many applications the reliability of hermetics at about  $\frac{1}{3}$  the cost. These compounds are superior in moisture resistance, thermal life and electronic stability over other plastics. Their heat resistant and shock protective qualities make them especially valuable in the unusually harsh environments of automotive applications. And molding cycle times are as short as 30 seconds. Circle No. 122.

*Pulsar units withstand 2,500 g's, symbolized by this strobe illuminated scene. Courtesy Time Computer, Inc., subsidiary HMW Industries, Inc.*

\*Trademark of HMW Industries, Inc.

For cooling high-density, high-performance modules, silicone fluids thin out very little, and silicone heat-sink compounds won't melt. This results in more effective heat dissipation, required in high-voltage power supplies operating over a wide temperature range. Circle 123.

Silicone rubber insulated wire and cable, used in nuclear power-plant instrumentation and controls, provide reliable service in applications to 260 C without gumming or



melting. And they continue to function even after a fire because of their nonconducting ash. Circle No. 124.

These electronic-quality silicone products are representative of a complete line of silicones that have inherent properties making them ideal protectors for almost every circuit/system.

Send today for "Silicones for Electronic Design," a 24-page brochure full of special applications for improving electronic circuits. Dow Corning Corporation, Department A-3202, Midland, Michigan 48640. Or call your nearest Dow Corning distributor.

**Silicones; simply the best way to protect electronic circuits.**

## DOW CORNING



## ACROSS THE DESK

(continued from page 7)

nents. It's easier than calculating tolerances.

5. Always use your favorite few transistors in every possible application. That way you won't be trapped by a seemingly better or cheaper device whose specs you can't find time to read carefully.

6. If you only need one, and six companies make it, design your own. After all, what did you go to engineering school for?

7. Catalogs and directories? They're for purchasing agents.

8. Trade magazines? Nothing there but ads. You get enough of that on TV.

9. Customers can find the bugs faster than you can. Ship it.

10. Never argue over delivery dates. You can always make up the time by shipping your prototype as the first production unit.

11. If what the customer specifies is obviously not what he really needs, that's his problem. You have enough of your own.

## For entrepreneurs

Everything you always wanted to know about opening your own shop, but somehow could never find out, has been told in "Up Your OWN Organization" by Donald M. Dibble. It's available for \$14.95 from the Entrepreneur Press, Mission Station, Drawer 2759T, Santa Clara, Calif. 95051.

## Managers need more than technical skills

I agree with all of E. W. Bush's points in "Getting the Best Inside Information" (ED No. 19, Sept. 13, 1973, pp. 86-88), with the exception of part of his last topic: that good engineers/technicians generally get pushed into management/supervisory roles. Most of these good technical people also rise to their highest level of incompetence.

I would urge engineers to include

(continued on page 17)



# Memory lag got you down?

## Relief is 4 easy steps away.

**Step 1.**

Think about  
the company.

**Step 2.**

Pick exactly  
what you need.

**Step 3.**

Know what to expect.

**Step 4.**

Call for Intersil.

## Think about the company.

You know us. Technology leader in bipolar RAMs. A top supplier in P/ROMs. The company with a wider range of memory performance, and more production techniques—bipolar TTL, CMOS, N-channel and P-channel MOS—than any independent solid-state memory manufacturer.

Look here:

## Pick exactly what you need.

	Memory Type	Description	Read Access Time, Max. (nSec)	Power Dissipation, Max. (mW)
RAMs	IM5501	16x4 TTL Static	60	500
	IM5503	256x1 TTL Static, 1 C/S	80	625
	IM5503A	256x1 TTL Static, 1 C/S	60	625
	IM5508	1024x1 TTL Static, 1 C/S	85	625
	IM5523	256x1 TTL Static, 3 C/S, Tri/St	80	625
	IM5523A	256x1 TTL Static, 3 C/S, Tri/St	60	625
	IM5533	256x1 TTL Static, 3 C/S	80	625
	IM5533A	256x1 TTL Static, 3 C/S	60	625
	IM7501	256x1 P-Ch MOS Static	1000	300
	IM7511	256x1 P-Ch MOS Static	750	250
	IM7512	256x1 P-Ch MOS Static	1200	160
	IM7552	1024x1 N-Ch MOS Static	1000	300
	IM7552-1	1024x1 N-Ch MOS Static	500	300
	P/ROMs	IM5600	32x8 TTL Static	50
IM5603A		256x4 TTL Static	60	500
IM5610		32x8 TTL Static, Tri/St	50	500
IM5623A		256x4 TTL Static, Tri/St	60	500
Shift Registers	IM7712	1024x1 P-Ch MOS Dynamic	3MHz	200
	IM7722	1024x1 P-Ch MOS Dynamic	3MHz	200
	IM7780	80x4 P-Ch MOS Dynamic	2.5MHz	355

## Know what to expect.

### Coming Up

IM7733	1024-bit N-Ch MOS Static S/R, 4MHz Freq.
IM6523	256-bit CMOS RAM, 20mW Active Pwr, .25mW Stby
IM5604	2048-bit TTL P/ROM, 80nS Access
IM6508	1024-bit CMOS RAM, 60mW Active Pwr, .30mW Stby
IM5605	4096-bit TTL Static P/ROM, 90nS Access
IM7507	4096-bit N-Ch MOS Dynamic RAM, 400nS Access

## Call for Intersil.

Intersil stocking distributors. Elmar/Liberty Electronics. Schweber Electronics. Semiconductor Specialists. Weatherford.

Intersil area sales offices. Boston (617) 861-7380. Chicago (312) 371-1440. Los Angeles (213) 370-5766. Minneapolis (612) 925-1844. New York (201) 567-5585. San Diego (714) 278-6053. San Francisco Bay Area (home office) (408) 257-5450.

Representatives in all major cities.



# ENI

## The world's leader in solid state rf power amplifiers

Once upon a time if you wanted broadband RF power, you had to settle for bulky tube-type power amplifiers. No more. Because ENI has developed a full line of all-solid-state Class A power amplifiers, covering the frequency spectrum of 10 kHz to 560 MHz, with power outputs ranging from 300 milliwatts to over 1000 watts. And there's more to come.

Driven by any signal generator, frequency synthesizer or sweeper, ENI's compact portable amplifiers, like the ones shown below, are versatile sources of power for general laboratory work, RFI/EMI testing, signal distribution, RF transmission, laser modulation, data transmission, NMR, ENDOR, ultrasonics and more.

Completely broadband and untuned, our highly linear units will amplify inputs of AM, FM, SSB, TV and pulse modulations with minimum

distortion. Although all power amplifiers deliver their rated power output to a matched load, only ENI power amplifiers will deliver their rated power to any load regardless of match.

We also designed our amplifiers to be unconditionally stable and failsafe—you need never fear damage or oscillation due to severe load conditions (including open or short circuit loads).

ENI instrumentation amplifiers come complete with an integral AC power supply and an RF output meter. Ruggedized amplifiers capable of operating under severe environmental conditions are available.

For a **complete** catalog of power amplifiers and multicouplers, write: ENI, 3000 Winton Road South, Rochester, New York 14623. Call 716-473-6900. TELEX 97-8283 ENI ROC.



### 40 WATT/ MODEL 240L

- 20KHz to 10MHz coverage
- More than 40w linear power output
- Up to 150w CW & pulse output
- Works into any load impedance
- Metered output

Extraordinary performance in a wide range of transducer drive applications. Deliver up to 150w into any load regardless of its impedance. Compatible with all signal and function generators, the 240L is a high quality laboratory instrument for ultrasonics, biological research & electro-optic modulation.

### 100 WATT/ MODEL 3100L

- 250 KHz to 105MHz coverage
- More than 100w linear output
- Up to 180w CW & pulse
- Works into any load
- Unconditionally stable

Designed to replace bulkier and less efficient tube type amplifiers, the Model 3100L will provide reliable and maintenance free operation. NMR, ENDOR, ultrasonics and laser modulation are just a few of the applications for this versatile source of RF energy.

### 20 WATT/ MODEL 420L

- 150KHz to 250MHz coverage
- 20 Watts power output
- Low noise figure
- 45dB  $\pm$  1.5dB gain
- Class A linearity

The widest band solid state power amplifier available at its 20w power level, the ENI 420L is a truly state-of-the-art instrument. As a drive source for high resolution acousto-optic modulators and deflectors the Model 420L is invaluable. Its Class A linearity will amplify AM, FM, TV and pulse signals with minimum distortion.

### .3 WATT/ MODEL 500L

- Flat 27dB gain 2MHz to 500 MHz
- 1.7MHz to 560MHz usable coverage
- Thin film construction
- 8dB noise figure
- Failsafe

This compact unit can deliver more than 300 milliwatts from 1.7MHz to 560MHz at low distortion. A thin film microelectronic circuit is the heart of this general utility laboratory amplifier. Extremely wide band response at a very modest price.

## ACROSS THE DESK

(continued from page 13)

management and communication courses as part of their undergraduate or continuing studies. A broad educational base would seem increasingly desirable in this age of "overspecialization" and "over-qualification."

Barry J. Lorenzo

DCA Reliability Laboratory, Inc.  
645 Clyde Ave.  
Mountain View, Calif. 94040

## Get more roots with N-R, readers say

Several readers have pointed out that the formula for the square root given in T. P. Sylvan's Idea for Design, "Simple Algorithm Computes Square Roots on a Four-Function Calculator" (ED No. 15, July 19, 1973, p. 104), is a special application of the Newton-Raphson technique for successive approximations. The readers offer this formula for the calculation of the  $M^{\text{th}}$  root of the  $N$ :

$$X_{k+1} = \frac{1}{M} \left[ \frac{N}{X_k^{(M-1)}} + (M-1) \cdot X_k \right] \quad (1)$$

The Newton-Raphson equation provides the successive approximation formula

$$X_{k+1} = X_k - \frac{f}{f'}, \quad (2)$$

to calculate the root(s) of the equation

$$f(X) = 0. \quad (3)$$

To derive an expression for the  $M^{\text{th}}$  root of  $N$ , choose

$$f(X) = N - X^M \quad (4)$$

and substitute this equation and its derivative for  $f$  and  $f'$  in Eq. 2 to get Eq. 1.

## And don't forget Grigsby-Barton

Your recent article on solid-state relays, "Solid-State Relays Are Finding Gradual Acceptance—at Last," (ED No. 19, Sept. 13, 1973, pp. 26-31), did not mention Grigsby-Barton, Inc. We originally introduced the Reedac (reed-triggered

(continued on page 19)

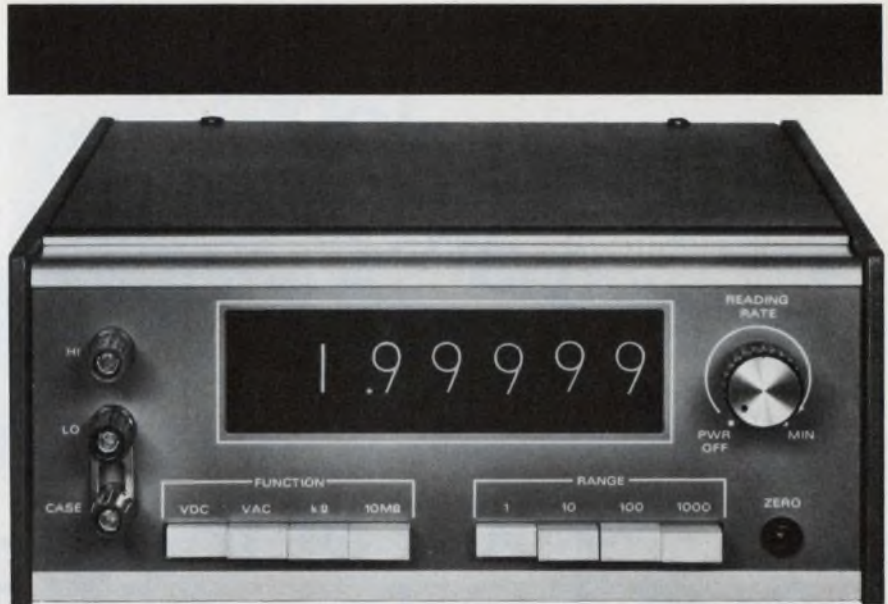

# NEW

5 1/2 digits }  
10 μV AC/DC } \$750  
10 mΩ/digit }  
BCD output }

The new Model 190 is a full-function ac/dc Digital Multimeter...including a built-in BCD output! It's the best value to hit the DMM market in a long time.

This new Keithley Digital Multimeter gives you 5 1/2-digit performance on a 4 1/2-digit budget. Now you don't have to try to read that last, flickering digit on a 4 1/2-digit multimeter to save money. The 190 gives you full performance too. Look at its capability:

- 10 μV/digit to 1000 volts dc
- 10 μV/digit to 1000 volts ac rms
- 10 mΩ/digit to 20 megohms
- 1000 megohm input resistance on 1 V range
- 500 volts low-ground isolation
- 80 dB NMRR, 100 dB CMRR

The Keithley Model 190 Digital Multimeter — the best value we know in a precision DMM. Send for more details or a demonstration now.



**KEITHLEY**  
INSTRUMENTS  
U.S.A. 28775 AURORA ROAD, CLEVELAND, OHIO 44139  
EUROPE 14 AVENUE VILLARDIN, 1009 PULLY, SUISSE

We've developed custom ICs  
more than 50 months  
in the last 18 months

Ours is one of the broadest  
54/74 TTL lines in the world



5000 production-line types  
make us dominant in discretes

Who makes  
more than 21 types of  
display drivers?



We're doers, not talkers!



# semiconductors



ITT Semiconductors is a division of International Telephone and Telegraph Corporation, 3301 Electronics Way, West Palm Beach, Florida 33407. Phone 305/842-2411.  
Factories in West Palm Beach, Florida • Lawrence, Massachusetts • Footscray, England • Colmar, France • Freiburg, Germany • Cascais, Portugal • Sydney, Australia.

# ITT

## ACROSS THE DESK

(continued from page 17)

triac) in May of 1966, and in January of this year we introduced the Synchro DIP (LED-coupled, zero-voltage SSR).

Joseph E. Pascente  
Vice President

Grigsby-Barton, Inc.  
3800 Industrial Dr.  
Rolling Meadows, Ill. 60008

## Correction

The position of resistor R<sub>1</sub> in Fig. 1 in the Idea for Design "Resistive Bridge and Op Amp Form a Multiplying DAC" (ED No. 19, Sept. 13, 1973, p. 92) is incorrect. It should be changed as follows:

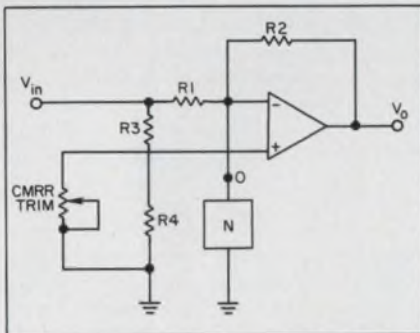

## ED's sex score: 'equal opportunity'

I'm becoming an avid reader of Across the Desk and your editorials, and must finally speak up on a very important matter. One of your readers was turned off by Janice (see "Turned Off by Janice," ED No. 12, June 7, 1973, p. 7). She's a doll, and so is the Guardian Angel just a few pages away. But, to be fair, let's examine the entire magazine.

In the March 15 issue—the one in which Janice first appeared—starting with six girls in the Exar ad on p. 1 and four girls in the HP ad on p. 2 and winding up with two hands (sex not given) in the Molex ad on the back inside cover, I find that the sex content of advertisements in the issue totals: 25 girls, 24 men, 3 bunches of men,

(continued on page 21)

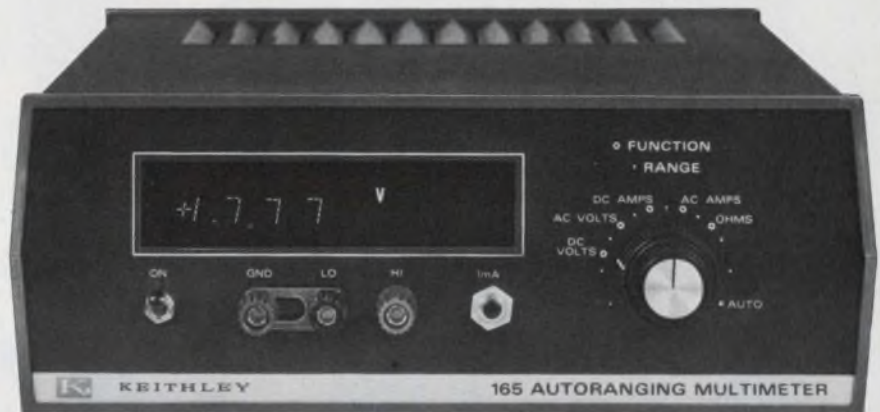

# NEW... 5-Function DMM gives 32 automatic or manual ranges of measuring power.

The new Keithley Model 165 Autoranging Digital Multimeter...virtually a complete test bench in a box. This unique DMM gives you more measuring power over wider limits than any comparable instrument:

- 10  $\mu$ V to 1000 V dc
- 10  $\mu$ V to 500 V rms ac, 20 Hz to 20 kHz
- 10 m $\Omega$  to 200 M $\Omega$
- 1 nA to 2 A dc
- 0.1  $\mu$ A to 2 A rms ac, 20 Hz to 20 kHz
- 50 amps ac and dc with optional shunt

But that's not all. The 165 is fully autoranging and it boasts a fuseless solid-state overload protection that really protects! There's more features you'll like — such as a low (10 mV) input drop on amps; 100 millivolts applied to the unknown on ohms; and... a built-in 1 mA current source that will turn on diode junctions so you can measure both forward and back resistances.

You'll really like the measuring power that the Model 165 gives you — all for the little price of only \$495... get complete data or a demo now.



**KEITHLEY  
INSTRUMENTS**  
U.S.A. 28775 AURORA ROAD, CLEVELAND, OHIO 44139  
EUROPE 14, AVENUE VILLARDIN, 1009 PULLY, SUISSE

# 3 SOLUTIONS TO IN-HOUSE POWER SUPPLY PROBLEMS YOU, ME & US

**YOU** can select up to 50 different models of low cost "building block" sub-modular power supplies. Add your own transformer and heatsink and you have the best power supply that you can build.

**ME** means Powertec takes your specs, selects from the same 50 standard sub-modules, and assembles, tests and delivers the best power supply that meets your standard or custom requirements.

**US** means that Powertec supplies a documented power kit consisting of a standard sub-module(s) and a transformer. And with our application engineering services, all you do is install the kit in your system.



Exclusive built-in rectifier, filter, regulator and OVP makes the standard sub-modular power supplies a unique low cost building block. Savings up to 60%. And that's what makes You, Me and Us happen.

**Features:**

- Built-in rectifier, filter, regulator, OVP
- Up to 30v, up to 75a
- Logic inhibit
- Adjustable voltage, current limit, OVP
- Regulation: line/load  $\pm$  0.075%
- Remote sensing
- Easily spared and maintained
- Maximum form factor flexibility
- No external components
- U.L. recognized

Our new catalog gives all the cost saving details, write or give us a call.

**VOLTAGE/CURRENT RATING CHART:**

MODEL	- 100		- 200		- 300		- 400		- 500		PRICES	
	*4.75V to 7.0V	*7.0V to 10.5V	*10.5V to 15.75V	*15.75V to 22.0V	*22.0V to 30.0V	1	100					
	5V	6V	8V	10V	12V	15V	18V	20V	24V	28V		to 999
<b>22AA</b>	.40A	.35A	.25A	.20A	.23A	.20A	.19A	.18A	.17A	.16A	\$ 15	\$ 10
<b>22A</b>	1.0A	.875A	.725A	.625A	.575A	.500A	.475A	.450A	.425A	.400A	23	15
<b>22B</b>	3.0A	2.5A	2.2A	1.9A	1.7A	1.5A	1.4A	1.3A	1.2A	1.1A	30	20
<b>22C</b>	6.0A	5.2A	4.4A	3.8A	3.4A	3.0A	2.8A	2.6A	2.5A	2.3A	45	30
<b>22D</b>	12.0A	10.4A	8.8A	7.6A	6.8A	6.0A	5.6A	5.2A	5.0A	4.7A	60	40
<b>22E</b>	18.0A	15.6A	13.2A	11.4A	10.2A	9.0A	8.4A	7.8A	7.5A	7.1A	75	50
<b>22F</b>	24.0A	21A	17.25A	15A	13.7A	12.2A	11.2A	10.7A	10.0A	9.4A	105	70
<b>22G</b>	36.0A	31.5A	26.0A	22.5A	20.6A	18.2A	16.8A	16.0A	15.0A	14.1A	145	95
<b>22H</b>	50.0A	43.8A	35.9A	31.3A	28.5A	25.3A	23.3A	22.3A	20.8A	19.6A	190	125
<b>22J</b>	75.0A	65.6A	53.9A	46.9A	42.8A	38.0A	35.0A	33.4A	31.3A	29.5A	265	175

Typical ordering information for 5V, 1.0A, Model 22A-100; and 12V, 6.8A, Model 22D-300, etc. \*Volt. adj. range.

**Powertec, Inc.,**  
 an Airtronics Subsidiary / 9168 DeSoto Avenue / Chatsworth, California 91311 / (213) 882-0004. TWX (910) 494-2092

# POWERTEC

## ACROSS THE DESK

(continued from page 19)

17 hands, 7 unisex drawings or other.

I want to congratulate ED on its almost "equal opportunity" for men and women. I note (excluding the "bunch" pictorials) that you're just one short on the men score; however, I'll climb into the Janice picture and we'll call it even.

Perhaps, as a friend of mine says, the motto of our profession might be: "We're engineers, not men."

Robert J. Horak  
Manager

Test Equipment Products

Ailtech  
19535 E. Walnut Dr.  
City of Industry, Calif. 91748

## Pornography? 'You know when you see it'

The editorial "Women" (ED No. 17, Aug. 16, 1973, p. 41), is very poor and you demean yourself by it. You know perfectly well what is good and bad taste in advertising and you know pornography when you see it.

There are ways of using images and references to females in advertising copy that are not insidiously and suggestively corrupting in a moral way. You know it; I know it; and so—I reckon—do most of your readers.

You also must be well aware by now how insidiously clever people with talent can be at generating corrupt art. Therefore please just exercise your judgement for the benefit of your readers and do not opt out of your responsibilities.

The answer to your question in paragraph 4—"Should I be arrogant enough to assume that others should not see an ad because I don't like it?"—is YES. Otherwise either you do not know your own mind or you haven't any backbone.

A. G. E. Mobey

54 Kingston Rd.  
Ewell, Epsom,  
Surrey,  
England

(continued on page 23)

# Here's the BEST probe-readout DMM for fast and accurate measurements.

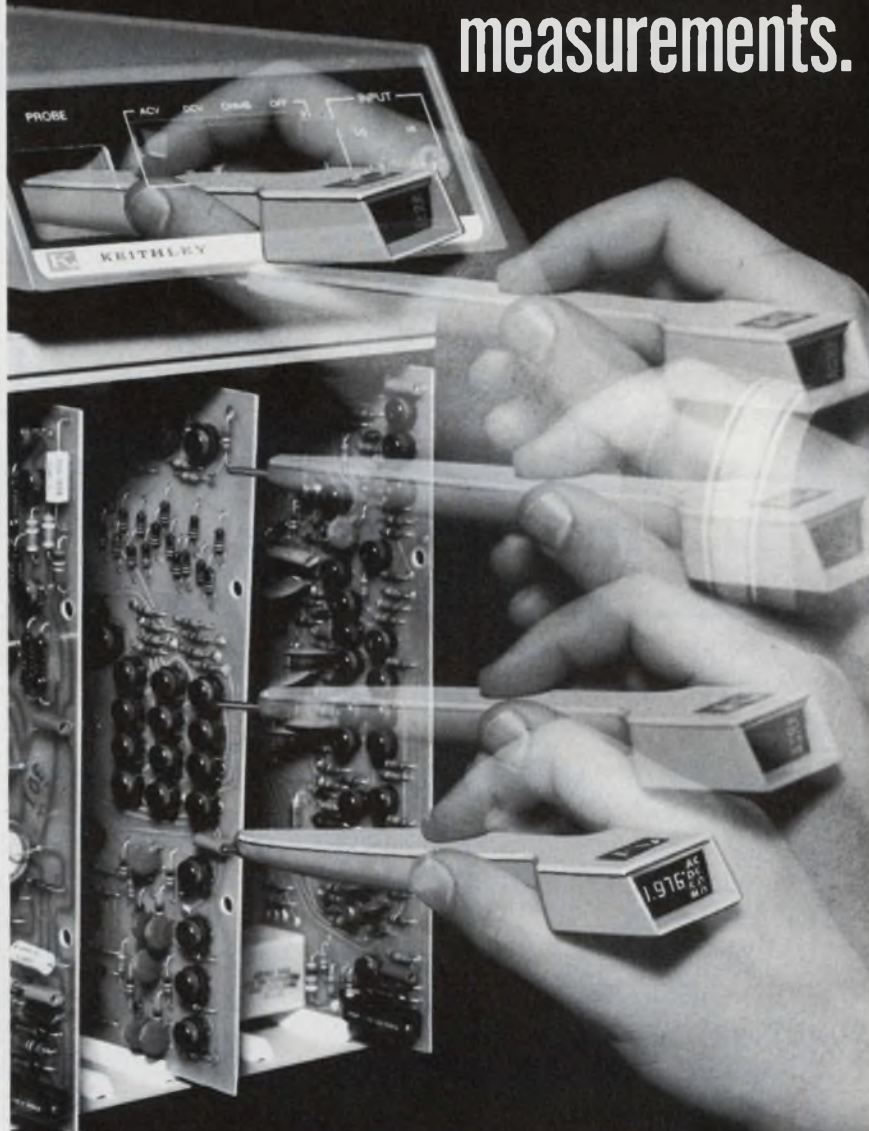

Keithley's Model 167 Auto-Probe DMM is *still* unmatched. We've kept the probe small... not the performance. Look at the features you can't get elsewhere in a probe-readout DMM:

- accuracy to 0.2% dc, 1% ac
- 55 megohms input resistance
- 5 readings (and range-changes) per second
- 20 Hz to 20 kHz ac bandwidth
- 20-hour continuous battery life

Of course, the Model 167 is autoranging... and overload-protected... and it can be line operated too.

The Model 167 Auto-Probe DMM — only \$325. Send for more details. You should have the best.



**KEITHLEY  
INSTRUMENTS**

U.S.A. 28775 AURORA ROAD CLEVELAND OHIO 44139  
EUROPE 14 AVENUE VILLARDIN 1009 PULLY SUISSE



# Spending too much time debugging wide band hi-slew op-amp circuits?

Try RCA's CA3100! Virtually free from Ringing.

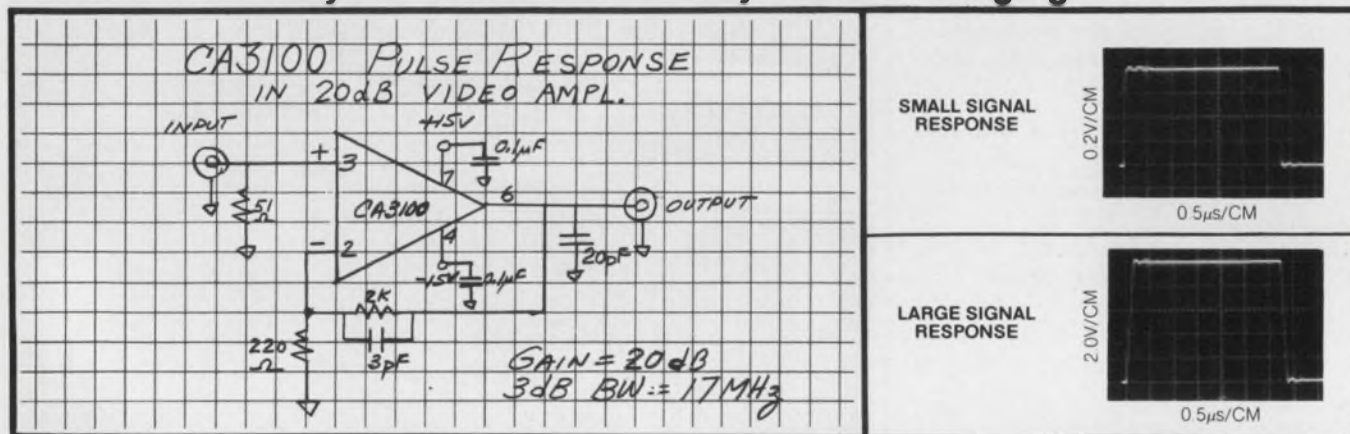

That's because we've combined all of the following features in a single device:

- High open-loop gain at video frequencies—42 dB at 1 MHz.
- High slew rate—70 V/usec (unity-gain, voltage follower, input compensated).
- High slew rate—25 V/usec (unity-gain, voltage follower, single capacitor compensated).
- Fast settling time—0.6 usec.
- High output current— $\pm 15$  mA(min.).

These features are achieved with simpler circuitry because we've combined P-MOS and bipolar transistors on a single chip.

Compare the CA3100 with other wideband op-amps. You'll see the difference. Large signal or small... output waveforms are true reproductions of the input—virtually free from ringing and distortion. Also, compare open loop gain at Video Frequencies—22 dB at 10 MHz.

The CA3100 features dc offset adjust terminals for applications requiring offset null. It can be compensated with a single external capacitor and is pin compatible with other op-amps such as the LM118, LM307, and UA748.

Whatever your applications... high-speed comparators, instrumentation, video... take advantage of the CA3100's characteristics. You get all these features and more... with no tradeoff in price—\$3.50 for 1000 unit quantities.

The CA3100 is available in the standard TO-5 hermetic package, CA3100T, or the dual-in-line version, CA3100S. You can get them in production quantities from your local distributor or direct from RCA.

Interested? Let us send you the complete DATA SHEET! Write: RCA Solid State, Section 57K-22 Box 3200, Somerville, N.J. 08876. Or phone: (201) 722-3200.

**RCA** Solid State  
products that make products pay off

Sprechen Sie . . . ?

**Systeme  
brauchen Elektronik**

Gemeinsam mit Partnern im In- und Ausland baut MBB den AIRBUS, das neue Kampflugzeug MRCA, Flugkörper Systeme sowie Forschungs- und Telekommunikations-satelliten. Diese Systeme brauchen Elektronik

Wir beziehen die Komponenten von führenden Firmen aus aller Welt. Unsere Aufgabe ist der Entwurf der Gesamtlogik, die Abstimmung der Teile, der Bau von Zwischengliedern und die Fertigung und Wartung der Gesamtsysteme.

Die Magnetschwebbahn, das Cabintaxi sowie der Bau von Telemetrie-, Betriebsdatenerfassungs- und Prozeßsteuerungsanlagen sind neue Anwendungsgebiete unserer Elektronikerfahrungen aus Luft- und Raumfahrtaktivität

Für die Mitarbeit an diesen Aufgaben sucht MBB

**INGENIEURE, PHYSIKER und MATHEMATIKER**

Die Vielfalt der Arbeiten schildert Ihnen der MBB-Stellenreport. Dieser Stellenreport gibt genaue Aufgabenbeschreibungen zu allen offenen Positionen. Er ermöglicht Ihnen eine gezielte Bewerbung. Fordern Sie bitte den MBB-Stellenreport an!



Ideen. Und Produkte. Für die Zukunft Europas.

An die  
Messerschmitt-Bolkow-Blohm,  
Bewerbungsleitstelle A14,  
8 München 80,  
Postfach 801149,  
Tel 089/60002243

**Coupon:**

Bitte senden Sie mir den „MBB System Elektronik Stellenreport“

Name \_\_\_\_\_

Anschrift \_\_\_\_\_

Derzeitige Position \_\_\_\_\_

Fachrichtung \_\_\_\_\_

This ad from West Germany's Messerschmitt-Bolkow-Blohm, which appears on page 283 this issue, was not published in error. It's the company's way of recruiting qualified engineers, physicists and mathematicians from the U.S.



**NEW  
AC/DC Digital Multimeter  
has all the sensitivity, ranges  
and functions you need  
... built in.**



The new Keithley Model 171 Microvolt Digital Multimeter provides you with more measuring ranges than any other multimeter in its class. At only \$895 the 4½ digit Model 171 is the only multimeter you need whether it be for bench, systems, or servicing use — or all three.

This DMM eliminates the need for add-on preamps, plug-in circuit boards, hang-on shunts or other run-arounds. The only option we need offer is an easy-to-interface BCD output — and that's available built in.

The Model 171 measures

- dc voltage - from 1 microvolt to 1000 volts
- ac voltage - from 10 microvolts to 1000 volts
- ac & dc current - from 100 picoamperes to 2 amps
- resistance - from 100 milliohms to 2000 megohms

With all its capability this new Multimeter is really "sweet to have" . . . and our newest "how sweet" button proclaims just that. Get yours — and complete data or a demonstration of the Model 171 — today.



**KEITHLEY  
INSTRUMENTS**  
U.S.A. 28775 AURORA ROAD, CLEVELAND, OHIO 44139  
EUROPE 14, AVENUE VILLARDIN, 1009 PULLY, SUISSE

# Get the world's first 556 Dual Timer free. And a 10% discount.



# Without any contributions on your part.

Raytheon Semiconductor has plenty of ideas on how you can incorporate this new 556 Dual Monolithic Timer into your circuit designs. Without asking you to do our work for us.

What we really want is your order. And to prove it we're offering a 10% discount on the first 1,000 pieces of the 556 Dual Timers you order.

We're sure that once you get your hands on our free sample, and read the applications brochure, you'll be as enthusiastic about this new standard 14-pin plastic DIP as we are.

And the ten percent saving is just the beginning. When you compare unit, insertion and inventory costs — and space saving per board — over the old single 555 timer, you can add another twenty percent.

Start thinking about Raytheon Semiconductor as your major source for linear IC's. Whether you're in the market for the new 556 Dual Timer or just the single 555 timer.

## Free 556 Designer's Kit plus 10% Discount Offer

- Rush me your free Designer's Kit with 556 Dual Timer and descriptive brochure.
- Send me a certificate which entitles me to a 10% discount on the first 1,000 pieces of the 556 Dual Timers I order.
- I'm only interested in your single 555 Timer, so please send me a free sample.

PLEASE PRINT

NAME

TITLE

COMPANY

ADDRESS

CITY

STATE

ZIP

Please check the following:

I presently use  single  dual timers.

I don't use timers now, but am considering using them in the near future.

Send to:

Raytheon Semiconductor  
Dept. 556  
350 Ellis Street  
Mountain View, California 94042

Discount applies to first order only. These offers expire midnight February 1, 1974. These offers are void where prohibited by law.

ED

**RAYTHEON**

# A startling announcement:

TRW's new  
Schottky Power  
Rectifier



gives a  
0.5V forward  
voltage drop



at 50 amps



at a  $T_j$  of...125°C!



If that doesn't startle all power supply designers, nothing will.

Here's the first, and only, Schottky power rectifier that doesn't fssst-out at 100°C—let alone, higher! In fact, TRW's new device actually operates at a  $T_j$  of 125°C with a 0.5V<sub>f</sub> at 50 amps.

Maybe you have heard discouraging talk about similar devices made by other companies. Or tried one, yourself. If so, you may have experienced "mysterious failures." Certainly you had

failure when  $T_j$  reached 100°C. And it was no mystery: the thing melted!

But this is different. This is made by TRW. After 5 years R&D to be sure it would work. And it does! At 100° At 125° With 35V reverse operating voltage.

Ask the nearest distributor for TRW's new Schottky power rectifier. Part number SD 51. Or contact John Powers, TRW Semiconductors, an Electronic Components Division of TRW, Inc., 14520 Aviation Boulevard, Lawndale, California 90260.

## **TRW** SEMICONDUCTORS

These products are available through the following authorized distributors:

Almo Electronics  
Bell Industries  
Cramer Electronics Inc.  
De Mambro Electronics

Eastern Radio Corp.  
Electronics Marketing Corp.  
Elmar Electronics Inc.  
Hall-Mark Electronics Corp.

Harvey-Michigan Inc.  
Liberty Electronics  
Powell Electronics  
Pytronics

Semiconductor Concepts Inc.  
Summit Distributor  
R. V. Weatherford Co.  
Westates Electronics Corp.

## Devices meeting will scan advances in 3 major areas

A new high-speed semiconductor that is twice as fast as MECL III...flat-panel displays that could replace cathode-ray tubes in television...pyroelectric vidicons that are smaller and cheaper than present infrared imagers.

These are some of the developments that will be discussed Dec. 3-5 at the IEEE International Electron Devices Meeting in Washington, D.C.

At the first of three device-technology sessions, Albert E. Cosand, a member of the technical staff at the TRW Systems Group, Redondo Beach, Calif., will tell of a new high-speed, low-power bipolar IC process known as OAT (for oxide aligned transistor). The new process is actually a modified form of emitter-coupled logic. According to Cosand, the fabrication technique consists of a buried collector epitaxial process that uses self-aligned diffusions and silicon-nitride selective oxidation masks.

The advantage, Cosand says, is that the process yields devices that are more than twice as fast as MECL III and at much lower power. An OAT divide-by-two circuit can toggle at frequencies as high as 1300 MHz with power dissipation of about 40 mW, Cosand reports. By comparison, the MC 1690, the highest-speed MECL III divide-by-2 circuit now available, has a toggle rate of only 500 MHz and power dissipation of 200 mW.

In explaining how the high speed of the OAT device is achieved, Cosand notes that very shallow diffusions are used. For low power, he goes on, parasitic capacitance is reduced by the self-aligning process and 200-mV differential signals are used instead of the 600-mV, single-ended signal in conventional emitter-coupled logic.

Flat-panel television display advances will be reported by several

companies in five sessions on image transducers and optoelectronic devices. Included is a paper by Y. Amano of Sony, who will tell of a 105-by-140-mm (4.1-by-5.5-inch) television display that contains 60,000 picture elements, can differentiate 32 shades of gray and has a resolution of 210 by 280 lines.

Unlike cathode-ray tubes, which form an image by scanning the display area, the image on the Sony gas-discharge panel is formed by x-y addressing. The intensity of the picture can be controlled by changes in the magnitude and duration of the current applied to the display.

Liquid crystals are also being explored for flat-screen TV. According to Henry T. Peterson, an engineer from Hughes Aircraft Co., Culver City, Calif., liquid crystals offer good visibility under high ambient light. The work at Hughes, Peterson will tell the conference, has yielded a liquid-crystal display that is 1 inch square and contains almost 10,000 picture elements. This display also uses an x-y addressing scheme, he notes, and the transistor driving matrix is fabricated on a single silicon chip.

Peterson says that for specialized applications, a 10-inch diagonal screen might be commercially feasible in about three years.

Optoelectronic advances are also being made in infrared imaging, papers at the conference will indicate. Pyroelectric vidicons that are sensitive to heat are being developed to replace bulkier and more expensive forward-looking infrared units.

The pyroelectric material in these devices, Lynn Garn, engineer with the Army Electronics Command, Ft. Belvoir, Va., notes in a paper, are sensitive to radiation in the 8-to-14- $\mu$  range. When the temperature of the material

changes, so does the material's spontaneous polarization. The change in polarization alters the surface charge on the material, which results in a video signal.

Pyroelectric vidicons, once commercially available, will cost between \$2000 and \$5000 and will replace devices now costing \$100,000, Garn will report.

## New IBM semis aim for terahertz range

A new class of semiconductor devices that uses the wave nature of electrons instead of their particle properties is being developed at IBM's Thomas J. Watson Research Center in Yorktown Heights, N.Y.

Known as a superlattice device, the new semiconductor interacts with an electron wave in much the same way that optical filters interact with light. Thus the device essentially has no upper frequency limit.

According to Leo Esaki, head of the company's superlattice research program and a winner of this year's Nobel prize in physics, the new device, while experimental at present, could result in oscillators, amplifiers and switches that operate in the terahertz range.

Electrons moving through a semiconductor normally encounter periodic electrical potential, caused by the regularly spaced, positively charged ions of the crystal lattice.

In the superlattice semiconductor, Esaki explains, alternating layers of gallium arsenide and gallium aluminum arsenide, 100 Å apart, create additional periodic electrical disturbances. This gives the material a negative-resistance property, thereby making the device potentially suitable for oscillators, amplifiers and switches.

To achieve the 100 Å spacing, well defined structures are necessary. These structures cannot be achieved using normal processing techniques. Instead, says Esaki, a molecular-beam epitaxy technique is used. This technique is governed by surface kinetics and does not occur near thermodynamic equilibrium; therefore it can produce the necessary well-defined structure.

Samples of superlattice devices

made so far, reports Esaki, show a slight negative resistance—the property that should permit high-frequency oscillation of the devices. However, a further improvement in crystal perfection in the samples is necessary to increase the average distance that electrons travel between collisions with ions. In present samples, he goes on, the distance is too short to permit the full interaction with the superlattice required to produce strong negative-resistance effects. Improvements in the crystal-growing system should overcome this problem, he says.

Esaki declined to speculate when such devices would become practicable.

## AF presses design of 'flying computer'

The Air Force says it's on schedule in its long-range effort "to revolutionize aircraft electronics." Gradually taking form in what the Air Force calls the Digital Avionics Information System, or Dais, the concept calls for feeding all sensor outputs in an aircraft into an elaborately programmed central computer. Computer modules will handle all the sensor information in the aircraft, make computations and display the appropriate information to the crew at the right times.

To do this, all information is reduced to digital form, which enables the computer to switch from handling television displays, for example, to weapon-delivery calculations and then to navigation.

Dais is in the study phase at present, but equipment is to be built and ready for testing in the laboratory by the end of 1976, according to a spokesman at the Air Force Avionics Laboratory, Wright-Patterson Air Force Base, Ohio.

Common data formats are to be used as well as data routes, known as data busses, to replace the miles of electrical wires now used in military aircraft.

Most changes will be handled by altering software rather than hardware, but with the system modular, it will be easy to change sensors through a plug-out, plug-in arrangement. To convert a "daytime"

fighter-bomber into a night fighter plane, for example, the television weapon-delivery system can be pulled out and an infrared unit slipped in.

Work on Dais is being directed at the Air Force Avionics Laboratory by a team of engineers headed up by Lt. Col. John Ruth.

Greater MTBF is to be described into Dais through the use of redundancy at subsystem, equipment and component levels. If certain processors or memory units should fail, the system will be capable of continuing to perform the most important mission functions by switching on other processors in a network of multi-processors.

At the heart of Dais is a multiplexed information data bus, which will transmit information among the sensors, the information-processing system and the information presentation and control system. A common data format will be one of the keys to the flexibility of the system. It will be possible to plug a new or different sensor into the data bus in the same way that a new computer terminal gets plugged into a time-shared computer network with use of the telephone line as the data bus.

## Dc motor generates own tach signal

A new type of dc motor provides a tachometer signal from its armature winding, in contrast with motors with separate armature and tachometer windings or motors coupled to a separate tachometer.

"The object of the development program," according to John Luneau, president of Torque Systems Incorporated, Waltham, Mass., "was a low-cost tachometer feedback system for 0.01-to-0.1-hp servo motors capable of precise feed control, particularly in the lower 10% of its operating range."

The motor built by Torque Systems, called a Motac, can be produced for about two-thirds the cost of the two-winding motors and about half that of the motor and tachometer combination, Luneau says.

The Motac, he explains, has a single commutator. The key to the design is a special brush arrange-

ment and electrical interconnections. The tachometer signal is independent of the back emf of the windings that carry motor-armature current. The Motac operates over a speed range of 100 to 1, Luneau reports. Depending on the particular motor, operating speed may range from 5 to 500 rpm or 50 to 5000. Speed stability is on the order of 2 to 5% of the speed at which the system is set, Luneau notes. This compares with 0.2 to 1% for separate motor-tachometer systems and 5 to 20% for competitive IR-compensation systems, he says.

## Multiple medical pack a NASA spinoff

A 40-pound diagnostic and therapeutic medical unit developed under a NASA contract has been placed on the market for emergency care.

Called Telecare by its developer, SCI Systems of Houston, Tex., the unit includes a capability for voice and telemetry communications, through an ambulance repeater, to a medical center. The 1-W FM transmitter can send an electrocardiogram on a 460-MHz link from the scene of an accident to a doctor at a remote site.

Included in the 21-by-10-by-14-inch box is:

- A respiratory resuscitation system.
- A 15-minute oxygen supply.
- An electrocardiogram display and telemetry system.
- A defibrillator for external heart simulation.
- A semiautomatic, indirect blood-pressure measurement system that uses a microphone placed beneath a hand-inflated cuff—similar to the blood-pressure device used in the Skylab program.
- A basic pharmaceutical pack.

According to Craig Castle, marketing manager at SCI, the blood-pressure measurement system improves accuracy by amplifying the lower frequencies of the blood-pressure waveform, mixing them with a voltage-controlled oscillator and translating them to higher frequencies that the human ear is more sensitive to.

Telecare will sell for less than \$10,000, according to the company.

# WHEN BUDGETS AND SPACE ARE TIGHT...



specify the better  $\frac{3}{4}$ " long  
10-turn precision potentiometer!

## **BOURNS** NEW MODEL **3540**

*MODEL 3540 IS RUGGED, TOO! CHECK THE EXCLUSIVE CONSTRUCTION FEATURES.*

- SILVERWELD® UNITIZED TERMINATION — Why settle for multi-joint, terminal-to-element connection? Get the direct element-to-terminal connection method that guards against catastrophic failures

\*1000-1999 quantity  
U.S. Dollars, F.O.B., U.S.A.

- MOLDED-IN, SHAFT-TO-ROTOR CONSTRUCTION — This Bourns feature optimizes stop-strength and minimizes accidental rotor/shaft displacement and slippage
- NON-CEMENTED, ALL-MECHANICAL ASSEMBLY. Snap-on straps provide all mechanical assembly. No cemented joints, heat-forming, or ultrasonic welding

### *LOOK AT THE SIGNIFICANT SPECS!*

- LINEARITY: 0.25%
- TEMPERATURE RANGE: -55 to +125°C
- RESISTANCE RANGE: 100 ohms to 100K ohms



BOURNS, INC., TRIMPOT PRODUCTS DIVISION • 1200 COLUMBIA AVE., RIVERSIDE, CALIF. 92507



# Here are two of the world's best oscilloscopes.

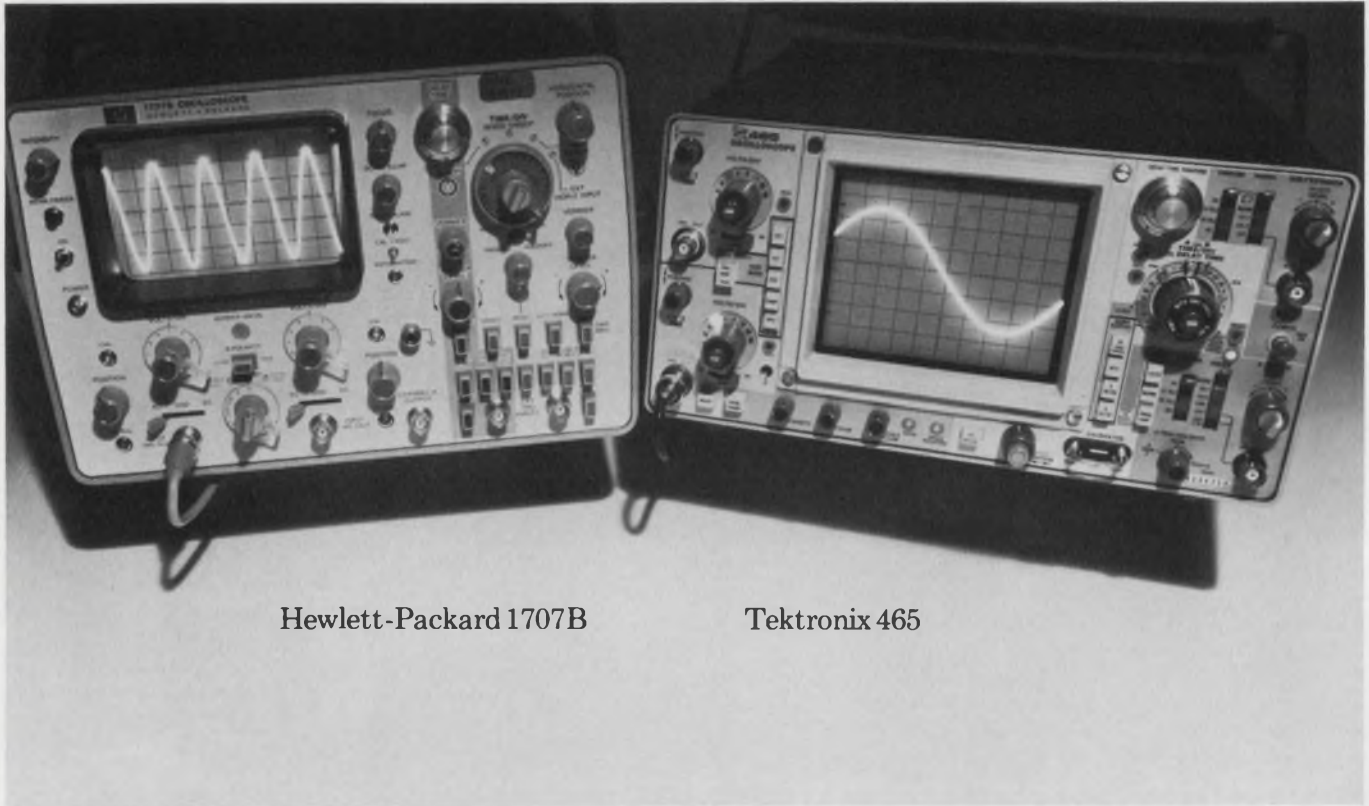

Hewlett-Packard 1707B

Tektronix 465

## Here's why you shouldn't own either one.

You can lease one for as little as \$45 per month.

We can give you immediate delivery on either the Hewlett-Packard 1707B or the Tektronix 465, in quantity.

The Hewlett-Packard scope lease is \$45 per month for 36 months. The Tektronix 465 is \$50 per month for 36 months.

Anyway you choose, leasing is the best thing that ever happened to a tight capital equipment budget. You pay for your scope as you use it ... and you pay for it out of the profits it generates.

Call your closest Instant Inventory Center and ask us about short term rentals, delivery, and other lease terms for scopes or any other electronic equipment you need, up to and including minicomputers.



Anaheim, California (714) 879-0561

Dallas, Texas (214) 661-8082

Fort Lauderdale, Florida (305) 771-3500

Gaithersburg, Maryland (301) 948-0620

Lexington, Massachusetts (617) 861-0667

Mountain View, California (415) 968-8845

Oakland, New Jersey (201) 337-3757

Rexdale (Toronto) Ont., Canada (416) 677-7513

Rosemont, Illinois (312) 671-2464

## Rental Electronics, Inc.

A **PEPSICO** leasing company.

# Centralab perspectives

FOR USERS OF ELECTRONIC COMPONENTS



**CENTRALAB**

Electronics Division  
GLOBE-UNION INC.

5757 NORTH GREEN BAY AVENUE  
MILWAUKEE, WISCONSIN 53201

## New Selectashaft Rotary Switch program corrects industry shortcoming.

**Users of custom rotary switches can now get delivery within days, thanks to this new field assembly program offered by participating Centralab Distributors.**

If it's taking you several weeks or even months to get delivery of custom rotary switches, you'll want to look into a new field assembly program pioneered by Centralab and available from their Selectashaft™ Distributors.

The thrust of the program is to ship orders of custom rotary switches within hours of their receipt. Eliminated are lengthy factory delays and special factory set-up charges.

Customers are finding the scope of Selectashaft switches indeed awesome. More than 100,000 combinations of miniature and subminiature



Custom switch assemblies with more than 100,000 combinations are available in days from Centralab Selectashaft Distributors.

switches are available, filling 95% of user needs.

The program enables you to select the exact length front shaft,

exact shaft end details, and the exact shaft flat angles required. You can choose from 92 types of rotary switches for field assembly by the Distributor to your choice of three .250 inch diameter shaft styles: plain round, .218 inch flat, or .156 flat configurations. The shafts themselves are offered in 24 sizes from .687 inch to 2.375 inches long from the mounting surface. Shaft flat angles can be specified in increments of 15°.

The Selectashaft Distributor program has been underway barely a year, and both Distributors and customers agree it meets a definite shortcoming that previously existed. In that short span, the number of participating distributors has grown to make the benefits of Selectashaft rotary switches available nationwide — on a local basis.

For complete product and price information, contact the Centralab Selectashaft Distributor nearest you. Or write Centralab Distributor Products, Dept. SAS-1. 

### CALIFORNIA

Elmar Electronics Inc.  
Mountain View 94041  
415/961-3611

Fisher/Brownell, Inc.  
Los Angeles 90061  
213/532-2170

Fisher/Brownell, Inc.  
Santa Clara 95050  
408/244-6182

Kierulff Electronics Inc.  
Los Angeles 90022  
213/685-5511

Milo of California  
San Diego 92111  
714/292-0900

R.P.S. Electronics  
Los Angeles 90015  
213/748-1271

### FLORIDA

Electronic Equipment Co.  
Miami 33142  
305/871-3500

Hammond Electronics  
Orlando 32802  
305/241-6601

### INDIANA

Radio Distributing Co., Inc.  
South Bend 46624  
219/287-2911

Ra-Dis-Co, Inc.  
Indianapolis 46202  
317/637-5571

### MASSACHUSETTS

Electrical Supply Corp.  
Cambridge 02138  
617/491-3300

### MICHIGAN

RS Electronics  
Detroit 48227  
313/491-1012

MINNESOTA  
Gopher Electronics Co.  
St. Paul 55113  
612/645-0241

### NEW YORK

Peerless Radio Corp.  
Lynbrook, L.I. 11563  
516/593-2121

Summit Distributors  
Buffalo 14202  
716/884-3450

### NORTH CAROLINA

Kirkman Electronics  
Winston-Salem 27108  
919/724-0541

### OHIO

Esco, Incorporated  
Dayton 45403  
513/226-1133

Pioneer-Standard Electronics  
Cleveland 44105  
216/587-3600

Stotts-Friedman Company  
Dayton 45402  
513/224-1111

### PENNSYLVANIA

Cameradio Company  
Pittsburgh 15222  
412/391-7400

Herbach & Rademan, Inc.  
Philadelphia 19134  
215/426-1700

Philadelphia Electronics Inc.  
Philadelphia 19107  
215/568-8288

### TEXAS

Harrison Equipment Inc.  
Houston 77004  
713/224-9131

Texas Instruments Supply  
Dallas 75235  
214/238-6811

Southwest Electronics Inc.  
Houston 77036  
713/782-3060

### WASHINGTON

Almac/Stroum Electronics  
Seattle 98108  
206/763-2300

# FIVE CMOS DECODERS

THE FULL COMPLEMENT  
FOR 2, 3, AND 4-BIT  
BINARY TO 1 OF  $2^N$   
LINE DECODING

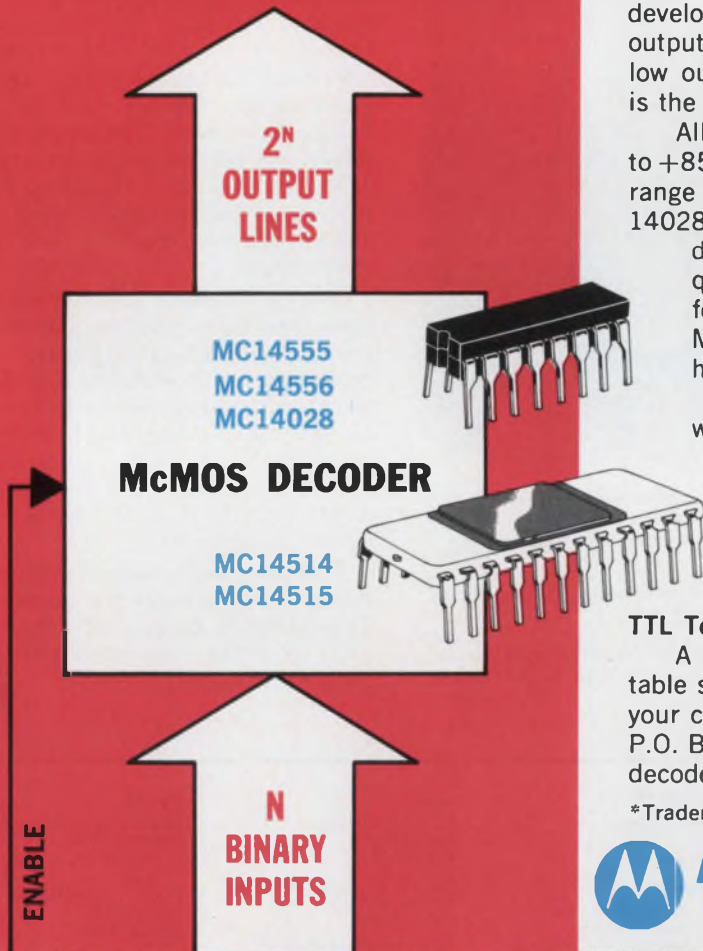

There's a CMOS\* decoder for the job, whatever your need for two, three, or four-bit decoding in code conversion, data routing, memory selection, and similar CMOS systems applications. Only Motorola's user oriented CMOS family supplies this full complement.

**MC14555 and MC14556** A pair of dual two-bit binary to 1 of 4 decoders. The '55 is the CMOS equivalent to a couple of popular TTL functions, with active high outputs. The '56 is the same function, but with active low outputs where the selected line goes to the low state. Expansion of the decoding function, such as binary to hexadecimal, is achieved by connecting additional units.

**MC14028** This three-bit binary to 1 of 8 line decoder is versatile, also serving as a BCD to 1 of 10 line decoder. It has active high outputs and an enable input.

**MC14514 and MC14515** Here are two output options of a 4 to 16 line decoder with latched inputs, developed by Motorola. The 14514 has active high outputs and the opposite number 14515 has active low outputs, but the important thing to remember is the four-bit input latches (R-S type flip-flops).

All five types are available in both McMOS<sup>®</sup> -40° to +85°C commercial (CL) and wide (AL) temperature range dual in-line ceramic packaging, and the MC-14028, MC14555, and MC14556 are also available in dual in-line plastic (CP). CL and CP 100-999 quantity prices are in the \$3.12 to \$3.67 range for the 555, 556, and 028 decoders, and the MC14514 and 515CLs are understandably higher at \$13.75.

These decoders, as with all Motorola CMOS whether it be second source or the predominant Motorola designed 14500 series, share the outstanding characteristics of the McMOS family of which they are all a part. They are available from Motorola distributors and sales offices.

#### TTL To McMOS Function Reference Available

A brand new TTL to McMOS function conversion table suitable for wall mounting is just out. Send for your copy to Motorola Semiconductor Products Inc., P.O. Box 20912, Phoenix, Arizona 85036. We'll send decoder data too.

\*Trademark of Motorola Inc.

 **MOTOROLA MOS**  
Expanding dimensions in digital design

# McMOS

LOGIC OF THE 70's

# washington report



Heather M. David  
Washington Bureau

## **Metric conversion faces test in House**

The House Science and Astronautics Committee bill calling for development of a national plan for conversion to the metric system will be challenged on the House floor. Rep. Robert McClory (R-Ill.) will offer an amendment, with some backing from other Congressmen, to do away with the requirement for a "comprehensive national plan" subject to the approval of the President, the Congress and the Commerce Dept. McClory argues that each industry will require separate plans for conversions, with continual revision. Also, getting everyone to agree on a single comprehensive plan could delay defacto conversion indefinitely. The Senate Commerce Committee recently voted out a metric-conversion bill, without holding hearings, and it has received Senate approval. While metric-conversion bills have been floating around Congress for almost a decade, this is the farthest they have progressed with time enough left in the session to get a single bill agreed upon by both houses.

## **Navy seeks new mobile communications**

The Navy wants to develop a new class of super-secure portable communications gear. It would permit the command staff on a ship to communicate with other personnel on the ship or with other ships or shore installation, without going through a communications room. The concept, drawn up by the Naval Electronics Laboratory, calls for a family of uhf gear, including communications helmets to be worn by key personnel, particularly in high noise environments, such as aircraft and helicopter landing areas. The helmets would be in touch with fixed and portable transreceivers and base station control centers. Cryptographic techniques would be incorporated. The name of the new program is Man-on-the-Move Communications—or in Navy lingo, MOMCOM.

## **AF to replace strategic communications system**

In what may be one of the biggest communications equipment programs in recent years, the Air Force is planning a massive replacement of its 465L Strategic Air Command Communications system. The new program, called the Satin IV (Strategic Air Command Total Information Network), will replace an older, often one-way, partly nonsecure system. Satin IV is to have two-way secure communications and greatly increased network capacity. It will also have such features as terminals with CRT consoles and mass storage units.

The Air Force Electronics Systems Div. expects to get the system operational in five years, using state-of-the-art design. The system will involve a network of 400 to 500 terminals linking SAC headquarters units, aircraft bases and missile bases. A single system contractor will be chosen probably in late 1975, for system development, including hardware, software, integration and support. The new network will have near real-time data communications capability, using AUTOVON lines. Interested contractors can get a copy of "A Preliminary Design Concept for SATIN IV" from ESD.

## **TV tuner redesign delayed again**

For the second time, the Federal Communications Commission has extended the deadline for meeting its requirement that uhf TV sets be built with the same tuning accuracy now found in vhf receivers. At first the cutoff date for old tuners was July 1, 1974. But after complaints by industry and the Electronic Industries Association, the FCC delayed the deadline until 1975. Now with a second extension, TV manufacturers have until July 1, 1976, to meet the new standard. The requirement states that black and white uhf TV sets have 70-position tuners with an accuracy of  $\pm 1$  MHz. Fine-tuning for color TV must be automatic.

## **Defense Dept. feeling component pinch**

Contracting for "captive" production lines for hard-to-get electronic components is one of several ideas being explored by a special Defense Dept. study group. Electronic specialists in the department say the shortage of military electronic components, caused by tremendous demand from the commercial market, is causing some concern. One-of-a-kind military projects are particularly feeling the pinch, since some contractors are reported reluctant to fill custom integrated-circuit orders when they could be doing a mass commercial business. The Defense Scientific Advisory Board is looking at a wide range of options.

**Capital Capsules:** The Dept. of Commerce forecasts an 11% increase in electronics business this year over 1972. Total sales should hit \$37.1-billion, the department says, with \$23.5-billion accounted for by components and industrial and consumer electronics, \$6.2-billion by computers; \$4.9-billion by telecommunications and \$2.5-billion by instruments and controls. . . . The Senate Armed Services Committee has ordered the General Accounting Office to investigate the Defense Dept.'s practice of giving contractors funds for independent research and development programs. The probe was ordered to head off a huge cut by Congress in such funds this year. The GAO is gathering data on the 25 top defense contractors. . . . The Naval Air Systems Command plans to contract for development of an advanced monopulse, semi-active radar seeker for the Sparrow AIM-7F air-to-air missile. The command is looking for contractors who have worked in advanced electromechanical guidance systems since 1969, with solid-state experience preferred. . . . The Air Force, Army and Navy are becoming very interested in the use of small inexpensive remotely piloted vehicles, or mini-RPVs for a host of reconnaissance and attack roles. The Air Force has been selected to act as manager of a program for the Defense Dept.'s Advanced Research Projects Agency and the other services to develop a small RPV that, with avionics and warhead, would cost around \$20,000.

# stores anywhere...

**With the Tektronix dual-trace 214 you make storage measurements anywhere, anytime, and with a minimum of effort.**

If you operate a scope around heavy equipment, on catwalks or under other adverse conditions, you'll appreciate the 3½ pounds that the 214 weighs. And its small size of 3 x 5½ x 9½ inches lets you conveniently store it when not in use.

The 214 is the third miniscope from Tektronix. Like the non-storage 211 and dual trace 212, it has a bandwidth of 500 kHz and vertical deflection from 1 mV/div to 50 V/div. Sweep speeds range from 5 µs/div to 500 ms/div. All three are con-

structed of high-impact plastic to withstand rough treatment, and they are double-insulated for greater protection while making high-voltage measurements. Rechargeable internal batteries allow up to 5 hours continuous operation with non-storage and up to 3½ hours in the storage mode.

Costly equipment breakdown in the field requires that you get there with the right tools, find the problem and solve it. And you need to do it fast. In those times, oscilloscope storage is proving itself more and more valuable.

Many times, low or random repetition rate signals are difficult to view. The 214 combines storage with triggered single

sweep to automatically wait for and capture an elusive event. It writes in the storage mode at up to 500 div/ms, and holds the display for up to an hour.

**214 Dual-Trace Storage Oscilloscope . . . . . \$985**

Tektronix has field offices in or near all major cities. Call yours for a look at the miniscopes. Or write Tektronix, Inc., P.O. Box 500, Beaverton, Oregon 97005. In Europe, write Tektronix Ltd., P.O. Box 36, St. Peter Port, Guernsey, C.I., U.K.



**FOR DEMONSTRATION, CIRCLE 232**



# SPEND A LITTLE LESS, GET A LITTLE MORE.

Spend \$495, get a 9-column digital data printer. With buffered BCD outputs. DTL and T<sup>2</sup>L input compatibility. Externally controlled printing rate up to 3.7 lines/sec. And a single rotating print-drum designed for millions of cycles without readjustment.

Maintenance is easy because the ICs are socket-mounted. Replacement is even easier when you get our optional IC spares kit.

If you need a little more, spend a little more and get 18 columns for \$590.

Either way, the new Newport 810 digital printer offers

a lot of data input for a small dollar outlay. Options include universal breadboard card, input data storage, digital clock and events counter.

Get all the facts. Spend a second and circle the reader service number. Or spend a minute and write Newport Laboratories at 630 East Young Street, Santa Ana, California 92705. For immediate information, call collect. Dial (714) 540-4914. Ask for Lyell Kinney. Or TWX: 910-595-1787.

## NEWPORT

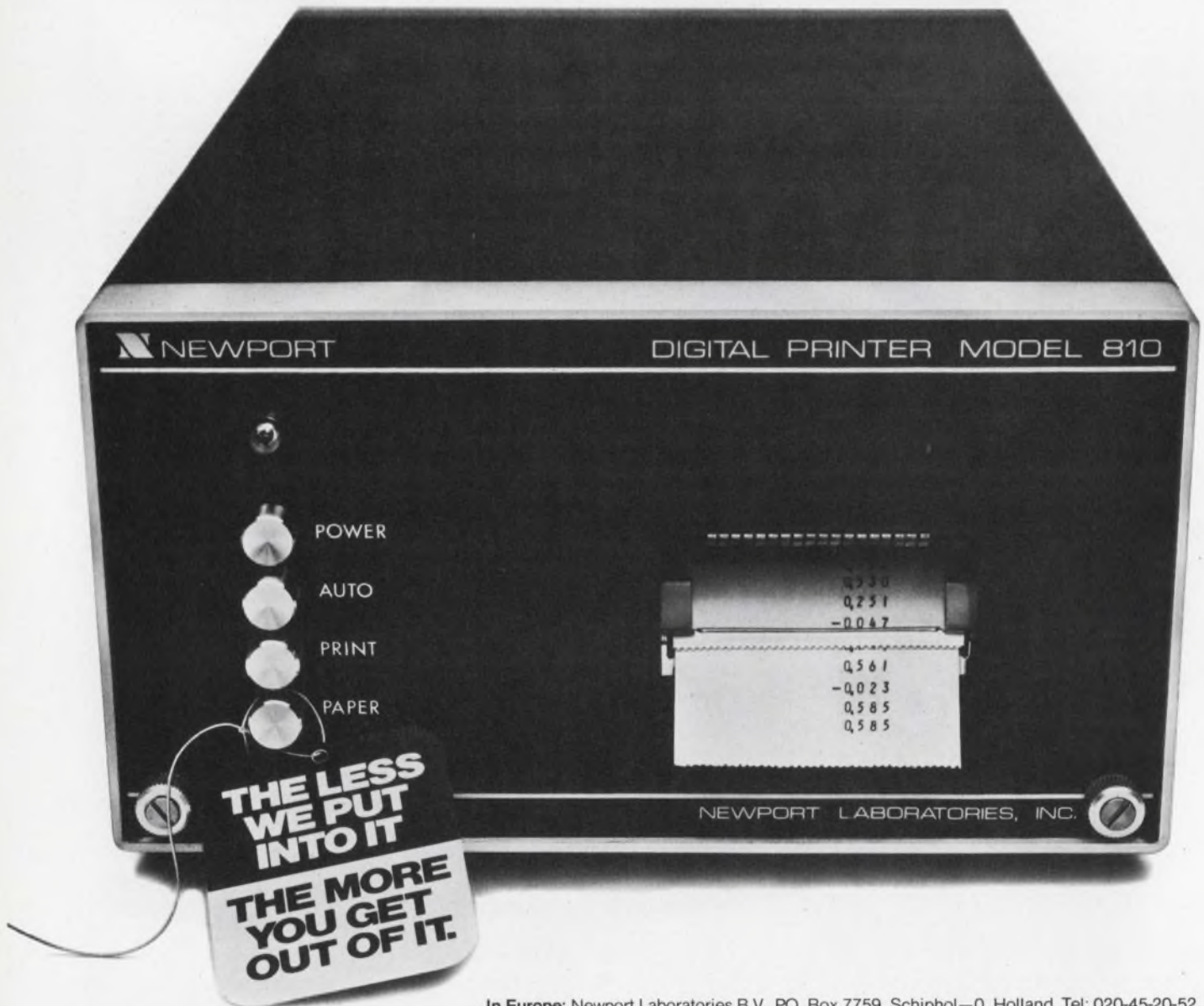

In Europe: Newport Laboratories B.V., PO. Box 7759, Schiphol-0, Holland, Tel: 020-45-20-52  
INFORMATION RETRIEVAL NUMBER 26

ELECTRONIC DESIGN 24, November 22, 1973

# INTRODUCING THE TEKTRONIX TRANSIENT DIGITIZER



## The new way to look at transients.

Not all transients are created equal.

But then again, neither are all transient measurement systems.

Some transients don't need much more than just normal methods of observation.

Others require something special. Because the faster the transient, the more difficult it is to observe.

How, what, where and when it all happened is a tough job when it's your responsibility to come up with fast answers.

But no device can help you quite like the Tektronix R7912 Transient Digitizer: the revolutionary, new addition to our versatile 7000-Series measurement instruments.

It puts you on the right track to fully analyzing the transient within seconds of its occurrence. And all you get blamed for is saving time and money.

The Tektronix Transient Digitizer can digitize single events with subnanosecond risetimes. It lets you focus accurately on transients with speed and convenience never before attainable.

It gives you complete waveform data. Fast and easy. By offering more resolution than ever before. By providing a writing rate equivalent to 8 div/ns. And an optional local memory of 4096 words. By generating an electronic graticule

which increases visual measurement accuracy. By displaying visually on a large, bright TV monitor. By expanding to multi-channel performance for low cost-per-channel operation. And by eliminating slow, tedious camerawork.

See how much more you can see with the Tektronix Transient Digitizer.

It's the new way to look at transients.

For many transients, it's the only way.

Prices vary with options and plug-ins selected.

An operating system is available for as low as \$10,460. To obtain a copy of "New Ways to See Fast Transients" contact your Tektronix Field Engineer or use the reader service card or write TEKTRONIX, Inc., PO Box 500A, Beaverton, Oregon 97005. Phone: 503/644-0161. In Europe: TEKTRONIX Ltd. Guernsey, C.I., U.K.



INFORMATION RETRIEVAL NUMBER 27  
FOR DEMONSTRATION, CIRCLE 231



## Quiet breakthroughs for the designer's indispensable tools

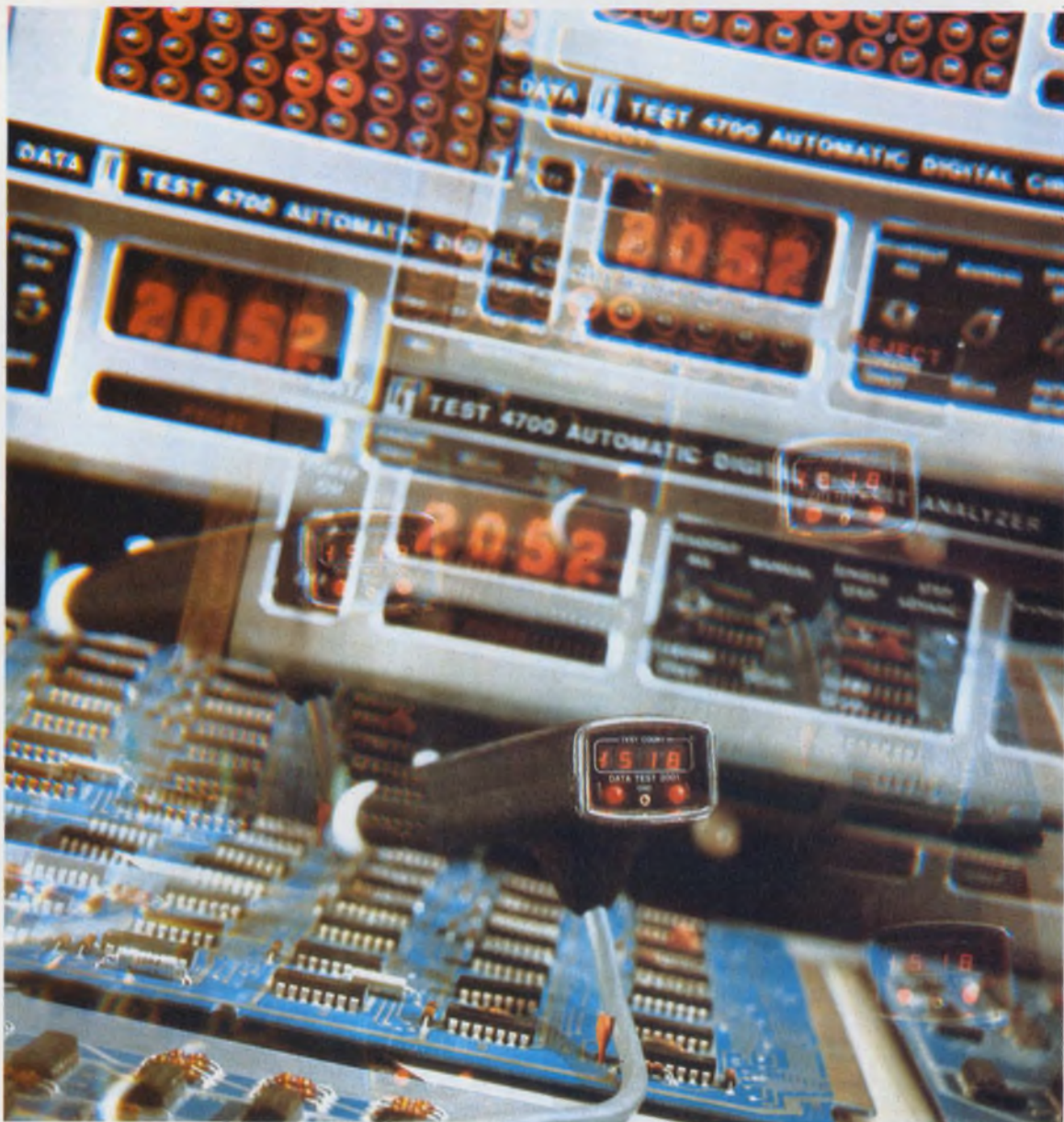

**T**ake away the designer's DVM, his scope, his signal generator and a few other critical instruments and instrument systems that everyone takes for granted, and try to envision the havoc: Communications systems failing at government and industrial installations . . . consumers complaining bitterly about unreliable electronics in the home . . . airliners and military aircraft lost or crashing because of faulty instrumentation . . . moon shots that never reach the moon . . . assembly-line shutdowns at peak factory production times. The list is all but endless. Electronics has permeated the world so thoroughly that civilizations would topple without it. And without precise measuring instruments, the electronic designer simply could not keep pace.

How would he test his circuits? How could he define performance with assurance? How would he know if components intended for exacting service were reliable? Even the performance of the simplest of components—the carbon resistor—would be in question.

Electronic instruments have come a long way from the simple, single vacuum-tube voltmeter of the 1930s to today's 500-transistors-on-a-chip multitester. Yet, as in many areas of endeavor, instrument advances have rarely been revolutionary; they have evolved quietly, particularly in the last few years. An isolated instrument comes along with new functions, and often designers are slow to grasp the significance. Soon they find

---

**Composite photo** at left shows 4700 automatic high-volume test system and 2001 diagnostic test probe from Data Test Corp.

these innovative functions incorporated in all other instruments of the same type. A new class of instruments has been born, another has been made obsolete.

What are the broad trends in instruments today? A dual effort is under way: to produce instruments that can measure faster while providing less ambiguous readings. Involved is the growing effort to merge measurement and computation, either in a single instrument or in an instrument/computer alliance.

Other trends in current instruments include:

- Smaller size and simpler internal circuitry as a result of ICs. In fact, new LSI circuits have enabled manufacturers to reduce the size of some digital multimeters to the point where the batteries needed to power them take up more room than the electronics.

- The incorporation of advanced analog-to-digital conversion that has cut prices and complexity and yielded tenfold improvements in accuracy.

- Easier-to-use instruments, with combined controls and pushbuttons instead of rotary switches.

- An increasing variety of readouts, including multicolor LED displays, fast CRTs, liquid-crystal displays and planar gas-discharge panels.

- The development of "smart" instruments, which can perform not only the traditional stimulus and measurement functions but also store data, compute averages and provide summary results.

For a panoramic view of today's versatile instrumentation, start turning the pages of this special report.

## Contents

- |     |   |
|-----|---|
| 40  | Inside the instrument—Those dazzling advances depend on industry-wide teamwork.         |
| 56  | Instrument packaging—Is it convenient to use? Gains are both outside and inside.        |
| 66  | New types of instruments—Digital logic results in three devices for easing design work. |
| 74  | Systems compatibility—Instrument interfacing can be done—but it takes a bit of doing.   |
| 84  | Personality profile—Andrew F. Kay: Once an inventor, it's hard to stop creating.        |
| 90  | Oscilloscopes and spectrum analyzers—They're getting faster, smaller and more digital.  |
| 98  | Signal sources—The new generators are sharp setters, and they keep quiet.               |
| 108 | E-I-R meters—Analog aren't dead, but they're facing a digital onslaught.                |
| 118 | Time and frequency instruments—For versatility and choice, try the bargain counters.    |
| 126 | Personality profile—The DuMont legacy lives on, reflected in the modern CRT.            |
| 132 | Component and circuit testers—Bench instruments or systems, they come with high IQs.    |
| 140 | Recording equipment—Data storage improves with new magnetic and paper tape units.       |
| 146 | Standards and calibration—Precision, precision: Federal bureau sets the pace.           |

# Those dazzling advances depend on industry-wide teamwork

**M**uch of the improved performance of today's instruments can be traced directly to ICs. Higher speeds, higher densities and lower power demands from a new generation of monolithic circuits are helping instrument designers develop new and better equipment.

But the technological advances are not limited to ICs. Progress with traditional components, as well as developments hot from the laboratory, are contributing to the emergence of tomorrow's instruments today. And, not to be overlooked, circuit-design innovations are resulting in more efficient use of the components.

Look inside some new instruments, and you'll quickly find one or more of the following:

- Faster CRTs and an increasing variety of readout displays are simplifying tests and measurements in a wider range of applications.
- High-frequency, thin-film amplifiers and transistors are pushing frequency response, bandwidth and power levels to new heights.
- High-speed bipolar digital logic families are upgrading fast instruments and permitting more comprehensive tests on ever faster circuits. Low-power MOS families are spearheading a trend toward portable instruments.
- Custom and standard ICs are reducing the size of and simplifying internal circuitry. Analog and digital LSI chips can now provide most functions in digital meters.
- Improved a/d circuit techniques are reducing errors, increasing the resolution of meters and permitting the use of fewer, less precise components.
- Sophisticated processing chips and circuits have ushered in the era of "smart" instrumentation—instruments that perform measurements,

process data and act on the results with little or no display of test results.

## CRTs: faster than ever

Basic improvements in the design of CRTs have sent the writing speeds for storage types soaring. Not too long ago the highest writing speed, or rate that the beam could track a transient, was 1 cm/ $\mu$ s. Now it's up in the hundreds.

Two companies—Hewlett-Packard and Tektronix—have developed the ever faster storage scopes. Tektronix, using its own process, started the race with a 5-cm/ $\mu$ s scope. HP followed with a 100-cm/ $\mu$ s model. Both companies now have faster tubes, with HP setting the pace with the 400-cm/ $\mu$ s Model 184.

The HP development was achieved by steady improvements in the variable persistence structure, consisting of two fine screen meshes just inside the tube. Better deposition techniques have increased the sensitivity of the mesh surfaces for a higher writing speed.

The same techniques have produced more rugged mesh surfaces, resulting in a high degree of burn resistance for storage scopes. Previously tubes were prone to burnouts, or visible marks on the surface, when exposed to high beam intensities. Now storage scopes can be handled with the same minimum care that standard types require without fear of burnouts.

Recent developments in standard CRT designs have brought increasing bandwidths. Complete oscilloscopes are available from Tektronix with over-all bandwidths to 500 MHz. The bandwidth can be increased to 1 GHz by direct accessing of the tube, thus bypassing the internal amplifiers that limit system bandwidth. In oscilloscopes the tube is much faster than the system.

Manufacturers have increased the bandwidths of standard scopes by modifying the deflection-

plate configuration. In place of a single plate, which has limited bandwidth, fast tubes use a helical, segmented deflection configuration. A distributed effect produces a transmission-line environment that can be used to enhance bandwidths.

### Display types on the increase

A designer doesn't have far to go to notice the wide variety of readouts used in instruments. For the shortest displays, you're probably looking at either LEDs or planar gas-discharge devices. Both types can use multiplexing techniques, since like segments of each numeric are usually connected in parallel.

Multiplexing offers several design advantages, including a reduction in the number of decoders



LEDs, Nixie neon tubes and seven-segment Sperry tubes are used by Analogic in its line of DPMs. The displays have 2-1/2 to 4-3/4 digits.

and drivers. With interconnections reduced as well, drive circuitry becomes simpler, cheaper and more reliable. However, to obtain a parallel BCD output—a common requirement in large-digit displays—a multiplexed drive must be augmented with additional circuitry.

LED displays can be found in many instruments, and for several reasons. LEDs can be multiplexed to obtain about the same apparent level of brightness as if they were driven steadily. For smaller—and therefore cheaper—LEDs, a

simple magnifying lens can be used to increase their apparent size. Furthermore LEDs are rugged, withstand wide temperature extremes and can operate from 5-V supplies, as most digital circuits do.

While colors other than red have been available in LEDs for some time, until fairly recently only the red were priced low enough to gain wide acceptance. But Monsanto has announced price reductions in its green and yellow LEDs to the level of equivalent red displays. If other manufacturers follow this lead, you may be reading more yellow and green readouts.

The planar gas-discharge panels, such as Burroughs' Panaplex displays, produce light over a fairly broad range of wavelengths from red to orange. Hence they can be filtered to show various shades of amber, orange and red. However, gas-discharge devices require very high supply voltages, although they draw currents in the microampere region. Also, rf shielding may be required in some instruments because of the rf generated by the display gas or by transients produced by the drivers.

Sperry offers a planar gas-discharge unit, a quarter-inch in height and up, that comes in groups of one-and-a-half to three digits in half-digit steps. Besides adding packaging flexibility, the display characters appear to be all of one piece, although made of seven segments each.

Of course, you can still see the long-established Burroughs Nixie tube. This gas-discharge device uses a separate character for each cathode. Each character is stacked in depth in a glass envelope. A disadvantage of the Nixie is that the configuration restricts the viewing angle.

Where high ambient light levels are present, the display may be a directly viewed filament type, such as RCA's Numitron. It can be viewed under 10,000 foot-candles of background illumination. The life expectancy of such devices is much greater than might be expected. Unlike ordinary house lamps, the filament displays operate at considerably lower temperatures for very high life expectancies.

The liquid-crystal display, a fairly recent entry, leads in low power consumption—microwatt levels. Moreover its potential cost is very low, and it is directly compatible with low-power-consuming CMOS circuits. Hence it is an odds-on favorite for portable equipment.

But there are also problems with liquid-crystal displays. They relate to their speed, endurance and, more significantly, their appearance. How well you see a liquid-crystal display depends on whether it's a field-effect or dynamic scattering unit, on whether it's operated in a transmissive or reflective mode. Various schemes have been developed to provide good contrasting white-on-black readouts. In addition the displays are slow

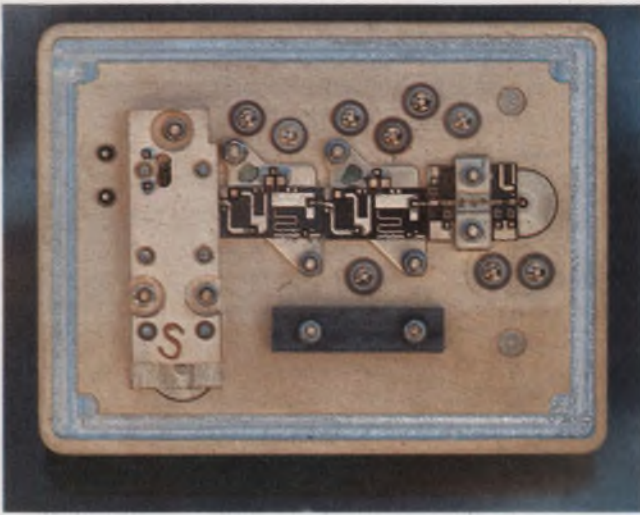

The amplitude control of a 1.8-to-4.2-GHz HP sweep oscillator contains four sapphire subassemblies: a modulator, two amplifiers and a detector.

and cannot compete with LEDs for high-speed applications. They have limited lifetimes and limited temperature ranges.

#### Components improve microwave instruments

Microwave instruments have been a major beneficiary of improved components. High-performance transistors and thin-film hybrid amplifiers have led to important advances. A convenient example is the HP 8640 signal generator for the 450-kHz-to-550-MHz frequency range. As a result of improved components, HP says the 8640 achieves the highest spectral purity at the rf output of any solid-state generator.

The generator's thin-film hybrid amplifiers operate over the rated frequency range and provide a linear output of +19 dBm. They have a slew rate exceeding 15,000 V/ $\mu$ s and maintain harmonics below 35 dB down to 128 MHz and below 30 dB down to 512 MHz. Two amplifiers are used to improve the over-all S/N ratio by 8 to 18 dB.

"Above a few gigahertz," according to Scott Wright, manager for microwave instruments at HP, "you're forced into a hybrid technology rather than discrete because of the problem of parasitics."

It doesn't take much parasitic capacitance or inductance, he says, to deteriorate frequency response. And unlike lower-frequency ICs, hybrid microwave ICs can actually be better than discrete equivalents because of reduced parasitics. Other benefits of thin-film amplifiers, Scott notes, are reduced size and increased reliability.

The spectral purity of the instrument originates from a coaxial resonant cavity that contains a new low-noise transistor—the HP 21. The transistor and cavity form a 230-to-550-MHz

oscillator. The transistor's high  $f_t$  and current-handling capabilities at the high frequencies provide the spectral characteristics.

The cavity is a foreshortened quarter-wavelength resonator that tunes primarily by a variation of its capacitive load. A short at the end of the cavity provides the inductance for resonance.

The 8640 also contains 550-MHz monolithic dividers that are used twice: as a prescaler for the built-in frequency counter and as the first in a series of binary dividers for the lower frequency ranges. The separation of these two scalars eliminates subharmonic problems that would occur if all dividers were operating all the time to drive the counter.

#### Op amps pervade all circuitry

The most common component by far is the op amp. In its traditional form as a general-purpose amplifier and in variations or elaborations—comparators and voltage regulators, for example—the op amp pervades instrumentation circuitry.

Of all, the 741 type is by far the most widely used. "But next in popularity is the FET op amp," says Stan Harris, marketing manager at Analog Devices.

Harris notes that FET op amps are commonly positioned close to the transducer, or pickup, because of the device's high input impedance and low bias current. Moreover falling prices and small size are contributing to their acceptance by designers.

A typical low-priced FET op amp for general-purpose use, according to Harris, is his company's AD540J. It features a maximum bias current of 50 pA, a maximum drift rating of 75  $\mu$ V/ $^{\circ}$ C, an offset voltage of 50 mV and a differential input range of  $\pm 20$  V. Similar ICs are available from other manufacturers.

Such specifications, says Harris, can satisfy the bulk of applications for FET op amps. However, if tighter specs are required, they can be obtained. Harris notes that FET op amps with low drifts of 1  $\mu$ V/ $^{\circ}$ C are readily available. These can exhibit low noise—5  $\mu$ V pk-pk in a 10-Hz bandwidth—and bias currents of less than 5 pA. Of course, such devices are priced considerably higher than the general-purpose types.

#### High-speed logic upgrades instruments

For the highest speeds generally required in new digital systems—typical propagation delays of 2 to 3 ns—most designers are using either ECL 10,000, introduced by Motorola, or Schottky-clamped TTL (S-TTL) from Texas Instruments.

Both families offer substantial speed advantages over standard TTL. And like TTL, ECL 10,000 and S-TTL products are available in vol-

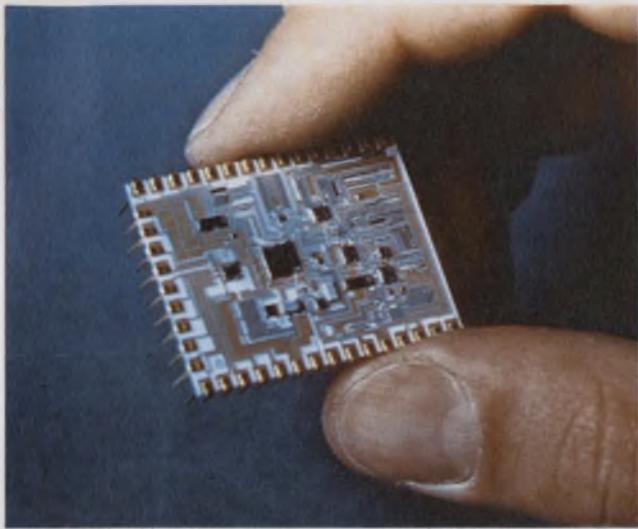

The thin-film hybrid IC in the HP 970A multimeter provides additional circuitry for an NMOS IC that contains most of the control and switch functions.

ume and in a wide range of functions from original or alternate sources. But because of the high speeds, each type requires carefully designed interconnections, often involving rf techniques, to achieve optimum circuit performance.

ECL 10,000 has the lower propagation delay—a nanosecond less than S-TTL. But to achieve that reduction, designers must cope with the OR/NOR logic techniques required for ECL rather than the more familiar AND/NAND logic.

Still, both families are finding increasing applications. Some designers are going to S-TTL when upgrading existing TTL systems, because S-TTL provides full TTL compatibility. For new systems, the choice of ECL 10,000 is often made.

The standard line with the highest speed—Motorola's MECL III, with a typical gate delay of only 1 ns—can also be found in new systems. But for gate delays of about a nanosecond and less, some instrument manufacturers are building their own circuits. Differences in packaging and integration-level requirements are major reasons for this.

HP, for example, has developed EFL, or emitter-function logic. Unlike most modern logic families, which use an inverting gate to perform the basic functions, EFL uses a noninverting gate. Although this approach does not entirely reduce the need for an inverter, HP says it does substantially cut the number of inversions needed for reduction in power dissipation and propagation delay. The EFL configuration can be used to obtain a reported power-delay product of only 1.37 pJ.

While computer applications spurred the growth of high-speed logic ICs, Dick Horton, applications engineer at Texas Instruments, notes that frequency counters were an early beneficiary of S-TTL.

"When S-TTL flip-flops were introduced," he says, "Heath applied the circuits to the front-end of its counters." The result: an immediate doubling of the input frequency capabilities. Earlier counter models used 74H-TTL circuits, which have a maximum toggle frequency of 50 MHz. With S-TTL J/K flip-flops, toggle frequency reaches 125 MHz.

Another application area for high-speed logic, according to Horton, is test equipment at both the component and PC-board level. For example, the testing of newer semiconductor memories requires higher speed circuits. Previously standard TTL or DTL were fast enough for most memory checkout and testing applications. But recent memory types include n-channel MOS, Schottky-TTL and high-speed ECL. These now provide the highest speeds for MOS and bipolar memories.

Moreover the emergence of smart instruments has increased the importance of high-speed ICs for digital processing—for example, the 74S281 4-bit S-TTL parallel processor. Horton notes that such instruments require "intelligence" to identify, localize and correct faults. The arithmetic digital unit, he says, meet many of the circuit requirements.

Standard TTL circuits make up the bulk of digital circuits in instruments. They allow clock rates up to 20 MHz, or perhaps 25 MHz for very sophisticated designs, according to Horton. S-TTL has raised the level to over 60 MHz.

Still further improvements can be expected from the next generation of high-speed TTL. TI expects to introduce next year a faster version of its S-TTL line. Horton says the new circuits will handle toggle rates of 200 to 300 MHz, surpassing present ratings for ECL 10,000.

### Custom and standard ICs simplify circuitry

With the increasing use of both standard and custom high-density ICs, more digital functions, as well as more analog, have been compressed onto tiny ICs than ever before. For instruments, the development has meant smaller and simpler internal circuitry.

Fairchild's 3814 digital voltmeter logic array, for example, contains the basic digital functions for implementing a multiplexed 4-1/2 digit multimeter/counter display. The 3814 can operate with a clocking frequency up to 600 kHz; the maximum frequency of operation determines the settling time of the digital readout. Similar ICs are offered by Mostek and Motorola.

The 3814 also features auto-ranging control logic, 10-count delay to eliminate errors caused by switching transients and strobe-synchronized BCD outputs for driving TTL display decoder/drivers. Among others, Dana uses the new chip

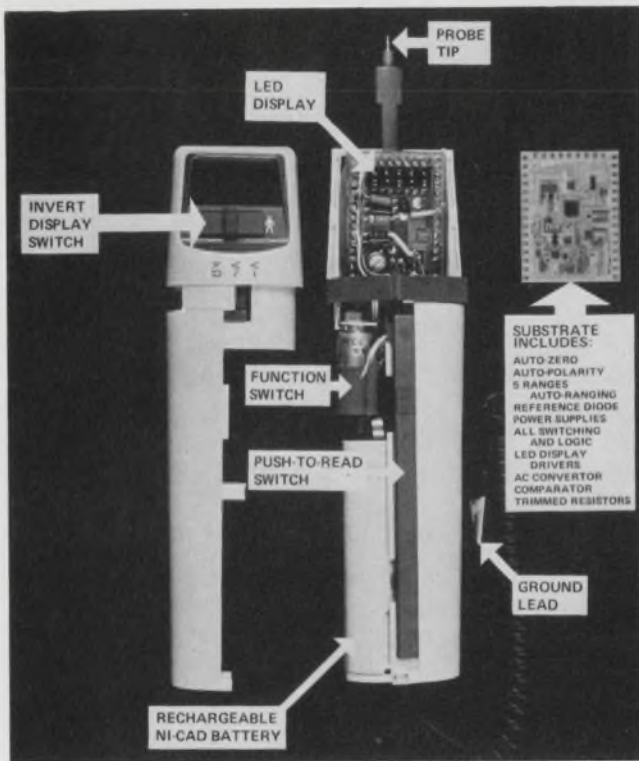

Portable HP 970A multimeter contains measuring electronics, converter and a LED display. The 3-1/2-digit unit also auto-ranges.

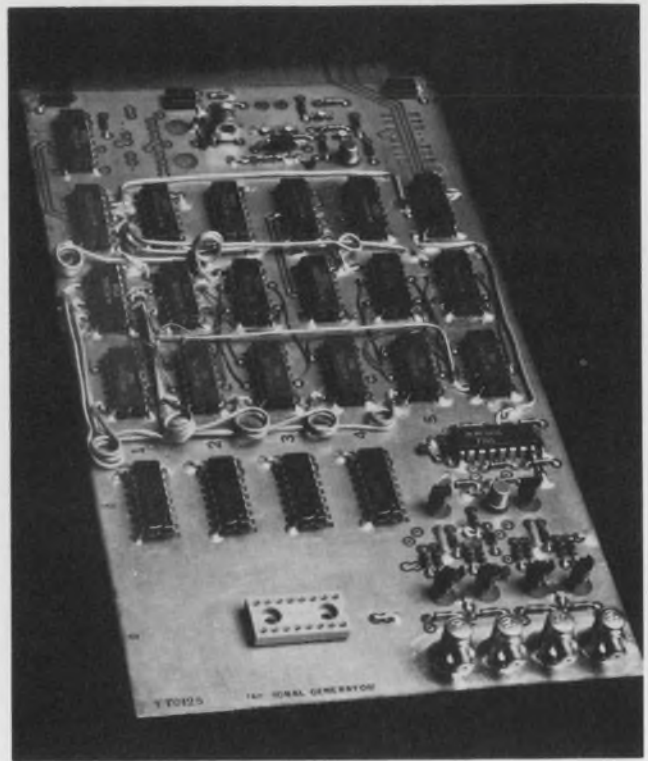

A frequency-synthesizer card from Tau-Tron uses high-speed Motorola ECL circuits. The fast signals are routed through microstrip transmission lines or miniature coax.

in its Model 4300 multimeter.

The recent availability of phase-locked-loop (PLL) ICs has further improved instruments. Systron-Donner uses Motorola's PLL ICs in its 1600 Series of microwave frequency synthesizers. The basic synthesizer stage consists of a divide-by-N loop, a mixer and a summing loop (Fig. 1). An MC12014 frequency extender permits operation to 20 MHz. The circuit allows the output oscillator always to be the sum of the prior stage signal and the divide-by-N signal, and it ensures that the output oscillator operates on the high side of the divide-by-N signal.

A dramatic example of circuit reduction through LSI is Fluke's 8000A 3-1/2-digit DMM. Most of the functions are on two chips. It uses an LSI analog and an LSI digital circuit and voltage-to-frequency  $a/d$  conversion rather than the more common dual-slope method.

Like dual-slope conversion, the voltage-to-frequency method is an integrating process. But instead of counting a fixed frequency for a variable time, the voltage-to-frequency converter counts a variable frequency for a fixed time. In both cases the final accuracy depends on the accurate conversion of voltage into time or frequency.

Below about 10 MHz, CMOS is giving the lowest dissipation of any technology being used in instruments. It has very high noise immunity and good switching speeds. And instrument designers are rapidly swinging over to CMOS circuits, especially where portability requirements

dictate low power drain.

The wide use of CMOS has been made possible, in part, by its similarity to TTL circuit techniques. Most designers are more familiar with TTL than any other logic family. Moreover CMOS is very tolerant of high noise spikes and varying supply levels—variations up to almost half the nominal supply voltage can be handled. As a result, designers report CMOS is very easy to use.

RCA's COS MOS ICs are the most widely used CMOS circuits. However, within the last few years a host of semiconductor manufacturers have begun to alternate-source COS/MOS or to introduce proprietary CMOS circuits. Some offer substantial improvements in speed over the RCA line. Specifically, Harris uses dielectric-isolation techniques while Inselek uses silicon-on-sapphire (rather than silicon substrates) to achieve the faster circuits.

CMOS has not been limited to digital functions. Analog CMOS circuits are finding their way into many instruments, as well. Several instrument manufacturers either have or expect to introduce shortly all-CMOS circuitry in their instruments.

#### Dual-slope techniques advance

Most  $a/d$  converters use the dual-slope technique or some variation of it. The method yields lower conversion rates than other techniques.

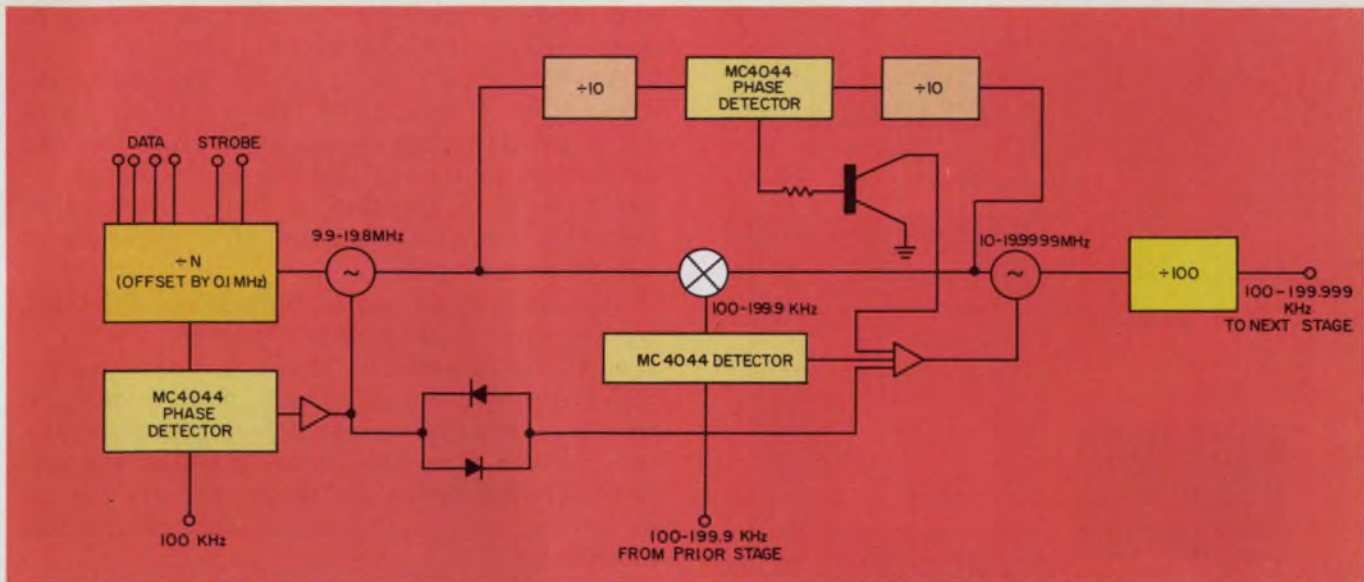

1. Systron-Donner has developed improved microwave frequency synthesizers, in part through the use of phase-

locked loop ICs (from Motorola) in the basic synthesizer stage. The synthesizers are the 1600 series.

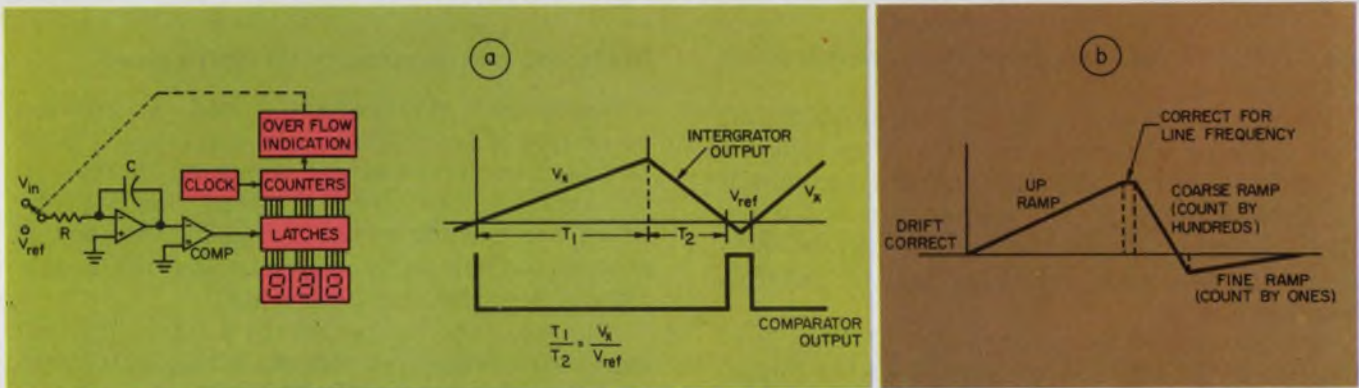

2. A variation of the basic dual-slope technique (a) is the triple-slope a/d conversion technique (b) used by

Weston in its Model 4444 4-digit DMM. The triple slope permits increased resolution for the same clock rate.

However, dual slope offers high accuracy with relatively inexpensive components. And high-speed conversions are rarely needed.

The basic dual-slope converter connects an unknown voltage to an op-amp integrator for a fixed time (Fig. 2). The output of the integrator consists of a linear ramp whose slope depends on the unknown voltage. Next, the integrator input connects to a reference voltage that has an opposite polarity.

The output of the integrator now produces a linear slope in the opposite direction—hence the name dual slope. The converter monitors the time required for the integrator output to fall to the starting level. The ratio of fixed-to-monitored periods of time equals the ratio of unknown-to-reference voltages.

A typical dual-slope converter contains a clock and a comparator. These need not be highly time-stable components, so long as the clock period and comparator threshold don't drift sig-

nificantly during a conversion cycle. This looseness in the stability requirements permits the use of low-cost components.

An improved version of the basic dual-slope converter appears in Weston's Model 4444, a 4-digit auto-ranging DMM. Weston uses a triple-slope converter to obtain an internal resolution of six digits. Triple-slope conversion allows this resolution without an increase in clock rate or decrease in conversion speed.

The improved resolution results from a splitting of the down ramp of the integrator into two phases: A  $\pm 10$ -V reference controls the first phase, while a 100-mV reference controls the second. During the first phase the integrator ramps down rapidly, and each clock pulse is counted as 100 digits. A count accurate to the next higher 100 results when the curve crosses the starting level.

Then the reference shifts to 100 mV of the opposite polarity. Each clock pulse is counted as



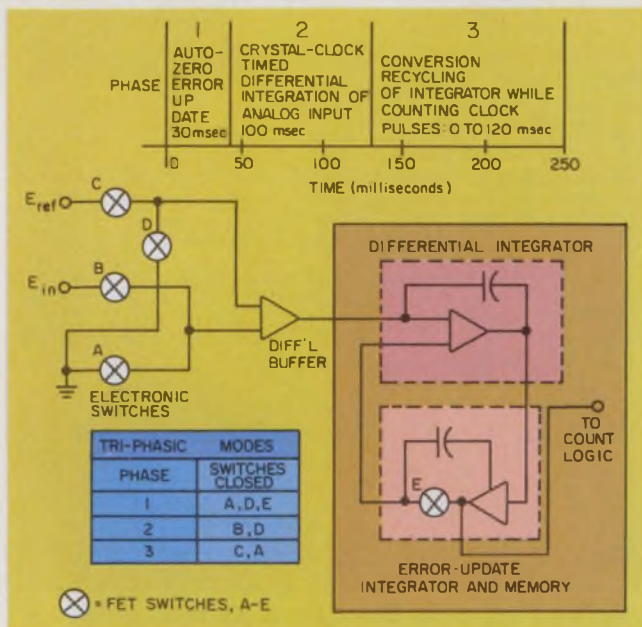

3. Data Precision's Tri-Phasic conversion cycle substantially reduces errors caused by offsets and tolerances, as well as drift errors.

one digit, and residual errors in the coarse count are corrected.

The Weston 4444 also uses a Plessey MOS/LSI chip for all digital decisions. The chip contains all the counters, shift registers and zero-crossing detectors. The IC multiplexes signals for display, controls signals for decimal points, performs up or down auto-ranging and controls relay switching.

For Harold Goldberg, president of Data Precision, the Tri-Phasic cycle represents an important circuit-design contribution for dual-slope a/d conversion. Among its advantages, Goldberg says, "Tri-Phasic eliminates front-panel zero adjustments with less exotic, and therefore less expensive, circuitry."

Basically the Tri-Phasic technique (Fig. 3) significantly reduces three of the four major sources of error in conventional DVM circuits: zero offset and offset drift, resistance tolerance and drift, and ramp time-constant tolerance and drift. In the first phase of operation, automatic zero-setting occurs; an error integrator/memory circuit is updated at the beginning of each conversion cycle. In the second phase, the analog input is integrated in the differential integrator, one input of which is the stored error. Thus offset and drift components from the integrated output are eliminated.

The time constant of the integrator is not an accuracy-determining factor. No component or parameter affects accuracy in Tri-Phasic, except the reference voltage standard and the range-divider resistor ratios, which are used only on the higher ranges. Finally, in the third phase of operation, the conversion to digital format oc-

curs, and the integrator is returned to its zero state through the original time constant.

Analog Devices uses its Analok dual-slope technique (Fig. 4) in a DPM. The technique introduces a stabilizing sequence between the end of the last conversion and the beginning of the next. Its main function is to eliminate drift errors in the analog section of a conventional dual-slope converter.

The input signal passes through an RC filter, for improved normal-mode rejection, and on to a set of analog switches. These selectively switch the reference and input signals, as in a standard converter, but they also switch in correction signals derived from the analog stabilization network. The correction signals compensate for the dc errors of the integrator and comparator amplifiers.

The method of switching and type of feedback present a high input resistance to the input signal, eliminating the need for an input amplifier. The effective offset voltage is typically 5 V, and bias current is about 200 pA.

### ROMs and microprocessors for 'intelligence'

Instrument manufacturers see a growing separation of instruments into small, bench types and fast, comprehensive equipment. In the latter area are the so-called smart instruments, which are performing an increasing number of process and control functions in addition to traditional tests and measurements.

An important component in both bench and more sophisticated instruments is the ROM, often used for signal waveshaping (Fig. 5). In this application the ROM functions as a general-purpose lookup table positioned between the a/d block and the output. Temperature and pressure-sensing instruments represent a major application area for waveshaping ROMs.

Richard Lee, head of development engineering at Boonton, says the use of ROMs for waveshaping offers several advantages over competing techniques. In an analog approach—used in Boonton's rf voltmeters—finite segments approximating a straight line are obtained with an op amp. But this technique, Lee notes, introduces conversion errors because of accuracy limitations.

A digital alternative obtains segmented shaping with variable modulus counting. With data loaded into a counter, information is counted down at a fixed rate. Then a count up occurs at a variable rate, dependent on input information. Compared with the ROM approach, Lee says, variable modulus counting doesn't have as much resolution, since the number of segments are limited.

In instruments with microprocessors, or "com-

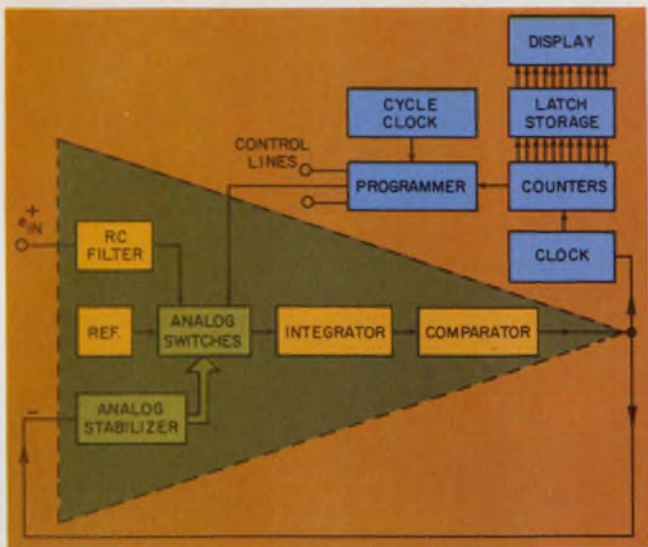

4. Analog Devices' Analog circuit, used in the company's DPMs, provides drift-error compensation, and it uses CMOS ICs (green boxes) for low power.

puters-on-chip," ROMs are used to store the instruction table. The microprocessor controls logic and performs calculations. In Boonton's Model 76A, an automatic 1-MHz capacitance bridge, Intel's MCS-4 microcomputer set controls the system. It achieves an automatic balance of the bridge with a test component and calculates a number of parameters, including series capacitance, series resistance, dissipation and Q.

The use of microprocessors, Lee points out, permits a change in the nature of the instrument without a change in hardware. Changes in instrument functions can be achieved through software. And the final instruction table can be stored in ROMs.

Some instrument makers are using the versatility of the microprocessor for general process-control applications. Analogic offers the AN7000 series, which features programmable a/d conversion, computation and control.

Like the Boonton bridge, the Analogic instrument is built around the MCS-4 system from Intel. But Analogic has added a high-precision a/d converter and the necessary circuitry to form a complete industrial controller. Bernard Gordon, chairman of the board of Analogic, says the instrument represents "an implementation of the trend of instruments toward complete systems."

Microprocessors are being offered by a growing number of semiconductor manufacturers. Intel, Fairchild Semiconductor, National Semiconductor and Rockwell Microelectronics have commercially available processor ICs that use p-channel technology. Signetics and Western Digital are expected to join the field shortly with higher-speed, n-channel ICs. And AMI plans to introduce a microprocessor fabricated with its ion-implantation process.

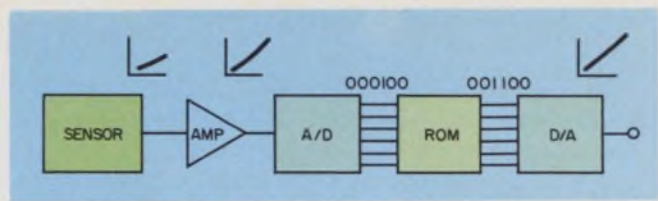

5. ROMs are frequently used for wave-shaping. In this application the ROM functions as a general-purpose look-up table that compensates for nonlinearities.

The recent emergence of MOS/LSI microprocessors for instrumentation has resulted from the need for decentralized, cheaper minis as remote, programmable controllers. Microprocessors are filling a gap between calculator chips and minicomputers.

Many of the MOS/LSI processors have evolved from calculator chips, which can also be found in new instruments. And like the calculator chips, microprocessors can be programmed to perform arithmetic functions. But an added advantage of microprocessors is their greater adaptability for programmed data processing.

While processors are in some cases replacing small, dedicated minis, no instrument maker sees the two as competitors at present. The MOS ICs operate at speeds that are about an order of magnitude slower than minicomputers with bipolar circuits. And no processors manufacturer can yet compete with the mini makers when it comes to software backup.

Microprocessors are aimed rather at applications using hard-wired, or permanent, logic. These are generally inflexible and costly in-house-developed systems. Replacing such systems with microprocessor systems is an economical choice, since the MOS ICs are priced substantially below minis.

There are several tradeoffs when choosing between microprocessors or random logic designs—as, for example, when speed is required. Microprocessors are much slower. And their initial use requires designers to cope with relatively unfamiliar disciplines, primarily software. Moreover the complexity and wide-ranging capabilities of microprocessors demand increased system design to ensure that the over-all design functions properly.

Still the advantages of microprocessors over random logic are impressive. They permit a tradeoff of software for hardware to achieve increased system capability and versatility. They can perform many functions and efficiently handle multiple inputs.

As a result, instrument makers generally see the impact of microprocessors as pervasive and strong. No one yet claims they will become as common as op amps now are. But manufacturers aren't denying that possibility either. ■■

When Frank Riccobono, DDC's Instruments Product Manager, makes an offer to introduce you to our fine family of synchro instruments, who can refuse?

After all, what company can more logically set the pace in synchro instruments than DDC . . . the people who have set the pace in synchro converters for years!

Representing Frank's family of solid-state Synchro and Resolver Test Instruments are units from the low cost, 3 or 4 digit "panel meter" configuration SR-300 . . . to the fully militarized HMSR-102A, a  $\pm 0.01^\circ$  angle indicator designed to meet the environmental requirements of MIL-T-21200 . . . to the MSR-236, a two-speed indicator in a portable, fully militarized carrying case.

Programmable standards—as well as programmable computer interfaced angle indicators—are also present and accounted for in the SR-400, SR-102, and the custom-designed instruments immediately to Frank's left.

The SR-202 combines all the best features of remote and manual control in a single, half-rack, push-

button-controlled indicator. And it's capable of interfacing with just about every commonly-used synchro or resolver at various voltages and frequencies, with accuracies to  $\pm 0.01^\circ$

That's quite a complete family of Synchro Test Instrumentation already . . . and there are some newcomers on the way! Why not give Frank the opportunity to introduce them to you personally. After all, when Frank makes you such an inviting offer, do you dare refuse?

Standard and Custom Synchro Instrumentation for Avionic, Shipboard, ATE, and Laboratory



A subsidiary of ILC Industries, Inc.

## ILC DATA DEVICE CORPORATION

100 TEC STREET, HICKSVILLE, N. Y. 11801 • PHONE: (516) 433-5330

### APPLICATION CENTERS

Long Beach, Calif.  
(213) 597-5744

Washington, D. C.  
(703) 536-2212

Bruxelles, Belgium  
Tel. 62.01.59

**Come in and  
meet  
the family.**



INFORMATION RETRIEVAL NUMBER 28

# mi 1973



Shown Half Actual Size (Dimensions: 5½" H. x 11" W.)

**mi MARCONI**  
**INSTRUMENTS**  
DIVISION OF MARCONI ELECTRONICS INC.

- Signal Generators, FM/AM/Transistorized
- FM Deviation Meters
- Bridges and Q Meters
- Mobile Radio Test Gear
- Receivers, AM/FM/SSB
- Television Test Equipment
- Intermodulation and Baseband Test Gear
- Programmable Test Equipment
- Microwave Instrumentation
- Automatic Test Systems
- P.C.M.



**MODEL 2006/1 DIGITALLY TUNED PRECISION FM GENERATOR** — This generator employs a digital synchronizer to achieve a frequency stability of  $2 \times 10^{-7}$ . The generation of the signal over the range 10 to 500MHz gives spectral purity and low noise not to be found in synthesizers yet provides digital accuracy, convenience and full FM capability.



**MODEL 2015 LOW COST, HIGH PERFORMANCE AM/FM GENERATOR** — Model 2015 is the latest Marconi Instruments solid state AM/FM Signal Generator. The design objective of a low cost, simple to use unit, has been achieved with a performance equal to the test and service requirements of modern receivers in the range 10-520MHz. Fundamental frequency generation is by voltage tuned oscillators. Special tuning controls permit easy tuning to narrow band communication receivers even at the highest frequencies.

## FM/AM SIGNAL GENERATORS

DESCRIPTION	FREQUENCY	FEATURES
FM/AM SIGNAL GENERATOR Model 2002B	10KHz to 88MHz	0.1 $\mu$ V to 1V $\pm$ 1dB, fully solid state, AM variable to 100%, FM deviation $\pm$ 1KHz to $\pm$ 50KHz max. dependent upon range. Incremental frequency controls with discrimination of 0.025% and direct readout in KHz. Xtal calibrator. External frequency shift permits phase mod. or phase locking.
DIGITAL SYNCHRONIZER Model 2170B	32KHz to 88MHz	Used with Model 2002B Generator to lock frequency in steps of 10Hz frequency stability $1 \times 10^{-4}$ . Permits full modulations ideal for SSB applications.
AM/FM SIGNAL GENERATOR AND SWEEP GENERATOR Model 2008	10KHz to 510MHz	This unique combination Generator/Sweeper provides both facilities without sacrifice to the precision quality of either function. Eleven bands with 1 : 1.5 cover span from VLF thru UHF. Output 0.1 $\mu$ V to 100mV into 50 $\Omega$ . Stability 5 p.p.m. FM deviation $\pm$ 3KHz $\pm$ 10KHz $\pm$ 30KHz $\pm$ 100KHz and above 45MHz $\pm$ 300KHz. Mod. frequency to 125KHz. AM to 80%. Comprehensive sweep facilities on all bands. Full Modulation facilities may be retained in sweep mode. Xtal calibrator and markers.
AM/FM SIGNAL GENERATOR AND SWEEP GENERATOR Model 2008/1	10KHz to 510MHz	Same as Model 2008 but with built in counter, 6 digit display of carrier frequency, automatic operation of display. Integral RF screening of entire system gives leakage performance far superior to external counter techniques.
FM/AM SIGNAL GENERATOR (6625-913-7223) Model 995B/Series	200KHz to 220MHz	0.1 $\mu$ V to 100mV. Calibrated $\Delta$ F. Step attenuator. Crystal standardized; extremely stable. Deviation $\pm$ 600KHz on top bands. Has simultaneous FM & AM. Also available for narrow band working FM spurious less than 25Hz. Model 995B/5.
FM SIGNAL GENERATOR (6625-929-4277) Model 1066B/1	10MHz to 470MHz	0.1 $\mu$ V to 100mV. 50 $\Omega$ , $f_m$ at 1KHz and 5KHz internal, deviation to $\pm$ 100KHz, $\Delta$ F to $\pm$ 100 KHz, both meter monitored. Stability .0025% 10 min.
FM SIGNAL GENERATOR (6625-937-2801) Model 1066B/6	10MHz to 470MHz	Similar to 1066B/1 but, wider deviations to 400KHz $f_m$ 30Hz to 100KHz, also incorporates xtal calibrator.
FM GENERATOR/SYNCHRONIZER Model 2006/1	10MHz to 500MHz	Special high stability version of 2006, fitted with digital synchronizer which locks carrier and gives 7 digit readout of frequency. Receiver bandwidth measurements can be made rapidly, repeatably and accurately on even the narrowest response curves by adjusting synchronizer alone. See illustration above and 2006 details below.
FM/AM SIGNAL GENERATOR Model 2015	10MHz to 520MHz	Covers 10MHz to 520MHz in 11 bands with discrimination permitting tuning to narrow band ( $\pm$ 3KHz) receivers. FM deviation 10KHz and 100KHz. AM to 80%. Precision ALC eliminates need for external set carrier control. Fundamental signal with low spurious content. Will also operate from external 24VDC. Portable, 5 1/2" high 11" wide. Lowest cost for performance generator on USA market today. See illustration above and on cover.
LOW NOISE VHF FM SIGNAL GENERATOR Model 2011	130MHz to 180MHz	Highly stable low noise unit for testing VHF narrow band mobile receivers. Velvet vernier tuning. Infinitesimal leakage. Noise less than $-140$ dB/Hz. 20KHz from carrier. Output level 0.01 $\mu$ V to 100mV into 50 $\Omega$ FM deviation to $\pm$ 30KHz $f_m$ 300Hz to 3KHz.
LOW NOISE UHF FM SIGNAL GENERATOR Model 2012	400MHz to 520MHz	Highly stable low noise unit for testing UHF narrow band mobile receivers. Velvet vernier tuning. Infinitesimal leakage. Noise less than $-140$ dB/Hz. 20KHz from carrier. Output level 0.01 $\mu$ V to 100mV into 50 $\Omega$ FM deviation to $\pm$ 30KHz $f_m$ 300Hz to 3KHz.
LOW NOISE FM SIGNAL GENERATOR Model 2013	800MHz to 960MHz	Highly stable low noise unit for testing high band UHF mobile receivers. Velvet vernier tuning. Infinitesimal leakage. Noise less than $-125$ dB/Hz. 20KHz from carrier. Output level 0.01 $\mu$ V to 100mV into 50 $\Omega$ FM deviation to $\pm$ 30KHz $f_m$ 300Hz to 3KHz.
SOLID STATE PRECISION FM SIGNAL GENERATOR (6625-491-7755) Model 2006	4MHz to 1000MHz	Solid state precision FM unit accepts any 4 of 5 oscillators with bands 4 to 10MHz; 10 to 90MHz; 88 to 220MHz, 215 to 500MHz and 440 to 1000MHz. Output 0.1 $\mu$ V to 100mV into 50 $\Omega$ . FM $\pm$ 100KHz to $\pm$ 300KHz max. dependent on frequency. Mod frequencies 20Hz to 125KHz internal or external.



**VHF DIGITAL ERROR TEST SET** — This high speed PCM test set comprises of VHF Pseudo Random Pattern Generator, Error Detector and Error Counter Display. Test patterns  $2^{10-1}$  sequence are generated at rates up to 281Mbit/s. Important applications include development and testing of coaxial and digital Microwave Radio Systems.



**PCM MULTIPLEX TEST SET** — Embodies in one convenient field portable package, are all the necessary functions to completely maintain or commission PCM Multiplex. Sine wave and pseudo random noise test signals provide testing to latest International Recommendations. Configurations available for domestic and military systems, alternate versions for international and satellite requirements.

## DIGITAL COMMUNICATIONS – P.C.M. TEST GEAR

DESCRIPTION	FREQUENCY	FEATURES
MULTIPLEX TEST SET Model 2807	Voice Channel	Both sinewave and pseudo random noise stimulus available to measure channel gain, frequency response, idle channel noise, gain linearity, quantization distortion and interchannel crosstalk. National and International models available.
PATTERN GENERATOR AND ERROR DETECTOR Model 2808	1.536 to 8.448 Mbit/s	Generates pseudo random test signal in AMI, RZ or NRZ formats. Errors and blanking can be introduced to test regenerator clock recovery. Automatic locking of pseudo random signal in receiver. Performs bit by bit analysis of received signal.
DATA LINE ANALYZER Model 2809	300Hz to 3400Hz	Used for testing data transmission lines and links; measures peak-to-average rating (PAR), frequency response and system noise level. Has correction for phase-intercept distortion.
VHF DIGITAL ERROR TEST SET Model 2813-19	8.5Mbit/s to 281Mbit/s	System provides pseudo random test pattern $2^{10-1}$ sequence in true or complement (invert) NRZ format. Internal or external clock inputs. Individual errors detected up to maximum error density. Employs MECL III circuitry. Recorder output and remote operation facilities.



**MODEL 2303 MOBILE RADIO DEVIATION METER.** This new modulation meter is a portable instrument, designed for measuring FM in all mobile bands up to 520MHz and up to 95% AM on carriers to 225MHz. It operates off rechargeable battery or AC. Weighs only 13 lbs. See other mobile instruments below.



**MODEL 2424 MOBILE RADIO FREQUENCY COUNTER** — A small field portable counter especially designed for mobile users in the VHF/UHF band. An eight digit display of frequency is achieved by alternate LED display of first or last four digits. Operates from NiCads or A.C. Field carrying case and full range of attenuators, loads and sampling unit available.

## MOBILE RADIO TEST GEAR

PORTABLE MODULATION METER Model 2303	25 to 520MHz	Measures FM on all mobile bands thru 520MHz deviations 15, 5 and 1.5KHz. Accuracy 3%. Low noise. AM measurements to 225MHz. 95% depth. 3% accuracy. AC or battery operated. 13 lbs.
PORTABLE MOBILE RADIO COUNTER Model 2424	VHF & UHF Bands	Covers 500KHz to 250MHz, 400MHz to 520MHz bands. Sensitivity better than 60mV. Can measure eight digits, displays first or last four as required. AC or battery. Portable. 6½ lbs.
MOBILE RADIO SIGNAL GENERATORS	All Mobile Bands	Special low noise signal generator series for all bands. 130MHz thru 960MHz. See Signal Generator Section, Models 2011, 2012, 2013.
MOBILE RADIO TEST SET Model 2950	Low and High Band	Test set comprises an FM/AM Signal Generator covering low and high bands, FM/AM modulation meter, RF power meter terminated and through line with forward and reflected power, 1KHz audio oscillator and AF voltmeter.

## FM DEVIATION METERS

FM DEVIATION METER (6625-060-3320) Model 791D	4MHz to 1024MHz	Deviation ranges, $\pm 5$ , $\pm 25$ , $\pm 75$ and $\pm 125$ KHz full scale. Accuracy 3%. Crystal standardized. Local oscillator can be xtal controlled for measuring deviations down to 10Hz.
FM DEVIATION/ AM MODULATION METER Model 2300A	4MHz to 1000MHz to 2500MHz using ext. oscillator	Wide range, mod. freq. up to 200KHz; deviation ranges $\pm 1.5$ , $\pm 5$ , $\pm 15$ , $\pm 50$ , $\pm 150$ , $\pm 500$ KHz. Local oscillator can be xtal locked, external oscillator can be used. De-emphasis 50µsec. 75µsec. switch selected. FM accuracy $\pm 3\%$ for deviation up to $\pm 500$ KHz $f_m$ 30Hz to 150KHz. AM modulation two ranges 30% and 100% mod. freqs. 30Hz to 50KHz (carrier 4 to 350MHz).
PROGRAMMABLE FM/AM MODULATION METER Model 2301	4MHz to 1000MHz	FM deviation in six ranges from $\pm 1.5$ KHz to $\pm 500$ KHz FS. $f_m$ 30Hz to 200KHz demodulated output distortion 0.25%. AM 30% and 100% FS. Automatic internal carrier level setting.
MOBILE RADIO MODULATION METER Model 2303	25 to 520MHz	See Mobile Radio Test Gear Section above.



**MODELS 2914 and 2915 TV AUTOMATIC MONITORING SYSTEM** — This automatic monitoring system can provide the necessary executive control over remote TV Transmitters or microwave links by analysis of signal path degradations. The system performs simultaneous measurements of twelve or more critical parameters using the vertical interval test signals and then compares the results with pre-determined limits. A data output gives the conditions of these limits, allowing immediate report of transmitter failure or severe transmission impairment.



**MODEL 2090B NOISE LOADING TEST SET** — This new unit measures Noise Power Ratio directly in db and picowatts. A standardizing noise generator is built into the receiver to facilitate out-of-band measurements. Band limiting and slot filters for all CCIR/CCITT and D.C.A. recommendations. Special frequencies to order.

## INTERMODULATION AND BASEBAND TEST GEAR

DESCRIPTION	FREQUENCY	FEATURES
NOISE LOADING TEST SET TRANSISTORIZED (6625-965-8625) (AN/GSM 161A) Model 2090A	12KHz to 12.388MHz (i.e. up to 2700 channels)	Solid state unit has built-in standardizing noise source in receiver for gain setting, out-of-band testing, etc. Includes noise generator, receiver and a choice of many different filters. NPR measurements can be made up to 75 dB.
NOISE LOADING TEST SET Model 2090B	12KHz to 12.388MHz	Designed to meet latest CCIR and CCITT requirements (Recommendation 399-1 Oslo 1966). Operation similar to model 2090A.
Model 2099AB		This filter extension box can be added to any 2090A or 2090B system to provide accommodation for up to nine extra high, low or band stop filters and six extra band pass filters with oscillators. Minor modification required to existing generators and receivers to provide access. Simple field modification kits available.
TWELVE CHANNEL NOISE GENERATOR (6625-948-4724) Model TM7816	300Hz to 3400Hz	Generates twelve non-related channels of Gaussian noise from twelve separate solid state sources. Output: each channel 1mW in 600Ω balanced, 300Hz to 3400Hz. Attenuation to -32 dbm in 2 db steps. Spurious noise in OFF channel (all other channels ON) is less than 10 dba (-75 dbm FIA weighted).
TV AUTOMATIC MONITORING SYSTEM Models 2914 and 2915		Automatically analyzes and displays all essential parameters including: amplitudes of bar, sync, various T pulses, and noise; luminance linearity, chrominance gain, chrominance/luminance crosstalk, etc., all measured in the most suitable units of measure and presented digitally when under manual control (see also illustration above). Versions for national and international systems.

## BRIDGES AND Q METERS

UNIVERSAL BRIDGE Model 1313A	1KHz and 10KHz 20Hz to 20KHz External	0.1μh to 110h, 0.1pf / 100μf, 0.003Ω to 110MΩ. Accuracy 0.1%. Built-in osc. and det. Direct reading; simplest possible operation. Uses adapter TM6113 for biasing inductors to 200ma.
PORTABLE UNIVERSAL BRIDGE Model 2700	1KHz internal 20Hz to 20KHz External	0.2μh to 110h, 0.5pf to 1100μf, 0.01Ω to 11MΩ. Accuracy 1%. Transistorized, simple. Measures incremental L, electrolytics & non-linear resistance using external bias supplies.
Q METER Model 1245A	1KHz to 300MHz	Q ranges 5 to 1000, ΔQ 25-0-25. Accuracy 5% to 100MHz, 20% to 300MHz. Calibrated capacitor 7.5 to 500pf, ΔC ranges ±1 and ±5pf. Extremely stable and easy to operate. Uses separate oscillators. Dielectric and Series Loss Test Jigs available. Also HF & LF inductors.

## MICROWAVE SIGNAL SOURCES

Model 6055 Model 6056 Model 6057 Model 6058 Model 6059 Model 6070 Model 6551	0.85 to 2.15GHz 2.0 to 4.0GHz 4.5 to 8.5GHz 8.0 to 12.5GHz 12.0 to 18.0GHz 0.4 to 1.2GHz 1.4 to 1.7GHz	A unique series of transistor and gunn diode microwave signal sources covering 400MHz to 18.0GHz. Digital display of frequency, accuracy typically ±1%. Variable output levels typically 10mW on gunn diode sources. Up to 150mW on transistor models, Gunn Diode Models are 6057, 6058 and 6059. Model 6551 has FM. Special frequency coverages on request.
--	--	--

## COMMUNICATIONS RECEIVERS

Model 850/4 Model 1830 Model 990R Model 990S	10KHz to 600KHz 120 KHz to 30MHz 27MHz to 240MHz 230MHz to 870MHz	A unique series of communications receivers covering 10KHz thru 870MHz. All feature superb construction and top performance. Low frequency models provide AM/CW/SSB. 990 series offer AM/FM. Xtal locking facility optional on all models to enhance stability.
---	--	---

# for you

In the past two years the digital multimeter field has undergone many dramatic changes. Over 20 new multimeters have been introduced, prices have been reduced, higher accuracies and better resolutions have been offered. As a buyer of multimeters, your value received has increased substantially.

These changes, which affected the entire digital multimeter industry, were triggered by the introduction of our Series 2000 5½-digit and 4½-digit Triphasic™ digital multimeters. Priced at 50% to 80% less than comparable models, Data Precision Multimeters exploded the myth of "you gotta be expensive to be accurate." The specs and associated prices were hard to believe. The fact is that customer evaluations indicated the 2000's are even better than we said they would be.

# from us...

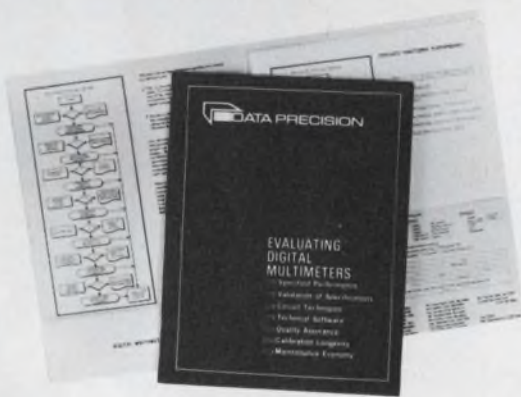

Two years and many model introductions later, our Series 2000 multimeters are still the best demonstrated value on the market. Plus, with thousands in use, they are the most field-proven and accepted of all the new models available.



Just as we changed the industry two years ago, we did it again with our incredible Model 245 pocket multimeter, the only 4½-digit instrument of its kind in the world.

We have designed a DMM Evaluation Kit which will allow you to determine realistically and objectively just what your multimeter requirements are. This kit will enable you to compare the salient features of any instrument so you can determine what is truly best for your own needs. It's yours for the asking. Circle the reader service number or write: Data Precision Corporation, Audubon Road, Wakefield, MA. 01880. (617) 246-1600.

 **DATA PRECISION**  
**...years ahead**

INFORMATION RETRIEVAL NUMBER 29



# Is it convenient to use? Gains are being made outside and inside

**Y**ou're trying to arrange the instruments on a test bench for convenient use. But—

A carrying handle on top of the signal generator makes the input meter you are trying to place there slide off or tilt to an unreadable position. The side brackets for rack mounting on the pulse counter obscure part of the dial on the pulse generator. And the oscilloscope overheats because the ramp generator placed against the scope's right side blocks its ventilation louvres.

You mutter. You complain. You curse.

Sound familiar?

The problem is even worse when you try to fit a group of disparate instruments into a more permanent rack arrangement.

---

**Morris Grossman**  
Associate Editor

Instrument-case standardization would, of course, go a long way toward alleviating the problem. This is an old idea. However, though most manufacturers say they are for standardization, they are for it only so long as the standard is their own system. Standardization is like patriotism. Flag-waving is easy, but it takes an act of Congress and the draft to put the men in uniform.

It's clear that outside packaging plays a critical role in the ease with which engineers can use instruments. But it is only one factor in the user/instrument equation. Inside packaging is equally critical, because it affects ease of maintenance and the instrument's reliability. And here standardization is even more elusive; circuitry varies from manufacturer to manufacturer, depending on the designer's ingenuity. To keep the equipment operational while it is being serviced, every-



Card guides and cage, by Bivar, Inc., are symbolic of the popularity of PC cards in instruments.



The open range is a suitable background to dramatize Zero Manufacturing Co.'s wide range of enclosures. Its

VIP line offers the stackability and rackability that all electronic instruments should possess.

thing from extender boards for plug-ins to flexible cables are being used.

### The evils of standardization

There are many engineers who can give a good discourse on the evils of standardization in a fast-moving industry like electronics. Military specs are often mentioned as a prime example of the problems standardization can cause. These specs are said frequently to be obsolete before they're issued. Projects then require special approval for nonstandard, newly designed components, processes or instruments that were not even dreamed of when the specs were written.

Many engineers contend that when you freeze something on paper, you temporarily choke progress. The outcome, they say, is hassles with procurement and the standards department because a part or instrument is not on the company's approved list. Designers then just pick an "old reliable" from the list.

But if the standard is flexible and based on already widely practiced ideas that have stood the test of time, standards can work, proponents say.

### NIM can do it—why not others?

For instance, the concept behind NIM (Nuclear Instrument Module) is simple and effective. Fit instrument modules into bins that can slip into a standard 19-in. rack. Allow a choice of two heights—5-1/4 or 8-3/4 in.—that are also electronic-industry standards. Build the modules in multiples that are each 1.35-in. wide, and let each bin accommodate from one to 12 modules. Use a standardized 42-pin rear-plug arrangement and standard supply voltages (6, 12 and 24), and you have covered most of NIM.

The 42-pin plug and receptacle is made by AMP, Inc., of Harrisburg, Pa., and is part of its

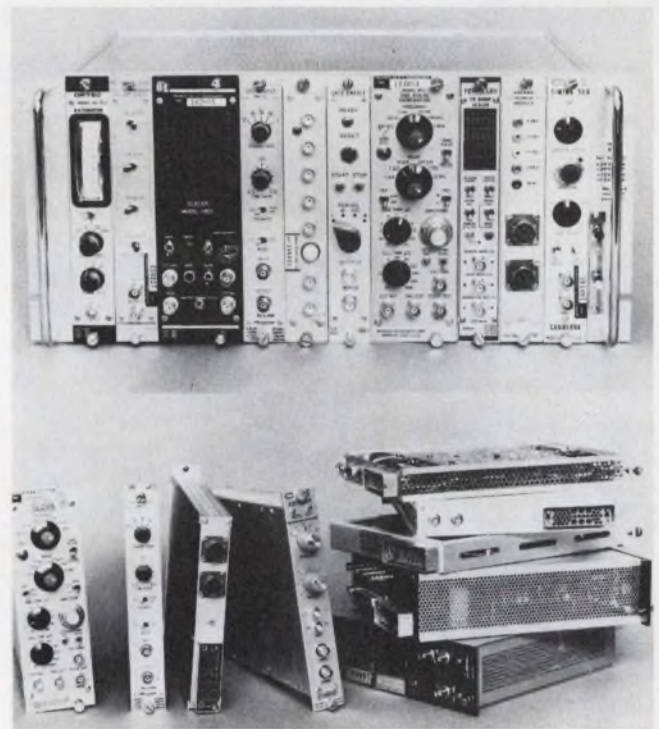

Together is the theme of the NIM packaging standard. Many instruments, each from a different manufacturer, can work together in a single bin.

M series connectors (AMP No. 202516-3). Handles are supplied by Cambridge Thermionic Corp. of Cambridge, Mass., and items like fasteners can be obtained from Amaton Electronic Hardware Co., New Rochelle, N.Y.

Anybody who wants details on the standard can get them from Louis Costrell, Chief of the Radiation Physics Instrumentation Section, National Bureau of Standards, Washington, D.C.

The vast majority of electronic instruments in the nuclear field—and they cover almost every type of instrument in general use—conform to NIM. Companies like Elron Inc. of Edison, N.J., John Fluke Manufacturing of Seattle, and Prince-

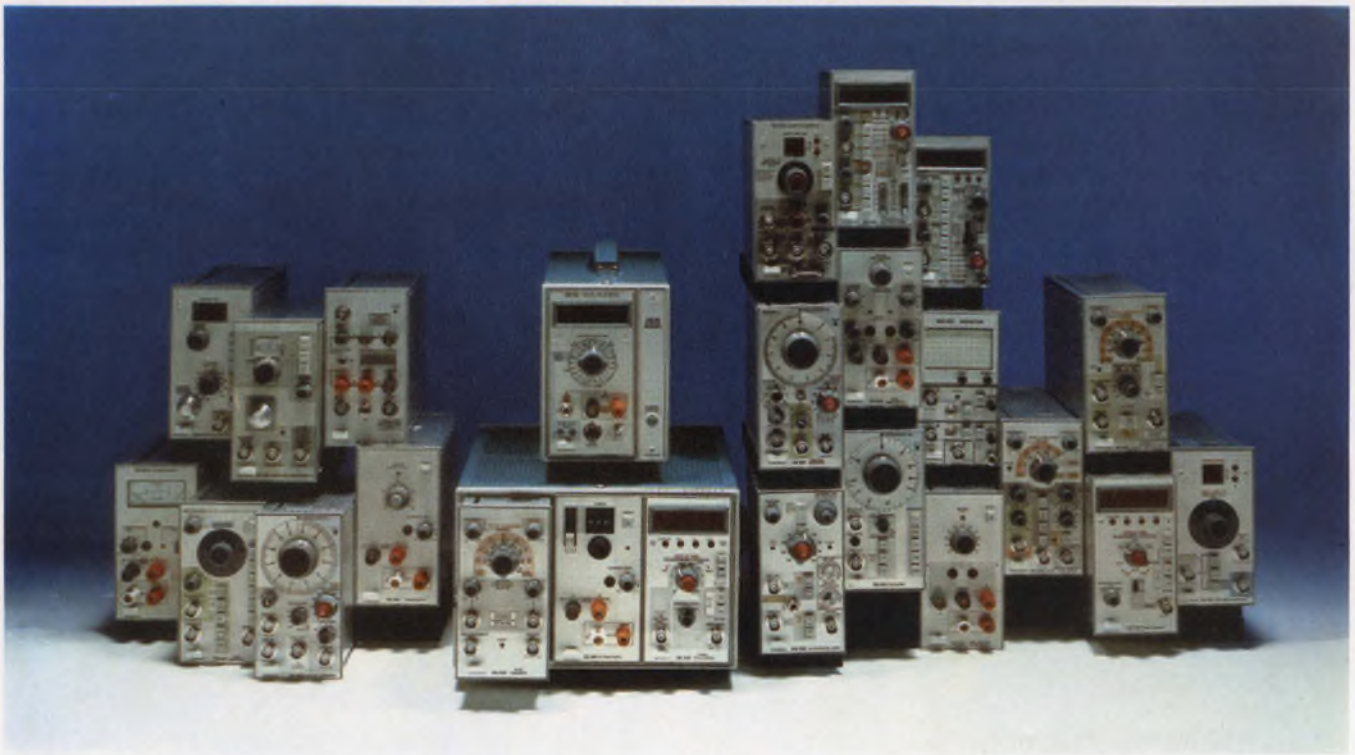

**Versatility and flexibility** characterize the Tektronix TM-500 series of modular instruments. Two bin sizes hold

any combination of three or six of the 24 available instrument modules to suit your needs.



**Some modular instruments are stacked horizontally.** Hewlett-Packard's 5300-A modular measuring system snaps together in vertical sections.

and module cards can be obtained from EG&G, Inc., of Salem, Mass., and Nuclear Specialties, Inc., of San Leandro, Calif., among many other companies.

Besides these simple mechanical requirements, CAMAC is mostly concerned with standardizing the interface of data-processing equipment. It spells out the assignment of lines for data and control signals in its bussing system.

Both NIM and CAMAC have received international acceptance through organizations such as CERN, a European group for nuclear research.

Costrell of the National Bureau of Standards, one of the originators of NIM, was asked why these obviously effective standards have not spread more widely beyond nuclear instrumentation. He told *ELECTRONIC DESIGN*: "The nuclear-instrument field is a pretty close community. We know each other. And we can present a unified market for the vendor. Perhaps other groups don't have our clout."

ton Applied Research of North Brunswick, N.J., among over 40 others, supply NIM instruments.

The use of data-processing equipment in the nuclear industry, however, ran afoul of NIM's heavy orientation toward analog equipment, and a new standard—CAMAC, for Computer Automated Measurement and Control—was developed to supplement NIM. The bin in NIM is called a crate in CAMAC, and the NIM module is divided roughly in half, so that, with a few other changes, there is room for 25 modules in a crate. Also, a double-sided, 86-contact edge connector is used in CAMAC. Thus a single-width module might consist of only a single PC board. Blank modules

### **Making it modular**

Some instrument makers have modular packages, but not to NIM standards. Tektronix's new TM-500 series is one of the few electronic instrument families that use a packaging approach that is very similar to NIM.

A total of 24 modules can plug into two sizes of mainframe bins of three and six-module capacities. Power supplies are part of the mainframe, but a separate power module is also avail-

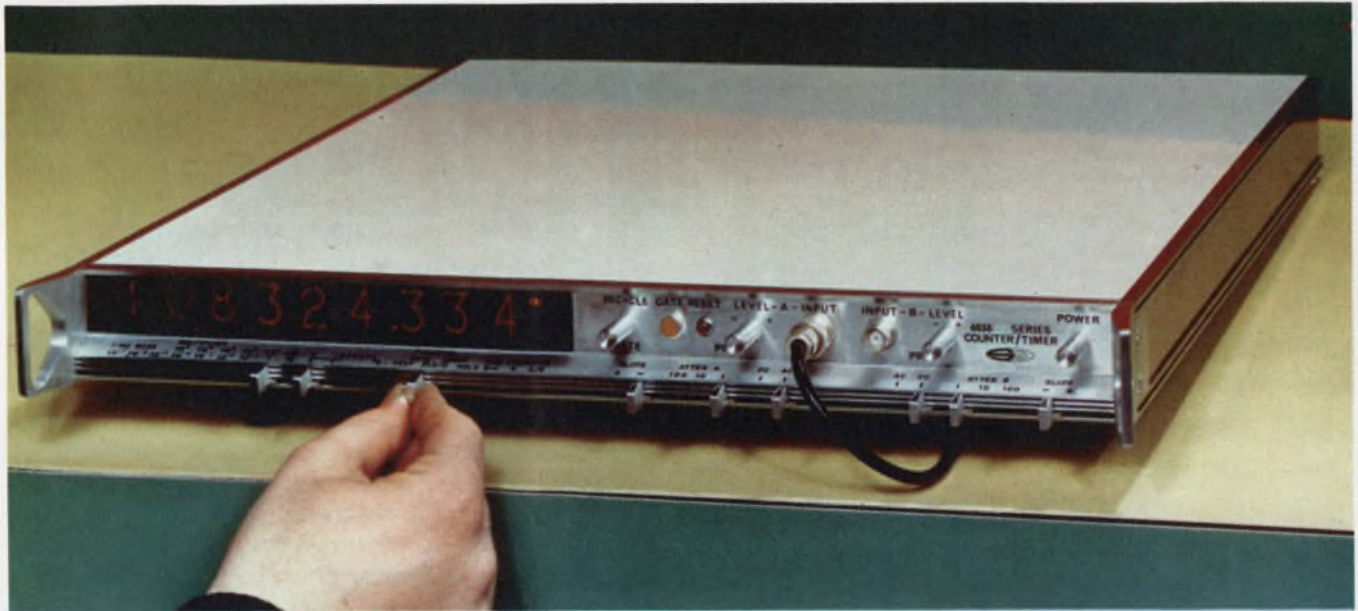

By making the instrument thin—only 1-3/4 in. high—Systron-Donner, with its thin-line counter design, can

able. Front-panel switches eliminate much bench clutter. They permit signals to be sent into individual modules from rear-panel connectors.

The three-module Tektronix bin can make a highly portable assembly. A single-unit case is also available; it can hold any of the 24 modules and the TM-501 power module.

Obviously this is an extension of the Tektronix philosophy of many instruments in one package, applied so successfully by the company for years in its scope lines.

Tau-Tron of Lowell, Mass., also has a modularized line of plug-in instruments. Its TMI series fits a rack-mountable bin with a capacity of four units. The plug-ins for the series, however, are mainly digitally oriented circuits.

At present you can't mix the modules from different vendors in the same bin. It will take considerable user pressure before this is possible outside a tightly knit field like nucleonics.

### Modularity isn't always best

But while some engineers praise modularity, others find good arguments to go the integral way. Gunther U. Sorger, chief marketing scientist for Singer Instrumentation in Palo Alto, Calif., says that his company's Model 9514/9515 broadband microwave sweeper would be better if it used a totally integral design rather than even the minimal plug-in arrangement that it does.

Besides lower cost, Sorger says, "all those subtle, but difficult-to-solve problems which result from combining several high-frequency circuits to produce a broadband sweeper—ground currents, hum and multiple ground points, erratic contacts, frequency fluctuations—are more easily

save valuable and usually limited panel height on crowded racks and benches.

eliminated in an integral design."

"With plug-ins," Sorger notes, "after each unit's end points have been adjusted just right, if you pull one of the plug-ins out and use it someplace else, you have to remember the serial number to make sure you don't have to go through a tedious readjustment procedure again."

Another place where modularity is of small advantage is when a particular combination of instruments is likely to be used continually. Like modular instruments, such multicapability instruments cut costs, with a single chassis and common power supply, and reduce bench-top clutter. And there are still synergistic payoffs: You often get more capability in the combined instrument than with individual units. A flip of a switch, and you can monitor the output level of the signal generator with the built-in multimeter or set the trigger level of the unit's frequency counter. Separate instruments would call for external cables, switches and other kludges. Perhaps best of all, nobody can borrow one of the instrument's units as soon as you turn your back.

Systron-Donner's Versatester-I is an example of such a high-use combination. Five test instruments—pulse generator, square-wave generator, sine-wave oscillator, frequency counter and multimeter—plus three test power supplies (5 V,  $\pm 15$  V and  $\pm 30$  V) are incorporated in one thin, 3-1/2-in. high unit.

### Slenderizing to conserve space

Panel space on a rack or bench is limited and valuable. Thin (in height) instruments can take full advantage of the available depth and width while keeping panel height to a minimum. The Systron-Donner's thin-line design, first introduc-

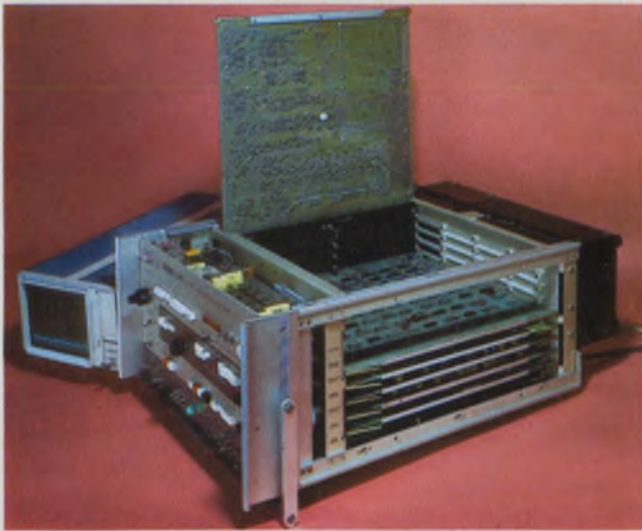

The service socket of Federal Scientific's Ubiquitous spectrum analyzer, Model UA-500, can hold any of its PC boards, and remain operational.



The flexible PC assembly in Analogic's Model 2530 DPM can be unrolled for convenient servicing, and the unit remains operational.

ed in 1967, remains a classic example of this style of packaging. Its 1-3/4-in. panel height requires different concepts in front-panel design. Knobs, switches, handles and interiors require special treatment.

A novel horizontal slide switch in the Systron-Donner 6038 counter/timer overcomes the front-panel height limit. A small magnet attached to a slide-switch lever actuates reed relays at specific points. Such a switch design needs little panel height. And, the few round knobs that are used are made slender and long, to allow a firm grip.

Modular or integral, a good bench unit should be stackable, interlockable and otherwise physically compatible with its mates. While many electronic instrument manufacturers have not paid enough attention to this, many enclosure makers, like Zero Manufacturing Co. of Burbank, Calif., have. Zero's VIP (Versatile Instrument Packaging) line interlocks horizontally and vertically and also rackmounts with the simple addition of joiner strips or brackets. Its broad range of

enclosures provide for adding self-retracting handles for portable briefcase designs and tilt stands for bench or desk-top use.

Of course, many others such as Optima Enclosures of Atlanta, Bud Radio, Inc., Willoughby, Ohio, and Premier Metal Products Co. of the Bronx, N.Y., also have complete lines of compatible electronic enclosures and hardware.

#### Some instruments stand alone

However, not all instruments have their destinies tied to a bench or rack. Field service imposes its own requirements. Such instruments must be portable and, if possible, hand-held.

Hewlett-Packard's 5300 series of snap-in units, a versatile group of instrument modules that includes a chargeable battery pack, provide most of the packaging features for field service work. Convenient carrying handles, a tilt stand and light weight and small size in the 5300 series all combine to ease field work. But though an assembled unit is small, it is not quite small enough to be considered hand-held—and not quite "square" enough to be an ideal bench instrument.

Many very excellent instruments come only in portable packages, though they often find most of their applications on the bench. With very little extra effort, the instrument manufacturer can make such instruments stackable for bench work or rackable for permanent installations.

For a good hand-held instrument, the Hewlett-Packard Model 970A multimeter is hard to beat. All electronics, the display and batteries are in one probe-like package. To eliminate most of the switching used in conventional multimeters, automatic ranging, decimal-point placement and polarity indication features are packed into the instrument's LSI substrate. Only three switch selections need be made—volts, ac or dc, or kilohms. And only two input leads serve all functions, with no line cord to get in the way.

The greatest advantage that a hand-held unit provides is that the digital display is close to the point of measurement; the user doesn't have to look away from the point of contact to read the meter and run the risk of shorting leads with the probe. An added feature permits the user to invert the displayed numbers with a flick of the thumb.

Keithley Instruments of Cleveland had these principles in mind when it designed its Model 167 digital multimeter. However, only the display and probe are hand-held in Keithley's unit; the electronics and pushbutton controls are in a separate table-mounted "mainframe."

It's reported that both Dana Laboratories of Irvine, Calif., and Data Technology, Santa Ana, Calif., also are readying hand-held digital multimeters to compete with HP's 970A.

Modularity inherently eases maintenance, because units can easily be unplugged for access to

the instrument's interior. But full-bin and integral designs need special attention.

### Making it maintainable

The Model UA-500 Ubiquitous Spectrum Analyzer, made by Federal Scientific Corp., New York City, is a good example of how the access problem can be approached. The instrument uses six relatively large, 14 × 14-in. plug-in boards. The instrument uses very little cabling, since the six boards plug into a mother board that carries most of the back-plane wiring. Only the front-panel controls, rear panel and power-supply circuit have harness wiring.

The six boards can be interchangeably inserted into any of the sockets and the instrument can still function. However, this is recommended only for test purposes.

For troubleshooting, any of the boards can be inserted into the top socket of the assembly. In addition a special service socket can hold any of the other boards in a vertical position, for easy access to both sides.

To keep the instruments operational while they are being serviced, some manufacturers provide extender boards. These can be easily lost, however, and may provide unstable support while they are being used. Another approach uses flexible cables, wired to the board, so the circuits can be placed in convenient servicing positions. While there are no items to lose, the flexible cable can take up valuable space and cause coupling and feedback problems. Flexible cable can eliminate possible poor socket connections, however.

Data Technology's Model 30 DMM avoids the need for a cable connection to its single PC board. The contact sections of its selector-switches are soldered directly to the board. And for maintenance, the user can easily remove the board from the case simply by sliding the shafts out of the contact sections. The switch knobs and shafts remain with the front panel, while the PC board, with the switch contact assemblies, slides out the rear of the instrument case. This special switch is supplied by CTS-Keene of Elkhart, Ind.

And where you really have to pack a lot of parts into a small space—such as in the miniature Tri-Phasic digital multimeter, Model 245, made by Data Precision of Wakefield, Mass.—a flexible PC-board assembly can fit in the limited space and still allow access for maintenance. The 245 multimeter uses a flexible circuit mount made of Teflon/Capton for its display-digit driver circuits. The flexible circuit wraps around the display units as a mandrel and the whole assembly plugs in for easy removal and repair.

Analogic Co. of Waltham, Mass., goes all the way in the use of a flexible PC assembly. Most of the circuits in its Model 2530 DPM, including



A flexible assembly for the indicator circuit and rigid boards for the rest allows Data Precision's Model 245 DMM to pack many parts in a small space.

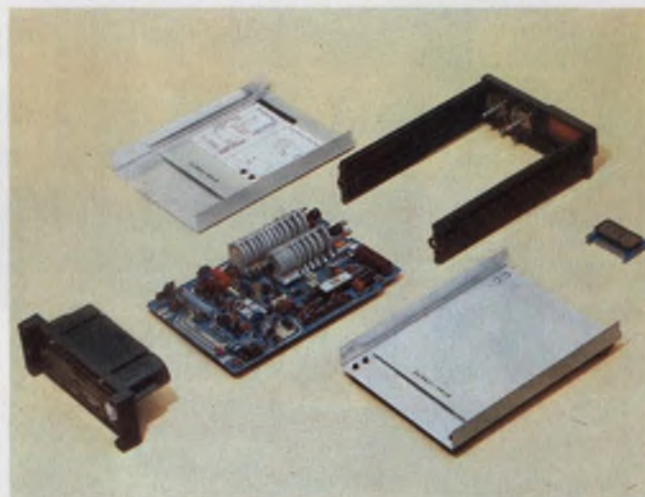

Slip the shafts out of the selector switches that are mounted to the PC board, and you avoid cable or socket wiring, as in Data Technology's Model 30 DMM.

the digital display, are assembled on a flexible strip, and the whole package rolls up and fits snugly in a 3.2 × 1.6 × 1.3-in. metal case. Best of all, the unit is fully operational when the flexible package outside its case is fully extended for troubleshooting.

Datel Systems of Canton, Mass., in its DM-2000 digital panel meter, uses conventional rigid PC boards. But the instrument has a unique arrangement to pack enough surface into its 1.8 × 3 × 2.2-in. interior to hold all the parts. Four PC cards plug into each other at right angles to form a cube-like structure, and the base card has an edge connector that then extends through a slot at the rear of the housing for external connections. The interboard connections are made of individual right-angle pin and socket terminations that are staked to the boards. And the front vertical board contains the display digits. There are no cables, and all components and connections are on the four interlocking PC boards. In the assembled configuration all components and connections are readily accessible. ■■

**The \$5,600  
computer you  
don't have to  
talk down to.**

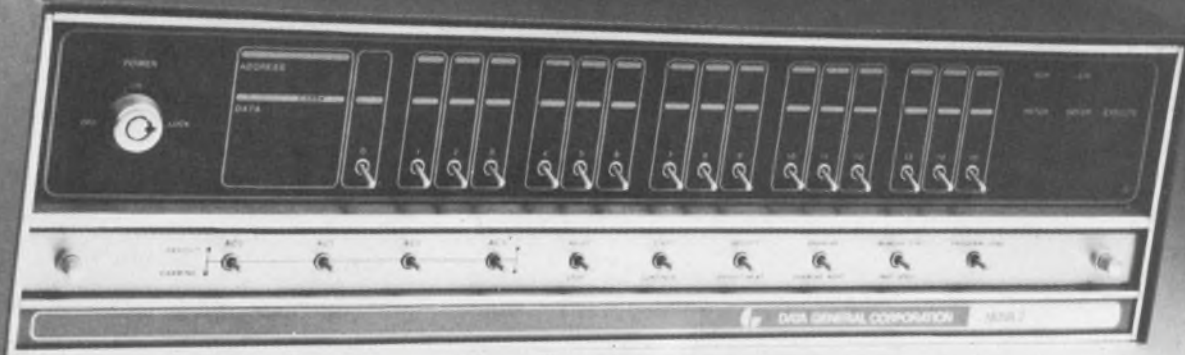

**We've got an idea that ought to interest any OEM who's trying to bring down the price of his product.**

**Go buy yourself 5\* Nova 2's with the new 16K memory boards. (Yes, we know you can probably get away with less memory. Bear with us.)**

**Now take a look at what you get: a high speed multi-accumulator 16 bit CPU, an I/O system with programmed data transfer, 16 levels of programmed priority interrupt, high speed Direct Memory Access, programmer's console, 4-slot mainframe, power supply and 16,384 words of 1 microsecond memory, expandable to 32K. With 4K and 8K memory modules also available.**

**That, you'll have to admit, is an awful lot of computer for the money. With twice the memory of other computers in that price range.**

**Hold on. It gets even better.**

**With that 16K memory, you won't have to talk down to the computer in machine language. You're going to be able to program in higher level languages.**

**So your programmers will be able to spend more time on what they want it to do and less on how to say it.**

**Which means they'll get the job done faster. And you'll get your product out on the market faster.**

**Both of you are going to save yourselves a lot of time and money.**

**Think about that for a minute.**

**Consider how your system costs go down when your programming time goes down.**

**The \$5,600 price tag looks even better now, doesn't it?**

**And that's before the quantity discounts get figured in.**

\*Five systems is the minimum order.

# **The 16K Nova 2 Data General**

**Southboro, Massachusetts 01772 (617) 485-9100.**





# 3,500 VOLT ISOLATION 100% CURRENT TRANSFER OPTO COUPLER

## HOW GENERAL ELECTRIC DOES IT

General Electric's unique glass isolation produces precise alignment and controlled spacing between the LED and the silicon detector thus optimizing photon coupling...minimizing the effect of the inverse relationship of isolation voltage and current transfer ratio...and yielding optoelectronic couplers with BOTH high isolation voltage and high current transfer ratios.

3 new models 4N35, 36, 37 are characterized for high isolation voltage and high current transfer ratios. 4N35 offers 3,500 volts (peak) and 100% transfer ratio for \$1.85 each in 1,000 lot quantities.

Available now from any authorized GE Semiconductor distributor or GE Electronic Components Sales Office.

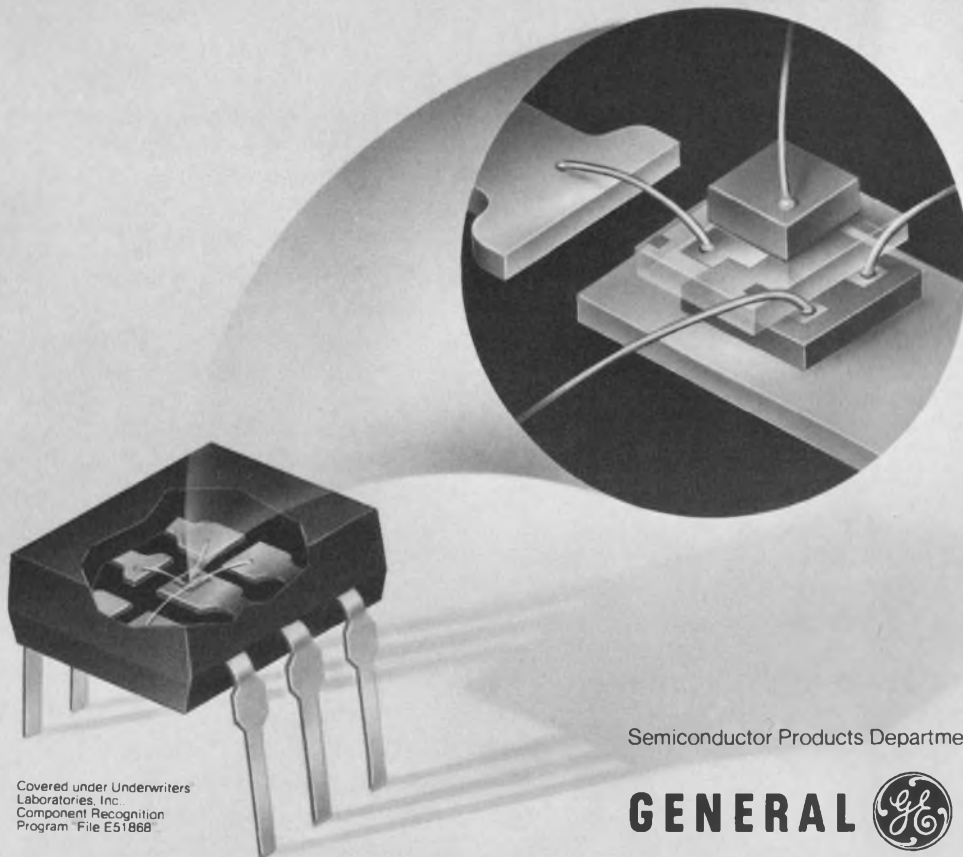

Covered under Underwriters  
Laboratories, Inc.  
Component Recognition  
Program "File E51868"

Semiconductor Products Department, Syracuse, New York.

GENERAL  ELECTRIC

You don't have  
to give up  
carbon composition  
performance to  
save space.

If you're really  
serious about cost,  
be serious about quality.

Are you cramped for board space but not in power handling capabilities? Is reliable performance vital? Then use Allen-Bradley 1/8 watt carbon composition resistors. Get the pulse handling and overload capabilities that are superior to resistors manufactured by other technologies. Exclusive hot molded construction for a

dense resistance element which reduces noise, and results in a consistent performance. Most importantly, our 1/8 watt resistors have all of the quality and reliability common to our larger sizes. Quality that really can cut your fixed resistor costs. If you think resistors are identical, write for "7 Ways to Tell the Difference in

Fixed Resistors." Available from your Allen-Bradley Electronic Distributor, or: Allen-Bradley Electronics Division, 1201 South Second Street, Milwaukee, Wisconsin 53204. Export: Bloomfield, N.J. 07003. Canada: Allen-Bradley Canada Limited, Cambridge, Ontario. United Kingdom: Jarrow, Co. Durham NE32 3EN.

Actual size

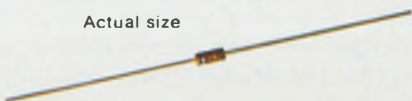

INFORMATION RETRIEVAL NUMBER 33



**Allen-Bradley**

Milwaukee, Wisconsin 53204

# Digital logic gives rise to three devices for easing design work

**W**hat have instrument makers done for you recently? How about transient recorders, logic analyzers and "smart" instruments? Three to five years ago they didn't exist. Today they are making life simpler for designers.

With transient recorders, it's now possible to record and view signals that formerly were too fast to work with—pulses of 0.35 ns, for example. And the new recorders are making a/d conversion easier and faster, too.

Logic analyzers, by providing an over-all view of system operation, are making it easier to troubleshoot the systems.

As for "smart" instruments, they are performing not only the traditional functions of stimulus and measurement but also such related tasks as storing data, computing averages and providing summary results rather than the mere raw data.

All three classes of instruments owe their birth to digital logic.

## A 'look back in time' possible

The transient recorder converts analog signals into digital data and then stores the information in a digital memory. The output from such a recorder can be either digital or analog. A self-contained d/a converter provides the analog output.

An unusual feature of transient recorders is that they record the signal just prior to the transient event. Often referred to as pretrigger recording, this makes it possible for the designer to "look back in time" to see what happened just prior to the event.

To look back the designer lets the unit record



The 1601L Logic State Analyzer from HP is the newest arrival on the digital test equipment scene. It allows designers to analyze parallel data streams and displays information in truth table format.

continuously until the trigger signal is received, then uses the signal to stop the recording process. This freezes in memory the data that was received prior to the trigger signal.

Transient recorders first made the scene about three years ago, when the Biomation Corp. of Cupertino, Calif., introduced a recorder with a 6-bit a/d converter and a conversion rate of 10 MHz. Since then several other companies—including Ballantine, Nicolet, Macrodyne, Inter-Computer and Tektronix—have entered the market with competing instruments. The choice for users is wide.

On the inexpensive, low-performance end are instruments, like the Model 7050A electronic sig-

nal recorder from Ballantine Laboratories, Boonton, N.J. It uses an endless loop of computer-grade tape to record repetitive or transient signals up to 100 kHz with a maximum rise time of 3.6  $\mu$ s.

Aside from its \$985 price, the attractive feature of the 7050A is that the captured signal can be played back on any oscilloscope at 3000 divisions per millisecond and can be minutely examined with any of the scope's display features.

Unlike a storage scope, in which transients can be stored and viewed for only a limited time, the Ballantine recorder stores signals indefinitely, allowing viewing at any time.

On the expensive, high-speed end of the spectrum is the R7912 Transient Digitizer from Tektronix, Beaverton, Ore. It can cost as much as \$12,000 for a complete system. The R7912 makes use of a new scan-converter tube that has a silicon-diode-array target. The waveform to be recorded is written on the target as a charge image by one electron gun and read out of the scan-converter by another electron gun. This approach yields an instrument that has a clock rate of 100 GHz—several orders of magnitude faster than the Biomation device, which is generally considered the yardstick for transient recorders. A big disadvantage of the Tektronix unit, however, is that the silicon target has a latency, or retention time, of only about 100 ms; thus the information stored on it must be used before then or stored in an optional buffer memory.

### Action in the middle ground

Most of the action in transient recorders is taking place between the extremes, however. Biomation's Model 8100 transient recorder, for example, is a two-channel device that features a high-speed, 8-bit a/d converter with a maximum word conversion rate of 100 MHz. The unit, which costs \$9850, also contains an 8-bit, 2000-word MOS shift-register memory to store the converted analog waveform. Because of its rapid sampling rate, the recorder can digitize high-frequency signals that are much faster than those normally inputted directly to a digital device. It stores the information and subsequently outputs the data at slower rates, as required.

Inter-Computer Electronics, Inc., of Lansdale, Pa., has added improvements with its PTR-9200 pulse and transient recorder. The memory used to store the converted signal is an addressable, random-access memory that can be expanded up to 11,264 words of 8 bits each. This means that more information can be stored and that individual items in the memory can be addressed by a computer, if necessary. The cost of the Inter-Computer recorder is \$9300.

Further improvement has been made by Nicolet

Instrument Corp., Madison, Wis., with its 1090 Digital Storage Scope. Although it's called a scope, the 1090 is simply a transient recorder with a cathode-ray tube display.

Jack Krause, vice president of marketing for Nicolet, contends that the Biomation device fell short of what would be a "really useful" device. It is not a self-contained unit, he notes, in that it requires additional equipment to be used effectively. Nicolet therefore integrated the CRT display and added a numerical display capability, so the device can be used not only to record but to measure as well.

Another feature of the Nicolet unit is that it offers the highest resolution of any transient recorder so far—12-bit resolution on the voltage axis and 4000 data points on the time axis. It



The ERDAC III transient recorder from Macrodyne is a complete 4-channel 1-MHz data acquisition system. The unit contains a CRT display, magnetic tape recorder, digital display and a transient recorder.

does this, however, at the expense of speed—a bandwidth of only 100 kHz. The price for the 1090 ranges from \$4800 for a single channel device to \$6300 for a dual channel.

The idea of integrating a transient recorder with a CRT display is not new. Medical-equipment manufacturers have had such a unit for years. Known as a nonfade display, it is used to store and display electrocardiograph signals. The display allows the physician to look at the ECG waveform just before some critical change in it occurs.

The integration of the transient recorder with peripheral equipment is carried one step further by Macrodyne, Inc., of Mechanicville, N.Y. It has come up with a unit that contains a transient recorder, CRT display, magnetic-tape recorder and digital readout display. The unit, known as the ERDAC III Transient Recorder, costs \$9800. The

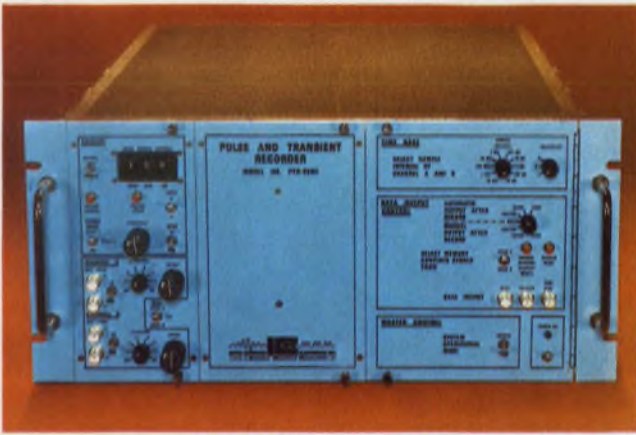

An expandable random access memory is the key feature of the PTR-9200 pulse and transient recorder available from Inter-Computer Electronics, Inc.



The Digital Storage Scope from Nicolet features a 12-bit resolution transient recorder and a CRT display. The bandwidth of the 1090 scope is 100 kHz.

standard unit comes with four input channels, but an input multiplexer is available for still greater channel capacity. ERDAC III contains a 10-bit a/d converter and has a sampling rate of 1 MHz.

#### Analyzer displays truth tables

The increasing complexity of logic circuitry and the high speed of operation often encountered have led to the design of logic testers with revo-

lutionary capabilities. One is the 1601L Logic State Analyzer from Hewlett-Packard, Palo Alto, Calif.

Capable of collecting data at speeds up to 10 megabits per second, the 1601L allows digital designers, for the first time, to analyze parallel data streams in digital systems and to have the results displayed as ONEs and ZEROS in truth-table format on a CRT.

Data from as many as 12 parallel lines are presented as 16 consecutive 12-bit words. Since the information is stored in shift registers, it can be displayed indefinitely. In addition data can be displayed in either BCD or octal—three columns of four bits or four columns of three bits. There is also a logic sense switch, which can be used to invert the displayed pattern for negative-true logic systems.

Priced at \$2650, the 1601L provides an over-all view of system operation by showing the engineer exactly what the ONEs and ZEROS in his system are doing.

Before the 1601L analyzer became available, engineers had to use logic analyzers like the Data Display Systems' 4015 or the HP 5000A. With the 5000A, the newest of the two, data bits are captured and displayed individually by light-emitting diodes. It can store and compare data on two independent input channels and look at selected bits way upstream or downstream.

Whereas the display for the newer 1601L Logic State Analyzer is a CRT, the 5000A uses two rows of 32 LEDs each. It can operate at rates of up to 10 megabits per second, and since it is clocked by the clock of the system under test, there is no synchronization problem. The 5000A costs \$1900.

Another type of digital analyzer, referred to as a "logic multimeter," is made by Bow Industries, Inc., of Bailey's Crossroads, Va. Designated the Model 173, this instrument, unlike the earlier analyzers, can be used to measure pulse parameters. The parameters are read out on a 3-to-5-digit LED display.

According to Dale Whyson, designer of the Bow instrument, it can measure such parameters as pulse width, timing accuracy, pulse spacing and frequency without need for an oscilloscope. The instrument is battery-operated and crystal-controlled, with a frequency range from 1 kHz to 10 MHz. The price varies from \$329.95 for the three-digit version, to \$369.95 for the five-digit.

#### Probes and pulsers for testing

On the low-cost end of the digital test-equipment spectrum are logic probes and pulsers, which have become commonplace in the last few years. Manufacturers include Kurz-Kasch of Day-



A 4-channel transient recorder from Biomation features 10-bit a/d conversion at rates up to 100 kHz. Data are stored in four 1024 word memories.



Logic pulsers and clips, like these from HP, are used to provide a stimulus to a logic device and indicate its response to that stimulus.

ton, Ohio; Hewlett-Packard, Palo Alto, Calif.; Signal Laboratories, Orange, Calif.; Acron Corp., Lakewood, N.J.; and Aqua Survey and Instrument Co., Cincinnati, to name a few.

In general, logic probes are all similar. They either draw power from the circuit under test or contain their own batteries. In any case, the logic circuitry in the probe drives one or more indicators, either LED or incandescent, and this shows the presence of a ONE or ZERO.

The minimum pulse width detectable with these probes is 5 ns, and the maximum pulse repetition frequency is 50 MHz. Logic probes can often replace oscilloscopes for troubleshooting.

Probes are useful when individual points in a circuit are checked, but to check an entire IC, it is more convenient to use a logic clip, such as the HP 10528A. With this, up to 16 signals on a given IC can be checked simultaneously. This is

particularly useful when a decade counter is tested, for example. It is necessary to check at least one input and four outputs simultaneously to determine if the device is operating properly.

While logic probes and clips are good for indicating what the logic states are, the engineer must apply a test signal and observe the response to that signal to determine if the device is operating properly. Logic pulsers, or signal injectors, do this.

Devices such as the P-2002 Signal Injector from Aqua Survey and Instrument offer two modes of operation: individual pulses varying from 1  $\mu$ s to 10 ms and pulse trains from 100 Hz to 1 MHz.

### 'Smart' instruments

With smart instruments, data can be taken faster and more accurately than manually. Often the data can be stored directly in machine-readable form; this eliminates the tedious and error-prone process of re-entering the data by hand if calculator or computer processing is later desired.

Smart instruments also allow more data to be taken. And with the use of either a calculator or a computer, some real-time data processing can be done, thereby allowing early detection and correction of errors.

The internal digital processor in smart instruments often simplifies instrument control, both from the front panel and remotely. A good example of this is the HP 3330 frequency synthesizer. The engineer can program it from the front panel to sweep its frequency or amplitude in any step size over any band simply by entering the parameters on its calculator-like keyboard. In addition it can expand or contract the sweep on command from the internal processor.

Extra performance is also available from smart instruments, as in the Tektronix 7704A Digital Processing Oscilloscope. In addition to displaying a signal as a conventional scope does, the 7704A can also average signals to eliminate noise, display the signal in the frequency domain by calculating its Fourier transform, correct for signal errors caused by impedance mismatches and automatically scale a displayed waveform to any convenient form.

The newest smart instrument on the market is the AN 7000 from Analogic. A low-cost instrument, in the \$1000 range, it is designed for measurement and process control. The instrument is basically an a/d converter connected to a microprocessor and memory. An analog signal is fed into the a/d converter and digitized. The signal can then be put into memory or used to perform some computation and then stored. The output of the device can be digital or analog, if a d/a converter is added. ■■

# NEW FROM TRW

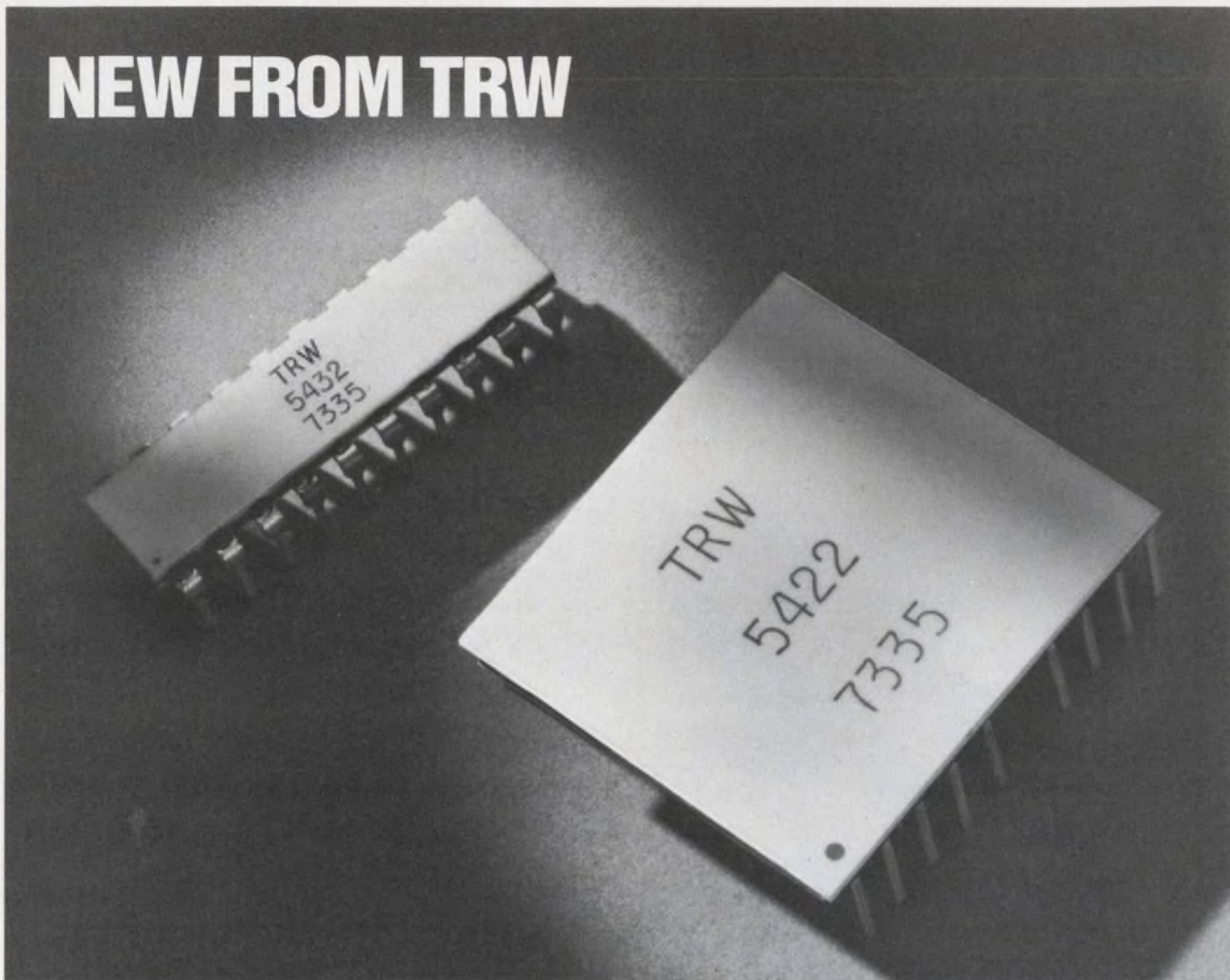

## 12-Bit TaNFilm® Binary Ladder Networks

These networks—representative of TRW/IRC's tantalum nitride film capability—are now available in standard DIP configurations in 12-bit accuracies. They are also available in a larger version that is pin compatible with an earlier, popular design.

TaNFilm networks—designed for digital-to-analog and analog-to-digital conversion—offer excellent stability, high accuracy, low noise, fast switching and fast settling time. Due to the inherent passivation of TaNFilm, they provide hermetic performance *without* hermetic cost. They retain half LSB accuracy over the entire operating temperature range and after extended operating life.

TaNFilm R-2R ladder networks include application resistors, permitting use of a variety of circuit con-

### Performance Characteristics

Ladder resistance values (R)	5K, 10K, 20K, 25K ohms
Ladder resistance tolerance	±1%
Absolute temp. coeff.	-75 to +125 PPM/°C
Maximum input voltage	20 volts
Operating temperature	-55 to +125°C
Storage temperature	-65 to +150°C
Conversion accuracy*	½ least significant bit (122 ppm)
Switch compensation	to 5 ohms
Settling time	to 20nSec.

\*Ladder voltage ratio accuracy is the maximum voltage ratio error expressed in ppm of full scale with any combination of bits activated.

figurations. Compensation to -5% can be provided in both input and application resistors.

Also available in special configurations—to meet your needs. Request new bulletin detailing performance, cost savings, mechanical characteristics. TRW/IRC Precision Network Operations, an Electronic Components Division of TRW, Inc., 2850 Mt. Pleasant St., Burlington, Iowa 52601. (319) 754-8491.

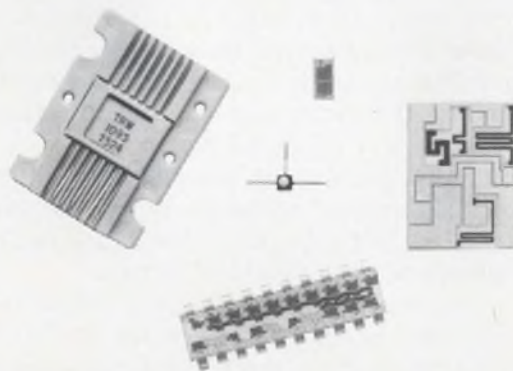

## TRW® IRC RESISTORS

INFORMATION RETRIEVAL NUMBER 34

# New function generator programs faster— functions better, longer.

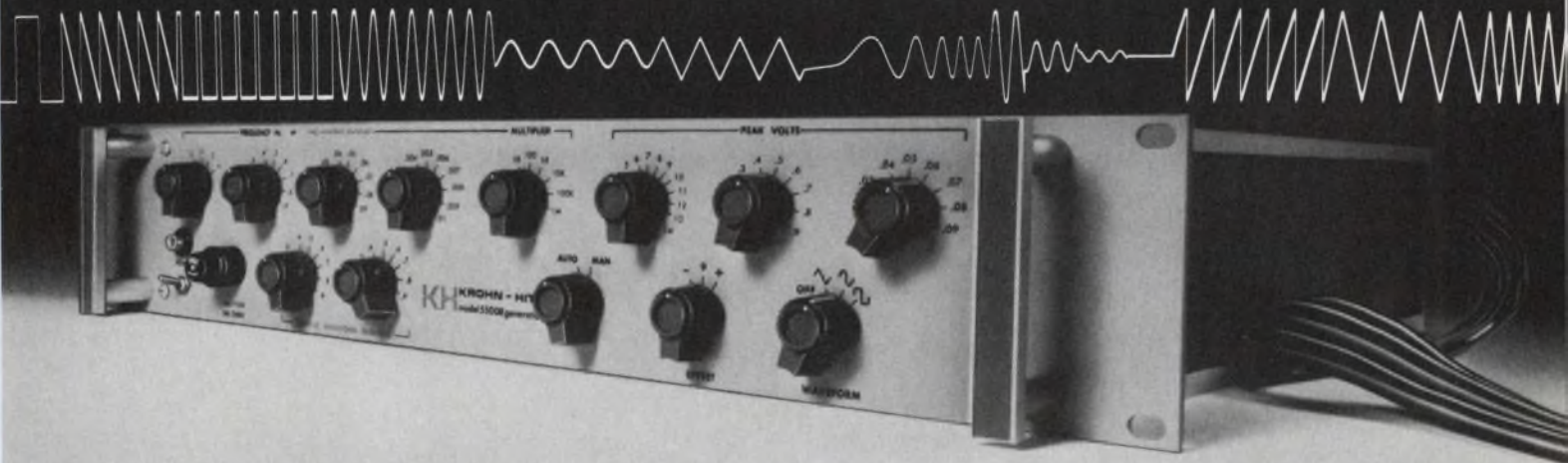

**The 5500R Programmable Function Generator utilizes high-speed FET switches for greater reliability and generates functions automatically in less than 100 $\mu$ . sec.**

There are no relays to break down. And optical coupling assures high isolation between system and logic drive. Frequency range is 0.0001Hz to 5MHz. Sine, square, triangle, pulse and sawtooth waveforms, as well as frequency, amplitude, DC offset and pulse width control functions, can all be selected auto-

matically or manually. And the 5500R programming interface is compatible with DTL, RTL, TTL logic and relay closures. It's ideally suited for automatic calibration and test systems. For fast action, call (617) 491-3211, TWX 710 320 6583, or contact your local KH representative listed below.

**KH KROHN-HITE  
CORPORATION**

580 Massachusetts Avenue, Cambridge, Massachusetts 02139

SALES OFFICES: ALA., Huntsville (205) 534-9771; CAL., Santa Clara (408) 243-2891, Inglewood (213) 674-6850; COLO., Littleton (303) 795-0250; CONN., Glastonbury (203) 633-0777; FLA., Orlando (305) 894-4401; HAWAII, Honolulu (808) 941-1574; ILL., Des Plaines (312) 298-3600; IND., Indianapolis (317) 244-2456; MASS., Lexington (617) 861-8620; MICH., Detroit (313) 526-8800; MINN., Minneapolis (612) 884-4336; MO., St. Louis (314) 423-1234; N.C., Burlington (919) 227-2581; N.J., Bordertown (609) 298-6700; N.M., Albuquerque (505) 255-2440; N.Y., E. Syracuse (315) 437-6666, Rochester (716) 328-2230, Wappingers Falls (914) 297-7777, Vestal (607) 785-9947, Elmont (516) 488-2100; OHIO, Cleveland (216) 261-5440, Dayton (513) 426-5551; PA., Pittsburgh (412) 371-9449; TEX., Houston (713) 468-3877, Dallas (214) 356-3704; VA., Springfield (703) 321-8630; WASH., Seattle (206) 762-2310; CANADA, Montreal, Quebec (514) 636-4411, Toronto, Ontario (416) 444-9111, Stittsville, Ontario (613) 836-4411, Vancouver, British Columbia (604) 688-2619.

INFORMATION RETRIEVAL NUMBER 35



**Reliability is 756 little dents  
and one big one.**



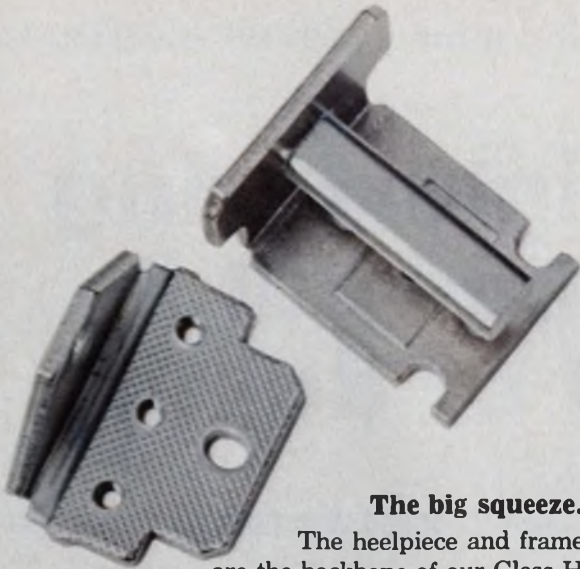

### The big squeeze.

The heelpiece and frame are the backbone of our Class H relay. The slightest squiggle or shimmy out of either and the whole relay is out of whack.

756 tiny dents on the heelpiece, plus one big one on the frame, make sure this'll never happen.

They're the result of planishing, a big squeeze. Planishing is an extra step we go through in forming the pieces to add strength and stability by relieving surface strain. It also makes the parts extra flat.

This takes the biggest press in the industry and the biggest squeeze. Both exclusively ours.

### A different kind of coil.

The heart of a relay is the coil. If ours looks different, it's because we build it around a glass-filled nylon bobbin. It costs us more, but you know how most plastic tends to chip and crack.

Also, moisture and humidity have no effect on glass-filled nylon. No effect means no malfunctions for you to worry about. No current leakage, either.

The coil is wound on the bobbin automatically. No chance of human error here.

### Springs and other things.

We don't take any chances with our contact assembly, either. Our contact springs are phosphor-bronze. Others use nickel-silver. Our lab gave this stuff a thorough check, but found nickel-silver too prone to stress-corrosion. Atmospheric conditions which cause tarnish and ultimately stress corrosion have almost no effect on phosphor-bronze.

Even things like the pileup insulators (those little black rectangles) get special attention. We precision mold them.



Other manufacturers just punch them out.

It makes a lot of difference. They're stronger, for one thing; and because they're molded, there's no chance of the insulators absorbing even a droplet of harmful moisture. Finally, they'll withstand the high temperatures that knock out punched insulators.

### Two are better than one.

Our next step was to make sure our contacts give a completed circuit every time. So we bifurcate both the make and break springs.

Each contact works independently to give you a completed circuit every time. Contact material is pure palladium with a gold overlay because no alloy works as well.

Edge-tinned contact springs save you the job of solder tinning them later. Also, edge-tinning enables you to safely use the same relay with sockets or mounted directly to a printed circuit board. A simple thing, but it takes a big chunk out of the inventory you have to stock.



### Finally, superior protection.

Out of the dozens of plastics to choose from for our dust cover, we picked a durable polycarbonate. The same material used for plastic windshields and special vehicle bodies. It's strong, resists high temperatures, and is unaffected by most cleaning solvents.

Then, for extra safety, we put a disposable cap over the cover's open end. This seals out dirt and dust while preventing damage to the terminals during shipping and handling.

### Etc. Etc. Etc.

There's a lot more to tell about what makes our Class H relay reliable. Now we're waiting to hear from you.

GTE Automatic Electric,  
Industrial Sales Division, Northlake,  
Illinois 60164.

# GTE AUTOMATIC ELECTRIC

# Instrument interfacing can be done—but it takes a bit of doing

If you want to build an automatic measuring system with bench instruments, you've got problems.

There are only informal standards to define the electrical interface to the instruments. There is little commonality between the arrangements of control and data signals from instrument to instrument and manufacturer to manufacturer. And there is just no compatibility between instrument data organization and that of the device that does the controlling—most often a minicomputer.

But some help is here, thanks to a compromise of sorts between instrument makers and minicomputer suppliers. The manufacturer supplies, as an option, digital TTL levels and BCD code groupings—because TTL logic is in the guts of his machine—and the minicomputer manufacturer supplies interface cards that convert TTL levels to data that a 16-bit minicomputer understands.

Still to come is a more comprehensive standard—now under consideration by the International Electrotechnical Commission—that will allow instruments to interface with one another regardless of what they do or who makes them. In the meantime the engineer can use clever interface gadgets to get instruments to work with one another without a minicomputer.

Regardless of which route you choose to assemble the system—minicomputer-based, calculator-based, intelligent controller or the IEC standard—it won't be any bed of roses. Minicomputers can handle up to 200 instruments, but they bog down in converting the BCD coding, typically used with instruments, to internal binary; it takes 0.5 to 2.5 ms for each conversion. Calculators, on the other hand, handle only a

maximum of 15 instruments, and the intelligent controller between four and five.

On top of that, there are substantial costs. Add about \$900 to the price of each instrument for the IEC interface; \$200 to \$400 for TTL programmability and \$300 to \$400 to connect each programmable instrument to a minicomputer, calculator or intelligent controller.

### Three levels of compatibility

There are three stages that the designer must consider when he prepares to interface an instrument to a minicomputer, programmable calculator or controller. At the first stage he specifies the electrical characteristics of the signal—such



A systems-oriented instrument that is also easy to program. The AMC 1010 waveform analyzer from E-H Research Labs gives digital readouts of voltage or time on a single channel, or measure time relationships between two channels. A serial ASCII command sequence that can be updated at will controls the operation. The two-channel unit can multiplex up to 100 probes—all under program control.

Seymour T. Levine  
Associate Editor

as contact-closure, analog or TTL. The second stage calls for a description of the unit of information and its timing—for example, BCD organization with parallel output. The third stage deals with the data sequence needed to operate the instrument—for example, a data-acquisition device often requires channel number, followed by channel gain, followed by an enable command. A word of caution: If the instruments at the first two stages do not have some degree of standardization, costs will skyrocket; each device will have to be custom-built for the intended instrument.

Not too many years ago instrument users faced almost insuperable odds in their attempts to assemble a system that had a variety of instruments. Specifications for the first two stages were as varied as designers' fingerprints. First, programmability often meant that an analog quantity—such as voltage, current or resistance—determined the instrument's state. And even if the control was digital, contact closures or an almost infinite variety of actual logic levels represented the ZERO or ONE state.

Similar chaos occurred when users tried to read the output of the instrument. The choice again was often an analog signal. And—to add to all the troubles—few, if any, techniques were known to organize the data and to control flow between instruments.

### ICs and MSI—the first step to standardization

Low-cost bipolar ICs and MSI opened the door to economical digital controls and readouts for test instruments. TTL logic levels have become

more or less standard electrical interfaces; the levels are 0 to 0.8 V and 2.4 V or greater. But definitions of these levels can vary. In so-called negative logic the lower level signifies a ONE, whereas in positive logic the lower level signifies a ZERO. Not infrequently, commands to an instrument are in negative logic (it used to be traditional to signify active lines by a pull to ground) and outputs are in positive logic.

Data levels set to TTL conventions help, but not much, since the question of how to encode remains open. For example, what bit pattern defines the setting of a range switch on a DVM?

Bench instruments, which are user-oriented, have begun to set a pattern. People prefer to count in radix 10. The trend is to represent decades with BCD codes. This is especially convenient with the increased use of DVMs that generate BCD displays. For slightly greater cost, the DVM output is brought to a connector as BCD. The catch is that many instruments require parallel-BCD input and present parallel-BCD output—which often gives the user the headache of controlling some 50 to 80 lines all at once.

Fortunately the problem can be solved for a price. Minicomputer manufacturers—such as Digital Equipment Corp., Varian and Modular Computer Systems—offer interface modules that convert the instrument's 40 to 80 data lines to 16-bit chunks to match the 16-bit word size of the computer. Expect to pay about \$400—the cost for modules that interface Fluke's Model 8200A DVM (66 lines for data and control) with the PDP-11 minicomputer. Rolm Corp. offers a similar range of instrument interface modules

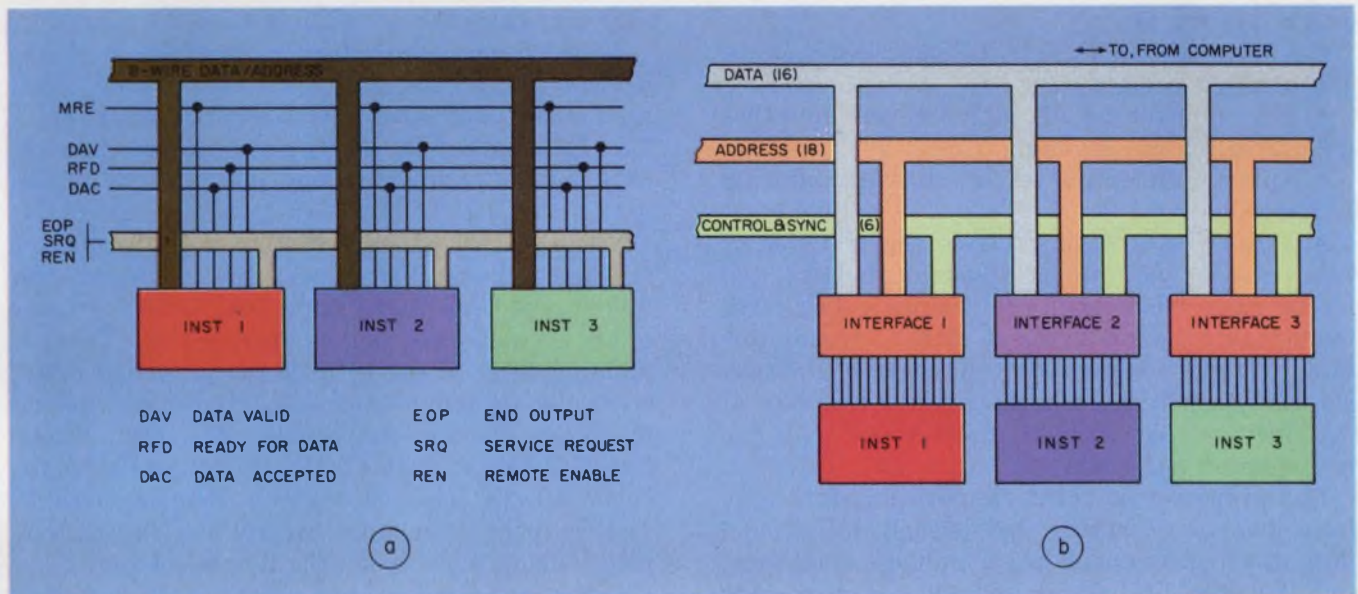

Asynchronous bus operation characterizes most of today's instrument-system communications. Hewlett-Packard's interface system (a) provides either byte-serial data transfer or addressing over eight lines and handles up to 15 properly equipped instruments. A minicom-

puter I/O bus (PDP-11 UNIBUS shown) has separate address and data lines. Almost any programmable instrument can be connected to the computer bus by use of appropriate interface circuits. Each circuit provides an unique address for the instrument served by it.



Instruments and devices equipped with HP's ASCII bus can be plugged together to make up a system. The programming device in this case is the HP 3260A marked-card programmer, which acts as the controller for the 3330A programmable frequency synthesizers.

that meet mil spec—a feature that helps to extend commercial practice to military systems.

### Systems standard under study

Even with informal standards of BCD data and TTL signal levels, instruments cannot be interconnected simply. Most often a minicomputer is required to take control and to issue a variety of commands.

But the IEC is considering a standard that may allow interconnection of up to 15 instruments. Any connected instrument could control or send information to up to 14 other instruments in the link-up. The standard—as proposed by Hewlett-Packard—employs a bus system for data transfer and control. The key advantages of such a system are:

- Ability to handle asynchronous communication between devices.
- Provision for data transfer at any rate that is suitable for the devices.
- Ability to interconnect devices with differing I/O speeds.

A three-wire system controls the transfer of data between the “talker” (source of data) and one or more “listeners” (data sinks). The three “handshake” wires—labeled RFD (ready-for-data), DAV (data-valid) and DAC (data-accepted)—permit asynchronous data transfer at any device speed without interference with the operation of faster devices.

The proposed standard employs an eight-wire data bus for carrying byte-serial, bit-parallel data. Each instrument has a numerical address, and the data line either addresses a particular unit or provides information, according to the logic condition of the MRE (multiple response enable) line.

The RFD, DAV and DAC lines adjust the data



TTL-compatible instruments become a stand-alone system when connected to Digital Equipment Corp.'s intelligent controller—the PDM70. Plug-in interface modules convert instrument responses to bit-serial ASCII for use on the internal controller busses. A user-entered stored program enables data transfer between instruments. A special module permits communication with ASCII-serial computer ports at rates up to 39,000 baud. Thus any computer that communicates with a TTY can also process instrument data.

rate and ensure that each receiver is both ready to accept data and has had enough time to store the data intended for it. At present HP holds a patent on this particular configuration; however, the company plans to license the system on a non-exclusive basis for a one-time nominal charge.

With the proposed interface standard, a single device—say, a card reader—is the “talker,” and the other addressed devices are “listeners.” Listeners indicate a readiness to accept data by letting RFD go high; talkers place a byte on the data lines, then set DAV low. Listeners allow the DAC to go high after they store the information in their register. To repeat the sequence, the talker sets DAV high; once DAC goes low, another byte of data can be transmitted. The remaining three of the 15 lines permit the systems controller to assign control to requesting instruments—by noting the Service Request (SRQ) line. The End Output (EOP) line allows absolute command by the controller; Remote Enable (REN) permits manual control via the instrument's front panel when the line is set high.

### Systems architecture being simplified

The data/control sequences found in the proposed interface standard share many common

elements with minicomputer and calculator I/O (input-output) busses. For example, the popular PDP-11 Unibus provides multiple lines for data, address and control. But the data are 16 lines, addresses 18 lines and controls six lines.

Obviously the bus described in the proposed standard cannot mate directly with the minicomputer I/O; a controller is needed to interface the two data systems. But—and it's a big but—with the proposed standard, up to 15 instruments operate off one controller; without it, each instrument requires a separate interface to the computer bus.

An approach to a stand-alone system is possible (no mini or calculator) even without the proposed standard. A bus-oriented programmable controller handles instrument-to-instrument communications. Instrument-to-computer communications is also available if needed. An example is Digital Equipment's PDM70.

The PDM70 is a desk-top unit whose cost varies from \$950 (bareboned) to \$1500 if you want a program display and user keyboard. Internally a pair of single-wire busses controlled by a stored program conveys data between sender and receiver in bit-serial ASCII form. External data from instruments or keyboards are converted to serial ASCII by special interface modules that employ UART (universal asynchronous receiver/transmitter) chips.

The necessary modules (one source and one destination) to hook up a typical DVM with TTL programmability cost about \$600.

One of the I/O modules (PDM70-J) permits two-way communication with computer TTY ports at speeds up to 39,000 baud. Therefore standard TTY software drivers can be used, as can the popular high-level languages that drive them, such as Basic, Fortran and PL/I. And the speeds are sufficient for most instrument-system requirements. One PDM70 handles any combination up to seven input and output options—eight if the keyboard and display are omitted. The stored program also provides user-selected waiting times between measurements.

Analog Devices' SERDEX modules were intended to provide an ASCII-serial interface to a TTY port for industrial instrumentation equipment such as transducers and DACs. But the ability of these modules to handle parallel binary inputs has led the company to try to interface bench instruments. Recent successes include Keithley's Model 160, a 3-1/2 digit DVM and Electronumeric's 3-1/2 digit DPM. Figure the typical costs as \$270, plus \$360 for each instrument used—up to 16 instruments. The data rates are 20-k baud (optical isolation bypassed) and 4800 baud with optical isolation.

Of course, the remaining alternative to systems configuration is to interface directly with



General Radio's 2200-line emphasizes binary computer/system communication and instrument-on-a-board circuitry. The 2260 automatic network analyzer shown can characterize circuit performance in the 200-kHz-to-500-MHz region with 0.1-Hz resolution. A simple user-oriented language controls the system.

the minicomputer I/O port, typically with some form of bus-oriented system. Many hardware techniques can do this, but the user must worry about connections, electrical-signal levels, data representation and software.

### Computer-device interfacing: the techniques

When DEC's series M modules are used in proper combinations, they can interface with most programmable instruments. Hewlett-Packard offers two types of interface with its 2100-series minicomputers: interface cards that plug into an I/O slot or a multiprogrammer (Models 6940A and 6941A).

The multiprogrammer system is a 12-bit multiplexer that allows up to 240, 12-bit channels to operate off a single 16-bit minicomputer channel. The 6940A chassis (\$1500) provides 15 slots for interface cards. Up to 15 additional 6941 chassis (\$900 each) can be daisy-chained from the 6940A. The cost of interface cards varies from \$200 to \$400, with the higher prices for relay-operated, contact-closure types. A single I/O slot can address up to 240 interface cards, each with 12-bit I/O capability. A large and varied number of devices can be controlled. And a full range of input and output signals (including varied-logic levels) and differential logic can be accommodated. Differential logic uses a two-wire system to overcome common-mode effects. ZERO and ONE

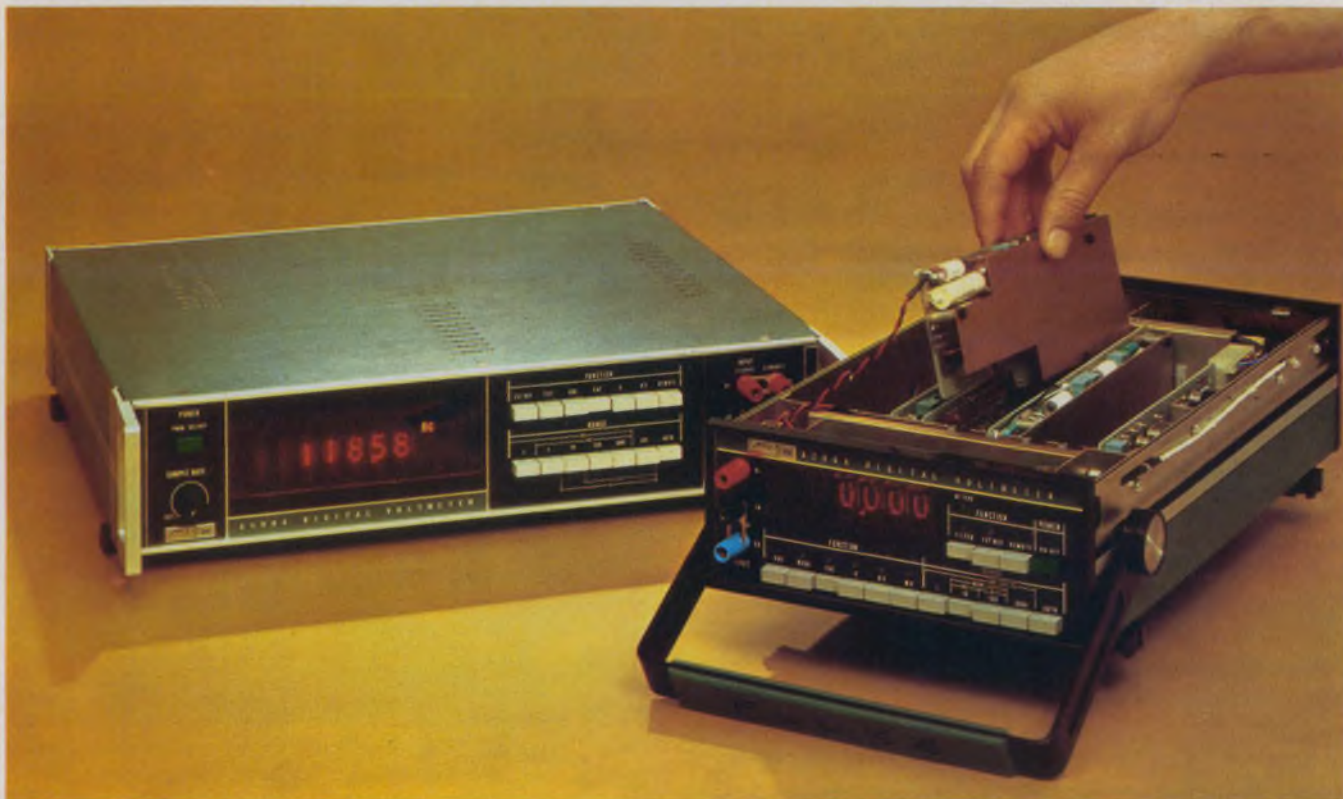

Digital multimeters perform most of the data-acquisition chores for automatic test equipment. Fluke's Model 8400 A (left) operates at a maximum of 30 readings per second and the 8200 A at 400 readings. Of course, the accuracy is reduced with the higher-speed instrument

(0.01% vs 0.004% over 90 days). The 8200 A can store input commands, be addressed and provide bit-parallel, BCD-serial outputs—all of which simplify interfacing. The DVM's ability to measure V, I or  $\Omega$  often outweighs the speed advantage of a DAC.

are defined by polarity (+- or -+) with 1 V magnitude.

Close examination of some HP interface cards—in particular, Interface Kit 12930A/-001/-002, labeled a "universal interface"—reveals a general-purpose card that is specifiable for TTL logic (negative or positive) and differential logic. A second HP kit—the 12566-B/-001/-002/—has similar versatility.

The concept of a universal I/O card also finds use in at least one manufacturer's automatic test equipment. Systron-Donner's approach is a single interface card that can drive practically any programmable instrument—such as counters, DVMs or synthesizers—from a computer. The cards fit into a chassis that is connected to the I/O bus and are jumpered for the unique addresses that define the instrument to the computer.

### Power supplies come of age

As a system component, the power supply needs programmable output levels. But as a stimulus, its capacity to destroy the unit under test is enormous. Most supplies still use some form of analog programming. However, power-supply manufacturers are beginning to offer a variety of TTL-to-analog interfaces. In a few cases, direct digital programming is available. For example,

the Tektronix R1140 bipolar, programmable power supply uses BCD format (parallel) at TTL levels to set separately four voltage supplies and one current supply—all in a single box. Voltage limits on the current supply are also programmable. The unit includes a buffer register to hold the strobed input data.

All supplies in the DCPS series from HP feature digital programming—up to 250 W. Most find application in sophisticated test systems.

Where less accuracy is needed, a more economical approach—standard analog programming plus digital-to-analog interface—provides systems operation. Typically the interfaces drive operational power supplies. Operational supplies have no output capacitor and can slew as rapidly as  $9 \text{ V}/\mu\text{s}$ , compared with  $250 \text{ V/s}$  for ordinary capacitor-filter supplies. In fact, they can also serve as programmable current sources if the sensing resistor is placed in the current path. Kepeco, for example, offers three basic programmer options:

1. Parallel BCD In, relay selection of feedback resistance Out.
2. Bit-parallel, serial-BCD In, relay selection of feedback resistance Out.
3. Bit-parallel binary or BCD-In, analog voltage Out.

A recent entry from Trygon Electronics, the

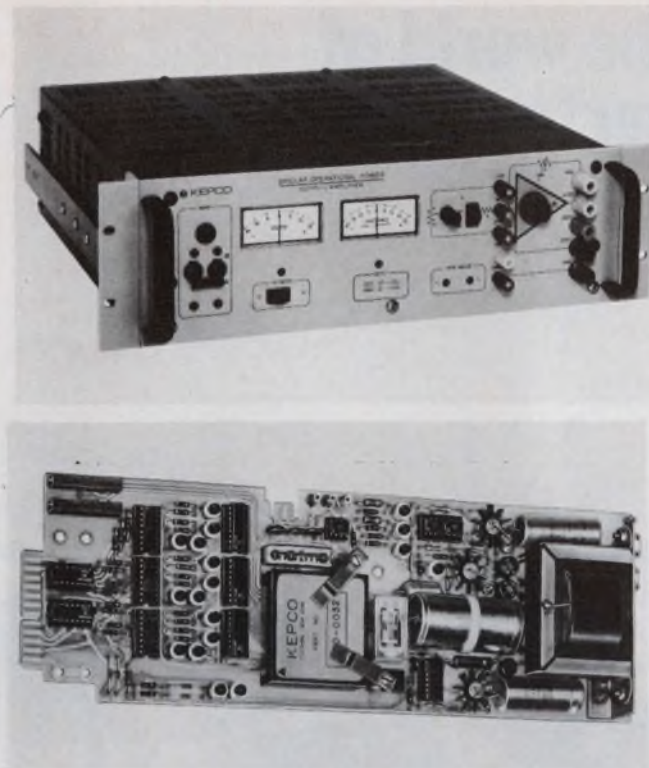

It looks like a giant op amp (top), but it's a programmable power supply. This, like most of today's power supplies, requires analog programming signals. But interfaces are available (bottom) to provide the proper analog output with TTL, BCD or binary inputs.

DPH series (dual configuration), can control two power supplies from a single computer I/O bus.

### Software standardization

In a typical system—that includes many automatic test systems—the DMM performs most of the data acquisition. Some form of switching system, usually a reed-relay group, connects stimuli to the unit under test and a minicomputer performs data reduction and control.

The first software problem entails conversion between BCD and binary notation. The computer's calculations are usually in floating-point binary—a feature that permits input-data ranges of about  $10^{-99}$  to  $10^{99}$  without need for user-supplied scale factors, as was the case with earlier analog computers. However, the instrument's range and measurement values usually follow the decimal scheme. Hence there's a need for constant conversions between the two number systems. These conversions are usually done by software and, as noted, require from 0.5 to 2 ms.

At least one manufacturer of automatic test equipment uses instruments that communicate in binary code. General Radio's 2200-line—notably the 2210C analog network analyzer—uses an instrument-on-a-card approach. Each card contains an instrument that can send and receive 24-bit

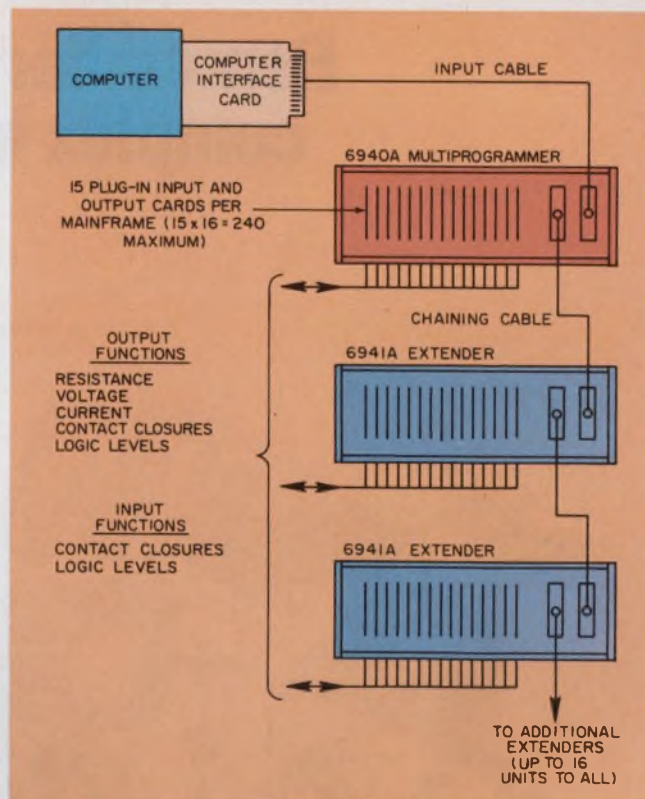

A wide variety of signal types are needed in many instruments used in automatic systems. With the Multi-programmer system from HP, a single 16-bit I/O channel provides up to 240, 12-bit I/O channels. Plug-in cards provide interface to these signal sources.

binary data. Binary rather than decimal ranging is also used, and the range data become the exponent portion of the floating-point word—a further saving in software manipulation. Of course, card size and mounting are standardized as well.

To proceed further into software standardization, the designer must consider the complexity of programming to communicate with the instrument. As an illustration, consider a frequency counter that has time-interval and multiple-period averaging as well as programmable trigger levels. This is a very complex instrument to program input-output handlers. For programming, the designer would like to see the instrument organized as follows:

- A pair of power supplies—one for each trigger level.
- A DVM—because the instrument can make digital measurements.
- A pulse generator—because you have to specify timing considerations; for example, the time base.

Communication with the instrument can be set up with a combination of software I/O modules, each written for a basic function. In short, the road to software standardization requires that manufacturers view their diverse instruments as combinations of more basic instruments, and specify their command sequences accordingly. ■■



# Remember the world of complex interfacing?

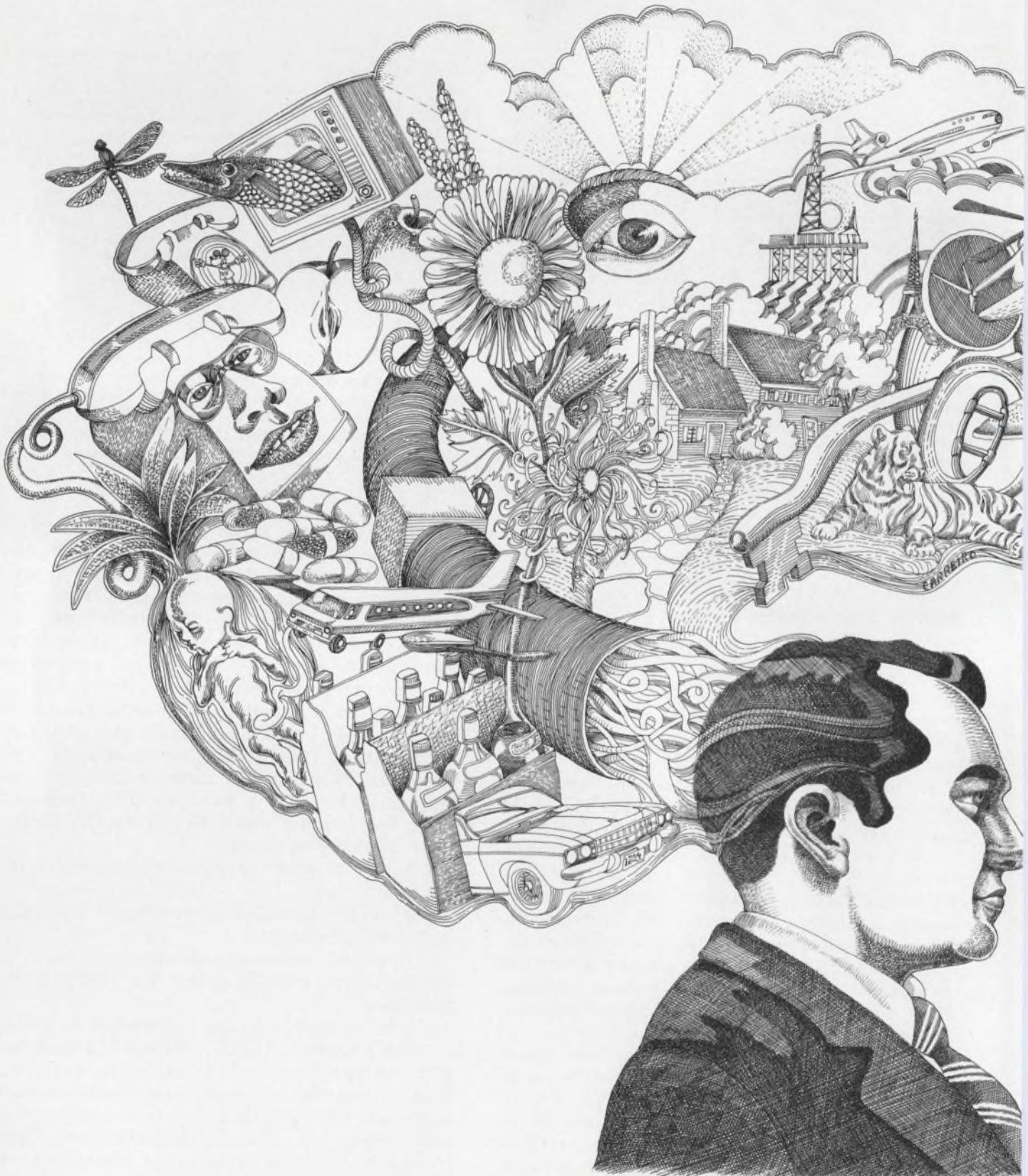

# Forget it.



## Analog Devices introduces SERDEX. A whole new concept in data exchange.

Twisted pair wiring and five SERDEX™ building block modules are all you need to interface a teletypewriter or minicomputer with transducers to find out what they have to say. About temperature, level, flow rate, stress, or RPM.

And they're all you need to tell control devices like solenoids, servos, and valves what to do. Or for data logging, factory automation, or digital control of instruments.

There's no more need for tons of traditional hardware and hours of tedious programming. Because SERDEX Modules connect directly to any teletypewriter port. And you program with nine ASCII characters using a simple computer language like BASIC.

In addition, the control capacity of SERDEX Modules can be varied from a system of only one channel to a system with thousands of channels. Whether your application is local or remote.

SERDEX. Serial data exchange. It's a whole new idea in communication and control systems from Analog Devices, the leading supplier of electronic components for instrumentation and control. For the whole story, just circle our reader service card number and we'll send you the specs and a brochure. Or call 617-329-4700 and we'll send a representative with an explanation of SERDEX. On videotape, if you'd like.

Either way, we'll change your whole way of thinking about computer control. Analog Devices Inc., Norwood, Massachusetts 02062.

SERDEX (SERial Data EXchange) Modules is a trademark of Analog Devices, Inc.



## Call 617-329-4700



## Beckman® HYBRID MICROCIRCUITS



UNIVERSAL  
ACTIVE FILTERS  
TELEPHONE  
TONE FILTERS  
PRECISION  
LADDER NETWORKS  
DAC/ADC  
PRODUCTS  
POWER  
AMPLIFIERS  
VOLTAGE  
REGULATORS  
INDUSTRIAL  
CONTROL  
CIRCUITS  
CUSTOM  
DISPLAY  
SUBSTRATES  
HYBRID MEDICAL  
FUNCTIONS  
MODEM FILTERS  
MIL-PERFORMANCE  
MICROCIRCUITS

### Beckman Electronic Component Distributors

**EASTERN REGION:** Arrow/Angus, P.O. Box 126, Moorestown, N.J., (609) 235-1900, (215) 928-1800 • Arrow Electronics, Inc., 5207 East Dr., Baltimore, Md., (202) 737-1700, (301) 247-5200 • Arrow Electronics, Inc., 900 Route 110, Farmingdale, N.Y., (516) 694-6800 • Arrow Electronics, Inc., 295 Treadwell St., Hamden, Conn., (203) 248-3801 • Arrow Electronics, Inc., No. 15 A Street, Burlington, Mass., (617) 273-0100 • Arrow Electronics, Inc., 285 Midland Ave., Saddle Brook, N.J., (201) 797-5800 • Harvey R & D Electronics, 44 Hartwell Ave., Lexington, Mass., (617) 861-9200 • Kierulff Electronics, Inc., 5 Industrial Dr., Rutherford, N.J., (201) 935-2120 • Lynch-Gentry Associates, Inc., 1932 Drew Street, Clearwater, Fla., (813) 443-2697 • Lynch-Gentry Associates, Inc., 3470 Bowman Dr., Winter Park, Fla., (305) 671-7649 • Marshall Industries, G. S. Marshall Products Group, 88 Needham St., Newton Highlands, Mass., (617) 965-5115 • M & C Sales, 500 Plasamour Drive, N.E., Atlanta, Ga., (404) 875-2525 • M & C Sales, 1106 Burke St., Winston-Salem, N.C., (919) 723-1001 • M & C Sales, 904 Bob Wallace Ave., Huntsville, Ala., (205) 539-8476 • Ossmann Component Sales Corp., 395 Cleveland Dr., Buffalo, N.Y., (716) 832-4271 • Ossmann Component Sales Corp., 411 Washington Ave., Kingston, N.Y., (914) 338-5505 • Ossman Component Sales Corp., 280 Metro Park, Rochester, N.Y., (716) 442-3290 • Ossmann Component Sales Corp., 132 Pickard Building, Syracuse, N.Y., (315) 454-4477 • Ossmann Component Sales Corp., 1911 Vestal Parkway East, Vestal, N.Y., (607) 785-9949 • **CENTRAL REGION:** Magnuson Electronics, 2420 Oakton St., P.O. Box 130, Mount Prospect, Ill., (312) 956-0700 • Magnuson Electronics, 1246 West 7th St., St. Paul, Minn., (612) 227-8495 • Norvell Electronics, 10210 Monroe Dr., Dallas, Tex., (214) 350-6771 • Norvell Electronics, 6440 Hillcroft Ave., Houston, Tex., (713) 774-2568 • Norvell Electronics, 3340 S. Memorial Dr., Tulsa, Okla., (918) 663-1247 • Sheridan Sales Co., Box 37826, Cincinnati, Ohio, (513) 761-5432 • Sheridan Sales Co., Box 4457, Cleveland, Ohio, (216) 524-8120 • Sheridan Sales Co., Box 423, Dayton, Ohio, (513) 277-8911 • Sheridan Sales Co., 33708 Grand River Ave., Farmington, Mich., (313) 477-3800 • Sheridan Sales Co., P.O. Box 677, Florissant, Mo., (314) 837-5200 • Sheridan Sales Co., Suite 5009, 1717 Penn Ave., Wilkinsburg, Penn., (412) 244-1640 • **WESTERN REGION:** Almac/Stroum Electronics, 8888 S.W. Canyon Rd., Portland, Ore., (503) 292-3534 • Almac/Stroum Electronics, 5811 Sixth Ave. South, Seattle, Wash., (206) 763-2300 • Barnhill Five, Inc., 1410-D Wyoming N.E., Albuquerque, N.M., (505) 299-7658 • Barnhill Five, Inc., 1170 S. Sheridan Blvd., Denver, Colo., (303) 934-5505 • Barnhill Five, Inc., 7329 E. Stetson Dr., Scottsdale, Ariz., (602) 947-7841 • Marshall Industries, G. S. Marshall Products Group, 9674 Telstar Ave., El Monte, Ca., (213) 686-0141 • Marshall Industries, G. S. Marshall Products Group, 8057 Raytheon Rd., San Diego, Ca., (714) 278-6350 • Marshall Industries, G. S. Marshall Products Group, 788 Palomar Ave., Sunnyvale, Ca., (408) 732-1100



# For breadth of line in microcircuits or in information, hit the right books.

Reliable, at-hand sources are some of the good things in life. Like the encyclopedia, for compact information. And, to more and more electronic designers, Beckman for our broad line of high-quality hybrid microcircuits at competitive prices.

Our distributors are a main reason. All around the country, they're stockpiled with the full line of standard hybrids, as well as with our industry-leading DIP resistor networks, trimmers, dials and pots. So they can offer delivery as fast as any in the industry, and usually faster.

Typical Beckman standards include universal active filters, for example. And telephone tone frequency filters. Precision ladder networks. Four-quadrant multiplying DACs. Successive approximation ADCs. High-power, high-slew FET input Op Amps. High-reliability MIL voltage regulators. And dual-tracking voltage regulators.

Our custom hybrid service is also something to turn to. Because we produce custom alterations or new products

in infinite variety. To time schedules few others can meet. We either build to customer design and specs or supply the design help when needed.

Typical custom units are modem and tone frequency filters. Entertainment system hybrid DACs and equalization filters. Custom display substrates (calculators, watches). Medical diagnostic timing and control functions. MIL-performance log amps, regulators, DACs, ADCs, and many others.

The point is, as a hybrid source, the Beckman line and distributor system are front-runners. For high quality and fast delivery. For competitive price and thorough service — including even a toll-free telephone express system to get literature to customers in just days. (Call toll-free 800-437-4677.)

It's no wonder thousands of designers think of the Beckman catalog as a "most-valued reference work."

# Andrew F. Kay: Once an inventor, it's hard to stop creating

**O**ver 20 years ago Andrew F. Kay dramatically improved the way that people measured things; he invented the digital voltmeter in 1952, and for the first time, people who didn't know much about measuring techniques could measure voltages with the ease of an expert.

Kay had his own vision then, and today he's still looking ahead, predicting, for instance, the following:

- An increase in complex instruments that use computer technology.
- A continuing trend toward a combination of microprocessors to perform generalized functions.
- A digital voltmeter in this decade so easy to use, so reliable and so inexpensive, that the do-it-yourself man will be using it at home as casually as he uses a wrench. And it will become so small that it will be used as a part of more sophisticated instruments.
- Medical electronics devices by the turn of the century that will warn of impending heart attacks.

Kay has faith in the engineer.

He doesn't think, for example, that computers will be used to design any more instruments tomorrow than they are today. He argues that to create the optimum design from existing components, the designer has to integrate his own reasoning with the computer results.

## From inventor to inventive manager

Since graduating from MIT in 1940 with a degree in general science, Kay, the classic inventor-engineer, has come a long way. He's now founder-president of Non-Linear Systems, Inc., a small



Kay displays one of his ruggedized voltmeters.

electronics firm in Del Mar, Calif., near San Diego. The company mirrors the man's creative bent: It consists of four rows of 16 wood-and-glass buildings that provide every room with a view of the landscaped areas between the buildings.

Did Kay ever think that he'd be president of his own company one day?

"My father had talked to me casually about having my own business," he says. "And I seemed to be heading that way, even in the early days. I always had the kind of job that could be called independent."

Richard L. Turmail  
Associate Editor

How does Kay like managing his own company? He has been willing to experiment. Back in the 60's Kay was urged by behavioral researchers to experiment with a management method that promised to boost production and reduce worker discontent. So he eliminated assembly lines and time cards, raised workers' wages, increased the decision-making powers of both workers and managers and had departments keep their own financial records. Perhaps this kind of management innovation works only during good times. It died, along with a lot of aerospace business, in the slump of 1970.

Of the experience, Kay says: "I must have lost sight of the purpose of business, which is not to develop new theories of management."

### Getting recognition was difficult

Kay will tell you that if he had to choose between inventing things and running a company, he'd rather keep a company running by inventing things. That would be fine if he could occasionally invent an instrument that had the same eventual impact on the industry as his digital voltmeter. He got the idea for the voltmeter in 1944, when he was making aerial reconnaissance test equipment.

"I needed something to measure a quarter of a percent," he recalls, "and the only tools we had then were balanced bridges; they were too subject to vibration to give readings that accurate."

Eight years later Kay developed the digital voltmeter. Before it was available, people had to use a pointer meter that measured to only one-tenth of a percent.

"There were other drawbacks, too," Kay notes. "An accidental whack on the top of one of those pointer meters, and before you knew it, you could be 5% off in your measurement."

He says, too, that not everybody knew how to interpolate a pointer but that almost everyone can read and count numbers.

It took Kay almost five years to get trade magazines to recognize digital measurement as a separate category of instrumentation and to get people to recognize what the digital voltmeter was good for.

"I remember demonstrating the meter at a Fall Joint Computer Conference," he muses, "and an MIT graduate, who'd been working on analog computers, was very impressed with the digital voltmeter but wondered what in the world he'd use it for. Of course, analog computer people are one of our best customers today."

The president of General Radio also came to Kay's booth that year and told him that if he'd invent a meter that could measure ac, he'd really have something.

"We remembered that," Kay says, "and about

two years later we came up with an ac/dc digital meter."

Looking back on that first digital voltmeter, Kay doesn't think, knowing what he knows now, that he'd have designed it any differently than he did.

"Of course, if we'd had the components then that we have now," he says, "the meter design would have been much simpler—the zener diodes that we used then, for example, had to be put into a temperature-controlled housing, which required additional design work."

Today the zener diodes are temperature-compensated.

Kay also remembers that the first digital voltmeters weren't nearly as reliable as the ones today; the relays in the instrument wouldn't always work, and the vacuum tube would pop occasionally.

Because of these annoying inconsistencies, Kay's first customers had to buy three digital voltmeters—one to use, and two to back it up.

"We wondered how that kind of buying could be profitable for our customer," Kay says, "but they assured us that it was."

It cost the customer \$200,000 to develop a rack of test equipment but he had to pay only \$50,000 for three digital voltmeters.

Has the digital voltmeter evolved as Kay expected?

"Pretty much so," he says. He admits to trying to push its evolution a bit when he decided to make a six-digit meter a few years back. Some marketing surveys showed that 18% of the people who were buying digital voltmeters would buy a six-digit one if it became available.

"We made only one sale," Kay says, "and Motorola is still using that one to test zener diodes."

"Our big push at Non-Linear now is combining our instruments with computers," Kay says, adding proudly: "And we're developing preventive medical electronic instruments."

"I like the trend I see in medical electronics. Instruments are being developed that will be helpful in therapeutic and preventive medicine; I'm also excited about electronics in psychology." According to Kay, the need for psychological test equipment, such as brain-wave probes and teaching machines, is growing.

"Non-Linear is getting some test and warning devices ready for the medical electronics market, probably by early 1974," Kay reports.

At 54, he is personally health conscious. He has to keep up with an active family that includes four children in their prime (24 to 30 years old). He runs a mile around the pool at his home every morning.

"I don't plan an early retirement," Kay says. "I look to be going strong when I'm 100." ■■

ANOTHER INNOVATION FROM LITRONIX

# THE IRRESISTIBLE LEDS

**Distributors**

**Arizona:** Hamilton/Avnet,  
Phoenix (602) 269-1391  
Kierulff, Phoenix  
(602) 273-7331

**California:** Hamilton/Avnet,  
Mountain View  
(415) 961-7000

**San Diego** (714) 279-2421  
Hamilton Electro,  
Culver City (213) 870-7171  
Kierulff, Palo Alto  
(415) 968-6292

**San Diego** (714) 278-2112  
Wesco Electronics,  
Los Angeles (213) 685-9525

**Colorado:** Hamilton/Avnet,  
Denver (303) 534-1212  
Kierulff, Denver  
(303) 343-7090

**Florida:** Hamilton/Avnet,  
Hollywood (305) 925-5401

**Georgia:** Hamilton/Avnet,  
Norcross (404) 448-0800

**Illinois:** Allied, Chicago  
(312) 421-2400  
Hamilton/Avnet, Schiller  
Park (Chicago)  
(312) 678-6310

Kierulff, Rosemont  
(Chicago) (312) 678-8560

**Kansas:** Hamilton/Avnet,  
Prairie Village (Kansas City)  
(913) 362-3250

**Maryland:** Hamilton/Avnet,  
Hanover (Baltimore)  
(301) 796-5000

Pioneer, Rockville  
(301) 427-3300

**Massachusetts:**  
Electrical Supply,  
Cambridge (617) 491-3300

Gerber, Dedham  
(617) 329-2400  
Hamilton/Avnet, Burlington  
(617) 273-2120

Kierulff, Needham Heights  
(617) 449-3600

**Michigan:** Hamilton/Avnet,  
Livonia (313) 522-4700

**Minnesota:** Hamilton/Avnet,  
Bloomington  
(612) 854-4800

**Missouri:** Hamilton/Avnet,  
Hazelwood (St. Louis)  
(314) 731-1144

**New Jersey:** Arrow,  
Saddlebrook (201) 256-7331

Hamilton/Avnet, Cherry Hill  
(609) 662-9337

Cedar Grove (201) 239-0800  
Haddonfield (609) 429-1526

**New Mexico:**  
Century, Albuquerque  
(505) 265-7837

Kierulff, Albuquerque  
(505) 247-1055

**New York:** Semiconductor  
Concepts, Hauppauge  
(516) 273-1234

Hamilton/Avnet, Syracuse  
(315) 437-2642

Westbury, L.I.  
(516) 333-5812

Arrow, Farmingdale  
(516) 694-6800

Summit, Buffalo  
(716) 884-3450

**North Carolina:** Pioneer,  
Greensboro (919) 273-4441

**Ohio:** Arrow, Dayton  
(513) 253-9176

Kierulff, Dayton  
(513) 278-9411

**Texas:** Hamilton/Avnet,  
Dallas (214) 638-2850

Houston (713) 526-4661  
Kierulff, Garland (Dallas)  
(214) 271-2471

**Utah:** Hamilton/Avnet,  
Salt Lake City (801) 262-8451

**Washington:**  
Hamilton/Avnet,  
Seattle (206) 624-5930

Kierulff, Seattle  
(206) 763-1550

**Canada:** Prelco, Montreal  
(514) 389-8051

Ottawa (613) 237-6150  
Electro Sonic Ind. Sales,  
Toronto (416) 924-9301

Hamilton/Avnet, Montreal  
(514) 735-6393

Toronto (416) 677-7432  
Ottawa (613) 725-3071

L. A. Varah, Vancouver, B.C.  
(604) 736-6411

Future Electronics  
Montreal (514) 735-5775

Ottawa (613) 232-7757  
Toronto (416) 677-7820



Our new Red-Lit C200 series constant brightness LED lamps are irresistible because they eliminate the need for external current limiting resistors — saving you time, space and money.

We've accomplished this by packaging a bipolar current regulating IC with the LED. This provides a constant current supply to the LED chip, ensuring a constant brightness over a supply range of 4.5 to 12.5 volts. In addition, the combination of the IC and the LED saves you both board area and

additional component costs. And because there's no need for individual drive circuits, your circuit design job is simplified. This all means that the Bright Guys have come up with another industry first. (Sometimes we feel we're pretty irresistible ourselves.)

There's an irresistible choice of package styles, too. The RLC-200 and RLC-201 are T 1 3/4 size lamps for panel mounting. They're only 50¢ in 1K quantities. The RLC-210 comes in a miniature T 1 size for small tight spaces. And it's priced at 60¢ in 1K quantities.

Want more information on our irresistible LEDs? Call or write the Bright Guys.

## the bright guys

### litronix

Litronix, Inc. • 19000 Homestead Road • Cupertino, California 95014 • (408) 257-7910 TWX: 910-338-0022  
European Headquarters: Litronix, Inc. • Bevan House, Bancroft Court  
Hitchin, Hertfordshire SG5 1LW England • Tel: Hitchin 2676 Telex: 825 497

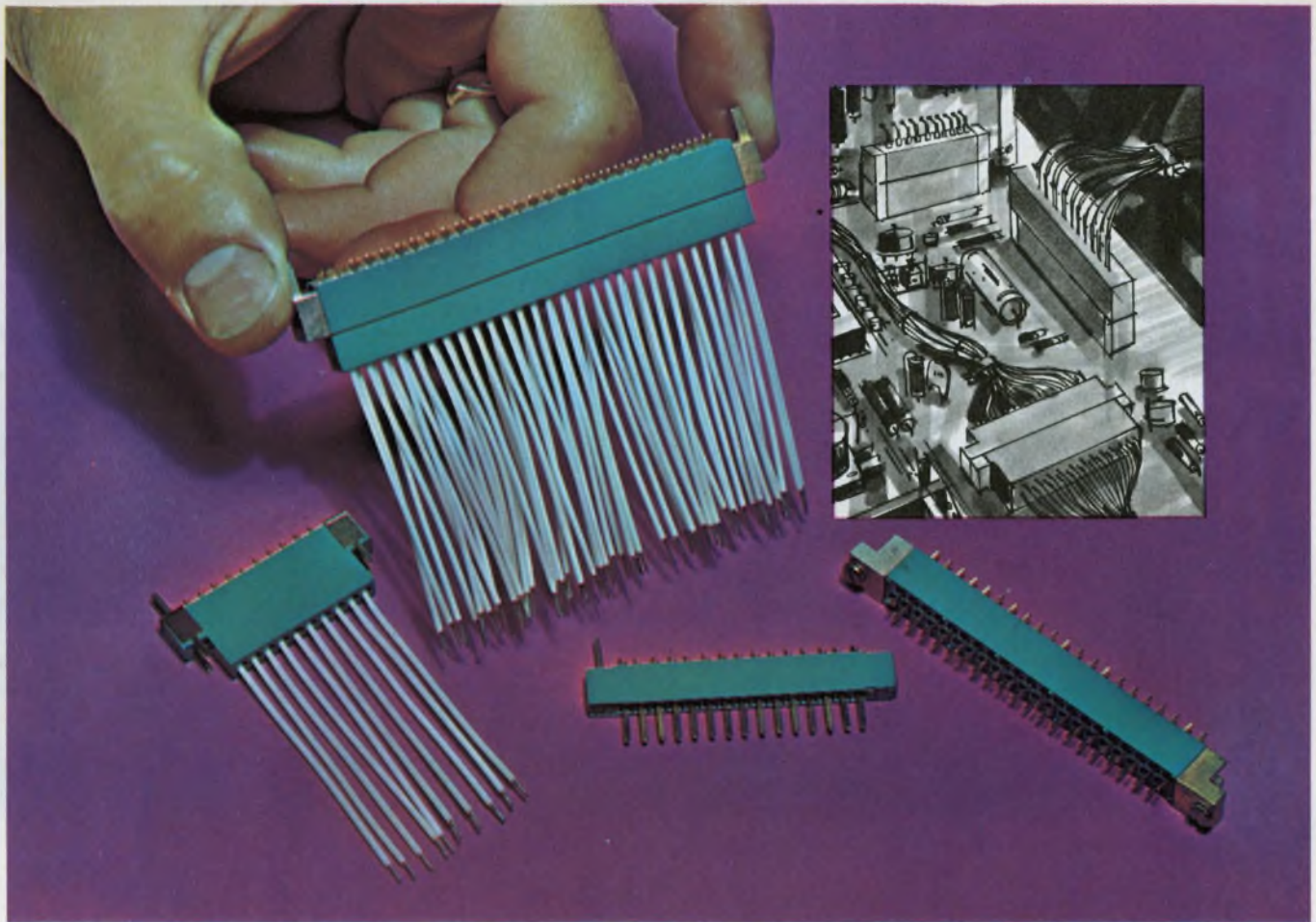

# Total Interconnect System with Varicon™ Contact Interface Reliability...

WITH A CHOICE OF THREE PACKAGING APPLICATIONS: BOARD-TO-BOARD, CABLE-TO-BOARD, CABLE-TO-CABLE. DOUBLE ROW AT .100". OFFSET GRID; SINGLE ROW AT .100" GRID.

Elco puts an end to design compromises imposed by miniconnector limitations. Actually, two compatible types of ends, which let you use board-to-cable or cable-to-cable contacts, and horizontal or vertical mounting, as you need. Our two new two-piece, metal-to-metal miniature crimp-type connectors mate perfectly with existing Elco built-in termination types. You can mix, match and mount them with almost unlimited flexibility.

New Series 8221 crimp and insert connectors are matable with Series 8219 installed termination type. Both are available in six sizes: 18, 30, 36, 42, 54 and 72 dual row contact positions on .100" offset grid for high density packaging.

Our other new crimp and insert connector, Series 8229, is matable with the existing Series 8129 built-in type. These series have single row contacts spaced on .100" centers, and are offered in 6, 9, 10, 12 and 15 contact positions.

High dielectric-strength, glass-filled diallyl phthalate insulators permit critical applications under severe

environmental conditions. Varicon™ low withdrawal force contacts (1-6 ounces per contact pair) ease assembly in the tightest places. With MIL-SPEC reliability, too (MIL-C-55302). And with hardware for any mounting requirement. Two most important points — Elco's published prices are much lower than costs for comparable pin and socket or other type connectors; and second, you get immediate, off-the-shelf delivery from our authorized distributors.

Just another service of Elco's Total Connector Capability.

For full details, contact your local Elco representative, or:

Elco Corporation  
Willow Grove, Pa. 19090  
(215) 659-7000

Elco Corporation  
2200 Park Place  
El Segundo, Calif. 90245  
(213) 675-3311

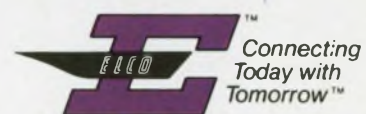

Operations in USA, Australia, Belgium, Canada, Denmark, England, France, Germany, Israel and Japan. Sales offices throughout the world. In Europe, Elco Belge, 77 Blancfloerlaan, Antwerp, Belgium, Tel. 03-190064. In the Far East, Elco International, TBR Building, 2-10-2 Nagatacho, Chiyoda-ku, Tokyo 100, Japan, Tel. 580-2711/5. Copyright © 1973 Elco Corp. All rights reserved.

INFORMATION RETRIEVAL NUMBER 43





THE INCREDIBLY FAST 5900+. 100 READINGS PER SECOND IN THE 4% DIGIT MODE.

**You can either make it better.  
Or you can make it cheaper.**

**Now, do both.**



*The challenge infuriates an engineer. Excellence cannot traditionally be compromised by economics. But if you can't afford it, you won't buy it. So sometimes we have to do both.*

*Above you see one of the "plus" machines from Dana. "Plus" because it is truly a better machine. And "plus" because it is priced to give you a new level of quality for the money.*

### **The 5900+. A new standard.**

This new unit may well be the world's most accurate and stable 5-digit multimeter.

It delivers 0.001% total accuracy.

It has 350 volts RMS protection on all ohms measurements.

It provides true systems capability. It has 5 DC ranges, 60% overrange, and full ratio capability. Its basic price is \$1795. Nothing at that price is comparable in accuracy and quality.

### **The 5000+ DVM. The price is lower. The standards aren't.**

This new DVM is the lowest priced 5-digit multimeter we've ever produced. Yet because it was engineered and built by men who have been dealing with units costing ten times as much, the 5000+ reflects their standards.

It is absolutely reliable. (Silicon solid state circuitry plus LED display.)

It has 5 DC ranges capable of measuring from 1  $\mu$ V through 1000V.

It offers autoranging in all functions and 100% overranging on all ranges.

It's available as a complete multimeter. Its basic price is \$995. Nothing with its features and its quality is available for the price.

Examine these products and study their incredible performance/price. Contact Cliff Hamilton at Dana Laboratories, Inc., 2401 Campus Drive, Irvine, California 92664. Or call collect at (714) 833-1234. Ask him about these plus machines.

**DANA**®

**Others measure by us.**

INFORMATION RETRIEVAL NUMBER 45

# Equipment is getting faster and smaller and much more digital

Instrument makers estimate that one-third of all the money spent world-wide on electronic test equipment goes for the purchase of oscilloscopes and spectrum analyzers. Here's what oscilloscope users are getting for their money.

In the last couple of years scopes have been linked to computers. They have come down in size to where there is a portable scope for almost any application. For servicing applications, scopes fit into an attache case and weigh less than five pounds.

The bandwidth of real-time scopes has risen to 500 MHz. Scan-conversion technology has come to the forefront for single-shot digitizing. And scopes have been combined with other instruments in a single package for more versatile measurements.

Finally, scopes have become easier to use. Controls have been combined, and pushbuttons have replaced rotary knobs.

Spectrum analyzers, advancing steadily since the first wideband, phase-locked, calibrated analyzer was introduced by Hewlett-Packard in 1963, likewise have fewer and simpler controls. Their readouts are calibrated, resolution has been improved by several orders of magnitude and dynamic range has been improved by many decibels. In addition, accessories such as tracking oscillators and counters have made the scene. Recently digital memory has been built into a low-frequency analyzer, eliminating the need for CRT persistence and resulting in 1-Hz resolution.

For extremely fine resolution and rapid spectrum analysis, many improvements have been made in real-time spectrum analyzers and fast-Fourier-transform (FFT) analyzers.

There is a "right" scope on the market for al-

most any application. No longer need the engineer buy higher performance than he needs.

If he wants to use the instrument in the laboratory, a scope with plug-in modules is probably dictated. The following options are available with plug-in scopes: militarized or standard construction; single-beam or dual-beam; digitizing or nondigitizing; one, two, three or four holes per mainframe; digital readout or nonreadout on the CRT; rack mount or no rack mount; storage or nonstorage. A choice of bandwidth, sensitivity, writing speed and sweep speed is also offered.

If the application is in the field, the user can pick from rugged, lightweight portable scopes, which usually do not have plug-ins. The portables can be divided into three main categories: (1) Those that stress high performance, comparable to laboratory performance; (2) Those with high portability—the miniscopes, and (3) Those that are inexpensive for simple servicing and production jobs.

## Three high-performance leaders

For high-performance laboratory oscilloscopes, three companies predominate: Tektronix, Hewlett-Packard of Colorado Springs, Colo., and Iwatsu of Japan, which markets its products in this country through Dumont Oscilloscope Laboratories in West Caldwell, N.J., under the Dumont label.

Most advanced of the general-purpose oscilloscope systems is the Tektronix 7904. With direct access to the CRT, a 1-GHz signal can be displayed in real time. With plug-in amplifiers, up to 500-MHz signals can be displayed with a deflection factor of 10-mV/div. And with the 7B92 time-base plug-in, a sweep rate of 500 ps/cm and a delaying sweep format are available. The CRT has an 8 × 10-cm viewing area.

Hewlett-Packard's advanced general-purpose oscilloscope system is the 180 series, with the 182C and 184 of special note. The 182C is a large-screen, 100-MHz-bandwidth scope that accepts two plug-ins. The screen has a viewing area of  $10.3 \times 12.9$  cm, the largest on a general-purpose laboratory oscilloscope. The 184, a storage scope, has a high  $400\text{-cm}/\mu\text{s}$  writing speed and a 100-MHz bandwidth with variable persistence.

Iwatsu makes a 500-MHz-bandwidth scope system, but it is not yet being supplied by Dumont.

The fastest writing speed in a storage scope is claimed by the Tektronix R7912 Transient Digitizer. It has an equivalent writing speed of  $8 \times 10^6$  cm/ $\mu\text{s}$ . This is at least four orders of magnitude faster than anything else on the market at present. A departure from a standard scope, the R7912 writes signals on a dual-gun scan converter tube. The information stored on the scan-converter target is then treated in one of two ways: It can be raster-scanned and displayed on a conventional TV monitor, or it can be digitized, stored in semiconductor memory, and interfaced directly with a computer. In the digital mode, the R7912 takes 512 samples of a waveform in a time window as short as 5 ns. This makes it a super-fast analog-to-digital converter.

Following Hewlett-Packard's emphasis on medium-performance, reasonably priced scopes

aimed at the broadest segment of the market, Tektronix recently introduced the 5400 series. These scopes have three holes for plug-ins and a 60-MHz bandwidth. The CRT is quite large ( $6\text{-}1/4$  in. diagonal) and can be used to display alphanumeric readouts of the scope settings.

#### When size is important

The most frenzied activity at present centers on the portables, particularly the miniscopes. Three manufacturers are currently pursuing this market: Tektronix, Philips Test and Measuring Instruments of Hicksville, N.Y., and Vu-Data Corp., San Diego. The Tektronix entries are the 211 single-trace and 212 dual-trace units, selling for \$545 and \$725, respectively. These scopes measure  $3 \times 5\text{-}1/3 \times 9\text{-}1/2$  in. and weigh just  $3\text{-}1/2$  pounds, including batteries. But the Tektronix miniscopes have a major limitation: They have a bandwidth of only 500 kHz. This is expected to rise in the near future.

Philips markets a Japanese-made miniscope with 5-MHz bandwidth. Also available in single and dual-trace models as the PM3000 and PM-3010, these scopes sell for \$645 and \$775, not including batteries. The scopes measure  $3.4 \times 5.4 \times 7.6$  in. and weigh four pounds, including batteries.

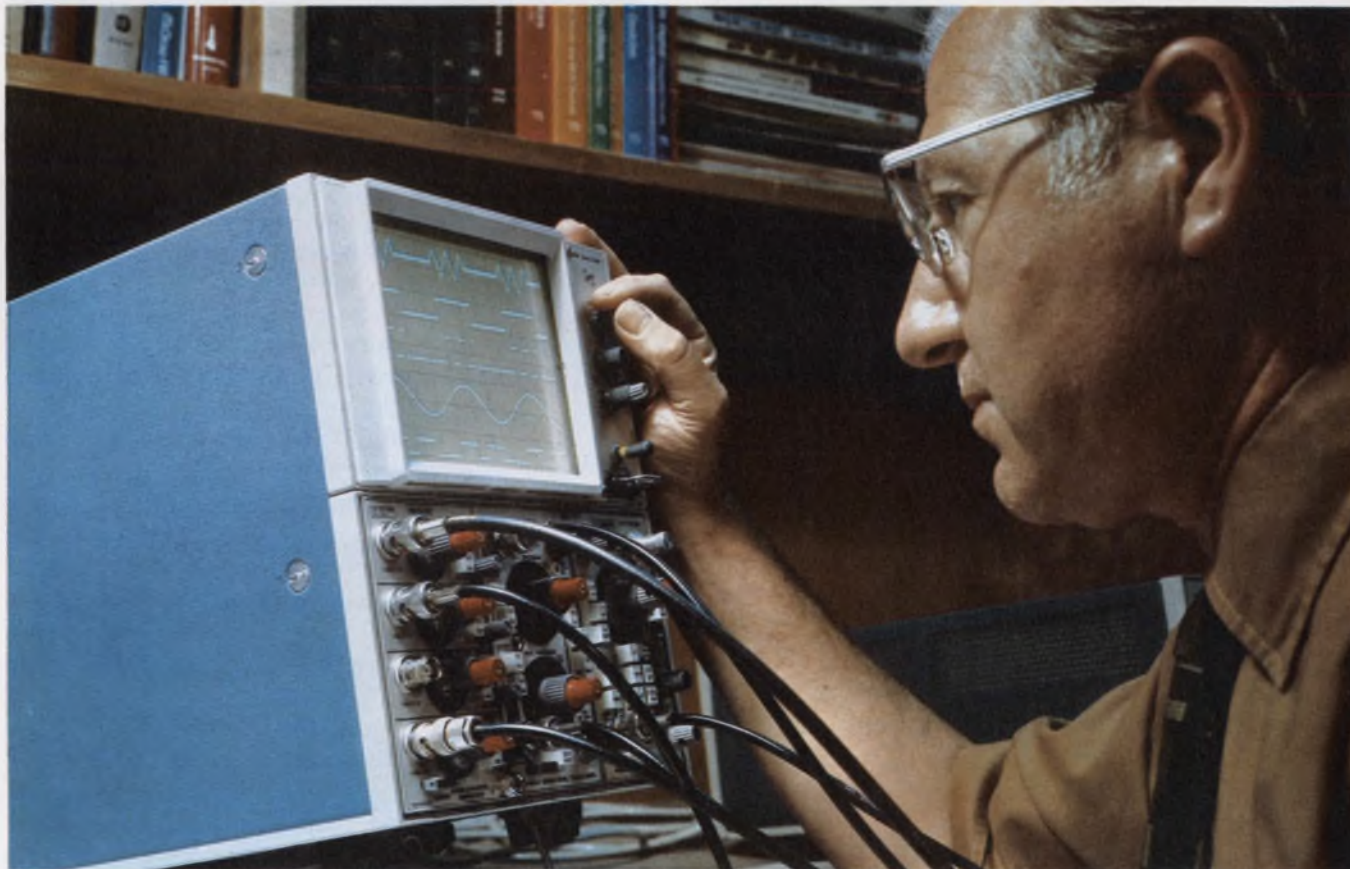

Hitting the mid-range of laboratory oscilloscope use is the Tektronix 5403, a 60-MHz scope. This three plug-in

instrument accepts 17 different plug-ins. The 5403's CRT readouts can be externally programmed.

Vu-Data miniscopes have the highest performance. The PS910A and PS940A are single and dual-trace units with 20-MHz bandwidth. Including batteries, these scopes weigh seven and 13 pounds and sell for \$595 and \$1095, respectively. The dimensions of the two models are 1-3/4 × 8-1/2 × 12 in. and 3-1/2 × 8-1/2 × 12 in.

Stuart Rauch, applications manager at Philips, notes: "About 80% of the field-service work that miniscopes are aimed at requires 5 MHz or less bandwidth. Most of the other 20% can be handled by a 20-MHz scope."

Tektronix and Vu-Data are in basic agreement with this analysis.

And don't forget module scopes, those tiny oscilloscopes that have been around for years and are designed to be built into systems. Sometimes they consist of little more than just a simple CRT with beam-positioning controls. A major manufacturer is James Millen Manufacturing Co. in Malden, Mass. Millen's scopes get as small as a 3/4-in.-diameter CRT and as large as a 5-in.-diameter.

#### Low-cost portables abound

There are oscilloscopes that can be called portable in size, weight and performance, but that are not always designed to be used in the field. They are produced by such companies as Telequipment of London, England; Hewlett-Packard; Ballantine Laboratories of Boonton, N.J.; Dumont; Philips, and Scopex, an English concern whose scope is marketed in this country by Jermyn Products of San Francisco.

Telequipment's entry is the D61, a 10-MHz, dual-trace scope with 10-mV sensitivity and sweep rates down to 500 ms/div. It sells for \$475.

Hewlett-Packard has the 1220A, a 15-MHz, dual-trace scope with 2-mV sensitivity and 3% accuracy. This scope, selling for \$625, has built-in TV sync separation for convenient TV troubleshooting.

Ballantine's entry is the 1010A, a 10-MHz, dual-trace scope. It weighs less than 15 pounds and sells for \$495.

The Dumont 2100 is a 10-MHz scope, weighing 14 pounds and offering delaying sweep for \$1095.

Philips markets a large number of scopes in this category. All are small and rugged and offer 10 or 15-MHz bandwidth.

Scopex, a spin-off from Telequipment, has the 4D-10, a 10-MHz, dual-trace scope with 10-mV sensitivity. It weighs 17 pounds and sells for \$450.

#### A look down the pike

What's next in scopes? Bill Walker, group vice president of engineering at Tektronix, lists these

advances that he expects to see in the next couple of years:

- Built-in microprocessors for internal programming and simple data processing.
- Continued increase in bandwidth.
- Picosecond measurement capabilities.
- Sampling scopes with built-in digital processing.
- Sampling scopes that will work to 25 GHz.
- Higher-bandwidth all-digital scopes.
- Auto-ranging in digital scopes.
- More different types of plug-ins to interact with the conventional scope and to add to the information that can be displayed.
- Digital sweeps that provide either delay by

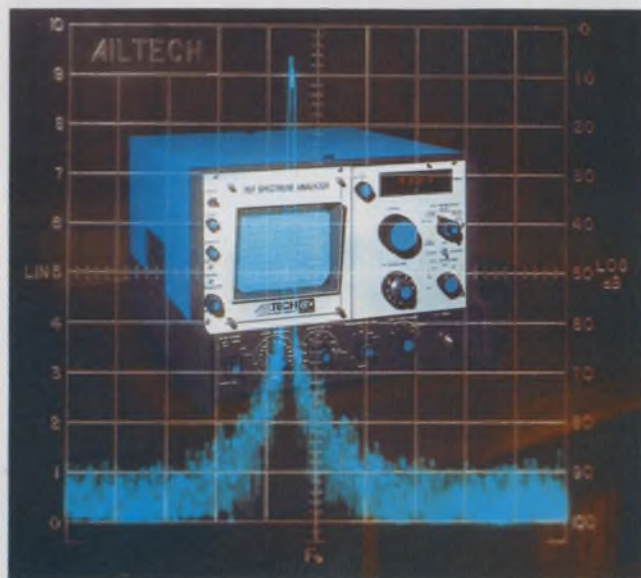

Complete with digital readout of center frequency, the Ailtech 707 microwave spectrum analyzer provides a 10-GHz frequency span. With a new YIG-tuned, Gunn local oscillator at 4 to 8 GHz, the analyzer works directly to 22.4 GHz. With external mixers, it goes to 40 GHz.

count or the more conventional delay by time.

- Increased accuracy, from about 3% to about 0.3%, with digital techniques.

- Wide use of built-in digital memory for waveform comparison and other applications.

Gene Warrington, product planning manager at Hewlett-Packard, is not quite as optimistic. He agrees that scopes will have a lot more digital electronics in them, but he doesn't expect to see microprocessors built soon. He does not believe that internal digitizing of waveforms will become widespread.

But Warrington looks to increased ease of operation of scopes. He points to color-coded push-buttons, easier ways to tell whether a button is in or out, automatic focus, automatic intensity control and, in some cases, alphanumeric callouts on the CRT. He also sees smaller, lighter and more reliable probes being developed. Finally he

looks to the scope doing more measurements—for example, it could easily measure duty cycle, peak amplitude and slope of the trace, he says.

Pat Zagaria, national sales manager for Dumont, notes that his company is already incorporating some future features in a soon-to-be-introduced scope called the Model 3100. A fully automatic, 100-MHz, fully programmable, auto-ranging scope, it can digitally break down the information on the screen with 8-bit resolution, and with use of digital memory, it can do trace comparisons. It will sell for about \$8000. Zagaria also expects multiple instrumentation test sets with built-in scopes.



The Philips PM3253 scope multiplies two waveforms and displays the result. It has a 60-MHz bandwidth and sells for \$3495. With it, the engineer can look at collector dissipation of a power transistor by applying both collector voltage and current simultaneously.

Rauch of Philips believes that for digital work, dual-beam scopes will start to replace dual-trace scopes.

Fred Katzmann, president of Ballantine, doesn't think that intelligence will be built into the scope but rather will be left to an external processor. He looks for more development along the lines of the Tektronix transient digitizer. He sees scopes becoming more and more tied to computers. In many cases, he believes, the CRT will not be needed, since man may be taken out of the loop.

There are currently two scopes that probably use more digital technology than any other scope on the market. One is the Tektronix Digital Processing Oscilloscope and the other is the Model 1090 digital storage oscilloscope from Nicolet Instrument Corp., Madison, Wis. The Tektronix is a 7000-series oscilloscope with an added processor

that can be programmed externally to operate on the displayed waveform. The Nicolet scope digitizes the waveform with 12-bit resolution, stores it in memory and then displays it on a CRT, but its biggest limitation is a 500-kHz bandwidth.

### Spectrum analyzers go digital

The most significant advance in low-frequency spectrum analyzers is the Hewlett-Packard 3580A from Loveland, Colo. It works from 5 Hz to 50 kHz and uses an internal digital memory to store the information prior to displaying it on a CRT. It achieves 1-Hz resolution and incorporates a feature called adaptive sweep. This means that, between spikes on the display, the analyzer sweeps about 20 times faster than it does when it hits a signal that must be displayed on the screen. Bill Parzybok, marketing manager at Hewlett-Packard, points out:

"The use of digital storage allows us to get rid of the more conventional variable persistence analog storage previously used in low frequency analyzers."

Parzybok believes that spectrum analyzers have progressed so far that wave analyzers will soon be obsolete.

In the medium-frequency range of 0 to 1800 MHz, one of the more advanced instruments to be introduced recently is the 7L13 from Tektronix. With a resolution of 30 Hz and a 70-dB dynamic range, it provides CRT readout of center frequency, reference level, frequency span, resolution bandwidth, video filter bandwidth and decibels per division. It also includes automatic phase lock and  $-125$  dBm sensitivity.

Other companies active in the medium-frequency spectrum analyzer field include: Hewlett-Packard of Santa Rosa, Calif.; Systron-Donner of Van Nuys, Calif.; Texscan of Indianapolis; Singer of Palo Alto, Calif.; Nelson-Ross Electronics of Lake Success, N. Y.; and Rohde & Schwarz of Munich, Germany.

Of the microwave spectrum analyzers on the market the most advanced are the Ailtech Model 707 004 and the Hewlett Packard 8555A, which goes from 10-MHz to 40-GHz with 70-dB dynamic range and a variable persistence display. The Ailtech analyzer covers a frequency span of 10-GHz, compared to 2-GHz for the 8555A, and has a dynamic range of 100 dB.

When very fast spectral measurements must be made in the 0-to-50-kHz frequency range, a real-time spectrum analyzer or a fast-Fourier-transform analyzer must be used. The major manufacturers of these products are Federal Scientific Corp. of New York, Spectral Dynamics Corp. of San Diego, and the Signal Analysis Operation of Honeywell in Hauppauge, N.Y. ■■

# Breakt

**The New HP 1601L  
Logic Analyzer.  
Introducing A  
New Concept That  
Actually Shows Your  
Logic design In Action.**

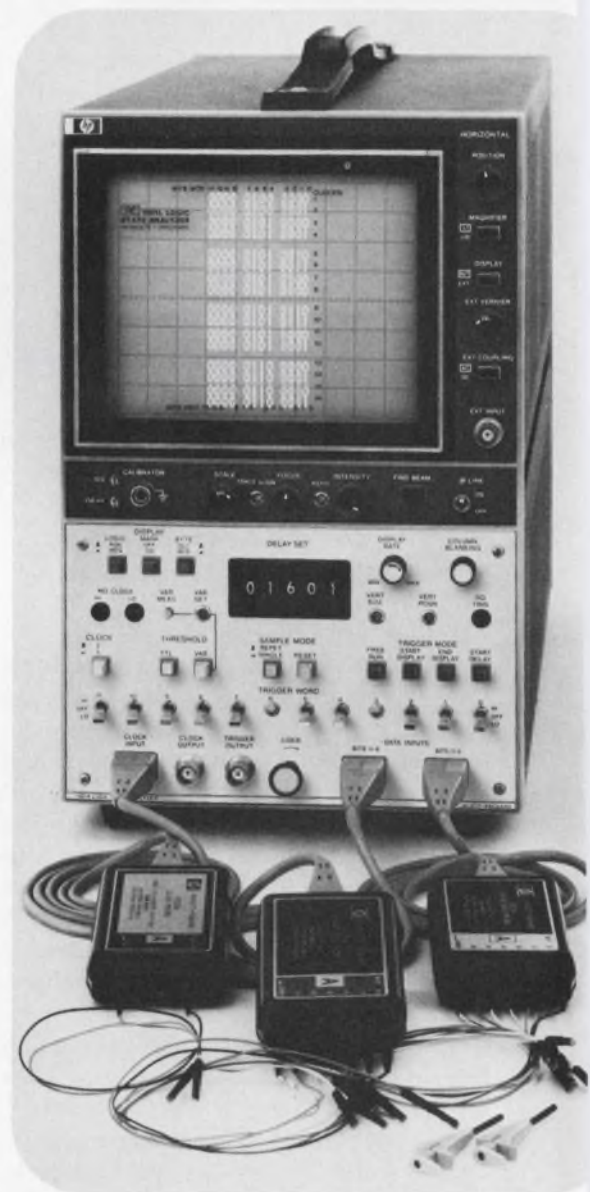

# through

**Helps you spot trouble faster than ever.** Think of the time you can save with the performance capability you're seeing on the screen illustrated here: sixteen twelve-bit words displayed in "1's," and "0's," in hexadecimal, BCD or octal format. You can trigger the display on the first word or the sixteenth word to see exactly what happens *after* or *before* a particular word of interest; A new way to design — a new concept in trouble-shooting.

**See negative time, Dynamic data flow, much more.** "Step inside" your design and watch it pace through its sequences. With the 1601L, if you discover a problem, end the display on the problem word and look back in time (negative time) to see what caused it. Your oscilloscope will help you to locate the component or circuit at fault; the 1601L provides a trigger for your scope making fault isolation even faster. **And there's digital delay.** Because the 1601L operates from your strobe signal (up to 10MHz), delay

can be conveniently dialed in up to  $10^5$  bits. You select positive or negative logic corresponding to the type of circuitry you're working with, and adjust threshold over the  $\pm 10V$  range provided.

**See things you've never seen before.** See those digital events you've always wanted to see. For all this capability the 1601L is priced at only \$2650\*. Or, consider the 5000A, a unit with LED display, two-channels, thirty-two bits. It sells for only \$1900\*. Your local HP field engineer will be happy to arrange a "hands-on" demonstration in your office or lab.

\*Domestic U.S. prices only.

HEWLETT  PACKARD

Sales, service and support in 172 centers in 65 countries.  
Palo Alto, California 94303. Offices in principal cities throughout the U.S.

083/8



# Look what 5 volts can get you.

These five DPMs use the same 5VDC supply that powers the digital logic in your system.

This simplifies your design and improves reliability. It saves space, saves money, and reduces the amount of heat that's generated. And, because there's no line-power voltage near the DPM, internally generated noise is virtually eliminated.

So you get more reliable readings.

And here's what else you can get for 5 volts. BCD outputs. Overvoltage, polarity, and status indication. Automatic zero correction and programmable decimal points. Aluminum cases that install in a snap.

Each meter is given a seven-day burn-in before shipping. And we're shipping right now.

Our 5 volt DPMs are a whole new class of digital panel meters — a whole new way of thinking. Because now you can think of the DPM as a component, just like any other component in your system.

Take a look below. You'll find a meter that solves your particular problem. Then give us a call. Order a sample.

**A low-cost 3½ digit DPM for OEM applications.** An advance in price/performance capabilities for 3½ digit DPMs. LED display. Bipolar, single-ended input. Full scale range of 0 to  $\pm 199.9\text{mV}$ . 0.05%  $\pm 1$  digit accuracy. Automatic zero and polarity. Normal mode rejection of 40dB at 60Hz or 50Hz. Common mode rejection of 60dB at  $\pm 200\text{mV}$ . Fully-latched DTL/TTL compatible outputs and control interface signals. Optional ratiometric input. Only ¾" deep. **\$89 in 100's. AD2010.**

**A high-performance 4½ digit DPM for systems applications.** Capable of performing precision measurements of floating differential voltages in noisy environments. LED display. Full scale range of 0 to  $\pm 1.9999\text{V}$ . 0.01%  $\pm 1$  digit accuracy. Automatic zero and polarity. Normal mode rejection of 60dB at 60Hz or 50Hz. Common mode rejection of 120dB at  $\pm 300\text{V}$ . Optically-isolated analog section. Fully-latched DTL/TTL compatible BCD outputs and control interface signals. **\$199 in 100's. AD2004.**

**A simple, reliable 3½ digit DPM for high-visibility display applications.** Incandescent display. Bipolar, single-ended input. Full scale range of 0 to  $\pm 199.9\text{mV}$ . 0.05%  $\pm 1$  digit accuracy. **\$89 in 100's. AD2001.**

**A high-performance 3½ digit DPM for systems applications.** The kind of performance you need for complex system interfacing and data processing. Incandescent display. True differential instrumentation amplifier input. Full scale range of 0 to  $\pm 199.9\text{mV}$ . 0.05%  $\pm 1$  digit accuracy. Automatic zero and polarity. Normal mode rejection of 40dB at 60Hz or 50Hz. Common mode rejection of 80dB at  $\pm 2.5\text{V}$ . Fully-latched DTL/TTL compatible BCD outputs and control interface signals. **\$99 in 100's. AD2003.**

**A low-cost 2½ digit replacement for analog meters.** Incandescent display. Unipolar, single-ended input. Full scale range of 0 to  $\pm 1.99\text{V}$ . 0.5%  $\pm 1$  digit accuracy. Optional: variable reading rates, BCD outputs, and control signals. **\$59 in 100's. AD2002.**



**ANALOG DEVICES**  
Norwood, Mass. 02062.

## Call 617-329-4700

for everything you need to know about 5 volt DC-powered DPMs.

INFORMATION RETRIEVAL NUMBER 48



# ONE KEY to your rf measurement problems

**One key** unlocks the full potential of the new GR 2260 Automatic Network Analyzer — a fully automatic system for detailed measurements of transmission, reflection, magnitude, phase, and group delay from 200 kHz to 500 MHz.

**One key** for rapid go/no-go production testing. The 2260 tests most devices almost as fast as they can be connected and produces simultaneous measurements of multiple rf parameters against individually tailored limits to speed testing and to eliminate the need for multiple test stations — all at the push of a button.

**One key** for high-precision R & D work. The 2260 provides real-time displays of interactive rf parameters for visual interpretation of design changes and allows modification of test conditions in seconds — all by ultra-simple keyboard commands.

The key —



**General Radio**

300 Baker Ave., Concord, MA 01742



# The new generators are sharp setters, and they keep quiet

**T**oday's generator makes it harder than ever to get your signals crossed. Compared with its predecessor of yesteryear, the modern signal source is set more accurately, does a better job of remaining set and spews out less hash with the desired signal.

There are new breeds today—function generators, frequency synthesizers and data generators, for example, and a young, but mighty offshoot—the programmable signal source.

The granddaddy of all signal sources—the venerable signal generator—is more accurate,

more stable and spectrally purer than units built just a few years ago. And this source of calibrated, stable, variable frequency and voltage has taken on a new look: built-in digital counters to set and read frequency. The days of the calibrated dial now seem numbered.

LogiMetrics, the company that pioneered the built-in counter, also introduced another major change of which the latest crop of sig gens can boast: the locked loop. With this feature, the output frequency is locked to the reference time-base of the internal counter, resulting in excellent frequency stability.

Included in the newest signal generators are the LogiMetrics 750A, Hewlett-Packard's 8640B, Singer Instrumentation's 6201 and the Boonton

---

Stanley Runyon  
Associate Editor

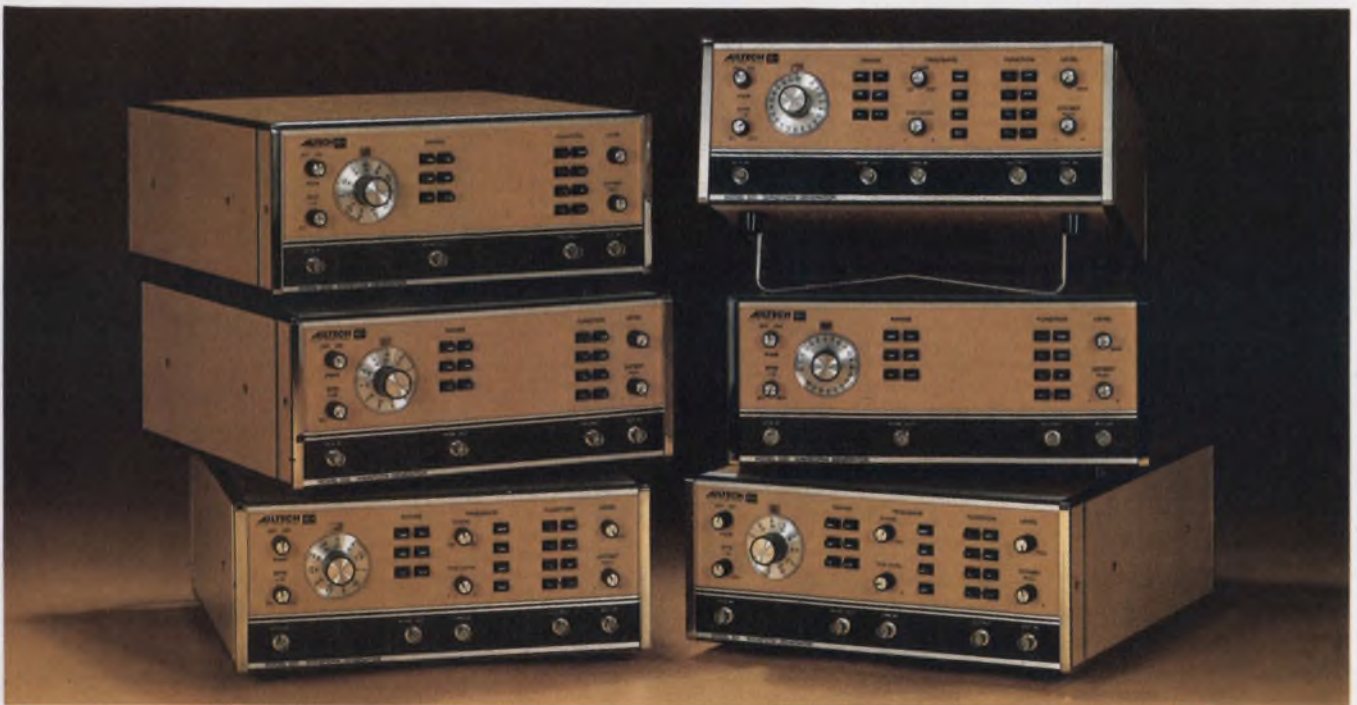

Ailtech's 500 Series of function generators are representative of what's happening with this instrument.

Various models in the line offer trigger/gating, external VCO, sweeping and counting.

Electronics 102A. Typical locked stabilities of these units are 0.05 ppm/hour for the HP and 1 ppm/24 hours for the Singer.

Other characteristics of the newer sig gens include all-solid-state design (one of the last instrument types to give up tubes), extended frequency range to above 500 MHz and to over 40 GHz for microwave sig gens, a plunge in noise specs to better than 120 dB down and extended modulation capabilities.

These—and other features—have enabled these “Cadillacs” of the sig-gen world to keep pace with stringent testing demands of the surging communications industry—demands that call for increasing frequency stability to test the ever-narrowing bandwidths of receivers and for lower and lower leakage of electromagnetic radiation to avoid undesirable interactions during tests of super-sensitive receivers.

But for those who don't need the ultimate in performance, who require instead a low or medium-priced general-purpose lab unit or a portable sig gen to field-check one of the burgeoning mobile communication sets, there's a wide selection available from Marconi, Daven/Measurements, Health/Schlumberger and others.

Other choices are possible. Signal generators today are caught in a squeeze play, seemingly trapped by the frequency synthesizer on one side and the generally less-expensive function generator on the other.

But even though sig gens are approaching synthesizers in stability, noise characteristics and settability—and even though synthesizers are dropping in price—neither is ready to replace the other just yet.

### Enter 'respectable' synthesizers

For one thing, synthesizers still offer the best frequency stability, phase noise and settability—six significant digits or more. For another, only synthesizers will do when a programmable, frequency-agile source is needed.

But for modulation capabilities—AM, FM or pulse; for calibrated attenuation or for metered power, only the sig gen will do.

The synthesizer is rapidly shedding its reputation as an expensive, garbage-spewing instrument. Newer types offer reductions both in price and in the spurious, nonharmonically related signals that have plagued the synthesizer since its inception.

At least three major synthesizer classes are available: direct, indirect and direct-digital synthesis.

In direct units, all output frequencies are derived from a standard—either internal or external—by mathematical division, multiplication, addition and subtraction.

In the indirect units, outputs are produced by variable oscillators that are phase-locked to a frequency reference.

And in the third type—direct digital—digital techniques generate all frequencies.

How do these types stack up? Each has its virtues and shortcomings, of course, but here's how they stand generally:

- Because of a lower parts count, indirect units are about one-third the cost of directs that cover the same frequency range.

- Directs offer finer frequency resolution (1 Hz, or better), and, since all frequencies are always present, faster switching times (about 20  $\mu$ s) between frequencies.

- Direct-digital units maintain phase coherence of both frequency and amplitude during switching, but the top output frequency of commercial-



A unique octal switch allows the SRC/Moxon Model 912SP data generator to output 960 bits.

ly available units is only about 2 MHz.

Top frequencies of synthesizers skyrocket to the microwave range. Watkins-Johnson, for instance, offers units that top 18 GHz.

And both General Radio and John Fluke offer indirect units of high stability and purity: GR's 1061 is stable to  $\pm 1 \times 10^{-9}$  per day, with an optional internal standard, while the Fluke 6160A offers a phase s/n and spurious noise of better than 62 and  $-75$  dB, respectively.

Other companies active in the synthesizer field include PRD Electronics, Rockland Systems with its digital synthesizer, Hewlett-Packard and Systron-Donner.

### Function generators step ahead

Joining the synthesizer in squeezing the standard signal generator is the function generator. In the 15 or so years since Hewlett-Packard introduced the first one, the function generator has become a sophisticated laboratory instrument.

Just what is its claim to fame? Simple. It outputs a potpourri of waveshapes—from sines



The 8640B signal generator, from Hewlett-Packard, features a digital counter and display to set and read

to triangles to squares to ramps and on to seldom-used oddball shapes—enough to satisfy most anybody's needs.

In short, the function generator is everyman's instrument—the universal signal source. And it spans the enormous frequency range of 1  $\mu$ Hz to 30 MHz—the former in Exact's Model 335 and the latter in Wavetek's recently introduced Model 162.

Now not many people need 1  $\mu$ Hz or have the patience to sweat out the 11 days, 13 hours and 46.6 minutes required to check one complete cycle. But the capability is there, and it attests to the extreme versatility of the function generator.

Wavetek not only holds top-frequency honors in function generators but has many other innovations to its credit. In fact, the function generator didn't come into its own until 1961, when Wavetek drew the wraps off its solid-state unit, the 101.

And Wavetek is still innovating: Besides the company's top-frequency contender, there's the Model 132—a unit that adds an independent noise generator to the standard function-generator repertoire. The combination lets an engineer create "noisy" signals with a calibrated s/n ratio.

A LED digital readout is what makes Wavetek's Model 147 stand out. A user can set up both frequency and amplitude via the readout. In fact, the company says, an entire waveform can be set up without any external test equipment.

Not all innovations in function generators come from Wavetek, of course. At least 14 other firms are in there slugging, turning out a host of eye-catching products in an attempt to capture part of the market.

frequency. Output frequencies can be locked to an internal reference.

The fierce competition for a fairly limited dollar amount has resulted in even more versatility in function generators. These universal units can now sweep, give single cycles or bursts in a triggered or gated mode, and they can operate as voltage-controlled oscillators in phase-locked loops or other VCO applications.

And, like many other instruments today, the function generator has gone portable. Krohn-Hite's battery-operated 5600 runs on "starvation" current levels. With the ac line eliminated, you can take it anywhere and not worry about "dirty" lines or ground loops.

Representing the function generators of the "1973 model year" is the Clarke-Hess 748. The phase-locked unit can be used as an AM/FM, tone-burst or swept-tone-burst generator; as a synchronous detector or as a binary phase-shift keyer. In short, the 748 is an almost-arbitrary waveform generator.

The 748 has plenty of company. Ailtech (formerly Microdot), with a broad line of function generators, offers stiff competition. The company's Series 500, for example, includes sweeping as well as counter-readout function generators.

With all the benefits of VCO and triggered/gated outputs, the Series 500 also brags of such features as an audio range that lets you cover the entire audio spectrum with one turn of the dial and a phase control that lets you select the start and stop points of the triggered waveform.

Other vendors that are active and significant in function generators are Exact Electronics, Interstate Electronics, Hewlett-Packard, Systron-Donner/Datapulse and Health/Schlumberger.

For those who don't need the more sophisti-

cated—and more expensive—function generator, Heath offers one of the lowest cost units available: The EU-81A. At \$245, this 3%, 1-MHz machine offers a VCO and a TTL-compatible sync output.

And Hewlett-Packard's 5%, 1-MHz Model 3311A is a competitor. Included in the \$249 price are VCO operation and a separate TTL-compatible pulse output that can sink 20-TTL loads.

Although the function generator can give you almost any waveshape, each shape generally isn't as good as you can get from a dedicated instrument.

Thus if you need, say, better pulses and square waves, or rep rates that are faster than 30 MHz, look to the pulse generator.

### The pulse generator: faster and faster

Hard on the heels of the fastest digital circuitry—ECL and Schottky TTL—is the pulse generator.

With pulse rise times and rep rates so fast as to strain even the fastest of scopes, today's top-of-the-line pulse generator also offers modes, features and functions that permit super control of the pulse output.

But while almost all vendors have units with outputs that are impressively fast and super clean, most also offer bottom-of-the-line pulsers—units with rep rates of up to, say, 10 or 20 MHz and without many nice, but not strictly necessary, frills. And many medium-priced, medium-performance machines are sandwiched in between, so that practically everybody can be satisfied.

Top-speed honors go to Takeda Riken, a Japanese firm, for its TR-4200 Series. You'll need a sampling scope to "freeze" the streaking 1-GHz rep rate of this performer. You'll also need \$45,000 to pay for the TR-4200; so you'd better be absolutely sure you need one.

Coming down out of the rep-rate stratosphere, you'll meet one of the fastest available pulsers at a more down-to-earth price—the E-H Research Laboratories Model 129. The rep rate of the \$3925 unit is 500 MHz, while its transition times are less than 500 ps. The 129 is one of over 20 models offered in E-H's pulse gen line.

While rep rate is the usual figure of merit for pulse gens, transition time, amplitude, duty cycle, jitter or other specs may be more important in most applications. Unfortunately, these specs are mutually limiting when paired, so tradeoffs must be made.

Available today are kilovolt pulses with nanosecond  $t_r$ 's—but at very low rep rates and duty cycles. And you can get your 1-GHz pulse, but at an amplitude of only 2-V.

These are extreme values. Most applications



Indirect synthesis to 160 MHz, 100-Hz resolution and 0.5-ms switching of frequencies, typify the Fluke 6160A synthesizer.

will be satisfied by what's available in the "middle" ground: pulses up to 50 MHz with 10-V amplitudes and  $t_r$ 's of roughly 5 ns; and up to 250 MHz with amplitudes and  $t_r$ 's of 5 V and 1 to 2 ns, respectively.

These, and many other units, can be found in the extensive lines of the Datapulse Div. of Systron-Donner, Hewlett-Packard, Interstate Electronics, Chronetics and other companies.

Datapulse, for example, offers such units as the "economy" 88—a 20-MHz, \$395 pulser—and the 116, a 50-MHz unit with both variable transition times and variable offset. The latter features are typical of what's being offered in today's pulse generators.

Variable rise and fall times are indeed useful—to simulate IC-device performance and to optimize pulse shape. Hewlett-Packard's newest pulse gen—the 8007B—offers this feature, as does the P25 from Interstate and the PG-32A from Chronetics.

But this and other modern features—such as variable baseline, gating mode, simultaneous complementary outputs and variable delay—jack the price of a unit way up.

One way to get all the features you need without plunking down a bundle is to go modular. By adding plug-ins as you need them, you spread out the cost.

For instance, with HP's 1900 Series, you can initially select your mainframe, then leisurely add plug-ins for required rate, width, transition time, offset and amplitude.

### Data generators: Another offshoot

One plug-in for the HP1900 is a member of a burgeoning special class of pulse generators—the word generator, or pattern or data generator as some manufacturers call it. These units simulate the bit patterns needed to test digital systems, circuits and communication lines.



A 500-MHz repetition rate and transition times of 500 ps makes E-H Research Laboratories' Model 129

Unlike traditional pulse generators, which emit a repetitive output, data generators can add or subtract pulses within a repetitive sequence. Some are known as pseudorandom generators and produce statistically random words. Others are used as character generators.

Except for clock rate, the traditional pulse parameters generally take a back seat in data generators, yielding to the seemingly more important considerations of bit capacity, code formats, ability to manipulate the patterns, ease of programming and number of channels.

But the data generator is still a pulse generator, so that waveform transitions, jitter and aberrations remain important.

The fastest rates available today are exemplified by Tau-Tron's DG-525 data generator. It can shoot out data at over 300 Mb/s.

Leading in bit capacity is the SRC Div. of Moxon, Inc., with its 912 generator. The unit provides either 80 parallel words of 12 bits each or 960 bits in a serial-data stream.

Despite the enormous bit capacity of the Moxon unit, the front panel isn't cluttered with 960 toggle switches. Bit programming is via a unique octal plugboard that keeps the panel remarkably small. Or you can opt for the 912CR version, in which the plugboard is replaced by a card reader.

Over a dozen data generators in the Systron-Donner/Datapulse line offer a vast number of programming options, frame and output formats, rates, word lengths and other features. Take your pick.

And, of course, Hewlett-Packard offers data generators—such as the 3760A, a unit that generates data and pseudorandom sequences to  $2^{15} - 1$

pulse generator one of the fastest available. Other features include variable baseline offset.

bits. Other companies offer many other types of data generators.

Perhaps the only thing the versatile data generator can't do is sweep. That feat can be found in the arsenal of some function generators. But, in the main, the most accurate sweep rests with an entirely separate class of instrument—the sweep generator.

### Sweepers go wideband

Although sweepers are available from near dc to upwards of 40 GHz, it's in the microwave region that they are most needed. In fact, the sweeper is as basic to a microwave lab as the scope is. And it's in the microwave region that most advances in sweepers have been made.

In the last five years the backward-wave oscillator has been shoved backwards, and practically out of the picture, by the forward thrust of solid-state devices. Today the top sweepers are all-solid-state units that are either varactor or YIG tuned and that output up to 100 mW. And, like the sig gen whence they came, today's sweepers are more stable and spectrally purer than ever.

To cover the enormous frequency span of microwave sweepers, manufacturers have gone to the modular design, and this concept dominates the industry today. Thus practically all vendors offer a selection of mainframes and plug-ins, with each plug-in covering a limited region (usually one octave) of the total frequency range.

But the modular concept is under fire. Advances in wideband microwave components—couplers, mixers, attenuators and active devices—

have resulted in new, broadband units that provide one, continuous, multiband sweep without a change of plug-ins.

Are integral, stand-alone units the wave of the future? As yet, no single unit covers the entire rf and microwave spectrum. But sweepers are apparently in a state of transition, and anything can happen.

Take Hewlett-Packard. Its 8620 solid-state sweepers accept a series of traditional single-band plug-ins, ranging from 3 MHz to 18 GHz. But a new plug-in, called an rf drawer, accepts its own modules—sort of a plug-in plug-in.

With the rf drawer, the frequencies of any two fundamental rf modules, plus that of a heterodyne module, can be multiplexed to a single output port, thereby providing a multiband sweep.

The sweepers of the Kruse Electronics Div. of Systron-Donner are all of plug-in concept. The first plug-ins to roll off the assembly line at Kruse were the 5000 series, now covering 10 kHz to 18 GHz in over 16 modules.

But although the 5000 series is still popular, the multiband concept has invaded the field. Kruse's 540 series mainframe accepts one plug-in—the 572—which gives a continuous sweep from 10 MHz to 4 GHz or from 4 to 18 GHz.

And then there's the Kruse 50520 multiband system, an instrument that combines mainframes, controllers, multiplexers and up to eight plug-ins, including a computer-controlled one that automates all functions.

Singer Instrumentation's Palo Alto operation sees the completely integrated unit, covering 100 MHz to 18 GHz, as the sweeper of tomorrow. But the company concedes that customer resistance has prevented it from going to total integration.

Thus in Singer's Alfred line of sweepers, the unit approaching—but not quite reaching—an integral design is the 6600/9514/9515 multirange, continuous-sweep system. This broadband sweeper—consisting of a mainframe, controller plug-in and oscillator unit—provides a continuous, leveled sweep from 100 MHz to 2 GHz from one port and 2 to 18 GHz from another.

One unit that is fully integrated is Narda's 9500 series. Each of the models in this all-solid-state, broadband line sweeps continuously over all or any part of its total band. For instance, the 9535 covers 1 to 18 GHz in one swoop.

Along with plug-ins, an old, familiar face—the slide-rule dial—has been left in the lurch by Narda. Replacing the dial in the 9500 series are digital thumbwheels to set and read the start, stop and marker frequencies.

Other companies are significantly and actively contributing to advances in gigahertz sweepers—Weinschel and Wiltron, to name two.

Some firms confine their activities principally to high-power units or to the vhf/uhf arena, and



Narda Microwave's 9530 sweep generator covers 2 to 18 GHz in one sweep. Start, stop and marker frequencies are set by digital thumbwheel switches.

consequently are well known in the TV and CATV industries. Included are Wavetek, Telonic, Ailtech, Texscan, Marconi and Kay Elemetrics.

#### Programmability a growing trend

One trend that's sweeping across all sweeper bailiwicks is programmability. Indeed, the move toward digital control of functions encompasses almost all signal sources, from synthesizer to pulser to sweeper.

This trend has kept pace with the general, industry-wide movement toward digital instruments of all kinds and toward computer-controlled systems—from automatic test to data-acquisition to process control.

Strangely enough, the seemingly inexorable pull to the more expensive, more sophisticated programmable source is balanced by another major trend in the opposite direction—toward simpler, less expensive and less accurate units for lab and portable uses.

What of the future? Will entirely new types of sources emerge? Will the current crop undergo still more radical changes?

Specialized signal sources, always hovering in the background, may play an increased role. Noise generators, precision-delay pulsers, high-power sources arbitrary waveform generators of various types and sig gens specialized for ILS and other applications are all being used more and more. Perhaps these will be the sources of tomorrow.

LSI and CMOS ICs have penetrated deep into many instruments, shrinking size and power consumption. Up to now the shortcomings of the analog IC has limited its use in sources. But perhaps new and improved ICs will lessen the present dependence of sources on discrete devices.

Perhaps new and unheard of circuits will radically change the signal source. ■■



# DUMONT OSCILLOSCOPES SINCE 1935

We make more scopes for science and industry today than ever before—

## Off-the-shelf delivery

In the finest tradition, today's Dumont-produced oscilloscopes offer the most advanced design, along with superlative performance and many exclusive product features...at highly competitive prices.

Dollar for dollar, Dumont 'scopes outperform all others. An exclusive triggering system contributes maximum sensitivity and control; improved CRT development produces additional brightness; sophisticated human engineering makes for ease of operation. Any way you look at it, Dumont's value excels.



Most important, you get off-the-shelf delivery because Dumont experience and know-how produces oscilloscopes...and ONLY oscilloscopes...in volume, for science and industry today. Performance...price...and delivery... whatever you may need -- rack, bench, portable, military or commercial -- Dumont gives you all.

Write or call for detailed specifications and performance data.

**DUMONT OSCILLOSCOPE LABORATORIES, INC.**  
40 Fairfield Place,  
West Caldwell, N.J. 07006  
201-575-8666

RECENT ADDITIONS TO THE DUMONT LINES.



**MODEL R-1064**  
60 MHz, bench or rack mounted  
Laboratory instrument, dual channel, delayed sweep, moderate cost



**MODEL 2100**  
10 MHz, field portable  
General purpose instrument,  
dual channel, delayed sweep  
Weighs only 14 lbs



**MODEL 1100**  
100 MHz, bench or rack mounted  
Dual channel, delayed sweep,  
unique triggering, moderate cost

**RECORDING CAMERAS**  
Polaroid or film pack holders, 1/25 to 1/100 sec speed 75mm lens, 128. Also 35 mm automatic shutter



INFORMATION RETRIEVAL NUMBER 50

## COUNTERSCAN SYSTEMS

## INTRODUCES TWO STATE OF THE ART PRODUCTS

### A SOPHISTICATED MULTIPLE CONDUCTOR WIRE ANALYZER



*Designed Exclusively For:*  
High Density Cable Testing  
High Density Backplane Testing  
Multiple Circuit Wire Verification

Now for the first time, you can get a wire checker that has followed the state of the art. Once programmed, all you need to do to test different cables, harnesses, backplanes, PW boards, etc., is to press a program select button. No mess with putting on reels of tape, cards, or hooking up other peripheral equipment. This machine is completely self contained and even includes a built-in special purpose computer. Programs are stored in electrically reprogrammable MOS LSI ROM's, and the first program is supplied FREE with the machine. The program content can consist of anything your choosing.

Machine capacities available from 240 points to 768,000 points, in 240 point increments.

Super sophisticated electronic circuitry utilizes CMOS technology almost exclusively. The high density switching is accomplished entirely by CMOS LSI bi-directional switches. Advanced packaging techniques reduce the select/deselect switching component volume by 87%. Choice of various test frequencies and test voltages is continuously available and is part of the program. Any pin connection to the device under test may be used as an input or output. An innovative cable attached keyboard/display unit contains all controls for machine operation.

Prices on request (includes printer, programming mating connectors and spare part kits).

*Bench model shown, Larger units are floor consoles.*



### A HIGH DENSITY 480 CHANNEL MULTIPLEXER

A giant multiplexer/demultiplexer is now introduced to satisfy all high density switching and selecting requirements. This innovative and extremely sophisticated unit utilizes the very latest in switch technology. State of the art solid state LSI-CMOS switches are used throughout. The physically compact unit has a tremendous capacity of 480 channels that may be used both as a multiplexer and Demultiplexer. Each channel is fully bi-directional and capable of passing plus or minus 12 VDC and 12 V peak AC to greater than one megahertz. The small size of the plug-in-able unit is made possible by one high density wire wrap panel and the utilization of the very new LSI-CMOS switches.

The LSI-CMOS integrated circuits support the Multiplexer design better than any other solid state devices in existence. The CMOS-LSI circuitry permits extremely low power consumption, high reliability, are fully bi-directional, extremely compact unit configuration, and uses electronics that represents the threshold of a new and coming technology. A nine bit parallel straight binary code supplies the address to all channels. Full address decoding with latching selects and maintains switch closures until a reset is desired. Interfacing and supporting components contained on the relatively small size wire wrap panel are all state of the art devices and includes a miniature high density data connector that contains 488 contacts and a miniature edge connector that terminates all 22 wires of a flat cable simultaneously with no preparation.

Prices for the Multiplexers start at \$1800.00 for a quantity of one.

COUNTERSCAN SYSTEMS P. O. BOX 536 PHONE 402-773-3875 SUTTON, NE 68979

INFORMATION RETRIEVAL NUMBER 51



# What's DAFL stability? 1 ppm/24 hrs.

The Model 6201 Signal Generator offers you a new experience in precision testing over the 61-kHz to 1024-MHz range. Simply set your desired frequency on the six-digit counter, flip the lock switch, and enjoy the confidence of a locked, crystal-stable output signal. That's what DAFL — Digital Automatic Frequency Lock — is all about. It means 1 ppm stability, all day, all night.

You can use this signal generator with the assurance that it will take your toughest tests in stride. Output power is

continuously adjustable and metered over a 166-dB range, high enough (20 dBm) for saturation data and low enough (-146 dBm) for critical sensitivity measurements. And it's a clean signal with broadband noise at least 130 dB down in a 1-Hz bandwidth. Residual FM is less than 5 Hz peak.

We invite you to treat yourself to DAFL stability and discover a new era in signal generators. Send for more information now. Contact Singer Instrumentation, 3176 Porter Drive, Palo Alto, Calif. 94304. Phone (415) 493-3231.

**SINGER**  
INSTRUMENTATION

INFORMATION RETRIEVAL NUMBER 52

# Most of your design problems can be solved by an unknown.



Put down your pencil. Give the pocket calculator to your kids. Stop waiting in line at the EDP department.

If you've got problems, we've got a solution. The very first and only programmable hand-held micro computer in the world. The Compucorp Micro Scientist. The professional's machine.

It thinks the way you think. It does stress analyses. Works design problems. Breezes through drafting calculations. Solves systems headaches. Plucks the best engineering solution out of a dozen possibilities.

The Scientist allows you to have two different 80-step programs in memory at the same time. Which means repetitive calculations are a snap. And you can take it wherever you go because it's battery operable.

The Compucorp Scientist is the first hand-held machine with 13-digit accuracy and a big, bright 10-digit display. And it's the first one with an algebraic keyboard and nested parentheses.

It's also the first one with built-in polar to rectangular; rectangular to polar; trig functions;  $\log_{10}$ ;  $\log_e$ ;  $10^x$  and  $e^x$ . It also handles different forms of angle entry.

You can do register arithmetic in and out of ten storage registers. And you can set the decimal point anywhere you want it and change it whenever you want to.

Get all the facts on Compucorp Micro Computers. We may be an unknown to you, but we're already solving tough problems for thousands of design engineers around the world.

See your local Compucorp dealer. Or write Computer Design Corporation, 12401 Olympic Boulevard, Los Angeles, California 90064.



**Compucorp®**  
**The Unknown Factor in 63 countries.**

INFORMATION RETRIEVAL NUMBER 53

INFORMATION RETRIEVAL NUMBER 56 ►

# 4999 counts instead of 1999.

## That's one difference between our 3½ digit DVM and their's.

If a 3-digit DVM reads to 999 and a 4-digit DVM reads to 9999, a 3½-digit DVM should read to 4999. Our's does. Their's doesn't.

Their 3½-digit DVM will read up to 1999 with 100% overrange. If your input exceeds 2000 counts you have to change ranges with loss of resolution. But Data Technology has changed all that.

Our new Model 30 has a full 1 through 5 readout in the first position. You have 4-digit accuracy for 5V and 20V logic, 20V and 30V telephone applications, 24V industrial supplies, 28V aerospace and analog applications, 36V military and 230V/440V/480V industrial voltages plus the same accuracy for 22, 27, and 47 ohm resistors. More importantly, the Model 30 provides

this capability for less money than any comparable meter: \$299 for line operation; \$319 with rechargeable batteries.

Using the bright new Sperry display, its low power requirements allow the Model 30 to operate 10-12 hours without recharging the batteries. A 26-range instrument, the Model 30 has five AC and five DC voltage ranges; six resistance ranges; five AC and five DC current ranges.

The 4999 counts instead of 1999 will be the first difference you'll notice between our 3½-digit DVM and their's, but there are lots of others. Try one and see for yourself.

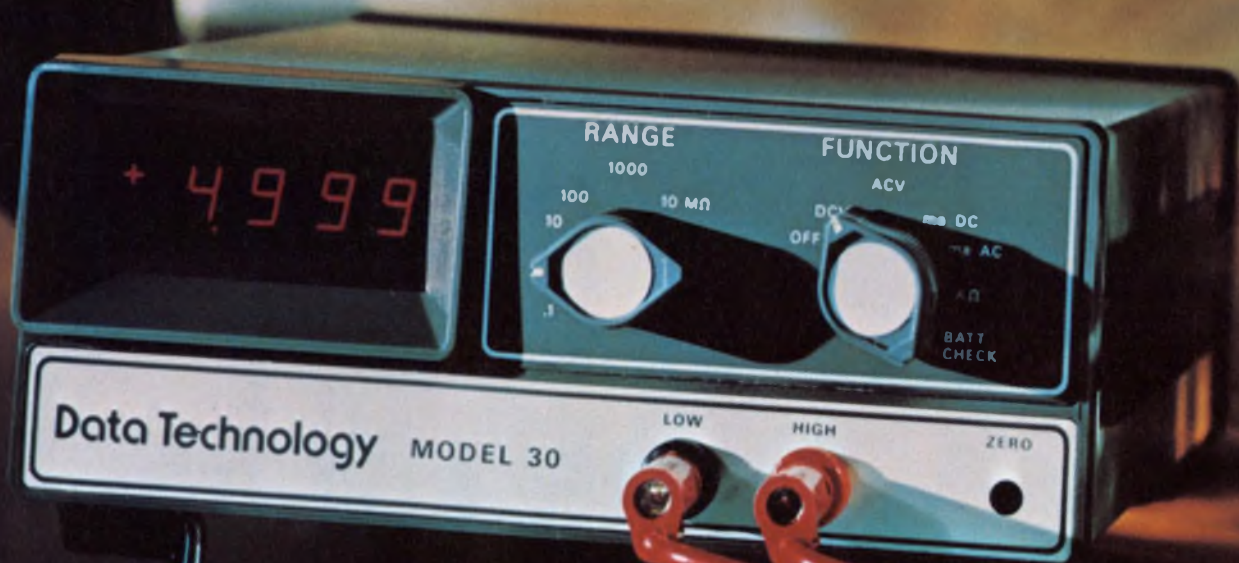

# the new data technology corp.

2700 S. FAIRVIEW ROAD, SANTA ANA, CALIF. 92704 (714) 546-7160 TWX: 910-595-1570



# Analogs aren't dead, but they're facing a digital onslaught

**W**alk into any engineering laboratory, and you'll find that almost any instrument you see has a digital readout. Digital instruments for measuring analog signals—such as voltage, current, impedance or power—are proliferating.

These multimeters, panel meters and specialized measuring instruments are all going digital—not only the display but the internal circuitry as well. Advances in analog-to-digital conversion methods have helped cut price and complexity,

and have yielded tenfold improvements in accuracy.

A few years ago laboratory instruments accurate to  $\pm 0.1\%$  were hard to find. When available at all, they were used as standards. Now it's not uncommon to find lab-bench digital multimeters (DMMs) accurate to within  $\pm 0.001\%$  and with resolution to 6-1/2 digits. You can even get field-test equipment with accuracies of  $\pm 0.05\%$  or better.

New LSI circuits have enabled manufacturers to reduce the size of the instruments to the point where the batteries needed to power the unit often take up more room than the electronics. This is dramatically illustrated in the new pocket-

**Dave Bursky**  
Associate Editor



The Triplet line of instruments covers the entire gamut. Illustrated here (from l to r, back row) is a DMM, a

high quality VOM and an analog panel meter. In front is a DPM and a pocket-sized VOM.

sized instruments that are now available.

But analog instruments are not dead—not by a long shot. They're still about half the cost of digital instruments, but their accuracy tolerances are on the order of 2 to 3% full scale. In the long run—especially as the digital units get cheaper—it is this limit on accuracy that will hasten the departure of the analogs.

For digital meters, high resolution and low cost are no longer mutually exclusive. Keithley, of Cleveland, for example, has introduced its Model 190 at \$750. This is said to be the lowest price for a 5-1/2 digit DMM that offers the five standard functions—ac/dc voltage, ac/dc current and resistance.

### DMMs: Take your pick

Digital multimeters come in all shapes, sizes and accuracies. Hewlett-Packard of Palo Alto, Calif., recently announced the world's smallest—the Model 970A—a shirt-pocket-sized, 3-1/2 digit, auto-ranging instrument that measures ac/dc volts and ohms. The price is a low \$275. And that's not all. The LED display is at the probe tip and can be inverted at the flick of a switch for easier viewing. The unit, including batteries weighs only 7 oz.

The 970A, HP says, can compete in measuring capability with any high-quality volt-ohm-milliammeter (VOM) and with some low-grade DMMs. The 970A's dc measurement accuracy is specified to better than 1%, but it drops off to 2% and 3%, respectively, for ohms and ac volts.

Top-of-the-line VOMs—like the Simpson Model 2795 analog multimeter—take away some of the 970A's glory. The Elgin, Ill., company's 2795 offers 68 ranges, 1% accuracy on ac and dc volts or current, FET-input circuitry for high-input impedance and, of course, battery operation. Included in the 68 ranges are six capacitance-measuring and 12 output ranges. For the resistance and capacitance scales, the measurement accuracy is 4% of reading at mid-scale or 1% of scale length. The price of this versatile VOM is only \$250. This beats the price of the HP DMM, but the Simpson unit is much bulkier and, of course, is not digital.

The Model 245 DMM from Data Precision of Wakefield, Mass., keeps cost down and resolution high. For \$295, the 4-1/2 digit meter comes with 21 scales of ac/dc volts, ac/dc current and ohms. It can operate from either a built-in, Ni-Cad battery pack or an external line adapter. The meter is about the size of a palm-sized transistor radio and weighs only 14 oz.

A more unusual unit is manufactured by Keithley. The company's Model 167 was the first to have the readout in its probe instead of in the meter case. The unit has a 3-1/2 digit LED

readout that auto-ranges but is limited to measuring ac/dc volts and ohms for a relatively high \$325 price tag. For use in the field, the unit can be strapped to the engineer's belt and run off an internal battery pack; for lab work, it can run off the ac line. Options include a current shunt.

Tekelec in West Lake Village, Calif., has introduced a portable 3-1/2 digit, five-function DMM, the Model TA356. It is one of the first to use a reflective liquid-crystal display, and costs only \$249. An unusual option is a touch-and-hold probe that can freeze the display at a measured value—a neat feature if you're inclined to let probes slip while testing circuits. This option adds only \$50 to the cost and brings the DMM price to a still-reasonable \$300.

Even companies that formerly made only ana-



The HP-970A takes top honors for being the smallest DMM available. It measures ac/dc volts and ohms, but still fits into a shirt pocket.



Model 167 from Keithley was the first DMM to have its digital readout in the probe. This eases viewing when testing circuits at hard-to-reach points.

log VOMs are starting to go digital. The newest "digital VOM" is the Simpson Model 360—a 3-1/2 digit unit. Except for the digital display, the 360 looks almost exactly like the older analog Model 260. Along with the digital display, the 360 includes an analog null-indicating meter. Other built-in features are a low-power ohms scale and an analog-signal output to interface with recorders and other instruments. Accuracy for the full-scale count of 1000 is 2%, and the price is \$275.

The idea of including an analog null indicator isn't new. (Such a feature helps speed the engineer's search for signal nulls and peaks.) General Rand Corp. of Edison, N.J., has the Normameter—a 3-1/2 digit DMM with a large zero-centered analog meter superimposed on the display. And Simpson has another unit, the Model 460, that includes an edge-reading analog meter mounted just below the digital display.

The Weston Model 4445 portable DMM offers the usual five scales, but has an extra twist. The Newark, N.J., company has added true rms-reading capability. The 3-1/2 digit DMM, measures true rms ac with an accuracy of 0.5% of full scale  $\pm 1$  digit. The accuracy covers waveforms that have a crest factor of 4-to-1 at full scale and at frequencies from 50 Hz to 5 kHz. The cost of the 2-1/2 lb unit is less than \$500—lower than for any other true-rms DMM.

Besides continued improvements in accuracy, capability and resolution, digital measuring instruments have also shown a marked increase in intelligence—with, for example, self-testing capability to determine operational status.

The HP 3490A DMM uses a read-only memory to perform several self-checks. Resolution is better than five digits, with a maximum count of 119,999. The bench instrument costs \$1650—somewhat more than some 5-1/2 digit units.

### The buy-what-you-need approach

Tektronix of Beaverton, Ore., the well-known scope manufacturer, has adopted a systems approach to digital instruments, with its TM-500 series. The series consists of modules that plug into a mainframe with built-in power supply. A choice of mainframes powers and accommodates a maximum of one, three or more instrument plug-ins. The Tektronix DM-501 plug-in, for example, is a 4-1/2 digit DMM that measures temperature along with the standard five functions. Accuracy is better than 0.7% on all scales, and the unit costs \$495, including the temperature probe.

Prices for the power-supply mainframes start at about \$115 for a one-wide unit and \$150 for a three-wide frame. Thus if you want only a complete DMM, you would have to pay \$610. If you decide to get several other functions—such



The DM-501 DMM plug-in is just one of many different units that fit into the TM-500 series of instrument mainframes developed by Tektronix.



This DMM, Model UGD 51, from Rohde & Schwarz measures ac/dc volts and ohms. It delivers very high accuracy readings with its maximum count of  $\pm 30,000$ .

as a counter and signal generator plug-in and the three-wide mainframe—the cost per unit for the power supply drops to \$50. The cost is now \$545—reasonable for a good 4-1/2 digit unit.

Another systems approach—that in the HP 3470—uses a snap-on, instead of plug-in, arrangement. The 3470 is separated into two sections: The upper section consists of a 4-1/2 (standard) or a 5-1/2 (optional) digit display, while the lower contains the measuring function—either a voltmeter, multimeter, counter or other device. The 30-day accuracy for the multimeter combination with the 5-1/2 digit display is given as 0.25% of reading  $\pm 0.05\%$  of range, and the price is about \$700.

### DMM versatility is increasing

Versatility is easy to find in DMMs. You can buy them with frequency, temperature or capacitance measurement options, or you can snap on what you need, as with the HP 3470.

Hickok of Cleveland, Valhalla Scientific of San Diego and California Instruments of San Diego, Calif., offer DMMs that double as frequency counters. Systron-Donner of Concord, Calif., has the Versatester—a digital multimeter that doubles as a frequency counter and as a sine, square wave and pulse generator. The unit also has several built-in power supplies for testing TTL or MOS circuits. The price for this electronic "octopus" is over \$1200.

Another versatile unit is the Model 20 DMM from Data Technology of Santa Ana, Calif. The unit measures capacitance, ac/dc volts and ohms. It also offers a 3-1/2 digit Sperry display and costs a low \$269.

Other interesting features available in other DMMs are four-wire resistance measurements, ratiometric voltage measurements and auto-zeroing of the inputs.

#### Like to build them yourself?

Do-it-yourselfers have a wide choice. Heathkit of Benton Harbor, Mich., probably the best-known kit manufacturer, has two units—the IM-102 and the IM-1202. The 102, which sells for less than \$250, is a full 3-1/2 digit DMM kit with 26 ranges of ac/dc volts, ac/dc current and ohms. If you're economy-minded, you might pick the 1202—a 2-1/2 digit DMM with 21 ranges for less than \$100.

Nobex of Burlingame, Calif., has the Model 8700K. This kit has 12 ranges, a 3-1/2 digit display and costs less than \$150. MITS, Inc., of Albuquerque, N.M., sells a 2-1/2 digit kit—the DVM 1600—offering ac/dc volts, ac/dc current and ohms, and accuracy of 0.1% on dc and 1% for the other scales. Added features are auto-polarity and 100% overranging. The price for the kit is \$89.

Edwards Electronics of Glen Ellyn, Ill., manufactures the Series 89—3-1/2 digit, DMM kits that measure capacitance, ac/dc volts, dc current and ohms. The 89K sells for \$100 and the 89FK offers frequency measuring capability for \$10 more. Or you can buy the unit fully assembled with or without the counter, for \$200 and \$170, respectively.

#### Computers speeding measurements

DMMs that can be computer-controlled form the heart of many instrumentation and calibration systems. For instance, Fluke of Seattle has several systems-oriented units in its DMM 8300 series. Various versions offer three-pole active switchable filters with a 60-Hz notch, a patented a/d conversion scheme that uses a recirculating remainder, auto-ranging, auto-polarity and 10,000-hour MTBFs. The basic version costs



The Keithley 616 electrometer is one of the new breed of specialized digital measuring instruments. It can measure currents down to 20 pA.



Data Technology's Model 20 DMM measures capacitance along with ac/dc volts and ohms. Its 3-1/2 digit Sperry display gives a clear, precise reading.

about \$1200, which may seem steep for a 5-1/2 digit display and three ranges of dc volts. However, 40 full 5-1/2 digit readings can be taken each second for high-accuracy, high-speed tests.

Dana of Irvine, Calif., markets a 5-1/2 digit DMM that reads true rms ac, dc volts and ohms. The unit costs several thousand dollars, but it offers computer compatibility. And Julie Research Labs of New York City has the DM-1000 series—high-accuracy DMMs that are intended for automated testing and calibration. They have a maximum count of 1,199,999 and a price of \$5500 or more, depending on the model.

Computer control offers important advantages for system testing: The range and scale switching can be done in microseconds—a saving in time and an increase in throughput.

#### Specialized meters? You name them

Specialized digital instruments are available for ultra-precise measurements in applications where analog instruments can't do the job. Many





Boonton's Model 42BD digital microwattmeter uses a balanced diode detector to measure rf energy over a 200 kHz to 18 GHz bandwidth.

companies have or are developing electrometers, nanovoltmeters, rf voltmeters, megohmmeters, wattmeters and phase-angle meters.

Keithley, for example, has the Model 616 electrometer. Along with a 3-1/2 digit display, it has an input resistance of greater than  $2 \times 10^{14} \Omega$  and measures currents as low as  $10^{-11} \text{ A}$  with an accuracy of better than 5%. The price is \$995.

The same company's Model 180 nanovoltmeter has a 4-1/2 digit readout and delivers resolution down to 10 nV/digit. Built-in auto-ranging and remote programmability are included in the \$1995 price. Options include a BCD output.

ITT Jennings of San Jose, Calif., has just announced its Minimeg 15100. This is a 3-1/2 digit megohmmeter that can measure to a maximum of 2000 M $\Omega$  with an accuracy of 2% of reading  $\pm 1$  digit. The unit also includes a 0-to-200- $\Omega$  range for continuity testing. The price of the Minimeg is \$495.

Boonton Electronics of Parsippany, N.J., has an rf microwattmeter, the Model 42AD. It provides a dual readout—a 3-1/2 digit display for power and an analog edge-reading meter for dBm. The frequency range covered is wide—200 kHz to 1 GHz—and options include auto-ranging and a digital readout for the dBm levels. Also available from Boonton is the Model 92AD rf millivoltmeter, which spans a voltage range of 100  $\mu\text{V}$  to 3 V and covers frequencies of 10 kHz to 1.2 GHz. Both the 42AD and 92AD sell for about \$1000 before options are added.

Clarke-Hess of New York City has a wide-band 3-1/2 digit wattmeter, the Model 235. Accuracy is 1% over a range of 2 W to 20 kW full

scale and a frequency span of 20 Hz to 20 kHz. The unit costs about \$2500.

ISC Magnetics of Huntington, N.Y., makes a 3-1/2 digit gaussmeter, the Model D. This unit covers a 1 milligauss to 10 kG full scale range with options available up to 40 kG. The probe on this unit also offers options that let it withstand temperature down to 4.2 K ( $-268.8 \text{ C}$ ). Prices for the Model D start at about \$1000. The workhorse unit is the Model A—an analog Hall effect meter that measures from 0 to 20 kG, depending upon model. Prices for this unit start at \$235. Both units include built-in magnetic reference sources.

Dranetz Engineering Labs of Plainfield, N.J., has a digital phase meter, the Model 305 C. It can display phase angles to an accuracy of 0.01 degree and offers BCD-coded outputs. Prices for this high-resolution unit start at about \$2700, less options.

Also in the phase-angle meter business is Thomson Engineering Co. of Berwyn, Pa. Its Model 117 resolves to 0.1 degree, but does it with all-digital circuitry. The cost is about \$800.

#### Panel meters go digital, too

Digital panel meters (DPMs) are fast approaching the versatility of analog meters. And most companies are also working to reduce the complexity of the DPM's measuring circuits. They are experimenting with the one and two-chip LSI sets that IC manufacturers are developing. The use of these chips should increase reliability and reduce DPM size.

The basic DPM is a single-function/single-scale meter that needs zeroing and calibration. Designers have changed it into an instrument that can auto-range and auto-zero itself.

The Datel Model DM-2000AR is the industry's first auto-ranging DPM, spanning three decades from 200 mV to 20 V full scale. Its accuracy is a high 0.1%. The Canton, Mass., company's 3-1/2 digit instrument sells for \$149.

Today's DPMs also incorporate upper and lower set points. LFE Corp. of Waltham, Mass., offers such a unit. Its Model 4350-K is a 2-1/2 digit DPM with 0.5% accuracy and presettable upper and lower limits. LED indicators show when the limits have been exceeded. Also included is an active filter on the input and fail-safe form C contacts for the output. The dual-set-point meter is available in four voltage and five current ranges at a base price of \$195.

Non-Linear Systems of Del Mar, Calif., recently introduced one of the smallest DPMs around—the PM-4, a four-digit LED panel meter that is less than 1 inch high, 3 inches wide and just

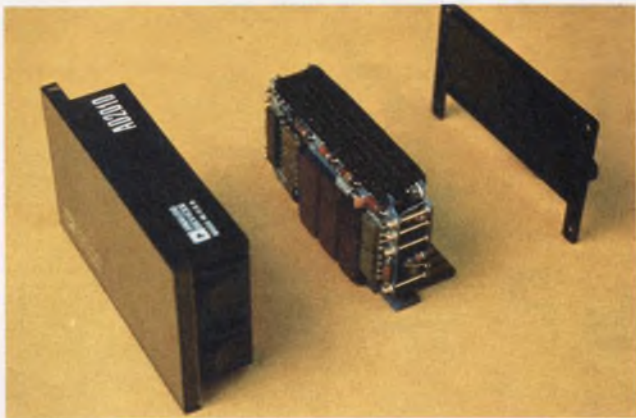

The Model 2010, 3-1/2 digit DPM, from Analog Devices, is one of the thinnest units available. It accepts bipolar inputs and delivers a latched BCD output.

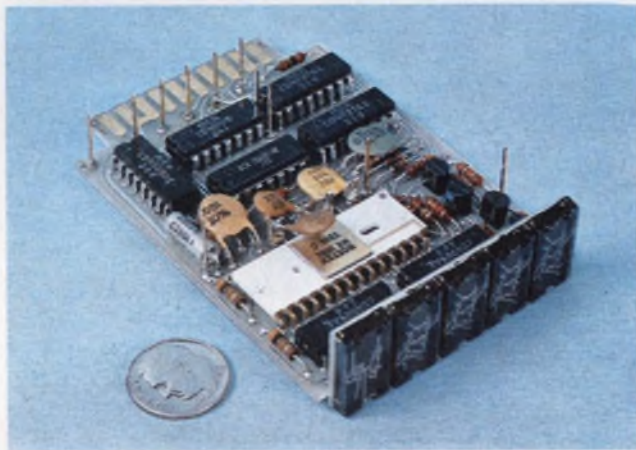

Non-Linear Systems' PM-4 four-digit DPM is one of the smallest units on the market. Its worst-case accuracy is 0.02% of reading +0.01% of full scale.

slightly over 3 inches deep. Accuracy is a high 0.02% of reading  $\pm 0.01\%$  of full scale +1 digit. The power requirement is 0.5 W at 5 V dc. The unit has auto-zeroing and auto-polarity as standard features. Options include 10- $\mu$ V resolution, 110-V ac line operation, BCD output and dc/dc ratio measurements.

Velonex of Santa Clara, Calif., also has tiny DPMs—with displays ranging from 3 to 4-1/2 digits. The Series 45 units have an over-all length of about 3 inches, width of less than 2.5 inches and height of about 3/4 of an inch. They have LED readouts and weigh less than 3.5 oz. The 4-1/2 digit model sells for \$225, but carries a three-year warranty.

One of the most inexpensive DPMs around is the \$89 AD2002 made by Analog Devices Corp. of Norwood, Mass. The 2-1/2 digit unit comes with a Numitron display. The DPM accepts only unipolar signals, runs off a 5-V dc power bus and delivers an unlatched BCD signal.

Going from low resolution and cost to the high-resolution domain, Analog Devices makes the AD2004—a 4-1/2 digit DPM that accepts either differential or bipolar signals and delivers a latched BCD signal. The price is \$299.

Tops in DPM resolution is the Series 3000 unit from Data Precision. It provides a 5-1/2 digit readout and is designed for single-range applications where resolution down to 1  $\mu$ V is needed. Its accuracy is 0.001% of full scale, and the DPM not only auto-zeros the input during each conversion cycle but also includes auto-polarity as standard features. Essentially a stripped-down multimeter, this DPM costs about \$645.

Newport Laboratories of Santa Ana, Calif., claims its 3-1/2 digit DPMs give the best resolution for the lowest cost. The Models 253 and 256 offer 10- $\mu$ V resolution and a choice of display: LED (\$115) or Sperry (\$120), respectively. The scale and the function (volts or current) are set by selecting a 16-pin, plug-in cordwood module that fits a socket inside the DPM. This lets one DPM serve a multitude of uses, and once the basic unit has finished its job, it can be removed and used somewhere else. The plug-in module contains all the R's and C's needed to change the scale and to convert the DPM from a current to a voltage-measuring instrument or vice-versa.

### Analogs are trying harder

Analog panel meters? Design advances—such as LED/photocell pairs for set-point switching, and moving coil movements where the coil is actually a printed-circuit card—are keeping them alive and well. Some manufacturers even feel that there is no direct competition between DPMs and their analog panel-meter counterparts.

Since the analogs don't require an extra power source, there are still many places where they reign supreme—in portable equipment, for example. In addition the need for a general position or trend indication rather than an exact numerical readout will, in some applications, exclude the use of digital equipment—especially in quick-decision applications. Needle positions on banks of meters can be compared faster than numbers on banks of numerical readouts.

DPMs of the future offer a lot. Electronic thermometers, scales, sound level meters and many new environmentally oriented types of test equipment are essentially specialized DPMs. The major difference between these newer types of instruments and those already discussed is that they contain extra circuitry to match, amplify and linearize signals from sensors and transducers. ■■

# Measuring flow rates, draw ratio, rpm, rates, totals, speeds or time periods?

The DigiTec Model 810 Digital Process Indicator can be used to measure an infinite variety of parameters through the use of state of the art design.



Featuring programmable normalization for direct reading in engineering units, the 810 uses an internal crystal clock for precise, measurement.

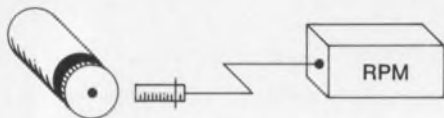

Available in models with 3, 4 or 5 digit non-blinking, LED displays, they have a basic input sensitivity of 10mV RMS for use with the outputs of magnetic pickups, photo cells, shaft encoders or any other pulse generating transducers.



1.89"H x 4.39"W x 4.50"D

The 810 has an input frequency range beyond 100KHz.

Although sensitive, the input can withstand up to 500V peak to peak without damage.

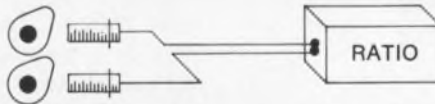

Once programmed for normalization and input sensitivity (both on a rear connector) the Model 810 Indicator becomes a "Hands off" readout, usable by non-technical personnel.

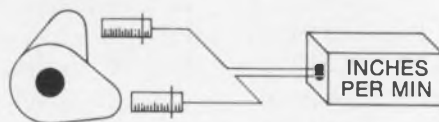

Optional stored BCD output for use with limit detector, recording peripherals and computer interface is also available.

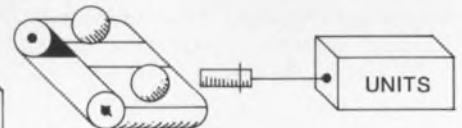

To see a DigiTec Model 810 Digital Process Indicator and obtain quantity prices, contact your nearest DigiTec or Monsanto Representative or write United Systems Corporation.

**Prices start at \$234.**

**United Systems Corporation**  
918 Woodley Road, Dayton, Ohio 45403  
Ph. (513) 254-6251 Twx: (810) 459-1728  
a subsidiary of

**Monsanto**



If you need  
a tester  
with **special**  
scales, ranges,  
accessories  
or any  
combination...

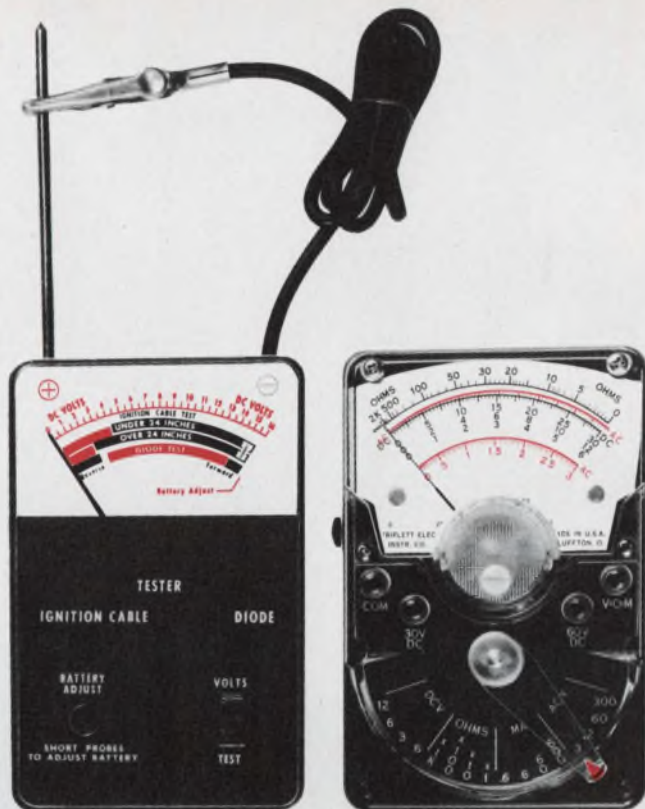

A

B

Buy a  
**Triplet** tester  
custom-designed  
for you



C

Triplet, manufacturer of the World's most complete line of V-O-M's, is ready, willing and able to design and manufacture special testers of virtually any size, style or type to meet your specifications.

Tester A (above) was designed to give auto mechanics a simple, rugged tester for "go/no go" tests that would otherwise be measured in electrical units unfamiliar to them.

Tester B is a modification of a

standard Triplet tester incorporating only the specific ranges needed by the field service engineers for whom it was designed. Tester C has special ranges and special input connectors and cables to permit a single-point connection for trouble-shooting and servicing all the circuits of a complex business machine.

Several other buyers of standard Triplet test equipment request their company name on the dial to personalize their testers.

If you think a custom tester may solve some problems for you, contact your Triplet representative. He'll put you in touch with the Tester Designers and Engineers at Triplet who'll help you analyze the problem and suggest the optimum cost/result solution. Triplet Corporation, Bluffton, Ohio 45817

**TRIPLET**  
BLUFFTON, OHIO 45817

Manufacturers of the World's  
most complete line of V-O-M's

INFORMATION RETRIEVAL NUMBER 55



# Piher components are going places

**W**ith our exports hitting an all time high in the first quarter of 1973—particularly carbon film resistors and trimming potentiometers—we can rightly claim that our products are going places. They are going to every country in the world where the name Piher is synonymous with product excellence in the highly competitive component business.

It takes much more than a slick sales machine to build up one of Europe's biggest component companies. It takes total dedication to one end—ensuring that every customer knows that the Piher label stands for technical excellence.

And it does.

That's the major reason why we have grown to nearly 4,000 employees in six major plants achieving a \$50m annual turnover.

We design all our own production machines to ensure quality and reliability. We have no licence agreements, no sub-contract working. From start to finish we are in control of every product that goes out to a customer. And we have a lot of customers.

We produce 8 million carbon film resistors *a day* to meet world demand—and we have the largest variety of quality preformed resistors available anywhere.

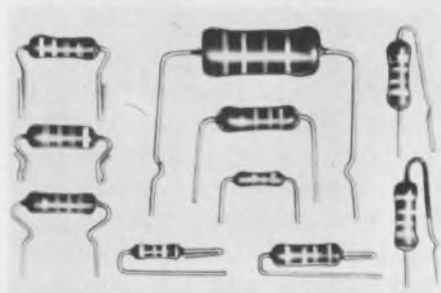

*Piher output of carbon film resistors is a staggering 8 million a day.*

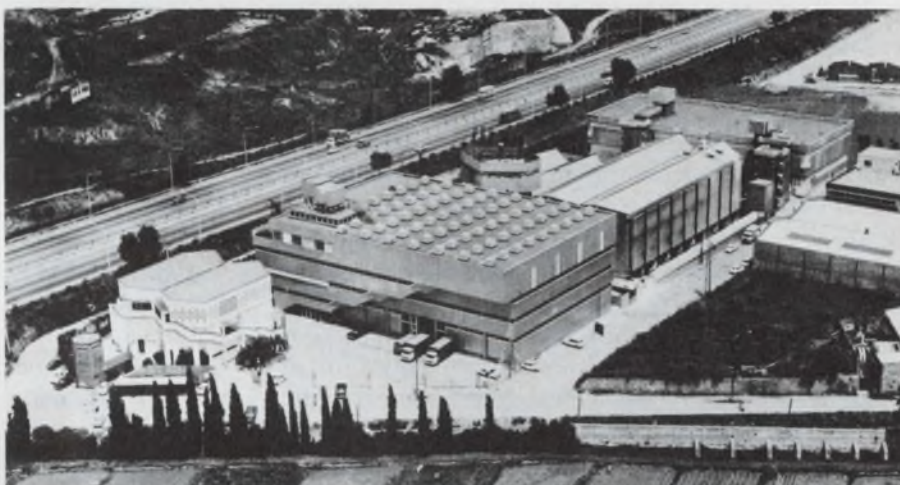

*Headquarters of Piher International in Barcelona. The company employs nearly 4,000 people in six major manufacturing centres throughout Spain.*

We also provide the best range of quality, low-cost encapsulated trimmer pots—also slider and rotary versions—for every type of application, custom built to specific requirements where the need arises.

And that's only the beginning.

Our small signal and medium power transistor range is growing fast.

Our ferrites are in the forefront of magnetic ceramic technology.

And we have just laid down the most modern ceramic capacitor line in Europe.

Apart from our six manufacturing centres we have a world-wide distribution network backed by five Piher companies in the USA, Germany, Great Britain, France and Italy. They are only a 'phone call away if you need details on the best components in the business.

Or write to us for data sheets on the product area you are interested in.

Find out more about us. It pays.

*U.K.*—Piher International Ltd., Romar House, The Causeway, Staines, Middlesex, England.  
Tel: Staines 56157. Telex 934167

*U.S.A.*—Piher International Corp. 1239 Rand Road, Des Plaines, Illinois 60016, U.S.A.  
Tel: 312-297 1560. Telex 282154

*Germany*—Piher International GmbH, 85 Nuremberg, Westtorgraben, 5. Germany.  
Tel: 0911 260 469. Telex 623354

*France*—Piher International SARL, 83 Rue Etienne Dolet, 94230, Cachan, France.  
Tel: 656 26 07. Telex 27107

*Italy*—Piher International S.P.A. Via Cenisio 34, 20154 Milan, Italy.  
Tel: 314532/316213

*Head Office*—Riera Cañado, s/n Apartado de Correos 53 Badalona (Barcelona) Spain.  
Tel: 389 03 00. Telex 59521



# For versatility and wide choice, try the bargain counters

**E**lectronic counters may be today's biggest bargain in test instruments.

They have traditionally been the fastest, most accurate and simplest devices for measuring frequency. Now the huge potential market has created stiff competition among the 50 or so manufacturers in the field, and the new instruments are more sensitive, have more digits, count faster and are more automatic than ever before. Prices have been dropping, too, making today's counters a better all-around value for the dollar.

To a large extent, the design improvements have been made possible by advances in component technology. Inside the new electronic counters arrays of MOS/LSI circuits; high-speed bipolar ICs; read-only memories and thin-film hybrid circuits. In 1952 the best counter on the market had 75 vacuum tubes; today not only are conventional components being replaced, but the capabilities of the new circuits are also being exploited. With the newer components, a design engineer can easily add features to counters that would have been prohibitively expensive before.

Choice of instruments? Take your pick from the basic frequency-only counter, the universal counter-timer, the plug-in, the microwave frequency counter and units that provide BCD output and can be programmed externally.

## The frequency-only counter

Many users want a basic frequency-only counter which will accurately measure up to 500 MHz at low cost. They are used to measure the frequency and stability of oscillators, multiplier chains and transmitter outputs. Such a basic counter can replace a number of traditional frequency-measuring techniques, such as Lissajous

patterns on a scope, wavemeters and heterodyne-frequency meters. Compared with most other methods, the counter is faster, more accurate, less error-prone and takes less equipment.

The prices of basic frequency counters range from \$225 to \$1500 or more, depending on the frequency range, resolution and accuracy of the time-base oscillator. The lowest-priced units count up to 15, 30, 50 or 80 MHz, have a relatively simple oscillator and a minimum of operational controls and options.

One of the lowest-priced units is the \$225 Heath/Schlumberger SM-118A. It is auto-ranging, counts up to 30 MHz, has a six-digit LED display and is available with an external pre-scaler that permits counting to as high as 600 MHz. Another low-priced unit is the Model 730 from Newport Laboratories, Santa Ana, Calif. It's priced at \$299. In addition to counting up to 50 MHz, this counter also has an accumulate and digital-stopwatch mode.

Above \$300, many counters have optional temperature-compensated crystal oscillators, battery packs or BCD outputs. Two specialized communications counters are made by Systron-Donner, Concord, Calif.—the Models 6251 and 6252, which count to 180 and 512 MHz, respectively. Both feature input overload protection, an rf meter for indicating input signal level and a special multiplier to allow audio counts to be made with 0.001-Hz resolution. Systron-Donner offers five optional time-base oscillators that range up to a \$450 oven-crystal unit.

Another interesting approach to the relatively low-priced counter comes from Hewlett-Packard in Santa Clara, Calif.—the Model 5300. The measurement system consists of a \$395 main-frame that rides piggyback on a variety of counter modules. The modules range from a 10-MHz counter for \$145 to a 525-MHz counter for \$800. The line includes a 10-MHz counter/digital multimeter and an optional battery pack

and BCD output.

Other manufacturers producing frequency-only instruments are Eldorado Electrodata, Anadex Instruments, Monsanto, John Fluke, and Berkeley Instruments.

### Universals—flexible with many options

Beyond the basic frequency-only counter there is the universal counter-timer. In addition to counting frequency accurately, typical instruments provide such measurements as period, frequency ratio, time interval and, sometimes, burst frequency, pulse width, pulse separation and elapsed time. Typically their front panels contain such controls as attenuators, trigger level and positive or negative slope triggering.

As Thomas E. Nawalinski, advertising manager of Hewlett-Packard, Santa Clara, Calif., explains: "Different manufacturers have different definitions of what constitutes a universal instrument. Some are dc-coupled, some ac-coupled—a very important factor for some uses. The purchaser of such an instrument has to shop very carefully, since if a function is missing which he needs later, there is usually no way to add it."

In general the frequency capability of a universal counter-timer is from 40 to 550 MHz, and most have several accurate time-base oscillator options.

Monsanto's Model 100C is imported from Israel. Distributed by United Systems Corp., Dayton, Ohio, the basic universal instrument sells for \$565. It is ac-coupled, counting from 5 to 50 MHz and measures period, period average, ratio and time interval. It is normally equipped with a six-digit display, but is available with seven—and, as the Model 101C, it is equipped with

binary-coded decimal output.

John Fluke Manufacturing Co., Seattle, manufactures the Model 1952A, which operates from dc to 80 MHz and has a plug-in prescaler for up to 515 MHz. It has selectable ac or dc coupling, an optional temperature-compensated crystal oscillator and optional BCD output. The unit sells for \$695, the oscillator costs \$185 and the prescaler \$300 more.

The Model 700 from Newport Laboratories offers most of the universal functions and, for a total of \$1370 for instrument and prescaler, will count up to a gigahertz. Perhaps the most flexible series of universal counter-timers is the Systron-Donner 6150 line. The basic unit is the Model 6150, which sells for \$1195. It's a 50-MHz unit that can be expanded by adding plug-in boards to 200, 515 MHz or 3 GHz. With the whole array of boards, it becomes the Model 6158 and costs \$2995. The 3-GHz range is provided by an automatic transfer oscillator. Options for the line include one or two additional digits (seven is standard), digital outputs, remote programming, analog trigger level control and a choice of four time-base oscillators, including both temperature-compensated and oven-crystal units.

### Plug-in counters: 'Everything to everybody'

The plug-in counter is still around, and traditionally its role is to try to be "everything to everybody." The traditional unit consists of a mainframe—a 50 or 150-MHz counter—that accepts a variety of plug-in front ends, consisting of heterodyne converters or transfer oscillators for measuring frequencies through 18 or 40 GHz, time-interval modules, prescalers and the like. In



100-MHz counter-timer from Newport Laboratories offers prescalers for 512 MHz and 1 GHz. Other features

include BCD output and period, interval, ratio and stop-watch modes. It sells for \$1370.





This 512-MHz communications counter from Systron-Donner has overload protection, rf meter and a multiplier for making audio measurements to 50 Hz.

In addition such units have precision time-base oscillator options and can provide various output frequencies from the time-base oscillator. These are basically laboratory instruments, since they are large and, when several plug-ins are added, can become expensive.

One design engineer from a company that makes the traditional plug-in counter says: "The concept of the plug-in counter is over a decade old and getting obsolete for most uses. The normal counting functions of the mainframe can be provided by a smaller, less expensive dedicated counter, and most of the microwave measurements are done as well or better by an automatic counter. Very few customers need the overall flexibility and are willing to pay the price."

There is still a market for the plug-in counter for laboratory work that needs the total capability and for some microwave measurements that cannot be made with an automatic counter.

The traditional plug-in counter is typified by the Hewlett-Packard 5245 series, which consists of three mainframes and 12 plug-in modules. The dc-to-150-MHz Model 5248L mainframe costs \$3100 and provides frequency, period and period averaging. It has an eight-digit readout, and the time base can provide output frequencies in decade steps from 0.1 Hz to 10 MHz. It will accept 512-MHz and 3, 12.4 and 18-GHz manual heterodyne converters, an 18-GHz manual transfer oscillator and a digital voltmeter, a time-interval unit, a video amplifier, prescalers and a preset counter. The Systron-Donner 1000 series plug-in counters are similar but include a 15-to-

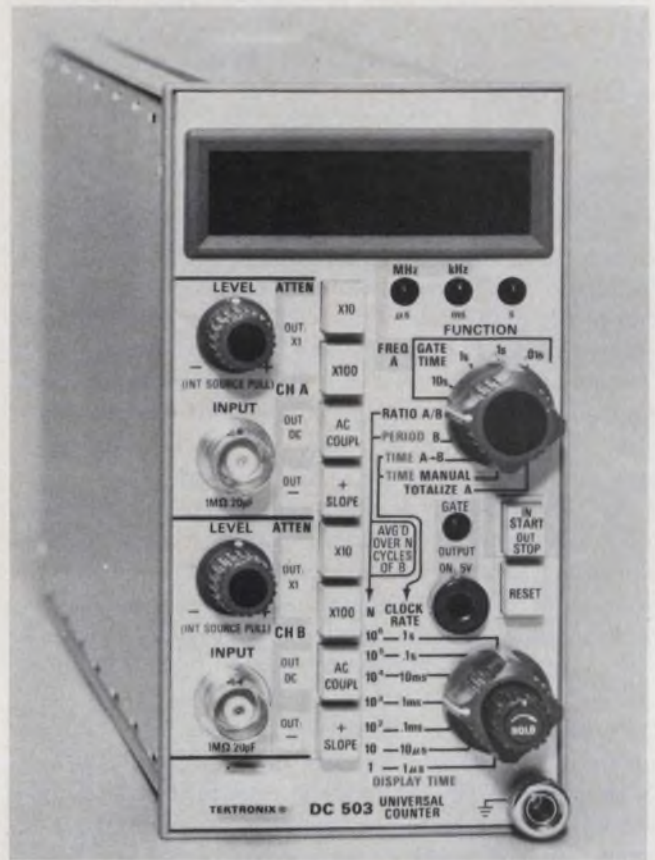

This 100-MHz universal counter-timer is part of the Tektronix TM-500 modular test equipment system which also includes 10-Hz to 550-MHz counter totalizers.

40-GHz transfer oscillator, several automatic transfer oscillators and a choice of four time-base oscillators.

Another instrument system that can be classed as plug-in, but is radically different in concept from the traditional unit, is the TM 500 series from Tektronix. The mainframes have integral power supplies and connectors to take either one, three or more modules. The system reduces the cost of certain instruments by eliminating the individual power supplies and making it possible for the user to fashion a custom test setup by combining modules on the triple mainframe assembly. The modules look very much like oscilloscope plug-ins, which is logical considering the background of the manufacturer. The electronic counters included in the series are a 10-Hz-to-110-MHz counter/totalizer, and a 100-MHz universal counter. The TM 500 series also includes plug-in power supplies, signal processors, signal sources, DMMs and three monitor scopes.

#### Microwave counters—fast and automatic

For those users interested in counting up to 18 GHz a variety of units are available, ranging in price from a 12.4-GHz counter selling for



EIP's Model 351C automatic frequency counter directly reads frequencies through 18 GHz. It provides 1-Hz

resolution at 1 reading per second. The unit is priced at \$5100.

about \$3700 to an 18-GHz instrument priced at about \$5400. None of the automatic microwave counters requires any extensive calculations, tuning or interpolations, which makes it extremely desirable for microwave-measuring applications where the need for accuracy and time savings justify the steep initial cost.

There are two basic approaches to automatic microwave measurements—the automatic heterodyne oscillator and the automatic transfer oscillator.

A heterodyne unit mixes the unknown frequency with a harmonic of a local oscillator to produce a difference frequency. The harmonic being applied to the mixer is increased until the difference frequency falls within the range of a conventional counter circuit. Then, by electronic addition of the measured frequency to the harmonic number, a direct readout of the frequency is produced.

The automatic transfer oscillator works by adjusting the frequency of the local oscillator until one of its harmonics can be phase-locked with the unknown frequency. Then the frequency of the local oscillator and the harmonic number are combined to produce a direct frequency readout.

There are inherent advantages to each system. The heterodyne converter usually provides the highest resolution and accuracy, can handle FM on the input signal and, when combined with a suitable counter, is capable of pulsed rf measurements. The transfer oscillator technique usually is more sensitive, and with manual techniques, the user can measure FM deviation and AM modulation products.

Counters using automatic heterodyne techniques are produced by EIP of Santa Clara, Calif., and Eldorado Electrodata of Concord,

Calif. The EIP models are the 350C and 351C, which cover 20 Hz to 12.4 and 18 GHz and sell for \$4500 and \$5100, respectively. The Eldorado models are the 988 and 989, covering the same ranges and selling for \$3675 and \$4175, respectively.

Automatic transfer-oscillator units include the Hewlett-Packard 5340A, which reads 10 Hz to 18 GHz and sells for \$5300, and the Systron-Donner 6057, selling for \$5450 and covering 20 Hz to 18 GHz. Each unit is available with high-accuracy time-base oscillators and a number of other options.

### Counters and computers

A growing number of electronic counters are being interfaced to small computers to provide a BCD output of measured data. A few counters can be programmed externally. In the simplest application a digital output allows a counter to be interfaced with a printer or data-storage device for later analysis of the recorded information.

In 1969, HP introduced its 5360 computing counter system—a mainframe counter with built-in arithmetic capabilities. It will accept front-end plug-ins, including a time-interval unit and heterodyne converters operating at 18 GHz. With its computing capability and the addition of a keyboard to allow programming of the instrument—and in some cases when combined with other test gear—the 5360 can measure the peak-to-peak deviation of an FM transmitter, phase angle, modulation index and oscillator warm-up characteristics.

With the availability of microprocessor chips and a number of inexpensive minicomputers, other manufacturers are expected to enter the computing counter business. ■■

**Two new autoranging  
110 MHz counters**

Introducing the new Heath/Schlumberger SM-128A and SM-128B... a pair of very high performance counters at very reasonable prices. The 128s deliver guaranteed performance to 110 MHz with 15 mV sensitivity. Typical performance is even better: 140 MHz at 2-10 mV sensitivity. A front panel sensitivity control allows you to adjust the input amplifier trigger level both above and below the zero-crossing point... a very handy feature to help minimize the effect of noise on the signal. Two preset gate intervals of 1

second and 10 milliseconds are switch-selectable... or use the autoranging function, which automatically determines the correct range for maximum resolution without overranging. Two time-base versions are available: the SM-128A uses a standard clock stable to  $\pm 10$  ppm over 0-40° C. For applications requiring very high precision, choose the SM-128B, with temperature stability of  $\pm 1$  ppm. Additional features of both versions include 7-digit LED readout with leading zero blanking... high impedance 1 megohm/15 pf input for minimum circuit loading... external time base oscillator input for very high accuracy measurements or frequency ratio work... dual primary power supply... rugged, compact design.

Find out all the details on the new 128s and the rest of our counter line. Use the coupon to get your FREE Heath/Schlumberger catalog.

Factory assembled & calibrated  
SM-128A,  
standard timebase,  
10 lbs... \$325.00\*

Factory assembled & calibrated  
SM-128B,  
high stability  
timebase,  
10 lbs... \$395.00\*

**The new SR-255B...  
the industry's most  
extraordinary value  
in a strip chart recorder**

Compare the SR-255B against the others. While other recorders in this price range provide only one input span, the 255B gives you pushbutton selection of four: 10 mV, 100 mV, 1 V & 10 V. Plus a built-in Variable span capability to allow expansion to 100 V FS. Other manufacturers are shouting about a "new concept"... the digitally-driven stepper motor chart drive. We pioneered this idea years ago, and it eliminates the backlash and adjustment problems of mechanical systems. The 255B provides switch-selection of 10 speeds: 10, 5, 2, 1, 0.5, 0.2, 0.1, 0.05, 0.02 and 0.01 inches or centimeters per minute. The high impedance floating input provides better than  $10^7$  ohms input impedance with less than 10 nA bias current on 10 mV, 100 mV and 100 V ranges. Impedance on the 10 V range is 1 megohm. Switchable input filtering enhances the recorder's ability to reject line frequency noise by 20 dB in both normal and common mode. Complete remote control capability by TTL signals is standard. Other standard features include easy conversion to metric system work... easy paper loading... electric pen lift... pushbutton chart advance... rackmount design.

To get complete details on our complete line of strip chart recorders, use the coupon now.

Factory assembled & calibrated  
SR-255B, 20 lbs. .... \$335.00\*

**Three new  
high performance,  
low cost design  
instruments from  
Heath/Schlumberger**

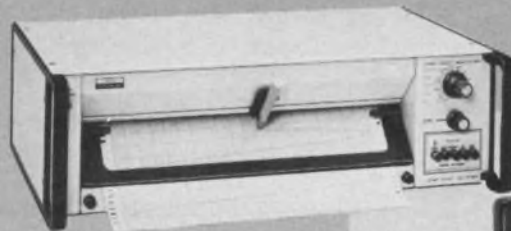

SR-255B 10" recorder, \$335\*

SM-128A 110 MHz counter, \$325\*



Get your FREE copy of the latest Heath/Schlumberger Electronic Instruments catalog. Use coupon now!



HEATH	
Schlumberger	
Heath/Schlumberger Instruments Dept. 531-261 Benton Harbor, Michigan 49022	
<input type="checkbox"/> Please send latest Electronic Instruments catalog	
Name _____	
Title _____	
Company/Institution _____	
Address _____	
City _____	State _____ Zip _____
*Mail order prices; FOB factory EK-401R	

# The most versatile switches we make are assembled by you.



It all starts with your design problem. You can solve it with the right combination of switch module and lighted (Series 2) or unlighted (Series 6) operator.

Since we have thousands of combinations in circuitry and color display, matching your specifications is simple.

For example, we offer 1, 2, 3 or 4-pole double-throw, twin-break contact arrangements, hermetically-sealed basics, low-energy and heavy-duty ratings, momentary and alternate action, solder, screw or quick-connect terminals, as well as many other variations.

In a word: variety. The kind that lets you design without being influenced by some switch that's only close to your needs.

Best of all, these combinations can be assembled in seconds without special tools.

For more information, contact your MICRO SWITCH Branch Office or Authorized Distributor (Yellow Pages, "Switches, Electric"). They'll prove their versatility by helping solve any switch problem you have.

**MICRO SWITCH**  
makes your ideas work.

**MICRO SWITCH**  
FREEPORT ILLINOIS 61032  
A DIVISION OF HONEYWELL



MICRO SWITCH products are available worldwide through Honeywell International.

INFORMATION RETRIEVAL NUMBER 59

## "Our Real Time Spectrum Analyzers were a good buy at \$7,900."

"During the past year our merger with Honeywell has produced exciting results — results that we are now able to pass on to you in the form of significant savings — with no sacrifice in capability or performance.

"We are now able to offer our Model 51B Real Time Analyzer at \$5,000. This is the same Model 51B — providing the exact same performance — that we were selling earlier this year for \$7,900. And it's the same Model 51B we'll be selling next year and the year after that.

"How are we able to offer such a price reduction at a time when most prices are going up? Well, we've always

known how to produce a superior real time analyzer. But Honeywell's automation expertise and quantity purchasing power coupled with increased volume has enabled us to reduce production costs to a point where we can pass on the savings to you.

"Just to refresh your memory, the 200-line Saicor 51B Real Time Analyzer/Digital Integrator offers built-in spectrum averaging and linear, peak hold and exponential averaging modes. It has dc to 50 kHz time compression operation (with 10 overlapping

frequency ranges). The 51B is portable, compact and completely self-contained.

"Incidentally, if your requirements justify a 400-line analyzer, we're offering similar savings on our Model 52B.

"Just call or write us today for a no-obligation demonstration. You'll find our service is as outstanding as our product and its price."

## Honeywell

Signal Analysis Operation  
Test Instruments Division  
595 Old Willets Path  
Hauppauge, New York 11787  
(516) 234-5700

# "At \$5,000 they're the best buy!"

— Elliot Levine, manager,  
Honeywell/SAO



CERAMIC  
AIR  
GLASS  
QUARTZ  
PLASTIC

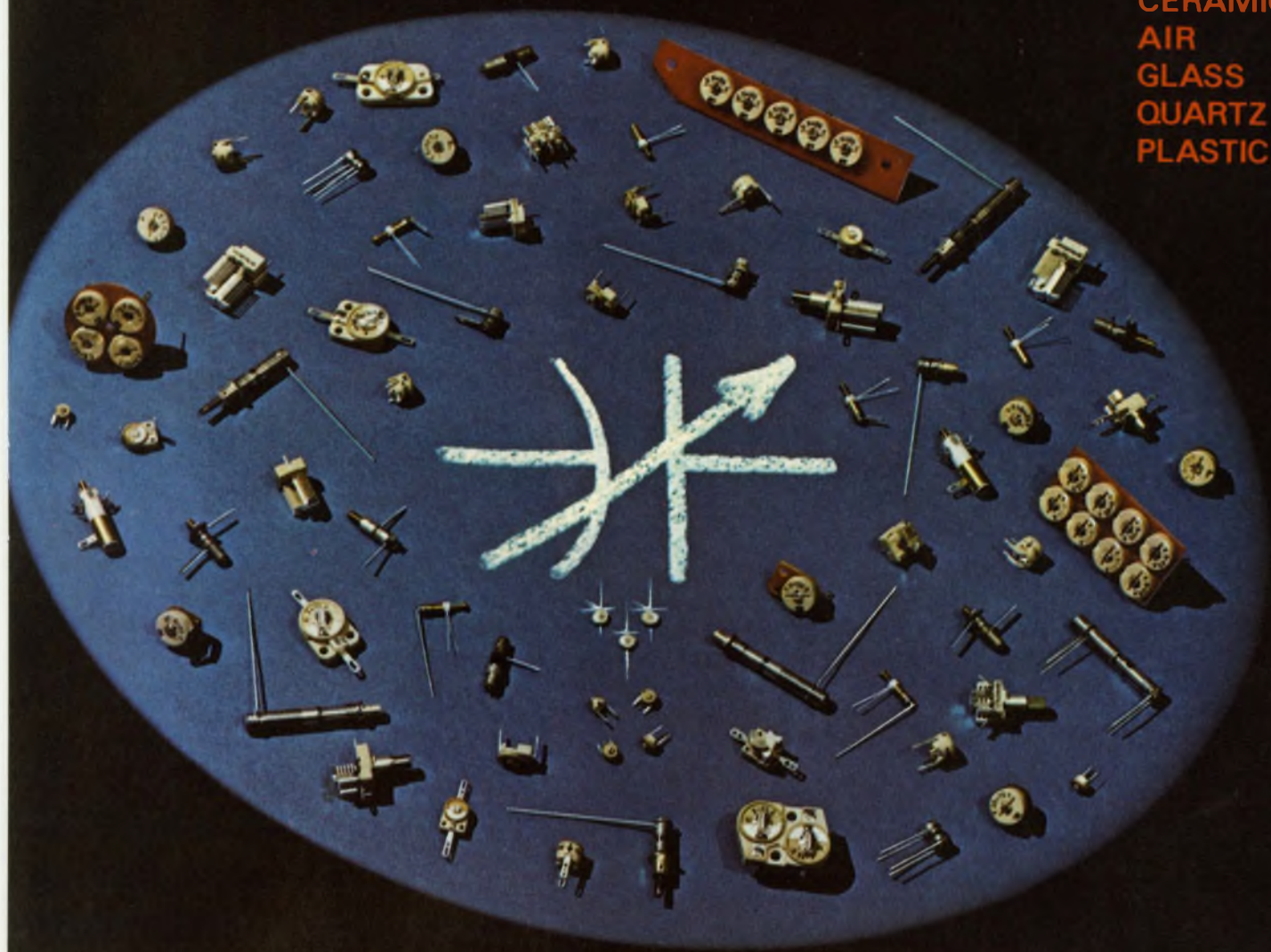

## THE TRIMMER CAPACITOR YOU NEED APPEARS SOMEWHERE IN THIS SPOTLIGHT

**MORE THAN 1,000 VARIATIONS TO CHOOSE  
FROM . . . AND ERIE DELIVERS ON TIME**

When engineering and purchasing people need Trimmer Capacitors, most look to ERIE first. And for good reason. It's easy to find the trimmers they need. The price is right . . . the quality is typically ERIE . . . and they know ERIE delivers on time to meet production schedules.

ERIE Trimmer Capacitors range in size from the tiny new "Vari-Thin" 515 Ceramic Trimmer for quartz watches and other miniature circuits . . . up to a variety of larger sizes and assemblies. Whether you need ceramic, air, glass, quartz or plastic, we have the dielectric, capacitance range and mounting arrangement to meet your requirements. If you have the application . . . ERIE has the Trimmer Capacitor. In the spotlight above, can you find the Trimmer best suited to your current bread-board circuit?

Let ERIE serve as your one-stop source for quality Trimmer Capacitors.

WRITE TODAY FOR OUR  
TRIMMER CAPACITOR  
CATALOG . . . 500  
OR CALL 814/453-5611

ERIE TECHNOLOGICAL PRODUCTS, INC.  
Erie, Pennsylvania 16512

**ERIE**

# The DuMont legacy lives on, reflected in the modern CRT

It has been said that what makes greatness is starting something that lives after you. If that's true, Allen B. DuMont built himself a lasting memorial in 1939 when he improved the cathode-ray picture tube and made the first TV sets for the public. He also developed the CRT for the oscilloscope (then called an oscillograph), and perfected the CRT as the final link in practical radar.

For nearly 50 years before DuMont arrived on the scene, a succession of inventors had struggled with the problem of transmitting a picture. Why did DuMont, who died in 1965, succeed where others had failed?

He was always sure of himself, and he wasn't afraid of being thought an eccentric because he was trying to build a TV picture tube when radio was still a technological wonder, his son, Allen B. DuMont Jr., says today.

"He was a very bright, optimistic person, who had a sense of humor," the son, a business consultant in Upper Montclair, N.J., told *ELECTRONIC DESIGN*. "He also had a broad interest in all the factors that make the world go round, which included knowing all the major league baseball batting averages."

Why did a man with such varied interests choose technology as his career, instead of medicine or law or business?

Allen B. DuMont was born in Brooklyn, and in 1912, when he was 11 years old, he was stricken by polio. His father got him a crystal radio set, and by the time he returned to school, he had studied the principles of radio and had built a receiving and transmitting set. A technologist was born.

In 1928, four years after graduating from Rensselaer Polytechnic Institute in Troy, N.Y.,



Allen, Jr., at age 5, holds his father's first CRT in 1934.

with a degree in electrical engineering, DuMont joined the DeForest Radio Co. in Passaic, N.J. Lee DeForest, inventor of the audion tube, was president, and DuMont became the director of research. He experimented in the field of "sight and sound" broadcasting.

In 1930 the DeForest experimental transmitter, W2XCD in Passaic, broadcast the first American TV program of record. The images were transmitted by a pick-up camera on location, broken up by whirling scanning discs at the transmitting end of the process and then "woven together" at the receiving end. This method pro-

---

Richard L. Turmail  
Associate Editor

duced distorted and unclear televised images. DuMont was convinced by these early tests that the only way to perfect television was to go to electronic scanning with the cathode-ray tube.

"My father was always very outspoken," DuMont Jr. says, "about an industry that kept trying to market products and improvements of products that they really hadn't perfected yet. He was dead set against the mechanical CBS disc-type color television, for example."

DuMont opposed the Columbia Broadcasting System's petition to the Federal Communications Commission in the early 50s "for the establishment of commercial color TV standards." The broadcaster wanted to institute its own sequential method of color television broadcasts. DuMont said that standardization adopted too soon would



An excellent navigator, DuMont spent hours on his boat.

deprive the public of "the ultimate in color TV."

DuMont Jr. says today: "In the hearings, dad had a color set made up with a 21-inch screen using both the electronic system and the mechanical system. To get a 21-inch picture mechanically, a disc about eight feet in diameter was required. I don't think he had to do much more than that to prove to the FCC that that method of color was totally impractical."

DuMont left his position at DeForest in 1931 and started his own company with an investment of \$500. He made \$70 that first year. From the basement of his home to his garage to a series of

stores in Upper Montclair, N.J., his company grew to a 30,000-square-foot plant in Passaic.

DuMont's company associates remember him as a pleasant, round-faced, blue-eyed man who lived a simple life. He dressed haphazardly and usually carried a slide rule in the breast pocket of his jacket. He is also remembered for developing special equipment to speed production and reduce costs, i.e., a high-speed sealing machine, and an automatic grid winding and welding machine.

At its height, Allen B. DuMont Laboratories served as an engineering and development group, a patent-holding company acting as licensors, a production plant for cathode-ray tubes and television transmitters and receivers, and as a television broadcasting system.

By 1951, the company was grossing about \$75-million a year. DuMont once told a graduating class of Rensselaer that the keys to engineering success were: optimism, study, sales-mindedness, aim for responsibility and think well of yourself.

According to his son, DuMont's toughest challenge was the financing of his business.

"Financing was one area he wasn't too well-equipped to handle," DuMont Jr. says. Lacking support from conservative bankers, DuMont was forced to sell 25% of his company stock to a major motion-picture company that also controlled the board of directors.

"They had experience and talent in television production and entertainment programming," DuMont Jr. says, "but they did nothing to promote our network; it appeared to us that their real interest was to hold back TV so that it wouldn't affect the success of the movie business.

"Had my father been a little bolder when they gave him a hard time, things might have been different. But he was basically a very gentle personality, and confrontations would upset him."

DuMont was also a perfectionist. He didn't, for instance, visualize that every TV repairman would like to buy a less-than-perfect oscilloscope for \$200 or \$300. DuMont was making oscilloscopes that sold for \$4000 and \$5000. Tektronix captured the cheaper market when it produced an oscilloscope for around \$700.

"Television evolved pretty much the way he thought it would," says DuMont Jr. "He thought the next step would be the flat TV tube; he also thought that the programs on TV should be upgraded. The length, content and interruptive characteristics of commercials irritated him. His favorite programs were news, sports and current events."

What would DuMont tell engineers today?

DuMont Jr. says: "I think he'd strongly recommend that engineers should work hard to be good in one field, but conserve enough energy and cultivate enough sense of humor to try to understand what else is going on in the world." ■■



yes,  
yes,  
no,  
yes,  
no.

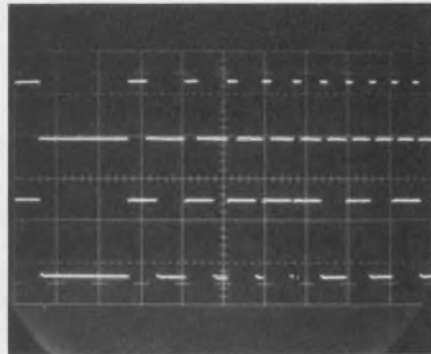

Upper trace: Constant Duty Cycle pulses over a 10:1 frequency range.  
Lower trace: Normal pulses over same range.

"Standard pulses with predetermined width are fine for most requirements, but when I'm changing repetition rates I have to fiddle with the width control to make sure that I don't lose the pulse. Does your 'Constant Duty Cycle' mode let me set width as a percent of pulse period so I can change rep rates *without* tweaking the other controls?" (YES)

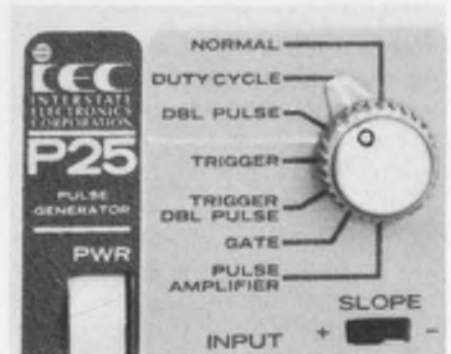

A single control selects all 7 modes

"That Duty Cycle mode could come in handy, but I also want the regular pulses that I'm used to, and double pulses, and 50% squarewaves to 50 MHz. How about trigger, gate, triggered double pulse, and pulse shaping? (And all of these modes better be easy to set!)" (YES)



All components are fully accessible

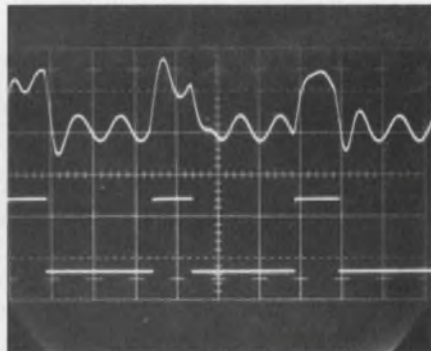

Upper trace: distorted, noisy input.  
Lower trace: pulse generator output (Pulse Amplifier Mode)

"My application calls for pure pulses with a bare minimum of overshoot and squiggles. And I need to clean up distorted signals — you know, send in a crummy pulse train and get out a nice squared-up pulse with the offset, amplitude, and rise/fall times I've set up on the generator. Can do?" (YES)



Four SERIES 20 models are available from \$575

"Your \$1095 P25 Pulse Generator has it all, including simultaneous positive and negative outputs, each with adjustable d-c offset and variable rise/fall times from 5 nanoseconds. But if I only need a single output or faster, fixed rise times, am I out of luck?" (NO)

ask a 50-MHz pulse generator these 5 questions  
if the answers are yes, yes, no, yes, no,  
it's INTERSTATE

the Interstate man with all the answers is John Norburg — call collect (714) 772-2811



**INTERSTATE ELECTRONICS CORPORATION**  
Subsidiary of A-T-O Inc.

U.S. HEADQUARTERS: Dept. 7000, Box 3117, Anaheim, CA. 92803; OVERSEAS SALES OFFICES: AUSTRALIA, Parameters Pty., Ltd.; BELGIUM-LUXEMBOURG, Regulation-Mesure S.P.R.L.; FINLAND, Havulinno Oy; FRANCE, Tekelec Airtronic, S.A.; ITALY, Tekelec Airtronic; ISRAEL, Radat International Company Ltd.; JAPAN, Asahi & Co., Ltd.; NETHERLANDS, Tekelec Airtronic, N.V.; NEW ZEALAND, David J. Reid, Ltd.; REPUBLIC OF CHINA, Bons International Co., Ltd.; SPAIN, Telco, S.L.; SWEDEN, M. Stenhardt AB.; SWITZERLAND, Traco Trading Co., Ltd.; UNITED KINGDOM, Euro Electronic Instruments, Ltd.; WEST GERMANY, Tekelec Airtronic GMBH; CANADA, Radionics, Limited  
TWX U.S.A. 910-591-1197 TELEX U.S.A. 655443 & 655419

INFORMATION RETRIEVAL NUMBER 62

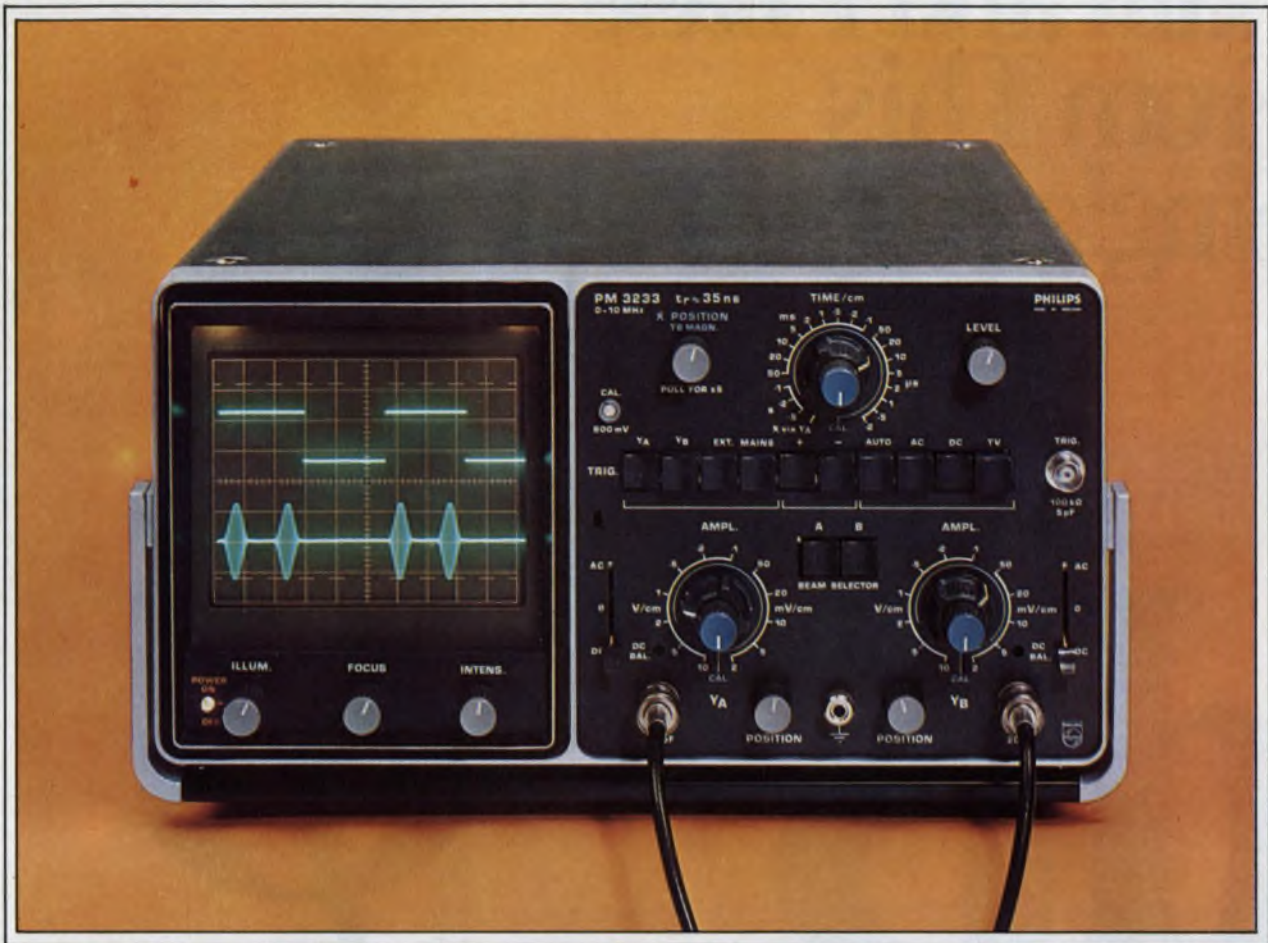

# It's a beauty alright... in more ways than one.

- **True dual-beam display:** Synchronous triggering eliminates phase error; no chopping or switching of waveforms; full screen brightness on both traces.
- **2 mV/cm at 10 MHz bandwidth:** Meets all basic requirements for lab, field or bench.
- **Fully automatic triggering:** Complete mode selection including TV line/frame.
- **10 KV brilliant display:** Excellent visibility, even for low duty cycle pulses.
- **8 x 10 cm rectangular screen:** Maximum resolution from full coverage of CRT with both beams.
- **Compact, lightweight, portable:** Only 21 lbs. Less than 20" deep x 13" wide x 7½" high. Snap on its front panel cover (supplied)... and that's your protective carrying case.

For complete data, contact: Test & Measuring Instruments Inc.,  
224 Duffy Avenue, Hicksville, New York 11802  
Telephone: 516-433-8800



Model PM3232: complete with snap-on front cover: \$795  
Model PM3233: Same as PM3232 but with 80 nsec visible delay in both channels: \$845

**TEST + MEASURING INSTRUMENTS INC.**  
A NORTH AMERICAN PHILIPS COMPANY

INFORMATION RETRIEVAL NUMBER 63

# Instant Gain and Phase From This Single Instrument

dB &  $\phi$

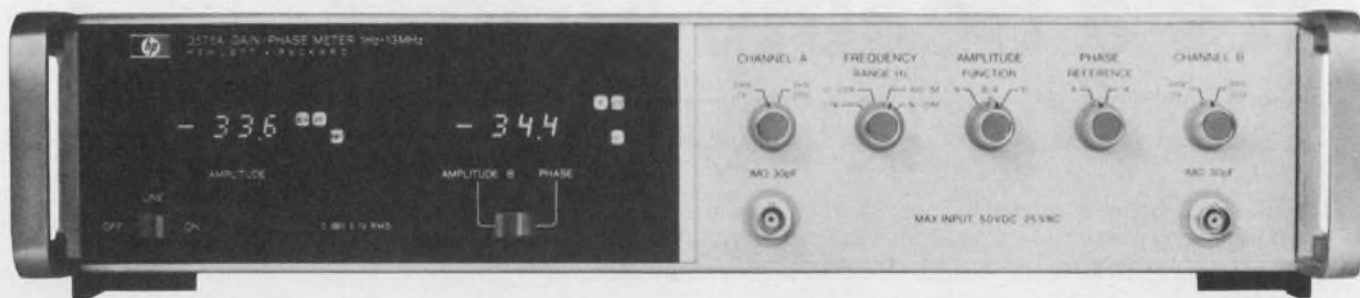

Phase measurements. You know they're necessary—even inevitable for the proper design of linear devices. But brother, what a nuisance. When you're faced with the prospect of tweaking a bunch of instruments for a half day, just to get one set of measurements, it's to your credit that you do them at all.

But that's all in the past. Today, you can put our 3575A Gain-Phase Meter on your bench and make those necessary, even critical, measurements in a matter of minutes. One instrument. One set-up. Simply adjust the input signal amplitude and frequency, then read dB and degrees directly on the LED displays.

With a frequency range from 1 Hz to 13 MHz, and levels from  $200\ \mu\text{V}$  to 20V, the 3575A has the breadth of coverage you need for most circuit applications: op amps, broadband amplifiers, RCL circuits, filters, etc. Even low-level circuits present no problem since the 3575A has outstanding noise immunity. The starting price of \$2450\* is low for the capability you get.

Making gain, phase and amplitude measurements the easy way is the subject of our Application Note. No. 157. It covers applications from components through networks. Get your copy by contacting your local HP field engineer. \*Domestic US Prices Only.

**For New Standards  
In Gain-Phase Meters,  
Think HP.**

HEWLETT  PACKARD

Sales, service and support in 172 centers in 65 countries.  
Palo Alto, California 94303. Offices in principal cities throughout the U.S.

093/44 A

# Quick appearing ROMs



## Before your eyes in 6 to 8 weeks

Electronic Arrays can deliver your custom ROMs to you in 6 to 8 weeks. That's because we're organized for the job. We've already made a quarter million of these MOS ROMs for people who demand fast deliveries.

Take your pick:

**The big one, EA4800,** stores 16K bits in a 2048 x 8 or 4096 x 4 format in a 24-pin package. It's a favorite for microprocessors. Has a maximum access time of 1.2  $\mu$ secs. Uses .032 mW/bit power. Requires +5v and -12v supplies. No clocks needed - it's static. No ad-

dress decoding required - it's on the chip. No input pull-up resistors needed - they're on the chip. Price is \$28 in quantities of 100.

**The fast one, EA4000,** has a 725-nanosecond guaranteed worst-case access time. Stores 512 10-bit words in a 24-pin package. Uses .04 mW

per bit power. Requires +12v and -12v supplies. Price is \$13 in quantities of 100.

**The low-power one, EA3800,** uses only .02 mW per bit. Stores 1024 12-bit words in a 28-pin package. Has a maximum access time of 3.3  $\mu$ secs. Requires +12v and -12v supplies. Price is \$22.50 in quantities of 100.

If you want ROMs fast and sure, get in touch with us right now. Electronic Arrays, Inc., 550 Middlefield Road, Mountain View, Calif. 94043. Phone (415) 964-4321.

Cramer Electronics is our distributor nationwide.



**The big one,  
16K bits**



**The fast one,  
725 ns**



**The low-power  
one, .02 mW/bit**

electronic arrays 

# Bench instruments or systems, they come with high IQs

**T**he newer instruments for testing components and circuits may "spoil" engineers who are used to working with pencil and pad, slide rule and desk calculator. Both bench-top instruments and test systems can do the thinking for you. The bench units have built-in microcomputers and the systems setups a mini-computer link.

Another major advance—modular design—is cutting the size of test instruments and systems, thereby giving users more room to work and simplifying servicing.

A good example of the trend toward "intelligent" test capability is the bench-top Model 76A, a 1-MHz capacitor bridge, by Boonton Electronics Corp., Parsippany, N.J. It is expected to sell for \$4500 when it hits the market in early '74.

"The 76A," says Wally White, marketing manager of Boonton, "has exactly the same bridge circuit as that of the old, manually balanced bridge. But now it's automatically balanced—an update of a very old technique."

"We've automated the bridge," says Dick Lee, Boonton's development engineering manager, "by breaking up the balance into discrete, switched balance steps, as opposed to the old, continuously variable method. But what is interesting is the fact that we have tied the bridge into a programmed 4-bit Intel microcomputer. This microcomputer controls all internal functions.

"One immediate result is that we can correct all of the predictable errors in the bridge by means of computer computation. This means that the correction charts and tables and error graphs that you normally have with a manual bridge are built into the instrument. And these corrections are automatically made before the reading appears.

**Jim McDermott**  
Eastern Editor



Ten independent, simultaneous test program can be run on this General Radio 2200 modular test system. Active or passive devices or logic circuits can be tested.

"But we haven't stopped there," Lee continues. "With the in-built computation capability, many of the user calculations that were necessary—such as for Q and dissipation D, are now automatic.

"We measure  $C_p$ , the parallel capacitance, and we measure the parallel terminal conductance,  $G_p$ . The computer takes those factors and calculates Q, which is  $wC_p/G_p$ . It then inverts that equation to provide D, which is  $1/Q$ .

"We can also calculate  $R_p$ , the equivalent

parallel resistance of the loss, which is  $1/G_0$ . Because a lot of people prefer to specify capacitance in terms of the series-equivalent factors,  $C_s$  and  $R_s$ , that transformation is also provided by the computer as an automatic calculation. These values are digitally displayed."

The bridge is fully automatic, Lee points out, with an auto-ranging capability over 0 to 2000 pF and 0 to 2000  $\mu$ mho.

Provisions are also incorporated for remote programming of the unit, Lee says. As a result, anything that can be measured or displayed from the front-panel controls can be done automatically through rear connections to standard parallel BCD inputs and outputs.

Modular bench instruments? Consider the \$1250 Versatester I, by Datapulse, Culver City, Calif.

It incorporates some of the most commonly used test instruments in one package, 3-1/2 inches high, 16-3/4 inches wide and 16-3/4 inches deep. Only the test connectors appear on the front panel.

Signal sources on the Versatester I include a sine wave, square wave and pulse generator, as well as 5 and 15-V dc power supplies to energize the circuits under test. An integral four-digit frequency counter displays the frequency of the instruments test signals, or it can be used to measure the repetition rates of external signals from 20 Hz to 20 MHz. The same display also serves as the display for a multimeter incorporated for signal and voltage measurements.

### System demand is booming

Progress in test systems has been equally dramatic. The almost explosive growth in use of integrated circuits in computers, industrial controls and consumer products has created a high demand for new computer-controlled production test systems for both digital and analog circuits. A spokesman for one manufacturer, Fred van Veen of Teradyne, Inc., Boston, says:

"We're on a very fast growth slope. We're selling all of our equipment—digital, linear and component test systems—in great quantities. We'll be over \$35-million in sales this year, compared to only \$13-million in 1971."

An area of particularly rapid expansion is linear-circuit testing, van Veen points out. "Our systems are being used to test linear ICs that are going into stereo receivers and television sets," he observes.

John Fluke, president of John Fluke Manufacturing Co., Inc., Seattle, sees several influences behind the extraordinary demand for test systems.

"First of all," he says, "electronic assemblies and products are becoming appreciably more

complicated as time goes on."

Second, he points out, these systems are being used to reduce costs and offset rapid increases in business costs over recent years. Another important influence is the fact that "the country is at the bottom of the trained-manpower barrel."

"It is not easy to obtain good technicians and good technical people to perform tests," he says. "And the higher the degree of capability, the less the desire to do repetitive work."

An obvious benefit of automated testing is a reduction in technical manpower requirements. And test results are more uniform, Fluke insists, because the computer-driven equipment eliminates the variations in human performance.

A demand for higher accuracy, particularly for some of the waveform and network-measuring setups, has produced a variety of design ad-



Node transition counts are compared to verify circuit operation in this Trender 1000 Logictester. To isolate a defect in an IC a special test fixture is used.

vances. One example is the low-frequency (10 Hz to 50 kHz) Model 2449 wave and spectrum analyzer by Quan-Tech, Whippany, N.J. Another is the 2260 network analyzer (200 kHz to 500 MHz) by General Radio.

The \$2000 Quan-Tech 2449—a bench instrument—has several "firsts," according to John Anderson, engineering sales manager. A key feature is an electronic sweep with sweep periods of 50 or 500 seconds. Instruments costing up to \$3000 are manually set, Anderson notes, and then the sweeping requires an auxiliary unit to provide mechanical driving of the frequency control.

Another 2449 plus is that the oscillator frequency is displayed at all times. A five-digit LED display driven by a built-in meter gives, to

0.01%, the frequency to which the oscillator is set. This is a considerable advance over a conventional dial or mechanical digital display connected to a mechanical oscillator frequency control, Anderson says.

To save time in calibrating the X-Y recorders used with the 2449, a circuit allows the operator to calibrate the recorder for maximum coordinates. The scale factor, set on the test instrument automatically, becomes the end calibrating points on the recorder. For field use, the 2449 can be battery operated.

### Systems going modular

The use of modular design in multistation, computer-controlled test equipment is exemplified by the General Radio 2200.

"The 2200 is a time-shared, multistation component and circuit tester suitable for both analog and digital devices," says Will Swope, product manager of analog test equipment. "The key features are individual test modules that are integrated into the station structure."

Rather than having an off-the-shelf DVM and other test equipment cluttering up the test area, the equipment was designed into the module, Swope points out. And instruments of substantially more accuracy and speed are used, he adds.

In the 2200 there are 10 completely unrelated test stations, explains Peter Previte, General Radio's assistant product manager of logic test equipment. "Each station is independent, and 10 separate test programs on 10 different analog or digital modules can be run," he notes.

### Modules give bench instruments flexibility

The clutter of wiring between bench instruments assembled for component or circuit test is eliminated by modular designs, like the Versatester I.

Another firm adopting the benefits of modularity is Tektronix. The company is now producing initial modules for a plug-in and mainframe system adapted from its oscilloscope designs. Called the TM-500, the system will eventually be implemented with a line of plug-in counters, sine-wave generators, pulse generators, function generators, DVMs and power supplies. All will fit into a couple of standard mainframes. An obvious advantage of this arrangement is that instruments can be selected for a particular circuit or component test setup.

Hewlett-Packard's entry is the combined 5326 counter and 5327 DVM. The top half is a mainframe while the bottom half is a snap-on unit.

"This can be further expanded," says Tom Nawalinski, HP product manager, "for testing of components, such as a resistor that changes



Final tests on character generators and dynamic shift registers are being made with Teradyne's J235 system. Digital ICs, hybrids and PC boards can also be tested.

with temperature, or a crystal oscillator. An a/d converter can be added directly to the same package, and in this case the three right-most digits on the DVM could be used to measure very small resistance changes. The arrangement could also give an expanded scale of analog voltages for strip chart recording.

"This philosophy fights instrument obsolescence."

### Op-amp checking eased

The testing of such linear ICs as operational amplifiers, comparators, differential amplifiers and regulators poses substantially different problems than the testing of digital circuits, which have either an ON or OFF state. These linear devices are usually checked at two or more points, and the gain curve is usually interpolated between them. But that doesn't tell the whole story. The entire gain curve must be seen, and for this, a curve tracer must be used.

Tektronix has developed—for use with its industry-standard 577 transistor curve-tracer scope—a new fixture, the 178, for testing op amps and regulators.

"Right now the 178 comes equipped with a special card for the op amps," says Jerry Rogers, curve-tracer market specialist. "Shortly we'll have an optional regulator card."

Tektronix was surprised to find during development of the new module that an op amp's small-signal dc gain—which is almost universally specified on the basis of two selected points—could vary widely between the points.

"Taking the 741 op amp," says Darrell Barrett,

the company's curve-tracer product evaluator, "most people aren't aware that its small signal gain will actually range from negative through positive numbers, even passing through infinity. This is clearly shown on the trace.

"The nonlinear gain characteristic appears to be coming from thermal effects. The 741 has a very small chip, and thermal heating in the output stage quickly reaches the input. The effect, when sweeping between the specified two points of measurement, is to introduce the variations between them."

To provide even more useful trace information, Tektronix has designed an optional split-screen storage scope for the tracer.

"You can trace a family of curves for a device on the top half of the screen and then compare its characteristics with those of another device on the bottom half," Barrett says.

### Two approaches to digital tests

Testers designed for digital IC board checking and troubleshooting are based on two approaches. One uses a minicomputer and the other pseudo-random testing signals.

The minicomputer approach is, by far, the most widespread for generating test signals and exercising logic circuits. These systems store, in the computer memory, the expected logic responses at the board outputs. The computer both generates the logic signals and compares the outputs with the stored reference data.

A new tester by Data Test Corp., Concord, Calif.—the Datatester 2400, designed to test and troubleshoot boards with LSI chips—is the first portable one to incorporate a microprocessor.

"We made the 2400 a very much more powerful tester by adding the microprocessor," says Neal Vinson, president of Data Test. "It is the first portable card-testing unit to have a microprocessor—one designed specifically for testing rather than a general-purpose microprocessor like Intel's. Our device [which has a 300-ns memory-cycle time] is much faster, and we're able to test rates up to 1 MHz, which is high.

"Another key point is that we've developed a programming station—a ROM simulator—to go along with the 2400. With this, you can write a program and verify it, and then exercise the board under test as a final check.

"Finally, you can reproduce the program onto a programmable read-only memory—we have a pROM fusible-link burner—for permanent use.

"The 2400 is a functional test. In operation we program a series of ONE and ZERO patterns into the board and program the expected number of transitions that should occur at every output pin for that unique series of input patterns. We count the numbers of logic transitions from a

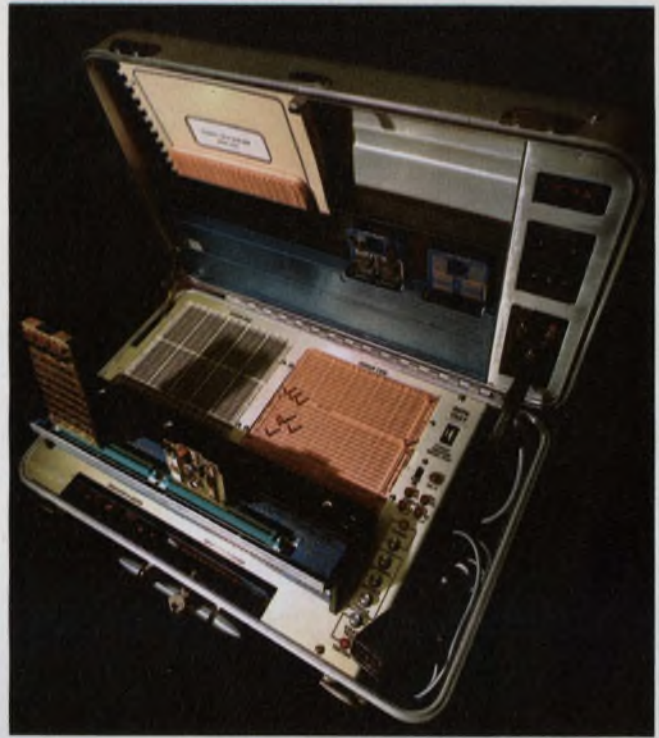

The microprocessor built into this portable digital board tester, the Data Tester 2400, has a sophisticated program that exercises logic with patterns of 1's and 0's.

ONE to a ZERO state and compare all subsequent tests against it."

To reduce the cost of computer-controlled test systems, Trendar Automation Corp., Mountain View, Calif., is taking a maverick approach—the use of pseudo-random signals instead of a computer.

"All of our test equipment is comparative in nature," says Barry Saper, president. "But rather than comparing the outputs of an IC card under test with a computer program, we compare them to the outputs of a known good card. In fault isolation and troubleshooting on our large 200 test station, we compare each individual IC to a known good IC.

"For the 1000, which is portable and has no comparators, we count the expected number of transitions at each circuit node. These can be empirically determined and written on the schematic."

The circuits are exercised in Trendar equipment at an unusually high 4-MHz rate, with the use of what are termed pseudo-random generated signals.

"We believe," Saper says, "that exercising the circuit under test can be done more efficiently by using a pseudo-random pattern-generation system—and at much less cost, because you don't have to analyze the circuit to determine what the pattern should be. So long as the outputs of the card under test agree with the reference card, there is no problem." ■■



FOR NEW STANDARDS IN SPECTRUM ANALYZERS, THINK HP

141T Variable Persistence and Storage Display Section. Gives bright high-resolution traces at slow scans, \$1900. Also available: economical normal persistence and large screen displays.

8556A Tuning Section, 20 Hz—300 KHz, with built-in tracking generator, \$1840.

8553B Tuning Section, 1 KHz—110 MHz, \$2425.

8552B High Resolution IF Section has 10 Hz bandwidth, manual scan, two log plus linear scales, \$3050. Lower cost unit (8552A, \$2375) also available.

## The Widest Choice in Spectrum Analyzers.

With HP's neatly-interrelated spectrum analyzers, you choose tuning sections, displays and companion instruments to tailor a system for your measurement needs all the way from 20 Hz to 40 GHz. Then, as your requirements expand, re-configure your system simply by adding the related piece of equipment. For example, when you need to cover a new frequency range simply add that tuning section.

By themselves, any of the 4 spectrum analyzers give you tremendous signal analysis capability made possible by absolute amplitude calibration, low distortion, high resolution, and wide frequency scans coupled with the ability to zoom down to a narrow scan.

Value really multiplies when you add the companion instruments. For example, the tracking generators combined with

the analyzers make swept measurements over a 120 dB range thus forming precision swept frequency test systems.

And our automatic preselector for the microwave tuning unit does away with virtually all image, multiple and spurious responses.

All in all, HP's family of spectrum analyzers gives you the greatest depth and breadth of performance and the best value in signal analysis equipment available anywhere. For more information, call your local HP field engineer or write.

HEWLETT  PACKARD

Sales and service from 172 offices in 65 countries.  
1501 Page Mill Road, Palo Alto, California 94304

INFORMATION RETRIEVAL NUMBER 67

Tracking generators for wide dynamic range, swept frequency response measurements.

8443A 110 MHz Tracking Generator/Counter, \$3700.

8444A 1300 MHz Tracking Generator, \$2950.

8445B, 18 GHz Automatic Preselector, for wide scans, free from unwanted responses, \$2300. (\$2950 with LED frequency readout option.)

8554B Tuning Section, 0.1—1250 MHz, \$3500.

8555A Tuning Section, 10 MHz—40 GHz, \$6275.



# OUR NEW IC OP AMP TESTER IS A CHEAP LITTLE KNOW-IT-ALL



All you really need to know about our new Model 1234 IC Op Amp Tester is the following:

1. It tests virtually all IC op amps, monolithic and hybrid.
2. It costs under \$700 but it performs the six most important tests accomplished by earlier testers costing thousands.

Here are the test results the 1234 puts up on its direct reading digital display (3 places):

- A. input offset voltage.
- B. bias current, inverting input.
- C. bias current, non-inverting input.
- D. dc open-loop gain.
- E. dc common-mode rejection ratio.

In addition each device under test is monitored full-time for unity gain oscillations, which will light an oscillation detector lamp.

The 1234 accepts the common package styles, DIP and TO-5, with or without plastic carriers. Test conditions for each op amp are established by a small plug-in pc board ("Test Condition Card"). Not only does the Model 1234 eliminate your incoming disasters, it allows you to sort your op amps and vendors by accurate test results for most efficient and least costly circuit design.

Measurement ranges are:  
 Offset voltage: 1, 10, and 100 millivolts full scale, minimum resolution 1 microvolt.  
 Bias currents: 10, 100, 1000 nanoamperes full scale, minimum resolution 10 picoamperes.  
 Common-mode rejection ratio and gain: 120 dB full scale, minimum resolution 1 dB.

Write for the complete information on this new tester, the companion instrument to our Model 1248 functional tester for digital ICs.



Electro Scientific Industries  
 13900 NW Science Park Drive  
 Portland, Oregon 97229  
 Telephone: 503/646-4141  
 Telex: 36-0273

**esi**  
 ELECTRO  
 SCIENTIFIC

# 556: A real IC two-timer.

## The timer of 1001 uses.

(Priced so low it's measured in cents.)

At least. A true standard IC timer with almost universal applications. The one featured here. Signetics 556. It's a timer. And so simple to use. With design flexibility that's never been matched. And the price. 556 functions interchangeably as a timer delay, oscillator, pulse detector or power modulator. Timing from microseconds through one hour. With lots of other applications available.

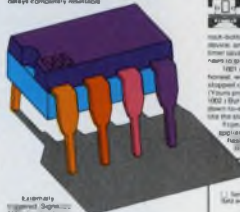

**Extremely Versatile Signetics 556** and other timer ICs offer an economical duty cycle from 50% to 0.01%. Timing can be changed 10:1 ratio. Operating from 5 to 15 volts and up to 150°C. Operating temperature range: 0°C to 150°C. **Signetics 556** is a product of the world's largest IC manufacturer. Run free or latch with external triggering. You've got a time span from microseconds to an hour, and



...duty cycles are adjustable from 50% down to 0.01%. If you're a knob twirler, enjoy yourself by changing timing at will on a 10:1 ratio.

No sweat on power, either. Anywhere from 5 to 15 volts does the job, with only 1% maximum timing change from bottom to top. And what you get out will source or sink 100mA. Temperature stability is instrumentation grade, 0.005%/°C.

Intrigued? Curious? Want to try one for yourself? For our own amazement, send us any application diagram you can think up for the 556 dual timer. We'll reward you with a FREE sample to tinker with. In timely fashion.

Signetics Linear—Dual Timer  
811 East Arques Avenue  
Sunnyvale, California 94086 (408) 739-7700

Signetics Linear  
811 East Arques Avenue  
Sunnyvale, California 94086  
Send all correspondence to Signetics  
Linear—Dual Timer  
Dept. 556  
Name \_\_\_\_\_  
Title \_\_\_\_\_  
Company \_\_\_\_\_  
Address \_\_\_\_\_  
City \_\_\_\_\_ State \_\_\_\_\_ Zip \_\_\_\_\_  
Telephone \_\_\_\_\_

signetics

Man, did you inundate us with applications for the 555 single timer.

You used it for every possible function from light switches to audio generators to RF outputs. And then, you often used a second 555 to control the function you'd generated with the first one.

We got the message: put two of these babies on one chip. Here it is — the 556 dual timer. Two 555's on a chip. Twice the product at less than twice the cost. 100 up: \$1.25. How's that for responsiveness?

Think of what you can do. Each timer on the 556 chip is independent, and needs only the appropriate values of C and R to function as a time delay,

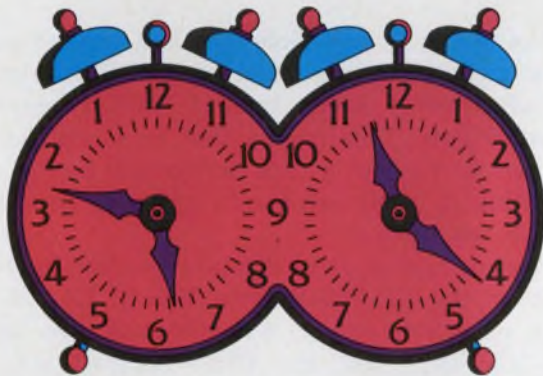

oscillator, pulse detector, power modulator, or what have you. Any kind of output you can dream up from one side, and the control from the other side. Go wild—it can become anything from a toy to a household appliance to a communications breakthrough.

Run free or latch with external triggering. You've got a time span from microseconds to an hour, and



CLIP THIS TO YOUR LETTERHEAD FOR FAST REPLY.

Signetics Linear—Dual Timer  
811 East Arques Avenue  
Sunnyvale, California 94086 (408) 739-7700

- Here it is, my application suggestion for the 556 universal dual IC timer. Shoot me out my FREE sample unit.
- Just send me the specs and data on the 556, please.
- Somehow, I never got the word on the 555 single timer—throw in some poop on that dealie, too, please.

Name	Title	
Company		
Address		
City	State	Zip

Signetics Corporation. A subsidiary of Corning Glass Works

signetics

INFORMATION RETRIEVAL NUMBER 69

# Data storage improves with new magnetic and paper tape units

**W**hether you want to record your data on magnetic tape or paper, you can now do it with smaller equipment that is more reliable, has more extra features and is often cheaper than ever before.

The most dramatic changes in instrument recorders appear to be occurring in magnetic tape units. According to Jerome Raffel, vice president and general manager of the Instrument Div. of Ampex in Redwood City, Calif., we're getting away from direct analog recording and going towards a digital format. With this format, notes Raffel, analog data is digitized and recorded on an analog machine in digital form.

Known as high density digital recording the new technique offers higher bit densities per track inch than conventional computer tape units and a wider dynamic range than conventional analog recorders.

William Zondler, product line manager at Bell & Howell's Electronics and Instruments Group in Pasadena, Calif., notes that with conventional 2-MHz instrument recorders it is possible to achieve a dynamic range of between 22 and 24 dB. If on the other hand, he goes on, the analog signal is digitized by an 8-bit a/d converter and recorded with the high density technique on an analog machine, the dynamic range that can be achieved is about 50 dB. To retrieve the analog signal it is only necessary to play back the signal and pass it through an 8-bit d/a converter.

As far as bit density is concerned, 33,000 bits per-track-inch is possible using Bell & Howell's high density recording technique known as Enhanced-NRZ coding. This density compares quite favorably with computer tape systems which only have a density of 1600 bits per inch.

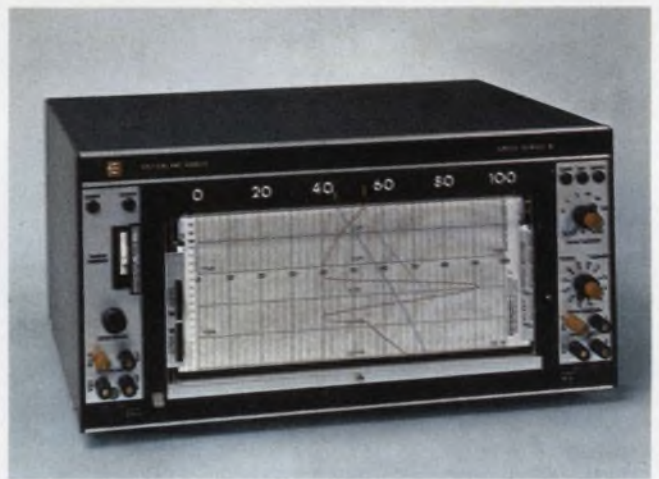

Linear servo-motor chart recorder from Esterline Angus has only one moving part and offers a choice of either a disposable pen or thermal stylus.

The Bell & Howell technique is a type of pulse-code modulation that adds a serial odd-parity bit after every seven bits of NRZ (nonreturn to zero) data. This means that no more than 14 bit periods without a flux change will be recorded resulting in a bit error rate of no greater than one in ten million.

Present high-density digital recording systems, such as the VR-3700B from Bell & Howell, are very expensive—about \$30,000—and are meant for laboratory use, not OEM applications. But industrial versions are just around the corner. Ampex's Raffel says that he is thinking of applying the high density technique to cassette recorders which would be considerably cheaper.

## Broader bandwidth at lower speeds

Another trend in magnetic instrument recorders is to higher recorder bandwidth at lower speeds. A recorder bandwidth of 2 MHz at a tape

speed of 120 inches per second (ips) is not uncommon. Manufacturers however are pushing towards 2 MHz at 60 ips in order to record more information per square inch.

Bell & Howell's Zondler explains that the increased bandwidth at lower tape speeds can be achieved designing new tape heads and by using higher performance tapes such as the 971 high energy tape from 3M Co. High energy tapes make it possible to record shorter wavelengths of information, he continues. These in turn can be more easily recovered because the tape has high magnetic remanence.

While 2-MHz instrumentation recorders are available, they are very expensive and meant primarily for laboratory applications. For the majority of commercial industrial uses less expensive recorders with bandwidths ranging from 25 kHz at 7.5 ips to 375 kHz at 30 ips are used, notes Richard Major, national sales manager for Lockheed Electronics' Recorder Div., Azusa, Calif. These recorders, he goes on, generally use 1/2 or 1-inch tapes and range in price from \$8000 to \$12,000.

Magnetic recorders today are capable of providing 32 channels of information on a one inch tape, and 42 channels are possible in the laboratory, says Ampex's Raffel. Five years ago that wouldn't have been possible, he continues. Tape head design wouldn't have allowed such close packing and component design—mainly the lack of ICs—would have made the unit a monster.

#### Portable recorders become popular

A lot of work is being done on developing small portable recorders, says Myron Hunt, sales manager for Hewlett-Packard's Recorder Div. in San Diego. Since more and more recorder applications require in-the-field recording, portable units are a must. Units such as the HP 3960 which is a 4-channel portable recorder that can work in either the direct or FM modes range in price from \$4700 to \$6000.

For more channels, a portable recorder such as the Bell & Howell CPR 4010 can be used. This unit provides either 7 or 14 recording channels and starts at \$11,000.

For applications where space is at a premium and wide bandwidth is necessary, there is the Astro-Science M-14E, also from Bell & Howell. This recorder differs markedly from other instrument recorders in that it uses coaxial reels—one behind the other—instead of the more common coplanar reels. With a bandwidth of 2 MHz at 120 ips, the M-14E is capable of a recording density of 16,667 cycles per inch. The price of the unit is about \$29,000.

Much talk has been heard throughout the instrument recorder industry about cassette tape

systems and opinions as to their viability are varied. Users would prefer to have a cassette system, notes HP's Hunt, because cassettes are easier to handle than regular tapes and they can be used by unskilled personnel. There were early mechanical problems with cassettes, he continues, but these have been ironed out.

Bell & Howell's Zondler agrees that cassettes would be nice, but notes that present day cassettes still don't offer the features required for instrument recorders. One of the problems with cassettes is that even the best designed ones do not provide accurate tape alignment across the surface of the magnetic recording head. Another problem, according to Zondler, is that cassette tapes are generally too narrow and too short. "If someone would come out with a large cassette



Portable magnetic instrument recorder from Bell & Howell uses a coaxial reel system and it has a bandwidth of 2 MHz at a tape speed of 120 ips.

with about 5000 feet of 1/2 or 1-inch tape at a reasonable price, manufacturers would design recorders to use it."

#### Strip chart recorders make progress

Improvements in recorders are not limited to tape systems alone. Strip chart and XY recorders have been making progress as well. Some of the new developments for these paper writing recorders include:

- A trend away from capillary inking systems.
- Use of print heads to provide additional information on the recording.
- Design of new motors that can stand off-scale voltages and not burn up.
- Replacement of ac synchronous motors with dc and stepper motors.



A pressurized ink system that allows high speed, uniform, skip proof traces is used in this XY recorder from Gould Inc. The pen is disposable.

■ A trend towards a systems approach to recorder design.

There are many possible ways a recorder can draw a line on a piece of paper. Methods include capillary ink, felt-tipped pen, pressurized ink, heated stylus, pressure-sensitive paper and electrosensitive paper.

In the past the most popular writing method has been capillary ink because it is simple and inexpensive. This system consists of a metal pen tip connected to an ink reservoir by a piece of tubing. Ink is fed to the pen tip on demand by capillary action. As the paper moves relative to the pen tip, it pulls ink from it at a rate determined by the viscosity of the ink, the size of the orifice in the pen tip and the speed of the relative motion between the pen and the paper.

There is a tendency today to go away from capillary writing systems, says HP's Hunt. They are generally messy and pens can get clogged easily. In place of capillary pens, he continues, many manufacturers are now using disposable felt tipped pens. The disposable pens are more reliable, says Hunt, and are easier to use.

Felt tipped pens provide many parallel passages for the ink and thus, are less susceptible to clogging than capillary pens. They are also able to write without skipping at reasonably high speeds. A disadvantage of these pens however is that as the tip wears, it tends to make broader lines. In addition, fiber pens will deposit a pool of ink if left standing in one spot.

A pressurized ink system is generally used if really high speed ink writing is required. Such systems modulate the pressure applied to the ink



A novel card-chart recorder from Leeds & Northrup allows analog information to be recorded on cards for easy filing and later retrieval.

as the pen speed varies. This results in very uniform lines over a wide range of speeds. The drawback to the pressurized ink method, however, is that it is much more expensive than either the capillary ink or felt tipped pen approaches.

Another way of overcoming the problems of capillary ink systems is to use a thermal writing system, says Ted Krajewski, product applications manager of Gulton Industries Recorder Systems Div., East Greenwich, R.I.

In the thermal writing approach, a heated stylus is used to melt a wax coated paper. When the wax melts it becomes transparent and exposes a black base.

Heat sensitive paper is more expensive than plain chart recorder paper—about twice the price—notes Krajewski, but this added cost is generally not critical, he contends. An advantage of thermal writing systems is that since the stylus does not have to press heavily against the paper, it can be used with high-speed galvanometers to produce clean, high-contrast records of high frequency signals.

#### Analog recorders can print also

The use of a thermal writing system allows Gulton to add printing capability to chart recorders, says Krajewski. Digital data can be recorded directly on the analog chart, he explains, by using a nonimpact thermal printhead. The printhead consists of a thick film seven-segment resistor matrix. Binary coded inputs cause the resistors in the matrix to heat up and print a



**Matrix electrostatic writing** is the recording technique used in the Versatec printer/plotter. A special electrographic paper must be used with these units.

number on the chart. Gulton offers recorders with two modes of printing. In the TMD-25ID—which costs \$555—recorder digital data is printed in a serial mode along the edge of the chart at a rate of 4 characters per second. In the TMD-25DP, which costs \$655, data are printed out in a parallel mode across the center of the chart at a rate of one line per second. A line can contain 2, 4 or 6 characters.

Another approach to printing digital data on analog chart recorders is taken by MFE Corp., Wilmington, Mass. Instead of using a thermal printer, MFE uses a 12-segment character wheel in an inked impact printer system. This device can print a continuous sequence of digital data on the margin of the chart, parallel with the direction of paper motion.

#### **New motors are being used**

Several new motor developments are having an impact on the recorder industry. New designs feature heavier wire so that motors won't burn up if large off-scale voltages are applied.

In addition, the standard synchronous motor is giving way to linear motors, stepper motors and dc motors, says Hunt of HP.

An example of a linear motor recorder is the HP 7123 strip chart recorder, which sells for \$750. Linear motors are attractive, says Hunt,

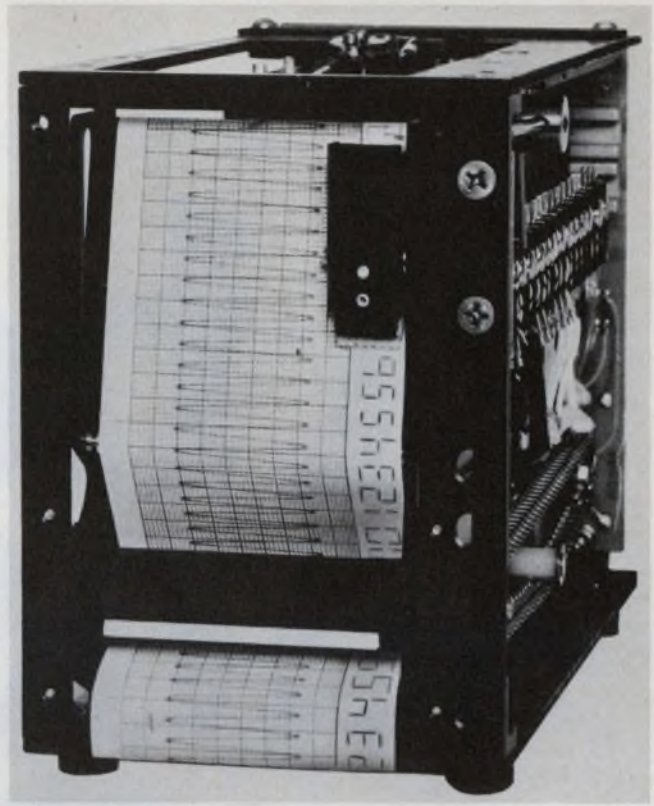

**A strip chart recorder with serial printing capability** is available from Gulton. The recorder uses thermal writing and prints up to 4 characters per second.

because they eliminate the gears, cables and pulleys normally used in strip chart recorders, and thus tend to be more reliable. The only moving part in the recorder is the motor slider/pen assembly. This assembly is the motor armature and it slides back and forth over the length of a fixed cylindrical stator.

The major disadvantage of linear motor recorders is that they require a big magnet, thus the recorder is very heavy.

Stepper motors, which have become so popular in digital tape systems, are also replacing synchronous motors in recorder applications. Such motors are driven from an internal oscillator that is independent of the frequency of the power supply. These motors are finding increasing use because they eliminate the need for complicated gear arrangements that synchronous motors require in order to change chart speed. With a stepper motor it is only necessary to change the pulse frequency to change the speed.

Another extra that the stepper motor provides is the ability to control chart speed externally. Thus it is possible to make the speed of the paper proportional to some variable of interest.

A recorder that uses a stepper motor instead of a synchronous one is available from HP. It is the model 7155 and costs \$985. The unit is a portable device and is designed to operate at temperatures, ranging from  $-28\text{ C}$  to  $65\text{ C}$ . ■■



# A better answer.

TI's unique modular building block construction permits custom configurations at minimal cost.

Standard .150 inches travel with 2.0 ounces actuating force. Also available with .100 inches travel and lower profile.

High quality double shot molded thermoplastic keytops available in many colors. Or you can buy keyboards alone.

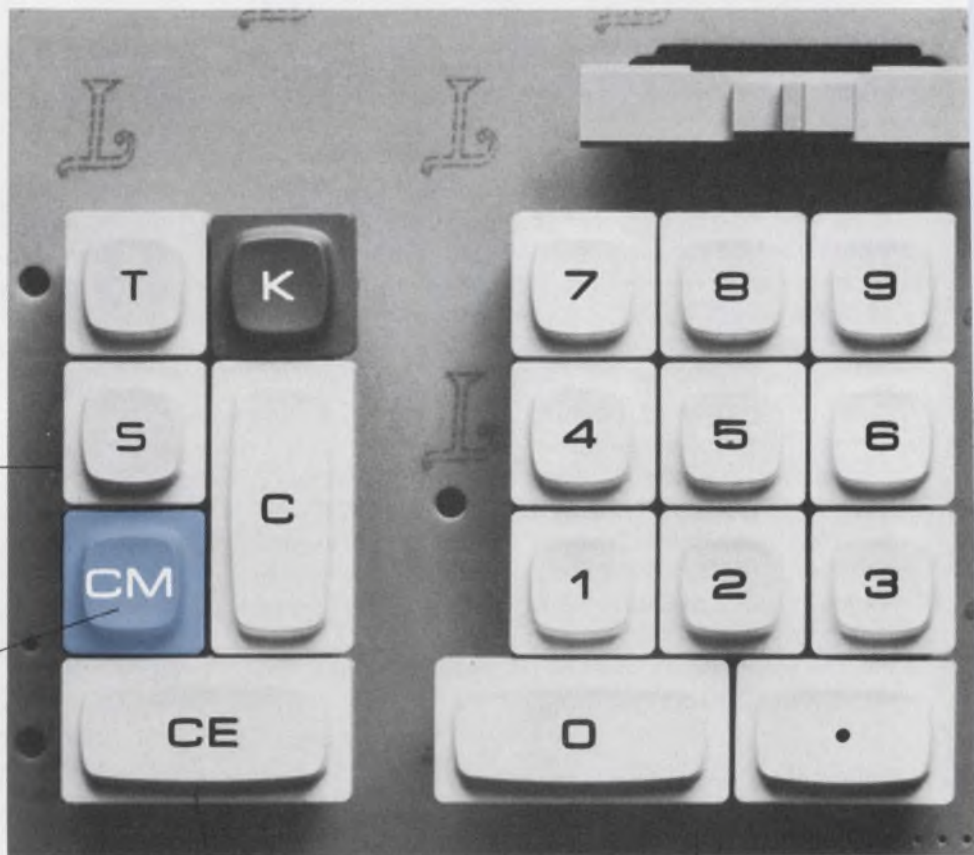

Keyswitch materials and a high length-over-diameter ratio provide the smooth, quality feel necessary for professional users.

Fully assembled on a circuit board to reduce your assembly costs.

**The new 5KS desktop keyboard from Texas Instruments, the world's leading supplier of pocket calculator keyboards. A new money-saving modular keyboard system provides the design flexibility desktop calculator manufacturers need for quick and inexpensive model changes.**

Before Texas Instruments modular keyboard systems, you could get keyboards for desktop calculators two ways. First you could buy individual keyswitches or keyswitch rows and assemble them yourself. (This assembly, which includes mounting on PC boards, soldering and testing, adds at least 25% to the price of the keyswitch alone.) Secondly, you could buy a custom molded assembly which requires a high tooling charge.

Now the people who brought you the pocket calculator keyboard bring you the best of two worlds. The first complete travel keyboard that gives you economy and flexibility using a unique modular keyboard system.

The keyswitches consist of only four parts for simple trouble-free operation and low cost. The keyboard assembly is a series of keyswitch clusters that can be arranged on a printed circuit board in any desired layout. Using TI's established library of available cluster modules, calculator manufacturers can change models with only a low cost circuit board revision.

This is the new 5KS from TI, a dependable low cost keyboard for desktop calculators, credit card verifiers, point-of-sale terminals, and other equipment where a keyboard is required. For more information, fill in the coupon.

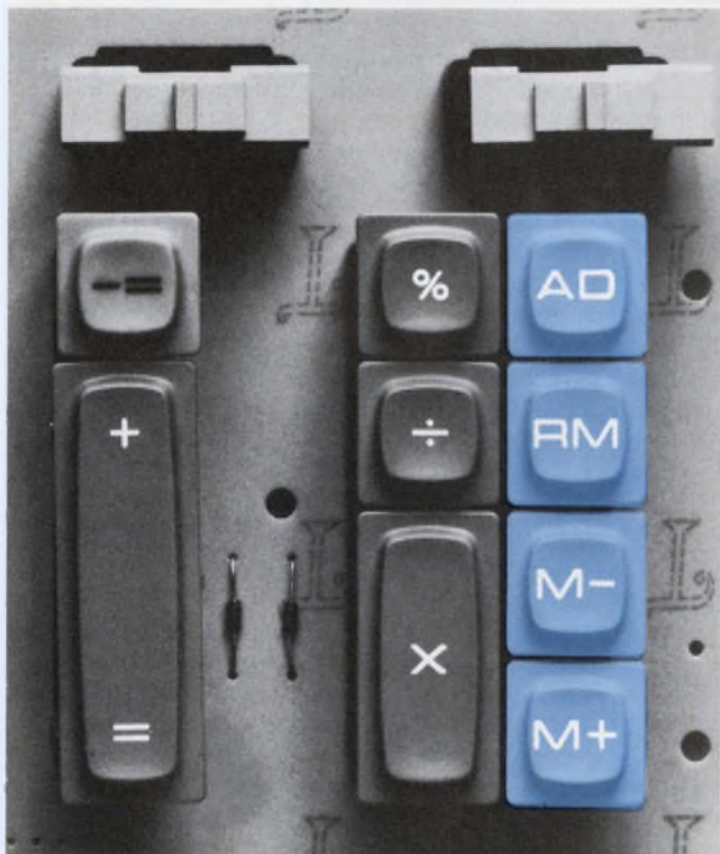

Actual size.

Texas Instruments Incorporated  
Keyboard Products Marketing  
MS 12-33/DE  
Attleboro, Mass. 02703

Name \_\_\_\_\_

Title \_\_\_\_\_

Company \_\_\_\_\_

Address \_\_\_\_\_

City \_\_\_\_\_

State \_\_\_\_\_ Zip \_\_\_\_\_

Keyboard application:

- Desk-top Calculator       Pocket Calculator  
 Point of Sale Terminal       Credit Card Verifier

Other \_\_\_\_\_

Application is new       or existing

Approximate annual usage \_\_\_\_\_ units

Please have a TI Field Engineer call

**TEXAS INSTRUMENTS**  
INCORPORATED  
**Putting new technologies at your fingertips.**

# Precision, precision: Federal bureau sets the pace for industry

**Y**ou'd never guess by looking at those rolling, campus-green grounds—576 acres of them—at the National Bureau of Standards headquarters outside Gaithersburg, Md., how much action goes on inside the agency's 23 sleek, glass and concrete buildings. The same goes for the bureau's 14-building, 205-acre complex that lies serenely at the foot of the Rockies near Boulder, Colo.

But in both there are efforts that are vital to any progress the electronics industry hopes to make, as well as for every aspect of life that requires precise measurements of any kind. This latter category includes the means for knowing that a pound of potatoes is really a pound, that the correct time is correct enough to operate time-difference radio navigation systems, and for measuring accurately the amount of power a laser is emitting. Knowing the power output of a laser's pencil-beam light is important, for one thing, for personal safety.

Handling this gigantic job—being guardian of measurements in a society as dynamic as today's—means keeping one or, better still, two steps ahead of progress. NBS must make the fine measurements required as new components, more accurate and with greater resolution, emerge.

When, for example, a new semiconductor needs improved resistivity measurements—helpful in characterizing single-crystal silicon and germanium—the bureau must provide them. When the Federal Communications Commission makes tougher requirements to protect equipment from electromagnetic radiation, NBS must measure it. And when a precise laboratory power supply needs to be calibrated, NBS must determine the voltage to a finer degree.

How is the bureau doing all this?

---

**John F. Mason**  
Associate Editor

Right now, according to J. M. Cameron, chief of the Office of Measurement Services of the Institute for Basic Standards at Gaithersburg, the big push is to dispel the widely believed myth that "traceability" alone—being able to prove where your standard comes from—is enough.

"The important thing," Cameron says, "is knowing that your measurements are accurate enough back on the production line where the equipment will be used."

Does the trip back from Boulder or Gaithersburg to the plant change the instrument's calibration? Does the environment where the instruments have to operate alter their readings?

"The whole thing," Cameron says, "boils down to one question: Are you sure your measurements are good enough for your purposes?"

Producing the means for answering this in the affirmative is NBS's major effort. One procedure for doing it is called the Measurement Assurance Program, and it consists of four parts.

First, quality control at the bureau is assured through continuous surveillance of standards plus "elaborate statistical controls," says Deputy Director Ernest Ambler.

Second, NBS finds out what the customer really needs. Defense laboratories, for example, require very precise certification with respect to the legal volt, while other laboratories need only one part in  $10^5$  to link up their rf measurements with dc measurements.

Third, in some cases the standard is now sent to the user. "In the old days," Cameron says, "the manufacturer sent his cell to us, we calibrated it and sent it back, but we never knew in what condition it arrived."

And now, quality control is maintained en route. Before, when standard voltage cells were shipped in containers without temperature control, it generally took weeks for the standard cell to settle down after arrival at its destination,

'Ambler says. It would be calibrated and sent back and would, of course, have to settle down again.

Now, working with manufacturers, NBS has enclosures controlled to about 0.001 of a degree. "We usually send four saturated standard cells by air freight in an air bath," Cameron says. "Power is maintained at all times so no time is lost in starting up the experiment. When standard cells are exposed to a temperature change, the recovery time can last as long as three months."

Along with the transport cells, NBS sends test procedures to check out the user's apparatus. "In this way we can analyze the measurements he gets to determine how his equipment and personnel are performing," says Norman Belecki, chief of the Electrical Reference Standards Section.

Also part of the program, says Ambler, is getting more industry laboratories to cooperate. "For example, in the case of mass, we have some 20 laboratories participating. In the case of the volt, we have almost 30. Programs that we're working on now are resistance, capacitance, rf power, rf voltage, rf impedance and attenuation, length, laser power, temperature, cryogenic flow and radionuclides [radioactivity standards]."

Besides making calibrations, the bureau also develops the means for making measurements. Last year its engineers developed an accelerometer. It was built for the Dept. of Defense and aerospace companies, but it turned out to interest the civilian sector as well. Companies have found it useful in determining how well packages can withstand shock while being transported.

### Breaking new ground

The bureau is pioneering in many areas. One involves the use of lasers for linear measurement, and another uses the Josephson effect—based on superconductivity at low temperatures—to measure dc voltage by its known relationship to frequency.

One experiment has consisted of stabilizing a laser so that its wavelength is reproducible in excess of one part in  $10^{12}$ . The stabilization process depends on saturated molecular absorption. The bureau compared the laser measurements with a conventional krypton-lamp length standard. The krypton lamp realizes an accuracy of a few parts in  $10^9$ .

Interferometry, NBS concluded, is therefore possible over much longer distances with the laser than with the krypton lamp—tens of meters, compared with considerably less than one meter. Moreover the laser is a simpler and more practical instrument, small and easy to manufacture, while the krypton lamp is a complex cryogenic device.

In another series of experiments NBS engineers and scientists have measured the frequency of lasers up into the infrared and close to the visible region.

"In fact," Ambler says, "we have been able to measure the frequency in which we're very much interested for the length standard—3.39 micrometers.

"It will turn out that the limitation on measuring the speed of light will be the accuracy with which we can realize the length standard—presently about a few parts in  $10^9$ ."

NBS has suggested the adoption of the 3.39- $\mu\text{m}$  HeNe laser, stabilized by saturated molecular absorption in methane, as the new definition of the meter. Meanwhile the bureau is developing other lasers as secondary standards, particularly in the visible region.



Designed specifically for calibrating microwave noise sources, the Ailtech 82 requires only 28 V dc at less than 15 mA. Earlier devices were bulky and power hungry.

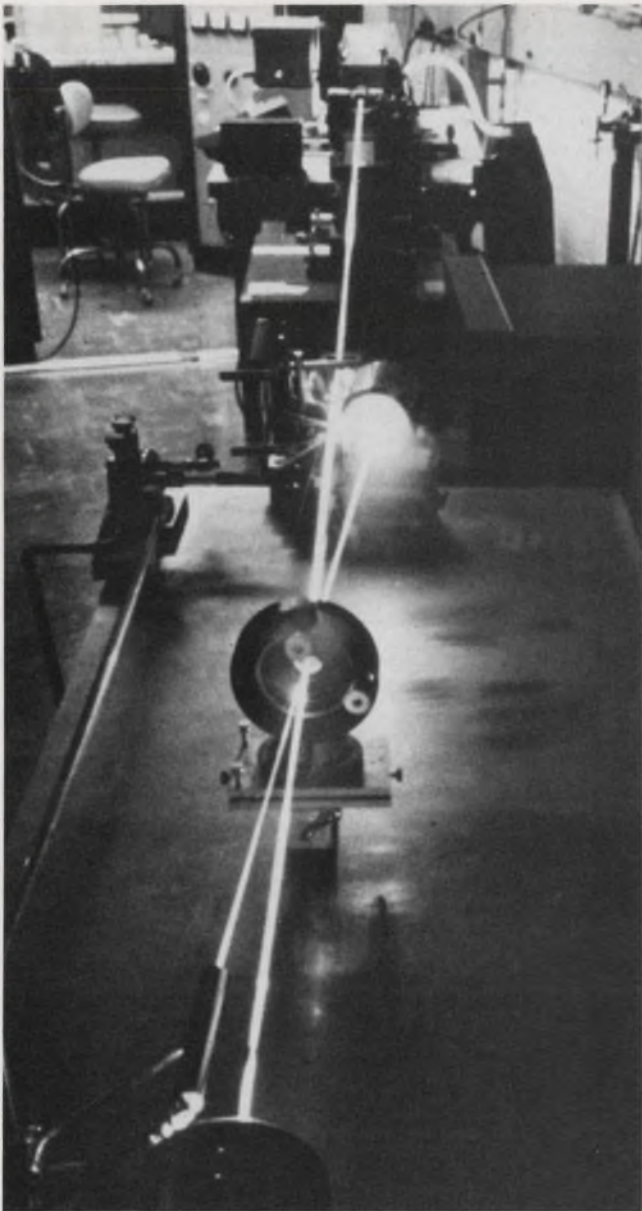

NBS has suggested adoption of the  $3.39 \mu\text{m}$  HeNe laser as the new definition of the meter. Lasers are proving to be more accurate than the conventional krypton lamp.

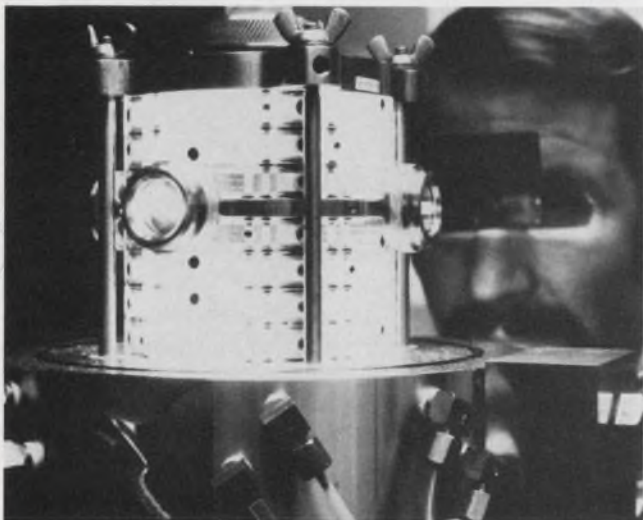

Arc source for high-temperature plasma studies (shown is hydrogen plasma at 20,000 K) was used to develop ways to measure very high temperatures in plasma.

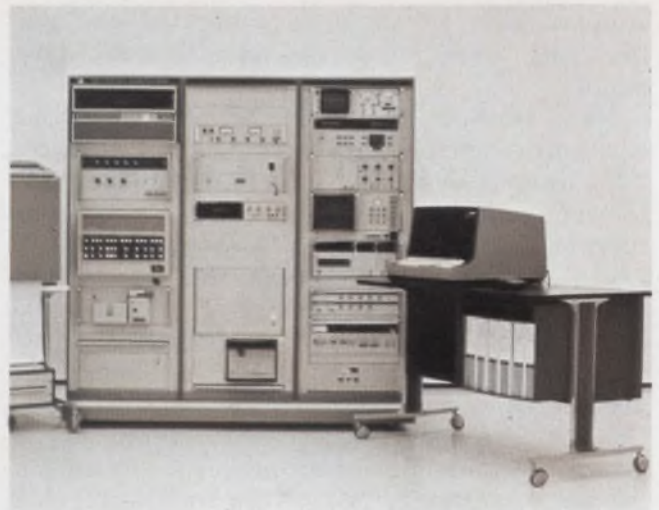

Hewlett-Packard's computer-controlled 9550 series handles a wide variety of calibration laboratory instruments, such as DVMS, signal generators and oscilloscopes.

In using the Josephson effect to measure voltages, NBS has a diode consisting of two superconducting metals separated by a very thin insulating layer. The frequency of this diode provides an extremely accurate reading of the voltage. The results have proved that use of the Josephson effect is more accurate than the individual standard cells used for maintaining the legal volt.

NBS is also looking at Josephson junctions for use in noise meters at very low temperatures and in the new field of cryoelectronics. First, however, the bureau hopes to use the junctions to measure voltages not only at the dc level but also in the rf and perhaps microwave region. Accuracies greater than those conventionally obtained are expected.

### Industry takes its lead from NBS

While the major roads to standardization lead to NBS, there are several hundred standards laboratories operated by other U.S. Government agencies, by most states, by private groups and by hundreds of corporations. The standards in these laboratories are checked periodically with the primary standards at NBS. The laboratories provide calibration services to their own organizations and to other companies.

In still another part of the measurement scene, a number of companies are building standards and calibration equipment for anyone who wants it—from NBS on down. The competition is keen, and healthy improvements in calibration devices continually emerge. A number of manufacturers, for example, are putting emphasis on portable calibration units to check out equipment on the production line in its working environment. Others are striving for more versatile units—sets that can test several kinds of instruments. Inte-

grated circuits have helped make such equipment possible, and the ultimate is to build systems with built-in self-checking capability. And, of course, the checking units themselves will have to be checked occasionally, probably with portable equipment.

One new calibrating technique being offered by a giant in the field, Leeds & Northrup of North Wales, Pa., has a computer program that accepts dial readings from manually operated precision instruments. The computer makes the necessary computations and prints out correction data on the final calibration report.

This technique, says R. H. Verity, manager of the company's standards laboratory, greatly reduces the possibility of operator error and results in appreciable time savings, especially when many instruments have to be checked.

There is also a trend toward testing and calibrating directly on the production floor in the equipment's natural environment. This, of course, calls for transportable reference standards.

Going a step beyond this is the self-checking unit built into the equipment being checked.

Holt Instrument Laboratories, Inc., of Oconto, Wis., is reducing the size and weight of its calibration instruments and making them do multiple jobs, according to Vice President Chester E. Howells. Made possible by the use of ICs, these multipurpose instruments simplify the calibration task, reduce the performance time and limit the required instrument inventory for a modern standards or engineering laboratory.

Holt's 7200 calibration standard provides all of the output signals to calibrate ac or dc voltmeters, ammeters, wattmeters, multimeters and ohmmeters. It is fully variable in output amplitude, provides four commonly used internal frequencies and has the power to calibrate devices that draw large amounts of power. Built-in controls permit checking of scale linearity and percent error directly without interpretation or computation. Holt has built the unit in the hope that it will become "the workhorse of the industry."

Tektronix, Inc., of Beaverton, Ore., offers a multifunctional unit for calibrating oscilloscopes that can be carried to the engineer's workbench or a production site for verifying a scope's performance.

Called TM 500, the unit has modular construction for interconnecting test and measurement instruments. The present unit accommodates 24 general-purpose modular test instruments, including digital counters, digital multimeters, signal sources, power supplies, signal processors and CRT monitors. In time more are to be added.

Ectron Corp., San Diego, offers a multipurpose laboratory standard, called Model 1100, for precise calibration of conventional dc measuring devices, thermocouples, thermocouple measuring



**Precision digital voltmeter**, by Leeds & Northrup, allows user to standardize the instrument at the work station. All that's needed are a screwdriver and five minutes.

equipment, temperature controllers and related devices. The various thermocouple modes use an integral computing capability, allowing the operator simply to dial temperature in degrees. The instrument automatically produces the proper output for the selected thermocouple type.

After five years of intensive development, Hewlett-Packard, Santa Clara, Calif., is offering an improved version of its 5061A cesium-beam frequency time standard. The absolute accuracy has been improved 30% to  $\pm 7$  parts in  $10^{12}$ , long-term stability increased by 40% to  $\pm 3$  parts in  $10^{12}$ , settability by 700% to  $\pm 1$  part in  $10^{13}$ , magnetic field susceptibility by 100% to 2 parts in  $10^{13}$ . Short-term stability was improved by a factor of 10 to  $\pm 5$  parts in  $10^{12}$  for one-second averaging, which makes the cesium-beam standard equal to the rubidium frequency standard.

HP has reduced the size of its cesium-beam standard by 40% for navigation on ships and aircraft. The smaller unit is called the 5062C cesium-beam frequency reference.

For people who already own previous HP cesium-beam standards, the company provides a modification kit to bring the old standards up to the performance level of the new 5061A.

Ailtech, a Cutler-Hammer company, offers "the only commercially available" instrumentation designed specifically for the calibration of microwave noise sources. The system is an i-f-switched radiometer operating from 10 MHz to 1 GHz. In the past these standards were bulky, high-voltage, gas-discharge devices or temperature-limited diodes, both of which depended heavily on high-current, highly-regulated power supplies for precision. The solid-state standards are extremely broadband and require only 28 V dc at less than 15 mA. NBS is presently evaluating the stability and precision of similar devices. ■■

# New **KAY** HALF-RACK Sweep Generator Series



**Half The Space . . . Full Rack Capability  
Including Digital Display of Frequency**

Model	Frequency Range	Sweep Width	RF Output	Flatness	Distortion	Price (plus markers)
9054	50 KHz-110 MHz	0-110 MHz	1V RMS	$\pm .25$ db	>35 db down	\$ 995.
9059	.5-300 MHz	0-300 MHz	1V RMS	$\pm .25$ db	>30 db down	845.
9060	.5-500 MHz	.5-500 MHz	1V RMS	$\pm .3$ db	>35 db down	1150.
9062	1-1000 MHz	.5-1000 MHz	.5V RMS	$\pm .25$ db	>30 db down	1395.
9063	1-1500 MHz Band 1: 1-900 MHz Band 2: 800-1500 MHz	Band 1: 500 KHz-1000 MHz Band 2: 200 KHz-700 MHz	.5V RMS	Band 1: $\pm .25$ db Band 2: $\pm .3$ db	>30 db down	1495.

## **KAY** Attenuators

- High Accuracy
- Low VSWR
- Minimal Insertion Loss

DC-12.4 GHz  
Sliding Block  
132 db



\$395.

DC-2 GHz  
Rotary  
70 db



\$125.

DC-1 GHz  
In-Line Toggle  
132 db



\$99.

**Noise Figure Meters • Gain-Loss, Return Loss Bridges  
LIN/LOG Amplifiers • RF Detectors  
1 GHz Electronic Switch • Test Equipment**

For Complete Information, Write

# **KAY** Elemetrics Corp

Maple Avenue, Pine Brook, N.J. 07058

INFORMATION RETRIEVAL NUMBER 72

# Available! RCA UHF Power Amplifier Modules... in production quantities.

RCA Solid State invites you to meet its broad family of UHF Power Amplifier Modules. This complete line covers the 395 MHz to 512 MHz band with three different power levels of 10, 13, and 15 watts.

Consider the economical and technical advantages of IC power modules. They're ready for instant use... designed, developed, pre-tuned and tested... ready to plug them into your system.

RCA UHF Power Amplifier Modules incorporate a reliable thin-film technology. And they are designed to meet stringent reliability specs. All modules feature 50-ohm input and output impedance, infinite load-VSWR

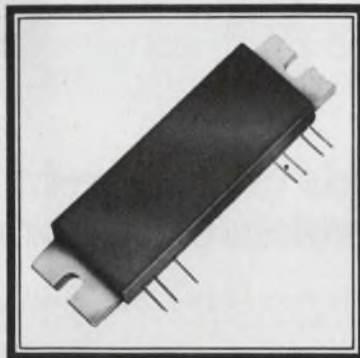

and compact size for high density packaging. Take a look

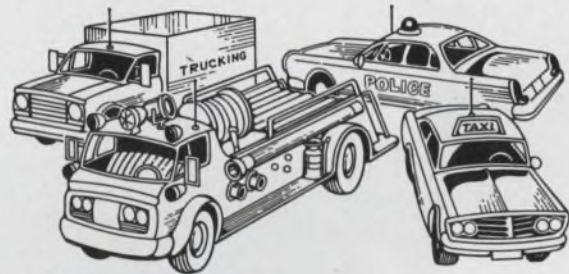

at the variety of modules available to you.

And best of all they are available now... in volume production quantities — at very attractive prices.

So if you have a need for high performance, broad bandwidth UHF Power Modules, come to RCA Solid State — the home of the RF Performance Expanders.

Want more information? Write: RCA Solid State, Section 57K-22 Box 3200, Somerville, N.J. 08876. Or phone: (201) 722-3200.

CHARACTERISTICS	R44M10	R44M13	R44M15	R47M10	R47M13	R47M15	R51M10	R51M12
Frequency Range (MHz)	395-440	395-440	395-440	440-470	440-470	440-470	470-512	470-512
Power Output, Min. (W)	10	13	15	10	13	15	10	12
Supply Voltage, Nom.	12.5	12.5	12.5	12.5	12.5	12.5	12.5	12.5
Power Gain, Min. (dB)	20	20	20	20	20	20	20	20
Overall Efficiency, Min. (%)	35	35	35	35	35	35	35	35

**RCA Solid State family of UHF Power Modules**

**RCA Solid State**  
products that make products pay off



# Did your data disappear, when the power failed?

## Store your data where it needs no power—in NITRON'S new MOS/LSI low-power, non-volatile memories—EAROMs.

An acronym for Electrically Alterable Read Only Memory, the EAROM has been just a good idea until now. Today we are announcing the world's first family of EAROMs, including 64-bit and 1024-bit capacity. They're non-volatile, very low-power and can be reprogrammed  $10^6$  times without removing them from your system.

### EAROM CHARACTERISTICS

Operating power:  $3\mu\text{W}/\text{bit}$ . A full 1K part operates with only 3mW.

Current drain is less than  $100\mu\text{A}$ .

Storage power: Zero. Until you want to alter it, an EAROM acts like a permanently programmed ROM in your system.

Writing requirements: Programmed the same way you program a RAM, our EAROMs simply require a clear pulse; then you can write new data in with the write pulse. No fusible links. No UV irradiation required.

Configuration: 1024X1 or 512X2, depending on your pin strapping.

Speed: Read cycle time is less than  $10\mu\text{sec}$ . Writing cycle is typically 1 msec.

### EAROM APPLICATIONS

- battery operated digital systems
- program and buffer storage
- communication systems encoding
- preset radio tuning systems
- telephone auto-dialing

- navigation systems
- POS terminals
- numerical control systems
- anywhere you need a little memory that won't go away when the power goes off.

### What to ask us for

Write, call or TWX for the data sheets on our NC7000 series (64-bit and 1024-bit EAROMs). Nitron also offers custom MOS/LSI in this non-volatile EAROM technology, as well as hi or lo threshold P-Channel (ion implanted or nitride) and N-Channel. Our address is:

10420 Bubb Road, Cupertino,  
CA 95014. (408) 255-7550/  
TWX 910-338-0222.

## **NITRON CORP.**

A COMPANY OF

**MCDONNELL DOUGLAS**



CORPORATION

INFORMATION RETRIEVAL NUMBER 74

# Undistorted truth

from the new Weston 4445 DMM with true RMS capability.

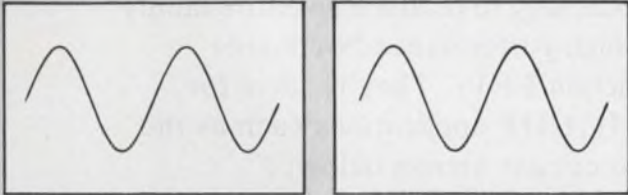

Can your present average-reading DMM tell the difference between these two computer-generated sine waves? Probably not.

But the Weston new model 4445, a low-cost, 3½-digit RMS-responding DMM can. It can seek out and detect the 1% distortion in the third harmonic of the wave on the right. And it could do the same even if the wave were square, triangular or odd-shaped.

So don't depend on just any DMM for those critical AC voltage readings. Stop guessing at those last one or two digits. Get a Weston model 4445 with RMS capability and read every wave to a guaranteed  $\pm 0.5\%$  accuracy  $\pm$  one digit across ranges from a low 200mV to a full 1000V with 100uV resolution.

For only \$450 you get all this, plus 5 DC voltage ranges, 200mV to 1000V; 6 resistance ranges, 200 ohms to 20 megohms; 2 DC current ranges, 200uA to 2mA; plus 2 AC RMS current ranges, 2uA to 2mA—all fully over-load protected.

And you get it all inside a fully portable, shock-resistant case measuring only

2.25" x 5.45" x 7". Weighs only 2.5 lbs. Comes complete with four nickel cadmium batteries for up to 10 hours continuous operation, and AC line converter for bench-work. Fuses, probes, and carrying case are included, of course.

**9744 Transducer adds RMS to any one-volt digital instrument.**

If you already use a digital voltmeter with 1-volt DC range, you can add RMS with the new Weston 9744 Transducer.

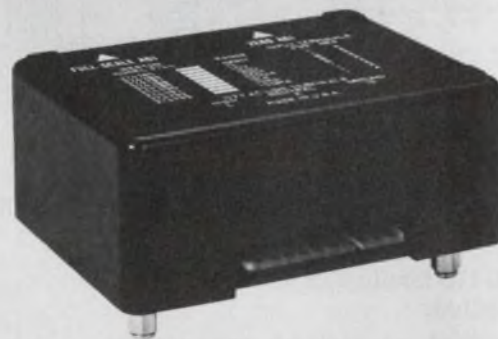

Model 9744 can be ranged to accept AC input from 100mV through 700V. It converts the input to a 1-volt DC output signal for the full-scale RMS value of the AC signal. Will also scale AC current input from 1uA to 1mA. Operates on either 115V or 230V, 50-60 Hz line.

List price only \$150 with case.

See both these exciting new examples of WESTON leadership in test equipment at your nearby distributor today. Or, write direct to Weston Instruments, Inc., 614 Frelinghuysen Ave., Newark, N.J. 07114.

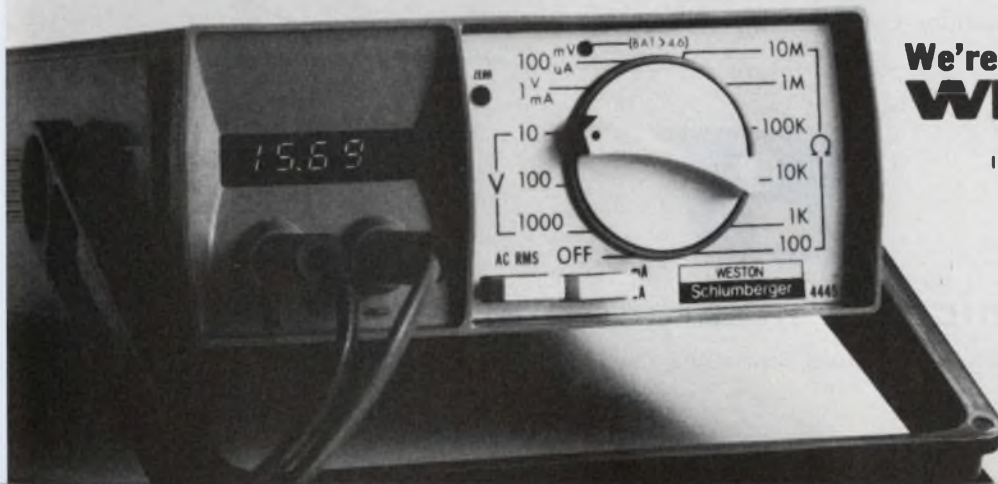

**We're either first or best. Or both.**  
**WESTON**®  
Schlumberger

INFORMATION RETRIEVAL NUMBER 75

Meet our new series of  
high-frequency problem solvers . . .

# High-Performance VHF/UHF FET Family

Remember the U310? Some people call it the SuperFET. We introduced it a year ago: worst-case 75Ω input match VSWR of 1.25:1. Figure of merit  $2.35 \times 10^9$  typical. Third order intercept point of +29 dBm.

Now we've extended the U310 technology to produce an entire family of high-performance N-channel junction FETs. They're ideal for VHF/UHF applications such as the two circuits shown below:

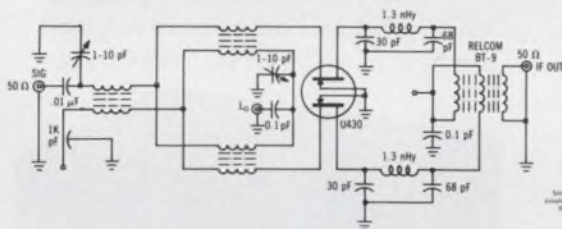

Single-balanced active mixer — 100 dB dynamic range.  
+ 2.5 dB conversion gain, + 32 dBm intercept point, 50-250 MHz.

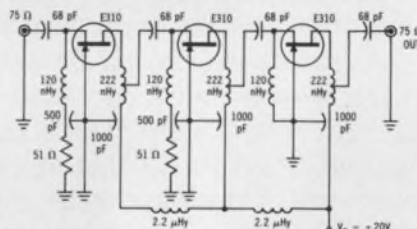

Wideband amplifier — 225 MHz center frequency.  
1 dB bandwidth of 50 MHz, 24 dB gain.

U310 family characteristics include:

- High power gain (common gate) — 16 dB at 100 MHz, 11 dB at 450 MHz.
- Noise figure = 3 dB typical at 450 MHz.
- High transconductance = 10,000 to 20,000 μmhos.

Select the right FET for your application from this array:

Type	Package	Feature	Applications	Price (1K units)
E308	Epoxy TO-106	$V_p = -1.0$ to $-6.0$ V $I_{DSS} = 12$ to 60 mA	High-frequency, small signal VHF or UHF source followers, amplifiers, mixers, or oscillators.	\$ 0.57
U308	Metal TO-52			\$ 3.70
E309	Epoxy TO-106	$V_p = -1.0$ to $-4.0$ V $I_{DSS} = 12$ to 30 mA		\$ 0.75
U309	Metal TO-52			\$ 4.45
E310	Epoxy TO-106	$V_p = -2.0$ to $-6.0$ V $I_{DSS} = 24$ to 60 mA		\$ 0.75
U310	Metal TO-52			\$ 4.45
U310 family dual FETs have $V_p$ , $I_{DSS}$ , and $g_m$ parameters matched to 10%. Packages designed for easy insertion into printed circuit boards.				
E430	Epoxy Si-105	$V_p = -1.0$ to $-4.0$ V $I_{DSS} = 12$ to 30 mA	VHF/UHF balanced mixers and cascode amplifiers	\$ 1.70
U430	Metal TO-99	$g_m = 10$ to 20 mmho		\$ 9.95
E431	Epoxy Si-105	$V_p = -2.0$ to $-6.0$ V $I_{DSS} = 24$ to 60 mA		\$ 1.70
U431	Metal TO-99	$g_m = 10$ to 20 mmho		\$ 9.95

Get the complete story on this advanced high-frequency FET family.  
For application notes and technical information

## write for data

Applications Engineering: (408) 246-8000 Ext. 802



Siliconix incorporated

2201 Laurelwood Road, Santa Clara, California 95054

## The real inflation fighters are those who innovate

In this era of skyrocketing inflation, you may note some important facts about our economy if, as I recently did, you try the following exercise: Write down all the products and services you can think of that cost *less* today than they did, say 10 years ago.

Stuck? Try again, because there are some. Here's a clue: Many of the counterinflationary items are products of the electronics industry—things like tape recorders, electronic calculators and portable radios.

The economic lesson, of course, is that true growth comes from technical innovation, new discoveries and increased productivity—in short, from the creative work of engineers and others who can, for example, replace expensive, hand-wired circuits with single ICs. It doesn't come from increased wages extracted with a strike threat by a monopolistic union. Neither does it come from a price increase inflicted on consumers by a monopolistic corporation. Nor does it come from trade tariffs erected for manufacturers who are scared to compete with foreign producers.

Government-imposed price controls won't stop inflation either. Those industries most in need of controls usually have the political clout to skirt the rules and get away with it. Consider the auto industry.

The Government allowed car manufacturers an average 2% price rise on 1974 models, but for the buyers of Pintos, Ford managed to convert the 2% into over 10% by a succession of pricing tricks. To start with, the company produced the "average" by drastically hiking the prices of subcompact cars, while leaving those of the larger cars virtually unchanged. (That will really help the energy crisis and solve pollution problems!) Secondly, Ford changed the specs (for example, increasing the 2-liter engine to 2.3 liters) so that, if it were challenged at its game, the company could argue that the 1974 model wasn't really the same car as the 1973 version. Thirdly, to make it impossible to unravel what really happened, Ford dazzled the buyers with footwork by making some of the options standard.

Perhaps when Detroit gets hurt as badly by foreign competition as the consumer electronics industry did, it will learn that technical innovations (stratified charge, Wankel, etc.), not pricing gimmicks, yield true economic growth.



A handwritten signature in dark ink that reads "Michael Elphick". The signature is written in a cursive, slightly slanted style.

MICHAEL ELPHICK  
Managing Editor

# LARGEST LINE OF

## SOLDERLESS WIRE-WRAPPED TERMINATION PRINTED CIRCUIT CONNECTORS

**.025" and .045"  
Square Contact Terminations  
for Wire-Wrapping**

Various sizes from 12 to 100  
terminals with a choice of  
.100", .125", .156" or .200"  
contact centers. Accept  
.054"-.071" printed circuit  
board (1/16").

**WRITE OR PHONE  
FOR COMPLETE  
PRINTED CIRCUIT  
CATALOGS:  
(212) 899-4422**



*For the Sales Representative Nearest You, See Our Listings in EEM and VSMF Directories.*

# CONTINENTAL CONNECTORS

CONTINENTAL CONNECTOR CORPORATION • WOODSIDE, NEW YORK 11377

INFORMATION RETRIEVAL NUMBER 77

# Fastest

This new wide band inverting op amp is so fast no other monolithic device can match its speed.

Until now the only way you could obtain the performance speed of our new HA-2530 wide band inverting op amp was with expensive discrete modules. Say at around \$50 each. Now, for far less money you can have it all on

one cost-saving chip. For example, typical slew rate at + 25°C is 320V/μS, settling time (0.1%) is 550nS. No other monolithic op amp can match these speeds. Application range is excellent, too. Among applications are video

summations, high speed integrators, wave form generators, coaxial line drivers, and fast D/A outputs. For details see your Harris distributor or representative.

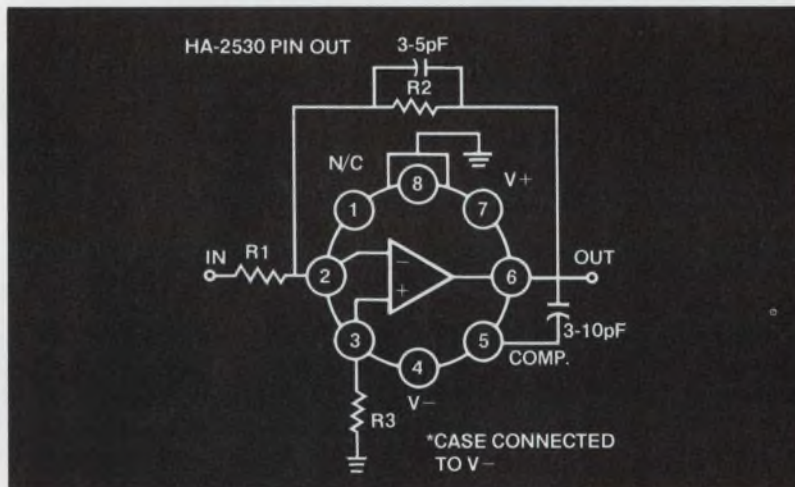

#### Features:

Offset voltage	0.8V
Average offset voltage drift	5μV/°C
Slew rate	±320 V/μS
Power bandwidth	5 MHz
Gain bandwidth	70 MHz
Settling time	550nS
Open loop voltage gain	140db
Power consumption	100mW
Supplied	TO-99 pin out

100-999 units

HA-2535	0°C to + 70°C	\$14.30
HA-2530	- 55°C to + 125°C	\$33.00

# Harris



**HARRIS**  
**SEMICONDUCTOR**  
A DIVISION OF HARRIS-INTERTYPE CORPORATION

P.O. Box 883, Melbourne, Florida 32901  
(305) 727-5430

**WHERE TO BUY THEM:** ARIZONA: Phoenix—Liberty, Weatherford; Scottsdale—HAR (602) 946-3556 CALIFORNIA: Anaheim—Weatherford, El Segundo—Liberty, Glendale—Weatherford, Long Beach—HAR (213) 426-7687; Mountain View—Elmar, Palo Alto—Weatherford, HAR (415) 964-6443; Pomona—Weatherford, San Diego—Weatherford, Western COLORADO: Denver—Elmar, Weatherford WASHINGTON, D.C.: HAR (202) 337-3170 FLORIDA: Hollywood—Schweber, Melbourne—HAR (305) 727-5430 GEORGIA: Atlanta—Schweber ILLINOIS: Chicago—Schweber, Schaumburg—HAR (312) 894-8824 MARYLAND: Rockville—Schweber MASSACHUSETTS: Lexington—R&D, Waltham—Schweber, Wellesley—HAR (617) 237-5430 NEW JERSEY: Somerset—Schweber NEW MEXICO: Albuquerque—Weatherford NEW YORK: Melville—HAR (516) 249-4500; Syracuse—HAR (315) 463-3373; Rochester—Schweber, Westbury—Schweber OHIO: Beachwood—Schweber, Dayton—HAR (513) 226-0636 PENNSYLVANIA: Wayne—HAR (215) 687-6680 TEXAS: Dallas—Weatherford, HAR (214) 231-9031; Houston—Weatherford WASHINGTON: Seattle—Liberty, Weatherford

**LEGEND FOR HARRIS SALES OFFICES & DISTRIBUTORS:** Harris Semiconductor (HAR); Elmar Electronics (Elmar); Harvey/R&D Electronics (R&D); Liberty Electronics (Liberty); Schweber Electronics (Schweber); R. V. Weatherford Co. (Weatherford); Western Radio (Western)

INFORMATION RETRIEVAL NUMBER 78

## DPMs vs analog meters: Is there a clear victor in the battle for panel space? The answer is neither can handle every job. Find out which is best for you.

Will the DPM replace the analog moving-coil meter? Opposing claims by proponents of each tend to confuse the very different nature of these two displays.

Actually no one meter can do every job. DPMs excel where unambiguous readings—with high resolution—are needed, and where such features as memory, speed and BCD outputs are important.

An analog meter, on the other hand, has these assets, among others: It's passive, gives trends and is less expensive.

But both types have drawbacks as well. Let's look at specifics.

### What's the number?

In general, analog meters are superb at answering the question—"Where is my equipment operating with regard to end points, danger zones, null positions or safe regions? The answer is given with up to 0.5% accuracy with D'Arsonval meters.

DPMs are best at answering the question "What's the number?" with quickly read, absolute numerals.

Frequently a specific application clearly points to one type of panel instrument over the other. In general, repetitive, critical measurements of physical and electrical variables—such as voltage, current, weight, thickness and frequency—may require four or five-digit resolution, with little room for error.

On the other hand, many variables—physiological ones, say—are not measurable to more than 1% accuracy, and additional resolution only confuses the issue. A patient is in equal trouble whether his heart rate is 10 or 10.15 beats/min. The analogy is obvious in the case of 1% variables read with 0.05% resolution: more digits but no more useful information.

Analog instruments cost half as much as DPMs

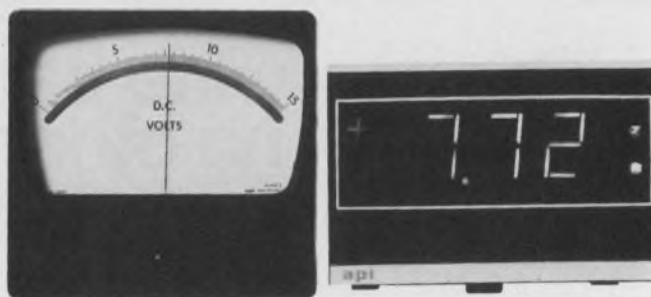

1. Equivalent readings on analog and digital panel instruments. The digital display can be read 30 to 50 times more quickly than the analog.

of comparable accuracy. Yet some performance features, routine with the analog meter, would cause DPMs to cost five times as much. And some D'Arsonval attributes are totally unobtainable in DPMs—and vice versa.

### DPMs vs analog meters: memory and power

Display memory is found in most DPMs. Analog meter memory—if it's available—is a costly option. However, analog memory can be made fail-safe if power is lost. By contrast, a DPM's display memory behaves like an old soldier if the power goes—it just fades away.

The signal power required by most DPMs is usually 10,000 times less than that needed by a sensitive (10  $\mu$ A full scale) D'Arsonval meter. Yet, since DPMs aren't passive, the total power used by a battery-powered DPM is easily 100,000 times greater than its analog counterpart.

### The physical facts of life

If minimum package size is an overriding criterion, the choice is analog. Miniature D'Arsonval panel and edgewise indicators can be crammed into a cubic inch, although the smallest easily available volume is closer to 2 in<sup>3</sup>. The most compact DPM now on the market occupies approximately 5 in<sup>3</sup>.

In panel space, analog meters are found at both

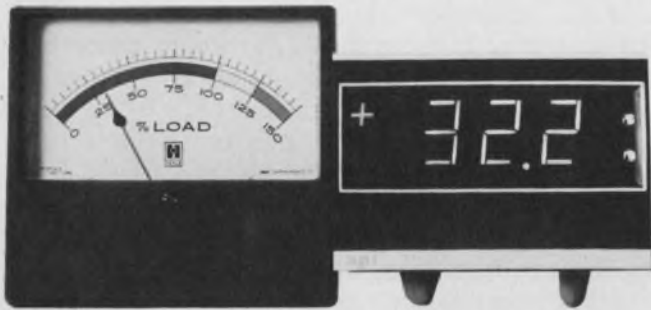

2. Equivalent displays of motor load in percentage. The operating status is determined more rapidly from the analog display, which contains three colored zones.

ends of a wide range, with digital displays falling somewhere in between. For example, a 0.5-by-1.5-in. edgewise meter fills 0.75 in<sup>2</sup> of panel space, while a 10-by-10-in. analog meter sprawls over 100 in<sup>2</sup>. Most DPMs occupy from 4 in<sup>2</sup> to 10 in<sup>2</sup> of panel area. For the same panel space, however, the DPM always offers bigger numerals.

### Operating temperature limits

With respect to operating temperature, a DPM is usually limited in range by its internal semiconductors. For industrial devices, this range is usually 0 to 85 C. Allowing for ambient rise inside the DPM case, manufacturers usually give operating ranges from 0 to 55 or 65 C. The use of military semiconductors would extend this range, but the resulting instrument would be much too expensive for commercial/industrial markets.

By contrast, a D'Arsonval meter is basically temperature-limited by its materials: magnet, insulated wire, metal brackets, springs and case. Thermoplastic cases (usually acrylics) begin to soften around 70 C but remain rigid at very cold temperatures approaching -40 C.

Thermosetting plastic cases, with glass windows, remain sturdy above 100 C; at higher temperatures, melting wire insulation and coefficients of expansion take their toll. Thermosetting plastic meters are readily available, and provide an op-

erating range from -40 to +100 C.

Humidity above 90% can lower the resistance of nonconductive paths across printed foils and impair DPM performance. Of course, circuit boards intended for tropical conditions can be sealed with a moisture-proof varnish at moderate extra cost.

### The moisture problem in analogs

The effect of high humidity on moving-coil instruments is somewhat different. Moisture may be absorbed by a painted pointer, thereby changing its balance and causing a reading error. Condensing moisture—actual droplets—can also introduce a serious balance error, and if the water lodges between the moving coil and magnet, it can cause even more gross inaccuracy.

Thus analog meters must be hermetically sealed if high humidity is expected. Such meters are roughly twice as costly as standard units, but they are readily available.

Where shock and vibration are important, tests are described in the analog meter industry's standard, ANSI C39.1. In this standard, shock and vibration are applied to all three mutually perpendicular axes of the instrument, after which the meter is tested for permanent changes of calibration or accuracy.

Subjecting a DPM to the 0.020-in. excursions and 50 g shock called out in this standard strains the heavier components or those with the longest leads—for example, transformers, capacitors and board interconnections. All D'Arsonval meters should be able to withstand these tests. The question is: Can the DPM?

### Which gives the fastest reading?

How fast can you get a measurement from an analog meter? It usually takes three to five seconds from the first observation of a stable reading to say, "It's running at 16.3 ft/sec."

On the other hand, you can remember a DPM readout within about 100 ms of first seeing the display (Fig. 1). Thus when both analog and



digital displays indicate the same value, the digital is read much more quickly.

Since no translation is necessary with DPMs, it is very rare to misinterpret a digital display; to interpret an analog display, however, you usually have to count index lines and interpolate pointer position. Not only does the analog task take 30 to 50 times longer, it is more subject to ambiguity error.

Digital panel instruments can be made as precise as linear-circuit technology permits: Figures of 0.005% are fairly common for 4-1/2 digit units. With the moving-coil, the fundamental limits of precision stem from the coil suspension.

Pivot-and-jewel suspensions normally have 1% friction or hysteresis, which combines with other lesser factors to produce 2% precision, at best, in nonlaboratory instruments.

Taut-band suspensions eliminate rubbing or rolling surfaces, but the band material has 0.1% to 0.2% hysteresis as it twists. Hence taut-band meters can be furnished with up to 0.5% precision.

### What about readability?

Parallax is the error introduced when a D'Arsonval meter is read at an angle to the dial. Antiparallax mirrors can be provided at relatively low cost to ensure that the viewer's line of sight is always at right angles to the meter face.

Obviously DPMs don't suffer from parallax. Planar displays can provide clear readability at a 65 degree angle from the instrument axis. However, nonplanar displays, such as those with stacked numbers, may become unreadable at

large angles from the instrument axis.

Under favorable lighting conditions, half-inch-high digital displays can be read up to 20 feet away and 7/8-in-high numbers to 40 feet. But even the largest analog meters (10 inch) have dial numerals no larger than 3/16-in.; they are readable up to only 15 feet away.

However, the pointer of a large meter will be clearly visible from 40 feet. Once an operator has learned the significance of the dial markings, the meter's reading will be quickly comprehended from a great distance (Fig. 2).

Fig. 3 illustrates the relative readability of a 10-in. analog meter and a 7/8-in-high numerical display. Hold the illustration at a distance to verify readability for yourself.

To adapt a moving-coil meter to display a nonlinear signal, you need merely provide the correct dial art work. Nonlinear scales are routine—for instance, five decades of range or temperature to absolute zero (Fig. 4).

DPM linearization, on the other hand, is much more complex and expensive. At present linearization is accomplished in either an analog fashion, by shaping the input signal prior to digitization, or by a digital method of changing digitizing constants at fixed increments of the readout value. Both methods are limited in following the number of inflections, or rate of change, of the nonlinearity.

It's sometimes desirable to display simultaneously two related variables—for example, temperature in both Fahrenheit and Celsius, or optical clarity in both transmittance and density units. With moving-coil instruments, the additional scales become minor problems of art work

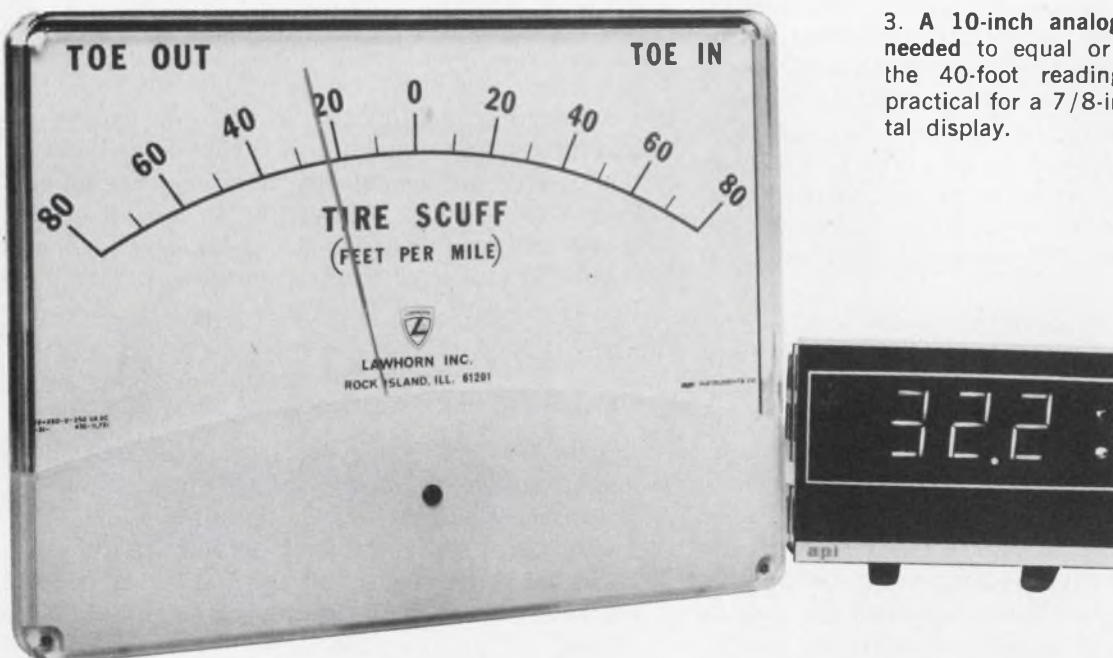

3. A 10-inch analog meter is needed to equal or to exceed the 40-foot reading distance practical for a 7/8-in-high digital display.

and cost little extra, if anything (Fig. 5).

Multiple ranges on a digital readout require either a separate DPM for each variable or else a multiposition switch with one DPM.

In applications where a large number of variables must be logged repetitively and accurately, digital readouts (and preferably printouts) are best.

However, when these variables must be compared with one another to identify trends or inconsistencies, one of the best methods of display is a bank of edgewise analog meters, or ribbon indicators, side-by-side.

Although DPMs can digitize at speeds of 100 per second and faster, the visual display is usable at reading rates up to only 3 or 5 per second. Slower rates are also frequently chosen to minimize the visually disturbing effects of electrical noise.

The quickest response time obtainable in D'Arsonval meters is approximately 150 ms, and the longest about 5 or 6 s. Response time varies with meter sensitivity and source impedance and is a powerful design tool to minimize the display of electrical noise.

Conversely dynamically changing variables are best displayed on moving-pointer instruments, which indicate not only level (in the presence of noise) but also direction of change. Measurements of sound levels, nulls and signal strength are examples where digital displays would be of little use.

On voltage ranges, DPM input-impedance specifications commonly run from 100 k $\Omega$  to 100 M $\Omega$ , with 10 M $\Omega$  a frequently cited value. But input bias currents, ranging from 1 to 250  $\mu$ A, detract from these seemingly high impedances.

#### Analogs consume less power

Analog voltmeter impedance, by contrast, is limited by the maximum current sensitivity available in standard instruments. For taut-band meters, 10  $\mu$ A is a practical limit. For 1-V, full-scale sensitivity, this corresponds to 100 k $\Omega$ . Off-the-shelf panel voltmeters are usually furnished with 1000 ohm/volt sensitivity. Multimeters normally have 20,000 ohm/volt sensitivity.

For a DPM with 10-M $\Omega$  input impedance and 1- $\mu$ A input-bias current, signal power dissipated by the input is 0.1  $\mu$ W. Because a D'Arsonval meter derives all of its power from the signal, input dissipation is somewhat higher: 10  $\mu$ W for a 10- $\mu$ A, 1-V, full-scale meter.

Because of low-power MOS circuitry, digital panel instruments are now available with battery-power dissipation of only about 200 mW. Signal power drain can be added to this figure, but it is negligibly small.

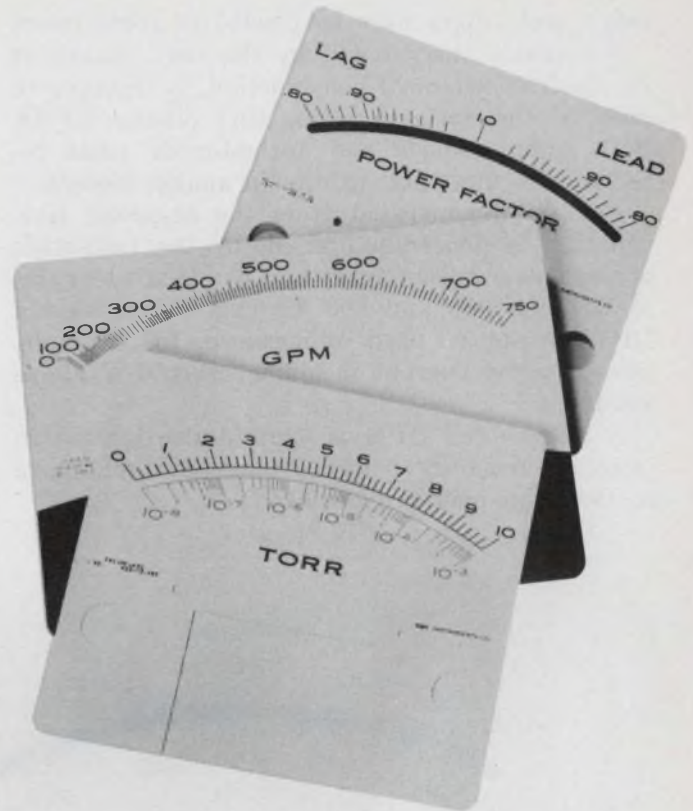

4. Nonlinear variables are handled easily by dial art in analog meters. Top: Power factor between voltage and current is a cosine-shaped function of phase angle. Center: Square-law flow dial, calibrated in gallons per hour. Bottom: Five decades are covered by this vacuum-gauge dial.

Analog panel instruments don't consume any power other than the input dissipation. Hence, for a 10- $\mu$ A meter, total power dissipation is still only 10  $\mu$ W.

What input voltage can permanently damage an instrument? We'd like to know this, of course.

DPM manufacturers provide protection ranging from 10 times full-scale input (2 V on a 200-mV instrument) to 250 V, regardless of input sensitivity (or 1250 times the full-scale sensitivity of a 200-mV range).

D'Arsonval meters will normally tolerate a continuous overload of 10 times full-scale input with no permanent damage or change in calibration. Tolerance of momentary overloads may be greater, but this depends strongly upon the overload waveshape.

One exception to this general rule is the thermocouple-actuated ammeter, which has a narrow overload range of 20% beyond full scale.

Typical DPM specifications for noise rejection range from 60 to 120 dB for common-mode rejection (noise common to both high and low sides of the input), and 20 to 40 dB for normal-mode rejection (60-Hz noise on the high-input line

only) and filters may be needed in some cases.

An analog instrument, by the very nature of its electromechanical construction, is immune to most of the noise problems that plague DPMs. Both common-mode and normal-mode noise rejection are virtually infinite in analog meters.

For DPMs operated from the ac-power line, isolation is generally limited, by the insulation of the power transformer and by circuit leakage, to between 250 and 600 V. This means that a DPM cannot be used to measure, for example, power-supply current in a line at 1000 V above ground.

A dc-powered DPM is usually also limited in isolation from its power supply—in fact, more so than line-operated devices.

memory, the BCD output is usually a low-cost option, and is available either as a parallel or serial presentation.

D'Arsonval meters do not, of course, provide BCD outputs. You can, however, provide "one-of-n" decoding, where n may range from 4 to 32, by clamping the indicating pointer onto a printed-circuit commutating dial at regular time intervals. Such "analog a/d converters" are not common but can be useful in sorting and batching operations.

Temperature coefficients for DPMs are frequently specified from 0.001 to 0.01%/°C. With a 0.01% coefficient, a 3-1/2-digit instrument will show a two-digit change in reading for every 10° change in ambient temperature.

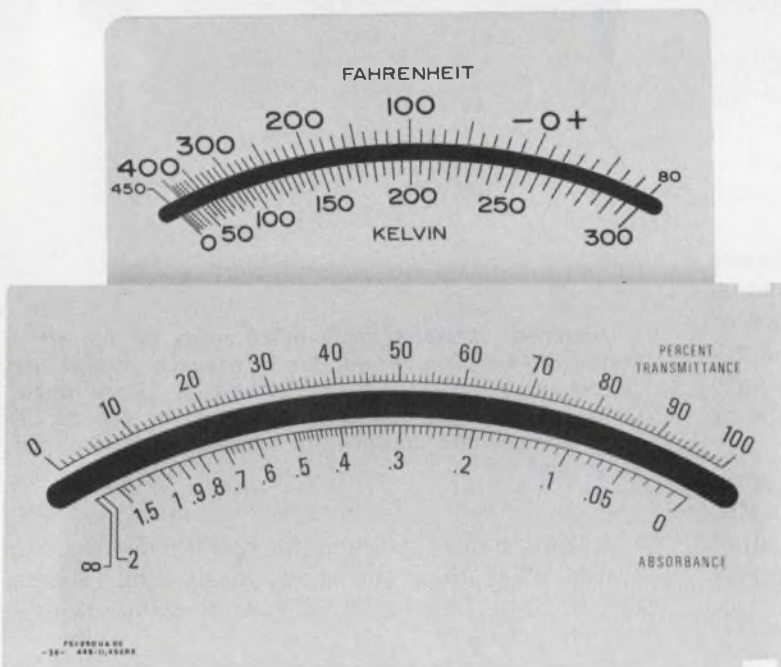

5. Multiple scales permit the simultaneous display of two or more related variables without range switching. Top: Temperatures from absolute zero is shown in both Kelvin and Fahrenheit. Bottom: Optical clarity of chemical solutions are displayed in units of both transmission (0 to 100%) and optical density (infinite to 0).

Since an analog meter has no power requirements—other than the input signal—it enjoys excellent isolation, limited only by the leakage resistance of the case between terminals and mounting panel. An isolation of 1500 V between terminals and panel is considered standard for most common analog ranges.

Display memory in a DPM is usually free (or a low-cost option), since storage is necessary anyway to provide a nonblinking display. But storage is erased by power failures.

Analog memory is an uncommon option, but it can be provided if the indicating pointer is clamped at its current location. Such analog "memory" can be made fail-safe—the clamping force remains even in the absence of line power.

Frequently DPMs provide a BCD output for comparative or data-logging purposes. As with

With analog instruments, temperature changes affect mostly the resistance of the copper wire in the moving coil. The change is about 0.4%/°C. This coefficient has little effect on current ranges. But unless the meter design provides compensation, tempco can cause serious inaccuracies in voltage ranges.

Often a large resistance is used in series with the moving coil to swamp out the changes in copper resistance. Or a negative-coefficient thermistor is used. With a combination of both resistor and thermistor compensation, analog voltmeters can maintain 1% accuracy over a temperature range of 100 C. This corresponds to a reading coefficient of 0.01%/°C.

Digital panel instruments are substantially more complex than their analog counterparts. Thus, simply on the basis of joint probabilities

RATIO OF ANALOG/DIGITAL METER PERFORMANCE BY FEATURE									
FEATURE	ANALOG BETTER			EQUAL	DIGITAL BETTER				
	$10^{-9}$	$10^{-5}$	$10^{-2}$	0.1	1	10	100	$10^3$	$10^4$
PHYSICAL	MINIMUM SIZE								
	MINIMUM PANEL SPACE								
	OPERATING TEMP RANGE								
	HUMIDITY RANGE								
	SHOCK AND VIBRATION								
DISPLAY	VISUAL READING SPEED								
	COMPREHENSION TIME								
	AMBIGUITY (APPROX)								
	PRECISION								
	PARALLAX								
	READING DISTANCE								
	MULTI-RANGE COST								
	NON-LINEAR COST								
	RESPONSE TIME								
PERFORMANCE	INPUT IMPEDANCE								
	INPUT POWER								
	TOTAL POWER								
	OVERLOAD PROTECTION								
	NOISE REJECTION								
	LINE ISOLATION								
	MEMORY								
	DIGITAL OUTPUT TEMPERATURE STABILITY								
RELIABILITY									
COST FOR EQUIVALENT ACCURACY									

6. Graphical comparison of performance of analog and digital-panel instruments. Numerical values are derived from the ratio of the analog spec to the digital spec, with ratios favorable to analog meters going to the left, and digital to the right. Total power consumption for analog meters is less than for DPMs, and is shown to the left. Noise rejection and isolation are greater for analog meters but the chart is drawn to the left to emphasize the favorable difference for analog displays.

of component failures, DPMs should be less reliable than D'Arsonval meters.

### Comparing reliability and price

This is essentially true, notwithstanding the figures for calculated MTBF published by some DPM manufacturers. Field experience indicates that warranty failure rates for DPMs range from 25% down to 2%, with most OEM users regarding satisfactory reliability at the 5% to 10% levels.

Warranty failure rates for analog meters lie in the range of 20% to 1%, with most users accepting 2 to 5%.

Such failure rates obviously vary with the nature and complexity of the instrument, from one manufacturer to another and with intervals of time. As a general observation, analog meters will be two to three times more reliable than DPMs.

With DPM prices still moving downward, it's difficult to make absolute cost comparisons between analog and digital-panel instruments. Very broadly, D'Arsonval meters are available in OEM quantities (100-up) from \$6 to \$20, whereas 2-1/2 and 3-1/2-digit DPMs are priced at \$50 to \$120 in similar quantities. ■■



There are hundreds of pages in our new I.C. Logic Card Handbook to help you lower costs — not just card costs but *total system costs*. As an example — there are probably more function-cards illustrated and all with Dynamic Decoupling\*, than in any other single logic card source. Function cards means less cards, less back plane wiring, less testing — and *less system costs*.

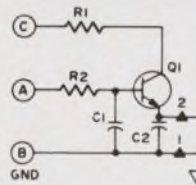

\*Dynamic Decoupling™ is a Datascan exclusive — it's a circuit right on the card which eliminates high and low frequency noise for extremely reliable system operation. You get a clean 5V DC power bus *on each card* — reducing system costs by eliminating system debugging.

Our many services to reduce costs start with letting you know what we have to offer — *get your own copy of Datascan's new Logic Card Handbook* — and see all the DTL, HTL (for high noise environment) and TTL circuits you don't have to design.



P.O. Box 785  
1111 Paulison Ave.  
Clifton, N.J. 07013  
Telephone: (201) 478-2800

## Datascan

Datascan  
Electronic  
Products

925

INFORMATION RETRIEVAL NUMBER 79

Variable compression  
mica capacitors:

# Small, Inexpensive, Wide-range, Go-anywhere Capacitance Packages

(Try 'em . . . you'll like 'em!)

Do you need a capacitor you can adjust from 1400 to 3055 pF (or almost *any other* range down to 0.9 to 7.0 pF)? As small as  $\frac{3}{8}$ " x  $\frac{1}{32}$ "? That mounts by *any* method, in *any* location, including PC applications? That has a high Q, smooth adjustment, low inductance, excellent thermal stability and resistance to shock, vibration and humidity?

*And that you can buy in quantity, off the shelf, typically for 15¢ each?*

It will pay you to look into EI-Menco variable compression mica trimmers and padders—the "old reliables" whose highly developed characteristics and extremely wide line today make them the capacitors of choice in hundreds of state-of-the-art communications, instrumentation, audio and military electronics equipment. For example: in RF, oscillator and FM antenna circuits . . . HF bias (tape) from 85 to 95 kHz . . . phase control circuits . . . compensation for other components . . .

SSB 2.0 MHz channel strips. And perhaps one of these possibilities gives you an idea: coax cable line termination, pulse transmission, an equalizing/matching network, a low-Q tone generator, or padding in a TV circuit, power supply or home appliance.

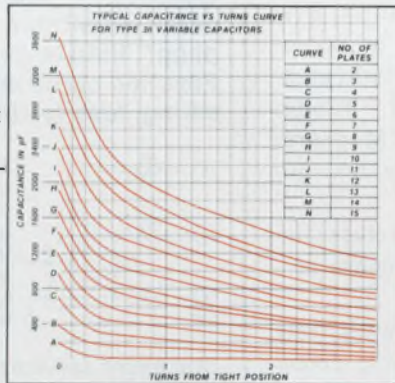

WRITE FOR COMPREHENSIVE TECHNICAL DATA:

a recent technical article reprint and a 29-page set of data sheets are yours for the asking. Send request directly to:



**THE ELECTRO MOTIVE MFG. CO., INC.**

Willimantic, Conn. 06226

West Coast: Collins and Hyde Co.

Nationwide: Arco Electronic Distributors

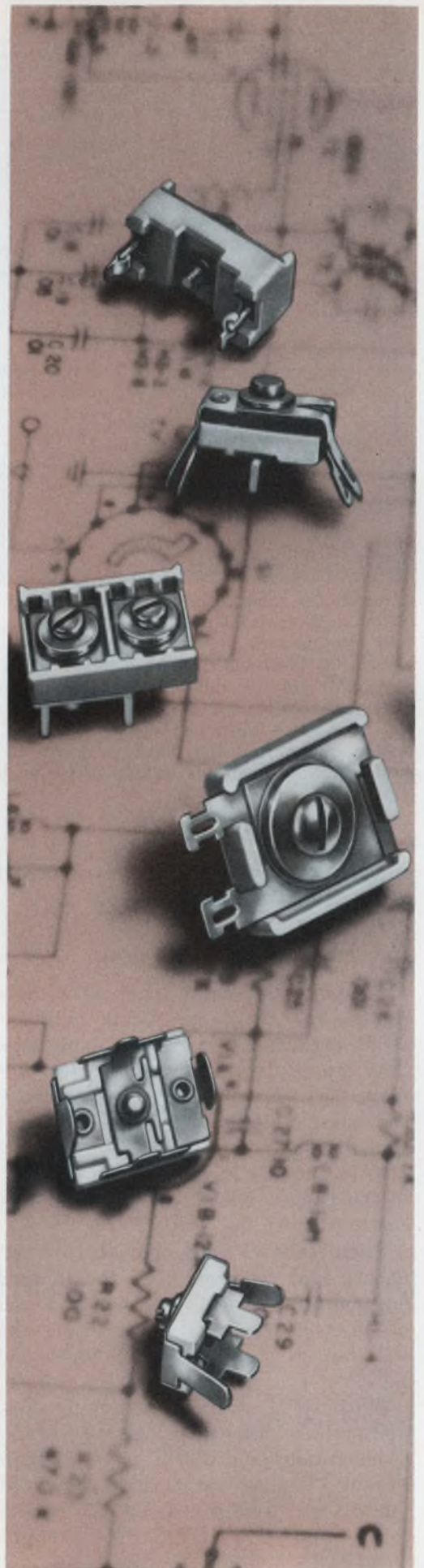

# Front panel components should look good.

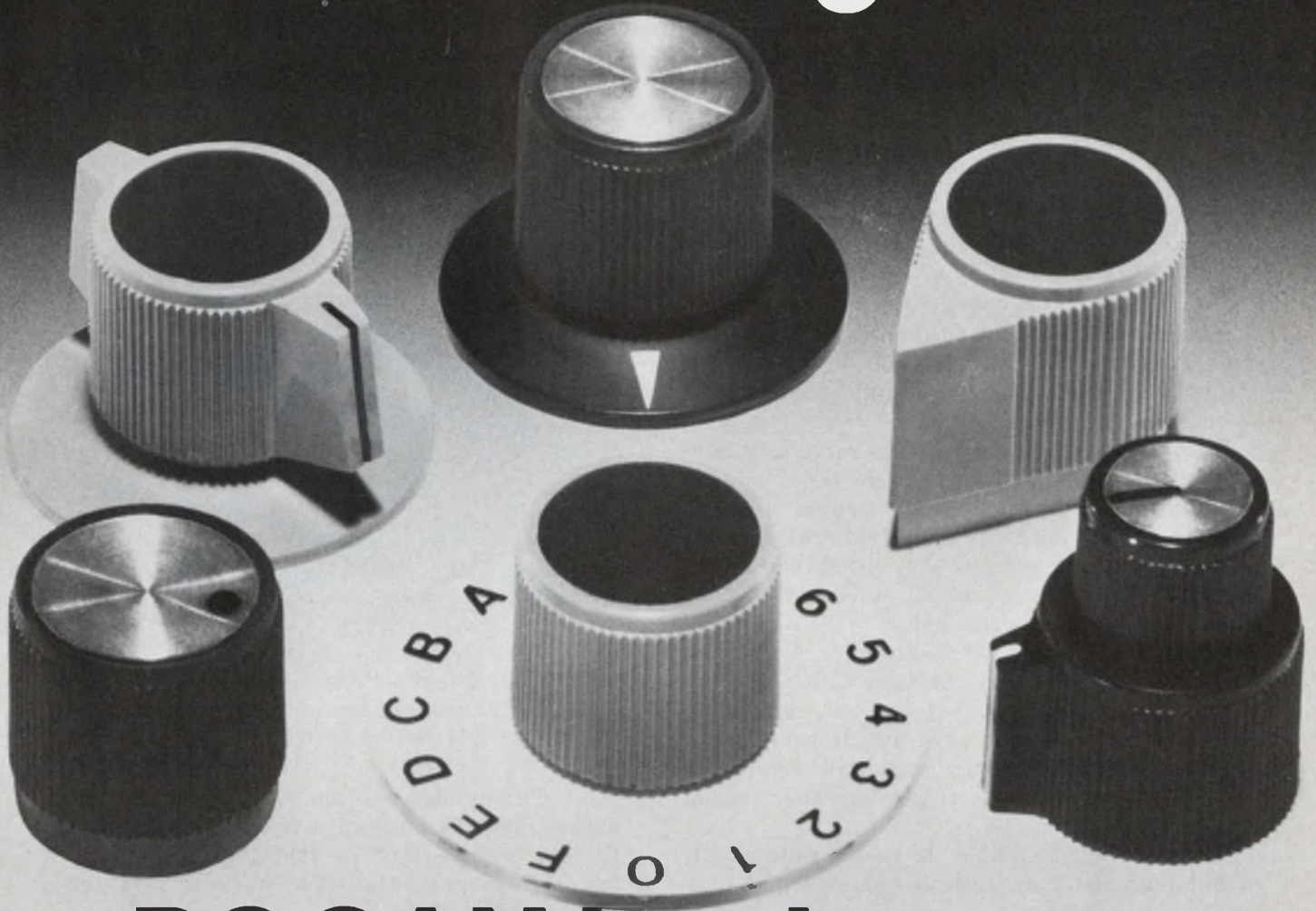

## ROGAN knobs and dials do.

Today's market is aesthetics-conscious. An attractive front panel adds to the acceptance of your product. Front panel components, including control knobs and dials, must contribute to the overall design. Some knobs and dials simply look better than others. We think that the Rogan line illustrates superior styling details, while offering the largest selection of functional shapes and sizes available. Obtain a copy of our catalog by contacting Rogan . . . the control knob and custom dial company.

**ROGAN**  
CORPORATION

3455 Woodhead Drive, Northbrook, Illinois 60062  
Phone: (312) 498-2300 · TWX: 910-686-0008

# DVMs aren't what they used to be.

More and more, they're being used as systems components. Here's what you should know to interface them with your system.

Digital voltmeters are not as simple as they used to be. Once they were used solely as stand-alone instruments; now they are being used increasingly as parts of systems—anything from simple DVM/printer combinations to giant computer-controlled applications involving many separate instruments.

How does the DVM communicate with the other elements of the system?

In any system one device must serve as a controller. In the case of the simple DVM/printer combination, the DVM tells the printer when to print the DVM data. In larger systems a calculator or computer acts as the system controller. Communication can be either unidirectional or, more commonly, bidirectional.

Early "systems" DVMs and most present bench DVMs are primarily transmitters that are capable of outputting data, but are not capable of being programmed to change function or range. Typically these machines can only accept, or "listen," to an external trigger and then output a reading.

Modern systems DVMs, however, cannot only output data but may also be remotely programmed.

When such a DVM is used in a system, the communication or flow of information must be managed somehow to avoid conflicts in timing. This management is the function of the interface.

## Interface standard is needed

A practical interface system needs three types of interchange lines:

1. Data lines—used for the actual flow of data. The data consist of range, function and polarity, as well as amplitude.

2. Control lines—systems-management lines that permit remote control, priority interrupt, etc., and, in the case of serial operation, provide a means of distinguishing between address information and data.

---

Larry Potter and Bob Frazer, Product Managers, Hewlett-Packard Co., Loveland Instrument Div., 815 14th St. S.W., Loveland, Colo. 80537.

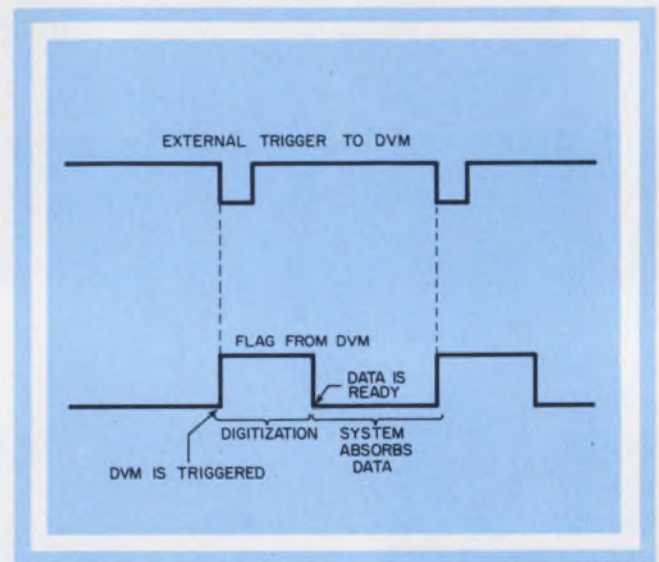

1. Typical "handshake" between DVM and other system elements ensures against timing conflicts.

3. Timing lines—often referred to as handshake lines. These ensure that there is no conflict in timing—that is, that the system is not trying to program the DVM while it is taking a reading (Fig. 1).

These three lines may transmit in parallel or in serial. Each has advantages and disadvantages.

Parallel operation uses a line-for-line approach to data transmission. Since output data is usually coded in an 8-4-2-1 sequence, each digit requires four lines. Function, range and polarity add additional lines. Programming is also on a line-for-line basis. Thus a typical five-digit DVM requires about 45 lines to transmit and to receive digital information.

The most fundamental signal coming into the DVM is the external trigger that commands the voltmeter to take a reading. To acknowledge the trigger, a "flag" line changes its logic state, then returns when the reading is completed. On most DVMs, the flag functions as a "DVM busy" signal, since the voltmeter will accept a trigger only when the flag is in the right logic state.

As with the external trigger, programming also requires management. Once the program lines are set—when range and function are selected—

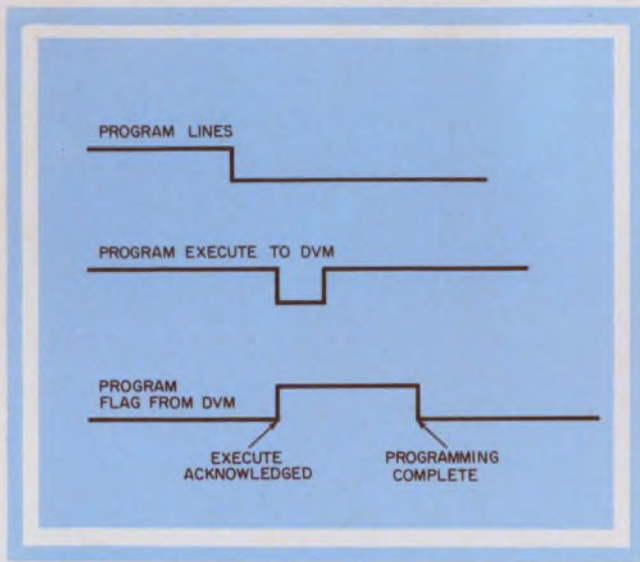

2. Management sequence strobes program information into the DVM after function and range are selected.

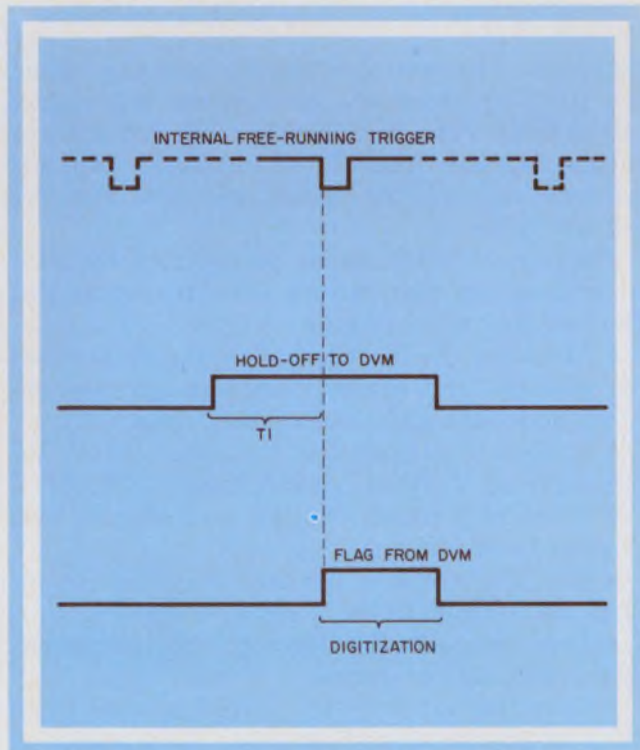

3. Printer/DVM combinations usually "talk" to each other by use of an indirect hold-off method.

a program execute line strobes the program-line information into the DVM (Fig. 2).

A program flag line then changes logic state to acknowledge the program-execute command, and it remains in that state until the programming is completed. The flag then reverts to its initial state.

Synchronization between programming and triggering varies from DVM to DVM. Most DVMs ignore an external trigger during programming. Others store the trigger until the programming is completed. (If a trigger is accepted during programming, the DVM may try to change function while it digitizes; hence, there's a need for synchronization lines.)

There is a second way—commonly used with printers—to tell a DVM to take a reading. This method, which is actually an indirect form of triggering, uses a hold-off line to inhibit the DVM's internal free-running trigger (Fig. 3). When the hold-off line is released, the next internal trigger starts digitization. Since the hold-off line is pulled high, independent of the internal trigger source, there is a variable time delay (shown as  $T_1$  in Fig. 3) before the DVM starts the measurement cycle. Thus precise timing control over digitization is lost.

### Serial interface reduces connections

A second means of digital data communications, used by a few DVMs, is the serial interface. This approach has not been popular in the past but promises to provide an accepted industrial standard. This standard, proposed by Hewlett-Packard to the International Electrotechnical Commission, is known as the General Purpose Interface Bus (GPIB). The interface is applicable not only to DVMs but to all types of instrument systems using computers, calculators and peripherals.

The GPIB shifts the functions of coding and decoding, as well as other functions, from the computer or calculator I/O card to the instrument. Consequently a system can be configured merely by connection of passive cables. Up to a total of 15 instruments can be connected to this



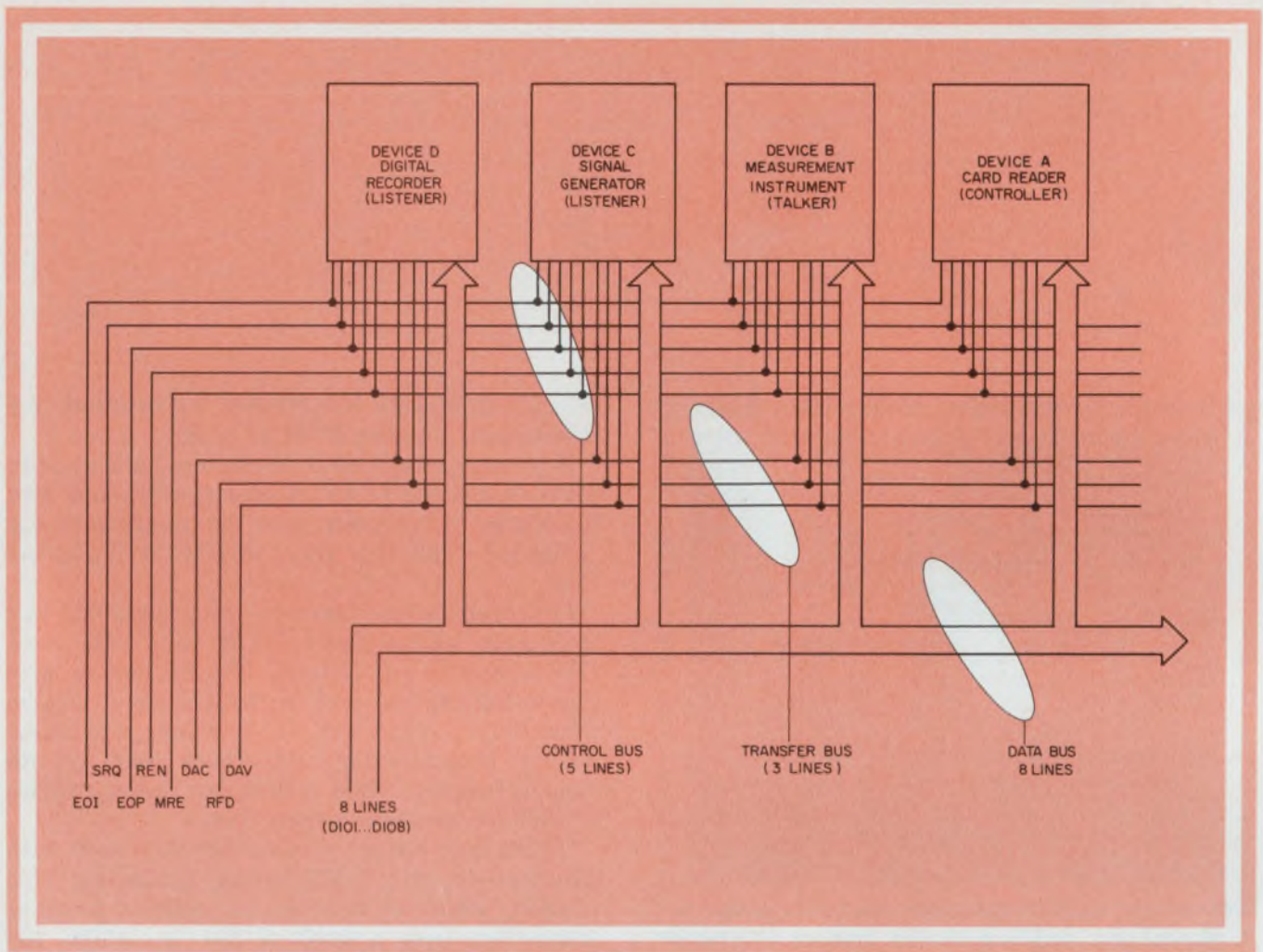

4. Systems communication network consists of three major busses: data, transfer and control.

common bus simply by daisy-chaining parallel cables.

To enable the controller (computer or calculator) and all instruments to communicate bidirectionally over the same set of lines, the interface must transmit data, including addresses, measurement results and commands; synchronize the transfer of information; and manage the information flow.

To do this, the interface uses an eight-line data bus, a three-line transfer-bus and five additional control-bus lines (Fig. 4). The data bus provides the capability of transmitting an eight-bit byte. Coding is not restricted but can be, for example, a seven-bit ASCII code with one parity bit. Information is exchanged in byte-serial fashion at data rates up to one megabyte per second.

Each device connected to the GPIB can act as a "talker"—it can output information to the data bus; a "listener"—it can accept information from the data bus; or a "controller," or GPIB manager. Interchange of roles is possible. For example, a DVM is a talker when it outputs data, and is a listener when it accepts program-

ming data. The controller permits only one talker at a time, but more than one listener is possible. In the latter case, each device must recognize a unique address. A DVM would have two addresses: one for the talker and one for the listener mode.

The control bus manages, or controls, the flow of information transmitted over the data bus. The bus does the following:

- Identifies the information on the data bus—for example, the control bus distinguishes between addresses and measurement data.
- Enables the controller to place system instruments in a remote-control mode.
- Provides a means for the controller to halt all data transmission.
- Provides a means for an instrument to inform the controller that it requires service.
- Lets the controller identify the instrument that is requesting service.

Finally the last bus—the transfer—uses three wires to provide these functions: the transfer of data asynchronously at any rate up to 1 Mbyte/s; the adjustment of data transfer to the slowest

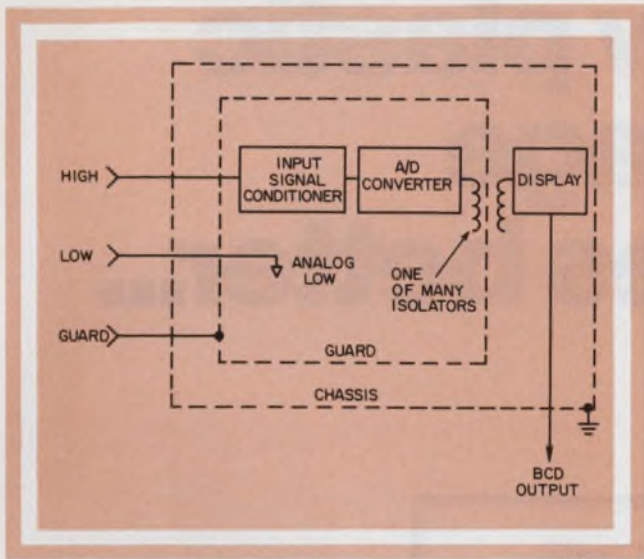

5. To avoid grounding problems, isolation of input/output signals is almost a must with systems DVMs.

device without interference with operation of the fastest device; and acceptance of data by more than one device at the same time.

#### Isolate the output

Whether data is outputted in parallel or in serial, it is highly desirable to have the data-output lines isolated; that is, the analog low-input terminal is isolated from system ground. This is because most system DVMs have a floating input, while the majority of the other system components are grounded.

If the DVM data-output lines are not isolated, they will be referenced back to the DVM chassis through power-line ground. Thus, nonisolated lines defeat the ability of the DVM to make floating measurements and create a path for ground loops that can seriously degrade common-mode rejection.

One way to isolate the analog inputs from the digital outputs is to use a guard (Fig. 5). Isolation is achieved by passing the digital information across the guard shield with pulse transformers, optical couplers or other means.

Since one isolator is needed for each data line, a five-digit, parallel-output DVM requires about 45 isolation devices.

To reduce the number of costly isolators, some DVMs make a parallel-to-serial conversion before they pass the digital information across the guard. In other DVMs, the specific analog-to-digital technique used is inherently serial in nature. This can drastically reduce the number of isolators needed.

In still other DVMs, the partitioning of the circuitry is such that the analog circuitry is "in-guard" and the digital circuitry is "outguard." This minimizes the number of lines needed to cross the guard. ■■

# NEW

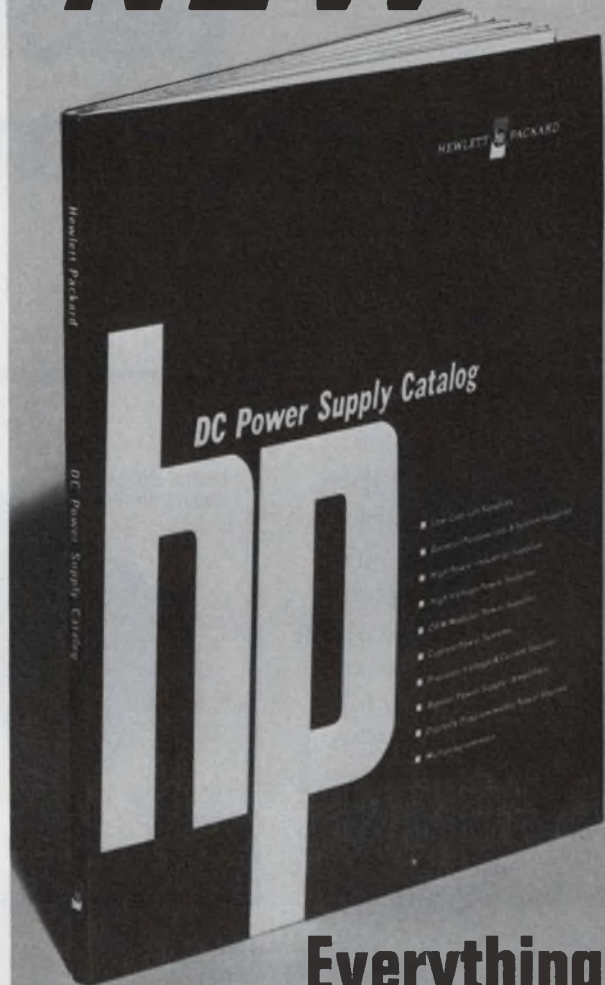

## Everything You Need To Know About HP DC Power Supplies

Choosing the right power supply for your application is easy with HP's new DC Power Supply Catalog . . . 120 pages . . . featuring photos, specs, drawings and options on HP's complete line of modular, lab, system and digital power supplies . . . PLUS factual and informative details like: Power Supply Terms and Definitions, How To Select Power Supplies, What To Expect From HP Equipment . . . and more . . . yours for the asking.

**For new standards in power supplies — think HP.**

HEWLETT  PACKARD

Sales and service from 172 offices in 65 countries.  
1501 Page Mill Road, Palo Alto, California 94304

21401

# RCA's new plastic package is 100 times better...

We call it the E-55 Plastic Packaging System: But you don't have to remember the name — because every plastic LINEAR IC you buy from RCA is packaged in this new system that features IMPROVED RELIABILITY OF TWO ORDERS OF MAGNITUDE... at no extra cost.

Just look at the results of five real-time indicator tests. They tell the story.

- Temperature Cycling (at 200 cycles) — 1600 times improvement.
- Thermal Shock — 610 times improvement.
- Pressure Cooker — 250 times improvement.
- Bond Pull Strength — 10 times improvement.
- Hot intermittent opens — 250 times improvement.

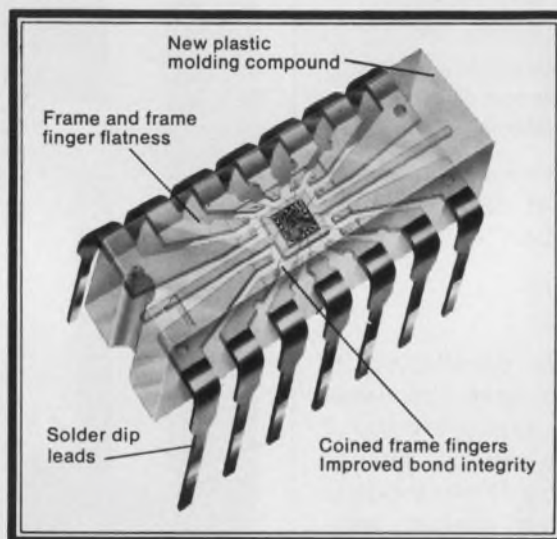

E-55 is a totally new system of plastic packaging. RCA has improved materials, handling procedures and process controls to bring you a low-cost state-of-the-art IC plastic package that matches the reliability of hermetic

packages under severe environmental stress. And it offers operation in the full temperature range of  $-55^{\circ}$  to  $+125^{\circ}\text{C}$ . So design in a real package of reliability... RCA's 100 times improved E-55 Plastic Packaging system.

Want more details on the E-55 plastic package system and reliability test data?

Write RCA Solid State, Section 57K-22, Box 3200, Somerville, New Jersey 08876. Or phone: (201) 722-3200.

**RCA** Solid State  
products that make products pay off

# $\Omega$ Micaply hmega™

## A new way to design with resistors.

Micaply Ohmega is a unique resistor-conductor circuit material that provides circuit designers with a new way to design with resistors. It's available in 10" x 36" sheets with 25 or 100 ohms per square sheet resistivity.

This unique material is an epoxy glass substrate completely covered on one or both sides with a bi-layer cladding. The thin film type layer against the substrate is resistive, the top layer is copper. Using conventional printed circuit produc-

tion techniques, patterns of conductors and resistors can be etched to produce circuits complete with integral resistors. The entire process is subtractive—no screening, firing, or vacuum equipment is required.

Micaply Ohmega is ideally suited for high resistor density, low resistor value circuits; multilayer circuits where the resistors can be put between layers; circuits where economical step and repeat methods can be used on large sheets of Micaply

Ohmega; and designs previously impractical or uneconomical with other materials.

Let's talk about your potential applications.

**The Mica Corporation**  
Culver City, California  
(213) 870-6861 and  
Micaply International, Silloth, England  
INFORMATION RETRIEVAL NUMBER 84

### We can assist in design and provide prototype circuit production.

*Multilayer printed circuit boards*

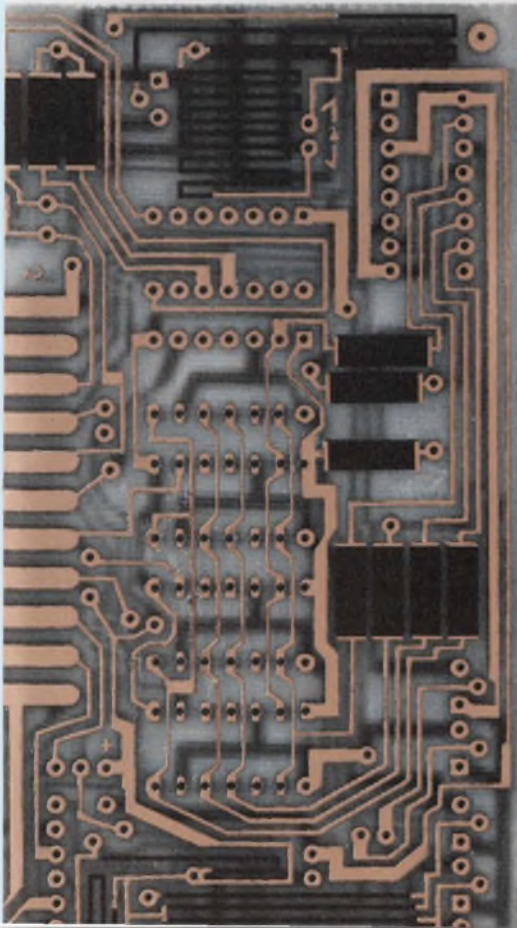

*High resistor density circuits*

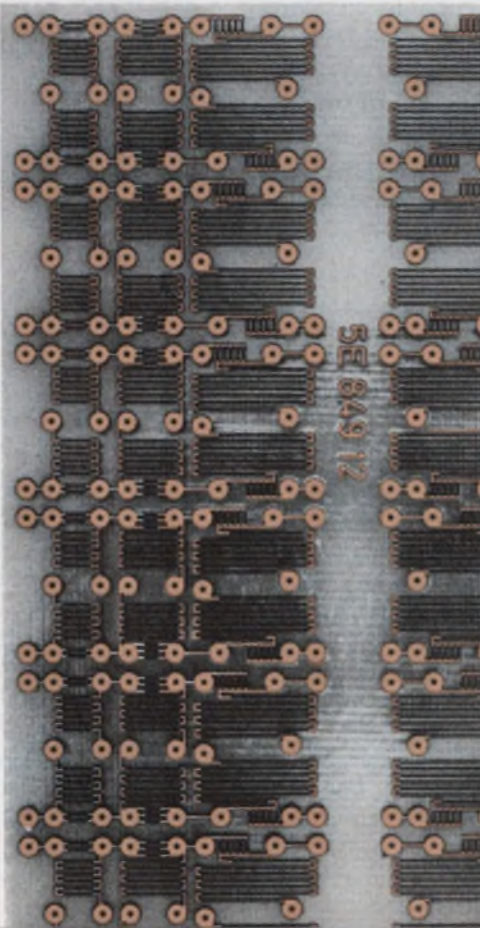

*Hybrid microelectronics*

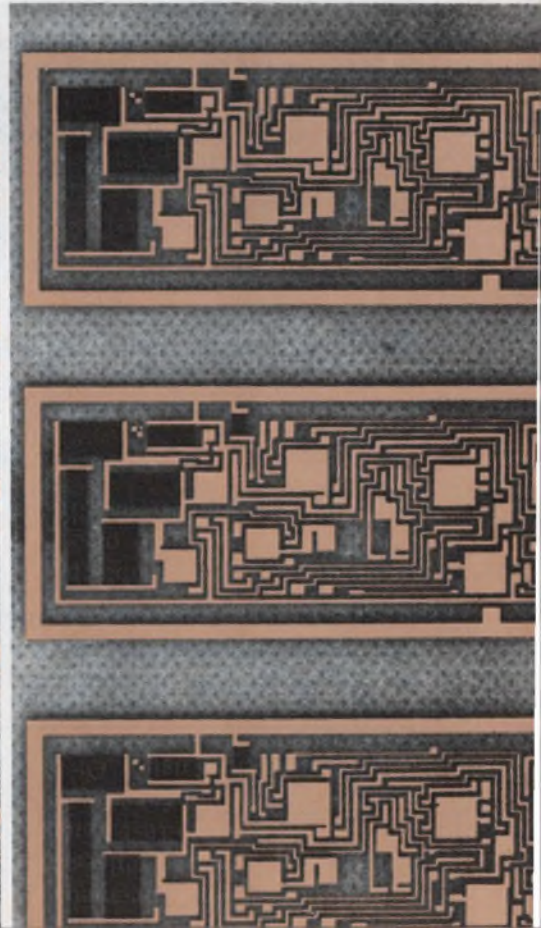

# Select digital testers systematically.

Flow charts help match your requirements to the equipment and show management what its money is buying.

When exploring commercial digital test systems, an engineer must develop specifications and then determine if a system meets those specifications. A flow chart will lighten the task (Fig. 1).

Begin by placing the unit under test (UUT) in one of several broad categories according to package, process, etc. The categories include dual-inline packages (DIPs), flat packs, wafers or chips, MOS/LSI and PC boards.

Once the UUT has been defined, collect details of commercially available test systems and simultaneously specify requirements. Performing these two functions together saves time and lessens the possibility that the system specs will be influenced by any one test system.

The availability of many dedicated test systems limits the number that need be considered. Thus, for testing PC boards, systems dedicated to testing MOS/LSI need not be considered. Some manufacturers report that their systems can handle almost any type of UUT, and, of course, these systems should be considered along with the others. Even including these, however, you'll usually have to check out 10 to 12 systems.

Compiling a list of manufacturers of digital test systems can be a problem, but several sources exist—buyers' guides and advertisements, for example.<sup>1,2</sup> The most useful sources are surveys and articles that describe commercial test systems and their applications.<sup>3-7</sup>

## Three major categories for test specs

Test system specs can be placed in three broad categories (Fig. 2):

1. Those for actual device tests.
2. Those for the test system/UUT interface.
3. Those for the operation and maintenance of the system.

These categories are not independent; inter-relationships appear as the various specifications are defined. System requirements can be listed, as shown in Fig. 3, under the three categories.

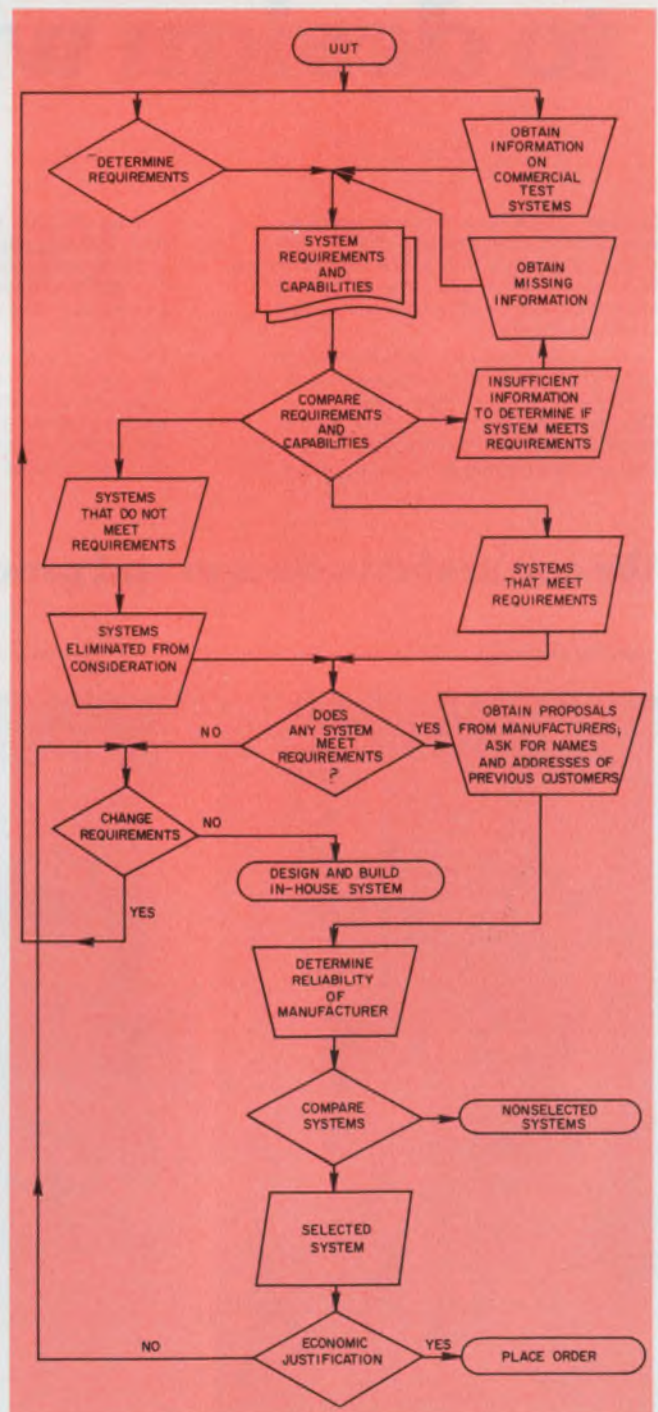

1. Flow chart formalizes test-system selection procedure and helps to match capabilities of commercial test systems to test requirements.

T. P. Brittingham, Development Engineer, and K. To, Member, Research Staff, Western Electric Co., Engineering Research Center, Princeton, N.J. 08540.

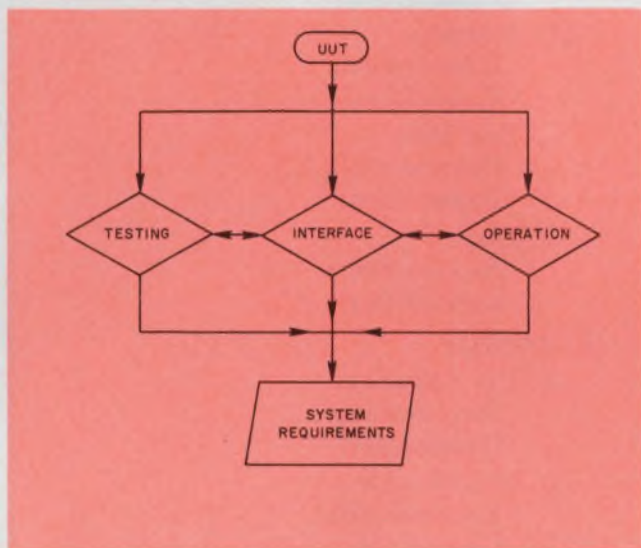

2. Test requirements can be put into three categories: those for device tests, those for interface and those for equipment operation and maintenance. The three are interdependent.

In each are the specs common to all test systems, with each spec having a section for requirements and a section for system capabilities. Thus requirements and systems capabilities can be compared directly.

Moreover with this technique you need not refer to catalogs and brochures every time a question about a system's capabilities arises or the requirements are changed. Also included in the documentation are sections for price and reliability evaluation. These are referred to after proposals have been received.

After determining the specs and receiving and entering the vendors' data, you must decide if each system meets your specs. Initially you'll reach one of three conclusions:

1. The information supplied by the manufacturer is insufficient.
2. The system does not meet the specifications.
3. The system meets specifications.

In some cases the manufacturer may be reluctant or unable to furnish all the requested information. This should be considered when evaluating reputation and reliability.

Naturally systems that don't meet specs are eliminated. However, don't discard the documentation; later specification changes may re-qualify a system.

If no commercial tester meets the original specs, consider changing the specs. If they can't be changed, then a test system will have to be designed in-house.

Next, solicit specific proposals from the manufacturers of those systems that meet the specs. List all specs in the request for proposal. Request the names and addresses of companies that have previously purchased the manufacturer's test system. An interested manufacturer will gladly provide such a list. Some will also describe the applications for which their systems were used, or will list the names and phone numbers of engineers originally responsible for these systems.

### Economics plays a role

When the proposals are received, enter the prices into the documentation. Rival systems may then be compared by use of an accounting technique, such as evaluation of incremental investments.

Usually you must justify the purchase to management as economically feasible, and one way to do this is by the payback method.<sup>8</sup> The criterion used is the length of time necessary for the return to equal the investment, where return is the savings obtained from using the test system over some previous method. The number of years required for the test system to pay for itself is then given by:

$$\text{Payback period} = \frac{\text{Cost of test system}}{\text{Annual savings}}$$

Savings may be found by subtracting the estimated cost of operation from the cost of testing with the previous method. If no previous method exists, the savings may represent the difference between the cost of operating the system and the cost of materials and labor that would have been wasted if no testing were done. Because savings are estimated, the payback period is also not exact.

Management will frequently specify a maximum time for an investment to pay for itself, thus placing a minimum annual savings requirement on an investment:

$$\text{Minimum annual savings} = \frac{\text{investment}}{\text{payback period}}$$

Because of fast changes in commercial test systems—with new companies entering the market and new systems rapidly making older models obsolete—a tester should have a payback period of no more than three years.

If you can't justify the purchase of a system economically, consider changing the specs. If you don't, you'll have to design and build your own tester. But a decision to change the specs means going through the entire evaluation procedure again: developing, updating, comparing, requesting and evaluating proposals, selecting a new system and justifying its purchase to management.

The amount of work involved may be enormous—or it may be confined to a change in only one spec; nevertheless new proposals will probably be required.

Your responsibility may not end with the placement of the purchase order—indeed, it has probably just begun: As an engineer, you may be required not to only watch the system being built but also to install and debug it. However, the development of test-system specs is the most critical part of the evaluation procedure.

### How to develop specs

Developing realistic specs the first time will minimize the number of times you'll have to go through this procedure. The logical starting point is to determine those specs that relate to the actual testing of the UUT digital circuit. Tests can be put into one of four groups:

1. Dc parametric—tests used to evaluate the direct-current characteristics of the UUT, including threshold voltages, currents, fan-in and fan-out, and leakage currents.

2. Functional—tests of the Boolean logic of the circuit, as represented by the circuit's truth table.

3. Pulse parametric, or dynamic—tests of the switching characteristics of the circuit, including rise time, fall time and transition time.

4. Clock-rate—functional tests performed at the maximum clocking rate of the circuit.<sup>9</sup>

One or more of these tests can be specified for a system. The choice will depend to some degree on the circuits to be tested and the eventual location of the tester in the production process.

The choice of tests will also influence the voltage specs; for example, to perform dc parametric tests, precise voltages must be applied to the UUT. Thus the tester will need precision power

## COMPANY NAME & ADDRESS

## SYSTEM NAME/MODEL NO.

### I. Testing

A. Type of test(s)  
Requirements:  
Capabilities:

B. Voltages  
Requirements:  
Capabilities:

C. Test Rate  
Requirements:  
Capabilities:

D. Other  
Requirements:  
Capabilities:

### II. Interface

A. Pin Capacity  
Requirements:  
Capabilities:

B. Multiplexing  
Requirements:  
Capabilities:

C. Other  
Requirements:  
Capabilities:

### III. Operation

A. Throughput Rate  
Requirements:  
Capabilities:

B. Test Results  
Requirements:  
Capabilities:

C. Programming  
Requirements:  
Capabilities:

D. Maintenance  
Requirements:  
Capabilities:

E. Other  
Requirements:  
Capabilities:

### IV. Reliability of Manufacturer

A. Experience within our company  
B. Experience of other companies

### V. Price

3. Equipment specs can be itemized, along with requirements, for each vendor. In this way catalogs won't be needed each time a question arises.

supplies. Related specs include the nominal voltage, voltage ranges and precision, and current capacities. Voltage requirements will also be greatly influenced by the UUT, particularly in the case of MOS/LSI circuits, which have large negative biases and swings.

Test rates are dictated primarily by the required types of tests. Slow rates are required for dc parametric and dynamic testing, but extremely fast rates (5 MHz or greater) are required for clock-rate testing of MOS/LSI circuits. Test rates may also be influenced by the throughput rate—the number of UUTs that must be tested in a given time.

Other requirements that may be imposed by the nature of the tests and the UUT include special instruments or circuits for dc parametric or dynamic testing, four-phase clocks for MOS/LSI circuits, and special loads for nonstandard UUTs.

### Specifying the interface

Interface requirements are influenced most by the UUT. The interface, generally referred to as the test head or test station, includes the connector adapters for mating the UUT to the test system, circuits for selecting the inputs, outputs, power and grounds, and perhaps special handling equipment to connect and disconnect the UUT.

The interface may be in the same cabinet as the test circuits, instruments and program-control equipment. Or it may be in a separate cabinet some distance from the main system.

In developing interface specs be sure that the pin capacity of the test system equals or exceeds the number of pins on any UUT that may be tested. Occasionally a UUT with more pins than can be handled by the system may be tested by use of sophisticated programming techniques.<sup>10</sup> However, such testing should not be initially designed into the system.

When the throughput rate is slow, consider using multiple test heads. With multiplexing, one test system can handle several production lines on a time-shared basis. This considerably reduces the idle time of the system and cuts investment and operating costs. Switching requirements for the interface are influenced by the UUT, which dictates the number of switching circuits, and by the types of tests. For dc parametric or dynamic tests, interface switching circuits should not significantly affect the UUT inputs and outputs. In most cases each pin on the interface connector should function as either an input or output. But to preserve critical signals, input and output lines should be kept separate.

Other interface requirements can include aux-

iliary circuitry in the test head, special handling equipment and special adapters.

As for operation and maintenance, requirements depend more on the decisions made in specifying the test and interface requirements than on the UUT.

### Throughput rate may be critical

The most important operational requirement, at least from management's viewpoint, is the throughput rate. Usually the rate is directly specified by management or indirectly limited by the production line. To determine whether the throughput rate of a tester meets the requirement, calculate:

$$\text{Hourly throughput} = \frac{3600}{t_T + t_i}$$

where  $t_T$  = test time in seconds =  
average number of tests per UUT

test rate  
+ time from "start-test" command  
to first test  
+ time from last test to final  
go/no-go decision,

and

$t_i$  = insertion time in seconds.

The insertion time is the total time needed for the operator to remove the previous UUT, insert the new one and initiate the "start-test" command. The throughput rate can be improved by a reduction in either  $t_T$  or  $t_i$ . Test time,  $t_T$ , can be reduced most readily by increasing the test rate, if the rate is not near the maximum (as would be the case in clock-rate testing). Insertion time can be reduced by use of automatic handling equipment.

But improvement in the throughput through reduction of  $t_T$  or  $t_i$  may still not be enough to meet the required rate. However, with system multiplexing—the use of two or more test heads, so one UUT can be tested while another is being disconnected—the problem may be solved. ■■

### References:

1. "Electronics '71 Buyers' Guide," McGraw-Hill, New York, 1970.
2. "Electronic Engineers Master," 1971-1972, United Technical Publications, Garden City, New York, 1971.
3. "IC and Semiconductor Testers," *Electronic Design*, Oct. 25, 1970.
4. Edelman, S., "Testing Integrated Circuits," *The Electronic Engineer*, September, 1970.
5. "IC Test Equipment Buyers' Guide," *Solid State Technology*, March, 1970.
6. Venn, F. V., "An Introduction to IC Testing," *IEEE Spectrum*, December, 1971.
7. Runyon, S., "Focus on MSI/LSI Testers," *Electronic Design*, Aug. 17, 1972.
8. Riggs, J. L., "Economic Decision Models for Engineers and Managers," McGraw-Hill, New York, 1968.
9. Mc Aleer, H. T., "A Look at Automatic Testing," *IEEE Spectrum*, May, 1971.
10. Franson, P., "Learn to Evaluate IC Tester Performance," *Electronic Design*, Oct. 25, 1970.



# WOULD YOU LIKE A CAREFREE WEEK FOR TWO IN THE BLUE CARIBBEAN?

Relax or lend a hand, swim, scuba dive, or just put your feet on the rail. Visit exotic tropical islands and foreign ports. It's the vacation for thinking people with a spirit of adventure. Sail in air conditioned comfort on big, safe windjammers. Choice of Bahamas, Virgin Islands, Windward or Leeward islands cruises. Pick your own departure dates. It's a trip you'll always remember. AND it's only part of the big first prize offered this year.



## PLUS: \$1,000 IN CASH!

Everyone can use some extra money—especially on a cruise. Use it for babysitters, tropical clothes, shop the free ports, bank it or spend it. It goes along as an extra bonus to the lucky first prize winner who picks the Top Ten ads in the January 4 issue.



**REPEATING  
BY POPULAR  
DEMAND**

**Electronic**  
**1974 SUPER TOP**

LOOK FOR COMPLETE INFORMATION—LIST OF PRIZES

## AND: FREE JET TRANSPORTATION

This really makes the 1st prize complete. Think about it! The cruise . . . the \$1,000 in cash, AND free round-trip tickets *for two* on



regularly scheduled American Airlines jets to the cruise's point of departure. It all adds up to the vacation of a lifetime. AND, *you* can be the lucky winner!

## AND: YOU CAN WIN VALUES UP TO \$4,500—OR MORE— FOR YOUR COMPANY

Another big feature of the Top Ten Contest is the free advertising you can win for your company. Here's what your company can win if it has an ad in the January 4 issue:

**A FREE RERUN . . .** for each of the ads that are voted in the Top Ten by *Electronic Design's* readers.

**A FREE RERUN . . .** if one of your company's engineers wins any one of the first 3 prizes — whether or not your ad placed in the top ten.

**A FREE RERUN . . .** if one of your company's advertising or marketing people, or your advertising agency, wins any of the first 3 prizes.

Suppose you are one of the first three prize winners. If your company has a full page, 2-color ad in the January 4 issue, your company will receive a free rerun worth \$2,375. But suppose it is a 4-color spread. You've just racked up space worth \$4,700 for your top brass.

Be sure to alert your advertising or marketing manager to these possibilities. Urge him to schedule your company's ad in the January 4 issue . . . It's an opportunity no company can afford to miss.

# Design

# TEN CONTEST

## RULES—ENTRY BLANKS IN THE JANUARY 4 ISSUE

**ADDITIONAL  
PRIZES  
TO BE  
ANNOUNCED  
SOON**

**NO STRINGS, NO GIMMICKS  
... HERE'S ALL YOU HAVE  
TO DO TO ENTER**

- (1) Read the January 4th issue of *Electronic Design* with extra care.
- (2) Select the ten advertisements that you think will be best remembered by your 79,666 fellow engineer readers.
- (3) Identify the advertisements by company name and *Information Retrieval Number* (Reader Service Number) on the entry blanks bound in the issue. Mail before midnight February 15.



**MARK JANUARY 4  
ON YOUR  
CALENDAR NOW**

Try for the Top Ten. Contest judges will compare your selections with "Percent Recall Seen" scores on Reader Recall—*Electronic Design's* method of rating readership. Complete information, rules, and entry blanks will appear in the January 4 issue.

# Don't clobber your circuit with repeated waveforms. Tickle it with a single pulse and get all your results—faster, more accurately and with less heating.

You have a measurement problem. Maybe you have to measure fast pulses at low repetition rates. Maybe you have to test a large number of devices, and you're looking for a way to do it fast—in fact, much faster than usual. Or maybe you're testing a temperature-dependent device and you want to measure its response at very low duty cycles to avoid heating.

In any of these cases, your best solution may lie in a relatively new and different measurement technique—one that obtains all the necessary information in a single pass of a waveform. That technique is known as single-shot, sample-and-hold.

## Eliminate repeating waveshape

The principle behind single-shot is simple: All the information you need is contained in a single pass of a waveform, and that waveform can be measured if the bandwidth of your measurement instrumentation is sufficiently wide.

This principle contrasts with that of real-time scopes, in which a repetitive train of identical waveshapes "directs" an electron beam on a CRT screen. Each scan of the CRT phosphor reinforces the emitted light of the previous scan, so that a "picture" of the average waveform appears to the eye.

The sampling scope forms a bridge between the principle of the real-time scope and the single-shot instrument. The sampling scope also requires a repetitive waveform, but instead of tracing each waveform on the CRT, the sampler builds up a composite picture of the waveform that contains as many as 1000 dots. Each dot represents a voltage level obtained by a sampling strobe—typically 20 to 200-ps wide—that is delayed by an exact amount with respect to a known trigger signal (Fig. 1).

Then single-shot voltage measurements can be thought of as one step beyond sampling scopes—just as the sampling scope goes one step beyond

the real-time scope.

Essentially the voltage-measuring technique uses sample-and-hold circuitry (such as that of the sampling scope) to capture a single, information-carrying pulse, which is subsequently digitized (Fig. 2).

Single-shot time measurements, on the other hand, use a somewhat different technique. Here a constant-current source is turned on and off by START/STOP discriminators that are programmed at predetermined voltage levels.

The constant-current source forms part of a time-to-height converter whose output is proportional to the measured-time interval. Then the output information is sent to an external digitizer for processing and data storage.

Where signal averaging is desired to eliminate noise, both the time and voltage single-shot measurement techniques can be made to have repetitive modes.

Thus single-shot instrumentation can do a number of jobs that scopes can't do; in some cases, it can also do a more accurate job. And since single-shot outputs can be digitized and stored easily, you can play back the information later through an inexpensive scope at a comfortable viewing rate.

## The problem of low rep rates

Let's look at low rep-rate measurements—a problem that gives engineers eyestrain and headaches.

If you use a real-time scope to measure waveforms with a repetition frequency of less than 10 Hz, the trace becomes increasingly difficult to see as sweep speed increases. This happens because trace brightness is directly proportional to the amount of time the electron beam can spend pouring energy into an individual CRT phosphor.

When those phosphors aren't refreshed often enough, the trace becomes invisible to the eye. On a scope with an efficient CRT phosphor, like P31, a single trace becomes invisible at around 20 ns/cm for nondark-adapted eyes and 10 ns/cm for dark-adapted.

Two problems occur on a sampling scope. First,

---

Martin Marshall, Product Applications Engineer, E-H Research Laboratories, 515 11th St., Oakland, Calif. 94604.

at 10 Hz or less, the internal memory circuits start to discharge. "Dot slash" or "bleeding" results—a phenomenon that manifests itself as a downward or upward drift of the CRT dots. Second, a single measurement usually requires as many as 2000 waveforms to establish the CRT dots. This means that at 10 Hz, 3.2 minutes are

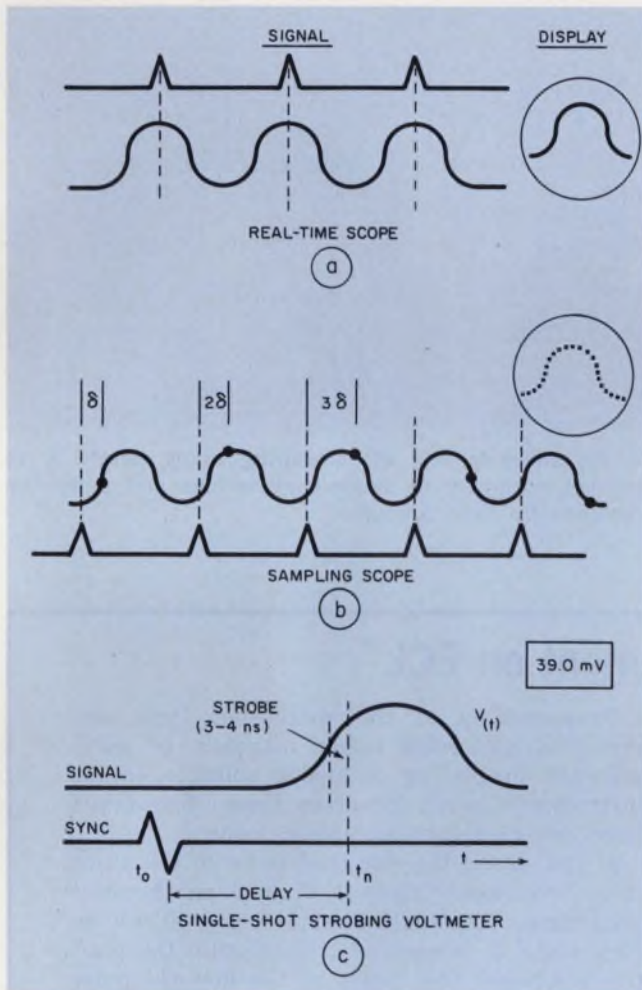

1. Typical displays of three waveform measurement techniques: real-time scope (a), sampling scope (b) and the single-shot strobing voltmeter (c). The first two methods require a repetitive waveform, while the latter makes the measurement on the first cycle.

needed for one measurement. If you're making an average of, say, ten measurements, you'll need at least 11,000 waveforms, or 1100 seconds at 10 Hz. That's a lot of engineering dead time.

With single-shot, on the other hand, low re-rate measurements need just one waveform, if you assume that the time frame of interest is greater than the 3-to-4-ns strobe window of the single-shot instrumentation.

If you really want to get fancy, you can use either a recirculating delay line (Fig. 3) or a string of paralleled strobing voltmeters (Fig. 4) to measure a number of points on the initial portion of a waveform.

Of course, with the recirculating delay-line set-up, each successive pass degrades the waveform's

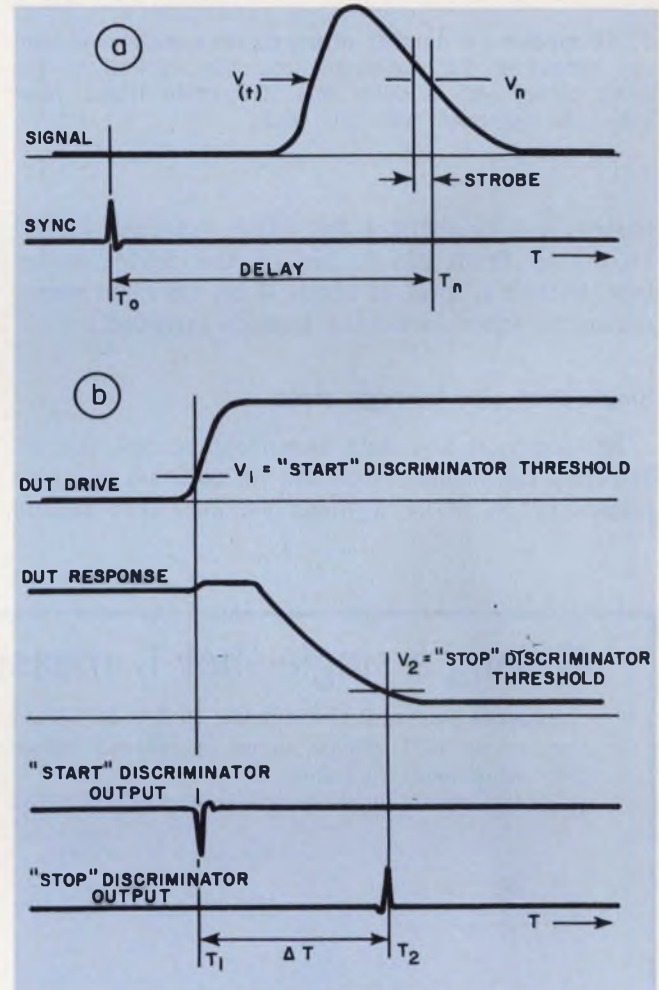

2. Two basic measurement problems—solved with the one-shot method—are determination of a voltage,  $V_n$ , at time  $T_n$  after a sync pulse (a), and measurement of a time difference,  $\Delta T$ , between points defined by discrete voltage levels (b).

time characteristics, so that the final rise time,  $T_r(n)$ , is given by

$$T_r(n) = \sqrt{T_0^2 + T_r(n-1)^2},$$

where  $T_n$  is the rise time of the delay line,  $T_r(n-1)$  is the rise time of the previous pass, and  $T_r(n)$  is the rise time of the  $n^{\text{th}}$  pass.

Automated testing is another application especially suited for single-shot. For example, the measurement-cycle time of a typical single-shot

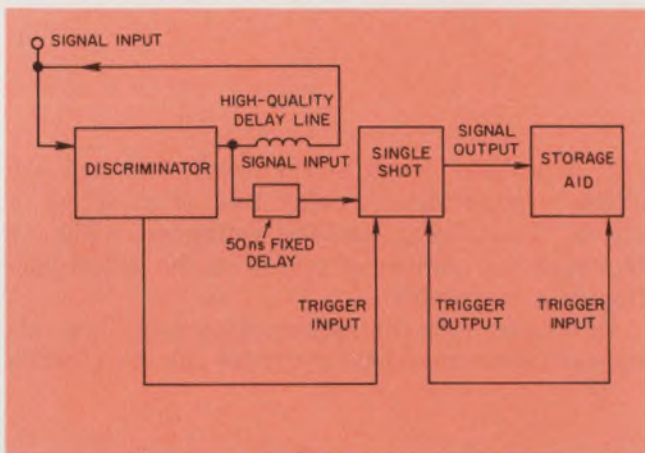

3. To measure a number of points on a waveform without repeating the waveform, you can recirculate the input signal with a delay line. Transition times, however, are degraded with each pass.

instrument is about 1 ms. With automated reed switching from pin to pin of the device under test, there's a total of about 4 ms between measurements when switching time is included.

### Single-shot zips through tests

By contrast the best sampling scopes run at 100-kHz data rates. For the up to 2000 samples necessary to make a measurement, this means

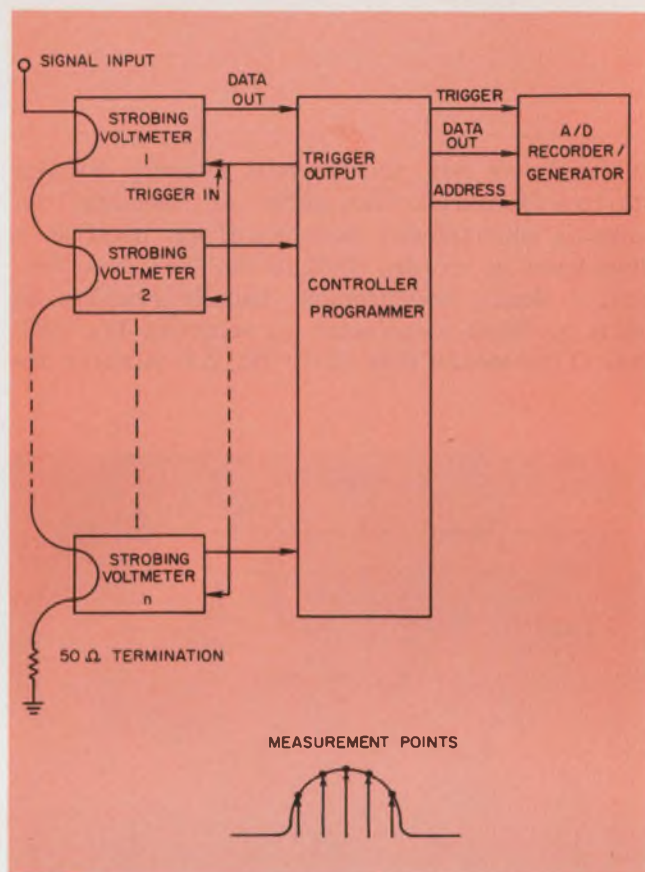

4. An alternate way of measuring many points is to parallel a number of single-shot devices and delay the readings by fixed amounts.

## Making a single-shot $T_r$ measurement on ECL

Suppose you want to check the 10% to 90% rise time on an ECL device, using an 800-mV pulse. The setup looks like this:

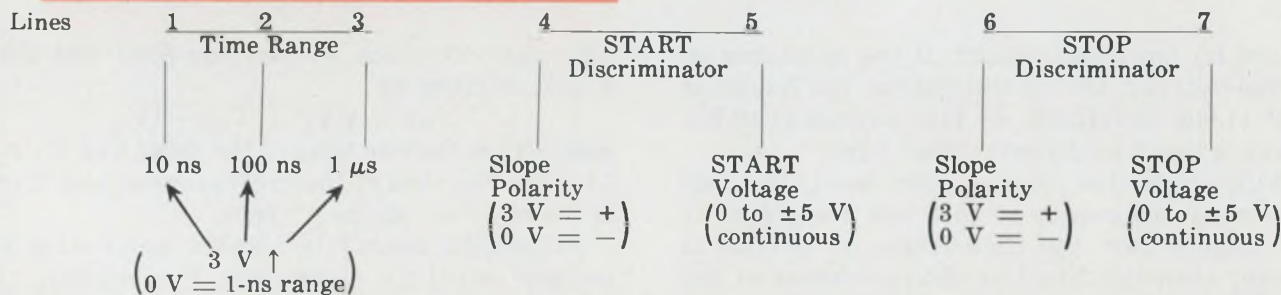
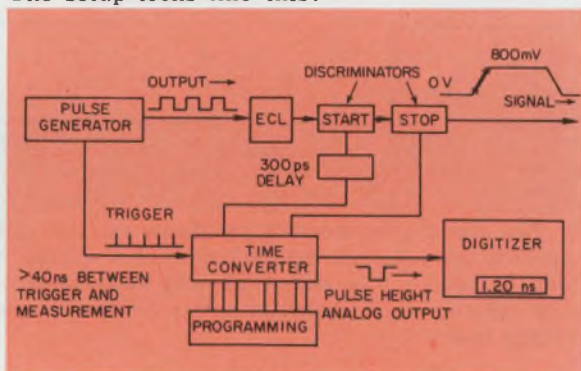

Programming of the single-shot time converter is performed either manually or automatically by placing dc analog voltages on the instrument's seven program lines. The seven lines are organized as shown below.

If you expect the rise time to be in the 10-ns range, you would place 3 V, 0, 0 on the first three lines. You would place 3 V and 80 mV on lines 4 and 5, respectively, to indicate the positive slope and 10% point of the 800-mV pulse for the START discriminator. Similarly, for the 90% STOP point you would put 3 V and 720 mV on lines 6 and 7, so that the entire program is: 3 V-0-0-3 V-80 mV-3 V-720 mV. Now you are ready to measure.

20 to 35 ms per measurement.

From these examples the advantage of single-shot quickly becomes apparent—measurements are typically 10 times as fast as those with sampling scopes. Sampling scopes can hedge by making fewer samples per division, but even then they run at a 6-to-1 disadvantage when compared with single-shots. This makes a tremendous difference for an engineer with a lot of devices to test.

Here's another area where one-shot excels: When testing devices with high temperature dependence—such as fast, bipolar semiconductors—you'd like to limit the device to just a few stimuli. By the time you get to, say, the 1000th stimulus, the device has heated up, levels have drifted and the device is no longer performing as it would under actual applications conditions. With one-shot, you can get your results on the first stimulus.

When you compare the accuracy of scopes and single-shots, note this: Because single-shot measurements use a 3-to-4-ns sampling strobe—compared with the 20-ps strobe of a sampling scope—they sample more efficiently—that is, they include more of a varying waveform—and therefore give better accuracy.

Thus, for fast waveforms, the voltage accuracy of even the best sampling scopes is 2%, while that of a good single-shot is 1%. And, under certain conditions, you can extend the accuracy to 0.1% with the single-shot method.

Time-measurement accuracy is a different story. The best time-accuracy spec for a sampling scope is about 1% full scale; for a single-shot time converter, accuracy is about 3% of reading.

The crossover point between the two accuracy specs occurs at a 33%-of-full-scale reading. The explanation for this lies in the fact that both single-shot and scope time measurements run up against the same inherent problem—the creation of a very linear ramp.

However there's one difference: Sampling scopes like to measure between points displayed on the CRT, whereas the discriminators in a single-shot time converter measure voltages referenced to ground.

Consequently, with a sampling scope, it's easy to measure the time between, say, the 10 and 90% points of a waveform. But if the entire waveform drifts in baseline level with respect to ground, then ground-referenced measurements become difficult and cumbersome.

Single-shot instruments are available commercially. Manufacturers of automatic test equipment—such as Teradyne and Fairchild—use single-shot modules in some ATE lines. Stand-alone instruments are available from Bionation, Inter-Computer Electronics, Physical Data, Inc., and E-H Research Laboratories. ■■

## A CAMBION Double "QQ" Product Line

Whether you want micro-miniature types 1/10th the size of a TO-5 transistor, fixed chokes, L-C filters, balun transformers or toroids, Cambion makes high "Q" standard coils for industrial, commercial and defense-related applications in a wide variety of package and mounting styles. We also have large families of coils with overlapping inductance ranges, variable units and shielded or unshielded units for chassis or printed circuit mounting.

If your design requires a custom coil, Cambion can engineer and produce it. So the choice is yours. Whether it's a standard or custom Cambion inductive device, you're assured of repeatable operating characteristics, no matter how many you require. That's the Cambion double "QQ" approach – the Quality stands up as the Quantity goes on. You'll find them all in our latest catalog. Cambridge Thermionic Corporation, 445 Concord Avenue, Cambridge, Mass. 02138. Phone: 617-491-5400. In Los Angeles: 8703 La Tijera Blvd. 90045. Phone: 213-776-0472.

# Cambion's cure for the common coil.

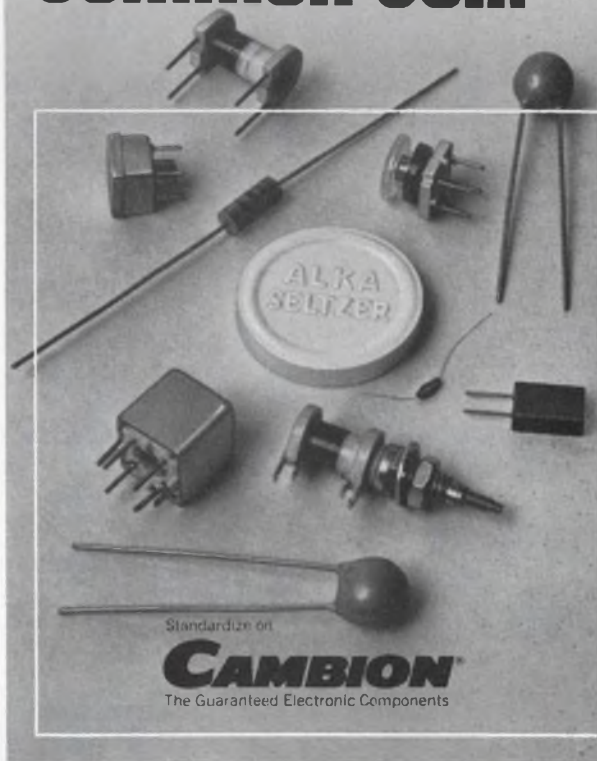

# Plug in these mini-transformers.

# Wave solder them.

# Pocket the saving.



TRW/UTC can help you open up some refreshing solutions to your printed circuit board audio transformer problems. Our Ouncer, Subouncer and Sub-subouncer lines, the quality standards for years, are now available with plug-in terminals for labor- and cost-saving board mounting. Leads are designed for wave soldering.

These plug-in units offer all the quality, reliability and utility of the famous UTC ouncer line with insulated leads. Nothing has been compromised.

Special Subouncer and Sub-subouncer molded units can be furnished in place of any open frame model. Metal encased types to MIL Grade 4 are available from stock or can be made to your specs.

This is the transformer line that couples highest performance and reliability with plug-in economy and the shortest delivery cycles. Call or write for catalog on your letterhead. TRW/UTC Transformers, an Electronic Components Division of TRW, Inc., 150 Varick Street, New York, N.Y. 10013. Tel: (212) 255-3500.

## **TRW<sup>®</sup> UTC TRANSFORMERS**

INFORMATION RETRIEVAL NUMBER 88

# Patstone Writes.

## Digitizing dynamic data.

Did you ever consider that *aperture time* and *sampling rate* may not, depending upon the application, be directly related? That they may be separate considerations to the designer converting dynamic analog data into a digital format? Well, they may not necessarily go together, but there is no doubt that they are the two most basic pieces of information required in data conversion system designs. Let me explain.

### Know your frequency.

First, it is extremely important that the designer know the highest frequency component of the dynamic waveform to be digitized, since if you sample the data at less than twice the frequency of the highest signal component you build into the digitized data a non-recoverable low-frequency component; i.e. you will alias your data as shown. Thus, the frequency spectrum of the data to be sampled puts a lower limit on *sampling rate*.

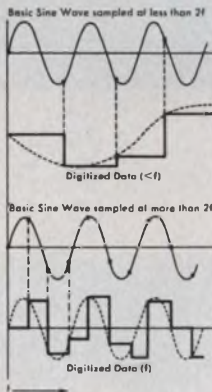

### Know your accuracy.

Next it is essential to know the accuracy required of the total conversion system, often specified in percentages of full scale or in numbers of bits. Tying accuracy with the idea of the dynamics of the wave form itself, it should be evident that you only have a limited period of time to convert the data. If during this *aperture time* the signal moves more than the allowable amount, you're in trouble. Since the slope of a sine wave is maximum when it passes through zero, a sampling window at this zero-crossing point produces the greatest sampling error and the formula shown below clearly indicates that the error voltage as a percentage of full scale is proportional to the product of the

frequency and aperture time ( $\Delta t$ ).

$$\text{Percentage Error} = \frac{\Delta V}{A} = 2\pi f \Delta t$$

Where  $\Delta V$  = Aperture Time Error  
 $A$  = Maximum Signal Amplitude  
 $f$  = Maximum Signal Frequency  
 $\Delta t$  = Aperture Time

So, given a certain percentage, the higher the signal frequency, the smaller the allowable time window to freeze the data.

### Know your application.

In many applications the conversion time of general purpose ADC's will produce insignificant aperture time errors. However, in more demanding applications that require high speed data conversion, high signal frequencies force window times to nanosecond levels, where two distinctively different solutions to conversion problems are possible. You can use a very high-speed Analog-to-Digital Converter to freeze the data accurately just because of the very short conversion time of such devices. Unfortunately, they are damn expensive! Alternately, you can use a high-speed sample-hold amplifier with a low aperture time, holding the data long enough to permit a slower ADC to perform the conversion.

For many applications this combination of high-speed sample-hold and moderate-speed ADC represents the best price performance trade-off.

### Know your hardware.

The Philbrick Model 4853 sample-hold amplifier is designed for very high-speed data conversion systems with 12 bit accuracy.

With state-of-the-art performance features, such as 10 nanoseconds maximum aperture time and  $\pm 1$  nanosecond aperture time uncertainty, the 4853 is also ideal for display DAC deglitch circuits, fast peak and valley detectors, precision one-shot pulse recorders, fast-response automatic gain-ranging systems, etc.

### If you don't know, ask.

If there's a question you have about digitizing dynamic data. Or, if you're faced with a particularly difficult problem. Or would just like to know more about the whole subject, give us a call. Toll-free at (800) 225-7883, in Massachusetts at (617) 329-1600. Or write us, Dedham, Mass. 02026.

 **TELEDYNE  
PHILBRICK**

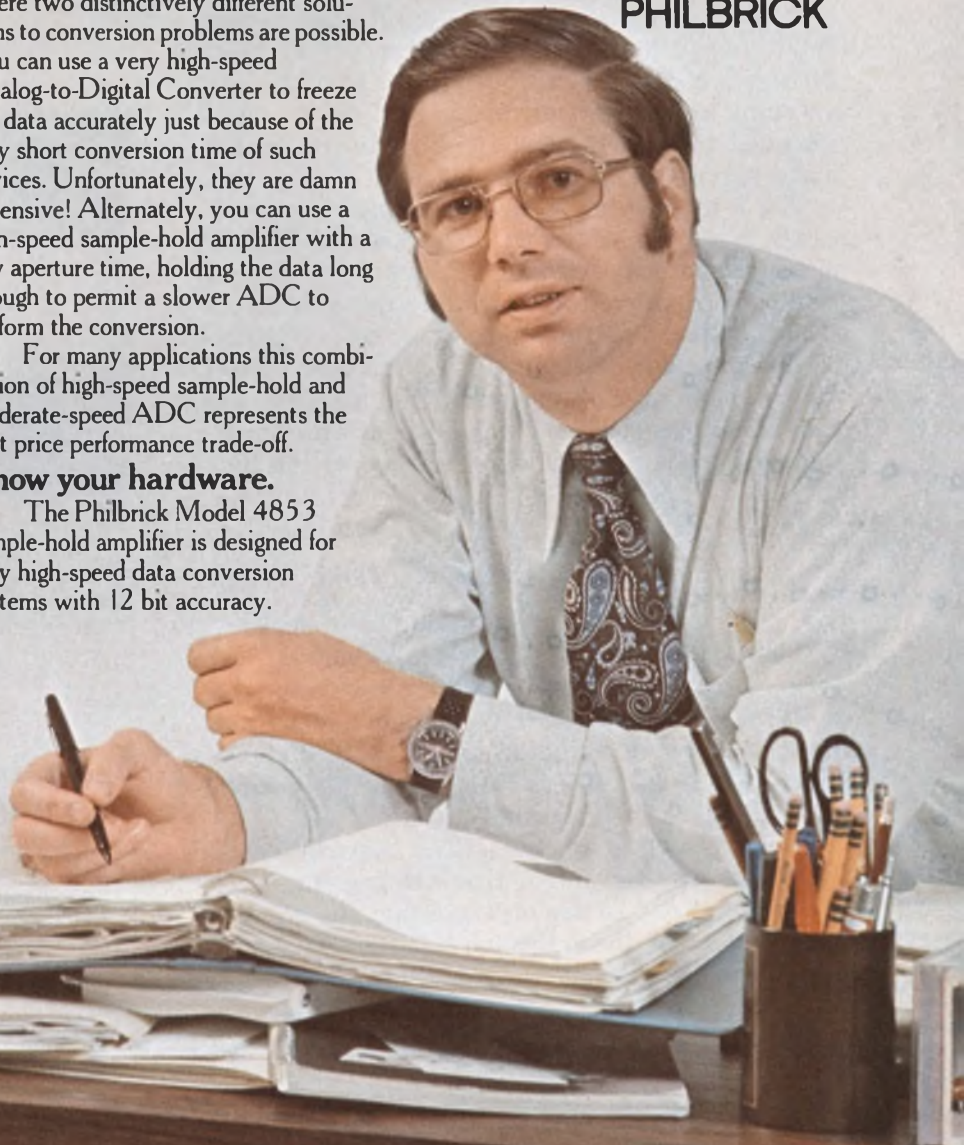



# Don't eyeball noise.

Measure it accurately—and repeatably—with just a two-channel scope. The secret lies in a unique tangential method.

To verify signal-to-noise ratios without a video noise meter, engineers usually “eyeball” a scope trace. But this type of reading can vary as widely as 3 to 6 dB.<sup>1,2</sup> A better technique, referred to as the tangential method, gives straightforward, repeatable s/n ratios and still uses just a two-channel scope. And accuracies to within a decibel are possible.

## Conventional scope method has problems

Although it's easier merely to connect a noise signal to a scope and observe the noise peaks, there are several disadvantages to doing this.

First, you're measuring the quasi peak-to-peak amplitude—not the true rms noise voltage needed to calculate the s/n. With quasi peak-to-peak, an empirical conversion factor of from 14 to 17 dB must be used to convert pk-pk to the equivalent rms value.<sup>2</sup>

The 3-dB spread of the conversion factor directly relates to a second disadvantage—that of measurement repeatability. Because the noise peaks are random, their visibility depends on the scope intensity setting (Fig. 1), the persistence of the phosphor, the duration of the observation, and perhaps even the mood of the operator. The tangential method, however, retains the advantages of scope measurement but avoids the limitations.

## Tangential method also uses a scope

Here's how the tangential technique works:

Connect the noise signal to both channels of a two-channel scope having alternate-sweep capability. Two noise traces will appear, separated by a dark band (Fig. 2). With both channels identically calibrated, adjust the voltage offset until the dark band just disappears.

Now remove the signal. The separation between the two noise-free traces represents twice the rms noise. (To demonstrate that the result is independent of the intensity setting, try repeating the measurement with a different intensity

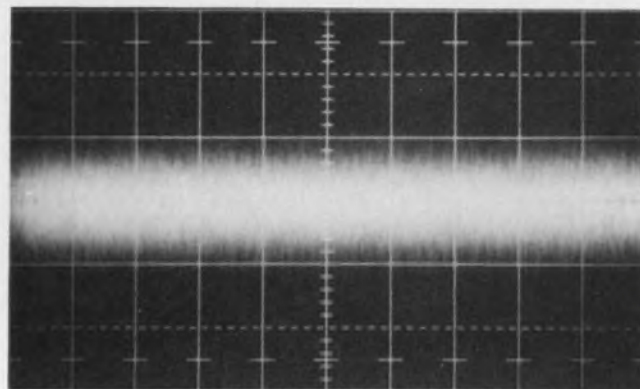

(a)

(b)

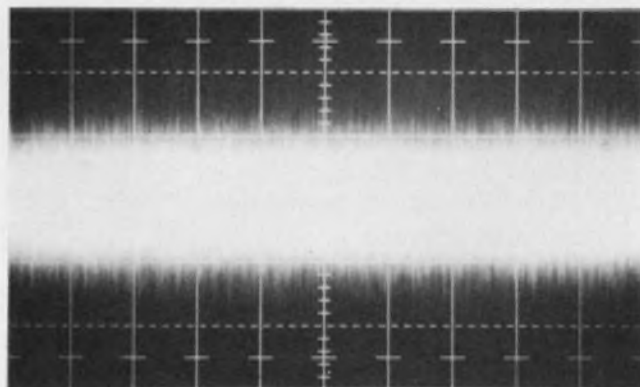

1. Scope measurements of video noise are not repeatable because of variations of intensity and measurement time. Photos show the same noise signal at different intensity settings.

Table 1. Comparison: tangential and conventional noise measurements

Measurement Method	Video Noise Meter	Voltmeter	Tangential Method
Rms noise voltage	15.5 mV	16.35 mV	17.4 mV
Signal/noise	42.2 dB	41.75 dB	41.2 dB
Variation	+ .45 dB	-0 dB	- .55 dB

Note: Values listed in the table were derived from a system other than the one from which the scope photos were taken.

Gary Franklin and Troy Hatley, Analog Systems, Data Disc, Inc., Sunnyvale, Calif. 94086.

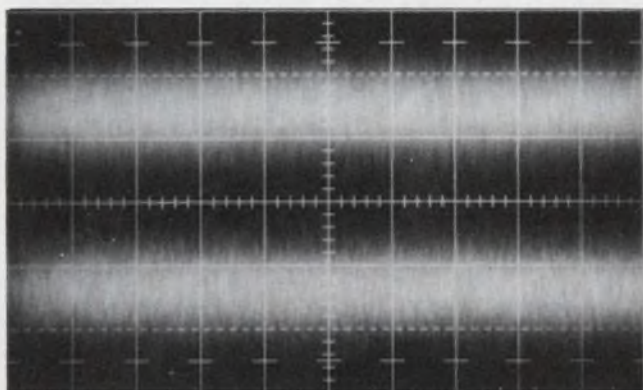

(a)

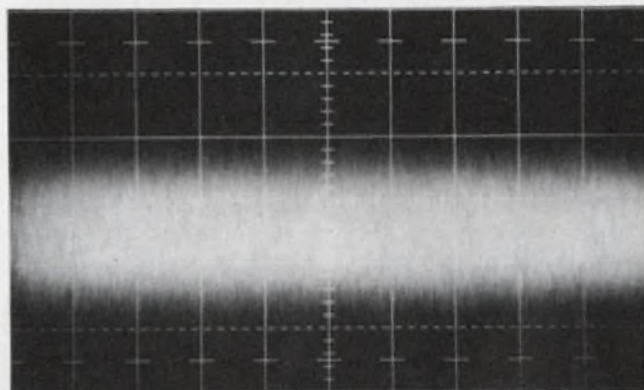

(b)

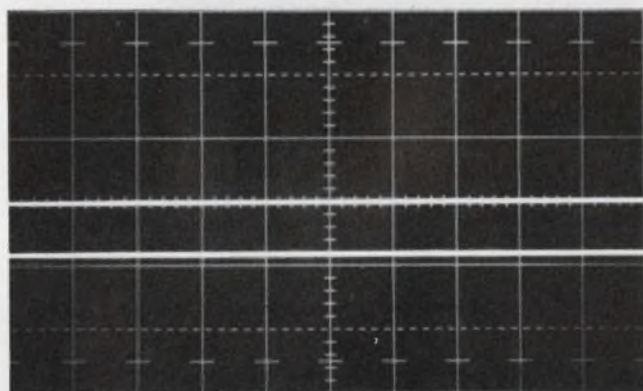

(c)

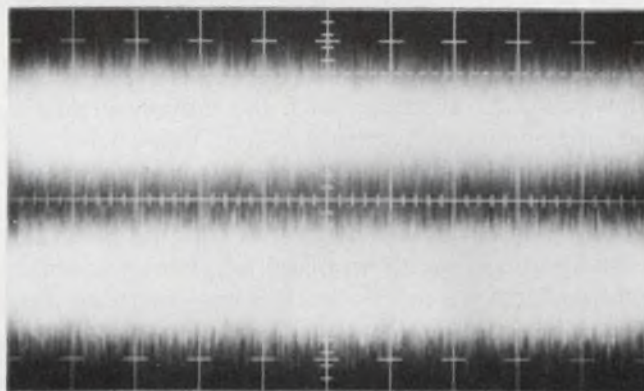

(d)

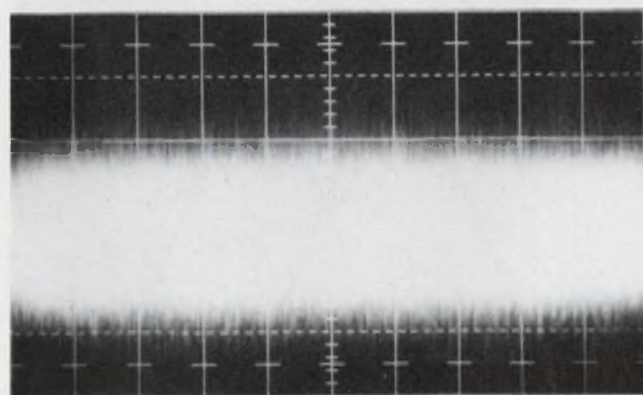

(e)

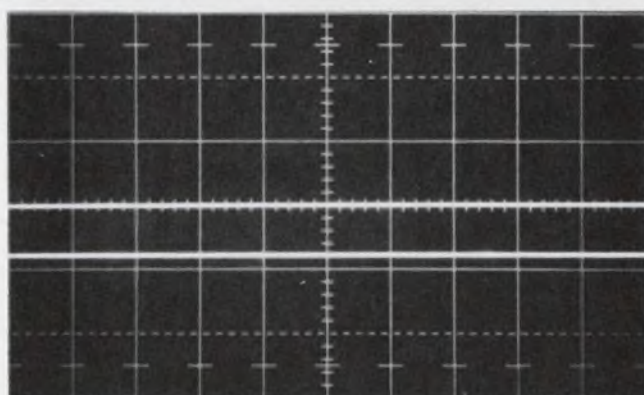

(f)

2. With the tangential method the noise signal is connected to both channels of a dual-channel scope used in the alternate-sweep mode (a). The offset voltage is adjusted until the traces just merge (b). The noise signal is then removed. The difference in the noise-free traces

is twice the rms noise voltage (c). This is repeated at a different intensity to show that the method is independent of intensity (d,e,f). Scope and camera settings are: horiz =  $500 \mu\text{s}/\text{cm}$ , vert =  $20 \text{ mV}/\text{cm}$ , camera =  $f/5.6$ ,  $1/25 \text{ s}$ .

setting.) When making the measurement, be sure to adjust the offset, pause and look for the dark band before further adjustment.

With the signal removed, the separation of the two traces, called displayed noise, may be used to directly calculate the s/n as follows:

$$s/n \text{ (in dB)} = 20 \log \left( \frac{\text{(pk-pk signal)}}{\frac{\text{displayed noise}}{2}} \right)$$

To verify that the tangential method does indeed give accurate measurements—comparable to those obtainable with a video noise meter or rms voltmeter—you can compare the two methods directly. For example, a Rohde & Schwarz video noise meter and a Tektronix 547 dual-channel scope were each used to measure the noise output of a video disc recorder (Fig. 3). The signal recorded on the disc represented a video waveform with a  $-0.3\text{-V}$  sync tip and a video level of  $+0.35\text{ V}$ , or mid-gray. The signal-to-noise ratio of the input signal was 67 dB.

To compare the tangential method with an rms voltmeter, the input signal was removed and the recorder input was terminated in  $75\ \Omega$ . Removal of the signal thus represented a zero-volt, or blanking-level, input. Rms noise measurements were then taken with a Ballantine Model 323 rms voltmeter.

The results of these measurements (Table 1) show that the readings with the tangential method correspond to within 1 dB of those with the two meters. Further, these results are easily repeated by other operators with different scopes.

The tangential method relies on the fact that two identical Gaussian-distribution curves combine to form a single smooth curve—with no dips

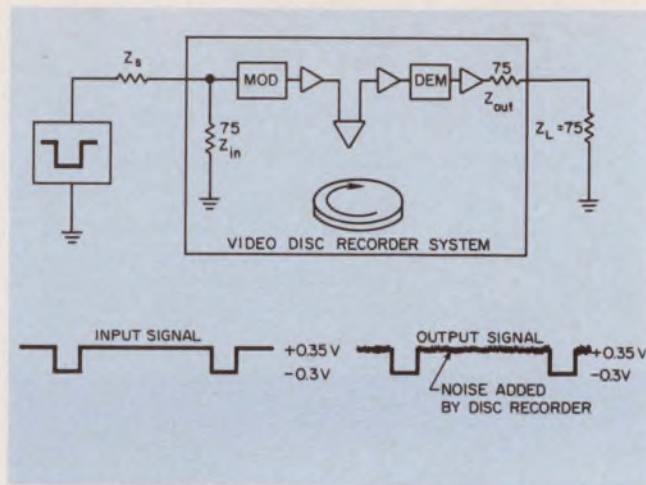

3. Test set-up for experimental verification: Noise of a video disc recorder is measured using a video noise meter, an rms voltmeter and the tangential method.

—when the curves are separated by exactly two standard deviations (Fig. 4). And the point where this occurs is independent of the height of the curves, length of observation, or scope intensity.

Because video noise is normally Gaussian, the rms level is defined at the standard deviation. We can use this property to make repeatable measurements.

The intuitive implications of this graphical explanation can be verified mathematically. If we start with the equation for a normalized Gaussian function,

$$f(x) = e^{\frac{-x^2}{2\sigma^2}}, \quad (1)$$

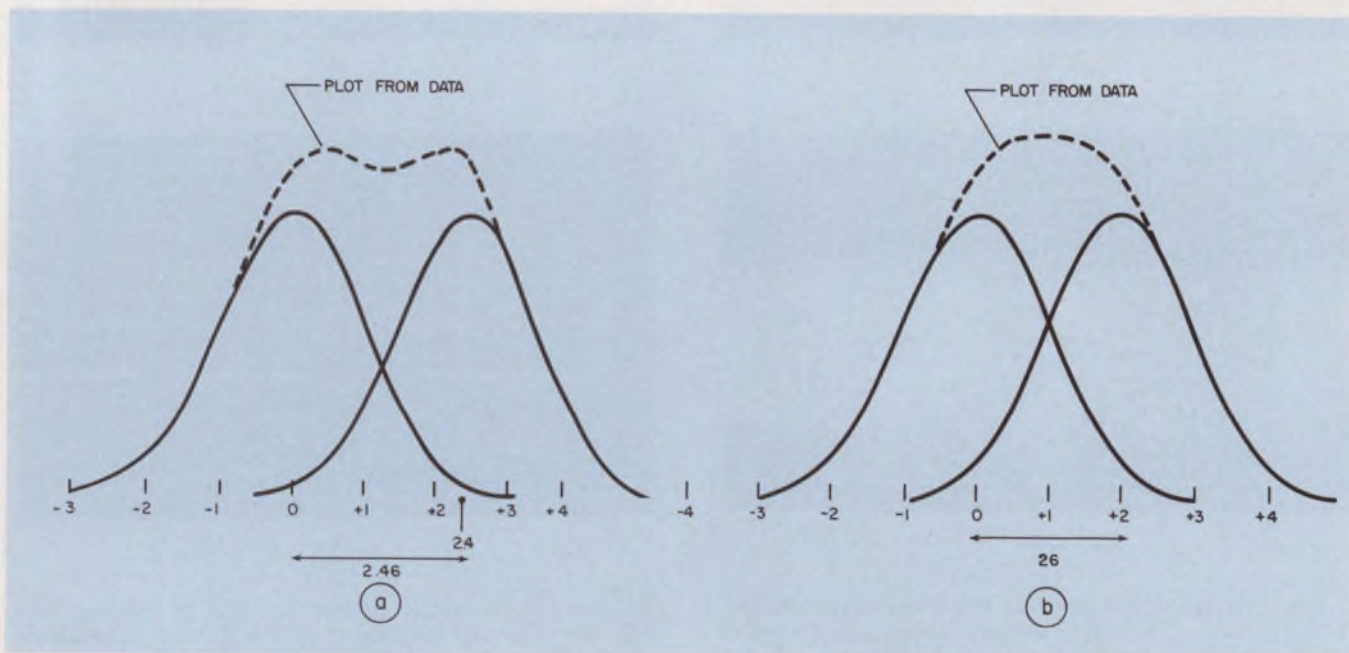

4. Adding two Gaussian curves usually results in a dip, or saddle point (a). But a smooth curve with no dip

results when the curves are separated by exactly  $2\sigma$  (b), forming the basis for the tangential method.

**Table 2. Data for plotting Gaussian curves of Fig. 4.**

Fig. 4a			Fig. 4b		
x	x'	Q(x) + Q(x')	x	x'	Q(x) + Q(x')
0.0	2.4	.4213	0.0	2.0	.4529
0.2	2.2	.4265	0.2	1.8	.4700
0.4	2.0	.4223	0.4	1.6	.4792
0.6	1.8	.4122	0.6	1.4	.4829
0.8	1.6	.4006	0.8	1.2	.4839
1.0	1.4	.3917	1.0	1.0	.4840
1.2	1.2	.3884	1.2	0.8	.4839
1.4	1.0	.3917	1.4	0.6	.4892
1.6	0.8	.4122	1.6	0.4	.4729
1.8	0.6	.4122	1.8	0.2	.4700
2.0	0.4	.4223	2.0	0.0	.4529
2.2	0.2	.4265	2.2	0.2	.4265
2.4	0.0	.4213	2.4	0.4	.3556
2.6	0.2	.4046	2.6	0.6	.3468
2.8	0.4	.3762	2.8	0.8	.2976
3.0	0.6	.3376	3.0	1.0	.2464
3.2	0.8	.2921	3.2	1.2	.1966
3.4	1.0	.2432	3.4	1.4	.1509
3.6	1.2	.1948	3.6	1.6	.1115
3.8	1.4	.1500	3.8	1.8	.0793
4.0	1.6	.1110	4.0	2.0	.0541

the addition of two identical functions separated along the X axis by d gives

$$g(x) = f(x) + f(x-d). \tag{2}$$

The value of d at the point where the saddle just disappears is found from  $g''(d/2) = 0$ . Thus

$$g(x) = e^{-\frac{x^2}{2\sigma^2}} + e^{-\frac{(x-d)^2}{2\sigma^2}}$$

$$g''(x) = \frac{x^2}{\sigma^2} e^{-\frac{x^2}{2\sigma^2}} - e^{-\frac{x^2}{2\sigma^2}} + \left(\frac{x-d}{\sigma}\right)^2 e^{-\frac{(x-d)^2}{2\sigma^2}} - e^{-\frac{(x-d)^2}{2\sigma^2}}$$

$$g''\left(\frac{d}{2}\right) = \left(\frac{d^2}{4\sigma^2} - 1\right) e^{-\frac{d^2}{8\sigma^2}} \tag{3}$$

Setting  $g''$  to zero, we get:

$$d = 2\sigma. \tag{4}$$

Thus we have proved the theoretical basis for the tangential method. However, the measurement accuracy is affected by the contrast perception of the observer's eye as he closes the trace separation to eliminate the dark band between the two noise traces.

It has been empirically determined that the eye can distinguish contrast variations as small as 1% when working with typical intensity ranges. You can establish this by applying a sine wave to the Z axis of a scope, a low-frequency ramp to the Y axis and at the same time sweeping the X axis at a fast rate. The resulting dis-

play consists of bars whose intensity varies uniformly across the screen. The sine wave amplitude is then reduced until the bars just disappear.

The variation can be stated mathematically as

$$\frac{g(0) - g(d/2)}{\frac{1}{2} [g(d/2) + g(0)]} = 0.01, \tag{5}$$

or

$$g(d/2) = 0.99 g(0).$$

Substituting  $g(d/2)$  and solving for d, we get

$$2e^{-\frac{d^2}{8\sigma^2}} = 0.99 \left[ 1 + e^{-\frac{d^2}{2\sigma^2}} \right]$$

$$e^{-\frac{d^2}{2\sigma^2}} - 0.495 e^{-\frac{d^2}{2\sigma^2}} = 0.495,$$

which yields  $d = 2.23 \sigma$ . (6)

Therefore, as a worst case, when the trace separation is  $2.23 \sigma$  or less, the tangential condition will appear to have been reached. From the theoretically correct spacing of  $2d$ , we can then calculate:

$$\epsilon \leq \frac{2}{2.23} = 1.115 \approx 0.9 \text{ dB.} \tag{7}$$

This is the maximum error. ■■

**References:**

1. Putnam, R. E., "Measurement of Signal-to-Noise Ratios," *Journal of the SMPTE*, March, 1966, p. 221.
2. Siocos, C. A., and Quinn, S. F., "Oscilloscope Method for Measuring Signal-to-Noise Ratios," *Journal of the SMPTE*, February, 1967, p. 121.
3. Garuts, Val, and Samuel, Charles, "Measuring Conventional Oscilloscope Noise," *Tekscope* (Tektronix, Inc.), Volume 1, No. 2, April, 1969.

# Profits in motion for communications equipment



You can reduce assembly and inventory costs, get reliable total functions in minimum space, and obtain application help when you ask TRW/Globe to build your motion package.

Four builders of communications equipment can affirm this from their experience with the packages on this page.

**1.** TRW/Globe supplies this complete cassette drive module for a telephone answering system. The customer avoids assembly costs as well as the problem of aligning the two output shafts.

**2.** This blower was built to fit the space available after most of a military transceiver had been designed. TRW/Globe also helped the customer de-

termine the system's resistance to air flow.

**3.** TRW/Globe meets all functional requirements in this rotary actuator for switching bands on a military transceiver. The package includes gearing, limit switch, mechanical stop, slip clutch, electro-mechanical brake, and filter.

**4.** This package drives the scanner in a facsimile transceiver. TRW/Globe's experience with hysteresis synchronous motors assures that both the transmitter and recorder will be synced.

To get your profits in motion, call or write: TRW/Globe Motors, an Electronic Components Division of TRW Inc., Dayton, Ohio 45404 (513-228-3171).

## **TRW**® GLOBE MOTORS

INFORMATION RETRIEVAL NUMBER 90

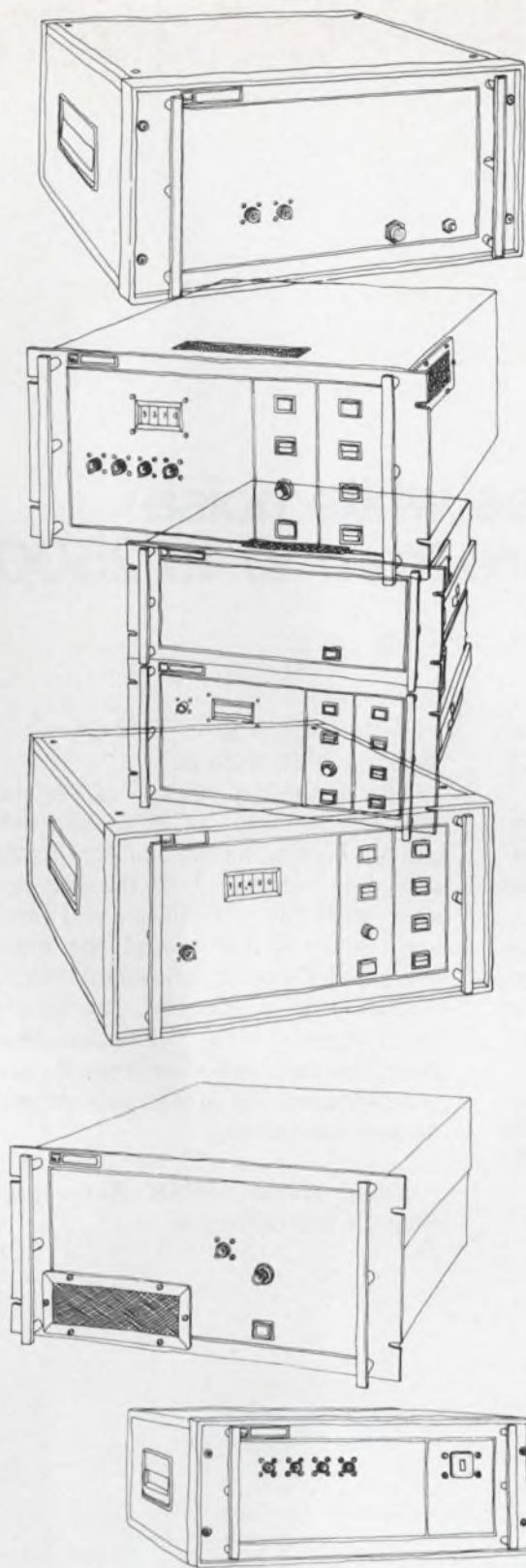

***Frequency Accuracy,  
Stability, and  
Programmability  
with  
W-J's 0.5-18 GHz  
FREQUENCY  
SYNTHESIZERS***

With over seven years experience building microwave frequency synthesizers for Government agencies and commercial firms, Watkins-Johnson has established eminence in the custom design of synthesizers to stringent customer requirements. As a bonus, this productivity has netted a selection of excellent designs which are now available as standard models.

A W-J frequency synthesizer is completely self-contained and provides the desired signal output when ac power is applied and a frequency command is given. The full 0.5-18 GHz range, or any portion, can be digitally programmed locally or from a remote position. Stability up to and beyond  $1 \times 10^{-9}$ /day is available and a wide choice of output power may be specified.

For details, contact Charles Foster in Palo Alto or get in touch with your nearby W-J sales office/representative.

WATKINS-JOHNSON SYSTEMS • performance • reliability • imagination



Watkins-Johnson—U.S.A.: 3333 Hillview Ave., Palo Alto, CA 94304 • (415) 493-4141 • 700 Quince Orchard Rd., Gaithersburg, MD 20760 • (301) 948-7550 • United Kingdom: Shirley Ave., Windsor, Berkshire SL4 5JU, England • Tel: Windsor 69241 • Cable: WJUKW-WINDSOR • Telex: 847578 • West Germany: 8033 Planegg, Muenchenerstr. 17 • Tel: (0811) 71 36 57 • Cable: WJDBM-MUENCHEN • Telex: 529401 • Italy: Piazza G. Marconi, 25 00144 Rome-EUR • Tel: 59 45 54 • Cable: WJROM-ROMA • Telex: 60117

## Measuring system uses white noise to indicate temperature from 10 to 2500 °K

A system based on the Nyquist formula for white noise;

$$E_n = \sqrt{4kTRB},$$

permits the measurement of temperatures over a range of 10 °K to 2500 °K with accuracy to 0.1 °K.

A bandpass filter, built with op amp A<sub>1</sub>, selects a portion of the white-noise spectrum from the bridge. Op amp A<sub>2</sub> provides feedback to make the output independent of bridge parameters. The output of the third amplifier is proportional to the noise voltage squared—due to the squaring effect of the voltage-dependent resistor (VDR). This also makes the output of A<sub>3</sub> proportional to the absolute temperature T.

The bandpass filter is designed for a center frequency  $f_0 = 20$  Hz, gain at resonance  $A_0 = 40$  dB and bandwidth  $B = 1$  Hz. It follows with  $C_1 = C_2$  chosen as 10 μF that

$$R_3 = 1/\pi C_1 B = 32 \text{ k}\Omega,$$

$$R_1 = R_3/2 A_0 = 400 \Omega.$$

Since

$$Q = f_0/B = 20$$

and

$$R_1 \parallel R_2 = R_3/2 Q^2,$$

then

$$R_2 \simeq 40 \Omega.$$

Due to the dependence of resistance R on frequency, the value of R to use with this circuit cannot be calculated exactly. Rather, the entire device is calibrated at fixed points—in accordance with the International Practical Temperature Scale of 1968—and the mean value of R evaluated from experimental data.

The source voltage V<sub>0</sub> (about 2 V) provides a small current that increases the noise signal from the resistors—resistors R<sub>s</sub> are the temperature sensors, the 500-Ω potentiometer is used to balance the bridge.

*Kamil Kraus, SPSE Koterovska 85, 307 00 Plzen, Czechoslovakia.*

CIRCLE No. 311

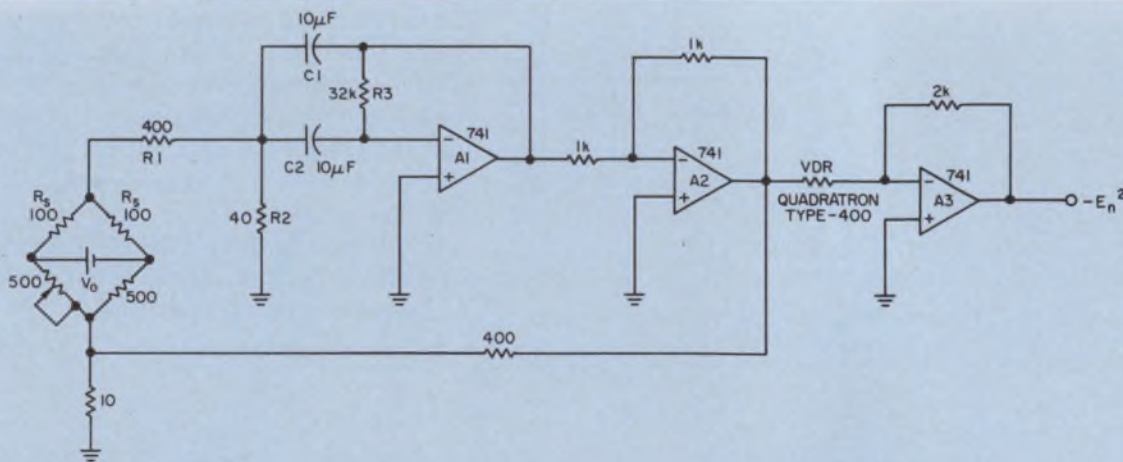

White noise developed across the bridge is filtered and amplified to provide an output signal proportional to the absolute temperature sensed at R<sub>s</sub>.

The voltage-dependent resistor (VDR) provides the necessary squaring action on the narrowband noise signal from A<sub>2</sub>.

# Our tester is a big name-dropper.



## Where IC test time is concerned.

Our Hustler 44 — the IC tester that's bought by people who really understand automatic testing — has KO'd our big competitors time after time.

And for good reason. Ours does more, yet costs less.

Take device test time, which is really the name of the game. The chart clearly shows that our Hustler 44 can DC & functionally test from 5 to 10 times more IC's per hour than either Teradyne's SLOT or Fairchild's Sentry series.

For Parametric testing our worthy opponents use a switching matrix to apply a stimulus to an IC input and then sequentially monitor all outputs (a slow process indeed).

At the other end of the speed spectrum, Datatron's Hustler 44 has separate programmable forcing and monitoring circuitry for each pin of the device under test. This makes it easy to expand or update the system. Up to 256 pins!

With this unique parallel test

concept, we can force & monitor all inputs & outputs simultaneously. This dramatically reduces test time and simulates actual IC operation.

That's why such knowledgeable companies as Bell Labs, Control Data, Fairchild Semiconductors, Honeywell,

ITT Semiconductors, Motorola, RCA, Stewart Warner & Western Electric (just to name-drop a few) have chosen our tester. And many are repeat customers.

Here's an offer you can't refuse. If you're really serious about testing, send us (and our competitors) a sample IC & spec sheet. We'll write a program and show you how fast we can test your device.

### IC TEST TIME BOX SCORE

	Datatron Hustler 44	Teradyne SLOT	Fairchild Sentry Series
T <sup>2</sup> L, DTL, C-MOS Gates (30 to 40 tests)	144,000/hr	28,000/hr	22,000/hr
MSI T <sup>2</sup> L (9300)	120,000/hr	14,000/hr	18,000/hr
Gate Testing Cost*	\$0.00011/device	\$0.00089/device	\$0.00075/device
MSI Testing Cost*	\$0.00013/device	\$0.00178/device	\$0.00092/device
Performance Boards Required	No	Yes	Yes
Approximate Cost Of Tester	\$100,000	\$150,000	\$100,000

\*Detailed analysis available @ DATATRON



Datatron Hustler 44

# datatron inc.

1562 REYNOLDS AVENUE • SANTA ANA, CALIFORNIA 92711 • (714) 540-9330





**Ansley**

**BLUE STREAK™**  
CABLE/CONNECTOR SYSTEM



Here's Ansley's new cable for your wiring needs. It's rated for 105°C... flame retardant... 50 conductors or less... .050" centers... choice of 28 AWG stranded or solid or 30 AWG solid... cable on 100' reels from stock! Want more features? It's color coded every fifth conductor... separates by hand for breakouts... connectors to match from stock.

And there's more... plus a SHURE-STAKE® hand tool for the field installation.

Write for complete brochure and sample.

**Ansley**

**ANSLEY ELECTRONICS CORP.**

Subsidiary of Thomas & Betts Corporation

3208 Humboldt St., Los Angeles, Ca. 90031  
Tel. (213)223-2331, TWX 910-321-3938

INFORMATION RETRIEVAL NUMBER 93

## Versatile circuit detects changes in voltage or frequency

A functionally simple circuit that consists of a CMOS quad-switch (CD 4016) and a low-power op amp can perform any one of the following operations:

- Signal when a reference voltages rises.
- Generate a pulse train whenever an input frequency falls below a given set-point.
- Generate variable-width pulses.

As an added benefit, the entire circuit draws only 400  $\mu$ A from the power supply.

Circuit operation is based on the complementary charge and discharge of two capacitors. When the clock signal goes low, pin 9 of the 4016 is grounded, pin 3 is open and pin 2 is at  $V_{REF}$ . Consequently  $C_2$  charges rapidly toward  $V_{REF}$  while  $C_1$  discharges to zero. With the clock signal high, pins 2 and 9 go open while pin 3 is connected to  $V_{REF}$ . Now  $C_1$  charges toward  $V_{REF}$  with time-constant  $R_1C_1$  while  $C_2$  discharges with time-constant  $R_2C_2$ .

With

$$V_{REF} = \text{constant}, \quad (1)$$

$$R_2C_2 = 2.2 R_1C_1, \quad (2)$$

and

$$F_{\text{clock}} = \frac{1}{2 R_1C_1}, \quad (3)$$

$C_1$  charges to within  $V_{REF}(1 - e^{-1})$  while  $C_2$  discharges by  $V_{REF} e^{-1}$  during the time the clock pulse is high. Under these conditions the voltage at pin 2 ( $V_{C2}$ ) of the op amp (used as a comparator) always exceeds the voltage at pin 3—except for the moment that they are equal, which takes zero time. Hence the comparator does not change state.

When  $V_{REF}$  increases,  $V_{C1}$  will exceed  $V_{C2}$  during a portion of the clock pulse—and the comparator changes state during this time. The resultant pulse is the circuit output—the pulse width is proportional to the rate-of-change of  $V_{REF}$ . With the ICs shown, the minimum detectable rate-of-change is 50 mV/clock-pulse; use of a faster comparator permits detection of slower changes.

One of the conditions for detection of changes in  $V_{REF}$  is given in Eq. 3. However, if the clock frequency falls below this value, with  $V_{REF}$  constant, the output of the op amp is a pulse train whose rep-rate equals that of the input and whose width is proportional to the difference between the actual frequency and

$$F_{\text{SET}} = \frac{1}{2 R_1C_1}. \quad (4)$$

(continued on page 194)

# a new STANDARD for JUMPERS

**FLAT**

**ROUND**

Additional problem a manufacturer faces  
in making a wiring jumper is to provide  
a means to engage board components  
without mechanical stress on them.  
The flatness of the jumper is a key  
factor in this regard. The following  
diagram illustrates the stress of flexure  
on a round jumper. The stress is  
concentrated at the top and bottom  
of the wire.

NO  
STRESS  
HERE

Stress of flexure extends over  
entire flat cross sectional area

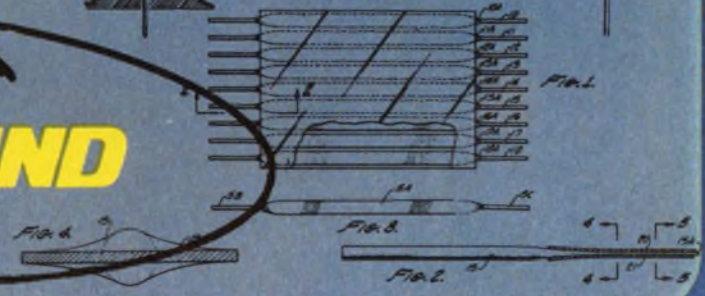

U.S. PATENT NO. 3,601,755

## from Ansley

Ansley's new patented FLEXSTRIP® Jumpers have flat conductors laminated between high performance insulating materials and are available from stock in thousands of part numbers. The flatness gives them flexibility where it's needed ... the round contacts insert easily into p.c. board holes or sockets. This combination of flat/round provides a generous radius when flexed, thus eliminating stress from the contacts.

Here's what this means to you ... no broken conductors ... easy insertion of ready to solder contacts ... no fault

assemblies ... reliable interface ... lower installed cost ... available from stock.

Specify FLEXSTRIP® Jumpers. Flex them a hundred or a thousand times and there'll be no failures.

Ansley's FLEXSTRIP® Jumpers come in standard lengths; four options of insulation; 2 to 60 conductors; .050, .100, .125, .150 or .200 conductor center distances and four pin configuration options. Specials, too, of course.

Contact your Ansley representative.

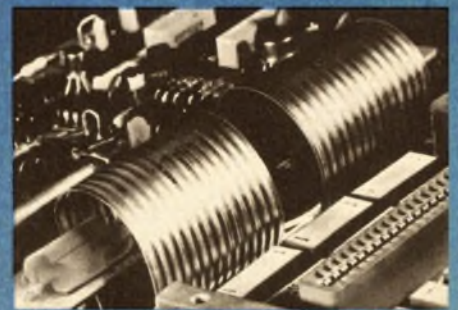
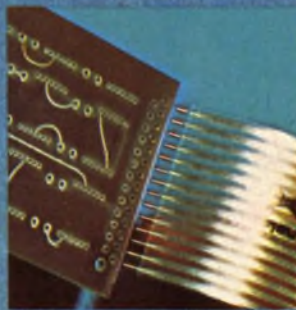
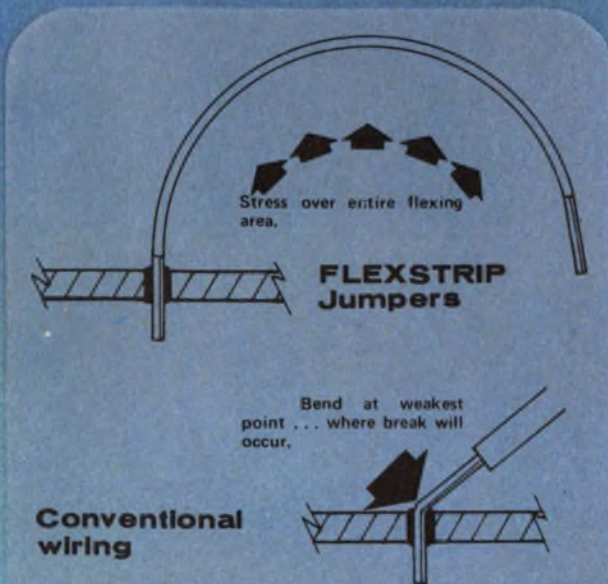

Photo courtesy of Computest Corp.

## Ansley

**ANSLEY ELECTRONICS CORP.**

Subsidiary of Thomas & Betts Corporation

3208 Humboldt St., Los Angeles, Ca. 90031

Tel. (213)223-2331, TWX 910-321-3938

# FREE ...



**1974  
TUCKER ELECTRONICS  
COMPANY  
Electronic Instrumentation  
Catalog**

Now available, the 1974 Tucker Electronics Company general catalog includes 150 pages of electronic test instruments. 17 lines of low cost distributor products and thousands of reconditioned instruments representative of the 15,000 instruments made by over 600 manufacturers are illustrated. The new Tucker manufactured Pulse/Function Generator is featured. This 1 MHz instrument generates 0.1 Hz to 1 MHz with 0 to 10 volts into 50 ohms and has switchable functions including variable pulse, sine-wave, square-wave and triangle wave outputs generated from a well built, high-reliability unit. Price only \$295.00. The 300A is also available for \$175.00 less the variable pulse output. The new 1974 catalog shows you how to rent, trade-in old instruments, buy at discount and how to rent for one month or more with high purchase options. This is the first true Instrument Distributor Catalog and should become a buying guide for all who procure instruments. CALL TOLL FREE (Except Texas) 800-527-4642 or write for your copy to:



**TUCKER**  
ELECTRONICS • COMPANY  
P. O. Box 1050 • Garland, Texas 75040

INFORMATION RETRIEVAL NUMBER 95

(continued from page 192)

In this mode Eqs. 1 and 2 also apply. To generate variable-width pulses, select component values and frequency according to Eqs. 1, 2 and 4—but use potentiometers for  $R_1$ ,  $R_2$  or both. A pulse output will appear as soon as  $R_1$  or  $R_2$  is decreased. The pulse-width increases as  $R_1$  or  $R_2$  is decreased. Use of a potentiometer in place of  $R_2$  allows adjustment of rise and fall times. A fast comparator such as the LM 710 will result in still faster rise and fall times—but the current consumption will increase to 16 mA.

*Jack E. Holzschuh, Project Engineer, Department of the Navy, Naval Undersea Center, P.O. Box 997, Kailua, Hawaii 96734.*

CIRCLE NO. 312

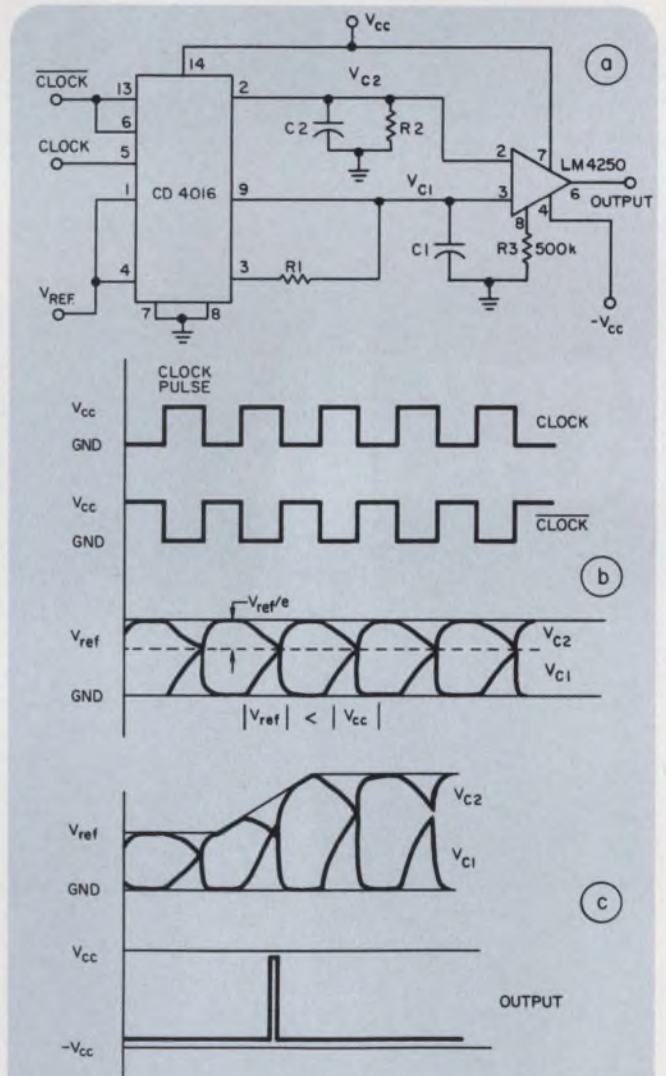

Circuit detects increase of reference voltage or decrease in clock frequency (a). The switch (CD 4016), actuated by the clock signal, causes  $C_1$  and  $C_2$  to charge and to discharge in a complementary manner (b). As long as  $V_{REF}$  remains constant,  $V_{C2} \geq V_{C1}$  and the state of the comparator remains unchanged. Increases in  $V_{REF}$  momentarily reverse the inequality and result in an output signal (c).

***CINCH CONNECTORS***

***IRC RESISTORS***

***UTC TRANSFORMERS***

***GLOBE MOTORS***

***HOLYOKE WIRE & CABLE***

***CINCH-GRAPHIK***

***IRC POTENTIOMETERS***

***SEMICONDUCTORS***

***SUPERMET PRODUCTS***

***CINCH-MONADNOCK***

***CAPACITORS***

***ELECTRONIC FUNCTIONS***

***CONSUMER INTERNATIONAL***

You know us well enough to call us by our first name...

# Chroma demodulator chip makes low-distortion AM detector

Synchronous detectors for AM modulation offer the following advantages over diode detectors:

- Low distortion—typically 0.7%.
- Ability to follow fast modulation waveforms.
- Ability to provide circuit gain.

A practical, synchronous detector can be built with a single IC and a few external components. The original IC was designed as a TV chroma (color) demodulator, but only a portion of the circuitry is used now. The double-balanced demodulators perform the synchronous detection. The tint amplifier, used as a limiter, provides extra gain for the carrier to ensure adequate demodulator drive during modulation dips.

Circuit performance is good: With a 35-mV (rms) carrier, an 0.45-V audio signal is obtained. And the distortion is less than 0.7% with 80% modulation. Good results are obtained with inputs as low as 3-mV rms.

Carrier frequencies from 10 kHz to 10 MHz require no circuit modifications. Above 10 MHz substitute a tuned circuit for  $R_1$ —to allow adjustment of carrier phase.

*Thomas B. Mills, Design Engineer, National Semiconductor Corp., 2900 Semiconductor Dr., Santa Clara, Calif. 95051.*

CIRCLE No. 313

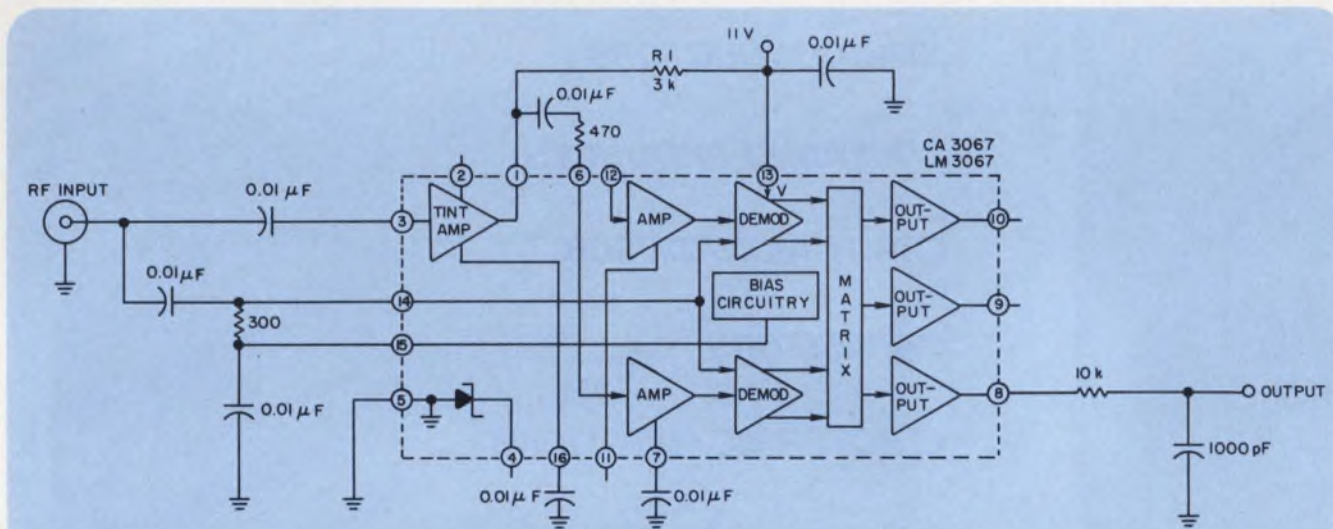

Double-balanced demodulators in chroma-demodulator chip provide synchronous AM detection. The

circuit works with rf inputs from 3 to 35 mV and uses the tint amplifier as a limiter.

## IFD Winner of July 19, 1973

T. P. Sylvan, Teradyne, Inc., 183 Essex St., Boston, Mass. 02111. His idea "Simple algorithm computes square roots on a four-function calculator" has been voted the most valuable of Issue Award.

Vote for the Best Idea in this issue by circling the number for your selection on the Information Retrieval Card at the back of this issue.

**SEND US YOUR IDEAS FOR DESIGN.** You may win a grand total of \$1050 (cash)! Here's how. Submit your IFD describing a new or important circuit or design technique, the clever use of a new component or test equipment, packaging tips, cost-saving ideas to our Ideas for Design editor. Ideas can only be considered for publication if they are submitted exclusively to ELECTRONIC DESIGN. You will receive \$20 for each published idea, \$30 more if it is voted best of issue by our readers. The best-of-issue winners become eligible for the Idea of the Year award of \$1000.

ELECTRONIC DESIGN cannot assume responsibility for circuits shown nor represent freedom from patent infringement.

**TRW<sup>®</sup> CINCH CONNECTORS**

**TRW<sup>®</sup> IRC RESISTORS**

**TRW<sup>®</sup> UTC TRANSFORMERS**

**TRW<sup>®</sup> GLOBE MOTORS**

**TRW<sup>®</sup> HOLYOKE WIRE & CABLE**

**TRW<sup>®</sup> CINCH-GRAFIK**

**TRW<sup>®</sup> IRC POTENTIOMETERS**

**TRW<sup>®</sup> SEMICONDUCTORS**

**TRW<sup>®</sup> SUPERMET PRODUCTS**

**TRW<sup>®</sup> CINCH-MONADNOCK**

**TRW<sup>®</sup> CAPACITORS**

**TRW<sup>®</sup> ELECTRONIC FUNCTIONS**

**TRW<sup>®</sup> CONSUMER INTERNATIONAL**

**We all have the same first name.**

More important, we all operate under the same philosophy, with the same standard of quality, reliability and service. Each of us specializes in a particular area of manufacturing. But not as separate companies. As the operating units of one entity, TRW Electronic Components.

That means you can enjoy all the unarguable advantages of having a single, reliable source for your electronic needs.

Between us, we make over 300 different kinds

of electronic components. And, among us, we have the ability to make whatever you want. High-technology, high-volume—or both. It's all in the family. Or can be.

So it will pay you to get familiar with us, to think of us on a first name basis. In this case familiarity breeds...contentment. With TRW reliability, quality, and service for the components you need. Because we can supply them.

And because we are TRW.

**TRW<sup>®</sup> ELECTRONIC COMPONENTS**

10880 Wilshire Blvd., Los Angeles, CA. 90024

## Hard-wire FFT processor aids on-line signal analysis

A hard-wired processor capable of performing fast Fourier transform calculations is said to be particularly suitable for on-line analysis of signals in experimental situations, such as real-time data analysis from satellites.

Developed by Logica in London, the processor is suitable for operation with most small computers that have a word length of at least 16 bits. Interfacing to the host computer and a software-driver package are included.

The FFT computer performs normal or inverse Fourier trans-

forms on up to 1024 points in about 11 ms. Numbers are processed as 16 bits real plus 16 bits imaginary, with data transferred to and from the host computer by direct-memory access.

The equipment's capability can be expanded by optional features. These include faster processing (1024 points transformed in less than 7 ms), larger arrays (processing of up to 2048 points) and additional functions (self-conjugate, cross-conjugate, and Hanning function).

CIRCLE NO. 318

## Study seeks control of optical waveguides

A technique for control of the propagation characteristics of low-loss, optical planar waveguides is under investigation at University College in London, England. Still under development, the method has been used to make a synchronous optical coupler.

Control is affected during the sputter-deposition process. Previously little attempt was made to exert control over the optical refractive indices of rf-sputtered films. The propagation characteristics of planar optical waveguides depend on the difference in the refractive ability of the indices of the deposited optical film and the substrate. Modification of a standard, rf-sputtering system controlled the refractive index and reduced occluded contamination and film stoichiometry. Scattering from film defects produced losses of 1 to 2 dB/cm.

## Circuits switch faster with field-effect logic

A new generation of monolithic integrated logic circuits, with subnanosecond switching times, has been developed by Thomson-CSF in France. The circuits use field-effect transistors that are faster than bipolar devices.

The field-effect logic has been fabricated by a variety of methods, including electron-beam pattern generation, electron-image wafer exposure, ion-beam etching, ion implantation and thin-film deposition by sputtering. Line widths down to 0.5  $\mu\text{m}$  are used, with alignment tolerances to 0.1  $\mu\text{m}$ .

Field-effect transistors have been fabricated with 1- $\mu\text{m}$ , n-type channels. They are integrated on a high-resistivity substrate with no isolating wall capacitance. The circuits can switch as fast as 0.5 ns per gate. Power requirements are in the microwatt range.

CIRCLE NO. 319

**If your  
copy of the  
High  
Performance  
Power  
Instrument  
Brochure  
from Lambda  
has been  
removed...**

**please check  
the proper  
number on the  
reader service  
card for your  
free copy.**

Do you face  
a make or buy  
decision on  
power supplies?

**BUY LAMBDA'S  
HIGH PERFORMANCE  
POWER INSTRUMENTS.**



**5-YEAR  
GUARANTEED**

bench and rack  
mounted power supplies  
for laboratory,  
test instrumentation  
and general  
purpose use.

**LAMBDA  
ELECTRONICS CORP.**

A Veeco Company

515 BROAD HOLLOW RD. MELVILLE, N.Y. 11746

INFORMATION RETRIEVAL NUMBER 246

# If, after all those years of becoming a professional you find that the rewards are still down the road, listen: National believes in paying for work done now. Now.

Some of our very best talent has come to us from competitors because they found here what they weren't getting there: Immediate recognition for engineering talent; rewards now, when they're earned. Not down the road.

Working on new products at National will give you the chance to use your imagination, your education, and your experience. All of which

will keep National ahead of the competition by a country mile.

National believes in paying for work done now. If it has been a long, long time since you were last offered a real challenge, solved a problem your own way, got a raise *and* a pat on the back, or had the satisfaction of seeing your own ideas put into practice, then

you'd better check us out. Now.

Forward your resume to Dennis Lyon, Professional Employment Manager, 2900 Semiconductor Way, Santa Clara, California 95051. We are an equal opportunity employer male and female.

**NS National Semiconductor**





# How to solve your precision power resistor problems:

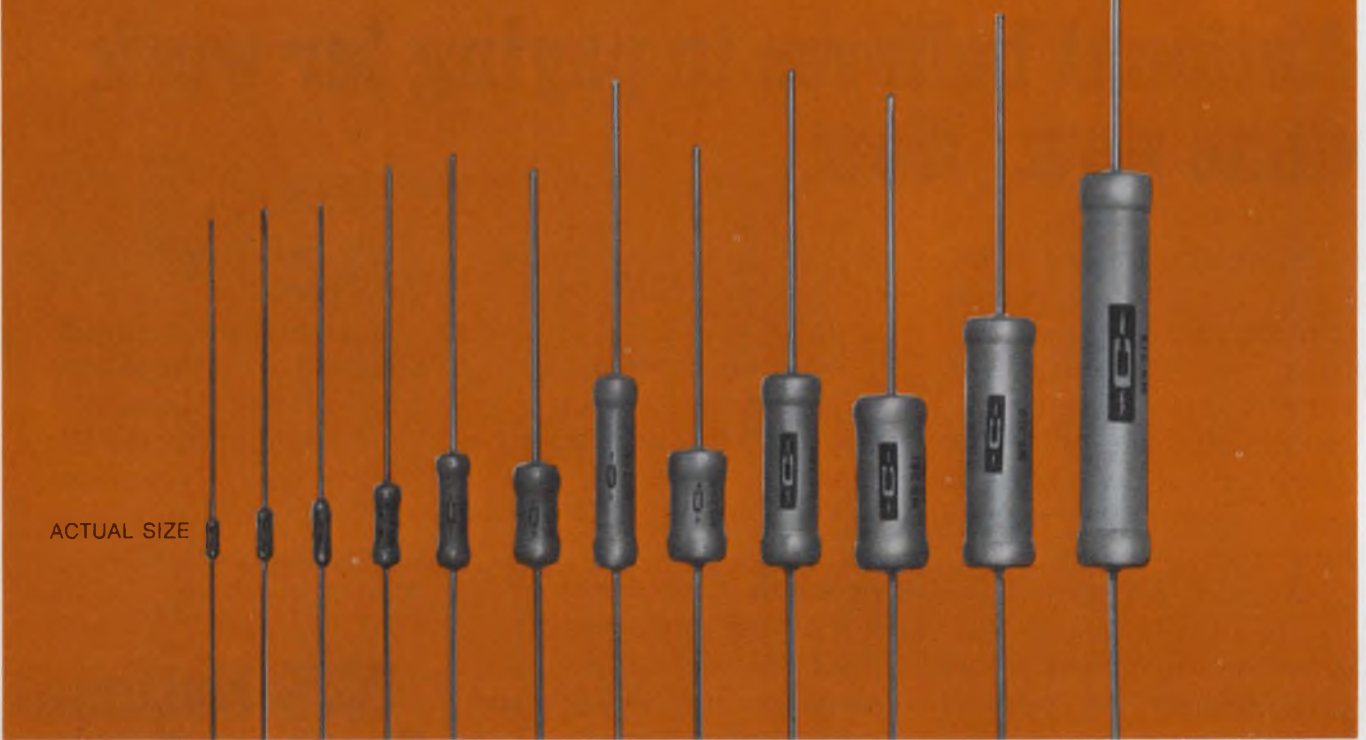

ACTUAL SIZE

## Move up to Caddock power film.

**Delivery. Performance. Quality. The three greatest problems facing specifiers of precision power resistors. Here is Caddock's solution to these problems:**

**Delivery.** We normally quote four week delivery on standard catalog MS type Power Film Resistors.

**Performance.** Compare our specs against any wirewound you may have been using recently: Power ratings up to 12.5 watts. Voltages up to 6 KV. Resistance values to 30 megohms (to 3 megohms without derating power). Standard temperature coefficient: 50 PPM/°C. Non-Inductive construction available in most models, and at no additional cost.

**Quality.** Quality starts with Micronox, a proprietary resistance film produced exclusively by Caddock Electronics. High performance characteristics include: Resistance tolerances from 1.0% (standard) to 0.1% (on special order). Extremely stable at ambient temperatures as high as 275°C. Available in matched sets for ratio tracking with temperature to within 2 PPM/°C.

All type MS Power Film Resistors feature Micronox film on high strength core. End cap construction. Silicone conformal encapsulation. Gold plated Dumet leadwire. All MS models except MS126, MS151, MS176 derated to zero at 275°C from 25°C. MS126, MS151, MS176 derated to zero at 275°C from 125°C.

For complete specifications, application information, quantity pricing and general catalog, circle the Reader Service No. below.



*Non-Inductive construction available in most models. Specify with N suffix on Model No.*

Model No.	Wattage	Max. Voltage	Body Length	Body Dia.	Lead Dia.	Resistance	
						Min.	Max.
MS 126	.25	200	.188	.070	.020	10Ω	1 Meg
MS 150	.5	—	.188	.070	.020	10Ω	2 K
MS 151	.5	300	.250	.094	.025	10Ω	2 Meg
MS 175	.75	—	.250	.094	.025	10Ω	2 K
MS 176	.75	500	.313	.094	.025	20Ω	5 Meg
MS 210	1.0	—	.313	.094	.025	20Ω	3 K
MS 220	2.0	1000	.400	.140	.025	20Ω	10 Meg
MS 221	3.0	1000	.575	.165	.030	30Ω	10 Meg
MS 223	3.0	800	.480	.230	.040	10Ω	4 Meg
MS 244	4.0	2000	.950	.230	.040	30Ω	15 Meg
MS 245	4.0	800	.570	.300	.040	10Ω	6 Meg
MS 260	6.0	2000	.970	.300	.040	20Ω	15 Meg
MS 281	8.0	2000	.910	.350	.040	10Ω	8 Meg
MS 310	10.0	4500	1.25	.350	.040	30Ω	20 Meg
MS 313	12.5	6000	2.00	.350	.040	50Ω	30 Meg

**CADDOCK** In film resistors, a new dimension

**CADDOCK ELECTRONICS** 3127 Chicago Ave., Riverside, CA 92507 • Tel: (714) 683-5361 • TWX: 910-332-6108

INFORMATION RETRIEVAL NUMBER 98

## new products

# Thin, copper-clad laminate replaces ceramics in hybrids

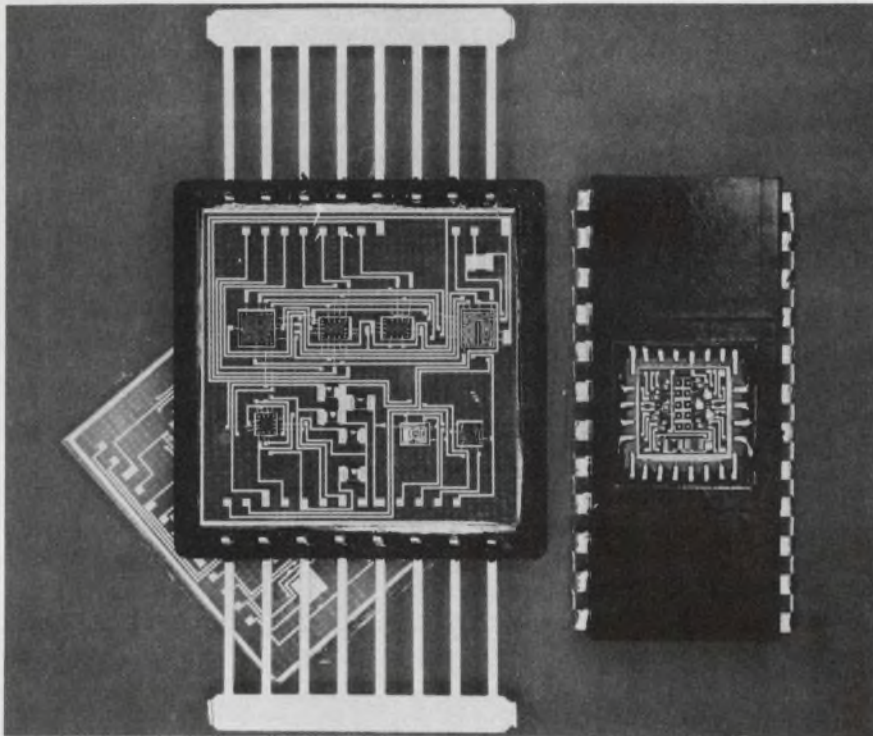

*The Mica Corp., 4031 Elenda St., Culver City, Calif. 90230. (213) 870-6861. See text.*

A new board material for film hybrid circuits, known as Micro-Thin Copper Laminate, is made of epoxy-impregnated fiber glass that is clad on one or both sides with copper. The copper is only 100 microinches thick. This laminate can replace metal-coated ceramic substrates and costs less.

Micro-Thin Copper Laminate can be used for all hybrid fabrication applications that presently use thick or thin-film processes on ceramic substrates. Applications cover a wide range—from biomedical electronics to electronic wrist-watches. The hybrids in the photograph were fabricated by Micro-Telemetry Systems Co. of Anaheim, Calif.

The Mica Corp. has established a preliminary price of 10¢/in<sup>2</sup> for a double-sided laminate. Standard core thickness is 0.025 in. This low price compares very favorably

with ceramic substrates clad with chromium/copper that sell for approximately \$0.75 to \$1.31/in<sup>2</sup>. And chromium/gold-coated ceramic is even more expensive at approximately \$1.50/in<sup>2</sup>. In addition, since the laminate can be processed in large panels, the final circuit cost is further reduced. Micro-Thin comes in sizes to 10 × 12 in., but ceramic substrates often warp when fired if they are much larger than 2 × 2 in. It takes the same amount of labor to process a large laminate as it does to process a 2 × 2-in. ceramic substrate.

Lower cost is not the only advantage of the copper laminate. Finer lines are possible than with thick-films on ceramics. Thick-film screen printing limits line widths to about 10 mils, but two-mil etched lines are completely practical with the laminate. And the laminate does not have a pin-hole problem that often plagues sputtered or evaporated, metal-coated, ceramic plates in thin-film proc-

esses. Thus the laminate has the advantages of high line density—as in thin-film methods—but without many of its problems and at a much lower cost.

According to Mica Corp., it is easy to multilayer 10 × 12-in. laminate panels to produce complex and high-density circuits; but to fire a pre-printed, green, ceramic multilayer substrate is very chancy. Interlayer connections in multilayer laminates use standard PC-board techniques, but ceramic multilayer structures need pre-punched "vias" to the inner layers. Further, active and passive chips bond easily to laminate boards with standard techniques. And circuits can be constructed without gold or other precious metals.

CIRCLE NO. 259

## Cable holder fastens with pressure adhesive

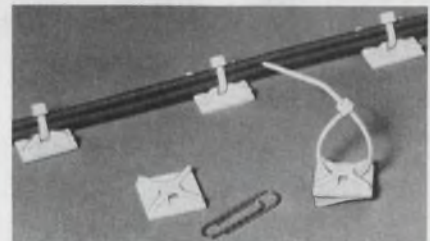

*Panduit Corp., 17301 Ridgeland Ave., Tinley Park, Ill. 60477. (312) 532-1800.*

A new adhesive-backed mount, ABMM-A, secures wire bundles in locations with limited space. Its pressure-sensitive adhesive backing has a peel-off paper cover. The mount uses Panduit's miniature cross-section cable ties, Pan-Ty and Sta-Strap, which can handle wire bundles to a diameter of 2 in. The mount measures 3/4 × 3/4 in. and can support 1/8 lb when properly applied on any clean, dry, smooth, grease-free surface.

CIRCLE NO. 334

**Fastener locks to snap-in nut in 1/4 turn**



Don Alt/Gamut Inc., 79 Washington St., Hempstead, N.Y. 11550. (516) 485-9400.

Dzus SQA4 fasteners can replace cumbersome captive screws in many applications. They are ideal for fastening where repeated, rapid access is needed. One-quarter turn moves the fastener from lock-to-unlock position. A snap-in receptacle provides reduced assembly time—no tapped hole is required. A wide variety of head styles is available.

CIRCLE NO. 271

**Ferrofluids dampen mechanical motions**



Ferrofluidics Corp., 144 Middlesex Turnpike, Burlington, Mass. 01803. (617) 272-5206.

Magnetic fluids can provide a solution for damping and motion control. Ferrofluids contain micro-fine magnetic particles (100 atoms long) that are colloiddally suspended in liquid bases such as hydrocarbons, fluorocarbons, organometallics and other chemical families. A magnetic field can make ferrofluids conform to almost any stable configuration. The viscosity of a ferrofluid can be controlled by a choice of the liquid base and the amount of solids. Damping coefficients can be produced to span five orders of magnitude.

CIRCLE NO. 272

**Ceramic paper can take continuous 2300 F**



Cotronics Corp., 37 W. 29th St., New York, N.Y. 10018. (212) 695-7997. \$112 per 400 ft. roll, 0.02-in. thick (unit qty).

Cotronics' ceramic paper is made from high-purity refractory fibers with a melting point of 3200 F. It can be cut with ordinary hand scissors and formed into complex shapes. Ceramic paper can be folded, wrapped, rolled and it can go around sharp corners. Strong free-standing shapes and tubes are easily produced. The material is ideal for high-temperature gaskets, furnace linings and as an electrical insulator with continuous use temperatures of 2300 F. The paper is available in 0.020, 0.040 or 0.080-in. thickness.

CIRCLE NO. 273

# Value Packed SPECTRUM ANALYZERS

0.5 Hz — 6.5 GHz

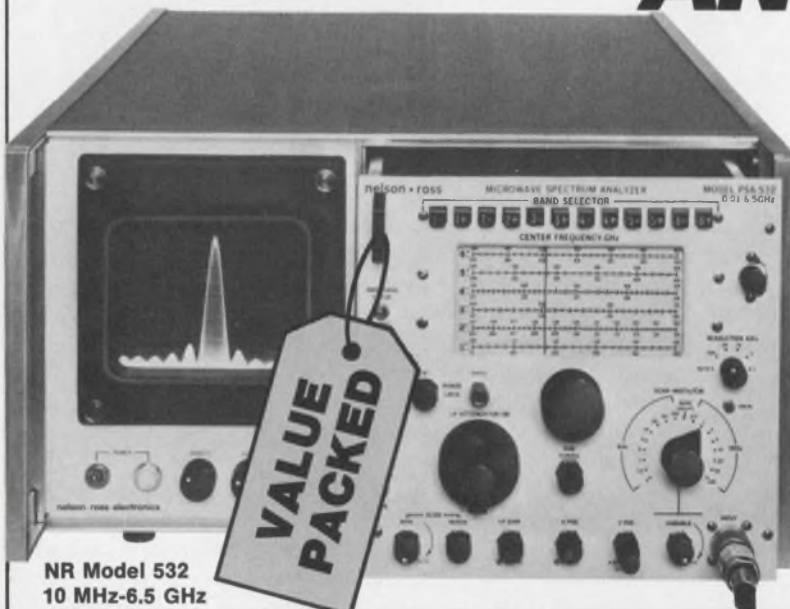

NR Model 532  
10 MHz-6.5 GHz

**The Specs You NEED at the Price You Want**

... You choose from the largest selection of complete Spectrum Analyzers and plug-ins.\* Get specifications you need at lowest cost. Our analyzers cover Sub-Audio, Audio, Ultrasonic, Video, Telemetry Subcarrier, RF/SSB, RF/UHF, CATV, and Microwave applications. And, Nelson-Ross' reliability has been proven by thousands of users for more than a decade.

**Get your Nelson-Ross Spectrum Analyzer Catalog;** phone, write or circle the reader service number.

\* For HP 140/141 series, Tektronix 530/540/550/580 "Letter" series and 560 series scopes.

**nelson • ross  
electronics**

A DIVISION OF POLARAD ELECTRONICS CORP.  
5 Delaware Drive/Lake Success, N.Y. 11040  
516-328-1100 • TWX: 510-223-0414

## Multilevel connector provides 80 points

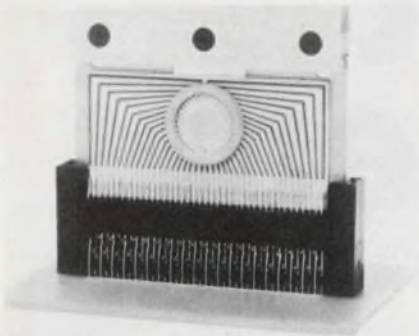

Elco Corp., Maryland Rd. and Computer Ave., Willow Grove, Pa. 19090. (215) 659-7000.

Series 8401 two-piece, multilevel connector is the latest approach to hybrid microelectronic packaging. The contacts are offset on 0.025-in. centers into two different levels and sub-divided in each level. This eliminates the simultaneous engagement of contacts during mating and results in low total connector insertion withdrawal forces. This high density connector can accommodate up to 80 interconnections within a  $2 \times 0.300$ -in. space. It will accept either ceramic substrates or PC boards in a variety of configurations—one double-sided unit, or two single-sided units (back-to-back). Contacts are rated at 1 A and 12 mΩ, max. The withdrawal force is 1 to 3 oz per contact pair, and the insertion force is 1 to 4 oz per contact pair.

CIRCLE NO. 274

## Instant circuit board is low cost for throw-away

Instant Instruments Inc., 306 River St., Haverhill, Mass. 01830. (617) 373-9260. \$2 to \$8.60 (1-9).

This new instant-circuit breadboard is for the designer who requires a simple and low cost method to assemble his idea from paper to hard-wired electronics. Without drilling, inserting components or cutting PC boards, the designer simply solders to pre-etched patterns of large lift-resistant copper grid pads. Although the instant breadboard is cheap enough to be a throwaway item, it is easy to salvage both components and board. Four basic patterns are available with optional prepunched front panels.

CIRCLE NO. 275

# NOW...

## The Only Complete Line of THICK FILM RESISTORS...

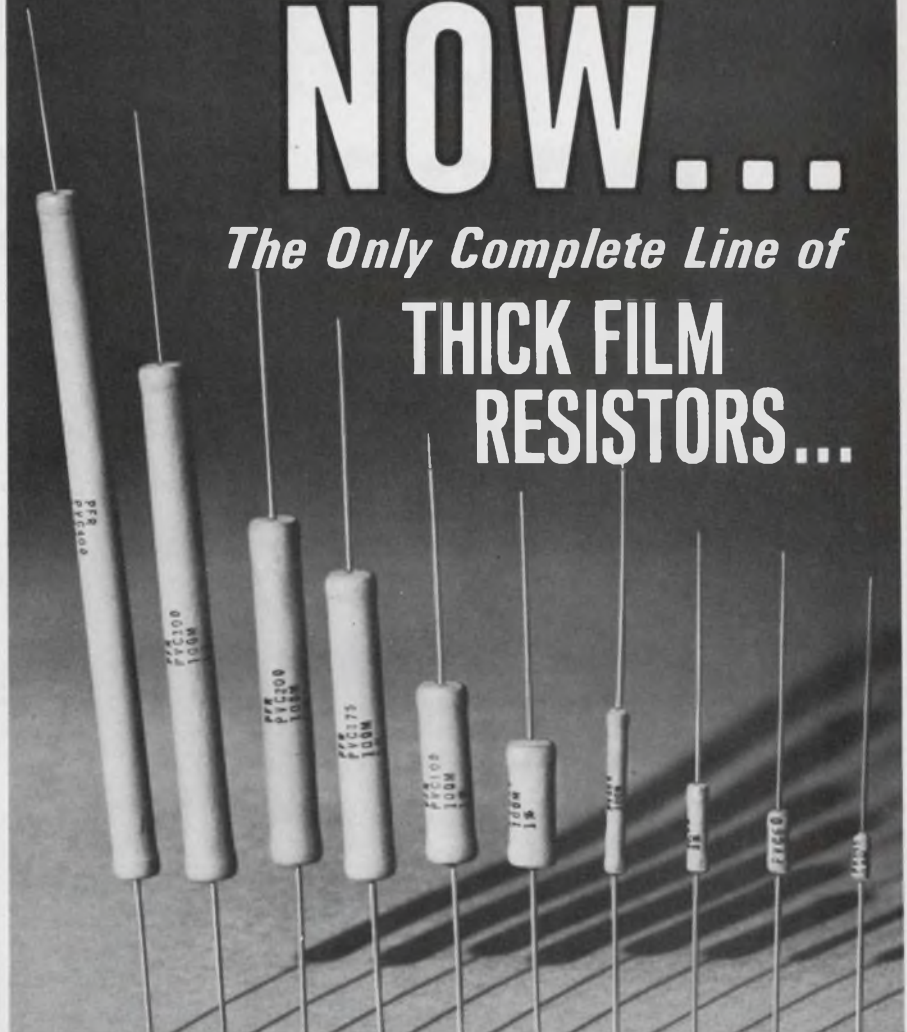

Watts Max.	5.25	3.75	3	3	1.5	1	1/4	1/4	1/4	1/8
Voltage Max.	17.5KV	12.5KV	10KV	10KV	5KV	3.5KV	1000	500	500	250
Resistance Range	50K-1000M	35K-1000M	20K-1000M	20K-1000M	10K-1000M	10K-500M	10K-500M	10K-200M	10K-100M	10K-50M

### TC 100 PPM/°C

...and if it's not here, we'll make it to satisfy your requirements!

NEW DATA SHEET AVAILABLE . . . detailing every parameter needed to specify. More than that, Pyrofilm doesn't play the game of specmanship, each Thick Film Resistor meets or exceeds specifications, and that's a guarantee.



Setting New Standards in Reliability  
**PYROFILM**

904

60 S. Jefferson Road • Whippany, N. J. 07981 • (201) 887-8100

# Dialight sees a need:

(**Need:** Find a very small fault in a very large system.)

## See Dialight.

All printed-circuit boards need a fault indicator; that's why Dialight has developed such a broad family. These tiny LED devices signal where and when a fault occurs in a complex electronic circuit — and this can reduce downtime to a minimum. With some Dialight fault indicators, you can get as many as 10 units in just 1" of space. These devices, which come in a variety of sizes, are designed to operate from 1.6 to 14 volts and are available with both axial and right angle leads. They



can be driven directly from DTL or TTL logic and can also serve as logic-state indicators, binary data displays, or just as indicators, as in this p-c board furnished by Struthers-Dunn, Inc.\* But Dialight's fault finders are only a small part of their fast growing family of light-emitting diodes. Additional opto-electronic devices are extensively used in cartridges, lighted push-button switches, optoisolators, and readouts, all supplied by Dialight. A wide variety of discrete LEDs further adds to the broad family.

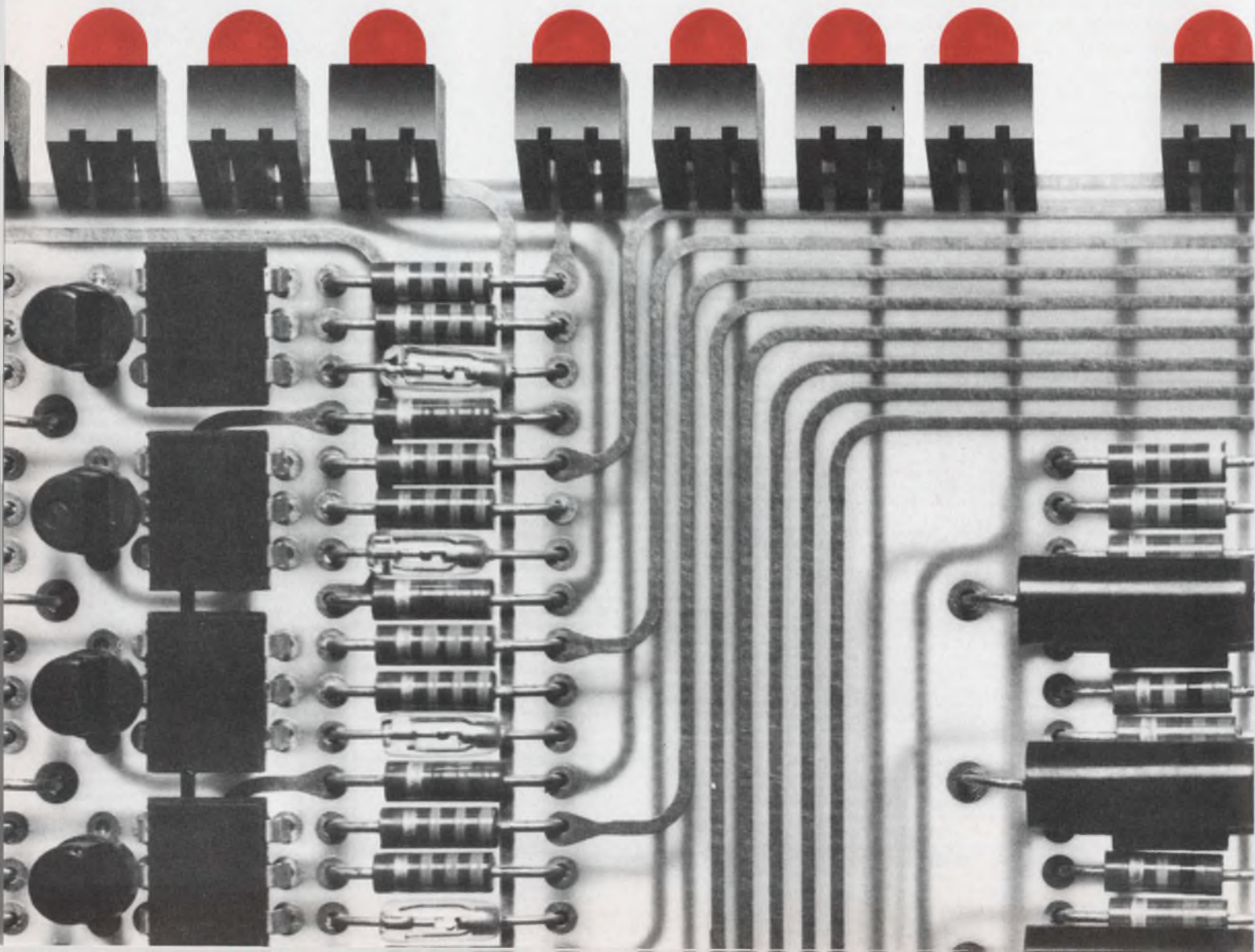

Dialight is a company that looks for needs . . . and develops solutions. That's why we developed the industry's broadest line of switches, indicator lights and readouts using LEDs. No other company offers you one-stop shopping in all these product areas. And no one has more experience in the visual display field. Dialight can help you do more with them. Talk to the specialists at Dialight first. You won't have to talk to anyone else. We can help you do more with LEDs than anyone else because we've done more with them.

Here are a few products in this family: **1.** Ultra-miniature indicator lights **2.** Datalamp cartridges **3.** Bi-pin LED lamp **4.** Opto-isolators **5.** LED solid state lamps **6.** Logic state fault indicators

\*Used in their VIP Programmable Controller

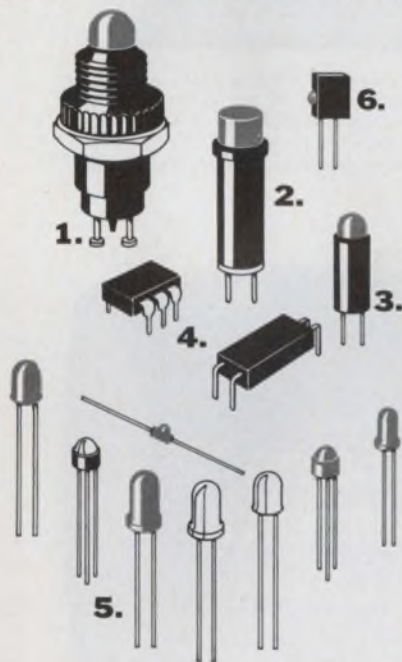

Please send data on your LED products.

NAME \_\_\_\_\_

TITLE \_\_\_\_\_

COMPANY \_\_\_\_\_

ADDRESS \_\_\_\_\_

CITY \_\_\_\_\_ STATE \_\_\_\_\_

**DIALIGHT**

Dialight Corporation, A North American Philips Company  
60 Stewart Avenue, Brooklyn, N.Y. 11237 (212) 497-7600

INFORMATION RETRIEVAL NUMBER 101

ICs & SEMICONDUCTORS

## Two-wire line-drivers come in TO-packages

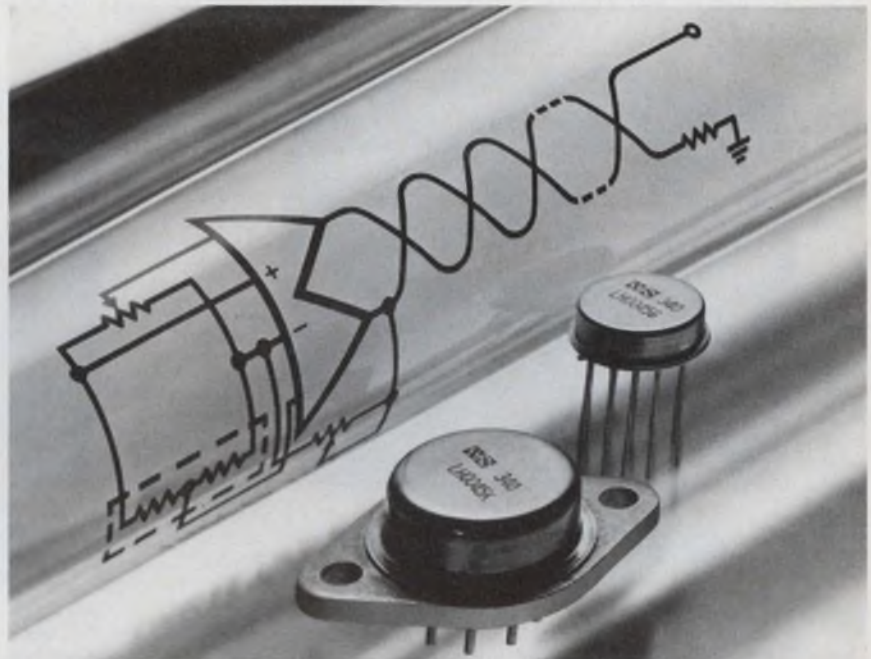

National Semiconductor Corp., 2900 Semiconductor Dr., Santa Clara, Calif. 95051. (408) 732-5000. P&A: See text.

Replace an entire rack-mounted analog line-driver circuit with a single hybrid IC? It's now possible. National Semiconductor's LH0045 series of two-wire line drivers fit in TO-style metal cans. The transconductance circuits can be scaled to deliver 4 to 20 mA or 10 to 50 mA of output current.

Performance of these circuits is comparable to that of large rack-mounted units. The sensitivity is 10 mA/ $\mu$ V, and the input offset voltage is 10 mV max (comm. temp version) and 3 mV (MIL temp version).

Input bias current is less than 3 or 10 nA for the military or commercial versions, respectively. The units will operate over a supply voltage spread of 10 to 50 V and are reverse-voltage protected—an important consideration when long cables are being connected.

Models LH0045G and LH0045K are specified for operation over the -55 to +125 C MIL temp range and are available in the TO-8 and

TO-3 packages, respectively. The commercial-grade units, the LH0045CG and the LH0045CK, operate over the -25 to +85 temp range and are also available in the TO-8 and TO-3 cases, respectively.

The TO-3 cased model can dissipate 3 W while the TO-8 case can dissipate 1.5 W. The TO-8 versions have extra leads that provide a programmable bridge reference voltage of 5 to 30 V, while the TO-3 version has a fixed, 5.1-V reference. Power ratings can be boosted by adding external heat sinks.

Unlike some rack-mounted transmitters, the span and null adjustments don't interact. These circuits can detect and amplify the small voltages developed in sensor circuits, such as strain-gauge bridges, and transmit the changes as a variable current over a twisted-pair cable.

Prices for the LH0045 series are as follows: 45CG, \$27.75; 45G, \$52.50; 45CK, \$32.25; and the 45K, \$57—all for single units. Prices for 100-up lots are about 1/3 lower.

INQUIRE DIRECT

# Oak presents a short course in keyboard switch selection you can't afford to miss.

Our course could be called "Basic Economics in Keyboard Switch Design." It sums up more than 40 years of leadership in switch design and manufacture at Oak. Take a look at our course:



At the top: the Oak Series 400 Standard Keyboard Switch. It's what you're looking for if you want economy plus reliability. Millions are in use today in every kind of keyboard application.

And our Series 475 Compact Keyboard Switches (bottom) are about the shortest premium quality units you can buy. And, like the Series 400, they're ultra-reliable and economical.



We make so many types and sizes, you can specify Oak across the keyboard. Call on us for complete assemblies to your specifications or standard keypads. The most frequently used 10, 12 or 16 button arrays are stocked in quantity by Oak distributors.



Next subject: Oak Series 415 Low-Profile Keyboard Switches designed for calculators, security devices and data entry equipment. Note the streamlined silhouette. Select colors, custom caps and legends,  $\frac{1}{2}$ " or  $\frac{3}{8}$ ", single and double keys to fit your needs exactly.



We can say that because our automated manufacturing and test equipment ensures quality. And we design our keyboard switches with the operator feel, reliability, and economy it takes for such applications as data terminals, calculators, business machines, and more.

That's it. Just be sure to follow up on what you've learned. Write for Oak Keyboard Bulletins. Class dismissed.

**OAK Industries Inc.**

SWITCH DIVISION / CRYSTAL LAKE, ILLINOIS 60014  
TELEPHONE: 815-459-5000 • TWX 910-834-3353 • TELEX 72-2447

INFORMATION RETRIEVAL NUMBER 102

# Who to call for fast delivery on Oak Keyboard Switches

SERIES 400



SERIES 415



Oak Series 400 and Series 415 Keyboard Switches are available from a distributor near you. He'll supply your desired quantities and ship standard 10, 12 and 16-button keypads as well. It's the way to get Oak quality switches fast!

## DEMAMBRO ELECTRONICS

MASSACHUSETTS, Boston.....(617) 787-1200

## DRW

MASSACHUSETTS, Watertown.....(617) 923-1900  
NEW YORK, Farmingdale.....(516) 249-2660

## EDMAR ELECTRONICS

ILLINOIS, DesPlaines.....(312) 298-8580

## FEDERATED PURCHASER

NEW JERSEY, Springfield.....(201) 376-8900

## GRAHAM ELECTRONICS

INDIANA, Indianapolis.....(317) 634-8486

## G. S. MARSHALL

ALL BRANCH LOCATIONS—HOME OFFICE:  
CALIFORNIA, El Monte.....(213-686-1500)

## HALL-MARK

ALL BRANCH LOCATIONS—HOME OFFICE:  
TEXAS, Dallas.....(214-231-6111)

## HERBACH & RADEMAN

PENNSYLVANIA, Philadelphia.....(215) 426-1700

## INDUSTRIAL COMPONENTS

MINNESOTA, Minneapolis.....(612) 831-2666

## MILGRAY/WASHINGTON

MARYLAND, Hyattsville.....(301) 864-1111

## OHM/ELECTRONICS

ILLINOIS, Palatine.....(312) 359-5500

## RADAR ELECTRIC CO.

WASHINGTON, Seattle.....(206) 282-2511

## SCHOMBURG SALES

NEW YORK, Rochester.....(716) 244-0920

## SOLID STATE ELECTRONICS

TEXAS, Dallas.....(214) 352-2601

**OAK** Industries Inc.

SWITCH DIVISION / CRYSTAL LAKE, ILLINOIS 60014

## DATA PROCESSING

# Minicomputer interface card speeds data at 1 M word/sec

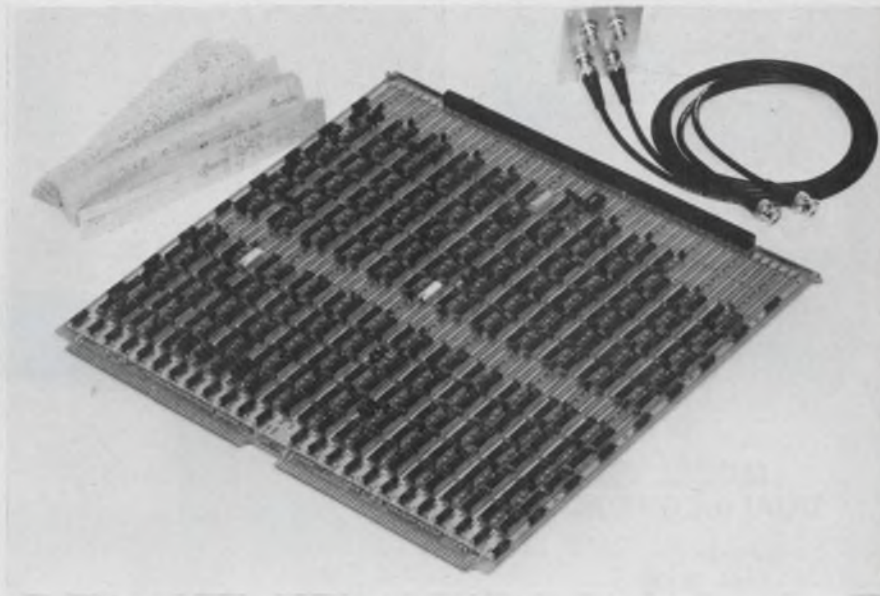

*Elsytec, Inc., 212 Michael Dr., Syosset, N.Y. 11791. (516) 364-0560. P&A: See text; 60 to 90 day.*

Need speed for communication between Nova minicomputers? Elsytec, Inc., has an answer—its MCI-10 interface board. This unit—along with its software package—allows up to 16 minicomputers to talk, memory-to-memory, at data transfer rates of a million words per second.

The MCI-10 is a 15 × 15-in. circuit card that plugs into any existing Nova chassis or extension chassis. Only a slight modification to the computer backplane is required. In addition the unit requires a 5-V (at 5 A) power supply which may already be available in the system. Each minicomputer connected into the system needs its own board, but only two coaxial cables are needed to connect the computer into the bus-oriented network.

A maximum of 16 minis can be interconnected at a maximum distance of 250 feet between processors. And—as long as two signal paths don't cross—up to eight minis can talk to eight others at the same time. For example, computers 1 and 2 can talk to each other, and so can 3 and 4. But pairs 1

and 3 and 2 and 4 can't.

The closest competitor is Data General Corp.—manufacturer of the Nova mini. That company's data interface board, the MCA, allows a maximum data-transfer rate of only 140 kilowords per second and permits a maximum separation of 50 feet between minis. The interface also requires a multiwire connecting cable between each mini—with at least one wire for each bit of the data word. Like Elsytec's MCI-10, one board is needed for each mini; but the cost per MCA board is only \$2100.

Although the MCI-10 costs \$3800—almost double the cost of Data General's card—it allows the data to be transmitted over a pair of coax cables, thus saving a large interconnect cost.

The software package for the board is minimal—it requires only a few hundred words of memory and is supplied on a prepunched paper tape.

Uses for the multiprocessor setups include radar-signal processing, fast-Fourier-transform calculations and other multiple signal-processing applications.

Elsytec  
Data General

CIRCLE NO. 260  
CIRCLE NO. 266



# NEW 18 Bit Bipolar A/D Converter



## MODEL 107 DUAL-SLOPE ADC

- **Resolution**  
4½ Digits BCD plus Sign  
or 14 Bits Binary plus Sign
- **±0.005% max. Nonlinearity**
- **Low Drift —**  
±2ppm/°C max. Offset  
Drift and  
±5ppm/°C max. Gain  
Drift
- **Automatic Zero Correction**
- **Rejects 60Hz/50Hz Noise**
- **Pin compatible with Analog  
Devices 17-1 and 14-1**

And this new analog-to-digital converter is versatile... you can connect it to automatically recycle or to convert on external command. Also you can connect it for ratiometric operation or use the internal references.



And they're in stock!

Call or write today.

**Function Modules, Inc.**  
2441 Campus Drive  
Irvine, California 92664  
Phone: (714) 833-8314  
TWX: 910-595-1706

## INSTRUMENTATION

# Measure GHz power and freq with only one instrument



*Nytek Electronics, Inc., P.O. Box 358, Los Altos, Calif. 94022. (415) 321-4191. P&A: See text.*

A dual-function, digital frequency and power meter does both measurements at the same time. The Model 9012 from Nytek Electronics covers the frequency range of 1.5 to 20 GHz and a power range from -40 to +10 dBm—displaying both quantities simultaneously on dual numeric displays.

The YIG-filter frequency meter is more accurate than tunable-cavity wavemeters. It has an accuracy of better than ±0.02% from 1.5 to 18.5 GHz and ±0.1% at the 20-GHz top frequency. Resolution is 1 MHz on the five-digit readout.

Accuracy of the power meter in the 9012 is at least as good as other crystal-detector power meters. At the highest frequency, it is ±1.8 dB and it improves to ±0.3 dB at the low frequency end. In addition, the crystal detector element is self-contained and temperature controlled, thus preventing any accuracy degradation due to cable or ambient temperature problems. Resolution is to 0.01 dB on the four-digit display.

Packaged in a case 3.5 by 9 by 10.5 in., with a weight of 12 lb., the unit is portable and has no operating controls save for a front-panel on-off switch. Signal input is through a single type-N rf connector also mounted on the front panel.

YIG frequency meters operate by applying a ramp current to an electromagnet that surrounds the YIG element. As current increases in the coil, the YIG filter is tuned through its frequency range until the signal frequency is detected by the diode detector. The linearity and synchronization of the ramp generator and the processing of ramp-related data are factors that determine the instrument accuracy.

A read-only memory is built into the 9012 to compensate for frequency dependent errors inherent in YIG filters.

The basic instrument costs \$2590, with delivery from 6 to 8 wk. There are two options available—an analog and TTL-compatible output for \$200 or an analog only output for \$100.

CIRCLE NO. 265

# The first name in sweep generators is also no. 1 in price/performance value.

Telonic Sweep Generators have a lot more built into them than just components. For example — more experience and application know-how than you'll find in any instrument; operating features we've incorporated from talking to hundreds of users; dependability based on designs that are field-proven in thousands of locations. Today, Telonic sweepers give you a lot more than just specs. They give you maximum instrument for your investment.

Consider: 1) The Model 1202, solid state, all modular, covering 100 kHz to 100 MHz, built-in single or harmonic markers, built-in 102 dB of attenuation, variable sweep rate, excellent flatness, linearity, resolution and accuracy, with a basic price of only \$895.00.

2) The Model 1204 with all those same fine features, for use in the 1 MHz to 500 MHz frequency range, and it starts out at \$1,095.00.

3) The Model 1205 gives you all the benefits of our other models, operates out to 1500 MHz, and it, too, is a big value with a base price of \$1,395.00.

4) For displaying swept signals, the Model 121 Oscilloscope is an ideal mate for any of the above sweepers. It incorporates an 11" diagonal screen, is sensitive to 1 mv/division, has a bandwidth of 15 kHz and is priced at \$495.00.

5) The Model 122 Oscilloscope is a dual display unit for two sweeper traces or a reference trace, and it's not twice the price, only \$695.00.

Who was it that said, "investigate before you invest"? We have a new 60-page catalog on sweepers, oscilloscopes, and detectors. We would like you to investigate it, it's free.

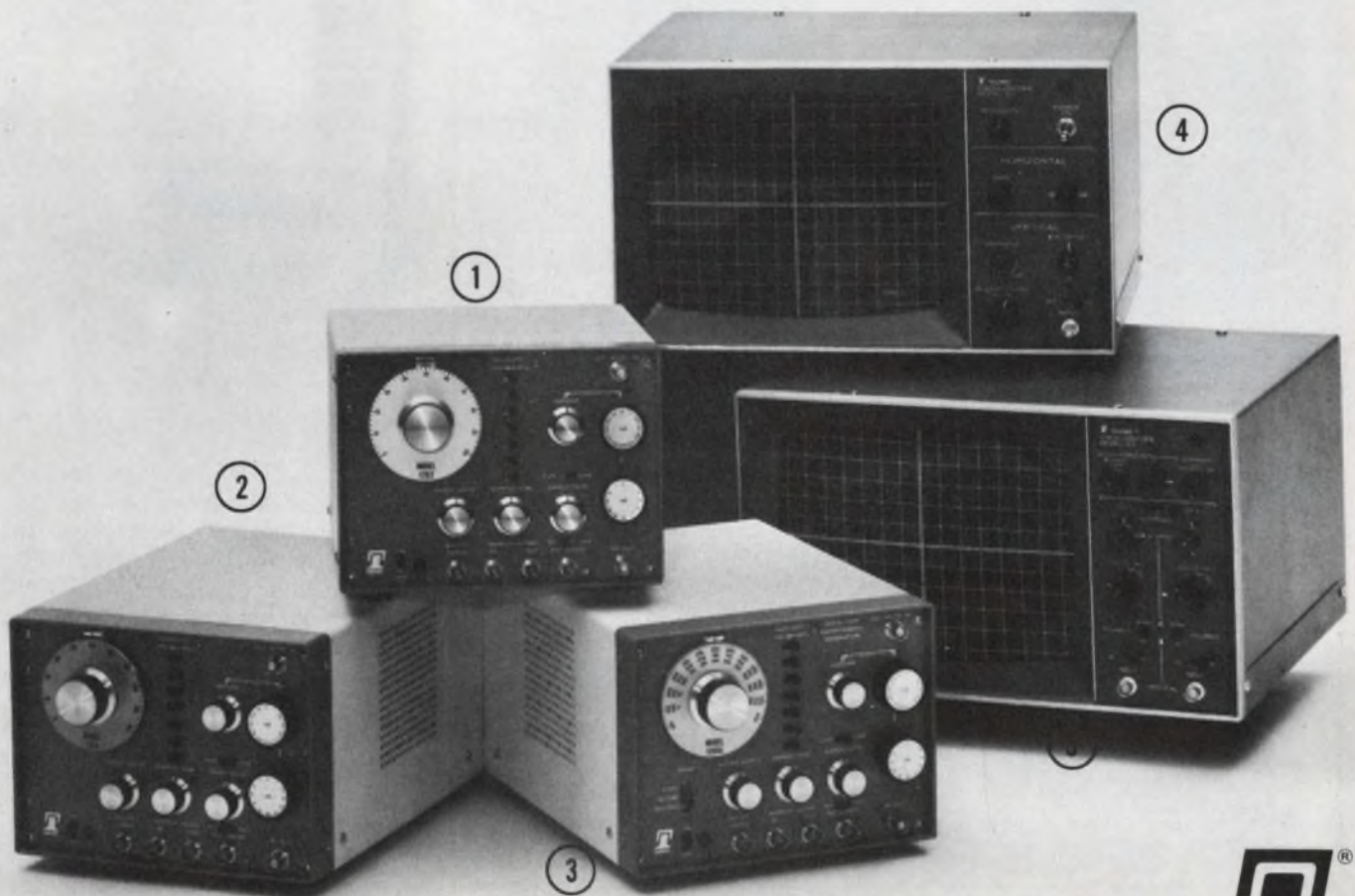

**TELONIC INDUSTRIES, INC.**

21282 Laguna Canyon Road • Laguna Beach, California 92652 Tel: 714 494-9401 • TWX: 910 596-1320



INSTRUMENTATION

**DPMs replace older units**



Electronic Research Co., P.O. Box 913, Shawnee Mission, Kan. 66201. (913) 631-6700. \$400 and up; 3 wk. Series 4000A DPM succeed and replace the 4000 Series. The new instruments, which have reduced power consumption, are available as dc voltmeters and dc ammeters. An optional multiple conversion averaging feature is available which allows the meter to display the averaging of 100 or 1000 conversions.

CIRCLE NO. 276

**Wiring analyzer programs itself**



Plexus, Inc., 7345 E. Evans Rd., Scottsdale, Ariz. 85260. (602) 948-3150. \$11,900; 60 days.

WA2K Wiring Analyzer System tests backplanes, PC-cards and cable harnesses. All that is needed to program the WA2K is a wiring network known to be good, fixturing and a connector assignment. The system then programs itself, stores the program on cassette tape, and, prints a hard-copy output that pinpoints all wiring discrepancies. The basic system can test up to 1024 points.

CIRCLE NO. 277

**This Christmas give your car a Mark Ten B Capacitive Discharge Ignition. You and your car will enjoy it all year.**



The Mark Ten B keeps your car in tune. That means increased mileage, less maintenance and a better running car. A well-tuned car also decreases emission contaminants. All this adds up to more driving enjoyment for you. Mark Ten B, the perfect gift—for cars—and their owners.

**DELTA PRODUCTS, INC.**

P.O. Box 1147, Dept. ED  
Grand Junction, Colo. 81501  
(303) 242-9000

Here's my Christmas order. Please rush!

Please send me free literature.

Enclosed is \$ \_\_\_\_\_  Ship ppd.  Ship C.O.D.

Please send: \_\_\_\_\_ Mark Ten B assembled @ \$59.95 ppd. \_\_\_\_\_ Mark Ten B Kit @ \$44.95

ppd. 12 volt negative ground only \* \_\_\_\_\_ Standard Mark Ten. assembled. @ \$44.95 ppd.

\_\_\_\_\_ 6 Volt: Neg. Ground Only \_\_\_\_\_ 12 Volt: Specify \_\_\_\_\_ Pos. Ground \_\_\_\_\_ Neg.

Ground \* \_\_\_\_\_ Standard Mark Ten Deltakit® @ \$29.95 ppd. (12 Volt Positive or Negative

Ground Only)

Car Year \_\_\_\_\_ Make \_\_\_\_\_

Name \_\_\_\_\_

Address \_\_\_\_\_

City/State \_\_\_\_\_

Zip \_\_\_\_\_

**Benchtop unit checks ICs**

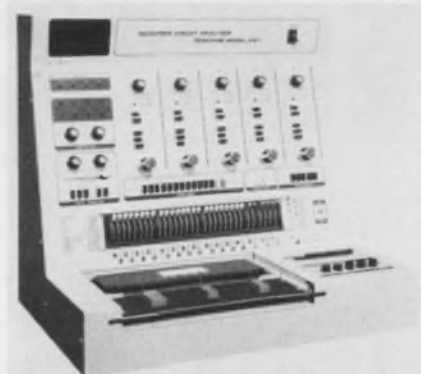

Teradyne, Inc., 183 Essex St., Boston, Mass. 02111. (617) 482-2700. \$3500; 4 wk.

Model J127 IC tester is the first in a line of bench-top instruments to be developed by Accutest Corp. and marketed by Teradyne. The J127 includes four constant-voltage supplies, a constant-current supply, four dual-limit comparators, a manually controlled 24-pin matrix, and a 3-1/2-digit panel meter. The system can perform both functional and dc parametric tests on a wide variety of digital ICs, as well as on certain discrete, linear, and opto-electronic devices.

CIRCLE NO. 278

## Dual-channel/dual-trace scope offered



Leader Instruments, 151 Dupont St., Plainview, L.I., N.Y. 11803. (516) 822-9300. \$699.95.

LBO-302, 3-in. Dual-Channel, Dual-Trace, Solid-State Scope features pushbutton controls for triggered or automatic sweep, with ac and dc-coupling on each channel. Bandwidth is dc to 10 MHz with separate or simultaneous display of the sweep mode in channels 1 and 2; alternating, chopped, algebraically added and vector (X-Y). The sweep range is from 1  $\mu$ s/div to 0.2 s/div, 17 steps calibrated. Vertical sensitivity is at 10 mV pk-pk/div to 5 V pk-pk/div in nine calibrated steps.

CIRCLE NO. 279

## Analyzer plots amplitude and phase shift response



BAFCO, Inc., 717 Mearns Rd., Warminster, Pa. 18974. (215) 674-1700. \$11,250; 4-6 wk.

Model 913/72 Two-Channel Frequency Response Analyzer makes a complete frequency-response plot of amplitude ratio and phase shift vs log frequency automatically over as much as 6-1/2 decades of frequency, 80 dB of amplitude (in each of two channels of analysis) and phase shift of  $\pm 180^\circ$  in one continuous sweep. The unit extracts the fundamental of both return signals by Fourier-integral analysis. Open-loop frequency-response can be measured and plotted while the system is operating closed loop.

CIRCLE NO. 280

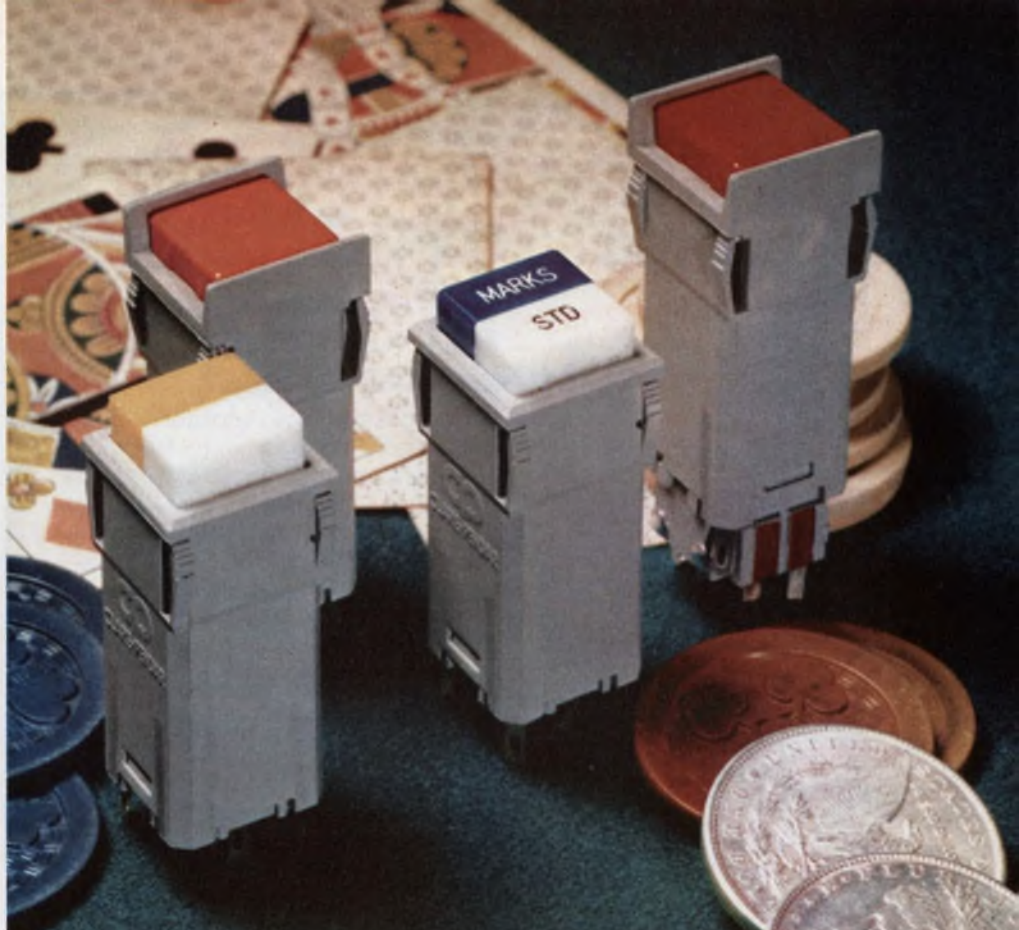

# Just two bucks for a sure thing!

## monoform switchlights

### A whole family from out of the West

There are still plenty of places where you can lay your money down and take your chances. We're not one of them. We don't believe in luck at Clare-Pendar. When you invest two silver cartwheels for a switchlight, we deliver a unit that's so dependable and versatile that people think it has to be expensive. It's not. And there's a whole low-cost family.

**Monoform I** (the single lamp, momentary & alternate, rated 2 amp 120 Vac).

**Monoform II** (two independent lamps for horizontal split legends, mom. & alt., 2 amp 120 Vac).

**Monoform III** (10 amp, 1/4 H.P. power switch).

So, when the chips are down . . . when you want fast delivery of a fine product, depend on Clare-Pendar.

 **CLARE-PENDAR**  
Phone 208-773-4541

P.O. Box 785 Post Falls, Idaho 83854

Telex 32-6448

# The Non-forgettable Memory

## Why Non-forgettable?

Because a digital cassette tape recorder should not ever forget unless it is programmed to forget - and it should remember nothing extra. The things that make it forget - capstans, pinch rollers, solenoids, belts - are simply not there. The patented constant tape speed motor control system eliminates noise susceptibility. Please call or write now for all the details.

**Spend less for less . . . and get more.**



**ROSS CONTROLS CORPORATION**

257 Crescent Street, Waltham, Massachusetts 02154, Tel. (617) 891-9600  
An Affiliate of American Research & Development Corp. (ARD)

INFORMATION RETRIEVAL NUMBER 107

## We Stock What We Catalog in the 1974 Allied Electronics

### ENGINEERING MANUAL & PURCHASING GUIDE

Allied has a reputation for delivery! We stock what we catalog, at three key locations for immediate nationwide delivery. If you see it in our Engineering Manual & Purchasing Guide, it's because we've got it ready for your use!  
THE MOST WIDELY USED BOOK IN THE COUNTRY!

#### TECHNICAL INFORMATION

Complete information on all items. Both electrical properties and physical dimensions.

#### \$5.00 VALUE

Special Offer! Only \$1.00 to readers of Electronic Design

#### ALL ITEMS IN STOCK

Highest percentage of order filling in the country on standard and stock items. Thousands of popular and hard-to-get items.

#### NEW FROM COVER TO COVER

The only up to date annual in the electronics field.

#### EASY TO USE

Find what you're looking for - Fast!

It has always been the "Answer Book" for Purchasing Agents, Plant, Research, Product, and Maintenance Engineers. Used in all industries. Our 1974 edition is loaded with more information than ever. Complete engineering drawings on most components. It's

**The Best Order Filling System In The Country —**

Mail Coupon and \$1.00 to cover cost of handling to:  
Cat. 910-9999-5

Allied Electronics Corporation  
2400 W. Washington Blvd.  Chicago, Ill. 60612

Name \_\_\_\_\_  
Company \_\_\_\_\_  
Address \_\_\_\_\_  
City \_\_\_\_\_  
State \_\_\_\_\_ Zip \_\_\_\_\_

**ALLIED ELECTRONICS** DIVISION OF TANDY CORP.

INFORMATION RETRIEVAL NUMBER 108

## INSTRUMENTATION

### Photometer measures 1- $\mu$ s pulsed light



Photo Research, 3000 N. Hollywood Way, Burbank, Calif. 91505.  
(213) 849-6017. \$5290; 60 days.

Pulsed-Light Photometer, Model 1980-PL, has been specially designed to measure the integrated (average) value of sources from  $10^{-5}$  to  $10^7$  foot-lambert-seconds (full-scale) for pulses as short as 10  $\mu$ s. The instrument is also equipped with a high-speed (video) amplifier, which can be used in conjunction with a high-speed scope to study the shape and peak value of pulses as short as 1  $\mu$ s.

CIRCLE NO. 281

### Precision unit calibrates strain gauges



William T. Bean, Inc., 18915 Grand River Ave., Detroit, Mich. 48223.  
(313) 838-6700. \$125 ea.; stock.

Model 120 and Model 350 Precision Calibrators are used to simulate 120 or 350- $\Omega$  strain-gauge, bridges, half or full, and to calibrate readout and recording instruments directly in millivolts per volt, or equivalent microstrain. Bridge zero balance is set within 0.0025 mV/V; 10 steps provide a range of  $\pm 5$  mV/V, or  $\pm 10,000$  microstrain, with an accuracy of  $\pm 0.025\%$  and a linearity of  $\pm 0.01\%$ . The units are certified, with calibration accuracy traceable to National Bureau of Standards.

CIRCLE NO. 282

## 500-MHz synthesizer switches in under 100 $\mu$ s

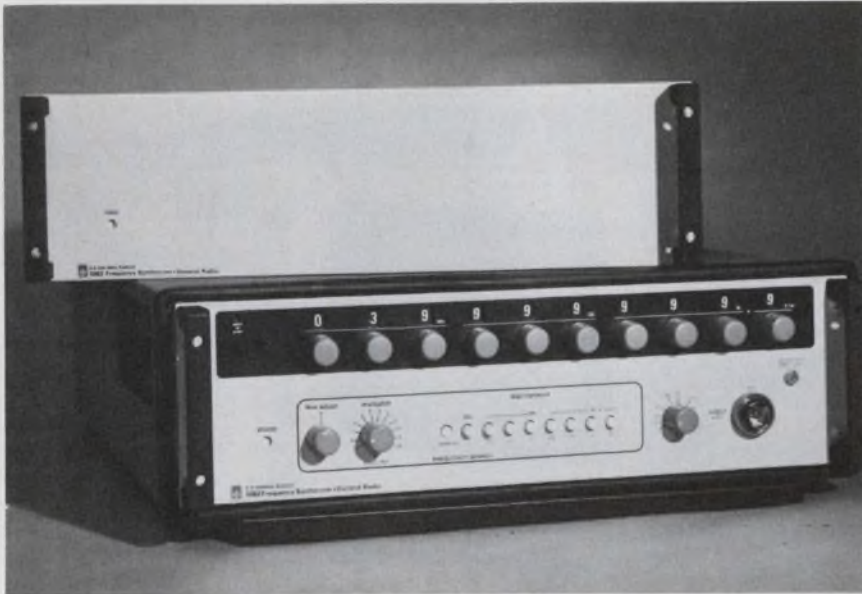

General Radio, 300 Baker Ave., Concord, Mass. 01742. (617) 369-4400. Basic unit: \$8700.

With the introduction of its Model 1062 Frequency Synthesizer, General Radio has pushed the top frequency of its synthesizer line to the 500-MHz mark.

Besides its frequency capability, the 1062 boasts a 100- $\mu$ s switching speed—said by GR to be ten times faster than most synthesizers—and requires only 5-1/4 inches of panel height.

Other key specs include an 80-dB signal-to-spurious ratio over the 10 kHz to 500 MHz range, a resolution of 10 kHz (optionally expandable to 0.1 Hz), and a levelled output of -7 to +13 dBm into 50  $\Omega$ .

Also, phase noise is down at least 60 dB, while harmonics are reduced by a minimum of 25 dB.

Both frequency and output level can be remotely programmed. In fact, the basic 1062 comes without front-panel controls, which are optional.

A useful feature of GR's new unit is the built-in search-sweep, which allows any decade up to 1 MHz to be continuously-adjusted via an external dc signal or saw-

tooth. This capability extends the resolution of the 1062 by two decades and allows sweep-frequency, resonance and bandpass studies.

Also built in, and controlled by external signals, are AM, FM and PM capabilities.

General Radio sees the 1062 as competition for Hewlett-Packard's popular 8660, a 1 to 1300 MHz unit with a switching speed of 5 ms, a spurious S/N of 80 dB and a phase S/N of 50 dB. Both search/sweep and FM are optional on the \$8340 HP unit, while AM is standard.

But other general-purpose rf units also output 500 MHz, or more, albeit at higher cost in most cases. Included among these are the Rohde & Schwarz SMDW, the Schlumberger 4000 and the HP 5105A.

And other vendors—such as LogiMetrics, Systron-Donner and Watkins-Johnson—offer microwave units, with top frequencies extending to 18 GHz.

For General Radio **CIRCLE NO. 253**  
 For Hewlett-Packard **CIRCLE NO. 254**  
 For LogiMetrics **CIRCLE NO. 255**  
 For Rohde & Schwarz **CIRCLE NO. 256**  
 For Schlumberger **CIRCLE NO. 257**  
 For Watkins-Johnson **CIRCLE NO. 258**

## Faster digital systems checkout with Kurz-Kasch Logic Probes

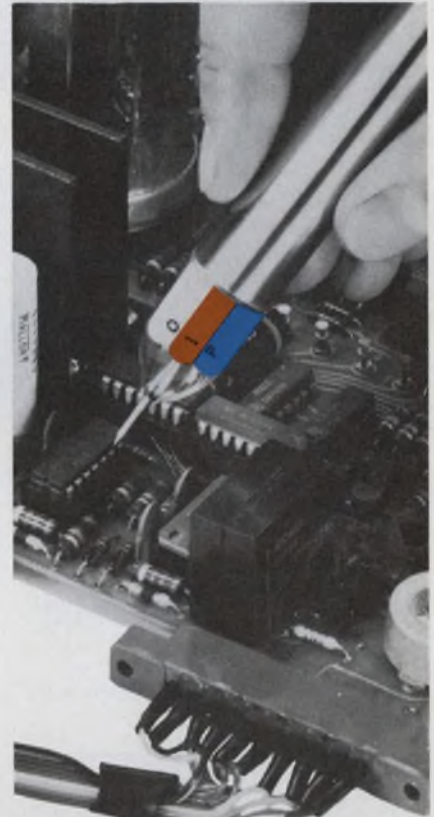

Kurz-Kasch's patented logic probes identify

- (1) logic low (TTL .0V to 0.8VDC) white light
- (2) logic high (2.4 to Vc) red light
- (3) deadbands (0.8V to 2.4V) no light
- (4) pulses (any excursion) blue light
- (5) open circuits — no light

Logic probes are also available for MOS, HTL, RTL and discrete logic. Prices from \$6995 to \$9995. Send for free literature. For a 30 day free trial probe or special information, telephone Tom Barth, General Manager, Kurz-Kasch Electronics, 2876 Culver Ave., Dayton, Ohio 45429, Telephone: (513) 296-0330

 **Kurz-Kasch, Inc.**  
ELECTRONICS DIVISION

**NOW ...  
LITTLE LIGHTS  
WITH  
STYLE**



**Plus  
High Performance ...  
Low Cost ...  
Immediate Availability**

**LED's** — with built-in resistors for 3 to 28 volt applications.

**SELF DRIVEN INCANDESCENTS** — with built-in drivers & keep alive bias. Interface directly with TTL and MOS. Life ratings to 10+ years.

**STANDARD INCANDESCENTS AND NEONS** — single unit prices start below \$1.00.

**CUSTOMS TOO!**

All Data Display Products panel indicator lights are ruggedly built. They are available with low profile or standard lens projections.

*Call or write for more information today!*

*the little light people*

**DATA DISPLAY  
PRODUCTS**

5428 W. 104th St., Los Angeles, Ca. 90045  
(213) 641-1232

INSTRUMENTATION

**Lightweight 15-MHz scope  
sells for just \$500**



*Hewlett-Packard, 1501 Page Mill Rd., Palo Alto, Calif. 94304. (415) 493-1501. See text; 30 days.*

When Hewlett-Packard comes out with a low-cost, lightweight oscilloscope, as it just did with its new Models 1220A/1221A, you can be pretty sure there's a large market to be reached.

And there is. With a bandwidth of 15 MHz, 2-mV vertical sensitivity, and a weight of 15 pounds, the new scopes will appeal to the huge servicing, industrial and educational markets.

Tektronix' Telequipment line plus models from Test and Measurements (Philips) and other companies have targeted this market for years. Now, HP's new contenders should toughen the competitive battle.

Features included for the \$500 price of the single-channel 1221A, and the \$625 price of the dual-channel 1220A, are  $\pm 3\%$  vertical accuracy ( $\pm 5\%$  on the 2-mV setting); a large 8 x 10-cm display with internal graticule; automatic triggered sweep and dc-coupling.

And a number of convenience features that are normally found only on high-priced lab scopes, are standard with the new units.

For example, how much time have you wasted just trying to find the beam on many scopes? With the 1220A/1221A, you just push a button and the scope tells you where the beam is.

In the dual-channel version, the scope automatically selects the mode to give the best display—alternate or chopped. And all triggering is derived from the channel-A input.

For the time base, sweep ranges from 0.1  $\mu\text{s}/\text{cm}$  to 0.5 s/cm in a 21-range, 1-2-5 sequence; and a knob expands the sweep by a factor of 10. Sweep accuracy is  $\pm 4\%$ .

Servicing the all-solid-state scope should be simple: A one-piece frame supports three PC boards and the CRT, so that all circuits are readily accessible. And a number of safety factors lessen the chances of shock damage or of burning something out.

For those worried about using the 1221A/1220A in dirty environments, the low dissipation of 40 W has enabled HP to eliminate all vents, thereby eliminating problems from dust or moisture.

For HP	<b>CIRCLE NO. 250</b>
For Telequipment	<b>CIRCLE NO. 251</b>
For Philips	<b>CIRCLE NO. 252</b>

FETs in the camper. Make your guess on the entry blank and on the lower left-hand corner of the outside of your envelope, and mail it before March 31, 1974 along with your "Request for Quote" (or order) on your FETs requirements.

And cross your fingers.

**Our new  
NDF 9401-10 Series**

One of our new FETs that we're pretty proud of is a process 94 — NDF9401-10 for most critical op amp input applications where process 83-2N5196-99 won't quite hack it.

The leakage,  $I_G < 5\text{pA}$  at 35V and  $\text{CMRR} > 120\text{dB}$ , means flexibility in design permitting negligible error with large voltage swings. The high  $g_{fs}$  typically means low noise particularly in broadband applications. It's even monolithic for unexcelled thermal stability.

# Grand Prize

Volkswagen Camper

## 1st Prize

Apache Camping Trailer  
or  
Scorpion Snowmobile

## 2nd Prize

Telescope 14 pc. Set of  
Patio Furniture  
or

Northland Matching His 'n  
Hers Stein Eriksen Skis

## 3rd Prize

Thermos Prairie  
Schooner Camping Tent  
or  
Sony Battery Pack 9"  
B&W TV

## 4th Prize

Samsonite 4 pc. Set of  
Action Pack Luggage  
or

Orine Mustang Chain Saw

## 5th Prize

Bernzomatic Portable  
Electric 12 & 110 volt  
Refrigerator  
or

GAF Super 8 Movie Camera  
And 10 other great prizes.

**Our recent addition, the  
2N5397-8 High  
Frequency Amplifier/  
Mixer/Oscillator.**

Some designers were not quite satisfied with the 2N4416 type of FET. They wanted more gain, particularly common gate and lower noise at 450 MHZ. 2N5397, 2N5398 or U312 gives it to them. Featuring typically 10dB Gps and 3dB NF at 450 MHZ, common gate, un-neutralized design is easy.

**Our new  
U310 VHF-UHF  
Amp/Mixer/Oscillator**

The new U310 offers the designer high frequency performance and enough common gate power gain (typically 16 dB's at 100 MHZ and 13dB's at 450 MHZ) to satisfy circuit requirements. High input and output isolation means an excellent oscillator.

### You do not have to buy our FETs in order to enter the contest.

On the other hand, you do not have to *not* buy our FETs in order to enter the contest, either.

The # FETs in the camper is \_\_\_\_\_

Please send me:

An RFQ on Device #'s \_\_\_\_\_ Quantity \_\_\_\_\_

Your new FET Selection Guide. My area of interest \_\_\_\_\_

Mail to: National Semiconductor  
P.O. Box 3, New York, New York 10046

Name \_\_\_\_\_ Title \_\_\_\_\_

Company \_\_\_\_\_

Address \_\_\_\_\_

City \_\_\_\_\_

State \_\_\_\_\_ Zip \_\_\_\_\_

#### Rules for the "National Semiconductor" Contest

1. On an official entry blank, print your name, address and your estimate of the number of FETs in the camper.
2. Mail your entry to: National Semiconductor, P.O. Box 3, New York, N.Y. 10046.  
IMPORTANT: Write your estimate of the number of FETs on the lower left hand corner of the outside of the envelope.
3. Entries will be judged under the supervision of Marden-Kane and independent judging organization whose decisions are final, on the basis of who estimated the closest number of FETs in the camper. In the event of ties, the entry bearing the earliest postmark will win.
4. Entries must be postmarked by March 31, 1974, and received by April 15, 1974. Contest open to residents of the United States except employees and their families of National Semiconductor, their advertising agencies and Marden-Kane, Inc.  
No purchase necessary. Void where prohibited or restricted by law. All Local, Federal and State laws apply. No Purchase Required.

**National** the FET people.



**Another fun-filled challenge from National Semiconductor.**

The person who guesses closest will win the camper. (In the event of a tie, earliest postmark).

And the next 15 closest guesses will also win prizes (turn the page for details and entry blank).

(Clue: there's 305 boxes of FETs in the camper).

So get your slide rule out.

Now, you may think all this is kind of dumb.

Like a fox.

We're trying to make a point. That National makes FETs, and we've got a lot of them.

This camper full of FETs will, we think, make our point that we've got a lot of FETs.

This list may help, too.

**National makes:**

36 kinds of general purpose N-channel amps. 14 general purpose P-channel amps. 6 ultra-low input current amps. 12 low-frequency-low noise amps. 8 VHF/UHF amplifiers/mixers/oscillators. 22 RF/VHF amps. 48 switching (chopper) N-channel. 16 switching (chopper) P-channel switches. 39 general purpose duals. 10 low-frequency-low noise duals. 6 wide band-low noise duals. 12 low leakage — high CMRR — wide band duals. And hundreds of other FET types.



**Guess the  
in this camper**



That's a lot of FETs. And we have a lot of each of them, too.

The only thing we don't have is production or delivery problems.

We've got 'em, and we can get most types to you in just about any quantity in 2 to 3 weeks.

We want to drive home the point that National has lots of FETs.

It could lead to your being able to drive home more than a point.

**Don't be too unhappy if you don't win the camper.**

You could win one of our fifteen other prizes.

1st prize is a camping trailer or a snowmobile. 2nd prize, patio furniture or two pairs of skis.

3rd, a tent or a battery-pack TV.

4th, a set of luggage or a chain saw. 5th, portable refrigerator or movie camera.

And many other prizes including fishing outfit, sleeping bag, ice chest, hammock, lantern, jet fogger, knapsack, skin divers watch, picnic food tote and picnic blanket.

So put on your thinking cap and guess the number of

# number of FETs and win it.

## INSTRUMENTATION

### FM/AM demodulator monitors transmitters

Rohde & Schwarz, 111 Lexington Ave., Passaic, N.J. 07055. (201) 773-8010. \$4100.

Type FAB FM-AM Demodulator is for testing and monitoring FM transmitters, including stereo operation in the vhf-uhf bands. Four oscillator plug-ins cover the four

frequency bands between 47 and 860 MHz. Besides the pilot lamp indication of mono or stereo operation, the instrument contains a built-in frequency deviation standard. Measurement capability includes: modulation frequency response; center-frequency error; frequency deviation; spurious AM; and with accessories include: distortion; intermodulation distortion; noise voltages.

CIRCLE NO. 283

### Benchtop unit checks calculator ICs



Macrodata Corp., 6203 Variel Ave., Woodland Hills, Calif. 91364. (213) 887-5500. \$20,000 to \$30,000; 45 day.

Designated the MD-16, this new calculator set tester provides parametric and zero overhead functional testing of up to 16-digit calculators. A user can test a number of different types of calculator sets and maintain the throughput he would have on larger systems costing up to 10 times more. Program storage is in semiconductor RAM, providing continuous test patterns at device rates.

CIRCLE NO. 284

# Your mini's graphic display, at \$1095 it's no steal.

No need for your display to cycle steal. Megatek's graphic interface (now available for NOVA Series) provides a built-in memory with 50Hz refresh to generate flicker-free (regardless what your CPU is doing) dynamic displays on your x-y scope.

Free 90% of your mini's time and save software expense. Interactive graphics are now available with Megatek supplied software. Ready to use.

And to preserve your scope displays use Megatek's hard copy x-y recorder adapter. Performance at the lowest cost, seeing is believing. Call us for details on NOVA, PDP-11 and NAKED MINI/ALPHA 16 — (213) 530-0654 or write Megatek, 1526 West 240th Street, Harbor City, CA. 90710.

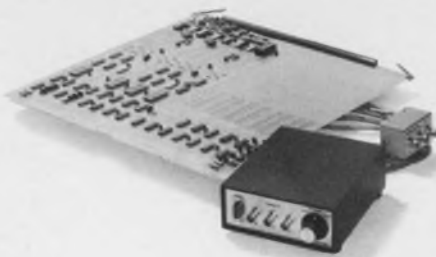
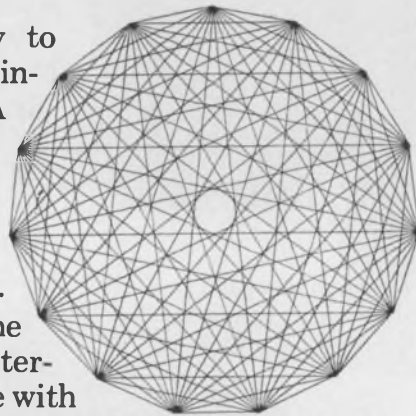

**MEGATEK**  
BUDGET PERIPHERALS

## Graphics Interface: its own refresh memory.

INFORMATION RETRIEVAL NUMBER 111

### Unit measures wow and flutter



Manke Instruments, 4860 E. Simpson, Fresno, Calif. 93703. (209) 255-5255. \$350.

Model M-1 Wow and Flutter Meter is said to be the first and only fully automatic portable unit to use a wide-carrier-range percentage demodulator. The demodulator accepts any carrier with frequency between approximately 2 and 8 kHz. Thus only one prerecorded tape is needed to make multiple speed measurements. Other features include: an automatic level set that eliminates level controls and compensates automatically for tape drop-outs; switchable filters; built-in oscillator; and battery operation.

CIRCLE NO. 285

**Unbeatable  
portability  
and range  
coverage!**



the  
new **Simpson** **460** DIGITAL  
VOM



- Completely portable . . . no separate battery pack or power supply needed. Self-contained battery or line operation.
- Non-blinking 3½-digit display of 26 most used ranges . . . 5 each AC/DC voltages and AC/DC currents . . . 6 resistances . . . with "plus" and "minus" and overrange . . . analog meter readout . . . analog to digital converter uses the dual slope technique.
- A compact, lightweight, multi-use Digital VOM for lab, in-field or general testing . . . . . only \$375.00 (less batteries)

GET "OFF THE SHELF" DELIVERY FROM YOUR LOCAL ELECTRONIC DISTRIBUTOR . . . AND WRITE TODAY FOR CATALOG 4200.

KATY INDUSTRIES



ELECTRICAL EQUIPMENT GROUP



**SIMPSON ELECTRIC COMPANY**

853 Dundee Avenue, Elgin, Illinois 60120  
(312) 695-1121 • Cable: SIMELCO • Telex: 72-2416

**IN CANADA:** Bach-Simpson, Ltd., London, Ontario  
**IN ENGLAND:** Bach-Simpson (U.K.) Limited, Wadebridge, Cornwall  
**IN INDIA:** Ruttonsha-Simpson Private, Ltd., Vikhroli, Bombay

INFORMATION RETRIEVAL NUMBER 112

# Who said you can't beat the option game when buying a true-rms voltmeter?

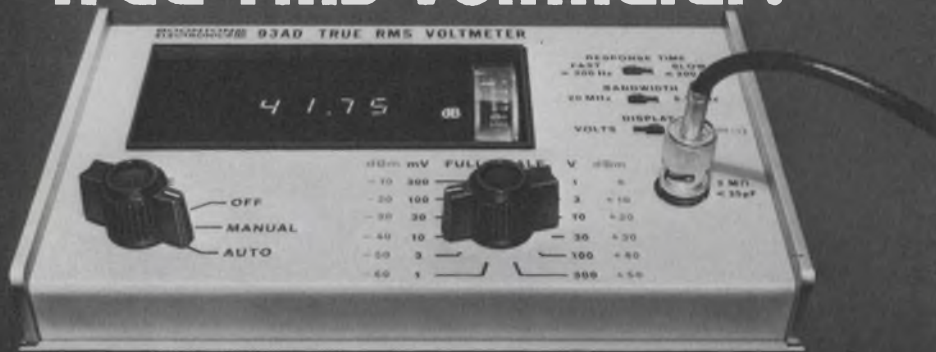

## The one with the works

At \$1,200, our Model 93AD gives you the best price and the best performance. It's not just priced 20 to 32 percent under competition. It's complete with standard performance and convenience features that the other manufacturer tags on as costly options . . . or can't give you at all.

Take remote programming and BCD outputs. They are a necessity for any kind of test automation. We don't ask you to pay an extra \$450 . . . we've made them standard.

If you're doing low-frequency work, spurious high-frequency signals are always a problem . . . but not with Boonton's selectable bandwidth. On the 100 kHz setting, you get immunity from spurious pickup; on the 20 MHz position, you get *twice* the full-performance bandwidth of the older designs at lower cost.

We've even removed the conflicting advantages of digital and analog readouts. We give you *both* — a 3½ digit LED display for absolute readings, and a special analog dB meter for easy peak/null adjustments . . . as standard.

Our dB option is not only \$100 less than the higher-priced spread but also gives you an ex-

tra digit for a constant 0.01 dB resolution . . . available in your choice of 50 Ω, 75 Ω, 600 Ω, or 1 V references.

And we have a low-cost 10 MΩ, low-capacitance probe for negligible circuit loading at high frequencies — not available from the competition.

*What don't we do?*

Well, our autoranging option costs \$25 more than the competition and we don't go down to 2 Hz or up to 100 MHz. But unlike some, we don't pretend to "cover" a frequency range beyond our capability. Their advertised 100 MHz bandwidth is useable on only the 0.1 and 1 volt ranges. On all other ranges, their upper frequency is 10 MHz or less. The 93AD has a 10 Hz to 20 MHz bandwidth specified down to 300 μV with full calibrated accuracy.

But see for yourself. Before you pay more for less, write or call for the full specs or a demonstration: Boonton Electronics Corporation, Rt. 287 at Smith Road, Parsippany, New Jersey 07054; (201) 887-5110.

**DON'T NEED DIGITAL? OUR FULLY-PROGRAMMABLE ANALOG MODEL 93A GOES FOR A LOW \$600.**



# BOONTON

## INSTRUMENTATION

### 100-W power amplifier shows 1/4% distortion



*Pulse Dynamics Manufacturing Co., Depot St., Colchester, Ill. 62326. (309) 776-4544. \$200.*

This 100-W rms continuous duty solid-state audio power amplifier is for professional sound applications, and is designed for 4 to 8-Ω loading or 25-V line application. Output characteristics include 1/4% typical harmonic distortion over the 20 to 15,000-Hz frequency range. The amplifier (M-250) requires 0.8 V across its 10,000-Ω input impedance to drive it to full output.

CIRCLE NO. 286

### DPM features 10-μV sensitivity



*Newport Labs, 630 E. Young St., Santa Ana, Calif. 92705. (714) 540-4914. \$120; 2 to 4 wk.*

Model 253 Digital Panel Meter features a 20-mV full-scale basic range with 10-μV sensitivity. Four additional dc-voltage ranges and seven dc-current ranges are selected by simply changing one internal plug-in, 16-pin DIP module. 5-V powered, the Model 253 includes parallel BCD data outputs, 3-wire ratio measurement, readout blanking and overrange indication as standard features.

CIRCLE NO. 287

## System detects faults in transmission lines



Weston/Schlumberger, P.O. Box 3041, Sarasota, Fla. 33578. (813) 958-0811. \$14,230; 4 mo.

Type DLNS is a new fault-location system for high-voltage transmission lines. The unit can automatically locate intermittent faults at points of weakened insulation. Features include no required transmission; direct distance display in miles; accuracy of  $\pm 3\%$  of line length  $\pm 1$  digit; and phase and ground faults location. Each monitored line in the substation is equipped with a sensing unit, type DALD 2420, connected to a display unit, type DLNS 1500, common to up to nine lines.

CIRCLE NO. 288

## Continuity tester signals audibly



Projects Unlimited, 3680 Wyse Rd., Dayton, Ohio 45414. (513) 890-1918. Under \$20; stock.

You can trace wires and check circuits with this portable, 4-oz (without batteries) continuity and tone test set, the Model P1461-SSA. The unit contains a solid-state audio indicator and triple-duty function switch. Encased in a molded high-impact ABS case, the test set is powered by two D cells. Simple press-release terminals allow speedy hook-up to a variety of test leads. Over-all size of the set: 3-5/8 x 3-1/8 x 2-in.

CIRCLE NO. 289



Who said a digital-readout signal generator has to be hard to handle, hot and heavy, and cost \$4,450?

## Not us!

Our Model 102A, at \$2,975, has everything you need for just about any AM/FM application — plus seven performance and convenience features you won't get in the \$4,450 design.

### What did we leave out?

Phase-lock synchronization, for one (but our dc-coupled FM channel can be externally locked if you need better stability than our typical 4 ppm); and narrow-pulse modulation (belongs in a different class of generators).

### What did we add?

Four different signal-generation techniques — for optimum performance in each band, from 4.3 to 520 MHz, without the usual compromises in noise, stability, or residual-distortion characteristics.

The most logical panel layout and convenient control setup you've ever seen. And a unique adjustable "feel" main drive mechanism for narrow-band receiver setting with ease — even without our electrical vernier.

Separate meters for modulation and output — no annoying auto-ranging or out-of-range annunciators . . . we don't need them.

15 minute warmup to typically

meet 10 ppm/10 minute stability — made possible by low internal dissipation (only 30 watts; no fan!)

Wider FM deviation at low carrier frequencies than any other design in this class (how does 2 MHz peak-to-peak grab you?)

A detected-AM-output option, to verify our negligible phase-shift for VHF-omni testing.

Versatile modulation features — like five internal frequencies, 30% and 100% AM scales, and true-peak-responding AM and FM metering.

All these performance pluses are coupled with low spurious and close-in noise, excellent low-frequency phase integrity, really effective leveling, a low and flat VSWR curve, accurate wide-range attenuation, high output power . . . all of it buttoned up tight for low leakage in a lightweight 30 pound package.

. . . and it's all yours for \$2,975. Get the full specs today — before you spend 50% more .

For complete data or a demonstration write or call Boonton Electronics Corp., Rt. 287 at Smith Road, Parsippany, N. J. 07054, (201) 887-5110.

# BOONTON

# Look what \$450 buys!



## New 2 MHz sweep function generator

It's the only one at that price... Systron-Donner's Model 411 sweep function generator. Check these features: **Frequency** in 6 decade ranges from 0.02 Hz to 2 MHz—Dial accuracy 2% of full scale typical—**Waveform outputs:** sine, square, triangle, ramp and a T2L compatible sync pulse square wave. **Plus:** Model 411 is the only low cost sweep function generator which allows the operator to set the upper frequency limit to dial accuracy. **Contact:** your nearest Scientific Devices office or Systron-Donner Datapulse Division, 10150 W. Jefferson Blvd., Culver City, CA 90230. Phone (213) 836-6100.

SYSTRON  DONNER

INFORMATION RETRIEVAL NUMBER 115

# VERSATESTER I™



## What is it? A labstrument\*

**VERSATESTER I** □ Generates Pulses, Sine waves and Square waves to 20MHz □ Supplies dc power at +5v, +15v, -15v, ±30v □ Digitally Measures frequency from 20Hz to 20MHz, with autoranging; DC and AC volts, 0-500v; Resistance to 5 Megohms. □ Complete for only \$1,250!  
□ Contact your nearest Scientific Devices Office for specs or demo or Datapulse Division, Systron-Donner, 10150 W. Jefferson Blvd., Culver City, CA 90230. Phone (213) 836-6100.

\*lab-stru-ment \ˈlab-strə-mənt\ n 1: a complete test lab in one lightweight, portable, 3½" panel height Systron-Donner/Datapulse instrument.

DATAPULSE  
DIVISION  
SYSTRON  DONNER

INFORMATION RETRIEVAL NUMBER 116

## MODULES & SUBASSEMBLIES

### Instrumentation amp has ±300 V CMR

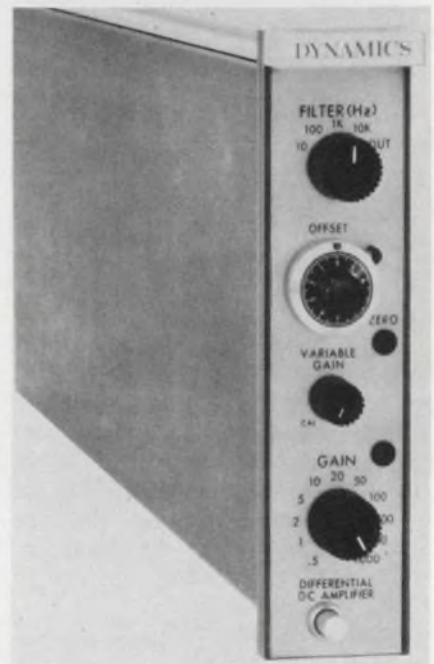

*Dynamics, 12117 E. Slauson Ave., Sante Fe, Calif. 90670. (213) 945-2493. \$535; stock to 30 day.*

The Model 7522 is a direct coupled instrumentation amplifier that can handle ±300-V common-mode. Several gain options are available to cover the range of 1 to 3300 V/V. Also available is a simple dual output, a dual output with filter, current limiting and offset control. Standard features include output capability of ±10 V at 100 mA, bandwidth from dc to 75 kHz, 120 dB CMRR, 0.1% gain accuracy and 0.01% linearity. The 7522 is completely interchangeable with earlier Models 7514 and 7521.

CIRCLE NO. 290

### Active filters have sharp attenuation

*Polyphase Instrument Co., E. Fourth St., Bridgeport, Pa. 19405. (215) 279-4660. \$85 (1 to 4).*

The 3100 series of super octave bandpass active filters cover a frequency range of 10 Hz to 100 kHz. Skirt attenuation is 48 dB at one-third and three times center frequency. The filters use a single-ended power supply of from 4 to 30 V. No external trimming components are needed and the filter size is 2.14 by 1.95 by 0.5 in.

CIRCLE NO. 291

# Another OEM doesn't go to the devil.

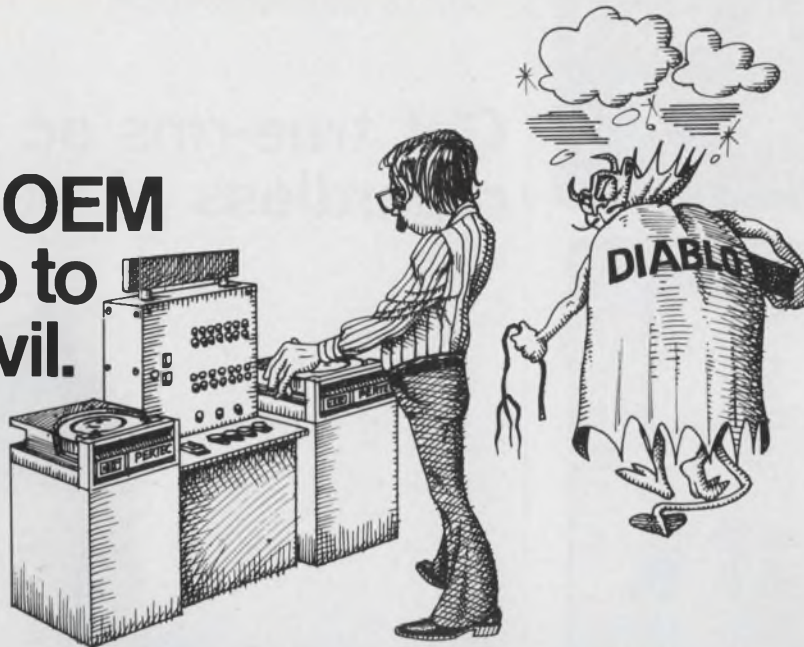

He went to Pertec for his disk drives. And he's buying drives that exceed Diablo capabilities while interfacing just as they do. A good business decision. And very good drives for his systems.

He had his choice from Pertec's top and front loading versions. Both are plug compatible and identical in interface and size. They offer 35 msec access time (twice as fast as Diablo), margin testing, a choice of electronic or mechanical sectoring, and an optional fixed platter.

And they offer many standard features that you cannot even get as options on a Diablo Series 30 or 40 drive. Like independent write-protect for each platter, track offset and a built-in power supply.

And all of these features fit into a serviceable and compact 8 $\frac{3}{4}$  x 26 inches. We can even provide a cost free Diablo Series 30 compatible interface and align our heads to offset the tracks just as they do. So there is no costly redesign time if you're currently buying Diablo drives.

Of course you get the same assistance in design, development and maintenance of your system with our disk drives as you do with our tape drives and printers... Factory training for your service people. And back up by a sales, service and support network spanning major U.S. cities and many foreign countries.

All at surprisingly low prices.

Pertec is serious about satisfying your disk drive requirements. And we'd like to prove it. Call us collect in the area nearest you: Boston (617) 890-6230; Chicago (312) 696-2460; Los Angeles (213) 996-1333; London (Reading) 582-115. Or write us at 9600 Irondale Avenue, Chatsworth, California 91311.



The best values in  
computer peripherals  
come from

## PERTEC

Already the world's  
largest independent  
manufacturer  
of tape transports.

INFORMATION RETRIEVAL NUMBER 117



# Test & Sort RCLZ

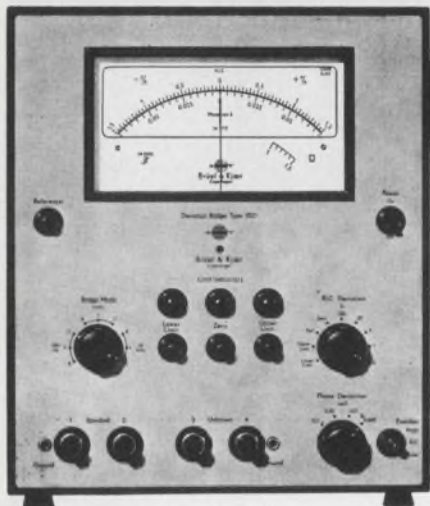

Size Shown 1:4

B & K's 1519 and 1521 Deviation Test Bridges are direct-reading instruments for fast, accurate determination of the percentage deviation of impedance and phase angle difference of capacitors, inductors, and resistors. No need for expensive Standards; use your acceptable component as reference.

## APPLICATIONS

- Precision capacitor, inductor, and resistor measurements
- Control instrument for automatic sorting and manufacturing systems
- Comparison measurements on motor windings, solenoids, and relay coils
- Locating tracking errors in ganged controls
- Testing
  - Wiring harnesses
  - Transformers
  - Passive subassemblies

## FEATURES

- Impedance comparison to 0.01% deviation full scale
- Phase angle comparison to  $\tan \delta = 0.001$  difference
- Tolerance-limit indicator lamps
- Analog output for recording and automatic control
- Relay output to sorters
- Interchangeable meter scales

**B&K Instruments, Inc.**

Bruel & Kjaer Precision Instruments  
5111 West 164th Street, Cleveland, Ohio 44142 / Telephone: (216) 297-4800  
1420 South State College Boulevard, Anaheim, Cal. 92806 / Telephone: (714) 778-2450



## MODULES & SUBASSEMBLIES

# Get true-rms ac equivalents regardless of waveshape

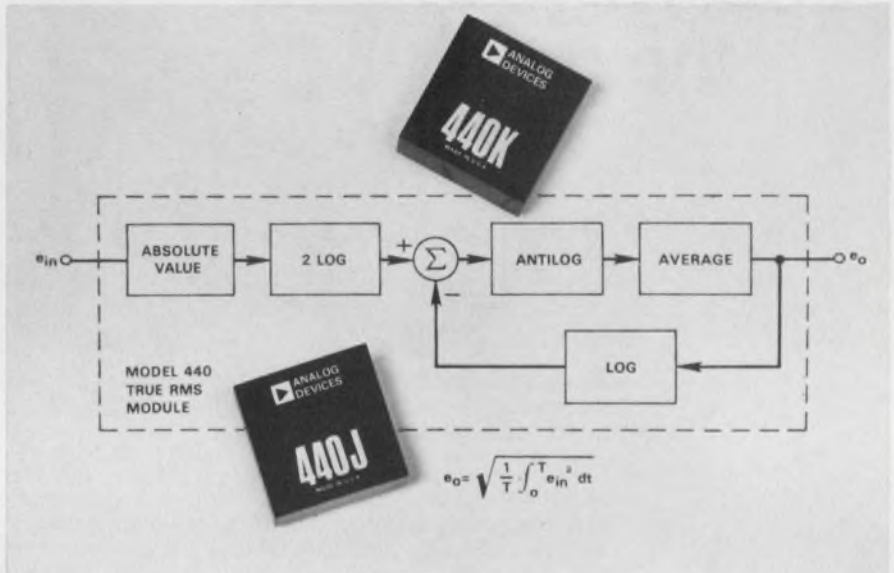

Analog Devices Corp., Route 1 Industrial Park, Norwood, Mass. 02062. (617) 329-4700. P&A: See text.

True-rms ac is becoming easier to measure thanks to circuits like the new Analog Devices 440J and 440K. These true-rms converter modules provide accuracies of  $\pm 15 \text{ mV} \pm 0.2\%$  of reading and  $\pm 5 \text{ mV} \pm 0.1\%$  of reading, respectively—regardless of input waveshape and without external trimming. If externally trimmed, the 440J has an accuracy of  $\pm 10 \text{ mV} \pm 0.1\%$  of reading, while the 440K accuracy improves to  $\pm 2 \text{ mV} \pm 0.05\%$  of reading.

Both models have input voltage ranges of 20-V pk-pk ( $\pm 10 \text{ V}$ ) and input impedances of 10 k $\Omega$ . The circuits can supply a load current of 10 mA over a 0-to-10-V range.

The acceptable crest factor ranges to a maximum of 10, while the averaging response time is a low 10 ms—two orders of magnitude better than for any conventional thermal converter. Also, the response time is programmable—just change the value of an external capacitor.

The offset voltage drift of  $\pm 0.2 \text{ mV}/^\circ\text{C}$  max and the scale factor drift of  $\pm 0.02\%/^\circ\text{C}$  keep the units

operating within specifications over the 0-to-70-C temp range.

The case size of  $1.5 \times 1.5 \times 0.41$  in. makes these units the smallest true-rms modules available. Their wide 3-dB bandwidth of 500 kHz also enables them to process high-frequency signals. And, since the 440 units perform rms calculations simultaneously on both the dc and ac components of complex waveforms, they can measure low-frequency signals accurately.

Similar units from Intronics (Model R101), Function Modules, Inc. (Model 591) and Burr-Brown (Model 4128) offer similar accuracies— $\pm 10 \text{ mV} \pm 0.4\%$  of reading for the R101,  $\pm 2 \text{ mV} \pm 0.2\%$  for the 591 and  $\pm 25 \text{ mV} \pm 0.25\%$  for the 4128. These units cost \$85, \$98 and \$105, respectively. Higher-accuracy units are also available from these companies.

The Analog Devices 440J and 440K require dual supplies of from 12 to 18 V at a current rating of  $\pm 10 \text{ mA}$ . Delivery is from stock. In 1-to-9 quantities, the 440J costs \$62 and the 440K \$75.

Analog Devices	CIRCLE NO. 261
Intronics	CIRCLE NO. 262
Function Modules	CIRCLE NO. 263
Burr-Brown	CIRCLE NO. 264

# When you need a custom high voltage power supply, ELDEC designs, packages, and builds them so you can rely on them.

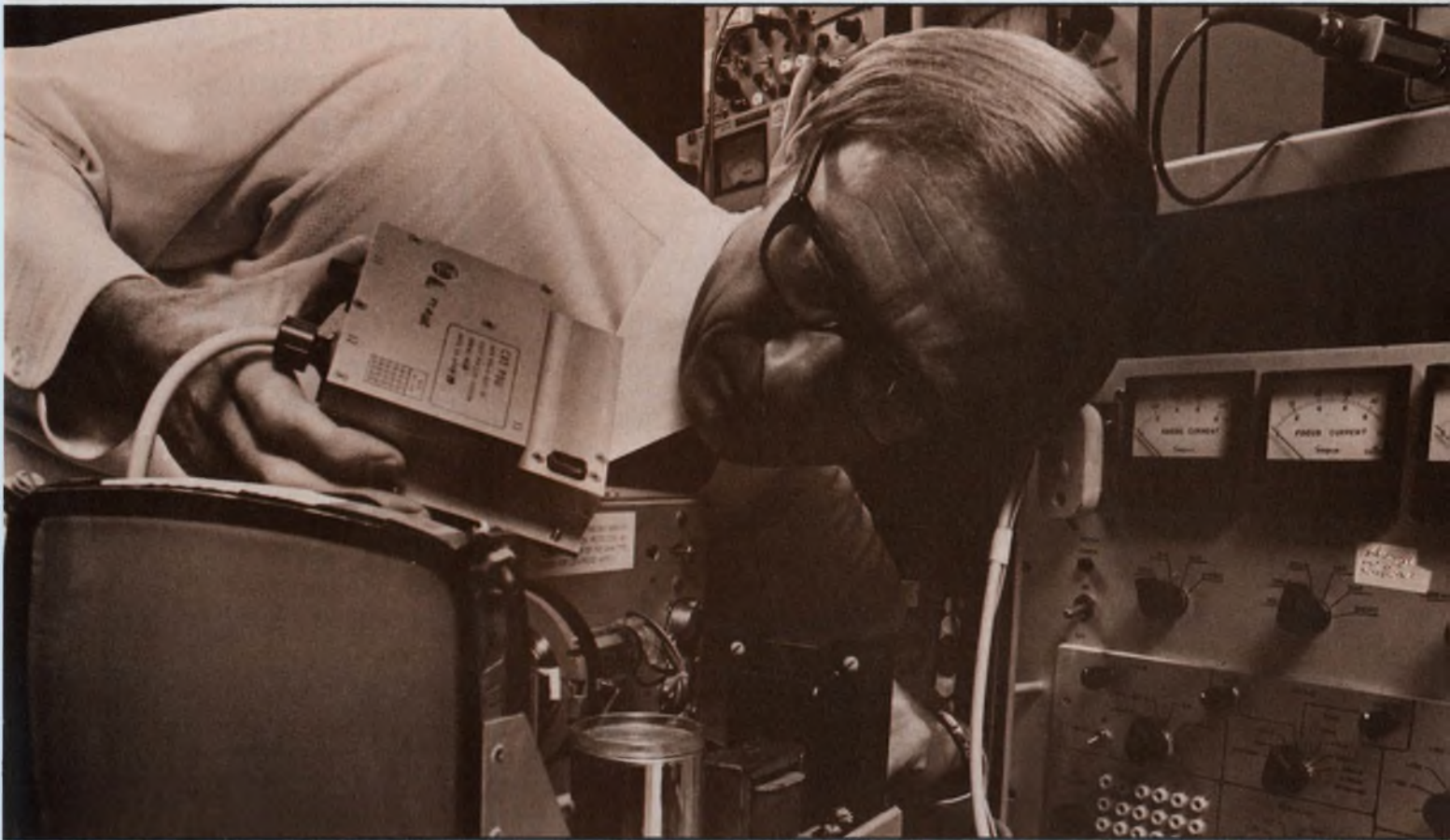

Power supplies for CRT displays. Small size. Light weight. Look to ELDEC. We have years of experience combined with field proven reliability. ELDEC specializes in high voltage, custom mil-spec requirements. Air, ground, or shipboard.

Now by-pass that make or buy decision. When reliability is on the line, rely on proven experience. And ELDEC delivers. No gap between promises and prototype. High quality levels of manufacturing? You can bet on it!

We understand the custom business. Plenty of back-up documentation and service support. A successful track record you can check on. Ask for our brochure. Write me, Kevin Hall, Marketing Manager, ELDEC Corporation, 16700 - 13th Ave. W., Lynnwood, Washington 98036. Phone (206) 743-1313.



*Formerly Electro Development Corporation*

INFORMATION RETRIEVAL NUMBER 119

(Advertisement)

## NEW -- FREE -- DATA PLASTIC/CERAMIC FOAMS



ECCOFOAM® is the broadest line of plastic and ceramic foams for electronics. Foam-in-place; sheet stock; pourable syntactic; artificial dielectrics all described and properties tabulated in new booklet. Send for copy.

INFORMATION RETRIEVAL NUMBER 240

## ECCOSORB® ANECHOIC CHAMBERS



The most advanced anechoic and shielded chambers . . . used worldwide for antenna pattern, radar cross-section, VSWR and RF compatibility measurements. Send for data.

INFORMATION RETRIEVAL NUMBER 241

## CRYSTAL CLEAR EPOXY CASTING RESIN



Several transparent Stycast® resins are offered for making display embeddings or castings. A convenient chart is available to aid in selection of the most appropriate system. It is yours for the asking.

INFORMATION RETRIEVAL NUMBER 242

## Emerson & Cuming, Inc.



CANTON, MASS.  
GARDENA, CALIF.  
NORTHBROOK, ILL.  
Sales Offices  
in Principal Cities

EMERSON & CUMING EUROPE N.V., Oevel, Belgium

## MODULES & SUBASSEMBLIES

### Light activated power controller handles 25 A



Ohmite Manufacturing Co., 3601 W. Howard St., Skokie, Ill. 60076. (312) 675-2600.

A photocell, sensing ambient light triggers a solid-state device which controls power to lamps. The controller is rated at 25 A and 240 V. The device provides reduced voltage in darkness to conserve power, and increases voltage gradually as light increases thus ensuring adequate illumination.

CIRCLE NO. 292

### TCXO covers wide range of output frequencies

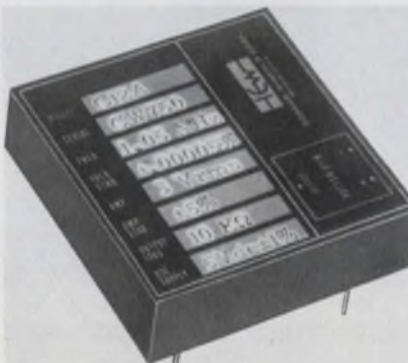

Conner-Winfield Corp., West Chicago, Ill. 60185. (312) 231-5270. Stock to 4 wk.

Model C12A is a temperature compensated crystal oscillator that can provide square waves at any fixed frequency from 10 kHz to 20 MHz. Frequency tolerance is  $\pm 0.0015\%$  from  $-25$  to  $+70$  C. The output can drive CMOS or 10 TTL loads with a duty cycle of  $50/50 \pm 1\%$  and a rise time less than 50 ns. Power requirements are 50 to 100 mA at 5 V dc with  $\pm 1\%$  regulation. The TCXO is in a metal case 0.4 in. high by 1.5 in. square.

CIRCLE NO. 293



### NEW HIGHS in Performance, in Reliability...

## LITHOCON® II SCAN CONVERTER

Sharper, clearer images  
for your display system  
...at no price increase

Step up your electronic information display system with the new PEP-400-R . . . today's most advanced low-cost scan conversion and image storage unit.

It's complete, self-contained . . . combining both improved circuitry and our unique, enhanced LITHOCON® II silicon-silicon oxide image storage tube.

Consider these new features for your display system application:

- Higher resolution . . . over 2,300 TV lines
- Improved corner resolution
- Unmatched image uniformity
- High-speed erase — one to two frames
- Extended image retention time
- Stability over  $0^\circ$  to  $50^\circ$  C temperature range
- More stable frame grabbing, slow-scan input/output
- Easier operational adjustments—top accessible.

Plus, of course, all the other features which have made the PEP Lithocon® series of imaging systems your first choice for storage and display of video and graphics, x-y dot writing and waveforms. Now, better than ever with the Lithocon® II.

Phone or write us today for more information: Princeton Electronic Products, Inc., P.O. Box 101, North Brunswick, New Jersey 08902, (201) 297-4448.



PRINCETON  
ELECTRONIC  
PRODUCTS, INC.

INFORMATION RETRIEVAL NUMBER 125

ELECTRONIC DESIGN 24, November 22, 1973

## Wide temp range drivers handle up to 12 lamps

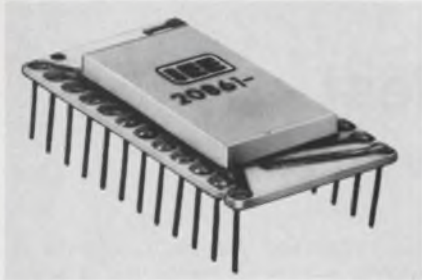

Industrial Electronic Engineers, Inc., 7720 Lemona Ave., Van Nuys, Calif. 91405. (213) 787-0311. 20861: \$47 (1000-up).

The Series 20861 and 22100 hybrid circuit driver/decoders are housed in 24-pin DIPs and combine all the decoding and driving electronics required for (12) 150 mA lamps. Mechanically, the packages are militarized with a total hermetic seal. The units are compatible with DTL and low power TTL data levels and include lamp blanking. The 22100 is made with input-data storage latches and the 20861 is made without. Each circuit will decode four 8421 binary coded data lines and can drive 10, 11, or 12 outputs. Both can operate over the temp range of  $-55$  to  $+100$  C.

CIRCLE NO. 294

## Multipliers have wide 5-MHz bandwidths



Teledyne Philbrick, Allied Dr. at Route 128, Dedham, Mass. 02026. (617) 329-1600. \$98 (4456); \$130 (4457); stock.

Models 4456 and 4457 wideband multipliers require no external trimming to perform multiplication, division, squaring or square-root operations. Both have small signal bandwidths of 5 MHz and 150 V/ $\mu$ s slew rates. Pretrimmed accuracy is 1% for the 4456 and 0.5% for the 4457 while scale factor drift for both is only 0.02%/°C. Both units are epoxy encapsulated in 1.5 by 1.5 by 0.6 in. modules and are rated for operation from  $-25$  to  $+85$  C.

CIRCLE NO. 295

# Which Heinemann overvoltage protector should watch over your electronics?

**Below 5 amp dc** Our tiniest hybrid (a thick-film microcircuit) packs a sensing amplifier, control circuit, and SCR "crowbar". When voltage equals the protector's rating, the SCR fires, shunting the load to ground in 500 nanoseconds—before any damage can be done.

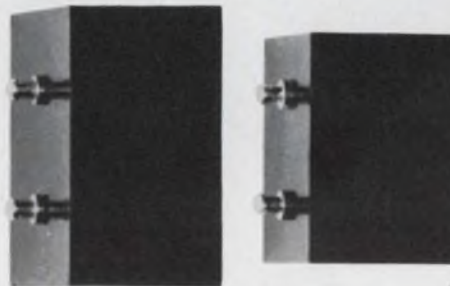

**5-30 amp dc** These protectors are made from discrete electronic components, but they offer the same protection and economy as the hybrids. Series 10 can handle up to 10 amp. Series 30 is good for 30 amp. Both are available in a range of trip voltages.



**Up to 1 amp ac** A 200V trip rating makes our Series 1 protector ideal for electronic equipment operating from a 117V line.



**Transient clipper** This device absorbs the energy of a transient while clamping the line to a predetermined voltage, allowing your circuits to continue operating during a voltage transient.

You can't build protectors like these for anywhere near our low prices. And our single-package design eliminates all the multi-component assembly and mounting problems of do-it-yourself units. For complete technical data, have us send you Bulletin 3372. Heinemann Electric Company, Brunswick Pike, Trenton, N.J. 08602.

 **HEINEMANN**

© Heinemann

5756

INFORMATION RETRIEVAL NUMBER 126

# Eight-bit a/d converter is smallest available in size, price and power

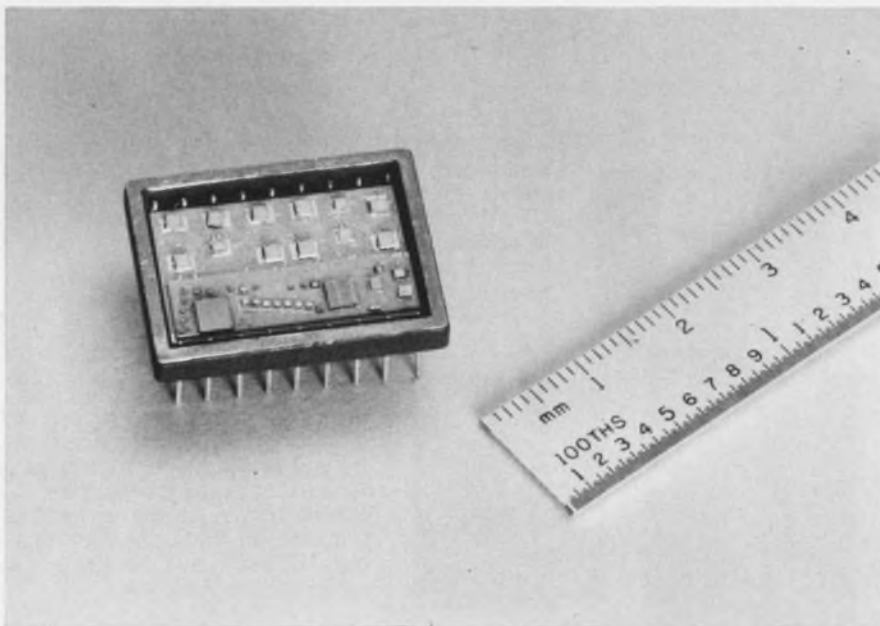

Micro Networks Corp., 5 Barbara Lane, Worcester, Mass. 01604. (617) 756-4635. P&A: See text.

Flea-power analog-to-digital converters packaged in 24-pin double DIPs are now available from Micro Networks Corp. The MN506 series of CMOS a/d converters deliver 8-bit outputs while they draw less than 102 mW from the single 15-V supply.

Linearity for these units is  $\pm 1/2$  LSB over the operating temperature range of either 0 to 70 C or -55 to +125 C. The 506 is spec'd

over the commercial range, and the 506H for the MIL.

The 8-bit output requires a 100- $\mu$ s conversion time and is available as either a latched parallel signal or a serial nonreturn-to-zero signal. Full-scale error over the respective full-temperature ranges is  $\pm 1$  LSB.

Input signals can span a range of -5 to +5 V with an input impedance that stays at a comfortable 50 k $\Omega$ . Output logic levels range from a ZERO of 0.01 V max to a ONE of 11.95 V min. The fan-

out capability for high outputs is -0.65 mA min, while for a logic low it is 1 mA.

With a power supply of 15 V, the current drain is less than 8 mA maximum. Power-supply rejection is a respectable 0.02% full scale/% supply. Since the circuit is CMOS, the slower it operates, the lower the power consumption. Thus for the longest conversion time, 100  $\mu$ s, the converter will typically use only 53 mW.

For greater efficiency, these a/d converters can automatically shut off their own analog sections when they're not converting. A 12-V car battery could continuously power the MN506 for 90 days, the company says.

The only competitor at the 8-bit level is Datel's ADC-CM8B, which requires several external adjustments, fills a 3 x 2 x 0.8-in. plastic case, draws 140 mW max and costs \$199.

By comparison, the MN506 fits a 1 x 0.78 x 0.14-in. hermetic case, requires no external adjustments and is available in a full MIL-temp version for \$280. The regular commercial version sells for \$189.

Delivery for both the 506 and the 506H is from 2 to 4 wk.

Micro Networks                      CIRCLE NO. 269  
Datel    CIRCLE NO. 270



**ANALOGY**  
BEAT THE BAD GUYS WITH THE A-856 A/D HIGH SPEED CONVERTER. RESOLVES 1:65,536 WITH CONVERSION SPEED OF 8 $\mu$ S, THAT'S 125,000 SAMPLES PER SECOND! TEMPERATURE STABILITY OF  $\pm 5$  PPM/ $^{\circ}$ C, LINEARITY  $\pm 10$  PPM.

**intech** INCORPORATED  
(408) 244-0500  
1220 COLEMAN, SANTA CLARA CA 95050

# BEST



## Computer- Compatible 16 Channel Analog Filters

- Direct interface with computer, programmer or switch closures; local, remote and on-card programming.
- Plug-in filter cards provide as many as 16 independent channels in 5¼" high panel.
- Cutoff frequency range: 10 Hz to 150 KHz.
- Low Pass, High Pass, Band Pass, Band Reject functions.
- Attenuation Slope: 48 db/ octave/channel
- Attenuation characteristic: Butterworth.
- Dynamic Range: 80 db.
- Passband gain: 0 db.

## Dual Hi/Lo Analog Filters

- Digital selection of Cutoff frequency
- Cutoff frequency range .001 Hz to 1.1 MHz.
- Local and remote programming
- 24 and 48 db/octave/channel attenuation slopes
- Low Pass, High Pass, Band-Pass, Band Reject functions
- Passband gains of 0, 20, and 40 db
- Butterworth, Bessel and RC attenuation characteristics

## Frequency Synthesizers

- 0.001 Hz to 2 MHz Range
- 0.001 Hz Resolution
- Full Programmability: Binary or BCD
- No Switching Transients
- Direct Digital Technique: No mixing or phase locking
- High Spectral Purity:  
-70 db Spurious  
-55 db Harmonic
- High Stability:  
 $\pm 2 \times 10^{-8}/^{\circ}\text{C}$  Standard  
 $\pm 2 \times 10^{-10}/^{\circ}\text{C}$  Optional

*For immediate information on how Rockland's instruments can meet your specific application and delivery requirements — call our local rep or Dave Kohn directly at:*

# ROCKLAND

Rockland Systems Corporation 230 W. Nyack Road, West Nyack, N.Y. 10994 • (914) 623-6666 • TWX 710-575-2631

INFORMATION RETRIEVAL NUMBER 128

# Unother Modular DC Supply Line

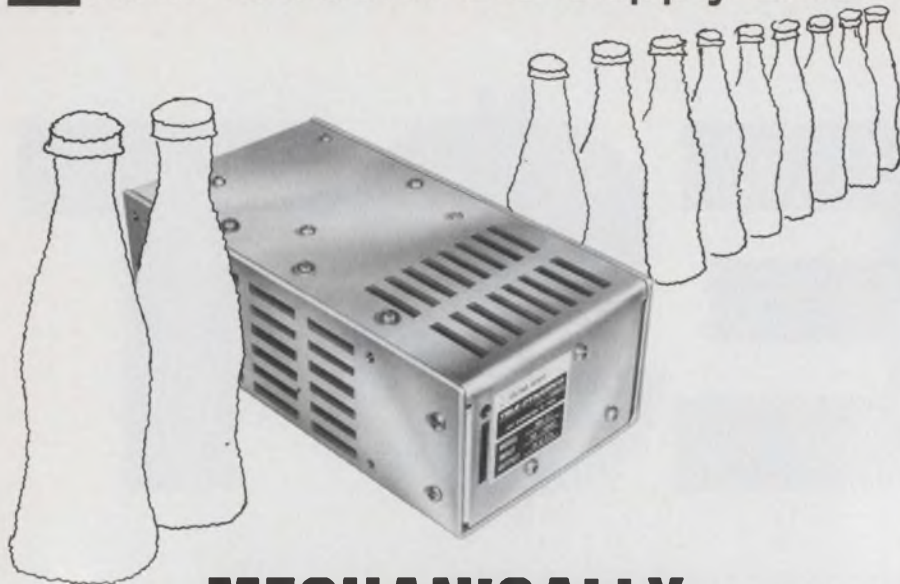

## MECHANICALLY INTERCHANGEABLE WITH "the others"

Available from Local  
Distributors\*

### 30 Stock Hi-Rel Models

- Equivalent & interchangeable with Lambda LM and other popular makes.
- 5 to 28 Vdc, 1.3 to 20 amps in 5 case sizes.
- 115 and 230 Vac inputs on all units.
- $\pm 0.05\%$  line/load regulation.
- Current cutback, overload & short protection.
- Remote sensing and programming.

Send for FREE 36 Page Catalog

Get complete specifications on this newest HR series and other power supplies from pc modules to our 1200 watt "Brute."



### \* WHERE TO GET 'EM.

70 stocking distributor locations—one near you. Allied • Arrow-Angus • Cramer Intermark • Olive Radio • Newark • Philadelphia Electronics • Pioneer Radio Products Ralph's • Stark • Sterling (Calif.) • Summit • Terminal-Hudon (Calif.) • T.I. Supply • Zack

## TELE-DYNAMICS / WANLASS

DIVISION OF **AMBAC**

525 VIRGINIA DRIVE • FORT WASHINGTON, PA. 19034 • 215-643-6161

Career opportunities available for power supply engineers.  
Write Mr. W. Booth. All Equal opportunity employer M/F.

INFORMATION RETRIEVAL NUMBER 129

### MODULES & SUBASSEMBLIES

#### Servo-amp/motor pair deliver high power

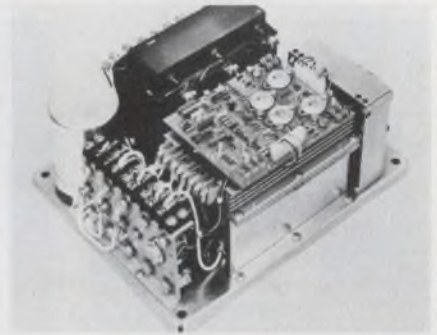

Westamp, Inc., 1542-15th St., Santa Monica, Calif. 90404. (213) 393-0401. \$1000; 8 to 12 wk.

The Model A6282 amplifier and M108 motor make a fast, heavy duty positioning system. The A6282 pulse width modulated amplifier drives the M108 low inertia motor. This motor can rotate a 250 lb table 0.1 in. 10 times a second. The A6282 has a gain of 1000 A/V and will mate with numerical or computer control systems.

CIRCLE NO. 296

#### Power hybrid amplifiers reach into uhf region

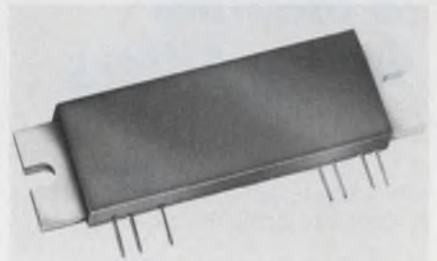

RCA Solid State Div., Box 3200, Somerville, N.J. 08876. (201) 722-3200. R47M10: \$31.20; R47M13: \$36.00; R47M15: \$42; stock.

The R47M10, R47M13 and R47M15, solid-state hybrid, integrated, power amplifiers deliver 10, 13 and 15 W, respectively. Each amplifier consists of three cascaded stages interconnected by matching networks that use microstrip lines and thick-film capacitors on alumina substrates. They operate across the frequency range of 440 to 470 MHz, with 20 dB gain and a power supply of 12.5 V. Efficiency is typically 40% while they have 50  $\Omega$  input and output impedances and infinite load-VSWR capability. The package is compact, permitting high packing density.

CIRCLE NO. 297

## Temp compensated Xtal oscillator is stable

*Electronic Research Co., a Textron Div., P.O. Box 913, Shawnee Mission, Kan. 66201. (913) 631-6700.*

The EROS-620-LC11 is a 12.8 MHz temperature compensated hybrid crystal oscillator. It weighs 1.5 oz. while the size is 2 by 1.5 by 0.47 in. Frequency vs temperature stability is  $\pm 1.5$  ppm from  $-46$  to  $-1$  C;  $\pm 0.5$  ppm from 0 to  $+70$  C; and  $\pm 1.5$  ppm from  $+71$  to  $+95$  C. Aging is less than 0.02 ppm/week at 25 C. The oscillator requires a  $-15$  and a  $+5$  V supply.

CIRCLE NO. 298

## VCXO allows high modulation rate

*Damon/Electronics Div., 80 Wilson Way, Westwood, Mass. 02090. (617) 329-5340.*

Model 6725 WXA-1, a 70 MHz voltage controlled crystal oscillator, can be modulated at rates up to 200 kHz. The FM distortion at 200 kHz is kept to less than 5%. Frequency deviation for this model is  $\pm 14$  kHz. Other models are available with deviation and modulation capabilities varying in proportion to center frequency. Other specifications include: sensitivity, 1.4 kHz/V; modulation rate, dc to 200 kHz,  $\pm 2$  dB; frequency stability,  $\pm 10$  ppm, at 15 to 35 C and case size, 4 by 2 by 1 in.

CIRCLE NO. 299

## Telephone tone decoder draws only 25 mA

*Palomar Engineers, P.O. Box 455, Escondido, Calif. 92025. (714) 747-3343. \$39.95.*

Model T-2 tone decoder module responds to just one digit (tone pair). Decoders are available for characters 1, 2, 3, 4, 5, 6, 7, 8, 9, 0, # and \*. The built-in relay can activate any desired remote control function. Its contacts are spst and can handle 0.5 A. The decoder operates from any dc power from 9 to 30 V but has a current drain of 25-mA standby and 40-mA activated at a 12-V supply level. It is designed to plug into a standard octal socket.

CIRCLE NO. 300

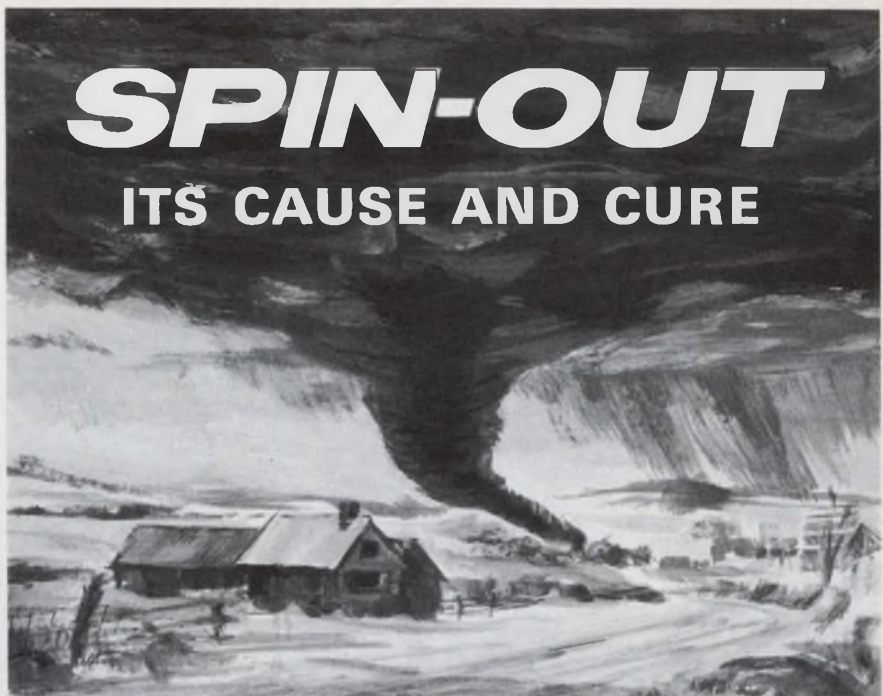

# SPIN-OUT

## ITS CAUSE AND CURE

Mercury Spin-Out in mercury displacement load relays, due to high and persistent inrush currents, can impair the function of your circuit.

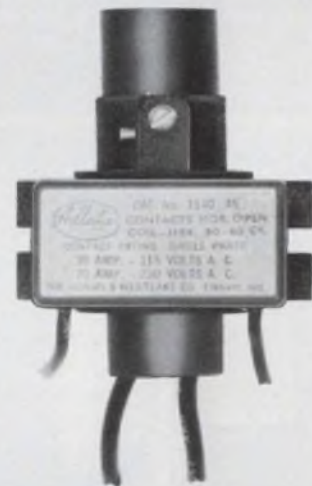

Type 1140-45

Inrush current (up to 8K) will not damage Adlake's Mercury Displacement Load Relays with unique, built-in "Anti-Spin-Out" protection.

Choose SPST to 3PST (N.O. or N.C.) for loads up to 35 amps in street lighting, stage lighting, radio-microwave, mining machinery, railroad equipment, and other demanding applications where high and persistent inrush currents are a problem.

*For complete specifying data and a comprehensive, free technical brochure on "Spin-Out", its cause and cure, use reader-service number below.*

## THE ADAMS & WESTLAKE COMPANY



ELKHART, INDIANA 46514  
219 · 264 1141  
TELEX 25 8458  
CABLE ADLAKE

INFORMATION RETRIEVAL NUMBER 130





# rotary solenoids

...practical ways to actuate and position

**application simplicity**



**It's simple to apply. Just attach load to armature or to either shaft end, and you have direct rotary motion.**

**action in arc or straight line**

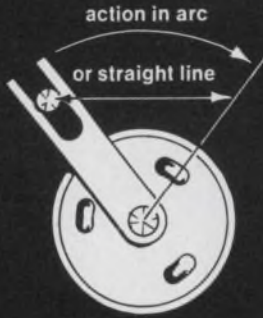

**Output of a rotary solenoid is relatively uniform, so it's also a practical linear actuating solution.**

**long range dependability**

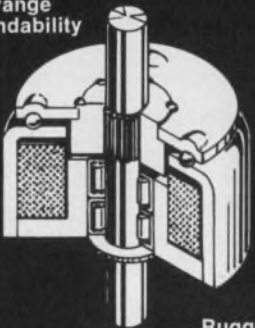

**Rugged and dependable endurance engineered models give you over 100 million operations.**

**indexing flexibility**



**To increase indexing flexibility, new Ledex interface circuits let you control acceleration and deceleration, program pulses, or work from logic level sources.**

What makes the Ledex rotary solenoid a practical way to actuate and position is that it's engineered to help keep your design simple and economical. It gets the job done—without the need for complex motion converters, tubing, fluids, and the like.

For a quick start on your prototype, choose from 250 shelf models—eight sizes, with torque to 117 pound-inches.

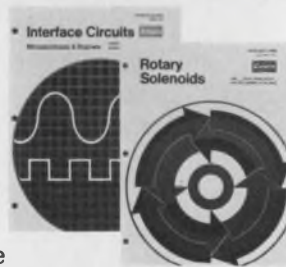

**LEDEX INC.**  
123 Webster Street  
Dayton, Ohio 45401/513-224-9891



Positioning • Switching • Interface Circuits

Toll free number for name of your nearest representative: 800-645-9200; New York firms call 316-245-0990.

INFORMATION RETRIEVAL NUMBER 131

## COMPONENTS

### Thin-film networks use chromium/cobalt

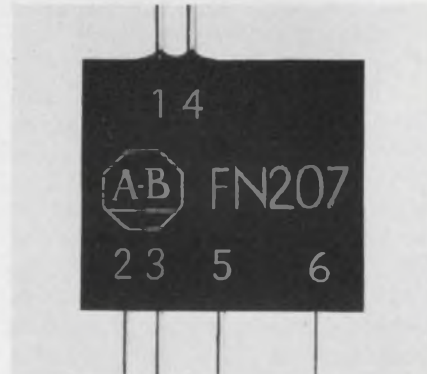

Allen-Bradley Co., 1201 S. Second St., Milwaukee, Wis. 53204. (414) 671-2000.

Allen-Bradley's line of precision attenuator resistor networks uses chromium/cobalt thin-film technology. Resistive elements are vacuum deposited on special high-purity glass substrates. Typical of this line is the FN207 voltage divider, which contains five resistors in series in a decade relationship. The tolerance on ratio numbers is  $\pm 0.01\%$  at 25 C with a temperature tracking of 3 to 5 ppm/ $^{\circ}\text{C}$ . Also R/2R ladder networks can provide from 8 to 15 bits at conventional functional accuracies of  $\pm 1/2$  LSB and 16-bit ladders are a state-of-the-art possibility. Typical of this family of R/2R ladder networks is the 10-bit FN131 and the 13-bit FN132.

CIRCLE NO. 301

### Filtered blower unit has four outlets

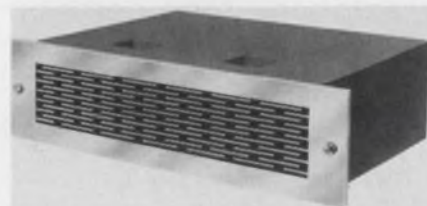

McLean Engineering Laboratories, Princeton Junction, N.J. 08550. (609) 799-0100.

The two vertical-top and two diagonal-rear outlets provide a uniform filtered airflow in the Model 4EB300 air blower. Airflow capacities of 250 or 450  $\text{ft}^3/\text{min}$ . are available. The units provide low audible noise levels and they come with brushed-aluminum or stainless-steel grilles.

CIRCLE NO. 302

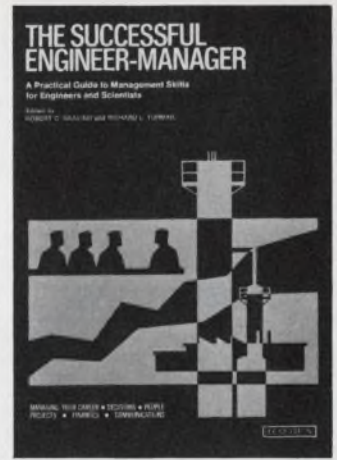
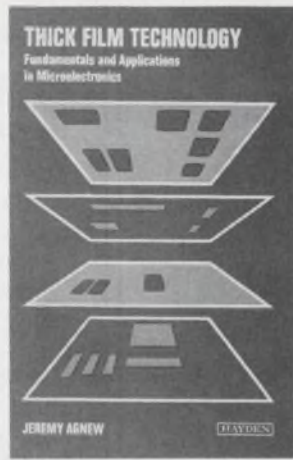
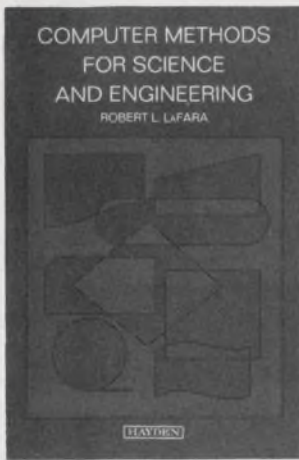

# 4 GUIDES AND REFERENCES FOR YOUR ON-THE-JOB ENGINEERING NEEDS... AVAILABLE ON 15-DAY EXAMINATION.

## COMPUTER METHODS FOR SCIENCE AND ENGINEERING

By Robert L. LaFara

Offers basic computing methods scientists and engineers need to solve many numerical problems. Features clear-cut methods for problem organization and flowcharting with practical applica-

tions; unique chapters on smoothing of experimental data; and FORTRAN techniques for iterative solutions of equations. 336 pp., #5766-0, cloth, \$12.95.

## THICK FILM TECHNOLOGY: Fundamentals and Applications in Microelectronics

By Jeremy Agnew

A complete, working guide on thick film principles, techniques and applications. Details processing phases, describes what to do and what pitfalls to avoid. Includes techniques for using various "add-on" components and outlines methods of attaching

active and passive devices and wires. Covers packaging methods and processing hazards and precautions. 176 pp., #5803-9, cloth, \$20.00.

## INTRODUCTION TO DEFENSE RADAR SYSTEMS ENGINEERING

By James N. Constant

Comprehensive, logical coverage of the techniques, tools and analytical procedures radar systems engineers need to develop optimized systems for particular environments and users. Covers

everything from fundamental equations to a step-by-step development of a system for a given application. 176 pp., #9194, cloth, \$8.50.

## THE SUCCESSFUL ENGINEER-MANAGER

Edited by Robert C. Haavind

A "variety pack" of valuable advice carefully selected from articles which various experts prepared for *Electronic Design*. A logically ordered success course covering six crucial phases in

managing: career, decisions, people, projects, finances, and communications. 176 pp., #5879-9, cloth, \$8.95.



**HAYDEN BOOK COMPANY, INC., 50 Essex Street, Rochelle Park, New Jersey 07662**

Please send the book(s) checked on 15-day free examination. At the end of that time, I will remit payment plus postage, or return the book(s) with no further obligation.

5766-0     5803-9     9194     5879-9

**\$10.00 minimum for free exam orders.**

Because of higher billing and collection costs, we must ask for payment in full with any order for less than \$10.00. Books will be shipped postpaid. Same 15-day return privilege for full refund if not satisfied.

**Save Money!** On all prepaid orders Hayden pays postage — same return privilege.

Name \_\_\_\_\_

Firm \_\_\_\_\_

Address \_\_\_\_\_

City/State \_\_\_\_\_ Zip \_\_\_\_\_

ISBN Prefix 0-8104

73-65a

## 10 amps of switching in a 1" cube!

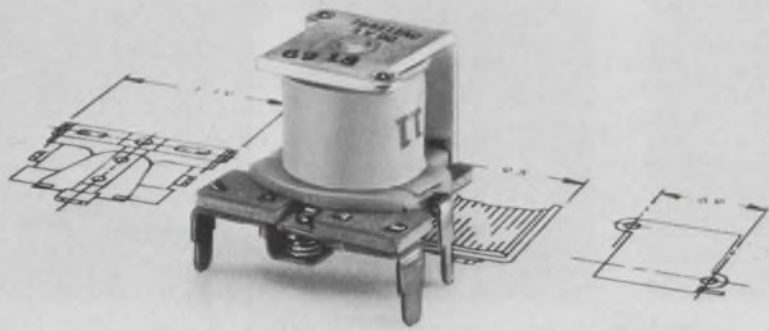

### We call it our Series 19 Relay. You'll call it one of the most compact and reliable packages you've ever used.

Remarkable 10 amp Series 19 relay is low in cost, too — less than \$1.00 each in quantity. But price is only part of the story. The Series 19 also offers the advantages of miniaturization and the capacity to handle heavy switching loads. Result: more performance in a smaller overall package. Contact arrangement is SPDT. Rated 10 amps at 28 vdc or 115 v, 60 hz. Coil voltages available range from 3 to 24 vdc. The Series 19 is an ideal choice for a multitude of low level to 10 amp switching applications, including remote control, alarm systems and many other industrial and commercial uses. Equally important, the Series 19 is part of a whole family of interrelated low-cost relays which will lend themselves to multiple usage in the same system. Included are:

**Series 10.** Sensitive, low cost, highly reliable SPDT relay rated at 3 amps, 28 vdc. Coil voltages 3-24 vdc. Can be used for a



wide range of industrial and commer-

cial control functions and alarm systems.

**Series 28.** Same as Series 10, but furnished with a dust cover for use in appliance controls, remote TV tuning, industrial process controls and similar functions.

**Series 38.** DPDT, 3 amp 28 vdc contacts. Coil ratings 3-24 vdc. Applications include business machine controls, antenna rotor controls, industrial process controls, etc.

**GP.** A miniature general purpose relay with 2, 4, or 6 PDT contacts, rated 1, 2 or 5 amps, 28 vdc or 115 v, 60 hz. Coil voltages: 6-115 vdc. Consider the GP for copiers, business machines, control or alarm systems, etc. Available with single or bifurcated contacts.



Send for information. Complete technical data on NAPCC relays available on request. Write today.

PRICE ELECTRIC RELAYS

## NORTH AMERICAN PHILIPS CONTROLS CORP.

A NORTH AMERICAN PHILIPS COMPANY  
E. Church & 2nd St. • Frederick, Md. 21701 • (301) 663-5141

INFORMATION RETRIEVAL NUMBER 133

## COMPONENTS

### Chips provide cooling in small space

Melcor, Material Electronic Products Corp., 990 Spruce St., Trenton, N.J. 08638. (609) 393-4178.

The FC series of solid-state, ceramic microcooling modules, called Frigichips, are a complete family of thermoelectric heat pumps. They use metallized, solderable, beryllia-ceramic plates for high electrical insulation and excellent thermal conductivity. Cold surface areas for basic modules range from  $0.08 \times 0.16$  to  $0.36 \times 0.36$  in. with a maximum current span of 1.1 to 1.9 A. Multistage configurations can be provided to handle higher temperature differentials. Maximum BTU/h ratings at a hot-face temperature of 27 C range from 1.02 to 14.20.

CIRCLE NO. 303

### CRT for data displays in four colors

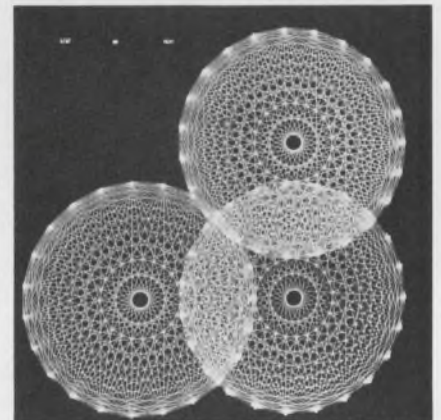

Westinghouse Electric Corp., Gateway Center, Pittsburgh, Pa. 15222. (412) 255-3329. \$600 (unit qty); 2 mo.

A new cathode-ray tube generates displays in as many as four colors with the resolution, light output and contrast of black and white designs. This enables the display of many different classes of information simultaneously and intelligibly. Red, orange, yellow and green displays are generated by switching anode voltages to vary electron-beam penetration of the phosphor. A spot size of 15 mils provides a sharp image. Light output is 25 fL. Diagonals to 21 in. and either magnetic or electrostatic focusing is available.

CIRCLE NO. 304

## Linear potentiometer measures to 0.001 in.



Humphrey, Inc., 9212 Balboa, Ave.,  
San Diego, Calif. 92123. (714)  
565-6631.

Model RP101-0101-1 spring-loaded linear potentiometer can measure up to 0.70 in. of displacement with an accuracy of 0.001 in. and a response time of less than 50 ms for a full stroke. The unit has zero backlash, a life expectancy of 100,000 cycles and is capable of withstanding a 100-g shock. A pressure plate allows the unit to tilt freely, so precise alignment is not required. The spring force is 1.2 lb when fully compressed.

CIRCLE NO. 305

## Cermet-film resistor has TC under 100 ppm/°C

Allen-Bradley, 1201 S. Second St.,  
Milwaukee, Wis. 53204. (414) 671-  
2000. \$0.11 to \$0.14 (250-1000);  
6-8 wks.

Allen-Bradley's new cermet-film fixed resistor, designated Type CC, uses a sintered end termination joined to high-temperature, metallurgically fused leads that are embedded in the core to provide reliable interconnections. According to Allen-Bradley, this design does away with a major cause of film-resistor failure. A 1/4-W size (0.250 L × 0.090 D-in.) resistor provides performance characteristics substantially superior to reliability-specification MIL-R-39017 and stability-specification MIL-R-10509. Average temperature coefficients are well below 100 ppm/°C. The new resistor is available in a standard 1% tolerance, decade, preferred-number values from 10 to 1 MΩ. Baked-on markings are highly resistant to flux and solvents encountered in PC-board soldering operations. They also resist the abrasion and chipping associated with automatic handling machinery. The resistors meet MIL-STD-202, Method-215 resistance-to-solvents requirements. Easily read marking, in two places, eases identification regardless of the resistor's orientation.

CIRCLE NO. 306

## The Non-Couples.

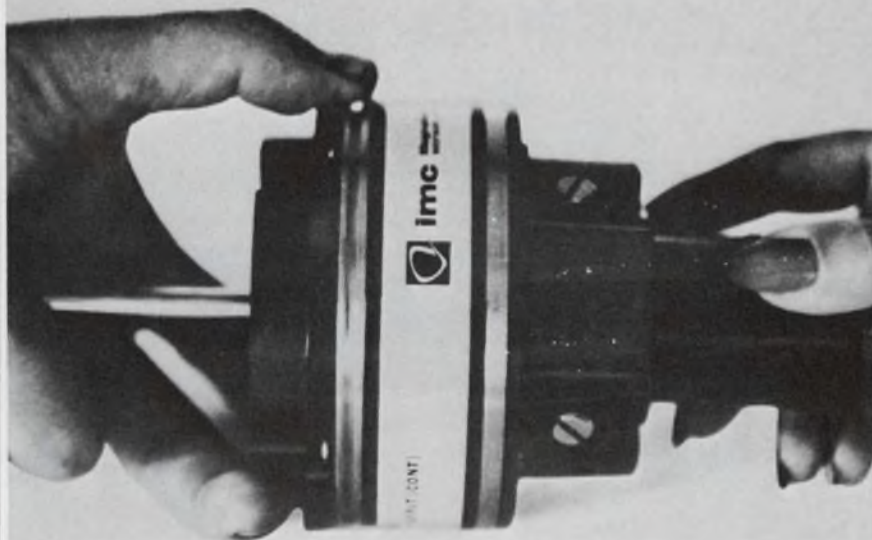

**IMC's high acceleration Alpha Max motor and IMCcoder optical encoder are designed to share the same shaft.**

**We also match the Alpha Max with our DC Tachometer.**

**No coupling. No misalignment. No flex. No backlash.**

**It's the perfect marriage.**

**Alpha Max moving coil motor.** Low armature inertia — .00039 oz-in-sec<sup>2</sup>. Low inductance — under 100 microhenries, and resistance — 0.9 Ohm. Produces instantaneous response, maximum acceleration—410,000 rad-sec<sup>2</sup>, and pulse torque capability — 450 oz-in. Unmatched by conventional DC or printed circuit designs.

**IMCcoder incremental encoder.** Unique fluxor arrangement — minimizes run-out problems, improves angle information accuracy. Efficient light source — single externally replaceable lamp is easily field-serviced. Single channel or dual channel versions for rotation direction sensing — line counts up to 2400 per revolution.

**DC tachometer.** High accuracy — linearity 0.1% of output. Low ripple — RMS 3% of output (max.) for any speed over 100 rpm. Miniature size — adds just 1<sup>15</sup>/<sub>16</sub>" to overall assembly length.

Integral motor-encoder, or motor-tachometer assembly, it adds up to optimum reliability performance in incremental drive and control applications — tape transports, memory disc, video recorder, computer peripherals and the like.

For complete technical data, literature, or custom engineering assistance, give us a call or write: **IMC Magnetics Corp., Eastern Division**, 570 Main Street, Westbury, New York 11590. Tel. 516-334-7070, TWX 510-222-4469, Cable: Magnetop.  **We're reliable.**

INFORMATION RETRIEVAL NUMBER 134

Resolutions of 1 microvolt DC and 1 milliohm, along with 100% overranging on all functions, make the Hickok 3410 a value leader at \$695. This is a full capability instrument, measuring DC and AC voltage and current, and resistance. High level recorder output is provided. Options include an internal rechargeable battery and 300%

overranging. Send for complete specifications in 3400 Series Data Sheet.

## HICKOK

the value innovator

Instrumentation & Controls Division  
The Hickok Electrical Instrument Co.  
10514 Dupont Ave. • Cleveland, Ohio 44108  
(216) 541-8060 • TWX: 810-421-8286

# 4-digit microvolt multimeter for \$695



INFORMATION RETRIEVAL NUMBER 135

The new Hickok 5310 gives you high performance at a low price — performance like ultrastable triggering to 15 MHz, 5 mV/cm sensitivity and full overload protection. Even for low repetition rate signals, the CRT display is clear and sharp because of the high accelerating potential and P31 phosphor. For broadcast work, the 5310 has an

easy-to-use automatic VITS capability. Also, trace invert and beam finder.

## HICKOK

the value innovator

Instrumentation & Controls Division  
The Hickok Electrical Instrument Co.  
10514 Dupont Ave. • Cleveland, Ohio 44108  
(216) 541-8060 • TWX: 810-421-8286

Bright,  
8x10 cm  
display  
and 10 MHz  
for \$425

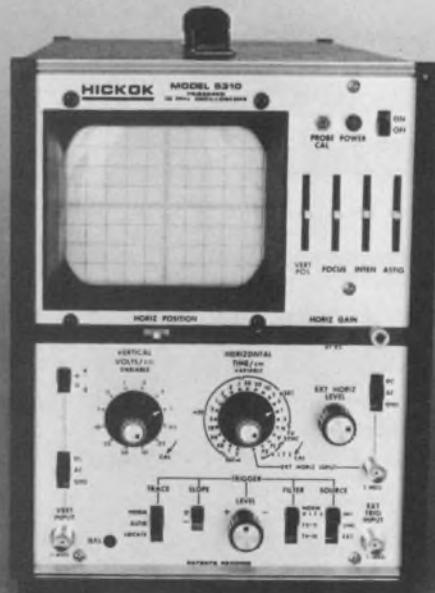

INFORMATION RETRIEVAL NUMBER 136

## MICROWAVES & LASERS

### FM antennas come circularly polarized

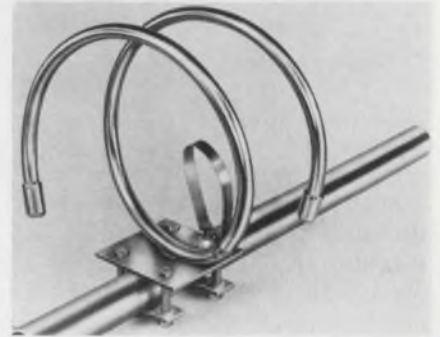

Phelps Dodge Communications,  
Route 79, Marlboro, N.J. 07746.  
(201) 462-1880.

Six models of circularly polarized antennas are available for educational applications. Called ECFM-1 through 6, power ratings vary from 0.2 to 0.5 kW. Power gain ratings range from 0.43 to 2.99, while field gain extends from 0.65 to 1.73. FS at one mile, 1 kW, MV/M is from 90 to 239. The new antennas are fabricated of 7/8-inch stainless steel tubing. Circular polarization is achieved with a 1-1/2-turn helix.

CIRCLE NO. 307

### Coax-cable assemblies contain phase trimmer



B & W Associates, Inc., 21 B St.,  
Burlington, Mass. 01803. (617)  
272-4420.

Coaxial cable assemblies contain built-in phase trimmable SMA connectors, eliminating the need of phase shifters. They are available in both flexible and semi-rigid versions through 18 GHz. An impedance compensated, stretchable connector with a maximum VSWR of 1.2:1 is attached to the cables and trimmed to the desired degree. Typical trimming accuracy—a function of frequency—is  $\pm 1/2^\circ$  at C band and  $\pm 1^\circ$  at 18 GHz.

CIRCLE NO. 308

# RCA COS/MOS in low cost ceramic.

RCA now offers COS/MOS in a new low cost ceramic package. So you can select, from our complete line of COS/MOS circuits, an IC package to meet your exact needs for performance and price.

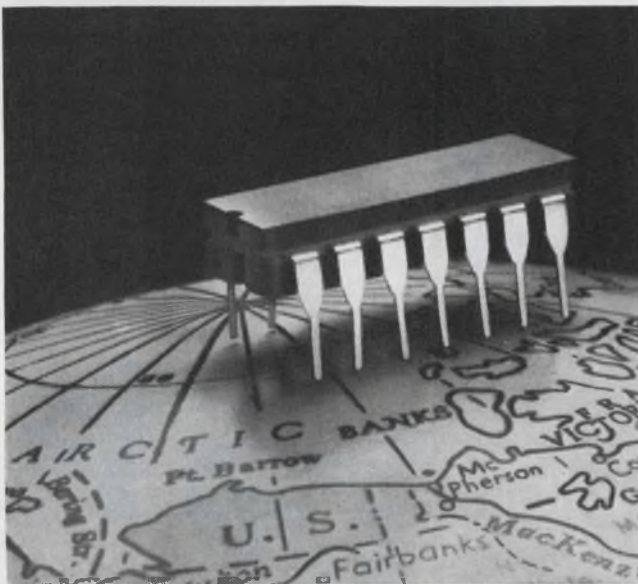

Our new CD4000AF Ceramic IC's feature electrical characteristics identical to the present AD and AK series weld seal ceramic COS/MOS circuits. You get a completely hermetic package designed to operate over the full military temperature range of  $-55^{\circ}\text{C}$  to  $+125^{\circ}\text{C}$ ... at a commercial price.

Compare the prices of our new ceramic IC's. If you've needed the temperature range and hermetic features of ceramic, but couldn't afford

TYPE NO.	FUNCTION	AF PRICE (1000+)
CD4001AF	Quad 2-input NOR gate	\$ .98
CD4011AF	Quad 2-input NAND gate	.98
CD4013AF	Dual "D" master-slave Flip-Flop	2.03
CD4020AF	14-stage binary/ripple counter	5.90
CD4027AF	Dual J-K master-slave Flip-Flop	3.14
CD4029AF	Presetable up/down counter	7.94
CD4042AF	Quad clocked "D" latch	4.23
CD4046AF	Micropower phase- locked loop	5.63
CD4047AF	Monostable/Astable multivibrator	3.75

the price, now you can discover the digital world of COS/MOS in RCA's new low cost ceramic package.

Our complete new line of COS/MOS CD4000AF Series Ceramic IC's, in 14-lead or 16-lead dual-in-line packages, are available at your local distributor. Or you can order them direct from RCA.

For complete pricing and data sheet write: RCA Solid State, Section 57K-22 Box 3200, Somerville, N.J. 08876. Or phone: (201) 722-3200.

**RCA Solid State**  
products that make products pay off



**New 16-BIT Digital Generator for Bread-Board Testing** — Simple-to-operate Model 901 has three power supplies built-in for fast, easy breadboard testing (0 to 7 VDC, 0 to +15 VDC and 0 to -15 VDC). Latching pushbutton switches quickly program 16 digital bits in serial, dynamic parallel or "hard-wired" parallel form. Outputs offered are repetitive, non-repetitive and popular "walking" combinations. Rates to 15 MHz.

CIRCLE NO. 237



**New Low Cost Digital Transducer Monitor** — A precision companion to your linear and torque transducers. It features selectable excitation voltages and signal conditioning. Accurate 3½ or 4½ digit display and output at rear connector in decimal, metric, torque, HP or RPM units. Front panel HIGH and LOW limit thumbwheel switches control internal comparison. HIGH/NORMAL/LOW lights indicate results.

CIRCLE NO. 238



**New Time Code Translator/Generator** — Precision unit provides *simultaneous* and *independent* generation and translation of any time code format. All modular plug-in design and wire-wrap interconnection eliminates "mother boards" for easier maintenance and field modification. Seven-segment gas discharge displays present outstanding readability. Days, pulse rate and parallel outputs are standard.

CIRCLE NO. 239



**SRC DIVISION/Moxon Inc.**  
2222 Michelson Drive  
Newport Beach, Calif. 92664  
Phone: (714) 833-2000

MICROWAVES & LASERS

**Stripline launchers meet wide requirements**

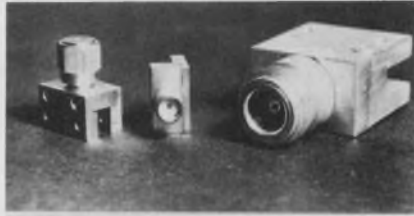

*Tek-wave, Inc., 71 Old Camplain Rd., Somerville, N.J. 08876. (201) 526-1150. Stock.*

Stripline launchers operating up to 18 GHz are offered in 3mm/SMA and 7mm/SMA type TNC and N, right-angle or end-launch configurations, with one-piece stainless steel or aluminum bodies. Mounting types include flange, bulkhead and flush. Gold-plated, beryllium-copper center conductors are epoxy captivated in a Teflon dielectric, and are offered in either pin or flexible tab versions. Launcher VSWR is 1.05.

CIRCLE NO. 309

**Planar triode can handle up to 150 W**

*Eimac Div. of Varian, 1678 S. Pioneer Rd., Salt Lake City, Utah 84104. (801) 487-7561.*

The 8933 planar triode can be used for airborne and space applications up to 3.0 GHz. With additional radiators for forced air cooling, an anode dissipation up to 150 W can be permitted. The 8933 can also be employed in switch-tube applications up to 8 kV dc. It has an average amplification factor of 120.

CIRCLE NO. 310

**USC GR/RGR HIGH DENSITY WRAP/CRIMP CONNECTORS**

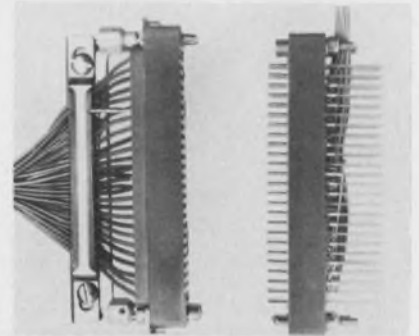

1 of over 20,000 types of Connectors. Send today for GR/RGR Series Catalog.

**U. S. COMPONENTS, INC.**

*Leader in advanced engineering & design*

1338 Zerega Avenue, Bronx, N. Y. 10462  
(212) 824-1600 TWX: 710-593-2141  
Telex: 1-2411 Cable: COMPONENTS, N.Y.C.

INFORMATION RETRIEVAL NUMBER 140

**HELP** from

THE PEOPLE DOING THINGS THAT MATTER... IMAGINATIVELY



electronic research co. • a control div.

**SERIES 9400 SCANNER**



- 10 Channel System—\$484
- Capacity—1000 Channels
- Multi-Mode Operation
- Scan rates to 100 Channels-Per-Second
- High Channel-to-Channel Isolation
- System Building Blocks

Telephone (913) 631-6700  
7618 Wedd  
Overland Park, Kansas 66204  
Mail to: P.O. Box 913, Dept. 136  
Shawnee Mission • Kansas 66201  
TWX: (910) 749-6477

## Coax switches operate to 3 GHz

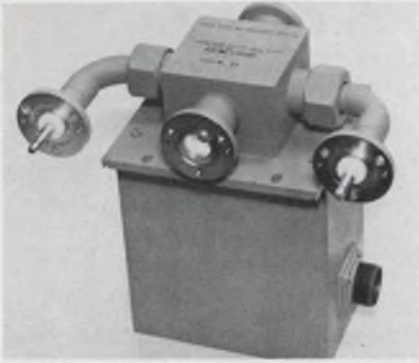

Struthers Electronics Corp., 4 Du-  
bon Ct., Farmingdale, N.Y. 11735.  
(516) 420-9000. 90 to 120 days.

The Series 1334 coaxial switches  
can be used up to 3 GHz with  
power levels to 75% of full-line  
capability. Insertion loss is less  
than 0.3 dB and isolation is great-  
er than 50 dB. Switch models are  
available in 3 or 4-part configura-  
tions and in 7/8-in., 1-5/8-in., and  
3-1/8-in. EIA.

CIRCLE NO. 320

## Hybrid ICs slash size of limiting amps

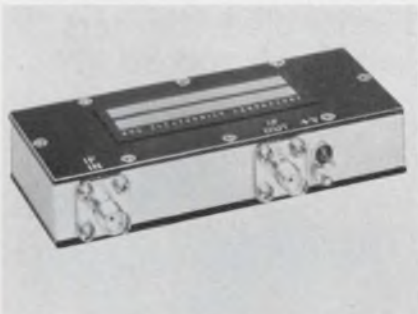

RHG Electronics Laboratory, 161  
E. Industry Ct., Deer Park, N.Y.  
11729. (516) 242-1100. \$625; 30  
days.

A line of constant-phase, wide  
range, i-f limiters, called the ICTL  
series and featuring hybrid IC  
construction, have center frequen-  
cies from 10 to 160 MHz with  
bandwidths up to 40 MHz. The use  
of thin-film technology results in  
a package that is one-tenth the  
volume of equivalent discrete units,  
according to RHG. Standard mod-  
els feature a dynamic range of  
-70 to 0 dBm, a phase shift over  
the range of typically less than  
10° and phase match between  
three units of typically less than  
5°. The output level is +10 dBm,  
with a  $\pm 1$ -dB variation.

CIRCLE NO. 321

# Can a high-quality socket-maker produce a good, low-cost IC Socket?

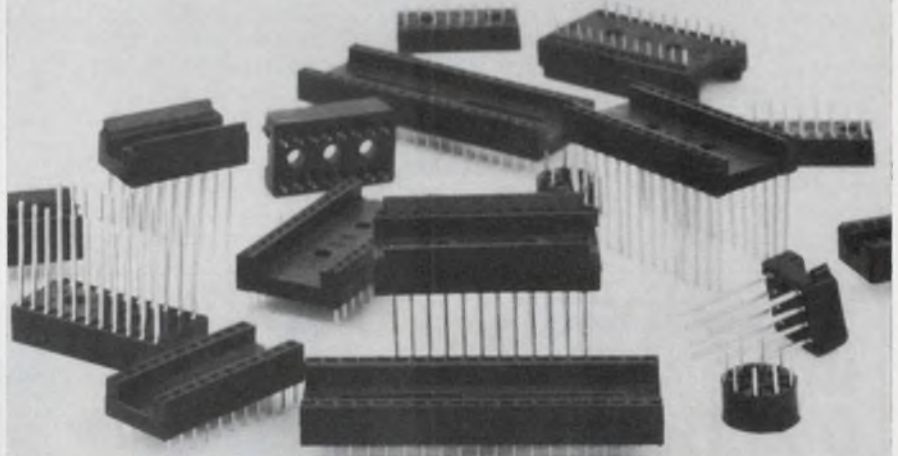

## RN does.

We use our know-how and experience to make  
quality IC sockets at competitive prices. We call  
them the inflation fighters. They're for production  
applications where gold plating isn't really needed.  
Nor its cost. Where glass-filled nylon gives you all  
the body required. And where typical R-N quality  
can give you an edge. Interested? See the  
Socket People.



ROBINSON NUGENT INC.  
800 EAST EIGHTH STREET  
NEW ALBANY, INDIANA 47150  
(812) 945-0211/TWX 810-540-4082

INFORMATION RETRIEVAL NUMBER 141



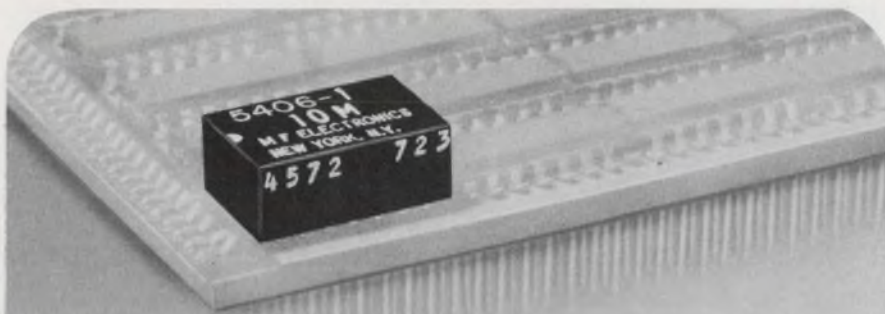

## LOW PROFILE, PLUG-IN CRYSTAL OSCILLATORS FOR DIP USE

The MF Model 5406 oscillator module is designed for direct insertion into DIP sockets, or can be soldered into PC boards if desired. Only 0.3" in height when seated, it offers the advantage of allowing standard 0.5" board spacing. Any frequency from 4 MHz to 45 MHz may be specified with a stability of  $\pm 50$  ppm or  $\pm 25$  ppm from 0° to 65° C. Temperature range from -55° to +125° C is also available. Input voltage is 5v and the TTL output sinks 16 ma up to 10 MHz, and 20 ma above 10 MHz (10 TTL loads). Typical price, in quantities of 1 through 4 is \$35.00. Delivery is within four weeks, and many frequencies are available for immediate shipment. For information regarding these and other MF crystal oscillators, contact:



*MF Electronics Corp.*

118 East 25th Street, New York, NY 10010 • (212) 674-5360

INFORMATION RETRIEVAL NUMBER 143

## Breadboard a Circuit In Less Than 5 Minutes

You must agree that our MINI-MOUNTS™ give you the fastest, easiest, most flexible, no-hole, no-drilling DC to GHz breadboarding system, or we'll refund your

**\$75** within two weeks. (And you keep the layout pad.)

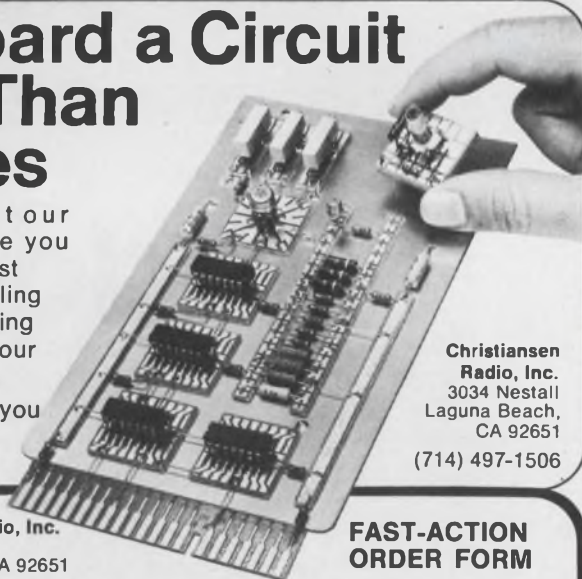

Christiansen  
Radio, Inc.  
3034 Nestall  
Laguna Beach,  
CA 92651  
(714) 497-1506



Christiansen Radio, Inc.  
3034 Nestall  
Laguna Beach, CA 92651

**FAST-ACTION  
ORDER FORM**

Yes, old-fashioned breadboarding is a drag, and I'm desperate enough to order your \$75\* breadboarding system with 150 assorted reusable Mini-Mounts, 4" x 8" ground plane, and easy-to-follow illustrated instructions. But hurry, please! If you've pulled my leg, I'll return it within two weeks, and you'd better smile as you tear up the invoice. I'll keep the 4 x 8 layout pad in any event. (\*All orders F.O.B. factory, plus sales tax where applicable.)

Name \_\_\_\_\_ Title \_\_\_\_\_

Company \_\_\_\_\_ Dept \_\_\_\_\_

Address \_\_\_\_\_

City, State, ZIP \_\_\_\_\_

Signature \_\_\_\_\_ P.O. No. \_\_\_\_\_

INFORMATION RETRIEVAL NUMBER 142

## MICROWAVES & LASERS

### Log amp handles 25% duty factor



American Astronics, 291 Kalmus Dr., Costa Mesa, Calif. 92626. (714) 540-4330. \$920 (1-9); 4 wk.

A baseline servoed log-video amplifier provides ac coupling with duty factors greater than 25%. The amplifier can process an input voltage dynamic range as great as 90 dB, or an input power dynamic range of 50 dBm when matched to an rf detector. These ranges are available at video bandwidths as great as 5 MHz, and log linearity of  $\pm 0.75$  dB. The amplifier temperature characteristic doesn't exceed 0.07 dB/°C over the 0-to-50-C temperature range.

CIRCLE NO. 322

### Ferrite-diode limiters handle 15 and 30 kW

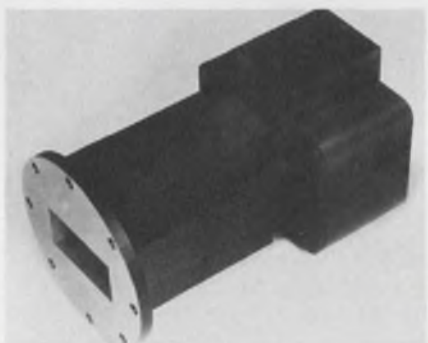

Microwave Associates, South Ave., Burlington, Mass. 01803. (617) 272-3000.

Two ferrite-diode limiters, for S and C bands, have power ratings of 30 and 15 kW, respectively. The MA-31005S covers an S-band frequency range of 2.9 to 3.1 GHz, while the MA-31008C covers the 4.9-to-5.5-GHz range. Both limiters have lifetimes exceeding 10,000 hours. The S-band unit has a recovery time of 0.5  $\mu$ s and VSWR or 1.3. The C-band unit ratings are recovery time of 0.1  $\mu$ s and VSWR of 1.4. The two limiters can operate from -40 to +70 C.

CIRCLE NO. 323

**PERSONNEL  
RECRUITMENT  
ADVERTISING  
IN  
Electronic Design  
REACHES THE  
RIGHT PEOPLE  
AT A LOWER COST  
PER THOUSAND**

*Call the  
HOTLINE  
today  
for complete  
information:  
(201) 843-0550  
extension 203*

**This is not  
the end  
of the line**

**FOR GRAYHILL  
TERMINATION HARDWARE.**

We currently make over one hundred different items of termination hardware. And we're constantly adding to the line so there's no end to it.

But that's not the termination of our hardware story either. What we really make are quality features our customers couldn't find in existing hardware products. Like firm positive contacts the first time and every time a connection is made with a push post. Or rapid test clip connections without having to open and close jaws manually. Plus caps that resist melting at soldering temperatures, exceptional dielectric strength and better insulation.

Want to learn more about our hardware and miniature switch lines? Write today for our newest Engineering Catalog. Grayhill, Inc., 565 Hillgrove Avenue, La Grange, Illinois 60525. (312) 354-1040.



INFORMATION RETRIEVAL NUMBER 144

**DC TYPE  
VOLTAGE SENSOR**

The unit features an internal potentiometer for adjustment of the trip voltage and the differential. The output is a solid state driver which will drive relays or lamp loads of up to 250mA. without additional circuitry. An input attenuator reduces the input voltage to a small level for the comparator section which is controlled by a variable reference. When the input level exceeds this reference, the output driver is energized and a positive feedback loop is closed to obtain differential. When the low limit is reached, the circuit automatically reverts to the zero output state and continues sensing.



**SENSITROL, INC.**

200 S. 4th Street  
P. O. Box 150  
Albion, Illinois 62806

INFORMATION RETRIEVAL NUMBER 145

# When PRD makes frequency synthesizers, the performance is high...



# not the price.

**Our 7828 Frequency Synthesizer** is offered with 1 kHz phase-locked steps from 1 kHz to 80 MHz. An optional vernier provides 1 Hz resolution. It's fully programmable with contact closures, RTL, DTL, or TTL logic; 1 part in  $10^6$ /mo stability; up to 1.0 volt output into 50 ohms.

**Our 7808 Signal Generator/Frequency Synthesizer-Sweeper** has digital synthesizer performance, yet retains the manual and vernier tuning and low spurious output of conventional signal generators. Its frequency range is 0.05 to 80 MHz. Key functions are programmable.

Best of all, these synthesizers cost little more than half the price of comparable instruments. For literature, write:

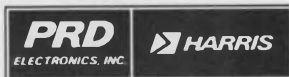

**PRD Electronics, Inc.**  
A subsidiary of Harris-Intertype Corporation  
1200 Prospect Avenue  
Westbury, N.Y. 11590 Tel: (516) 334-7810

INFORMATION RETRIEVAL NUMBER 147

## TRIMLINE ENCLOSURES BY PREMIER METAL PRODUCTS CO.

337 Manida St., Bronx, N.Y. 10474/(212) 991-6600

OVER 1300 ITEMS IN OUR CATALOG



INFORMATION RETRIEVAL NUMBER 148

## MICROWAVES & LASERS

### Laser receiver responds in 8 ns

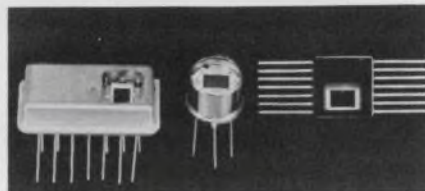

*Meret, Inc., 1815 - 24th St., Santa Monica, Calif. 90404. (213) 828-7496. \$150 (2-4); stock to 2 wk.*

Integrated photodiodes and transimpedance amplifiers provide fast response and high sensitivity at 905 and 1060 nm—the wavelengths of GaAs and Nd:YAG lasers. In the fully depleted condition the transit time of the carriers is less than 5 ns. A matching transimpedance amplifier in the same package provides current-to-voltage conversion over a bandwidth from dc to 60 MHz. Responsivity of 5 mV per microwatt at 905 nm and 2 mV per microwatt at 1060 nm are achieved with rise times less than 8 ns. Rms noise voltage levels over this bandwidth are less than 100  $\mu$ V, for a signal-to-noise ratio better than 5:1 with 100 nW incident on the detector.

CIRCLE NO. 324

### Short filter covers uhf range



*Transco Products, 4241 Glencoe Ave., Venice, Calif. 90291. (213) 821-7911.*

A uhf low-pass filter, called the 90C15200, has a passband of 200 to 425 MHz and a cutoff of 500 MHz. The isolation is 60 dB from 900 to 2200 MHz. This lumped-constant filter measures 2.6 inches long and weighs 0.25 lb. According to the company, standard filters with similar characteristics are over 5 inches long. Passband insertion loss is less than 0.2 dB and passband VSWR is less than 1.15.

CIRCLE NO. 325

# Now two RCA 5-inch scopes... DC to 10 MHz response

The Triggered/Recurrent  
Sweep WO-535A . . .  
\$349.00 (Optional Price)  
including probe



The Recurrent  
Sweep WO-505A . . .  
\$329.00 (Optional Price)  
including probe

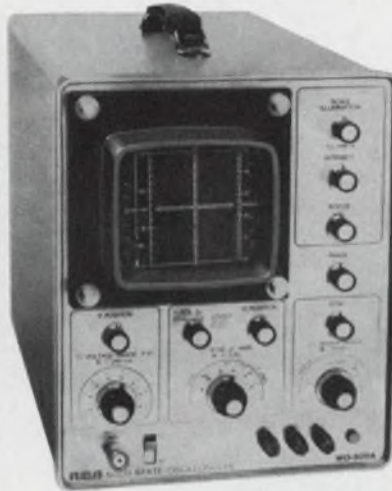

**To buy:**  
order from any one of the more  
than 1,000 Authorized RCA  
Distributors worldwide, or through  
RCA Electronic Instruments  
Headquarters, Harrison, N.J. 07029.  
(RCA will forward your order  
to the distributor of your choice.)  
Also ask for your copy of the  
new full-line Electronic Instruments  
1Q1218F catalog.

**RCA** Electronic  
Instruments

INFORMATION RETRIEVAL NUMBER 149

Millions already in use  
**NEW KIT LETS YOU TRY IT**

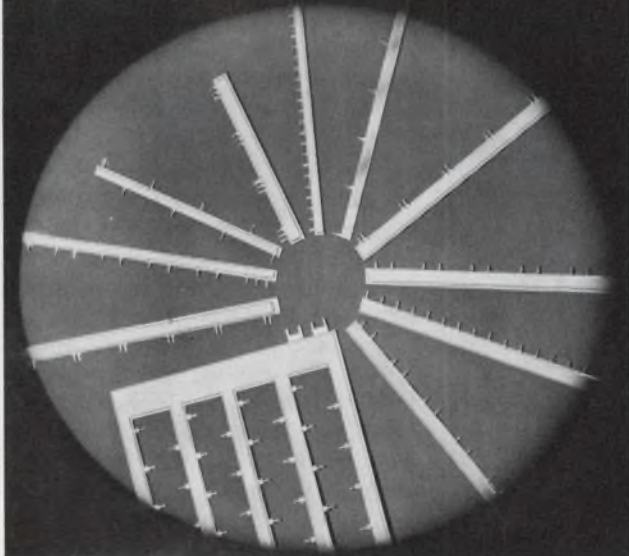

Evaluation kits @ \$25 in stock.  
Standard parts on 2 weeks delivery, or less!  
Custom parts 4 to 6 weeks delivery!

**MINI-BUS** The low-cost, noise attenuating,  
high packaging density, power distribution system for  
PC boards. Ask for data.



Rogers Corporation / Chandler, Arizona 85224  
West: (602) 963-4584 East: (203) 774-9605

INFORMATION RETRIEVAL NUMBER 150

ELECTRONIC DESIGN 24, November 22, 1973

**encapsulated  
snap-mount LEDs  
in red or green!**



SoLiCo solid state GAP light emitting diodes  
are designed for low-voltage applications  
where panel space and speed of installation  
are important. Light output is exceptional:  
3 milli-candellas at 20 milli-amps. Molded  
nylon bodies snap-fit into panel front with no  
tools required. Model D-503 provides a re-  
sistor in series, and forward voltages 5-6V,  
12-14V, 18V or 28V can apply directly. Color-  
coded 6" insulated leads save valuable as-  
sembly time. Write: SORENSON LIGHTED  
CONTROLS, INC., Suite 810, 1428 Brickell  
Ave., Miami, Florida 33131. Tel. (305) 358-6112.

**SoLiCo**

INFORMATION RETRIEVAL NUMBER 151

**“ECI lets  
good people  
grow and  
move up  
fast.”**

JOE KING,  
Senior  
Principal  
Engineer

“Some companies assign you to a slot and you can't break out. Not here. We want only the top people who want an environment conducive to learning. Here, you can go to the experts in another area and get their help. You just go in and talk it out — there's a lot of interplay. It's really one big group at ECI, instead of lots of little groups.”

**Career opportunities for electronic engineers:**

We have openings at all levels for electronic engineers experienced in the design and development of communications systems, RF, digital, and modem equipment. You'll be working with major UHF command and control systems, satellite relay and telemetry systems, and a variety of other challenging long-term projects including advanced mail handling systems.

**If your specialty doesn't match exactly:**

If you're a creative Electronic Design or R & D engineer, really know the fundamentals of electronics, and are highly flexible, we'd like to hear from you. It may well be that you're the man for us.

ECI is on Florida's West Coast in sunny, cosmopolitan St. Petersburg. If you're interested in a career opportunity on long-term programs in a stimulating environment, write in confidence today to William C. Peterson, Personnel Manager, Electronic Communications, Inc., Box 12248, St. Petersburg, Fla. 33733.

**ELECTRONIC COMMUNICATIONS, INC.**

A subsidiary of NCR  
An equal opportunity employer.



**MICROWAVES & LASERS**

**Trimmer capacitors allow X-band tweaking**

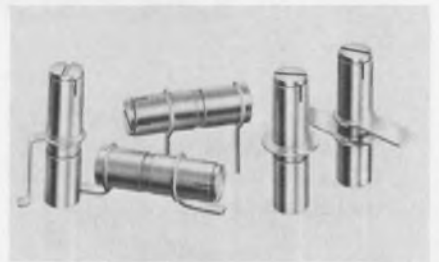

Johanson Manufacturing, 400 Rockaway Valley Rd., Boonton, N.J. 07005. (201) 334-2676. \$4.35 (1000); stock.

Trimmer capacitors permit tweaking at frequencies up to X band for a simple means of fine tuning hybrid circuits and MICs. Called the 7290 series, the trimmers are available in 10 mounting styles and have capacitance ranges from 0.8-8.0 to 7.0-35.0 pF. Qs are greater than 2000 at 100 MHz.

CIRCLE NO. 326

**Interferometer resolves 2.5 microinches in 6"**

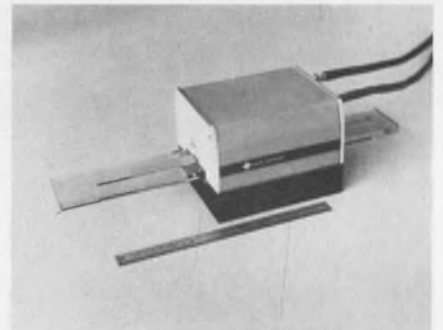

Holograf Corp., 670 National Ave., Mountain View, Calif. 94040. (415) 967-2323. \$975; 60 day.

Combining features of optical scales and laser interferometers, the company's Laser-Scale Interferometer measures displacements as small as 2.5 microinches over a six-inch range. Exactly 100,000 interference fringes per inch of motion are provided, as compared with about 80,280 for a conventional interferometer, according to Holograf. Quadrature detection provides up-down directional information and a further division by four. A new digital count is generated for every 2.5 microinches of scale motion.

CIRCLE NO. 327

# Where can you find a 65 watt power oscillator with longer life-plus minimum leakage?



We finally had to build one.

Six plug-in heads

And here's what we built into it:

Model	Freq. (MHz)	Pwr. (MIN)
6047	10-50	65
6048	50-200	65
6049	200-500	65
6050	500-1000	65
6051	1000-2000	40
6052	2000-2500	25

- solid state circuitry
- short and open circuit protection
- frequency stability  $\pm 0.1$  db
- external pulse or AM modulation
- internal square wave modulation
- low tube cost / operating hour
- qualified to MIL-STD-468 and 810

End your search for a stable, reliable r-f source—call or write for complete data. Better still, ask for a demonstration. MCL, Inc., 10 North Beach Avenue, La Grange, Illinois 60525, (312) 354-4350



See us in EEM-Vol. 1 pp. 551-566

INFORMATION RETRIEVAL NUMBER 153



For the finest in Instrument **KNOBS**

- Silk-Screening
- Hot Stamping
- Frosting

You can depend on

# BUCKEYE

To supplement the recognized high quality of the BUCKEYE MATCHING INSTRUMENT KNOB LINE, Buckeye Craftsmen have developed unique capabilities in fine silk-screening, hot stamping and frosting. They can decorate or mark to your specific requirements any of the wide selection of styles, types, colors and sizes of Buckeye Knobs and Skirts. To see for yourself the quality of Buckeye Craftsmanship, ask for **FREE** sample of the knob illustrated above. You can depend on Buckeye for your control knob needs . . . and other instrument-packaging products.



the BUCKEYE stamping co.  
555 Marion Road, Columbus, Ohio 43207  
Quality Products Since 1902

INFORMATION RETRIEVAL NUMBER 154

ELECTRONIC DESIGN 24, November 22, 1973

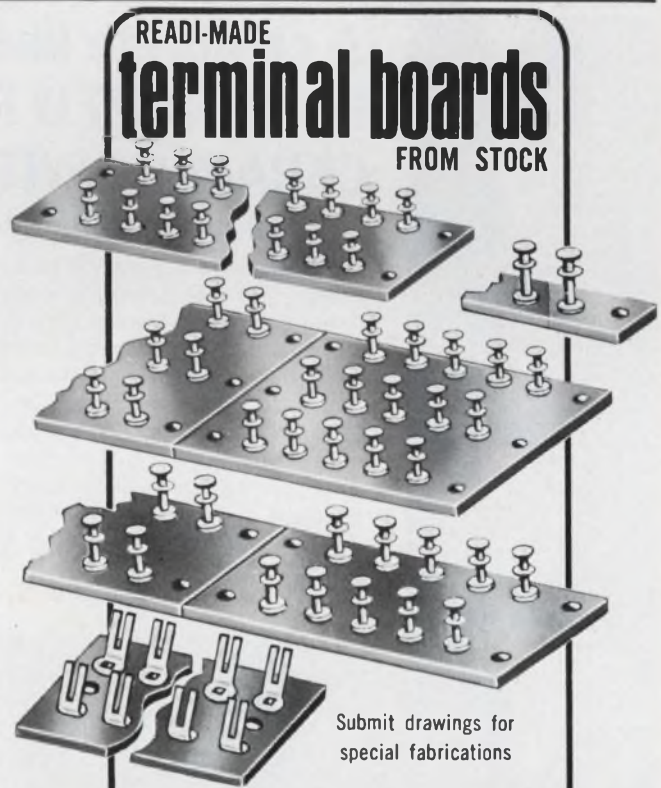

READI-MADE  
**terminal boards**  
FROM STOCK

Submit drawings for special fabrications

Manufacturers of Standardized Hardware

**NEW FREE CATALOG ON REQUEST**



**KEYSTONE**  
ELECTRONICS CORP.

49 Bleecker St., New York, N.Y. 10012

INFORMATION RETRIEVAL NUMBER 155

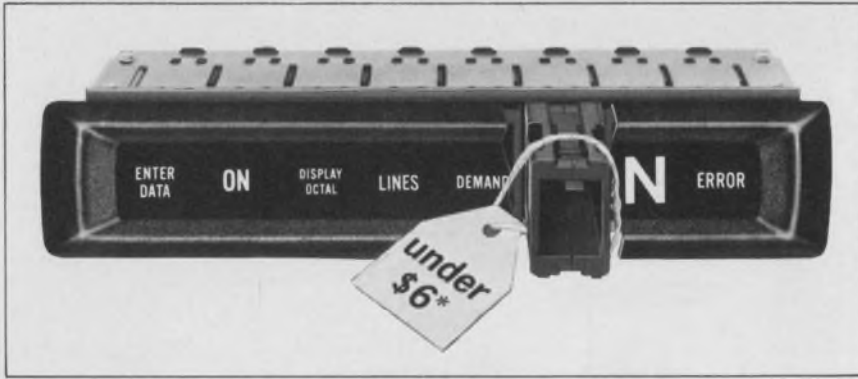

## NOW! A REAR-PROJECTION DISPLAY FOR UNDER \$6

IEE introduces the Series 1100 Readout, the first Rear-Projection display under \$6. Series 1100 costs far less than equivalent Rear-Projection models, yet packs all the similar features. We're talking of a .6" character displaying bright, crisp messages, numerals, symbols or colors, easily read from 20 feet. The total plug-in package (12 positions per readout) offers quick front panel removal for lamp and film servicing. Series 1100 accepts 5, 14 or 28 volt lamps compatible with DTL/TTL input

with a light output of 100 ft-L. Equally inexpensive is the mating Driver Decoder, the long life Series 7800. The Series 1100, low cost . . . high reliability . . . from the world leader in Rear-Projection displays. Give us a call. **Industrial Electronic Engineers, Inc., 7740 Leona Ave., Van Nuys, Ca. 91405, Telephone: (213) 787-0311. TWX 910-495-1707.** Our European Office: 6707 Schifferstadt, Eichendorff-Allee 19, Germany, Phone: 06235-662.



\*In quantities of 1000

INFORMATION RETRIEVAL NUMBER 156

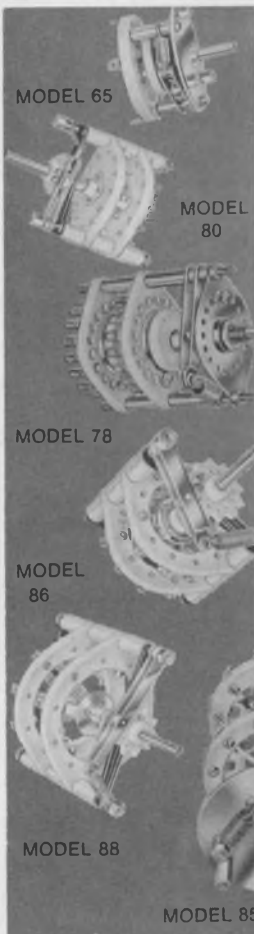

## A complete line of CUSTOMIZED ROTARY CERAMIC SWITCHES...

For RF and POWER APPLICATIONS

RSC switches are available in a variety of switching models. RSC high precision, quality built units are designed for applications requiring long life maintenance-free service. Types include shorting and non-shorting, single and multi-deck, up to 18 pole positions. Features include, 10 to 100 amp current carrying capacity, 20° to 90° detents, 2000 to 24000 volts flashover and corrosion-proof construction.

Write for catalog no. 960 and complete information.

**RADIO SWITCH CORPORATION**

Rt. 79, Marlboro, N. J. 07746



INFORMATION RETRIEVAL NUMBER 157

### POWER SOURCES

## UPS system can deliver up to 600 kW



Lorain Products Corp., 1122 F St., Lorain, Ohio 44052. (216) 288-9191.

The ContinuAC Inverter System is a constantly operating, uninterruptible power source that provides reliable ac power to critical loads. A load protected by the ContinuAC System is unaffected by disturbances or failures on the commercial ac line including complete ac power failure (blackout), momentary interruptions or transients on the ac line (flickout), and intentional reduction of voltage from the ac line (brownout). Standard systems are available in single-phase and three-phase with capacities from 500 VA to 600 kW and higher.

CIRCLE NO. 328

## Precision V/I source is accurate to 0.05% of fs



North Hills Electronics, Inc., Alexander Pl., Glen Cove, N.Y. 11542. (516) 671-5700. \$1275; stock.

Model CVS-264 is a constant voltage/constant current regulated supply. Current and voltage limits are 100 mA and 100 V, with voltage or current mode operation selected by a front-panel switch. Full scale settings are 1, 10 and 100 mA or V. The output level is read directly by the settings of five decade selector switches with automatic decimal point indication. Accuracy of reading is 0.05% of full scale. The output circuit is a bipolar design that permits generation of regulated ac output current or voltage with or without a dc component.

CIRCLE NO. 329

# HIGH PERFORMANCE ENCODERS USING DECITRAK<sup>®</sup>



Whether your requirement is incremental or absolute, English or metric, DECITRAK can provide a high performance, reliable encoder at a reasonable price.

- Absolute BCD Output to 999999
- Incremental range to 2000 pulses/rev.
- Rugged heavy-duty industrial design
- Requires only 5 VDC for operation

Have a systems problem? THETA can solve that too. Send for your FREE copy of DIGITAL SOLUTIONS to AUTOMATIC CONTROL.

*Theta* **INSTRUMENT CORP.**

Specialists in Digital Automation  
Fairfield, New Jersey 07006  
Phone: 201 - 227-1700

INFORMATION RETRIEVAL NUMBER 158

## Your load impedances can't upset our 1 kW broadband amplifier

**Model 1000L will drive  
any load impedance**

**10 KHZ - 220 MHZ**

Versatile and reliable -- that's the best way to describe Amplifier Research's Model 1000L. This powerful 1000-watt unit features unique protective circuitry to permit operation into any load impedance without shutdown or damage. And it's simple to operate -- all you need is a standard sweep or signal generator. Convenient front panel controls permit you to select the desired operating mode -- 100 or 1000-watt CW output or 4-kilowatt pulse output. Model 1000L is ideally suited for antenna and component testing, equipment calibration, EMI susceptibility testing, biological research, and a variety of other applications. For complete information, write or call Amplifier Research, 160 School House Road, Souderton, Pa. 18964 Phone 215-723-8181



**AR** **AMPLIFIER  
RESEARCH**

INFORMATION RETRIEVAL NUMBER 159

ELECTRONIC DESIGN 24, November 22, 1973

# Need to know where it's at?

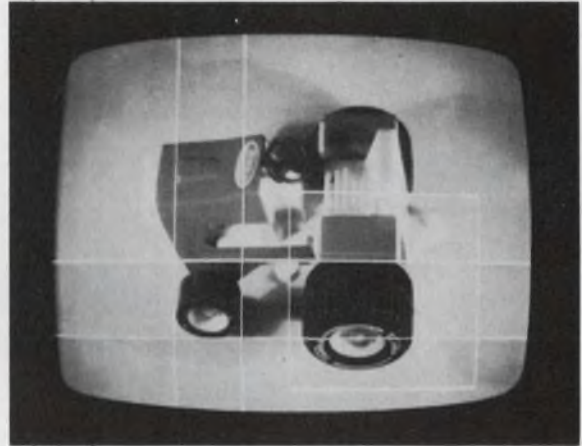

CVI video instruments provide X-Y coordinate information from TV signals -- produce boresight reticules -- digitize target location -- analyse scenes -- and more. If you use television and need to reduce data, add special markers, or perform other operations, please call us.

We make things like:

- 304 Motion Detector
- 321 Video Analyser
- 603 Data Insertion Generator
- 610 Video Pointer
- 621 X-Y Indicator
- 622 X-Y Digitizer
- 630 Anomaly Detector

**cv***i*

Colorado Video, Incorporated  
P.O. Box 928  
Boulder, Colorado 80302  
(303) 444-3972

Video instruments for data acquisition, processing, Transmission, and display.

INFORMATION RETRIEVAL NUMBER 160

263





## This probe detects EMI problems...

At least 80% of today's magnetic shield designs were developed at the Magnetic Shield Division of Perfection Mica Co. Our Netic and Co-Netic shielding materials are recognized industry standards around the world. They are cited in many military procedural documents.



and CRT shields - Zero gauss chambers - Transformer, relay, motor and other component shields - Shielded rooms - Field evaluator probes - Tape data preservers - Shielded conduit & cable.

We'll tackle prototype through production runs.

Our shielding experience has resulted in the world's most comprehensive line of standardized and specialized designs like: Netic and Co-Netic foil and sheet stock - Photo-multiplier

**MAGNETIC SHIELD DIVISION**  
Perfection Mica Company  
740 Thomas Drive  
Bensenville, Illinois 60106  
(312) 766-7800

...and our complete line of shielding materials solves them.

INFORMATION RETRIEVAL NUMBER 191

## ANALOG - TO - DIGITAL CONVERTER 15 BINARY BITS - 1.0 MICROSECOND



**SERIES 2000** - from 8 bits in 100 nanoseconds to 15 bits in 1.0 microsecond.

**SERIES 2100** - from 8 bits in 500 nanoseconds to 15 bits in 3.0 microseconds.

Complete data systems featuring multiplexers and sample and hold amplifiers are available. Up to 256 channels may be provided in one 5 1/4" high by 19" wide cabinet. High level, low level and simultaneous sample and hold systems are available.



**TUSTIN ELECTRONICS CO.**  
1656 South Minnie Street  
Santa Ana, Calif. 92707  
(714) 835-0677

INFORMATION RETRIEVAL NUMBER 192

## POWER SOURCES

**Dc modular supply costs \$9.95 and delivers  $\pm 12$  V**



*Kenmark Development Group, Inc., 71 Mott Ave., Inwood, N.Y. 11696. (516) 239-6688. \$9.95 (1 to 100); 2 to 4 wk.*

The Model 12100 encapsulated power supply delivers  $\pm 12$  V dc at  $\pm 100$  mA. It operates from any 115-V-ac line and has internal short-circuit protection. Size is 3 by 2-3/4 by 1-1/2 in. and it weighs less than 11 oz. Provisions are available for a  $\pm 10\%$  customer adjustment of the nominal 12 V output voltages.

CIRCLE NO. 330

**Modular dc supplies provide up to 800 VA**



*Ragen Data Systems, Inc. 45-13 Little Neck Pkwy., Little Neck, N.Y. 11363. (212) 423-6800. Stock.*

The Datapower series of power supplies can deliver multiple dc outputs at power ratings to 800 VA. A typical multiple output supply could include 5 V dc with 0.01% regulation and a 28-V-dc output with 5% regulation along with outputs of 7.5 V, 2% regulation,  $\pm 15$  V, 1% regulation. There are seven "off-the-shelf" modules packaged in four standard power cases. All supplies draw power from input voltages of 105 to 260 V ac, 47 to 440 Hz, and operate at full output in temperature environments of 0 to 40 C.

CIRCLE NO. 331

# Versatile, rugged problem solvers in compact 1" pkgs. CTS 223 Series Selector Switch

Today's demanding applications make construction versatility a key feature in switch design. CTS gives you this and more. Rugged, reliable 223 series switches meet the critical electrical and environmental characteristics required by both the industrial and military markets.

These switches are strong, yet small—and save critical space—a mere 1" diameter. Fully interchangeable. There's also 30° - 36° - 45° - or 60° indexing . . . insulated shafts . . . high voltage standoffs . . . and

concentric constructions with variable resistor and power switch combinations. Crisp switching action over 25,000 cycles—50,000 cycles available. Meets MIL-S-3786 Style SRO5 specs.

Call your CTS sales representative now. Have him demonstrate the crisp action of the double ball detent construction—and the many other quality features of our 223 series. CTS Keene, Inc., 3230 Riverside Avenue, Paso Robles, California 93446—Phone (805) 238-0350.

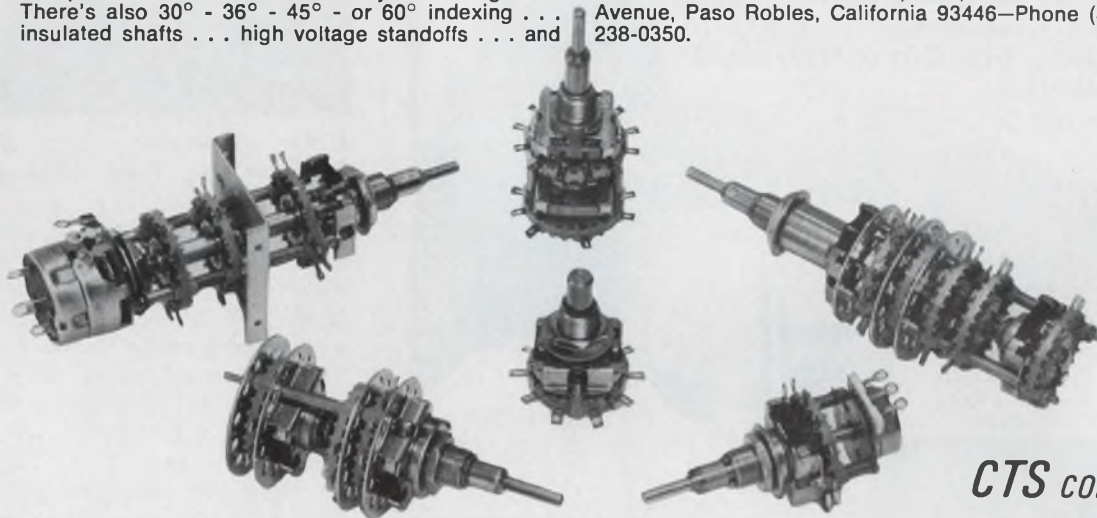

**CTS CORPORATION**  
Elkhart, Indiana

INFORMATION RETRIEVAL NUMBER 193

**FUJI**

## 16K BYTES MEMORY CARD

CMS2803

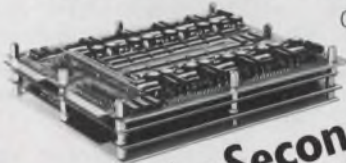

**The Second Best Seller**  
Doesn't necessarily imply second best

CMS2802



CMS2802: EMM micro 3000  
CMS2803: AMPLEX 1800 series

Plug-to-plug compatible.

A clear system using our own hybrid circuit ICs

	Access time	Cycle time	Temp. range	Power supply voltage
CMS2802	300 ns	650 ns	0° ~ +50°C	+5V ±3%, 4.0A max +15V ±3%, 4.0A max -15V ±3%, 0.9A max
CMS2803	340 ns	850 ns	0° ~ +55°C	+5V ±5%, 3.5A max -15V ±3%, 4.5A max

**FUJI ELECTROCHEMICAL CO., LTD.**

Head Office: Hamagomu Bldg. 5-36-11, Shinbashi, Minato-ku, Tokyo, Japan. TEL: 434-1271  
Overseas Office:  
New York, TEL: (212) 532-5630/Los Angeles, TEL: (213) 620-1640/Düsseldorf, TEL: (211) 89031

INFORMATION RETRIEVAL NUMBER 194

ELECTRONIC DESIGN 24, November 22, 1973

## Look to Ballantine for scopes

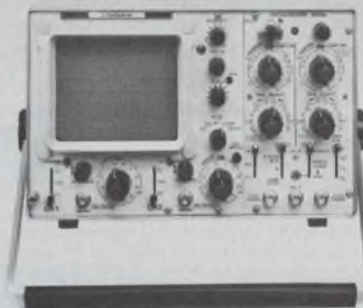

Portable • Dual Trace • X-Y

1040A	40 MHz, 5 mV Delayed Sweep Only 27 lbs.	\$1200
1066B	20 MHz, 5 mV	\$745
1010A	10 MHz, 5 mV, Only 15 lbs.	\$495
7050A	Electronic Transient Recorder	\$985



**Ballantine Laboratories, Inc.**

P.O. Box 97, Boonton, New Jersey 07005  
201-335-0900, TWX 710-987-8380

INFORMATION RETRIEVAL NUMBER 195

## VIBRATION METER

PROTECT ALL MOVING MACHINERY BY MEASUREMENT OF DISPLACEMENT • VELOCITY • ACCELERATION

The Columbia Model VM-103 Vibration Meter allows detection of problems on all rotating or moving machinery by a change in vibration level due to unbalance, bearing wear, misalignment and all mechanical mal-function. Simple and easy to operate by practically untrained personnel, the instrument gives advanced warning of impending breakdown, preventing costly run away to catastrophic failure and down time. Routine checks almost invariably result in incalculable savings for maintenance and replacement of equipment. Measurement in displacement from 0.0001 to 10 inches, velocity from 0.01 to 1000 inches/sec. and acceleration from 0.001 to 100 G.

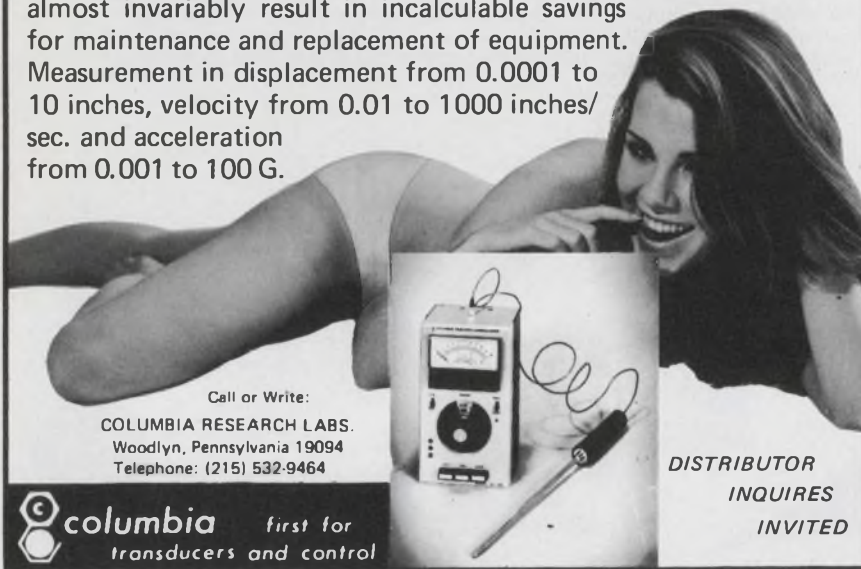

Call or Write:

COLUMBIA RESEARCH LABS.  
Woodlyn, Pennsylvania 19094  
Telephone: (215) 532-9464



**columbia** first for  
transducers and control

DISTRIBUTOR  
INQUIRES  
INVITED

INFORMATION RETRIEVAL NUMBER 196

## Our new connector gives you 92 contacts in 3.9 inches with 144 polarizing positions.

This PC board connector is designed for maximum versatility. All 92 contacts are protected by a molded shroud. You have your choice of Wire-Wrap®, dip pin, or soldercup terminations for complete circuit integrity. For details on the WGE-92, call 214-233-2000, or write our Dallas plant at 4321 Airborn Drive, Addison, Texas 75001. Where system integrity counts, count on AirBorn.

### **AirBorn, Inc.**

® Registered TM of Gardner-Denver Company.



INFORMATION RETRIEVAL NUMBER 197

## POWER SOURCES

### Battery chargers meet UL safety standards



Motor Generator Div., Hobart Brothers Co., Troy, Ohio 45373. (513) 339-6011.

Ferroresonant battery chargers meet UL safety standards as set under classification number UL 1236. The chargers are UL listed under certification number 692N. They are available in three case sizes for charging lead-acid batteries of six to 36-cells with ampere-hour ratings up to 1400 Ah, for eight hour charging and up to 2200 Ah for 16 hour charging. The power transformers, with lifetime warranties, are dual voltage, 115/230 or 230/460, each with a tap for a 208-V line. The ferroresonant transformer in the charger controls the charging current. It limits the current at the start of the recharge cycle to a safe level and holds voltage near the finish of the cycle within  $\pm 1\%$  even if the line voltage varies as much as  $\pm 10\%$ .

CIRCLE NO. 332

### Power supply modules offer 10-year warranty

American Power Systems Corp., 51 Jackson St., Worcester, Mass. 01608. (617) 753-8103. Stock.

Five Series A power supply modules are available in a range of 30 to 140 W. Standard features on all models include: remote or local sensing and voltage adjustment, overload and short-circuit protection, all UL and CSA approved materials, and a 10-year warranty. Options available are a dual ac primary (115/230 V ac), overvoltage protection, dual, triple or quad outputs and a choice of box color.

CIRCLE NO. 333

## New Low Cost DIGITAL CLOCKS



Thousands of Configurations at Off-the-Shelf Prices. Options Include:

- LED dot matrix shaped-character displays.
- Various time ranges, calendar ranges and time bases.
- Parallel and character serial BCD digital outputs, TTL compatible, gated and buffered.
- Available as plug-in cards for OEM applications or with rack or instrument type mounting chassis.
- Other Models include other panel displays, internal standby battery power and character generator outputs for remote video display of digital time.
- Complete line of Time Code Generators, Readers and Tape Search Systems.

Write or call Chrono-log Corporation, 2583 West Chester Pike, Broomall, Penna. 19008, 215-EL 6-6771



INFORMATION RETRIEVAL NUMBER 221

### WE'VE BEEN ACCUSED OF MAKING OUR LOG VIDEO AMPLIFIERS WITH

## HOCUS POCUS!

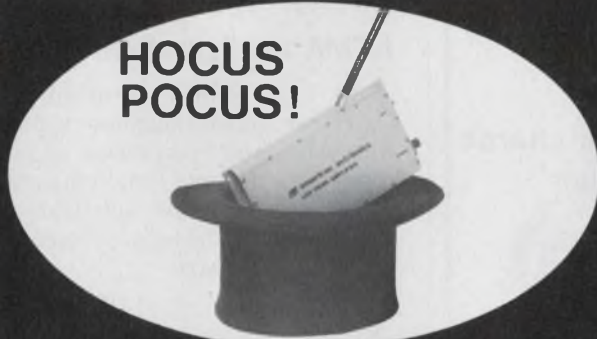

We don't use hocus pocus. Just maximum design efficiency developed over 6 years in the business. Our AC COUPLED LVA's combine the unique features of high speed and wide dynamic range. They can log 200 nsec to 1.0 usec pulses over a full 80 dB dynamic range with  $\pm 1.5$  dB log linearity, and with pulse width optimization, 30 nsec pulses can be logged. We also supply them in bipolar configurations to provide a full 80 dBv dynamic range in either direction.

Our DIRECT COUPLED LVA's process pulses with duty factors in excess of 25%, accurate enough to detect a small pulse whose leading edge occurs 2 to 3 usec after the trailing edge of a large pulse. Our basic dc unit has been expanded to operate as a bipolar amplifier with a dynamic range of 80 dBv in either direction.

We recently announced a new BASELINE SERVOED LOG AMP that permits ac coupling with 25% or greater duty factors, and minimal baseline shift. All our log amps can be provided as high speed LOGARITHMIC MICROWAVE RECEIVERS mated with RF detectors in octave bandwidths from 0.10 GHz to 18.0 GHz. For the whole story circle the number below or write:

**american astrionics**  
Division of TECHNICAL, INC.  
291 KALMUS DRIVE  
COSTA MESA, CALIFORNIA 92626  
TELEPHONE (714) 557-8480

INFORMATION RETRIEVAL NUMBER 222

ELECTRONIC DESIGN 24, November 22, 1973

## ac, dc, volts, amps, ohms 25 ranges \$595 complete 5-day delivery



- New expanded AC response to 100 KHz
- New carrying case option
- New color-coded pushbuttons
- New battery pack with recharger (\$95) mounts internally
- 0.01% dc accuracy
- 1,000 megohm input impedance on 3 lowest ranges
- lab, field, or systems use.

For Model 7004A literature, contact your Scientific Devices office or Systron-Donner at 10 Systron Drive, Concord, CA 94518. Phone (415) 682-6161. **Europe:** Munich, W-Germany; Leamington Spa, U.K.; Systron-Donner S.A. Paris (Port Marly) France. In **Australia:** Systron-Donner Pty. Ltd. Melbourne.

**SYSTRON**  **DONNER**

INFORMATION RETRIEVAL NUMBER 223



## Will your next frequency counter have all these features?

Here's the first 512 MHz Frequency Counter designed specifically for communications people... Systron-Donner's Model 6252. It's the only counter offering all these features:

**Relay input protection. Indicator light and reset button.**

**Metered input. Visually indicates high/low signal strength.**

**Tone measurement. Example: measure 1020.001 Hz in 1 second.**

**Accuracy. Stabilities to 5 parts in 10<sup>6</sup>.**

**Built-in battery. An exclusive 6252 option. Take your counter anywhere.**

**FCC. Meets or exceeds FCC requirements.**

All of these features, plus more, for \$1,095. For immediate details, call us collect on our Quick Reaction line: (415) 682-6471. Or you may contact your Scientific Devices office or Systron-Donner at 10 Systron Drive, Concord, CA 94518.

**SYSTRON**  **DONNER**

INFORMATION RETRIEVAL NUMBER 224

**WHICH IS FASTER, MORE RELIABLE,  
AND EASIER TO USE  
FOR PROGRAM  
PREPARATION?**



**LINC TAPE  
and it comes**

**with a Complete Operating System**

Computer Operations has plug-compatible, mass-memory for NOVA, DEC PDP-11, HP-2100, and many other mini-computers. The LINC Tape Operating System provides complete support for assemblers, loaders, text editors, BASIC, FORTRAN and file utilities.

LINC Tape is 28 times faster than paper tape and 15 times faster than cassettes. And it has proven error-free performance and reliability.

- Low Price and quick delivery
- Complete plug-to-plug compatibility
- Block addressable disc format
- 8400 bytes/sec transfer rate
- 100,000 passes without error guaranteed
- 204,800 or 335,872 data bytes per reel in blocks of 512
- Utility software drivers - complete operating system for most popular minis
- Expandable to 16 drives
- Optional compatibility with DEC tape®



LINC TAPE  
TRANSPORT

For your own satisfaction, see LINC Tape demonstrated before you decide on any mass-memory system.

**Computer Operations, Inc.**

10774 TUCKER ST. BELTSVILLE, MD.  
20705 301-937-5377

INFORMATION RETRIEVAL NUMBER 199

## FREQUENCY RESPONSE ANALYZERS

005 - 20,000 HZ AMPLITUDE RATIO & PHASE SHIFT  
40 db NOISE AND HARMONIC REJECTION ONE & TWO  
CHANNEL SWEEP AND PLOT OR POINT BY POINT



LOW COST - DUAL METERS

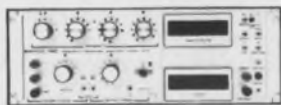

DUAL DIGITAL READOUT OF AMPLITUDE  
RATIO (db) AND PHASE SHIFT



60 db DYNAMIC RANGE TWO CHANNEL - SWEEP  
AND PLOT AMPLITUDE RATIO (db) AND PHASE  
SHIFT VS. LOG FREQUENCY

**BAFCO, INC.**

717 MEARNS ROAD  
WARMINSTER, PENNSYLVANIA 18974  
TEL.: (215) 674-1700 • TWX No. 510-665-6860

INFORMATION RETRIEVAL NUMBER 200

## CUSTOM POWER SUPPLIES

**O**ne day delivery  
**M**oney saving  
**N**o engineering charge  
**I**ngenious design

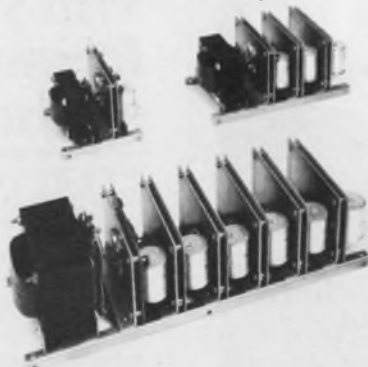

"OMNI" POWER SYSTEMS  
Request free bulletin 115A  
or call for field engineer.

L-206

**Deltron**

WISSAHICKON AVE. NORTH WALES, PA 19454  
PHONE (215) 699-9261 • TWX (510) 661-8061

INFORMATION RETRIEVAL NUMBER 201

## design aids

### National selection guides

An updated voltage-comparator selection guide contains complete information on all of National's voltage comparators including the new quad comparator, the LM139, and the new high-speed comparators, the LM160 and LM161. Another guide contains complete information on all of National's hybrid and monolithic op amps, including the new quad op amps, the LM124 and LM3900. National Semiconductor, 2900 Semiconductor Dr., Santa Clara, Calif. 95051.

INQUIRE DIRECT

### Heat-shrinkable tubing

An eight-page guide outlines and illustrates Thermofit heat-shrinkable tubings. A selection chart includes available materials and their characteristics, descriptions, applications, strength and dielectric behavior and functional specifications, as well as applicable UL and government material recognition. Raychem Corp.

CIRCLE NO. 335

### NEMA configuration chart

An AH/NEMA configuration chart for general-purpose nonlocking plugs and receptacles and the company's locking-type plugs and receptacles is now available on 8-1/2 x 11 in. sheets, printed two sides. Arrow-Hart.

CIRCLE NO. 336

### Motor controls

Whatever the type motor to be controlled, designers will find the right solid-state motor control in this selection guide, says the manufacturer. KB Electronics.

CIRCLE NO. 337

### Microvolt/dBm scale

A conversion scale converts microvolts to dBm and vice versa. The 10-in. scale is printed on silver foil with adhesive backing suitable for permanent attachment to an instrument. Over-all size is 11 x 1-1/8 in. Singer Instrumentation.

CIRCLE NO. 338



**NEED TOP QUALITY ENCODERS?  
THEN, COME TO THE LEADER!**

Itek manufactures Digisec<sup>®</sup>, the line of optical shaft encoders. Digisec encoders are available from 1-1/2-inch synchro mount to 8-inch through hole for on axis mounting. DIGISEC encoders range in resolution from 100 counts/revolution to 21 bits/revolution—absolute and incremental models. Send for free catalog.



STANDARD FOR THE INDUSTRY



MEASUREMENT SYSTEMS DIVISION  
Christina Street, Newton, MA 02161  
(617)969-7300 TWX 710-335-6783

INFORMATION RETRIEVAL NUMBER 202

**DID YOU GET THE WORD?**

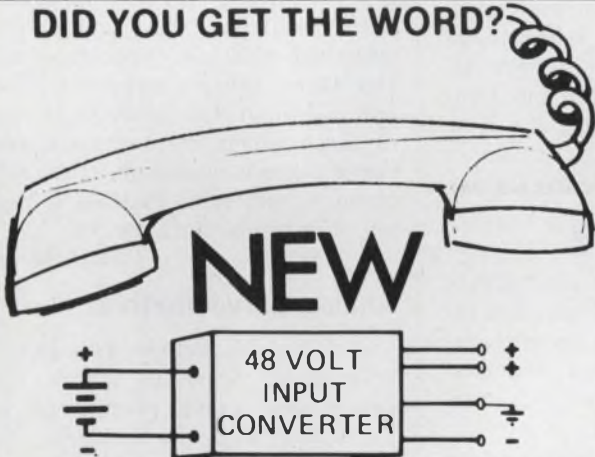

MIL ELECTRONICS can convert your 48 Volt DC source into something usable, like 5VDC . . . or  $\pm 15$ VDC . . . or both . . . or any other voltage . . . or two . . . or three

**FREE!** SEND FOR Bulletin No. 732 for complete list of models available



**MIL ELECTRONICS, INC.**  
LOWELL, MASS. 01854 617-453-4142

INFORMATION RETRIEVAL NUMBER 203

ELECTRONIC DESIGN 24, November 22, 1973

**MEASUREMENTS**

**JUST ANOTHER  
SIGNAL GENERATOR?**

**NOPE!**



**IT'S THE 880!**

A new MEASUREMENTS instrument from our expanded facilities in Manchester, N.H. is our MODEL 880 SOLID STATE AM SIGNAL GENERATOR. Replacing the famous MODEL 80 unit, the new 880 provides . . .

- Very stable carrier frequencies from 2 to 470 MHz
- Electronic fine tuning
- Low R.F. leakage for sensitivity measurements to 0.1  $\mu$ V
- Clean signals with 1000 Hz internal sine wave modulation
- Accurate and automatic control of output voltage
- Direct reading scales and dials
- Frequency dial individually calibrated
- Carrier frequency, modulation and output voltage controls designed for ease of operation
- Solid state power supply and modulator
- Provision for external modulation to 20 kHz

880's close tolerance specs—plus its portability, lightweight and rugged construction—make it ideal for testing radio and television equipment in the field, on the production line or in the lab.

For complete Model 880 literature, contact . . .



**McGRAW-EDISON  
COMPANY**

**Edison Electronics Division**  
Greiner Field Municipal Airport,  
Manchester, New Hampshire 03103  
(603) 669-0940 • TWX 710-220-1747

INFORMATION RETRIEVAL NUMBER 204

269



# POWER

FOR YOUR

- OP AMPS
- LINE RECEIVERS
- COMPARATORS

Convenient, money saving, practical — V-PAC\* power sources give you needed voltages for linear ICs from standard +5v source. Operate as many as 25 linear devices from a single V-PAC power source!

Standard DIP pin configuration, and less than a third cubic inch volume, lets you use V-PAC sources right on the PC card, with minimum length interconnections.

TYPE:	VA 12-12	VA 15-15	VA 12-6
VOLTAGES:	+12 -12	+15 -15	+12 -6

Write or call for full specifications.

**WEST:**

213-843-5200  
214-231-6181  
505-265-6794  
312-654-8645  
415-593-2189  
206-747-9424

**EAST:**

513-761-5432  
201-992-2505  
803-288-4450  
416-743-9130  
617-272-7655  
305-941-5544



**Reliability, Inc.**

5325 Glenmont, Houston, Texas  
77036 • 713-666-3261

Europe and the Far East: TISCO (TI Supply Co.)

TWX: 910-881-1739 \*TM, Reliability, Inc.

INFORMATION RETRIEVAL NUMBER 205

## application notes

### Bobbin-coil production

Information on quintupling bobbin coil production with a model 5-SPA attachment is given in a two-page bulletin. Geo. Stevens Manufacturing Co., Chicago, Ill.

CIRCLE NO. 339

### SCR power controllers

Six application notes describe the use of "Red-Pac" series of SCR power controllers. These notes cover manual and automatic control applications involving various feedback circuits required for current limiting, current regulation, voltage regulation and thermistor inputs. Vectrol, Rockville, Md.

CIRCLE NO. 340

### Copper alloys

Engineering properties of a copper-magnesium-zirconium-chromium alloy—including high-temperature strength, electrical conductivity, elongation and creep—are documented in a four-page paper entitled "A New Copper Alloy with High Strength and Conductivity." AMAX Copper, New York, N.Y.

CIRCLE NO. 341

### Throughhole testing

Two techniques for nondestructively testing the thickness and integrity of the plating in through-holes of PC boards are described in a paper. Unit Process Assemblies, Woodside, N.Y.

CIRCLE NO. 342

### XYZs of remote plotting

The coming of age of remote plotting is uniquely illustrated in a four-color, 16-page brochure. The brochure is devoted to exploring the birth and development of time-shared remote plotting, the present capabilities of remote computer graphics and answering such questions as who can use remote plotting systems and what systems are presently available. Zeta Research, Lafayette, Calif.

CIRCLE NO. 343

### Nickel powders

An illustrated technical bulletin features the properties and uses of nickel powders. The composition, physical characteristics and applications are given for the company's Type 123, 255, 287 and 435 powders. International Nickel Co., New York, N.Y.

CIRCLE NO. 344

### Graphic-processing system

"Printed Circuit Board Application Brochure" describes the use of the AGS 700 graphic-processing system in producing drawings, documentation, artwork masters and numerical-control data. Applicon, Burlington, Mass.

CIRCLE NO. 345

### Flexible heating elements

Design applications for flexible silicone rubber heating elements are described in a four-page brochure. Electro-Flex Heat, Bloomfield, Conn.

CIRCLE NO. 346

### Electrical insulation

The 42-page Electrical Insulation Materials Guidebook covers heat-shrinkable tubing of all kinds; with insulated wire and cable, electrical sleeving, pressure-sensitive tapes, fabrics and yard goods and Eastman 910 adhesive. Prices of the products discussed are generally shown alongside the data given. Commercial Plastics & Supply, Cornwells Heights, Pa.

CIRCLE NO. 347

### Analog servo method

A four-page article uses circuit schematics, drawings, block diagrams and curves, plus simple algebra to explain the operation of a reel-to-reel drive that provides constant tape velocity in digital cassette recorders. Ross Controls, Waltham, Mass.

CIRCLE NO. 348

### Self-sealing fasteners

Two "Applications in Industry" notes provide background data and technical illustrations on Seelskrew applications in hydraulic control systems and recalibration instrumentation for industrial thermometers. APM-Hexseal, Englewood, N.J.

CIRCLE NO. 349

## ALPAC® ... A Semtech Original!

There are a lot of rectifier assemblies that look like ALPAC. But only the original ALPAC (a Semtech trademark) has a time-tested proven design.

ALPAC, short for aluminum package, features insulated terminals and rugged terminal/rectifier construction.

Introduced by Semtech more than 10 years ago, ALPAC continues to give the industry a new packaging concept offering increased reliability while lowering equipment production costs.

ALPAC is the only series of component assemblies that utilizes the "state-of-the-art" Metoxilite hermetically sealed rectifier — the silicon rectifier with more NASA and MIL approvals than any other device manufactured today.

Internal components are supported in a low thermal impedance, epoxy thermoset-filled high alumina ceramic. This construction firmly secures and insulates the internal components to temperatures above 300°C.

Don't specify a "look alike" specify ALPAC, the original!

NOTE: "Fast Recovery" available in all ALPAC types.



## ALPAC 50

... Nice to have a-round!



A complete line of single phase full wave silicon bridge rectifiers available in the ALPAC 50 round (2 inch dia. x 1.0 inch high) package. Average rectified current of 50A @ 75°C case temperature, single cycle surge 375A, PIV from 50 to 1000V.

## New ALPAC R 50

... With corners!

Available in single phase and three phase full wave bridge assemblies. Measuring only

1.0x2.0x1.1 inches, a solution to stud rectifier packaging problems. Rated to handle 50A at 55°C case temperature. PIV from 50 to 600V. Single cycle surge current is 375A.



"We're number 1 because we try harder"



**SEMTECH**  
CORPORATION

652 Mitchell Road, Newbury Park, California 91320  
(805) 498-2111, (213) 628-5392 / TWX: 910-336-1264

CHICAGO: (312) 352-3227  
DALLAS: (214) 253-7644  
FLORIDA: (305) 644-5404  
NEW JERSEY: (201) 654-4884  
SAN FRANCISCO: (415) 328-8025  
EUROPEAN SALES: (Switzerland) (042) 323-242

®ALPAC IS A REGISTERED TRADEMARK  
OF THE SEMTECH CORPORATION

## ALPAC ... The industry standard!

The first ALPAC bridge rectifier on the market, has a proven record in such applications as power supplies, AC to DC converters and motor controls. Designed to eliminate stud rectifier packaging problems. Available in medium and fast recovery with PIV of 50 to 600V and average rectified current of 25A at 55°C case temperature (20A for fast recovery devices). Size 1.125 x 1.125 x 1.0 inches. Also available are doubler and center taps.



## ALPAC Jr.

... The big little package!



Even though this multipurpose device features a small case (.75x.75x.50 inches), it can handle an average rectified current of 5A at 55°C case temperature. Single cycle surge rating of 50A and available in PIV from 50 to 600V.

## ALPAC Sr.

... For the big jobs!

When you need an average rectified current of 150 to 250A with PIV from 50 to 600V, look to ALPAC Sr. They can handle the load. Available in full wave, three phase full wave and three phase half wave bridges, doublers and center taps.

## ALPAC - 3

... Phase three!



A logical extension to our original ALPAC is a three phase, full wave bridge rectifier. Average rectified current rating at 55°C case temperature is 25A, PIV from 50 to 600V, single cycle surge 150A. Size 2.25x.80x.75 inches.

## New

## ALPAC-3 Jr.

... The smallest three phase!



A three phase full wave rectifier, measuring only 1.25x.45x.40 inches. The device has a low profile. Although small, ALPAC-3 Jr. will handle an average rectified current of 5A at 55°C case temperature, PIV of 50 to 600V, and a single cycle surge current of 50A.

## New ALPAC3-"T"

... The thin one!



A small three phase full wave rectifier, measuring .75x 1.25x .40 inches, capable of supplying an average rectified current of 10A at 55°C case temperature. Single cycle surge rating of 150A, available in PIV from 50- 600V.



# new literature



## Filters and oscillators

A 24-page catalog offers specification guidelines and illustrates crystals, crystal filters and crystal oscillators. Metric dimensions are included. McCoy Electronics, Mount Holly Springs, Pa.

CIRCLE NO. 350

## Fluorescent readouts

Construction, electrical and brightness characteristics, applications, and drive circuits for single and multidigit fluorescent green-emitting tubes are covered in a 24-page catalog and a 4-page data sheet. Ise Electronics, Gardena, Calif.

CIRCLE NO. 351

## Power supplies

Power supplies specifically designed to fit in spaces that would not accommodate conventionally shaped supplies are described in a bulletin. Acopian, Easton, Pa.

CIRCLE NO. 352

## Printer interface

Basic interfacing of matrix electrostatic printers and plotters to various computers is detailed in an eight-page bulletin. The bulletin includes pin-connection lists and timing diagrams. Also discussed are print, plot and simultaneous print/plot operations. Versatec, Cupertino, Calif.

CIRCLE NO. 353

## Rare and specialty gases

A 90-page catalog describes 172 rare and specialty gases and mixtures. Prices are included. Airco Industrial Gases, Murray Hill, N.J.

CIRCLE NO. 354

## Delay lines

A 20-page catalog presents precision delay lines, laboratory decade delay lines, variable and fixed attenuators and video equalizers. "How-to-specify delay lines" covers definitions, types of delay lines, applications, construction and cost factors. Allen Avionics, Mineola, N.Y.

CIRCLE NO. 355

## Control devices

A 20-page brochure describes final control devices, including motor operators and solid-state power controllers. The brochure has a selection guide and lists features, accessories, specifications, ordering instructions and prices. West Instrument Div., Schiller Park, Ill.

CIRCLE NO. 356

## EMI filter connectors

Electrical and physical specifications for connectors with integral EMI protection for sensitive circuits are provided in a 24-page catalog. The Bendix Corp., Sidney, N.Y.

CIRCLE NO. 357

## Annunciators

Annunciators and off-normal monitors are illustrated and described in a 16-page condensed catalog. Panalarm Div., Skokie, Ill.

CIRCLE NO. 358

## Ovens

A 20-page catalog describes specially designed laboratory and production equipment. Specifications are provided for precisely controlled reach-in and walk-in ovens for electronic, chemical and metal processing in addition to refrigerated and humidified test chambers and incubators. Hotpack Corp., Philadelphia, Pa.

CIRCLE NO. 359

## IC replacement guide

An integrated-circuit replacement guide cross-references more than 1700 linear and digital IC types to the equivalent Sylvania devices. GTE Sylvania, Emporium, Pa.

CIRCLE NO. 360

## Resistor handbook

An updated handbook on precision and power wire-wound resistors includes cross-reference charts for MIL-spec resistors, data on resistance temperature characteristics, fast rise time resistors, high-frequency resistors and heat distribution curves for beryllium and other core materials. RCL Electronics, Irvington, N.J.

CIRCLE NO. 361

## R&D instrumentation

A two-page illustrated short-form catalog provides capsule descriptions, specifications and applications of an infrared micro-scanner, microscopes, precision radiation thermometers, photo-electronic pyrometer and infrared detectors. Barnes Engineering, Stamford, Conn.

CIRCLE NO. 362

## Transformers

Transformers are described and illustrated in a 14-page bulletin. Included are channel frame mount open coil, bracket mount open coil, specialty and universal mount control transformers. Dormeyer Industries, Chicago, Ill.

CIRCLE NO. 363

## Photosensitive devices

A full-color, plastic-coated card includes curves showing the spectral response of different photocathode materials as a function of wavelength. It includes, too, the emission wavelength of various materials like As, Hg, GaP, HeNe and GaAs. Included also are an absorbance chart, a decibel-conversion chart, a radiation-conversion chart, important physical constants and key energy-conversion factors. The card accompanies a 24-page catalog of photomultiplier tubes, phototubes, photocells, pickup tubes, various types of video equipment and accessories. Hamamatsu TV, Middlesex, N.J.

CIRCLE NO. 364

# Greater RFI/EMI shielding in new, narrow-width contact strips from Instrument Specialties

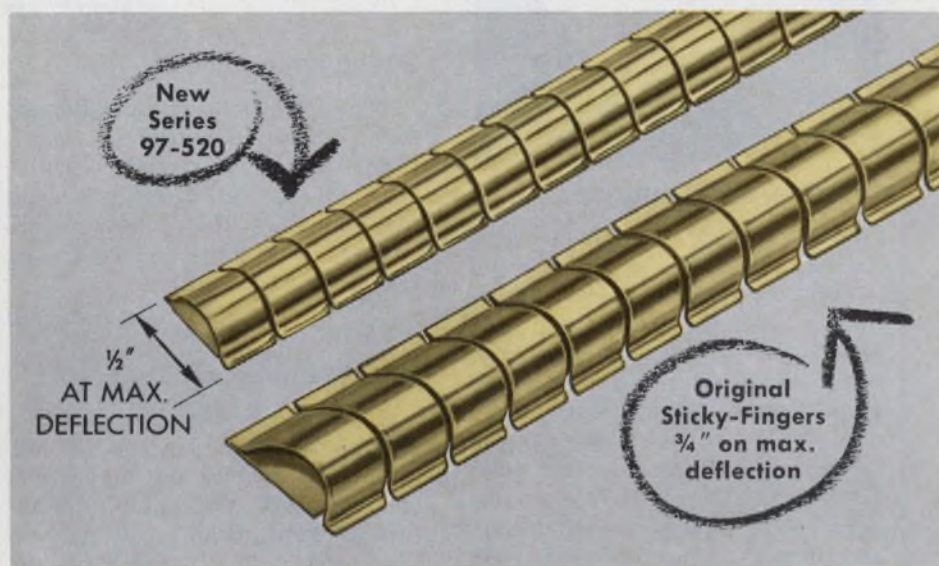

Latest addition to **sticky fingers**® line!

Instrument Specialties now offers Sticky-Fingers self-adhesive, beryllium copper contact strips in three variations to solve your most critical RFI/EMI problems.

Comparable to the shielding effectiveness of the original Sticky-Fingers, our newest series 97-520\* offers shielding effectiveness of 92 dB at 10 GHz plane wave or greater than 92 dB at 1 MHz magnetic, and has a dynamic range of 0.10". Yet, it measures a scant 3/8" wide, and 1/2" at maximum deflection.

Supplied in standard 16" lengths, series 97-520 is ideal for metal cabinets and electronic enclosures where variations exist in the space to be shielded, and where high shielding effectiveness must be maintained in narrow spaces, even with frequent opening and closing of the cabinet.

Select the exact series that fits your application best. Write today for a complete catalog, list of finishes available, and our latest Independent Shielding Evaluation Report. Address: Dept. ED-68

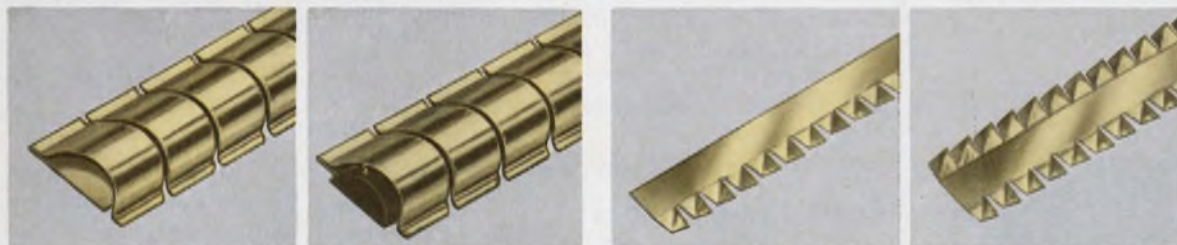

Series 97-500\*—the original 3/4" wide Sticky-Fingers. Specify when you require greatest possible shielding and where space permits. Also, supplied as 97-510 with Magnifil® for optimum magnetic shielding.

For those all-purpose applications where economy and space are both factors, specify the 3/8" wide single-twist series 97-555, or 1/2" wide double-twist series 97-560 Sticky-Fingers.

*Specialists in beryllium copper springs since 1938*

\*Patented

INFORMATION RETRIEVAL NUMBER 207

ELECTRONIC DESIGN 24, November 22, 1973

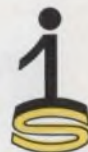

INSTRUMENT SPECIALTIES CO., INC.  
Little Falls, New Jersey  
Phone 201-256-3500

273

# Switch switches fast

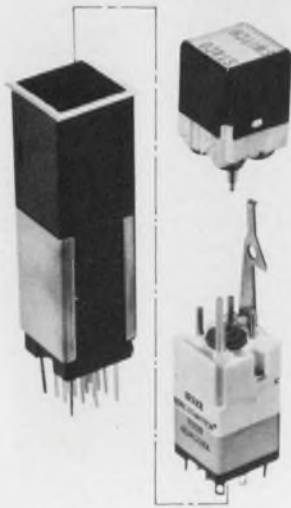

On those rare occasions when a switch malfunction shuts down equipment, STACO's Model 49 Illuminated Pushbutton Switch, with its plug-in switch module, can have things running again in less than 60 seconds. Simply flip a lever to remove the display pushbutton, and pull out the toilworn switch module. Slip in the plug-in replacement unit and reinsert the display pushbutton. It's that simple... and that fast!

No need to touch the behind-the-panel wiring. Once terminations are wired into the system, plug-in modules can be removed and replaced from front of panel. Choice of economical, dependable solder or wrap type terminations.

If your operation cannot tolerate downtime, then STACO's Model 49 can help keep the wheels turning. Its proven switch mechanism assures long service life and when at long last it needs replacing, a new module quickly plugs in. There's a choice of switch action and circuitry to meet your requirement.

When you think switch... think STACOSWITCH.



**STACOSWITCH**  
a STACO, Inc. company

1139 BAKER STREET, COSTA MESA, CALIF. 92626  
(714) 549-3041 TWX 910-595-1507

Other STACO Company products: Fixed Ratio Transformers, STACO, INCORPORATED, Richmond, Indiana; Variable Transformers, STACO, INCORPORATED, Dayton, Ohio.

INFORMATION RETRIEVAL NUMBER 208

## NEW LITERATURE



### Ferrites and memories

Four large catalogs provide comprehensive background information as well as specific product information on a very wide variety of ferrite components and memories. The first, in 132 pages, covers ferrites "mainly for consumer use." The second, in 364 pages, is for "telecommunication and industrial fields." The third, in 158 pages, deals with microwave materials and devices. The fourth, in 236 pages, covers cores, planes, stacks, complete memories, pulse transformers and computers. TDK Electronics Co., Ltd., Chicago, Ill.

CIRCLE NO. 365

### Communication components

A loose-leaf catalog features specifications and dimension diagrams for communication and magnetic components. ADC Products, Minneapolis, Minn.

CIRCLE NO. 366

### GaP crystals

A stock list on gallium-phosphide single crystals describes over 100 crystals including wafers and boules, both doped and undoped, in various carrier concentration ranges. Most of the crystals are (111) orientation, but a few (100) grown crystals are described. Image Analyzing Computers, Monsey, N.Y.

CIRCLE NO. 367

### Coaxial terminations

"Where Terminations Begin" features specifications, derating curves and outline dimension drawings on broadband precision fixed coaxial, medium-power and high-power fixed coaxial terminations and coaxial adapters. Narda Microwave, Plainview, N.Y.

CIRCLE NO. 368

### Delay equalizers

Specifications, schematics and curves for a low-cost delay equalizer for use in facsimile and fast data circuits are described in a bulletin. Polyphase Instruments, Bridgeport, Pa.

CIRCLE NO. 369

### Spectrum analyzer

"The 30-Hz Resolution Revolution" shows applications, waveforms and characteristics which you can use to determine what the company's 7L13 spectrum analyzer can do for you. Tektronix, Beaverton, Ore.

CIRCLE NO. 370

### Ultra-miniature connectors

A handbook describes the use of an ultra-miniature line of connectors and cables for high-density miniature packaging. Microtech, Folcroft, Pa.

CIRCLE NO. 371

### Molded tantalum-chip C's

Tiny tantalum-chip capacitors, in values from 0.1 to 22  $\mu$ F and 6.3 to 35 V, molded to simplify handling for PC or ceramic-substrate mounting, are covered in five pages of specifications that accompany a 4-page brochure on dipped tantalums. Both types are said to be available for quick delivery. Matsuo Electronics, Gardena, Calif.

CIRCLE NO. 372

### Dc power supplies

Specifications for IC regulated modular dc power supplies are contained in a two-color, four-page catalog. Power One, Woodland Hills, Calif.

CIRCLE NO. 373

### Components

The major feature of an Engineering Manual & Purchasing Guide includes engineering drawings of electronic components. Physical dimensions allow efficient design of electronic packages before components are purchased. Electrical properties of all items are included. For your copy, send \$1 for postage and handling to: Allied Electronics, 2400 W. Washington Blvd., Chicago, Ill. 60612.

SEASTROM OFFERS ITS ALL NEW COMPREHENSIVE CATALOG #40B. This 250 page catalog features the company's full range of products in a colorful book specially indexed for ready reference.

Including such items as . . .

- Flat Round Washers—Metallic
- Flat Round Washers—Non-Metallic
- Spring Washers
- Shoulder Washers
- Tab & Notch Washers
- Washers—Miscellaneous Configurations
- Expansion Plugs
- Military Standards
- Clamps & Brackets
- Spring Clips
- Solder Lugs
- Solid State Insulators
- Bus Bars, Terminal Blocks & Insulating Strips
- Miscellaneous Electrical/Electronic Hardware/Tags
- Sheet Metal Nuts & Strips
- Engineering Tables, Materials & Finish Specifications
- Numerical & Alphabetical Index of Parts

No need to design it . . . you will undoubtedly find it in Seastrom's Catalog all stocked for immediate delivery . . . write to



**SEASTROM**

MANUFACTURING CO., INC.

701 SONORA AVE., DEPT.  
GLENDALE, CALIF. 91201  
(213) 245-9121 • TWX 910-497-2271

**PREP**



INFORMATION RETRIEVAL NUMBER 209

**Test record not required!  
Designed for CD-4  
demodulator measurements**



MSG-321

CD-4 System Record Signal Generator

The MSG-321 is a record signal generator of the discrete four-channel system type. It generates a signal corresponding to left and right components of one side of the groove of a CD-4 record, thereby eliminating the need for a test record. Applications include research, adjustment, and inspection for demodulator isolation, distortion, and signal-to-noise ratio.

Please see our catalog for details.



**MEGURO DENPA SOKKI K.K.**

No. 5, 1, 2-chome, Chuo-cho, Meguro-ku, Tokyo, Japan  
TEL: 715-1211 Cables: MEGURODENPA TOKYO

INFORMATION RETRIEVAL NUMBER 210

ELECTRONIC DESIGN 24, November 22, 1973



**Here Now . . .  
A New Advance  
In Low Voltage  
Safety . . .**

**DORMEYER  
CONVERTER/CHARGER**

- Meets all requirements for safe low voltage.
- Virtually eliminates UL listing problems.
- Greatly reduces heat in final application.
- Compact . . . dependable . . . low cost.
- Versatile—use as AC-DC power converter, AC-DC power converter/charger, AC-DC converter, AC-AC low voltage transformer or nickel-cadmium charger.

Request bulletin and quote.



**DORMEYER INDUSTRIES**

A Division of A. F. Dormeyer Mfg. Co., Inc.

3414 N. Milwaukee Ave., Chicago, Ill. 60641

Factories: Chicago, Ill., Kentland and Rockville, Ind.

Telephone: 312-283-4000

Leading Manufacturers of Solenoids, Coils & Transformers

INFORMATION RETRIEVAL NUMBER 211

**No down-time  
in rotary  
switches**

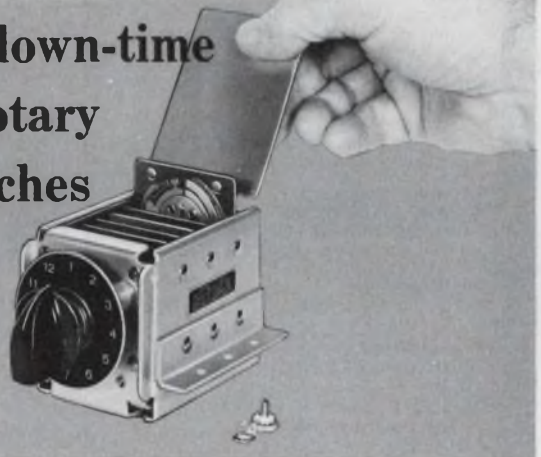

**Unique 5-second water replacement obsoletes other switches. Simply lift out old wafer, slip in new wafer. No unsoldering . . . no disassembling . . . no wire removing.**

CDI patented switches with dust covers are available in sizes 2" x 2", 3" x 3", and 4" x 4" with lengths to accommodate up to 36 wafers. Switches can be customized to your specifications.

Operation may be manual, motor or solenoid for use in any rotary selector switch application. Now supplied for numerous military and commercial applications.

Mfd. under Tabel U. S. Patents 2,841,660, 2,971,066, 3,015,000, 2,956,131, 2,988,607.

**CHICAGO DYNAMIC INDUSTRIES, INC.**



PRECISION PRODUCTS DIVISION

1725 Diversey Blvd., Chicago, Ill. 60614. Phone 312, WE 5-4600

INFORMATION RETRIEVAL NUMBER 220

CIRCUIT-STIK introduces

# GP BOARDS

**GENERAL PURPOSE  
CIRCUIT BOARDS  
Plug-in & Chassis Mounting  
and ELECTRONIC  
PACKAGING MATERIALS**

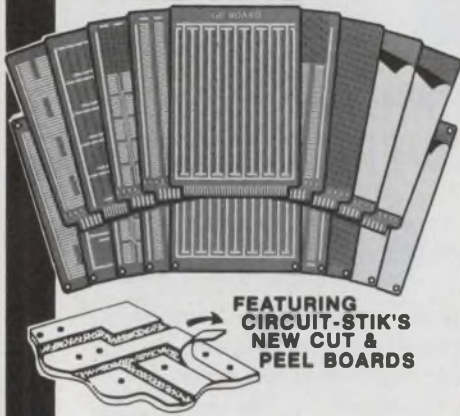

**FEATURING  
CIRCUIT-STIK'S  
NEW CUT &  
PEEL BOARDS**

## GP CIRCUIT BOARDS

### HIGH QUALITY

- FR-4 Blue Epoxy Glass
- Computer "DRILLED", High Accuracy Holes (not punched)
- Mil-Spec Plating
- Precision Routed Edges

### VERSATILITY

- Mix All Types of DIP Sockets (8 to 40 Leads)
- Low, Medium and High Profile Interconnections
- Hybrid Designs for Mixing Discretes and Sockets
- Designed for Edge Connector "Plug-In" or Chassis Mounting
- RFI Shielding

### HIGHEST DENSITY

- Up to 50 DIP's on one 4½" x 6½" Plug-In Card Plus Space for 50 Decoupling Capacitors

### COMPLETENESS of STANDARD DESIGNS

- Choose from 74 Off-the-Shelf Boards
- 4 Sizes of Boards available

### APPEARANCE

- Beautiful Gold, Blue and Bright Tin

### FULL LINE of ACCESSORIES (HIGH QUANTITY PRICING AVAILABLE)

- Sockets - Low and Standard Profile, P.C. and Wire Wrap - Molded Nylon and Highest Quality Gold Contacts
- Adapterplugs
- Connectors
- Card Pull Handles

### EPOXY GLASS BOARD MATERIALS

- 76 Standard off-the-Shelf Boards
- Including Unclad, Copper Clad, Cut & Peel Copper Clad, Pre-etched "X-Y" Pattern and Plated thru Hole Copper Clad
- .100" Grid Hole Pattern or Undrilled

SEND FOR YOUR FREE CATALOG

**circuit-stik**®

P.O. BOX 3396  
Torrance, California 90510  
Phone (213) 530-5530

INFORMATION RETRIEVAL NUMBER 212

## NEW LITERATURE



### 1N, 2N, 3N semiconductors

A 44-page Interchangeability & Cross-Reference Guide lists over 600 semiconductor types including 1N, 2N, 3N and popular industry house numbers with cross-references to either an exact GE type or a suggested replacement. General Electric, Syracuse, N.Y.

CIRCLE NO. 374

### Resistive devices

A 14-page catalog outlines compact thin-film and thick-film resistive devices. Airco Speer Electronics, Niagara Falls, N.Y.

CIRCLE NO. 375

### Microwave components

An eight-page brochure describes microwave components and rf absorbing material. Eastern Microwave, Winchester, Mass.

CIRCLE NO. 376

### Solvent cleaners

At least a half-dozen ways in which production costs might be reduced by incorporating a freon solvent cleaning system in the manufacturing process are cited in a brochure. DuPont Co., Wilmington, Del.

CIRCLE NO. 377

### Desktop index

The AMT Desktop Index gathers together articles from a number of publications in a convenient manner. The cost of the index is \$7 by itself, or the index and the first six-month supplement are available for a cost of \$9. AMT Desktop Index, P.O. Box 11275, Kansas City, Kan. 66111.

## Relays and switches

An eight-page catalog features relays, stepping switches and accessories. A photo and diagram of each product, plus particulars on design terminals, contacts, coil, maximum ambient temperature, maximum switching rate and other data are included. Schrack Electrical Sales Corp., New York, N.Y.

CIRCLE NO. 378

## Epoxy adhesives

A brochure contains detailed charts of epoxy, adhesive and insulating compounds. Amicon Corp., Lexington, Mass.

CIRCLE NO. 379

## Mixers and transformers

Double-balanced mixers, power splitter/combiners and rf wide-band transformers are featured in a catalog. The catalog includes definition of terms, reliability considerations, applications, specifications and 365 performance curves. Mini-Circuits Laboratory, Brooklyn, N.Y.

CIRCLE NO. 380

## Back-panel wires

Kynar insulated, UL/CSA listed back-panel wires, featuring flame, chemical and radiation resistance, mechanical toughness and thermal stability up to 130 C, are described in a data sheet. Brand-Rex, Willimantic, Conn.

CIRCLE NO. 381

## Matrix controller

A description and application data for a programmable matrix controller are contained in a four-color, 12-page brochure. Allen-Bradley, Highland Heights, Ohio.

CIRCLE NO. 382

## MECL data book

The "MECL Integrated Circuits Data Book," third edition, has been expanded to 585 pages and lists almost 500 devices. A new section covers phase-locked loops. Reference lists of articles and application notes are included, as well as a general information section with its own index. A quick selector guide facilitates device selection. The price is \$3 per copy. Order direct from Motorola Semiconductor Products Div., P.O. Box 20924, Phoenix, Ariz.

# THE SPACE SAVER

## WITH 10 AMP CAPABILITY

The RU 110 series is a new miniature low profile relay with an unusually high rated breaking capacity of 10 amps at 2200 VA. The 1 Form C relay contact is rated @ 6 amps, 250 VAC continuous duty. Dimensions: 1 1/8" long x 3/4" wide x 1/2" high, in clear dust cover for PCB mounting. Coil voltages range from 5-110 VDC. The relay can be operated in any position. Call or write for catalogs and complete specifications.

**SCHRACK** ELECTRICAL SALES CORP.  
1140 Broadway  
New York, N.Y. 10001  
(212) 683-0790

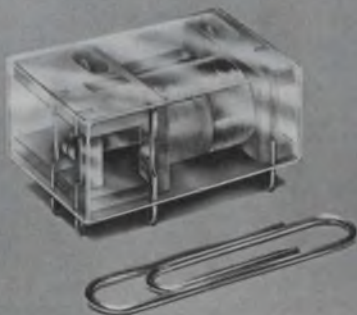

INFORMATION RETRIEVAL NUMBER 213

Engineering samples on request.



## May we offer you a light?

The super-dependable light of C&K's newest ILLUMINATED ROCKER SWITCHES. Available in SPDT and DPDT models, these contemporary, sub-miniature snap-in switches are completely "made-in-America" from quality materials, yet the prices are surprisingly competitive! Front relampable, they accommodate midget screw base bulbs in popular T-1 1/2 and T-1 3/4 sizes, and you can choose snap-off actuator/lens in either Red, Green, Amber or White. And, quite honestly, they're matchless! **C&K COMPONENTS, INC.**, 103 Morse Street, Watertown, MA 02172. Tel: (617) 926-0800 TWX: 710-327-0460.

INFORMATION RETRIEVAL NUMBER 214

## NOW YOU CAN USE YOUR OWN MICROSCOPE TO ACCURATELY MEASURE THIN FILM THICKNESS

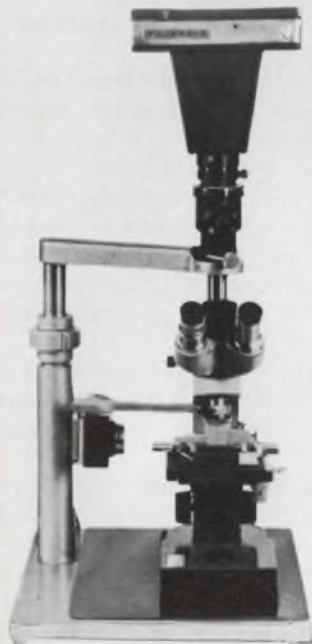

The Watson Interference Objectives can be used with almost any microscope; measure film thickness within 200 Å and 2 microns; no contact, non-destructive, Michelson principle. Objectives have RMS thread for use with any available microscope. No special adaptation. Most economic and convenient method to measure film thickness quickly and accurately.

Request reprint of article "Technique for Fine Depth Measurement" and Brochure



**HACKER INSTRUMENTS, INC.**  
Box 646, Fairfield, New Jersey 07006 • (201) 226-8450

INFORMATION RETRIEVAL NUMBER 215

# Eliminate HP400 tube degradation!

## Throw out tubes, plug in FETRONs.

The major cause of HP400 recalibration problems is tube degradation. FETRONs eliminate tube degradation once and for all. FETRONs are solid-state vacuum tube replacements that plug directly into your HP400 voltmeter tube sockets. Unlike vacuum tubes, the solid-state FETRON doesn't drift and it lasts for the life of the equipment. Wouldn't you like to cut maintenance costs to nearly nothing? Call or write for more information on our simple HP400 FETRON conversion kit.



**TELEDYNE SEMICONDUCTOR**

1300 Terra Bella Avenue, Mountain View, California 94043  
Phone (415) 968-9241 TWX 910-379-6494 Telex 34-8416

INFORMATION RETRIEVAL NUMBER 216

**I'm an L.E.D.  
illuminated  
Capitol Switch**  
..QUALITY and  
DEPENDABILITY ...  
that's where I shine!



**We're just part of  
the gang . . . .**  
Top quality, dependable  
circuit selector  
push-button and  
lever switches - - -  
many custom combinations  
and assemblies

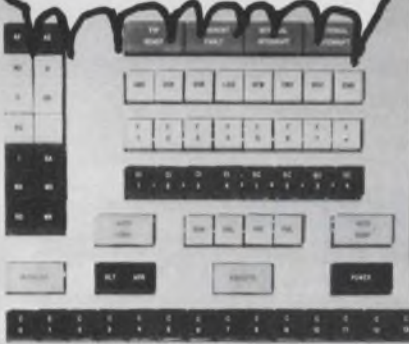

**ALTERNATE ACTION PUSH BUTTON  
SWITCHES**  
ILLUMINATED, NON-ILLUMINATED  
SINGLE POSITION, MULTIPLE  
POSITION

**LEVER SWITCHES**  
ILLUMINATED, NON-ILLUMINATED

**MOMENTARY PUSH BUTTON  
SWITCHES**  
ILLUMINATED, NON-ILLUMINATED  
SINGLE POSITION

**INTERLOCKING PUSH BUTTON  
SWITCHES**  
ILLUMINATED, NON-ILLUMINATED

**INDICATOR LITES**  
SINGLE POSITION, MULTIPLE  
POSITION

**Write for our 24 page catalogue**  
Representatives in principal cities.

**CAPITOL SWITCHES**

THE CAPITOL MACHINE & SWITCH CO.  
87 NEWTOWN RD. DANBURY, CONN. 06810

INFORMATION RETRIEVAL NUMBER 217

## bulletin board

Fairchild Camera & Instrument Corp. has announced it will serve as an alternate source for the 8T series of line drivers and receivers. The series includes the 8T13 and 8T14 general-purpose driver and receiver, and the 8T23 and 8T24 driver and receiver which meet the requirements for interfacing IBM System 360/370 input-output systems to TTL and DTL logic elements.

CIRCLE NO. 383

National Semiconductor Corp., 2900 Semiconductor Dr., Santa Clara, Calif. 95051 has expanded its 54C/74C line of CMOS circuits with the addition of five new circuit types. The 54C/74C line now consists of 26 devices functionally equivalent to, and pin-for-pin and power-supply compatible with standard and low-power 54/74 series TTL.

INQUIRE DIRECT

Four-Phase Systems has released a new version of DATA IV/70, the key-to-disc software package provided with the firm's Intelligent Terminal Systems. The system provides enhanced data validation capability and supports up to 22 video terminals for use in keypunch replacement and source data entry applications.

CIRCLE NO. 384

Signetics, 811 E. Arques Ave., Sunnyvale, Calif. 94086, has announced a design applications contest to promote the company's new D-MOS field-effect transistors. Included are the SD202/203 8.8-GHz amplifiers, SD210/211 digital and analog switches and the SD304 low-cost dual-gate vhf amplifier. The contest began Oct. 1 and ends Jan. 15, 1974. Every respondent will receive a contest entry kit containing one free D-MOS device of his choice. First prize is a 1974 air-conditioned Vega. Second prizes are two HP45 scientific calculators, and third prizes are 25 hand-held four-function electronic calculators.

INQUIRE DIRECT

Motorola Inc., Semiconductor Products Div., has introduced seven plastic-packaged integrated circuits in its MECL 10,000 fast-logic family. Motorola is now committed to the production of nearly all existing ECL 10,000 logic functions in low-cost plastic.

CIRCLE NO. 385

A CRT intelligent data terminal is in the works at Pertec Corp., Santa Ana, Calif. Including a built-in microprocessor, the terminal will handle data rates of from 110 to 9600 b/s and will display 920 characters. The characters will be generated using a 7 x 9 dot matrix. An option will expand the display to 1920 characters. First production is anticipated in the first quarter of 1974.

CIRCLE NO. 386

The Cyphernetics Corp. has announced a time series data-base management system called TSAM, Time Series Access Methods.

CIRCLE NO. 387

### Price reductions

Tensor Corp.'s model 4900A telephone recorder has been reduced in price by \$30 to \$139.95; similar price reductions have been made on other models in the line. An increased warranty policy covers all machines for one year on labor and six months on parts.

CIRCLE NO. 388

OEM prices for The Bendix Corp.'s all-electronic Datagrid Digitizer system have been reduced for the second time this year. The new OEM pricing is complemented by an improved discount schedule which can save an additional 15% on quantities of 16 or more units.

CIRCLE NO. 389

Dialight Corp. has reduced prices 20% on its 730 series readouts.

CIRCLE NO. 390

Texas Instruments has lowered prices on its line of low-profile, solder-tail IC sockets by an average of 10%. TI has achieved these price reductions without lowering gold thickness on its connector contacts despite the increasing gold price and the trend to reduce or eliminate gold.

CIRCLE NO. 391

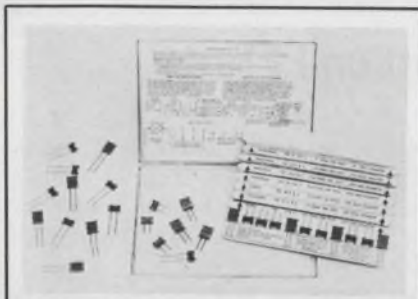

**Do-it-yourself instant resistor kit.** No more waiting for delivery. We supply you with everything you need to make that resistor. Each kit contains 6 different value insulated resistance wires (.5 to 30 ohms/ft.), bobbins, and instructions. Temperature stability 10 ppm. Chromomite Labs, 21011 S. Figueroa St., Carson, Calif. 90047. (213) 320-9452

INFORMATION RETRIEVAL NUMBER 181



**1090 Digital Storage Oscilloscope.** Easy operation, exceptional resolution, numerical readout, mid-signal triggering, display expansion up to 64 times on both axes, and ability to store and display up to 4 waveforms simultaneously are just some of its features. Nicolet Instrument Corporation, 5225 Verona Road, Madison, Wisconsin 53711. (608) 271-3333.

INFORMATION RETRIEVAL NUMBER 182



**Thin-Trim variable capacitors** provide a reliable means of adjusting capacitance without abrasive trimming or interchange of fixed capacitors. Series 9401 has high Q's and a range of capacitance values from 0.2-0.6 pf to 3.0-12.0 pf and 250 WVDC working voltage. Johanson Manufacturing Corporation, Boonton, New Jersey (201) 334-2676.

INFORMATION RETRIEVAL NUMBER 183



**Hot Shots: StripTweez, ResisTweez, ConducTweez, LapFlo—4** separate tools that plug into one power supply. For soldering, unsoldering, lap flow soldering, wire stripping, conformal coating removal, repairing broken circuit runs, unclenching leads, releasing sweat joints, etc. Pace, Inc., 9329 Fraser Street, Silver Spring, MD 20910. (301) 587-1696.

INFORMATION RETRIEVAL NUMBER 184

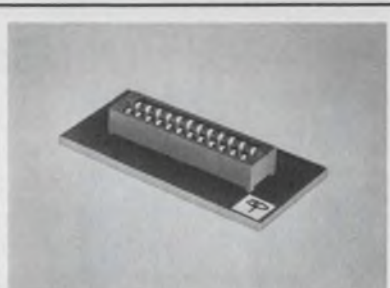

**Economical 16, 20, & 24 Pin Low Profile Edge-board Connector** available for 1/16" thick circuit board. Designed for panel meter industry where display board mounts perpendicular to mother board. Holding force approximately 8 pounds. Pins on .100" centers; rows .200" across. A P Products Incorporated, Box 110, Painesville, Ohio 44077.

INFORMATION RETRIEVAL NUMBER 185



**ASR 33 replacement keyboards.** TTL scanning circuitry provides error free two-key rollover. Features include internal repeat functions, custom two-shot molded keytops, optional coded adder block. Keyboard enclosure available. Contact: KEY TRONIC CORPORATION, Bldg. 14, Spokane Industrial Park, Spokane, Washington 99216

INFORMATION RETRIEVAL NUMBER 186



**TEMPERATURE STABLE VARIABLE COIL** Inductance values .065 uh to 4700 uh with extremely High "Q". Adjustable to plus or minus 15% standard and plus or minus 30% upon special request Temp. range -55°C to plus 125°C. Jarry Electronics 613-632-2751

INFORMATION RETRIEVAL NUMBER 187



**New working lab standard.** Precision AC-DC current calibrator produces precise current levels from 1 $\mu$ a F.S. through 1 amp F.S.. Delivers up to 2 amps at a compliance voltage of  $\pm$  10 volts. Ideal for DVM current calibration  $\pm$ .01% on DC and  $\pm$ .05% on AC to 10 KHz. Price: \$895. De. Stock. Valhalla Scientific, Inc., 7707 Convoy Ct., San Diego, CA 92111

INFORMATION RETRIEVAL NUMBER 188

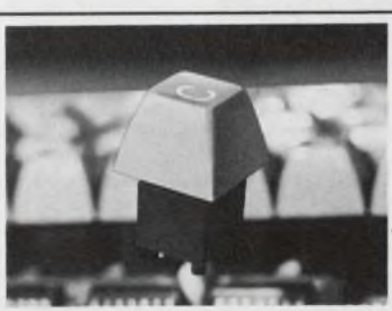

**Gold v-bar keyboard switches . . .** These inexpensive\*, low-bounce, high-reliability switches cut design costs. Letterhead request brings free sample. Or call (703) 751-3030. Mechanical Enterprises, 5249 Duke St., Alexandria, Va. 22304. \* (as low as 17¢ each in production quantities.)

INFORMATION RETRIEVAL NUMBER 189



ELECTRONIC DESIGN's function is:

- To aid progress in the electronics manufacturing industry by promoting good design.
- To give the electronic design engineer concepts and ideas that make his job easier and more productive.
- To provide a central source of timely electronics information.
- To promote communication among members of the electronics engineering community.

**Want a subscription?** ELECTRONIC DESIGN is sent free to qualified engineers and engineering managers doing design work, supervising design or setting standards in the United States and Western Europe. For a free subscription, use the application form bound in the magazine. If none is included, write to us direct for an application form.

If you do not qualify, you may take out a paid subscription for \$30 a year in the U.S.A., \$40 a year elsewhere. Single copies are \$1.50 each.

If you change your address, send us an old mailing label and your new address; there is generally a postcard for this bound in the magazine. You will have to requalify to continue receiving ELECTRONIC DESIGN free.

**The accuracy policy** of ELECTRONIC DESIGN is:

- To make diligent efforts to ensure the accuracy of editorial matter.
- To publish prompt corrections whenever inaccuracies are brought to our attention. Corrections appear in "Across the Desk."
- To encourage our readers as responsible members of our business community to report to us misleading or fraudulent advertising.
- To refuse any advertisement deemed to be misleading or fraudulent.

Microfilm copies are available of complete volumes of ELECTRONIC DESIGN at \$19.00 per volume, beginning with Volume 9, 1961. Work is now in process to complete the microfilm edition of Volumes 1-8. Reprints of individual articles may be obtained for \$2.00 each, prepaid (\$.50 for each additional copy of the same article) no matter how long the article. For further details and to place orders, contact the Customer Services Department, University Microfilms, 300 North Zeeb Road, Ann Arbor, Michigan 48106 telephone (313) 761-4700.

**Want to contact us?** If you have any comments or wish to submit a manuscript or article outline, address your correspondence to:

Editor  
ELECTRONIC DESIGN  
50 Essex Street  
Rochelle Park, N.J. 07662

# Design Data from

## Free Comparison Report on FFTs

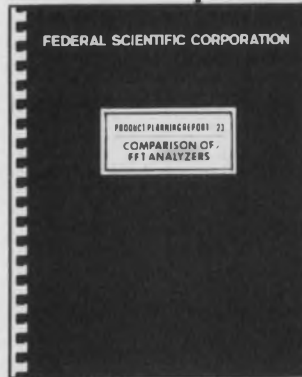

Recently Federal Scientific conducted a detailed side-by-side analysis of current Fast Fourier Transform systems—specification by specification—with the aim of designing a better unit, its own Omniferous™ FFT Analyzer.

This Product Planning Report #23, originally prepared as an internal document, includes comparisons of speed, dynamic range, usable resolution, ease-of-use, price.

Please call or write Joseph Flink, VP Data Processing.

### Federal Scientific Corp.

CIRCLE NO. 171

An affil. of Nicolet Instrument  
615 West 131st Street, New York, N.Y. 10027. (212) 286-4400.

## Free — Modular Ac to Dc and Dc to Dc Power Supply Catalog



Modular D.C. Power Supplies are described in this new 20 page brochure. It gives applications, specifications and features on a complete line of P.C. board mounting D.C. Power Supplies for both digital and linear integrated circuits.

Included is a selection guide which categorizes D.C. Power Supplies according to output (volts and current), regulation data, price information, and complete mechanical specifications.

CIRCLE NO. 172

### DATEL SYSTEMS, INC.

1020 Turnpike Street, Canton, MA. 02021

## 400 IDEAS FOR DESIGN Volume 2

Edited by Frank Egan



A unique sourcebook of practical design techniques and approaches using the latest components, representing the best contributions to *Electronic Design's* "Ideas for Design" column. All selected for their practical value in solving the design engineer's most common, everyday problems. They have proved useful as parts of larger designs or as aids in measuring the parameters and testing the effectiveness of existing designs. 288 pp., 7 1/8 x 9 3/4, illus., cloth, \$11.95. Circle the reader-service number to order a 15-day examination copy.

CIRCLE NO. 173



HAYDEN BOOK COMPANY, INC., 50 Essex St., Rochelle Park, N.J. 07662

# Manufacturers

Advertisements of booklets, brochures, catalogs and data sheets. To order use Reader-Service Card.  
(Advertisement)

## DIGITAL FOURIER ANALYSIS SYSTEM 306



Provides complete spectral, cross spectral, correlation, cross correlation and related analysis.

- One Push Button per function eliminates programming.
- Simultaneous display of two spectra or phase and magnitude.
- Digital storage provides uninterrupted display (flicker-free).
- Drives two XY Plotters simultaneously (doubles throughput).
- Zoom FFT analysis for super high resolution.
- Unique Fourier-Fortran™ for your own non-standard or automated analysis.
- 1/3 and 1/15 octave analysis.

OPTIONAL: Magnetic tapes and discs, high speed plotters, multi processor configurations, multi channel analog multiplexer, teletypes and CRT Terminals.

ALSO AVAILABLE: Medium and high speed hardwired FFT and general purpose array processors for Data General Nova Computers.

### ELSYTEC

212 Michael Drive, Syosset, N.Y. 11791  
Phone (516) 364-0560

CIRCLE NO. 174

## PRACTICAL RELAY CIRCUITS

By Frank J. Oliver



Uniquely groups various relay circuits according to the functions they perform, enabling the systems designer to quickly select the best circuit for his specific purposes. Includes arc and RFI suppression systems; time delay function; audio tone control and resonant-reed relays; sequential relays; protective functions of relays against overload overvoltage, and overcurrent, pulse generation and detection; logic circuits; and more. Particularly important is coverage of pulse-operated relay systems now extensively used with automated control systems. Illustrated with many circuit diagrams using the latest American National Standard graphical symbols. 363 pp., 6 x 9 1/4, illus., cloth, \$14.95. Circle the reader-service number to order a 15-day examination copy.

CIRCLE NO. 175



HAYDEN BOOK COMPANY, INC., 50 Essex St., Rochelle Park, N.J. 07662

## New Precision Low Frequency Analyzer



Model 2449  
Wave and Spectrum  
Analyzer  
PORTABLE  
LOW FREQUENCY  
HIGH RESOLUTION

A new brochure describes Quan-Tech's new Model 2449 Wave and Spectrum Analyzer which covers frequency measurements from 10 Hz to 50 KHz in one range with 1 Hz resolution. Frequency readout: 5 digit LED display. Electronic tuning with sweep increments of 5 or 50 KHz can be initiated at any starting frequency in the spectral range. Selectable sweep periods of 50 or 500 seconds. Select a 7 Hz bandwidth for high precision frequency measurements—a 1000 Hz bandwidth for high scan capability—or a 100 Hz bandwidth for a compromise between resolution and scan speed. Dynamic range greater than 75 dB, full scale input signal voltage from 30  $\mu$ V to 300 V in 15 ranges. Priced at only \$2050., the instrument is portable—weighs 20 lbs. Option provides 115 VAC for lab use or 12 VDC for field use. Front and rear covers available. Delivery: 30 days.

CIRCLE NO. 176

### Quan-Tech

Div. of KMS Industries, Inc.  
43 South Jefferson Road  
Whippany, N. J. 07981

# Electronic Design

## Advertising Sales Staff

Tom W. Carr  
Vice President &  
Sales Manager

## Rochelle Park, N.J. 07662

Robert W. Gascoigne  
Daniel J. Rowland  
50 Essex Street  
(201) 843-0550  
TWX: 710-990-5071

## Philadelphia

Thomas P. Barth  
50 Essex Street  
Rochelle Park, N.J. 07662  
(201) 843-0550

## Boston 02178

Gene Pritchard  
P.O. Box 379  
Belmont, Mass. 02178  
(617) 489-2340

## Chicago 60611

Thomas P. Kavooras  
Berry Conner, Jr.  
200 East Ontario  
(312) 337-0588

## Cleveland

Thomas P. Kavooras  
(Chicago)  
(312) 337-0588  
(call collect)

## Los Angeles 90303

Stanley I. Ehrenclou  
Burt Underwood  
2930 Imperial Highway  
Inglewood, Calif.  
(213) 757-0183

## San Francisco 94022

Jerry D. Latta  
P.O. Box 1248  
Los Altos, Calif.  
(415) 965-2636

## London W. 1

For United Kingdom and Holland  
Brayton C. Nichols

For Eastern Europe  
Peter Kehr

The American Magazine Group

9 Warwick Street  
London, W. 1, England  
Phone: 437 5462  
Cable: Ammagnic, London

## Tokyo

Haruki Hirayama  
Electronic Media Service  
5th Floor, Lila Bldg.,  
4-9-8 Roppong  
Minato-ku  
Phone: 402-4556  
Cable: Electronicmedia, Tokyo

## Recruitment, Quick Ads, Classified

Allen Weinberg  
50 Essex Street  
Rochelle Park, N.J. 07662  
(201) 843-0550



# advertiser's index

Advertiser	Page	Advertiser	Page	Advertiser	Page
AMP, Incorporated	Cover II	Federal Scientific Corporation	281	PRD Electronics, Inc.	258
AP Products	279	Fuji Ltd.	265	Pace, Inc.	279
Adams & Westlake Company, Inc., The	247	Function Modules, Inc.	224	Perfection Mica Company	264
AirBorn, Inc.	266	GTE Automatic Electric	72, 73	Pertec Corporation	239
Allen Bradley Co.	65	General Electric Company	64	*Philips Industries, Electronic Components and Materials	73
Allied Electronics, Division of Tandy Corp.	228	General Radio Company	97	Piher International	116, 117
American Astrionics	267	Grayhill, Inc.	257	Powertec, Inc., An Airtronics Subsidiary	20
Amphenol Industrial Division, Bunker-Ramo Corp.	8, 9	Hacker Instruments, Inc.	277	Premier Metal Products Company	258
Amplifier Research Corporation	263	Harris Semiconductor, A Division of Harris Intertype Corporation	157	Princeton Electronic Products, Inc.	242
Analog Devices, Inc.	80, 81, 96	Heath/Schlumberger Scientific Instruments	122	Pyrofilm Corporation	219
Ansley Electronics Corp.	192, 193	Heinemann Electronic Company	243	Quan-Tech, Division of KMS Industries, Inc.	281
B & K Instruments, Inc.	240	Hewlett-Packard	2, 94, 95, 130, 136, 137, 169	RCA Instrumentation	259
Bafco, Inc.	268	Hickok Instrumentation and Controls Division	252	RCA Solid State Division	22, 151, 170, 253, Cover IV
Ballantine Laboratories, Inc.	265	Honeywell, Signal Analysis Operation	124	Radio Switch Corporation	262
Beckman Instruments, Inc. Helipot Division	82, 83	Iic Data Devices, Inc.	48	Raytheon Semiconductor	24, 25
Boonton Electronics Corporation	236, 237	Imc Magnetics Corporation	251	Rental Electronics, Inc.	30
Bourns, Inc., Trimpot Products Division	29	Itt Semiconductor, A Division of International Telephone and Telegraph Corporation	18	Reliability, Inc.	270
Buckeye Stamping Company, Inc.	261	Industrial Electronic Engineers, Inc.	262	Robinson Nugent, Incorporated	255
C & K Components, Inc.	277	Instrument Specialties Company, Inc.	273	Rockland Systems Corporation	245
CTS Corporation	265	Intech, Incorporated	244	Rogan Corporation	165
Caddock Electronics	216	Intersil	14, 15	Rogers Corporation	259
Cambridge Thermionic Corporation	181	Interstate Electronics Corporation	128	Ross Controls Corporation	228
Capitol Machine & Switch Co., Inc., The	278	Itek Measurement Systems Division	269	SRC Division/Moxon, Inc.	254
Centralab, The Electronics Division of Globe-Union, Inc.	31	Jarry Electronics	279	Schrack Electrical Sales Co.	277
Chicago Dynamics Industries, Inc.	275	Johanson Manufacturing Corp.	7, 279	Seastrom Manufacturing Co., Inc.	275
Chronomite Laboratories	279	Kay Elemetrics Corp.	150	Semtech Corporation	271
Christensen Radio, Inc.	256	Keithley Instruments, Inc.	17, 19, 21, 23	SenSitol, Inc.	257
Chrono-log Corp.	267	Keystone Electronics Corp.	261	Signetics Corporation	139
Circuit-Stik	276	Keytronic Corp.	279	Siliconix, Incorporated	154
Clare & Co., C. P.	Cover IV	Krohn-Hite Corporation	71	Simpson Electric Company	235
Clare-Pendar	227	Kurz-Kasch, Inc.	229	Singer Instrumentation, The Singer Company	105
Colorado Video, Incorporated	263	Lambda Electronics Corp.	198 thru 214	Sorensen Lighted Controls, Inc.	259
Columbia Research Labs.	266	Ledex, Inc.	248	Sprague Electric Company	6
Computer Design Corporation	106	Litronix, Inc.	64	Staco Switch	274
Computer Operations	268	MCL, Inc.	261	Systron-Donner	238, 267
Continental Connector Corporation	156	Mf Electronics, Inc.	256	TRW, Electronic Components	195, 197
Corning Glass Works, Electronic Products Division	4, 5	McGraw-Edison Company	269	TRW, Globe Motors, An Electronic Components Division of TRW Inc.	188
Counterscan	104	Magnecraft Electric Company	286	TRW/IRC Resistors, An Electronic Component Division of TRW, Inc.	70
Dana Laboratories, Inc.	88, 89	Marconi Instruments	49 thru 54	TRW/UTC Transformers, An Electronic Components Division of TRW Inc.	182
Data Display Products	230	Mechanical Enterprises	279	TRW Semiconductors, Electronic Components Division of TRW Inc.	26
Data General Corporation	62, 63	Megatek	234	Tektronix, Inc.	35, 37
Data Precision Corporation	55	Meguro Denpa Sokki, K.K.	275	Tele-Dynamics/Wanlass Division of Ambac	246
Data Technology Corporation	107	Messerschmitt-Bolkow-Blohm	283	Teledyne Philbrick	183
Datascan Electronic Products	163	Mica Corporation	171	Teledyne Semiconductors	277
Datel Systems, Inc.	280	Microswitch, A Division of Honeywell	123	Telonic Industries, Inc.	225
Datatron, Inc.	191	Mil Electronics, Inc.	269	Test & Measuring Instruments, Inc.	129
Delta Products, Inc.	226	Motorola Semiconductor Products, Inc.	10, 11, 32	Texas Instruments, Incorporated	144, 145, 191
Deltron, Inc.	268	National Semiconductor Corporation	215, 231, 232, 233	Theta Instrument Corp.	263
Dialight Corporation	220, 221	Nelson Ross Electronics	218	Triplett Corporation	115
Dormeyer Industries, Inc.	275	Newport Laboratories, Inc.	36	Tucker Electronics Company	194
Dow Corning Corporation	12, 13	Nicolet Instrument	279	Tustin Electronics Co.	264
Dumont Laboratories	104	Nitron Corp.	152	U.S. Components, Inc.	254
Elco Corporation	87	North American Philips Controls Corp.	250	United Systems Corporation	114
ELDEC Corporation	241	Oak Industries, Inc.	222, 223, 285	Valhalla Scientific, Inc.	279
Electro-Motive Mfg. Co., Inc.	164			Watkins-Johnson	189
Electro Scientific Industries	138			Weston Instruments, Inc.	153
Electronic Arrays, Inc.	131				
Electronic Design	176, 177				
Electronic Communications, Inc.	260				
Electronic Navigation Industries	16				
Electronic Research Corporation	254				
Elsytec, Inc.	281				
Emerson & Cuming, Inc.	242				
Erie Technological Products Inc.	125				
Exar Integrated Systems	1				

recruitment  
and  
classified Ads

**SALES ENGINEER  
TEST INSTRUMENTS**

Engineers required with proven sales ability and general experience in the area of test instrumentation, RF measurement, Automatic Test Systems. Good knowledge of communication, microwave, telephone and TV industries desired.

Send resume to  
Mr. K. Elkins

**mi MARCONI  
INSTRUMENTS**  
DIVISION OF MARCONI ELECTRONICS INC.

111 CEDAR LANE □ ENGLEWOOD, NEW JERSEY 07631

**College dollars need  
time to grow.**



**Take stock in America.**  
With higher paying U.S. Savings Bonds.

**equipment for sale**

**IMMEDIATE DELIVERY  
Minis & Peripherals**

DEC-HIS-NOVA  
SEL-HP-MOHAWK  
CPU, Card, Printer, Tape,  
Disk

NEW-MOHAWK  
4320 PRINTERS

DATA PRINTER V132C  
DEC & HONEYWELL  
MODULES

PDP8 CPU \$1,500  
\$750 MINIS

TELETYPE 35 & 37  
For Sale/Rent  
617/261-1100

Send for Free Report  
"Maintenance of Computers"  
AMERICAN USED COMPUTER  
CORP.

P. O. Box 68, Kenmore Station  
Boston, MA 02215

CIRCLE NO. 180

**DESIGNER'S KIT.**

Four audible signalling devices produce 13 different sounds at \$29.95. Check or M.O.

**C. A. BRIGGS CO.**

PO Box 151, Glenside, PA 19038  
Phone 215-885-2244

**GIVE...  
HEART  
FUND**



**FREE ALARM CATALOG**

Full line of professional burglar and fire alarm systems and supplies. 80 pages, 400 items. Off the shelf delivery, quantity prices.

 mountain west alarm  
4215 n. 16th st., phoenix, az. 85016

**Systeme  
brauchen Elektronik**

Gemeinsam mit Partnern im In- und Ausland baut MBB den AIRBUS, das neue Kampfflugzeug MRCA, Flugkörper-Systeme sowie Forschungs- und Telekommunikations-satelliten. Diese Systeme brauchen Elektronik.

Wir beziehen die Komponenten von führenden Firmen aus aller Welt. Unsere Aufgabe ist der Entwurf der Gesamtlogik, die Abstimmung der Teile, der Bau von Zwischengliedern und die Fertigung und Wartung der Gesamtsysteme.

Die Magnetschwebbahn, das Cabintaxi sowie der Bau von Telemetrie-, Betriebsdatenerfassungs- und Prozeßsteuerungsanlagen sind neue Anwendungsgebiete unserer Elektronikerfahrungen aus Luft- und Raumfahrtaktivität.

Für die Mitarbeit an diesen Aufgaben sucht MBB

**INGENIEURE, PHYSIKER und  
MATHEMATIKER**

Die Vielfalt der Arbeiten schildert Ihnen der MBB-Stellenreport. Dieser Stellenreport gibt genaue Aufgabenbeschreibungen zu allen offenen Positionen. Er ermöglicht Ihnen eine gezielte Bewerbung. Fordern Sie bitte den MBB-Stellenreport an!

**MBB**  
MESSERSCHMITT-BÖLKOW-BLOHM

**Ideen. Und Produkte. Für die Zukunft Europas.**

An die  
Messerschmitt-Bölkow-Blohm,  
Bewerbungsleitstelle A14,  
8 München 80,  
Postfach 80 11 49,  
Tel. 0 89/60 00 22 43

**Coupon:**

Bitte senden Sie mir den „MBB System-Elektronik-Stellenreport“.

Name: \_\_\_\_\_

Anschrift: \_\_\_\_\_

Derzeitige Position: \_\_\_\_\_

Fachrichtung: \_\_\_\_\_

# product index

**Information Retrieval Service.** New Products, Evaluation Samples (ES), Design Aids (DA), Application Notes (AN), and New Literature (NL) in this issue are listed here with page and Information Retrieval numbers. Reader requests will be promptly processed by computer and mailed to the manufacturer within three days.

Category	Page	IRN	Category	Page	IRN	Category	Page	IRN
<b>Components</b>			<b>Instrumentation</b>			interference objectives	259	151
blower unit	248	302	amplifier, power	236	286	interferometer	260	327
CRT, color, data	250	304	analyzer, frequency	227	280	launchers, stripline	254	309
capacitors	7	6	analyzer, network	97	49	limiters, ferrite-diode	256	323
capacitors	164	80	analyzer, wiring	226	277	receiver, laser	258	324
components	4	5	analyzers, spectrum	124	60	switches, coax	255	320
components	117	57	analyzers, spectrum	136	67	triode, planer	254	310
cooling, thermo-elect.	250	303	analyzers, spectrum	218	99			
coupler, optical	10	15	bridges, test	240	118			
filters	6	5	calibrator, strain-gauge	228	282			
indicator, digital	114	54	clocks, digital	253	136	<b>Modules &amp; Subassemblies</b>		
LEDs	221	101	counter, frequency	253	139	amplifier	246	297
minitransformers	182	88	counters	122	58	amplifier	263	159
motors	188	90	DMM	253	138	amplifier, instr.	238	290
networks, resistor	248	301	DPM	226	276	amplifier, s/h	183	89
potentiometer	29	21	DPM	236	287	amplifier, servo	246	296
potentiometer, linear	251	305	DPMs	80	38	amplifiers	16	11
readout	262	156	DVM	107	56	controller, power	242	292
relay	72	36	demodulator, FM/AM	234	283	converter, a/d	224	103
relay	250	133	digitizer, transient	37	27	converter, a/d	244	270
relay, miniature	277	213	fault locator	237	288	converter/charger	275	211
relays	III	244	generator, digital	254	237	converter, digital	264	192
relays	247	130	generator, function	71	35	converter, scan	242	125
resistor, cermet-film	251	306	generator, pulse	128	62	converter, true rms	240	261
resistor circuit	171	84	generator, signal	105	52	converters	269	203
resistors	65	33	generator, signal	269	204	decoder, tone	247	300
resistors	70	34	generators, frequency	235	112	driver, lamp	243	294
resistors	219	100	generators, sweep	225	104	encoders	269	202
resistors, film	216	98	instrument	248	49	encoders, digital	263	158
solenoids, rotary	248	131	instruments, video	263	160	filter, active	238	291
switch lights	227	106	MDRs	286	219	generator, signal	237	114
switches	123	59	meter, instrument	224	265	ignition, electronic	226	105
switches	222	102	meter, vibration	266	196	multipliers, wideband	243	295
switches	262	157	meter, wow	234	285	oscillator, crystal	247	298
switches	278	217	meters	268	200	oscillator, power	261	153
switches, pushbutton	274	208	meters, gain-phase	130	64	oscillator, temp-comp.	242	293
switches, rocker	277	214	multimeter	88	45	oscillator, transmittal	247	299
switches, rotary	31	23	multimeter	252	135	oscillators, crystal	256	142
switches, rotary	265	193	oscilloscope	35	25	sensor, voltage	257	145
switches, rotary	275	212	oscilloscope	129	63			
switches, rotary	285	218	oscilloscope	227	279	<b>Packaging &amp; Materials</b>		
timer	1	2	oscilloscope	230	250	boards, circuit	276	212
timer, dual	24	19	oscilloscope	252	136	boards, terminal	261	155
			oscilloscopes	265	195	breadboard	219	275
<b>Data Processing</b>			oscilloscopes, rental	30	22	breadboard	219	275
display, cathode	2	3	photometer	228	281	cableholder	217	334
display, graphic	234	111	printer, digital	36	26	ceramic paper	218	273
drives, disc	239	117	synthesizer	229	253	connector, hybrids	219	274
interface card	223	260	synthesizer, frequency	258	147	connector, pin and socket	II	243
memories, tape	268	199	synthesizers, frequency	189	91	connectors	87	43
multiplexer, wire analyzer	104	51	synthesizers, frequency	245	128	connectors, board	266	197
probes, logic	229	109	synthesizers, frequency	237	289	connectors, cable	192	93
			tester, continuity	147	73	connectors, wrap/crimp	254	140
			tester, IC	226	278	enclosures, metal	258	148
			tester, IC	234	284	ferrofluids	218	272
			VOM, digital	235	112	hardware, termination	257	144
			VOMs	115	55	interconnectors	8	7
						kits	259	150
<b>ICs &amp; Semiconductors</b>			<b>Microwaves &amp; Lasers</b>			knobs	261	154
amps, log video	253	137	amp, log-video	256	322	knobs and dials	165	81
ICs	18	13	antennas, FM	252	307	resins and plastic foam	242	242
MOS/LSI	125	61	assemblies, coax-cable	252	308	screw, captive	218	271
op amp, inverting	157	78	capacitors, trimmer	260	326	shields	264	191
RAMs	14	9	filter, low-pass	258	325	strips, contact	273	207
ROMs	131	65	ICs, hybrid	255	321	substrate, copper-clad	217	257
rectifier, bridge	271	206						
rectifier, power	26	20						
rectifiers	IV	245						

# "We are such stuff as dreams are made on.."

W. Shakespeare



Life would be pretty dull if people couldn't dream. Take that boat you're always dreaming about. Just thinking about it makes you feel pretty good. But you won't just have to dream if you buy U.S. Savings Bonds. Because Bonds can make your dream boat a reality.

Now Bonds mature in less than six years. Which means maybe it won't take forever for your ship to come in.

Just knowing you've got the safety and security of U.S. Savings Bonds working for you can make dreaming for anything a lot more fun. Because, with Bonds, the good times and the good things can really happen.

So, don't give up dreaming. Just keep buying U.S. Savings Bonds—they're the stuff dreams are made of.



Now E Bonds pay 5 1/2% interest when held to maturity of 5 years, 10 months (4% the first year). Bonds are replaced if lost, stolen, or destroyed. When needed they can be cashed at your bank. Interest is not subject to state or local income taxes, and federal tax may be deferred until redemption.



## Take stock in America.

Now Bonds mature in less than six years.

Category	Page	IRN
----------	------	-----

<b>Power Sources</b>		
charger, battery	266	332
source, precision	262	329
supplies, modular	264	331
supplies, power	20	15
supplies, power	198	246
supplies, power	268	201
supply, dc	266	333
supply, modular dc	264	330
supply, modular, dc power	246	129
systems, UPS	262	328

### new literature

adhesives, epoxy	276	379
analyzer, spectrum	274	370
annunciators	272	358
capacitors, tantalum-chip	274	372
catalog	82	40
catalog	163	79
catalog	194	95
catalog	228	108
components, communication	274	366
components, microwave	276	376
connectors, EMI filter	272	357
connector, ultra-mini.	274	371
control devices	272	356
controller, matrix	276	382
crystals, GaP	274	367
delay equalizer	274	369
delay lines	272	355
ferrites and memories	274	365
filters and oscillators	272	350
IC replacement guide	272	360
mixers and transformers	276	380
ovens	272	359
photosensitive devices	272	364
printer interface	272	353
R&D instrumentation	272	362
rare and specialty gases	272	354
readouts, fluorescent	272	351
relays and switches	276	378
resistive devices	276	375
resistor handbook	270	361
semiconductors	276	374
solvent cleaners	276	377
supplies, dc power	274	273
supplies, power	272	353
terminations, coaxial	274	368
transformers	272	363
wires, back-panel	276	381

### application notes

analog servo	270	348
bobbin-coil production	270	339
controllers, SCR power	270	340
copper alloys	270	341
electrical insulation	270	347
fasteners	270	349
flexible heating elements	270	346
graphic processing system	270	345
plotting, remote	270	343
powders, nickel	270	344
throughhole testing	270	342

### design aids

chart, configuration	268	336
controls, motor	268	337
scale, microvolt/dBm	268	338
tubing, heat-shrinkable	268	335

## Need rotary switches? 2-million combinations, 72-hr. delivery from your Oak Moduline™ distributor.



Quick-and-easy ordering of Oak-quality rotary switches in lots of 1 to 99. The Moduline system lets you specify switch components by number (no drawings needed). Your order is shipped within 3 days. Contact these Moduline distributors:

### DRW

MASSACHUSETTS, Watertown. (617) 923-1900\*  
NEW YORK, Farmingdale. (516) 249-2660\*

### HALL-MARK

ALABAMA, Huntsville. (205) 539-0691  
FLORIDA, Orlando. (305) 855-4020\*  
GEORGIA, Atlanta. (404) 963-9728  
ILLINOIS, Chicago. (312) 437-8800  
KANSAS, Kansas City. (913) 888-4747  
KANSAS, Wichita. (316) 682-2073  
MARYLAND, Baltimore. (301) 265-8500  
MINNESOTA, Minneapolis. (612) 925-2944  
MISSOURI, St. Louis. (314) 521-3800  
NORTH CAROLINA, Raleigh. (919) 832-4465  
NEW YORK, New York. (516) 293-7500  
OHIO, Dayton. (513) 278-6963  
OKLAHOMA, Okla. City. Enterprise 50094  
OKLAHOMA, Tulsa. (918) 835-8458  
PENNSYLVANIA, Philadelphia. (215) 355-7300  
TEXAS, Austin. (512) 454-4839  
TEXAS, Dallas. (214) 231-6111  
TEXAS, Houston. (713) 781-6100  
WISCONSIN, Milwaukee. (414) 476-1270

### INDUSTRIAL COMPONENTS

MINNESOTA, Minneapolis. (612) 831-2666\*

### SOLID STATE

TEXAS, Dallas. (214) 352-2601\*  
TEXAS, Houston. (713) 785-5205

\*Assembly Locations

**OAK Industries Inc.**  
SWITCH DIVISION, CRYSTAL LAKE, ILLINOIS 60014

# MDR



## MERCURY DISPLACEMENT POWER RELAYS

Where sealed contact protection is required for explosive, corrosive, dirty or moist ambient conditions; where the use of contactors does not permit contact maintenance; where noiseless operation is required; where weight, size, and cost must be a minimum for contact ratings up to 100 amps,

Mercury Displacement Relays are unsurpassed.

This unique design, which incorporates broad cross-sections of liquid mercury for switching, is what makes the Mercury Displacement relay a high current, high voltage, high power device. Whereas conventional relays, which use hard contacts are destroyed by pitting and sticking under high load conditions, the perpetually self-renewing, mercury-to-mercury contacts insure maximum contact life and in-rush capabilities up to 15 times rated loads.

In a highly competitive business, delivery can be a deciding factor. If delivery is important to you, be aware that Magnecraft ships better than 90% of all incoming orders for stock relays, received before noon, THE SAME DAY (substantiated by an independent auditing firm). In addition to our shipping record, most stock items are available off-the-shelf from our local distributor.

# FREE!



## MDR CATALOG

The purpose of this 16-page catalog is to assist the design engineer in specifying the proper relay for a given application. The book completely describes 20, 35, 60, and 100 amp versions with one, two, or three poles as well as Time Delay models of Mercury Displacement Power Relays.

**Magnecraft** ELECTRIC COMPANY

5575 NORTH LYNCH AVENUE • CHICAGO, ILLINOIS 60630 • 312 • 282-5500 • TWX 910 221 5221

INFORMATION RETRIEVAL NUMBER 219

ELECTRONIC DESIGN 24, November 22, 1973

**“Service and replacement costs are skyrocketing. First, more is expected of my equipment and it’s a lot more complicated.**



**Next, the cost of sending a man out to remove and replace a simple component keeps going up. Add to that the cost of simple human error, and maintenance**

**costs go right out of sight.”**

The obvious answer is maintenance-free components. When it comes to relays, it's a simple choice: use capsule instead of open-faced electromechanical relays. And that's where Clare can help.

Clare's family of dry reed relays—PRME, MRB and remnant reed relays—eliminate the need for oversensitive, complex electromechanical devices. You cut maintenance costs and hike performance levels by designing out

your problems. And Clare makes every part of your relays—including the hermetically sealed capsules. Capsules are manufactured in a white-room environment and every single one is inspected for physical and electrical reliability. So, when you specify Clare reed relays, you know you're getting maximum reliability and quality.

Our expertise lies in the advanced design and manufacture of relays of all kinds, but our energy lies in the

application of relays to help you solve specific problems. We specialize in getting down to work.

If you need help—or just some good information—get in touch with us right now. The “right now bunch” is ready to go to work for you.

Contact your local Clare Distributor or Sales Engineer. C. P. Clare & Co., 3101 Pratt Avenue, Chicago, Ill. 60645 312/262-7700.

**QUALITY/SERVICE/RELIABILITY**

**we help. get in touch with us.  CLARE the “right now” bunch.**

a GENERAL INSTRUMENT company

GENERAL PURPOSE RELAYS MERCURY-WETTED RELAYS REED RELAYS SOLID STATE RELAYS TELEPHONE RELAYS STEPPING SWITCHES

INFORMATION RETRIEVAL NUMBER 244



# More than 6,000,000 good reasons...

## To insist on RCA Rectifiers and SCR's for your fast-switching applications.

If you have an immediate need for fast-switching devices, come to RCA where large quantity production of quality products is a way of life.

We produced over six million fast-switching thyristors for TV production during the past twelve months ... and millions of fast-switching rectifiers and SCR's for other industry needs during the same period.

These low cost dependable devices represent a lot of good reasons why you should insist on RCA Thyristors and Rectifiers.

Want more good reasons?

RCA offers a large selection of fast-switching devices for your most demanding applications. High-speed inverters, choppers, high-current pulse circuits, or "free-wheeling" diode circuits ... whatever your needs

are ... you'll find the right SCR or rectifier to match your circuit design.

RCA's all-diffused SCR's bring you the best combination of features ...

- fast turn-off time
- high di/dt and dv/dt
- high peak current capability
- exceptional uniformity and stability of characteristics

Match this combination with RCA's fast recovery rectifier features ...

- low reverse-recovery current
- low forward-voltage drop
- low thermal-resistance design ... and you can rest assured that your equipment is backed by the industry's leader in fast-switching technology.

No need to be concerned about quantity, availability, or cost. RCA fast-switching devices are available in quantity ... at prices you can afford.

Want more information? Write: RCA Solid State, Section 57K-22, Box 3200, Somerville, N.J. 08876. Or phone: (201) 722-3200,

Fast Switching SCR's		40555	S3704	S5210	2N3653	2N3658
Package		TO-66	TO-66	¼" stud	TO-48	TO-48
I <sub>RMS</sub>		5 amps	5 amps	10 amps	35 amps	35 amps
T <sub>OFF</sub> (Microseconds)		2-6	6-10	5-10	10-15	6-10
1K Price:	200V	1.67	.90	3.00	7.24	7.89
	600V	2.89	1.30	12.20	15.60	17.20

Fast Recovery Rectifiers		TA7895	44938	43884	43894	43904	40960
Package		DO-26	DO-15	DO-4	DO-4	DO-5	DO-5
I <sub>AV</sub>		1 amp	1 amp	6 amps	12 amps	20 amps	40 amps
T <sub>RR</sub> (Nanoseconds)		50-500	150-500	150-350	150-350	150-350	150-350
1K Price:	200V	.44	.42	1.79	2.42	3.20	3.40
	600V	.72	.66	3.13	4.37	6.00	6.70

**RCA Solid State**  
products that make products pay off

International: RCA, Sunbury-on-Thames, U.K., or Fuji Building, 7-4 Kasumigaseki, 3-Chome, Chiyoda-Ku, Tokyo, Japan. In Canada: RCA Limited, Ste. Anne de Bellevue B10, Canada.