

Electronic Design 12

VOL. 21 NO.

FOR ENGINEERS AND ENGINEERING MANAGERS

JUNE 7, 1973

Millions of R-C-L discretes still fill new circuits in spite of ICs. And older types serve side by side with the latest chips. But, old or new, they all suffer from

the basic problems: Time and stress still take their toll of life and tolerance. And specs still don't tell all. For a complete update on discretes, see p.56.

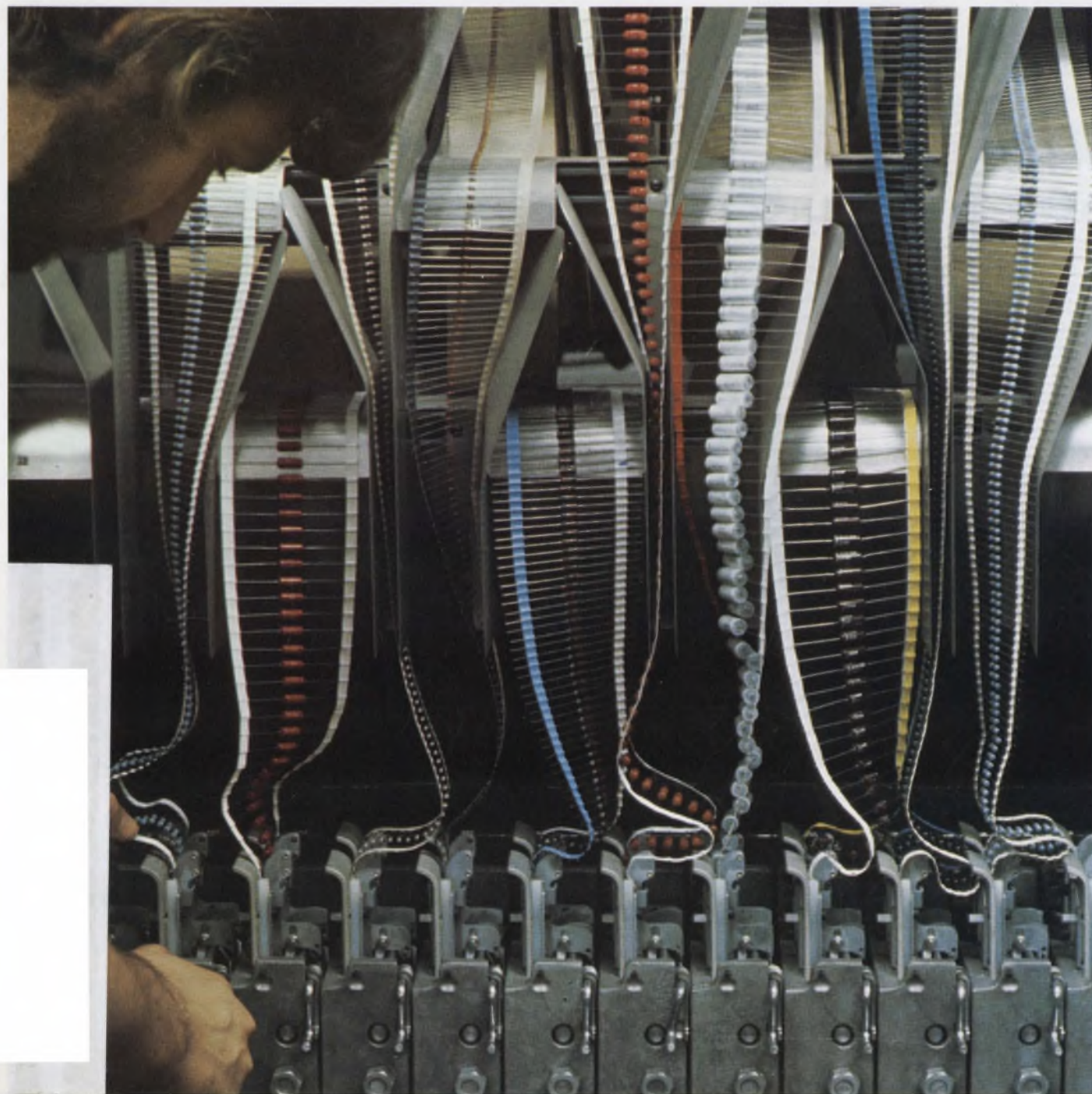

Do you face
a make or buy
decision on
power supplies?

BUY LAMBDA'S LZ SERIES THE ONLY FIELD REPAIRABLE P-C MOUNTABLE POWER SUPPLY.

Available in 3 package sizes,
in 26 single output and 19 dual output models
from \$35, up to 28 volts, up to 1400 mA.

COMPETITOR COMPARISON CHART

Lambda-Pak	Competitors' Model		Lambda-Pak	Competitors' Model		Lambda-Pak	Competitors' Model	
YES	NO	Fully repairable	YES	NO	Wide input voltage range—105-132 Vac	YES	NO	single and dual (tracking) outputs
YES	NO	Continuously adjustable voltage	YES	NO	Short-circuit proof	YES	NO	Designed for series operation
YES	NO	Multivoltage rated	YES	NO	Vacuum-impregnated transformer	YES	NO	Stocked and distributed from Los Angeles, Montreal, Chicago and New York
YES	NO	Foldback current limiting	YES	NO	Three different power packages			

LZ SERIES SINGLE OUTPUT MODELS

MODEL	VOLTAGE VDC	CURRENT mA	PRICE
LZS-10	5	450	\$35
LZS-11	12	195	35
LZS-20	15	300	55
LZS-30	5	900	65
LZS-33	15	400	65
NEW LZS-34	5	1400	95

LZ SERIES DUAL TRACKING OUTPUT MODELS

MODEL	VOLTAGE VDC	CURRENT mA	PRICE
NEW LZD-12	±15V	50	\$35
LZD-21	± 5	300	55
LZD-22	±15	90	40
LZD-23	±15	150	55
LZD-31	± 5	500	65
LZD-32	±15	220	65
NEW LZD-35	±15	300	95

For additional voltages, send for Lambda's 1973 catalog supplement L-3.

**1-DAY DELIVERY
60-DAY GUARANTEE**

LZ SERIES AVAILABLE IN 3 NEW MODELS



Regulation 0.15%—line or load; models LZS-10, LZS-30, LZS-34, LZD-21 and LZD-31 have load regulation of 0.15% + 5mV; model LZD-12 has line or load regulation of 0.25%.

Ripple and noise 1.5mV RMS.

Temp. Coefficient 0.03%/°C

Tracking accuracy 2% absolute voltage difference (dual output models only) 0.2% change for all conditions of line, load and temperature

AC input 105 to 132 Vac, 57-63 Hz

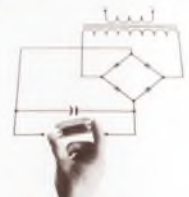

**WHETHER
YOU MAKE
OR BUY...**

**LAMBDA
ELECTRONICS CORP.**

MELVILLE, NEW YORK 11746 515 Broad Hollow Road Tel. 516-694-4200
ARLINGTON HEIGHTS, ILL. 60005 2420 East Oakton St., Unit Q Tel. 312 593-2550
NORTH HOLLYWOOD, CALIF. 91605 7316 Varna Ave. Tel. 213-875-2744
MONTREAL, QUEBEC 100C Hymus Blvd., Pointe Claire, Quebec 730 Tel. 514-697-6520
PORTSMOUTH, HANTS, ENG. Marshlands Road, Farlington Tel. Cosham 73221
VERSAILLES, FRANCE 64a 70 rue des Chantiers 78004 Tel. 950-2224

INFORMATION RETRIEVAL NUMBER 246

YOU HUM THE TUNE, EXAR PLL WILL SING IT



XR-2567



XR-210



XR-215



XR-567



XR-S200



Exar PLL

We have the broadest chorus line of Phase Lock Loop circuits available today. Take a brief look at our ever-expanding PLL line:

The XR-210 is designed for FSK Modulation and Demodulation and features a self-contained output logic driver, compatible with RS-232C requirements.

Use the XR-215 for FM or FSK demodulation, frequency synthesis and filter tracking. It has a 5V to 26V supply range and 0.5 Hz to 35 MHz frequency bandwidth. What's more, it's bipolar logic compatible.

The XR-S200 is a do-it-yourself building block. With this you design your own PLL circuits by selecting external connections and components. You get instant pro-

totypes with minimum fuss and costs.

Moving right along . . . the XR-567 PLL is designed for tone and frequency decoding. It has a bandwidth adjustable from 0 to 14%, sinks up to 100 mA of load current and has a logic compatible output. Our dual version, the XR-2567, is a real hummer with even better temperature tracking and matching characteristics. Power supply rejection is improved by an order of magnitude over the single version. The dual outputs can switch up to 100 mA at 26 volts.

All together now. We would like to send you the complete musical score on our PLL products. Our data sheets are good and they're filled with applications data. Write now, write.

EXAR SPEAKS YOUR LANGUAGE



EXAR INTEGRATED SYSTEMS

750 Palomar Sunnyvale, California 94086 (408) 732-7970 TWX 910-339-9233

EXAR SALES REPRESENTATIVES Alabama, Georgia, Mississippi, North Carolina, South Carolina and Tennessee: K & E Associates, Kennesaw, Georgia (404) 974-4264
Arkansas, Louisiana, Oklahoma and Texas: Evans-McDowell, Dallas, Texas (214) 238-7157 California: De Angelo, Rothman and Co., Culver City (213) 398-6239, Logan
Sales Co., Redwood City (415) 369-6726 Connecticut, Maine, Massachusetts, New Hampshire, Rhode Island and Vermont: Com-Sale, Waltham, Massachusetts (617)
890-0011, Meriden, Conn. (203) 634-0179 Indiana, Kentucky and Ohio: McFadden Sales, Columbus, Ohio (614) 221-3363 Idaho, Oregon and Washington: SD-R
Products & Sales, Bellevue, Washington (206) 747-9424 Illinois and Wisconsin: Mar-Con Associates, Inc., Skokie, Illinois (312) 675-6450 Maryland, Virginia and
Washington, D.C.: Rep-Iron, Inc., Silver Spring, Maryland (301) 593-4844 New Jersey (South) and Pennsylvania: Harry Nash Associates, Willow Grove, Pennsylvania
(215) 657-2213 New Jersey (North) and New York: MOS Associates, Floral Park, New York (516) 694-5923 Canada: Harvard Electronic Sales, Laval, Quebec (514) 681-1400
EXAR DISTRIBUTORS California: EEP Corporation, Culver City (213) 838-1912, Intermark Electronics, San Carlos (415) 592-1641, San Diego (714) 279-5200, Santa Ana
(714) 540-1322 Colorado: Intermark Electronics, Denver (303) 936-8284 Indiana: Graham Electronics, Indianapolis (317) 634-8202 Massachusetts: Gerber Electronics,
Dedham (617) 329-2400 Washington: Intermark Electronics, Seattle (206) 767-3160

INFORMATION RETRIEVAL NUMBER 2

191 FLAVORS OF BECKMAN DIPS



All 191 flavors of RESNET™ DIPs offer system compatibility because we use the same packages you use for I.C.s; plus you get ceramic dependability at plastic prices.

Whether you're inserting resistors automatically or by hand — call your local Beckman/Helipot representative and ask how you can save money using RESNET DIPs. He stocks locally for immediate delivery.

To request technical data, call your local Beckman/Helipot representative. Or write to Beckman Instruments, Inc., Helipot Division, 2500 Harbor Blvd., Fullerton, Calif. 92634.

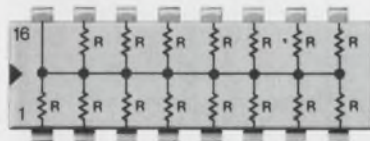

898-1 (15 resistors)
Price (1,000-4,999) \$3.85

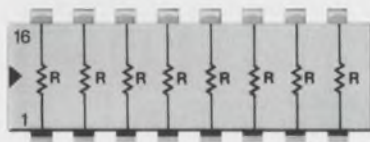

898-3 (8 resistors)
Price (1,000-4,999) \$.76

STANDARD RESISTANCE VALUES
(± 2% or ± 2Ω)

62*	110	330	1.0K	2.2K	6.0K	15.0K
68	150	470	1.5K	3.3K	6.8K	22.0K
100	220	680	2.0K†	4.7K	10.0K	

*Standard in 898-3 only.
†Standard in 898-1 only.

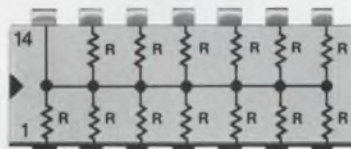

899-1 (13 resistors)
Price (1,000-4,999) \$.81

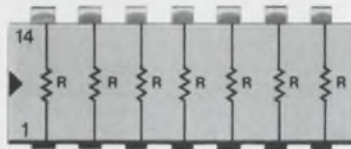

899-3 (7 resistors)
Price (1,000-4,999) \$.72

STANDARD RESISTANCE VALUES
(± 2% or ± 2Ω)

22	62	180	510	1.5K	4.3K	11K
24	68	200	560	1.6K	4.7K	12K
27	75	220	620	1.8K	5.1K	13K
30	82	240	680	2.0K	5.6K	15K
33	91	270	750	2.2K	6.0K	16K
36	100	300	820	2.4K	6.2K	18K
39	110	330	910	2.7K	6.8K	20K
43	120	360	1.0K	3.0K	7.5K	22K
47	130	390	1.1K	3.3K	8.2K	
51	150	430	1.2K	3.6K	9.1K	
56	160	470	1.3K	3.9K	10K	

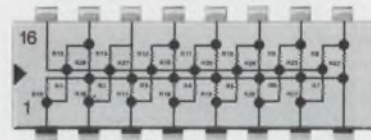

898-5-R220/330
Pulse squaring TTL terminator.
Price (1,000-4,999) \$1.45

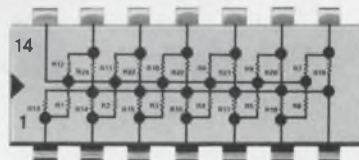

899-5-R220/330
Pulse squaring TTL terminator.
Price (1,000-4,999) \$1.35

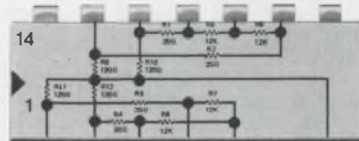

899-19
DIP interface network providing resistors for μA711 core sense amplifier configuration.
Price (1,000-4,999) \$1.18

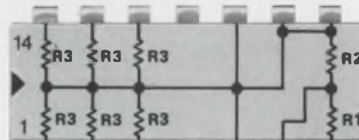

899-40
DIP network provides six line terminators and the threshold setting divider for the Intel 3208A sense amplifier.
Price (1,000-4,999) \$1.35



INFORMATION RETRIEVAL NUMBER 3

NEWS

- 19 **News Scope**
22 **Laser image recording system** developed by RCA produces color pictures on black-and-white film.
36 **Green LED production spurred** by a new process at Ferranti.
38 **A bubble memory-logic chip?** IBM heads toward that goal.
40 **At the Information Display Show**—Liquid-crystal panel overcomes video rate operating barrier.
43 **Ceramic image-storing device** can project data by reflection.
45 **Washington Report**
49 **Technology Abroad**

TECHNOLOGY

- 56 **Focus on Fixed passive components:** A special report on resistors, capacitors and inductors—old types and the latest chips—with helpful guides to selection and specification.
70 **Be on guard when using DVMs.** Noise can lead to erroneous readings. Combat it with the proper rejection technique and correct hook-up of the voltmeter.
76 **Build stable frequency synthesizers** by using off-the-shelf ICs in a phase-locked-loop configuration with variable-modulus control.
84 **Unconventional uses for IC timers** can be found everywhere. Build anything from car tachometers to program controllers with these simple devices.
92 **Program gives FET model from specs.** With only one simulation routine written for SCEPTRE, curves can be obtained for all characteristic regions.
100 **Consider the part-time engineer,** says this small-company manager. You can use him effectively if you learn to use technicians as project 'finishers.'
104 **Ideas for Design:** Optical isolators provide diverse functions in signal-detector circuit . . . Use a 723 as a switching regulator and get half an amp from a plastic TO-5 transistor . . . Low-temperature-coefficient current source becomes ultra-compliant with two resistors.
110 **Design Decision:** No-contact dc transformer measures high bus currents.

PRODUCTS

- 114 **Modules & Subassemblies:** Monolithic s/d converter boasts high reliability.
124 **ICs & Semiconductors:** Programmed logic array replaces 131 k bits of ROM.
127 **ICs & Semiconductors:** Ion-implanted diodes switch 1 to 30 A in 25 ns.
132 Components
140 Microwaves & Lasers
148 Instrumentation
158 Data Processing
168 Packaging & Materials

Departments

- 53 **Editorial:** How was Europe?
7 Across the Desk
174 Application Notes
175 Design Aids
176 New Literature
182 Bulletin Board
186 Advertisers' Index
188 Product Index
190 Information Retrieval Card

Cover: Electric components for color TV sets are being placed into proper sequence for automatic insertion into Dura-Module carrier panels. Photo provided by the courtesy of Zenith Radio Corp.



GR's Measure- Anything Resistance Bridge

Enough #10 wire to reach the moon will total about 1 megohm. The GR 1666 DC Resistance Bridge will measure that to within $\pm 0.01\%$, or the equivalent of ± 25 miles. Better yet, if a piece as short as 440 yards is removed from the translunar span, the 1666 bridge will resolve the 1-ohm difference.

Most striking about the 1666 bridge is its wide measurement range. It will measure a piece of the same size wire long enough to reach from here to Neptune, 2.7 billion miles (10 gigohms), or a 1½-inch piece (100 microohms), both within $\pm 2\%$ accuracy. And that feat doesn't really tax the 1666; it has enough resolution and detector sensitivity to distinguish between 0 and 2 microohms and between ∞ and 500 gigohms (measured as 2 picomhos conductance).

Here, for \$950, is a bridge that will measure contact resistance and dielectric leakage, transformer windings and insulation, diode forward and back resistance, relays open and closed . . . and all with precision.

The 1666 has a *fast-responding* detector. The 1666 is self-contained. The 1666 has guard and Kelvin connections. The 1666 is essential if you measure resistance.

From General Radio, Concord, Mass. and, in Europe, Postfach, CH 8034 Zurich, Switzerland.



General Radio

300 BAKER AVENUE, CONCORD, MASS 01742

NEW YORK (N.Y.) 212 964-2722, (N.J.) 201 791-8990 • BOSTON 417 646-0550
DAYTON 513 294-1500 • CHICAGO 312 992-0800 • WASHINGTON, D. C. 301 948-7071
ATLANTA 404 457-2485 • DALLAS 214 234-3357 • LOS ANGELES 714 540-9830
SAN FRANCISCO 415 948-8233 • TORONTO 416 252-3395 • ZURICH (01) 55 24 20

GR COMPANIES • Grason-Stadler • Time/Data • Techware Computing Corp.
GR ASSOCIATE • Micronetic Systems Inc.

Instant Capacitors

Complete warehousing in the U.S. providing capacitors for the home entertainment, computer and industrial electronic industries.

PRODUCTION ITEMS

Electrolytic Capacitors
Ceramic Capacitors
Film Capacitors
Oil Filled Capacitors
— without P.C.B.
Metallized Paper Capacitors
Wax Paper Capacitors
Mica Capacitors
Hybrid IC's
P.T.C. Thermister
Trim Pot



nichicon We help keep your world going on.

NICHICON (AMERICA) CORP.

6428 N. Ridgeway Ave.
Chicago, Ill. 60645 Phone: 312-679-6530

Division of NICHICON CAPACITOR LTD.
Kyoto, Japan

SERVICED BY THE FOLLOWING LOCAL SALES REPRESENTATIVES

ARIZONA

ILLINOIS

Midwest Electronic Sales
(312) 626-0030

MINNESOTA

Robert W. Marshall Co.
(612) 929-0457

OHIO

G & H Sales
(513) 771-8231

CALIFORNIA Northern

INDIANA

Midwest Electronic Sales
(317) 926-3736

NEW JERSEY Northern

Friedman-Smith
Electronic Sales Inc.
(914) 664-4866

PENNSYLVANIA Eastern

TAI Inc.
(215) 627-6615

CALIFORNIA Southern

V & L Assoc.
(213) 986-9703

IOWA

Midwest Electronic Sales
(319) 362-4410

NEW JERSEY Southern

TAI Corp.
(609) 854-3011

PENNSYLVANIA Western

H. C. Johnson Agency
(412) 923-2877

COLORADO

KANSAS

Mid-America Electronics
(913) 236-4800

NEW YORK State

H. C. Johnson Agency
(716) 482-3000

TEXAS

Gordon V. Peck Co.
(214) 341-8311

CONNECTICUT

Sales Engineering Co.
(617) 369-3943

MARYLAND

Component Sales Inc.
(301) 484-3647

NEW YORK City Area

Friedman-Smith
Electronic Sales Inc.
(914) 664-4866

WASHINGTON

Ray Over Sales
(216) 454-4551

FLORIDA

MASSACHUSETTS

Sales Engineering Co.
(617) 369-3943

NORTH CAROLINA

Component Sales Inc.
(919) 876-5550

WISCONSIN

Midwest Electronic Sales
(414) 542-5129

GEORGIA

MICHIGAN

J. L. Montgomery Assoc.
(313) 358-2616

AUTHORIZED STOCKING DISTRIBUTORS

FLORIDA

Hall-Mark Electronics
(305) 855-4020

ILLINOIS

Hall-Mark Electronics
(312) 437-8800

NEW YORK City Area

B.E.C. Electronics
(516) 567-6060

PENNSYLVANIA

Hall-Mark Electronics
(215) 355-7300

TEXAS

Hall-Mark Electronics
(214) 231-5101

One "no" and your power supply doesn't go.

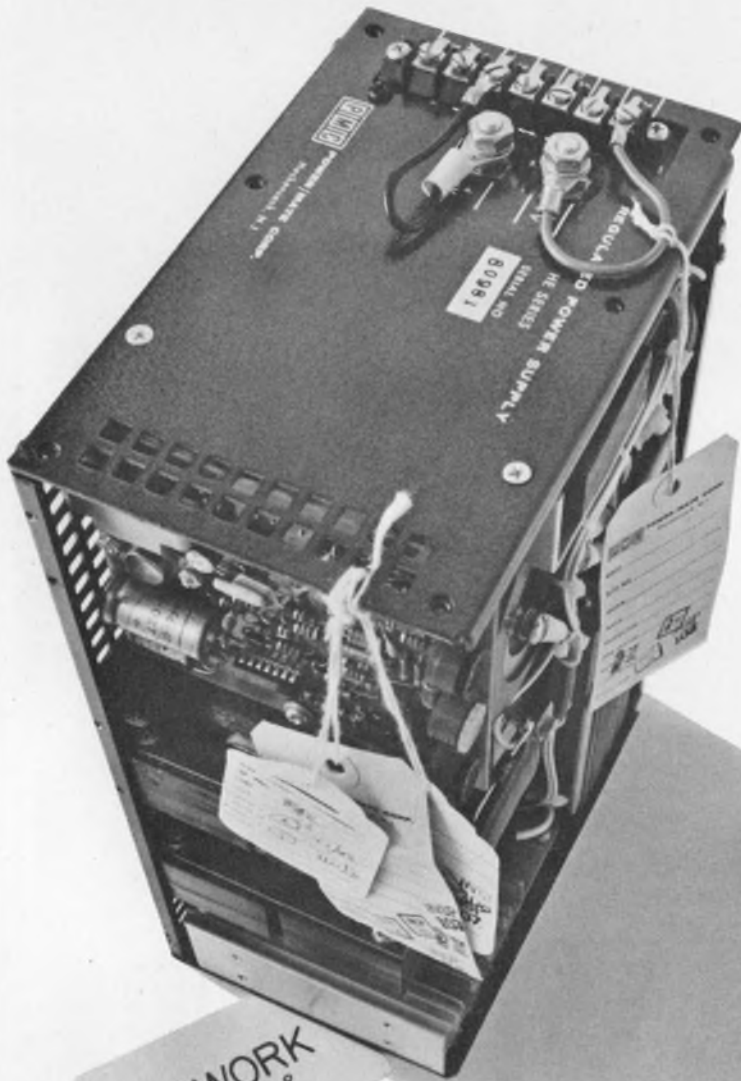

Did you know that each and every Power/Mate power supply gets 42 separate inspections?

A "no" in any one means that your power supply doesn't go out the door.

That's the insistence and emphasis that the new Power/Mate puts on quality. Sure, it costs us more, but that's how Power/Mate makes friends . . . and why Power/Mate is the world's largest producer of quality power supplies.

Send for the Power/Mate catalog . . . 32,500 models . . . most available for same-day shipment.



THE NEW

POWER/MATE CORR

514 S. River Street, Hackensack, N. J. 07601 Phone (201) 343-6294
TWX 710-990-5023

Vice President, Publisher
Peter Coley

Editors

Editorial Offices
50 Essex St.
Rochelle Park, N.J. 07662
(201) 843-0550
TWX: 710-990 5071
Cable: Haydenpubs Rochellepark

Editor-in-Chief: George Rostky

Managing Editors:

Ralph Dobriner
Michael Elphick

Associate Editors:

Dave Bursky
Jules H. Gilder
Morris Grossman
Seymour T. Levine
John F. Mason
Stanley Runyon
Edward A. Torrero
Richard L. Turmail

Contributing Editor:

Peter N. Budzilovich

Editorial Field Offices

East

Jim McDermott, Eastern Editor
P.O. Box 272
Easthampton, Mass. 01027
(413) 527-3632

West

David N. Kaye, Senior Western Editor
2930 West Imperial Highway
Inglewood, Calif. 90303
(213) 757-0183
Northe K. Osbrink, Western Editor
112 Coloma St.
Santa Cruz, Calif. 95060
(408) 426-3211

Washington

Heather M. David, Bureau Chief
2506 Eye St., N.W.
Washington, D.C. 20037
(202) 338-3470

Editorial Production

Marjorie A. Duffy

Art

Art Director, William Kelly
Richard Luce
Anthony J. Fischetto

Production

Manager, Dollie S. Viebig
Helen De Polo
Maxine Correal
Anne Molfetas

Circulation

Manager, Nancy L. Merritt
Ron Deramo

Information Retrieval

Peggy Long

Promotion

Manager, Jeffrey A. Weiner
Karen Kerrigan

across the desk

Turned off by Janice

Janice, the sullen, sultry girl in the Jermyn Industries ad, appears to have caused at least one reader to pout, too. He sent the following letter to Jermyn:

I take personal offense to your ad in ELECTRONIC DESIGN March 15. Do you have a good quality product to sell, or are you just trying to put down women? An ad such as yours can only give one the impression women are only sex objects.

Never mind sending the catalog. Just tell me how much you paid to "Janice" to prostitute her body for your commercial gain.

Sincerely yours,
H.J.M

(Name withheld)

Jermyn's ad agency, Evenett & Desoutter in London, sent H.J.M. the following reply:

Thank you for your letter. Artists, sculptors, illustrators throughout the ages have admired the female form. Who are you and I to change all that?

Yours sincerely,
John D. Evenett

P.S. Janice is well paid.

Janice herself was puzzled by it all. Shown the letter by H.J.M., she jotted down this comment:

—John—We certainly get some strange ones. This I feel is quite unanswerable!

The bare facts urged on encapsulants

Re: Your paragraphs on encapsulants and potting compounds in "Focus on Materials," ED No. 8, April 12, 1973:

You, above all others, should be aware that taking it off is sometimes more important than put-

ting it on. A word or two about the Access process for stripping encapsulants wouldn't have hurt—especially for those readers who are vitally interested in getting right down to the bare facts.

Phoebe Williams,
Advertising and Sales
Promotion Manager

Amphenol Sams Div.
9201 Independence Ave.
Chatsworth, Calif. 91311

Correction

In the article, "Increase Phototransistor Bandwidth Without Sacrificing Output Voltage," (ED No. 8, April 12, 1973, pp. 102-104) the following two corrections should be made: The value of R_i in the last equation (p. 102) should be 47 k, not 4.7 k. The value of R_L in curve d, shown in Fig. 2, p. 103, should be 470 Ω instead of 470 k.

Reader feels burned by regulator advice

I have been reading and enjoying ELECTRONIC DESIGN magazine for about seven years and have found it a useful source of information. It is written at an understandable level and generally avoids the "chest-thumping" articles praising a particular manufacturer's product and written by his own engineers.

But I feel that the article in ED No. 5 by Hnatek and Goldstein ("Don't Get Burned!" March 1, 1973, pp. 72-75) is an example of the type of problems mentioned in your excellent editorial in the same issue. The article's third paragraph gets right to the heart of my complaint: If I, as a user, am to be able to use the regulator in contin-

(continued on page 13)

Electronic Design welcomes the opinions of its readers on the issues raised in the magazine's editorial columns. Address letters to Managing Editor, Electronic Design, 50 Essex St. Rochelle Park, N. J. 07662. Try to keep letters under 200 words. Letters must be signed. Names will be withheld on request.

low cost ceramic trimmer capacitors



These ceramic trimmer capacitors are designed for broadband application, from audio to 500 MHz and afford an ideal low cost means of "trimming" circuitry such as crystal oscillators, CATV amplifiers and all varieties of communication and test equipment.

FEATURES

- Capacitance values from 1 - 3 to 5 - 25 pf
- Low profile - .208 above board height
- Low cost - 75c in 1000 quantities
- Delivery from stock

Johanson

MANUFACTURING CORPORATION

BOONTON, NEW JERSEY 07005
201 / 334-2676
TWX 710-987-8367

INFORMATION RETRIEVAL NUMBER 7 ►



Patent Pending

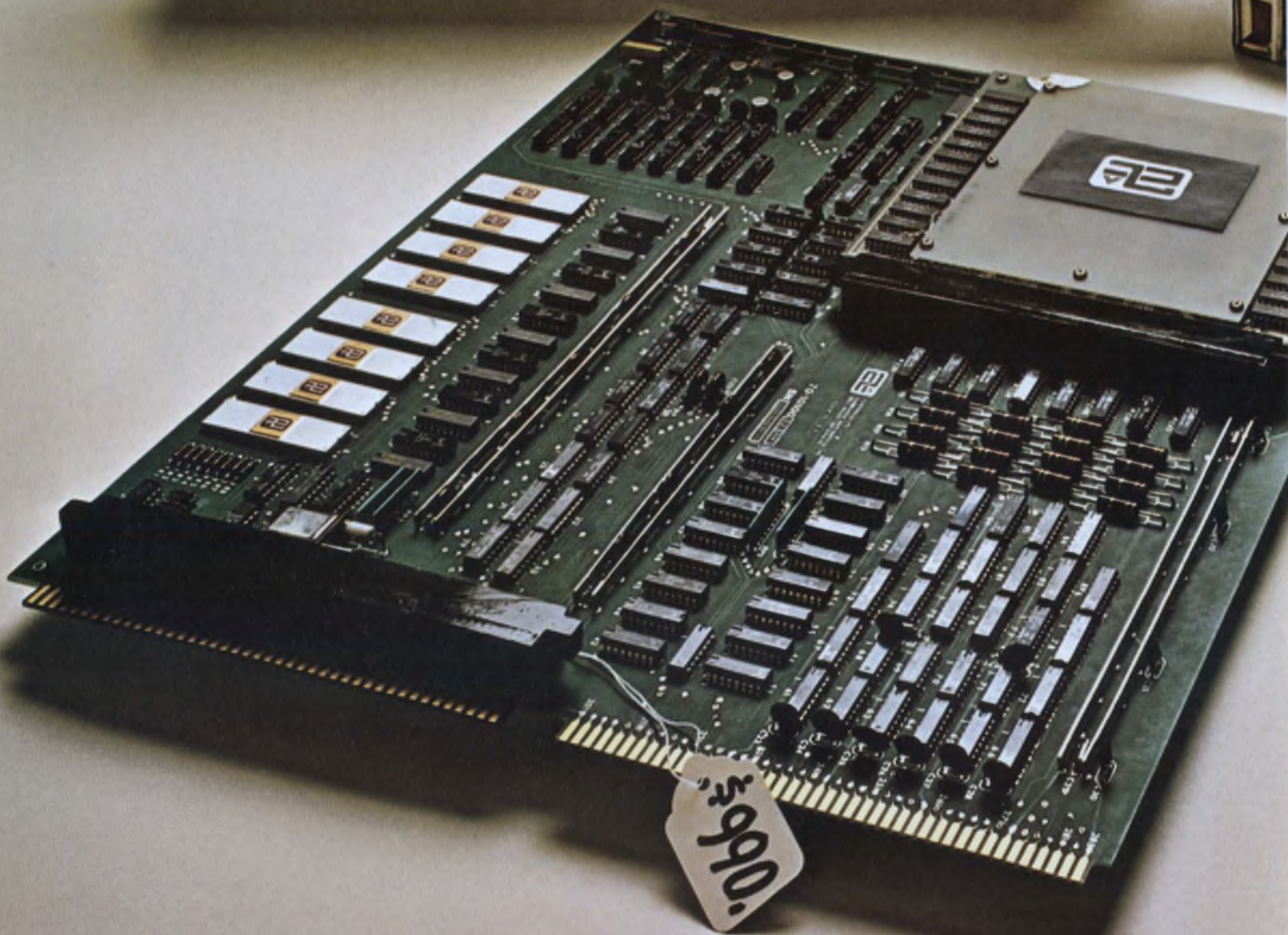

The NAKED MINI/LSI™

What this country needs is a good \$1,000 full-scale computer.



Introducing the computer for everybody. **NAKED MINI/LSI.**[™]

It's the computer for people who never thought they could afford a computer for their product.

It's also for people who have always been able to afford more, but have always gotten less computer than this.

NAKED MINI/LSI is the first OEM computer designed for widespread, multi-level use. The first computer able to do more jobs than any computer could ever do before.

Jobs that computers were too expensive to do. Jobs that were, consequently, always left to old-fashioned hardwired circuitry. Which meant that products weren't as flexible or immune to obsolescence as they could have been.

Or jobs that were done by more expensive computers. Which meant that products cost more and were less competitive than they should have been.

To make a computer capable of handling this kind of range, we had to give it an unheard of combination: extensive 16-bit computing power and a small price tag. Specifically, NAKED

MINI/LSI is the first computer powered to satisfy 90% of all potential minicomputer applications — and yet be priced as low as \$990 in OEM quantities of 200.

Imagine it. For a price less than most hardwired circuitry, your product can benefit from a computer having arithmetic capabilities, full byte and 16-bit word processing, and extremely flexible input/output. Without going into all the jazzy widget features, let's just say that the NAKED MINI/LSI gives your product all the intelligence it needs to monitor, sequence, and control effectively.

At this point, you may be wondering why a computer with all this clout was ever named the NAKED MINI/LSI. Actually, the name is very appropriate.

The NAKED MINI means that we designed it without all the over-design found on other minicomputers. All the extra, redundant features that make other minis too unwieldy and costly for OEM use have been purposely left off. (But everything you need has been deliberately built in.)

The LSI stands for large-scale integration, the latest technological advance in electronics. It enabled us to build a complete computer that fits on a single 1" x 15" x 17" card, weighs only 4 lbs., and uses 89% fewer components for unequalled reliability.

For full details on the NAKED MINI/LSI (or its stand-alone counterpart, ALPHA/LSI[™]), write Computer Automation Inc., 18651 Von Karman, Irvine, California 92664. Or call: (714) 833-8830. TWX 910-595-1767.

from Computer Automation.

All Panel Meters are not created equal.



We try to build an edge into General Electric panel meters.

For instance, you won't see a GE panel meter turn yellow, because we use a special white paint that stays white. You won't get eyestrain either. GE panel meters come with extra-wide scales, big numerals, tapered pointers, and shadow-free cover plates for quick, sure readings. We're fussy about things like that.

Once you've installed them, forget 'em.

GE's famous reliability just doesn't happen, we *build* it in! We designed-out a lot of extra parts that might fail, just to give you extra instrument reliability. To make sure, we added a 20% overload capability to our voltmeters and ammeters. Still not satisfied, we decided to measure instrument quality from parts to finished product in order to screen out anything marginal. Now, it's just too tough for a lemon to squeeze through.



GE panel meters come from a good family.

They look good individually and they look good together. Choose the rounded BIG LOOK® design for unique style and wide-eyed readability. Or choose the clean HORIZON LINE® case for its behind-panel mounting flexibility (*without* the usual bezel), and its snap-off mask available in six colors. GE makes panel meters to suit you and to add snap to your application.



You can count on General Electric panel meters.

They're built to help you do a better job. At GE, we're not interested in product equality. We want ours to be *better* than the rest.



For a complete catalog of competitively priced and readily available GE panel meters, see your nearby authorized GE distributor. Or write to General Electric Company, Section 592-43, One River Road, Schenectady, N. Y. 12345.

592-43

**Specify
General Electric...
just for good measure.**

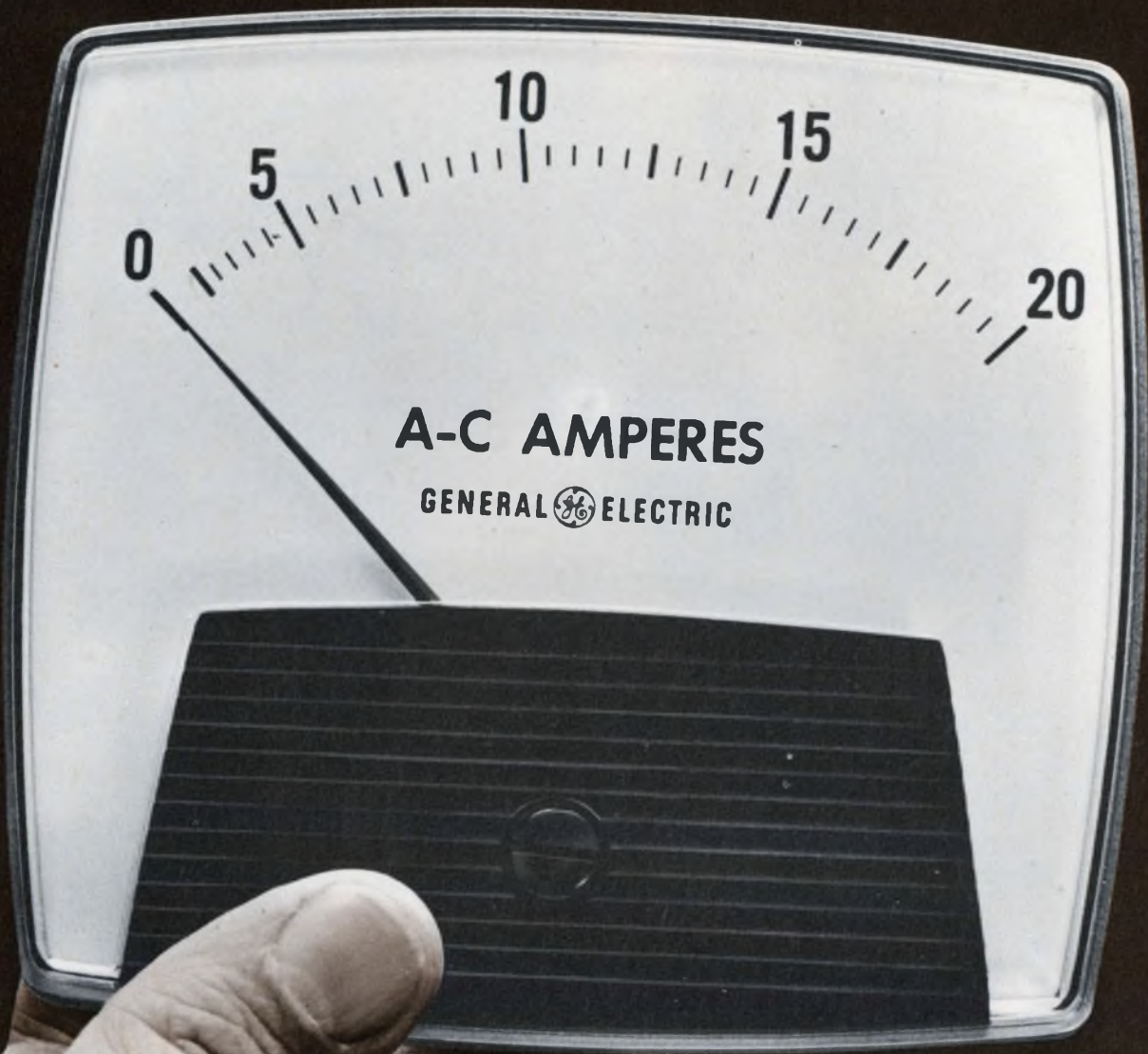

A-C AMPERES

GENERAL  ELECTRIC

GENERAL  ELECTRIC



Silicone-packaged devices: The answer to a hot problem.

Within seconds after the match flame was applied to both the epoxy (left) and the silicone ICs (right), the epoxy burst into flame.

The hot issue in electronics today is flame retardancy. While epoxies and other plastics support combustion, silicone-packaged devices are virtually nonflammable. So, they don't need flame-retardant additives that alter the electrical and mechanical properties of epoxies and other materials.

And there are several other good reasons to specify silicone packaging compounds:

- excellent performance under thermal cycling
- low thermal expansion minimizes damage to components and lead wires
- basic electrical, physical, and chemical properties that remain constant over the widest temperature (-55 to 250 C), time, and frequency ranges
- uniform, lifetime electrical characteristics
- superior performance in 85 C/85% RH (biased) test
- total compatibility with all kinds of devices, including ICs, both digital and linear, MOS, CMOS, power transistors, SCRs, high-voltage rectifiers, etc.
- optimum reliability reduces manufacturing and repair/warranty costs
- safe, clean, inert, and require no special handling

Whether you are a device manufacturer or user, these advantages are important in semiconductor devices. Make the switch to nonburning silicone packaging compounds now. Write or call Jack Broser, Product Market Supervisor, Dow Corning Corporation, Department A-3312, Midland, Michigan 48640.

Silicones; simply the best way to protect electronic circuits

DOW CORNING

DOW CORNING

Six good reasons why Dow Corning should be your primary packaging-materials supplier.

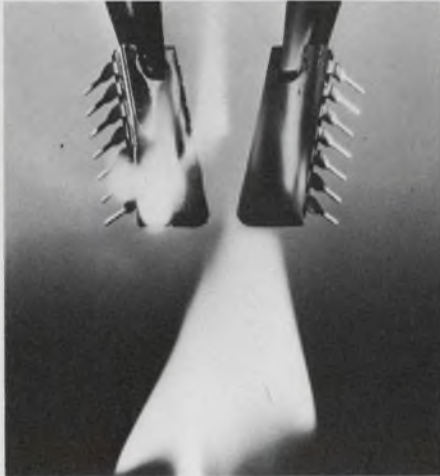

In addition to the many important advantages of silicone molding compounds, there are other good reasons why it is to your advantage to plan your growth in the electronics market with help from Dow Corning.

1. We are helping to develop the market for you. Extensive publicity, promotion, direct mail, and trade-show appearances are all educating your customers about the very substantial advantages of silicones in all kinds of harsh electronic/electrical environments.

2. Since service is extremely important in helping manufacturers in the development of advanced packaging systems, we have Technical Service & Development men strategically located worldwide to help solve your problems.

3. Your competitive advantage with Dow Corning molding compounds is a complete family of products, totally compatible with each other and with most other materials used in electronic systems, devices, or components.

4. Product-line breadth gives you the ability to design or produce the most reliable and economical packaging to protect any system, regardless of its sophistication or environment.

5. Technical leadership constantly applied in our own laboratories and with our customers results in the development of product modifications and new technologies to handle the needs and requirements of next generation devices.

6. Worldwide delivery from strategically located distribution points enables us to work with you to supply standard or special molding materials as required.

Major commitments like these indicate the kinds of things we are doing to earn your business. We'd like to discuss with you in more detail how we can grow together in this rapidly expanding area. Call or write Jack Broser, Product Market Supervisor, Dow Corning Corporation, Department A-3313, Midland, Michigan 48640. Phone: (517) 636-9460

Silicones; simply the best way to protect electronic circuits.

DOW CORNING



ACROSS THE DESK

(continued from page 7)

uous duty, then shouldn't I expect to get specifications applicable to that use—certainly the normal mode of regulator use. The article, in essence, tells me how to fudge my testing so my results agree with the manufacturer's unrealistic test conditions rather than with my operating conditions. I hope you will avoid such articles in the future.

Finally I whole-heartedly agree with your plea for manufacturers to send prices with literature. I circular-file all ads without prices.

Robert N. Nelson, Ph.D.
Asst. Prof. of Chemistry

Georgia Southern College
Statesboro, Ga. 30458.

Ed. Note: Dr. Nelson seems to have missed the point. Manufacturers of IC regulators are forced to use high-speed automated testing to stay cost-competitive. But, as the article points out, many users assume that regulators are tested under actual operating conditions. Therefore we published the article because we felt that readers should be told about this problem. This article is certainly not the type of self-serving article described in the ED editorial. On the contrary, its short-term effect may be to hurt sales of IC regulators, because engineers will think twice before using them in applications where their performance may not be adequate. As Dr. Nelson implies, it would be helpful if manufacturers tested the ICs under normal operating conditions. But would Dr. Nelson be prepared to pay higher prices for the parts? This marketing problem is outside the scope of the article, which is solely concerned with the testing problems.

Better idea suggested for counter design

I want to congratulate you on the sense of humor that caused you to print the design idea "Shift Option Improves Handling of Binary Counter Data," by Akavia Kaniel, in the April 1 issue (ED No. 7, p. 84). In case some of your readers missed the subtle joke, here is the proper, modern solution to this design problem:

(continued on page 17)

new from General Instrument...

FOUR-DIGIT DISPLAY DRIVERS

The AY-5-4007A Four-Digit Display Driver is an LSI subsystem designed for application in counting display systems such as frequency counters, digital voltmeters, digital timers, and event counters using 7 segment numeric displays. It contains a 4 decade up/down synchronous BCD counter, a storage register, multiplexing circuits, internal oscillator for digit selection and 7 segment decoder to count and display to 9,999.

The AY-5-4007A is constructed on a single monolithic chip and is packaged in a 40 lead DIP.

Features

- Minimum interface required to drive most common types of LED, fluorescent, incandescent seven segment displays
- Large output current capability on seven segment outputs, typically 25 mA at 1V
- Fully synchronous up/down counting operation
- Internal oscillator for operating the digit select counter
- Four-digit select line outputs with inversion control for display driving flexibility
- Serial output of BCD storage register
- TTL/DTL compatible on inputs and outputs
- Economy version available in a 24 lead DIP

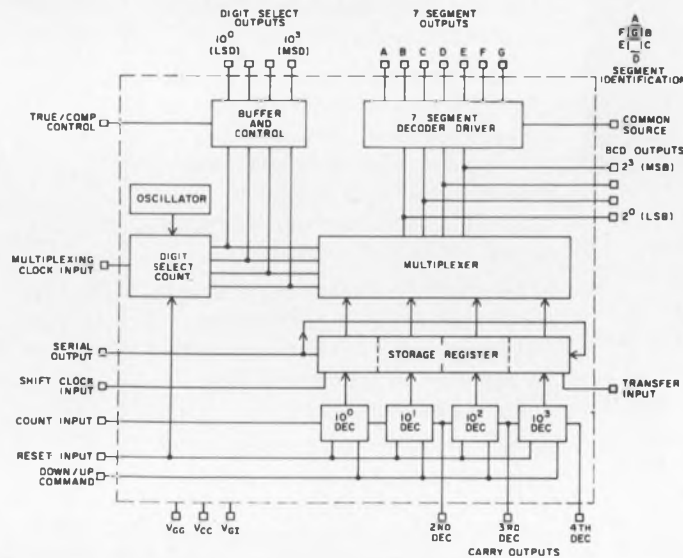

YOUR DISPLAY DRIVER MAN AT GI



Stan Schiller is a veteran of 15 years in the industry, 12 of which were spent in design engineering and applications. A graduate of CCNY, he holds BEE and MEE degrees. In his background are the designs of great numbers of highly successful analog and digital discrete and integrated circuits and systems.

For the past 3 years he's been in product marketing with General Instrument and now he's your "Display Man" at GI. Call him any time at the toll-free number below (In New York State call 516-733-3107).

800-645-9247

TOLL FREE



GENERAL INSTRUMENT CORPORATION • 600 WEST JOHN STREET, HICKSVILLE, L. I., NEW YORK 11802

The AY-5-4007A FOUR-DIGIT DISPLAY DRIVER is available through these authorized General Instrument distributors.

ALABAMA: Cramer/E. W., Huntsville (205) 539-5722; ARIZONA: Cramer Electronics, Phoenix (602) 263-1112, TWX: 910-951-1382; CALIFORNIA - NORTHERN: Intermark Electronics, Palo Alto (415) 961-6437, TWX: 010-373-1195-910; CALIFORNIA - SOUTHERN: Avnet, Culver City (213) 836-7200, TWX: 910-340-6753; Kierulff Electronics, Los Angeles (213) 685-5511; Semiconductor Concepts, Woodland Hills (213) 884-4560. COLORADO: Cramer Electronics, Denver (303) 758-2100, TWX: 910-431-0440. CONNECTICUT: Greene/Shaw, Stratford (203) 378-0485. FLORIDA: Cramer/E. W., Orlando (305) 894-1511; Cramer/E. W., Hollywood (305) 923-8181; ILLINOIS: Semiconductor Specialists, Elmhurst (312) 279-1000, TWX: 910-254-0169; INDIANA: Semiconductor Specialists, Indianapolis (317) 243-8271. IOWA: Deeco, Cedar Rapids (319) 365-7551. KANSAS: Hall-Mark Electronics, Kansas City (913) 888-9797. MARYLAND - WASHINGTON, D.C.: Cramer/E. W., Gaithersburg (301) 948-0110, TWX: 710-828-9745; Milgray/Washington, Hyattsville (301) 864-1111, TWX: 710-826-1127; Radio Electric Service of Baltimore (301) 823-0070. MASSACHUSETTS: Greene/Shaw, Newton (617) 969-8900. MICHIGAN: Semiconductor Specialists, Detroit (313) 255-0300. MINNESOTA: Hall-Mark Electronics, Minneapolis (612) 925-2944; Semiconductor Specialists, Minneapolis (612) 854-8841. MISSOURI: Semiconductor Specialists, St. Louis (314) 428-6100. NEW MEXICO: Cramer Electronics, Albuquerque (505) 265-5767. NEW YORK (METROPOLITAN AREA): Milgray Electronics, Freeport (516) 546-6000, TWX: 510-225-3673; Semiconductor Concepts, Hauppauge (516) 273-1234. NEW YORK STATE: Summit Distributors, Buffalo (716) 884-3450. NORTH CAROLINA: Cramer/E. W., Winston Salem (919) 725-8711. OHIO: Newark Elect., Cincinnati (513) 421-5282, TWX: 810-461-2662; Semiconductor Specialists, Dayton (513) 278-9455. PENNSYLVANIA - SOUTH JERSEY: Herbach & Rademan, Philadelphia (215) 426-1700, TWX: 710-670-9760; Milgray Delaware Valley, Cherry Hill (609) 424-1300, (215) 228-2000. PHILADELPHIA: Philadelphia (215) LO 8-8288, (215) EM 5-6704. SEMICONDUCTOR SPECIALISTS, Pittsburgh (412) 781-8120. TEXAS: Computer Components, Addison (214) 239-0271, TWX: 910-860-5006; Lenet Company, Houston (713) 225-1465; Semiconductor Specialists, Dallas (214) 358-5211; UTAH: Cramer Electronics, Salt Lake City (801) 487-3681; Alta Electronics, Salt Lake City (801) 486-7227.

COMPARE THE PHILIPS PM 3400

*with any other sampling scope
on the market—*

FOR SIMPLICITY, STABILITY, SENSITIVITY

SIMPLICITY is the keynote. The PM3400 is a general purpose, 1.7 GHz, compact instrument that you operate just as you would any ordinary scope, except that you select a sampling mode and you adjust the sampling rate—both with a single control.

The display of the PM3400 looks just like the display of a conventional scope, too; no flicker at all; not even at low frequencies.

It's this low-frequency capability (real time sampling from DC to 10 KHz) that makes the PM3400 a truly universal scope for any application between DC and 1.7 GHz.

STABILITY of the PM3400 is so high that once set up, it stays exactly where you set it—even if you have to shut down and then re-start an hour later. This saves significant time and energy, especially on a production line. And remember—the PM3400 is the sampling scope that's simple enough for anybody to use in a production test environment.

SENSITIVITY is $400 \mu\text{V}/\text{cm}$ over the entire frequency range. Whether you're working with devices having f_T in the GHz range...or working on AF-modulated UHF signals...or looking for low-level signals in the presence of noise, the remarkable triggering abilities of the PM3400 combine with its high sensitivity and special filtering circuits for significantly clearer, steadier displays.

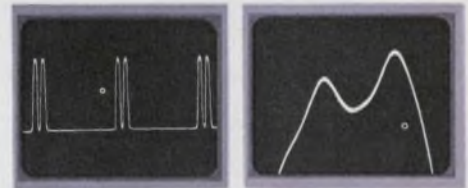

HIGH SENSITIVITY; GREAT DYNAMIC RANGE

Left, typical double pulses with rise time of 4 nsec; right, peak of one pulse magnified 100X vertically and horizontally, showing fine detail. PM3400 positioning control has range of $\pm 1.6 \text{ V}$ at any sensitivity. Note clarity of display achieved by special filtering circuits; total noise is less than 0.8 mV

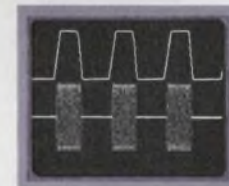

ACCURATE INTERNAL TRIGGERING TO 1.75 GHz

Accuracy of PM3400 internal triggering circuits is dramatically demonstrated here. Photo shows AF-modulated 2 GHz carrier along with its 1 KHz modulating waveform. This display is only feasible on a sequential sampling instrument such as the PM3400.

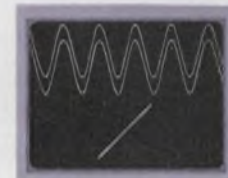

X-Y DISPLAYS AT 100 MHz with $<1^\circ$ PHASE ERROR

Photo shows two displays superimposed. Top traces are the same 100 MHz sine wave applied to both channels with mode selector set to "A and B". Bottom line is obtained when mode selector is switched to "A VERT., B HOR." (X-Y display) with same 100 MHz sine wave on both channels. Note accuracy and linearity of display; calculated phase error of less than 1° is not visible in display.

SUMMARY OF IMPORTANT FEATURES:

- Dual trace sampling from DC to 1.7 GHz
- 200X dynamic range
- Input sensitivity $400 \mu\text{V}/\text{cm}$
- Automatic internal triggering to 1.75 GHz at 3 mV
- Continuously variable sampling rate, 5 to $>1000/\text{cm}$; up to 10,000 samples in any display
- 8 nsec visible delay; you see leading edges, even at high scan rates
- Real-time sampling, DC to 10 KHz, including single-shot phenomena
- Compact; weighs only 40 lb.
- Economical; only \$2890, complete... no plug-ins or extras to buy

The best way to learn about the versatile and economical PM3400 is to see it in operation. For a demonstration or for full technical details, contact: Test & Measuring Instruments Inc., 224 Duffy Avenue, Hicksville, New York 11802. Telephone: 516-433-8800



PRICED TO FIT YOUR WALLET



BOURNS LOW COST FAMILY

**OF INDUSTRIAL
TRIMPOT® POTENTIOMETERS**

POWER: ½ WATT (OR BETTER) AT 70°C

TEMPCO: CERMET— AS LOW AS 100 PPM/°C
WIREWOUND — AS LOW AS 70 PPM/°C

TEMPERATURE RANGE: -55° UP TO +150°C

Join the growing population of industrial equipment designers who have discovered that *Bourns quality has never cost so little.*

Bourns LOW-COST FAMILY of industrial TRIMPOT® potentiometers was designed specifically to give cost-conscious industrial electronics equipment manufacturers superior product quality and performance . . . AT LOWER PRICES.

We invite you to compare price and specs on Bourns LOW COST FAMILY models with those of our prime competitors.

AVAILABILITY

The Cermet and Wirewound models shown are stocked in-depth . . . RIGHT NOW, so delivery is off-the-shelf from your local Bourns distributor or factory-direct.

Complete data, price and delivery details on all LOW-COST FAMILY models is available upon request. Just write, or call, your local Bourns Sales Office, representative, or distributor.

**AVAILABLE FOR IMMEDIATE DELIVERY
FROM YOUR LOCAL BOURNS DISTRIBUTOR**



BOURNS, INC., TRIMPOT PRODUCTS DIVISION • 1200 COLUMBIA AVENUE, RIVERSIDE, CALIFORNIA 92507

INFORMATION RETRIEVAL NUMBER 14

ACROSS THE DESK

(continued from page 13)

For over four years we have been selling a monolithic MSI circuit called 9316 that contains all the functions performed by the seven integrated circuits in Mr. Kaniel's design. The 9316 runs faster (> 30 MHz), dissipates less power, occupies less space and costs less than the SSI design. It has been so successful that even our competitors have copied it, calling it the 74161. It is a synchronous, four-bit binary counter with synchronous parallel load inputs that can be interconnected for synchronous shift operation.

Today gates and flip-flops have become the most expensive form of logic. They should be used sparingly only as "glue" between MSI packages. Any digital design that uses more gate and flip-flop packages from MSI packages is inefficient and would benefit from a more imaginative use of MSI.

Peter Alfke

Manager, Digital Applications

Fairchild Semiconductor
464 Ellis St.

Mountain View, Calif. 94040

The tri-flop strikes reader as old hat

The author of the tri-flop article "And Now . . . The Tri-Flop," in ED No. 23, Nov. 9, 1972, pp. 80-81 says that he researched over 300 relevant periodicals ("The Tri-Flop: Who Got There Fustest?" Across the Desk ED No. 4, Feb. 15, 1973, p. 7) and concluded that the idea had not been published before. Too bad he didn't check **ELECTRONIC DESIGN** for the following articles:

- "NAND Gates Form Tri-Stable Flip-Flop," Robert M. Walker (ED No. 11, May 10, 1966, p. 64).

- "Design Flip-Flops From LSI Cells," Robert M. Walker (ED No. 12, June 6, 1968, p. 82-86).

- "Build Flip-Flops With AOI Gates," Richard B. Derickson and Robert M. Walker (ED No. 23, Nov. 8, 1969, p. 72-80).

Robert M. Walker

Fairchild Semiconductor
484 Ellis St.

Mountain View, Calif. 94040



OTHER RESISTORS DO A SLOW BURN UNDER SPRAGUE'S TORCH TEST!

CERON® CERAMIC-INSULATED FLAME-PROOF WIREWOUND RESISTORS are a new development to meet the need for a truly non-flammable resistor in electronic equipment. Unlike some other so-called "flame-proof" resistors, which open-circuit before burning when subjected to high overloads, new and exclusive Sprague Ceron® Resistors are absolutely inert in the presence of heat or flame. They will not ignite under any degree of overload. Actually, they will not burn even when placed directly into the open flame of an oxyacetylene torch! This is clearly indicated in the photo, which dramatizes the protective qualities of the flame-proof Ceron® coating as compared with that of a

conventional silicone-coated resistor.

The special coating is completely resistant to standard industrial cleaning solvents. Totally inorganic, it is also immune to attack by fungus. It provides excellent protection against thermal shock, humidity, and vibration. Dielectric strength, measured in a "V" block, is 500 volts a-c.

Series 380E (standard) and Series 400E (non-inductive) Ceron® Resistors meet moisture requirements of Specification MIL-R-26. Resistance values range from 1 to 60,000 ohms, in wattage ratings from 1 to 10 watts. Resistance tolerances as close as $\pm 1\%$ are available. Sizes range from $\frac{1}{8}$ " D. x $\frac{3}{8}$ " L. for the 1-watt resistor to $\frac{5}{16}$ " D. x $1\frac{3}{4}$ " L. for the 10-watt unit.

For complete technical data, write for Engineering Bulletin 7250 to: Technical Literature Service, Sprague Electric Co., 347 Marshall St., North Adams, Mass. 01247.

THE BROAD-LINE PRODUCER OF ELECTRONIC PARTS



*Here's a dependable, quick-delivery source
for Zero Defect*

High Voltage Silicon Rectifiers

- MEETS STRINGENT ENVIRONMENTAL REQUIREMENTS.
- HIGH TRANSIENT VOLTAGE RATINGS.
- EXTREMELY LOW LEAKAGE.
- WORKING VOLTAGE RANGE . . . 200V. THROUGH 50kV.

If you're looking for on-time delivery of miniature and microminiature High Voltage Silicon Rectifiers, look no further than ERIE. You simply can't beat our zero defect rectifiers since these units were first designed for high reliability night vision, lunar and aerospace applications. Their small size makes ERIE rectifiers ideal for thick film substrates, miniature power supplies, airborne displays, CRT displays, color TV, microwave ovens and other industrial and commercial applications where small size, reliability and superior performance are critical. All ERIE High Voltage Silicon Rectifiers feature conservative voltage ratings, fast recovery time, fast turn-on time, wide operating temperature range, high transient voltage ratings, low reverse leakage and unsurpassed reliability.

ERIE also offers double sealed, miniature Full Wave Bridge Rectifiers . . . perfect for P.C. use, with ratings up to 1000 volts per leg. So think ERIE for your High Voltage Silicon Rectifiers. Write TODAY for our new 24-page catalog . . . High Voltage Components and Devices.



ERIE TECHNOLOGICAL PRODUCTS • Erie, Pennsylvania 16512

U.S. still favors solar cells despite Skylab difficulties

Despite the massive problems caused by the failure of the Skylab I's workshop solar panel array to deploy, top engineers of the National Aeronautics and Space Administration say most earth-orbital vehicles will continue to depend upon solar panels for electrical energy.

There were a few pangs of regret that the old SNAP (Space Nuclear Auxiliary Power) programs had been killed in the budgetary squeeze several years ago. Both types of SNAP programs—reactors and isotopic generators—were hailed in the early days of space flight as a way to provide huge amounts of power for extended missions.

"When NASA first thought about Skylab [in fiscal 1963], it considered fuel cells, isotopic generators and other power sources," Skylab's director of experiments, Thomas Hanes, explains, "But it was decided that solar cells were the most economical for the time span. Generally speaking, solar cells still are the most economical power plant to use, in terms of weight and volume."

Congressional sources say the SNAP programs were curtailed because the only missions that demanded such large amounts of power would be interplanetary flights past Jupiter or a direct broadcast satellite in synchronous orbit.

Skylab's solar-cell problem was one of mechanics rather than technological. It resulted when a meteoroid shield broke loose during launching and damaged the solar-panel wings on the workshop area.

Four panels arranged in a windmill design on the Apollo Telescope Module section deployed, as planned, and have been performing even somewhat better than expected in providing power. This solar array has produced 2500 W of av-

erage orbital power, with the spacecraft pitched up in a 50° angle to reduce temperatures created by exposure to the sun after loss of the shield.

The panels are expected to produce better than 4 kW when the spacecraft is put back into its normal attitude.

Although Skylab originally was planned to have more than 11 kW available, most of the high-priority experiments can be performed with reduced power levels, Hanes said. These include medical, solar-telescope and earth-resources experiments.

An experiment of high interest to the electronics industry—the growth of crystals in a weightless environment—may be dropped because of high electrical and manpower requirements.

Although the space agency worked to put more oxygen and hydrogen in the Apollo command-module fuel cell to extend its life from 14 days to about 17, none of this power can be transferred to the workshop.

Skylab will require between 3000 and 3500 W for essential housekeeping operations, including refrigeration of spoilables and the operation of crew equipment and communications, Hanes estimated.

Even as NASA struggled with its energy crisis, the House and Senate Space Committees voted to add \$10-million to the fiscal 1974 NASA budget to keep some of the advanced nuclear technology work alive.

Magnetic semi urged to widen automation

Probing, sorting and bonding of semiconductor devices—the final steps in assembly that have eluded mass-handling techniques—would

be automated under a magnetic approach proposed by Bell Laboratories. But a new type of semiconductor—one with magnetic elements deposited on the chip—would be needed to take advantage of the approach.

The proposal was outlined in a paper presented at the Electronic Components Conference in Washington, D.C., by Dr. M. Herbert Wachs, a scientist with Bell Laboratories in Reading, Pa.

With the new technique, an iron, nickel and cobalt alloy is incorporated into the metallization of the semiconductor chip. The magnetic material, says Wachs, then makes it possible to automatically orient many chips simultaneously into a precise array. This is done with the aid of a special disc magnet that contains a series of alternating north-south pole pairs.

Once formed into an array, the devices can be fed into the mechanized probing and bonding equipment. Electrical or optical measurements, or both together, determine if a device is good or bad. If the device is good, the apparatus moves to the next device; if it is bad, a vacuum removes it from the array.

After this probing and sorting has been completed, Wachs notes, a new matrix of only good devices can be formed quickly and fed to a bonding machine.

Chopper-stabilized amp shrunk by new process

Using a new processing technique that involves one step more than standard bipolar processing, Texas Instruments has shrunk the size of a chopper-stabilized op amp so it can fit in a 14-pin DIP.

The bipolar/JFET process, as described by Michael Callahan Jr., Design Engineer of the TI Dallas Division, involves diffusing a lightly doped p-layer into the epitaxial layer. This step is done just before the base diffusion, and thus it forms the JFET channel. The light p-doping results in a higher JFET G_m , a controlled pinchoff and a higher breakdown voltage. High-quality JFETs can thus be fabricated on the same chip as bipolar circuits, according to Callahan.

The first commercial circuit made with this process is a chopper-stabilized op amp with a differential input and a voltage drift of $0.6 \mu\text{V}/^\circ\text{C}$. The amplifier is actually two chips, one of which is a combination of bipolar transistors and JFETs and the other all MOS. Both chips are mounted in a single package.

Bipolar transistors and JFETs on the same chip are not new, but TI claims to have increased the JFET breakdown voltage more than fivefold—in excess of 40 V. This chip contains two linear op amps. One—the main amplifier—is an internally compensated, high-frequency, wideband unit. The other amplifier is a low-frequency JFET-input op amp that is used as a low-pass filter and null adjust for the wideband amplifier. The JFET-input main amp has a bandwidth of 3 MHz, a slew rate of $25 \text{ V}/\mu\text{s}$ and a CMRR of 80 dB.

The other chip is an all-MOS-FET device described as one of the first commercial applications of linear MOS amplifiers. On the chip are three MOS linear op amps, a clock generator, a flip-flop countdown chain, MOS analog switches and control logic and decoding circuitry. The chip performs the chopper control, synchronous demodulation control and some sample/hold functions.

A better transducer sought for automobiles

Two General Motors research engineers have called for a greatly improved transducer for automotive electronic control systems.

In a paper presented in Detroit at the spring Society of Automotive Engineers meeting, Harry R. Mitchell and Ralph W. McGill of GM Research Laboratories predicted growth in automotive applications of transducers in the next few years.

"Most commercially available transducers," they said, "are suitable for laboratory, aerospace or industrial-process applications, but do not meet additional, stringent automotive requirements."

A common misconception, the authors noted, "is that the automotive industry need only translate to automotive needs the trans-

ducer technology developed over the last decade in association with the aerospace industry.

"However, this is not the case," they went on, "because automotive performance criteria will often exceed those for aerospace applications."

Plastic semi packages may rival hermetics

Plastic packages for semiconductors and microcircuits may start replacing hermetically sealed glass, metal and ceramic packages next year if improvements continue at the current rate, an Army semiconductor specialist believes.

The specialist, Edward B. Hakim, head of the Reliability and Physics Failure Group at the Army Electronics Technology and Devices Laboratory, Fort Monmouth, N.J., gave his views in a paper at the Electronic Components Conference in Washington, D.C. He noted that while plastic devices were still not reliable enough for widespread military use, improvements in bond reliability, moisture resistance and over-all field reliability indicated that by 1974-1975 the failure rates of hermetic and plastic devices would approach each other.

According to Hakim, when the military first considered using plastic, it was interested primarily in moisture resistance. After testing, however, it found that open and intermittent bonds were a more serious problem.

Another big problem with plastic devices, Hakim said, is that vendors are not interested in supplying plastic devices to high-reliability specifications.

When questioned about this, Jack Saddler, Motorola's manager of federal marketing, Semiconductor Div., said that lot testing was not a problem but production was. Plastic devices for the military, Saddler explained, do not use the aluminum-gold metal systems used on commercial devices. They use an all-gold system.

"When you're shipping a million devices a week, its uneconomical to switch production to an all-gold system for short runs," he said.

According to Saddler, the relia-

bility of plastic devices depends more on their hermeticity than on bonding. If a more hermetic plastic were developed, he said, most problems would be eliminated.

Robert McKenna, marketing manager for digital military circuits at Texas Instruments, Houston, disagrees with Hakim. He says that TI's current line of industrial plastic devices can satisfy military needs. "We use a gold ball-aluminum system and have no problems with bond failures."

As far as testing is concerned, TI is not at all reluctant to do the testing the military requires, he says.

First hybrid relay line offered for factory use

An integrated line of hybrid relays has been developed finally to meet the rigors of the industrial environment.

Factory installations are tough on the SCRs and triacs used in solid-state relays because of the following:

- The high currents encountered in starting big motors can overheat chips, causing thermal fatigue and eventual failure.
- Heavy line voltage surges tend to damage junctions.
- Line noises and pulses combine with high temperatures and lead to accidental turn-on.
- High vibration levels from machines cause stress failures.

The new line of hybrids, made by the Control Products Div. of Texas Instruments, Attleboro, Mass., is designed to withstand these hostile conditions. The relays are electrically and mechanically equivalent to their electromechanical counterparts and are essentially interchangeable with them.

The 2TI series is designed for switching 120-V inductive and small motor loads. It is said to have a 100-million-cycle life.

The 3TI series will handle up to 10-hp motors and heater loads of up to 45 A at 600 V. This series includes what is, according to TI, the first solid-state reversing motor controller on the market.

At present all the new units are selling for about twice the cost of equivalent electromechanical relays.

NEW SOLID STATE RELAYS

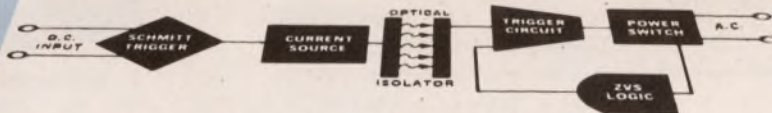
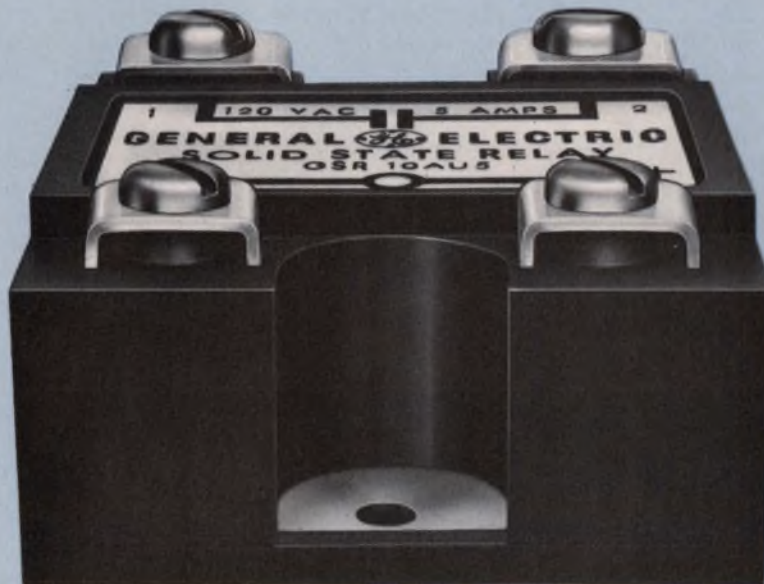

FROM GENERAL ELECTRIC

All the technology that went into making General Electric a leader in couplers and power semiconductors is in our first solid state relay. Two models, 5 Amp. GSR10AU5 and 10 Amp. GSR10AU10, feature

- 120 V line operation
- Zero voltage switching, 5V max.
- T²L operation — 30 to 100° C
- Operates from 6.3 to 140 V RMS
- 1500 V RMS Photon Isolation

AVAILABLE NOW FROM YOUR AUTHORIZED GE DISTRIBUTOR

GENERAL  ELECTRIC

Laser-scanner system produces color pictures on black-white film

Black-and-white film transparencies that show up as color pictures when viewed through a simple optical setup are produced by a laser image-recording system.

Developed by RCA for recording multispectral images from earth sensors in the Earth Resources Technology Satellite (ERTS), the system modulates the laser beam with color-carrier signals. Each of the carriers contains color information of a different spectral band ranging from violet to the infrared.

The modulation scheme produces a synthetic diffraction grating on the film that has both color and image information in it. The laser signals are deflected onto a moving roll of film by a spinning scan mirror that is synchronized with the raster scan of the ERTS cameras or other equipment. The coded images, like those of a hologram, cannot be seen without the playback optical system.

Jim McDermott
Eastern Editor

In the playback system, light from off-axis colored sources is diffracted by the encoded transparency, passes through an on-axis spatial filter and emerges as an image on a screen.

Other uses besides ERTS

Steven L. Corsover, senior staff member at RCA's Advanced Technology Laboratories in Camden, N. J.—the system's designer—sees potential use for the basic system in other areas besides ERTS analysis, including these:

- The visual interpretation of IR photos by use of false colors.
- The recording and reproduction of color facsimile photos.
- The distribution of TV color programs by use of low-cost black-and-white film instead of expensive color. As an alternative, prints could be made with RCA's embossed vinyl-film process developed originally for a holographic TV playback system.

The new system is unique, Corsover explains, in that it uses purely electrical inputs, instead of

images, to produce the black-and-white, color-coded film. Other systems that can produce a similar film have been developed, but they require optical gratings plus color-photo image inputs.

Color information in the RCA system can be encoded by use of a diffraction grating, Corsover says, because the diffraction pattern impressed on the black-and-white film is the optical Fourier transform of the grating. An inverse transform of the diffraction pattern yields the original grating to

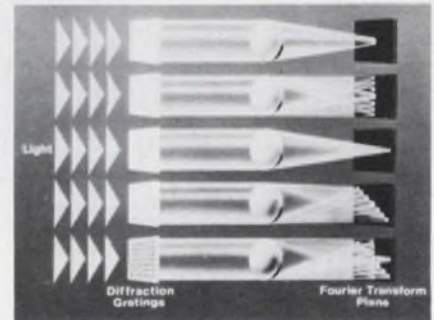

2. Diffraction patterns of gratings can be optically processed to recover impressed information.

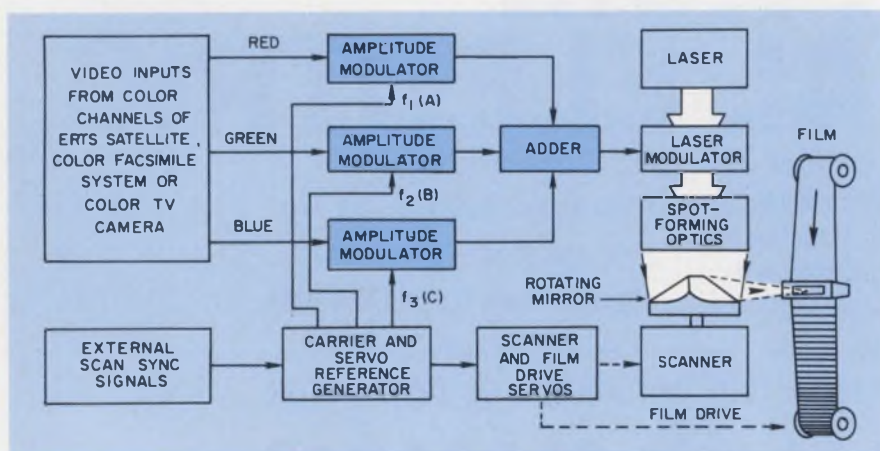

1. Modulated-laser scanner system records multicolor coded images on black-and-white film. Laser produces synthetic diffraction gratings on the film. They contain the image and color information.

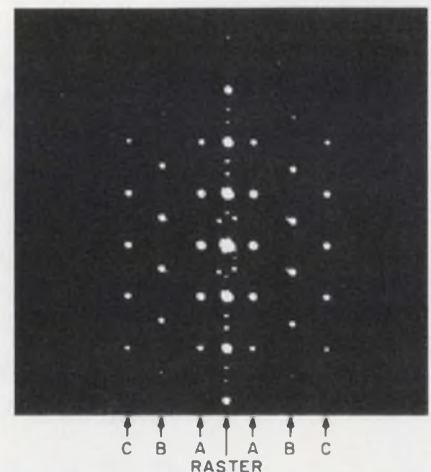

3. Synthetic gratings formed by modulating laser with three carriers have a unique white-light pattern.

Remember



1953 . . . It was high noon for the bad guys when this famous movie ran. 1953 . . . President Eisenhower had just arranged a truce in Korea. 1953 . . . An American firm successfully demonstrated the first full color video tape recording. And engineering and purchasing were having a hard time getting electronic parts and components. Distributors were taking care of their best customers, and delivery of large piece quantities of discretos was out of sight.

1973 . . . We remember. We're U. S. Capacitor Corporation (a subsidiary of Globe-Union) and we know history repeats itself. During the intervening years, capacitor technology advanced exponentially, but the component market

place still fluctuates with the economy.

Another bit of history . . . after each shortage and pipeline filling, the market place has restored to a higher level of consumption . . . 1953, 1973.

U. S. Capacitor Corporation is preparing to meet the current delivery crunch. We've made a substantial commitment to new, automated production machinery so that our customer's needs will be satisfied, and we're also expanding our facilities.

We know the history of our industry and we're investing in it.

We make excellent high-rel and commercial monolithic ceramic capacitors and EMI/RFI filters.

Remember. U. S. Capacitor Corporation.



USCC/Centralab
Electronics Division • Globe-Union, Inc.



2151 North Lincoln Street • Burbank, California 91504

gether with the color and image information that has been impressed on it.

If collimated light is allowed to fall on a blank slide in a simple optical system like that shown in Fig. 2, the light can be focused down to a single spot on a screen.

Substituting a diffraction grating for the blank slide produces a diffraction pattern that is at right angles to the grating lines. If three gratings are superimposed one on the other, the pattern that appears in the focal plane of the lens is the linear addition of all.

In his investigation, Corsover determined that with a laser recorder using a horizontal scan or raster like that of a TV, such gratings can be directly synthesized by modulating the laser output with signals related to the scan rate.

In the first prototype RCA sys-

tem the scan rate was 24 per second, and three carriers were used: 120 kHz ($= 5.10^3 \times 24/s$), 300.659 kHz ($= 12.527472 \times 10^3 \times 24/s$) and 456 kHz ($= 19.10^3 \times 24/s$). These carriers were related to red, green and blue colors, and when all were simultaneously impressed on the film (as in Fig. 4, lower right) this corresponded to a white region of the encoded transparency.

The image information is impressed on the film when the contrast ratio of the gratings is varied in accordance with image brightness. The contrast ratio is changed when the levels of the amplitude modulators are changed.

These carriers have been chosen, Corsover says, with enough differences in their frequency so the diffraction patterns associated with each carrier can be separated.

Because these synthetic gratings are made with a raster scanner, the scan lines are a chopping frequency for the grating. As a result, the synthetic gratings have a diffraction pattern that contains an array of components, as shown in Fig. 3. Here a photo was taken of a pattern formed when the laser beam was sent through a grating region corresponding to white light. The spots formed by each carrier are labeled. The vertical line of spots in the center was formed by the scan raster.

The display system for color-encoded transparencies is most effective with off-axis illumination, as in Fig. 5.

3 point-source lamps needed

To obtain full-color reproduction a minimum of three point-source lamps are needed, one for each of the spatial color carriers (red, green, blue). In an RCA laboratory model the brightness of the individual colors could be adjusted to view a given spectral region.

The original feasibility model, Corsover says, had a single mirror and was used with 70-mm film. The latest model has been improved with a six-faceted scan mirror and a 1250-per-second scan rate (compared with 24 per second). Five-inch film is used.

To provide signals for laboratory testing of the system, a color facsimile system was built. In this, a white-light, flat-field scanner was used to scan a color transparency. The light was separated and fed to three phototubes, one for each of the three primary colors. Signals from the phototubes were applied to the laser modulators.

Basic resolution of the system is good, Corsover says, with 120 line pairs per millimeter for the highest spatial carrier. This is better than conventional TV.

The direct-recording bandwidth of the 24 scan-per-second system is 500 kHz, while that for the latest system is 25 MHz. The video bandwidths for these systems are 100 kHz and 3.2 MHz, respectively. Corsover sees scan rates of 4500 per second and bandwidths of 100 MHz in future systems with 9.5-inch film.

The recording time for the system using 70-mm film is three minutes. ■■

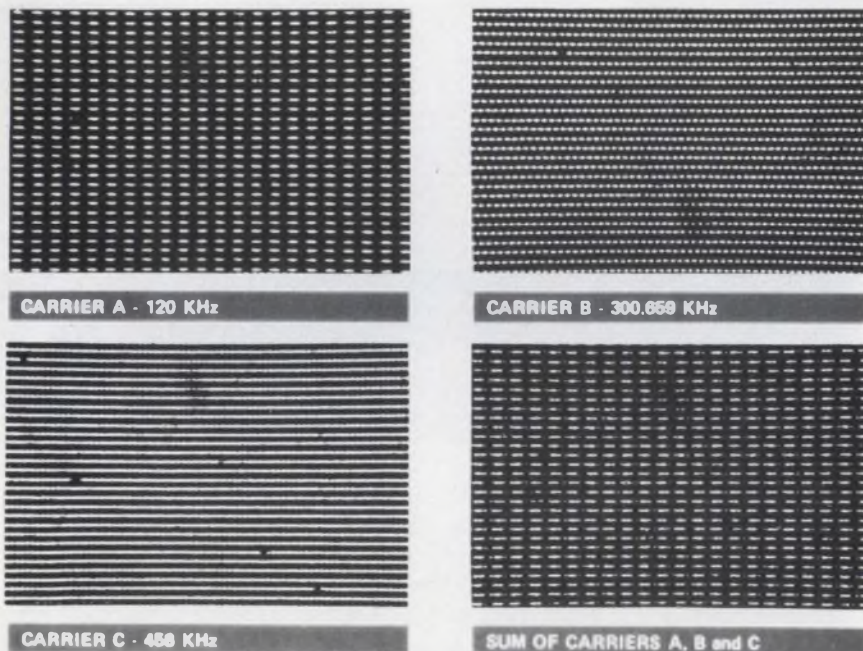

4. Microphotograph of a recorded film shows the synthetic diffraction gratings produced for red, green and blue colors. Their sum is white.

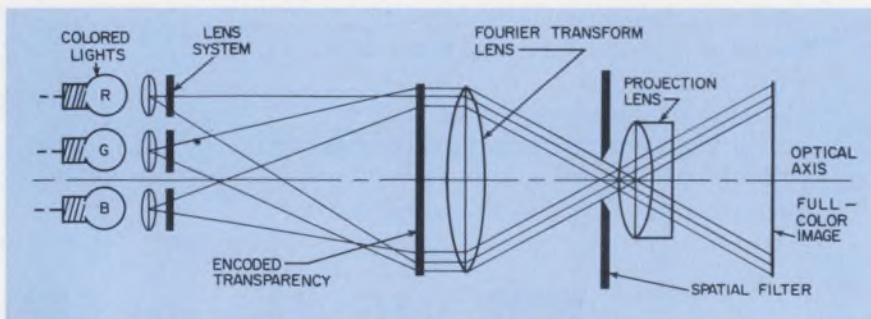

5. Simple optical system transforms the diffraction components of tricolor carrier gratings into a full-color reconstruction of original scene.

JUNE, 1973

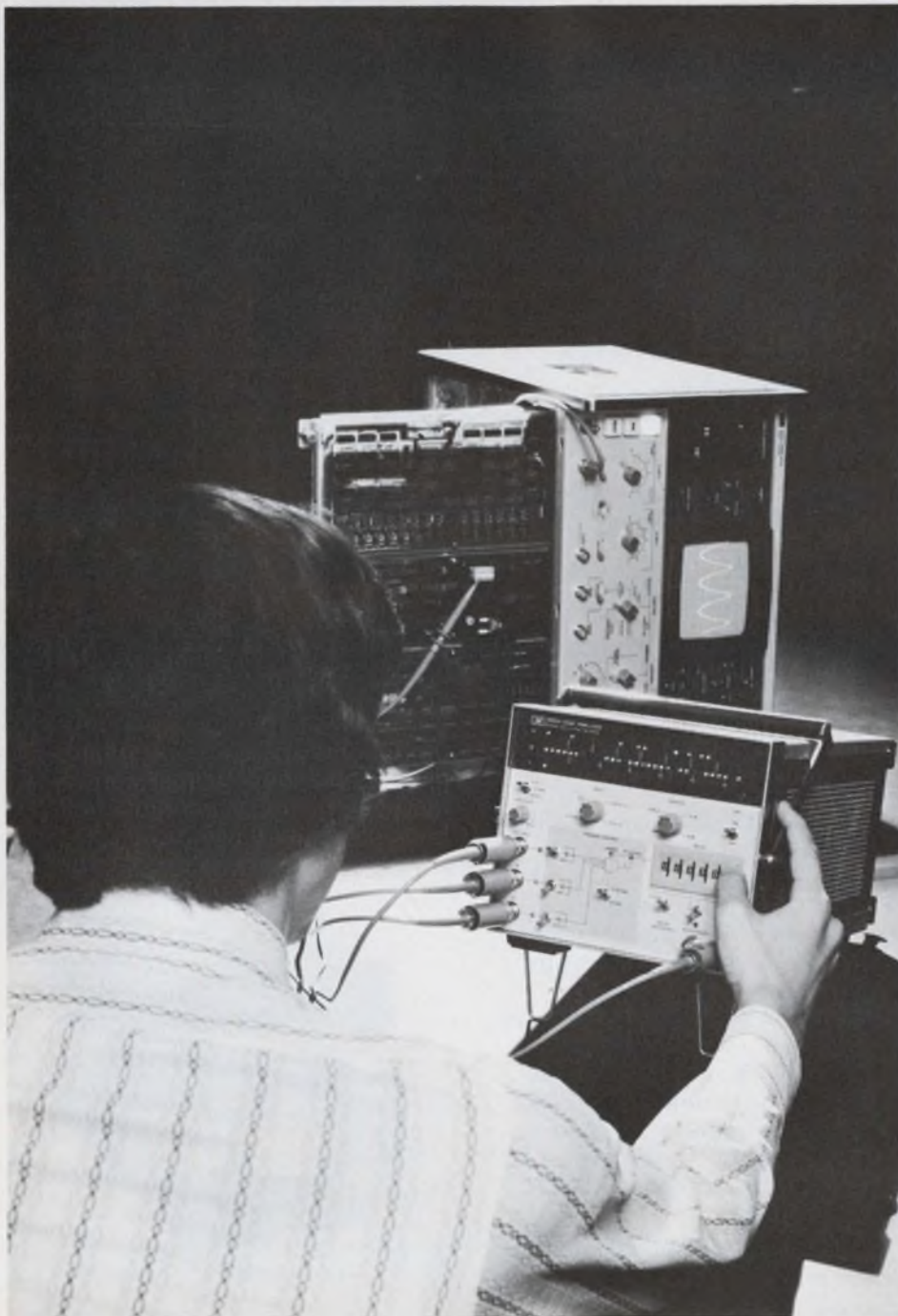

in this issue

Statistics right at
your fingertips

Real-time software
for large or small systems

Three scopes in one

New HP logic analyzer solves digital problems

The new 5000A logic analyzer checks
digital signals from a correlator

Until now, bit watchers have attempted to extend their analog oscilloscopes to their digital problems. HP's new 5000A logic analyzer brings a new dimension to the study of logic states vs. time. Now, single-shot bit streams are captured automatically and stored indefinitely. Long digital sequences can be analyzed precisely because the 5000A delay is digital, locked to the clock of the system under test. And a catastrophic event may be used as a trigger source; the analyzer can even display information that preceded this trigger event.

The 5000A logic analyzer displays 32 clock cycles for each of two data channels (or 64 clock cycles for a single channel). The display is by bit—i.e., the analyzer's 32 LEDs per

(Continued on page 4)

Detect cable faults less than 1 inch apart

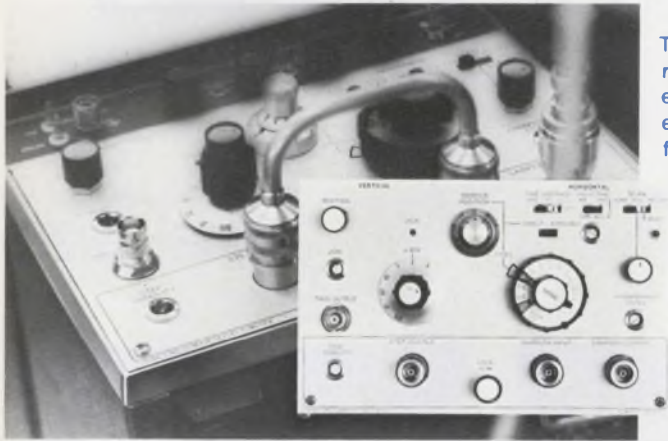

The 1818A time domain reflectometer is easy to use and extremely practical for field measurements

Time domain reflectometry is used to check transmission systems, components and terminations. Now, HP makes it easy for you; merely insert a low-cost, 170-ps TDR plug-in into any 180 series oscilloscope main-frame. You get quick, accurate displays on cable lengths up to 1000 ft (300 m).

A time domain reflectometer displays reflected voltages caused by discontinuities in a transmission line. The display shows the location, magnitude and nature of each impedance discontinuity. HP's 1818A

plug-in resolves discontinuities less than an inch (2.54 cm) apart, so you can pinpoint problems in a long cable without having to physically examine the entire cable length. Because it is so compact, this lightweight wideband TDR system is especially useful for checking shipboard, airborne or remote communications equipment.

For details and specifications, check B on the HP Reply Card.

System monitors spectrum automatically



Spectrum surveillance and monitoring using a van-mounted 8580B is thorough and accurate.



The HP 8580B automatic spectrum analyzer, a fundamental measurement tool for a broad range of applications, can be augmented with optional equipment to optimize spectrum surveillance and monitor-

ing. The 8580B collects and analyzes large amounts of data and can operate unattended.

Performance is further enhanced by a new set of optional preselector/preamplifier units covering 0.1 to 18 GHz in three bands. They increase system sensitivity by 15 to 30 dB, eliminate unwanted responses, and reduce intermodulation distortion caused by strong out-of-band signals. These features also permit the automatic spectrum analyzer to make rapid and accurate EMI/RFI measurements.

For full information, check K on the HP Reply Card.

New multimeter, display for modular instrument

Two new "snap-on" accessories—a high-sensitivity multifunction unit and a 5½ digit display—enhance HP's 3470 measurement system. The 3470 system consists of five compact instruments that fit together in various combinations to form a digital voltmeter, a multimeter, a battery-operated field instrument, or a digitizer with BCD output.

The new 34703A dc/dca/ohms meter features six dc voltage ranges from 10 mV to 1000 V full scale, six dc current ranges from 1 μ A to 100 mA full scale, and eight resistance ranges from 1 Ω to 10 M Ω full scale. Basic sensitivity is 1 μ V in dc voltage. Overranging is 100% on all functions and ranges, except 20% on the 1000 V range. Besides overranging, the multimeter features fast autoranging (< 250 ms) and a new self-test feature that performs 16 different tests on the internal circuitry.

Snap the new 34750A display module on top, and your answers appear on a 5-1/2 digit display.

For more information, check E on the HP Reply Card.

With these two modules, the 3470 measurement system now has seven different instrument combinations.



New flexible dc power supplies for OEM

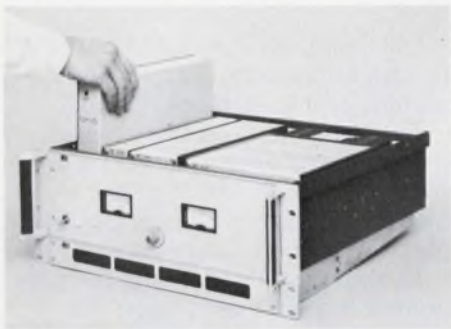

OEM supplies come in $\frac{1}{8}$, $\frac{1}{4}$ and $\frac{1}{2}$ rack widths; you can choose any combination up to a full rack width.

Need a multiple output dc power system that you can plug in and forget? HP's new family of modular power supplies and rack accessories lets you choose from over 50 different standard models (both 62000 series linear and 62600 series transistor-switching types) with ratings from 3V to 48V. That includes the most popular ratings, such as: 5V at 2, 4, 8, 16 and 40A; 12V at 1.5, 3.6, 12 and 23A; and 15V at 1.25, 2.5, 5, 10 and 20A. To supplement these standard ratings, HP uses an interactive computer-aided design system to produce a quantity of supplies with special output ratings.

To complete your power system, just add a 19-in. (48 cm) rack mounting tray, front and rear panels, and slides. The rack tray accommodates any combination of modules totaling a full rack or less. There's plenty of room behind the front and rear panels to add wiring for meters, switches, controls, terminal blocks and fuse holders. You can choose one of several standard panels, modify low-cost blank panels on your own, or let us build the complete system to your specifications. If you need extra cooling, a compatible cooling unit mounts directly below the rack tray and blows room-temperature air up into the power supplies.

OEM and quantity discounts are available. For more information, check P on the HP Reply Card.

New systems minicomputer is microprogrammable

For greater microprogramming convenience, add the 12908B writeable control store option to the 2100S. Two WCS cards, each containing 256 24-bit words of storage, can be plugged directly into the computer.



Now, HP offers a minicomputer with built-in "extras" including microprogramming. Extended arithmetic instructions, floating point hardware, dual-channel direct memory access, power fail interrupt, memory parity check, and memory protect—they're all built into the new 2100S computer. A programmable time base generator, communications control channel, and 16K words of 16-bit memory are also standard.

You can run programs in assembly language, FORTRAN, BASIC or ALGOL. A full range of software systems are available for batch processing, real-time, time-sharing,

data acquisition, and automatic testing.

Because the 2100S contains an efficient microprocessor (a computer within the computer), you can write and store microprograms to suit your application and save valuable memory space. With this 196-ns microprocessor, critical subroutines are executed 5 to 10 times faster than if you use conventional software.

For more on our new "mini," check D on the HP Reply Card.

Powerful new calculator makes statistics easier

Analyze data quickly and easily with this new desktop statistical calculator

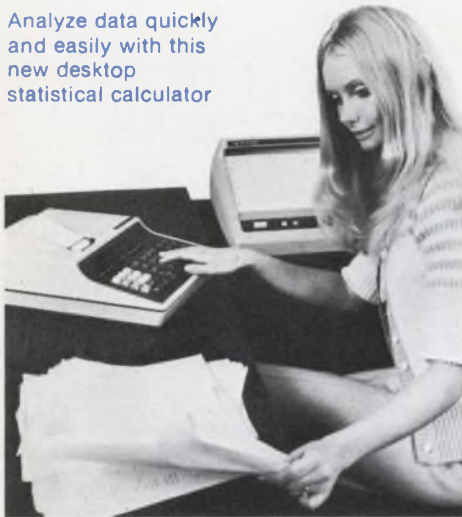

Should you need to analyze research data, HP offers a new dedicated statistics calculator that solves many basic statistical problems with a single keystroke. The new 9805A desktop calculator has a solid-state memory similar to those used in computers. The built-in printer uses standard adding machine paper tape; it prints ten digits plus

the sign, and up to six places to the right of the decimal point.

With the 9805A, you can:

- Calculate and plot a complete histogram with normal curve overlay.
- Fit curves using linear, parabolic, power, exponential, and logarithmic regressions. The plotting option lets you plot these curves with labelled axes.
- Calculate mean and standard deviation.
- Calculate t for both paired and unpaired data.
- Calculate one way analysis of variance for any number of data groups.

Other built-in functions include percentage, $1/x$, $x/12$, $1n x$, logarithms, exponentiation, and grand total accumulation. Options include 10-digit display, plotter compatibility, and additional statistical calculations.

For more information, check O on the HP Reply Card.

(Continued from page 1)

channel represent 32 successive clock cycles of the system under test. The LEDs turn on for a logic "high," and turn off for a logic "low".

To view data beyond the first 32 bits after the trigger, use digital delay to bring it into the analyzer's display. (Up to 999,999 bits of delay can be used.) If the data of interest is before the trigger, up to 32 bits of negative delay allows you to look ahead of the trigger event to see what has happened.

You can select any unique system event to trigger the 5000A: either

data channel; an external trigger input; or high and low combinations of the three inputs ANDed together for parallel triggering. The 5000A is compatible with all logic families—TTL, ECL, MOS, RTL, HTL and CMOS.

With this new logic analyzer, you can design, test or service digital equipment faster and more efficiently.

For more information, check G on the HP Reply Card.

RF signal generator has synthesizer precision

Fully-calibrated AM, FM and CW signals with synthesizer accuracy, stability and spectral purity are under your fingertip control with the HP 8660B synthesized RF signal generator. Keyboard entry of frequency settings (with LED readout) plus swept and manual tuning provide operating flexibility that's truly unique in signal generators. RF plug-ins are available with these frequency ranges: 10 kHz to 110 MHz, 10 kHz to 160 MHz, and 1 MHz to 1300 MHz. All offer 1 Hz resolution.

Some key performance characteristics are: 3×10^{-8} /day frequency stability, -80 dB spurious (at most frequencies), < 1.5 Hz residual FM, and calibrated output levels from +10 to -146 dBm. All functions—frequency, output level, even modulation—can be remotely programmed, which makes the 8660 a natural choice for automatic test system applications.

For details and specifications, check L on the HP Reply Card.

If your requirements call for precision generation of signals in the frequency range between audio and UHF, there's an 8660 configuration that will fill your needs.



New card reader accepts any type card



The new 7260A card reader simplifies record keeping, is quiet enough for the office.

A new optical mark card reader accepts all types of punched or marked tab cards and reads them up to 300/min. You can use tab cards without clock marks or any card length from 7-3/8 in. (18.7 cm) to 11 in. (27.9 cm). It's easy, compact and quiet enough for office use, yet can run unattended under computer control. (An optional stacker is available for computerized operation.)

Data transmission rate ranges from 110 to 2400 baud. The card data is stored in buffers to optimize the feed rate for high transmission efficiency.

Besides saving computer input time, the 7260A is well suited to many applications. In hospitals, patients' lab test results can be recorded on cards then later added to medical records; the costs of the lab tests can be marked on other cards for the billing department. Schools use card data entry for student records, grades, test results, and course registration. The new card reader can also process the results of laboratory and field research.

For more information, check J on the HP Reply Card.

New couplers for wide range swept testing

Two new broadband directional couplers add economy and convenience to swept reflection and transmission coaxial measurements. With their wide frequency coverage (2 to 18 GHz), these couplers can replace several conventional couplers, thereby reducing setup, calibration and measurement time.

Both the 11692D (dual) and 11691D (single) have at least 30 dB directivity from 2 to 8 GHz, 26 dB from 8 to 18 GHz. Coupling variation with frequency is less than ± 1 dB, and auxiliary arms typically track within ± 0.7 dB.

Precision performance and wide bandwidth make these couplers ideal companions for the HP 8755 frequency response test set, a 0.1 to 18 GHz detection and display system. You can make simultaneous swept measurements of insertion loss and

return loss with this versatile microwave measuring system.

For more information, check C on the HP Reply Card.

Make accurate reflection measurements over several octaves (2 to 18 GHz) with the 11692D dual directional coupler.



New pulse generators test fast logic circuits

Two new pulse generators—a plug-in and an independent instrument—test modern high-speed logic circuitry such as TTL-S, ECL-I, ECL-II and MECL 10000. Each has rep rates up to 100 MHz, 5V

amplitude, variable transition times, variable offset and several output formats. A constant 50Ω source impedance ensures minimum pulse distortions.

The new stand-alone generator, 8007B, is well suited for measuring propagation delay and testing wideband linear amplifiers. Pulse transition time can be 2 ns to $250 \mu\text{s}$; independent control of transition times permits ratios up to 50:1. Slope nonlinearity is below 3% above 20 ns.

Model 1916A plugs into a 1900A or 1901A pulse generator mainframe. Slope nonlinearity is under 5% above 5 ns. Like the 8007B, the 1916A output format may be positive or negative, and complementary or symmetric. In addition, the 1916A features dual output.



Both the plug-in (top) and stand-alone (bottom) pulse generators can be externally triggered and their pulse widths, externally controlled.

For details, check S on the HP Reply Card.

New low-cost core-based
real-time system

Distributed systems: one plus one is greater than two



Now, a core-based real-time system
from HP

HP introduces a new real-time computer data acquisition and control system for small, dedicated applications in industry and in research and development laboratories.

Many small laboratory or testing situations require scheduling, multi-programming and priority interrupt; but they don't need foreground and background programs or a large data base. The answer: RTE-C, a smaller low-cost version of HP's real-time executive, that provides concurrent program operations with on-line control by the operator.

System languages are HP FORTRAN and assembly language. Memory capacity is 8K to 32K words; the number of I/O channels vary from 1 to 42. And as your application grows, you can move up to a disc-based system without costly modifications to existing software.

For details, check M on the HP Reply Card.

HP's 9700 series
distributed system

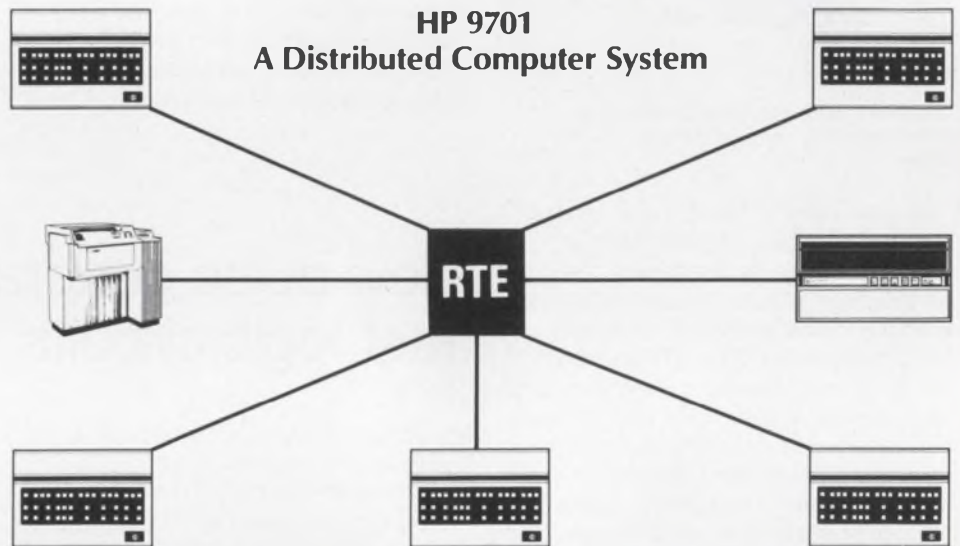

The 9700 distributed system concept involves satellite computers that interface with a central multiprogramming real-time information system. Remote computers can be added in modular fashion.

HP distributed systems solve many of the problems confronting multi-computer system users. In large systems, it is often advantageous to distributed computer processing over a number of independent minicomputers. The HP 9701 distributed system interface kit allocates functional capabilities to multiple remote computers that communicate with a central real-time executive by common carrier telephone lines or by cable (up to 2 miles).

Data collection, sensor-based data acquisition, automatic testing, laboratory automation, and process

monitoring and control can be dedicated to the remote computers, while program development and storage, data management, additional data analysis, and report generation occur at the RTE information center. You can program in ALGOL, FORTRAN, or assembly language. And as your application needs increase, additional remote computers can be interfaced.

To find out how distributed systems can fit your particular application, check N on the HP Reply Card.

HP components: new catalog tells all

Send for this complimentary catalog for component users.

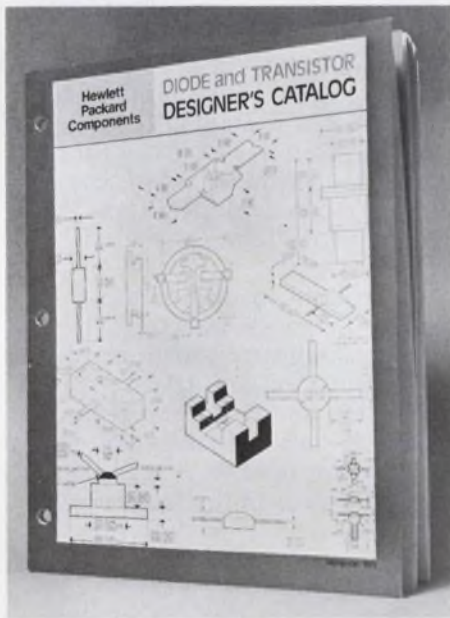

If you are a circuit designer, development engineer or instrument manufacturer, the 1973 HP components catalog should be on your desk. This 160-page "Designer's Catalog" contains complete descriptions and specifications for HP diodes and transistors, including:

- General purpose Schottky diodes
- Microwave Schottky diodes
- PIN diodes
- Step recovery diodes
- IMPATT diodes
- Microwave transistors
- Devices for hybrid integrated circuits.

For a free copy, check Q on the HP Reply Card.

PIN diodes for UHF/VHF switches, attenuators

A new low-capacitance device, the 5082-3077 PIN diode is designed for RF switching, modulating and automatic gain control applications. You can use it in RF duplexers, antenna switching matrices, digital phase shifters, analog phase shifters, electronically-tuned filters, and variable RF attenuators.

Effective minority carrier lifetime is > 100 ns, resulting in low harmonic distortion in the 100 to

1000 MHz frequency range. Dynamic range is 1Ω to $10 \text{ k}\Omega$; reverse bias capacitance is less than 0.3 pF . CW power switching capability is 2.5 W .

Delivery is from stock.

For more information, check H on the HP Reply Card.

New band switching PIN diodes

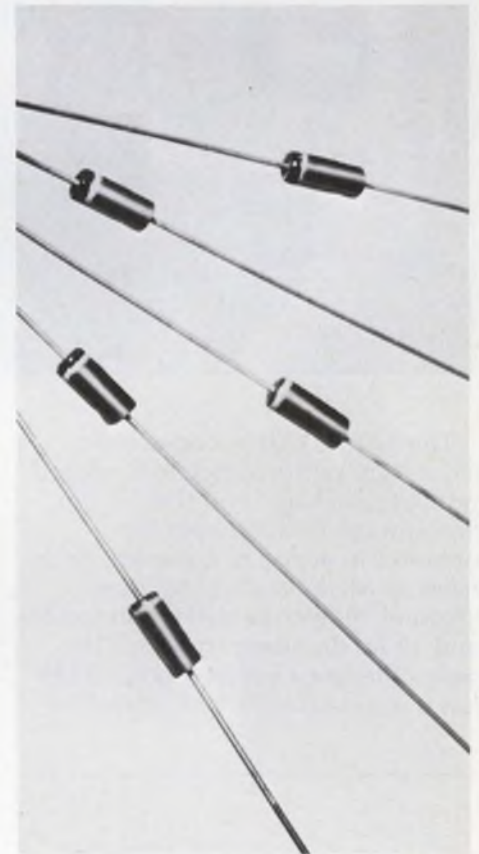

The 5082-3168/3188 planar passivated silicon diodes come in an axial lead, hermetically sealed glass package.

Two new low-cost PIN diodes are available for VHF/UHF switching and general-purpose switching applications that require high performance and mechanical ruggedness. Capacitance is less than 1.0 pF at -20V , and the residual series resistance is typically $.35 \text{ ohms}$ at 10 mA .

For specifications and details, check I on the HP Reply Card.

Use HP battery-powered storage scopes in the field and in the lab



Here, a 1703A storage scope is used to check the audio circuits in a videotape machine

The 1702A/1703A scopes offer laboratory performance in a rugged portable package, and they're the first storage oscilloscopes that operate on ac, dc or batteries. Both have 35-MHz bandwidths, dual-channel 10 mV/div deflection factors, and 10 ns/div sweep speeds. (The only difference is that model 1702A has a standard time base while the

1703A has a calibrated delayed sweep.) You can use either as a conventional scope, a variable persistence scope, or a storage scope.

The 1702A/1703A scopes have a bright, crisp trace. CRT linearity, bandwidth and deflection factors are specified over the entire 6×10 division (0.85 cm/div) display, from dc to 35 MHz. The burn-resistant tube

requires no more operating care than a conventional CRT.

Need variable persistence? You can retain a trace for over an hour. Variable persistence provides extra brightness for dim traces—such as rep rate pulses—and eliminates flicker, common to slow sweep speeds.

With storage, you can capture single-shot events (e.g., noise-related transients) or infrequently-occurring events (e.g., random-bit dropout). Just push STORE, and your waveform is preserved for up to one hour. Either storage scope replaces a conventional scope and a camera (with all the associated inconvenience).

Applications for these scopes include such areas as acoustics, biology, chemistry, oceanography, pneumatic, fluid, electrical, mechanical and civil engineering. Battery operation enables you to use them for field service applications, as well as in the laboratory.

For more information, check A on the HP Reply Card.

HEWLETT  **PACKARD**

Sales, service and support in 172 centers in 65 countries.

East—W 120 Century Road, Paramus, N.J. 07652, Ph. (201) 265-5000.

South—P. O. Box 2834, Atlanta, Ga. 30328, Ph. (404) 436-6181.

Midwest—5500 Howard Street, Skokie, Ill. 60076, Ph. (312) 677-0400.

West—3939 Lankershim Boulevard, North Hollywood, Calif. 91604, Ph. (213) 877-1282.

Europe—Post Office Box 85, CH-1217 Meyrin 2, Geneva, Switzerland, Ph. (022) 41 54 00.

Canada—275 Hymus Boulevard, Pointe Claire, Quebec, Canada, Ph. (518) 561-6520.

Japan—Yokogawa-Hewlett-Packard, 1-59-1, Yoyogi, Shibuya-ku, Tokyo, 151.

Everything you always wanted to know about Drive Motors.



Into these five booklets we've crammed 156 pages of the latest information on Kearfott's line of Drive Motors.

Kearfott, as you probably already know, is a primary supplier of drive motors. And has a reputation for quality, service and on-time delivery.

We can furnish you with drive motors in individual units or in packages to fit any of your aerospace or industrial applications. From counters to computers. From business machines to printers and tape readers.

Let's take a look at the type and range of motors we're talking about.

DC TACHOMETERS



Kearfott Tachometers are designed specifically for precision speed sensing and as rate generators to help velocity servos achieve fast response.

Features include: outputs to 100V dc/1000rpm;

minimum ripple at high commutation frequency; high linearity; low friction torque.

These are ideal for computer tape transports where efficient data retrieval is a must. And for business machine and numerical control machine tools.

DC TORQUERS

You can get sizes 12 through 42, uncased for gimbal mount applications and cased for direct drive torque motor positioning.

Kearfott can also supply them with a variety of integral feedback elements such as potentiometers, synchros and tachometers—in a single housing.

You've a choice of standard design, inverted construction (inner member is magnetic and transfers power to an outer armature) and brushless Limited Rotation design.



DC MOTORS



These are Moving Coil Motors used for high-response DC servos such as High-Speed Printer and Capatan drives.

One of their unique features is that they need less cooling than equivalent competitive units. The reason: low internal impedance which allows a high cooling flow rate at low developed pressures.

Permanent magnet and wound-field types are available for standard aerospace and industrial applications, including high acceleration motors with integral tachometers for terminal printers.

AC MOTORS



Kearfott induction or synchronous motors of the hysteresis or reluctance type come in a broad range of frame sizes. And from sub-fractional power to 15 HP.

We can furnish motors that run on up to 440 volts ac, single, 2 or 3 phase.

Induction motors that operate on 2, 4, 6, 8 or 12 pole design.

And dual speed motors such as needed for driving memory discs in large computers.

You can also get: high-slip motors for aircraft requirements at 400 cps; synchronous motors for constant rotating speeds with varying loads; gear motors for extremely low speeds or speeds incompatible with the power supply frequency.

STEPPER MOTORS

If you want precision control—for example for small peripheral devices, small line printers and tape readers—Kearfott Steppers provide it via discreet steps and high slew rates. And in a wide choice of stepping rates and torque levels.

Typical Kearfott units have 15° stepping angles, compatible with all 24-tooth sprockets. They give high holding torque, high stepping speed and fast response.

Units with other step angles, such as 1.8°, 7.5°, 10°, 30°, 45° and 90° are readily available in frame sizes through 50.

But why not get all the details? Mail the coupon for our new booklets now. The Singer Company, Kearfott Division, 1150 McBride Avenue, Little Falls, N.J. 07424.



SINGER

AEROSPACE & MARINE SYSTEMS

ED-10

The Singer Company, Kearfott Division
1150 McBride Avenue
Little Falls, New Jersey 07424

Gentlemen:

Rush me your new booklets on Kearfott Drive Motors.

Name _____

Title _____

Company _____

Address _____

City _____ State _____ Zip _____

Harris CM

Here are the eight latest additions to our DI/CMOS family-- the fastest low-power logic devices on the market. And they're completely free of SCR latch-up problems.

Last fall we introduced our first eight DI/CMOS logic devices. Now, through our continuing development program, we've added eight more. Like the first group, these offer speeds twice as fast as any comparable IC's (typically 10ns with 10-volt power supplies) and extremely low power dissipation. Power dissipation for each of the eight new devices is typically 1nW. These units also permit a wide power supply range (3VDC to 18VDC), while providing large noise immunity—typically 45% of supply voltage. And because of our dielectric isolation process, SCR latch-up problems are completely eliminated.

Chip reliability is currently reported at more than 325,000 device hours at +125°C without failure.

The first six devices diagrammed here (HD-4000 series) are pin for pin compatible with the CD-4000A series. The last two are Harris proprietary devices (HD-4800 series). All are available in 14-pin DIP's except the HD-4814, which comes in a 16-pin package. For details see your Harris distributor or representative.

9

HD-4002
Dual 4 NOR Gate

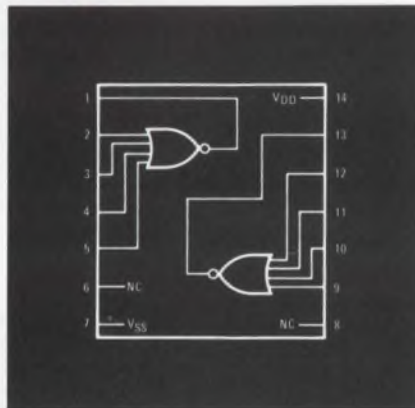

Pin for pin compatible with CD-4002A.
100-999 units
-40°C to +85°C \$1.00
-55°C to +125°C \$3.40

10

HD-4007
Dual Complementary Pair Plus Inverter

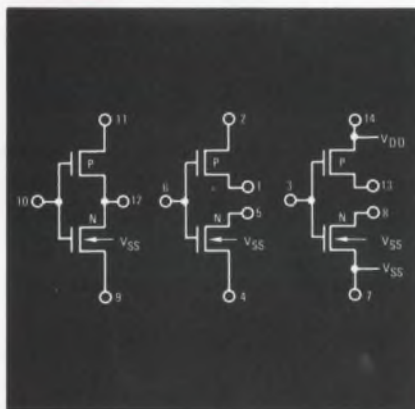

Pin for pin compatible with CD-4007A.
100-999 units
-40°C to +85°C \$1.00
-55°C to +125°C \$2.65

11

HD-4019
Quad AND/OR Gate

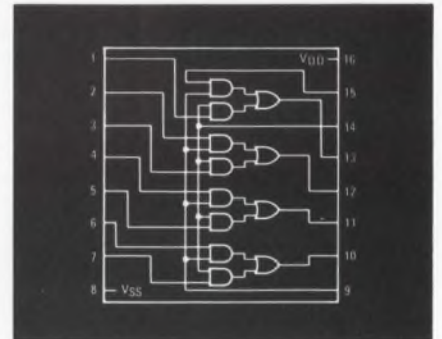

Pin for pin compatible with CD-4019A.
100-999 units
-40°C to +85°C \$2.45
-55°C to +125°C \$5.05

12

HD-4023
Triple 3 NAND Gate

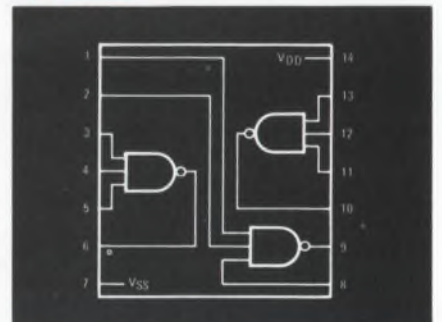

Pin for pin compatible with CD-4023A.
100-999 units
-40°C to +85°C \$1.00
-55°C to +125°C \$3.40

13

HD-4025
Triple 3 NOR Gate

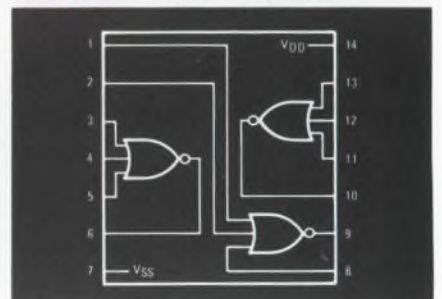

OS cont'd:

Pin for pin compatible with CD-4025A.
 100-999 units
 -40°C to +85°C \$1.00
 -55°C to +125°C \$3.40

14 HD-4030
 Quad Exclusive OR Gate

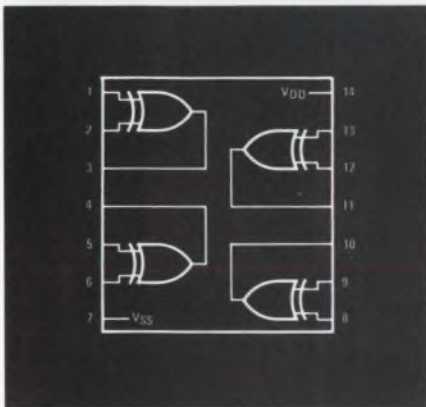

Pin for pin compatible with CD-4030A.
 100-999 units
 -40°C to +85°C \$2.10
 -55°C to +125°C \$3.80

15 HD-4811
 Quad Exclusive NOR Gate

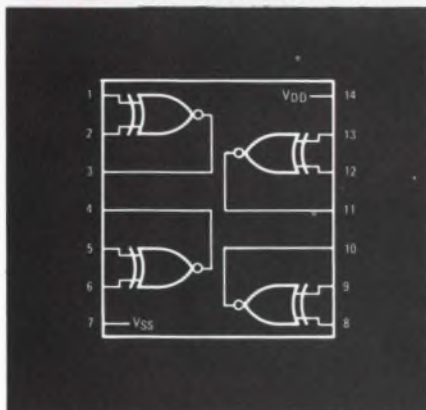

A Harris proprietary device.
 100-999 units
 -40°C to +85°C \$2.10
 -55°C to +125°C \$3.80

16 HD-4814
 Hex Inverter

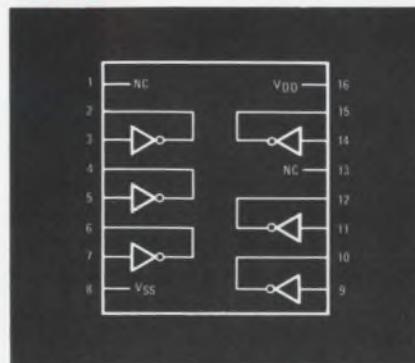

A Harris proprietary device.
 Replaces HD-4009 in applications
 requiring only the inverting function.
 100-999 units
 -40°C to +85°C \$2.10
 -55°C to +125°C \$3.80

*1 thru 8

In case you missed the ad describing our first eight CMOS devices, here they are again. All are high-speed, low-power units. The HD-4000 series is pin for pin compatible with the CD-4000A series. The HD-4809 is a Harris proprietary device.

	100-999 units	
	-40°C to +85°C	-55°C to +125°C
1. HD-4000 Dual 3 NOR Gate	\$1.00	\$3.10
2. HD-4001 Quad 2 NOR Gate	\$1.00	\$3.30
3. HD-4009 HEX Inverter	\$2.20	\$5.25
4. HD-4010 HEX Buffer	\$2.20	\$5.25
5. HD-4011 Quad 2 NAND Gate	\$1.00	\$3.30
6. HD-4012 Dual 4 NAND Gate	\$1.00	\$3.45
7. HD-4013 Dual "D" Flip Flop	\$2.10	\$4.75
8. HD-4809 Triple/True Complement Buffer	\$2.25	\$5.30



HARRIS
SEMICONDUCTOR
 A DIVISION OF HARRIS-INTERTYPE CORPORATION

P.O. Box 883, Melbourne, Fla. 32901
 (305) 727-5430

WHERE TO BUY THEM: ARIZONA: Phoenix—Liberty, Weatherford, Scottsdale—HAR (602) 946-3556
 CALIFORNIA: Anaheim—Weatherford, El Segundo—Liberty, Glendale—Weatherford, Long Beach—HAR (213) 426-7687, Mountain View—Elmar, Palo Alto—Weatherford, HAR (415) 964-6443, Pomona—Weatherford, San Diego—Weatherford, Western
 COLORADO: Denver—Elmar, Weatherford
 WASHINGTON, D.C.: HAR (202) 337-3170
 FLORIDA: Hollywood—Schweber, Melbourne—HAR (305) 727-5430
 GEORGIA: Atlanta—Schweber
 ILLINOIS: Chicago—Semi-Specs, Schweber, Palos Heights—HAR (312) 587-7510
 INDIANA: Indianapolis—Semi-Specs
 MARYLAND: Rockville—Schweber
 MASSACHUSETTS: Lexington—R&D, Waltham—Schweber, Wellesley—HAR (617) 237-5430
 MICHIGAN: Detroit—Semi-Specs
 MINNESOTA: Minneapolis—Semi-Specs
 MISSOURI: Kansas City—Semi-Specs, St. Louis—Semi-Specs
 NEW MEXICO: Albuquerque—Weatherford
 NEW YORK: Melville—HAR (516) 249-4500, Syracuse—HAR (315) 463-3373, Rochester—Schweber, Westbury—Schweber
 OHIO: Beachwood—Schweber, Dayton—Semi-Specs
 PENNSYLVANIA: Pittsburgh—Semi-Specs, Wayne—HAR (215) 687-6680
 TEXAS: Dallas—Weatherford, Semi-Specs, HAR (214) 231-9031
 WASHINGTON: Seattle—Liberty, Weatherford
 WISCONSIN: Wauwatosa—Semi-Specs
LEGEND FOR HARRIS SALES OFFICES & DISTRIBUTORS: Harris Semiconductor (HAR), Elmar Electronics (Elmar), Harvey/R&D Electronics (R&D), Liberty Electronics (Liberty), Schweber Electronics (Schweber), Semiconductor Specialists, Inc. (Semi-Specs), R. V. Weatherford Co. (Weatherford), Western Radio (Western).

the changing face of time



CAL-TEX digital clock/calendar circuit

If you are one of the people who are causing change, then Cal-Tex has a product of value to you. If you are designing tomorrow's time display and measurement systems today, then our CT 7001 Digital Clock/Calendar circuit has application.

Here are some of its functions; let your mind choose the application:

- 4 or 6 Digit, 7 Segment display banking.
- Display outputs can be "Wire Or'd" allowing chip to share displays such as with a calculator.
- On Chip 50/60 Hz backup oscillator for power failure, with low battery voltage warning indicator.
- 28/30/31 Day Calendar eliminating the need for monthly resetting.
- 10 Minute Snooze Alarm.
- Separate Alarm Control and Counter Input which are set independently of each other.
- 50 or 60 Hz operation.
- 12 Hour AM/PM indication or 24 Hour clock.
- Clock Radio and Timer Controls.
- True 24 hour Alarm which need not be reset.

IF YOU ARE INTERESTED IN CHANGING THE FACE OF TIME,
A CALL CAN START IT RIGHT NOW!



CAL-TEX SEMICONDUCTOR, INC.

3090 ALFRED STREET, SANTA CLARA, CALIFORNIA 95050 • (408) 247-7660 • TELEX: 357424

INFORMATION RETRIEVAL NUMBER 163

Laser system tracks where radar can't

A laser tracking system for missiles that permits tracking in the low altitudes where ground clutter causes radar to fail is being tested at the White Sands Missile Range, N.M.

The system is reported able to track white-painted targets traveling 1000 mph with four-inch accuracy at up to 0.9 mile. Positions are computed every 5 ms.

Used with radar, the laser system provides accurate tracking of a test missile throughout its flight. The system—called an LRTS, for Laser Ranging and Tracking System—was built by the Autonetics Div. of Rockwell International, Anaheim, Calif., to specifications outlined by the Instrumentation Directorate of the Army Test and Evaluation Command.

A 5145-Å beam from a fixed, 5-W cw argon laser is fed to a transceiver head mounted on a precision gimbal. The transceiver aims the beam at the target missile, and an image dissector tube mounted in the transceiver head detects the reflected light. The missiles are painted white to increase their reflectivity.

A Systems Engineering Laboratories SEL-810B computer with an 8-k core memory handles both signal conditioning and gimbal control functions.

"The system is flexible," explains John A. Roth, Army project manager. "The laser tracker can either scan above the target missile to initiate tracking as it passes or can be locked on before the launch."

Since it is a skin-tracking system rather than a beacon tracker, no transponders or reflectors need be installed on the test vehicle. Further, no optical or tracking augmentation is required on the ground for the system to work.

The prototype LRTS, costing about \$1-million, has been undergoing tests at White Sands for more than two years, and the final phases of testing are taking place now, according to the Army. ■■

nimo CRT THE 64 GUN SALUTE



BOOM... big information in a small package. *nimo*®, a 1.5" MINI-CRT requiring no internal or external focusing or deflection.

Each of 64 independent guns can display a single letter, number or symbol up to .6" high, or a complete message of up to 3 lines of 6 characters (.187" high). In effect, this ingenious display provides a Read-Only-Memory for your fixed data with extremely simple and inexpensive T²L interfacing; i.e., an 8 x 8 drive structure requires only two SN 7442N decoders, and four MC 1820 P Hex inverters to complete the package.

Unmatched legibility (true form characters), and contrast ratio, boom loud and clear, all on a single plane.



Don't restrict your thinking about the *nimo 64's* applications, they're great for key-to-tape/disc terminals for character entry verifications, digital instrumentation, annunciator systems, computer prompters, optical data scanning systems, teaching machines, and point of sale terminals.

The price? At ease men... 60¢ a message. *nimo 64*, the ultimate display—GIVE IT A SHOT!

Give us a call. Industrial Electronic Engineers, Inc., 7740 Lemona Avenue, Van Nuys, Calif. 91405, Telephone: (213) 787-0311, TWX 910-495-1707. Our European Office: 6707 Schifferstadt, Eichendorff-Allee 19, Germany, Phone: 06235-662.



Green LED production spurred by a new process at Ferranti

A new process for greatly improving the batch fabrication of green LEDs is reported by Ferranti Ltd., Chadderton, Oldham, England. "Excellent performance" in the laboratory has been obtained from nitrogen-doped, gallium phosphide devices with an emission peak at 565 nm, the company says.

The process is described in a paper, "Green LED Displays—A Planar Approach," by A. R. Peaker and V. M. Pastore of Ferranti.

The shortcomings of red-emitting, gallium-arsenide-phosphide devices, which now dominate the LED market, were summarized this way by the authors:

"Red LEDs emit at a wavelength of approximately 655 nm—the extreme end of the eye's response—which results in operator problems, such as fatigue after prolonged use, focusing difficulties and high error rates."

These factors, combined with the unacceptable psychological connotations of red displays in some environments like aircraft cockpits, have created a pressing need for green and yellow light-emitting diode displays, with costs and characteristics comparable to those for GaAsP.

Others make green LEDs

Most companies—such as Monsanto of Cupertino, Calif.; Microsystems International of Ottawa; Matsushita of Japan; Opcoa, Edison, N.J., and Siemens of West Germany—use either the liquid-phase or vapor-phase epitaxy process.

The liquid-epitaxy process now widely used to fabricate gallium phosphide diodes produces an emitting region between the individual grown p and n regions. This

junction is essentially continuous across the whole slice, so that the emitting areas must be defined by cutting or etching.

This process severely limits the available configurations and makes testing impracticable prior to dicing.

The process that Ferranti chose for fabricating gallium-phosphide diodes commercially, the paper said, calls for a single liquid-epitaxy growth followed by a low-tempera-

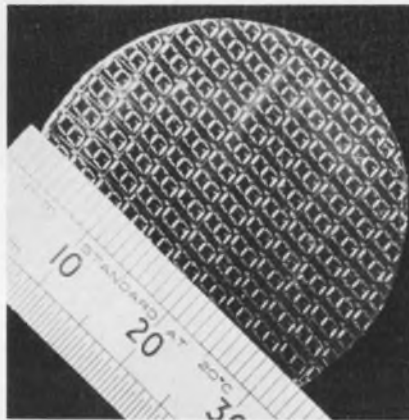

This slice of green-doped gallium-phosphide material has been processed to produce seven-segment numerics, each 2.5 mm high.

ture diffusion using a silicon-nitride mask. To obtain the flexibility to make any shape of diode required—and in large quantities—photoprocessing techniques similar to those for making silicon diodes had to be used. This called for very smooth surfaces—with undulations no larger than 1 μm . This smoothness, in turn, put great demands on the epitaxial growth process, causing Ferranti to go to a process that uses horizontal spades, or substrates, in a vertical crucible.

N-type epitaxial layers are de-

posited on up to 20 slices of 10 cm^2 each. The layer is doped with sulphur from a solid source and nitrogen from ammonia gas.

After growth, a silicon-nitride layer is deposited on the slice, and normal photoresist techniques are used to delineate the diode areas. Fluorine ions from the tetrafluoromethane plasma are used to etch windows in the nitride, and subsequently zinc is diffused into the gallium phosphide.

The dice can be mounted on the display matrix substrates by alloying, soldering or epoxy-bonding. Consequently, according to the authors, high yields can be obtained with conventional semiconductor equipment—an important point in hybrid displays, where the LED manufacturer is often supplying uncut wafers rather than finished devices.

Special uses cited

One area where green-emitting devices have a large advantage over red LEDs, the authors reported, is in data recording on photographic film. The green device is suitable for recording on orthochromatic and many blue-sensitive films while providing superior results on color, panchromatic and most infrared material. In film applications the transparency of the gallium phosphide enables the light to be taken out through the substrate so that very small characters and dot-spacing can be achieved. The information is relayed to the film via a fiber-optic faceplate for "in contact" marking, or via a lens if further size reduction is required.

A Ferranti spokesman says the company is now capable of producing 10-million green LED chips a year at a cost that is only 20% higher than red LEDs. ■■

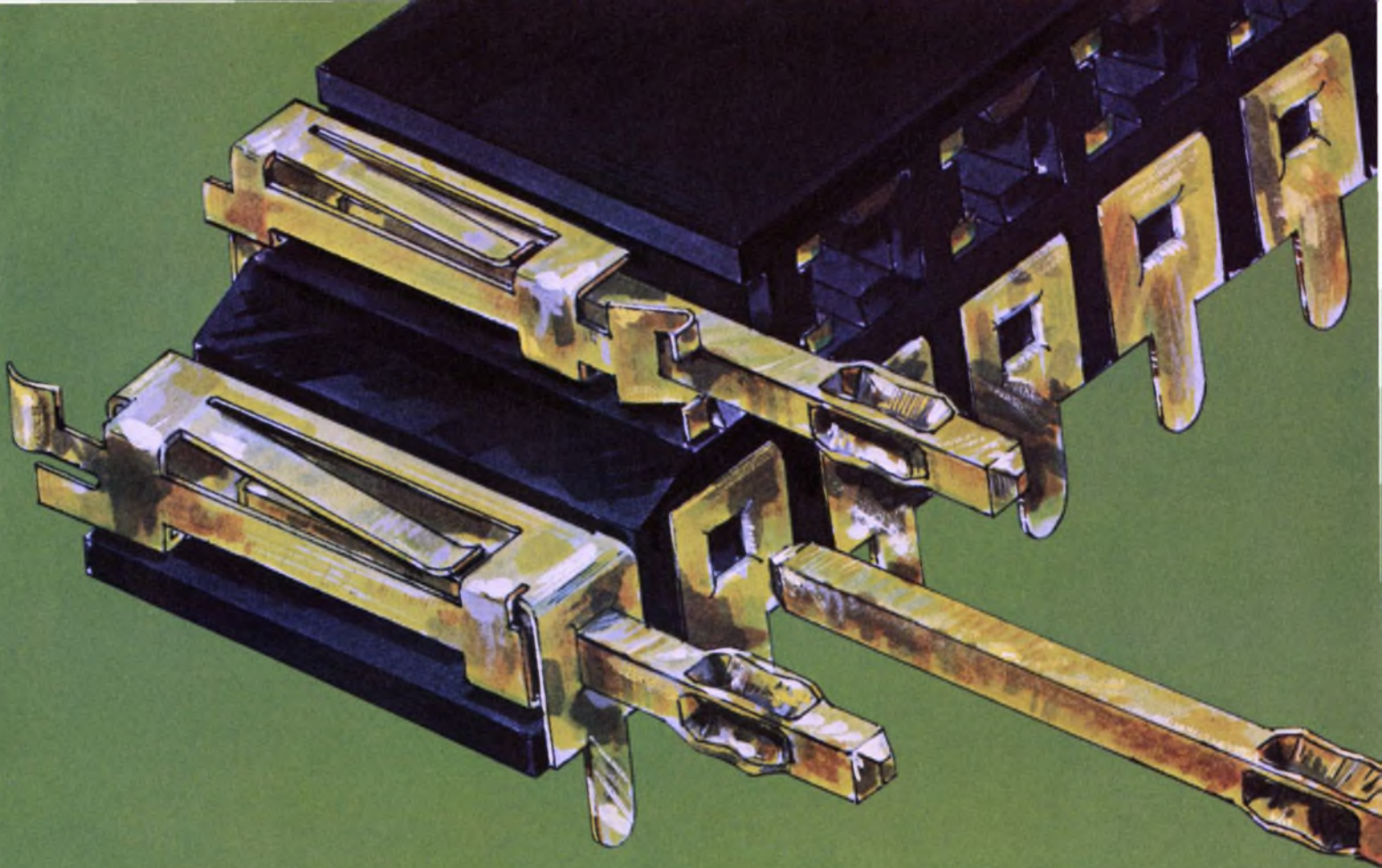

THE PERFECT MATING

Any .025" square post, yours or ours. And Elco's Varipost Box™ connector. For true togetherness in board-to-board and cable-to-board connections. Our new single row (Series 8243) and dual row (Series 8242), connectors will mate with any .025" square posts on the market, even if they're wire-wrapped one level. Which means you can hold with your existing design and still make the connections you need.

Let's peek inside one of our Varipost Box™ connectors and see why they're so receptive.

First, the contact surfaces of the spring members are parallel to the surface of the p.c. board, and thus can span post-to-post tolerance deviations in your board. This compensates for misalignment between posts and contacts, so you get a perfect mating every time. Competi-

tive box connectors—on the other hand—have perpendicular contact surfaces that demand tighter post-to-post tolerances to insure the mating of every contact with its corresponding post.

The spring contacts in our Varipost Box™ connector are longer, deflect farther and provide a longer wiping action than competitive connectors. Our contacts extend all the way to the entrance of the connector, so they'll mate with shorter-than-standard posts. And if your posts are longer than standard, a built-in stop prevents the posts from extending out the rear of the connector and shorting out with the upper row of contacts in the dual row version.

There's more. Our contacts can be removed from the housing and replaced without deformation. And sequential mating in dual row con-

nectors—first one row, then the other—reduces insertion forces by half.

A wide range of models is now available . . . right off the shelf. Cable-to-board units with contact spacing on .100" and .125" centers in single row (with up to 25 contacts) and dual row with up to 50. Board-to-board (.100" centers) versions with up to 50 contacts, and dual row (.100" by .100") with up to 100 contacts.

As companion pieces, we offer our new .025" square posts, Elco Variposts™. And we've the insertion equipment to stake these posts into the board. So we can supply your p.c. board with posts already inserted, ready for mating.

Leave it to Elco, the Matchmaker. Another service in keeping with CONNECTRONICS, Elco's Total Connector Capability.

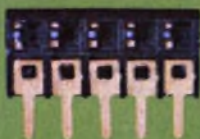

Elco Corporation,
Willow Grove, Pa. 19090
(215) 659-7000

Elco Corporation,
2200 Park Place,
El Segundo, Calif. 90245
(213) 675-3311



A bubble memory-logic chip? IBM heads toward that goal

Magnetic-bubble memories would be much more attractive if they could perform logic as well as storage. IBM researchers have taken the first step toward achieving this goal by designing a universal bubble logic element that can perform any logic function.

The development was described at the National Computer Conference in New York by Frank Tung, a staff member at the IBM Research Laboratory in San Jose, Calif. Noting that early attempts at bubble-logic design concentrated on AND/OR gates, he observed: "This is a very primitive form of logic and is inflexible." The early attempts were not sophisticated enough to take advantage of large-scale integration, he pointed out.

The bubble circuit under development at IBM overcomes these problems, Tung reported. It is simply an implementation of the symmetric switching function—a function that has been known for many years. Its use in a design has been limited until now, Tung noted, because it is not easily implemented with solid-state logic. But it is very easy to use with bubbles, he said.

It performs any logic function

Like NOR/NAND logic, the symmetric switching function is a universal operator. It can be made to perform any logic function—such as that of an AND/OR gate, carry-bit generator or sum-bit generator—simply by changing parameters known as A-numbers in the control bubble stream (see diagram).

Jules H. Gilder
Associate Editor

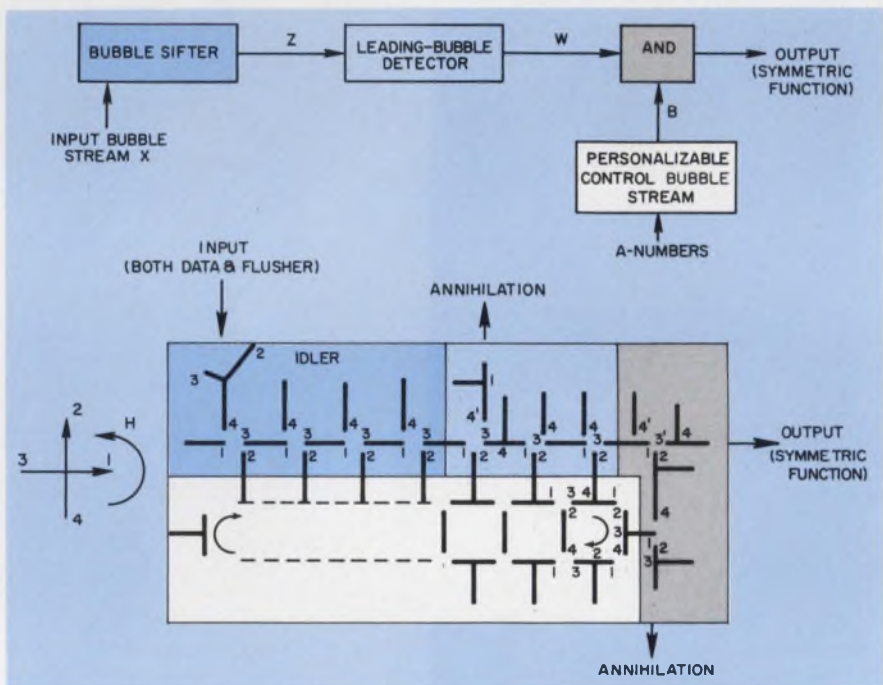

Required bubble mechanisms to realize symmetric switching functions are shown in the block diagram (above) and the permalloy pattern (below).

Generation of logic functions, Tung said, is made possible by the magnetic forces that exist between bubbles. The magnetic force emanating from a bubble, he explained, is adequate to move an adjacent bubble as far as two or three diameters away.

In explaining how the symmetric-function bubble device works, Tung noted that data were first entered into the bubble sifter. The sifter merely separates the bubbles, which represent ONES, from the voids, which represent ZEROS. When a bubble enters an idler, it remains there unless it is forced out by another bubble. It is this property that permits the sifting, or separating, of bubbles and voids.

The output of the sifter (Z in the diagram) is then fed to the leading bubble detector. This is done by entering additional bubbles known as flushers. The position of the first bubble, which is determined by the time it takes the bubble to be detected, is an indication of the total number of bubbles. This number must be known to perform logic operations.

When the leading bubble enters the detector, it forces a bubble that was loaded into the detector as an additional condition into the AND gate. In the meantime the leading bubble remains in the center idler of the detector and, by magnetic repulsion, forces all subsequent bubbles to be annihilated. Thus the output of the detector stage con-

tains only one bubble.

The A-numbers are stored in a recirculating shift register. By proper timing, Tung said, the information coming out of the leading bubble detector stage is required to AND with the A-numbers of the control bubble stream. If both inputs to the AND gate are ONEs, a bubble appears at the output, indicating that the function is true. If, on the other hand, one of the inputs to the AND gate is a void or ZERO, the bubble at the other input goes to the bubble annihilator and the output is ZERO.

In the symmetric-function bubble device, Tung said, the logic operation is performed by counting the number of bubbles. If the A-numbers are chosen as 2 and 3, the device becomes a carry-bit generator. In this case, if the number of bubbles equals 2 or 3, a carry bit is generated.

By changing the A-numbers to 1 and 3, the device becomes a sum-bit generator. The carry and sum functions can be combined to form an adder.

Blending memory and logic

The bubble-logic device is fabricated with T and I permalloy patterns, which are very similar to those used for bubble memories, Tung reported. Because of this similarity, it is feasible to blend memory and logic on the same chip. Such a mixture would offer lowered cost and low power dissipation.

Traditionally, memory and logic are packaged separately. For example, the ferrite core memory and semiconductor central processing unit are separate because of different technologies. In semiconductors, memory and logic are separated mainly because read-write memory is volatile while logic is not.

Combining logic and memory on the same chip will also lead to increased reliability and shorter delay times, Tung predicted. With logic and memory on the same chip, the number of interconnections will be reduced and reliability will go up, he noted.

The new capability, Tung speculated, may foster revolutionary changes in computer organization and architecture. ■■

monoform

out of the West!

A whole family of switchlights
that don't cost much

It used to be you touched a spur to a horse and something happened right away. Nowadays, you lay a finger to a switch that better be even more reliable. And because you may need hundreds of them, they should be low cost and arrive in a hurry. That's the way it is with our Monoform family of switchlights.

Monoform I (the single lamp, momentary & alternate, rated 2 amp 120 Vac).

Monoform II (two independent lamps for horizontal split legends, mom. & alt., 2 amp 120 Vac).

Monoform III (10 amp, ¼ H.P. power switch).

There's a whole family designed by Clare-Pendar to give you more value, more flexibility than any other switchlight that costs just about two silver dollars.



 CLARE-PENDAR
Phone 208-773-4541

Liquid-crystal panel overcomes video-rate operating 'barrier'

Until now the operation of a liquid-crystal panel at video rates has not been possible, because of crosstalk between elements and the slow response time of the crystals. A solution to these problems was presented at the Society for Information Display's International Symposium and Exhibition, held in New York City May 15 to 17.

A paper by Lewis T. Lipton and N. John Koda of the Industrial Products Div. of Hughes Aircraft Co., Oceanside, Calif., described a panel design that used thin-film transistors as a switching element and integrated the transistors with other structures required by the cell. Nematic liquid crystals in a reflective mode were employed, but the authors said the design could be adapted to other liquid crystals and to a transmissive mode of operation.

The basic requirement for operating liquid cells, the paper explained, is the application of an electric field across the liquid crystal to orient its molecules. Various

modes of operation are then possible. The one chosen by the authors was the dynamic scattering mode, in which increased fields are applied and the corresponding ionic current creates scattering sites.

Photolithography used

Fabrication of the thin-film transistors was achieved by standard photolithography and thin-film deposition techniques. In this approach the gates are chrome and are formed by etching. The insulator is usually silicon monoxide or aluminum oxide, and the semiconductor is cadmium selenide. No masking is required for the deposition of these materials, except at the panel edge, where contacts are made.

The operating panel is completed by sandwiching the transistor array with a suitable liquid crystal, a Mylar spacer and a covering plate that has a tin oxide electrode.

The authors' initial effort centered on obtaining the required thin-film-transistor performance. They began by constructing a coarse 2-by-3 array that would solve both the photolithography and transis-

tor fabrication problems.

After the desired array of transistors had been fabricated, the authors constructed the panel by combining the array with a dynamic scattering-mode liquid-crystal material. The panel successfully demonstrated thin-film-transistor control of the individual liquid-crystal elements with no crosstalk, the paper reported. The contrast ratio with collimated light was in excess of 10:1, with 25 V between the source and drain.

The array also demonstrated the concept of rapid address of the liquid crystal via charge storage on the parallel capacitor. The authors said further that a pulse on the gate of the thin-film transistor was able to excite the liquid crystal at a rate approximately one order of magnitude faster than the response time of the liquid crystal alone. The actual rate was controlled by the RC time constant of the transistor ON resistance and the buffer capacitance. The rate is limited by the excessively large capacitance of the coarse 2-by-3 array. Work is now under way, the authors say, to extend the concept to larger panels. ■■

John F. Mason
Associate Editor

Ceramic image-storing device can project data by reflection

A new type of ferroelectric-photoconductive image-storing device has been developed that allows the stored data to be projected on a screen by reflection from the surface, as well as by light being transmitted through it. Previously

similar devices operated only by transmitted light.

There are distinct advantages to the new technique, according to Cecil E. Land and Willis D. Smith of Sandia Laboratories, Albuquerque, N. M., who developed the new

reflective device, called the Fericon, and a light-transmission predecessor, the Cerampic. The two men described their findings in a paper at the recent information display show in New York.

The Fericon provides higher

The GI book club



Here's a book club for capacitor guys. Almost everything you want to know about capacitors. Types. Specifications. Cross references. A real "how to" manual in an easy-to-use three ring binder. A binder we register in your name and periodically update. It's not a club for everybody, but if you're a qualified capacitor guy, membership is yours for the asking. From General Instrument . . . the people who wrote the book on capacitors. Capacitor Division, General Instrument Corporation, 165 Front Street, Chicopee, MA 01014. Phone (413) 592-7795.



**General
Instrument**
the capacitor company

Off the shelf delivery from Miconics/G.I. distributors coast to coast.
Call (N.Y.) 212/361-2266 or (Calif.) 213/769-6782 for the name of the distributor nearest you.

Lighted pushbutton switches this good should cost dollars more.

Our prices:

\$125*

\$160†



OAK SERIES 300.

Get premium performance—at much less than a premium price. Oak Series 300 lighted pushbutton switches give you tested-for-reliability operation and long life. The economical solution to pushbutton applications for bank terminals, calculators, copiers, and more.

Modular design simplifies panel design. Oak Series 300 switches are relampable from the front, with

replaceable lenses, legend plates, and button assemblies. The snap-on lamp holders withstand physical shock, help prolong lamp life.

Choose from single, dual, or four-lamp display, as well as indicators and non-lighted types. Specify one to twelve station banks, with momentary, interlock, alternate action, or any switching combination available on the same bank.

Colors? Your choice of any one of the following for single-legend switches (or any combination for split-legend switches): lunar white, white, red, green, amber, yellow, orange, blue.

Get the complete details. Write for our Series 300 brochure.

* Single-legend, single-lamp, normal latch, 2P2T, glass alkylid insulation, no engraving, less lamps. OEM quantities.

† Split-legend, four-lamp, normal latch, 2P2T, glass alkylid insulation, no engraving, less lamps. OEM quantities.

OAK Industries Inc.

SWITCH DIVISION / CRYSTAL LAKE, ILLINOIS 60014
TELEPHONE: 815-459-5000 ■ TWX: 910-634-3353 ■ TELEX: 72-2447

INFORMATION RETRIEVAL NUMBER 23

Who to call for fast delivery on Oak Series 300 Switches.



Now you can order Oak Series 300 Lighted Pushbutton Switches and assemblies (single-legend/single-lamp or non-illuminated) in quantities up to 149 from your regional Oak distributor. These distributors are equipped to assemble custom units and ship within 3 days.

DRW

MASSACHUSETTS, Watertown. (617) 923-1900
 NEW YORK, Farmingdale. (516) 249-2660*

G. S. MARSHALL

CALIFORNIA, El Monte. (213) 686-1500*
 CALIFORNIA, San Diego. (714) 278-6350
 CALIFORNIA, Sunnyvale. (408) 732-1100
 COLORADO, Arvada. (303) 427-5858
 OHIO, Dayton. (513) 278-9496

HALL-MARK

ALABAMA, Huntsville. (205) 539-0691
 FLORIDA, Orlando. (305) 855-4020*
 GEORGIA, Atlanta. (404) 963-9728
 ILLINOIS, Chicago. (312) 437-8800
 KANSAS, Kansas City. (913) 888-4747
 KANSAS, Wichita. (316) 682-2073
 MARYLAND, Baltimore. (301) 265-8500
 MINNESOTA, Minneapolis. (612) 925-2944
 MISSOURI, St. Louis. (314) 521-3800
 NORTH CAROLINA, Raleigh. (919) 832-4465
 NEW YORK, New York. (516) 293-7500
 OHIO, Dayton. (513) 278-6963
 OKLAHOMA, Okla. City. Enterprise 50094
 OKLAHOMA, Tulsa. (918) 835-8458
 PENNSYLVANIA, Philadelphia. (215) 355-7300
 TEXAS, Austin. (512) 454-4839
 TEXAS, Dallas. (214) 231-6111*
 TEXAS, Houston. (713) 781-6100
 WISCONSIN, Milwaukee. (414) 476-1270.

INTERFACE ELECTRONICS

WASHINGTON, Seattle. (206) 285-3500*
 * Assembly Locations

OAK Industries Inc.
 Crystal Lake, Illinois 60014

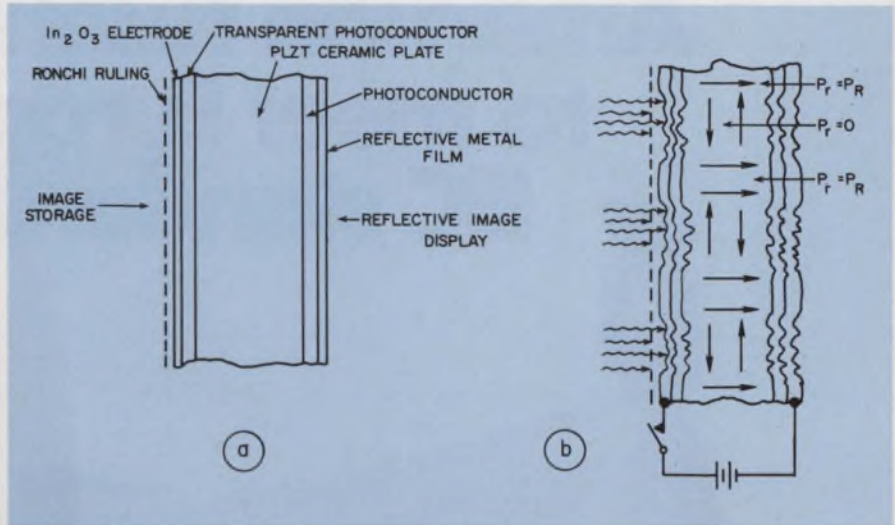

Fericon structure (a) stores images as strain-induced deformations (b) on the surfaces of lead lanthanum zirconate titanate (PLZT) plates.

resolution, they said. And there is less light lost in viewing the image. The latter, the developers noted, permits the use of a smaller light source, which, of course, requires less power.

The Fericon stores its images in strain-induced deformations on the surfaces of lead lanthanum zirconate titanate (PLZT) plates. These surface deformations, which form relief patterns of the stored information, are made with carefully controlled and localized ferroelectric domain switching by longitudinal electric fields.

The stored information can be projected either by reflected or transmitted light through Schlieren optics onto a viewing screen. But the preferred configuration is the reflective-mode device, the paper said.

A five-layer structure includes two photoconductive layers that allow surface deformations to occur at both major surfaces of the ceramic plate during image storage and erasure. This technique, the developers said, minimizes strains that might distort the structure from its planar configuration.

Memory is nonvolatile

The ceramic used is a PLZT electro-optic memory composition that is transparent and exhibits nonvolatile memory. With nonvolatility, all of the stored data or

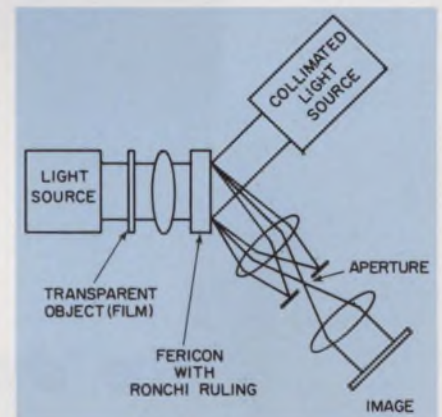

Phase-sensitive optical system is used for storing and projecting images stored in the Fericon.

portions of it can be erased.

One electrode is transparent indium-tin oxide and the other a thin, flexible, metal film that is opaque and highly reflective. Surface deformations in the ceramic plate are replicated by the photoconductive films and the metal electrode. The input image or information is introduced from the transparent electrode side and projected in reflection from the electrode on the opposite side.

To obtain a continuous tone image, an optical (Ronchi) ruling is interposed adjacent to the transparent electrode. An image focused on the photoconductor is then modulated with a spatial frequency equal to that of the Ronchi ruling. ■■

Introducing the first American fuseholder to meet Europe's IEC standards.



The "shock-safe" 3AG fuseholder.

Our new fuseholder isn't really red, white and blue. Its standard color is black, just like all other fuseholders.

But there the similarity ends.

For this Littelfuse fuseholder is the only American-made holder designed to meet current International Electrotechnic Commission standards.

IEC's Publication No. 65, accepted by all European countries, requires fuseholders to offer absolute protection against electric shock, even under fault conditions.

And that's exactly what our new 3AG "Shock-Safe" fuseholder does! Several safety features have been incorporated into the fuseholder design to protect the user from any possibility of touching live parts.

In addition, our "Shock-Safe" fuseholder offers another important form of protection by

assuring your acceptance in European markets. For if the fuseholder used in your product doesn't meet IEC standards, that product could be rejected by European testing and approval boards, which refer to Publication No. 65 for the purchase of equipment.

The "Shock-Safe" fuseholder #345001 has been designed to retrofit existing panel mounting holes and is the **only** 3AG fuseholder currently available for continuous operation to **20 amperes** and **300 volts**.

"Shock-Safe" fuseholders from Littelfuse.

A basic necessity if you're selling the European market.

For more information, send for Product Bulletin #1000 or contact your local Littelfuse distributor.

LITTELFUSE

Subsidiary of Tracor

800 E. Northwest Highway • (312) 824-1188 • Des Plaines, Illinois 60016

INFORMATION RETRIEVAL NUMBER 25

washington report



Heather M. David
Washington Bureau

Trade reform fight heating up

The President's proposed Trade Reform Act is headed for a long hot summer of argument. Both the Aerospace Industries Association and the Electronic Industries Association are fighting it. At stake is the Administration's proposed repeal of Tariff Items 806.30 and 807, which provide duty-free entry—except for value added—of products manufactured abroad with components furnished by U.S.-based companies. The EIA estimates repeal would cost the semiconductor industry alone \$5-million a year. The AIA argues that offshore assembly is necessary for American companies to stay competitive in the world market. Without such assembly, the association contends, 37,000 jobs needed to manufacture U.S. components will be lost. But the AFL-CIO, which has strongly favored the highly protectionist Burke-Hartke bill, is adamant that any tax measure must discourage investment abroad by American companies.

Military pressing for laser weapons

All three military services have asked Congress for permission to re-program more than \$10-million in extra funds from other fiscal 1973 accounts so they can step up laser-weapon design work. In heavily censored testimony just released, an Air Force brigadier general, Howard Fish, said a significant breakthrough in laser weapons had occurred since last year's budget preparation. The Air Force, which appears to favor the gas dynamic laser over chemical types, reportedly wants to design and test high-energy rays for bomber defense. The Navy, the Army and Marine Corps, in a joint effort, also want to test high-energy lasers for anti-air and anti-surface missile use. The cost of development for all three applications is expected to total \$500-million.

Minority recruiting for engineering lags

Of all the skilled professions, engineering may be having the most trouble attracting minorities the National Academy of Engineering says. In 1970 Cornell University estimated that only one-half of 1% of all engineers were black. Only 1% of present engineering students represent minority groups.

It could cost the Government as much as \$312-million over the next decade to increase minority engineering enrollment, Cornell University's Donald Dickason told a recent National Academy of Engineering sym-

posium, but the benefit to the nation would be worth the cost, he noted. The money would be spent on special programs, recruiting campaigns and scholarships.

Meanwhile the engineers Joint Council sees a continuing decline in the number of engineering graduates—to about 32,000 in 1975, against 43,000 in 1972—resulting in an annual shortage of 10,000 engineers.

Defense navigation satellite proposals to be sought

The Air Force will ask for industry proposals in about a month for the design and definition of the satellite portion of the proposed Defense Navigation Satellite System. The system would give military aircraft, ships and ground vehicles precise positioning information.

The Air Force already is evaluating proposals from four bidding teams—by General Dynamics Electronics, Grumman Aerospace, ITT Avionics and Philco-Ford—for the design of ground stations and aircraft and ship user equipment. The Pentagon is proceeding cautiously on the program and has given approval only for the design of equipment to demonstrate the concept. A final decision will be withheld until all aspects are proven technologically and economically feasible.

Capital Capsules: NASA has established a **General Aviation Technology Office**, with Roger L. Winblade, an engineer and holder of a patent on the X-15 aircraft, as head. . . . Sen. Edward Kennedy (D.-Mass.), chairman of the Senate National Science Foundation Subcommittee, plans hearings on the proposed National Science Policy and Priorities Act and the Civilian Science and Technology Act. **Both measures would promote the transfer of aerospace technology to the civilian sector.** . . . NASA has invited **industries and research organizations that are seeking experienced engineers, scientists and skilled technicians to choose from among the 600 NASA employees** whose positions will be abolished by June 30. Employment offices at the Goddard Space Flight Center, Greenbelt, Md., Lewis Research Center, Cleveland and Marshall Space Flight Center, Huntsville, Ala. have details. . . . The Aerospace Industries Association has joined other technical associations in supporting **voluntary conversion to the metric system.** The AIA asks that the cost of conversion be recoverable in the prices of products. . . . The Air Force is getting ready to contract for **yet another study of electro-magnetic pulse (EMP) phenomena** and is looking for companies capable of working on the conceptual design of advanced pulse generators. . . . The Naval Ship Systems Command is looking for R&D sources to develop a **shipboard data multiplex system.** It would handle navigation, ship-control and command-decision data. . . . General Electric's Valley Forge Space Center has won a contract to **study earth-resources systems, from data acquisition to applications** and to advise NASA on instrumentation, vehicles and procedures. . . . The National Bureau of Standards' Institute for Computer Sciences and Technology and the Dept. of Defense are initiating a COBOL compiler testing service whereby commercial vendors and Government agencies can test compiling equipment to assure compatibility with Government computer operations. . . . The Senate Commerce Committee is holding hearings on the bill which would direct the Secretary of Transportation to **study the feasibility of a high-speed ground transportation system** stretching from Vancouver, B.C., to the major cities in California.

MORE VALUE IN TELEEQUIPMENT

DUAL-TRACE OSCILLOSCOPES

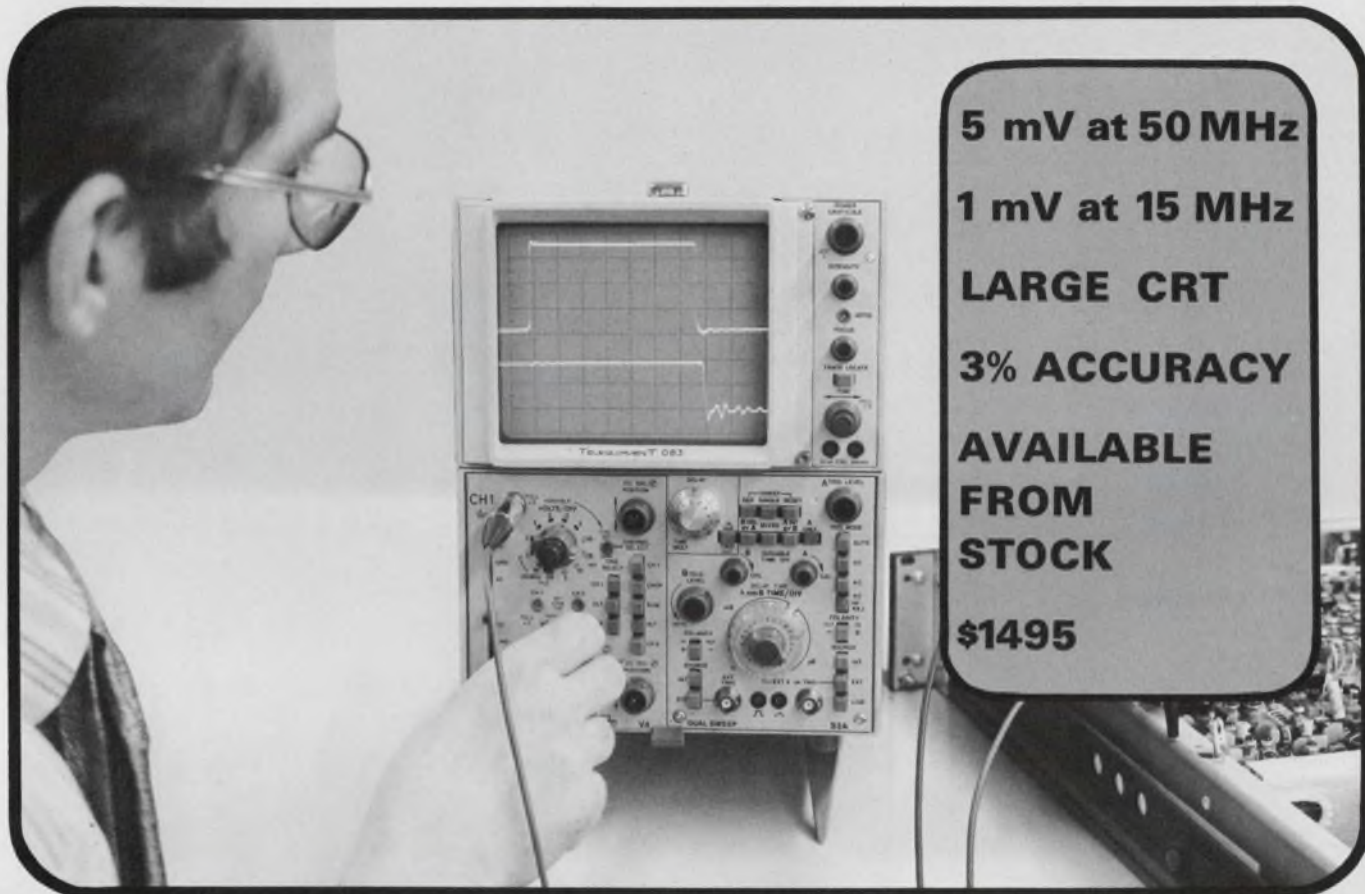

5 mV at 50 MHz
1 mV at 15 MHz
LARGE CRT
3% ACCURACY
AVAILABLE FROM STOCK
\$1495

\$1495 makes the D83 the lowest-priced 50-MHz oscilloscope available today.

You can select either a dual-trace or differential vertical plug-in. The 5 mV to 20 V/div (1 mV with X5 gain) dual-trace plug-in offers 5 operating modes including alternate, chop, and algebraic add. The 50 μ V to 10 V/div differential plug-in has a CMRR of 100,000:1 at 50 μ V/div. Both plug-ins are accurate within 3%.

15,000-Volt CRT accelerating potential ensures bright displays of even low rep-rate signals in high ambient light. The large 8 x 10-div CRT

(1.22 cm/div) allows you to view dual-trace displays from several feet.

The dual time-base incorporates delayed sweep; mixed sweep and single-shot. Sweep ranges extend from 100 ns (10 ns with mag) to 2 sec/div in 23 steps, accurate within 3%. Full trigger source selection is provided.

Standard convenience features include: a 1% calibrator; "Trace Locate" button for quickly determining the position of an off screen display; and gate and sawtooth signal outputs.

U.S. Sales Prices FOB Beaverton, Oregon

All TELEEQUIPMENT scopes are backed with the same one-year warranty as other TEKTRONIX products and are marketed and supported through the same International network of Tektronix Field Offices, Service Centers, Distributors and Representatives. Call your nearest office, or write Tektronix, Inc., P.O. Box 500, Beaverton, Oregon 97005. A new catalog showing the entire TELEEQUIPMENT line is available on request.

Part of the Telequipment line from Tektronix, Inc.

INFORMATION RETRIEVAL NUMBER 26

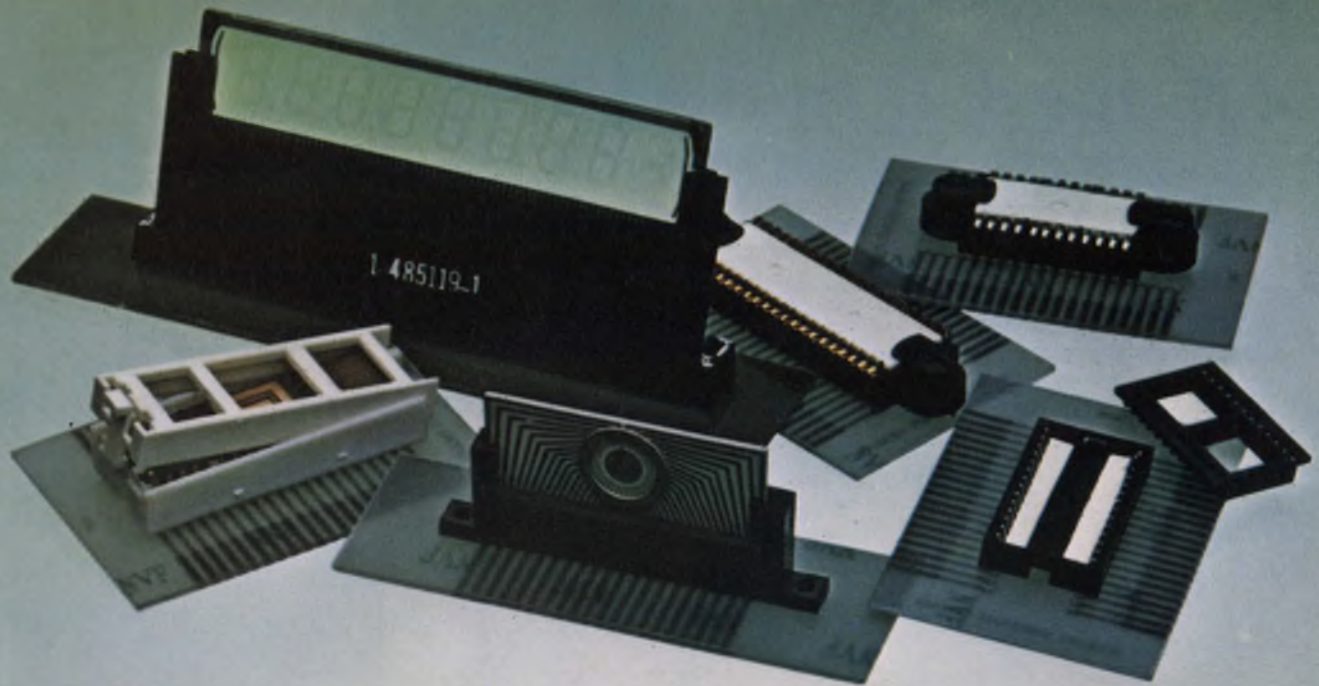

AMP is making things smaller,

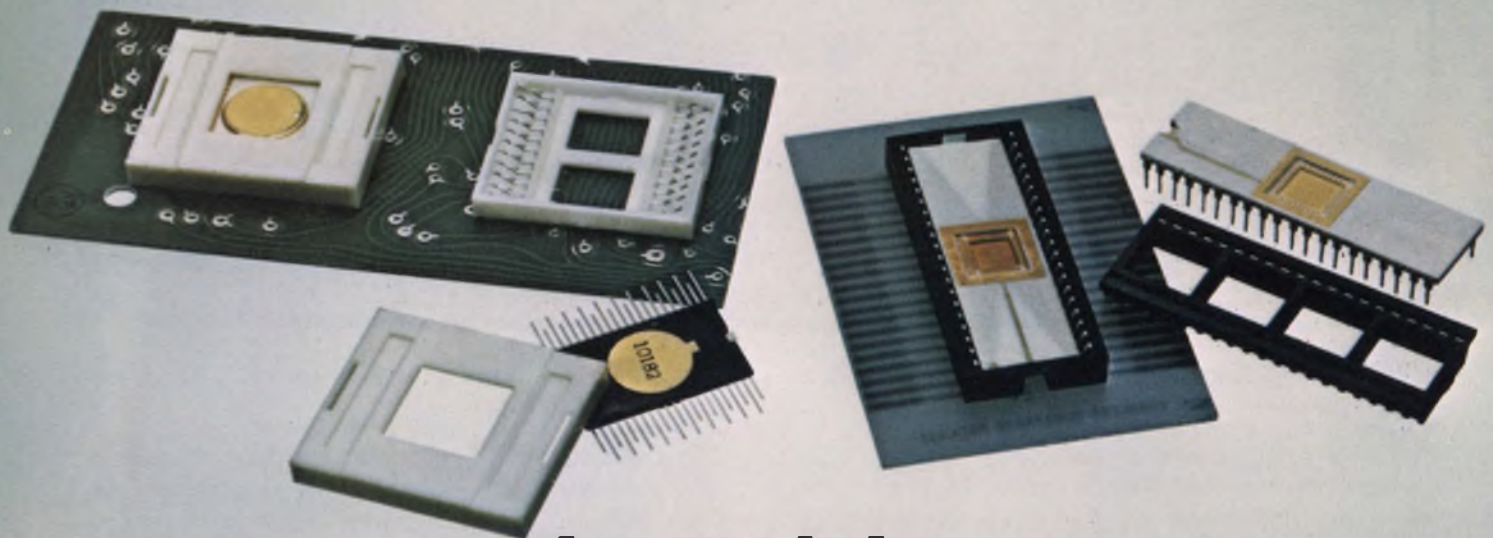

**easier and denser
for interconnecting MOS.**

Take the 42-position connector in the foreground, for example. It's less than .250-inch high, with lid installed. And only .050-inch lead centers! Simple, easy to use. With zero entry force.

Then, there's our 40-position connector (far right, foreground). It's only .235-inch high, .100-inch lead centers and — with its snap-on

adapter — converts in seconds to accept leaded as well as leadless packages. Also available for 24 and 28 package configurations.

We have others, too. Bottom metallized arrays, liquid crystal connectors, etc. But that's another story. To get the AMP microelectronics story, write AMP Industrial Division, Harrisburg, Pa. 17105.

AMP microelectronics: doing small things in a big way.

AMP
INCORPORATED

AMP is a trademark of AMP Incorporated.

AMP District Offices.

NEW ENGLAND DISTRICT

Suite 107, Riverside Park
Weston, MA 02193. (617) 891-7500

NEW YORK DISTRICT

25 Commerce Drive
Cranford, N.J. 07016
(212) 285-9575 (N.Y.)
(201) 276-4382 (Cranford)

MID-ATLANTIC DISTRICT

400 W. Swedesford Rd.
Berwyn, Pa. 19312
(215) 647-6060

SOUTH ATLANTIC DISTRICT

955 L'Enfant Plaza North, S.W.
Suite 4010
Washington, D.C. 20024. (202) 484-9596

GULF DISTRICT

2220 Parklane Drive, N.E.
Suite 485
Atlanta, GA 30345. (404) 934-6363

OHIO DISTRICT

Landings Office Bldg. — Suite 207
3040 Riverside Dr.
Columbus, OH 43221. (614) 486-0276

LAKE DISTRICT

30555 Southfield Rd. — Suite 440
Southfield, MI 48075. (313) 645-5590

ILLINOIS DISTRICT

1050 Morse Ave.
Centex Industrial Park
Elk Grove Village, IL 60007
(312) 439-5800

NORTH CENTRAL DISTRICT

4600 W. 77th St. — Rm. 319
Minneapolis, MN 55435. (612) 920-8210
TWX (910) 576-2849

SOUTHWESTERN DISTRICT

Frito Lay Tower — Suite 1440
Exchange Park, Dallas, TX 75235
(214) 352-4852-4853
TWX (910) 861-4227

SOUTHERN PACIFIC DISTRICT

1840 S. Wilmington Ave.
Compton, CA 90220. (213) 537-4490
TWX (910) 346-7044

NORTHERN PACIFIC DISTRICT

Vallco Park
10300 N. Tantau Ave.
Cupertino, CA 95014. (408) 255-3830

technology abroad

A pilot production line for liquid-crystal display devices has been started by Thomson-CSF in Paris. The displays fall into three categories. One is dynamic-scattering-mode devices that operate at 15 to 20 V and at frequencies between 25 and 100 Hz; their power consumption is $100 \mu\text{W}/\text{cm}^2$, and they have a predicted lifetime of 7000 to 10,000 hours. In the second category are twisted (field-effect) nematic devices, op-

erating at less than 5 V at a frequency of about 1 kHz; their power consumption is about $1 \mu\text{W}/\text{cm}^2$, with a life expectancy of 30,000 hours. The third category is variable-color devices. Based on the double-refraction effect, they operate at about 7 V at 10 kHz, with a power consumption of $10 \mu\text{W}/\text{cm}^2$; their estimated life is 30,000 hours. Products are available in the first two categories.

CHECK NO. 921

Two MOS integrated circuits for use in an electronic weighing machine have been developed by Siemens of West Germany. The electronic scale calculates the price of a commodity from its weight and unit-weight price. The weight graduations are encoded on a glass disc inside the machine. The disc is rotated by the weighing lever of an inclined balance. Phototransistors keep track

of the weight on the disc. The MOS circuits multiply the weight by the unit-weight price, which is fed in through a 10-digit keyboard. The process is repeated up to 10 times per second. The selling price appears on indicator tubes. The MOS circuits are mounted in two 24-pin dual in-line packages that contain 1800 and 1150 transistors, respectively.

CHECK NO. 922

A new group of triodes by Brown Boveri of Baden, Switzerland, has been designed to meet the severe environment encountered in industrial rf applications while supplying the guaranteed power without drift. The triodes are designed for power outputs ranging from 15 to 300 kW up to a maximum frequency of 120 MHz. A high-perveance, high-stability mesh cathode gives emission re-

serve to cope with system voltage fluctuations and stresses caused by intermittent operation. A stiffened grid cage provides good stability and can carry rf charging currents of several hundred amperes. The tubes have small inductances and low gains (an advantage when dealing with load fluctuations), low driving power and high grid and anode dissipation reserves.

CHECK NO. 923

A continuous-wave dye laser with high frequency and amplitude stability has been produced at the Queen's University of Belfast, Northern Ireland. The laser can be tuned to emit a wavelength of less than 1 Å broad. Operating in the single-transverse mode, the laser can be tuned over most of the visible spectrum. As a result, it can be used in such applications as selective-excitation spectroscopy, saturation spectroscopy

and selective-scattering experiments. With second-harmonic generation, the ultraviolet range (2500 to 3500 Å) can also be covered. The laser can be passively mode-locked to produce continuous trains of tunable picosecond pulses. Direct measurements of the pulse trains indicate that the single pulses are less than 5 ps in duration with negligible background radiation.

CHECK NO. 924

AMP

INCORPORATED

Now you can program
fusible-link, diode junction-shorting,
electro-chemical fusing, and floating gate
avalanche-injection ROMs from any
manufacturer on the same programmer.

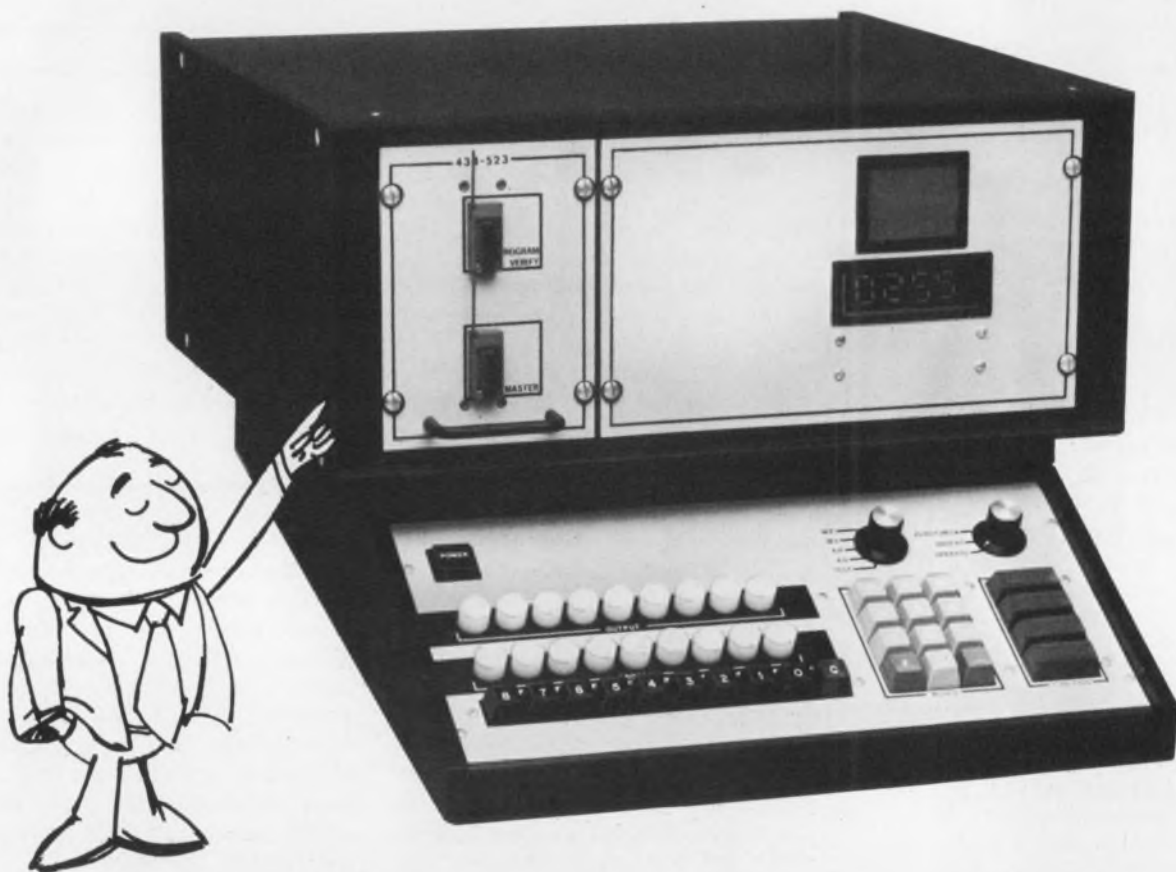

Just change this module to change personalities.

Send today for complete specifications on the all new Model 550, the Universal Programmer/Verifier. It has keyboard entry, exceptionally fast programming and verification speed, 9 bits per word data capacity and address capacity expandable from 9,999 to 99,999 words. □ These are but a few of the 550's exciting features. It's a must for anyone using field programmable IC ROMs. Send for details. Spectrum Dynamics, Inc., 1302 W. McNab Road, Fort Lauderdale, Florida 33309. Phone (305) 974-9500.

spectrum dynamics



INFORMATION RETRIEVAL NUMBER 29



WE'VE GOT SOME SMALL IDEAS ABOUT BIGNESS

You're looking at one of the thin-film leadless chip resistor networks our Special Components Department makes for hybrid circuit applications. This one, only 30 x 30 mils, features tight tolerances and resistance matches; tight TC tracking is inherent. It is adjusted to value by the most advanced laser technique while computer control lets us produce them on an economical basis. Other Airco Speer resistive devices are equally unique. For example, an eight resistor binary network with integral gold beam leads on a 25 mil square passivated silicon chip. The leads are monolithically grown.

Where higher resistance values are needed, you can turn to our thick-film technology for values up to 500 megohms in a variety of small chip sizes. Tolerances range from 1% to 20%. This high value expertise offers an approach to high-voltage divider networks—with infinite opportunities for custom designs.

That's not all either. We offer thin-film resistor networks with high density packaging of precision resistors in chip format—as flat packs; DIP's, plug-ins; etc.

If you too have some small ideas, write to P.O. Box 828, Niagara Falls, N.Y. 14302 and ask for brochure AS20.

Airco Speer Electronics—The Home of the Ω

RF Chokes • Shielded Coils • Molded Capacitors • Flat Power Film Resistors • Fixed Composition Resistors • Fixed Carbon Film Resistors • Thick and Thin Film Chips and Networks



P-channel
J FET



N-channel
J FET



CMOS
FETs



P-channel
MOS FET



N-channel
MOS FET

Since 1962, Siliconix has evolved FET technology and applied it to a complete line of singles, duals, arrays, and ICs. So what's new?

Switch 10 MHz Signals with better than 60 dB OFF Isolation

The Siliconix DG181-DG191 family of FET switch/IC drivers is well-suited for processing high-frequency signals, and is directly compatible with most computer logic. FET switch/monolithic driver combinations are available in SPST, SPDT, or DPST functions.

Features include:

- Constant ON resistance with signals to ± 10 V and 100 MHz
- 60 dB OFF isolation at 10 MHz with 75 Ω load
- t_{on} and t_{off} = 150 ns typical
- 1 nA max (100 pA typical) leakage from signal channel in either ON or OFF state.

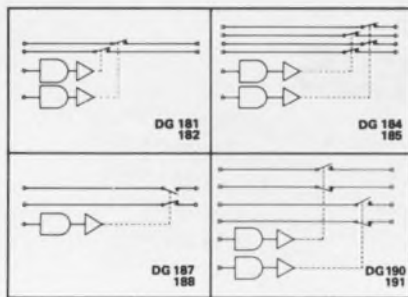

DG181-DG191 Functional Diagrams

The key to this exceptional performance is the Siliconix concept of monolithic driver design, with careful attention to critical details such as low driver output impedance. DG181-DG191 driver (switch OFF) resistance

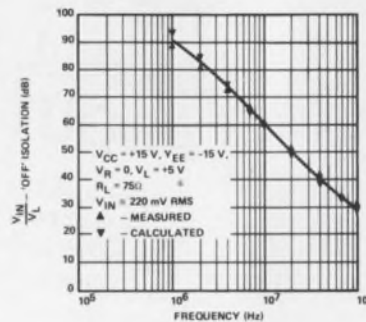

Switch OFF Isolation vs Frequency—DG181

to ground is only 200 Ω , providing good a-c by-pass on the FET switch gate. Contrast this with other driver circuits with impedances as high as 26 M Ω , which adversely affect isolation characteristics.

The DG181-DG191 series of FET analog switches is an ideal solution to most switching problems. If your case is unique—and whose isn't—our applications people are eager to help. For complete information

write for data

Applications Engineering (408) 246-8000, Ext. 501



Siliconix incorporated

2201 Laurelwood Road, Santa Clara, California 95054

INFORMATION RETRIEVAL NUMBER 32

How was Europe?

Having recently returned from a visit to the important electronics powers in Europe—France, Germany, England and Philips—I'm often asked, "How did you find Europe?" My first inclination is to reply that I stepped off the plane and there it was.

The fact, though, is that it's no easier to describe electronics in Europe than to describe electronics in the U.S. Some European companies, with or without government support, just plod along—as do many companies in the U.S. Others are stimulatingly aggressive—exploring ever wider markets, including those in the U.S.

What about Europe's engineers and managers? They're like ours, too. Some are very sharp and imaginative. Others follow tradition; they're competent, but easily lost in a crowd of two. Throw a challenge at one man, and he bubbles with excitement as he starts conjuring up 40 ways to tackle the problem and win the goal. Throw the same challenge at another man and, very methodically and carefully, he tells you why the job can't be done. Armed with 40 reasons, difficulties and problems, he shows you that he doesn't have a large enough staff, that his people don't have enough experience, that he doesn't have adequate equipment and financial resources, that his hands are tied by tradition, bureaucracy and company policy, and that the job should be done by somebody else's department. How typically European! How typically American!

And the products? Like those in the States, most in Europe are "me-too" products, differing only slightly from products already on the market. And a few, which you'll be seeing in these pages, are dazzlers.

What's the conclusion? Companies, and the engineers and managers who give them life, are pretty much the same all over the world. Can we learn from each other? Of course. Regardless of language, pay scales, working environment and social traditions, the wide-awake, dynamic individuals throughout the world are those who *give* most and, in so doing, *receive* most in personal achievement, self-respect and personal satisfaction. We should all emulate them.



A handwritten signature in cursive script that reads "George Rostky".

GEORGE ROSTKY
Editor-in-Chief



From start to finish



No licence agreements, no sub-contract work. From start to finish we are in control of every product that goes out to you, the customer, bearing the name Piher. We take a pride in the name. We take a pride in our products. That's why we are now a world leader in component technology.

Don't take our word for it. Let the facts speak for themselves.

We produce over 7 million carbon film resistors per day to meet world demand and have the largest variety of quality preformed resistors available anywhere.

We also provide the best range of quality, low-cost encapsulated trim-

mer pots on the market for every type of application – custom built to your own specific requirement where the need arises.





- Piher technology

And these components are only the beginning.

Piher is a company that works in professional electronics, developing the best in closed circuit and professional TV, radio-telephones, etc.

And with our ferrites we are in the forefront of magnetic ceramic technology.

We are a high technology company with 6 manufacturing centres employing over 3000 people. And our world-wide distribution network is backed by 5 Piher companies in the U.S.A., Germany, U.K., France and Italy.

That's why our exports have increased by 75% in the past three

years. That's why, when people think components, they should think Piher.

Find out more about us. It pays.



USA - 1239, Rand Road, Des Plaines - Illinois, 60016.
Tel: (312) 297-1560. Telex: 0282514.

GERMANY - 85 Nuremberg, Westtorgraben, 5.
Tel: (0911) 260469. Telex: 623354.

UK - Romar House, The Causeway, Staines, Middlesex. Tel: 56157. Telex: 934167.

FRANCE - 83 Rue Etienne Dolet, 94230 Cachan, France. Tel: 6562607. Telex: 27107.

ITALY - Via Soldati, 16, 20154 Milano.
Tel: 314.532/316.213.



PIHER

Head Office - **SPAIN**
Riera Canado, s/n. Apartado de Correos, 53 Badalona
(Barcelona), Spain. Tel: 389 03 00. Telex: 59521.

Focus on Fixed passive components

Unlike the dramatic quantum-jump changes in semiconductor and IC technology, the passive component field has tended to follow a slow, evolutionary path. There have been changes in the last 10 years, but new passive components appear to take more time to develop and the old products longer to die than was originally believed. Comments like these have been bandied about in the marketplace and trade press over the years:

- 1965—"IC manufacturers are designing capacitors and inductors out of their circuits."
- 1967—"Conventional discrete components are dead."
- 1969—"Conventional discrete components are holding their own, but are beginning to look less conventional."
- 1971—"The pallbearers will have to wait a long time. Passive components are alive and well."
- 1973—"Vendors struggle to meet soaring demands for delivery of discrete passive components."

A long way from dead

The universal observation at the 1973 IEEE Intercon was that the predicted demise of discrete passive components had discouraged many suppliers from expanding. Then the recent upsurge in electronics sales caught them short. The result: Manufacturers have extended lead times from weeks to months. Advice to customers: Plan ahead, especially for high-quantity needs, and avoid specials.

ICs have certainly made inroads into territory occupied by low-cost, low-stability resistors and capacitors, and IC manufacturers have done their best to avoid the use of inductors and

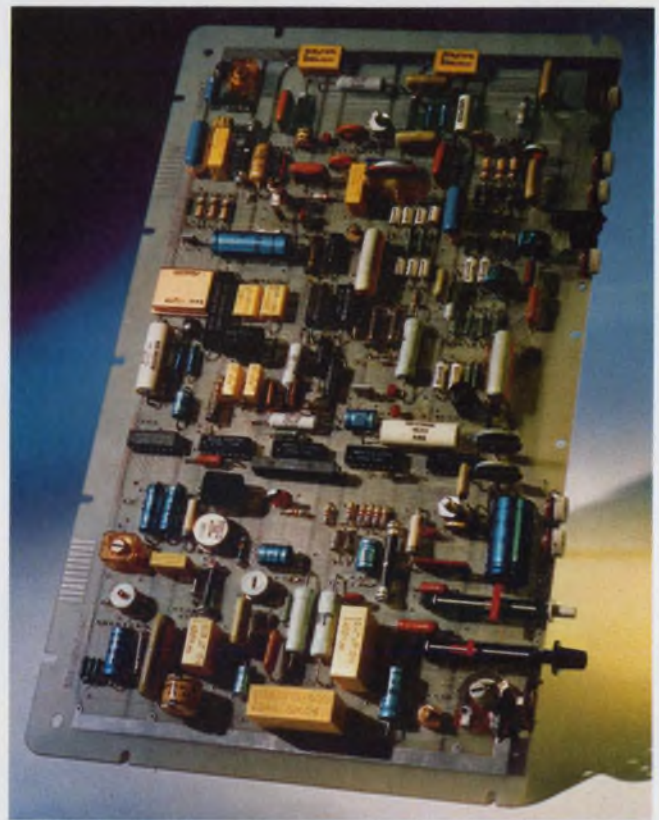

Conventional components are being used side by side with the latest chip, thick-film and thin-film networks in dual-inline packages as on this Mepco PC board.

higher-valued capacitors. Yet discrete passive components continue to meet the challenge by changing form.

Changes in form, fit and function

The most obvious change has been the development of the chip, or pellet, component (Fig. 1). Capacitors were the first to take on this form

Morris Grossman
Associate Editor

for use in hybrid ICs. Resistors followed, and now even inductors come in chip form. And chips have led to the DIP network, such as Corning's Cordip line, which uses chip resistors, capacitors and diodes to create, besides a large selection of standard networks, custom combinations of up to 20 components in a 14-pin package and 23 components in a 16-pin package. Circuit interconnections can be made internally in the Cordip line in almost unlimited combinations (Fig. 2).

Fit has also improved. However, in trying to reduce the size of a resistor drastically, the manufacturer is, of course, limited by heat-dissipation ability and permissible temperature rise. Thus further dramatic size reductions can't be expected beyond the present chips and some of the newer, tiny 1/8-W discrete units. But materials of higher dielectric constant and improved



1. Chip components, such as American Technical Ceramics' rf capacitors, are the passive-component manufacturers' answer to IC-sized hybrid circuits.

packaging methods can materially reduce capacitor sizes—with serious tradeoffs against stability, however. Inductors have also grown a bit smaller with toroids that require fewer turns of wire because of improved cores.

The functional capabilities of passive components have advanced, too—but very gradually. Film resistors can be trimmed to $\pm 0.005\%$ accuracy by lasers, electrolytic capacitors now have

ultra-low impedance (less than 0.001Ω at 10 kHz and less than 0.01Ω at 1 MHz), and small toroid inductors can carry up to 60 A dc without saturation. Again, nothing really dramatic and no breakthroughs. The surprise dielectric and the super-permeability core material still elude the companies hard at work to develop them.

But improvements or not, design engineers must still specify passive components. And there is no substitute for knowledge here.

Passive, they are not

Though design engineers really know better, many have been lulled into a false belief by the very name "passive components." They accept the devices as truly passive. But are they? The capacitor, in particular, masquerades as an ideal component, and the resistor is only a step behind. But each falls short. Only the inductor seems to be correctly recognized for its deviation from the ideal.

The word passive implies that the component will not change in value with voltage, frequency, temperature, time, radiation or any other influence, and that, therefore, the current is a linear function of the voltage, according to Ohm's Law. But real capacitors are not just microfarads, and real resistors are not just ohms.

Even if a resistor were ideal with respect to all external influences, including applied voltage and current, the circuit of Fig. 3 would still be required to represent it accurately. In fact, the figure depicts a universal component that behaves as a pure resistor only at low frequencies. At high frequencies the capacitive or inductive components may provide the dominant impedance (Fig. 4). In a similar way, at high frequencies, an inductance can behave as a capacitor and a capacitor can appear as an inductance.

Manufacturers' specifications should supply enough data so design engineers can deal realistically with the nonpurity of the ohms, microfarads or henrys they are buying. Most manufacturers give merely the component's value, initial tolerance and power or voltage rating—far from enough data.

Time and stress take their toll

Good data must also include the effects of time, temperature and repeated stress. How well do these so-called passive components resist aging and mechanical rigors? Nothing lasts forever. Even granite erodes in time.

But the time and stress tolerances of passive components are all too frequently omitted from data sheets. And even when they are provided, they present problems when the user tries to draw comparisons; there are no industrywide

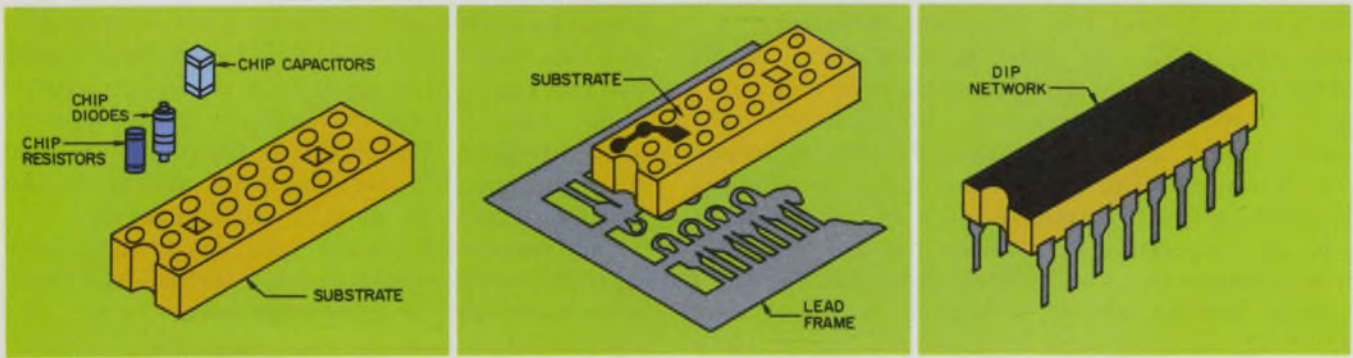

2. For compatibility with popular DIP circuits, passive components are also packaged in DIP form, as in Corning's Cordip line. Custom network designs, and an

ever expanding variety of standard configurations, are offered by several manufacturers. As many as 23 components can fit into a 16-pin package.

spec standards to define the parameters.

Along with the initial tolerance at purchase—often the only one supplied by the vendor—the following time and stress tolerances should be included on the spec sheet:

- **Shelf-storage**—Components can drift while merely waiting on the shelf, and after assembly they may drift while stored or turned off.

- **Installation-stress**—Mechanical stress or other assembly treatment, such as heat, solvents and humidity, can cause permanent value changes.

- **Load-stress**—Permanent value changes result from a component's normal or overloaded operation.

These tolerances reflect permanent changes in the value of a component from its initial value to its end-of-life value. Because not every component of a specific type will behave in exactly the same way, a single figure can represent only a dispersion—such as three standard deviations (3σ), which covers 99.7% of the resistors in a sample group. Fig. 5 shows an example of the cumulative spread of tolerance as TRW resistors progress from initial purchase to 10,000 hours, or five years, of full-power operation. Similar curves could be drawn for capacitors and inductors.

Coefficients can cause trouble

Adding to these permanent time and stress changes, and also often overlooked, are reversible changes represented by coefficients that are functions of temperature, voltage and current.

Components that exhibit these coefficients create harmonic distortion, or nonlinear performance. Many baffling circuit problems have been traced to a component's unsuspected sensitivity to voltage or current. Even very small coefficients can cause trouble in some demanding applications. For example, would you suspect that a supposedly passive resistor could generate harmonics or modulation products?

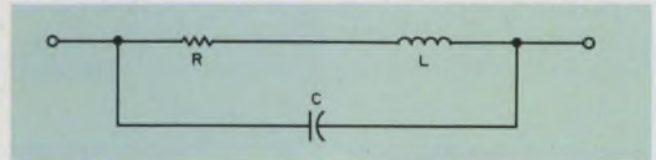

3. No component can provide a pure impedance, whether resistive, capacitive or inductive. Each one of the three passive components has, to some degree, the characteristics of the two others.

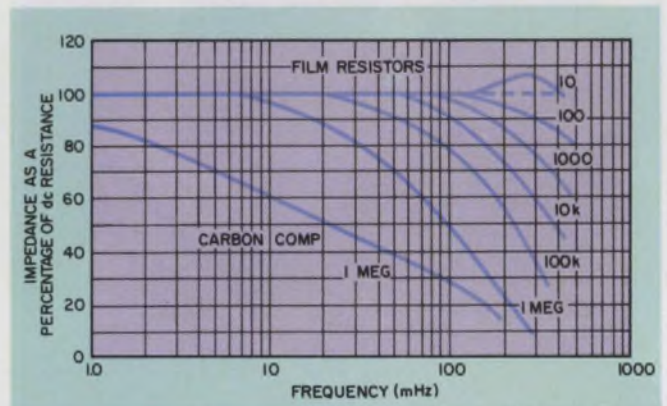

4. The impedance of composition and film resistors generally drops at higher frequencies because of capacitive shunting. Note that only the Mepco 10- Ω film resistor shows an inductive effect above 150 MHz. Wound resistors, of course, show the greatest inductive effects and film resistors the lowest capacitive effects.

Spec sheets often leave out important parameters such as these, and usually designers fail to ask about them. Yet, the universal cry from component vendors is, "Why don't they ask?" So why not take them up on it?

The classic mistakes are still repeated

There are many other ways in which passive components can create problems in design. Some of the classic mistakes still made are:

- Components are often specified and operated too close to their maximum limits.
- Designers are still trapped by that word

“typical,” which can mean anything from “We once made one unit that met the specs, and we hope we can make another” to compliance with the spec by virtually every unit.

- Derating specs are often ignored.
- Designers still order parts by vendor numbers, thus cutting out competitors who may have better and cheaper products that differ only in minor aspects.

So much for general precautions. Let's turn now to the specific types of components.

Film resistors take over

The common carbon-composition resistor may soon be not so common. The film resistor is overtaking it (Fig. 6)—and in the range where the composition units held dominance for so long, 5 to 20% tolerance and up to 2-W power rating. Not only are some film types—Piher International's carbon film, for example—about half the cost of composition types, but the film units also offer four times the shelf life, less noise (roughly 0.5 $\mu\text{V}/\text{V}$), and up to 80% better temperature stability (about 180 to 500 ppm/ $^{\circ}\text{C}$ for film vs 1500 to 3000 ppm/ $^{\circ}\text{C}$ for composition).

Mepco/Electra's C and CR series carbon-film resistors have low-precision characteristics that are very similar to Piher's. And Mepco's other film-resistor types (metal-film) occupy all the precision and temperature-coefficient ranges from semi-precision (1 to 2% tolerance) to ultra-precision (0.1% tolerance) and zero to selected plus or minus TCs. Also, Mepco's cermet thick-film GE series provides resistance ranges of 20 to 50 M Ω .

Pyrofilm also has a line of metal-film resistors, with heavy emphasis on MIL-spec conformance. The company claims it is the first to receive approval for an extended resistance range to 15 M Ω in accordance with MIL-R-55182.

TRW/IRC touches all bases with its wide range of types from carbon-composition to wire-wound units, along with a comprehensive line of metal-film types. Many of the TRW film types overlap the Mepco line, and some extend into the ultra-precision region—such as the AR40, which has tolerances to $\pm 0.01\%$, temperature coefficients in the ± 2 to ± 5 ppm/ $^{\circ}\text{C}$ range and radial-lead mounting.

Thus the film resistor now seems to span almost the total range of resistor applications. Even the power region above 5 W isn't holding firm against it. Caddock is offering precision, power film resistors for ratings to 15 W with $\pm 1\%$ tolerances.

Caddock's newest noninductive thick-film resistor line embodies an interesting idea. Until recently, some of the company's axial-lead film resistors were fabricated with resistive patterns

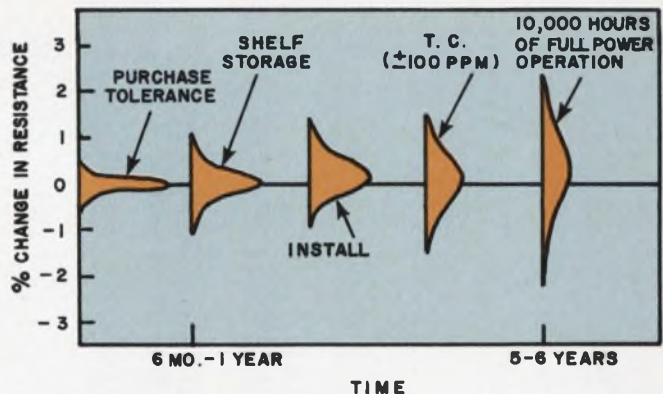

Design tolerance

Type	Purchase Tolerance	Design Tolerance
Precision Wirewound*	$\leq 0.1\%$	0.2 to 0.5%
Ultra-Precision Film	$\leq 0.1\%$	0.2 to 0.5%
Precision Film	0.5% to 1.0%	0.5% to 2.0%
Semi-Precision Film	2.0% to 5.0%	4% to 8%
Carbon Film	5% to 10%	10% to 15%
Carbon Composition	5% to 20%	10% to 30%

* Not including lab standards measured in ppm/yr

5. The purchase tolerance is not the value to use for the circuit's design. Every step from vendor to installation causes an additional spread in the tolerance of a component. Even when the component sits on the shelf, there is an effect on tolerance, as illustrated by these curves for TRW's 1/4 W, TO55 Metalglaze resistors.

in a helical pattern, to obtain the needed length. But a helix is a highly inductive pattern that can cause problems at high frequencies. Even patterns that are opposingly wound from both ends to the middle, don't cancel the inductance fully. Caddock therefore hit upon the serpentine pattern (Fig. 7). Opposing flux fields, which are generated by adjacent and closely spaced paths, can more effectively cancel each other. Therefore the resistors have about the same inductance as a straight piece of wire of the same length.

In the area of ultra-ultra precise resistors—with $\pm 0.005\%$ tolerances and TCs of ± 1 ppm/ $^{\circ}\text{C}$ —Vishay offers a proprietary bulk metal-film type, with some styles direct replacements for wire-wound units. By eliminating such stresses as drawing, winding and stretching—as required in wire-wound resistor manufacturing—Vishay reports that it obtains exceptional stability for this series of resistors. Shelf life of 25 ppm for one year is reported, along with a load life of 0.03% for 2000 hours at 125 C and generally superior over-all performance. Care is taken so that the resistor material is maintained stress-free during manufacturing. And after final assembly, the resistor is protected by mounting it

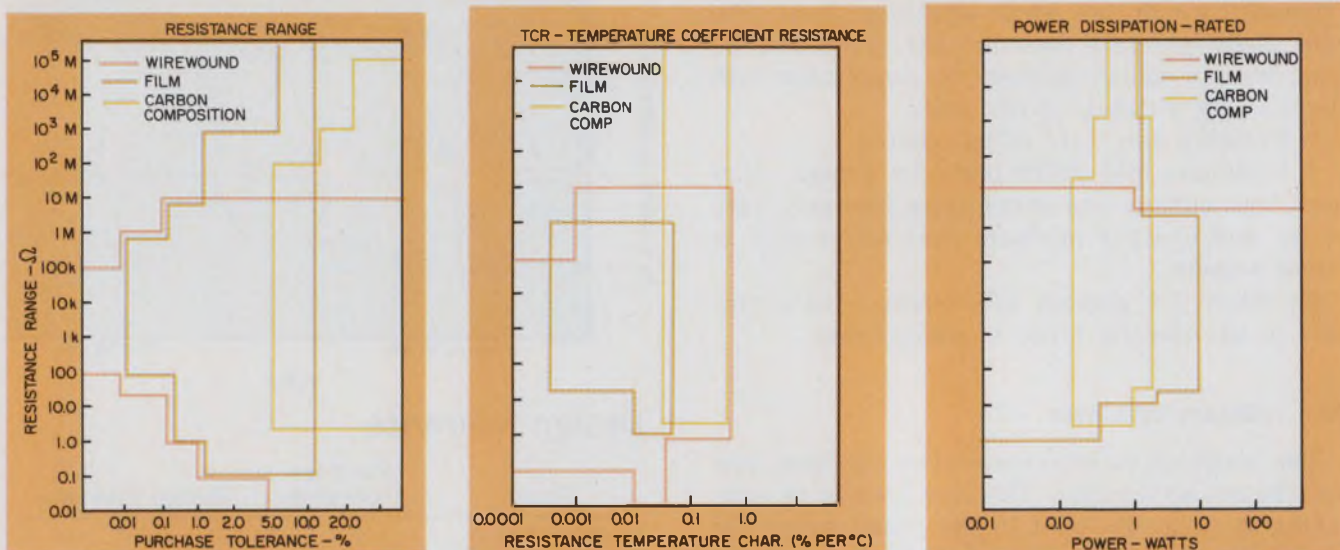

6. Some ranges of tolerance, temperature coefficient and power are dominated by a particular type of resistor, while other ranges can be handled by many different

types. TRW's charts show the wide range of characteristics that its various lines cover. Film resistors appear to overlap more of the ranges than any other type.

in shock-absorbing insulation. In addition the temperature coefficients of expansion of the various materials used to construct the resistor are matched to minimize deformation of the resistors.

A thick-film cermet resistor technique is used to make Bourns' rather different selectable fixed resistor, the SFR 4002 (Fig. 8). With soldered jumpers, you can select 90 resistance values with a 1% definition in a single unit. With only 15 units, you can cover the 33-Ω-to-1.25 MΩ range in 1% steps, the equivalent of 1350 resistance values. Selectable fixed resistors can replace variable potentiometers and trimmers in those adjust-and-forget applications.

Resistor networks spurt ahead

The fastest riser among passive component products is the resistance network in a DIP. For example, Beckman's Helipot Div. offers a new specialty—the Series 898 terminator line, designed for the ECL lines of almost all IC manufacturers. CTS Microelectronics takes a more general route with its cermet resistor modules. CTS has 35 units in its 760 DIP series for pull-up or pull-down resistors, terminator networks, voltage dividers, independent resistors and other possible network combinations.

And HyComp concentrates on d/a precision networks. About 13 different styles cover the HC/HCN line—from 12-bit weighted ladder units to three-decade BCD ladder networks. HyComp points out that you can get much better tolerances by specifying ratios rather than absolute resistance values. In d/a ladder networks it is the ratios that really count.

Sprague, RCL, Ultronix, TRW (Fig. 9), Mepco

and almost every other resistor manufacturer offers a line of networks—most in DIP, others in various multipinned packages—to your specifications.

The network-packaged resistor is, of course, a result of the impact of the dual-inline packaging explosion which provides component mounting, wiring and appearance that is compatible with DIP ICs, like the popular 7400 series.

Chip resistors for microcircuits

The irresistible pressure to small size for microcircuit applications is met by chip resistors which are small indeed. Hybrex's 10-Ω-to-511-kΩ units occupy only 30 by 30 mil's of area, with higher values to 1.6 MΩ in a 50-by-50 mil size. Power ratings are 250 mW, and the dielectric breakdown from the chip to its substrate is 400 V. Tolerances are 1, 5 or 10%. The temperature coefficient, formerly a problem with most resistor chips, is now only ±50 ppm/°C for values above 1000 Ω in the Hybrex units.

And RCL offers a larger chip of 0.5 by 0.5 by 0.062 inch in its C-1 series—which, surprisingly, can handle 23 W. The secret of the high-power capability is, of course, intimate contact with the large heat-sinking substrate to which it must be mounted. The heat sink must be maintained at below 75 C. The C-1 units have a ±5% standard tolerance and a TC of ±100 ppm/°C.

Pyrofilm, too, recently introduced a chip-resistor line. Some types handle up to 20 W and operate to 12.4 GHz.

But discrete resistor chips must compete with integrated, thick or thin-film resistors that are fabricated directly on the substrate. This seems to be the cheaper method for now, since laser

trimming methods can economically produce very accurate integrated resistors.

Capacitor chips are preferred

But with capacitors, the chip prevails. Integrated capacitors made from semiconductor material, as in some monolithic ICs, tend to be very unstable. And even though circuit designers devote considerable effort to eliminating capacitors from their designs, the resulting cure is often worse than the original problem. Thus discrete capacitors appear here to stay, even in micro-circuits.

Capacitors can be made small for IC-sized structures if high-K materials, thin dielectrics and even thinner metal-film plates are used. But high-K materials and good stability don't go hand in hand. High K also produces high loss at high frequencies.

Thus for rf work, where small valued capacitor chips (1 to 500 pF, with typical dimensions of 50 by 80 by 50 mils) are usually sufficient, low-loss porcelain dielectrics are used for frequencies well through the X band. At audio frequencies, chips having titanate-ceramic dielectrics with Ks to 50,000 can provide roughly 100 to 50,000 pF; these chips are 30 to 240 mils square and 50 mils thick. And for those audio-filtering, decoupling and low-frequency bypassing applications, tantalum chip capacitors fill the bill; they cover a range of values from 0.1 to 100 μ F. A 2.2 μ F chip measures about 50 by 50 by 100 mils.

American Technical Ceramics specializes in rf capacitors. To educate users, ATC has put together "The RF Capacitor Handbook," which has an excellent collection of articles, design aids, charts and graphs.

Dielectric materials for rf capacitors should be vitreous and nonporous, ATC says. The company uses porcelain, and the best chip shape, the company adds, is cubic, to minimize the L-to-C ratio. Such items as the capacitor's Q and its equivalent-series inductance and resistance become especially important in the specification of an rf capacitor. And a few seldom considered effects, such as a piezoelectric coefficient or capacitor hysteresis (nonretrace of a capacitor's value with temperature), may be important, too, in some high-frequency applications. In addition, of course, temperature coefficient, insulation resistance, voltage rating, temperature range and shelf life are all vital.

Vitramon, another vendor with a line of special microwave chip capacitors, warns against failure to consider aging when capacitors are selected. In an interesting paper entitled "Ceramic Chip Capacitor Reliability," Vitramon provides details of life testing, age-acceleration methods and environmental testing. The paper is free.

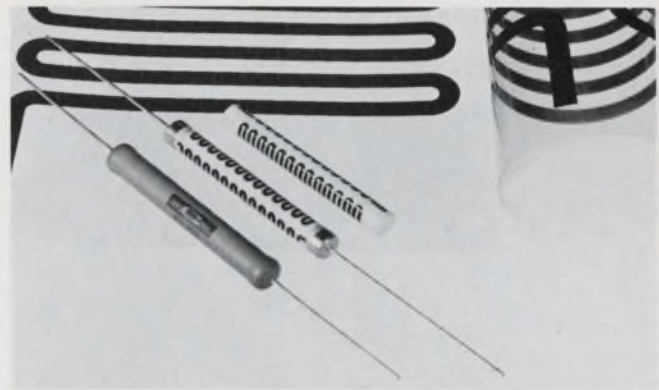

7. Caddock's serpentine film resistors have a minimum of inductance—little more than that of a wire the length of the resistor.

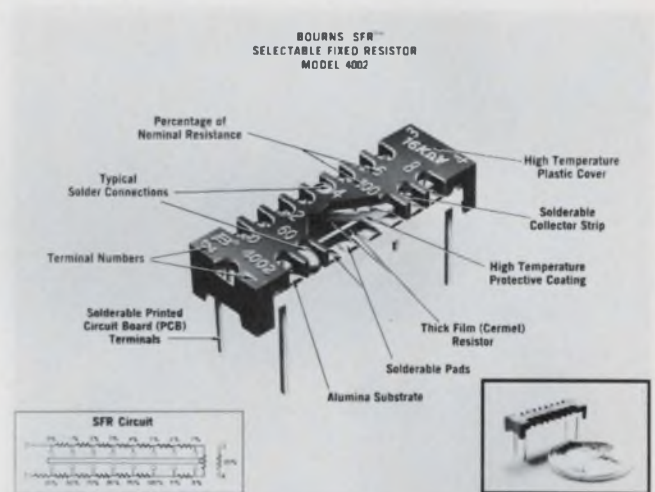

8. For those set-once-and-forget applications, Bourn's SFR selectable, fixed resistors provide a definition of 1% and a resistance range of 33 Ω to 1.25 M Ω with only 15 units.

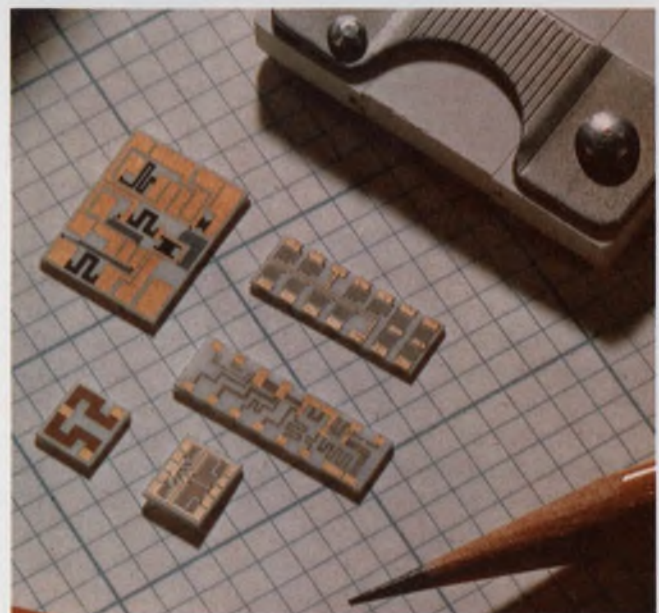

9. Resistor networks, such as these TRW TanFilm units, are filling industry needs for package-compatible components for hybrid and DIP configured circuits.

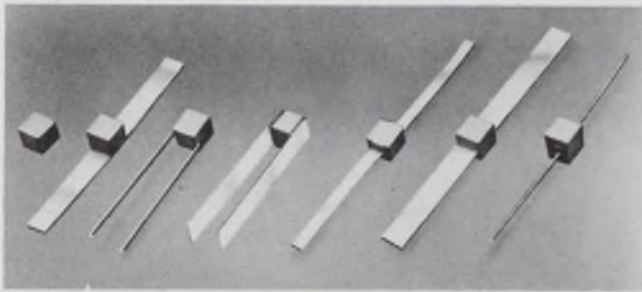

10. Terminations for chip components come in a variety of styles, as illustrated by American Technical Ceramics' rf capacitors.



11. General-purpose, chip capacitors from USCC/Centralab fill a wide range of af and rf applications.

Both ATC and Vitramon emphasize that chip terminations (Fig. 10) must be rugged enough to withstand assembly and soldering stresses. Part of the problem here results from differences in the coefficient of expansion of chips, terminating materials, bonding material and the mounting substrate. Another factor is the leaching away of the termination metal during soldering.

General-purpose ceramic-chip capacitors (Fig. 11) are supplied by many vendors including Vitramon, Johanson Manufacturing, Centralab, Erie Tech and Republic Electronics. But though ceramic dielectrics provide high K, you will have to compromise on stability and a poor temperature coefficient. For example, high-K ceramic

chip capacitors have a TC of 2000 ± 400 to 5600 ± 1000 ppm/ $^{\circ}$ C compared with 0 ± 30 to 90 ± 20 ppm/ $^{\circ}$ C for microwave chips.

National Components Industry specializes in tantalum capacitors in all styles and sizes, as you will quickly find out when you reach for its 162-page catalog. On p. 107 you find its Blue Chip, solid-electrolyte chip line. But before you reach for the order pad and expect off-the-shelf delivery, be warned. The company's sales manager, Jerry R. Behrens, advises: "Tantalum capacitors will continue in short supply for at least the next 12 to 18 months." Selection of standard values available at distributors is recommended.

NCI's Blue Chip line covers sizes from $0.1 \mu\text{F}$ to $100 \mu\text{F}$, voltages from 4 to 50 V, tolerances of $\pm 5\%$ to $\pm 20\%$ and an operating temperature range of -55 to 85 C.

Conventional capacitor styles survive

In conventional styles, the capacitors of 25 years ago have not changed dramatically (see capacitor-selection chart). The medium-sized, wound, tubular capacitors of yesterday used a paper dielectric for af bypass and coupling work, but today plastic dielectrics and metallized-plastic films have largely superseded paper and reduced the capacitor's volume by more than 50% in some cases. The wound construction also is giving way. Siemens' MKM capacitors use a stacked, metallized-polycarbonate film formed into compact, mechanically stable blocks, which further reduces size. Values range from 0.001 to $0.68 \mu\text{F}$, with tolerances to $\pm 5\%$ and maximum rated voltages of 100 and 200 V.

Another company, S & EI, also offers a line of metallized-polycarbonate capacitors that emphasizes size reduction. Since low voltages are used for semiconductor devices, the thinner dielectrics permit S & EI to produce a 50-V dc capacitor that is roughly a third the size of more conventional units. For instance, its $20\text{-}\mu\text{F}$ unit is only 0.62 inch in diameter and 1.68 inch long. This is quite small for a $20\text{-}\mu\text{F}$ nonpolarized capacitor.

And mica capacitors are still being made, but they are smaller and generally for lower voltages than in the past. The old molded postage-stamp style has been replaced by the dipped-mica package, such as Cornell-Dubilier's CD units (Fig. 12).

Since semiconductor circuits are characterized by lower impedances and lower voltages than vacuum-tube designs, capacitor styles and values should be changed accordingly, manufacturers advise. However, both the military and industry often use standards that reflect the high-imped-



12. Dipped silvered mica-dielectric capacitors, such as Cornell-Dubilier's CD units, provide more capacitance in

less space than the old postage-stamp types, and with better stability, tolerances and Q ratings.

ance, high-voltage requirements of vacuum-tube days. Such old-fashioned rules can lead to unnecessary costs and poor designs according to Matt Simon, assistant marketing manager of AVX Ceramics.

Simon warns of another problem: Some designers insist on specifying ceramic disc capacitors with high Ks, because of their small size, and end up with circuit instability. They do this, he notes, even though in many cases the space for larger and more stable lower-K units is available in the design.

"Because of the versatile nature of ceramics, competitors try to outspec one another," Simon says, but many manufacturers are "trying hard to educate" designers.

Digital circuitry with its many bypassing needs, has provided an enormous market for ceramic disc capacitors. Because most digital equipment operates at room temperature, and tight tolerances and high stability are not required, the bypass function is easily fulfilled by the ceramic capacitor. The result: Multilayer, high-K ceramic capacitors are very popular in the computer industry. For instance, the 0.1- μ F, Z5U capacitor is a standard bypass unit used in million quantities. A single computer installation can use as many as 50,000 capacitors of this one size. Companies like AVX, Centralab, Mepco and Siemens, among others, offer ceramic capacitors.



13. Sprague's stacked-foil, aluminum electrolytic is a good example of a functional improvement in a conventional passive components. Internal impedance is reduced to below 0.001 Ω and inductance to less than 2 nH—well below most other electrolytic capacitors.

Small signal capacitor selection chart

Type	Cou-pling	Bypass	Tuning	Timing	Cap range μF	Volt. range	Relative size	Relative cost
Aluminum electrolytic	Occa-sional	Yes	No	Occa-sional	0.1 to 500 k	3 to 450	Mod. to large	Mod.
Ceramic disc	Yes	Yes	Yes	Seldom	10^{-6} to 0.1	10 to 6 k	Small to large	Lowest
Ceramic monolithic	Yes	Yes	Yes	Yes	10^{-9} to 10	25 to 3 k	Small	Mod. to high
Ceramic chip	Yes	Yes	Yes	Yes	10^{-6} to .5	25 to 200	Small	Low to mod.
Film	Yes	Yes	Seldom	Yes	.001 to 12	50 to 1000	Mod. to large	Low to mod.
Metalized film	Yes	Yes	Occa-sional	Yes	.001 to 12	50 to 500	Small to large	Low to high
Mica	Yes	Seldom	Yes	Occa-sional	10^{-6} to 0.1	1 to 50 k	Mod.	Low to mod.
Paper	Occa-sional	Occa-sional	No	Seldom	.001 to 10	100 to 5 k	Mod. to large	Mod. to high
Tantalum	Occa-sional	Yes	No	Occa-sional	0.1 to 500	3 to 75	Small	Mod. to high

Chart by Ed Bolton of AVX Ceramics Corp.

Gradual, almost imperceptible improvements in electrolytic capacitors continue. Packages and seals get better and sizes slowly shrink, but the changes are quite undramatic. However, two new items are worth mentioning.

Electrolytics are also getting better

First, there is Sprague's Type 432D stacked-foil aluminum electrolytic capacitor for ultra-low-impedance applications (Fig. 13). Capacitors to 100,000 μF , with 5-to-50 V ratings have typical equivalent-series resistances of less than 0.001 Ω at about 10 kHz, and all ratings are guaranteed to have less than 2-nH inductance. Also, maximum safe ripple currents run in the 10-to-50-A range at 85 C. Data-processing, power-supply systems are particularly good applications for these capacitors.

The second new development is Cornell-Dubilier's low-inductance type-UFT aluminum-electrolytic capacitor. A rather interesting four-terminal, feed-through construction produces a decrease in impedance at frequencies above 10 kHz, rather than the usual increase for two-terminal electrolytics. The capacitor forms an H filter configuration, with the four leads. In this way, the capacitor's own internal impedance, even though it is of conventional proportions, has a reduced effect at the higher frequencies. Cornell-Dubilier's No. 1 designer kit, "Low-Inductance Electrolytic Capacitors," explains all the details. The capacitors come in sizes to 16,000 μF at 5 V dc, and to 320 μF at 200-V-dc ratings.

When price is all important, the engineer should select an aluminum electrolytic. If size is

the prime consideration, a tantalum is best. For low impedances, of course, the wet electrolytic is the one to use. And solid tantalums are a poor choice for heavy current-surge applications. Wet units, both aluminum and tantalum, also handle reverse voltages better than do solids. But reverse-voltage applications need special considerations that are rarely mentioned in spec sheets. Ask the vendor for his recommendations.

Use ac-rated capacitors for ac operation

The reverse-voltage problem brings us to Electro Cube. One of its major capacitor lines is designated specifically for ac operation. F. L. Johnson of Electro Cube puts it this way: "While it is a fact that there are many dc-designed and rated units that can, and do, operate satisfactorily in some ac circuits, this fact is a result of a fortunate coincidence for that particular instance."

The use of a dc-voltage rating that is higher than the expected peak ac is not necessarily a solution to the problem. Besides voltage-gradient stress, ac on a capacitor generates other stresses, such as internal heating and tiny corona discharges, which can rapidly cause failure in dc capacitors. Electro Cube's Technical Bulletins 07 and 08 explain what happens in ac-operated capacitors.

The company's ac capacitors are metallized polycarbonate types in a variety of styles. Capacitances range from 0.01 to 2.0 μF in most, and their rating is 115 V ac (rms) at 400 Hz.

While hybrid and IC-circuit designers have been trying to minimize use of capacitors, they have gone all out to eliminate the inductor completely. This attitude has carried over from pre-

IC days, and it has been reinforced by the difficulty of making integrated inductors. This has forced engineers to come up with ways to synthesize the effect of inductance without the use of a real inductive component.

Inductors are down but not out

Active RC circuits and mechanical resonators made of quartz or ceramic materials can be packaged in smaller sizes than equivalent tuned circuits that contain inductors. A great deal of research has also gone into new, promising frequency-selective packages—like thermoelectric filters, gyrator circuits and resonant-gate FETs. And because of the economics of IC production, several pn junctions are often more economical than a single inductor. Further, although the resulting circuit may seem more complex, the space requirements without an inductor can be less.

But magnetic-component makers are fighting back. They say that a single passive inductive component is more reliable, more stable and can take more extremes of environment than a complex semiconductor circuit. Thus magnetic components are often preferred to active semiconductor circuits for military, space and other high-reliability, high-stability applications. Inductors are more resistant to nuclear radiation, and some core materials give excellent performance over wide temperature ranges.

Inductor chips help comeback

Printed-circuit inductors have been used for many years, but they have, hitherto, been limited to only a few microhenries.

In response, San Fernando Electric Manufacturing has developed an unusual chip inductor, the Magna-Chip. The unit is formed from a stack of U-shaped conductor patterns that are screened onto ferrite tape material. The stacked patterns allow inductance that is three orders of magnitude greater than a single-layer PC inductor occupying the same area. Inductances range from 0.2 to 5 μH , and the Q is specified to have a minimum of 20 over roughly 10 to 25 MHz, with a temperature coefficient of less than 500 ppm/ $^{\circ}\text{C}$ from -55 to 125 C. The current rating is 1 A at 0.3 W.

Almost any method of bonding or attachment to the precious-metal terminations is possible, and the company says the unit is "virtually indestructible up to 1500 F because of its monolithic fused construction." All this in an 80-mil cube.

Another chip inductor, Vanguard's Super-Q, occupies 0.16 by 0.125 by 0.125 inch, but can provide inductances from 0.1 μH to 100,00 μH and Qs from about 25 to 80. For instance, a 10-

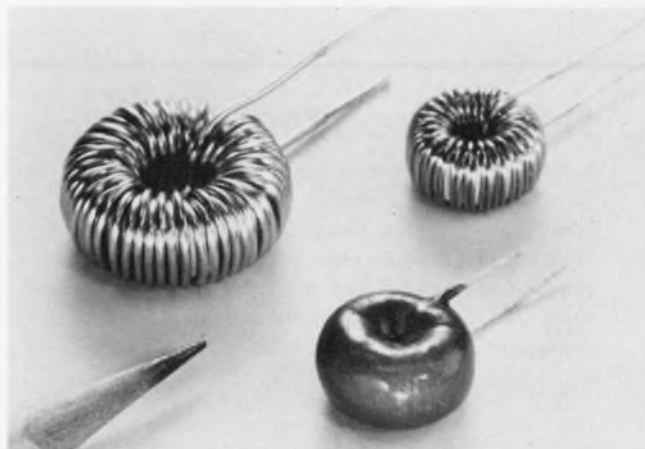

14. Improved core materials have allowed smaller coils to handle large amounts of current without saturation.

μH unit lists a Q of 70 at a test frequency of 7.9 MHz, and a 10,000 μH unit lists the Q at 55 at 0.25 MHz. Rated currents vary from 3 mA for the 100,000 μH unit to 750 mA for the 0.10 μH .

The Super-Q's package is suitable for reflow-soldering assembly and can be handled by automatic-insertion equipment. The unit is enclosed in an all-welded housing to resist moisture, and it has an operating temperature range from -55 to 125 C.

The larger inductors are still around

To improve the normally sized inductor, many magnetic-component makers have been experimenting with core materials to raise permeabilities and saturation levels and to reduce size. New core shapes are also being offered to overcome the winding problems of toroidal shapes, but the changes have provided marginal improvements so far.

A recent innovation is National Micronetics' new line of SN coils (Fig. 14). They feature a powdered-iron core with exceptionally high-saturation flux densities ranging to 15,000 gauss—which is four to five times greater than the rating of conventional ferrite-core material. The high-saturation feature makes these coils particularly suitable for applications where high-level dc must pass through the coil.

The SN coils come in 36 standard configurations and can carry from 2 to 60 A without saturation. One important application for the coils is in noise-filtering circuits for power lines and in circuits that use thyristors, relays and other switching devices. Besides the improved performance, National Micronetics says that the SN units are less expensive than conventional ferrite or tape-wound cores. ■■

(continued on page 66)

Need more information?

The companies and products cited in this report have, of necessity, received only cursory coverage. They've been selected for their illustrative, or in some cases, unique qualities. Companies not mentioned may offer similar products. Readers may wish to consult these manufacturers for further details:

- AVX Ceramics Corp., 10 Forbes Rd., Braintree, Mass. 02184. (617) 848-6220. (C) **CHECK 320**
- Airco Speer Electronics, P.O. Box 547, Bradford, Pa. 16701. (814) 362-5536. (C), (R) **CHECK 321**
- Allen Avionics, 255 E. 2nd, Mineola, N. Y. 11501. (516) 248-8080. (L) **CHECK 322**
- Allen-Bradley Co., 1201 S. 2nd St., Milwaukee, Wis. 53204. (414) 671-2000. (C), (R) **CHECK 323**
- Allen-Organ, Dept. P., Macungie, Pa. 18062. (215) 965-9801. (L) **CHECK 324**
- Alpha Components Corp., 4087 Glencoe Ave., Venice, Calif. 90291. (213) 821-4964. (R) **CHECK 325**
- American Components Inc., 8th Ave. at Harry St., Conshohocken, Pa. 19428. (215) 828-6240. (C), (R) **CHECK 326**
- American Lava Corp., Manufacturers Rd., Chattanooga, Tenn. 37405. (615) 265-3411. (C) **CHECK 327**
- American Technical Ceramics, 1 Norden Lane, Huntington Station, N. Y. 11746. (516) 271-9600. (C) **CHECK 328**
- Arcidy Associates Inc., 370 Commercial St., Manchester, N.H. 03101. (603) 668-2111. (R) **CHECK 329**
- Arco Electronics Inc., Community Dr., Great Neck, N.Y. 11022. (516) 487-0500. (C) **CHECK 330**
- Astro Electronics, Inc., 1160 E. Ash Ave., Fullerton, Calif. 92631. (714) 526-5581. (R) **CHECK 331**
- Astrosystems, 6 Nevada Dr., Lake Success, N. Y. 11040. (516) 328-3300. (L) **CHECK 332**
- Automatic Coil, 55 S. Denton Ave., New Hyde Park, N.Y. 11040. (516) 328-3300. (L) **CHECK 333**
- Automatic Manufacturing, 65 Gouvener St., Newark, N.J. 07102. (201) 485-2100. (L) **CHECK 334**
- Balco Electronics Inc., 307 Washington St., Orange, N.J. 07050. (201) 677-1200. (C) **CHECK 335**
- Beckman Instruments Inc., Helipot Div., 2500 Harbor Blvd., Fullerton, Calif. 92634. (714) 871-4848. (R) **CHECK 336**
- Bel-Tronics Corp., 344 W. Interstate Rd., Addison, Ill. 60101. (312) 543-7777. (R) **CHECK 337**
- Biddle, James G., Co., Township Line & Jolly Rd., Plymouth Meeting, Pa. 19462. (215) 646-9200. (R) **CHECK 338**
- Bourns, 1200 Columbia Ave., Riverside, Calif. 92507. (714) 684-1700. (L), (R) **CHECK 339**
- Bowmar/TIC, Inc., Components Div., 850 Lawrence Dr., Newbury Park, Calif. 91320. (805) 498-2161. (R) **CHECK 340**
- Bradohm Inc., 65 South Ave., Salamanca, N. Y. 14779. (716) 945-2340. (R) **CHECK 341**
- CTS Microelectronics, Inc., Box 1278, Lafayette, Ind. 47902. (317) 463-2565. (R) **CHECK 342**
- CW Industrial, 550 Davisville Rd., Warminster, Pa. 18974. (215) 355-7080. (R) **CHECK 343**
- Caddell-Burns, 40 E. 2nd St., Mineola, N.Y. 11501. (516) 746-2310. (L) **CHECK 344**
- Caddock Electronics Inc., 3127 Chicago Ave., Riverside, Calif. 92507. (714) 683-5361. (R) **CHECK 345**
- Callins Industries, Inc., P. O. Box C, Greenfield, Tenn. 38230. (901) 235-2234. (C) **CHECK 346**
- Cal-R, Inc., 1601 Olympic Blvd., Santa Monica, Calif. 90404. (213) 451-9761. (C) **CHECK 347**
- Carborundum Co., Electric Products Branch, P.O. Box 339, Niagara Falls, N.Y. 14302. (716) 278-2521. (R) **CHECK 348**
- Carter Manufacturing Corp., 23 Washington St., Hudson, Mass. 01749. (617) 562-6987. (R) **CHECK 349**
- Capco, Inc., Foresight, Industrial Park, Grand Junction, Colo. 81501. (303) 243-8750. (R) **CHECK 350**
- Center Engineering, 307 Benner Pike, State College, Pa. 16801. (814) 237-0321. (C) **CHECK 351**
- Center Resistor Corp., 507 Factory Rd., Addison, Ill. 60101. (312) 543-3814. (R) **CHECK 352**
- Centralab Div., Globe-Union Inc., 5757 N. Green Bay Ave., Milwaukee, Wis. 53201. (414) 228-2769. (C) **CHECK 353**
- Chicago Condenser Corp., 3255 W. Armitage Ave., Chicago, Ill. 60647. (312) 227-7070. (C) **CHECK 354**
- ClaroStat Manufacturing Co. Inc., Main & Washington, Dover, N.H. 03820. (603) 742-1120 (R) **CHECK 355**
- Colber Corp., 26 Buffington St., Irvington, N. J. 07111. (201) 375-3004. (R) **CHECK 356**
- Cole-Hersee Co., 20 Old Colony Ave., Boston, Mass. 02127. (617) 268-2100. (R) **CHECK 357**
- Component Research Co. Inc., 1717-19th St., Santa Monica, Calif. 90404. (213) 393-3755. (C) **CHECK 358**
- Condenser Products Corp., P.O. Box 997, Brooksville, Fla. 33512. (904) 796-3562. (C) **CHECK 359**
- Cornell-Dubilier Electronics, 150 Ave. L, Newark, N.J. 07101. (201) 589-7500. (C) **CHECK 360**
- Corning Glass Works, Electronics Prod. Div., Houghton Park, Corning, N.Y. 14830. (607) 962-4444. (C), (R) **CHECK 361**
- Dale Electronics, P.O. Box 609, Columbus, Neb. 68601. (402) 564-3131. (L), (R) **CHECK 362**
- Del Electronics Corp., 250 E. Sanford Blvd., Mount Vernon, N.Y. 10550. (914) 699-2000. (C), (L) **CHECK 363**
- Delevan Electronics, 270 Quaker Rd., E. Aurora, N.Y. 14052. (716) 652-3600. (L) **CHECK 364**
- Delta Coils, 4312 Main St., Philadelphia, Pa. 19104. (215) 482-9350. (L) **CHECK 365**
- Dickson Electronics, P.O. Box 1390, Scottsdale, Ariz. 85252. (602) 947-2231. (C) **CHECK 366**
- Dolinko & Wilkens Inc., 1907 Summit Ave., Union City, N.J. 07087. (201) 867-6630. (C) **CHECK 367**
- Duncan Electronics, Inc., 2865 Fairview Rd., Costa Mesa, Calif. 92626. (714) 545-8261. (R) **CHECK 368**
- Electra-Midland Corp., 11468 Sorrento Valley Rd., San Diego, Calif. 92121. (714) 453-0332. (R), (C) **CHECK 369**
- Electrocube Inc., 1710 S. Del Mar Ave., San Gabriel, Calif. 91776. (714) 547-1771. (C) **CHECK 370**
- Electro-Flex Heat, Inc., Northwood Industrial Park, Bloomfield, Conn. 06002. (203) 242-6287. (R) **CHECK 371**
- Electro Materials Div., ITW Inc., 11620 Sorrento Valley Rd., San Diego, Calif. 92121. (714) 459-4355. (C) **CHECK 372**
- Electro Motive Manufacturing Co. Inc., S. Park & John St., Willimantic, Conn. 06226. (203) 423-9231. (C) **CHECK 373**
- Electro Scientific Industries, 13900 NW Science Park, Portland, Ore. 97229. (503) 646-4141. (R) **CHECK 374**
- Eltec Instruments, Inc., Central Industrial Park, Daytona Beach, Fla. 32014. (904) 252-0411. (R) **CHECK 375**
- Engineered Components Co., 2134 W. Rosecrans Ave., Gardena, Calif. 90249. (213) 321-6565. (C) **CHECK 376**
- Erie Technological Products Inc., 644 W. 12th St., Erie, Pa. 16512. (814) 453-5611. (C), (R) **CHECK 377**
- Film Microelectronics Inc., 17 A St., Burlington, Mass. 01803. (617) 272-5650. (R) **CHECK 378**
- Freed Transformer, 1795 Weirfield St., Brooklyn, N.Y. 11227. (212) 386-1300. (L) **CHECK 379**
- Gamble, Charles T., Industries, N.J. Ave. & Fairview St., Riverside, N.J. 08075. (609) 461-1900. (R) **CHECK 380**
- Gamewell Potentiometer Div., Servo Instrument Corp., 235 Lynn St., Baraboo, Wis. 53913. (608) 356-9095. (R) **CHECK 381**
- General Electric, 6001 S. Anthony Blvd., Fort Wayne, Ind. 46802. (219) 447-1511. (L) **CHECK 382**
- General Electric Co., P.O. 1388, Columbia, S.C. 29202. (803) 772-2500. (C) **CHECK 383**
- General Instrument Corp., 150 Front St., Chicopee, Mass. 01014. (413) 594-4781. (C) **CHECK 384**
- General Resistance, Inc., 500 Nuber Ave., Mount Vernon, N.Y. 10550. (914) 699-8010. (R) **CHECK 385**
- Gudeman Div., 340 W. Huron St., Chicago, Ill. 60610. (312) 337-7400. (C) **CHECK 386**
- Halex Inc., 3500 W. Torrance Blvd., Torrance, Calif. 90509. (213) 772-4461. (R) **CHECK 387**
- Hamilton-Hall Resistor Corp., 227 N. Water St., Milwaukee, Wis. 53202. (414) 273-6460. (R) **CHECK 388**
- High Energy Inc., Malvern Industrial Park, Malvern, Pa. 19335. (215) 644-7600. (C) **CHECK 389**
- Hipotronics Inc., Drawer A, Brewster, N.Y. 10509. (914) 279-8091. (C) **CHECK 402**
- Hisonic, 249 N. Troost, Olathe, Kan. 66061. (913) 782-0012. (L) **CHECK 403**
- Hughes Aircraft Co., 500 Superior Ave., Newport Beach, Calif. 92663. (714) 548-0671. (R) **CHECK 404**
- Humphrey Inc., 2805 Canon St., San Diego, Calif. 92106. (714) 223-1654. (R) **CHECK 405**
- Huntington Electric Inc., 550 Conduit Box 366, Huntington, Ind. 46750. (219) 356-0756. (R) **CHECK 406**
- Hybrex, Div. of Burr-Brown, 6730 S. Tucson Blvd., Tucson, Ariz. 85706. (602) 294-1431. **CHECK 407**
- HyComp, Inc., 146 Main St., Box 250, Maynard, Mass. 01754. (617) 897-4578. (R) **CHECK 408**
- ITT Semiconductors, 500 Broadway, Lawrence, Mass. 08142. (617) 688-1881. (C) **CHECK 409**
- Icore Electro-Plastic, 3015 Copper Rd., Santa Clara, Calif. 95051. (407) 732-5400. (L) **CHECK 410**
- Industrial Condenser Corp., 3243 N. Calif. Ave., Chicago, Ill. 60618. (312) 463-2200. (C) **CHECK 411**
- International Electronics Corp., 316 S. Service Rd., Melville, N.Y. 11749. (516) 694-7700. (C) **CHECK 412**
- JFD Electronics Corp., 1462 62nd St., Brooklyn, N.Y. 11219. (212) 331-1000. (C) **CHECK 413**
- James Electronics, 4050 N. Rockwell, Chicago, Ill. 60618. (312) 463-6500. (L) **CHECK 390**
- Johanson Manufacturing Corp., P.O. Box 329, Boonton, N.J. 07005. (201) 334-2676. (C) **CHECK 391**
- E. F. Johnson Co., Waseca, Minn. 56093. (507) 835-2050. (C) **CHECK 392**
- Julie Research Laboratories Inc., 211 W. 61st St., New York, N.Y. 10023. (212) 245-2727. (R) **CHECK 393**
- K-F Development Co., 2606 Spring St., Redwood City, Calif. 94063. (415) 368-5670. (R) **CHECK 394**

Kelvin, 5919 Noble Ave., Van Nuys, Calif. 91401. (213) 782-6662. (R) **CHECK 395**
 Kidco, Inc., P.O. Box 278, Medford, N.J. 08055. (609) 267-2100. (R) **CHECK 396**
 Kulite Semiconductor Products, Inc., 1039 Hoyt Ave., Ridgefield, N.J. 07657. (201) 945-3000. (R) **CHECK 397**
 Harry Levinson Co., Diplomatic Div., 1211 E. Denny, Seattle, Wash. 98112. (206) 323-5100. (R) **CHECK 398**
 Lenox-Fugle Electronics, 100 Sylvania Pl., S. Plainfield, N.J. 07080. (201) 756-1164. (L) **CHECK 399**
 Magnetic Circuit Elements, 2455A Garden Rd., Monterey, Calif. 93940. (408) 373-0456. (L) **CHECK 400**
 Mallory Capacitor Co., 3029 E. Washington, Indianapolis, Ind. 46206. (317) 636-5353. (C) **CHECK 401**
 Mallory Controls Co., State Rd. 28 W, Frankfort, Ind. 46041. (317) 654-5501. (R) **CHECK 414**
 Marshall Industries, 1960 Walker Ave., Monrovia, Calif. 91016. (213) 359-8281. (C) **CHECK 415**
 McGraw-Edison Co., Edison Electronics Div., Grenier Field, Municipal Airport, Manchester, N.H. 03103. (603) 669-0940. (R) **CHECK 416**
 Mel-Rain Corp., 3100 Roosevelt Ave., Indianapolis, Ind. 46204. (317) 637-3531. (R) **CHECK 417**
 Memcor, 1320 Flaxmill Rd., Huntington, Ind. 46750. (219) 356-4300. (R) **CHECK 418**
 Mepco/Electra, Inc., Columbia Rd., Morristown, N.J. 07960. (201) 539-2000. (R) **CHECK 419**
 Metavac, Div. of Optics Technology, Inc., 45-68 162nd St., Flushing, N.Y. 11358. (212) 445-0400 (R) **CHECK 420**
 Micro Components Associates, 202 E. Stevens, Santa Ana, Calif. 92707. (714) 979-8833. (R) **CHECK 421**
 Micro Networks Corp., 5 Barbara Lane, Worcester, Mass. 01604. (617) 756-4635. (R) **CHECK 422**
 Micro-Ohm Corp., 4900 Santa Anita Ave., El Monte, Calif. 91731. (213) 686-0535. (R) **CHECK 423**
 Microtran, 145 E. Mineola, Valley Stream, N.Y. 11582. (516) 10-16050. (L) **CHECK 424**
 Midwec Corp., P.O. Box 417, Scotts Bluff, Neb. 69361. (308) 632-4127. (C) **CHECK 435**
 Miller, J.W., 19070 Reyes Ave., Compton, Calif. 90221. (213) 537-5200. (L) **CHECK 425**
 Milwaukee Resistor Corp., 700 W. Virginia St., Milwaukee, Wis. 53204. (414) 271-9900. (R) **CHECK 426**
 Mini-Systems Inc., 20 David Rd., Box 67, N. Appleboro, Mass. 02761. (617) 695-0206. (R) **CHECK 427**
 Model Rectifier Corp., 2500 Woodbridge Ave., Edison, N.J. 08817. (201) 985-7800. (R) **CHECK 428**
 Murata Corp. of America, Murata Manufacturing Co., 2 Westchester Plaza, Elmsford, N.Y. 10523. (914) 592-9180. (C) **CHECK 429**
 NL Industries, Inc., Wykoff Mills Rd., Hightstown, N.J. 08520. (609) 448-3200. (R) **CHECK 430**
 Narda Microwave Corp., 75 Hill Commercial St., Plainview, N.Y. 11803. (516) 433-9000. (R) **CHECK 431**
 National Components Industries, Capacitor Div., 5900 Australian Ave., W. Palm Beach, Fla. 33407. (305) 842-3201. (C) **CHECK 432**
 National Micronetics, Route 28 W. Hurley, N.Y. 12491. (914) 338-0333. (L) **CHECK 433**
 National Radio, 111 Washington St., Melrose, Mass. 02176. (617) 662-7700. (L) **CHECK 434**
 North American Philips Corp., 100 E. 42nd St., N.Y., N.Y. 10017. (212) 697-3600. (C) **CHECK 436**
 North Hills Electronics, Alexander Pl., Glen Cove, N.Y. 11542. (516) 671-5700. (L) **CHECK 437**
 Nucleonic Products Co. Inc., 6660 Variel Ave., Canoga Park, Calif. 91303. (213) 887-1010. (C) **CHECK 438**
 Nytronics Inc., Orange St., Darlington, S.C. 29532. (803) 393-5421. (C), (R), (L) **CHECK 439**
 Ohio Carbon Co., 12508 Berea Rd., Cleveland, Ohio 44111. (216) 252-6100. (R) **CHECK 440**
 Ohmite Manufacturing Co., N. American Philips Co., 3601 Howard St., Skokie, Ill. 60076. (312) 675-2600. (R) **CHECK 441**
 Omtronics Manufacturing, Inc., 2406 Leavenworth St., Omaha, Neb. 68105. (402) 348-9500. (R) **CHECK 442**
 Peerless Electrical Products, 1515 S. Manchester Ave., Anaheim, Calif. 92803. (714) 774-5373. (L) **CHECK 443**
 Piconics, Cummings Rd., Tyngsboro, Mass. 01879. (617) 649-7501. (L) **CHECK 444**
 Piher International Corp., 1239 Rand Rd., Des Plaines, Ill. 60016. (312) 297-1560. (R), (C) **CHECK 445**
 Plastic Capacitors Inc., 2620 N. Clybourn Ave., Chicago, Ill. 60614. (312) 348-3735. (C) **CHECK 446**
 Precision Electronic Coil, 18300 Oxnard St., Tarzana, Calif. 91356. (213) 345-7811. (R) **CHECK 447**
 Precision Inc., 3415 48th Ave. N., Minneapolis, Minn. 55429. (612) 588-9441. (R) **CHECK 448**
 Precision Resistor Co. Inc., 109 Route 22, Hillside, N.J. 07205. (201) 926-3036. (R) **CHECK 449**
 Pyrofilm Corp., 60 S. Jefferson Rd., Whippany, N.J. 07981. (201) 887-8100. (R) **CHECK 450**
 RCL Electronics Inc., 700 S. 21st St., Irvington, N.J. 07111. (201) 374-3311. (R) **CHECK 464**
 RF Interonics, 100 Pine Aire Dr., Bay Shore, N.Y. 11706. (516) 231-6400. (C) **CHECK 465**
 R-Ohm Corp., P.O. Box 4455, 17835 Sky Park Circle Dr., Irvine, Calif. 92664. (714) 546-7750. (R) **CHECK 466**
 Raytheon Ind. Components, 465 Centre St., Quincy, Mass. 02169. (617) 479-5300. (R) **CHECK 467**
 Reon Resistor Corp., 155 Saw Mill River, Yonkers, N.Y. 10701. (914) 965-9850. (R) **CHECK 468**
 Republic Electronics Corp., 176 E. 7th St., Paterson, N.J. 07524. (201) 279-0300. (C) **CHECK 469**
 Resistance Products Co., 914 S. 13th St., Harrisburg, Pa. 17104. (717) 236-5081. (R) **CHECK 470**
 Rex Rheostat & Co., Inc., 149 Babylon Turnpike, Roosevelt, N.Y. 11575. (516) 379-1030. (R) **CHECK 471**
 Rubicon Instruments, Penn Airborne Products Co., Industrial Blvd., Southampton, Pa. 18966. (215) 355-3400. (R) **CHECK 472**
 S & El Manufacturing, 18800 Parthenia, Northridge, Calif. 91324. (213) 349-4111. (C) **CHECK 473**
 Sangamo Electric Co., Box 128, Pickens, S.C. 2967. (803) 878-6311. (C), (L) **CHECK 474**
 San Fernando Electric Manufacturing Co., 1501 First St., San Fernando, Calif. 91341. (213) 365-9411. (C) **CHECK 475**
 Semtech Corp., 652 Mitchell Rd., Newbury Park, Calif. 91320. (213) 628-5392. (C) **CHECK 452**
 Shallcross, Cutler-Hammer Co., Selma, N.C. 27576. (919) 965-2341. (R) **CHECK 453**
 Shallco, Inc., Hwy 3Q1-S, P.O. Box 1089, Smithfield, N.C. 27577. (919) 965-2341. (R) **CHECK 454**
 Siemens Corp., 186 Wood Ave. S., Iselin, N.J. 08830. (201) 494-1000. (C) **CHECK 455**
 Signal Transformer, 1 Junius St., Brooklyn, N.Y. 11212. (212) 498-5111. (L) **CHECK 456**
 Solar Manufacturing Corp., 4553 Seville Ave., Los Angeles, Calif. 90058. (213) 583-1411. (C) **CHECK 457**
 Solid State Electronics, 15321 Rayen St., Sepulveda, Calif. 91343. (213) 894-2271. (L) **CHECK 458**
 Solitron Devices, Inc., 256 Oak Tree Rd., Tappan, N.Y. 10983. (914) 359-5050. (R) **CHECK 459**
 Spectrol Electronics Corp., 7070 E. Gale Ave., City of Industry, Calif. 91745. (213) 964-6565. (R) **CHECK 460**
 Sprague Electric, 449 Marshall St., North Adams, Mass. 02147. (413) 664-4411. (C), (R), (L) **CHECK 451**
 Stackpole Carbon Co., 201 Stackpole Rd., St. Mary's, Pa. 15857. (814) 781-1234. (R) **CHECK 461**
 Stancor Electronics, 3501 W. Addison St., Chicago, Ill. 60618. (312) 463-7400. (L) **CHECK 462**
 Stettner-Trush Inc., 67 Albany St., Cazenovia, N.Y. 13035. (315) 655-8141. (C) (R) **CHECK 463**
 TRW-IRC Fixed Resistors, TRW Inc., P.O. Box 393, Boone, N.C. 28607. (704) 264-8861. (R) **CHECK 476**
 TRW Capacitor Div., TRW Inc., 112 W. First St., Ogallala, Neb. 69153. (308) 284-0361 (C) **CHECK 477**
 Tech OHM Electronics, Inc., 36-11 33rd St., Long Island City, N.Y. 01106. (212) 786-2274. (R) **CHECK 478**
 Tel-Labs Inc., 1050 2nd St., Manchester, N.H. 03102. (603) 625-8994. (R) **CHECK 479**
 Texas Capacitor Co. Inc., 7830 Westglen Dr., Houston, Tex. 77042. (713) 782-9232. (C) **CHECK 480**
 Thordarson-Meissner, Electronics Ctr., Mount Carmel, Ill. 62863. (618) 262-5121. (L) **CHECK 481**
 Torotel, 13402 S. 71 Hwy., Grandview, Mo. 64030. (816) 501-6314. (L) **CHECK 482**
 Torwico Electronics, Route 70, Lakewood, N.J. 08701. (201) 364-1800. (L) **CHECK 484**
 Transistor Electronics, West Rd., Bennington, Vt. 05201. (802) 442-5473. (C) **CHECK 483**
 Triad Div./Litton, 305 N. Briant St., Huntington, Ind. 46750. (219) 356-6500. (L) **CHECK 485**
 Ultronic, Inc., 461 N. 22nd St., Grand Junction, Colo. 81501. (303) 242-0810. (R) **CHECK 486**
 Union Carbide-Components, P.O. Box 5928, Greenville, S.C. 29606. (803) 963-7421. (C) **CHECK 487**
 United Transformer, 150 Varick, N.Y., N.Y. 10013. (212) 255-3500. (L) **CHECK 488**
 U.S. Capacitor Corp., 2151 N. Lincoln St., Burbank, Calif. 91504. (213) 843-4222. (C) **CHECK 489**
 Valor Electronics Inc., 1642 Kaiser Ave., Santa Ana, Calif. 92705. (714) 540-9261. (R) **CHECK 490**
 Vanguard, 930 W. Hyde Park Pl. Blvd., Inglewood, Calif. 90302. (213) 678-7161. (L) **CHECK 491**
 Vari-L, 3883 Monaco Pkwy., Denver, Colo. 80207. (303) 321-1511. (L) **CHECK 492**
 Varo, 2203 Walnut, Garland, Tex. 75040. (214) 272-3561. (C) **CHECK 493**
 Victoreen Instrument Div., 10101 Woodland Ave., Cleveland, Ohio 44104. (216) 795-8200. (R) **CHECK 494**
 Vishay Resistor Products, 63 Lincoln Hwy., Malvern, Pa. 19355. (215) 644-1300. (R) **CHECK 495**
 Vitramon Inc., P.O. Box 544, Bridgeport, Conn. 06601. (203) 268-6261. (C) **CHECK 496**
 Vossco Inc., P.O. Box 39, LaSalle Station, Niagara Falls, N.Y. 14304. (716) 693-5483. (R) **CHECK 497**
 Wabash Magnetics, 1375 Swan St., Huntington, Ind. 46750. (219) 356-8300. (L) **CHECK 498**
 Ward Leonard Electric Co. Inc., 31 South St., Mount Vernon, N.Y. 10550. (914) 664-1000. (R) **CHECK 499**
 Workman Electronic Products, P.O. Box 3828, Sarasota, Fla. 33578. (813) 955-4241. (R), (L) **CHECK 500**



More TI integrated circuits are used in today's electronic systems than any other brand in the world. And for the reasons you'd expect: Technology. Volume. Price. Breadth. Dependability. Service. Quality. Weigh them all when you buy high-speed logic.

SCHOTTKY

It's a 54/74 world.

And TI's Schottky TTL family grows at every turn.

Designing now with 3-ns Schottky can help you stay ahead of the pace.

You're in a race. A race to provide the best performance, price, delivery and reliability for your customers. Not just now...but from now on. TI's 3-ns 54S/74S Schottky TTL can help you get out front. And stay there.

TI introduced 54/74 TTL in 1965 and 54S/74S Schottky in 1970...and 54/74 logic has become the most popular, fastest growing, most second-sourced logic form. It has set the standards for the industry.

Since it is fully compatible with conventional TTL, TI's Schottky can be used selectively to improve system performance. Economically. Combine this with the broadest and fastest growing choice of functions and you can see that a decision to design now with Schottky TTL could be vital in your product planning.

With constant demand for higher performance at lower costs, the trend is toward increased use of Schottky TTL... up to 90% in many new designs.

For your new designs (or upgrading existing ones) TI's Schottky offers an unmatched combination of performance, choice, volume availability, low cost, design simplicity, versatility, reliability and complexity. Consider these advantages:

- **Broadest choice of functions.** No one has introduced and delivered more Schottky circuit functions than TI. Check the list at right. Newest circuits are starred, and more are coming soon...including higher complexity MSI functions.
- **Volume production.** TI has been building Schottky TTL in production quantities for more than three years. The results are high volume capability, good yields and lower costs for you.
- **Proven reliability.** The same built-in reliability found in all TI 54/74 ICs has been proven for TI Schottky through extensive factory testing and field experience.
- **Full temperature and package choice.** TI Schottky is available in both industrial and military temperature ranges, and in plastic or ceramic DIPs and ceramic flat packs.

Series 54S/74S Schottky MSI Circuits

SN54S/74S174	Hex D-type storage register, 110MHz
SN54S/74S175	Quad D-type storage register, 110MHz
SN54S/74S194	4-bit bi-directional shift register, 105 MHz
SN54S/74S195	4-bit parallel-access shift register, 105 MHz

*SN54S/74S85	4-bit magnitude comparator
SN54S/74S86	Quad Exclusive-OR
SN54S/74S135	Quad Exclusive-OR/NOR
SN54S/74S181	4-bit ALU and function generator
SN54S/74S182	Carry look-ahead for SN54S/74S181
*SN54S/74S280	9-bit odd/even parity generator/checker

SN54S/74S151	8 to 1-line multiplexer
SN54S/74S251	8 to 1-line multiplexer, 3-state output
SN54S/74S157	Quad 2 to 1-line multiplexer
SN54S/74S257	Quad 2 to 1-line multiplexer, 3-state output
SN54S/74S158	Quad 2 to 1-line multiplexer
SN54S/74S258	Quad 2 to 1-line multiplexer, 3-state output
SN54S/74S153	Dual 4 to 1-line multiplexer

SN54S/74S138	3-8-line decoder/demultiplexer
SN54S/74S139	Dual 2 to 4-line decoder/demultiplexer
*SN54S/74S124	Voltage controlled oscillator (VCO)

Series 54S/74S Schottky SSI Circuits

SN54S/74S00	Quad 2-input NAND gate
*SN54S/74S02	Quad 2-input NOR gate
SN54S/74S03	Quad 2-input NAND gate, o.c. output
SN54S/74S04	Hex inverter
SN54S/74S05	Hex inverter, o.c. output
SN54S/74S10	Triple 3-input NAND gate
SN54S/74S11	Triple 3-input AND gate
SN54S/74S15	Triple 3-input AND gate, o.c. output
SN54S/74S20	Dual 4-input NAND gate
SN54S/74S22	Dual 4-input NAND gate, o.c. output
*SN54S/74S30	8-input NAND gate
SN54S/74S40	Dual 4-input NAND buffer
*SN54S/74S51	Dual 2-wide, 2-input AND-OR-INVERT gate
SN54S/74S64	4-2-3-2-input AND-OR-INVERT gate
SN54S/74S65	4-2-3-2-input AND-OR-INVERT gate, o.c. output
SN54S/74S74	Dual D-type flip-flop (110MHz), preset, clear
SN54S/74S112	Dual J-K flip-flop (125 MHz), preset, clear
SN54S/74S113	Dual J-K flip-flop (125 MHz), preset
SN54S/74S114	Dual J-K flip-flop (125 MHz), common clock, clear
*SN54S/74S132	Quad 2-input NAND Schmitt trigger
SN54S/74S133	13-input NAND gate
SN54S/74S134	12-input NAND gate, 3-state output
SN54S/74S140	Dual 4-input NAND 50-ohm line driver
*SN54S/74S260	Dual 5-input NOR gate

*Recent introductions

For new 54S/74S applications report, Bulletin CA-176, write on company letterhead to Texas Instruments Incorporated, P.O. Box 5012, M/S 308, Dallas, Texas 75222.



Be on guard when using DVMs.

Noise can lead to erroneous readings. Combat it with the proper rejection technique and correct hook-up of the voltmeter.

Like most sensitive, high-resolution instruments, digital voltmeters are prone to erroneous readings from noise at the input terminals. This becomes especially severe in system applications of DVMs, where leads tend to get long and coupling between adjacent leads is common.

To avoid erroneous readings—and to prevent possible damage to the DVM—the user must do two things: First, select a DVM that can handle the anticipated sources and types of noise. Second, know how to connect the DVM input terminals to the measurement points. To do these two things, it's important to understand both the noise mechanism and the measures taken by manufacturers to protect DVMs from both damage and errors.

Two error modes exist

Noise can be split into two general modes, depending on its origin relative to the DVM signal input lines: (1) Normal-mode noise, which enters with, and is superimposed on, the signal to be measured, and (2) Common-mode noise, which is common to both the high and low signal inputs.

Normal-mode noise may stem from power-line pickup and stray electromagnetic fields, or it may originate within the device being measured. Whatever its origin or mode, noise can take on many forms—such as sinusoids, spikes or even white noise.

If there is such a thing as typical noise, it might look like that depicted in Fig. 1. Here, a periodic ripple, combined with noise spikes, is superimposed on a dc signal. Such noise can cause errors of 100% or more in a typical DVM, unless the instrument is protected in some way.

Two techniques are used to reduce normal-mode noise: integration and filtering. In integration a measurement is made over a fixed time interval during which unwanted amplitude variations are averaged out. If the integration period includes an integral number of periodic noise cycles, the noise will be averaged out to zero.

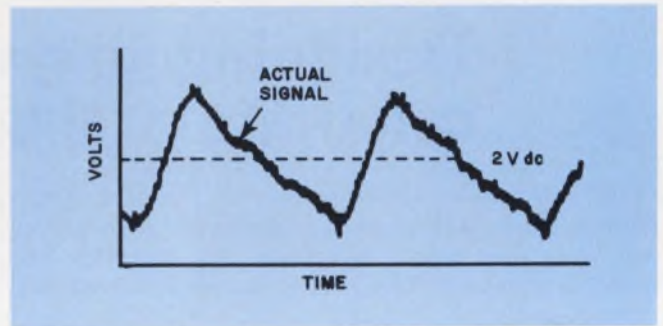

1. A "typical" noise signal consists of a periodic ripple and noise spikes—both superimposed on a dc level. This noise can cause 100% errors.

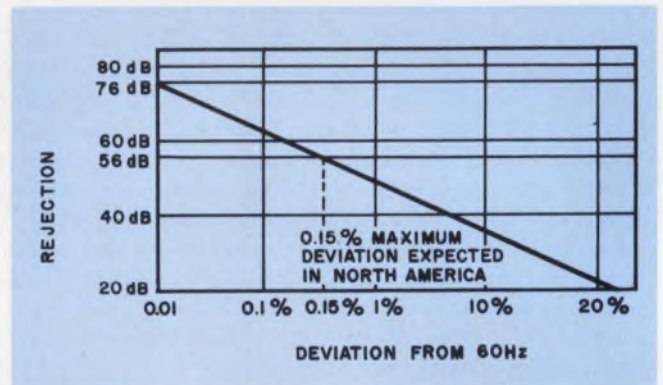

2. Integrating DVM with 1/60-s period of integration exhibits 56-dB of rejection for commonly-encountered line-frequency fluctuations of $\pm 0.15\%$.

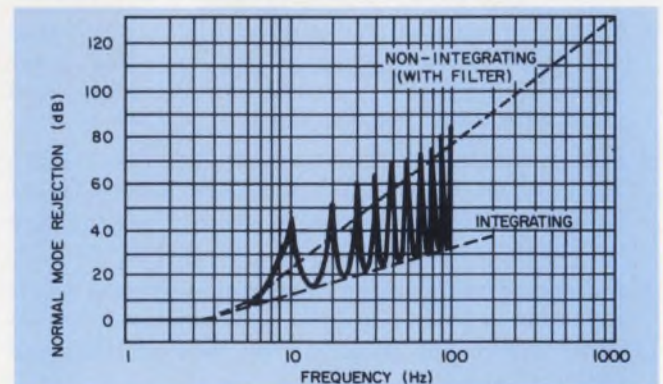

3. A comparison of an integrating and a filtered-input DVM shows that filtering is best for broadband noise. integration for line-related noise.

Larry Potter, Product Manager, DVMs, Hewlett-Packard, Loveland Instrument Div., Loveland, Colo. 80573.

For example, a DVM with a 1/60th-second integration period would average out one 60-Hz noise cycle, two 120-Hz cycles, four 240-Hz cycles, etc. In North America, the line frequency is subject to short-term frequency fluctuations, typically less than $\pm 0.15\%$. An integrating DVM with a 1/60th-second integration period achieves 56 dB of rejection for a 0.15% deviation from 60 Hz (Fig. 2). This magnitude of rejection is more than adequate for most measurements.

In the filtering technique, ac noise is rejected or attenuated by one or more active filters in a DVM's front end. But DVMs using such filters become progressively slower with increasing amounts of filtering. Quite often different degrees of filtering are switch-selectable, thus giving the user the flexibility of trading noise rejection for measurement speed (see table).

An obvious question is, Which technique is better? The answer depends on the type of noise expected. Integration is better for rejecting line-related noise; filtering is better for broad-band noise.

Take two DVMs with almost identical characteristics, except for the noise rejection technique (Fig. 3). Both instruments have a reading speed of, say, two to three readings per second. Note that the integrating DVM has a 1/10th-second integration period, with cusps at 10, 20, 30 Hz and higher. At 60 Hz, integration gives higher rejection. But to either side of 60 Hz, filtering wins out.

For the "typical" noise (Fig. 1), part is periodic and part is random, or non-line-related. A combination of both filtering and integration might work best in this situation.

Common-mode noise is hard to eliminate

Floating dc-voltage measurements are usually plagued by common-mode noise. Often this noise

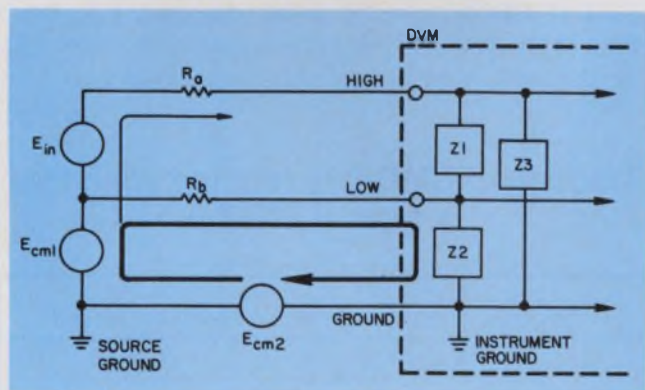

4. Two sources of noise— E_{cm1} and E_{cm2} —can appear in a floating measurement, in which neither source terminal is grounded.

is ac line-related noise stemming from grounding differences between the DVM and the voltage source being measured. The magnitude of common-mode noise can range from a few millivolts to hundreds of volts.

Common-mode currents usually cannot be eliminated by the DVM, but they can be made to flow around the measuring circuit. In this regard, a DVM's first line of defense is passive shielding. However, once the common-mode current gets into the input terminals, the DVM's normal-mode rejection becomes the second line of defense.

A floating input is one in which the low input terminal is isolated from ground (Fig. 4). In this case there are now two potential sources of noise: one from grounding differences (E_{cm1}) and the other from the floating measurement (E_{cm2}).

A floating DVM significantly reduces the errors of common-mode currents, because Z_2 is usually high. In other words, the instrument's low input is well isolated from the ground. However, since

How to specify CMR

Rejection of either normal-mode or common-mode noise is specified in decibels as follows:

$$\text{dB} = 20 \log \frac{\text{noise voltage}}{\text{voltage error}}$$

Both the numerator and the denominator must be measured in the same way. For example, if a 10-V peak noise signal is applied to a DVM and its readout deviates 100- μV peak, the noise rejection equals 100 dB. The calculation is as follows:

$$20 \log \frac{10 \text{ V peak}}{100 \times 10^{-6} \text{ V peak}} = 100 \text{ dB.}$$

This measurement is usually made with zero signal input, so that any observed deviation is roughly zero. The noise affects the DVM by introducing changes in the last digit or digits. By looking for the maximum excursion in the display, the user can determine the peak voltage error.

The CMR specification includes the condition of a 1-k Ω unbalance in the low lead, which represents the worst case between the two leads. This lead resistance is critical to common-mode rejection. If its size is decreased by a decade to 100 Ω , the common-mode rejection appears to improve by 20 dB.

There are really two types of common-mode rejection. The ratio, in decibels, of the common-mode signal to the normal-mode signal it produces is pure CMR and results strictly from shielding or guarding. The effective CMR is a combination of pure CMR and NMR, and this is what actually affects a reading.

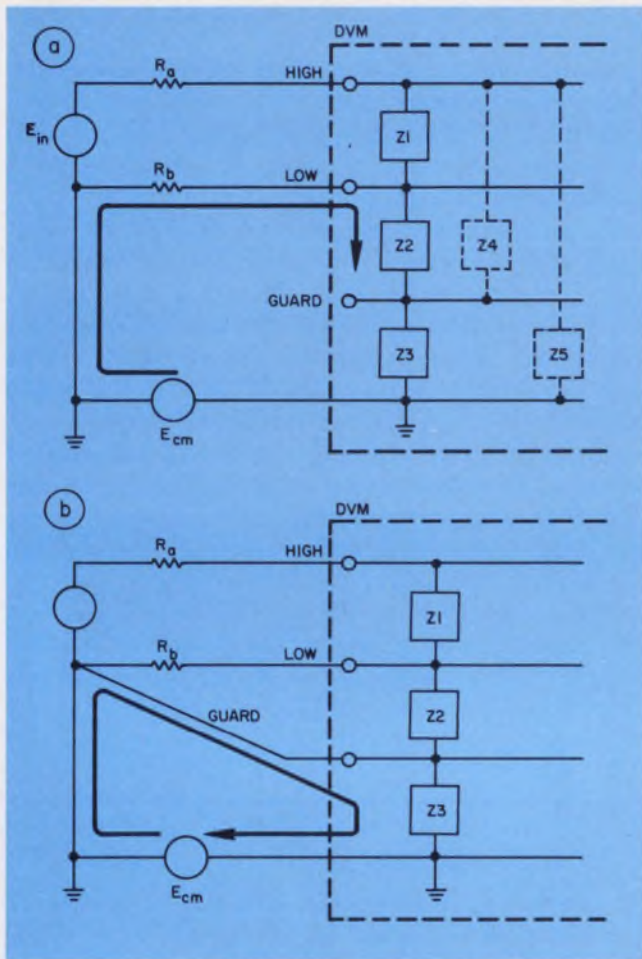

5. In DVMs with a guard, the impedance between low and ground is increased by Z_3 (a). Connecting the guard to the source low terminal shunts unwanted currents (b).

good instrument design will keep Z_1 and Z_3 higher than Z_2 , most of the common-mode current will still flow through the low input-lead resistance, R_b .

The floating connection is usually satisfactory for bench DVMs. But for DVMs used in a system—especially where resolution and sensitivity are important—the floating input may not yield enough common-mode noise rejection (CMR).

This is especially true for transducer bridge measurements, where the output level may be in millivolts and the source resistance may be high. To increase CMR in such cases, an additional shield—called a guard—is used around the measuring circuit. The guard is brought out to the front panel as an additional terminal.

A guard effectively increases the impedance between the low input and ground, thereby reducing the effect of common-mode currents. The real strength in guarding, however, comes from what the guard can do if it is properly connected to the circuit being measured.

Contrasting connections (Fig. 5) show how the guard works. The situation in Fig. 5a is similar to that of the floating input, except that the low-to-ground impedance is higher. In the second

connection (Fig. 5b), the guard shunts common-mode currents at the source. Here, the current caused by E_{cm} finds a path through Z_3 , the path of least resistance. The low input and guard are kept at about the same potential, so little current flows through Z_2 .

Use the guard terminal

For best results, the guard terminal should always be used. Here are rules for connecting the guard:

1. Connect the guard so that it and the low terminal are at the same voltage, or as close to it as possible.
2. Connect the guard so that no common-mode current or guard current flows through any resistance across the input terminals (especially the low source resistance).

Physically the guard is nothing more than a sheet-metal box surrounding the measuring circuits, and itself surrounded, in turn, by the outer chassis of the DVM. The guard shield often passes through the windings of the power transformer. Information generated "in-guard" must be passed "out-guard" in a manner that maintains isolation: for example, via pulse transformers, reed relays or photo-isolators (Fig. 6).

Sometimes a pulse transformer is time-shared for a two-way flow of information. At other times the reading is passed serially and reconstructed on the out-guard side to reduce the number of pulse transformers.

It's not enough to know just the basic rules for connecting a guard. For instance, there are three ways to connect a guard to a source (Fig. 7). The device being measured in the figure is assumed to be a floating dc power supply with low source resistance. Lead resistances R_a and R_b form the bulk of the source resistance.

Of the three connections, the top one is the best. The guard here is at practically the same potential as the low input terminal and no common-mode current passes through R_a or R_b .

In the middle example, the bar provided with most DVMs is used to short the guard to low. This is the easiest connection, and may very well be the one most commonly used. Although low

Tradeoffs: CMRR vs reading speed for a typical DVM

Filter position	60-Hz rejection	Readings/second
Out	None	1000
A	> 30 dB	5
B	> 80 dB	1

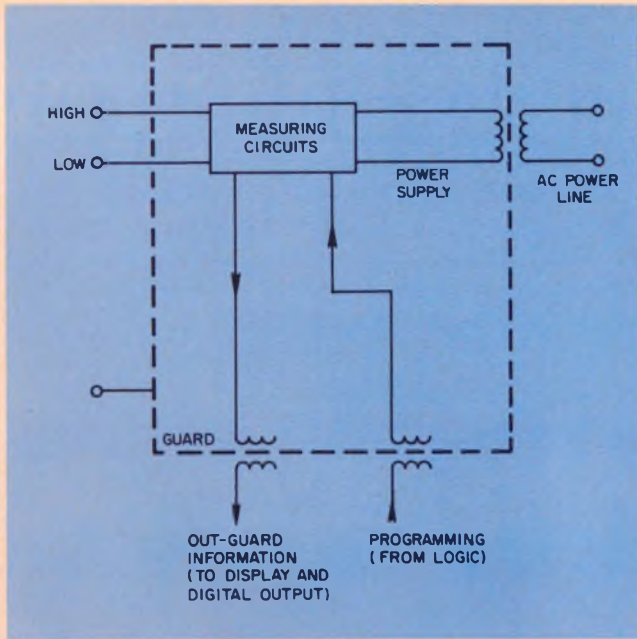

6. Guard-shield isolation must be maintained when information is passed from one side of the guard to the other. Pulse transformers are often used for this.

and guard are at the same potential, all of the common-mode current flows through R_b . The drop across R_b becomes part of the input signal and must be rejected by the DVM as a normal-mode signal. Also, since Z_2 is shorted and the low-to-ground impedance is lower than in the top connection, more common-mode current flows. In a system where the leads are long, the value of R_b becomes significant. The middle example, then, is not a good way to connect the guard.

The lower example gives two additional connections. The solid line shows the guard connected at the source's ground. This can be a good connection because it shunts common-mode currents originating between the grounds. However, guard and low may not end up at the same potential. And common-mode currents originating within the source would not be shunted away from R_b .

Note, too, that on most DVMs the breakdown voltage between guard and low is usually a lot less than that between guard and chassis. This may impose a limitation on the measurement.

The dotted line in the lower figure shows the guard shorted to chassis. Again, the impedance between low and ground is reduced by shorting Z_3 .

There is one other alternative—leave the guard open. Just about any connection is better than this. The values of Z_2 and Z_3 are usually unequal, and if a floating measurement is made, the guard will seek its own division ratio. A 500-V floating measurement could easily result in over 200 V between the guard and low. This would damage many DVMs. ■■

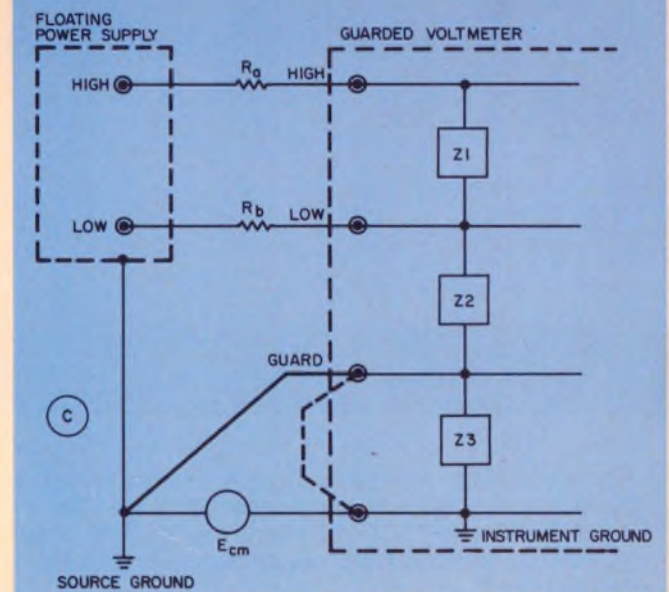
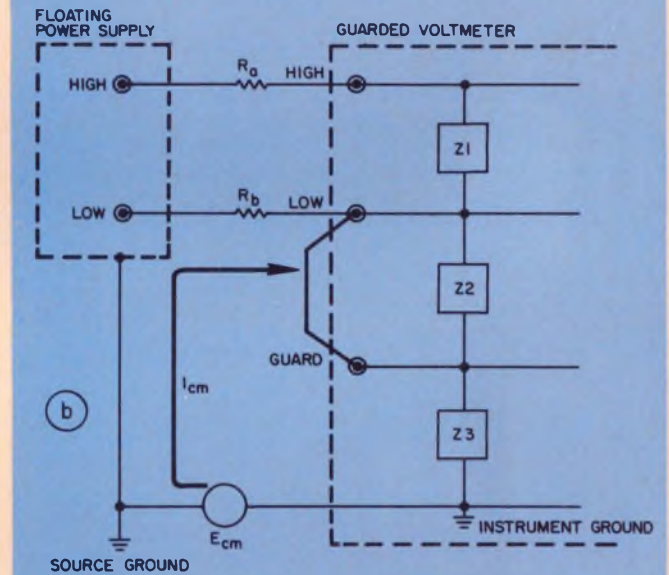
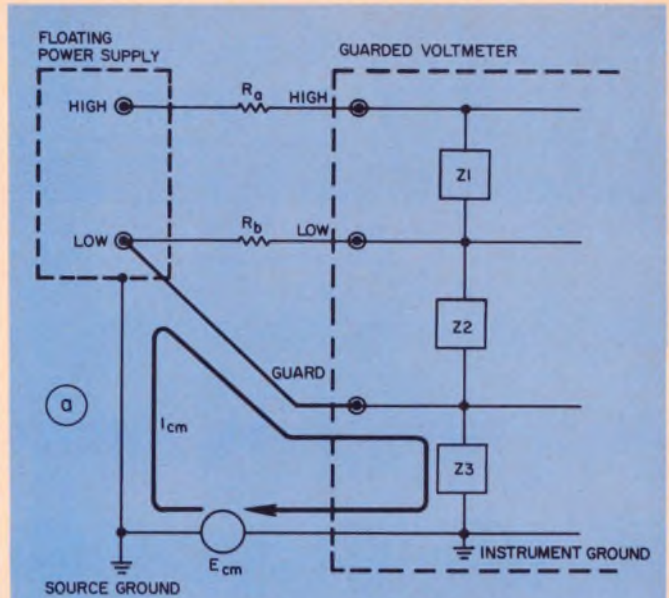

7. A source and guard can be connected in three ways. In the preferred connection (a), no common-mode current flows through R_a or R_b . In the other two connections (b, c), some current may flow in R_b .

New from Amphenol's Spectrum

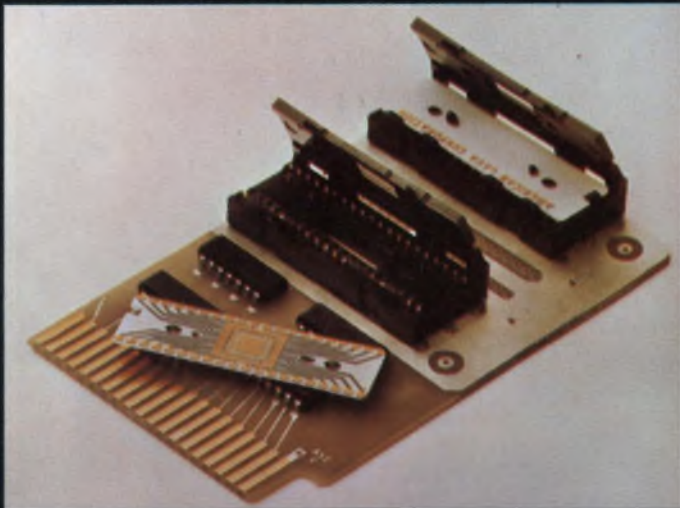

level 1 MOS/LSI Planar Plug-In connectors (above) for leadless, flat mount ceramic substrates. Permits fast, easy replacement of IC package, no screws, has snap-down lid. ■ Free-standing terminal (below) terminates IC's to PC boards for lowest total systems cost.

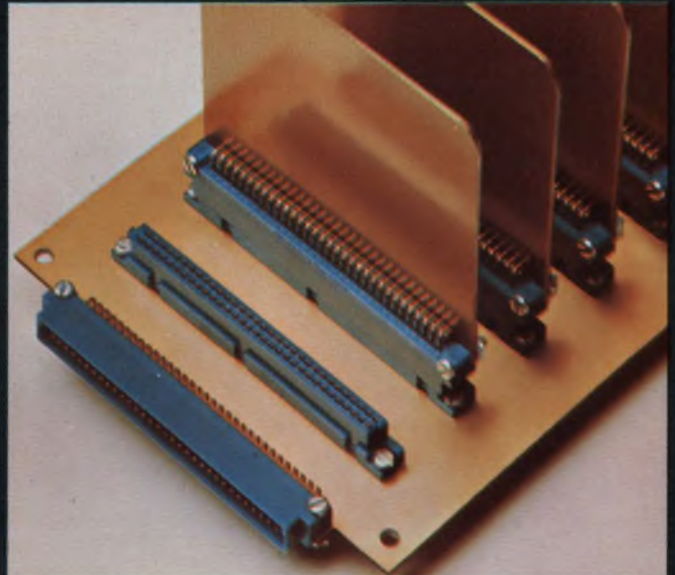
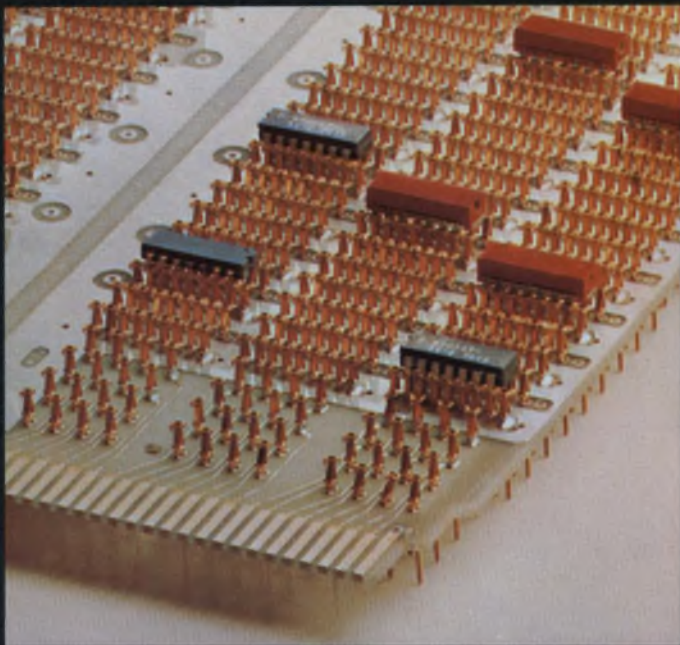

level 2 Box contact connectors (above) intermate with .025" square or round contacts. Low insertion force. Terminations for crimp, wire wrapping or wave solder. ■ Zero insertion force connectors (below) improve PC board and connector life by eliminating strain and wear.

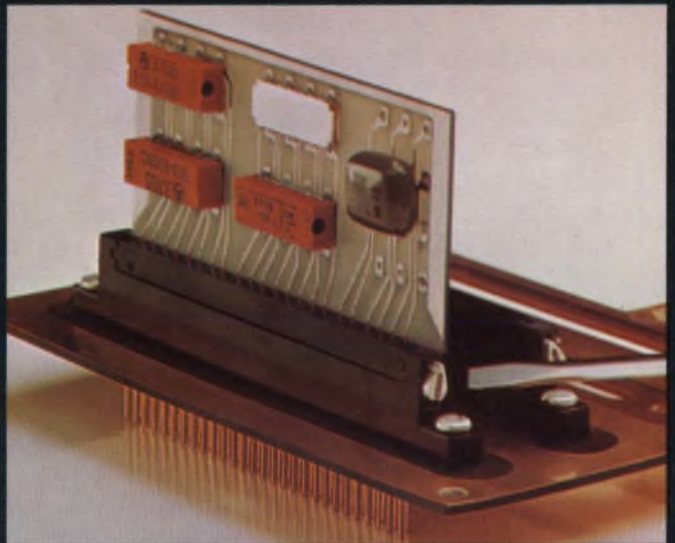

Above are seven new ideas from Amphenol Industrial Division's Spectrum of interconnection capability.

Amphenol's SPECTRUM offers you *all four* levels of interconnections from our unmatched breadth of product line:

Level 1 . . . DEVICE TO BOARD OR CHASSIS. We offer interconnections for components such as tubes, relays, transistors, IC packages, trimmers, resistors or capacitors to a PC board or chassis.

Level 2 . . . BOARD TO MOTHERBOARD OR BACK PLANE. We offer interconnections for PC boards or

other sub-circuit modules to a motherboard or to a back plane.

Level 3 . . . MOTHERBOARD OR BACK PLANE WIRING. We offer interconnections for levels to each other and to other sub-circuits with multi-layer circuit boards, wire wrapping, clip terminations, jumper techniques and dip-soldering.

Level 4 . . . INPUT/OUTPUT CONNECTIONS. We offer interconnections for power and signals to and from a system. This interface may be between sub-assemblies within the same enclosure or between individual units.

of interconnections.

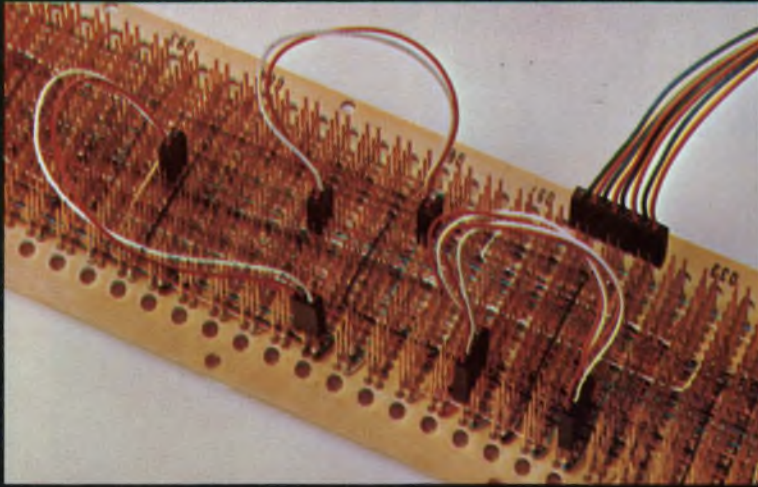

level 3 Low cost strip connectors (above) are used as jumpers in back plane wiring. Internates with .025" square or round posts. ■ Circuit Concentration Bay (below) consists of wire wrappable panels that are five times as compact as the telephone distribution frames they replace.

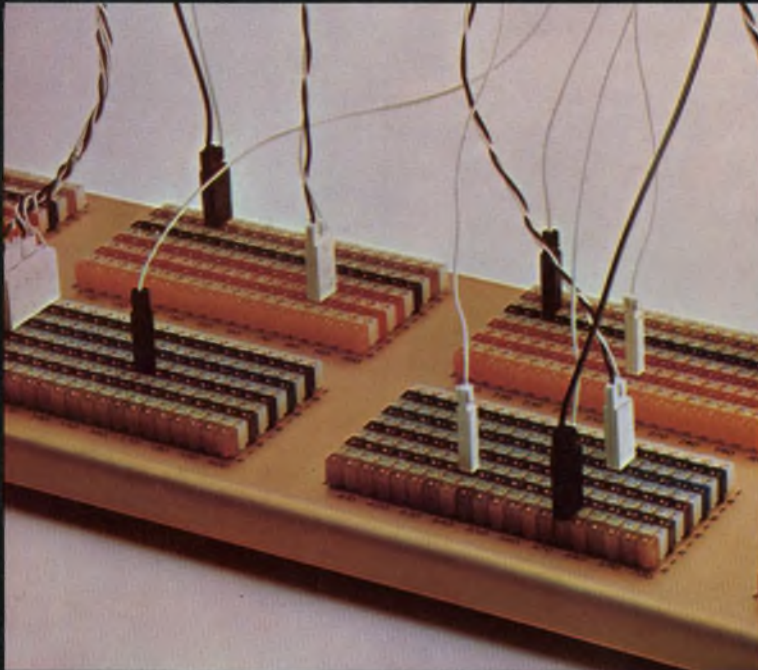

level 4 Modular Integral Connector concept lets you make your own pin & socket connector to fit your needs. Five contact sizes, thousands of combinations. Sufficient components for six connectors in handy MIC-KIT. Design and assemble your own prototypes.



From the simple tube socket—to a myriad of electrical/electronic connectors—to complete and complex termination systems . . . SPECTRUM.

But SPECTRUM is far more than products. It is a depth of capability in engineering, manufacturing and quality control. Amphenol's SPECTRUM is a new height of service, availability and distribution backed by seven Amphenol interconnection-oriented divisions.

Amphenol can fulfill your total interconnection requirements because we are not limited to specifics such as one or two product lines, one or two levels.

Therefore we approach your interconnection needs with complete open-mindedness.

For more new ideas and specific information, write for your copy of "SPECTRUM." Amphenol Industrial Division, Bunker Ramo Corp., 1830 South 54th Ave., Chicago, Illinois 60650.

BUNKER RAMO AMPHENOL

Build stable frequency synthesizers

by using off-the-shelf ICs in a phase-locked-loop configuration with variable-modulus control.

If the design calls for many narrowly spaced, stable frequency channels—and today's communications systems often do—don't use a collection of quartz-crystal oscillators to generate the frequencies. With the availability of suitable, inexpensive ICs, a more economical approach is now possible.

With a single crystal and a few ICs, all the channels for any system can be generated easily, with a stability approaching that of crystals and with minimum complexity and size. This approach makes use of the newer synthesizer circuits, which employ phase-locked loops (PLLs). And the relative simplicity of these circuits eliminates the need for extensive production testing and alignment.

Such circuitry is needed in systems intended for operation in the FM band, with its 100 channels spaced 200 kHz apart over an 88-to-108-MHz span. Another example is the Citizens Band, with its 23 channels occupying the spectrum between 26.96 and 27.23 MHz.

The traditional way of generating the various frequencies with the required accuracy is to use a quartz crystal—usually with a multiplier chain to bring the crystal into the 10-to-50-MHz range. For just one or a few channels, this is an economical and proven route. But a large number of channels would require a correspondingly large number of crystals, with attendant high circuit costs. Therefore phase-locked loop synthesizers using ICs usually provide a better approach.

Building a PLL frequency synthesizer

A basic PLL circuit is shown in Fig. 1a. The VCO output frequency need not be the same as the input frequency. All we really have to do is compare a reference frequency to some frequency that is representative of the output. Thus we can use any harmonic or subharmonic of the VCO's frequency.

One good way to do this is to add a suitable

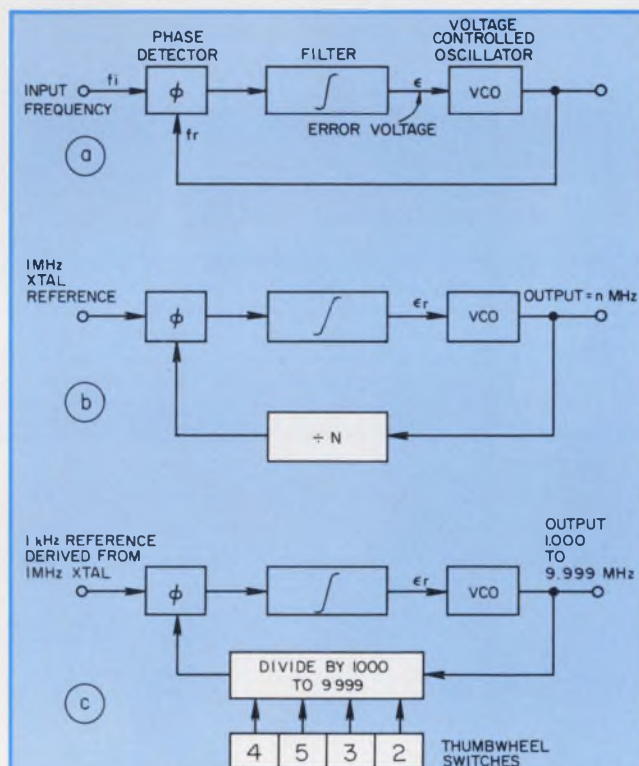

1. In a basic phase-locked loop (a), the VCO output is locked with the crystal oscillator. If a fixed divide-by-N circuit is inserted in the feedback loop (b), the output of the VCO can differ from the input reference. Any number of output frequencies within the range of the VCO can be obtained by setting the divide-by-N circuit with BCD thumbwheel switches (c).

digital divide-by-N circuit between the VCO and the phase detector (Fig. 1b). Suppose we use a 1-MHz crystal as the reference and let $N = 10$. Then the VCO should run at 10 MHz. If it deviates from this frequency, the resulting error voltage will force it back to the desired 10-MHz output.

But suppose we vary N . Then we can generate a wide range of frequencies, depending on the VCO's range. The long-term stability of every output frequency will be as good as that of the crystal, while the short-term settling time and noise will be determined by the filter and the

Donald Lancaster, Consulting Engineer, Synergetics, Parker, Ariz. 85344.

VCO stability, over the temperature range.

If we were interested in building an accurate 1-to-10-MHz signal generator, we could do it with a circuit like that shown in Fig. 1c. This circuit would generate around 9000 discrete frequencies under direct crystal control. For instance, if we use a 1-kHz reference derived from the crystal, and if we set our thumbwheel switches to 4531, the output frequency will be 4.531 MHz.

By suitable switching, we can generate any megahertz-range frequency with a 1-kHz resolution. One obvious use for such a device is in ham radio, where the 40, 80 and 160-meter bands can be covered and crystal stability can be achieved on any 1-kHz frequency increment in any band. By offsetting the switch settings properly, we can easily allow for the receiver's intermediate-frequency difference. Typically, three ICs would be needed for the divider, one for the phase detector and one or two for the VCO. Thus the whole circuit can be built for the price of a few crystals. A similar PLL synthesizer system can be used for an airborne direction finder.

Using the PLL approach with hf and vhf circuits

Unfortunately it is not very reasonable to extend this technique to circuits operating at several megahertz. While the VCO poses no problem, the divide-by-N becomes difficult. Thus in our 10-MHz synthesizer, the divide-by-N counter had around 100 μ s in which to re-enter the number to be divided. But for a frequency range of, say, 148 to 172 MHz, we have less than 6.7 ns in which to determine that the counter has finished its sequence and to set up a new division sequence. While 100 μ s is feasible for this type of circuit, 7 ns is not.

Before turning our attention to a new and versatile approach—variable-modulus synthesis—it will be useful to consider a few other accepted methods for solving this divide-by-N problem. One obvious one is to run the VCO at one-ninth the output frequency and add two triplers in series with the output (Fig. 2a). The triplers multiply the VCO frequency by nine, while the VCO and the dividers operate in the 10-to-20-MHz range.

But there are several disadvantages. The tripler design gets sticky, particularly if we need bandwidth—and we are back with analog circuitry and production adjustments. We do, of course, eliminate the need for high-frequency dividers, thus reducing our power requirements. But we also increase the noise and settling time of the loop, since it now takes nine times as long to get an error signal as it did before.

Another traditional method employs a mixer to add a high-frequency offset (Fig. 2b). For instance, if we are covering a 148-to-172-MHz

range, we might use a 140-MHz offset and have the basic synthesizer cover frequencies from 8 to 32 MHz. But this technique involves a high-frequency reference and a mixer output filter—meaning more analog circuitry and production problems with calibration and alignment. However, we have eliminated the need for division of the reference (which is now set to the channel separation), so that errors are corrected nine times faster, and we thus have a tighter and cleaner loop.

Another variation of the same approach is to

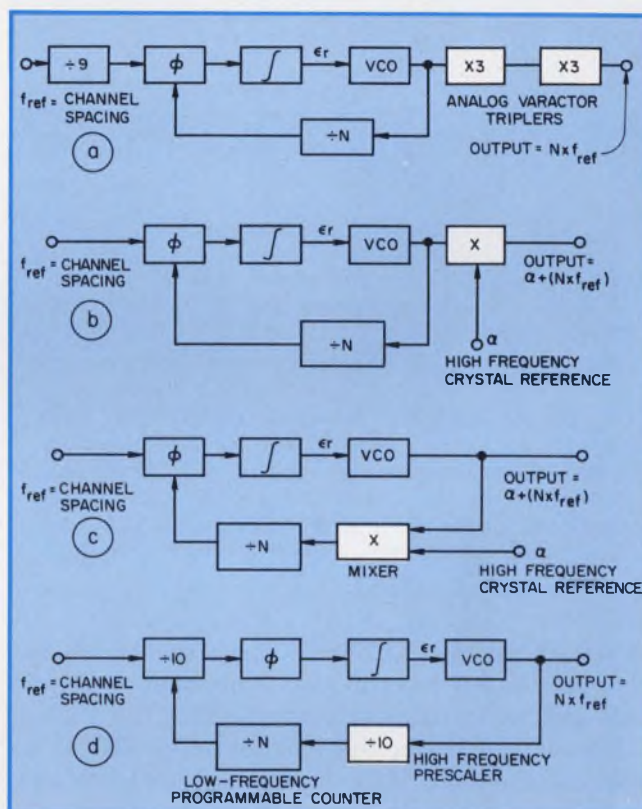

2. Higher frequencies can be obtained by multiplying the VCO output (a), by adding a serial mixer to produce a suitable offset frequency (b), by adding a mixer in the loop (c) or by inserting a high-frequency prescaler into the feedback loop (d).

mix down (Fig. 2c). The only difference here is that the VCO now runs at the output frequency. For instance, the VCO could cover the 148-to-172-MHz range, while the 140-MHz offset would reduce the divide-by-N frequency to 8 to 32 MHz. We have exactly the same advantages and disadvantages as when mixing up. However, the VCO design is usually simpler, because the circuit uses smaller components and it operates over a narrower bandwidth.

Neither of the mixing schemes requires high-frequency, premium ICs, and neither consumes the supply power required by other circuits. Thus

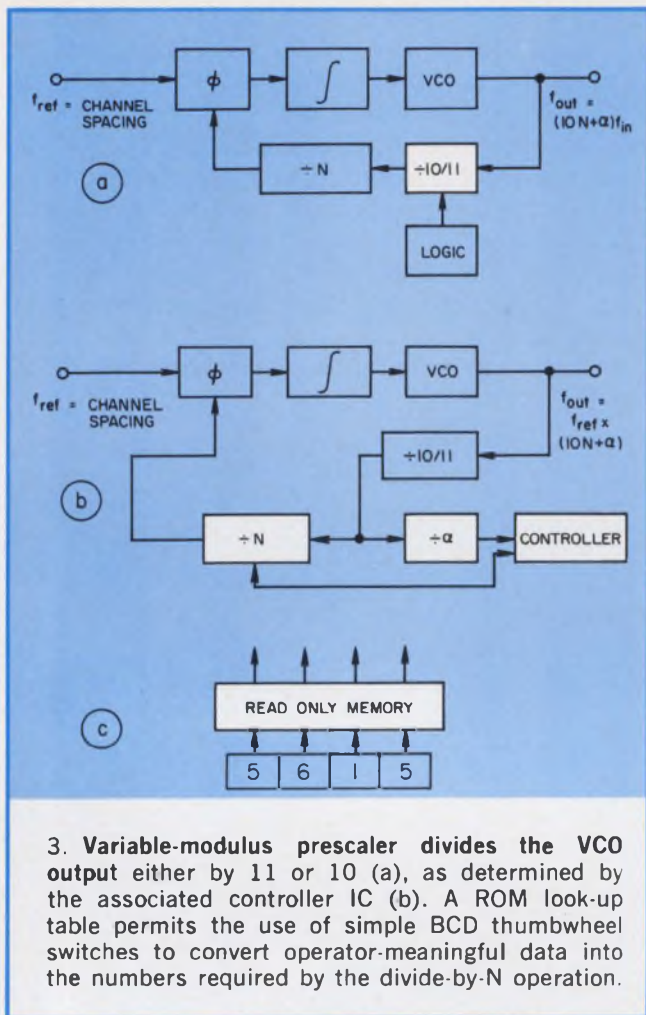

either of the mixing circuits represents a good approach when micropower operation is essential, such as in portable equipment.

One of the newer approaches (Fig. 2d) is to prescale the VCO output with a high-frequency counter and then use a low-frequency divide-by-N. Prescaling by a factor of 10 is popular.

In Fig. 2d the high-frequency prescaler is an ECL device (MC1678). It divides by 10, and thus reduces the frequency seen by the divide-by-N to 17 MHz or less. The rest of the divide-by-N can be built with low-cost TTL or CMOS programmable dividers. The only two real disadvantages of this circuit are the need to divide the reference by 10 and the fact that we sample the error only one-tenth as often as we would like to (which leads to more noise and longer settling times).

Variable-modulus prescaling does the trick

Looking at Fig. 2d, we see that if we could trick the high-frequency prescaler into doing more than one task at one time, we could eliminate the need for the extra divide-by-10 section. This would also improve the error and noise performance of the circuit by a factor of 10.

Thus suppose that, instead of a divide-by-10, we use a prescaler that we could teach to divide either by 10 or 11 (Fig. 3a). Also, suppose that the input to the divide-by-11 persists for A cycles and is then switched to the divide-by-10 for the rest of the divide-by-N sequence. Furthermore, for each A cycle, one extra count is added to the total division—that is, if $N = 40$ and $A = 3$, the high-frequency prescaler cycles four times. During the first three cycles it runs for 11 counts each; in the final cycle it runs for 10 counts. The total is 43 counts. If $N = 40$ and $A = 2$, we get $(11 + 11 + 10 + 10) = 42$ counts. Similar N and A sequencing is used to produce other needed total counts.

For every 10 N counts, A extra counts are generated. The output frequency is:

$$f_{out} = (10N + A)f_{in}$$

Thus we see that division by any N is possible and is not limited to the decade increments, as is the case with straight high-frequency prescaling. With the variable-modulus method (using the MC12012, for example), error detection and correction run 10 times faster—even with a single high-speed, high-current divider. A control IC (such as the MC12014) is required for sequencing the high-speed divider and to change from a divide-by-11 to a divide-by-10 count. But this command is needed only once for each divide-by-N sequence; consequently it does not present any speed problems.

A frequency synthesizer using the variable-modulus approach (Fig. 3b) has two counters: an A and an N. Both start out in the zero state. The controller lets the two-modulus scaler run as a divide-by-11 counter for A counts. After A counts, the A-counter reaches zero and is held in the reset condition by the controller. The variable modulus prescaler is then switched to divide by 10 for the rest of the N count sequence. At the end of N counts, counter A is released and the sequence repeats.

Thus the variable-modulus synthesizer uses only two high-frequency ICs, eliminates the division below the channel spacing and gives us the best possible error-response time. There is, however, one restriction with this method: N must be greater than 10A.

One minor problem is that the numbers on the thumbwheel switches may not correspond to the numbers required for the division, particularly if we are dealing with channel numbers instead of actual frequencies. One way to overcome this problem is with special switches.

A more universal solution is to use a read-only memory (ROM) as a look-up table to change from numbers that mean something to the operator to numbers that mean something to the synthesizer (Fig. 3c). Ordinary BCD thumbwheel switches can then be used. ■■

P&B's compact R10 relays help you solve more application problems than with any other relay.

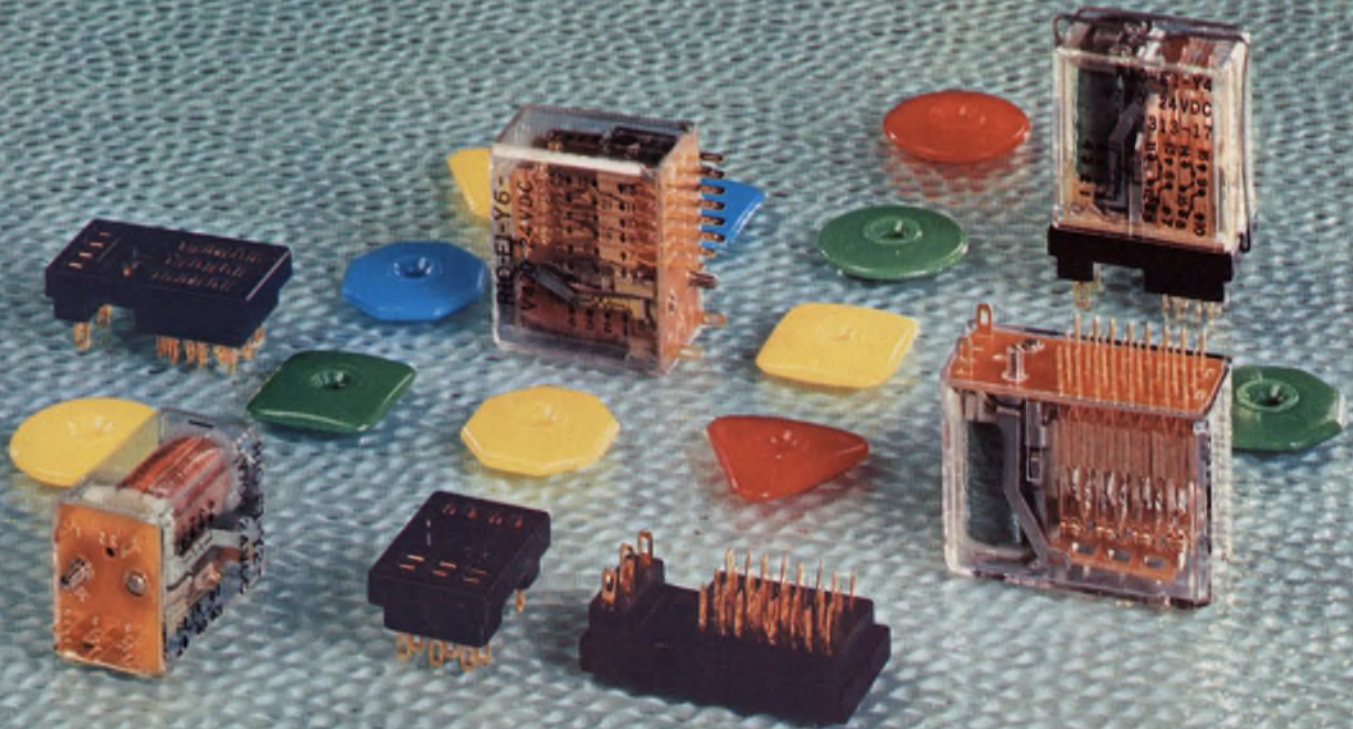

Relays shown actual size.

Our R10 relay series offers designers a whole family of AC and DC industrial relays that combine extraordinary versatility of application, the reliability of telephone-type relays, plus small size (less than a cubic inch). They are widely used in copiers, computer peripherals, business machines, and precision instruments.

These relays have so many options that each model may literally be designed by you to meet your particular needs. This single family of relays, with many common mechanical dimensions and mounting techniques, cover the whole range of switching loads from dry circuit to 10 amperes, 28 VDC, 120 VAC. There are terminal styles for octal plug,

solder, or pc board mounting. And, sockets multiply design options even more.

R10 relays can be ordered with Form A, B, C and D contacts and up to 8 Form C. Recognized by Underwriters Laboratories under file 42810. R10 relays have a continuous power dissipation of 2.2 watts maximum. Standard sensitivity is 125 miliwatts per pole (more sensitive units available on special order). Electrical life ranges from 100,000 to 100 million operations.

For complete information on R10 industrial relays, call your local P&B Representative. Or, call or write Potter & Brumfield Division AMF Incorporated, Princeton, Indiana 47670. Telephone 812 385 5251.



FREE PUZZLE*

Arrange the pieces so that no color or shape is duplicated in any row, column, or either diagonal. As an engineer, you should solve this puzzle in 27 minutes.

Like to try your hand at solving the puzzle shown above? Ask your P&B representative for one.

*"Bali-Buttons". © Behavioral Sciences, Inc.

Solving switching problems is what we're all about.

INFORMATION RETRIEVAL NUMBER 36

AMF
Potter & Brumfield

Total resistor capability spoken here

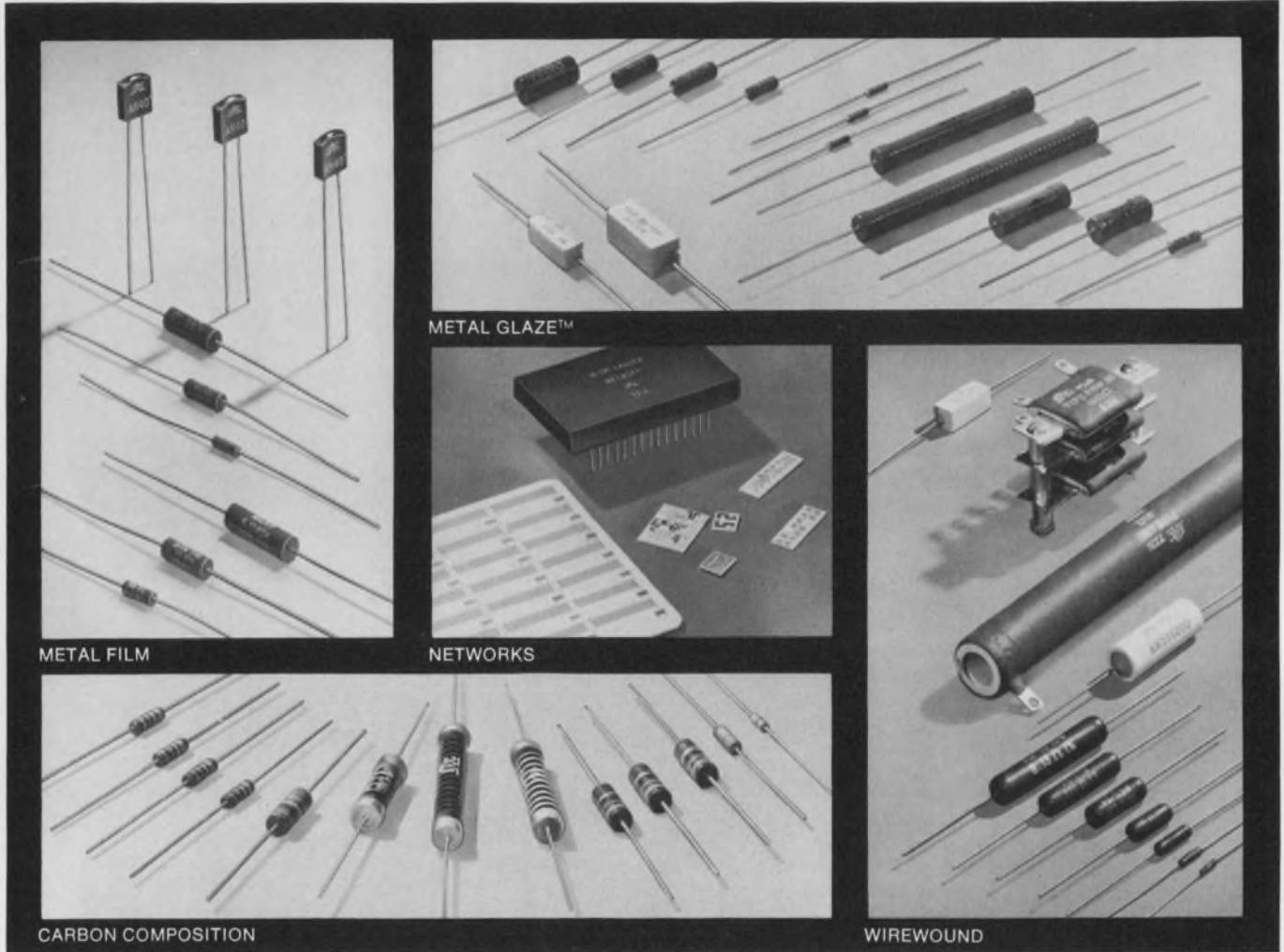

METAL FILM

METAL GLAZE™

NETWORKS

CARBON COMPOSITION

WIREWOUND

TRW/IRC Carbon Composition Resistors

Used by *billions* in consumer, industrial and military applications, TRW/IRC carbon composition capability ranges from standard commercial type through established reliability RCR's, to ultra-high range (10^{11} ohms). Where you are using carbon comp.'s in automated assembly, TRW/IRC packaging techniques can help cut the cost of interfacing with your machines. Card packs, lead tape reels, cut and formed leads . . . we'll be glad to explore the potential economies with you.

TRW/IRC Metal Glaze™ Resistors

This is TRW/IRC's thick-film technology—for every type of low power resistor application. Metal Glaze is widely accepted for its built-in power handling reliability, resistance range, and cost effectiveness. Available in numerous standard and special designs—precision, semi-precision, flameproof, high-reliability, high-voltage.

TRW/IRC Wirewound Resistors

The line starts with molded wirewound resistors—"space-savers" that bridge the cost-performance gap between composition resistors and precision wirewounds. It proceeds to standard, non-insulated types for appliance/automotive use . . . to precision subminiatures offering high power density . . . to ceramic, flameproof units for TV and computer applications . . . to tubular and flat power wirewounds with ratings to 250 W.

TRW/IRC Metal Film Resistors

TRW/IRC has brought the state-of-the-art in thin-film resistors to an equal performance level with high-stability wirewounds. Capabilities here include resistors with tolerances to $\pm 0.01\%$. . . high-reliability units to MIL and aerospace specs . . . precision subminiatures . . . and standards, of course. You can also look at alloy films offering high-temperature and high-voltage capability at low cost.

TRW/IRC Resistive Networks

Advanced resistor technology here. These IC compatible, precision tantalum-film circuits provide inherent low noise, excellent stability, and hermetic performance without hermetic cost. Tolerances from 5% to 0.05% are available in custom designs. TRW/IRC also offers the industry's most complete line of discrete fixed resistors.

All types . . . all technologies . . . from one source

To wrap it up, TRW/IRC offers you the broadest line of fixed resistors in the business, with extensive, nationwide distribution. All available from one source—your local TRW/IRC distributor. With a direct pipeline to each of our plants, he can give you fast delivery. Contact your local TRW/IRC sales office for application assistance, custom designs, and special engineering help when you need it. TRW/IRC Fixed Resistors, 401 N. Broad Street, Philadelphia, Pa. 19108 — (215) 922-8900 • Greenway Road, Boone, N.C. 28607 — (704) 264-8861 • 2850 Mt. Pleasant Street, Burlington, Iowa 52601 —(319) 754-8491.

TRW[®] IRC RESISTORS

INFORMATION RETRIEVAL NUMBER 37



The Bud story. There's no end to it!

DESIGN is an important part of it. Well-built enclosures, racks and subassembly cabinets closely keyed to contemporary appearance to make your product look as good as it is. And that flair is evident from the smallest utility unit to the largest, most sophisticated of Bud's 2,677 products — The Designers' Group! Then, add 321 stocking industrial distributors as near as your phone for fastest possible service.

That's Bud — the smart way to give your product a distinctive look and competitive selling edge without custom-design costs and custom-design delays!



BUD

SERIES 2000 — part of The Designers' Group, created by award-winning Industrial Designers' to make your components look better; sell better.

BUD Radio, Inc.
Willoughby, Ohio 44094

Write for the whole story on The Designers' Group.
Please send brochure to:

Name _____ Title _____
Company _____
Street _____
City _____ State _____ Zip _____

A new concept in packaged power circuits as convenient as the TV dinner.

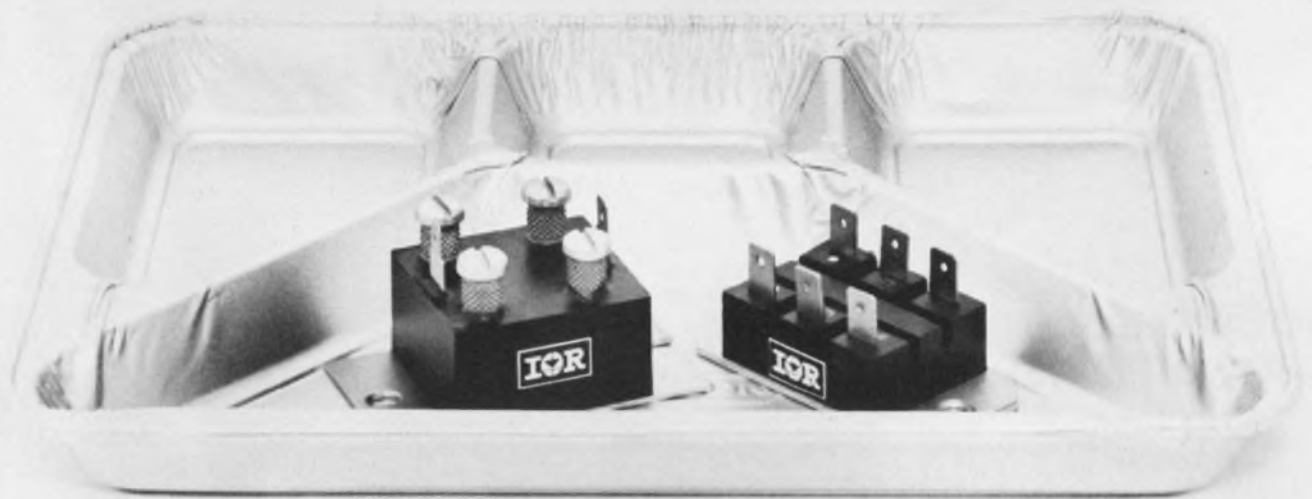

The International Rectifier PACE/pak™ is the device behind this new concept.

They are power integrated circuits, made up of SCRs, diodes, triacs, etc. which give you a complete control circuit function in a single package. And like the TV dinner, they take most of the shopping and assembly times out of the job.

But that's just the beginning of the benefits they offer.

Smaller size. PACE/paks (Passivated Assembled Circuit Elements) are electrically isolated up to 2.5 kV. There's no need for a separate isolated heat-sink, so you get up to 60% reduction in space requirements.

A better designed system. With the smaller size of these power hybrid control circuits you get more design and packaging flexibility. And since you don't have to spend time designing with discrete components, you have more time to make other improvements.

One-fifth the assembly time. No more do you have to assemble five to seven devices for single and 3-phase functions. With the PACE/pak there is just one part to mount, one part to interconnect with push-on or screw terminals. Your system reliability is higher, too.

Just think of the other savings you can make in testing, inspection and field servicing.

Lower inventory costs. We estimate a 7-to-1 reduction in inventory, plus savings in procurement time and costs. Standard PACE/pak circuits now cover 90% of single-phase power circuit requirements, with more in development for 3-phase applications.

They are available as standards with 25 or 42.5 Amp current ratings, in either 120 or 230 Volt RMS versions.

Find out how PACE/paks will revolutionize your designs like dc motor controls, inverters, chopper drives, generator exciters, solid-state circuit breakers, battery chargers and variable dc power supplies.

Call your local IR sales office for details or contact the factory: *International Rectifier • 233 Kansas Street, El Segundo, CA 90245 • (213) 678-6281 • TELEX: 67-4666.*

International Rectifier

... the innovative power people 

For built-in reliability, design with "Scotchflex" Flat Cable/Connector Systems.

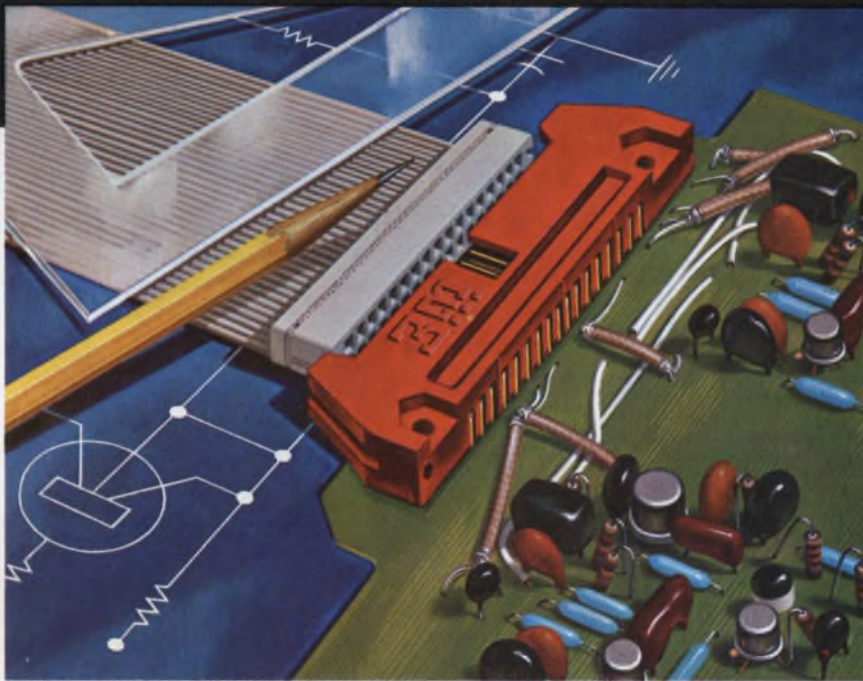

"SCOTCHFLEX" IS A REGISTERED TRADEMARK OF 3M CO.

"Scotchflex" Flat Cable and Connectors can offer you trouble-free packaging for your next generation equipment.

There's built-in reliability for your circuit inter-connects. Our flat, flexible PVC Cable has up to 50 precisely spaced conductors. The gold plated U-contacts are set into a plastic body to provide positive alignment. They strip through the insulation, capture the conductor, and provide a gas-tight pressure connection.

Assembly cost reductions are built-in, too. "Scotchflex" Connectors make up to 50 simultaneous connections without stripping or soldering. No special training or

costly assembly equipment is needed.

Off-the-shelf stock offers you flat cable in a choice of lengths and number of conductors from 14 to 50. Connector models interface with standard DIP sockets, wrap posts on .100 x .100 in. grid, or printed circuit boards. Headers are available to provide a de-pluggable inter-connection between cable jumpers and printed circuit boards (as shown). Custom assemblies are also available on request.

For full information on the "Scotchflex" systems approach to circuitry, write to Dept. EAH-1, 3M Center, St. Paul, Minn. 55101.

3M
COMPANY

Unconventional uses for IC timers

can be found everywhere. Build anything from car tachometers to program controllers with these simple devices.

Timing functions are at work everywhere—in monostable multivibrators, voltage-to-pulse-duration circuits, speed-warning devices, error-detector circuits, liquid-level detectors, display-time controls, motor-speed controls, car tachometer circuits and, of course, in electronic timers. In whatever form they appear, timers are important elements in signal-conditioning and control.

Until recently, bulky thermal relays and electromechanical devices have dominated this field. Now the 555 monolithic timer IC is available from several manufacturers in an eight-pin DIP for less than a dollar. This circuit largely overcomes the size, weight and cost limitations of other timing devices.

Low-cost IC timers are opening up many unusual applications where it would have been impractical to use older devices. One cost-sensitive area is automotive electronics, where mechanical tachometers and speed controls are slowly being replaced by the solid-state devices. Instrumentation and systems control are other areas where IC timers are making inroads.

Besides low cost, the new ICs offer the following advantages:

- A time-delay repeatability of 1%.
- A maximum operating frequency of 200 kHz when connected as an oscillator.
- A maximum output current of 200 mA, either as a source or sink.
- A delay instability of only 40 ppm/°C with temperature changes.
- Operation from 4.5 to 18 V dc at a maximum current drain of 15 mA.

Here are a few design examples of how IC timers can be used in new application areas.

Speed-warning device

To obtain speed information, an electronic pickup is mounted on the brake backing plate. A magnet, attached to the brake drum, induces trigger pulses in the pickup coil. Each time the

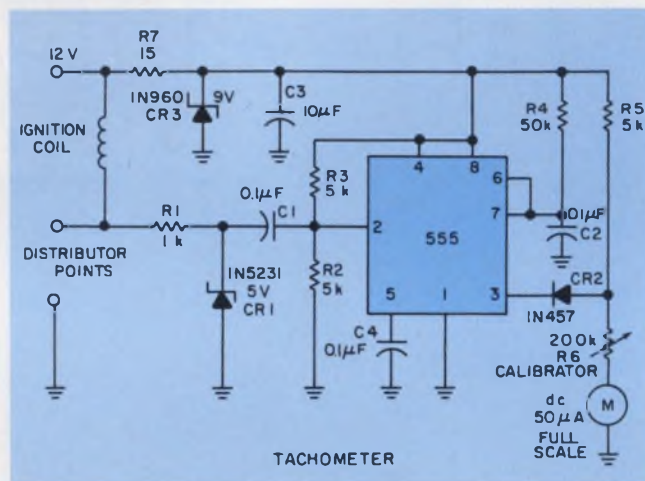

1. A car tachometer can be replaced by this low power circuit. The load current drawn by the 555 is negligible.

wheel rotates, a pulse triggers the first of two timers connected as missing-pulse detectors. If the pulses occur at a low enough frequency (Fig. 2a), the output from the first timer will alternate between its high and low states. The second timer, IC₂, is then driven from the output of the first (Fig. 2b). If pulses continue to appear at the input to IC₂, the second detector's output remains high. When the speed setting is exceeded, pulses occur too rapidly for the RC time constant of IC₁ to react, and its output remains in the high state. After the delay, this, in turn, causes the output of IC₂ to go to its low state and turn on a warning indicator.

The necessary time constants can be calculated from tire size. A tire with an outer diameter of 25 inches covers a distance of πD or 78.5 inches. One mile per hour equals 1.467 ft/sec; hence each revolution can equate to mph. The time constant of IC₁ is then calibrated to, say, multiples of 5 mph. Resistor R₁ can then be either a calibrated potentiometer or several fixed resistors and a rotary switch.

The car tachometer

Pulses generated by the opening and closing of the distributor points are fed into the input

The 555: How it works

The 555 monolithic IC contains two comparators, a flip-flop, a high-current output stage, a voltage reference and a resistive divider. The flip-flop is controlled by the comparators, and the comparators are referenced to V_{cc} . Comparator II sets the initial state of the flip-flop. It is controlled by an external threshold signal (referenced to one-third of V_{cc}) that is applied to pin 2. The flip-flop, in turn, controls the state of the output. A negative-going pulse (of magnitude less than one-third V_{cc}), applied to the trigger input, sets comparator II and the flip-flop.

Two of the fundamental modes of operation are as a monostable one-shot and as a free-running multivibrator (astable). For the monostable mode, a negative going pulse from V_{cc} to less than one-third of V_{cc} at pin 2 changes the flip-flop state. This sends the output high and removes a short-circuit from capacitor C. The voltage across C (V_c) then rises exponentially until it reaches two-thirds of V_{cc} . The time-constant (τ) is determined by R_a multiplied by C. Therefore the charge time is $1.1(R_a C)$. When V_c reaches two-thirds of V_{cc} , comparator I resets the flip-flop and the output again goes low.

The astable circuit is a bit more complex. Resistors R_a , R_b , and capacitor C determine the various time constants. When power is turned on, pin 2 sees a low signal and thus removes

the short from C. The capacitor then starts charging—the time, t_1 , required for C to charge equals $0.685(R_a + R_b)C$. When V_c reaches two-thirds of V_{cc} , the output goes low, and C discharges through R_b and pin 7 until it reaches one-third of V_{cc} . The discharge time, t_2 , equals $0.685(R_b C)$. Thus the total period, T, equals $t_1 + t_2$ or 0.685 times $(R_a + 2R_b)C$, and the frequency of oscillation is given by the inverse of T. The pulse duty cycle, D, equals R_b divided by $(R_a + 2R_b)$.¹

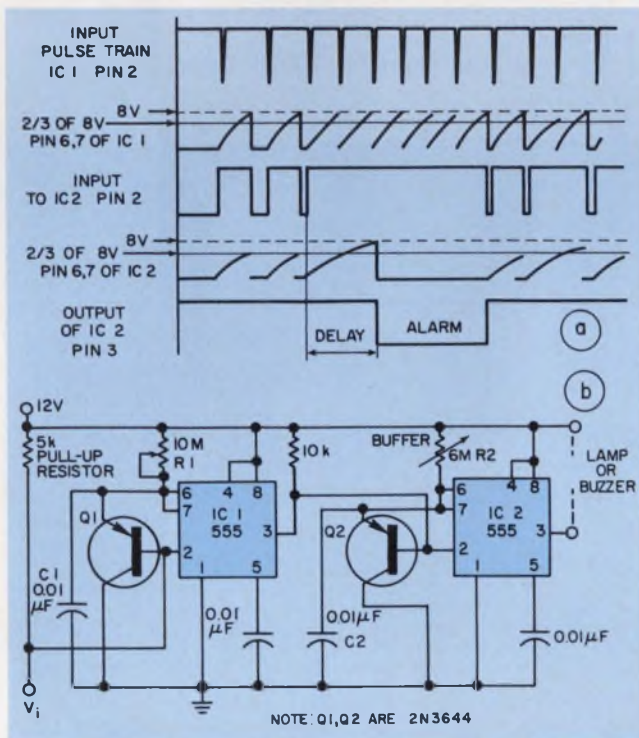
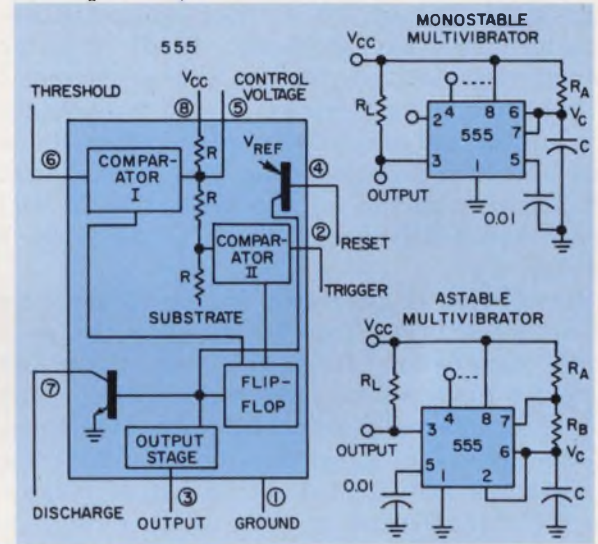

2. A speed warning device senses the car speed by comparing the frequency of pulses generated by the rotating wheel. The generated pulse train (a) is processed by the two timer circuit (b) and activates an alarm signal if the speed is too high.

of the tachometer circuit, Fig. 1, and are shaped and clamped by R_1 and CR_1 . They are then passed on to the trigger terminal of the timer by C_1 . Triggering of pin 2 causes the output of the timer to go high for a period determined by

$$T = 1.1 (R_4 C_2)$$

During this time diode CR_2 is back-biased and resistors R_5 and R_6 provide a calibrated current to the meter. After the time duration elapses, pin 3 goes low, shunting all current around the meter. The ratio of the time for which current flows through the meter to the time for which it is shunted to ground provides an accurate meter reading of engine rev/min. For a V-8 engine, the frequency of pulses at the ignition points is four times the engine rev/min—since the points close eight times per revolution of the camshaft and the engine runs at twice the speed of the distributor shaft. A constant current must be applied to the meter during the one-shot period. This is supplied by the vehicle's electrical system via R_7 , C_3 and a 9-V zener, CR_3 .

Voltage-to-pulse-duration converter

The circuit in Fig. 3a can convert a voltage level to a pulse duration by integrating the input voltage and comparing its value with the charge

on C_1 . The timer is set up so that it operates in a monostable mode when no voltage is present at the input. When the input voltage increases, the width of the output pulses increases, but the frequency of the pulse train input to pin 2 remains the same (Fig. 3b). Basically this circuit is a dual-slope integrator and has an accuracy of better than 1%. Possible uses occur in data-acquisition and telemetry.

Servo system controller

In the motor controller shown in Fig. 4, the transmitter consists of a timer connected as a variable-duty-cycle oscillator. Diode CR_1 and potentiometer R_1 provide the charge current to C_1 , which sets the duration of the positive portion of the output cycle. Potentiometer R_1 can vary the time duration from 1 to 2 ms. During the negative portion of the cycle, CR_1 is back-biased and a discharge time of 16 ms is set by resistor R_2 .

Servo drive is generated by the IC servo-amplifier (WE3141). This IC receives the pulse-width modulation from the transmitter and compares the 1-to-2-ms pulse width with the duration of an internally generated pulse. If the pulse widths are not of equal duration, the difference is stretched and applied to the output stage of the WE3141. Depending upon whether the input pulse is longer or shorter than the generated pulse, the motor will be driven either clockwise or counterclockwise, to adjust the internal pulse width to match that of the transmitter.

Resistors R_1 and R_2 set the null point of the

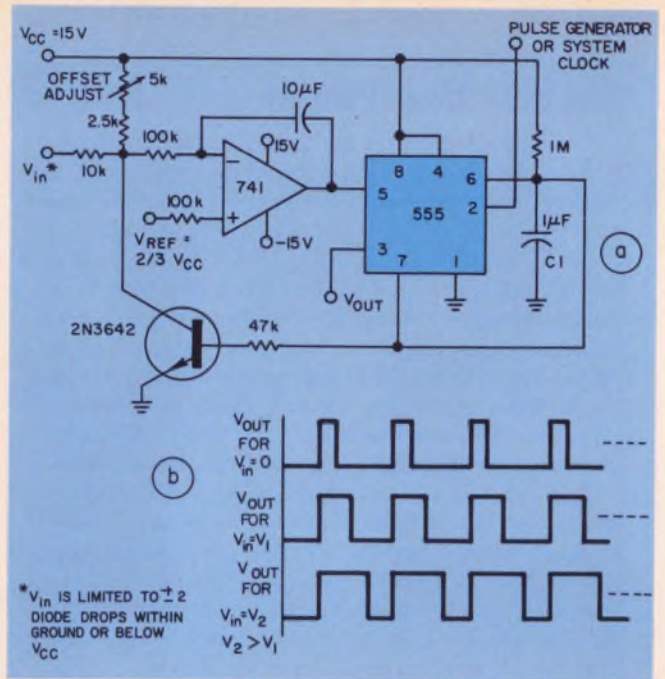

3. Voltage levels can be converted to pulse durations by combining an op amp and a timer IC. Accuracies to better than 1% can be obtained with this circuit (a) and the output signals (b) still retain the original frequency— independent of input voltage.

amplifier. The 33- Ω values allow a null period of about 4 to 5 μ s. This hysteresis is necessary to prevent the system from hunting. This type of circuit is useful in a wide range of remote-control systems. ■■

Reference

1. Signetics Data Sheet for NE555 timer.

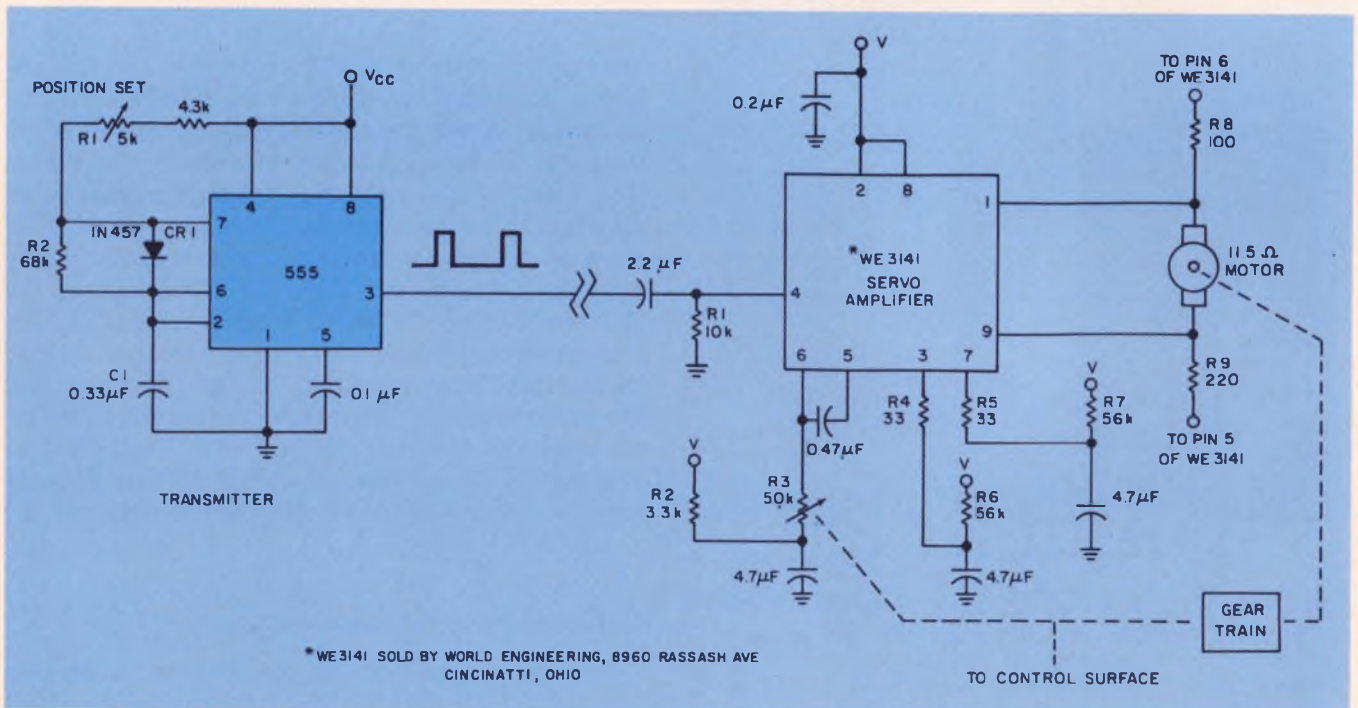

4. To remotely control a servo-motor, the 555 needs only six extra components.

**Your mother
didn't scrub floors
for 18 years to send
you through Cal Tech
just so you could
end up hardwiring
a processor.**

Introducing National's IMP-16C. The processor you buy instead of build.

Buying a controller instead of building it frees up engineers' time from this routine job. Freeing them up for more important tasks like solving real systems problems instead of tinkering around putting together nuts and bolts.

Starting from scratch and designing all the circuitry of a hardwired controller, then building, testing and documenting it could take an investment of as much as \$200,000 and months of engineering time.

The IMP-16C is an off-the-shelf microprocessor that allows you to build into your system precisely the capabilities you need, and to customize it to your immediate application, by programming, rather than laborious hardwiring.

It's not a computer, or even a minicomputer. It's a microprocessor. A lot simpler and cheaper than a minicomputer.

IMP-16C consists of a 16-bit microprocessor, clock system, memory and I/O port with bus drivers, 256 words of read/write memory (RAM), and provisions for 512 words of ROM/pROM memory. All on an 8½ by 11 inch PC card, shown here actual size. A teletype or most any peripheral can be connected to the I/O port and up to 32K words of memory can be controlled by the memory port.

A standard set of 42 instructions makes the IMP-16C ideal for the control of equipment such as data terminals, test systems, communications equipment, machine tools, process control systems, and peripheral device control systems.

This is the first of our GPC/P (General Purpose Controller/Processor) family of LSI functional building blocks for configuring parallel processors.

All in a proven, totally debugged system.

Get one and play around with it.

You'd be surprised how much money (and aspirins) it'll save you.

For further information write
National Semiconductor Corporation,
2900 Semiconductor Drive,
Santa Clara, California 95051.

If not for yourself, for your mother.

National



System timing
and I/O Buffering

16 bit CPU

256 x 16
RAM

512 x 16
pROM

The boxes may seem quite similar. The specifications can appear identical. But when it comes to performance, as seen on a screen, the picture suddenly changes.* Because that's where the Wavetek 2001 shows its class. The width of its crystal-controlled markers is adjustable for wide- or narrow-band operation and the

amplitude is always the same. The equal spacing between markers is an indication of the RF output linearity. The kind of output you need for precise work. The kind of output most people will gladly pay \$1,695 to get.

*Measurement conditions for both units were the same: 10 MHz harmonic markers measured directly at the RF output connector using an HP Model 423A detector.

1 MHz to 1.4 GHz freq. range
+10dBm to -80 dBm calibrated output
200 KHz to 500 MHz sweep width
P.I.N. diode leveling
Plug-in markers accurate to .005%

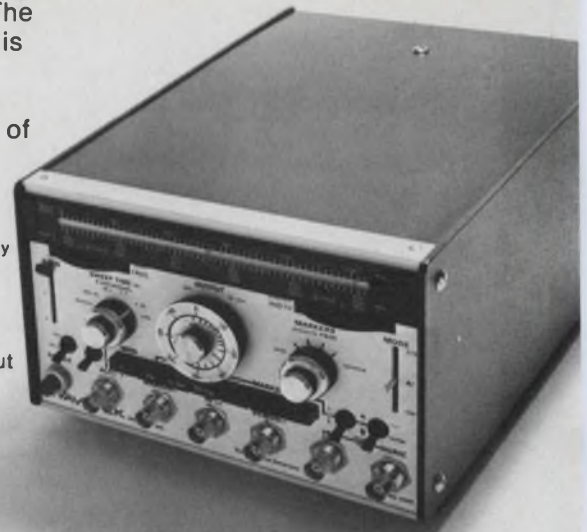

Anyone who thinks sweep generators look alike must not be an oscilloscope.

Wavetek 2001.

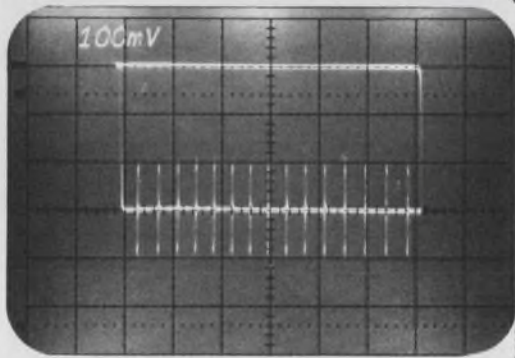

A major competitor.

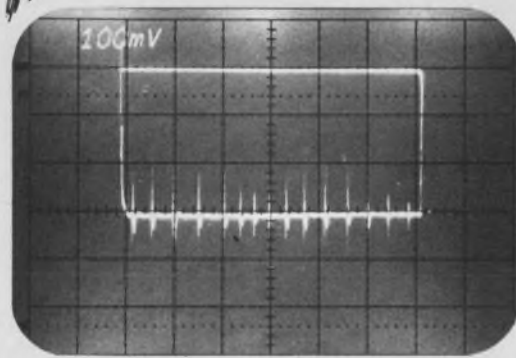

WAVETEK®

INDIANA INCORPORATED
P. O. Box 190, 66 North First Avenue
Beech Grove, Indiana 46107
Tel. (317) 783-3221 TWX 810-341-3226

INFORMATION RETRIEVAL NUMBER 41

ECL 10K: Now easy as ABC

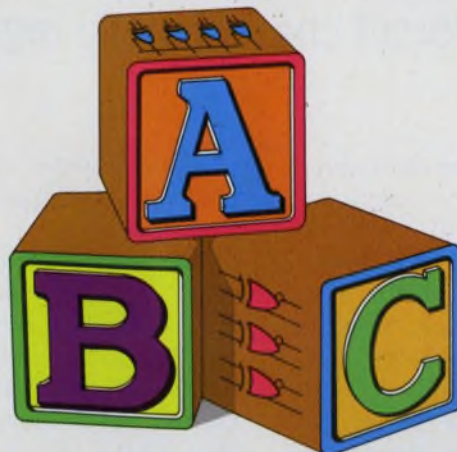

The big three basics come first at Signetics.

Availability. The fastest turnaround anywhere in 2ns high speed logic. What you see here, is what you can get from Signetics. Now. No delays, no alibis, no fooling around for months. Standard parts straight from proven, line-ready stock. MIL STD 883 Class B takes just a little longer.

Broad line. Twelve new memory, MSI and interface ECL 10K devices join the logic functions we're already shipping in volume world-wide. One-call access to the full range of part types and parameters, packaged in plastic DIP, Cerdip, or chips. A complete high speed logic family, from one single source: for greater design flexibility, plus significant cost advantages on a mixed buy.

ALTERNATE SOURCED FUNCTIONS					
10101	10106	10110	10116	10119	10131
10102	10107	10111	10117	10121	10161
10105	10109	10115	10118	10130	10162
SIGNETICS ORIGINATED FUNCTIONS					
10112	Dual 3-Input 1OR/2 NOR Gate				
10113	Quad Exclusive OR with enable				
10171	Dual 1-of-4 Demux/Decoder (Low)				
10172	Dual 1-of-4 Demux/Decoder (High)				

Compatibility. Pin-for-pin identical with Motorola MECL 10,000, with industry-accepted temperature coefficients and ranges (-30° to $+85^{\circ}$ C). Two in-depth, production-proven sources insure service and delivery. You can use Signetics ECL 10K in mixed systems without the subtle penalties or noise immunity reductions that occur with compensated 10K families. Switching rise/fall times are compatible with conventional system layouts.

FREE ECL 10K PARTS KIT

To introduce our new ECL 10,000 products, we're offering an Evaluation Kit: six free parts to give you first-hand experience with Signetics optimized ECL 10K.

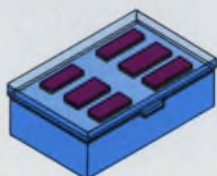

NEW ECL 10,000 FUNCTIONS:

Supergate

10100

Quad 3-input gate. Most useful 10K function, most reasonably priced.

Interface

10124/10125

Quad differential line drivers/receivers, ECL-TTL translators. 5ns high-performance delivers density and flexibility, below the cost of any other similar devices.

Multiplexers

10132/10134/10173

Logically powerful, 2.5ns high speed Mux-latches.

10164/10174

8 to 1/dual 4 to 1. Large fan-in multiplexers, operating at 3.5ns.

Parity

10170

9-plus-2 input expandable parity circuit.

Storage

10133

Quad D-type latch, with gated outputs.

Memory

10139*

Extremely fast 17ns PROM, 32x8 organization.

10145*

Extremely fast 9ns RAM, 16x4 organization.

*In characterization now. Coming soon.

Please rush us your free sample ECL 10K Evaluation Kit. Our design/production application is _____

Send complete specs, data and application notes on your complete ECL 10K line.

Name _____

Title _____

Attach this coupon to your company letterhead, and mail to:

Signetics-ECL
811 East Arques Avenue
Sunnyvale, California 94086
(408) 739-7700

Signetics Corporation. A subsidiary of Corning Glass Works.

signetics

INFORMATION RETRIEVAL NUMBER 42

Program gives FET model from specs.

With only one simulation routine written for SCEPTRE, curves can be obtained for all characteristic regions.

When designing with the help of the computer, most engineers use several models to calculate field-effect-transistor characteristics. But with a new program, written for SCEPTRE, one model covers all regions of FET operation. And the program accepts FET parameters that are readily obtained from manufacturers' spec sheets.

The three regions of FET operation—triode, pinchoff and cutoff—are shown in Fig. 1a. To fuse the three, it's imperative that boundary transitions not overlap. Our model uses a translation technique developed from device physical characteristics to maintain piecewise continuity through all boundaries.

A complete n-channel junction-FET model is presented in Fig. 1b. For p-channel devices, all polarities and the diode are reversed. A corresponding model for MOSFETs would not require the junction diode. The FET model is valid for any gate-to-source voltage, so long as the drain-to-source voltage is less than the avalanche level.

Spec sheets provide basic input

The basic parameters, readily available from manufacturers' specification sheets, consist of the following:

- V_p = pinchoff voltage, normally given as gate-to-source cutoff voltage, V_{GS} (CUTOFF).
- I_{DSS} = zero-gate-voltage drain current.
- G_m = transconductance, normally found in the form of forward transadmittance, Y_{fs} .
- G_{gd} = gate-to-drain capacitance, generally given as the reverse transfer capacitance, C_{rss} .
- C_{gs} , the gate-to-source capacitance, is found from the input capacitance, C_{iss} , and C_{rss} from the relation $C_{gs} = C_{iss} - C_{rss}$.
- G_{do} —the slope of the $V_{gs} = 0$ curve on the I_d vs V_{ds} plane—is calculated from the relation $G_{do} = (\Delta V_{ds} / \Delta I_d)$ at $V_{gs} = 0$.
- R_{ds} —the drain-to-source resistance when the FET is off—is generally so large that it can be left out with little sacrifice in accuracy. Hence

it often doesn't appear on spec sheets. In our model its inclusion allows for software voltage development.

The model parameters include the following: $R_t = 1/G_{in}$, D_{rs} = junction diode, and $I_{dp} = I_{DSS} [1 - V_{gs}/V_p]^2$, the drain current at pinchoff. Voltage V -translate = $V_p - V_{rs}$, the drain voltage at pinchoff used to translate the origin of the V_{gs} curve along the pinchoff line. Resistance $R_{ds} = 1/G_{do} (1 - V_{rs}/V_p)$. And the triode equation, defining current I_{dtr} , is given as $I_{dtr} = (I_{DSS} V_{ds}/V_p) [2(V_{rs}/V_p - 1) - V_{ds}/V_p]$.

Software selects region of operation

To apply the model, we use software to delete the parameters not being used in each region of FET operation. Boundary equations provide the criteria for switching parameters in and out. On a boundary line, either region's parameters will give identical values.

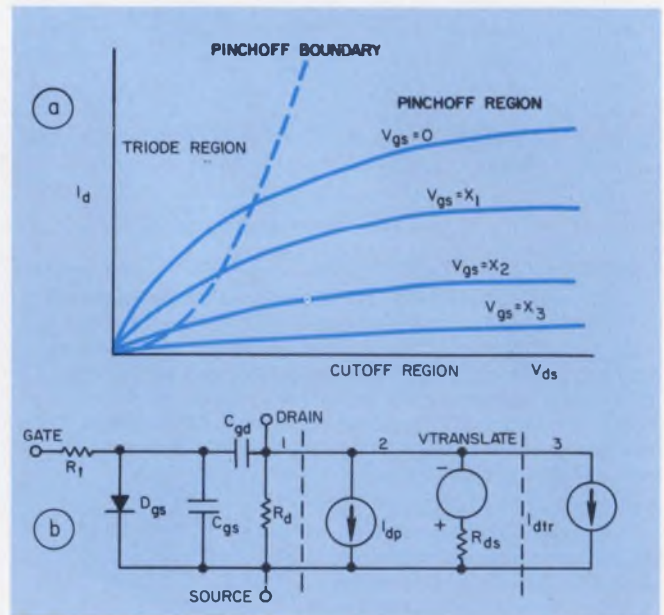

1. The three regions of FET operation, shown in a multi-curve plot of I_d vs V_{ds} (a), can be modeled with the circuit of b. The portions of the circuit labeled 1, 2, and 3 are used as the circuit model for, respectively, for cutoff, pinchoff and triode-region operation.

Raymond A. Muggli, Senior Associate Engineer, IBM, Monterey and Cottle Rds., San Jose, Calif. 95114.

The model for each region is shown in Fig. 2. The boundary equations between regions were used to derive the inequalities.

The boundaries determine how the operation point moves from one region model to another, and they also allow the region models to be fused into one FET model. The pinchoff region was modeled by use of a slope-origin translation scheme to allow the region conductance to originate at pinchoff.

Region boundaries provide continuity

To be piecewise continuous, the boundary between the triode and pinchoff region must have the same drain current when approached from either region. Therefore the boundary equation should evolve from simultaneous solutions for the drain-current equations for each region.

The commonly used equation for drain current at pinchoff,

$$I_d = I_{dss} \left(1 - \frac{V_{gs}}{V_p}\right)^2, \quad (1)$$

is valid only for drain current at the physical pinchoff.

For a drain-current characterization that applies over the full triode region, including pinch-off, we use the following triode equation:

$$I_{dtr} = \frac{I_{dss}}{V_p} V_{ds} \left[2 \left(\frac{V_{gs}}{V_p} - 1 \right) - \frac{V_{ds}}{V_p} \right]. \quad (2)$$

At the boundary between the triode and pinch-off region, the drain-to-source voltage is given by the following:

$$V_{ds} = V_{gs} - V_p. \quad (3)$$

This equation can be derived by simultaneously solving Eqs. 1 and 2. Piecewise continuity results between regions, since both region models have identical values along the entire boundary.

The equation that defines the boundary between the pinchoff and cutoff regions is

$$V_{gs} = V_p. \quad (4)$$

The slope of the characteristic curves in the pinchoff region result from space-charge limiting. The slope for these curves is modeled by conductance:

$$G_{ds} = \frac{\Delta I_d}{\Delta V_{ds}}, \quad V_{gs} = \text{constant} \quad (5)$$

The slope angle differs for every constant V_{gs} curve. Since an infinite number of V_{gs} curves are possible, measuring all of these varying slopes is impractical. In our model, constant V_{gs} curve slopes are normalized to the $V_{gs} = 0$ curve slope, defined as $G_0 \triangleq G_{ds}$ at $V_{gs} = 0$ (see Fig. 3). The value of G_0 can be interpolated from manufacturers' curves.

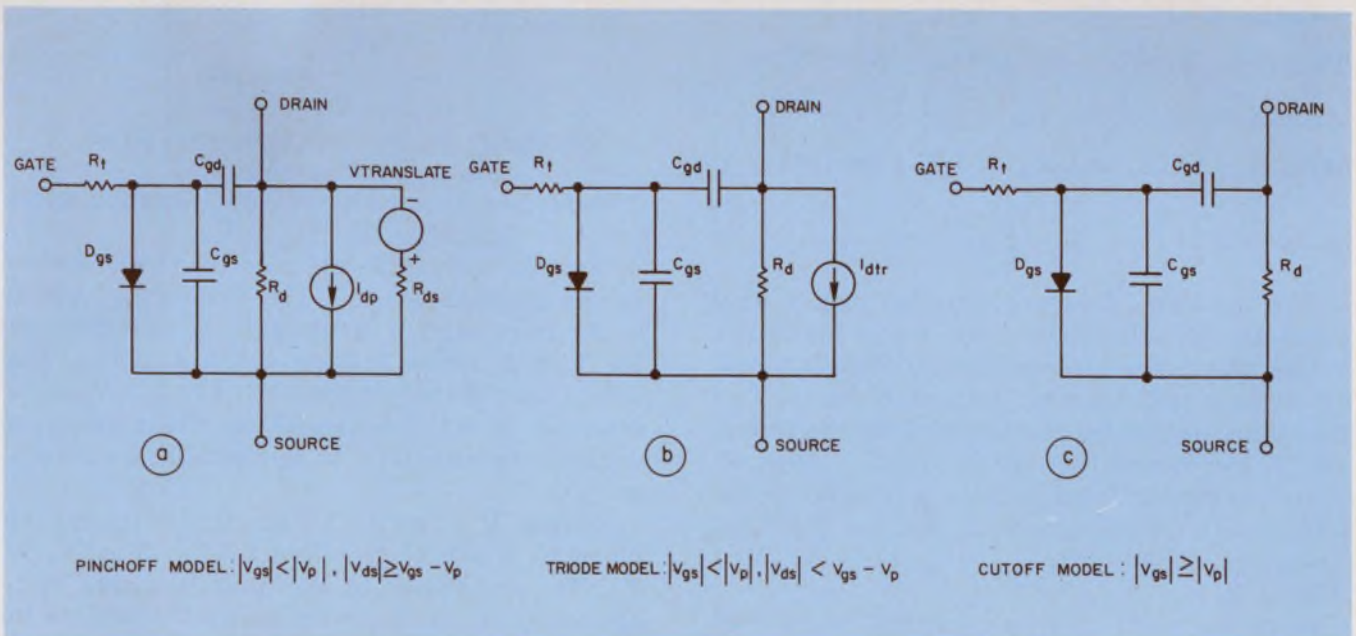

2. Depending on relative values for V_{gs} and V_{ds} , the circuit models for the pinchoff (a), triode (b) and cutoff (c) regions of FET operation can be applied. The models are valid for all values of drain current and

gate-to-source voltage, so long as the avalanche drain-to-gate voltage is not reached in either a forward to reverse-mode of operation,—handled in the program with a sign factor that reverses generators.

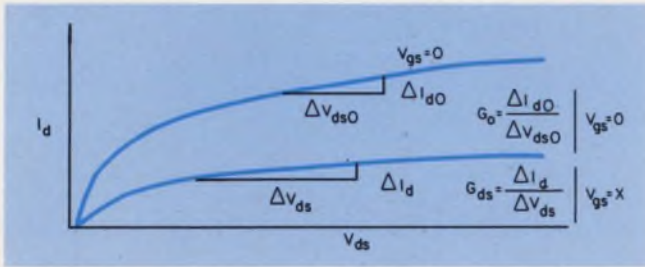

3. Conductance in the pinchoff region is normalized to the $V_{gs} = 0$ curve slope, G_0 . This conductance can be interpolated from manufacturers' curves.

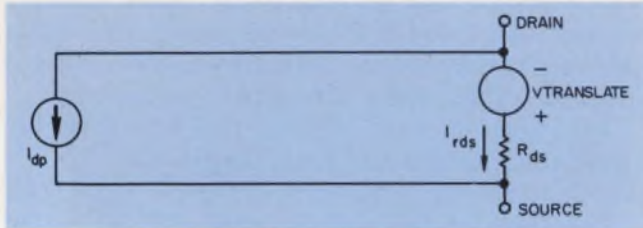

4. The model for the G_{ds} -slope at origin variation presumes that the G_{ds} curve begins at the pinchoff boundary. The difference between the actual origin and the boundary origin is accounted for by source V-translate.

The general conductance, G_{ds} , can be seen in Figs. 1 and 2 in its inverse form, R_{ds} , which is derived as follows: From semiconductor physics,¹ we see that

$$G_{ds} = \frac{C_{dc} \mu_{eff}}{\ell^2} (V_{gs} - V_p),$$

where μ_{eff} = effective channel mobility, C_{dc} = effective drain-channel coupling capacitance, ℓ = total channel length and V_p = pinchoff voltage.

$$\text{Define } K_1 \triangleq \frac{C_{dc} \mu_{eff}}{\ell^2}.$$

Then $G_{ds} = K_1 (V_{gs} - V_p)$ and $G_0 = K_1 (-V_p)$.

$$\text{Since } K_1 = \frac{G_0}{-V_{pp}}, G_{ds} = G_0 \left(\frac{V_{gs} - V_p}{-V_p} \right).$$

With $R_0 = 1/G_0$ and $R_{ds} = 1/G_{ds}$, we get:

$$R_{ds} = \frac{R_0}{1 - \frac{V_{gs}}{V_p}}. \quad (6)$$

The G_{ds} slope does not have an origin until pinchoff, and subsequent space-charge limitation, occurs. Beginning the conductance slope at pinch-off gives a drain current defined by Eq. 1. This maintains the needed continuity along the boundary. It also means that the current I_{rds} (Fig. 4) is zero at pinchoff and becomes a function of the differential voltage across R_{ds} beyond pinchoff. Therefore, at pinchoff, $I_d = I_{dss} (1 - V_{gs}/V_p)^2 + \Delta V_{ds}/R_{ds}$.

Since the point at which pinchoff is reached varies for different values of V_{gs} , every V_{gs} curve will have its own origin. And the origins translate along the pinchoff boundary line for a changing V_{gs} .

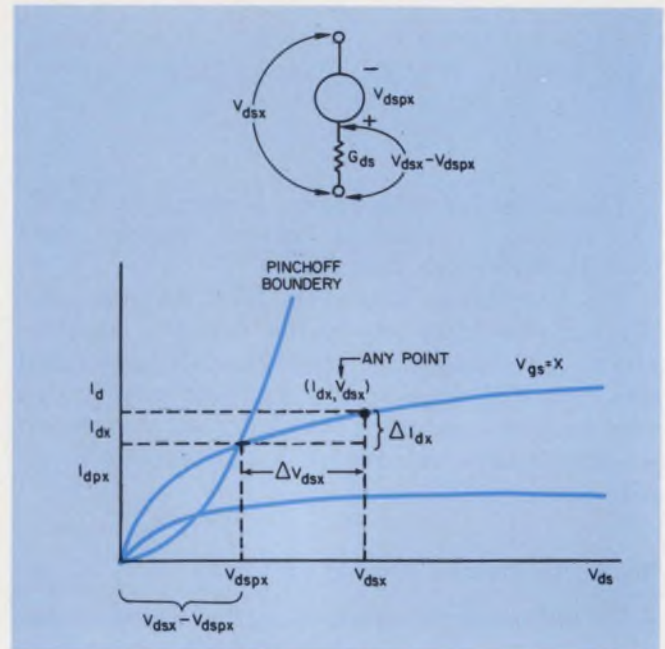

5. The origin of any V_{gs} curve is set at the pinchoff boundary to maintain the needed continuity along the boundary. Voltage source V_{dsp} is used to account for the difference between this origin and the actual one.

To derive this translation, the origin of any V_{gs} curve is set at the pinchoff boundary, with the difference taken up by voltage source V_{dsp} (see Fig. 5).

In the following development for the origin translation, subscript p denotes a value along the pinchoff boundary. Subscript x denotes a value on the $V_{gs} = x$ curve.

Given any I_d in the pinchoff region,

$$I_{dx} = I_{dpx} + \Delta I_{dx}.$$

Since slope $G_x = \frac{\Delta I_{dx}}{\Delta V_{dsx}}$, then

$$\Delta I_{dx} = G_x \cdot \Delta V_{dsx} \text{ and } \Delta V_{dsx} = V_{dsx} - V_{dspx}.$$

Combining the last two equations gives

$$\Delta I_{dx} = G_x (V_{dsx} - V_{dspx}).$$

Combining this with the first equation gives

$$I_d = I_{dpx} + G_x (V_{dsx} - V_{dspx}). \quad (7)$$

This equation shows the need for two branches in our modeling scheme. The first is I_{dpx} , which is the drain current at pinchoff, as described by Eq. 1 (it is shown in Figs. 1 and 4 as I_{dp}). The second part of the equation— $G_x (V_{dsx} - V_{dspx})$ —describes a current caused by drain-to-source voltage, translated by V_{dspx} , through a conductance, G_x .

Voltage V_{dspx} refers to the drain voltage at pinchoff, which is described by Eq. 3 as $V_p - V_{gs}$. The translation of the drain-to-source voltage across R_{ds} is accomplished by V-translate in Fig. 4.

If we neglect stray capacitance and assume that the total input capacitance is lumped as gate-to-drain and gate-to-source capacitance, we find

```

CIRCUIT DESCRIPTION
THIS IS A N-CHANNEL FET IRM-F5
UNITS ARE MA,VOLTS,KOHM,PF,NSEC
CHANGABLE VARIABLES ARE--
PGM=TRANSCONDUCTANCE
PVP=PINCHOFF VOLTAGE
PIDSS=IDSS
PRDO=INVERSE SLOPE IN THE PINCHOFF REGION OF THE VGS=0 CURVE
PD=CUTOFF RESISTANCE
CGS=CISS-CRSS
RAY MUGGLI
ELEMENTS
EG1,GND-GATE=0.
EDS,GND-DRAIN=TABLE 1 (TIME)
RSHT ,S/PORCE=GND=1.E-6
RT,GATE-G11=EQUATION 1 (PGM)
CGS,G11-SOURCE=7.
JDI,G11-SOURCE=TABLE 2 (VCGS)
PD,DRAIN-SOURCE=1.E7
JFET,DRAIN-SOURCE=EQJAT ION 14 (P1,PJ1,P2,PJ2)
ETRAN,TRAN-DRAIN=EQUATION 15 (PVP,VCGS,P1,PSIGN)
RDS,SOURCE-TRAN=EQUATION 16 (PR1,P1,PR2,P2,PR3,P3)
DEFINED PARAMETERS
PGM=2.2
PIDSS=2.4
PVP=-2.
PRDO=50.
PJ1=EQUATION 2 (PIDSS,VCGS,PVP,PSIGN)
PERR=.0001
PSIGN=EQUATION 3 (VRD)
PJ1=EQUATION 4 (PRDO,VCGS,PVP)
PA=EQUATION 5 (VRD,VCGS,PVP)
P1R=EQUATION 6 (PA,PERR)
P1=EQUATION 7 (P1R,P3)
PJ2=EQUATION 8 (PIDSS,VRD,PVP,VCGS)
P2=1.E6
P2B=EQUATION 9 (PA)
P2=EQUATION 10 (P2B,P3)
P3=1.E6
P3A=EQUATION 11 (VCGS,PVP)
P3R=EQUATION 12 (P3A,PERR)
P3=EQUATION 13 (P3R)
OUTPUTS
(RSHT,PLOT(VRD)
P1,P2,P3
FUNCTIONS
EQUATION 1 (A)= (1./A)
EQUATION 2 (A,B,C,D)= ((A*(1.-B/C)**2)*D)
EQUATION 3 (A)= (A/(DABS(A)+1E-06))
EQUATION 4 (A,B,C)= (A/(1.-B/C))
EQUATION 5 (A,B,C)= (DABS(A)-|B-C|)
EQUATION 6 (A,B)= (DABS(A+B)*1.D10,0.001)
EQUATION 7 (A,B)= (1.-DEXP(-A))* (1.-B)
EQUATION 8 (A,B,C,D)= (1+(A*B/C)*12.*(7/C-1.-B/C))
EQUATION 9 (A)= (DMIN(|A*1.D10,0.001))
EQUATION 10 (A,B)= (1.-DEXP(A))* (1.-B)
EQUATION 11 (A,B)= (DABS(A)-DABS(B))
EQUATION 12 (A,B)= (DABS(|(A+B)*1.D10,0.001))
EQUATION 13 (A)= (1.-DEXP(-A))
EQUATION 14 (A,B,C,D)= (A*B*C*D)
EQUATION 15 (A,B,C,D)= ((A-B)*C*D)
EQUATION 16 (A,B,C,D,E,F)= (A*B*C*D+E*F)
TABLE 1
0,0
100000,5
TABLE 2
-55,-.001, 0,0, .5,1, .8,5
RUN CONTROLS
MAXIMUM INTEGRATION PASSE=50000
INTEGRATION ROUTINE=TRAP
STOP TIME=10000
MINIMUM STEP SIZE=.000001
END

```

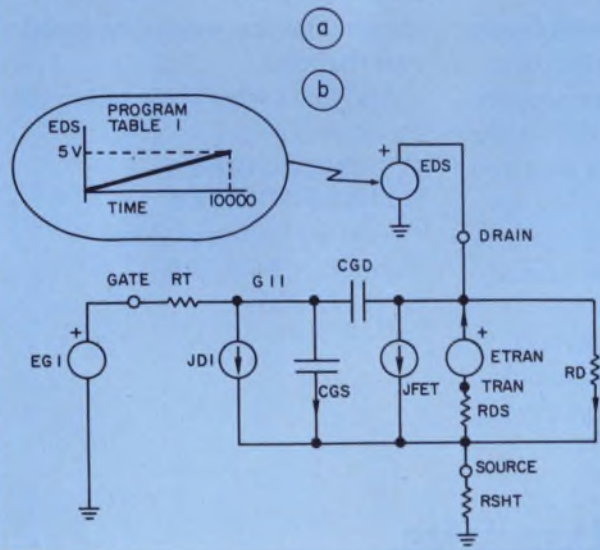

6. A program listing in SCEPTRE (a) permits the generation of FET I_d vs V_{ds} curves for constant V_{gs} . The accompanying schematic (b) relates the FET model derived to the program. A curve-tracer mode simulation is achieved by storing data points for various values of gate-to-source voltage (EG1) and formatting the output to display all V_{gs} curves on one I_d vs V_{ds} plane.

that the gain-bandwidth product is inversely proportional to transient delay. Transient delay is the time it takes the drain current to respond to a change in gate-to-source voltage², or

$$\tau_t = \frac{C_{in}}{g_m} \quad (8)$$

This is modeled by placing resistor $R_t = 1/g_m$ in series with the input capacitance (Figs. 1 and 2).

SCEPTRE listing calculates I_d vs V_{ds}

SCEPTRE's commonly used computer-aided circuit design program³ can be used to generate I_d -vs- V_{ds} curves for constant V_{gs} . The program listing is shown in Fig. 6, with the accompanying schematic illustrating the software development.

In the schematic, the following applies: RSHT is a short-circuit resistor to sample I_{ds} for display, EDS sweeps the drain-to-source voltage for a curve-tracer mode display; EG1 sets the V_{gs} voltage for each sweep, and JFET, ETRAN and RDS depend on the region of operation.

Switching software in the program makes JFET become I_{dp} in the pinchoff region and I_{dtr} in the triode region. ETRAN is shorted out in the cutoff and triode regions and becomes V-translate in the pinchoff region. RDS becomes a finite R_{ds} only in the pinchoff region. And PSIGN reverses the generator when the FET is used in the reverse mode—that is, when EDS goes negative.

Three regions of operation are obtained with a special software switching scheme that was used to stay in the SCEPTRE format. In the pinchoff region, for example, $|VRD| \geq VCGS - PVP$ and $|VCGS| < |PVP|$. Moreover $P1 = 1$, $P2 = 0$, and $P3 = 0$.

In the switching scheme, PA gives a positive value in the pinchoff region and a negative value in the triode region. P1B will be 0 if PA is negative; otherwise it will be a very large positive value. P1 uses P1B in an exponential to switch. If P1B is 0, then $P1 = 0$, and if P1B is a very large positive value, then $P1 = 1$, as required for the triode region.

The parameters in this region are given by the following: $PJ1 = I_{dp}$, $PR1 = R_{ds}$ and $PRDO = I/G_{do}$. The switching conversion criterion is controlled by PERROR. ■■

References:

1. Wollmark, J. Torkel and Johnson, Harwick, "Field-Effect Transistors: Physics, Technology and Applications," p. 138, Prentice-Hall, Inc., Englewood Cliffs, N.J., 1966.
2. Shockley, W., "A Unipolar Field-Effect Transistor," *Proc. IRE*, Vol. 40, pp. 1365-1376, November, 1952.
3. Mathers, Harry W.; Sedore, Stephen R.; Sents, John R., *Revised SCEPTRE User's Manual*, IBM, Owego, N.Y., 1968.

Expertise, schmexpertise. It's good old-fashioned know-how.

That's why people buy so many of our PIN diodes.

Because we make them good, we make them fast, and we make them to sell at a price you can afford.

Like less than 50¢ apiece for our glass MA-47110 in quantities of 10,000. The MA-47110 is hermetically-sealed for reliability and is ideally suited for general-purpose switching and attenuating from VHF well into the microwave range. It's the first of a whole series of other economical control devices.

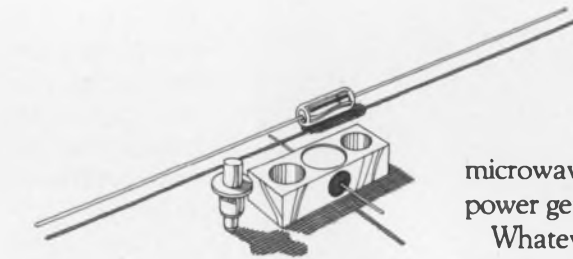

If your application requires it, we can produce PIN diodes to solve your particular power-control problem. Like our silicon-nitride passivated beam leads and hermetically sealed stripline devices. We'll make them in any quantity you want, too. Just a few. Or a whole lot, like the big batch of PIN diodes we successfully delivered for a major phased-array-radar program.

PIN diodes, Schottky barriers, Gunn and Impatt diodes, and lots of other semiconductor devices for

microwave frequency conversion, power generation, and control.

Whatever you want, when you want it, at a nice low price.

Plus the proven understanding of microwave circuits and control applications that we've developed over the years.

And that's what know-how is all about, isn't it?

 **MICROWAVE ASSOCIATES**

Northwest Industrial Park
Burlington, Mass. 01803
(617) 272-3000

**We're Microwave Associates.
We know how.**

Five watt power in a cermet pot!



Allen-Bradley Type CJ. That's right, 5 watts at 70°C. Now you can have the stepless control of cermet without sacrificing power-handling capability. Replace wirewounds with performance that's hard to match. Low noise. No inductance. Smooth mechanical operation. Operating temperature range -65°C to +150°C. Less than 10% re-

sistance change over 50,000 cycle rotational life. Resistances from 100 ohms to 5 megs. Single, dual or triple section units with plain or locking bushings. Dust-tight and "splash-proof." Large variety of shaft and bushing options available. Allen-Bradley CJ brings new power handling capability to cermet variable resistors. Request our Publication

5215. Available through your appointed Allen-Bradley Electronic Distributor, or write Allen-Bradley Electronics Division, 1201 South Second Street, Milwaukee, Wis. 53204. Export: Bloomfield, N. J. 07003. Canada: Allen-Bradley Canada Limited, Cambridge, Ontario. United Kingdom: Jarrow, County Durham NE32 3EN.

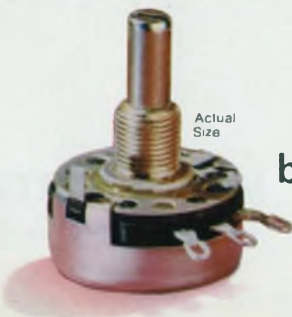

Actual Size

If you're really serious about cost, be serious about quality.

INFORMATION RETRIEVAL NUMBER 152



Allen-Bradley
Milwaukee, Wisconsin 53204

Maximum switching performance comes in two sizes: small and smaller.

MICRO SWITCH SM and 1SX subminiatures offer electrical capacity normally found only in much larger switches. The result is big switch performance in a smaller package.

Since both devices are extremely versatile, they can be used whenever space and weight are critical.

Choose from hundreds of versions, including some that meet MIL-S-8805. Our small SM (up to 11 amp capacity) and the smaller 1SX (up to 7 amp capacity) are both available with a variety of actuator and terminal styles. There's even a screw-terminal

SM as well as a sealed-plunger version for wet or dirty applications. UL and CSA listings are standard. Low operating force, bifurcated gold contact and low differential travel types are available for your application.

For more information, contact your MICRO SWITCH Branch Office or Authorized Distributor (Yellow Pages, "Switches, Electric"). No request is too small for them to handle.

MICRO SWITCH makes your ideas work.

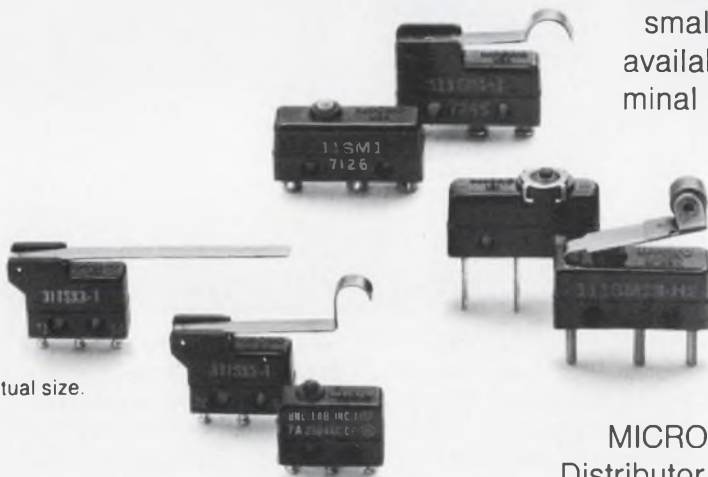

Shown actual size.

YOUR NEXT LOGICAL STEP TO HIGH SPEED CMOS —

THE INS4000S SERIES

- INS4001S — Quad 2-Input Positive NOR
- INS4007S — Dual/Pair Inverter
- INS4009S — Hex Buffer Inverting
- INS4010S — Hex Buffer Non-Inverting
- INS4012S — Dual 4-Input Nand Gate
- INS4013S — Dual "D" Flip Flop With Set/Reset
- INS4027S — Dual J-K Flip Flop
- INS4030S — Quad Exclusive-or-Gate

- CMOS that has a better power-speed product.
- CMOS that is 3 times faster than monolithic CMOS.
- CMOS that is as fast as TTL logic, but dissipates typically less than 100 nW
- CMOS that is full temperature rated from -55°C to 125°C . That means it is ideal for industrial and military customers.
- CMOS that offers you bipolar speed with MOS power in a single package.
- CMOS that can be customized for your LSI application.
- CMOS that is price competitive.

QUANTITIES 100-999

INS4001S	\$3.30	INS4012S	3.40
INS4007S	2.65	INS4013S	4.75
INS4009S	5.25	INS4027S	5.25
INS4010S	5.25	INS4030S	3.80



For further information, call or write: Bob Heller, Dept. 6;
University Park; 743 Alexander Road, Princeton, N. J. 08540
Phone: (609) 452-2222; Cable: Inselek

REGIONAL SALES OFFICES

EASTERN REGIONAL SALES OFFICE

JACK SCHULTZ
REGIONAL SALES MANAGER
191 SUDBURY RD.
CONCORD, MASS. 01742
(617) 369-5298

WESTERN REGIONAL SALES OFFICE

JOHN SPOER
REGIONAL SALES MANAGER
30811 MAINMAST DR.
AGOURA, CALIF. 91301
(213) 889-2788

Consider the part-time engineer, says this small-company manager. You can use him effectively if you learn to use technicians as project 'finishers.'

Small electronics companies—those grossing \$1-million to \$10-million a year—usually can't afford the salaries of senior engineering talent or the time to train new engineering graduates properly. But they have a good alternative: They can hire engineers who have been in the field for three or four years and are extremely competent—but who want to work part-time only.

That's only half the battle, however. Using part-time engineers presents two major problems to management: completing projects on time and building an R&D capability. To meet these challenges, it's necessary to employ the second half of the one-two engineering punch for small companies: Use the part-time engineers strictly for the creative aspects of the project, and let technicians carry the work to completion as "product finishers."

I once got a call from an engineer I was ready to hire. He told me that he wanted to work only 25 to 30 hours a week so he'd have enough time to counsel drug addicts. Right then I realized that for a company our size to complete a project successfully, we'd have to organize the schedule so that the person in charge could finish it without spending his life on it.

Some small companies might be able to do this by using a lot of part-timers, but that depends on whether the company is in an area where technical talent is plentiful. Our company is situated where the pool of technical talent is not very deep.

The part-time engineers who are available to us are professionals who want to design exclusively. They're interested in a small-company atmosphere, and they like a great deal of freedom to come and go as they please. They like to choose the projects they work on, and they like to see the results of their work quickly. We recently hired two designers who had one or two years in a large company and who didn't want to get stuck with the red tape of a project.

How did I use these designers effectively?

A senior manager of the local technical com-

munity gave me an idea. He said that one problem small-to-medium electronics manufacturers had was that they didn't train people to do their jobs. They always go out and look for someone to fit the job.

Refining the raw talent

So I got to thinking that it would be a very good investment for us to train people off the assembly line or from the test department—people who weren't engineers but who had the raw talent to carry a program or at least to work into a technical position. I figured they'd be a great help to engineers who didn't want project responsibility after they had completed the design function.

So we organized into two-man project teams, with a technician (called a product engineer) and a designer on each team. The technician typically did not have a degree. This spot could be handled by a draftsman or a mechanical engineer. The basic qualifications were these: He should be capable of mechanical and printed-circuit design. And while he could not design circuits, he should be able to read and draw schematics for a simple d-to-a converter—a typical product that a company like ours makes.

Today our product engineer follows up all those detail jobs that the designer is usually heir to. He buys the parts for the product, calls meetings, orders the PC boards, checks the accuracy of the art work on the PC boards and, in general, helps keep the designer on schedule.

Prior to this system we had virtually no support for the designer, just a pool of service. Now, for each designer, we assign two men through the design phase. The third man handles product releases. He takes the product at the conclusion of the second pilot run.

When the breadboard is complete, the product engineer starts taking control of the project by acquiring the material for the prototype. The designer does the actual evaluation and investigation of the prototype, while the product engineer virtually peers over his shoulder, writing down changes and updating the paperwork and order-

Donald L. Peinetti, Director of Engineering, Zeltex, Inc., Concord, Calif. 94520.

ing parts for the second prototype. The second prototype should be a finished product, barring really serious design problems. Depending on the project, we may make as many as 10 to 15 prototype units.

Then we go into our first "A" revision of all the documents. The product engineer sees that these documents are filed as a revision "A" for pilot production only. The product engineer sees further that the first pilot run is billed under an engineering number, which joins the finished-goods inventory at the completion of the pilot run. The product engineer organizes the assembly labor and sees that all of the test equipment is available. He also assists in testing the product with a third member of the team who is now added—another technician. The designer will have been assigned another project by now.

Wherever there are changes in documents, the product engineer makes sure that the changes are incorporated into the product for the second pilot run. He also makes sure that the long-lead parts for it are on order, and he transfers the second pilot run to what we call a release-product group. The technician of this group keeps track of component evaluation and does most of the testing. He sees that the second pilot run gets built in manufacturing.

Before the product engineer leaves the project, he stocks replacement parts and files the documents.

The part-time designer is also the key to building up the company's R&D potential. With his creative freedom, he can concentrate on the innovative, while the technician follows through on the nitty-gritty of building the prototype.

Whether building an established product or developing a new one, the designer—or project engineer—is the only one who is an electronics engineer; he phases out of the project earlier than he used to because others are doing the "finishing" work.

Benefits of the system

The other people were always here; they aren't new people. They're just taking on more responsibility. They did the same jobs before but they weren't responsible for them in any kind of time frame. Now they're more responsible to the project. In the past the design engineer had to see that all the finishing work was done. The product engineer would do the work when he was told, but he was never motivated to do the work on his own.

The new system has other benefits, too.

It allows more people to become involved in the project.

It gives the manager visibility on the projects. I can go to the product engineers of each project to see how a project is going. And I can get schedules from a man who's more interested in drawing them up than the designer was.

It allows the part-time designer freedom to design. In the old days when I worked as a project engineer, I ran around all day, shuffling papers and getting parts ordered and checking to see if Joe was making boards for me and checking to see if the girl on the line could build them for me. Then I spent all night designing the circuit. Now, the engineer with the camper can design in his garage if he wants to. ■■

Donald L. Peinetti



Education: San Diego State College, math and physics; graduate studies in electronics engineering.

Responsibility: Direct electronic, process and mechanical engineering efforts in the development of hybrid and modular amplifiers and conversion products.

Experience: Ten years electronics engineering including three years engineering management. Lectured in solid-state oscillator design. Developed 24 solid-state electronic test instruments including function generators, oscillators and measurement equipment. Designed 17 amplifiers, analog-to-digital and digital-to-analog conversion products.

Personal: Married; two children, a boy 10 and a girl 9. Hobbies include handball and golf.

Employer: Zeltex, Inc., was founded in 1962 as a manufacturer of analog computer components. It pioneered the manufacturing of general purpose modular operational amplifiers. In recent years it has become a leader in modular a/d and d/a conversion products.

NOW, 400V & 600V DARLINGTONS FROM



Delco Electronics

DIVISION OF GENERAL MOTORS CORPORATION, KOKOMO, INDIANA

Delco's new DTS-4000 series Darlington's with V_{CEO} 's of 400V and 600V are triple diffused mesa units built for rugged duty. They come to you with a practical 15 Ampere rating that you can depend on all the way up to the high voltage requirements of ac motor speed controls, for instance—or the 1.5 kW switching regulator in the illustration.

And they offer new possibilities

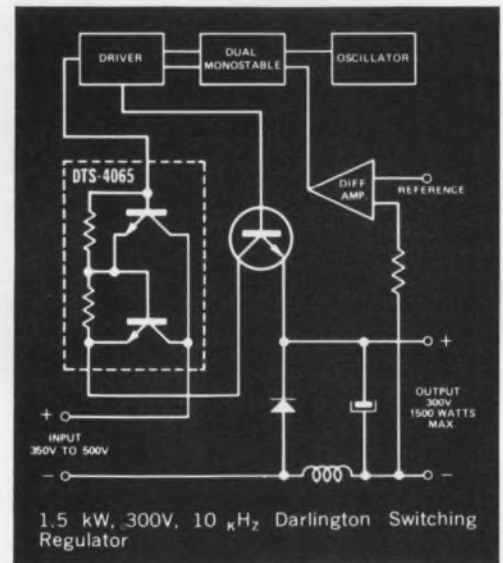

in circuit design where dc drive conditions may have created awkward problems when using SCR's.

Our new Darlington's can save you space and give you more design flexibility. The high energy capability of the DTS-4000 series is

SAFE OPERATING CURVES

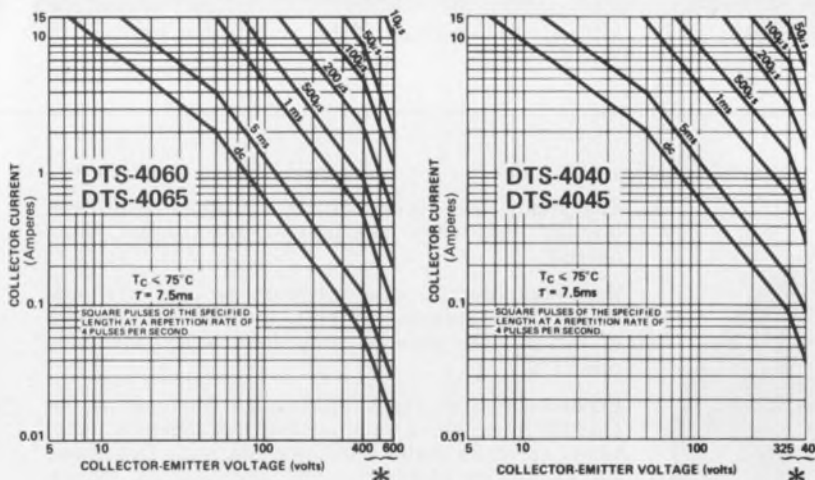

*Reverse Bias Required

TYPE	V_{CEO}	I_C (Cont.)	V_{EBO} (Max.)	V_{CEO} (sus)	h_{FE} @ I_C	t_f (com. base)	P_D (max.)
DTS-4040	400V	15A	20V	325V	250/3A	$0.25\mu s$	100W
DTS-4045	400V	15A	20V	325V	500/3A	$0.25\mu s$	100W
DTS-4060	600V	15A	20V	400V	250/3A	$0.25\mu s$	100W
DTS-4065	600V	15A	20V	400V	500/3A	$0.25\mu s$	100W

NPN—Triple diffused Darlington transistors packaged in solid copper TO-204MA (TO-3) cases.

HIGH ENERGY THE KOKOMOANS.

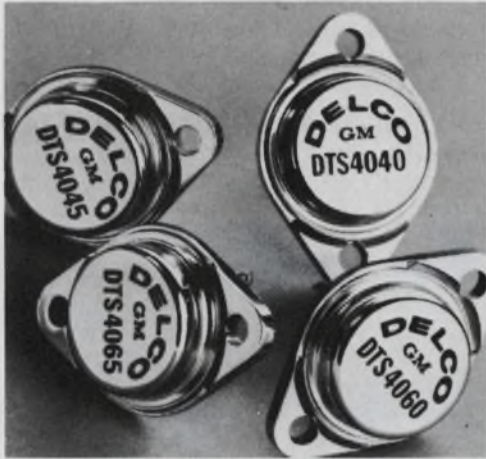

backed by safe operating curves up to 600 volts, as shown at left. And to further aid your circuit design h_{FE} is plotted continuously from 15mA to the maximum collector current rating of 15A.

As you expected, the new DTS-4000's are in stock and ready for delivery. Contact us or your nearest Delco distributor for complete details. Ask for Application Note 52 on the switching regulator.

Now available from these distributors in production quantities:

ALA., BIRMINGHAM • Forbes Distributing Co., Inc. (205)-251-4104
 ALA., HUNTSVILLE • Powell Electronics (205)-539-2731
 ARIZ., PHOENIX • Sterling Electronics (602)-258-4531
 CAL., GOLETA • Radio Products Sales, Inc. (805)-964-4764
 CAL., LOS ANGELES • Kierulff Electronics, Inc. (213)-685-5511 • Radio Products Sales, Inc. (213)-748-1271
 CAL., PALO ALTO • Kierulff Electronics, Inc. (415)-968-6292
 CAL., SAN DIEGO • Radio Products Sales, Inc. (714)-292-5611
 CAL., SAN DIEGO • Kierulff Electronics, Inc. (714)-278-2112
 CAL., SUNNYVALE • Cramer/San Francisco (408)-739-3011
 COLO., DENVER • Cramer/Denver (303)-758-2100
 CONN., NORWALK • Harvey/Connecticut (203)-853-1515
 FLA., MIAMI SPRINGS • Powell/Gulf Electronics (305)-885-8761
 FLA., ORLANDO • Powell/Gulf Electronics (305)-859-1450

ILL., ROSEMONT (Chicago) • Kierulff Electronics (312)-678-8560
 ILL., SKOKIE (Chicago) • Bell Industries (312)-282-5400
 IND., INDIANAPOLIS • Graham Electronics Supply, Inc. (317)-634-8202
 MD., BALTIMORE • Radio Electric Service Co. (301)-823-0070
 MASS., NEEDHAM HEIGHTS • Kierulff Electronics, Inc., (617)-449-3600
 MASS., NEWTON • The Greene-Shaw Co., Inc. (617)-969-8900
 MICH., FARMINGTON • Harvey-Michigan (313)-477-1650
 MINN., MINNEAPOLIS • Stark Electronics Supply Co. (612)-332-1325
 MO., NO. KANSAS CITY • LCOMP-Kansas City, Inc. (816)-221-2400
 MO., ST. LOUIS • LCOMP-St. Louis, Inc. (314)-647-5505
 N.J., CLIFTON • Eastern Radio Corporation (201)-365-2600, (212)-244-8930
 N.Y., BINGHAMTON • Harvey/Federal (607)-748-8211
 N.Y., EAST SYRACUSE • Cramer/Syracuse (315)-437-6671
 N.Y., ROCHESTER • Cramer/Rochester (716)-275-0300
 N.Y., WOODBURY • Harvey/New York (516)-921-8700, (212)-895-9260
 OHIO, CINCINNATI • United Radio, Inc. (513)-761-4030
 OHIO, CLEVELAND • Pattison Supply (216)-441-3000
 OHIO, DAYTON • Kierulff Electronics (513)-278-9411
 PENN., PHILADELPHIA • Almo Electronics (215)-676-6000
 PENN., PITTSBURGH • RPC Electronics (412)-782-3770
 S.C., COLUMBIA • Dixie Radio Supply Co., Inc. (803)-253-5333
 TEXAS, DALLAS • Adleta Electronics Co. (214)-741-3151
 TEXAS, FORT WORTH • Adleta Electronics Co. (817)-336-7446
 TEXAS, GARLAND • Kierulff Electronics, Inc. (214)-271-2471
 TEXAS, HOUSTON • Harrison Equipment Co., Inc. (713)-224-9131
 UTAH, SALT LAKE CITY • Cramer/Utah (801)-487-3681
 VA., RICHMOND • Meridian Electronics, Inc., a Sterling Electronics Company (703)-353-6648
 WASH., SEATTLE • Kierulff Electronics, Inc. (206)-763-1550
 CANADA, ONT., SCARBOROUGH • Lake Engineering Co., Ltd. (416)-751-5980
 ALL OVERSEAS INQUIRIES:
 General Motors Overseas Operations
 Power and Industrial Products Dept.
 767 Fifth Avenue, New York, N.Y.
 10022. Phone: (212)-486-3723
 Kokomoans' Regional Headquarters.
 Union, New Jersey 07083, Box 1018, Chestnut Station, (201) 687-3770.
 El Segundo, Calif. 90245, 354 Coral Circle, (213)-640-0443.
 Kokomo, Ind. 46901, 700 E. Firmin, (317) 459-2175 (Home Office)



Optical isolators provide diverse functions in signal-detector circuit

Optical isolators provide a simple way to detect ultrasonic frequencies. And the isolators can also be used for other circuit functions.

A bandpass filter (Fig. 1) extracts the desired range of frequencies from a wideband input signal. The LM318H op amp delivers an output signal like that shown in Fig. 2a. This signal is then full-wave rectified by the light-emitting diodes in the optical isolators. Since the op amp delivers a bipolar signal, the LEDs will be successively turned on with increasing intensity up to a predetermined maximum. Therefore the phototransistors, too, are successively driven harder and harder into conduction. This in turn causes the 0.1- μ F capacitor to charge up to the trigger level of the voltage comparator (Fig. 2b). Once the voltage comparator triggers, the NAND gate (or other TTL logic) is enabled, and an indicator can be activated.

When there is no input signal in the filter passband, the emitter-follower phototransistor pair presents a low output impedance and the 0.1- μ F capacitor discharges very rapidly.

Compared with conventional detectors, this circuit eliminates the two 0.7-V diode drops that

would be present in each branch of a full-wave rectifier. Also, it avoids the need for special high-frequency transformers.

Irving Krell, Amtec Engineering Corp., 351F W. Commonwealth Ave., Fullerton, Calif. 92633.

CHECK NO. 311

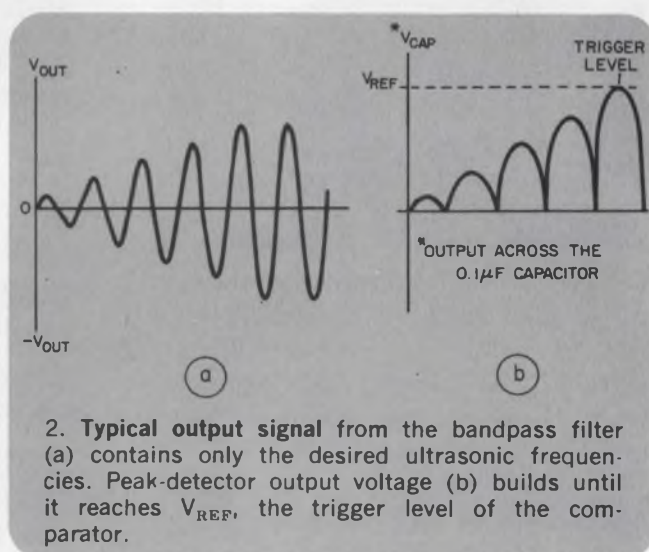

2. Typical output signal from the bandpass filter (a) contains only the desired ultrasonic frequencies. Peak-detector output voltage (b) builds until it reaches V_{REF} , the trigger level of the comparator.

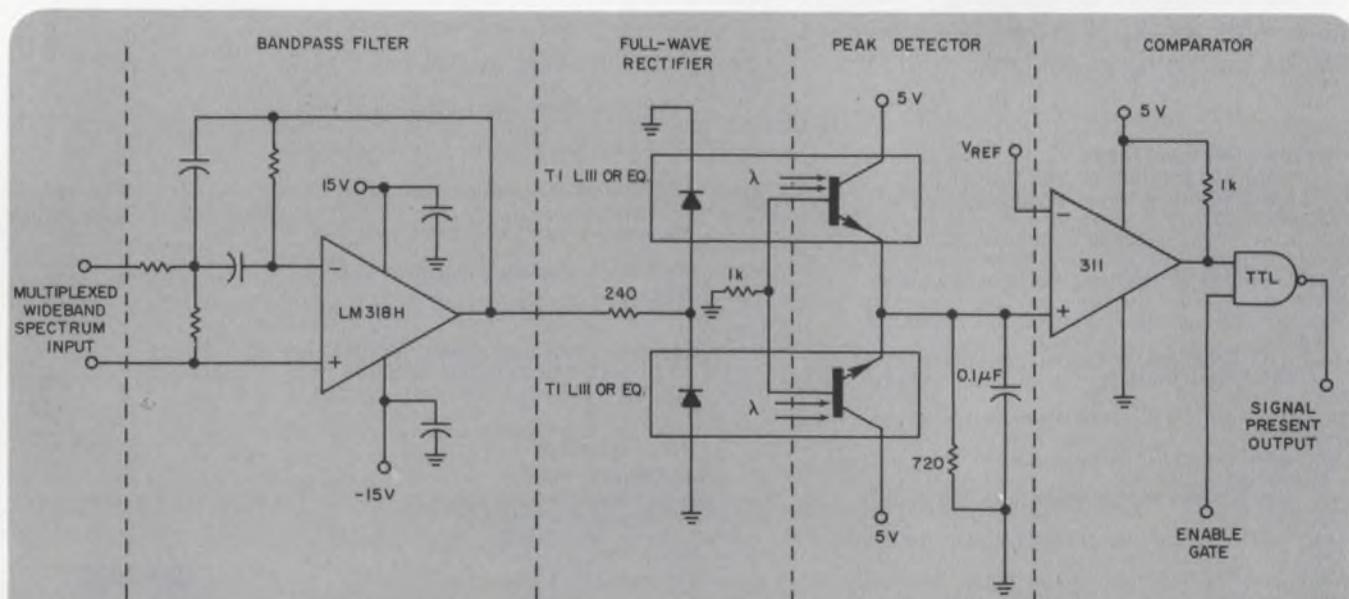

1. Ultrasonic detector with optical isolators avoids need for a transformer and bridge rectifier.

If you need **cool,** accurate, **reliable** DPMs ... **Buy Triplet**

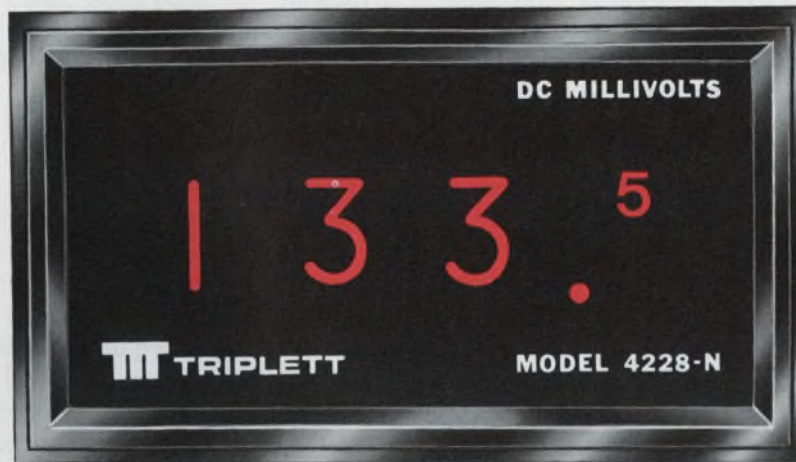

Model **4228-N**

actual size

\$140

1. $2\frac{3}{4}$ digits — Provides double the accuracy (0.25% of reading $\pm \frac{1}{2}$ digit) and double the resolution at lower cost.
2. Instantaneous Response — 16-millisecond display rate with 60 times per second sampling rate.
3. Fool-proof Numeral display blurs beyond over-range and with negative polarity.

Designed for OEM applications as well as R&D, production, quality control, maintenance and education use, Triplet's line of digital panel meters combine compactness, convenience and capability with characteristic Triplet accuracy and quality.

To 2 Watts power consumption (for reduced heat and increased reliability) and positive over-range and reverse polarity indications, Triplet's Model 4228-N adds a unique (patent pending) $2\frac{3}{4}$ -digit display that effectively doubles the accuracy and resolution of $2\frac{1}{2}$ -digit instruments . . . at the cost of $2\frac{1}{2}$ -digits. Accuracy is $\pm 0.25\%$ of reading ± 1 digit.

Model
4235-F \$240

1. $3\frac{1}{2}$ digits with auto-polarity.
2. Low Power Drain — provides low operating temperature and long-lived reliability.
3. Single-plane, Seven-bar Readout — for accurate, wide-angle readability.

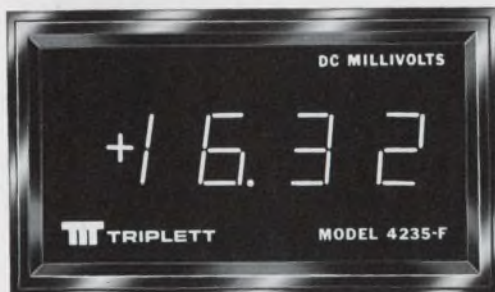

The Model **4228-N** is a real value at **\$140**, so call your local Triplet Sales/Service/Modification Center or Triplet sales representative right now. Either will also be pleased to demonstrate two companion products: Triplet's Model **4225-N** at **\$125** which merely omits the neon lamp "1" (thus reading to 995) and offers $\pm 0.50\% \pm 1$ digit accuracy; and the Model **4220-N** at **\$110** — a 2-digit instrument (reading to 99) with $\pm 1\% \pm 1$ digit accuracy.

Mounted in the same size case and boasting the same low power consumption and positive over-range indication, Triplet's $3\frac{1}{2}$ -digit Model 4235-F adds auto-polarity

(with polarity indication) display hold capability, high input resistance (from 10 to 1,000 megohms depending on range) and a $3\frac{1}{2}$ -digit single-plane seven-bar fluorescent display. For many users, the wide-angle viewing capability — enhanced by a green, circularly-polarized viewing window that eliminates confusing internal reflections — will make the 4235-F the obvious choice.

Boasting a voltage accuracy of $\pm 0.10\%$ (current $\pm 0.15\%$) of reading ± 1 digit, Triplet's Model **4235-F** sells for **\$240**. Its companion, the 3-digit Model **4230-F** is **\$220**. More information, or a free demonstration of both models, is available from your Triplet Sales/Service/Modification Center or your Triplet sales representative. Triplet Corporation, Bluffton, Ohio 45817.

TRIPLET

Manufacturers of the World's most complete line of V-O-Ms.

Use a 723 as a switching regulator and get half an amp from a plastic TO-5 transistor

Convert batteries, op-amp supplies or MOS supplies into +5 V to drive TTL or DTL circuitry. By using a μ A723 IC regulator and some other components, you can build a switching regulator that is immune to overloads and short-circuits, free of starting overshoot and undervoltage burnout, and has an efficiency of more than 70%.

The circuit shown is designed for a nominal load current of 0.5 A, but it can deliver from 150 mA to a 1 A maximum—at which point it current-limits. Input voltages can range from 9.5 to 40 V.

The output current is limited by Q_2 , which senses the voltage across R_7 . The hysteresis provided by positive feedback at the emitter of Q_2 keeps Q_1 switching under overload or short-circuit conditions. Because it continues to switch at moderate rates and current levels, Q_1 rides through load faults and startup transients. The current limit also prevents startup output overshoot.

The current-limit transistor built into the μ A723 controls the drive to Q_1 . This drive, set by R_1 , varies with the regulator output load to maximize operating efficiency.

Resistor R_7 also provides a main control-loop signal that is proportional to the current ramp in L_1 . Thus operating frequency and peak transistor currents are almost unaffected by any load capacitance in parallel with C_3 .

Diode CR_2 in the reference-voltage feedback path fixes the amplitude of the control-loop hysteresis voltage and makes it independent of

the input voltage. The combination of this fixed hysteresis with the inductor current feedback through C_2 stabilizes the operating frequency. As a result, the frequency changes by less than 2 to 1, while the input voltage varies by more than 4 to 1.

At any given input voltage, the operating frequency is an inverse function of the inductance of L_1 . The inductor may be modified to vary the operating frequency if sufficient current-carrying capacity is provided. The unit described here operates between 4 and 8 kHz. The inductor begins to saturate above 500-mA output current; therefore the frequency will increase for heavy loading. Saturation is gradual, so the current-limit circuit retains control. Winding the inductor with fewer turns of larger-gauge wire will result in better high-current performance, but at the expense of higher operating frequency and reduced efficiency at lower currents.

The resistor values shown provide a nominal output of 5 V. Resistor tolerances and individual differences in μ A723 ICs can cause an unacceptable regulated voltage. The optional resistor, R_9 , can be connected to raise or lower the output voltage, as required. The value given for R_9 should, when properly connected, bring the regulator into the voltage range required for TTL. By making R_9 a "select-at-test" component, you can trim the regulator output to a tighter tolerance.

A. Paul Brokaw, Group Leader for Advanced Development, Nova Devices, Inc., 829 Woburn St., Wilmington, Mass. 01887. CHECK NO. 312

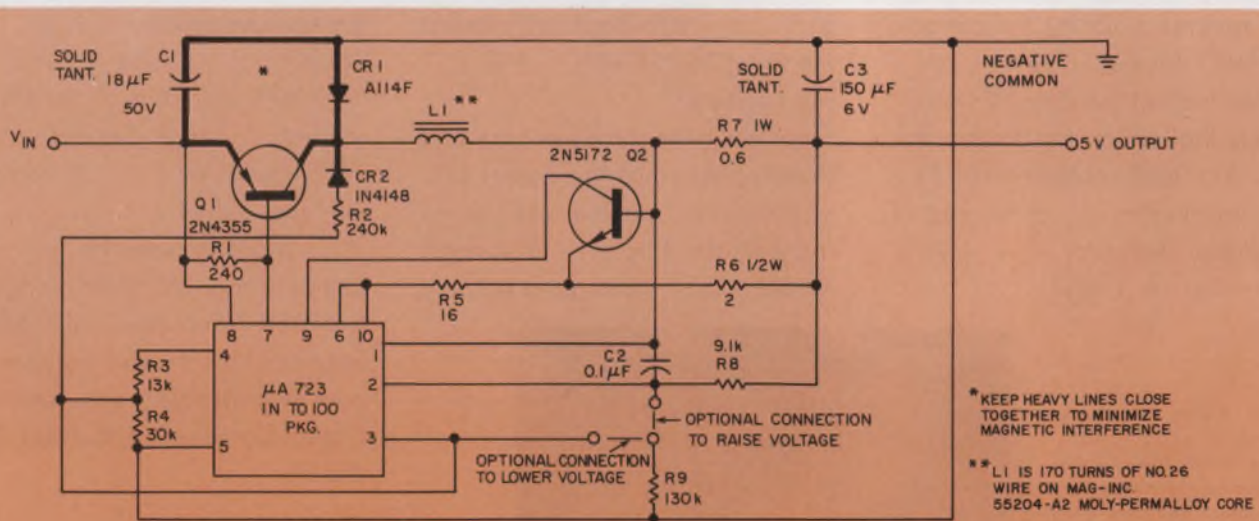

Switched regulator with current limiting can deliver half an amp using a low-cost plastic-packaged out-

put transistor. Output voltage can be adjusted by hand selecting resistor R_9 during final testing.

* KEEP HEAVY LINES CLOSE TOGETHER TO MINIMIZE MAGNETIC INTERFERENCE

** L_1 IS 170 TURNS OF NO.26 WIRE ON MAG-INC. 55204-A2 MOLY-PERMALLOY CORE

More ways to go with DVM's & DMM's from DigiTec



All DigiTec instruments are available for rental or lease through Rental Electronics, Inc.

The DigiTec line of digital voltmeters offers a selection that will enable you to choose the perfect instrument for your needs. Each unit provides its own special features. You select the instrument that has the functions you require, and you'll pay for only the useful features you want. For digital voltmeters with guarded inputs, isolated BCD outputs, LED displays and basic accuracy of .02%, you can

select from:

the model 266, 4 range DVM at \$525.

the model 267, 4 range auto-ranging DVM at \$625.

the model 268, 6 range DVM with $1\mu\text{V}$ resolution at \$795.

the model 269, 23 range DMM at \$695.

Portability is available with either:
the model 261C, a 10 range VOM at \$289.

the model 262C, a 25 range DMM at \$345.

Both offer .05% basic accuracy, LED displays and integral batteries as standard equipment.

All DigiTec instrumentation is backed by a one year warranty and a network of Field Service Centers in the U.S. and Canada. Contact your nearest DigiTec representative or call, United Systems Corp.

United Systems Corporation
918 Woodley Road, Dayton, Ohio 45403
Ph. (513) 254-6251 Twx: (810) 459-1728
a subsidiary of

Monsanto

DigiTec

Low-temperature-coefficient current source becomes ultra-compliant with two resistors

New low-voltage, low-temperature-coefficient reference diodes¹ are making it possible to perform circuit functions that previously would have been awkward or impossible to do. Among these are high voltage-compliance, low-temperature-coefficient current sources that can take advantage of the low reference voltage to improve circuit efficiency.

Shown in Fig. 1 is a basic high-compliance current regulator, arranged to source current and operate from a single supply. The current I_o supplied by transistor Q_1 is V_{ref} divided by R_1 , where V_{ref} is the 1.2-V breakdown voltage of CR_1 .

The availability of the low reference voltage allows the voltage compliance of Q_1 to be maximized through an increase in the portion of the supply voltage made available to the load. In this case the compliance is

$$V_{comp} = V_{cc} - (1.2 \text{ V} + V_{CE(sat)} Q_1).$$

If a low-saturation voltage transistor is used for Q_1 , the loss of voltage will be negligible in comparison with the 1.2 V dropped across R_1 .

An ultra-high-compliance version of this circuit can be built if the 1.2 V reference is reduced

to an even lower potential to decrease further the drop across R_1 . This is shown in Fig. 2. Resistors R_3 and R_4 reduce the reference voltage applied to the op amp, A_1 , to 120 mV. This is possible with the 101A op amp because it continues to operate linearly as its positive common-mode range extends to the supply potential. This allows R_1 to drop only 120 mV for regulation of I_o . In both circuits the level-shift zener, CR_2 , is used to ensure turn-off of Q_1 , since the output swing of A_1 does not reach a sufficiently positive voltage to drive Q_1 directly.

This technique reduces the loss of compliance to a point where the regulation drop and the $V_{CE(sat)}$ of Q_1 are comparable. A side benefit of the low reference voltage is the decrease in power dissipated by R_1 . This enhances the resistor's stability and makes selection easier.

Reference

1. Dobkin, R. C., "1.2-Volt Reference," National Semiconductor, AN-56, Dec. 1971.

Walter Jung, 1946 Pleasantville Rd., Forest Hill, Md. 21050.

CHECK NO. 313

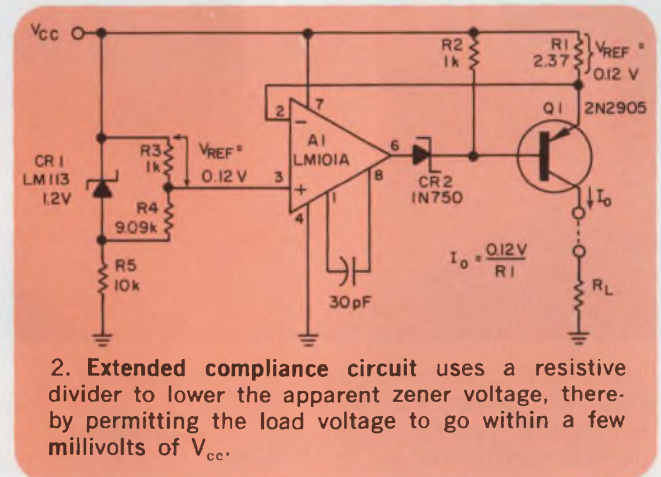
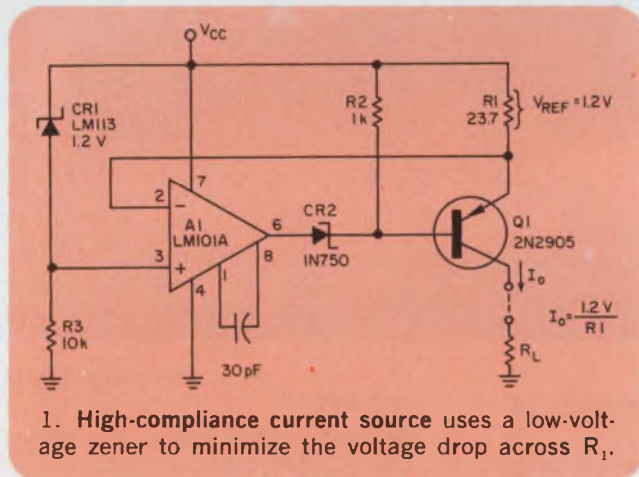

IFD Winner of February 1, 1973

S. Hari, Special Equipment Div., LRDE, PB 5108, Bangalore 1, India. His idea "Minor changes convert an astable multivibrator into a sweep generator" has been voted the Most Valuable of Issue Award.

Vote for the Best Idea in this issue by checking the number for your selection on the Information Retrieval Card at the back of this issue.

SEND US YOUR IDEAS FOR DESIGN. You may win a grand total of \$1050 (cash)! Here's how. Submit your IFD describing a new or important circuit or design technique, the clever use of a new component or test equipment, packaging tips, cost-saving ideas to our Ideas for Design editor. Ideas can only be considered for publication if they are submitted exclusively to ELECTRONIC DESIGN. You will receive \$20 for each published idea, \$30 more if it is voted best of issue by our readers. The best-of-issue winners become eligible for the Idea of the Year award of \$1000.

ELECTRONIC DESIGN cannot assume responsibility for circuits shown nor represent freedom from patent infringement.



**If you need Custom-Built Timing Controls,
it will pay you to let us build them.**

That's because we design and build them better — faster at less cost. It is our 28 years of experience that makes it possible . . . years in which we have filled 5,124 orders for customer timing controls.

In 28 years we have accumulated the knowledge and facilities for design, develop-

ment, purchasing, assembling and testing to provide the right answers to your specific requirements.

Why not put our 28 years of know-how to work for you now. Tell us what you need. Write or call 201 — 887-2200 for same day service.



Industrial Timer Corp., U.S. Hwy 287, Parsippany, N.J. 07054 201/887-2200

INFORMATION RETRIEVAL NUMBER 47



1,500,000

KNOB TO CHOOSE FROM...

and they're "Warranted for Life"

Kurz-Kasch has over 1½ million low cost, high quality knobs in inventory, ready to ship to you. (You save . . . no tooling cost on stock knobs, specials 4 to 6 weeks delivery.) Your local distributor's stock is available at factory prices. Select instrument and control knobs from 24 families with 367 basic sizes and shapes in general purpose phenolics, melamines and ureas. All Kurz-Kasch knobs are warranted for the life of the product on which they're used. Send now for free 20 page catalog. (Also found in THOMAS REGISTER "THOMCAT.")



Kurz-Kasch, Inc.

2876 Culver Avenue
Dayton, Ohio 45429
(513) 296-0330

INFORMATION RETRIEVAL NUMBER 48

ELECTRONIC DESIGN 12, June 7, 1973

The finest



**lighted
pushbutton**

**switches and
indicators are**



**also the easiest
to install**



Snap!

- Snap-in instant panel mounting
- Choice of sizes, colors, and lens styles
- Flush or barrier configurations
- Re-lampable from front of panel.

*Lighten your decisions
contact . . .*

MARCO-OAK

Subsidiary of OAK Industries Inc.

P.O. Box 4011
207 S. Helena Street, Anaheim, Calif. 92803
Tel. (714) 535-6037 • TWX — 910-591-1185

INFORMATION RETRIEVAL NUMBER 49

No-contact dc transformer measures high bus currents

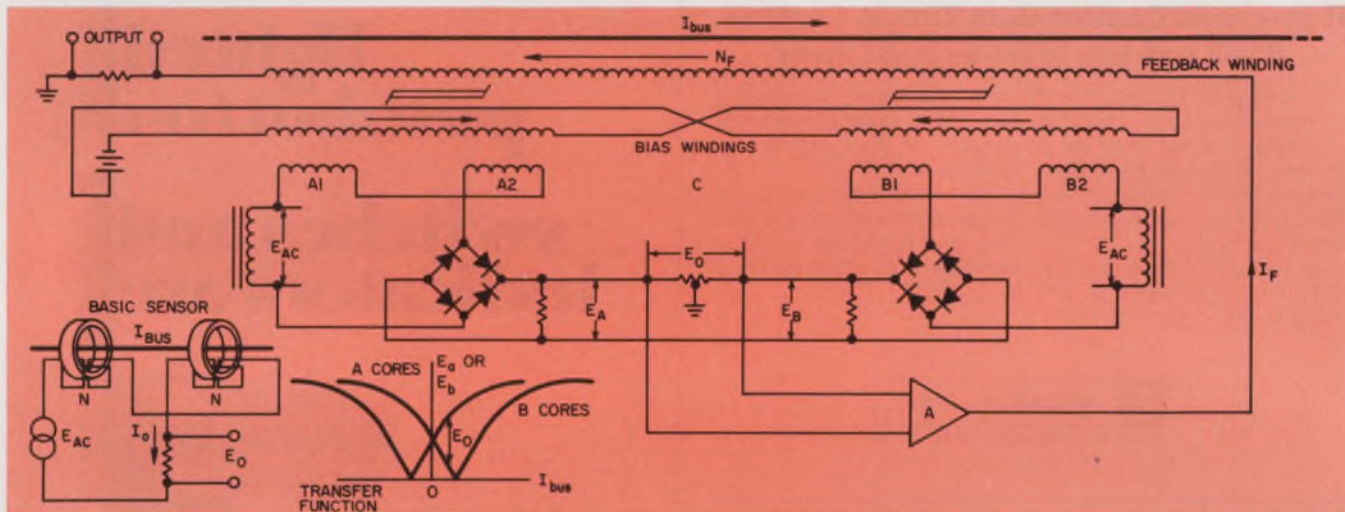

Here's a tough problem: Measure a bipolar dc current of up to 10,000 A without breaking or touching the line and without loading. And do this to within a linearity of 0.015% and with a circuit that's not affected by temperature changes, line-voltage variations, magnetic fields or aging.

The Transrex Div. of Gulton Industries solves the problem with its Transrector—a dc-current transformer that uses bias and feedback windings to achieve the desired performance.

As shown in the figure, the Transrector has seven windings. They are as follows:

- Two pairs of toroidal, or main, windings that measure the magnitude and direction of the dc current by sensing the magnetic field produced by the monitored current.
- A pair of bias windings that allow the output of the main windings to be a balanced, differential voltage. This cancels temperature drift, noise, line-voltage changes and other undesirable variations.
- A feedback winding that reduces the operating flux levels and thereby makes it possible to monitor large currents within the linear core region.

The two toroidal windings of each main pair are connected in opposition and excited by an ac source (E_{ac}). When dc current flows in the bus, one core becomes magnetically saturated, while the other remains in the linear region.

These magnetic states alternate with each half-cycle of the supply frequency.

The current in the toroidal windings is given by $I_o = I_{bus}/N$, where N is the number of turns on each toroid. A second winding, called the bias, is added to each core.

Bias current flows in a direction that enhances the magnetic effect in one pair of cores and reduces the effect in the other. The output signal, E_o , is taken as the difference between the voltages of each core pair, and its polarity thus depends on the direction of the bus current.

With this configuration, the transfer curve, E_o vs I_{bus} , flattens at high current levels. To extend the linear region, a third winding, called the feedback winding, is added to the cores.

Voltage E_o is now applied to a high-gain amplifier, whose output is connected to the feedback winding. As a result, E_o is driven to null.

Any undesirable variations in the difference voltage produce a large feedback current, which unbalances the core pairs in a direction that minimizes the variations and restores E_o to null. Consequently the feedback current is proportional to the dc-bus current.

The technique achieves high isolation, since there is only magnetic coupling between the dc bus and the measuring head, not direct contact. In addition tight coupling between the bus and head produces fast response: The 3-dB bandwidth is 1000 Hz. ■■

WORLD'S FIRST PRODUCTION CCD



Our 500-Element Linear Image Sensor: World's First Production CCD.

New CCD101. High sensitivity, wide dynamic range, self-scanning device. Available now for prototyping at \$1200.

The CCD101 Linear Image Sensor uses charge-coupled technology and a buried-channel structure to create a rugged, monolithic, self-scanned, 500-element sensor designed for high sensitivity conversion of images to analog signals. For slow-scan TV, facsimile, and other high-resolution linear imaging applications.

The impact of CCD on imaging is analogous to that of the transistor on vacuum tubes. It has been called by one high level government scientist "the most important breakthrough in semiconductors since the development of MOS"



CCD101 Linear Image Sensor

The array is a 500-element photo-sensing chip, 60 x 635 mils. It includes, in addition, charge transfer gates, two 250-element CCD analog shift registers, a 2-element output register, and a preamplifier. The device allows sequential reading of the 500 imaging elements with a typical dynamic range of 1000:1 at 1 MHz. Sensitivity is typically 15×10^{-6} footcandle-seconds. Operating voltages are under 20V. On-chip preamplifier allows a low-impedance interface. The 24-lead dual in-line ceramic package— $1\frac{1}{4}$ " long x $\frac{1}{2}$ " wide x $\frac{5}{16}$ " high—has a sealed anti-reflectance glass window and non-reflective interior.

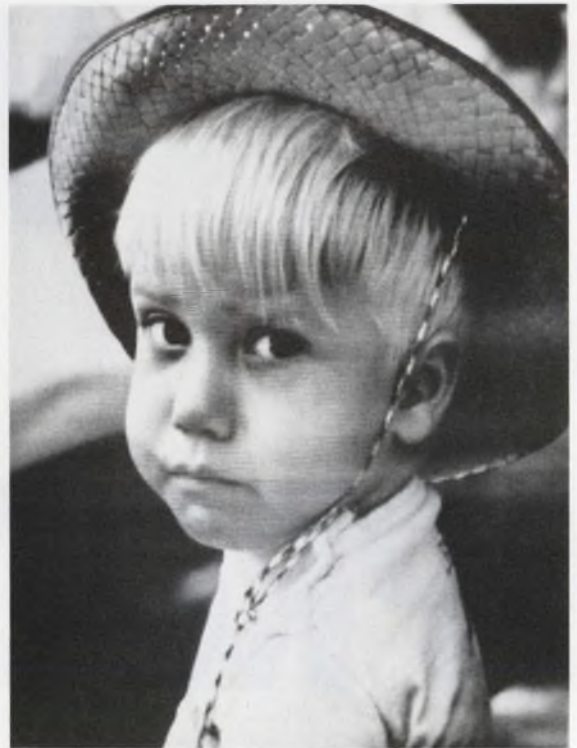

Normal incandescent room lighting. (No filtration. Peak incident illumination around 30 footcandles.)



1/100 normal room lighting.

99.999% Transfer Efficiency

Key to CCD101 high sensitivity imaging is the buried channel structure which reduces charge-transfer loss, thus permitting greater image element density. The result is demonstrated above.

The 4 photos illustrate the device's capacity for generating a clear video picture of a single frame at



1/10 normal room lighting.



1/1000 normal room lighting.

widely varying levels of illumination. The photos show the face of a CRT displaying the output of a CCD101 sensor clocked at 1 MHz scanning a black-and-white photo on a rotating drum. Increasingly dense filters were inserted between the sensor and the scanned photo. The intensity dropped, but the image remained usable.

CCD Imaging Advantages

CCD technology provides the first high-performance method for solid state imaging. The CCD101 is the first CCD product, and thus the first to clearly demonstrate its high performance advantages, high reliability and dimensional accuracy, with lower noise video, low-voltage operation and self-scanning that eliminates much external control circuitry. All made possible by our CCD buried N-channel technology.

CCD advantages over other types of imaging devices are manifest:

As Compared To Vacuum Tube Imaging Devices	As Compared To Non-CCD Solid State Imaging Systems or Devices
<ul style="list-style-type: none"> • Small size • Long Life • Lower power • Lower operating voltages (none greater than 20V) • Solid state ruggedness • Inherent metric accuracy • Low impedance interface • Greater dynamic range 	<ul style="list-style-type: none"> • Low clock interference • No pattern noise • Low, uniform dark current • Better detectivity • On-chip preamp • Lower power

For more information.

Call our Hot Line number — (415) 962-3333 — for a complete information package: data sheets, application notes, and a technical paper on the physics and applications of charge-coupled devices.

**MADE IN
FAIRCHILD**

new products

Monolithic s/d converter boasts high reliability



Analog Devices, Route 1 Industrial Park, Norwood, Mass. 02062. (617) 329-4700. SDC1602: \$680; SDC1064: \$480.

Monolithic analog switches, linear ICs, MSI logic and thin-film resistor networks have been combined by Analog Devices to produce the SDC series—a new family of reliable synchro-to-digital and digital-to-synchro converters. The company has calculated a 200,000-hour MTBF, at 25 C, for the 1602—the 400-Hz, 14-bit member of the tracking s/d family.

Eight basic models are offered, with price depending on the choice of resolution, the temperature range and the frequency. For example, the 14-bit unit—operating over the standard 0 to 70 C range—costs \$680. A 10-bit version, the 1604, is identical to the 1602, except for resolution. The 1604 sells for \$480.

Either unit can be ordered at additional cost for 60-Hz operation, or with an extended temperature range of -55 to +125 C.

The 14-bit 1602 has a listed ac-

curacy of ± 4 minutes of arc, while the 10-bit 1604 is accurate to ± 30 minutes. And the stated accuracy applies not only over the temperature range but also for variations of $\pm 10\%$ in signal and reference amplitude, for variations of $\pm 10\%$ in reference frequency, for 10% harmonic distortion in signal and reference, and for $\pm 5\%$ power-supply variations. The tracking rate of both models is specified as 1440 deg/sec.

Although they are a new product line for Analog Devices, tracking s/d converters in modular form are offered by at least a dozen manufacturers, including North Atlantic Industries and ILC Data Device Corp. In fact, the Analog's SDC appears to be pin-for-pin compatible with DDC's ESDC series. However, Analog Devices appears to be the first to use monolithic, rather than discrete, circuitry in its converters.

DDC's 14-bit version, the ESDC H3, tracks at 360 deg/sec, has 4-minute accuracy and sells for \$695.

North Atlantic's Series 780 is

another competing module that has 14-bit resolution, ± 3 -minute accuracy and a tracking speed of 4000 deg/sec. It sells for about \$650.

Other features and specs of Analog's SDC series include an acceleration of 180 deg/s² for an error of 1 LSB, a 179-degree step response of 300 ms for a 1-LSB error and a power dissipation of 2.5 W, maximum. The outputs are TTL/DTL-compatible, with a fanout of four TTL loads. The seven-ounce 1602 measures 3-1/8 × 2-5/8 × 0.8-in.

For Analog Devices CHECK NO. 250

For ILC Data Device CHECK NO. 251

For North Atlantic

Industries

CHECK NO. 252

Temperature controller is compact and accurate

Heinemann Electric, 132 Magnetic Dr., Trenton, N.J. 08602. (609) 882-4800. \$37.50 (50 up).

The model-TB temperature controller is a 4.4-in.² board with built-in power supply and triac output, matched precision setpoint potentiometer, dial-plate, and encapsulated RTD sensor. The unit operates from any 120/240 V, 60-Hz power source. Controlling range is from room ambient temperature to 650 F using the 100 Ω nickel RTD sensor—but can be extended to 1000 F by substituting an optional platinum sensor. Sensors can be remote-located up to 200 ft from the control module. With "burst-fire" proportioning the unit can remain stable to within 0.1 F for 24 h at ambients up to 130 F. Accuracy is unaffected by voltage variations from +10% to -15%. Setpoint resolution is 0.5% of full-scale; setpoint control is a single-turn, 280 Ω , 3-W pot supplied with the controller.

CHECK NO. 253

AVX Sky Caps

from the world's
largest manufacturer of
ceramic capacitors



Sky Cap® is a dip-coated version of the best in multilayers. That's because nobody makes more or better multilayers than AVX. Production of hundreds of millions of Ceralam® parts is proof of AVX's capability and competence.

Sky Caps come in six basic sizes and a new rectangular configuration with ¼-inch lead spacing. Capacities range between 2.2 pF and 4.7 MF. Standard tolerances. Temperature coefficients include NPO, X7R, and Z5U. Working voltages of 50, 100 and 200 volts — with 25 to 500 volt ratings available on special order. In-line quality control assures the performance you require and expect.

Prices?

Very competitive in production quantities.

Availability?

Nationally from authorized distributors in 50 locations.

For complete information, request a copy of the AVX Short Form Catalog. Write, AVX Ceramics Corporation, P.O. Box 867, Myrtle Beach, S.C. 29577. Telephone: (803) 448-3191. TWX: (810) 661-2252.

Specify Sky Caps — you get quick delivery, top quality and a price you'll like.



THE CERAMIC CAPACITOR MANUFACTURER

Braintree, MA.

FREE



NEW INSULATOR CATALOG

Now you can order from a single source... a complete line of Film, Beryllium oxide (BeO) and Hard anodized aluminum insulators for semiconductors. Thermalloy also supplies custom insulators to meet specific design problems in a variety of materials and price ranges.



Write for
FREE
Catalog

Thermalloy

P. O. Box 34829
2021 W. Valley View
Dallas, Texas 75234
Phone: 214/243-4321
TWX: 910/860-5542

MODULES & SUBASSEMBLIES

Peak detectors have adjustable hold time

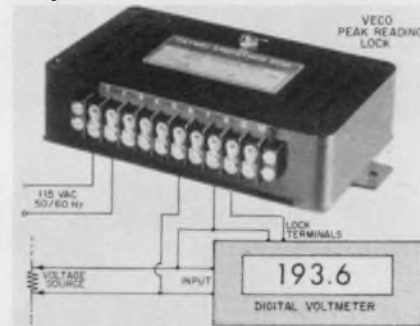

Victory Engineering, Victory Rd., Springfield, N.J. 07081. (201) 379-5900. From \$99.50; 2 to 3 wk.

The MDL2 series will hold a peak reading on a DVM or DPM for an adjustable time period after occurrence of the peak value. The series includes models MDL2-20MV-1, MDL2-100MV-1, MDL2-1V-1, MDL2-10V-1 and MDL2-100V-1, with ranges of 20 mV, 100 mV, 1 V, 10 V and 100 V dc, respectively. All models have hold times that are variable to 10 s or infinite, automatic or manual reset, max operating temperature of 50 C, and input impedance of 10 M Ω min. Dimensions are 4-1/4 w \times 7-1/4 l \times 1-3/4 h in.

CHECK NO. 254

Dc-to-dc power supplies fit on a 5-by-6 in. card

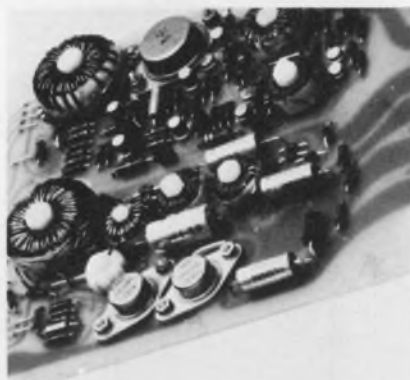

Mil Electronics, 176 Walker St., Lowell, Mass. 01854. (617) 453-4142. \$195 (10-24 pcs); stock to 2 wk.

Series "C" 15 W dc-to-dc power supplies are designed for 20-to-60 V inputs. One, two or three-output models are available to deliver from 5 to 500 V. All models feature short-circuit protection. Open 5-by-6 in. printed-circuit-board construction is used for easy repair.

CHECK NO. 255

Replace many interface modules by one package

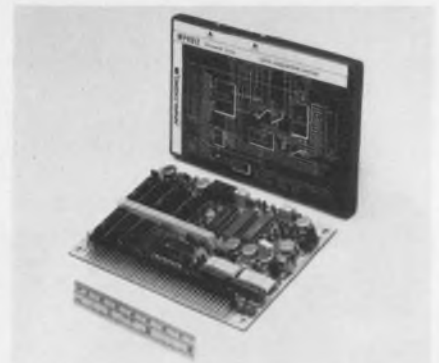

Analogic, Audubon Rd., Wakefield, Mass. 01880. (617) 246-0300. \$695; 4 to 6 wk.

The MP6912 12-bit a/d system provides all the scanning, signal-conditioning, a/d-conversion and program/control/timing circuitry needed for multichannel, high-speed operation. Maximum resolution/throughput combinations on the MP6912 are 100 kHz for 12-bits or 500 kHz for 4-bits. The module is 0.375 in. high, thus compatible with the 0.5 in. card spacing of most racks. Internal shielding from electromagnetic and electrostatic interference allows close proximity to high-energy noise sources. The MP6912 can operate in the "overlap" mode, permitting selection of a new channel while the analog value from the preceding sample is being held for conversion.

CHECK NO. 256

Digital lock uses a five-digit enabling code

Elesis Laboratory, P.O. Box 387, Chillicothe, Ohio 45601. (614) 773-1414. \$40 complete system (1-9); stock to 3 wk.

The series-L "Touch-Latch" system consists of an input keyboard and an epoxy encapsulated control module, interconnected by a 12-conductor cable of convenient length. A pin-plug termination at the module end permits the user to program a five-digit enabling code. Both a momentary output (high while the last code digit remains depressed) and a latched output are provided. The system operates from a +5-V-dc supply or from any supply between +6 and +30 V with the addition of an external resistor.

CHECK NO. 257

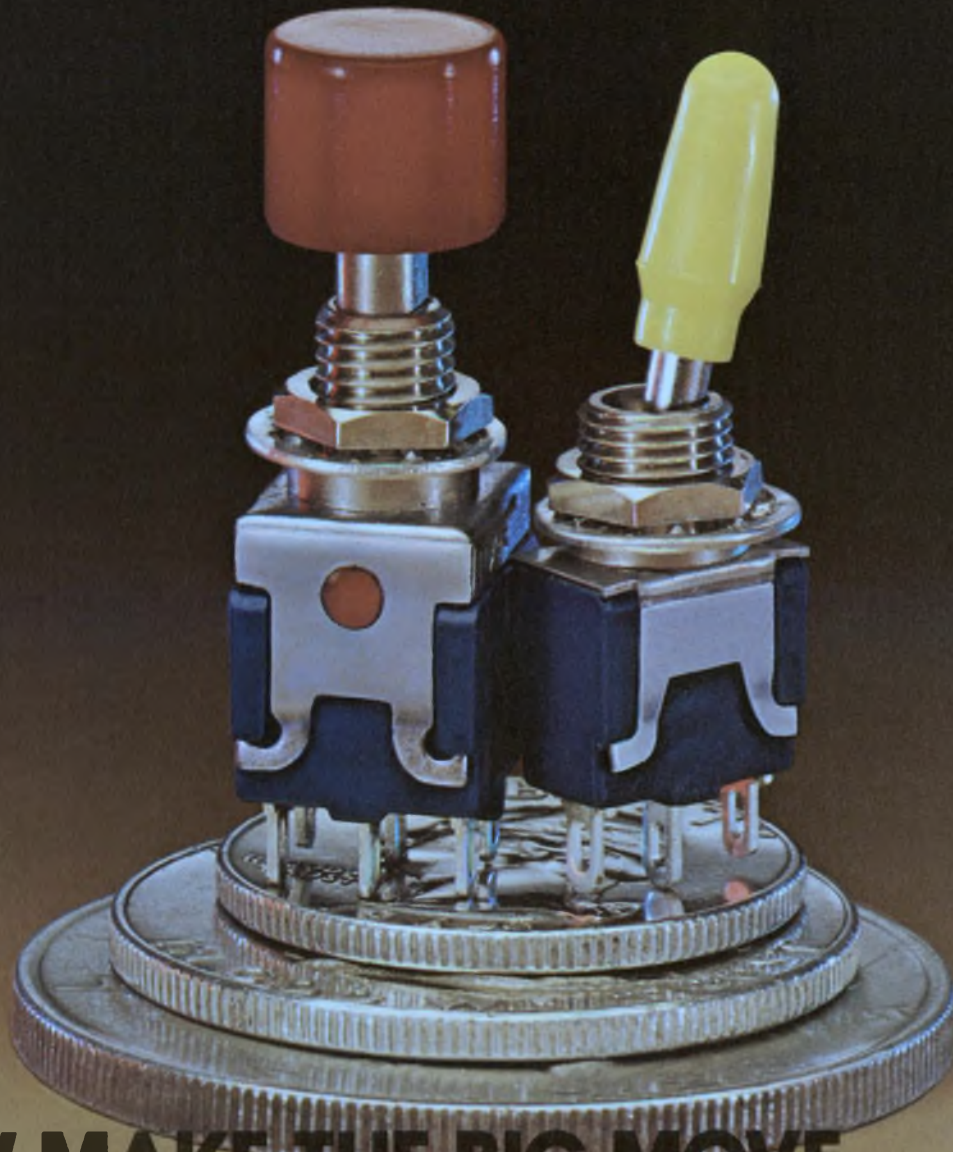

NOW MAKE THE BIG MOVE TO MINIATURIZATION WITH CUTLER-HAMMER.

As you miniaturize your products, rely on these space-saving new Cutler-Hammer ultra-miniature switches. They deliver additional quality, together with a full choice of style, color, and shape.

You get full current-carrying capacity at 115 V.A-c in toggles or pushbuttons. One or two poles in 5 different circuits.

Superior construction details include: a 1/4-inch bushing for con-

venient one-hole mounting, silver-alloy contacts with initial contact resistance of only 0.010 ohm maximum, a polyester base partially jacketed in steel for extra switch-mechanism protection, and either solder-lug or PC terminals.

Cutler-Hammer's remarkable application flexibility continues externally with a wide range of decorator caps, buttons, and bezels in many colors.

And all circuits are in stock for fast delivery.

To learn more about how this highly adaptable new line can add function and style to your products, check with your nearest Cutler-Hammer Sales Office, or Authorized Stocking Distributor.



Cutler-Hammer ultra-miniature switches are available in a variety of designs and colors. In both toggles and pushbuttons.

Switch
to No.1

More than just switches;
prompt availability,
field help, innovation,
quality assurance, too.

INFORMATION RETRIEVAL NUMBER 53



CUTLER-HAMMER
SPECIALTY PRODUCTS DIVISION, Milwaukee, Wis. 53201

SPST switch driver has only 10-ns delay

LRC Inc., 11 Hazelwood Rd., Hudson, N.H. 03051. (603) 883-8001. \$85 (1-9); stock to 20 days.

A single-pole, single-throw switch driver has less than 10-ns delay (total switching time). It is compatible with TTL logic. Model SD-1201, used with shunt and series switches, provides positive and negative outputs. Ten switches can be driven from each TTL gate. Supplied in a flatpack configuration, it meets MIL-STD-883 specifications and operates over a temperature range from -55 to +125 C.

CHECK NO. 258

Sinewave oscillators are resistively tunable

Frequency Devices, 25 Locust St., Haverhill, Mass. 01830. (617) 372-6930. \$56 (100 qty); stock to 2 wk.

Series 440 quadrature oscillators are tuned by two external resistors. The oscillators provide buffered low distortion (0.08%) quadrature outputs (90° ± 0.1°) with amplitude-ratio tracking to better than 100 ppm/°C, and output amplitudes externally adjustable from 2 V to 20 V pk-pk. They are externally tunable over a 1000:1 range with 2 equal resistors. Models 440, 442 and 444 cover a total range of 0.05 Hz to 20 kHz and the maximum frequencies are 50 Hz, 500 Hz and 20 kHz, respectively.

CHECK NO. 259

D/a converter resolves to 16-bits for only \$89



Datel, 1020 Turnpike St., Canton, Mass. 02021. (617) 828-6395. \$89 (unit qty).

Model DAC-169-16 is available in either a B or D version. The B unit will convert 16-bit straight or offset binary and the D model can handle a four-digit BCD code. Both models offer either a current or voltage output and are in a 2 × 2 × 0.375 in. case. Output settling time is 750 ns or 30 μs for the current or voltage outputs, respectively. Full-scale outputs for the binary version are 0 to +10, 0 to -10, or ±5 V at ±5 mA. The current output can be selected for 0 to +2 mA or ±1 mA. In the BCD version, the voltage output can be either 0 to 10 V or 0 to -10 V at 5 mA while the current output can be pin strapped for 0 to 1.25 mA full-scale. All digital inputs are TTL/DTL compatible, and offset and gain adjustments are provided to compensate for long-term drift. Linearity of either model is ±0.005% of full scale while the temperature linearity is ±0.0005%/°C over an operating temperature range of 0 to 70 C. Accuracy is adjustable to 0.005% of full scale, and the resolution is 150 μV (1 LSB) for the binary model and 1 mV (1 LSD) for the BCD version.

CHECK NO. 260

Card switch operates 25k times before cleaning

Hickok, 10514 Dupont Ave., Cleveland, Ohio 44108. (216) 541-8060. \$75 (unit qty); 30 days.

Model 50B offers 50 card-programmable contacts for economical system programming or personnel identification. The programming cards are 1-1/2 by 3-3/4 in. and are made from either Mylar or vinyl. Each card contains a 5-by-10-hole matrix on 0.25-in. centers. The switch can be programmed by punching holes in the card with a simple hand punch and will read cards 0.007 to 0.03 in. thick. Environmental operating specifications are -40 to +65 C for temperature and from 0 to 99% for humidity. The model 50B will perform more than 25,000 operations, when switching 115 V, before contact cleaning is necessary. Size of the model 50B is 1 × 2-1/8 × 3-1/2 in.

CHECK NO. 261

Precision voltage-ratio dividers meet MIL specs

Singer Instrumentation, 3211 S. La Cienega, Los Angeles, Calif. 90016. (213) 870-2761.

Series-CRT coaxial ratio transformers are precision ac voltage dividers that are only 2-1/2 in. diameter (for the military version) and 3-1/2 in. (for commercial versions). All units are certified to MIL specs for vibration, shock, salt spray, fungus and humidity. Terminal linearity is from 0.001%. Accuracy is grouped in two frequency ranges and depends upon model. The two ranges are 50 to 3000 Hz and 3 to 10 kHz.

CHECK NO. 262



ANALOGY

BEAT THE BAD GUYS WITH THE A-856 A/D HIGH SPEED CONVERTER. RESOLVES 1:65 536 WITH CONVERSION SPEED OF 8MS, THAT'S 125,000 SAMPLES PER SECOND! TEMPERATURE STABILITY OF ± 5 PPM/°C, LINEARITY ± 10 PPM.

intech INCORPORATED
(408) 244-0500
1220 COLEMAN, SANTA CLARA CA 95050

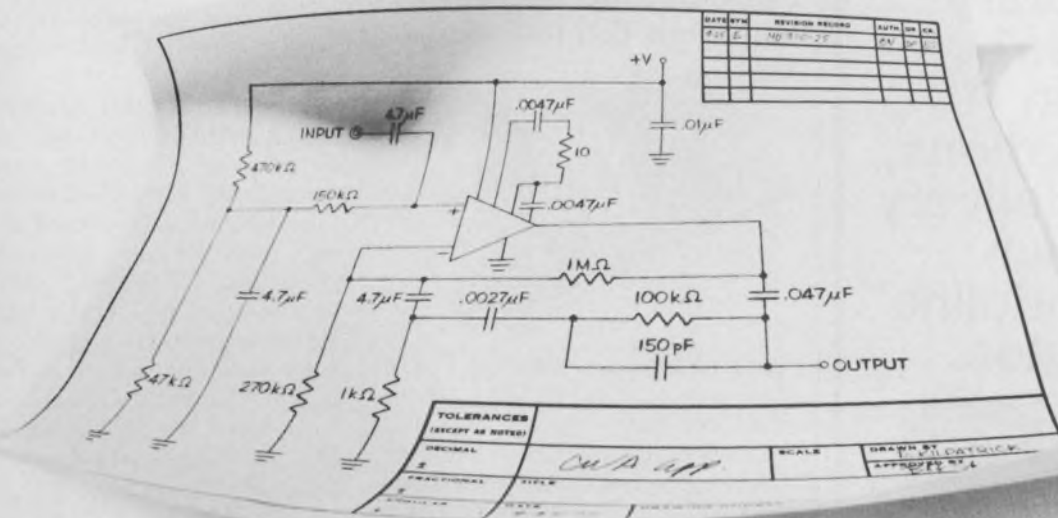

Designing a hybrid circuit shouldn't be all work and no play.

If you want to make sure the circuit you've designed really plays, you need to do more than see a schematic of it.

You need to see the real thing.

And that's what the new KEMET® Hybrid Circuit Chip Kit allows you to do.

Containing 280 tantalum and ceramic chip capacitors with high temperature capabilities, plus supporting technical literature, it's the industry's first kit covering the complete capacitance range used in hybrid circuits.

All of which gives you the freedom you need to build a prototype of the schematic you've been working on.

So fill out the coupon and order your Chip Kit today. Or, for more information, get in touch with us at Union Carbide, Components Department, Box 5928, Greenville, S.C. 29606. Phone (803) 963-7421.

All work and no play makes a dull career.

I want to play. Enclosed is \$99.00 in check or money order for your KEMET Hybrid Circuit Chip Capacitor Kit.

I do not wish to play right now. But please send me more information on your Chip Kit anyway.

Name _____

Title _____

Company _____

Street _____

City _____

State _____ Zip _____



COMPONENTS DEPARTMENT

Available through your KEMET distributor

In Europe: Union Carbide Europe, S.A., 5 Rue Pedro Meylan, Geneva 17, Switzerland

Need rotary switches? 2-million combinations, 72-hr. delivery from your Oak Moduline™ distributor.



Quick-and-easy ordering of Oak-quality rotary switches in lots of 1 to 99. The Moduline system lets you specify switch components by number (no drawings needed). Your order is shipped within 3 days. Contact these Moduline distributors:

DRW

MASSACHUSETTS, Watertown. (617) 923-1900*
NEW YORK, Farmingdale..... (516) 249-2660*

HALL-MARK

ALABAMA, Huntsville..... (205) 539-0691
FLORIDA, Orlando..... (305) 855-4020*
GEORGIA, Atlanta..... (404) 963-9728
ILLINOIS, Chicago..... (312) 437-8800
KANSAS, Kansas City..... (913) 888-4747
KANSAS, Wichita..... (316) 682-2073
MARYLAND, Baltimore..... (301) 265-8500
MINNESOTA, Minneapolis... (612) 925-2944
MISSOURI, St. Louis..... (314) 521-3800
NORTH CAROLINA, Raleigh... (919) 832-4465
NEW YORK, New York..... (516) 293-7500
OHIO, Dayton..... (513) 278-6963
OKLAHOMA, Okla. City.... Enterprise 50094
OKLAHOMA, Tulsa..... (918) 835-8458
PENNSYLVANIA, Philadelphia. (215) 355-7300
TEXAS, Austin..... (512) 454-4839
TEXAS, Dallas..... (214) 231-6111
TEXAS, Houston..... (713) 781-6100
WISCONSIN, Milwaukee..... (414) 476-1270

INDUSTRIAL COMPONENTS

MINNESOTA, Minneapolis... (612) 831-2666*

SOLID STATE

TEXAS, Dallas..... (214) 352-2601*
TEXAS, Houston..... (713) 785-5205

WEATHERFORD

CALIFORNIA, Glendale..... (213) 849-3451*
CALIFORNIA, Palo Alto..... (415) 493-5373

*Assembly Locations

OKA Industries Inc.
Crystal Lake, Illinois 60014

INFORMATION RETRIEVAL NUMBER 56

MODULES & SUBASSEMBLIES

Pulse-to-tone encoder is less than 0.6 in.³



Alpha Electronic Services, 8431 Monroe Ave., Stanton, Calif. 90680. (714) 821-4400.

The AE-50 produces a burst of tone on any frequency between 20 and 3000 Hz. The burst or pulse duration can be varied from 100 ms to 15 s. Or the circuit can be strapped for continuous encoding. The size is 1-1/4 × 15/16 × 1/2 in. The unit works over a temperature range of -40 to +100 C; current drain is 4 mA at 12-V dc. Frequency stability is ±0.5% over the temperature range. The output level is adjustable to greater than 7 V pk-pk into a high impedance load.

CHECK NO. 263

Pressure sensor detects decay of 0.1 psi/min



Bourns, 1200 Columbia Ave., Riverside, Calif. 92507. (714) 684-1700.

Model 811 rapid-pressure-loss detector provides a calibrated output signal proportional to rate of change of pressure as well as a calibrated output proportional to the absolute pressure of the atmosphere within a chamber. The transducer detects pressure-decay rates of 0.1 psi/min., or greater. Signal conditioning for pressure-analog and rate-analog signals is provided within the 811 by a high density circuit. Also, a decision circuit within the instrument provides discrete relay closures when a pre-selected rate trigger level is reached.

CHECK NO. 264

Linearity of 0.00015% featured in 16-bit DAC

Datel, 1020 Turnpike St., Canton, Mass. 02021. (617) 828-6395. \$495; stock.

The DAC-HR16B d/a converter has a resolution of one part in 65,000, a linearity error of ±0.00015% and is said to have the lowest temperature coefficient of any commercially available d/a converter—1.5 ppm/°C. The unit is in a compact 2 × 4 × 0.4-in. plastic encapsulated module, yet is fully repairable. With a full-scale output of 1 V, DAC-HR16B can resolve down to 15 μV—a 96.3-dB change. The output settling time is typically 200 ns to within 0.025% of full-scale, and a maximum of 1 μs to 0.00015% of full scale. DAC-HR16B may be used for either unipolar or bipolar applications.

CHECK NO. 265

Digital tachometer and counter has LED display



Airpax Electronics, 6801 W. Sunrise Blvd., Fort Lauderdale, Fla. 33313. (305) 587-1100. \$275 (4-digit version); 8 to 12 wk.

The series-77 digital tachometers and counters are in 5-3/16 × 3-3/8 × 5-9/16 in. cases with unblinking LED displays. They can be used for "event-per-unit-time" (tachometer) or "accumulation" (counter) applications. The systems operate from signals produced by magnetic, analog or digital transducers and signal sources such as proximity sensors, switches, photo cells, flow meters, etc. Other specifications include: input sensitivity, 50 mV rms with adjustable threshold for noise; input frequency to 250 kHz; contact closure or standard TTL; 3-to-6 digit LED display (0.25-in. char height).

CHECK NO. 266

INFORMATION RETRIEVAL NUMBER 57 ►

SPECTRA-BOTH



Side-Arm and Coaxial. We swing either way.

We're in two classes by ourselves. Our design capability makes us the only company that can deliver both side-arm and coaxial tubes.

If you need a tube that will go in a small package, we can provide a coaxial. If size is not a problem, we can provide a side-arm tube at considerable savings. Example: a 2.0mW, TEM₀₀, coaxial tube in quantities is \$90.00; a 2.0mW, TEM₀₀, side-arm tube in quantities is \$85.00.

Our capability gives us the broadest

line of Helium/Neon plasma tubes in the business. Over 30 different standard plasma tubes, from 0.5mW to 50mW. Most off the shelf. With internal or external mirrors. All internal mirror tubes and lasers warranted for 18 months.

Moreover, if you need a Helium/Neon laser specially designed, we can design it just for you—using the same parameters that we have tested to 26,000 hours MTF and 15,000 hours average lifetime. We can even handle such special requests as a modulated laser

to 50 KHz, or a .01% noise laser, or you name it.

One more Both to brag about. We make more lasers than anybody, and so we have the expertise that brings you both high quality and low cost.

Home office: 1250 West Middlefield Road, Mountain View, CA 94040. 415/961-2550.



Spectra-Physics

SPECTRA-PHYSICS

Keep centers even when pushbuttons are stacked

Grayhill, 565 Hillgrove Ave., La Grange, Ill. 60525. (312) 354-1040.

Six, three, two and one-button versions of a PC-mount push-button switch can be stacked horizontally or vertically while maintaining 11/16-in. centers between buttons. Choice of available con-

tacts includes standard spst (N.O.) to 4pst (N.O.) sections: internally shorted sections which connect several poles in the down position; and sequential contacts which ensure that the common terminal makes last. A one-button module is 0.75-in. high off its PC board mount and 0.683-in. square. Each switch is rated to make and break 100 mA at 5 V dc, for an anticipated life of 250,000 operations.

CHECK NO. 267

THE INSIDE STORY...

ON A CONSTANT VOLTAGE TRANSFORMER THAT LOOKS AS GOOD AS IT PERFORMS.

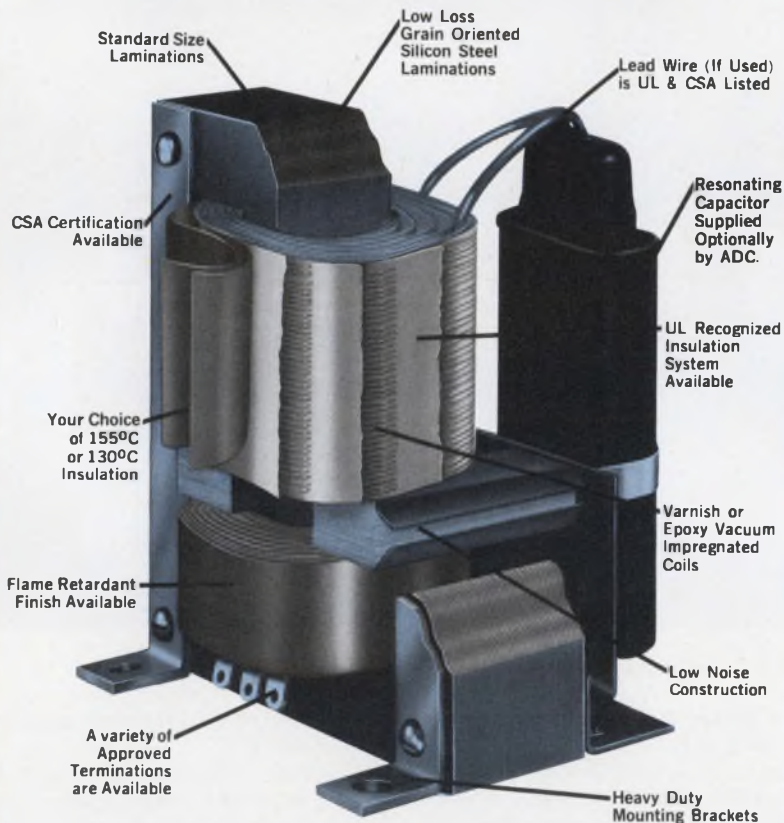

Computer-assisted design plus quality construction. Designed to meet the requirements of UL-478 for Data Processing Equipment.

For additional information contact Magnetics Division, ADC Products, or send for Bulletin 9-3.

ADC PRODUCTS

4900 West 78th Street, Minneapolis, Minnesota 55435
Tel. (612) 835 6800 - TWX 910 576 2832 - TELEX 29-0321



Buy power supplies with or without transformers

Essex Data Information Systems, 17 Arthur Rd., Lincoln Park, N.J. 07035. (201) 696-8788. With transformers from \$19.95 (100 up); stock.

The TS-100 series power supplies are small (4 × 4 × 2-1/2 in.) and have predrilled mounting-holes to ease installation. Five models are available. They are designated 15105, 15112, 15115, 15124, and 15212. Output voltages for these models are 5, 12, 15, 24 and ±12 V dc, respectively. Each unit has a 100,000-h MTBF, built-in short-circuit protection, current limiting, line and load regulation better than 0.2%, and a ripple voltage of 2.2 mV rms max. Overvoltage protection is available on all models. As a user option, all supplies are available with or without the transformer.

CHECK NO. 268

Functional module is a "Jack-of-all-trades"

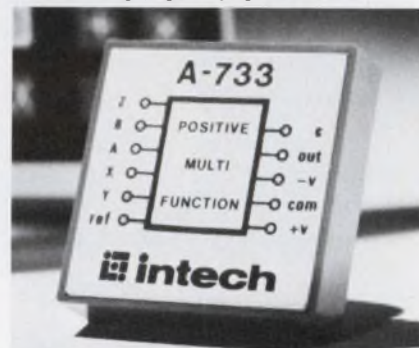

Intech, 1220 Coleman Ave., Santa Clara, Calif. 95050. (408) 244-0500. \$70 (1 to 9); stock.

A multiple-function mathematical module, the A-733, can be programmed to multiply, divide, square root, square, square of a ratio, and raise voltage ratios to an arbitrary power. The output error is essentially independent of input signal levels. Input levels from 100 mV to 10 V can be processed with a maximum output error of less than 0.5% of full scale. The module has a gain drift at full scale of ±1 mV/°C maximum and an output offset drift (at zero input) of ±1 mV/°C maximum. The A-733 is made up of four sections: a log ratio circuit, log circuit, an antilog amplifier, and a reference-voltage source.

CHECK NO. 269



MULTI-CHANNEL GRAPHIC DISPLAY SYSTEMS

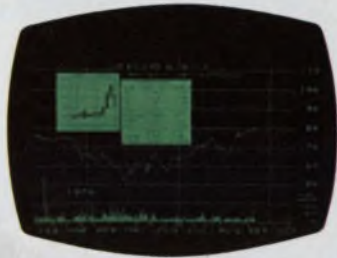

MULTI-TERMINAL SYSTEMS

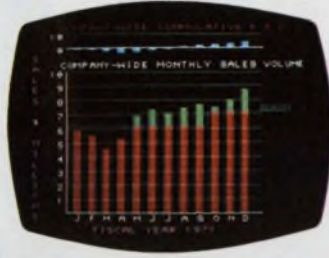
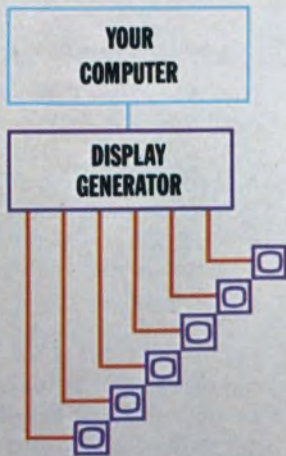

COLOR OR GRAY SCALE DISPLAY

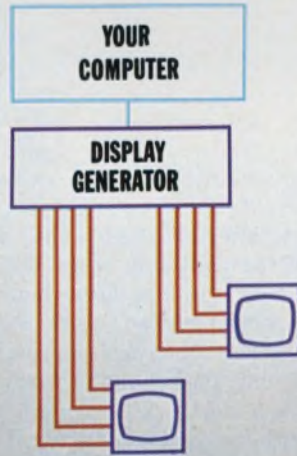

FORM OVERLAY DISPLAY

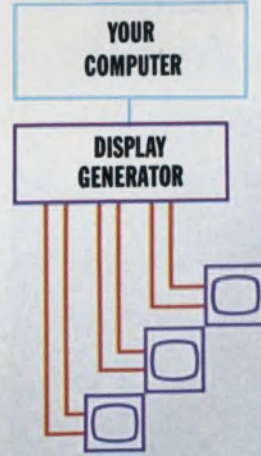

Choose one from column A, two from column B

Or choose all from column C, or...

Because this is a multichannel graphic display system, you can choose most any combination you wish. And like a Chinese dinner, any way you order it, you get an excellent buy.

This system uses a common display generator and a disc memory refresh to drive up to 16 independent, high resolution channels.

For **multiterminal applications**, use each channel to drive a low cost, daylight viewable TV monitor. Cost for a 16 terminal monochrome system, complete with 14" monitors, keyboards, and typical computer interface, works out to just under \$4000/terminal.

If you want **color or gray scale displays**, just combine channels. Two channels give you three colors and black; four channels give you 16 colors plus

black. And for a full color display (4095 levels) use twelve channels. Color can make even the most complex graphics understandable.

You can also use **multiple channels for convenience in editing or data entry**. Put a standard grid or form on one channel, your graph or data on another. Then superimpose the channels on a single display monitor. Because you don't have to regenerate the grid when you change the data, you can have more efficient software.

These systems have all the capability you need for most applications—there are over 1/4 million individually addressable points in the graphic display. You can selectively erase any rectangular area of the screen; write up to 51 lines of 85 alphanumeric characters. And because the displays are disc re-

freshed, the CPU need generate each display only once.

So think of the multichannel display system when you need computer graphics. Call your Data Disc representative for more information, or contact us at 686 West Maude Avenue, Sunnyvale, California 94086; 408 / 732-7330.

And for dessert, have a fortune cookie.





**our products
are more fully
developed...**

Standard Condenser capacitors are indeed fully developed to produce the optimum in performance and durability. Standard is in one business only, the design and manufacture of the world's finest capacitors. We have designed and delivered thousands of specialized capacitors for industry. In fact, what you think of as "special" may be among the many designs already available from stock at Standard. However, if you require capacitors of unusual shape, size, value and material, our engineering department will help you design and produce them to your exact specifications at stock prices. For immediate action, send us a sketch and complete details.

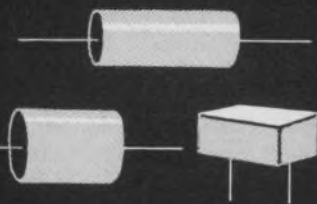

Write or phone for catalog and details.

Standard

CONDENSER CORPORATION

Dept. ED-7 1065 West Addison Street
Chicago, Illinois 60613 • (312) 327-5440

INFORMATION RETRIEVAL NUMBER 60

124

ICs & SEMICONDUCTORS

Programmed logic array replaces 131 k bits of ROM

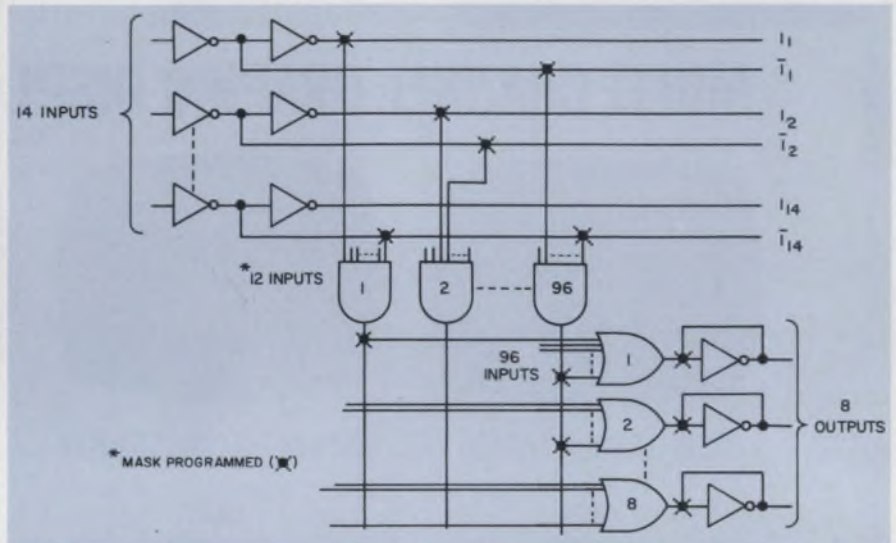

*National Semiconductor Corp.,
2900 Semiconductor Dr., Santa
Clara, Calif. 95051. (408) 732-
5000. \$39.60 (1-99 units); stock.*

An alternative to the use of ROMs is available when the application is random logic generation or a microprogram store. A faster and more economical approach uses a bipolar programmed logic array (PLA).

National Semiconductor is offering a mask-programmable PLA in a 24-pin DIP. Depending on a user's specific requirements, the circuit accepts a number of data inputs and produces outputs each of which is represented by a logical expression with the data inputs as variables. National's PLA has up to 14 inputs and 8 outputs. Each output can contain as many as 96 partial product terms.

The circuit comes in four different versions—the DM7575/DM8575 and the DM7576/DM8576. The difference between the 75XX models and the 85XX models is that the former has conventional outputs, while the latter has inverted outputs. The XX75 models have TTL-active pullups on the outputs, whereas the XX76 models have open collector outputs. The circuits use bipolar technology which results in a 90-ns input-output delay

for the PLA. Typical power dissipation is 550 mW.

The National PLAs have 2112 bits of mask-programmable memory to define the outputs. A comparable ROM to perform the same function would require 131,072 bits of memory.

If more inputs or more outputs are needed, the PLA is readily expandable. The outputs need only to be wire-ANDed together. However, regardless of the number of inputs gained through expansion, any output may still use only 14 input variables.

The arrays come in both plastic and ceramic 24-pin DIPs. Maximum storage-temperature range is -65 to +150 C and the maximum operating temperature range is -55 to +125 C.

The PLA requires just a single 5-V power supply. All data inputs and outputs are at TTL levels.

National plans to introduce a field programmable version of these PLAs at a later date. Some additional applications of the PLA include code conversion, address mapping in the micro-instruction control portion of a microprogrammed computer and the implementation of specialized arithmetic functions that are not readily available in integrated form.

INQUIRE DIRECT

INFORMATION RETRIEVAL NUMBER 61 ►

a tool kit full of measurement solutions...

Now there's a 3-pound scope that can be carried in your tool kit, suitcase, briefcase, coat pocket, glove compartment . . . almost anywhere.

It's the 211, our first laboratory-quality mini-scope. Size is only $3 \times 5\frac{1}{4} \times 9$ inches. Bandwidth is 500 kHz. A lot of scope in a small package.

The 211 is easy to use. You spend your time solving measurement problems, not studying scope operation. Deflection factors from 1 mV/div and sweep rates from $5 \mu\text{s}/\text{div}$ are read out from controls easily related directly to the CRT. One rotary control does all the triggering.

Ever wanted to float a scope? Here's one that floats to 500 volts RMS when operated from its internal batteries.

Price? It's lower than you might expect. Only \$545, FOB Beaverton, Oregon.

For a demo, just contact your local Tektronix Field Engineer. He probably has a 211 in his briefcase. Ask him for complete information or write Tektronix, Inc., P.O. Box 500, Beaverton, Oregon 97005. In Europe, write Tektronix Ltd., P.O. Box 36, St. Peter Port, Guernsey, C. I., U. K.



TEKTRONIX®

committed to
technical excellence

Dialight sees a need:

(**Need:** A large $\frac{5}{8}$ " high LED readout at a low \$4.95* price.)

See Dialight.

Each digit in this bezel assembly contains a Dialight light-emitting diode, decoder/driver, and resistor network that produces a bright, highly visible readout that can be easily installed in a panel. The readout display is supplied with discrete gallium phosphide or gallium arsenide phosphide diodes arranged in a seven-segment format. These generate a bright, highly legible red character (0.625 inch



high—the largest size character in the industry) with the lowest power consumption for a character of this size. Ideal for mounting on a control panel, or in a digital clock, meter, credit-card verifier, TV channel indicator, or hospital room status-board indicator. The contrast ratio between the illuminated and non-illuminated segments is further enhanced by a one-piece red nonglare window.



Dialight is a company that looks for needs...and develops solutions. That's how we developed the industry's broadest line of LED light sources, indicator lights and readouts. No other company offers you one-stop shopping in LED visual displays. And no one has more experience in the visual display field. Dialight can help you do more with LEDs than anyone else because we have done more with them. Talk to the specialists at Dialight first. You won't have to talk to anyone else.

Here are a few products in this family: **1.** Multidigit readout assembly in 0.205" character height **2.** Status display module with 6 LEDs with adjustable light cells **3.** LED readout in character height 0.625" **4.** Alphanumeric display complete with code generator/driver character height 0.300" **5.** 5 x 7 dot matrix alphanumeric display in character height 0.300" **6.** Hexadecimal display with logic character height 0.270" **7.** Single digit LED readout module in 0.125" character height. **8.** Numeric display with integral TTL MSI circuit chip with counter character height 0.270" **9.** Single digit LED readout module in 0.270" character height (MAN 1 equiv.). *1000 lot quantity for 730-1003

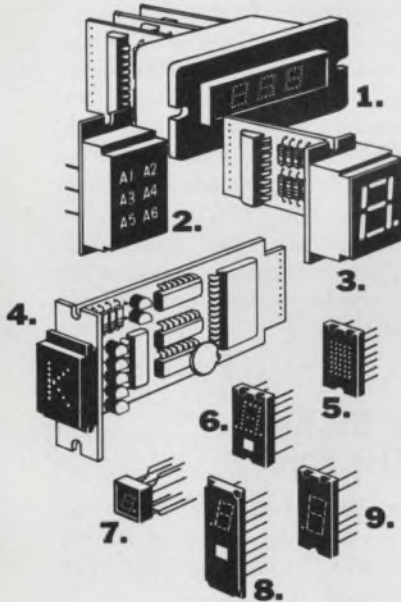

Please send data on your LED readouts.

NAME _____

TITLE _____

COMPANY _____

ADDRESS _____

CITY _____ STATE _____

DIALIGHT

Dialight Corporation, A North American Philips Company
60 Stewart Avenue, Brooklyn, N.Y. 11237 (212) 497-7600

INFORMATION RETRIEVAL NUMBER 62

Ion-implanted diodes switch 1 to 30 A in 25 ns or less

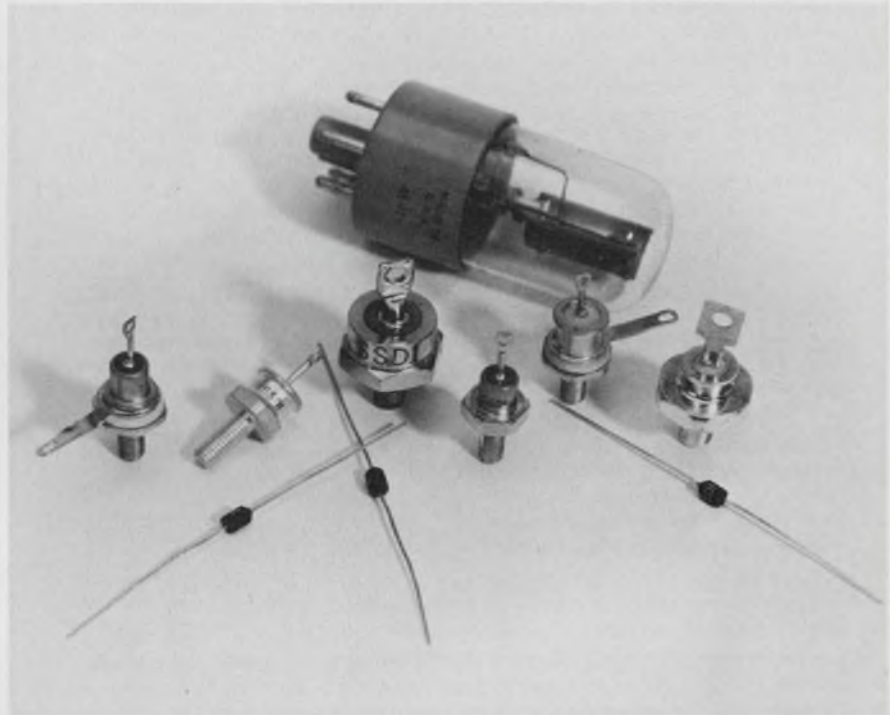

Solid State Devices Inc., 14830, Valley View, La Mirada, Calif. 90638. (213) 921-9660. See text; stock to 4 wk.

Rectifiers built with a new ion-implantation process called Epion, switch currents of 1 to 30 A in 25 ns or less—reportedly five to ten times faster than other devices on the market. These switching times hold for peak reverse voltages of 10 to 100 V.

Rectifiers with six different current ratings are presently available from Solid State Devices. The 1-A model is packaged in a miniature radial-lead package. The 1.5, 3, 8, 20 and 30-A models come in stud-mounted packages. The three lowest-current models all switch in 10 ns or less. The three higher current models switch in 15, 20 and 25 ns, respectively. Forward recovery time for all models is about 1 ns, maximum.

For a 1-mA conduction, the forward threshold voltage of all types is less than 0.45 V. And, for full-

rated conduction, the forward voltage drop is less than 0.95 V.

For a 1- μ s surge pulse of current, the rectifiers can tolerate from a 100 A surge for the low current rectifiers to 1000 A for the 30 A stud-mounting model.

The maximum storage temperature range of all models is -55 to +175 C with a maximum operating temperature range of -55 to +150 C. They are also said to have "high rectification efficiency" to operating frequencies of 10 MHz and above due to their very high switching speed.

Pricing varies with quantity and peak reverse voltage for each current rating. Typical prices at the 100-V, 1000-unit level vary from \$4.05 for the 1-A model to \$67.05 for the 30-A model.

Major areas of application for the rectifiers are expected to be high-efficiency power supplies, shunts, clamps and switching regulators.

CHECK NO. 270

An Important Public Service Message

HyComp Addresses the Problem of Inflation

Q What is better than two
for the price of one?

A Using one instead of two
for the price of one!

WHEN YOU USE PRECISION THIN FILM RESISTOR LADDER NETWORKS WITH CURRENT SWITCHES AS INTERSIL'S 8018A THRU 8020A AND FAIRCHILD'S μ A 9650 FOR A/D AND D/A CONVERSION, YOU CAN REDUCE COSTS AND SIZE SIGNIFICANTLY!

HOW? WITH HyCOMP'S HC-130 AND HC-135 SERIES 12 BIT WEIGHTED LADDER NETWORKS WHICH ARE MADE ON SINGLE 110 x 190 MIL GLASS SUBSTRATE CHIPS AND REPLACE THE PREVIOUS STANDARD TWO CHIP NETWORKS. THEY PROVIDE SUPERIOR TC TRACKING AND OTHER CHARACTERISTICS AND COST AS LITTLE AS \$24(1-9) and \$17(1K). AVAILABLE IN 24 LEAD DIP OR FLAT PACK, HERMETIC OR NON-HERMETIC OR IN CHIP FORM. HC-130 SERIES USED WITH INTERSIL SWITCHES. HC-135 SERIES USED WITH FAIRCHILD'S

THE THREE DECADE BCD WEIGHTED LADDER COUNTERPARTS, DESIGNATED HC-130A AND HC-135A, HAVE THE SAME EXCELLENT SPECS AS THE OTHER HyCOMP RESISTOR LADDER NETWORKS WITH THE EXCEPTION THAT RATIO ACCURACY IS 0.05% AND MAXIMUM ACCUMULATED POSITIVE OR NEGATIVE ERROR IS 0.05% F.S.

IF THE OLD STANDARD TWO PACKAGES HAVE ALREADY BEEN FROZEN INTO YOUR DESIGNS THEN USE THE HC-420 AND HC-430 SERIES WITH THE INTERSIL SWITCHES AVAILABLE IN 14 LEAD DIP OR FLATPACK.

AND WHEN YOU USE THIN FILM R-2R LADDER NETWORKS, GET THEM ON THE SMALLEST SINGLE CHIPS AND AT THE LOWEST PRICES!

HC-1000 SERIES 12 BIT LADDER NETWORK WITH STANDARD RESISTANCE VALUES OF 5K, 10K, and 25K IN 16 LEAD DIP OR FLATPACK, HERMETIC OR NON-HERMETIC OR 100 x 150 MIL CHIP AS LITTLE AS \$23.20(1-99)

HC-210 SERIES 12 BIT LADDER NETWORK WITH A RESISTANCE VALUE OF 50K for MOS OR ANY ANALOG SWITCH WITH A HIGH SATURATION RESISTANCE AS LITTLE AS \$25(1-99). AVAILABLE IN 16 LEAD DIP OR FLATPACK, HERMETIC OR NON-HERMETIC OR 100 x 190 MIL CHIP.

SPECIFICATIONS FOR 12 BIT THIN FILM LADDER NETWORKS (unless otherwise noted).

TC TRACKING: < 1 PPM/°C RATIO ACCURACY: 0.01%
MAXIMUM ACCUMULATED POSITIVE OR NEGATIVE ERROR: 0.012%
10 AND 8 BIT MODELS ALSO AVAILABLE

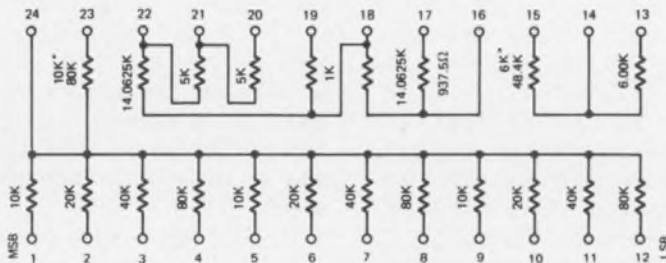

In addition to supplying many other standard precision thin film resistor ladder networks and hybrid D/A and D/S converters with a normal delivery time of two weeks, HyComp is pleased to consider modifications to standard products and customized circuits whenever economically feasible



146 Main Street, Box 250 Maynard, Mass. 01754 (617) 897-4578

ICs & SEMICONDUCTORS

MOSFETs have very low feedback capacitance

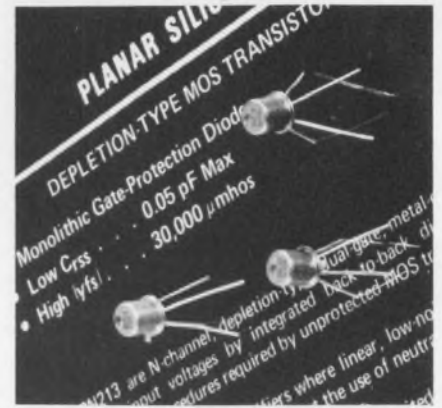

Texas Instruments, P.O. Box 5012, M/S 308, Dallas, Tex. 75222. (214) 238-2011. \$0.90 (3N211 & 212), \$0.95 (3N213) (100-999); stock.

Designated the 3N211, 3N212, and the 3N213, these depletion-type MOS transistors have a low feedback capacitance of 0.05 pF maximum and a high forward transconductance (y_{fs}) of typically 25 micromhos. Typical common-source spot-noise figure for these MOSFETs is 2 dB at 200 MHz. Power gain is 28 dB at 200 MHz. Integrated back-to-back diodes between gates and source protect inputs against static charges. The 3N211 has extremely low feedback capacitance, the 3N212 provides low-noise operation and the 3N213 has higher breakdown voltages to provide more power output for linear detection.

CHECK NO. 271

2k-bit SR has 10-MHz rate

Hughes Microelectronic Products, 500 Superior Ave., Newport Beach, Calif. 92663. (714) 548-0671. \$36 (100); stock.

A 2048-bit multiplexed dynamic shift register provides a 10-MHz shifting rate over the -55 to +125 C temperature range. The new MOS circuit, called HDSR 2048, uses ion implantation to achieve its high rate and is structured as a dual 1024-bit shift register. Power dissipation is typically 300 mW at 25 C with 50% duty-cycle clocks per 1024 bits. Bipolar circuits may be driven by the 2048.

CHECK NO. 272

ECL quad D-type latch has gated outputs

Signetics, 811 E. Arques Ave., Sunnyvale, Calif. 94086. (408) 739-7700. \$5.90 (100 up).

A high-speed, low-power ECL quad latch consists of four bistable latch circuits with D-type inputs and gated Q outputs. Typical clock or data-to-output time is 4.0 ns; typical enable-to-output time is 2.0 ns, and typical setup and hold time is 0.7 ns. Dissipation is typically 290 mW per package with no load. The circuit can drive four 50-Ω lines.

INQUIRE DIRECT

Hockey-puck SCRs rated up to 1500 V



Motorola Semiconductor Products, P.O. Box 20924, Phoenix, Ariz. 85036. (602) 244-3466. \$15 to \$300 (5-9); 4 wks.

A line of high current SCRs, in 1/2-inch hockey-puck packages, are offered as the MR 235, 380 and 470 (device number gives rms current). The slower speed devices are available with voltage ratings up to 1500 V; high speed devices, from 600 to 1200 V. Switching speeds range from 10 to 40 μs.

CHECK NO. 273

100-W Darlington transistors have gain of 750

RCA Solid State, Route 202, Somerville, N.J. 08876. (201) 722-3200. 2N6055: \$1.50; 2N6056: \$1.67 (100 up); stock.

Two 100-W npn Darlington transistors feature a gain of 750 at 4 A. Called the 2N6055 and 2N6056 the new devices have 60 and 80-V ratings and are manufactured with a double-epitaxial construction for a high forward and reverse secondary breakdown capability.

CHECK NO. 274

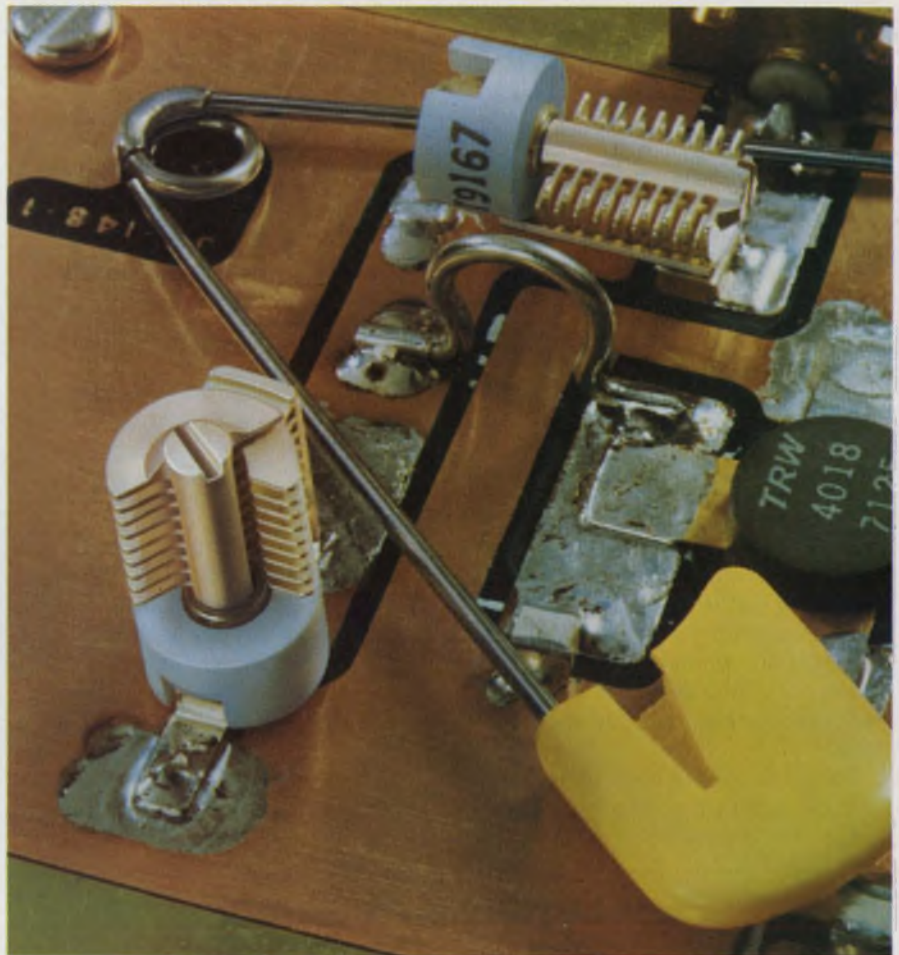

The smallest 180° tuning air variable capacitors just had babies!

Right. Johnson's exclusive subminiature type "T" air variable capacitors (PC mounts) now come with stripline terminals for microwave applications, either vertical or horizontal tuning.

These space-savers are only about 1/3 the volume of a "U" capacitor, but they offer extraordinarily high mechanical and electrical performance for critical applications.

Rotors and stators are as stable and uniform as precision machining from solid brass extrusion can make them. A high 1 1/2 to 8 ounce-inches torque holds the rotor securely under vibration. Temperature coefficient is very low plus 30 ± 15 ppm/° C. Q is high, typically 1800 at 200 MHz. Three capacitance ranges span from 1.3 pF to 15.7 pF.

Our 45 years of experience really shows up in these new capacitors. But why take our word for it when a stamp will get you a couple of freebies and you can check them out for yourself.

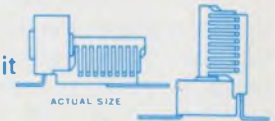

E. F. JOHNSON COMPANY / 3306 Tenth Ave., S.W. / Waseca, Minnesota 56093

Check type and range of sample(s) needed:	Capacitance range	1.3 to 5.4	1.7 to 11.0	1.9 to 15.7
	Horizontal tuning	<input type="checkbox"/>	<input type="checkbox"/>	<input type="checkbox"/>
	Vertical tuning	<input type="checkbox"/>	<input type="checkbox"/>	<input type="checkbox"/>

Name _____ Phone _____

Firm _____ Title _____

Address _____

City _____ State _____ Zip _____



E. F. JOHNSON COMPANY

INFORMATION RETRIEVAL NUMBER 64

You gain fundamental design advantages with General Electric infrared SSL's (LED's).

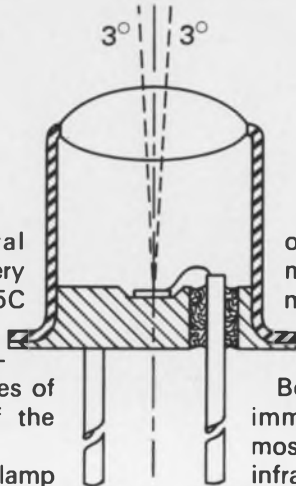

For example, General Electric guarantees* every SSL-55B and SSL-55C infrared lamp for:

Precision beam alignment, to within 3 degrees of the mechanical axis of the lamp.

Power output of each lamp will be within the less than 2 to 1 range, as published; the SSL-55B

output ranges from 3.5 mW minimum to 6.0 mW maximum; the SSL-55C from 4.8 mW minimum to 7.5 mW maximum.

Both types are available for immediate delivery, as are most other General Electric infrared SSL's. For prices and complete SSL infrared data write or call today.

Green Glow Lamp for flexibility.



Actual Size

This GE broad spectrum bright green glow lamp gives you greater design flexibility than ever before. It also emits blue, with suitable color filter.

Called the G2B, it is directly interchangeable electrically and physically with GE's high-brightness C2A red/orange/yellow glow lamp. You can use the G2B alone for 120 volt green indicator service. Or together

with the C2A to emphasize multiple functions with colors. For example: for safe/unsafe functions, for dual state indications and to show multiple operations in up to 5 colors.

They should be operated in series with an appropriate current limiting resistor. Both the G2B and C2A save money because of low cost, small size and rugged construction.

Now Wedge Base Lamps in two sizes.

If space for indicator lights is your problem, the GE T-1¼ size all-glass wedge-base lamp is your solution. It measures only .240" max. diam. The wedge-base construction virtually ends corrosion problems; it won't freeze in the socket. Like

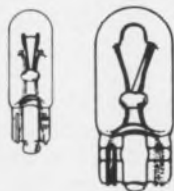

its big brother — the T-3¼ wedge base lamp with a .405" max. diam., the filament is always positioned in the same relation to the base.

And it makes possible simplified socket design.

For free technical information on any or all of these lamps, just write: General Electric Company, Miniature Lamp Products Department, #4454-L, Nela Park, Cleveland, Ohio 44112.

*Lamps not meeting published specifications will be replaced or money refunded.

GENERAL ELECTRIC

INFORMATION RETRIEVAL NUMBER 65

ICs & SEMICONDUCTORS

Darlington transistors can handle high currents



Solitron, 1177 Blue Heron Blvd., Riviera Beach, Fla. 33404. (305) 848-4311. (1-99) \$5 (TO-66), \$3 (TO-5); stock.

The SDM 3100-3400 series Darlington devices are packaged in three-lead TO-66 and four-lead TO-5 cases. Typical features include: V_{CE0} from 40 to 80 V, multiple gain selections at 2.5 or 5 A, typical 5 A H_{FE} of 1000 min, 1 A H_{FE} of 10,000 min, low-leakage planar construction (less than μA 's at 80% of V_{CRO} , V_{ERO}) high speed (f_t is 40 MHz typical, rise and fall times 200 ns typical) Θ_{J-C} less than 5 °C/W (TO-66) and 25 °C/W (TO-5).

CHECK NO. 275

Quad line receivers provide own hysteresis

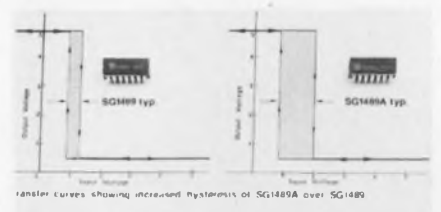

Silicon General, 7382 Bolsa Ave., Westminster, Calif. 92683. (714) 892-5531. SG1489J: \$4.00 (100 up); stock.

The SG1489J and SG1489AJ quad line receivers offer built-in threshold hysteresis. The hysteresis in the A version exceeds that of the SG1489J by more than 2:1. Both types offer logic threshold shifting and input noise filtering capability. Input resistance ranges from 3 to 7 kΩ and input signal range is ± 30 V. Package style is 14-pin cerdip.

CHECK NO. 276

Tiny bridge rectifiers can handle 1.5 A

Edal Ind., 4 Short Beach Rd., East Haven, Conn. 06512. (203) 467-2591.

Subminiature silicon single-phase bridge-rectifiers sealed in epoxy provide a low silhouette, for stacking miniature circuit cards. Units contain double-diffused passivated junction diodes in a cold case design. Voltage ratings of 50 to 1000-V PIV are offered with a current rating of 1.5 A in open-air mounting. Special ratings and other circuit configurations available on request.

CHECK NO. 277

15-V dual regulator tracks within 50 mV

Ratheon, 350 Ellis St., Mountain View, Calif. 94040. (415) 968-9211. \$2.18 (100 up).

A dual-tracking voltage regulator in a standard eight-pin mini-DIP delivers positive and negative 15-V outputs that track within 50 mV. Called the RC4195, it provides line regulation of 2 mV and load regulation of 5 mV with only 0.005% drift per degree centigrade. The circuit provides 100 mA at each output and requires only two bypass capacitors. It also includes thermal shutdown at junction temperatures exceeding 175 C. The miniDIP dissipates 600 mW.

CHECK NO. 278

Low voltage avalanche diodes need only 50 μ A

TRW Electronic Components, 14520 Aviation Blvd., Lawndale, Calif. 90260. (213) 679-4561. \$15.40: PS1314A (OEM qty); 6-8 wk.

Types PS1300A through PS1314A are reference elements featuring temperature compensation and very low current levels. The zener voltage is 6.5 V \pm 5%. The diodes provide a stable reference at currents as low as 50 μ A and temperature coefficients as low as 0.0005%/°C. The avalanche diode is said to have a very sharp knee. The unit can therefore operate at far lower current levels than are possible with a conventional zener diode.

CHECK NO. 280

Your custom resistor network is only an idea away!

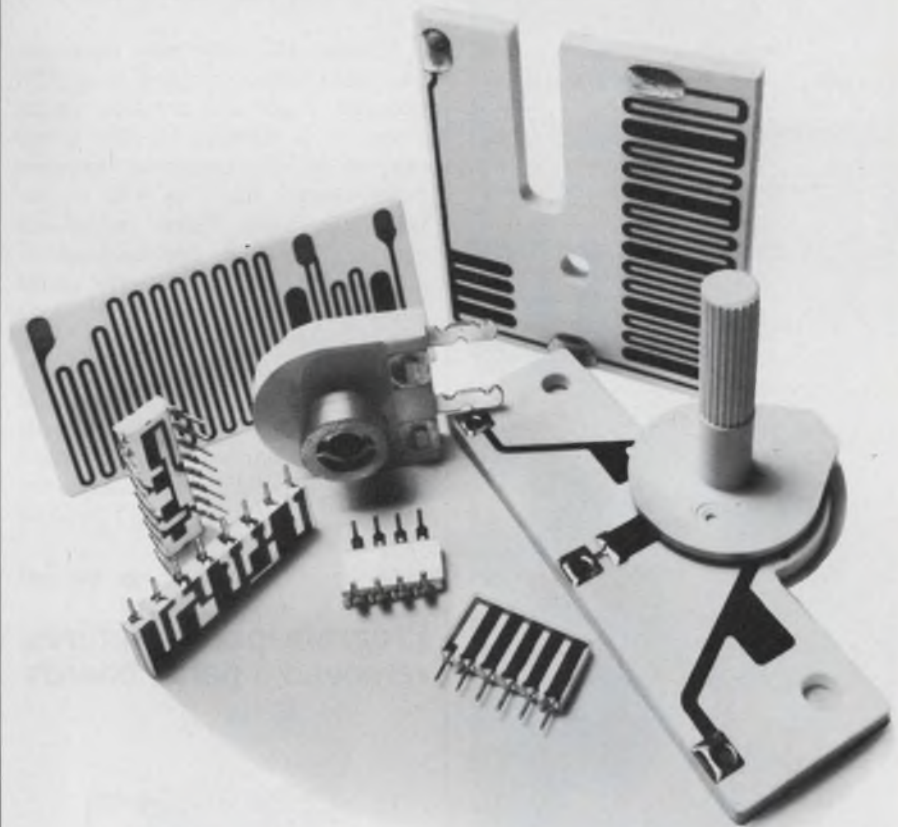

CTS CORPORATION, a pioneer in cermet network packaging, HAS WHAT YOU NEED TO SOLVE "CUSTOM" RESISTOR REQUIREMENTS! Complete thick film facilities save in-house investments: existing tools speed production—cut costs...capabilities you can't afford to overlook. Resistors and resistor networks are our business...not just a sideline.

Whatever your needs, from standard in-line and DIP networks to custom high power/high voltage packages, you can rely on CTS experience and know-how.

Unmatched field reliability, high volume mechanization, and over a decade of cermet thick film-technology make CTS resistors "the engineers' choice". We have what it takes for both standard and custom resistor packages. Call on CTS EXPERIENCE...today! CTS CORPORATION, 905 N. West Boulevard, Elkhart, Indiana 46514, Phone: (219) 293-7511.

CTS CORPORATION
Elkhart, Indiana



A world leader in cermet and variable resistor technology.

INFORMATION RETRIEVAL NUMBER 66

Ectron TAKES THE NOISE OUT

... with a new DC amplifier concept designed for data acquisition, process control, general purpose or environmental application.

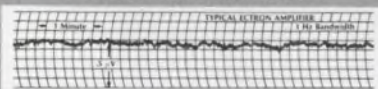
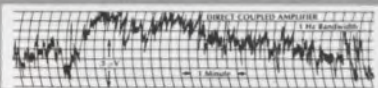

Ectron amplifiers feature:

- Direct thermocouple input
- Strain gauge signal conditioning
- High Common Mode rating
- RFI protection
- $0.2\mu\text{V}/^\circ\text{C}$; 0.005% stability
- RTI zero suppression
- Gain up to 1,000,000



Ectron Model 418
Ask for detailed
information on all
types of DC ampli-
fiers from ...



Ectron
CORPORATION

8133 ENGINEER ROAD
SAN DIEGO, CALIFORNIA 92111
TELEPHONE (714) 278-0600

INFORMATION RETRIEVAL NUMBER 67

COMPONENTS

RC networks can suppress noise and EMI

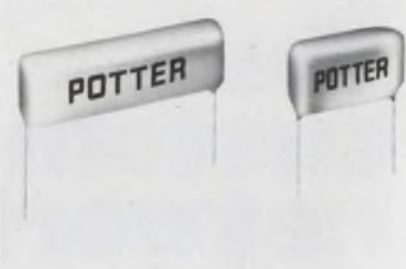

Potter, 10441 Roselle St., San Diego, Calif. 92121. (714) 453-6610. From less than \$0.30; 4 to 8 wk.

Bluseal RC networks have capacitance values ranging from 0.25 through $2\mu\text{F}$ and resistor values from 10Ω through $1\text{M}\Omega$. Units operate in environmental temperatures from -40°C to $+85^\circ\text{C}$. Series-4909 units have radial-lead construction and are encased in rigid flame-retardant epoxy; series 4900 have axial leads with cases of thermosetting polyester film and end fills of epoxy; series 4902 also is constructed with axial leads, but have rigid phenolic cases and flame-retardant epoxy end fills. The smallest networks are only $0.78 (l) \times 0.33 (w) \times 0.63 (h)$ in.

CHECK NO. 281

Program panel features removable patch boards

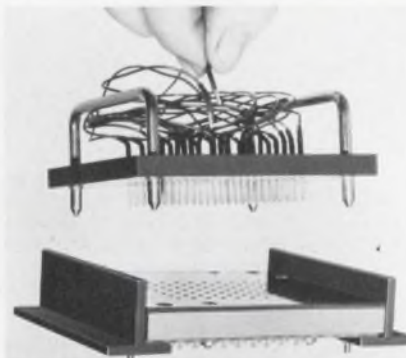

Sealectro Corp., 225 Hoyt St., Mamaroneck, N. Y. 10543. (914) 698-5600.

A quickly removable 7×10 program panel provides ready access to circuits for testing and program changes. The unit features Teflon-insulated jumper wires and silver-plated contact surfaces. Mating is controlled by oversized guide pins.

CHECK NO. 282

20-yr life claimed for wet electrolytics

Philips, Elcoma Div., P.O. Box 523, Eindhoven, The Netherlands.

Philips' new 108-series of wet aluminum electrolytic capacitors has a rated working life of over 20 yr, at 40°C and rated voltage, with no change in parameters. Rated voltages range from 6.3 V to 63 V and capacitance values from 33 to $2200\mu\text{F}$ with a -10 to $+50\%$ tolerance. Life drops to 10,000 hr at 85°C and rated voltage.

CHECK NO. 283

Terminator networks serve ECL circuits

Beckman Instruments, 2500 Harbor Blvd., Fullerton, Calif. 92634. (714) 871-4848.

The Series 898 line of DIP terminators is specifically designed for use with new emitter-coupled logic such as ECL 10,000 and 9500-series ECL. The five standard configurations now available include: -2.0V units (Series 898-41), -5.2V units (Series 898-42), Thevenin-equivalent terminators (Series 898-43), series-line terminators (Series 898-44) and TTL-to-ECL translators (Series 898-45). The networks include ceramic $0.01\mu\text{F}$ capacitors to decouple the supply busses.

CHECK NO. 284

See-through switches allow new design ideas

Industrial Electronic Engineers, Inc., 7720 Lemona Ave., Van Nuys, Calif. 91405. (213) 787-0311. \$0.30 per switch plus cost of hardware; 6 wk.

Finger-tip pressure switches, called Cue-Switches, are made of matrixed conductors embedded in transparent plastic membranes. The switches operate without mechanical linkages, springs or buttons. Because of their transparency, the switch elements do not obscure the readability of printed, silk-screened or projected data. Products now available are a line of lighted push-button assemblies on 0.8-in. centers, bezel units that combine with rear-projection read-outs and a line of 3×4 switch matrices with telephone or adding-machine formats.

CHECK NO. 285



New Sperry Clock Display lowers the cost of electronic clocks!



This unique Sperry Clock Display not only helps cut engineering expense, reduce assembly time and lower component costs, it looks a lot better than other displays now on the market. This new unit, the SP-151, has the same bright, clear, continuous, easy-to-read characters that have

made Sperry a major supplier of readouts in only two short years. It's ideal for eye appealing home and auto clocks of all kinds as well as a clock and/or frequency readout for radios and television sets.

And, the new displays are low in cost. Just \$7.00 each in 1,000 unit quantities. That's less than \$1.75 per digit. In large OEM quantities, the cost is under a \$1.00 per digit. Interfacing with MOS/LSI clock chips, these planar gas discharge displays can be used in all dc or multiplexed applications, with or without blanking zeros. Character height is 0.50" with centerline spacing of 0.160". The display's face is only 1.593" x 1.120". Depth is just 0.255" plus 0.260" for the pins.

The units can be viewed easily at distances over 30 feet and have a viewing angle of 130°. The natural color is an eye-pleasing orange. Other colors are available with filters.

SPECIAL EVALUATION KIT AVAILABLE

So that you can have the time of your life and evaluate the SP151, Sperry is offering a special Evaluation Kit complete with one clock display, connectors, MOS/LSI clock chip, printed circuit boards, 9-page application note and detailed assembly instructions. You supply the capacitors, resistors, diodes, transistors and power transformer.

AVAILABLE FOR LIMITED TIME ONLY FROM YOUR SPERRY DISTRIBUTOR — \$19.95 PER KIT. ONLY ONE PER CUSTOMER. Offer ends July 1, 1973.

FOR THE NAME OF YOUR LOCAL SPERRY DISTRIBUTOR SIMPLY DIAL EEM TOLL FREE (800) 645-9200 (in N.Y. State call collect 516-294-0990).



There's more eye appeal in Sperry® Displays!

PDQ

from your Triad Distributor



TRIAD'S low cost, wide range adjustable, 40-watt power supplies.

Triad's WR Series of 4 models feature open top construction, extruded integral heat sink housing, all silicon semiconductors, 10-year life computer grade capacitors, FR glass epoxy pc boards, and electrostatically shielded transformers. All units are convection cooled, have automatic current limiting, and are designed to meet UL-CSA requirements. In stock and available now from Triad distributors.



B size slot supplies for OEM systems.

NCB Series in 5 voltage ranges delivers 25 to 45 watts of precisely regulated DC power at extremely low ripple. With built-in overvoltage protection, automatic fold back current limitation and reverse polarity protection. Lower in cost, they retrofit many models on the market today. In stock now at Triad distributors.



TRIAD-UTRAD DISTRIBUTOR

305 North Briant Street, Huntington, Indiana 46750

INFORMATION RETRIEVAL NUMBER 69

COMPONENTS

Phase sensitive relays protect 3-phase devices



TimeMark Corp., 4566 E. 29th St., P.O. Box 15127, Tulsa, Okla. 74114. (918) 939-5811. \$21 (100 up); Stock.

The Series 250 phase-sensitive relay senses if the three phases are connected in the correct rotating sequence. The unit contains a SPDT relay with 5-A contacts and it plugs into a standard eight-pin octal socket. The contacts close when the correct sequence is applied.

CHECK NO. 286

Small thermocouple can test electronic parts

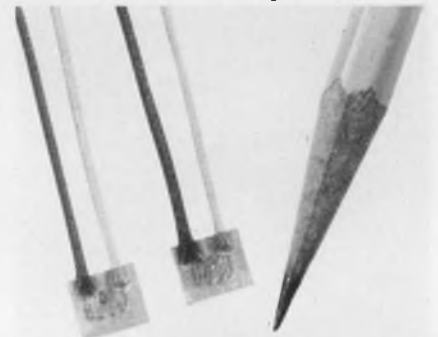

Hy-Cal Engineering, 12105 Los Nietos Rd., Santa Fe Springs, Calif. 90670. (213) 698-7785.

Hy-Cal's Zig/Zag TC-2345 thermocouple is small, only 1/4 x 1/4 in., and has a 20 ms response which makes it suitable for electronic and semiconductor application. The small couple mounted on a patch is easily attached to TO-5 cans, diodes, DIPs and other electronic components. Only finger-tip pressure secures the patch to most surfaces, and the couple can operate over a temperature range of -320 to +350 F. All the base metal thermocouple types such as J, K, T and E are available. Six inches of 28-gauge, fiberglass-insulated thermocouple leadwire is standard.

CHECK NO. 287

Thumbwheels set predetermined counter



Kessler-Ellis Products, 120 1st Ave., Atlantic Highlands, N. J. 07716. (201) 291-0500. \$14 (100 up); 2 wks.

It looks like three thumbwheel switches, but it functions like an electrical predetermining counter. You first set in the desired number manually. Electrical pulses fed to the counter cause it to count down to zero where a SPDT switch is actuated. An adding version counts upwards from any preset number, but this unit has no built-in switch. The counter is supplied with snap-in mounting clips. Standard models are available for 12, 24 and 110 V, dc or ac.

CHECK NO. 288

Thermoelectric module provides heat or cold

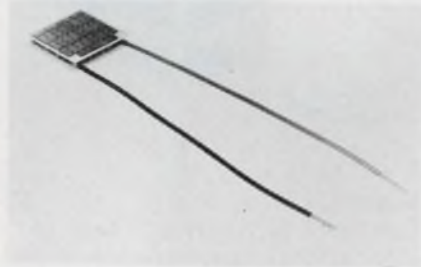

Cambridge Thermionic, 445 Concord Ave., Cambridge, Mass. 02138. (617) 491-5400.

Thermoelectric module, Model 801-2001-01, can supply heat, or cool water, a small refrigerator or an electronic component. Its ceramic construction and metalized plates allow both good thermal transfer and electrical isolation. Maximum current is 8.5 A at a nominal voltage of 3.5 V dc. The unit can provide a max temperature differential of 60 C when little or no heat is transferred, and the max heat transferred is about 19 W at small temperature differentials (1 to 2 C).

CHECK NO. 289

How can you resist a 400% improvement in feedback stability?

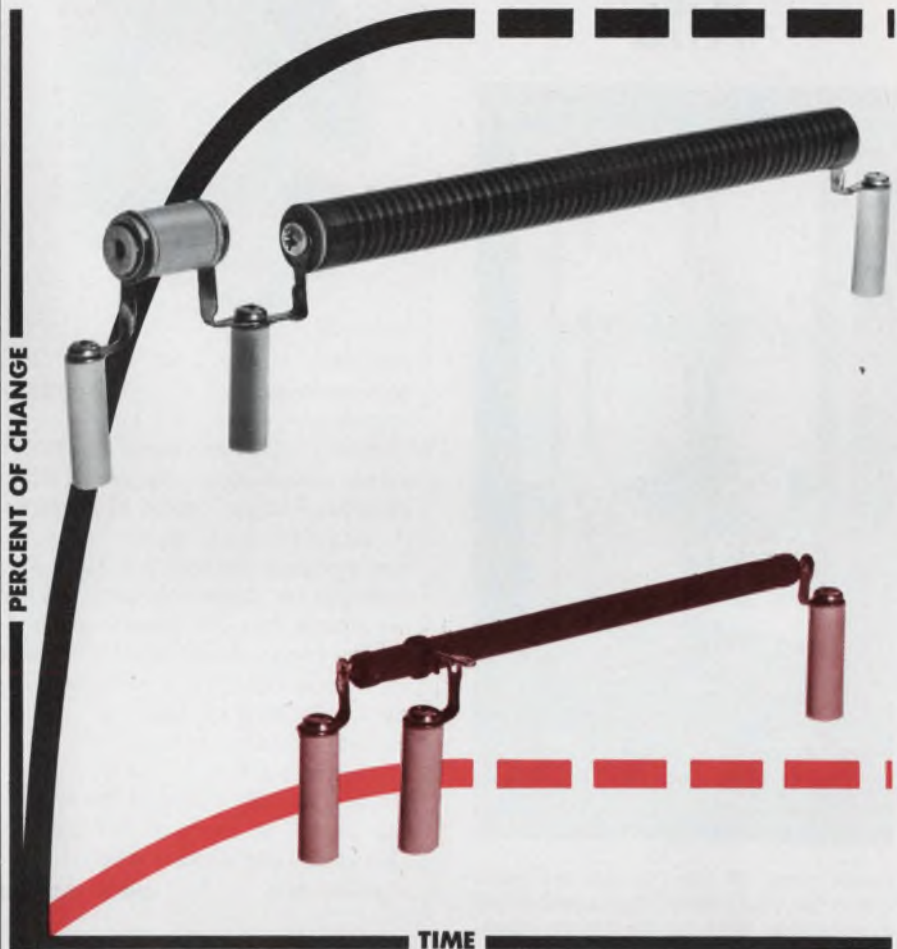

So beautifully done!

With DIVIDER-MOX resistors, the effects of T-C matching, V-C, self-generated heat, and other control variables are minimized by a unique manufacturing process.

Precision is % allowable change over operating temperature range; DIVIDER-MOX resistors give 0.5% stability at 10% power dissipation over a temperature range of -55° to 125° C.

And, along with precision and stability you also get size advantages as well . . . DIVIDER-MOX resistors are about $\frac{1}{2}$ as large as the equivalent resistance carbon film.

Resistance ranges available from 25K to 2000 Megs with maximum power ratings up to 10W at 30kV. Customers may specify divider ratios in the range of 300:1 to 10,000:1.

Victoreen...where else can you get so many accurate ohms for your money:

VICTOREEN INSTRUMENT DIVISION
VLN Corporation
10101 Woodland Avenue
Cleveland, Ohio 44104



INFORMATION RETRIEVAL NUMBER 70

The Elegant Transformer Kits

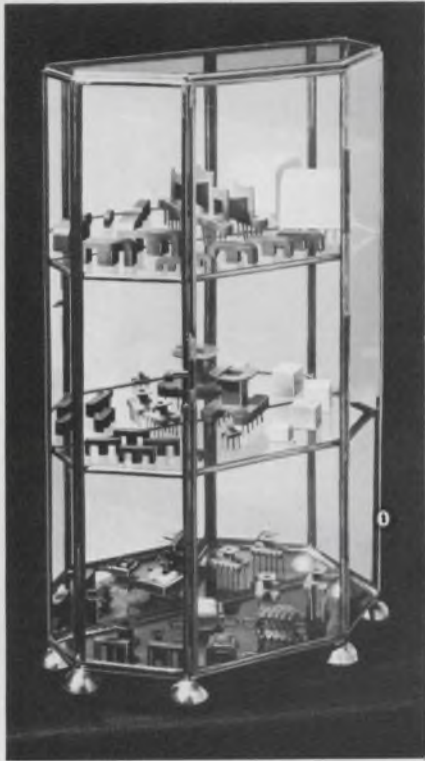

Select from 157 kits. To find the exact match for your needs. Plus ready-made economies. With ferrite cores. Steel frames. Cases. And bobbin/coil forms that pin precisely into standard printed-circuit grid patterns.

Six materials: fluorocarbon, nylon, glass-reinforced nylon, DAP, polyester and epoxy. For stability at temperature ranges from 105 to 200 C.

The complete collection expresses the craftsmanship you expect from EPC as an EAI component company. Look to EPC also for custom-molded parts. Or to EAI for thick-film audio amps. Capacitors. Custom coils. Solenoids. Active filters. Analog/digital converters and other special function modules. Plus a growing list of other elegantly crafted etceteras.

EPC

Electrical Plastics Corporation
500 Long Branch Avenue
Long Branch, New Jersey 07740
Tel. (201) 870-9500

A Subsidiary of Electronic Associates, Inc.

INFORMATION RETRIEVAL NUMBER 71

COMPONENTS

Sector switch skips circuits when switching

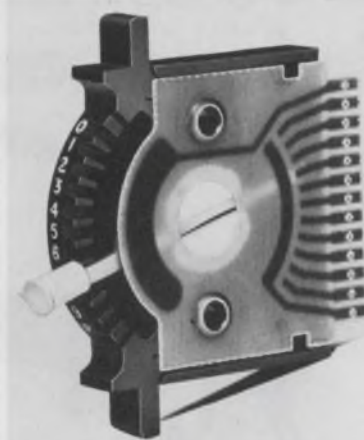

Selectro Corp., 22 Hoyt St., Mamaroneck, N. Y. 10543. (914) 698-5600.

Slide'N Switch circuit selector skips unwanted circuits when switching to any one of 11 contacts. A pull-slide-push action operates the modular switch. The unit also provides a buss contact during switching that can actuate a make-ready circuit. Gold-plated terminals on the switch fit a standard PC card connector or they can accommodate solder connections. The switch is 2-5/8 × 11/32 in. and extends 1-23/32 in. behind the mounting panel. It is rated for 250,000 operations per contact when switching 250 mA.

CHECK NO. 290

Trimmer pot is 1/4-in. high, yet handles 3/4 W

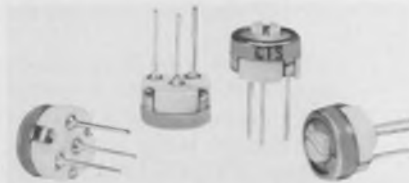

CTS Corp., 406 Parr Rd., Berne, Ind. 46711. (219) 589-3111. \$1.37 (100 up); stock.

The miniature 345-series trimmer pot has a TC of ±100 ppm/°C, which is standard for most resistance values. The cermet resistance element is in a completely enclosed package (sealed resistance element). The trimmer also offers: 0.18 in. high profile, 0.03% settable, a resistance range of 50 Ω to 1 MΩ and resistance tolerance of ±20%. Power rating is 3/4 W at 25 C derated to no load at 150 C.

CHECK NO. 291

Multipole DIP switches come in five styles

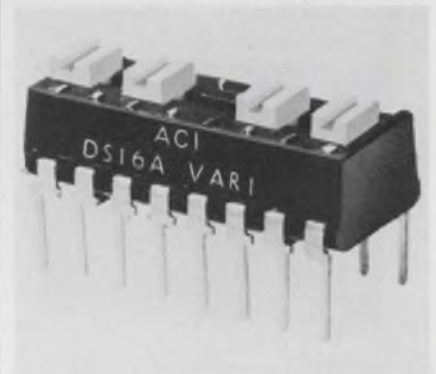

American Components, Inc., 8th Ave. at Harry St., Conshohocken, Pa. 19428. (215) 828-6240.

DIL 16, dual-inline switches, come in five multipole and multiposition styles. They provide break-before-make operation and positive wiping action. All styles are 0.779 L × 0.330 W × 0.335 H in. A 16-lead configuration is standard.

CHECK NO. 292

Scott-T transformer is smaller than 1/3 in.³

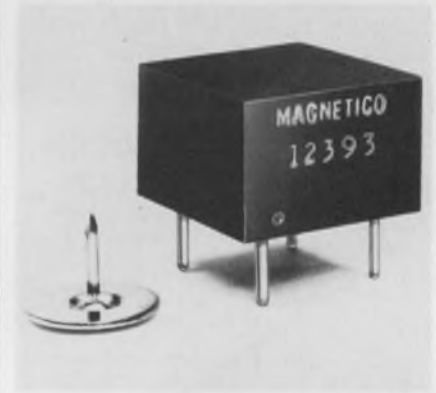

Magneto, 10 Richter Ct., E. Northport, N.Y. 11731. (516) 261-4502. \$19 (100 up); stock to 3 wk.

The model 12393 converts synchro information into resolver information. Its size is 0.75 × 0.75 × 0.6 in. and it comes in a molded type unit with PC pins (0.025 dia.) on a 0.1-in. grid. It operates over a temperature range of -55 C to +125 C and with MIL-spec environments. Other specifications include an input of 11.8 V rms line to line, 400-Hz synchro information, and a standard output of 6-V sine/cosine. Accuracy is typically 30 arc seconds to 3 arc minutes, where output loading is 100 kΩ. The unit can also be supplied in a low-profile configuration (0.75 × 1.75 × 0.375 in.).

CHECK NO. 293

"Scotch" X-1284 passed five flame retardant tests.



X-1284 is a pressure-sensitive polyester film tape that handles like "Scotch" 56. However, the color is red, and because of its outstanding self-extinguishing characteristics, it can be used on radio and TV components and wiring involving fire or shock hazards.

It passed the rigid test outlined in U/L Subject No. 492, No. 510 and No. 94 with flying colors. ASTM D-635 was passed. Federal Highway Administration Safety Standard #302. Passed. ASTM D-1000-70a extinguishes in less than 3 seconds. Passed. 3M Cello Fusee extinguishes in less than 3 seconds. Passed.

The reason "Scotch" brand flame retardant X-1284 tape won't support combustion is that the "Scotchpar" polyester

film backing and the unique adhesive system are both flame retardant. One of the key technological advantages, included in the "Scotchpar" Type 7300 polyester film backing, is that the flame retardant properties are built in directly. They cannot delaminate or flake off.

X-1284 provides excellent tear resistance. It's ideal for coil holding and coil covering applications, high temperature harness wraps, color TV flyback transformer insulation and yoke coil assemblies.

For more information write Dielectric Materials & Systems Division, 224-64, 3M Company, 3M Center, St. Paul, Minnesota 55101.

See our product data in EEM.



Hybrid transformer can terminate 4 wire lines

Magnetics, 6 Richter Ct., East Northport, N.Y. 11731. (516) 261-4502. \$12 (1000 up); stock to 4 wk.

Designed to meet telephone company requirements for data and voice access, model 50819 contains a hybrid pair for converting a four-wire terminal into a two-wire

voice path, or the reverse. Its frequency response over 300 to 3500 Hz is $\pm 1/2$ dB, over levels from -45 dBm to +7 dBm. Longitudinal balance is 45 dB minimum and return loss 26 dB minimum. The transhybrid loss exceeds 50 dB and impedance match is within $\pm 10\%$. The unit can also be supplied, to tolerate without degradation, the normal 120-mA dc current unbalance typical of signal or hold current in a switched telephone line.

CHECK NO. 294

Now there's a big name in miniatures.

It's Raytheon. And you know with Raytheon on a miniature switch you get quality, dependability and most important — availability. Popular toggle, push-button, proximity, rotary and rocker-type designs carry the Rayswitch name and Raytheon's reputation for excellence in electronics.

Whatever your application, from test equipment to computer peripherals, there's a Rayswitch for your panel. Switch to the big name in miniatures.

Call your Raytheon representative. Or for a FREE copy of our Rayswitch catalog write Raytheon Company, Fourth Avenue, Burlington, Mass. 01803.



INFORMATION RETRIEVAL NUMBER 73

Mini load cell claims to be lowest cost unit



Interface Inc., 7210 E. Acoma Dr., Scottsdale, Ariz. 85254. (602) 948-5555. \$99 (11 up); stock (small qty).

A standard miniature load cell has guaranteed specifications of $\pm 0.03\%$ linearity, $\pm 0.2\%$ hysteresis, and $\pm 0.01\%$ nonrepeatability. Rated output of the MB-50/75/100/150 is 3 mV/V. Full-scale deflection is 0.005 in. It is available in standard ranges of 0 to ± 50 , 0 to ± 75 , 0 to ± 100 , and 0 to ± 150 lb. Over-all dimensions of the Minibeam are just 2-3/8 (l) \times 1 (h) \times 1/2 (w) in.

CHECK NO. 295

Small cathode-ray tube provides 0.6 mil spot



Video Products, 7550 San Fernando Rd., Sun Valley, Calif. 91352. (213) 767-0748.

A miniature cathode-ray tube, type VPI-1, is 1 in. OD, has high resolution, a small spot size (0.6 mils) and comes complete with deflection yokes and a Mu-metal shield. It operates over a 5-to-10-kV range, can handle 850 lines and is capable of 350 ft-L output. The tube weighs only 39 g, is 5.5-in. long and has a flat face.

CHECK NO. 296

ANNOUNCING A LOT LESS TO GO WRONG.

We've got a 50 MHz frequency meter with simpler circuitry and better performance than anything anywhere near its price range.

It's the Newport 730 Counter-Timer and it only costs \$299.

The new 730 offers 50 mV input sensitivity. A count range from 10 Hz to 50 MHz. Frequency, accumulate and digital stopwatch modes. Five selectable gate times. Six-digit LED readout. Internal crystal controlled time base.

It also has many features you wouldn't expect in a low-cost instrument. Including readout display storage with storage override control. Precision crystal oscillator accurate to two parts per

million. And a multi-range time base selector switch which permits maximum resolution of the frequency being measured.

For easy maintenance, we made the ICs socket-mounted. For ease of replacement, we offer an optional IC spares kit.

For more information, just circle reader service number 232 or write Newport Laboratories, Inc., 630 East Young Street, Santa Ana, California 92705. For immediate information, call collect. Dial (714) 540-4914. Ask for Walt Boris. Or TWX: 910-595-1787

NEWPORT



**MORE
THAN THIN-FILM
METALLIZED
SUBSTRATES,
RESISTOR
NETWORKS
& CUSTOM
HYBRIDS**

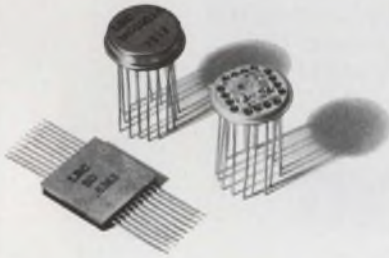

LRC, Inc. is providing a variety of thin-film substrates and devices with two important advantages: A Quick-Reaction Capability for custom resistor networks and hybrid circuits. Complete LRC facilities for testing and screening all devices to MIL-STD-883.

Thin film metallizations include chrome/gold, tantalum-tantalum-nitride / gold, chrome / copper, chrome/copper/gold and many other combinations. Unique LRC trimming methods and heat treatment assure highly reliable, stable resistive elements. Standard packages include DIP, TO- and Flatpacks.

TYPICAL PERFORMANCE

Resistor Values	3 ohms to 1 megohm
Resistor Tolerances	As low as $\pm 0.05\%$ depending on resistor values
Temp. Coeff.	As low as -15 ppm Typically -50 ppm
Temp. Tracking	Typically less than 1 ppm
Power Dissip.	Up to 1 watt
Oper. Temp.	-55°C to $+125^{\circ}\text{C}$

For your copy of the new LRC
THIN FILM brochure,
call or write:



11 Hazelwood Road
Hudson, N.H. 03051
(603) 883-8001
(603) 883-9351
TWX 710 228-1377

MICROWAVES & LASERS

**CATV transistor lists
8-dB NF at 210 MHz**

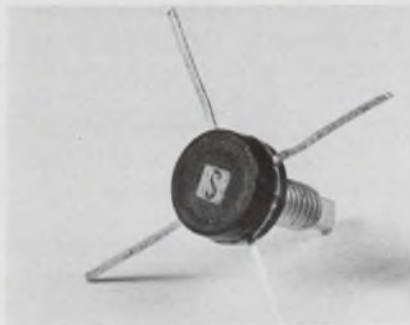

Solitron/Microwave, 1440 W. Indiantown Rd., Jupiter, Fla. 33458. (305) 746-8311. \$5.40 (1-99); 3 wks.

The SC3000 CATV transistor has a broadband noise figure of 8 dB at 210 MHz and a cross-modulation figure of -95 dB at $+35$ dBm for 20 channels. Intended primarily for bridge and trunk amplifiers, the SC3000 comes packaged in a stripline TO-117 case.

CHECK NO. 297

**Rf linear amp
delivers 40 W**



Electronic Navigation Industries, 3000 Winton Rd. S., Rochester, N. Y. 14623. (716) 473-6900. \$1450; 60 days.

The Model 240L solid-state instrumentation amplifier can supply up to 40 W of linear rf power or up to 150 W of saturated power over the 20-kHz-to-10-MHz frequency range. The unit supplies its rated output to any load regardless of the impedance value. The 240L has a gain of 50-dB, with variations limited to ± 1.5 dB. Harmonic distortion is typically more than 30-dB below the fundamental at an output power of 40 W, while maximum noise figure is 8 dB.

CHECK NO. 298

**Laser system has
5-wavelength output**

International Rectifier, 1521 Grand Ave., El Segundo, Calif. 90245. (213) 322-4987.

A high-power, high rep-rate laser system offers outputs at 1.06, 0.53, 0.265, 0.6943 and 0.3472 μ . The five wavelengths are obtained by interchanging ruby and Nd-glass laser rods. The system's power control operates at a peak current of 75 A and switches at zero voltage level. Voltage to the charging circuit can range up to 12 kV, and is maintained within 1/2%.

CHECK NO. 299

**Power-chip resistors
cover 40-M Ω range**

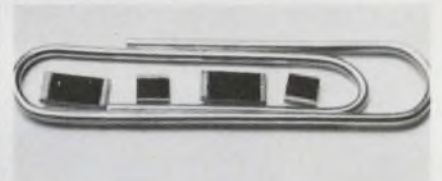

Micro Components Assoc., 202 E. Stevens, Suite G, Santa Ana, Calif. 92707. (714) 979-8833. Size E: 80¢ (100 up).

Power-chip resistors for S-band applications range from 1 Ω to 40 M Ω . Available tolerances are 0.5, 1, 2, 5 and 10%. The chip resistors are offered in these configurations: Size E—0.10 \times 0.10 \times 0.02 inch and 3-W dissipation—and Size F—0.10 \times 0.20 \times 0.02 inch and 5-W dissipation.

CHECK NO. 300

**Double-balanced mixer
has 2-to-500-MHz range**

Elcom Systems, 151-15 W. Industry Ct., Deer Park, N.Y. 11729. (516) 667-5800. \$39.50 (small qty.); stock to 30 days.

A double-balanced mixer operates in the 2-to-500-MHz frequency range. Called the DBM-500/BNC, the mixer's i-f output covers frequencies from dc to 500 MHz. Typically the mixer exhibits 15 to 50 dB of isolation between ports and a conversion loss of 5 to 10 dB (SSB N.F.), with a +7 dBm LO input-signal level. And the use of Schottky-barrier diodes permits a total power input of +23 dBm over the temperature range of -54 to $+71$ C.

CHECK NO. 301

We're everything you need in cermet trimmers. We're TRW/IRC Potentiometers.



These infinite resolution pots cover the complete size range from 1/4" round to 1 1/4" rectangular in the industry's widest selection of mounting configurations.

The exclusive Metal Glaze® element results in a cermet trimmer with higher power rating and wider temperature range than other manufacturers' units of the same size. Maximum temperature coefficients

of ± 100 ppm/°C. are standard, with TCs of ± 50 ppm available on most types.

For fast delivery, from stock, call any TRW/IRC Potentiometer distributor listed on the adjacent page. For information of the complete line, contact your distributor or TRW/IRC Potentiometers, an Electronic Components Division of TRW Inc., 2801-72nd Street North, St. Petersburg, Florida 33733; phone (813) 347-2181.

TRW[®] IRC POTENTIOMETERS

CPI-7305

Get the designer's edge

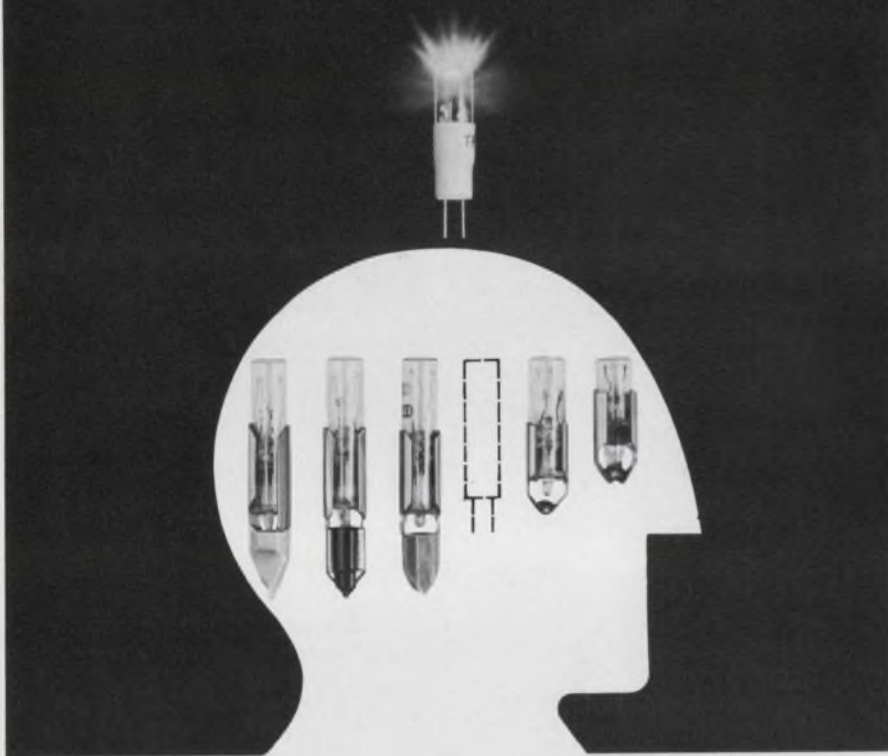

with the industry's broadest line of subminiature T-2 lamps.

Specify A lamp with the light output at the business end of the bulb. Maximum end viewing in signalling applications is assured with our T-2 flat top bulb construction.

Specify Simplicity A .250 O.D. lamp in over one hundred types assures design continuity and consistency.

Specify Versatility You can trade off design economy, light output, voltage, current and size with a choice of pilot, indicator and telephone lamps in up to 5 base styles.

Specify the Total Package We have the hardware to match the light source — a complete line of pilot and indicator sockets and lenses.

Specify Reliability The most widely used light source in telephone industry signalling applications. Specify telecommunications reliability.

Get the designer's edge — write for specification data.



ONE SOURCE, ONE CATALOG. GET THE EDGE.

Send for our new 28-page catalog.
Sylvania Miniature Lighting Products Inc.,
West Main St., Hillsboro, N. H. 03244 (603) 464-5533

GTE SYLVANIA

INFORMATION RETRIEVAL NUMBER 77

MICROWAVES & LASERS Log amp accuracy varies over temp by ± 1 dB

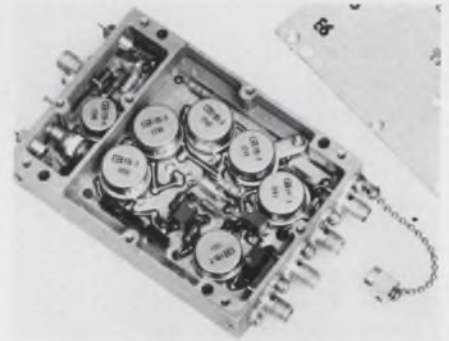

Circuit Technology, 160 Smith St., Farmingdale, N.Y. 11735. (516) 293-8686. From \$650 (unit qty); stock to 14 wk.

With a 60-MHz center frequency and a bandwidth of 25 MHz, models CTL60s-1 and -2 provide logging accuracies of ± 1 and ± 2 dB, respectively. The log accuracy applies over the operating temperature range of -20 to $+65$ C and -75 to -5 dBm input dynamic range. Rise time is a minimum of 50 ns. Gain scale factor is 30 mV/dB with a video output drive capability of 0 to $+2.1$ V into 100 Ω . The matched dual log amps measure only $4.88 \times 3.35 \times 0.68$ in. and the single units are only $2.44 \times 3.35 \times 0.68$ in. The CTL60D-1 and -2 models are dual versions of the CTL60s-1 and -2.

CHECK NO. 302

Avalanche diodes have 20 kV PIVs at 1 A



AFI Ind., 400 Warburton Ave., P.O. Box 476, Long Branch, N.J. 07740. (201) 229-8300. From \$1.50 ea.

Designated the 500A series, the avalanche rectifiers have an 8 to 20-kV PIV and are specifically designed for use in commercial or industrial type microwave cooking ovens. The rectifiers feature output currents from 300 to 1000 mA.

CHECK NO. 303

Stripline hybrid has quadrature output

Technical Research and Manufacturing, Grenier Field, Kelly Ave., R.F.D. #3, Manchester, N.H. 03103. (603) 668-0120. \$25 (1-4); stock to 2 wk.

The miniature stripline hybrid Model HQ 502-1 for direct installation into microstrip circuits uses strip transmission-line construction. Power handling is on the level of 100-W cw with 3-kW peaks. Typical specifications for model HQ 502-1 are: frequency range 225 to 400 MHz; isolation, 20 dB (min.); VSWR, 1.20:1 (max.); amplitude balance, ± 0.5 dB; phase balance, $\pm 1.5^\circ$; insertion loss, 0.25 dB (max.); size 1.25 in² \times 0.11 in. thick.

CHECK NO. 304

Cavity oscillator has 0.25% stability

Solid State Technology, 3650 Charles St., Santa Clara, Calif. 95050. (408) 247-8620. \$595 to \$1176 (small qty.); 60 days.

The SSC-0204 cavity oscillator features a frequency stability of 0.25%, at temperatures greater than 100 C, during 12 hours of operation after 15 minutes of warm-up. The oscillator can replace phase-locked oscillators and has a voltage-tuning capability over a 0.4% bandwidth at rates from dc to 10 MHz. Mechanically tuned bandwidths of typically 10% can be obtained from 500 MHz to X band. Harmonic and spurious rejection are -30 and -60 dB, respectively.

CHECK NO. 305

Power dividers work from 2 to 18 GHz

Narda, 75 Commercial, Plainview, L.I., N.Y. 11803. (516) 433-9000. Two-way: \$300; four-way: \$425; stock.

A series of broadband two and four-way power dividers, Model 3300 and 4300 series, can be used in the 2-to-18-GHz frequency range. The new stripline units provide equal in-phase division of input powers, with low VSWRs ranging from 1.2 to 1.35 (typical). Output-port isolations are typically about 20 dB.

CHECK NO. 306

"Airpax UPL Series Circuit Protectors make our entire systems possible."

AIRPAX™ TYPE UPL Electromagnetic Circuit Protectors

Airpax Type UPL Circuit Protectors provide reliable, low cost power switching, circuit protection, and circuit control. UL Recognized, the UPL line offers many configurations including series, shunt and relay. Multipole assemblies are available with a mix of current ratings, delays, and internal configurations. Full load current ratings from 0.05 to 100 amperes.

Avtec Industries designs and manufactures pre-fabricated modular Utility Distribution Systems for one-point connection to multiple-unit batteries of equipment or to special laboratory equipment; and Electra-Poles, unique systems that plug into the ceiling when power is needed and unplug when the equipment is removed.

These systems require positive protection — AIRPAX protection!

In the words of Mr. Bruce A.

Zimmerman, Vice President of Avtec, "These entire systems are possible because we use Airpax UPL Series Circuit Protectors, which provide built-in 'point-of-use' protection and eliminate the need for running branch circuits from the panel box."

Shouldn't you investigate Airpax Circuit Protectors for your next design?

Write for specifications.

Airpax Electronics / CAMBRIDGE DIVISION / Cambridge, Md. 21613 / Phone (301) 228-4600

AIRPAX™

25 YEARS OF PROGRESS

INFORMATION RETRIEVAL NUMBER 78

Cover the 5 to 200-MHz range with 3 attenuators

Radiation Devices, P.O. Box 8450, Baltimore, Md. 21234. (301) 665-2764. (unit qty) \$42 (VCA-1) \$38 (-2), \$35 (-3); 30 days.

A series of three voltage-controlled p-i-n-diode attenuators covers the frequency range of 5 to 200

MHz—model VCA-1, 40 dB, 5 to 100 MHz; VCA-2, 30 dB, 5 to 100 MHz; VCA-3, 20 dB, 5 to 200 MHz. Maximum insertion loss is 6 dB. VSWR varies from 3.0 to less than 1.5 depending on attenuation setting. Units require up to 105 mA supply current and less than 5 mA control current. Connectors available include BNC, JCM (SMA compatible) and TNC. Unit size is 5.8 × 5.3 × 3.1 cm.

CHECK NO. 307

Transistors offer 1 to 5 W at 1 to 2 GHz

Raytheon Co., Wayside Ave., Burlington, Mass. 01803. (617) 862-6600. 1605: \$44; 2501: \$48 (1-9); stock.

Two npn planar silicon transistors boast 5-W output with 6-dB gain at 1 GHz (RMT 1605) and 1-W output with 5-dB gain at 2 GHz (RMT 2501). Both transistors can be used for linear amplifier and oscillator applications. They are available in hermetically sealed stripline-stud packages featuring low-inductance leads. Maximum dissipation ratings are 12 W for the RMT 1605 and 5.8 W for the RMT 2501.

CHECK NO. 308

He-Cd laser offers 10 mW in radiated blue

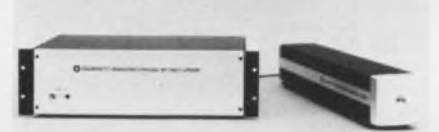

Coherent Radiation, 310 Porter Dr., Palo Alto, Calif. 94304. (415) 493-2111. \$1950; stock.

The helium-cadmium Model 90 laser provides greater than 10 mW at the 441.6-nm wavelength (visible blue). Tube life, according to the company, exceeds 1000 hours and the tube can be replaced in minutes. Lasing action is obtained within two minutes after turn-on and full power is obtained within eight minutes.

CHECK NO. 309

Dye lasers achieve 0.001-nm resolution

Molelectron, 930 Thompson Pl., Sunnyvale, Calif. 94086. (408) 738-2661. DL-300: \$9235; 3 months.

Dye lasers are offered in the DL-Series with resolutions reaching 0.001 nm in the 350-to-740-nm range. The series starts with the DL-100 that provides 0.2-nm resolution in the wavelength range. The DL-200 adds a beam-expanding telescope to the DL-100 and provides 0.01-nm resolution. By adding an intracavity etalon to the DL-200, the DL-300 resolution reaches 0.001 nm. The lasers are nitrogen laser pumped and built on the Hansch principle.

CHECK NO. 310

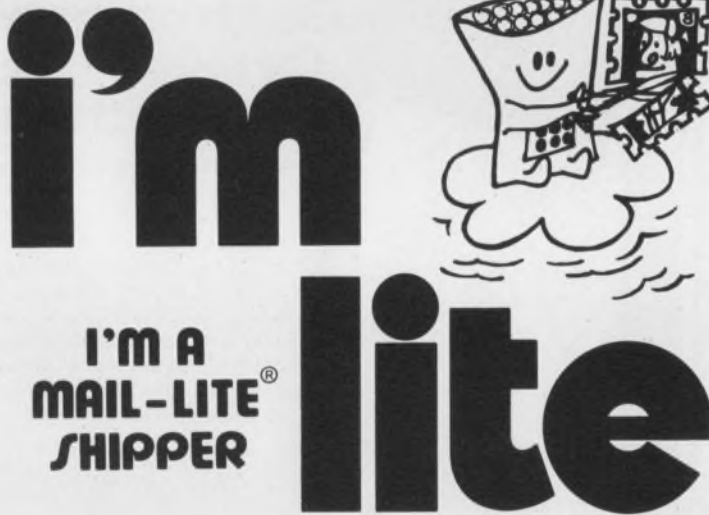

THE LIGHTEST CUSHIONED SHIPPING BAG YOU CAN BUY . . .

LIGHT because I'm lined with clean plastic bubbles of air laminated to heavy duty golden kraft. I can reduce your shipping weight by up to 8 ounces versus a mailer box and offer a postal savings of 8 cents an ounce in first class and 4 cents an ounce in third class. Compare the cost to mail:

	Weight	Postage per M First Class	Postage per M Third Class
MAIL-LITE — 14¼" x 20"	2.7 ounces	\$240	\$120
Padded Bag — 14¼" x 20"	9.7 ounces	\$800	\$400
Mailer Box — 10" x 16" x 2"	10.8 ounces	\$880	\$440

I'm tough, clean, waterproof and heat sealable too. Like all Sealed Air® products, my bubbles are barrier coated for better protection.

Write for FREE MAIL-LITE SAMPLE . . . and receive the Mail-Lite Guaranteed Postal Savings Chart.



Sealed Air Corporation

19-01 STATE HIGHWAY 208/FAIR LAWN, NEW JERSEY 07410

A flexcircuit for electronic pocket camera control.



We did it for Kodak.

The Kodak Pocket Instamatic, one of the major marketing successes of the decade.

Many of the pocket Instamatic® cameras, Model 50 and 60 pack the Schjeldahl flexcircuit you see above. One circuit containing two integrated circuits, all other electronics and flexed into 12 planes. That's using flexcircuitry as it should be used.

But there's more to the Schjeldahl circuit than that. It is only 8 mils thick yet it's fully insulated on both sides. Components mount directly to the flexcircuit and they can be hand or wave soldered. It replaces all wire and all circuit boards and provides the entire interconnection function.

To help make its great new camera possible, Kodak needed a compact, sophisticated flexible circuit that could be produced at the rate of thousands per week.

Schjeldahl did it for Kodak.



Schjeldahl Company

Electrical Products Division
Northfield, Minnesota 55057

The state of the art people in volume flexible circuits

And we can do it for you.

INFORMATION RETRIEVAL NUMBER 80

MICROWAVES & LASERS

PIN diodes have low insertion loss

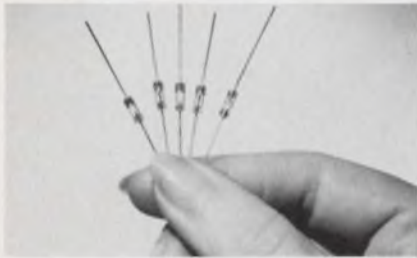

Varian, Salem Rd., Beverly, Mass. 01915. (617) 922-6000.

The VSD-300 series p-i-n diodes feature SiO_2 passivation and are available with breakdown voltages of 50, 100, 200 or 500 V. Performance characteristics obtained with the VSD-300 series include: junction capacitances ranging from 0.05 to 0.75 pF and series resistances from 0.3 to 2 Ω . Typical, minority carrier lifetimes for VSD-300 diodes are between 5 and 350 ns. The diodes will withstand operating temperatures from -65 to $+150$ C, and storage temperatures from -85 to $+300$ C.

CHECK NO. 316

Ion laser line offered



Coherent Radiation, 3210 Porter Dr., Palo Alto, Calif. 94304. (415) 493-2111. \$8350 up; under 30 days.

The CR-Series of ion lasers consists of argon, krypton and mixed-gas (argon and krypton) types. The argon lasers delivers 2, 3, 5 and 8 W; the krypton lasers, 500 and 750 mW at 647.1 nm; and the mixed-gas lasers, 250 mW at 488 nm, 514.5 nm and 746.1 nm. All lasers have an amplitude noise that is less than 0.5% rms and single frequency stability that is better than ± 8 MHz. According to the company, the lasers will operate in excess of 6000 hours.

CHECK NO. 317

Entire S-band paramp provides 45-dB gain



Micromega Div., 12575 Beatrice St., Los Angeles, Calif. 90066. (213) 391-7137.

An S-band paramp with built-in power supply and temperature stabilization circuitry provides low-noise amplification of rf signals in the 2.2-to-2.3-GHz band with a nominal insertion gain of 45 dB. Other specifications include noise temperature of 125 K max and gain stability of ± 1.0 dB/24 hours over the 0 to 125 F temperature range. The bandpass ripple is 1 dB pk-pk max and gain compression is 1.0 dB max with input signal level at -40 dBm.

CHECK NO. 318

How flexible can you get?

Ultra-flexible with ultra fine wire stranding, combining wires as slim as .001 of an inch in diameter. Super supple pliability makes it a must for in-movement service.

WOVEN ELECTRONICS

P.O. Box 189
Mauldin, South Carolina 29662



5.4-5.9 GHz Gunn VCO drifts 10 MHz typical



Texscan, 2446 N. Shadeland Ave., Indianapolis, Ind. 46219. (317) 357-8781. \$615; 6 wk.

A Gunn-effect oscillator, the ETO-217, exhibits a typical frequency drift of 10 MHz (20 MHz worst case) over the temperature range of -10 to $+60$ C while varactor tuned anywhere in the 5.4-to-5.9-GHz band. Minimum power output is 40 mW with tuning and temperature-induced variations of ± 2 dB. Tuning voltage is 5 to 60 V and the bias is 14 V dc at 1/2 A. The oscillator measures $1/2 \times 1 \times 2-1/4$ inches and weighs less than 2 ounces.

CHECK NO. 893

Panoramic/sector rcvr covers GHz range



Watkins-Johnson, 6006 Executive Blvd., Rockville, Md. 20852. (301) 881-3300.

Full panoramic or sector coverage of the 2-to-1000-MHz frequency range is offered by the 208 series of receivers. Seven receivers are required for complete coverage, however 11 receivers with various band coverages are available. In the panoramic mode, the full frequency band of the receiver is swept at an adjustable rate varying from 0.1 to 25 sweeps per second. The sector mode permits a sector scan variable from zero to full band, continuously adjustable by front panel control.

CHECK NO. 894

INFORMATION RETRIEVAL NUMBER 82 ►

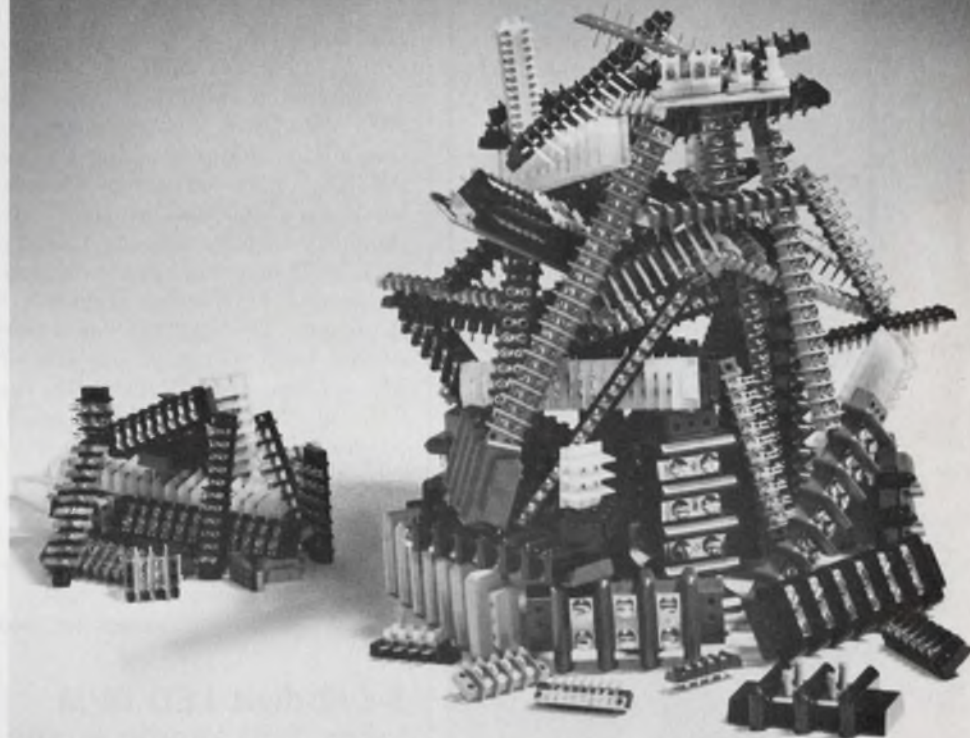

WE OVERSHADOW THE COMPETITION

Our stack is on the right. It's quite an assortment.

After all, we're the largest manufacturer of terminal boards, blocks and strips in the world.

And we offer more variations than anyone else.

"One" meets your specific requirement. Delivery? Allow a few weeks for our good old standards, longer for the oddballs. So plan ahead and get the best.

Kulka

A NORTH AMERICAN PHILIPS COMPANY

SE UL

Kulka Electric Corp., 520 South Fulton Avenue, Mount Vernon, New York 10551

innovation yesterday

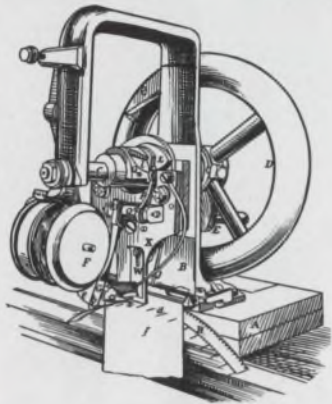

The First Elias Howe Sewing Machine

innovation today



MINILEVER[®] Series 28000 Fast-Lever Actuated Digital Switch

The sewing machine must have increased the clothing industry's output a thousand fold. It was a clever and efficient idea. Here's a clever idea in switching. MiniLever. Each switch module can be actuated through the full range of digits (0 to 10 or 0 to 12) with a quick flick of the lever. And there are dozens of codes available. Anyone who has to use computer terminals to check credit, make hotel or other types of reservations will love the MiniLever. So, ask us about MiniLever or send for a catalog sheet. We think that's a good idea too.

THE **DIGITRAN** COMPANY
A Division of Becton, Dickinson and Co. **B-D**
855 So. Arroyo Parkway, Pasadena, Ca. 91105
Tel. (213) 449-3110 • TWX 910-588-3794

INFORMATION RETRIEVAL NUMBER 83

INSTRUMENTATION

Dual-trace storage scope offers 50-MHz bw



Test & Measuring Instruments,
224 Duffy Ave., Hicksville, N.Y.
11802. (516) 433-8800.

Designated PM3251, This 50-MHz dual-trace storage scope offers all the features of the Philips PM3250 high-sensitivity broadband scope and also provides continuously-variable storage time up to 2 hr in addition to continuously-variable persistence from 0.3 s to 15 min. The PM3251 has a sensitivity of 2 mV/cm at 50 MHz or 200 μ V/cm at 5 MHz. Like the PM3250, the PM3251 allows simultaneous display of trace A-B vs \pm B, chopped or alternate, and allows X vs Y display with 2-mV sensitivity on the X axis and 200 μ V on the Y axis, with phase shift of only 3 deg at 100 kHz.

CHECK NO. 502

3-1/2-digit LED DPM takes 200 readings/sec

Datel Systems, 1020 Turnpike St.,
Canton, Mass. 02021. (617) 828-
6395. \$99; stock.

Model DM-2000 3-1/2-digit DPM (LED display) contains a true differential input. Both inputs and the analog common can sustain up to ± 2 V, common-mode, with respect to the digital-output common. Other features include a choice of input range, ± 1.999 mV or 1.999 V fs, a common-mode rejection ratio of 70 dB at 60 Hz, input bias current of 20 nA and an input impedance of 100 M Ω , plus automatic polarity. Model DM-2000 has a specified accuracy of $\pm 0.05\%$ and can resolve to 100 μ V over 0 to +70 C. Input settling time is 50 μ s and up to 200 readings can be made asynchronously or synchronously.

CHECK NO. 503

Automated test system is easy to use

Julie Research Labs, 211 W. 61st,
New York, N.Y., 10023. (212) 245-
2727. \$25,000 to over \$100,000;
8-20 wk.

LOCOST-106, Labor Optimized Computer Operated System Test facility, can be operated by a laboratory technician. The control system consists of a calculator with a 10 to 12K capability, coupled with a data terminal, high-speed thermal printer, and a 32,000-word, programming-cassette memory. The system, which uses BASIC language, has an alphanumeric keyboard and an interactive 32-character display, as well as a 15-k byte mainline memory. Pre-programmed software makes it possible to generate, store and carry out test programs for new instruments.

CHECK NO. 504

Units detect, categorize power-line transients



Programmed Power, Inc., 141 Jef-
ferson Dr., Menlo Park, Calif.
94025. (415) 323-8454. \$2995 to
\$3600; 8 wks.

The 3200 Series is a family of three power-line disturbance monitors. The portable instruments simultaneously detect, count, categorize, time and record overvoltages, undervoltages, fast transients and frequency variations on single or three phase power lines. Provided are audio/visual alarms and hard-copy printout indicating day, hour and minute, plus a code digit correlating to the specific power anomaly noted. The latter feature permits unattended, remote applications. Transient response ranges from 0.5 to 100 μ s and transient amplitudes range from ± 50 to ± 600 V.

CHECK NO. 505

Switching technology vs. series-pass. Now there's a choice.

Series-pass regulation offers great advantages in compact size, established design technology and exceptionally clean output. While switching technology is theoretically even more compact, it's virtually impossible to produce because of the inherent high noise and RFI problems.

Right?

Wrong. Sorensen's STM series of modular power supplies prove the point. First, for a given power rating, STM's offer twice the efficiency, half the size and lower price than equivalent series-pass units (and all STM's have built-in over-voltage protection). Plus a big plus. Low RFI and noise. We ran conducted interference tests and fully met the requirements of MIL-STD-461A above 20KHz.

The STM series presently consists of 30 switching transistor power supplies — with 10 models to follow shortly. STM efficiencies approach 75% keeping dissipation low. In many systems applications these high efficiencies obviate the need for forced air cooling systems.

Switching technology is no longer a bugaboo. It works. Beautifully. Send for our complete catalog and see for yourself (and see our great series-pass supplies too). Write Sorensen Company, a unit of the Raytheon Company, 676 Island Pond Rd., Manchester, N.H. 03103. Telephone (603) 668-4500. Or TWX 710-220-1339.

Specification	Sorensen STM5-24	Brand "X"
Size	3 ⁵ / ₁₆ x 5 ¹ / ₈ x 9 ¹ / ₂	4 ¹⁵ / ₁₆ x 7 ¹ / ₂ x 9 ³ / ₈
Volume	160 in ³	344 in ³
Price	\$229	\$235
Efficiency	58%	29%
Regulation (line & load combined)	0.05%	0.2%
Temperature Coefficient	0.01%/°C	0.03%/°C
Overload Protection	Current limiting- adjustable electronic	
Overvoltage Protection	Built-in adjustable, all models	Optional @ \$30 (except built-in, fixed, on 5-volt model only)

Compare this point-by-point spec-check between Sorensen's STM5-24 and Brand "X".

STM: twice the efficiency, half the size.

Sorensen
POWER SUPPLIES

INFORMATION RETRIEVAL NUMBER 84

D/A SETTLES IN 15 NS!

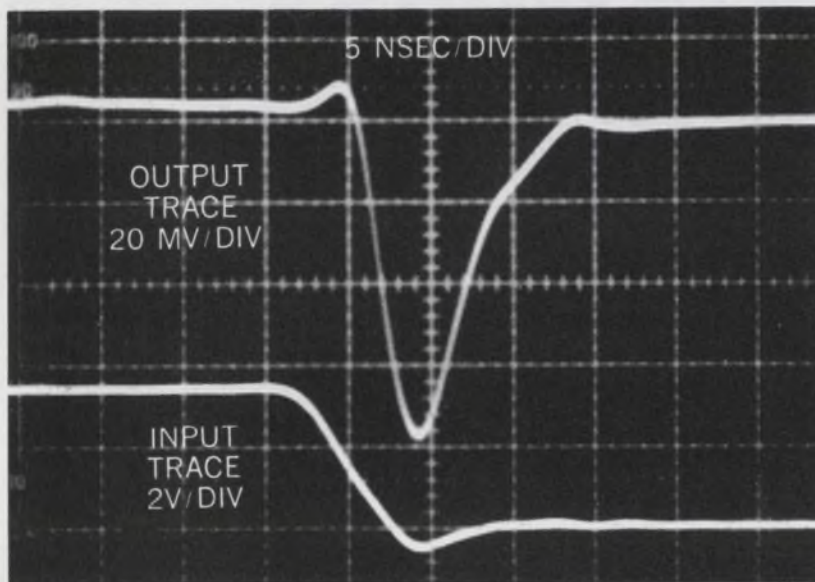

Unretouched photo of scope traces showing settling time for Computer Labs MDS-0815 under worst-case conditions of MSB switching out of phase with all other bits.

Now you can get D/A's with 8-bit settling time as low as 15 ns; 10-bit settling in 20 ns! The Computer Labs MDS/MDP Series offers a complete range of 8 and 10-bit converters with cost/performance tradeoffs in speed and temperature coefficients. All settling times are specified at full current output of 15 mA or +1.5V for unipolar operation; and ± 7.5 mA at ± 1.1 V for bipolar output.

That makes these D/A's ideal for applications requiring ample driving currents and exceptionally fast conversion. Call or write now for complete information on the fastest and most economical 8 and 10-bit D/A's available.

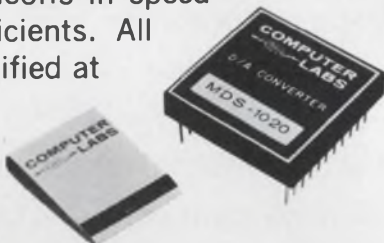

**COMPUTER
LABS**

1109 South Chapman Street / Greensboro, North Carolina 27403 / (919) 292-6427

INFORMATION RETRIEVAL NUMBER 85

INSTRUMENTATION

Digital storage scope has internal memory



Nicolet Instrument, 5225 Verona Rd., Madison, Wis. 53711. (608) 271-3333. \$4800; 4-6 wks.

The 1090 digital storage scope has a nonvolatile magnetic-core memory with the capacity to store a waveform to a resolution of one part in 4096 on both voltage and time axes. It's comprised of a main frame and plug-in units. Movable crosshairs are used to select any region of the stored waveform for closer inspection. This selected area can then be expanded in voltage and/or time dimensions, in steps of two, up to a factor of 64X. A touch of a button allows the present, preceding, or following signal to be held (whichever is desired) and another touch returns the operation to real time. Several waveforms may be stored and superimposed. Pen recorder drive and binary output are included.

CHECK NO. 506

VOM measures current to 12 A, ac/dc

Simpson Electric Co., 5200 W. Kinzie St., Chicago, Ill. 60644. (312) ES 9-1121. \$105; stock.

Features of the Model 265 include high ac and dc current capability, to 12 A, and the ability to take ac voltage and ac current measurements almost simultaneously. The 265 is housed in the familiar Simpson 260-style case and is equipped with a single, central-range switch and adjust-a-vue handle, which doubles as a meter stand.

CHECK NO. 507

4-3/4-digit DMM offers 300% overrange



Hickok Electrical Instrument Co.,
10514 Dupont Ave., Cleveland, Ohio
44108. (216) 541-8060. \$595; 60
days.

With optional 300% overranging, the Hickok 3400 offers five-digit accuracy for measurements up to a maximum display of 39999. The Hickok 3400 contains 26 ranges: Five each for dc and ac volts and dc and ac current, and six for ohms. A three-year warranty is standard. The 3400 is 3-1/2 x 8-3/8 x 13 in. and weighs 10 pounds.

CHECK NO. 508

Digital printer mates to many sources



Beckman Instruments, 3900 River
Rd., Schiller Park, Ill. 60176. (312)
671-3300. \$750; stock.

Model 1453B digital printer can accept data from a wide variety of sources. The instrument offers a 1 to 12-column printout capacity, and is designed to replace existing Beckman Models 1453 and 1453A printers. Adding appropriate input modules provides the 1453B with flexibility of input codes, levels and format. These modules include BCD or 10-line input, and vacuum tube, transistor or integrated circuit levels. A continuously rotating print drum, spring-loaded print hammers, paper advance system, print color selector, and dc motor are the instrument's only moving parts.

CHECK NO. 509

The fast and easy way to troubleshoot

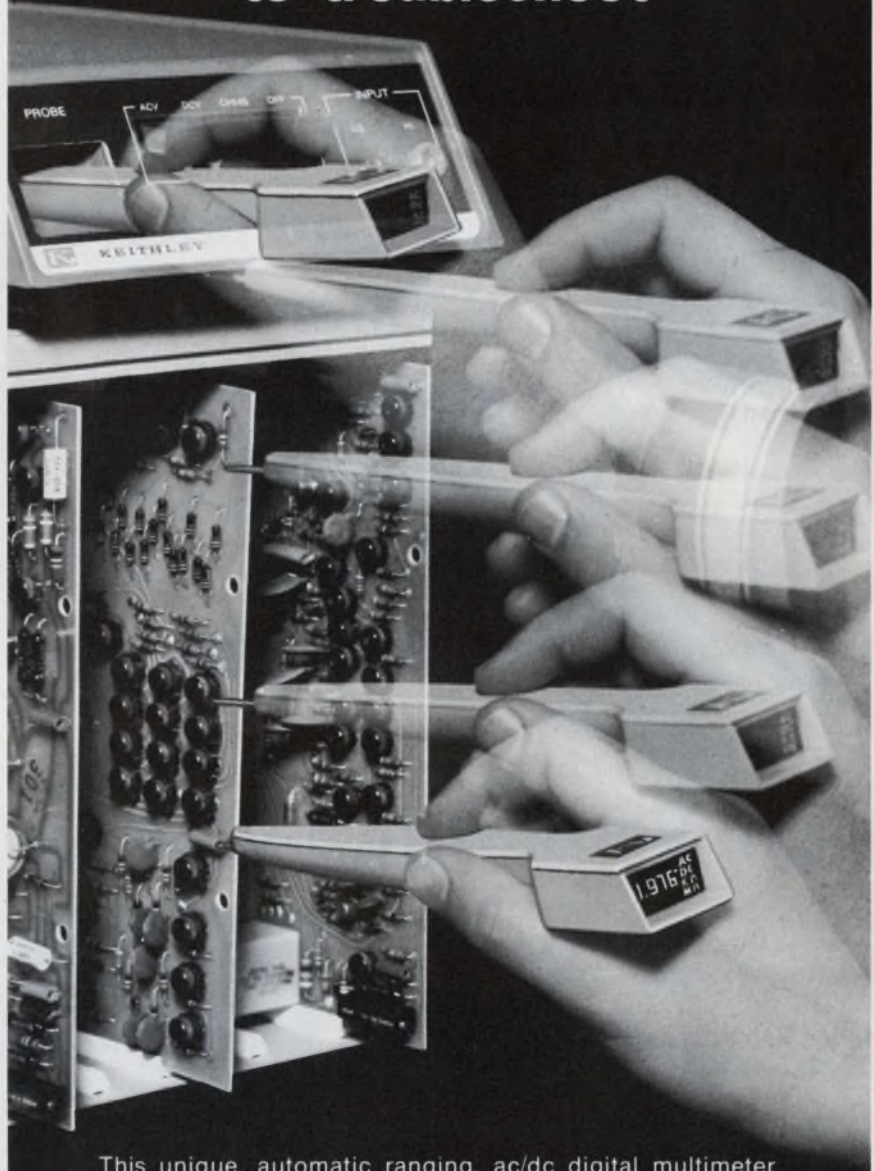

This unique, automatic ranging, ac/dc digital multimeter puts the data right at your fingertips.

The Model 167 Auto-Probe DMM:

- measures dc voltage - 1 mV to 1000 volts
- measures ac voltage - 1 mV to 500 volts rms
- measures resistance - 1 ohm to 20 megohms
- measures current - with optional shunts
- battery operated (line adapter optional)

It's fast (saves time!), it's accurate, and its readout is right in the hand-held probe.

The Model 167 Auto-Probe DMM — only \$325. Send for more details.



**KEITHLEY
INSTRUMENTS**
U.S.A. 28775 AURORA ROAD, CLEVELAND, OHIO 44139
EUROPE: 14, AVENUE VILLARDIN, 1009 PULLY, SUISSE



why go to the
far places
for a miniature
IF Filter
under \$4*?
It's right
at your
doorstep

from Vernitron... (the filters people)

If you're after miniaturization, performance and low cost—and think you have to go to overseas sources to get them—you don't!

Here's Vernitron's new TAF-02A encapsulated ceramic filter for today's compact Comm receivers and transceivers. Gives you performance equal to four IF cans in a space smaller than one. Sharp clean selectivity to beyond 40 dB. Good resistance to shock, vibration, humidity. Immune to magnetic fields—so you can eliminate shielding. That's design flexibility!

Made for automated assembly—and produced right here at home, where you have full design assistance right on tap. And you can't beat the price.

* In production quantities

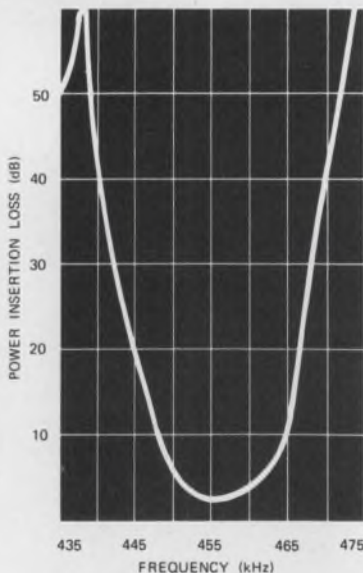

Complete application info is yours for the asking



Vernitron Piezoelectric Division

232 Forbes Road / Bedford, Ohio 44146 / (216) 232-8600

INFORMATION RETRIEVAL NUMBER 87

INSTRUMENTATION

Four-digit DMM
sells for \$595



Syston-Donner, 10 Syston Dr., Concord, Calif. 94518. (415) 682-6161. \$595; 5 days.

Model 7004A 4-digit DMM offers 25 measuring ranges: ac V, dc V, amps and ohms. Dc accuracy is 0.01%, and ac response covers the range to 100 kHz. Color-coded push-buttons simplify selection of desired function and range. Inputs are fully guarded for highest common-mode operation. An optional rechargeable battery pack can be mounted internally and a BCD output option makes it possible to record measurements on an associated digital printer.

CHECK NO. 510

3-in. portable scope
gives 2-MHz bw



Dynascan Corp., 1801 W. Belle Plaine Ave., Chicago, Ill. 60613. (312) 327-7270. \$180.

The B & K 1403 "MiniScope" is a general-purpose 3-in. scope with a bw of dc to 2 MHz, and direct-deflection terminals for viewing waveforms to 150 MHz. It's 100% solid state and has dc amplifiers on both horizontal and vertical axes. Over-all size is 5-1/4 x 7-3/8 x 11-1/4-in., and weight is only 8.5 lb. Vertical sensitivity is 20 mV/cm and input impedance is 1 MΩ shunted by 30 pF.

CHECK NO. 511

Lock-in amplifier is sensitive to 100-nV fs



Princeton Applied Research, Box 2565, Princeton, N.J. 08540. (609) 452-2111. \$2295; 90 days.

Model 186 lock-in amplifier measures amplitude and phase angle of signals obscured by noise. It provides 100-nV fs sensitivity and handles transient noise overloads as much as 300,000 times fs. A unique feature is the lock-in's ability to yield low drift under high overload conditions. Stability to 10 ppm/°C is possible with overloads to 3000 times fs and 100 ppm is typical with overloads to 30,000 times fs. Operating frequency range is 0.5 Hz to 100 kHz but the signal need not be frequency stable; it can drift and the lock-in will automatically track.

CHECK NO. 512

Purchase 3-1/2-digit multimeter in kit form



Nobex Electronics, P.O. Box 4365, Burlingame, Calif. 94010. (415) 344-7691. \$149.95 (unit qty); stock.

Nobex Model 8700K digital multimeter, when assembled, has an accuracy of 0.5% by using an internal oven-controlled voltage reference. The kit is engineered for easy sequential assembly. Ranges include 1, 10, 100, and 1000 V dc with 300% overrange, 1, 10, 100 and 1000 V ac with 100% overrange, 1 k, 10 k, 100 k and 1 MΩ with 300% overrange and 300-V fuseless input protection. The unit can be calibrated, with its internal voltage standard, using only a screwdriver.

CHECK NO. 513

...YOU'LL LIKE IT!

TRUE RMS VOLTMETER RESOLVES 0.01 dB

PROGRAMMABLE ■ SENSITIVE ■ WIDE BANDWIDTH

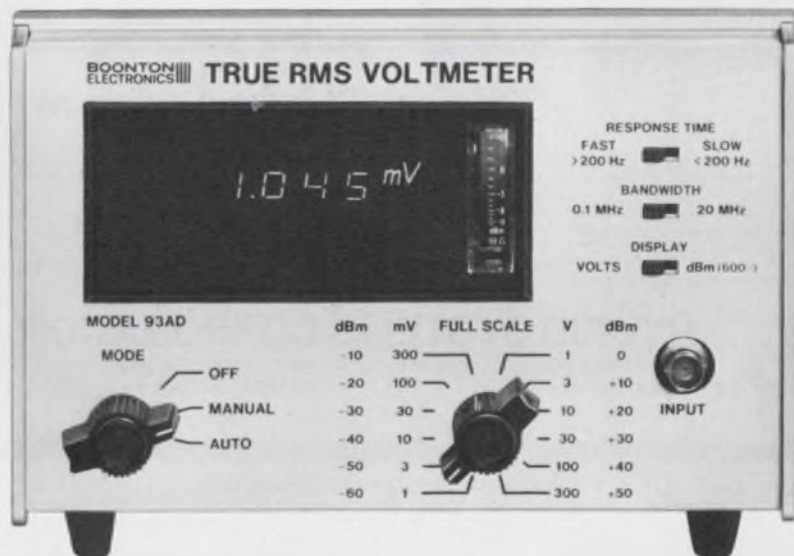

These important features, usually extra-cost or unavailable, are standard with the 3½ digit 93AD at its \$1200 base price:

- 300 μ V sensitivity usable over the full 20 MHz bandwidth.
- Full remote control.
- Digital and analog outputs.
- Auxiliary analog meter.
- Selectable bandwidth and response time.

Several options and accessories are available for special requirements:

- Digital dB display and outputs.
- Automatic ranging.
- High impedance probe.

BOONTON ELECTRONICS

ROUTE 287 AT SMITH RD.
PARSIPPANY, N.J. 07054
TEL.: 201-887-5110
TWX: 710-986-8241

NEW Super Small, 12-Bit D/A Converter



DAC371I-12

- $\pm 0.025\%$ Linearity
- Complete and Ready-to-Use
- Binary or BCD Coding
- All Hermetic Components
- TTL/DTL Compatible

\$35 in singles

The current output DAC371I-12 — the smallest 12 bit D/A converter on the market — has been especially designed for the size and price-conscious engineer. The unit is so small (1.1" x 1.7" x 0.4") that it only takes up the size of two standard 16 pin IC sockets. And, it's priced right too, selling for \$35.00 in singles.

The DAC uses some significant new proprietary breakthroughs in component technology to achieve this size and cost. Nonetheless, the unit is complete with precision resistor ladder, switches, and a high accuracy internal reference, and just requires $\pm 15V$ power for operation. Contact us for full details.



HYBRID SYSTEMS CORPORATION

87 Second Avenue, Northwest Industrial Park, Burlington, Mass. 01803
Telephone: 617-272-1522 TWX: 710-332-7584

Write for our new data conversion products catalog

INFORMATION RETRIEVAL NUMBER 89

The Servo-Tek World of DC Servomotors



Wide range of permanent-magnet dc models available.

Servo-Tek's Permanent-Magnet DC Servomotors are precision made to give highly reliable performance. Their stability, high output-to-size ratio and speed range from 0-10,000 rpm with output torques to 2.0 oz-in make them ideal as prime movers in servomechanisms. Diameter 1.135 in. lengths up to 3.253 in. A unique field structure of Alnico VI results in minimized cogging (slot lock), a prerequisite to optimum servo performance. Models are available with a variety of operating voltages and with various mountings and integral gearing. Moderately priced with quantity discounts.

FREE CATALOG of
rotating components available.

Be Selective, Turn To...

SERVO-TEK
PRODUCTS COMPANY

1086 Goffle Road, Hawthorne, NJ 07506 · 201-427-3100

Servo-Tek of California, Inc.

8155 Van Nuys Blvd., Van Nuys, CA 91402 · 213-786-0690

INFORMATION RETRIEVAL NUMBER 90

INSTRUMENTATION

Pulse generators give 100-MHz rep rate



Hewlett-Packard, 1501 Page Mill Rd., Palo Alto, Calif. 94304. (415) 493-1501. 1916A: \$1290; 8007B: \$1750; 90 days.

Two new pulse generators, one a plug-in (Model 1916A) and one an independent instrument (Model 8007B), test high-speed TTL-S, ECL-I, ECL-II and low-power ECL to repetition rates up to 100 MHz. Each unit offers variable transition time, variable offset, and a variety of output formats and operating modes. The Model 8007B holds nonlinearity of transition slopes below 3% for transitions greater than 20 ns. Pulse transition times may be varied from 2 ns to 250 μ s; rise and fall transitions may differ as much as 50:1. Pulse amplitude is 5 V, positive or negative, and dc offset may be set ± 4 V, independent of amplitude.

CHECK NO. 514

Test set measures chatter of contacts

Atec, Inc., Box 19426, Houston, Tex. 77024. (713) 468-7971. \$2685; 60 to 90 days.

Model 4201 Contact Chatter Test Set offers 0.1- μ s resolution of duration of contact chatter observed over a preselected period or window. This window moves continuously with time, permitting uninterrupted observation, unless maximum allowable duration of chatter is exceeded. The moving window can be selected for periods from 100 μ s to 1 ms in increments of 100 μ s. Maximum allowable total duration of chatter during this moving period can be selected from 0 to 999.9 μ s, in increments of 0.1 μ s.

CHECK NO. 515

One part in 10 million from 0° to 55°C. Without an oven.

Unlike an oven oscillator, it's smaller, more reliable, uses less power, needs no warm-up time, and it's not as expensive. The K1098A TCXO has TTL compatible output, $\pm 1 \times 10^{-9}$ /sec. rms short term stability, operates from 5 and 12VDC. Prototype quantities available at 10MHz for immediate delivery. Full details from Motorola Component Products Dept., 2553 No. Edgington, Franklin Park, Ill. 60131.



MOTOROLA

INFORMATION RETRIEVAL NUMBER 91



PURGE THE SURGE

USE TII's 3 ELECTRODE
GAS TUBE ARRESTER
FOR TOTAL PROTECTION
AGAINST METALLIC
SURGES

REA ACCEPTED
UL LISTED

Worldwide Patents:
1,121,300; 1,120,361; 1,455,343;
3,281,625; 763,840; 3,333,153;
3,340,431; 788,066; 792,356;
3,525,779; 3,522,970.



Model 16 (left) is used in all TII Surge Protectors such as Model 316 shown.

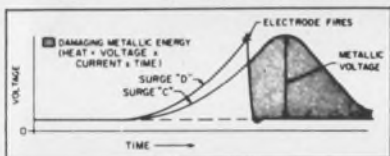

TWO-ELECTRODE OPERATION

Graph shows the relatively high transient voltages and, more important, the long duration of heating time applied to the equipment (solid state junctions).

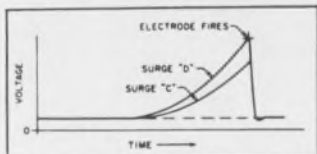

THREE-ELECTRODE OPERATION

Graph shows the same spike as before being arrested and now simultaneously grounding the second leg to achieve two important results: 1 - The transient is reduced; 2 - Solid state punch-throughs are prevented. Metallic Surge is Eliminated!

DETAILED LITERATURE ON REQUEST



**TELECOMMUNICATIONS
INDUSTRIES, INC.**

1375 Akron Street
Copiague, New York 11726
(516) 842-5000

INSTRUMENTATION Power-line recorder checks every cycle



Micro Instrument, 580 Opper St., Escondido, Calif. 92025. (714) 746-2010. \$1950; stock.

Model 5209 sag-surge recorder provides simultaneous dual-pen recording of all power line transients, plus sags and surges. The power line is continuously monitored, point by point, every cycle to detect both fast transients or slow changes that may occur. With a frequency response of dc to 1 MHz, the instrument monitors over a voltage range of 0 to 1000 V to within $\pm 5\%$ accuracy. The range may be extended to 100 kV. Several analog output voltages are provided to permit operation of the recorder with fast data loggers, video recorders or scopes.

CHECK NO. 516

Function generator has built-in modulation

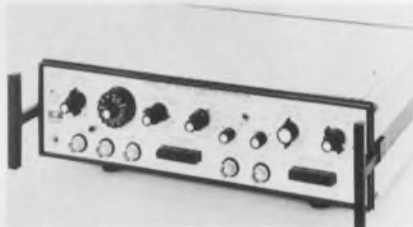

Exact Electronics, 455 S.E. 2nd Ave., Hillsboro, Ore. 97123. (503) 648-6661. \$795; stock to 2 wks.

The Model 129 contains two independent generators, one for carrier and a second for AM/FM. Both the carrier and modulating signals offer sine, triangle and square waves. The carrier ranges from 0.1 Hz to 5 MHz and can be triggered (single cycle) or gated (tone burst, pulse burst) from either the internal AM/FM generator or externally. Carrier output is 10 V pk-pk into 50 Ω , 20 V pk-pk, open circuit. The output has a precision attenuator of 60 dB in 10-dB steps, plus a continuously variable attenuator of 20-dB. AM/FM frequencies range from 1 Hz to 1 MHz.

CHECK NO. 517

3-1/2-digit OEM DPM has wide input range

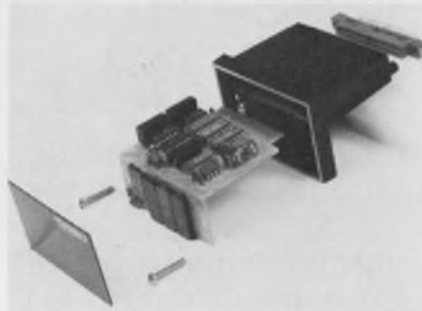

Meterex Corp., 646 Summer St., Brockton, Mass. 02402. (617) 588-8826. \$79 (100 up); stock.

DRM2000 series of 3-1/2-digit OEM digital ratio meters feature wide dynamic full-scale range, independently floated and differential input and reference channels, simultaneous sample-and-hold inputs for both channels, internal reference for absolute voltage measuring and system compatible inputs and outputs. In the ratio mode full-scale reading is set by the signal amplitude across the reference terminals and the device computes the ratio of E input/E reference. The reference input voltage can be set as low as $\pm 20 \mu\text{V}$ to as high as $\pm 400 \text{ mV}$. Time from the follow mode to the hold mode is less than 100 ns. The common-mode range is limited from -1 to $+5 \text{ V}$ and common-mode rejection is 80 dB. Power consumed is 3 W at 5 V dc.

CHECK NO. 518

Compact millivolt source provides 1- μV steps



Zi-Tech Div. of Aikenwood Co., 223 Forest Ave., Palo Alto, Calif. 94301. (415) 326-2151. \$180.

The TE404 is a millivolt source that provides 1- μV steps with 0.1% accuracy. Output is in three ranges from 0 to 999.9 mV, set by a four-decade thumbwheel switch. A built-in standard cell functions as an internal reference. The instrument weighs less than 2 lb. and runs from six size-AA cells.

CHECK NO. 519



EMI SHIELDING

- Knitted wire shielding strip gaskets and special shapes.
- Wire mesh and elastomer seal/shield gaskets.
- Thin elastomer filled meshes for shielding/sealing.
- Honeycomb, screen and mesh shielded vent panels.
- Shielded optical viewing windows.
- Metal or carbon filled conductive elastomers.
- Conductive paint, adhesives, epoxies and caulking compounds.

These and more in TECKNIT's Design Guide.

TECKNIT® Technical Wire Products, Inc.

Eastern Division • 129 Dermody St., Cranford, NJ 07016 (201) 272-5500
Western Division • 427 Olive St., Santa Barbara, CA 93101 (805) 963-1867

INFORMATION RETRIEVAL NUMBER 93

Now!! Selling Direct To Public

Big Powerful 7 H.P. Briggs & Stratton Mustang RIDING MOWER

DIRECT FROM FACTORY TO YOU.

1973 Model

constructed of steel and built for constant rugged use, this powerful 7 H.P. Mower will easily cut grass and weeds 3 feet deep, pull fertilizer distributor, seeder, roller or any other lawn attachment for your lawn needs.



Compare at \$434.95

ACTUAL PHOTO OF MOWER YOU WILL RECEIVE

now **\$229.95** FULL PRICE

Tax & Freight Paid TO YOUR DOOR

TO OWN ONE RUSH CHECK OR MONEY ORDER

TO: FRANKLIN MANUFACTURING SALES
2783 MAIN STREET
EAST POINT, GEORGIA 30344
PHONE (404) 768-4585

- ONE FULL YEAR NATIONWIDE FACTORY WARRANTY
- COMES COMPLETE WITH ILLUSTRATED PARTS LIST AND FULL OPERATING INSTRUCTIONS.
- TWO DAY SERVICE ON PARTS MOST STATES
- COMES COMPLETELY ASSEMBLED IN CRATE
- BEAUTIFUL BAKED ON RUST PROOF ENAMEL FINISH
- MADE IN U.S.A.

FEATURES

- 7 H.P. BRIGGS & STRATTON (EASY SPIN START) ENGINE
- HEAVY GAGE ALL STEEL CONSTRUCTION
- BIG 25" CLUTTER AND MOWING DECK
- RUGGED!! THREE-POSITION TRANSMISSION
- EASY HEIGHT ADJUSTMENT, VARIABLE FROM 1 1/2" to 3 1/2"
- AUTO TYPE STEERING
- BALL JOINT ADJUSTABLE TIE-RODS
- TROUBLE FREE POSI-TRAC CHAIN DRIVE
- LARGE 3 x 10 TRACTOR CLEAR SURE GRIP REAR TIRES
- ALL TIRES SEMI-NEUMATIC
- SAFETY CLUTCH
- WIND TUNNEL DESIGN VACUUM SUCTION AUS-TEMPERED STEEL DECK

— ALSO AVAILABLE: —

- STURDY, LARGE GRASSCATCHER ONLY \$20.00
- SNOW PLOW ATTACHMENT LOW PRICE OF \$34.50 THIS PRICE ONLY APPLIES WHEN PURCHASED WITH LAWN MOWER.

A TRULY GREAT OFFER, UNBELIEVABLE, AT TODAY'S INFLATED PRICES

INFORMATION RETRIEVAL NUMBER 94

ELECTRONIC DESIGN 12, June 7, 1973

TI Introduces the \$1.10 Relay.

TI has come up with a new line of snap-acting time delay relays costing only \$1.10 to \$3.00 when ordered in quantity. That's up to 25% less than conventional creep-acting blade relays—50% less than snap-acting blade relays—less than many conventional magnetic relays or contactors.

They're smaller than ordinary relays, too. They'll operate in any position, and they're resistant to shock and vibration. They also have a proven life that exceeds 100,000 switching cycles.

The secret is our Klixon® snap-acting disc and a new, low-cost electrically-heated ceramic element mounted in a compact phenolic housing.

As an OEM, you owe it to yourself to find out more. Our technical literature spells it all out.



Texas Instruments
MS 952
P.O. Box 5012
Dallas, Texas 75222.

Gentlemen: Please send me literature on your new line of snap-acting time delay relays.

Name _____

Company _____

Address _____

Zip _____

TEXAS INSTRUMENTS
INCORPORATED

INFORMATION RETRIEVAL NUMBER 95

GENERAL ELECTRIC'S 69F MIL TYPE TANTALUM WET SLUG CAPACITOR...



Four series to choose from:

69F — Unique patented double O-ring elastomer seal, with proved superiority over other elastomer seal designs.

69F2000 — Provides two-to-three times more capacitance in the same case size, with the patented double O-ring elastomer seal.

69F3000 — Glass-to-metal hermetic seal. Fully qualified to MIL-C-3965/24, Style CL66/67.

69F4000 — Glass-to-tantalum hermetic seal. Fully qualified to MIL-C-39006/9C, Style CLR65.

Same quality features in all four:

- High Volumetric Efficiency — for minimum size and weight.
- Low Leakage Current — for timing applications.
- Broad dual rated temperature range — from -55 C to +85/125 C.
- Thixotropic gelled electrolyte — for maximum stability throughout extreme temperature ranges.

For more information on these, or any other General Electric capacitors, call your nearest GE sales office, or write Section 430-52, Schenectady, N. Y. 12345.

MAKE SOMETHING OUT OF IT!

GENERAL  ELECTRIC

INFORMATION RETRIEVAL NUMBER 96

DATA PROCESSING

Encoder checkout unit selects PCM words



Coded Communications Corp., 1620 Linda Vista Dr., San Marcos, Calif. 92069. (714) 744-3710. \$3200; 60 days.

The Model ECO-2 pulse-code modulation (PCM) checkout unit is a miniature stored-format, frame and subframe, demultiplexer and word selector that operates directly from a PCM encoder or from a bit synchronizer. The features of the ECO-2 include four switchable formats, data rates from 1 bit/s to 5 Mbit/s, decimal thumbwheel selection of any word from the frame or subframe, and data word display via decimal LEDs plus analog meter. The unit accepts codes compatible with IRIG 106-71 and provides parity checking as well as subframe synchronization. Model ECO-2 recognizes a frame sync pattern up to 33 bits in length plus an 8-bit SFID pattern for frame identification. Also it can be programmed for three to twelve bits per word with a maximum 512 words per frame and 256 frames per subframe.

CHECK NO. 520

Rotating mass memory intended for OEM use

Datum, 170 E. Liberty Ave., Anaheim, Calif. 92801. (714) 879-3070. From \$1550; 30-45 days.

This series of compact drum-like mass memories is offered in five models having 4, 8, 16, 32 and 64 tracks. Units are said to combine the technologies of discs and drums. A given track holds 4096 words of 16-bits each. Only one track at a time may be accessed; the word transfer rate is 122 kHz. The memories come in a 10-in. package and weigh 25 lb. Prices range from \$1550 for a 16 k-word system to \$2950 for the 262 k-word system.

CHECK NO. 521

Medium speed modem line offers broad choice

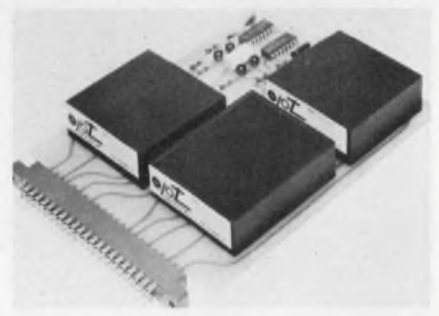

OPT Industries Inc., 300 Red School Lane, Phillipsburg, N. J. 08865. (201) 454-2600. From \$95 (OEM quan.); stock.

Series-1030 modems are completely end to end compatible with the Bell System 103 family of data sets. The major functions, i.e., modulator, bandpass filter, discriminator and interface are assembled in modules, and can be changed quickly and at minimal expense. Frequencies, speeds (to 600 baud) and interfaces can be changed in the field. Alternatively, narrow band channel filters are offered to allow FDM of several modems over one voice-grade telephone line. Four standard interfaces are offered: EIA RS-232 B/C, Teleprinter, CCITT and DTL/TTL.

CHECK NO. 522

Minicomputer boasts 20% speed increase



Digital Computer Controls, 12 Industrial Rd., Fairfield, N.J. 07006. (201) 227-4861. From \$4000; April.

Model D-116H minicomputer has a full cycle time of 960 ns, which represents a 20% increase in speed over its predecessor, the D-116. The D-116H has a storage capacity of 32 k × 16-bits in a 5.25 in. chassis, compared to 64 k for the D-116. Prices for the D-116H begin at \$4000 (with 4-k memory, programmer's console, central processor and external I/O connector). Direct memory access is standard on all D-116H computers.

CHECK NO. 523

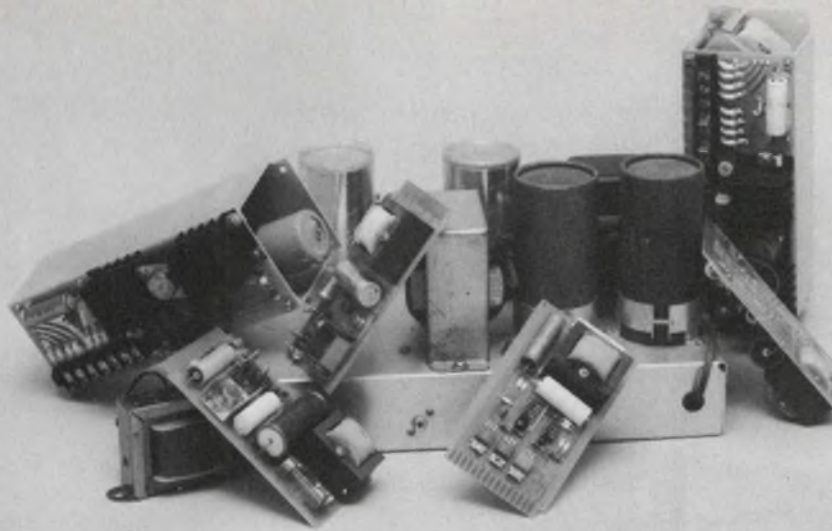

Retire the Relics.

Unless you're going into the antique electronics business ... now's the time to replace those open-frame power supplies with today's space-saving, encapsulated power modules.

Our miniature power modules are "triple-tested" for reliability. And backed with a 2-year warranty. Because they're easy to replace, downtime is significantly reduced. And if that isn't enough ... we provide a lower cost per watt than the relics of past generations.

Delivery? Five days from receipt of order. Right from the stocking shelves of the largest manufacturer of encapsulated power supplies, Computer Products, Inc. So don't save the relics — save money, save time, and save space. Write or call

us for more information today. As for the relics, maybe the Smithsonian will take them off your hands.

STOCKING DISTRIBUTION CENTERS: Gordon V. Peck Co., Garland, Tex., (214) 341-8311; B. J. Wolfe Ent., North Hollywood, Calif., (213) 877-5518; Powermart Associates, Hartford, Conn. (203) 525-8592; and Pen-Stock, Inc., Las Altos, Calif., (415) 948-6533.



COMPUTER PRODUCTS.

(305) 974-5500 • 1400 NW 70 ST. • FT. LAUDERDALE, FLA. 33308
TWX (510) 956-9895

INFORMATION RETRIEVAL NUMBER 97

**Here's everything
you'd expect from a high-priced
portable multimeter.**

Except a high price.

Compare our major features: Both high and low power ohms ranges; a .1 V low voltage scale (AC & DC); a DC current range of $1 \mu A$ full-scale; fuse protection; input impedance of $15 M \Omega$ on DC; 1% precision resistors; a $4\frac{1}{2}$ inch, $50 \mu A$ mirrored scale meter; frequency response flat to 150 KHz and 59 ranges; battery operated.

You'd expect to pay a lot more for a portable multi-meter like the B & K 277.

Check the specs. Call your B & K distributor or write Dynascan Corporation.

\$99⁹⁵



BK Very good equipment at a very good price.

Product of Dynascan Corporation
1801 West Belle Plaine Avenue, Chicago, Illinois 60613

INFORMATION RETRIEVAL NUMBER 98

ELECTRONIC DESIGN 12, June 7, 1973

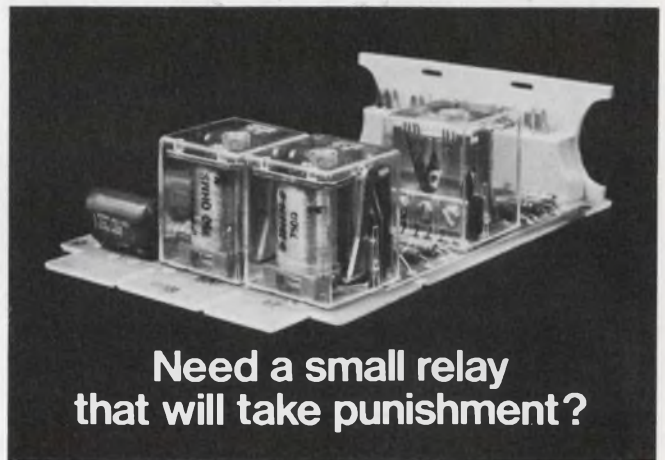

**Need a small relay
that will take punishment?**

Our class H relay may be just the answer. Its unique actuating card assures contact reliability — over 100 million operations are standard. Available from stock too. Write for information, GTE Automatic Electric, Industrial Sales Division, Northlake, Illinois 60164.

THE SOURCE

GTE AUTOMATIC ELECTRIC

INFORMATION RETRIEVAL NUMBER 99

MONOLITHIC CRYSTAL FILTERS



THE X-Y EFFECT

X.

Recently, we received an assignment from customer X to work with him in the development of his new product. Our monolithic crystal filter was to be a key part of his product's system. We started with him on his project at earliest breadboard and carried through over a two year span to final manufacturing. We worked in close collaboration with X, tailoring filter and product to one another. The result is a product unique in its field, which, based on performance and cost, has gained outstanding market acceptance. Our custom monolithics helped.

Y.

Not every new product requires two years to develop. Customer Y saw an immediate market for a new application of radio control. But his existing control receiver would be subject to interference in the new environment. Time was short. We were consulted, and recommended a standard model filter that provided the necessary i-f selectivity. Prototypes were shipped from stock. Later we were able to speed his first production run by supplying several hundred of the same standard model filter in less than four weeks. In addition to saving time, customer Y was able to take advantage of standard model engineering and pricing for his requirement, which eventually totaled a very modest, but highly successful, 1500 units for Y.

And success is the name of the game. Whether it's a brand-new project or a fast retread of an old standby we've got the filters to make your design successful. First there's the industry's largest selection of standard model monolithic and tandem monolithic crystal filters. And when it comes to custom modes, our unmatched experience assures you of the sound engineering advice you need. Last but not least, our unequalled capacity gets you your production units on time. We've proved it for X and Y and we'd like to add you to our alphabet. Drop us a line or call us.

Pi

Piezo Technology Inc.

2400 Diversified Way
Orlando, Florida 32804
305-425-1574

The Standard in monolithic
crystal filters.

DATA PROCESSING

Video expander unit reconstitutes TV images



Colorado Video, Inc., Box 928, Boulder, Colo. 80302. (303) 444-3972. \$5500; 120 days.

Data fed into the Model 261 at a slow rate (30-60 s/frame) are used to build up a continuously refreshed image on a standard TV screen. Input TV signals are converted to six-bit digital format, reconverted to analog form and recorded on the magnetic disc memory. Internal circuitry detects the necessary "frame-start" and "line-sync" signals. For computer output applications, parallel six bit data can be fed to the unit's buffer inputs at standard TTL logic levels. Either the internal time base or an external signal can control the location of the image. Options include selective data erasure, storage for multiple images and multiple channels for color synthesis.

CHECK NO. 524

Printing calculator keeps pace with results

Victor Comptometer Corp., 3900 N. Rockwell St., Chicago, Ill. 60618. (312) 539-8200. \$545-\$725; 30-60 days.

The 110 char/s printing speed of the series-1900 calculators is said to be faster than for any other calculator on the market. The four members of this series range in price from \$545 to \$725, and they figure percentages, round-off, subtotal and total as well as providing constants. Several models have one or two memories, "change-sign" keys and multiplicand entry for the second memory. One model has automatic square root and an item-count key. The units provide switch selectable fixed or floating decimal point and have 16-digit capacity. OEMs can purchase the dot matrix impact printer separately (single-unit price is \$275) quantity discounts are available.

CHECK NO. 525

Card reader plugs into calculator's I/O bus



Digital Laboratories, 377 Putnam Ave., Cambridge, Mass. 02139. (617) 876-6220. \$3850; 30-60 days.

Model IW-770 provides automatic punched-card reading for the Wang 700 and 600 series calculators. The unit plugs into the I/O bus and requires no modifications to the calculator. The reader handles stacks of up to 500 cards at rates up to 200 cards/min., without operator intervention. When a card is read, its data remains stored in an external buffer until the next card is read. Punched data are formatted as required to represent numbers or commands for the calculator.

CHECK NO. 526

Cassette recorder meets IRIG standard



Video Research Corp., 524 N. Frederick Ave., Gaithersburg, Md. 20760. (301) 948-7770. \$2450; 30 days.

Use of the data cassette recently introduced by the 3M Co. makes possible a portable cassette instrument recorder with features such as 0.5% servo speed control, speeds from 1/2 to 30 in/s with four channel record and reproduce heads. Both direct and FM recordings meet IRIG standards. Direct recording bandwidth is 200 Hz to 75 kHz at 15 in/s which decreases to 4.5 kc at 15/16 in/s, and the SNR is 30 dB. Bandwidth for FM recording is dc to 5 kHz at 15 in/s with 40 dB SNR.

CHECK NO. 527

mi·cro·temp (mī'krō tēmp')

A patented, positive safety thermal cutoff.

It will interrupt a circuit when the operating temperature exceeds the rated temperature of the cutoff. Normally employed as a back-up safety protector to cut off power to electronic circuits or components that develop abnormal temperature build-up, this device is fast, reliable and accurate to $\pm 3^\circ\text{F}$.

MICROTEMPS are CSA listed and insure product safety. Costing as little as 7.5¢ each, MICROTEMPS are available in a wide range of configurations, ratings and terminations to suit your individual applications. MICROTEMPS are hermetically sealed; unaffected by vibration, shock, aging or positioning, and meet UL standard 1020. For specific details, call or write:

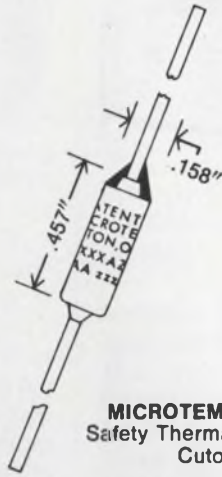

MICROTEMP
Safety Thermal
Cutoff



MICRO DEVICES CORP.

1881 Southtown Blvd. Dayton, Ohio 45439
Ph. (513) 294-0581 Telex: 28-8087

INFORMATION RETRIEVAL NUMBER 101



**Need a small relay
with a choice of termination?**

Our class E relay is the answer. From printed wiring to plug-in, we offer more methods of termination than anyone. And that means you can use the least costly production method. Just write us. GTE Automatic Electric, Industrial Sales Division, Northlake, Illinois 60164.

THE SOURCE

GTE AUTOMATIC ELECTRIC

INFORMATION RETRIEVAL NUMBER 102

ELECTRONIC DESIGN 12, June 7, 1973

DO-IT-YOURSELF grabber



NEW

- Simplified Assembly
- Versatile
- Comfortable Finger Grip Action
- Completely Field Serviceable
- Molded of Tough Lexan*

Model 3925
Mini Test Clip
Shown Actual Size

This test clip with gold plated hook is excellent for rapid testing of components and Wire Wrap pins. Clip is completely insulated to point of connection. Build any combination of test leads with wire up to .090 dia. Easy and comfortable to operate. Molded of rugged Lexan to resist melting when soldering. Write for literature and prices.

SIMPLIFIED ASSEMBLY

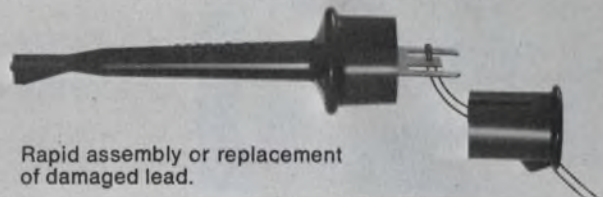

Rapid assembly or replacement
of damaged lead.

MODEL 3925

hooks onto components or slips over square Wire-Wrap pins

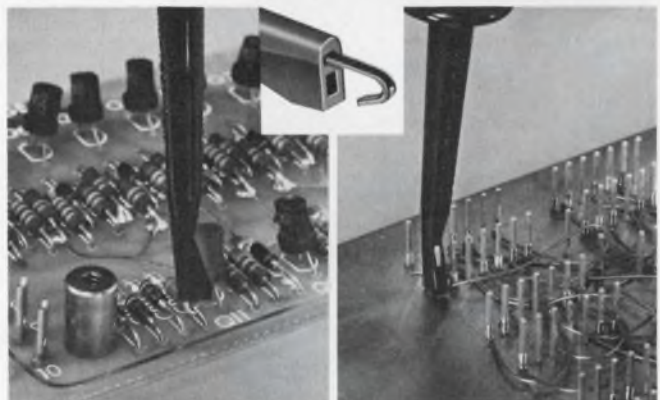

*Lexan is a General Electric trade-mark. †Registered trade-mark of Gardner-Denver Co.



POMONA ELECTRONICS

A Subsidiary of ITT

1500 East Ninth St., Pomona, Calif. 91766
Telephone (714) 623-3463

INFORMATION RETRIEVAL NUMBER 103

syntronic

OPTIMUM CORNER FOCUS

Is a function of ...

- deflection angle
- light output
- yoke impedance
- display speed
- CRT neck diameter
- CRT length
- yoke production capability

To produce one or one hundred yokes having optimum corner focus requires a thorough knowledge of system design trade-offs.

To see the difference our 25 years of experience can make, let us focus on your yoke problem.



SYNTRONIC INSTRUMENTS, INC.
100 Industrial Road, Addison, IL 60101
Phone: (312) 543-6444

DATA PROCESSING

PCM bit synchronizer has selectable rates



Coded Communications Corp., 1620 Linda Vista Dr., San Marcos, Calif. 92069. (714) 744-3710. \$4500; 60 days.

Model 7130 PCM bit synchronizer offers thumbwheel-programmable rates from 1 k bit/s to 2 M bit/s with independent input and output selection in all standard IRIG codes. The unit accepts noisy data in any of the eight IRIG codes via one of four selectable input channels. It outputs an in-phase clock, regenerated (cleaned) input data, NRZ-L data, and any selected code of the eight IRIG codes. Data are detected by an integrate-and-reset circuit. The clock is generated by a phase-locked loop using wide or narrow tracking. The bit rate ranges are 1 kbit/s to 2 Mbit/s for NRZ codes and 500 bit/s to 1 Mbit/s for RZ, DM, and Bi- ϕ codes.

CHECK NO. 528

Analysis program also performs optimization

Scientific System Technology, Inc., 603 Business Parkway, Richardson, Tex. 75080. (214) 238-7291. See text; stock.

MAGIC, a large scale circuit-analysis program provides frequency analysis, sensitivity analysis and optimization for circuits operating between a few Hz and many GHz. The program includes built-in models for such microwave elements as transmission lines and stubs. MAGIC will adjust up to 50 circuit components to obtain a least-squares fit to any circuit response curve specified by the user. A large-scale computer such as the Univac 1108 or CDC 6000 with 48-k words of core is required to execute the program, or the user can access it on a time-shared basis from University Computing Corp. In house rental costs \$2500/mo.

CHECK NO. 529

Programmable industrial controller is modular



Struthers-Dunn, 1101 State St., Bettendorf, Iowa 52722. (319) 359-0318. From \$5000; stock.

A modular approach allows the engineer to add controller capacity in small increments as needed. The VIP 250 programmable controller is available with 32 to 256 I/O ports in multiples of 16. Maximum memory capacity is 4096 words, in multiples of 256. High noise immunity is obtained through use of proper logic, photo-isolated inputs and a ferroresonant power supply. No special training is required for programming which can start from relay ladder diagrams, Boolean equations or English statement—as desired. Price ranges from \$5000 (128 I/O ports, 256 words) to \$12,000 (256 I/O ports, 4096 words).

CHECK NO. 530

Tape punch handles a variety of tape materials



EECO, 1601 East Chestnut Ave., Santa Ana, Calif. 92701. (714) 547-5651. \$1435; stock.

Model TPS9960 tape punch handles Mylar, paper-Mylar, aluminum Mylar and paper tapes and can punch 5, 6, 7 or 8 levels. The self-contained unit operates synchronously at 60 char/s and asynchronously from zero to 60 char/s. Supply and take-up reels hold up to 1000 ft of tape. Dimensions of the model TPS9960 are 10-1/2 high by 12-1/2 in. deep and the 30-lb unit mounts in a standard 19-in. rack. Single-unit price is \$1435 with OEM discounts available.

CHECK NO. 531

**PERSONNEL
RECRUITMENT
ADVERTISING
IN
Electronic Design
REACHES THE
RIGHT PEOPLE
AT A LOWER COST
PER THOUSAND**

*Call the
HOTLINE
today
for complete
information:
(201) 843-0550
extension 209*

For a limited time only, Cambion's new general purpose ceramic module 801-2001-01 will be sold for 1/3 off the usual \$30 price. It can be used in water coolers, small refrigerators, hot and cold temperature sources, spot cooling for electronic components, and many other applications. You'll also get a free copy of Cambion's Thermoelectric handbook.

To order, send name and address along with \$20 check or money order. Cambridge Thermionic Corporation, 445 Concord Ave., Cambridge, Mass. 02138

Special introductory offer
It costs less to buy
our new low cost
thermoelectric module **NOW**.

OPERATING CHARACTERISTICS

ΔT Max. at Q_c Zero = (60°C)
Max. current = (8.5 amps.)
Nom. Voltage = (3.5 VDC)
 T_h = (50°C)
 Q_c Max. at ΔT Zero = (19 Watts)
Max. Op. temp. = 100°C

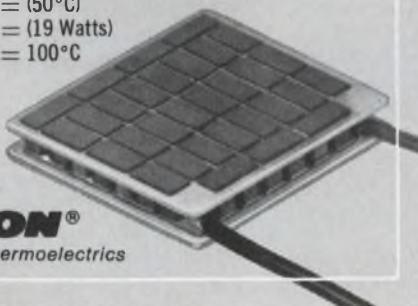

Standardize on
CAMBION[®]
The Guaranteed Thermoelectrics



**Looking for one relay
to do the work of four?**

Our class W relay can transfer as many as 51 circuits at one time. And do it with communications system reliability. That's why it's used for telephone switching and computer peripheral equipment applications. Write us for details on other ways to use it. GTE Automatic Electric, Industrial Sales Division, Northlake, Ill. 60164.

**THE
SOURCE**

GTE AUTOMATIC ELECTRIC

Free-cursor digitizer relies on software

California Computer Products, 2411 W. La Palma Ave., Anaheim, Calif. 92801. (714) 821-2541. \$20,764.

Five buttons on the cursor control all digitizing functions on the model 942, and the result is 0.001-in. resolution and 0.005-in. accuracy. Model 942 is a self-contained

unit. The work surface is a standard drafting table with adjustments for surface tilt (0 to 90 degrees) and elevation (34 to 46 in.). One cursor button defines the origin, the second increments the 4-digit counter and the other three are used for digitizing the data. The company offers host computer software for functions such as scaling, gridding and coordinate conversion. Interfaces are available for teletypewriters and for the IBM model 029 keypunch.

CHECK NO. 533

Computer interface speeds data acquisition



BiRa Systems, 9617 Acoma S. E., Albuquerque, N. M. 87123. (505) 298-4321. See text; 30-60 days.

The MBD-11 is a 16-bit real-time microprocessor for use in data logging and control applications. It is designed to control and collect data from upwards of 150 modules such as multiplexers, a/d converters and TTL logic. The data are buffered, formatted and combined for transmission via direct-memory-access channels to the PDP-11 host computer. Most real-time data acquisition tasks are handled by plugging in circuits according to a simple flow chart. The MBD-11 can perform a complete control function in 350 ns. The unit costs \$5495 with a 256-word bipolar memory.

CHECK NO. 534

Modems connect directly to phone lines

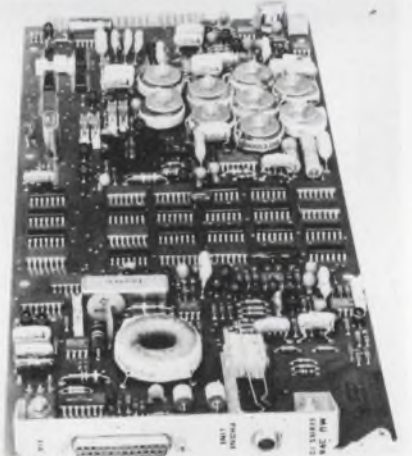



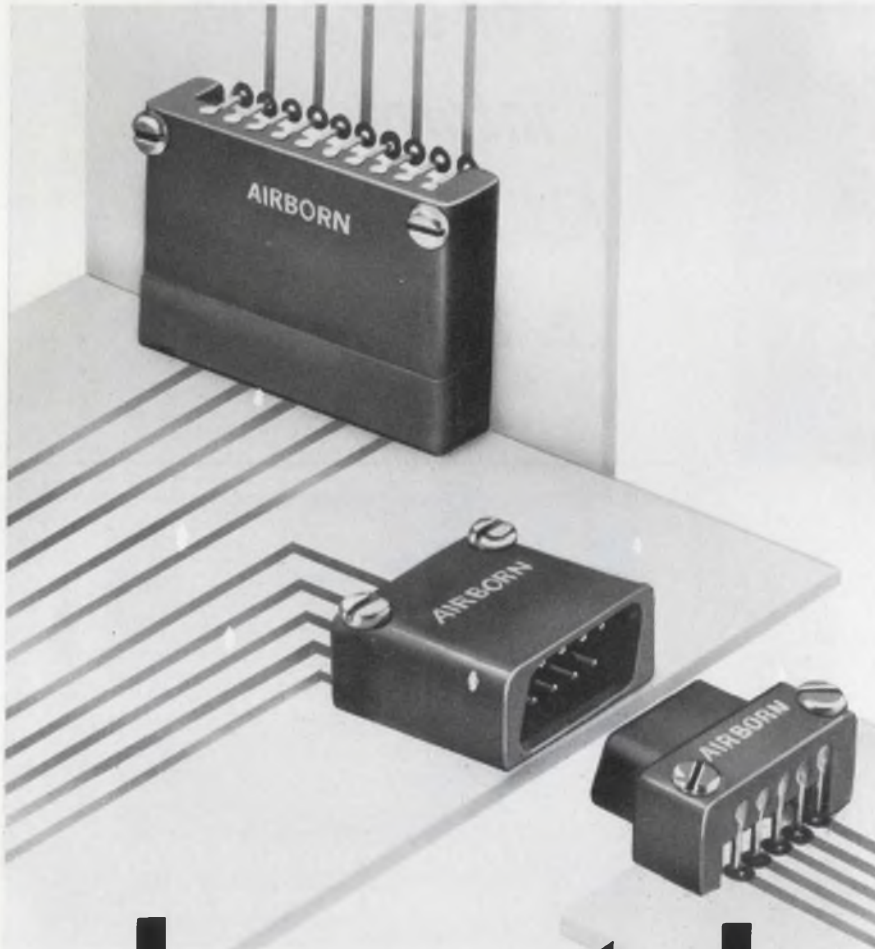

Anderson-Jacobson, 1065 Morse Ave., Sunnyvale, Calif. 94086. (408) 734-4300. From \$295; stock.

Modems MU 296/12 and 396/12 are designed to replace the Bell 103 A/E and 112 B modems. Both modems connect directly to a telephone line without the need for a data-access arrangement. Both answer incoming calls automatically and provide full-duplex service. The MU 396/12 also allows automatic call origination. The modems transmit data at speeds up to 450 baud and have -50 dBm sensitivity. The purchase prices are \$270 for the MU 296/12 and \$295 for the MU 396/12.

CHECK NO. 535



Innovate!

with  to , , or  connectors.

New flexibility in electronic design is possible with AirBorn's WTE series of right angle connectors. Use any combination - right angle to right angle, perpendicular, parallel, or extender boards. Two sizes: 10 and 20 contacts. Spacing: .100"; 2 rows; offset .050. Write 2618 Manana Drive, Dallas, Texas 75220, or call 214-357-0274 and let us help you INNOVATE!

AirBorn, Inc.

DUAL POSITION DRUM INDICATOR



ACTUAL SIZE

The Minelco® MI61M, L and LD internal drum-type BITE Indicators provide optimum visible indication for avionics instrumentation and control applications.

Latching or self-restoring, environmentally sealed, the MI61M, L or LD are optionally available with O-ring panel seal and special finish to provide RFI shielding. Standard voltages available are 6, 12, 24 and 28. A wide choice of variations is available to meet circuit condition indicator requirements. The display drum accommodates combinations of colors and up to 5 letters, 3/32" high, to meet individual requirements.

Further information on MI61M, L and LD BITE Indicators available on request.



MINELCO
DIVISION
GENERAL TIME CORP.
A Talley Industries Company

135 SOUTH MAIN STREET • THOMASTON, CONN. 06787
PHONE: 203/283-8261 • TWX: 710/475-1091

INFORMATION RETRIEVAL NUMBER 109

DC to AC Sine Wave Inverters



SPECIFICATIONS

Output Voltage Regulation:

less than $\pm 5\%$ for line and load

Frequency Stability:

$\pm 0.5\%$ of fixed frequency; 0.05% optional

Total Harmonic Distortion:

less than 5% at full load and nominal line

GW Series — Typical 60 Hz Models

Power (VA)	Input (VDC)	Output (VAC)	Priced from	Delivery
250	12, 24, 28, 48	115, 230	\$ 695	Stock
500	12, 24, 28, 48	115, 230	1195	Stock
1000	12, 24, 28, 48	115, 230	1700	Stock
2000	12, 24, 28	115, 230	3000	3 days
3000	12, 24, 28	115, 230	4400	3 days

(50 and 400 Hz models available)

TOPAZ
ELECTRONICS

SOLUTIONS TO
POWER PROBLEMS

3855 Ruffin Road, San Diego, CA 92123 Phone (714) 279-0831

INFORMATION RETRIEVAL NUMBER 110

ELECTRONIC DESIGN 12, June 7, 1973

FREE...



1973 Heath/Schlumberger electronic instrumentation catalog.

The new '73 Heath/Schlumberger instrumentation catalog is here...52 pages of high performance electronic equipment...all at budget-stretching prices. Whatever it is that you need in electronic equipment for test and design work, R&D applications or for teaching, Heath/Schlumberger has it...



at less than you planned to spend. 600 MHz frequency counter with 7-digit LED readout and complete programmability for only \$795* (left)... dual trace 15 MHz scope only \$595*... multi-range, multi-speed strip chart recorder system just \$675*

...a patchable mini-computer interface system, just \$1250*... the famous Malmstadt-Enke Lab Stations... dozens of plug-in circuit cards... power supplies... generators... digital multimeters... and hundreds of other instruments. To get your FREE copy of this catalog now, visit your local Heathkit Electronic Center or use the coupon below.

HEATH	
Schlumberger	
Heath/Schlumberger Scientific Instruments	
Dept. 581-266	
Benton Harbor, Michigan 49022	
<input type="checkbox"/> Please send 1973 Electronic Instrumentation catalog.	
Name _____	
Title _____	
Company/Institution _____	
Address _____	
City _____	State _____
Zip _____	
*Mail order prices; F.O.B. factory.	
EK-355	

INFORMATION RETRIEVAL NUMBER 111

165

SPECIAL PURPOSE TELEVISION CAMERAS

1270 SERIES



- General Purpose • Low Cost
- 800 Line Horizontal Resolution
- Environmental Proofed • Rugged
- Remote Control

1400 SERIES



- Miniature Size • Low Cost
- 800 Line Horizontal Resolution
- Low Power Requirement

1500 SERIES



- Subminiature Size • Extra Rugged
- 800 Line Horizontal Resolution
- Battery or Line Operated

2800 SERIES

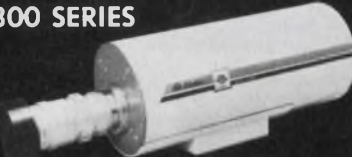

- Self-Contained • General Purpose
- 800 Line Horizontal Resolution
- RS 170 Synch Generator
- Power Line Operation

MODEL V1000



- Ultra High Resolution (30 MHz bandwidth)
- Photographic Quality
- Flat Field
- Multiple Scanning Rates (525-1225)

**MONITORS • SWITCHERS
PAN & TILTS
VIDEO TAPE RECORDERS
REMOTE CONTROLS
ACCESSORIES**



Edo Western CORP.

GENERAL OFFICES: 2645 South 300 West, Salt Lake City, Utah 84115
(801) 466-7481 • Telex: 308-315

DATA PROCESSING

Minicomputer features higher throughput rate



Rolm Corp., 10300 N. Tantau Dr.,
Cupertino, Calif. 95014. (408)
257-6440. \$18,500.

Increases in execution speed will allow the 1602 Ruggednova to solve complex time constrained problems. The 16-bit machine, designed for military environments, boasts an average speed increase of 6 times over that of its predecessor, the 1601. Computational speed and flexibility are provided by internal microprogram capability. The augmented instruction set includes a push-down stack, n-bit shift instruction and a file search instruction. Additional interrupt capability includes several preprogrammed interrupt sequences which reduce interrupt processing time. Rolm also offers the full set of software packages provided with the 1602's predecessor. The price quoted includes the CPU and an 8k x 16 bit core memory.

CHECK NO. 536

Fast drum plotter has three pens

California Computer Products,
2411 W. La Palma Ave., Anaheim,
Calif. 92801. (714) 821-2541.
\$12,600; stock.

The model-936 three-pen drum plotter operates on-line or off-line and is compatible with all members of CalComp's 900-series controller family. The unit has an axial speed of 3.6 in/s (pen down) and 5.0 in/s (pen up). This allows a diagonal rate of 5.1 in/s and 7.1 in/s, respectively. Interchangeable drums enable use of 33-in. and 11-7 in. paper widths. An electronic scaling device compensates for paper-width or inking variations. A built-in cutting bar facilitates easy removal of completed plots.

CHECK NO. 537

Loader program is stored in a ROM device

Computerwise, Inc., 13124 S. 71
Hwy., Grandview, Mo. 64030.
(816) 765-3330. \$450; stock.

The RM-11A ROM loader provides program loading for PDP-11 series computers. The RM-11A is a 96-word IC read-only-memory which is contained on one printed circuit board. It plugs into any available small peripheral-interface slot in the processors. The unit is compatible with the standard absolute loader program and, in addition, performs an automatic device selection sequence for the high speed reader or low speed reader (with standard bus addresses). The ROM loader program utilizes the highest four words of read/write memory for temporary storage and leaves the bus address of the selected input device in the last word. Comprehensive documentation and a diagnostic are provided with each unit.

CHECK NO. 538

Metal housing reduces tape cassette problems



Conrac Corp., Cramer Div., Mill
Rock Rd., Old Saybrook, Conn.
06475. (203) 388-3574. \$5.50 in
1000 qty; stock.

Die-cast aluminum construction assures dimensional stability for the CM-300 metal cassette in spite of ambient temperature and humidity variations. The metal housing acts as a ground, eliminating static-charge problems that can cause tape to stick to itself and result in jamming or tearing. The replaceable foam-type pressure pad meets ANSI and ECMA standards for pressure and torque. Tape speeds are 50 in/s for read-write and 400 in/s for search. Cassette tape capacity is 300 ft with a packing density of 800 bit/in.

CHECK NO. 539

For once in your life...live.

A sleek graceful sailing vessel glides across the sometimes green, sometimes blue Caribbean. The cargo: you. And an intimate group of lively, fun-loving shipmates.

Uniform of the day: Shorts and tee shirts. Or your bikini if you want. And bare feet.

Mission: A leisurely cruise to remote islands with names like Martinique, Grenada, Antigua—those are the ones you've heard of. Before the cruise ends, you'll



know the names of many more. You'll know intimately the enchanting different mood of each...and its own beauty and charm.



Spend ten nights watching the moon rise and getting to know interesting people. It could be the most meaningful experience of your life...and it's easily the best vacation you've had.



Life aboard your big sailing yacht is informal. Relaxed. Romantic.

There's good food. And 'grog.' And a few pleasant comforts... but any resemblance to a plush pretentious resort hotel is accidental.

Spend 10 days exploring paradise.

A cruise is forming now. Your share from \$245. Write Cap'n Mike for your free adventure booklet in full color.

Come on and live.



Windjammer Cruises.
WINDJAMMER INTERNATIONAL SUBSIDIARY - OTC

Name _____
Address _____
City _____ State _____ Zip _____
Phone _____

P.O. Box 120, Dept. Miami Beach, Florida 33139

OPTIMA ACTION RACK

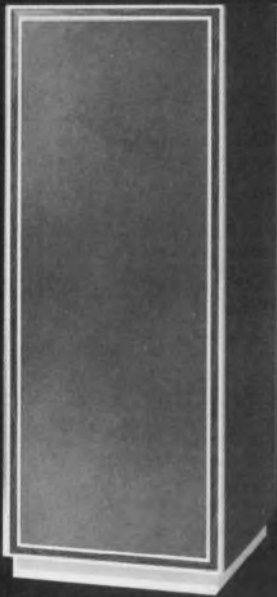

The all new **ACTION RACK** provides the top quality package with an exciting range of features and applications.

■ **Multibay Systems**—The **ACTION RACK** is at its best arranged in series, wedges and wrap-arounds. Future system expansion is a simple and easy operation.

■ **Turret Display Modules**—Isolate and focus attention as required in display, monitor and CRT applications.

■ **Accessories**—A decade of experience has gone into development of these useful accessories—Panels and handles, recessed mounting rails, trim inserts, doors, leveling feet, casters, caster plate, stabilizers, power outlets, chassis slides and support angles, storage shelf, blowers, vent grilles and louvers, drawers and a variety of writing surfaces.

Engineered to provide full use of the expanded **OPTIMA** line of accessories and styling features at a money-saving cost. Available in 7 panel heights (22", 28", 35", 42", 52", 61", and 70") for 19" panel width and 24" panel-to-panel depth. Depth is adjusted with recessed mounting rails. **ACTION RACK** is delivered completely assembled and finished in two colors from a great selection of 16 vinyl colors.

Write or call **OPTIMA ENCLOSURES**
Division of Scientific-Atlanta, Inc.
2166 Mountain Industrial Blvd.
Tucker, Ga. 30084 (404) 939-6340

INFORMATION RETRIEVAL NUMBER 116

PACKAGING & MATERIALS

Foam flux offered for automated soldering



Multicore Solders, Dept. LF 122, Westbury, N. Y. 11590. (516) ED 4-7450.

Called foam fluxes, these new liquid fluxes are specially designed for automated soldering of PC boards. Type 366 is an activated noncorrosive rosin foam flux. The flux is supplied with a 38% solids content and is intended for immediate use without thinning for all electronic general-purpose soldering. Type 366A-25 has a 25% solids content. It is used where a lower rosin content is permissible. A hard, protective, nonconductive, insulating residue is left on the soldered assemblies. Both new fluxes contain WW Gum Rosin.

CHECK NO. 540

Socket accepts TO-66 9-pin IC packages



Jermyn, 712 Montgomery St., San Francisco, Calif. 94111. (415) 362-7431. \$0.80 (250 up).

Socket A1369 enables nine-lead TO-66 devices to be mounted on heat sinks and chassis without soldering the leads. The devices are secured with two screws. A solder lug under one screw can be used for grounding. The socket material, black phenolic thermosetting plastic, is suitable for continuous operation to 150 C. The socket contacts are silver plated.

CHECK NO. 541

Maximize dissipation by using basket heat sink

Precision Dipbrazed Tor, 14715 Armenta St., Van Nuys, Calif. 91402. (213) 786-6524. Stock.

Model LP-12 aluminum heat sink maximizes heat dissipation in a small space for transistors in TO-3, TO-66 and TO-36 cases. Thermal resistance with natural convection is 10.1°C/W. Using forced convection, a thermal resistance of 2.5°C/W is achieved. By mounting the heat sink on a Tor 1549-1 bracket, the thermal resistance will lower to 8.3°C/W with natural convection and 2.1°C/W with forced convection.

CHECK NO. 542

Ceramic powder gives a surface finish of 4 μ in.



Comco, 9421 Telfair Ave., Sun Valley, Calif. 91352. (213) 768-5450.

A powder for ceramic substrates is 99.5% Al₂O₃, and provides substrate surface finishes of 4 μ in. or better—as fired (no glazing, grinding or polishing). Substrate thicknesses range from 0.01 to 0.03 in.

CHECK NO. 543

Potting compound has mix-and-dispense bag

Allied Resin Corp., Weymouth Industrial Park, E. Weymouth, Mass. 02189. (617) 337-6070. \$1.90 (100 cc).

AP 8500 is a two-part epoxy casting compound that is prepackaged in a two-section pouch. You break the divider that separates the catalyst and resin and you knead the mixture before using. Then just snip off a corner to dispense the epoxy. Working time is approximately 30 min. for 100 cc at 72 F. Cured, it is tough and semirigid. The epoxy can withstand a maximum temperature of 215 F.

CHECK NO. 544

battery holders

PRE-TESTED • LOW COST • LIGHTWEIGHT

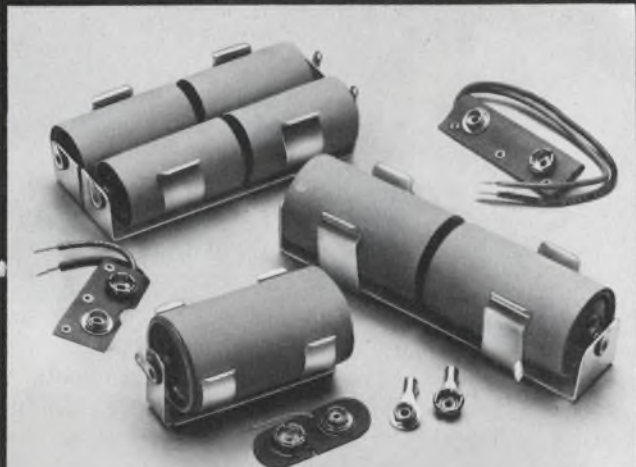

A complete standard line of battery holders and connectors, for use with all type batteries. Aluminum or steel nickel plated, single and multiple holders.

Free engineering service for your special custom built holders.

NEW FREE CATALOG ON REQUEST

Manufacturers of Standardized Hardware for Electronics



KEYSTONE

ELECTRONICS CORP.

49 Bleecker Street • New York, N.Y. 10012

INFORMATION RETRIEVAL NUMBER 117



**Best buy power module for op amps.
± 15V (tracking) 400 ma ... \$85.**

Regulation, ± 0.1%; ripple, 1.5 mv. Size, 3.4" H x 5.1" W x 5.1" D. Input voltage, 105-125 VAC, 50-400 Hz. Order Model TD15-40. For 1.0 amp outputs, Model TD15-100... price, \$125. Other high quality models are available to power balanced loads drawing from 25 ma to 8.5 amps. Five year warranty. 3 day shipment guaranteed.



Acopian Corp., Easton, Pa. 18042
Telephone: (215) 258-5441

INFORMATION RETRIEVAL NUMBER 118

ELECTRONIC DESIGN 12, June 7, 1973

Three Simple, Safe



Temperature Indicators for Electronics

Let you know when rated temperature is reached ... with an accuracy of ± 1%

1. TEMPILABELS[®]: self-adhesive temperature monitors consisting of one or more heat-sensitive indicators sealed under transparent, heat resistant windows. The centers of the indicator circles turn from white to black irreversibly at the temperature ratings shown on the label. Tempilabels[®] are available in several sizes, and in single or multiple temperature ratings from 100° to 500°F. Accuracy is within ± 1% of the stated rating. They are particularly useful for monitoring operating temperatures of equipment or processes; obtaining temperature data of components as a guide to design and material selection; safeguarding temperature-sensitive materials in storage or transit. To serve as a permanent record, Tempilabels[®] can be removed from the surface and attached to a report.



2. TEMPILAQ[®]: materials of calibrated melting points suspended in an inert, volatile non-flammable vehicle. Available in over 100 systematically spaced temperature ratings from 100° to 2500°F. Tempilaq[®] indicates its temperature rating by liquefying within ± 1% of its rating. Available in bottles or spray cans.

3. TEMPILSTIKS[®]: temperature-indicating crayons of calibrated melting points. Available in over 100 systematically spaced temperature ratings. Tempilstiks[®] cover the range from 100° to 2500°F. Tempilstiks[®] indicate the specified temperature, by liquefying with a tolerance of ± 1% of its rating.

Detailed data and price sheets as well as samples are available upon request.

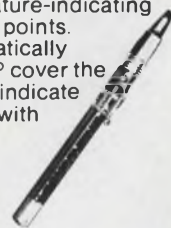

Tempil[®]

DIVISION, BIG THREE INDUSTRIES, INC.

Hamilton Blvd., South Plainfield, N. J. 07080
Phone: 201 • 757-8300 • Telex: 138662

INFORMATION RETRIEVAL NUMBER 119

TRIACs & SCR's NEW ELECTRICALLY ISOLATED 1/2" press-fit series



TRIACs: 6A to 40A [$I_{T(RMS)}$]
50V-600V (V_{DROM})
SCR'S: 8A to 35A [$I_{T(RMS)}$]
50V-600V (V_{DROM})

Three new additions to Hutson's 1/2" press-fit series: isolated press-fit package; isolated press-fit and stud mount with BeO insulators for greatly improved thermal characteristics. All 1/2" press-fit devices feature patented Di-Mesa construction of void-free glass-passivated center gate chips.

Write for complete information.



HUTSON INDUSTRIES

BOX 34235 • 2019 W. VALLEY VIEW, DALLAS, TEX. 75234 (214) 241-3511 TWX 910-860-5537

Distributed by:

In Canada: WEBER-SEMAD ELECTRONICS, Downsview, Ont. 416/635 9880

Vice-President, European Operations:

30 Rue Pierre Semard, Yerres, 91 France Tel: Paris 925-8258 • TELEX 21-311

Distributed in Europe by:

Belgium: C. N. ROOD S.A. Brussels 02-352135
Denmark: E. V. JOHANSEN A/S, Copenhagen (01)* 295622
Norway: INTELCO, Box 158, 47 2 207451, Sentrum, Oslo
Spain: BELPORT, Madrid 234.62.62
Sweden: ELEKTROFLEX, Sundbyberg 08-28 9290
Switzerland: D. LEITGEB, Dubendorf 051 85 9666
UK: CLAUDE LYONS, LTD, Hoddeston, Hertfordshire (09924) 67161

INFORMATION RETRIEVAL NUMBER 120

PACKAGING & MATERIALS

Portable case sized for aircraft carry-on

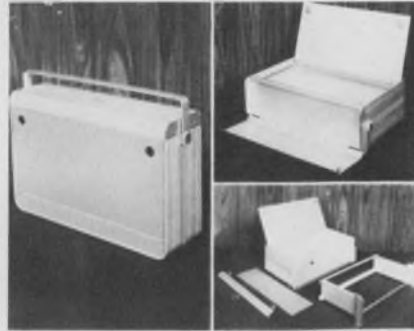

Buckeye Stamping Co., 555 Marion Rd., Columbus, Ohio 43207. (614) 443-9458.

Adaptability is stressed in the "buck-i-pak" portable instrument case. Standard dimensions—5-1/4 H x 18 W x 11-1/2 D in.—conform to aircraft carry-on requirements. The case is made of anodized, extruded aluminum panels, and it is trimmed with a suede finish paint. A U-shaped extrusion provides an internal mounting chassis for securing components. The chassis is removable to permit easy component assembly. An extruded-aluminum handle swings out of the way when not in use. A hinged dust cover protects the control panel, and it can be held out of the way by a magnet.

CHECK NO. 545

Conductive adhesive has only one component



Chomerics, 77 Dragon Ct., Woburn, Mass. 01801. (617) 935-4850.

Cho-Bond 1030 is an RTV adhesive which cures when exposed to atmospheric moisture. It remains resilient and flexible, and has twice the peel strength of other RTVs—typically 3 lb./in. width. Uncured, it's a smooth paste with a working time of 30 minutes. A set is obtained in 24 hours, a full cure is achieved in 48 hours at room temperature with 50% relative humidity.

CHECK NO. 546

Eliminate fire and shock hazards in equipment

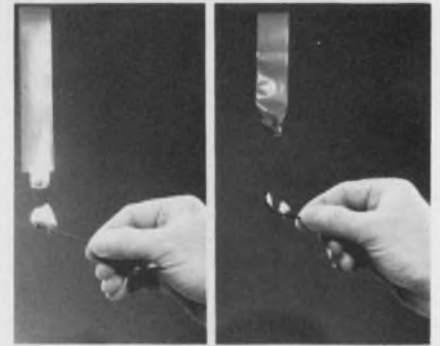

3M Co., P.O. Box 33600, St. Paul, Minn. 55133. (612) 733-9654.

The X-1284 tape has both a flame-retardant polyester backing and flame-retardant adhesive system. It has a functional temperature limit of 130 C and meets flame retardancy specifications including U/L subjects 492, 510 and 94, and U.S. Highway Administration standard No. 302. The tape is highly conformable to irregular surfaces and has excellent tear resistance for fine-wire coils.

CHECK NO. 547

Connector provides electrical/thermal link

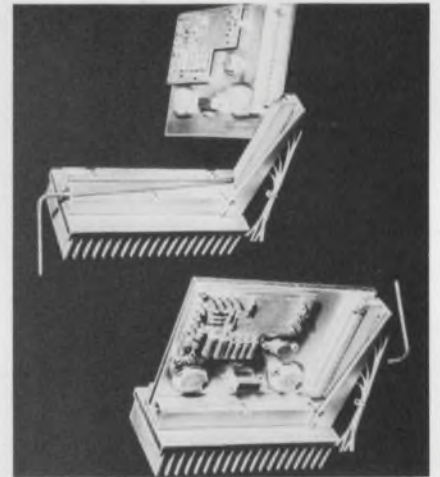

Electro-Module, Inc., 2855 Metropolitan Pl., Pomona, Calif. 91767. (714) 593-3565.

Designers of power circuits can now package with plug-in modules that disconnect thermally as well as electrically. Power circuits have traditionally been hardmounted so that they had a long mean-time-to-repair. The advantages of the plug-in concept can thus apply to power circuits, too. And external case cooling becomes practical with the thermal connector, thus simplifying environmental and EMI sealing.

CHECK NO. 548

Delay Lines

You name it. We've got it.

Catalog Number	Impedance Z ₀ (ohms ±10%)	Total Delay (ns ±5%)	No. of Taps	Delay Per Tap	Rise Time (ns max)
9822	50	100	10	10	17
9823	50	125	10	12.5	21
9825	100	100	10	10	17
9826	100	125	10	12.5	21
9827	100	150	10	15	25
9828	100	200	10	20	34
9829	100	250	10	25	42
20410	100	10	4	2.5	4
20411	100	20	4	5.0	7
20412	100	30	4	7.5	10

Now you can choose from the broadest selection of DIP Delay Lines ever.

Available today from quantity stock at any PULSE ENGINEERING regional office in the United States and Europe.

Featuring:

- Fast rise time and low distortion
- Total delay 10 ns to 250 ns
- Delay per tap 2.5 ns to 25 ns

Order today and send for our free product line catalog.

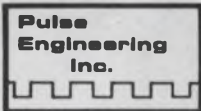

A Varian Subsidiary

Pulse Engineering, Inc.

P.O. Box 12235 • San Diego, Calif. 92112
Phone 714-279-5900 • TWX 910-335-1527



INFORMATION RETRIEVAL NUMBER 121

portable
power



break-
through

The revolutionary lithium primary battery is now a reality, with performance that obsoletes ordinary batteries.

- 2.8 volts-per-cell nominal operating voltage — double ordinary batteries
- highest energy per unit weight and volume
- outstanding shelf life — 5 years and more
- remarkable low-temperature performance, down to -65F
- completely sealed, leakproof design and rugged construction

Write or phone for full specs on ETERNACELL batteries in a broad range of capacities. To help you design lighter, more-compact, higher-performance, and longer-lived portable electrical and electronic equipment.

ETERNACELL batteries are available in production quantities, for immediate delivery, at prices competitive with premium primary batteries.



Power Conversion, Inc.

70 MacQuesten Parkway South
Mount Vernon, N.Y. 10550

Telephone: 914-699-7333

INFORMATION RETRIEVAL NUMBER 122

ELECTRONIC DESIGN 12, June 7, 1973

make us your source of light.



Here's how to get the lamps you need, when you need them, at the lowest prices you've ever seen. Miniature, sub-miniature, micro-miniature, neon, axial lead, and bi-pin types. Engineered to deliver long service life, our lamps are made to standard U.S. specifications, and are available in the widest range of amperage and candlepower. Why settle for less than the best. The best from Shigoto will always cost you less. Our free Catalog is yours for the asking.

Shigoto Industries Ltd.

Empire State Bldg., 350 Fifth Ave., N.Y. 10001
(212) 695-0200 / Telex 224219

One of the World's Largest Manufacturing Importers

INFORMATION RETRIEVAL NUMBER 123



hot stuff

or cold, CHR's family of TEMP-R-TAPE of KAPTON* polyimide film provides outstanding endurance. They retain their excellent mechanical and electrical properties over a wide temperature range, -100 to +500F.

Available in thicknesses from .001" to .0045" with a choice of several adhesive systems including flame retardant.

Find your CHR distributor in the Yellow Pages under "Tapes, Industrial" or in industrial directories. Or write for complete specification kit and sample. The Connecticut Hard Rubber Company, New Haven, Conn. 06509.

*Du Pont reg.t.m.



a HITCO company

INFORMATION RETRIEVAL NUMBER 124

PACKAGING & MATERIALS

Jumper strip fits wide variety of pin types

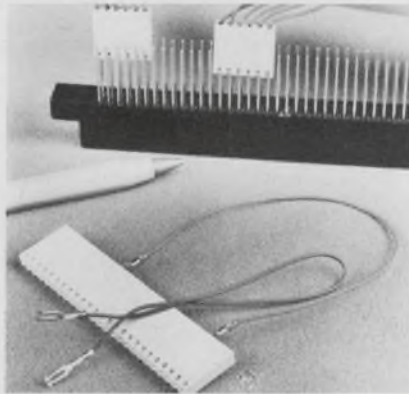

Amphenol Industrial Div., 1830 S. 54th Ave., Chicago, Ill. 60650. (312) 242-1000.

Series 221 jumper strip connectors are available in strips of two to 25 contacts. These connectors mate with most pin types including wrapped wire and dip-solder tails. They can be used for backplane interconnection, multilayer PC boards, socket panels, and PC connector panels. Contacts are of the crimp Poke-Home removable type. The strip contacts are on 0.1-in. centers. Each contact is housed in its own pocket in the thermoplastic-strip body. The insert has a height of 0.565 in. and a width of 0.134 in.

CHECK NO. 895

Card-puller handle holds without fasteners

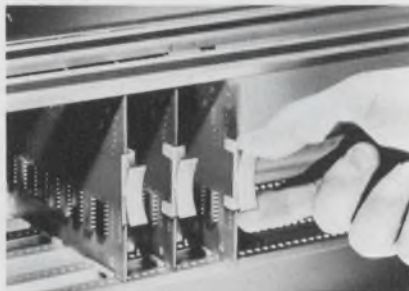

Richco Plastic Co., 5825 N. Tripp Ave., Chicago, Ill. 60646. (312) 539-4060.

The one-piece nylon Series CCP card puller fastens to the card without rivets. The puller is only 1.5 x 0.87 x 0.28 in., and it attaches to the card by snapping it into two 0.125-in. D holes. It fits all cards up to 0.045-in. thick. A horizontal pull on the flaired handle of the puller withdraws the card. Free samples are available.

CHECK NO. 896

Standard parts make many cabinets

Vector Electronic, 12460 Gladstone Ave., Sylmar, Calif. 91342. (213) 365-9661. \$2.40 to \$10.00; stock.

Standard parts, optional accessories and modern finishes combine in Vector's new line of card cases, called Multi Mod, to provide twenty-seven basic models. Interior sizes range from 2.0 to 207 cu-in. and many variations in configuration are possible. Circuit boards mount in grooves and need no additional fastening devices. Some models can provide as much as 60 dB of attenuation without special RFI gasketing.

CHECK NO. 897

Wrapping tool loads wire from the side



Universal Instruments, 139 E. Frederick St., Binghamton, N.Y. 13902. (607) 772-1710.

A side-loading wrap tool for hand guns features easy wire insertion instead of the awkward loading required by end-loading tools. The tool reduces wire breaking. It fits standard hand guns and stock models are available for 24, 26 or 30 gauge wire. Many other combinations are also available.

CHECK NO. 900

Flameless heat gun raises temp to 650 F

Master Appliance, 2512 18 St., Racine, Wis. 53403. (414) 633-7791. \$34.95 (unit qty).

The Mite, a flameless heat gun with a silver element, can provide a maximum temperature of 650 F. An optional heating element heats only to a maximum of 500 F. It weighs less than 2 lb and is evenly balanced. Other design features include a tough housing, a chrome-plated inner barrel, a recessed switch for one-hand operation and a pilot light for power-on indication.

CHECK NO. 920

ac, dc, volts, amps, ohms
 25 ranges
 \$595 complete
 5-day delivery



- New expanded AC response to 100 KHz
- New carrying case option
- New color-coded pushbuttons
- Optional battery pack with recharger (\$95) mounts internally
- 0.01% dc accuracy
- 1,000 megohm input impedance on 3 lowest ranges
- lab, field, or systems use.

For Model 7004A literature, contact your Scientific Devices office or Systron-Donner at 10 Systron Drive, Concord, CA 94518. Phone (415) 682-6161. **Europe:** Munich, W-Germany; Leamington Spa, U.K.; Systron-Donner S.A. Paris (Port Marly) France. In **Australia:** Systron-Donner Pty. Ltd. Melbourne.

SYSTRON  **DONNER**

INFORMATION RETRIEVAL NUMBER 125

QUICKIE[®] CONNECTOR . . .

FOR THE RAPID, RELIABLE TERMINATION OF FLAT FLEXIBLE CABLE.

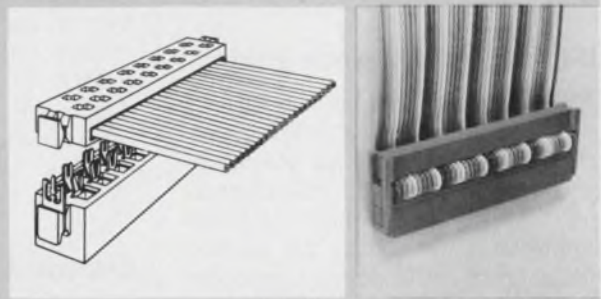

The Berg QUICKIE, a female connector, simultaneously terminates multi-lead flexible round cable *without* pre-stripping. The askewed tines of the contact effect a stripping action which terminates virtually any brand of cable, regardless of insulation material, in about 10 seconds. Design assures redundant electrical contact, and allows for visual inspection *before* assembly. QUICKIE can be used to interface cable on .050" centers to .025" square wire-wrapping posts on .100" sq. grid. Write for Catalog 125 or call:

*Berg Electronics Trademark



New Cumberland, Pa. 17070 Phone: (717) 938-6711

INFORMATION RETRIEVAL NUMBER 127

SOLOK[®] TERMINALS

CLIP ONTO SUBSTRATE.
 THERE'S NO DRILLING . . . NO BREAKAGE!

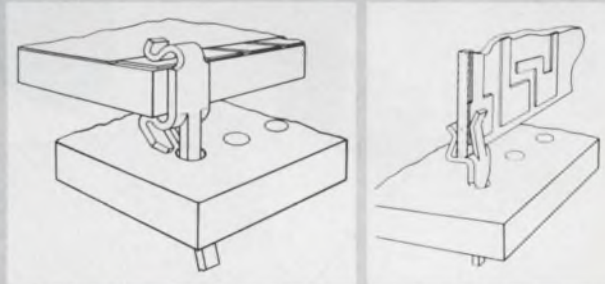

These Ceramic Substrate Connectors clip-in-place on the substrate and mechanically hold their position until wave soldered for a permanent connection. No drilling is required. DIP-CLIP type mounts onto DIP packs; EDGE-CLIP is designed for edge mounting. Available in brass, phosphor bronze or steel. Supplied in strip form for manual operations or for Berg high-speed application machines which assure higher assembly rates while lowering applied costs. Berg also offers fast turn around in designing special connectors and application tools for large-volume applications. Write for Catalog 124, or call:

*DuPont Trademark



New Cumberland, Pa. 17070 Phone: (717) 938-6711

INFORMATION RETRIEVAL NUMBER 128

TWO *New* SCRs from NATIONAL ELECTRONICS featuring

- Patented Regenerative Gate
- High di/dt with low power gate drive

F-390 850 A RMS, 500-1300 V. DC motor control and power supplies.

F-395 700 A RMS, 100-600V. Fast switching, high frequency for inverter use.



NATIONAL ELECTRONICS
 a varian division
 geneva, illinois 60134 (312) 232-4300

INFORMATION RETRIEVAL NUMBER 126

application notes

JFET cross-reference guide

A comprehensive cross-reference guide lists over 1300 JFET types. The guide includes all European type numbers and all manufacturers, listing both their in-house numbers as well as the 2N number designations. Teledyne Semiconductor, Mountain View, Calif.

CHECK NO. 550

Anodic stripping

The principles of anodic stripping voltammetry and the required instrumentation are described in an eight-page application note. The note shows how a specially designed cell and working electrode permit savings in analysis time over conventional apparatus. Experimental results are given to illustrate performance of the equipment. Mc-Kee-Pedersen Instruments, Danville, Calif.

CHECK NO. 551

Dry-type transformers

A four-page, illustrated article discusses how the OSHA legislation of 1970 has resulted in new guidelines for the dry-type transformer specifier and customer, as spelled out in the UL 506 and NEMA ST-20-1972 standards. Also discussed are transformer life considerations and system life predictions. General Electric, Scotia, N.Y.

CHECK NO. 552

Electrical insulation

"Electrical Insulation Materials" incorporates relevant information needed to apply sleeving, heat-shrinkable and insulated wire. The 42-page guidebook covers extruded tubing, fiberglass-coated and impregnated tubing, heat-shrinkable tubing, Comco extruded rod and Teflon sheet and phenolics, tapes and adhesives. Data includes standard and special-cut lengths; MIL-spec and UL designations; stocked colors vs colors to order and standard spooling. Commercial Plastics & Supply Corp., Cornwells Heights, Pa.

CHECK NO. 553

Power tube cooling

"Application Guide For Forced-Air Cooling of RCA Power Tubes" provides information on power tube cooling procedures that will improve tube life and reduce equipment downtime. The guide points out the need for an analysis of environmental considerations such as altitude and temperature of outside air. A step-by-step example is provided to describe procedures for selecting the blower unit. Curves, nomographs and drawings are included. RCA Commercial Engineering, Harrison, N.J.

CHECK NO. 554

Beryllium and fluorometry

Fluorometry Review provides discussions of several fluorometric analyses for beryllium and includes 30 references. Fluorometry offers the extreme sensitivity and simplicity required for the analysis of submicrogram quantities of beryllium. The flexibility of fluorometry makes it useful for analyzing the relatively large amounts of beryllium found in ores. G.K. Turner Associates, Palo Alto, Calif.

CHECK NO. 555

RADIAL LEAD COMPONENT ENCAPSULATION SHELLS

Largest selection of sizes in the world!

No customer too small or too large!

Designed Especially for

Write or call for details

- CORED HOLES
- STAND-OFF FEET

- RESISTORS
- CAPACITORS
- DIODES
- RECTIFIERS
- CHOKES
- INDUCTORS



ROBISON ELECTRONICS, INC.

2134 West Rosecrans Avenue
Gardena, California 90249
Phone (213) 321-0080, 327-5661



The U. S. Government does not pay for this advertisement. It is presented as a public service in cooperation with The Department of the Treasury and The Advertising Council.

The Payroll Savings Plan helps you save some of your living for later.

Sure there are lots of things you want right now. Lots of things you need.

But, the sun's going to shine tomorrow, too.

That's why it's important you do something today to build a little nest egg for the future. And there's no easier way to do that than by joining the Payroll Savings Plan where you work. You sign up once and any amount you specify will be set aside from each paycheck and used to buy U.S. Savings Bonds.

The Payroll Savings Plan. The perfect way to help your good life stay that way.



Now E Bonds pay 5 1/4 % interest when held to maturity of 5 years, 10 months (4% the first year). Bonds are replaced if lost, stolen, or destroyed. When needed they can be cashed at your bank. Interest is not subject to state or local income taxes, and federal tax may be deferred until redemption.

Take stock in America.
Join the Payroll Savings Plan.

design aids

Stripline couplers

Tables for designing quarter-wavelength stripline directional couplers show coefficient ratio values from 1 to 12 dB for broad-side designs and from 5 to 60 dB for edgewise designs. The ratios are for line width to ground plane spacing and line spacing to ground plane spacing. Graphs plot dielectric thickness/line width for both RT/duroid 5870 and 5880. Rogers Corp.

CHECK NO. 556

Metric calculator

A metric pocket-size calculator helps convert lengths, areas, weights and volumes quickly and easily from the inch/pound system. It provides dual dimensioning at a glance. Included in the converter are a quick conversion table of standard weights and measures, a Fahrenheit-to-centigrade conversion table and a simple inch or metric rule. American Koyo Corp.

CHECK NO. 557

Conversion tables

"Useful Conversion Tables" exhibits general information beneficial for precious metal operations. The guide covers conversions of units of area, length, volume, weight and liquid measure. Additional tables give basic information of the elements and chemical properties of precious metal. Precious Metal Recovery Div., The Sel-Rex Co.

CHECK NO. 558

Electronic phosphors

A reference table on electronic phosphors provides data on phosphors used in the manufacture of CRTs. Emission color, spectral energy distribution, brightness, persistence and particle-size data are presented for 29 different phosphors. The overleaf describes methods and equipment for making measurements on phosphors and explains what the various measurements mean. General Electric.

CHECK NO. 559

For five cents, I'd start something.

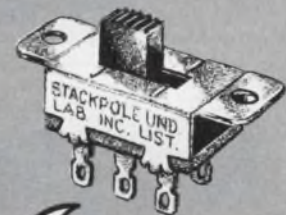
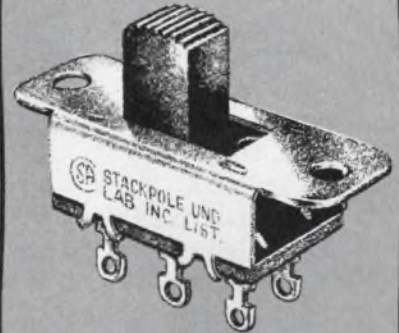

me too.

Turn on with a Stackpole slide switch. Prices start at 5¢ for this field proven standard of the industry. Available in two sizes, Regular and the new 50% smaller Miniature Series. Fully UL and CSA approved. Rated from 1 to 10 amps @ 125 and 250 volts (Miniature Series rated at 3 amps @ 125 V). Over 23 basic types, 7960 variations of slide and rocker switch adaptations. For complete details, send for Bulletin 78/79-100.



The test, the whole test, and nothing but the test.

Our System 1000A/1100A is a — no, the — complete digital communications test set. It transmits, receives, synchronizes, measures and displays error rates under pseudo-noise conditions at bit rates from 120 MHz per second to 300 MHz per second. Errors may be accumulated and totalized, or counted against the number of bits (which gives you a direct reading of bit error rate). Automatic sync, pseudo-random sequences, frame sync . . . the specs are a sight for sore digital communications systems. Drop us a line, and we'll send you spec sheets, our applications folder and a whole catalog full of the fastest, surest, most economical digital equipment in the world.



The Troubleshooters, from **Tau-Tron, Inc.**

685 Lawrence Street Lowell, Massachusetts 01852

INFORMATION RETRIEVAL NUMBER 132

NOISE SPIKES SPIKED

You no longer need worry about high speed switching transients. We've spiked the noise beforehand with our unique power distribution system. Concentrate on your design problems: we've already solved your noise problems.

Low Frequency Decoupling with several 10 or 20 μ fd tantalum capacitors.

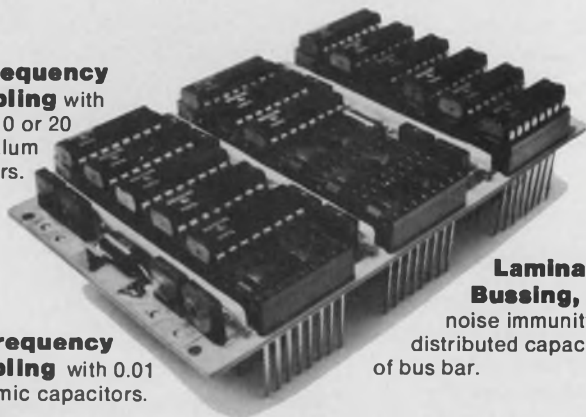

High Frequency Decoupling with 0.01 μ fd ceramic capacitors.

Laminated Power Bussing, maintains high noise immunity. 40 to 80 pf of distributed capacitance per inch of bus bar.

Free Test Data: Get this eye opener! Scope traces of comparable IC logic circuits show convincingly how EECO's power distribution system performs, how you save hours of debugging agony. EECO, 1441 E. Chestnut Ave., Santa Ana, California 92705. For fast answers up-front, call Electronic Packaging Products. (714) 547-5651.

NOISE TEST REPORT

EECO IC PACKAGING

INFORMATION RETRIEVAL NUMBER 133

new literature



Screens and masks

The "Handbook for Quality Screens and Masks" contains information on specifying and ordering screens and masks for thick-film printing. It includes specifications on coatings, emulsion and foil thicknesses, mesh and frame sizes and artwork generation. Industrial Reproductions, Nashua, N.H.

CHECK NO. 560

Pushbutton switches

Mechanical and electrical specifications and ordering data (both military and commercial) for eight illuminated pushbutton switches recently qualified under MIL-S-22885 and listed on QPL 2285 are described in an eight-page catalog. Marco-Oak, Anaheim, Calif.

CHECK NO. 561

Mil-Spec connectors

Four brochures illustrate connecting devices qualified to the latest military specifications. Deutsch, Banning, Calif.

CHECK NO. 562

TV and radio manuals

Master Index covers all the company's existing monochrome and color-TV manuals and all radio manuals back to the 1926-38 issue. Instructions on how to obtain material needed in the manuals or as single diagram service data are given. The 48-page index costs 50¢. Supreme Publications, 1760 Balsam Rd., Highland Park, Ill. 60035.

Radio noise meter

Quick and accurate testing for RFI pollution, as required by the power industry, is performed by the radio noise meter described in Data Bulletin RFI-102B. The four-page bulletin contains ordering instructions for specifying special frequencies and for selecting appropriate antennas. Singer Instrumentation, Los Angeles, Calif.

CHECK NO. 563

Minicomputer systems

"The Value of Power . . . and how it saves you money on your minicomputer system," a 256-page handbook, gives a short history of computers. Other chapters include numbers and logic; the makings of a computer; addressing modes; the instruction set; evaluating instruction sets; input, output and interrupts; internal interrupts; input, output and interrupt hardware and design considerations; read-only memory and microprogramming; system software; operating systems; and how to buy a minicomputer. General Automation, Anaheim, Calif.

CHECK NO. 564

PC hardware

Circuit-board hardware is illustrated in a 16-page booklet. Circuit-board supports, hold-down strips, spacers, PCB guides, card pullers, circuit-board ejectors and edge protectors are described. Richco Plastic Co., Chicago, Ill.

CHECK NO. 565

Sensing, interface valves

Photos, specifications, dimensional data, operational descriptions, performance ratings and curves for the company's sensing and interface valves, components and accessories are described in a 24-page, two-color catalog. Northeast Fluidics, Cincinnati, Ohio.

CHECK NO. 566

Wire tester

A four-page bulletin describes and illustrates the company's VD 36 wire tester that finds and identifies a particular wire in a mass of wires. The bulletin includes description of applications and mode of operation as well as technical data. Siemens, Iselin, N.J.

CHECK NO. 567

Disc-drive systems

Series-8000 cartridge disc-drive systems are described in a four-page bulletin. The bulletin contains photographs and a general description along with a list of features and specifications. Reliability, packaging, options and the interface are described. Microdata Corp., Irvine, Calif.

CHECK NO. 568

Temperature indicators

Thermocouple, RTD and thermistor models are described in a four-page digital temperature indicator catalog. A selection guide provides temperature range charts indicating the specifications for each model. RdF Corp., Hudson, N.H.

CHECK NO. 569

Flexible heating elements

Heating elements, drum heaters and temperature controllers are described in a four-page catalog. Each type of flexible silicone-rubber heating element is described, and specifications and operating characteristics are given. Electro-Flex Heat, Bloomfield, Conn.

CHECK NO. 570

Insulators, mounting kits

Physical, electrical and mechanical properties of insulators commonly used with semiconductor devices are featured in a 12-page catalog. Prepackaged mounting kits with Thermafilm insulators and the necessary hardware are also described. Thermalloy, Dallas, Tex.

CHECK NO. 571

System modules

"Modules for Systems Applications," a two-color, 16-page brochure, describes modules that are available as OEM units for in-house system designers. These modules include tape and computer interface units, waveform analyzers, programmable pulse generators, a/d recorder/generators and single-shot modules. The brochure provides information on relations in the time domain, including pulse response vs bandpass, excess reactance, coaxial-cable equations and rise-time relationships. E-H Research Laboratories, Oakland, Calif.

CHECK NO. 572

You're a penny-pinching, up-tight, li'l switch with no spark.

True.

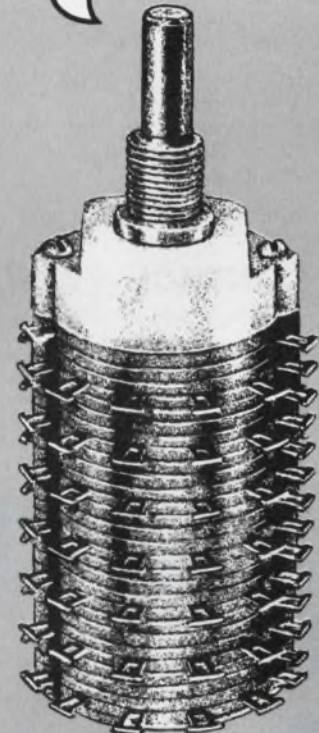

There's no better value than a Stackpole rotary switch. Fast delivery and quality features, but at a price you can afford. Unique design achieves a totally enclosed rotary, without sacrificing complex switching capability. Rigid construction and molded terminals produce a switch so tight it's explosion proof. Samples immediately. Production quantities in 1 to 2 weeks. Including switches with PC mounting. For details, send for Bulletin 73-103.



STACKPOLE
COMPONENTS COMPANY
Raleigh, N. C. 27610

**WE WEREN'T BORN YESTERDAY...
25 YEARS OF SWITCHLIGHT
EXPERIENCE WENT INTO THE
DESIGN OF THESE
ILLUMINATED PUSHBUTTONS FOR
THE O.E.M. MARKET**

- UL Approved
- Sliding Contacts for 'Bounceless' Operation
- Front Relamping
- Combination Spade and Solder Lug Terminations
- Wide Variety of Lens Colors and Sizes, Circuits and Legends Available

Write for Portfolio of Applications Bulletins

CONTROL SWITCH INC.

A SUBSIDIARY OF CUTLER-HAMMER INC.

1420 DELMAR DRIVE • FOLCROFT, PA. 19032 (215) LU 6-7500

Representatives and stocking distributors throughout the United States, Canada, and Europe



INFORMATION RETRIEVAL NUMBER 135

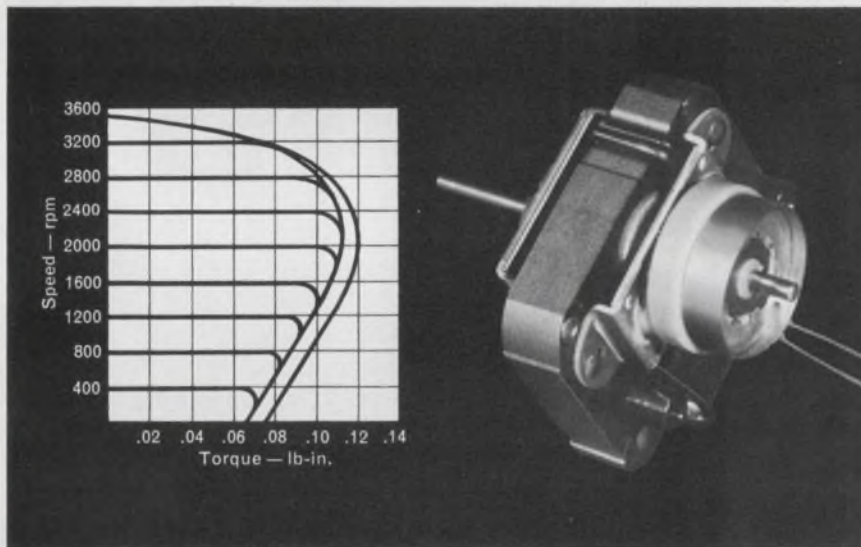

**new shaded-pole motor
speed regulated with precision speed control**

Accurate speed control over a wide torque range (see speed/torque curve). Infinitely variable speed adjustment within speed range while motor is running—selected by externally setting a potentiometer control. No-load to full-load speed regulation throughout the 10:1 speed range of 300—3000 rpm. Up to .01 hp with standard control circuitry. Preassembled speed control circuits now available for prototype model testing. Consult your Barber-Colman representative for details, or write direct for new Bulletin No. F-14897.



BARBER-COLMAN COMPANY

Motor Division
Dept. R, 12117 Rock Street, Rockford, Illinois 61101

INFORMATION RETRIEVAL NUMBER 136

NEW LITERATURE



Transistors

Power transistors, hybrids and microwave transistors are described in a 68-page, two-color catalog. The catalog provides a quick reference guide to discrete power devices, hybrid power regulators, rf power devices and Schottky diodes. Man-rated space parts, JAN qualified devices and quality/reliability information are included. Solitron Devices, Inc., Riviera Beach, Fla.

CHECK NO. 573

All-digital modem packs

A 24-page brochure describes a complete line of all-digital modem packs for switched voice networks and leased-line applications. Specifications are listed along with charts depicting the probability of error vs signal-to-noise ratio. Sanders Associates, Nashua, N.H.

CHECK NO. 574

Multiplexer/a-d converter

A high-speed, low-level multiplexer/a-d converter is described in an eight-page data sheet. Vidar, Mountain View, Calif.

CHECK NO. 783

Image devices

A four-page brochure details the use of the company's video storage units in picture processing for slow-scan thermography. The brochure, *Hughes Focus*, is the first in a series to be published at regular intervals discussing new applications of image devices. Hughes Image Devices, Oceanside, Calif.

CHECK NO. 784

ONE OF A KIND

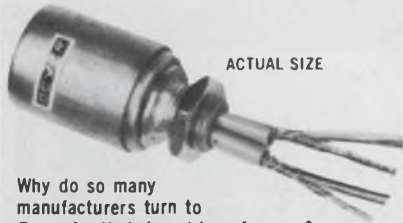

Why do so many manufacturers turn to Beyer for their input transformers?

Even though they could get them from the people who supply their power transformers?

Because *this* one has a unique winding process that permits miniaturization while maintaining studio quality frequency response, low distortion, and level capability—at reasonable cost.

Because *this* one represents 40 years of quality manufacturing experience.

Who are the manufacturers we're talking about? The leaders. Including Ampex, Ampro, Barcus-Berry, Bell P.A., Bozak, Electro-Sound, Rauland-Borg, RCA, 3M, and many others.

You can obtain Beyer transformers at retail through Gotham's franchised dealer organization. Or in OEM quantities directly from Gotham. Write today:

GOTHAM
AUDIO CORPORATION
Headquarters: 741 Washington St.
New York, NY 10014 Tel: (212) 741-7411

Digital Multimeter



YOUR personal Digital Multimeter is here! The functions you need most — at the right price — with no sacrifice in quality. Full factory warranty.

- Autopolarity
- 100% Overrange
- LSI & C/MOS Circuitry
- Large 0.55" Digits

\$145

SPECIFICATIONS FOR MODEL 3000

DC VOLTS	1, 10, 100, 1000
AC VOLTS	1, 10, 100, 1000
OHMS	1K, 10K, 100K, 1M, 10M
RESOLUTION	0.1% All Ranges
ACCURACY	
DC & OHMS	0.5% ± 1 Digit
AC	1.0% ± 1 Digit
POWER	105-125 VAC 60 Hz 3W

Payment with personal check, money order, BankAmericard, and Master Charge card acceptable. Include all raised information on charge cards. Net 30 days to well rated firms. No COD orders. Add \$3 for postage and insurance.

EXPORT model available. Write for details.

LINEAR DIGITAL SYSTEMS corp.
PO BOX 954 GLENWOOD SPRINGS, COLORADO 81601

Image digitizers

Image digitizers are described in an illustrated six-page brochure. The brochure describes how film images are converted to computer-compatible forms and how the computer may be used to extract relevant image features and various photometric data by program control. The conversion of pictures to "digital images" is graphically illustrated. The features of five basic model types are compared in tabular form. Dicomed Corp., Minneapolis, Minn. **CHECK NO. 791**

Matrix switches

Included in a guide of matrix switches for rapid circuit selection and programming are product listings, engineering drawings, specifications, operating characteristics and technical data on standard and custom-designed units. Cherry Electrical Products, Waukegan, Ill. **CHECK NO. 792**

Microwave components

An illustrated 12-page guide to microwave components and calorimetric systems gives detailed specifications for the company's waveguide and coaxial waterloads and power controls. Raytheon, Waltham, Mass. **CHECK NO. 793**

Interconnect system

An eight-page catalog describes the concept and components of the company's solderless interconnect system. Technical and test data on one-piece, low-profile (0.025-in. above board) contact/terminals are provided. Photographs, drawings and charts are included. Robinson-Nugent, New Albany, Ind. **CHECK NO. 811**

Panel assemblies

Technical, descriptive and specification data on the company's panels and assemblies for telephone and other communications applications are contained in a six-page bulletin. The bulletin includes a selection guide to permit designing and specifying complete assemblies from individual components. ADC Products, Minneapolis, Minn. **CHECK NO. 812**

Switch on **NOISE**,
Switch off **NOISE**,
Switch on **NOISE**,
Switch off **NOISE**.

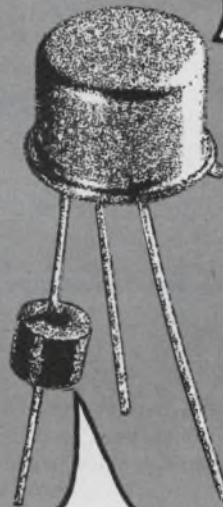

Quiet!



Ceramag® ferrite beads provide a simple, inexpensive means of obtaining RF decoupling, shielding and parasitic suppression without sacrificing low frequency power or signal level. Install beads by slipping one (or more) over appropriate conductor(s) for desired effect. Sizes from .020" ID - .038" OD - .050" L. Beads available with leads for PC boards. Send for samples.



STACKPOLE

Electronic Components Division

St. Marys, Pa. 15857

The 3½ digit DPM: easy fit, easy price.



Easy fit, easy price. Our new Series 3500 DPM measures up both ways for standard size interchangeability that gives you more in the bargain. Like the extra large (.55 char. height) 7-segment gas discharge readout.

The LED option. And, like all Faratron DPM's, it's front panel installed/removable with screw-free

wedge-lock method. All this and more, in a bipolar DPM with over range indication, BCD output and Faratron's built-in quality plus. Price: \$85.00 in 100 quantities. Contact: Faratron Corp., 280 Green Street, South Hackensack, N.J. 07606; (201) 488-1440

FARATRON

INFORMATION RETRIEVAL NUMBER 138

MEMO

FROM: *Bill Wright*
Purchasing
TO: *Engineering Dept.*
Looks Interesting

IC REGULATED DUAL OUTPUT POWER SUPPLIES



MODEL PSQ15-.4D
\$95.00

for OP AMPS and IC's
Each Output: 5-15V, 0-.4A

- .01% regulation
- 500 microvolts pard
- negligible settling effects
- cermet adjustment pots
- series, parallel, tracking

Deltron inc.

Wissahickon Ave.,
North Wales, Pa. 19454



L-204

INFORMATION RETRIEVAL NUMBER 139

ovens

SERIES 3147 OVENS OFFER

- OVER 20 PROVEN THERMAL DESIGNS
- RUGGED PACKAGE FOR HIGH SHOCK AND VIBRATION ENVIRONMENTS
- WIDE VARIETY OF APPLICATIONS



Cavity Size (")	1.95 X 1.95 X 1.00	1.95 X 1.95 X 1.00
Case Size (")	2.56 X 2.94 X 1.50	3.00 X 3.50 X 2.50
Cavity Temp.	+70° C.	+75° C.
Stability	± 0.5° C.	± 0.1° C.
Ambient	-10° C. to +60° C.	+15° C. to +65° C.
Power Supply	21 to 28 VDC	12 VDC ± 1%
Header	9 Pin Miniature	8 Pin Hooked
Mounting	(4) 6-32 Studs	(4) 6-32 Studs
Model Number	3147-11	3147-16
Prices (1-3 units)	\$109.25	\$133.00

WRITE FOR
CATALOG NO. 0273
TODAY!



OVEN INDUSTRIES, INC.

1106 E. SIMPSON RD. P.O. BOX 229
MECHANICSBURG, PA. 17055

PH. (717) 766-0721 Cable: "OVENMETRIC"

INFORMATION RETRIEVAL NUMBER 140

NEW LITERATURE



Megohmmeters

A four-page, two-color brochure presents the advantages offered by heavy-duty industrial megohmmeters (HV and HVM series) and precision measuring scientific megohmmeters (HM series) for testing the insulation resistance on all electrical equipment to ASTM specifications and applicable MIL and UL standards at ranges up to 20-million megohms. Hipotronics, Brewster, N.Y.

CHECK NO. 813

Hardware options

Multiprocessing hardware options for the PDP-11 family of computers are described in a 24-page brochure. The brochure contains descriptions of three hardware devices, the Unibus switch, the Unibus window and the Unibus link. Digital Equipment Corp., Maynard, Mass.

CHECK NO. 814

Disc recorders

Wideband instrumentation disc recorders and their applications are described in an eight-page brochure. Specifications, typical block diagrams and information on configuration options are included. Data Disc, Sunnyvale, Calif.

CHECK NO. 815

Connector products

A 28-page Design Guide catalog describes plate connector and molded connector products. National Connector, Minneapolis, Minn.

CHECK NO. 816

Contact assemblies

"A Guide to Contact Assemblies for Electromechanical Applications" discusses points to be considered in the design, specification and purchase of switch assemblies, contacts and springs. Other sections in the 20-page guide give an explanation of contact attachment, clad contacts and molded modules. Tricon Manufacturing Co., Downers Grove, Ill.

CHECK NO. 817

Zinc ferrite material

A two-page bulletin describes with charts and graphs specifications and characteristics of manganese zinc ferrite materials—available in E cores, U cores, toroids, I cores, pot cores, threaded cores and other shapes. The bulletin lists magnetic properties and applications. Fair-Rite Products, Wallkill, N.Y.

CHECK NO. 821

Thumbwheel switch modules

General-purpose Digiswitch, a compact, finger-actuated modular switch that features precise setting and high readability for general-panel applications, is described in a two-color data sheet. The brochure details the capabilities of the series-300 switch and provides a listing of typical specifications. Photograph, outline drawings and assembly dimensions graphically illustrate the modules. The Digistran Co., Pasadena, Calif.

CHECK NO. 822

PH systems

Bulletin K-15B describes pH measurement systems. The brochure discusses the nature of pH, applications and instrumentation. The Foxboro Co., Foxboro, Mass.

CHECK NO. 823

Coaxial connectors

Nu-Lok high-performance coaxial connectors that meet MIL-C-25516 are described in a 16-page catalog. The publication details 14 basic connector types and adapters that are available in a range of sizes and mounting styles and provides electrical, physical and environmental characteristics. Cinch Connectors, div. of TRW, Minneapolis, Minn.

CHECK NO. 824

Temperature controllers

Ninety power-output combinations possible with the company's 400 Series thermocouple temperature controller are described in two data sheets. Full dimensional specifications are given for both table-mounted and panel-mounted models. Thermo Electric, Saddle Brook, N.J.

CHECK NO. 825

Desoldering equipment

Desoldering equipment, including Bazooka solder gobblers, vacuum sources, controls, tips and accessories, are featured in an eight-page bulletin. The bulletin offers suggestions on improving desoldering efficiency, an explanation of the principle of operation and cleaning and maintenance instructions. Air-Vac Engineering Milford, Conn.

CHECK NO. 826

Vibration shock isolation

Complete Designers Guide to vibration isolation mountings, shock control mounting and elastomeric flexible couplings includes details for selecting motor and engine mountings, fractional and integral-hp drive-train couplings, electronic equipment mountings, shock-impact protection, and vibration damping. The 40-page guide includes specifications, selection curves and load characteristics. Lordco Supply, Erie, Pa.

CHECK NO. 827

Lighting products

Choosing the right indicator light, switch or lampholder is made easy by the "Product Lighting Guide." Full-color illustrations and pertinent electromechanical characteristics are included. Leecraft Manufacturing Co., Long Island City, N.Y.

CHECK NO. 828

Electron tubes

The Electron Tube Abridged Data Book describes European electron tubes and devices. Two families of tubes—EEV and M-OV—are color coded for easy identification. An index lists over 3000 types of tubes for which there is an EEV/M-OV equivalent. English Electric Valve Co., Chelmsford, CM1 2QU, U.K.

CHECK NO. 851

Cut and formed leads reduce assembly costs.

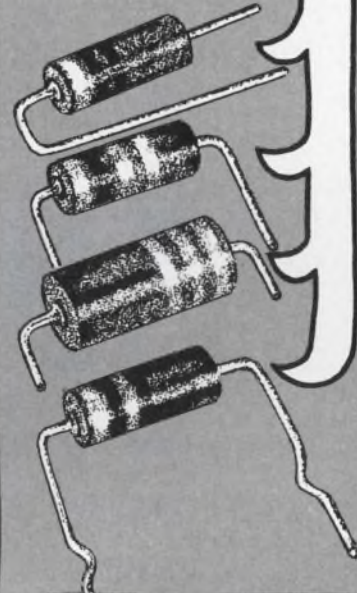

Now that's a nice twist.

Pre-shaped and trimmed resistor leads significantly reduce installation time. All Stackpole carbon composition resistors, 2, 1, 1/2, and 1/4 watts are available with cut and formed leads, to your specifications. Leads are coated for easy soldering. All resistors are 100% tested. Samples available. Send for Bulletin 80-100.



STACKPOLE

Electronic Components Division

Kane, Pa. 16735

i of the month omate

The industry's broadest line of mini peripherals. All available from one supplier. With volume discounts across the full product mix.

We built reliability into the Model 2032 photoelectric paper tape reader by taking out the moving parts. All except a sure-footed stepping motor and sprocket wheel that advances the tape at 400 cps synchronous, 300 asynchronous. In either direction.

It has integrated data and sprocket channel amplifiers. Needs no lens. Changes bulbs in a flash. Comes complete with power supply and electronics.

All at a shamefully low price.

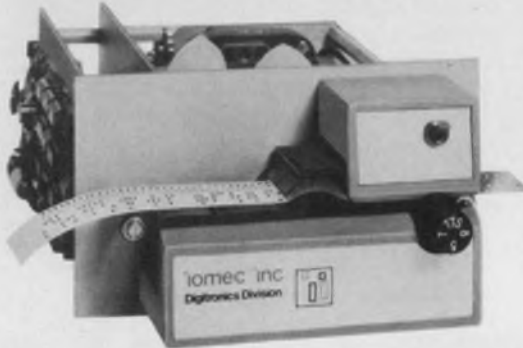

iomec inc
Digitronics Division

Route 9, Southboro, Massachusetts 01772 (617) 481-2500 TWX 710-390-0306

INFORMATION RETRIEVAL NUMBER 143

bulletin board

Dynamic Measurements Corp. has expanded its line of d/a converters to include the popular Analog Devices DAC QZ and DAC QS series. These converters are directly interchangeable with the A.D. types but at substantially lower prices, the company claims. Prices 1-9 are: DAC 12 QZ BIN, \$59; DAC 12 QZ BCD, \$59; DAC 10 Z-1, \$45; DAC 10 Z-3, \$45; MDA 10 Z-25, \$43; MDA 10 Z-110, \$43; DAC 8 QSCB, \$75; DAC 10 QSCB, \$95; DAC 12 QSCB, \$115; DAC 10 QSCBD, \$115. Dynamic Measurements is also offering high-speed versions of the QS series with settling times of under 1 μ s. These are the 222-VF8QS (DAC 8 QSCB), \$95 (1-9); 222-VF10QS (DAC 10 QSCB), \$115 (1-9); 222-VF12QS (DAC 12 QSCB), \$135 (1-9).

CHECK NO. 852

An internally compensated operational amplifier family, pin compatible with National Semiconductor's LM112 series, is now available from Advanced Micro Devices. These circuits operate over a ± 5 -to-20-V range with typical power consumption of only 12 mW.

CHECK NO. 853

Inselek Co. has announced the introduction of three INS4000S series devices. They are the INS4001S (quad two-input positive NOR), the INS4009S (hex buffer-inverting) and the INS4010S (hex buffer noninverting). These devices are pin-for-pin compatible with the CD4000 series. Pricing is \$3.30 (100-999) for the INS4001S; \$5.25 (100-999) for the INS4009S and INS4010S.

CHECK NO. 854

AVX Ceramics Corp. has just been granted the first QPL to MIL-C-55681-A covering ceramic chip capacitor styles CDR01-02-03-04-05-06. Approval covers the M failure level in all styles. Capacitors of this type are used in thick and thin-film military hybrid applications.

CHECK NO. 855

COMPUTER MAINFRAME ENGINEERS & MICRO PROGRAMMERS

Dual Solution For A Satisfying Future:

LIVE IN TULSA . . .
Uncrowded, lake-studded region of rolling hills, the greenery of trees. Educational, cultural and civic facilities are superb. Living is relaxed, and you can find housing you might never afford in any city; enjoy golf, sailing, hunting . . . long sunny days.

WORK WITH TELEX . . .
The preferred computer products company, with an earned reputation as Number One in engineering excellence. In a highly competitive field, we've won a major share, built a strong position. As we push state of the art ahead with new products, this is an excellent time to join us in Tulsa.

Telex Computer Products has several immediate openings at all levels of experience:

BS degree with 2 or more years experience in CPU, I/O channel, memory logic design and micro-programming. 360/370 experience or knowledge preferred, but not essential for most positions.

TTL, Schottky TTL and ECL or equivalent logic families desirable.

Openings also exist for: Engineers with BS degree and 2 or more years experience in the following disciplines:

- Logic Designers, Communications, tape and disk subsystems.
- Systems Programmers: 360/370 OS, Sysgen & maintenance exper.
- Packaging: electrical & mechanical for all above.
- Design Automation Programmers: Must know P.C. Board routing, logic partitioning, placement and simulation. Prefer TTL or ECL exp.
- Circuits Designers: Read Write, servo control or power distribution.
- Mechanical Design: high speed tape or disk mechanisms.
- Circuits Design and Reliability Engineer: Should be familiar with application of state of the art circuits.

Convenient Interviews Arranged:

Please call Mr. Harold Bell **918 627-1111**

If unable to call, please write to him, indicating salary history, chief interests, at:

Telex Computer Products, Inc.

6422 East 41st Street, Tulsa, Oklahoma 74135
An Equal Opportunity Employer M/F

INFORMATION RETRIEVAL NUMBER 901

RCA has developed a laser system that can record color images and other multispectral data on black-and-white film. The system can be used to display and interpret multispectral information generated by sensors used in airplanes and spacecraft. It can be used with color scanners in facsimile systems.

CHECK NO. 866

A software package that gives full batch-processing capabilities to Nova computer users has been introduced by Data General Corp. The software package, BATCH, can run jobs in assembly language, ALGOL, FORTRAN IV and the company's new FORTRAN 5. It runs under the company's real time disc operating system (RDOS).

CHECK NO. 867

Bodine Electric Co. has announced that permanent lubrication is now a standard design feature of its K-2 line of motors and gear-motors.

CHECK NO. 868

Hazeltine Corp. has introduced a low-cost teletypewriter-compatible CRT terminal, the "Hazeltine 1000." Features of the new terminal include a 960 (eighty-by-twelve) character display screen, full alphanumeric keyboard, and communication capability up to 9600 bps with a line interface conforming to EIA Standard RS 232C. The unit also offers half/full duplex transmission and parity generation and checking. Rental price is \$49/month (including maintenance) based on a 12-month rental contract. Purchase price for the terminal is \$1790.

CHECK NO. 882

The National Fire Protection Assoc. has released an interpretational Code pertaining to installation of outlet, switch and junction boxes and fittings.

CHECK NO. 883

In keeping with the long-term movement toward more general use of the metric system, here and abroad, General Motors' implementation to the metric system within GM will be governed by the release of new parts, metrically dimensioned, and by the normal phasing out of in-production parts.

CHECK NO. 884

Double-button switches have been added to low-profile keyboard switches by Oak Industries Inc., Switch Div. The switch stands only 0.415 in. high, including key cap, and sells for less than 25¢ each in production quantities.

CHECK NO. 885

Control Data Corp. has announced a multipartition mass-storage operating system to enhance processing capabilities of the CDC 3000 series medium-scale computer systems.

CHECK NO. 886

A program to make blind computer programmers more productive is available through Honeywell's application sharing system. The system, called Braille-All-Output (BRIALL) has been developed by the Electronic Processing Center, Inc. The company is offering the package to any Honeywell computer user that has blind programmers.

CHECK NO. 887

Transitron Electronic Corp. has added to its Schottky TTL digital logic line five MSI circuits for data selection, multiplexing and carry generator applications.

CHECK NO. 888

A miniature three-electrode lightning arrester for the protection of telephone equipment is being marketed in the U.S. by The English Electric Corp.

CHECK NO. 889

Recognition Equipment has announced that its Total Data Entry systems offer the ability to process data printed in Katakana as an optional feature. Katakana, the Japanese font derived from the basic Japanese Kangii language, is the EPP industry standard for Japan.

CHECK NO. 890

Price reductions

Ailtech has reduced prices on three function generators—Model 511 (10-MHz unit with trigger-gate) to \$595 from \$695; Model 520 (20-MHz unit without trigger-gate) to \$695 from \$795; and Model 521 (20-MHz unit with trigger-gate) for \$795 from \$895.

CHECK NO. 891

Simpson Electric Co. has reduced the price of its 460 VOM from \$395 to \$375.

CHECK NO. 892

Do-it-yourself molded cable you don't have to do yourself.

You don't have to go into the cable assembly business to get the kind of special assembly, quality or cost you're looking for. What you consider custom, Switchcraft considers production. We have just about every kind of plug, jack, junction, clamp, connector or wire you can specify. We just put them together any way you want. Including color variations and special markings. And we save you money.

We help you make precise specifications that lower costs, cut corners without cutting quality. We also pass along some of our manufacturing efficiency (in dollars and cents) with extra service. And of course, Switchcraft reliability saves you money. Service and replacement costs dwindle because we do some extra things to protect your equipment—like an improved method of strain relief to minimize wear and tear and contamination. Or 100% testing for continuity, shorts and voltage breakdown.

Do-it-yourself the easy way. Send for your free Switchcraft Engineering Specification File for Molded Cable Assemblies. Or contact Switchcraft Inc., 5555 N. Elston Ave., Chicago, Ill. 60630 or our local representative directly.

SWITCHCRAFT



FREE TUTORIAL ON REAL-TIME ANALYZERS

11
QUESTIONS
YOU SHOULD
ASK WHEN
BUYING A
REAL-TIME
SPECTRUM ANALYZER

federal scientific



For application in the fields of
VIBRATION—diagnose complex machinery.
NOISE—identify sources.
UNDERWATER—detect faint signals.

Federal's latest Tutorial Brochure answers such meaningful questions as:

- Why do I need real time?
- How much resolution do I really need?
- Can I calibrate frequency and amplitude quickly and accurately?
- Do I need spectrum averaging?
- How can I compare past data with new data?
- How do I know I am analyzing (or averaging) valid data?
- Can I interface to my computer?

FEDERAL SCIENTIFIC CORP.

CIRCLE NO. 171

An affil. of Nicolet Instrument
615 West 131st St., New York, N.Y. 10027 (212) 286-4400

Giant Free Catalog! 4,000 Unusual Bargains



New 164-page catalog! Packed with 1,000's of hard-to-find buys in Optics, Science, Electronics. Loaded with optical, scientific, electronic equipment available from stock. Rare surplus buys. Many "one-of-a-kinds". Ingenious scientific tools. Components galore: lenses, prisms, wedges, mirrors, mounts, accessories. 100's of instruments: pollution test equipment, lasers, comparators, magnifiers, microscopes, projectors, telescopes, binoculars, photo attachments, unique lighting. Shop, save by mail! Request free Catalog "DA".

CIRCLE NO. 172

Edmund Scientific Co.

America's Largest Science-Optics-Electronics Mart
300 Edscorp Bldg., Barrington, New Jersey 08007 (609) 547-3488

Measure Vector Angle, Magnitude And Components



The new PAR™ Model 129A Two Phase Lock-In/Vector Voltmeter, enables you to simultaneously measure the magnitude and phase angle with respect to a reference signal of virtually any low-level signal within its range of 0.5 Hz to 100 kHz—even if the signal is buried 60 dB beneath background noise. At the flip of a switch, you can also measure the in-phase and quadrature components of the vector. The Model 129A features fully automatic reference tracking, independent output expansion and filtering for each channel. Complete specifications are contained in bulletin T-314, available on request.

CIRCLE NO. 173

PRINCETON APPLIED RESEARCH CORPORATION

P.O. Box 2565
Princeton, New Jersey 08540

ELECTRONIC DESIGN's function is:

- To aid progress in the electronics manufacturing industry by promoting good design.
- To give the electronic design engineer concepts and ideas that make his job easier and more productive.
- To provide a central source of timely electronics information.
- To promote communication among members of the electronics engineering community.

Want a subscription? ELECTRONIC DESIGN is sent free to qualified engineers and engineering managers doing design work, supervising design or setting standards in the United States and Western Europe. For a free subscription, use the application form bound in the magazine. If none is included, write to us direct for an application form.

If you do not qualify, you may take out a paid subscription for \$30 a year in the U.S.A., \$40 a year elsewhere. Single copies are \$1.50 each.

If you change your address. send us an old mailing label and your new address; there is generally a postcard for this bound in the magazine. You will have to requalify to continue receiving ELECTRONIC DESIGN free.

The accuracy policy of ELECTRONIC DESIGN is:

- To make diligent efforts to ensure the accuracy of editorial matter.
- To publish prompt corrections whenever inaccuracies are brought to our attention. Corrections appear in "Across the Desk."
- To encourage our readers as responsible members of our business community to report to us misleading or fraudulent advertising.
- To refuse any advertisement deemed to be misleading or fraudulent.

Microfilm copies are available of complete volumes of ELECTRONIC DESIGN at \$19.00 per volume, beginning with Volume 9, 1961. Work is now in process to complete the microfilm edition of Volumes 1-8. Reprints of individual articles may be obtained for \$2.00 each, prepaid (\$.50 for each additional copy of the same article) no matter how long the article. For further details and to place orders, contact the Customer Services Department, University Microfilms, 300 North Zeeb Road, Ann Arbor, Michigan 48106 telephone (313) 761-4700.

Want to contact us? If you have any comments or wish to submit a manuscript or article outline, address your correspondence to:

Editor
ELECTRONIC DESIGN
50 Essex Street
Rochelle Park, N.J. 07662

DO COLLEGES HELP BUSINESS AS MUCH AS BUSINESS HELPS COLLEGES?

Yes, they do. But not in the same proportion.

Business contributes about 15% of the total voluntary support received by colleges.

But today, business gets half the college-trained people who are employed. Tomorrow, it will need even more.

As a result, businessmen should think seriously about increasing the level of corporate giving to education. Can you, as a businessman, think of a better investment?

For the latest national figures on corporate giving to higher education, write on your letterhead for "CFAE Survey of Corporation Support of Higher Education," and enclose \$2.00 to help cover costs. Mail to: Council for Financial Aid to Education, 6 East 45th Street, New York, N.Y. 10017.

Give to the college of your choice. Now.



Advertising contributed for the public good.

Electronic Design

Advertising Sales Staff
Tom W. Carr
Sales Manager

Rochelle Park, N.J. 07662
Robert W. Gascoigne
Daniel J. Rowland
50 Essex Street
(201) 843-0550
TWX: 710-990-5071

Philadelphia
Thomas P. Barth
50 Essex Street
Rochelle Park, N. J. 07662
(201) 843-0550

Boston 02116
50 Essex Street
Rochelle Park, N. J. 07662
(201) 843-0550
(617) 482-7989

Chicago 60611
Thomas P. Kavooras
Berry Conner, Jr.
200 East Ontario
(312) 337-0588

Cleveland
Thomas P. Kavooras
(Chicago)
(312) 337-0588
(call collect)

Los Angeles 90303
Stanley I. Ehrenclou
Burt Underwood
2930 Imperial Highway
Inglewood, Calif
(213) 757-0183

San Francisco 94022
Jerry D. Latta
P.O. Box 1248
Los Altos, Calif.
(415) 965-2636

London W. 1
For United Kingdom and Holland
Brayton C. Nichols
For Eastern Europe
Peter Kehr
The American Magazine Group
9 Warwick Street
London, W. 1, England
Phone: 437 5462
Cable: Ammagnic, London

Tokyo
Haruki Hirayama
Electronic Media Service
5th Floor, Lila Bldg.,
4-9-8 Roppong,
Minato-ku
Phone: 402-4556
Cable: Electronicmedia, Tokyo



For positive dependability in count measurement and control, Microtronics offers the M-7272C Digital Clock, the M-7274C Frequency-Event Counter, the M-7275C Presettable Up-Down Counter, and the M-7276C Event-Totalizer Counter.

Built-in limits make these instruments ideal for automatic production and process control. Six types of buffered BCD outputs and up to 128 set points with memory and scanner are available options.

Digital Clocks feature 0.005% accuracy. Frequency Counters gate at 1/sec., 1/sec., 10/sec., & 100/sec. accurate to ± 1 count. Up-Down Presettable Counters feature automatic polarity, phase detection and 6 digit count to ± 999999 . Power fail detection, data storage and digital limits are common to all units. Two styles available . . . bench/rack type as shown or behind panel mounting.

For more data and performance information, write or phone
MICROTRONICS Corp.
203 Gateway Road, Bensenville, Ill. 60106
(312) 595-9330.

advertiser's index

Advertiser	Page
ADC Products, Magnetics Division	122
AMP, Incorporated	48, 49
AVX Ceramics Corporation	115
Acopian Corp.	169
AirBorn, Inc.	164
Airco Speer Electronics	51
Airpax Electronics, Cambridge Division	143
Allen Bradley Co.	97
Amp'anol Connector Division, Bunker-Ramo Corporation	50A-B, 130A-B
Amp'anol Industrial Division, Bunker-Ramo Corporation	74, 75
Andex Corp.	189
Barber-Colman Company	178
Beckman Instruments, Inc. Helipot Division	2
Berg Electronics, Inc.	173
Boonton Electronics Corporation	153
Bourns, Inc. Trimpot Products Division	16
Bud Radio, Inc.	81
Burroughs Corporation	Cover IV
CTS Corporation	131
Cal-Tex Semiconductors, Inc. Cambridge Thermionic Corporation	34D
CELCO (Constantine Engineering Laboratories, Inc.)	163
Clare-Pendar	39
Computer Automation, Inc.	8, 9
Computer Labs	150
Computer Peripherals, Inc.	187
Computer Products, Inc.	159
Connecticut Hard Rubber Co., The	172
Constantine Engineering Laboratories Company	163
Control Switch, Inc.	178
Cutler-Hammer	117
Data Disc, Inc.	123
Delco Electronics, Division of General Motors Corporation	102, 103
Deltron, Inc.	180
Dialight Corporation	126, 127
Digitran Company, The	148
Dow Corning Corporation	12, 13
Dynascan Corporation	159
ECCO	176
E-T-A Products Co. of America	189
Ectron Corporation	132
Edo Western Corp.	166
Edmund Scientific Company	184
Elco Corporation	37
Electrical Plastics Corporation	136
Erie Technological Products, Inc.	18
Exar Integrated Systems	1
Fairchild Semiconductor, A Division of Fairchild Camera and Instrument Corporation	111, 112, 113
Faratron Corporation	180
Federal Scientific Corporation	184
Franklin Manufacturing Sales	157
GTE Automatic Electric	159, 161, 163
GTE Sylvania Miniature Lighting Products, Inc.	142
General Electric Company	10, 11, 158
General Electric Company, Miniature Lamp Products Department	130
General Electric Company, Semiconductor Products Department	21

Advertiser	Page
General Instrument Corporation	14
General Instrument Corporation, Capacitor Division	41
General Radio Company	4
Gotham Audio Corporation	179
Harris Semiconductor, A Division of Harris Intertype Corporation	34B, 34C
Heath/Schlumberger Scientific Instruments	165
Hewlett-Packard	25, 26, 27, 28, 29, 30, 31, 32, 33, 34
Hutson Industries	170
Hybrid Systems Corp.	154
HyComp Inc.	128
Industrial Electronic Engineers, Inc.	35
Industrial Timer, A Unit of Esterline Corporation	109
Inselek	99
Intech, Incorporated	118
International Rectifier	82
Iomec, Inc.	182
Johanson Manufacturing Corp.	7, 189
Johnson Company, E.F.	129
Keithley Instruments, Inc.	151
Keystone Electronics Corp.	169
Kulka Electric Company	147
Kurz-Kasch, Inc.	109
LRC, Inc.	140
Lambda Electronics Corp.	Cover II
Linear Digital Systems Corp.	179
Littlefuse, Inc.	44
Litton Industries, Inc., Triad Distributor Division	134
3M Company	83
3M Company, Dielectric Division	137
Magnecraft Electric Company	190
Magneto, Inc.	189
Marco-Oak, Subsidiary of Oak Industries, Inc.	109
Microswitch, A Division of Honeywell	98
Microtronics Corp.	185
Microwave Associates	96
Microwave Devices Corp.	161
Minelco Division, General Time Corp.	165
Molex Incorporated	Cover III
Monolithic Systems Corp.	189
Motorola Components Products Dept.	155
Moxon/SRC Division	189
National Cash Register Company, Inc.	187
National Connector Corporation	189
National Electronics, A Varian Division	173
National Semiconductor Corporation	87, 88, 89
Newport Laboratories, Inc.	139
Nichicon Corporation	5
Oak Industries, Inc.	42, 43, 120
Optima, A Division of Scientific Atlanta, Inc.	168
Oven Industries Inc.	180
Philips Industries, Test and Measuring Instruments Dept.	98A
Piezo Technology, Inc.	160
Piher International	54, 55

Advertiser	Page
Pomona Electronics Co., Inc.	161
Power Conversion Inc.	171
Potter & Brumfield, Division of AMF Incorporated	79
Power/Mate Corp.	6, 189
Princeton Applied Research Corp.	184
Pulse Engineering, Inc.	171
Raytheon Company	138
Robison Electronics, Inc.	174
Schjeldahl Company, G.T.	145
Sealed Air Corporation	144
Servo-Tek Products Company	154
Shigoto Industries, Inc.	171
Signetics Corporation	91
Siliconix, Incorporated	52
Singer Company, The, Kearfott Division	34A
Sorensen Company, a unit of the Raytheon Company	149
Spectra Physics	121
Spectrum Dynamics, Inc.	50
Sperry Information Displays	133
Sprague Electric Company	17
Stackpole Components Company	175, 177
Stackpole Carbon Company	179, 181
Standard Condenser Corporation	124
Switchcraft, Inc.	183
Sylvania Miniature Lighting Products	142
Syntronic Instruments, Inc.	162
Systron-Donner	173
TRW/IRC Fixed Resistors, An operation of TRW Electronic Components	80
TRW/IRC Potentiometers, An Electronic Component Division of TRW, Inc.	141
Tau-Tron, Inc.	176
Technical Wire Products, Inc.	157
Tektronics, Inc.	47, 125
Telecommunication Industries, Inc.	156
Telex Computer Products Inc.	182
Tempil Division, Big Three Industries, Inc.	169
Test & Measuring Instruments, Inc.	15
Texas Instruments, Incorporated	157
Texas Instruments, Incorporated, Components Group	68, 69
Thermalloy Company	116
Topaz Electronics	165
Triplett Corporation	105
USCC/Centralab Electronics Division, Globe-Union, Inc.	23
Union Carbide, Components Dept.	119
United Detector Technology, Inc.	189
United Systems Corporation	107
Vernitron Piezoelectric Division	152
Victoreen Instruments, Div. of VLN Corp.	135
Wavetek Indiana Incorporated	90
Windjammer Cruises	167
Woven Electronics	146

**COMPUTER PERIPHERALS, INC.
PRINTER PRODUCTS DIVISION
ROCHESTER, MICHIGAN**

This newly formed (May 1972) Joint Venture Company of Control Data Corporation and NCR —The National Cash Register—offers exceptional opportunities for professional level engineers in design and development of highly complex and reliable printers at its division headquarters and principal engineering/manufacturing facility in Rochester, Michigan.

**MECHANICAL
AND
ELECTRICAL ENGINEERS**

For design of high speed electro-mechanical mechanism, Logic design, Circuit design, and Servo Systems.

These positions call for a high degree of individual initiative and effort in a very visible environment.

For an immediate response regarding placement possibilities, reply now to:

**Robert W. Donovan
Employment Manager**



Computer Peripherals, Inc.
1480 North Rochester Road
Rochester, Michigan 48063

An Equal Opportunity Employer m/f

INFORMATION RETRIEVAL NUMBER 902

**"YOUR
OPPORTUNITY"**

WITH KNOWN DISTRIBUTOR — MANUFACTURER OF TELEPHONY EQUIPMENT SEEKING PRODUCTS TO ADD TO ITS LINE FOR NATIONAL DISTRIBUTION. ALL FACILITIES AVAILABLE FOR COMPLETE DEVELOPMENT.

in confidence reply to
INFORMATION RETRIEVAL NUMBER 903

**Get a jump on tomorrow,
save today.**



Take stock in America.
With higher paying U.S. Savings Bonds.

Engineers

HAVE YOU HEARD ABOUT NCR'S NEW PRODUCTS?

Their capabilities open the way to advanced systems in retail stores and financial institutions. Release of additional equipment and software builds a growing base of NCR computer users.

Maintaining our role as a leader in the business systems and equipment industry requires we work for our future. Make your future a part of ours. The technology is here. The market is defined. All we need are the engineers to implement the new ideas of NCR.

Engineers: Logic Design, Circuit Design or Systems with at least two years of design experience are invited to talk to us. We can offer you an exciting new career as well as the opportunity to locate wherever your personal growth may take you.

To learn how, just send your resume including salary history to us. We'll do the rest.

Write NCR, Worldwide Headquarters, Corporate Executive & Professional Placement, Dayton, Ohio 45479.

NCR

An Equal Opportunity Employer M/F

INFORMATION RETRIEVAL NUMBER 904

product index

Information Retrieval Service. New Products, Evaluation Samples (ES), Design Aids (DA), Application Notes (AN), and New Literature (NL) in this issue are listed here with page and Information Retrieval numbers. Reader requests will be promptly processed by computer and mailed to the manufacturer within three days.

Category	Page	IRN	Category	Page	IRN	Category	Page	IRN
Components			oscilloscope	150	506	new literature		
bluseal RC network	132	281	printer	150	509	circuit soldering	179	785
capacitor, wet	132	283	pulse generator	154	514	communication tubes	179	789
cathode-ray tube	138	296	transient monitor	148	505	connectors	179	790
counter, predetermined	135	288	transient monitor	156	516	connectors, Mil-Spec	176	562
hybrid transformer	138	294	VOM	150	507	connector products	180	816
load cell	138	295	Microwaves & Lasers			connectors, coaxial	181	824
patch panel	132	282	amplifier, log	142	302	contact assemblies	181	817
relay, phase sens.	134	286	amplifier, rf	140	298	controllers	181	825
resistor networks	132	284	laser system	140	299	converter, a/d	178	783
switch, selector	136	290	lasers	144	309	desoldering equipment	181	826
switch, transparent	132	285	lasers, dye	144	310	disc-drive systems	176	568
switches, DIP	136	292	lasers, diode	140	297	disc recorders	180	815
thermocouple	134	287	CATV, transistor	142	303	electron tubes	181	851
thermoelectric cooler	135	289	diodes, avalanche	142	303	HV megohmmeters	180	813
transformer, Scott T	136	293	lasers, ion	146	317	hardware, avionics	179	786
trimmer, resistive	136	291	microstrip hybrids	143	304	hardware options	180	814
Data Processing			mixer, double-balanced	140	301	hardware, PC	176	565
calculator, desk	160	525	oscillator	143	305	heating elements	176	570
calculator, pocket	164	532	p-i-n diodes	146	316	image devices	178	784
cassette, digital	166	539	paramp	146	318	image digitizers	179	791
controller, process	162	530	power dividers	143	306	indicators, temp	176	569
converter, scan	160	524	resistors, power-chip	140	300	insulators	176	571
decoder, PCM	158	520	rf attenuators	144	307	interconnect system	179	811
digitizer, graphic	164	533	sector/receiver	147	894	laminates	179	787
interface, data	164	534	transistors	144	308	lighting products	181	828
memory, drum	158	521	VCO, Gunn	147	893	microwave components	179	793
minicomputer	158	523	Modules & Subassemblies			minicomputer systems	176	564
minicomputer	166	536	a/d data acquisition	116	256	modem packs	178	574
modem, data	158	522	d/a converters	120	265	PH systems	181	823
modem, data	164	535	d/a converters, 16-bit	118	260	panel assemblies	179	812
plotter, digital	166	537	digital	116	257	radio noise meter	176	563
program, analysis	162	529	digital tach/counter	120	266	screens and masks	176	560
program loader	166	538	divider, voltage-ratio	118	262	sensing, interface valves	176	566
punch, tape	162	531	functional module	122	269	switch	181	822
reader, card	160	526	IC switch	118	258	switches, matrix	179	792
recorder, instrument	160	527	oscillators	118	259	switches, microwave	179	788
synchronizer, PCM	162	528	peak detectors	116	254	switches, pushbutton	176	561
ICs & Semiconductors			power supplies	122	268	system modules	176	572
diodes, rectifier	127	270	power supplies, dc to dc	116	255	transistors	178	573
receivers, line	130	276	pressure transducer	120	264	wire tester	176	567
rectifier	131	277	pushbutton switches	122	267	zinc ferrite material	181	821
regulator, voltage	131	278	pulse tone encoder	120	363			
SCRs	121	272	s/d converter	114	250	application notes		
SCRs	129	273	s/d converter	114	251	anodic stripping	174	551
transistors, Darlington	129	274	s/d converter	114	252	beryllium fluodometry	174	555
transistors, Darlington	130	275	switch programmable	118	261	dry-type transformer	174	552
transistors, MOSFET	128	271	temp controller	114	253	insulation	174	553
zener diodes	131	280	Packaging & Materials			JFET guide	174	550
Instrumentation			adhesive	170	546	power tube cooling	174	554
automatic test system	148	504	cabinets	172	897			
contacts tester	154	515	card puller	172	896	design aids		
DMM	150	508	case, instrument	170	545	conversion tables	174	558
DMM	152	510	connector, jumper	172	895	electronic phosphors	174	559
DMM	153	513	connector, thermal	170	548	metric calculator	175	557
DPM	148	503	flux, soldering	168	540	stripline couplers	175	556
DPM	156	518	heat sinks	168	542	vibration shock isolation	181	827
generator, function	156	517	hot-air blowers	172	901			
lock-in amplifier	153	512	IC socket, TO-66	168	541			
millivolt source	156	519	insulators	170	547			
oscilloscope	152	511	potting compounds	168	544			
oscilloscope	148	502	substrates, ceramic	168	543			
			wire-wrapping tool	172	900			

UDT PHOTOPS 450

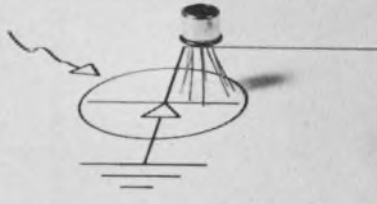

PHOTOPS detector/amplifier combos end interface problems. PHOTOPS combine a high speed, low noise photodetector (sensing areas to 1cm^2) and a FET input amplifier in a hybrid package. Sensitivity to 1×10^{-12} watt. Bandwidth to 10MHz. United Detector Technology, 1732 21st Street, Santa Monica, CA.

INFORMATION RETRIEVAL NUMBER 181



New headers—Here's our new top line of nine right angle molded printed circuit headers for use with 0.100" center wire wrapped plates. One 34-pin model, four 56-pins, one 70-pin and three 112-pins. Your National Connector salesman has all the details. NATIONAL CONNECTOR, 5901 So. County Rd. 18, Mpls., Mn. 55436. (612) 935-0133.

INFORMATION RETRIEVAL NUMBER 182



Thin-Trim variable capacitors provide a reliable means of adjusting capacitance without abrasive trimming or interchange of fixed capacitors. Series 9401 has high Q's and a range of capacitance values from 0.2-0.6 pf to 3.0-12.0 pf and 250 WVDC working voltage. Johanson Manufacturing Corporation, Boonton, New Jersey (201) 334-2676.

INFORMATION RETRIEVAL NUMBER 183

Power Supply Catalog



Free catalog of 34,500 power supplies from the worlds largest manufacturer of quality Power Supplies. New '73 catalog covers over 34,500 D.C. Power Supplies for every application. All units are UL approved, and meet most military and commercial specs for industrial and computer uses. Power Mate Corp. (201) 343-6294.

INFORMATION RETRIEVAL NUMBER 184



Battery quality DC power supply. \$29.95 buys a good supply, if you don't mind undesirable hum and noise. If you demand more, you have 3 choices . . . messy batteries . . . expensive supplies . . . or a low cost MITEY MITE with noise under 20 uV, 0-25 VDC output @ 200 mA . . . battery quality at low cost. MOXON/SRC. DIV., 2222 Michelson Dr., Irvine, Calif. 92664, (714) 833-2000.

INFORMATION RETRIEVAL NUMBER 185

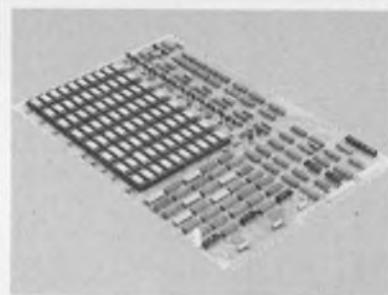

Low cost semiconductor memory system monostore IV/Planar 4K x 20 on a single card 9-3/4"x 14". Cycle 650 ns. Includes timing control, refresh, address register, decoding, sense and memory array. TTL compatible. 0.5" card spacing. 4Kx16 \$900 from stock. Monolithic Systems Corp., Englewood, Co. 80110 (303) 761-2275.

INFORMATION RETRIEVAL NUMBER 186

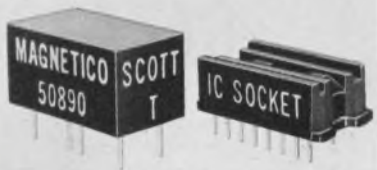

Scott T transformer—dual in line size. In a DIP type size and pin spacing, Scott T No: 50890 converts 400 Hz 11.8V RMS line to line synchro information to 6V RMS Sine and Cosine resolver outputs. Accuracy is 2 arc minutes. Cost is \$25.00 in qty. For any Scott T call: Magnetics, Inc., East Northport, N.Y. 11731. Tel: (516) 261-4502.

INFORMATION RETRIEVAL NUMBER 187



Ceramic low frequency bandpass filters, available from 6 kHz to 55 kHz for military and commercial applications. Sealed in HC-6/U crystal cans. Typical parameters are 0.9% minimum 3 dB BDW., 20 dB/3 dB skirt ratio < 13, insertion loss < 5 dB, 30 dB stopband to 100 kHz. Analex Corporation, Middleburg Hts., Ohio, (216) 842-5339

INFORMATION RETRIEVAL NUMBER 188

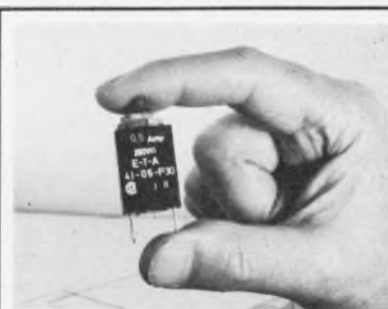

Overcurrent protector, manual reset eliminates fuse replacement. Convenient panel mounting. 15 fractional ratings from 0.1 to 3 amp. Other models up to 400 amp. UL and CSA approved. 93 cents ea. In 1000 lots. E-T-A Products Co. of America, 6284 N. Cicero Ave., Chicago, Ill. 60646. Tel: (312) 545-1553.

INFORMATION RETRIEVAL NUMBER 189

G P

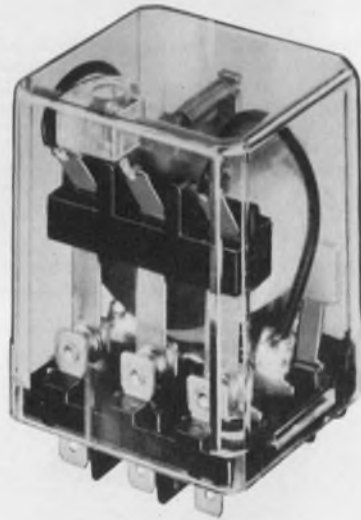

MAGNECRAFT'S NEW CLASS 388 GENERAL PURPOSE RELAY

Magnecraft is pleased to introduce the new Class 388 General Purpose Relay. This inexpensive, high performance line of stock relays offers many quality features found only in custom built versions. Available in either a covered plug-in or open style with a wide choice of AC or DC coil voltages and SPDT, DPDT, or 3PDT 10 amp contacts.

All Class 388 relays have 3-way pierced terminals. While spaced for standard plug-in mounting, the flat terminals (0.187" x 0.020") also accept quick-connect receptacles or direct soldering. For plug-in use, three types of chassis mounted sockets are available; quick-connect, solder, or printed circuit terminals. Covered plug-in version has a tough clear polycarbonate plastic cover.

In a highly competitive business, delivery can be a deciding factor. If delivery is important to you, be aware that Magnecraft ships better than 90% of all incoming orders for stock relays, received before noon, THE SAME DAY (substantiated by an independent auditing firm). In addition to our shipping record, most stock items are available off-the-shelf from our local distributor.

FREE!



DESIGNER'S CATALOG

The purpose of this 36-page catalog is to assist the design engineer in specifying the proper relay for a given application. The book completely describes General Purpose, Sensitive General Purpose, and Mechanical Power Relays. New products include the complete line of Class 388 General Purpose Relays.

Magnecraft ELECTRIC COMPANY

5575 NORTH LYNCH AVENUE • CHICAGO, ILLINOIS 60630 • 312 • 282-5500 • TWX 910 221 5221

INFORMATION RETRIEVAL NUMBER 146

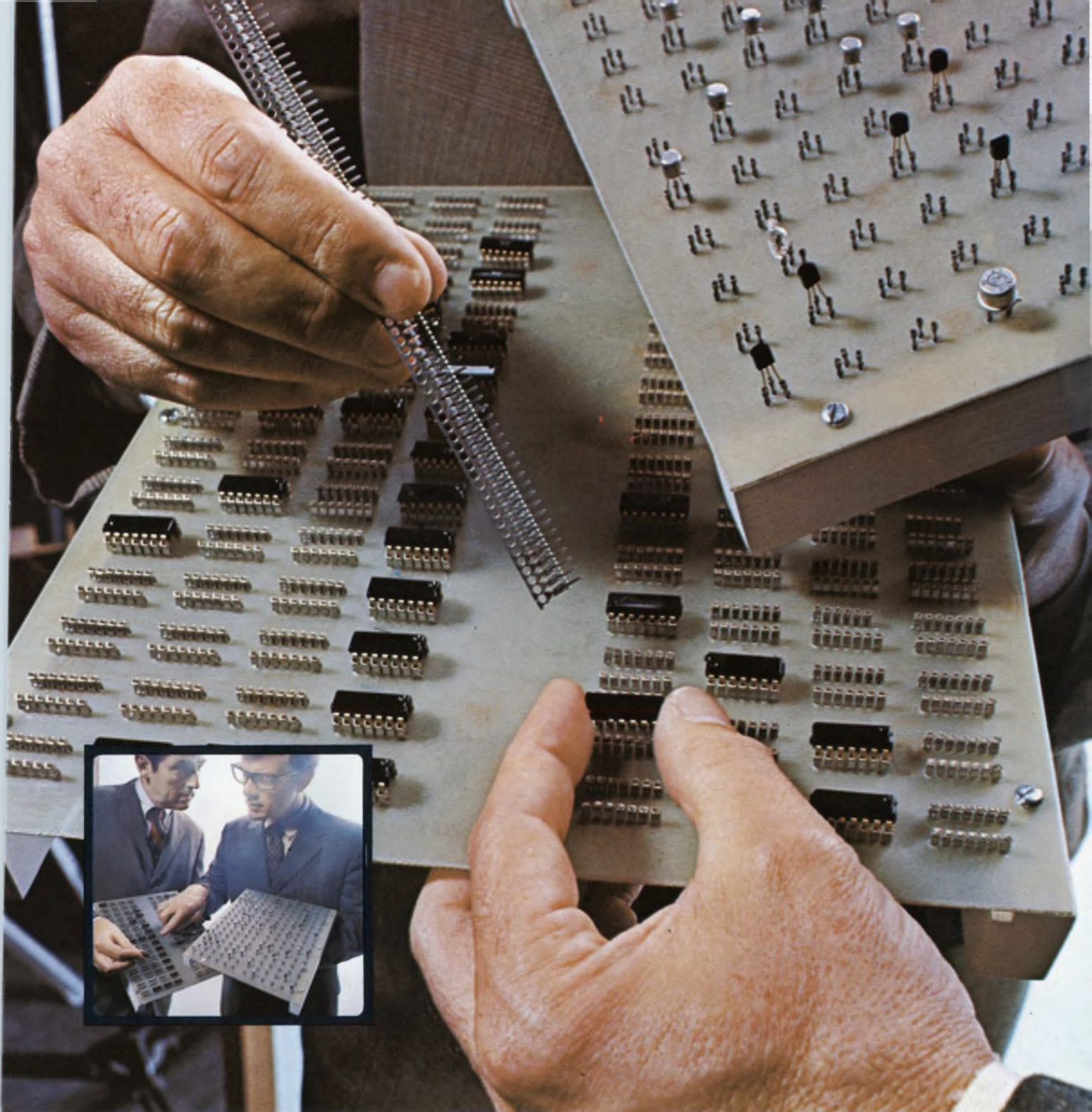

HERE'S A NEW AND BETTER WAY: To make printed circuit board connections. Reliably. At low, low cost. They're Molex Soldercon[®] terminals. Integrated circuit and transistor terminals. Offering the convenience of plug-in I.C.'s and transistors *without* the cost of insulators. They fit directly on the board. And there is equipment available to do the job *automatically*. Fast! Soldercon terminals save time. Money. Speed installation. Make

testing easier, too. And simplify service problems. It's another example of Molex ingenuity . . . in creating components that simplify circuitry. Molex has the know-how and facilities to provide the interconnecting system you need. You can make connections by calling (312) 969-4550. Or write . . . Molex Incorporated, Lisle, Illinois 60532.

*... creating components that
simplify circuitry*

INFORMATION RETRIEVAL NUMBER 247



Burroughs panel displays help you sell your products

"The SELF-SCAN panel display provides a CompuWriter® feature never before available. . . now an average typist can set quality typography with ease because the SELF-SCAN panel displays each character and function as she keyboards so that she can verify or make corrections by individual character, word, or complete line. Burroughs panel displays DO help you sell your product." — Mr. John Peterson, Vice President, Domestic Marketing, for Compugraphic Corporation, 80 Industrial Way, Wilmington, Massachusetts 01887.

Helping you to sell your product helps us sell our product. That's why Burroughs family of panel displays is designed to provide the most pleasing, most readable character available today. Whether your application is for 8, 16, 32, 80, or 256 alphanumeric characters, Burroughs SELF-SCAN panel displays provide an economical approach to your readout requirement plus offer the extra advantage of adding aesthetic quality to your product.

Ask a Burroughs salesman to drop by and demonstrate his terminal in a briefcase. His SELF-SCAN panel display demonstrator is our best salesman.

Write or call
Burroughs Corporation,
Electronic Components
Division, Box 1226,
Plainfield, N.J. 07061
(201) 757-3400



SELF-SCAN PANEL

Burroughs



Only Burroughs manufactures NIXIE® tubes, SELF SCAN® panel displays and PANAPLEX™ numeric panel displays