

# Electronic Design

VOL. 21 NO.

# 8

FOR ENGINEERS AND ENGINEERING MANAGERS

APRIL 12, 1973

RECEIVED  
APR 11 1973  
CALM

**Materials selection is important** for special design requirements and for reducing product costs. For consumer electronic products safety standards demand use of

flame-resistant dielectric material. For pinching pennies in design, conductive materials offer newer methods of connection, assembly and parts fabrication. See p.74.



Do you face a make or buy decision on power supplies?

# BUY LAMBDA LX SERIES

Choose from 9 packages, 54 models. Listed in Underwriters' Laboratories Recognized Components Index.\* All designed to meet MIL environmental specifications.



### "3" PACKAGE

DUAL OUTPUT... \$85  $\pm 15$  to  $\pm 12$  V 0.4 A



### "A" PACKAGE

SINGLE OUTPUT... \$85 5 V 4 A (with O.V.)  
DUAL OUTPUT... \$125  $\pm 15$  to  $\pm 12$  V 1 A



### "B" PACKAGE

SINGLE OUTPUT... \$125 5 V 5.8 A (with O.V.)  
DUAL OUTPUT... \$150  $\pm 15$  to  $\pm 12$  V 1.6 A



### "C" PACKAGE

SINGLE OUTPUT... \$150 5 V 9 A (with O.V.)  
DUAL OUTPUT... \$160  $\pm 15$  to  $\pm 12$  V 2.5 A



### "D" PACKAGE

SINGLE OUTPUT... \$235 5 V 27.5 A (with O.V.)  
DUAL OUTPUT... \$280  $\pm 15$  to  $\pm 12$  V 6.2 A  
TRIPLE OUTPUT... \$375  $\pm 15$  to  $\pm 12$  V 3.1 A  
5 V  $\pm 5\%$  12 A (with O.V.)



### "4" PACKAGE

SINGLE OUTPUT... \$135 5 V 7.4 A (with O.V.)



### "CC" PACKAGE

SINGLE OUTPUT... \$200 5 V 16 A (with O.V.)  
DUAL OUTPUT... \$235  $\pm 15$  to  $\pm 12$  V 4 A



### "EE" PACKAGE

SINGLE OUTPUT... \$425 5 V 45 A (with O.V.)  
DUAL OUTPUT... \$435  $\pm 15$  to  $\pm 12$  V 12.5 A



### NEW "8" PACKAGE

SINGLE OUTPUT... \$560 5 V 85 A (with O.V.)

Line regulation 0.1% Load regulation 0.1%  
Ripple and noise 1.5 mV RMS, 5 mV P-P  
AC input 105-132 VAC; 47-440 Hz.  
All 5-volt models include built-in overvoltage protection.  
\* LX-8 and LX-EE models presently undergoing qualifying tests

 **LAMBDA** ELECTRONICS CORP.

1-DAY DELIVERY

Send for 1973 Power Supply Catalog and Application Handbook

5-YEAR GUARANTEED

MELVILLE, NEW YORK 11746 515 Broad Hollow Road Tel. 516-694-4200 ARLINGTON HEIGHTS, ILL. 60005 2420 East Oakton St., Unit Q Tel. 312-593-2550  
NORTH HOLLYWOOD, CALIF. 91605 7316 Varna Ave. Tel. 213-875-2744 MONTREAL, QUEBEC 100C Hymus Blvd., Pointe-Claire, Quebec-730 Tel. 514-697-6520  
PORTSMOUTH, HANTS, ENG. Marshlands Road, Farlington Tel. Cosham 73221 VERSAILLES, FRANCE 64a 70 rue des Chantiers 78004 Tel. 950-2224

INFORMATION RETRIEVAL NUMBER 245

# YOU HUM THE TUNE, EXAR PLL WILL SING IT



XR-2567



XR-210



XR-215



XR-567



XR-S200



Exar PLL

We have the broadest chorus line of Phase Lock Loop circuits available today. Take a brief look at our ever-expanding PLL line:

The XR-210 is designed for FSK Modulation and Demodulation and features a self-contained output logic driver, compatible with RS-232C requirements.

Use the XR-215 for FM or FSK demodulation, frequency synthesis and filter tracking. It has a 5V to 26V supply range and 0.5 Hz to 35 MHz frequency bandwidth. What's more, it's bipolar logic compatible.

The XR-S200 is a do-it-yourself building block. With this you design your own PLL circuits by selecting external connections and components. You get instant pro-

totypes with minimum fuss and costs.

Moving right along . . . the XR-567 PLL is designed for tone and frequency decoding. It has a bandwidth adjustable from 0 to 14%, sinks up to 100 mA of load current and has a logic compatible output. Our dual version, the XR-2567, is a real hummer with even better temperature tracking and matching characteristics. Power supply rejection is improved by an order of magnitude over the single version. The dual outputs can switch up to 100 mA at 26 volts.

All together now. We would like to send you the complete musical score on our PLL products. Our data sheets are good and they're filled with applications data. Write now, write.

## EXAR SPEAKS YOUR LANGUAGE



EXAR INTEGRATED SYSTEMS

750 Palomar Sunnyvale, California 94086 (408) 732-7970 TWX 910-339-9233

**EXAR SALES REPRESENTATIVES** Alabama, Georgia, Mississippi, North Carolina, South Carolina and Tennessee: K & E Associates, Kennesaw, Georgia (404) 974-4264  
 Arkansas, Louisiana, Oklahoma and Texas: Evans-McDowell, Dallas, Texas (214) 238-7157 California: De Angelo, Rothman and Co., Culver City (213) 398-6239, Logan  
 Sales Co., Redwood City (415) 369-6726 Connecticut, Maine, Massachusetts, New Hampshire, Rhode Island and Vermont: Com-Sale, Waltham, Massachusetts (617)  
 890-0011, Meriden, Conn. (203) 634-0179 Indiana, Kentucky and Ohio: McFadden Sales, Columbus, Ohio (614) 221-3363 Idaho, Oregon and Washington: SD-R  
 Products & Sales, Bellevue, Washington (206) 747-9424 Illinois and Wisconsin: Mar-Con Associates, Inc., Skokie, Illinois (312) 675-6450 Maryland, Virginia and  
 Washington, D.C.: Rep-Tron, Inc., Silver Spring, Maryland (301) 593-4844 New Jersey (South) and Pennsylvania: Harry Nash Associates, Willow Grove, Pennsylvania  
 (215) 657-2213 New Jersey (North) and New York: MOS Associates, Floral Park, New York (516) 694-5923 Canada: Harvard Electronic Sales, Laval, Quebec (514) 681-1400  
**EXAR DISTRIBUTORS** California: EEP Corporation, Culver City (213) 838-1912, Intermark Electronics, San Carlos (415) 592-1641, San Diego (714) 279-5200, Santa Ana  
 (714) 540-1322 Colorado: Intermark Electronics, Denver (303) 936-8284 Indiana: Graham Electronics, Indianapolis (317) 634-8202 Massachusetts: Gerber Electronics,  
 Dedham (617) 329-2400 Washington: Intermark Electronics, Seattle (206) 767-3160

INFORMATION RETRIEVAL NUMBER 2

# This problem should take you about 42 minutes to solve.

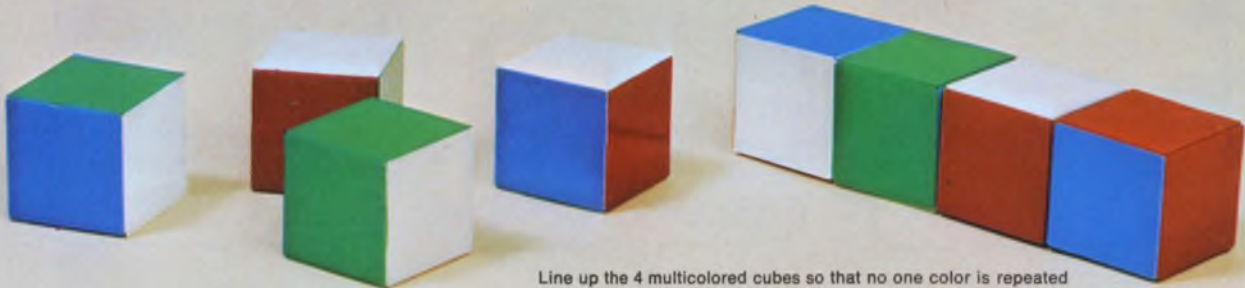

Line up the 4 multicolored cubes so that no one color is repeated on any side.† As an engineer you should do this in 42 minutes.\*

## With P&B's four new time delay relays you solve cost, accuracy and size problems. Immediately.



These new solid state time delays—each designed to solve different design problems—are built around our compact, widely accepted R10 relay. Each is available in 2 or 4 Form C contact arrangements and may be mounted directly to a chassis, printed circuit board, special mounting strip or in sockets having solder or printed circuit terminals.

**R12 Series.** A high resolution, 15-turn potentiometer provides delay on operate timing variations within ranges of 0.1 to 2.0, 1.0 to 30 and 5.0 to 120 seconds. Coils are for 12, 24 or 48V DC. Six contact styles cover a load range from dry circuit to 10 amperes.

**R13 Series.** These fixed, delay on operate time delays are available in 10 timing ranges from 1 to 300 seconds. They require less than 240 milliwatts of DC to operate. Operating voltages are 12, 24 and 48V DC. Contact ratings: dry circuit to 5 amperes.

**R14 Series.** Seven timing ranges provide delay on operate (R14) or interval timing (R14A) from .025 to 600 seconds. Available fixed or externally adjustable with coil voltages of 6, 12, 24 and 48V DC. Contacts may be specified from dry circuit to 10 amperes.

**R15 Series.** AC operated from 12, 24, 48 and 115V power sources,

these compact time delays may be ordered fixed or externally adjustable in seven timing ranges from .025 to 300 seconds. Delay on operate (R15) or interval timer (R15A) modes are available.

Get complete specifications from your local P&B representative or call Potter & Brumfield Division AMF Incorporated, Princeton, Indiana 47670. 812-385-5251.

*\*Think you can readily solve the puzzle shown above? Ask your P&B representative for one.*

Solving switching problems is what we're all about.

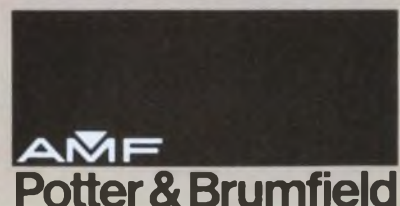

---

## NEWS

- 25 **News Scope**  
28 **Skylab, the biggest spacecraft ever built for human habitation** is being readied for man's longest stay in space.  
36 **Fighting the skyjacker** is testing the resources of the Federal Government and private industry. Anyone have a bomb detector?  
53 **A new MIL spec—cost—and designers must meet it.**  
57 **IBM puts entire disc system in one removable cartridge.**  
66 **Technology Abroad**  
59 **Washington Report**

---

## TECHNOLOGY

- 74 **Focus on Materials:** A special report on how to minimize costs, while improving product quality and reliability, by choosing the right conducting and insulating materials.  
84 **Ease multiplexing and a/d conversion** in data acquisition by using programmable-gain amplifiers. They operate from digital signals to provide precise gain control.  
92 **Shedding light on LED luminance:** There's more to measuring light output than meets the eye. Here are basic steps to determine LED energy with precision.  
102 **Increase phototransistor bandwidth** without sacrificing output voltage. The solution is to use an op amp in lieu of an emitter load resistor.  
106 **Divide by n with the 7490**—and do it without external parts. Merely wire between pins. All circuits except one also provide a BCD output.  
110 **Raises: How often and how much?** It's not only what the employee can do as an individual that counts, says this manager, but how he fits into the team picture.  
114 **Annual Index of Articles:** January through December, 1972  
128 **Ideas for Design:** Biphase data-transmission system uses IC one-shot as converter and doubler . . . Countdown technique simplifies BCD-to-binary conversion circuitry.

---

## PRODUCTS

- 135 **ICs & Semiconductors:** Bucket brigade MOS ICs delay analog signals.  
136 **ICs & Semiconductors:** Variable-modulus prescaling ICs simplify PLLs for 200 MHz.  
138 **ICs & Semiconductors:** CMOS and bipolar on chip drive LED numeric display.  
142 **Data Processing:** CRT terminal gives sophistication at low cost.  
148 **Packaging & Materials:** Voice-coil driven laser trimmers offers accuracy to  $\pm 0.005\%$  and  $m\Omega$ — $M\Omega$  range.  
152 Instrumentation  
156 Components  
158 Microwaves & Lasers  
160 Modules & Subassemblies

---

## Departments

- 71 **Editorial:** Guidelines drawn in invisible ink  
7 Across the Desk  
164 Application Notes  
166 New Literature  
171 Bulletin Board  
174 Advertisers' Index  
176 Product Index  
178 Information Retrieval Card

**Cover:** Photo of a silicone dual-inline package under flame test.  
Picture taken by Lloyd Wright for Dow Corning Corp.

# Now that we're a \$13 million mini giant, will we forget everything we learned?

## What the industry taught us about minicomputer introductions.



### The gutless wonder.

Yes,ree, fans, here it comes. Marvel of marvels. The greatest little number cruncher yet. Every bell and whistle you've ever wanted. Split-bill: second speeds to boot. State-of-the-art everything. Amazing. That anybody listens, that is. Because this little gem exists only in the dreams of the optimists in somebody's marketing department. Designing it and building it are details they'll worry about later.

Nine months from now — maybe — when they get around to making a real one, nobody will remember all those promises anyway. Will they?

### Just another pretty face.

This is how they introduce new computers that never were. And never will be. The old cosmetic trick.

Simple, really. All you need is a few new lights. A few new buttons. A few new knobs.

And plenty of new paint.

Don't worry about what's inside those magnificent new skins. No sweat. It's all just beautiful. Right?

## Introducing the Interdata New Series.

### What you see is what you get.

What you get from Interdata is something else. Something extra.

First, you get a whole new series of minis. Not promises. Facts.

You get Interdata's much-imitated architecture. Which means they're all upward compatible. So you get extra protection for your investment in software and peripherals.

The Model 70\* has a solid-state LSI read-only memory, built-in multiply/divide and floating point hardware and 4 channels of DMA. So it's extra powerful and flexible.

It has 113 instructions and automatic I/O and 16 g.p. registers and built-in interfaces. So it's extra easy to configure and use.

The Model 80 has everything the Model 70 has. Plus a 350-nanosecond semi-conductor main memory. So it's extra fast.

\*OEM price — \$5190, quantity of 1.



We'll demonstrate them for you. Not 9 months from now. Now. Even run a benchmark, if you like. What you see is what you get. And what you get is something extra from Interdata.

We've learned our lesson about minicomputer introductions.

Interdata  
2 Crescent Place, Ossongeort, New Jersey 07757

Gentlemen

Maybe you have learned something

Send more information

Let's talk. And bring me a "What You See Is What You Get" button.

Name \_\_\_\_\_ Title \_\_\_\_\_

Company \_\_\_\_\_

Address \_\_\_\_\_

City \_\_\_\_\_ State \_\_\_\_\_ Zip \_\_\_\_\_



We've learned a lot in the last 5 years. Mostly from the biggies who used to delight in kicking a little sand in our face once in a while.

We learned that when you introduce a new family of processors, for example, you'd better have a bona-fide new family of processors. And not made out of cardboard, either. So we waited until we'd built the Interdata New Series before we introduced it. People believed us. And we're not about to forget that.

When it came to pricing, we learned just like everybody else — the hard way. By getting our pants

taken off in the marketplace a few times. That's something you just don't forget. Same about making promises you can't keep. We can't afford to forget that.

We even learned a lot about OEMs. Very smart. Won't pay for a lot of bells and whistles they don't really need. So we designed a special mini just for OEMs. The Model 74. Good but cheap and upward compatible with our other minis — just like the man wanted. If we ever forget that, we can kiss our OEM business goodbye.

And we learned a lot more along that hard road up.

Interdata  
New Jersey Headquarters — (201) 228-8040. In Canada — (416) 678-1900.  
In Great Britain — (01-832) 5252. In West Germany — (0811) 1460017.

## What the industry taught us about minicomputer pricing.



### We've learned the hard way.

Step right up, fans. Here's the greatest little dollar-saver to ever come down the pike. Cycle times too fast to measure. Memory 'til it won't quit. All for a price so amazingly low that it defies the laws of economics.

Terrific. Until you realize they're talking about a processor so stripped down it won't even hum by itself. Its assembly may be your next do-it-yourself project. Except for the tic-tac-toe game, the software won't work without 16 KB more memory and enough peripheral gear to triple your costs. And the discount they used was based on a 1000 unit-per-month schedule.

No question about it. When it comes to minicomputers, some guys really know how to price. And there's a big difference in how they price their basic processors and how they price every-thing else.

We ought to know. We've lost our knickers in the trick-pricing game often enough to be experts.

### Promise them anything.

We've learned that you can make a lot of promises.

About delivery, for example. "For a customer as important as you, we'll cut our 9-month shipping schedule in half." About documentation. "We don't have all the manuals yet, but we'll work that out together." And about customer engineering. "Of course we'll assign a full-time man to the Isle of Wight."

But what we've really learned is we don't have to make promises we can't keep. We don't do business that way. We just don't have the stomach.



## Introducing the Interdata New Series.

### What you see is what you get.

What you get from Interdata when it comes to pricing is something extra. Extra value.

Extra processor facilities, for example. With our Model 70,<sup>1</sup> you get hardware multiply/divide. Built-in 32 bit floating point arithmetic. Privileged instructions. 4 direct memory access ports. Automatic I/O. And 16 general registers.

All for no charge. With other manufacturers, these facilities either cost you extra or are not even available.

From Interdata you get extra reliable memory modules designed in-house for each specific model. With or without parity. With or without automatic memory protect. And they cost you less than if you got them from our major competitors. Again, if they've got them.

And there are a lot of other extras about the Interdata New Series.

Like our Universal Clock Module. And our teletypewriter controller built into our basic processor.

What all these add up to is extra price/performance.

<sup>1</sup>OEM price - \$4028, quantity of 25.



Whether you're from Missouri or not, make us prove it. About our Interdata New Series.

We're ready to demonstrate for you now. Not 9 months from now. We'll even run a benchmark for you.

You could well end up with the best minicomputer price you've ever had. From the minicomputer company who's learned its lesson about pricing.

Interdata  
2 Crescent Place, Oceanport, New Jersey 07757  
Gentlemen: Maybe you have learned something.  
 Send more information.  
 Let's talk about a benchmark. And bring me a pair of Interdata suspenders to help me keep my gourd up.

Name \_\_\_\_\_ Title \_\_\_\_\_  
Company \_\_\_\_\_  
Address \_\_\_\_\_  
City \_\_\_\_\_ State \_\_\_\_\_ Zip \_\_\_\_\_

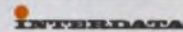

New Jersey headquarters - (201) 229-4040. Boston - (617) 890-0557. Chicago - (312) 437-5120. Dallas - (214) 238-9656. Denver - (303) 758-0474. Detroit - (313) 356-5515. Houston - (713) 783-1830. Los Angeles - (213) 640-0451. Palo Alto - (415) 969-1180. Philadelphia - (215) 436-5579. Washington - (703) 525-4806. Toronto - (416) 678-1500. United Kingdom - Uxbridge 52441. Sydney - NSW 439-4155. West Germany - 0811/8543887. Tokyo - 270-7711.

Like how to make true DC processors instead of modifying GP processors for Data Communications people. Like how to put together a family of software packages that really work before we started peddling them. Operating systems like RTOS, DOS, BOSS and a telecommunications operating system, RTEK. And like how to put a well trained and equipped service network in place before we beat the bushes in East Oshkosh.

Some of our lessons were painful. Maybe that's why they stick. Maybe it's because we know if we hadn't learned, we never would have made it.

And maybe because we plan to grow even faster, we know we'll have to learn a lot more than we know now. And get a lot smarter about how to do a better job for our customers.

Will success spoil Interdata?

Forget it.



2 Crescent Place, Oceanport, New Jersey 07757 (201) 229-4040. Denver - (303) 758-0474. Boston - (617) 890-0557. Chicago - (312) 437-5120. Dallas - (214) 238-9656. Detroit - (313) 356-5515. Houston - (713) 783-1830. Los Angeles - (213) 640-0451. Palo Alto - (415) 969-1180. Philadelphia - (215) 436-5579. Washington - (703) 525-4806. Toronto - (416) 678-1500. United Kingdom - Uxbridge 52441. Sydney - NSW 439-4155. West Germany - 0811/8543887. Tokyo - 270-7711.

INFORMATION RETRIEVAL NUMBER 4

# One "no" and your power supply doesn't go.



Did you know that each and every Power/Mate power supply gets 42 separate inspections?

A "no" in any one means that your power supply doesn't go out the door.

That's the insistence and emphasis that the new Power/Mate puts on quality. Sure, it costs us more, but that's how Power/Mate makes friends . . . and why Power/Mate is the world's largest producer of quality power supplies.

Send for the Power/Mate catalog . . . 32,500 models . . . most available for same-day shipment.

THE NEW **P/M/C**  
**POWER/MATE CORP.**

514 S. River Street, Hackensack, N. J. 07601 / Phone (201) 343-6294  
TWX 710-990-5023

**Vice President, Publisher**  
Peter Coley

## Editors

Editorial Offices  
50 Essex St.  
Rochelle Park, N.J. 07662  
(201) 843-0550  
TWX: 710-990 5071  
Cable: Haydenpubs Rochellepark  
**Editor-in-Chief:** George Rostky

## Managing Editors:

Ralph Dobriner  
Michael Elphick

## Associate Editors:

Dave Bursky  
Jules H. Gilder  
Morris Grossman  
Seymour T. Levine  
John F. Mason  
Stanley Runyon  
Edward A. Torrero  
Richard L. Turmail

## Contributing Editor:

Peter N. Budzilovich

## Editorial Field Offices

### East

Jim McDermott, Eastern Editor  
P.O. Box 272  
Easthampton, Mass. 01027  
(413) 527-3632

### West

David N. Kaye, Senior Western Editor  
2930 West Imperial Highway  
Inglewood, Calif. 90303  
(213) 757-0183

### Washington

Heather M. David, Bureau Chief  
2506 Eye St., N.W.  
Washington, D.C. 20037  
(202) 338-3470

## Editorial Production

Marjorie A. Duffy

## Art

**Art Director,** William Kelly  
Richard Luce  
Anthony J. Fischetto

## Production

**Manager,** Dollie S. Viebig  
Helen De Polo  
Maxine Correal  
Anne Molfetas

## Circulation

**Manager,** Nancy L. Merritt  
Ron Deramo

## Information Retrieval

Peggy Long

## Promotion

**Manager,** Jeffrey A. Weiner  
Karen Kerrigan



## across the desk

### A relatively new entry in a/d converter field

The article "Focus on A/D and D/A Converters" (ED 1, Jan. 4, 1973, p. 56) was read with great interest. Succinct in its material content, it yet conveyed the essential information relative to the state of the art.

QCI is a relatively new entry into the a/d converter business and would appreciate being added to the list of manufacturers at the end of the article. We feel our products are innovative in many respects and should be of interest to any prospective users. We encourage inquiries.

*Ben A. Cerruti*  
Vice President-Marketing

QCI Inc.  
2908 Scott Blvd.  
Santa Clara, Calif. 95050.

CIRCLE NO. 318

### A foreign touch urged in U.S. trade shows

I enjoyed your editorial "Selling is a Dirty Word" (ED 2, Jan. 18, 1973, p. 47). I would, however, like to make a couple of personal observations, in view of my trade-show experience on both sides of the Atlantic. Perhaps my comments will provide some thoughts useful to exhibitors—but, more importantly, to convention management.

In the first place, it appears the original, and still guiding, principle behind most U.S. technical conventions is the diffusion of firsthand knowledge within peer groups. The collateral exhibition of products by manufacturers seems to have developed solely as a means to help finance these events. As such, the actual selling of products has been down-played,

if not expressly prohibited.

The major European shows, on the other hand, were designed from the beginning to be selling events. They are unabashedly "trade fairs." Further, the establishment of coincident technical symposia seems to have been an afterthought—an extra attraction to help encourage greater attendance.

Although U.S. and European trade shows seem to have common precursors—county, regional and national fairs—we somehow have sanitized our approach along the way. I agree with your comment, "Our loftiness and stupidity make our shows duller." Maybe the real solution lies in the importation of promoters from Europe to organize new (or reorganize old) trade shows. The foreign competition might well improve matters considerably.

*Ricardo J. Alfaro 2d*  
Account Supervisor

Klemtner Advertising Inc.  
680 Beach St.  
San Francisco, Calif. 94109.

### Impressive objective

From a recent annual report: The company "is now rapidly growing towards our near term objective, which is to become a major medium-sized electronic company."

### How to connect

If you'd like to share your special knowledge of connectors, the Electronic Connector Study Group has an ideal forum at its Sixth Annual Connector Symposium, scheduled for October, 1973, in Cherry Hill, N.J. For information on how to present a paper,

CIRCLE NO. 319  
(continued on page 10)

Electronic Design welcomes the opinions of its readers on the issues raised in the magazine's editorial columns. Address letters to Managing Editor, Electronic Design, 50 Essex St. Rochelle Park, N. J. 07662. Try to keep letters under 200 words. Letters must be signed. Names will be withheld on request.

## Subminiature PANEL LIGHTS THAT LAST (up to 50 years)



### low cost IMMEDIATE AVAILABILITY

- LED's (3/16" & 1/4" mtg. dia.)
- Self-Driven  
Incandescents  
(built-in drivers & keep alive bias)
- Standard Neons  
& Incandescents
- Customs too!

Ruggedly built with shock proof and fully insulated bodies. ■ Attractively designed and available in several lens and collar colors. ■ Low profile and standard mounting models.

Call or write for more information today!

*the little light people*

## DATA DISPLAY PRODUCTS

5428 W. 104th St., Los Angeles, Ca. 90045  
(213) 641-1232

INFORMATION RETRIEVAL NUMBER 6

**THE CHEAPEST  
MINICOMPUTER  
VS.  
THE CHEAPEST  
SOLUTION**

Before you buy a minicomputer, do yourself a favor. Make a very fundamental decision. Do you want the cheapest machine you can find or the cheapest total solution to your problem?

We think it's the latter.

Because the cheapest machine is just that. It's raw hardware at a rock bottom price. And virtually every minicomputer supplier offers a product like this. Including us.

But your goal should be to get the lowest cost total solution for your problems. And paying less now could cost you more later if the machine you buy has been designed for rock bottom price alone. Be careful. You should look beyond raw iron. You need a computer package that saves you money at both ends. One that's been designed with the total solution in mind. A powerful blend of hardware, systems software, and extensive peripherals.

You also should look for a supplier that has built his business on fulfilling this need. That's us.

### **The world's most powerful mini.**

We've developed the most effective minicomputer package you can buy: the SPC-16. Six different models to choose from and the *most powerful* instruction set available anywhere.

The SPC-16 does more things in less time with less memory. That's why it can actually save you money on your total system.

And we've recently enhanced the capability of our SPC-16 family with a number of new products including:

Multi-user BASIC, and the real-time, multi-programming capability of our RTOS-16 operating system. And our new extended FORTRAN IV.

New peripherals like a low speed line printer, head per track disk and a floppy disk.

High speed floating point processor,

8K memory board, heavy duty process I/O boards, A/D and D/A converters and digital I/O boards.

And completely new asynchronous communications multiplexer system.

Here's another reason for choosing us:

### **We've already had our tryouts.**

Today all the big mini manufacturers are announcing that they're "in the systems business."

We've been in it from the start.

And while everybody else was churning out iron, we were building systems and piling up applications know-how.

We got involved with our customers' problems. We listened and we learned. Then we rolled up our sleeves and went to work.

As a result our people don't have to be retrained for this new approach because it isn't new at all. Not to us.

Over the years we've supplied systems to solve some very tough problems in the automotive industry, in production machine control, in electrical testing and communications. And this experience has built a fund of systems expertise no mini manufacturer can match.

There's a good chance we already have a system that fits your needs. If not, we have the know-how to design it for you. Or *with* you.

In fact, we can probably utilize our experience to solve your system problem faster than others can deliver a bid.

### **Read all about it.**

If you're determined to reduce systems cost, we have a book for you. It's titled "The Value of Power." It covers everything you'll need to know to make the right decisions, for the right reasons, to end up with the right system for your specific needs. It's free.

Write for a copy. The address is 1055 South East Street, Anaheim, California 92804. Or phone (714) 778-4800.



# **General Automation**

INFORMATION RETRIEVAL NUMBER 7

*(continued from page 7)*

## A look at past called useful for future

Your 20th anniversary issue (ED 24, Nov. 23) was a very pleasant surprise. I strongly disagree with Robert Simpson of Grumman Aircraft [who found the look backward in the issue of no "design value"]. We do not advance our profession by treading always on new technologies, as evidenced by the further development of the Electret, Ovonic, et al. A good look at where we have been points the way to where we should go or should be. Many times a look at past developments has sparked tangential paths into new discoveries.

Your sporadic spurts of nostalgia are welcome if they produce other issues like that one.

J. W. Colon  
Project Engineer

International Data Products, Inc.  
P.O. Box F  
Carolina, Puerto Rico 00630

## Modified headline

We don't want anybody to get the impression that function-generator-manufacturer, Wavetek, pays any attention to function-generator-manufacturer Exact Electronics. But ELECTRONIC DESIGN's March 1 editorial, "How exact is engineering?" elicited the following response from Tom Kurtz of Wavetek.

"I feel we have substantially improved your headline. I hope you like it." Mr. Kurtz's version follows.

**WAVETEK**  
How ~~exact~~ is engineering?

## Scarcity of engineers? Not so, asserts IEEE

*A flurry of articles has appeared in print recently predicting a shortage of engineers in the*

*(continued on page 15)*

14-16 bits  
Accuracy to  $\pm 1'$   
A-Series—single or  
multi-speed converters

14 bits  
Accuracy  $\pm 5.3'$   
Model ESDC

10 bits  
Accuracy  $\pm 30'$   
Model LSDC

## and now meet our new 10 bit synchro converter

For those who may not need that extra measure of accuracy designed into the A-Series and ESDC synchro-to-digital converters, we've designed a more economical alternative—the LSDC. It's based on the field-proven, highly-successful ESDC design concepts, but can save you \$200 or more.

Performance? With a total worst case error of  $\pm 30'$  at tracking velocities over 900 rpm, the new LSDC is ideal for a broad range of military and industrial applications. All mil grade components (no plastic) assures excellent MTBF.

Take your pick. ESDC and A-Series, the best S/D converters available. And now LSDC, the best economy/performance trade-off.

For product or technical applications information, write or call Jim Sheahan or Hans Schloss. They're engineers, so they talk your language.

**DDC**

**ILC DATA DEVICE CORPORATION**  
100 TEC STREET, HICKSVILLE, N. Y. 11801 • PHONE: (516) 433-5330

**APPLICATION CENTERS**

Long Beach, Calif. (213) 597-5744	Washington, D. C. (703) 525-4825	Bruxelles, Belgium (Tel.) 62.01.59
--------------------------------------	-------------------------------------	---------------------------------------

1. Can it be used for p.c. board-to-board, cable-to-board, and cable-to-cable applications?
2. Does it have one contact interface for all interconnect requirements?
3. Is it reliable?
4. Does it possess outstanding low force characteristics?
5. Can it be easily "peeled" apart without damage to contacts?
6. Does it have polarity and keying to prevent mismating?
7. Will it accept standard hardware?
8. Can it be mounted in any position?
9. Will it accept contacts crimped to wire?
10. Will it accept wire-wrapping?
11. Will it accept soldering to wire or printed-circuitry?
12. Does it feature the proven Varicon™ contacts?
13. Are the contacts on standard .100" square grid?
14. Do the contacts have a floating action for easy alignment?
15. Is there a choice of commonly used sizes or number of contacts, like 24, 48, 72 or 96?
16. Is it available "off the shelf" from a local Elco Distributor?

In numerical order, here are the answers to all of these questions: . . . Yes.

# ELCO SAYS YES!

To the 16 most important questions asked about miniature printed-circuit connectors . . .  
their new **Series 8223**.

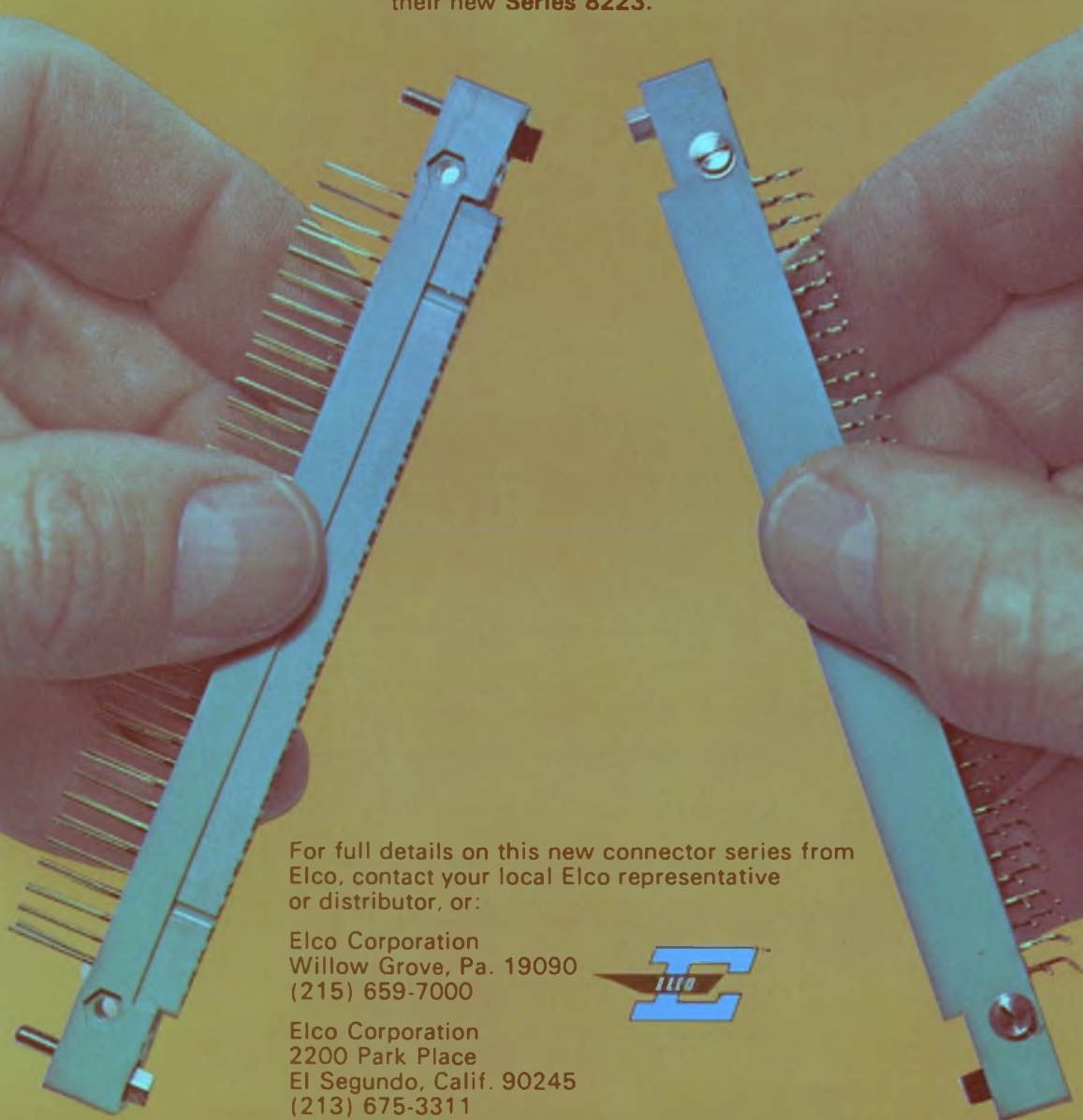

For full details on this new connector series from Elco, contact your local Elco representative or distributor, or:

Elco Corporation  
Willow Grove, Pa. 19090  
(215) 659-7000



Elco Corporation  
2200 Park Place  
El Segundo, Calif. 90245  
(213) 675-3311

# Save 37 weeks on your next microwave amplifier design— with MICroAMPs

Send for this. Read it. You'll be convinced.

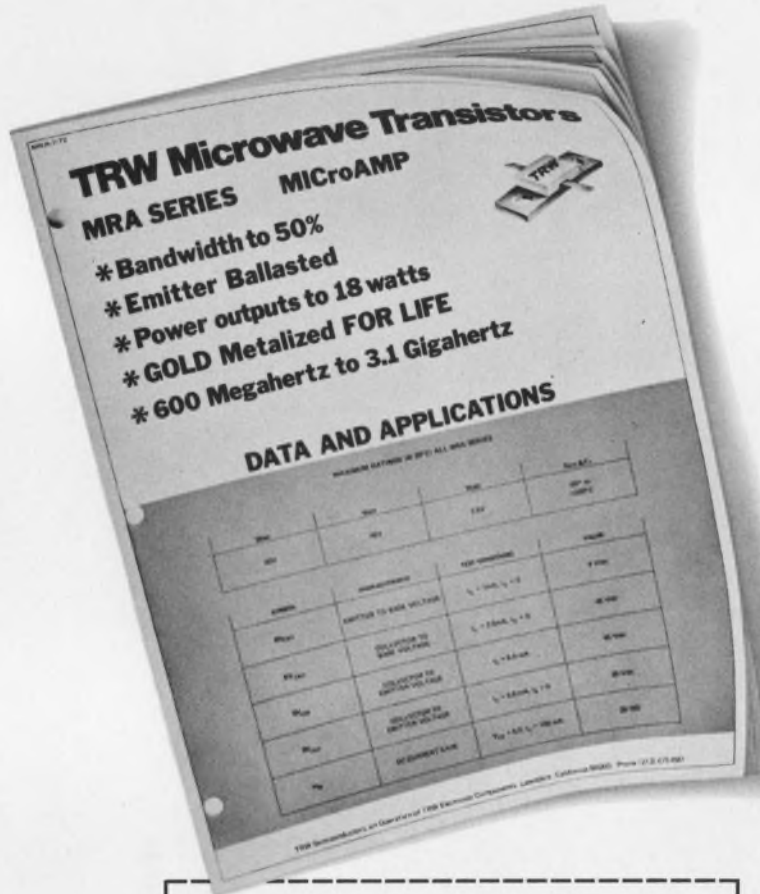

OK, convince me. Send your data and applications booklet on TRW MICroAMPs. Show me how input matching can help my broadband design go from paper to hardware in just 2 weeks.

Name \_\_\_\_\_ Title \_\_\_\_\_

Company \_\_\_\_\_

Address \_\_\_\_\_

City \_\_\_\_\_ State \_\_\_\_\_ Zip \_\_\_\_\_

Clip coupon and mail to Sales Manager, TRW Semiconductors, an Electronic Component Division of TRW Inc., 14520 Aviation Blvd., Lawndale, Ca. 90260. If you can't wait, phone: (213) 679-4561.

## TRW<sup>®</sup> SEMICONDUCTORS

INFORMATION RETRIEVAL NUMBER 10

ELECTRONIC DESIGN 8, April 12, 1973



all DVM's  
start  
like this

...but only **CIMRON**  
puts it all together  
like this...

and like this



## HAVE YOU HEARD ABOUT THE CIMRON **SAINT LOGIC**?

Do you need a 5½ digit systems DMM with optical coupled programming, parallel and serial BCD outputs? Do you need high noise rejection coupled with high speed and accuracy? The DMM 50 does it all.

Then, there's the DMM 40. Do you need 5 ranges of AC and DC, 6 ranges of ohms plus internal AC and DC current shunts and complete autoranging... all with 140% overrange? How about battery operation and isolated data outputs? The DMM 40 does it all at an extremely attractive price.

For more information about these and other Cimron multimeters or to arrange for a demonstration of these state-of-the-art instruments, write or call Lear Siegler, Inc., Cimron Instruments, 714 North Brookhurst Street, Anaheim, California 92803, (714) 774-1010, or circle the number below.



LEAR SIEGLER, INC.

ELECTRONIC INSTRUMENTATION DIVISION  
CIMRON INSTRUMENTS



## Silicone-packaged devices: The answer to a hot problem.

Within seconds after the match flame was applied to both the epoxy (left) and the silicone ICs (right), the epoxy burst into flame.

The hot issue in electronics today is flame retardancy. While epoxies and other plastics support combustion, silicone-packaged devices are virtually nonflammable. So, they don't need flame-retardant additives that alter the electrical and mechanical properties of epoxies and other materials.

And there are several other good reasons to specify silicone packaging compounds:

- excellent performance under thermal cycling
- low thermal expansion minimizes damage to components and lead wires
- basic electrical, physical, and chemical properties that remain constant over the widest temperature (-55 to 250 C), time, and frequency ranges
- uniform, lifetime electrical characteristics
- superior performance in 85 C/85% RH (biased) test
- total compatibility with all kinds of devices, including ICs, both digital and linear, MOS, CMOS, power transistors, SCRs, high-voltage rectifiers, etc.
- optimum reliability reduces manufacturing and repair/warranty costs
- safe, clean, inert, and require no special handling

Whether you are a device manufacturer or user, these advantages are important in semiconductor devices. Make the switch to nonburning silicone packaging compounds now. Write or call Jack Broser, Product Market Supervisor, Dow Corning Corporation, Department A-3312, Midland, Michigan 48640.

*Silicones; simply the best way to protect electronic circuits*

**DOW CORNING**

DOW CORNING



(continued from page 10)

United States in the years ahead. Following are comments by Joel B. Snyder, P.E., chairman of the Long Island (N.Y.) Section of the Institute of Electrical and Electronics Engineers. He made them in a letter to *The Wall Street Journal* rebutting reports of a "growing shortage" of engineers:

"Back in the 1950s when the space program got under way, aerospace companies wastefully absorbed all available engineering talent, because they were working on cost-plus contracts which paid for every person hired. Surveys in the late 50s showed that engineers were about 35% utilized. At the same time the aerospace companies, through the Engineers Joint Council, conducted a huge publicity campaign about an alleged shortage, which brought the engineering population to the million mark by the 60s.

"Considering the poor utilization, there was never really a shortage. With every major contract termination, aerospace companies laid off a total of over 20,000 engineers. This happened in 1957-58, 1962-63, 1966, 1969-72. Right after each of these manpower holocausts, the Engineers Joint Council renewed its publicity about the 'shortage of engineers.' This was to prevent the reduction of engineering enrollments which would normally follow such recessions. As recently as 1968, the EJC was predicting a 100,000-engineer shortage by 1971. In point of fact, engineering unemployment in '71 was close to the 100,000 figure. Also in 1971, industry was able to absorb only about 50% of all engineering graduates into engineering jobs (often laying off experienced engineers).

"With the easing of cold-war tensions in the 60s, cost-plus contracts started to disappear, and more engineers were let go. Finally, in the late 60s, the defense budget was cut, and many small aerospace companies folded, while others like Boeing, Lockheed and Grumman cut staffs drastically.

(continued on page 19)

## Six good reasons why Dow Corning should be your primary packaging-materials supplier.

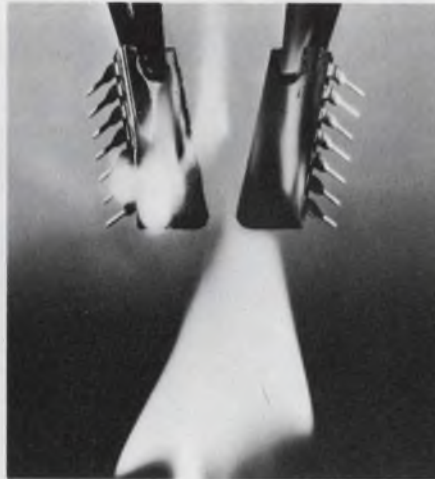

In addition to the many important advantages of silicone molding compounds, there are other good reasons why it is to your advantage to plan your growth in the electronics market with help from Dow Corning.

**1. We are helping to develop the market for you.** Extensive publicity, promotion, direct mail, and trade-show appearances are all educating your customers about the very substantial advantages of silicones in all kinds of harsh electronic/electrical environments.

**2. Since service is extremely important** in helping manufacturers in the development of advanced packaging systems, we have Technical Service & Development men strategically located worldwide to help solve your problems.

**3. Your competitive advantage** with Dow Corning molding compounds is a complete family of products, totally compatible with each other and with most other materials used in electronic systems, devices, or components.

**4. Product-line breadth** gives you the ability to design or produce the most reliable and economical packaging to protect any system, regardless of its sophistication or environment.

**5. Technical leadership** constantly applied in our own laboratories and with our customers results in the development of product modifications and new technologies to handle the needs and requirements of next generation devices.

**6. Worldwide delivery** from strategically located distribution points enables us to work with you to supply standard or special molding materials as required.

Major commitments like these indicate the kinds of things we are doing to earn your business. We'd like to discuss with you in more detail how we can grow together in this rapidly expanding area. Call or write Jack Broser, Product Market Supervisor, Dow Corning Corporation, Department A-3313, Midland, Michigan 48640.

*Silicones; simply the best way to protect electronic circuits.*

**DOW CORNING**

DOW CORNING

# For built-in reliability, design with "Scotchflex" Flat Cable/Connector Systems.

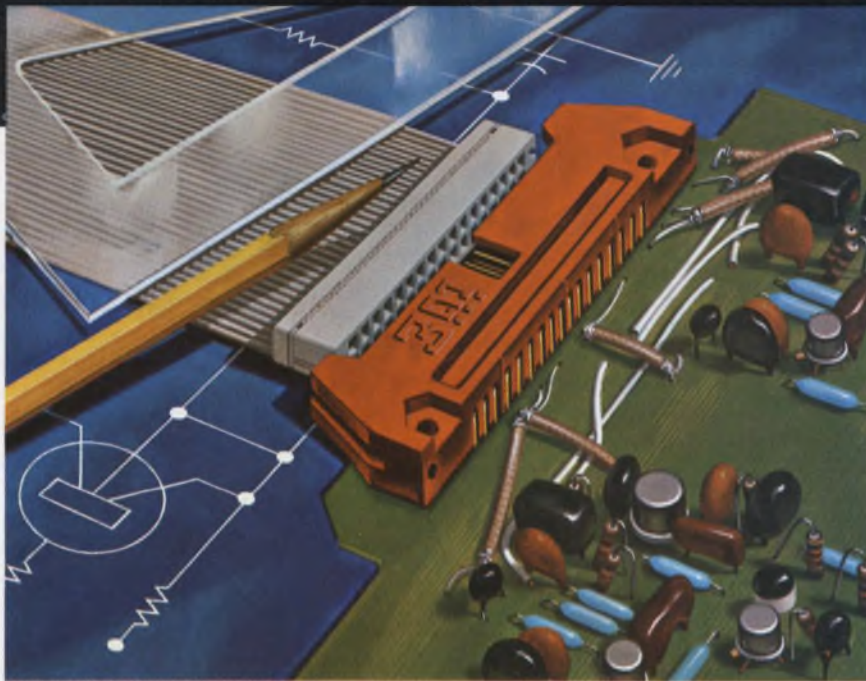

"SCOTCHFLEX" IS A REGISTERED TRADEMARK OF 3M CO.

"Scotchflex" Flat Cable and Connectors can offer you trouble-free packaging for your next generation equipment.

There's built-in reliability for your circuit inter-connects. Our flat, flexible PVC Cable has up to 50 precisely spaced conductors. The gold plated U-contacts are set into a plastic body to provide positive alignment. They strip through the insulation, capture the conductor, and provide a gas-tight pressure connection.

Assembly cost reductions are built-in, too. "Scotchflex" Connectors make up to 50 simultaneous connections without stripping or soldering. No special training or

costly assembly equipment is needed.

Off-the-shelf stock offers you flat cable in a choice of lengths and number of conductors from 14 to 50. Connector models interface with standard DIP sockets, wrap posts on .100 x .100 in. grid, or printed circuit boards. Headers are available to provide a de-pluggable inter-connection between cable jumpers and printed circuit boards (as shown). Custom assemblies are also available on request.

For full information on the "Scotchflex" systems approach to circuitry, write to Dept. EAH-1, 3M Center, St. Paul, Minn. 55101.

**3M**  
COMPANY

# The world's smallest DPM is also the world's finest.



Full four digits.  
Less than 1" high.  
Automatic polarity.

Automatic zeroing.  
Edgewise configuration.  
Programmable decimal.

Easy to stack.

MOS/LSI construction.

Low power:  $< \frac{1}{2}W$ .

LED digital display.

Only \$170 each.

(Less than \$100 in OEM quantities.)

The size of a DPM is important. That's why NLS designed the PM-4 to be less than 1 inch in height... less than 8 cubic inches in volume... less than 4 ounces in weight.

But other things are important, too; like reliability... accuracy... convenience... and price. That's why you should try the PM-4... from NLS, originator of the digital voltmeter. The culmination of 20 years of NLS experience in developing and manufacturing DVM's, the PM-4 provides the accuracy and versatility of four digits for the price of three. And the PM-4 is complete, ready to go to work. All you need is a 5-volt power supply. No extras to buy. Choice of four ranges (from  $\pm .0000$  to  $\pm 999.9$  VDC). Decimal location is easily changed by moving jumper on connector. Dynamic scale can be expanded by screwdriver adjustment for readings of transducer signals in units other than volts. Rugged plastic case easily opens for inspection or for changing range (merely add or remove one to three resistors). The PM-4 mounts with clips to eliminate screw holes in panel. LED digital display (Light-Emitting Diodes) eliminates light bulbs and the need to replace them.



Simple construction, simple in operation, simple to install. Backed by the 20-year NLS reputation for reliability and innovation... plus an NLS warranty for one full year. Try the PM-4 today. Call your local distributor. If he's temporarily out of stock, call Bob Hager free for additional sources: 800-854-2758 (Californians call 714-755-1134 collect).

*The PM-4 is available off-the-shelf at your distributor... along with these NLS DVM's.*



**MX-1**  
\$1,000

The world's lowest cost 5-digit multimeter (with sixth digit over-ranging). Measures five DC voltage ranges from 0.1 volt full scale to 1000 volt full scale, ohms, AC volts, and multifunction ratios. Auto-ranging included. Order off-the-shelf from your distributor.



**LX-2**  
\$550

Greatest value in four-digit multimeters (plus fifth digit over-ranging). Standard model measures DC volts, AC volts, resistance, and multifunction ratios. Automatic ranging included. No instrument can match its quality for the price. Order from your distributor.

Originator of the digital voltmeter



**Non-Linear Systems, Inc.**

P. O. Box N, Del Mar, California 92014  
800-854-2758 or 714-755-1134 or TWX 910-322-1132

INFORMATION RETRIEVAL NUMBER 141

# A NEW FIELD-OF-ONE IN LIGHTED PUSHBUTTON SWITCHES.

**Switchcraft's "PUSH-LITE" switch offers reliable leafspring switching in a neat little package.**

This whole new field of compact (1" x 1 1/8" x 1 3/4") pushbutton switches reduces the size of your control panels, consoles—and cost, too! Our new field-of-one consists of 6 series—including non-illuminated and illuminated single and twin-lamp units in two housing colors (black or grey). Up to 4PDT switching in momentary and push-lock / push-release functions. Ratings range from dry circuit switching, up to 3 amps., A.C., non-inductive load.

A rugged molded housing encloses the highly reliable leafspring switching and protects against dust, dirt and mishandling.

Pick from flange or barrier mounting—individually or in matrix configurations. Series PL "PUSH-LITE" switches mount from front of panel with clamp brackets, simply and quickly. No mounting screws show!

Design with up to two lamps and either full or split display screens—vertically or horizontally. Full display provides up to 3 lines of 6 characters each. Virtually unlimited lighting versatility

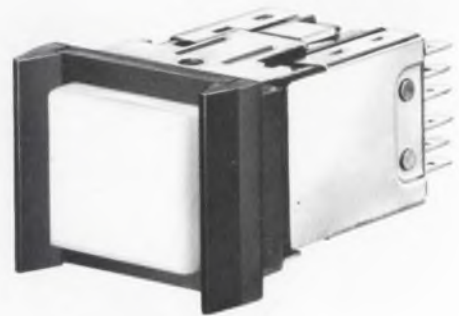

ACTUAL SIZE

provided by 7 different colors of pushbuttons, insert filters and silicone boots.

For additional information, contact a Switchcraft Representative or write for Catalog S-345. SWITCHCRAFT, INC. 5529 N. Elston Avenue Chicago, Illinois 60630

**SWITCHCRAFT**  
INC.

INFORMATION RETRIEVAL NUMBER 142

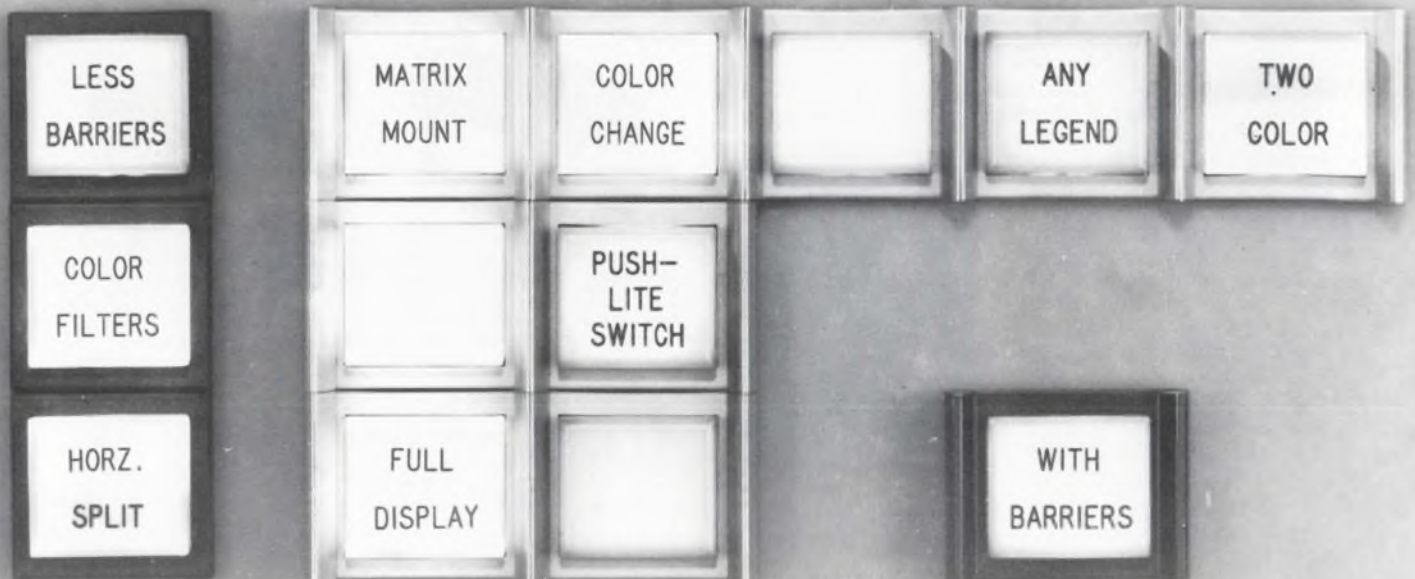

# WE PUT IT ALL TOGETHER...

MATERIALS

PROCESSES

COMPONENTS

ASSEMBLIES

for Electronic — Electrical  
Electromechanical Applications



**Cermetrol Products.** Metallized Berlox® and alumina components and assemblies, R. F. transistor headers, and packages for discrete devices, in production quantities. Bulletins 201, 202, 204.

Check No. 211



**Tech-Ceram Products.** Berlox® and alumina components for a wide variety of electrical and electronic applications which benefit from the unique thermal conductivity of beryllia; standard heat sinks, washers and other mounting devices. Bulletins 301, 302, 305.

Check No. 212

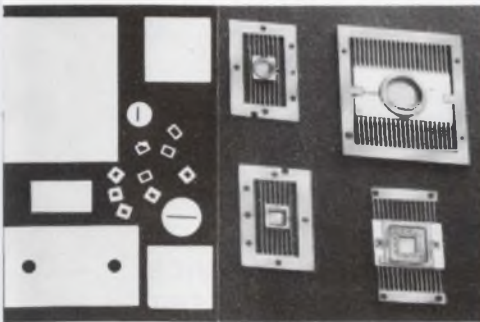

**Microstrate Products.** Substrates, laminated ceramic structures, printed circuit boards and packages based on casting technology in alumina, Berlox® and other oxide ceramics. Sophisticated production techniques make possible as-fired finishes as low as 4 micro-inches, with high yield and maximum reliability. Bulletins 601, 602.

Check No. 213



**Ceramex Products.** Precision machined and fabricated ceramic components and assemblies, characterized by exceptionally close tolerances, in prototype or production quantities. The Ceramex Division functions at all levels of production from raw materials to finished products. Bulletin 307.

Check No. 214

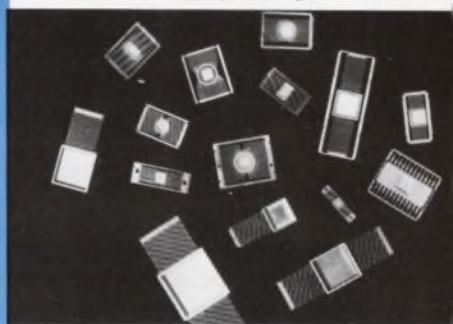

**Sealox Products**

**Microelectronic Packages.** Volume production of alumina, Berlox®, or Kovar flat packs, dual in-line packages and other carriers for thick and thin film circuitry, IC's and microelectronic devices, in a wide variety of standard sizes and configurations. Bulletin 502.

Check No. 215

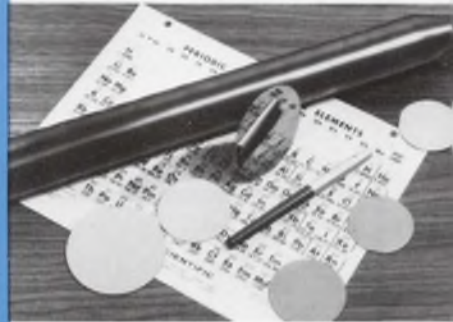

**Sealox Products**

**Single Crystal Silicon.** Czochralski-grown single crystal silicon in ingot, slice or polished wafer form, up to 3/4" diameter, N or P types, 1-1-1 and 1-0-0 orientation, are produced and processed in one of the industry's most modern facilities. Bulletin 503.

Check No. 216

National Beryllia Corp. is the largest manufacturer of beryllia, a major supplier of oxide ceramics and components based on oxide ceramics for the electronics industry.

Materials include Berlox®, alumina, thoria, Carberlox®, and other oxide ceramics; and Czochralski-grown single crystal silicon, in ingot, slice or wafer form.

Complete, modern facilities for metallizing, fabrication and assembly of electronic and electrical devices are available, supplemented by volume production of standard flat packs, cold weld headers and other packaging components. Also operating is a highly sophisticated manufacturing complex for the production and finishing of high quality, single crystal silicon.

Through these facilities, National Beryllia Corp. offers the industry's most complete capability for the development and application of oxide ceramic products, and the production of ceramic-based components and assemblies.

For prototypes or production quantities, write or call Sales Department,

 **National Beryllia**  
CORP.

Haskell, N. J. 07420, telephone — 201-839-1600 • TWX 710-988-5363

# Candidate for the PE license this year?

Use these up-to-date guides...  
specifically tailored for  
your study campaign

## HAYDEN PROFESSIONAL ENGINEERING EXAMINATION SERIES

LAWRENCE J. HOLLANDER, Editor-in-Chief,  
Professional Engineer, New York State

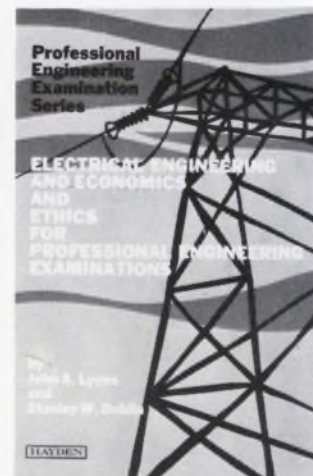
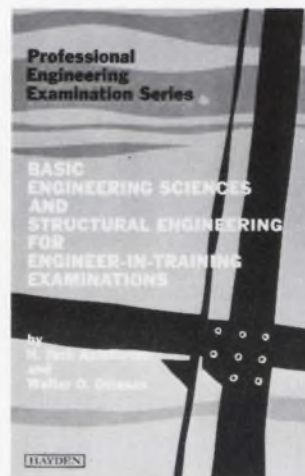

Written with your needs kept foremost,  
these study guides offer . . .

- a wide selection of actual, realistic problems from recent state examinations arranged by subject for convenient study
- detailed step-by-step solutions that bring out underlying principles to equip you to handle the unexpected
- concise background discussions precede the problems, presenting you with a mini-review of theory, principles, terminology
- separate tables of contents for subjects and problems quickly pinpoint the specifics for rapid review or "open book" examinations
- numerous schematic diagrams and detailed drawings to insure in-depth understanding

Review the books that concern you for  
15 full days—FREE!

### FOR 15-DAY FREE EXAMINATION

Please send the book(s) circled below on a 15-day examination basis. At the end of that time, I will remit payment, plus postage, or return the book(s) without further obligation.

5712-1      5715-6      5716-4

(For those ordering by ISBN, the Hayden Prefix is: 0-8104)

Save money! On all prepaid orders Hayden pays postage —  
same 15-day return guarantee! 72-29 ED

Name \_\_\_\_\_

Firm \_\_\_\_\_

Address \_\_\_\_\_

City/State \_\_\_\_\_ Zip \_\_\_\_\_



HAYDEN BOOK COMPANY, INC.  
50 Essex Street, Rochelle Park, N.J. 07662

### BASIC ENGINEERING SCIENCES AND STRUCTURAL ENGINEERING FOR ENGINEER-IN-TRAINING EXAMINATIONS

H. JACK APFELBAUM, P.E., Department of Mechanical Engineering, Lowell  
Technological Institute; and WALTER O. OTTESEN, P.E., Patent Counsel

Nearly 200 solved problems selected from a nationwide survey of recent E-I-T examinations offer you a complete, well organized review of the concepts and techniques that must be understood to successfully pass the preliminary exam. Unlike other study guides that stress one aspect of the field while shortchanging others, this volume provides balanced coverage of the three broad engineering areas: *the basic sciences*: mathematics, physics, and chemistry; *the engineering sciences*: statics, dynamics, fluid mechanics, thermodynamics, electricity, and engineering economy; and *structural engineering*. More than 300 detailed illustrations pinpoint key concepts and problem-solving techniques.

408 pp., 6 x 9, illus., cloth, #5712-1, \$13.95

### ELECTRICAL ENGINEERING AND ECONOMICS AND ETHICS FOR PROFESSIONAL ENGINEERING EXAMINATIONS

JOHN S. LYONS, P.E., and STANLEY W. DUBLIN, Institute of Environmental  
Medicine, New York University Medical Center

Concentrating on the subjects and topics that form the foundation of this rapidly changing technology, this book analyzes and solves for you almost 100 problems from a nationwide sampling of recent PE examinations. Its comprehensive, up-to-date coverage includes materials and problems not found in other guides of this type, such as electrical-magnetic-thermal analogs, semiconductors, and power system short circuits. More than 170 detailed illustrations are included. The separate section devoted to economics and ethics features an unusual approach to such topics as interest, costs, valuation, and others—the summarized use of formulas in solving nearly 50 typical problems.

302 pp., 6 x 9, illus., cloth, #5715-6, \$12.95

also available

### MECHANICAL ENGINEERING AND ECONOMICS AND ETHICS FOR PROFESSIONAL ENGINEERING EXAMINATIONS

EUGENE STAMPER, P.E., and STANLEY DUBLIN

Over 200 solved problems in mechanical engineering, along with the same thorough coverage of economics and ethics.

392 pp., 6 x 9, illus., cloth, #5716-4, \$14.95

**We have a half  
million ways to  
solve your card  
packaging problems...**

**We  
do it  
better**

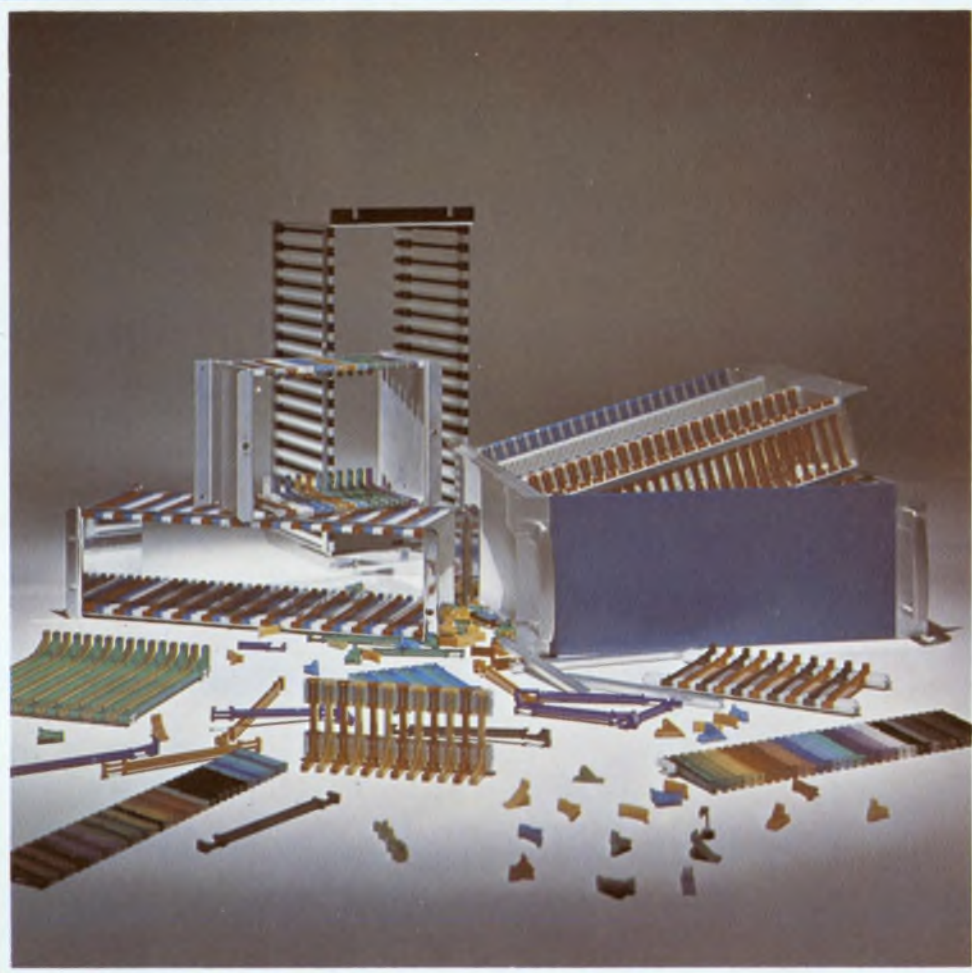

Configurations are virtually unlimited . . . bulk components, subassemblies, files, kits, drawers—horizontal or vertical.

We do it by offering nylon guides with integral connector mounting feet. This insures precise card/connector alignment while permitting complete card length and spacing flexibility.

We do it with guides that snap-on to strong extruded aluminum bars between end plates or drawer frames. This provides an exceptionally rugged, lightweight package perfectly suited to your particular card file needs . . . when it's put together, it stays together.

We do it by mounting mother boards and back planes in single or multiple row files. We do it by

mounting large or small cards with any connector arrangement.

We do it by really solving packaging problems . . . yours, his and theirs. So give Scanbe a call or send us your requirements. Either way, we can help you do it better.



**"The Packaging People"**

Scanbe Manufacturing Corporation  
3445 Fletcher Avenue  
El Monte, California 91731

(213) 579-2300/686-1202 TWX: 910-587-3437

# ★ SIMPLIFY PROCUREMENT ★

## BOURNS NOW OFFERS

# 16 MIL SPEC

Save paperwork, money and time by ordering all your Mil Spec potentiometers from Bourns, the most complete single source in the industry. It's sound logistics — one purchase order, one approved source. At the same time you're protected by Bourns tradition of excellence. Each Bourns potentiometer is designed and manufactured to consistently exceed Mil Spec requirements.

## POTENTIOMETERS / VARIABLE RESISTORS

### ★ NON-WIREWOUND - MIL-R-22097



\*RJ12 C-F



\*RJ22 C-F



\*RJ24 C-F



\*RJ26 C-F



\*RJ50 C-F

### ★ WIREWOUND - MIL-R-27208



RT10



\*RT12

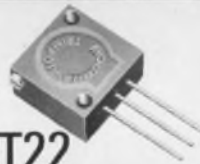

\*RT22



\*RT24



\*RT26

### ★ ESTABLISHED RELIABILITY - MIL-R-39015

### MIL-R-39035 ★



RTR12

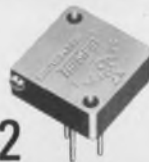

RTR22



RTR24 (NEW)



RJR12 C-F (NEW)

### ★ MIL-R-94

### MIL-R-23285 ★



\*RV6

BOURNS HAS MORE  
POTENTIOMETERS  
ON QPL THAN ANY  
OTHER MANUFACTURER!



RVC6 (NEW)

BOURNS, INC., TRIMPOT PRODUCTS DIVISION • 1200 COLUMBIA AVE., RIVERSIDE, CALIF. 92507

\* AVAILABLE FROM STOCK AT YOUR LOCAL BOURNS DISTRIBUTOR

INFORMATION RETRIEVAL NUMBER 16

ELECTRONIC DESIGN 8, April 12, 1973



(continued from page 15)

“Those aerospace companies that found non-aerospace business, discovered they needed fewer engineers. For every million dollars in aerospace business, 10 engineers could be employed. For every million in non-aerospace business, only one engineer is employed. Thus to employ all the laid-off aerospace engineers, about 10 times as much non-aerospace business is needed—business that is simply not showing up. It is obvious that the number of engineers needed will continue to dwindle, as we convert to a non-defense economy in the 70s.

“The personnel men and college professors who allege the shortage are not fit judges. When a professor sees empty seats in the classroom, he states that the nation’s well-being will suffer if his class is not filled. When personnel men have trouble in recruiting top talent at reasonable salaries with exactly the experience they want, they cry out about the ‘shortage’ and call for higher enrollments.

“However, engineering schools do not turn out experts in computer technology, airport engineering or medical electronics. They do give a broad education, after which the graduate’s field experience produces an expert. Thus the 30,000 unemployed engineers are more qualified than the new graduates. Even if they lack experience in some particular technology, they have years of experience in solving analogous problems.

“We can only conclude that the cries of engineering shortage are totally self-serving, insofar as they perpetuate a horrendous excess of American engineering talent. This keeps industry close to the point of ‘instant engineers’ in any specialty whatsoever, and the practicing engineer close to the point of professional bankruptcy.

“The only solution to this dilemma is to publicize the true facts of engineering life and to seek means of regulating entry to the field—not to create a shortage of talent (as with the AMA) but to turn engineering into the profession it ought to be.”

**Cut package count . . . Simplify board layout . . .  
Reduce equipment size . . . with**

# DIP MULTI-COMP<sup>®</sup> RESISTOR-CAPACITOR NETWORKS



(Metanel<sup>®</sup> Film Resistors, Monolythic<sup>®</sup> Ceramic Capacitors)

## STANDARDIZED DESIGNS \* FOR BETTER AVAILABILITY, BETTER PRICES

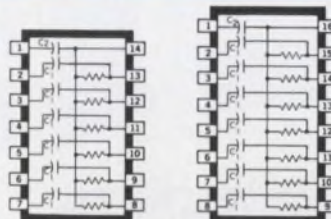

R (Ω)			C <sub>1</sub>
100	470	2000	100pF
150	500	2200	330pF
200	680	3300	0.01μF
220	1000	4700	C <sub>2</sub>
330	1500	6800	0.05μF

### BYPASSED PULL-UP AND R-C COUPLING NETWORKS

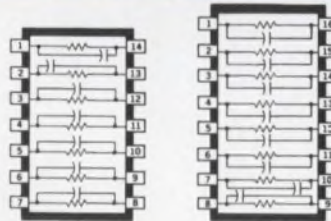

R (Ω)			C
100	470	2000	1000pF
150	500	2200	3300pF
200	680	3300	0.01μF
220	1000	4700	
330	1500	6800	

### SPEED-UP NETWORKS

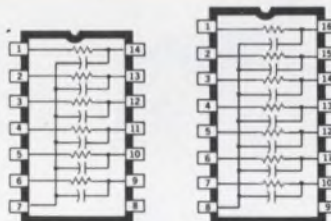

R (Ω)			C (pF)
100	470	2000	100
150	500	2200	330
200	680	3300	
220	1000	4700	
330	1500	6800	

### ACTIVE TERMINATOR NETWORKS

\* OTHER PACKAGES, CIRCUIT CONFIGURATIONS, AND RATINGS AVAILABLE ON SPECIAL ORDER

## Sprague puts more passive component families into dual in-line packages than any other manufacturer:

- TANTALUM CAPACITORS
- CERAMIC CAPACITORS
- TANTALUM-CERAMIC NETWORKS
- RESISTOR-CAPACITOR NETWORKS
- PULSE TRANSFORMERS
- TOROIDAL INDUCTORS
- HYBRID CIRCUITS
- TAPPED DELAY LINES
- SPECIAL COMPONENT COMBINATIONS
- THICK-FILM RESISTOR NETWORKS
- THIN-FILM RESISTOR NETWORKS
- ION-IMPLANTED RESISTOR NETWORKS

For more information on Sprague DIP components, write or call Ed Geissler, Manager, Specialty Components Marketing, Sprague Electric Co., 347 Marshall St., North Adams, Mass. 01247. Tel. 413/664-4411.

THE BROAD-LINE PRODUCER OF ELECTRONIC PARTS





# GR's Measure- Anything Resistance Bridge

Enough #10 wire to reach the moon will total about 1 megohm. The GR 1666 DC Resistance Bridge will measure that to within  $\pm 0.01\%$ , or the equivalent of  $\pm 25$  miles. Better yet, if a piece as short as 440 yards is removed from the translunar span, the 1666 bridge will resolve the 1-ohm difference.

Most striking about the 1666 bridge is its wide measurement range. It will measure a piece of the same size wire long enough to reach from here to Neptune, 2.7 billion miles (10 gigohms), or a 1½-inch piece (100 microohms), both within  $\pm 2\%$  accuracy. And that feat doesn't really tax the 1666; it has enough resolution and detector sensitivity to distinguish between 0 and 2 micro-ohms and between  $\infty$  and 500 gigohms (measured as 2 picomhos conductance).

Here, for \$950, is a bridge that will measure contact resistance and dielectric leakage, transformer windings and insulation, diode forward and back resistance, relays open and closed . . . and all with precision.

The 1666 has a *fast-responding* detector. The 1666 is self-contained. The 1666 has guard and Kelvin connections. The 1666 is essential if you measure resistance.

From General Radio, Concord, Mass. and, in Europe, Postfach, CH 8034 Zurich, Switzerland.



**General Radio**

300 BAKER AVENUE, CONCORD, MASS 01742

NEW YORK (N.Y.) 212 964-2722, (N.J.) 201 791-8990 • BOSTON 617 646-0550  
DAYTON 513 294-1500 • CHICAGO 312 992-0800 • WASHINGTON, D. C. 301 948-7071  
ATLANTA 404 457-2485 • DALLAS 214 234-3357 • LOS ANGELES 714 540-9830  
SAN FRANCISCO 415 948-8233 • TORONTO 416 252-3395 • ZURICH (01) 55 24 20

GR COMPANIES • Grason-Stadler • Time/Data • Techware Computing Corp.  
GR ASSOCIATE • Micronetic Systems Inc.

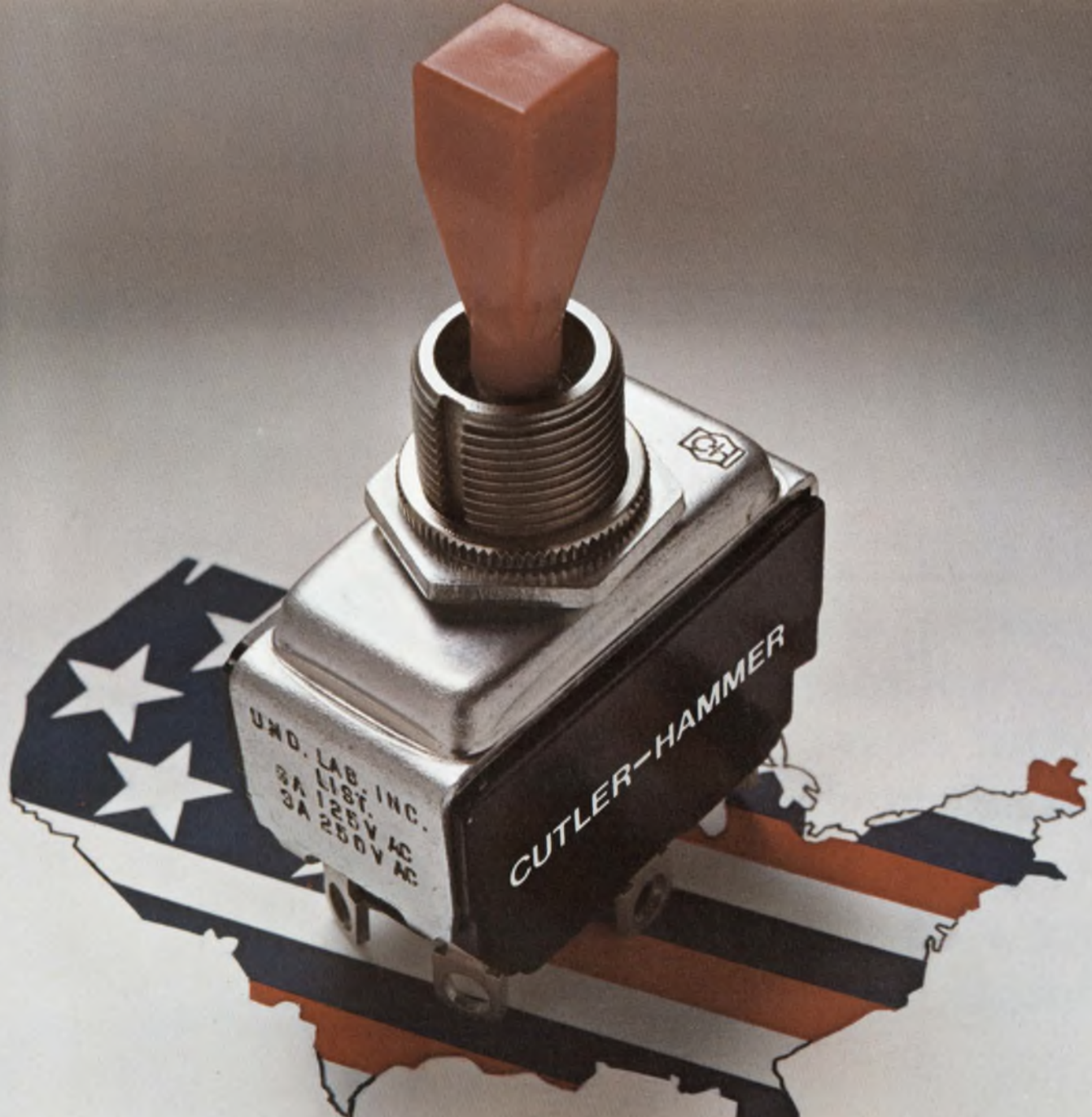

# TOGGLE TERRITORY.

It's anywhere you are in the whole land.

It's anywhere you have to put your hands on exactly the right toggle switch to complete your design.

Especially if you need extraordinary design flexibility, distinctive appearance and proved performance in your toggle switches.

Cutler-Hammer not only provides the broadest line of toggle switches available, but offers you the greatest selection of ratings, terminations,

hardware, toggle shapes, materials and colors.

AC-rated. AC/DC. Low energy. Dry-circuit capability, or up to 25 amps. One, two and four poles. Select Cutler-Hammer Designer Line, miniature, slow-make/slow-break or hesitation switches from the complete Cutler-Hammer line. We have thousands of varieties ready for delivery. And if the toggle you need isn't among those thousands, we'll work with you to build exactly what you want.

You needn't look very far to get the finest quality in toggle switches. Wherever you are in the U.S.A., get the toggle you want. Because we cover Toggle Territory best. With

more distributors than anyone else. Call your Cutler-Hammer Sales Office or Stocking Distributor. Or write for full-line catalog LD-110A.



Switch  
to No. 1

More than just switches;  
prompt availability,  
field help, innovation,  
quality assurance, too.

INFORMATION RETRIEVAL NUMBER 19



**CUTLER-HAMMER**  
SPECIALTY PRODUCTS DIVISION, Milwaukee, Wis. 53201

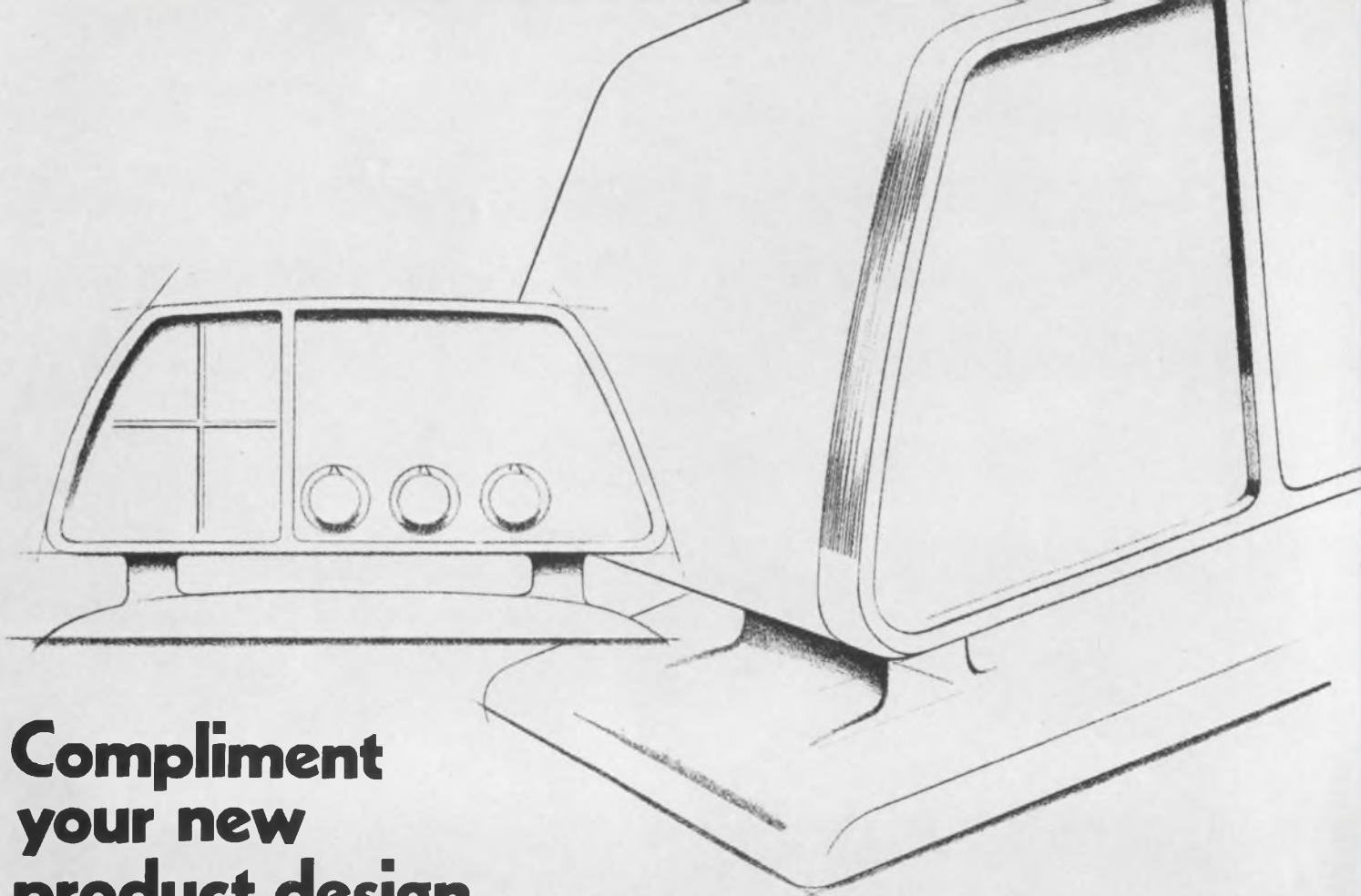

**Compliment  
your new  
product design  
with an exciting  
new control  
knob.**



**Rogan's new  
Alpha-knobs.**

**ROGAN**

3455 Woodhead Drive • Northbrook, Ill. 60062

(312) 498-2300

TWX: 910-686-0008

INFORMATION RETRIEVAL NUMBER 20

Fluke problem solvers

# A new AC calibration system with wide range, superb stability, high accuracy and complete programmability.



**Here's the best ac calibration system you've ever seen. It's designed to give you state-of-the-art performance in the cal lab, in the factory or in automatic test systems.**

The new system consists of the Model 5200A AC Calibrator and the Model 5205A Precision Power Amplifier.

Covering a frequency range of 10 Hz. to 1.2 MHz, the Model 5200A output is from 100 microvolts to 120 volts at current levels up to 50 milliamperes. Mid-band accuracy is  $\pm 0.02$  percent. Short term amplitude stability is  $\pm 10$  ppm. Six month stability,  $\pm 0.01$  percent. Working with the 5200A, the Model 5205A provides output voltages from 100 volts to 1200 volts at current levels up to 200 milliamperes. Combined 5200A/5205A amplitude accuracy is  $\pm 0.03$  percent.

The 5205A can also be used as a stand-alone amplifier providing programmable gains of X10 and X100 for frequencies from dc to 120 kHz. Output amplitudes from 1 millivolt to 1700 volts peak are offered for a wide variety of waveforms including pulses, sawtooths and triangles. All functions are remotely programmable with standard TTL logic levels. Uniquely, the 5205A can be programmed by both the 5200A and another control source so that it can be time-shared in an automatic system to perform a multitude of functions.

Price of the Model 5200A AC Calibrator is \$3,995. The Model 5205A sells for \$2,495.

To arrange a demonstration or get more details just dial 800-426-0361 for the location of your nearest Fluke sales office. Call it free anywhere in the contiguous United States.

Fluke, P.O. Box 7428, Seattle, Washington 98133. Phone (206) 774-2211.  
TWX: 910-449-2850 / In Europe, address Fluke Nederland (N.V.), P.O. Box 5053, Tilburg,  
Holland. Phone (04250) 70130. Telex: 884-55237. In the U.K., address Fluke  
International Corp. Garnett Close, Watford, WD2, 4TT. Phone, Watford, 33066. Telex: 934583.



# Simplicity

## PLUS IBM 3330 PERFORMANCE

DM-330 . . . the simply designed, simply interfaced Ampex disk drive that simply outperforms all others.

It's here. Now. In quantity. At OEM prices. A fast, compact, high-capacity, top-loading, easy-to-operate disk drive with simple, straight-forward interfaces. The Ampex DM-330 meets any of your disk-drive needs, including IBM compatibility. Any mass storage application requiring rapid random access is a natural for DM-330.

**OPTIMUM COST / PERFORMANCE.** The standard DM-330 has a pack capacity of 100 million bytes. Average access time is only 28 milliseconds, and start and stop times are only 15 seconds. Throughput of the OEM system is increased, processor time is saved and time to load and unload drives is reduced.

**OEM INTERFACES.** Specify any custom interface to meet your requirements. You can be sure it will be the simplest possible design. Or, for maximum economy, choose from three standard interfaces . . . our low-noise differential interface, a 5-volt TTL interface and an IBM interface.

**COMPACT, SPACE-SAVING SIZE.** A stand-alone unit, the DM-330 is only 38 inches high, 19.5 inches wide and 34 inches deep. Each DM-330 has its own self-contained regulated power supply and can be located wherever convenient.

**TOP-LOADING CONVENIENCE.** Because the Ampex DM-330 has a top-loading single pack configuration, with a 32-inch pack loading height, operator fatigue is materially reduced.

Getting complete details is just as simple as our disk system designs. Call our disk expert at 800-421-6554.



# AMPEX

AMPEX COMPUTER PRODUCTS DIVISION  
13031 West Jefferson Boulevard  
Marina del Rey, CA 90291 (213) 821-8933

VISIT AMPEX AT NATIONAL COMPUTER CONFERENCE BOOTH 2417

INFORMATION RETRIEVAL NUMBER 22

ELECTRONIC DESIGN 8, April 12, 1973

## \$100 electronic slide rule could make it this year

A \$100 electronic slide rule before the end of the year?

The potential is now there, with the completion by Rockwell Microelectronics, Anaheim, Calif., of a long-awaited slide-rule chip. The company is sending prototypes of the chip to calculator manufacturers for evaluation.

The only presently available electronic slide rule with full function costs \$395. Hewlett-Packard makes it.

Rockwell's chip uses a low-voltage PMOS process that is billed as "the most powerful complex circuit that's ever been put on a chip." While pricing information is not yet available, speculation is that the chip will cost between \$20 and \$30 in minimum quantities of 25,000.

According to John Spence, the circuit designer of the chip, it is organized into a dense CPU, a RAM, a microprogrammed ROM, output logic and an internal clock. "To operate it," he says, "all you need is a power supply [15 V] and a few resistors."

In comparing it with the HP-35 electronic slide rule, Spence notes that the new chip can perform the same functions.

Although it was designed to be competitive with the HP-35, the Rockwell chip has some significant differences. A calculator made with the new chip requires only that one chip, while the HP-35 uses five, Spence notes. However, the one-chip calculator would have only an eight-digit display, with a guaranteed accuracy of six digits for the scientific functions. This is in contrast with HP's 12-digit display, which uses two digits for scientific notation, 10 for data and guarantees eight-digit accuracy.

Spence emphasizes that the Rockwell chip was designed as a slide-rule replacement and has no

scientific notation capability. The person using a calculator made with this chip must keep track of the exponent, just as he does with a regular slide rule.

The output of the slide-rule chip is under program control and can be presented in parallel form for read-out on tubes or LEDs, in serial form for interfacing with another chip that would drive a liquid-crystal display, or in binary-coded-decimal form for use in printers or other digital instruments.

An electronic slide rule built with this chip, Spence says, could be smaller than the HP-35—probably about the size of a four-function pocket calculator—and would probably have a 20-to-25-button keyboard. The small number of buttons is achieved by having two functions on one key and by using a shifting arrangement.

Although the chip is presently set up to work as a slide rule, it has more capabilities than that, Spence reports. It could, for example, be used as a 12-digit, two-memory calculator. But to do that, he goes on, one would have to sacrifice the scientific function capability.

The slide rule chip is housed in a standard 42-lead, dual in-line package, and speculation is that production quantities of the chip will be available within two months.

### Air-pollution detection creating wide interest

More than 50 companies, from Boeing down to almost unknown electronics firms, are vying for what would appear to be a minor NASA contract—an award that will amount to only a few million dollars to design and integrate a

system of instruments to detect gaseous and particle pollution in the upper atmosphere. The apparent reason for contractor interest: to get in on the ground floor of what everyone hopes will be a burgeoning market for instrumentation and sensors to deal with atmospheric pollution.

The NASA system is to be flown first in a Boeing 747 and later in other planes, including some foreign aircraft. Along with the instrumentation system, the 747 will also carry a particulate collector developed by NASA's Lewis Research Center. Pollutants collected by the filter will be analyzed by neutron activation and other techniques to identify specific pollutants.

To analyze pollutants at even higher altitudes, NASA is adapting a high-speed interferometer for the British-French Concorde SST.

To measure the scattering properties of aerosols in the stratosphere, the space agency is planning an 18-month ground test program that calls for use of a tunable dye laser and a pulsed ruby laser radar called Lidar.

### Diffused junction gives rms-to-dc conversion

A diffused base-emitter transistor junction is being used as the thermal sense element in a newly patented thermal rms-to-dc converter. Other thermal converters in use today use either thermopiles, thermistors or other devices that do not lend themselves as readily to miniaturization and integrated-circuit production.

Henry Koerner, inventor of the converter and manager of the Advanced Development Group at the Burr-Brown Research Corp. in Tucson, Ariz., notes: "The thermal converter consists of two monolithic silicon chips mounted on a thermal insulator. The insulator is in turn mounted on a highly thermally conductive or isothermal surface. Each chip contains a diffused resistor and transistor."

Each chip is in one leg of a bridge network.

Koerner explains that the input waveform is applied to the resistor on one of the chips. As the re-

sistor heats the base-emitter junction of the transistor on the same chip, a current is induced that unbalances the bridge. The imbalance drives a differential op amp at the terminus of the bridge, which in turn is tied to the resistor on the second chip. As this resistor heats, it affects the transistor on the second chip, changing its output in the direction of the first chip's output. When the outputs of the two transistors match, the sustaining voltage at the output of the op amp is the dc level corresponding to the rms input.

For a 1-V pulse applied to the input, the settling time to  $\pm 0.05\%$  accuracy is about 2 s. For a 90% reduction in the input amplitude, the cool-off time is about 4 s.

"With diffused resistors," Koerner reports, "the upper frequency limit for 0.05% accuracy is about 200 kHz. If thin-film resistors are used, the limit might be 10 MHz."

## 6000-line resolution planned in TV camera

A reconnaissance television camera being designed for the Air Force will have higher resolution than any such camera now being flown in aircraft—6000 lines per picture frame, according to its designer, the RCA Aerospace Systems Div. (the usual home TV set has 525 lines).

Two other features will distinguish the new camera: It will be able to hold one picture on a screen indefinitely, as if the picture were a photograph, and it will be able to enlarge a portion of the picture being shown.

The new camera's only flying equivalent is the return-beam vidicon camera in the Earth Resources Technological Satellite, RCA says.

The ability to hold a picture on a screen indefinitely is accomplished by two techniques. The camera makes use of a special material on a high-capacity storage photoconductor that prevents the picture from decaying. And, electronically, it separates the erase function from the video read—a design features that also achieves improved signal-to-noise ratio and allows for haze cancellation.

The ability to enlarge a portion of a picture is done by use of a

raster underscan technique. A small portion of the picture is scanned and made to fill the entire screen.

If the reconnaissance pilot wants another picture, he presses a button. The picture on the screen decays, and a new one appears.

It will also be possible to tele-meter pictures and display them in a ground facility, or to store them on magnetic tape for return to the ground.

The new camera will cover four times the area that the ERTS camera does because it has a 4 1/2-inch pickup tube, whereas the satellite camera tube measures but 2 1/2 inches, RCA says.

"Also," says Paul E. Seeley, manager of radiation systems engineering for RCA Aerospace, Burlington, Mass., "the new camera will have full resolution in the corners of the picture."

The camera is capable of both electrical and optical outputs, enabling it to handle data from a wide variety of sensors, such as radar, infrared and TV, as well as to store information from computers, film and magnetic tape.

## U. S. acts to implement consumer safety rules

New Federal safety rules for the design of consumer electronic products, with Government inspections at plants to ensure enforcement, are to be implemented in the next 12 months.

The vehicle for the new procedure is the Consumer Product Safety Act, which was signed into law by President Nixon last Oct. 27, and went into effect 60 days later. A five-man commission to implement the law is being picked. After their names have been announced, five directors will be chosen to head up specific product areas.

Consumer products under the law's jurisdiction cover the entire spectrum—from kitchen equipment to outdoor recreational products, both domestic and foreign. If imported products are found unsafe at the point of entry, they may be returned to their country of origin.

Existing industry standards will be used whenever possible, the Government indicates, but the com-

mission's say on any standard is final. If new standards are needed, the need is to be published so industry can make recommendations.

## Interactive design takes another step forward

From initial idea to final circuit without need for pencil and paper—that's the promise of a new interactive design system.

The system, which is to be announced next week by the Gerber Scientific Instrument Co., South Windsor, Conn., is described by the company's president, H. Joseph Gerber, as the most advanced interactive design system ever built. It makes extensive use of minicomputers to enable the engineer to compose, digitize, edit and plot complex circuit diagrams and mechanical drawings.

Robert Layton, marketing manager for Gerber, says that Hewlett-Packard 2100A minis are used both for central processor and terminal controller applications. The central-processor mini comes with 12-k bits of core storage but is expandable to 32-k bits. The minis used in the terminal controllers have 2-k bits of storage.

While other interactive design systems have used minis for central-processor applications, Layton says, the Gerber system is the first to employ the computers in both central processors and terminal controllers. This increased use, he continues, makes the system respond more quickly because the mini in the terminal does some of the work ordinarily handled by the CPU, such as interpolation of data. It also makes interfacing with plotters and cathode-ray tube displays easier, he says, by using software control instead of hard-wire logic.

In explaining how the new system eliminates the need for pencil and paper, Layton notes that an engineer can draw his initial circuit idea on a CRT display simply by moving the cursor to the desired location and pushing one of 80 function keys that automatically cause the symbol to be drawn. If the required symbol is not on one of the 80 keys, it can be called from a library of symbols by typing out the name of the symbol.



# INCREASE CIRCUIT DENSITY WITH AISI<sup>®</sup> MAG<sup>®</sup> HYBRID COMPONENTS

BRAND

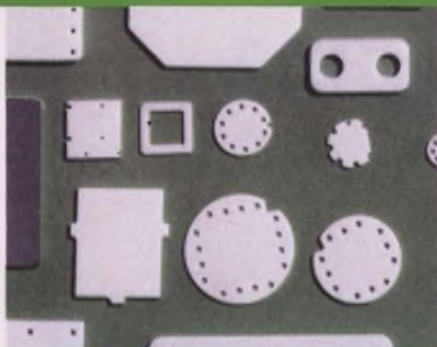

## SUBSTRATES

Extra strong ceramic substrates for thick and thin film processes. Special purpose substrates to get rid of heat, to save space, to match thermal expansion of glass, for light sensitive devices or for a contrasting background. Substrates with high dielectric constants. Bulletin 712 on request. Phone 803/682-3215.

Telex 570449.

CIRCLE NO. 201

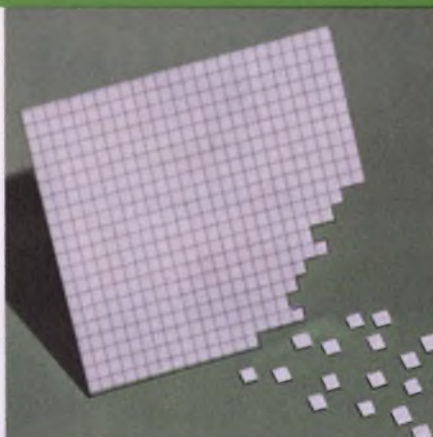

## SNAP-STRATES

From tooling for economy or from laser for accuracy, Snap-Strates are a proven cost reducer. Have you considered how much Snap-Strates and multiple processing can save you? Bulletin 712 on request. Phone 803/682-3215.

Telex 570449.

CIRCLE NO. 202

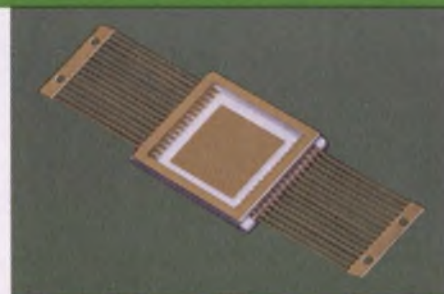

## HYBRID PACKAGES

All ceramic construction plus brazed-on leads for maximum reliability. Co-fired monolithic ceramic structure eliminates hermeticity problems, greatly increases thermal conductivity and structural strength. Ceramic construction permits mounting the package over conductors on circuit board. Custom made or write for current list of standard packages. Phone 615/265-3411.

Telex 558432.

CIRCLE NO. 203

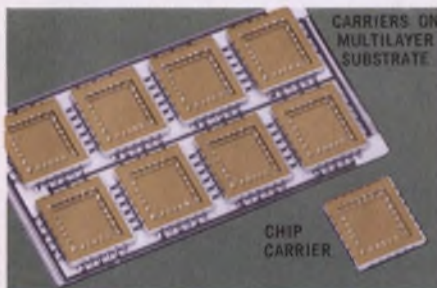

## CHIP CARRIERS

These small hermetic chip carriers allow far greater circuit density. Electrical testing after hermetic sealing allows storage of good devices in a less expensive package before committing to the circuit. The design permits conventional die attach, wire bonding and lid sealing operations . . . and re-flow solder attachment to a multilayer ceramic substrate, hybrid substrate or phenolic circuit board. Phone 615/265-3411.

Telex 558432.

CIRCLE NO. 204

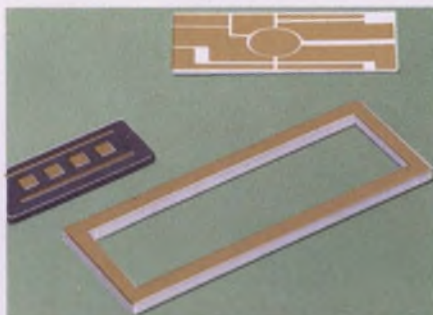

## CUSTOM METALLIZING

Tailored for maximum bond strength on wide choice of our own ceramic compositions including Black Alumina, White Alumina and Beryllia. All popular metallizations and platings, applied by both precision generation and photo-etching. Where air firing is required, ceramics can be supplied with noble metals, surface or buried in multilayer ceramics. Phone 615/265-3411.

Telex 558432.

CIRCLE NO. 205

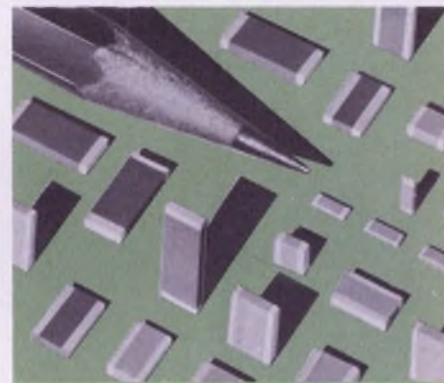

## CAPACITOR CHIPS

Single or multilayer, custom made or stock. Diced chips from 1 pf to .05 mfd. Sizes .020" square and up. Multi-Cap<sup>®</sup> capacitors in all EIA preferred sizes, .080" x .050" and up. Available in TC compositions from P120 to N5600 and in all high dielectric constant materials. Bulletins 689 and 694 on request. Phone 803/682-3215.

Telex 570449.

CIRCLE NO. 206

see us at  
**BOOTH 4531**  
NEPCON EAST

**AMERICAN LAVA CORPORATION**  
Chattanooga, Tennessee 37405 Laurens, South Carolina 29360

SUBSIDIARY OF  
**3M**  
COMPANY

# Ready for man's longest stay in space

John F. Mason, Associate Editor

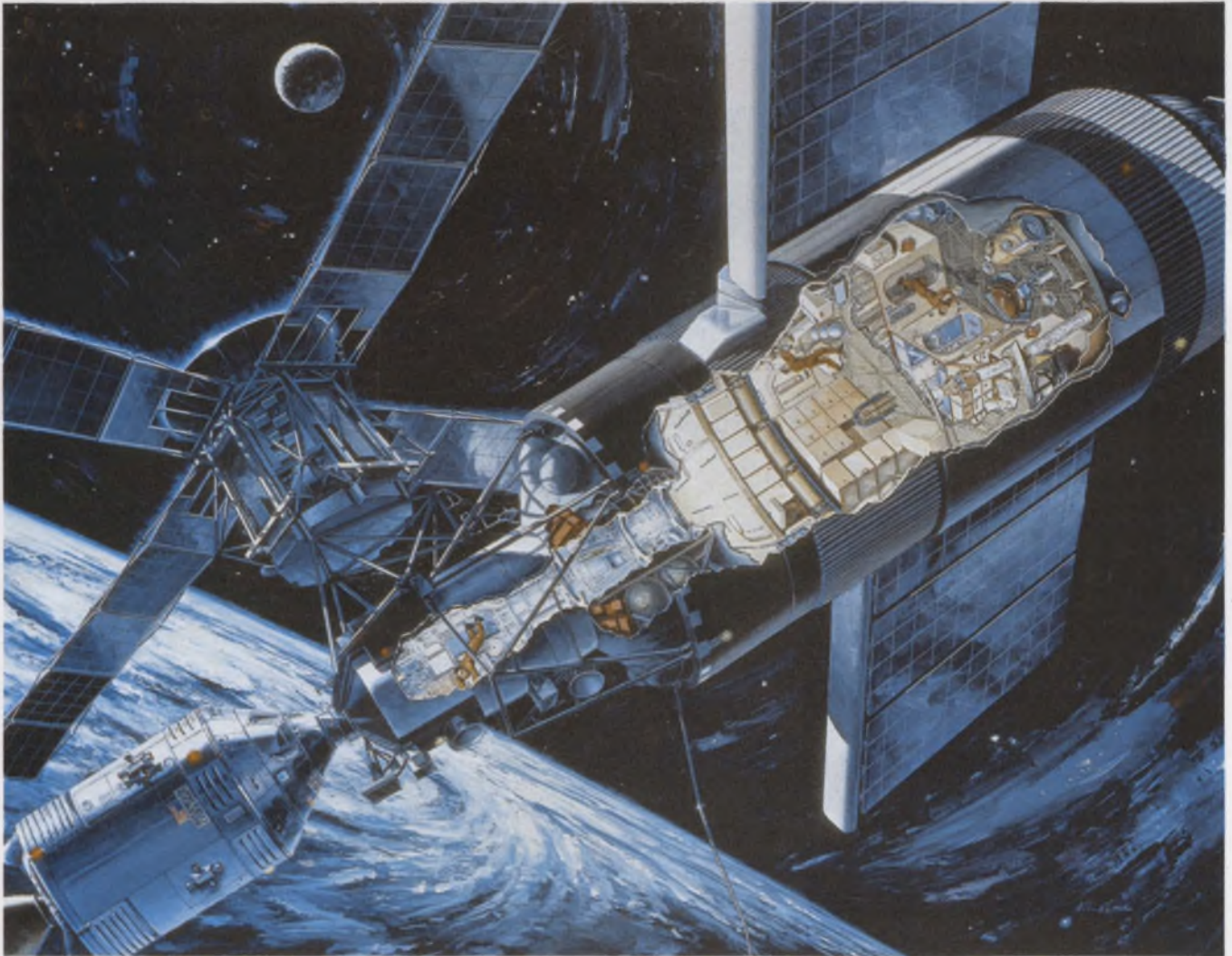

Skylab. The most spacious spacecraft ever built for human habitation. A scientific workshop powered by the sun, with more than a thousand sensors collecting data. An orbiting experiment in psychology. A television studio in the sky. "Home" for three astronaut crews for weeks on end.

Early next month the first three astronauts are scheduled to fly to Skylab, 235 nautical miles above

the earth. They will dock their modified Apollo Command and Service Module with the space station, enter it and begin a 28-day mission—twice as long as American astronauts have remained in orbit before (the Gemini VII mission lasted 13-1/2 days).

Unlike Apollo, which explored the moon, Skylab will look to earth, directly and indirectly.

With a 24,650-pound solar ob-

servatory, multispectral scanners and vidicon cameras, its crews will study the earth's resources. They will also examine the sun, with eight telescopes and other equipment, to determine its effect on the earth and on near-space. They will look at stars in our galaxy and investigate nonvisible sources of energy.

They will test the feasibility of manufacturing certain highly deli-

cate items in the vacuum and weightlessness of space—such as ball bearings and electronic crystals.

And, finally, they will study man's ability to live and function in space for periods twice as long, and then four times as long, as any astronauts have ever flown before.

Large and comfortable, the astronauts' workshop is a modified second stage of a Saturn launch vehicle. It will give them 9550 cubic feet of living space, compared with Apollo's 366. The workshop is 48 feet long and 22 feet in diameter. Counting the living space in the workshop's adjuncts—the instrument unit, the airlock module, the multiple docking adapter and the command and service module—the men will have 11,700 cubic feet of shirtsleeve environment.

On the 28th day the first three astronauts will close the lab, enter the command module with up to 1200 pounds of film, specimens and records, and return to earth.

### 56-day missions due

Sixty days later a second command and service module with another three-man crew will fly to Skylab, still orbiting the earth every 93 minutes. They will stay in the station 56 days and return. Then a month later a third crew will take off for another 56-day mission. Before they leave for earth, they will deactivate the workshop, closing it forever, until one day it, too, will drop out of orbit, dragged down into the atmosphere, where it will disintegrate.

But before this dust-to-dust ending takes place—in the eight to nine months that the laboratory houses nine scientists and engineers—more than 50 experiments in four areas will have been made.

The power for this activity will come from two solar-cell arrays, each twice as large as any the National Aeronautics and Space Administration has ever flown. One array will provide power for the manned workshop and the other for the telescope mount. The workshop array consists of two wings, each 28 by 30 feet. The other array, which will power 18 Ni-Cd batteries for the telescope,



The workshop is a modified second-stage Saturn launch vehicle, 48 feet long and 22 feet in diameter, with 9550 cubic feet of living space; Apollo had 366. The console, at left, monitors the Apollo Telescope Mount's eight telescopes.

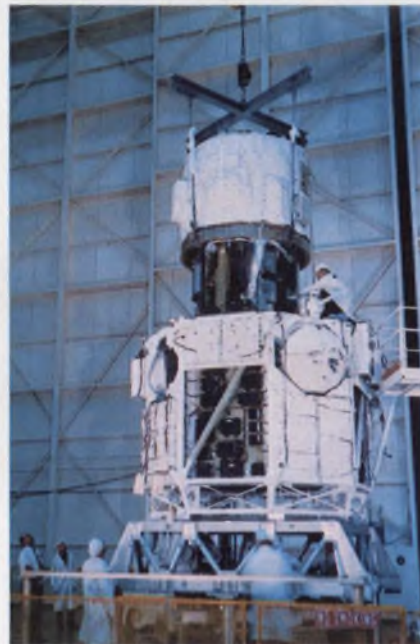

Apollo Telescope Mount canister is being lowered into its outer cluster. The solar observatory weighs 24,650 pounds, contains eight telescopes.

consists of four wings covering 1567.5 square feet. Under ideal conditions the workshop array can generate over 12,000 W of electrical power and the telescope array about 11,000. (See "NASA's Biggest Solar-Cell Array to Power First Space Station in '73," ED 23, Nov. 9, 1972, p. 36.)

Communications within the Skylab cluster and to and from ground stations will be elaborate, but with only a few improvements over

those of the Apollo system. A "first" in space will be a teleprinter that automatically prints out messages sent from the Lyndon B. Johnson Space Center (formerly the Manned Space Flight Center) near Houston, Tex.

For crew communications, a 13-station internal system will enable crew members to talk to one another anywhere in Skylab or outside at the EVA (extra-vehicular-activity) work stations.

Measurements by sensors throughout the cluster—433 sensors in the workshop, 40 in the multiple docking adapter and 896 in the telescope mount—will be telemetered to earth automatically.

### Only pertinent data sent

Why wasn't a computer put on board to cull the information and send only what is significant? "Putting a heavy computer into space is expensive, and it would also create a big software problem," says James Atherton, manager of communications for the Apollo Telescope Mount complex

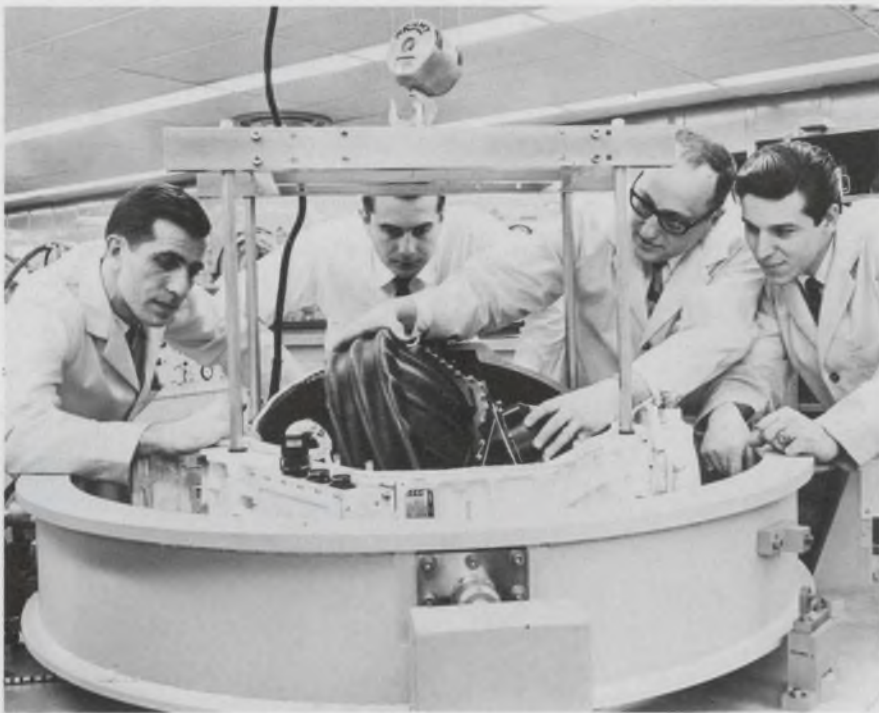

Three control-moment gyros, like this one, control the attitude of the telescope mount within  $\pm 2$  minutes of arc. Each gyro is 22 inches in diameter and spins at about 9000 rpm. For backup, conventional gas nozzles are used.



Astronaut Charles Conrad Jr. sits at the control and display panel of the Apollo Telescope Mount, where data from eight telescopes are received on five TV screens, then sent on to earth for immediate evaluation.

at NASA's Marshall Space Flight Center, Huntsville, Ala. "It's cheaper to down-link everything and then run it through a computer on the ground. Only the pertinent data are sent on to Houston."

In line with NASA's instructions to use available equipment where possible, the Saturn telemetry system was used with only one change.

"We basically kept the analog-digital pcm vhf system that we already had," Atherton explains, "but to record some of the 72-kbit real-time flow, we took a core memory and programmed into a portion of it the addresses in the pcm wave train that we wanted recorded. So, while it's actually being transmitted, whether we're over a ground station or not, we are recording selected portions of

it. We record for 90 minutes at a 4-kbit rate and play it back at 72 kbits in five minutes over a ground station."

The spacecraft will be within line-of-sight of a ground station about one-third of the time.

Dipole antennas with linear polarization, riding on two solar wings, are used for telemetry.

Skylab will carry six television cameras. A switching system will route signals from any of the five TV cameras on the solar telescopes to a main control and display panel. It will be possible to transmit TV displays from the solar cameras to earth in real time so ground-based experimenters can get immediate results. The sixth camera, portable and in color, will



Astronaut Paul J. Weitz lies in the lower-body, negative-pressure device to measure loss of cardiovascular reflex in space. Astronaut Joseph P. Kerwin is standing, and Charles Conrad Jr. is seated.

be used to view astronaut activity, both inside and outside the cluster.

Changes were made in a Westinghouse TV camera that will be extended outside the craft on a boom, anywhere from 1-1/2 to 21 feet. The camera had to be fortified to withstand the changes in temperature when it is moved from the solar side of the craft to the cold side. The camera was re-packaged, to provide an equal heat load throughout; some circuit changes were made and more micro-circuits were used. An EBS (electron-bombardment-silicon) vidicon tube, made by Westinghouse, was used because it's not susceptible to spot-heat burning. This tube is similar to RCA's SIT (silicon intensifier tube), used on the lunar

Fixed resistor  
difference  
is visible to  
the naked eye.

If you're really  
serious about cost,  
be serious about quality.

Paying the lowest price for fixed resistors doesn't mean they're costing you less. Split an A-B resistor apart and discover the difference between Allen-Bradley and all the others. Our exclusive hot molding process forms the elements into an integral structure. Physically strong. With a densely packed, uniform resistance track. Note

how the leads are firmly and thoroughly imbedded to reduce circuit noise. Hot molding is just one way we have engineered more quality into our resistors. Consistent A-B quality that can lower your installed costs and put more reliability into your products. If you think all resistors are the same, read "7 ways to tell the difference in

fixed resistors." See your A-B electronic distributor, or write Allen-Bradley Electronics Division, 1201 South Second Street, Milwaukee, Wisconsin 53204. Export: Bloomfield, New Jersey 07003. Canada: Allen-Bradley Canada Limited, Cambridge, Ontario. United Kingdom: Jarrow, County Durham NE32 3EN.





A new mission control center has been set up for Skylab at the space center near Houston. Information goes directly from digital data to a CRT display. The equipment occupies a fourth the space of Apollo's system.



The readout for the earth-resources data from Skylab will be presented on this CRT in any of 512 shades of "pseudo color" arbitrarily assigned to different sensors to make particular features stand out.

rover in the final Apollo missions.

A prime object for study is man himself. How long and how well can he function without gravity? And what does it do to him physiologically?

A number of elaborate devices are on board Skylab to answer these questions. The results are to be recorded and then "dumped" by telemetry when Skylab is over a ground station.

The astronauts will not be bugged with transducers, except during launch and re-entry and extravehicular activities. But during special experiments they will be

more extensively measured physiologically than the Apollo crews were.

During sleeping periods one of the astronauts with known sleeping habits will wear a cap fitted with electrodes, preamplifiers and accelerometers. These will determine the depth, or stages, of his sleep, and the results will be telemetered to earth.

Each man will be weighed daily in space in a linear spring-mass pendulum chair. To operate it, the astronaut sits in the chair, releases a control lever and the chair begins to oscillate. The inertia of

the mass in the chair causes a pendulum cycle, the period of which is determined by the mass being measured. The device electronically times the period of the pendulum and directly displays the results for determination of body mass.

A smaller mass-measurement system will be used to weigh, or determine the mass of, food residues and body wastes.

A lower-body, negative-pressure experiment will determine how well man's cardiovascular system adapts to weightlessness. While an astronaut is lying in a waist-high cylindrical tank, a number of physiological measurements will be taken, including blood pressure by a new automatic apparatus that automatically takes a measurement once a minute. The same instrument is part of a bicycle ergometer exercise apparatus, which also will measure heart rate and respiratory gas expelled.

Other experiments will measure the reactions of a crew member while he is rotated in a chair—his head motion and any physical symptoms he might have.

The solar observatory, called the Apollo Telescope Mount, will—with its eight telescopes and 24,650-pound weight—not only be the largest solar observatory ever to go into space; the way it controls its attitude is also new. The prime mechanism for executing maneuvers is not a jet nozzle, as has been used in the past, but three large and powerful control-moment gyros, which are momentum-storage devices.

The entire telescope mount consists of two concentric elements. The outer one, the rack, is octagonal, 11 feet from side to side and 12 feet high. The inner structure is the solar experiment canister, and it is about 7 feet in diameter and 10 feet long.

The principal attitude-sensing equipment in Skylab will be a rate-gyro system, which will measure vehicle attitude rates and calculate the vehicle's attitude. Reference attitude information will be provided by a run sensor, which will indicate whether Skylab is pointed at the sun or not, and a star tracker, which will sense the position of predetermined stars.

The three control-moment gyro wheels, or rotors, are mounted in

*Here's a dependable, quick-delivery source  
for Zero Defect*

# High Voltage Silicon Rectifiers

- MEETS STRINGENT ENVIRONMENTAL REQUIREMENTS.
- HIGH TRANSIENT VOLTAGE RATINGS.
- EXTREMELY LOW LEAKAGE.
- WORKING VOLTAGE RANGE . . . 200V. THROUGH 50kV.

If you're looking for on-time delivery of miniature and micro-miniature High Voltage Silicon Rectifiers, look no further than ERIE. You simply can't beat our zero defect rectifiers since these units were first designed for high reliability night vision, lunar and aerospace applications. Their small size makes ERIE rectifiers ideal for thick film substrates, miniature power supplies, airborne displays, CRT displays, color TV, microwave ovens and other industrial and commercial applications where small size, reliability and superior performance are critical. All ERIE High Voltage Silicon Rectifiers feature conservative voltage ratings, fast recovery time, fast turn-on time, wide operating temperature range, high transient voltage ratings, low reverse leakage and unsurpassed reliability.

ERIE also offers double sealed, miniature Full Wave Bridge Rectifiers . . . perfect for P.C. use, with ratings up to 1000 volts per leg. So think ERIE for your High Voltage Silicon Rectifiers. Write TODAY for our new 24-page catalog . . . High Voltage Components and Devices.



# ERIE

ERIE TECHNOLOGICAL PRODUCTS • Erie, Pennsylvania 16512

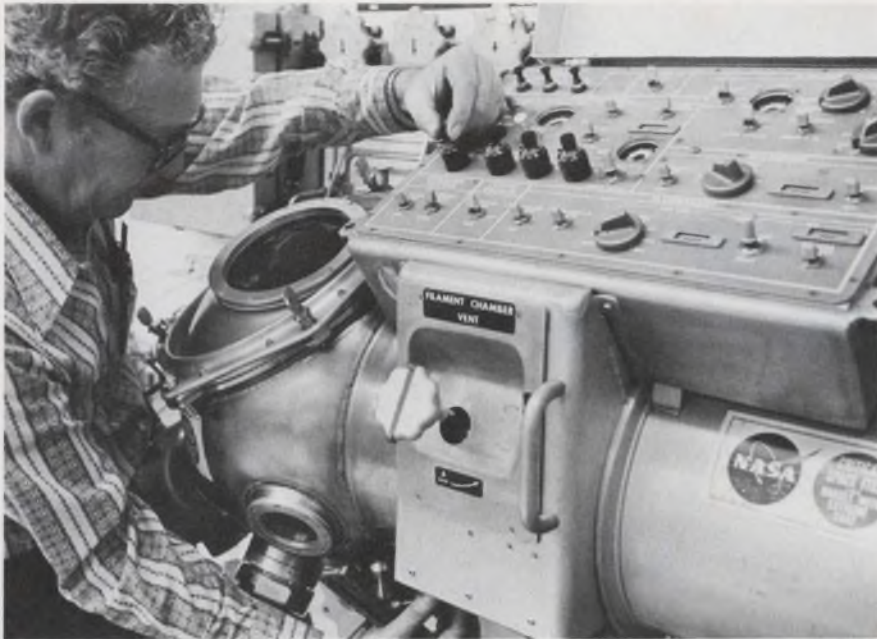

**Manufacturing facility** in Skylab consists of a vacuum work chamber 16 inches in diameter with four-inch-diameter opening to space. Tests will include electron-beam welding, crystal growing and metals melting.

gimbals, with their axes nominally mutually perpendicular. Each rotor is 22 inches in diameter and spins at about 9000 rpm. To maneuver the spacecraft, the astronaut inputs the desired attitude to a digital computer, which compares this with the present attitude. If rotation is required, the axis of one or more of the gyros is shifted by computer command. For backup or for turning the telescope toward earth and away from the sun—a maneuver so drastic the gyros can't comprehend it—there are a series of conventional gas-explosion nozzles, mounted on the aft end of the workshop.

The outer element of the mount—the rack—can maintain an attitude accurate to within  $\pm 2$  minutes of arc. The inner element—or canister—can point with an accuracy of 2-1/2 arc seconds, or less than one inch a mile away. This accuracy is achieved with a fine sun sensor, the computer and servo-mechanisms.

Skylab's high-resolution vidicon cameras and multispectral scanners for looking at the earth will sense and record data about oceans and rivers, crops, forests, geological patterns and geography. The data will be stored on a 14-track flight tape in a pcm format and telemetered as the craft passes over a ground station.

At the space center, the earth-

resources data will be processed into a universal format through Control Data Corp. Cyber 73 computer and recorded on computer-compatible tape. Radiometric and geometric corrections will be made, and the resulting tape will be carried from the Cyber 73 to one of two passive microwave systems—one made by Bendix Research Laboratories in Southfield, Mich., and the other by the Microwave Div. of Aerojet-General in El Monte, Calif.

These imaging systems are equipped with software to read universal computer-compatible tape and to convert scan-line information to a data disc, which can be used as a memory-refresh disc for a CRT display. The Skylab data will be fed from the disc to a d/a unit and displayed on a 525-line television screen. The image formed on the screen will appear in any of 512 shades of "pseudo color"—false colors the operator has arbitrarily assigned to different channels or sensors. If the object of the experiment is to reveal a cold current in the ocean, a cold sensor reading might be assigned to the color red while slightly warmer readings are given to blue, green or even white—anything to make the object of interest stand out clearly.

Besides displaying the information the CRT monitor also stores

it on a nine-track computer-compatible tape and photographs it on nine-inch color or black-and-white strip film.

### Manufacturing in space

What happens to a piece of molten metal left hanging in a weightless vacuum? Will it harden into a perfect sphere unattainable on earth? This is one of a number of questions that NASA hopes its "Materials Processing in Space" facility will answer. The spaceborne manufacturing facility will consist of a vacuum work chamber 16 inches in diameter. The system includes ports for floodlights, a 16-mm data-acquisition camera and a port for a vacuum cleaner to remove debris.

It also contains three sources of energy: a battery-powered, lightweight electron-beam gun, capable of providing 2 kW for 10 minutes; chemical exothermic cartridges, and a resistance heating system.

The experiments will consist of metals melting, exothermic brazing, sphere-forming, composite casting and crystal growth.

Besides information on melted-metal solidification without the effects of gravity, NASA also wants to learn how effective the electron-beam process is as a joining and cutting technique for the assembly and repair of structures in space. And, in an attempt to obtain better crystals for electronic devices, crystals will be grown from a polycrystalline slug of gallium. The experiment will show the differences in characteristics between seeded and self-nucleated crystals.

Mission control for Skylab at the Lyndon B. Johnson Space Center is an improvement over the one used for Apollo.

"Mission control for Apollo and early Gemini," says Jim Miller, director of Skylab mission control, "used a Charactron system that required video cameras. For Skylab, we replaced this with a direct digital-to-television system—no camera is needed. We go directly from digital information through the character vector generator to a video display. This removed the scanning problem and the TV camera that introduced noise into the system." ■■





## Over 1000 promises we can keep.

When you need the right coaxial connectors, excuses just won't do. That's why we stock over 1000 different types of microwave interconnections. From low cost UHF types to highly sophisticated 7mm precision designs.

Connectors in all common series for your growing communications requirements as well as the latest types to MIL-C-39012. Subminiature SMA and SUB-Minax 27 Series, BNC, TNC, and N series. All available in crimp style with a full line of adapters and receptacles.

With the largest coax inventory in the world we can ship one or 1000 in a matter of days.

If none of these standards fill the bill, we'll custom design for your special problems.

Call us, we'll get you what you want when you need it. We promise. Amphenol RF Division, Bunker Ramo Corporation, 33 E. Franklin St., Danbury, Conn. 06810. 203/743-9272.

**BUNKER  
RAMO**

**AMPHENOL**

INFORMATION RETRIEVAL NUMBER 25

# Fighting the skyjacking menace: Anyone have a bomb detector?

The Federal Aviation Administration is now the largest buyer of magnetometers in the world.

And if someone would come up with a practical electronic bomb-detection device, the FAA likely would corner the market in that. It is "desperate" for this equipment.

The nation's airlines, meanwhile, have become major customers for sophisticated X-ray equipment.

These developments have come about because of a crash program by the Federal agency that is pitting technology against skyjackers and aerial extortionists. So far the program has yielded some important dividends in its attempt to ferret out illicit guns and explosives before they are car-

ried on board airliners, but a complete solution is not yet in sight.

The magnitude of the job is illustrated by the fact that there are 531 airports serving scheduled carriers in the United States, with 2800 boarding gates. Some 2000 jet transports make daily flights into these airports, making a total of 15,000 flights a day, carrying 500,000 passengers accompanied by more than a million parcels and pieces of luggage.

## Millions of magnetometers

In its fight against gun-toting skyjackers, the FAA has bought virtually all magnetometers now in production. Some 1200 hand-held metal detectors, already have been delivered to airlines, and 600 of a total of 1090 walk-through units that have been ordered are now in place. The FAA has spent \$2.7-million for these "people search-

ers," and a bill before Congress would provide \$7.5-million more.

The first weapon detectors purchased were simple hand-held magnetometers, which were set to measure the local magnetic field and triggered to set off an alarm if they measured a preset amount of ferromagnetic material disturbing the field.

The second-generation units now being installed are active units that use an electrically generated field to obtain a higher signal-to-noise ratio. This has considerably raised the capability for discrimination and the measurement of all metals.

According to the FAA's Aircraft Research Div. chief, George Bates, the agency has set as a goal the detection of the so-called "Saturday Night Special," a pistol made of cheap pot metal that may only have as much ferromagnetic material as a set of keys, although it is distributed differently.

"They are sold in the thousands, and the FAA had to consider them rather strongly," Bates says.

## Successful active unit

One of the more successful active gun detectors is the Metor, a trade-name device based on a design developed originally for the mining industry by Outokumpu Oy of Tapiola, Finland. The device was designed to detect belts, drill bits and other tramp metal from ore. It is being manufactured here by a licensee Harrison S. Cooper Associates, Salt Lake City, in a joint venture with Roy J. Ricci Associates, Washington, D. C.

The Metor employs a two-part coil system—one part a transmitter producing an electromagnetic field, the other a two-piece receiver coil (see diagram). The coils are imbedded in a walk-

Heather M. David  
Washington Editor



**Metor weapons detector** employs a two-part coil system embedded in a walk-through shell. One part is a transmitter producing an electromagnetic field, the other is a two-piece receiver coil. A phase discriminator measures the electrical core loss to determine the presence of weapons.

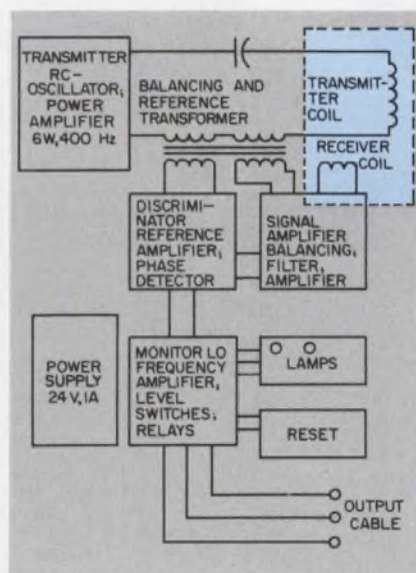

# No-hitch Schottky Comparators



**Compatible multi-function plug-ins:  
more speed—more output—more profits in the end.**

Really bugs you, doesn't it? Make your move into ultra high speed comparators—and the penalty whistle goes off. Currently available parts just can't get along with TTL levels, and input characteristics are much too stringent.

Start counting your blessings: 521, 522. Signetics' exclusive linear breakthrough in extremely fast trouble-free dual comparators. There's nothing else on the market today that can touch 521/522 for cost-conscious ease of use, over a unique range of applications. You work *with* the remarkably high speed that Schottky technology delivers, instead of against it.

The 521 typically operates at 6ns, with 10ns guaranteed; 522, from 10-15ns. But you can't take advantage of these major increments in comparator speed if penalties keep cutting you down to size.

Use the 521/522 any place you'd snap your old 710/711/760 and you clear the board for maximized action. Pin-for-pin replacements for 75107/108; but Signetics' no-forfeit performance can't be matched, while requiring fewer auxiliary parts.

Absolutely TTL compatible in both strobes and output structure. Rock-bottom input characteristics for industrial applications. 20  $\mu$ A max input bias current guaranteed—so low you won't load down your input transducers. And you no longer add a preamplifier to detect more minute variations of input voltage.

We built in function flexibility too. You not only reduce parts count, you save on stock variety needs as well. These versatile Schottky-fast dual



comparators are smooth design-in's as zero crossing detectors, Schottky line receivers, and for A/D and D/A conversions. Plus the most popular alternate application to date—as MOS RAM sense amplifiers.

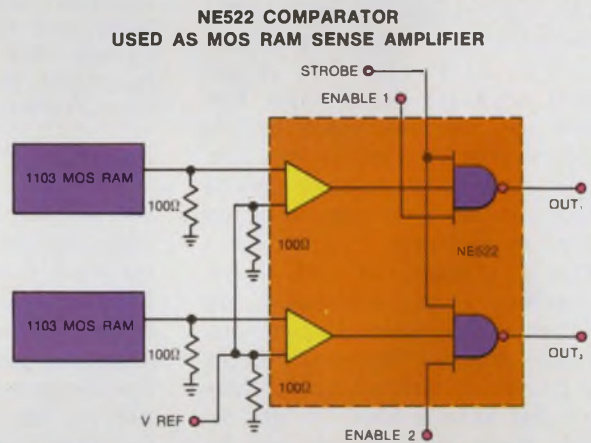

Optimized system performance, with lower costs coming in and going out. That's our commitment to you, the user. From one end of our linear line to the other: from phase locked loops and the IC timer, to these innovative 521/522 high speed Schottky-clamped comparators.

And they're all on the shelf at your distributor. Now.

## CLIP THIS COUPON TO YOUR LETTERHEAD FOR IMMEDIATE ATTENTION

- Please send us a free sample of 521/522.
- Include complete specs, data sheets and application literature for ultra high speed 521/522 comparators.

Name \_\_\_\_\_

Title \_\_\_\_\_

Attach this box to company letterhead, and mail to:  
Signetics-Linear  
811 East Arques Avenue  
Sunnyvale, California 94086  
(408) 739-7700

Signetics Corporation. A subsidiary of Corning Glass Works

**signetics**

INFORMATION RETRIEVAL NUMBER 26

through fiberglass shell and arranged so that the field is multi-directional.

The unit designed for airport use transmits a single low frequency of less than 400 Hz at 6 W. The output signals from the receiver coil are proportional to the change in the electromagnetic field. The unit measures with a phase discriminator only the electrical core loss to determine whether a weapon is present.

"The electrical core loss is by far the most significant indication of metallic properties of importance to weapons detection," Dr. Roy Ricci, president of Roy J. Ricci Associates, feels. Measurement of magnetization is costly and not necessary, he believes, particularly since not all weapons are ferromagnetic.

The sensitivity of the airport Metor unit, as specified by the FAA, is relatively low compared with that used in the mining industry, but it will easily detect a gun or knife, Ricci says. For prison use, the unit could be adjusted to pick up a one or two-inch length of hacksaw, or even show a safety pin on a person with no fillings in his teeth.

The unit reads out with a red or green light, depending on whether it has detected suspicious amounts of metal. United Air Lines and Northwest are among the carriers that have ordered the device.

The Metor receiver coil must be balanced every two to four weeks, depending on whether other metal objects, such as furniture, have been changed in the area. Balancing potentiometers are located on the front panel of the electronics cabinet for this purpose. Solid-state electronics are used throughout.

A walk-through metal-detection unit made by the Electronic Systems Support Div. of Westinghouse, Cockeysville, Md., is the most complex of those currently in use, and is achieving only a 5% false-alarm rate, according to the FAA. Developed and evaluated by the Federal agency, it is the only unit using two frequencies and measuring both magnetization and electrical core loss.

Westinghouse uses a low-frequency field—below 100 Hz—to measure the mass of the material, and a high-frequency field—above



Photo from Torrex X-ray fluoroscope shows (top) two pistols and telescopic sight boxed and packed in shredded paper. Bottom photo reveals clock mechanism in a shaving kit bag. Also shown is the level of the liquid in an aerosol can and loose staples on the heel of a shoe.

500 Hz—to measure density. Both magnetization and loss are metered for each field. According to Jack Kelvington, of Westinghouse's Protection System Dept., both measurements are important for the low-frequency field, but magnetization is the key measurement in the high-frequency.

The system triggers a visual alarm if certain thresholds of lower-frequency magnetization and loss and higher-frequency magnetization are breached.

Kelvington explains that a person carrying four aerosol cans would show enough ferrous material to trigger both low-frequency readings, producing a reading similar to that of a Saturday Night Special. However, the higher-frequency loss threshold would not be breached, indicating that the metal would not be dense enough to be a weapon. Coverage in all three axes means sure detection of any object in the passageway, Kelvington says.

Some 19 airlines are using the Westinghouse unit, which works on a 60-cycle electrical system and draws 250 W. The company also offers a battery and inverter for use in case of airport power

troubles, and it suggests that a simple gas generator could be used to run the unit in emergencies.

Other companies with FAA contracts for walk-through and hand-held detectors include Sperry Rand Corp., Gainesville, Fla., Solco Engineering, Canoga Park, Calif., Federal Laboratories, Saltsburg, Pa., and Rems Manufacturing Co., Creswell, Ore.

The FAA now requires that all units have an 85% probability of detection, with no more than 15% false-alarm rate. The units could be set to detect 100% of the time, Bates points out, but the false-alarm rate would be unmanageable.

"We are still receptive to anyone's idea of how to build a better detector," Bates says. "We now have a good grip on the technology, and we have been helped by the military and security agencies. But if someone has a better idea, we'd like to hear it. We don't like to have to go to too expensive technology, and to equipment that requires too much extra manpower."

### X-ray to screen luggage

The FAA has considered the possibility of using X-rays to screen passengers, but it has ruled out the idea because of potential psychological problems. Pulse X-ray units, Bates says, have such a low dose rate that they could be safely used even if some passengers traveled every day for 365 days, but convincing the public is a problem the agency has decided not to tackle. But the FAA is interested in using pulse X-ray to screen luggage.

However, individual airlines have, on their own, ordered X-ray devices to examine hand luggage and some luggage in the holds of airliners. It is within the technology, Bates points out, to blend X-ray technology with pattern recognition—it has been done in classified military projects—and to make a device that would essentially be self-discriminating. But with costs for X-ray units already ranging from \$5000 to \$25,000 per unit, such a capability might be too expensive.

Successful examples of simpler, less expensive X-ray units are fluoroscopy devices manufactured

# G P

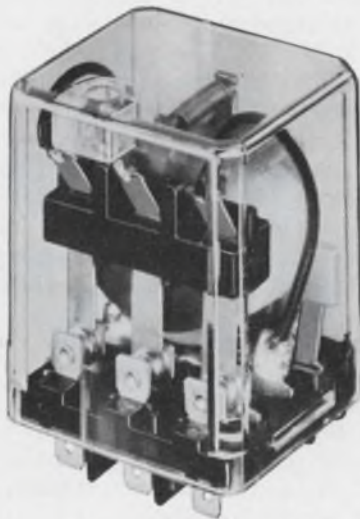

## MAGNECRAFT'S NEW CLASS 388 GENERAL PURPOSE RELAY

Magnecraft is pleased to introduce the new Class 388 General Purpose Relay. This inexpensive, high performance line of stock relays offers many quality features found only in custom built versions. Available in either a covered plug-in or open style with a wide choice of AC or DC coil voltages and SPDT, DPDT, or 3PDT 10 amp contacts.

All Class 388 relays have 3-way pierced terminals. While spaced for standard plug-in mounting, the flat terminals (0.187" x 0.020") also accept quick-connect receptacles or direct soldering. For plug-in use, three types of chassis mounted sockets are available; quick-connect, solder, or printed circuit terminals. Covered plug-in version has a tough clear polycarbonate plastic cover.

In a highly competitive business, delivery can be a deciding factor. If delivery is important to you, be aware that Magnecraft ships better than 90% of all incoming orders for stock relays, received before noon, THE SAME DAY (substantiated by an independent auditing firm). In addition to our shipping record, most stock items are available off-the-shelf from our local distributor.

# FREE!



## DESIGNER'S CATALOG

The purpose of this 36-page catalog is to assist the design engineer in specifying the proper relay for a given application. The book completely describes General Purpose, Sensitive General Purpose, and Mechanical Power Relays. New products include the complete line of Class 388 General Purpose Relays.

**Magnecraft** ELECTRIC COMPANY

5575 NORTH LYNCH AVENUE • CHICAGO, ILLINOIS 60630 • 312 • 282 5500 • TWX 910 221 5221

INFORMATION RETRIEVAL NUMBER 27

by Torr Laboratories, Los Angeles, such as the Torrex II and Dynafluor. The two units, essentially the same design electronically, are heavily shielded, continuous-beam machines that put out 100 milliroentgens per minute within the shielded compartment. Leakage outside is less than 0.5 milliroentgen per hour at two inches, according to Torr's president, Victor de Lucia.

"The X-ray dose will cloud film, but it will not affect any other material carried within luggage," de Lucia says. He estimates that equipping the more than 500 airline airports in the U.S. with three Torr machines each would cost about \$6-million, compared with an investment of perhaps \$30-million for the more expensive, but lower-dose X-ray pulse machines. The higher-beam machines also give a better picture, he adds.

The components of the Torr system include a lightweight industrial type of X-ray tube with a 150-kV, 5- $\mu$ A capability, operating from a 110 or 220-V source. The tube has a beryllium window for smaller packages, and a copper filter can be added for larger, denser objects. The copper filter is used in conjunction with a higher energy dose, the filter eliminating the soft X-ray components of the dose so that a concentrated beam of hard X-rays is focused on the larger packages. The fluorescent screen has a resolution of three line pairs per millimeter, and a peak response in the 5300-Å region. The unit is oil-cooled and can be operated 24 hours a day, de Lucia says.

The FAA has tested two pulse X-ray systems, manufactured by American Science and Engineering, Cambridge, Mass., and Bendix Aerospace Systems Div., Ann Arbor, Mich., and found them successful for the detection of weapons in hand luggage. Pan American World Airways has ordered a large number of the Bendix units, according to James Arey, Pan Am's Security Systems chief and is sending personnel to Bendix to be trained in their operation.

The Bendix-Ray Inspection System produces only a 40-ns burst of X-radiation, with a beam of 30 microroentgens per pulse at four feet. This level is so low that, even in the beam, a person would re-

ceive less exposure from 100,000 pulses than from a single dental X-ray, Bendix says.

The short pulse—too quick for the human eye to scan—is stored on an image storage and control unit built for Bendix by Princeton Electronic Products, North Brunswick, N. J. The unit can retain and read out the single pulse image for at least 10 minutes, and it can enhance the image without erasure or distortion. It has a zoom capability of 4:1.

The key to the storage system is a Lithocon silicon storage tube invented by Steven A. Hofstein, president of Princeton Electronic Products. The company also provides similar electronic equipment for other pulse X-ray detectors made by Philips Electronic Instruments, Mount Vernon, N. Y., Varian Atomic, Palo Alto, Calif., and American Science and Engineering, Cambridge, Mass.

The Lithocon tube stores an image as a charge pattern on a silicon-silicon oxide wafer that is its target. The image is then put in the read mode and can be read out in a video raster format at TV speeds for display.

If more clarification is needed, a second pulse can be superimposed upon the first. Two pulses generally are needed to penetrate aluminum or steel boxes up to 0.080 inch thick. Bendix says the system has better resolution than that offered by continuous-beam machines and better clarity, with 10 logarithmic shades of gray.

Can pulse X-ray systems fog unexposed film in inspected luggage? Manufacturers of the systems say no. But R. V. McIninch of Eastman Kodak demurs. While noting that "some units have reduced the X-ray exposure down to a very few milliroentgens or even a few microroentgens," he adds:

"Although we realize that only rarely will the results of such low exposures be detectable or objectionable in photographs, we are convinced that any X-ray exposure constitutes some hazard to unprocessed photographic film."

A passenger subject to several plane changes and several inspections might have some problems, he indicates. As a guide, he suggests that film will be safe if each single dose is kept well below 1 milliroentgen and total ac-

cumulation from multiple exposures is not allowed to exceed 5 milliroentgens.

## A bomb detector sought

X-ray is not nearly so easy to use to detect bombs in luggage, since the components of a bomb can be arranged in almost any shape, although most need wires or caps that can be identified by a skillful observer. TNT and plastic show up as indistinct masses, but a trained observer can at least identify such masses as suspicious and call for a hand search. The FAA still is searching for a workable bomb-detection device, and it has several ideas under R&D contract. The Illinois Institute of Technology Research Institute, in Chicago, for instance, is looking at the possibility of using gas chromatography and is trying to establish the sensitive envelope required. Standard values, says the FAA's Bates, could be set up for TNT or dynamite with which vapors from luggage could be compared. However, at present it takes two physicists to operate chromatograph devices and at least one minute to get a sample.

Mass spectographs have also been investigated, but thus far their operation time is even slower than the chromatograph, he says.

The FAA also has tested the idea of bombarding luggage with high energy or thermal neutrons. The radioactivity can be detected and measured relatively quickly, perhaps within 20 seconds, and then compared with the specific radioactivity of various substances. A Fast Neutron Activation Analysis system was tested in Los Angeles, but it had difficulties in discriminating between explosive nitrogen and copper.

The FAA also is looking at the possibility of putting some trace element into explosives and ammunition that would show up quickly when irradiated.

So far, however, none of the attempts at bomb detection, has proved as effective as specially trained German Shepherd dogs.

They can detect telltale nitrogen glycol, present in dynamite and TNT, in concentrations of one molecule in  $10^{10}$  or  $10^{11}$  molecules.

As Bates puts it simply, "We are desperate for a solution." ■■

# hp MEASUREMENT NEWS

innovations from Hewlett-Packard

APRIL edition

## in this issue

New "super tube" for cesium beam standard

Turn on to HP's new switching power supplies

New RF spectrum analyzer

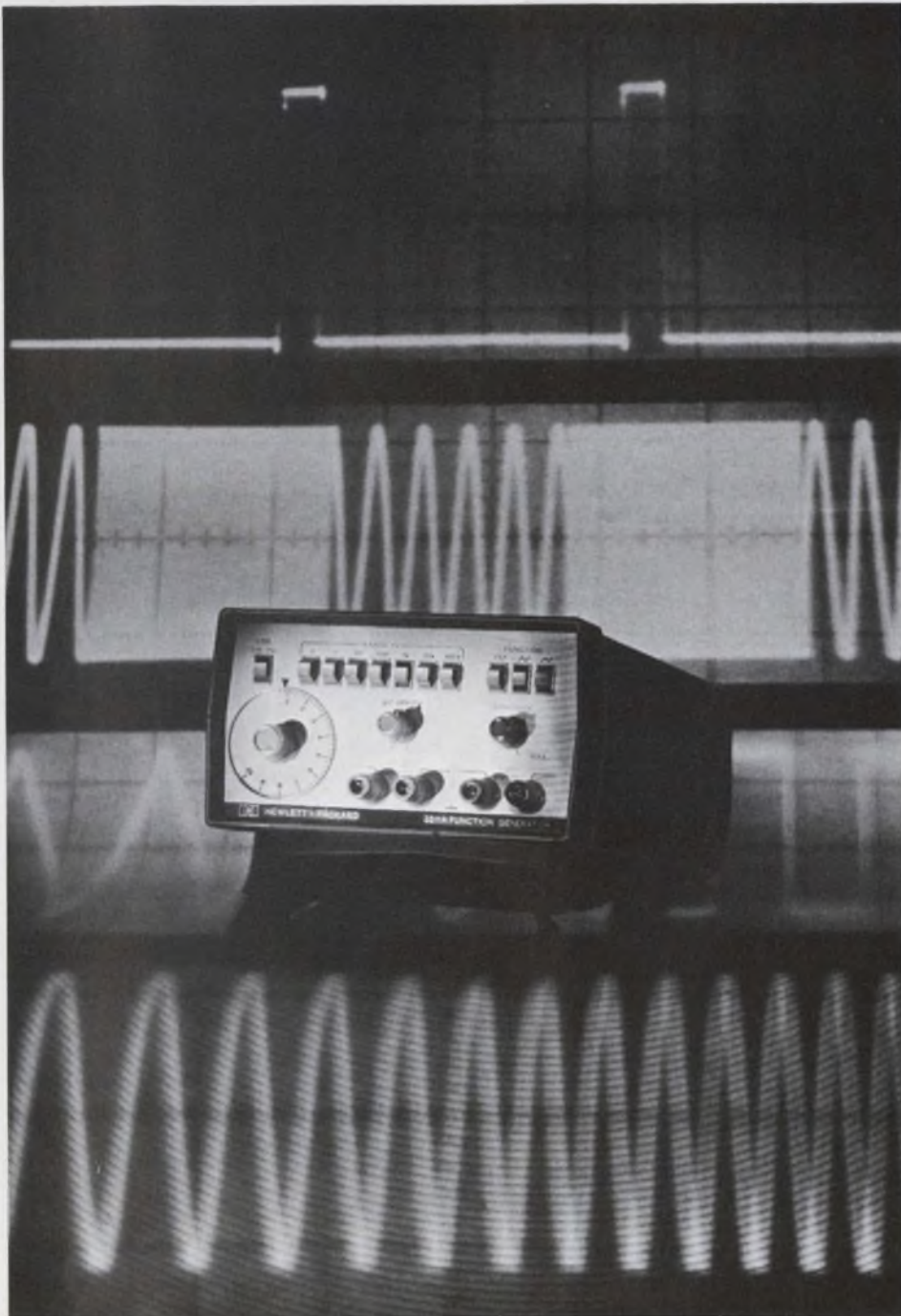

### New low-cost way to generate basic waveforms

Square, triangle or sine waves—new signal source provides all three.

Don't be fooled by small size or low price—the 3311A function generator has sine, square, triangle and positive pulse outputs, plus many features not generally found in low-cost instruments. A TTL-compatible pulse output provides current sinking for up to 20 loads, and an external VCO input is provided for phase-locked loop FM and swept-frequency applications.

Merely push a button to select the frequency, from 0.1 Hz to 1 MHz. Dial accuracy is  $\pm 5\%$  of full scale. A variable attenuator adjusts the output over  $> 30$  dB range. Pulse risetime is better than 25 ns, so the 3311A can be used to clock logic breadboards or to synchronize signals.

To learn more, check E on the HP Reply Card.

# Graphic plotter enhances your time-share terminal

New OEM recorder offers more than 50 options



A graph is often more useful, easier to understand and easier to interpret than long lists of numbers.

Using data directly from a time-sharing terminal, the HP 7200A graphic plotter draws points, irregular curves, circles, straight lines, ellipses, contours, bar graphs and pie charts. Now, you can quickly review a graphical solution to your problem instead of interpreting long lists of numbers or wrestling with bulky printouts. And no special software is required; you can use either BASIC or FORTRAN source language.

The plotter accepts standard EIA ASCII inputs from the teleprinter and draws vectors between the points to form smooth curves. Graphs may be any size up to 11 by

17 inches (28 by 43 cm). Static accuracy is  $\pm 0.015$  in. ( $\pm 0.38$  cm), and resolution is 1 in 10,000. HP utility routines are available to handle scaling, axis and curve generation, curve synthesis, formatting, coordinate transformation, and contour mapping (including three-dimensional plotting).

A picture may well be worth a thousand numbers. If you already have a time-share system and terminals, the cost of adding plotter capability is minimal.

For more information on the 7200A plotter, check N on the HP Reply Card.



You can customize this strip-chart recorder by choosing the speed, frequency, span, etc. that are right for your application.

Now, there's a two-pen strip-chart recorder truly designed for OEMs. It starts with a durable mainframe, 10-inch (25 cm) writing width, modular construction with plug-in PC boards for easy servicing, and a trouble-free servo system that doesn't use gears or clutches. Instead, the pens are driven by a plastic belt that's quieter and more reliable than conventional servo systems. Recorder response time is  $< 0.5$  sec., and accuracy is  $\pm 0.2\%$  of full scale.

You take over from there and select what you need from over 50 options. Choose one of six chart speeds from 6 in. (15 cm) per minute to 1 in. (2.5 cm) per hour. And you're not limited to just one speed; choose two, four or eight. Both 50 Hz and 60 Hz recorders are available. One of six input spans from 1 mV to 100 V on each channel may be specified. Other options include remote controls, chart on-off, pen lift, retransmitting potentiometer, limit switches, and a rear control connector.

## Send for this useful microwave catalog

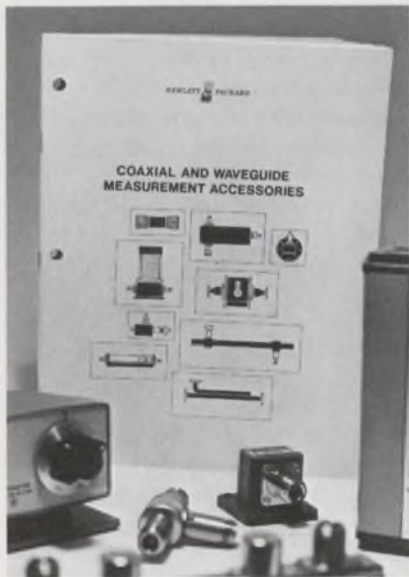

A new 64-page catalog features our extensive selection of precision coaxial and waveguide instrumentation. Complete specifications are presented for such items as:

- Directional couplers
- Slotted-line equipment
- Attenuators
- Frequency meters
- Detectors
- Mixers
- Filters
- Modulators
- Terminations

This book lists all the hardware you might need to make accurate microwave measurements.

For your copy, check Q on the HP Reply Card.

To learn more, check M on the HP Reply Card.



## New RF spectrum analyzer is low cost, easy to use

Economy is now coupled with high performance in the new HP 8558B spectrum analyzer—an oscilloscope plug-in that makes accurate measurements over a 0.1 to 1500 MHz frequency range. It's extremely easy to operate; most measurements are made using only these three controls:

- **Tuning**—Set the center or "start-of-sweep" frequency which is displayed on the 3½ digit LED readout.
- **Frequency Span**—Examine frequency sweeps as wide as 1000 MHz and as narrow as 50 kHz. The analyzer automatically selects optimum sweep time and resolution bandwidth. If required, you can easily override the automatic function to select any combination of sweep time and resolution. With bandwidths from 1 kHz to 3 MHz, you can resolve close signals, analyze pulsed RF, and recover complex modulation.
- **Reference Level** (amplitude control)—Measure the absolute power level of displayed signals from -115 dBm to +30 dBm. The control also indicates maximum and optimum input signal levels for 70 dB spurious-free display. This minimizes the chance of erroneous measurements or overload damage.

You can use the 8558B spectrum analyzer with any HP 180 series oscilloscope. The 182A scope, with a large 10 by 13 cm. CRT display, is ideally suited for bench use; while the 181A scope, with variable persistence and storage CRT, is useful for high-resolution analyses and signal comparisons.

*For more information, check P on the HP Reply Card.*

Make wide range frequency-domain measurements with the new 8558B RF spectrum analyzer.



## Police search vast data files quickly with an HP computer



The patrolman radios a description back to headquarters.



The computer flips through its file of offenders and identifies the suspect.



Later, a fingerprint search is performed.

The Oakland, California, police department has a new "detective"—a low-cost HP 2120A disc operating system. The computer system helps identify criminals by comparing known physical characteristics and methods of committing crimes with information in police arrest files. The system can identify the vehicle involved in a crime—given a partial license number and the automobile make, model, year or color. It also matches fingerprints found at the scene of a crime with those on file. A fingerprint search that used to take 4 to 5 hours is now completed in only 15 or 20 minutes with the HP system.

The computer interfaces with two microfiche viewers. One displays photographs so that police and witnesses can identify offenders; the

other displays fingerprints. During the first few weeks of testing, eight burglars were identified and arrested through computer-directed fingerprint searches, while six robbery suspects were identified from photos.

You don't have to be a law enforcement agency to have the same problems that the Oakland police did: voluminous files, inadequate information retrieval, and time-consuming manual search techniques when you need the answer immediately. The solution: an HP disc operating system that holds vast amounts of data, automatically analyzes it, and presents the information in seconds rather than hours.

*For more information, check D on the HP Reply Card.*

# The HP-35: a better way to solve problems like these

Three in one: counter, D/A converter, DMM

Unlike your slide rule, the HP-35 automatically positions the decimal point.



**Problem 2:** Great circle distance between San Francisco and Miami

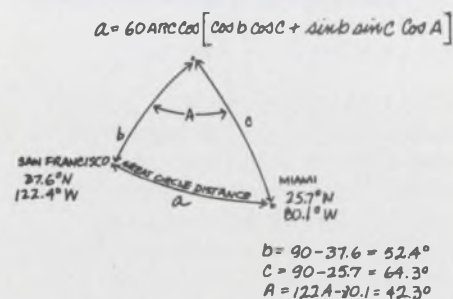

HP-35 solution:

52.4 [COS] 64.3 [COS] [X] 52.4 [SIN] 64.3 [SIN] [X]  
 42.3 [COS] [X] [+/-] [ARC COS] 60 [X] → 2254.093016

Slide rule solution: 2255 m.m.

Time on HP-35: 65 seconds  
 Time on slide rule: 5 minutes

The HP-35 consistently performed computations in 10%-20% of the "slide rule time." Isn't your time worth it?

For more information, check A on the HP Reply Card.



A multimeter and a D/A converter are the most recent in a growing line of "snap-on" modules for the 5300 counter.

When is a counter more than a counter? When it's a multimeter and a digital-to-analog converter as well. Now, you can get two new snap-on modules—a five-digit multimeter and a D/A converter—to increase the versatility of HP's 5300 Measuring System. Time interval and frequency (10, 50 or 525 MHz) modules and a battery pack are also available.

The 5306A multimeter module measures frequency to 10 MHz; ac and dc voltage, from 1 mV to > 99V; and resistance, from 0.1Ω to 10 MΩ. Accuracy depends on what and where you are measuring; for example, accuracy of the lower dc ranges is 0.03% of reading +0.003% of scale. Two sample rates let you trade off between speed and resolution.

The 5311A D/A converter fits between the counter display and any function module. You can make expanded-scale analog recordings of frequency, period, time interval, ratio, dc and ac volts, or ohms.

There's more. Check K on the HP Reply Card.

Are you still using your old college slide rule? Step up to an HP-35, the 9 ounce computer calculator that handles logarithms, exponents and trigonometric functions within seconds. Four registers and a solid-state memory hold intermediate solutions to problems, then automatically bring them back later for further processing. Answers are shown to ten significant digits.

Just for the fun of it, we compared the HP-35 with a slide rule. Here are two problems that show the relative time advantage and the significant advantage of greater accuracy.

**Problem 1:** Collection solid angle from a point source.

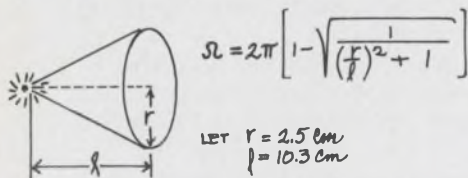

HP-35 solution:

2.5 [÷] 10.3 [÷] [X] 1 [+/-] [VZ] [F] [CH B] [÷] 1 [+]  
 2 [X] [π] [X] → .1772825509

Slide rule solution: .176

Time on the HP-35: 20 seconds  
 Time on slide rule: 3 minutes,  
 15 seconds

Cesium beam standard now more accurate than ever

## Multi-faceted new tape drive for OEM and end-user alike

The HP cesium beam standard has long been recognized as the world's most accurate commercial instrument. Now, the 5061A cesium beam primary frequency/time standard is even more accurate— $\pm 7$  parts in  $10^{12}$ —thanks to a new optional high-performance tube that took five years to develop.

Short-term stability of the 5061A was  $\pm 5 \times 10^{-11}$  (1 sec. average); the new tube improves that stability by a factor of ten. It's the only instrument with the long-term stability of a primary standard and the excellent short-term stability associated with rubidium standards.

We've also further improved immunity to the effects of external magnetic fields and reduced sensitivity to acceleration, vibration, rotation and temperature change. No wonder HP's cesium beam standards are used for navigation, communications, and tracking satellites.

For more information, check H on the HP Reply Card.



HP cesium beam standards undergo extensive environmental testing. Here, one is being tested at high altitude and high and low temperatures.



The versatile 7970E tape drive features fast data transfer—up to 72,000 characters/second.

HP's new digital magnetic tape drive can handle virtually any recording problem—200, 556 or 800 cpi NRZI; any speed from 25 to 45 ips; or 1600 cpi phase-encoded recording that is ANSI/IBM compatible. You get 7 and 9 track, multi-density, NRZI and PE capability—all in one read-only tape drive, model 7970E.

The 7970E is simple, reliable, and accurate. There are no gears, belts, or complex linkages. Direct drive motors handle the tape precisely and gently. Yet, all major transport assemblies are easily accessible for service, and all data electronics are

on plug-in cards. Many of these features are usually found only in higher priced and more complex tape drives.

For the end-user, complete 7970E subsystems include the tape drive, interface controller, and all software required for operation with either HP 2100 or 3000 series computers. For the OEM, several configurations and options customize the tape drive to any application. (OEM discounts are available.)

For more details, check O on the HP Reply Card.

# New bit error rate test set for digital communications



Besides testing PCM equipment, the 3760A/3761A tests computer memories, disc storage, digital recorders, and high-speed logic circuits.

Now, there's a new bit-error-rate test set to check the performance of digital communications systems, particularly those that use pulse-code-modulation. The test system consists of a 3760A data generator and a 3761A error detector. Using pseudo random binary sequences

(PRBS) with bit-by-bit comparison, the system measures bit error rate and total error count at rates from 1.5 to 150 megabits/sec. The bit error rate is automatically ranged on the LED readout, and the test set catches both random and systematic errors.

It's extremely flexible. Data and clock outputs and their complements have adjustable levels and offsets; synchronization and gating are compatible with almost any PCM system condition; and PRBS length is variable. Data delay and phasing controls let you equalize the effects of cable length. Attach a printer, and you can let the system run unattended. The system also checks itself through deliberate introduction of errors.

To learn more, check F on the HP Reply Card.

# Switch to HP's new high efficiency power supplies

Nine voltage outputs most often used in system, computer and buried OEM applications are available in the 62600J series of switching regulated power supplies. Output voltage ratings range from 4V, 160W to 28V, 300W. The 5V, 40A model is especially popular for TTL logic power applications.

The supplies feature an advanced 20 kHz transistor switching design with up to 80% efficiency. You get more power in a smaller, cooler-operating package, with 0.2% combined line and load regulation, 20 mV rms/30 mV p-p ripple and noise (20 Hz to 20 MHz). And, HP thinks ahead to give you all the built-in protection you need: overvoltage, overcurrent, overtemperature, reverse voltage, and protected remote sensing.

For systems applications, the overvoltage protection circuit can be tripped by an external trigger



These regulated power supplies are packaged in half-rack width cases.

pulse. The circuit will also generate an output pulse when activated internally. Turn-on and turn-off sequencing of several supplies can be accomplished by external contact closures.

OEM and quantity discounts are available.

For more information, check L on the HP Reply Card.

Now, measure microwave power more accurately



For microwave power measurement, this system has high accuracy with wide dynamic range and broad frequency coverage.

Mismatch uncertainty, usually the largest single source of error in microwave power measurements, is now greatly reduced when you use our new thermocouple power meter. The HP 435A power meter/8481A power sensor measures power levels over a 55 dB range from 0.3  $\mu$ W to 100 mW in the frequency range from 10 MHz to 18 GHz. The thermocouple sensor boasts a VSWR < 1.2 for 30 MHz to 12.4 GHz, and < 1.3 for 12.4 GHz to 18 GHz—less than half the reflection specified for most other microwave power detectors.

The thermocouple power sensor is unique: it's a silicon-integrated device that is sensitive yet rugged, small yet precise. Advanced silicon technology accounts for the sensor's low VSWR and broadband performance.

Other important features include:

- Built-in precision RF power reference which permits the user to verify calibration anytime, anywhere.
- Optional internal battery for field applications.
- Sensor can be placed up to 200 feet from the meter for remote power monitoring.

For details, check G on the HP Reply Card.

# New limiter protects microwave instruments against overload

Now, you can protect sensitive instruments from external signal overloads—without affecting lower-level measurements or inhibiting the dynamic range. HP's new 11693A microwave limiter typically introduces less than  $\pm\frac{1}{2}$  dB variation in frequency response from 0.1 to 12.4 GHz.

Limiting action begins around 5 mW. Even if 1W CW or 75 W peak power is applied, the microwave limiter's output stays well below 100 mW.

Use it to protect amplifier front ends, mixer diodes, and sampling circuits. The limiter is especially valuable if connected to a receiver or spectrum analyzer input when an antenna could be picking up strong signals, unbeknownst to the operator.

For details, check C on the HP Reply Card.

The unobtrusive 11693A limiter can help protect your microwave instrument investment.

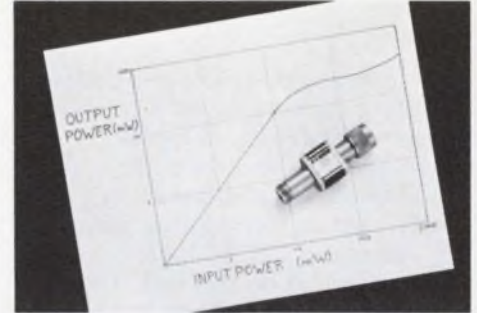

## HEWLETT-PACKARD COMPONENT NEWS

### HP's new combination: resistor and LED

This new 5082-4860 resistor-LED is ideal for panel-mounting.



Now, HP has added two resistor-LEDs to its popular line of LED lamps. Because of the integral current-limiting resistor, the new LED can replace 5 V lamps directly.

Choose model 5082-4468 with clear diffused lens and .125 in. (.3 cm) diameter, or model 5082-4860 with red diffused lens and .200 in. (.5 cm) diameter. The latter, has long leads for easy wire-wrapping.

Both resistor-LEDs are TTL compatible with a typical forward current of 16 mA at 5 V. Luminous intensity is .8 mcd typical.

For more information, check J on the HP Reply Card.

### New fast-switching PIN diodes



The 3305 comes in a ceramic pill-type package (shown here); the 3306, in a ceramic double-stud package.

Two new PIN diodes provide the unusual combination of fast RF switching ( $< 5$  ns, typical) and low residual series resistance ( $< 1 \Omega$ ). At the same time, the 5082-3305/3306 series have high power limiting capability (50W peak power).

The new diodes control and process microwave signals up to Ku band. You can use them in single and multi-throw switches, pulse modulators, amplitude modulations, phase shifters, duplexers, duplexers, TR switches and limiters.

For complete specifications, check I on the HP Reply Card.

# A fast, efficient way to troubleshoot digital circuits

One major difficulty in troubleshooting digital circuits is observing the results of long, complex waveforms on several nodes simultaneously and detecting a single shot or intermittent error. HP offers the 10529A logic comparator to do this task. Using a component comparison technique, it makes in-circuit functional tests of suspect ICs. By paralleling the IC under test and a reference IC, the comparator checks the responses of both ICs to the system's operating waveforms and indicates differences as errors. Intermittent errors as

short as 200 ns are "stretched" to a 0.1 sec. indication on the LED display.

This portable, hand-sized instrument is ideal for field service and production tests where you have to repair complex circuits rapidly. By focusing attention on the area of malfunction, the comparator eliminates time-consuming tests on areas that are operating properly. You thus apply your skills solving the problem, not looking for it.

Another challenge in digital testing is large feedback loops. The only effective method is to see that

each component in the loop responds properly to the signal received, *regardless of signal validity*. By looking for bad components instead of expected waveforms, the comparator eliminates wasted time and energy chasing around the feedback loop.

An HP logic comparator soon pays for itself through decreased repair time and increased user efficiency.

*For more on digital troubleshooting, check B on the HP Reply Card.*



To use the logic comparator, merely select the IC to be tested.



Select a reference board with a good IC that has the same type number.



Insert the reference board into the logic comparator.



Attach the clip to the suspect IC and check the comparator display.



The suspect and reference IC are compared automatically. Indicator lights signal which pins are faulty.

**HEWLETT**  **PACKARD**

Measurement, Analysis, Computation

**East**—W 120 Century Road, Paramus, N.J. 07652.  
Ph. (201) 265-5000.  
**South**—P.O. Box 2834, Atlanta, Ga. 30328.  
Ph. (404) 436-6181.  
**Midwest**—5500 Howard Street, Skokie, Ill. 60076  
Ph. (312) 677-0400.  
**West**—3939 Lankershim Boulevard, North  
Hollywood, Calif. 91604, Ph. (213) 877-1282.  
**Europe**—Post Office Box 85, CH-1217 Meyrin 2,  
Geneva, Switzerland, Ph. (022) 41 54 00.  
**Canada**—275 Hymus Boulevard, Pointe Claire,  
Quebec, Canada, Ph. (518) 561-6520.  
**Japan**—Yokogawa-Hewlett-Packard, 1-59-1,  
Yoyogi, Shibuya-ku, Tokyo, 151.

# Raytheon Semiconductor announces two super products that just made us No.1 in voltage regulators.

## No gimmicks. Just proof.

Here they are. Adjustable and fixed dual-tracking voltage regulators that are so simple to design into your system you can forget about your slide rule and calculator. They require fewer external components so they take up less space. Compared to other voltage regulators, they provide more than twice as much current. Which means you can supply a lot more systems for a lot less money in the long run. And they are the first voltage regulators to provide thermal shut-down protection for both outputs at a junction temperature of  $+175^{\circ}\text{C}$ .

### Adjustable 4194

With the 4194 you get both positive and negative outputs from 50mV to 42V — the widest range available today. All it takes is one external resistor ( $R_O$ ) to ground for setting the desired output voltage. And to find out the value of  $R_O$  you just use this simple formula:  $2.5 \times V_O = R_O (K\Omega)$ .

Or if you want to program the outputs simultaneously, use one pot calibrated for 2500 ohms/volt.

Depending on the application, you'll only need from 4 to 6 external components — compared to 8 to 12 for other regulators.

The 4194 provides 200mA at both outputs simultaneously, with

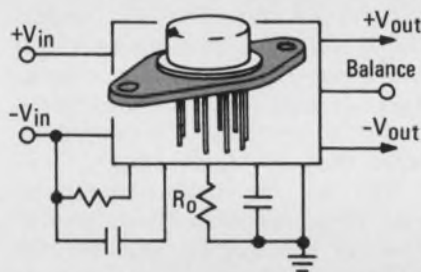

4194

0.2% load regulation over the entire voltage range. You need just one resistor to provide asymmetrical tracking voltages for the popular 710, 711, 702, 106 or the like. And with external pass transistors the 4194 can supply output currents to 10A.

### Fixed 4195

Check these features against competition. The 4195 provides positive and negative 15V outputs at 100mA each. And it does it with only two bypass capacitors, compared to competition's six external components. That

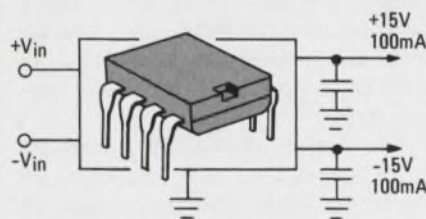

4195

means you can power a lot more op amps for a lot less money.

The 4195 can be used as a single supply with an output of up to +50 volts. It comes in 3W and 900mW packages or — and this is another first — an 8-pin plastic mini-DIP!

**RAYTHEON**

Raytheon Semiconductor  
350 Ellis Street  
Mountain View  
California 94040  
Phone (415) 968-9211.

Send me information right away on the voltage regulators checked below.

- |  |                               |
|--|-------------------------------|
| <input type="checkbox"/> LM104/204/304 | <input type="checkbox"/> 723  |
| <input type="checkbox"/> LM105/205/305 | <input type="checkbox"/> 4194 |
| <input type="checkbox"/> LM109/209/309 | <input type="checkbox"/> 4195 |

NAME \_\_\_\_\_

TITLE \_\_\_\_\_

COMPANY \_\_\_\_\_

ADDRESS \_\_\_\_\_

CITY/STATE/ZIP \_\_\_\_\_

# A new MIL spec-cost; Designers must meet it

The Defense Dept. has embarked on a new program of penny-pinching, and electronic designers are assuming new importance in defense work as a result.

Stung by outcries in Congress and elsewhere against chronic cost overruns in defense contracts, the department is making price a critical parameter of the design phase of weapons systems. Defense contractors, who heretofore have enjoyed almost financial carte blanche in the design of military systems, are being warned that if they wish to continue doing business with the Pentagon, they must learn to emulate the cost-consciousness of commercial manufacturers in highly competitive markets.

"We are probably the only engineering community in the United States that has not paid attention to the ultimate cost of what is developed," Leonard Sullivan, Deputy Defense Research and Engineering Director, told ELECTRONIC DESIGN in an interview.

The new policy of design-to-cost—or design-to-price, as it is sometimes called—means that the Defense Dept. will now specify a unit-cost target for a specified production run before competition for the design contract begins.

To explain the ramifications to industry, the Government Procurement Relations Council of the Electronic Industries Association will hold a seminar in Washington, D. C., April 25 and 26.

## Commercial techniques studied

Pressure to find a new way of doing business came out of a Pentagon study some months ago, when top planners projected the costs of all systems under way and found that in eight years they would be some \$5-billion a year more than the projected budget allotment to the Defense Dept.

Defense officials then made a study of successful commercial companies to find out what they were doing that the military wasn't to produce items that met their original cost estimates. That one element, the officials concluded, was the presence of a cost target in the design phase that was closely adhered to by the design engineering team.

The design-to-cost feature is now being incorporated by the Defense Dept. in more than a dozen electronic subsystems and in an equal number of full weapons systems. Examples range from a \$10,000-per-unit TACAN navigational aid to a \$5-million-per-unit short-take-off-and-landing transport aircraft, both being competitively designed and developed by more than one contractor.

The key to making design-to-cost work, defense officials emphasize, is the design engineer. In addition to direct effects on labor and materials, his design can affect overhead by requiring special tooling, clean-room facilities and other special manufacturing processes. The design also affects the maintainability of the item, which makes a tremendous difference in its life-cycle cost. Maintenance often has been the bane of the military services.

The new contracts with design-to-cost clauses provide for flexibility, so that a design engineer may trade off some performance and schedule to attain the target price, Sullivan explained. Admittedly, he added, this calls for wisdom by the project manager to spell out which performance aspects are mandatory and which are secondary, as well as to choose a reasonable target price.

The design of the STOL aircraft is an example of how tradeoffs can be made. When the first round of proposals came in over the target-

# AMP International locations.

## ARGENTINA

AMP S.A. Argentina  
4 de Febrero, 76, Villa Zagla—SAN MARTIN  
Buenos Aires, Argentina

## AUSTRALIA

Australian AMP Pty. Limited  
155 Briens Road  
Northmead, N.S.W. 2152 Australia  
Mailing Address:  
P.O. Box 194, Baulkham Hills, N.S.W.  
2153 Australia  
Phone: 630-7377

## BRAZIL

AMP do Brasil Ltda.  
Rua 7 de Abril 355  
Sao Paulo, Brasil. Phone: 335204

## CANADA

AMP OF CANADA LTD.  
20 Esna Park Drive  
Markham, Ontario  
Phone: 416-499-1251

## FRANCE

AMP de France  
29, Chaussee Jules-Cesar  
Boite Postale No. 39  
95301-Pontoise (Val d' Oise), France  
Phone: 464-92-20  
464-92-30

## GREAT BRITAIN

AMP of Great Britain Limited  
Terminal House  
Stanmore, Middlesex, England  
Phone: 01-954-2356

## GERMANY

AMP Deutschland G.m.b.H.  
Amperstrasse 7-11  
607-Langen, B.FFM.,  
West Germany. Phone: (06103) 7091  
Branch in Vienna, Austria  
Zweigniederlassung Oesterreich  
Markgraf-Ruediger Str. 6-8  
1150 Vienna/Austria, Phone: 924191/92

## HOLLAND

AMP Holland N.V.  
Papierstraat 2  
's-Hertogenbosch, Holland  
Phone: (04100) 25221  
AMP Belgium  
Rue de Brabant 62-66  
Brussels, Belgium. Phone: 175-517

## SWEDEN

AMP Scandinavia AB  
Datavagen 5  
175 00 Jakobsberg, Sweden  
Mailing Address:  
Fack  
S-175 20 JARFALLA 1  
Sweden, Phone: 0758/104 00

## MEXICO

AMP de Mexico, S.A.  
Apartado Postal 179, Naucalpan de Juarez  
Edo. de Mexico  
Phone: Mexico City 576-41-55

## ITALY

AMP Italia S.p.A.  
Via Fratelli Cervi 15  
10093-Collegno (Torino), Italy  
Phone: 785-656

## SPAIN

AMP Española, S.A.  
Apartado 5294  
Pedro IV, 491, 495  
Barcelona 5, Spain  
Phone: 307-75-50

## JAPAN

AMP (Japan), Ltd.  
No. 15-14, 7-Chome, Roppongi  
Minato-Ku, Tokyo, Japan  
Phone: 404-7171

# AMP

INCORPORATED

INFORMATION RETRIEVAL NUMBER 131  
ELECTRONIC DESIGN 8, April 12, 1973



# Nylon. A new twist in cutting circular connector costs.

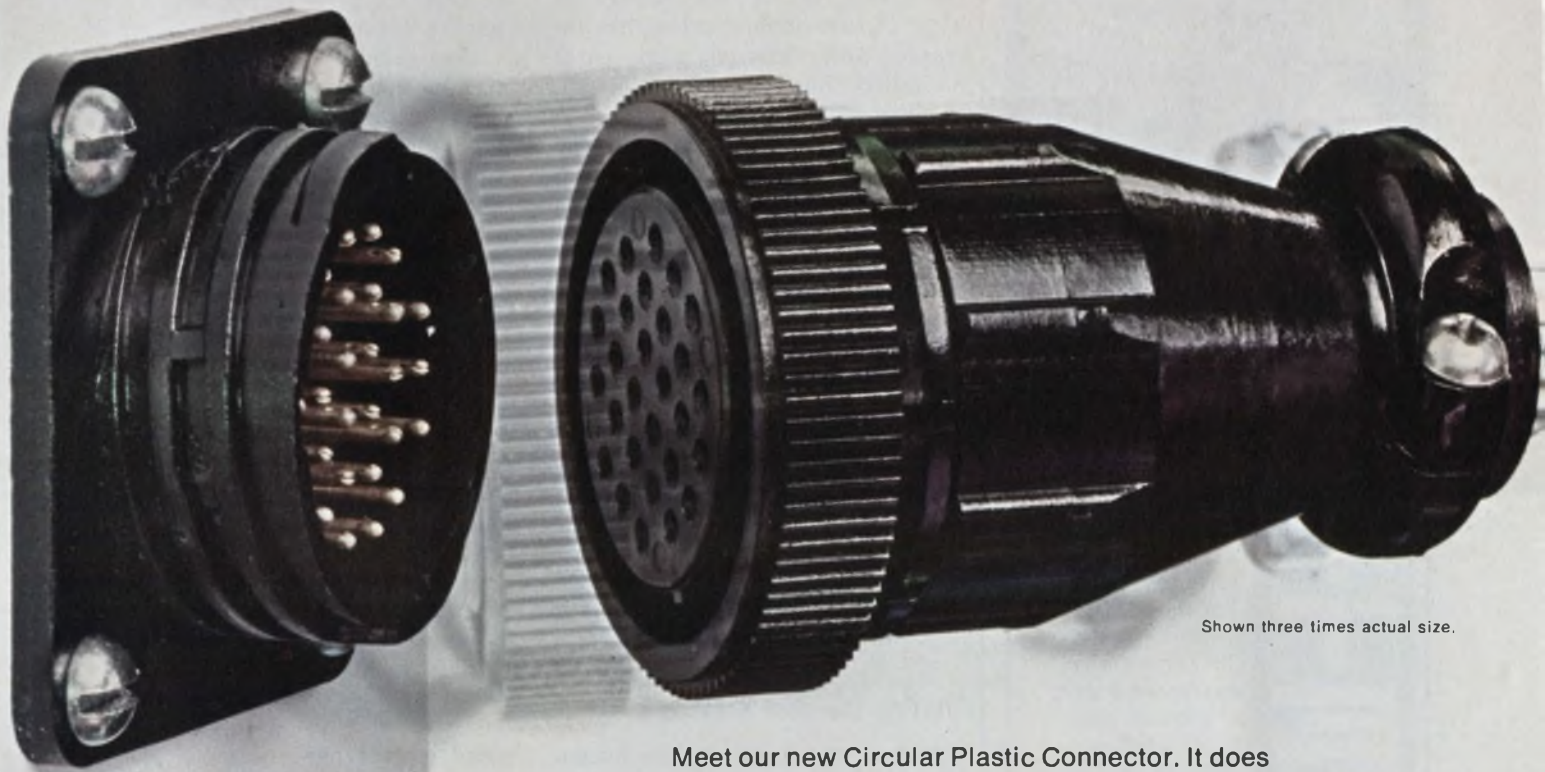

Shown three times actual size.

Meet our new Circular Plastic Connector. It does everything a metal-shell connector will do. Except cost lots of money. We make it of high-strength, glass-filled nylon. So it's just as rugged . . . but lighter, nonconducting and less expensive.

Circular Plastic Connectors cost less to buy. And less to use . . . because you can terminate their pin and socket contacts on our high-speed, automated customer-provided machines. And load only the contacts you need.

We make this new nylon connector in most popular sizes, including 63-position,  $1\frac{1}{8}$ -inch O.D.; 28-position,  $1\frac{1}{8}$ -inch O.D.; and 8-position,  $\frac{1}{2}$ -inch O.D. Mountable or free-hanging. Standard or splashproof. Rated 7.5 to 15 amp.

Ready for a new twist in circular connectors? Write for details to **AMP Incorporated, Industrial Division, Harrisburg, Pa. 17105.**

**AMP**  
INCORPORATED

Manufacturing and direct sales facilities worldwide: Barcelona, Brussels, Buenos Aires, Frankfurt, London, Mexico City, Paris, Puerto Rico, Sao Paulo, s'Herlogenbosch (Holland), Sydney, Stockholm, Tokyo, Toronto, Turin, Vienna.

132 PLEASE SEND LITERATURE—IMMEDIATE INTEREST.

133 PLEASE SEND LITERATURE—POSSIBLE FUTURE INTEREST.

# TOP QUALITY *Still at* LOW PRICE

## Thermostatic DELAY RELAYS

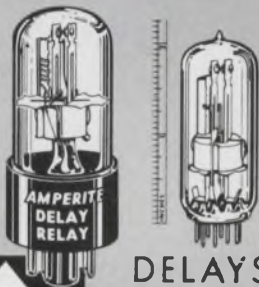

DELAYS:  
**2 to 180**  
SECONDS\*

Actuated by a heater, they operate on A.C., D.C., or Pulsating Current. Being hermetically sealed, they are not affected by altitude, moisture, or climate changes.

... SPST only—normally open or normally closed... Compensated for ambient temperature changes from  $-55^{\circ}$  to  $+80^{\circ}$  C... Heaters consume approximately 2 W. and may be operated continuously. The units are rugged, explosion-proof, long-lived, and inexpensive!

TYPES: Standard Radio

Octal and 9-Pin Miniature. . . . List Price, \$4.00

\*Miniatures Delays: 2 to 120 seconds.

All Amperite Delay Relays are recognized under component program of Underwriters' Laboratories, Inc. for all voltages up to and including 115V.

PROBLEM? Send for Bulletin No. TR-81.

### AMPERITE BALLAST REGULATORS

Hermetically sealed, they are not affected by changes in altitude, ambient temperature ( $-50^{\circ}$  to  $+70^{\circ}$  C.), or humidity... Rugged, light, compact, most inexpensive.

List Price, \$3.00

Write for 4-p. Bulletin No. AB-51.



# AMPERITE

600 PALISADE AVE., UNION CITY, N.J. 07087

Telephone: 201 UNion 4-9503

In Canada: Atlas Radio Corp., Ltd.,

50 Wingold Ave., Toronto 10

ed \$5-million unit cost, the Air Force re-evaluated its requirements and found it could reduce cargo compartment, takeoff distance and speed specifications. This permitted one of the competing manufacturers to change his design from a swing wing to a fixed wing, resulting in a considerable saving.

Design-to-cost is especially important in the design of electronic systems, Jacques Gansler, assistant director for defense research and engineering for electronics, points out. He notes that military electronics equipment, comprising 20 to 30% of many weapons systems, has grown in cost an average of 25% a year. Sophistication has increased, but while electronic parts reliability has improved, the reliability of these new sophisticated systems has remained low. The focus on cost has resulted in a hard look at reliability figures, since they control life-cycle costs.

Air-to-air radars, for example, now cost some \$500,000 each or more, but have an average field reliability of only 20 hours and some significantly less. Gansler indicates that as a corollary to design-to-cost, the Defense Dept. is considering buying field warranties for equipment, making the manufacturer responsible for its operation for the first few years of use. This could provide incentive to industry to reduce the causes of field failure in the design phase, he notes.

### Shifting the cost emphasis

Before the military crackdown on unit costs, some defense planners say, contractor design engineers were responsible for performance, reliability and schedule but often were not considered to have even a "need to know" regarding financial information. Some companies had separate production teams that were responsible for modifying the completed design to meet any cost restraints.

The Pentagon has run several successful experiments with the design-to-cost concept. In one case the three services decided on a figure of \$33,000 a unit in a lot of 50 for a tactical 16-inch CRT display system—a complex piece of equipment that combined a radar display, computer graphics, including mapping and alphanumeric leg-

ends, and other features. The design team, in which design engineers were supplemented by a production engineer and a quality-control engineer, met the target cost after several design attempts. One approach was found to simplify the design greatly while producing the required performance.

Rather than monitor every small element of a program, the Defense Dept. has suggested that in many instances the "pare-to" principle can be applied. Under this principle, if 20% of the items in a system account for 80% of the total costs, say, only a relatively few high-cost items need be monitored to keep the price of the whole system in control.

Cost analysis—including a determination of production-process learning curves, tooling philosophy, production rates, inflation-escalation factors, shipping costs and the like—must be applied as the design progresses. This may result in longer design phases, Defense officials note, but the few months' wait and additional dollars spent on the design contract itself should, they believe, translate into substantial dollar savings on the finished product.

The design-to-cost procedure differs from total package procurement in that each step is taken separately and the manufacturer's cost figures can be tested before the Pentagon is committed to production. It should not be confused with "should cost," an approach taken by the Defense Dept. when an item already is in production (and usually overpriced) to determine what the price should be after a study of the manufacturer's production methods.

If the objectives of the design-to-cost program are met, defense planners say, the changes for Congressional approval for production of equipment should be noticeably higher. The Cheyenne helicopter and Main Battle Tank projects were canceled after hundreds of millions of dollars had been spent on development, defense specialists note ruefully, because the equipment did not work and the costs were far above initial estimates. Had these projects been designed to a cost figure, the Defense Dept. now says, the problems would have been visible immediately in the design phase. ■■

# The Bud story. There's no end to it!

2,677 PRODUCTS are an important part of it. The most extensive line of enclosures, cabinet racks and subassembly cabinetry available from stock, anywhere. Everything from utility enclosures and miniboxes to the sophisticated, high-style Designers' Group. All with a design flair that makes your products look as good as they are. And for super-fast service, there are 321 stocking

industrial distributors as near as your phone.

That's Bud — the smart way to give your components a distinctive look and competitive selling edge without custom-design costs or custom-design delays.

## BUD



CLASSIC II Enclosures — part of The Designers' Group, created by award-winning Industrial Designers. And an outstanding Series that's typical of the 2,677 racks, cabinets and enclosures available from stock.

BUD Radio, Inc., Willoughby, Ohio 44094

Write for the whole story on The Designers' Group. Please send brochure to:

Name \_\_\_\_\_ Title \_\_\_\_\_

Company \_\_\_\_\_

Street \_\_\_\_\_

City \_\_\_\_\_

State \_\_\_\_\_ Zip \_\_\_\_\_

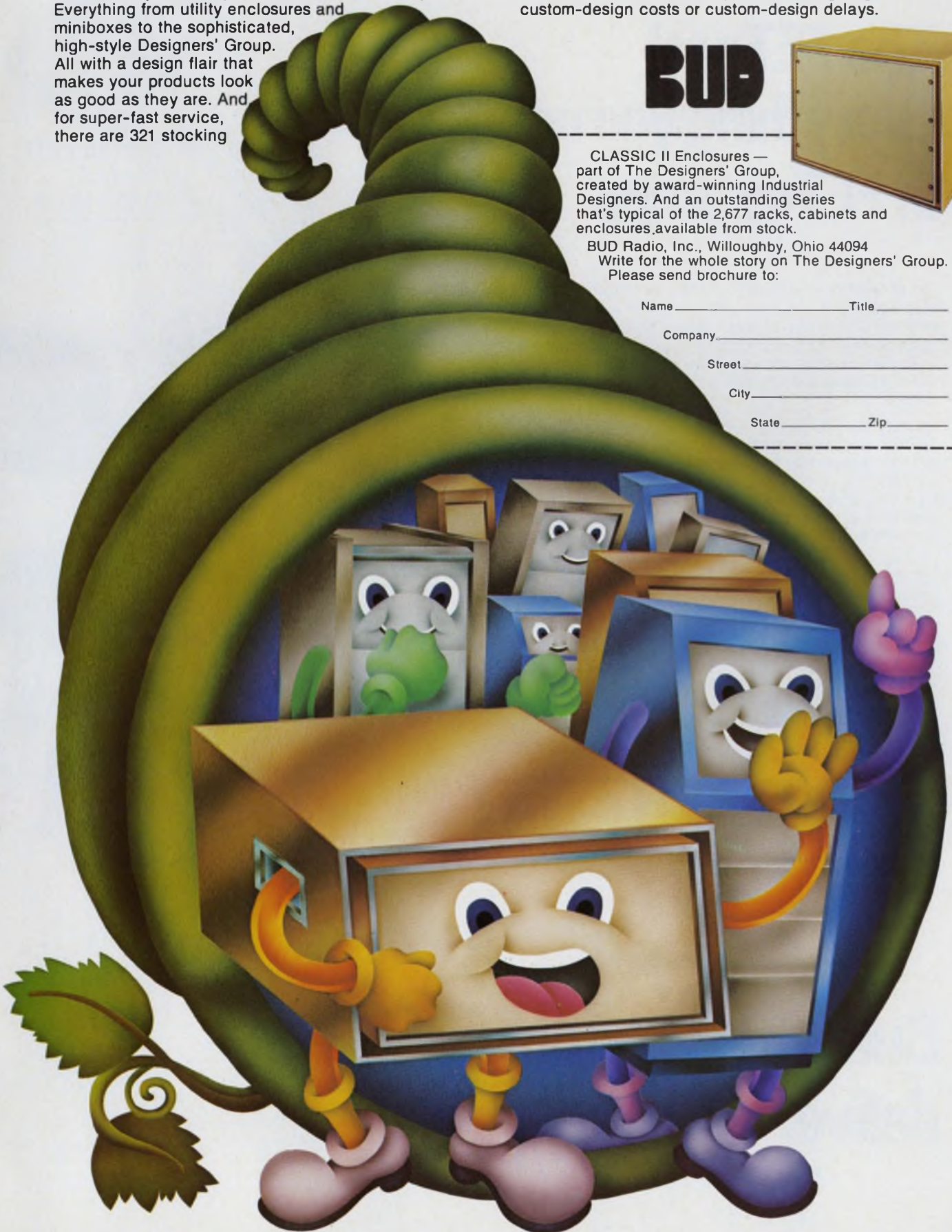

# The FET set! Everything you need in FET op amps

The Burr-Brown family of TO-99 FET op amps offers you a one-stop source for the exact FET units you need, regardless of your requirements. The three units highlighted below are representative of the performance and price advantages available from Burr-Brown's new 14 unit series. They are pin compatible with 741 types and are 100% tested to all min/max specifications.

Hybrid/thin-film techniques and a monolithic FET input stage provide excellent drift characteristics for source impedances to 1 M $\Omega$ . Active laser trimming of proprietary Burr-Brown high-stability, thin-film resistors contributes to outstanding performance at reasonable prices. Both output short circuit and input-to-supply-voltage protection are provided. Units are also available with MIL temperature ratings and MIL-883 screening.

MODEL NO.	3521L	3522L	3542J
Input Offset Voltage vs Temperature, Max.	$\pm 1\mu\text{V}/^\circ\text{C}$	$\pm 25\mu\text{V}/^\circ\text{C}$	$\pm 50\mu\text{V}/^\circ\text{C}$
Initial Offset, 25°C, Max.	250 $\mu\text{V}$	$\pm 500\mu\text{V}$	$\pm 20\text{mV}$
Input Bias Current, Max.	-10pA	$\pm 1\text{pA}$	-25pA
Price, 100 up	\$28.00	\$12.50	\$4.50

FOR COMPLETE INFORMATION, use this publication's reader service card or call Burr-Brown.

INFORMATION RETRIEVAL NUMBER 121

**BURR-BROWN**

RESEARCH CORPORATION

International Airport Industrial Park • Tucson, Arizona 85706  
TEL 602-294-1431 • TWX 910-952-1111 • CABLE BBRCORP

CHICAGO OFFICE (312) 832-6520

UNITED KINGDOM OFFICE: Watford WD1 8BY PHONE 33080/30336

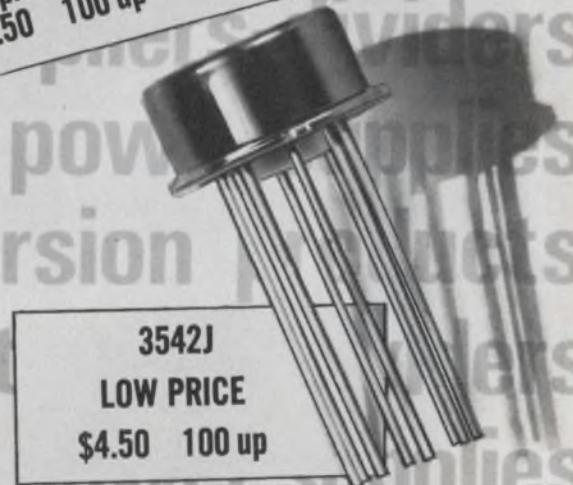
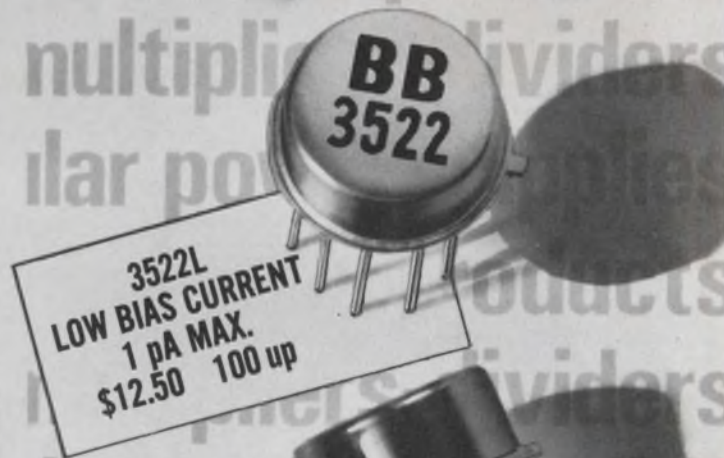

## Burr-Brown amplifiers deliver what they promise!

# Low Cost Power

## For Modules and IC's

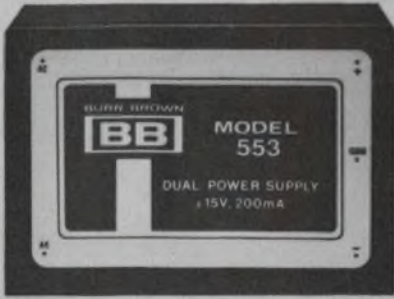

Burr-Brown's new line of small, low-cost modular power supplies offers outstanding economy and flexibility. Dual supplies are available with outputs from  $\pm 12\text{Vdc}$  to  $\pm 26\text{Vdc}$  and current ratings of  $\pm 25\text{mA}$  to  $\pm 200\text{mA}$  as well as 5 Volt logic supplies rated from 250mA to 1.0 amp and a wide variety of DC-DC converters. A few of the more popular models are listed below.

$\pm 15\text{VDC}$ DUAL SUPPLIES	RATED OUTPUT Current (min.)	REGULATION No load to full load (max.)	PRICE (1-9)
550	$\pm 25\text{mA}$	$\pm 0.1\%$	\$23.00
551	$\pm 50\text{mA}$	$\pm 0.05\%$	\$37.00
552	$\pm 100\text{mA}$	$\pm 0.05\%$	\$49.00
553	$\pm 200\text{mA}$	$\pm 0.05\%$	\$69.00

### 5VDC LOGIC SUPPLIES

560	250mA	$\pm 0.1\%$	\$39.00
561	500mA	$\pm 0.1\%$	\$47.00
562	1.00A	$\pm 0.1\%$	\$67.00

FOR COMPLETE INFORMATION use this publication's reader service card or contact Burr-Brown.



International Airport Industrial Park • Tucson, Arizona 85706  
Tel. 602-298-1181 • TWX 910-952-1111 • Cable: BURRCORP

**Burr-Brown  
modular  
power supplies  
deliver what  
they promise**

## IBM puts entire disc system in one removable cartridge

A new concept in magnetic-disc information storage has emerged with the introduction of IBM's Model 115 of the System 370 computer. The disc unit, known as the IBM 3340 Data Module, combines disc recording surfaces, access arms and read/write heads into a single removable cartridge.

The data module, an IBM spokesman notes, writes more than 1.5 million bits of data per square inch on the disc surface—twice the recording density of the IBM 3330, the former top disc unit.

The company attributes the high density to four factors:

1. The data modules are sealed and operate in a clean-air environment to prevent errors caused by airborne contaminants.

2. The read/write head operates closer to the disc than on other devices.

3. A servo track following technique is used to help position the head more precisely.

4. The same head is used both to read in and write out the data, thereby eliminating misalignment problems.

Other advantages of the new

disc system, IBM says, include a lower average seek time—25 ms, compared with 30 ms for the IBM 3330—and a higher maximum data rate—885,000 bytes-per-second, compared with 806,000.

Not all the characteristics of the 3340 surpass the older 3330. The disc of the new data module spins slower than the older disc device and thus has a longer average latency—10.1 ms, compared with 8.3. Latency is the time required for one revolution.

Another disadvantage of the 3340 is that it can only hold a maximum of 69.8 million bytes, while the 3330 can hold up to 100 million.

The reliability of the 3340 data module is enhanced by an error-correction code that automatically corrects a single loss of data up to three bits long and detects errors up to 11 bits long in each record. A detailed error logging procedure detects potential problems before they become otherwise noticeable.

Although it was introduced with the new Model 115 computer, the 3340 data module can be used on other 370 computers as well. ■■



Increased data reliability results from combining disc, access arms and read/write heads into a single removable cartridge.

# VALOX

## WHEN WE SAID VALOX<sup>®</sup> FLAMES OUT IN ZERO SECONDS, A FEW PEOPLE MADE THE CONNECTION.

Introduced only recently, VALOX thermoplastic polyester is already turning up in electrical connectors for everything from appliances and cars to oil drilling and tv sets.

Why? Because in tough UL flammability tests, VALOX resin flames out in zero seconds flat. So it surpasses UL SE-O and Group I self-extinguishing standards.

What's more, unlike nylon, VALOX resin offers better dimensional stability, much lower water

absorption and better high-temperature electrical properties.

Unlike phenolic, it has better electricals and overall toughness.

And unlike DAP, it provides greater impact resistance and higher dielectric strength at lower finished-part cost.

VALOX resin has the rigidity and dimensional stability to prevent warpage, changing tolerances and loss of critical contacts. Plus heat resistance to over 400° F, built-in

lubricity and unsurpassed chemical resistance. And it usually molds easier and injection cycles faster than any other engineering plastic.

For full details on VALOX thermoplastic polyester, The Connector Material, write Section 176, Plastics Dept., General Electric Co., One Plastics Ave., Pittsfield, Mass. 01201

World Leader in Engineering Plastics  
LEXAN<sup>®</sup> • NORYL<sup>™</sup> • GENAL<sup>™</sup> • PHENOLICS • VALOX<sup>™</sup>

GENERAL  ELECTRIC

# washington report



Heather M. David  
Washington Bureau

## **R&D for energy: A potentially big field?**

New opportunities for segments of the electronics industry may be generated by a bill that proposes spending \$20-billion for a crash R&D program to make the U.S. independent in meeting its own energy needs by 1983. The bill calls for development of new, more efficient ways to generate energy, transmit and use it. The bill is sponsored by Senators Henry Jackson (D-Wash.), Warren Magnuson (D-Wash.) and Jennings Randolph (D-W. Va.).

At the present time almost 75% of the current \$800-million energy R&D budget is earmarked for nuclear projects, with only a pittance going to the National Science Foundation and the National Aeronautics and Space Administration, Washington, D.C., for other technology efforts. Sponsors of the new bill, which would raise the level of R&D for energy to \$2-billion a year, say they have enough votes to get the bill passed and, if necessary, override a Presidential veto.

## **Congress to investigate computers and communications industries**

A probe into the structure of the computing and communications industries is receiving priority attention in a survey by the Senate Anti-Trust and Monopoly Subcommittee. Staff sources say major industry witnesses will be called later this year to testify in connection with a bill introduced by Sen. Philip Hart (D-Mich.), which would establish a commission to reorganize major industries where monopoly may exist. Although the bill is not expected to pass this session, the subcommittee's intent is to call attention to problems that may exist, and that could be acted upon immediately by enforcement agencies such as the Justice Dept. With feelings riding high in Washington on the various litigations involving IBM and other computer companies, the hearings could produce some real fireworks.

## **A new try to cut patent red tape**

Inventors of new electronic devices may find it far easier to get their designs patented if a proposal to streamline the patent system is adopted by Congress. According to Sen. Philip Hart (D-Mich.), who is calling for the first overhaul of the patent system since 1836, the present system frustrates invention and ties up technology. Present backlog in the Patent Office, he notes, is 2-1/2 years.

The proposed Legislation would make the Patent Office independent of the Commerce Dept.'s interests, and give it powers to subpoena, investigate and research the patentability of an invention. This would enable

the Patent Office to deny patents that are being found invalid in courts in great numbers at the present time.

Hart would set a low rate for patent fees at the time of filing, increasing them only when an invention is put to work and the inventor can afford them. Patent hearings which are now secret would be replaced with public adversary hearings including public counsel in the patent office to argue for the public interest.

## **Wanted: smarter anti-radiation missiles**

The Navy is looking for a contractor for a three-year program to develop a new radar homing missile for its tactical aircraft. The new weapon would replace the Shrike and Standard anti-radiation missiles whose performance has been criticized by both the military and Congress; both anti-radiation missiles can be foiled if the enemy radar is turned off. The Navy presumably will look for means to overcome this problem—possibly by incorporating a memory into the missile guidance system. Companies interested in participating in the design, development and testing of guidance, control and air frame subsystems can contact the Naval Air Systems Command, Washington, D.C., by April 18.

**Capital capsules:** Three companies are in on the ground floor of a potentially large project as the Air Force starts **design of its next generation of data-gathering and electronic-warfare drones**. Competitive design contracts have been awarded to Hughes Aircraft, Sperry Rand, Univac and RCA. Two will be chosen next year for a prototype flyoff competition. . . . Rumors of a potential overrun in the Air Force's F-15 aircraft program have prompted **groans from lower-level electronics subcontractors and components manufacturers**. "As the price goes up, the number of systems goes down, and we sell that much less," one manufacturer points out. . . . The American Satellite Corp., a joint venture of Fairchild Industries and Western Union International, has made arrangements with NASA to **launch its first satellite in the fall of 1974**, if the FCC approves. Amsat recently contracted with Hughes Aircraft for the construction of three 12-transponder satellites. . . . Sen. William Proxmire (D-Wis.), chairman of a Space Appropriations Subcommittee, indicates he will move to **cut most of NASA's \$28-million request for supersonic transport research**. A subcommittee of Proxmire's Joint Economic Committee has issued a report concluding that the U.S. should stop funding SST research. . . . The Boeing Co. has finally signed a contract with Westinghouse Electric for the **overland radar system for the Airborne Warning and Control System**. The \$70-million advance contract brings money spent on radar development for the project to almost \$250-million, part of which went to Hughes Aircraft in earlier competition. . . . NASA indicates its **High Energy Astronomy Observatory program, now in a state of budgetary suspension, may go ahead in a year or so**. Current thinking is toward a three-launch program with a 2800-pound payload boosted by the Atlas-Centaur rocket. . . . Rep. Edwin Forsyth (R-N.J.) has asked the General Accounting Office to investigate a Navy plan to spend \$600,000 for R&D on a **computerized telecommunication system that, he says, is available off-the-shelf** from Comdata Systems, Inc., of Burlington, N. J. . . . The Dept. of Transportation's Federal Railroad Administration has awarded a \$600,000 contract to Grumman Aerospace for the first eight months of a **three-year test of an electrically propelled, tracked air-cushion vehicle**.



# the TEKTRONIX DIGITAL PROCESSING OSCILLOSCOPE...

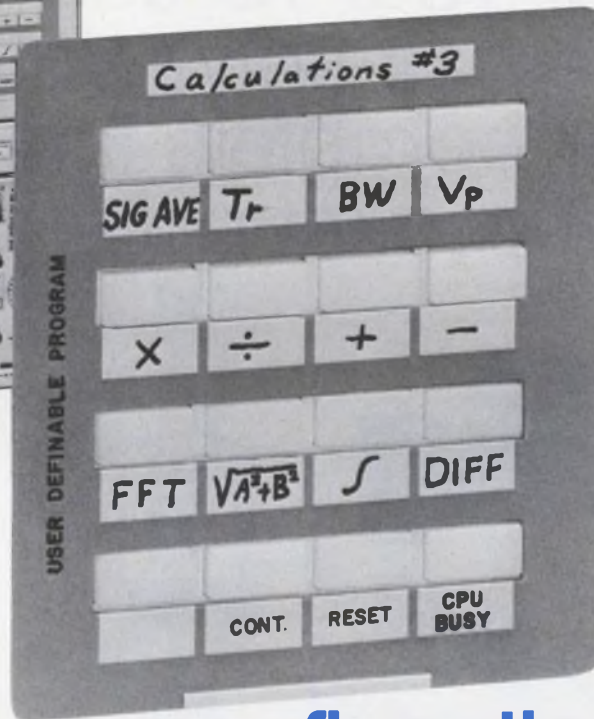
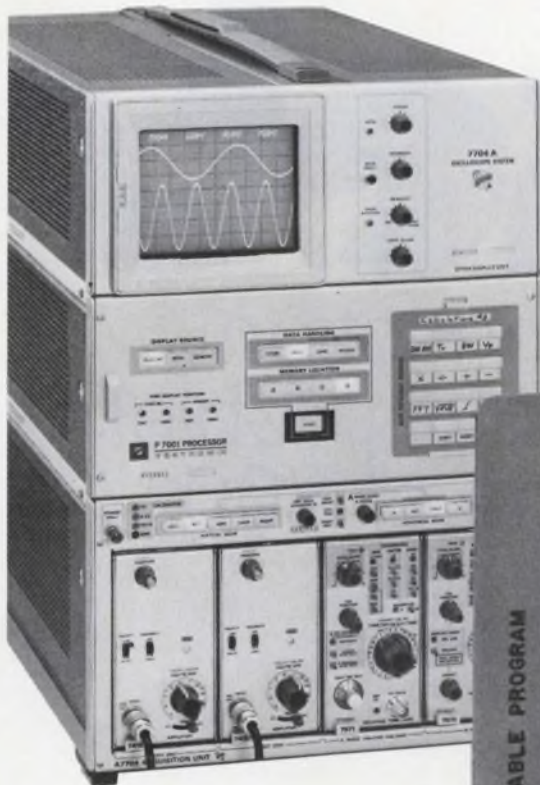

...fingertip selection  
of entirely new waveform measurements.

The popular 7704A laboratory oscilloscope now has digital processing capability. The Acquisition unit A7704 and Display unit D7704 have a new look with a P7001 Processor unit inserted between them forming the APD unit. The Processor together with a PDP-11/05 minicomputer brings the power of computer processing to the signal display and acquisition capabilities of the Type 7704A.

The A7704 accepts more than 25 7000-Series plug-ins. Signal dimensions range from microvolts to kilovolts in amplitude, and from picoseconds to seconds in time, with bandwidths from DC to 14 GHz. The Digital Processing Oscilloscope is more than just a computerized oscilloscope. It is offered in packages complete with PDP-11/05 computers, computer terminals, computer peripherals and measurement software. TEKTRONIX offers two software packages APD BASIC I for the PDP-11 with 8 k core memory and APD BASIC II for 16 k core machines.

Using APD BASIC you store desired measurement programs in the computer. You may then fill in the User

Definable Program overlay as shown above and your routines are available at the press of a button. The range of possible measurements is almost unlimited. You may have measurement operations which range from simple addition or multiplication to sophisticated integration, FFT and many more. A complete program involving many operations is easily stored and assigned to a desired push-button.

To learn the complete Digital Processing Oscilloscope story write for a copy of "The Digital Processing Oscilloscope", and "The 7000-Series Oscilloscope Catalog", or check the reader service box.



**TEKTRONIX®**

P.O. Box 500  
Beaverton, Oregon 97005  
in Europe — TEKTRONIX LTD.  
Guernsey, C.I., U.K.

# Sockets

Whatever your IC connection need, we can solve your problem - from our complete line of 800 standard socket products.

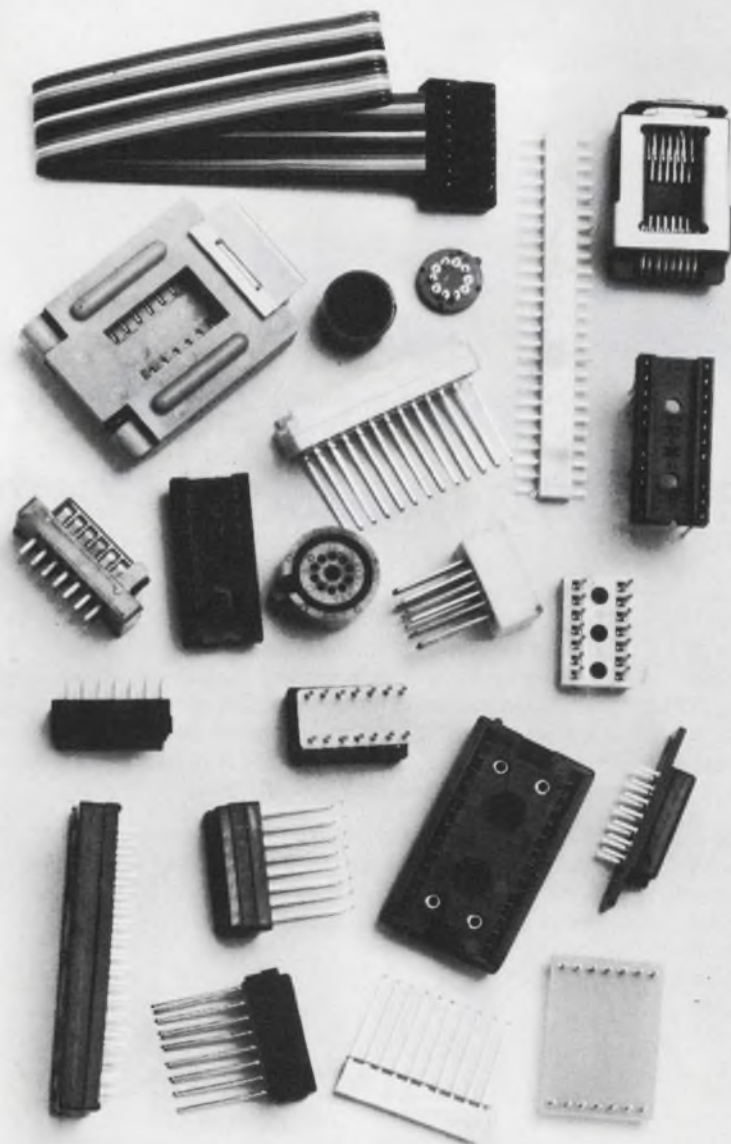

Beside being able to furnish everything from IC Sockets to a total IC interconnection system - with anytime availability through our local distributors, we've a couple more compelling reasons why you should contact us first. Robinson-Nugent quality and competitive pricing.

For prompt attention to your requirements, contact the Socket People:



800 East Eighth Street  
New Albany, Indiana 47150  
(812) 945-0211 TWX 810-540-4082

# MORE VALUE IN TELEQUIPMENT



## DUAL-TRACE OSCILLOSCOPES

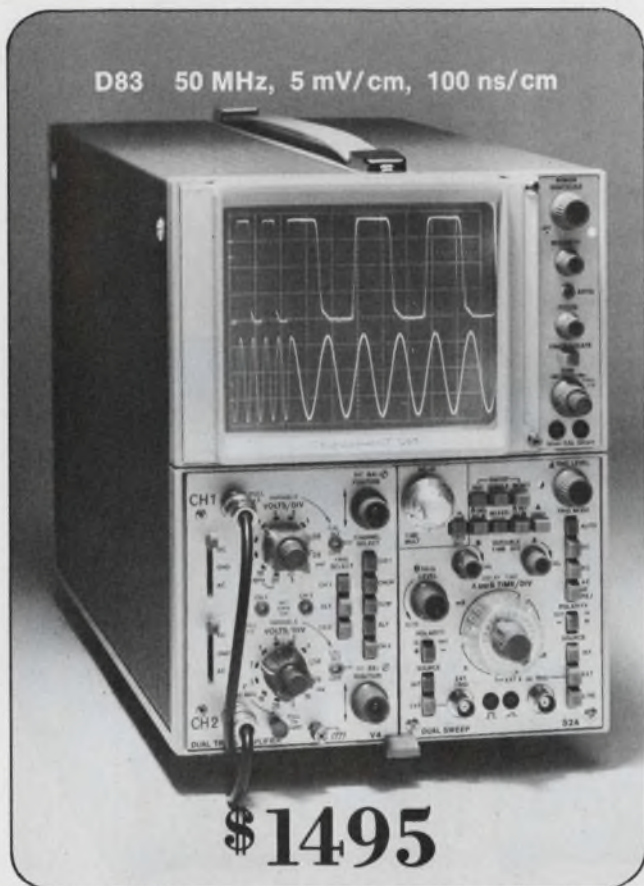

**Lowest cost 50-MHz dual-trace delaying sweep oscilloscope.** Large, bright 6½-inch CRT, 3% accuracy. Two vertical plug-ins are available: 5 mV/cm dual-trace and a differential amplifier. The time base is calibrated to 100 ns/div (10 ns with X10 MAG); mixed sweep is standard.

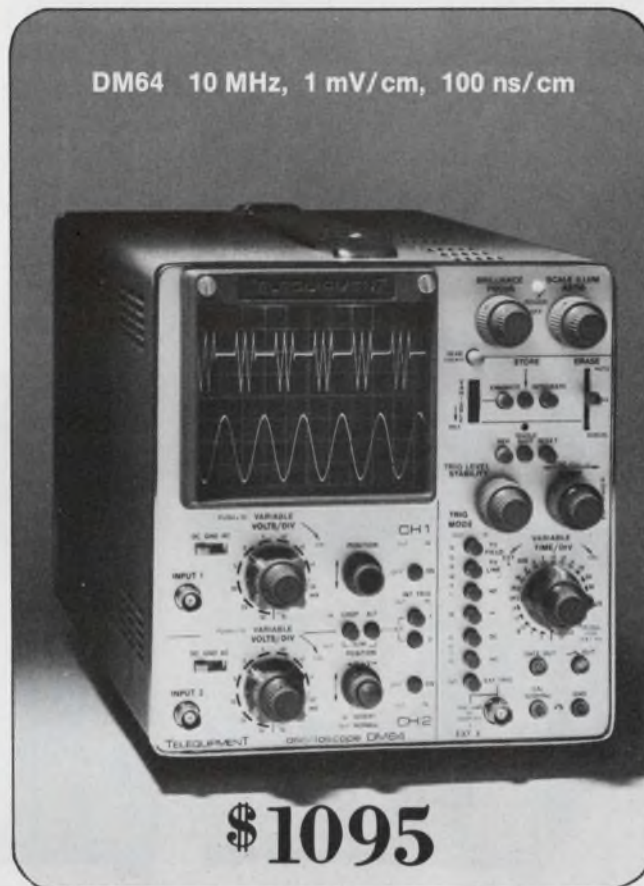

**Lowest cost 10-MHz dual-trace oscilloscope with bistable storage.** The DM64 lets you view displays for up to one hour. Other features include 1 mV/cm vertical, 100 ns/cm time base (40 ns with MAG), triggered sweep, and much more.

**Both of these new value leaders are available from stock.**

The TELEQUIPMENT line is backed with the same warranty as other TEKTRONIX products, and is marketed and supported through an international network of TEKTRONIX Field Offices, Service Centers, Distributors, and Representatives. Call your nearest office, or write Tektronix, Inc., P.O. Box 500, Beaverton, Oregon 97005. A new catalog showing the entire TELEQUIPMENT line is available on request.

## Part of the Telequipment line from Tektronix, Inc.

U.S. Sales Prices FOB Beaverton, Oregon

INFORMATION RETRIEVAL NUMBER 37

# Fast Stored Writing Speed, With Long Viewing Times.

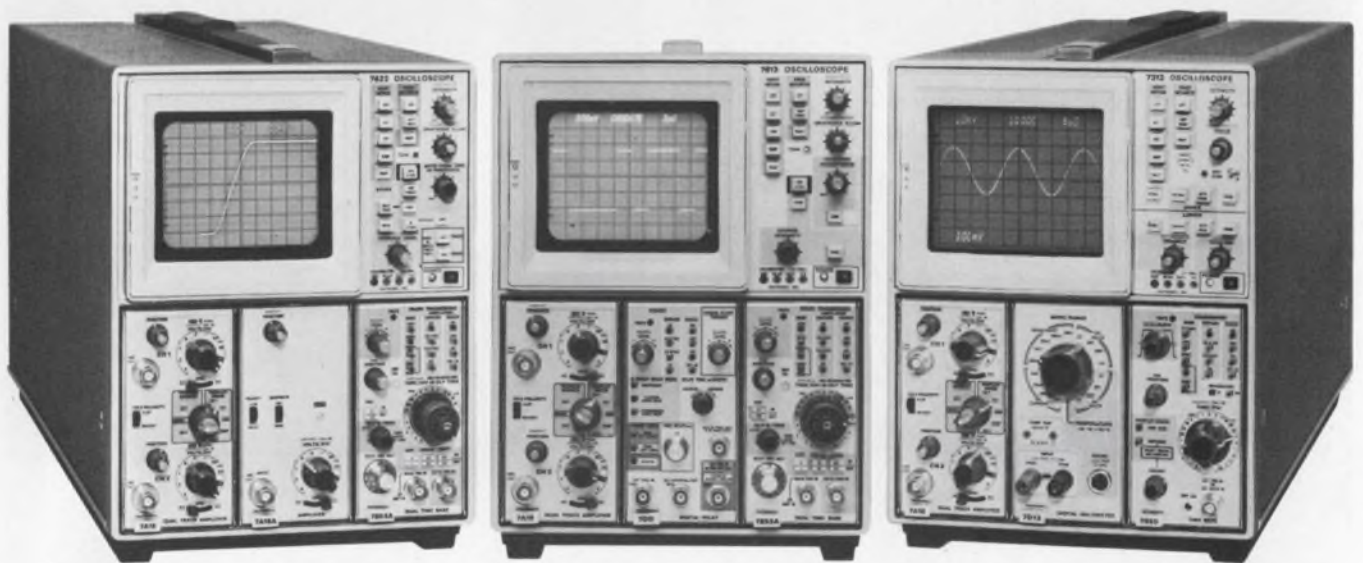

## The Tektronix 7000-Series Storage Family

Your requirements, to store and look at increasingly-faster waveforms, spurs us on in our storage R & D effort. Storage technology is not new to TEKTRONIX, we are now in our 11th year of delivering Storage Scopes. We believe that the multimode 7623 Storage Oscilloscope, our latest and fastest storage mainframe, offers you the very best storage/view-time capability available today

(200 cm/ $\mu$ s for hours). We invite you to try this multimode scope in your application and see for yourself. And high-speed storage is just one of the modes available in this mainframe. You may also choose Variable Persistence, Bistable Storage or Non-storage operation at the push of a button.

There are four other members in the TEKTRONIX 7000-Series

Storage Family with each one offering an excellent price/performance ratio. Choose the 7613/R7613 for Variable Persistence Storage or the 7313/R7313 for Bistable Phosphor Storage. All four models have stored writing speeds up to 5 cm/ $\mu$ s and operate in two modes: STORE and NONSTORE (conventional).

# Three Types of Storage, Six Mainframes

## Multimode Storage (7623/R7623)

**4 modes of Operation**  
**100 MHz bandwidth**

**FAST**—stores up to 200cm/ $\mu$ s with the FAST CRT option and up to 100 div/ $\mu$ s (0.9 div/cm) in the standard model.

**VARIABLE PERSISTENCE**—for those bright high contrast or halftone displays.

**BISTABLE**—for the lower writing speed requirements of 30 div/ms and slower.

**NONSTORE**—for the conventional oscilloscope applications.

## Variable Persistence Storage (7613/R7613)

**2 modes of operation**  
**100 MHz bandwidth**

**VARIABLE PERSISTENCE**—gives bright high contrast display of fast-risetime low rep-rate signals, ideal display for the 7L12 Spectrum Analyzer. Stores up to 5 div/ $\mu$ s (0.9 div/cm).

**NONSTORE**—for the conventional oscilloscope applications.

## Bistable Phosphor Storage (7313/R7313) 2 modes of operation

**25 MHz bandwidth**

**STORE**—retains fast waveforms moving up to 5 cm/ $\mu$ s. Features split-screen operation for realtime and stored waveform comparisons.

**NONSTORE**—for the conventional oscilloscope applications.



complex, in many disciplines, are solvable with 7000-Series plug-ins. Choose from: Amplifiers, Time Bases, Curve Tracer, Digital Multimeter, Digital Counters, Digital Delay, Sampler and Spectrum Analyzer Plug-ins . . . and there are more coming.

Tektronix, Inc. . . . the pioneering pacesetter in storage display technology, offers sales, after sales support, and service . . . world wide.

## All oscilloscopes with CRT READOUT

You gain overall efficiency in operator speed and accuracy and simplify your measurements by using CRT READOUT. It puts the measurement parameters, right on the CRT, adjacent to the waveform you are viewing, measuring or photographing.

With CRT READOUT you can use the complete line of Digital plug-ins available in the 7000 Series.

**All CRT's are extremely burn resistant . . . requiring no special operating precautions.**

**7000-Series . . . more than just an oscilloscope.**

A 7000-Series mainframe equipped from a selection of over 22 plug-ins plus an entire line of probes, cameras, SCOPE-MOBILE carts and other accessories offers you the widest scale of measurement solutions available today.

Measurement problems, ranging from the very simplest to the most

### PRICES without plug-ins:

Mainframe	w/o CRT	
	READOUT	STANDARD
7623	\$2450	\$2850
R7623	\$2550	\$2950
<b>for FAST WRITING CRT add \$500</b>		
7613	\$2100	\$2500
R7613	\$2200	\$2600
7313	\$1600	\$2000
R7313	\$1700	\$2100

For a "hands-on" demonstration of the only total storage capability, contact your nearby TEKTRONIX Field Engineer or write: Tektronix, Inc., P.O. Box 500, Beaverton, Oregon 97005. In Europe write: Tektronix Ltd., P.O. Box 36, St. Peter Port, Guernsey, Channel Islands.



**TEKTRONIX®**  
committed to  
technical excellence

INFORMATION RETRIEVAL NUMBER 38

### CHARTS SHOW PROPERTIES OF DIELECTRIC MATERIALS



Two charts in full color show dielectric and other properties of hundreds of materials used by electrical/electronic engineers . . . arranged by dielectric constant and dissipation factor. Send for free copies.

INFORMATION RETRIEVAL NUMBER 207

### NEW TECHNICAL DATA ON EPOXY CASTING RESINS



STYCAST® Casting Resins are described and properties tabulated in this new folder/wall chart. Includes all significant properties of 24 high-performance resins plus notes on curing agents, cure procedures and use. Valuable reference.

INFORMATION RETRIEVAL NUMBER 208

## ECCOAMP

### ELECTRICALLY CONDUCTIVE ADHESIVES & COATINGS



New four page folder describes materials from 0.0001 to 100 ohm-cm. Adhesive pastes to replace hot solder, thin liquids, silver lacquer in aerosol spray, lossy coatings, etc.

INFORMATION RETRIEVAL NUMBER 209

### Emerson & Cuming, Inc.



CANTON, MASS.  
GARDENA, CALIF.  
NORTHBROOK, ILL.  
Sales Offices  
in Principal Cities

EMERSON & CUMING EUROPE N.V., Corval, Belgium

## technology abroad

Laser control of Czochralski crystal growing, used for making large single crystals of semiconductor materials, has been achieved by Philips of Aachen, West Germany. The new method, which depends on the laser and an associated detector to sense interferometrically the slope of a certain point in the meniscus between the growing crystal and the melt, can be applied to any crystal material and crucible de-

sign. The reflected signal from the slope is picked up by two filtered photodiodes arranged so the ratio of their photocurrents is proportional to the deflection angle. The difference signal can be used to control the speed of rotation of the pulled crystal and the melt temperature so the slope (and hence crystal diameter) changes at the desired rate of speed.

CIRCLE NO. 445

A direct-measuring, direct-display frequency/period meter with fully programmable measurements up to 1 GHz has been produced by Racal Instruments of Windsor, England. This development is based on the use of Plessey's recently announced Process III

high-speed, bipolar integrated circuits. The frequency meter—the 9025—has an eight-digit display with memory, a precision crystal standard stable to within three parts in 10<sup>9</sup>, long term, and an input sensitivity of 50 mV.

CIRCLE NO. 446

Infrared reflectance is being used in Sweden in an on-line optical system to measure the moisture content in iron ore. By selection of the proper wavelength and the application of high power at this infrared peak, variations in reflected radiation—depending on

the moisture content in the sample—provide good results. This technique, developed by the LKAB mining company of Sweden with the Sira Institute of England, has been used in mining operations at Malberget, Sweden, within the Arctic Circle. CIRCLE NO. 447

The upper limit of bit rate that can be transmitted by a digital waveguide system is under investigation by a West German research team. Experiments have been carried out at 38 GHz with a bit rate of 640 Mbit/s. These limits were imposed by the microelectronic devices used in the tests. The transmitter developed

by the Germans at the Forschungsinstitut Fernmeldetechnisches Zentralamt, Darmstadt, West Germany, uses a simulator to generate a 640 Mbit/s pcm test signal. Modulation was achieved with a varactor diode installed in a rectangular R-band waveguide.

CIRCLE NO. 448

# Basic switches that help do everything from print a baby's picture to play a top tune.

Think MICRO SWITCH when you're in the market for precision, snap-action switches.

Because we offer the largest selection in the world. With most of them available right off your distributor's shelf.

MICRO SWITCH basics are extensively used on applications ranging from coin-operated phonographs (V3) to automatic film splicers (BZ). In other words, just about any application that demands

dependability and stable operating characteristics.



These features are designed into our complete line.

From our standard-size BZ to our sub-miniature 1SX. So no matter how demanding

or unique your application is, you can be confident we have the right switch for the job.

Engineers have put this design freedom to use in some unusual places. For example, the next time you're in an eye doctor's chair, there's a good chance a BA switch will be helping to make you comfortable.

To help with your applications, we have a staff of Application Engineers standing by to provide field support.

Contact your MICRO SWITCH Branch Office or Authorized Distributor (Yellow Pages, "Switches, Electric") for more information.

For additional assistance in solving your basic switch application problems, we've written a 145-page book, *APPLYING PRECISION SWITCHES*. Write us on your letterhead and we'll send you a copy.

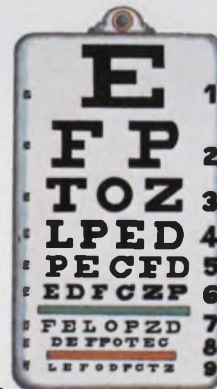

MICRO SWITCH makes your ideas work.

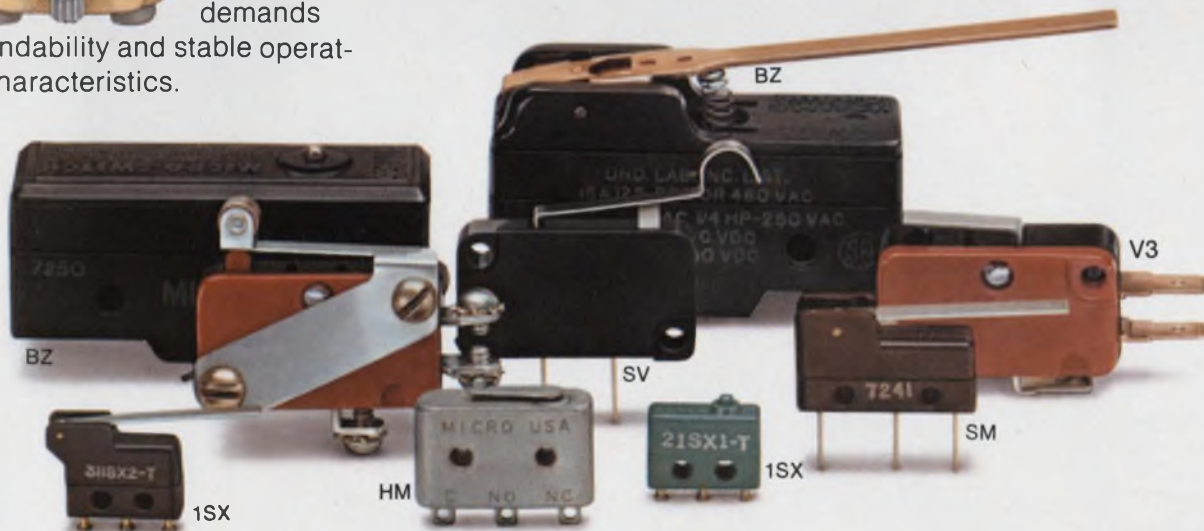

**MICRO SWITCH**  
FREEPORT ILLINOIS 61032  
A DIVISION OF HONEYWELL

MICRO SWITCH products are available worldwide through Honeywell International.

INFORMATION RETRIEVAL NUMBER 39

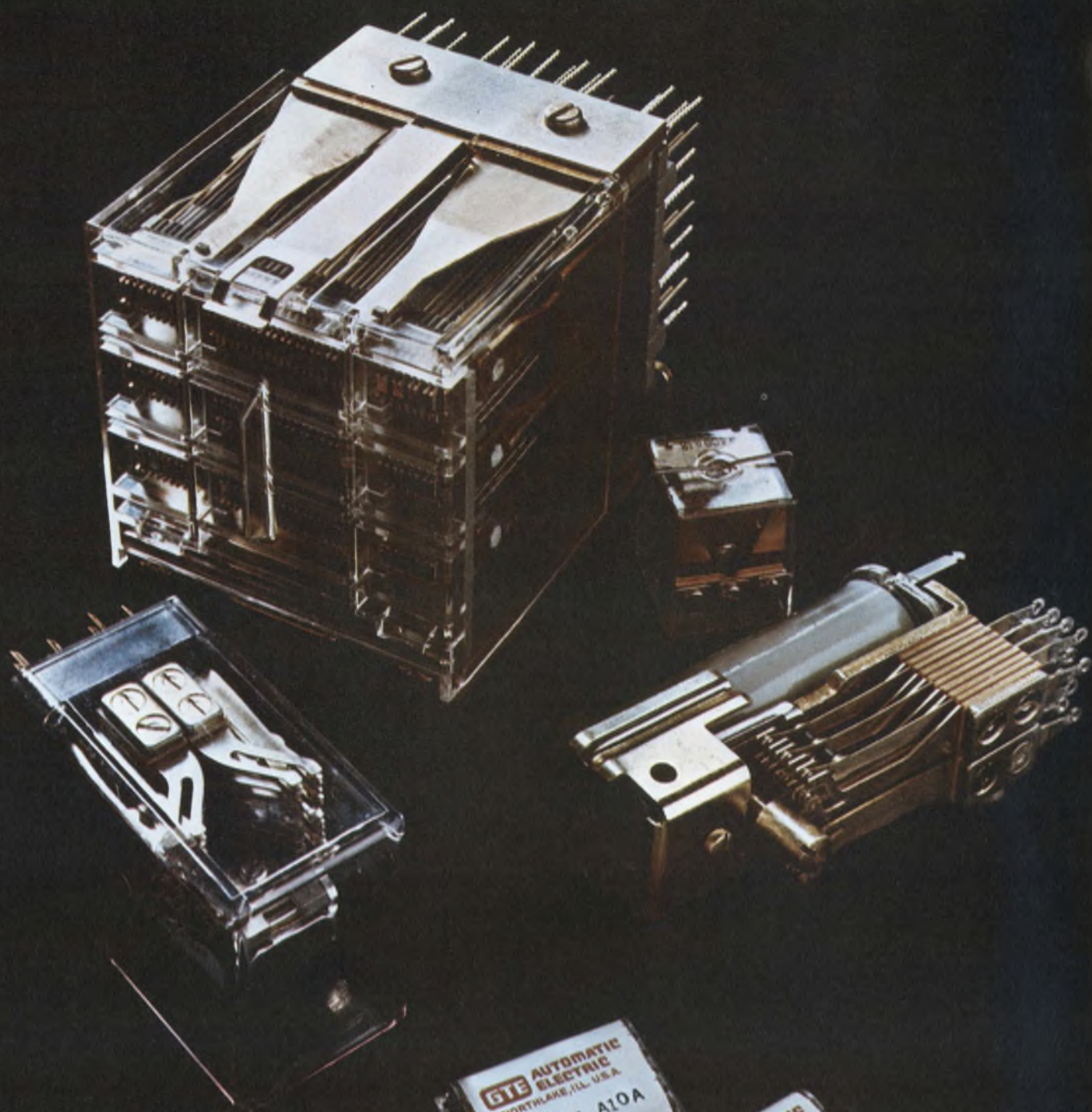

**GTE** AUTOMATIC  
ELECTRIC  
NORTHLAKE, ILL. U.S.A.

PD1311 A10A  
1930 OHMS

**GTE** AUTOMATIC  
ELECTRIC  
NORTHLAKE, ILL. U.S.A.

PD1308 A11A  
2600 OHMS



# Announcing the rediscovery of the relay.

In an age when most people think solid state is the only way to go, some designers have rediscovered the good old electro-mechanical relay. They found relays still can't be beat when it comes to certain jobs. And when they're dealing with tight fisted cost control committees. Maybe you can save some effort and expense by rediscovering the relay whenever you need these things:

## **1. Simple logic:**

Relays let you combine both power switching and logic functions economically. Memory can usually be retained, even after a power loss. And you don't need special power supplies or noise suppression techniques.

## **2. Easy troubleshooting:**

Most relay failures (and they do occur occasionally) can be identified visually. You can see what's wrong. And fix it easily.

## **3. Heat resistance:**

A relay shrugs off a short dose of overheating. Give a solid state device the same treatment while it's functioning near capacity and it's ruined forever. The amount of heat a solid state device can take is usually dependent on the heat sink used. It can take up all the room you expected to save with solid state in the first place. And finding the right heat sink design can become very involved.

## **4. Electrical isolation:**

Relays have a natural isolation between input

circuits, between output circuits, and between output and input control circuits. You can't get that with junction type semiconductors.

## **5. High insulation resistance:**

Open relay contacts have an insignificant amount of leakage ( $10^{10}$  ohms or more). Semiconductors can't match this. And, their leakage rates vary greatly with temperature changes.

## **6. Wide operating power range:**

Relays work with operating power anywhere from milliwatts to watts. And they usually don't require regulated power. Semiconductors do.

## **7. Transient voltage immunity:**

Transient voltage doesn't bother a relay. But high voltage, short duration transients can be sure death to semiconductors.

## **8. Forgiveness:**

Relays give you a little margin of safety should you want to change your mind. Maybe you find you need more contacts, or uncover a timing problem, or discover a need for absolute input-output isolation. You can change your circuit design a lot easier with relays.

If your project or product needs any of these things, just ask our salesman to help you rediscover relays. GTE Automatic Electric, Industrial Sales Division, Northlake, Illinois 60164.

**GTE AUTOMATIC ELECTRIC**

INFORMATION RETRIEVAL NUMBER 40



P-channel  
J FET



N-channel  
J FET



CMOS  
FETs



P-channel  
MOS FET



N-channel  
MOS FET

Since 1962, Siliconix has evolved FET technology and applied it to a complete line of singles, duals, arrays, and ICs. So what's new?

# Switch 10 MHz Signals with better than 60 dB OFF Isolation

The Siliconix DG181-DG191 family of FET switch/IC drivers is well-suited for processing high-frequency signals, and is directly compatible with most computer logic. FET switch/monolithic driver combinations are available in SPST, SPDT, or DPST functions.

Features include:

- Constant ON resistance with signals to  $\pm 10$  V and 100 MHz
- 60 dB OFF isolation at 10 MHz with 75  $\Omega$  load
- $t_{on}$  and  $t_{off}$  = 150 ns typical
- 1 nA max (100 pA typical) leakage from signal channel in either ON or OFF state.

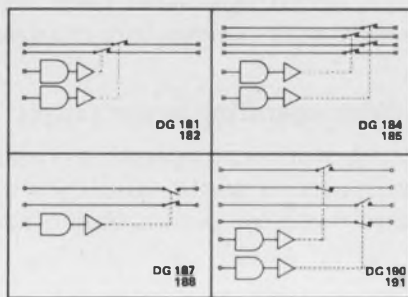

DG181-DG191 Functional Diagrams

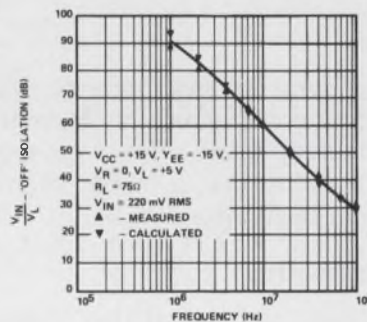

Switch OFF Isolation vs Frequency—DG181

The key to this exceptional performance is the Siliconix concept of monolithic driver design, with careful attention to critical details such as low driver output impedance. DG181-DG191 driver (switch OFF) resistance

to ground is only 200 $\Omega$ , providing good a-c by-pass on the FET switch gate. Contrast this with other driver circuits with impedances as high as 26 M $\Omega$ , which adversely affect isolation characteristics.

The DG181-DG191 series of FET analog switches is an ideal solution to most switching problems. If your case is unique—and whose isn't—our applications people are eager to help. For complete information

## write for data

Applications Engineering (408) 246-8000, Ext. 501



### Siliconix incorporated

2201 Laurelwood Road, Santa Clara, California 95054

INFORMATION RETRIEVAL NUMBER 41

## Guidelines drawn in invisible ink

A document to guide engineers/scientists and their employers to a "mutually satisfying" employment relationship was developed recently by representatives of over a dozen engineering societies, including the IEEE. Suggestions for conduct for both employee and employer were set down in the areas of recruitment, terms of employment, professional development, and job termination and transfer.

Employers are urged to provide opportunities for advancement and recognition to those engineers who don't want to be managers. Adequate pension plans are also called for, among other fringes. And employees are generally advised to be loyal to their employers and to maintain their technical competence.

But because of wide variations in employment circumstances and company practices, the drafters all but erase their guidelines by admitting that they should be construed as general goals rather than minimum standards. And there's the rub.

The guidelines are far too general to be useful. That old bromide, strength in unity, is always comforting. But what works for the American Institute of Chemists will not necessarily work for the American Society of Civil Engineers or for the Institute of Electrical and Electronics Engineers, because the working situations are often not comparable.

We also wonder how practical some of the guidelines are. For example, one suggests that the employee not use funds and time from his current employer for seeking new employment unless approved by the current employer. Are they kidding? If an engineer tells his boss that he's looking for another job, he'll likely have all his days free to look for it. And if he doesn't tell his boss, how does the company enforce the guideline?

The main trouble with guidelines, of course, is that no one follows them unless (a) they want to or (b) they have to. Even the Government has trouble getting people to follow its guidelines, and it has muscle to enforce them.

The developers of the document say the guidelines don't represent the official views of their organizations until they are formally endorsed by their respective governing bodies. But what's the point of endorsing something that has no real meaning?



*Richard L. Turmail*

RICHARD L. TURMAIL  
Management Editor

Sure



# Guardian's number one in solenoids

The Guardian Angel put us in the winner's circle by offering you more types of solenoids . . . with more features . . . than anyone else in the world. Solenoids in every imaginable shape and size to meet any electromechanical requirement you can name. Solenoids with hefty 50 pound pull . . . or a fraction of an ounce. AC and DC. Intermittent or continuous duty. Pull or push or with switch attached. In more than a score of basic designs and 61 thousand variations! Plus specials to fit your specialized applications.

## ...but what have we done for you lately?

**NOW:** Virtually all Guardian Solenoids are recognized under the component program of Underwriters' Laboratories, Inc.

**NEW:** Uni-Guard Molded Coil Covers are now standard on most Guardian laminated, box-frame and U-frame solenoids.

**MORE:** The Tubular Solenoid line is expanded to include pull and push types from lifts of a fraction of an ounce to 10-pounds-plus.

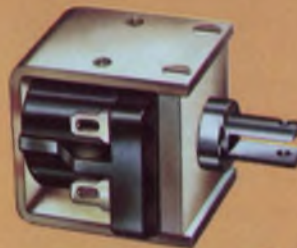

**Box-Frame Solenoids** in AC or DC for mechanical life of millions of cycles.

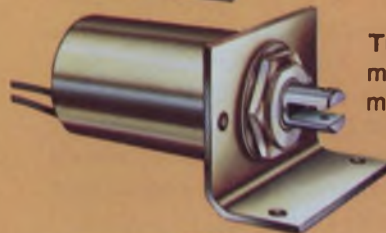

**Tubular Solenoids** that mount with only one mounting hole. DC only.



**U-Frame Solenoids** in AC or DC for minimum cost with high reliability.

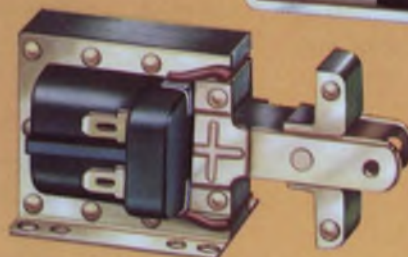

**Laminated Solenoids** in AC only for more pull over a longer stroke than DC solenoids of the same size.



# GUARDIAN®

GUARDIAN ELECTRIC MANUFACTURING CO. • 1550 West Carroll Ave., Chicago, Illinois 60607

*In a hurry? Call your Guardian Distributor.*

# FOCUS

on  
Materials

The attack on the United States dollar in international monetary circles, the upsurge of American consumerism and new trends in automobiles may seem of little immediate consequence to the general design of electronics products. But all are helping to shape the future of materials that designers use.

In the case of the dollar crisis, one result has been a sharp rise in the price of gold. Of growing concern to the users of conductive compounds for thick films and microcircuits is the steep rise in the price of precious metals they use—like gold and platinum. No proved substitute for these metals is yet available, but several manufacturers of compounds are trying to develop alternatives.

Consumerism has brought about demands for flame-resistant products and other safety features. In electronics this has reached the point where self-extinguishing dielectric materials for consumer items must meet the flame-resistance tests of Underwriters Laboratories or risk almost certain failure in the marketplace.

And a trend toward electronics under the hood of the car, where the environment is said to be tougher than that in space, is spurring a hunt for lower-cost, high-performance dielectric materials.

In nearly all electronic designing the choice of materials narrows to two basic ones: conducting materials and insulating materials. There are other materials, of course—like magnetic and electro-optical—but applications for these are more specialized.

## Conducting materials are cost-cutters

Conductive materials, resistive materials and conductive-filled plastics and elastomers are giv-

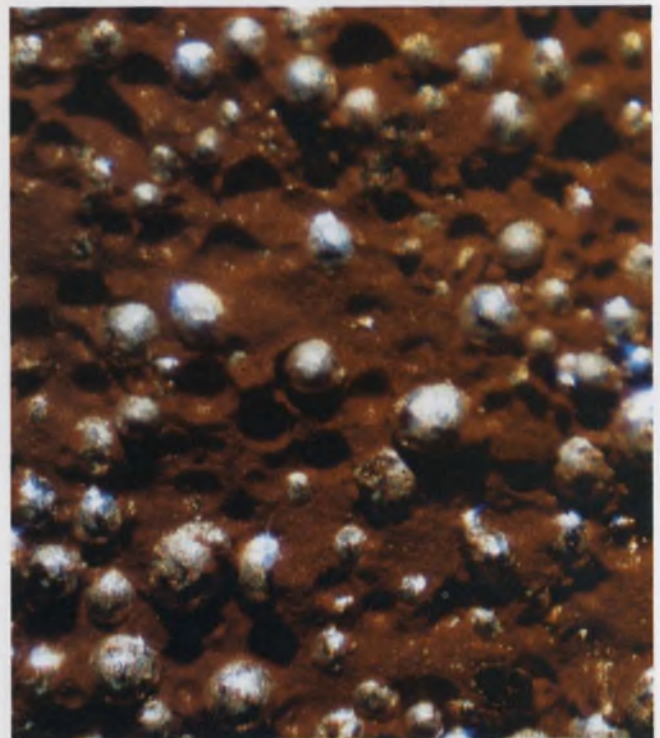

**Conductive elastomer compounds** are filled with conductive particles. This silicone rubber, by Chomerics, is mixed with micron-sized, silver-plated-copper powder.

ing the designer ways to slash costs. Formulated in conventional form, adhesives, pastes and liquids, these materials are being used for circuit and device interconnection, circuit fabrication and bonding. Their uses seem limited only by the imagination of the designer.

For example, two silver-impregnated conductive nylon tapes—one covered with hooks, the other with soft-pile loops—press together to form a secure EMI-proof joint. Produced by Technical Wire Products of Cranford, N.J., these tapes are

---

Jim McDermott  
East Coast Editor

bonded around the perimeter of equipment covers with conductive silicone or epoxy adhesives, thus eliminating hardware.

The conductive and resistive materials include these classes:

- Conductive tapes.
- Conductive coatings.
- Conductors for microcircuit packages and thick-film hybrid circuits.
- Resistive coatings.
- Conducting and resistive compounds and adhesives.

The conductive materials are applied in a vari-



Use of thick-film circuitry is expanding. These samples from Sel Rex show a variety of microcircuits that were fabricated with thick-film compounds.

ety of ways, including screen-printing, brushing, dipping and spraying.

### Conductors for microcircuits

Conductive coatings for microcircuit packages and thick-film circuits are comprised of metallic, powdered materials suspended in organic or inorganic binders, such as glass. Some compounds can be air-dried, but most are screened onto a substrate and fired.

These conducting materials are commonly used to produce the electrical conducting paths on substrates for connecting microcircuits to their connector pins, or for connecting hybrid circuit elements together on such substrates as the aluminas, steatites, glass, mica and quartz.

Materials for these applications include silver, gold, platinum-gold, palladium-silver, palladium-gold, palladium-copper-silver, molybdenum-tungsten, molybdenum alloy, molybdenum-manganese, nickel and nickel oxides (for overprinting), ruthenium and palladium-silver (for resistors).

For these conductive compounds, the firing and temperature cycles are critical. Deviations from the proper cycles can adversely affect the adhesion of the material to the substrate and the solderability of the conductive paths.

### Compounds with a range of resistivity

Conducting compounds don't necessarily have to have the conductivity of base copper, silver or gold metals to be useful. A wide number of available compounds range in resistivity from 10  $\Omega$  to 100 M $\Omega$  per square for a 1-mil film thickness.

Because of the development of microcircuits in ever-increasing complexity, there is a demand for smaller and smaller line widths. Many of the gold pastes, particularly those without a glass binder, can produce lines in 5-mil widths, but 10-15 mils is more likely in general production.

Owens Illinois of Toledo, Ohio, says that its new glass-free gold conductor material is good for 3-mil line resolution. Du Pont is pushing for reduced line widths of 1 to 5 mils with a new Fodel photoprintable paste.

Of major concern to the electronics industry are rising prices of gold, platinum and other precious metals. Owens Illinois has recently introduced on a trial basis a screen-printable copper paste for microcircuit applications. Its cost is low—about one-third that of the precious metals—and it has an exceptionally high bond strength to the alumina substrates. But there's a hitch when it comes to thick-film technology: The copper is not compatible with the commonly used ruthenium or the silver-palladium resistors.

Another limitation is the fact that the copper—to avoid oxidation—must be processed in an inert nitrogen atmosphere. And if the copper is subject to prolonged exposure to oven temperatures—for over 10 minutes at 400 C—soldering becomes difficult.

The copper does promise, however, to be useful in dual in-line packages, and 40-pin prototypes

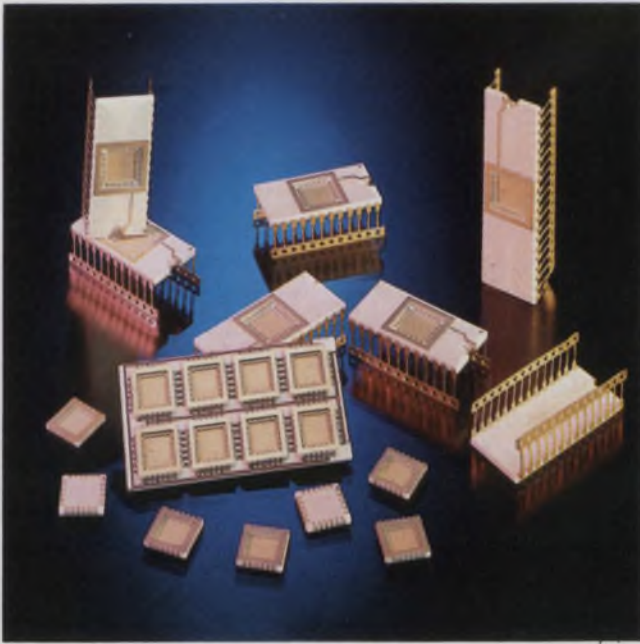

Multilayer alumina ceramic packages for ICs, by American Lava, have 24, 28 and 40 side-brazed pins. Side brazing increases die area and eliminates lead-forming.

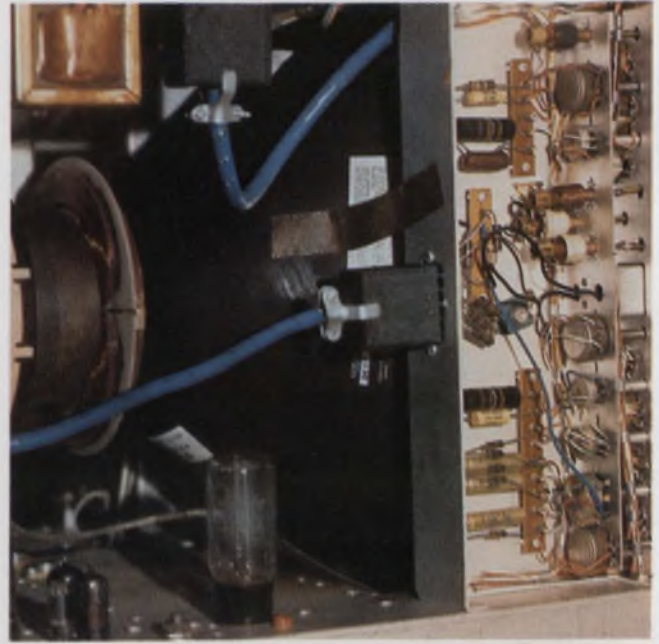

Metal tapes and conductive paints are a low-cost means of grounding and bonding. This embossed copper tape, by 3M, drains high-voltage charges from a TV tube.

have been produced for evaluation. Owens Illinois is also experimenting with pastes of aluminum, zinc nickel and iron.

George Lane, president of the Electro Materials Corp. of America, Mamaroneck, N.Y., says that his company has a nickel conductive paste that can substitute for reactive metal pastes. The new paste, he explains, can be used in such devices as triacs and transistors instead of molybdenum manganese, which requires an additional nickel plating.

#### Problems with compounds

Although conducting compounds are now widely used in thick-film work, they are not as easy to work with as some of the applications literature indicates. The percentage of materials in compounds varies from batch to batch, according to Lane. Before using a new batch, the designer must check whether it produces the same results as an older compound. If this is not done, Lane warns, there may be changes in component values.

It is also advisable to determine whether the new batch changes characteristics in the firing stages. For example, does it become difficult to solder the conductors after the second firing step? Also, if too much voltage is placed across a resistor, a permanent reduction in resistance may occur.

There is also considerable evidence, Lane notes, that laser trimming of resistors produces drift or other instabilities. Why this is so is not exactly clear, he says.

To determine whether or not a laser-trimmed

resistor will remain stable, Lane advises a high-temperature soak—say at 150 C for 10 hours.

#### Fabricating hybrid circuits

Electrically conductive gold and silver-filled epoxies provide a reliable, low-cost method of mounting semiconductor chips on hybrid substrates, and they can be used in the packaging of electro-optical devices, such as LEDs and photo-sensors. Their use eliminates the need for high-temperature eutectic bonding, which frequently alters device characteristics.

But epoxy bonding has limitations. It's slower than high-speed eutectic bonding and soldering. And its strength wanes at elevated temperatures.

Lamrier Associates, Inc., of Westford, Mass., reports, from an investigation, that the high temperatures used in wire bonding can weaken the epoxy. Because the temperature of epoxy-bonded chips should be below 150 C to maintain epoxy strength, it is necessary to use ultrasonic bonding or pulsed heat.

Another problem may arise when some metals, like gold are epoxy-bonded. Test results have shown that the bond strength is less than optimum. But adhesion can be enhanced if the metal surface is abraded.

A final word of caution: Epoxy cements withstand well a single temperature cycle for testing, but NASA experiments have demonstrated that the bond is seriously weakened when cycled repeatedly.

Michael Kennedy, president of the M.S. Kennedy Corp., Syracuse, N.Y., manufacturer of high-speed analog amplifiers for radar processing



and visual displays, uses a silver-epoxy adhesive produced by Epoxy Technology to bond some 28 semiconductors and three capacitors to a substrate. These amplifiers are designed to operate over a range of  $-55$  to  $125$  C.

To bond eutectically such a large number of components Kennedy notes, the components would "have to spend some 45 minutes at temperatures of about  $380$  C.

"Such an environment degrades transistor breakdown voltages and the beta gain," he says, adding: "We use the epoxy, which in this case is cured at  $150$  C and which is about the normal junction temperature. Putting the wires on these, we shy away from wire bonding for two reasons: First, wire bonding exposes the components to elevated temperatures. And, second, our experience is that epoxies tend to soften under the heat of thermocompression bonding. As a result, we adopted ultrasonic bonding of the wires."

### Conductive elastomers connect ICs

Conductive plastic connectors for MOS IC packages can eliminate the use of circuit-board leads, pins or solder, according to Robert Rothenberg, marketing manager of Chomerics, Inc., Woburn, Mass.

The operating currents of MSI digital MOS microcircuits, such as those in electronic calculators, are sufficiently low so that the conductive elastomers—with a resistivity of about  $0.001 \Omega$  cm—can make connections between the MSI chip leads and contacts on the PC board.

These elastomers are typically filled, about 80% by weight, with metal particles, that are silver or silver-plated copper. When the elastomer is squeezed, it forms bridging paths between the particles, reducing the resistance to about  $0.001 \Omega$  cm.

In a Chomeric prototype elastomer IC connection system, rubbery contacts are molded into holes placed at the 40 stations of a 40-pin MOS substrate. The elastomer contacts extend, like bumps, on both sides of the IC substrate. The metallized conductor pattern of the MOS circuit is pressed and fastened against the top side of the substrate. Each of the 40 MOS conductor-pattern pads makes contact with a resilient conductive bump.

This package is then pressed into place against a 40-pin array of contacts on a PC board and fastened. This technique, Rothenberg points out, eliminates solder problems and lead-frame damage. It is suitable for packaging and mounting LED liquid crystal displays, he says.

Another use of conductive elastomers is in electronic calculator keyboards. Here the conductive elastomers act as switch contact. Such a keyboard consists of a substrate with a special con-

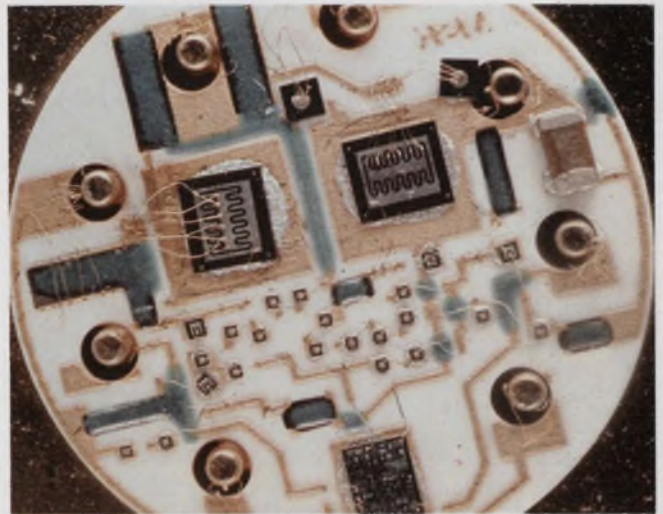

Hybrid power-amplifier chips are glued to the substrate with conductive, silver-filled epoxy. The adhesive, by Epoxy Technology, eliminates hot eutectic bonding.

ductive-ink, printed-circuit pattern. A conductive elastomeric sheet is suspended above this pattern keyboard; numerals are printed on top of the sheet. By pressing down on a digit the user makes contact with the conductive pattern that provides a binary number for the computer circuits.

Although the closed-contact resistance may be on the order of  $10 \Omega$ , it is compatible with the operation of MOS calculator circuitry.

### Solid-state switches available

Among the newer conductive materials are solid-state switches. Two manufacturers—Du Pont and Essex International—each produced their own version of such materials, but to date they have withheld details on the composition of the materials.

The Du Pont development is a thick-film composition called Tyox. Actually it is a line of air-firable compositions that can electrically switch a current either by exceeding a threshold voltage in one form of the material or by exceeding a given temperature in another. The switch also has the properties of a volatile memory.

For thermal applications, the switching temperature is about  $70$  C. A typical change of resistance is from about  $5000 \Omega$  below the switching temperature to about  $10 \Omega$  when the temperature exceeds  $70$  C. Power can be controlled from  $150$  mW to  $100$  W.

In the electronic mode, the switching characteristics are similar to those of diac and triac semiconductor devices. The geometry of the Tyox pattern and the choice of the composition can vary switching threshold voltage from  $5$  V to close to  $20$  kV, with threshold currents of from  $3$  to  $50$  mA. Maximum power in the electronic mode is limited to about  $10$  W.

Because of the low ON resistance, the Du Pont



Electronic switching action is given by screen-printed and air-fired Tyox by Du Pont. The material is used in light dimmers and, here, as a switch in a thermostat.



Pressing a new conductive elastomer in this steering-wheel button causes the horn to sound. The material, Pressex, has positive switching characteristics.

switch dissipates negligible power. Switching speed, the company says, can be as low as 1  $\mu$ s with a turn-off of 10  $\mu$ s.

The new conducting elastomer introduced by Essex, called Pressex, acts like a switch when pressed or like a circuit breaker when an excessive current level is reached.

While other filled elastomers can also change resistance from a high to substantially low value when compressed, the Essex compound appears to have a substantially greater ratio of change. One use of this material is as a switch in the horn ring of an auto. A second use is in a multi-contact connector. In the latter application, the Pressex contacts are round, molded pieces—somewhat like pencil erasers—held in a connector.

Studies have indicated that even though the resistance of Pressex is higher than that of a metal connector insert, the broad areas of contact reduce the effective resistance to less than that of comparable metal contacts. But Pressex connections, with sufficient connector pressure, show less than half the millivolt drop of conventional connectors.

For switching applications, the greater the compression of the material, the lower the resistance in the ON state. Switching elements have operating pressures of from 1 ounce to 100 pounds, and with operating travels of 1 to 125 mils. The conductivity ranges from megohms to milliohms, depending upon the operating pressure.

The material also acts like a circuit breaker, in that when current through it exceeds a specific limit, it opens to the OFF resistance in less than 1 msec.

### Choosing insulating materials

When it comes to insulating materials, selection looks deceptively simple. The materials themselves are, after all, intrinsically simple, and

their electrical properties are the major considerations to designers. But careful analysis of other properties—physical, chemical resistance, thermal and mechanical—call for tradeoffs.

The basic materials are available in a number of forms of organic plastics or inorganic silicone, ceramic and glass compounds. They may be either thermoplastic or thermosetting. The materials are supplied as films, tapes, tubing and sleeves, flat-cable insulation, extrusions, coatings, foams, flexible substrates, rigid substrates, and flexible and rigid compounds for potting, molding, encapsulating, embedding and impregnating.

Thermoplastic materials are processed by heating to a soft state, then shaped by the application of pressure or tension, followed by cooling. Thermosetting materials are cured, set or hardened into a permanent shape, usually under heat. For some of the room-temperature-vulcanizing silicones and some other thermosets curing is at room temperature.

The thermosetting materials tend to have the better mechanical properties. They're harder and more temperature-resistant. The thermoplastic materials, while softer, tend to have the better electrical properties.

High-performance insulating materials—those with better combinations of environmental and temperature resistance, chemical inertness, mechanical strength and electrical characteristics—are costly, but they are required for equipment that must operate in severe environments.

One of the better high-performance materials is the fluorocarbon class. The most widely used is tetrafluoroethylene (TFE), better known as Teflon. It has a useful temperature range between  $-300$  and  $500$  F, very low losses and is slippery, tough and abrasion-resistant.

A particularly rugged application satisfied by Teflon is in the automatic transmission of a car. A Teflon-insulated wire connects a pressure-

actuated switch inside the transmission to a through-terminal mounted on the case. During operation the wire is bathed in hot automatic-transmission fluid, which can exceed 250 F.

The tough environment under the hood of the car calls for thermosetting silicones and epoxies to protect electrical and electronic systems. For the jacketing on spark-plug wire, ignition coil terminals and spark-plug boots, plastic elastomers or silicone rubber are used.

Glen Harland, supervisor of advanced development at Delco Electronics, Kokomo, Ind., says that the electronic package of his company's voltage regulator is encapsulated with silicone to provide a moisture and particle barrier and to protect the circuit from temperature extremes. It is not intended to be a hermetic seal, he points out, but it serves to hold down dirt and ionic contamination of the package.

The encapsulated voltage regulator is then placed in an alkyd housing and bolted inside the alternator. The alkyd is also used for electronic ignition systems, because it is hard, durable and not distorted by "cold flow" during extremes of temperature cycling.

While the specified under-the-hood ambient is -40 to 125 C, Harland says the upper value likely will increase because car engines, with gadgets for pollution and accessories like air conditioners, are running hotter than they once did.

A newer fluoropolymer for rugged electrical insulation—ethylene tetrafluoroethylene (ETFE)—is harder but lighter than TFE. It was de-



High-performance insulation materials for wire and cable, like these from Du Pont, are needed to withstand tough environments, including those under the hood of a car.

veloped originally by Du Pont for wire insulation for aircraft and computers. The mechanical properties have been improved but at the cost of temperature rating—150 C, considerably lower than that of other members of the fluoropolymer family, which can operate at 200 C and more.

While most of the fluorocarbon family is not

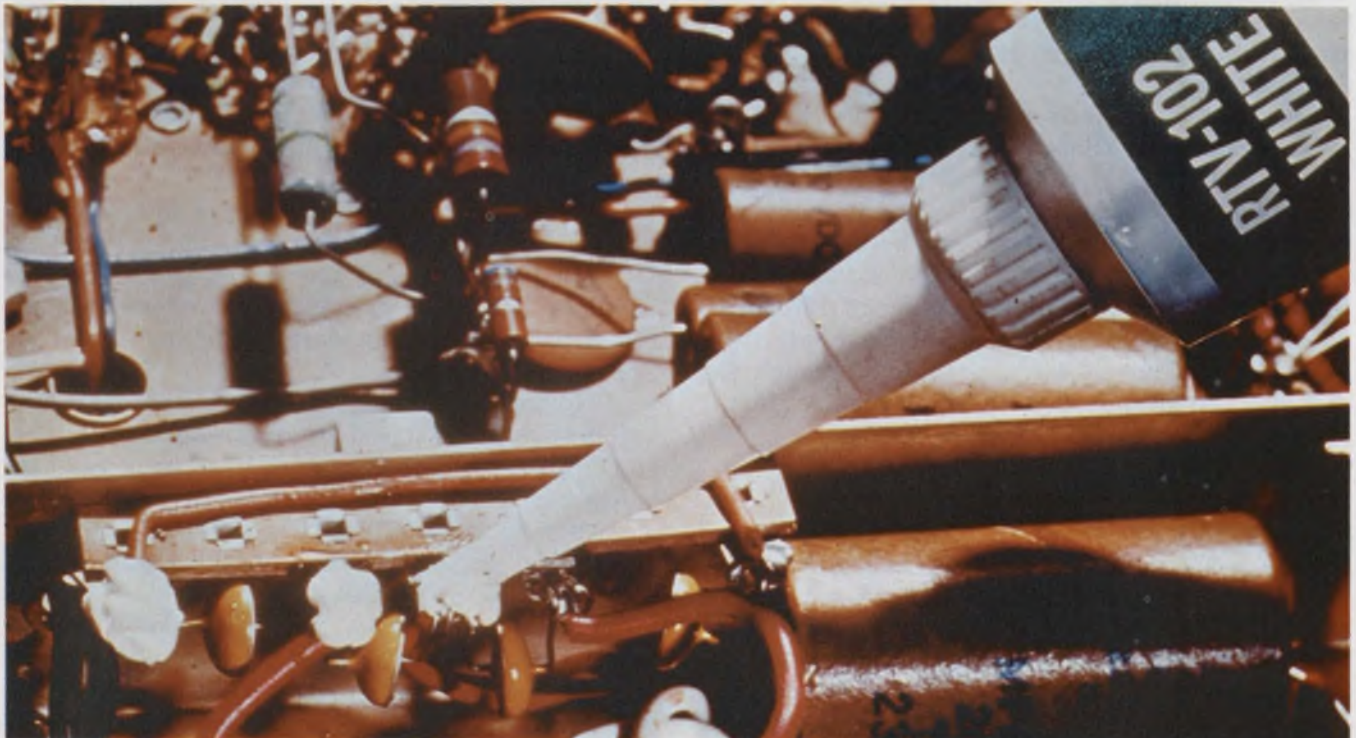

Silicone rubber adhesives, suitable for use over a temperature range of -75 to 400 F, have excellent low-loss dielectric properties and high dielectric strength. The

General Electric RTV adhesive shown here cures at room temperatures and protects terminals against shorts. Conductive-filled silicones are useful for bonding.



**Epoxy compounds** make up most of the potting materials. Components potted with this flexible epoxy gel, by Emerson & Cuming, can be dug out, replaced and repotted.

easy to work with mechanically, polyvinylidene fluoride (PVF<sub>2</sub>) is. It is good electrically and has a slightly reduced temperature rating of about 300 F max. A principal use is in wire insulation.

Newer than the Teflons and with a higher temperature rating are the polyimides. This material is useful over 400 F, with an ultimate zero strength at about 800 F. If set on fire, it is self-extinguishing.

One of the polyimides is Du Pont's Kapton. Produced in thin films, Kapton has a rating of 7000 V/mil at 60 Hz. One use of this material is as motor insulation, where space normally occupied by thicker insulation can be used to add wire for a more powerful motor, according to Benjamin Melvin Jr., sales manager of the Electrical Insulation Products Div., of Du Pont.

Kapton's dielectric strength is high enough so that an 8-to-12 mil sheet is equivalent to 20 to 30 mils of mica.

The polyimides have better mechanical properties and dimensional stability than the Teflon fluorocarbons. However, the electrical characteristics are not quite so good. Polyimides are useful at very low temperatures (-380 F). Their main disadvantage is that they absorb moisture in high humidity. Both the physical and electrical properties are somewhat degraded in such an environment.

Mylar, the toughest of plastic films, with excellent dielectric properties and high tear strength, is made from polyethylene terephtha-

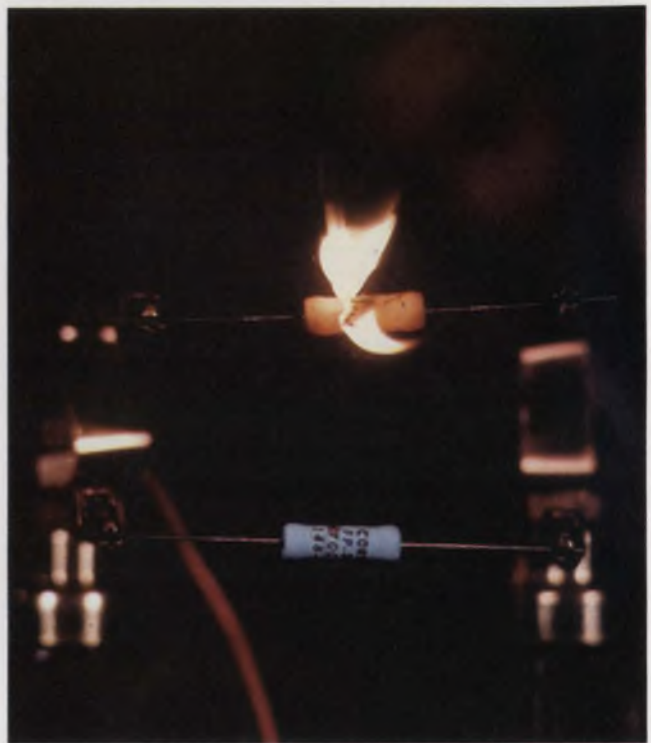

**Consumer electronics** need safe materials and parts. Here, a Corning Glass fusible resistor opens up under a heavy overload while a common resistor type burns.

lates. It has a room-temperature tensile strength of up to 45,000 psi—higher than any other plastic film. At 480 F the tensile strength is close to 3000 psi.

Mylar has a dielectric strength of 7500 V/mil at 60 Hz—slightly higher than that of Kapton. A principal application is as an extremely thin, high-dielectric-constant material for dc capacitors, to reduce capacitor size while retaining the same voltage rating.

These capacitor films, which are metallized on one or both sides, are but 0.014-mil thick.

Both polyimide and the Mylar films are also used as flexible printed-circuit carriers, because they both resist the elevated temperatures of soldering operations.

Polyethylene, which has excellent electrical properties, is produced in larger quantities than any other insulation material in its class. Its dielectric constant and power factor are constant between 60 Hz and 10 GHz. Principal uses are in coaxial cables, TV lead-in wire and multi-conductor control cables.

Polyethylene film is used to make electrical tape. The material is also used as a foam for coaxial-cable insulation. Polyethylene copolymers—ethylene-butene—are compounded for use as wire and cable covering. They have very high stress-cracking resistance. Special flame-retardant compounds are available.

The strongest, most temperature-resistant plastic dielectric material today is polysulfone. It has electrical and mechanical properties that are stable over a temperature range of -150 to 300 F for extended periods and is self-extinguishing. It is used in double-insulated power tools and in computer switches.

### Dielectrics for potting and encapsulation

Of the dielectrics for potting and encapsulation, thermosetting organic and inorganic materials are primarily used. The epoxies, by far, head the list for these purposes, providing tough, hard embedments. A principal use today is in plastic encapsulation of semiconductors and ICs.

Flexible, gel-like encapsulants and potting compounds are provided by the silicones and also by the polyesters and polysulfides with the latter being used for potting electrical connectors.

Silicones, epoxies and phenolics are also used for potting semiconductors. Homer Mitchell, head of material evaluation at Sprague Electric, North Adams, Mass., says that silicone is clearly the best high-temperature material. However, he notes that epoxies are being developed to withstand the same temperatures as the silicones.

"The silicone compounds," says David Thorp, IC factory manager at Sprague's Semiconductor Div. in Worcester, Mass., "do not give as good a hermetic seal as the epoxies, because there is no

*(continued on next page)*

## Need more information?

The companies and products cited in this report have, of necessity, received only brief coverage. They've been selected for their illustrative qualities. Many companies not mentioned may offer similar products. Readers may wish to consult manufacturers from this partial listing for further details:

### Conductive Materials

- Acheson Colloids Co., 1935 Washington Ave., Port Huron, Mich. 48060. (313) 984-5518. (John Lott). **Circle No. 350**
- Chomerics, 77 Dragon Ct., Woburn, Mass. 01801. (617) 935-4850. (Bob Rothenberg). **Circle No. 351**
- Corning Glass Works, Corning, N.Y. 14830. (607) 962-4444. (Allan F. Donnelly). **Circle No. 352**
- Du Pont Co., Electronics Materials Div., Wilmington, Del. 19898. (302) 774-2421. (Donald Sutherland). **Circle No. 353**
- Electro Materials Corp. of America, 605 Center Ave., Mamaroneck, N.Y. 15034. (914) 698-8434. (Don Davis). **Circle No. 354**
- Electro-Science Laboratories Inc., 1601 Sherman Ave., Pennsauken, N.J. 08110. (609) 663-7777. (Adrean Rose). **Circle No. 355**
- Electronic Materials, 320 Long Island Expressway South, Melville, N.Y. 11746. (516) 694-7900. (William Dawson). **Circle No. 356**
- Emerson and Cummings Inc., 869 Washington St., Taunton, Mass. 02021. (617) 823-3300. **Circle No. 357**
- Engelhard Minerals and Chemicals Corp., 430 Mountain Ave., Murray Hill, N.J. 07974. (201) 464-7000. (J. G. Rush). **Circle No. 358**
- Epoxy Technology Inc., 65 Grove St., Watertown, Mass. 02172. (617) 926-0136. (Frank W. Kulesza). **Circle No. 359**
- Essex International Inc., 1601 Wall St., Fort Wayne, Ind. 46804. (219) 743-0311. (James J. Kress). **Circle No. 360**
- GC Electronics, 400 South Wyman St., Rockford, Ill. 61101. (815) 968-9661. **Circle No. 361**
- Isochem Resins Co., 99 Cook St., Lincoln, R. I. 02865. (401) 723-2100. (Herman Selya). **Circle No. 362**
- Metex Corp., 970 New Durham Rd., Edison, N.J. 08817. (201) 287-0800. (Burt Rashkow). **Circle No. 363**
- Owens-Illinois, P.O. Box 1035, Toledo, Ohio 43601. (419) 242-6543. (Michael Kavanaugh). **Circle No. 364**
- Sel-Rex Co., 75 River Rd., Nutley, N.J. 07110. (201) 667-5200. (Louie Brown). **Circle No. 365**
- Technical Wire Products, 129 Dermody St., Cranford, N.J. 07016. (201) 272-5500. (Dick Ventimiglia). **Circle No. 366**

### Dielectric Materials—Thermoplastic

- Celanese Plastics Co., 550 Broad St., Newark, N.J. 07102. (201) 877-2300. (J. E. Giordano). **Circle No. 367**
- Du Pont Co., Electronics Materials Div., Wilmington, Del. 19898. (302) 774-2421. (Donald Sutherland). **Circle No. 368**
- Dow Chemical Co., Box 1682, Midland Mich. 48640. (516) 636-8000. (R. F. Dalton). **Circle No. 369**
- Dow Corning Corp., Midland, Mich. 48640. (517) 636-8000. (Philip K. Blumer). **Circle No. 370**

- Eastman Chemical Products Inc., subsidiary of Eastman Kodak Co., Box 431, Kingsport, Tenn. 37662. (615) 247-0411. **Circle No. 371**
- General Electric, Plastics Business Dept., One Plastics Ave., Pittsfield, Mass. 01021. (413) 494-1110. (Gregg Bronk). **Circle No. 372**
- General Electric, Silicone Prod. Dept., Waterford, N.Y. 12188. (518) 237-3330. (Jim Crawford). **Circle No. 373**
- Hercules, Inc., 910 Market St., Wilmington, Del. 19899. (302) 656-9811. (W. C. Brown). **Circle No. 374**
- Minnesota Mining & Manufacturing Co., 3M Center, Saint Paul, Minn. 55101. (612) 733-1673. (Robert J. Modersohn). **Circle No. 375**
- Mobay Chemical Corp., Pkwy. W. Rte 22 & 30, Pittsburgh, Pa. 15205. (412) 923-2700. (D. H. Bryan). **Circle No. 376**
- Monsanto Co., 800 N. Lindberg Blvd., St. Louis, Mo. 63166. (413) 788-6911. **Circle No. 377**
- Polymer Corp., 2120 Fairmont Ave., Reading, Pa. 19603. (215) 929-5858. (R. F. Barthold). **Circle No. 378**
- U.S. Industrial Chemicals Co., 99 Park Ave., N.Y., N.Y. 10016. (212) 697-0700. **Circle No. 379**
- Union Carbide Corp., Mat'ls Systems Div., Compas. Dept., Box 5928, Greenville, S.C. 29606. (803) 963-7421. **Circle No. 380**

### Dielectric Materials—Thermosetting

- Allied Chemical Corp., P.O. Box 70, Morristown, N.J. 07960. (201) 538-8000. **Circle No. 381**
- American Cyanamid Co., Industrial Chemicals and Plastics Div., Wayne, N.J. 07470. (201) 831-1234. **Circle No. 382**
- Ciba-Geigy Corp., Resins Dept., Ardsley, N.Y. 10502. (914) 478-3131. **Circle No. 383**
- Dow Chemical Co., Box 1682, Midland, Mich. 48640. (516) 636-8000. (R. F. Dalton). **Circle No. 384**
- Hooker Chemical Corp., 1940 Ward St., Niagara Falls, N.Y. 14302. (716) 285-6655. **Circle No. 385**
- Monsanto Co., 800 N. Lindberg Blvd., St. Louis, Mo. 63166. (413) 788-6911. **Circle No. 386**
- Rohm & Hass Co., Independence Mall W., Philadelphia, Pa. 19105. (215) 592-3000. **Circle No. 387**
- Shell Chemical Co., One Shell Plaza, Houston, Tex. 77002. (713) 220-4867. **Circle No. 388**
- Union Carbide Corp., Mat'ls Systems Div., Compas. Dept., Box 5928, Greenville, S.C. 29606. (803) 963-7421. **Circle No. 389**

### Ceramics

- American Lava Corp., Cherokee Blvd. and Manufacturers Rd., Chattanooga, Tenn. 37405. (651) 265-3411. (Jim Wade). **Circle No. 390**
- Coors Porcelain Co., 600 9th St., Golden, Colo. 80401. (303) 279-6565. **Circle No. 391**
- Corning Glass Works, Corning, N.Y. 14830. (607) 962-4444. (Allan F. Donnelly). **Circle No. 392**
- Dow Chemical Corp., Midland, Mich. 48640. (517) 636-8000. (R. F. Dalton). **Circle No. 393**
- Du Pont Co., Electronics Materials Div., Wilmington, Del. 19898. (302) 774-2421. **Circle No. 394**
- Metalized Ceramic Corp., 100 Niantic Ave., Providence, R.I. 02907. (401) 943-2200. (Joe Feeley). **Circle No. 395**
- National Beryllia Corp., Greenwood Ave., Haskell, N.J. 07420. (201) 839-1600. (Henry Kalstad). **Circle No. 396**
- Plessy Frenchtown, 8th and Harrison St., Frenchtown, N.J. 08825. (201) 996-2121. (Walt Ripple). **Circle No. 397**
- SCS Corp., Electronics Packages Div., 601 Walnut Circle East, Garland, Tex. 70504. (214) 272-5481. **Circle No. 398**

(continued from page 81)

locking action around the semiconductor leads." Also, he notes, the silicones don't shrink and form a chemical bond the way epoxies do.

"Epoxies have a further advantage in that they tend to reduce the forming and trimming time," Thorp says. They are molded in a shorter cycle.

But a limitation of epoxies, the Sprague manager points out, is that they tend to be loaded with abrasives, which increases the cost of mold and tool maintenance.

### Flame-resistant insulation demanded

Flammable insulation materials have had such tragic consequences in the last 10 years—in the Apollo spacecraft fire and in a rash of blazes in color television sets, to mention two prominent cases—that a National Commission on Product Safety investigated the situation. In response to two reports of this commission, Underwriters' Laboratories, Inc., made revisions in its Safety Standard 492 on radio and television.

The revisions call for use of self-extinguishing materials in wire insulation, in component-encapsulation systems and even in the structural materials of components demonstrated to be fire-starters.

Components affected by this standard are wiring connectors, power interlocks, terminal

boards, PC boards, tube and transistor sockets, deflection yokes, horizontal output transformers and solid-state, high-voltage multipliers.

To market consumer electronics, the approval of Underwriters' Laboratories is a must. However, the testing process for approval is costly. Testing by UL, which includes aging of materials, is charged for on an hourly basis, notes Richard Sanderson, manager of product safety for the Sylvania Entertainment Products Div., Batavia, N.Y. The investigation of a new TV design might cost about \$5000, even under the most favorable circumstances, he reports.

Many materials and components have not been tested and approved by UL. For this reason, even if a designer incorporates materials he knows by personal test to be fireproof, his product will not be approved by UL until the material undergoes UL screening. To hold down costs, designers are advised to use UL-approved materials. The UL "Recognized Component Index" lists over 1000 materials that UL has evaluated.

Sanderson suggests another valuable materials source—"Modern Plastics Encyclopedia," a McGraw-Hill publication.

He also recommends the following UL standards; UL 94, "Tests for Flammability of Plastic Materials for Parts in Devices and Appliances;" UL 224, "Extruded Thermoplastic Insulating Tubing" and UL 510, "Insulating Tape." ■■

# Introducing-Monsanto's New 6 Digit 110 MHz Counter.



In addition to Monsanto's standard high quality craftsmanship, this great counter has these specific features; standard 6 digit display with 8 digit option—frequency range from 5Hz to 110MHz—sensitivity of 20 mV—crystal controlled clock—3 basic time bases—non-blinking display with memory—state-of-the-art circuits including LSI, MOS and MECL 10000—optional BCD output—**\$395** optional I.F. subtraction.

Contact your local Monsanto Representative today or call: **United Systems Corporation**, 918 Woodley Road, Dayton, Ohio 45403, Ph: (513) 254-6251, subsidiary of

## Monsanto

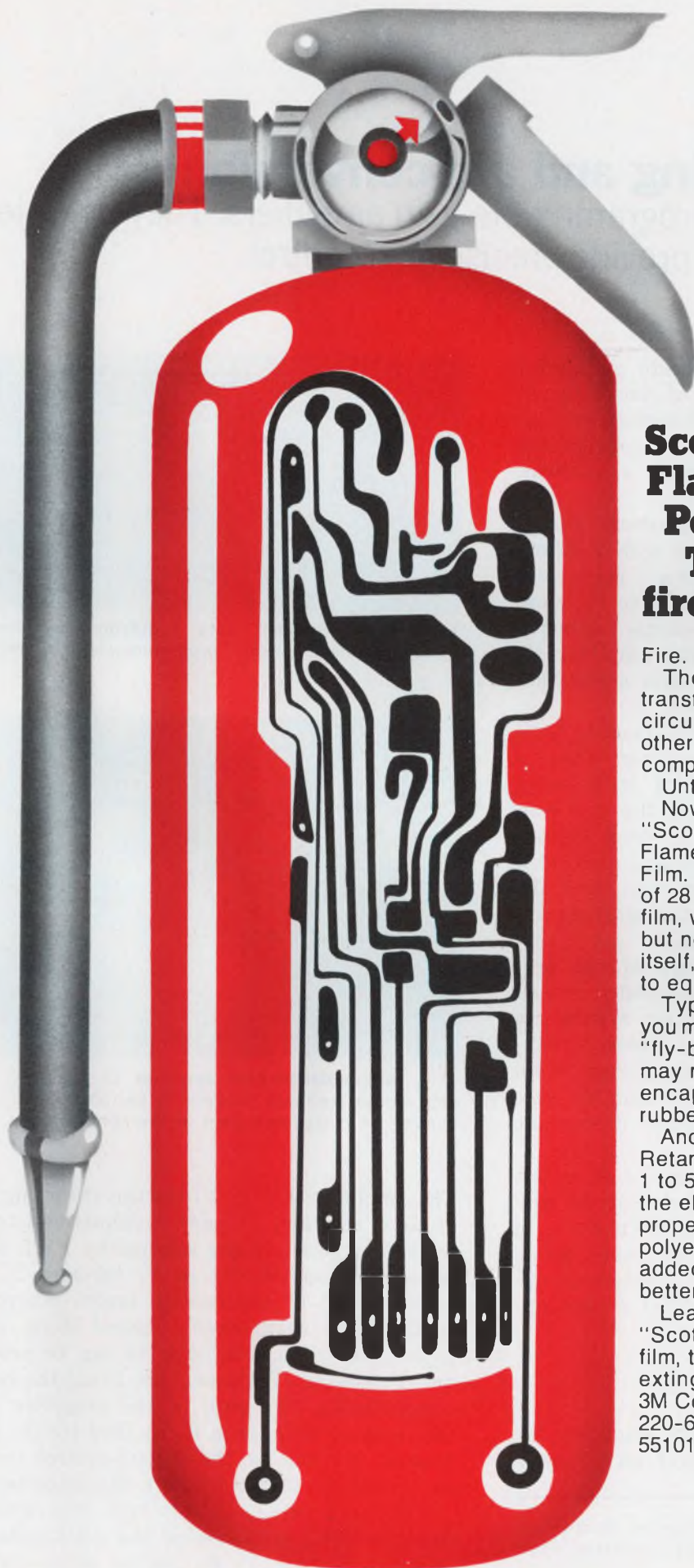

## **Scotchpar® Brand Flame Retardant Polyester Film. The built-in fire extinguisher.**

Fire.

The common enemy of transformers, flexible circuits, flat cables and other electrical/electronic components.

Until now.

Now 3M introduces "Scotchpar" Type 7300 Flame Retardant Polyester Film. With an Oxygen Index of 28 minimum, Type 7300 film, when ignited, will melt but not burn. It extinguishes itself, easing further danger to equipment and lives.

Type 7300 film can save you money, too. For example, "fly-back" transformers may no longer need encapsulation in silicone rubber.

And, "Scotchpar" Flame Retardant Film, available in 1 to 5 mil thicknesses, has the electrical and physical properties of standard polyester films, with the added benefit of a much better winding surface.

Learn more about "Scotchpar" Type 7300 film, the built-in fire extinguisher by, writing 3M Company, 3M Center, 220-6E, St. Paul, Minnesota 55101.

**3M**  
COMPANY

# Ease multiplexing and a/d conversion in data acquisition by using programmable-gain amplifiers. They operate from digital signals to provide precise gain control.

Modern computer systems operate on digital data, whereas the vast majority of sensor transducers provide analog outputs. Therefore, analog-to-digital converters are needed to convert the transducer data, and immediately a problem arises.

Sensors like strain gauges, pressure transducers and thermocouples provide widely differing signal levels, and the required a/d converters—which must, therefore, cover a wide dynamic range from millivolts to volts—become expensive and slow. The programmable-gain amplifier allows an inexpensive method of data acquisition from widely differing sensor levels.

A programmable amplifier can adjust the level of voltages going into an a/d converter so that a wide input range can be handled with many fewer converter bits (Fig. 1). If the a/d converter were used alone, the high-level signals would not normally need the resolution provided by the least-significant group of bits, and the low-level signals would not use the most-significant bits—an inefficient operation.

Digital signals control the gain of the programmable amplifier. When the amplifier is used in a computer-based data-acquisition system, its gain can be changed as each multiplexer channel is selected. This provides the accuracy of an amplifier-per-channel approach without the substantial costs involved in providing a separate data amplifier for each channel.

Amplifier gain may be programmed on a per-channel basis, based upon knowledge of the sensor characteristics for each channel. Or the gain may be auto-ranged to bring the output signal to a desired level after channel selection. Auto-ranging is desirable when individual sensor outputs are not readily predictable.

## Analyzing the amplifier

The simplest programmable-gain amplifiers are single-ended and designed around an op amp.

**Gene E. Tobey**, Product Marketing Engineer, Burr-Brown Research Corp., International Airport Industrial Park, Tucson, Ariz. 85706.

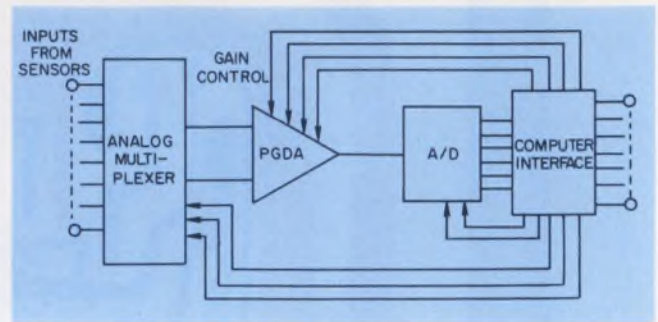

1. Computer oriented data acquisition systems can make very effective use of programmable-gain amplifiers.

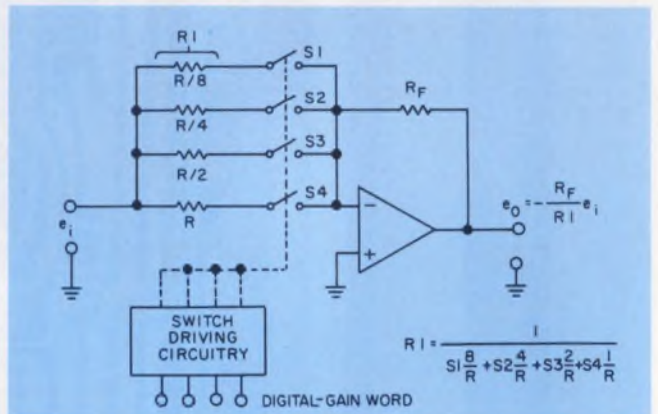

2. A programmable-gain amplifier is basically an op amp whose feedback network is switched to accurately control the closed-loop gain of the configuration.

The amplifier of Fig. 2 uses the inverting input of an op amp and a binary weighted resistor network. The resistors are selected by FET switches, shown symbolically as  $S_1$  through  $S_4$ . This configuration is particularly useful where gain control must be in closely spaced steps. All integer gains from 0 through 15 can be programmed by closing of the switches in all the possible combinations. The gain of the amplifier equals the feedback resistance  $R_F$  divided by the resistance  $R_1$  selected by the digital-control word. A sign inversion occurs through the amplifier.

One disadvantage of this type of amplifier is that the ON resistances of the solid-state FET switches,  $S_1$  through  $S_4$ , are in series with the



gain-setting resistors. This can produce a gain error that becomes most serious for the  $S_1$  switch, since it is in series with the smallest resistor. Typical MOSFET switches have ON resistances from 100 to 500  $\Omega$ . For a gain error of less than 0.01%, the value of  $R/8$  must therefore be in the neighborhood of 1 to 5 M $\Omega$ , and the other resistors must be correspondingly larger. Unfortunately, such large values of resistance are not compatible with high-speed, low-noise and low-drift performance.

Bipolar transistor switches have a much lower ON resistance than typical FET switches and may be used with considerably smaller values of gain resistors. However, the finite saturation voltage of the transistor switch appears as an offset error. Note that a single compensating adjustment for all gains, even if all the switches are identical, is not effective under all conditions, since the gain for an offset voltage is  $1 + R_F/R_1$ . This value is not quite equal to the magnitude of the gain for a signal input, which is  $R_F/R_1$ . Thus the offset voltage will not remain nulled on all ranges.

Other switching alternatives include very-low-

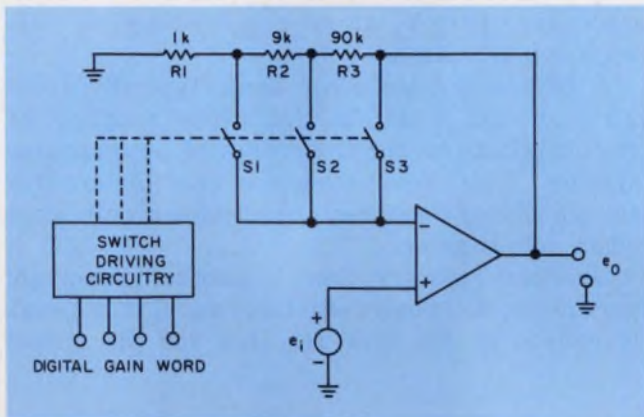

3. By placing the switches in series with the op-amp input and closing only one switch at a time, you eliminate a troublesome switch-resistance problem.

resistance FET switches and reed relays. But with present technology, such FETs are expensive and reeds are slow.

A somewhat different feedback arrangement can eliminate the switch-resistance problem. The single-ended programmable-gain amplifier in Fig. 3 provides the answer. The gain of this amplifier configuration is given by  $1/\beta$ , where  $\beta$  is the feedback ratio determined by resistors  $R_1$  and  $R_2$  and switches  $S_1$ ,  $S_2$  and  $S_3$ .

However, only one switch at a time can be ON for each gain level. Because the switches are in series with the inverting input of the op amp, they carry very little current. Therefore their ON resistance can be ignored, and a very trouble-

some problem is eliminated. If more than one switch were turned ON, the switches would carry a portion of the resistor-network current, and thus the switch resistances would enter into the value of  $\beta$ . The circuit shown provides only three steps of gain—1, 10 and 100.

The Fig. 3 configuration, in addition, has a very high input impedance, in contrast with the circuit of Fig. 2. Its input impedance equals the common-mode input impedance of the op amp, which in a well-designed amplifier can be 50 M $\Omega$  or more.

Thus the circuit of Fig. 3 is appropriate when there are relatively few gain settings and when high input impedance is needed. The circuit of Fig. 2, by contrast, is suitable when many steps of gain control are needed and low input impedance can be tolerated.

### Weak signals need differential amplifiers

Figure 4 is probably the most popular differential amplifier circuit for low-level applications. Amplifiers  $A_1$  and  $A_2$  form a differential-input/differential-output stage. The gain for a dif-

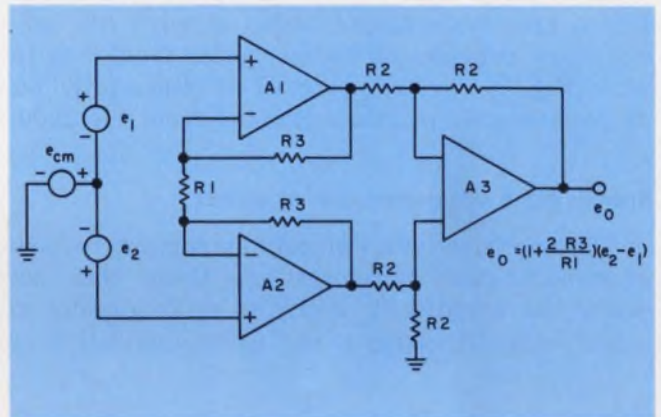

4. Low-level signals are best handled with balanced differential amplifiers to take advantage of their inherent common-mode noise rejection ability.

ferential signal input is

$$1 + 2R_0/R_1,$$

but the common-mode gain of  $A_1$  and  $A_2$  is only unity, regardless of the values of  $R_0$  and  $R_1$ . The third amplifier,  $A_3$ , converts the differential output signal of  $A_1$  and  $A_2$  to an output signal referenced to ground. Common-mode rejection of  $A_3$  is determined principally by the accuracy with which the four resistors,  $R_2$ , are matched. A low variation of offset voltage with temperature is obtained by careful matching of amplifiers  $A_1$  and  $A_2$ .

Figure 5 shows the same amplifier converted to a programmable-gain amplifier. The gain-selector switches operate in pairs—usually in

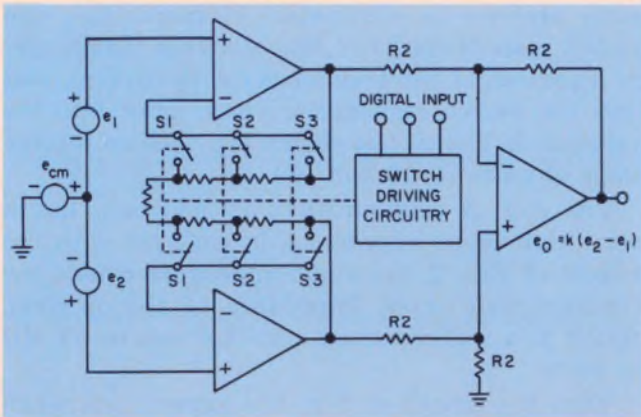

5. A differential-input programmable-amplifier system offers many advantages when multiplexing low-level signals, such as its high common-mode rejection ratio.

steps such as 1-10-100 or 1-16-256. Note that only one pair of switches is ON at any given time. Thus, as in the single-ended amplifier of Fig. 3, the switch resistance is eliminated from the gain equation.

However, where a wide range of gains is required, with relatively fine resolution between major gain steps, a second stage of gain programming may be added. This approach is illustrated in Fig. 6. A differential input stage as in Fig. 5 provides gains of 1-10-100, while the second stage provides all integer gains from 0 to 15 as in Fig. 2. Thus the over-all amplifier provides 46 possible gain positions ranging from 0 to 1500.

### Specifying a programmable amplifier

The specifications uniquely important to programmable-gain amplifiers are those that describe the amplifier's ability to settle rapidly to a new value of output signal after application of

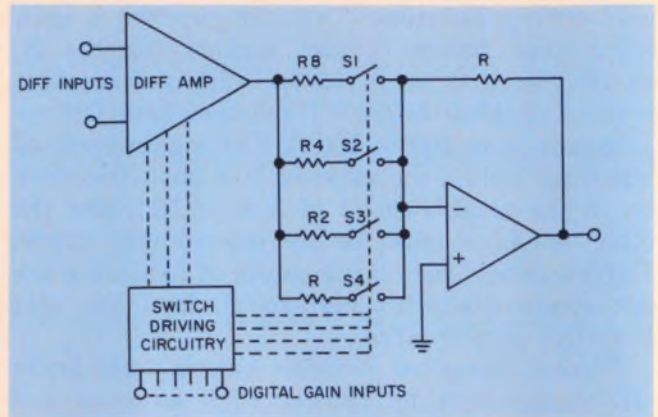

6. This two-stage programmable-gain system offers the combined advantages of differential input, high input impedance, and coarse and fine gain-controlled ranges.

a step input or following a gain change. Settling times, usually expressed in microseconds, fall into three categories.

Amplifier settling time (Fig. 7), is defined as the time required for the amplifier's output voltage to reach and remain within a specified error band after the occurrence of an input signal step. The complete amplifier settling time must include the switching time of the gain-selector switches. The error band is normally given in millivolts, typically  $\pm 10$  mV, or as a percentage of full-scale output, such as  $\pm 0.01\%$ .

A broad-tolerance error band, typically about  $\pm 1\%$  of full scale, is also often supplied by the manufacturer for the design of auto-ranging systems. This broad-tolerance spec determines the amount of delay required between gain steps when auto-ranging.

Overload recovery time is another important parameter. Although definitions vary, it is usually defined as the time required for the output

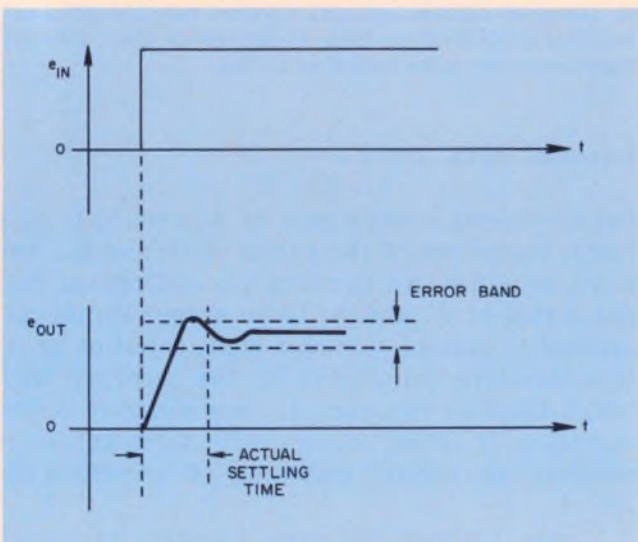

7. Settling time is particularly important when specifying a programmable-gain amplifier.

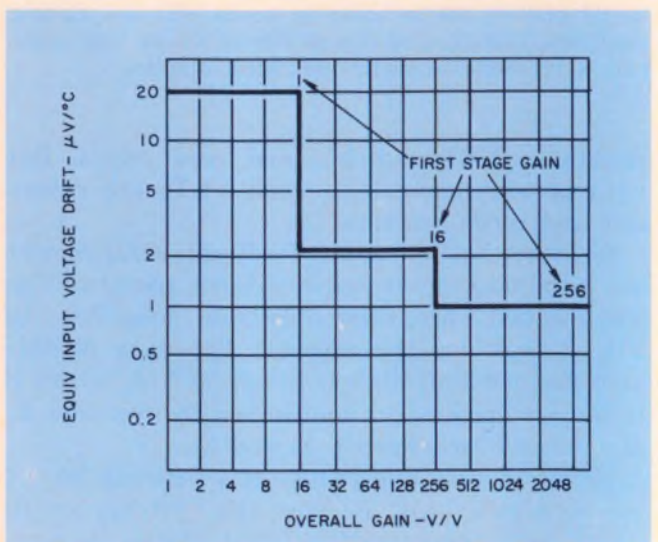

8. First-stage gain has a substantial effect on the amplifier's voltage drift.

signal to recover from saturation and reach its final value after removal of the signal that caused the overload. The recovery time is usually specified for the level, or percentage, of input overdrive that exceeds the linear input range. A worst-case gain situation—usually the highest range—is assumed, unless otherwise specified.

When used in a multiplexing system, as in Fig. 1, the maximum achievable throughput rate of the programmable amplifier depends on the time needed for total amplifier settling—sufficient to allow for overload recovery, gain ranging and final accurate settling of the output voltage.

### Two stages make a better design

If the amplifier operates over a wide range of gains, such as 1000:1 or greater, the gain—for best gain accuracy, linearity and settling time—should be distributed between two stages (Fig. 6). An added advantage is that separate coarse and fine gain control settings can be made.

Gain accuracy and linearity are limited by the open-loop gain available. For example, a typical op amp with open-loop gain of  $10^5$  can provide gain accuracy of  $\pm 0.1\%$  when feedback reduces the closed-loop gain to about  $10^2$ . Thus, to get high closed-loop gain—without deterioration in accuracy and linearity—more than one stage of gain switching is normally used. This prevents the closed-loop gain of any single amplifier stage from becoming too high. Also, too much gain in a single stage can lead to unstable operation and even oscillations.

Because the open-loop nonlinearity of an op amp, typically  $\pm 10\%$ , is reduced by a factor proportional to the gain reduction, the  $\pm 10\%$  linearity becomes  $\pm 0.01\%$  when the open-loop gain of  $10^5$  is reduced to  $10^2$ .

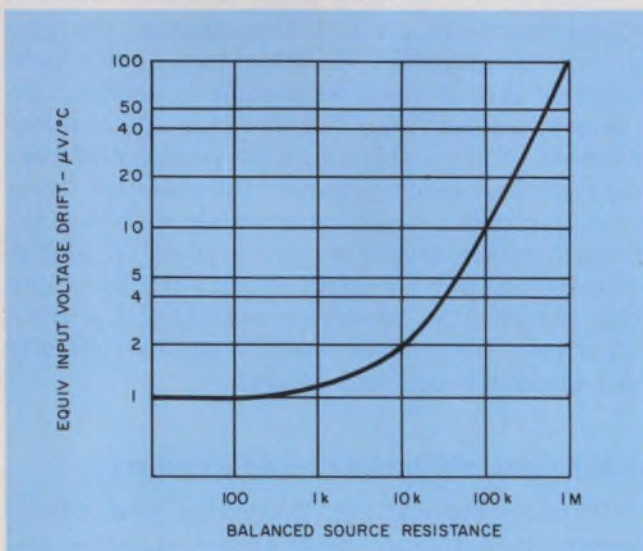

9. Input-source resistance helps determine drift. Low input-bias current reduces this problem.

Another advantage of using a two-stage system is that generally the response-speed of an amplifier decreases as gain increases. Thus if a wide range of gains is necessary, but speed is also important, it's best to cascade two amplifiers. The resulting gain-bandwidth product of the cascaded amplifiers will be greater, and the settling time will be less, than for a single amplifier operating over the same range of gains.

Input voltage drift is not, however, optimized by the use of two stages. At high values of first-stage gain, the drift of the first stage predominates. Changes in the gain of the second stage does not contribute significantly to total drift. A plot of equivalent-input-voltage drift vs over-all gain is shown in Fig. 8 for a typical, two-stage amplifier system. First-stage gains are noted on the plot. The amplifier, used as an example, has first-stage gains of 1, 16 and 256 and second-stage gains of 0-15.

### Factors controlling resolution

The resolution of a programmable amplifier is mainly limited by the unpredictability of the dc offset. Although the input offset voltage can be nulled for a particular temperature, source impedance and gain, each of these parameters is likely to vary rather widely under operating conditions. The effects of temperature can be minimized by selection of an op amp having very low voltage drift. Op amps with drifts as low as  $\pm 1 \mu\text{V}/^\circ\text{C}$  are widely available.

In a multiplexed system variations in source impedance can occur. To reduce offset uncertainty from this source, the amplifier must be selected for low bias current. Fig. 9 shows typical variations of offset voltage as a function of balanced source resistance. FET inputs for the amplifiers tend to reduce this source of error because of their high input impedance and low bias current.

Further, since the gain of a programmable amplifier is continually being changed, the equivalent input offset voltage should remain constant as gain changes, so that a single null control can serve all gain settings. This is best achieved by reducing the bias current flowing in the feedback network to negligibly small values. Again, a FET stage, serving as an input to the programmable-gain amplifier can solve the problem.

### Programmable amplifiers gather data

High-level signals pose no problem when programmable-gain amplifiers are used to collect data. But low-level signals, especially when common-mode levels and noise may be present, require careful attention to the details of grounds

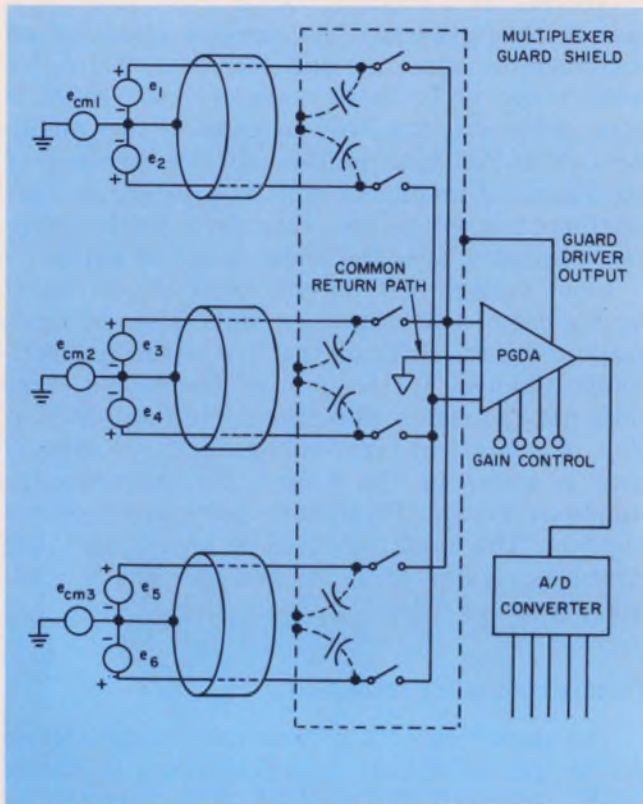

10. Some programmable gain amplifiers provide a guard-driver output to help reduce noise by driving the guard shield for the multiplexer circuits.

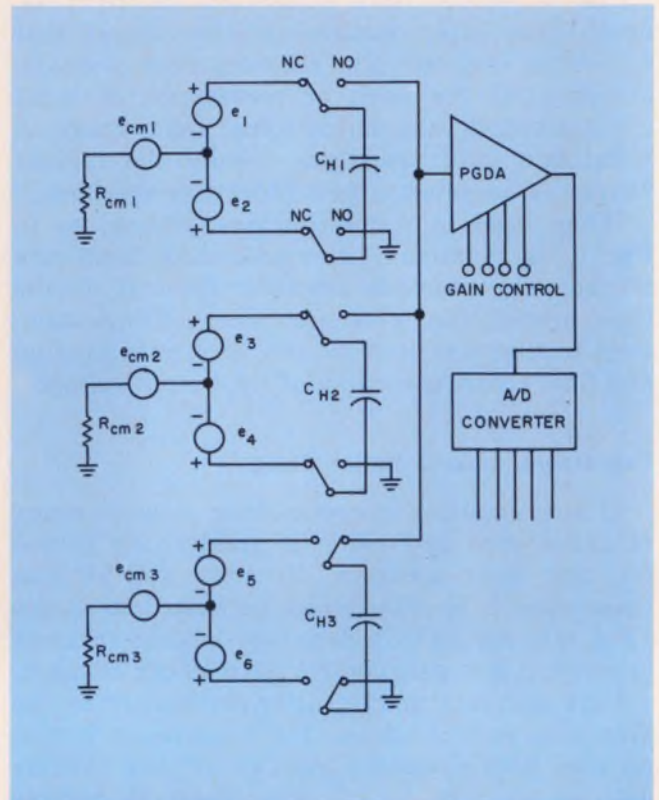

11. A flying-capacitor multiplexing system can maintain a high common-mode rejection ratio and handle large common-mode input voltages.

and signal-return paths.

For systems of transducers, where the common-mode voltage does not exceed about  $\pm 10$  V, the direct-coupled technique of Fig. 10 is commonly used. The system uses a two-wire multiplexing technique, in which the individual cable shields connect to the common-mode potential at the signal sources. The guard shield of the multiplexer connects to a common-mode signal derived within the programmable amplifier. Driving the guard shield with the common-mode potential prevents degradation of common-mode rejection caused by unbalanced capacitances between the two input leads and the guard shield. However, the guard-drive output from a typical programmable-gain amplifier has a high output impedance (about  $50 \text{ k}\Omega$ ) and should not be overloaded. A buffer amplifier can be added to provide a lower output impedance.

An alternative technique uses a third switch in each channel to connect each cable shield successively to the multiplexer guard shield. This method does not need to use the guard-driver output of the amplifier.

Since programmable-gain amplifiers are most often directly coupled devices, the system must include a dc common, or ground return, for the input path. To preserve the common-mode rejection capability and balance, this return path should have a reasonably low resistance—not ex-

ceeding  $1 \text{ M}\Omega$ . If this return path is not inherent in the signal source, as would occur with a floating source, it must be provided externally.

Another technique for using programmable amplifiers with low-level multiplexing is shown in Fig. 11. This is the flying-capacitor technique, where the capacitor is first switched across the terminals of the signal source and allowed to charge to the signal level. The switches, usually mercury-wetted relays, then toggle sequentially in pairs to the opposite poles, transferring each signal sample in turn, to the input of the programmable amplifier. The advantage of this technique is that it provides complete isolation between source and amplifier and thus allows measurement of small signals in the presence of very high common-mode voltages. Because the flying capacitor eliminates common-mode voltages, the programmable amplifier can even be a single-ended type. A FET input stage with low-input bias current then becomes a necessary feature—otherwise bias current would load the capacitor and cause measurement errors.

#### Auto-ranging with programmable amplifiers

In many applications, the signal level cannot be predicted. In such cases an auto-ranging amplifier system can eliminate the need for computer control of gain. Once the gain has been

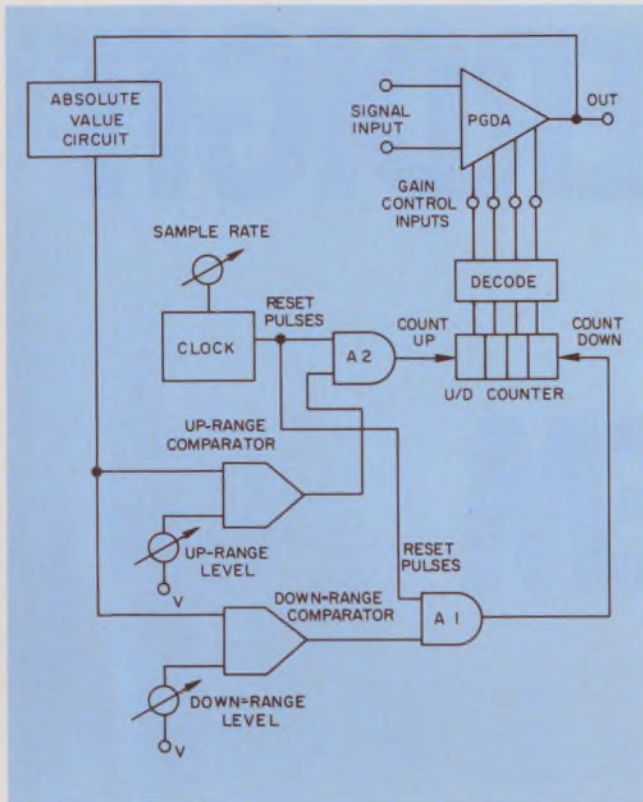

12. Auto-ranging is used where input signal levels are difficult to predict. This cuts down on programming, and the computer, instead, receives range data.

set by the auto-ranging circuit, the gain value is transmitted to the computer as a digital input together with the normalized signal level from the a/d converter.

Many algorithms for auto-ranging of gain are possible. Two will illustrate their use with programmable-gain amplifiers. The first (Fig. 12) works better for single-input signals than for multiplexed inputs. The output voltage of the programmable amplifier is compared continuously with two reference voltage levels. The down-range level is usually set slightly above the rated output voltage of the programmable amplifier. If this level is exceeded, the down-range comparator changes state from ZERO to ONE. An internal clock feeds pulses to the up/down counter until the comparator changes its state to ZERO when the amplifier's gain is reduced sufficiently that the output falls below the down-range level. The clock rate must allow sufficient time between pulses for all settling needs—amplifier settling, overload recovery-time, and multiplexing and auto-ranging switching time.

Both up-range and down-range comparators will be in their ZERO states once the gain of the amplifier is within the desired range. The next clock pulse, after the occurrence of ZEROs on both range comparators, can then initiate sampling of the output voltage and conversion to digital data (not shown in Fig. 12).

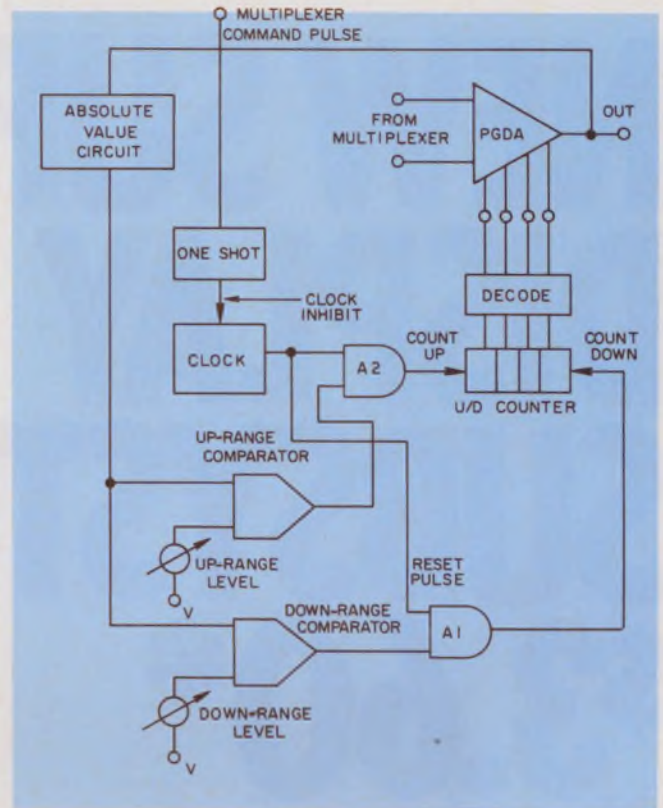

13. A complete auto-ranging system must provide sufficient settling time between multiplexing steps for the programmable amplifier to deliver accurate outputs.

The spread between the up-range level and the down-range level must be slightly greater than the ratio between nominal gain steps, to avoid hunting of the gain-ranging circuit. Thus, for gain stepping in ratios of 10, the up-range level should equal slightly less than one-tenth of the down-range level. This provides a small overlap of adjacent ranges. The direction of signal change dictates which range is selected, and no ambiguity in choice occurs. If instead a range gap existed, the system would hunt near the range limits and never find a place to settle.

A time delay built into the level-comparison circuit prevents false ranging on transient noise. The range comparator must remain tripped for a specified length of time before the gain can start to change to the next level. Thus only sustained signals can change the range.

The auto-ranging scheme in Fig. 13 can handle multiplexed signals. It is similar to that of Fig. 12, but with circuits added for suppressing auto-ranging during multiplexer channel switching. The one-shot, triggered by a command pulse from the multiplexing system, inhibits the clock for a finite time during and after channel selection. This prevents operation of the auto-ranger while the transients induced by a multiplexer step are settling. The total recovery time of the programmable amplifier determines the required time interval for the one-shot. ■■

**NEW SUPERDIGIT™  
DISPLAY  
SUBSYSTEM  
\$3.60\***

**SUPERDIGIT™ LED+ new decoder/driver:  
brightest, simplest, most cost-effective display  
subsystem to be seen anywhere. Two packages.  
No external components required.**

**Made for each other:** Our new 9368 Decoder/Driver and our FND-70 SUPERDIGIT ¼" LED Display. Just hook them together to make a simple, economical supersubsystem. Super because of the way it looks – great from any point of view. Super because of the way it's priced. And super because two packages include all necessary gating, storage, decoding, driving and display in a system that's compatible with standard 5V supplies. No external components. Reduced circuitry, installation, size, complexity, wiring.

**SUPERDIGIT** is the sharpest thing in LED displays. Bright, bold numbers that look crisp and clear and uniform over a 140° viewing angle. Thanks to new production techniques, SUPERDIGIT is priced low and we can maintain ½ million in perpetual inventory. With smallest ratio of total package to digit size (2:1), 4 digits occupy less space than 3 conventional units. Leads are straight, so SUPERDIGIT can be stacked horizontally or vertically.

**Superdriver** combines a high-speed 4-bit latch, a 7-segment decoder, and output drivers. Data can be strobed into the latches at normal TTL speed. Leading and trailing zero blanking circuits provide easily readable decimal display. Zero input current when latch is not enabled facilitates multiplex driving from MOS logic. Available in 16-pin DIP.

Production quantities and complete data can be had from your Fairchild distributor or your local Fairchild sales office.

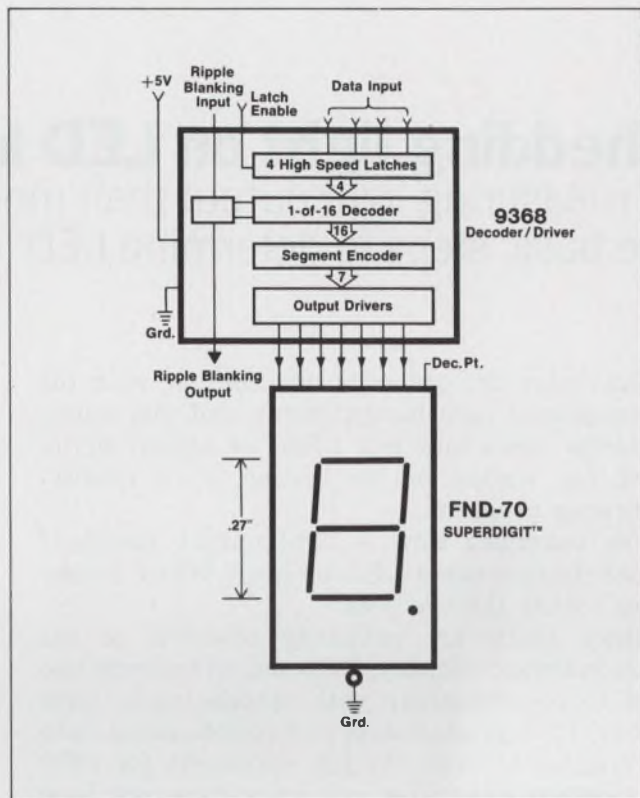

Fairchild's simple, new 2-package digital display subsystem.

Immediately available at these low prices:

	1-24	25-99	100-999	1K-4999	5K-9999	10K Up
9368 Decoder/Driver	\$3.65	\$3.35	\$2.90	\$2.35	\$2.05	\$1.75
FND-70 SUPERDIGIT	3.50	3.50	2.80	2.50	2.10	1.85
Additional Components	None	None	None	None	None	None
Total Subsystem	\$7.15	\$6.85	\$5.70	\$4.85	\$4.15	\$3.60

**MADE IN  
FAIRCHILD**

# Shedding light on LED luminance: There's more to measuring light output than meets the eye. Here are basic steps to determine LED energy with precision.

Engineers are generally not familiar with the techniques of light measurement, and this causes problems when they buy LEDs or optical equipment for testing or for setting up a quality-assurance program.

For example: How is light output specified? At what angle can a LED be seen? Which sensor "sees" what the eye sees?

Since LEDs are primarily offshoots of the semiconductor industry, LED manufacturers also tend to be unfamiliar with optoelectronic technology. LED product data and specifications have suffered as a result. As yet, standards for LED light-output quantities and units have not been established, although efforts are under way by the IEEE and other technical societies. (The National Bureau of Standards is presently calibrating LEDs to be used as primary standards.)

Before you can spec or measure LED light output, you've got to understand the response of both the human eye and the photosensor to light. And you must know the effects of such psychological factors as acuity and pattern recognition. Finally, you've got to select the right instrument.

Two quantities are important when sensing a radiant or luminous source: radiometric quantities, in terms of radiant intensity, and photometric, in terms of luminous intensity. Their relative importance is determined by the nature of the sensor and source and by the geometry of the source/sensor combination (Fig. 1).

## Sensor response depends on optics

In any imaging system, luminance and radiance dominate. This is because an optical system—such as the eye or a camera—casts an image of the source area on the retina or film. The brightness (luminance) of the image equals that of the source, modified by the index of refraction of the media through which the light passes.

In a nonimaging system, a sensor—such as a phototransistor—primarily responds to the irradiance (H) at its sensing plane. This quantity is directly related to the intensity (J) of the

radiant source when the source can be considered to be a point source. The relationship is given by

$$H (\text{mW}/\text{cm}^2) = \frac{J (\text{mW}/\text{sr})}{s^2}, \quad (1)$$

where

s = source-to-sensor distance in cm.

Now the eye is an imaging sensor normally, and it behaves like a nonimaging sensor when it can no longer clearly discern the dimensions of the luminous area. It thus becomes responsive to luminous intensity when a two-dimensional image is no longer cast on the retina. So in the visual process the luminance of a source—like LEDs—is of prime importance if that source is self-luminous. If the source is not self-luminous—reflective liquid crystals, say—then the eye becomes responsive to the "scene" luminance, which is proportional to the illumination upon that scene provided by some external source. If you're dealing with a point source, then the illumination at the scene plane (E) is given by

$$E (\text{lm}/\text{cm}^2) = \frac{I}{s^2}, \quad (2)$$

where

I = source luminous intensity in cd.

s = source-to-scene distance in cm.

Finally, if the scene is a lambertian uniformly reflective surface, the reflected scene luminance (L) is given by

$$L (\text{cd}/\text{cm}^2) = \frac{r E}{\pi}, \quad (3)$$

where

r = scene reflectance.

E = scene illumination (lm/cm<sup>2</sup>).

π = normalizing factor.

Alternatively another set of units that can be used with lambertian-cosine radiating surfaces includes the quantity π into the units of luminance:

$$L (\text{lamberts}) = r E (\text{lm}/\text{cm}^2). \quad (4)$$

Thus a surface illuminated with 1 lumen/cm<sup>2</sup> will have a luminance of 1 lambert if the surface is 100% reflective. It can be seen that

$$1 \text{ lambert} = \left( \frac{1}{\pi} \text{ cd}/\text{cm}^2 \right) \text{ and}$$

$$L (\text{lamberts}) = \pi L (\text{cd}/\text{cm}^2).$$

In physiological optics the millilambert is the ap-

Joe Horwath, Optoelectronic Engineer, Fairchild Microwave and Optoelectronics, Palo Alto, Calif. 94304.



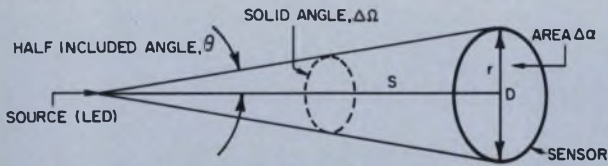

$$\Delta\Omega \cong \Delta a / s^2, \quad s = \text{source/sensor separation}$$

$$\Delta a = \text{sensor area}$$

For  $1 < s$  e.g.  $s = 10r$

$$\theta \cong r/s \text{ [radians]} \quad \Delta\Omega = \pi (r/s)^2 \text{ or } \frac{\pi}{4} (D/s)^2$$

$$\text{Solid Angle} \cong \pi \times (\text{half included angle})^2$$

$$\Delta\Omega \cong \pi \times \theta^2$$

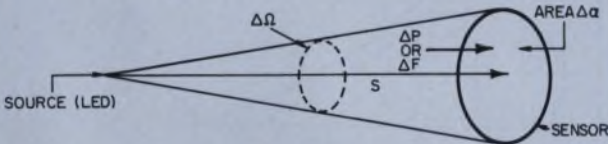

$$\text{Intensity} = \frac{\text{Power (or Flux)}}{\text{Unit Solid Angle}}, \quad J_o = \frac{\Delta P}{\Delta\Omega}$$

$$\text{or } I_o = \frac{\Delta F}{\Delta\Omega}$$

$$\Delta\Omega = \Delta a / s^2 \quad \text{Thus } J_o = \left( \frac{\Delta P}{\Delta a} \right) \times s^2$$

$$\text{or } I_o = \left( \frac{\Delta F}{\Delta a} \right) s^2$$

$$\left( \frac{\Delta P}{\Delta a} \right) = \text{Irradiance, } H \text{ or}$$

$$\left( \frac{\Delta F}{\Delta a} \right) = \text{Illuminance, } E$$

$$\text{Radiant intensity} = \text{Irradiance} \times (\text{Separation})^2$$

$$J_o = H s^2,$$

$$\text{Luminous intensity} = \text{Illuminance} \times (\text{Separation})^2$$

$$I_o = E s^2,$$

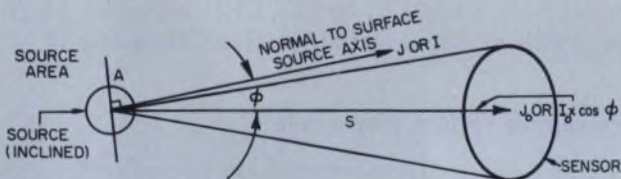

$\phi$  = Source inclination angle with respect to source/sensor axis

Radiometric

Photometric

Radiance of source,  $N$   
as seen from sensor  
axis

$$N = \frac{J_o \cos \phi}{A \cos \phi} = J_o / A$$

Radiance of source =  
(Radiant intensity  
(in given direction)  
Source projected area  
(in same direction))

Luminance of source,  
 $L$  as seen at sensor  
axis

$$L = \frac{I_o \cos \phi}{A \cos \phi} = I_o / A$$

Luminance of source =  
(Luminous intensity  
(in given direction)  
Source projected area  
(in same direction))

1. Relative geometry of point source and sensor (top and center) determine light intensity at the sensor. Area of extended source (bottom) affects intensity.

appropriate unit of luminance.

LEDs are typically 1-mcd sources for a chip area on the order of  $0.001 \text{ cm}^2$  and for a diode forward-current of 10 to 20 mA for GaAsP LEDs and 1 to 2 mA for GaP LEDs. The luminance of a typical diode chip is therefore

$$\text{LED chip luminance} \cong \frac{1 \text{ mcd}}{.001 \text{ cm}^2} = 1 \frac{\text{candela}}{\text{cm}^2} \quad (5)$$

Or in equivalent lambertian units, LED chip luminance  $\cong \pi$  lamberts  $\cong 3000 \text{ mL}$ . This is quite high.

### Visual acuity is important

However, note that visual acuity (VA)—the ability of the eye to resolve the fine details of objects in the field of view—saturates somewhere between 100 and 1000 mL (Fig. 2). It is apparent that normal acuity of 1 (corresponding to visual acuity of 1/1<sup>1</sup>, or 20/20 vision) is obtained for luminance levels around 1 to 10 mL. How does this apply when a LED is viewed? Let's work out an example.

Given a GaAsP LED chip with luminous intensity of 1 mcd, an area of  $.001 \text{ cm}^2$  and diameter  $\cong 0.3 \text{ mm}$ . What is the maximum distance over which you can barely resolve the LED? Assuming that the chip is a cosine source, we see that

$$L_{(\text{axial})} = I_{(\text{axial})} / A \text{ (projected along axis)}. \quad (6)$$

$$L = 1000 \text{ mcd} = 3000 \text{ mL}.$$

From the acuity-vs-log-luminance curve, the VA is seen to be about 1.7. The corresponding resolution distance for a 20/20-observer is calculated from

Visual angle to be resolved ( $\Delta\theta_R$ ) =

$$\frac{\text{Diameter of LED } (\phi)}{\text{Observer Distance } (S_o)} \quad (7)$$

Since visual acuity is the reciprocal of the angle resolved in minutes of arc, then

$$\text{VA} = \frac{1}{\Delta\theta_R \text{ (minutes)}} \quad (8)$$

Performing a minutes-to-radian conversion gives the resolution-distance equation:

$$S_o = 3480 \times \phi_{\text{LED}} \times \text{VA}. \quad (9)$$

Thus for 20/20 vision,  $S_o = 3480 \times 0.3 \text{ mm} \times 1.7 = 1.75 \text{ meters}$  (about 7 feet); and for 20/40 vision,  $S_o = 0.87 \text{ m}$  (3.5 feet).

Here's another problem: At what distance can a diffuse epoxy-lens-LED, viewed axially, be "comfortably" seen with good resolution against a red background? The background is illuminated to 10 foot-candles and has a reflectance of 10%—for example, a red display bezel. With the LED chip of our first example encapsulated in a .180-inch diffuse lens, the bezel illuminance is seen to be

$$L \text{ (foot-lamberts)} = r \times E \text{ (foot-candles, fc)}.$$

$$L_{\text{bezel}} = 0.1 \times 10 \text{ fc} = 1 \text{ ft-L}.$$

The LED's diffuse-lens luminance can be ap-

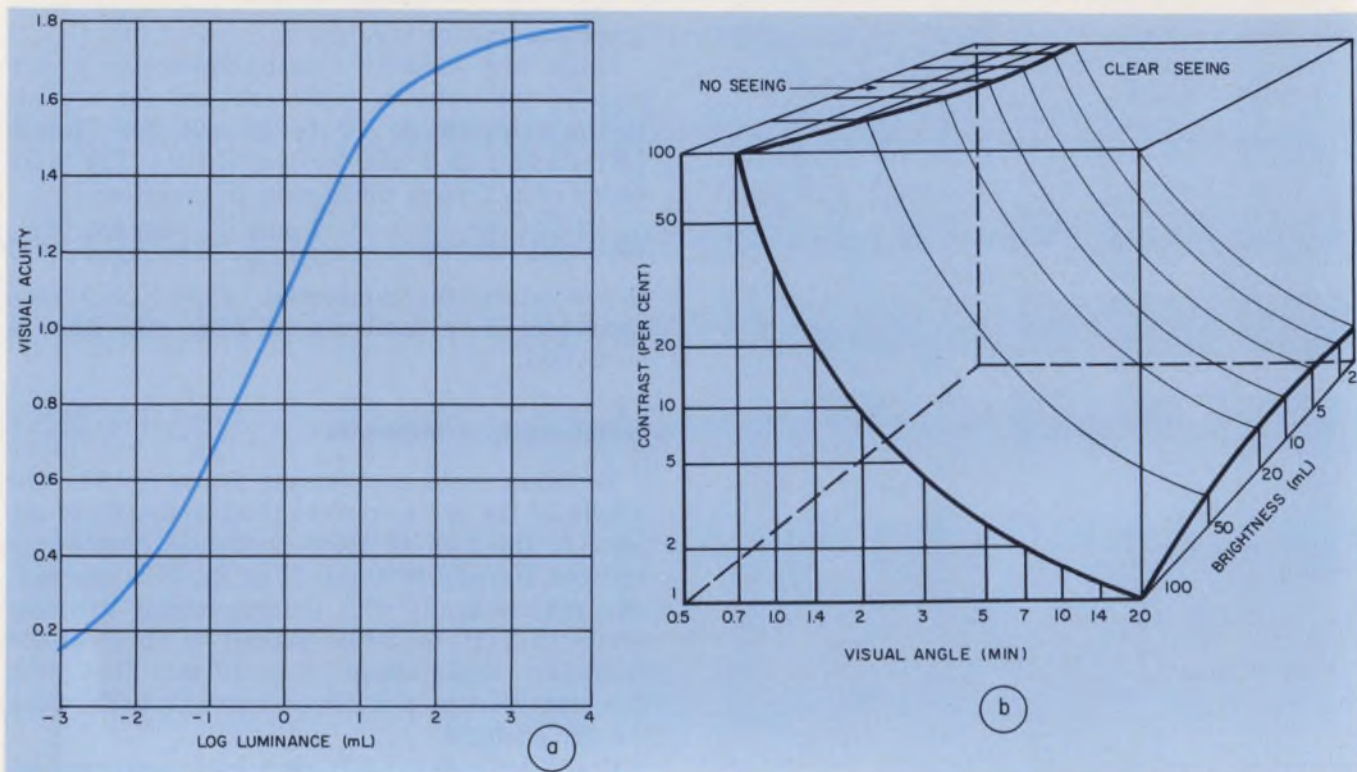

2. The eye's ability to distinguish detail (cone vision) depends on the scene luminance (a). Contrast—a meas-

ure of minimum to maximum brightness variation—also affects the visual acuity (b).

proximated if we assume that the product of axial luminance and axial projected area is conserved—that is, the light loss of a diffuse lens is offset by the increased light output provided by the high index of refraction (1.4 to 1.5) of epoxy lenses. Except for absorption, flux is thus approximately conserved. Therefore

$$L_{\text{lens}} = L_{\text{LED chip}} \times \frac{\text{Area of LED chip}}{\text{Area of diffuse LED lens}} \quad (10)$$

$$= 3000 \text{ mL} \times \frac{0.001 \text{ cm}^2}{0.160 \text{ cm}^2} \cong 20 \text{ mL}.$$

From the visual acuity/log luminance curve, the VA is seen to be about 1.5 for cone (color) vision. Plugging the quantities into the resolution distance, we get, for 20/20 vision,  $S_0 = 3480 \times 4.5 \text{ mm} \times 1.5 = 23.5 \text{ mm}$  (78.3 feet); and for 20/40 vision,  $S_0 = 11.8 \text{ mm}$  (39.2 feet).

Besides field luminance, another quantity—contrast—plays a crucial role in what we can or can't discriminate. The contrast percentage is defined as

$$C = \frac{L_H - L_L}{L_H} \times 100\% = (1 - L_L/L_H) \times 100\%, \quad (11)$$

$L_H$  = highest scene luminance.

$L_L$  = lowest scene luminance.

For  $L_H \gg L_L$ , the contrast approaches 100%. (Often the ratio to the lower luminance is used; find out which in a particular situation.) In our case

$$C \cong (1 - \frac{1 \text{ mL}}{10 \text{ mL}}) \times 100\% = 90\%.$$

Let's now look at a LED large-digit resolution problem: Construct a resolution-distance/log-luminance graph (Fig. 3) showing resolution distance vs character height or width for numerics from 0.100 inch (2.5 mm) to 0.500 inch (12.5 mm), in 0.040-inch (1 mm) increments. This is a complex problem. The question is, what is to be resolved? The height of the entire digit or its width? Or should it be the LED segment height or width or some combination of these two?

#### Perceptive factors play a role

Here, the pattern-recognition aspects of vision become important. Let's take a conservative stance and say that the segment length must be resolved to make a digit legible and, further, that a segment (such as the seven-segment numeric display) is one-half the character height. The resolution-distance equation for seven-segment numerics then becomes

$$\phi(m) = 1/2 \times 3480 \times \phi_{\text{LED numeric}}(\text{mm}) \times \text{VA}. \quad (12)$$

Alternatively, let's construct a resolution-distance/log luminance graph (Fig. 4) that gives the viewing effectiveness of numeric segmented LEDs ranging in size from 0.010 (1/4 mm) to 0.100 inch (2.5 mm) under luminance levels ranging from  $10^{-1}$  to  $10^5$  mL. If we assume optimum visual conditions, 100% contrast and a 20/20 observer, the applicable equation is

$$\phi(m) = 3480 \times \phi_{\text{LED}}(\text{mm}) \times \text{VA}. \quad (13)$$

Fig. 4 shows the expected distances over which a LED can be resolved, based on 20/20 vision and 100% contrast. However, psychophysical phenomena can dramatically affect ability to discriminate detail. Thus the equations and the resolution graphs are not absolute. But they do give major relevant parameters that can be modified as needed.

For example, visual acuity is dependent upon a number of variables, such as field luminance and contrast. The manner in which contrast affects the VA for a particular background luminance is shown in Fig. 2b. Assuming a two-order magnitude variation in contrast, the visual angle can change from 0.7 to 20 minutes for a background brightness of 100 mL. This corresponds to a VA between 0.05 and 1.43, which, in turn, corresponds to a change in resolution distance of about 30 to 1.

If we say that 20/40 is sufficient acuity, it becomes apparent that the maximum resolution-distance equation and graphs would have to be derated by as much as 50 or 60 to 1. (For a comprehensive view of this subject, consult the bibliography).

Radiometric output power (mW) is the most

often quoted index of merit for infrared-emitting LEDs. However, it is not generally used for visible LEDs, in which luminous total output power, in millilumens, is the important quantity.

### Which instrument is best?

Several types of instruments and sensors are used to measure the radiometric and photometric properties of radiant energy and light. They include thermopiles and photometers that use photomultipliers or solid-state cells of silicon, cadmium-sulfide or selenium. Of these, the most widely used for LEDs are the photomultiplier and silicon-cell photometers.

In the photomultiplier photometer the photomultiplier is coupled to an optical system, usually a microscope, that has an aperture with a fixed diameter. Light emitted from the device is focused on the aperture and measured by the photomultiplier. The chief advantage of this photometer is its sensitivity. But it has these drawbacks:

- If, as is the case with LEDs, the emitter area is smaller than the aperture area within the field of the microscope, a subjective judgment must be made to select the part of the emitting

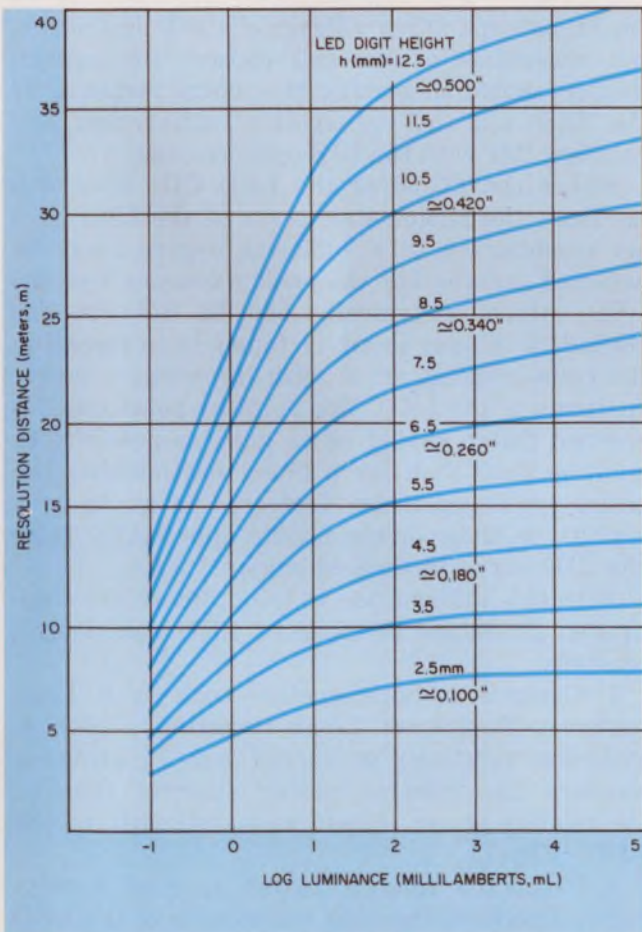

3. Graph shows distances over which a seven-segment LED numeral can be just resolved, assuming a scene contrast of 100 percent and 20/20 vision.

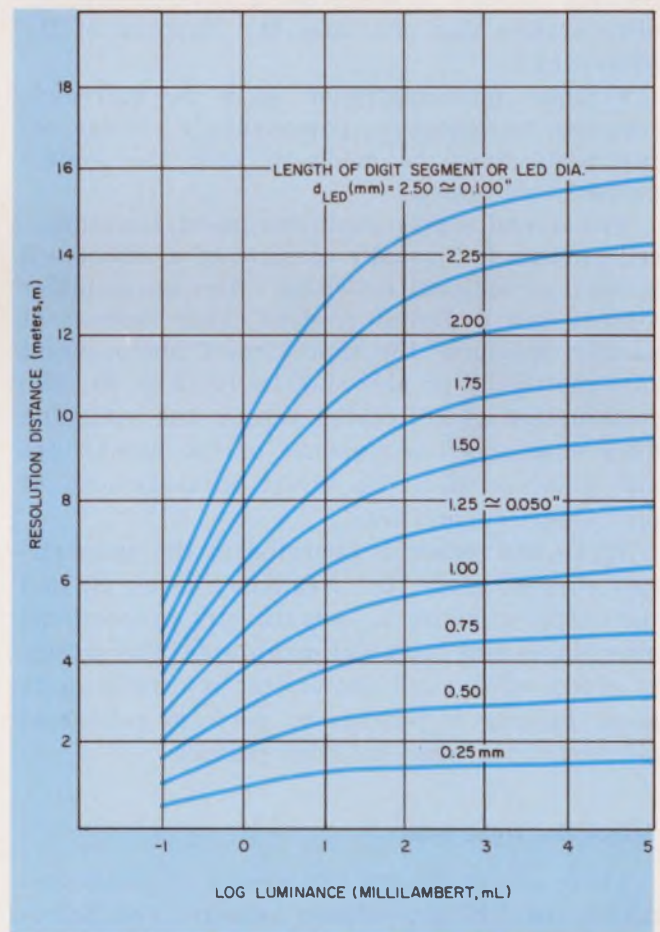

4. Resolution distances are shown for segment lengths from 0.01 to 0.1 in. Contrast is 100%, vision is 20/20, but psychophysical effects are not included.

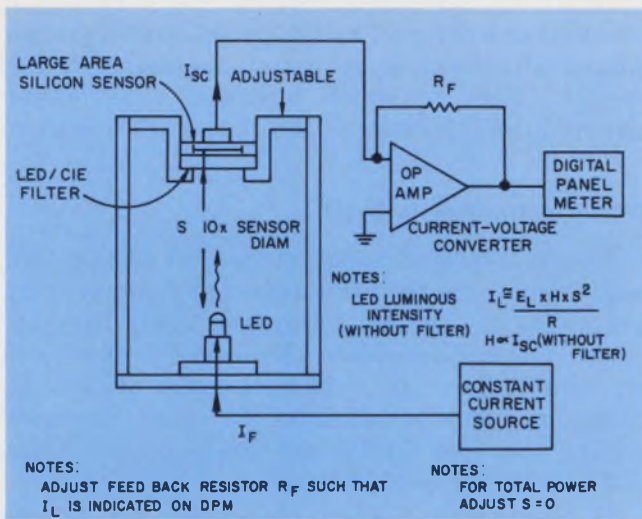

5. Silicon-cell photometer measures short-circuit photo current. DPM is scaled to read light intensity seen by eye-matching sensor-filter combination.

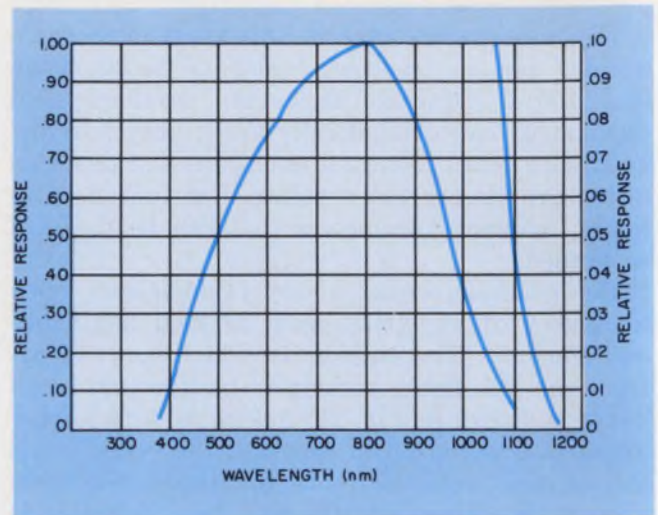

6. Silicon sensor (PIN 10D) calibration curve shows relative spectral response. Responsivity of cell at 800 nm (peak  $\lambda$ ) is 0.379 A/(W/cm<sup>2</sup>).

surface upon which to focus. Hence it's difficult to obtain consistency in measurements. (This is not the case, however, when a photomultiplier photometer measures the surface brightness of large-area emitting surfaces, such as CRTs.)

- It's hard to make precise photometric measurements with a photomultiplier, since it's extremely difficult to construct a photomultiplier/filter system that simulates the response of the human eye.

- Since photomultiplier gain is extremely sensitive to excitation, power-supply voltage adjustments must be made to keep the system properly calibrated.

The second widely used instrument, the silicon-cell photometer, usually consists of a silicon-cell sensor, an optional matching filter, an amplifier system and a digital readout. This instrument usually measures the short-circuit photocurrent radiometrically or photometrically (Fig. 5). The combination of silicon-cell sensor and matching filter simulates the response of the human eye and thus permits the direct measurement of photometric quantities.

When the sensor is operated in the short-circuit current mode, the irradiance level,  $H$ , and the output current,  $I_{sc}$ , are directly proportional over six to nine orders of magnitude. The stability of the silicon cell photometer is usually quite good, making it possible to perform calibrated measurements over extended periods.

### Select the right filter

There are at present two grades of filters that match red LEDs to silicon sensors: the Schott BG-38 glass filter and the LED CIE filter made by California Optoelectronics Industries. The latter, when mated to an appropriate sensor, closely ap-

proximates the response of the human eye and gives photometric accuracy of better than 95%. It can be used to test both GaAsP (red) and GaP (orange) LEDs. But it's more expensive than the BG-38 filter.

A combination—the BG-38 Schott green filter and United Detector Technology's Pin 10D Silicon Sensor—also approximates the response of the human eye. Other silicon cells will do the job, but regardless of the cell chosen, the experimenter should determine the exact response of the filter and cell by spectral calibration and compare this with the CIE eye response.

Either the BG-38 or the LED CIE filter will minimize the photometric error of the filter/sensor combination to a sufficient degree over the expected variation of the peak wavelength of the LED, which is typically 650 to 675 nm for GaAsP. The filter error is found by integrating the point-by-point error with the relative power spectrum of the LED. The point-by-point relative spectral match should be as good as possible. In addition don't look for a filter that matches the entire visible spectrum (referred to as an area match), as these filters deviate appreciably from the CIE curve in the red region.

With this information in mind, here's the step-by-step procedure to measure LED radiometric intensity:

- Using a monochromator—such as a Leiss (prism), Bausch & Lomb (grating), McKee-Pedersen (grating) or Jarrell Ash (grating)—measure the relative power spectral density, the relative power output vs wavelength, of the LED (Fig. 7).

- From the relative power spectral density curve, determine the peak wavelength of the LED emission.

- Obtain a silicon cell and have it calibrated radiometrically by a secondary standards labo-

ratory—like Optronics Laboratories, EG&G, California Optoelectronics Industries, Eppley Labs—in terms of responsiveness in amps/watt or responsivity in mA/(mW/cm<sup>2</sup>) (Fig. 6). Using the calibration curve, find the sensor responsiveness, R<sub>PK</sub> (A/W) at the LED peak wavelength.

4. Separate the source and the sensor so that the distance between them is at least 10 times the diameter of the sensor or the source, whichever is greater. (For the “exact” distance see Step 8.)

5. Measure I<sub>sc</sub>, the photo short-circuit current of the silicon cell, in milliamps.

6. Since the incident power (in milliwatts) on the silicon cell is

$$P = I_{sc}/R$$

and the solid angle (in sr) subtended at the cell of sensing area A is

$$\Omega = A/s^2,$$

the radiant intensity, J, (in mW/sr) is

$$J = P/\Omega = (I_{sc}/R) \times (s^2/A). \quad (14)$$

7. If the responsivity, R, in A/(W/cm<sup>2</sup>) is the known quantity, the expression for intensity is

$$J = (I_{sc}/R) s^2 \quad (15)$$

8. Repeat the procedure from Step 4 at successively larger distances, in 1-cm increments, where 5 cm < s < 20 cm. By plotting J, a curve is traced that asymptotically approaches the true radiant intensity. The final accuracy is governed by the care and patience of the experimenter.

Note that the photocurrent you can expect from a 1-cm<sup>2</sup> silicon sensor, when illuminated by a LED under normal forward-current excitation, varies from 100 to 1 nA. An ammeter with sufficient sensitivity and resolution is thus required (Keithley 150B or equivalent).

#### Power measurements are troublesome

As for LED power output, the simplest way to measure it is to butt the LED against a large (1 cm<sup>2</sup> or larger) photovoltaic silicon sensor and then measure the short-circuit photocurrent. This implies a measuring instrument with a low input impedance, ideally zero. To the extent the sensor intercepts the total radiation pattern of the LED, the total power is measured.

A second technique tries to compensate for the loss of light from the sides of the LED by placing a reflective cone about the diode. This fixture is usually gold plated. With this method, virtually all the light is reflected onto the sensor.

A third way to collect the LED's light is to use a small aluminum integrating sphere that has a diffuse reflecting surface on the inside. Generally it is coated with a white, highly-reflective material, such as barium sulfate or magnesium oxide. The sensor does not look at the LED directly but measures the illumination of the cavity walls. It's assumed that the sensor

samples the light from the source uniformly and that therefore the sensor output will correlate well with the output power of the LED.

These techniques are all valid, in the sense that they sample some fraction of the total output power. The question is, What fraction is collected? And to what extent is collection method dependent upon the radiation pattern? Here's a technique that gives repeatable results.

First, select a LED to be used as a transfer standard. Next, calibrate the LED on a goniometer. The total power can be calculated from the intensity measurements. The calibrated LED is then transferred to any power-measurement fixture, which is then calibrated in turn. Routine total power measurements may then be performed for any particular device that has the same

Table. CIE (λ) luminous efficiency

λ in nm	Standard Values
380	0.00004
390	.00012
400	.0004
410	.0012
420	.0040
430	.0116
440	.023
450	.038
460	.060
470	.091
480	.139
490	.208
500	.323
510	.503
520	.710
530	.862
540	.954
550	.995
560	.995
570	.952
580	.870
590	.757
600	.631
610	.503
620	.381
630	.265
640	.175
650	.107
660	.061
670	.032
680	.017
690	.0082
700	.0041
710	.0021
720	.00105
730	.00052
740	.00025
750	.00012
760	.00006

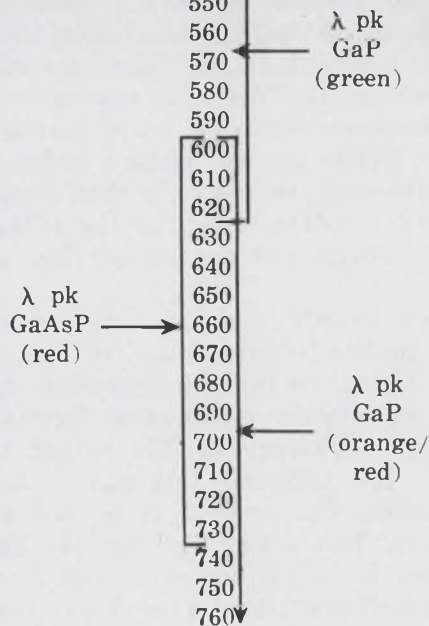

optics as the transfer standard.

The equation that relates radiant flux to angular intensity is

$$\phi = 2\pi \int I_{\theta} \sin \theta d\theta.$$

This reduces, in practice, to a numerical integration:

$$\phi = 2\pi I_0 \sum_{\theta=0}^{\theta_{\max}} R_{\theta} \sin \theta \Delta \theta,$$

where

$$I = I_0 \times R_{\theta}.$$

$I_0$  = axial radiant intensity, found as outlined.

$R_{\theta}$  = the relative intensity, as found from the angular radiation pattern measurements.

$\Delta \theta \cong 1$  to  $5^{\circ}$  increments, depending on the time/accuracy of the lab work.

Repeatable results are obtained when you average out the angular intensity over four quadrants. This is done by finding the radiation pattern along one axis of elevation and one of azimuth.

The sensor spacing should be such that the source/sensor separation distance equals the sensor diameter divided by the angular increment  $\Delta \theta$ . For example, for  $\Delta \theta = 6^{\circ}$ , 30 measurements of relative angular intensity per axis are required over a  $180^{\circ}$  field of view. If a  $1\text{-cm}^2$  area sensor is used, this corresponds to  $S = 10$  cm. (The author uses  $S = 20$  cm with a  $1\text{-cm}^2$  area sensor. This results in  $2^{\circ}$  increments.)

Note that infrared LEDs are measured by irradiating the silicon sensor directly, while luminous flux measurements should use a LED CIE filter.

### Compute the luminous intensity

To convert the radiant intensity to luminous intensity, perform an approximate calculation: From the CIE photopic table, find the value of  $V(\lambda)$  at peak wavelength. This value approximately equals the luminous efficiency,  $\eta_l$ , of the LED. Multiply  $\eta_l$  by 685 to get the efficacy factor  $e_l$ . The luminous intensity, or power, is then obtained by taking the product of  $e_l$  and the radiant intensity. This works well for GaAsP but not well for GaP.

Or, to convert exactly, find the luminous efficiency for the system by calculating the normalized product integral. (A computer program that performs this calculation is available from the author.) Multiply efficiency by 680 to get the efficacy factor. The luminous intensity is then obtained by taking the product of  $e_l$  and the radiant intensity. This works well for any kind of light source, including tungsten and fluorescents and GaAsP and GaP LEDs of any color or spectrum.

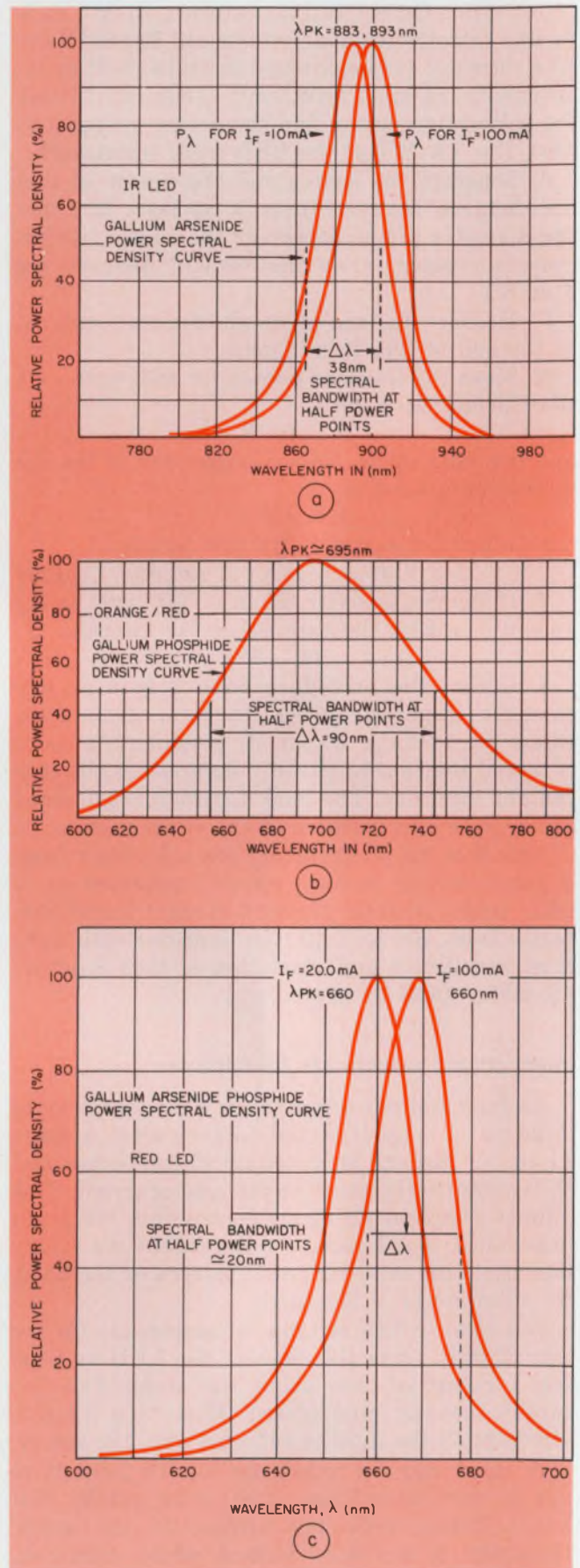

7. Relative power spectral density curves give LED emission as a function of wavelength. Infrared LEDs give peak emission at about 890 nm (a), orange/reds peak at 695 nm (b) and red LEDs peak at 660 nm (c).

A photometric measurement can be made more quickly and readily than a radiometric measurement, since the latter requires finding the efficacy factor separately via the product integral. Hence the photometric method is generally preferred to measure the properties of a LED routinely.

On the other hand, a filter changes the aperture size of the sensor for a point source. Also, the photometric error for a given source spectrum is not zero. For this reason, a photometric measurement is inherently less accurate than a radiometric. The radiometric measurement is thus a preferred *calibration* technique, while the photometric, with filter, is a practical technique used for the routine evaluation of LEDs.

This is corroborated in practice: If the properties of a particular LED are measured radiometrically and photometrically by several independent experimenters—and the measurement calibrations are traced to standards of the National Bureau of Standards—the photometric measurements will show typically about 10 to 25% correlation, while radiometric measurements will show 10% or better. ■■

#### Bibliography

##### General survey article on LEDs

Bergh, Arpad A., Dean, P. J., "Light Emitting Diodes," *Proceedings of the IEEE*, Vol. 60, No. 2, February, 1972.

##### Manufacturers application notes

Ahrons, Richard W., "Gallium Phosphide Diodes Offer Brighter Lamps and Displays." Opcoa Inc., Edison, N.J.

Fletcher, D., "The Photometry of LEDs a Primer in Photometry," Application Note AN601, Monsanto, Cupertino, Calif.

Smith, George, "LEDs and Photometry," Application Note 1, Litronix Inc., Cupertino, Calif.

Sorenson, Hans O., "Do LED Light Measurements Make You See Red," *Electro-Optical Systems Design*, August, 1972.

Zaha, Michael A., "Shedding Some Needed Light on Optical Measurements," *Electronics*, November 6, 1972.

##### Photometry and Radiometry

Brown, E. B., Ch. 5: "Radiometry and Photometry," *Modern Optics*, Reinhold Publishing Co., 1965.

Jenkins and White, Ch. 7: "The Effect of Stops," *Fundamentals of Optics*, McGraw Hill, 1957.

Teele, R. P., "Vol. I: Photometry;" Nicodemus, F. E., "Vol. IV: Radiometry," *Applied Optics and Optical Engineering*.

Luxenberg, H. R., and Kuehn, R. L., Ch. 3: "Photometry," *Display Systems Engineering*, McGraw Hill, 1968.

Smith, W. J., Ch. 8: "Radiometry and Photometry," *Modern Optical Engineering*, McGraw Hill, 1966.

##### Psychophysics and human factors: vision

Graham, E. H., Ch. 8-12 and 16, In *Depth: Vision and Visual Perception*, Wiley and Sons, second edition.

Leavitt, George A., "Spectral Response of the Eye," *Optical Spectra*, September, 1971.

Woodson, W. E., and Conover, D. W., Ch. 3: "Vision," Survey: *Human Engineering Guide*, second edition, University of California Press, 1964.

##### Terminology, symbols, units and quantities

"Nomenclature and Definitions for Illuminating Engineering," United States of America Standards Institute, USASZ7.1-1967.

USA Standard RP16.

# BARGAIN! MINI-PRICES

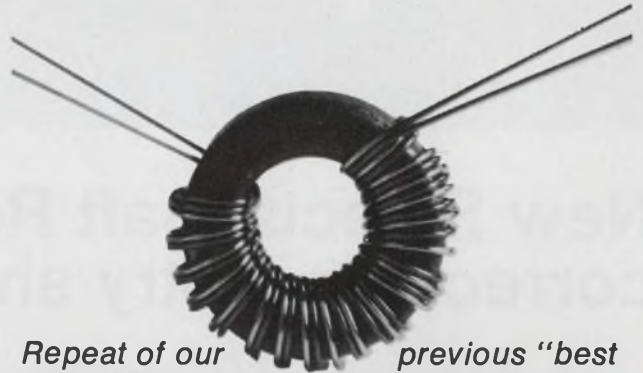

Repeat of our previous "best seller." Hottest price for precision manufactured mini open transformers. Bifilar wound with exciting two-color solder pot strippable wiring. The perfect touch for your new balun, floating switches, inhibit drive and coupling applications. Eliminates time-consuming core search and winding.

Low, low factory to you prices. 25¢ each (lots of 500)

Guaranteed, immediate shipping within 24-hours of your order for any item in the vast selection described below. Delivered fresh to you in convenient packages of 50. If you're a big spender, ask for special quotes for lots of 1,000 or more.

#### ELECTRICAL SPECIFICATIONS

Catalog Number	Turns Ratio $\pm 5\%$	Primary OCL $\mu\text{H min}$	ET Volt- $\mu\text{sec Min}$	Cww pf max	L L $\mu\text{H max}$	DCR ohms max
PE 52104	1:1	10	1.0	1.5	0.18	.14
PE 52106	1:1	20	1.3	2.0	0.20	.17
PE 52108	1:1	35	1.6	2.5	0.20	.23
PE 52110	1:1	60	1.8	3.5	0.22	.25
PE 52112	1:1	85	2.1	4.0	0.22	.28
PE 52114	1:1	125	2.7	5.0	0.22	.30
PE 52116	1:1	160	2.8	6.5	0.22	.35
PE 52118	1:1	215	2.8	8.5	0.22	.35
PE 52120	1:1	240	3.2	10.0	0.22	.37
PE 52122	1:1	290	3.6	12.0	0.22	.41
PE 52124	1:1	360	3.9	12.5	0.24	.42
PE 52126	1:1	385	4.2	12.5	0.28	.48
PE 52128	1:1	445	4.4	14.0	0.28	.50
PE 52130	1:1	515	4.9	14.5	0.32	.54

#### PHYSICAL DIMENSIONS

Lead Length: Start 1.5 in. min. Finish .75 in. min. O.D.—0.220 max. Height—0.100 max. Inspection per MIL STD 105 1% AQL Level 2	Rating Range Average Power Rating (40°C Rise) 250 mw Dissipation Rating 75 mw Peak Pulse Voltage 50 volts High Potential Test 200v rms Insulation Resistance 10,000M $\Omega$
---	---

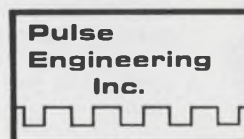

A Varian Subsidiary

**Pulse Engineering, Inc.**

P.O. Box 12235 • San Diego, Calif. 92112  
Phone 714-279-5900 • TWX 910-335-1527

# Centralab perspectives

FOR USERS OF ELECTRONIC COMPONENTS



**CENTRALAB**

Electronics Division  
GLOBE-UNION INC.

5757 NORTH GREEN BAY AVENUE  
MILWAUKEE, WISCONSIN 53201

## New Selectashaft Rotary Switch program corrects industry shortcoming.

**Users of custom rotary switches can now get delivery within days, thanks to this new field assembly program offered by participating Centralab Distributors.**

If it's taking you several weeks or even months to get delivery of custom rotary switches, you'll want to look into a new field assembly program pioneered by Centralab and available from their Selectashaft™ Distributors.

The thrust of the program is to ship orders of custom rotary switches within hours of their receipt. Eliminated are lengthy factory delays and special factory set-up charges.

Customers are finding the scope of Selectashaft switches indeed awesome. More than 100,000 combinations of miniature and subminiature



Custom switch assemblies with more than 100,000 combinations are available in days from Centralab Selectashaft Distributors.

switches are available, filling 95% of user needs.

The program enables you to select the exact length front shaft,

INFORMATION RETRIEVAL NUMBER 167

exact shaft end details, and the exact shaft flat angles required. You can choose from 92 types of rotary switches for field assembly by the Distributor to your choice of three .250 inch diameter shaft styles: plain round, .218 inch flat, or .156 flat configurations. The shafts themselves are offered in 24 sizes from .687 inch to 2.375 inches long from the mounting surface. Shaft flat angles can be specified in increments of 15°.

The Selectashaft Distributor program has been underway barely a year, and both Distributors and customers agree it meets a definite shortcoming that previously existed. In that short span, the number of participating distributors has grown to make the benefits of Selectashaft rotary switches available nationwide — on a local basis.

For complete product and price information, contact the Centralab Selectashaft Distributor nearest you. Or write Centralab Distributor Products, Dept. SAS-1.

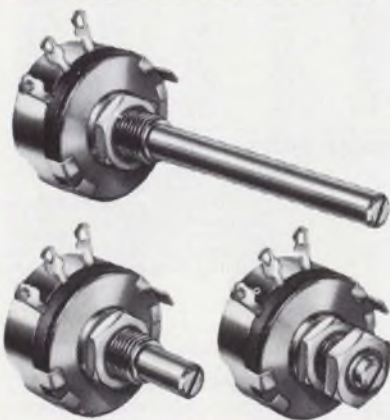

**MIL spec pots. A few words about a big bargain.** What more can be said about a line of hot molded potentiometers that meets MIL-R-94C requirements—and can be purchased for as little as 92¢ each, in quantities of 251-500? How about the fact that the pots are shelf items and available immediately. And that they're made by Centralab, whose quality control sets the standard for the industry. Why not write for the catalog which gives a few more reasons to try them before buying them. Ask for Catalog 34-I supplement.



**New 100 VDC transistor circuit caps.** Low voltage rating of 100 VDC is combined with high capacitance of .005 mf to .1 mf in these new ceramic disc capacitors from Centralab. Their miniature size is specially designed for transistor circuits, where tighter tolerances are essential. Write for Bulletin 42D562.



# A new concept in packaged power circuits as convenient as the TV dinner.

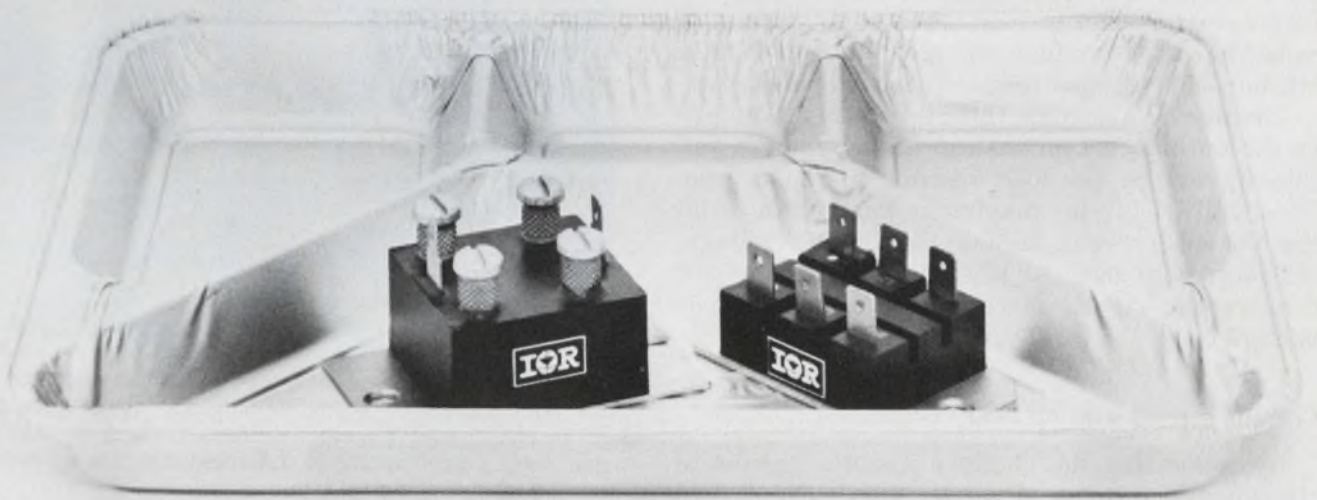

The International Rectifier PACE/pak™ is the device behind this new concept.

They are power integrated circuits, made up of SCRs, diodes, triacs, etc. which give you a complete control circuit function in a single package. And like the TV dinner, they take most of the shopping and assembly times out of the job.

But that's just the beginning of the benefits they offer.

**Smaller size.** PACE/paks (Passivated Assembled Circuit Elements) are electrically isolated up to 2.5 kV. There's no need for a separate isolated heat-sink, so you get up to 60% reduction in space requirements.

**A better designed system.** With the smaller size of these power hybrid control circuits you get more design and packaging flexibility. And since you don't have to spend time designing with discrete components, you have more time to make other improvements.

**One-fifth the assembly time.** No more do you have to assemble five to seven devices for single and 3-phase functions. With the PACE/pak there is just one part to mount, one part to interconnect with push-on or screw terminals. Your system reliability is higher, too.

Just think of the other savings you can make in testing, inspection and field servicing.

**Lower inventory costs.** We estimate a 7-to-1 reduction in inventory, plus savings in procurement time and costs. Standard PACE/pak circuits now cover 90% of single-phase power circuit requirements, with more in development for 3-phase applications.

They are available as standards with 25 or 42.5 Amp current ratings, in either 120 or 230 Volt RMS versions.

Find out how PACE/paks will revolutionize your designs like dc motor controls, inverters, chopper drives, generator exciters, solid-state circuit breakers, battery chargers and variable dc power supplies.

Call your local IR sales office for details or contact the factory: *International Rectifier* • 233 Kansas Street, El Segundo, CA 90245 • (213) 678-6281 • TELEX: 67-4666.

## International Rectifier

... the innovative power people



# Increase phototransistor bandwidth

without sacrificing output voltage. The solution is to use an op amp in lieu of an emitter load resistor.

A common problem with phototransistors is that the output bandwidth decreases as the designer attempts to increase the output voltage. At first glance, it appears the solution is obvious: Increase the emitter load resistance. This will raise the output voltage all right, but—and it's a big but—it will also reduce the bandwidth.

The way to overcome this restraint is to amplify the output current instead of the voltage and thereby permit the load resistor to go to zero. This will yield the maximum bandwidth. And the output current, unlike the output voltage, will not go to zero. At this point an op amp can convert the signal current to a usable output voltage level.

## Current sensed with op amp

By connecting the phototransistor's emitter to the inverting input of an op amp (Fig. 1) to sense the phototransistor current, we can achieve both zero load resistance and a voltage output. The low input impedance at the inverting terminal approximates a zero load resistance. Usable output voltage results because most of the photocurrent flows through the feedback resistor. And as a bonus, the output impedance of the op amp is very low.

Since the inverting input (pin 2) of the op amp is at a "virtual" ground, the op amp shows close to zero load resistance to the phototransistor, thereby yielding maximum bandwidth. Because of the op-amp gain, the net quiescent signal current into the inverting input is nominally zero:

$$i_{in}(t) + \frac{v_o(t)}{R_f} = 0$$

or

$$v_o(t) = -R_f i_{in}(t). \quad (1)$$

Thus, as the phototransistor delivers current to the op amp, feedback resistor  $R_f$  provides a path

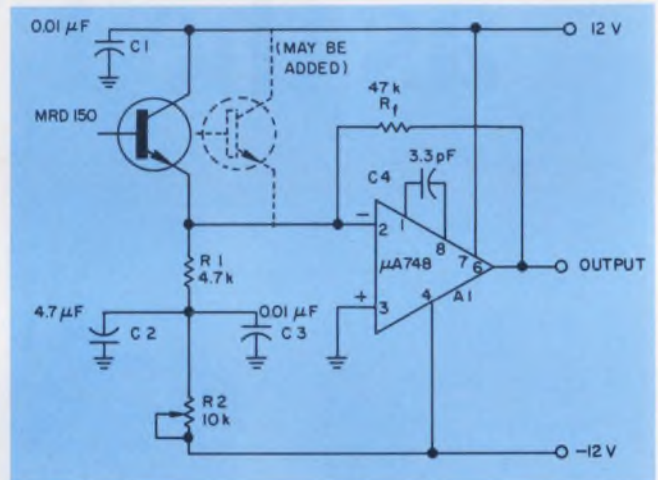

1. Op amp  $\mu A748$  extends the frequency response of the phototransistor by maintaining the device's output at an effective ac ground. Feedback resistor  $R_f$  adjusts gain, and potentiometer  $R_2$  balances out the quiescent current of the phototransistor.

to the output, maintaining the op-amp input current at zero.

Resistors  $R_1$  and  $R_2$  are used for dc-offset cancellation for the  $\mu A748$  op amp. Potentiometer  $R_2$  zeros the output voltage for ambient light input. This balances the quiescent current of the phototransistor. The ac gain of the circuit is at least equal to  $R_f/R_1$ , or 10, and the op amp is compensated for this gain.

The frequency response of this circuit (Fig. 2) is markedly improved over that of the phototransistor by itself. The output stays completely flat to 100 kHz, and a much larger output signal occurs at all frequencies.

## Evaluating circuit performance

The gain of the  $\mu A748$  C op amp is typically a function of frequency. At 10 kHz,  $|A|$  is typically 1000. Since most of the input current flows through the feedback resistor, we see that

$$V_o \approx -R_f \cdot I_{in} = -47 \text{ k} \cdot I_{in}.$$

Also,

$$Z_{in} \approx \frac{R_f}{|A|} = \frac{4.7 \text{ k}}{1000} = 4.7 \Omega.$$

Dana F. Geiger, Senior Project Engineer, Photocircuits Div., Kollmorgen Corp., 31 Sea Cliff Ave., Glen Cove, N. Y. 11542

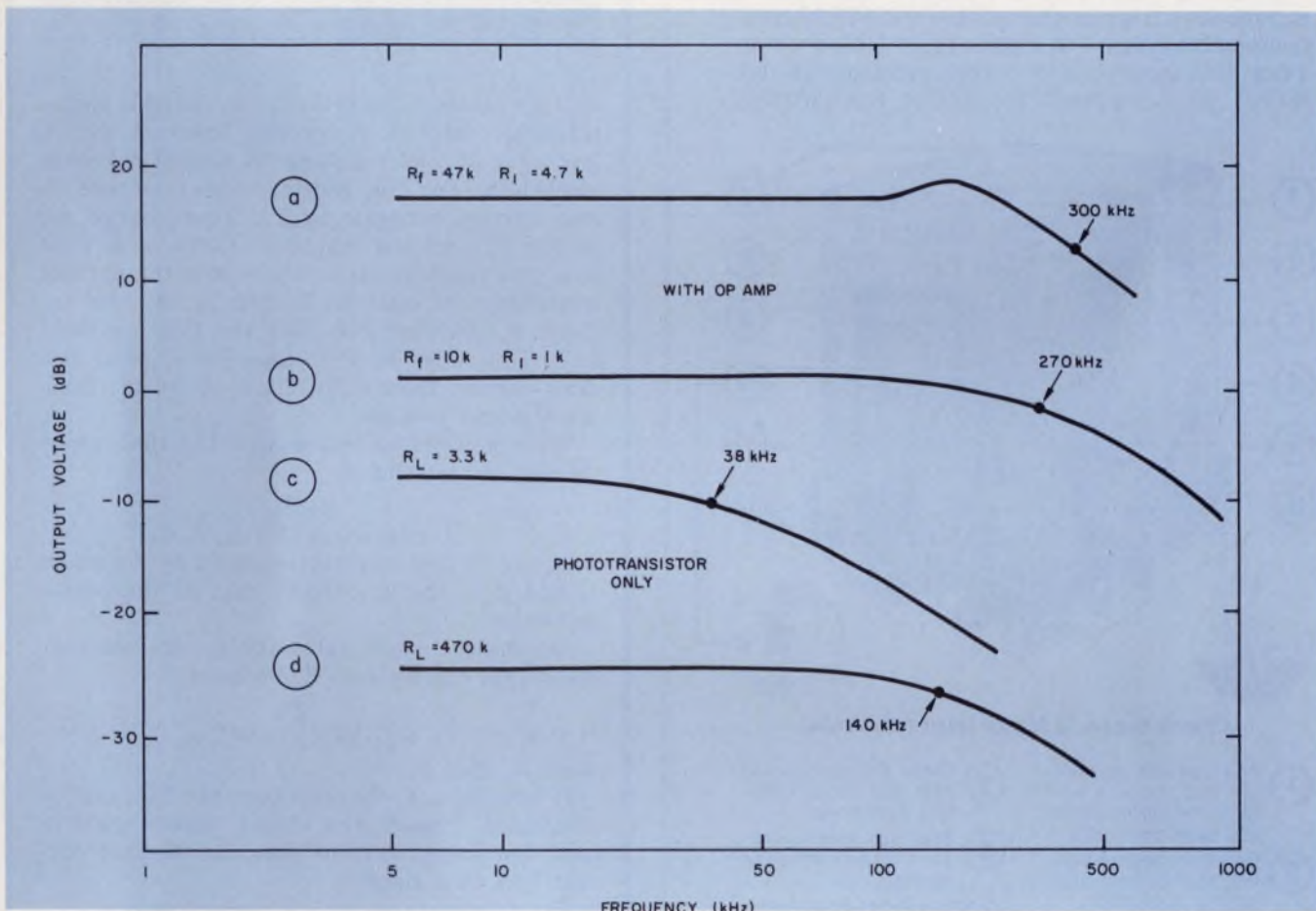

2. Frequency response of the op amp circuit for two different values of gain (a and b) shows marked im-

provement over the response of the phototransistor with just a load resistor (c and d).

The phototransistor produces an output voltage,  $V_o$ , as if it were being developed across a 47-k $\Omega$  resistor, yet it sees a load of only 47  $\Omega$ .

At frequencies higher than 10 kHz, the gain deteriorates. At 1 MHz,  $|A| \approx 10$ . So,

$$V_o \approx -47\text{ k} \cdot I_{in}$$

but

$$Z_{in} \approx \frac{R_f}{|A|} = \frac{47\text{ k}}{10} = 4.7\text{ k}\Omega.$$

Though performance is degraded, the phototransistor develops a voltage as if it were across 47

k $\Omega$ , yet it sees a load of only 4.7 k $\Omega$ . A more expensive op amp than the  $\mu\text{A}748$ , if it has more open loop gain at high frequencies, will further improve performance.

The gain of the circuit can be varied by changing the value of  $R_f$ . But then  $R_1$  must also be changed to maintain the ratio of  $R_f/R_1$  at 10:1. If the quiescent current of the phototransistor is low, it may be necessary to increase the value of  $R_2$  to 100 k $\Omega$  to balance out the current.

Any number of phototransistors may be added in parallel at the op-amp input—as for FM can-

# INTRODUCING OUR NEW 10 AMP ULTRA RELIABLE POWER RELAY

Our new, imported power relay has everything going for it because it is the product of an all-out effort to achieve complete reliability and durability in a more compact 10 ampere model.

Point-by-point, we have designed into it every conceivable improvement dictated by our broad engineering capabilities and extensive field testing experiences. It is interchangeable with widely used, comparable types — at a lower price. Delivery from stock. Call us or write for quotes and samples. Ask for HP. UL Component recognition No. E36213C.

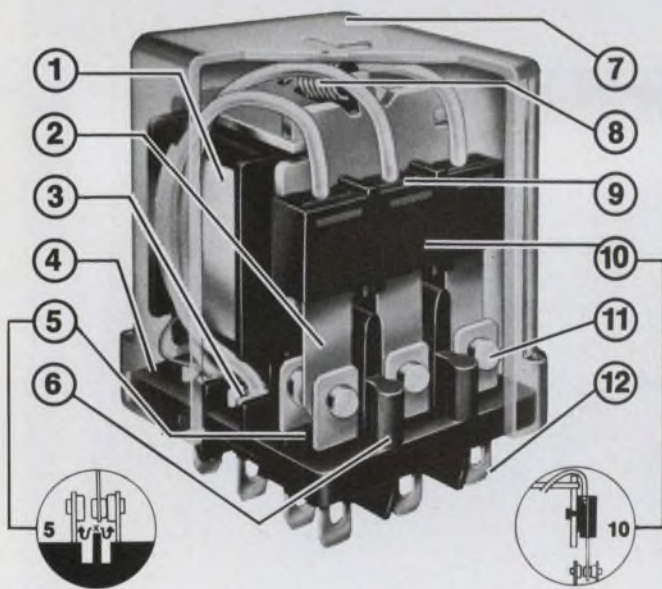

### Check these 12 Major Improvements:

- ① Polyurethane enamel-coated copper wire coil for maximum insulation and heat resistance.
- ② Beryllium copper contact spring. Best alloy for this application.
- ③ Welded leads through-out. Eliminates soldering irregularities.
- ④ Ammonia-free phenolic base. Maximum resistance against arcing and insulation deterioration.
- ⑤ Rib and groove barriers to maintain highest insulation between contacts.
- ⑥ Arc barriers to prevent pole flash-overs.
- ⑦ Clear Polycarbonate heat and shock resistant dust cover.
- ⑧ Stainless steel corrosion proof release spring.
- ⑨ Springs and wires molded into one piece with FGR #66 Nylon.
- ⑩ Plastic spring holder securely heat riveted to the armature.
- ⑪ Stabilized silver contacts for low contact resistance. Long shelf life.
- ⑫ Terminals firmly molded into the base. Choice of: plug-in, solder or 0.187" push-on wire terminations.



**LINE RELAYS**

A UNIT OF ESTERLINE CORPORATION

Line Electric Company, U.S. Highway 287, Parsippany, N.J. 07054  
201/887-8200

INFORMATION RETRIEVAL NUMBER 49

## How loading decreases bandwidth

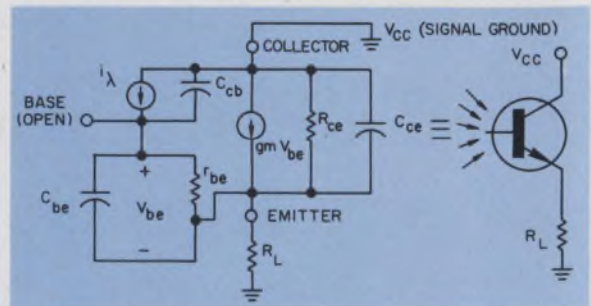

If we examine the hybrid-pi model of a photo-transistor (above), it becomes apparent why a low value of load resistance is needed for wide bandwidth. For the emitter output voltage to rise, current generator  $g_m V_{be}$  must charge capacitor  $C_{ce}$ . But the capacitor charges according to a time constant,  $RC_{ce}$ , where  $R$  is the parallel combination of resistors  $R_L$  and  $R_{ce}$ . As load resistor  $R_L$  decreases, so does the time constant  $RC_{ce}$ . Thus when  $R_L = 0$ , capacitor  $C_{ce}$  does not draw current from  $g_m V_{be}$ . This allows the fastest response possible.

We can write an expression for the output voltage,  $V_o$ , as follows:

$$V_o \approx \frac{R\beta I_\lambda}{(1 + j\omega RC_{ce})(1 + j\omega r_{be} C_{be})}, \quad (1)$$

where  $I_\lambda$  = base current produced by radiation  $\lambda$ , and  $\beta$  = the ac current gain of the photo-transistor.

Assuming a small value for  $R_L$ , we see that the output current into  $R_L$  becomes

$$I_o = \frac{V_o}{R_L} \approx \frac{\beta I_\lambda}{(1 + j\omega RC_{ce})(1 + j\omega r_{be} C_{be})}, \quad (2)$$

when  $R_L \ll R_{ce}$ .

If now  $R_L = 0$ , the time constant  $RC_{ce}$  can be eliminated. Though the output voltage goes to zero, the output current does not. Output current  $I_o$  is thus simply

$$I_o = \frac{\beta I_\lambda}{1 + j\omega r_{be} C_{be}} \cdot R_L = 0, \quad (3)$$

This eliminates the  $RC_{ce}$  time constant thus yielding the highest bandwidth.

cellation in optical encoders.

This current-sensing scheme improves upon the popular "high-frequency-boost" method, because it avoids adjusting a time constant in the op-amp circuit to match the high-frequency roll-off of a particular transistor. The op amp functions better than a simple transistor because it offers a low output impedance, controlled characteristics (voltage gain, input impedance, etc.) and a relatively low price. ■■

# If you knew what we know about subminiature lamps, you'd specify Chicago Miniature.

## The smaller the lamp the tougher the job.

First, subminiature lamps are usually applied in critical situations where a lot more than light is demanded. Where reliability is essential. Like system warning lights. Or status signals. Or critical instructions. And that's why you find Chicago Miniature lamps in tough jobs like the manned space flights.

Second, subminiature lamps are a lot tougher to make. They have all the same components as larger lamps, but everything's reduced to almost impossible manufacturing dimensions. The filaments, complicated assembly, critical material and atmosphere control—all are magnified problems when you work in the subminiature range.

## Chicago Miniature specializes in subminiature lamps.

We're expert when it comes to doing tiny things in a big way. For example, we have a special method for coiling the filament to precisely the right fraction of a turn to give you exactly the light output for your application. We also know the importance of precise filament mounting. Our filament mounting process is automated to eliminate the human variable. Both mean you get lamps with uniformity of brightness, and significantly longer life under typical operating conditions. All this and more, and within the subminiature range.



(ACTUAL SIZE)

## We invest in flexibility.

It takes a lot of skill and imagination to consistently make dependable subminiature lamps. And Chicago Miniature invests in skilled people and special automated systems no other company can provide. It means that whether you need a standard lamp or a special component, Chicago Miniature has the capability to support you. Right now. Even special requirements are handled systematically and quickly.

## Quality control comes naturally. It has to.

We're addicted to detail. All along the line. And that's the best kind of quality control. Chicago Miniature practices "controlled quality"—carefully monitoring key processes all the time. You get only those lamps that measure up. Nothing is left to chance.



CHICAGO MINIATURE  
LAMP WORKS  
4433 N. Ravenswood Ave.  
Chicago, Illinois 60640  
(312) 784-1020

a GENERAL INSTRUMENT company

**THE LIGHTING BUGS**

## We help you avoid costly specials.

Chicago Miniature already has more subminiature lamps than any other manufacturer. Immediately available are the T-3/4, T-1, T-1 1/4, T-1 1/2 and T-1 3/4 sizes. We offer standard wire terminals, flanged and bi-pin bases and a variety of other configurations.

## As much service as you need.

For problem solving application assistance, call your Chicago Miniature Sales Representative. Or call us directly for applications engineering assistance. Phone 312/784-1020. For off-the-shelf delivery, call your local Chicago Miniature Electronic Distributor

*Chicago Miniature also publishes technical data on subminiature lamp performance, under various operating and environmental conditions. This document represents over 9 million lamp hours of test data. Send the coupon for your free copy.*



### Chicago Miniature Lamp Works

4433 N. Ravenswood Ave., Chicago, Illinois 60640

- Please send me your free booklet on Subminiature Lamp Performance, including 9 million hours of test data.
- Please send me your catalog.

Name \_\_\_\_\_

Title \_\_\_\_\_

Company \_\_\_\_\_

Address \_\_\_\_\_

City \_\_\_\_\_ State \_\_\_\_\_ ZIP \_\_\_\_\_

Comments: \_\_\_\_\_

\_\_\_\_\_

\_\_\_\_\_

# Divide by n with the 7490—and do it without external parts. Merely wire between pins. All circuits except one also provide a BCD output.

Probably no other IC counter is as popular or as widely available as the 7490 decade counter. As ICs go, it is ancient; it was introduced at least seven years ago. Although it was originally designed to provide only a divide by two, by five or by 10, or a BCD count-of-10 sequence, the 7490 can also be connected to divide by an integer from two to 10—and without external components. All that is needed is correct wiring between pins (see accompanying table).

From the logic designer's point of view, to pick apart the details of the schematic of the

counter serves little purpose. Every manufacturer's specification sheet provides an identical schematic drawing. Briefly stated, the 7490 is made up of four J-K master-slave flip-flops (Fig. 1). These flip-flops are separated into two independent circuits, with the A flip-flop separate from the B, C, D combination. The A circuit is a divide-by-two and the B, C, D a divide-by-five. In addition there are two dual-input NAND gates to provide nonclocked direct setting to the all-ZERO or to the binary-9 state.

Of the four flip-flops, only on the A and C flip-flops do the true and complementary outputs alone connect back to their K and J steering inputs, respectively. Thus every falling signal edge to the CP trigger inputs of flip-flops A or C causes them to complement. But the B and D flip-flops have additional AND inputs to their J steering points that modify the behavior of these flip-flops: They toggle only on specific falling CP signal edges, to make the B, C and D flip-flops work as a divide-by-five circuit.

For simplicity, the reset-to-ZERO and reset-to-binary-9 gates have been omitted from the block diagram of Fig. 1. These gates are conventional TTL, NAND gates. If both inputs in either gate are high, the low output forces both the master and slave flip-flops of the respective circuits to the desired ZERO or binary-9 states (Fig. 2).

Unfortunately, the block diagrams provided by manufacturers (Fig. 3) leave out important details of the 7490 circuitry. This obscures some possibilities for unconventional counter designs. Note that the J-K steering inputs for the flip-flops are not shown in full detail and that the details for D are, at best, unclear.

Dr. Roger Camp, Iowa State University, Ames, Iowa 50010.

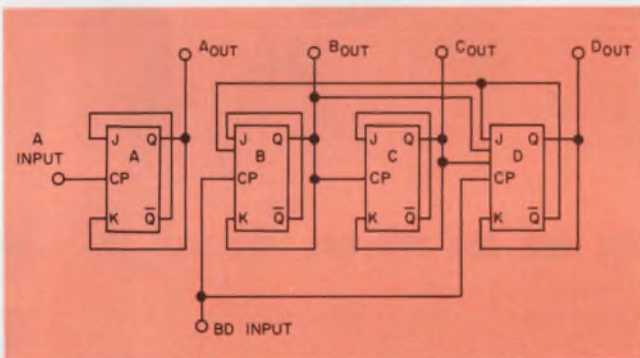

1. A simplified block diagram supplies the details of the 7490's J-K inputs that are important to the design of the divide-by-n circuits.

RESET/COUNT				OUTPUT			
RESET INPUTS				D	C	B	A
R <sub>0</sub> (2)	R <sub>0</sub> (1)	R <sub>9</sub> (1)	R <sub>9</sub> (2)				
1	1	0	x	0	0	0	0
1	1	x	0	0	0	0	0
x	x	1	1	1	0	0	1
x	0	x	0				COUNT
0	x	0	x				COUNT
0	x	x	0				COUNT
x	0	0	x				COUNT

2. The reset/count truth table shows the reset input conditions for setting the 7490 to the ZERO, binary-9 or count condition.

## Division by integers two to ten

The conventional BCD decade connection is shown in Fig. 4a. If a symmetrical square-wave output is required in a divide-by-10 configuration, use Fig. 4b. However, Fig. 4b does not provide a BCD output code. Since it uses the counter's divide-by-five section followed by the divide-by-two, this arrangement results in a modulo-5 and modulo-2 residual code.

The concept behind dividing by an integer between 2 and 10 is as follows: One or two output variables can be returned to either the reset-to-ZERO or reset-to-NINE inputs. This allows the count to continue from the ZERO or binary-9 state until the reset state is again reached. Some of the possible connections for the 7490 in a divide-by-n counting mode are given in the table. The average logic designer can readily verify for himself that each of the configurations works as described. ■■

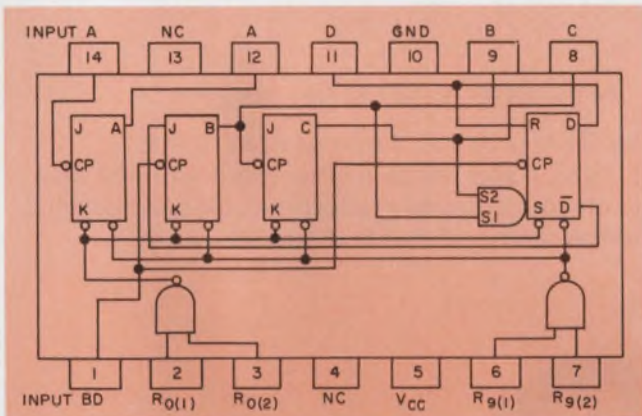

3. Manufacturers' block diagrams provide pin arrangements and the reset-circuit internal wiring, but leave out the important J-K input details.

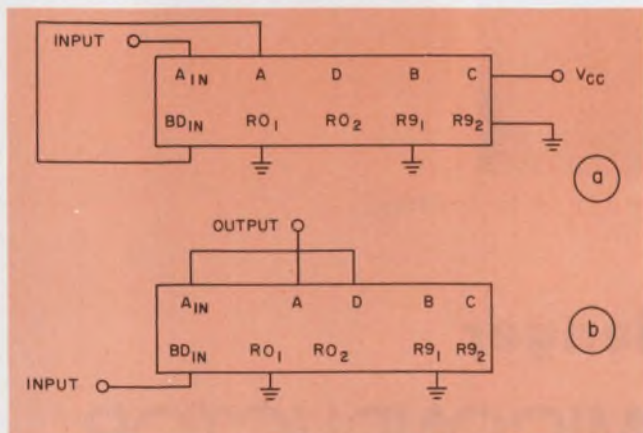

4. The counter configurations provided on spec sheets are only (a) a conventional BCD counter hook-up and (b) a symmetrical-wave output divide-by-ten.

## Hookups for 7490 divide-by-n counting

n	CONFIGURATION	REMARKS
2		÷ 5 SECTION UNUSED
3		BCD COUNT OBTAINED ON FLIP-FLOPS A AND B
4		BCD COUNT OBTAINED ON FLIP-FLOPS A AND B
5		BCD COUNT OBTAINED ON FLIP-FLOPS A, B AND C A IS UNUSED, BCD COUNT OBTAINED ON FLIP-FLOPS B, C AND D
6		BCD COUNT OBTAINED ON FLIP-FLOPS A, B AND C
7		RESET-TO-NINE USED. BCD COUNT NOT AVAILABLE
8		BCD COUNT OBTAINED ON FLIP-FLOPS A, B, C AND D
9		BCD COUNT OBTAINED ON FLIP-FLOPS A, B, C AND D
10		BCD COUNT OBTAINED ON FLIP-FLOPS A, B, C AND D

# What national semiconductor firm would you turn to to fill the op amp price/performance gap?

**Wrong!** We got it first, the LM 141/142. And we're going to second source it even if the first source isn't ready. Why? Because there's a crying need for an op amp like this from any source.

Here's why: When you're all set to design with op amps and the 741 type simply runs out of gas or the 108 type offers too much performance for the price, the LM 141/142 fills that gap.

The fully compensated 141 offers five times better input bias and offset current than the 741 and faster slew rate. The 142, with standard compensation equals the large signal performance of the 101A without feedforward compensation.

Both perform extremely well in sample and hold circuits, long interval integrators, active filters, and extended frequency range amplifiers with full output swing through the audio range.

We also have an LM 341/342 relaxed specification version priced at 99¢ in 100-999.

## Compare:

Specification	141	142	741	101A	108	
Input offset current (max.)	5	5	200	10	.2	nA @ 25°C
Input bias current (max.)	30	30	500	75	2.0	nA @ 25°C
Slew rate (min.)	1.0	1.0	.3	.3	.1	V/μs @ 25°C
Distributor list price of popular brands (100-999)	\$4.25	\$3.95	\$3.95	\$7.95*	\$12.95*	

**Then Sample Order.** We'll give you a *free* sample of the LM 141/142 or 341/342, if you tell us a little about yourself and intended use. Write on your company letterhead. Or call National and give them a nudge, we need that first source.



**I'll Drink to That.** (I'll Drink to Anything.)

## the challenger

# TELEDYNE SEMICONDUCTOR

1300 Terra Bella Avenue Mountain View, California 94040 (415) 968-9241 TWX: 910-379-6494 Telex: 34-8416

*\*Teledyne's prices on these IC's are lower.*

INFORMATION RETRIEVAL NUMBER 51



**If you've been looking for a miniature crystal-controlled clock oscillator in a 14 pin DIP package to fit standard PC board sockets, stop looking and start ordering. Get details on model K1091A from Motorola Component Products Dept. 2553 No. Edgington Franklin Park, Ill. 60131**



**MOTOROLA**

INFORMATION RETRIEVAL NUMBER 52

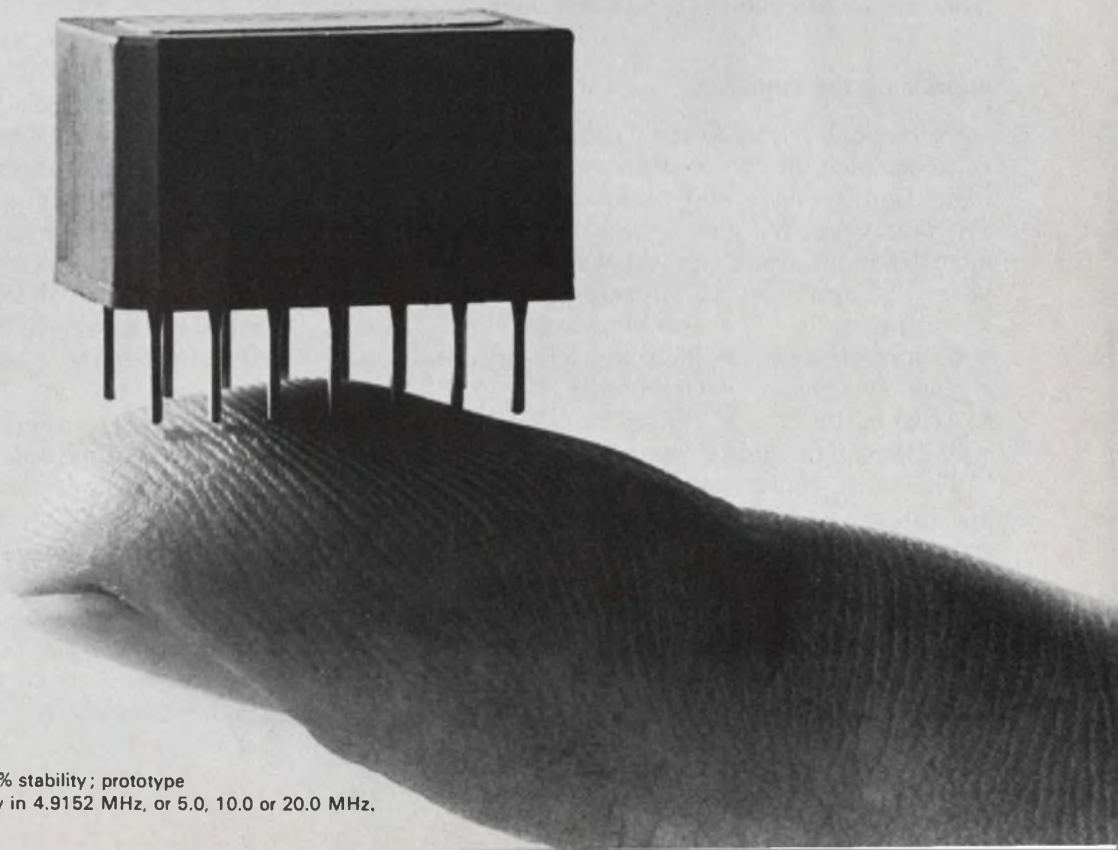

Specifications: 4 to 20 MHz range; 0.01% stability; prototype quantities available for immediate delivery in 4.9152 MHz, or 5.0, 10.0 or 20.0 MHz.

## Raises: How often and how much? It's not only what the employee can do as an individual that counts, says this manager, but how he fits into the team picture.

*If any man's work abide which he hath built thereupon, he shall receive a reward. I Corinthians 3:14.*

Giving a man a raise for work that "abides" is probably as good a reason as any. But how often he gets a raise, how it's handled and how much he gets are all a matter of company policy, with a few inputs from supervisors like myself. And while I don't claim to be an expert on salary reviews, I figure that there are a few thousand engineering managers out there who'll find it helpful to compare notes on some of the decisions and machinations involved in raise-giving.

For example: What is a good raise? I think 10 per cent of a man's salary is a very good one, it is also rare; 5 per cent follows today's national guidelines and certainly covers the inflationary spiral of the cost of living. Our company has been known to give a 15 per cent hike to employees who have earned special degrees while on the job, or have otherwise contributed in a major way to the company. Our salary spread for engineers is roughly 3 to 1—that is, from about \$10,000 a year to \$30,000.

### Appraising the employee

To come as close to the "right" percentage of raise as possible, we use an employee appraisal form that reviews objectives that were set the previous year. We also assign objectives for the next year and grade employees at the end of that year. The activities we appraise are these.

- Initiative.
- Job knowledge.
- Communication.
- Planning and organization.
- Cost awareness.
- Originality.
- Accountability.
- Judgment.
- Management ability (as may be applicable).

The most important to me, as a supervisor, are initiative, judgment, cost awareness and accountability because without these the others aren't too valuable. There are five appraisal categories, from unsatisfactory to outstanding.

The employee's immediate supervisor fills out

the appraisal form, and he, in turn, must talk to his supervisor to see if they're in agreement. This same form is used by junior engineers and by department heads who manage up to 200 people. Most professional people are appraised once a year. An exception may be the engineer who was hired without a degree and who is reviewed as soon as he has earned his degree.

The first line supervisor may make monetary recommendations and these are combined by myself and the general manager into a formal salary recommendation. The form is then passed to the personnel department for processing and/or review at the corporate level if special considerations are involved. In due time, the paper work is returned indicating the salary change and category (promotion or raise). We review it again to ensure there are no surprises, and a copy is delivered to the employee by his immediate supervisor, and always before the raise shows up in his paycheck.

### Those sticky appraisal situations

Of course, there are problems related to the giving of raises. There is, for example, the case of the man who feels that his raise has not been sufficient. He wants to know why. If his raise is below the corporate guideline, all other things being equal, I would suspect that we goofed. But if it's within these guidelines, then I would ask him why his contribution is much more significant than that of the people he sees around him? He'd have to be specific and compare capabilities and make pertinent comments. The situation has never come up, but if I thought he had a case, I think my reaction would be that I wouldn't promise anything but I'd plead the case for him.

There is the question of whether to hire a man at \$1000 more than you were paying the man you just lost. The answer, I believe, depends on the salary level. At the \$10,000-to-\$13,000 level, I think there are enough men to choose from to find someone at the price I can afford to pay. In other words, I would not allow a salary inequity of more than about 7% among staff members at that dollar level.

---

Ed Reamer, Chief Engineer, Products Div., Interstate Electronics Corp., Anaheim, Calif. 92803.



**Edward D. Reamer**

**Education:** B.A. in physics, Miami University, Oxford, Ohio; graduate studies in business management and electrical engineering at UCLA and University of Maryland; special courses in operations research, and special weapons and guided missiles.

**Responsibility:** Managing the development of state-of-the-art electronic test instruments, notably function generators and pulse generators.

**Experience:** Twenty-two years general engineering experience including twelve years of management/supervisory responsibility for development of solid state electronic instruments; five years of electronic system design and management; and five years of Operations Research in air defense weapon systems.

**Articles:** *Can't Decide Which Instrument to Buy*, November, 1972; *S-Band Beacon Utilization*, September, 1967; *FBM Program S-Band Telemetry Design Considerations*, March, 1966; *Detection and Measurement of Cycle Skipping*

*and Phase Offsets in Frequency Multiplying Phase-Lock Filters*, October, 1963 (National Electronics Space Symposium).

**Personal:** Married; three children, ages 14, 12 and 6; member of the Board of Directors, Youth Science Center, Fullerton, California. Hobbies include: camping, youth activities, photography and real estate investments.

**Employer:** Interstate Electronics Corp. was founded in January, 1956, as an instrument systems business and became the prime contractor for instrumentation to the Fleet Ballistics Missile (Polaris) program. In 1964 the Products Div. was formed as a nonmilitary design and manufacturing activity to support custom engineering requirements for phase-lock devices and hybrid analog/digital equipments. Acquired by ATO, Inc., in 1967, Interstate directed its Products Div. developmental activities to the design of the state-of-the-art commercial/industrial test instruments. Current products include 15 models of function generators and pulse generators. Latest products to be introduced are four models of the Series 20 (50 MHz) Pulse Generators.

Above that level it's different, and it calls for gingerly treatment. If the salary inequity for, say, a \$20,000 man is between \$1000 and \$2000 (I won't talk about anything over 10 per cent), then I consider the relative value and contribution to the division of the people who are crowded by this hike. If I can't reach a decision, or if there are many inequities like this, then I'll hire an outside consultant, because the decisions will have both short-term and long-term ramifications.

The toughest problem I had in appraising people was with a man I thought had a talent but who was unable to put himself to work in our particular environment. To me it was extremely frustrating not to be able to find a way to use his talent.

Many people would call that a problem of management. I would not. Remember that old saying? "God grant me the serenity to accept the things I cannot change, the courage to change the things I can and the wisdom to know the difference." I think that when a man turns up in the middle of a functioning organization and he's unable to match stripes with the people around him in doing his share, he's obviously a misfit. This misfit looked for a particular kind of environment that I suggested in another company, and he has been happy ever since.

### On the fringes

Aside from raises, our employees have a number of fringe benefits. While the company doesn't provide stock options and profit-sharing, we do offer pluses, such as these:

*The opportunity to present ideas to top management.* We don't have a specific mechanism for that, but I like to think that management is always open to suggestions and ideas. We're small enough to handle it informally.

*Being advised of company plans.* From two to four times a year, we have a departmental meeting at which I make a formal presentation—where we've been, how well we did while we were there and where we think we're going and why. This is particularly important when everyone's busy on his own crash program. I try to keep them up to date on how these programs fit into the over-all company goal.

*Freedom to attend society meetings on company time.* Within reasonable budgetary constraints, I support that because it allows my people to get out and learn something of what's going on in the industry in a fashion they won't take the time to do on the job.

*Opportunity to obtain an advanced degree.* We specifically encourage that and reimburse tuition if the man gets a 'C' or better.

*Titles.* We have several categories of professional titles. The recent graduate starts as an



associate engineer. After two years he's automatically an engineer. After another three, he's eligible for the title of senior engineer; he doesn't get it automatically. Then there's staff engineer and principal engineer, but it's nearly impossible to become a principal engineer—you have to walk fairly high on the water for that.

*A chance to speak at sales and technical meetings.* In general, that's highly encouraged in our division. Anyone on my staff who wants to do booth duty at Wescon is encouraged to meet the customer community and tell them what the instruments can do and listen to customer comments. That's the most powerful motivation I've found for improving the product.

*A private telephone.* Every engineer has his own telephone.

*Partitioned office.* We're usually set up for two-man offices. At present we've got more space than people, and so everyone has his own office.

*Christmas week off.* We've got a paid week off between Christmas and New Year's Day.

*A day at Disneyland.* Once every year our company rents Disneyland at a nominal charge for each employee and each member of his family, and for every guest he brings. The park is closed to the public that evening, and everyone rides anything he wants to over and over again for the same set admission price.

### Team man rates high

Generally speaking, the commercial product business is highly oriented around cost-consciousness and the ability to pick up something that has escaped the group's attention. If I get the "I'll do my part; you go do your part" kind of guy, my reaction is not negative, but then it's not positive either. If a man who's not too busy is willing to help the man who is, or if he takes the initiative to do what has to be done without big fanfare, I tend to regard that positively. I tend to rate a man's contribution especially high if he's good at working for the good of the group. ■■

# We've developed more than 50 custom ICs in the last 18 months

More than 50 times in the last 18 months, customers have brought us IC problems that couldn't be solved with standard circuits. In every case we've developed a custom circuit that filled the bill. Our circuits are now in TV sets, watches and clocks, electronic organs, calculators, automobiles, office copiers and a host of other applications. We've delivered samples in as little as 8 weeks ARO; few problems have required more than 20 weeks to solution. Shouldn't a semiconductor company with a record like that get a shot at your custom circuit requirement?

## We're doers, not talkers!

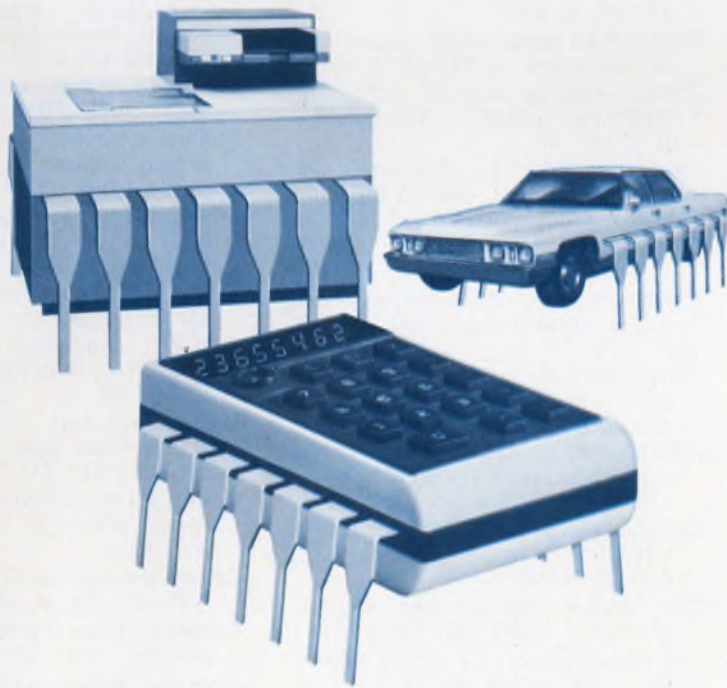

# semiconductors

ITT Semiconductors is a division of International Telephone and Telegraph Corporation, 3301 Electronics Way, West Palm Beach, Florida 33407. Phone 305/842-2411. Factories in West Palm Beach, Florida • Lawrence, Massachusetts • Footscray, England • Colmar, France • Freiburg, Germany • Cascais, Portugal • Sydney, Australia.

# ITT

# Electronic Design 1972 annual index of articles

## Circuits & Circuit Theory

Ac reference achieves 0.01% accuracy with ROM d/a converter combination... IFD, ED 20, p. 82

Add a synchronous sawtooth output to your function generator... IFD, ED 9, p. 70

Add current limiting to your lab power supply with simple circuit... IFD, ED 17, p. 98

Add FET to threshold detector to improve hysteresis... IFD, ED 12, p. 78

Add thermal cutoff to current limiting for complete protection of pass transistors... IFD, ED 15, p. 74

Adjustable couplings improve interdigital bandpass filters... IFD, ED 4, p. 94

Analog polarity reversed by CMOS switch... IFD, ED 4, p. 100

And now... the Tri-Flop... ART, ED 23, p. 80

Assembling large-array IC memories... ART, ED 4, p. 76

Auto-crossover power supply uses single reference... IFD, ED 8, p. 88

Avoid ECL-10,000 wiring problems... ART, ED 18, p. 48

Binary-to-gray or gray-to-binary translator needs no power supply... IFD, ED 19, p. 160

Boost op-amp bandwidths and slew rates... ART, ED 15, p. 64

Boost varactor-doubler power capacity... ART, ED 16, p. 54

Build a long-period one-shot with separate set and reset inputs... IFD, ED 17, p. 94

Build a precision pulse-time multiplier... ART, ED 9, p. 58

Build a quartz-crystal controlled digital clock with only six ICs... IFD, ED 16, p. 60

Build high-stability regulators... ART, ED 3, p. 62

Build-it-yourself stepper motor drive... ART, ED 10, p. 52

Build reliable optoelectronic circuits... ART, ED 3, p. 52

CMOS logic expands use of variable duty cycle oscillator... IFD, ED 11, p. 68

## Departments key

ART	Technical Article
IFD	Idea for Design
NEWS	News
PF	Product Feature
SR	Special Report

Calculate multivibrator timing... ART, ED 5, p. 58

Charge-pump circuit eliminates bias supply for NMOS devices... IFD, ED 23, p. 100

Circuit eliminates input offset in a common-base amplifier... IFD, ED 6, p. 158

Circuit monitors TTL outputs for minimum output voltages... IFD, ED 10, p. 68

Circuit tells which pulse occurs first in two trains... IFD, ED 8, p. 94

Clamp negative outputs without introducing spikes... IFD, ED 11, p. 70

Clock oscillator for telemetry system uses CMOS chip to minimize power drain... IFD, ED 20, p. 84

Clock oscillator guaranteed to start... IFD, ED 2, p. 56

Clock-select circuit minimizes initial phase uncertainty... IFD, ED 13, p. 102

Complementary transistor latch is built with two tunnel diodes... IFD, ED 13, p. 96

Convert four-bit-binary to binary-coded decimal... IFD, ED 6, p. 160

Counter delay slashed in half with interconnection scheme... IFD, ED 13, p. 98

Cut system testing and troubleshooting... ART, ED 13, p. 78

Cut transients in FET analog switches... ART, ED 9, p. 50

Dc amp has automatic offset recovery... IFD, ED 24, p. 172

Decode counter state, use a NOR gate instead of an AND... IFD, ED 17, p. 96

Design your own dynamic phase shifter... ART, ED 12, p. 60

Detect errors in complex logic... ART, ED 21, p. 88

Digital nonintegration method boosts response time of vertical sync separator... IFD, ED 19, p. 156

Digital sweep generator maintains constant output voltage at specified time... IFD, ED 18, p. 66

Digital tone-burst generator uses 4 ICs... IFD, ED 8, p. 90

Digitize analog curves with an integrator... IFD, ED 3, p. 66

Diode gates cut costs and customize wideband coaxial switch-design... IFD, ED 19, p. 158

Diodes insure multivibrator start-up... IFD, ED 6, p. 158

Discharge capacitors with a MOSFET... IFD, ED 1, p. 95

Divide two pulse rates with TTL logic... IFD, ED 11, p. 72

Edge-triggered sequence generator results from Johnson counter... IFD, ED 14, p. 78

Eliminate spikes in dc-to-dc converters... ART, ED 22, p. 68

Eliminate troublesome common-mode output voltages in IC video amplifiers... IFD, ED 25, p. 100

FET gain-control stage handles high-level signals... IFD, ED 5, p. 64

FSK oscillator uses twin-T network for high phase sensitivity... IFD, ED 23, p. 96

Fast ECL eliminates laser rangefinder resolution problems... IFD, ED 23, p. 98

Gated zero-start oscillator reaches steady-state amplitude on first cycle... IFD, ED 19, p. 164

Gating scheme maximizes dc-dc converter efficiency... IFD, ED 13, p. 100

Generate noise-free timing pulses... ART, ED 10, p. 56

Generate programmable rectangular pulses... IFD, ED 7, p. 58

Generate stable high-frequency signals... ART, ED 1, p. 78

Generate triangular waves with VCO... IFD, ED 5, p. 66

Here are simpler circuit models... ART, ED 19, p. 144

IC one-shot generates pulses with programmable widths...IFD, ED 12, p. 74

Improve efficiency in power control...ART, ED 15, p. 54

Improve your Karnaugh mapping skills...ART, ED 26, p. 54

Increase optical-isolator speed...ART, ED 19, p. 128

Insure safety in control logic...IFD, ED 1, p. 98

Inverted mode switching gives digital control of analog signal...IFD, ED 13, p. 96

Keep front-end noise figures low...ART, ED 25, p. 78

LED-phototransistor couplers isolate analog signals...IFD, ED 8, p. 90

Linearize analog signals continuously...ART, ED 24, p. 156

Line-voltage fluctuation indicator detects single cycle variations...IFD, ED 22, p. 80

Logic probe responds to TTL pulses of less than 10 ns in width...IFD, ED 9, p. 76

Logarithmic-feedback zero-crossing detector features wide input range and TTL output...IFD, ED 23, p. 94

MOS gyrator replaces conventional inductors...NEWS, ED 2, p. 24

Micropower switching regulator has a low standby current...IFD, ED 6, p. 166

Missing-pulse detector reacts to 100-ns pulse widths...IFD, ED 24, p. 174

Modified reed switch acts as overload current sensor...IFD, ED 14, p. 76

Monitor power supplies continuously...IFD, ED 1, p. 92

Motor load-current sensor prevents false counter totals...IFD, ED 21, p. 96

Multiplicity counter uses IC logic...IFD, ED 25, p. 102

Multivibrator uses IC one-shots...IFD, ED 7, p. 56

One-shot multivibrator uses single IC...IFD, ED 3, p. 68

Op amp boosts phototransistor speed...IFD, ED 5, p. 62

Op-amp current source achieves wide voltage compliance...IFD, ED 22, p. 82

Optical coupling isolates ac current limiter to insulate load circuit from line power...IFD, ED 10, p. 66

Optical-trigger-link scheme minimizes standby power...IFD, ED 18, p. 62

Optimize second-order active filters...ART, ED 4, p. 70

Packaged pulse-width modulator simplifies series-switching regulator design...IFD, ED 19, p. 162

Penetrate the mystique of MOS specs...ART, ED 8, p. 64

Phase-locked loop decodes narrow bands...IFD, ED 2, p. 58

## Subject Listing

Circuits & Circuit Theory	General Industry
Civionics	Industrial Electronics
Communications, Microwaves & Lasers	Management
Components	Materials & Packaging
Computers & Data Processing	Medical Electronics
Consumer Electronics	Military & Aerospace
Displays	Semiconductors
Electro-Optics	Test & Measuring

Phase-locked loop generates stereo multiplex switching source...IFD, ED 4, p. 96

Pick a filter from this chart...ART, ED 24, p. 166

Planning to use high-speed logic? ART, ED 26, p. 48

Power-enable circuit offers variable time-delay...IFD, ED 14, p. 80

Precision limiter minimizes 'rounding'...IFD, ED 9, p. 74

Pulse stretcher indicates presence and polarity of TTL pulses to 20 MHz...IFD, ED 22, p. 84

Pulse width and rep rate are controlled by gating...IFD, ED 16, p. 62

Ramp generator has 20-ns settling time...IFD, ED 4, p. 98

Reconstruct NRZ-L and clocks from biphas-level PCM signal...IFD, ED 16, p. 58

Reduce noise in feedback circuits...ART, ED 25, p. 72

Reduce numeric LED-display errors...ART, ED 22, p. 76

Replace your bridge circuit with this...ART, ED 13, p. 84

Ring map minimizes logic circuit...ART, ED 17, p. 80

SCRs drive pulse-latched ferrite switch...IFD, ED 1, p. 90

Scheme uses fewer gates in bidirectional shift register...IFD, ED 15, p. 76

Schmitt trigger design uses CMOS logic...IFD, ED 9, p. 72

Self-commutating power output stage cuts losses in switching-mode converter...IFD, ED 12, p. 72

Self-stabilized zener insures constant current in op-amp voltage reference...IFD, ED 26, p. 66

Sensing amplifier stabilizes VCO frequency for temperature and supply variations...IFD, ED 24, p. 170

Sequenced switching circuit cleans up encoder signals...IFD, ED 3, p. 68

Simplify shift-counter design with this...ART, ED 13, p. 70

Single relay protects a three-phase line...IFD, ED 5, p. 64

Solve filter parameter problems...ART, ED 6, p. 152

Speed uhf microstrip amplifier design...ART, ED 21, p. 80

State of CPU determined at remote card reader...IFD, ED 24, p. 172

Stop ac motors with triac control...IFD, ED 6, p. 162

Synchronous gating controls complementary clock signals...IFD, ED 18, p. 64

TV set is display for data terminal...ART, ED 19, p. 134

Television test-pattern modulator uses multiplier to improve linearity...IFD, ED 21, p. 94

Test one-shots for min, max widths...IFD, ED 1, p. 96

Three-frequency gated oscillator generates full-width clocks...IFD, ED 9, p. 72

Three-LED circuit indicates ac or dc and polarity...IFD, ED 11, p. 68

Transconductance amplifier increases accuracy of sample-and-hold circuit...IFD, ED 21, p. 98

Transfer data with this flexible circuit...IFD, ED 2, p. 56

Transformerless voltage doubler has good output regulation...IFD, ED 26, p. 64

Triangle-wave generator keeps slopes constant as amplitude changes...IFD, ED 20, p. 80

Try a piecewise-linear approach...ART, ED 1, p. 66

Try building a pulse generator...ART, ED 17, p. 84

Use a single-ended switching regulator...ART, ED 1, p. 72

Use an IC voltage regulator in simple lab power supply...IFD, ED 15, p. 78

Use an op amp for simple Schmitt trigger...IFD, ED 2, p. 57

Use diodes for amplitude control in 0.001-Hz Wien Bridge...IFD, ED 7, p. 56

Use ECL 10,000 layout rules...ART, ED 17, p. 72

Use hybrid voltage regulators...ART, ED 7, p. 50

Use op amps with greater confidence...PF, ED 6, p. 140

Use the wired-AND and implied-OR...ART, ED 20, p. 76

Use three-state logic with confidence...ART, ED 14, p. 70

## ANNUAL INDEX

- Variable threshold circuit separates sync pulses from composite video signal... IFD, ED 21, p. 100
- Variable voltage gain need not depend on the control-voltage slope... IFD, ED 12, p. 74
- Voltage-to-frequency converter produces TTL logic output... IFD, ED 6, p. 156
- Zero-crossing detector avoids hysteresis problem with complementary dual comparator... IFD, ED 26, p. 64

### Civionics

- Accelerometers in Atlas missiles converted to earthquake sensors... NEWS, ED 19, p. 32
- Acoustic radar detects jet turbulence... NEWS, ED 9, p. 30
- All the weather from one compact station... NEWS, ED 10, p. 28
- Analog-sensor compass gives digital output without conversion... NEWS, ED 7, p. 23
- Computer voice warns fliers of nearby traffic... NEWS, ED 13, p. 23
- Cryogenic power nets seem feasible in tests... NEWS, ED 13, p. 24
- ERTS photos and data available to public... NEWS, ED 19, p. 22
- Electronic air monitor to be tested for mines... NEWS, ED 7, p. 20
- Electronics whiz kids display better ideas for building cars... NEWS, ED 20, p. 38
- Exit the meter man; enter electronics... NEWS, ED 21, p. 40
- FAA calls for proposals for air-security systems... NEWS, ED 7, p. 19
- FCC to study crowding in land, mobile bands... NEWS, ED 15, p. 24
- Ferrite phased-array radar developed for smaller planes... NEWS, ED 11, p. 38
- IBM plans 5-year study of computer security... NEWS, ED 12, p. 24
- If designers build well and slash costs, this market will go vroom!... NEWS, ED 19, p. 78
- Miniature computer traps road speeders... NEWS, ED 26, p. 24
- Missile tiltmeter to spot eruptions in the earth... NEWS, ED 24, p. 40
- Moving radar helps police trap speeders... NEWS, ED 14, p. 23
- New A-plant may use advanced electronics... NEWS, ED 19, p. 21
- New ILS overcomes rf reflection effects... NEWS, ED 20, p. 28
- New transponder system monitors ship traffic... NEWS, ED 16, p. 21
- Portable Loran repeater pinpoints vehicle position... NEWS, ED 7, p. 19
- Power feeder built for 300-mph trains... NEWS, ED 26, p. 23

- President's pilot talks about China's ATC... NEWS, ED 5, p. 19
- Private TV networks beginning to form... NEWS, ED 25, p. 25
- Radar warns driver of tailgating hazard... NEWS, ED 12, p. 23
- Rising market seen for electrical vehicles... NEWS, ED 2, p. 24
- Simplified CAS proposed for all aircraft at low cost... NEWS, ED 13, p. 23
- Solid-state designers matching wits with burglars in the home... NEWS, ED 16, p. 28
- Space-age technology opening new doors for the blind, deaf, and crippled... NEWS, ED 11, p. 24
- TRW proposes train suspended by magnets... NEWS, ED 7, p. 20
- Transit receiver developed for small craft... NEWS, ED 19, p. 34
- U.S. agency offers transportation data... NEWS, ED 14, p. 24
- U.S. offers 7 volumes to access technology... NEWS, ED 4, p. 24
- Ultrasonic 'people finder' tracks users anywhere in a building... NEWS, ED 9, p. 28
- Ultrasonics touches off underwater explosions... NEWS, ED 7, p. 27
- Very low-light-level TV camera developed... NEWS, ED 16, p. 21
- Volkswagen thinks big with a new exhaust-test center on wheels... NEWS, ED 8, p. 28
- War electronics proving useful in search for oil in jungle... NEWS, ED 18, p. 28
- Ways to revive the nation's drooping cities... SR, ED 6, p. 80
- 2-way cable TV system being built in N.J... NEWS, ED 16, p. 22
- 1000 V delivered by thermal battery... NEWS, ED 21, p. 28
- \$1.4-billion market seen for traffic-control units... NEWS, ED 26, p. 24

### Communications, Microwaves and Lasers

- Device drastically cuts radio-frequency noise... NEWS, ED 16, p. 21
- FCC to study crowding in land, mobile bands... NEWS, ED 15, p. 24
- FIFO memory chip buffers data-communication systems... PF, ED 12, p. 93
- Fast ECL eliminates laser range-finder resolution problems... IFD, ED 23, p. 98
- Hybrid pulser and injection laser has fast narrow pulses... PF, ED 24, p. 200
- Improved waveguide built of graphite... NEWS, ED 18, p. 26
- Keep front-end noise figures low... ART, ED 25, p. 78
- LHA: A communications 'first'... NEWS, ED 10, p. 30
- Laser communications to be tested by NASA... NEWS, ED 6, p. 24

- Laser fax sends newspaper page in 1 min... NEWS, ED 2, p. 27
- Laser-machining process makes circuits in one-step... NEWS, ED 12, p. 32
- Laser powered by sunlight... NEWS, ED 3, p. 35
- Laser printer puts digital data on paper... NEWS, ED 24, p. 39
- Laser printing system tested by Bell Labs... NEWS, ED 25, p. 26
- Laser radar gives super accuracy... NEWS, ED 3, p. 30
- Linear rf amp challenges tubes with 100-W output... PF, ED 26, p. 71
- Microwave rf detection made easy... NEWS, ED 14, p. 32
- Microwaves: Aids to cars, aviation and data-sending... SR, ED 6, p. 79
- Mobile radio capacity upped 100-fold... NEWS, ED 2, p. 30
- Monolithic phase-locked loops extend the frequency range to 35 MHz... PF, ED 13, p. 112
- Need to keep digital data secure?... ART, ED 23, p. 68
- New communication possibilities flowing from IC optoelectronics... NEWS, ED 6 p. 32
- New metal-vapor laser may compete with he-ne... NEWS, ED 2, p. 24
- New telemetry: Less data, real-time analysis and adaptive... NEWS, ED 23, p. 26
- Next in tubes: the 'printed circuit' TWT... NEWS, ED 26, p. 28
- Nuclear communications proposed as competitive... ED 17, NEWS, p. 27
- OCR costs slashed with use of a laser... NEWS, ED 1, p. 24
- OICs: When they come, they'll revolutionize communications... NEWS, ED 12, p. 26
- Optical communications links are successfully demonstrated... NEWS, ED 22, p. 34
- Phase-locked loop decodes narrow bands... IFD, ED 2, p. 58
- Power raised in zig-zag laser by linking it to 2 smaller lasers... NEWS, ED 13, p. 32
- Pseudorandom codes can be cracked... ART, ED 23, p. 74
- Radio dish gets a home... NEWS, ED 8, p. 33
- Reduce errors in data transmission... ART, ED 4, p. 84
- Scholarly paper and technology join forces to start a revolution... SR, ED 24, p. 94
- Tiny high-gain rf amps are housed in 16-pins DIPs... PF, ED 12, p. 81
- Two-inch laser offers optical IC possibilities... NEWS, ED 9, p. 21
- World's most potent comsat to test new concepts for future satellites... NEWS, ED 26, p. 32
- X-ray laser: Real or illusory? The stakes in outcome are high... NEWS, ED 25, p. 28



# Evolution and the function generator



## Lessons from the Dodo

IEC, in building its high-quality, low-cost Series 30 Function Generator, learned from the mistakes of others. (Yes, the industry has had its Dodos.) We knew that only a strong, highly reliable unit would survive, so we developed our compact, hard-working 0.3Hz-3Mhz Series 30 accordingly.

Performance and quality are built into the unit right from the beginning. Interstate Electronics Corporation's independent QC lab puts every Series 30 semiconductor through a rigorous performance test before production acceptance. Then, after Unit Testing, Calibration, Burn-In, and Stress Cycling, each instrument ticketed for shipment has to pass QC's computerized Assurance Test before it goes to our customer.



## Monkeying with Ontogeny

The Unit Test is the first evaluation to identify and correct operative problems in the working instrument. Each of Series 30's versatile outputs, including variable Width Pulse, Sweep Sawtooth, Adjustable D-C Level, and Sine, Square, and Triangle waveforms are scrutinized for pure, consistent performance up to 20V p-p. In addition, our direct-reading Sweep Limit, 40-db Calibrated Attenuator, and other controls are handled for "feel" as well as accuracy.

During Calibration, Trigger, Gate, Burst, and Sweep Modes are given full play. By such critical inspections, we learn more about the instruments we make, and the product species as a whole is improved.

IEC actually over-calibrates to reach an exceptional quality of performance. While we spec a respectable 0.3% sine distortion, our generators typically achieve 0.18%.

## Loss of the Sixth Toe

As part of the stress Cycle, we developed a "Shake 'n Bake" test that jolted and jarred Series 30 prototypes, then operated them in a 70°C. heat chamber. We still burn-in each Series 30 generator, but after extensive Unit Tests without a vibration failure, the "shake" cycle was declared obsolete.



## Mutation Elimination

We don't produce to MIL-SPECS, but our procedures are amazingly close to it. During four in-process inspections, a QC team checks everything from each solder joint to screw mounts, rejecting the slightest imperfections. We expect each Series 30 unit to evolve exactly as specified, with absolutely no mutations.



## Survival of the Fittest

After calibration, the Series 30 generator undergoes a minimum 120-hour "mileage" test. We turn each instrument on and off at irregular intervals during this stress cycling to simulate real-world strain, and our exclusive Output Limit Indicator glows to confirm that the Generator is operating under stress.

Following this, all instruments are processed by a final automated lab system. At this point the Function Generator *must* continue to perform precisely, with an exacting degree of conformity and predictability. Only by surpassing the highest standards of the species does the Series 30 survive in the field, and enjoy the lowest return in the industry.

**We're ready to back up our claims. Go ahead . . . call John Norburg, collect, at (714) 772-2811, and ask for a demo!**

F34 . . . \$495

**5 Other Models available in Series 30 From \$295 to \$695**



**IEC** INTERSTATE ELECTRONICS CORPORATION

a subsidiary of A-T-O Inc.  
Dept. 7000, Box 3117, Anaheim, Calif. 92803.  
TWX 714-776-0280 TELEX 655443 & 655419

5 kW in S band achieved by Navy lab's helix TWT...NEWS, ED 22, p. 23

## Components

Almost 16-bit d/a converter is industry's fastest, most stable, least expensive...PF, ED 16, p. 65

Assemble pulse generators by the module...PF, ED 15, p. 86

Compact 12-bit d/a converter settles in 50 ns to 0.05%...PF, ED 19, p. 98

Comparators costs slashed by introduction of quad...PF, ED 18, p. 72

Components: Tiny filters and ferrites dominate...SR, ED 6, p. 70

Devices shrink and their reliability expands to keep up with transistors...SR, ED 24, p. 122

Display society planning show with wide appeal...NEWS, ED 10, p. 24

Dual-tracking voltage regulator extends operating range to 90 V...PF, ED 8, p. 97

FOCUS on Fast logic...SR, ED 12, p. 50

FOCUS on keyboards...SR, ED 23, p. 54

FOCUS on lighted switches...SR, ED 5, p. 40

FOCUS on Reed Relays...SR, ED 14, p. 50

FOCUS on Time-delay relays...SR, ED 21, p. 62

Hall-effect transducer replaces resolvers...NEWS, ED 22, p. 24

Lamp prices halved from 29 to 30 cents...NEWS, ED 1, p. 24

Latest ac-line voltage regulators are lighter and cheaper than competing units...PF, ED 13, p. 134

Multiple outputs available on a dc-ac converter...PF, ED 19, p. 100

New concept in high-density switches...NEWS, ED 5, p. 28

New varistors extend transient protection...NEWS, ED 1, p. 23

Next in tubes: the 'printed circuit' TWT...NEWS, ED 26, p. 28

Noninductive resistors made from serpentine film pattern...PF, ED 26, p. 75

Programmable slot supplies get smaller and cheaper...PF, ED 9, p. 90

Quad amps offered, one at lowest op-amp price...NEWS, ED 10, p. 23

Regulated power supplies 'stabilized' in new standard...NEWS, ED 19, p. 21

Sample-and-hold module settles to 0.005% in 5  $\mu$ s...PF, ED 14, p. 95

Small, low-cost, modular power supplies woo light-minded users...PF, ED 15, p. 83

Solid-electrolyte device is capacitor, battery or timer...PF, ED 21, p. 116

Static tab-card reader handles hold misalignment with brush contacts...PF, ED 17, p. 110

Tiny high-gain rf amps are housed in 16-pin DIPs...PF, ED 12, p. 81

Tiny 10-bit d/a converter plugs into 16-pin IC socket...PF, ED 25, p. 107

Triple outputs in a modular DIP offered in new power-supply line...PF, ED 23, p. 108

Wideband multiplier reaches accuracy of averaging types...PF, ED 3, p. 71

World standards pushed for component quality...NEWS, ED 14, p. 23

4-bit analog-to-digital unit converts at 100-MHz rate...PF, ED 26, p. 78

## Computers & Data Processing

Almost 16-bit d/a converter is industry's fastest, most stable, least expensive...PF, ED 16, p. 65

An 'amazing' top war secret is barred, and a new age in civilization results...SR, ED 24, p. 86

BASIC program expresses any number as a rational fraction...IFD, ED 25, p. 102

Building-block computer setups gaining...NEWS, ED 25, p. 36

CMOS shrinks size and price of data-acquisition systems...PF, ED 19, p. 104

Calculator and the engineer...ART, ED 20, p. 56

Cassette and cartridge recorders...SR, ED 18, p. 40

Circuit reduces the gates needed in TTL comparator for 16-bit words...IFD, ED 26, p. 62

Compact analog-to-digital circuit performs 8-bit conversion in 100 ns...PF, ED 6, p. 122

Compact 12-bit d/a converter settles in 50 ns to 0.05%...PF, ED 19, p. 98

Computer makers opt for one show a year...NEWS, ED 17, p. 27

Computer voice warns fliers of nearby traffic...NEWS, ED 13, p. 23

Computers: Large-scale ICs rising in use, falling in cost...SR, ED 6, p. 74

Consumer ICs busting out all over, and semi memories advance, too...NEWS, ED 19, p. 76

Conversational algebraic calculator rivals minicomputer performance...PF, ED 7, p. 80

Convert four-bit-binary to binary-coded decimal...IFD, ED 6, p. 160

Cruise vessels getting computerized radar...NEWS, ED 6, p. 24

Cut synchro-to-digital conversion costs...ART, ED 20, p. 62

Data acquisition module is cheaper, smaller & slower...PF, ED 4, p. 122

Data logger can operate 6 months on car battery...PF, ED 19, p. 184

Design your own filters by computer...ART, ED 2, p. 48

Desk-top calculator rivals minicomputer in capability and memory capacity...PF, ED 10, p. C-39

Detect overflow errors in binary adders...ART, ED 5, p. 54

Digital-cassette drive is speed-controlled and uses only two moving mechanical parts...PF, ED 14, p. 90

Digital cassette tape transport stores up to 8 million bits in 300 ft...PF, ED 13, p. 128

Digital data systems work faster...ART, ED 24, p. 150

Domain-tip memories challenging discs...NEWS, ED 9, p. 21

Domain-tip memory offers core speed at disc prices...PF, ED 10, p. C-40

Dual-processor mini performs many communications tasks...PF, ED 24, p. 184

Electro-Optics: Memories and displays with a future...SR, ED 6, p. 76

Electronic systems to pace the 1972 Summer Olympics...NEWS, ED 17, p. 36

Expand programmable calculators...ART, ED 22, p. 62

FIFO memory chip boasts improved data-buffer specs...PF, ED 18, p. 75

FIFO memory chip buffers data-communications systems...PF, ED 12, p. 93

Fast printer/plotter makes neat mate to mini...PF, ED 8, p. 106

First digital joystick has high rate at low-cost...PF, ED 4, p. 105

FOCUS on disc and drum memories...SR, ED 10, p. C-16

Get a statistical analysis in seconds...ART, ED 25, p. 84

Get the mini you really need...SR, ED 10, p. C-28

Here are simpler circuit models...ART, ED 19, p. 144

IBM plans 5-year study of computer security...NEWS, ED 12, p. 24

Implement digital transfer functions...ART, ED 6, p. 134

Improved movies simplifying simulations...NEWS, ED 25, p. 38

It's getting so you can't separate the calculators from the computers...NEWS, ED 19, p. 82

Kit patches peripherals to popular PDP-8 mini...PF, ED 8, p. 104

Let a computer design your i-f amplifier...ART, ED 6, p. 146

Low-cost holographic ROM cracks the commercial market...NEWS, ED 11, p. 36

Low-cost minicomputer race gets a new OEM entry...PF, ED 15, p. 94

Miniature computer traps road speeders...NEWS, ED 26, p. 24

Stackpole's phenomenal  
Ceramag® ferrite bead

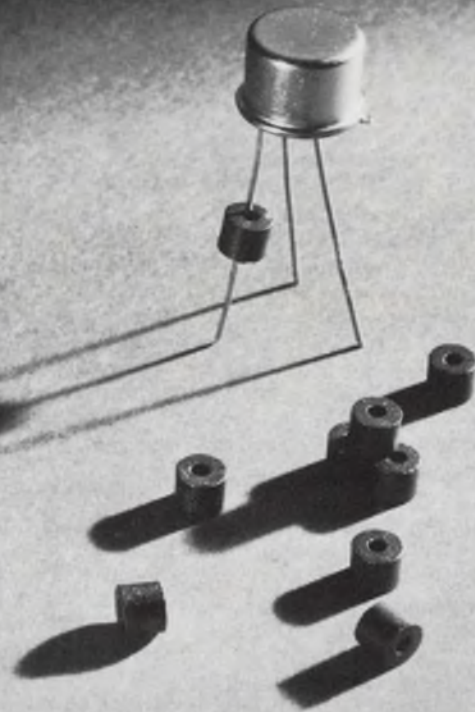

## The Silencers

### Ceramag® Beads Do Away with Noise

Stackpole ferrite beads offer a simple, yet effective means of suppressing spurious RF signals to prevent them from entering areas susceptible to such "noise." No other filtering method is as inexpensive as a ferrite bead.

How can you use a bead? Consider it as a frequency-sensitive impedance (Z) element. Beads are available in a variety of

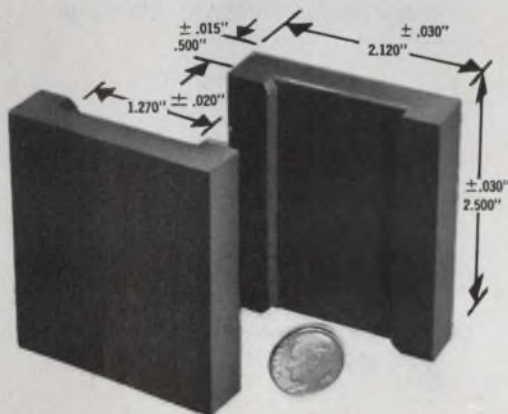

Stackpole Ceramag® materials. Depending upon the material selected, beads can provide increasing impedances. From 1 MHz to over 200 MHz. Keep in mind, the higher the permeability, the lower the frequency at which the bead becomes effective.

Should a ferrite bead be small? Not necessarily. The unique, giant bead shown below is used by IBM to eliminate the effect of transient noise.

The impedance of Stackpole ferrite beads can be changed by simply varying the length or the O.D.-I.D. ratio.

Installation of Stackpole beads is easy. And inexpensive. Simply slip one (or several) over the appropriate conductor(s) for the desired noise suppression or high frequency isolation.

Additional savings in production time and labor costs are possible by utilizing automatic insertion equipment to install ferrite beads *with leads* in printed circuit boards.

### CERAMAG® FERRITE BEAD CHARACTERISTICS

	24	7D	5N	11
Initial Permeability	2500	850	500	125
Volume Resistivity @ 25°C	1.0x10 <sup>2</sup>	1.4x10 <sup>5</sup>	1.0x10 <sup>3</sup>	2.0x10 <sup>7</sup>
Effective Suppression At:	1 MHz.	20 MHz.	50 MHz.	100 MHz.
Curie Temperature	205	140	200	385

Beads are available in sleeve form in a range of sizes starting at .020 I.D., .038 O.D., and .050 long. For special compact filtering applications, beads can be supplied to tight mechanical tolerances.

Sample quantities of beads and beads with leads are available upon request. Send your requirements to: Stackpole Carbon Company, Electronic Components Division, St. Marys, Pa. 15857. Phone: 814-781-8521. TWX: 510-693-4511.



**STACKPOLE**  
ELECTRONIC COMPONENTS DIVISION

- Minicomputer taking over in factories in blue-collar and white-collar roles... NEWS, ED 15, p. 28
- Modular midi-computer to be placed on market... NEWS, ED 12, p. 24
- Need a hard-copy peripheral?... ART, ED 18, p. 54
- Need to keep digital data secure?... ART, ED 23, p. 68
- New Honeywell series vies with IBM computer... NEWS, ED 3, p. 24
- New military computer introduced by RCA... NEWS, ED 4, p. 24
- New processor gives instant microfiche... NEWS, ED 11, p. 22
- New system monitors keeping tabs on computer performance... NEWS, ED 25, p. 34
- Next computer generation: 'Polysystem' predicted... NEWS, ED 21, p. 27
- Nova minis to be shown at Peking trade fair... NEWS, ED 17, p. 28
- OCR costs slashed with use of a laser... NEWS, ED 1, p. 24
- Over 100,000 computers in U.S., census reveals... NEWS, ED 26, p. 24
- Pen-entry system locates position by sound and digitizes data for computer... PF, ED 10, p. C-44
- Plotter microprocessor saves memory core space... PF, ED 10, p. C-42
- Programmable calculator languages... ART, ED 21, p. 74
- Programmable controller, 'mini' for the poor man, upstages DNC... NEWS, ED 21, p. 30
- Programmable transmitter is asynchronous or synchronous... PF, ED 23, p. 103
- Pseudorandom codes can be cracked... ART, ED 23, p. 74
- Pulse width and phase encoding compete to be cassette standard... NEWS, ED 23, p. 34
- ROMs are versatile in digital systems... ART, ED 12, p. 66
- Red Chinese are turning out computer with 'modest' ICs... NEWS, ED 20, p. 27
- Reduce errors in data transmission... ART, ED 4, p. 84
- Serial-output a/d converters make data-shuffling easier... PF, ED 18, p. 71
- Simple recursion solves ladder networks... IFD, ED 10, p. 69
- Simple way to sense magnetic bubbles... NEWS, ED 21, p. 40
- Single-transistor memory cell: A promise with many problems... NEWS, ED 4, p. 34
- Solid-state system synthesizes voice... NEWS, ED 18, p. 20
- Special site now checks accuracy of ship sonar... NEWS, ED 6, p. 24
- Speed active multipole filter design... ART, ED 24, p. 142
- Speed computer-aided circuit design... ART, ED 11, p. 54
- SUPER BASIC designs unbalanced-T or pi attenuator... IFD, ED 6, p. 162
- Super-fast teleprinter offered at cut in price... NEWS, ED 5, p. 20
- Switch to digital filter design... ART, ED 20, p. 70
- Tape-cassette unit replaces paper-tape punch and reader... PF, ED 15, p. 96
- Thermal printer: Hot challenger to the 'flying-hammer' method... NEWS, ED 8, p. 26
- Try it on the calculator... ART, ED 20, p. 57
- Twenty-fold increase in memory promised with new core material... NEWS, ED 12, p. 34
- Two more slide rules enter calculator race... NEWS, ED 25, p. 25
- Virtual storage added to IBM's 370 computer... NEWS, ED 17, p. 28
- Wire technicians aided by voice of a computer... NEWS, ED 4, p. 23
- 5 W per million bits of memory... ART, ED 5, p. 50
- 8, 120-bit registers advance a/d converter designs... PF, ED 17, p. 103
- 9 new minis offered by General Automation... NEWS, ED 2, p. 23
- 64-bit bubble memory delivered to Air Force... NEWS, ED 21, p. 27
- 100-Mbit electron-beam promises fast access at .01¢/bit... NEWS, ED 10, p. 26
- 1024-bit Si-fuse bipolar pROM guarantees 45-ns access time... PF, ED 12, p. 90
- 1103-1024 memory bits on a chip... ART, ED 2, p. 40

### Consumer Electronics

- Aerospace technology urged to streamline U.S. kitchens... NEWS, ED 16, p. 24
- Anyone for armchair tennis? Try it soon on your TV screen... NEWS, ED 17, p. 40
- Color TV disc player is shown by Philips... NEWS, ED 20, p. 27
- Communications: A high-level look at the future of CATV... SR, ED 6, p. 82
- 'Computerized' FM tuner has 0.2% output distortion... NEWS, ED 5, p. 22
- Consumer ICs busting out all over, and semi memories advance, too... SR, ED 19, p. 76
- Consumer show offers an expanded bill... NEWS, ED 14, p. 24
- EIA testing a reference sign for precision color television... NEWS, ED 1, p. 36

- FOCUS on Consumer ICs... SR, ED 16, p. 42
- How good are the new watches? Electronic claims split industry... NEWS, ED 20, p. 30
- IC device integrates inductors; Coil-less radio and TV coming... NEWS, ED 21, p. 36
- IC manufacturers have yet to tap a vast consumer-goods market... NEWS, ED 6, p. 34
- Live radio is becoming passe; Enter the automated station... NEWS, ED 18, p. 22
- Low-cost TV recorder-player systems on the way—finally... NEWS, ED 16, p. 32
- New, bigger in-line tubes touching off TV color battle... NEWS, ED 26, p. 23
- New quartz wristwatch drops price below \$100... NEWS, ED 14, p. 23
- Phase-locked loop generates stereo multiplex switching source... IFD, ED 4, p. 96
- RCA quietly showing a new TV disc player... NEWS, ED 18, p. 20
- RCA to market magnetic tape color video player... NEWS, ED 8, p. 24
- Radio and TV waddle into spotlight, steal show and never stop growing... SR, ED 24, p. 114
- Russian air spoilers stabilize TV antennas... NEWS, ED 25, p. 26
- Signals to let deaf 'hear' TV tested... NEWS, ED 6, p. 36
- Solar-cell wristwatch planned for sale in '73... NEWS, ED 17, p. 27
- Solid-state designers matching wits with burglars in the home... NEWS, ED 16, p. 28
- Surface-wave device may shrink TV tuner... NEWS, ED 15, p. 23
- Video disc may provide home color-TV movies... NEWS, ED 15, p. 23
- Video sync generator on chip provides all waveforms for TV signal... PF, ED 13, p. 114
- 2 sec-a-week accuracy expected with new electronic wristwatch... NEWS, ED 3, p. 32
- \$395 LED calculator a 'slide rule'—and more... NEWS, ED 3, p. 23

### Displays

- Ceramic imaging device stores high resolution pictures... NEWS, ED 5, p. 26
- Charge-transfer ICs compete as TV sensors... NEWS, ED 8, p. 23
- Display society planning show with wide appeal... NEWS, ED 10, p. 24

Electronic systems to pace the 1972 Summer Olympics... NEWS, ED 17, p. 36

Electro-Optics: Memories and displays with a future... SR, ED 6, p. 76

Felix, a fast liquid crystal, is easy on power, easy on the eye... NEWS, ED 20, p. 44

Flat CRT for military may go commercial... NEWS, ED 15, p. 23

Full-color holographic display reconstructed with white light... NEWS, ED 7, p. 22

Improved movies simplifying simulations... NEWS, ED 25, p. 38

Indicator light plus TTL gives convenient package... PF, ED 19, p. 174

LED display with 0.27-in. character has lowest cost, smallest package... PF, ED 14, p. 88

LED makers getting the red out, offer choice of green and yellow... NEWS, ED 19, p. 24

LED readout in DMM probe cuts language pollution... PF, ED 6, p. 108

Latch-decoder-driver chip simplifies display circuitry and lowers cost... PF, ED 21, p. 103

Liquid-crystal displays avoids flicker trouble... NEWS, ED 23, p. 23

Liquid crystals pushed for calculator display... NEWS, ED 21, p. 28

Memory reduces connections in a GaP, eight-digit display... NEWS, ED 7, p. 24

Overflow detector uses counter-output display... IFD, ED 26, p. 68

Reduce numeric LED-display errors... ART, ED 22, p. 76

TV cameras getting tinier... NEWS, ED 8, p. 33

TV set is display for data terminal... ART, ED 19, p. 134

Thin-film incandescent display outshines LEDs in key areas... NEWS, ED 26, p. 26

Which LED is best?... ART, ED 19, p. 120

### Electro-Optics

Build reliable optoelectronic circuits... ART, ED 3, p. 52.

Ceramic imaging device stores high-resolution pictures... NEWS, ED 5, p. 26

Electronics tunes new optical filter... NEWS, ED 10, p. 23

Electro-optic lenses shield eyes from nuclear flashes... NEWS, ED 18, p. 30

Electro-Optics: Memories and displays with a future... SR, ED 6, p. 76

Far-IR sensor detects objects by noting 0.5-C variations... NEWS, ED 6, p. 38

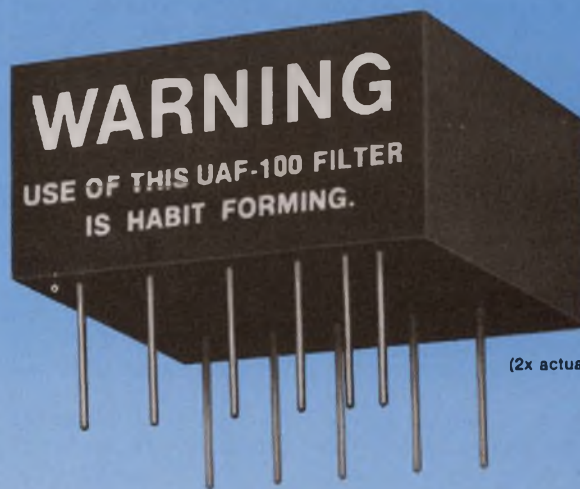

(2x actual size)

Draw on SPRAGUE's Advanced Active Filter Design, which includes op-amps, thin film resistor networks, and NP0 capacitors encapsulated in a single plastic pack. This new series of active filters overcomes passive RLC wave-shaping network problems of insertion loss plus critical tuning and loading... with short and long term stability of 0.1%, Q up to 100, frequency drift with temperature of less than 50 ppm/°C. Not to forget low offset and low noise.

Take your choice of twelve standard tuning ranges (25Hz to 12kHz) in three temperature ranges up to 125 C. The UAF-100 is versatile, lets you select any of six different second-order functions by changing the resistance values of a few external components.

Unsurpassed for signal detection, instrumentation, A/D systems, FSK systems, and telemetry applications.

Try our UAF-100 filter, sit back and relax! Here's a habit you'll enjoy... and it's good for you!

Sprague Catalog Number*	Resonant Freq. Tuning Range $f_c$ (Hz)		Unit Price†	Sprague Catalog Number*	Resonant Freq. Tuning Range $f_c$ (Hz)		Unit Price†
	Min.	Max.			Min.	Max.	
UAF-100A1N	25	300	(1-24)	UAF-100B3N	600	5000	(1-24)
UAF-100A2N	200	1500	\$43.15	UAF-100B4N	300	12000	\$43.15
UAF-100A3N	300	2000	(25-99)	UAF-100C1N	150	2000	(25-99)
UAF-100A4N	120	6500	\$35.95	UAF-100C2N	1000	10000	\$35.95
UAF-100B1N	60	800	(100-999)	UAF-100C3N	1800	12000	(100-999)
UAF-100B2N	500	3500	\$29.95	UAF-100C4N	800	12000	\$29.95

Standard Size: 1.125" x 1.125" x .450" Initial Frequency Tolerance:  $\pm 0.5\%$   
 Power Supply:  $\pm 5V$  to  $\pm 22V$  Frequency Drift:  $\pm 0.005\%/^{\circ}C$  Passband Gain:  $\pm 0.02dB$

\*"N" at end of Cat. No. denotes operating temperature range from 0C to +70 C. For -25 C to +85 C, change "N" to "E". For -30 C to +125 C, change "N" to "M".

†Complete price and delivery information is available from your Sprague district office or sales representative.

Get complete information from Dick Cummings, Semiconductor Division, Sprague Electric Co., 115 Northeast Cutoff, Worcester, Mass. 01606 Tel. 617/853-5000.



Fiber optics leaps ahead of optical ICs...NEWS, ED 25, p. 30  
 Increase optical-isolator speed...ART, ED 19, p. 128  
 Laser fax sends newspaper page in 1 min...NEWS, ED 2, p. 27  
 Light amplifier boosts color film sensitivity...NEWS, ED 16, p. 21  
 Liquid-core optic fiber has lowest loss yet...NEWS, ED 8, p. 24  
 New communication possibilities flowing from IC optoelectronics...NEWS, ED 6, p. 32  
 OICs: When they come, they'll revolutionize communications...NEWS, ED 12, p. 26  
 Optical waveguide developed as key to IC light devices...NEWS, ED 8, p. 30  
 Physicist with a mind of his own helps usher in the world of lasers...NEWS, ED 24, p. 130  
 Pyroelectric array, a first, introduced...NEWS, ED 23, p. 32  
 Thin-film optical switch modulates laser beam...NEWS, ED 24, p. 39  
 Use LEDs, not lasers, in range-finders...ART, ED 11, p. 48  
 Wireless voltage sensor holds promise for commercial use...NEWS, ED 1, p. 32

### General Industry

Anxiety in Japan, Part 2...SR, ED 1, p. 60  
 China market reported a tough nut to crack...NEWS, ED 10, p. 23  
 Computer show looking for drop in attendance...NEWS, ED 9, p. 22  
 Computer show looks for a sellout in fall...NEWS, ED 21, p. 28  
 Duty-free importers get an X-ray assist...NEWS, ED 3, p. 24  
 EIA crystal ball shows trends in electronics to the year 2012...NEWS, ED 13, p. 34  
 EIA delays a stand on barriers to trade...NEWS, ED 7, p. 19  
 Eastern Europe buying more than ever from U.S....NEWS, ED 1, p. 24  
 "Electronics 1985." A blurred vision...NEWS, ED 12, p. 24  
 FCC's proposed EMI rules stir anxiety in industry...NEWS, ED 6, p. 23  
 Florida paper to set up electronic newsroom...NEWS, ED 6, p. 23  
 Foreign industries duel American for world electronics leadership...NEWS, ED 19, p. 83  
 Growth of 8% a year forecast for electronics...NEWS, ED 17, p. 27  
 IEEE acts to upgrade its 1972 exhibition...NEWS, ED 13, p. 24  
 IEEE announces major changes for next year...NEWS, ED 8, p. 23  
 IEEE pension plan under consideration...NEWS, ED 9, p. 22  
 IEEE poll backs changes; pensions and lobbying due...NEWS, ED 24, p. 39  
 IEEE show to ease exhibitors' burden...NEWS, ED 24, p. 40  
 IEEE strengthening show to boost lagging attendance...NEWS, ED 2, p. 23  
 IEEE '72: A leaner show, but a lively one...SR, ED 6, p. 68  
 If designers build well and slash costs, this market will go vroom!...NEWS, ED 19, p. 78  
 Industry forecast for 1972. Electronics taking off strongly after a year of stop and go...NEWS, ED 1, p. 26  
 Industry group formed to fight trade barriers...NEWS, ED 4, p. 23  
 Israel: The brainy 'Taiwan' of electronics in the Mideast...SR, ED 4, p. 60  
 Japan's electronics makers keep pace despite recession at home...NEWS, ED 23, p. 30  
 Live radio is becoming passe; Enter the automated station...NEWS, ED 18, p. 22  
 Machine tool show lures Soviet buyers...NEWS, ED 20, p. 27  
 Martin division hiring aerospace engineers...NEWS, ED 5, p. 19  
 New EIA data book shows '71 statistics...NEWS, ED 16, p. 22  
 Nixon vs. McGovern two views of engineering issues...NEWS, ED 22, p. 30  
 Over 100,000 computers in U.S., census reveals...NEWS, ED 26, p. 24  
 Programmable controller, 'mini' for the poor man, upstages DNC...NEWS, ED 21, p. 30  
 RCA endows 2 chairs at MIT and Harvard...NEWS, ED 22, p. 24  
 RCA kicks off sale of electronics to China...NEWS, ED 6, p. 23  
 Recovery for instrument market foreseen...NEWS, ED 5, p. 20  
 Red China expanding her satcom facilities...NEWS, ED 19, p. 22  
 Regulated power supplies 'stabilized' in new standard...NEWS, ED 19, p. 21  
 Russians unimpressed by components show...NEWS, ED 12, p. 23  
 Semi show looking for doubled attendance...NEWS, ED 11, p. 22  
 Senate unit backs bill for metric conversion...NEWS, ED 18, p. 20  
 'Severe' shortage of engineers feared...NEWS, ED 25, p. 25  
 U.S. aims new thrust at import 'dumping'...NEWS, ED 12, p. 23

U.S. move to break up IBM raises hopes of competitors...NEWS, ED 23, p. 23  
 U.S. urged to foster education electronics...NEWS, ED 13, p. 23  
 Wescon, 1972: A new beginning...SR, ED 19, p. 74  
 World standards pushed for component quality...NEWS, ED 14, p. 23  
 9.6%-a-year growth seen for electronics...NEWS, ED 3, p. 24

### Industrial Electronics

Assembly-line test systems stop the defects before they're built in...NEWS, ED 22, p. 26  
 Better crystals seen with new furnace...NEWS, ED 20, p. 28  
 Crowbar option protects slot supplies and systems...PF, ED 6, p. 124  
 D/a and a/d line offers something for everyone...PF, ED 2, p. 68  
 Danish tester screens assembly-line resistors...NEWS, ED 15, p. 24  
 Digital testing costs can be cut...ART, ED 7, p. 44  
 FOCUS on Resistor trimming equipment...ART, ED 3, p. 44  
 IR scanner checks tires...NEWS, ED 8, p. 31  
 Industrial electronics: Where today's action is...NEWS, ED 15, p. 26  
 Laser-machining process makes circuits in one step...NEWS, ED 12, p. 32  
 Laser setup offers machine-tool control...NEWS, ED 21, p. 28  
 Linearize analog signals continuously...ART, ED 24, p. 156  
 Low-cost sensor made for industrial controls...NEWS, ED 22, p. 23  
 Machine Tool show lures Soviet buyers...NEWS, ED 20, p. 27  
 Minicomputers taking over in factories in blue-collar and white-collar roles...NEWS, ED 15, p. 28  
 Power devices pushing into new fields as costs fall and performance soars...NEWS, ED 15, p. 34  
 TI discloses how it achieves non-volatility in MOS memory...NEWS, ED 21, p. 38  
 Volkswagen thinks big with a new exhaust-test center on wheels...NEWS, ED 8, p. 28  
 Wire technicians aided by voice of a computer...NEWS, ED 4, p. 23

### Management

ABC's of engineering management...ART, ED 23, p. 88  
 Adjust to the management role gracefully...ART, ED 11, p. 64

'Cleaning up' is the key to promotion... ART, ED 1, p. 84

Compare your career with your peers... ART, ED 9, p. 42

Cultivate a budding manager this year... ART, ED 25, p. 94

Define before you design... ART, ED 8, p. 76

Design products that others build... ART, ED 17, p. 88

Guide your engineers to self-rule... ART, ED 2, p. 52

Haggerly and OST—or how TI grew two-hundred fold in 25 years... ART, ED 24, p. 82

No design is sacred. It must be sold... ART, ED 4, p. 90

Put 'tiger teams' in your managing game... ART, ED 13, p. 90

What's wrong with the IEEE show? Engineers suggest changes to reverse attendance drop... ART, ED 6, p. 86

When a merger causes company friction... ART, ED 19, p. 150

You have to earn management's support... ART, ED 15, p. 68

### Materials & Packaging

Avoid ECL-10,000 wiring problems... ART, ED 18, p. 48

Better crystals seen with new furnace... NEWS, ED 20, p. 28

Blind riveting system is magazine loaded... PF, ED 6, p. 128

Deposited metal underpasses enhance LSI interconnections... NEWS, ED 13, p. 30

Dielectric materials made superconductive... NEWS, ED 15, p. 24

Do-it-yourself kit for custom connectors... PF, ED 12, p. 86

Dry-transfer method gives fine PC prototype details... PF, ED 4, p. 140

Epoxy IC package gives surer bonds... NEWS, ED 19, p. 21

Fiber optics finding growing use in data systems—and it pays handsomely... NEWS, ED 4, p. 26

FOCUS on Flexible flat cable and PCs... SR, ED 25, p. 60

High-frequency phonons to aid materials research... NEWS, ED 5, p. 20

High negative bias sputtering: A revolution for thick films?... NEWS, ED 2, p. 26

Hybrid circuits are great... ART, ED 3, p. 58

Improved waveguide built of graphite... NEWS, ED 18, p. 26

Low-power beam leads hailed... NEWS, ED 3, p. 35

Multilayer density boosted... NEWS, ED 10, p. 37

**Compact package...  
dual speed capabilities  
and 5.5 oz-in.  
synchronous  
torque at  
600rpm.**

## Meet the 86600...workhorse of our economy-priced synchronous motor family.

Designing medical or scientific instruments, computer peripherals, environmental control units or other devices needing a better synchronous drive? Take a look at our new, compact 86600 economy-priced synchronous motor. Its increased power can open up whole new design possibilities for you.

### Greater Torque

A UL recognized component and built to NEMA type 2-11 configuration, the 86600 gives you 5.5 oz-in at 600 rpm rotor speed. You have a selection of 10 gear trains to handle torque loads up to 200 oz-in.

### Dual Speed Capabilities

High torque isn't the only advantage you'll gain. You can use the

86600 either as a single speed electrically reversible motor, or you can specify it in a variety of unidirectional dual speed combinations. Either way, the 86600 is reliable, efficient and compact. A real space saver! Models are available for 120 VAC, 24 VAC, or 230 VAC.

### All in the Family

If your requirements call for something else, remember that NAPCC offers a full range of synchronous motors—starting at .75 oz-in at 300 rpm rotor speed. Chances are we can fill your needs off the shelf. If not, we have the capabilities to design and build a motor to your specifications. Try us.

**Write for details today!**

A. W. HAYDON CO. PRODUCTS

**NORTH AMERICAN PHILIPS CONTROLS CORP.**

A NORTH AMERICAN PHILIPS COMPANY  
Cheshire, Conn. 06410 • (203) 272-0301  
INFORMATION RETRIEVAL NUMBER 57

## ANNUAL INDEX

New CMOS offering 4-to-1 area reduction...NEWS, ED 22, p. 23  
New rubbery material has switching uses...NEWS, ED 11, p. 22  
Nick of time, automation comes and with it miniature modules...PF, ED 24, p. 126  
Now you see it, now you don't with secret stripper...PF, ED 5, p. 72  
Planning to use high-speed logic...ART, ED 26, p. 48  
RCA criticizes aluminum TO-3's...NEWS, ED 13, p. 24  
Solderless-wrap board handles ECL 10,000 logic...PF, ED 18, p. 68  
Staggered two-level contacts give rugged, high-density connector...PF, ED 24, p. 177  
Synthetic crystal an alternative to quartz...NEWS, ED 19, p. 34  
Terminal combines clip action with wrapped-wire termination...PF, ED 24, p. 180  
Thick-film paste narrows line widths...NEWS, ED 24, p. 39  
Thick-film technique promises switches at a fraction of a cent...NEWS, ED 13, p. 26  
Wrapped-wire board permits plug-in or wave-solder link...PF, ED 19, p. 108

### Medical Electronics

Coming: Atom pacemaker...NEWS, ED 6, p. 41  
Condition of pacemakers determined via telephone...NEWS, ED 1, p. 24  
Medical Electronics: Devices for tomorrow's hospital ward...SR, ED 6, p. 77  
New title and job is emerging in a growing field: bioengineer...NEWS, ED 19, p. 80  
Skin 'transducer' used in touch communication...NEWS, ED 12, p. 23  
U.S. investigates perils in medical equipment...NEWS, ED 17, p. 28

### Military & Aerospace

Army hopes to salvage part of the Cheyenne...NEWS, ED 18, p. 19  
Army speeds design of microwave ICs...NEWS, ED 10, p. 23  
Backscatter radar on 2 coasts to detect planes over horizon...NEWS, ED 14, p. 30  
Big nonsecret in Washington alters U.S. defense capability and history...SR, ED 24, p. 110  
Biggest telescope in orbit...NEWS, ED 19, p. 37

Down-to-earth avionics planned for versatile space shuttle...NEWS, ED 17, p. 30  
Drone 'air force' for combat being designed by two teams...NEWS, ED 3, p. 26  
ECM crisis in Vietnam reported by ex-combat pilot...NEWS, ED 11, p. 21  
Electrical multiplexer to control B-1 bomber...NEWS, ED 1, p. 23  
Electronic envelope to guard SAC aircraft...NEWS, ED 19, p. 22  
Experiments sought for celestial satellite...NEWS, ED 15, p. 24  
Further research due on organic solar cells...NEWS, ED 22, p. 24  
How U.S. hopes to settle the life-on-Mars question...NEWS, ED 14, p. 26  
LHA: A communication 'first'...NEWS, ED 10, p. 30  
Marine Corps to test near 'hands off' radio...NEWS, ED 23, p. 24  
Martin division hiring aerospace engineers...NEWS, ED 5, p. 19  
Military urged to alter its relay-testing specs...NEWS, ED 9, p. 21  
NASA studies orbiting solar power station...NEWS, ED 16, p. 22  
NASA will launch ERTS-A this month...NEWS, ED 14, p. 24  
NASA's biggest solar-cell array to power first space station in 1973...NEWS, ED 23, p. 36  
New air command post sought to counter A-peril...NEWS, ED 4, p. 24  
New aircraft material resists radar detection...NEWS, ED 19, p. 22  
New military computer introduced by RCA...NEWS, ED 4, p. 24  
New opportunities seen for anti-sub engineers...NEWS, ED 17, p. 28  
New radars 'go underground' to spot targets below surface...NEWS, ED 9, p. 24  
New semi processes to be tested in space...NEWS, ED 23, p. 24  
Norden signs agreement to build British missile...NEWS, ED 9, p. 22  
Portable Loran repeater pinpoints vehicle position...NEWS, ED 7, p. 19  
Radar 'field test' in the lab? Yes, and with better results...NEWS, ED 10, p. 34  
Radar for Awacs system about to be selected...NEWS, ED 8, p. 24  
Radar-radiometer to offer best of each...NEWS, ED 10, p. 24  
Sensitive X-ray to scan GI mail for contraband...NEWS, ED 5, p. 20  
'Smart' bombing technique is about to become smarter...NEWS, ED 20, p. 30  
Subcontracting time nears for space shuttle...NEWS, ED 18, p. 19  
Ulms: The submarine that will bristle with new electronics...NEWS,

ED 4, p. 30

U.S. advised to rebuild a 'useless' air defense...NEWS, ED 3, p. 23  
U.S. to put satcom transceivers in all military planes and ships...NEWS, ED 9, p. 32  
Venus-Mercury flight to crack two frontiers...NEWS, ED 25, p. 26  
Western Union gets green light on satellite...NEWS, ED 18, p. 19  
1-kW, 170-lb. battery developed for extra-long space missions...NEWS, ED 26, p. 36  
5 kW in S band achieved by Navy lab's helix TWT...NEWS, ED 22, p. 23  
64-bit bubble memory delivered to Air Force...NEWS, ED 21, p. 27

### Semiconductors

Air abrasion cuts ICs with a soft touch...NEWS, ED 17, p. 34  
All-solid-state color TV camera, the first, is built experimentally...NEWS, ED 19, p. 30  
Analog portion of 17-bit A/D is offered in a 14-pin DIP...PF, ED 9, p. 86  
Assembling large-array IC memories...ART, ED 4, p. 76  
BIFET promises faster and denser ICs...NEWS, ED 26, p. 30  
Bipolar device enters desk-calculator field...NEWS, ED 2, p. 23  
Bipolar logic forges ahead: More speed, less dissipation...NEWS, ED 6, p. 28  
CMOS line uses dielectric isolation for fastest CMOS ICs on silicon...PF, ED 22, p. 87  
Cascaded divide-by-N CMOS counters avoid external logic...PF, ED 16, p. 68  
Charge-coupled devices await mass applications by industry...NEWS, ED 6, p. 27  
Charge-pump circuit eliminates bias supply for NMOS devices...IFD, ED 23, p. 100  
Charge-transfer ICs compete as TV sensors...NEWS, ED 8, p. 23  
Comparator costs slashed by introduction of quad...PF, ED 18, p. 72  
Discharge capacitors with a MOSFET...IFD, ED 1, p. 95  
FET-input preamp combines speed and versatility...PF, ED 15, p. 88  
FIFO memory chip boasts improved data-buffer specs...PF, ED 18, p. 75  
FIFO memory chip buffers data-communication systems...PF, ED 12, p. 93  
Flapack photodetector/amp has wide field view...PF, ED 9, p. 82  
FOCUS on CMOS...SR, ED 8, p. 54



FOCUS on comparator IC's...SR, ED 22, p. 52

FOCUS on Consumer IC's...SR, ED 16, p. 42

FOCUS on Fast Logic...SR, ED 12, p. 50

High-density IC process announced by Motorola...NEWS, ED 8, p. 23

Hybrid ladder switch cuts cost for precision designs...PF, ED 17, p. 104

Improved op-amp regulator comes with lower price tag...PF, ED 19, p. 169

Internally compensated, fully protected op amp beats key specs of 725 family...PF, ED 15, p. 92

Latch decoder-driver chip simplifies display circuitry and lower cost...PF, ED 21, p. 103

Low-power beam leads hailed...NEWS, ED 3, p. 35

MOS gyrator replaces conventional inductors...NEWS, ED 2, p. 24

MOS 4-1/2-digit multimeter chip features auto ranging...PF, ED 5, p. 70

Microelectronics: Circuitry at a significant power saving...SR, ED 6, p. 72

Monolithic clock chip offers flexibility in digital systems...PF, ED 12, p. 94

Monolithic phase-locked loops extend the frequency range to 35 MHz...PF, ED 13, p. 112

N-channel technology invading semiconductor memory field...NEWS, ED 6, p. 26

New line said to double CMOS device speed...NEWS, ED 21, p. 27

New semi processes to be tested in space...NEWS, ED 23, p. 24

Op-amp cost plummets with introduction of 2 quads...PF, ED 11, p. 89

Penetrate the mystique of MOS specs...ART, ED 8, p. 64

Power needs cut dramatically for ocean-floor monitor systems...NEWS, ED 2, p. 28

Programmable transmitter is asynchronous or synchronous...PF, ED 23, p. 103

SOS diode arrays may oust MOS ROMs with high-speed logic in digital systems...PF, ED 6, p. 126

Semi show looking for doubled attendance...NEWS, ED 11, p. 22

Single-transistor memory cell: A promise with many problems...NEWS, ED 4, p. 34

Smallest IC-package line begins with popular linears...PF, ED 19, p. 170

Solar-cell efficiency surges to 18% with gallium arsenide...NEWS, ED 12, p. 38

## Improved magnetic characteristics!



### Unique coil core design of new GP relay family minimizes eddy current losses.

Two features have been incorporated into the new NAPCC Series 12 and 13 GP relay family to improve operating characteristics. First is a unique new spiral wrap core. This helps minimize eddy current losses and results in cooler operation. Second, the core has been welded to the frame to further improve magnetic characteristics. The results: an improved relay which is available to you at competitive prices.

Contact arrangement is SPDT, DPDT, or 3 PDT. Coil voltages range from 6—230 V, 60 hz, or 6—110 vdc. Series 12 has contact rating of 10 amp

resistive and is available with .087" quick connect terminals. Series 13 is available in 5 and 10 amp contact ratings and in octal, PC or wired terminals. Each Series comes in open or enclosed styles.

If you are currently working with such applications as machine controls, data processing equipment and office copiers, garage door openers, appliances and other devices where space is at a premium and premium performance essential, it will pay you to investigate the Series 12 and 13 relay family. Their improved characteristics offer many advantages.

Send for information today!

PRICE ELECTRIC RELAYS

**NORTH AMERICAN PHILIPS CONTROLS CORP.**

A NORTH AMERICAN PHILIPS COMPANY  
E. Church & 2nd St. • Frederick, Md. 21701 • (301) 663-5141

INFORMATION RETRIEVAL NUMBER 58

Surface-wave device may shrink TV tuner...NEWS, ED 15, p. 23  
 TTL-compatible MOS circuit is complete counter-timer...PF, ED 10, p. 84  
 TV cameras getting tinier...NEWS, ED 8, p. 33  
 Transistor years: A new design freedom begins...SR, ED 24, p. 66  
 Trusty transistors and ICs dethrone the power-demanding vacuum tube...SR, ED 24, p. 72  
 Versatile multiplier chip extends bandwidth while reducing design complexity...PF, ED 22, p. 88  
 Video sync generator on chip provides all waveforms for TV signal...PF, ED 13, p. 114  
 Voltage comparator reduces uncertainty band to  $\pm 1$  mV...PF, ED 3, p. 73  
 'We found, as expected'...The birth of the transistor, an unforgettable event...SR, ED 24, p. 68  
 Westinghouse 'banking' its semis to cut delays...NEWS, ED 5, p. 19  
 4-k RAMs slated to make debut...NEWS, ED 26, p. 23  
 5 W per million bits of memory...ART, ED 5, p. 50  
 8, 120-bit registers advance a/d converter designs...PF, ED 17, p. 103  
 1103-1024 memory bits on a chip...ART, ED 2, p. 40  
 2048-bit PROM matches chip area of 1024-bit counterpart...PF, ED 26, p. 82

### Test & Measuring

Accurate IC logic delays measurements...ART, ED 9, p. 64  
 Add a synchronous sawtooth output to your function generator...IFD, ED 9, p. 70  
 Analyzer reads direct transmission gain/loss, VSWR & return loss...PF, ED 10, p. 72  
 Assemble pulse generators by the module...PF, ED 15, p. 86  
 Assembly-line test systems stop the defects before they're built in...NEWS, ED 22, p. 26  
 Benchtop tester checks 4096  $\times$  8-bit RAMs-ROMs...PF, ED 19, p. 92  
 Both high and 50-ohm inputs are given in 100-MHz scope...PF, ED 2, p. 61  
 Breakthrough reported in measurement science...NEWS, ED 4, p. 24  
 Broadband power measuring simplified...NEWS, ED 5, p. 24  
 Can't decide which instrument to buy?...ART, ED 4, p. 162  
 Capacitive strain gage operates at 1750 F...NEWS, ED 17, p. 34  
 Cut the testing time of digital circuits...ART, ED 25, p. 90  
 Danish tester screens assembly-line resistors...NEWS, ED 15, p. 24  
 Data-acquisition module is cheaper, smaller & slower...PF, ED 4, p. 122  
 Digital-readout sig gens battle on price accuracy, stability and modulation...PF, ED 11, p. 78  
 Digital-test logic probes detect pulses down to 5 ns...PF, ED 3, p. 76  
 Digital testing costs can be cut...ART, ED 7, p. 44  
 Digital tone-burst generator uses 4 ICs...IFD, ED 8, p. 90  
 Digitally swept synthesizers have built-in keyboards...PF, ED 6, p. 110  
 Endless-loop signal recorder converts real-time scope to storage unit...PF, ED 13, p. 105  
 Exit the meter man; enter electronics...NEWS, ED 21, p. 40  
 Fast DMM provides 1-ppm accuracy...PF, ED 6, p. 112  
 Fastest portable scope shows 350 MHz at 5 mV/div...PF, ED 5, p. 67  
 FOCUS on Digital Panel Meters...SR, ED 1, p. 48  
 FOCUS on Function generators...SR, ED 7, p. 36  
 FOCUS on MSI/LSI testers...SR, ED 17, p. 60  
 Function generator ramp doesn't drift when held...PF, ED 5, p. 68  
 Generate programmable rectangular pulses...IFD, ED 7, p. 58  
 Liquid-crystal DPM sets price/performance standards...PF, ED 1, p. 101  
 Logic pulser and probe simplify in-circuit logic functional tests...PF, ED 9, p. 92  
 Low-cost DPM may replace conventional pointer meters...PF, ED 14, p. 86  
 Low-cost 8-bit a/d converter completes conversion in 2  $\mu$ s...PF, ED 7, p. 77  
 Measure phase balance easily...ART, ED 11, p. 60  
 Measure phase instead of amplitude...ART, ED 8, p. 72  
 Monolithic d/a converter achieves 0.05% linearity with 10-bit resolution...PF, ED 9, p. 79  
 More DVM for less \$...PF, ED 5, p. 115  
 Phase-locked signal generators yield ultra-stable frequencies...PF, ED 20, p. 90  
 Pitfalls in DPM selection...ART, ED 14, p. 62  
 Power needs cut dramatically for ocean-floor monitor system...NEWS, ED 2, p. 28  
 Quick-change readout in low-parts-count DPM...PF, ED 10, p. 74  
 Replace your bridge circuit with this...ART, ED 13, p. 84  
 Self-test, 5-digit DMM helps alleviate uncertainty...PF, ED 11, p. 77  
 'Shock wave' technique checks printed circuits...NEWS, ED 1, p. 23  
 Silicon crystal senses fluid pressure...NEWS, ED 20, p. 36  
 Solid-electrolyte device is capacitor, battery or timer...PF, ED 21, p. 116  
 Special site now checks accuracy of ship sonar...NEWS, ED 6, p. 24  
 Storage scope features fastest writing speed...NEWS, ED 16, p. 22  
 Storage-scope writing rate jumps to lofty 400 cm/ $\mu$ s...PF, ED 19, p. 94  
 Storage scopes leap ahead in writing rate, bandwidth, tube life...PF, ED 14, p. 83  
 Test one-shots for min, max widths...IFD, ED 1, p. 96  
 Test system at MIT controls temperature to microdegrees...NEWS, ED 1, p. 34  
 Touch of solid state miniaturizes equipment and enhances readability...SR, ED 24, p. 102  
 Try building a pulse generator...ART, ED 17, p. 84  
 Two-in-one function generator calipers FM and AM...PF, ED 6, p. 116  
 Watch out for traps in hybrid IC tests...ART, ED 26, p. 58  
 Waveform generator offers variable-phase outputs...PF, ED 24, p. 194  
 Waveform generators offer low-cost, high performance...PF, ED 6, p. 169  
 Which DPM, five-volt or line powered?...ART, ED 16, p. 50  
 Will your DPM work with your system?...ART, ED 15, p. 60  
 Wireless voltage sensor holds promise for commercial use...NEWS, ED 1, p. 32  
 4-bit analog-to-digital unit converts at 100-MHz rate...PF, ED 26, p. 78  
 4-1/2-digit DPM uses 5 V and has floating input...PF, ED 24, p. 192  
 4-1/2-digit pocket multimeter slashes size, price and power consumption...PF, ED 20, p. 87  
 8-digit counter/timer gives automatic operation at \$575...PF, ED 19, p. 90  
 20-MHz mini-portable scope weighs only 5-1/2 pounds...PF, ED 1, p. 104

# 30 MHz

for only \$225\*?



## Prove it to yourself with the Heath/Schlumberger 30-day trial offer

- Auto-ranging
- 5 Hz to 30 MHz range
- 10 mV input sensitivity
- 6-digit LED readout with leading zero blanking

Heath/Schlumberger does it again...with the new SM-118A. Compare features and price against the competition. The new 118A provides 5 Hz to 30 MHz guaranteed range...2 Hz to 40 MHz typical...10 mV sensitivity guaranteed over the entire range...5-8 mV typical. Plus features not found on other low cost counters: Autoranging with four automatically selected ranges of 10 sec., 1 sec., 100 ms or 10 ms., plus switch-selected time base ranges of 1 sec. and 10 msec....1 MHz time base provides stability of 1 part in  $10^6$ /mo...plus a rear panel input to allow use of an external time base oscillator for extreme accuracy or frequency ratio measurements. Other features include 6-digit LED readout with leading zero blanking...combination carrying handle/tilt stand...small size and light weight...120/240 VAC operation.

A value? You decide. Check the details of our trial offer at right and put one to work for 30 days. We think you'll keep it.

Factory assembled & calibrated SM-118A, 7 lbs. ....\$225.00\*



Send for our FREE 1973 Electronic Instruments catalog and get complete details on this and other high performance, low cost instruments. Use the coupon to receive your FREE copy now.

How we can sell high performance instrumentation at low cost. Heath/Schlumberger sells direct to you, through the mail. No salesmen, no distributors. Result? Lower selling costs...lower prices. Heath/Schlumberger is a division of the Heath Company, the world's largest manufacturer of electronic kits, one of the

world's largest buyers of electronic components. That means real purchasing power for us, lower costs for you.

And we're not a small company struggling with high overhead, but a small division of a very large company, getting the benefit of sharing some other very important (and expensive) facilities. Again, this means lower costs for us...and for you.

Take advantage of our 30-day trial offer and prove it to yourself.

### The Heath/Schlumberger 30-day trial offer.

We're so sure that our products can deliver on our claim of high performance and low cost that we make this offer: try this or any other Heath/Schlumberger product in your lab for 30 days. Just send us your purchase order with the statement below typed on it.

**"This order is placed for 30-day evaluation. The equipment ordered may be returned within 30 days if, in the buyer's opinion, it is not suitable. The buyer agrees to pay transportation costs in both directions."**

If, in *your* opinion, the product is not suitable for *any* reason, just return it to us within the 30-day limit and pay the shipping costs. After the 30-day limit we'll process your PO and bill you for the product. Send your PO now...and prove it to yourself.

HEATH Schlumberger	
Heath/Schlumberger Scientific Instruments Dept. 531-264 Benton Harbor, Michigan 49022	
<input type="checkbox"/> Please send 1973 Electronic Instruments catalog	
<input type="checkbox"/> Enclosed is my purchase order for a 30-day trial evaluation	
Name _____	
Title _____	
Company/Institution _____	
Address _____	
City _____	State _____ Zip _____
*Mail order prices; FOB factory.	
EK-370	

## Biphase data transmission system uses IC one-shot as converter and doubler

Biphase modulation is used in systems where clock information has to be contained within the data to minimize the number of transmission lines. Both the transmitter and the receiver of such a system can be implemented with an IC bidirectional one-shot. The 8T20 IC unit contains an input comparator that may be set to trigger an internal one-shot on the positive and negative edges of the incoming signal.

A single 8T20 and one flip-flop (Fig. 1a) convert a binary waveform and its clock to a biphase signal. The clock is fed into the comparator input, which in this case is referenced to about 2 V for TTL compatibility. However, any low-level analog signal with a swing that exceeds the  $\pm 4$  mV input offset will suffice. Versatility is increased by the counter and shift register; data from up to 10 channels can be multiplexed. The shift register, IC<sub>3</sub>, is loaded once every 10 counts and provides binary serial data to the PEC input of IC<sub>1</sub>. Clock pulses for the counter, IC<sub>4</sub>, are taken from the A and  $\bar{A}$  outputs of IC<sub>1</sub>. The output pulse width,  $T_w$ , of IC<sub>1</sub>, must be at least 20 ns to trigger the flip-flop reliably, but it must not exceed the half-bit-cell size (Fig. 1b). Resistor R and capacitor C govern  $T_w$ :

$$2 \text{ k}\Omega \leq R \leq 40 \text{ k}\Omega \quad (1a)$$

$$0 \leq C \leq 1000 \mu\text{F} \quad (1b)$$

$$T_w = RC \log_2 2 \approx 0.69 RC \quad (1c)$$

The biphase-to-binary receiver (Fig. 2a) uses the 8T20 unit as a line receiver, frequency doubler and one-shot to reconstruct the binary data and the clock. Either single-ended or differential signals (twisted pair) can be used to input the signal.

Voltage  $V_{REF}$  accommodates TTL levels at the comparator. As with the transmitter, the input pulse width to the flip-flop must lie between

$$20 \text{ ns} \leq T_w \leq 1/2 \text{ bit-cell},$$

and it is determined by Eq. 1. A clock for the

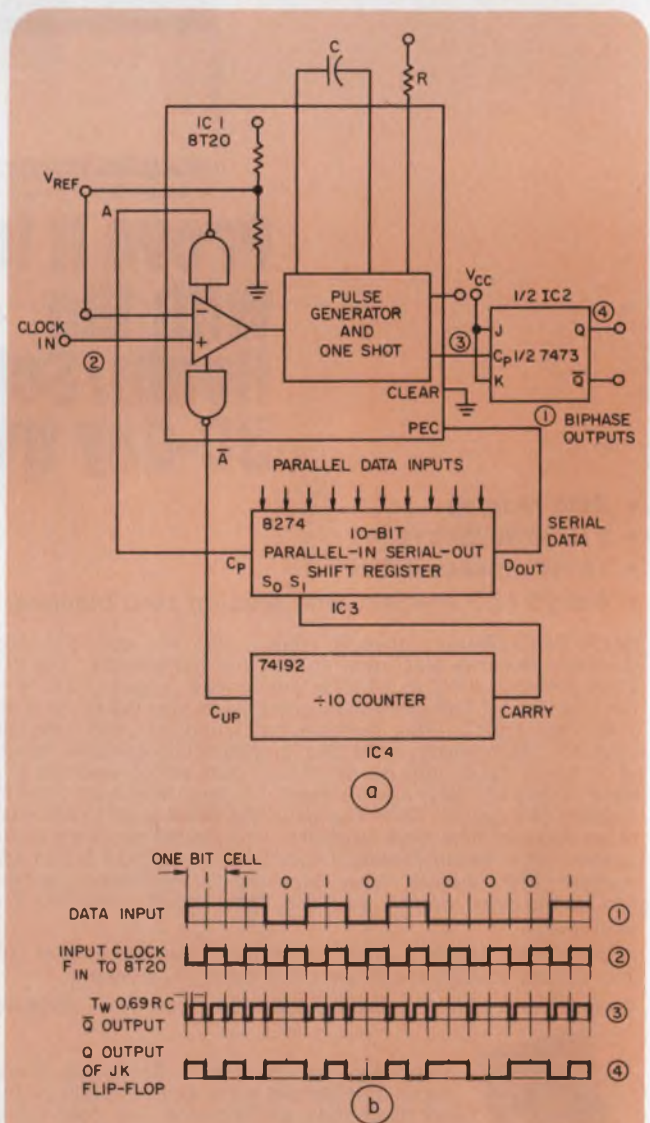

1. Circuit to convert serial binary data to biphase form makes use of a one-shot pulse generator (a) that responds to negative and positive signal transitions. Two clock periods are allotted for each bit (b). The flip-flop constructs the final binary output from the narrow one-shot pulses.

# "THE PRACTICALS" A COMPLETE FAMILY OF LOW-COST HIGH PERFORMANCE PACKAGED AC-DC REGULATED POWER SUPPLIES

*They make systems engineers cost-efficiency experts*

Today's OEM Engineer must assume many responsibilities beyond the pure design of systems.

He must realistically specify the components and sub-systems; buy the required performance specifications at competitive prices; package the system in its most compact form. In short, he must achieve the greatest cost-efficiency and reliability per dollar invested.

Just compare the basic specifications and prices of "The Practicals" with other open construction power supplies. Then consider that we give "The Practicals" the identical 5-Year Warranty as our premium mil spec units.

Standard output voltages and power availabilities satisfy the most popular circuits. Custom specifications can easily be adapted to order.

"The Practicals" are an OEM Engineer's most realistic answer to any power supply need. Call, wire or write today for immediate delivery.

## TECHNIPOWER "PRACTICALS"

### Standard Specifications

Single, Dual, Triple, and Quadruple Output Models

Source voltage range: 105-125 volts  
 Source frequency range: 47-420 Hz.  
 Combined Source and Load Effects (Regulation):  $\pm 0.5\%$   
 PARD (Ripple) (RMS): 2mv.  
 Temperature Coefficient: (TYP.) 0.02%/°C.  
 Polarity: May be used positive or negative.  
 Output voltage and current: See model listing.  
 Short circuit protection: Automatic circuit protects the power supply if the output is shorted continuously. Automatic return upon removal of short circuit.  
 Remote sensing: Provisions are made for remote sensing to eliminate effects of lead resistance on dc regulation.  
 Ambient Operating Temperature: 0°C to +55°C for current ratings specified in model listings.  
 Storage temperature: -20°C to +85°C.  
 Recovery time: (TYP.) Less than 50 usec, 1/2 L to FL.  
 Fixed Output and Dual Input Available: Consult factory  
 OEM quantity and less than 25 unit prices quoted upon request.  
 Custom specifications easily adapted to order.

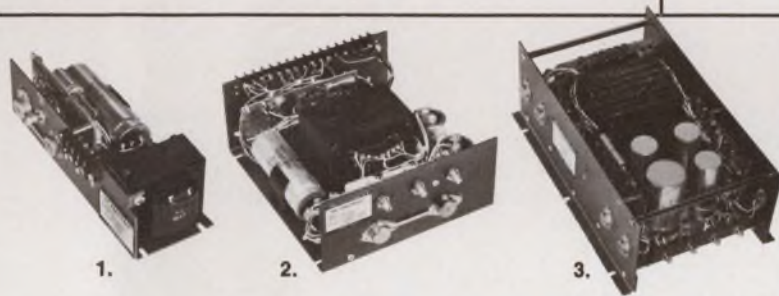

3 CASE SIZES

Case Size	L	W	H
#1	8 1/2"	3 1/8"	2 5/8"
#2	8 1/4"	7 1/2"	3 3/8"
#3	14"	8 1/2"	5"

## NEW! HIGHER POWER MODELS IN 3 CASE SIZES

SINGLE OUTPUT SERIES designed for logic, op-amp, signal and other commercial applications

Adjustable Output Voltage	Output Current Amperes	Standard Model No.	Output Current Amperes	Standard Model No.	Output Current Amperes	Standard Model No.
5.0 $\pm 5\%$	5.0	LP5.0-5.0	10.0	LP5.0-10.0	20.0	LP5.0-20.0
6.0 $\pm 5\%$	4.5	LP6.0-4.5	9.0	LP6.0-9.0	18.0	LP6.0-18.0
12.0 $\pm 5\%$	2.5	LP12.0-2.5	8.0	LP12.0-8.0	16.0	LP12.0-16.0
15.0 $\pm 5\%$	2.0	LP15.0-2.0	7.0	LP15.0-7.0	14.0	LP15.0-14.0
24.0 $\pm 5\%$	1.5	LP24.0-1.5	4.5	LP24.0-4.5	9.0	LP24.0-9.0
28.0 $\pm 5\%$	1.2	LP28.0-1.2	4.0	LP28.0-4.0	8.0	LP28.0-8.0

CASE SIZE #1

**\$39<sup>80</sup>**

ALL MODELS  
25 or more  
combined units  
Unit Price \$49.75

CASE SIZE #2

**\$79<sup>80</sup>**

ALL MODELS  
25 or more  
combined units  
Unit Price \$99.75

CASE SIZE #3

**\$131<sup>80</sup>**

ALL MODELS  
25 or more  
combined units  
Unit Price \$164.75

Overvoltage protection available on all models (LPC series). Add \$5.00 for case size 1, \$10.00 for case size 2, \$15.00 for case size 3.

BACKED BY TECHNIPOWER 5-YEAR WARRANTY  
U.L. APPROVED.

See Technipower products in Volume 1 of the 1972/1973 EEM. Pages 964-989.

**TECHNIPOWER, INC.**  
A BENRUS DIVISION

Benrus Center, Ridgefield, Ct 06877 203-438-0333 TWX: 710-467-0666

DUAL OUTPUT TRACKING SERIES designed for op-amp and other commercial applications.

CASE SIZE #1

Adjustable Output Voltage	Output Current Amperes	Standard Model No.
$\pm 12.0 \pm 5\%$	1.2	LPDT-12.0-1.2
$\pm 15.0 \pm 5\%$	1.0	LPDT-15.0-1.0

**\$64<sup>60</sup>**

25 or more  
combined units  
Unit Price \$80.75

Overvoltage Protection available on all models (LPDTC series). Add \$10.00. Independent output adjustment (non-tracking) provided at slight additional cost.

Modification of standard output voltages can be provided over the range of  $\pm 5$  to  $\pm 28$  volts at slight additional cost. Voltages below  $\pm 7$  volts not available in Tracking models.

TRIPLE OUTPUT SERIES combines single and dual output functions

CASE SIZE #2

Adjustable Output Voltage	Output Current Amperes	Standard Model No.
+5.0 $\pm 5\%$	5.0	LPM-1
+12.0 $\pm 5\%$	1.2	
-12.0 $\pm 5\%$	1.2	
+5.0 $\pm 5\%$	5.0	LPM-2
+15.0 $\pm 5\%$	1.0	
-15.0 $\pm 5\%$	1.0	

**\$124<sup>60</sup>**

25 or more  
combined units  
Unit Price \$155.75

Overvoltage Protection is standard on 5 Volt Output at no additional cost. Available on the  $\pm 12$  or  $\pm 15$  volt output (LPMC series). Add \$10.00.

Modification of standard output voltages can be provided at slight additional cost.

QUADRUPLE OUTPUT SERIES combines triple output functions plus output for indicator or drive voltage

CASE SIZE #3

Adjustable Output Voltage	Output Current Amperes	Standard Model No.
+5.0 $\pm 5\%$	10.0	LPQ-1
+15.0 $\pm 5\%$	2.0	
-15.0 $\pm 5\%$	2.0	
+28.0 $\pm 5\%$	1.0	
+5.0 $\pm 5\%$	7.5	LPQ-2
+15.0 $\pm 5\%$	4.0	
-15.0 $\pm 5\%$	4.0	
+28.0 $\pm 5\%$	1.0	
+5.0 $\pm 5\%$	10.0	LPQ-4
+12.0 $\pm 5\%$	2.5	
-12.0 $\pm 5\%$	2.5	
+28.0 $\pm 5\%$	1.0	

From  
**\$203<sup>80</sup>**

25 or more  
combined units  
Unit Price  
From \$254.75

Overvoltage Protection is standard on 5 Volt Output at no additional cost. Available on the  $\pm 12$  or  $\pm 15$  volt output (LPQC series). Add \$20.00 Modification of standard output voltages can be provided at slight additional cost.

INFORMATION RETRIEVAL NUMBER 60

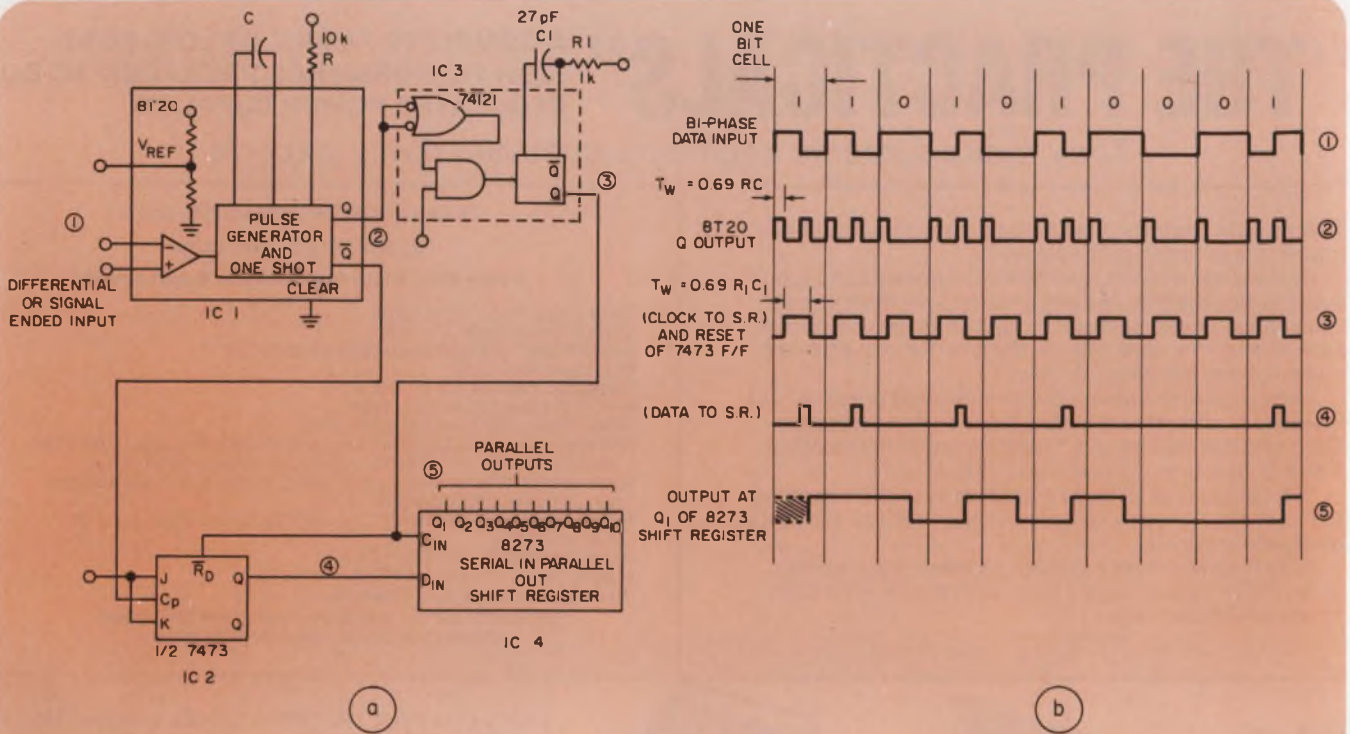

2. Receiver circuit recovers both the clock and the original binary data. The narrow pulses from the Q terminal of IC<sub>1</sub> are stretched by the nonretriggerable one-shot, IC<sub>3</sub>, to obtain the clock. The clocking

transitions in the middle of each bit-cell trigger the flip-flops which provides the reconstructed binary data. The clock pulses arrive at the proper time (b) to gate the data into the shift register.

10-bit, serial-in, and parallel-out register is provided by the nonretriggerable one-shot, IC<sub>3</sub>. The output pulse width from IC<sub>3</sub> must be at least half-bit-cell wide, and it also is calculated with Eq. 1. The clocking transitions in the middle of each bit cell trigger the flip-flop at the end of each one-shot pulse. This insures that sufficient setup and hold time is provided for data input to the shift register for each clocking transition.

The system operates at data rates up to 8 MHz and provides two advantages over a similar scheme 1: (1) Use of the precision one-shots in-

roduces less than 1% variation in output pulse width with normal supply and temperature variations, and (2) The 8T20 one-shot IC replaces line receivers, frequency doublers, extra flip-flops and gating.

**Reference**

1. Bentley, Walter E., "Reconstruct NRZ-L and Clocks From Biphas-Level PCM Signal," *Electronic Design* 16, Aug. 3, 1972, p. 58.

Gerd Schlitt, Senior Application Engineer, Signetics, Inc., 811 E. Arques Ave., Sunnyvale, Calif. 94086. CIRCLE No. 311

## Countdown technique simplifies BCD-to-binary conversion circuitry

When speed is not important in converting binary to decimal, a dual-register countdown technique allows an exchange of conversion speed for circuit simplicity.

The two counters, one binary and the other decimal, are driven in opposite directions by an

additional clock. While the data in the BCD counter is being decremented, the binary counter is incremented. After the BCD counter empties, it generates a "borrow" signal, which inhibits the test clock and leaves the binary count in readiness for regular operation.



SOS/CMOS

# INSELEK

## HIGH-SPEED·LOW-POWER CMOS

### THE INS4000S SERIES

**INS4007S—DUAL/PAIR INVERTER**

**INS4012S—DUAL FOUR-INPUT NAND GATE**

**INS4013S—DUAL "D" FLIP-FLOP WITH SET/RESET**

**INS4027S—DUAL J-K FLIP-FLOP**

**INS4030S—QUAD EXCLUSIVE-OR GATE**

- **CMOS** that has a lower power-speed product than any other logic family in existence.
- **CMOS** that is 5 times faster than monolithic **CMOS**.
- **CMOS** that is as fast as TTL logic, but dissipates only 1/10,000,000th the power in standby mode.
- **CMOS** that is full temperature rated from —55°C to 125°C. That means it's ideal for industrial and military customers.
- **CMOS** that offers you bipolar speed with **MOS** power in a single package.
- **CMOS** that is price competitive.

#### QUANTITIES 100-999

INS4007S	2.65
INS4012S	3.40
INS4013S	4.75
INS4027S	5.25
INS4030S	3.80



SOS/CMOS

# INSELEK

For Further Information,  
Call or Write: Bob Heller—  
Dept 6; University Park;  
743 Alexander Rd., Princeton,  
N. J. 08540  
Telephone (609) 452-2222  
Cable: Inselek

#### REGIONAL SALES OFFICES

EASTERN REGIONAL SALES OFFICE  
191 SUDBURY RD.  
CONCORD, MASS. 01742  
(617) 369-5298

WESTERN REGIONAL SALES OFFICE  
30811 MAINMAST DR.  
AGOURA, CALIF. 91301  
(213) 889-2788

INFORMATION RETRIEVAL NUMBER 61

System timing is provided by one-shots MM<sub>1</sub> through MM<sub>3</sub>. Once the BCD thumbwheels are set and the "start conversion" button pressed, a pulse from one-shot MM<sub>1</sub> loads the decade counter and simultaneously trips MM<sub>2</sub>. The pulse from MM<sub>2</sub> enables the count through the gates. When the BCD counter empties, a borrow signal from the "hundreds" decade trips MM<sub>3</sub> and stops the count. Two requirements must be met by the pulse durations of MM<sub>2</sub> and MM<sub>3</sub>:

$$t_{MM2} \geq Nt_0 \quad (1)$$

and

$$t_{MM3} > t_{MM2} - Nt_0, \quad (2)$$

where N and t<sub>0</sub> are the maximum integer value and test clock period, respectively. These equations are based on the following requirements: (a) The pulse duration of MM<sub>2</sub> must provide sufficient time to complete the countdown, and (b) The pulse duration from MM<sub>3</sub> must be long enough to prevent renewal of the count at the end of the inhibit period.

*Eliezer A. Sheffer, Tamkin Computers Ltd., P.O. Box 11014, Tel Aviv, Israel.*

CIRCLE NO. 312

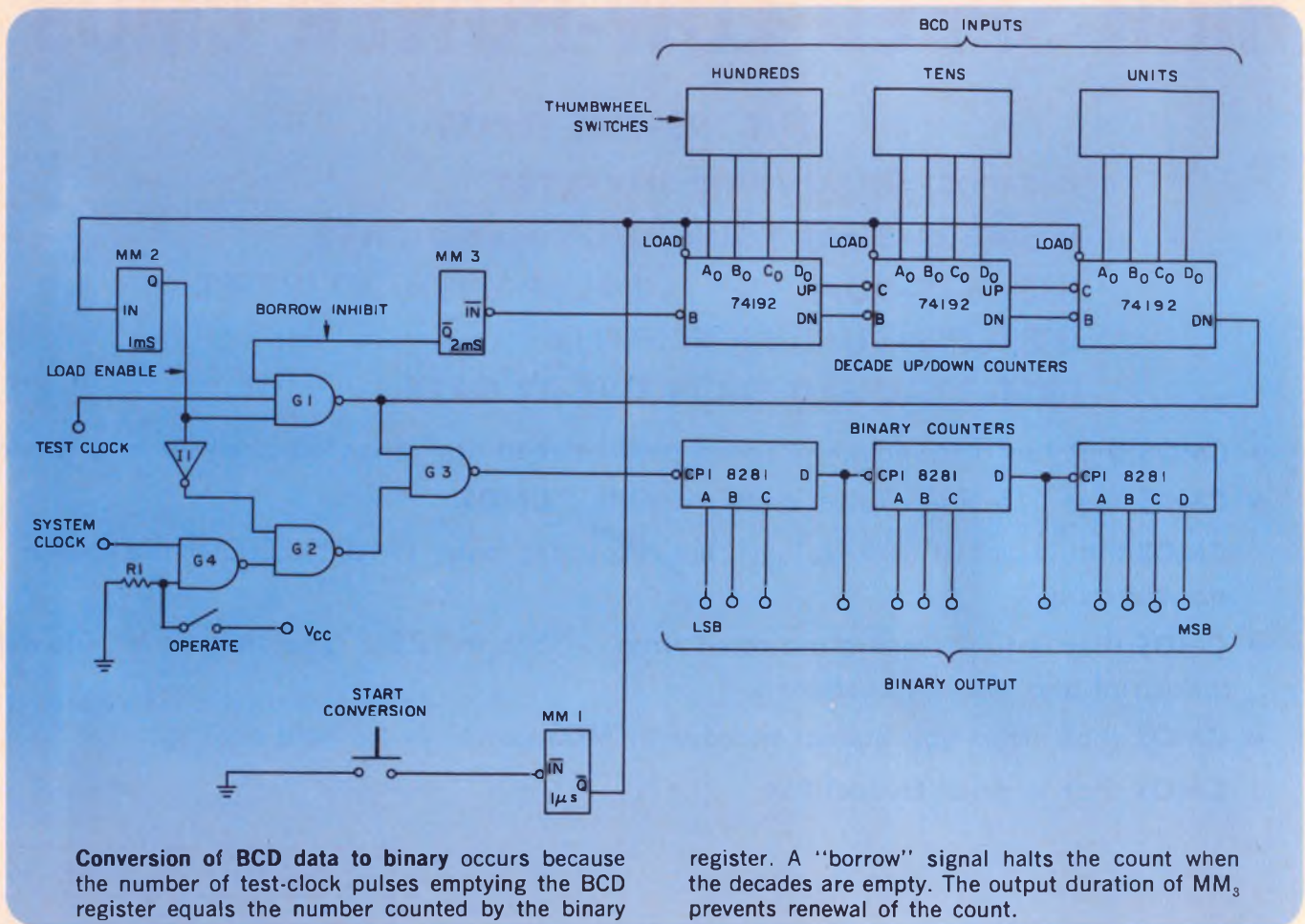

### IFD Winner of December 7, 1972

S. Sareen, Design Engineer, Aertech Industries, 825 Steward Dr., Sunnyvale, Calif. 94086. His idea "Eliminate troublesome common-mode output voltages in IC video amplifiers" has been voted the Most Valuable of Issue Award.

Vote for the Best Idea in this issue by circling the number for your selection on the Information Retrieval Card at the back of this issue.

**SEND US YOUR IDEAS FOR DESIGN.** You may win a grand total of \$1050 (cash)! Here's how. Submit your IFD describing a new or important circuit or design technique, the clever use of a new component or test equipment, packaging tips, cost-saving ideas to our Ideas for Design editor. Ideas can only be considered for publication if they are submitted exclusively to ELECTRONIC DESIGN. You will receive \$20 for each published idea, \$30 more if it is voted best of issue by our readers. The best-of-issue winners become eligible for the Idea of the Year award of \$1000.



# Switching technology vs. series-pass. Now there's a choice.

Series-pass regulation offers great advantages in compact size, established design technology and exceptionally clean output. While switching technology is theoretically even more compact, it's virtually impossible to produce because of the inherent high noise and RFI problems.

Right?

Wrong. Sorensen's STM series of modular power supplies prove the point. First, for a given power rating, STM's offer twice the efficiency, half the size and lower price than equivalent series-pass units (and all STM's have built-in overvoltage protection). Plus a big plus. Low RFI and noise. We ran conducted interference tests and fully met the requirements of MIL-STD-461A above 20KHz.

The STM series presently consists of 30 switching transistor power supplies — with 10 models to follow shortly. STM efficiencies approach 75% keeping dissipation low. In many systems applications these high efficiencies obviate the need for forced air cooling systems.

Switching technology is no longer a bugaboo. It works. Beautifully. Send for our complete catalog and see for yourself (and see our great series-pass supplies too). Write Sorensen Company, a unit of the Raytheon Company, 676 Island Pond Rd., Manchester, N.H. 03103. Telephone (603) 668-4500. Or TWX 710-220-1339.

Specification	Sorensen STM5-24	Brand "X"
Size	3 <sup>5</sup> / <sub>16</sub> x 5 <sup>1</sup> / <sub>8</sub> x 9 <sup>1</sup> / <sub>2</sub>	4 <sup>15</sup> / <sub>16</sub> x 7 <sup>1</sup> / <sub>2</sub> x 9 <sup>3</sup> / <sub>8</sub>
Volume	160 in <sup>3</sup>	344 in <sup>3</sup>
Price	\$229	\$235
Efficiency	58%	29%
Regulation (line & load combined)	0.05%	0.2%
Temperature Coefficient	0.01%/°C	0.03%/°C
Overload Protection	Current limiting- adjustable electronic	
Overvoltage Protection	Built-in adjustable, all models	Optional @ \$30 (except built-in, fixed, on 5-volt model only)

Compare this point-by-point spec-check between Sorensen's STM5-24 and Brand "X".

## STM: twice the efficiency, half the size.

**Sorensen**  
**POWER SUPPLIES**

INFORMATION RETRIEVAL NUMBER 62

# SILENT\*

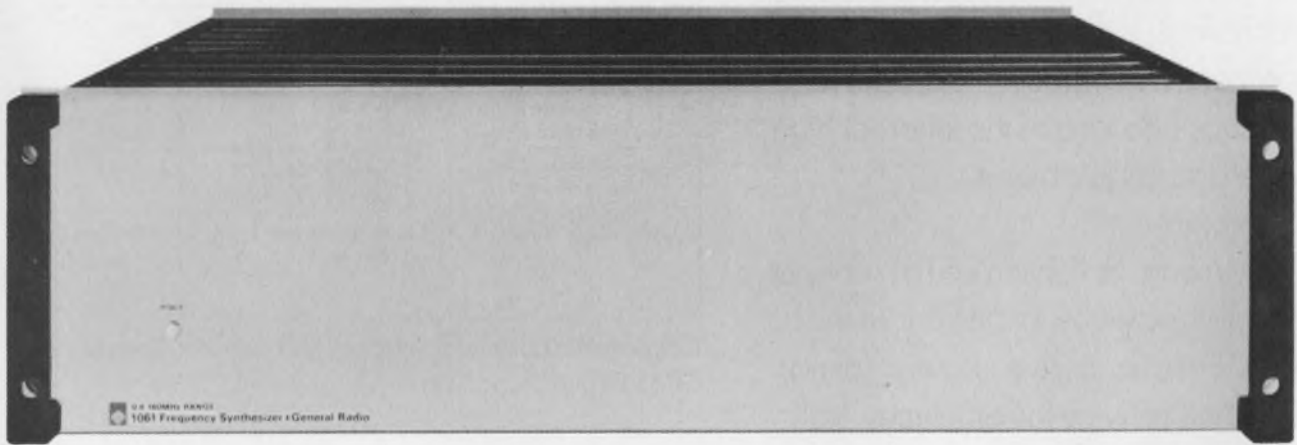

**... so silent that no other synthesizer exceeds its noise performance over the entire frequency range:**

	GR 1061	Runner-up A	Runner-up B
Frequency	dc to 160 MHz	1 MHz to 160 MHz	10 kHz to 110 MHz
Switching Speed	< 100 $\mu$ s	1 ms	5 to 100 ms
Output Level	+20 dBm	+13 dBm	+13 dBm
Spurious	-80 dB	-70 to -100 dB	-80 dB
Phase Noise	-63 dB	-60 dB	-50 dB
A-M, F-M Capability	standard	no	optional
Search-Sweep	standard	no	optional

Data current as of February, 1973

\* silent\si'lent\ adj... free from... noise: STILL.

For the GR 1061, silence means phase-modulation noise of -63 dB (typically -66 dB) in a 15-kHz bandwidth. Residual phase noise in a 1-Hz bandwidth is -98 dB, 10 Hz from the carrier, and -124 dB, 10 kHz from the carrier. Spurs are -80 dB and harmonics are -27 dB as referenced to a leveled output of up to +20 dBm. Not bad for \$4700!

Silence and price are only two virtues of the 1061. There are others, including search-sweep, am and fm capability, wide frequency range, fast switching speed, high output, and complete programmability. And, to complete the list, there is a broad selection of options to tailor the 1061 to **your** needs: A full control panel, two different reference oscillators, resolution to 10 digits, and phase-modulation capability. All in all, quite a value.



## General Radio

NEW YORK (N.Y.) 212 964-2722, (N.J.) 201 791-8990 • BOSTON 617 646-0550  
 CHICAGO 312 992-0800 • WASHINGTON, D. C. 301 948-7071 • ATLANTA 404 457-2485  
 DALLAS 214 234-3357 • LOS ANGELES 714 540-9830 • SAN FRANCISCO 415 948-8233  
 TORONTO 416 252-3395 • ZURICH (01) 55 24 20

GR COMPANIES • Grason-Stadler • Time/Data • Techware Computing Corp.  
 GR ASSOCIATE • Micronetic Systems Inc.

INFORMATION RETRIEVAL NUMBER 63

## new products

# Bucket-brigade MOS ICs delay analog signals

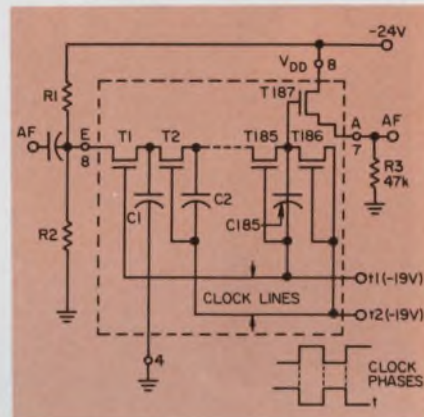
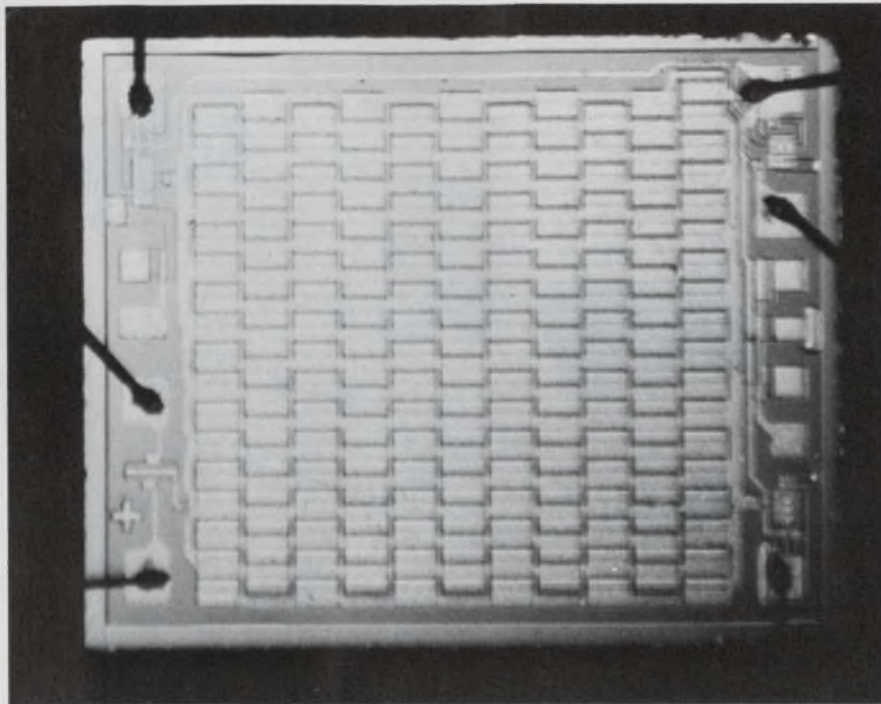

covers the sampled analog signal.

The 100-unit prices for the ITT and Amperex devices are as follows: TCA-350, \$5.70; M31, \$12; TCA-590, \$40.

For ITT

CIRCLE NO. 258

For Amperex

CIRCLE NO. 259

## Generate characters with bipolar ROMs

*Monolithic Memories, 1165 E. Arques Ave., Sunnyvale, Calif. 94086. (408) 739-3535. \$25 to \$45 (100 up); stock.*

A series of  $5 \times 7$  and  $7 \times 9$  character generators, using 8, 9 and 10 k-bit bipolar ROMs, can be used to display 64 alphanumerics or 128 characters. The series provides for row and column scan. Among the devices is the MM6055 with a 10-MHz speed (maximum access of 100 ns); this  $5 \times 7$  generator provides 64 alphanumerics in a column scan and comes in an 18-pin DIP. The other character generators, called MM6056, 6061/62 and 6071/74 list a maximum access of 175 ns and come in a 24-pin DIP. All devices have a power dissipation of 450 mW and use a single 5-V supply.

CIRCLE NO. 260

ITT Semiconductors, 3301 Electronics Way, West Palm Beach, Fla. 33407. (305) 842-2411. P: (See text); stock.

Before the advent of bucket-brigade shift registers in IC form, large analog time delays could be obtained only with costly discrete circuits. The latest entry, ITT Semiconductors' TCA-350—a 185-stage bucket-brigade shift register—brings to three the number currently available. The TCA-350 competes with Amperex's M31, a 32-stage device, and Amperex's TCA-590, a 512-stage unit.

The time delay in a bucket-brigade shift register is a function of analog signal frequency ( $f_a$ ), clock frequency ( $f_c$ ) and total tolerable signal distortion (harmonic distortion and voltage attenuation). The TCA-350 has a minimum delay of 185  $\mu$ s compared with 160  $\mu$ s for the M31 and 850  $\mu$ s for the TCA-590. For the minimum delays specified, the maximum recommended input frequencies are 100, 20 and 70 kHz, respectively (this

allows  $f_c \geq 4 f_a$  for low distortion).

Maximum delay time ( $\tau_d$ ) depends heavily on  $f_a$  and  $f_c$ . The  $\tau_d$  is equal to the number of shift register stages divided by at least twice  $f_c$ .

Of the three devices, the TCA-350 offers the shortest maximum delay time, but it accepts the highest input frequency: at  $\tau_d = 18.5$  ms,  $f_{amax} = 1$  kHz. The M31 has  $\tau_d = 32$  ms and  $f_{amax} = 125$  Hz, and the TCA-590 has  $\tau_d = 256$  ms and  $f_{amax} = 200$  Hz.

The two-phase clock pulse for the TCA-350 causes capacitor  $C_1$  (see schematic) to sample the incoming analog signal and then transfer its stored value down the line. From Shannons' Sampling Theorem,  $f_c$  (the sampling frequency) must be at least twice  $f_a$  to recover the original signal. ITT and Amperex, however, recommend that  $f_c \geq 4 f_a$ , to limit the distortion of the analog signal. At the output, a low-pass filter with a cutoff frequency of one-half  $f_c$  re-

## The Elegant Molded Parts

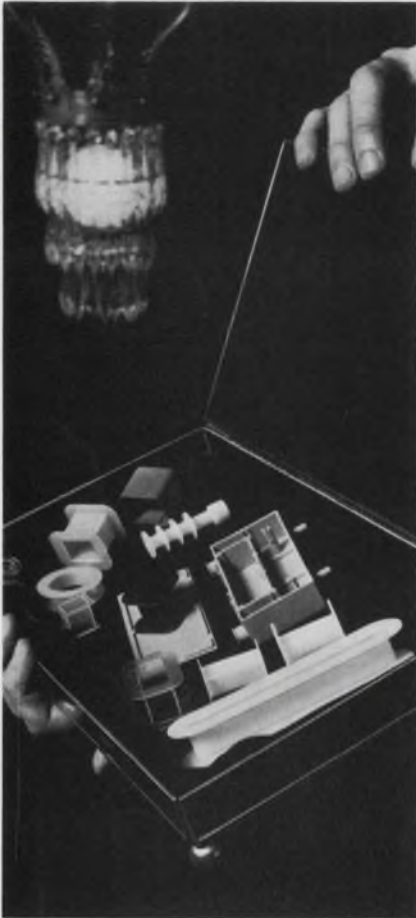

For elegant applications. Custom-made or standard, EPC parts come with thin walls down to 5 mils, tolerances to  $\pm .05\%$  — even threaded bushings. In six different materials: fluorocarbon, nylon, glass-reinforced nylon, DAP, polyester and epoxy. For temperature ranges that go up to 200°C.

It's just the sort of selection and craftsmanship that you expect from EPC as an EAI component company. Look to EPC also for transformer kits. Or to EAI



for thick-film audio amps. Capacitors. Custom coils. Solenoids. Active filters. Analog/digital converters and other special function modules. Plus a growing list of other elegantly crafted etceteras.

# EPC

Electrical Plastics Corporation  
500 Long Branch Avenue  
Long Branch, New Jersey 07740  
Tel. (201) 870-9500

A Subsidiary of Electronic Associates, Inc.

## Variable-modulus ICs simplify PLLs for 200 MHz

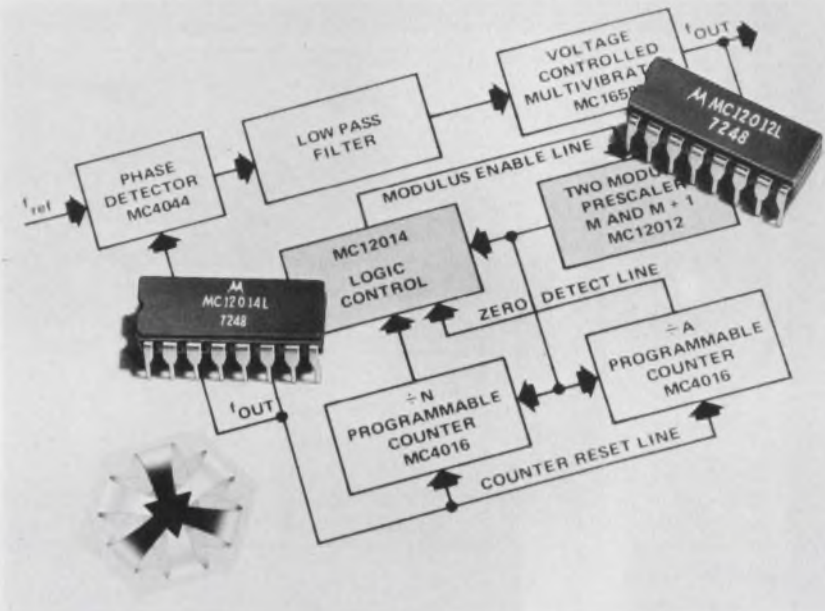

Motorola Semiconductor Products, P.O. Box 20912, Phoenix, Ariz. 85036. (602) 244-3466. P&A: See below.

In high-frequency phase-locked loops (PLLs) for signal generation, it's often necessary to scale down the VCO frequency in the feedback path so that inexpensive bipolar circuits can be used as the counter chain. Now that function can be performed by two ICs that form a variable-modulus prescaling subsystem for a typical PLL output frequency of 200 MHz. The new ICs are the MC12012 two-modulus prescaler and the MC12014 control-logic block.

The prescaler contains three function blocks: a controllable divide-by-5/divide-by-6 prescaler, a divide-by-2 prescaler and an ECL-to-TTL translator. While the MC12012 performs variable prescaling, the MC12014 controls the modulus of the prescaler and the operation of the bipolar programmable counters. An "early-decode" feature of the MC12014 increases the useful frequency range of a programmable counter like the

MC4016 from 8 to 25 MHz.

The MC12012 can prescale by a wide selection of moduli:  $\div 5/\div 6$ ;  $\div 10/\div 11$ ,  $\div 10/\div 12$ ,  $\div 20/\div 21$ ,  $\div 20/\div 22$ , and so on. These moduli result from the control block's ability to switch the prescaler's division mode in mid cycle. Division by say 11, for example, results when five plus six input pulses are counted before an output pulse is generated by the MC12012.

The technique of variable-modulus prescaling overcomes a disadvantage of fixed-modulus frequency division. In a fixed-modulus PLL, the reference frequency must also be divided by the modulus, with a corresponding loss of resolution. The variable-modulus technique allows relatively slow TTL programmable counters to control the ECL prescaler for direct high-frequency prescaling.

The MC12012 can be operated from +5 or -5.2-V supplies. Each IC comes in a ceramic 16-pin DIP. In quantities of 100, the MC12012 is priced at \$13; the MC12014, at \$4.25. Delivery is from stock.

CIRCLE NO. 261

# Tempil<sup>®</sup>

# Temperature Indicators

LOW COST • HIGHLY ACCURATE • NO SKILL REQUIRED FOR USE

## Tempilstik<sup>®</sup>

TEMPERATURE INDICATING

### Crayons

Marking turns to liquid smear at rated temperature. Accurate within  $\pm 1\%$  of ratings.



AVAILABLE IN THE FOLLOWING DEGREES (°F)							
100	169	250	331	475	900	1400	1950
103	175	256	338	488	932	1425	2000
106	182	263	344	500	950	1450	2050
109	188	269	350	525	977	1480	2100
113	194	275	363	550	1000	1500	2150
119	200	282	375	575	1022	1550	2200
125	206	288	388	600	1050	1600	2250
131	213	294	400	625	1100	1650	2300
138	219	300	413	650	1150	1700	2350
144	225	306	425	700	1200	1750	2400
150	231	313	438	750	1250	1800	2450
156	238	319	450	800	1300	1850	2500
163	244	325	463	850	1350	1900	

LOW COST. **\$250**

per stick in adjustable aluminum holder. Lead-free and sulfur-free Tempilstiks<sup>®</sup> available.

## Tempilaq<sup>®</sup>

TEMPERATURE INDICATING

### Liquids

Fast drying coating that liquefies at rated temperature. Accurate within  $\pm 1\%$  of ratings.



LOW COST. **\$250**

per 2 ounce bottle. **\$11.00** per 16 ounce spray can.

## Tempil<sup>®</sup> Pellets

TEMPERATURE INDICATING

### Pellets

Available in same ratings as Tempilstiks<sup>®</sup>, plus 2550F, 2600F, 2650F, 2700F, 2800F, 2900F, 3000F, 3100F, 3200F. Miniature, standard and custom sizes for every application.

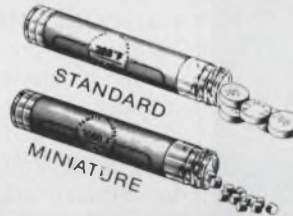

LOW COST. **\$250**

per tube of 20.

## Tempilabel<sup>®</sup>

TEMPERATURE INDICATING

### Labels

Adhesive-backed temperature monitors. Circle centers turn black at rated temperatures, from 100F-650F. Available as (1) single temperature Tempilabels<sup>®</sup> in standard and miniature size. (2) Multiple temperature Tempilabels<sup>®</sup> in 10, 25, or 50 degree steps. Custom sizes and ratings also available.



LOW COST. **75¢-\$200**

each depending on type.

CHOOSE THE TEMPIL<sup>®</sup> TEMPERATURE INDICATOR BEST FOR YOUR NEED

# Tempil<sup>®</sup>

DIVISION, BIG THREE INDUSTRIES, INC.

Hamilton Blvd., South Plainfield, N. J. 07080 201•757-8300 Telex 138662

Call or write for free samples

INFORMATION RETRIEVAL NUMBER 65

16405

# A 1/9 ad page size for only \$300 including production charges

Quick Ads will be placed in their own special section, attractively laid out to insure maximum attention. Each will have its own Information Retrieval Number, assuring many inquiries, many sales leads. You simply provide an 8 x 10" glossy photograph, plus approximately 40 words of copy. We do the rest at no cost to you.

For full information, including even lower frequency rates, mail the form at right to Tom W. Carr Sales Manager Electronic Design, 50 Essex Street, Rochelle Park, N.J. 07662

# Quickads

PLEASE RUSH ME FULL DETAILS ON QUICK ADS IN ELECTRONIC DESIGN

NAME \_\_\_\_\_ FIRM \_\_\_\_\_ STREET \_\_\_\_\_ CITY \_\_\_\_\_ STATE \_\_\_\_\_ ZIP \_\_\_\_\_

TITLE \_\_\_\_\_

for  
**rapid  
reaction**

INQUIRY > QUOTE  
ORDER > DELIVERY

Specify



Mica Capacitors



CMR Type

For hermetically sealed or potted in applications.



CER Type

For specialized mounting arrangements and operation under selected environmental parameters.



CEM Type

For specialized form factors and operation under environmental extremes.

Custom Electronics can fill your mica capacitor requirements in minimum reaction time (inquiry-to quote; order-to-delivery).

Meet your design engineer's requirements for higher voltage, higher temperature and greater reliability by calling on Custom Electronics for Mica Capacitors.

The greatest single cause for capacitor failure is a short in the dielectric material. Consequently, we precisely inspect and grade all of our dielectric material **before** production. The result is the finest quality capacitors of their kind available today.

Write or call on your application today!



**CUSTOM ELECTRONICS, Inc.**  
4 Browne St., Oneonta, N. Y. 13820  
PH: 607-432-3880 TWX 510-241-8292

ICs & SEMICONDUCTORS

## CMOS and bipolar on chip drive LED numeric display

Solid State Scientific, Montgomeryville Industrial Center, Montgomeryville, Pa. 18936. (215) 855-8400. P&A: See below.

Driving seven-segment LED displays with CMOS circuitry has advantages: low power and high-noise immunity in the counter/decoder. But because of the relatively low output currents available with CMOS, a seven-transistor bipolar array generally had to be used to interface the driving circuitry with the LED display. Now Solid State Scientific's SCL 4426A or 4433A decade-counter/seven-segment decoder eliminates the need for the bipolar array.

Each of the new ICs consists of CMOS logic for the counting and decoding functions and seven npn Darlington bipolar transistors for the outputs—all on the same chip. With a supply voltage ( $V_{DD}$ ) of 10 V, the minimum drive current is 20 mA. At 25 C, typical drive current with the same supply reaches 60 mA.

The SCL 4426A features a display-enable input-control function so the seven decoded outputs can be forced off the display regardless of the counter state. The SCL 4433A has a ripple-blanking input, in place of the display-enable function, for the automatic blanking of insignificant zeros in the display.

The new circuits are pin-compatible with the 4026A and 4033A—all-CMOS decoders performing the same respective functions and available from Solid State Scientific, RCA and other CMOS manufacturers.

Maximum supply-voltage ratings are +15 V ( $V_{DD}$ ) and -0.5 V ( $V_{SS}$ ). Dc current drain is limited to 20 mA per segment, while maximum power dissipation is 300 mW per package. At all inputs, voltages may range from  $V_{DD}$  at the high end down to  $V_{SS}$ .

The decoders use a five-stage Johnson decade counter. An output decoder converts the Johnson

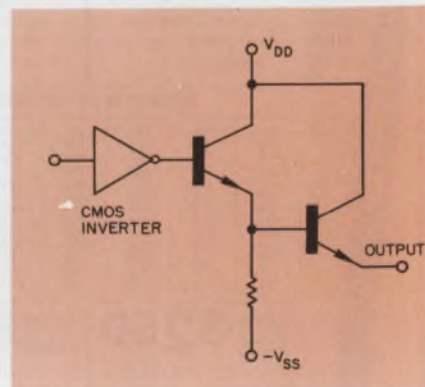

Each of seven output stages has an npn Darlington transistor network for higher drive currents.

code to a seven-segment decoded output for each display stage. A HIGH reset signal clears the decade counter to a zero count. With the clock-enable signal LOW, the counter advances one count at the positive clock-signal transition; counter advancement is inhibited when the clock-enable signal is LOW. Antilock gating in the counter assures the proper counting sequence.

In quantities of 1000, both devices are available for \$5.65 apiece. Delivery is from stock.

CIRCLE NO. 262

## Power diodes recover in 200 ns

Sarkes Tarzian, 415 N. College Ave., Bloomington, Ind. 47401. (812) 332-1435.

A line of epitaxial power diodes, the S6453 Series, has a maximum recovery time of 200 ns with a soft-recovery curve. Rated at 10 A with an IFSM of 150 and  $I^2t$  of 135, the diodes are available with PIV ratings of 25, 50, 75 and 100 V. The units are housed in DO21 hermetically sealed cases.

CIRCLE NO. 263

# Carefree™

## RECHARGEABLE BATTERIES IN TWENTY-EIGHT SIZES ...



Standard sizes are available in 1, 2.6, 5, 8, 12 and 30 ampere hour capacities, and 6, 12, 18 and 24 volt configurations. Manufacturing capabilities include any 2 volt increments in the 2.6, 5 and 30 ampere hour category.

All Eagle-Picher Carefree batteries are backed by a half century of constant research on electrochemical systems and space technology. Carefree™ batteries can be recharged hundreds of times up to full power. Their advanced performance characteristics assure you of proven safety and high reliability even under abnormal circumstances. They are sealed, require no maintenance and retain useful capacity after very long periods of time. As their name implies . . . they're carefree!

Let us assist you with your battery requirements . . . from stock or customized to your specific requirements. Call or write today.



**EAGLE-PICHER  
INDUSTRIES, INC.**

Commercial Products Division  
Phone 417-776-2258  
TWX 910-774-4508  
P.O. Box 130 Dept. ED  
Seneca, Missouri 64865

INFORMATION RETRIEVAL NUMBER 68

THE GREATEST  
ACHIEVEMENT  
YET IN  
**ELAPSED  
TIME  
INDICATORS!**



CompaC T12

Yes, ENM has put it *all* together in a small package and gift wrapped it for you. Everything you've ever wanted in an elapsed time indicator that records to 100,000 hours.

Epicyclic gearing conserves space and delivers an easy-to-read 6 digit indicator only 1.72" wide. And it even counts tenths of hours.

The versatile CompaC T12 is interchangeable with competitive devices and may be base mounted or back panel mounted for multiple stacking in minimum space. Or add a bezel for front panel mounting.

And we didn't forget price, either. How does \$5.68 in 100 lots grab you? That's the gift wrapping.

WRITE FOR LITERATURE



**ENM COMPANY**

5340 Northwest Highway, Chicago, Ill. 60630  
PHONE: (312) 775-8400 TELEX: 25-4068

INFORMATION RETRIEVAL NUMBER 69

ELECTRONIC DESIGN 8, April 12, 1973

**This is not  
the end  
of the line**

FOR GRAYHILL  
TERMINATION HARDWARE.

We currently make over one hundred different items of termination hardware. And we're constantly adding to the line so there's no end to it.

But that's not the termination of our hardware story either. What we really make are quality features our customers couldn't find in existing hardware products. Like firm positive contacts the first time and every time a connection is made with a push post. Or rapid test clip connections without having to open and close jaws manually. Plus caps that resist melting at soldering temperatures, exceptional dielectric strength and better insulation.

Want to learn more about our hardware and miniature switch lines? Write today for our newest Engineering Catalog. Grayhill, Inc., 565 Hillgrove Avenue, La Grange, Illinois 60525. (312) 354-1040.



INFORMATION RETRIEVAL NUMBER 70

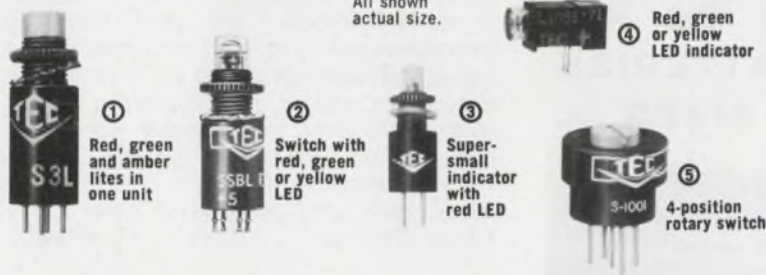

### THE SUBMINIATURE SPECIALISTS

We've licked the space problem with highly reliable, long life devices that fit most any application. Just 5 are shown here... we have 35 more in stock. And if you have a unique space problem, we'll design a unit for you at a surprisingly low price.

① Three incandescent lamps with color filters in a single .360" diam. body offer 3 color indications. ② Momentary SPST N.O. DB switch/indicator with .360" diam. body; also available as indicator only. ③ Indicator with 1/4" diam. body; also available as N.O., N.C., or N.O. & N.C. momentary switch. ④ PCB-mounted indicator only .625" long. ⑤ PCB-mounted N.O. maintained switch with 1/2" diam. body.



9800 NORTH ORACLE ROAD  
TUCSON, ARIZONA 85704 — (602) 297-1111

INCORPORATED

INFORMATION RETRIEVAL NUMBER 71

## A complete line of CUSTOMIZED ROTARY CERAMIC SWITCHES...

For RF and POWER APPLICATIONS

RSC switches are available in a variety of switching models. RSC high precision, quality built units are designed for applications requiring long life maintenance-free service. Types include shorting and non-shorting, single and multi-deck, up to 18 pole positions. Features include, 10 to 100 amp current carrying capacity, 20° to 90° detents, 2000 to 24000 volts flashover and corrosion-proof construction.

Write for catalog no. 960  
and complete information.



**RADIO SWITCH CORPORATION**

Rt. 79, Marlboro, N. J. 07746

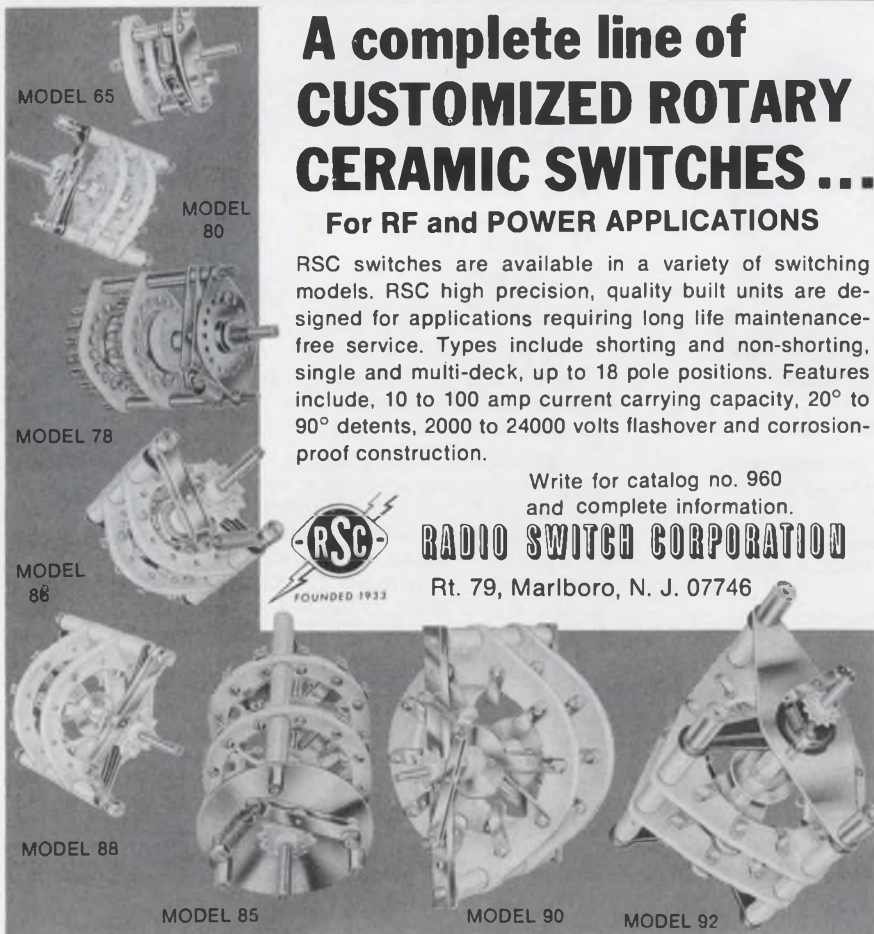

## 256-bit RAM boosts bipolar speed

*Monolithic Memories, 1165 E. Arques Ave., Sunnyvale, Calif. 94086. (408) 739-3535. Stock.*

The MM6530/5530 256-bit  $\times$  1-word Schottky-type bipolar RAM reportedly offers the highest speed over the rated voltage and temperature range for a memory of this type. The commercial version (MM6530) has a 55-ns maximum access (vs the typical 85 ns) for a 5 V  $\pm$  5% supply and over the 0 to 75 C temperature range. The military version (MM5530) offers a 65-ns maximum access (vs the standard 100 ns) with a 5 V  $\pm$  10% supply. The improved performance is said to result from an advanced Schottky-TTL design.

CIRCLE NO. 264

## MECL 10k drvvr/rcvr for TTL, IBM levels

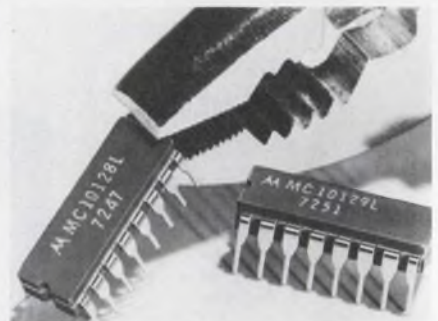

*Motorola Semiconductor Products, P.O. Box 20924, Phoenix, Ariz. 85036. (602) 244-3466. MC10128 and MC10129: \$6.50 (100 up).*

A dual bus driver, the MC10128, and a quad bus receiver, the MC10129, permit the interfacing of ECL 10,000 circuits to busses operating at TTL or IBM logic levels. The driver accepts ECL 10,000 logic levels and yields the selectable outputs of TTL or IBM-type levels (HIGH  $>$  +3.11 V, LOW  $<$  +0.15 V). For the TTL mode, the 10128 drives as low as a 25- $\Omega$  load terminated to +1.5 V dc, or a 50- $\Omega$  load terminated to ground. Nominal data propagation delay through either device is 11 ns, and latches are included.

CIRCLE NO. 265



## Rectifiers exceed MIL specs

Microsemiconductor Corp., 2830 S. Fairview St., Santa Ana, Calif. 92704. (714) 979-8220. \$3.60 to \$19.80 (100-499).

A line of high-voltage rectifiers come in the company's voidless glass package; as a result, the devices are said to exceed all military and aerospace requirements, including MIL-S-19500. The line includes eight high-power, medium-recovery devices rated at 1500 to 3000 PIV at 500 mA, or 4000 to 10,000 PIV at 250 mA. Recurrent surges are 2.5 and 1.0 A and cycle surges are 10 and 4 A, respectively. Operating temperature range is -65 to at least 125 C. Also available in the line are fast recovery and JEDEC versions.

CIRCLE NO. 266

## Power transistor ratings reach 400 V

Texas Instruments, P.O. Box 5012, M/S 308, Dallas, Tex. 75222. (214) 238-3741. TIP55: \$2.50; TIP554: \$2.90. (100 up); stock.

Seven npn high-voltage power transistors have voltage ratings ranging from 200 to 400 V. The new devices consist of four plastic versions (TIP55/58) and three in TO-3 metal cans (TIP554/56). The seven transistors feature reverse-energy rating of 100 millijoules and power dissipation of 125 W at 25 C case temperature. Maximum collector current ranges from 5 to 7.5 A. For all devices  $f_T$  is 10 MHz minimum at 10 V and 0.2 A.

CIRCLE NO. 267

## Transistors for hybrids handle 1 A

N. V. Philips, P.O. Box 523, Eindhoven, The Netherlands.

Four transistors for thick and thin-film circuits come in a SOT-23 plastic envelope and list peak currents of 1 A. Designated BCX-17 through 20, the transistors can dissipate up to 310 mW. They are available with collector-emitter-voltage ratings of 30 or 50 V. The BCX17 and 18 devices are pnp transistors, the BCX19 and 20, npn types.

CIRCLE NO. 268

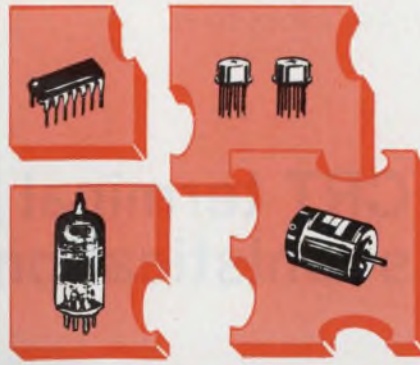

# TROUBLE?

finding components to solve your design puzzle ...  
**ADLAKE** has them!

### ADLAKE MERCURY WETTED RELAYS

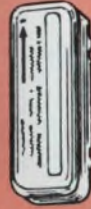

Single side stable or bistable; multiple poles; sensitive form C, D, or K, or neutral form D; millions of trouble-free operations; low, stable contact resistance; plug-in or PC mountings.

### ADLAKE MERCURY DISPLACEMENT TIME DELAY RELAYS



Time delays from 0 to 20 minutes; N.O. or N.C. slow "make" and N.O. slow "break" switching. AC and DC operated units, -37 to 200°F operating temperature range. 0.5-15 ampere ratings, non-inductive at 115 volts, 60Hz. Screw terminal or pigtail leads. U.L. listed types.

### ADLAKE LOAD RELAYS

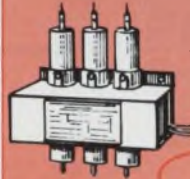

Light, medium, and heavy load switching; up to 3 poles. Screw or pigtail leads. Ratings from 35 to 100 amp, non-inductive at 115 volts 60 Hz. U.L. listed types. All popular coil voltages.

### ADLAKE DRY REED RELAYS

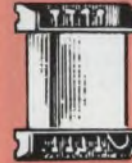

1, 2, 3, and 4-pole styles, hermetically sealed precious metal contacts, extended life, magnetic shielding, high operating speeds. Miniature, intermediate and standard sizes.

### ADLAKE HYBRID TIMERS

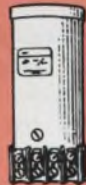

Highly reliable operation handles 35 amp loads. 12, 24, 32, 48 and 115 VAC or VDC inputs. Fast recycle time, fixed or adjustable timing from 100 msec. to 2+ minutes. Wide selection of N.O., N.C., On, Off, Delay, or Instant Close or Open switching.

### ADLAKE TRANSFER TIMERS, LATCHES



Transfer timers switch DC input to output with precise delay times. Close tolerance accuracy, wide operating temperature range, quick recycle, 1 amp rating. Pulse latch switches 2 amp (100% duty cycle) "off" and "on." Choice of packages.

Adlake components are ideal interface timing and switching control components for the most modern and complete systems. Fast, stable, and reliable operation are prime features. Dry circuit to heavy current loads, input/output isolation, excellent environmental features, choice of packaging, terminations.

Let ADLAKE supply the missing piece!

USE READER SERVICE NUMBER FOR COMPLETE INFORMATION

## THE ADAMS & WESTLAKE COMPANY



ELKHART, INDIANA 46514  
219 · 264 1141  
TELEX 25 8458  
CABLE ADLAKE

**WHAT MULTIMETER  
MEASURES —  $\frac{1}{\epsilon}$ ,  
VOLTS, OHMS,  
AMPS, CURRENT**

and costs only

**\$216?**



**ONLY THE  
new  
anaconic  
MODEL 90!**

WHAT A BUY! NO OTHER  
DIGITAL MULTIMETER DOES  
SO MUCH WORK FOR SO  
LITTLE COST!

**LOOK AT THESE ADVANTAGES:**

**ANACONIC Model 90 Features**

3½ DIGIT SPERRY PLANAR DISPLAY WITH POLARIZED FILTER FOR GLARE-FREE VIEWING • ACCURACIES TO .1% • CRYSTAL OSCILLATOR OUTPUT • REMOTE CONTROL JACKS • 10 VOLT INTERNAL REFERENCE • 20% OVERRANGE CAPABILITY WITH NO LOSS OF ACCURACY • HARD WIRED THROUGHOUT • OVERLOAD INDICATION • SHIPPED FROM STOCK.

**ANACONIC Model 90 Functions**

DC VOLTS IN FOUR RANGES • AC VOLTS IN FOUR RANGES • DC MA. IN THREE RANGES • OHMS IN SIX RANGES • CAPACITY IN SIX RANGES • DC UA. IN THREE RANGES • AC MA. IN THREE RANGES.

The new ANACONIC Model 90 delivers unmatched performance, value, handiness, variety of functions and accuracy. The attractive case has all functions marked on the front panel for easy interpretation in familiar engineering units.

**ORDER TODAY, OR SEND FOR  
COMPLETE INFORMATION**

**ANACONIC, INC.**

845 Dundee Avenue  
Barrington, Illinois 60010  
Phone: (312) 381-3388

Ask these Distributors for  
ANACONIC, INC. Multimeters:

Rowe Electronics, 35 Union Place  
Summit, New Jersey 07901  
Phone: (201) 273-8300

Metered Systems, 3750 Industrial Ave.  
Rolling Meadows, Ill. 60008  
Phone: (312) 398-1420

## CRT terminal gives sophistication at low cost



*Ann Arbor Terminals, Inc., 6107 Jackson Rd., Ann Arbor, Mich. 48103. (313) 769-0926. \$1940; from 15 days.*

Savings of 15% or more on the CRT-terminal section of computer systems, with a high level of sophistication, are offered by Ann Arbor Terminals' new "pollable" CRT system. It has an 80-character-by-24-line display, cursor control, characters protected from keyboard entry, an RS 232 compatible I/O to 9600 baud (asynchronous) and formatting capability.

The terminal consists of three components; a keyboard (RB200B), controller (ASR208A1) and an 11-inch video display monitor (EVM 011). The controller acts as the central interface between the keyboard, host computer I/O line and monitors. It also contains an MOS dynamic shift register (1920 characters) for refreshing the screens.

Multiple daisy-chained video monitors can be placed many feet from the controller. The allowable keyboard-controller separation is

about 12 feet. Each of the monitors displays the same flicker-free information, refreshed at the rate of 60 frames/sec, and each shows any of 64 ASCII characters.

Both the computer or user can enter data to a cursor-addressed memory position. The cursor appears as an underline to the 5-by-7-dot matrix characters. Data are stored and displayed until changed by either the keyboard or computer. The user can manually position the cursor with a return, line-feed, right, left, up or down command. The computer can directly replace the manual commands for cursor position, or address the absolute position of the cursor.

To send or receive data, the computer polls, or addresses, any individual terminal. The machine generates a three-character string for polling. The first character is constant and denotes polling. The middle character specifies from one to 64 terminals, and the last whether the data will be read from or entered into the terminal.

... switch, indicator, and circuit protector *all in a single compact package.*

To simplify formatting, the computer can specify protected characters. These are displayed with reduced brightness on the screen and cannot be altered from the keyboard. Manually entered and unprotected characters are displayed at full brightness.

A comparison between this system and other terminals with similar functions gives it a clear price advantage. Competing low-cost terminals with similar capabilities—a 1920-character display, polling and cursor control—include the TEC Model 425 (\$2570), Conrac's Model 401 (\$2300, OEM quantities), Infoton's Vistar Model (\$2295, no polling) and Hazeltine's Model 2000 (\$2300 to \$2500).

Ordinary TV receivers can be substituted for the video display monitor in the Ann Arbor system. The controller can be specified with an optional port that drives a TV receiver tuned to vhf-Channel 4.

For Ann Arbor	CIRCLE NO. 250
For Conrac	CIRCLE NO. 251
For Hazeltine	CIRCLE NO. 252
For Infoton	CIRCLE NO. 253
For TEC	CIRCLE NO. 254

## Monitor adds 4-color background to display

CPS, Inc., 722 E. Evelyn Ave., Sunnyvale, Calif. 94086. (408) 738-0530. \$11,800; stock.

Most CRT displays for scientific or industrial graphics application show only black-and-white pictures. In the model 8001 monitor, two TTL input lines are provided which can be coded for red, orange, yellow or green display. Color selection is produced by varying the voltage of an electron beam, thereby penetrating various layers of a phosphor screen. The colors allow high density displays of easily distinguishable graphics data.

CIRCLE NO. 269

## AIRPAX™ TYPE 203 Electromagnetic Circuit Protector

Airpax Type 203 Electromagnetic Circuit Protectors offer a choice of many mechanical and electrical configurations for maximum versatility. Series, shunt, and relay trip internal circuits are available and can be combined in single, two and three-pole versions. Current ratings from 0.02 to 20 amperes at 120V ac and 0.02 to 10 amperes at 250V ac. Inverse time delay or instant trip.



Photo courtesy of Kappa Scientific Corp.

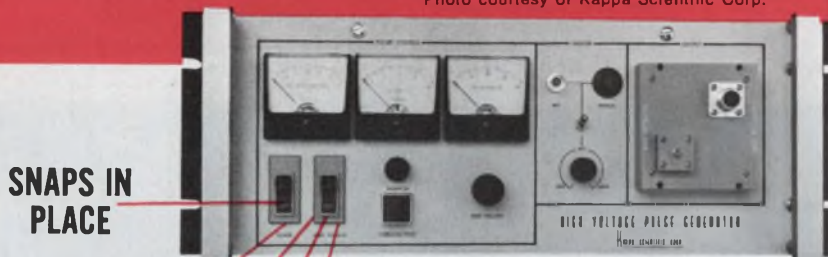

SNAPS IN PLACE

SAVES SPACE

STYLISH DESIGN

REDUCES COST

LOW MAINTENANCE

Here's why Kappa Scientific selected Airpax Type 203 Circuit Protectors for their new High Voltage Pulse Generator.

We quote: "... because it features a switch, indicator, and circuit protector all in a single compact package. This is an advantage because we require switching, indication, and protection for both input power and high voltage. Especially important is that total cost is competitive with individual switch, light, and fuse components. This approach eliminates unsightly fuseholders and fuse replacement, but better, prevents the not-uncommon practice of substituting high amperage fuses (the penny-in-the-fusebox remedy) with subsequent circuit damage."

**Shouldn't your next design include a Type 203?**

Write for full specifications.

Airpax Electronics / CAMBRIDGE DIVISION / Cambridge, Md. 21613 / Phone (301) 228-4600

**AIRPAX™** 25 YEARS OF PROGRESS  
INFORMATION RETRIEVAL NUMBER 75

## Say when.

If you're looking for precise start/stop control of synchronous or asynchronous input data, you ought to look at our PFC-101. It gives you (a) four independent timing channels of programmable width and delay, (b) input data rates from 1 B/sec to 35 MB/sec, (c) 1 ns resolution, regardless of programmed value, (d) manual or remote programming, or both. For the xyz's, and for a lot of information about all the other great digital test equipment we call The Troubleshooters, write. And write now.

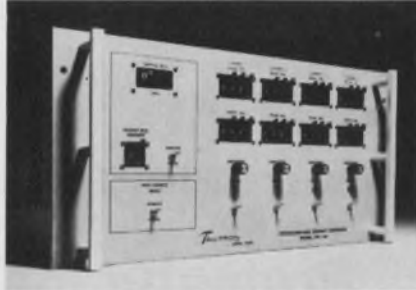

## The Troubleshooters, from **Tau-Tron, Inc.**

685 Lawrence Street Lowell, Massachusetts 01852

INFORMATION RETRIEVAL NUMBER 76

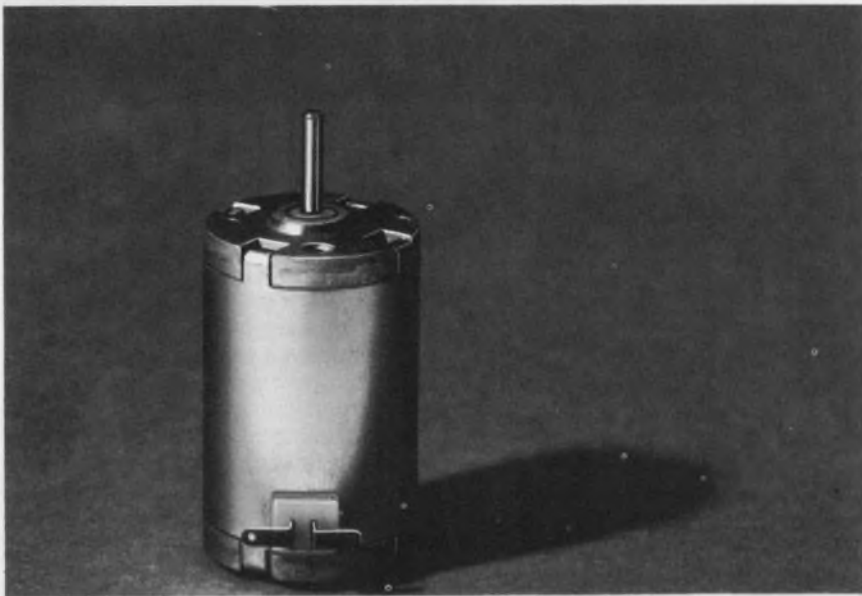

## new low-cost d-c motor @ \$1.60 - \$2.00 in quantities of 10,000 and up

Now . . . for your volume products that need more than a "toy" motor, but can't justify a precision-motor price: Our new low-cost ungoverned FYQM motors include prelubricated, porous bronze bearings; hefty 1/8" dia shaft; 7-pole winding; rugged 1-1/4" dia housing construction that reflects the quality engineered into your own product. Write for Bulletin F-15058, plus complete quantity pricing.



**BARBER-COLMAN COMPANY**

Motor Division  
Dept. P, 12117 Rock Street, Rockford, Illinois 61101

INFORMATION RETRIEVAL NUMBER 77

## DATA PROCESSING

### Versatile data terminal uses cassette memory



*The National Cash Register Co., Dayton, Ohio 45409. (513) 449-2150. Rent \$150/mo.; June.*

Model 260-6 ASR (Automatic Send-Receive) terminal combines non-impact printing with the ability to send and receive information automatically. Messages can be keyed in and left for later dial-up retrieval by the computer, messages from the computer can be received and stored on the cassette tape for later printing. The thermal printer operates at 300 words/min. and the cassette stores 2000, 80-character blocks. A search feature permits location of the data by block number.

CIRCLE NO. 270

### Hardwired logic unit speeds array processing

*Elystec, 212 Michael Dr., Syosset, N.Y. 11791. (516) 364-0560. \$4000; 90 days.*

The APGEN-2 is a hardwired logic unit which boosts minicomputer array processing speeds by a factor of six to 70. The unit performs addition, subtraction, multiplication and division on two arrays each composed of 16-bit words. It is also capable of taking the square root, integrating, accumulating and performing logic operations on the array elements. Arrays may contain from two to 8192 words. APGEN-2 plugs into the mainframe of any Data General computer with no modification required to the computer. Interfaces for other minis are available on request.

CIRCLE NO. 271

## ROM assembler helps program CPU chip

Intel Corp., 3065 Bowers Ave., Santa Clara, Calif. 95051. (408) 246-7501. \$200 to \$648.

The assembly program is contained in eight preprogrammed pROMs (A0-840 to 847) and a TTY tape (A0-848). The pROMs are plugged into the company's SIM8 prototyping board, and the tape is read into RAMs on the prototyping board which then performs the functions of a Fortran IV assembler. Two passes are needed against the source text. A name table and source listing are created on the first pass. The source text is re-read on the second pass, and an object program is punched on TTY tape. This program can be entered into the system RAMs or pROMs. The tape and pROM option costs \$648, the assembly program on tapes only is \$200.

CIRCLE NO. 272

## Tape-spooler winds paper tape at 11.5 in/s

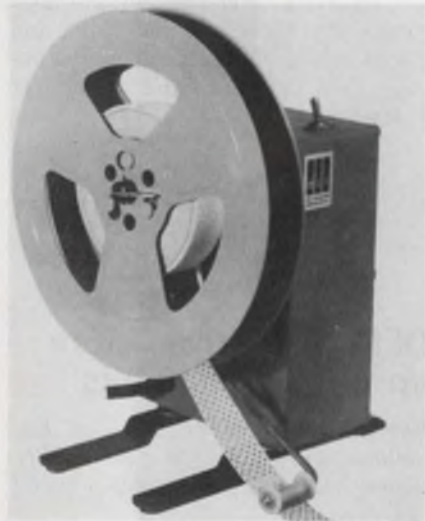

Data Specialties, Inc., 1548 Old Skokie Rd., Highland Park, Ill. 60035. (312) 831-3570. \$90; stock.

The TM/270 tape-winder collects tape that is being expelled from readers or punches at rates up to 115 characters per second or 11-1/2 in. per second. A tape-tensioning control arm and servo braking system allows the device to collect tape even when the tape source is starting and stopping quickly. The winder is supplied with an 8-1/2 in. diameter, separable tape reel.

CIRCLE NO. 273

# A lot of module for your money.

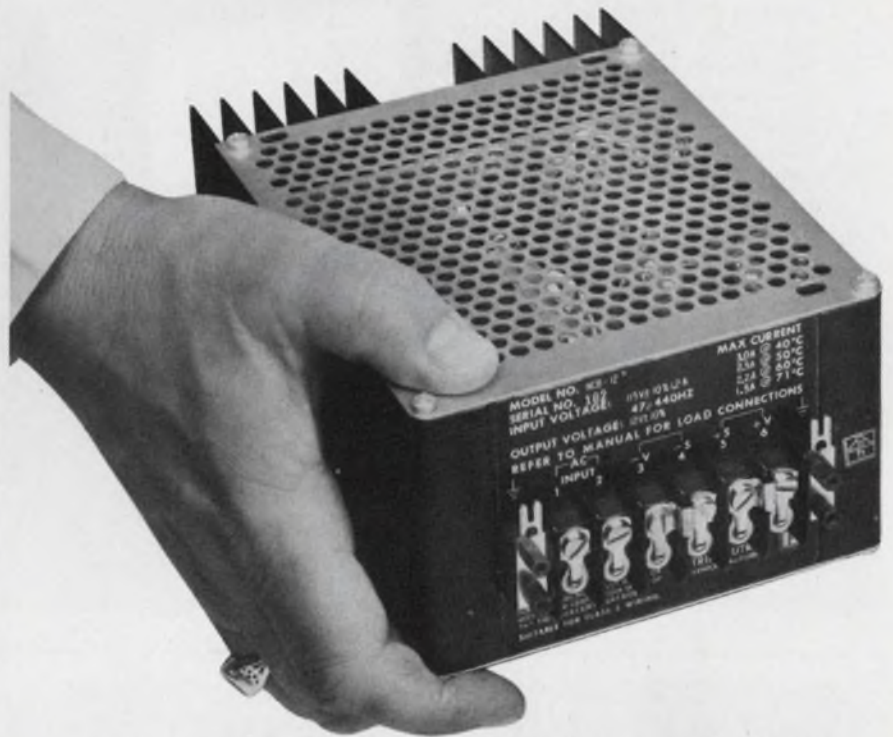

## TRIAD'S slot power supplies in B package for OEM systems.

Designed for computers, peripheral equipment and similar applications, Triad's NCB Series in 5 voltage ranges delivers from 25 to 45 precisely regulated watts of DC power at extremely low ripple. They feature built-in overvoltage protection, automatic fold back current limitation, 10-year life computer grade capacitors, and reverse polarity protection. Lower in cost, the NCB's retrofit many models on the market today. In stock and available now from Triad distributors.

## Wide range, adjustable 40-watt regulated power supplies.

The low cost WR Series features open top construction, integral heat sink housing, 10-year life computer grade capacitors, all silicon semiconductors, FR glass epoxy pc boards, and electrostatically shielded transformers. In stock and available now from Triad distributors.



## TRIAD-UTRAD DISTRIBUTOR

305 North Briant Street, Huntington, Indiana 46750

INFORMATION RETRIEVAL NUMBER 78

# Control Meter Relay Systems

Servo-Tek's NEW Control Meter Relay Speed Indicating System is designed for accurate speed monitoring and speed limit control in process and control machinery. Adjustable single and double set point systems, accuracy  $\pm 2\%$  full scale, repeatability 0.5%, speed ranges from 0-10 rpm to 0-12,000 rpm. Double set points adjust to  $0^\circ$  of each other. The system's permanent magnet dc generator can also provide a signal to auxiliary equipment.



FREE CATALOG of rotating components available.

Be Selective. Turn To...

**SERVO-TEK**  
PRODUCTS COMPANY

1086 Goffle Road, Hawthorne, NJ 07506 • 201-427-3100

Servo-Tek of California, Inc.  
8155 Van Nuys Blvd., Van Nuys, CA 91402 • 213-786-0690

INFORMATION RETRIEVAL NUMBER 79

## Houdaille's versatile new n/c systems offer pluggable circuits, countless options -- and unbelievably low cost!

2- or 3-axis systems. Options include computer-assisted tape preparation, sophisticated contouring capability. The low cost is standard. So is Houdaille's nationwide factory service. Request information, and learn how to custom-automate economically with Houdaille. Electronics Division, Houdaille Industries Inc. 9035 Wehrle Drive/Clarence, N.Y. 14031/716-632-8412.

ELECTRONICS  HOU DAILLE



INFORMATION RETRIEVAL NUMBER 80

## DATA PROCESSING

### Flatbed plotter combines speed with large surface



Xynerics, Inc., 6710 Variel Ave., Canoga Park, Calif. 91303. (213) 887-1022. From \$60,000; 12-16 wks.

Claimed to be the fastest plotter for its size, the Series 2000 units slew at 30 in/s. and have work areas ranging from 6 by 10 ft to 6 by 20 ft. Maximum acceleration is 0.8 G. Three linear motors provide direct drive to the drafting head; two operate in parallel for X-axis movement and the third controls Y-axis movement. Plotting accuracy is  $\pm 0.005$  in. for the entire drawing area. The drafting head is designed for use with liquid pens, dry pens, scribe tools and photo heads. Options include a paper feed system and computer software.

CIRCLE NO. 274

### OEM disc drives store up to 75 million bits

Remex Electronics (Div. of Ex-Cello-o Corp.), 1733 Alton St., Santa Ana, Calif. 92705. (910) 595-1715.

Series 3320 disc drives are available in four models, 3320-1 through 3320-4. Storage capacity ranges from 75 M bits to 300 M bits in 75 M-bit increments. Daisy chaining permits storage expansion up to eight units. Average rotational latency and head positioning times are 8.3 and 30 ms, respectively. Up to 6.45 M bit/sec. can be transferred. Data integrity is ensured by use of non-contacting heads which automatically retract in the event of a power failure.

CIRCLE NO. 275

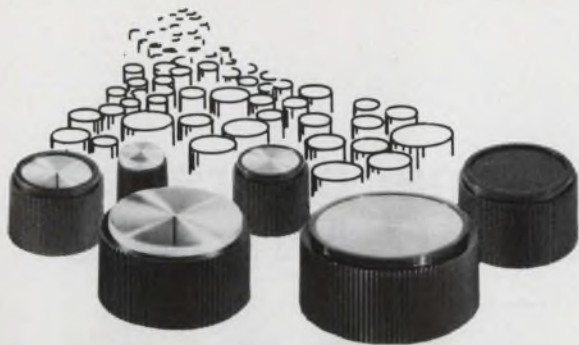

# 1,500,000

## KNOBS TO CHOOSE FROM...

and they're "Warranted for Life"

Kurz-Kasch has over 1½ million low cost, high quality knobs in inventory, ready to ship to you. (You save . . . no tooling cost on stock knobs, specials 4 to 6 weeks delivery.) Your local distributor's stock is available at factory prices. Select instrument and control knobs from 24 families with 367 basic sizes and shapes in general purpose phenolics, melamines and ureas. All Kurz-Kasch knobs are warranted for the life of the product on which they're used. Send now for free 20 page catalog. (Also found in THOMAS REGISTER "THOMCAT."®)



**Kurz-Kasch, Inc.**

1421 S. Broadway  
Dayton, Ohio 45401  
513/223-8161

INFORMATION RETRIEVAL NUMBER 81

## IT'S YOUR MOVE TO BETTER MATRIX BOARDS

125 CENTERS	RELIABILITY • ECONOMY AND STANDARDIZATION		UP TO 8 DECK SWITCHING
	.250 CENTERS	.100 CENTERS	BUSSED CONTACT
ISOLATED CONTACT			DUAL CONTACT STRIPS
CLOSED ENTRY DESIGN			MIXED CONTACTS
	COLOR PIN HANDLES	TENTH INCH MATRIX AT \$.08 PER POINT	
SHORTING PINS	TERMINAL OPTIONS	MOUNTING OPTIONS	COOED PANELS
WRITE FOR CATALOG	DIODE PINS	LIGHTED PINS	COLORLED PANELS

**CO-ORD SWITCH**

A DIVISION OF LVC INDUSTRIES INC.

135-25 37th AVE., FLUSHING, N.Y. 11354 • 212-939-9777

INFORMATION RETRIEVAL NUMBER 82

ELECTRONIC DESIGN 8, April 12, 1973

# If SAICOR'S correlator could talk it would say...

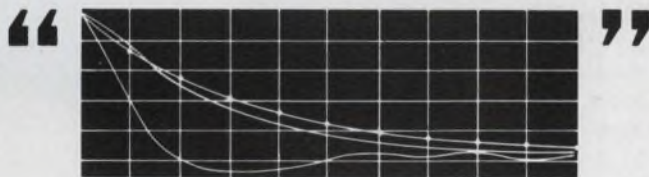

Decay rate reveals molecular properties of materials

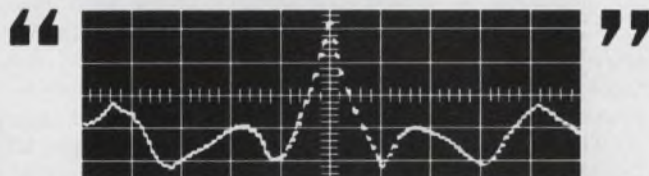

Location of peak allows measurement and control of flow velocities and propagation time

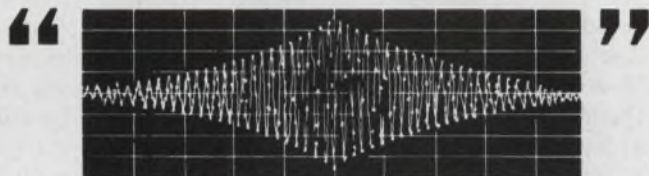

Chamber pressure characteristics point up jet engine combustion problems

These quotations, and many more, are delivered by this unique all digital, high speed processing instrument. It performs auto and cross correlation, signal averaging, and probability, density and distribution analysis in real time.

The 400 point SAI-43A has a minimum  $\Delta t$  of 0.2  $\mu$ sec (5MHz sampling rate) and 800 precomputation delay points, linear and exponential averaging, digital bin markers and readout. Full digital input circuitry for photon counting applications is available. For those applications requiring only 100 point analysis, the new improved SAI-42A is available.



Let the SAICOR Correlators tell their own story. Call (516) 234-5700 for a demonstration or detailed technical data.

**Honeywell**



SIGNAL ANALYSIS OPERATION • TEST INSTRUMENTS DIVISION  
595 Old Willets Path, Hauppauge, New York 11787 • 516/234-5700

INFORMATION RETRIEVAL NUMBER 83

147

# Voice-coil-driven laser trimmer offers accuracy to $\pm 0.005\%$ and $m\Omega$ - $M\Omega$ range

*Electro Scientific Industries, 13900 S.W. Science Park Dr., Portland, Ore. 97229. (503) 646-4141. See Text.*

Besides extreme accuracy and extended resistance ranges, Electro Scientific Industries' new laser resistor-trimming equipment, the System 25, has many other features that merit attention. ESI's 25, which replaces the company's Model 20 series, offers trimming accuracy to  $\pm 0.005\%$  +1  $m\Omega$  for resistances to 2  $M\Omega$  at temperatures of 20 to 26 C and relative humidity of 30 to 70%. Accuracy to 2  $M\Omega$  is still  $\pm 0.01\%$  +2  $m\Omega$  without environmental control. And the accuracy is  $\pm 0.05\%$  between 2  $M\Omega$  and 16.77  $M\Omega$ . The values are almost a magnitude better than those offered by the Micronetic Systems Model 80. Its accuracy is  $\pm (0.06 + 0.03 R \times 10^{-6})\%$ , which applies to the 10  $\Omega$  to 10  $M\Omega$  range.

Teradyne's Model W301 specs out at  $\pm 0.02\%$  from 100  $\Omega$  to 100 k $\Omega$ , but the accuracy isn't specified outside this resistance range. A newer Model W311 with a proprietary Davis bridge circuit may offer greater accuracy and other improvements. W311 accuracy specs were not available at press time.

Though ultra-precise measurement is useful, it is not, for most applications, the overriding spec for a resistor trimmer. The models of all three companies provide sufficient accuracy for most jobs. Resistance ranges, too, need not be extreme for most jobs, though ESI again, pushes the high end to 1073  $M\Omega$  (at 0.5% accuracy), compared with 10  $M\Omega$  for Teradyne's W301. At the low end, ESI can measure milliohms with its Kelvin bridge circuit, whereas the two other companies list only 1  $\Omega$ .

Further, the System 25 can measure resistors with inaccessible nodes, to permit the adjustment of networks, and its floating bridge still does an accurate job when the unknown resistor has resistance to



ground from its two ends—a feature that may tip the balance in the 25's favor in some applications.

The 25 has replaced the X-Y table, moved by stepping motors and lead screws to position the laser beam, with low-friction, ball-bearing ways that are moved by voice-coil linear actuators. Linear optical encoders control the positioning. The result: a smooth, stepless, linear motion with better than 0.1-mil repeatability over its entire 3-by-3-in. range. However, this same repeatability is offered by Micronetic's 80, which uses a lead-screw drive. Also, the 80's spec sheet indicates an accuracy of 0.1 mil/in. of travel. But ESI contends that absolute accuracy is secondary to repeatability.

Teradyne's W301 (also the W311), on the other hand, uses a galvanometer mechanism to direct the laser beam. It provides only a 2-by-2-in. square, or 2.8-in-diameter, work range. And its accuracy (or is it repeatability?) is only 1 mil. Galvanometer systems are very fast, and they can move the laser beam anywhere within its work range in a maximum of 30 ms. This easily beats the System 25's top positioning speed of 4 in/s and the Micronetic 80's 8 in/s.

But trimming speeds for all three systems are, of course, slower. For resistance accuracies of

$\pm 5\%$ , ESI's speed is about 2 in/s, and it is much slower for the very highest accuracies. Since trimming consumes most of the over-all time, this is one reason the galvanometer system's high-speed positioning capability is of small advantage. Another is that the distance from one trimmed resistor to the next is usually small—on the order of 100 mils. It takes less than 30 ms to travel this distance at the System 25's speed of 4 in/s.

The optical system of the 25 is mounted on the positioning carrier, and the final objective lens is always parallel to, and at a fixed distance from, the substrate. Thus the beam is always in focus over the entire work area, and more uniform trimming results. This contrasts with the approach taken by the galvanometer system, where the laser beam changes its angle of incidence on the focusing lens as the beam is moved across the work. Also, the System 25 needs fewer optical elements, so there is less laser radiation loss, and more cutting power reaches the substrate. The Micronetic 80 also uses a linear X-Y carrier, as does the 25, and all the optical advantages of parallel motion can apparently also apply to it.

The System 25 uses a pumped YAG laser with an acousto-optic Q switch capable of delivering 3-W cw in the TEM<sub>00</sub> mode. The Model 80 offers the same specs, and the W301 differs only in that 1.5-W cw is standard, with a 4-W option.

ESI offers a basic fully-functional System 25 for about \$85,000 with delivery in 60 to 120 days, Micronetic's Model 80 basic system goes for \$69,000 and Teradyne's latest W311 carries a basic price of \$97,500. But a basic system for each company may include different things, so investigate before you invest.

For ESI	CIRCLE NO. 255
For Teradyne	CIRCLE NO. 256
For Micronetics	CIRCLE NO. 257



# How come she can produce engineering drawings up to 30 times faster?

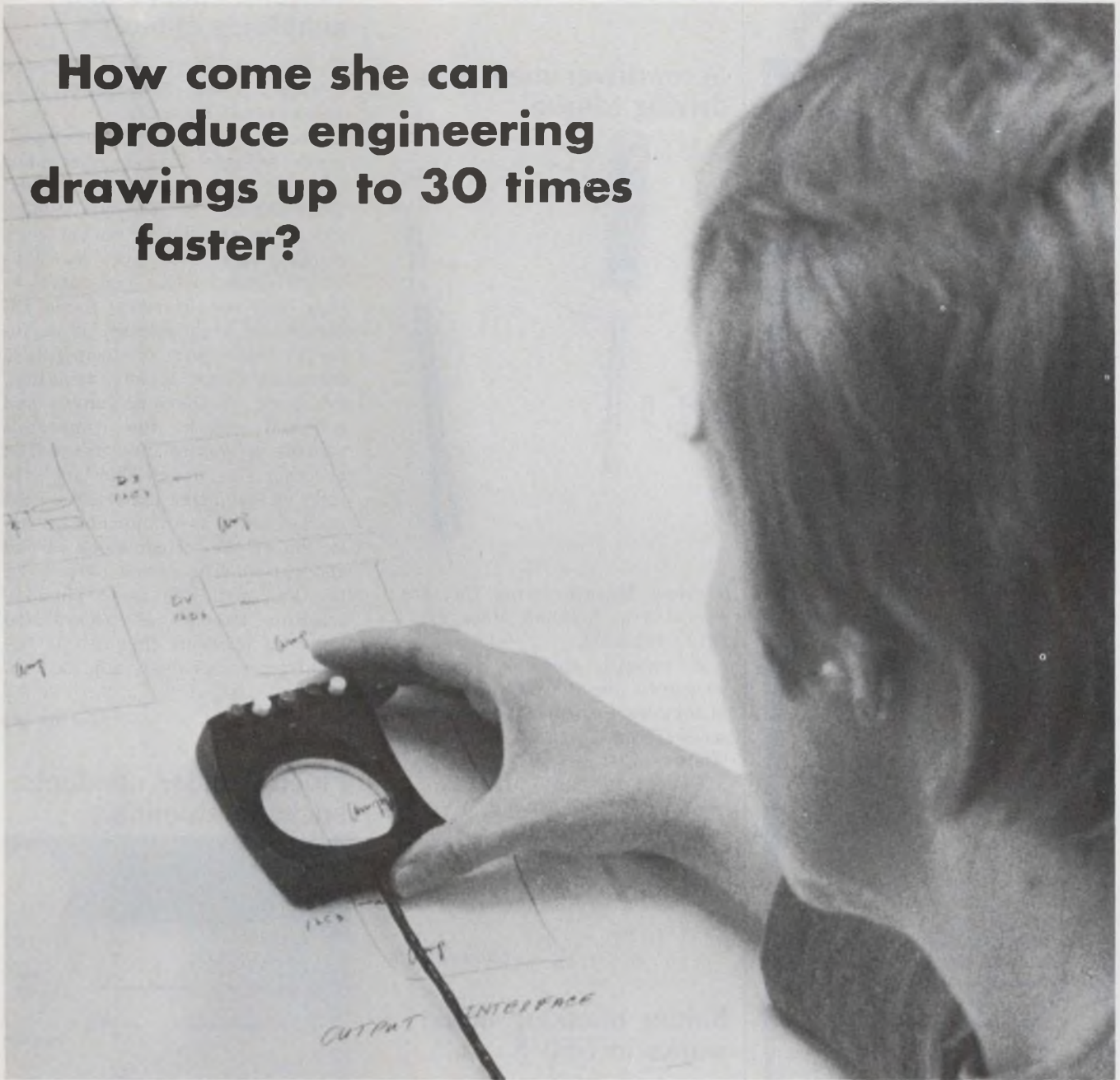

It's simple. She has a Bendix Interactive Drafting System 100. It constructs precise engineering drawings from rough sketches a whopping *five to thirty* times faster than conventional methods.



The Bendix Interactive Drafting System 100.

For you, it's sure to mean substantial cost savings. Plus an incredibly quick return on your investment.

System 100 doesn't require operators with high technical skills either to achieve consistent quality. Handle revisions faster. All this from a menu selection of symbols and drawing instructions for simple operation.

The heart of System 100 is the unique and flexible Datagrid™ Digitizer. It's also available separately for general-purpose digitizing. Use it with a selection

of options and popular output devices, too.

And now that Bendix has a way to produce drawings up to 30 times faster, shouldn't you? For more information, contact The Bendix Corporation, Computer Graphics, 32969 Hamilton Court, Farmington, Michigan 48024. (313) 477-3700.

**Bendix** Computer  
Graphics

INFORMATION RETRIEVAL NUMBER 84

# TRIACS

NEW POWER SERIES

# 60 Amp 200 to 1000 V



Hutson's advanced thyristor technology has produced a new power triac series in hermetically sealed  $\frac{3}{4}$ " press fit and stud mount packages.

*This series features:*

- 60 Amps ( $I_{HRMS}$ )
- 200 V to 1000 V ( $V_{DR0M}$ )
- 100 V/ $\mu$ sec. ( $dv/dt$ ) (min)
- 600 Amps ( $I_{TSM}$ ) at  $T_C = 75^\circ C$
- $0.64^\circ C/W$  ( $R_{\theta JC}$ )
- 42 W for 10  $\mu$ sec ( $P_{GM}$ )
- Operating temperature range ( $T_C$ ) -40 to  $+125^\circ C$
- Center gate design for faster turn-on, lower switching losses and improved di/dt characteristics



Call or write for complete information.

## HUTSON INDUSTRIES

BOX 34235 • 2019 W. VALLEY VIEW, DALLAS, TEX. 75234 (214) 241-3511 TWX 910-860-5537

Distributed by:

In Canada: WEBER-SEMAE ELECTRONICS, Downsview, Ont. 416/635-9880

Vice-President, European Operations:

30 Rue Pierre Semard, Yverres, 91 France Tel: Paris 925-8258 • TELEX 21-311

Distributed in Europe by:

Belgium: C. N. ROOD S.A. Brussels 02-352135  
■ Denmark: E. V. JOHANSEN A/S, Copenhagen (01)\* 295622 ■ Norway: INTELCO, Box 158, 47 2 207451, Sentrum, Oslo ■ Spain: BELPORT, Madrid 234.62.62 ■ Sweden: ELEKTROFLEX, Sundyberg 08-28-9290 ■ Switzerland: D. LEITGEB, Dubendorf 051 85 9666 ■ UK: CLAUDE LYONS, LTD, Hoddeston, Hertfordshire (09924) 67161

INFORMATION RETRIEVAL NUMBER 85

## PACKAGING & MATERIALS

### Screwdriver measures driving torque



Seekonk Manufacturing Co., Inc., Perrin Ave., Seekonk, Mass. 02771. (617) 761-8284.

A versatile torque screwdriver measures torque in inch-grams, inch-ounces or inch-pounds. The screwdriver features thrust and lateral bearings, an accuracy to  $\pm 3\%$  (of full scale?) and can accommodate torques from 0 to 100 inch-pounds. Three interchangeable bits—a screwdriver-slotted, a recessed and a 1/4-in. square-drive bit—are provided with every screwdriver.

CIRCLE NO. 278

### Solder masking liquid works to 550 F

Lancer Chemical Industries, 91 Highland Ave., Barrington, R.I. 02806. (401) 245-5493.

Masking of gold fingers and pins with liquid-Lancer RR-458 coating resists most processing baths. The mask can be removed with conventional degreasing equipment (trichloro-ethylene or chlorethyne) after passing through the solder wave, or solder reflow. Application of this liquid is by dip, spray, daub or silk screen. Cure is room temperature or forced hot air. The solder masking solution will withstand solder temperatures up to 550 F, depending on the thickness of the coating, and the duration at temperature.

CIRCLE NO. 279

### Silicone rubber line simplifies choices

General Electric Co., Silicone Products Dept., Waterford, N.Y. 12188. (518) 237-3330.

The Electrilsil line of electrical-grade silicone rubber compounds for use as wire and cable insulations offers the benefits fundamental to all silicone rubber compounds plus such specific individual features as resistance to very high temperatures, flame, radiation or high voltage. With inherent resistance to temperature extremes, ozone, corona, radiation, moisture, weathering, fungus and chemical attack, the compounds provide a service life unmatched by other elastomers. The large variety of insulating materials on the market tends to complicate the selection of the proper stock for an application. The prime purpose of the Electrilsil line is to simplify selection through a systematized group of products that satisfy the requirements of many applications.

CIRCLE NO. 280

### Plastic solder conducts, sticks to aluminum



Emerson & Cuming, Inc., Canton, Mass. 02021. (617) 828-3300. \$18 per lb.

Eccobond Solder 72-C is a two-component, electrically-conductive plastic adhesive. It is said to effectively replace hot solders. Though Eccobond's volume resistivity ( $0.01 \Omega\text{-cm}$ ) is five times that of silver-filled compounds it is adequate for most applications and costs one fourth as much. Aluminum wires or plates are easily bonded by plastic solders. The plastic provides the additional advantage that the conductive fillers are automatically protected against corrosion.

CIRCLE NO. 281

## Insertion tools in all sizes protect DIPs



G. D. Patrick Enterprises, P.O. Box 23054, San Diego, Calif. 92123. (714) 279-8856. Stock.

Insertion Master tools handle the insertion of DIPs of all standard lengths and pin spacings. They are supplied with heads for 14 and 16-pin DIPs on 0.3-in. pin spacing and for 20 and 40-pin DIPs on 0.6-in. pin spacing. An Insertion Master can pick up a DIP from its storage magazine and insert it into the board with a single motion. A spring-loaded plunger at the top releases and seats the DIP in place.

CIRCLE NO. 300

## Gold-filled epoxy has high conductivity

Epoxy Technology, Inc., 65 Grove St., Watertown, Mass. 02172. (617) 926-0136. \$75/1/2 oz. kit; stock.

A gold-filled, single-component epoxy features an outstanding electrical conductivity rating of 0.0001-0.0003 ohm-cm that is fully reproducible. Epo-Tek H44 is particularly recommended for bonding semiconductor chips in hybrid circuits as well as attaching LSI and MOS chips. The epoxy has the consistency of a soft, smooth thixotropic paste, contains no solvents and produces extremely sharp-definition prints when used in silk-screening applications. Even when allowed to stand for several days, pads screened with Epo-Tek H44 do not dry out and exhibit no skimming, which can make chips difficult to put down. The minimum curing schedule for Epo-Tek H44 is 45 minutes at 120 C and 15 minutes at 150 C. Lap shear strength is in excess of 2000 psi and the cured epoxy can be used for thermal compression wire bonding in the 300-350 C range.

CIRCLE NO. 301

# What's your magnetic field?

## RFL covers them all...

- Magnetization
- Stabilization
- Measurement

When it comes to magnetic instrumentation, come to RFL. You'll profit from our more than three decades of experience . . . and the most complete line of quality engineered equipment available anywhere.

RFL magnetic measuring instruments provide precise determination of flux densities from as low as a few gamma to as high as 50,000 gauss. Our magnet chargers provide energy capacities ranging from 18 to 10,000 joules . . . enough for almost any permanent magnet including the rare earths. And the RFL Magnetreater® provides precision adjustment and stabilization of magnets and magnetic assemblies.

Equipment is just a part of our service. We also provide application engineering assistance . . . free fixture design for processing magnets and magnetic assemblies . . . and, where needed, complete systems for semi-automatic or automatic processing of permanent magnets or assemblies.



EST. 1922

Call or write today for full information.

**RFL Industries, Inc.**

Instrumentation Division • Boonton, N. J. 07005

Tel: 201-334-3100/TWX: 710-987-8352/CABLE: RADAIRCO, N. J.

## MONOLITHIC CRYSTAL FILTERS

# THE STATE OF THE ART

### Thank you, Ma Bell...



For years, mobile radios operating in urban areas have been plagued with interference problems. One of the biggest is intermodulation. This is where Ma Bell comes in. Mobile telephone channels assigned to her can generate IM products at nearby frequencies allocated to local cab companies.

The solution—a monolithic front-end filter in each cab radio to protect the first stage. We started making these filters five years ago as custom jobs. Now we're making them in low-cost OEM quantities for paging, medical telemetry and other single-channel receivers.

### Speaking of intermodulation...



It should be noted that crystal filters—even ours—can generate IM products. Happily, this non-linear proclivity can be controlled. If your application involves IM requirements for either out-of-band or in-band signals, we may be able to help where others have failed.

Drop us a line about your project or, if you're really in a hurry, give us a call via Ma Bell at (305) 425-1574.

# Pti

**Piezo Technology Inc.**  
2400 Diversified Way  
Orlando, Fla. 32804  
(305) 425-1574

The standard in monolithic  
crystal filters.

## INSTRUMENTATION

### Duplicator copies 1-k pROM in 3 sec.

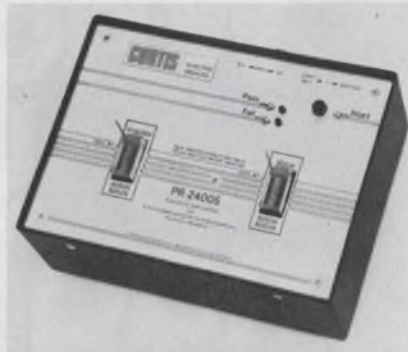

Curtis Electro Devices, Inc., Box 4090, Mountain View, Calif. 94040. (415) 964-3136. \$499.50; stock to 2 wks.

A high-speed, low-cost production duplicator for the Signetics 82S26 and 82S29 1024-bit field-programmable ROM is offered by Curtis Electro Devices. The compact, table-top instrument will duplicate from a pin-compatible ROM, ROM simulator or computer with an average programming time of three seconds. The PR-2400S is designed for production use by unskilled personnel who merely load blank pROMs, press the START button, and watch for a PASS or FAIL lamp indication. A verify-only function is available for checking unknown devices without programming. Size is 10 × 8 × 4-in., and weight is 5 lbs.

CIRCLE NO. 302

### 8-bit a/d converter features 1-ns aperture

Inter-Computer Electronics, MS/1123, P.O. Box 507, Lansdale, Pa. 19446. (215) 822-2929. \$2500; 4 wks.

Featuring 1-ns aperture time, ICE Model IAD-1308 converts analog signals to an eight-bit digital word at conversion rates up to 1.5 MHz with an accuracy of ±0.2% of full scale at ±1/2 LSB. The unit is a complete conversion system that includes sample and hold, d/a encoder, system timing and power supplies. It operates either asynchronously from an internal clock, or synchronously from an external signal source.

CIRCLE NO. 303

### 10-MHz scope costs just \$425

Hickok Electrical Instrument, 10514 Dupont Ave., Cleveland, Ohio 44108. (216) 541-8060. \$425; 60 days.

The 5310 is an economical scope with bandwidth from dc to 10 MHz, ac or dc coupled. Using digital-trigger circuitry, the Model 5310 offers stable triggering to 15 MHz. Vertical ranges are from 10 mV/cm to 50 V/cm in 12 calibrated ranges. Accuracy is ±3%. An uncalibrated continuously-variable control increases sensitivity to 5 mV/cm. Sweep ranges are from 0.5 ms/cm to 0.2 s/cm in 18 calibrated steps. Linearity is better than 1% through full horizontal sweep. The unit has an 8 × 10-cm display. Weight is only 15 pounds.

CIRCLE NO. 304

### Bench top unit tests any d/a converter

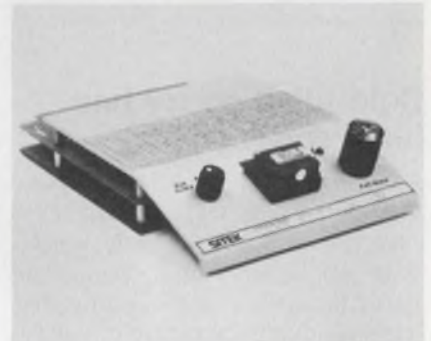

Sitek, Inc., 1078 W. Evelyn Ave., Sunnyvale, Calif. 94086. (408) 735-9800. \$750; 6 wks.

An automatic bench-top tester for d/a converters is a new option to the company's Model 1420 linear IC tester and can be used to inspect any modular or monolithic d/a converter up to 12 bits. A program board inserted in the front panel of the 1420 accepts converters in all standard packages. A reference device with a tc of 2 ppm/°C is built into the board. The tester compares the operation of the device under test to this reference with a resulting accuracy of 0.002%. Tests performed include power consumption overrange, normal power consumption, and output error for each bit or group to bits addressed. Nominal test time for a 10-bit converter is 4 s.

CIRCLE NO. 305

## Function generator is portable

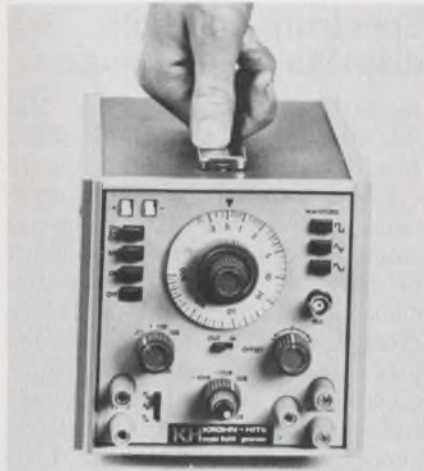

Krohn-Hite Corp., 580 Massachusetts Ave., Cambridge, Mass. 02139. (617) 491-3211. \$395 plus \$70 for portable battery kit; 4-6 wks.

Model 5600 portable function generator provides sine, square and triangle waveforms. Output frequency ranges from 0.002 Hz to 2 MHz, with a frequency accuracy of  $\pm 5\%$  of reading. Output is controlled by a three-position attenuator and amplitude vernier, providing both a 50  $\Omega$  single-ended and a 600  $\Omega$  balanced output. These outputs provide 15-V pk-pk and 30-V pk-pk, respectively. The portable unit is powered from two rechargeable NiCad batteries and will operate continuously for up to ten hours. Power consumption is 2.5 W. Weight is 7 lbs. and size is 5-1/2  $\times$  5-1/4  $\times$  10-in.

CIRCLE NO. 306

## 32-MHz counter weighs just 3 lb

United Systems, 918 Woodley Rd., Dayton, Ohio 45403. (513) 254-6251. \$475; stock to 2 wks.

Model 150A features a counting range from 5 Hz to 32 MHz, a crystal-controlled clock, five-digit LED display, and automatic ranging for full resolution. Decimal points and units are automatic. Nonsignificant zeros are automatically blanked. Operation is from standard ac or from an optional battery. Model 150 A has a built-in test position and an overrange indicator in the manual mode. The unit is 2  $\times$  4-1/2  $\times$  7-1/2 in. and weighs 3 lb.

CIRCLE NO. 307

This  
Sweet  
**MICROVOLT**  
**MULTIMETER** is  
SENSITIVE to  $1\mu\text{V}$ ,  
STABLE within  $2\mu\text{V/day}$   
and easy on the budget at  
**\$560**

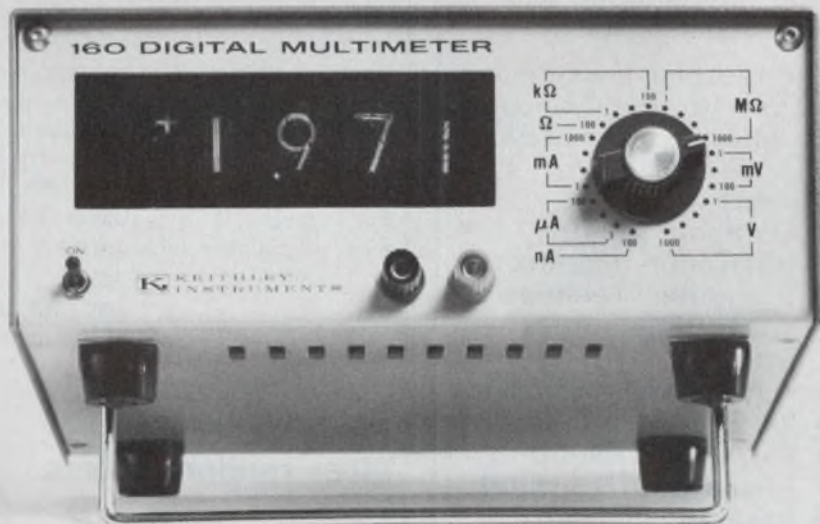

Users call it "the-how-sweet-it-is-meter". But it's really the Model 160 that...

- MEASURES WITH DIGITAL ACCURACY
  - Voltage** —  $1\mu\text{V}$  to 1000V
  - Current** — 0.1 nA to 2A
  - Resistance** — 0.1  $\Omega$  to 2000 M $\Omega$
- 100% OVERRANGING
- ANALOG and OPTIONAL BCD OUTPUT
- AC/DC PROBE ACCESSORY
- MANY MORE SWEET PERFORMANCE FEATURES



**KEITHLEY**  
**INSTRUMENTS**

U. S. A.: 28775 Aurora Road, Cleveland, Ohio, 44139  
Europe: 14, Ave. Villardin, 1009 Pully, Suisse

SEND FOR FULL DETAILS AND YOUR FREE "HOW SWEET IT IS" BUTTON

Log BCD data  
on paper tape...



... then let a  
computer  
analyze the data

SYSTEM I automatically collects BCD data from digital instruments and eliminates the fatiguing and time consuming task of manual data logging.

The recorder links the laboratory to the computer, thereby improving accuracy and simplifying data analysis.

- Eliminate fatigue, frustration and error
- Computer/Teletype compatible output (ASCII)
- Automate data analysis
- 24 hour recording
- Permanent record
- Priced from \$595.00
- Basic mechanisms available for OEM applications

Circle No. 161

## TAPE WINDERS

Used with:

- Teletypes
- Punches
- Readers
- Typesetters

\$75.00

Circle No. 162



**d s i**

DATA SPECIALTIES, INC.  
1548 Old Skokie Road  
Highland Park, Ill. 60035  
(312) 831 3750

## INSTRUMENTATION

### Computer-controlled unit tests zeners and diodes



Teradyne, 183 Essex St., Boston, Mass. 02111. (617) 482-2700. \$49,000; 8 wks.

Z337 is a computer-operated test system for diodes, rectifiers and zener diodes. The unit offers a  $\Delta V$  capability under software control, which means that the system can measure the "squareness" of the voltage change at zener-breakdown voltage or on a controlled-avalanche rectifier. The system also has a wide range of analog capability. For diodes and rectifiers, it can supply forward current to 10 A and reverse voltage at 1200 V. For zeners, it includes a 1-kHz zener impedance measurement and up to 200-V zener voltage.

CIRCLE NO. 308

### Pulse generator gives random pulses

Berkeley Nucleonics, 1198 Tenth St., Berkeley, Calif. 94710. (415) 527-1121. \$1000; stock to 30 days.

The Model DB-2, a random pulse generator, accurately simulates the random and pile-up characteristics of pulses from radiation detectors. The instrument is most useful for testing the resolution, linearity and stability of amplifiers by closely simulating experimental conditions. In both the random and repetitive modes, the count rate is adjustable from 10 Hz to 1 MHz. The output pulses are stable to  $\pm 0.02\%/^{\circ}\text{C}$  and exhibit a change of amplitude less than  $\pm 0.05\%$  from 10 Hz to 100 kHz. The rise and fall times are independently adjustable and the amplitude is adjustable to 10 V with an integral linearity of  $\pm 0.1\%$ .

CIRCLE NO. 309

### Spectrum analyzer displays 70-dB range

Hewlett-Packard, 1501 Page Mill Rd., Palo Alto, Calif. 94304. (415) 493-1501. \$3350; April.

Model 8558B is a plug-in spectrum analyzer for HP 180-series scopes. The instrument spans 0.1 to 1500 MHz, with  $\pm 1\text{-dB}$  frequency response, and offers a greater than 70-dB dynamic-display range. Normally, only three controls will be used: tuning sets either the center or the start-frequency of the 3-1/2-digit LED display. Frequency span sets the width of the frequency window. Span range is 1000 MHz to 50 kHz. Reference level (amplitude) calibrates the display in absolute power units. Range is  $-115$  to  $+30$  dBm. When the frequency span control is set, the analyzer automatically selects the optimum resolution bandwidth and sweep time. Or, resolution bandwidths from 1 kHz to 3 MHz can be manually chosen. The analyzer also indicates optimum and maximum input level for the chosen amplitude control setting.

CIRCLE NO. 310

### Voltage divider offers low-input impedance

Julie Research Labs, 211 W. 61st St., New York, N.Y. 10023. (212) 245-2727. \$2890; 2 wks.

RVD-106L is a low-impedance (10 k $\Omega$ ) programmable voltage divider designed for computer-controlled and automated test systems. The six-decade precision divider is designed for either manual or automated operation. Input impedance is 10 k $\Omega$  and accuracy and long term stability is 0.001% (10 ppm). The RVD-106L comes standard with 10-line decimal input relay logic and analog output. Other models offer BCD input logic, BCD output, or both. Other specs include a resolution of 0.0001% (1 ppm); max. input voltage of 300 V; self-heating coefficient of 1.0 ppm/W and tempco of 0.25 ppm/ $^{\circ}\text{C}$ . Response time is better than 10 ms.

CIRCLE NO. 320

## 4-1/2-digit DMM also counts to 200 MHz



Valhalla Scientific Inc., 7707 Convoy Ct., San Diego, Calif. 92111. (714) 277-2732. \$590; stock to 30 days.

This 4-1/2-digit DMM-counter, the Model 4004, offers gated-frequency counting to 200 MHz. Standard features include five ranges of dc and ac volts with 10- $\mu$ V resolution, five ranges of dc and ac current with 10-nA resolution, six ranges of resistance with 10-M $\Omega$  resolution, five ranges of true frequency counting. A wideband frequency-multiplier option allows low-frequency signals to be measured virtually error-free in 1/100 of the normal time, independent of zero-crossing distortion. A 10-Hz signal can be resolved to 0.001 Hz in 10 seconds, whereas normally 1000 seconds are required. The high-frequency divider options expand the counter capability to 200 MHz. The basic accuracies are: for dc volts and frequency, 0.01%; for resistance, 0.02%; and 0.1% for ac volts.

CIRCLE NO. 321

## Photoresist power meter measures UV energy

International Material Research, 2960 Scott Blvd., Santa Clara, Calif. 95050. (408) 244-3434. \$350; stock.

Model 400 is a Photoresist Power Meter that allows the mask maker and semiconductor wafer aligner to measure energy from an ultraviolet exposure source. Spectral response of the Model 400 is 310 to 490 nm. Peak response is at 400 nm. The small sensor head (2  $\times$  2 mm) includes a filter which admits only the UV light that affects the photoresist. 100% of all other light is filtered out. Active area is only 4 mm<sup>2</sup>. The solid-state unit operates from two 9-V batteries. Calibration accuracy is 5% at 404.7 nm (traceable to N.B.S.), guaranteed for six months. The meter range is 0.6 to 150 mW/cm<sup>2</sup>.

CIRCLE NO. 322

# ...YOU'LL LIKE IT!

## TRUE RMS VOLTMETER RESOLVES 0.01 dB

PROGRAMMABLE ■ SENSITIVE ■ WIDE BANDWIDTH

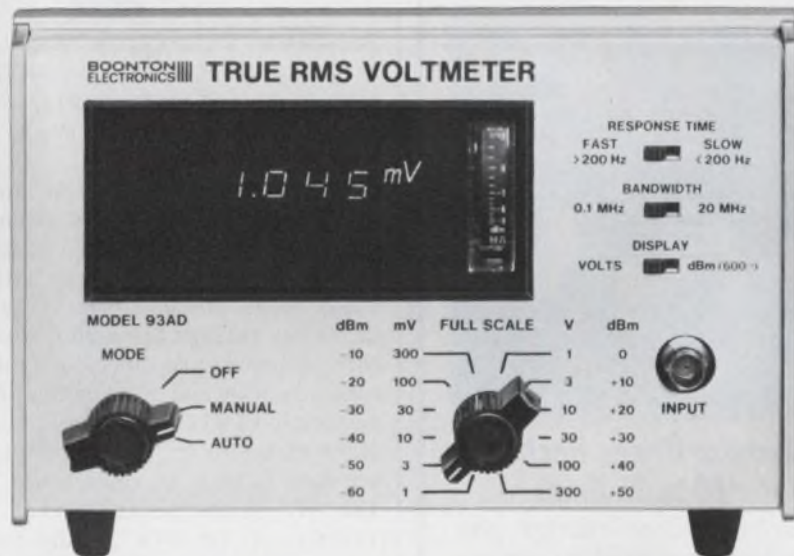

These important features, usually extra-cost or unavailable, are standard with the 3½ digit 93AD at its \$1200 base price:

- 300  $\mu$ V sensitivity usable over the full 20 MHz bandwidth.
- Full remote control.
- Digital and analog outputs.
- Auxiliary analog meter.
- Selectable bandwidth and response time.

Several options and accessories are available for special requirements:

- Digital dB display and outputs.
- Automatic ranging.
- High impedance probe.

# BOONTON ELECTRONICS

ROUTE 287 AT SMITH RD.  
PARSIPPANY, N.J. 07054  
TEL.: 201-887-5110  
TWX: 710-986-8241

INFORMATION RETRIEVAL NUMBER 90

## Tung-Sol® 3 to 500 Amp Power Rectifiers

Tung-Sol rectifiers are conservatively rated to assure the widest possible margin of safety and reliability. Press-fit rectifiers to 44 Amps. Stud-mounted types to 420 Amps. Ratings to 500 Amps in flat-base construction.



### Modular Bridge Rectifiers 10 to 35 Amps

Highest surge ratings give designers maximum protection against voltage overloads.

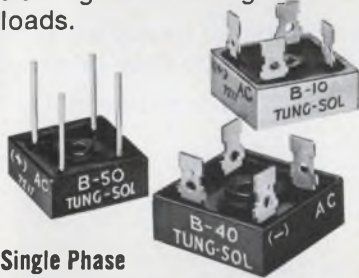

#### Single Phase

**B-50 Series**—To 10 Amps DC.  
50 to 600 PRV. 300 Amps surge.

**B-40 Series**—To 15 Amps DC.  
50 to 1,000 PRV. 300 Amps surge.

**B-10 Series**—To 30 Amps DC.  
50 to 1,000 PRV. 400 Amps surge.



#### Three Phase

**B-20 Series**—To 35 Amps DC.  
50 to 1,000 PRV. 400 Amps surge.

WRITE FOR TECHNICAL INFORMATION  
SPECIFY BRIDGES, OR POWER RECTIFIERS.

SILICON PRODUCTS SECTION  
**WAGNER ELECTRIC CORPORATION**

630 West Mt Pleasant Ave. Livingston, N.J. 07039

TWX: 710-994-4865 PHONE: (201) 992-1100  
(212) 732-5426

Trademark TUNG-SOL Reg. U. S. Pat. Off. and  
Marcas Registradas

## COMPONENTS

### Wound motor replaces printed-armature motor

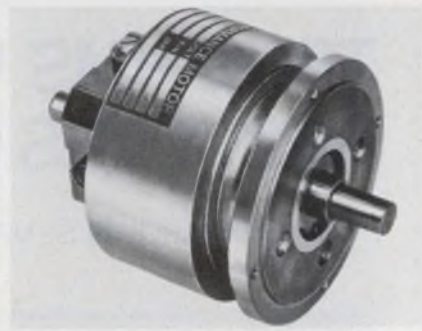

*Sequential Information Systems, Inc., 249 N. Saw Mill River Rd., Elmsford, N.Y. 10523, (914) 592-5930. Under \$80 (OEM qty.); 30 days.*

The Sequential Series HM Model 5016-01 motor is a direct replacement for printed-armature motors. It is a surface-wound motor with a rated speed of 3500 rpm at 24 V dc. Other ratings for a 25 C armature temperature include: rated continuous torque of 44 oz-in., pulsed torque of 412 oz-in., torque constant of 6.8 oz-in. per ampere and a power output, at rated speed, of 114 W. With dimensions of 3-11/16-in. L by 4-in. D, the four-pole 5016-01 has 21 commutator bars and weighs under 6 lbs.

CIRCLE NO. 323

### Laser tunes with single dial and vernier

*Spectra-Physics, Inc., 1250 W. Middlefield Rd., Mountain View, Calif. 94040. (415) 961-2550. \$5250; 90 days.*

CW dye laser, Model 370, is tunable from 560 to 630 nm with better than 0.01 nm resolution and the line width is less than 1 Å, with 0.5 Å typical. When the 370 is optically pumped by a 1-W argon laser, the output is typically between 150 and 200 mW. Conversion efficiency is between 15% and 20% and the amplitude is stable to  $\pm 5\%$  over several hours. Wavelength is tuned with a single dial and vernier located safely away from the output aperture. The dyes are contained in a removable cell. The filter and solution do not need frequent changes because of their high purity.

CIRCLE NO. 324

# FOR PRECISION SIGNALING AND CONTROL...

## muRata MICROFORKS®

Murata subminiature piezoelectric tuning forks are designed to provide the reliability and frequency stability required by the most demanding signaling or control application. A wide selection of specific audio frequencies ranging from 150 Hz to 3000 Hz as well as all standard E.I.A. audio frequencies are available in both coding and decoding configurations. What's more, Murata's new EFM-U tuning fork and H8C-200 hybrid amplifier combination can provide both functions in a single transmitter/receiver unit.

There's no doubt that Murata is the world's largest manufacturer of precision tuning forks for every type of critical application. Our reputation for reliability and performance is based on years of experience in the design and production of these precision devices . . . so why not put us to work for you. Complete technical specifications are available free. Write today.

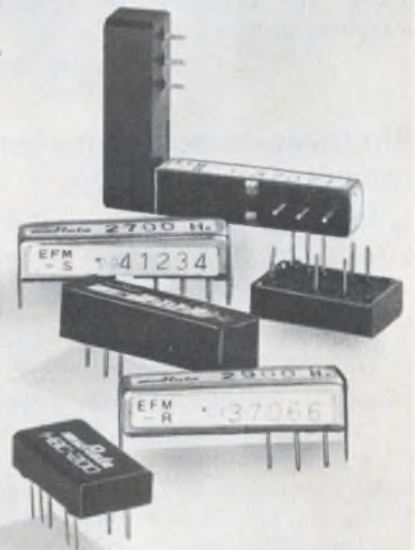

## muRata

**MURATA CORPORATION OF AMERICA**

2 Westchester Plaza, Elmsford, New York 10523

Telex: MURATA EMFD 137332

Phone: 914/592-9180

A Subsidiary of  
Murata Mfg. Co., Ltd., Japan

INFORMATION RETRIEVAL NUMBER 163  
ELECTRONIC DESIGN 8, April 12, 1973



## Trimmer capacitors offer $Q > 10,000$

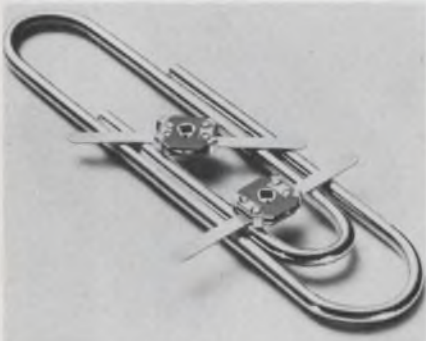

Johanson Manufacturing Corp., 400 Rockaway Valley Rd., Boonton, N.J. 07005. (201) 334-2676. \$0.95 (OEM qty.); stock.

Series 9401 trimmers feature  $Q$ s of greater than 10,000 at 100 MHz and lead configurations adapted for stripline, hybrid circuit and PC mounting. They can replace chip capacitors to provide trimming without cut-and-try adjustment using abrasives. The series includes five standard models with capacitances that range from 0.2 to 4.0 pF. Additional models are also available to 50 pF. All models have test voltages of 500 V dc and are easily adjusted by rotating a special tuning socket.

CIRCLE NO. 325

## Chip inductors available in 0.2 to 5 $\mu$ H range

San Fernando Electric Manufacturing Co., 1501 First St., San Fernando, Calif. 91341. (213) 365-9411.

Magna-Chip is a monolithic ceramic-chip inductor, the first in a family of ceramic-chip magnetic devices by San Fernando Electric, already established in ceramic-chip capacitor technology. Thick and thin-film circuit designers have traditionally excluded the use of inductors, because building micro-miniature inductors by a thick or thin-film process met with little success. Therefore performance frequently suffered. The Magna-Chip measures 0.08 in. max and is supplied with palladium gold terminations. The inductance range is 0.2 to 5  $\mu$ H.  $Q$  is a minimum of 20 with a self-resonant frequency greater than 50 MHz.

CIRCLE NO. 326

## Thin-film chip array contains 20 resistors

Hybrex, Div. of Burr-Brown, International Airport Industrial Park, Tucson, Ariz. 85706. (602) 294-1431. \$0.59 for 20% units (100-499).

Series "E" is a new series of passivated thin-film chip resistor arrays. The units have stabilities to  $\pm 50$  ppm/ $^{\circ}$ C and consist of 20 resistors. Ten of the resistors are of value R and ten are of value 10R

where R may be from 10 to 300  $\Omega$ . They are designed to withstand high temperature hybrid-circuit assembly techniques. Their gold-silicon backing permits die bonding when using eutectic, epoxy or other conventional die attachment techniques. All chips are 30  $\times$  30 mils square and 7 to 12 mils thick. Tolerances from 1% to 20% are available off-the-shelf. Power rating is 250 mW.

CIRCLE NO. 327

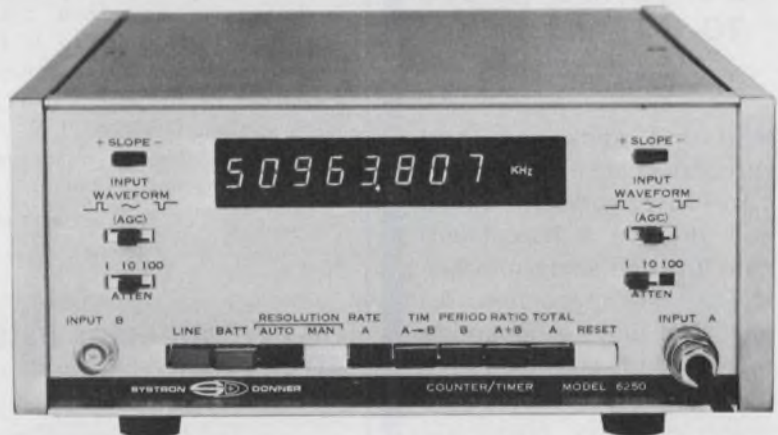

## 50 MHz automatic counter/timer

Frequency, TIM, period, ratio, totalize  
Automatic gain control  
Autoranging  
Leading zero suppression  
8-digit readout (standard)  
25 mV input sensitivity  
BCD output

### Model 6250 Options include:

Choice of 5 higher oscillator stabilities  
Internal battery pack

Contact your Scientific Devices office or Concord Instruments Division, 10 Systron Drive, Concord, CA 94518. (415) 682-6161  
Europe: Munich, W. Germany, Leamington Spa, U.K.

**SYSTRON**  **DONNER**

INFORMATION RETRIEVAL NUMBER 92

# PC BOARD SEMICONDUCTOR DEVICES

## We can mount 'em



### TO-5, TO-18's, TO-99's TO-100's and similar IC packages

Mounting pads and lead spreaders help protect semiconductor junctions and cool devices ■ Help eliminate top-side solder bridges ■ Facilitate inspection, repair, and uniform mounting ■ Nylon pads offer exclusive color coding (5 colors) to speed assembly. Also available in black DAP. Over 120 designs to choose from.

**Call your local distributor  
for immediate delivery.**

Free complete  
catalog with  
samples.

**Write for  
your copy.**



**Thermalloy**

P.O. BOX 34829  
2021 W. VALLEY VIEW LANE DALLAS, TEXAS 75234  
PHONE 214-243-4321 / TWX 910-860-5542

## MICROWAVES & LASERS

### Overload protectors cover broad band

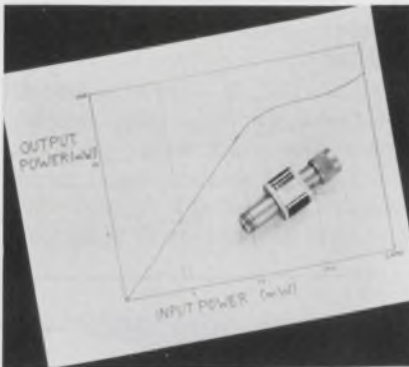

Hewlett-Packard Co., 1501 Page Mill Rd., Palo Alto, Calif. 94304. (415) 493-1501. \$200; 2 wks.

Sensitive microwave instruments can be protected from overload damage with a new limiter, the Model 11693A, which reportedly has minimal effect on lower-level measurements. The 11693A typically introduces frequency response variations of less than  $\pm 0.5$  dB across the 100 MHz to 12.4 GHz range. Limiting action begins at signal levels around 5 mW. Even with applied levels of 1 W cw, or 75 W peak, the output from the limiter stays well below 100 mW.

CIRCLE NO. 328

### CATV connector lists 40 dB return loss



EG&G, Moulton St., Georgetown, Mass. 01833. (617) 352-6200.

A CATV-connector line, for use with the company's fused disc coaxial cable, has a low return loss exceeding 40 dB across the 5 to 300 MHz frequency range. Return loss for the cable is rated at better than 35 dB. The low loss rating of the connector allows for the cascading of lines over long trunk or feeder runs.

CIRCLE NO. 329

### Hybrid coupler covers 1-to-12 GHz

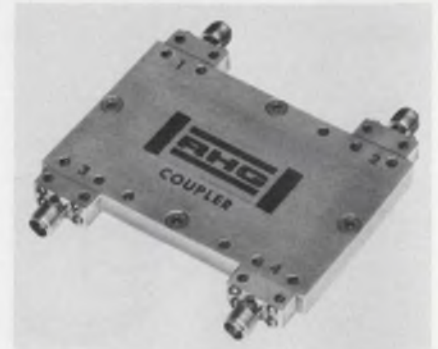

RHG Electronics Laboratory, Inc., 161 E. Industry Ct., Deer Park, N.Y. 11729. (516) 242-1100. \$425 (small qty.); 30 days.

A broadband 3-dB quadrature coupler operates over the frequency range of 1 to 12 GHz with a typical insertion loss of 0.5 dB. Called the Model QH 1-12, it reportedly provides performance characteristics comparable to standard octave hybrids, but spans four of the most used bands. Special features include amplitude balance of  $\pm 0.5$  dB, phase balance of  $\pm 5^\circ$  (from  $90^\circ$ ), and isolation of 20 dB.

CIRCLE NO. 330

### TWT GHz amps output 100-200 W

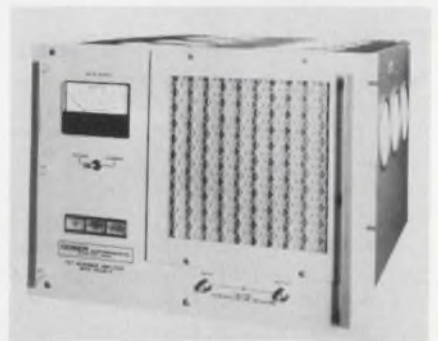

Cober Electronics, Inc., 7 Gleason Ave., Stamford, Conn. 06902. (203) 327-0003. \$10,000 to \$20,000; 90 days.

Standard traveling wave tube amplifiers are now available with average output powers from 100 to 200 W and that cover octave bandwidths over the frequency range of 1 to 18 GHz. Five models are at the 100 W level; five at the 200 W level. Minimum gains are 30 to 50 dB depending on the octave selected. Power supplies are fully solid state.

CIRCLE NO. 331



## CONDUCTIVE ELASTOMERS

• Highly to moderately, electrically conductive compounds to provide tailor-made electrical and mechanical properties • Volume resistivity from .001 to 100,000 ohm-cm • Molded parts • Extruded shapes • Standard sheets • Heating • Motion-sensing • Static discharge • Grounding • Inter-Connecting • Contacting • Write for data #850.



**TECKNIT®** Technical Wire Products, Inc.

Eastern Division • 129 Dermody St., Cranford, NJ 07016 (201) 272-5500  
Western Division • 427 Olive St., Santa Barbara, CA 93101 (805) 963-1867

INFORMATION RETRIEVAL NUMBER 94



## New Era in film capacitors!

**POLYESTER  
MICROMATIC®  
CAPACITOR\***

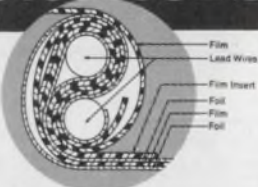

The Polyester Micromatic Capacitor provides another film capacitor design breakthrough from ITW Paktron. Here's a new polyester film capacitor smaller in size than comparable wrap and fill polyester units. And competitive with shrink-tube and/or conformal coated axial lead products presently marketed. Completely self-encased and wound on its own leads. No outside wrapping, no separate lead attachment needed. Capacitance tolerances are a low  $\pm 5\%$ . Capacitance value range .001 to 0.15mfd. Up to 600 volts. Ideal for PC board insertion due to lead concentricity. Also available in polypropylene dielectrics. Phone or write: Paktron, Division Illinois Tool Works Inc., 1321 Leslie Avenue, Alexandria, Va. 22301. Phone (703) 548-4400. TWX 710-832-9811.

**PAKTRON**

The Electronic Group of ITW • PAKTRON • LICOR • ELECTRO MATERIALS • CHROMATIC

© Illinois Tool Works Inc. 1973

\* Patent No. 3638056  
Other Patents Pending

INFORMATION RETRIEVAL NUMBER 95

ELECTRONIC DESIGN 8, April 12, 1973

RELIABILITY ✓

QUALIFICATION ✓

EVALUATION ✓

ENVIRONMENTAL ✓

COMPONENT  
SCREENING ✓

DYNAMICS  
TESTING:  
SHOCK AND  
VIBRATION ✓

Whether it's a whole system or a single component... whether it's intended for commercial, military or industrial use... it's vital to your customers—and your company's image—that your product works and stays working.

Making sure of that is ATL's business. ATL has built a nationwide reputation as an independent source for a TOTAL ELECTRONICS & AVIONICS TESTING CAPABILITY few others can match.

How? Fifteen years experience as one of industry's leading test labs... a modern facility utilizing the most up-to-date test equipment... and references in almost every product area. Testing can be performed to your specs, military specs or to your industry standards. Where required, we can even establish a program for you.

Remember: the product you engineer is only as effective as the evaluation and reliability planning that go into it. Let ATL see that it gets the best of both.



**ASSOCIATED  
TESTING  
LABORATORIES, INC.**

NORTHWEST INDUSTRIAL PARK, BURLINGTON, MASS. 01803, (617) 272-9050  
9 BRIGHTON ROAD, CLIFTON, N.J. 07012, (201) 473-6455

INFORMATION RETRIEVAL NUMBER 96

## Gas-discharge display interfaces with clock IC



Sperry Information Displays, P.O. Box 3579, Scottsdale, Ariz. 85257. (602) 947-8371. \$7 (1000s); stock.

SP-151 planar gas-discharge display is designed for clock applications. It features four half-inch-high digits, a colon, AM and PM alpha readouts and it interfaces with MOS/LSI clock chips. The planar gas-discharge unit can be used in all dc or multiplexed applications, with or without blanked zeros. Characteristics include an anode voltage of 160 V, cathode current of 130  $\mu$ A per segment and interdigit blanking requirements of 40  $\mu$ s. Character height is 0.50-in. with centerline spacing at 0.160 in. The display face is 1.593  $\times$  1.120 in. Depth of the unit is 0.255 in. plus 0.260 in. for the pins. The natural color is orange. Other colors are available with filters.

CIRCLE NO. 332

## Universal active filter extends to 300 kHz

Kinetic Technology Inc., 3393 De La Cruz Blvd., Santa Clara, Calif. 95050. (408) 296-9305. \$40 (100 up); stock.

The FS-30 high-frequency universal active filter ranges to 300 kHz. Multiloop negative feedback allows simultaneous high-pass, low-pass and bandpass transfer functions. Independent tuning of gain, center frequency and Q is accomplished with the addition of external resistors. Qs as high as 1000 are possible below 100 kHz. The FS-30 comes in a 14-pin DIP measuring 1.5 by 0.5-in. Operating temperature range is 0 to 70 C and power consumption is 156 to 225 mW at  $\pm$ 15 to  $\pm$ 20 V.

CIRCLE NO. 333

## Computer power supply is immune to line failure

Pioneer Magnetics, 1745 Berkeley St., Santa Monica, Calif. 90404. (213) 829-3305. \$395 (100s); 60 days.

Designated the Model PM2408 multiple output computer power supply, the new device provides immunity to ac-line failures and will operate under brownout and blackout conditions. Power outages up to 20 ms and longer do not affect normal operation. RFI filtering is provided on both input and output channels. In a typical 500-W configuration, the unit comes with three output channels: +5 V dc at 50 A, +15 V dc at 10 A, and -15 V dc at 5 A.

CIRCLE NO. 334

## Line of preamps offered for p-i-n photodiodes

United Detector Technology, Inc., 1732 21st St., Santa Monica, Calif. 90404. (213) 829-3357. 101A: \$95; 101B: \$195; 201A: \$225; 301A: \$145; stock.

UDT's current-sensing amplifiers are for use with the p-i-n silicon photodiodes. Both dc and ac current signals are linearly amplified and converted to a voltage output. They are designated the UDT-101A high-gain, medium-frequency preamp, the UDT-101B ultra-low-noise preamp, the UDT-201A broadband fast-rise preamp, and the UDT-301A sum-and-difference preamp. The 101B makes light detection possible from  $10^{-14}$  to  $10^{-9}$  W. The 101A is a general-purpose preamplifier. The 201A offers a 5-MHz bw.

CIRCLE NO. 335

## Frequency-to-analog unit offers 0.1% accuracy

Richard Lee Co., Box 724, New Providence, N.J. 07974. (201) 665-1333. \$37 (100-499); 2-4 wks.

Model 713 frequency-to-analog converter is designed for use in accurate rate measurement or monitoring instruments and systems. Accuracy is better than 0.1% FS. Input signals can be sine, square, triangular waves or pulses to 15 kHz. Input signal levels can be as low as 5 or 10 mV rms. Output is 0 to 1 mA into zero to 1750  $\Omega$ . Input impedance is 50 k $\Omega$ . Tempo is 0.015%/ $^{\circ}$ C max. Size is 1.5  $\times$  1.5  $\times$  0.6-in. Required power is 30 mA at 12 V dc.

CIRCLE NO. 336



**ANALOGY**  
YOU'RE A WINNER EVERYTIME WITH THE A-852 12-BIT, HIGH SPEED BINARY A/D. IT HAS A 4 $\mu$ S. CONVERSION TIME,  $\pm$ 5 PPM/ $^{\circ}$ C TEMPERATURE STABILITY AND LINEARITY OF  $\pm$  1/2 LSB. INSENSITIVE TO SUPPLY VARIATION. FOR COMPLETE ANSWERS, WRITE ANA.

**intech** INCORPORATED  
(408) 244-0500  
1220 COLEMAN, SANTA CLARA CA 95050



The U.S. Government does not pay for this advertisement. It is presented as a public service in cooperation with The Department of the Treasury and The Advertising Council.

# The Payroll Savings Plan helps you save some of your living for later.

Sure there are lots of things you want right now. Lots of things you need.

But, the sun's going to shine tomorrow, too.

That's why it's important you do something today to build a little nest egg for the future. And there's no easier way to do that than by joining the Payroll Savings Plan where you work. You sign up once and any amount you specify will be set aside from each paycheck and used to buy U.S. Savings Bonds.

The Payroll Savings Plan. The perfect way to help your good life stay that way.



Now E Bonds pay 5½% interest when held to maturity of 5 years, 10 months (4% the first year). Bonds are replaced if lost, stolen, or destroyed. When needed they can be cashed at your bank. Interest is not subject to state or local income taxes, and federal tax may be deferred until redemption.

**Take stock in America.**  
Join the Payroll Savings Plan.

## Thin-profile oscillator fits 14-pin DIP



*Bliley Electric, 2545 West Grandview Blvd., Erie, Pa. 16512. (814) 838-3571.*

Model CKO-31 clock oscillator is available for specified frequencies in the 300 kHz to 25 MHz range. The package is supplied with four pin-terminals that can be used for PC-board mounting or with a standard 14-pin DIP socket. The oscillator is designed for +5-V-dc operation with a logic output that will drive 10 TTL ICs. Frequency is maintained to within ±50 ppm over a 0 to 50 C temperature range.

CIRCLE NO. 337

## Low-cost s/d converters track at 4000 deg/s



*North Atlantic Industries Inc., Terminal Dr., Plainview, N.Y. 11803. (516) 681-8600. About \$650 per channel; stock.*

Series 780 Synchro Data Modules are designed for conversion in both directions (analog-to-digital, and digital-to-analog) for resolver and synchros. They are available in a wide range of operating voltages, frequencies and digital output codes. The modules provide 14-bit resolution at three minutes ±0.9 LSB accuracy for the S/D and R/D modes, and four-minute accuracy for the D/S and R/S modes of operation, at 0 to 70 C temperature range, and for input angles 0 through 360 degrees. Tracking rate is 4000 deg/s, with tracking accuracy defined by velocity constant,  $K_v$ , of 20,000 sec<sup>-1</sup>.

CIRCLE NO. 338

I'm an L.E.D. illuminated Capitol Switch... QUALITY and DEPENDABILITY... that's where I shine!



We're just part of the gang....

Top quality, dependable circuit selector push-button and lever switches...

many custom combinations and assemblies

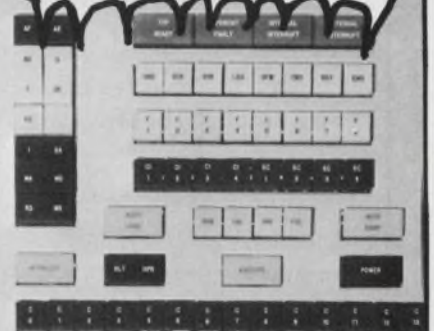

### ALTERNATE ACTION PUSH BUTTON SWITCHES

ILLUMINATED, NON-ILLUMINATED  
SINGLE POSITION, MULTIPLE POSITION

### LEVER SWITCHES

ILLUMINATED, NON-ILLUMINATED

### MOMENTARY PUSH BUTTON SWITCHES

ILLUMINATED, NON-ILLUMINATED  
SINGLE POSITION

### INTERLOCKING PUSH BUTTON SWITCHES

ILLUMINATED, NON-ILLUMINATED

### INDICATOR LITES

SINGLE POSITION, MULTIPLE POSITION

Write for our 24 page catalogue

Representatives in principal cities.

# CAPITOL SWITCHES

THE CAPITOL MACHINE & SWITCH CO.  
87 NEWTOWN RD. DANBURY, CONN. 06810

INFORMATION RETRIEVAL NUMBER 98

# 16 Bit D/A Converters with

## UNPARALLELED STABILITY

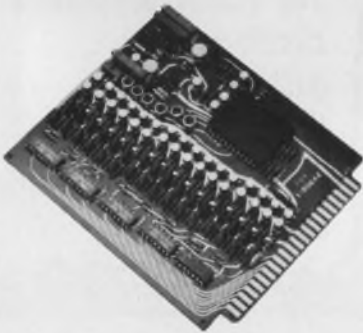

Note the features of  
Model 1670R:

Total Temp Coeff.: 5PPM/°C  
Resolution: .0015% FSR  
Absolute Accuracy: .005% FSR  
Linearity: .0015%  
Input Register included  
Settling Time: less than  
20  $\mu$ sec.

Other versions available:

Glitch-free  
12 thru 15 bits  
Settling time to 1  $\mu$ sec.

If it's stability, accuracy,  
speed, or all-around quality  
performance you need in D/A  
and A/D converters, get in  
touch with Phoenix Data now!



### PHOENIX DATA, INC.

3384 West Osborn Road  
Phoenix, Arizona 85017  
Ph. (602) 278-8528. TWX 910-951-1364

#### MODULES & SUBASSEMBLIES

### Photoelectric control uses remote optics

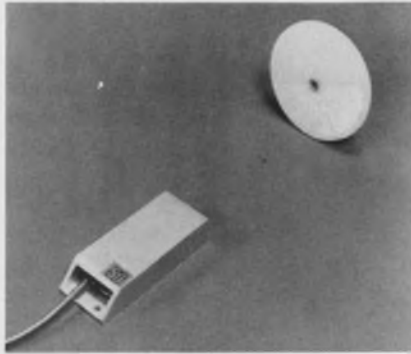

*Scientific Technology Inc., 1157  
San Antonio Rd., Mountain View,  
Calif. 94040. (415) 965-0910. \$119.*

Model 2034 is a reflex photoelectric control. A small, hermetically-sealed optics assembly may be mounted up to 100 feet from the supporting electronics. The controls, which use invisible infrared light, may be used in practically any environment, indoors or out. Range of the Model 2034 is 1 to 25 feet with a standard 3-in. retro-target. Additional targets extend the range. As a proximity sensor, unaided by a reflective target, the unit will detect the arrival or departure of almost any object up to 14 in. from an optics assembly.

CIRCLE NO. 339

### Miniature Xformer exhibits flat response

*Vanguard Electronics, 930 W. Hyde  
Park, Inglewood, Calif. 90302.  
(213) 678-7161. (1000); 3-4 wks.*

Series 18288 wideband transformer exhibits a virtually flat response curve at 25 mA dc. The curve at both zero load and 25 mA duplicates the reference sweep signal (1 to 110 MHz), providing a nearly noiseless device. The Series 18288 features a frequency range from 0.3 to 400 MHz and is offered in three standard configurations: unbalanced to balanced with no dc isolation; unbalanced to balanced with dc isolation; and unbalanced to unbalanced with no dc isolation. Impedance ranges from 50 to 200  $\Omega$ . The device measures only 0.25  $\times$  0.25  $\times$  0.125 in.

CIRCLE NO. 340

# Planning to write a book?

If you are contemplating writing a book in electrical or electronics engineering, we are most interested in hearing from you.

Hayden Book Company has active publishing and promotional programs for practical professional references and design aids, management guides, and fundamental texts and training materials.

### FREE AUTHOR'S GUIDE

The 32-page **Hayden Author's Guide** is yours for the asking, and contains useful information on preparing manuscript and illustrations, styling, and publishing procedures.

For a free copy write Irving Lopatin, Editorial Director, at the address below. Please outline your book idea as fully as possible in your letter.



**HAYDEN BOOK COMPANY, INC.**  
50 Essex Street  
Rochelle Park, New Jersey 07662

## Rejection filter attenuates to 38 dB

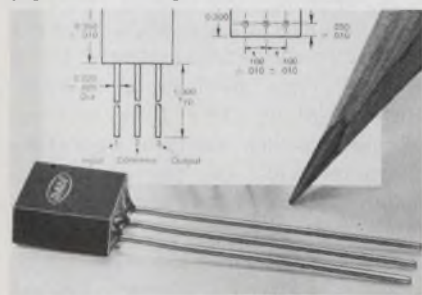

Dale Electronics, P.O. Box 74, Norfolk, Neb. 68701. (402) 371-0080. \$8.35 (100-500); 8-10 wks.

Available in three models—HCFP1001PB 60 Hz, HCFP1003-PB 50 Hz and HCFP1002PB 120 Hz, this new filter has the characteristics of a Twin-T RC filter and is most suitable for applications where the pass frequencies lie outside of the 0.4fn to 2.5fn range. The rejection filter produces optimum attenuation at 25 C ( $\pm 10$  C) with the rms input voltage less than 1.4 V and dc input voltage less than 10 V. The unit has a minimum of 38-dBV attenuation when tested at 25 C and 0.7-V rms input at the rejection frequency. Source and load impedance are 600- $\Omega$  max and 100-k $\Omega$  min. Dimensions are 0.375  $\times$  0.350  $\times$  0.200 in.

CIRCLE NO. 341

## Amplifier shows no drift with temperature change

Sierra Systems, 2255 Old Middlefield Way, Mountain View, Calif. 94040. (415) 969-3056. \$500 (1-4); 6 wks.

Model 615 power amplifier maintains an accurate power output level within  $\pm 0.1$  dB regardless of temperature or input drive level changes. Power output is adjustable by means of a 20-turn pot between the limits of 0.25 to 1.0 W. Constant output power is maintained over a temperature range of 0 to +65 C and with input level changes of -20 to 0 dBm. All harmonics and spurious signals, removed  $\pm 20\%$  from the desired signal, are suppressed a minimum of 60-dB below the output signal. Center frequency is factory tuned between 10 to 50 MHz. Dc requirements are +28 V. Size is 1  $\times$  2  $\times$  3 in.

CIRCLE NO. 342

# WRITE or PHONE TODAY FOR THIS FREE ILLUSTRATED CIRCUIT DESIGN CATALOG!



Here, in one idea-crammed catalog, are countless low-cost breadboard design pointers and test equipment that let you design, build, layout and test any combination of i.c. and discrete components without soldering and in complete safety. Plus, you'll find tremendous savings on many hard-to-find semiconductor components. Catalog includes . . .

- Inexpensive Circuit Design Testers • Plug-In Socket Boards • Logic Tester Probes • Breadboard/Sockets • Breadboarding Systems • Sophisticated Circuit Design/Interface Test Systems • Power Supplies • Pulse Generators
- Plus many, many more

Write or phone for your copy today! It's absolutely FREE!

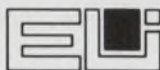

**EL INSTRUMENTS, INCORPORATED**

61 First Street/Derby, CT 06418 • phone 203/735-8774

INFORMATION RETRIEVAL NUMBER 101

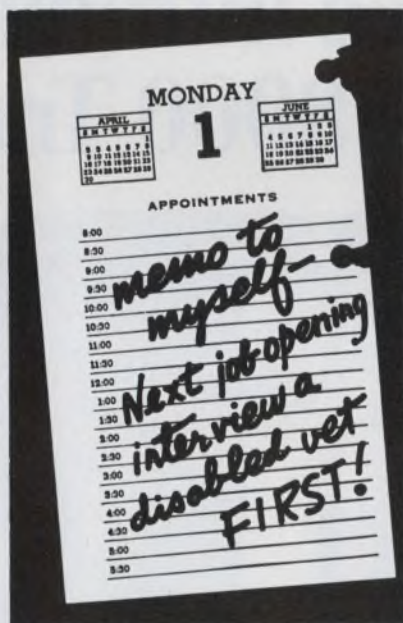

The President's Committee  
on Employment of the Handicapped  
Washington, D.C. 20210

## Less than 1 $\mu$ V Offset!

### New Ultra-Low Thermal emf Reed Relays!



- Unique new method (pat. pend.) virtually eliminates thermal offsets, permits use of almost any type reed switch . . . Hg wet, dry, high voltage.
- Remarkably independent of ambient temperature, environment.
- Many contact forms, pin configurations available.
- Units also available at less than 500 nanovolts per switch, or less than 1 $\mu$ V differentially between switches.
- Greater than 10<sup>11</sup> ohms isolation resistance.
- Rugged molded package. Moderate price.

Write for Complete New Catalog MR-6.1



**COTO-COIL COMPANY, INC.**  
59 Pavilion Avenue, Providence, R. I. 02905  
Tel: (401) 941-3355

INFORMATION RETRIEVAL NUMBER 102

## application notes

### Measurement handbook

The Handbook of Measurement and Control fills the application information gap on linear variable differential transformers and related transducer devices. The 228-page book begins with an introduction to measurements and describes in detail elementary transducer elements through design considerations of complete measurement systems. Mathematical discussions are minimized in favor of description, illustrations and other graphic presentations. The book is available free to design engineers whose specialty is transducer and controls instrumentation; copies to others are \$7.95 each. Schaevitz Engineering, Camden, N.J.

CIRCLE NO. 343

### Data conversion

Application notes on voltage-to-frequency and frequency-to-voltage converters include information on such applications as low-cost, high-common-mode-capability a/d converters, ultralinear voltage-controlled ramp generators, current-to-frequency conversion and high-resolution data-transmission systems, plus specifications on the company's low-cost modular converters. Teledyne Philbrick, Dedham, Mass.

CIRCLE NO. 344

### Solid-state modules

How to use solid-state function modules as basic building blocks in automated alarm, control and/or instrumentation systems is the subject of a 12-page paper. Applications discussed range from simple one-channel alarms to elaborate multichannel rack-mounted control systems. The booklet contains block diagrams and illustrations. Calex, Alamo, Calif.

CIRCLE NO. 345

### Display, optoelectronics

A 48-page "Solid-State Display and Optoelectronics Designer's Guide" contains data sheets for a line of opto devices and solid-state displays. The four sections of the catalog contain operating characteristics of photodetectors, isolators, LED lamps and displays. Each section has a selection guide. Hewlett Packard, Palo Alto, Calif.

CIRCLE NO. 346

### Microcircuit design

"The Microcircuit Designer's Handbook," a 24-page publication, features comprehensive guidelines for converting discrete component circuits into thick-film microcircuits. The fully illustrated handbook offers complete sections on microcircuit applications, designing by plan, production and product reliability. Beckman Instruments, Inc., Helipot Div., Santa Ana, Calif.

CIRCLE NO. 347

# Pertec introduces the new T8000 Transport.



SALES OFFICE: Los Angeles (213) 882-0030 • Orange County (714) 830-9323 • San Francisco (415) 964-9966 • Chicago (312) 696-2460



## Analog timers

General characteristics of digital and analog timers and counters are compared from the viewpoints of both users and equipment designers. Detailed comments and suggestions are provided on the effective use of analog timers for a variety of industrial, commercial and military applications. Curtis Instruments, Inc., Mount Kisco, N.Y.

CIRCLE NO. 348

## Function generators

An application note describes the demonstration of phase-locked-loop principles. Wavetek, San Diego, Calif.

CIRCLE NO. 349

## Flat cable

Reprints of two technical papers are devoted to a recently developed flat cable for fast-pulse applications in signal transmission. Ansley Electronics, Doylestown, Pa.

CIRCLE NO. 399

## FETs as analog switches

An application note describes the characteristics of field-effect transistors when used as analog switches. The paper deals with behavior of junction FET, PMOS FET and CMOS FET switches and associated driver circuits. Topics discussed include device performance tradeoffs for ON and OFF switch states, solutions to specific load problems and selection of drivers for various circuit functions. Siliconix, Santa Clara, Calif.

CIRCLE NO. 400

## Contamination in ICs

A 45-page manual offers solutions to the particulate contamination problems encountered most frequently in photomask and wafer production. Application Manual AM501 contains instructions on solving such problems, including recommended equipment and schematic installation diagrams. Millipore Corp., Bedford, Mass.

CIRCLE NO. 401

## Analyzing faults

An application note describes the use of the AEDCAP circuit-simulation system for analyzing faults in electronic circuits. SofTech, Waltham, Mass.

CIRCLE NO. 402

## PM motors

An eight-page guide to proper selection of NEMA dc permanent magnet motors for adjustable-speed applications stresses the importance of extensive testing and analysis of specific application needs. Indiana General, Oglesby, Ill.

CIRCLE NO. 403

## Teleprinter interfaces

A six-page technical report describes a representative list of specially engineered teleprinter interfaces to minicomputers, card readers, plotters and other devices. Western Union Data Services, Mahwah, N.J.

CIRCLE NO. 404

# Packed with customer inspired features. At the same low price.

Now you can have the easiest tape loading and the most rugged transport for your data entry, remote terminal, or minicomputer system. And it won't cost you any more.

Pertec introduces new 10½-inch reel tape transports with increased data reliability and convenient new features that you have been looking for. Like an all new quick-lock hub which automatically seats the tape reel. Retractable tension arms and contoured head cover for easier tape loading. A new tape cleaner. A fast 200 ips rewind speed. Rotatable card cage for ease of maintenance. And a rugged, attractive new design to enhance your own system.

And these IBM compatible transports also have all the standard Pertec reliable features such as single-adjustment electronic write deskewing, remote edit capability, dynamic braking, photo-sensing arm positioner, low power consumption and temperature stable head guide assembly.

Pertec T8000-Series transports are available in 7 or 9 track, NRZI or 1600 cpi phase encoded or the new NRZI/PE electronically switchable tape formats. They're completely compatible with the popular Pertec 6000-Series transports and our own exclusive data formatter. Tape speed is up to 45 ips and you can choose from a variety of models including read only.

Pertec's new T8000 transports are backed by a complete factory-trained customer service and support organization in 30 U.S. cities and 20 foreign countries. We also offer complete application assistance to help you in your special requirements.

For more information on the new Pertec T8000 transport and the company behind it, write or call today. Pertec Corporation, Peripheral Equipment division, 9600 Irondale Avenue, Chatsworth, California 91311. (213) 882-0030.

# PERTEC

Boston (617) 890-6230 • Washington, D.C. (301) 942-5540 • New York (203) 966-3453 • Detroit (313) 769-4376 • London Reading 582115

INFORMATION RETRIEVAL NUMBER 104

## new literature



### Load cells

Low-profile load cells and related products for force measurements are described in a 16-page catalog. The catalog details electrical and mechanical specifications and prices for cells in ranges from 50 to 200,000 pounds. Interface, Inc., Scottsdale, Ariz.

CIRCLE NO. 405

### Servo system components

Industrial servo-system components designed for automatic control applications are featured in a 12-page catalog. Motor-pots, amplifiers, power supplies and command pots and dials are fully described. Charts, photographs and specifications support the text. Beckman Instruments, Fullerton, Calif.

CIRCLE NO. 406

### Foot switches

Open and shielded foot switches are described in a six-page illustrated folder. Included is information on the company's single-stage, standard-form foot switches which meet OSHA requirements. Features and descriptions are given, along with contact operation, ordering information, ratings and outline drawings with dimensions. General Electric Co., Scotia, N.Y.

CIRCLE NO. 407

### Switches

Specifications on nine basic series of thumbwheel and leverwheel switches available in a full range of alphanumeric readouts and output codes are included in an eighteen-page guide. Cherry Electrical Products, Waukegan, Ill.

CIRCLE NO. 408

### Infrared arrays

Wide sensitivity and fast response characteristics of dual-module infrared source-and-sensor arrays, wavelength outputs, electrical characteristics, drop-in packaging and ratings specifications are described in a four-page bulletin. Plots of pertinent typical characteristics, including interface and speed characteristics for digital IC outputs, are on the back cover. Sensor Technology, Chatsworth, Calif.

CIRCLE NO. 409

### JAN ICs

A simplified guide (CB-151) to specifying JAN integrated circuits answers questions and clarifies misunderstandings that have arisen because of the complexity of qualification specifications and procedures. A cross-reference between JAN and standard catalog part numbers is provided. The JAN class, package and lead-finish codes are defined along with the company's standard package and lead-finish combinations. A chart of recommended usage is also included. Texas Instruments, Dallas, Tex.

CIRCLE NO. 410

### Molding materials

A four-color, 24-page ready-reference guide describes physical and electrical properties of thermosetting molding materials, including phenolics, diallyl phthalates and alkyds. Durez Div., N. Tonawanda, N.Y.

CIRCLE NO. 411

### Tantalum capacitors

Complete MIL-Spec references, including the most recent revisions of the Established Reliability specs, and separate color-coded sections on wet and solid tantalum capacitors with specific application notes are featured in a 162-page catalog. National Components Industries, W. Palm Beach, Fla.

CIRCLE NO. 412

### Inductive devices

Technical and performance specifications, dimensional data and military part numbers, where applicable, for inductive devices and custom networks are described in a 24-page, two-color brochure. Included are molded rf chokes, encapsulated subminiature and miniature toroidal and variable inductors, wideband transformers, computer pulse transformers, transfer-molded dual-inline pulse transformers, DIP delay lines, DIP custom networks, shielded plug-in coils, SCR trigger transformers, double balanced mixers, diode switches and miniature rf filters. Vanguard Electronics, Inglewood, Calif.

CIRCLE NO. 413

### Pushbuttons

A pushbutton selection guide includes a selection matrix, actual-size color photographs and a reference fold-out. The guide describes mounting, display options, lamp data, relamping, legending, button size, panel front area, depth behind panel, panel seal, bailing coils, modularity, agency listing, switch rating/action and circuitry/termination. Micro Switch, Freeport, Ill.

CIRCLE NO. 414

### Spectrum analyzer

An eight-page brochure presents performance advantages and operating features of the 7L12 spectrum analyzer. The brochure is illustrated with actual displays. Tektronix, Beaverton, Ore.

CIRCLE NO. 415

### Storage tubes

A brochure describes the company's line of direct-view storage tubes. ITT Electron Tube Div., Roanoke, Va.

CIRCLE NO. 416

# Yuasa introduces powerful, rechargeable baby batteries.

Power-packed nickel-cadmium batteries from Yuasa. Made to last longer than most similar cells. And re-charge faster, too.

Yuasa is Japan's leading battery manufacturer. In 50 years of activity Yuasa has built a reputation for advanced techniques and innovation in storage battery manufacture.

The very same expertise went to work to make Yuasa's new baby batteries.



**YUASA BATTERY CO., LTD.**

12-7, 8-Chome, Ginza, Chuo-ku, Tokyo 104, JAPAN

INFORMATION RETRIEVAL NUMBER 105

## STRIP-BUS by Rogers

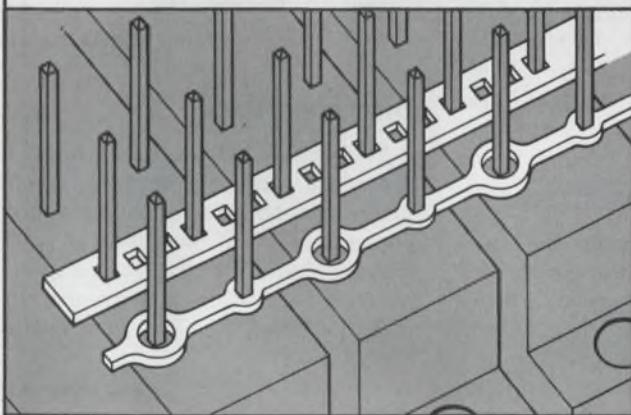

**Low Cost Bussing Systems  
Easy Installation  
Reliable Solder Joints  
Greater Pin Exposure**



Write or call for details

Rogers Corporation / Rogers, Conn. 06263 (203) 774-9605

INFORMATION RETRIEVAL NUMBER 106

ELECTRONIC DESIGN 8, April 12, 1973

## FREE SAMPLE

DO-IT-YOURSELF PRECISION  
RESISTORS,  
ON THE SPOT,  
AT LOW  
PRICES ?  
**YOU  
BETTER  
BELIEVE  
IT!**



It's easy with Chronomite's new low-cost INSTANT OHM Resistor Kits. Each kit contains 6 polyurethane enamel insulated Karma and Manganin resistance wire sizes, ranging from .4 ohms to 30 ohms per foot, plus 11 glass epoxy bobbins, plus engineering data. It's new, low-cost, and gives you everything needed to make unlimited resistance selections. ALL FOR JUST \$12.95 PER KIT.

### SPECIFICATIONS

- Low noise - .05MV<sup>0</sup>C.
- Thermal stability - 10 ppm.
- Non-magnetic.
- Average tensile strength- 180,000 PSI.
- Temp. coefficient Karma- .0002 between 50<sup>0</sup>-105<sup>0</sup>C.
- Temp. coefficient Manganin - .000015 between 15<sup>0</sup>- 35<sup>0</sup>C.
- Thermal EMF against copper- less than .003MV<sup>0</sup>C.

FREE SAMPLES TO PHONE OR LETTERHEAD REQUESTS. Call or write today.

CHRONOMITE LABORATORIES

21011 So. Figueroa St. Carson, California 90745  
(213) 320-9452.

INFORMATION RETRIEVAL NUMBER 107



As one of the leading innovators in the telephone industry, we'd like to talk Diagnostic Programming with you.

We currently have a number of creative positions which require individuals able to design fault recovery and diagnostic programs for stored program, electronic switching systems. Experience in software and hardware design of large real time, multi-processing systems with *automatic* malfunction detection, recovery and diagnostics is required. Familiarity with on-line, multi-programming design and testing, using assembly language techniques is a must, in addition to knowledge of software loading processes and all phases of testing (on-line, batch and hands on).

Individuals with a technical degree are preferred, and a minimum of two years' experience is required.

Interested? Please submit your detailed resumé and salary requirements to:

**Mr. Dennis Kave**  
Professional Employment

**GTE AUTOMATIC ELECTRIC LABORATORIES**

400 North Wolf Road, Northlake, Ill. 60164  
An Equal Opportunity Employer

## NEW LITERATURE

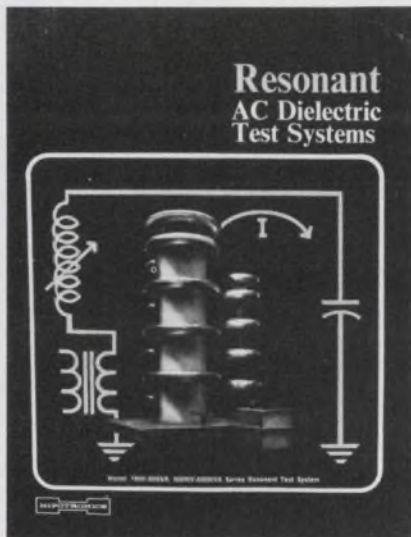

### Ac dielectric test systems

A 16-page, two-color brochure describes resonant ac dielectric test systems. Both the series resonant and parallel resonant techniques are described, and models of both types are illustrated along with block diagram analyses and diagrams. Hipotronics, Inc., Brewster, N.Y.

CIRCLE NO. 417

### Oscillators

An eight-page catalog describes F300 series oscillators. Complete specifications and application data are included. Ailtech, City of Industry, Calif.

CIRCLE NO. 418

### Minimodule power supplies

Bulletin 1172 outlines the features of the RMX minimodule series designed for use with photo-multipliers, Geiger-Mueller tubes, ionization gauges, CRTs, image intensifiers, electron beam systems, scintillation counters and other applications. Detailed specifications are included along with outline drawings, pictures and complete installation instructions. The  $2 \times 2$ -in. modules are available in output voltage ranges as low as 400 V dc and as high as 4 kV dc. Spellman High Voltage Electronic Corp., Bronx, N.Y.

CIRCLE NO. 419

### Rf power modules

Rf power-module characteristics are summarized in a technical data sheet. The devices, types MX7.5 and MX12, are rugged power-amplifier functions designed for 12-V broadband uhf applications. Electrical specifications, a photograph and outline drawings are included. Engineering information on gain control of the units is provided along with a section on drive limiting and another on voltage protection. A typical transfer characteristic curve is shown. TRW Semiconductors, Lawndale, Calif.

CIRCLE NO. 420

### Glass-sealed connectors

A 28-page hermetic-seal handbook includes general information on glass-sealed connectors, leak-rate conversion charts, contact sizes and resistance values, materials usage and applicable MIL specs. ITT Cannon Electric, Phoenix, Ariz.

CIRCLE NO. 421

### Differential amplifiers

A four-page brochure describes the 700-series differential amplifiers. The bulletin shows how low-level transducer signals are reproduced for recording or readout devices for direct-writing oscillographs to wideband magnetic-tape recorders. B & F Instruments, Cornwells Heights, Pa.

CIRCLE NO. 422

### Disc recorders

Wideband instrumentation disc recorders and their applications are described in an eight-page brochure. Specifications, typical block diagrams and information on available configuration options are included. Data Disc, Inc., Sunnyvale, Calif.

CIRCLE NO. 423

### Variable attenuators

A four-page brochure details absorptive solid-state variable attenuators and absorptive nanosecond switches. The catalog contains electrical and physical specifications and performance curves. Hyletronics Corp., Littleton, Mass.

CIRCLE NO. 424

## Precision resistors

Bulk metal-film precision resistors are featured in an eight-page brochure. An informative chart compares the performance of the company's resistors to wirewound and metal-film units when tested against MIL-R-10509E and MIL-R-93C. Another chart outlines various styles available, dimensions in both decimal and metric units, value ranges, wattage ratings and working voltages. The brochure discusses shelf and load-life stability, high-frequency and nonmeasurable noise characteristics of the resistors. Vishay Resistor Products, Malvern, Pa.

CIRCLE NO. 425

## Graphic tablet

A graphics tablet, the 10-bit Model GT50/10, is featured in a catalog. The manual contains specifications of graphic, control, electrical and mechanical features, a detailed description of the theory of operation, uses of the tablet, interface specifications, maintenance aid and information on installation and operation. Computek, Cambridge, Mass.

CIRCLE NO. 426

## Fasteners

The full range of the company's fasteners and drive systems is detailed in a 16-page, two-color brochure. The booklet presents the capabilities of its self-drilling fasteners, thread-forming screws for both metal and plastics and prevailing torque fasteners. Accompanying the individual product's major features are application case histories. Elco Industries, Rockford, Ill.

CIRCLE NO. 427

## IC package material

Properties and test results of a new semiconductor IC package material, Epoxy B, are described in a 16-page booklet. The report includes background information on the development of Epoxy B and the results of various studies conducted by the company on devices made with Epoxy B. National Semiconductor, 2900 Semiconductor Dr., Santa Clara, Calif. 95051.

## Motors

The Quiet-Line, medium sized ac motors are described in a four-page data sheet and price list. The illustrated booklet provides descriptive data on the motors, as well as detailed charts giving the sound levels (both sound pressure and sound power) for the T and the U-frame motors at various ratings. Westinghouse, Pittsburgh, Pa.

CIRCLE NO. 428

## PC connectors

An 88-page connector catalog covers printed card and flexible cable applications. Electrical and mechanical specifications, illustrations, outline drawings and ordering information are contained in the catalog. Continental Connector Corp., Woodside, N.Y.

CIRCLE NO. 429

## Instrumentation

Equipment described in a 32-page catalog is intended for low-frequency-to-microwave test purposes, EMI/RFI testing, two-way radio servicing, CATV, etc. Signal generators, communications service monitors, spectrum analyzers, EMI/RFI instrumentation, sweep oscillators, marker generators, network analyzers, microwave amplifiers and components, rf components, ac instrumentation, synchro/resolver instrumentation, ratio and special transformers are included. Singer Instrumentation, Los Angeles, Calif.

CIRCLE NO. 430

## Antennas

Land mobile communication antenna systems are described in a colorful, 74-page catalog. Also described are mounting hardware and accessories, cavity resonators and duplexers, matching harnesses plus coaxial cable and cable systems. A section details technical data which incorporates patterns, a diagrammatic presentation of base station antenna installation procedure and curves indicating antenna performance. Phelps Dodge Communications Co., Marlboro, N.J.

CIRCLE NO. 431



As one of the leading innovators in the telephone industry, we'd like to talk Hardware Design with you.

We have openings available for System Hardware Design Engineers who will be responsible for the hardware design and development of medium and large scale, stored program, electronic switching systems. Ability to comprehend the system as a whole and make appropriate trade-off decisions is necessary. Involvement will be in originating, planning and designing circuits for new systems or modifying existing ones.

These positions require a BSEE or MSEE with relevant design experience.

Interested? Please submit your detailed resume and salary requirements to:

Mr. Dennis Kave  
Professional Employment

**GTE** AUTOMATIC  
ELECTRIC  
LABORATORIES

400 North Wolf Road, Northlake, Ill. 60164  
An Equal Opportunity Employer



Thin-Trim variable capacitors provide a reliable means of adjusting capacitance without abrasive trimming or interchange of fixed capacitors. Series 9401 has high Q's and a range of capacitance values from 0.2-0.6 pf to 3.0-12.0 pf and 250 WVDC working voltage. Johanson Manufacturing Corporation, Boonton, New Jersey (201) 334-2676.

INFORMATION RETRIEVAL NUMBER 181

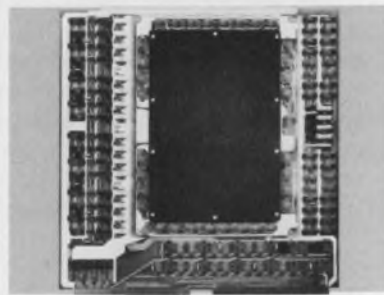

Digital computer controls has developed the only 16K by 16 bit memory subassembly on a single 15" x 15" PC board. The 116875 can expand their D-116 memory to 64K in a 5 1/4" chassis. Compatible with the "Nova 1200" series computers. \$5225 for a single board. Digital Computer Controls Inc., Fairfield, N.J. 07006. (201) 227-4861.

INFORMATION RETRIEVAL NUMBER 182

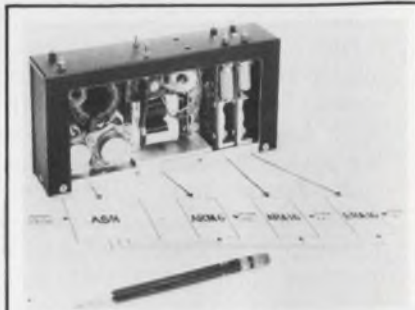

Miniaturized/modular power supplies. AC or DC inputs with up to 6 isolated and regulated DC outputs to 150 watts. Over 1200 "Design As You Order" configurations using standard sub-modules. Completed systems provided in pretested, encapsulated miniature packages. Immediate delivery. Arnold Magnetics, Culver City, Ca. (213) 870-7014.

INFORMATION RETRIEVAL NUMBER 183



Free catalog of 32,000 power supplies from the worlds largest manufacturer of quality Power Supplies. New '73 catalog covers over 32,000 D.C. Power Supplies for every application. All units are UL approved, and meet most military and commercial specs for industrial and computer uses. Power Mate Corp. (201) 343-6294.

INFORMATION RETRIEVAL NUMBER 185



400 Ideas for Design, Vol. 2, Edited by Frank Egan. Ready to borrow, modify, or adapt, the top recent contributions to Electronic Design's popular "Ideas for Design" column range from amplifiers to switching circuits. 288 pp., illus., cloth, \$11.95. Circle below for 15-day examination copies. Hayden Book Co., New York, N.Y. 10011.

INFORMATION RETRIEVAL NUMBER 186

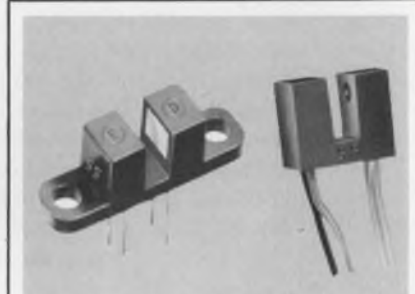

Hermetically sealed optical switch: Contains discrete matched hermetic LED/photo transistors. DTL/TTL compatible output. SSOS-700 straight package. SSOS-800 package with flange. Gap dimension between photo transistor & LED is .110". Solar Systems, Inc., 8124 Central Park, Skokie, Ill. 60076. Phone: (312) 676-2040.

INFORMATION RETRIEVAL NUMBER 187

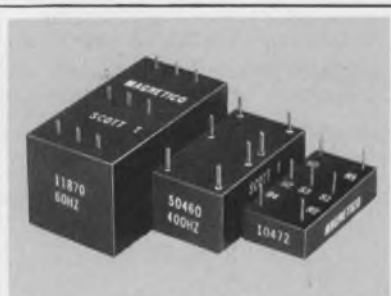

Scott T Transformer. 11870: 60HZ, 90v, L-L In. 1.1x2.1x1.1. 50460: 400HZ, 90v, L-L In. 7/8x1-5/8 x11/16. 50642: 400HZ, 11.8v, L-L In. 7/8x1-5/8x11/16. 10472: 400HZ, 11.8v, L-L In. 3/4x1-1/2x3/8. All with 6v RMS sine & cosine output. MAGNETICO, INC., E. Northport, N.Y. 11731. 516-261-4502.

INFORMATION RETRIEVAL NUMBER 189

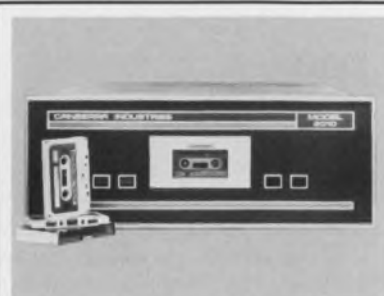

Designed specifically for OEM applications, the Canberra Model 2010 offers a hi-speed, ultra-reliable alternative to paper tape at a very competitive price. The 2010 is plug and format compatible with the field-proven Model 2020 triple drive unit. CANBERRA IND. 45 Gracey Ave., Meriden, Ct. 06450, (203) 238-2351.

INFORMATION RETRIEVAL NUMBER 190



Electronic high voltage load for static and dynamic testing of high voltage sources to 30 kV at 2 mA. Switches two independently adjustable load levels from dc to 100 kHz. Provides for ripple, regulation, and recovery time in a single display. Advanced High Voltage Co., 14532 Arminta St., Van Nuys, CA 91402. (213) 997-7222.

INFORMATION RETRIEVAL NUMBER 191

# bulletin board

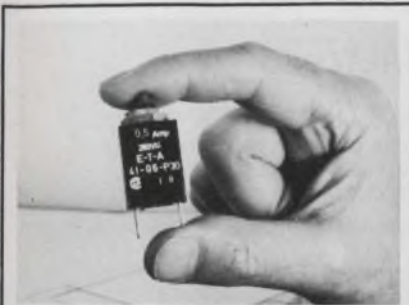

**Overcurrent protector**, manual reset eliminates fuse replacement. Convenient panel mounting. 15 fractional ratings from 0.1 to 3 amp. Other models up to 400 amp. UL and CSA approved. 93 cents ea. In 1000 lots. E-T-A Products Co. of America, 6284 N. Cicero Ave., Chicago, Ill. 60646. Tel: (312) 545-1553.

INFORMATION RETRIEVAL NUMBER 184

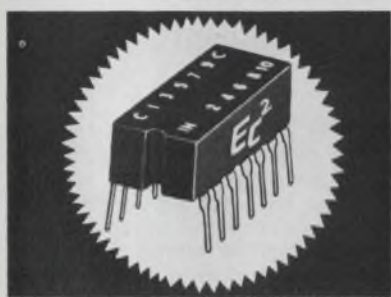

**EC<sup>2</sup>** offers over 200 "DIP Series" Lumped-Constant Delay Lines with delays from 4 to 150 nanoseconds. Packaged in a low silhouette, epoxy encapsulated, 14-pin dual in-line configuration, DIPs feature either fixed or tapped delays. Engineered Components Company, 2134 W. Rosecrans Avenue, Gardena, California. 90249. (213) 321-6565.

INFORMATION RETRIEVAL NUMBER 188

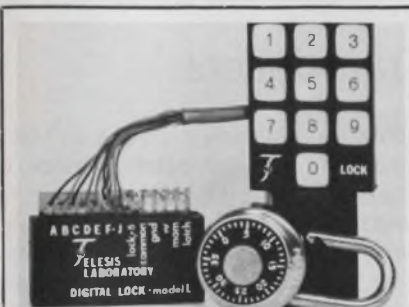

**Low cost digital combination lock** Model L input keyboard and control module. Momentary and latched outputs are enabled by easily programmed 5 digit code(s). Actuation by a 'drunk' or 'observer' may be prevented. Under \$40. +5 to 30V at 30mA. Telesis Laboratory, Box 387 Chillicothe, OH. 45601 (614) 773-1414

INFORMATION RETRIEVAL NUMBER 192

Honeywell has announced the addition of the **Model 2030A computer** to its Series 2000 line and an increased access and retrieval capability to its Series 2000 and 200 disc equipment. Additional main memory doubles the capacity of the Models 2050A and 2070 computers to a maximum of more than one-million characters.

CIRCLE NO. 432

Six families of **npn and pnp silicon Versawatt transistors** for power-amplifier and high-speed-switching applications in complementary-symmetry circuits have been announced by the RCA Solid State Div.

CIRCLE NO. 433

The Varian Instrument Div. has established direct sales and service in the U.S. for its line of **potentiometric strip-chart recorders**.

CIRCLE NO. 434

Texas Instruments has announced the availability in production quantities of 27 **JAN (Joint Army Navy) integrated circuits** meeting Class B reliability requirements of military specification MIL-M-38510.

CIRCLE NO. 435

Allied Electronics has announced a **guaranteed delivery program** for well-known brand-name merchandise, which it is currently advertising.

CIRCLE NO. 436

Ampex Corp. has announced the availability of **all-ferrite replacement heads** warranted for 4000 hours for **Model FR-1400 instrumentation recorder/reproducers**. Previously, the all-ferrite heads were available only as original equipment and for replacements on FR-2000 and FR-1900 recorders.

CIRCLE NO. 437

A 1% Acceptability Quality Level (AQL) and a two-year warranty on all functional requirements of **Hall-effect keyboards** has been announced by **Micro Switch**.

CIRCLE NO. 438

Plessey Montvale has announced price increases averaging 50 cents per thousand on **stamped lead frames** for dual in-line packages.

CIRCLE NO. 439

ITT Data Equipment and Systems Div. has announced a full line of **receive-only printers** to complement the Asciscope CRT display terminal. The RO printers include units operating at 10 and 30 characters per second, friction or sprocket feed, printing up to six copies, plus a 30-character-per-second thermal printer. Prices range from \$50 to \$130 per month, including maintenance.

CIRCLE NO. 440

## Price reductions

Motorola has announced a price reduction for **npn silicon-photo-transistors** in quantities of 100 to 999. The MRD300 has been reduced to \$1.75 from \$7; MRD310 down to \$1.50 from \$3; MRD3055 reduced to \$0.95 from \$1.40; and the MRD3056 lowered to \$1.10 from \$1.60.

CIRCLE NO. 441

Opto-Logic Corp. has announced price cuts up to 40% across the board in the 147,000-bit version of its **optical slide programmable read-only memory**.

CIRCLE NO. 442

The Microwave and Optoelectronics Div. of Fairchild Camera & Instrument Corp. has announced across-the-board price reductions in its line of **solid-state lamps**, with reduction up to 60% in large quantities for some units.

CIRCLE NO. 443

ELECTRONIC DESIGN's function is:

- To aid progress in the electronics manufacturing industry by promoting good design.
- To give the electronic design engineer concepts and ideas that make his job easier and more productive.
- To provide a central source of timely electronics information.
- To promote communication among members of the electronics engineering community.

**Want a subscription?** ELECTRONIC DESIGN is sent free to qualified engineers and engineering managers doing design work, supervising design or setting standards in the United States and Western Europe. For a free subscription, use the application form bound in the magazine. If none is included, write to us direct for an application form.

If you do not qualify, you may take out a paid subscription for \$30 a year in the U.S.A., \$40 a year elsewhere. Single copies are \$1.50 each.

**If you change your address,** send us an old mailing label and your new address; there is generally a postcard for this bound in the magazine. You will have to requalify to continue receiving ELECTRONIC DESIGN free.

**The accuracy policy of ELECTRONIC DESIGN is:**

- To make diligent efforts to ensure the accuracy of editorial matter.
- To publish prompt corrections whenever inaccuracies are brought to our attention. Corrections appear in "Across the Desk."
- To encourage our readers as responsible members of our business community to report to us misleading or fraudulent advertising.
- To refuse any advertisement deemed to be misleading or fraudulent.

Microfilm copies are available of complete volumes of ELECTRONIC DESIGN at \$19.00 per volume, beginning with Volume 9, 1961. Work is now in process to complete the microfilm edition of Volumes 1-8. Reprints of individual articles may be obtained for \$2.00 each, prepaid (\$.50 for each additional copy of the same article) no matter how long the article. For further details and to place orders, contact the Customer Services Department, University Microfilms, 300 North Zeeb Road, Ann Arbor, Michigan 48106 telephone (313) 761-4700.

**Want to contact us?** If you have any comments or wish to submit a manuscript or article outline, address your correspondence to:

Editor  
ELECTRONIC DESIGN  
50 Essex Street  
Rochelle Park, N.J. 07662

## FREE TUTORIAL ON REAL-TIME ANALYZERS

11  
QUESTIONS  
YOU SHOULD  
ASK WHEN  
BUYING A  
REAL-TIME  
SPECTRUM ANALYZER

federal scientific



For application in the fields of  
VIBRATION—diagnose complex machinery.  
NOISE—identify sources.  
UNDERWATER—detect faint signals.

Federal's latest Tutorial Brochure answers such meaningful questions as:

- Why do I need real time?
- How much resolution do I really need?
- Can I calibrate frequency and amplitude quickly and accurately?
- Do I need spectrum averaging?
- How can I compare past data with new data?
- How do I know I am analyzing (or averaging) valid data?
- Can I interface to my computer?

CIRCLE NO. 171

## FEDERAL SCIENTIFIC CORP.

An affil. of Nicolet Instrument  
615 West 131st St., New York, N.Y. 10027 (212) 286-4400

## Measure Vector Angle, Magnitude And Components



The new PAR<sup>TM</sup> Model 129A Two Phase Lock-In/Vector Voltmeter, enables you to simultaneously measure the magnitude and phase angle with respect to a reference signal of virtually any low-level signal within its range of 0.5 Hz to 100 kHz—even if the signal is buried 60 dB beneath background noise. At the flip of a switch, you can also measure the in-phase and quadrature components of the vector. The Model 129A features fully automatic reference tracking, independent output expansion and filtering for each channel. Complete specifications are contained in bulletin T-314, available on request.

CIRCLE NO. 172

## PRINCETON APPLIED RESEARCH CORPORATION

P.O. Box 2565  
Princeton, New Jersey 08540

## Practical Instrumentation Transducers



A thorough, authoritative information source on transducer selection and use. This well-planned guide by Frank J. Oliver covers virtually every known device for industrial or aerospace application. Stressing topics neglected elsewhere, it clarifies such areas as interference problems in hard-wire telemetry systems, and transducers as feedback devices in servo systems. Hundreds of diagrams, charts, and tables included. 352 pp., 7-1/8 x 9-3/4, illus., cloth, \$20.00. Circle the reader-service number for 15-day examination copies.

CIRCLE NO. 173

## Hayden Book Company, Inc.

50 Essex Street  
Rochelle Park, N.J. 07662



# Manufacturers

Advertisements of booklets, brochures, catalogs and data sheets. To order use Reader-Service Card.  
(Advertisement)

## 150 DIFFERENT DIGITAL POWER SUPPLIES



Kepeco's digital controllers mate with any of the some 150 programmable voltage and current stabilizers. You can easily put together a digital power supply from 10 to 100 watts up to 1000 volts, unipolar or bipolar, using one of the programming interfaces described in Kepeco's new eight page booklet.

CIRCLE NO. 174

**KEPCO, INC.**  
131-38 Sanford Avenue  
Flushing, N.Y. 11352

## EXTRUDED HEAT SINKS WALL CHART



Now available is a short form catalog that opens into a convenient wall chart featuring 107 popular standard models of TOR™ aluminum heat sink extrusions. Accompanying a drawing of each model is the size of the dissipating surface, thermal resistance and weight. Also included are the various standard hole patterns, stud clearance hole options and extrusion tolerances. The introduction of Models 1722A and 1722B Forced Convection Heat Sinks is featured in the catalog. Incorporating new ideas in heat sink design, units are half the size and weight of conventional units at a 20% to 40% cost reduction.

CIRCLE NO. 175

Heat Sink Division  
**PRECISION DIPBRAZE TOR, INC.**  
14715 Arminta Street  
Van Nuys, California 91402  
(213) 786-6524

## Why Test Semi-Conductors For Noise?



The **QUAN-TECH NOISE FILE** contains technical reports on the nature and origin of electrical noise in semi-conductors.

The effects of noise in terms of impaired performance have been widely recognized, and the **RELATIONSHIP BETWEEN NOISE AND COMPONENT RELIABILITY** generally accepted in the electronic industry. Thus the analysis of electrical noise generated by components is not only vital to the development and production of low-noise circuits, but also is becoming of major importance in achieving maximum reliability of instrumentation.

Instruments are available for testing noise of transistors, and thin film circuits. Applications include Incoming Inspection, Laboratory Studies, and High-Speed Production Testing.

CIRCLE NO. 176

**Quan-Tech**  
Div. of KMS Industries, Inc.  
43 South Jefferson Road  
Whippany, N. J., 07981

# Electronic Design

## Advertising Sales Staff

Tom W. Carr  
Sales Manager

## Rochelle Park, N.J. 07662

Robert W. Gascoigne  
Daniel J. Rowland  
50 Essex Street  
(201) 843-0550  
TWX: 710-990-5071

## Philadelphia

Thomas P. Barth  
50 Essex Street  
Rochelle Park, N. J. 07662  
(201) 843-0550

## Boston 02116

Richard L. Green  
20 Columbus Avenue  
Boston, Mass.  
(617) 482-7989

## Chicago 60611

Thomas P. Kavooras  
Berry Conner, Jr.  
200 East Ontario  
(312) 337-0588

## Cleveland

Thomas P. Kavooras  
(Chicago)  
(312) 337-0588  
(call collect)

## Los Angeles 90303

Stanley I. Ehrenclou  
Burt Underwood  
2930 Imperial Highway  
Inglewood, Calif  
(213) 757-0183

## San Francisco 94022

Jerry D. Latta  
P.O. Box 1248  
Los Altos, Calif.  
(415) 965-2636

## London W. 1

For United Kingdom and Holland  
Brayton C. Nichols

For Eastern Europe  
Peter Kehr

The American Magazine Group  
9 Warwick Street  
London, W. 1, England  
Phone: 437 5462

Cable: Ammagnic, London

## 4800 Verviers, Belgium

For Continental Europe

Andre Jamar  
Rue Mallar, 1  
(087) 253.85 Telex 41563

## Tokyo

Haruki Hirayama  
Electronic Media Service  
5th Floor, Lila Bldg.,  
4-9-8 Roppongi  
Minato-ku  
Phone: 402-4556  
Cable: Electronicmedia, Tokyo



**AMERICAN BUSINESS PRESS, INC.**

# advertiser's index

Advertiser	Page
AMP, Incorporated	52, 53
Adams & Westlake Company, The	141
Advanced High Voltage Co.	170
Airpax Electronics, Cambridge Division	143
Allen-Bradley Co.	31
American Lava Corporation	27
Amperite	54
Ampex Computer Products Division	24
Amphenol, RF Division of Bunker-Ramo Corporation	35
Anaonic, Inc.	142
Arnold Magnetics	170
Associated Testing Laboratories, Inc.	159
Barber-Coleman Company	144
Bendix Corporation, The, Computer Graphics	149
Boonton Electronics Corporation	155
Bourns, Inc., Trimpot Products Division	18
Bud Radio, Inc.	55
Burr-Brown Research Corporation	56, 57
Canberra Industries	170
Capitol Machine & Switch Co., Inc.	161
Centralab, the Electronics Division of Globe-Union, Inc.	100
Chicago Miniature Lamp Works	105
Chronomite Laboratories	167
Cimron	13
Collins Radio Company	177
Co-Ord Switch, A Division of LVC Industries, Inc.	147
Coto Coil Company, Inc.	163
Custom Electronics, Inc.	138
Cutler-Hammer	21
Data Display Products	7
Data Specialties Inc.	154
Digital Computer Controls, Inc.	170
Dow Corning Corporation	14, 15
EL Instruments, Inc.	163
ENM Company	139
E-T-A Products Co. of America	171
Eagle-Picher Industries, Inc.	139
Elco Corporation	11
Electrical Plastics Corporation	136
Emerson & Cuming, Inc.	66
Engineered Components Co.	171
Erie Technological Products, Inc.	33
Exar Integrated Systems	1
Fairchild Semiconductor, A Division Fairchild Camera and Instrument Corporation	90, 91
Federal Scientific Corporation	172
Fluke Mfg. Co., Inc., John	23

Advertiser	Page
GTE Automatic Electric	68, 69
GE Automatic Electric Laboratories	168, 169
General Automation, Inc.	8, 9
General Electric Company	58
General Radio Company	20, 134
Grayhill, Inc.	139
Guardian Electric Manufacturing Company	72, 73
Hayden Book Company, Inc.	16D, 72, 73, 162, 170, 172
Heath Company	127
Hewlett-Packard	41, 42, 43, 44, 45, 46, 47, 48, 49, 50
Honeywell, Signal Analysis Operation	147
Houdaille Industries, Inc.	146
Hutson Industries	150
ILC Data Devices, Inc.	10
ITT Semiconductors, A Division of International Telephone and Telegraph Corporation	113
Inselek	131
Intech, Incorporated	160
Interdata	4, 5
International Rectifier	101
Interstate Electronics Corporation	117
Johanson Manufacturing Corp.	170
Keithley Instruments, Inc.	153
Kepeco, Inc.	173
Kurz-Kasch, Inc.	147
Lambda Electronics Corp.	Cover II
Line Relays, A Unit of Esterline Corporation	104
Litton Industries, Triad Distributor Division	145
3M Company	16
3M Company, Film & Allied Products Division	83
Magnecraft Electric Company	39
Magneto, Inc.	170
MicroSwitch, A Division of Honeywell	67
Molex, Incorporated	Cover III
Motorola Component Products Dept.	109
MuRata Corporation of America	156
National Beryllia Corporation	16C
Non-Linear Systems, Inc.	16A
North American Philips Controls Corp.	123, 125

Advertiser	Page
Paktron Division, Illinois Tool Works, Inc.	159
Pertec Corporation	164, 165
Philips Industries	69
Phoenix Data, Inc.	162
Piezo Technology, Inc.	152
Potter & Brumfield Division of AMF Incorporated	2
Power/Mate Corp.	6, 170
Precision Dipbrazing Tor, Inc.	173
Princeton Applied Research Corp.	172
Pulse Engineering, Inc.	99
Quan Tech Div. of KMS Industries, Inc.	173
RCA Solid State Division	Cover IV
RFL Industries, Inc.	151
Radio Switch Corporation	140
Raytheon Semiconductor	51
Robinson Nugent, Incorporated	62
Rogan Corporation	22
Rogers Corporation	167
Scanbe Manufacturing Corp.	17
Servo-Tek Products Company	146
Shigoto Industries, Inc.	175
Signetics Corporation	37
Siliconix Incorporated	70
Solar Systems, Inc.	170
Sorensen Operation, A Unit of Raytheon Company	133
Sprague Electric Company	19, 121
Stackpole Carbon Company	119
Switchcraft, Inc.	16B
Systron-Donner Corporation	157
Tau-Tron, Inc.	144
TEC, Incorporated	140
TRW Semiconductor Division of TRW, Inc.	12
Technical Wire Products, Inc.	159
Technipower, Inc., A Benrus Subsidiary	129
Tektronix, Inc.	61, 63, 64, 65
Teledyne Semiconductor	108
Telesis Laboratory	171
Tempil Division, Big Three Industries, Inc.	137
Thermalloy Company	158
United Systems Corporation	82
Wagner Electric Company	156
Yuasa Battery Co., Ltd.	167
Zeltex, Inc.	178

**"YOUR  
OPPORTUNITY"**

WITH KNOWN DISTRIBUTOR — MANUFACTURER OF TELEPHONY EQUIPMENT SEEKING PRODUCTS TO ADD TO ITS LINE FOR NATIONAL DISTRIBUTION. ALL FACILITIES AVAILABLE FOR COMPLETE DEVELOPMENT.

in confidence reply to  
INFORMATION RETRIEVAL NUMBER 903

**Get a jump on tomorrow,  
save today.**



**Take stock in America.**  
With higher paying U.S. Savings Bonds.

# how to buy a resistor..



Our new Catalog tells you what to look for in carbon composition, carbon and metal film fixed resistors. In addition to specifications of the broad range of Shigoto resistors, it contains data on EIA tolerances and ratings. And it proves why Shigoto resistors offer more. In consistent quality. In reliability. In performance. In breadth of values. In construction. And in unique features that make Shigoto your best quality-price value. The Catalog is yours, free on request.



**Shigoto Industries Ltd.**

Empire State Bldg., 350 Fifth Ave., N. Y. 10001  
(212) 695-0200 / Telex 224219  
One of the World's Largest Manufacturing Importers

INFORMATION RETRIEVAL NUMBER 108

**PERSONNEL  
RECRUITMENT  
ADVERTISING  
IN  
Electronic Design  
REACHES THE  
RIGHT PEOPLE  
AT A LOWER COST  
PER THOUSAND**

*Call the  
HOTLINE  
today  
for complete  
information:  
(201) 843-0550  
extension 209*

# product index

**Information Retrieval Service.** New Products, Evaluation Samples (ES), Design Aids (DA), Application Notes (AN), and New Literature (NL) in this issue are listed here with page and Information Retrieval numbers. Reader requests will be promptly processed by computer and mailed to the manufacturer within three days.

Category	Page	IRN	Category	Page	IRN	Category	Page	IRN
<b>Components</b>			<b>Instrumentation</b>			insertion tool, DIP	151	<b>300</b>
capacitor, trimmer	157	<b>325</b>	a/d converter	152	<b>303</b>	masking liquid	150	<b>279</b>
inductive devices (NL)	166	<b>413</b>	analog timers (AN)	165	<b>348</b>	microcircuit design (AN)	164	<b>347</b>
inductors, chip	157	<b>326</b>	automatic test system	154	<b>308</b>	molding materials (NL)	166	<b>411</b>
laser, CW dye	156	<b>324</b>	counter	153	<b>307</b>	PC connectors (NL)	169	<b>430</b>
limiter	158	<b>328</b>	digital multimeter	155	<b>321</b>	silicone rubber	150	<b>280</b>
load cells (NL)	166	<b>405</b>	function generator	153	<b>306</b>	solder, plastic	150	<b>281</b>
motor, low inertia	156	<b>323</b>	IC tester	152	<b>305</b>	torque screwdriver	150	<b>278</b>
motors (NL)	169	<b>428</b>	instrumentation (NL)	169	<b>430</b>	trimmer, laser	148	<b>255</b>
PM motors (AN)	165	<b>403</b>	measurements (AN)	164	<b>343</b>	trimmer, laser	148	<b>256</b>
power diodes	138	<b>263</b>	oscillators (NL)	168	<b>418</b>	trimmer, laser	148	<b>257</b>
pushbuttons (NL)	166	<b>414</b>	oscilloscope	152	<b>304</b>	winder, paper-tape	145	<b>273</b>
rectifiers	141	<b>266</b>	plotter, flatbed	146	<b>274</b>			
resistors, precision (NL)	169	<b>425</b>	precision divider	154	<b>320</b>			
resistors, thin-film	157	<b>327</b>	pulse generator	154	<b>309</b>			
storage tubes (NL)	166	<b>416</b>	ROM duplicator	152	<b>302</b>			
switches (NL)	166	<b>408</b>	s/d converter	161	<b>338</b>			
switches, foot (NL)	166	<b>407</b>	spectrum analyzer	154	<b>310</b>			
tantalum capacitors (NL)	166	<b>412</b>	spectrum analyzer (NL)	166	<b>415</b>			
transformer	162	<b>340</b>	test systems, ac (NL)	168	<b>417</b>			
variable attenuators (NL)	168	<b>424</b>	UV meter	155	<b>322</b>			
			<b>Microwaves &amp; Lasers</b>			<b>new literature</b>		
<b>Data Processing</b>			amplifiers	158	<b>331</b>	amplifiers, differential	168	<b>422</b>
analyzing faults (AN)	165	<b>402</b>	antennas (NL)	169	<b>431</b>	antennas	169	<b>431</b>
assembler, pROM	145	<b>272</b>	connector line	158	<b>329</b>	connectors, glass-sealed	168	<b>421</b>
automatic test system	154	<b>308</b>	coupler, hybrid	158	<b>330</b>	contamination in ICs	166	<b>401</b>
disc drive, OEM	146	<b>275</b>	laser, CW dye	156	<b>324</b>	disc recorders	168	<b>423</b>
disc recorders (NL)	168	<b>423</b>	limiter	158	<b>328</b>	fasteners	169	<b>427</b>
graphics tablet (NL)	169	<b>426</b>	UV meter	155	<b>322</b>	graphics tablet	169	<b>426</b>
monitor, CRT	143	<b>269</b>				inductive devices	166	<b>413</b>
plotter, flatbed	146	<b>274</b>	<b>Modules &amp; Subassemblies</b>			infrared arrays	166	<b>409</b>
power supply	160	<b>334</b>	active filters	160	<b>333</b>	instrumentation	169	<b>430</b>
processor, array	144	<b>271</b>	amplifiers, differential (NL)	168	<b>422</b>	JAN ICs	166	<b>410</b>
ROM duplicator	152	<b>302</b>	clock oscillators	161	<b>337</b>	load cells	166	<b>405</b>
s/d converter	161	<b>338</b>	data conversion (AN)	164	<b>344</b>	molding materials	166	<b>411</b>
teleprinter (AN)	165	<b>404</b>	display	160	<b>332</b>	motors	169	<b>428</b>
terminal, CRT	142	<b>250</b>	display, optoelectronics (AN)	164	<b>346</b>	oscillators	168	<b>418</b>
terminal, CRT	142	<b>251</b>	filters	163	<b>341</b>	PC connectors	169	<b>430</b>
terminal, CRT	142	<b>252</b>	frequency-to-analog converter	160	<b>336</b>	power supplies, mini-module	168	<b>419</b>
terminal, CRT	142	<b>253</b>	function generators (AN)	165	<b>349</b>	pushbuttons	166	<b>414</b>
terminal, CRT	142	<b>254</b>	infrared arrays (NL)	166	<b>409</b>	rf power modules	168	<b>420</b>
trimmer, laser	148	<b>255</b>	photoelectric control	162	<b>339</b>	resistors, precision	169	<b>425</b>
terminal, cassette	144	<b>270</b>	power amplifier	163	<b>342</b>	servo system components	166	<b>406</b>
winder, paper-tape	145	<b>273</b>	power supplies	160	<b>334</b>	spectrum analyzer	166	<b>415</b>
			power supplies, mini-module (NL)	168	<b>419</b>	storage tubes	166	<b>416</b>
<b>ICs &amp; Semiconductors</b>			preamplifiers	160	<b>335</b>	switches	166	<b>408</b>
contamination in ICs (NL)	165	<b>401</b>	rf power modules (NL)	168	<b>420</b>	switches, foot	166	<b>407</b>
decade-counter/decoder	138	<b>262</b>	s/d converter	161	<b>338</b>	tantalum capacitors	166	<b>412</b>
driver/receiver	140	<b>265</b>	servo system components (NL)	166	<b>406</b>	test systems, ac	168	<b>417</b>
FETs (AN)	165	<b>400</b>	solid-state modules (AN)	164	<b>345</b>	variable attenuators	168	<b>424</b>
JAN ICs (NL)	166	<b>410</b>	transformer	162	<b>340</b>			
MOS ICs	135	<b>258</b>				<b>application notes</b>		
MOC ICs	135	<b>259</b>	<b>Packaging &amp; Materials</b>			analog timers	165	<b>348</b>
power diodes	138	<b>263</b>	assembler, pROM	145	<b>272</b>	analyzing faults	165	<b>402</b>
power transistor	141	<b>267</b>	connectors, glass-sealed (NL)	168	<b>421</b>	data conversion	164	<b>344</b>
prescaler/control-logic block	136	<b>261</b>	epoxy	151	<b>301</b>	display, optoelectronics	164	<b>346</b>
RAM	140	<b>264</b>	fasteners (NL)	169	<b>427</b>	FETs	165	<b>400</b>
ROMs	135	<b>260</b>	flat cable (AN)	165	<b>399</b>	flat cable	165	<b>399</b>
rectifiers	141	<b>266</b>				function generators	165	<b>349</b>
transistors	141	<b>268</b>				measurements	164	<b>343</b>
						microcircuit design	164	<b>347</b>
						PM motors	165	<b>403</b>
						solid-state modules	164	<b>345</b>
						teleprinter	165	<b>404</b>

# Expand your Engineering Career with Collins

You can take part in advanced technical programs that will challenge your professional abilities and offer opportunity for continuing growth. Collins is a leader in avionics and telecommunication technology and sales, with a diversified line of products drawing on a wide range of disciplines.

You and your family can enjoy the life style of a medium-sized midwestern city. Freedom from congestion. Excellent cultural and educational programs, with three colleges and a major university nearby. A variety of recreational opportunities for all seasons.



We have a place for you if you have had up to five years of experience in any of these areas:

## **Circuit/Equipment Design**

- VHF Communication
- HF Communication
- UHF Communication
- ATC Transponder
- Weather Radar
- Radio Altimeters
- Frequency Synthesizers
- IF Amplifiers
- Digital Encoding/Decoding
- Digital and Analog Computation
- Microwave
- L-Band
- VHF Omni Range
- Instrument Landing System
- Automatic Direction Finder
- Distance Measuring Equipment

## **Systems Development**

- Flight Control
- HF and UHF Communication
- Satellite Communication
- Area Navigation
- Ocean and Marine
- Airborne Command and Control
- Buoy

## **Other Specialized Disciplines**

- Human Factors Engineering
- Mechanical Packaging
- Software Development Programming
- Maintainability
- Sales Engineers
- Quality Control

Send your resume in confidence to  
J. M. Boyer, Manager of Employment,  
Collins Radio Company,  
Cedar Rapids, Iowa 52406  
Or call collect 319/395-3608

An equal opportunity employer M/F

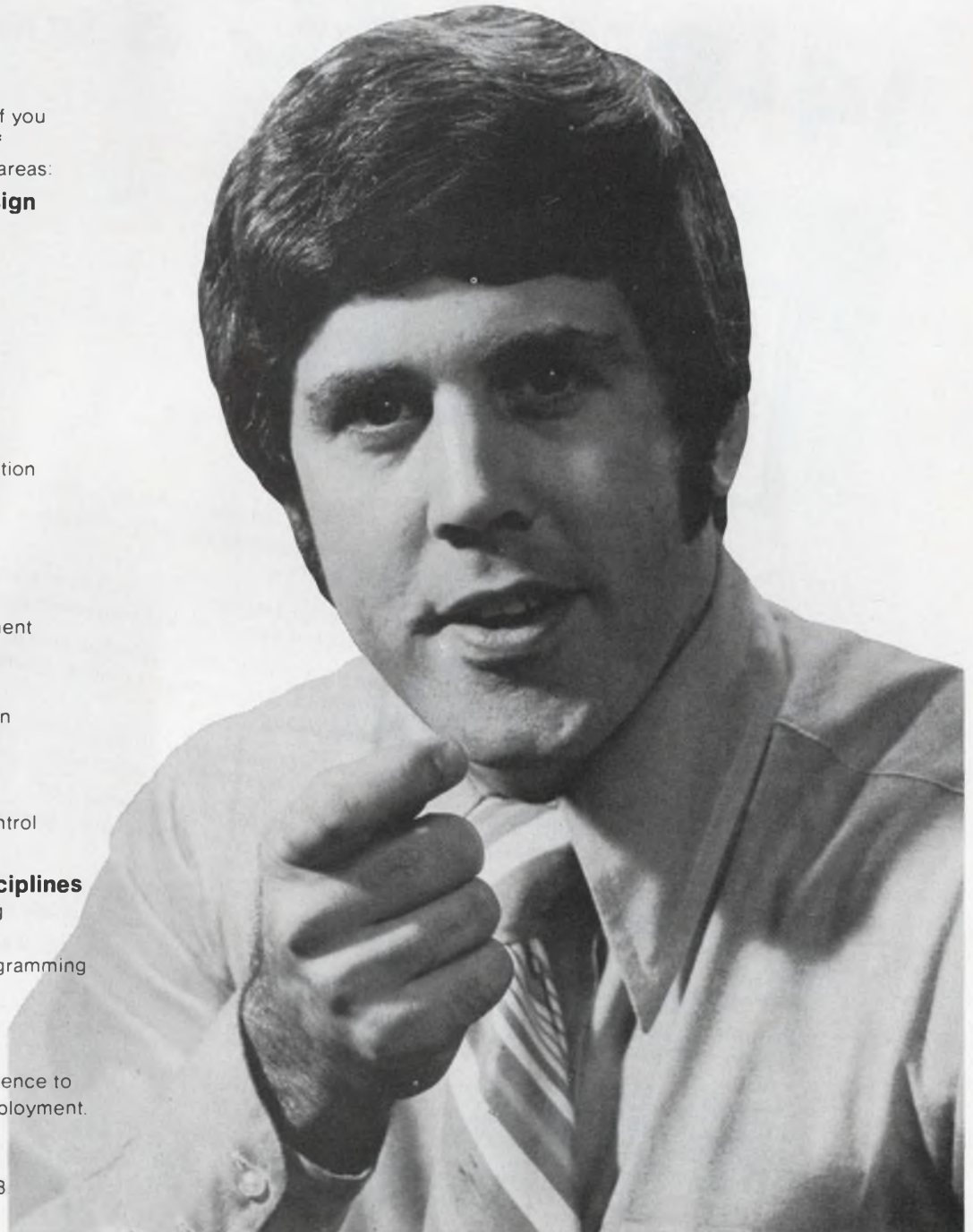

# from ZELTEX...

# 14-Bit DAC's from \$85

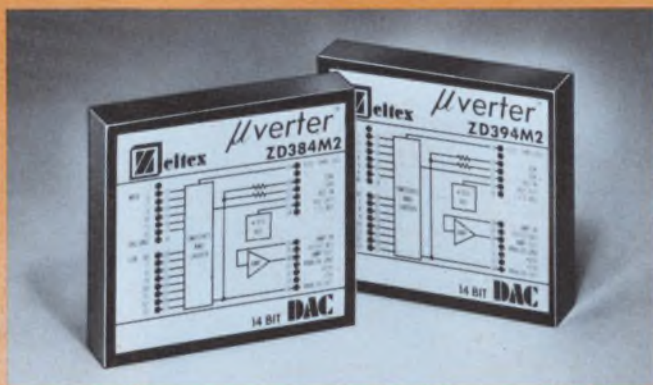

**LOW COST 14-BIT DAC's**—The new ZD300 Series include ten new models that offer excellent linearity, fast settling, current and voltage outputs, bipolar and unipolar coding, slaveable reference, and two quadrant multiplication. Prices range from \$85 to \$179 in single quantities.

**FAST SETTling TIMES (1 us)**—Settling times as fast as 1 us for current output models and 2 us for voltage output DAC's makes the ZD300 Series useful in a variety of data conversion applications.

**UNIPOLAR, BIPOLAR OUTPUTS**—Unipolar and bipolar operation is specified at 0 to 10V, and  $\pm 10V$ , respectively. Current output models are rated at 0-2 mA. Voltage output models also feature current output capability as well as two-quadrant multiplication-up to 100 kHz.

**LINEARITY 0.005%**—High performance units feature linearity error of only 0.005% of full scale. Moreover, the extremely low linearity temperature coefficient of only 0.0005%/°C ensures high resolution accuracy.

**SMALLEST 14-BIT DAC's**—The ZD300 Series modular DAC's measure only 1.96 x 1.76 x 0.40 inches high—less than 1.4 cubic inches in volume. Low profile, DIP pinning compatibility and interchangeability of models make the series highly desirable for OEM usage.

**APPLICATIONS**—The versatility of the ZD300 Series makes them an excellent choice for use in process-control systems, automated test equipment, servo/synchro/resolver systems, and biomedical instrumentation.

Multiplying capabilities further enhance their use for CRT character generation, digital modulation, and polar-to-rectangular coordinate conversion.

**Zeltex** INC. LEADERS IN DATA CONVERSION TECHNOLOGY

CALL or WRITE TODAY for detailed data on these and other ZELTEX Conversion and Linear products.

1000 CHALOMAR ROAD • CONCORD, CALIFORNIA 94518 • (415) 686-6660 TWX 910 - 481-9477

INFORMATION RETRIEVAL NUMBER 110



**HERE ARE TWO EASY WAYS TO SOLVE LIGHTED PUSH BUTTON SWITCH PROBLEMS. Economically. Reliably. Fast. The Molex 1175 snap mounts. Offers spade or wire terminals for fast, easy assembly. A choice of nine colors, 500 variations. And look at the Molex 1820. You can use one, or a gang of them, for an infinite variety of applications. Lighted push button can be wired to light independently of the switch. And it's available in colors galore. Best of all . . . both switches are priced considerably under one**

**dollar in quantity. ■ These components are good examples of the Molex creative approach to design problems. And we have the ability to design reliability and ease of assembly into a product without letting costs run wild due to over-engineering. ■ If this makes sense, and you would like a *free sample* of either the 1175 or 1820 switch, write: Molex Incorporated, Lisle, Illinois 60532. Or phone (312) 969-4550.**

*...creating components that simplify circuitry*



The RCA line of RF devices is expanding in all directions. New types, higher frequencies, broader bandwidths and new packages . . . all aimed at improving your system performance. That's why we call them the RF performance expanders.

Here are ten of the new types now available up to 3.5 GHz. They include such features as emitter ballasting; multi-cell structure for low thermal resistance

and . . . micromatch (microstrip package with partial input and output impedance matching).

Type	Freq. (MHz)	Output Power (W)	Gain (db)	Supply (Volts)
TA7992/TA877B	3500	4.5/1.5	5	28
TA8807/8/9	3000	1/3/5	5	28
2N6390/1/2	2000	3/5/10	7	28
RCA2003/05/10	2000	3/5/10	7	28
TA8340	1700	0.5	Oscillator	20
TA8695	1300	30	8	28
R44M 10/13/15	390-440	10/13/15	20	12.5

So if you want to design reliability and high performance into your system, de-

sign in RCA's RF performance expanders.

Want more information? Write RCA Solid State, Section 57D-12, Box 3200, Somerville, N.J. 08876. Or phone: (201) 722-3200.

**RCA** State Solid

# RF performance expanders.

